

ATLC-107-919-100
Issue 1, April 1982

TECHNICAL MANUAL
FOR
INTERVIEW[®] 29/30/40



ATLANTIC RESEARCH CORPORATION TELEPRODUCTS DIVISION
5390 CHEROKEE AVENUE, ALEXANDRIA, VIRGINIA 22314

© 1982 Atlantic Research Corporation

NOTICE

Atlantic Research Corporation reserves the right to improve this manual or the equipment that it describes without prior notice. Further software releases will not necessarily affect the material covered in the manual.

The menu configurations shown in this manual are intended only to demonstrate various techniques for programming the INTERVIEW. They are not necessarily appropriate for your real-world data environment.

Any duplication of this material in any form without prior written authorization of Atlantic Research Corporation is strictly prohibited.

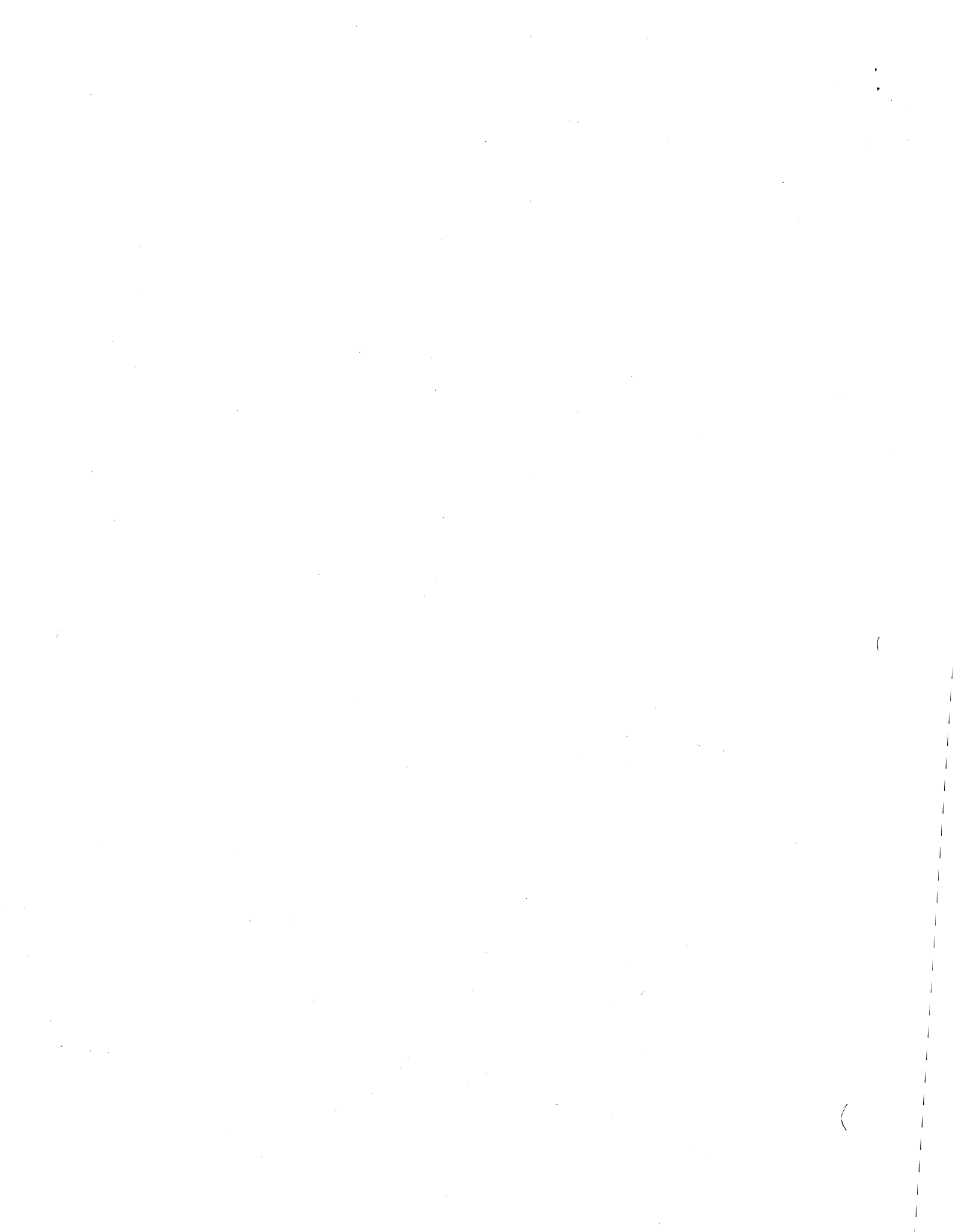

CONTENTS

	<u>Page</u>
I. GENERAL DESCRIPTION AND BACKGROUND INFORMATION	
1 OVERVIEW OF THE INTERVIEW 29/30/40	1
2 HEXADECIMAL KEYBOARD	3
2.1 Key Functions and Color Coding	3
2.2 Character Entry; Code Conversion	4
2.3 HEX Key On: Hexadecimal Entries	4
2.4 HEX Key Off: Entries Converted to Characters	4
2.5 Decimal Number Entries	4
2.6 The ALT Key	5
3 ALPHANUMERIC KEYBOARD	7
3.1 Key Functions and Color Coding	7
3.2 Code Conversions	8
3.3 Hexadecimal Entries	8
4 TRANSLATIONS	9
4.1 Code Translate Charts (Program E)	9
4.2 Hexadecimal-Binary Conversions	9
II. POWER-UP AND BASIC MONITORING	
5 POWER-UP INFORMATION	13
5.1 Voltage Selection	13
5.2 Power Frequency Selection	13
5.3 Setup	13
5.4 Power-Up	15
6 THE INTERFACE PANEL: OBSERVING AND CONTROLLING RS-232/V.24 LEADS	17

	<u>Page</u>
7	HOW TO USE THE PROGRAM MENUS 19
7.1	Selecting Program Menus 19
7.2	Using the Cursor to Make Program Selections 19
7.3	Decimal Fields 20
7.4	ASCII-Character Fields 21
7.5	Bit Status Fields 21
8	ESSENTIAL PARAMETERS: CODE AND FORMAT SELECTIONS (PROGRAM 0) 23
8.1	Code (Line 3) 23
8.2	Information Bits (Line 4) 23
8.3	Parity (Line 5) 23
8.4	Format (Line 6) 24
8.4.1	SYNC Selections 24
	(a) SYNC Chars (Line 7) 24
	(b) Outsync (Line 8) 25
	(c) Idle Display (Line 9) 26
	(d) Auto SYNC (Line 10) 26
8.4.2	Bit-Oriented Protocols 26
8.4.3	Asynchronous Operation 27
9	ESSENTIAL PARAMETERS: BLOCK CHECK CALCULATIONS (PROGRAM 0) 29
9.1	Receive BCC (Line 11) 29
9.2	Type of BCC (Line 12) 29
10	ESSENTIAL PARAMETERS: SYSTEM CHARACTERISTICS (PROGRAM 0) 33
10.1	Data (Line 13) 33
10.2	Interface (Line 14) 33
10.3	Clock (Line 15) 34
10.4	Speed (Line 15) 34

III. THE DATA DISPLAY

11	CONTROLLING THE DISPLAY (PROGRAM 0) 37
11.1	Display Mode (Line 16) 37
11.2	Suppressing Data (Line 17) 37
	(a) Flag Byte 39
	(b) Bit Mask 39
	(c) Not Equal 39
11.3	Enhancing Data (Line 18) 39

	<u>Page</u>
12 RUN MODE: REAL-TIME DATA DISPLAY	41
12.1 Status Line	41
12.2 Counter and Timer Readings	41
12.3 Display Format	41
12.4 Block Check Characters	43
12.5 Enhancements	43
12.6 Manual Controls	43
12.7 Prompts	43
13 RUN MODE: THE CRT DATA BUFFER	45
13.1 The Cursor; Scrolling	45
13.2 Hexadecimal Display	47
13.3 Binary Character Display	47
13.4 Trigger Freeze	47
13.5 Trigger Delay Stop	47
13.6 Manual Freeze	49
13.7 Data Buffer Display (Program Mode)	49
IV. THE TRIGGERS	
14 THE TRIGGER CONCEPT	51
15 SELECTING TRIGGER CONDITIONS	53
15.1 Looking for Data Conditions	53
15.1.1 Monitor (Line 3)	53
15.1.2 For (Line 4)	54
(a) String	54
(b) "One of" Character	54
(c) Good or Bad Block Check	54
(d) Aborted Block	54
(e) Parity Error	54
15.1.3 Character-Entry Field (Line 5)	54
(a) String Entry	54
(b) "1 OF" Character Entry	55
15.2 Monitoring Interface Leads (Lines 6 Through 8)	55
15.3 Manual Control	56
15.4 Monitoring Internal Flags (Line 9)	56
15.5 Timeout (Line 9)	57
16 SELECTING TRIGGER ACTIONS	59
16.1 Displaying a Prompt (Message to the Operator; Line 10).	59
16.2 Controlling the Timeout Timer (Line 11)	59

	<u>Page</u>
16.3 Controlling the CRT (Lines 12 and 13)	60
(a) Reverse Image	60
(b) Freeze	60
(c) Low Intensity	61
(d) Delay Stop	61
16.4 Setting Flags (Line 14)	61
(a) Increment Flags	61
(b) Set	61
(c) No Flag Action	61
(d) Example: Counting with Flags	61
(e) Example: Increasing the Maximum Timeout	62
(f) Example: Program Control with a Flag	62
(g) Auxiliary Output	62
16.5 Controlling the Timer (Line 15)	64
16.6 Controlling the Counter (Line 16)	64
16.7 Setting an Alarm (Line 17)	64
16.8 Forcing a Receiver Out of Synchronization (Line 17)	64
 17 TRIGGER TIMING AND SEQUENCE (TECHNICAL NOTES)	 65
17.1 Order of Processing	65
17.2 Examples	65

V. INTERACTIVE TESTING

18 THE INTERACTIVE TEST MODES	71
18.1 Selecting the Test Mode	71
18.2 Clocking	72
18.3 Interactive Menu Selection	73
18.4 BERT Test	73
 19 SETUP FOR HANDSHAKING: INTERFACE CONTROL MENU (PROGRAM 5)	 75
19.1 Static Leads: DTR, DSR	75
19.2 Switched Leads: RTS, CTS, RLSD	77
(a) On	77
(b) RTS, Switch	78
(c) CTS, Switch	78
(d) RLSD, Switch	78
(e) Xmit Delay	78
(f) INTERVIEW Handshaking	78
19.3 Manual Interface Control	78

	<u>Page</u>
20 THE INTERACTIVE TEST (PROGRAM 7):	
GENERAL DESCRIPTION	79
20.1 Introduction	79
20.2 Sequencing	79
20.3 Conditions	81
20.4 Transmission	81
20.5 Making Selections on the Interactive Test Menu	81
20.6 Practicing Programming without a Data Source	81
21 THE INTERACTIVE TEST (PROGRAM 7): "WAIT FOR" ENTRIES	83
21.1 String	83
21.2 Run Key	83
21.3 Enter	85
21.4 Timeout	85
21.5 Trigger	85
21.6 Blank Xmit Fields	85
21.7 Loop	87
21.8 End	87
21.9 Neither Loop nor End	87
22 THE INTERACTIVE TEST (PROGRAM 7): MESSAGE	
FORMATTING AND CONTENT	89
22.1 Message Characters	89
22.2 Other Messages	89
(a) Standard Fox Message	89
(b) Message Buffer	89
22.3 Blank "Wait For" Fields	89
22.4 Block Check Transmission	90
23 MESSAGES FOR TRANSMISSION: TRANSMIT MODE MENU	
(PROGRAM 6)	91
23.1 Mode	91
23.2 Message Buffer	91
23.3 Fox Message	92

VI. INTERVIEW OPTIONS (In Preparation)

VII. APPENDIXES

- APPENDIX A. CODE TRANSLATE CHARTS
- APPENDIX B. HEXADECIMAL KEYBOARD KEY FUNCTIONS
- APPENDIX C. ALPHANUMERIC KEYBOARD KEY FUNCTIONS
- APPENDIX D. ADJUSTMENTS, MAINTENANCE, AND SERVICE INFORMATION
 - D.1 General Cleaning
 - D.2 CRT Brightness Adjustment
 - D.3 Removing the Top Cover
 - D.4 Power Frequency Selection
 - D.5 Fuse
 - D.6 Power-up Self Tests
 - D.7 Error Codes in Run Mode
- APPENDIX E. PACKING AND SHIPPING
- APPENDIX F. CONTROL CHARACTER MNEMONICS
- APPENDIX G. USER-INFORMATION FORM

VIII. INDEX (In Preparation)

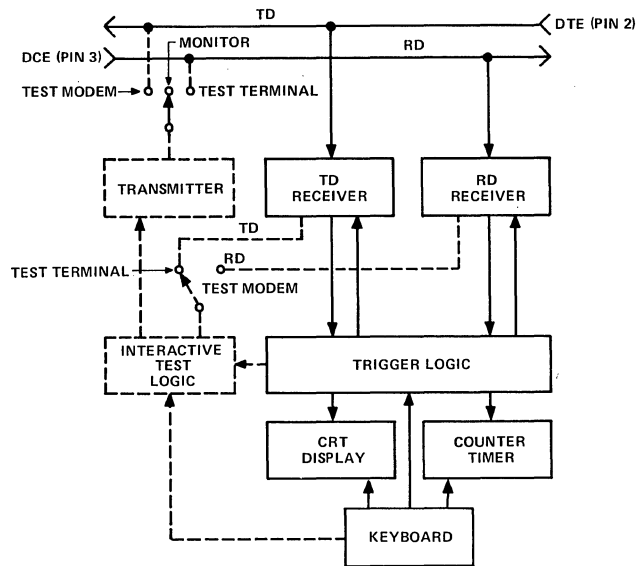

Figure 1-1 Functional block diagram of the INTERVIEW 29/30/40. Basic monitoring operation of all units is denoted by the solid lines. The Interactive Test (INTERVIEW 40A) is shown by the dashed lines. When options are added, the basic operation shown here does not change.

Notice that all displayed data is received from the interface, so even if the INTERVIEW is transmitting, it always displays what it has actually sent on the data lead.

In either Test Mode, the Trigger Logic--and hence the CRT, counter, and timer--sees both TD and RD, but the Interactive Test Logic sees only the incoming data.

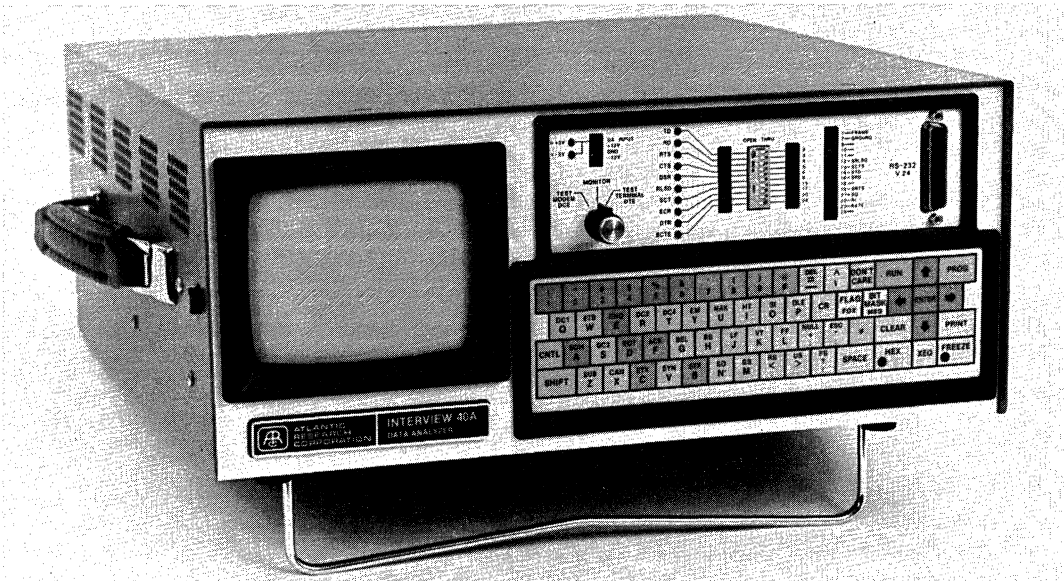

Figure 1-2 An INTERVIEW 40A. The rotary switch at the lower left of the interface panel is present only on units with the BERT Option or the Interactive Test. This switch is the only difference in the front panels of the various models.

1

OVERVIEW OF THE INTERVIEW 29/30/40

Figure 1-1 is a functional block diagram of INTERVIEW 29/30/40 operation. Table 1-1 defines the three INTERVIEW series and their options. All units have an interface access panel, a CRT display with 16-page buffer, one of two keyboards, one DTE and one DCE receiver, three triggers for program control, and a counter and timer. Additionally, your unit may be equipped with any of the following:

- Interactive Testing. The INTERVIEW 40A (shown in Figure 1-2) can imitate a modem (DCE) in order to test a terminal; or imitate a terminal (DTE) in order to test a modem.

- Bit or Block Error Rate Testing (BERT). The INTERVIEW will transmit a standard 511- or 2047-bit pseudorandom pattern.

- Printer Output Control. This enables you to print any program menu or the entire 16-page data buffer to most asynchronous ASCII printers.

- Remote Program Transfer. Tests can be downloaded from a central facility to a unit in the field.

- EPROM or EEPROM Memory. Stores a test library of basic protocol setups and up to 50 complete tests.

- Random Access Memory (RAM).

- X.25-SDLC Monitor Trace Expansion Display.

Use of the INTERVIEW 29/30/40 for basic monitoring is the same for all models, no matter which options are installed. Thus, Sections 2 or 3 and 4 through 17 apply to all units. Sections 18 through 23 apply only to the INTERVIEW 40A. Succeeding sections are devoted to various options. Appendixes contain useful information that you will need in certain circumstances.

Most of the figures in this manual are printed directly from the INTERVIEW's video output. Because positive images of the screen are difficult to read on the printed page, we have used negative reproductions throughout.

TABLE 1-1
INTERVIEW SERIES DEFINITIONS

Item Name	Reference	INTERVIEW 29A	INTERVIEW 30A	INTERVIEW 40A
Keyboard				
Hexadecimal	Part I	STD	NA	NA
Alphanumeric	Part I	NA	STD	STD
Interactive Testing	Part V	NA	NA	STD
Bit/Block Error Rate Test	Part VI	NA	OPT-04	STD
Output to Asynchronous ASCII Printer	Part VI	OPT-11	OPT-11	OPT-11
Remote Program Transfer	Part VI	NA	OPT-12	OPT-12
Memory Adapter-Programmer	Part VI	NA	OPT-20	OPT-20
EPR0M Memory	Part VI	NA	OPT-21	OPT-21
RAM Memory	Part VI	NA	OPT-22	OPT-22
EEPROM Memory	Part VI	NA	OPT-23	OPT-23
Top Cover with Door	Part VI	NA	OPT-24	OPT-24
X.25 Monitor Protocol Trace Display	Part VI	OPT-30	OPT-30	OPT-30

2

HEXADECIMAL KEYBOARD

Figure 2-1 shows the INTERVIEW'S hexadecimal keyboard. In Appendix B you will find a detailed description of the key functions for this keyboard.

Each correct key action is confirmed with a brief "chirp"; illegal key use is announced with a longer "beep," and no action is taken.

2.1 KEY FUNCTIONS AND COLOR CODING

At the upper right of the keyboard are two red keys, RUN and PROG (program). You will use these two keys to select the operating mode of the INTERVIEW. The RUN key starts the real-

time data display, restarts the program, and resets the CRT buffer. The PROG key selects Program Mode and displays the Menu Selections directory; it may then be used in conjunction with other keys to obtain the various program menus.

You will use the pad of 16 blue keys labeled with hexadecimal numbers 0 through F whenever you need to enter data on a menu. The four green keys immediately to the right of the hexadecimal keypad are also data-entry keys, but they are used for special characters which will be explained at their point of use. There are a number of light gray keys with special functions that will also be explained later.

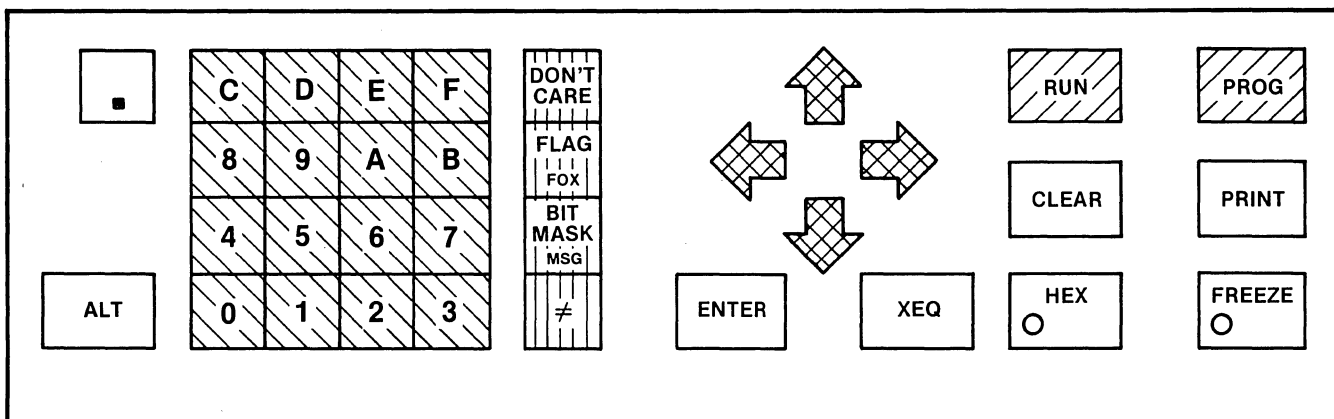

Figure 2-1 Hexadecimal keyboard.

The cursor is controlled with the four dark gray arrows and the light gray ENTER key.

2.2 CHARACTER ENTRY; CODE CONVERSION

The INTERVIEW accepts hexadecimal digits only in pairs. If you move the cursor from a character-entry position after entering only one digit of the hex number, the first digit will be discarded.

To use the hexadecimal keypad to enter data, you need to know the hexadecimal value of the character that you want to enter for the specific code that you are using. You can easily obtain this information from the INTERVIEW as explained in Section 4.1.

If you know only the bit pattern you wish to enter, conversion to hexadecimal is easily accomplished (see Section 4.2).

2.3 HEX KEY ON: HEXADECIMAL ENTRIES

When the HEX key at the right of the keyboard is locked ON, the red indicator on the key will be lit. All entries made while the HEX key is on will be displayed in hexadecimal and no parity adjustment will be made. This means that if you have selected PARITY on the Program 0 menu, and HEX is ON, you must be careful to adjust the parity yourself before making the entry. You can avoid this trouble if you use character entries, as explained in the following section, or if you use the correct Code Translate Chart, as explained in Section 4.1. (See also Appendix A.)

HEX ON is useful if you want to introduce a parity error.

2.4 HEX KEY OFF: ENTRIES CONVERTED TO CHARACTERS

When the HEX key is OFF the indicator light will be off. Each entry made from the hexadecimal keypad with HEX off is automatically converted to the correct character in the data code selected on the Program 0 menu, and this character is displayed on the menu. The INTERVIEW can display all characters in the standard ASCII character set. Entries for which no character can be displayed will be shown in hexadecimal.

When HEX is off and PARITY has been selected on the Program 0 menu, you need not adjust your entry for parity: the INTERVIEW will automatically adjust the entry in accordance with your parity selection.

2.5 DECIMAL NUMBER ENTRIES

For certain numeric-entry fields, called decimal fields, the logic will automatically read the input from the hexadecimal keypad as a decimal entry, whether or not HEX is ON. In these fields only, you can use the decimal point key at the top left of the hexadecimal keypad. To enter the decimal number 2.4, for example, you would depress three keys in succession: 2, decimal point, 4.

These decimal fields are as follows: On the Program 0 menu, the OUTSYNC # field and the SPEED field; on the Program 5 menu, the TIMEOUT, MSEC DELAY, SPEED, and PADS fields.

2.6 THE ALT KEY

The ALT key will ALTER the functions of a number of keys. To do this, you press it simultaneously with the other key. Thus, it is the equivalent of CONTROL or SHIFT on the alphanumeric keyboard. In this manual, most of the

functions designated as SHIFT/CONTROL-KEY should be performed by ALT-KEY if you have the hexadecimal keyboard.

For example, ALT-HEX on the hexadecimal keyboard displays only control characters in hexadecimal, just as does CONTROL/SHIFT-HEX on the alphanumeric keyboard.

ALT is not valid with any of the 16 hexadecimal keys.

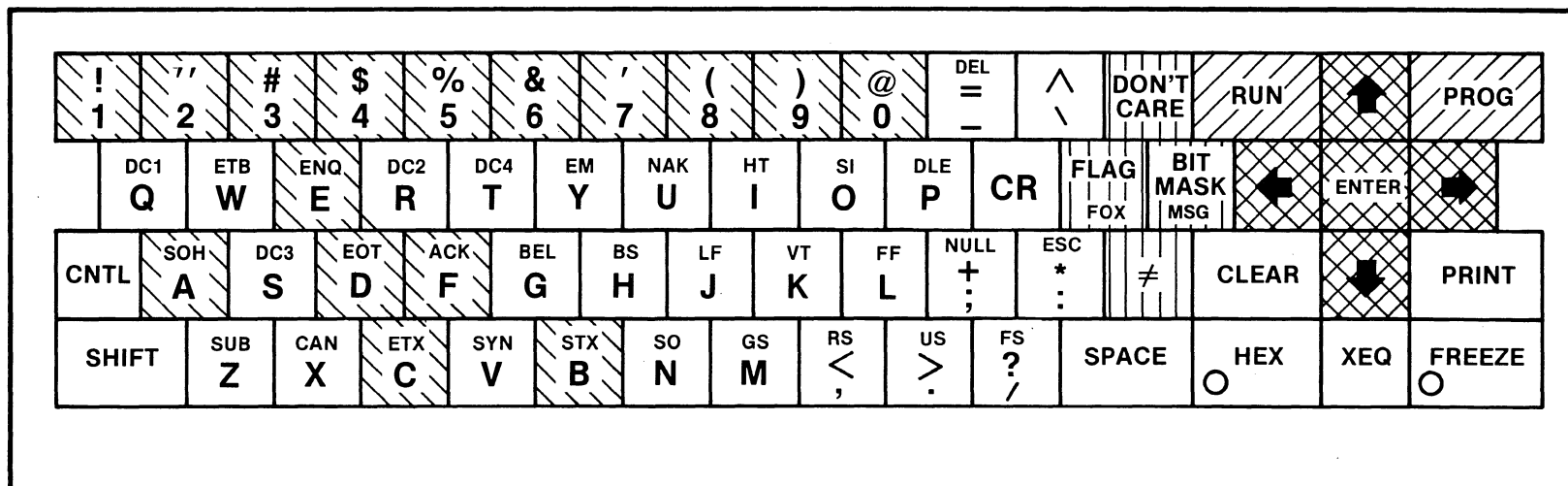

Figure 3-1 Alphanumeric keyboard.

3

ALPHANUMERIC KEYBOARD

The INTERVIEW's alphanumeric keyboard, shown in Figure 3-1, is an ASCII keyboard with most of the characters in the standard ASCII font. It permits you to make entries in any code selected on the Program 0 menu without looking up the code translation. Appendix C is a detailed description of the key functions in the INTERVIEW's various operating modes.

Each correct key action is confirmed with a brief "chirp"; illegal key use is announced with a longer "beep," and no action is taken.

3.1 KEY FUNCTIONS AND COLOR CODING

At the upper right of the keyboard are two red keys, RUN and PROG (program). You will use these two keys to select the operating mode of the INTERVIEW: The RUN key starts the real-time data display, restarts the program, and resets the CRT buffer. The PROG key puts the unit in Program Mode and displays the Menu Selections directory; it is used with other keys to obtain the various program menus.

The SHIFT key must be held down while the character key is depressed for

capitals or for the special characters to be entered. To enter control characters, depress the CONTROL key while you simultaneously press the control character key.

Many special keyboard functions can be obtained by pressing either SHIFT or CONTROL and another key simultaneously. In this manual, we designate this option as SHIFT/CONTROL. SHIFT/CONTROL-HEX, for instance, means to hold down either the SHIFT or the CONTROL key while you press HEX.

The blue keys within the alphanumeric layout are the keys for hexadecimal entries. The four green keys immediately to the right of the alphanumeric character keys are also data-entry keys but they are used for special characters which will be explained as they are needed.

The cursor is controlled with the dark gray ENTER key and the four dark gray arrows arrayed at the upper right of the keyboard.

Other light gray keys at the right of the keyboard--CLEAR, PRINT, SPACE, HEX, XEQ, and FREEZE--are special-function keys that will be explained later in this manual.

3.2 CODE CONVERSIONS

When a code other than ASCII has been selected on the Program 0 menu, the INTERVIEW automatically translates each ASCII character or control character mnemonic into the correct bit pattern for that code. Appendix A contains translation tables for the INTERVIEW's standard codes.

Appendix F defines the control character mnemonics displayed by the INTERVIEW.

3.3 HEXADECIMAL ENTRIES

The HEX key at the lower right of the keyboard locks on, as shown by the red indicator on the key. When HEX is ON in Program Mode, only the blue keys, 0 through F, are legal. Each two consecutive blue keys are interpreted as a two-digit hexadecimal number, and displayed in one character space in the data-entry field.

HEX is an alternate action key; press it again to turn HEX off. The indicator will go off and HEX will be disabled.

The INTERVIEW accepts the hexadecimal digits only in pairs. If you move the cursor from a character-entry position after entering an odd number of digits with the HEX key on, the last digit will be discarded. If you try to turn HEX off after entering only one digit in a character-entry position, the error tone will sound. You will not be allowed to turn HEX off until you have either entered a second digit or moved the cursor to another position.

The INTERVIEW does not compute parity on hexadecimal entries. If you have selected PARITY on the Program 0 menu, you must remember to adjust each hexadecimal entry for parity.



5. POWER-UP INFORMATION

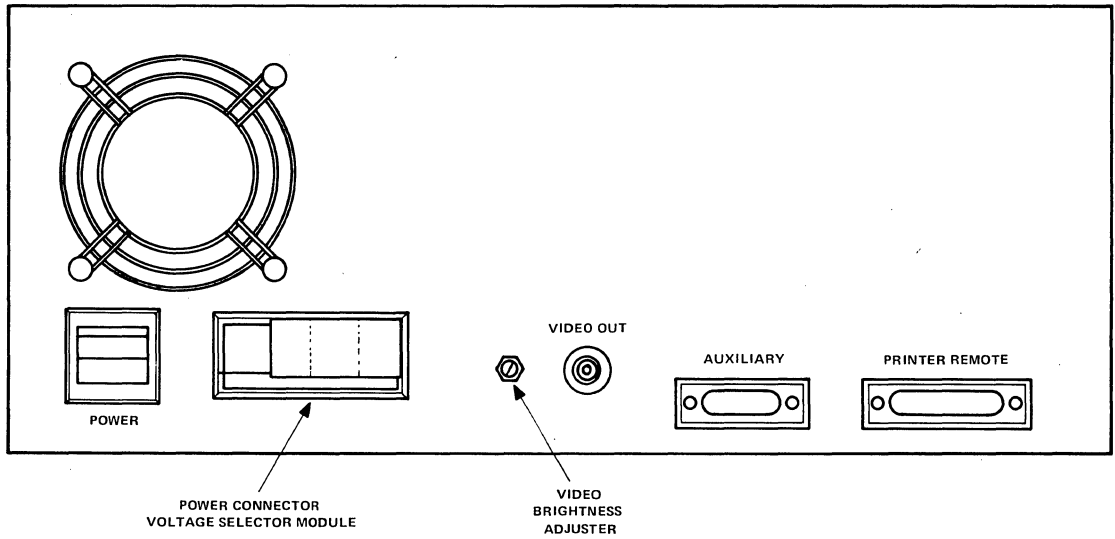

Figure 5-1 Rear panel of the INTERVIEW 29/30/40.

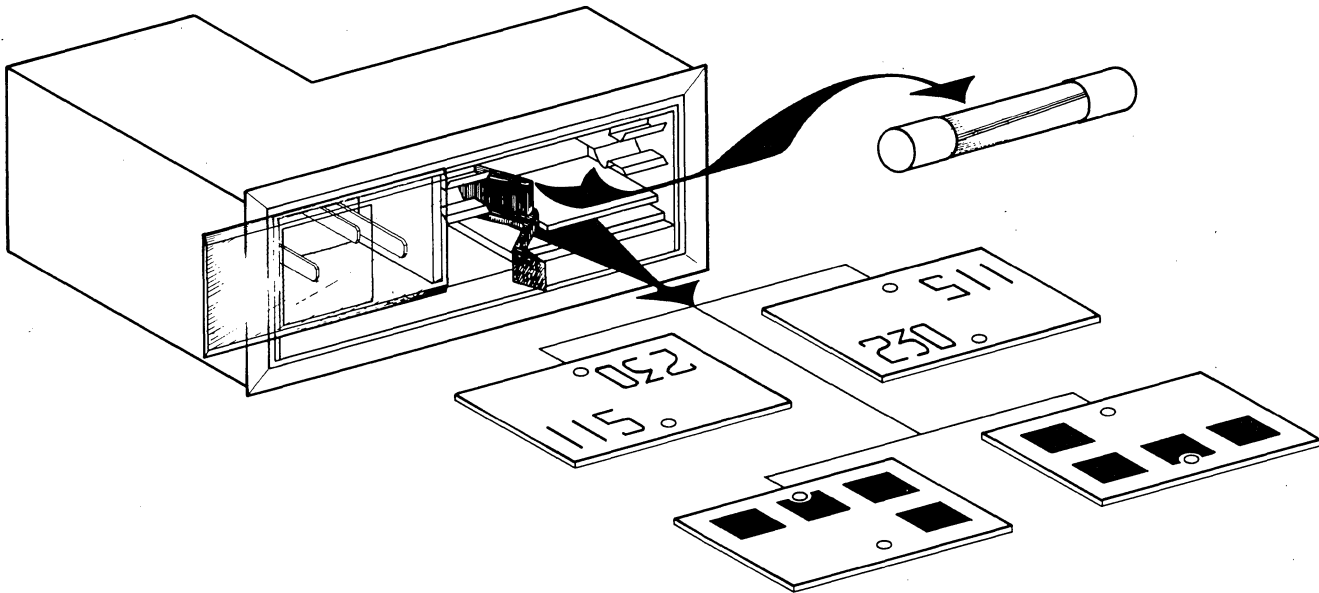

Figure 5-2 Power connector-voltage selector module (see Figure 5-1).

5

POWER-UP INFORMATION

5.1 VOLTAGE SELECTION

The INTERVIEW is designed to operate at 90 to 132 V ac, 50 or 60 Hz when the unit is set for 115 V; or from 180 to 264 V ac, 50 or 60 Hz when it is set for 230 V.

NOTE: The frequency must be selected separately (see Section 5.3).

The voltage selector is part of the power connector module on the rear panel of the INTERVIEW (see Figures 5-1 and 5-2). Slide the transparent window to the left. The line voltage selector card can be seen at the bottom of the window with the present voltage selection visible--and right side up.

To change the line voltage selection, swing the fuse extractor handle labeled FUSE PULL out toward the left and remove the fuse. The voltage selector card can then be removed and turned so that the correct line voltage can be read in the window. When the voltage selector card has been seated correctly, rotate the fuse extractor handle to the right and in, and replace the fuse.

5.2 POWER FREQUENCY SELECTION

The INTERVIEW can be operated at either 50 or 60 Hz. It is shipped

adjusted for 60-Hz operation. If it fails to operate properly, see the instructions for setting the power frequency in Appendix D.

5.3 SETUP

Rotate the stand on the bottom of the unit forward until it locks; then set the unit on its stand as shown in Figure 5-3.

The front cover of the INTERVIEW is a separate piece. To remove the cover, press the buttons on each side of the cover and hold them in while you slide the cover forward (see Figure 5-3).

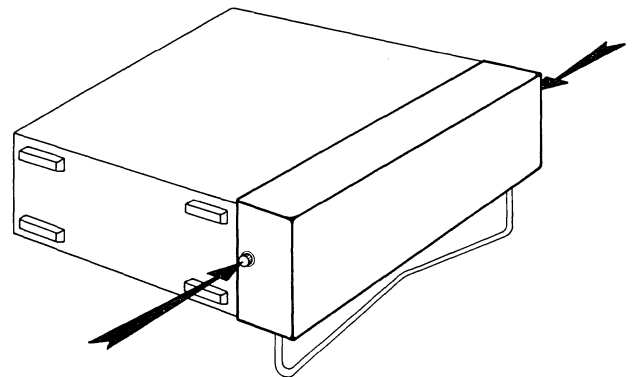

Figure 5-3 INTERVIEW 29/30/40 with front cover on. To remove the front cover, depress the latch on each side as you slide the cover forward.

```

** INTERVIEW 40A **

RS-232 / V.24 INTERFACE

SELF TEST ERROR(S): NONE

PRESS PROG KEY FOR MENU PAGE

SOFTWARE VERSION: 2.01B
OPTIONS: NONE
    
```



Figure 5-4

```

**MENU SELECTIONS**

0  PROTOCOL SETUP
1  TRIGGER 1
2  TRIGGER 2
3  TRIGGER 3

5  TIMEOUT/INTERFACE/PRINTER
6  TRANSMIT MODE
7  INTERACTIVE TEST
8  TEST LIBRARY
9  REMOTE TRANSFER

E  CODE TRANSLATE CHART
F  DATA BUFFER
    
```

Figure 5-6

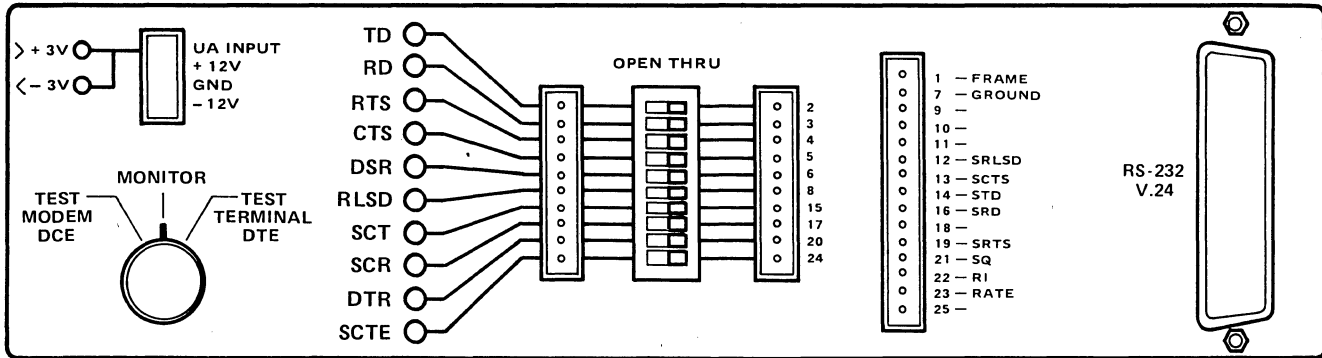

Figure 5-5 Interface panel of the INTERVIEW 40A.

CAUTION: Do not attempt to stand the INTERVIEW unit up on its front panel with the cover off.

In the front cover, you will find a power cord, RS-232/V.24 T ribbon cable, and patch cords.

Slide the window on the power connector module to the right to expose the connector pins, and connect the power cord to the INTERVIEW.

WARNING: Be sure to connect the INTERVIEW only to a properly grounded power outlet.

Connect the power cord to a third-wire ground power outlet. The power cord supplied connects a third protective-ground wire to the chassis.

CAUTION: When you power up the INTERVIEW, be sure that the ventilator fan in the rear runs and that neither the fan exhaust nor the intake holes in the side of the case are obstructed.

5.4 POWER-UP

CAUTION: Do not connect the unit to a live data interface until you have finished reading this section.

Turn on the INTERVIEW using the POWER rocker switch on the rear of the unit (see Figure 5-1). A long "beep" tone will confirm that the unit is operating. (Later, you will find that a long beep is also used as an error tone and as an alarm.)

The heading of the Power-up display (Figure 5-4) tells you which INTERVIEW model you are using. (See Section 1 for definitions of the three model series.) The next line tells you what data interface the unit is compatible with.

After a short delay for the automatic power-up tests, the SELF TEST ERROR(S) line should display NONE. If an error code should be displayed, see Appendix D before you attempt to use the unit.

At the bottom of the display are two other useful pieces of information. You would need the SOFTWARE VERSION if you were to contact Atlantic Research about your unit. The OPTIONS line tells you which of the options discussed in this manual have been installed in the unit.

If you have an INTERVIEW 40A unit or if the BERT Option is installed, there will be a rotary switch at the left of the Interface Panel, as shown in Figure 5-5. Set this switch to MONITOR, to insure that the INTERVIEW's transmitter cannot disturb any traffic on the interface. Connect the RS-232/V.24 connector at the right of the interface panel using either the T ribbon cable supplied with the INTERVIEW or the patch equipment at the site. For normal monitoring operation all the breakout switches in the center of the panel should be in THRU position so that the INTERVIEW can monitor all the leads of the RS-232/V.24 interface.

Press the red PROG key to display the Menu Selections directory. This lists all the Program Mode menus and displays that are available (Figure 5-6) in your particular unit. You can now monitor data by making a few selections on the Program 0 menu as explained in Sections 7 through 10.

6

THE INTERFACE PANEL: OBSERVING AND CONTROLLING RS-232/V.24 LEADS

Figure 6-1 represents the interface panel of an INTERVIEW 30A. At the far right of the panel is the female RS-232/V.24 data connector.

In the center of the interface panel is the breakout area. Just to the left of the data connector are two columns of patch jacks, labeled with the interface pin numbers. Not only may each of the 10 leads in the left-hand column be patched, but the INTERVIEW's access to each of them also can be broken with the corresponding breakout (OPEN/THRU) switches in the center of the panel. These 10 leads are TD (Pin 2), RD (Pin 3), RTS (Pin 4), CTS (Pin 5), DSR (Pin 6), RLSD (Pin 8), SCT (Pin 15), SCR (Pin 17), DTR (Pin 20), and

SCTE (Pin 24). Because the INTERVIEW is connected to the interface with a T-cable, these switches do not affect the data circuit. They can, however, break the INTERVIEW's connection to that circuit.

When an INTERVIEW 40A is in either of its Test Modes, the switches control not only what it sees, but also its output to the terminal or modem. This provides flexibility additional to the selections on the Interface Control menu (see Section 19).

To the left of the breakout switches is another row of patch jacks for the 10 switched leads. This gives you access to the signals actually seen or output by the INTERVIEW on these 10

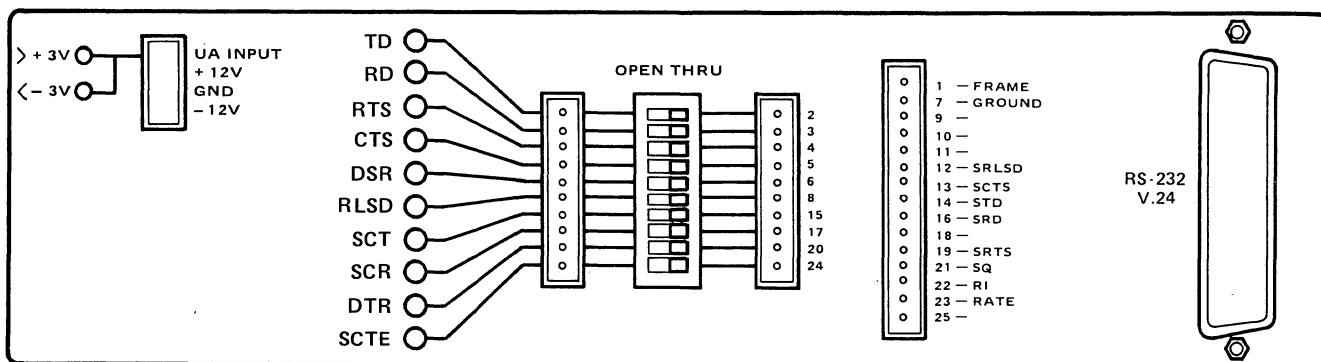

Figure 6-1 Interface Panel of INTERVIEW 30A.

leads. There is also a red LED indicator for each of the 10 leads. These indicators light for nominal voltages over +3 V.

These indicators always show what the INTERVIEW sees, but, because of the breakout switches, not necessarily what is on the interface. An INTERVIEW 40A unit in Test DTE mode, for example, may be driving SCT as shown by the indicator light, but if the switch on pin 15 is open, the signal will not be seen on the interface.

At the upper left of the Interface Panel is the UA (User-Assigned) input jack. If a signal patched to this jack is +3 V (nominal) or more positive, the >+3V indicator to the left of the jack

will go on; if the signal is -3 V (nominal) or more negative, the <-3V indicator will go on. Any signal patched to this input can be monitored by the INTERVIEW'S triggers.

There is a glitch catcher on the UA input. Whenever the voltage is greater than +3V or less than -3V for at least 1 microsecond, it will be latched until the trigger logic checks it. Thus, the UA trigger condition can be used to detect glitches on any interface lead.

Below the UA input are three more patch jacks: The INTERVIEW drives one to +12 V through a 1-kohm resistor, and another to -12 V through a 1-kohm resistor. The third jack is at signal ground.

7

HOW TO USE THE PROGRAM MENUS

7.1 SELECTING PROGRAM MENUS

The INTERVIEW is programmed by filling out a series of menus. All the menus available in your unit are listed on the Menu Selections directory (shown in Figure 7-1) that is displayed when you first put the unit in Program Mode by pressing the red PROG key.

To see a menu, find its identification number in the first column of the Menu Selections directory; then enter this identification number from the keyboard. The menu you want will immediately be displayed, and you can make your programming selections on it.

```
      **MENU SELECTIONS**
0  PROTOCOL SETUP
1  TRIGGER 1
2  TRIGGER 2
3  TRIGGER 3

5  TIMEOUT/INTERFACE/PRINTER
6  TRANSMIT MODE
7  INTERACTIVE TEST
8  TEST LIBRARY
9  REMOTE TRANSFER

E  CODE TRANSLATE CHART
F  DATA BUFFER
```

Figure 7-1

The Menu Selections directory must be on the screen when you enter the menu identification number. To display the Menu Selections directory again at any time, press the PROG key.

7.2 USING THE CURSOR TO MAKE PROGRAM SELECTIONS

The INTERVIEW's various program menus offer two categories of programming fields: selection fields and data-entry fields. In a selection field, you are offered a choice of entries and the current selection is displayed in low-intensity reverse image as in the CODE line of Figure 7-2. Entries in data-entry fields are displayed in bright

```
      **PROTOCOL SETUP**
CODE: ASCII BCDIC IPARS BAUDOT
BITS: 8 7 6 5
+PARITY: NONE ODD EVEN MRK SPC
FORMAT: SYNC BOP BOP/NRZI ASYNC
SYNC CHARS: 33
OUTSYNC: OFF ON CHAR: 8 #: 11
IDLE DISPLAY: OFF ON
AUTO SYNC: OFF ON
REC BCC: OFF ON

DATA: NORMAL INV REV INV/REV
I/F: EIA MIL
CLOCK: EXT INT
DISPLAY: SINGLE DUAL
SUPPRESS: _____
ENHANCE : _____
```

Figure 7-2

reverse image to indicate that you may type in data directly from the keyboard. In Figure 7-2, for instance, OUTSYNC: OFF ON is a selection field, and the box after CHAR: is a data-entry field. SUPPRESS is also a data-entry field. When entries are made in this field, they will appear in bright reverse image.

Selections are made by positioning the blinking, bright, reverse-image cursor. To move the cursor from one field to the next, without changing prior selections, press the ENTER key. The cursor will move directly to the default or prior selection in the next field or to the first position in the case of a data-entry field. To move the cursor within a field, use the left and right arrows. Once you have made your selection, use ENTER to leave the field. The UP or DOWN arrow will take you to the preceding or next line, respectively. The cursor will go to the current selection in a selection field or to the first position in a data-entry field.

NOTE: It is not a good habit to use the LEFT or RIGHT arrow to go to another field: it may change your selection in the present or in an intervening field.

```

**TRIGGER 1**

MON: NEITHER  DTE  DCE
FOR:  SIG  10F  GDBCC  BDBCC  ABT  PAR

INTERFACE:
RTS CTS DSR DTR RLSD UA ENTR
       
FLAGS:        
TIMEOUT:  YES

PROMPT:
TIMEOUT:  RESTART  STOP
CRT: REV FRZ LOW
   DLY STP:  YES
FLAGS: INC      
TIMER:  RESTART  STOP CONTINUE
COUNTER:  INC  DEC RESET
ALARM: NO  YES OUTSYNC: NO  YES

```

Figure 7-3

For example, suppose that you have selected MON:DTE on the first line of Figure 7-3. If you use the right arrow to go to the FOR field, it will change your MON selection to DCE.

To return to a previous field, press the UP arrow to return to the preceding line; then, if necessary, use the ENTER key to get to the field in which you are interested. For example, if the cursor is on OUTSYNC:YES, the last field in Figure 7-3, using the left arrow to select ALARM:YES will change the Outsinc action to NO.

To correct a data entry, you may position the cursor on the error and write over it. (Although backspacing with the LEFT arrow changes selections, it does not alter data entries.) Press CLEAR to clear a data-entry field in which the cursor is located. CLEAR is an illegal key in a selection field. To clear an entire menu to default condition, press SHIFT-CLEAR or CONTROL-CLEAR.

7.3 DECIMAL FIELDS

Certain fields are decimal-entry fields for both the hexadecimal keyboard and the alphanumeric keyboard.

For the hexadecimal keyboard, these are the only fields in which decimal entries may be made, and also the only fields in which the decimal point key is legal. Whether the HEX key is ON or OFF, all entries in these fields are interpreted by the INTERVIEW as decimal numbers. Type in the decimal number from the hexadecimal keypad just as though each key was a decimal digit.

If you have the alphanumeric keyboard, only numerals and the decimal point are legal in the decimal fields. If HEX is ON while you are making entries in these fields, the INTERVIEW will ignore it.

On the Program 0 menu, OUTSYNC # and SPEED are decimal fields. On the Program 5 menu, TIMEOUT, CTS DELAY time, printer SPEED, and number of PADS are all decimal fields.

7.4 ASCII-CHARACTER FIELDS

There are several program menu fields in which only characters in the ASCII font will be accepted. With the hexadecimal keyboard, all hexadecimal input to these fields will be translated into alphanumeric characters, whether or not the HEX key is ON.

With the alphanumeric keyboard, only alphanumeric keyboard characters should be used. If the HEX key is ON, it will be ignored, and all keys will be treated as though HEX were OFF.

There are three of these ASCII character fields in the INTERVIEW: the PROMPT-entry line on each Trigger menu (shown in Figure 7-3), the NEW LINE field on the Program 5 menu, and the HEADER field on the TEST LIBRARY menu (Program 8).

7.5 BIT STATUS FIELDS

There are a number of data-entry fields in which there are just three legal entries: 1 for ON; 0 for OFF; and DON'T CARE (X). These are the BIT MASK fields on the Program 0 and Trigger menus, STATIC LEADS on Program 5, and INTERFACE, FLAGS, and CRT on the Trigger menus (see Figure 7-3).

For these fields, for either keyboard, it does not matter whether HEX is ON or OFF.

8

ESSENTIAL PARAMETERS: CODE AND FORMAT SELECTIONS (PROGRAM 0)

The Protocol Setup menu is obtained by pressing the PROG key followed by numeral 0 (zero). On Lines 3 through 14 of this menu, you can choose all the parameters the INTERVIEW needs to monitor data. This section covers Lines 3 through 10. The rest of the essential parameters are explained in Sections 9 and 10.

8.1 CODE (LINE 3)

The standard code selections, as shown in Figure 8-1, are ASCII, EBCDIC, IPARS, and BAUDOT. Your unit may have different codes in the third and fourth positions of this field if special option codes have been installed.

8.2 INFORMATION BITS (LINE 4)

In this field, select the number of information bits in your code. Do not include the parity bit in your count.

8.3 PARITY (LINE 5)

Here select the type of parity used in your system. The choices are NONE, ODD, EVEN, MARK, and SPACE. The parity bit is additional to the information bits.

```

**PROTOCOL SETUP**
CODE: ASCII EBCDIC IPARS BAUDOT
BITS: 8 7 6 5
+PARITY: NONE ODD EVEN MRK SPC
FORMAT: SYNC BOP BOP/NRZI ASYNC
SYNC CHARS: 55
OUTSYNC: OFF ON CHAR: A #: 1
IDLE DISPLAY: OFF ON
AUTO SYNC: OFF ON
REC BCC: OFF ON

DATA: NORMAL INV REV INV/REV
I/F: IA MIL
CLOCK: EXT INT
DISPLAY: SINGLE DUAL
SUPPRESS: _____
ENHANCE : _____
```

Figure 8-1

When Parity is selected, every data character received with a parity error will be displayed with a bar through it.

NOTE: 8-bit odd or 8-bit even parity is a functional choice, but the INTERVIEW cannot handle 8 bits with mark or space parity.

8.4 FORMAT (LINE 6)

The FORMAT selection field allows you to program the INTERVIEW correctly for the protocol to be monitored. The selection made determines what choices are allowed on the next four lines.

8.4.1 SYNC Selections

Selecting SYNC for FORMAT results in a group of choices on Lines 7 through 10, as shown in Figure 8-1. Choose SYNC for BISYNC or BISYNC-framed X.25.

(a) SYNC CHARS (Line 7). This data-entry field determines the synchronization pattern for synchronous data protocols. The synchronization characters default to SY SY on the menu as shown in Figure 8-1, except for IPARS, for which the actual value of SY1 SY2 (3F 3E, hex) is always shown (Figure 8-2). (With IPARS selected, the mnemonic entry SY SY will give an invalid synchronization pattern.)

The INTERVIEW automatically checks the code chart and selects the proper synchronization pattern for the selected code. Adjustments for your parity selection are also automatic: For example, SY in odd-parity ASCII is 16 (hex) but in even-parity ASCII the INTERVIEW converts SY to 96 (hex). For most cases, therefore, you will not have to make any entry in the SYNC CHARS field.

The default synchronization patterns for the various standard and optional codes in the INTERVIEW are listed in Table 8-1.

```

**PROTOCOL SETUP**
CODE: ASCII EBCDIC IPARS BAUDOT
BITS: 8 7 6 5
+PARITY: NONE ODD EVEN MRK SPC
FORMAT: SYNC BOP BOP/NRZI ASYNC
SYNC CHARS: SY SY
OUTSYNC: OFF ON CHAR:   #:  
IDLE DISPLAY: OFF ON
AUTO SYNC: OFF ON
REC BCC: OFF ON

DATA: NORMAL INV REV INV/REV
I/F: EIA MIL
CLOCK: EXT INT
DISPLAY: SINGLE DUAL
SUPPRESS: _____
ENHANCE : _____
    
```

Figure 8-2

Any other one- or two-character sequence may be entered, using alphanumeric keys, control characters, or hexadecimal. The code chart will be ignored, and the character entered will be adjusted for parity (if PARITY is selected) unless the entry is made in hexadecimal.

NOTE: If HEX is ON while you are entering the synchronization pattern, you must adjust your entry to account for parity.

To enter a one-character synchronization pattern, position the cursor on the first character in the SYNC CHARS field and depress the CLEAR key; then enter only the desired character.

(b) OUTSYNC (Line 8). OUTSYNC causes a receiver to go out of synchronization if it finds a certain number of the specified character in the data stream. The default OUTSYNC sequence is one pad (FF, hex) character, as shown in Figure 8-1. Any character may be entered in the CHAR field. The number field (#) is a decimal field. It allows you to specify how many times the character must occur consecutively (from one to 99 times) before OUTSYNC occurs.

In transparent text, there is the possibility that legitimate data FF (hex) will occur, making it necessary to change the OUTSYNC character or turn OUTSYNC off. Also, the block check character may occasionally mimic the

TABLE 8-1
DEFAULT SYNCHRONIZATION CHARACTERS (Note 1)

Code	Menu Display	Sync Chars. (hex)
EBCDIC	SY SY	32 32
ASCII	SY SY	16 16
IPARS (Note 2)	3F 3E	3F 3E
BAUDOT	----	----
EBCD	SY SY	3D 3D
SELECTRIC	----	----
XS-3	35 35	35 35

Note 1: For standard and optional codes.

Note 2: For IPARS, the mnemonic entry SY SY will result in an invalid synchronization pattern.

OUTSYNC character. The latter problem is usually solved by increasing the number of OUTSYNC characters to 2.

(c) IDLE DISPLAY (Line 9). OFF suppresses display of idle characters from the time the receivers go out of synchronization until they see the synchronization pattern again. If you select ON, the idle characters will be displayed, but in low intensity.

(d) AUTO SYNC (Line 10). AUTO SYNC allows the INTERVIEW to recognize a synchronization pattern at any time even though the receiver logic may "think" it is already in synchronization. AUTO SYNC should only be used with a two-character synchronization pattern. When AUTO SYNC is enabled, the logic constantly tests for the two-character pattern on a bit-by-bit basis. When a match is found, it becomes the new reference point for character framing. AUTO SYNC thus eliminates the need to "bit shift" the data to find synchronization.

NOTE: Because the number of bits between transmissions may not be an exact multiple of a character,

there usually will be extra bits that cause the SYNC characters to be skewed and appear as garbage characters.

AUTO SYNC is extremely useful where there is no particular end of message character (OUTSYNC), or where one block of data follows another by less than a full character interval. AUTO SYNC will detect the synchronization pattern even though it is skewed from the previous block and display the following data correctly.

NOTE: If AUTO SYNC is on, the second (and following) synchronization character will not be displayed when the synchronization pattern is found, but the first one may show up either as SY or as a "garbage" character.

8.4.2 Bit-Oriented Protocols

The BOP FORMAT selection selects bit-oriented protocols that use 7E framing and zero insertion such as X.25, X.75, and SDLC. BOP/NRZI enables the INTERVIEW to decode BOP transmissions with Non-Return-to-Zero Inverted encoding.

In BOP protocols, the synchronization flag pattern, conditions for OUTSYNC, and block check calculation are always defined, so Lines 7 through 12 on the menu will be blank (see Figure 8-3).

```

**PROTOCOL SETUP**
CODE: ASCII EBCDIC IPARS BAUDOT
BITS: 8 7 6 5
+PARITY: NONE ODD EVEN MRK SPC
FORMAT: SYNC BOP BOP/NRZI ASYNC

DATA: NORMAL INV REV INV/REV
I/F: ATA MIL
CLOCK: EXT INT
DISPLAY: SINGLE DUAL
SUPPRESS: _____
ENHANCE : _____

```

Figure 8-3

8.4.3 Asynchronous Operation

For asynchronous start-stop data, choose ASYNC for FORMAT. Then, you may choose among 1, 1.5, and 2 stop bits on Line 7, as shown in Figure 8-4. With EXTERNAL clock, ASYNC operation is isochronous.

```

**PROTOCOL SETUP**
CODE: ASCII EBCDIC IPARS BAUDOT
BITS: 8 7 6 5
+PARITY: NONE ODD EVEN MRK SPC
FORMAT: SYNC BOP BOP/NRZI ASYNC
STOP BITS: 1 1.5 2

REC BCC: OFF ON

DATA: NORMAL INV REV INV/REV
I/F: ATA MIL
CLOCK: EXT INT
DISPLAY: SINGLE DUAL
SUPPRESS: _____
ENHANCE : _____

```

Figure 8-4

9

ESSENTIAL PARAMETERS: BLOCK CHECK CALCULATIONS (PROGRAM 0)

9.1 RECEIVE BCC (LINE 11)

When REC BCC is ON (Figure 9-1), the INTERVIEW does a block check calculation on each block received and identifies the result by replacing the second block check character with a reverse-image G for a good block check, or a bright reverse B for a bad block check (Figure 9-2). For BOP or BOP/NRZI, an aborted block is represented by a bright reverse A.

The block check calculations done by the INTERVIEW for various codes and protocols are given in Table 9-1.

When REC BCC is OFF, no block check calculations are done on received data and the block check characters actually received are displayed in Run Mode.

For BOP and BOP/NRZI, Receive BCC is always ON, so this selection does not appear (see Figure 9-3).

9.2 TYPE OF BCC (LINE 12)

When ASCII is selected, you may choose the TYPE of block check calculation from CRC-16, Even LRC, and Odd LRC. See Table 9-1 for a summary of the INTERVIEW's block check calculations.

TABLE 9-1
INTERVIEW BLOCK CHECK CALCULATIONS

Code or Format	BCC	BCC Starts	BCC Resets on (Note 1)	Ignores (Strips from Calculations)	BCC Ends with	Aborts (No BCC)
EBCDIC	CRC-16: $x^{16} + x^{15} + x^2 + 1$	First bit after STX or SOH (Note 3)	---	SY	ETX, ETB, or ITB	ENQ (Note 2)
		First bit after DLE STX	---	DLE SY (Note 4)	DLE ETX, DLE ETB, or DLE ITB	DLE ENQ (Note 2)
ASCII	CRC-16: $x^{16} + x^{15} + x^2 + 1$ (Note 5)	First bit after STX or SOH (Note 3)	---	SY	ETX, ETB, or ITB	ENQ (Note 2)
		First bit after DLE STX	---	DLE SY (Note 4)	DLE ETX, DLE ETB, or DLE ITB	DLE ENQ (Note 2)
ASCII	LRC-8 or LRC-7	First bit after STX or SOH (Note 3)	---	SY	ETX, ETB, or ITB	ENQ (Note 2)
IPARS	CRC-6: $x^6 + x^5 + 1$	First bit after SY1 SY2	Next bit after CRC	---	EOM-PB, EOM-1, EOM-C, or EOM-U	SY1
BSC/X.25 (Select SYNC, ASCII or EBCDIC)	CRC-16: $x^{16} + x^{15} + x^2 + 1$	First bit after DLE STX	---	DLE or DLE SY (Note 4)	DLE ETX, DLE ETB, or DLE ITB	DLE ENQ (Note 2)
BOP (ASCII or EBCDIC)	CRC-CITT: $x^{16} + x^{12} + x^5 + 1$	Address byte (included in calculation)	---	Inserted zeros	FCS (BCC included in calculation)	7 contiguous 1's

(Continued)

TABLE 9-1 (Continued)

Code or Format	BCC	BCC Starts	BCC Resets on (Note 1)	Ignores (Strips from Calculations)	BCC Ends with	Aborts (No BCC)
EBCD(ASYNC), REV EBCD,or SELECTRIC						
Transmit	LRC (Note 6)	First text char.	EOT (Note 7)	# (bid char) at start of message	ETB	EOT
Receive	LRC (Note 8)	First text char. (Note 9)	EOT (Note 10)	---	ETB	EOT (Note 10)
XS-3	LRC	SOM	---	---	EOM (Not included in BCC)	---

Note 1: Calculations are reset whenever OUTSYNC or AUTOSYNC occurs.

Note 2: The INTERVIEW does not display aborts except for BOP.

Note 3: BCC starts with the first bit of the next frame following a frame ending in ITB unless the first byte is an STX, SOH (starts after either) or SY (ignored).

Note 4: When DLE is followed by a non-SY char, the INTERVIEW strips DLE; when DLE is followed by SY, both are stripped; when DLE is followed by DLE, the first DLE is stripped.

Note 5: ASCII CRC is selected on the BCC lines of the PROGRAM 0 menu.

Note 6: Parity bit of LRC = LRC of all parity bits in transmission.

Note 7: EOT resets LRC.

Note 8: LRC ignores parity bits.

Note 9: The bid character (#) at start of first transmission is not included in calculation, but thereafter all bid characters are included until an EOT is received.

Note 10: An EOT on one side of the line resets the other side of the line also.

TABLE 10-1

DATA Selection	Logic		Least Sig. Bit	Idle
	1	0		
NORMAL	-12V	+12V	First	-12V
INV	+12V	-12V	First	-12V
REV	-12V	+12V	Last	-12V
INV/REV	+12V	-12V	Last	-12V

```

**PROTOCOL SETUP**
CODE: ASCII EBCDIC IPARS BAUDOT
BITS: 8 7 6 5
+PARITY: NONE ODD EVEN MRK SPC
FORMAT: SYN BOP BOP/NRZI ASYNC
SYNC CHARS: 2
OUTSYNC: OFF ON CHAR: 1 #: 1
IDLE DISPLAY: OFF ON
AUTO SYNC: OFF ON
REC BCC: OFF ON

DATA: NORMAL INV REV INV/REV
I/F: ATA MIL
CLOCK: EXT INT
DISPLAY: SINGLE DUAL
SUPPRESS: _____
ENHANCE : _____

```

Figure 10-1

10

ESSENTIAL PARAMETERS: SYSTEM CHARACTERISTICS (PROGRAM 0)

10.1 DATA (LINE 13)

The selections in this field (Figure 10-1) allow you to use the INTERVIEW for nonstandard systems. You must know the characteristics of your system in order to make the correct choice. For MIL-188 operation, see Section 10.2.

When you select NORMAL, the INTERVIEW is set up for a system that idles at -12 V (MARK), defines logic 1 as -12 V (MARK) and logic 0 as +12 V (SPACE) and in which the first bit sent and received is the least significant bit. When you select INV, the INTERVIEW expects the logic to be inverted: that is, logic 1 is +12 V and logic 0 is -12 V. When you select REV, the INTERVIEW expects the order of the information bits to be reversed: the first bit sent and received is the most significant information bit. If parity has been selected, the parity bit will still follow the information bits.

When REV is selected in ASYNC operation, the START bit is still first,

followed by the information bits in reverse order, then the parity bit, and the STOP bit(s).

NOTE: Neither INV nor REV affects the idle configuration.

Table 10-1 summarizes the DATA selections.

10.2 INTERFACE (LINE 14)

In this field you choose between Electronic Industries Association (EIA) operation and MIL-188 (MIL) operation. MIL inverts all signals on the data leads, including idle. Thus, the INTERVIEW will expect the data leads to idle at +12 V, logic 1 to be +12 V, and logic 0 to be -12 V. For receiving (or sending--if you have the INTERVIEW 40A) MIL-188 data, therefore, there is no need to select INV in the DATA field. MIL does not affect clock.

10.3 CLOCK (LINE 15)

If clock is provided on the RS-232/V.24 interface (Pins 15 and 17 or 24), you may select either INT or EXT. EXT allows the INTERVIEW'S data receivers to use the external clock. The external clock must be a 1 x baud clock with the negative-going transition occurring at the middle of the data bit period.

For systems where there is no external clock, select INT. The INTERVIEW'S internal clock logic will regenerate clock information from the data. When INT has been selected, you must also select speed (see Figure 10-2).

10.4 SPEED (LINE 15)

This decimal field appears only when INTERNAL clock has been selected. The correct speed of the system must be entered here for clock information to be regenerated from the data. You may use up to five digits or four digits and a decimal point. The maximum standard speed is 19.2 kbps.

```

**PROTOCOL SETUP**
CODE: ASCII BBCDTC IPARS BAUDOT
BITS: 8 7 6 5
+PARITY: NONE ODD EVEN MRK SPC
FORMAT: SYNC BOP BOP/NRZI ASYNC
SYNC CHARS: 23
OUTSYNC: OFF ON CHAR: 1 #: 1
IDLE DISPLAY: OFF ON
AUTO SYNC: OFF ON
REC BCC: OFF ON

DATA: NORMAL INV REV INV/REV
I/F: EIA MIL
CLOCK: EXT INT SPEED: 2400
DISPLAY: SINGLE DATE
SUPPRESS: _____
ENHANCE : _____
    
```

Figure 10-2

TECHNICAL NOTE: The actual speed generated internally is determined by dividing the speed entered in this field into 57,600. The result is rounded to the nearest integer and becomes the clock divider value. The true internal speed is equal to the clock divider value divided into 57,600.

11. CONTROLLING THE DISPLAY

11

CONTROLLING THE DISPLAY (PROGRAM 0)

The last three fields of the PROGRAM 0 menu (Figure 11-1) control the format of the data display and enhance it. The triggers may be used for further CRT control (see Section 16).

11.1 DISPLAY MODE (LINE 16)

When SINGLE is selected, DCE and DTE data are displayed alternately on the same line (see Figure 11-2). In DUAL display (Figure 11-3), DTE data begins on the first data line and DCE data is shown on the alternate lines. DCE data is always underlined in either display mode.

TECHNICAL NOTE: In dual-line display the relationship between the Transmit and Receive data is accurate to within plus or minus 1 character.

11.2 SUPPRESSING DATA (LINE 17)

On this line (see Figure 11-1) you may enter up to eight characters to be suppressed from the CRT display. They will not appear on the CRT or in the CRT buffer, which allows you to obtain a highly condensed selective display. However, the suppressed characters will be received, considered by the triggers, and included in counting and timing. The SUPPRESS line may include--

- Upper- and lower-case alpha characters and numerals
- Control character mnemonics
- Hexadecimal entries
- The 7E (hex) Flag that frames bit-oriented protocols
- One Bit Mask
- All characters Not Equal to either a given character or Bit Mask.

```

**PROTOCOL SETUP**

CODE: ASCII  ASCII  EBCDIC IPARS BAUDOT
BITS:  7  6  5
+PARITY:  NONE  ODD  EVEN  MRK  SPC
FORMAT:  SYNC  BOP  BOP/NRZI  ASYNC
SYNC CHARS:  7.5
OUTSYNC: OFF  ON CHAR:  #: 
IDLE DISPLAY:  OFF  ON
AUTO SYNC:  OFF  ON
REC BCC: OFF  ON

DATA:  NORMAL  INV  REV  INV/REV
I/F:  EIA  MIL
CLOCK:  EXT  INT
DISPLAY: SINGLE  DUAL
SUPPRESS:  M: _____
ENHANCE : _____

```

Figure 11-4

```

**PROTOCOL SETUP**

CODE: ASCII  ASCII  EBCDIC IPARS BAUDOT
BITS:  7  6  5
+PARITY:  NONE  ODD  EVEN  MRK  SPC
FORMAT:  SYNC  BOP  BOP/NRZI  ASYNC
SYNC CHARS:  7.5
OUTSYNC: OFF  ON CHAR:  #: 
IDLE DISPLAY:  OFF  ON
AUTO SYNC:  OFF  ON
REC BCC: OFF  ON

DATA:  NORMAL  INV  REV  INV/REV
I/F:  EIA  MIL
CLOCK:  EXT  INT
DISPLAY: SINGLE  DUAL
SUPPRESS:  M:  XXXXXXXX
ENHANCE : _____

```

Figure 11-5

```

**PROTOCOL SETUP**

CODE: ASCII  ASCII  EBCDIC IPARS BAUDOT
BITS:  7  6  5
+PARITY:  NONE  ODD  EVEN  MRK  SPC
FORMAT:  SYNC  BOP  BOP/NRZI  ASYNC
SYNC CHARS:  7.5
OUTSYNC: OFF  ON CHAR:  #: 
IDLE DISPLAY:  OFF  ON
AUTO SYNC:  OFF  ON
REC BCC: OFF  ON

DATA:  NORMAL  INV  REV  INV/REV
I/F:  EIA  MIL
CLOCK:  EXT  INT
DISPLAY: SINGLE  DUAL
SUPPRESS:  M:  XXXXXXXX
ENHANCE : _____

```

Figure 11-6

```

**PROTOCOL SETUP**

CODE: ASCII  ASCII  EBCDIC IPARS BAUDOT
BITS:  7  6  5
+PARITY:  NONE  ODD  EVEN  MRK  SPC
FORMAT:  SYNC  BOP  BOP/NRZI  ASYNC
SYNC CHARS:  7.5
OUTSYNC: OFF  ON CHAR:  #: 
IDLE DISPLAY:  OFF  ON
AUTO SYNC:  OFF  ON
REC BCC: OFF  ON

DATA:  NORMAL  INV  REV  INV/REV
I/F:  EIA  MIL
CLOCK:  EXT  INT
DISPLAY: SINGLE  DUAL
SUPPRESS:  M:  XXXXXXXX
ENHANCE : _____

```

Figure 11-7

```

**PROTOCOL SETUP**

CODE: ASCII  ASCII  EBCDIC IPARS BAUDOT
BITS:  7  6  5
+PARITY:  NONE  ODD  EVEN  MRK  SPC
FORMAT:  SYNC  BOP  BOP/NRZI  ASYNC
SYNC CHARS:  7.5
OUTSYNC: OFF  ON CHAR:  #: 
IDLE DISPLAY:  OFF  ON
AUTO SYNC:  OFF  ON
REC BCC: OFF  ON

DATA:  NORMAL  INV  REV  INV/REV
I/F:  EIA  MIL
CLOCK:  EXT  INT
DISPLAY: SINGLE  DUAL
SUPPRESS:  M:  XXXXXXXX
ENHANCE : _____

```

Figure 11-8

(a) Flag Byte. To enter the 7E (hex) Flag used for framing bit-oriented protocols, press the green FLAG key. On the data-entry line the Flag key entry will appear in low-intensity reverse image to distinguish it from a data 7E (hex) (see Figure 11-4). The logic will not read the key sequence HEX, 7, E as a Flag, but will assume that it is a data character to which bit stuffing applies.

NOTE: A low-intensity character in a data-entry field always indicates that the character represents something other than itself.

(b) Bit Mask. With the cursor on the SUPPRESS line, press the green BIT MASK key. This enters a low-intensity M at the cursor position. To the right of the data-entry line will appear M: followed by a special eight-place field (see Figure 11-5). The cursor will now be at the first place in the new field.

Each X in this field represents one bit of an 8-bit character, with the low-order, first serial bit on the right. An X means Don't Care; that is, the INTERVIEW will not check that bit. You may replace any of the X's with ones and (or) zeros. If, for instance, you enter 00 for Bits 8 and 7, the pattern will now be 00XX XXXX. All characters having 00 for Bits 8 and 7 will now be suppressed, as indicated by the low-intensity M in the list of suppressed characters (Figure 11-6). In EBCDIC all control characters have zeros for bits 7 and 8, so all control characters will now be suppressed from the display.

To return to the M in the SUPPRESS list, press the LEFT cursor arrow. To go to the next character in the Suppress list, press the ENTER key.

If ENTER or an arrow has been used to move the cursor into the Mask field, the ENTER key will move the cursor to the ENHANCE field instead of back into the SUPPRESS field. In other words, the

Mask field is now just like any other field on the menu.

NOTE: Changing the code selection does not affect the number of bits displayed in the mask. If you have selected a code with less than eight information bits, say five, use the five lower-order (rightmost) bits and ignore the three excess higher-order bits.

NOTE: Selecting REV in the DATA field does not change the position of the low-order bit in the Bit Mask field. The INTERVIEW will automatically reverse the order of the bits that you enter. Also, 1 always means a logic 1 whether or not DATA:INV has been selected.

(c) Not Equal. You may suppress all characters not equal to any given character. To suppress all characters but NAKs, for example, press the green NOT EQUAL key; then enter a NAK. Figure 11-7 shows NK displayed in the SUPPRESS list with a horizontal bar through it to indicate "not equal."

To suppress everything but characters that fit a certain bit mask, press NOT EQUAL, then BIT MASK. All characters that do not fit whatever pattern you then enter for the bit mask will be suppressed, and the low-intensity M in the SUPPRESS list will have a horizontal bar through it. For example, suppressing the Not Equal Bit Mask in Figure 11-8 would suppress all text characters; only EBCDIC control characters would be displayed.

11.3 ENHANCING DATA (LINE 18)

Enhanced characters will be displayed in bright, reverse image. You may enter up to eight characters on the ENHANCE line. The valid characters are the same as for SUPPRESS.

ASCII/7/ODD/BOP
COUNTER=0000 TIMER=0000

Figure 12-1

EBCDIC/8/NONE/SYNC/3/3
COUNTER=0000 TIMER=0000

Figure 12-2

EBCDIC/8/NONE/SYNC/3/3 STEP=0
COUNTER=0000 TIMER=0000

Figure 12-3

EBCDIC/8/NONE/SYNC/3/3 STEP=0
COUNTER=0028 TIMER=0000
23456789%1%THE QUICK BROWN F
G THE FOX%2%THE QUICK BROWN F
OX JUMPS OVER THE LAZY DOG 01234
56789%1%THE QUICK BROWN F
HE FOX%2%THE QUICK BROWN FOX
JUMPS OVER THE LAZY DOG 01234567
89%1%THE QUICK BROWN FOX
RHOUMNNT IFNOGX TJHUEM PESO X0%
V%ER% THE LAZY DOG 0123456789%
1%THE QUICK BROWN FOX JUMPS
OVER THE LAZY DOG 0123456789%
%THE QUICK BROWN FOX JUMPS
%THE QUICK BROWN FOX JUMPS
%THE QUICK BROWN FOX JUMPS
%THE QUICK BROWN FOX JUMPS
%THE QUICK BROWN FOX JUMPS

Figure 12-4

ESQ X0%V%ER% THE LAZY DOG 01

EBCDIC/8/NONE/SYNC/3/3 STEP=0
COUNTER=0005 TIMER=0000
WN FOX JUMPS OVER THE LAZY DOG 0

123456789%1%THE QUICK BROWN F

OX JUMPS OVER THE LAZY DOG 01234
G THE FOX%2%THE QUICK BROWN F

56789%1%THE QUICK BROWN F

E FOX%2%THE QUICK BROWN F

OX JUMPS OVER THE LAZY

DOG 0123456789%1%THE QUICK BROWN F

HOUNDS ARE HUNTING THE FOX%2%THE QUICK BRO

UNTING THE FOX%2%THE QUICK BRO

Figure 12-5

12

RUN MODE: REAL-TIME DATA DISPLAY

The INTERVIEW can display two status lines and 512 data characters (in 16 36-character rows). Each 512-character display is called a "page." The CRT buffer capacity is 8096 characters, or 16 pages.

12.1 STATUS LINE

To see the real-time data display, press the RUN key. This will restart the program and reset the CRT data buffer. A status line will appear at the top of the screen, showing you the code and format for which the INTERVIEW is set up. Figure 12-1, for instance, shows you that the INTERVIEW is expecting ASCII data, 7 information bits, odd parity, in a bit-oriented protocol. Figure 12-2 shows a status line for BISYNC operation with 8 information bits, no parity, and synchronization pattern 32 32 (hex).

Figure 12-3 shows the status lines when the INTERVIEW 40A is in a Test Mode. The number of the current Interactive Test (Program 7 menu) step is displayed at the upper right.

12.2 COUNTER AND TIMER READINGS

On the second line, is the real-time counter and timer display (Figure 12-4). The counter and the timer are controlled by the triggers. Both may be reset manually by pressing the RUN key. In addition to resetting the counter and timer, this always initializes the program and resets the CRT buffer.

12.3 DISPLAY FORMAT

Figure 12-4 shows a single-line data display (single- or dual-line display is selected on the Program 0 menu; see Section 11.1). All DCE data is underlined because it comes from the communication line. The DTE data alternates with the DCE data.

Figure 12-5 is a dual-line data display. The DTE data is shown on the first line; then the underlined DCE data on the next line. Time correlation is maintained by the L-shaped fill symbols. Dual-line display is needed for presenting the time correlation between TD and RD in a full-duplex system. However, it does not use the CRT or buffer space as efficiently as does the single-line display, so it should not be used when it is not needed.

If you have an INTERVIEW 40A, the rotary switch just to the right of the CRT will tell you what operating mode the INTERVIEW is in and which data is being transmitted by the INTERVIEW. In Test Terminal Mode the INTERVIEW is imitating a DCE, so the transmitted data will be underlined; in Test Modem Mode, the INTERVIEW will be receiving the underlined data.

12.4 BLOCK CHECK CHARACTERS

Notice in the figures that the last block check character is replaced with a low-intensity reverse-image G, for Good BCC, or a bright reverse-image B, for Bad BCC. An Abort is represented by a bright reverse-image A. Figure 12-6 shows data with RECEIVE BCC OFF (Program 0 menu). Both characters in each received block check sequence are shown because the INTERVIEW's block check logic has been turned off.

12.5 ENHANCEMENTS

Specific characters may be enhanced by showing them in bright reverse image (see Section 11.3). Triggers can be used to display strings of data in low intensity and (or) reverse image (see Section 16.3). In Figure 12-7, the LCNs in the DCE data are enhanced.

The 7E (hex) flags used in HDLC-framed protocols are always shown in low-intensity, reverse image (Figure 12-8). The flags may be suppressed from the display using the SUPPRESS selection on the Program 0 menu (see Figure 12-9).

When PARITY is selected on the Program 0 menu, all characters with parity errors are automatically displayed with bars through them as in Figure 12-8. Notice that the pad characters and some of the block check characters are shown this way because there is no parity on these characters when they are transmitted. (Some block check characters accidentally have the correct parity bit.)

12.6 MANUAL CONTROLS

Figure 12-7 shows the entire display in hexadecimal; in Figure 12-9, only protocol characters are in hexadecimal. To obtain the hexadecimal display, press the HEX key. The indicator on the key will light while the hexadecimal display is on. Press HEX again to turn it off. The hexadecimal protocol character display is obtained with SHIFT/CONTROL-HEX.

Use the CLEAR key to momentarily clear all data from the screen. CLEAR will not clear the counter-timer display. The RUN key initializes the program and resets the CRT buffer, as well as resetting the counter and timer.

12.7 PROMPTS

In Figure 12-10, the status display on Line 1 is replaced by a message to the operator, or Prompt, which can be displayed by the trigger program (see Section 16.1). The prompt remains until it is replaced by another prompt or cleared by the RUN key.

```

EBCDIC/8/NONE/SYNC/
DTE=11111111
DK.PROTECTED&E .%E/>DISPLAYED<%F
1>%NON-DIS%-<NON-DISPLAYED%HO%/
%IJ.NON-PROTECTED%1% .%1%P%/>%A%1%
%.%<%-ALPHA%.?%/>%J%.@.%1<%-NUM
ERIC%<"%/>%(%<%<%-ALPHA NON-DI
SPLAYED%J%YINTERSHAKE Analyzes
And Finds Your Data Communicatio
ns Problems Fast! 1234567890%y%
%
ON-PROTECTED.....
.....%1%->%1%S.....
.....%1%_<%1.0>%1.2.....%1.'<%1(
>%1(B%1((%i%12%/ AID%Z/ %%/
%(%/%%-%-% %%%
5!%1 -%Z3270 75 % .TEST%-1B-%C0*%

```

Figure 13-1

```

EBCDIC/8/NONE/SYNC/ LN=248
DTE=11111111
DK.PROTECTED&E .%E/>DISPLAYED<%F
1>%NON-DIS%-<NON-DISPLAYED%HO%/
%IJ.NON-PROTECTED%1% .%1%P%/>%A%1%
%.%<%-ALPHA%.?%/>%J%.@.%1<%-NUM
ERIC%<"%/>%(%<%<%-ALPHA NON-DI
SPLAYED%J%YINTERSHAKE Analyzes
And Finds Your Data Communicatio
ns Problems Fast! 1234567890%y%
%

```

Figure 13-2

13

RUN MODE: THE CRT DATA BUFFER

You may stop addition of data to the INTERVIEW's CRT data buffer, and hence "freeze" data on the screen, in order to inspect the content of the 16-page buffer. There are four different modes for doing this:

- (1) Trigger Freeze;
- (2) Trigger Delay Stop;
- (3) Manual Freeze;
- (4) Data Buffer Display (Program F).

These four modes are described below, and summarized in Table 13-1. Instructions for obtaining the two trigger-controlled modes are in Section 16.

13.1 THE CURSOR; SCROLLING

In all of these "frozen" display modes except Trigger Freeze, you may scroll through the INTERVIEW's 16-page CRT data buffer using the UP and DOWN cursor arrows. While data is being received two lines are left blank, so that you can easily see where the new data is being added to the screen. In Delay Stop and Manual Freeze modes, these two lines remain blank until you move the cursor. Then the old data that

was being overwritten when addition of data stopped goes away (compare Figures 13-2 and 13-1). You can see this data, however, by scrolling back through the buffer with the UP arrow.

Because the Data Buffer display (PROG F) takes data directly from the "frozen" buffer, only the latest data will be shown before the cursor is moved.

When the cursor reaches the top or bottom of the CRT, each depression of the UP or DOWN arrow pulls another line of data from the buffer onto the screen. You can see the entire adjoining page of the buffer by pressing SHIFT/CONTROL-UP (or DOWN). You can then scroll line by line through this page, and so on.

You can go immediately to the Beginning of the buffer by pressing the B key; or to the End of the buffer by pressing the E key.

At the upper right of the display (see Figure 13-2), the buffer line number of the first line of data on the display is shown. LN=000 is the first line in the buffer; LN=256 is the last line of the buffer.

```

EBCDIC/8/NONE/SYNC/      LN=242
DTE=00000011
.....NON-PROTECTED.....
>1(B4((i12/AIDZ/ /
DK.PROTECTED%E .E/>DISPLAYED<F
1>%NON-DIS%-<NON-DISPLAYED%H0%/
%IJ.NON-PROTECTED% .%A%4
%.<-ALPHA%.?/>J%.@.1<-NUM
ERIC%<"%/>(%<-ALPHA NON-DI
SPLOYED%J%YINTERSHAKE Analyzes
And Finds Your Data Communicatio
ns Problems Fast! 1234567890%y%
%
  
```

Figure 13-3

```

EBCDIC/8/NONE/SYNC/      LN=242
DCE=00110010
.....NON-PROTECTED.....
>1(B4((i12/AIDZ/ /
DK.PROTECTED%E .E/>DISPLAYED<F
1>%NON-DIS%-<NON-DISPLAYED%H0%/
%IJ.NON-PROTECTED% .%A%4
%.<-ALPHA%.?/>J%.@.1<-NUM
ERIC%<"%/>(%<-ALPHA NON-DI
SPLOYED%J%YINTERSHAKE Analyzes
And Finds Your Data Communicatio
ns Problems Fast! 1234567890%y%
%
  
```

Figure 13-4

```

EBCDIC/8/NONE/SYNC>      LN=112
DTE=11111111 DCE=00110010
=====
/ /
=====
=====
=====
=====
=====
===== 3
=====
*( AID% K1 % N AID% !2 % )1111
11111111%
=====
=====12/AID%Z3 /%
=====
=====
=====
  
```

Figure 13-5

You may also move the cursor right or left with the RIGHT or LEFT cursor arrow.

13.2 HEXADECIMAL DISPLAY

The HEX key and SHIFT/CONTROL-HEX work the same way as on the real-time display: You may show all data in clear text or in hexadecimal, or only control characters in hexadecimal.

13.3 BINARY CHARACTER DISPLAY

In each of these display modes except Trigger Freeze, an eight-digit binary number is displayed on Line 2 (see Figures 13-3 and 13-4). This is the binary value of the character at the cursor position. Since you can scroll the cursor through the display buffer at will, you can see this binary expansion for any character in the buffer. Notice that the DTE (TD) expansion is always on the left of Line 2; and the DCE (RD) expansion, on the right. In DUAL-line display, two characters are expanded, since the cursor is dual (see Figure 13-5).

For normal data, the low-order (rightmost) digit, Bit 1, is the first bit received; the high-order (leftmost) digit, Bit 8, the last bit received. (If DATA:REV has been selected on the Program 0 menu, this order is reversed.) This is an important point, especially with regard to bit-oriented protocols, because the order in which the bits are numbered and printed in the literature varies greatly.

13.4 TRIGGER FREEZE

The display may be frozen by selecting CRT:FRZ 1 as a trigger action. When the display is frozen by triggers, the indicator on the FREEZE key remains

off. The receivers are still in synchronization, and the trigger program--and, in the INTERVIEW 40A, the Interactive Test--continues. The status line (Line 1) remains on the screen. Data is being received even though it is not being added to the CRT buffer. Data can still be counted and timed, and the real-time values can still be read on Line 2. In the INTERVIEW 40A the Step display on Line 1 will continue to show the status of the Interactive Test.

You may observe one screenful of data, but you cannot scroll through the buffer.

Trigger Freeze usually should be turned off by a trigger. You can cancel it with the RUN key, but this initializes the program and also resets the data buffer. Trigger Freeze cannot be cancelled by the FREEZE key.

13.5 TRIGGER DELAY STOP

When the trigger conditions for DELAY STOP are satisfied, 256 more characters are received and added to the display; then the indicator on the FREEZE key lights and no more data is added to the buffer. All program activity and data reception stop, so counters and timers stop. On Line 1 status information is shown just as during the real-time data display, and the buffer line number is added at the right. On Line 2 is displayed the binary expansion of the cursor character, or characters.

In Delay Stop, you may scroll through all 16 pages of the CRT buffer.

In single-line display mode, you can easily find the character that arrived at the time the causing trigger came true, eight lines or 256 characters previously. Do not move the cursor right or left when the data flow

```
EBCDIC/8/NONE/SYNC/STEP=2      DCE=01000000  
_ QUICK BROWN FOX JUMPS OVER THE  
LAZY DOG 0123456789%&#x21;THE QUI  
CK BROWN FOX JUMPS OVER THE LAZY  
DOG 0123456789%&#x21;THE QUICK B  
ROWN FOX JUMPS OVER THE  
  
_ CK BROWN  
FOX JUMPS OVER THE LAZY DOG 012  
3456789%&#x21;THE QUICK BROWN FOX  
JUMPS OVER THE LAZY DOG 0123456  
789%&#x21;THE QUICK BROWN FOX JUM  
PS OVER THE LAZY DOG 0123456789%  
&#x21;THE QUICK BROWN FOX JUMPS O  
VER THE LAZY DOG 0123456789%&#x21;  
&#x21;THE QUICK BROWN FOX JUMPS OVER  
THE LAZY DOG 0123456789%&#x21;THE
```

Figure 13-6

```
EBCDIC/8/NONE/SYNC/ LN=028      DCE=11100111  
&#x21;THE QUICK BROWN FOX JUMPS O  
VER THE LAZY DOG 0123456789%&#x21;  
&#x21;THE QUICK BROWN FOX JUMPS OVER  
THE LAZY DOG 0123456789%&#x21;THE  
QUICK BROWN FOX JUMPS OVER THE  
LAZY DOG 0123456789%&#x21;THE QUI  
CK BROWN FOX JUMPS OVER THE LAZY  
DOG 0123456789%&#x21;THE QUICK B  
ROWN FOX JUMPS OVER THE
```

Figure 13-7

```
**DATA BUFFER**      LN=128  
DTE=11111111  
11111111%&#x21; / AID$Z3 %&#x21;  
/ %&#x21; / %&#x21;  
%&#x21; %&#x21; %&#x21;  
%&#x21; %&#x21; %&#x21;  
%&#x21; %&#x21; %&#x21;  
%&#x21; %&#x21; %&#x21;  
%&#x21; %&#x21; %&#x21;  
%&#x21; %&#x21; %&#x21;  
%&#x21; %&#x21; %&#x21;  
%&#x21;
```

Figure 13-8

stops; just scroll upward eight lines, and the cursor will be on the trigger character. Figure 13-6 shows a Delay Stop display triggered by the DCE string FOX. Scrolling back eight lines (Figure 13-7) positions the cursor on the last character of that string. There is no confusion about which FOX string caused the trigger.

Data flow cannot be restarted by a trigger action, so to get out of the Delay Stop Mode, press the PROGRAM or the RUN key.

13.6 MANUAL FREEZE

You may freeze the display manually by pressing the FREEZE key. The Freeze indicator on the key will go on, and addition of data to the CRT buffer will stop immediately. The frozen display looks exactly like that for Delay Stop, and you can scroll through the buffer in the same fashion. Trigger activity stops and therefore the counter and timer stop.

In Manual Freeze, in contrast to Delay Stop, you may restore the data flow by pressing the FREEZE key again. The Freeze indicator will go off, the program will be initialized, and trigger

control will begin. However, the CRT buffer will not be reset, and the counter and timer will continue without resetting.

13.7 DATA BUFFER DISPLAY (PROGRAM MODE)

If you press the PROG key while the INTERVIEW is in Run Mode, the receivers go out of synchronization and no more data is added to the CRT buffer. However, the last 16 pages of data received will remain in the buffer until you press the RUN key. If you want to see this data, press PROG followed by the F key.

Line 1 will identify the display as the DATA BUFFER and the buffer line number will be at the right (see Figure 13-8). On Line 2 will appear the binary expansion of the cursor character just as in Freeze and Delay Stop modes. You may scroll through the entire 16-page buffer, and use the cursor to select any character on the screen for binary expansion. From the Data Buffer display, you may return to Program Mode using the PROG key without resetting the buffer. When you press the RUN key to enter Run Mode the buffer will be reset.

TABLE 13-1
VIEWING THE DATA BUFFER

Activity	Trigger Freeze	Delay Stop	Manual Freeze	Data Buffer
To turn on	On Trigger, enter 1 for CRT FRZ.	On Trigger, select DLY STP:YES.	Press FREEZE key.	Press PROGRAM followed by F key.
To turn off	On Trigger, enter 0 for CRT FRZ.	Cannot be turned off by trigger. Press PROGRAM, RUN, or FREEZE key.	Press FREEZE key again, or RUN key.	--
Indicator light on FREEZE key	Off	On when 256 more characters have been received.	On	On
Scrolling	Cannot scroll; only one page can be viewed.	Entire 16-page data buffer may be viewed.	Entire 16-page data buffer may be viewed.	Entire 16-page data buffer may be viewed.
Status line	Yes	Yes	Yes	Yes
Counter and timer operation	Continue to operate; readings displayed on Line 2	Stop; readings not displayed.	Stop; readings not displayed.	Stop; readings not displayed.
Binary cursor character expansion on Line 2	No	Yes	Yes	Yes

14

THE TRIGGER CONCEPT

The INTERVIEW employs the simple, nonsequential programming technique of Triggers: You merely specify what condition or combination of conditions you wish a trigger to look for, and what action or actions you wish it to take when all the conditions are satisfied.

The identification numbers of the triggers in your unit may be found on the Menu Selections directory. Any trigger menu can be displayed by pressing the PROG key followed by the trigger's identification number. Each trigger menu (Figure 14-1) is divided into two groups of fields: The upper group is the Conditions selections; the lower group is the Actions selections.

Each trigger may look for any or all of five conditions: specific characters or combinations of characters from either the DCE (RD) or DTE (TD), RS-232/V.24 interface lead status, status of the ENTER key, status of eight internal flags, and timeout of a special timer. For a trigger to take action, all conditions selected must be true.

Trigger actions fall into eight categories: displaying a message to the operator (Prompt), sounding an alarm,

controlling the CRT data display, driving a receiver out of synchronization, setting the internal flags, controlling a counter and a timer for making statistical measurements, and controlling the timeout timer.

In the INTERVIEW 40A, message transmission conditions and actions are programmed on another menu, the Interactive Test (Program 7). Trigger conditions can be used as conditions in the Interactive Test. (See Section 21.)

```

**TRIGGER 1**
MON:  NEITHER DTE DCE

INTERFACE:
RTS CTS DSR DTR RLSD UA ENTR
      
FLAGS:        
TIMEOUT:  NO YES

PROMPT:
TIMEOUT:  NO RESTART STOP
CRT: REV FRZ LOW
    DLY STP:  YES
FLAGS: INC  SET     
TIMER:  NO RESTART STOP CONTINUE
COUNTER:  NO INC DEC RESET
ALARM:  NO YES OUTSYNC:  YES
```

Figure 14-1

15

SELECTING TRIGGER CONDITIONS

Figure 15-1 is a default trigger menu. On the top half of the menu are all the conditions that the INTERVIEW will look for. All conditions selected must be satisfied for the trigger to be true. Only then will the actions on the lower half of the menu be taken.

15.1 LOOKING FOR DATA CONDITIONS

When you want a trigger to monitor the data on either TD or RD, use the fields on Lines 3, 4, and 5. A trigger cannot look at both data leads, but you can use two triggers if you want the INTERVIEW to look at both sides of the line.

```

**TRIGGER 1**
MON: NEITHER DTE DCE

INTERFACE:
RTS CTS DSR DTR RLSD UA ENTR
█ █ █ █ █ █ █
FLAGS: XXXXXXXXXX TIMEOUT: NO YES

PROMPT: _____
TIMEOUT: NO RESTART STOP
CRT: REV FRZ LOW
█ █ █ DLY STP: NO YES
FLAGS: INC SET XXXXXXXXXX
TIMER: NO RESTART STOP CONTINUE
COUNTER: NO INC DEC RESET
ALARM: NO YES OUTSYNC: NO YES
  
```

Figure 15-1

15.1.1 Monitor (Line 3)

If you select NEITHER, data will not be used as a trigger condition. When you move the cursor to DTE or DCE, two new fields will appear on Lines 4 and 5 (compare Figures 15-1 and 15-2).

If you select DTE, then TD (Pin 2) will be monitored for the condition selected on Line 4. Similarly, when you select DCE, RD (Pin 3) will be monitored for the condition selected on Line 4.

In the INTERVIEW 40A, each trigger can monitor either the INTERVIEW's own transmissions or the received data.

```

**TRIGGER 1**
MON: NEITHER DTE DCE
FOR: STG 10F GDBCC BDBCC ABT PAR

INTERFACE:
RTS CTS DSR DTR RLSD UA ENTR
█ █ █ █ █ █ █
FLAGS: XXXXXXXXXX TIMEOUT: NO YES

PROMPT: _____
TIMEOUT: NO RESTART STOP
CRT: REV FRZ LOW
█ █ █ DLY STP: NO YES
FLAGS: INC SET XXXXXXXXXX
TIMER: NO RESTART STOP CONTINUE
COUNTER: NO INC DEC RESET
ALARM: NO YES OUTSYNC: NO YES
  
```

Figure 15-2

If you select DTE or DCE and make a selection on Line 4 (and an entry on Line 5), then Line 4 (and 5) will not be returned to default condition if you then select NEITHER. Your selection will remain dormant and reappear if you again select DTE or DCE.

15.1.2 For (Line 4)

On this line, select the data you want the trigger to look for on the TD or RD lead. The selections are as follows:

(a) String. The default selection is STRG, which allows you to enter a string of up to eight characters on the next line. (See Section 15.1.3 for the list of legal characters.) The entire, exact sequence of characters entered must be received for the condition to be true.

(b) "One of" Character. When "10F" is selected, the trigger looks for any one of the characters in the list of up to eight characters entered in the next field. (See Section 15.1.3 for the list of legal characters.)

(c) Good or Bad Block Check. GDBCC (Good Block Check Character) and BDBCC (Bad Block Check Character) cannot be used as conditions unless Received Block Check is ON (Program 0 menu; see Section 9). Select GDBCC or BDBCC when you want the trigger to take action on receipt of the BCC. The INTERVIEW does the appropriate block check calculation for the CODE and FORMAT selected on the Program 0 menu and compares it with the received block check characters. (See Table 9-1 for the block check calculations done by the INTERVIEW.)

(d) Aborted Block. When BOP or BOP/NRZI has been selected for FORMAT on the Program 0 menu, you can choose ABT as a trigger condition. In BOP or BOP/NRZI, seven consecutive 1's always constitute an ABORT.

(e) Parity Error. PAR selects PARity error as a trigger condition. The logic automatically computes parity in accordance with your selections on the Program 0 menu.

15.1.3 Character-Entry Field (Line 5)

This is the data-entry line for a character string, if STRG has been selected, or for a character list, if "10F" has been selected. Up to eight characters may be entered.

(a) String Entry. A string must be received in the exact order it is entered in this field for the condition to be true. The eight characters allowed in the string may include any of the following in any order or number (see Figure 15-3 for an example of each):

```

**TRIGGER 1**

MON: NEITHER DTE DCE
FOR: STRG 10F GDBCC BDBCC ABT PAR
Q1: RTS CTS DSR DTR RLSD UA ENTR
M: M1 M2 M3 M4 M5 M6 M7 M8
INTERFACE:
RTS CTS DSR DTR RLSD UA ENTR
      
FLAGS:        
TIMEOUT:  NO  YES

PROMPT:
TIMEOUT:  NO  RESTART  STOP
CRT: REV FRZ LOW
      
DLY STP:  NO  YES
FLAGS:  INC  SET    
TIMER:  NO  RESTART  STOP  CONTINUE
COUNTER:  NO  INC  DEC  RESET
ALARM:  NO  YES  OUTSYNC:  NO  YES

```

Figure 15-3

- All upper- and lower-case alpha characters and numerals.
- All control character mnemonics.
- Two-digit hexadecimal entries. Characters entered in hexadecimal (HEX key ON) are not translated and parity is not calculated for them.
- Flags. Always use the FLAG key to enter the 7E (hex) Flag byte used to frame bit-oriented protocols. The logic will not read the key sequence HEX, 7, E as a Flag.
- Not Equal entries. If you press the green Not Equal (≠) key before a character key, all characters not equal to that character will satisfy that position in the string. In the data-entry field, that character will be displayed with a bar through it.
- Don't Care entries. The green DON'T CARE key permits any character received in that position in the string to satisfy the condition. A Don't Care character is represented in the data-entry field by a low-intensity reverse-image DC.
- Bit Mask. This allows you to select the status of specific bits in a character.

To enter a Bit Mask, use the BIT MASK key at the desired location in the string. Bit Mask fields are explained in Section 11.2.

NOTE: The logic will look for the exact bit patterns and sequence of characters that you enter. Therefore, the following two points are important: (1) In transparent BISYNC protocols, the communications equipment may insert characters in the data: DLE or DLE SYN, for example. The INTERVIEW will not be able to find a string with inserted characters unless they are specified in the character-entry field. (2) The INTERVIEW will not be able to find a character with a parity error unless the character you enter exactly matches the errored character in the data.

(b) "1 OF" Character Entry. Up to eight characters may be entered from the same list as for strings (see (a) above). The condition will be true upon receipt of the first character to match any one of the characters in the list.

If Don't Care is used, only one character should be entered. If all characters are entered as Not Equal, a match is found on each character that is not any one of the characters entered.

15.2 MONITORING INTERFACE LEADS (LINES 6 THROUGH 8)

Use the INTERFACE field to monitor status of the RS-232/V.24 interface leads or to look for status of the ENTER key. The trigger will look for the

specific pattern of ON and OFF voltages and ENTER key status that you select on Line 8. If the only condition selected on a trigger is status of one interface lead, then the trigger will be true when it sees the transition to that state. If another condition (or conditions) is selected with one interface lead, then the trigger will look for the state of the interface lead when the other condition(s) is true.

NOTE: The term OFF or ON implies that a lead is at either OFF or ON voltage in accordance with the RS-232/V.24 standard. A signal is defined as OFF when it is more negative than -3 volts with respect to signal ground. It is defined as ON when it is more positive than +3 volts with respect to signal ground.

On Line 8, enter a 1 in the box under a lead to indicate ON; a 0 for OFF (see Figure 15-4). No entry (X) will be read as Don't Care: The trigger logic will not look at this lead. There are entry fields for five leads: RTS (Pin 4), CTS (Pin 5), DSR (Pin 6), DTR (Pin 20), and RLSD (Pin 8).

You may monitor a sixth RS-232/V.24 lead by patching the desired lead to the UA input jack on the interface panel and entering 1 or 0 in the UA box in the INTERFACE field. Triggers can detect glitches at this input. See Section 3 for an explanation of the INTERVIEW's interface panel and the glitch catcher.

15.3 MANUAL CONTROL

You can use the INTERFACE field to obtain manual control of trigger actions. When you put a 1 in the ENTR box, the trigger will look for the ENTER key to be depressed. This effectively gives you manual control of trigger actions, for the trigger conditions cannot be true until, in Run Mode, you press the ENTER key. Only 1 and X (Don't Care) are valid for ENTR.

15.4 MONITORING INTERNAL FLAGS (LINE 9)

An internal flag is a bit that a trigger can set ON or OFF and can be monitored by either another or the same trigger. Flags may be used to control program operation or to provide a link between triggers.

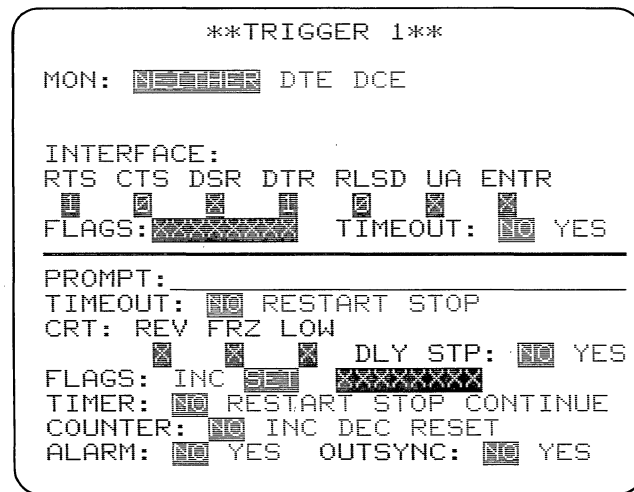

Figure 15-4

There are eight internal flags in the INTERVIEW and they all may be monitored by one trigger, or all set by one trigger, or monitored and set in any combination by different triggers. All flags are set to 0 when the INTERVIEW enters Run Mode or if the RUN key is pressed when the unit is already in Run Mode. In the flag mask enter a 1 to look for a flag ON, a 0 to look for a flag OFF, or X for Don't Care (see Figure 15-5).

```

**TRIGGER 1**
MON:  NEITHER DTE DCE

INTERFACE:
RTS CTS DSR DTR RLSD UA ENTR
      
FLAGS:        
TIMEOUT:  YES

PROMPT: _____
TIMEOUT:  RESTART STOP
CRT: REV FRZ LOW
   DLY STP:  YES
FLAGS: INC     
TIMER:  RESTART STOP CONTINUE
COUNTER:  INC DEC RESET
ALARM:  YES OUTSYNC:  YES

```

Figure 15-5

If a flag is the only condition entered on a trigger menu, then the trigger will look for the transition from 0 to 1 or 1 to 0. If more than one flag condition is entered, then the trigger will look for the last transition necessary to match the flag mask. If the trigger is looking for both a flag (or flags) and another condition, then it will look for the state of the flag (or flags) when the other condition comes true.

NOTE: If a FLAG condition is used with a MONITOR (string or character-type; Line 4) condition, then the flag is tested when the monitor condition has been satisfied. The flag condition is not tested on each character of a string.

15.5 TIMEOUT (LINE 9)

When TIMEOUT YES is selected, the trigger looks for the occurrence of the timeout set by another trigger (see Section 16.2) or--in the INTERVIEW 40A--by the Interactive Test (see Section 21.4). The default selection is NO.

```

**TRIGGER 1**
MON: NEITHER DTE DCE

INTERFACE:
RTS CTS DSR DTR RLSD UA ENTR
  X  X  X  X  X  X  X  X
FLAGS:XXXXXXXXX TIMEOUT: NO YES

PROMPT:
TIMEOUT: NO RESTART STOP
CRT: REV FRZ LOW
  X  X  X  X  X  X  X  X  X  X  X  X
FLAGS: INC SET XXXXXXXXX
TIMER: NO RESTART STOP CONTINUE
COUNTER: NO INC DEC RESET
ALARM: NO YES OUTSYNC: NO YES

```

Figure 16-1

```

**TIMEOUT/INTERFACE/PRINTER**
TIMEOUT=1.000 SECS

INTERFACE CONTROL
STATIC LEADS: DTR DSR
  X  X
RTS: ON SWITCH
CTS: ON SWITCH
RLSD: ON SWITCH
XMIT DELAY: 2 mSECS

PRINTER CONTROL
SPEED: 2400
NEW LINE: LF
  FOLLOWED BY 5 PADS
CHAR PER LINE: 72 120

```

Figure 16-2

16

SELECTING TRIGGER ACTIONS

Figure 16-1 is a default trigger menu, showing the action selections on the lower half of the menu. When all conditions selected on the top half of the trigger menu are true, the actions will be taken. Details of the action sequence are explained in Section 17.

16.1 DISPLAYING A PROMPT (MESSAGE TO THE OPERATOR; LINE 10)

On this data-entry line you may enter a message to the operator of up to 25 characters. When the trigger is true, this Prompt will be displayed on Line 1 of the CRT. It will stay on the display until it is replaced by another prompt or until you clear it by pressing the RUN key.

PROMPT is an ASCII-character field and only alphanumeric characters are legal. If you have the hexadecimal keyboard, the logic will ignore the state of the HEX key.

16.2 CONTROLLING THE TIMEOUT TIMER (LINE 11)

The INTERVIEW has a timer dedicated to the timeout function; that is, a timer that may be set to "time out" at a specified value which then may be used as a trigger condition. Enter the duration of the timeout on the TIMEOUT (Program 5) menu (Figure 16-2). TIMEOUT is a decimal field in which you may enter up to 4 digits and one decimal point. The maximum value for a single timeout is 65.53 seconds. The default timeout value is 1 second.

It is possible to obtain longer timeouts by using the flags to look for multiple occurrences of the timeout. The maximum is 256 (which is the maximum value of the flag mask) times 65.53 seconds or approximately 280 minutes. This use of flags is explained in Section 16.4.

In the INTERVIEW 40A, the same timeout timer is used both by triggers and by the Interactive Test. Triggers usually should not set the timeout if TIMEOUT is selected as a condition on the Interactive Test: Because the Interactive Test always resets the timeout, it will interfere with the trigger program.

RESTART: When RESTART is selected, the trigger resets the timeout timer to 0 and it begins to increment.

STOP: When STOP is selected, the trigger stops the timer--which has been started by another trigger or by the Interactive Test--and the timeout condition does not occur.

When the default selection is NO, the trigger will not control the timer.

16.3 CONTROLLING THE CRT (LINES 12 and 13)

Triggers can be used to selectively enhance data or display specific data on the CRT. Control of the CRT does not affect counter and timer operation. The 512-character (36 x 16) display and the 8096-character (16-page) display buffer are controlled together.

To turn a CRT action ON (see Figure 16-3), enter a numeral 1 in the corresponding box on Line 13; to turn an action OFF, enter a zero (0). An X (Don't Care key) means that no action will be taken.

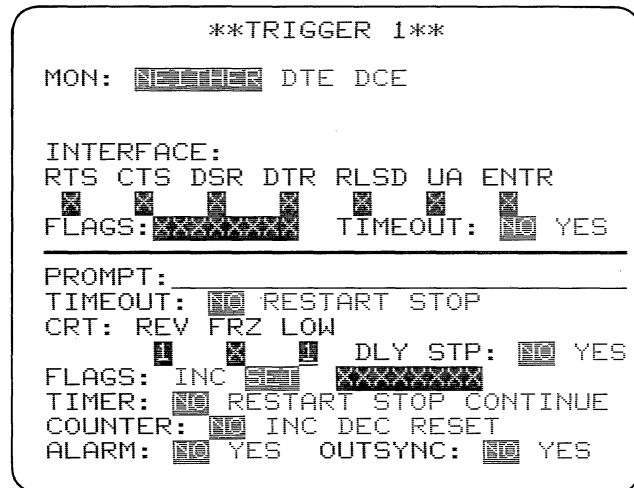

Figure 16-3

(a) Reverse Image. Reverse-imaged characters are presented in black on a light background. REVERSE image is very effective when used in combination with low intensity, but hard to read if it occurs over a large area of the screen.

(b) Freeze. When FRZ is on, no new data is received by the CRT buffer or displayed until freeze is turned off. However, the data withheld from the CRT during trigger freeze is still received by the trigger logic and the program continues to operate, so valid counter and timer data will still be furnished.

Trigger freeze usually should be turned off by another trigger. It can be canceled manually with the RUN key, but this always resets the program.

See Section 13 for more about Freeze.

(c) Low Intensity. LOW intensity is useful to display data of lesser importance. However, in combination with reverse image, it creates a highlight that is immediately noticeable.

(d) Delay Stop. If DLY STP:Yes is selected, then when the trigger conditions are true, 256 more characters are added to the display. The receivers are then driven out of synchronization so no new data is presented either to the trigger logic or to the CRT buffer. In Delay Stop Mode, you have access to all 16 pages of data in the INTERVIEW's CRT data buffer. For more about this, see Section 13.

16.4 SETTING FLAGS (LINE 14)

Flags are bits that can be set on or off by the program. The INTERVIEW has eight flags. There are two choices of FLAG actions: The trigger can INCrement the flags, or it can set specified flags ON or OFF. When the program is reset by the RUN key, all flags are set to 0 (off).

(a) Increment Flags. INC can be used to control recursive routines. Each time the trigger conditions are satisfied, the value of the flag mask, considered as a binary number, will increment by one.

NOTE: The high-order bit is on the left (Flag 8); the low-order bit on the right (Flag 1).

To reset Flag Increment, use the flag SET action (b).

(b) Set. To turn specified flags on or off, select SET; then use the ENTER key to move the cursor to the field of eight numbered boxes. Enter a 1 under the number of any flag, or flags, that you want the trigger to turn on; a 0 for any flag, or flags, you wish turned off. X means Don't Care: the trigger will not change the status of this flag. The trigger action will be to set the flags according to the mask you have entered. The initial flag status when the INTERVIEW first enters Run Mode is all flags OFF.

SET entries will remain dormant if you select INC without clearing them. Then when you select SET again, your flag mask entries will reappear.

(c) No Flag Action. Choose SET with all flags X (Don't Care).

(d) Example: Counting with Flags. Suppose that you wanted to count polls over an extended period of time. The maximum counter value is 9999, but using flags you can multiply this by as much as 256, which is the maximum value of the flag mask. The example shown in

Figures 16-4 and 16-5 uses both the INC and the SET actions to increase counter capacity by a factor of 10.

Trigger 1 looks for the poll from DTE and increments the flag mask upon receipt of each poll. When 10 polls have been received, Trigger 2 sees the flag mask increment to XXXX 1010 (decimal value 10) and increments the counter once. It also resets the flag mask to XXXX 0000 so that it can start counting again upon receipt of the next poll.

When you read the counter, remember to multiply the displayed value by 10 to find the actual number of polls.

(e) Example: Increasing the Maximum Timeout. Figures 16-6 through 16-8 illustrate how the flag increment action can be used to increase the length of a timeout. Once the timeout timer is started (Trigger 1), the timeout is used as the condition to restart the timer (Trigger 2) and increment the flag mask, and any duration up to 256 x TIMEOUT can be used as the condition for the desired action (Trigger 3). Trigger 3 could be used as the condition for a transmission (see Section 21.4).

(f) Example: Program Control with a Flag. Suppose you suspected that a bad BCC always followed a certain

string. One trigger cannot look for both a string and a BCC. To do this, we SET a single flag to link the two conditions. Our example is shown in Figures 16-9 through 16-11.

Trigger 1 looks for the DCE string (DISP) and turns Flag 8 on. Trigger 2 looks for a bad BCC from DCE while Flag 8 is on. It sounds the alarm and increments the counter each time the conditions are true. In addition, it turns Flag 8 off so that Trigger 2 cannot be true again until Trigger 1 has found another (DISP). Trigger 3 prevents Trigger 2 from counting BCCs that are not on the same block as the string (Figure 16-11).

(g) Auxiliary Output. When FLAGS:SET is selected, an output on Pin 7 of the INTERVIEW's AUXILIARY connector (on the rear) follows the status of Flag 1, that is, the right-most flag in the mask. When this flag is set to 1, the output will be +5 volts and when the flag is set to 0, the output will be 0 volts. The output driver is a 74LS04 which can sink up to 8 mA. Ground on the auxiliary connector is on Pin 6.

The FLAGS:INC action will not cause any auxiliary output.

```

**TRIGGER 1**
MON: NEITHER DTE DCE
FOR: STG 10F GDBCC BDBCC ABT PAR
AS
INTERFACE:
RTS CTS DSR DTR RLSD UA ENTR
AS
FLAGS: XXXXXXXX TIMEOUT: NO YES
-----
PROMPT:
TIMEOUT: NO RESTART STOP
CRT: REV FRZ LOW
AS AS AS DLY STP: NO YES
FLAGS: INC SET
TIMER: NO RESTART STOP CONTINUE
COUNTER: NO INC DEC RESET
ALARM: NO YES OUTSYNC: NO YES
    
```

Figure 16-4

```

**TRIGGER 2**
MON: NEITHER DTE DCE
INTERFACE:
RTS CTS DSR DTR RLSD UA ENTR
AS
FLAGS: XXXX1010 TIMEOUT: NO YES
-----
PROMPT:
TIMEOUT: NO RESTART STOP
CRT: REV FRZ LOW
AS AS AS DLY STP: NO YES
FLAGS: INC SET XXXXXXXX
TIMER: NO RESTART STOP CONTINUE
COUNTER: NO INC DEC RESET
ALARM: NO YES OUTSYNC: NO YES
    
```

Figure 16-5

```

**TRIGGER 1**
MON: NEITHER DTE DCE
FOR: STG 10F GDBCC BDBCC ABT PAR
DS
INTERFACE:
RTS CTS DSR DTR RLSD UA ENTR
  [X] [X] [X] [X] [X] [X] [X]
FLAGS: XXXXXXXX TIMEOUT: NO YES
-----
PROMPT:
TIMEOUT: NO RESTART STOP
CRT: REV FRZ LOW
  [X] [X] [X] DLY STP: NO YES
FLAGS: INC SET XXXXXXXX
TIMER: NO RESTART STOP CONTINUE
COUNTER: NO INC DEC RESET
ALARM: NO YES OUTSYNC: NO YES
    
```

Figure 16-6

```

**TRIGGER 2**
MON: NEITHER DTE DCE
INTERFACE:
RTS CTS DSR DTR RLSD UA ENTR
  [X] [X] [X] [X] [X] [X] [X]
FLAGS: XXXXXXXX TIMEOUT: NO YES
-----
PROMPT:
TIMEOUT: NO RESTART STOP
CRT: REV FRZ LOW
  [X] [X] [X] DLY STP: NO YES
FLAGS: INC SET
TIMER: NO RESTART STOP CONTINUE
COUNTER: NO INC DEC RESET
ALARM: NO YES OUTSYNC: NO YES
    
```

Figure 16-7

```

**TRIGGER 3**
MON: NEITHER DTE DCE
INTERFACE:
RTS CTS DSR DTR RLSD UA ENTR
  [X] [X] [X] [X] [X] [X] [X]
FLAGS: XXXXXXXX TIMEOUT: NO YES
-----
PROMPT:
TIMEOUT: NO RESTART STOP
CRT: REV FRZ LOW
  [X] [X] [X] DLY STP: NO YES
FLAGS: INC SET XXXXXXXX
TIMER: NO RESTART STOP CONTINUE
COUNTER: NO INC DEC RESET
ALARM: NO YES OUTSYNC: NO YES
    
```

Figure 16-8

```

**TRIGGER 1**
MON: NEITHER DTE DCE
FOR: STG 10F GDBCC BDBCC ABT PAR
DISP
INTERFACE:
RTS CTS DSR DTR RLSD UA ENTR
  [X] [X] [X] [X] [X] [X] [X]
FLAGS: XXXXXXXX TIMEOUT: NO YES
-----
PROMPT:
TIMEOUT: NO RESTART STOP
CRT: REV FRZ LOW
  [X] [X] [X] DLY STP: NO YES
FLAGS: INC SET XXXXXXXX
TIMER: NO RESTART STOP CONTINUE
COUNTER: NO INC DEC RESET
ALARM: NO YES OUTSYNC: NO YES
    
```

Figure 16-9

```

**TRIGGER 2**
MON: NEITHER DTE DCE
FOR: STG 10F GDBCC BDBCC ABT PAR
INTERFACE:
RTS CTS DSR DTR RLSD UA ENTR
  [X] [X] [X] [X] [X] [X] [X]
FLAGS: XXXXXXXX TIMEOUT: NO YES
-----
PROMPT:
TIMEOUT: NO RESTART STOP
CRT: REV FRZ LOW
  [X] [X] [X] DLY STP: NO YES
FLAGS: INC SET XXXXXXXX
TIMER: NO RESTART STOP CONTINUE
COUNTER: NO INC DEC RESET
ALARM: NO YES OUTSYNC: NO YES
    
```

Figure 16-10

```

**TRIGGER 3**
MON: NEITHER DTE DCE
FOR: STG 10F GDBCC BDBCC ABT PAR
INTERFACE:
RTS CTS DSR DTR RLSD UA ENTR
  [X] [X] [X] [X] [X] [X] [X]
FLAGS: XXXXXXXX TIMEOUT: NO YES
-----
PROMPT:
TIMEOUT: NO RESTART STOP
CRT: REV FRZ LOW
  [X] [X] [X] DLY STP: NO YES
FLAGS: INC SET XXXXXXXX
TIMER: NO RESTART STOP CONTINUE
COUNTER: NO INC DEC RESET
ALARM: NO YES OUTSYNC: NO YES
    
```

Figure 16-11

16.5 CONTROLLING THE TIMER (LINE 15)

The INTERVIEW has one timer for statistical measurements, which is controlled by the TIMER field. (A separate timeout timer is also available; see Section 16.2.) The default selection is NO. When the timer is set, the real-time timer readings will be displayed on Line 2 (see Section 12.2). The maximum value for the timer is 9999.

(a) RESTART causes the timer to reset to 0 and begin counting.

(b) CONTINUE causes the timer to begin adding to the existing count.

(c) STOP stops the timer.

NOTE: The timebase is 1 msec. If the durations are less than 1 msec, a rounding effect occurs, where some shorter periods are missed and others counted. This effect will usually average out for counts above 100. Since the 1-msec timebase runs continuously and is not initialized for each measurement, the accuracy of measurements will always be plus or minus 1 msec.

16.6 CONTROLLING THE COUNTER (LINE 16)

The default Counter selection is NO. When the counter is set, its real-time readings will be displayed on Line 2 while the unit is in Run Mode (see Section 12.2). The maximum count is 9999; the minimum is 0.

INCREMENT. When INC is selected, each trigger occurrence adds 1 (one) to the counter value.

DECREMENT. When DEC is selected, each trigger occurrence subtracts 1 (one) from the counter value.

RESET sets the counter to 0 (zero).

16.7 SETTING AN ALARM (LINE 17)

In this field, YES selects an audible alarm as the trigger action.

16.8 FORCING A RECEIVER OUT OF SYNCHRONIZATION (LINE 17)

When OUTSYNC is selected, the DCE (RD) or DTE (TD) receiver, whichever is selected as the Monitor condition, goes out of synchronization from trigger true until it sees the next synchronization pattern. While the receiver is out of synchronization, no data from that side of the line is presented to the INTERVIEW display or to the counter or timer (unless DISPLAY IDLE has been selected on the Program 0 menu).

This ability is useful when the information after a header group is of no interest, but you need to see data on the other side of the line. In this case, Freeze would not be applicable since it inhibits addition of all data to the display.

When ASYNC has been selected on the Program 0 menu, OUTSYNC is not a valid trigger action. OUTSYNC should not be selected on the same trigger as EIA conditions.

17

TRIGGER TIMING AND SEQUENCE (TECHNICAL NOTES)

Although all triggers are simultaneously active, there is an order in which they are processed. The order of trigger processing is significant only in special situations (as in Section 17.2).

17.1 ORDER OF PROCESSING

Basically, the triggers are first evaluated in their numerical order for their conditions to be true; then the trigger actions are taken in order. This process permits the same internal flag to be sensed and set by the same trigger.

The sequence that occurs after each character is received is as follows:

- (1) Evaluate triggers that do not look for data.
- (2) Evaluate triggers that look for DTE data.
- (3) Evaluate triggers that look for DCE data.
- (4) Set all actions applicable for each trigger in numerical order.

17.2 EXAMPLES

Usually the timing described in Section 17.1 is not important. However, under certain circumstances, such as when internal flags are being set and tested, these timing relationships are significant.

Consider the case in which a string on the DTE line sets a flag; another DTE string resets the flag; and that flag in conjunction with a DCE string restarts the timer. Figures 17-1 through 17-3 show this example. Trigger 1 looks for a string, BC, on the DTE side of the line and turns Flag 1 ON when the string is found. Trigger 2 looks for a string, DE, on the DTE side and turns Flag 1 OFF when the string is found. Trigger 3 looks for Flag 1 to be ON in conjunction with a DCE string of HI and restarts the timer when this condition is met.

Suppose that the following data is received and shown in dual-line display on the CRT:

```
DTE -- A B C D E F
DCE -- G H I J K L
```

Before we consider what the program of Figures 17-1 through 17-3 will do with this data, we must understand how this data may have been received. First, the time correlation between the DTE and DCE lines on the display is accurate to +1 character. Second, the display has a resolution, at the very best, of only one character. Thus, the two lines may actually be skewed by half a character or even one bit, but this cannot be shown on the display. Third, the program processes characters within microseconds after they are received. Thus, two characters that appear on the screen to have been received simultaneously may not have been treated that way by the program.

Our sample program is looking for a string of BC on the DTE line and HI on the DCE line. On the display, these characters appear to have been received simultaneously, but actually string BC may have been received (1) before, (2) after, or (3) simultaneously with string HI. We now consider what action would be taken in each of the three cases.

(1) BC String Received before HI String: The Trigger 1 conditions and actions are processed before the Trigger 3 conditions and actions. Thus, when BC is received, Flag 1 is turned ON. When HI is received Flag 1 is already ON and the Trigger 3 conditions are met, so the timer is restarted.

(2) BC String Received after HI String: Trigger 1 conditions and actions are processed after the Trigger 3 conditions and actions. Thus, when the HI string is received, Flag 1 has not yet been turned ON and the Trigger 3 conditions are not met, so the timer is not restarted.

(3) BC and HI Strings Received Simultaneously: For this case, we must consider the trigger timing discussed in Section 17.1. Remember that all trigger conditions are tested before any of the actions are taken. First, the string BC on the DTE line is checked and found to be true, but no action is taken yet. Next, the string HI on the DCE line is evaluated, but since the Trigger 1 action has not yet been taken, Flag 1 has not been turned ON and the Trigger 3 conditions are not met.

Now that all of the conditions have been evaluated, the actions will be taken. The Trigger 1 condition having been met, the Trigger 1 action is taken first, so Flag 1 is now turned ON. Because the Trigger 3 condition has not been met, the Trigger 3 action is not taken, so the timer is not restarted. In this case, even though Flag 1 has been turned ON, the timer is not restarted, because the flag was not turned ON until after the Trigger 3 condition was tested.

Thus we see that for the same CRT display two different actions may be taken by the program. This is due to the resolution limitations of the CRT. The program is executing within microseconds of receiving each character and with much better resolution than is possible on the CRT.

18. INTERACTIVE TESTING (INTERVIEW 40A)

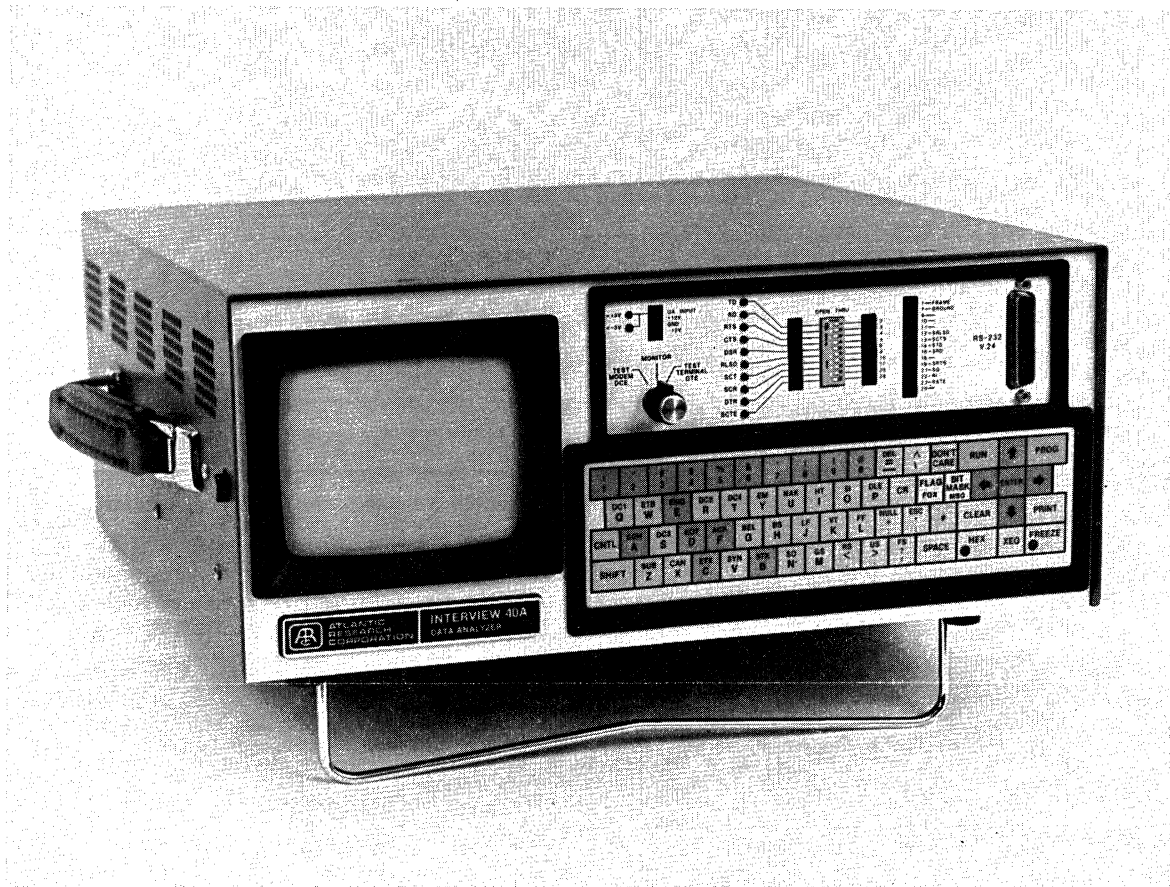

Figure 18-1 The INTERVIEW 40A. The rotary mode switch on the left selects MONITOR, TEST MODEM, or TEST TERMINAL modes.

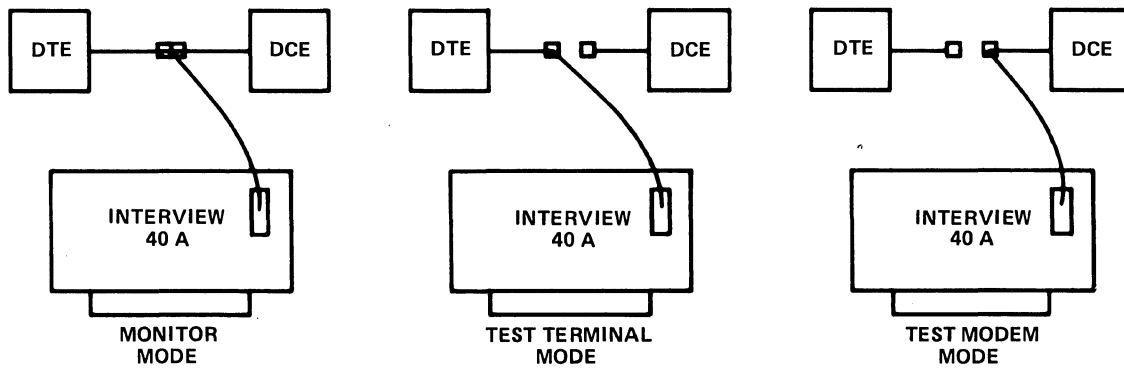

Figure 18-2 Connecting the INTERVIEW 40A to the RS-232/V.24 interface: (a) MONITOR mode; (b) TEST TERMINAL mode; (c) TEST MODEM mode.

18

THE INTERACTIVE TEST MODES

Figure 18-1 is an INTERVIEW 40A. As shown in the figure, this model always has a three-position rotary mode switch to the left of the interface panel, and the alphanumeric keyboard is standard. It also has several special program menus, to be used for setting up interactive tests. These are explained in Sections 19 through 23.

Select TEST TERMINAL or TEST MODEM with the rotary switch at the left of the interface panel (see Figure 18-1). If you want the INTERVIEW 40A to imitate a DCE, select TEST TERMINAL. The INTERVIEW 40A will now be able to transmit data, control signals, and clock toward the terminal, using the leads usually controlled by the DCE.

18.1 SELECTING THE TEST MODE

When the INTERVIEW 40A is monitoring data, it is connected to the RS-232/V.24 interface with a T-cable. To use the INTERVIEW 40A interactively, you must break the line manually (or with the patching equipment at the site) toward either DTE or DCE (see Figure 18-2).

CAUTION: As soon as the INTERVIEW is switched to either of its Test Modes, it will interfere with any active communications on the interface. Be sure that it is all right to break the line and transmit test data on it.

To imitate a DTE, select TEST MODEM. The INTERVIEW 40A will now be able to control the leads usually controlled by the DTE.

NOTE: To shorten any interruption in communications, you may wish to set up the test menus in the unit before you switch the INTERVIEW 40A to a test mode. All menu selections that you will need are shown whether or not the unit is in a test mode. (See Sections 20 and 21.)

As soon as you have selected one of the Test Modes the indicators for the leads controlled by the INTERVIEW 40A will light on the interface panel.

NOTE: If the interface leads are not terminated, the indicator readings will be unpredictable.

Table 18-1 specifies which leads are controlled by the INTERVIEW 40A in each Test Mode and gives electrical data for them.

18.2 CLOCKING

The INTERVIEW 40A's transmitters will operate off external clock if it is supplied from the interface. If there is no external clock, you must select CLOCK:INT on the Program 0 menu. In Test Modem Mode, the INTERVIEW 40A will drive SCTE and in Test Terminal Mode it will drive SCT and SCR. Table 18-2 summarizes clock operation for various operating selections.

TABLE 18-1
INTERFACE LEADS CONTROLLED BY THE INTERVIEW

RS-232/V.24 Lead				TEST MODEM Mode	TEST TERMINAL Mode	MONITOR Mode
Pin	Name	EIA	CCITT			
2	TD	BA	103	Driven by INTERVIEW	GND via 3.3 kohms	Input to 30-kohm receiver
3	RD	BB	104	GND via 3.3 kohms	Driven by INTERVIEW	Input to 30-kohm receiver
20	DTR	CD	108/2	Driven by INTERVIEW	GND via 3.3 kohms	Input to 30-kohm receiver
4	RTS	CA	105	Driven by INTERVIEW	GND via 3.3 kohms	Input to 30-kohm receiver
8	RLSD	CF	109	GND via 3.3 kohms	Driven by INTERVIEW	Input to 30-kohm receiver
5	CTS	CB	106	GND via 3.3 kohms	Driven by INTERVIEW	Input to 30-kohm receiver
15	SCT	DB	114	GND via 3.3 kohms	Driven by INTERVIEW	Input to 30-kohm receiver
17	SCR	DD	115	GND via 3.3 kohms	Driven by INTERVIEW	Input to 30-kohm receiver
24	SCTE	DA	113	Driven by INTERVIEW	GND via 3.3 kohms	Input to 30-kohm receiver
6	DSR	CC	107	GND via 3.3 kohms	Driven by INTERVIEW	Input to 30-kohm receiver

18.3 INTERACTIVE MENU SELECTION

Three special menus are included in the INTERVIEW 40A. The interface handshaking sequence must be specified on the Interface Control menu (PROG 5), discussed in Section 19. The interactive program is entered on the Interactive Test menu (PROG 7), which is explained in Sections 20 through 22. To use the INTERVIEW 40A in either of its Test Modes you will need both these menus.

You may also wish to use the Message Buffer or the stored Fox Message. Both of these may be seen on the Transmit Mode menu (PROG 6) discussed in Section 23.

18.4 BERT TEST

The Bit Error Rate Test (BERT) option is standard in the INTERVIEW 40A. See Part VI of this manual for a complete description of this option.

TABLE 18-2
INTERVIEW CLOCKING SELECTIONS

Mode Switch Position	FORMAT: SYNC or BOP		FORMAT: ASYNC	
	CLOCK: INT	CLOCK: EXT	CLOCK: INT	CLOCK: EXT
MONITOR	Uses internal clock	Uses SCT and SCR	Uses internal clock	Uses SCT and SCR
TEST DTE	Uses internal clock	Uses SCTE	Uses internal clock	Uses SCTE
	Drives SCT and SCR to equal internal clock	Drives SCT and SCR to equal SCTE	Drives SCT and SCR ON (+12 V)	Drives SCT and SCR to equal SCTE
TEST DCE	Uses internal clock	Uses SCT and SCR	Uses internal clock	Uses SCT and SCR
	Drives SCTE to equal internal clock	Drives SCTE ON (+12 V)	Drives SCTE to equal internal clock	Drives SCTE ON (+12 V)

19

SETUP FOR HANDSHAKING: INTERFACE CONTROL MENU (PROGRAM 5)

The Interface Control menu (Figure 19-1) has two purposes: (1) to specify how the INTERVIEW 40A is to control the RS-232/V.24 leads and (2) to tell it what signals to expect from the other side of the interface. To use this menu effectively you must understand the handshaking procedure of the system you will be testing.

Table 19-1 and Figure 19-2 summarize the handshaking possibilities in the INTERVIEW 40A's two Test Modes.

19.1 STATIC LEADS: DTR, DSR

NOTE: The terms ON and OFF imply that an RS-232/V.24 lead is driven to either on or off voltage in accordance with the RS-232/V.24 standard. The standard defines a signal as OFF when it is more negative than -3 volts with respect to signal ground. A signal is defined as ON when it is more positive than +3 volts with respect to signal ground. Thus, OFF always implies that the lead is driven to the off state and we use the term "inactive" to mean that a lead is not being driven on or off.

Use the Static Leads field to instruct the INTERVIEW 40A to drive either DTR or DSR--depending on the test mode--constantly on or off. Enter a 1 for ON; and a 0 for OFF. No entry is necessary in the box for the other--that is, received--lead.

When the INTERVIEW 40A is in either test mode, it will drive the lead it controls on if the entry is X. If you want a static lead to be inactive, it can be manually switched out using the corresponding breakout switch (see Section 6).

```

**TIMEOUT/INTERFACE/PRINTER**
TIMEOUT=1.000 SECS

      INTERFACE CONTROL
STATIC LEADS: DTR DSR
                 
RTS:  SWITCH
CTS:  SWITCH
RLSD:  SWITCH
XMIT DELAY:     mSECS

      PRINTER CONTROL
SPEED: 2400
NEW LINE: 65
        FOLLOWED BY 5 PADS
CHAR PER LINE: 72 120

```

Figure 19-1

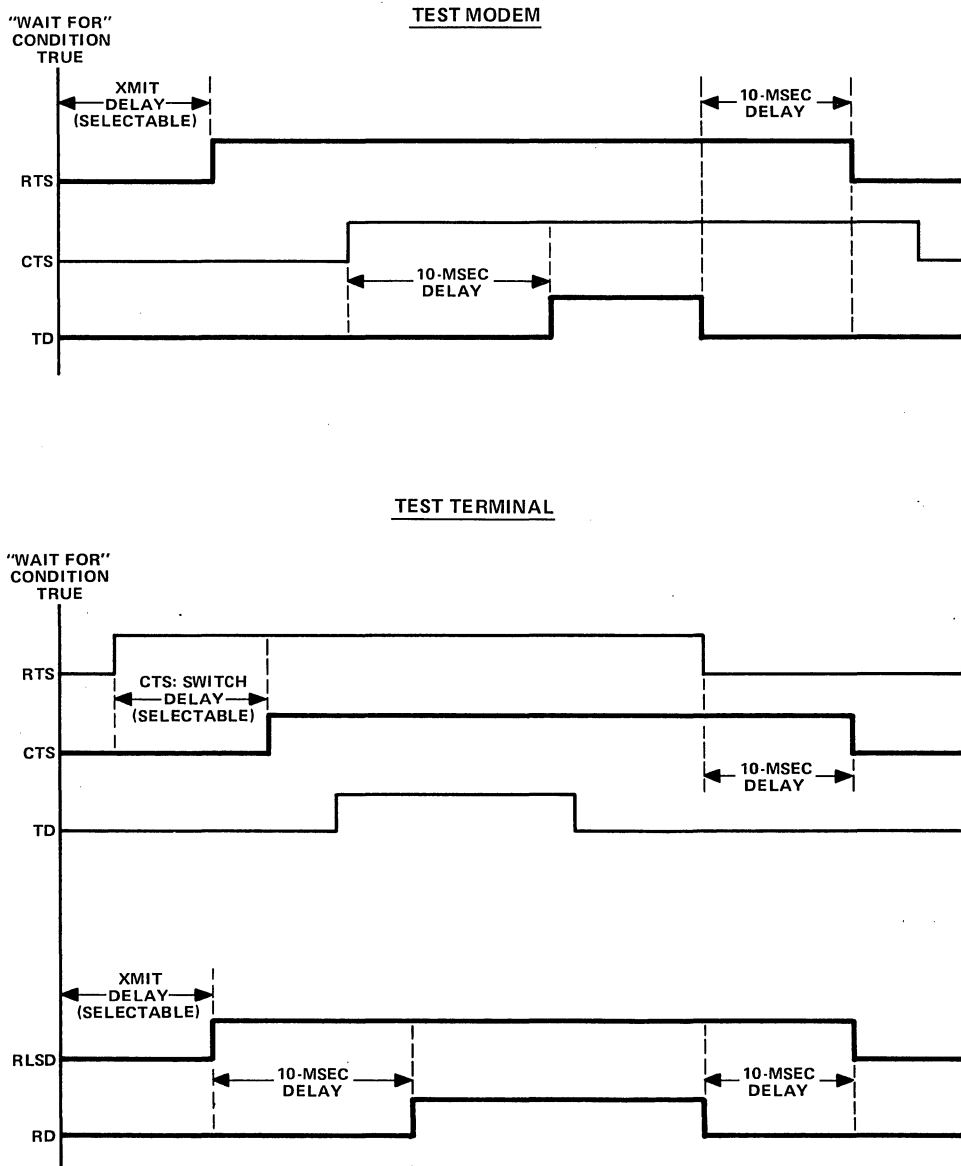

Figure 19-2 Delay times for RS-232/V.24 leads controlled by the INTERVIEW 40A in its Test Modes. Heavy lines denote leads controlled by the INTERVIEW 40A; lighter lines indicate the opposite side of the interface. XMIT DELAY is selected in the XMIT DELAY field of the Interface Control menu (Program 5); CTS:SWITCH DELAY, on the CTS line of that menu.

TABLE 19-1
INTERVIEW 40A HANDSHAKING CONTROL

Lead		Test Terminal Mode		Test Modem Mode	
Pin	Name	Controls	Looks for	Controls	Looks for
Static Leads					
20	DTR	N	Y	Y	N
6	DSR	Y	N	N	Y
Switched Leads					
4	RTS	N	Y	Y	N
5	CTS	Y	N	N	Y
8	RLSD	Y	N	N	Y

The INTERVIEW 40A will control one of the static leads at all times whenever the rotary switch on the front panel is switched to either test mode. It does not relinquish control when it is in Program Mode.

19.2 SWITCHED LEADS: RTS, CTS, RLSD

These selections enable the INTERVIEW 40A to turn these three leads on and off, if it is controlling them. The rotary Mode switch determines which leads it controls: RTS when it is in Test Modem mode and CTS and RLSD when it is in Test Terminal mode. The delay times discussed in the following paragraphs only apply to the leads controlled by the INTERVIEW 40A. The INTERVIEW 40A does not care what the delay times are on the other side of the interface. Figure 19-2 summarizes the delay times for each test mode.

(a) On. For RTS, CTS, and RLSD you can choose between ON and SWITCHED. If you choose ON, the INTERVIEW 40A will apply a constant ON voltage to that lead as long as it is in Run Mode, if it is in the correct test mode to control that lead. ON is appropriate for continuous carrier, or full-duplex use, while SWITCHED must be used for half-duplex or multidrop systems.

If you don't want to send or receive a signal on one (or more) of these leads, you can manually disable it with the breakout switch on the interface panel.

With RTS ON selected in Test Modem mode, the INTERVIEW 40A will transmit immediately when the test conditions are satisfied, but only if it sees CTS on. With RLSD ON selected in Test Terminal Mode, it will transmit as soon as the conditions are satisfied.

(b) RTS, Switch. If the INTERVIEW 40A is controlling RTS, that is, if it is in Test Modem Mode, it will turn RTS ON as soon as the conditions for transmission are satisfied unless you enter a delay in the XMIT DELAY field (see below). It will send data 10 msec after it sees CTS come on and turn RTS off 10 msec after it has sent either the block check characters or the end of the message, if there is no BCC.

(c) CTS, Switch. When you have selected SWITCH for CTS (see Figure 19-3), you may enter a DELAY time of from 0 to 999 msec in the DELAY field on the same line (DELAY is a decimal field with a default value of 250 msec). If the INTERVIEW 40A is controlling CTS, that is, if it is in Test Terminal Mode, when it sees RTS go on it will wait this delay time before turning CTS on. After it sees RTS go off, it will wait 10 msec to turn CTS off.

(d) RLSD, Switch. If the INTERVIEW 40A is controlling RLSD, that is, if it is in Test Terminal Mode, it will turn RLSD on as soon as the conditions for transmission are satisfied unless you have entered a delay time in the XMIT DELAY field (see below). It will send data 10 msec after it turns RLSD on, and turn RLSD off 10 msec after the block check characters or the end of transmission.

(e) Xmit Delay. In this decimal field you may enter a delay between the instant the conditions for transmission become true and the start of the handshaking for transmission; that is, RTS ON in Test Modem mode or RLSD ON in Test Terminal mode. If there is no handshaking routine, as when ON has been selected instead of SWITCH, XMIT DELAY will be the delay to the transmission of the first message character.

This field enables you to use characters near the beginning of a received block as the condition for transmission but delay the start of transmission until after the entire block has been received. It may also be used to simulate a response delay.

(f) INTERVIEW Handshaking. If SWITCHED is selected for RTS, CTS, and RLSD, the INTERVIEW assumes it is in a two-wire half-duplex system. In Test Terminal Mode, if RTS, CTS, and RLSD are SWITCHED, the INTERVIEW will not issue CTS until it has dropped RLSD, nor will it issue RLSD while it is sending CTS.

In Test Modem Mode, if RTS and CTS are SWITCHED, the INTERVIEW will not initiate the next transmission until CTS has gone off following the preceding transmission.

19.3 MANUAL INTERFACE CONTROL

Ten RS-232/V.24 interface leads can be controlled ON and OFF manually using the breakout switches on the interface panel of the INTERVIEW 40A. The breakout switches are explained in Section 6.

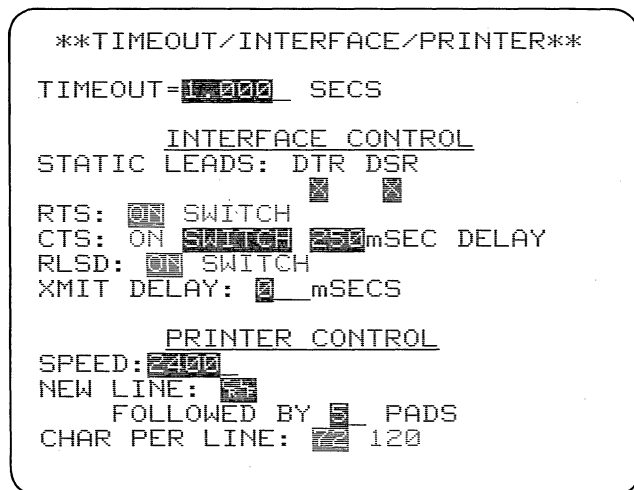

Figure 19-3

20

THE INTERACTIVE TEST (PROGRAM 7): GENERAL DESCRIPTION

20.1 INTRODUCTION

All transmission program instructions must be entered on the INTERVIEW 40A's Interactive Test menu, obtained by pressing PROG followed by numeral 7. Figure 20-1 shows the default menu. The conditions for all transmissions used in a test are entered in the left, or WAIT FOR, column; the content of each transmission is specified in the XMIT column to the right. The block check for each transmission is specified in the BCC column at the far right. There can be as many as 16 conditions and 16 transmit actions in one loop of the test.

20.2 SEQUENCING

Each line of the Interactive Test menu is one step in the program. Each step will be read and acted on in strict sequence, from left to right, and only after the preceding step. No condition will be looked for until all preceding conditions have been satisfied and all preceding transmit actions have been initiated. (Notice the contrast with the trigger sequencing explained in Section 17.)

Figure 20-2 illustrates a simple test sequence in which the INTERVIEW 40A

INTERACTIVE TEST		
WAIT FOR	XMIT	BCC
<input checked="" type="checkbox"/>	-	GD
	-	GD
	-	GD
	-	GD
	-	GD
	-	GD
	-	GD
	-	GD
	-	GD
	-	GD
	-	GD
	-	GD
	-	GD
	-	GD
	-	GD
	-	GD

Figure 20-1

is in Test Terminal Mode; that is, it is imitating a modem. To start the test it sends ENQ upon entering Run Mode. It waits for an ACK 0, then sends a message block; waits for ACK 1 and sends another message block, and so on. The trigger program (Figures 20-3 and 20-4) measures the delay between CTS ON and the acknowledgment by the terminal. The timer accumulates all these delays and Trigger 1 counts the number of responses. You can then obtain the average response time by dividing the timer value by the counter.

Figure 20-5 shows this test in operation. During execution of the Interactive Test, the current step number is always displayed at the upper right-hand corner of the screen.

20.3 CONDITIONS

The conditions for message transmission, that is, the WAIT FOR entries, may be chosen from the following list:

- (1) The RUN key;
- (2) A received string of up to eight characters;
- (3) One of the INTERVIEW 40A's triggers being satisfied;
- (4) Depression of the ENTER key;
- (5) Timeout of a dedicated timer.

Additionally, you may use the Wait For column to LOOP or to END the test.

20.4 TRANSMISSION

Each message-entry (XMIT) line is 12 characters long, but any or all of these characters may be replaced by the INTERVIEW 40A's standard Fox message or by its 128-character Message Buffer. Thus a message could be as long as $12 \times 128 = 1536$ characters in length. Each transmission may be sent with a good BCC or a bad BCC, calculated by the INTERVIEW 40A. You may also choose to specify the block check characters yourself or to send an abort.

20.5 MAKING SELECTIONS ON THE INTERACTIVE TEST MENU

There are three fields on each line of the Interactive Test menu. The cursor is used to make selections and data entries in the same fashion as on other menus. However, two fields, WAIT FOR and BCC, have rotating selections. With the cursor on either of these fields, press XEQ (or SHIFT/CONTROL-DOWN) or SHIFT/CONTROL-UP to display the next, or preceding, selection.

In the WAIT FOR field, the rotating selections are STRING (the default selection, indicated by a blank line), ENTER, TIMEOUT, LOOP, END, and TRIGGER. Trigger is the furthest from STRING if you use XEQ or SHIFT/CONTROL-DOWN but the nearest if you use SHIFT/CONTROL-UP.

In the BCC field, the selections are GD (the default selection), BD, and NO.

20.6 PRACTICING PROGRAMMING WITHOUT A DATA SOURCE

It is easy to develop skill in using the interactive INTERVIEW 40A and programming its triggers and Interactive Test menu without any line data. Select TEST TERMINAL with the rotary switch. Be sure to select CLOCK:INT on the Program 0 menu. To start transmission, leave the first WAIT FOR entry line blank.

Remember that the Interactive Test cannot use the INTERVIEW 40A's own transmissions for conditions, but the triggers can. Once you have a transmission program looping, you can use the transmitted data to check most of your trigger programming ideas and to become familiar with the INTERVIEW 40A's display modes.

21

THE INTERACTIVE TEST (PROGRAM 7): “WAIT FOR” ENTRIES

21.1 STRING

This is the default menu selection, identified by a blank Wait For line as shown in Figure 21-1. You may enter any eight characters from the same list as for trigger strings, namely--

- Upper- and lower-case alpha characters and numerals
- Control character mnemonics
- Two-digit hexadecimal entries
- 7E flags.
- Not Equal characters.
- Don't Care characters.
- One Bit Mask.

Figure 21-2 shows examples of these string characters. As on other menus, characters that represent something other than themselves--flags, bit mask, Don't Care characters--are displayed in low-intensity, reverse image; characters Not Equal to a character are indicated by a bar through the character.

NOTE: The INTERVIEW will not look for WAIT FOR data on the same side of the interface that it is controlling: if it is in Test Terminal Mode, it will only monitor TD; if it is in Test Modem Mode, it will monitor RD. To look at data in the INTERVIEW's own transmissions, use TRIG as the Wait For condition (see Section 21.5).

21.2 RUN KEY

The Interactive Test can be started by the RUN key, whether it is used to enter Run Mode or to restart the program while it is running. Just leave a blank string-entry field in the first step, and the program will restart with the next entry in the program, whether it is an Xmit action or a Wait For condition, as soon as the RUN key is depressed. Figure 21-3 is an example; the message in Step 1 will be sent every time the RUN key is depressed.

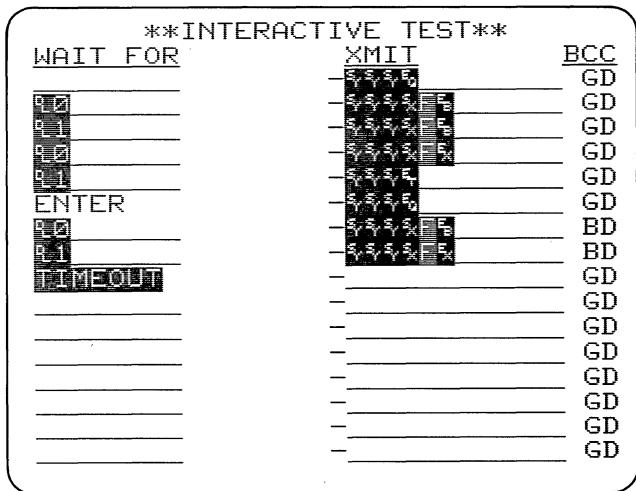

Figure 21-4

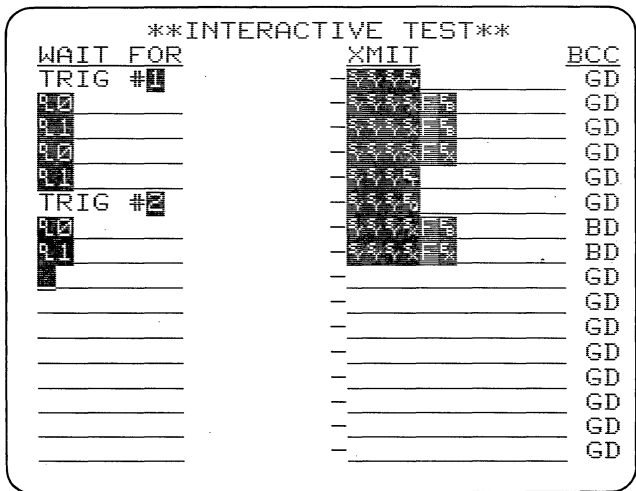

Figure 21-5

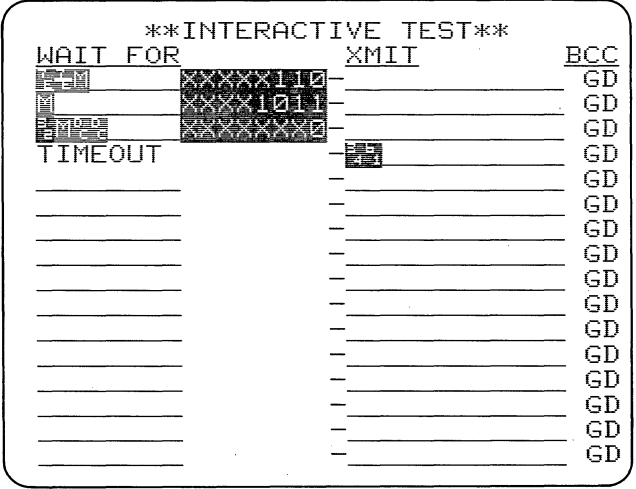

Figure 21-6

21.3 ENTER

When ENTER (Figure 21-4) is selected, the test logic looks for the ENTER key to be depressed. This effectively gives you manual control over the transmission program. In Figure 21-4, for example, the section of the test that sends bad block checks will not occur until the ENTER key is pressed.

21.4 TIMEOUT

To use the TIMEOUT condition, enter the timeout value on the Program 5 menu (see the instructions in Section 16.2). Then select TIMEOUT in the WAIT FOR column of the Interactive Test menu (Figure 21-4). The timeout timer will be restarted when the TIMEOUT condition is reached in the test sequence. Thus, if there is a transmission in the preceding step, the timeout will be started as soon as the transmission has begun. The next XMIT action will be taken when timeout occurs. The timeout shown in Figure 21-4 prevents the INTERVIEW from attempting the transmission in Step 1 before Step 8 has been completed.

The triggers use the same timeout timer as the Interactive Test. A timeout that has been set by the Interactive Test may be used as a condition for trigger actions. Also, you may use a timeout set by a trigger as a condition in the Interactive Test by selecting TRIG (see Section 21.5) instead of TIMEOUT.

However, you should not set a timeout on a trigger and also select

TIMEOUT as a condition on the Interactive Test menu. Since the Interactive Test always resets the timeout timer as soon as it comes to the TIMEOUT condition, the timeout set by the trigger might never occur and the trigger program could not function properly.

21.5 TRIGGER

You may use the conditions from one of the INTERVIEW's triggers as a condition for transmission. When the trigger is true, the next transmission will be sent. The default trigger is #1 (as in Step 1 of Figure 21-5). You may select another trigger by writing over the trigger number (Step 6 of Figure 21-5).

If Actions are set on a trigger that is also being used as a WAIT FOR condition, then all actions on that trigger will be taken before the XMIT action is taken.

21.6 BLANK XMIT FIELDS

Whenever no Xmit condition has been entered in a field, the Interactive Test logic simply goes on to the next item in the sequence, namely, the next "Wait For" field.

You may increase the length of the string or the number of conditions that the INTERVIEW will look for by leaving one or more consecutive lines of the XMIT column blank. In Figure 21-6, this method has been used to enter three Bit Masks in one string.

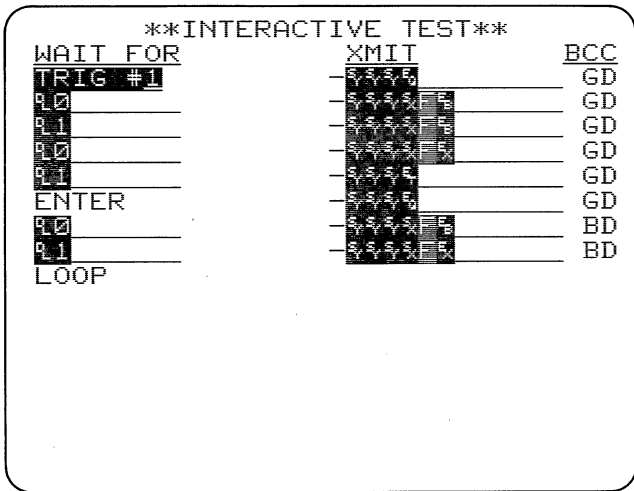

Figure 21-7

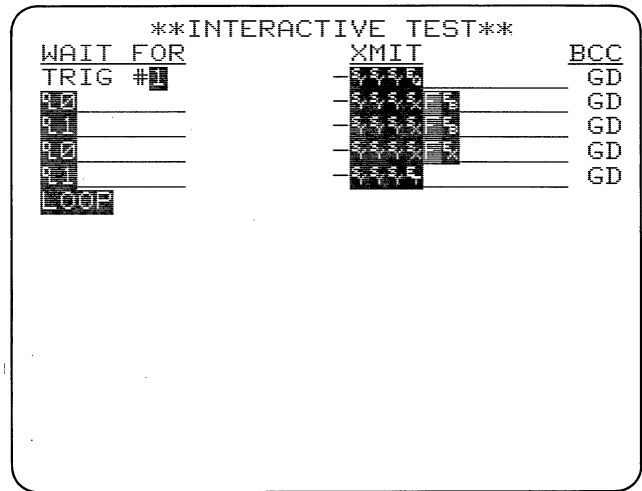

Figure 21-8

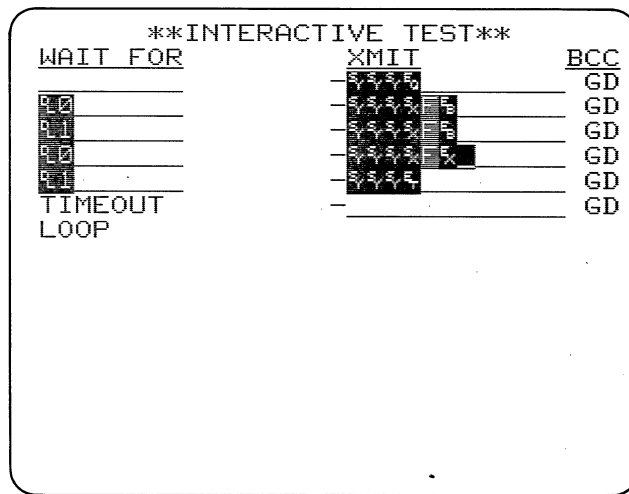

Figure 21-9

21.7 LOOP

When you select LOOP, all the succeeding WAIT FOR and XMIT selections will go away. (Compare Figures 21-7 and 21-8.) The test steps from Step 1 to LOOP in Figure 21-8 will repeat as long as the INTERVIEW is in Run Mode, but Steps 6 through 8 will not occur at all. To stop the test, press the FREEZE or the PROG key; to restart it press RUN.

If LOOP is replaced by any selection but END, the dormant succeeding selections will reappear.

In some cases, like that shown in Figure 21-9, a TIMEOUT is needed before LOOP so that there is time for the last transmission to be completed before Step 1 starts.

21.8 END

When END is selected, all succeeding selections become dormant until END is replaced by any selection but LOOP. When the test program reaches END, the INTERVIEW will not transmit anymore whether or not the WAIT FOR conditions are true.

END and LOOP are both useful for debugging tests section by section.

21.9 NEITHER LOOP NOR END

If neither LOOP nor END is selected as a WAIT FOR condition, then the entire Interactive Test will loop through all the steps until it is cancelled by the FREEZE or PROG key.

If there is no Wait For entry in Step 1, a TIMEOUT after the last transmission may be necessary to allow the last transmission to be completed before Step 1 begins.

INTERACTIVE TEST		
WAIT FOR	XMIT	BCC
	AB	GD
		GD
		GD
		GD
		GD
		GD
		GD
		GD
		GD
		GD
		GD
		GD
		GD
		GD
		GD
		GD
		GD
		GD
		GD
		GD
		GD
		GD

Figure 22-1

INTERACTIVE TEST		
WAIT FOR	XMIT	BCC
	AB	GD
		GD
		GD
		GD
		GD
		GD
		GD
		GD
		GD
		GD
		GD
		GD
		GD
		GD
		GD
		GD
		GD
		GD
		GD
		GD
		GD
		GD

Figure 22-2

INTERACTIVE TEST		
WAIT FOR	XMIT	BCC
	AB	GD
TIMEOUT	***AB***	BD
TIMEOUT		GD
		GD
		GD
		GD
		GD
		GD
		GD
		GD
		GD
		GD
		GD
		GD
		GD
		GD
		GD
		GD
		GD
		GD
		GD
		GD

Figure 22-3

22

THE INTERACTIVE TEST (PROGRAM 7): MESSAGE FORMATTING AND CONTENT

22.1 MESSAGE CHARACTERS

Up to 12 alphanumeric, control, or hexadecimal characters may be entered in the XMIT field. Figure 22-1 shows examples of all these. Notice that synchronization characters, headers, and other protocol can all be entered in the Xmit fields.

22.2 OTHER MESSAGES

(a) Standard Fox Message. The INTERVIEW 40A's standard Fox message (see Section 23.3) may be substituted for any number of the 12 characters in the Xmit field. Use the FLAG key to make this entry. The Fox message will be represented in the Xmit field of this menu by a reverse-image F as shown in Figure 22-2.

(b) Message Buffer. The Message Buffer described in Section 23.2 may also be sent in place of any number of the 12 message characters. To select the Message Buffer, press the BIT MASK key. The Message Buffer will be represented in the Xmit field of this menu by a reverse-image M as shown in Figure 22-2.

NOTE: In the Wait For field, low-intensity reverse-image F means a 7E Flag, and low-intensity reverse-image M means Bit Mask.

22.3 BLANK "WAIT FOR" FIELDS

Whenever no Wait For condition has been entered in a field, the test logic simply goes on to the next item in the sequence, namely, the next Xmit field. If it finds no entry in the XMIT column, it looks at the next condition.

The Transmit Buffer will hold one pending transmission while one is being sent. However, the test logic goes to the next condition as soon as a transmission has been initiated. This means that, if there is no condition between two Xmit entries, it will attempt to send the next message while another is being sent. This will cause the transmit buffer to overflow. Therefore, when you want to send two consecutive transmissions, do not leave the Wait For field between transmissions blank, but select TIMEOUT in that field (see Figure 22-3).

On the Program 5 menu, enter a timeout value sufficient to ensure that the preceding transmission will have been completed before the second begins. (This, of course, depends both on the length of the transmission and on the data speed.)

If two transmissions are sent in succession, each is considered as a separate block, and a separate handshaking routine is initiated for each.

22.4 BLOCK CHECK TRANSMISSION

There are three rotating block check calculation selections in the BCC

column. If you select GD, the INTERVIEW will calculate and send the correct block check character for the code and format selected on the Program 0 menu. One XMIT field is always treated as one block. If you select BD, the INTERVIEW will calculate the correct block check character and invert it for a bad BCC.

Table 9-1 lists all block check calculations done by the INTERVIEW.

If you want to send an Abort (in BOP or BOP/NRZI) or to send a specific block check character, select NO. You can then enter the abort or any character you choose in the XMIT field.

23

MESSAGES FOR TRANSMISSION: TRANSMIT MODE MENU (PROGRAM 6)

There are three menus concerned with interactive operation--Interface Control, Interactive Test, and Transmit Mode Setup. You must always fill out the Interface Control (Program 5) and Interactive Test (Program 7) menus correctly. Then, if you wish to send a message longer than the 12 characters allowed on the Interactive Test menu, you can use either the Message Buffer or the Fox Message from the Program 6 menu (Figure 23-1).

23.1 MODE

Since the BERT option (Section 25) is standard in the INTERVIEW 40A, a MODE selection appears on this menu. Be sure that MSGS has been selected in this field.

23.2 MESSAGE BUFFER

On the four Message Buffer data-entry lines, you can enter up to 128 characters. Valid characters are all alphanumeric, control, and hexadecimal characters. Special keys such as the

FLAG and BIT MASK keys are illegal. Use the ENTER key to move the cursor from one data-entry line to the next, and the UP arrow to return to the previous line.

To send the Message Buffer, use the BIT MASK key in the Xmit field of the Interactive Test menu. The entire Message Buffer will be sent in lieu of the low-intensity reverse-image M that is displayed in the Xmit field.

```

**TRANSMIT MODE**
MODE: MSGS BERT

MESSAGE BUFFER:
____
____
____

FOX MESSAGE:
THE QUICK BROWN FOX JUMPS OVER
THE LAZY DOG 0123456789
```

Figure 23-1

23.3 FOX MESSAGE

To send the Fox Message, use the FLAG key in the Xmit field of the Interactive Test menu. This will enter

a low-intensity reverse-image letter F to represent the Fox Message in the field. The characters actually sent in the Fox Message will vary according to the code selected on the Program 0 menu:

Unshifted codes, 54 characters:

THE QUICK BROWN FOX JUMPS OVER THE LAZY DOG 0123456789

Upper/lower case shifted codes, 56 characters:

^THE QUICK BROWN FOX JUMPS OVER THE LAZY DOG \ 0123456789

Letters/figures shifted codes, 56 characters:

\THE QUICK BROWN FOX JUMPS OVER THE LAZY DOG ^ 0123456789

Appendix A

CODE TRANSLATE CHARTS

CODE TRANSLATE CHART

```

000000000000000000001111111111111111
0123456789ABCDEF0123456789ABCDEF
@#%&'()*+,-./:;<=>?`{|}~
0123456789ABCDEF0123456789ABCDEF
!"#$%&'()*+,-./:;<=>?`{|}~
444444444444444444445555555555555555
0123456789ABCDEF0123456789ABCDEF
@ABCDEFGHIJKLMN0PQRSTUWXYZ
555555555555555555556666666666666666
0123456789ABCDEF0123456789ABCDEF
abcdefghijklmnopqrstuvwxyz
888888888888888888889999999999999999
0123456789ABCDEF0123456789ABCDEF

AAAAAAAAAAAAAAAAAAAAABBBBBBBBBBBBBBBB
0123456789ABCDEF0123456789ABCDEF

CCCCCCCCCCCCCCCCCCCCDDDDDDDDDDDDDDDDDD
0123456789ABCDEF0123456789ABCDEF

EEEEEEEEEEEEEEEEEEEEFFFFFFFFFFFFFFFFFFFF
0123456789ABCDEF0123456789ABCDEF

```

ASCII, 7 BITS, SPACE

CODE TRANSLATE CHART

```

000000000000000000001111111111111111
0123456789ABCDEF0123456789ABCDEF
1234567890*+ @ STUVWXYZ-#
0123456789ABCDEF0123456789ABCDEF
@JKLMN0PQR<+ ICFABCDEF GHI?<
444444444444444444445555555555555555
0123456789ABCDEF0123456789ABCDEF

555555555555555555556666666666666666
0123456789ABCDEF0123456789ABCDEF

888888888888888888889999999999999999
0123456789ABCDEF0123456789ABCDEF

AAAAAAAAAAAAAAAAAAAAABBBBBBBBBBBBBBBB
0123456789ABCDEF0123456789ABCDEF

CCCCCCCCCCCCCCCCCCCCDDDDDDDDDDDDDDDDDD
0123456789ABCDEF0123456789ABCDEF

EEEEEEEEEEEEEEEEEEEEFFFFFFFFFFFFFFFFFFFF
0123456789ABCDEF0123456789ABCDEF

```

IPARS, 6 BITS, NONE, INV/REV

CODE TRANSLATE CHART

```

000000000000000000001111111111111111
0123456789ABCDEF0123456789ABCDEF
E$A S!U$DRJNFCKTZLWHYPQO0BC^MXXV
0123456789ABCDEF0123456789ABCDEF

444444444444444444445555555555555555
0123456789ABCDEF0123456789ABCDEF

555555555555555555556666666666666666
0123456789ABCDEF0123456789ABCDEF

000000000000000000001111111111111111
0123456789ABCDEF0123456789ABCDEF
3- 875$4' . : (5")2#601988
0123456789ABCDEF0123456789ABCDEF

444444444444444444445555555555555555
0123456789ABCDEF0123456789ABCDEF

555555555555555555556666666666666666
0123456789ABCDEF0123456789ABCDEF

```

BAUDOT, 5 BITS, NONE

Appendix B

HEXADECIMAL KEYBOARD KEY FUNCTIONS

APPENDIX B
HEXADECIMAL KEYBOARD KEY FUNCTIONS

Key	Functions		
	Program Mode	Real-Time Data Display	CRT Buffer Displays
<u>Red Keys</u>			
PROG	Displays the Menu Selections directory.	Places unit in Program Mode and displays the Menu Selections directory.	Places unit in Program Mode and displays the Menu Selections directory.
RUN	Puts unit in Run Mode and restarts the program. Resets counter and timer, resets CRT buffer.	Restarts program, resets counter and timer, resets CRT buffer.	Puts unit in Run Mode. Restarts program, resets counter and timer, resets CRT buffer.
<u>Blue Keys</u>			
0 - F	Used to make entries, in hexadecimal, in all data-entry fields.	Invalid	Invalid
<u>Green Keys</u>			
DON'T CARE	Enters Don't Care character in a data-entry field.	Invalid	Invalid
FLAG	Enters 7E (hex) flag byte for HDLC or SDLC framing.	Invalid	Invalid
BIT MASK	Allows you to specify status of each bit in a character.	Invalid	Invalid

(Continued)

Key	Functions		
	Program Mode	Real-Time Data Display	CRT Buffer Displays
≠ (Not Equal)	Not Equal followed by a character (or BIT MASK) specifies all characters not equal to that character.	Invalid	Invalid

Dark Gray Keys

Cursor arrows

UP	Moves cursor to current selection or first data-entry position of first field on preceding line.	Invalid	Moves cursor up 1 line in the CRT buffer. From first line, pulls preceding line from buffer onto screen.
DOWN	Moves cursor to current selection or first data-entry position of first field on next line.	Invalid	Moves cursor down 1 line in the CRT buffer. From last line, pulls next line from buffer onto screen.
RIGHT	Moves cursor one position to the right (which may be first position on next line).	Invalid	Moves cursor 1 character to right, or to first character in next line.
LEFT	Moves cursor 1 position to left (may be last position on preceding line).	Invalid	Moves cursor 1 character to left, or to last character in preceding line.
ALT-UP; ALT-DOWN	Invalid	Invalid	Displays preceding or next page of the buffer, respectively.

(Continued)

Key	Program Mode	Functions	
		Real-Time Data Display	CRT Buffer Displays
ENTER	Moves cursor to current selection or first data-entry position of next field in menu, whether to right or down.	May be used as a trigger condition.	Invalid
<u>Light Gray Keys</u>			
Decimal Point (.)	Valid only in <u>decimal fields.</u>	Invalid	Invalid
ALT	Enables alternate function of key pressed simultaneously with it; Valid only with certain keys.	Enables alternate function of key pressed simultaneously with it; Valid only with certain keys.	Enables alternate function of key pressed simultaneously with it; Valid only with certain keys.
CLEAR	Clears data-entry field (including binary fields) where the cursor is. Invalid in selection fields.	Clears data display and prompt. Does not clear CRT buffer or Lines 1 and 2 of the display.	Invalid
ALT-CLEAR (both keys pressed simultaneously)	Clears entire menu to default condition.	Invalid	Invalid
XEQ (Execute)	In INTERVIEW 40A, displays rotating selections in Wait For and BCC fields.	-----	-----
PRINT	If Printer Control option is installed, prints menu currently displayed.	Invalid	If Printer Control option is installed, prints current data display.

(Continued)

Key	Functions		
	Program Mode	Real-Time Data Display	CRT Buffer Displays
ALT-PRINT	Invalid	Invalid	If Printer Control option is installed, prints entire 16-page buffer.
HEX (alternate-action key; indicator lights when HEX is ON)			
ON	All data entries will be shown in hexadecimal. If parity is selected operator must adjust parity of entry.	Displays all data in hexadecimal.	Displays all data in hexadecimal.
OFF	Data entries will be shown as alphanumeric characters unless there is no equivalent. Parity is automatically adjusted.	Displays all data in clear text.	Displays all data in clear text.
ALT-HEX (both keys depressed simultaneously)	Invalid	Displays control characters only in hexadecimal.	Displays control characters only in hexadecimal.
FREEZE (indicator lights for Manual Freeze Control ON)			
ON	Invalid	Stops addition of data to CRT buffer. Stops program.	NA
OFF	Invalid	NA	Restores trigger control of CRT.

Appendix C

ALPHANUMERIC KEYBOARD KEY FUNCTIONS

APPENDIX C
ALPHANUMERIC KEYBOARD KEY FUNCTIONS

Key	Functions		
	Program Mode	Real-Time Data Display	CRT Buffer Displays

Red Keys

PROG	Displays the Menu Selections directory.	Places unit in Program Mode and displays the Menu Selections directory.	Places unit in Program Mode and displays the Menu Selections directory.
RUN	Puts unit in Run Mode and restarts the program. Resets counter and timer, resets CRT buffer.	Restarts program, resets counter and timer, resets CRT buffer.	Places unit in Run Mode; Restarts program, resets counter and timer, resets CRT buffer.

Blue Keys

0 - F	Used for alphanumeric entries in data-entry fields; also used, with HEX key ON, to make hexadecimal entries.	Invalid	Invalid
-------	--	---------	---------

Green Keys

DON'T CARE	Enters Don't Care character in a data-entry field.	Invalid	Invalid
FLAG	Enters 7E (hex) flag byte for HDLC or SDLC framing. In Interactive Test Xmit fields, enters Fox message.	Invalid	Invalid

(Continued)

Key	Functions		
	Program Mode	Real-Time Data Display	CRT Buffer Displays
BIT MASK	Allows you to specify status of each bit of a character in a data-entry field. In Interactive Test Xmit fields, enters Message Buffer.	Invalid	Invalid
≠ (Not Equal)	Not Equal followed by any alphanumeric or hexadecimal character (or BIT MASK) specifies all characters not equal to that character.	Invalid	Invalid

Dark Gray Keys

Cursor arrows

UP	Moves cursor to current selection or first data-entry position of first field on preceding line.	Invalid	Moves cursor up 1 line in the CRT buffer. From first line, pulls preceding line from buffer onto screen.
DOWN	Moves cursor to current selection or first data-entry position of first field on next line.	Invalid	Moves cursor down 1 line in the CRT buffer. From last line, pulls next line from buffer onto screen.
RIGHT	Moves cursor one position to the right (which may be first position on next line).	Invalid	Moves cursor 1 character to right, or to first character in next line.

(Continued)

Key	Program Mode	Functions	
		Real-Time Data Display	CRT Buffer Displays
LEFT	Moves cursor 1 position to left (may be last position on preceding line).	Invalid	Moves cursor 1 character to left, or to last character in preceding line.
SHIFT-UP; SHIFT-DOWN (Two keys pressed simultaneously)	In INTERVIEW 40A, displays rotating selections in Wait For and BCC fields.	Invalid	Displays preceding or next page of the buffer, respectively.
CONTROL-UP; CONTROL-DOWN	In INTERVIEW 40A, displays rotating selections in Wait For and BCC fields.	Invalid	Displays preceding or next page of the buffer, respectively.
ENTER	Moves cursor to current selection or first data-entry position of next field in menu, whether to right or down.	May be used as either a trigger or an Interactive Test condition.	Invalid
<u>Light Gray Keys</u>			
CLEAR	Clears data-entry field (including binary fields) where the cursor is. Invalid in selection fields.	Clears data display. Does not clear buffer or Lines 1 and 2 on the CRT.	Invalid
SHIFT/CONTROL-CLEAR	Clears entire menu to a default condition.	Invalid	Invalid
XEQ (Execute)	In INTERVIEW 40A, displays rotating selections in Wait For and BCC fields.	Invalid	Invalid

(Continued)

Key	Functions		
	Program Mode	Real-Time Data Display	CRT Buffer Displays
PRINT	If Printer Control option is installed, prints menu currently displayed.	Invalid	If Printer Control option is installed, prints current data display.
SHIFT/CONTROL-PRINT	Invalid	Invalid	If Printer Control option is installed, prints entire 16-page buffer.
HEX (alternate-action key; indicator lights for HEX ON)			
ON	Only blue (hexadecimal) keys are legal. Every two consecutive keys are taken as one 2-digit hexadecimal number. If parity is selected, operator must adjust parity of each entry.	Displays all data in hexadecimal.	Displays all data in hexadecimal.
OFF	Hexadecimal entries cannot be made. All blue keys will be taken as alphanumeric characters. If parity is selected, all entries will be adjusted for parity automatically.	Displays all data as clear text.	Displays all data as clear text.
SHIFT-HEX	Invalid	Displays only control characters in hexadecimal.	Displays only control characters in hexadecimal.

(Continued)

Key	Program Mode	Functions	
		Real-Time Data Display	CRT Buffer Displays
CONTROL-HEX	Invalid	Displays only control characters in hexadecimal.	Displays only control characters in hexadecimal.
FREEZE (alternate-action key; indicator lights for Manual Freeze Control ON)			
ON	Invalid	Stops addition of data to CRT buffer. Stops program.	NA
OFF	Invalid	NA	Valid only in Freeze. Restarts Program and resets data buffer. Restores trigger control of CRT.
Alphanumeric keys	Valid in data-entry fields. Not all keys are valid in all data-entry fields.	Invalid	B displays Beginning of CRT buffer; E displays End of buffer.

(4) Observing the display, turn the adjusting screw counterclockwise to increase the brightness until defocusing occurs. This will be most noticeable around the bright characters, as on the first line. The bright characters will appear to bleed into the dark background.

(5) Now back the brightness adjustment down (clockwise) just to the point that defocusing or bleeding is eliminated.

This is the maximal usable brightness setting. A higher setting will degrade the clarity of the display. If a lower setting is desired for a low ambient light environment, be careful not to reduce the brightness to the point that low-intensity characters are illegible. Check the contrast on the Program 0 menu.

D.3 REMOVING THE TOP COVER

WARNING: Removing the top cover of the INTERVIEW 29/30/40 with or without the power cord connected may expose personnel to dangerous high voltages and high-vacuum CRT hazard. Under no circumstances should anyone but qualified service technicians remove the top cover of this instrument.

You will need a Phillips (cross-point) screwdriver to remove the top cover.

(1) Disconnect the power cord from the INTERVIEW and remove the front cover. Rotate the stand back against the bottom of the case so that the unit will lie flat on the work surface.

(2) Twelve screws must be removed: three screws on each side, about 1 1/2 inches from the bottom of the unit (do not remove the screw 1 1/2 inch to the rear of each front cover latch); two screws on the top near the front edge of the cover; two on the rear just below the top edge; and one on the rear under each foot.

(3) Lift the cover up and then off, keeping your fingers on the outside of the case.

WARNING: Figure D-3 shows the location of the hazardous areas inside the case. Please refer to this drawing before you proceed any further.

(4) To replace the cover, reverse this procedure. Notice that the two longest screws go under the two feet on the rear and the two shortest screws are for the top front of the cover.

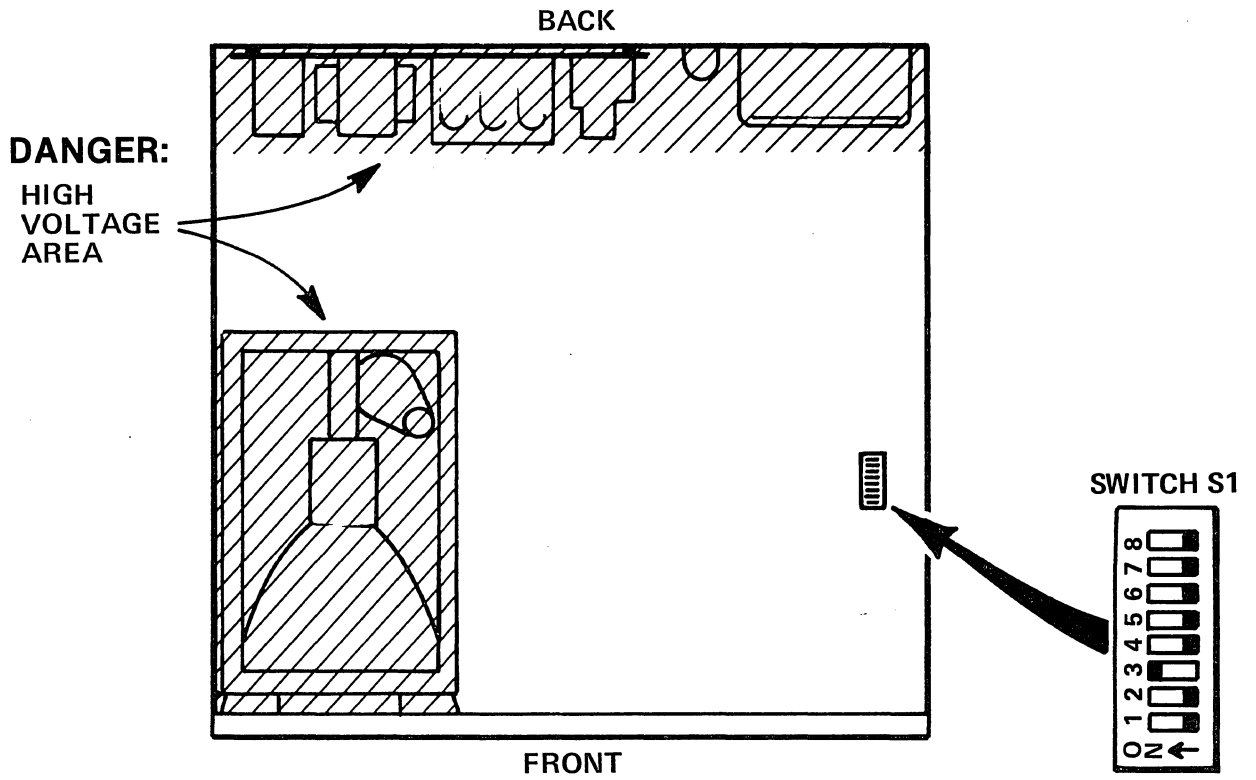

Figure D-3 Diagram of INTERVIEW 29/30/40 with top cover removed.

D.4 POWER FREQUENCY SELECTION

WARNING: Do not attempt this adjustment until you have read Section D.3.

To change the power frequency selection between 50- and 60-cycle operation, it is necessary to remove the top cover of the unit as explained in Section D.3.

The power frequency is set with the DIP switch S1 at the right front of the unit's main printed-circuit board (see Figure D-3). For the unit to operate properly, S1 must be set as follows:

- S1-1, OFF for 60-Hz power frequency; ON for 50 Hz.
- S1-2 OFF
- S1-3, ON
- S1-4, OFF
- S1-5, OFF
- S1-6, OFF
- S1-7, OFF
- S1-8, OFF

D.5 FUSE

A 3-ampere fuse is installed in the voltage selector-power connector module on the rear of the INTERVIEW. To inspect or replace the fuse, remove the power cord and slide the transparent window to the left. Swing the fuse extractor handle out toward the left and remove the fuse. Rotate the extractor handle in and replace the fuse.

D.6 POWER-UP SELF TESTS

If any of the following Self-Test Error Codes appear on the power-up menu, the INTERVIEW will not operate properly. Make a record of the Error Code (or codes) that is displayed and contact Atlantic Research Corporation for service information.

We will need to know the model number and software version of the unit in addition to the Error Code information.

The following is a list of the Self-Test Error Codes that may appear:

0(xx xx, xx, xx)	RAM
1	PROM AA
2	PROM AB
3	PROM AC
4	PROM AD
5	PROM AE
6	PROM AF
7	PROM AG
8	PROM AH
9	PROM AJ
A	PROM AK
B	PROM AL
C	PROM AM

D.7 ERROR CODES IN RUN MODE

There are a number of error messages that indicate only that you have programmed a unit to do something it doesn't know how to do. Atlantic Research Corporation would appreciate it if you would let us know how all the program menus were set up when you received any of the following messages:

- COMP ERR (01)
- COMP ERR (02)
- OVERFLOW (10)
- OVERFLOW (11)
- OVERFLOW (12)

If you should receive the following error message,

XMIT OVERFLOW (20)

please record how the Interactive Test menu (Program 7) was set up and contact Atlantic Research Corporation.

Appendix E

PACKING AND SHIPPING

When the INTERVIEW 29/30/40 is hand-carried, it will probably be subjected to much less severe treatment than when it is shipped by freight. Atlantic Research Corporation offers its INTERVIEW 29/30/40 Option 919-99-1 Padded Travel Bag, stock No. 37409, for this purpose. This bag provides two inches of high-density foam protection for all surfaces of the INTERVIEW. It is yellow for easy identification among other luggage. An identification card case, FRAGILE markings, and leather appointments are standard features. Inside is a large pocket for carrying notes, manuals, and so forth. The bag is considered to be reasonable protection for the INTERVIEW 29/30/40. However, Atlantic Research Corporation can assume

no liability for damage to units transported in this bag, as circumstances will be beyond our control.

For freight shipment, the INTERVIEW 29/30/40 should be packed only in high-density Styrofoam "clamshell" and a heavy-duty outer cardboard carton, as delivered by Atlantic Research. This packing system has been designed to provide maximum reasonable protection to the INTERVIEW and insure its safe arrival. However, damages due to mishandling must be the responsibility of the Carrier.

NOTE: Please do not return any unit to Atlantic Research Corporation without prior authorization.

Appendix F

CONTROL CHARACTER MNEMONICS

AK	ACK: Acknowledgment	FS	Field separator
BL	BEL: Bell	GS	Group separator (or Interchange group separator)
BS	Backspace	HT	Horizontal tabulate
CN	CAN: Cancel	LF	Line feed
CR	Carriage return	NK	NAK: Negative acknowledgment
D1	DC1: Device control 1	NU	Null
D2	DC2: Device control 2	Pad	DEL or idle line
D3	DC3: Device control 3	RS	Record separator
D4	DC4: Device control 4	SB	SUB: Substitute
DL	DLE: Data link escape	SH	SOH: Start of header
EB	ETB, EOB: End of transmission block	SI	Shift in
EC	EOC: End of card	SO	Shift out
EM	EOM: End of message	SX	STX: Start of text
EQ	ENQ: Enquiry	SY	SYN: Synchronization character
ET	EOT: End of transmission	US	Unit separator
EX	ETX: End of text	VT	Vertical tabulate
FF	Form feed		

Appendix G

USER-INFORMATION FORM

