

# communications



**OPERATING and SERVICE  
INSTRUCTIONS**



**the hallicrafters co.**

MANUFACTURERS OF ELECTRONIC EQUIPMENT, CHICAGO 24, U. S. A.

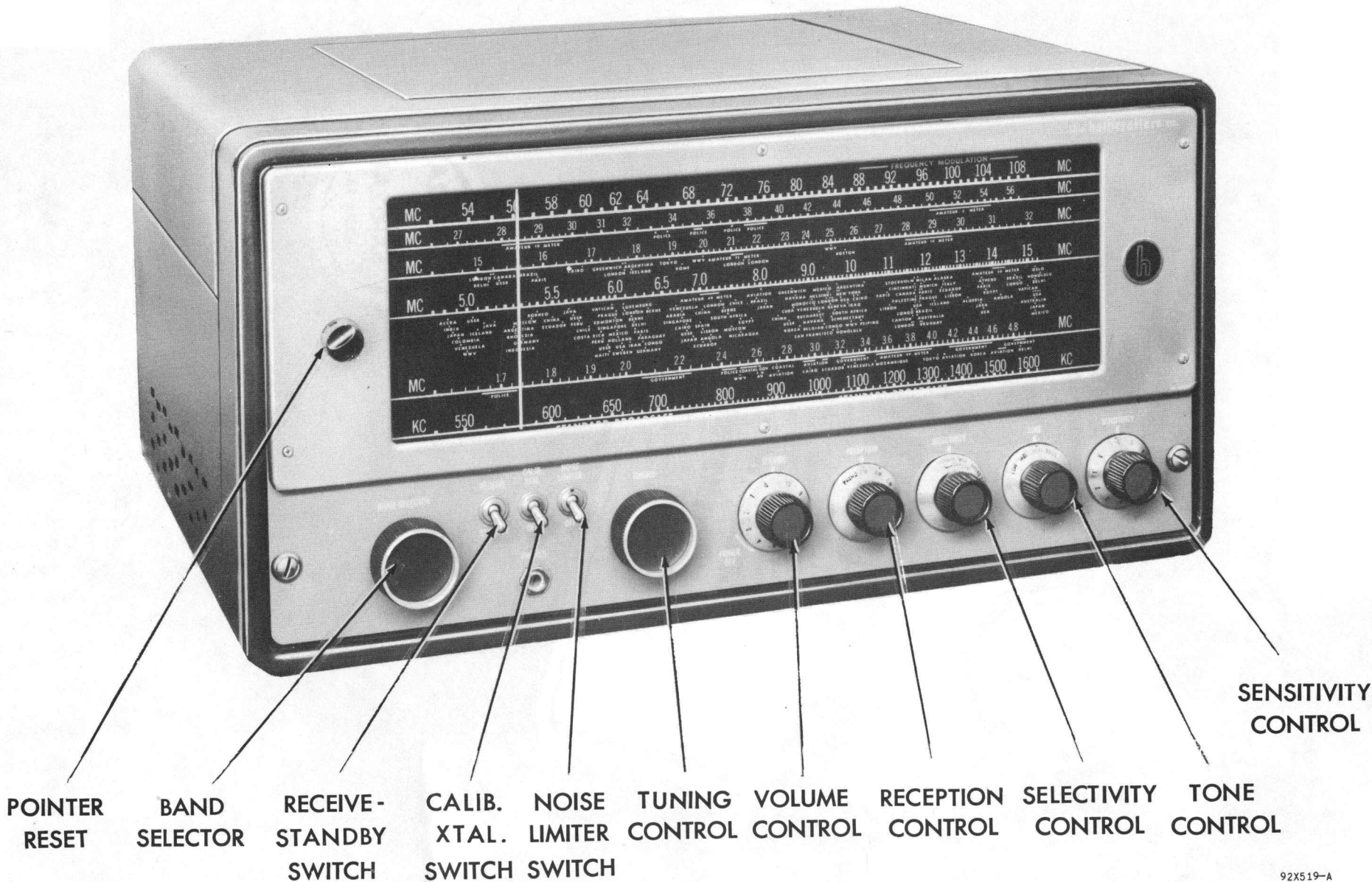

Fig. 1. Radio Receiver Model SX-62A/62AU

# GENERAL SPECIFICATIONS

Tubes . . . . .	Fourteen plus voltage regulator and rectifier
Speaker Output. . . . .	3.2/8/500
Headset Output. . . . .	High impedance
Antenna Input. . . . .	For 50 to 600 ohm line or single wire lead-in
Phono Input. . . . .	High impedance
External Power Connector . .	Std. octal socket
Tuning Range . . . . .	See Frequency Coverage
Intermediate Frequency	
Bands 1, 2, 3, 4 . . . . .	455 KC
Bands 5, 6 . . . . .	10.7 MC
Power Supply. . . SX-62A	105-125V 50/60 Cycles AC
SX-62AU	105-250V 25/100 Cycles AC
Power Consumption . . . . .	120 Watts

## FREQUENCY COVERAGE

BAND	FREQUENCY RANGE	TYPE OF RECEPTION
1	540 KC - 1620 KC	AM/CW
2	1.62 MC - 4.9 MC	AM/CW
3	4.9 MC - 15 MC	AM/CW
4	15 MC - 32 MC	AM/CW
5	27 MC - 56 MC	AM/FM/CW
6	54 MC - 109 MC	AM/FM/CW

The Model SX-62A/62AU is a sensitive high fidelity superheterodyne receiver covering all of the broadcasting services between 540 kilocycles (KC) and 109 megacycles (MC). The receiver is capable of receiving both the FM (Frequency Modulation) and AM (Amplitude Modulation) broadcasts transmitted in this frequency range as shown in the FREQUENCY COVERAGE chart.

A built-in 500 kc crystal controlled calibrating oscillator and adjustable dial pointer permit accurate dial calibration on the large direct reading slide rule dial. Marker signals appear every 500 kc on the dial scale with this type of marker oscillator; hence, dial calibration may be held to very close limits over the entire dial scale by comparison with the marker signal.

This calibration feature of the receiver makes it possible to log the most prominent shortwave stations by countries directly on the dial. In addition, many of the active communication channels; government, amateur, police, aviation, etc. are logged by bars to indicate their location on the dial. World-wide reception is accomplished simply by selecting the desired frequency band (band selector switch) and adjusting the tuning control so that the pointer is above the station locating dot.

The receiver selectivity is adjustable to accommodate the broad response required for high fidelity FM and AM broadcast reception to the sharpest crystal selectivity required for code reception in the crowded channels of the short wave bands.

The high fidelity tone compensated audio system provides four distinct tone ranges covering full range reception for entertainment purposes as well as the restricted range required for communication work in either voice or code.

An automatic noise limiter, operated by a toggle switch, permits the operator to reduce the background noise caused by severe electrical disturbances. Background noise is reduced in the receiver with a minimum of audio distortion.

A RECEIVE-STANDBY switch permits receiver disabling for short standby periods without having to wait for the tube heaters to reach operation temperature when reception is again required.

The SX-62A operates from a 105-125 volt 50/60 cycle alternating current (AC) source. A connector for operating the receiver with external batteries or equivalent power is provided to permit operation in areas where AC current does not exist. The universal model, the SX-62AU, permits operation from 25 to 100 cycle alternating current sources operating at voltages ranging from 105-250 volts. The power requirements for your receiver must be checked carefully. Read over the installation section of this book before connecting to your power source.

### IMPORTANT

Your careful attention is especially invited to the installation and operating instructions. They have been provided to insure the satisfaction you have a right to expect from a Hallicrafters "Precision Built" product. Your receiver has an unusually high degree of sensitivity necessary to receive weak and distant stations. Careless operation of a high sensitivity receiver may result in excess noise or background hiss. These undesirable effects can be held to a minimum by careful adjustment of the sensitivity, tuning and tone controls as well as proper selection and arrangement of the antenna.

# INSTALLATION

**UNPACKING** - Check all shipping instruction tags carefully before removing them.

**LOCATION** - The receiver is equipped with rubber feet for table top or shelf mounting. When locating the receiver, avoid excessively warm locations such as near radiators, hot air registers, or confined dead air spaces such as are encountered in recessed installations.

**POWER SOURCE** - Two types of power sources may be used to operate the receiver. The receiver may be operated directly from an AC source or indirectly from a battery or DC source as follows:

**AC operation** - The SX-62A receiver operates from a 105 to 125 volt, 50/60 cycle AC outlet. Power consumption is approximately 120 watts. If you are in doubt or unfamiliar with the voltage and frequency rating of your utility service, consult your local power company representative. Attempting to operate the receiver from other sources of power than specified may involve costly repairs.

The universal model, the SX-62AU, operates on 115 V./130 V./150 V./220 V./250 V. 25/100 cycle AC sources. A selector switch on the power transformer permits operation on any of the line voltages shown.

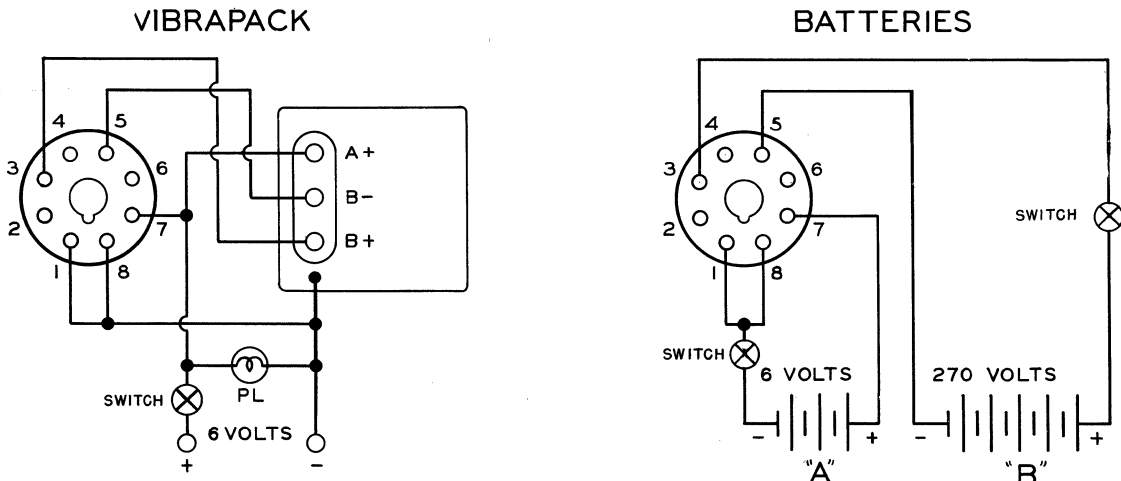

Fig. 2. Wiring diagrams, DC power plug.

92B520

**CAUTION** - When operating the universal model, it is necessary to check, and set if necessary, the selector switch on the power transformer before connecting the receiver to the source of power.

Note - The receiver will not operate from an AC source unless the jumper plug is located in its BATTERY POWER receptacle. See Fig. 3.

**DC Operation** - The receiver may be operated from a 6-volt DC source (storage battery or equal) and a 270-volt DC supply in the form of "B" batteries, vibrator power pack, or motor generator set. The DC source must be capable of supplying the following voltages and currents for optimum results.

"B" voltage	270 Volts
"B" current	150 Milliampere
Heater voltage	6.3 Volts
Heater current	5 Amperes

Total current drain, when operating entirely from a storage battery, will run approximately 15 to 20 amperes.

DC power is connected to the receiver through the octal socket located on the rear apron of the chassis. The jumper plug normally in this socket for AC operation is replaced with a standard octal plug for DC operation.

Wire the octal plug for DC operation as shown in Fig. 2.

**SPEAKER CONNECTION** - A four-terminal strip, marked "COM-3.2-8.0-500" is provided at the rear of the receiver for speaker connections. Any speaker having an impedance of 3.2 or 8 ohms can be used with the receiver by connecting one lead from the speaker to the common ground terminal marked "COM" and the other lead to the terminal which corresponds to the speaker impedance. When using a speaker with an impedance other than 3.2 or 8 ohms, a matching transformer should be used to insure optimum performance. The matching transformer should have a 10-watt power rating, a 500-ohm primary impedance, and a secondary impedance to match the impedance of the speaker being used. The transformer should be mounted on or near the speaker. Connect the primary of transformer to the terminals marked "500" and "COM" and the secondary to the speaker voice coil. The Hallicrafters R-46 and R-46A speakers are both designed for use with your receiver. The R-46 speaker connects to the terminals marked "500" and "COM"; the R-46A speaker connects to the terminals marked "3.2" and "G".

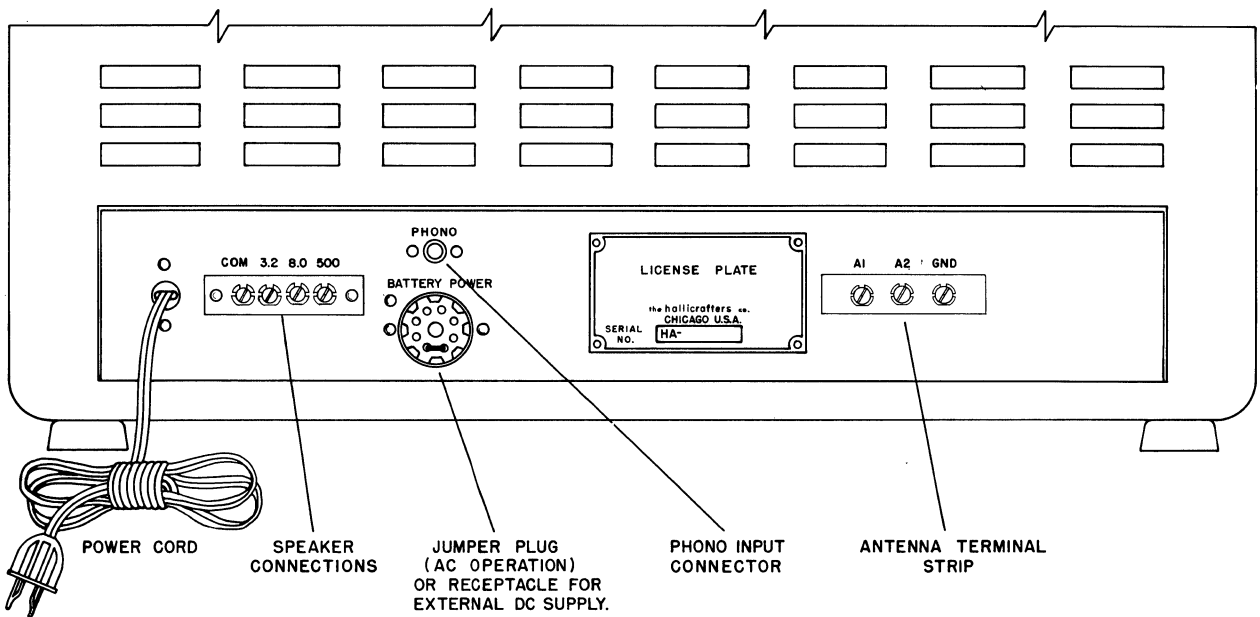

Fig. 3. Rear view.

920521-A

**RECORD PLAYER CONNECTION** - A phono jack is provided at the rear of your receiver for attaching a record player. (See Fig. 3.) Any record player using a crystal pickup, or a magnetic pickup with a suitable pre-amplifier, will provide satisfactory results. For phono operation, insert the pin-plug from the record player or pre-amplifier into the phono jack, set the **RECEPTION** control at "PHONO", set the **RECEIVE-STANDBY** switch at "RECEIVE", and adjust the **VOLUME** and **TONE** controls as desired. The remaining controls are inoperative and will have no effect on phono operation.

**ANTENNAS** - The r-f input of the receiver is designed to operate from either a single-wire antenna, or a half-wave doublet or other tuned antenna employing a 50 to 600 ohm transmission line. Antenna connections are made to a three-terminal strip at the rear of the receiver marked "A1", "A2", and "GND".

**Single-Wire Antenna.** The simplest antenna and one which will provide satisfactory performance throughout the entire tuning range is a conventional single-wire antenna. In most localities, satisfactory results can be obtained with just the 15-foot antenna wire included with the receiver. Simply attach one end of this wire to terminal "A1", connect the jumper wire between "A2" and "GND", and run the wire about the room in any convenient manner. (See Fig. 4.)

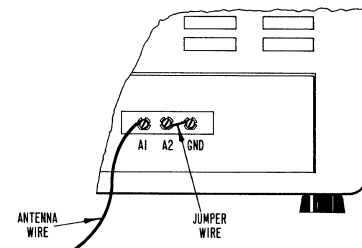

Fig. 4. Single Wire Antenna

9282403

If the receiver is operated in a steel constructed building or where receiving conditions are exceptionally poor, an outside antenna 50 to 100 feet long may be necessary. In some locations, reception may be improved by connecting a ground wire (ordinary copper wire) from the terminal marked "GND" to a cold water pipe or outside ground rod.

**Half-Wave Doublet Antenna.** For top performance, especially on the shortwave and amateur bands, the use of a half-wave doublet or other type of antenna employing a 50 to 600 ohm transmission line is recommended. A typical doublet antenna installation is shown in Fig. 5. The doublet antenna should be cut to the proper length for the most used frequency or band of frequencies. The overall length in feet of a doublet antenna is determined by the following formula:

$$\text{Length in feet} = \frac{468}{\text{Frequency in megacycles}}$$

For maximum signal pickup, the doublet antenna should be erected with its length at right angles to the desired station.

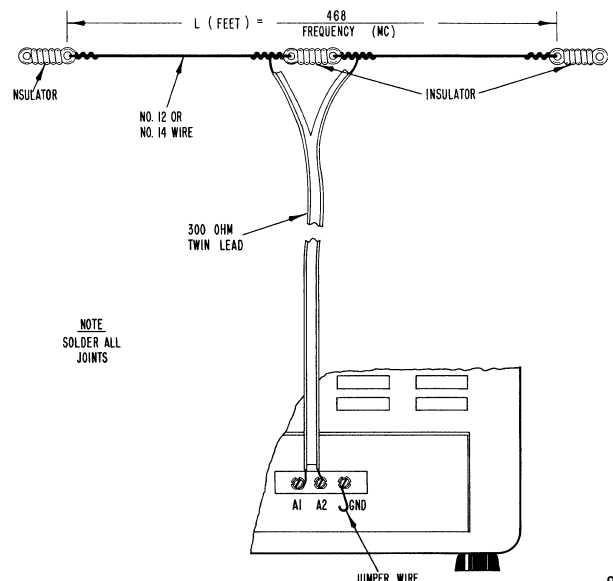

Fig. 5. Doublet Antenna using Twin-Lead Transmission Line

9202404

- over -

The doublet antenna may be fed with either a balanced or unbalanced transmission line. When a balanced transmission line such as "twin-lead" or a twisted pair is used, the transmission line connects to terminals "A1" and "A2", and the jumper wire between terminals "A2" and "GND" is disconnected. (See Fig. 5.) When using an unbalanced transmission line such as coaxial cable, the inner conductor connects to terminal "A1", the outer braid connects to terminal "A2", and the jumper wire connects between terminals "A2" and "GND". A ground wire may improve reception when using an unbalanced transmission line. By feeding the doublet antenna with a transmission line having an impedance of 300 ohms, a broader frequency response is obtained than that possible with a 50-75 ohm line.

The doublet antenna provides optimum performance only at the frequency for which it is cut. Therefore, it may be desirable for reception on frequencies remote from the antenna frequency to utilize the antenna as a single wire type. This is accomplished by connecting the two transmission line leads together and connecting them to terminal "A1". The jumper wire in this case should be connected between terminals "A2" and "GND".

In an installation where the receiver is used in conjunction with a transmitter, it may be advantageous to use the same antenna for receiving as for transmitting. This is especially true when a directive antenna is used since the directive effects and power gain of the transmitting antenna are the same for receiving as for transmitting. Switching of the antenna from the transmitter to the receiver may be accomplished with a double-pole, double-throw antenna changeover relay or knife switch connected in the antenna leads.

For further information regarding antennas, refer to the "Radio Amateur's Handbook" or the "A.R.R.L. Antenna Book", both published by the American Radio Relay League, West Hartford, Conn., U.S.A.

## OPERATION

**GENERAL BROADCAST RECEPTION** - Certain front panel controls have been color coded to simplify the tuning procedure for general entertainment purposes. High fidelity reception in the standard broadcast (AM) and frequency modulation (FM) bands may be accomplished as follows: Turn the volume control clockwise beyond the tell tale click of the switch. This turns the receiver on as indicated by the illumination of one of the dial scales. Similarly the receiver is turned off by turning the control counter-clockwise beyond the click of the switch. At this point the three "bat-handle" switches may be set at "RECEIVE" and "OFF" and forgotten. To receive standard broadcast (AM) services; set the BAND SELECTOR for the position that illuminates the 550-1620 kilocycle scale (bottom scale), set the RECEPTION, SELECTIVITY, TONE and SENSITIVITY controls per the red dot, and adjust the TUNING and VOLUME controls in the normal manner, tuning for clearest reception as usual.

<u>CONTROL</u>	<u>RADIO-TELEPHONE</u>	<u>CW</u>
VOLUME control -	This control turns the receiver on and off in addition to controlling the volume. Turn the control clockwise to turn on the receiver or increase volume, and counter-clockwise to reduce volume or turn off the receiver.	Same
RECEIVE/STANDBY switch -	Normally set at "RECEIVE". May be set at "STANDBY" to disable the receiver for short standby periods and yet keep the tube heaters at operating temperature for instant use.	Same
RECEPTION control -	Set at "AM" for reception of amplitude modulated stations located in the standard broadcast band or any of the shortwave bands, or at "FM" for reception of FM stations located in the two highest frequency ranges (two top dial scales).	Set at "CW"
BAND SELECTOR -	Set for position that illuminates the dial scale covering the desired band of frequencies. Extreme left hand position of this control illuminates the lowest dial scale.	Same
TUNING control -	The tuning control sets the frequency of reception, tuning the band of frequencies shown on the illuminated dial scale. The frequency of reception is shown in kilocycles (KC) on the standard broadcast range and in megacycles (MC) on the shortwave and FM ranges. The frequencies of the local stations are generally listed in newspapers, AM stations in kilocycles and FM stations in megacycles. Information on short wave stations, not identified directly from the dial, may be obtained from published log books available at most book stores or radio supply houses. When tuning for the station, tune carefully for the clearest reception and obtain top performance from your receiver.	The tuning control sets the frequency of reception, tuning the band of frequencies shown on the illuminated dial scale. The frequency of reception is shown in megacycles (MC) on the shortwave bands used by code transmitters. When tuning for the station, tune for the pitch of the code signal found easiest to copy. The pitch of the code signal will usually run approximately 1000 cycles.

## CONTROL

## RADIO-TELEPHONE

## CW

SELECTIVITY  
control -

Normally set at "NORMAL/BROAD" for high fidelity reception in the standard broadcast and FM bands. Use the "NORMAL/MED." or "NORMAL/SHARP" for the more crowded conditions existing in most of the short-wave ranges. Note that as the receiver is made more selective, the background noise and interference from nearby stations is reduced. The setting of the selectivity control is generally best determined by receiving conditions, using just enough selectivity to isolate the desired stations. The "CRYSTAL/BROAD" position may be used when the frequency of reception is extremely congested.

This control may be set at "NORMAL/MED." OR "NORMAL/SHARP" for the reception of code stations not suffering local interference. Congested receiving conditions may be handled by increasing selectivity, switching to one of the three crystal positions for the degree of selectivity required. Note that in the crystal position the tuning of the receiver changes, i.e. the desired station will be very loud on one side of zero beat and very weak (crystal slot) on the other side.

SENSITIVITY  
control -

Normally set maximum clockwise. Local high powered stations may overload the receiver, showing up as distortion, hence conditions may require that this control be turned counter-clockwise to reduce the sensitivity of the receiver accordingly.

The receiver sensitivity must be controlled manually for code reception, hence the SENSITIVITY control must be advanced just enough to keep the code stations from blocking the receiver.

## TONE control -

Normally set at "HI-FI" or "BASS" for AM or FM entertainment purposes. The "LOW" and "MED." positions will be found desirable when listening on the shortwave bands.

Normally set at "LOW" or "MED." for code reception.

**USE OF THE CALIBRATING CRYSTAL** - A built-in secondary frequency standard and adjustable dial pointer permits accurate frequency calibration over any portion of the receiver dial. Three degrees of dial calibration accuracy may be had as follows:

1. General Dial Indexing - Run the dial pointer down to the left hand end of the dial scale, turning the TUNING knob until the left hand dial stop is reached. Line up the dial pointer with the index line using the small POINTER RESET knob located to the left of the dial escutcheon.
2. Average Dial Calibration - Index the dial pointer as described above. Set the CALIB. XTAL switch at "CALIB. XTAL", RECEPTION switch at CW, and tune the receiver to zero beat with the calibrating oscillator signal, i.e. the pitch of the whistle or beat note will pass through zero cycles at the exact center of the marker signal. The oscillator signals will be found at multiples of 500 kilocycles on the lower 5 dial scales, i.e. 1000 kc and 1500 kc; 2 mc, 2.5 mc, 3 mc etc.; 5 mc, 5.5 mc, 6 mc, etc.; 15 mc, 15.5 mc, 16 mc, etc.; or 27 mc, 27.5 mc, 28 mc, etc. After setting the TUNING control for zero beat, center the dial pointer exactly on the half-megacycle dial division. For best results, the receiver sensitivity must be held to a minimum while making calibration adjustments.
3. Precise Dial Calibration - To obtain a precise dial calibration the procedure outlined above should be repeated for the particular section of the dial in use rather than merely checking calibration at either end of the dial scale. Since the calibration signals appear every 500 kc along the dial, a calibration point may easily be obtained on either side of the frequency of reception at any point along the dial.

After calibrating the receiver dial with the calibrating crystal, the oscillator is switched OFF and the RECEPTION switch returned to the desired setting for normal reception.

**RECORD PLAYER OPERATION** - With a record player connected to the receiver it is merely necessary to set the RECEPTION control at PHONO and operate the VOLUME and TONE controls as for normal radio reception.

**NOTE:** The receiver will not respond if the RECEIVE/STANDBY switch is set at "STANDBY". The setting of the remaining controls, except those mentioned above, is immaterial as they are not in use for record player operation.

**HEADPHONE RECEPTION** - A headset jack, located at the front panel, provides for headphone reception. Insertion of the headset plug disables the speaker. Any high impedance headset, magnetic or crystal, will work with the receiver.

## SERVICE

**TUBE REPLACEMENT** - The types of tubes required and their relative position in the receiver are shown in the illustration, Fig. 6. When installing a replacement tube, insert the center guide pin into the center hole of the tube socket; rotate the tube until the key on the guide pin drops into the notch in the socket hole; and push down until the base of the tube rests firmly on the socket. A slightly different technique must be used on the miniature tubes. They have seven small pins which have to be lined up with the socket holes before pushing into place. Handle with care as all tubes are considered fragile and do not tolerate much mechanical abuse.

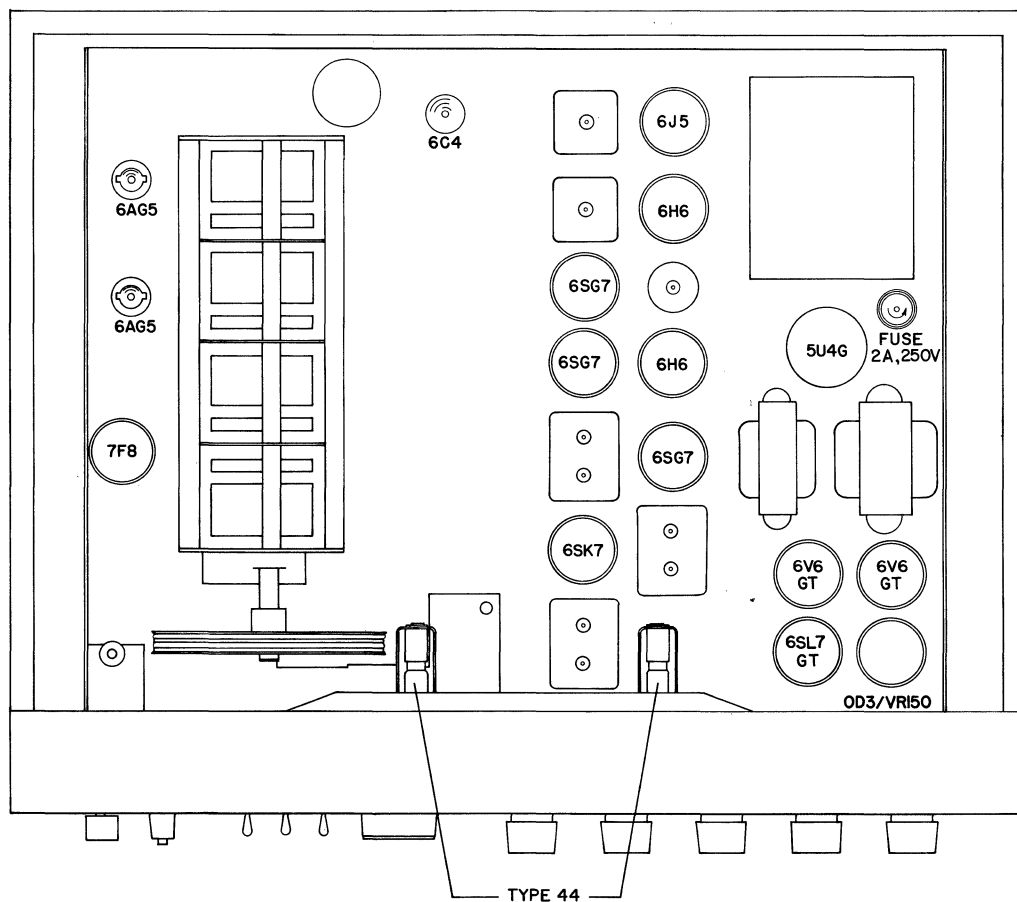

920524-B

Fig. 6. Top view showing location of tubes and dial lamps

**DIAL LAMP REPLACEMENT** - Refer to Fig. 6 for the location of the dial lamps used in the receiver. To gain access to defective lamps, open the cabinet cover, remove the light shield (four screws) and unclip the dial lamp socket by compressing the side springs. The socket may then be brought out into the open to change the defective lamps. Replace all lamps with 6-8 volt Mazda No. 44 (blue bead) or equivalent.

**SERVICE OR OPERATING QUESTIONS** - For further details regarding operation or servicing of the receiver, contact your dealer. Make no service shipments directly to the factory before first writing for authorization and instructions.

*The factory cannot accept responsibility for unauthorized shipments.*

The Hallicrafters Co. reserves the privilege of making revisions in current production of equipment and assumes no obligation to incorporate these revisions in earlier models.

## POSITIONING CONTROL KNOBS

**BAND SELECTOR** . . . As required by flat on shaft  
**VOLUME** . . . . . Set at 10 for full clockwise rotation  
**RECEPTION** . . . . . As required by markings

**SELECTIVITY** . . . As required by markings  
**tone** . . . . . As required by markings  
**SENSITIVITY** . . . Set at 10 for full clockwise rotation



## DIAL CORD RESTRINGING

1. Remove **POINTER RESET** knob and then remove dial escutcheon by removing two screws at each side.
2. Remove chassis from cabinet by removing top and bottom screws at each side of front panel and three screws at rear on underside of cabinet.
3. Remove front control knobs, and toggle switch and **PHONES** jack mounting nuts.
4. Remove front panel from chassis by removing two screws at each side of front panel.
5. Lift dial pointer off rail and out of way to prevent damage to pointer.
6. Remove two inner screws at each side of dial that secure dial assembly to side support brackets.
7. Loosen clamp which secures dial lamp cable to chassis and then position dial assembly forward to gain access to front of drive pulley.

Restring the tuning capacitor drive with a 45 inch length of 30 lb. test dial cord. Tie one end of the cord to the tension spring at position A and follow the stringing sequence A through H as shown. At position H stretch the tension spring and tie the cord securely to the spring. Note that the dial cord is wrapped around the tuning drive shaft two and three-quarters times for proper traction.

Restring the dial pointer drive with a 75 inch length of 30 lb. test dial cord. Tie one end of the cord to the tension spring at position 1 and follow the stringing sequence 1 through 11 as illustrated. At position 11 stretch the tension spring and tie the cord securely.

Index the dial pointer by setting the tuning gang at maximum capacity, the **RESET** control in the middle of its range, and aligning the pointer with the left hand dial index marker.

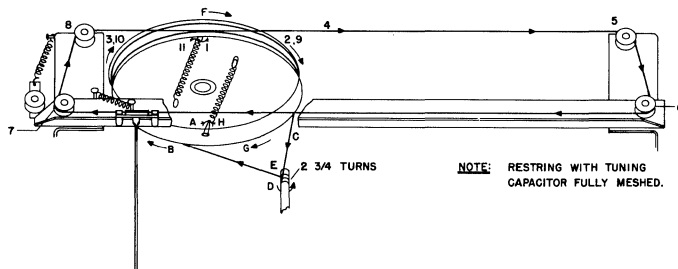

92C1481-A

Fig. 7. Dial cable stringing procedure

## ALIGNMENT PROCEDURE

**IF ALIGNMENT (455 KC)**- Set the controls as follows:

BAND SELECTOR . . . . .	550/1620 kc range	RECEPTION control . . . . .	AM
RECEIVE/STANDBY switch . .	RECEIVE	SELECTIVITY control . . . . .	NORMAL/SHARP
CALIB. XTAL switch . . . . .	OFF	SENSITIVITY control . . . . .	Near Maximum
NOISE LIMITER switch . . . .	OFF		Set tuning dial pointer at approximately 1,000 kc.
VOLUME control . . . . .	Near Maximum		

Connect high side of signal generator through an 0.1 mfd. capacitor to pin #1, of the 7F8 converter tube. With signal generator set at approximately 455 kc align slugs S-1 3, 5, 10, 12 and 14 for maximum output.

Set **RECEPTION** control at CW and adjust slug S-8 for a 1,000 cycle note.

Set the **SELECTIVITY** control at **CRYSTAL/BROAD**. While slowly turning slug S-10 in one direction across the resonant setting obtained above, "rock" the signal generator tuning and observe the dip in the output meter reading as the adjustment passes through the response of the crystal filter. The correct setting of the slug S-10 is in the center of the observed dip. Set the signal generator at the weaker of the two responses obtained on either side of zero beat and adjust the crystal phasing trimmer C-57 for the null.

Set the **SELECTIVITY** control at **CRYSTAL/SHARP** and with trimmer C-61 set near minimum capacity, slowly increase its capacity while "rocking" the signal generator and adjust for maximum output. It may be necessary at this point to reduce the signal generator input and the receiver sensitivity to prevent overloading. After peaking the adjustment turn the trimmer in until a drop in output of about 2 db occurs. At this point the sharp crystal will have very good selectivity without sacrificing too much gain.

Tune the signal generator to exact crystal frequency and note output meter reading. Set the **SELECTIVITY** control at **CRYSTAL/BROAD** and note the drop in output, and output meter reading. Now switch to **CRYSTAL/MEDIUM** and with trimmer C-60 near minimum capacity, slowly increase its capacity, while "rocking" the signal generator, until the output meter indicates about midway between the output readings obtained in sharp crystal and broad crystal position.

Set the **SELECTIVITY** control at **CRYSTAL/SHARP** and reset signal generator for the exact crystal frequency. Switch to **NORMAL/SHARP** and reset slugs S-1,3,5 12,14 and trimmer C-58 for maximum output.

Set the **RECEPTION** control at CW and adjust the BFO slug S-8 for zero beat.

**IF ALIGNMENT (10.7 MC)**- Set the controls as follows:

BAND SELECTOR . . . . .	27/56 mc range	RECEPTION control . . . . .	AM
RECEIVE/STANDBY switch . .	RECEIVE	SELECTIVITY control . . . . .	NORMAL/SHARP
CALIB. XTAL switch . . . . .	OFF	SENSITIVITY control . . . . .	Near Maximum
NOISE LIMITER switch . . . .	OFF		Set tuning dial pointer at approx. midscale.
VOLUME . . . . .	Near Maximum		

Connect the high side of the signal generator through an 0.1 mfd. capacitor to pin #1 of the 7F8 converter tube. Set signal generator at 10.7 mc and adjust slugs S-4,6,9,13 and 15 for maximum output. Now set slugs S-2 and S-11 for maximum output but do not readjust slugs S-4 6,9, 13 and 15.

Set **RECEPTION** control at CW and adjust slugs S-17 for zero beat.

Set RECEPTION control at FM and adjust slug S-16 for maximum output. Now set Slug S-7 for the null or minimum output as indicated on the output meter. Check the discriminator by slowly tuning the signal generator through 10.7 mc and observe the two maximum audio level readings on the output meter. If the two peaks are equal the job is done; if not it may be necessary to reset Slug S-16 until a reasonable balance is obtained.

### RF ALIGNMENT

After completing the alignment of the IF amplifier stages the RF amplifier stages may be aligned according to the following chart. Connect the high side of the signal generator to terminal A-1 through the dummy antenna specified and connect a jumper between antenna terminal A-2 and GND. Use just enough signal generator output to obtain a 500 milliwatt audio output level for best results.

## ALIGNMENT CHART

Dummy Antenna	Signal Generator Frequency	Band Selector Range	Radio Dial Setting	Adjust	Remarks
RMA	1500 kc	550-1600 kc	1500 kc	C-47*, 6, 21, 35	Adjust for max. output
	600 kc		600 kc	S-36*	
RMA	4.0 mc	1.62-4.9 mc	4.0 mc	C-45*, 20,34	Adjust for max. output
	1.8 mc		1.8 mc	S-35*	
RMA	14.0 mc	4.9-15 mc	14.0 mc	C-43*, 4, 19, 33	Adjust for max. output
	7.0 mc		7.0 mc	S-34*, 22, 26, 30	
RMA	28 mc	15-32 mc	28 mc	C-42*, 3, 18, 32	Adjust for max. output
	18 mc		18 mc	S-33*, 21, 25, 29	
300-ohm non-inductive resistor	50 mc	27-56 mc	50 mc	C-41*, 2, 17, 31	Adjust for max. output
	30 mc		30 mc	S-32*, 20, 24, 28	
300-ohm non-inductive resistor	105 mc	54-109 mc	105 mc	C-40*, 1, 16, 30	Adjust for max. output
	60 mc		60 mc	S-31*, 19, 23, 27	

\* Note - Calibration adjustment.

Note - The standard RMA dummy antenna mention in the alignment chart consists of a 200 mmf condenser in series with a 20 uh r-f choke which is shunted by a 400 mmf condenser in series with a 400 ohm carbon resistor.

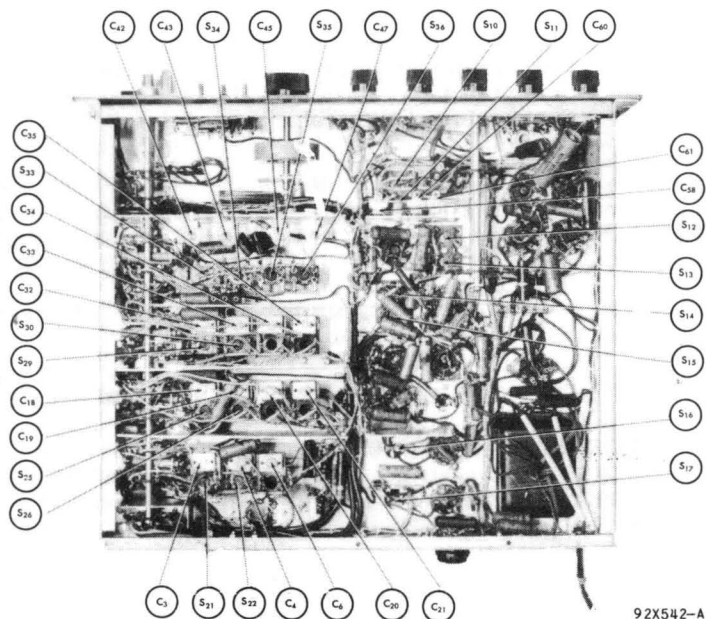

92X542-A

Fig. 8. Alignment adjustments, bottom view

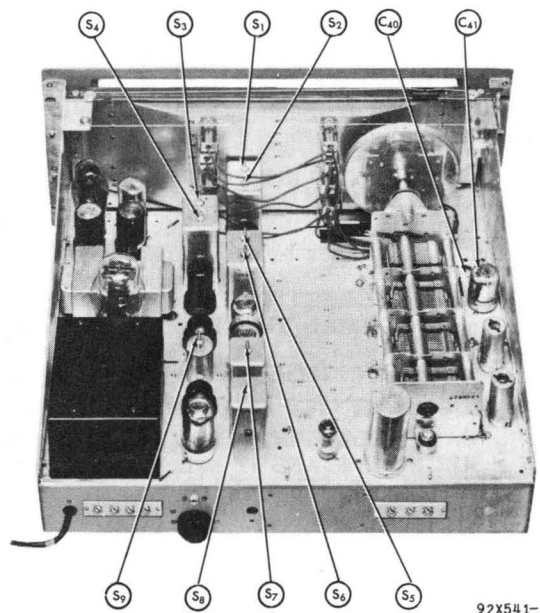

92X541-A

Fig. 9. Alignment adjustments, top view

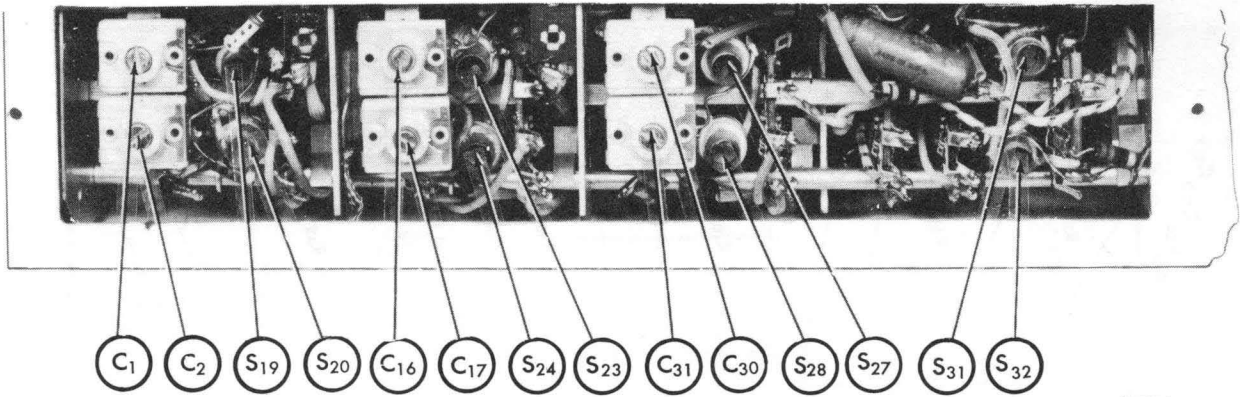

Fig. 10 Alignment adjustments, left side view

92X543

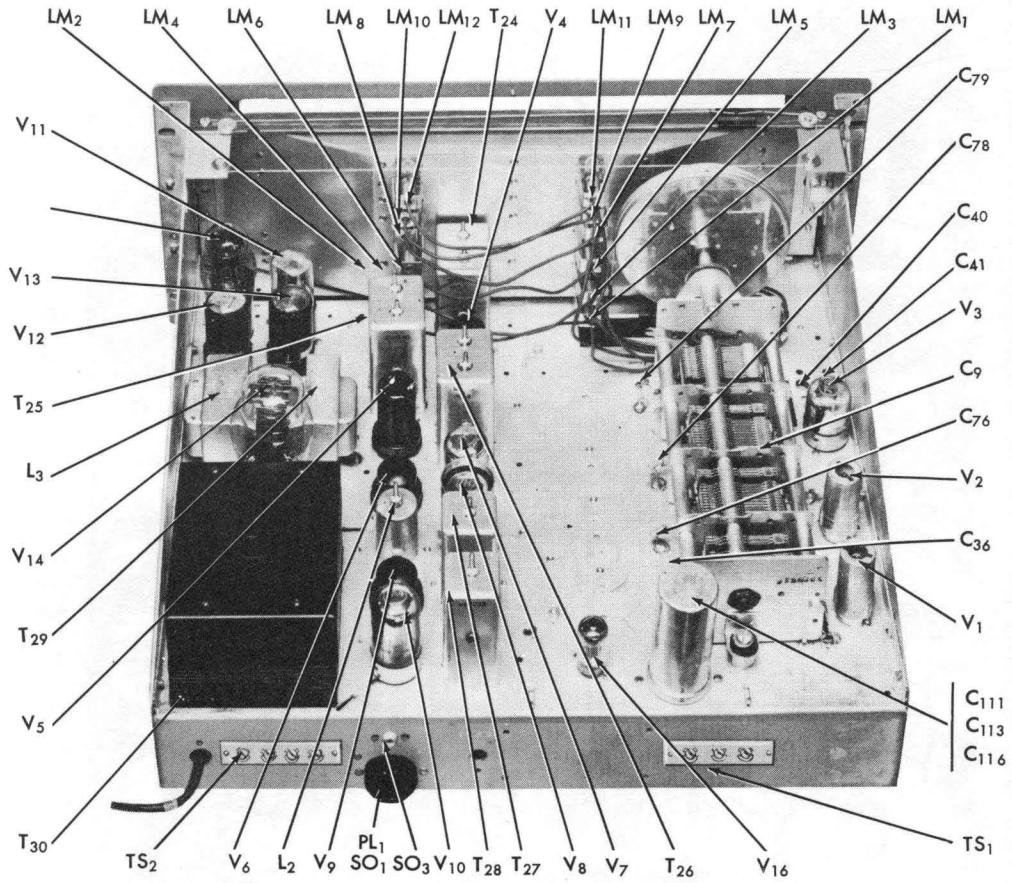

Fig. 11 Component locations, top view

92X544-B

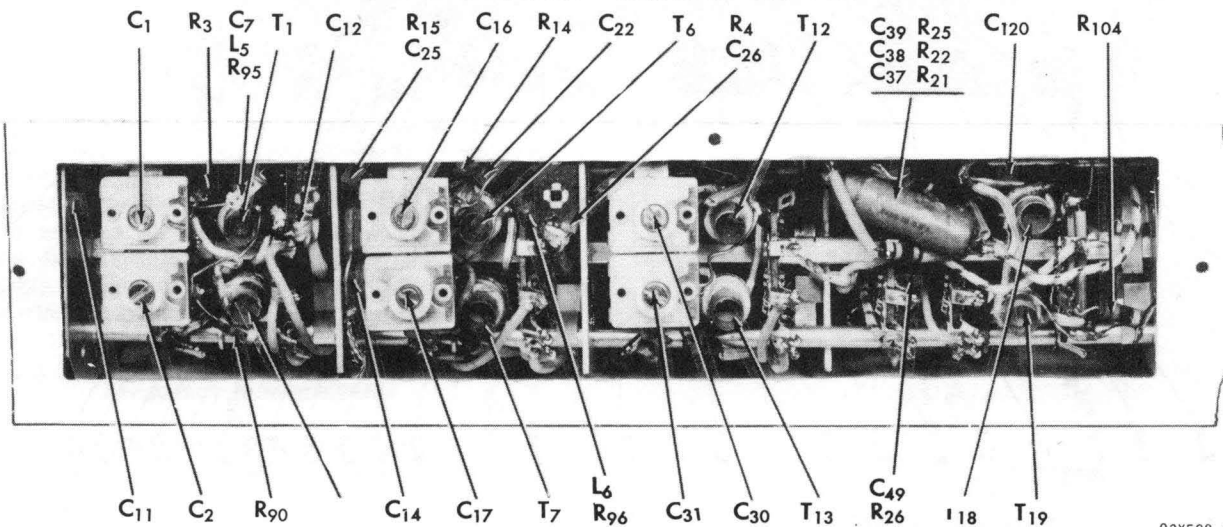
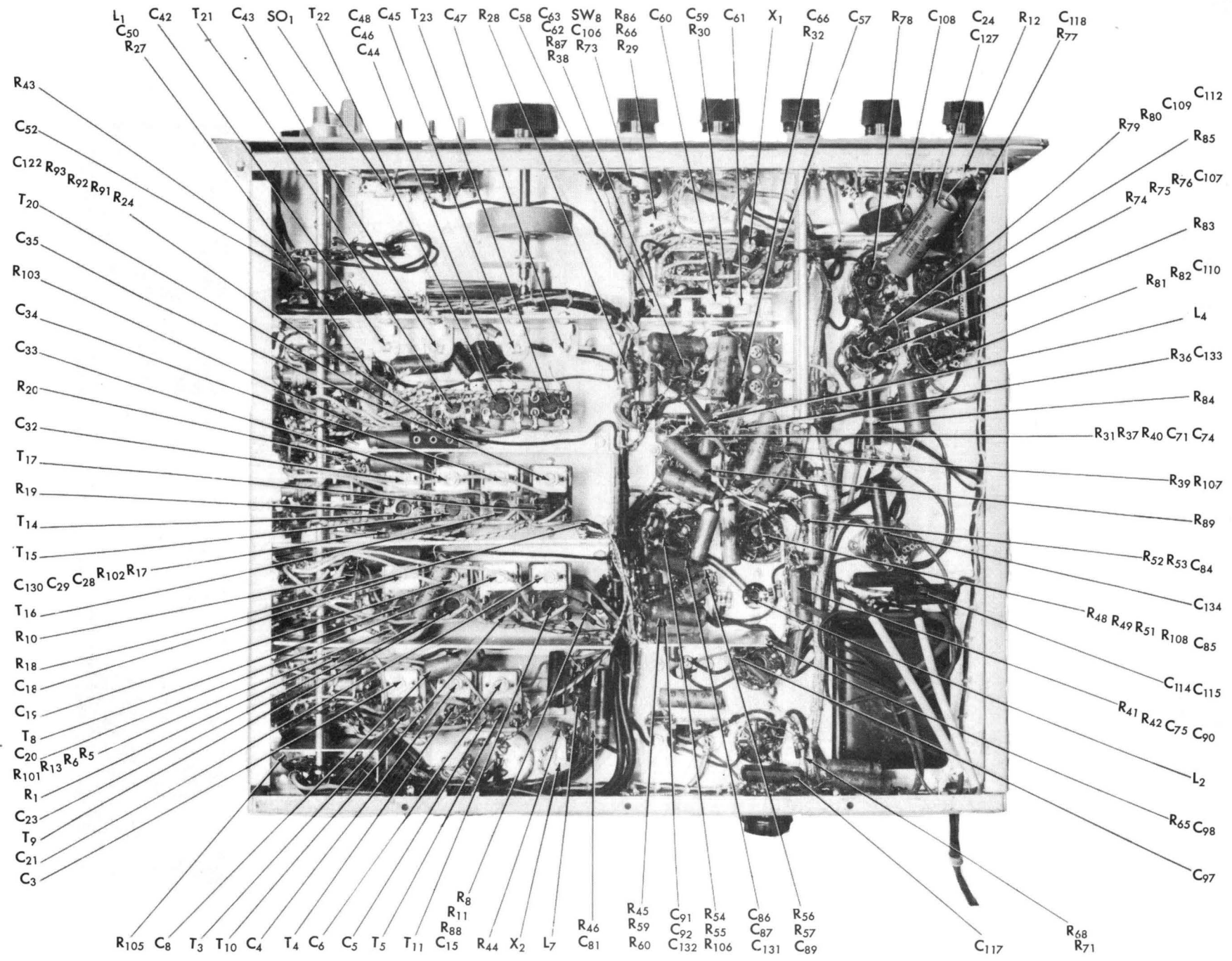

Fig. 12 Component locations, left side view.

92X580-A



92X545-A

Fig. 13. Component locations, bottom view

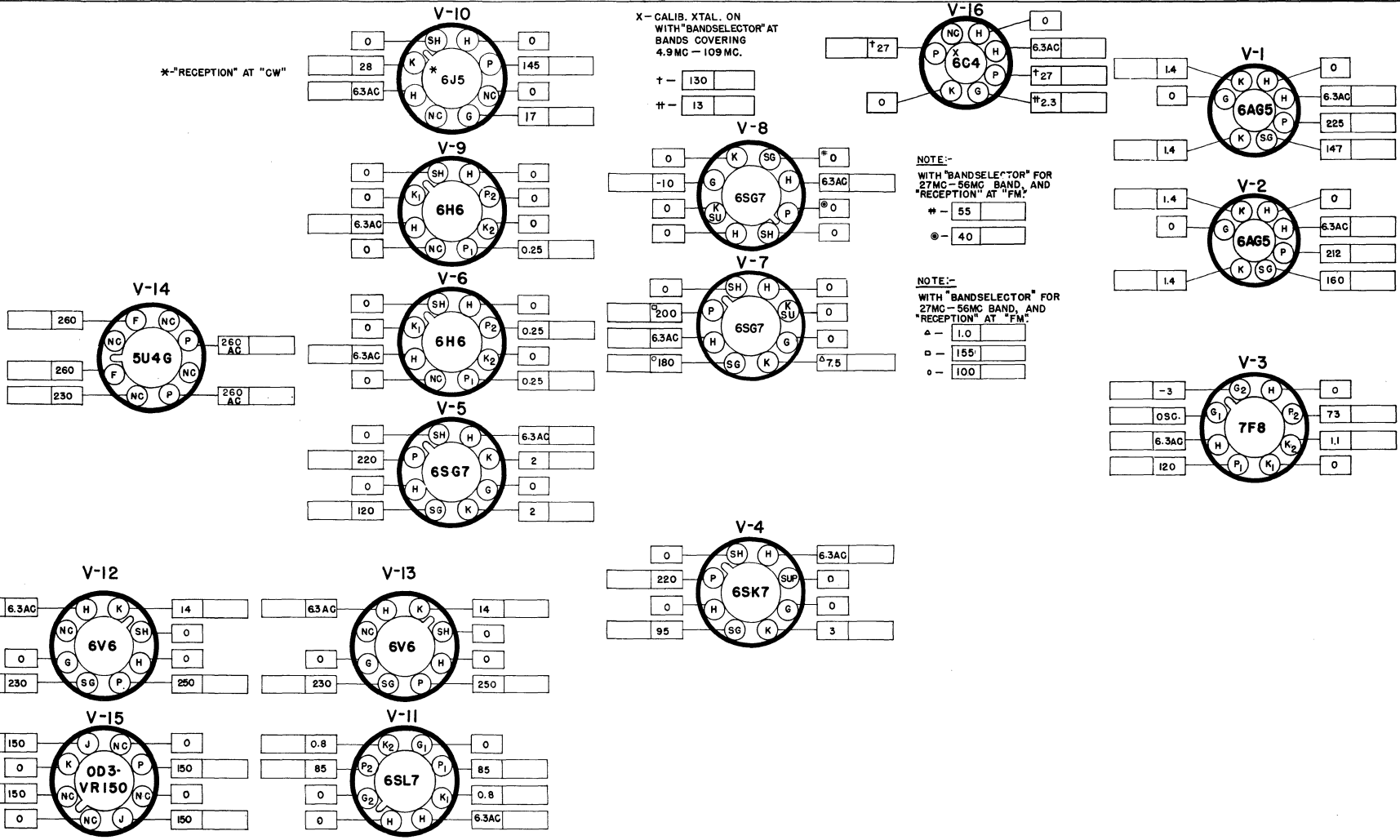

- NOTES**
1. SOCKET VIEWS ARE BOTTOM VIEWS.
  2. ALL VOLTAGES MEASURED BETWEEN TUBE SOCKET TERMINALS AND GROUND.
  3. LINE VOLTAGE—117 V. AC.
  4. ALL VOLTAGES SHOWN ARE DC UNLESS OTHERWISE SPECIFIED.
  5. VOLTAGES SHOWN WERE MEASURED WITH A 20,000 OHM/VOLT METER.
  6. "NC"—NO CONNECTION.
  7.  THE BLANK SPACES ARE PROVIDED FOR THE SERVICEMAN. FILL IN THE ACTUAL READING AS TAKEN WITH YOUR OWN EQUIPMENT. A NORMAL OPERATING RADIO SHOULD BE USED FOR THESE MEASUREMENTS.

- FRONT PANEL NOTES (CONT.)**
8. CONTROL SETTING—UNLESS SPECIFIED. "BAND SELECTOR" AT BAND 1. "RECEPTION" AT "AM". "CALIB. XTAL" AT "OFF". "NOISE LIMITER" AT "OFF". "RECEIVE—STANDBY" AT "RECEIVE". "SENSITIVITY" AT MAXIMUM GAIN. "SELECTIVITY" AT "NORMAL / BOARD".

920546-A

Fig. 14 Tube socket voltage chart

# SERVICE PARTS LIST

Schematic Symbol	Description	Hallicrafters Part Number	Schematic Symbol	Description	Hallicrafters Part Number	Schematic Symbol	Description	Hallicrafters Part Number
*RESISTORS			TRANSFORMERS AND COILS			CAPACITORS		
R1,10,51	100K ohms 20%	451-253104	T1	Transformer, antenna stage; band 6	051-200829	C1,2,16,17,30,31	Trimmmers, adjustable; 2 section; antenna, RF amp, and mixer stages	044-200165
R2	12 ohms	451-252120	T2	Transformer, antenna stage; band 5	051-200828	C3,4,6,18,19,20,21,32,33,34,35	Part of transformers T3,4,5,8, 9,10,11,14,15,16 and 17 respectively	-----
R3,15	150 ohms	451-252151	T3	Transformer, antenna stage; band 4	051-200990	C5,129,130	2.2 mmf. 500V., bakelite	047-100160-04
R4,54	47K ohms, 1 watt	451-352473	T4	Transformer, antenna stage; band 3	051-200826	C7,79	5 mmf. 500V., ceramic	491-002050-95
R5,9,14,19,90,103,104	15 ohms 20%	451-252150	T5	Transformer, antenna stage; band 1	051-200823	C8,11,25	.047 mfd. 200V., molded tubular	499-014473
R6,13,17,20	2.2K ohms 20%	451-253222	T6	Transformer, RF stage; band 6	051-200833	C9	Capacitor, main tuning	048-300204
R7,18,40,67,74,78	1.2K ohms	451-252122	T7	Transformer, RF stage; band 4	051-200989	C13,15,27,29,50,59,63,74,86,87,91,	109,112,132	049-031223
R8,43,109	470K ohms 20%	451-253474	T8	Transformer, RF stage; band 3	051-200987	C14,28	.022 mfd. 600V., molded tubular	499-031223
R12	Variable; Sensitivity Control	025-100548	T9	Transformer, antenna stage; band 2	051-200824	C22,123	5600 mmf. 500V., mica	470-514562
R16,22,32,45,86,106,110	1K ohm 20%	451-253102	T10	Transformer, RF stage; band 1	051-200824	C23,62,70,84	15 mmf. 500V., ceramic	491-006150-95
R21,107	2.2 megohms	451-252225	T11	Transformer, mixer stage; band 5	051-200844	C23,62,70,84	.047 mfd. 200V., molded tubular	499-011473
R23	47 ohms 20%	451-253470	T12	Transformer, mixer stage; band 6	051-200833	C24	.22 mfd. 200V., molded tubular	499-011224
R24	33 ohms 20%	451-253330	T13	Transformer, mixer stage; band 4	051-200989	C36,76,78,120	7 mmf. 500V., ceramic	491-006070-95
R25,75	10K ohms	451-252103	T14	Transformer, mixer stage; band 3	051-200988	C37,97	47 mmf. 500V., mica	470-213470
R26	5.6K ohms, 1 watt	451-352562	T15	Transformer, mixer stage; band 2	051-200986	C12,26,38,75,81,92,106,114,115,117,	121,122,131,133,134,135	499-031103
R27	470 ohms 20%	451-253471	T16	Transformer, mixer stage; band 1	051-200985	C39,49	110 mmf. 500V., ceramic	491-025111-95
R28	68K ohms, 1 watt	451-352683	T17	Transformer, oscillator stage; band 6	051-200839	C40,41,57	Trimmer, adjustable; oscillator section bands 5 and 6; crystal phasing	044-100078
R29	120 ohms	451-252121	T18	Transformer, oscillator stage; band 5	051-200838	C42	Trimmer, adjustable; oscillator section, band 4	044-100347
R30,42,52	1 megohm 20%	451-253105	T19	Transformer, oscillator stage; band 4	051-200991	C43,45	Trimmer, adjustable; oscillator section, bands 2 and 3	044-100077
R31,60	330 ohms	451-252331	T20	Transformer, oscillator stage; band 3	051-200836	C44	4700 mmf. 2%, 500V., silver mica	470-521472
R36	1.2 megohms	451-252125	T21	Transformer, oscillator stage; band 2	051-200835	C46	1500 mmf. 2%, 500V., silver mica	470-421152
R37	100K ohms, 1 watt	451-352104	T22	Transformer, oscillator stage; band 1	051-200834	C47	Trimmer, adjustable; oscillator section band 1	044-100076
R38	270 ohms	451-252271	T23	Transformer, 1st IF amp. stage	050-300198	C48	470 mmf. 2%, 500V., silver mica	470-231471
R39,59,87	56K ohms	451-252563	T24	Transformer, 2nd IF amp. stage	050-300190	C51	220 mmf. 2%, 500V., silver mica	470-341221
R41,49,58,79,80,81,83	220K ohms	451-252224	T25	Transformer, 3rd IF amp. stage	050-300373	C52,66,71,99,108,118,137	.047 mfd. 600V., molded tubular	499-031473
R44	4.7 megohms	451-252475	T26	Transformer, FM detector	050-300373	C58,60,61	Trimmer, adjustable; crystal phasing	044-200164
R46,47	27K ohms, 2 watts	451-552273	T27	Transformer, BFO	050-300191	C89,90	180 mmf. 500V., mica	470-213181
R50	680 ohms	451-252681	T28	Transformer, audio output	050-300655	C98	560 mmf. 500V., mica	470-313561
R53	820K ohms	451-252824	T29	Transformer, power; 115V. 50/60 cycles (Model SX-62A)	053-300213	C107	10 mfd. 25V., electrolytic	045-100121
R55	10K ohms, 1 watt	451-352103	T30	Transformer, power; 115/230 V. 25/60 cycles (Model SX-62AU)	052-300131	C110	680 mmf. 500V., mica	470-313681
R56,57,71,94	47K ohms	451-252473	L1	RF choke (coded red)	053-200008	C111,113,116	20 mfd. 25V., 30-20 mfd. 450V. electrolytic	045-100041
R65	150K ohms	451-252154	L2	IF coupling coil	053-200104	C127	100 mfd. 25V., electrolytic	045-100116
R66	1.5 megohms	451-252155	L3	Choke, filter	056-200087			
R68	5.1K ohms, 5%	451-251512	L4	RF choke; filament	053-100009			
R73	Variable; Volume Control	025-100549	L5,6	RF choke; screen (wound on R95 & R96)	053-100117			
R76,92	56 ohms	451-252560	L7	RF choke; plate	053-100139			
R77	1K ohm, 2 watts	451-552102						
R82	8.2K ohms	451-252822						
R84	220 ohms, 2 watts	451-552221						
R85	2K ohms, 5%, 10 watts; WW	453-061202						
R88	2.2 megohms 20%	451-253225						
R89	68K ohms	451-252683						
R91,93	4.7K ohms	451-252472						
R101,102	330 ohms 20%	451-253331						
R105	100 ohms	451-252101						
R108	6.8 ohms, 1 watt	451-352068						
			MISCELLANEOUS					
			X1	Clip, dial scale & window mtg.	076-100403			
			X2	Crystal, 455 KC	019-100123			
				Crystal, calibration; 500KC	019-101211	SWITCHES		
				Dial cord (specify length)	083-100026	SW1	Switch, BAND SELECTOR	060-400329
				Dial pointer	082-300301	SW2	Switch, SELECTIVITY	060-100234
				Dial scale (calibrated)	022-400215	SW3	Switch, RECEPTION	060-200330
				Escutcheon	007-400078	SW4	Switch, TONE	060-300236
				Flywheel, dial drive	071-100178	SW5,6,7	Switch, toggle; SPST	060-100138
			F1	Fuse, 2 amp. 250V; type 3AG	039-100428	SW8	Switch, power (part of volume control R73)	-----
				Fuse holder	006-100451			
				Knob, BAND SELECTOR OR TUNING	015-001593			
				Knob, POINTER RESET	015-001609			
				Knob, RECEPTION, SELECTIVITY, TONE, VOLUME & SENSITIVITY control	015-001601			
				Lock, line cord; male section	076-000397-01			
				Lock, line cord; female section	076-000397-02			
				Mounting foot; rubber	016-100029			
				Pulley, Assembly	028-300111			
				Shaft, general coverage dial	074-100252			
				Shaft, index control	074-002650			
				Spring, dial drive	075-100232			
				Spring, pointer index	075-100232			
			TS1	Terminal strip, antenna	088-200976			
			TS2	Terminal strip, speaker	088-200936			
				Ring, Retaining; index control	076-100551			
				Ring, Retaining; index control	per W-12947			
				Shaft, dial	022-300214			
TUBES AND LAMPS						PLUGS AND SOCKETS		
V1,2	Type 6AG5, 1st and 2nd RF amplifiers	090-900791	PL1	Plug, JUMPER (for AC operation)	035-100003-01			
V3	Type 7F8, oscillator/mixer	090-901145	PL2	Plug and cord, power	087-100078			
V4	Type 6SK7, 1st IF amplifier	090-901233	SO1	Socket, octal; BATTERY POWER	006-100250			
V5	Type 6SG7, 2nd IF amplifier	090-901181	SO2	Jack, PHONE	036-200004			
V6,9	Type 6H6, noise limiter & discriminator	090-900847	SO3	Jack, PHONO	036-100041			
V7,8	Type 6SG7, 3rd IF amplifier & AM detector	090-901181		Socket, dial lamp	086-200073-01			
V10	Type 6J5, BFO	090-901141		Socket, octal; black molded	006-200296			
V11	Type 6SL7GT, phase inverter	090-901219		Socket, octal; mica	006-100223			
V12,13	Type 6V6GT, AF power amplifier	090-901221		Socket, miniature 7 pin; mica	006-100268			
V14	Type 5U4G, rectifier	090-900719		Socket, miniature 7 pin; molded bakelite	006-100292			
V15	Type OD3/VR150, voltage regulator	090-901234		Socket, octal	006-100250			
V16	Type 6C4, calibration oscillator	090-900830						
LMI,2,3,4,5,6,7,8,9,10,11,12	Lamp, pilot; 6-8V., Mazda #44 (blue bead)	039-100003						

\*All Resistors are 10%, 1/2 watt, carbon type unless otherwise noted.

# SX-62A & SX-62AU

## MARK 2A

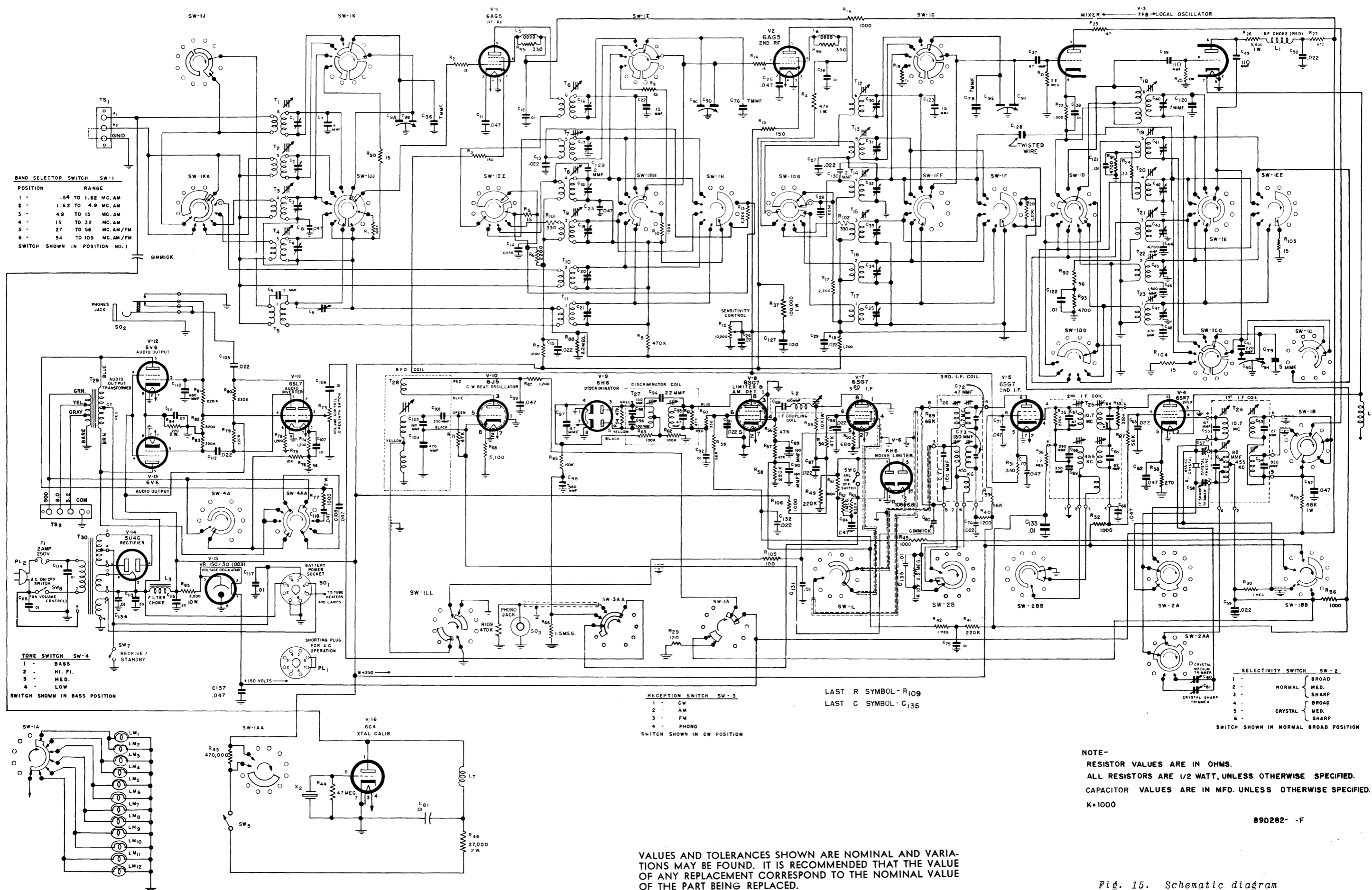

Fig. 15. Schematic diagram

## Warranty

*"The Hallicrafter's Company warrants each new radio product manufactured by it to be free from defective material and workmanship and agrees to remedy any such defect or to furnish a new part in exchange for any part of any unit of its manufacture which under normal installation, use and service discloses such defect, provided the unit is delivered by the owner to our authorized radio dealer, wholesaler, from whom purchased, or, authorized service center, intact, for examination, with all transportation charges prepaid within ninety days from the date of sale to original purchaser and provided that such examination discloses in our judgment that it is thus defective.*

*This warranty does not extend to any of our radio products which have been subjected to misuse, neglect, accident, incorrect wiring not our own, improper installation, or to use in violation of instructions furnished by us, nor extend to units which have been repaired or altered outside of our factory or authorized service center, nor to cases where the serial number thereof has been removed, defaced or changed, nor to accessories used therewith not of our own manufacture.*

*Any part of a unit approved for remedy or exchange hereunder will be remedied or exchanged by the authorized radio dealer or wholesaler without charge to the owner.*

*This warranty is in lieu of all other warranties expressed or implied and no representative or person is authorized to assume for us any other liability in connection with the sale of our radio products."*

Form No. 94X622

*the Hallicrafters co.*