

[®] **MICOM** *3EX* **type 3**

X.25 Packet Switch



User's Manual

800-1390-2a

[®] **MICOM** *BITX* **type 3**

X.25 Packet Switch

User's Manual

Stock Number 800-1390-2a

WARNING

This equipment generates, uses, and can radiate radio frequency energy and if not installed and used in accordance with this manual, may cause interference to radio communications. It has been tested and found to comply with the limits for a Class A computing device pursuant to Subpart J of Part 15 of FCC Rules, which are designed to provide reasonable protection against such interference when operated in a commercial environment. Operation of this equipment in a residential area is likely to cause interference in which case the user at his own expense will be required to take whatever measures may be required to correct the interference.

If radio frequency interference is encountered after installation of the equipment, necessary corrective measures are required to reduce this interference. Information about recommendations for such measures can be obtained from the manufacturer. Contact MICOM Corporate Headquarters for assistance.

November 1986

Copyright © MICOM Systems, Inc. 1986
All rights reserved

No part of this manual may be copied without
written permission from MICOM Systems, Inc.

THANK YOU FOR CHOOSING THE MICOM BOX Type 3 X.25 PACKET SWITCH

The MICOM BOX Type 3 X.25 Packet Switch, a member of MICOM's family of intelligent data communications products, is designed to help you get the most out of your communications lines.

This User's Manual, in turn, is designed to help you get the most out of your new X.25 Packet Switch by giving you all the information you need to use it effectively.

WARRANTY

MICOM provides a warranty for the X.25 Packet Switch, as described on the Warranty Page. Information about equipment repair by MICOM Customer Service is also on the Warranty Page.

PUBLICATION CHANGE REQUEST

At the end of this manual, there is a comment form for you to use if you think of an improvement to (or find a mistake in) this manual.

NOTICE

Specifications, tolerances, and design characteristics described in this manual are subject to change without notice.

TRADEMARKS

MICOM and FEATUREPAK are trademarks of MICOM Systems, Inc.

SAFETY WARNING

Always observe standard safety precautions during installation, operation, and maintenance of this product. To avoid the possibility of electrical shock, be sure to disconnect the power cord from the power source before you remove the power supply fuse or perform any repairs.

WARRANTY

MICOM warrants that the equipment delivered shall be free from defective material and workmanship for a period of 1 year from the date of delivery of equipment when given normal, proper and intended usage, and agrees to repair or replace, without cost, any part manufactured by MICOM provided that:

- (a) MICOM is promptly notified upon discovery that the equipment is defective;
- (b) The equipment is returned prepaid to the MICOM plant from which the equipment was shipped; and
- (c) MICOM's examination of the equipment shall disclose that any defect was not caused by accident, misuse, neglect, alteration, improper installation, unauthorized repair or improper testing.

MICOM may, in its sole discretion, elect to repair or replace the equipment, in which event MICOM shall have a reasonable time to make repairs or to replace the equipment. MICOM will return the equipment freight prepaid.

THE PROVISIONS OF THIS WARRANTY ARE IN LIEU OF ANY OTHER WARRANTY, WHETHER EXPRESS OR IMPLIED, WRITTEN OR ORAL (INCLUDING ANY WARRANTY OF MERCHANTABILITY OR FITNESS FOR A PARTICULAR PURPOSE), AND MICOM'S LIABILITY ARISING OUT OF THE MANUFACTURE, SALE, OR SUPPLYING OF THE EQUIPMENT OR ITS USE, WHETHER BASED UPON WARRANTY, CONTRACT, NEGLIGENCE, PRODUCTS LIABILITY OR OTHERWISE, SHALL NOT EXCEED THE ORIGINAL COST TO THE BUYER OF THE EQUIPMENT. IN NO EVENT SHALL MICOM BE LIABLE TO THE BUYER OR ANY OTHER PERSON OR ENTITY FOR UNINTENDED OR CONSEQUENTIAL DAMAGES (INCLUDING, BUT NOT LIMITED TO, LOSS OF PROFITS OR USE DAMAGES) ARISING OUT OF THE MANUFACTURE, SALE OR SUPPLYING OF THE EQUIPMENT.

MICOM warrants all repairs or upgrades performed at its factory location or performed by MICOM Customer Service for a period of 90 days after completion.

HOW TO GET YOUR EQUIPMENT FIXED BY MICOM CUSTOMER SERVICE

MICOM's Customer Service offers a wide range of support functions, including complete factory repair for both in-warranty and out-of-warranty equipment.

Before returning any equipment, please contact MICOM Customer Service or your local Distributor. In the U.S.A. and Canada, call MICOM's Customer Service Hotline (800) 833-3282. In all other countries, contact your local MICOM Distributor.

A Customer Service engineer will answer warranty-related questions, discuss your specific equipment problems, and — when necessary — give you shipping instructions for returning equipment to MICOM for repair. To return a product for service or repair, you *must* obtain a Return Authorization number from MICOM Customer Service.

When you do call Customer Service, it will be very helpful to know the PROM set number of the unit malfunctioning. You can easily determine this information by looking at the label on the bottom of the FEATUREPAK cartridge.

Shipping charges must be prepaid.

CONTENTS

| Paragraph | Topic | Page |
|--|---|------|
| SECTION 1 - PRODUCT AND DOCUMENT OVERVIEW | | |
| 1.1 | DOCUMENT ORGANIZATION | 1-3 |
| 1.2 | MODULES | 1-5 |
| 1.3 | MAJOR COMPONENTS OF THE SWITCH | 1-7 |
| | Enclosure | 1-7 |
| | Touch Panel | 1-7 |
| | Indicators | 1-7 |
| | FEATUREPAK Cartridge | 1-8 |
| | Power Supply | 1-8 |
| 1.4 | GENERAL CHARACTERISTICS | 1-8 |
| 1.5 | X.25 LINK CHARACTERISTICS | 1-10 |
| 1.6 | TYPES OF LINKS | 1-11 |
| 1.7 | PHYSICAL SPECIFICATIONS | 1-13 |
| 1.8 | ABBREVIATIONS | 1-14 |
| SECTION 2 - INSTALLATION AND CONFIGURATION | | |
| 2.1 | SELECTING THE INSTALLATION LOCATION | 2-1 |
| 2.2 | INSTALLATION | 2-1 |
| | Applying the Link Number and Indicator Strips | 2-2 |
| | Installing and Removing an Expansion Module | 2-4 |
| | Installing and Removing a FEATUREPAK Cartridge | 2-8 |
| | Standalone or Rack-Mount Installation | 2-9 |
| | System Connections | 2-11 |
| 2.3 | USING THE TOUCH PANEL TO SET OPERATING PARAMETERS AND THE SWITCH IDENTIFIER | 2-19 |
| | How the Switch Stores Parameters | 2-20 |
| | Using the Touch Panel | 2-20 |
| SECTION 3 - SWITCHING AND ROUTING CAPABILITIES | | |
| 3.1 | ADDRESS ASSIGNMENT | 3-1 |
| | Typical Public Data Network Address | 3-1 |
| | Typical Private Network Address | 3-2 |
| | Subaddressing | 3-2 |

CONTENTS

| Paragraph | Topic | Page |
|--|--|------|
| SECTION 3 - SWITCHING AND ROUTING CAPABILITIES (continued) | | |
| 3.2 | HOW THE SWITCH USES THE ADDRESS FIELD | 3-3 |
| | Speed Dial | 3-3 |
| | Class Route | 3-4 |
| 3.3 | LINK PROFILE | 3-5 |
| 3.4 | ROUTING | 3-7 |
| | Selection of Eligible Link Set | 3-7 |
| | Checking the Status of Links | 3-8 |
| | Best-Path Selection | 3-8 |
| | Logical Channel Selection | 3-10 |
| 3.5 | CALL FACILITY MANIPULATION | 3-10 |
| 3.6 | CALL CLEARING PROCEDURES | 3-11 |
| | At Call Setup Time | 3-11 |
| | Upon Detection of a Link or Switch Failure | 3-11 |
| | Upon Receipt of a Clear Request Packet on a DE or PN Link | 3-11 |
| | Upon Detection of a Disconnect LCN Command | 3-11 |
| 3.7 | HANDLING OF PACKETS | 3-12 |
| | Packets That Pass Through Transparently | 3-12 |
| | Packets That Require Special Handling | 3-12 |
| 3.8 | FLOW CONTROL | 3-13 |
| 3.9 | REMOTE ACCESS TO THE COMMAND FACILITY | 3-13 |
| 3.10 | HANDLING OF WILD CALLS | 3-13 |
| SECTION 4 - APPLICATION EXAMPLES | | |
| 4.1 | SWITCHING CONCENTRATOR IN A SINGLE-SWITCH PRIVATE NETWORK | 4-2 |
| 4.2 | SWITCHING CONCENTRATOR WITH MULTIPLE SWITCHES IN A PRIVATE NETWORK | 4-4 |
| 4.3 | PAD CONCENTRATOR AND PDN GATEWAY | 4-8 |
| 4.4 | HOST PADS CONCENTRATOR AND PDN GATEWAY | 4-9 |
| 4.5 | HOST ACCESS THROUGH TWO PDNs | 4-11 |

CONTENTS

| Paragraph | Topic | Page |
|--|---|------|
| SECTION 4 - APPLICATION EXAMPLES (continued) | | |
| 4.6 | BRIDGE BETWEEN PRIVATE NETWORK AND PDN | 4-12 |
| 4.7 | MULTIPLE-SWITCH ARRANGEMENT WITH PDNs | 4-17 |
| SECTION 5 - ADMINISTRATIVE PROCEDURES | | |
| 5.1 | SETTING UP THE SWITCH | 5-2 |
| 5.2 | ACCESSING THE COMMAND FACILITY | 5-2 |
| | Accessing the Command Facility Locally | 5-2 |
| | Accessing the Command Facility Remotely | 5-3 |
| 5.3 | LOGGING ON TO THE COMMAND FACILITY | 5-4 |
| 5.4 | CONFIGURATION | 5-6 |
| | Defining Link Profiles | 5-11 |
| | Setting Up the Routing Table | 5-20 |
| | Setting Up the Speed Dial Table | 5-24 |
| | Setting Up the Class Route Table | 5-26 |
| | Defining the Command Facility Address and Parameters | 5-27 |
| | Defining System Parameters | 5-34 |
| | The Switch's Network User Identification (NUI) Facility | 5-36 |
| 5.5 | OTHER COMMAND MENU FUNCTIONS | 5-42 |
| | Disconnect LCN Command | 5-42 |
| | Reset PVC Command | 5-43 |
| | Busyout Link Command | 5-43 |
| | Link Down Command | 5-44 |
| | Link Up Command | 5-44 |
| | List Stat (Link) Command | 5-45 |
| | List Stat (Pkt) Command | 5-47 |
| | List Routing Table Command | 5-49 |
| | List Speed Dial Command | 5-52 |
| | List Class Route Command | 5-53 |
| | List NUI Command | 5-54 |
| | Reset Stat Command | 5-57 |
| | Monitor Command | 5-58 |
| | Reset Switch Command | 5-60 |
| | Logout Command | 5-61 |

CONTENTS

| Paragraph | Topic | Page |
|---|---|------|
| SECTION 5 - ADMINISTRATIVE PROCEDURES (continued) | | |
| 5.6 | EVENT REPORTING | 5-61 |
| | Link Up | 5-61 |
| | Link Down | 5-62 |
| | Restart | 5-62 |
| | Wild Call | 5-62 |
| 5.7 | CALL ACCOUNTING | 5-63 |
| SECTION 6 - DIAGNOSTICS | | |
| 6.1 | LEVELS OFFERED BY THE SWITCH | 6-1 |
| 6.2 | INDICATORS | 6-2 |
| 6.3 | TERMINAL-ACTIVATED CHANNEL TESTS | 6-4 |
| | TACT LOCAL Loopback Test | 6-5 |
| | TACT TERMINAL Loopback Test | 6-6 |
| | TACT REMOTE Loopback Test | 6-7 |
| | TACT SYSTEM Loopback Test | 6-10 |
| 6.4 | OFF-LINE MEMORY DUMP | 6-12 |
| 6.5 | CAUSE AND DIAGNOSTIC CODES | 6-15 |
| 6.6 | SUPPORT OF 1984 DTE CAUSE CODES | 6-21 |
| APPENDIXES | | |
| A | CONFIGURATION WORKSHEETS | A-1 |
| B | HIGH-SPEED OPTIONS | B-1 |
| B.1 | INSTALLING A SWITCH WITH A HIGH-SPEED X.25 LINK | B-1 |
| B.2 | UPGRADING A STANDARD RS-232-C X.25 LINK TO HIGH-SPEED | B-3 |
| B.3 | PIN ASSIGNMENTS FOR HIGH-SPEED LINKS | B-6 |
| B.4 | CABLING | B-8 |
| C | ASCII CHART | C-1 |

FIGURES

| Figure | Title | Page |
|--------|--|------|
| 1-1 | The MICOM BOX Type 3 | 1-1 |
| 1-2 | Model Numbers for the MICOM BOX Type 3 X.25 Packet Switch | 1-2 |
| 1-3 | Locations of the Modules and Major Components | 1-5 |
| 1-4 | Single-Switch Network | 1-9 |
| 1-5 | Types of Links | 1-12 |
| 2-1 | Applying Link Number Strips to the Back Panel | 2-2 |
| 2-2 | Applying Indicator Strips to the Modules | 2-3 |
| 2-3 | Opening and Closing the Enclosure | 2-5 |
| 2-4 | Module Installation and Removal | 2-7 |
| 2-5 | FEATUREPAK Cartridge Removal and Installation | 2-9 |
| 2-6 | Rack-Mount Installation | 2-10 |
| 2-7 | Connectors on the Back Panel of the Enclosure | 2-11 |
| 2-8 | Example of System Cabling | 2-13 |
| 2-9 | Pin Assignments for the Straight Cable | 2-14 |
| 2-10 | Pin Assignments for the Crossover Cable | 2-15 |
| 2-11 | Pin Assignments for the Unique Straight Cable | 2-16 |
| 2-12 | Pin Assignments for the Interswitch Crossover Cable | 2-17 |
| 2-13 | Touch Panel | 2-19 |
| 2-14 | Using the SYS 1 Key to Set Operating Parameters | 2-21 |
| 2-15 | Using the SYS 2 Key to Set the Switch Identifier | 2-21 |
| 3-1 | Speed Dial Function | 3-4 |
| 3-2 | Class Route Function | 3-5 |
| 4-1 | Switching Concentrator in a Single-Switch Private Network | 4-2 |
| 4-2 | Switching Concentrator With Multiple Switches in a Private Network | 4-4 |
| 4-3 | PAD Concentrator and PDN Gateway | 4-8 |
| 4-4 | Host PADs Concentrator and PDN Gateway | 4-9 |
| 4-5 | Host Access Through Two PDNs | 4-11 |
| 4-6 | Bridge Between Private Network and PDN | 4-13 |
| 4-7 | Multiple-Switch Arrangement With PDNs | 4-18 |
| 5-1 | Command Menu | 5-5 |
| 5-2 | Displaying the Configure Menu | 5-6 |
| 5-3 | Configure Menu | 5-7 |
| 5-4 | Prompts Related to Configure Menu Items | 5-8 |
| 5-5 | Sample Page From the Routing Table | 5-21 |
| 5-6 | Speed Dial Table | 5-24 |
| 5-7 | Class Route Table | 5-26 |
| 5-8 | Sample Page From the NUI Table | 5-39 |
| 5-9 | Link Level Statistics Report | 5-45 |
| 5-10 | Packet Level Statistics Report | 5-47 |
| 5-11 | Routing Table | 5-49 |
| 5-12 | Speed Dial Table | 5-52 |

FIGURES

| Figure | Title | Page |
|--------|--|------|
| 5-13 | Class Route Table | 5-53 |
| 5-14 | NUI Table | 5-55 |
| 5-15 | Monitor Report | 5-58 |
| 5-16 | Sample Call Accounting Record | 5-63 |
| 6-1 | Indicators | 6-2 |
| 6-2 | Switch User Dialogue for the TACT LOCAL Loopback Test | 6-5 |
| 6-3 | Switch User Dialogue for the TACT TERMINAL Loopback Test | 6-6 |
| 6-4 | Equipment Setup for the TACT LOCAL or TERMINAL Loopback Test | 6-7 |
| 6-5 | Switch User Dialogue for the TACT REMOTE Loopback Test | 6-9 |
| 6-6 | Switch User Dialogue for the TACT SYSTEM Loopback Test | 6-10 |
| 6-7 | Equipment Setup for the TACT REMOTE or SYSTEM Loopback Test | 6-11 |
| 6-8 | Sample Off-Line Memory Dump Session | 6-13 |
| B-1 | The Base Module With Standard Daughterboards | B-3 |
| B-2 | Configuring a High-Speed Daughterboard as DTE or DCE | B-4 |
| B-3 | High-Speed Daughterboard Mountng Holes and Connectors | B-5 |
| B-4 | V.35 DCE Shielded Cable for Connection to a DTE Device | B-9 |
| B-5 | V.35 DTE Shielded Cable for Connection to a DCE Device | B-10 |
| B-6 | X.21 DCE Shielded Cable for Connection to a DTE Device | B-11 |
| B-7 | X.21 DTE Shielded Cable for Connection to a DCE Device | B-12 |

TABLES

| Table | Title | Page |
|-------|---|------|
| 1-1 | Module Descriptions | 1-6 |
| 2-1 | Correlation of Soft Switch Selections to Indicators | 2-22 |
| 5-1 | Logon Prompts | 5-4 |
| 5-2 | Link Profile Prompts | 5-12 |
| 5-3 | Routing Mask Prompts | 5-22 |
| 5-4 | Speed Dial Prompts | 5-25 |
| 5-5 | Class Route Prompts | 5-27 |
| 5-6 | CMD/XCC Facility Prompts | 5-28 |
| 5-7 | System Parameters Prompts | 5-34 |
| 5-8 | NUI Table Prompts | 5-40 |
| 5-9 | Disconnect LCN Prompts | 5-42 |

TABLES

| Table | Title | Page |
|-------|--|------|
| 5-10 | Link Level Statistics Report | 5-46 |
| 5-11 | Packet Level Statistics Report | 5-47 |
| 5-12 | Monitor Report | 5-59 |
| 5-13 | EIA Signals | 5-60 |
| 5-14 | Call Accounting Record | 5-65 |
| 6-1 | Indicators | 6-3 |
| 6-2 | Restart Packet Cause and Diagnostic Codes | 6-15 |
| 6-3 | Clear Packet Cause and Diagnostic Codes | 6-16 |
| 6-4 | Reset Packet Cause and Diagnostic Codes | 6-20 |
| B-1 | High-Speed Daughterboard Upgrade Kits | B-2 |
| B-2 | Link 1 Pin Assignments -- X.21 to a DTE Device | B-6 |
| B-3 | Link 1 Pin Assignments -- X.21 to a DCE Device | B-6 |
| B-4 | Link 1 Pin Assignments -- V.35 to a DTE Device | B-7 |
| B-5 | Link 1 Pin Assignments -- V.35 to a DCE Device | B-7 |

SECTION 1

PRODUCT AND DOCUMENT OVERVIEW

The unit shown in figure 1-1 is the MICOM BOX Type 3 (MB3). This manual describes one use for the unit -- as an X.25 Packet Switch. The MB3 X.25 Packet Switch is available with either all standard RS-232-C X.25 links, or with one of its links an optional high-speed X.21 or V.35 X.25 link (described in appendix B). Figure 1-2 explains model numbers for the various units.

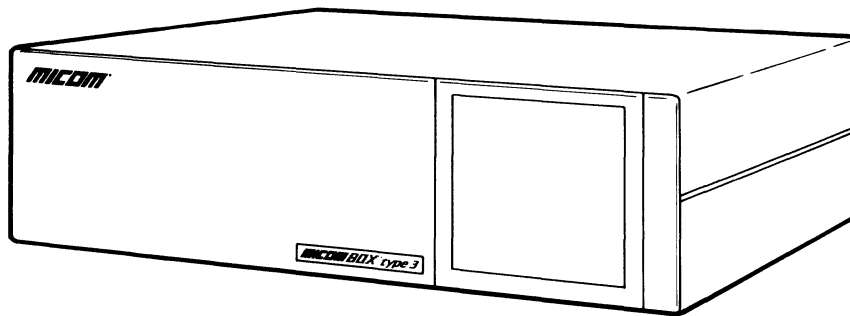

MI-1387-1a-01

Figure 1-1. The MICOM BOX Type 3

The operational features of the standard switch product and the high-speed switch product are identical, with the exception of support for the standard or the high-speed link. Throughout this document, both the standard and the high-speed products are referred to as the switch or the packet switch. Refer to appendix B for specific information on the high-speed link options.

The purpose of the switch is to route calls between different X.25 devices. It enables up to 11 X.25 links, from packet assembler/disassemblers (PADs) or X.25 hosts, to be concentrated onto one or more Public Data Network (PDN) access links. In addition, it can act as a switching hub for up to 12 X.25 links in a private X.25 network.

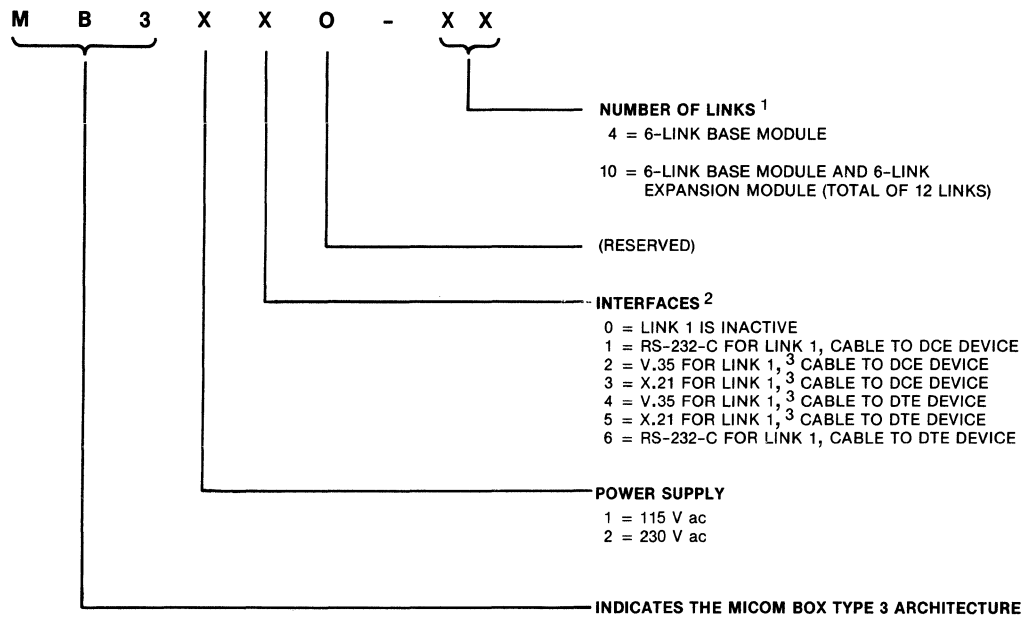

EXAMPLE:
 MB3120-10 DENOTES A 12-LINK, 115 V ac TYPE 3 MICOM BOX, WITH A V.35 INTERFACE FOR LINK 1, A V.35 CABLE THAT CONNECTS TO A DCE DEVICE, AND RS-232-C INTERFACES FOR THE REMAINING 11 LINKS.

¹ WHEN THE MICOM BOX TYPE 3 IS USED AS A PACKET SWITCH, THERE ARE 6 X.25 LINKS AVAILABLE WITH THE BASE MODULE, AND 12 X.25 LINKS AVAILABLE WITH THE BASE AND EXPANSION MODULES. HOWEVER, THE MODEL NUMBERING SCHEME ILLUSTRATED IN THIS FIGURE STILL APPLIES.

² THE INTERFACE OPTIONS 0 THROUGH 6 RELATE TO LINK 1 ONLY. ALL OTHER LINK INTERFACES ARE ALWAYS RS-232-C.

³ REQUIRES THE HIGH-SPEED FEATUREPAK CARTRIDGE, MB3-PSW-HS

MI-1390-1a-66

Figure 1-2. Model Numbers for the MICOM BOX Type 3 X.25 Packet Switch

The modular design of the switch makes it easy to install and adapt to your needs. You can purchase the unit with a base module, and then add an expansion module as your needs grow. In addition, the standard RS-232-C X.25 link interface circuitry is contained on a daughterboard that can be easily removed and exchanged for a high-speed X.21 or V.35 link daughterboard. Also, the power supply can be set for either 115 V ac or 230 V ac operation.

Modularity and flexibility apply in the area of switch firmware as well. All the PROMs that contain the operating software reside in an easy-to-install FEATUREPAK cartridge (refer to paragraph 1.3.4).

1.1 DOCUMENT ORGANIZATION

This document is designed to assist you in understanding the different capabilities of the switch. It is intended for use by the Network Administrator, the designer, and the technician.

This section introduces you to the switch by describing its:

- Modules and other major hardware components.
- General and X.25 link characteristics.
- Different types of links.
- Physical specifications.

At the end of this section is a list of abbreviations that are used throughout the manual.

The following paragraphs describe the general content of each of the remaining sections and appendixes in this manual.

SECTION 2 INSTALLATION AND CONFIGURATION provides the Network Administrator and the communications technician with information on selecting an installation location, installing major components, checking link-selection strap settings, performing a standalone or a rack-mount installation, connecting cables, connecting power, and setting software (soft) switch group selections to meet the operating requirements.

SECTION 3 SWITCHING AND ROUTING CAPABILITIES provides reference-type information on the following items:

- Network address assignment
- Subaddressing supported
- Speed dial and class routing capabilities
- Link profiles
- Routing tables
- Selection of eligible link set, best-path, and logical channel
- Call facility manipulation
- Call clearing procedures
- Handling of packets (Interrupt, Reset, and so on)
- Remote access to Command Facility
- Handling of wild calls

SECTION 4 APPLICATION EXAMPLES includes illustrations of various switch applications. For example, the switch is shown as a switching concentrator in a private X.25 network, as a gateway to a Public Data Network (PDN), and as a gateway to more than one PDN. The illustrations are accompanied by descriptions and configuration instructions.

- SECTION 5 ADMINISTRATIVE PROCEDURES describes the items on the Command and Configure Menus, including instructions on defining the link profiles and setting up the routing tables. This section also includes information on the switch's statistics, event reporting, and call accounting capabilities.
- SECTION 6 DIAGNOSTICS describes the indicators and the terminal-activated channel tests (TACT). It also tells how to use the off-line memory dump capability, and includes tables of cause and diagnostic codes.
- APPENDIX A CONFIGURATION SHEETS contains the selection sheets that may be used to summarize all the parameters that can be configured using the Command Facility. Default parameters are also shown. These sheets should be prepared carefully and completely and should be retained for future reference.
- APPENDIX B HIGH-SPEED OPTIONS describes the switch's V.35 and X.21 high-speed X.25 link options. These options include a special FEATUREPAK cartridge and an X.21 or V.35 daughterboard for the link 1 interface. The installation and upgrade procedures included in this appendix are intended for the experienced communications technician.
- APPENDIX C ASCII CHART is a reference guide that is provided for your convenience.

1.2 MODULES

The switch's modules are circuit boards that contain the logic and support circuitry necessary for operation. There are two modules available for the switch. They are:

- MB3-CCM -- A 6-link base module
- MB3-EM6 -- A 6-link expansion module

The modules are illustrated in figure 1-3 and described in table 1-1.

(Refer to appendix B for descriptions of the optional high-speed modules.)

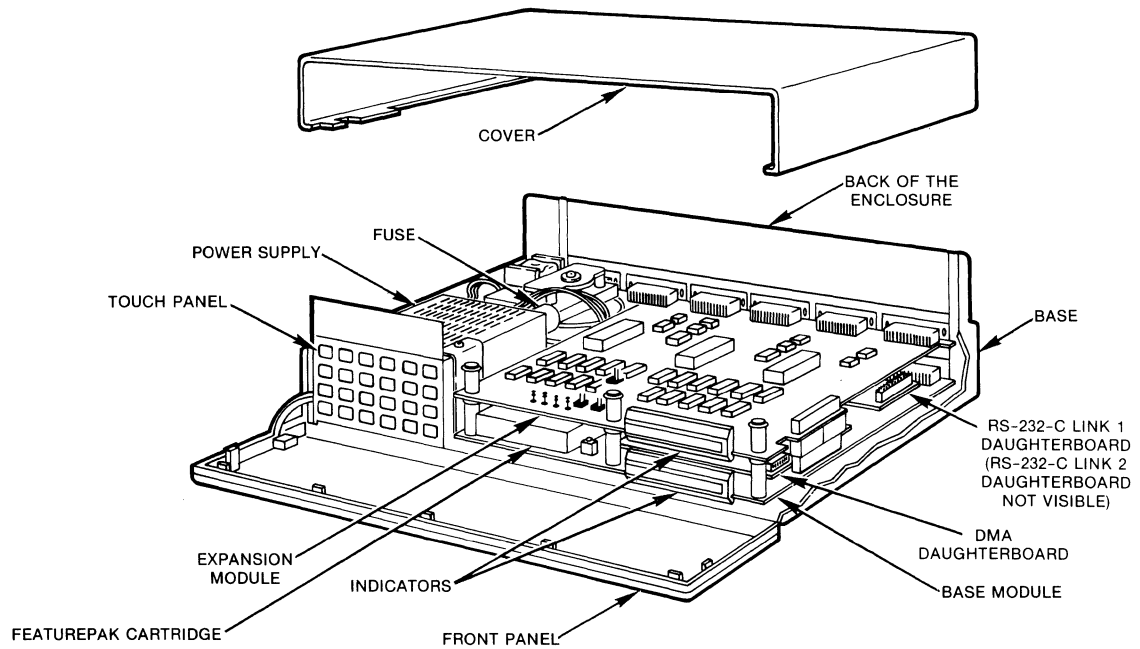

MI-1390-1a-02

Figure 1-3. Locations of the Modules and Major Components

Table 1-1. Module Descriptions

| Module Number | Module Description |
|--|---|
| MB3-CCM | <p>A 6-link base (communications control) module that is the only module in the 6-link model, and is part of all other models. It has:</p> <ul style="list-style-type: none"> • A Z80B microprocessor running at 6 MHz. • Standard EIA RS-232-C interface connectors for all six links. • 256 K of RAM, which is used for data buffer, control blocks, and machine code • 8 K of CMOS RAM, which is used for storage of configuration data that determines the operation of the unit. • A lithium battery that provides standby power for the CMOS RAM. • The slot for the FEATUREPAK cartridge. • Two RS-232-C daughterboards that provide interface circuitry for links 1 and 2.¹ <p>(When using one of the switch's high-speed options, the RS-232-C daughterboard that provides interface circuitry for link 1 is replaced with either an X.21 or a V.35 daughterboard. Refer to appendix B for more information.)</p> <ul style="list-style-type: none"> • One Direct Memory Access (DMA) daughterboard. Although physically present, the DMA daughterboard is not active unless one of the switch's high-speed link options is used. |
| MB3-EM6 | A 6-link expansion module that is included in the 12-link model. |
| <p>¹A spare RS-232-C daughterboard (and related cable) is available for link 1. To order it, use kit number MBK-232-to-DCE. Kits are also available for the high-speed (X.21 or V.35) daughterboards (refer to appendix B).</p> | |

1.3 MAJOR COMPONENTS OF THE SWITCH

In addition to the modules described in paragraph 1.2, the switch's major components include the following, which are illustrated in figure 1-3:

- Enclosure (base, cover, front panel, and back)
- Touch Panel
- Indicators
- FEATUREPAK cartridge
- Power supply

An optional Rack-Mount Upgrade Kit (MB-RMK-1) is available for installing the switch in a 19-inch wide rack (refer to paragraph 2.2.4).

1.3.1 Enclosure

The enclosure consists of a base, a cover, a front panel, and the back. The base, which interlocks with the cover, holds the major components. The movable and translucent front panel swings open for access to the inside of the unit. The back consists of interlocking panels that are attached to the modules. A blank panel is installed when an expansion module is not in place. The one enclosure allows a 6-link model to be field-upgraded to 12 links.

1.3.2 Touch Panel

This is located behind the front panel. The membrane surface of the panel is sectioned into 24 keys. The Touch Panel is used to configure some of the switch's operating parameters and to reset the switch (refer to paragraph 2.3).

1.3.3 Indicators

The indicators are also located behind the front panel and are labeled with their abbreviated names. They display the operating status of the unit and are used with the Touch Panel keys. When a unit is plugged into a power outlet, some indicators will go ON and will be visible through the front panel.

1.3.4 FEATUREPAK Cartridge

CAUTION: To avoid possible damage to an expansion module from static discharge, be sure to touch the switch's metal enclosure before reaching for the FEATUREPAK cartridge.

A FEATUREPAK cartridge is inserted into an opening behind the front panel (see figure 1-3). It contains the system software. Currently, two FEATUREPAK cartridges are available for the switch:

- MB3-PSW-STD (MICOM BOX Type 3, Packet Switch, Standard), which supports all standard RS-232-C X.25 links
- MB3-PSW-HS (MICOM BOX Type 3, Packet Switch, High Speed), which supports one high-speed X.21 or V.35 X.25 link

1.3.5 Power Supply

A multi-output ac power supply is installed prior to shipment. The input voltage is 115 or 230 V ac, 50 to 60 Hz. Output voltages are +5, +12, and -12 V dc.

Prior to shipment, the power supply is set for the voltage that is used within your area and an appropriate fuse is installed.

1.4 GENERAL CHARACTERISTICS

The switch has the following general characteristics:

- Is fully-configurable, on-site, to meet the operating requirements of CCITT-compatible PDNs, X.25 PADs, and most existing terminals and computer systems
- Meets all the requirements of CCITT Recommendation X.25 (1980 version)
- Is highly versatile. As shown in figure 1-4, a single switch can be used to build a small network. In contrast, clusters of switches can be used to build a sophisticated private data network that spans a large geographical area, interconnecting private leased lines and PDNs (refer to section 4).
- Supports a variety of network topologies, such as star, loop, and tree

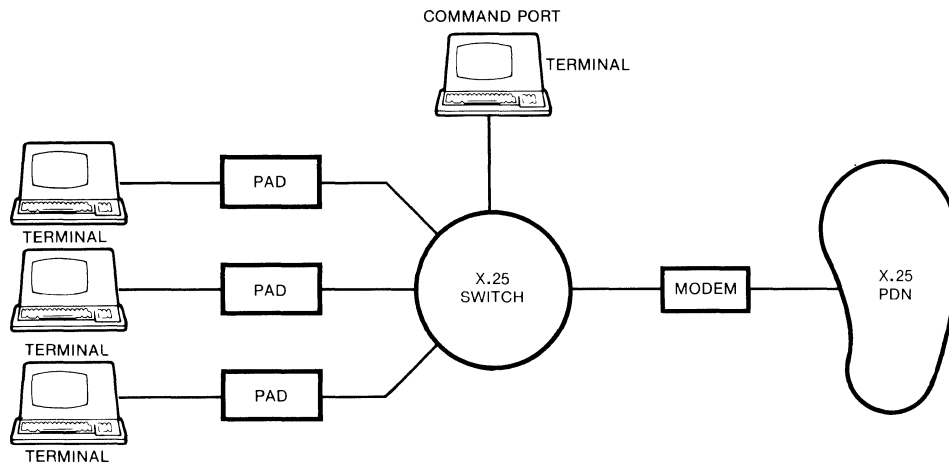

MI-1371-1a-43

Figure 1-4. Single-Switch Network

- Offers alternate routing to ensure that service will not be lost in the event of a link or equipment failure
- Provides the user with a virtually unlimited number of routing addresses, through its "wildcard" capability
- Has a common routing addresses pool for maximum flexibility
- Supports hunt groups, which allow calls to be routed automatically to a group of links that share the same address
- Offers load sharing, when multiple links are defined. During normal operation, data is spread evenly over the multiple links. If one link fails, remaining links accept the extra load.
- Allows for automatic insertion, deletion, and validation of X.25 facilities, including the Network User Identification (NUI) facility
- Currently, does not support the Fast Select Facility
- Provides address conversion. This allows two private networks to interconnect through a public network, without the entry of long public network addresses.
- Supports both X.121 and Call User Data (CUD) subaddressing
- Supports up to 32 speed dial numbers, for easy access to PDN resources
- Contains default configuration parameters upon power-up for easy installation
- Stores configuration parameters in separate memory (which is protected by a backup battery)
- Allows one link to be configured as a dedicated Command Port

- Handles 50 packets per second, with packet sizes of 128 bytes
- Offers powerful, nondisruptive link path tests, as well as an interactive off-line memory dump capability
- Generates link-level and packet-level statistical reports
- Monitors status of links and generates status reports
- Lists configuration tables, such as routing and speed dial
- Reports events, such as link down, to the Command Facility
- Provides call accounting information
- Comes in tabletop or rack-mount version
- Has a modular hardware design for ease of module installation and upgrade
- Has its software housed in a FEATUREPAK cartridge for ease of firmware installation and upgrade

1.5 X.25 LINK CHARACTERISTICS

The switch has the following link characteristics:

- Is compatible with 1980 version of Recommendation X.25 LAPB/HDLC operation
- Supports speeds up to 19,200 bps with internal or external clock (supports speeds up to 72,000 bps with one of its high-speed options)
- Supports logical group numbers (LGNs) and logical channel numbers (LCNs)
- Performs incoming call validation based on the following facilities:
 - Fast select
 - Network User Identification (NUI)
 - Reverse charging
- Allows individual configuration of the following parameters for each X.25 link:
 - k (frame level window)
 - n2 (number of retransmissions)
 - t1 (acknowledgment timer)
 - t3 (link assurance timer)
 - t11/t21 (call request timeout timer)
 - t12/t22 (reset request timeout timer)
 - t13/t23 (clear request timeout timer)
 - modulo 8 (standard packet sequence numbering)

1.6 TYPES OF LINKS

A switch can have one or more of the following types of links:

- A DE link is used to connect the switch to X.25 Data Terminal Equipment (DTE).
- An IS link is used to connect one switch to another switch (Interswitch).
- A PN link is used to connect the switch to a PDN.

There are several areas where the link type plays a part. One area relates to setting up the link profiles (refer to paragraph 5.4.1). More specifically, when the switch has selected an outgoing link of the PN type, it checks its speed dial table before forwarding the call to a PDN (refer to paragraph 3.2.1 for information on the speed dial capability).

See figure 1-5 for an illustration of the types of links.

PDN (PN) LINKS

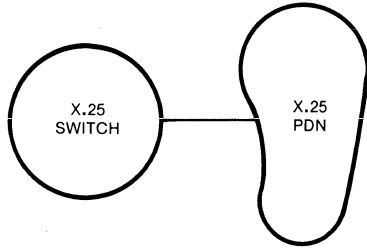

PLUS

DTE (DE) LINKS

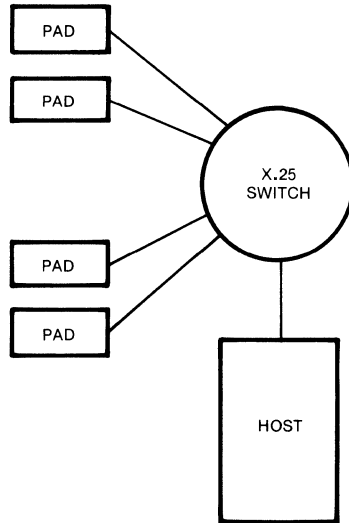

PLUS

INTERSWITCH (IS) LINKS

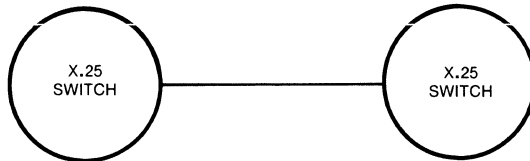

CREATES A NETWORK

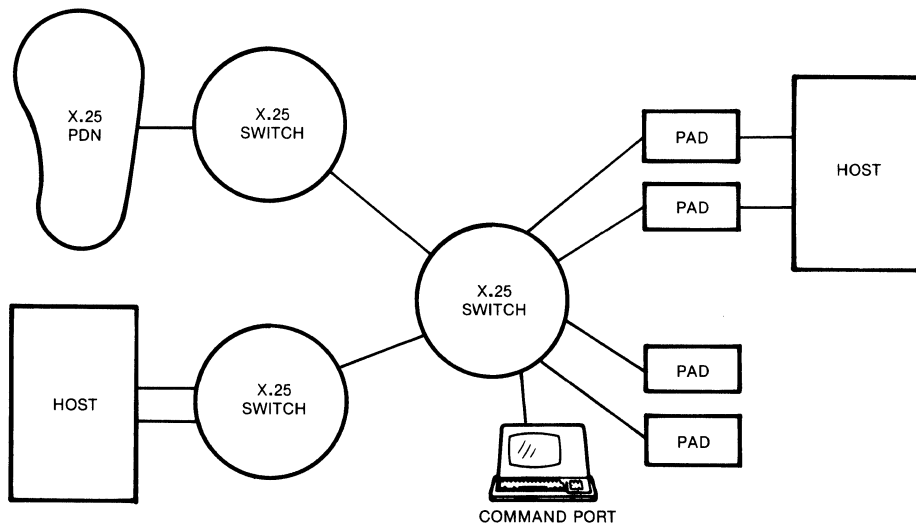

MI-1390-1a-03

Figure 1-5. Types of Links

1.7 PHYSICAL SPECIFICATIONS

Operating Environment

32 to 114°F (0 to 45°C)
0 to 95 percent relative humidity (non-condensing)

Power

115 or 230 V ac \pm 10 percent, 50 to 60 Hz

Size

Standalone:

15 1/2 inches (39.4 cm) wide
4 1/2 inches (11.4 cm) high
11 3/4 inches (29.8 cm) deep
Weight: 8 pounds (3.6 kg)

Rack-Mounted with Upgrade Kit MB-RMK-1:

19 inches (48.3 cm) wide
5 1/4 inches (13.3 cm) high
11 1/2 inches (29.2 cm) deep

Storage Temperature

-40 to 176°F (-40 to 80°C)

Emissions Control

Complies with FCC Part 15, Subpart J, Class A, for control of radio-frequency interference

Status Displays

The base module has 12 indicators.
The expansion module has six indicators.

Lithium Battery

Located on the base module, the battery supplies power to CMOS RAM for an accumulated power-down life of two years. User life of the battery is four years (not rechargeable).

1.8 ABBREVIATIONS

Throughout this document, the following abbreviations will be used:

| | |
|-----------|---|
| CUD | Call User Data |
| DE link | Link connecting an X.25 DTE to the switch |
| DISC | Disconnect |
| DM | Disconnect Mode |
| FRMR | Frame Reject |
| IS link | Link interconnecting two switches |
| LAPB/HDLC | Line Access Procedures, Balanced/High-Level Data Link Control |
| LCN | Logical Channel Number |
| LGN | Logical Group Number |
| NUI | Network User Identification |
| PAD | Packet Assembler/Disassembler |
| PDN | Public Data Network |
| PN link | Link connecting the switch to a PDN |
| PVC | Permanent Virtual Circuit |
| REJ | Reject |
| RNR | Receive Not Ready |
| RR | Receive Ready |
| SABM | Set Asynchronous Balanced Mode |
| SVC | Switched Virtual Circuit |
| UA | Unnumbered Acknowledgement |

SECTION 2

INSTALLATION AND CONFIGURATION

This section provides the experienced communications technician with the information needed to install the switch and configure some of its parameters in preparation for operation. The Network Administrator should refer to section 4 for sample private and public network layouts, and to section 5 for complete information on configuration.

2.1 SELECTING THE INSTALLATION LOCATION

The unit has specific size, ventilation, and cabling requirements. The following list contains information that will guide you in your selection of a location.

- Take into account the size of the enclosure (including the space needed for the rear connectors): 15 1/2 inches (39.4 cm) wide, 4 1/2 inches (11.4 cm) high, and 14 inches (35.6 cm) deep.
- The air vents on the bottom of the enclosure must always be kept clear of obstructions. Do not place the unit on paper or on any material that can be moved by suction; it will seal off the intake vent.
- All cables that are used to connect terminals and external modems to the switch must be shielded and cannot be longer than 50 feet (15.2 meters).
- External cables must be disconnected from the rear connectors before the removal of the modules is attempted.
- The distance to the ac power outlet should not exceed 6 feet (1.8 meters).

2.2 INSTALLATION

Instructions for installation include:

- Link number and indicator adhesive strips
- Expansion module
- FEATUREPAK cartridge
- Standalone or rack-mount installation
- System connections

2.2.1 Applying the Link Number and Indicator Strips

Your switch FEATUREPAK cartridge (MB3-PSW-STD or MB3-PSW-HS) comes with adhesive strips that allow you to customize your MICOM BOX Type 3 for use as a packet switch.

There are link number strips that go on the switch's back panel (on the backs of the modules). They show link numbers 1 through 6 (for 6-link units) or 1 through 12 (for 12-link units). These numbers guide you when you attach cables to your switch.

In addition, there are indicator strips that go over the switch's indicators. The strips show the abbreviated names of the system-status indicators, and the numbers of the link-status indicators.

To apply the link number strips to the backs of the modules:

1. Locate the strips labeled LINK 1 through LINK 6 and apply them over the existing base module labels, in the locations shown in figure 2-1.
2. If you have an expansion module to install, locate the strips labeled LINK 7 through LINK 12 and apply them over the existing expansion module labels, in the locations shown in figure 2-1.

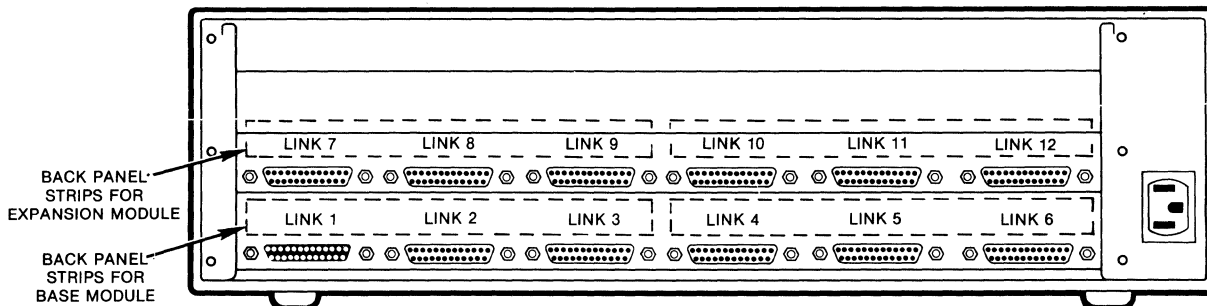

MI-1390-1a-67

Figure 2-1. Applying Link Number Strips to the Back Panel

To apply the indicator strips:

The indicators are located behind the front panel. To open the front panel, pull the top edge of it out and down.

1. Locate the strip with both alpha and numeric labels and apply it on the base module, as shown in figure 2-2.
2. If you have an expansion module to install, locate the strip labeled 7 through 12 (right to left) and apply it on the expansion module, as shown in figure 2-2.

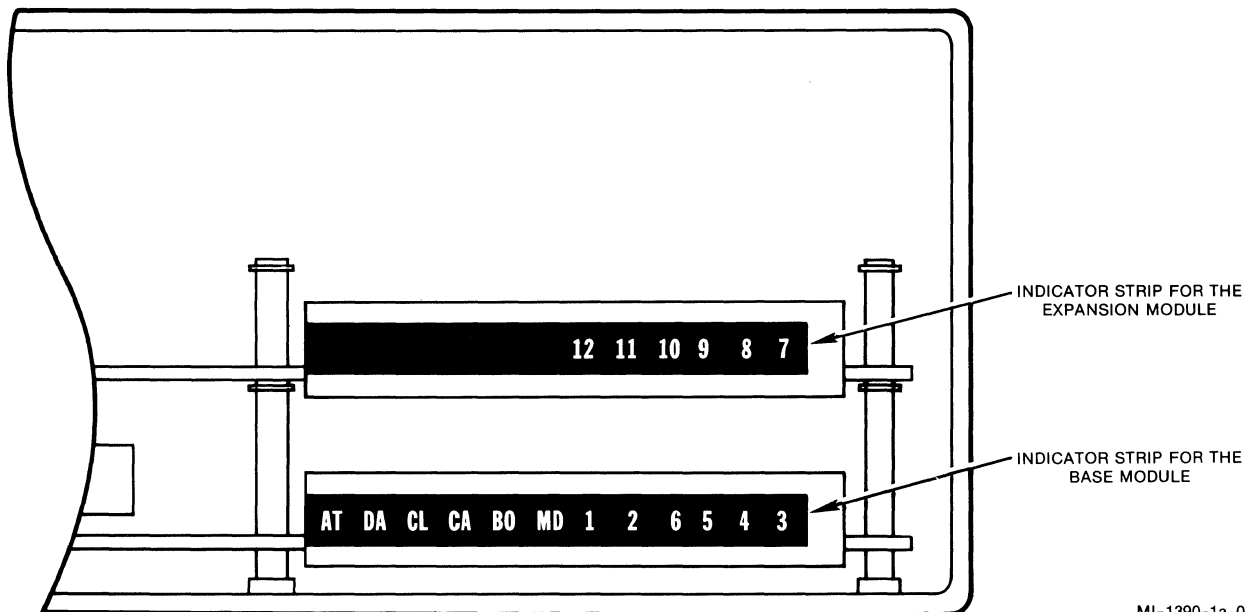

MI-1390-1a-04

Figure 2-2. Applying Indicator Strips to the Modules

2.2.2 Installing and Removing an Expansion Module

CAUTION: To avoid possible damage to an expansion module from static discharge, be sure to touch the switch's metal enclosure before installing or removing a module.

To install or remove an expansion module you need to open the switch.

To open the unit, you need a Phillips-type screwdriver and the MICOM User Key (or a screwdriver with a 1/4-inch blade).

There are two screws on each side of the enclosure (see figure 2-3). Use a Phillips-type screwdriver to remove all four screws. Then release the four locking clips using the MICOM User Key. The MICOM User Key is provided with the equipment for your safety (a screwdriver with a 1/4-inch blade may also be used). Insert the User Key blade not more than halfway in the four slots on both sides of the base (see figure 2-3). Pry the cover up with the key in each of the four slots to release the clips. Lift the cover off when all four clips are released.

To close the unit, identify the front of the cover (see the stamp on the underside of the cover). Align the front of the cover with the front of the base and place the cover over the base. Align the slots in the cover edges on both sides with the tabs on the base edges (see figure 2-3). Push in the edge of the cover over the alignment tabs as you press the cover down. The locking clips will lock the cover in place. Then replace the four screws that you removed to open the unit.

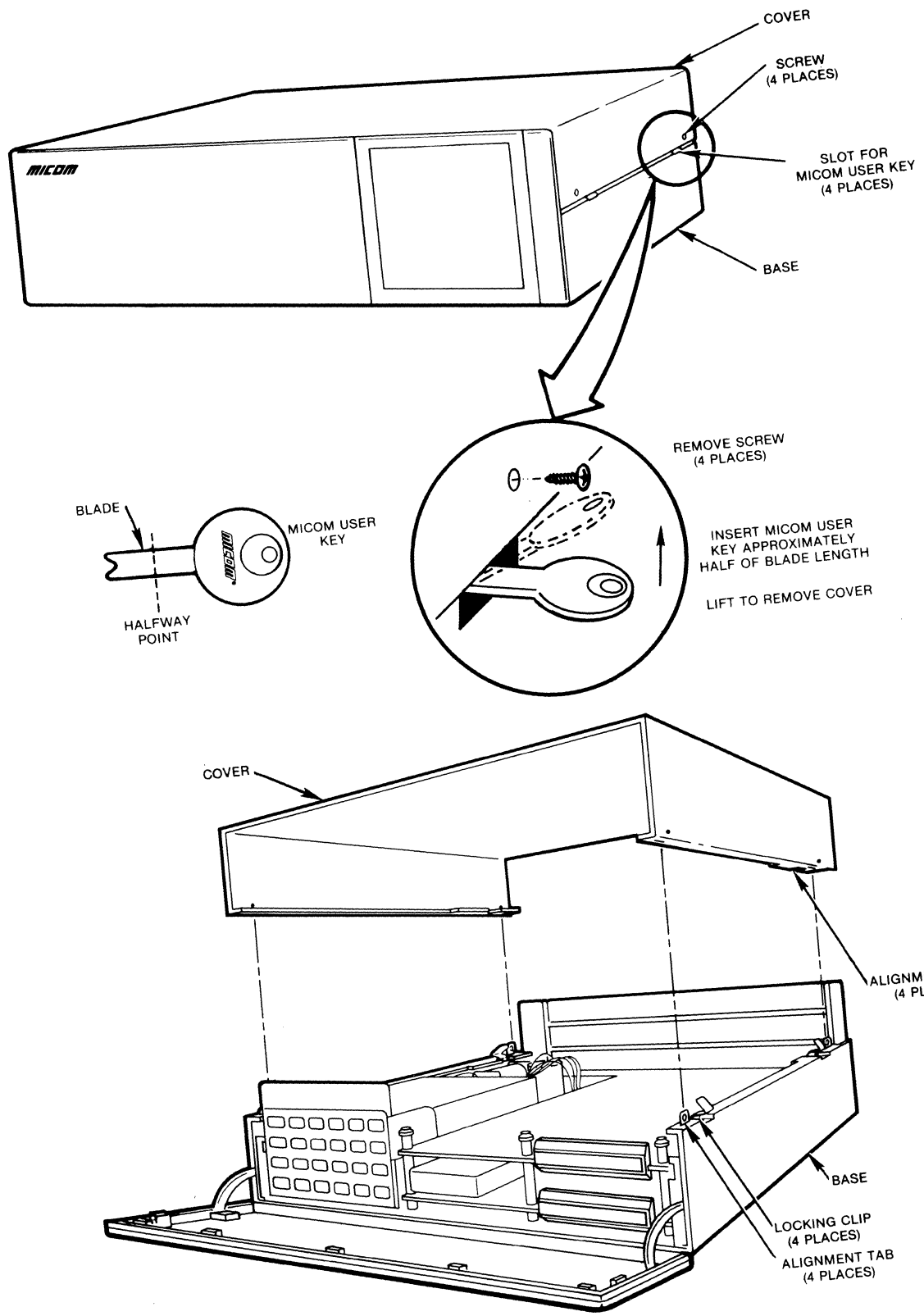

MI-1366-1a-60

Figure 2-3. Opening and Closing the Enclosure

To install an expansion module:

NOTE: Make sure you have applied the link number and indicator strips, as described in paragraph 2.2.1.

1. Install the jumper for link selection.

A jumper must be installed properly on the expansion module to select links 7 through 12. Ensure that the jumper is installed on header E3 on the expansion module (see figure 2-4).

2. Secure the back of the module (see figure 2-4).

A panel is attached to the back of the expansion module. Slide the panel into the side guides until it couples with the panel below. Where a module is not installed, you must slide in a panel without an attached module to form a solid back for the switch's enclosure.

Installing the expansion module requires the use of stacking connectors (perform step 3).

3. Connect the stacking connectors.

A stacking connector has two parts: a shroud and a block. The shroud is on the bottom of the module being installed and fits over the block on the module below. As you slide in the back panel, align the shroud and the block. Then press the two together until the connector is completely coupled.

4. Secure the front of the module.

In the front, the modules snap together using three standoffs. Place the standoffs (on the bottom of the module being installed) over the standoffs that are on the module below. Place the MICOM User Key over the standoff, so that the top of the standoff fits into the depression in the handle of the key. Press down until the standoffs snap together (see figure 2-4).

5. Connect the external cables.

Connect the external cables to the connectors on the back of the enclosure (refer to paragraph 2.2.5).

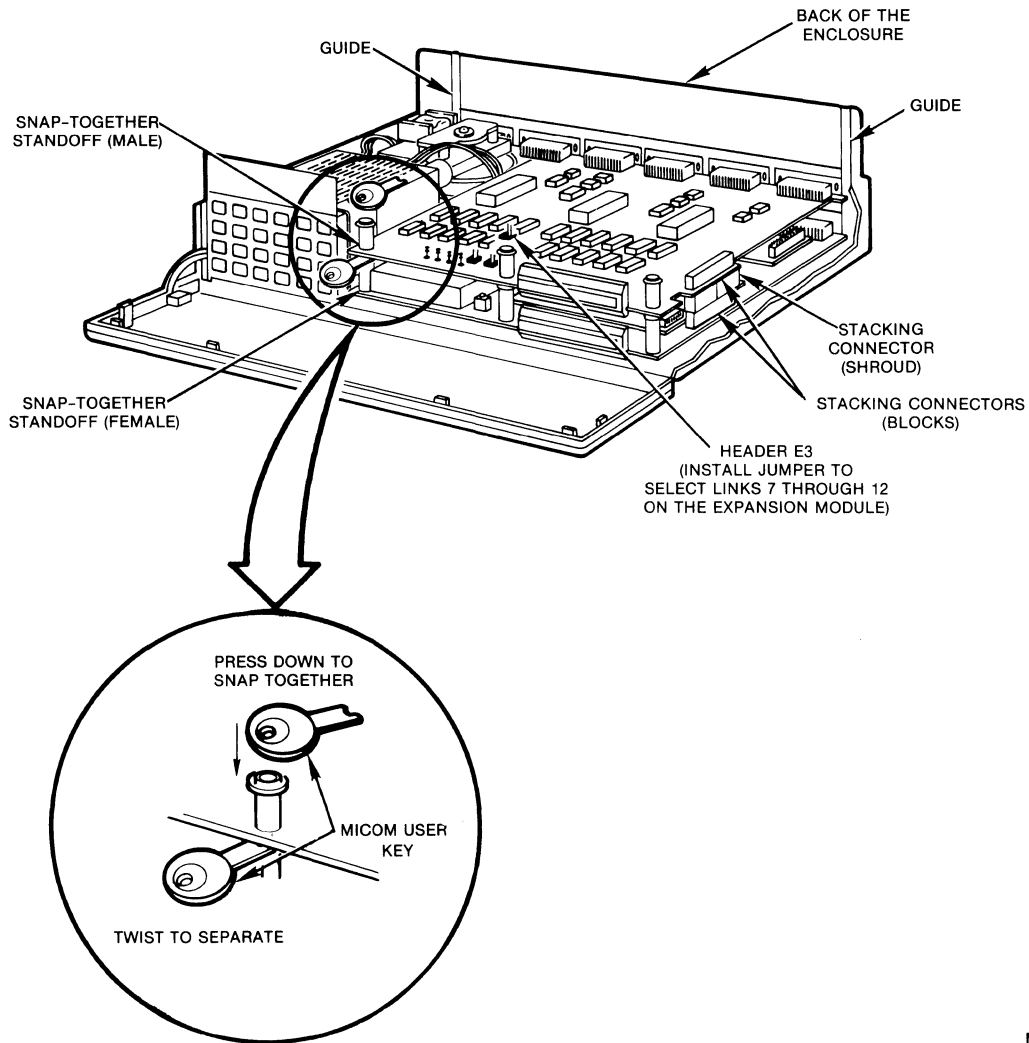

MI-1390-1a-05

Figure 2-4. Module Installation and Removal

To remove a module (see figure 2-4):

1. Disconnect the external cables from the back connectors.
2. Separate the three standoffs from the module using the MICOM User Key or a screwdriver with a 1/4-inch blade (refer to the CAUTION that follows). Firmly insert the User Key between the module edge and the standoff below. A fully inserted key will cause the module to unsnap (see figure 2-4). When the key is properly inserted, twist the key to one side to separate the module from the standoff. Repeat this operation for each standoff.

CAUTION: If you use a screwdriver instead of the MICOM User Key, be careful to avoid scratching or gouging the underside of the module.

3. Pull apart the stacking connector between the two modules.
4. Slide the back panel out of the side guides.

2.2.3 Installing and Removing a FEATUREPAK Cartridge

The receptacle for the FEATUREPAK cartridge is located behind the front panel (see figure 2-5). To open it, pull the panel top out and down.

CAUTION: To avoid possible damage to an expansion module from static discharge, be sure to touch the switch's metal enclosure before reaching for the FEATUREPAK cartridge.

To install, insert the FEATUREPAK cartridge into the receptacle with the connector pins going in first. Tracks on the cartridge will mate with the slides inside the unit. With a fair amount of pressure, push the cartridge until the pins of the connector are firmly seated. This will ensure the proper connection of the cartridge.

To remove, grip the cartridge firmly on the sides and pull with a fair amount of force to dislodge the connector. Then lift the front of the cartridge over the edge of the front panel.

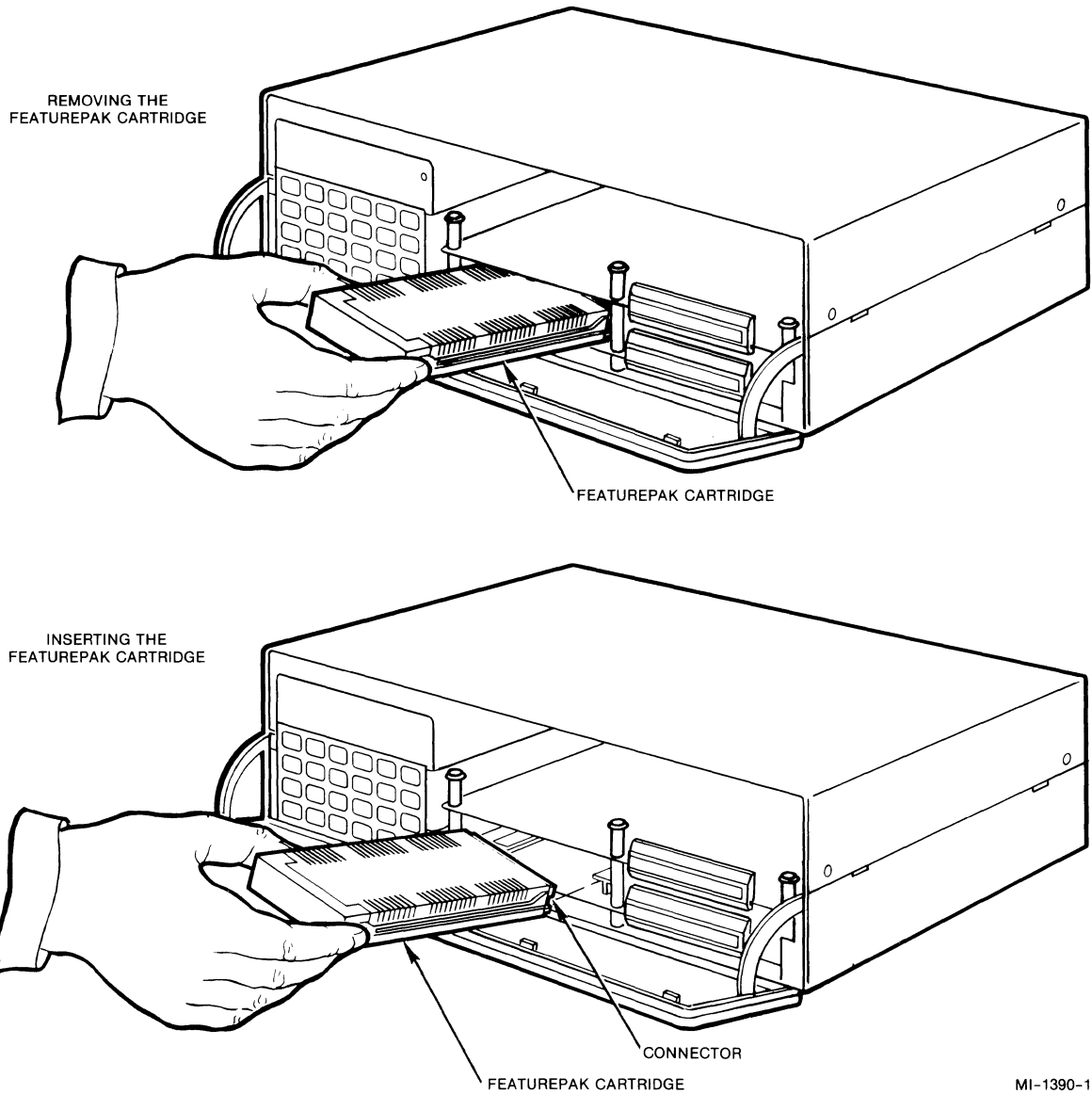

MI-1390-1a-06

Figure 2-5. FEATUREPAK Cartridge Removal and Installation

2.2.4 Standalone or Rack-Mount Installation

The unit can be installed either as a standalone or as a rack-mount. Each type of installation is described in the following paragraphs.

2.2.4.1 Standalone

Place the standalone unit on a tabletop or shelf. Allow enough space for cover removal, handling the back panel connectors, opening the front panel, and unobstructed air flow (refer to paragraph 2.1 for the size of the unit).

2.2.4.2 Rack-Mount

For a rack-mount installation, use a standalone unit with optional Rack-Mount Upgrade Kit MB-RMK-1 (see figure 2-6). Mount the standalone unit in a standard 19-inch wide rack, using the kit. Installation instructions are included with the kit.

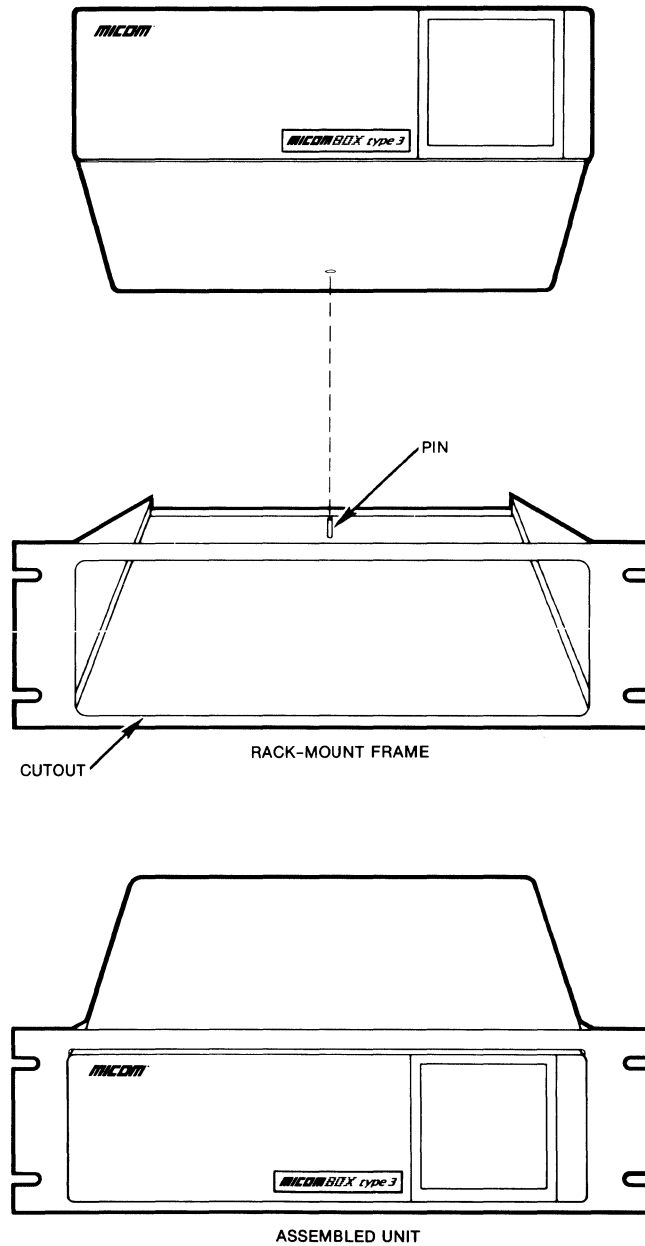

MI-1387-1a-04

Figure 2-6. Rack-Mount Installation

2.2.5 System Connections

System connections are made using MICOM-supplied cables. User-provided cables may also be used (refer to the NOTE that follows). Connect the cables to the connectors located on the back of the enclosure (see figure 2-7).

NOTE: Some equipment connected to the switch does not require a shielded enclosure and shielded cables for the switch in compliance with FCC Rules and Regulations, Part 15/J. When this is the case, it may be necessary to use a filtered connector between the switch and such equipment. This will provide the safeguards required by the FCC. Contact MICOM Sales Administration for the correct filter application.

The system connections to be made when installing the switch are:

- X.25 links
- Command Port
- Interswitch
- Power (ac)

Make sure you have applied the link number strips, as described in paragraph 2.2.1. These strips identify the link numbers.

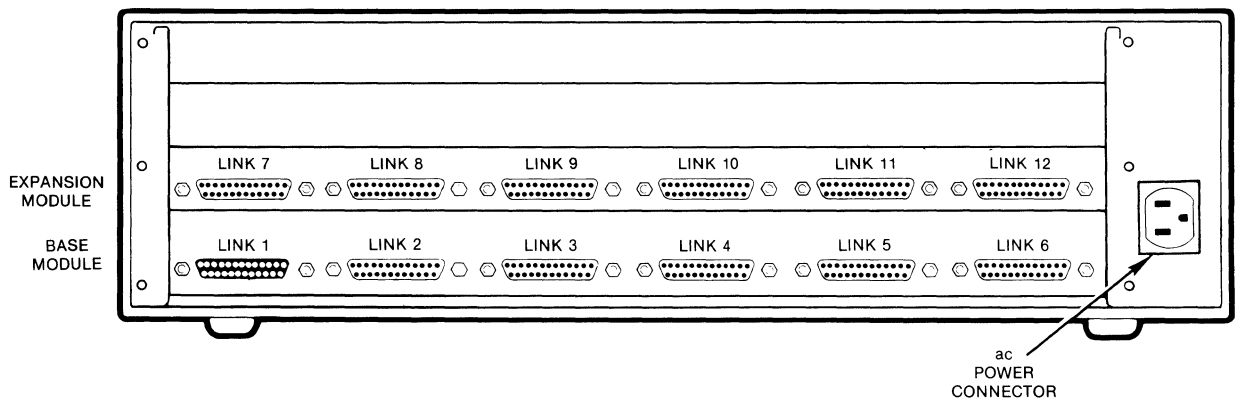

NOTES:
ON 6-LINK UNITS, LINK 6 CAN BE USED FOR A LOCAL COMMAND PORT.
ON 12-LINK UNITS, LINK 12 CAN BE USED FOR A LOCAL COMMAND PORT.
ON UNITS EQUIPPED WITH THE X.21 OR V.35 HIGH-SPEED OPTION, LINK 1 IS THE HIGH-SPEED LINK (REFER TO APPENDIX B).

MI-1390-1a-07

Figure 2-7. Connectors on the Back Panel of the Enclosure

2.2.5.1 System Cabling

This paragraph describes cabling for a switch equipped with all RS-232-C connectors. If your switch is equipped with one of the high-speed options, refer to appendix B for instructions on cabling the high-speed link (link 1).

System connections are made using MICOM-supplied cables. If other cables are used, they must be shielded and must not be longer than 50 feet (15.2 meters). (Refer to the NOTE in paragraph 2.2.5 for special cases where a filtered connector is used.)

The MICOM-supplied cables are identified by their names and part numbers. As shown in figure 2-8, there are numerous possibilities when cabling the switch. Figure 2-8 illustrates typical possibilities, but your specific cabling requirements may be different.

See figures 2-9 through 2-12 for the pin assignments of the following MICOM cables:

- Straight cable -- with a male connector on one end and a female connector on the other (MICOM part number 100-2200-xx)
- Crossover cable -- with a male connector on each end (MICOM part number 100-2352-xx)
- Unique straight cable -- with a male connector on each end (MICOM part number 100-2645-xx)
- Interswitch crossover cable -- with a male connector on each end (MICOM part number 100-2833-xx)

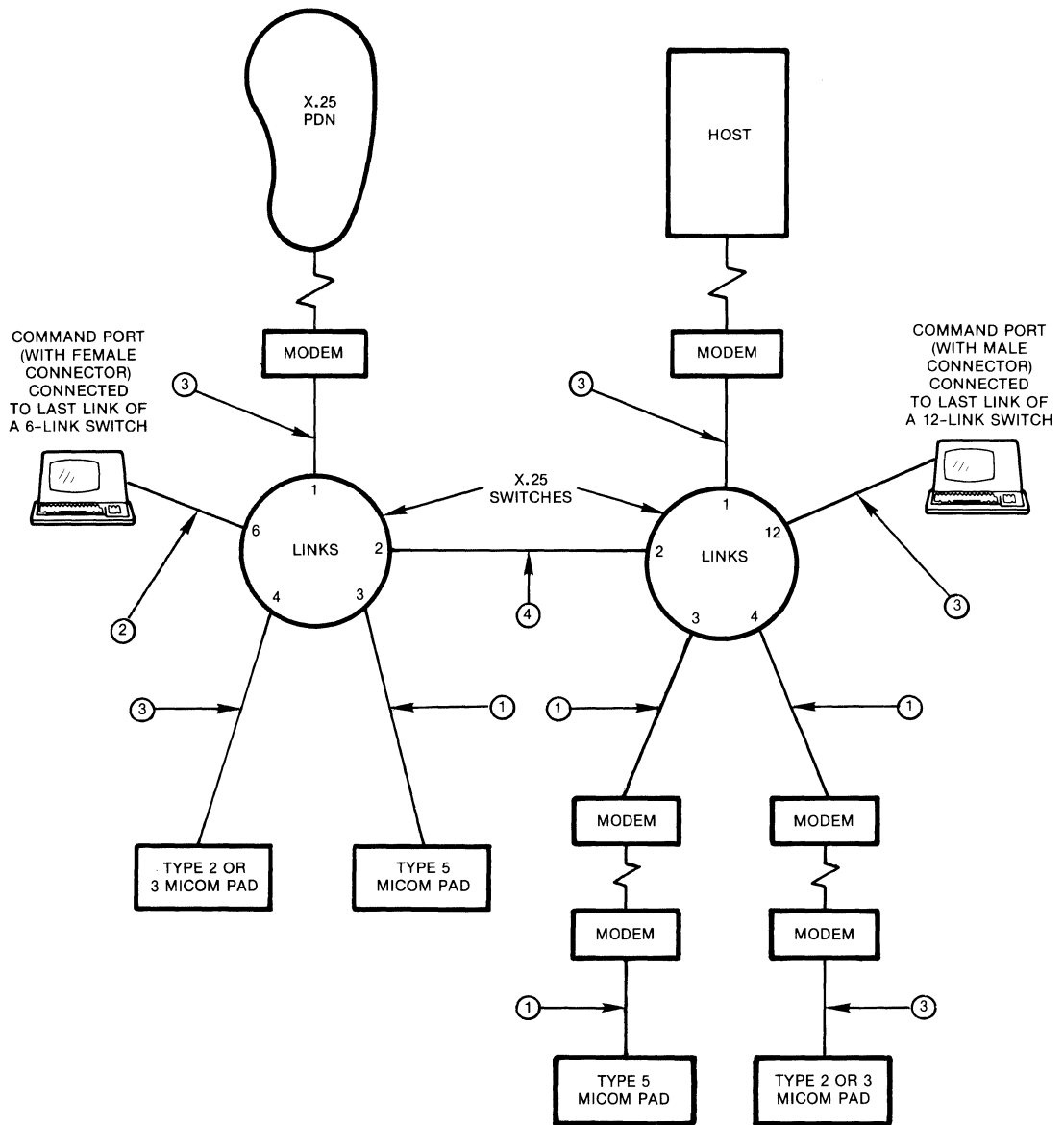

NOTES:

- ① CROSSOVER CABLE WITH A MALE CONNECTOR ON EACH END (MICOM PART NUMBER 100-2352-XX)
- ② UNIQUE STRAIGHT CABLE WITH A MALE CONNECTOR ON EACH END (MICOM PART NUMBER 100-2645-XX)
- ③ STRAIGHT CABLE WITH A MALE CONNECTOR ON ONE END AND A FEMALE CONNECTOR ON THE OTHER (MICOM PART NUMBER 100-2200-XX)
- ④ INTERSWITCH CROSSOVER CABLE WITH A MALE CONNECTOR ON EACH END (MICOM PART NUMBER 100-2833-XX)

MI-1390-1a-01

Figure 2-8. Example of System Cabling

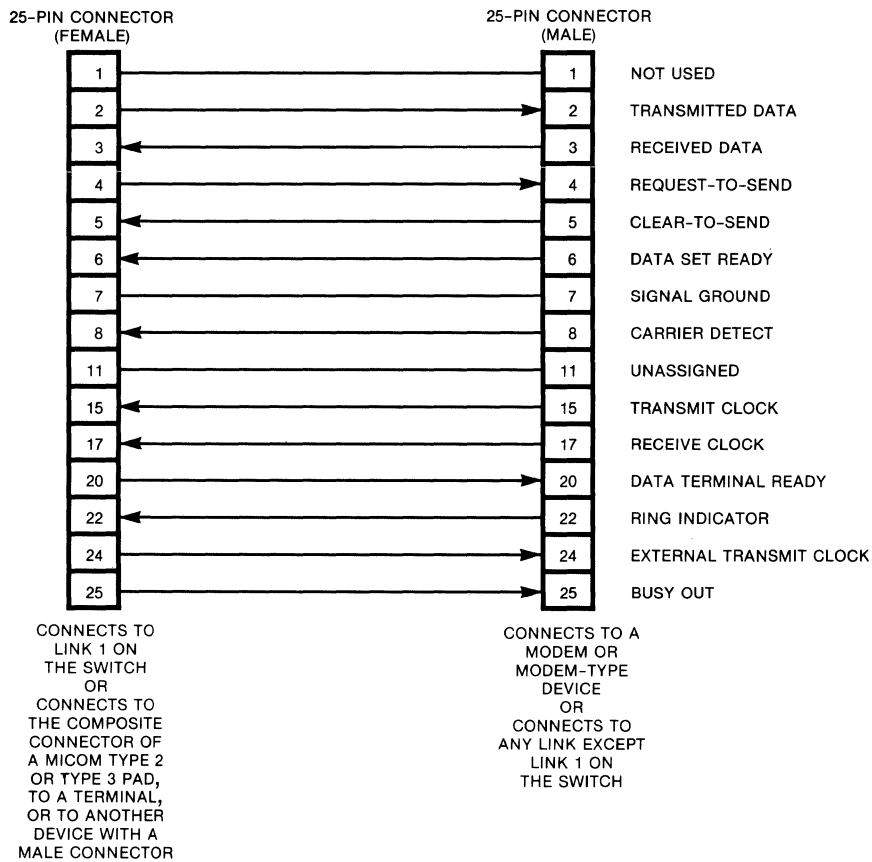

MI-1390-1a-10

Figure 2-9. Pin Assignments for the Straight Cable (MICOM part number 100-2200-xx)

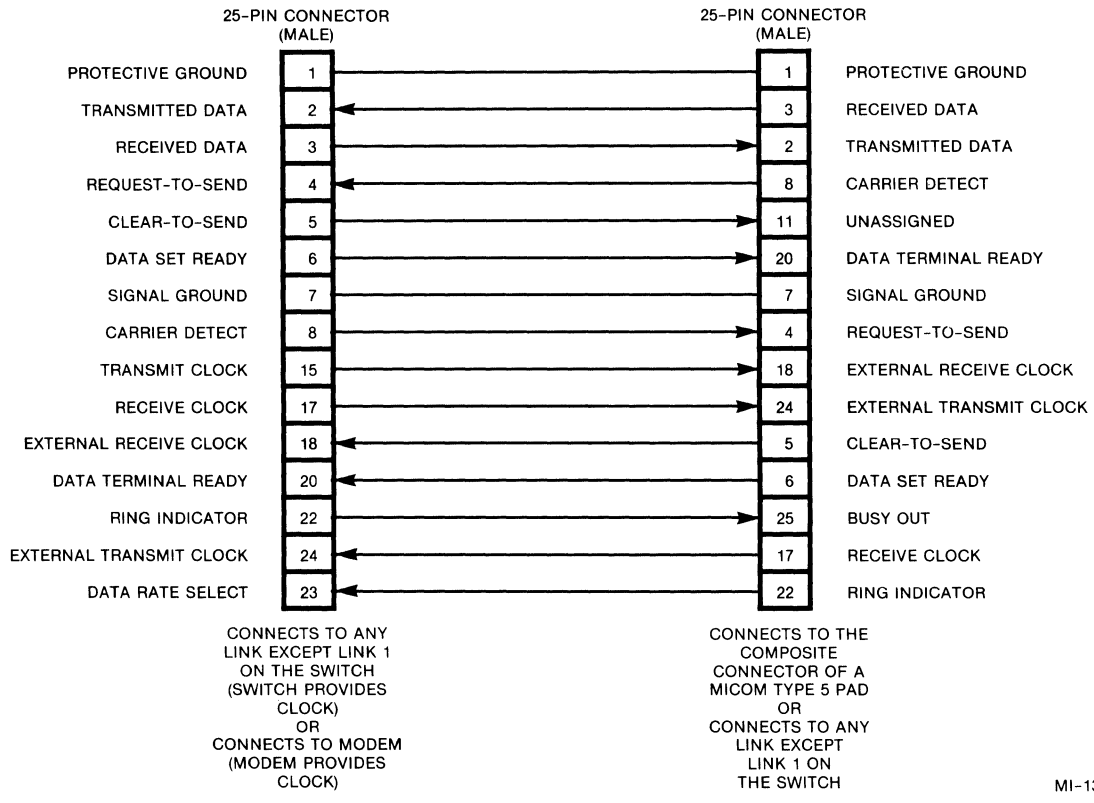

MI-1390-1a-08

Figure 2-10. Pin Assignments for the Crossover Cable (MICOM part number 100-2352-xx)

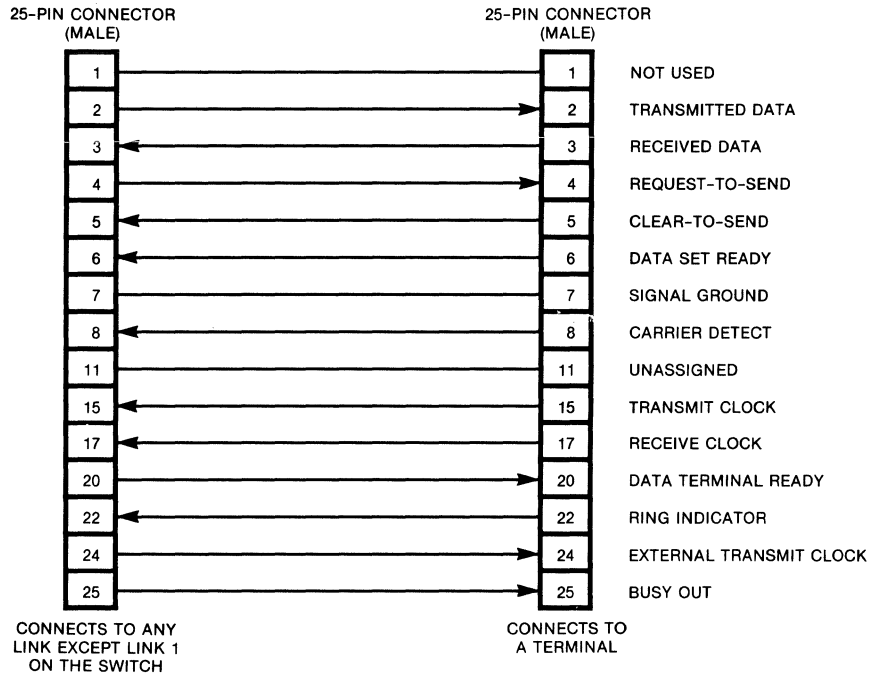

MI-1390-1a-09

Figure 2-11. Pin Assignments for the Unique Straight Cable (MICOM part number 100-2645-xx)

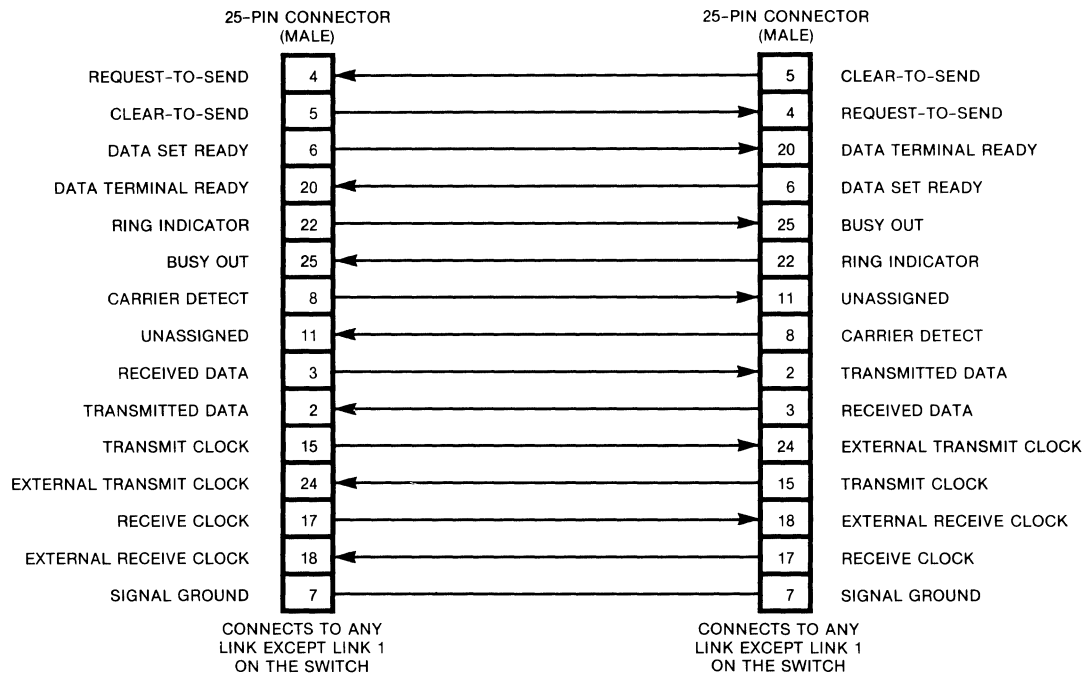

NOTE:
 THIS CABLE MAY BE USED TO CONNECT TWO SWITCHES, OR IT MAY BE USED TO
 CONNECT ANY TWO LINKS (EXCEPT LINK 1) ON THE SAME SWITCH (FOR TESTING).

MI-1390-1a-11

Figure 2-12. Pin Assignments for the Interswitch Crossover Cable
 (MICOM part number 100-2833-xx)

CAUTION: To prevent errors caused by induced noise, do not operate the switch
 with open-ended cables connected to the link interface connectors.
 The other ends of the cables must be connected to devices.

2.2.5.2 X.25 Link Connections

Depending on your unit, you will have 6 or 12 X.25 link connections to make. The following general rules apply when making the X.25 link connections:

- When connecting a modem to the switch's link 1, always use the straight cable (MICOM part number 100-2200-xx).
- Also use the straight cable (MICOM part number 100-2200-xx) when connecting a MICOM BOX Type 2 or Type 3 PAD to any link but link 1 on the switch.
- Use the crossover cable (MICOM part number 100-2352-xx) when connecting a MICOM BOX Type 5 PAD to any link but link 1 on the switch.
- Also use the crossover cable (MICOM part number 100-2352-xx) when connecting a modem to any link but link 1 on the switch. This cable is a crossover. Unlike a straight cable (where conductors are directly connected pin-for-pin), a crossover cable crosses over the pins so that a DCE can communicate with a DCE.

2.2.5.3 Command Port Connection

When connecting a dedicated Command Port to the switch, you must connect it to the last link (that is, to link 6 of a 6-link switch, or to link 12 of a 12-link switch). Depending on the type of connector on your Command Port terminal, you use either the straight cable (MICOM part number 100-2200-xx) or the unique straight cable (MICOM part number 100-2645-xx). These two cables have identical circuit pin assignments. The only difference between them is that 100-2200-xx has one male and one female connector, while 100-2645-xx has two male connectors.

NOTE: Make sure that selection 6 of soft switch group SYS 1 is ON to enable the last link as the Command Port (refer to paragraph 2.3.2).

Once a connection is made, and selection 6 of soft switch group SYS 1 is ON, the Command Port terminal is dedicated for use with the switch's Command Facility.

2.2.5.4 Interswitch Connection

When making a direct switch-to-switch connection, use the interswitch crossover cable (MICOM part number 100-2833-xx). Do not use the link 1 connector on either switch to make this connection.

2.2.5.5 Power Supply Connection

Using the MICOM power cord, plug its female connector into the power supply connector on the back panel (see figure 2-7). Plug the connector on the other end of the cord into the ac power supply wall outlet. Some indicators will go ON (refer to paragraph 6.2 for descriptions of the indicators).

2.3 USING THE TOUCH PANEL TO SET OPERATING PARAMETERS AND THE SWITCH IDENTIFIER

There are two ways to set the switch's operating parameters and its network identifier. One way uses the Command Facility (refer to paragraph 5.4.6). The other way, described in this paragraph, uses the Touch Panel. You can use whichever method you prefer.

The parameters that you set (using the Touch Panel or the Command Facility) relate to the switch's software (soft) switch groups. The ON or OFF settings of selections within those groups determine how the switch will operate and what the switch identifier will be. For example, one selection determines whether the switch will be cold or warm started upon reset.

You use Parameter and Value keys of the Touch Panel to set the switch's operating parameters and define its identifier (see figure 2-13). You use the Touch Panel's Reset keys to reset the switch. Paragraph 2.3.1 gives you background information on how the parameters are stored. Paragraph 2.3.2 describes the operation of the Touch Panel.

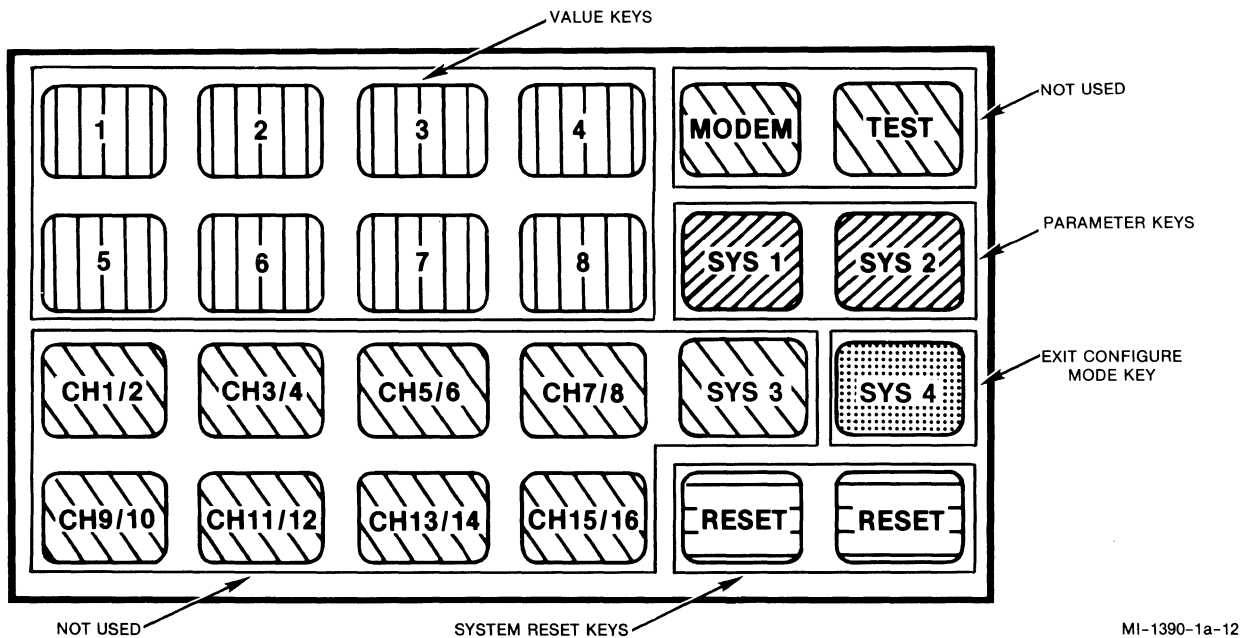

Figure 2-13. Touch Panel

2.3.1 How the Switch Stores Parameters

The parameters that you set using the Touch Panel (or the Command Facility) are stored in battery-backed, nonvolatile CMOS (the battery is not rechargeable). A CMOS failure is software-detectable.

When a CMOS error or a battery-low condition is detected by the switch, some indicators may go ON or start FLASHING. See table 6-1 for information on these indicators.

2.3.2 Using the Touch Panel

The switch's Touch Panel (see figure 2-13), in conjunction with its base module indicators, simplifies the setting of switch operating parameters and the switch identifier. You touch a Parameter Key (SYS 1 or SYS 2) that corresponds to the switch's SYS 1 or SYS 2 soft switch group. The switch is then in its Configure Mode. The base module indicators then show whether selections within that soft switch group are currently set to ON or to OFF.

The Touch Panel is located behind the front panel. To access the keys, pull the top edge of the front panel out and down.

1. Touch the SYS 1 key to select a group of operating parameters (see figure 2-14). Touch the SYS 2 key if you want to assign the switch's identifier (see figure 2-15). After you touch one of these keys, the indicators will show the current settings of the selections.

Also, after you touch the SYS 1 or SYS 2 key, a 25-second timer is started. If another SYS key or a numeric key is touched, the timer is restarted to 25 seconds. If the timer expires, the indicators revert back to their normal state; they reflect system status and link data activity rather than the current status of the operating parameters (refer to paragraph 6.2).

NOTE: If you wish to exit from the Configure Mode without waiting the 25 seconds, touch the SYS 4 key. The switch immediately goes back to its normal operating state, and its indicators reflect system status and link data activity.

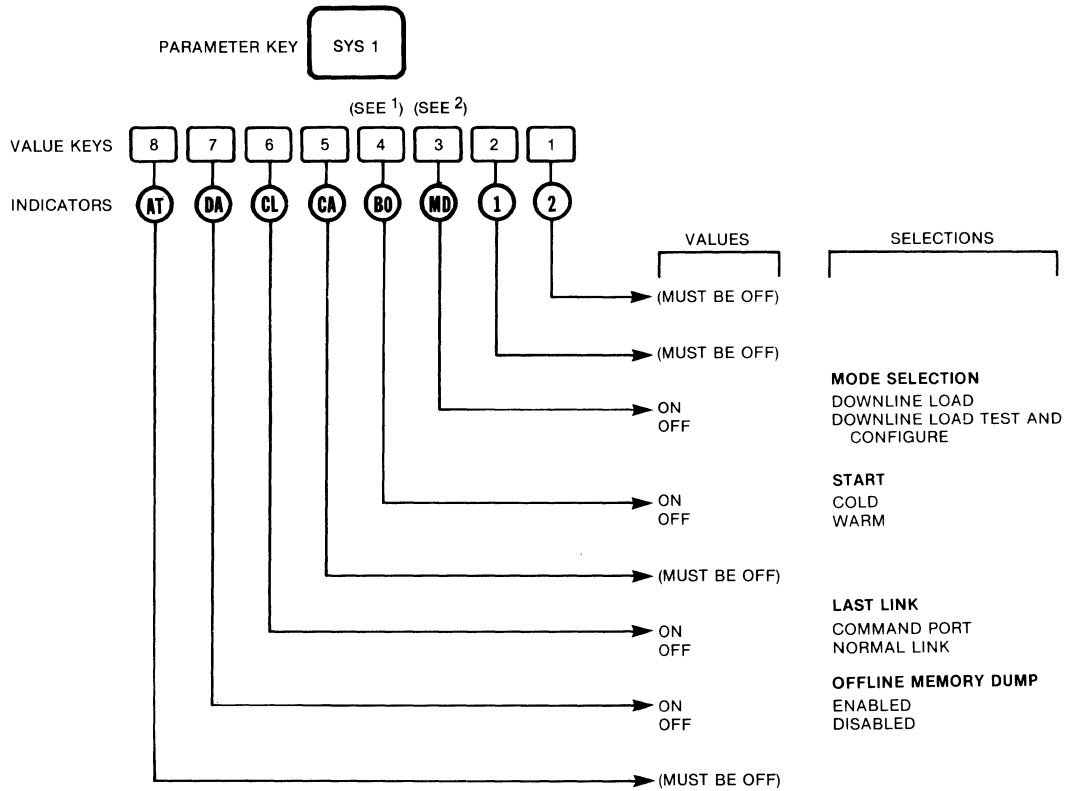

¹ FOLLOWING A COLD START, SELECTION 4 WILL BE TURNED OFF (WARM START). THE CURRENT ON OR OFF SETTINGS OF ALL OTHER SELECTIONS (SYS 1 AND SYS 2) WILL BE RETAINED.

² NOT IMPLEMENTED

MI-1390-1a-13

Figure 2-14. Using the SYS 1 Key to Set Operating Parameters

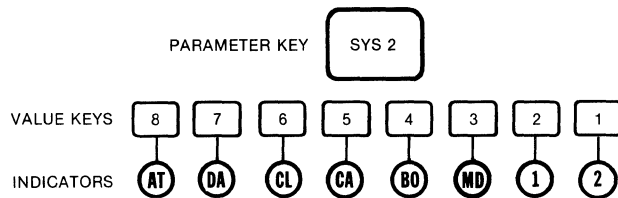

NOTE:
TOUCH SYS 2, AND THEN TOUCH A VALUE KEY OR A COMBINATION OF VALUE KEYS TO ASSIGN THE SWITCH IDENTIFIER NUMBER.

MI-1390-1a-14

Figure 2-15. Using the SYS 2 Key to Set the Switch Identifier

2. Touch the keys labeled 1 through 8 to make specific selections from the group of parameters (SYS 1 or SYS 2) you have just selected. Repeated touching of one of these keys toggles the corresponding value between OFF and ON. The new value (OFF or ON) is stored immediately in CMOS. The indicators (1 through 8) will show the new status (ON or OFF). The correlation of selections to indicators is shown in table 2-1.

Table 2-1. Correlation of Soft Switch Selections to Indicators

| Indicator | Selection |
|-----------|-----------|
| 2 | 1 |
| 1 | 2 |
| MD | 3 |
| BO | 4 |
| CA | 5 |
| CL | 6 |
| DA | 7 |
| AT | 8 |

3. Touch both Reset keys to reset the unit and store the current selection values. During the reset, the base module indicators should be ON.

NOTE: Following a cold-start reset, the value of selection 4 is changed to OFF (warm start). This prevents an accidental cold start of the switch. The values of all other selections stay as they were at the time of the reset.

SECTION 3

SWITCHING AND ROUTING CAPABILITIES

This section contains reference-type material on switching and routing capabilities. For procedures (for example, definition of a link profile), refer to section 5.

3.1 ADDRESS ASSIGNMENT

A network address identifies a particular X.25 link on the network. There are two areas of concern when assigning network addresses:

- The Public Data Network (PDN) address, which is assigned by the PDN authority
- The private network address, which is assigned by the private network administrator (this is part of configuration, described in section 5)

3.1.1 Typical Public Data Network Address

A typical PDN address (up to 15 digits) is comprised of three parts:

- Prefix (optional)
- DNIC -- Data Network Identifier Code
- NTN -- Network Terminal Number

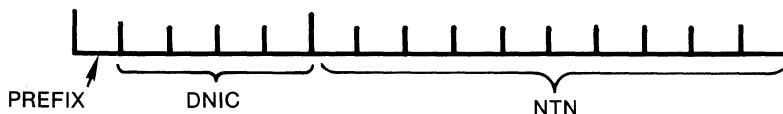

MI-1390-1a-61

The prefix is an optional (network-dependent) digit to indicate that the next four digits are to be interpreted as a DNIC.

The four-digit DNIC identifies a specific international network. The NTN (up to 10 digits) is assigned by the PDN authority to identify a particular X.25 DTE link on the PDN.

In addition, the switch supports both X.121 and Call User Data (CUD) sub-addressing (refer to paragraph 3.1.3).

3.1.2 Typical Private Network Address

A typical private network address (up to 14 digits) is comprised of a one-digit switch number, a one-digit link number, and a two-digit subaddress.

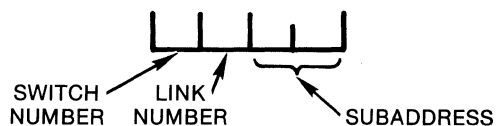

MI-1390-1a-62

The switch number identifies a particular switch in the private network. For private networks with more than nine switches, this would be a two-digit number (that is, 01, 03, 10, and so on).

The link number identifies a particular link on a specific switch. Again, this would be a two-digit number for switches with more than nine links.

The two-digit subaddress field is described in paragraph 3.1.3.

3.1.3 Subaddressing

A subaddress is an extension to a PDN address or a private network address. It allows for extra digits (usually two) to be passed through the network. Once through the network, the subaddress can be used by a PAD to select one of its channels.

The switch supports two types of subaddressing:

- X.121, where the subaddress digits are part of the Called or Calling Address field in the Call Request Packet
- CUD, where the subaddress digits are placed in the CUD field of the Call Request Packet

For each DE or PN link, you can configure the number of subaddress digits and the type of subaddressing (X.121 or CUD). (Refer to paragraph 3.3.) Internally, however, the switch processes all addresses in the X.121 format. When necessary, it converts CUD to X.121 and X.121 to CUD at incoming and outgoing links, respectively.

NOTE: When configuring the routing table for a switch (refer to paragraph 5.4.2), the masks must contain any subaddress digits in the X.121 format. A mask is the address or addresses related to a specific outgoing link.

3.2 HOW THE SWITCH USES THE ADDRESS FIELD

For a simple private network with no connection to a PDN (that is, a network with no PN links), the switch:

- Receives the Call Request Packet
- Converts the subaddress to the X.121 format (if necessary)
- Attempts to match the full address against masks in its routing table
- Forwards the Call Request Packet to the appropriate outgoing link (the link that is associated with the matched routing mask)

For private networks that are connected to PDNs (that is, networks that contain PN links), the switch can perform two types of address translation: speed dial (for outgoing calls to a PDN) or class route (for incoming calls from a PDN). Speed Dial and Class Route both appear on the switch's Configure Menu (described in detail in section 5). Each is described briefly in the following paragraphs.

3.2.1 Speed Dial

The speed dial function allows a Called Address in a private network (which is usually short) to be translated into a PDN Called Address (which is usually 10 to 15 digits). If any subaddress is present, it is carried over transparently.

The procedure is as follows (see figure 3-1). Before the switch forwards a call to a PDN (over a PN link), it tries to match the Called Address (excluding any subaddress) to a speed id in its speed dial table. If it finds a match, the switch replaces the Called Address in the Call Request Packet with the corresponding PDN address in the speed dial table. Any subaddress is passed through and appended to the new Called Address.

If no match is found, the original Called Address is left in its place, and the call is forwarded to the PDN.

The speed dial function facilitates the routing of calls which must go through PDNs. Therefore, this function has meaning only at PN links and only for outgoing calls (from the switch to a PDN).

The switch supports up to 32 speed dial entries. Each entry consists of a two-digit entry number, a two-to-six-digit speed id, an up-to-15-digit PDN address, and an insert id (the insert id defines whether or not the speed id should be inserted in the CUD field as the routing digits).

SAMPLE — SPEED DIAL FUNCTION

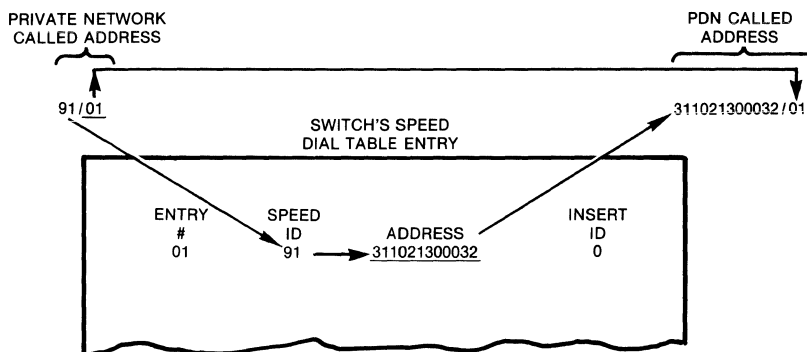

STEPS:

1. THE SWITCH MATCHES THE PRIVATE NETWORK CALLED ADDRESS (WITHOUT THE SUBADDRESS, WHICH IS CARRIED OVER TRANSPARENTLY) TO THE SPEED ID IN ITS SPEED DIAL TABLE.
2. THE SWITCH PICKS UP THE ADDRESS RELATED TO THAT SPEED ID AND MAKES IT THE NEW CALLED ADDRESS (APPENDING THE SUBADDRESS TO IT).

MI-1390-1a-69

Figure 3-1. Speed Dial Function

3.2.2 Class Route

Upon receiving an incoming call from a PDN, the switch first looks for routing digits in the CUD field of the incoming call, and uses the routing digits (along with any subaddress digits) to route the call in the private network (in this case, the class route function is not used).

If no routing digits are present, and a subaddress is present, the switch tries to match the subaddress with one of the route ids in the class route table (see figure 3-2). If a match is found, the address associated with that route id becomes the new Called Address (the original subaddress is not carried over). The switch then uses that address to route the call from the PDN to the destination device.

If the switch finds incomplete routing digits in the CUD field, and finds no class route id match, it uses the address and subaddress in the Call Request Packet to route the call in the private network.

The class route function facilitates the routing of calls from PDNs. Therefore, this function has meaning only at PN links, and only for incoming calls (from the PDN to the switch).

The switch supports up to 32 class route entries. Each entry consists of a two-digit entry number, a two-digit route id, and an up-to-12-digit address.

SAMPLE — CLASS ROUTE FUNCTION

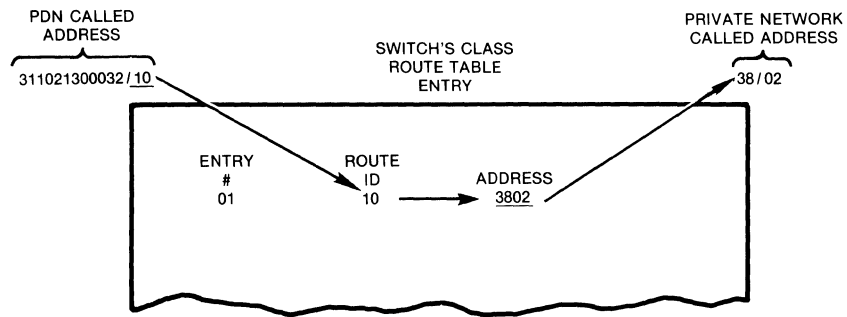

STEPS:

1. THE SWITCH MATCHES THE SUBADDRESS OF THE PDN CALLED ADDRESS TO THE ROUTE ID IN ITS CLASS ROUTE TABLE.
2. THE SWITCH PICKS UP THE ADDRESS RELATED TO THAT ROUTE ID AND MAKES IT THE NEW CALLED ADDRESS. THE NEW CALLED ADDRESS INCLUDES THE DESIRED SUBADDRESS (02).

MI-1390-1a-68

Figure 3-2. Class Route Function

3.3 LINK PROFILE

The user can define a link profile for each link on the switch, up to a maximum of 12. The link profile defines the following items:

- The link's physical characteristics:
 - Link number (01 through 12)
 - Speed (up to 19,200 bps, with internal or external clock; up to 72,000 bps on link 1 for a switch equipped with a high-speed option)
- The type of link:
 - IS
 - DE with X.121 subaddressing
 - DE with CUD subaddressing
 - PN with X.121 subaddressing
 - PN with CUD subaddressing
- The logical appearance of the link:
 - DCE
 - DTE

- The X.25 characteristics:
 - k (frame level window)
 - n2 (number of retransmissions)
 - t1 (acknowledgment timer)
 - t3 (link assurance timer)
 - t10/t20 (restart timer) is fixed at one minute
 - t11/t21 (call request timeout timer)
 - t12/t22 (reset request timeout timer)
 - t13/t23 (clear request timeout timer)
 - modulo 8 (standard packet sequencing)

- The type and number of logical channels (switched virtual circuits, or SVCs):
 - Up to 127 per link
 - Incoming only, outgoing only, or incoming and outgoing

- The handling of X.25 facilities:
 - Clear incoming calls with unwanted facilities
 - Insert or delete desired facilities before forwarding a call to a DE or PN link

- The handling of the address fields:
 - Number of digits for the subaddress on DE or PN links
 - Number of routing digits in the CUD field for incoming calls from PN links
 - Replace the calling address with the PDN calling address
 - Remove the calling address on calls to PN links

- Special routing capabilities:
 - Autoconnect to a specific link
 - Alternate autoconnect link
 - Load sharing

3.4 ROUTING

The heart of the switch is its ability to route calls in the quickest and most efficient way. It goes through a series of steps to select the best route. If no autoconnect link is configured, it references its routing table to select the eligible link or links (the eligible link set). Next, it determines which of those links are available; that is, which are operational and have Logical Channel Numbers (LCNs) available. Finally, the switch selects the optimum link from those that remain in the link set, based on a best-path selection algorithm.

3.4.1 Selection of Eligible Link Set

When the switch receives an incoming call packet, it checks the Called Address and CUD fields to obtain the routing information (refer to paragraph 3.2). It then compares the routing information with every mask in its routing table, and extracts an entry (or entries) from the table that matches the routing information (refer to paragraph 5.4.2 for instructions on setting up the routing table). These entries comprise the eligible link set.

NOTE: If an incoming call comes in on a link that is defined for autoconnect, the call is automatically forwarded to the defined link number. In this case, the switch does not reference its routing table.

The user can define up to 64 routing masks (up to 15 characters long) for the routing table. However, thousands of addresses on the network (not just 64) can be represented, because of the switch's "wildcard" capability. Wildcard characters in a mask are represented by the letter F (some masks may contain all Fs). Other valid entries in a mask are the digits 0 through 9. A mask might look like the following:

03110213000129F

MI-1390-1a-63

In this example, the mask would match any incoming calls with an address of 0311021300012 and a subaddress of 9F (that is 90 through 99). Links associated with that mask would comprise the eligible link set.

There can be up to four links related to a mask. Each link is coupled with a priority number. The entire routing table is illustrated in section 5, but one sample line in the table might appear as follows:

| entry | mask | link | priority | link | priority | link | priority | link | priority |
|-------|--------------------------------|------|----------|------|----------|------|----------|------|----------|
| 01 | up to 15 char- acters | 01 | 02 | 03 | 04 | 05 | 06 | 07 | 08 |

MI-1390-1a-64

As illustrated, links 01, 03, 05, and 07 (and their respective priority values) are related to the entry 01 mask. These four links comprise a link set. Lower values have the higher priority. That is, link 01 has the highest priority in the link set, because its related priority value is the smallest. One way in which the user has control over the configuration of his network is in the assignment of link priority values.

It is possible to have more than four links associated with a link set, by "chaining" masks. Mask chaining is accomplished by defining identical masks with different entry numbers. For example, the first two masks in the routing table might look like the following:

| entry | mask | link | priority | link | priority | link | priority | link | priority |
|-------|----------------|------|----------|------|----------|------|----------|------|----------|
| 01 | 311021300012FF | 01 | 01 | 03 | 02 | 05 | 03 | 07 | 04 |
| 02 | 311021300012FF | 02 | 05 | 04 | 06 | 06 | 07 | 08 | 08 |

MI-1390-1a-65

In the preceding example, eight links are associated with two identical masks.

One very useful way to assign link priorities is to count the number of hops for the link and assign that count as the link priority. The number of hops is defined as the number of intervening switches that a call must visit in order to reach its destination by way of that link.

The priority of a link may also be determined based on the cost of the link. Obviously, you would try to give lower-cost links higher priorities (lower priority values in the routing table).

3.4.2 Checking the Status of Links

The switch proceeds to reduce the number of links in the eligible link set by performing the following checks:

- It checks the type of incoming call. If the call is not a diagnostic call, the switch eliminates the PN or IS link from which the incoming call originated. That is, it prevents the call from being routed back to the switch from which it came.
- It checks the operational status of the links, and eliminates any which are nonoperational.
- It checks each link for the availability of LCNs. If the number of LCNs has reached the maximum number allowed, or if there are no outgoing LCNs available, the link is eliminated (refer to paragraph 3.3 for information on LCNs related to links).

3.4.3 Best-Path Selection

After completing the eligible link set selection process, the switch invokes the best-path selection algorithm to calculate the routing priority of each link in the eligible link set. In this case, the link with the highest value following the calculations is selected as the optimum link for forwarding the call.

The switch offers the user three choices in best-path selection:

- Static priority, as defined by the priority value in the routing table
- Dynamic priority, as determined by the available LCNs of the link
- A weighted combination of the static and dynamic methods

The best-path selection algorithm can be expressed as described in (A) and (B), which follow. The static priority is assigned the constant Beta and the dynamic priority is assigned the constant Delta. Beta and Delta are switch-wide (not link-specific) configurable values (refer to paragraph 5.4.6).

In the (A) and (B) algorithms:

- Speed equals the link speed as follows (speeds above 19,200 bps apply only to link 1, and only on switch's equipped with a high-speed option):

2 = 1200 bps
4 = 2400 bps
6 = 4800 bps
8 = 9600 bps
10 = 14400 bps
12 = 19200 bps
14 = 48000 bps
16 = 56000 bps
18 = 64000 bps
20 = 72000 bps

- Available LCNs (Av.LCN) is equal to:

Total number of LCNs - total number of active LCNs

- Link Static Priority (LSP) is the value defined in the routing table.
- Beta is a user-configurable system parameter, with valid values in the range 0 to 8, inclusive (default is 1).
- Delta is a user-configurable system parameter, with valid values in the range 0 to 8, inclusive (default is 0).

NOTE: If both Beta and Delta are set equal to 0, the switch will use a value of Beta equal to 1 (static priority).

(A) WHEN EITHER BETA OR DELTA IS EQUAL TO 0:

ROUTE PRIORITY = SPEED X AV.LCN X DELTA + (10 - LSP) X BETA

(B) WHEN BOTH BETA AND DELTA ARE EQUAL TO A VALUE
IN THE RANGE 1 THROUGH 8, INCLUSIVE:

ROUTE PRIORITY = [SPEED X AV.LCN X (DELTA X DELTA)]

+

[(10-LSP) X (BETA X BETA)]

MI-1390-1a-15

3.4.4 Logical Channel Selection

After the switch selects the best path, it proceeds to assign a Logical Channel Number (LCN) on that link. This is the LCN on which it will forward the call.

The switch assigns LCNs differently depending on the type of link (DCE or DTE), as defined in the link profile (refer to paragraph 3.3).

If the selected link is configured as DCE, the switch looks for the lowest available outgoing-only LCN (based on the link profile). If no outgoing-only LCNs are available, then the switch looks for the lowest available incoming/outgoing LCN.

If the selected link is configured as DTE, the switch looks for the highest available outgoing-only LCN (based on the link profile). If no outgoing-only LCNs are available, then the switch looks for the highest available incoming/outgoing LCN.

3.5 CALL FACILITY MANIPULATION

A link can be configured to clear an incoming call based on certain facilities (refer to paragraph 3.3). On the other hand, the link can be configured to insert or delete (mask) facilities in outgoing calls, to further the compatibility between networks and different types of equipment.

When the fast select, Network User Identification (NUI), or reverse charge facility is barred on a link, an incoming call with one of those facilities is cleared. This is valid only on DE and PN links (not on IS links). (Refer to paragraph 5.4.7 for information on the NUI facility support.)

Also valid only on DE and PN links is the facilities addition capability. In this case, the reverse charge, packet size negotiation, or window size negotiation facility can be inserted before a call is forwarded to the DE or PN link.

The switch's facilities deletion (masking) capability is also valid only on DE and PN links. In this case, the packet size negotiation, window size negotiation, throughput class negotiation, or NUI facility can be deleted (masked) before a call is forwarded to the DE or PN link.

For calls with the Closed User Group (CUG) facility, the switch does no verification. It passes such calls through to their destinations.

3.6 CALL CLEARING PROCEDURES

The switch may invoke call clearing procedures:

- At call setup time
- Upon detection of a link or switch failure
- Upon receipt of a Clear Request Packet

3.6.1 At Call Setup Time

The switch will clear a call if it encounters one of the following:

- A format error in the incoming call packet
- A facility that is barred on the incoming link
- A network problem that prohibits call completion

The clear cause codes and their definitions can be found in section 6.

3.6.2 Upon Detection of a Link or Switch Failure

When the switch detects that one of its DE, PN, or IS links has gone down, it clears all virtual calls established on that link.

3.6.3 Upon Receipt of a Clear Request Packet on a DE or PN Link

When the switch receives a Clear Request Packet, it sends the packet to the other link that is involved in the call. It then waits for a Clear Confirmation Packet to come in from that link. Upon receiving a Clear Confirmation on that link, the switch clears the call and makes the related LCNs available for another call.

If the switch receives a Clear Request Packet, but never receives a Clear Confirmation Packet, it waits for the t13/t23 (clear request timeout timer) to expire and then clears the call. (The t13/t23 values are configurable through the link profile, described in section 5.)

3.6.4 Upon Detection of a Disconnect LCN Command

At the operator's discretion, an LCN can be disconnected using the Disconnect LCN Command from the Command Menu. When the switch detects this command, it sends a Clear Request Packet in both directions.

3.7 HANDLING OF PACKETS

The switch passes some packets through transparently. Other packets require special handling by the switch. The two cases are described in the following paragraphs.

3.7.1 Packets That Pass Through Transparently

Data Packets The sequence numbering in Data Packets has end-to-end significance. The maximum packet size must be the same at the originating and destination ends of the network. The switch does not perform any recombination or splitting of Data Packets.

Interrupt Packets An Interrupt Packet received on a DE or PN link has end-to-end significance.

Rej, RR, RNR, and Diagnostic Packets These packets have end-to-end significance.

3.7.2 Packets That Require Special Handling

Call Packets The switch must route these, as described in paragraph 3.4.

Clear Packets The switch must perform some housecleaning. That is, it clears the SVCs in use.

Reset Packets Under some circumstances, the switch may generate these packets to indicate data loss or protocol violation (for example, receipt of an out-of-sequence Data Packet in the Data Transfer State). However, a Reset Packet received on a DE or PN link has end-to-end significance. All data queued for the virtual circuit is discarded.

Restart Packets The switch must perform some housecleaning. That is, it clears all calls on the specific link.

3.8 FLOW CONTROL

The switch exercises flow control at the link level, using a frame RNR. If the buffer levels get too low, the switch flow controls the link from which the largest number of packets are waiting to be forwarded. If necessary, it also flow controls other links.

3.9 REMOTE ACCESS TO THE COMMAND FACILITY

The user can assign a unique subaddress to the Command Facility to allow remote access to the facility. This subaddress is assigned through item 5 of the Configure Menu (refer to paragraph 5.4.5).

Upon receipt of an incoming call to the Command Facility, the switch sends the X.29 Set Message to configure the remote user's X.3 parameters to the required Command Facility values. When the remote user enters a Logout Command, the Command Facility sends out the Invitation to Clear Message to free itself for access by other users (unless the remote user entered a Logout Command in order to view statistics, or if event reporting is enabled).

Remote access to the Command Facility has higher priority than access to the local Command Port. Therefore, when the Command Facility is being accessed remotely, access to the local Command Port is prevented. Refer to paragraph 5.2 for information on accessing the Command Facility, both locally and remotely.

3.10 HANDLING OF WILD CALLS

A wild call is one that has:

- Visited too many stopover switches (hops) enroute to its destination. The maximum number of hops is configurable, through the system parameters selection of the Configure Menu (refer to paragraph 5.4.6).
- Visited the same switch more than once.

When the switch detects a wild call, it sends a message by way of the Command Facility. This is one of the event reporting capabilities. For details on event reporting, refer to paragraph 5.6.

SECTION 4

APPLICATION EXAMPLES

This section contains seven examples of switch applications. Both private and public network applications are illustrated. If you are setting up a private network, you should focus on paragraphs 4.1 and 4.2. On the other hand, if your network includes one or more PDNs, focus on paragraphs 4.3 through 4.7.

Along with each illustration is information on numbering and configuring the links. Where applicable, sample routing tables are also shown. Each example then explains how calls would be routed, based on certain assumptions.

Functions of the switch that are illustrated in the following examples are:

- Address conversion on incoming link -- paragraph 4.7
- Autoconnect link -- paragraph 4.3
- Autoconnect link with alternate link -- paragraph 4.5
- Class route -- paragraph 4.6
- Load sharing -- paragraphs 4.2, 4.6, and 4.7
- Speed dial -- paragraph 4.6

The Network Administrator should be aware that this section contains sample applications. There are so many different ways to set up networks that probably none of these application examples will be usable without first being modified to fit a specific network topology.

For details on link numbering, refer to paragraph 2.2.1. Section 5 contains information on configuring links and on setting up routing, class route, speed dial, and NUI tables.

4.1 SWITCHING CONCENTRATOR IN A SINGLE-SWITCH PRIVATE NETWORK

The private X.25 network shown in figure 4-1 allows terminal users (connected to X.25 PADs) at dispersed locations to access host computers. This is a simple, single-switch network. An example of how this network could be expanded is given in paragraph 4.2.

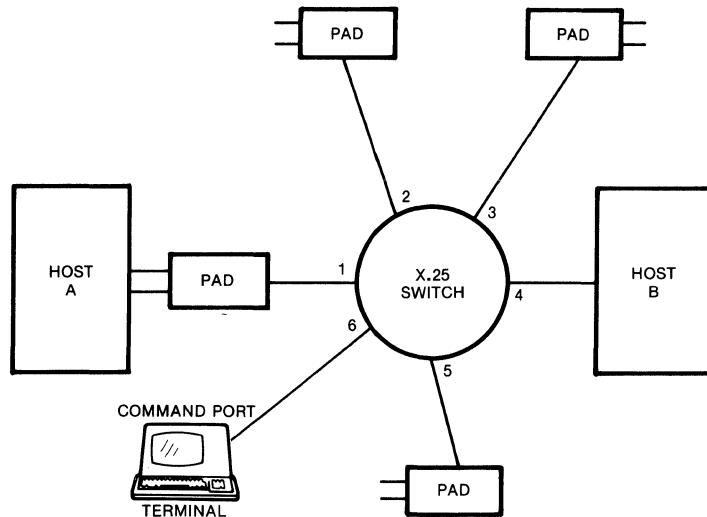

MI-1390-1a-16

Figure 4-1. Switching Concentrator in a Single-Switch Private Network

Assumptions:

- The X.25 switch is identified as switch 1.
- Excluding the Command Port connection (6), link numbering is 1 through 5, as shown in figure 4-1.
- All links are configured as DE.
- The Command Port provides network configuration and control capabilities, but it cannot receive calls. It is connected to the last link (that is, link 6 on a 6-link switch).
- The routing table is set up as follows:

| Entry | Mask | Link | Priority |
|-------|------|------|----------|
| 01 | 11FF | 1 | 0 |
| 02 | 12FF | 2 | 0 |
| 03 | 13FF | 3 | 0 |
| 04 | 14FF | 4 | 0 |
| 05 | 15FF | 5 | 0 |

- For simplicity, a four-digit addressing scheme is chosen:

First Digit = Destination Switch Number

Second Digit = Destination Link Number

Third and Fourth Digits = PAD Channel Class or Host Computer Application

- A terminal user connected to the link 5 PAD has entered the following Call Request (to call host computer A):

C 1112

Based on these assumptions, routing would be as follows:

- The switch would match the 1112 with entry 01 (11FF) in its routing table. Based on that match, it would forward the call to its link 1, passing the 12 of 1112 transparently to the PAD.
- Upon receiving the call, the PAD would use the 12 to perform its own routing.

4.2 SWITCHING CONCENTRATOR WITH MULTIPLE SWITCHES IN A PRIVATE NETWORK

The private X.25 network shown in figure 4-2 is an expanded version of the single-switch network shown in figure 4-1. Notice that the top part of figure 4-2 is identical to figure 4-1, except for the absence of the PAD originally connected to link 5. To accommodate increased traffic, the network has been expanded to include two more switches, one more host computer, and numerous PADS.

As shown in figure 4-2, there is a link between switch 1 and switch 3. It is there to facilitate service redundancy. For example, a call from a switch 1 PAD to host computer C can be routed to link 6, if primary link 5 is out of service.

This example also illustrates load sharing. The two links between switches 2 and 3 are configured for load sharing (refer to paragraph 5.4.1).

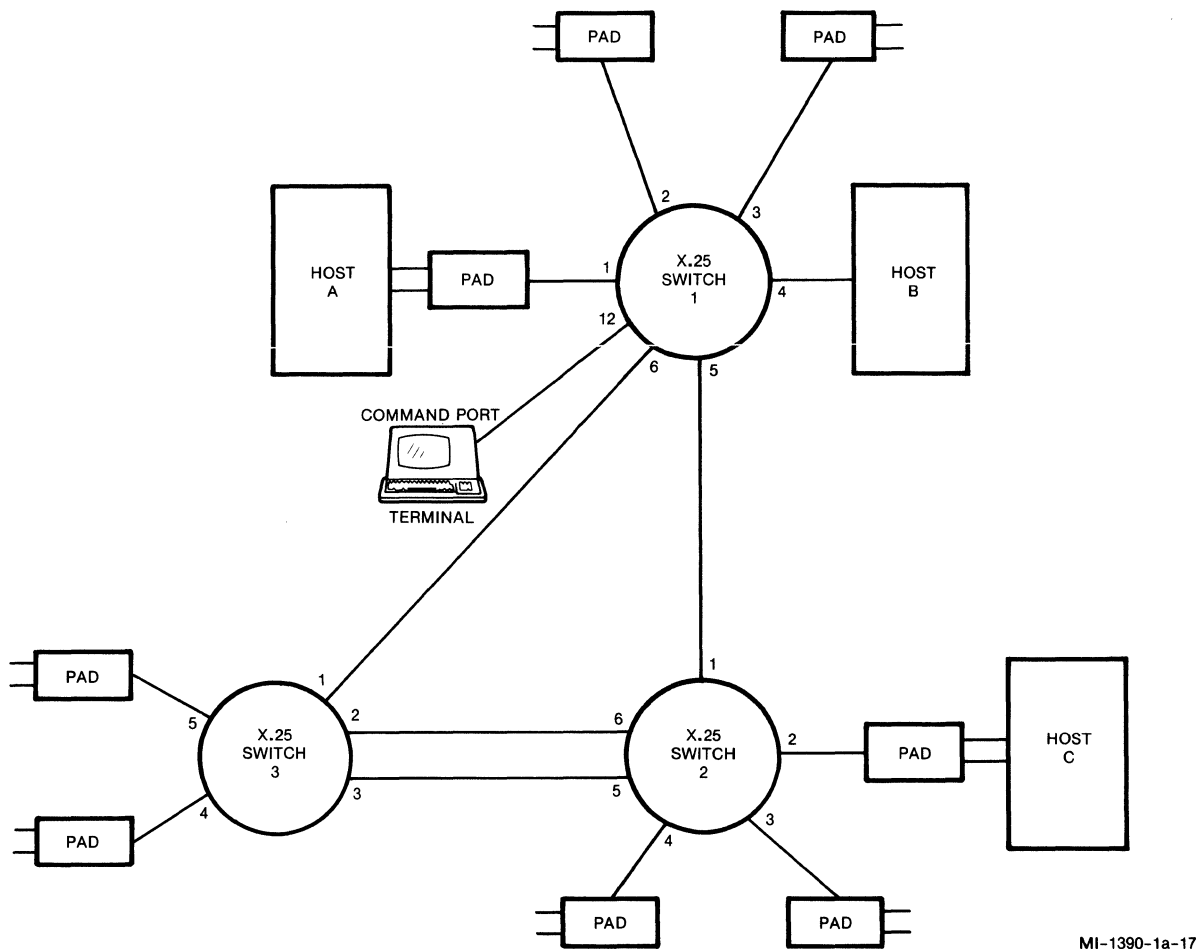

Figure 4-2. Switching Concentrator With Multiple Switches in a Private Network

Assumptions related to switch 1:

- Link numbering is 1 through 6, as shown in figure 4-2.
- Links 1 through 4 are configured as DE; links 5 and 6 are configured as IS.
- The Command Port provides network configuration and control capabilities, but it cannot receive calls. It is connected to the last link (that is, link 12 on a 12-link switch).
- The routing table is set up as follows (the first four entries are identical to those in the routing table in paragraph 4.1):

| Entry | Mask | Link | Priority | Link | Priority |
|-------|------|------|----------|------|----------|
| 01 | 11FF | 1 | 0 | | |
| 02 | 12FF | 2 | 0 | | |
| 03 | 13FF | 3 | 0 | | |
| 04 | 14FF | 4 | 0 | | |
| 05 | 2FFF | 5 | 0 | 6 | 5 |
| 06 | 3FFF | 6 | 0 | 5 | 5 |

Assumptions related to switch 2:

- Link numbering is 1 through 6, as shown in figure 4-2.
- Links 2, 3, and 4 are configured as DE; links 1, 5, and 6 are configured as IS.
- Links 5 and 6 are configured for load sharing.
- The routing table is set up as follows:

| Entry | Mask | Link | Priority | Link | Priority | Link | Priority |
|-------|------|------|----------|------|----------|------|----------|
| 01 | 1FFF | 1 | 0 | 6 | 5 | 5 | 5 |
| 02 | 3FFF | 6 | 0 | 5 | 0 | 1 | 8 |
| 03 | 22FF | 2 | 0 | | | | |
| 04 | 23FF | 3 | 0 | | | | |
| 05 | 24FF | 4 | 0 | | | | |

Assumptions related to switch 3:

- Link numbering is 1 through 5, as shown in figure 4-2.
- Links 4 and 5 are configured as DE; links 1, 2, and 3 are configured as IS.
- Links 2 and 3 are configured for load sharing.
- The routing table is set up as follows:

| Entry | Mask | Link | Priority | Link | Priority | Link | Priority |
|-------|------|------|----------|------|----------|------|----------|
| 01 | 1FFF | 1 | 0 | 2 | 5 | 3 | 5 |
| 02 | 2FFF | 2 | 0 | 3 | 0 | 1 | 8 |
| 03 | 34FF | 4 | 0 | | | | |
| 04 | 35FF | 5 | 0 | | | | |

General assumptions:

- For simplicity, a four-digit addressing scheme is chosen:

First Digit = Destination Switch Number

Second Digit = Destination Link Number

Third and Fourth Digits = PAD Channel Class or Host Computer
Application

- A user of a PAD connected to switch 3 has entered the following Call Request (to call host computer A):

C 1123

Based on these assumptions, routing would be as follows:

1. Switch 3 would find a match with entry 01 in its routing table. Then it would attempt to forward the call to its link 1 (link 1 has the highest priority in the eligible link set — refer to paragraph 3.4.1). Assume that link 1 was out of service. In that case, switch 3 would attempt to forward the call to its link 2 or 3, selecting the one with the fewest number of LCNs currently in use (load sharing).

Notice that links 2 and 3 have equal priority. This is how links configured for load sharing should appear in a routing table.

2. Upon receipt of the call, switch 2 would find a match with entry 01 of its routing table and would forward the call to link 1.
3. Upon receipt of the call, switch 1 would forward it to its link 1, passing the 23 (the PAD class) of C 1123 transparently to the PAD.
4. Upon receipt of the call, the PAD would use the 23 for its call routing.

As shown in this example, setting up a network with redundant paths allows calls to get through even when primary links are out of service. Also, by configuring links for load sharing, traffic on those links is spread out more evenly.

4.3 PAD CONCENTRATOR AND PDN GATEWAY

As shown in figure 4-3, the switch can act as a concentrator for X.25 PADs that wish to access a PDN. Numerous users in dispersed locations are able to access the PDN through a single X.25 access link.

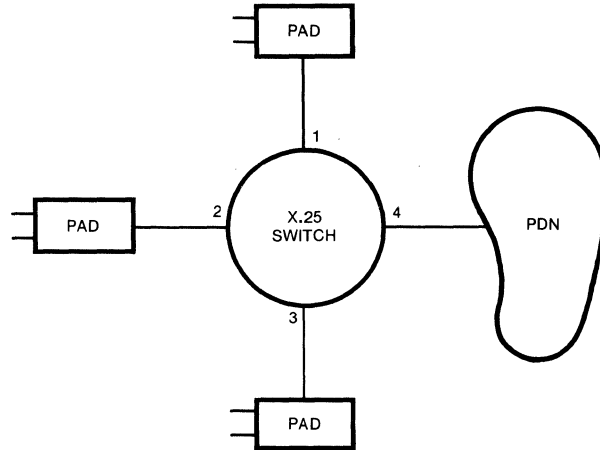

MI-1371-1a-36

Figure 4-3. PAD Concentrator and PDN Gateway

Assumptions:

- Link numbering is 1 through 4, as shown in figure 4-3.
- Links 1 through 3 are configured as DE; link 4 is configured as PN.
- Links 1, 2, and 3 are configured for autoconnect to link 4 (refer to paragraph 5.4.1 for information on the link profiles). Therefore, no routing table is required.

Based on these assumptions, the switch would automatically forward all incoming calls from link 1, 2, or 3 to link 4.

4.4 HOST PADs CONCENTRATOR AND PDN GATEWAY

As in the previous example, this example shows a switch offering numerous users access to a PDN through a single X.25 access link. In addition, this example illustrates how users of a PDN (in this example, PAD users) can access different host applications (see figure 4-4).

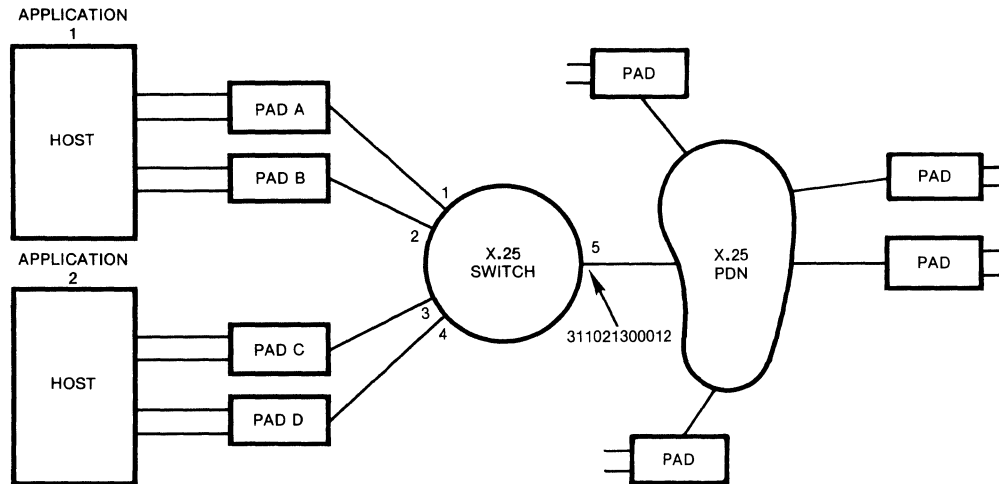

MI-1390-1a-18

Figure 4-4. Host PADs Concentrator and PDN Gateway

Assumptions:

- Each host is front-ended with two 16-channel PADS.
- The PDN supports X.121 subaddressing.
- The network address assigned to link 5 is 311021300012.
- Link numbering is 1 through 5, as shown in figure 4-4.
- Links 1 through 4 are configured as DE; link 5 is configured as PN.

- The channel class (subaddress) configurations for PADs A, B, C, and D are as follows:

PAD A: channels 1-11 class 10
 channels 12-16 class 12
 Command Facility class 99

PAD B: channels 1-8 class 10
 channels 9-11 class 12
 channels 12-16 class 10
 Command Facility class 89

PAD C: channels 1-12 class 30
 channels 13-16 class 32
 Command Facility class 79

PAD D: channels 1-4 class 30
 channels 5-11 class 32
 channels 12-16 class 30
 Command Facility class 69

The switch's routing table is set up as follows:

| Entry | Mask | Link | Priority | Link | Priority |
|-------|----------------|------|----------|------|----------|
| 01 | 31102130001299 | 1 | 5 | | |
| 02 | 3110213000121F | 1 | 3 | 2 | 5 |
| 03 | 31102130001289 | 2 | 5 | | |
| 04 | 3110213000123F | 3 | 2 | 4 | 7 |
| 05 | 31102130001279 | 3 | 5 | | |
| 06 | 31102130001269 | 4 | 5 | | |

Based on these assumptions, incoming calls from the PDN would be routed as follows:

- Those with class fields in the range 10 to 19 would get routed to link 1 or 2 (see entry 02 in the routing table).
- Those with class fields in the range 30 to 39 would get routed to link 3 or 4 (see entry 04 in the routing table).
- Command Facility classes would be routed as follows:

Class 99 to link 1 (see entry 01 in the routing table)
 Class 89 to link 2 (see entry 03 in the routing table)
 Class 79 to link 3 (see entry 05 in the routing table)
 Class 69 to link 4 (see entry 06 in the routing table)

4.5 HOST ACCESS THROUGH TWO PDNs

In this example, users of two different PDNs (in this example, PAD users), can access the same X.25 host computer (see figure 4-5). The host is equipped with two X.25 links to maintain service even if one link is nonoperational (the other link takes over).

This example is similar to the one in paragraph 4.3, where links are configured for autoconnect. In this example, the use of an alternate autoconnect link is also illustrated.

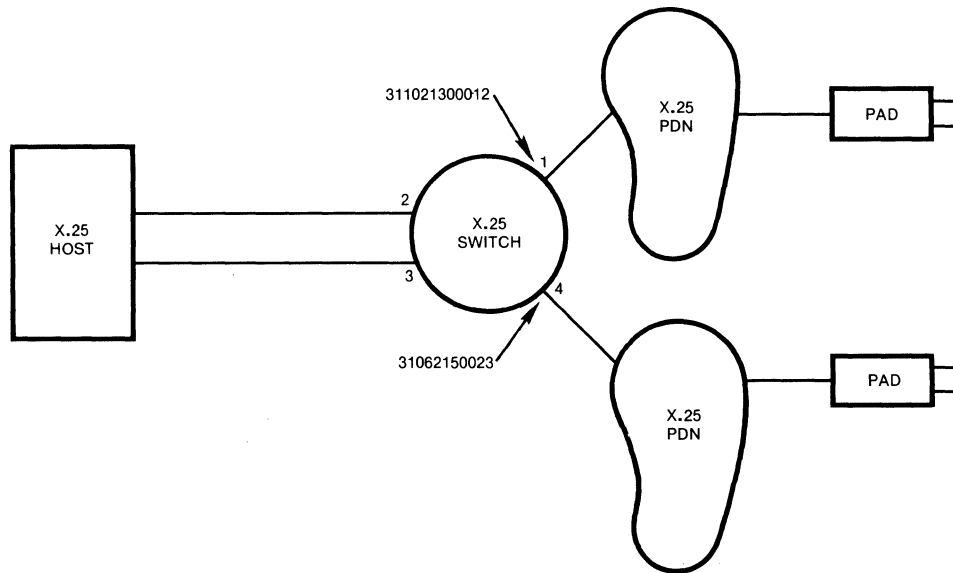

MI-1371-1a-40

Figure 4-5. Host Access Through Two PDNs

Assumptions:

- The host does not initiate any calls.
- Link numbering is 1 through 4, as shown in figure 4-5.
- Links 1 and 4 are configured as PN; links 2 and 3 are configured as DE.
- Link 1 is configured to autoconnect to link 2, with link 3 as the alternate (refer to paragraph 5.4.1 for information on the link profiles).
- Link 4 is configured to autoconnect to link 3, with link 2 as the alternate.

NOTE: Because links 1 and 4 are both autoconnect links, no routing table is required.

Based on these assumptions, links 2 and 3 would become eligible links when an incoming call was received on either link 1 or 4. If either link 2 or 3 were to become nonoperational, the other link would become the optimum link.

4.6 BRIDGE BETWEEN PRIVATE NETWORK AND PDN

This example shows how users outside the realm of a private network can access the private network's host applications. Unlike previous examples, this example illustrates the switch's class route and speed dial functions.

The class route function facilitates routing from a PDN to private network destinations (refer to paragraph 3.2.2). The speed dial function facilitates routing from a private network through a PDN (refer to paragraph 3.2.1).

As shown in figure 4-6, a PDN user connected to PAD A may want to access the host on PAD H in the private network. On the other hand, a user on PAD G in the private network may wish to access PAD A of the PDN.

This example also illustrates load sharing. The two links between switches 1 and 3 are configured for load sharing in both directions (refer to paragraph 5.4.1).

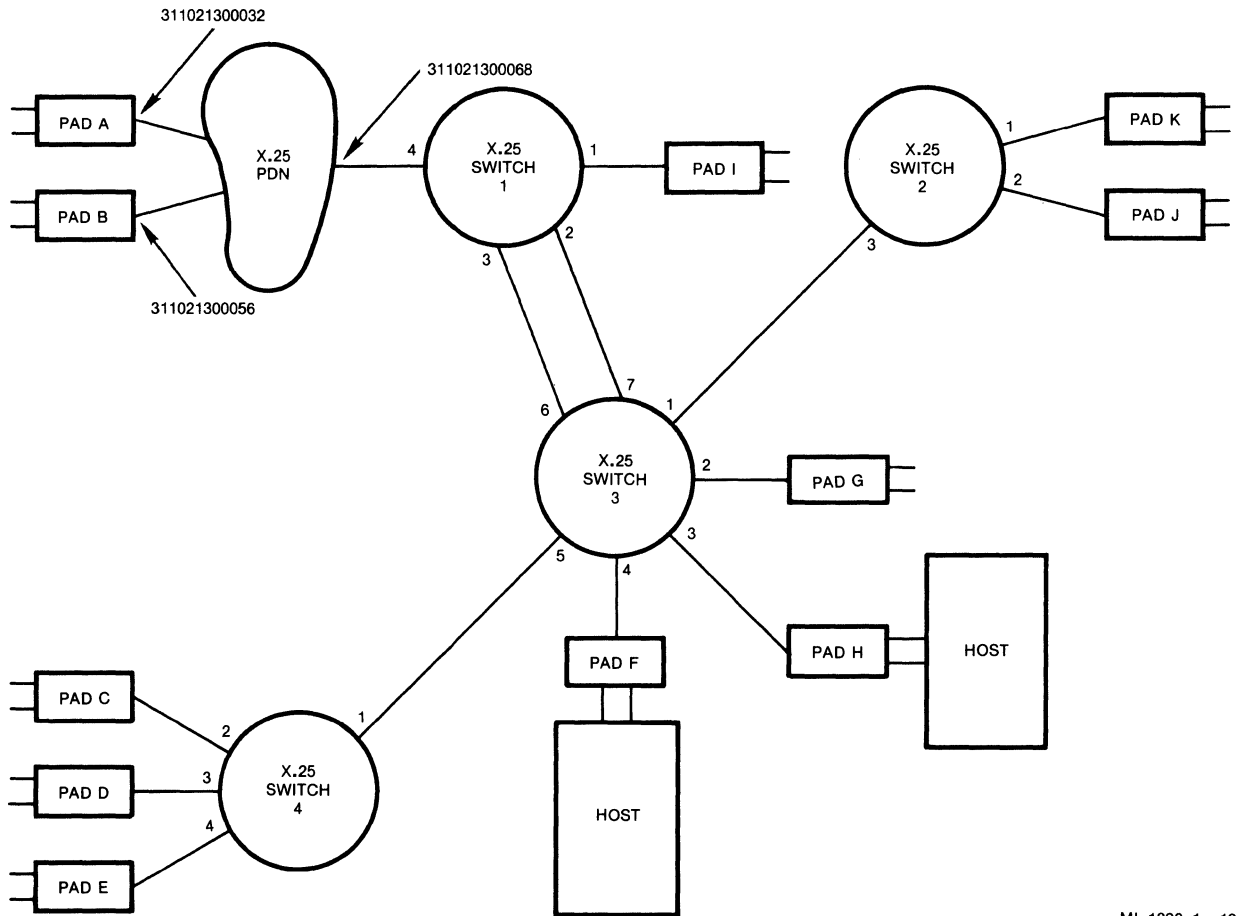

MI-1390-1a-19

Figure 4-6. Bridge Between Private Network and PDN

Assumptions related to switch 1:

- Link numbering is 1 through 4, as shown in figure 4-6.
- Link 1 is configured as DE; links 2 and 3 are configured as IS; and link 4 is configured as PN.
- Links 2 and 3 are configured for load sharing.

- The class route table is set up as follows:

| entry # | route id | address | entry # | route id | address |
|---------|----------|---------|---------|----------|---------|
| 01 | 10 | 3300 | 02 | 11 | 3400 |

- The speed dial table is set up as follows:

| entry # | speed id | address | insert id | entry # | speed id | address | insert id |
|---------|----------|--------------|-----------|---------|----------|--------------|-----------|
| 01 | 91 | 311021300032 | 0 | 02 | 92 | 311021300056 | 0 |

- The routing table is set up as follows:

| Entry | Mask | Link | Priority | Link | Priority |
|-------|--------------|------|----------|------|----------|
| 01 | 11FF | 1 | 5 | | |
| 02 | 2FFF | 2 | 5 | 3 | 5 |
| 03 | 3FFF | 2 | 5 | 3 | 5 |
| 04 | 4FFF | 2 | 5 | 3 | 5 |
| 05 | 9FFF | 4 | 5 | | |
| 06 | 3110FFFFFFFF | 4 | 5 | | |

Assumptions related to switch 2:

- Link numbering is 1 through 3, as shown in figure 4-6.
- Links 1 and 2 are configured as DE; link 3 is configured as IS.
- The routing table is set up as follows:

| Entry | Mask | Link | Priority | Link | Priority |
|-------|--------------|------|----------|------|----------|
| 01 | 21FF | 1 | 5 | | |
| 02 | 22FF | 2 | 5 | | |
| 03 | 1FFF | 3 | 5 | | |
| 04 | 3FFF | 3 | 5 | | |
| 05 | 4FFF | 3 | 5 | | |
| 06 | 9FFF | 3 | 5 | | |
| 07 | 3110FFFFFFFF | 3 | 5 | | |

Assumptions related to switch 3:

- Link numbering is 1 through 7, as shown in figure 4-6.
- Links 2, 3, and 4 are configured as DE; links 1, 5, 6, and 7 are configured as IS.
- Links 6 and 7 are configured for load sharing.
- The routing table is set up as follows:

| Entry | Mask | Link | Priority | Link | Priority |
|-------|--------------|------|----------|------|----------|
| 01 | 32FF | 2 | 5 | | |
| 02 | 33FF | 3 | 5 | | |
| 03 | 34FF | 4 | 5 | | |
| 04 | 1FFF | 6 | 5 | 7 | 5 |
| 05 | 2FFF | 1 | 5 | | |
| 06 | 4FFF | 5 | 5 | | |
| 07 | 9FFF | 6 | 5 | 7 | 5 |
| 08 | 3110FFFFFFFF | 6 | 5 | 7 | 5 |

Assumptions related to switch 4:

- Link numbering is 1 through 4, as shown in figure 4-6.
- Links 2, 3, and 4 are configured as DE; link 1 is configured as IS.
- The routing table is set up as follows:

| Entry | Mask | Link | Priority | Link | Priority |
|-------|--------------|------|----------|------|----------|
| 01 | 42FF | 2 | 5 | | |
| 02 | 43FF | 3 | 5 | | |
| 03 | 44FF | 4 | 5 | | |
| 04 | 1FFF | 1 | 5 | | |
| 05 | 2FFF | 1 | 5 | | |
| 06 | 3FFF | 1 | 5 | | |
| 07 | 9FFF | 1 | 5 | | |
| 08 | 3110FFFFFFFF | 1 | 5 | | |

General assumptions:

- PADs A through K are assigned the following addresses where:

The first digit represents the switch number (9 represents the PDN).

The second digit represents the link number.

The third and fourth digits represent the subaddress for PAD channel selection:

| | |
|----------|----------|
| A = 91FF | G = 32FF |
| B = 92FF | H = 33FF |
| C = 42FF | I = 11FF |
| D = 43FF | J = 22FF |
| E = 44FF | K = 21FF |
| F = 34FF | |

- PAD A's PDN address is 311021300032; PAD B's is 311021300056.

Based on these assumptions, if a PAD A user enters the following Call Request:

C 311021300068/10

The call would be handled as follows, with the class route function coming into play:

1. It would pass through the PDN to switch 1.
2. After finding no routing digits in the CUD field of the Call Request, switch 1 would match the 10 (the subaddress) to route id 10 in its class route table, pick up the 3300 related to route id 10, and create the following new Called Address:

3300
3. Switch 1 would then try to match 3300 to a mask in its routing table, finding entry 03 (3FFF) to be the only match. Based on that match, it would route the call to switch 3 on link 2 or link 3, selecting the one with the fewest number of LCNs currently in use (load sharing).
4. Upon receiving the call, switch 3 would attempt to match the 3300 to a mask in its routing table, finding entry 02 (33FF) to be the only match. Based on that match, it would route the call to PAD H on link 3.

Based on these assumptions, if a PAD G user enters the following Call Request:

C 91/01

The call would be handled as follows, with the speed dial function coming into play:

1. Upon receiving the call, switch 3 would attempt to match the 9101 to a mask in its routing table, finding entry 07 (9FFF) to be the only match. Based on that match, it would route the call to switch 1 on link 6 or link 7, selecting the one with the fewest number of LCNs currently in use (load sharing).
2. Upon receiving the call, switch 1 would attempt to match the 9101 to an entry in its routing table, finding entry 05 (9FFF) to be the only match.
3. Entry 05 in the routing table is associated with a PN link (link 4). Upon recognizing this as a PN link, switch 1 would attempt to match the 91 of 9101 to an entry in its speed dial table (the switch always drops any subaddress digits prior to attempting a speed id match).
4. After finding a match with entry 01 (speed id 91) in its speed dial table, switch 1 would pick up the associated PDN address (311021300032), make it the new Called Address, and forward the call to link 4.
5. Upon receiving the call, the PDN would send it to PAD A (PDN address 311021300032).

4.7 MULTIPLE-SWITCH ARRANGEMENT WITH PDNs

The following example shows how multiple switches allow users on two (or more) different PDNs to access PADs or other devices in the private network (see figure 4-7). This is possible through the switch's handling of the Called Address field for incoming calls from PDNs. In effect, its handling of the Called Address field creates a pseudo private network that includes PDNs.

This example also shows how IS links can be used as alternate links to provide service redundancy (see the routing tables). Keep in mind that when setting up a routing table, it is best to assign alternate links that do not involve more than one extra switch. For example, look at entry 11 in the routing table for switch 1. The alternate for link 7 is link 8. If you look at figure 4-7, you will see that link 1 could also be an alternate for link 7. However, with link 8 as the alternate only switch 3 must be visited to reach switch 4; with link 1, switches 2 and 3 must be visited.

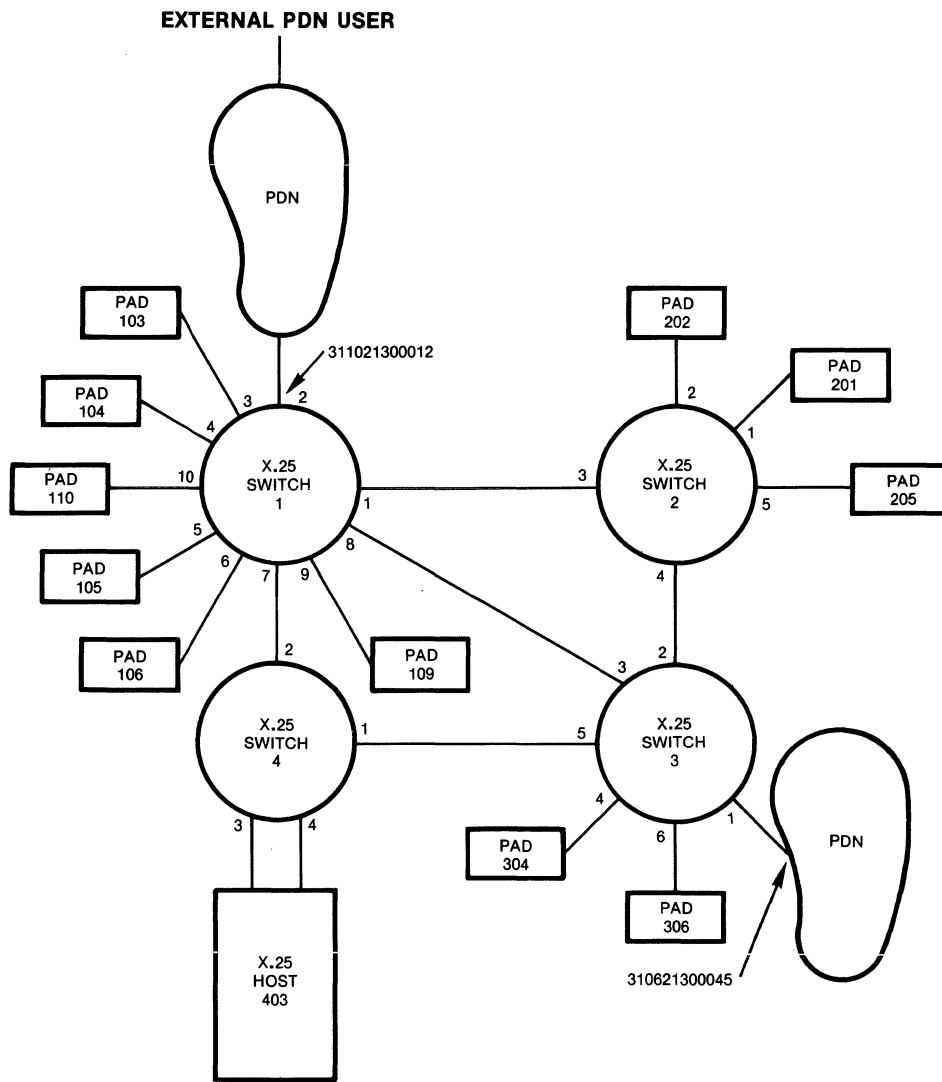

MI-1390-1a-20

Figure 4-7. Multiple-Switch Arrangement With PDNs

Assumptions related to switch 1:

- Link numbering is 1 through 10, as shown in figure 4-7.
- Links 3, 4, 5, 6, 9, and 10 are configured as DE; links 1, 7, and 8 are configured as IS; and link 2 is defined as PN.
- In the link profile for link 2 (the incoming link), the number of subaddress digits is equal to 2, and the number of route digits is equal to 3.
- The routing table is set up as follows:

| Entry | Mask | Link | Prior- ity | Link | Prior- ity | Link | Prior- ity |
|-------|--------------|------|---------------|------|---------------|------|---------------|
| 01 | 103FF | 3 | 5 | | | | |
| 02 | 104FF | 4 | 5 | | | | |
| 03 | 105FF | 5 | 5 | | | | |
| 04 | 106FF | 6 | 5 | | | | |
| 05 | 109FF | 9 | 5 | | | | |
| 06 | 110FF | 10 | 5 | | | | |
| 07 | 3106FFFFFFFF | 8 | 2 | 7 | 6 | 1 | 6 |
| 08 | 3110FFFFFFFF | 2 | 5 | | | | |
| 09 | 2FFFF | 1 | 2 | 8 | 6 | | |
| 10 | 3FFFF | 8 | 2 | 7 | 6 | | |
| 11 | 4FFFF | 7 | 2 | 8 | 6 | | |

Assumptions related to switch 2:

- Link numbering is 1 through 5, as shown in figure 4-7.
- Links 1, 2, and 5 are configured as DE; links 3 and 4 are configured as IS.
- The routing table is set up as follows:

| Entry | Mask | Link | Priority | Link | Priority |
|-------|--------------|------|----------|------|----------|
| 01 | 201FF | 1 | 5 | | |
| 02 | 202FF | 2 | 5 | | |
| 03 | 205FF | 5 | 5 | | |
| 04 | 3110FFFFFFFF | 3 | 2 | 4 | 6 |
| 05 | 3106FFFFFFFF | 4 | 2 | 3 | 6 |
| 06 | 1FFFF | 3 | 2 | 4 | 6 |
| 07 | 3FFFF | 4 | 2 | 3 | 6 |
| 08 | 4FFFF | 3 | 5 | 4 | 5 |

Assumptions related to switch 3:

- Link numbering is 1 through 6, as shown in figure 4-7.
- Links 4 and 6 are configured as DE; links 2, 3, and 5 are configured as IS; and link 1 is configured as PN.
- The routing table is set up as follows:

| Entry | Mask | Link | Prior-ity | Link | Prior-ity | Link | Prior-ity |
|-------|--------------|------|-----------|------|-----------|------|-----------|
| 01 | 304FF | 4 | 5 | | | | |
| 02 | 306FF | 6 | 5 | | | | |
| 03 | 3110FFFFFFFF | 3 | 2 | 5 | 6 | 2 | 6 |
| 04 | 3106FFFFFFFF | 1 | 1 | | | | |
| 05 | 1FFFF | 3 | 2 | 5 | 6 | | |
| 06 | 2FFFF | 2 | 2 | 3 | 6 | | |
| 07 | 4FFFF | 5 | 2 | 3 | 6 | | |

Assumptions related to switch 4:

- Link numbering is 1 through 4, as shown in figure 4-7.
- Links 3 and 4 are configured as DE; links 1 and 2 are configured as IS.
- Links 3 and 4 are configured for load sharing, to handle traffic to the X.25 host computer.
- The routing table is set up as follows:

| Entry | Mask | Link | Priority | Link | Priority |
|-------|--------------|------|----------|------|----------|
| 01 | 403FF | 3 | 5 | 4 | 5 |
| 02 | 3110FFFFFFFF | 2 | 5 | | |
| 03 | 3106FFFFFFFF | 1 | 5 | | |
| 04 | 1FFFF | 2 | 2 | 1 | 6 |
| 05 | 2FFFF | 2 | 5 | 1 | 5 |
| 06 | 3FFFF | 1 | 2 | 2 | 6 |

General Assumptions:

- Three-digit addresses are assigned to each PAD and to the X.25 host computer. The first digit indicates the switch number; the second and third digits indicate the link number.
- Two digits are required for subaddressing.
- The address of the PDN connected to switch 1 is 311021300012.
- The address of the PDN connected to switch 3 is 310621300045.
- An external user of the PDN connected to switch 1 enters the following Call Request (where 311021300012 represents the PDN address, 22 represents the subaddress, and 103 represents the CUD):

C 31102130001222*103

Based on these assumptions, switch 1 would perform the following functions:

1. It would look at the link profile for link 2 to find out the number of subaddress digits (2) and the number of route digits (3).
2. It would take the three-digit CUD (103) and the two-digit subaddress (22) and create the new routing address: 10322.
3. It would find a match with entry 01 (103FF) of its routing table, and then forward the call to link 3.

By handling the Called Address this way, the switch allows an external user of a PDN to call a specific PAD. In addition, by passing the subaddress (22) to the PAD, the switch allows that PDN user to select a specific application on that PAD.

A similar application could be set up between the PDN connected to switch 3, and other devices within the private network.

SECTION 5

ADMINISTRATIVE PROCEDURES

This section describes the software configuration procedures that must be performed in order for a switch to operate properly. The switch simplifies these procedures by supplying you with a menu-driven Command Facility. With the Command Facility, you can:

- Define the link profiles.
- Set up the routing, speed dial, class route, and NUI tables.
- Define the address and the terminal characteristics of the Command Facility, so that remote users can access it.
- Set up switch-wide parameters, related to best-path selection and maximum number of hops.
- Set the switch's software (soft) switches.
- Disconnect LCNs, busyout links, or reset the switch.
- Take a link down or bring a link up.
- List or reset statistics (link level or packet level).
- Display the routing, speed dial, class route, or NUI table.
- Display the current status of all links (6 or 12) on the switch.
- Configure your switch to provide you with call accounting and event information.

This section deals only with software configuration. Section 2 describes hardware installation, the assignment of link numbers, and use of the Touch Panel.

This section first introduces you to basic switch setup procedures. It then describes how to access and logon to the Command Facility. Detailed step-by-step descriptions of each Command Facility menu item are provided. Information on the switch's event reporting and call accounting capabilities complete this section.

5.1 SETTING UP THE SWITCH

Before you try to establish any kind of communications with the switch, review the following switch setup checklist:

1. The power is ON.
2. Indicators show normal status, as described in paragraph 6.2.
3. The soft switch selections reflect your requirements (refer to paragraph 5.4.6).
4. The cold or warm start soft switch selection is OFF, for warm start (see figure 2-14).
5. The offline memory dump soft switch selection is OFF, disabling the memory dump mode (see figure 2-14).
6. The time and date are correct. If not, you can change them using the Command Facility logon procedures (refer to paragraph 5.3).

5.2 ACCESSING THE COMMAND FACILITY

The Command Facility can be accessed by one of the following methods:

- Locally, using a dedicated or dial-up connection to the switch's Command Port. The connection is made on link 6 or on link 12, depending on the number of links on your switch. You must configure the last link as the Command Port by setting a soft switch selection (refer to paragraph 5.4.6 and see figure 2-14).
- Remotely, by placing a virtual call on a configured link from anywhere in the Network.

5.2.1 Accessing the Command Facility Locally

To access the switch's Command Facility locally, using the Command Port, you can use direct RS-232-C connections, private wire modems, or dial-in modems configured for auto-answer support. Perform the following procedure:

1. Set your terminal to full-duplex, use a data transmission rate not greater than 9600 bps, 7 ASCII-coded bits per character, and any parity type.
2. The default profile assigned to the Command Port supports autobaud and autoparity recognition (dv.parity is equal to 5). Therefore, you are required to logon using the following sequence (unless you have changed the profile through the CMD/XCC facility item of the Configure Menu):

carriage return.carriage return

3. You will be greeted with the message:

```
mb3-x.25 switch channel 0
```

If this does not occur, enter BREAK and retry step 2. You may now place a call, or access the Command Facility by entering two carriage returns.

4. The switch will prompt you for your password (refer to paragraph 5.3).
5. After successful connection to the Command Facility, you disconnect by either powering-off your terminal or selecting item 16 (Logout) from the Command Menu.

NOTE: You will not receive any message or be able to establish a dialogue with the local Command Port if the Command Facility is being accessed by a remote caller. You will also be disconnected from the local Command Port if a remote caller establishes a connection with the Command Facility.

5.2.2 Accessing the Command Facility Remotely

You can place a call to a switch's Command Facility from anywhere in the Network in the same way that you place any other call. You perform the following steps:

1. Enter a Call Request to call the Command Facility of the desired switch. The Call Request must contain the unique address of the CMD/XCC facility for that switch (refer to paragraph 5.4.5). Also the Call Request must contain the class (subaddress) of the Command Facility for that switch. (The default class value for the Command Facility is 99, but you can change it using selection 5 of the Configure Menu). For example, you might enter the following to call the Command Facility of switch 14:

```
C 14/99
```

2. Your connection will be confirmed with a com service signal. Enter a carriage return (CR).
3. The switch will prompt for your password (refer to paragraph 5.3).
4. After successful connection to the Command Facility, you disconnect by clearing the call (entering clr) or by selecting item 16 (Logout) from the Command Menu (using the Logout Command will leave the call in progress).

NOTE: When the Command Facility receives or initiates a call, it will (after the call setup stage) send an X.29 packet to set parameters 1 through 19 of the remote device.

5.3 LOGGING ON TO THE COMMAND FACILITY

To log on to the Command Facility, you must have the key to the Command Facility — the password. You may also use the logon procedure to change the factory-set or current password. Following the password, the Command Facility will display the software version identifier, the date, and the time (see table 5-1).

Table 5-1. Logon Prompts

| Prompt | Options and Defaults | Description |
|-----------------------|--|---|
| password | To change a password, enter the old password, a space, the new password, then a <u>CR</u> . DEFAULT = MX25 | The password field always consists of four characters. If you are connected to the Command Facility, you can prevent the password from being echoed by disabling echo (refer to paragraph 5.4.5). |
| version: M907-nnnn-aa | | The version identifier M907-nnnn-aa refers to the operating software. The aa refers to the revision level of software nnnn. |
| date aa-bb-cc | To change a date, enter new date in this order: month-day-year. Be sure to separate each entry with a colon or a hyphen. Then enter a <u>CR</u> . | The date aa bb cc represents the month (aa), day (bb), and year (cc). |
| time aa:bb:cc | To change the time, enter new time in this order: hour:minutes:seconds. Be sure to separate each entry with a hyphen or a colon. Then enter a <u>CR</u> to display the Command Menu. | The time aa bb cc represents the hour (aa), minutes (bb), and seconds (cc). This is a 24-hour clock; for example 2 p.m. is 14:00:00. |

Once you have logged on to the Command Facility, you will be presented with the Command Menu (see figure 5-1). The menu consists of clear descriptions of each of the available administrative functions. You can invoke any of the Command Facility management functions by making a selection.

NOTE: Item 3, Reset PVC, is not currently implemented.

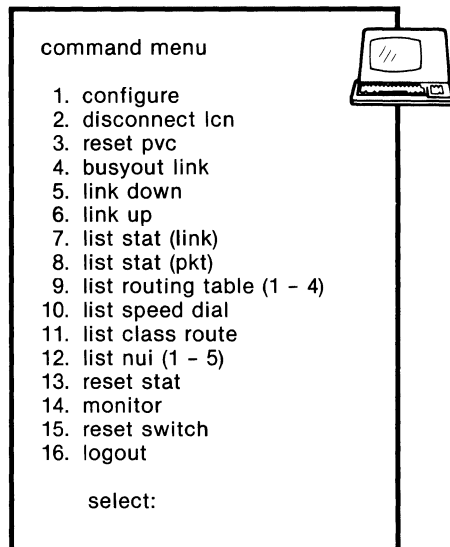

MI-1390-1a-21

Figure 5-1. Command Menu

Subsequent menus and data entry prompts guide you through the various administrative functions. This approach greatly simplifies configuration and management tasks, because you do not have to memorize special commands or complex syntax.

To select a command from the Command Menu, key-in the associated number and a CR. If you should make an error in your selection before entering CR, simply backspace and reenter the correct number. You can exit the Command Menu by using item 16 (Logout).

5.4 CONFIGURATION

The only other menu related to administrative functions is the Configure Menu. To display the Configure Menu, select item 1 from the Command Menu (see figure 5-2).

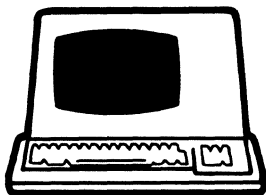

COMMAND FACILITY
COMMAND MENU



configure menu

1. link profile
2. routing mask
3. speed dial
4. class route
5. cmd/xcc facility
6. system parameters
7. nui

select:

MT-1390-1a-05

Figure 5-2. Displaying the Configure Menu

The format of the Configure Menu is shown in figure 5-3.

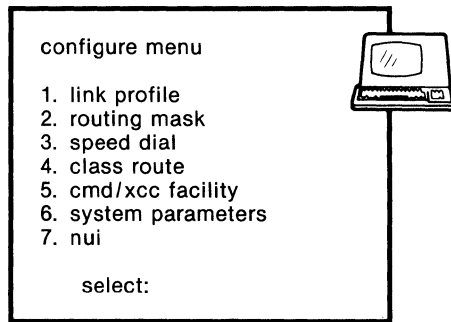

MI-1390-1a-23

Figure 5-3. Configure Menu

From the Configure Menu, you can perform the following configuration functions (see figure 5-4 for an illustration of the prompts related to each function):

- Define the link profiles
- Set up the routing table
- Set up the speed dial table
- Set up the class route table
- Set up the NUI table
- Define the address and the terminal characteristics of the Command Facility, so that remote users can access it
- Set soft switch selections
- Set up switch-wide parameters related to best-path selection and maximum number of hops

configure menu

1. link profile
2. routing mask
3. speed dial
4. class route
5. cmd/xcc facility
6. system parameters
7. nui

select:

entry #: [***] ¹
 billing #: [] ²
 pin: [] ³

delta: [0]
 beta: [1]
 max hop: [0]
 sys 1: [0]
 sys 2: [0]
 billing # length: [10]
 pin length: [4]

address: [**] ²
 class(cmd): [99]
 class(xcc): [98]
 audit log: [0]
 statperiod: [0]
 echo: [1]
 dv.flow: [1]
 s.signal: [5]
 cr.pad: [4]
 l.fold: [80]
 speed: [32]
 p.flow: [1]
 ff.pad: [4]
 edit: [1]
 c.del: [8]
 l.del: [24]
 l.disp: [18]
 dv.type: [2]
 bits/char: [2]
 dv.parity: [5]
 net.parity: [0]
 c.xon: [17]
 c.xoff: [19]
 special flow: [0]
 inactivity: [0]
 x29acc: [0]
 prompt: [*]

entry #: [**]
 mask: [**] ²
 eligible link: [0]
 priority: [0]
 eligible link: [0]
 priority: [0]
 eligible link: [0]
 priority: [0]
 eligible link: [0]
 priority: [0]

entry #: [**]
 speed dial id: [*****]
 address: [**] ²
 insert id: [0]

entry #: [**]
 class route id: [**]
 address: [**] ⁴

link#: [**]
 speed: [8]
 type: [1]
 dte/dce: [1]
 k: [7]
 t1: [5]
 n2: [5]
 t3: [15]
 w: [2]
 pkt size: [7]
 modulo: [0]
 # of svcs: [2]
 # of inc svcs: [0]
 lowest inc svc
 lgn: [0]
 lcn: [0]
 # of inc/out svcs: [2]
 lowest inc/out svc
 lgn: [0]
 lcn: [1]
 # of out svcs: [0]
 lowest out svc
 lgn: [0]
 lcn: [0]
 t11/21: [30]
 t12/22: [30]
 t13/23: [30]
 pkt timeout retry: [3]
 facility mask: [0]
 facility barred: [0]
 facility added: [0]
 # of subaddress digits: [2]
 # of route digits: [4]
 call pkt handling: [0]
 pdn address: [**] ²
 autoconnect: [0]
 alternate: [0]
 nui handling: [0]
 special option: [0]

¹ VALUES 1 THROUGH 100
² UP TO 15 ENTRIES
³ UP TO 14 ENTRIES
⁴ UP TO 12 ENTRIES

Figure 5-4. Prompts Related to Configure Menu Items

Please review the following guidelines and notational conventions before you go on to the descriptions of the configuration functions.

Guidelines and Notational Conventions

The following list summarizes general items that apply to all of the configuration functions:

1. You advance through a prompt sequence by entering a CR after each response to a prompt. For any parameter that has a default value, you do not have to respond to the prompt (just enter a CR). This causes the next prompt to appear. When you have reached the final prompt of a completed sequence, the manual provides you with the following informative message:

Done...the configure menu will be displayed.

2. Once you enter a prompt sequence, you must complete it; otherwise, the values you have entered will not be stored. For example, if you change the speed value in the link profile and then enter Ctrl-C, the Configure Menu is re-displayed and the change is cancelled. You must enter the new value and respond to each prompt that follows in a given sequence until the switch displays the message:

done

3. There are two types of errors that will cause the following message to appear:

error

The two types of errors are:

- Out-of-Range Error, where you enter a character outside the range of possible values.
- Consistency Check Error, where you enter a character that is logically inconsistent with some other character already entered.

The following list summarizes the time-saving notational conventions that are used. If necessary, refer back to paragraph 1.8 for a list of abbreviations.

1. A screen display is represented by the icon:



2. The abbreviation for a user entered carriage return is CR.
3. Press CR after every entry or response to a prompt.
4. Enter Ctrl-B and CR if you want to go back to the previous data entry field.
5. Press the backspace key or enter Ctrl-H to move the cursor left one position and delete the character at that position (Ctrl-H may be used if your keyboard has no backspace key).
6. Press CR if you accept the value currently displayed and simply want to continue to the next item.
7. Enter Ctrl-Y to clear ASCII-character fields.
8. Press CR if you want to exit from the Configure Menu.
9. Enter Ctrl-C and CR when you want to exit a procedure and return to the menu from which you are working.
10. Entries that are enclosed in brackets indicate the default values.
11. A prompt may include one or more *. This means that there is no value currently stored for a given parameter. The number of asterisks indicates the maximum length of the field.

Example:

```
link #: [**]
```

This prompt asks you to enter the number of the link to be defined. The two asterisks indicate the number has not been entered. When it is entered, it can be up to two digits.

12. When a range of possible values is given, it is always inclusive. For example, if values from 1 to 7 may be entered, the 1 and the 7 are included in the range.
13. Control characters are entered using the ^X format, where ^ is a caret character and X is the character required (for example, Ctrl-G, BEL, is entered as ^G).

5.4.1 Defining Link Profiles

The first item on the Configure Menu is Link Profile (see figure 5-3). You should configure a link profile for every link on your switch. Although the switch comes with a preconfigured link profile, you will probably have to modify it to meet your requirements.

After you select item 1 from the Configure Menu, the switch displays each prompt related to link configuration. The prompts are listed and described in table 5-2.

After you modify a link profile, the switch displays two messages in succession:

```
done
system reset required
```

To put the new link profile parameters into effect, you must perform a Reset. Enter the Reset Switch Command (refer to paragraph 5.5.14), or press both Reset keys on the Touch Panel (refer to paragraph 2.3.2).

NOTE: A major part of link profile configuration involves the definitions of SVCs. Following table 5-2 is an example of SVC definition.

Table 5-2. Link Profile Prompts

| Prompt | Options and Defaults | Description |
|-------------|--|---|
| link #:[**] | Values 1 through 12 NO DEFAULT | This designates the link number that you are now going to configure. This is the physical number of the link. (Refer to paragraph 2.2.1 for information on assigning the link numbers.) |
| speed:[8] | Values 2 through 20: 2 = 1200 bps 4 = 2400 bps 6 = 4800 bps 8 = 9600 bps 10 = 14400 bps 12 = 19200 bps 14 = 48000 bps 16 = 56000 bps 18 = 64000 bps 20 = 72000 bps Even value = internal clock Odd value = external clock DEFAULT = 8 (16 for a high-speed link) | This defines the speed of the link. The switch can provide clocking at the even-numbered speeds shown. If a modem or other external device is to provide the clocking, add 1 to the value shown (for example, for 9600 bps, enter 9). With external clocking, the represented speed is used only for throughput calculation. Speeds above 19,200 bps apply only to link 1, and only if your switch is equipped with a high-speed option (refer to appendix B). |

Table 5-2. Link Profile Prompts (continued)

| Prompt | Options and Defaults | Description |
|-------------|---|---|
| type:[1] | <p>Values 1 to 5:</p> <p>1 = IS link 2 = DE link and X.121 subaddressing 3 = DE link and CUD subaddressing 4 = PN link and X.121 subaddressing 5 = PN link and CUD subaddressing</p> <p>DEFAULT = 1</p> | <p>This defines the type of link, which is determined by the type of equipment it connects, and by the type of subaddressing.</p> |
| dte/dce:[1] | <p>Values 0 or 1:</p> <p>0 = DTE 1 = DCE</p> <p>DEFAULT = 1</p> | <p>This is the logical appearance of the link. This defines the frame level addressing and the selection of LCNs for incoming Call Request Packets.</p> |
| k:[7] | <p>Values 1 to 7</p> <p>DEFAULT = 7</p> | <p>This is the frame layer window size.</p> |
| t1:[5] | <p>Values 3 to 127</p> <p>DEFAULT = 5</p> | <p>This is the frame layer expiry timer, expressed in seconds.</p> |
| n2:[5] | <p>Values 1 to 20</p> <p>DEFAULT = 5</p> | <p>This is the maximum number of attempts allowed to complete a transmission (frame layer).</p> |

Table 5-2. Link Profile Prompts (continued)

| Prompt | Options and Defaults | Description |
|--------------------------------------|---|---|
| t3:[15] | Values 0, or 10 to 127 0 = disabled DEFAULT = 15 | This is the link assurance timer. If this timer is enabled, the value of t3 must be greater than the value of t1. This value is expressed in seconds. |
| w:[2] | Reserved for future use. Enter a <u>CR</u> . | This is the packet layer window size. |
| pkt size:[7] | Reserved for future use. Enter a <u>CR</u> . | This is the maximum data packet size allowed, expressed in bytes. |
| modulo:[0] | Values 0 or 1: 0 = modulo 8 1 = modulo 128 DEFAULT = 0 | This is the type of packet sequencing. Only modulo 8 (standard packet sequencing) is currently supported. |
| # of svcs:[2] | Values 0 to 127 DEFAULT = 2 | This is the maximum number of SVCs allowed. |
| # of inc svcs:[0] | Values 0 to 127 DEFAULT = 0 | This is the maximum number of incoming-only SVCs allowed. |
| lowest inc svc lgn:[0] lcn:[0] | LGN = 0 to 15 LCN = 0 to 255 DEFAULTS: LGN = 0 LCN = 0 | These are the lowest LGNs and LCNs to be used for incoming-only SVCs. |

Table 5-2. Link Profile Prompts (continued)

| Prompt | Options and Defaults | Description |
|--|--|--|
| # of inc/out svcs:[2] | Values 0 to 127 DEFAULT = 2 | This is the maximum number of incoming/outgoing SVCs allowed. |
| lowest inc/out svc lgn:[0] lcn:[1] | LGN = 0 to 15 LCN = 0 to 255 DEFAULTS: LGN = 0 LCN = 1 | These are the lowest LGNs and LCNs to be used for incoming/outgoing SVCs. |
| # of out svcs:[0] | Values 0 to 127 DEFAULT = 0 | This is the maximum number of outgoing-only SVCs allowed. |
| lowest out svc lgn:[0] lcn:[0] | LGN = 0 to 15 LCN = 0 to 255 DEFAULTS: LGN = 0 LCN = 0 | These are the lowest LGNs and LCNs to be used for outgoing-only SVCs. |
| t11/21:[30] | Values 15 to 255 DEFAULT = 30 | This is the Call Request Packet timeout timer, expressed in seconds. |
| t12/22:[30] | Values 15 to 255 DEFAULT = 30 | This is the Reset Request Packet timeout timer, expressed in seconds. |
| t13/23:[30] | Values 15 to 255 DEFAULT = 30 | This is the Clear Request Packet timeout timer, expressed in seconds. |
| pkt timeout retry:[3] | Values 0 to 127 | This is the number of times a Clear Request or Reset Request Packet is retransmitted after a timeout. (Not implemented.) |

Table 5-2. Link Profile Prompts (continued)

| Prompt | Options and Defaults | Description |
|----------------------------|---|---|
| facility mask:[0] | <p>Values 0 to 7:</p> <p>0 = None 1 = Packet size negotiation 2 = Window size negotiation 4 = Throughput class negotiation x = Any combination</p> <p>DEFAULT = 0</p> | <p>These are the facilities that will be removed from a Call Request Packet that is to be sent on a DE or PN link.</p> <p>This is an invalid entry for IS links.</p> |
| facility barred:[0] | <p>Values 0 to 3:</p> <p>0 = None 1 = Reverse charging 2 = Fast select x = Any combination</p> <p>DEFAULT = 0</p> | <p>A Call Request Packet that is received from a DE or PN link with any of these facilities will be cleared.</p> <p>This is an invalid entry for IS links.</p> |
| facility added:[0] | <p>Values 0 to 7:</p> <p>0 = None 1 = Reverse charging 2 = Packet size negotiation 4 = Window size negotiation x = Any combination</p> <p>DEFAULT = 0</p> | <p>These are the facilities that are to be added to a Call Request Packet, before it is transmitted on a DE or PN link.</p> <p>This is an invalid entry for IS links.</p> |
| # of subaddress digits:[2] | <p>Values 0 to 5</p> <p>DEFAULT = 2</p> | <p>This is the number of digits to be used as the subaddress on DE or PN links.</p> <p>This is an invalid entry for IS links.</p> |

Table 5-2. Link Profile Prompts (continued)

| Prompt | Options and Defaults | Description |
|-------------------------|---|---|
| # of route digits:[4] | Values 0 to 8 DEFAULT = 4 | This is the number of digits to be taken from the CUD field and used as routing digits in a Call Request Packet received on a PN link. This is an invalid entry for DE and IS links. |
| call pkt handling:[0] | Values 0 to 29: 0 = No handling 1 = Remove calling address 4 = 1980 Call Accept Packet, address length, and facilities length bytes must be present 8 = Replace calling address with PDN address 16 = Modulo 128 (KDD) call (not implemented) xx = Any combination DEFAULT = 0 | This is how a Call Request or a Call Accept Packet is to be formatted for transmission on DE and PN links. This handling allows one to tailor the link to satisfy PDN requirements. |
| pdn address: [*****] | 0 to 15 digits NO DEFAULT | For outgoing calls to a PDN, this will be used as the Calling Address, if so requested in the call pkt handling field (value 8). |

Table 5-2. Link Profile Prompts (continued)

| Prompt | Options and Defaults | Description |
|------------------|---|---|
| autoconnect:[0] | <p>Values 0 to 12:</p> <p>0 = No autoconnect link</p> <p>DEFAULT = 0</p> | <p>All Call Request Packets received on this link will be automatically routed to the link specified (1 to 12). The only exception is if the Call Request Packet contains the address of the Command Facility, in which case the call gets routed to the Command Facility. With autoconnect enabled, the switch does not reference the routing table.</p> |
| alternate:[0] | <p>Values 0 to 12:</p> <p>0 = No alternate link</p> <p>DEFAULT = 0</p> | <p>This number specifies the alternate link (1 to 12). This link is used as a backup, if the autoconnect link is unavailable. This link is used as a load share link, if the value 4 (load sharing) special option has been selected (see the last prompt in this table).</p> |
| nui handling:[0] | <p>Values 0 to 7:</p> <p>0 = No validation</p> <p>1 = Perform validation</p> <p>2 = Clear call if validation fails</p> <p>4 = Delete NUI from Call Request Packet</p> <p>x = Combination</p> <p>DEFAULT = 0</p> | <p>This determines whether or not the switch will validate the NUI string in a Call Request Packet coming in on this link (refer to paragraph 5.4.7).</p> <p>This is an invalid entry for IS links.</p> |

Table 5-2. Link Profile Prompts (continued)

| Prompt | Options and Defaults | Description |
|--|---|--|
| special option:[0] | <p>Values 0 to 7:</p> <p>0 = None 1 = Enable call accounting 2 = 1984 DTE cause codes 4 = Load sharing x = Combination</p> <p>DEFAULT = 0</p> | <p>Value 1 allows call accounting information regarding this link to be sent to the Command Facility. This is an invalid entry for IS links.</p> <p>Value 2 provides support of the CCITT 1984 DTE cause codes. This is an invalid entry for IS links.</p> <p>Value 4 defines the alternate link as a load sharing link. The alternate link is then used only when it has fewer SVCs currently in use than has the primary link.</p> |
| DONE ... THE CONFIGURE MENU WILL BE DISPLAYED. | | |

Example of SVC Configuration

The following illustrates the three tiers of SVC configuration (incoming, incoming/outgoing, and outgoing). Refer to paragraph 3.4.4 for a brief description of how the switch selects an LCN.

Notice, in the following example, that there is no overlap of LCNs between one tier and the preceding tier. That is, for incoming SVCs (tier 1) the range of LCNs ends at 14. For incoming/outgoing SVCs (tier 2), the range of LCNs begins at 15. Within the same LGN (0 in the following example), you must configure LCNs so that there is no overlap.

If you accidentally configure LCNs so that there is overlap, the switch displays the following message before it re-displays the Configure Menu:

profile error

Incoming SVCs (Tier 1)

| <u>Prompt</u> | <u>User Response</u> | <u>Range of LCNs</u> |
|----------------|----------------------|----------------------|
| # of inc svcs | 10 | |
| lowest inc svc | | 5 through 14 |
| lgn | 0 | |
| lcn | 5 | |

Incoming/Outgoing SVCs (Tier 2)

| <u>Prompt</u> | <u>User Response</u> | <u>Range of LCNs</u> |
|--------------------|----------------------|----------------------|
| # of inc/out svcs | 3 | |
| lowest inc/out svc | | 15 through 17 |
| lgn | 0 | |
| lcn | 15 | |

Outgoing SVCs (Tier 3)

| <u>Prompt</u> | <u>User Response</u> | <u>Range of LCNs</u> |
|----------------|----------------------|----------------------|
| # of out svcs | 8 | |
| lowest out svc | | 20 through 27 |
| lgn | 0 | |
| lcn | 20 | |

5.4.2 Setting Up the Routing Table

The routing table contains all the routing masks related to links on a switch. Except for autoconnect calls (refer to paragraph 5.4.1), the switch always references its routing table for routing instructions (refer to paragraph 3.4 for information on how the switch routes calls).

The routing table can contain up to 64 entries. The switch displays the table in four parts (or pages), each with 16 entries. One sample page of a routing table is shown in figure 5-5.

X.25 SWITCH ADDRESS ¹

| mb3-x.25 switch routing mask | | | nnnnn | | | time 00:00:00 | date 00-00-00 | |
|------------------------------|------|----------|-------|----------|------|---------------|---------------|----------|
| | | | | | | page 1 of 4 | | |
| entry mask | link | priority | link | priority | link | priority | link | priority |
| 01 | 00 | 00 | 00 | 00 | 00 | 00 | 00 | 00 |
| 02 | 00 | 00 | 00 | 00 | 00 | 00 | 00 | 00 |
| 03 | 00 | 00 | 00 | 00 | 00 | 00 | 00 | 00 |
| 04 | 00 | 00 | 00 | 00 | 00 | 00 | 00 | 00 |
| 05 | 00 | 00 | 00 | 00 | 00 | 00 | 00 | 00 |
| 06 | 00 | 00 | 00 | 00 | 00 | 00 | 00 | 00 |
| 07 | 00 | 00 | 00 | 00 | 00 | 00 | 00 | 00 |
| 08 | 00 | 00 | 00 | 00 | 00 | 00 | 00 | 00 |
| 09 | 00 | 00 | 00 | 00 | 00 | 00 | 00 | 00 |
| 10 | 00 | 00 | 00 | 00 | 00 | 00 | 00 | 00 |
| 11 | 00 | 00 | 00 | 00 | 00 | 00 | 00 | 00 |
| 12 | 00 | 00 | 00 | 00 | 00 | 00 | 00 | 00 |
| 13 | 00 | 00 | 00 | 00 | 00 | 00 | 00 | 00 |
| 14 | 00 | 00 | 00 | 00 | 00 | 00 | 00 | 00 |
| 15 | 00 | 00 | 00 | 00 | 00 | 00 | 00 | 00 |
| 16 | 00 | 00 | 00 | 00 | 00 | 00 | 00 | 00 |



¹ THIS FIELD CONTAINS THE ADDRESS THAT WAS DEFINED WITH THE CMD/XCC FACILITY SELECTION OF THE CONFIGURE MENU.

Figure 5-5. Sample Page From the Routing Table

A switch cannot do any routing (except autoconnect) until its routing table is set up. To set up the routing table, begin by selecting item 2 (Routing Mask) from the Configure Menu (see figure 5-3). See table 5-3 for descriptions of the prompts that appear.

Table 5-3. Routing Mask Prompts

| Prompt | Options and Defaults | Description |
|-------------------|---|---|
| entry #:[**] | Values 01 to 64 NO DEFAULT | This identifies one routing mask in the routing table. |
| mask: [*****] | From 2 to 15 alphanumeric entries. Valid numeric entries are 0 to 9; valid alpha entries are Fs. NO DEFAULT | When a call comes in, the switch tries to match the Called Address with this mask. The mask can be all digits, all Fs (F is the wildcard character), or a combination of digits and Fs. If a match is found, the related links become members of the eligible link set (for routing). (Refer to paragraph 3.4.1 for information on mask "chaining.") |
| eligible link:[0] | Values 0 to 12 DEFAULT = 0 | This is a specific link number that is associated with a specific entry # and mask. If a Called Address matches a mask, then link numbers associated with the mask become members of the eligible link set. Up to four link numbers can be associated with each mask. Each link number is paired with a priority value (see figure 5-5). |

Table 5-3. Routing Mask Prompts (continued)

| Prompt | Options and Defaults | Description |
|---|-----------------------------------|---|
| priority:[0] | Values 0 to 10 DEFAULT = 0 | <p>This is the static priority that is paired to a link number. If a link number becomes a member of an eligible link set, its priority also becomes a member.</p> <p>There can be up to four priority entries related to a mask (one entry for each link number, as shown in figure 5-5).</p> <p>The priority value is used by the best-path algorithm (refer to paragraph 3.4.3) when the switch selects a link from the eligible link set. Priority 0 is the highest priority; 10 is the lowest.</p> |
| <p>NOTE:</p> <p>From one to four pairs of link and priority may be defined for each mask. Therefore, the switch displays the following 10 prompts:</p> <pre> entry #:[**] mask:[*****] eligible link:[0] priority:[0] eligible link:[0] priority:[0] eligible link:[0] priority:[0] eligible link:[0] priority:[0] </pre> <p>To ensure that an entry is stored in the routing table, you must go through all 10 prompts. If you want only one eligible link-priority pair to be associated with a mask entry, answer the first four prompts with values; then enter <u>CR</u> for the remaining six prompts.</p> | | |
| <p>DONE ... THE CONFIGURE MENU WILL BE DISPLAYED.</p> | | |

5.4.3 Setting Up the Speed Dial Table

Before a switch forwards a call to a PDN (on a PN link), it tries to match the Called Address (excluding any subaddress) to a speed id in its speed dial table. If it finds a match, the switch replaces the existing Called Address with the PDN address related to the speed id. This allows a user to enter a two- to six-digit speed id number in a Call Request, instead of a long PDN address. The switch performs the necessary translation to the PDN address.

For more information on the speed dial function, refer to paragraph 3.2.1. Paragraph 4.6 is an example of a speed dial application.

The speed dial table is shown in figure 5-6. To set up the speed dial table, begin by selecting item 3 (Speed Dial) from the Configure Menu (see figure 5-3). See table 5-4 for descriptions of the prompts that appear.

X.25 SWITCH ADDRESS¹

| mb3-x.25 switch speed dial | | | | time 00:00:00 | | | | date 00-00-00 | |
|----------------------------|----------|---------|-----------|---------------|----------|---------|-----------|---------------|--|
| entry # | speed id | address | insert id | entry # | speed id | address | insert id | | |
| 01 | | | 0 | 02 | | | 0 | | |
| 03 | | | 0 | 04 | | | 0 | | |
| 05 | | | 0 | 06 | | | 0 | | |
| 07 | | | 0 | 08 | | | 0 | | |
| 09 | | | 0 | 10 | | | 0 | | |
| 11 | | | 0 | 12 | | | 0 | | |
| 13 | | | 0 | 14 | | | 0 | | |
| 15 | | | 0 | 16 | | | 0 | | |
| 17 | | | 0 | 18 | | | 0 | | |
| 19 | | | 0 | 20 | | | 0 | | |
| 21 | | | 0 | 22 | | | 0 | | |
| 23 | | | 0 | 24 | | | 0 | | |
| 25 | | | 0 | 26 | | | 0 | | |
| 27 | | | 0 | 28 | | | 0 | | |
| 29 | | | 0 | 30 | | | 0 | | |
| 31 | | | 0 | 32 | | | 0 | | |

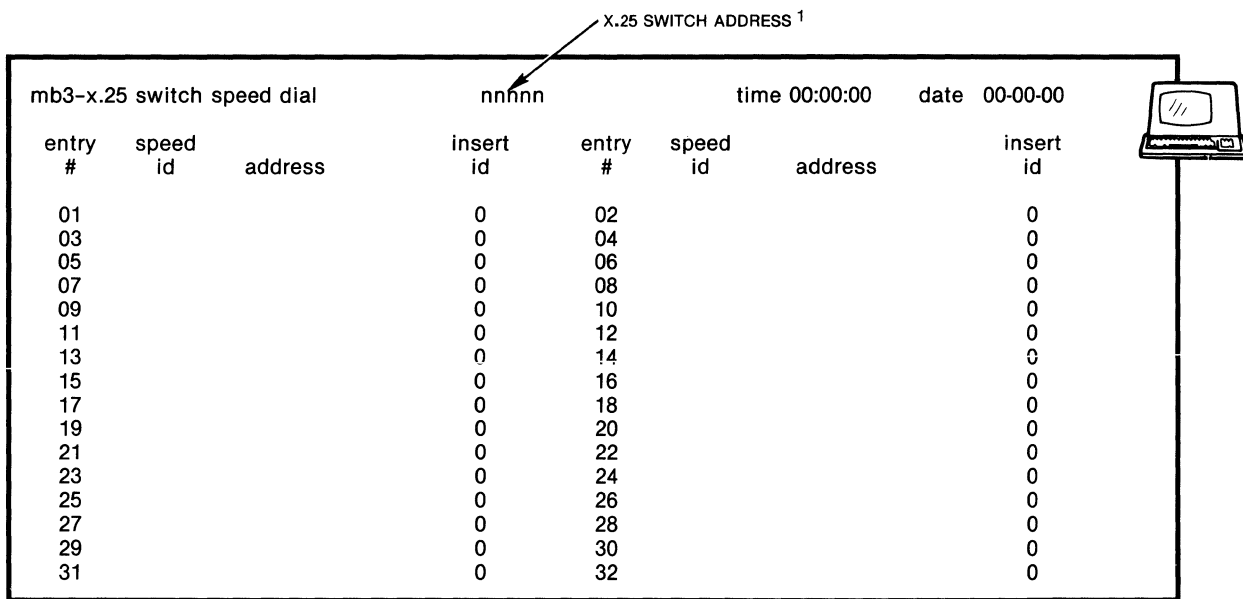

¹ THIS FIELD CONTAINS THE ADDRESS THAT WAS DEFINED WITH THE CMD/XCC FACILITY SELECTION OF THE CONFIGURE MENU.

Figure 5-6. Speed Dial Table

Table 5-4. Speed Dial Prompts

| Prompt | Options and Defaults | Description |
|--|--|---|
| entry #:[**] | Values 01 to 32 NO DEFAULT | This identifies one speed dial entry in the table. |
| speed dial id:[*****] | 2 to 6 digits NO DEFAULT | This is stored in the speed dial table, along with a related PDN address (see next prompt). It can then be used, instead of a lengthy PDN address, for outgoing calls to PDNs. |
| address: [*****] | Up to 15 digits NO DEFAULT | This is the PDN address related to a speed dial id. When a Called Address matches a speed dial id, the Called Address is replaced by this (PDN) address. The switch then places this PDN address in the Called Address field. |
| insert id:[0] | Values 0 or 1: 0 = Do not insert 1 = Insert DEFAULT = 0 | This tells the switch whether or not to insert the speed dial id into the CUD field. When insert is enabled, the speed dial id in the CUD field can be used later for routing purposes by another switch. |
| DONE ... THE CONFIGURE MENU WILL BE DISPLAYED. | | |

5.4.4 Setting Up the Class Route Table

The class route function can be contrasted to the speed dial function. Where speed dial handles calls outgoing to a PDN, class route handles those incoming from a PDN. Where speed dial takes a short Called Address and expands it to a full PDN address, class route takes the subaddress portion of a PDN address and translates it to a private network address. In both cases, the switch performs the PDN address translation for you.

Upon receiving an incoming call from a PDN, and if there are no routing digits (or incomplete digits) in the CUD field, the switch tries to match any subaddress digits with a route id in its class route table (see figure 5-7). If a match is found, the address associated with that route id becomes the new Called Address. For more information on class routing, refer to paragraph 3.2.2. Paragraph 4.6 illustrates a class route application.

To set up the class route table, begin by selecting item 4 (Class Route) from the Configure Menu (see figure 5-3). See table 5-5 for descriptions of the prompts that appear.

X.25 SWITCH ADDRESS ¹

| mb3-x.25 switch class route | | | nnnnn | time 00:00:00 date 00-00-00 | | |
|-----------------------------|----------|---------|---------|-----------------------------|---------|--|
| entry # | route id | address | entry # | route id | address | |
| 01 | 00 | | 02 | 00 | | |
| 03 | 00 | | 04 | 00 | | |
| 05 | 00 | | 06 | 00 | | |
| 07 | 00 | | 08 | 00 | | |
| 09 | 00 | | 10 | 00 | | |
| 11 | 00 | | 12 | 00 | | |
| 13 | 00 | | 14 | 00 | | |
| 15 | 00 | | 16 | 00 | | |
| 17 | 00 | | 18 | 00 | | |
| 19 | 00 | | 20 | 00 | | |
| 21 | 00 | | 22 | 00 | | |
| 23 | 00 | | 24 | 00 | | |
| 25 | 00 | | 26 | 00 | | |
| 27 | 00 | | 28 | 00 | | |
| 29 | 00 | | 30 | 00 | | |
| 31 | 00 | | 32 | 00 | | |



¹ THIS FIELD CONTAINS THE ADDRESS THAT WAS DEFINED WITH THE CMD/XCC FACILITY SELECTION OF THE CONFIGURE MENU.

Figure 5-7. Class Route Table

Table 5-5. Class Route Prompts

| Prompt | Options and Defaults | Description |
|--|-----------------------------------|--|
| entry #:[**] | Values 01 to 32 NO DEFAULT | This identifies one class route entry. |
| class route id:[**] | 2 digits NO DEFAULT | This is stored in the class route table, along with a related address (see next prompt). The switch then attempts to match the sub-address of an incoming Call Request Packet (from a PDN) with this class route id. It attempts to find the match, only if no routing digits are present in the CUD field of the incoming packet. |
| address:[*****] | Up to 12 digits NO DEFAULT | This is the address related to the class route id. If a match is found (as described in the previous prompt), then this address is placed in the Called Address field. This becomes the routing address. |
| DONE ... THE CONFIGURE MENU WILL BE DISPLAYED. | | |

5.4.5 Defining the Command Facility Address and Parameters

The Command Facility must have a network address, a subaddress, and specific parameters, so that it can be accessed both locally and remotely (refer to paragraph 5.2). For information on remote access of the Command Facility, refer to paragraph 3.9.

To set up the Command Facility, you select item 5 (CMD/XCC Facility) from the Configure Menu (see figure 5-3). See table 5-6 for descriptions of the prompts that will be displayed.

NOTE: After you modify CMD/XCC Facility values, perform a reset to put the new values into effect. Enter the Reset Switch Command (refer to paragraph 5.5.14), or press both Reset keys on the Touch Panel (refer to paragraph 2.3.2). If you do not wish to perform a reset, an optional way to put the new values into effect is to toggle the electrical signals on the Command Port link.

Table 5-6. CMD/XCC Facility Prompts

| Prompt | Options and Defaults | Description |
|---------------------|---|--|
| address: [*****] | Up to 15 digits. NO DEFAULT | This is a unique address that is used to identify the cmd/xcc facility (refer to paragraph 3.1). |
| class(cmd):[99] | 2 digits DEFAULT = 99 | This is the class (sub-address) that is used to identify the Command Facility. |
| class(xcc):[98] | 2 digits DEFAULT = 98 | This is the class (sub-address) that is used to identify MICOM's X.25 Control Center (XCC). |
| audit log:[0] | Values 0 or 1: 0 = Disabled 1 = Enabled DEFAULT = 0 | This enables or disables event reporting and call accounting to the Command Port. |
| statperiod:[0] | Values 0 to 6: 0 = Disabled 1-6 = Every 10 to 60 minutes, in 10-minute increments alternating between packet and link statistics DEFAULT = 0 | This specifies the frequency of statistics reporting. Even if you disable this periodic reporting, you may request statistics on demand. Counters are reset to 0 after each periodic report. You must logout to initiate periodic reporting. |
| echo:[1] | Values 0 or 1: 0 = Disable echo 1 = Enable echo DEFAULT = 1 | This specifies whether or not the Command Facility should echo received characters. |

Table 5-6. CMD/XCC Facility Prompts (continued)

| Prompt | Options and Defaults | Description |
|--------------|---|--|
| dv.flow:[1] | <p>Values 0 or 1:</p> <p>0 = No flow control 1 = XON/XOFF flow control</p> <p>DEFAULT = 1</p> | <p>This specifies whether or not the switch should use XON/XOFF to exercise flow control over the Command Port.</p> |
| s.signal:[5] | <p>Specific values:</p> <p>0 = No messages or service prompts 1 = Output messages only 4 = Output service prompts only 5 = Output messages and service prompts</p> <p>DEFAULT = 5</p> | <p>This specifies which messages and service prompts will be sent from the switch to the Command Facility.</p> |
| cr.pad:[4] | <p>Values 0 to 127:</p> <p>0 = No padding characters 1-127 = Number of padding characters after <u>CR</u></p> <p>DEFAULT = 4</p> | <p>This specifies the number of null (padding) characters to be output by the switch following the transmission of a <u>CR</u> to the Command Facility.</p> |
| l.fold:[80] | <p>Values 0 to 255:</p> <p>0 = No characters 1-255 = Number of characters that trigger linefolding</p> <p>DEFAULT = 80</p> | <p>This specifies the number of characters that will be output to the Command Facility before the switch automatically inserts a <u>CR</u> (before a line fold).</p> |

Table 5-6. CMD/XCC Facility Prompts (continued)

| Prompt | Options and Defaults | Description |
|------------|--|--|
| speed:[32] | <p>Specific values:</p> <ul style="list-style-type: none"> 0 = 110 bps 1 = 134.5 bps 2 = 300 bps 3 = 1200 bps 4 = 600 bps 5 = 75 bps 6 = 150 bps 7 = 1800 bps 8 = 200 bps 10 = 50 bps 12 = 2400 bps 13 = 4800 bps 14 = 9600 bps 32 = Autobaud (110-9600 bps, except 134.5 bps) <p>DEFAULT = 32</p> | <p>This specifies the data rate of the Command Port.</p> |
| p.flow:[1] | <p>Values 0 or 1:</p> <ul style="list-style-type: none"> 0 = Device cannot exercise flow control over the switch 1 = Device can exercise flow control, using XON/XOFF characters <p>DEFAULT = 1</p> | <p>This specifies whether or not the Command Port uses XON/XOFF flow control over the switch.</p> |
| lf.pad:[4] | <p>Values 0 to 127:</p> <ul style="list-style-type: none"> 0 = No line feed padding 1-127 = Number of padding nulls after line feed <p>DEFAULT = 4</p> | <p>This specifies the number of null (padding) characters to be output by the switch, following the transmission of a line feed to the Command Facility.</p> |

Table 5-6. CMD/XCC Facility Prompts (continued)

| Prompt | Options and Defaults | Description |
|---------------|---|--|
| edit:[1] | <p>Values 0 or 1:</p> <p>0 = Editing disabled 1 = Editing enabled</p> <p>DEFAULT = 1</p> | This specifies whether or not editing is enabled. |
| c.del:[8] | <p>Values 0 to 127</p> <p>DEFAULT = 8</p> | This specifies the ASCII character that is to be used by the Command Facility to request a character deletion. |
| l.del:[24] | <p>Values 0 to 127</p> <p>DEFAULT = 24</p> | This specifies the ASCII character that is to be used by the Command Facility to request a line deletion. |
| l.disp:[18] | <p>Values 0 to 127</p> <p>DEFAULT = 18</p> | This specifies the ASCII character that is to be used by the Command Facility to request display of the current input. |
| dv.type:[2] | <p>Values 1 or 2:</p> <p>1 = Hard copy device 2 = Video display</p> <p>DEFAULT = 2</p> | This specifies the type of device, so that the switch knows how to handle the editing control signals to the Command Port. |
| bits/char:[2] | <p>Values 0 to 3:</p> <p>0 = 5 bits 1 = 6 bits 2 = 7 bits 3 = 8 bits</p> <p>DEFAULT = 2</p> | This determines the number of bits per character, excluding the parity bit. |

Table 5-6. CMD/XCC Facility Prompts (continued)

| Prompt | Options and Defaults | Description |
|----------------|---|---|
| dv.parity:[5] | <p>Values 0 to 5:</p> <p>0 = Transparent parity 1 = Space 2 = Mark 3 = Even 4 = Odd 5 = Auto parity, as determined by autobaud sequence</p> <p>DEFAULT = 5</p> | <p>This indicates the parity to be used by the switch in communicating with the Command Port.</p> |
| net.parity:[0] | <p>Values 0 to 4:</p> <p>0 = Pass data as received 1 = Space 2 = Mark 3 = Even 4 = Odd</p> <p>DEFAULT = 0</p> | <p>This indicates the parity to be used by the switch when forwarding Command Port data to the Network.</p> |
| c.xon:[17] | <p>Values 0 to 127:</p> <p>0 = Ignored 1-127 = Decimal value of ASCII character for XON</p> <p>DEFAULT = 17</p> | <p>This specifies the character value to be used for the XON signaling character.</p> |
| c.xoff:[19] | <p>Values 0 to 127:</p> <p>0 = Ignored 1-127 = Decimal value of ASCII character for XOFF</p> <p>DEFAULT = 19</p> | <p>This specifies the character value to be used for the XOFF signaling character.</p> |

Table 5-6. CMD/XCC Facility Prompts (continued)

| Prompt | Options and Defaults | Description |
|---|--|--|
| special flow:[0] | <p>Specific values:</p> <p>0 = None</p> <p>1 = Device can flow control switch with RTS</p> <p>2 = Switch can flow control device with CTS</p> <p>4 = Switch issues BEL character to device in CTS flow control</p> <p>x = Any combination</p> <p>DEFAULT = 0</p> | <p>This specifies whether or not the Command Port can exercise flow control using Request-To-Send (RTS), or whether or not the switch can exercise flow control using Clear-To-Send (CTS).</p> |
| inactivity:[0] | <p>Values 0 to 255:</p> <p>0 = No disconnection on inactivity</p> <p>1-255 = Timer value, in one-minute increments.</p> <p>DEFAULT = 0</p> | <p>This causes the switch to clear a call, based on an inactivity period.</p> |
| x29acc:[0] | <p>Values 0 to 127:</p> <p>0 = X.29 access not allowed</p> <p>1-127 = Decimal value of ASCII character that enables X.29 access</p> <p>DEFAULT = 0</p> | <p>This specifies the character that enables entry of X.29 commands.</p> |
| prompt:[*] | <p>Up to 16 ASCII characters</p> <p>DEFAULT = *</p> | <p>This is the service prompt that advises the Command Facility user that X.28 commands may be entered.</p> |
| <p>DONE ... THE CONFIGURE MENU WILL BE DISPLAYED.</p> | | |

5.4.6 Defining System Parameters

There are several parameters that affect the switch as a whole, as opposed to affecting just a specific link. Because these apply to an entire switch, they are known as system parameters.

Several of these parameters affect routing (refer to paragraph 3.4). One parameter lets you set the operating parameters. Another parameter is used to assign the switch a unique network identifier. Finally, other parameters determine the length of entries in the switch's NUI table.

To define system parameters, select item 6 (System Parameters) from the Configure Menu (see figure 5-3). Table 5-7 describes the prompts that will be displayed.

After you modify system parameters, the switch displays two messages in succession:

```
done
system reset required
```

To put the new system parameters into effect, you must perform a Reset. Enter the Reset Switch Command (refer to paragraph 5.5.14), or press both Reset keys on the Touch Panel (refer to paragraph 2.3.2).

Table 5-7. System Parameters Prompts

| Prompt | Options and Defaults | Description |
|-----------|------------------------------|--|
| delta:[0] | Values 0 to 8 DEFAULT = 0 | This is the constant that represents dynamic priority in the best-path selection algorithm. The larger this value, the more emphasis given to dynamic routing. |
| beta:[1] | Values 0 to 8 DEFAULT = 1 | This is the constant that represents static priority in the best-path selection algorithm. The larger this value, the more emphasis given to static routing. |

Table 5-7. System Parameters Prompts (continued)

| Prompt | Options and Defaults | Description |
|-------------|---|--|
| max hop:[0] | Values 0 to 5 DEFAULT = 0 (disabled) | This is the maximum number of switches a call may visit without reaching its destination switch. If the maximum is exceeded, the call is cleared. |
| sys 1:[0] | Values 0 to 255 DEFAULT = 0 | This is the SYS 1 soft switch group (see figure 2-14). Values that you enter (by themselves or in combination with other values) determine some of the operating parameters: <ul style="list-style-type: none"> • Entering a value of 8 causes the switch to be cold started upon Reset. • Entering a value of 32 defines the last link as the local Command Port. • Entering a value of 64 enables off-line memory dump. |
| sys 2:[0] | Values 0 to 255 DEFAULT = 0 | This is the SYS 2 soft switch group (see figure 2-15). The value that you enter is the number that identifies the switch to the Network. Among other things, this number is used to determine if a call has visited this switch before (that is, whether a call is wild). |

Table 5-7. System Parameters Prompts (continued)

| Prompt | Options and Defaults | Description |
|--|------------------------------------|--|
| billing # length:[10] | Values 0 to 15 DEFAULT = 10 | This is the length of the billing numbers to be entered in the NUI table of this switch (refer to paragraph 5.4.7). |
| pin length:[4] | Values 0 to 14 DEFAULT = 4 | This is the length of the Personal Identification Numbers (PINs) to be entered in the NUI table of this switch (refer to paragraph 5.4.7). |
| DONE ... THE CONFIGURE MENU WILL BE DISPLAYED. | | |

5.4.7 The Switch's Network User Identification (NUI) Facility

The switch's support of the X.25 NUI facility provides security and allows for the retrieval of billing information (refer to paragraph 5.7 for information on how the switch uses this billing information in its call accounting records).

A DE or PN link can be configured to look for and validate the NUI facility request string in a Call Request Packet. The parameter in the NUI facility is considered to be made up of two parts: a billing number (which can be used by the switch for call accounting) and a Personal Identification Number (PIN), which is comparable to a user password. Upon receiving a Call Request Packet from a DE or PN link, the switch validates the NUI facility request by matching the billing number and PIN to a billing number and PIN in its NUI table.

At the link level, the switch can:

- Perform no NUI validation, and just pass the NUI through transparently (to be validated by the PDN).
- Perform an NUI validation check and clear a call if the validation fails.
- Perform an NUI validation check and accept a call if the validation fails.
- Delete the NUI facility string from an accepted and validated Call Request Packet before forwarding the packet to an outgoing link.

Each switch in a network can accept up to 100 entries in its NUI table. Each entry is comprised of up to 29 alphanumeric characters (15 for the billing number and 14 for the PIN).

The following paragraphs tell you how to configure your switch for NUI facility support. They describe how to:

- Configure link profiles for NUI handling.
- Provide the length values for the billing number and the PIN entries in the NUI table.
- Set up the NUI table.

Following paragraph 5.4.7.3 (which describes setup of the NUI table) are two examples of how the switch handles an NUI call.

5.4.7.1 Configuring the Link Profiles

Perform this procedure for every link that is to provide the NUI validation check on incoming calls (the default link profile provides no NUI validation check).

Select item 1 (Link Profile) from the Configure Menu (refer to paragraph 5.4.1). The second to the last prompt is:

nui handling

Answer this prompt with one of (or a combination of) the following values:

- 1 = Perform NUI validation check
- 2 = Clear call if NUI validation fails
- 4 = Delete NUI from Call Request Packet

If you do not change the nui handling default value of 0 (that is, you do not enter one of the previous values), calls will come into the switch with no NUI validation check.

NOTE: Configure only DE or PN links for NUI handling. This configuration is invalid for IS links.

5.4.7.2 Provide the Length Values for the Billing Number and the PIN

The billing number and the PIN are part of each entry in the NUI table. You must assign a length for each of these items, or accept the default lengths (10 and 4, respectively).

Select item 6 (System Parameters) from the Configure Menu (refer to paragraph 5.4.6). The second to the last prompt is:

billing # length

Answer this prompt with a value in the range 1 to 15, inclusive (the default is 10). This sets the length of all billing numbers to be entered in the NUI table.

The last prompt in System Parameters is:

pin length

Answer this prompt with a value in the range 1 to 14, inclusive (the default is 4). This sets the length of all PINs to be entered in the NUI table.

NOTE: After you enter values for the billing number and PIN, you must reset the switch to put the new values into effect. Enter the Reset Switch Command (refer to paragraph 5.5.14), or press both Reset keys on the Touch Panel (refer to paragraph 2.3.2). Following the switch reset, the lengths of all billing numbers and PINs entered in the NUI table must be as defined. In addition, any existing entries in the NUI table must be modified appropriately to meet the new length requirements.

5.4.7.3 Set Up the NUI Table

The NUI table contains all the user-entered PINs and billing numbers. Upon receiving a Call Request Packet, the switch attempts to match any NUI facility request to a PIN and related billing number in its NUI table (the switch also uses the billing number for call accounting purposes, as described in paragraph 5.7).

One sample page of the NUI table is shown in figure 5-8. To set up the NUI table, select item 7 (NUI) from the Configure Menu (see figure 5-3). You can input up to 100 entries in the NUI table. See table 5-8 for descriptions of the prompts that appear after you select item 7 from the Configure Menu.

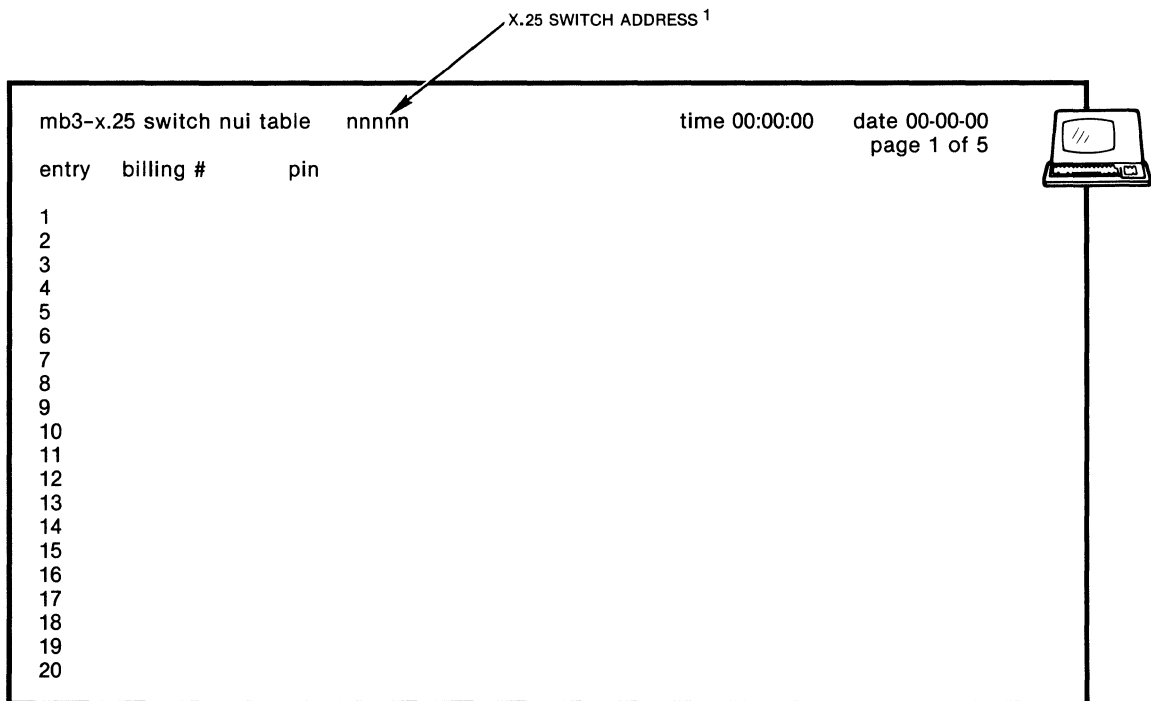

```
mb3-x.25 switch nui table nnnnn                time 00:00:00  date 00-00-00
entry  billing #    pin                                page 1 of 5
1
2
3
4
5
6
7
8
9
10
11
12
13
14
15
16
17
18
19
20
```

¹ THIS FIELD CONTAINS THE ADDRESS THAT WAS DEFINED WITH THE CMD/XCC FACILITY SELECTION OF THE CONFIGURE MENU.

Figure 5-8. Sample Page From the NUI Table

Table 5-8. NUI Table Prompts

| Prompt | Options and Defaults | Description |
|--|--|--|
| entry # :[***] | Values 1 through 100 NO DEFAULT | This identifies one NUI entry in the table. |
| billing # :[] | Up to 15 alphanumeric characters NO DEFAULT | The billing number is picked up for call accounting purposes if a match is found with the related PIN (see next prompt). The length of this entry is determined by the value of the billing # length item in System Parameters configuration (refer to paragraphs 5.4.6 and 5.4.7.2). The factory-set default length is 10. |
| pin:[] | Up to 14 alphanumeric characters NO DEFAULT | Upon receipt of a Call Request Packet, the switch attempts to match any NUI facility request string to this PIN and its related billing number. The length of this entry is determined by the value of the pin length item in System Parameters configuration (refer to paragraphs 5.4.6 and 5.4.7.2). The factory-set default length is 4. |
| DONE ... THE CONFIGURE MENU WILL BE DISPLAYED. | | |

NUI Example 1

The Call Request Packet of an incoming call has the following NUI facility request string:

123abc12345

The NUI handling field of the incoming link profile is equal to 5:

1 (perform NUI validation) + 4 (delete NUI from Call Request Packet)

The switch's NUI table includes the following entry:

| entry | billing # | pin |
|-------|-----------|-------|
| 86 | 123abc | 12345 |

The switch performs the following steps:

1. It checks the profile of the incoming link for NUI handling instructions and finds a value of 5.
2. It tries to match the NUI facility request string in the Call Request Packet with the entries in its NUI table.
3. It finds a match and accepts the call.
4. It picks up the billing number (123abc) related to PIN 12345, for call accounting purposes.
5. Based on the NUI handling instructions in the incoming link profile, it deletes the NUI facility string from the Call Request Packet before forwarding the packet to the outgoing link.

NUI Example 2

The Call Request Packet of an incoming call has the following NUI facility request string:

123abc12345

The NUI handling field of the incoming link profile is equal to 3:

1 (perform NUI validation) + 2 (clear call if NUI validation fails)

The switch's NUI table does NOT include an entry of billing number 123abc and PIN 12345.

The switch performs the following steps:

1. It checks the profile of the incoming link for NUI handling instructions and finds a value of 3.
2. It tries to match the NUI facility request string in the Call Request Packet with the entries in its NUI table.
3. It does not find a match.
4. Based on the NUI handling instructions in the incoming link profile, it clears the call, with cause code 03 (Invalid Facility Request) and diagnostic code 66 (Invalid NUI).

5.5 OTHER COMMAND MENU FUNCTIONS

All the configuration functions described in paragraph 5.4 stem from item 1 (Configure) of the Command Menu. The Command Menu includes many other items, which are described in the following paragraphs. For a list of these items, see figure 5-1.

5.5.1 Disconnect LCN Command

This function can be performed by selecting item 2 from the Command Menu (see figure 5-1). The Disconnect LCN Command causes the switch to clear a call in progress by sending a Clear Request Packet to both ends of the virtual circuit.

Table 5-9 describes the prompts that are displayed after you enter a Disconnect LCN Command:

Table 5-9. Disconnect LCN Prompts

| Prompt | Options and Defaults | Description |
|-------------|-----------------------------------|--|
| link #:[**] | Values 1 to 12 NO DEFAULT | This is the link on which the LCN is to be disconnected. |
| lgn:[0] | Values 0 to 15 DEFAULT = 0 | This is the LGN of the LCN to be disconnected. |
| lcn:[***] | Values 0 to 255 NO DEFAULT | This is the LCN to be disconnected. |

After you respond to the last prompt and enter a CR, the switch displays:

done

After that, the Command Menu is re-displayed.

5.5.2 Reset PVC Command

(Not implemented)

5.5.3 Busyout Link Command

This is item 4 of the Command Menu (see figure 5-1). It is used to put a link out of service. It is especially useful for protecting unused links from unauthorized access.

After a Busyout Link Command is entered, the switch does not allow any new calls to be established on the link. However, it does not clear any calls already in progress. A link is not completely idle until all calls in progress on the link are cleared.

After you select item 4 from the Command Menu and enter a CR, the switch displays the prompt:

link #:[**]

Enter a value from 1 to 12, which indicates the link that is to be busied out. After you enter a CR, the switch displays the message:

done

It then redisplay the Command Menu.

Once a link is busied out, no new calls will be accepted on it until the link is reenabled with a Link Up Command (refer to paragraph 5.5.5).

5.5.4 Link Down Command

This is item 5 of the Command Menu (see figure 5-1). It is used to logically disconnect a link (all virtual circuits are cleared). The Link Up Command (refer to paragraph 5.5.5) puts the link back in service.

After you select item 5 from the Command Menu and enter a CR, the switch displays the prompt:

```
link #:[**]
```

You enter a value from 1 to 12, which indicates the link that is to be logically disconnected. After you enter a CR, the switch displays the message:

```
done
```

It then re-displays the Command Menu.

5.5.5 Link Up Command

This is item 6 of the Command Menu (see figure 5-1). It is used to connect a link that is logically disconnected. It reverses the effect of the Link Down or Busyout Link Command (refer to paragraphs 5.5.3 and 5.5.4).

After you select item 6 from the Command Menu and enter a CR, the switch displays the prompt:

```
link #:[**]
```

Enter a value from 1 to 12, which indicates the link that is to be connected. After you enter a CR, the switch displays the message:

```
done
```

It then re-displays the Command Menu.

5.5.6 List Stat (Link) Command

This is item 7 of the Command Menu (see figure 5-1). It lets you display the Link (frame) Level Statistics Report, which includes statistics for every link on the switch. These statistics can be requested on-demand, or can be displayed on a periodic basis (see table 5-6 and refer to paragraph 5.5.15). The Link Level Statistics Report is shown in figure 5-9 and is described in table 5-10. After reviewing this statistics report, you redisplay the Command Menu by entering a CR.

X.25 SWITCH ADDRESS ¹

| mb3-x.25 switch statistics | | | | | | | | | | | | | | | time 00:00:00 | | date 00-00-00 | |
|----------------------------|-------|------|----|------|----|-----------|-----------|-----|----|------|-----|-----------|----|----|---------------|---|---------------|--|
| link # | speed | disc | | sabm | | t1 expiry | crc error | rnr | | frmr | rej | link down | | | | | | |
| | | tx | rx | tx | rx | | | tx | rx | | | | tx | rx | | | | |
| 01di | 9600 | 0 | 0 | 0 | 0 | 0 | 0 | 0 | 0 | 0 | 0 | 0 | 0 | 0 | 0 | 0 | 0 | |
| 02ui | 9600 | 0 | 0 | 0 | 0 | 0 | 0 | 0 | 0 | 0 | 0 | 0 | 0 | 0 | 0 | 0 | 0 | |
| 03di | 9600 | 0 | 0 | 0 | 0 | 0 | 0 | 0 | 0 | 0 | 0 | 0 | 0 | 0 | 0 | 0 | 0 | |
| 04di | 9600 | 0 | 0 | 0 | 0 | 0 | 0 | 0 | 0 | 0 | 0 | 0 | 0 | 0 | 0 | 0 | 0 | |
| 05di | 9600 | 0 | 0 | 0 | 0 | 0 | 0 | 0 | 0 | 0 | 0 | 0 | 0 | 0 | 0 | 0 | 0 | |
| 06di | 9600 | 0 | 0 | 0 | 0 | 0 | 0 | 0 | 0 | 0 | 0 | 0 | 0 | 0 | 0 | 0 | 0 | |
| 07di | 9600 | 0 | 0 | 0 | 0 | 0 | 0 | 0 | 0 | 0 | 0 | 0 | 0 | 0 | 0 | 0 | 0 | |
| 08di | 9600 | 0 | 0 | 0 | 0 | 0 | 0 | 0 | 0 | 0 | 0 | 0 | 0 | 0 | 0 | 0 | 0 | |
| 09di | 9600 | 0 | 0 | 0 | 0 | 0 | 0 | 0 | 0 | 0 | 0 | 0 | 0 | 0 | 0 | 0 | 0 | |
| 10di | 9600 | 0 | 0 | 0 | 0 | 0 | 0 | 0 | 0 | 0 | 0 | 0 | 0 | 0 | 0 | 0 | 0 | |
| 11di | 9600 | 0 | 0 | 0 | 0 | 0 | 0 | 0 | 0 | 0 | 0 | 0 | 0 | 0 | 0 | 0 | 0 | |
| 12di | 9600 | 0 | 0 | 0 | 0 | 0 | 0 | 0 | 0 | 0 | 0 | 0 | 0 | 0 | 0 | 0 | 0 | |

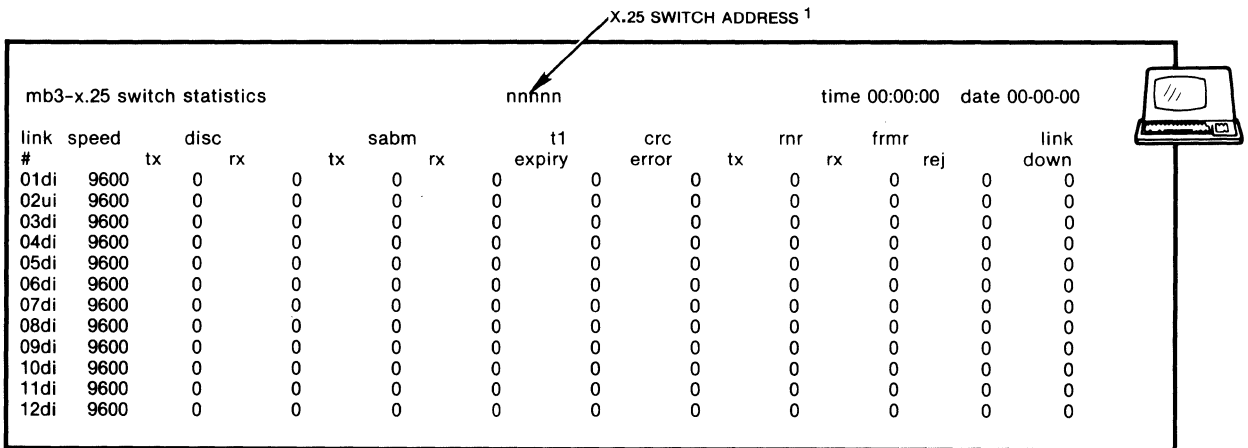

NOTE:
FOR UNITS EQUIPPED WITH THE X.21 OR V.35 HIGH-SPEED OPTION, THE DEFAULT SPEED VALUE FOR LINK 1 IS 56,000 bps (NOT 9600 bps).

¹ THIS FIELD CONTAINS THE ADDRESS THAT WAS DEFINED WITH THE CMD/XCC FACILITY SELECTION OF THE CONFIGURE MENU.

MI-1390-1a-28

Figure 5-9. Link Level Statistics Report

Table 5-10. Link Level Statistics Report

| Field Heading | Range of Values | Description |
|---------------|-----------------|---|
| link # | 1 to 12 | The physical number of the link. Alpha characters following the number indicate the link's status and link type: u = up, d = down, b = busyout e = de, i = is, p = pn |
| speed | 1200 to 72,000 | The speed of the link. Speeds above 19,200 apply to link 1 only, and only to switches equipped with a high-speed option. |
| disc (tx) | 0 to 65,535 | The number of Disc frames transmitted on this link |
| disc (rx) | 0 to 65,535 | The number of Disc frames received on this link |
| sabm (tx) | 0 to 65,535 | The number of sabm frames transmitted on this link |
| sabm (rx) | 0 to 65,535 | The number of sabm frames received on this link |
| ti expiry | 0 to 65,535 | The number of times this link has gone into timeout recovery |
| CRC error | 0 to 65,535 | The number of frames with bad CRC received on this link |
| rnr (tx) | 0 to 65,535 | The number of rnr frames transmitted on this link |
| rnr (rx) | 0 to 65,535 | The number of rnr frames received on this link |
| frmr/rej | 0 to 255 | The number of frmr and rej frames received on this link |
| link down | 0 to 255 | The number of times the link went down |

5.5.7 List Stat (Pkt) Command

This is item 8 of the Command Menu (see figure 5-1). It lets you display the Packet Level Statistics Report, which includes statistics for every link on the switch. These statistics can be requested on-demand, or can be displayed on a periodic basis (see table 5-6 and refer to paragraph 5.5.15). The Packet Level Statistics Report is shown in figure 5-10 and is described in table 5-11. After reviewing this statistics report, you re-display the Command Menu by entering a CR.

| mb3-x.25 switch statistics | | | | | | | | | | | | | |
|----------------------------|----------|----|---------|----|----------|--------------|--------------|----|------------|----|----------|---------|--|
| calls | | | | | | | | | | | | | |
| link # | accepted | | cleared | | call rej | call reroute | data packets | | characters | | re-start | inv pkt | |
| | tx | rx | tx | rx | | | tx | rx | tx | rx | | | |
| 01di | 0 | 0 | 0 | 0 | 0 | 0 | 0 | 0 | 0 | 0 | 0 | 0 | |
| 02ui | 0 | 0 | 0 | 0 | 0 | 0 | 0 | 0 | 0 | 0 | 0 | 0 | |
| 03di | 0 | 0 | 0 | 0 | 0 | 0 | 0 | 0 | 0 | 0 | 0 | 0 | |
| 04di | 0 | 0 | 0 | 0 | 0 | 0 | 0 | 0 | 0 | 0 | 0 | 0 | |
| 05di | 0 | 0 | 0 | 0 | 0 | 0 | 0 | 0 | 0 | 0 | 0 | 0 | |
| 06di | 0 | 0 | 0 | 0 | 0 | 0 | 0 | 0 | 0 | 0 | 0 | 0 | |
| 07di | 0 | 0 | 0 | 0 | 0 | 0 | 0 | 0 | 0 | 0 | 0 | 0 | |
| 08di | 0 | 0 | 0 | 0 | 0 | 0 | 0 | 0 | 0 | 0 | 0 | 0 | |
| 09di | 0 | 0 | 0 | 0 | 0 | 0 | 0 | 0 | 0 | 0 | 0 | 0 | |
| 10di | 0 | 0 | 0 | 0 | 0 | 0 | 0 | 0 | 0 | 0 | 0 | 0 | |
| 11di | 0 | 0 | 0 | 0 | 0 | 0 | 0 | 0 | 0 | 0 | 0 | 0 | |
| 12di | 0 | 0 | 0 | 0 | 0 | 0 | 0 | 0 | 0 | 0 | 0 | 0 | |

¹ THIS FIELD CONTAINS THE ADDRESS THAT WAS DEFINED WITH THE CMD/XCC FACILITY SELECTION OF THE CONFIGURE MENU.

Figure 5-10. Packet Level Statistics Report

Table 5-11. Packet Level Statistics Report

| Field Heading | Range of Values | Description |
|---------------------|-----------------|---|
| link # | 1 to 12 | The physical number of the link. Alpha characters following the number indicate the link's status and link type: u = up, d = down, b = busyout e = de, i = is, p = pn |
| calls accepted (tx) | 0 to 65,535 | The number of incoming calls accepted on this link |
| calls accepted (rx) | 0 to 65,535 | The number of outgoing calls accepted on this link |

Table 5-11. Packet Level Statistics Report (continued)

| Field Heading | Range of Values | Description |
|------------------------------|-----------------|---|
| calls cleared (tx) | 0 to 65,535 | The number of incoming calls cleared (refused) on this link |
| calls cleared (rx) | 0 to 65,535 | The number of outgoing calls cleared (refused) on this link |
| call rej | 0 to 255 | The number of calls placed through this link and cleared because of: invalid mask, maximum hop count exceeded, or no svcs available |
| call reroute | 0 to 65,535 | The number of calls placed through this link and rerouted because of a network-related problem (for example, a link down condition, or no svcs available) |
| data packets (tx) | 0 to 65,535 | The number of data packets transmitted on this link, expressed in number of packets |
| data packets (rx) | 0 to 65,535 | The number of data packets received on this link, expressed in number of packets |
| data characters (tx) (x 100) | 0 to 65,535 | The number of data characters transmitted on this link, in hundreds |
| data characters (rx) (x 100) | 0 to 65,535 | The number of data characters received on this link, in hundreds |
| restart | 0 to 255 | The number of restart packets transmitted and received on this link |
| inv pkt | 0 to 255 | The number of invalid packets received on this link |

5.5.8 List Routing Table Command

This is item 9 of the Command Menu (see figure 5-1). It lets you display a list of the switch's routing masks. Refer to paragraph 5.4.2 for information on setting up a routing table and for descriptions of the fields in the routing table.

The four pages of a routing table are shown in figure 5-11. They are displayed, one by one, when you select item 9 from the Command Menu. The switch leaves each routing table page on the screen until you enter a CR. To cancel a display and re-display the Command Menu, enter Ctrl-C. To re-display the Command Menu after viewing page 4 of the routing table, just enter a CR.

X.25 SWITCH ADDRESS ¹

| mb3-x.25 switch routing mask | | | | nnnnn | time 00:00:00 | date 00-00-00 | page 1 of 4 | |
|------------------------------|------|----------|------|----------|---------------|---------------|-------------|----------|
| entry mask | link | priority | link | priority | link | priority | link | priority |
| 01 | 00 | 00 | 00 | 00 | 00 | 00 | 00 | 00 |
| 02 | 00 | 00 | 00 | 00 | 00 | 00 | 00 | 00 |
| 03 | 00 | 00 | 00 | 00 | 00 | 00 | 00 | 00 |
| 04 | 00 | 00 | 00 | 00 | 00 | 00 | 00 | 00 |
| 05 | 00 | 00 | 00 | 00 | 00 | 00 | 00 | 00 |
| 06 | 00 | 00 | 00 | 00 | 00 | 00 | 00 | 00 |
| 07 | 00 | 00 | 00 | 00 | 00 | 00 | 00 | 00 |
| 08 | 00 | 00 | 00 | 00 | 00 | 00 | 00 | 00 |
| 09 | 00 | 00 | 00 | 00 | 00 | 00 | 00 | 00 |
| 10 | 00 | 00 | 00 | 00 | 00 | 00 | 00 | 00 |
| 11 | 00 | 00 | 00 | 00 | 00 | 00 | 00 | 00 |
| 12 | 00 | 00 | 00 | 00 | 00 | 00 | 00 | 00 |
| 13 | 00 | 00 | 00 | 00 | 00 | 00 | 00 | 00 |
| 14 | 00 | 00 | 00 | 00 | 00 | 00 | 00 | 00 |
| 15 | 00 | 00 | 00 | 00 | 00 | 00 | 00 | 00 |
| 16 | 00 | 00 | 00 | 00 | 00 | 00 | 00 | 00 |

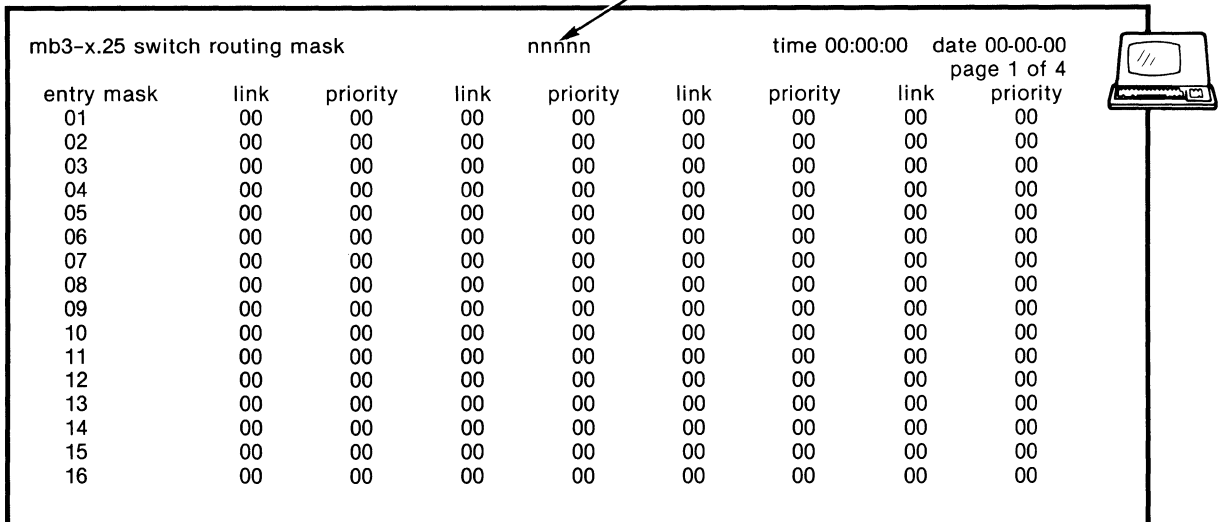

¹ THIS FIELD CONTAINS THE ADDRESS THAT WAS DEFINED WITH THE CMD/XCC FACILITY SELECTION OF THE CONFIGURE MENU.

Figure 5-11. Routing Table (1 of 4)

X.25 SWITCH ADDRESS ¹

| mb3-x.25 switch routing mask | | | | | | | | | |
|------------------------------|------|----------|------|----------|------|----------|------|----------|-----------------------------|
| entry mask | link | priority | link | priority | link | priority | link | priority | |
| | | | | | | | | | nnnnn |
| | | | | | | | | | time 00:00:00 date 00-00-00 |
| | | | | | | | | | page 2 of 4 |
| 17 | 00 | 00 | 00 | 00 | 00 | 00 | 00 | 00 | 00 |
| 18 | 00 | 00 | 00 | 00 | 00 | 00 | 00 | 00 | 00 |
| 19 | 00 | 00 | 00 | 00 | 00 | 00 | 00 | 00 | 00 |
| 20 | 00 | 00 | 00 | 00 | 00 | 00 | 00 | 00 | 00 |
| 21 | 00 | 00 | 00 | 00 | 00 | 00 | 00 | 00 | 00 |
| 22 | 00 | 00 | 00 | 00 | 00 | 00 | 00 | 00 | 00 |
| 23 | 00 | 00 | 00 | 00 | 00 | 00 | 00 | 00 | 00 |
| 24 | 00 | 00 | 00 | 00 | 00 | 00 | 00 | 00 | 00 |
| 25 | 00 | 00 | 00 | 00 | 00 | 00 | 00 | 00 | 00 |
| 26 | 00 | 00 | 00 | 00 | 00 | 00 | 00 | 00 | 00 |
| 27 | 00 | 00 | 00 | 00 | 00 | 00 | 00 | 00 | 00 |
| 28 | 00 | 00 | 00 | 00 | 00 | 00 | 00 | 00 | 00 |
| 29 | 00 | 00 | 00 | 00 | 00 | 00 | 00 | 00 | 00 |
| 30 | 00 | 00 | 00 | 00 | 00 | 00 | 00 | 00 | 00 |
| 31 | 00 | 00 | 00 | 00 | 00 | 00 | 00 | 00 | 00 |
| 32 | 00 | 00 | 00 | 00 | 00 | 00 | 00 | 00 | 00 |



¹ THIS FIELD CONTAINS THE ADDRESS THAT WAS DEFINED WITH THE CMD/XCC FACILITY SELECTION OF THE CONFIGURE MENU.

MI-1390-1a-30

Figure 5-11. Routing Table (2 of 4)

X.25 SWITCH ADDRESS ¹

| mb3-x.25 switch routing mask | | | | | | | | | |
|------------------------------|------|----------|------|----------|------|----------|------|----------|-----------------------------|
| entry mask | link | priority | link | priority | link | priority | link | priority | |
| | | | | | | | | | nnnnn |
| | | | | | | | | | time 00:00:00 date 00-00-00 |
| | | | | | | | | | page 3 of 4 |
| 33 | 00 | 00 | 00 | 00 | 00 | 00 | 00 | 00 | 00 |
| 34 | 00 | 00 | 00 | 00 | 00 | 00 | 00 | 00 | 00 |
| 35 | 00 | 00 | 00 | 00 | 00 | 00 | 00 | 00 | 00 |
| 36 | 00 | 00 | 00 | 00 | 00 | 00 | 00 | 00 | 00 |
| 37 | 00 | 00 | 00 | 00 | 00 | 00 | 00 | 00 | 00 |
| 38 | 00 | 00 | 00 | 00 | 00 | 00 | 00 | 00 | 00 |
| 39 | 00 | 00 | 00 | 00 | 00 | 00 | 00 | 00 | 00 |
| 40 | 00 | 00 | 00 | 00 | 00 | 00 | 00 | 00 | 00 |
| 41 | 00 | 00 | 00 | 00 | 00 | 00 | 00 | 00 | 00 |
| 42 | 00 | 00 | 00 | 00 | 00 | 00 | 00 | 00 | 00 |
| 43 | 00 | 00 | 00 | 00 | 00 | 00 | 00 | 00 | 00 |
| 44 | 00 | 00 | 00 | 00 | 00 | 00 | 00 | 00 | 00 |
| 45 | 00 | 00 | 00 | 00 | 00 | 00 | 00 | 00 | 00 |
| 46 | 00 | 00 | 00 | 00 | 00 | 00 | 00 | 00 | 00 |
| 47 | 00 | 00 | 00 | 00 | 00 | 00 | 00 | 00 | 00 |
| 48 | 00 | 00 | 00 | 00 | 00 | 00 | 00 | 00 | 00 |



¹ THIS FIELD CONTAINS THE ADDRESS THAT WAS DEFINED WITH THE CMD/XCC FACILITY SELECTION OF THE CONFIGURE MENU.

MI-1390-1a-31

Figure 5-11. Routing Table (3 of 4)

X.25 SWITCH ADDRESS ¹

| mb3-x.25 switch routing mask | | | | | | | | | |
|------------------------------|------|------|----------|-------|----------|------|----------|------|----------|
| entry | mask | link | priority | link | priority | link | priority | link | priority |
| | | | | nnnnn | | | | | |
| time 00:00:00 date 00-00-00 | | | | | | | | | |
| page 4 of 4 | | | | | | | | | |
| 49 | | 00 | 00 | 00 | 00 | 00 | 00 | 00 | 00 |
| 50 | | 00 | 00 | 00 | 00 | 00 | 00 | 00 | 00 |
| 51 | | 00 | 00 | 00 | 00 | 00 | 00 | 00 | 00 |
| 52 | | 00 | 00 | 00 | 00 | 00 | 00 | 00 | 00 |
| 53 | | 00 | 00 | 00 | 00 | 00 | 00 | 00 | 00 |
| 54 | | 00 | 00 | 00 | 00 | 00 | 00 | 00 | 00 |
| 55 | | 00 | 00 | 00 | 00 | 00 | 00 | 00 | 00 |
| 56 | | 00 | 00 | 00 | 00 | 00 | 00 | 00 | 00 |
| 57 | | 00 | 00 | 00 | 00 | 00 | 00 | 00 | 00 |
| 58 | | 00 | 00 | 00 | 00 | 00 | 00 | 00 | 00 |
| 59 | | 00 | 00 | 00 | 00 | 00 | 00 | 00 | 00 |
| 60 | | 00 | 00 | 00 | 00 | 00 | 00 | 00 | 00 |
| 61 | | 00 | 00 | 00 | 00 | 00 | 00 | 00 | 00 |
| 62 | | 00 | 00 | 00 | 00 | 00 | 00 | 00 | 00 |
| 63 | | 00 | 00 | 00 | 00 | 00 | 00 | 00 | 00 |
| 64 | | 00 | 00 | 00 | 00 | 00 | 00 | 00 | 00 |



¹ THIS FIELD CONTAINS THE ADDRESS THAT WAS DEFINED WITH THE CMD/XCC FACILITY SELECTION OF THE CONFIGURE MENU.

Figure 5-11. Routing Table (4 of 4)

5.5.9 List Speed Dial Command

This is item 10 of the Command Menu (see figure 5-1). It lets you review the current speed dial table for a switch. When you select item 10 and enter a CR, the switch displays the speed dial table, shown in figure 5-12.

X.25 SWITCH ADDRESS ¹

| mb3-x.25 switch speed dial | | | | nnnnn | | | | time 00:00:00 | date 00-00-00 |
|----------------------------|----------|---------|-----------|---------|----------|---------|-----------|---------------|---------------|
| entry # | speed id | address | insert id | entry # | speed id | address | insert id | | |
| 01 | | | 0 | 02 | | | 0 | | |
| 03 | | | 0 | 04 | | | 0 | | |
| 05 | | | 0 | 06 | | | 0 | | |
| 07 | | | 0 | 08 | | | 0 | | |
| 09 | | | 0 | 10 | | | 0 | | |
| 11 | | | 0 | 12 | | | 0 | | |
| 13 | | | 0 | 14 | | | 0 | | |
| 15 | | | 0 | 16 | | | 0 | | |
| 17 | | | 0 | 18 | | | 0 | | |
| 19 | | | 0 | 20 | | | 0 | | |
| 21 | | | 0 | 22 | | | 0 | | |
| 23 | | | 0 | 24 | | | 0 | | |
| 25 | | | 0 | 26 | | | 0 | | |
| 27 | | | 0 | 28 | | | 0 | | |
| 29 | | | 0 | 30 | | | 0 | | |
| 31 | | | 0 | 32 | | | 0 | | |

¹ THIS FIELD CONTAINS THE ADDRESS THAT WAS DEFINED WITH THE CMD/XCC FACILITY SELECTION OF THE CONFIGURE MENU.

Figure 5-12. Speed Dial Table

As shown in figure 5-12, entry numbers are listed in ascending order, from left to right and then down. They identify unique speed dial addresses.

The speed id number is what the switch tries to match with the Called Address (excluding any subaddress) of a Call Request Packet destined for a PN link. If a match is found, then the switch replaces the Called Address with the address related to this speed id (this is a PDN address).

The address is the actual PDN address that is to replace a Called Address (if a match is found as described previously).

Insert id is a yes or no field, where 1 equals yes and 0 equals no. When the insert id field contains a 0, no action is taken by the switch. When this field contains a 1, the switch is instructed to insert the related speed id into the CUD field of a Call Request Packet. The speed id in the CUD field can then be used for routing on the other side of the PDN. The sequence of events is as follows:

- The switch finds a match between a Called Address and a speed id.
- The address related to that speed id replaces the original Called Address.
- The speed id is inserted into the CUD field of a Call Request Packet and is passed through the PDN.

For information on setting up the speed dial table, refer to paragraph 5.4.3.

5.5.10 List Class Route Command

This is item 11 of the Command Menu (see figure 5-1). It lets you review the current class route table for a switch. When you select item 11 and enter a CR, the switch displays the class route table, shown in figure 5-13.

X.25 SWITCH ADDRESS ¹

| mb3-x.25 switch class route | | | nnnnn | | | time 00:00:00 | date 00-00-00 |
|-----------------------------|----------|---------|---------|----------|---------|---------------|---------------|
| entry # | route id | address | entry # | route id | address | | |
| 01 | 00 | | 02 | 00 | | | |
| 03 | 00 | | 04 | 00 | | | |
| 05 | 00 | | 06 | 00 | | | |
| 07 | 00 | | 08 | 00 | | | |
| 09 | 00 | | 10 | 00 | | | |
| 11 | 00 | | 12 | 00 | | | |
| 13 | 00 | | 14 | 00 | | | |
| 15 | 00 | | 16 | 00 | | | |
| 17 | 00 | | 18 | 00 | | | |
| 19 | 00 | | 20 | 00 | | | |
| 21 | 00 | | 22 | 00 | | | |
| 23 | 00 | | 24 | 00 | | | |
| 25 | 00 | | 26 | 00 | | | |
| 27 | 00 | | 28 | 00 | | | |
| 29 | 00 | | 30 | 00 | | | |
| 31 | 00 | | 32 | 00 | | | |



¹ THIS FIELD CONTAINS THE ADDRESS THAT WAS DEFINED WITH THE CMD/XCC FACILITY SELECTION OF THE CONFIGURE MENU.

Figure 5-13. Class Route Table

As shown in figure 5-13, entry numbers are listed in ascending order, from left to right and then down. They identify unique class route addresses.

The route id number is what the switch tries to match with the subaddress of a Call Request Packet from a PN link. It attempts this match only if there are no routing digits in the CUD field of the Call Request Packet. If a match is found, then the switch replaces the Called Address with the class route address related to this route id. If no match is found, the switch just passes the call through.

The address is the routing address that is to be placed in the Called Address field (if a match is found as described previously).

For information on setting up the class route table, refer to paragraph 5.4.4.

5.5.11 List NUI Command

This is item 12 of the Command Menu (see figure 5-1). It lets you display a list of the switch's NUI table entries. Refer to paragraph 5.4.7 for information on how to configure the switch for support of the NUI facility.

The five pages of the NUI table are shown in figure 5-14. They are displayed, one by one, when you select item 12 from the Command Menu. The switch leaves each NUI table page on the screen until you enter a CR. To cancel a display and re-display the Command Menu, enter Ctrl-C. To re-display the Command Menu after viewing page five of the NUI table, just enter a CR.

time 00:00:00 date 00-00-00
page 1 of 5



X.25 SWITCH ADDRESS ¹

| entry | billing # | pin |
|-------|-----------|-----|
| 1 | | |
| 2 | | |
| 3 | | |
| 4 | | |
| 5 | | |
| 6 | | |
| 7 | | |
| 8 | | |
| 9 | | |
| 10 | | |
| 11 | | |
| 12 | | |
| 13 | | |
| 14 | | |
| 15 | | |
| 16 | | |
| 17 | | |
| 18 | | |
| 19 | | |
| 20 | | |

¹ THIS FIELD CONTAINS THE ADDRESS THAT WAS DEFINED WITH THE CMD/XCC FACILITY SELECTION OF THE CONFIGURE MENU.

MI-1390-1a-33

time 00:00:00 date 00-00-00
page 2 of 5



X.25 SWITCH ADDRESS ¹

| entry | billing # | pin |
|-------|-----------|-----|
| 21 | | |
| 22 | | |
| 23 | | |
| 24 | | |
| 25 | | |
| 26 | | |
| 27 | | |
| 28 | | |
| 29 | | |
| 30 | | |
| 31 | | |
| 32 | | |
| 33 | | |
| 34 | | |
| 35 | | |
| 36 | | |
| 37 | | |
| 38 | | |
| 39 | | |
| 40 | | |

¹ THIS FIELD CONTAINS THE ADDRESS THAT WAS DEFINED WITH THE CMD/XCC FACILITY SELECTION OF THE CONFIGURE MENU.

MI-1390-1a-34

Figure 5-14. NUI Table (1 of 3)

X.25 SWITCH ADDRESS ¹

| | | | | | | |
|---------------------------|-----------|-----|-------|---------------|---------------|---|
| mb3-x.25 switch nui table | | | nnnnn | time 00:00:00 | date 00-00-00 |  |
| entry | billing # | pin | | | page 3 of 5 | |
| 41 | | | | | | |
| 42 | | | | | | |
| 43 | | | | | | |
| 44 | | | | | | |
| 45 | | | | | | |
| 46 | | | | | | |
| 47 | | | | | | |
| 48 | | | | | | |
| 49 | | | | | | |
| 50 | | | | | | |
| 51 | | | | | | |
| 52 | | | | | | |
| 53 | | | | | | |
| 54 | | | | | | |
| 55 | | | | | | |
| 56 | | | | | | |
| 57 | | | | | | |
| 58 | | | | | | |
| 59 | | | | | | |
| 60 | | | | | | |

¹ THIS FIELD CONTAINS THE ADDRESS THAT WAS DEFINED WITH THE CMD/XCC FACILITY SELECTION OF THE CONFIGURE MENU.

MI-1390-1a-35

X.25 SWITCH ADDRESS ¹

| | | | | | | |
|---------------------------|-----------|-----|-------|---------------|---------------|---|
| mb3-x.25 switch nui table | | | nnnnn | time 00:00:00 | date 00-00-00 |  |
| entry | billing # | pin | | | page 4 of 5 | |
| 61 | | | | | | |
| 62 | | | | | | |
| 63 | | | | | | |
| 64 | | | | | | |
| 65 | | | | | | |
| 66 | | | | | | |
| 67 | | | | | | |
| 68 | | | | | | |
| 69 | | | | | | |
| 70 | | | | | | |
| 71 | | | | | | |
| 72 | | | | | | |
| 73 | | | | | | |
| 74 | | | | | | |
| 75 | | | | | | |
| 76 | | | | | | |
| 77 | | | | | | |
| 78 | | | | | | |
| 79 | | | | | | |
| 80 | | | | | | |

¹ THIS FIELD CONTAINS THE ADDRESS THAT WAS DEFINED WITH THE CMD/XCC FACILITY SELECTION OF THE CONFIGURE MENU.

MI-1390-1a-36

Figure 5-14. NUI Table (2 of 3)

X.25 SWITCH ADDRESS ¹

| mb3-x.25 switch nui table | | | nnnnn | time 00:00:00 | date 00-00-00 |
|---------------------------|-----------|-----|-------|---------------|---------------|
| entry | billing # | pin | | | page 5 of 5 |
| 81 | | | | | |
| 82 | | | | | |
| 83 | | | | | |
| 84 | | | | | |
| 85 | | | | | |
| 86 | | | | | |
| 87 | | | | | |
| 88 | | | | | |
| 89 | | | | | |
| 90 | | | | | |
| 91 | | | | | |
| 92 | | | | | |
| 93 | | | | | |
| 94 | | | | | |
| 95 | | | | | |
| 96 | | | | | |
| 97 | | | | | |
| 98 | | | | | |
| 99 | | | | | |
| 100 | | | | | |



¹ THIS FIELD CONTAINS THE ADDRESS THAT WAS DEFINED WITH THE CMD/XCC FACILITY SELECTION OF THE CONFIGURE MENU.

Figure 5-14. NUI Table (3 of 3)

5.5.12 Reset Stat Command

This is item 13 of the Command Menu (see figure 5-1). It causes all the link-level and packet-level statistics to be reset to zero. The only exception is the speed value in link-level statistics. The switch retains the speed value as set in the link profile (refer to paragraph 5.4.1).

After you select item 13 from the Command Menu and enter a CR, the switch displays the prompt:

```
are you sure?(y/n)
```

If you enter an n (or any other character, except a y) and a CR, the switch displays the following message, and then re-displays the Command Menu:

```
aborted
```

If you enter a y and a CR, the switch displays the following message and then re-displays the Command Menu:

```
done
```

5.5.13 Monitor Command

This is item 14 of the Command Menu (see figure 5-1). It lets you review the current operational status for each link. The report that is generated, after you select item 14, is shown in figure 5-15. Table 5-12 describes the fields of the display.

X.25 SWITCH ADDRESS ¹

| mb3-x.25 switch | | monitor | | nnnnn | | lcN (out) | | time 00:00:00 | date 00-00-00 | eia controls | | buffer |
|------------------------------|-----------|---------|-------|--------|-------|-----------|-------|---------------|---------------|--------------|-------|--------|
| link | lcN (i/o) | active | avail | active | avail | active | avail | # | # | abc | defgh | % |
| # | | | | | | | | svc | pvc | | | |
| 01dic | 000 | 002 | 000 | 000 | 000 | 000 | 000 | 002 | 000 | 00000000 | | 00 |
| 02dic | 000 | 002 | 000 | 000 | 000 | 000 | 000 | 002 | 000 | 00000000 | | 00 |
| 03dic | 000 | 002 | 000 | 000 | 000 | 000 | 000 | 002 | 000 | 00000000 | | 00 |
| 04dic | 000 | 002 | 000 | 000 | 000 | 000 | 000 | 002 | 000 | 00000000 | | 00 |
| 05dic | 000 | 002 | 000 | 000 | 000 | 000 | 000 | 002 | 000 | 00000000 | | 00 |
| 06dic | 000 | 002 | 000 | 000 | 000 | 000 | 000 | 002 | 000 | 00000000 | | 00 |
| 07dic | 000 | 002 | 000 | 000 | 000 | 000 | 000 | 002 | 000 | 00000000 | | 00 |
| 08dic | 000 | 002 | 000 | 000 | 000 | 000 | 000 | 002 | 000 | 00000000 | | 00 |
| 09dic | 000 | 002 | 000 | 000 | 000 | 000 | 000 | 002 | 000 | 00000000 | | 00 |
| 10dic | 000 | 002 | 000 | 000 | 000 | 000 | 000 | 002 | 000 | 00000000 | | 00 |
| 11dic | 000 | 002 | 000 | 000 | 000 | 000 | 000 | 002 | 000 | 00000000 | | 00 |
| 12dic | 000 | 002 | 000 | 000 | 000 | 000 | 000 | 002 | 000 | 00000000 | | 00 |
| total buffer utilization nn% | | | | | | | | | | | | |



¹ THIS FIELD CONTAINS THE ADDRESS THAT WAS DEFINED WITH THE CMD/XCC FACILITY SELECTION OF THE CONFIGURE MENU.

Figure 5-15. Monitor Report

Table 5-12. Monitor Report

| Field Heading | Range of Values | Description |
|----------------------------------|-------------------|---|
| link # | 1 to 12 | The physical number of the link. Alpha characters following the number indicate the link's status and link type: u = up, d = down, b = busyout e = de, i = is, p = pn c = dce, t = dte |
| lcn (i/o) active | 0 to 127 | This is the number of incoming/outgoing SVCs which are active. |
| lcn (i/o) avail | 0 to 127 | This is the number of incoming/outgoing SVCs which are available. |
| lcn (in) active | 0 to 127 | This is the number of incoming-only SVCs which are active. |
| lcn (in) avail | 0 to 127 | This is the number of incoming-only SVCs which are available. |
| lcn (out) active | 0 to 127 | This is the number of outgoing-only SVCs which are active. |
| lcn (out) avail | 0 to 127 | This is the number of outgoing-only SVCs which are available. |
| # svc | 0 to 127 | This is the number of SVCs that are defined. |
| # pvc | 0 to 127 | When implemented, this will show the number of PVCs that are defined. |
| eia controls abcdefgh | 0 = Off 1 = On | This is the on or off status of the four input signals (a, b, c, and d) and the four output signals (e, f, g, and h) of the link (see table 5-13 for descriptions of these signals). |
| buffer % | 0 to 99 | This is the percentage of buffer used by this link. |
| total buffer utilization nn % | 1 to 99 | This is the percentage of buffers used by the whole switch (where nn represents the value). |

Table 5-13. EIA Signals

| Switch Nomenclature | Description | Pin Number | Input (I) or Output (O) |
|---------------------|-------------|------------|-------------------------|
| a | RTS | 4 | I |
| b | DTR | 20 | I |
| c | Unassigned | 11 | I |
| d | Busy | 25 | I |
| e | CTS | 5 | O |
| f | DSR | 6 | O |
| g | DCD | 8 | O |
| h | RI | 22 | O |

NOTE:
 The input or output status of the EIA signals shown in this table do not apply to link 1. For link 1, the letters a through d relate to output signals; the letters e through h relate to input signals.

5.5.14 Reset Switch Command

This is item 15 of the Command Menu (see figure 5-1). This command simulates the action of a Touch Panel reset, where the two Reset keys are touched (refer to paragraph 2.3.2). The Reset Switch Command causes the switch to unconditionally reinitialize itself.

CAUTION: If you enter the Reset Switch Command with selection 4 of soft switch group SYS 1 ON, you will cold-start the switch (see figure 2-14). This will cause your configurations to be replaced by defaults. For example, all of your link profiles will be replaced by system defaults. Therefore, make sure you know the setting of selection 4 before you request a switch reset.

After you enter 15 and a CR, the switch displays the following message:

are you sure?(y/n)

If you enter n (or any other character, except a y) and a CR, the following message is displayed and then the Command Menu is re-displayed:

aborted

If you enter y and a CR, the switch resets itself. Following the reset, it is in the same state as if you had just powered it on. Therefore, to use the Command Facility again, you must perform the necessary access and logon procedures, as described in paragraphs 5.2 and 5.3.

5.5.15 Logout Command

This is the last item on the Command Menu (see figure 5-1). It allows you to exit from the Command Facility. You would exit from the Command Facility for any of the following reasons:

- You completed a Command Facility function or functions (for example, configuration).
- You want to enable the periodic output of statistics (see table 5-6).
- You want to make the Command Facility accessible only to authorized users.

After you enter 16 and a CR, the following message is displayed:

```
logout
```

The virtual circuit is cleared for a remote user (if neither audit log nor periodic statistics is enabled). To use the Command Facility again, you must perform the necessary access and logon procedures, described in paragraphs 5.2 and 5.3.

5.6 EVENT REPORTING

The switch reports events to the Command Facility, if you have configured audit log to 1 (see table 5-6, CMD/XCC facility configuration).

The events reported are link up, link down, restart, and wild call. They are described in the following paragraphs.

5.6.1 Link Up

This event report tells you that a link is operational.

One time when you will see this event reported is after you enter a Link Up Command (refer to paragraph 5.5.5). The switch displays the event in the following format:

```
hh:mm link# nn up
```

where nn equals the link number and hh:mm equals the time when that link came up.

5.6.2 Link Down

This event report tells you that a link is no longer operational.

One time when you will see this event reported is after you enter a Link Down Command (refer to paragraph 5.5.4). The switch displays the event in the following format:

```
hh:mm link# nn down
```

where nn equals the link number and hh:mm equals the time when that link went down.

5.6.3 Restart

If you receive this event report, it means that a Restart Packet was sent or received on this link. Any calls on that link have been cleared.

One time when you will see this event reported is if you enter a Link Down Command and subsequently enter a Link Up Command for that same link. The switch displays the event in the following format:

```
hh:mm link# nn restart
```

where nn equals the link number and hh:mm equals the time when that link was restarted.

5.6.4 Wild Call

You receive this event report if:

- A call has visited too many switches without reaching its destination switch (see the max hop prompt in table 5-7).
- A call has visited the same switch twice (that is, it is in a routing loop).

The format of this event report is:

```
hh:mm link# nn wild call called/calling address
```

where nn equals the number of the link that received the wild call and hh:mm equals the time that the link received the wild call.

The called/calling address field can contain up to 32 digits. This field informs you of both the originator and receiver of the wild call.

For example, suppose a wild call is received on link 4 at 10:45 a.m. The calling address (originator) is 6789, and the called address (receiver) is 12345. The switch totals the number of digits in the calling address (4), the number of digits in the called address (5), and follows those two numbers with the actual called and calling addresses. The wild call event report would be:

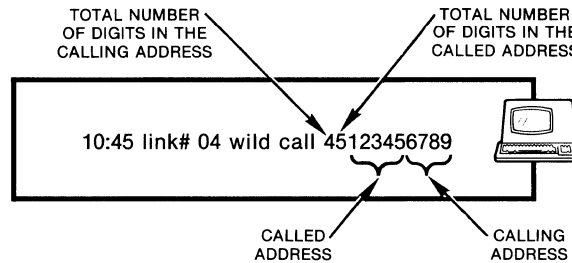

MI-1390-1a-39

5.7 CALL ACCOUNTING

Each DE or PN link on a switch can be configured to provide call accounting information. For each link so configured, the switch can provide a record of all calls originated or terminated. Therefore, if all links have call accounting enabled, a record can be generated at the originating and destination link (DE or PN only) for each virtual circuit.

The call accounting record (shown in figure 5-16) can be output to the local or to a remote Command Port. All that is required of the output device is that it be ready to accept data. It makes no difference whether or not the Command Port device user is currently logged on to or off of the Command Facility. A call accounting record is output upon completion (clearing) of a call.

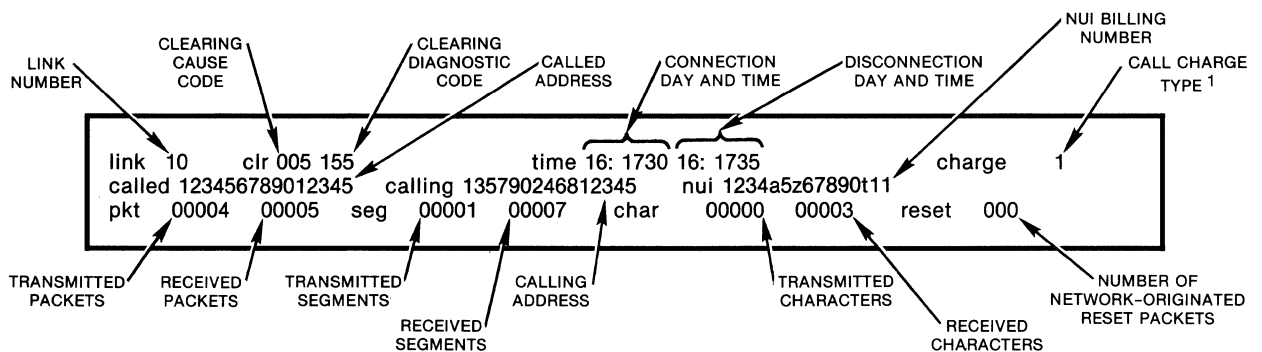

- 10 = LINK ORIGINATED A NORMAL CHARGE CALL
- 1 = LINK ORIGINATED A REVERSE CHARGE CALL
- 2 = LINK RECEIVED A NORMAL CHARGE CALL
- 3 = LINK RECEIVED A REVERSE CHARGE CALL

MI-1390-1a-40

Figure 5-16. Sample Call Accounting Record

When a call is in progress, if any counter reaches its maximum, a call accounting record is output (with the disconnection day and time equal to 00:0000). After output of the call accounting record, all counters are reset to 0.

NOTE: No call accounting records are output to the local Command Port for calls initiated at the local Command Port.

To set up your switch for call accounting, perform the following steps:

1. Turn on call accounting for the entire switch:
 - Select item 5 (CMD/XCC Facility) from the Configure Menu.
 - For the audit log prompt, enter a value of 1 (audit log enabled). (Refer to paragraph 5.4.5 for information on Command Facility configuration.)
2. Turn on call accounting for every link that is to provide call accounting information:
 - Select item 1 (Link Profile) from the Configure Menu.
 - For the special option prompt (the last one in link configuration), enter a value of 1 (by itself, or in combination with other values). (Refer to paragraph 5.4.1 for information on the link profile.)

NOTE: Step 1 MUST be performed before the switch will output any call accounting information. Just configuring a link for call accounting does not cause the generation of such information.

See table 5-14 for descriptions of all the fields in a call accounting record.

Table 5-14. Call Accounting Record

| Field Heading | Range of Values | Description |
|---------------|--------------------------|--|
| link | 1 to 12 | This is the number of the DE or PN link from which the call was originated or to which the call was terminated. |
| clr | 000 to 255 000 to 255 | This is the clearing cause code (in decimal). This is the clearing diagnostic code (in decimal). |
| time | Day:Hour & Minute | The first time is the time of call connection. The second time is the time of call disconnection. |
| charge | 0 to 3 | 0 = Link originated a normal charge call 1 = Link originated a reverse charge call 2 = Link received a normal charge call 3 = Link received a reverse charge call |
| called | Up to 15 digits | This is the Called Address from the Call Request Packet. |
| calling | Up to 15 digits | This is the Calling Address from the Call Request Packet. |
| NUI | Up to 15 digits | This is the billing number from the NUI table, or a "billing number" from the NUI facility field in the Call Request Packet. |
| pkt | 0 to 65,535 | The first is the number of packets transmitted. The second is the number of packets received. |
| seg | 0 to 65,535 | The first is the number of segments transmitted. The second is the number of segments received. |
| char | 0 to 65,535 | The first is the number of characters transmitted. The second is the number of characters received. The count is in multiples of 100 characters. |
| reset | 0 to 255 | This is the number of Reset Packets transmitted and received. |

SECTION 6
DIAGNOSTICS

6.1 LEVELS OFFERED BY THE SWITCH

The switch offers you many levels of diagnostics, including:

- Performance Reports -- which help you to foresee problems before they actually cause a link or your entire switch to be out-of-service

You can get these reports on-demand or at fixed, user-selectable intervals (refer to paragraphs 5.5.6 and 5.5.7). When using these statistics for diagnostic purposes, you want to pay particular attention to the following:

- Link discs
 - Link resets
 - Retransmissions
 - Time-outs
 - Frame errors
 - Link loss
 - Call reroutes
- Commands -- to perform the following functions:
 - Check the status of each link (refer to paragraph 5.5.13)
 - Check the routing table (refer to paragraph 5.5.8)
 - Check the speed dial table (refer to paragraph 5.5.9)
 - Check the class route table (refer to paragraph 5.5.10)
 - Check the NUI table (refer to paragraph 5.5.11)
 - Reset the switch (refer to paragraph 5.5.14)
 - Indicators -- for system and link status
 - Tests -- The Terminal-Activated Channel Tests (TACT) are initiated from the local Command Port. These tests help to pinpoint any problems in the user or the network connections.
 - Off-Line Memory Dump -- This interactive process lets you request a full or selective memory dump.
 - Cause and Diagnostic Codes -- which indicate to you why a particular event occurred (such as a cleared call). You can configure the switch to support CCITT 1984 DTE cause codes.

The first two levels of diagnostics are available through the Command Facility (refer to the appropriate paragraph in section 5). Indicators, tests, off-line dump, and cause and diagnostic codes are described in paragraphs 6.2 through 6.6.

In addition to diagnostic functions that involve the user, the switch performs the following confidence tests at power-up:

- PROM checksum
- Complete RAM
- SCC loopback on all links
- CMOS CRC corruption
- CMOS battery low

6.2 INDICATORS

Alerting you to error conditions and changing states of activity, the switch has six system indicators mounted on the base module (refer to paragraph 1.2 for information on modules). Besides the system indicators, the switch provides an indicator for each link. These are numbered 1, 2, 3, and so on, and each indicates the status of one link. There are six link status indicators on the base module. If you have an expansion module, it also has six link status indicators.

See figure 6-1 for an illustration of the system and link status indicators. Table 6-1 shows the significance of each indicator.

If all indicators are ON, the switch is in a constant Reset condition (make sure that the FEATUREPAK cartridge is installed properly). During normal operating conditions, the AT indicator is ON, all other alpha indicators are OFF, and numeric indicators are either ON, OFF, or FLASHING. If the FEATUREPAK cartridge is corrupted, the status of the indicators is random (they may all be FLASHING).

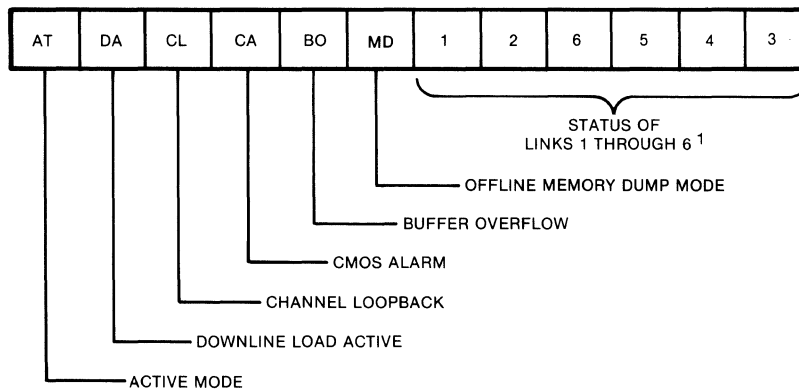

¹ THE LINK 1 INDICATOR SHOWS THE STATUS OF A HIGH-SPEED LINK IF YOUR SWITCH IS EQUIPPED WITH THE X.21 OR V.35 HIGH-SPEED OPTION.

Figure 6-1. Indicators

Table 6-1. Indicators

| Indicator | ON | OFF | FLASHING |
|--|--|-------------------|--|
| AT Active Mode | Normal operation | Undefined problem | Downline load model ¹ |
| DA Downline Load Active | Test and DLL configuration model ¹ | Normal operation | Downline load of operating code is in progress. ¹ |
| CL Channel Loopback | SVC established with DLL program ¹ | Normal operation | TACTS or TACTR call is in progress. |
| CA CMOS Alarm | CMOS or battery problem | Normal operation | CMOS DLL is in effect. ¹ Cold start is performed. ² |
| BO Buffer Overflow | Switch is discarding data. | Normal operation | Over 62.5 percent buffer utilization, selective link flow control |
| MD Memory Dump | Memory dump is in progress; all other system (alpha) indicators will be OFF. | | |
| 1 | Link 1 is down. | Link 1 is up. | Link 1 is retransmitting. |
| 2 | Link 2 is down. | Link 2 is up. | Link 2 is retransmitting. |
| 3, 4, 5, and so on, up to number of links on your switch ³ | Link is down. | Link is up. | Link is retransmitting. |
| ¹ Not implemented at this time. ² Should the CMOS memory become corrupted, the switch will automatically reload into CMOS the factory-set configuration values, regardless of the cold/warm start soft switch selection. ³ Refer to paragraph 2.2.1 for information on numbering the links. | | | |

The MD indicator is used in combination with other indicators when there are specific problems with your switch that may require the assistance of MICOM Customer Service. The following list describes these situations:

- MD + CA = PROM checksum error
- MD + CL = RAM test error
- MD + 1, 2, 3 ... 12 (for a 12-link switch) = bad link
- MD + BO = problem with your FEATUREPAK cartridge

NOTE: When the MD indicator is ON and all other alpha indicators are OFF, the switch is in its memory dump mode.

6.3 TERMINAL-ACTIVATED CHANNEL TESTS

During normal operation, the switch is connected to a variety of data communications equipment, such as, cables, modems, lines, and data terminals. When a problem occurs, it is desirable to find its origin as quickly as possible. To this end, the switch provides the user with a diagnostic capability called Terminal-Activated Channel Test (TACT).

TACT offers simple and easy-to-understand tests that are initiated locally at the Command Port (refer to paragraph 2.2.5.3 for information on the Command Port connection).

The TACT tests can be initiated without taking links down. In addition, the tests are nondisruptive, which means that active sessions and other links are not affected.

Any of the TACT tests can be terminated at any time by pressing the BREAK key.

Two of the tests (LOCAL and TERMINAL) are local. These test the link interconnecting the switch and the local Command Port. The other two TACT tests (REMOTE and SYSTEM) are remote. These test a user-specified route of links (maximum of 10), that loop back to the Command Port. All four TACT tests are described in the following paragraphs.

6.3.2 TACT TERMINAL Loopback Test

The TACTT Command activates a test between the Command Facility and the Command Port terminal, to stress-test the connection. After you enter the TACTT Command, the Command Facility responds with the following service signal:

```
in tact mode
```

The switch then starts transmitting a continuous stream of fox messages to the Command Port terminal, until the switch detects a BREAK signal.

Figure 6-3 illustrates the format of the TACT TERMINAL Loopback Test.

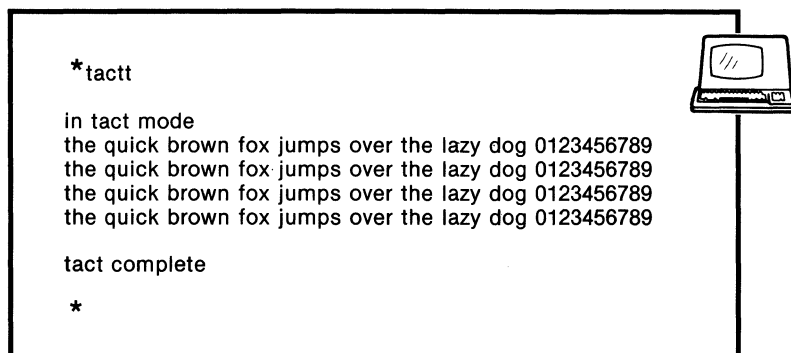

MI-1387-1a-47

Figure 6-3. Switch User Dialogue for the TACT TERMINAL Loopback Test

After you press the BREAK key, the switch displays the following service signal:

```
tact complete
```

Figure 6-4 illustrates the equipment setup for a TACT LOCAL or TERMINAL Loopback Test.

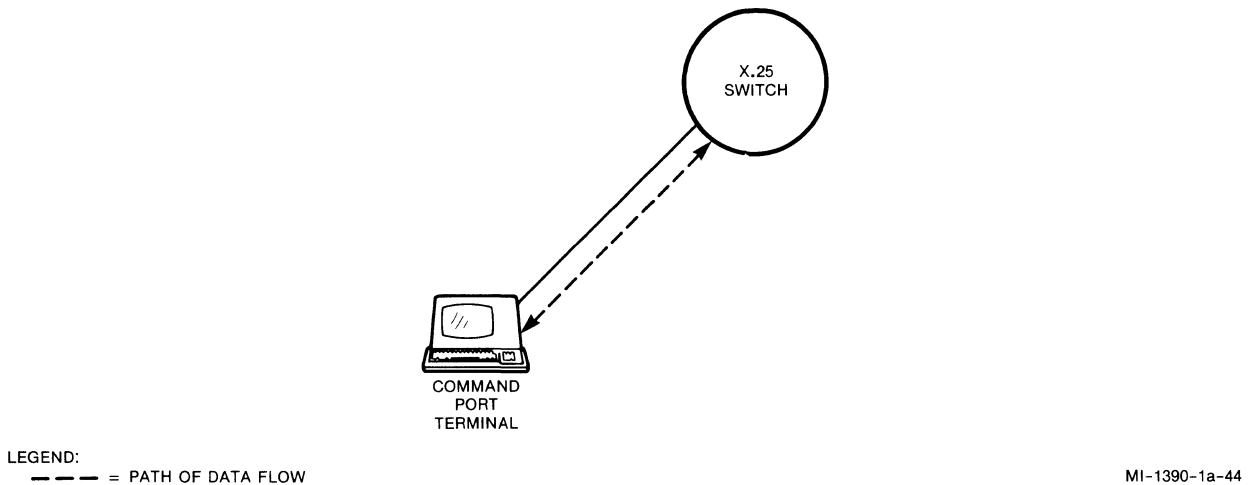

Figure 6-4. Equipment Setup for the TACT LOCAL or TERMINAL Loopback Test

6.3.3 TACT REMOTE Loopback Test

The TACTR Command activates a remote loopback test between the Command Port terminal and a variable number of switches in the network. The number of switches is determined by the user, who enters up to 10 link numbers in the TACTR Command. The switch then routes the TACTR call along that user-specified loop. The format of the TACTR Command is:

TACTR/sa*nn,nn,...nn

sa represents subaddress (this is entered to pad the subaddress field, and is ignored by the switch). It is output as the subaddress in the call accounting record.

nn represents the decimal value of each link to be tested (you can enter from 1 to 10 link numbers)

The link numbers that you enter in the TACTR Command are placed in the CUD field of the Call Request Packet. After you enter the TACTR Command, the switch issues a Call Request, using the Command Port terminal's address as both the Calling and the Called Address. It then forwards the call on the first link in the CUD field. (The routing table is not referenced.) For example, your TACTR Command might appear as follows:

```
TACTR/00*06,03,11
```

In this case, the first switch would forward the TACTR call on link 06 (the first link number in the CUD field). Upon receiving the call, the next switch would forward on link 03. The third switch would then forward on link 11. Upon receiving this call, the fourth switch would recognize that the list of links was depleted, and would automatically accept the call. Any subsequent data packets received would be looped back by the Command Facility in the last switch.

NOTE: If one of the links in the TACTR Command is a PN link (rather than an IS link), then the switch uses the pdn address field of the link profile (see table 5-2) to replace the Called Address, before the call is forwarded.

If one of the links in the TACTR Command is a DE link, with a MICOM PAD attached to it, the PAD will accept the call and loop back the data. No further links will be included in the TACTR call.

After placing a TACTR call, the switch displays the following service signal:

```
tact call placed
```

Once the call and loopback are established, the switch displays the following service signal:

```
com
```

All subsequent terminal user input goes through all the hops and is echoed back to the Command Port terminal.

After you press the BREAK key, the switch displays:

```
tact complete
```

If the call attempt fails, the switch displays one of the service signals described in table 6-3 (later in this section).

Figure 6-5 illustrates the format and service signals of the TACT REMOTE Loopback Test.

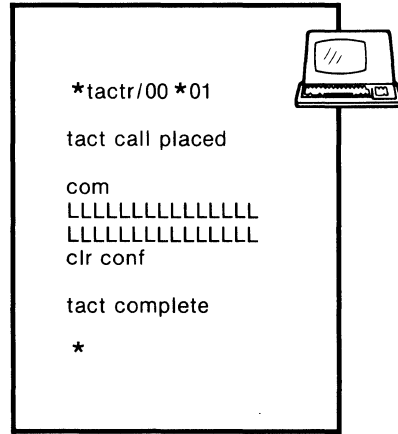

MI-1390-1a-76

Figure 6-5. Switch User Dialogue for the TACT REMOTE Loopback Test

6.3.4 TACT SYSTEM Loopback Test

This test is identical to the TACT REMOTE Loopback Test (refer to paragraph 6.3.3), except that a continuous stream of fox messages is sent from the last switch through the Network back to the Command Port terminal. The service signals are identical to those associated with the TACT REMOTE Loopback Test. The handling of link numbers in the CUD field is identical in both tests.

The TACTS Command format and service signals are shown in figure 6-6.

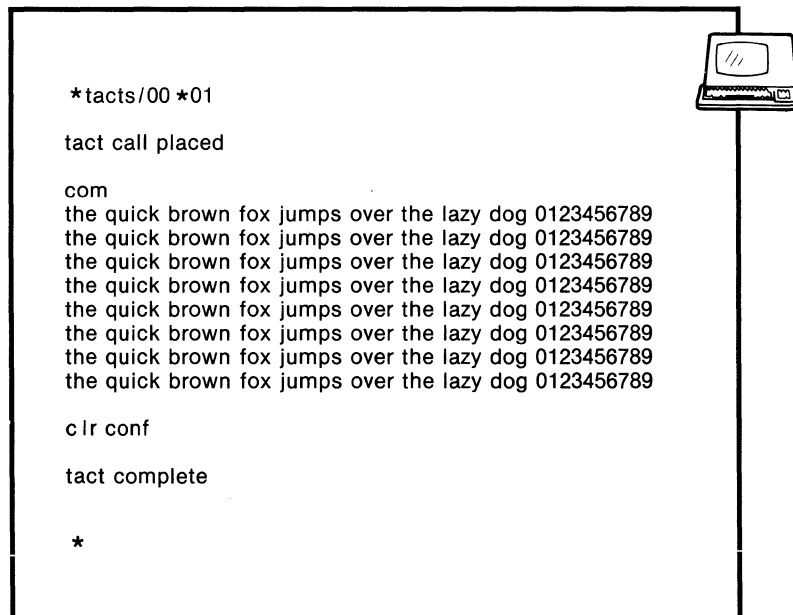

MI-1390-1a-75

Figure 6-6. Switch User Dialogue for the TACT SYSTEM Loopback Test

NOTE: The TACTR and TACTS Commands initiate a loopback test through the Network. Therefore, they require two SVCs.

Figure 6-7 shows one simple and one more complex equipment setup for the TACT REMOTE or SYSTEM Loopback Test.

EXAMPLE 1

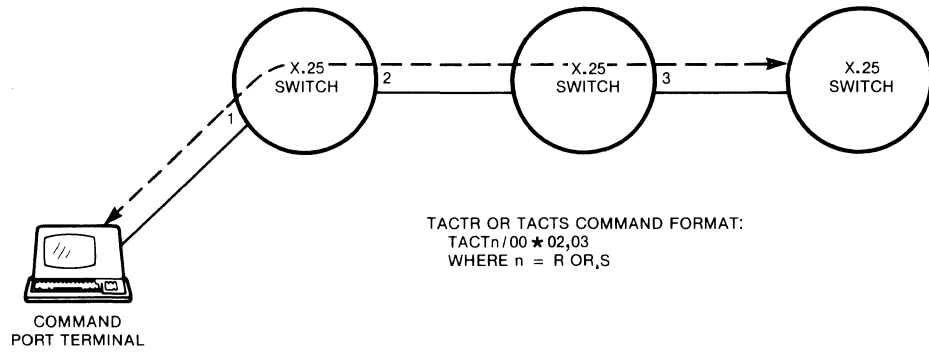

LEGEND:
----- = PATH OF DATA FLOW

MI-1390-1a-45

EXAMPLE 2

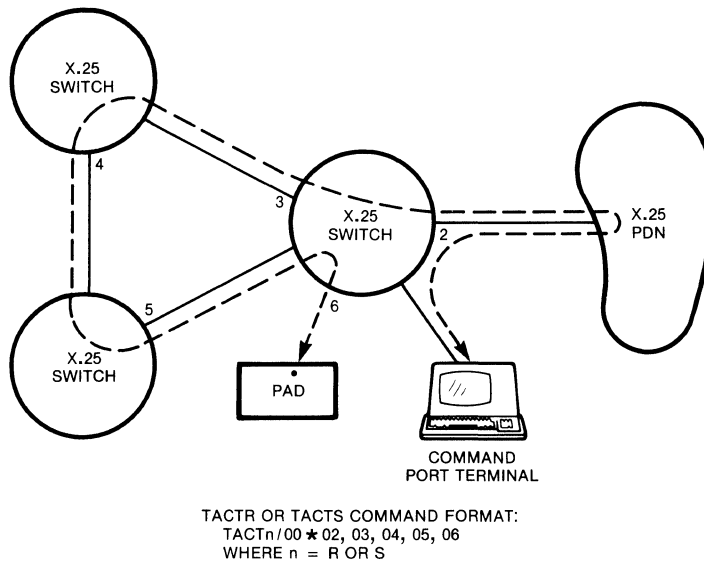

LEGEND:
----- = PATH OF DATA FLOW

MI-1390-1a-46

Figure 6-7. Equipment Setup for the TACT REMOTE or SYSTEM Loopback Test

6.4 OFF-LINE MEMORY DUMP

The switch offers an interactive off-line memory dump capability that lets you dump (output) all, or selective portions of, memory to an output device (terminal or printer). You enable off-line dump by setting a single soft switch selection ON (refer to the procedural steps that follow).

You might want to enable the switch for an off-line dump prior to performing a system reset. Or you might want to enable the switch for an off-line dump while it is running (if you suspect there is a problem with your switch). Then, if the switch crashes you will be able to obtain a memory dump at the point of the crash.

To use off-line dump, perform the following steps (see figure 6-8 for a sample off-line dump interactive session):

1. Connect the output device to your switch. There are two possibilities:
 - Connect the device (usually a printer) to the second-to-the-last link on your switch (link 5 for a 6-link switch, or link 11 for a 12-link switch). A device connected this way is known as a stand-alone printer. You would have a Command Port Terminal connected to the last link on your switch.
 - Connect the device (either a Command Port terminal or a printer with its own keyboard) to the last link on your switch.
2. Set the data transmission rate of the Command Port terminal and the output device to 1200 bps, 7 ASCII-coded bits per character, and any parity type.
3. Turn selection 7 of soft switch group SYS 1 ON. There are two ways to do this:
 - Use the Touch Panel (refer to paragraph 2.3.2)
 - Use the Command Facility (refer to paragraph 5.4.6)

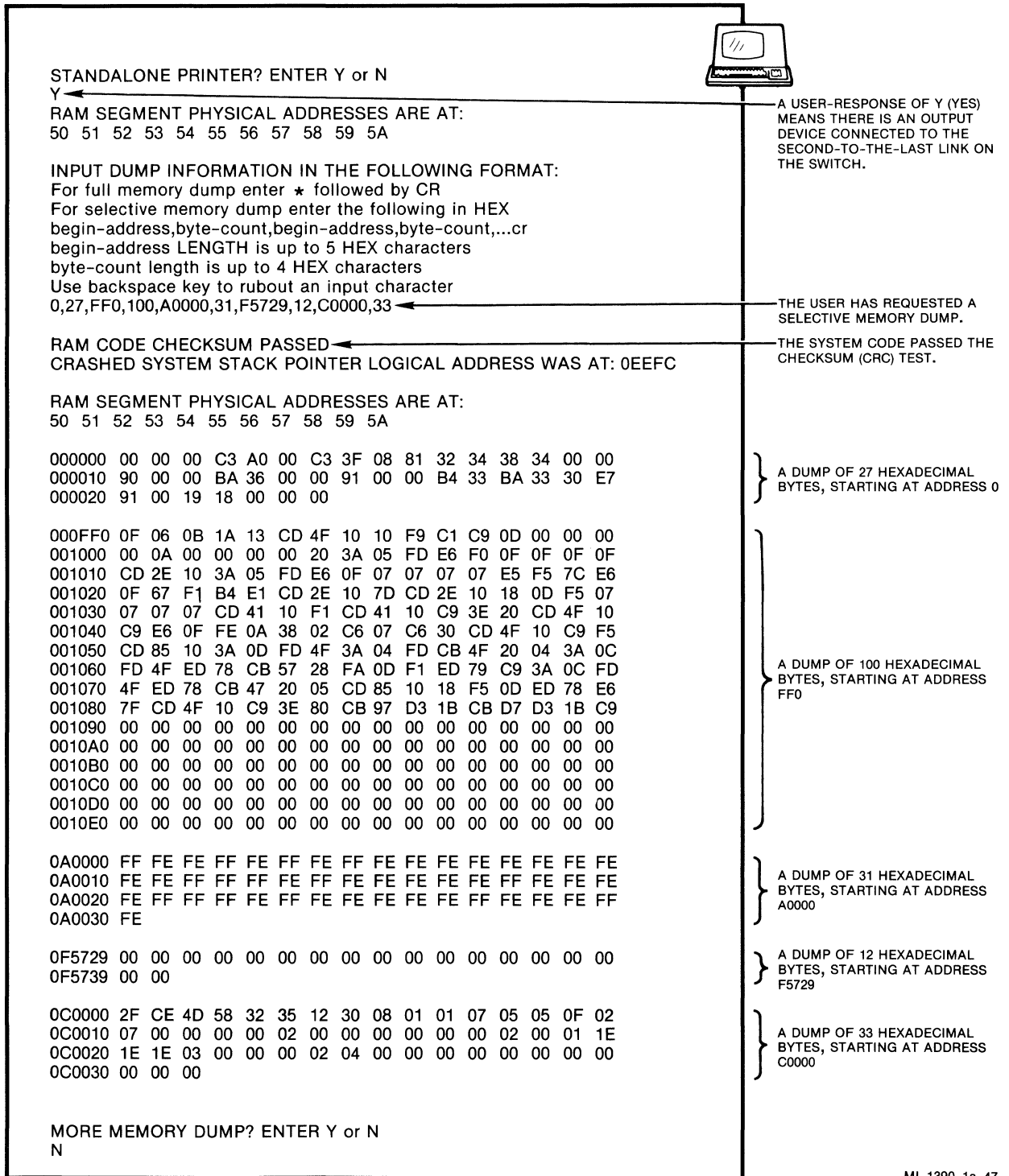

Figure 6-8. Sample Off-Line Memory Dump Session

4. Perform a switch reset (unless you want to leave the switch running because you expect a crash). There are two ways to do this:

- Use the Touch Panel (refer to paragraph 2.3)
- Use the Reset Switch Command (refer to paragraph 5.5.15)

The switch will go into its test mode. Its MD (memory dump) indicator will come ON and all other system (alpha) indicators will go OFF (refer to paragraph 6.2).

The switch will display the prompt:

```
standalone printer? enter y or n
```

5. Answer y if your output device is connected to the second-to-the-last link of your switch. Otherwise, answer n.

The switch will list the RAM segment physical addresses and then ask you if you want a full or a selective memory dump (see figure 6-8).

6. For a full memory dump, enter:

```
*
```

Then enter a CR.

7. For a selective memory dump, enter pairs of hexadecimal numbers where:

- The first number (up to five hexadecimals) in the pair is the physical address at which the dump is to begin
- The second number (up to four hexadecimals) in the pair is the number of bytes to be dumped

As shown in figure 6-8, entries must be separated by commas. To correct an input error, use the backspace key (or Ctrl-H, if your keyboard has no backspace key).

The switch performs a checksum test on the code that is resident in RAM, tells you the stack pointer logical address at the time of the system crash (reset), and then lists the RAM segment physical addresses again. It then begins its memory dump.

When the dump is completed, the switch displays the prompt:

```
more memory dump? enter y or n
```

8. Enter y to continue, or n to terminate the memory dump mode and return to the switch's normal operating mode.

6.5 CAUSE AND DIAGNOSTIC CODES

Tables 6-2 through 6-4 list and describe the cause and diagnostic codes related to Restart, Clear, and Reset Packets. Refer to paragraph 6.6 for information on the switch's support of 1984 DTE cause codes.

Table 6-2. Restart Packet Cause and Diagnostic Codes

| Cause Code | Diagnostic Code | Description |
|------------|-----------------|---|
| 01 | 17 | Local Procedure Error An illegal Restart Confirmation was received by the switch in state r1 (Packet Level Ready). |
| 01 | 52 | Local Procedure Error The timer for Restart Indication expired. |
| 03 | 03 | Network Congestion An operator-initiated Link Down Command was received by the switch. |
| 07 | 07 | Network Operational An operator-initiated Link Up Command was detected by the switch. The switch then sent a Restart Packet. |

Table 6-3. Clear Packet Cause and Diagnostic Codes

| Cause Code | Diagnostic Code | Description |
|------------|-----------------|---|
| 00 (dte) | xxx | DTE-originated cause and diagnostic codes (refer to paragraph 6.6 for 1984 DTE cause code support) |
| 01 (occ) | 153 | Number Busy The maximum number of SVCs was exceeded on the called DTE link. |
| 03 (inv) | 66 | Invalid Facility Request NUI is invalid. |
| 03 (inv) | 171 | Invalid Facility Request The reverse charging facility was specified in a Call Request, but was not allowed on the link (DE or PN). |
| 03 (inv) | 172 | Invalid Facility Request The fast select facility was specified in a Call Request, but was not accepted by the called DTE (DE or PN link). |
| 05 (nc) | 154 | Network Congestion The maximum number of SVCs (127) was exceeded at the source switch (DE or PN link). |
| 05 (nc) | 155 | Network Congestion A call was cleared as the result of an IS link going down. |
| 05 (nc) | 156 | Network Congestion A call was cleared by the operator at the Command Port. |
| 05 (nc) | 158 | Network Congestion A Restart Packet was received on an IS link. |
| 05 (nc) | 169 | Network Congestion A Call Request Packet was routed back to a previously visited switch (this is a wild call). |

Table 6-3. Clear Packet Cause and Diagnostic Codes (continued)

| Cause Code | Diagnostic Code | Description |
|-----------------------------|-----------------|--|
| 05 (nc) | 170 | <p>Network Congestion</p> <p>The maximum hop count value was exceeded, before a Call Request Packet reached its destination switch. This applies only to DE or PN links.</p> |
| 09 (der) | 136 | <p>Out of Order</p> <p>The switch was unable to route a TACT call, as a result of an operator-entered Link Down or Busyout Link Command.</p> |
| 09 (der) | 155 | <p>Out of Order</p> <p>A call was cleared as a result of a DE or PN link going down.</p> |
| 09 (der) | 160 | <p>Out of Order</p> <p>The switch was unable to route a call, because all alternate paths failed.</p> |
| 11 (na) | 157 | <p>Access Barred</p> <p>A Call Request Packet was received on or from a busied-out DE or PN link.</p> |
| 13 (np) | 67 | <p>Not Obtainable</p> <p>The switch was unable to route a call, because no routing mask matched the Called Address.</p> |
| 19 (err) | 20 | <p>Local Procedure Error</p> <p>A Call Accepted, Clear Confirmation, Data, Interrupt, Flow Control, Reset, or Reject Packet was received in the Ready State (p1).</p> |
| 19 (err) and 17 (rpe) | 21 | <p>Local Procedure Error</p> <p>Remote Procedure Error</p> <p>A Clear Confirmation, Data, Interrupt, Flow Control, Reset, or Reject Packet was received in the wrong state (if the link appearance is a DTE, this is state p2, DTE waiting; if the link appearance is a DCE, this is state p3, DCE waiting).</p> |

Table 6-3. Clear Packet Cause and Diagnostic Codes (continued)

| Cause Code | Diagnostic Code | Description |
|-----------------------------|-----------------|---|
| 19 (err) and 17 (rpe) | 22 | Local Procedure Error Remote Procedure Error A Call Request, Call Accept, Clear Confirmation, Data, Interrupt, Flow Control, Reset, or Reject Packet was received in the wrong state (if the link appearance is a DTE, this is state p3, DCE waiting; if the link appearance is a DCE, this is state p2, DTE waiting). |
| 19 (err) and 17 (rpe) | 23 | Local Procedure Error Remote Procedure Error A Call Request, Call Accept, or Clear Confirmation Packet was received in the Data Transfer State (p4). |
| 19 (err) and 17 (rpe) | 26 | Local Procedure Error Remote Procedure Error A Call Request, Call Accept, Clear Confirmation, Data, Interrupt, Flow Control, Reset, or Reject Packet was received in the wrong state (if the link appearance is a DTE, this is state p7, DCE Clear Indication; if the link appearance is a DCE, this is state p6, DTE Clear Request). |
| 19 (err) and 17 (rpe) | 33 | Local Procedure Error Remote Procedure Error An unidentifiable packet was received. |
| 19 (err) | 34 | Local Procedure Error A call was going the wrong way on a one-way logical channel. |
| 19 (err) | 36 | Local Procedure Error A packet was received on an unassigned logical channel. |

Table 6-3. Clear Packet Cause and Diagnostic Codes (continued)

| Cause Code | Diagnostic Code | Description |
|-----------------------------|-----------------|---|
| 19 (err) and 17 (rpe) | 38 | Local Procedure Error Remote Procedure Error The packet received was too short, while in a state other than Data Transfer (p4). |
| 19 (err) and 17 (rpe) | 39 | Local Procedure Error Remote Procedure Error A packet longer than 256 characters was received in a state other than Data Transfer (p4). |
| 17 (rpe) | 41 | Remote Procedure Error A Restart or a Restart Confirmation Packet was received on this logical channel. |
| 19 (err) | 49 | Local Procedure Error The timer expired for an incoming call. |
| 19 (err) | 50 | Local Procedure Error The timer expired for a Clear Indication. |
| 19 (err) | 76 | Local Procedure Error NUI validation was specified, but the Call Request Packet does not contain an NUI facility request string. |
| 19 (err) | 162 | Local Procedure Error A Call Request Packet was too long. |
| 19 (err) | 163 | Local Procedure Error A Call Request Packet contained no Called Address (the length was equal to 0). |
| 19 (err) | 164 | Local Procedure Error The Facility field in the Call Request Packet was too long. |

Table 6-3. Clear Packet Cause and Diagnostic Codes (continued)

| Cause Code | Diagnostic Code | Description |
|------------|-----------------|--|
| 19 (err) | 165 | Local Procedure Error The CUD field in the Call Request Packet was too long. |
| 19 (err) | 166 | Local Procedure Error The switch was unable to route a TACT call, because an illegal link number was specified. |

Table 6-4. Reset Packet Cause and Diagnostic Codes

| Cause Code | Diagnostic Code | Description |
|-----------------------------|-----------------|---|
| 05 (err) and 03 (rpe) | 01 | Local Procedure Error Remote Procedure Error Invalid P(S) (Packet Send Sequence Number) |
| 05 (err) and 03 (rpe) | 02 | Local Procedure Error Remote Procedure Error Invalid P(R) (Packet Receive Sequence Number) |
| 05 (err) and 03 (rpe) | 27 | Local Procedure Error Remote Procedure Error A Reset Confirmation Packet was received in the Flow Control Ready state (d1). |
| 05 (err) and 03 (rpe) | 29 | Local Procedure Error Remote Procedure Error A Reset Confirmation, Data, Interrupt, Flow Control, or Reject Packet was received in the wrong state (if the link appearance is a DTE, this is state d3, DCE Reset Indication; if the link appearance is a DCE, this is state d2, DTE Reset Request). |

Table 6-4. Reset Packet Cause and Diagnostic Codes (continued)

| Cause Code | Diagnostic Code | Description |
|-----------------------------|-----------------|--|
| 05 (err) and 03 (rpe) | 33 | Local Procedure Error Remote Procedure Error An unidentifiable packet was received. |
| 05 (err) and 03 (rpe) | 38 | Local Procedure Error Remote Procedure Error A packet was too short. |
| 05 (err) and 03 (rpe) | 39 | Local Procedure Error Remote Procedure Error A packet was too long. |
| 05 (err) and 03 (rpe) | 41 | Local Procedure Error Remote Procedure Error A Restart or a Restart Confirmation Packet was received on this logical channel (PVC only). |
| 05 (err) and 03 (rpe) | 51 | Local Procedure Error Remote Procedure Error The timer expired for a Reset Indication Packet. |

6.6 SUPPORT OF 1984 DTE CAUSE CODES

If a DE or PN link is so configured, a DTE can use cause codes 80 through FF (it is not limited to use cause code 00). That is, the switch then supports CCITT 1984 DTE cause codes for the DE or PN link.

To configure a DE or PN link to support 1984 DTE cause codes:

1. Select item 1 (Link Profile) from the Configure Menu.
2. For the special option prompt (the last one in link configuration), enter a value of 2 (by itself, or in combination with other values). (Refer to paragraph 5.4.1 for information on the link profile.)

APPENDIX A

CONFIGURATION WORKSHEETS

The configuration worksheets summarize all the parameters that can be configured using the Command Facility. You should prepare these sheets carefully and completely before you implement any configuration changes. Keep a copy of these sheets for future reference. Keep an additional copy in close proximity to the switch.

This page is intentionally left blank.

LINK PROFILE

| REMARKS | LINK# | SPEED | TYPE | DTE/DCE (0 = DTE, 1 = DCE) | K OUTSTANDING FRAMES | T1 LINE TIMEOUT | N2 RETRANSMISSIONS | T3 LINK ASSUR- ANCE TIMER | W OUTSTANDING PACKETS | PACKET SIZE (7 = 128, 8 = 256) | DEFAULTS | | | | | | | |
|---------|---------|---------|------|-------------------------------|-------------------------|--------------------|--------------------|------------------------------|--------------------------|-----------------------------------|-------------------|-------|-------|------|-------|-------|------|-------|
| | | | | | | | | | | | 0 | 2 | 0 | 0 | 0 | 2 | 0 | 1 |
| CABLES | TABLE 1 | TABLE 2 | | 0, 1 | 1-7 | 3-127 | 1-20 | 0, 10-127 | (SEE 1) | (SEE 1) | 0, 1 ² | 0-127 | 0-127 | 0-15 | 0-255 | 0-127 | 0-15 | 0-255 |
| | 1 | | | | | | | | | | | | | | | | | |
| | 2 | | | | | | | | | | | | | | | | | |
| | 3 | | | | | | | | | | | | | | | | | |
| | 4 | | | | | | | | | | | | | | | | | |
| | 5 | | | | | | | | | | | | | | | | | |
| | 6 | | | | | | | | | | | | | | | | | |
| | 7 | | | | | | | | | | | | | | | | | |
| | 8 | | | | | | | | | | | | | | | | | |
| | 9 | | | | | | | | | | | | | | | | | |
| | 10 | | | | | | | | | | | | | | | | | |
| | 11 | | | | | | | | | | | | | | | | | |
| | 12 | | | | | | | | | | | | | | | | | |

| VALUE ³ | SPEED (IN bps) |
|--------------------|----------------|
| 2 | 1200 |
| 4 | 2400 |
| 6 | 4800 |
| 8 | 9600 |
| 10 | 14,400 |
| 12 | 19,200 |
| 14 | 48,000 |
| 16 | 56,000 |
| 18 | 64,000 |
| 20 | 72,000 |

| VALUE | LINK TYPE | SUBADDRESSING TYPE |
|-------|-----------|--------------------|
| 1 | IS | X.121 |
| 2 | DE | X.121 |
| 3 | DE | CUD |
| 4 | PN | X.121 |
| 5 | PN | CUD |

VALID ONLY ON LINK 1, ON UNITS EQUIPPED WITH THE X.21 OR V.35 HIGH-SPEED OPTION. FOR UNITS SO EQUIPPED, THE DEFAULT SPEED FOR LINK 1 IS 56,000 bps (NOT 9600 bps).

¹ RESERVED FOR FUTURE USE
² MODULO 128 IS NOT IMPLEMENTED.
³ FOR EXTERNAL CLOCKING, ADD 1 TO THE VALUE SHOWN.

LINK PROFILE (continued)

| REMARKS | LINK# | DEFAULTS | | | | | | | | | | | | | | | | | |
|---------|-------|---------------------|---------------------------|---------------------------|------------------------------|-------------------------------|-------------------------------|-----------------------|---------------|-----------------|----------------|-------------------------|----------------------|----------------------|-------------|------------------------|----------------------|----------------------|----------------|
| | | # OF OUT-GOING SVCs | LOWEST OUTGOING SVC (LGN) | LOWEST OUTGOING SVC (LCN) | T11/T21 CALL REQUEST TIMEOUT | T12/T22 RESET REQUEST TIMEOUT | T13/T23 CLEAR REQUEST TIMEOUT | PACKET TIME-OUT RETRY | FACILITY MASK | FACILITY BARRED | FACILITY ADDED | # OF SUB-ADDRESS DIGITS | # OF ROUTE DIGITS | CALL PACKET HANDLING | PDN ADDRESS | AUTOCONNECT (0 = NONE) | ALTERNATE (0 = NONE) | NUI HANDLING | SPECIAL OPTION |
| | 0-127 | 0-15 | 0-255 | 15-255 | 15-255 | 15-255 | 0-127 | TABLE 3 | TABLE 4 | TABLE 5 | 0-5 | 0-8 | TABLE 6 ¹ | 0-15 DIGITS | 0-12 | 0-12 | TABLE 7 ¹ | TABLE 8 ¹ | |
| 1 | | | | | | | | | | | | | | | | | | | |
| 2 | | | | | | | | | | | | | | | | | | | |
| 3 | | | | | | | | | | | | | | | | | | | |
| 4 | | | | | | | | | | | | | | | | | | | |
| 5 | | | | | | | | | | | | | | | | | | | |
| 6 | | | | | | | | | | | | | | | | | | | |
| 7 | | | | | | | | | | | | | | | | | | | |
| 8 | | | | | | | | | | | | | | | | | | | |
| 9 | | | | | | | | | | | | | | | | | | | |
| 10 | | | | | | | | | | | | | | | | | | | |
| 11 | | | | | | | | | | | | | | | | | | | |
| 12 | | | | | | | | | | | | | | | | | | | |

TABLE 3 — FACILITY MASK

| VALUE | FACILITY TO BE REMOVED-OUTGOING CALL |
|-------|--------------------------------------|
| 0 | None |
| 1 | Packet Size Negotiation |
| 2 | Window Size Negotiation |
| 4 | Throughput Class Negotiation |
| x | Combination |

TABLE 4 — FACILITY BARRED

| VALUE | FACILITY NOT ALLOWED-INCOMING CALL |
|-------|------------------------------------|
| 0 | None |
| 1 | Reverse Charging |
| 2 | Fast Select |
| x | Combination |

TABLE 5 — FACILITY ADDED

| VALUE | FACILITY TO BE ADDED-OUTGOING CALL |
|-------|------------------------------------|
| 0 | None |
| 1 | Reverse Charging |
| 2 | Packet Size Negotiation |
| 4 | Window Size Negotiation |
| x | Combination |

¹ SEE NEXT PAGE.

| TABLE 6 — CALL PACKET HANDLING | |
|--------------------------------|--|
| VALUE | PACKET HANDLING |
| 0 | No Handling |
| 1 | Remove Calling Address |
| 4 | 1980 Call Accept Packet |
| 8 | Replace Calling Address with PDN Address |
| 16 | Modulo 128 (KDD) ¹ |
| xx | Combination |

¹ NOT IMPLEMENTED

| TABLE 7 — NUI HANDLING | |
|------------------------|-------------------------------------|
| VALUE | NUI HANDLING |
| 0 | No NUI Validation Check |
| 1 | Perform NUI Validation Check |
| 2 | Clear Call if NUI Validation Fails |
| 4 | Delete NUI from Call Request Packet |
| x | Combination |

| TABLE 8 — SPECIAL OPTION | |
|--------------------------|------------------------|
| VALUE | SPECIAL OPTION |
| 0 | None |
| 1 | Enable Call Accounting |
| 2 | 1984 Cause Codes |
| 4 | Load Sharing |
| x | Combination |

| SWITCH NUMBER | | ROUTING MASK | | | | | | | | PAGE 1 OF 4 | |
|---------------|-------------------|-------------------|-----------------------|-------------------|-----------------------|-------------------|-----------------------|-------------------|-----------------------|----------------|--|
| ENTRY | MASK ¹ | LINK ² | PRIORITY ² | LINK ² | PRIORITY ² | LINK ² | PRIORITY ² | LINK ² | PRIORITY ² | | |
| 01 | | | | | | | | | | | |
| 02 | | | | | | | | | | | |
| 03 | | | | | | | | | | | |
| 04 | | | | | | | | | | | |
| 05 | | | | | | | | | | | |
| 06 | | | | | | | | | | | |
| 07 | | | | | | | | | | | |
| 08 | | | | | | | | | | | |
| 09 | | | | | | | | | | | |
| 10 | | | | | | | | | | | |
| 11 | | | | | | | | | | | |
| 12 | | | | | | | | | | | |
| 13 | | | | | | | | | | | |
| 14 | | | | | | | | | | | |
| 15 | | | | | | | | | | | |
| 16 | | | | | | | | | | | |

¹ ENTER FROM 2 TO 15 CHARACTERS. VALID NUMERIC ENTRIES ARE 0 THROUGH 9;
VALID ALPHA ENTRIES ARE Fs ("DON'T CARE" CHARACTERS).

² THE DEFAULT VALUE FOR LINK AND PRIORITY IS 0.

| SWITCH NUMBER | | ROUTING MASK | | | | | | | | PAGE 2 OF 4 | |
|---------------|-------------------|-------------------|-----------------------|-------------------|-----------------------|-------------------|-----------------------|-------------------|-----------------------|-------------------|-----------------------|
| ENTRY | MASK ¹ | LINK ² | PRIORITY ² | LINK ² | PRIORITY ² | LINK ² | PRIORITY ² | LINK ² | PRIORITY ² | LINK ² | PRIORITY ² |
| 17 | | | | | | | | | | | |
| 18 | | | | | | | | | | | |
| 19 | | | | | | | | | | | |
| 20 | | | | | | | | | | | |
| 21 | | | | | | | | | | | |
| 22 | | | | | | | | | | | |
| 23 | | | | | | | | | | | |
| 24 | | | | | | | | | | | |
| 25 | | | | | | | | | | | |
| 26 | | | | | | | | | | | |
| 27 | | | | | | | | | | | |
| 28 | | | | | | | | | | | |
| 29 | | | | | | | | | | | |
| 30 | | | | | | | | | | | |
| 31 | | | | | | | | | | | |
| 32 | | | | | | | | | | | |

¹ ENTER FROM 2 TO 15 CHARACTERS. VALID NUMERIC ENTRIES ARE 0 THROUGH 9;
 VALID ALPHA ENTRIES ARE Fs ("DON'T CARE" CHARACTERS).

² THE DEFAULT VALUE FOR LINK AND PRIORITY IS 0.

| SWITCH NUMBER | | ROUTING MASK | | | | | | | | PAGE 3 OF 4 | |
|---------------|-------------------|-------------------|-----------------------|-------------------|-----------------------|-------------------|-----------------------|-------------------|-----------------------|-------------------|-----------------------|
| ENTRY | MASK ¹ | LINK ² | PRIORITY ² | LINK ² | PRIORITY ² | LINK ² | PRIORITY ² | LINK ² | PRIORITY ² | LINK ² | PRIORITY ² |
| 33 | | | | | | | | | | | |
| 34 | | | | | | | | | | | |
| 35 | | | | | | | | | | | |
| 36 | | | | | | | | | | | |
| 37 | | | | | | | | | | | |
| 38 | | | | | | | | | | | |
| 39 | | | | | | | | | | | |
| 40 | | | | | | | | | | | |
| 41 | | | | | | | | | | | |
| 42 | | | | | | | | | | | |
| 43 | | | | | | | | | | | |
| 44 | | | | | | | | | | | |
| 45 | | | | | | | | | | | |
| 46 | | | | | | | | | | | |
| 47 | | | | | | | | | | | |
| 48 | | | | | | | | | | | |

¹ ENTER FROM 2 TO 15 CHARACTERS. VALID NUMERIC ENTRIES ARE 0 THROUGH 9;
 VALID ALPHA ENTRIES ARE Fs ("DON'T CARE" CHARACTERS).
² THE DEFAULT VALUE FOR LINK AND PRIORITY IS 0.

| SWITCH NUMBER | | ROUTING MASK | | | | | | | | PAGE 4 OF 4 | |
|---------------|-------------------|-------------------|-----------------------|-------------------|-----------------------|-------------------|-----------------------|-------------------|-----------------------|-------------------|-----------------------|
| ENTRY | MASK ¹ | LINK ² | PRIORITY ² | LINK ² | PRIORITY ² | LINK ² | PRIORITY ² | LINK ² | PRIORITY ² | LINK ² | PRIORITY ² |
| 49 | | | | | | | | | | | |
| 50 | | | | | | | | | | | |
| 51 | | | | | | | | | | | |
| 52 | | | | | | | | | | | |
| 53 | | | | | | | | | | | |
| 54 | | | | | | | | | | | |
| 55 | | | | | | | | | | | |
| 56 | | | | | | | | | | | |
| 57 | | | | | | | | | | | |
| 58 | | | | | | | | | | | |
| 59 | | | | | | | | | | | |
| 60 | | | | | | | | | | | |
| 61 | | | | | | | | | | | |
| 62 | | | | | | | | | | | |
| 63 | | | | | | | | | | | |
| 64 | | | | | | | | | | | |

¹ ENTER FROM 2 TO 15 CHARACTERS. VALID NUMERIC ENTRIES ARE 0 THROUGH 9;
 VALID ALPHA ENTRIES ARE Fs ("DON'T CARE" CHARACTERS).
² THE DEFAULT VALUE FOR LINK AND PRIORITY IS 0.

| SWITCH NUMBER | | SPEED DIAL | | PAGE 1 OF 2 |
|---------------|-----------------------|------------|----------------------|------------------------|
| ENTRY# | SPEED ID ¹ | | ADDRESS ² | INSERT ID ³ |
| 01 | | | | |
| 02 | | | | |
| 03 | | | | |
| 04 | | | | |
| 05 | | | | |
| 06 | | | | |
| 07 | | | | |
| 08 | | | | |
| 09 | | | | |
| 10 | | | | |
| 11 | | | | |
| 12 | | | | |
| 13 | | | | |
| 14 | | | | |
| 15 | | | | |
| 16 | | | | |

¹ ENTER FROM TWO TO SIX DIGITS.
² ENTER UP TO 15 DIGITS.
³ 0 = NO INSERT (DEFAULT)
 1 = INSERT SPEED ID INTO CUD FIELD

| SWITCH NUMBER | | SPEED DIAL | | PAGE 2 OF 2 |
|---------------|-----------------------|----------------------|------------------------|----------------|
| ENTRY# | SPEED ID ¹ | ADDRESS ² | INSERT ID ³ | |
| 17 | | | | |
| 18 | | | | |
| 19 | | | | |
| 20 | | | | |
| 21 | | | | |
| 22 | | | | |
| 23 | | | | |
| 24 | | | | |
| 25 | | | | |
| 26 | | | | |
| 27 | | | | |
| 28 | | | | |
| 29 | | | | |
| 30 | | | | |
| 31 | | | | |
| 32 | | | | |

¹ ENTER FROM TWO TO SIX DIGITS.

² ENTER UP TO 15 DIGITS.

³ 0 = NO INSERT (DEFAULT)

1 = INSERT SPEED ID INTO CUD FIELD

| SWITCH NUMBER | | CLASS ROUTE | | PAGE 1 OF 2 |
|---------------|-----------------------|----------------------|--|----------------|
| ENTRY# | ROUTE ID ¹ | ADDRESS ² | | |
| 01 | | | | |
| 02 | | | | |
| 03 | | | | |
| 04 | | | | |
| 05 | | | | |
| 06 | | | | |
| 07 | | | | |
| 08 | | | | |
| 09 | | | | |
| 10 | | | | |
| 11 | | | | |
| 12 | | | | |
| 13 | | | | |
| 14 | | | | |
| 15 | | | | |
| 16 | | | | |

¹ ENTER TWO DIGITS.
² ENTER UP TO 12 DIGITS.

| SWITCH NUMBER | | CLASS ROUTE | | PAGE 2 OF 2 |
|---------------|-----------------------|----------------------|--|----------------|
| ENTRY# | ROUTE ID ¹ | ADDRESS ² | | |
| 17 | | | | |
| 18 | | | | |
| 19 | | | | |
| 20 | | | | |
| 21 | | | | |
| 22 | | | | |
| 23 | | | | |
| 24 | | | | |
| 25 | | | | |
| 26 | | | | |
| 27 | | | | |
| 28 | | | | |
| 29 | | | | |
| 30 | | | | |
| 31 | | | | |
| 32 | | | | |

¹ ENTER TWO DIGITS.
² ENTER UP TO 12 DIGITS.

| SWITCH NUMBER | COMMAND/XCC FACILITY | DEFAULTS | PAGE 1 OF 2 |
|---|------------------------------|----------|-------------|
| | | | |
| ADDRESS | UP TO 15 DIGITS ¹ | | |
| CLASS (CMD) | 2 DIGITS | 99 | |
| CLASS (XCC) | 2 DIGITS | 98 | |
| AUDIT LOG 0 = DISABLED 1 = ENABLED | 0, 1 | 0 | |
| STATPERIOD 0 = DISABLED 1-6 = 10-MINUTE INCREMENTS | 0-6 | 0 | |
| ECHO 0 = ECHO DISABLED 1 = ECHO ENABLED | 0, 1 | 1 | |
| DV.FLOW 0 = NO FLOW CONTROL 1 = SWITCH FLOW CONTROLS COMMAND PORT (XON/XOFF) | 0, 1 | 1 | |
| S.SIGNAL | SEE TABLE 9 (NEXT PAGE) | 5 | |
| CR.PAD 0 = NO PADDING CHARACTERS 1-127 = NUMBER OF PADDING CHARACTERS AFTER CR | 0-127 | 4 | |
| L.FOLD 0 = NO AUTOMATIC LINEFOLDING 1-255 = NUMBER OF CHARACTERS THAT TRIGGER LINEFOLDING | 0-255 | 80 | |
| SPEED | SEE TABLE 10 (NEXT PAGE) | 32 | |
| P.FLOW 0 = NO FLOW CONTROL 1 = COMMAND PORT FLOW CONTROLS SWITCH (XON/XOFF) | 0, 1 | 1 | |
| LF.PAD 0 = NO PADDING AFTER LINE FEED 1-127 = NUMBER OF PADDING NULLS AFTER LINE FEED | 0-127 | 4 | |
| EDIT 0 = EDITING DISABLED 1 = EDITING ENABLED | 0, 1 | 1 | |
| C.DEL ASCII CHARACTER USED TO REQUEST CHARACTER DELETION | 0-127 | 8 | |

¹ NO DEFAULT

| TABLE 9 — S.SIGNAL | |
|--------------------|------------------------------------|
| VALUE | MESSAGES OR SERVICE PROMPTS OUTPUT |
| 0 | NONE |
| 1 | MESSAGES ONLY |
| 4 | SERVICE PROMPTS ONLY |
| 5 | MESSAGES AND SERVICE PROMPTS |

| TABLE 10 — SPEED | |
|------------------|-----------------------|
| VALUE | SPEED IN bps |
| 0 | 110 |
| 1 | 134.5 |
| 2 | 300 |
| 3 | 1200 |
| 4 | 600 |
| 5 | 75 |
| 6 | 150 |
| 7 | 1800 |
| 8 | 200 |
| 10 | 50 |
| 12 | 2400 |
| 13 | 4800 |
| 14 | 9600 |
| 32 | AUTOBAUD ¹ |

¹ 110 TO 9600 bps, EXCEPT 134.5 bps

| SWITCH NUMBER | COMMAND/XCC FACILITY (continued) | DEFAULTS | PAGE 2 OF 2 |
|---------------|---|----------|-------------|
| | | | |
| L.DEL | 0-127 ASCII CHARACTER USED TO REQUEST LINE DELETION | 24 | |
| L.DISPLAY | 0-127 ASCII CHARACTER USED TO REQUEST DISPLAY OF CURRENT INPUT | 18 | |
| DV.TYPE | 1, 2 1 = HARD COPY DEVICE 2 = VIDEO DISPLAY | 2 | |
| BITS/CHAR | 0-3 0 = 5 1 = 6 2 = 7 3 = 8 | 2 | |
| DV.PARITY | SEE TABLE 11 (NEXT PAGE) | 5 | |
| NET.PARITY | SEE TABLE 12 (NEXT PAGE) | 0 | |
| C.XON | 0-127 0 = IGNORED 1-127 = ASCII CHARACTER USED TO SIGNAL XON | 17 | |
| C.XOFF | 0-127 0 = IGNORED 1-127 = ASCII CHARACTER USED TO SIGNAL XOFF | 19 | |
| SPECIAL FLOW | SEE TABLE 13 (NEXT PAGE) | 0 | |
| INACTIVITY | 0-255 0 = CALL NOT CLEARED ON INACTIVITY 1-255 = NUMBER OF MINUTES UNTIL CALL CLEAR | 0 | |
| X29ACC | 0-127 0 = X.29 ACCESS NOT ALLOWED 1-127 = ASCII CHARACTER FOR X.29 ACCESS | 0 | |
| PROMPT | UP TO 16 ASCII CHARACTERS ASCII CHARACTER USED FOR X.28 SERVICE PROMPT | * | |

MT-1390-1a-02

| TABLE 11 — DV.PARITY | |
|----------------------|---------------|
| VALUE | DEVICE PARITY |
| 0 | TRANSPARENT |
| 1 | SPACE |
| 2 | MARK |
| 3 | EVEN |
| 4 | ODD |
| 5 | AUTO PARITY |

| TABLE 12 — NET.PARITY | |
|-----------------------|-----------------------|
| VALUE | NETWORK PARITY |
| 0 | PASS DATA AS RECEIVED |
| 1 | SPACE |
| 2 | MARK |
| 3 | EVEN |
| 4 | ODD |

| TABLE 13 — SPECIAL FLOW | |
|-------------------------|---|
| VALUE | RTS OR CTS FLOW CONTROL |
| 0 | NONE |
| 1 | DEVICE CAN FLOW CONTROL SWITCH WITH RTS |
| 2 | SWITCH CAN FLOW CONTROL DEVICE WITH CTS |
| 4 | SWITCH ISSUES BEL CHARACTER TO DEVICE IN CTS FLOW CONTROL |
| X | COMBINATION |

MT-1390-1a-11

| SWITCH NUMBER | SYSTEM PARAMETERS | | |
|---|-------------------|--|----------|
| | | | DEFAULTS |
| DELTA CONSTANT THAT REPRESENTS DYNAMIC PRIORITY IN BEST-PATH SELECTION ALGORITHM | 0-8 | | 0 |
| BETA CONSTANT THAT REPRESENTS STATIC PRIORITY IN BEST-PATH SELECTION ALGORITHM | 0-8 | | 1 |
| MAX HOP MAXIMUM NUMBER OF SWITCHES A CALL MAY VISIT BEFORE REACHING ITS DESTINATION SWITCH | 0-5 | | 0 |
| SYS 1 ¹ ENTERING A VALUE OR A COMBINATION OF VALUES CAUSES RELATED POSITIONS TO GO ON | SEE TABLE 14 | | NONE |
| SYS 2 ¹ VALUE USED TO IDENTIFY THIS SWITCH TO THE NETWORK | 0-255 | | 0 |
| BILLING #LENGTH LENGTH USED FOR NUI BILLING NUMBER | 0-15 | | 10 |
| PIN LENGTH LENGTH USED FOR NUI PERSONAL IDENTIFICATION NUMBER (PIN) | 0-14 | | 4 |

| TABLE 14 — SYS 1 | | |
|------------------|---------------------------|---|
| VALUE | RESULT IF ON | RESULT IF OFF |
| 0 | ALL POSITIONS ARE OFF | |
| 1 | RESERVED (MUST BE OFF) | |
| 2 | RESERVED (MUST BE OFF) | |
| 4 ² | DOWNLINE LOAD | DOWNLINE LOAD TEST AND CONFIGURE |
| 8 | COLD START RESET | WARM START RESET |
| 16 | RESERVED (MUST BE OFF) | |
| 32 | LAST LINK IS COMMAND PORT | LAST LINK IS REGULAR LINK (SYNCHRONOUS) |
| 64 | OFF-LINE DUMP IS ENABLED | OFF-LINE DUMP IS DISABLED |
| 128 | RESERVED (MUST BE OFF) | |
| XXX | COMBINATION OF VALUES | |

¹ YOU MAY USE THE TOUCH PANEL TO SET THESE SOFT SWITCH SELECTIONS.

² NOT IMPLEMENTED

| SWITCH NUMBER | NETWORK USER IDENTIFICATION (NUI) | | PAGE 1 OF 5 |
|---------------|-----------------------------------|---|----------------|
| ENTRY# | BILLING # ¹ | PERSONAL IDENTIFICATION NUMBER (PIN) ¹ | |
| 01 | | | |
| 02 | | | |
| 03 | | | |
| 04 | | | |
| 05 | | | |
| 06 | | | |
| 07 | | | |
| 08 | | | |
| 09 | | | |
| 10 | | | |
| 11 | | | |
| 12 | | | |
| 13 | | | |
| 14 | | | |
| 15 | | | |
| 16 | | | |
| 17 | | | |
| 18 | | | |
| 19 | | | |
| 20 | | | |

¹ ENTER THE NUMBER OF ALPHANUMERIC CHARACTERS SPECIFIED IN SYSTEM PARAMETERS CONFIGURATION (BILLING # LENGTH AND PIN LENGTH PROMPTS).

| SWITCH NUMBER | NETWORK USER IDENTIFICATION (NUI) | | PAGE 2 OF 5 |
|---------------|-----------------------------------|--|-------------|
| ENTRY# | BILLING # 1 | PERSONAL IDENTIFICATION NUMBER (PIN) 1 | |
| 21 | | | |
| 22 | | | |
| 23 | | | |
| 24 | | | |
| 25 | | | |
| 26 | | | |
| 27 | | | |
| 28 | | | |
| 29 | | | |
| 30 | | | |
| 31 | | | |
| 32 | | | |
| 33 | | | |
| 34 | | | |
| 35 | | | |
| 36 | | | |
| 37 | | | |
| 38 | | | |
| 39 | | | |
| 40 | | | |

¹ ENTER THE NUMBER OF ALPHANUMERIC CHARACTERS SPECIFIED IN SYSTEM PARAMETERS CONFIGURATION (BILLING # LENGTH AND PIN LENGTH PROMPTS).

| SWITCH NUMBER | NETWORK USER IDENTIFICATION (NUI) | | PAGE 3 OF 5 |
|---------------|-----------------------------------|--|----------------|
| ENTRY# | BILLING # 1 | PERSONAL IDENTIFICATION NUMBER (PIN) 1 | |
| 41 | | | |
| 42 | | | |
| 43 | | | |
| 44 | | | |
| 45 | | | |
| 46 | | | |
| 47 | | | |
| 48 | | | |
| 49 | | | |
| 50 | | | |
| 51 | | | |
| 52 | | | |
| 53 | | | |
| 54 | | | |
| 55 | | | |
| 56 | | | |
| 57 | | | |
| 58 | | | |
| 59 | | | |
| 60 | | | |

¹ ENTER THE NUMBER OF ALPHANUMERIC CHARACTERS SPECIFIED IN SYSTEM PARAMETERS CONFIGURATION (BILLING # LENGTH AND PIN LENGTH PROMPTS).

| SWITCH NUMBER | NETWORK USER IDENTIFICATION (NUI) | | PAGE 4 OF 5 |
|---------------|-----------------------------------|---|----------------|
| ENTRY# | BILLING # ¹ | PERSONAL IDENTIFICATION NUMBER (PIN) ¹ | |
| 61 | | | |
| 62 | | | |
| 63 | | | |
| 64 | | | |
| 65 | | | |
| 66 | | | |
| 67 | | | |
| 68 | | | |
| 69 | | | |
| 70 | | | |
| 71 | | | |
| 72 | | | |
| 73 | | | |
| 74 | | | |
| 75 | | | |
| 76 | | | |
| 77 | | | |
| 78 | | | |
| 79 | | | |
| 80 | | | |

¹ ENTER THE NUMBER OF ALPHANUMERIC CHARACTERS SPECIFIED IN SYSTEM PARAMETERS CONFIGURATION (BILLING # LENGTH AND PIN LENGTH PROMPTS).

| SWITCH NUMBER | NETWORK USER IDENTIFICATION (NUI) | | PAGE 5 OF 5 |
|---------------|-----------------------------------|---|-------------|
| ENTRY# | BILLING # ¹ | PERSONAL IDENTIFICATION NUMBER (PIN) ¹ | |
| 81 | | | |
| 82 | | | |
| 83 | | | |
| 84 | | | |
| 85 | | | |
| 86 | | | |
| 87 | | | |
| 88 | | | |
| 89 | | | |
| 90 | | | |
| 91 | | | |
| 92 | | | |
| 93 | | | |
| 94 | | | |
| 95 | | | |
| 96 | | | |
| 97 | | | |
| 98 | | | |
| 99 | | | |
| 100 | | | |

¹ ENTER THE NUMBER OF ALPHANUMERIC CHARACTERS SPECIFIED IN SYSTEM PARAMETERS CONFIGURATION (BILLING # LENGTH AND PIN LENGTH PROMPTS).

APPENDIX B

HIGH-SPEED OPTIONS

The MICOM BOX Type 3 Packet Switch is available with either a V.35 or an X.21 high-speed X.25 link. When either of these options is installed, the X.25 link is capable of speeds up to 72,000 bps.

CCITT Recommendations V.35 and X.21 describe the electrical characteristics of the respective link. V.35 supports a variety of V.35 interface types, which are frequently used for telephone company applications. X.21 supports the X.21 interface. In addition, X.21 electrical characteristics are identical to those required for the RS-442 and V.36 interface types.

The switch's high-speed X.25 link option consists of:

- Either an X.21 or a V.35 interface daughterboard and related cable for the link 1 port.
- The high-speed FEATUREPAK cartridge: MB3-PSW-HS. The high-speed FEATUREPAK cartridge supports the X.21 or V.35 link and activates the Direct Memory Access (DMA) daughterboard. (The DMA daughterboard is present on all units, but is passive unless the high-speed FEATUREPAK cartridge is installed.)

The switch can be ordered initially with a high-speed link (see figure 1-2 for model numbers), or the standard unit can be easily upgraded in the field. To upgrade a standard switch to high-speed, you order the high-speed FEATUREPAK cartridge (MB3-PSW-HS), and an upgrade kit which contains a high-speed daughterboard and related cable (see table B-1).

As shown in table B-1, you order a daughterboard that is already configured as DTE or DCE. MICOM then provides you with the appropriate cable. This simplifies ordering and upgrading procedures.

B.1 INSTALLING A SWITCH WITH A HIGH-SPEED X.25 LINK

NOTE: It is assumed that you have applied the link number strips to the back panel of your switch, as described in paragraph 2.2.1 of this manual.

Switches that are initially ordered with a high-speed link are shipped with an X.21 or V.35 high-speed daughterboard already factory-installed on the base module. An X.21 or V.35 daughterboard can also be installed in the field (refer to paragraph B.2).

Table B-1. High-Speed Daughterboard Upgrade Kits

| Kit Number | Contents of Kit |
|----------------|---|
| MBK-V35-to-DTE | One V.35 daughterboard configured as DCE One 15-foot V.35 DCE cable, for connection to a DTE device (MICOM part number 100-2785) |
| MBK-V35-to-DCE | One V.35 daughterboard configured as DTE One 15-foot V.35 DTE cable, for connection to a DCE device (MICOM part number 100-2784) |
| MBK-X21-to-DTE | One X.21 daughterboard configured as DCE One 15-foot X.21 DCE cable, for connection to a DTE device (MICOM part number 100-2795) |
| MBK-X21-to-DCE | One X.21 daughterboard configured as DTE One 15-foot X.21 DTE cable, for connection to a DCE device (MICOM part number 100-2794) |

In addition to one of the preceding upgrade kits, the high-speed FEATUREPAK cartridge (MB3-PSW-HS) is required for the upgrade.

NOTE: The installation and upgrade procedures that follow are intended for the experienced communications technician.

Installation of a high-speed switch is identical to that of a standard unit (refer to section 2), with two exceptions:

- The cable used for the link varies. Refer to paragraph B.4 for information on cabling an X.21 or V.35 high-speed X.25 link.
- The X.21 and V.35 daughterboards come pre-configured as DCE or DTE (see table B-1). If you have to change the configuration, you can do so by means of a header and a four-position strap block. (The standard RS-232-C daughterboard is hard-wired as a DTE.) For information on changing the configuration of a daughterboard, see figure B-2. If you change this configuration, you will also have to change the cable (refer to paragraph B.4).

B.2 UPGRADING A STANDARD RS-232-C X.25 LINK TO HIGH-SPEED

A standard RS-232-C X.25 link can be easily upgraded to high-speed in the field. The procedure basically consists of removing the standard RS-232-C daughterboard (and related cable) for the link 1 port and installing either an X.21 or V.35 daughterboard (and appropriate cable) in its place. The standard FEATUREPAK cartridge must also be exchanged for a high-speed FEATUREPAK cartridge. Instructions are provided in the following procedures.

Removing the Standard RS-232-C Daughterboard

1. Remove all power to the unit.
2. Open the unit and remove the expansion module (if any), referring to the instructions in paragraph 2.2.2 of this manual.
3. Locate the standard RS-232-C daughterboard for the link 1 port on the base module (see figure B-1). The daughterboards are attached to the base module by means of threaded standoffs and nuts. Use a nut driver to remove the nuts.
4. Two female connectors on the daughterboard mate with two male connectors on the base module. Being very careful not to bend or break any pins, lift the daughterboard from one side and then the other with your hand, gradually lifting the daughterboard off the base module connector pins. Store the daughterboard in a static-sensitive bag (or equivalent).

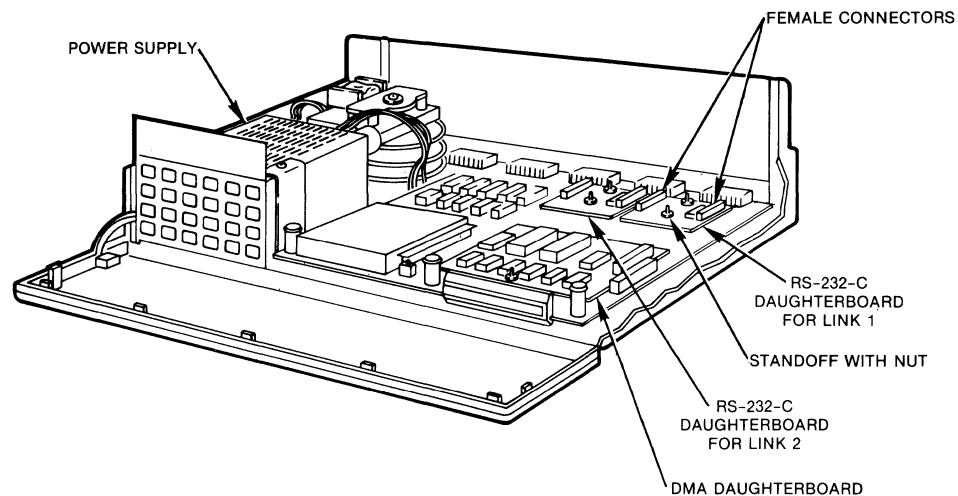

MI-1390-1a-70

Figure B-1. The Base Module With Standard Daughterboards

Configuring a High-Speed Daughterboard as DCE/DTE

5. The high-speed X.21 and V.35 daughterboards are configured as DCE or DTE by means of a header and a 4-position strap block. Daughterboards are shipped with strap blocks in the DCE or DTE position, depending on how you order them (see table B-1). If you need to change a configuration, remove the strap block and reinstall it in the other position (see figure B-2).

If you change the configuration of a daughterboard, make sure that the X.21 or V.35 cable matches the new configuration. For example, if you install the strap block on a V.35 daughterboard in the DCE position, make sure you install a V.35 cable that connects to a DTE device. Refer to paragraphs B.3 and B.4 for the cable pin assignments.

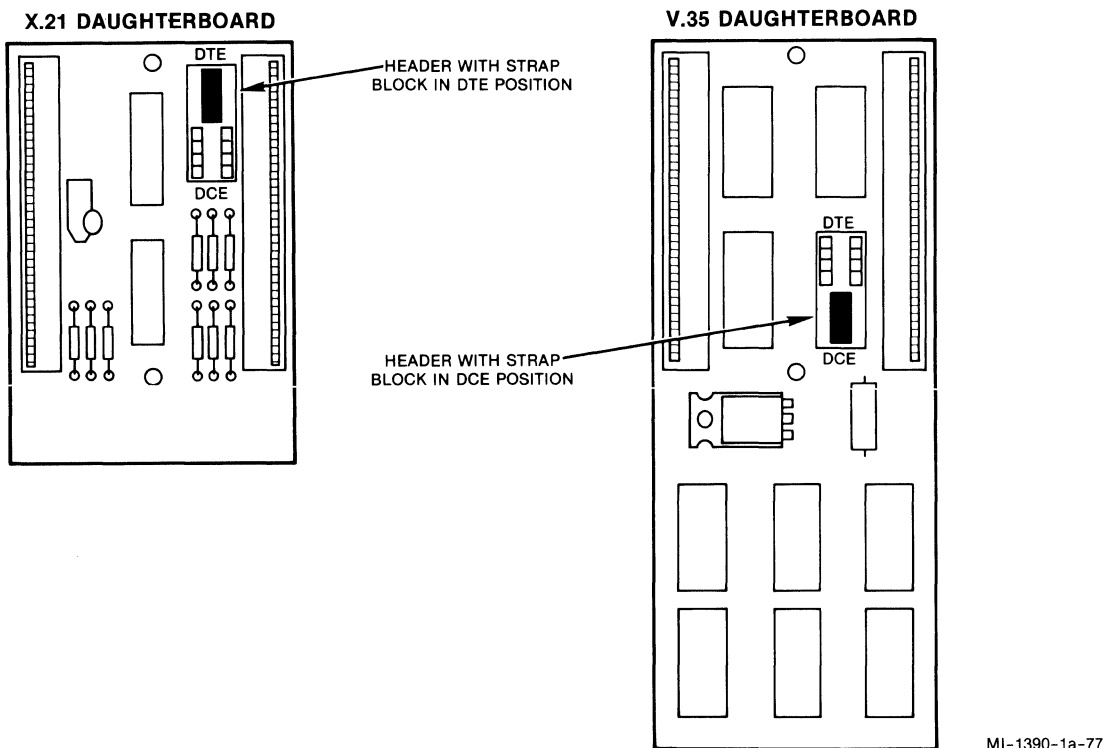
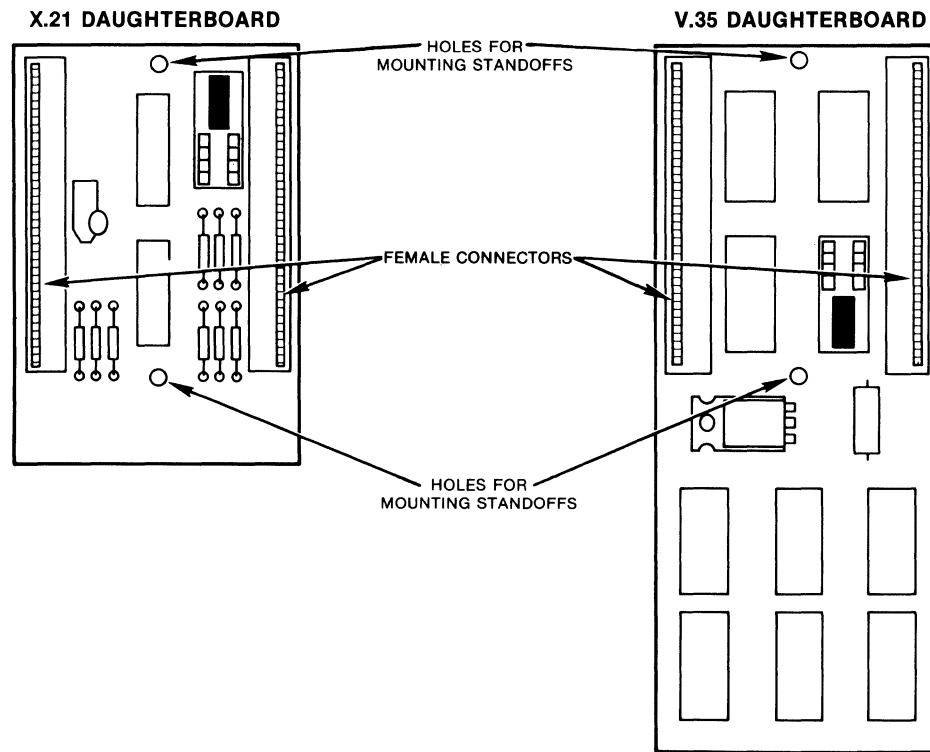

Figure B-2. Configuring a High-Speed Daughterboard as DTE or DCE

Installing a High-Speed X.21 or V.35 Daughterboard

6. Position the high-speed X.21 or V.35 daughterboard on the base module, aligning the mounting holes in the daughterboard with the base module standoffs. (See figure B-3.) The male connector pins on the base module will then align with the female connector on the daughterboard. Being careful that the alignment is correct and that pins are not being bent or broken, press the daughterboard down with your hand until it is fully seated on the base module.
7. Reinstall the nuts on the standoffs. Tighten the nuts with either your fingers or a nutdriver.
8. Reinstall the expansion module (if any) and close up the unit.
9. Remove the standard FEATUREPAK cartridge and install the high-speed FEATUREPAK cartridge (refer to paragraph 2.2.3 for instructions on installing a FEATUREPAK cartridge).



MI-1390-1a-78

Figure B-3. High-Speed Daughterboard Mounting Holes and Connectors

B.3 PIN ASSIGNMENTS FOR HIGH-SPEED LINKS

Pin assignments for the link 1 connector vary when a high-speed daughterboard is configured as DTE or DCE, and the appropriate cable is connected. Tables B-2 and B-3 list pin assignments for DTE and DCE X.21 links, and tables B-4 and B-5 list pin assignments for DTE and DCE V.35 links. These pin assignments are provided for the benefit of customers who wish to create their own cables. MICOM offers DTE X.21 and V.35 cables and DCE X.21 and V.35 cables in high-speed daughterboard kits, as shown in table B-1. Refer to paragraph B.4 for information on the individual MICOM cables.

Table B-2. Link 1 Pin Assignments -- X.21 to a DTE Device

| Connector Pin Number | Assigned Signal |
|----------------------|--------------------|
| 9 | Transmitted Data B |
| 24 | Transmitted Data A |
| 15 | Signal Timing A |
| 8 | Indication B |
| 7 | Signal Ground |
| 6 | Control A |
| 2 | Received Data A |
| 4 | Signal Timing B |
| 20 | Control B |
| 18 | Indication A |
| 3 | Received Data B |

Table B-3. Link 1 Pin Assignments -- X.21 to a DCE Device

| Connector Pin Number | Assigned Signal |
|----------------------|--------------------|
| 9 | Received Data B |
| 24 | Received Data A |
| 15 | Signal Timing A |
| 8 | Control B |
| 7 | Signal Ground |
| 6 | Indication A |
| 2 | Transmitted Data A |
| 4 | Signal Timing B |
| 20 | Indication B |
| 18 | Control A |
| 3 | Transmitted Data B |

Table B-4. Link 1 Pin Assignments -- V.35 to a DTE Device

| Connector Pin Number | Assigned Signal |
|----------------------|----------------------------------|
| 9 | Send Data B |
| 24 | Send Data A |
| 22 | Serial Clock Transmit External A |
| 15 | Serial Clock Transmit A |
| 20 | Data Set Ready |
| 7 | Signal Ground |
| 18 | Clear-To-Send |
| 2 | Received Data A |
| 10 | Received Line Signal Detect |
| 13 | Ring Indicator |
| 12 | Local Test |
| 17 | Serial Clock Transmit External B |
| 23 | Serial Clock Receive A |
| 8 | Request-To-Send |
| 6 | Data Terminal Ready |
| 5 | Serial Clock Receive B |
| 4 | Serial Clock Transmit B |
| 3 | Received Data B |

Table B-5. Link 1 Pin Assignments -- V.35 to a DCE Device

| Connector Pin Number | Assigned Signal |
|----------------------|----------------------------------|
| 9 | Received Data B |
| 24 | Received Data A |
| 23 | Serial Clock Transmit A |
| 22 | Serial Clock Receive A |
| 20 | Data Terminal Ready |
| 7 | Signal Ground |
| 10 | Request-To-Send |
| 2 | Send Data A |
| 8 | Received Line Signal Detect |
| 13 | Local Test |
| 12 | Ring Indicator |
| 5 | Serial Clock Transmit B |
| 15 | Serial Clock Transmit External A |
| 16 | Clear-To-Send |
| 6 | Data Set Ready |
| 4 | Serial Clock Transmit External B |
| 17 | Serial Clock Receive B |
| 3 | Send Data B |

B.4 CABLING

MICOM offers two V.35 cables and two X.21 cables. Each cable is 15 feet in length, shielded, and has a 25-pin female connector at one end for connection to the switch's male link 1 port. The connector at the other end varies with the interface. Figures B-4 through B-7 provide diagrams for each cable. The cables are:

| <u>MICOM Part Number</u> | <u>Cable Description</u> |
|--------------------------|--|
| 100-2785 | V.35 DCE, for connection to a DTE device |
| 100-2784 | V.35 DTE, for connection to a DCE device |
| 100-2795 | X.21 DCE, for connection to a DTE device |
| 100-2794 | X.21 DTE, for connection to a DCE device |

The link 1 connector pin assignments for X.21 and V.35 links are listed in tables B-2 through B-5 for the benefit of customers who wish to create their own cables.

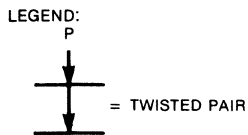
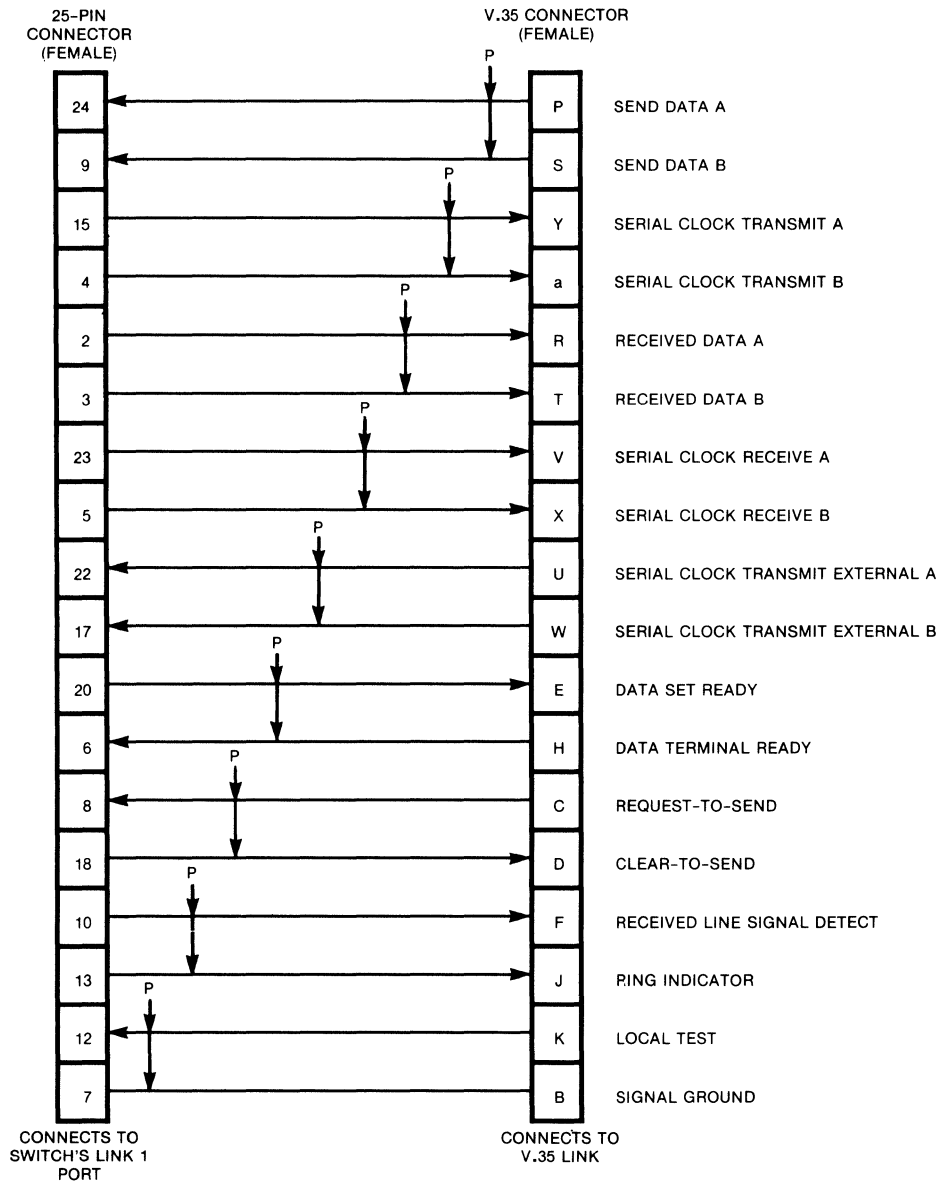

MI-1390-2a-79

Figure B-4. V.35 DCE Shielded Cable (MICOM part number 100-2785) for Connection to a DTE Device

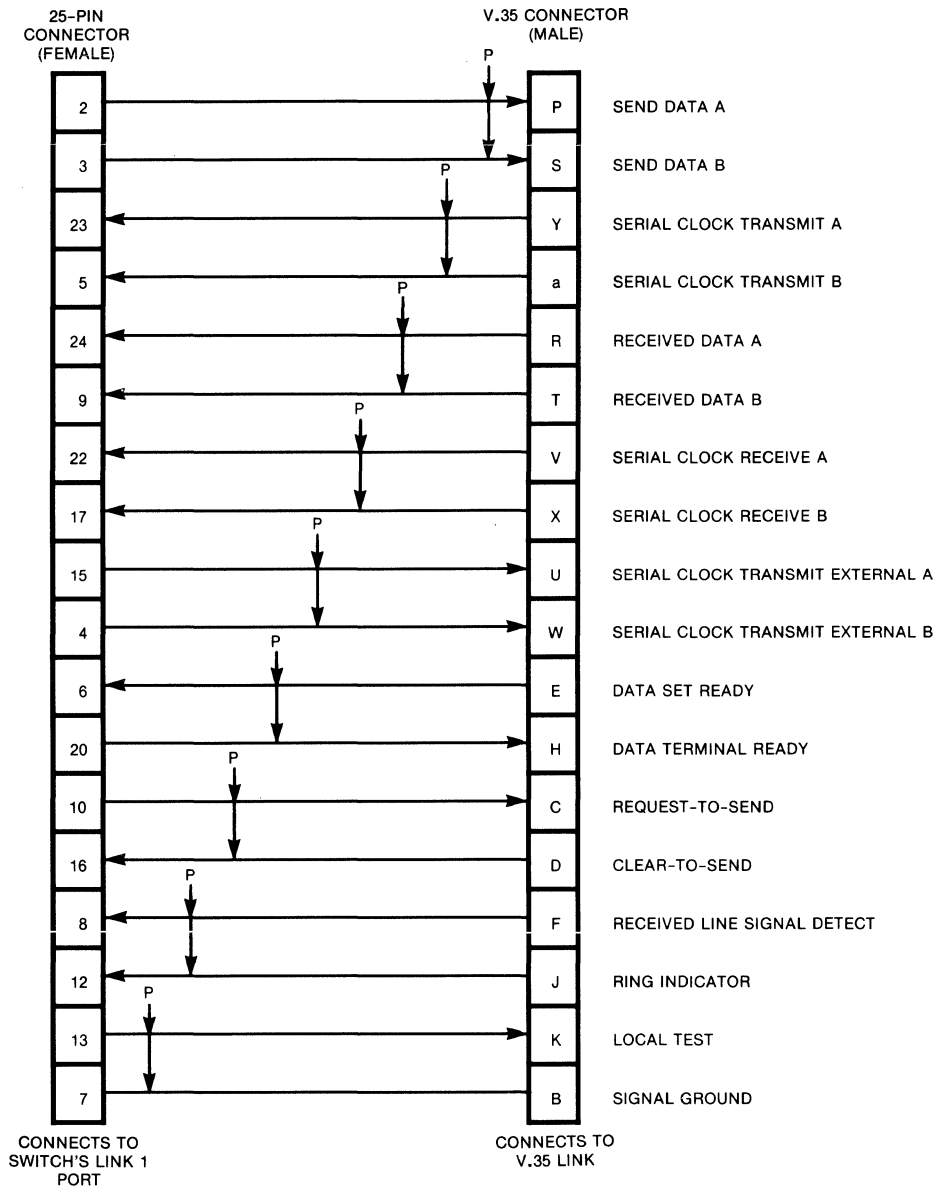

MI-1390-2a-80

Figure B-5. V.35 DTE Shielded Cable (MICOM part number 100-2784) for Connection to a DCE Device

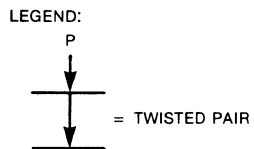
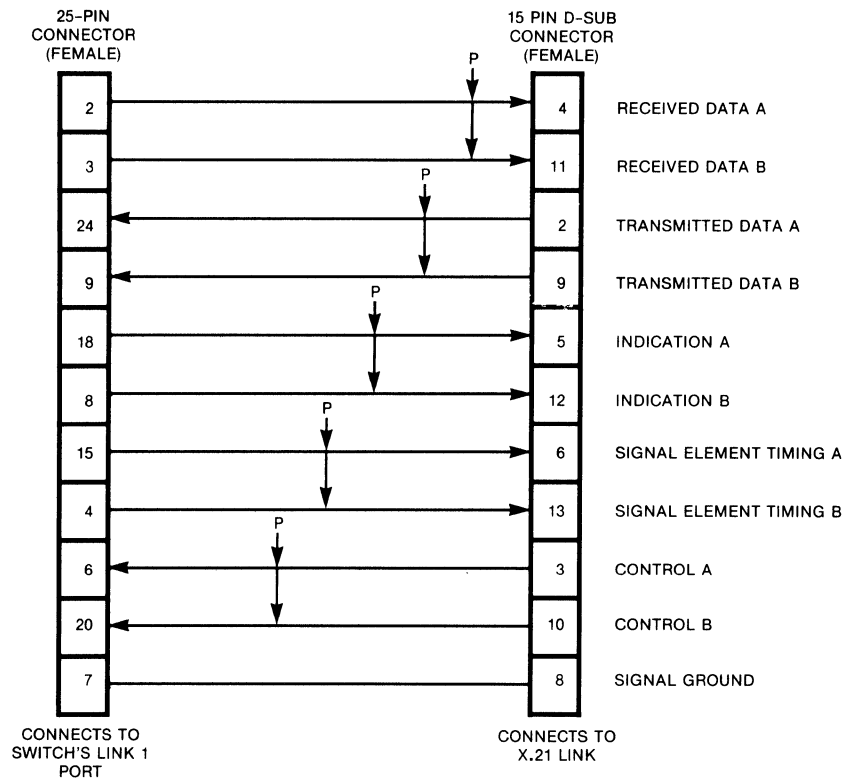

MI-1390-2a-81

Figure B-6. X.21 DCE Shielded Cable (MICOM part number 100-2795) for Connection to a DTE Device

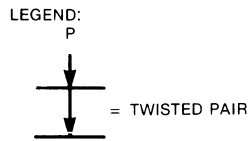
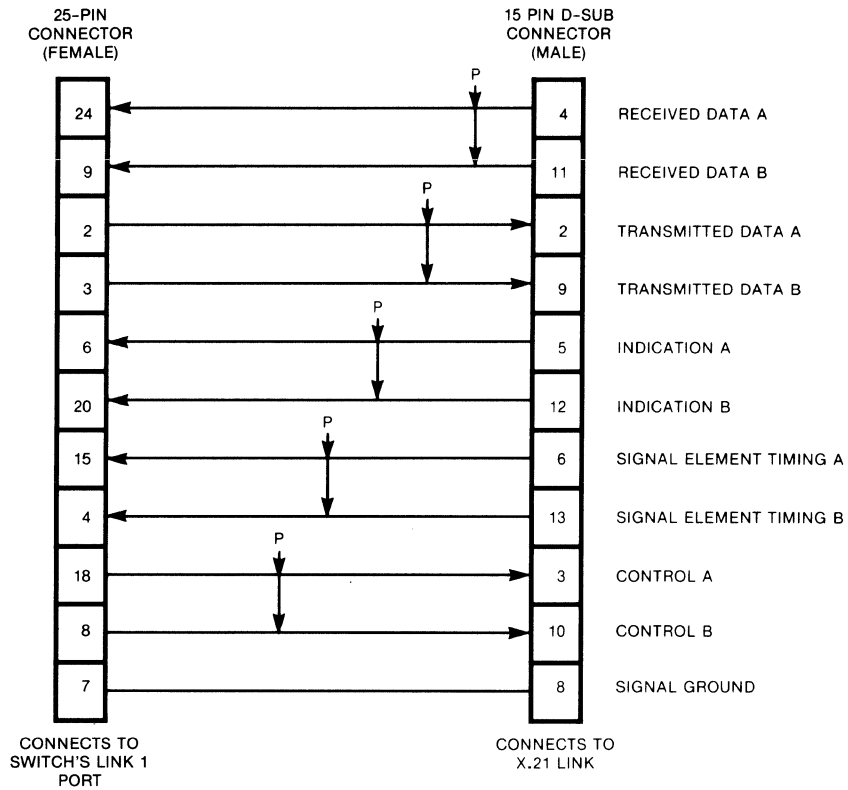

MI-1390-2a-82

Figure B-7. X.21 DTE Shielded Cable (MICOM part number 100-2794) for Connection to a DCE Device

APPENDIX C

ASCII CHART

| CONTROL | | NUMBERS SYMBOLS | | UPPER CASE | | LOWER CASE | |
|----------|-----------|--------------------|---------|------------|---------|------------|------------------------|
| NUL 0 | DLE 16 | SP 32 | O 48 | @ 64 | P 80 | \ 96 | p 112 |
| SOH 1 | DC1 17 | ! 33 | 1 49 | A 65 | Q 81 | a 97 | q 113 |
| STX 2 | DC2 18 | " 34 | 2 50 | B 66 | R 82 | b 98 | r 114 |
| ETX 3 | DC3 19 | # 35 | 3 51 | C 67 | S 83 | c 99 | s 115 |
| EOT 4 | DC4 20 | \$ 36 | 4 52 | D 68 | T 84 | d 100 | t 116 |
| ENQ 5 | NAK 21 | % 37 | 5 53 | E 69 | U 85 | e 101 | u 117 |
| ACK 6 | SYN 22 | & 38 | 6 54 | F 70 | V 86 | f 102 | v 118 |
| BEL 7 | ETB 23 | ' 39 | 7 55 | G 71 | W 87 | g 103 | w 119 |
| BS 8 | CAN 24 | (40 | 8 56 | H 72 | X 88 | h 104 | x 120 |
| HT 9 | EM 25 |) 41 | 9 57 | I 73 | Y 89 | i 105 | y 121 |
| LF 10 | SUB 26 | * 42 | : 58 | J 74 | Z 90 | j 106 | z 122 |
| VT 11 | ESC 27 | + 43 | ; 59 | K 75 | [91 | k 107 | { 123 |
| FF 12 | FS 28 | , 44 | < 60 | L 76 | \ 92 | l 108 | 124 |
| CR 13 | GS 29 | - 45 | = 61 | M 77 |] 93 | m 109 | } 125 |
| SO 14 | RS 30 | . 46 | > 62 | N 78 | ^ 94 | n 110 | ~ 126 |
| SI 15 | US 31 | / 47 | ? 63 | O 79 | _ 95 | o 111 | RUBOUT (DEL) 127 |

KEY

| |
|--------------------------|
| <p>NAK 21</p> |
|--------------------------|

ASCII character
decimal

MT-000-01

SUBJECT INDEX

A

Address assignment 3-1
 Private network 3-2
 Public Data Network (PDN) 3-1
Address field handling 3-3, 3-6,
 5-17
 Class route 3-4, 5-26, 5-27
 Example 4-17, 4-21
 Speed dial 3-3, 5-24, 5-25
Administrative procedures 5-1
 Accessing the Command Facility
 5-2, 5-3
 Configuration 5-6
 Setting up the switch 5-2
Alternate link 1-9, 3-6
 Configuration 5-18, 5-19
 Example 4-1, 4-11, 4-17
Application examples 4-1
ASCII chart C-1
Autocconnect link 3-6, 5-20,
 5-21
 Configuration 5-18
 Example 4-1, 4-8, 4-11, 4-12

B

Best-path selection 3-7 through
 3-9, 5-23, 5-34
Busyout Link Command 5-43, 5-44

C

Cables 2-12
 Command Port 2-18
 Example of cabling 2-13
 High-speed link B-1 through B-4,
 B-6 through B-12
 Standard links 2-11, 2-12, 2-14
 through 2-18
Call accounting 5-63 through 5-65
 Enabling a link 5-19
 Enabling Command Port 5-28
 Related to billing number in NUI
 Table 5-36, 5-39 through 5-41
 Sample record 5-63
Call clearing procedures 3-11

C (continued)

Call User Data (CUD) subaddressing
 3-1, 3-2, 3-5
 Related to type of link 3-5, 5-13
Cause and diagnostic codes 6-15
 Clear Packet 6-16 through 6-20
 DTE 1984 cause code support 5-19,
 6-21
 Reset Packet 6-20, 6-21
 Restart Packet 6-15
Characteristics of the switch 1-8
 General 1-8 through 1-10
 X.25 link 1-10
Class route 3-3, 3-4
 Examples 3-5, 4-12, 4-14, 4-16
 List Class Route Command 5-53
 Setting up the Class Route Table
 5-26, 5-27
 Worksheets A-12, A-13
Clear Packet 3-11, 3-12
 Cause and diagnostic codes 6-16
 through 6-20
CMD/XCC Facility 5-3, 5-27
 Configuration 5-27 through 5-33
 Worksheets A-14 through A-17
Command Facility 1-10, 4-10, 5-1
 Address 5-27, 5-28
 Configuration 5-6
 Functions available 5-1
 Local access 5-2, 5-3
 Logging on 5-4
 Logging out 5-61
 Menu 5-5
 Password 5-3, 5-4
 Remote access 3-13, 5-3
Command Menu 5-5
Command Port 1-9, 4-3, 4-5, 5-63
 Cabling 2-11, 2-18
 Configuration 5-28 through 5-33
 Dedicated 5-2, 5-3
 Enabling for call accounting and
 event reporting 5-28
 Memory dump 6-12
 Soft switch setting 2-21, 5-35
 Terminal-Activated Channel Tests
 6-1, 6-4 through 6-11
Components 1-5, 1-7
Configurable X.25 link parameters
 1-10, 3-6, 5-13 through 5-15

C (continued)

Configuration 5-1, 5-5, 5-6
 Class Route Table 5-26, 5-27
 CMD/XCC Facility 5-27
 through 5-33
 Link profiles 5-11 through 5-20
 Menu 5-6, 5-7
 NUI Facility 5-18, 5-36 through
 5-42
 Routing Table 5-20 through 5-23
 Speed Dial Table 5-24, 5-25
 System (Wide) Parameters 5-34
 through 5-36
Configure Menu 5-6, 5-7
 Prompts related to each menu item
 5-8
Connections 2-11, 2-12
 Command Port 2-18
 High-speed link B-1, B-6,
 B-7
 Interswitch 2-18
 Power 2-19
 X.25 links 2-18

D

Date and time 5-4
Daughterboards (V.35 or X.21) 1-2,
 1-6, B-1 through B-6
 Configuration as DCE or DTE B-2,
 B-4
 High-speed kits B-1, B-2
 Installation B-1 through B-5
Diagnostics 6-1
 Cause and diagnostic codes 6-15
 through 6-21
 DTE 1984 cause code support 5-19,
 6-21
 Indicators 1-7, 6-1 through 6-4
 Off-line memory dump 2-21, 6-12
 through 6-14
 Terminal-Activated Channel Tests
 6-4 through 6-11
Disconnect LCN Command 5-42

E

Eligible link 3-7, 3-8
Enclosure 1-7
 Opening and closing 2-4
 Size 1-13, 2-1

Index-2

E (continued)

Event reporting 5-61 through 5-63
 Enabling 5-28
 Link Down 5-62
 Link Up 5-61
 Restart 5-62
 Wild Call 5-62

F

Facilities handling 3-6, 3-10,
 5-16
FEATUREPAK cartridge 1-2, 1-7,
 1-8, 1-10, 2-1, 6-2
 High-speed 1-8, B-1 through
 B-3, B-5
 Installation and removal 2-8,
 2-9
 Standard 1-8
Flow control 3-13

H

High-speed options (V.35 or X.21)
 1-1, 5-12, B-1
 Cables B-8 through B-12
 Daughterboards 1-2, 1-6, B-1
 through B-6
 Installing B-1, B-2
 Pin assignments B-6, B-7
 Upgrading switch B-3 through B-5
Hop 3-8, 3-13, 5-7
 Configuring maximum 5-35

I

Indicators 1-7, 6-1 through 6-4
 Applying indicator strips 2-2,
 2-3
 For operating mode 6-2 through 6-4
 For soft switch configure mode
 2-20 through 2-22

800-1390-1a

I (continued)

Installation 2-1
 Cabling 2-12 through 2-18
 Expansion module 2-4, 2-6
 through 2-8
 FEATUREPAK cartridge 2-8, 2-9
 High-speed option B-1, B-2
 Opening and closing enclosure
 2-4, 2-5
 Power connection 2-19
 Rack-mount 2-9, 2-10
 Selecting location 2-1
 Standalone 2-9
Interswitch cable 2-18

J

Jumpers 2-6, 2-7

L

Labels (strips) 2-2
 Indicator strips 2-2, 2-3
 Link number strips 2-2
Link down 3-11, 5-46 through
 5-48, 5-62, 6-3
 Command 5-44
 Event report 5-62
Link priority 3-7 through
 3-9, 5-22, 5-23
Link profile 3-5
 Configuration 5-11 through
 5-19
 Worksheets A-3 through A-5
Link speeds 1-10, 3-5
Link types 1-11, 1-12
Link up 5-46, 5-47, 5-59, 6-3
 Command 5-44
 Event report 5-61
List (display) commands 5-1
 Class Route 5-53
 NUI 5-54
 Routing Table 5-49
 Speed Dial 5-52
 Statistics (Link) 5-45
 Statistics (Packet) 5-47

L (continued)

Load share 1-9, 3-6
 Configuration 5-18, 5-19
 Examples 4-4 through 4-7,
 4-13, 4-15 through 4-17,
 4-20
Logging on to the Command
 Facility 5-4
Logging out of the Command
 Facility 5-61
Logical appearance of link
 (DCE or DTE) 3-5, 3-10,
 5-13
Logical Channel Number (LCN)
 3-6, 5-59
 Configuration 5-14, 5-15,
 5-19, 5-20
 Disconnect LCN Command 5-42
 Selection 3-8, 3-10

M

Mask (routing) 3-2, 3-7, 3-8
 Chaining routing masks 3-8
 Defining in Routing Table
 5-20 through 5-23
 Displaying list 5-49
Memory dump 1-10, 6-1
 Enabling switch 2-21, 5-35
 How to use 6-12 through 6-14
MICOM BOX Type 3 1-1, 1-2
Model numbers 1-2
Modules (base and expansion) 1-5,
 1-6
 Installation and removal 2-4,
 2-6 through 2-8
Monitor Command 5-58

N

Network User Identification (NUI)
 Facility 1-9, 3-10, 5-36
 Configuring link profile 5-18,
 5-37
 Defining lengths of Billing #s and
 PINs in NUI Table 5-36, 5[B8
 Examples 5-41
 List NUI Command 5-54
 Setting up NUI Table 5-39, 5-40
 Worksheets A-19 through A-23
Notational conventions 5-9, 5-10

P

Packet handling 3-12
Packet statistics 5-47, 5-48
PAD 1-1, 1-8
 Connections 2-13 through 2-18
Password 5-4
Personal Identification Number (PIN)
 5-36 through 5-41
Physical specifications 1-13
Power supply 1-8
 Connecting power 2-19
Priority (routing) 3-7 through
 3-9, 5-22, 5-23
Private network 1-1, 1-8, 3-3, 3-4,
 4-1
 Address 3-1, 3-2
 Application examples 4-2, 4-4
Profile (link) 3-5, 5-11 through
 5-19
Public Data Network (PDN) 1-1, 1-8,
 3-3, 3-4, 4-1
 Address 3-1
 Address in link profile 5-17
 Application examples 4-8, 4-9,
 4-11, 4-12, 4-17
 Related to class route 5-26, 5-27
 Related to speed dial 5-24, 5-25

R

Rack-mount 1-7, 1-10, 2-10
Reports 1-10
 Call accounting 5-19, 5-63 through
 5-65
 Link level statistics 5-45, 5-46
 Monitor 5-58 through 5-60
 Packet level statistics 5-47,
 5-48
 Setting frequency of reporting
 5-28
Reset Packet 3-12
 Cause and diagnostic codes 6-20,
 6-21
Reset Statistics Command 5-57
Reset Switch 2-19, 2-22, 5-60
Restart 3-12
 Cause and diagnostic codes 6-15
 Event report 5-62

R (continued)

Routing 1-9, 3-7
 Class route 3-4
 Examples 4-1
 Masks 3-7, 3-8, 5-20, 5-22, 5-23,
 5-49
 Speed dial 3-3, 5-52
 Table 3-7 through 3-9, 5-18, 5-20
 through 5-23, 5-49 through 5-51
Routing Table 3-7 through 3-9, 5-18
 Examples 4-1
 List Routing Table Command 5-49
 Setting up 5-20 through 5-23
 Worksheets A-6 through A-9

S

Setting up the switch 5-2
Software (soft) switches 2-19,
 2-20, 5-2
 Cold/warm start 2-21, 5-2, 5-35
 Dedicated Command Port 2-18,
 2-21, 5-35
 Offline memory dump 2-21, 5-2,
 5-35, 6-12
 Switch identifier 2-21, 5-35
Speed dial 1-9, 3-3
 Examples 3-4, 4-12, 4-14, 4-17
 List Speed Dial Command 5-52
 Setting up the Speed Dial Table
 5-24, 5-25
 Worksheets A-10, A-11
Statistics 5-1, 5-28
 List Statistics (Link) Command
 5-45, 5-46
 List Statistics (Packet) Command
 5-47, 5-48
 Report (link level) 5-45, 5-46
 Report (packet level) 5-47, 5-48
 Reset Statistics Command 5-57
Subaddressing 1-9, 3-1, 3-2
 Call User Data 1-9, 3-1, 3-2,
 3-5, 5-13
 Configuration in link profile
 5-13
 X.121 1-9, 3-1, 3-2, 3-5, 5-13
Switched Virtual Circuit (SVC) 3-6,
 5-59
 Configuration in link profile
 5-14, 5-15, 5-19, 5-20

S (continued)

Switch identifier 2-19, 2-21, 5-34,
5-35
System (switch) parameters 5-1,
5-7, 5-34
Configuration 5-34 through 5-36
Worksheet A-18

T

Terminal-Activated Channel Tests
(TACT) 6-1, 6-4
Equipment setup for local
tests 6-7
Equipment setup for remote
tests 6-11
Touch Panel 1-7, 2-19, 2-20
To assign switch identifier 2-19
through 2-21
To reset switch 2-19, 2-22
To set operating parameters 2-19
through 2-21

W

Wild call 3-13, 5-35
Event report 5-62, 5-63
Wildcard 1-9, 3-7, 5-22
Worksheets (configuration) A-1

X

X.121 subaddressing 1-9, 3-1, 3-2,
3-5, 5-13
X.25 Control Center (XCC) facility
5-27 through 5-33

PUBLICATION CHANGE REQUEST

A message to our readers: we try to make our product manuals as accurate, complete, and easy to use as possible. If you have an improvement to suggest (or find an error in this manual), **LET US KNOW:**

- a. Fill in the four sections below.
- b. Staple any marked-up pages to this side of request form.
- c. Fold entire package in thirds—so that the MICOM address shows.
- d. Staple package shut.
- e. Fill in your return address in the space provided on both sides of this request form.
- f. Drop in mail box.

MANUAL IDENTIFICATION (take from the title page of your manual)

EQUIPMENT COVERED (take model number from silver tag on unit) _____

DATE OF MANUAL _____ STOCK NUMBER _____

PROBLEM *

SUGGESTED SOLUTION *

READER IDENTIFICATION

NAME AND TITLE _____ DATE _____

ADDRESS _____ TELEPHONE () _____

* The best way to help us identify and correct the problem you discovered is to attach marked-up copies of the affected pages.

Thank you for taking the time and making the effort to fill in this request. We will review and respond to your request by return mail.

MICOM Technical Publications

MICOM Form No 1077b



Fold Here

From: _____



**NO POSTAGE
NECESSARY
IF MAILED
IN THE
UNITED STATES**

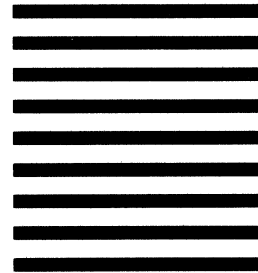

BUSINESS REPLY MAIL
FIRST CLASS PERMIT NO. 906 SIMI VALLEY, CA 93062

POSTAGE WILL BE PAID BY ADDRESSEE

MICOM Systems, Inc.
ATTENTION: Publication Change Control
4100 Los Angeles Avenue
P.O. Box 8100
Simi Valley, CA 93062-8100



Fold Here

NOTES

NOTES

NOTES

NOTES

NOTES

NOTES



MICOM Systems, Inc. • 4100 Los Angeles Ave. • PO Box 8100 • Simi Valley, CA 93062-8100