

Our 37th Year

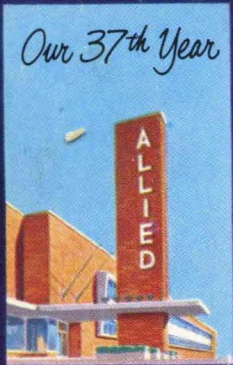

ALLIED RADIO

100 N. WESTERN AVE., CHICAGO 80, ILL.

Telephone—HAYmarket 1-6800

Everything in Electronics

RADIO TELESCOPE
SEE PAGE 1

CATALOG
NO. 170
1958

INDEX ON PAGE 397

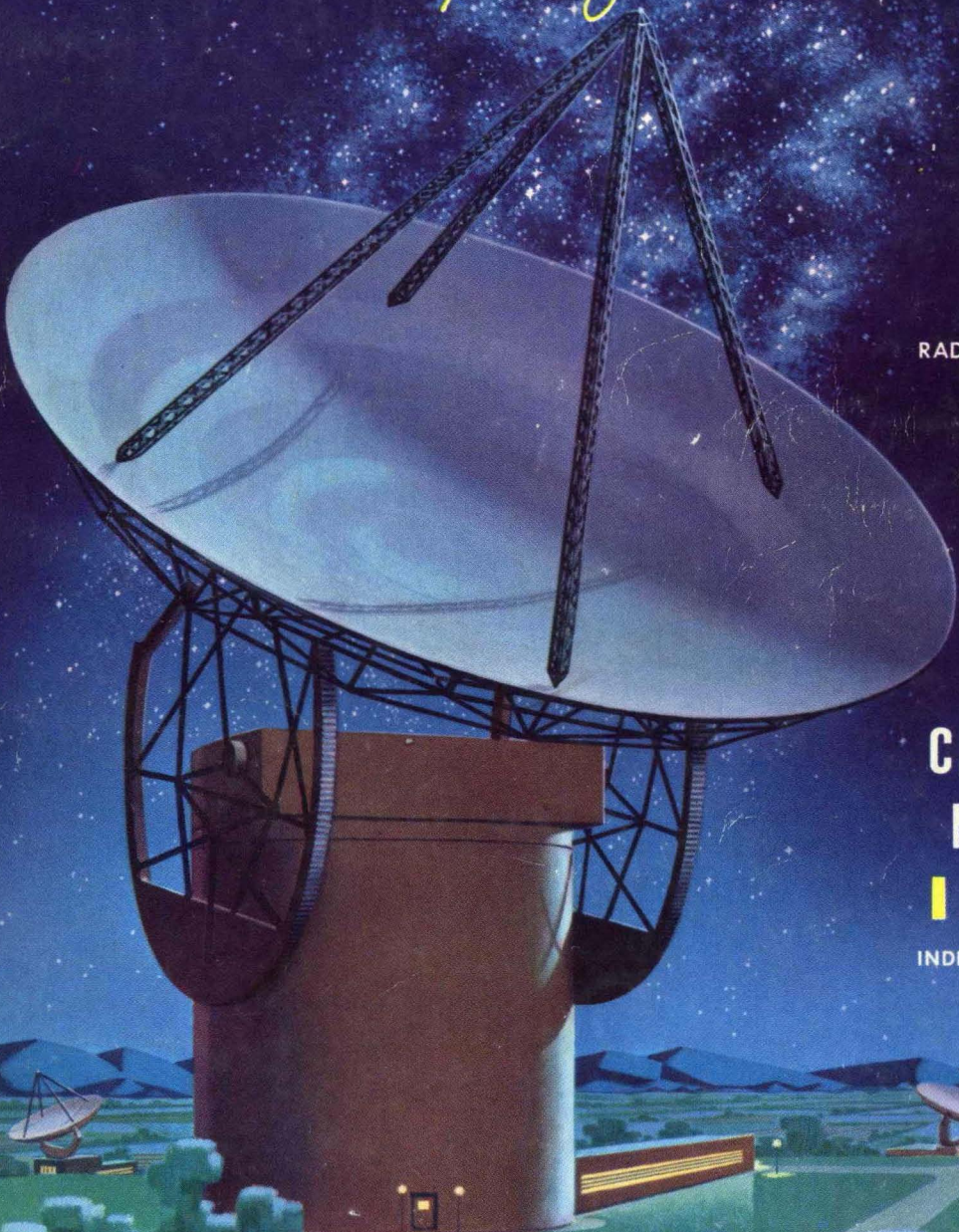

1958 • CATALOG 170 • ALLIED RADIO CORPORATION • CATALOG 170 • 1958

ALLIED presents
ElectroVoice **PHASE LOADING**



**EXCITING NEW SPEAKER SYSTEM
ACHIEVEMENT... For Superior,
In-Phase Bass Response from
Along-the-Wall Speaker Enclosures**

30-300 cps		3500-15,000 cps	
300-1000 cps		1000-3500 cps	

Unlike treble and mid-range tones, which are directional, bass tones are non-directional and ordinarily travel along two routes on the way to your ears—resulting in partial cancellation. One portion of a bass tone travels directly to your ears from the woofer, while another portion of the same tone travels first to the wall in back of the woofer, and then is reflected to your ears. Since the sound taking this second route travels further, it reaches you *later* than the sound that comes directly from the woofer—it is out of phase. "Phase Loading" corrects this bass-cancelling time lag by using a specially designed woofer in a sealed cavity, *facing the wall*. With this unique arrangement, *all of the bass is "bounced" back from the wall at the same time—and is in phase*. You hear *the entire audio spectrum* in phase, the bass tones plus the mid-range and treble. With "Phase Loading", the bass tones are augmented by 3 times—and you can place the enclosure *anywhere* along the reflecting wall.

HERE IS HOW IT WORKS

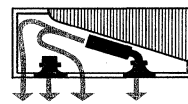

Two-way mid-range sound comes from MT30B horn; treble from T35B tweeter.

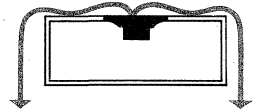

15BWK woofer "bounces" bass tones directly off reflecting wall.

Carlton IVA Phase-Loaded 4-Way Speaker System

AS LOW AS \$25970 Distinctively styled by skilled craftsmen to blend beautifully with any furnishing mode. The Carlton IVA in handsome, low-boy design, employs acoustically correct "Tapatone" grille cloth to add a touch of colorful accent to its graceful lines. A complete phase-loaded system, it features Model 117B 4-way speaker system components for superior bass response, natural mid-range and ultra-clean treble reproduction. Includes: 15BWK "K" type low-frequency driver, MT30B coaxial mid-bass and treble driver-horn assembly, T35B very-high-frequency driver, X336 crossover network, and two AT37 level controls. Handles 20 watts of program material; 40 watts peak power capacity. Size, 33-1/2" high, 26-1/4" wide, 19-1/2" deep. Shpg. wt., 124 lbs.

- 81 DZ 869. Mahogany. NET **\$259.70**
- 81 DZ 870. Limed Oak. NET **\$264.60**
- 81 DZ 871. Walnut. NET **\$264.60**

Duchess IVA Phase-Loaded 4-Way System

AS LOW AS \$25676 A perfect example of elegant contemporary design, the Duchess IVA 4-way system complements any room in which it is placed. Uses the same Model 117B speaker components as the Carlton, above. Size, 29-5/8" high, 25" wide, 19" deep. Shpg. wt., 110 lbs.

- 81 DZ 878. Mahogany. NET **\$256.76**
- 81 DZ 879. Limed Oak. NET **\$261.66**
- 81 DZ 880. Walnut. NET **\$261.66**

Empire IVA Phase-Loaded 4-Way System

AS LOW AS \$25970 Pleasingly styled and sparing of space, the Empire IVA 4-way speaker system offers phenomenal performance for its modest size. Employs the same Model 117B speaker components used in the Carlton, above. Only 29-5/8" high, 32" wide, 16" deep. Shpg. wt., 106 lbs.

- 81 DZ 875. Mahogany. NET **\$259.70**
- 81 DZ 876. Limed Oak. NET **\$266.56**
- 81 DZ 877. Walnut. NET **\$266.56**

Suzerain IVA Phase-Loaded 4-Way System

AS LOW AS \$29498 Reflecting the fresh, new Scandinavian styling influence, the Suzerain IVA 4-way speaker system sounds as good as it looks! Uses the same Model 117B speaker system components as the Carlton, above. Size, 36-1/2" high, 26" wide, 19-3/4" deep. Shpg. wt., 134 lbs.

- 81 DZ 881. Mahogany. NET **\$294.98**
- 81 DZ 882. Limed Oak. NET **\$301.84**
- 81 DZ 883. Walnut. NET **\$301.84**

See Page 50 for Complete Listings of Matching Electro-Voice Console Equipment Cabinets

Entire Contents Copyrighted 1957, by ALLIED RADIO CORP. Printed in U.S.A.

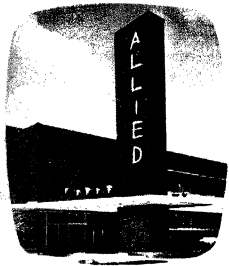

30

THE WORLD'S LARGEST ELECTRONIC SUPPLY HOUSE

Our 37th Year of Service

ALLIED Guarantees Your Complete Satisfaction

We guarantee to bring you the world's largest and finest stocks of radio, television and electronic equipment at lowest prices.

We guarantee to give you the immediate benefit of any price reductions made after this catalog is printed.

We guarantee that our merchandise conforms to the standards of the Radio-Electronics-Television Manufacturers' Association and will perform in the manner intended for such apparatus.

Every item you buy from us must satisfy in every way—or we want you to return it at once for exchange, repair or refund.

15-DAY TRIAL, MONEY-BACK GUARANTEE

Order any test instrument, amplifier, high-fidelity component, recorder, communications unit or any other equipment—on our regular terms. Try it under your own operating conditions. Then, if within 15 days you are not completely satisfied, return the equipment to us, and we will refund your full purchase price, less transportation charges. This Guarantee is further backed by the regular Radio-Electronics-Television Manufacturers' Warranty against defects in materials and workmanship.

You Get Every Buying Advantage at ALLIED

We save you money because our complete stocks permit you to order *all* of your electronic needs from one source. And you *always* buy at ALLIED at the *lowest* prevailing market prices.

We ship speedily and safely from the world's largest stocks of electronic equipment. Your orders are speeded to you by a skilled organization with a record of over 36 years of dependable service.

We satisfy you completely with expert personal help, intelligent service and the full resources that have made us the World's Leading Electronic Supply House.

Everything in Electronics from One Dependable Source

ALLIED RADIO

100 N. WESTERN AVE., CHICAGO 80, ILL.

phone: **HAYmarket 1-6800**

CONDENSED INDEX

To Everything in Electronics

Amateur Equipment.....	262-279
Antennas.....	274-276, 369-380, 163
Batteries.....	284-287
Books.....	298-310
Capacitors.....	122-138, 156-160
Cartridges.....	63, 65, 66, 81-84
Chemicals.....	334, 335
Coils & RF Chokes.....	152-161
Connectors.....	167-173, 354, 355
Fluorescent Fixtures.....	290-291
Fuses.....	190, 191
Hardware.....	332, 333
Headphones.....	279, 281-283
Hi-Fi Equipment.....	3-77, 210-217, 391, 393, Cov. 2, Cov. 3, Cov. 4
Intercom Equipment.....	225, 345, 362-366
Kits.....	209-236, 248, 250-253, 391, Cov. 4
Meters.....	256-261
Microphones & Accessories.....	348-355
Needles.....	85
PA Equipment.....	337-347
Phonographs.....	78, 79
Plugs & Jacks.....	167-169, 173-179
Power Supplies.....	287-289
Printed Circuit Components.....	137, 138
Racks & Cabinets.....	292, 294-297, 345
Records.....	80
Record Changers.....	62, 64, 69, 70, Cov. 3
Recorded Tapes.....	96
Recording Equipment.....	86-95
Relays.....	192-197
Resistors.....	111-115
Sockets.....	165-168
Soldering Guns and Irons.....	311-315
Speakers & Accessories.....	355-361
Switches.....	199-208
Test Equipment.....	230-256, 261
Tools.....	311-331, 336
Transformers.....	139-151
Transistors.....	102
Tubes.....	97-105
TV Antenna Equipment.....	389-389
TV Picture Tubes.....	97
Vibrators.....	164
Volume Controls.....	115-121
Wire & Cable.....	180-185

COMPLETE INDEX ON PAGE 397

For Easy Payment Plan
See Page 396

For How to Order
See Page 394



OUR COVER

Radio Astronomy comes of age. The giant 140-foot steerable Radio Telescope planned by the National Science Foundation promises to disclose new secrets of outer space by electronic detection, amplification and recording of radio waves from the far-flung galaxies of the universe, now beyond the reach of optical telescopes. The Radio Telescope shown on our cover will be located in the hills of West Virginia.

ALLIED *your dependable Electronic Supply Source* has the facilities and skill to **SERVE YOU BEST**

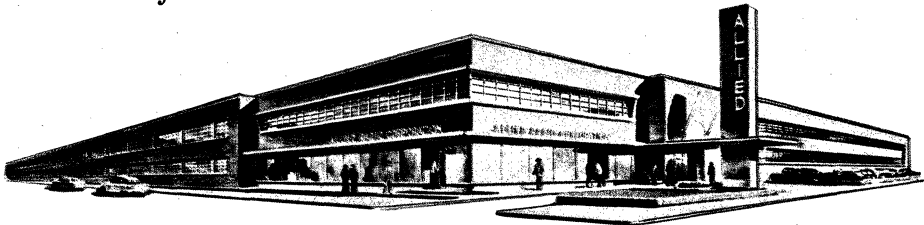

THE WORLD'S LARGEST ELECTRONIC SUPPLY HOUSE
complete stocks of everything in electronics

world's largest stocks at your command

At Allied, you make your selections from the world's largest stocks of quality parts and equipment for industrial electronics, television, radio, public address, high-fidelity, and virtually every other type of electronic application. Allied's staff of experienced electronic specialists keeps up with the latest technical developments and market conditions to anticipate your every need. More than 27,000 separate items from all leading manufacturers are constantly *in stock*. *One* order to Allied will cover *all* your needs. You save time, money and effort when you use this catalog.



fast shipment from ultra-modern plant

Our modern building covers a full city block, providing 187,000 square feet of floor space. More than 1500 feet of conveyor belts and nearly 1½ miles of pneumatic tubing carry transactions and merchandise on a rapid order-filling schedule. Skilled, *interested* people handle your orders. Up-to-date stock record systems, personal inspection and a final check before your order is carefully packed, insure accuracy. Whether you order by mail or phone, you can depend on Allied for fast, accurate shipment.



personal help and technical consulting service

Our greatest satisfaction comes from giving you personal service. All of your orders and letters are intelligently handled by people who take a genuine, *friendly* interest in your needs. You are invited to consult with our technical experts for information or guidance in your selection of merchandise. Write to us and you will receive a prompt, authoritative and friendly reply. For friendly service, for guaranteed quality and value, make your selections from this catalog—recognized everywhere as the most widely used Electronic Supply Guide.



ALLIED is America's High Fidelity Center



BUY WITH CONFIDENCE

Allied has been the leading source of quality music system components since the very beginning of High Fidelity. All of the hi-fi products we offer you, from our tremendous stock of systems and components in every price range, are quality-checked in our labs, and performance-checked on our *Auditioner* for instant, side-by-side comparison. Make your selection from the pages that follow and get the finest in hi-fi—your complete satisfaction is absolutely guaranteed.

**WE SELL MORE HIGH-FIDELITY EQUIPMENT THAN ANY OTHER FIRM
IN THE WORLD BECAUSE WE OFFER EVERY BUYING ADVANTAGE**

world's largest hi-fi stocks

This catalog presents *everything* in high-fidelity—amplifiers, tuners, speakers and speaker enclosures, record changers, turntables, cartridges, tape recorders, latest stereophonic equipment, etc. The famous names, the dependable standard brands, and the hard-to-get accessories—all are included here in a wide range of prices, *in stock, ready for prompt shipment to you.*

lowest prices

Allied offers the lowest prevailing market prices on all of the nation's leading high-fidelity components, with special savings on our matched radio-phono and phono systems, and on Allied's own, widely acclaimed Knight products. You can always be sure of maximum possible value for your hi-fi dollar, regardless of the size of your budget, when you do business with Allied.

easy terms to fit your budget

High-fidelity systems or any combination of separate components priced at \$45.00 or more, may be purchased on Allied's Easy Payment Plan. Pay only 10% down and the balance in easy-on-the-budget monthly payments. Start enjoying thrilling hi-fi right now, even if you don't have all of the ready cash. For full details on our Easy Pay Plan, see page 396.

expert consulting service

Our audio specialists are glad to answer any question on high fidelity. Should you desire any assistance in choosing a music system of balanced, custom hi-fi components to fit your taste and your budget, feel free to write to Allied's Audio Division—your inquiry will bring a prompt and detailed reply. Take advantage of this free, personal and friendly consulting service.

15-day trial, money-back guarantee

Any high-fidelity system or separate component you buy at Allied may be tested under the terms of our trial guarantee. Place your order on our regular cash terms or use our Easy Pay Plan. Then check performance in your own home. If within 15 days you are not fully satisfied, return the equipment to us. We will refund your full purchase price (less only transportation charges). Every hi-fi unit is also covered by the regular RETMA warranty against defects in material and workmanship—for your complete protection.

super-value knight Hi-Fi

For the best in musical reproduction at moderate cost, watch for the Knight name on high-fidelity products. Allied's value-packed, Knight custom components, are *unconditionally guaranteed for one full year.* Designed by Allied and built to the highest standards, these splendid high-fidelity units offer you more in performance, more in styling—and more in genuine quality.

select your hi-fi from the world's finest equipment...

YOU GET THE VERY BEST WHEN YOU BUY FROM ALLIED

ALLIED makes it easy for you to own and enjoy Hi-Fi

Allied's complete stocks enable you to fill all of your high-fidelity needs from one convenient source. You save money and your order is shipped to you speedily, efficiently and safely from the world's largest stocks of high-fidelity equipment.

Expert personal help, intelligent service and the full resources that have made us America's Hi-Fi Center, enable us to provide you with the high-fidelity music system best suited to your personal taste and budget—at the lowest prevailing prices.

THIS IS A BASIC HI-FI PHONO SYSTEM

THE AMPLIFIER

The amplifier is the "heart" of a high-fidelity music system. It "builds up" or amplifies the very small voltages which are fed into it by the phono cartridge, tape deck, or radio tuner, into electrical energy sufficient to operate the speaker. A hi-fi amplifier does this with maximum fidelity.

THE SPEAKER AND SPEAKER ENCLOSURE

The actual sound-reproducing unit. The speaker converts the electrical energy received from the amplifier into sound waves which are radiated from its cone. A proper enclosure, the "other half" of a speaker, is a vital factor in good tonal reproduction.

THE RECORD CHANGER AND CARTRIDGE

The turntable of a record changer or player "spins" the record. The pick-up arm contains a cartridge with a needle (stylus). The needle follows the record grooves, and the cartridge converts the side-to-side movements of the needle into small voltages which are then fed into the amplifier.



ADD THESE COMPONENTS NOW OR LATER



● **RADIO TUNER.** Performs the same function as your radio but does not contain an amplifier or speaker. It simply "tunes in" the radio signal and feeds it through the amplifier and speaker of your hi-fi system.

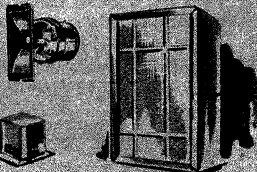

● **TWEETER AND CROSSOVER NETWORK.** A tweeter or high-frequency speaker, can be added to your single speaker system. The crossover network sends the right frequency to the proper speaker.



● **TAPE DECK.** Most hi-fi amplifiers have an input for a tape recorder or deck. A tape deck allows you to play your own tape recordings or commercially recorded tape through your hi-fi system.

STEREO. By using a two-channel sound source, such as a stereo tape deck, plus two amplifiers and two speakers, you will be able to enjoy breathtaking 3-D stereophonic sound. You can start out with stereo—or add the tape deck, extra amplifier and extra speaker whenever you wish.

Enjoy a Whole New World of Sound with Allied Hi-Fi

whether you're an audio expert or new to Hi-Fi...

the ALLIED RECOMMENDED SYSTEM PLAN gives you the most for your money

On pages 6 through 25, we present an outstanding selection of Allied High-Fidelity Systems—the famous, ready-to-play systems that give you the most for your hi-fi dollar. Each of these systems is a best buy in its price range—and each has been carefully selected by Allied's staff of audio experts.

Whatever system you choose, you will discover the pleasure of enjoying music with all the exciting realism of the original performance. And whatever your taste or budget, there's a balanced, perfectly matched Allied High-Fidelity Music System waiting for you. Check our "bonus" features below.

YOU SAVE MOST ON A COMPLETE SYSTEM

Every system is priced to save you money over the total price of the same individual components if purchased separately. The amount you save is clearly indicated in our descriptions—you can actually save up to \$100.00 when you buy a complete system!



YOU GET MATCHED COMPONENTS

System components are always selected on the basis of comparable quality and carefully evaluated by comparative listening tests on our renowned *Auditioner Control Console*—your assurance of peak high-fidelity performance.



YOU GET A MUSIC SYSTEM THAT'S EASIEST TO CONNECT

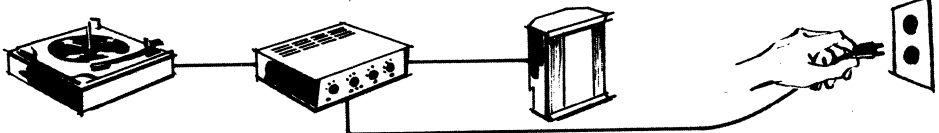

Plug the record changer connectors into the amplifier—they're color-coded—you can't make a wrong connection.

Connect the speaker to the amplifier—speaker cable and amplifier terminals are color-coded too, for easy matching.

Plug the amplifier into an AC outlet—and thrill to breathtaking music from your Allied Hi-Fi System.

COLOR CODING



No technical knowledge is required. Simply match the colors on receptacles to the colors on cables and plugs—you can't go wrong!

FULL INSTRUCTIONS



To help you get the most enjoyment from the hi-fi system of your choice, an easy-to-follow booklet containing valuable tips is included.

SPEAKER CABLE

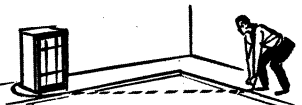

Every system is supplied with a 15-ft. length of color-coded, easy-to-connect speaker cable.

YOU GET PRE-SET STYLUS PRESSURE

The stylus pressure of the turntable or record changer arm is always carefully pre-set by Allied's technicians to assure optimum performance—there are no adjustments to make when you receive your system.



YOU GET A FREE RECORD CHANGER COVER

Made of durable vinylite plastic, and attractively styled in a silver-gray color, this valuable accessory helps protect your record changer or player from the harmful effects of dust and moisture.



YOU GET FREE VALUABLE BOOKLETS

Two highly informative and easy-to-understand booklets are included at no extra cost with every Allied hi-fi system. Both are written by our own audio experts and contain a wealth of valuable information.

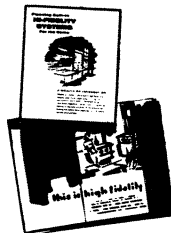

YOU GET SUBSTITUTION PRIVILEGES

You may replace any one component used in any Allied hi-fi system, with another one of your own selection; just add or subtract the difference in catalog price. In addition, stylus and cartridge may also be substituted.



15-Day Free Trial and Money-Back Guarantee on All Hi-Fi Equipment and Systems

EASY TERMS AVAILABLE TO FIT YOUR BUDGET



ALLIED "Bantam" HI-FI SYSTEMS

"SPACE-SAVER" Hi-Fi Systems Featuring
New KNIGHT "Bantam" 15-Watt Amplifier

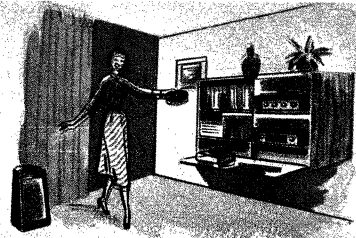

New Knight KN-515
"Bantam" 15-Watt Amplifier



New Knight KN-100
"Bantam" FM-AM Tuner



Garrard RC-121-4
Changer G.E. 4G-052
Cartridge with Diamond
Stylus

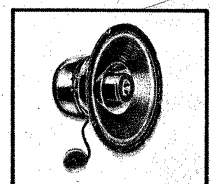
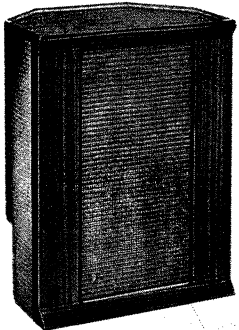

KN-1200 Enclosure with
KN-800 12" Speaker

ALTERNATE SPEAKER CHOICE

Baronet Enclosure

SP-8B 8"

T-35B

X-36
Crossover

AT-37
Control

"Bantam" Space-Saver Hi-Fi Systems

- As Low As **\$209.75**
Save up to \$34.34!
- High-Quality Components Used Throughout
 - Includes Diamond LP Needle
 - Beautifully Designed Cases and Enclosure
 - Exceptional High-Fidelity Performance

You can't go wrong when you choose a carefully selected Knight "Bantam" system! You are assured of excellent music reproduction by a matched group of fine components—and you save because each system is priced at far less than the total cost of individual components. Whenever you're ready, add tape recording and playback facilities—add stereophonic sound—or add extension speakers for other rooms.

Check these superior components: Knight KN-515 "Bantam" 15-Watt Amplifier; Garrard RC-121-4-Speed Changer; Changer Base is Mahogany, Lined Oak or Walnut; G.E.'s new 4G-052 Magnetic Cartridge (mounted in plug-in head) with Diamond Stylus for LP's and 45's, Sapphire Stylus for 78 rpm; famous Knight KN-800 12" 3-Way Speaker in the Knight-Klipsch KN-1200 Corner Enclosure—choice of Mahogany, Korina Blonde or Walnut Finish. The FM-AM-Phono system also includes the new "Bantam" FM-AM Tuner. Systems are for 110-120 volts, 60 cycle AC.

ALTERNATE SPEAKER SYSTEM. Where space is an important consideration, choose the alternate FM-AM-Phono or Phono system featuring the same components as above except for the speaker and enclosure. In their place are the E-V Corner "Baronet" Enclosure in Mahogany, Lined Oak or Walnut; with SP-8B 8" Speaker; T-35B Tweeter; X-36 Crossover Network and AT-37 High-Frequency Level Control installed, providing fine performance in limited space.

"BANTAM" PHONO SYSTEMS—LESS FM-AM TUNER

- WITH KNIGHT-KLIPSCH/3-WAY SPEAKER SYSTEM.** Complete with all components as above, except tuner; with color-coded cables, instructions, etc. Shpg. wt., 94 lbs. *Specify enclosure and changer base finish.*
91 PA 912. *Save \$14.57!* NET..... 224.50
- WITH E-V "BARONET" SPEAKER SYSTEM.** As above but with alternate speaker system. Wt., 69 lbs.
91 PA 935. *Save \$29.09!* NET..... 209.75

"BANTAM" FM-AM-PHONO SYSTEMS

- WITH KNIGHT-KLIPSCH/3-WAY SPEAKER SYSTEM.** With new Knight KN-100 "Bantam" tuner. 107 lbs.
91 PA 925. *Save \$19.07!* NET..... 294.50
- WITH E-V "BARONET" SPEAKER SYSTEM.** 82 lbs.
91 PA 934. *Save \$34.34!* NET..... 279.00

"Bantam" Custom Installation System

- ONLY \$158.75**
You Save \$15.81!
- PHONO SYSTEM.** Specially selected for installation in your own equipment cabinet, or a prized furniture piece. Supplied less speaker enclosure and record changer base. Includes: Knight "Bantam" Amplifier; Garrard RC-121-4 Changer; G.E. 4G-052 Cartridge (in plug-in head) with Diamond LP Stylus and Sapphire Stylus for 78's; and Knight 12" 3-Way Speaker. Shpg. wt., 46 lbs.
91 PA 933. *Only \$15.88 Down.* CASH NET..... 158.75
- FM-AM-PHONO SYSTEM.** As above, but with new Knight "Bantam" FM-AM tuner added. Shpg. wt., 57 lbs.
91 PA 932. *Save \$20.06!* NET..... 229.00

See Page 5 for Information About
Substitutions In Your Allied Hi-Fi System



ALLIED "Deluxe" HI-FI SYSTEMS

"SPACE-SAVER" Hi-Fi Systems Featuring
KNIGHT Deluxe 30-Watt Amplifier



Deluxe Space-Saver Hi-Fi Systems

As Low As
\$279.50

Save up to \$32.41!

- 15" 3-Way Speaker; 30-Watt Amplifier
- No Equipment Enclosure Needed
- Includes Diamond LP Needle
- Exclusive Knight "Trim-Line" Design

Hear music with diamond-like clarity on a superlative Allied Deluxe hi-fi system—from the subtle whisper of a muted violin, to the majestic splendor of the full orchestra! Planned by Allied, and made to rigid specifications, the Knight units in these systems offer styling and performance never before available at so low a price. Systems are priced far less than the total cost of the individual items.

The phono system includes: Knight "Deluxe" 30-Watt Amplifier; Garrard RC-88-4 4-Speed Changer; Changer Base is Mahogany, Lined Oak or Walnut; G.E.'s new 4G-052 Cartridge (mounted in plug-in head) with Diamond LP stylus, Sapphire 78 Stylus; famous Knight KN-810 15" 3-Way Speaker, installed in the Knight-Klipsch KN-1210 Enclosure in your choice of Mahogany, Korina Blonde or Walnut finish. The FM-AM-Phono system version also includes the brilliant new Knight KN-110 Deluxe FM-AM Tuner. Systems are for operation from 110-120 volts, 60 cycle AC.

ALTERNATE SPEAKER SYSTEM. In place of the 15" Knight 3-way speaker listed above, you may select the same system with the famous Electro-Voice 12TRX-B 12" Speaker installed in the Electro-Voice "Aristocrat" Enclosure. The enclosure is available in your choice of mahogany, lined oak or walnut finish.

DELUXE PHONO SYSTEMS—LESS FM-AM TUNER

WITH KNIGHT-KLIPSCH/3-WAY SPEAKER SYSTEM. All phono system components listed above, plus color-coded cables, instructions, etc. Shpg. wt., 114 lbs. *Specify enclosure finish and changer base finish when ordering.*
91 PA 931. Save \$15.67! NET. 294.00
WITH E-V "ARISTOCRAT"/12TRX-B SPEAKER SYSTEM. As above, but with alternate speaker system. Shpg. wt., 106 lbs.
91 PA 929. Save \$27.41! NET. 279.50

DELUXE FM-AM-PHONO SYSTEMS

WITH KNIGHT-KLIPSCH/3-WAY SPEAKER SYSTEM. Complete with the new Knight Deluxe Tuner, providing virtually flawless FM and AM. Shpg. wt., 131 lbs.
91 PA 930. Save \$19.67! NET. 389.50
WITH E-V "ARISTOCRAT"/12TRX-B SPEAKER SYSTEM. Shpg. wt., 123 lbs.
91 PA 928. Save \$32.41! NET. 374.00

Deluxe Custom Installation System

ONLY PHONO SYSTEM. The first-quality Deluxe components listed above, less changer base and speaker enclosure. You Save \$19.57! Perfect for modernization of obsolete phono consoles, or custom installation in your home or apartment, this system includes the Knight KN-530 Deluxe Amplifier; Garrard RC-88-4 Changer; G.E.'s new 4G-052 Cartridge installed in plug-in head; and Knight KN-810 15" 3-Way Speaker. With full instructions and information on "built-in" hi-fi systems. Shpg.wt., 61 lbs.
91 PA 926. Only \$20.98 Down. CASH NET. 209.75
FM-AM-PHONO SYSTEM. As above, but with new Knight "Deluxe" FM-AM Tuner added. Shpg. wt., 78 lbs.
91 PA 927. Save \$24.32! NET. 304.50



Knight KN-530 "Deluxe"
30-Watt Amplifier



Knight KN-110 "Deluxe"
FM-AM Tuner



Garrard RC-88-4
Changer with
G.E. 4G-052 Cartridge

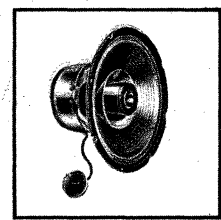
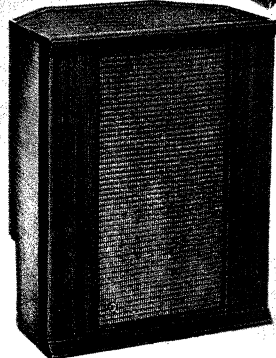

KN-1210 Enclosure with
KN-810 15" Speaker



ALTERNATE SPEAKER CHOICE

"Aristocrat" Enclosure with
E-V 12TRX-B 12" Speaker Installed



ALLIED-RECOMMENDED **knight** HI-FI SYSTEMS



New Knight KN-632
32-Watt Basic Amplifier

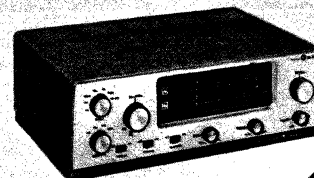

New Knight KN-200
Tuner-Preamp
with Controls

Garrard RC121-4
Record Changer with
Wood Base and
New G.E. 4G-052
Magnetic Cartridge

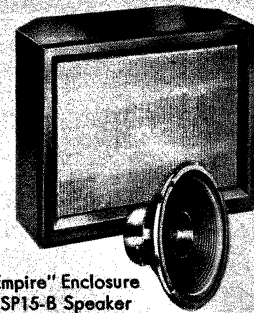

E-V "Empire" Enclosure
with SP15-B Speaker

"Space Saver" FM-AM Phono System Featuring KNIGHT KN-200 Tuner-Preamp

\$389⁷⁵

You Save \$28.48

- New Knight Tuner-Preamp
- New Knight 32-Watt Amplifier
- Diamond LP Needle
- E-V "Empire" Speaker System

Enthusiastically recommended by Allied's hi-fi experts, and ready to give you flawless reproduction, this exceptional array of space-saving components is priced at far less than the total cost of the individual components. You save \$28.48! System includes these perfectly matched hi-fi units: New Knight KN-200 FM-AM Tuner-Preamp; new Knight KN-632 32-Watt Basic Amplifier; Garrard RC121-4 4-Speed Record Changer with Wood Base; new G.E. 4G-052 Magnetic Cartridge with .001" Diamond and .003" Sapphire stylus, mounted in a plug-in head; Electro-Voice "Empire" Enclosure with E-V's SP15-B 15" Speaker installed; Plastic Record Changer Cover. *Record changer base and speaker enclosure are finished in mahogany, limed oak or walnut—specify when ordering.*

The new Knight FM-AM Tuner-Preamp, used as the centralized control unit for the system, features tuning eye, cathode follower output, tape head and microphone inputs, automatic frequency control on FM, bass and treble controls, and a rich new finish, styled to resemble natural leather. Its companion unit, the new Knight 32-watt basic amplifier, features an advanced-design low-distortion circuit offering high power handling capacity and superb tonal reproduction. G.E.'s new 4G-052 magnetic cartridge provides very wide frequency range and high output, at tracking pressures as low as 4 grams; mounted in plug-in head, ready for insertion in the renowned Garrard record changer, you'll be greatly pleased at the dazzling reproduction it provides. Electro-Voice's "Empire" enclosure with the SP15-B speaker, features expandable design for easily adding other speaker components. System operates from 110-120 v., 60 cycle AC. Shpg. wt., 133 lbs.

91 PA 913. Only \$38.98 Down. CASH NET. 389.75



New Knight
KN-315 "Uni-Fi"
Tuner-Amplifier with Case

Webcor 1842-21
Changer on Base
—with
G.E. 4G-050
Cartridge



"Space Saver" System Featuring New KNIGHT "Uni-Fi" FM-AM Tuner-Amplifier Combination

AS LOW AS

\$199⁵⁰

Save Up to \$14.20!

- New Knight KN-315 "Uni-Fi"
- Webcor "Magic Mind" Changer
- New G.E. Magnetic Cartridge
- Choice of Three Speaker Systems

Enjoy outstanding hi-fi performance, even if your apartment is small and your budget limited! Modestly priced, Allied's "Uni-Fi" FM-AM Phono-systems bring you thrillingly realistic sound, at a price far less than the total cost of components purchased separately. Systems include: New Knight KN-315 "Uni-Fi" FM-AM Tuner-Amplifier combination; Webcor 1842-21 4-Speed Record Changer on Metal Base; new G.E. 4G-050 Magnetic Cartridge with Dual Sapphire Styli; your choice of any of three Speaker Enclosures with Speakers installed; Plastic Record Changer Cover. The "Uni-Fi" consists of a sensitive FM-AM tuner, versatile preamp, and a 15-watt amplifier, with brown "plextone" metal case. Webcor's changer offers "Magic Mind" record intermixing. Systems operate from 110-120 v., 60 cycle AC.

CHOICE OF 3 SPEAKER SYSTEMS



"Baronet" with
SP8-B 8" Speaker
Installed

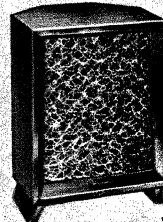

"Tiny-Mite" with
UXC-122 12" Speaker
Installed



KN-1240
Enclosure
with Diffusicone-8

"UNI-FI" SYSTEM WITH E-V "BARONET" CORNER ENCLOSURE. With SP8-B 8" speaker. *Specify mahogany, limed oak or walnut veneers.* Shpg. wt., 64 lbs.

91 PA 914. You Save \$14.14! NET. 225.50

"UNI-FI" SYSTEM WITH UNIVERSITY "TINY-MITE" ENCLOSURE. With University UXC-122 12" speaker. *In mahogany, blonde mahogany, or walnut veneers—specify when ordering.* Shpg. wt., 68 lbs.

91 PA 915. You Save \$14.20! NET. 227.50

"UNI-FI" SYSTEM WITH KNIGHT SHELF ENCLOSURE. With University Diffusicone-8 8" speaker. *Specify mahogany or korina blonde veneers.* 61 lbs.

91 PA 916. You Save \$13.88! CASH NET. 199.50

Allied Hi-Fi Systems Are Complete with
Instructions and Color-Coded Cables

ENJOY THIS SUPERB HIGH-FIDELITY SYSTEM NOW

CONVERT LATER TO A STEREO TAPE PLAYBACK SYSTEM

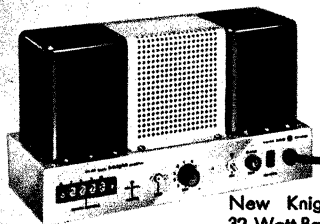

New Knight KN-632
32-Watt Basic Amplifier

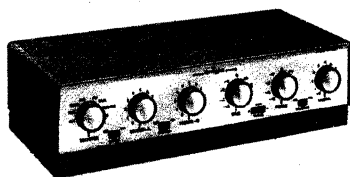

New Knight KN-700
Stereo-Monaural Preamplifier



Garrard RC88-4
Record Changer with
Base and G.E. 4G-052 Cartridge

"Space Saver" System with New KNIGHT Stereo Preamp

Phono System

\$314.50

You Save \$16.42!

- New Knight Stereo Preamp—Unlike All Others!
- New Knight 32-Watt Basic Amplifier
- New G.E. Cartridge with Diamond LP Needle
- Knight Reflex Enclosure with 15" 3-Way Speaker

A forward-looking hi-fi phono system, that's all ready for easy modification to stereo music reproduction from tapes or radio whenever you wish! Designed around the unique Knight Stereo Preamp, you can use it as a superb performing phono or FM-AM-Phono system now—later on, add the conversion components listed at bottom of page to have a complete stereo playback system. The stereo preamplifier is the only unit of its kind which includes complete phono equalization and other playback facilities! System includes: New Knight KN-700 Stereo-Monaural Preamplifier; new Knight KN-632 32-Watt Basic Amplifier; Garrard RC88-4 4-Speed Record Changer with Wood Base; new G.E. 4G-052 Magnetic Cartridge with .001" Diamond and .003" Sapphire Stylis, installed in plug-in head; Knight KN-1230U Bass Reflex Enclosure in Unfinished Mahogany Veneer, with Knight KN-810 3-Way, 15" Speaker installed; Plastic Record Changer Cover.

The Knight preamp, in metal case, handsomely finished to resemble natural leather, offers these control facilities: Rumble and scratch filters, loudness control, bass and treble controls, microphone input, equalized magnetic phono input, 2 equalized tape head inputs, tape recording output jacks for recording stereo tapes or stereo broadcasts, etc. The 32-watt amplifier features high power handling capacity with excellent response, and the renowned Garrard changer provides outstanding record-changing operation. The new Knight 15" 3-way speaker installed in the Knight bass reflex enclosure, offers superb reproduction across the entire audio spectrum. The completely assembled, unfinished enclosure is ready for quick, easy finishing. *Changer base in mahogany, limed oak or walnut finish—specify choice.* For 110-120 v., 60 cycle AC.

PHONO SYSTEM ONLY. Includes above components. Wt., 128 lbs.

91 PA 917. You Save \$16.42! NET..... 314.50

FM-AM-PHONO SYSTEM. Same as above, but with the addition of the new Knight KN-110 Deluxe FM-AM Basic Tuner. Shpg. wt., 145 lbs.

91 PA 918. You Save \$20.92! NET..... 409.50

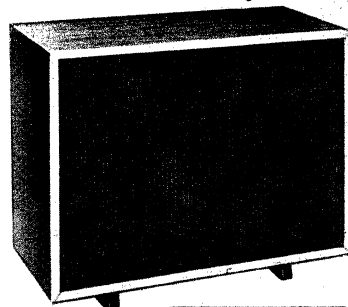

Knight Unfinished
Enclosure with
KN-810
15"
3-way Speaker
Installed

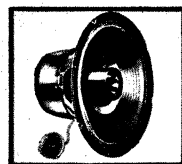

New Knight KN-110 Deluxe
FM-AM Basic Tuner

"ADD-ON" COMPONENTS—FOR CONVERTING THE ABOVE SYSTEM TO THRILLING STEREO SOUND

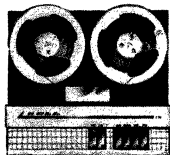

Bell T-202 Stereo
Tape Deck

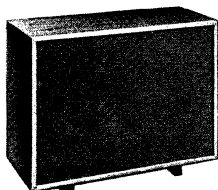

Knight Bass Reflex Enclosure



New Knight KN-632 32-Watt
Basic Amplifier



15" 3-Way
Speaker

Convert the above system to stereo sound with these "add-on" components. Enables you to enjoy the depth and astonishing realism of stereo. Includes: New Bell T-202 Stereo Tape Deck; new Knight KN-632 32-Watt Basic Amplifier; Knight KN-1230U unfinished Bass Reflex Enclosure, with the Knight 15" 3-Way Speaker installed. The Bell Stereo Tape Deck, described on page 88, allows you to playback monaural and stereo tapes, (either stacked or staggered-head recordings). Connecting these components to the above system is quick and easy—clearly written instructions are included. For operation from 110-120 volts, 60 cycle AC. Shpg. wt. 120 lbs.

91 PA 919. You Save \$13.30! NET..... 278.50



ALLIED'S "BEST BUY" HI-FI SYSTEMS

"Space Saver" Budget Systems Featuring the KNIGHT 10-Watt KN-510 "Mini-Fi" Amplifier



New Knight KN-510 "Mini-Fi" Amplifier



Garrard RC-121-4 Changer with G.E. 4G-050 Cartridge

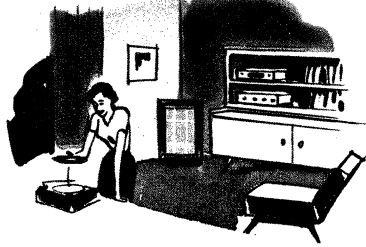

Allied's "Budget" Hi-Fi Phono System

ONLY
\$119.50

Save Up To \$33.56

- Superb Music Reproduction At Low Cost
- No Cabinets Needed—It's Complete
- World-Famous Garrard Changer
- New Knight KN-510 "Mini-Fi" Amplifier

There's no need to wait for hi-fi—choose this top-economy music system now, and enjoy savings of up to \$33.56 on the cost of the individual components! Carefully selected by Allied's hi-fi experts, this balanced system brings you true high-fidelity sound, reliable performance and top savings at a price that fits any budget. Changer, cartridge, amplifier and speaker system are perfectly matched; moreover, there's no installation—just connect the components and start playing records! The amplifier is in a case, and the speaker in its enclosure, ready to put where it's most convenient for you. Additionally, you have your choice of two fine speakers, each selected for its outstanding tone quality.

The complete system includes: Knight KN-510 "Mini-Fi" 10-Watt Music Amplifier; Garrard RC-121-4 Record Changer; New General Electric 4G-050 Magnetic Cartridge installed in Garrard Plug-In Head; Dual Sapphire Styli (installed); Record Changer Base (finished in your choice of Mahogany, Lined Oak or Walnut); plus your choice of either an Electro-Voice SP-12B 12" Speaker installed in an Argos AD-1 Enclosure (Mahogany or Blonde Leatherette), or a General Electric 850-D 8" Speaker installed in the same enclosure.

This is one of Allied's lowest cost hi-fi systems; it brings you all the music on your records, with correct tonal balance, at a truly economical price. With color-coded cables and full instructions for use. For operation from 110-120 volts, 60 cycles AC.

WITH ELECTRO-VOICE SP-12B SPEAKER. Specify finish of changer base and speaker enclosure when ordering. Shpg. wt., 75 lbs.

91 PA 920. You Save \$32.77! NET..... **119.50**

WITH GENERAL ELECTRIC 850-D SPEAKER. Specify finish of changer base and speaker enclosure when ordering. Shpg. wt., 65 lbs.

91 PA 921. You Save \$33.56! NET..... **99.50**

Low-Cost Phono System for Custom Installation

ONLY
\$89.50

You Save \$31.31!

- New Collaro 4-Speed Hi-Fi Changer
- New Knight KN-510 "Mini-Fi" Amplifier
- University UXC-122 12" Speaker
- New G. E. 4G-050 Magnetic Cartridge

Install this system in the custom cabinet of your choice, or in a favorite piece of furniture that can be adapted for hi-fi use—you'll be delighted with the results and you'll save \$31.31 over the cost of the individual components. Although this is one of our lowest priced systems, it brings you brilliant, exciting high-fidelity that easily outclasses conventional phono-consoles three times the price. The amplifier is in a handsome, compact case that may be placed on a shelf, table-top, etc. The precision-made Collaro changer handles records gently and smoothly, and comes complete with template to simplify custom installation. The University speaker is widely recognized as an unusual hi-fi value and delivers exceptionally clean reproduction. All together, the components in this system add up to thrilling high-fidelity—at a budget-sparing price!

Here is what the system includes: Knight KN-510 "Mini-Fi" 10-Watt Music Amplifier; New Collaro TC-340 4-Speed Changer; New General Electric 4G-050 Magnetic Cartridge installed in Collaro Pickup Arm, with Sapphire Styli for 78 rpm and LP records; University UXC-122 12" "Diffaxial" Speaker. The system easily accommodates additional components, should you wish to add them now or later. The "Mini-Fi" amplifier has an equalized input for direct playback from a tape deck, and an input for an FM or FM-AM tuner as well. Supplied with all necessary interconnecting cables. For 110-120 volts, 60 cycles AC. Shpg. wt., 39 lbs.

91 PA 922. Only \$8.95 Down. CASH NET..... **89.50**

See Allied's Interesting Booklet, "Planning Built-In Hi-Fi Systems", on Page 306.

See Page 29 for Full Description of the New "Mini-Fi" Amplifier

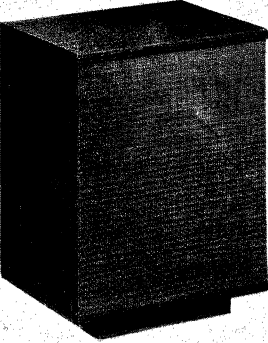

Argos AD-1 Enclosure and E-V SP-12B Speaker

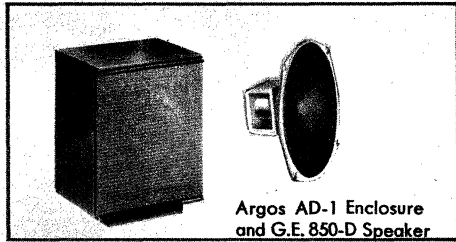
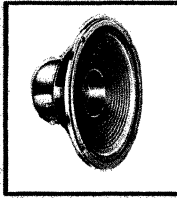

Argos AD-1 Enclosure and G.E. 850-D Speaker



New Knight KN-510 "Mini-Fi" Amplifier



New Collaro TC-340 4-Speed Changer with G.E. 4G-050 Cartridge

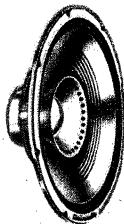

University UXC-122 12" Diffaxial Speaker

TOP VALUE. Allied's Special Value Systems are carefully selected to bring you the most for your hi-fi dollar. They combine Knight high-fidelity units of the most advanced design and performance standards, with time-proven components of the world's leading manufacturers of music reproduction equipment. Each component is a top value in its field—and you save additionally by buying the complete Allied system!

ALLIED'S SPECIAL-VALUE SYSTEMS

Save On These Low-Cost Music Systems with Quality Knight Hi-Fi Components



New Knight KN-510 "Mini-Fi" Amplifier



New Collaro TC-340 Changer on Base, with G.E. 4G-052 Cartridge

Top-Value "Space Saver" Hi-Fi Phono Systems

ONLY
\$179⁷⁵

You Save \$29.00!

- New Knight KN-510 "Mini-Fi" Amplifier
- New 4-Speed Collaro Changer
- G. E. Cartridge—Diamond LP Needle
- "Expandable" E-V Speaker System

PHONO SYSTEM. Here are truly remarkable savings on an up-to-the-minute high-fidelity system—you pay \$29.00 less than the total cost of the individual components! You get a first-class 10-watt amplifier—compact, versatile, and a superb performer. The enclosure is a true folded-horn type—it makes the most of the excellent acoustic properties of the SP-12B speaker. The British-built record changer is supplied with an attractive base finished in your choice of mahogany, walnut or limed oak. A convenient plug-in head for the changer contains the brilliant new General Electric 4G-052, a magnetic cartridge with very wide frequency range, low tracking pressure and hum-proof, shielded case.

These are the components: Knight KN-510 "Mini-Fi" 10-Watt Amplifier; Collaro TC-340 4-Speed Changer; Changer Base; New G.E. 4G-052 Magnetic Cartridge installed in Collaro Pickup Arm and with Diamond and Sapphire Stylis; Electro-Voice SP-12B 12" Speaker installed in Electro-Voice "Aristocrat" Enclosure. Supplied with the system are all necessary interconnecting cables and easy instructions; only a few minutes are required to set it up, and you're all set to listen to music!

The Electro-Voice speaker system is "expandable"; you may gradually expand it to a luxury system by adding components—cutouts provided in the enclosure for this purpose. System is for operation from 110-120 volts, 60 cycles AC. Specify mahogany, limed oak or walnut, base and speaker enclosure. Shpg. wt., 92 lbs.

91 PA 924. Only \$17.98 Down. CASH NET.....179.75

FM-AM-PHONO SYSTEM. Same components as listed above, with the addition of the new Knight KN-100 "Bantam" FM-AM Tuner. Indoor dipole antenna included. Shpg. wt., 105 lbs.

91 PA 923. You Save \$34.25! NET.....249.00

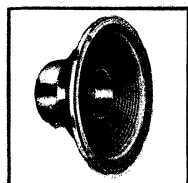

Electro-Voice SP-12B 12" Speaker installed in "Aristocrat"



Knight KN-100 "Bantam" FM-AM Tuner

"Space-Saver" FM-AM Music System

ONLY
\$159⁵⁰

You Save \$11.25!

- New Knight "Uni-Fi" Tuner-Amplifier
- University "Diffusicone-8" Speaker
- Compact Shelf-Type Reflex Enclosure
- Requires Minimum Space

Hear high-fidelity FM broadcasts just as they sound at the station—and AM broadcasts far better than on ordinary radios—with this compact FM-AM hi-fi system. You get the entire system for only \$159.50—\$11.25 less than the components would cost if you were to purchase them separately. It's an ideal system for the small apartment, or for waiting rooms, offices and stores, because it performs so well and occupies so little space. In ease of operation, sensitivity and tonal quality, it is greatly superior to conventional table model FM-AM radios; it will easily outperform consoles selling for much more!

System components are: New Knight KN-315 "Uni-Fi" Tuner-Amplifier with case; University "Diffusicone-8" 8-Inch Speaker; Knight Shelf-Type Bass-Reflex Enclosure in your choice of Korina Blonde or Mahogany Finish.

Compare this system to any conventional radio and its superiority is immediately apparent. The loudspeaker is specially designed for high-fidelity reproduction and its separate enclosure is an acoustically planned bass reflex type. The tuner-amplifier contains a full 15-watt high-fidelity amplifier, whose specifications far exceed those of table models; moreover, it is equipped with a full set of controls for use with a record player (which may be added easily at any time) including scratch and rumble filters, loudness control, record equalization and separate bass and treble controls. The speaker is supplied installed in the enclosure. The system is ready to play—even an indoor antenna is supplied! For 110-120 volts, 50-60 cycles AC. Shpg. wt., 46 lbs. Specify enclosure finish when ordering.

91 PA 936. Only \$15.95 Down. CASH NET.....159.50

You are allowed one component substitution in any Allied hi-fi system—see page 5.



Knight KN-315 "Uni-Fi" Tuner-Amplifier

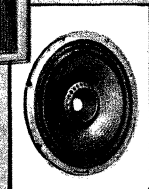
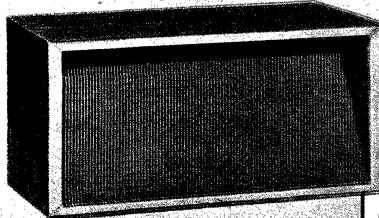

University "Diffusicone-8" Speaker in Knight Enclosure

See Page 396 for Allied's Easy Payment Plan

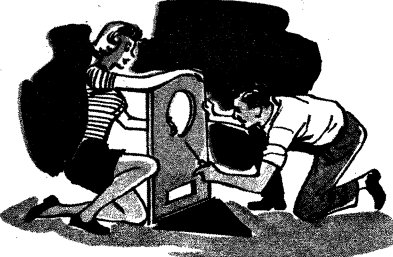

SAVE 2 WAYS ON THESE DO-IT-YOURSELF HI-FI SYSTEMS

You save more—in two important ways—when you choose an Allied "Do-it-Yourself" high-fidelity system. You save by buying at Allied's special system price; and you pocket big, additional savings by assembling the kit components yourself!

EASY TO ASSEMBLE! Knight-Kits are famous for their clear, detailed instruction booklets. No other electronic kits are as easy to assemble—even if you have had no previous experience with electronic equipment. Anyone can do it!

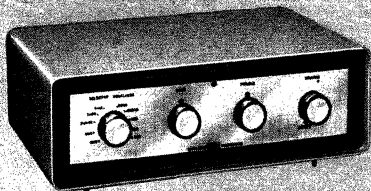

Knight-Kit
18-Watt Amplifier Kit

Garrard RC-121-4
Changer on Base with
G.E. 4G-052 Cartridge

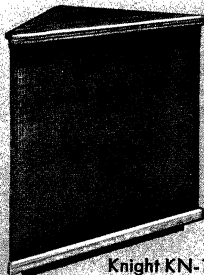

Knight KN-1320
Speaker Enclosure
Kit

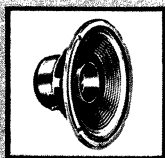

E-V SP-12-B Speaker

"Economy" Do-It-Yourself Hi-Fi Phono System

\$149.00

You Save \$19.82!

- New 18-Watt Knight-Kit Amplifier
- G.E. Cartridge—Diamond LP Needle
- Pre-Finished Enclosure Kit
- Free Set of Kit Assembly Tools

It's easy to own a quality hi-fi system when you "do-it-yourself"—this outstanding system saves you \$19.82 on the cost of components, and you gain extra savings by assembling the amplifier and speaker enclosure yourself! The heart of the "Economy" system is the remarkable new Knight-Kit 18-watt amplifier, offering superb music reproduction with concert "presence." Its flexibility of control and application would be difficult to approach even in a system of assembled units selling for much more than this low price.

System includes: Knight-Kit 18-Watt Amplifier Kit; Garrard RC-121-4 Changer; Changer Base in your choice of finish; G.E. 4G-052 Magnetic Cartridge with Diamond and Sapphire Stylis; E-V SP-12B 12" Speaker; Knight KN-1320 Corner Horn Enclosure Kit in choice of finish.

You'll also receive—at no extra cost—a full set of kit assembly tools: 2 screwdrivers, soldering iron, diagonal cutters and long-nose pliers. The amplifier will accommodate—whenever you wish to add them—a tuner, tape deck, TV sound, or any other source of music. It also provides 7 positions of equalization for faithful reproduction of recordings. The highly rated E-V speaker featured in this system delivers exceptional performance in the efficiently designed Knight corner enclosure. For 110-120 v., 60 cycles AC. Shpg. wt., 77 lbs. Specify mahogany, korina blonde or walnut enclosure kit, and mahogany, limed oak or walnut changer base.

91 PA 900. Only \$14.90 Down. CASH NET.149.00

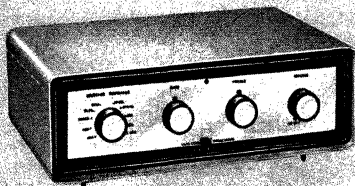

Knight-Kit
18-Watt
Amplifier Kit

Garrard RC-88-4
Changer on Base with
G.E. 4G-052 Cartridge



Knight KN-1300 "Quik-Craft" Speaker Enclosure Kit



Knight KN-800 12"
3-Way Speaker

"Popular" Do-It-Yourself Hi-Fi Phono System

\$199.50

You Save \$16.52!

- New Knight-Kit 18-Watt Amplifier
- New Knight KN-800 3-Way Speaker
- Knight-Klipsch KN-1300 Enclosure
- G.E. Cartridge—Diamond LP Needle

An excellent 18-watt system, featuring components of superior design throughout—yet priced within reach of modest budgets! You save \$16.52 by purchasing all of the components in system form—and you save even more by assembling the amplifier and enclosure, with the full set of tools supplied free—diagonal cutters, 2 screwdrivers, soldering iron, and long-nose pliers! There's no easier or more exciting way to become the owner of a music system—and the quality of reproduction will astonish and delight you!

The system includes: Knight-Kit 18-Watt Amplifier Kit; Garrard RC-88-4 Changer; Changer Base in choice of finish; G.E. 4G-052 Magnetic Cartridge with Diamond and Sapphire Stylis; famous Knight 3-Way 12" Speaker; Knight KN-1300 "Quik-Craft" Corner Folded-Horn Enclosure Kit, in choice of finish.

The RC-88-4 changer, built like a fine watch, is the most popular of the Garrard units; both enclosure and speaker offer the most advanced of design features. The enclosure incorporates world-renowned Klipsch folded-horn construction, for rich, natural bass tone. For 110-120 v., 60 cycle AC. Shpg. wt., 92 lbs. Specify mahogany, korina blonde or walnut enclosure kit, and mahogany, limed oak or walnut changer base.

91 PA 901. Only \$19.95 Down. CASH NET.199.50

See 209-217 for Full Descriptions of Knight-Kit Hi-Fi Kits

"Deluxe" Do-It-Yourself Hi-Fi Phono System

\$239.50

You Save \$22.22!

- New Knight-Kit 30-Watt Amplifier
- Superb Electro-Voice Speaker System
- G.E. Cartridge—Diamond LP Needle
- Full Set of Tools Included Free

A high-fidelity music system of truly exceptional quality can be yours for far less than you thought possible—when you choose this deluxe-quality system that saves money for you in two ways. First, Allied's system price is \$22.22 less than the total price of the individual components; second, you gain tremendous additional savings by doing the easy amplifier and speaker enclosure assembly yourself! The enclosure kit is quickly fitted together to become a fine furniture piece, already finished beautifully. The brilliantly engineered 30-watt amplifier is accompanied by a thorough instruction booklet—skillfully planned chassis layout, and exclusive Knight-Kit printed circuit switches, make assembly simple and enjoyable.

Included are: Knight-Kit 30-Watt Amplifier Kit; Electro-Voice unfinished "Aristocrat" Enclosure and Trim Grille Kit; Electro-Voice 12TRX-B 12" Speaker; G.E. 4G-052 Magnetic Cartridge (in plug-in head) with Diamond and Sapphire Styli; Garrard RC-88-4 Changer; Changer Base. With this system, Allied gives you a full set of kit assembly tools, containing soldering iron, diagonal cutters, 2 screwdrivers and long-nose pliers. For 110-120 v., 60 cycles AC. Shpg. wt., 96 lbs. *Specify mahogany, limed oak or walnut changer base finish when ordering.*

91 PA 903. Only \$23.95 Down. CASH NET. 239.50

"Master" Do-It-Yourself Hi-Fi Phono System

\$266.50

You Save \$19.47!

- Knight 15" 3-Way Speaker
- "Linear-Deluxe" 25-Watt Amplifier Kit
- Ultra-Versatile Knight-Kit Preamp Kit
- G.E. Cartridge—Diamond LP Needle

Every advanced feature has been incorporated in this superlative "do-it-yourself" hi-fi system, yet it is priced far below the cost of conventional music systems; additionally, you save \$19.47 on the total cost of the components if purchased separately! The separate pre-amplifier and basic amplifier provide unusual installation flexibility, as well as superb performance; the 15-inch speaker and Klipsch-designed corner folded-horn enclosure will reproduce the full majesty of a large orchestra with impressive realism.

The system includes: Knight-Kit 25-Watt Basic Amplifier Kit and metal cage; Knight-Kit Preamplifier Kit; Knight KN-1310 "Quik-Craft" Pre-Finished Klipsch-Designed Enclosure Kit; Knight KN-810 3-Way 15-Inch Speaker; Garrard RC-88-4 Record Changer; G.E. 4G-052 Magnetic Cartridge (in plug-in head) with Diamond and Sapphire Styli; Record Changer Base. Also included, free of charge, is a full set of tools with which you can assemble the kit components.

For operation from 110-120 volts, 60 cycles AC. Shpg. wt., 122 lbs. *Specify mahogany, korina blonde or walnut enclosure kit, and mahogany, limed oak or walnut changer base when ordering.*

91 PA 902. Only \$26.65 Down. CASH NET. 266.50

Knight-Kit
30-Watt
Amplifier Kit

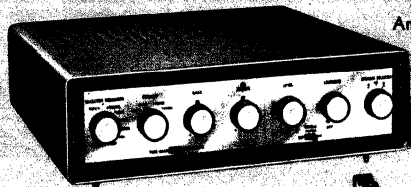

Garrard RC-88-4
Changer on Base
with G.E. 4G-052

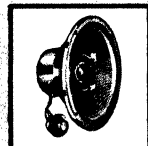

Electro-Voice
12TRX-B
Speaker

Aristocrat KD-6
Enclosure Kit

"Master" Do-It-Yourself Hi-Fi Phono System

\$266.50

You Save \$19.47!

- Knight 15" 3-Way Speaker
- "Linear-Deluxe" 25-Watt Amplifier Kit
- Ultra-Versatile Knight-Kit Preamp Kit
- G.E. Cartridge—Diamond LP Needle

Every advanced feature has been incorporated in this superlative "do-it-yourself" hi-fi system, yet it is priced far below the cost of conventional music systems; additionally, you save \$19.47 on the total cost of the components if purchased separately! The separate pre-amplifier and basic amplifier provide unusual installation flexibility, as well as superb performance; the 15-inch speaker and Klipsch-designed corner folded-horn enclosure will reproduce the full majesty of a large orchestra with impressive realism.

The system includes: Knight-Kit 25-Watt Basic Amplifier Kit and metal cage; Knight-Kit Preamplifier Kit; Knight KN-1310 "Quik-Craft" Pre-Finished Klipsch-Designed Enclosure Kit; Knight KN-810 3-Way 15-Inch Speaker; Garrard RC-88-4 Record Changer; G.E. 4G-052 Magnetic Cartridge (in plug-in head) with Diamond and Sapphire Styli; Record Changer Base. Also included, free of charge, is a full set of tools with which you can assemble the kit components.

For operation from 110-120 volts, 60 cycles AC. Shpg. wt., 122 lbs. *Specify mahogany, korina blonde or walnut enclosure kit, and mahogany, limed oak or walnut changer base when ordering.*

91 PA 902. Only \$26.65 Down. CASH NET. 266.50

Knight-Kit 25-Watt
Basic Amplifier Kit



Knight-Kit Preamplifier Kit

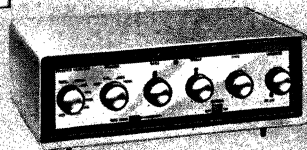

Garrard RC-88-4
Changer on Base
with G.E. 4G-052



Knight KN-1310
"Quik-Craft" Enclosure Kit

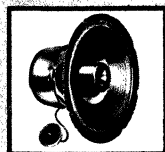

Knight KN-810
15" 3-Way Speaker



ADD A KNIGHT-KIT TUNER TO YOUR ALLIED HI-FI PHONO SYSTEM

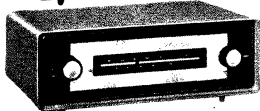

FM-AM TUNER KIT. Hear *all* the wonderful sound of genuine high-fidelity FM programming—plus the cleanest, clearest AM reception possible. *See page 213.* Wt., 12 lbs.
83 YX 787. NET. **49.95**

FM TUNER KIT. A remarkable new Knight-Kit, featuring printed-circuit construction, stunning design and advanced "lock-in" tuning. *See page 214.* Shpg. wt., 12 lbs.
83 YX 751. NET. **37.75**



ALLIED-RECOMMENDED HIGH-FIDELITY SYSTEMS . . .

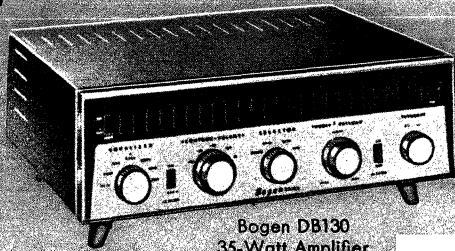

Bogen DB130
35-Watt Amplifier



Bogen R660
Basic FM-AM Tuner

Garrard RC88-4
Changer with Wood
Base and G. E.
4G-052 Cartridge

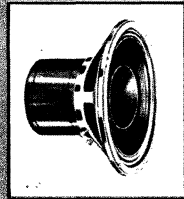
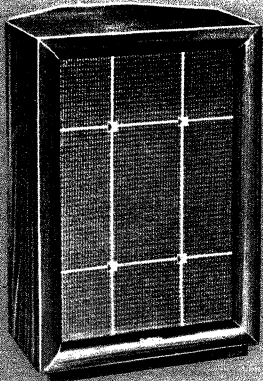

Electro-Voice SP12
12" Speaker installed
in "Aristocrat"
Enclosure

"Space Saver" Systems Featuring Bogen DB130 Amplifier

ONLY
\$298⁰⁰

You Save \$36.91!

- Bogen DB130 35-Watt Amplifier
- Garrard RC88-4 Record Changer
- G.E. Cartridge—Diamond LP Needle
- Electro-Voice SP12 12" Speaker
- E-V "Aristocrat" Enclosure

Perfectly balanced reproduction from records is yours with this exceptionally versatile hi-fi phono system. You'll enjoy the ease with which the highly flexible controls of the DB130 amplifier allow you to vary sound to suit your own taste, and you'll save \$36.91 over the total cost of components if purchased separately. System includes: Bogen DB130 35-Watt Amplifier with Metal Case; Garrard RC88-4 Record Changer with Wood Base; new G.E. 4G-052 Magnetic Cartridge with .001" diamond and .003" sapphire styli; E-V SP12 12" Speaker installed in the "Aristocrat" Enclosure; Plastic Changer Cover. The G.E. cartridge is mounted in plug-in head, ready for installation; E-V's thoroughbred team of SP12 and "Aristocrat" provide sparkling response. *Changer base and enclosure in mahogany, limed oak or walnut—specify choice.* For 110-120 v., 60 cycle AC. 103 lbs.

91 PA 941. Only \$29.80 Down. CASH NET. 298.00

SYSTEM AS ABOVE, WITH FM-AM TUNER. Same as above, but with the Bogen R660 FM-AM Basic Tuner. Its metal case perfectly matches the DB130. Has automatic frequency control, tuning meter, cathode follower and other quality features. Shpg. wt., 120 lbs.

91 PA 942. You Save \$49.41! NET. 412.00

Famous "Saturday Review-Recommended" Hi-Fi Phono System for Custom Installation

ONLY
\$143⁰⁰

You Save \$23.57!

- Bogen DB110 12-Watt Amplifier
- Garrard RC88-4 Record Changer
- G.E. Cartridge—Diamond LP Needle
- Electro-Voice SP12-B 12" Speaker

An unusually popular combination of high-fidelity components for custom installation, based on recommendations made in the noted "Saturday Review" book on music and sound reproduction. Although very moderately priced, the design features of this system provide excellent audio fidelity and smooth, dependable performance. You save \$23.57 over total cost of components if purchased separately. System includes: Bogen DB110 12-Watt Amplifier less Case; Garrard RC88-4 4-Speed Record Changer less Base; new G.E. 4G-052 Magnetic Cartridge with .001" diamond and .003" sapphire styli; Electro-Voice SP12-B 12" "Radax" Speaker; Plastic Record Changer Cover.

The DB110 delivers performance comparable to more costly amplifiers and includes 3-position equalizer; bass and treble controls; and ample inputs for accessories. The highly popular Garrard changer is built with the precision of a fine watch and assures efficient record-changing operation. G.E.'s new cartridge is mounted in Garrard plug-in head, ready for installation. Excellent sound is provided by E-V's SP12-B speaker. For 110-120 v., 60 cycle AC. Wt., 42 lbs.

91 PA 943. Only \$14.30 Down. CASH NET. 143.00

Allied Hi-Fi Systems Include Color-Coded Cables

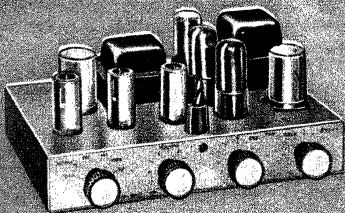

Bogen DB110
12-Watt Amplifier

Garrard RC88-4
Changer with G.E.
4G-052 Cartridge

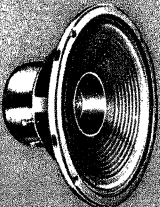
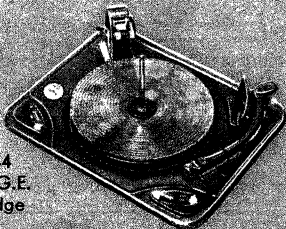

Electro-Voice
SP12-B 12"
Speaker

FEATURING *Bogen* QUALITY HI-FI COMPONENTS



Bogen DB115 15-Watt Amplifier



Bogen R620 FM-AM Basic Tuner

"Space Saver" Systems Featuring Bogen DB115 Amplifier

ONLY
\$245⁵⁰

You Save \$27.16!

- Bogen DB115 15-Watt Amplifier
- Webcor 1842-21 Record Changer
- New G.E. 4G-050 Magnetic Cartridge
- University 312 12" Speaker
- University EN-12 Enclosure

Space-sparing, ready-to-play hi-fi phono system featuring a group of matched components—each selected by Allied's experts to bring out the full beauty of your record collection. You save \$27.16 over total cost of components purchased individually! System includes: Bogen DB115 15-Watt Amplifier with Metal Case; Webcor 1842-21 Record Changer on Metal Base; new G.E. 4G-050 Magnetic Cartridge with .001" and .003" sapphire styli; University 312 12" Speaker installed in the EN-12 Enclosure; Plastic Record Changer Cover. The DB115 has an adequate number of inputs for all accessory hi-fi equipment, plus 3-position record equalizer, contour control, etc. Webcor's "Magic Mind" changer, with new G.E. cartridge installed in its pickup arm, provides "auto-magic" record changing of 33½ and 45 rpm records. University's 312 speaker in the EN-12 enclosure delivers brilliant reproduction. *Enclosure in mahogany, blonde mahogany or walnut—specify choice.* For 110-120 v., 60 cycle AC. Shpg. wt., 92 lbs.

91 PA 944. Only \$24.55 Down. CASH NET. 245.50

SYSTEM AS ABOVE, WITH FM-AM TUNER. As above, but with Bogen R620 FM-AM Basic Tuner with case. 108 lbs. 91 PA 945. You Save \$40.11! NET. 329.50



Webcor 1842-21 Record Changer on Metal Base—with G.E. 4G-050 Cartridge

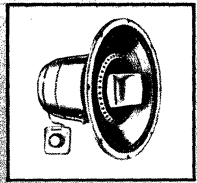
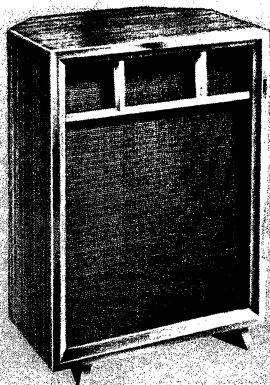

University 312 12" Speaker Installed in EN-12 Enclosure

Phono System Featuring HF10AG Amplifier

ONLY
\$144⁵⁰

You Save \$40.61!

- Bogen HF10AG 10-Watt Amplifier
- Collaro TC-340 Record Changer
- G.E. Cartridge—Diamond LP Needle
- University Speaker & Enclosure

An excellent hi-fi phono system, designed to bring you top performance from your records, at a modest price. Carefully matched, Allied-selected components offer thoroughly enjoyable hi-fi sound. You save \$40.61 over total cost of components when purchased separately. System includes: Bogen HF10AG 10-Watt Amplifier with Metal Case; Collaro TC-340 Record Changer with Wood Base (in mahogany, limed oak, or walnut); new G.E. 4G-052 Magnetic Cartridge with .001" diamond and .003" sapphire styli; University UXC-122 12" Speaker installed in the "Tiny-Mite" Corner Enclosure (in mahogany, blonde mahogany or walnut); Plastic Changer Cover.

Star performer of this feature-packed system is the HF10AG 10-watt amplifier. Its unusually flexible controls include record equalizer and separate bass and treble. Response is ±1 db from 30 to 20,000 cps; flat black metal cage contrasts with brass front panel. G.E.'s new cartridge is installed in the pickup arm of the imported, precision-built Collaro changer. Full-range hi-fi reproduction of excellent quality is delivered by the perfectly matched University enclosure and speaker. *Specify finishes when ordering.* For 110-120 v., 60 cycle AC. Shpg. wt., 58 lbs.

91 PA 946. Only \$14.45 Down. CASH NET. 144.50

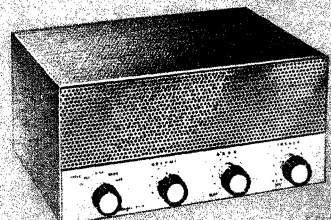

Bogen HF10AG 10-Watt Amplifier

Collaro TC-340 Changer with Base and G.E. 4G-052 Cartridge



University UXC-122 12" Speaker in the University "Tiny-Mite" Enclosure

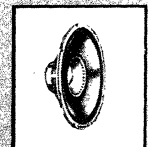
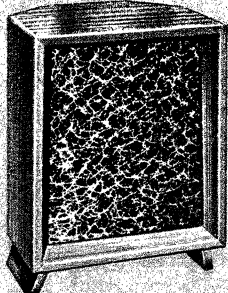

See Pages 32-33 for complete Bogen Listings

ALLIED-RECOMMENDED HIGH-FIDELITY SYSTEMS



Pilot AA-920
20-Watt Amplifier

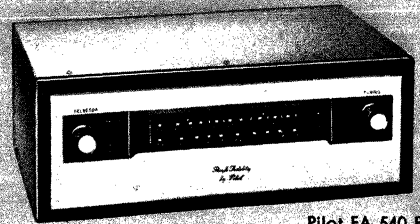

Pilot FA-540 Basic
FM-AM Tuner



Garrard RC88-4
Record Changer
with Wood Base and
G.E. 4G-052 Cartridge

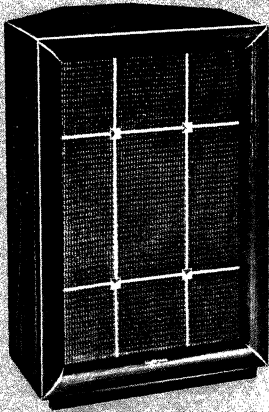

E-V 12TRX-B 12"
Speaker Installed in
"Aristocrat" Enclosure

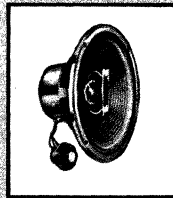

"Space Saver" System with AA-920 Amplifier

Phono System
\$276.00
You Save \$35.91!

- Pilot AA-920 20-Watt Amplifier
- Garrard RC88-4 Record Changer
- G.E. Cartridge—Diamond LP Needle
- E-V 12TRX-B in "Aristocrat" Enclosure

Moderately priced hi-fi phono system featuring space-saving convenience and top-notch reproduction of music from records. System includes: Pilot AA-920 20-Watt Amplifier with controls; Garrard RC88-4 Record Changer with Wood Base; new G.E. 4G-052 Magnetic Cartridge with .001" Diamond and .003" Sapphire styli; E-V 12TRX-B 12" 3-Way Speaker installed in the "Aristocrat" Enclosure; Plastic Changer Cover. The AA-920 Williamson-type amplifier, in attractive brushed brass metal enclosure, offers complete control versatility and highly dependable operation. G.E.'s new cartridge is mounted in plug-in head, ready for installation in the distinguished Garrard changer. E-V's matched pair, the 12TRX-B speaker and "Aristocrat" enclosure, deliver rich, silky smooth sound. *Changer base and enclosure in mahogany, limed oak or walnut—specify choices.* System operates from 110-120 v., 60 cycle AC. Shpg. wt., 99 lbs. 91 PA 957. Only \$27.60 Down. CASH NET. 276.00

SYSTEM AS ABOVE, WITH FM-AM TUNER. As above, but with addition of Pilot FA-540 Basic FM-AM Tuner. Shpg. wt., 113 lbs. 91 PA 958. You Save \$42.41 NET. 379.00

Phono System With AA-903B Amplifier

\$219.75
You Save \$34.54!

- Pilot AA-903B 14-Watt Amplifier
- Garrard RC121-4 Record Changer
- G.E. Cartridge—Diamond LP Needle
- E-V 3-Way System in "Baronet"

One of the finest, limited-space phono systems available! Selected by Allied's experts for exceptional tonal quality in even the smallest rooms or apartments, each component delivers outstanding hi-fi performance. System includes: Pilot AA-903B 14-Watt Amplifier; Garrard RC121-4 Record Changer with Wood Base; new G.E. 4G-052 Magnetic Cartridge with .001" Diamond and .003" Sapphire styli; E-V's SP8-B 8" Speaker, T35-B Tweeter, X36 Crossover Network and AT37 Level Control, installed in the "Baronet" Corner Enclosure; Plastic Changer Cover. The AA-903B 14-watt amplifier incorporates DC on preamp filaments for absolute minimum hum. G.E.'s new, high-output cartridge is mounted in plug-in head, ready for installation in the efficient Garrard changer. E-V's 3-way speaker system in the "Baronet" enclosure provides astonishingly clear reproduction from a unit standing barely 2 ft. high! *Changer base and enclosure in mahogany, limed oak or walnut—specify choice.* For 110-120 v., 60 cycle AC. Shpg. wt., 70 lbs. 91 PA 963. Only \$21.98 Down. CASH NET. 219.75

SYSTEM AS ABOVE, WITH "BARONET" ENCLOSURE IN KIT FORM. Same system as above, but with the "Baronet" enclosure in unassembled, unfinished form. You save \$38.92! *Changer base in mahogany, limed oak or walnut—specify choice when ordering.* Shpg. wt., 59 lbs. 91 PA 964. You Save \$38.92! NET. 196.75

Express Shipment Recommended For Hi-Fi Equipment



Pilot AA-903B 14-Watt Amplifier

Garrard RC121-4
Record Changer
with Wood Base &
G.E. 4G-052 Cartridge

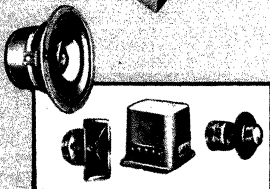

SP8-B 8" Speaker, T35-B Tweeter, X36 Crossover, AT37 Level Control installed in "Baronet"

FEATURING FAMOUS *Pilot* COMPONENTS



Pilot AA-410A 20-Watt Basic Amplifier

FM-AM-Phono System For Custom Installation

\$325⁰⁰ • Pilot Basic Amplifier & FM-AM Tuner
 You Save \$34.92! • Garrard RC88-4 Record Changer
 • G.E. Cartridge—Diamond LP Needle
 • University 312 3-Way 12" Speaker

A group of outstanding hi-fi components, ready for custom installation. Carefully selected to bring you brilliant, exciting record reproduction and excellent FM-AM broadcast reception. System includes: Pilot FA-550 FM-AM Tuner; Pilot AA-410A 20-Watt Basic Amplifier; Garrard RC88-4 Record Changer; G.E. 4G-052 Magnetic Cartridge with .001" Diamond and .003" Sapphire Styli; University 312 Three-Way 12" Speaker with Brilliance Control; Plastic Changer Cover. Complete control facilities are included on the FA-550 tuner; the Williamson-type AA-410A amplifier provides wide-range response. G.E.'s cartridge is mounted in Garrard plug-in head, ready for installing in the arm of this fine changer. The University Model 312 12" 3-way speaker offers remarkably clean bass, mid-range and treble. For operation from 110-120 v., 60 cycle AC. Shpg. wt., 64 lbs.

91 PA 959. Only \$32.50 Down. CASH NET. 325.00

SYSTEM AS ABOVE, WITH ENCLOSURE AND CHANGER BASE. As above, but University EN-12 enclosure, and wood base for changer. *Enclosure in mahogany, blonde mahogany or walnut; changer base in mahogany, limed oak, or walnut—specify choice.* 116 lbs.

91 PA 960. You Save \$40.25! NET. 399.00

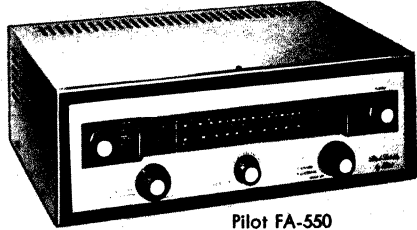

Pilot FA-550 FM-AM Tuner-Preamp

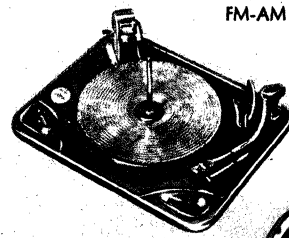

Garrard RC88-4 Record Changer and G. E. 4G-052 Cartridge



University 312 12" Speaker with Brilliance Control

"Space Saver" FM-AM-Phono System

\$349⁷⁵ • Pilot HF-30 FM-AM Tuner-Amplifier
 You Save \$46.82! • Garrard RC121-4 Record Changer
 • G.E. Cartridge—Diamond LP Needle
 • Jensen Enclosure & H-222 Speaker

Allied-selected array of components, in a space-sparing FM-AM-Phono system of extraordinary sound quality. Just 3 units give you excellent FM-AM broadcast reception and ultra-clean reproduction from records! You save \$46.82 over total cost of components if purchased separately! System includes: Pilot HF-30 Combination FM-AM Tuner, Preamp and 12-Watt Amplifier; Garrard RC121-4 Record Changer with Wood Base (mahogany, limed oak, or walnut); new G.E. 4G-052 Magnetic Cartridge with .001" Diamond and .003" Sapphire styli; Jensen's H-222 12" Coax Speaker installed in the new Jensen BL-1215 "Ultraflex" Ducted-Port Enclosure (mahogany, blonde oak, or walnut); Plastic Changer Cover. The HF-30 is enclosed in its own brushed-brass metal case; includes "Beacon-Eye" FM-AM tuning and other fine features. The new G.E. cartridge is mounted in Garrard plug-in head, ready for installation in this highly praised changer. Jensen's H-222 speaker and BL-1215 reflex enclosure provide smooth tonal quality. *Specify finishes.* For 110-120 v., 60 cycle AC. Shpg. wt., 113 lbs.

91 PA 961. Only \$34.98 Down. CASH NET. 349.75

ABOVE SYSTEM, LESS CHANGER BASE AND ENCLOSURE. For custom installation. As above, less changer base and BL-1215 enclosure. Shpg. wt., 53 lbs.

91 PA 962. You Save \$32.81! CASH NET. 259.75

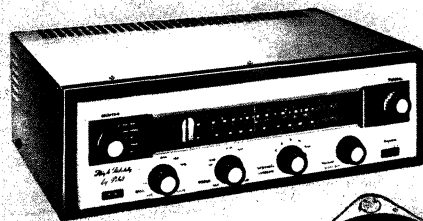

Pilot HF-30 Tuner-Amplifier

Garrard RC121-4 Record Changer with Wood Base and G. E. 4G-052 Cartridge

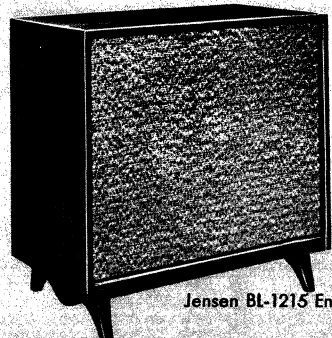

Jensen BL-1215 Enclosure

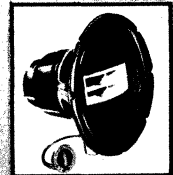

H-222 12" Speaker

See Pages 34-35 for All Pilot Units

ALLIED-RECOMMENDED HI-FI SYSTEMS

Every Allied high-fidelity system includes the booklet, "Planning Built-In Hi-Fi Systems." Complete instructions for building an "entertainment center" similar to the one shown on the left, as well as a wealth of information on custom-installing hi-fi components, wiring plans, cabinet construction, etc., are featured in the booklet.

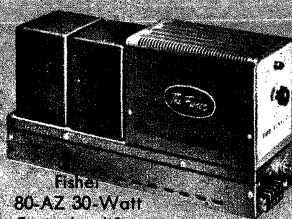
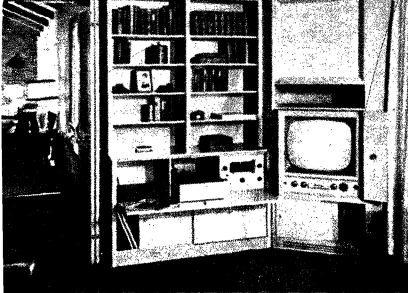

Fisher
80-AZ 30-Watt
Basic Amplifier

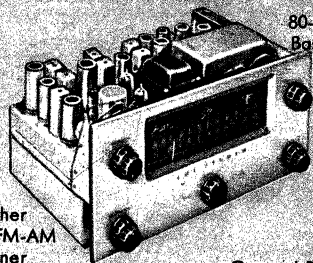

Fisher
80-T FM-AM
Tuner



Garrard RC88-4
Changer & Pickering
350DS Cartridge

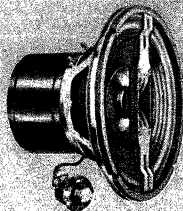

Electro-Voice
15TRX 3-Way
15" Speaker



Deluxe FM-AM-Phono Custom System

\$479⁷⁵

You Save \$60.68!

- Fisher Series 80 Tuner & Amplifier
- Garrard RC88-4 Record Changer
- Pickering 350DS Magnetic Cartridge
- Electro-Voice 15TRX 15" Speaker

Superlative home music system that combines five of the finest hi-fi components available, for superior audio reproduction from records and FM-AM broadcasts. Entire ensemble is intended for custom installation in wall panels, cabinets, or other fine furniture. Includes: Fisher 80-T FM-AM Tuner; Fisher 80-AZ 30-Watt Basic Amplifier; Garrard RC88-4 4-Speed Record Changer; Pickering 350DS Magnetic Cartridge with .001" diamond and .0027" sapphire styli; E-V 15TRX 15" 3-Way Speaker; Plastic Record Changer Cover. Each unit embodies engineering design of the highest order. The extremely sensitive Fisher tuner with controls, and its companion amplifier, are recognized standards of excellence—ideally matched in quality to the superb Garrard changer and Pickering cartridge. E-V's 15TRX speaker provides impressively smooth response. For 110-120 v., 60 cycle AC. Shpg. wt., 109 lbs.

91 PA 947. Only \$47.98 Down. NET. 479.75

SYSTEM AS ABOVE, WITH E-V "REGENCY" ENCLOSURE—Includes wood base for changer and wood cabinet for tuner. *Enclosure and changer base in mahogany, limed oak or walnut; tuner cabinet in mahogany or blonde—specify choice when ordering.* Shpg. wt., 172 lbs.

91 PA 948. You Save \$67.88. NET. 622.75

"Space Saver" Phono System

\$316⁰⁰

You Save \$36.34

- Fisher CA-40 25-Watt Amplifier
- New Collaro TC540 Record Changer
- G.E. Cartridge—Diamond LP Needle
- University Enclosure & Speaker

Superb, ready-to-use phono system, centered around the outstanding Fisher amplifier. This Allied-selected system delivers authentic high-fidelity reproduction from records—at a savings of \$36.34 over total cost of components when purchased separately! System includes: Fisher CA-40 25-Watt Amplifier; new Collaro TC540 4-Speed Record Changer with Wood Base; new G.E. 4G-052 Magnetic Cartridge with .001" diamond and .003" sapphire styli; University EN-12 Rear-Loding Enclosure with University's 312 12" Speaker installed; Plastic Changer Cover.

The advanced-design CA-40 amplifier with controls, features the unique ToneScope, a dramatic visual indication of the actual response curve obtained when bass and treble tone controls are adjusted. Curve is indicated on the illuminated front panel graph, as are different record equalization settings. The British-made Collaro changer is a model of fine workmanship and smooth, dependable operation; G.E.'s new cartridge is installed in the Collaro arm. University's "cornerless corner" EN-12 enclosure, together with the 312 speaker, offers splendid sound across the entire audio range. *Record changer base in mahogany, limed oak, or walnut; speaker enclosure in mahogany, blonde mahogany or walnut veneers—specify your choice.* System operates from 110-120 v., 60 cycle AC. Shpg. wt., 100 lbs.

91 PA 949. Only \$31.60 Down. CASH NET. 316.00

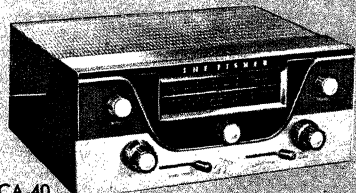

Fisher CA-40
25-Watt Amplifier

Collaro TC540
Changer with G.E.
4G-052 Cartridge
Installed

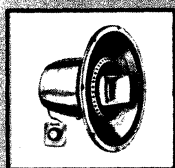
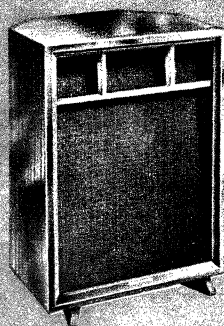

University EN-12
Enclosure with 312
12" Speaker Installed

FEATURING DELUXE FISHER COMPONENTS

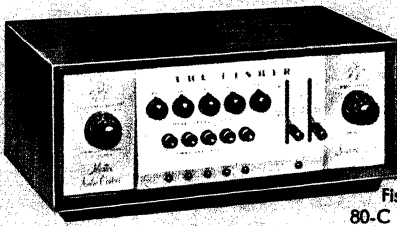

Fisher
80-C Master
Audio Control



Fisher 80-R
FM-AM Tuner

Professional High-Fidelity Phono System

\$629.00

You Save \$84.65!

- Fisher Audio Control & Basic Amplifier
- Rek-O-Kut Turntable & Pickup Arm
- Pickering Magnetic Cartridge
- New E-V Carlton IVA Speaker System

Absolute command over listening conditions, flawless performance and beauty of appearance—are yours with this professional phono system! Includes: Fisher 80-C Master Audio Control; Fisher 55-A 55-Watt Basic Amplifier; Rek-O-Kut B12 3-Speed Turntable on Wellcor Base with Rek-O-Kut 120 Pickup Arm, mounted and wired; Pickering 350DS Magnetic Cartridge with .001" diamond and .0027" sapphire styli; new E-V Carlton IVA Phase-Loaded 4-Way Speaker System; Plastic Record Changer Cover. The 80-C audio control offers complete, professional-studio mixing, fading and equalization facilities; the 55-A amplifier is easily comparable in quality to laboratory instruments. Faithful reproduction of music from records is provided by the Rek-O-Kut turntable and pickup arm with Pickering cartridge. E-V's masterfully designed Carlton IVA speaker system, employs new phase-loading principle for superior sound. *Turntable base and Carlton enclosure in mahogany or blonde—specify choices.* For 110-120 v., 60 cycle AC. Shpg. wt., 211 lbs. 91 PA 950. Only \$62.90 Down. CASH NET. 629.00

SYSTEM AS ABOVE, WITH FM-AM TUNER. As above, but with Fisher's 80-R Basic FM-AM Tuner. *Tuner cabinet in mahogany or blonde—specify choice.* 236 lbs. 91 PA 951. You Save \$101.60! NET. 799.50

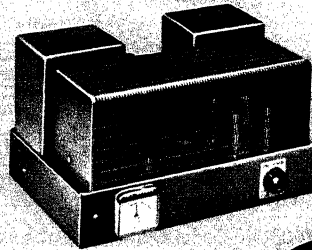

Fisher
55-A 55-Watt
Basic Amplifier



Rek-O-Kut B12
Turntable & 120 Arm
with Pickering 350DS
Cartridge

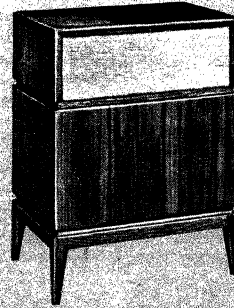

Electro-Voice
Carlton IVA
Speaker System

"Space-Saver" FM-AM-Phono Music System

\$419.75

You Save \$53.72!

- New Fisher "500" FM-AM Tuner-Amplifier
- Collaro RC440 Record Changer with Base
- G.E. Cartridge—Diamond LP Needle
- E-V "Empire" Enclosure and 15" Speaker

Deluxe FM-AM-Phono system, designed to meet the most exacting requirements of the music lover. Carefully selected by Allied's experts to give you the utmost in performance and value—you save \$53.72! System includes: Fisher "500" FM-AM Tuner/30-Watt Amplifier Combination Unit; Collaro RC-440 Record Changer with Wood Base; new G.E. 4G-052 Magnetic Cartridge, with .001" diamond and .003" sapphire styli; E-V SP15-B 15" Speaker installed in the "Empire" Enclosure; Plastic Record Changer Cover. *Changer base and "Empire" enclosure in mahogany, limed oak and walnut; wood cabinet for "500" in mahogany and blonde—specify choices when ordering.* Elegantly styled, the "500" tuner-amplifier has a host of excellent features, plus a full set of controls. The Collaro changer, with G.E. cartridge installed provides ultra-smooth record changing operation. E-V's "Empire" enclosure with SP15B speaker, offers phenomenally clean bass, mid-range and treble response. For 110-120 v., 60 cycle AC. Shpg. wt., 120 lbs. 91 PA 953. Only \$41.98 Down. CASH NET. 419.75

FM-AM-PHONO SYSTEM WITH "EMPIRE" ENCLOSURE IN KIT FORM. As above, but with "Empire" enclosure in unassembled, unfinished kit form. 109 lbs. 91 PA 952. You Save \$53.68! NET. 372.75

Full Descriptions of Fisher Units on Pages 38-39



New Fisher "500"
Tuner-Amplifier
Combination



Collaro RC-440
Changer with
Wood Base and G.E.
4G-052 Cartridge

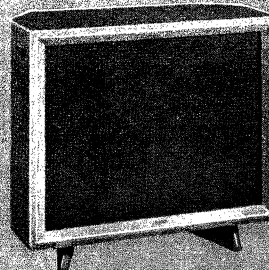

E-V SP15-B 15"
Speaker in the
"Empire" Enclosure

ALLIED-RECOMMENDED SYSTEMS WITH **Scott** COMPONENTS



Garrard RC88-4
with Base and
Pickering 350DS
Cartridge

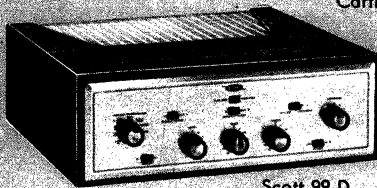

Scott 99-D
Amplifier in Case

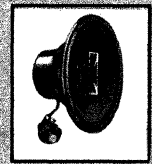
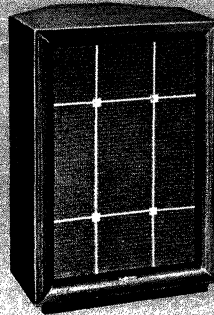

Electro-Voice 12TRX-B
12" Speaker Installed in
"Aristocrat" Enclosure

"Space-Saver" High-Fidelity Phono System Featuring Scott 99-D Amplifier

Phono System

\$316⁰⁰

You Save \$39.40!

- Scott 99-D 22-Watt Amplifier & Case
- Garrard RC88-4 Changer & Base
- Pickering 350DS Magnetic Cartridge
- E-V "Aristocrat" Enclosure & Speaker

An outstanding hi-fi phono system, made up of some of the finest components available, at a "best buy" price. Performance and features of this system fulfill the most exacting demands of the perceptive music lover—styling is dignified and graceful. Additionally, you save \$39.40 over the total cost of components when purchased separately! System includes: Improved Scott 99-D 22-Watt Amplifier & Wood Case, (case in mahogany or blonde veneers—specify when ordering); Garrard RC88-4 Record Changer with Base, (base in mahogany, limed oak or walnut finish—specify when ordering); Pickering 350DS Magnetic Cartridge with .001" Diamond and .0027" Sapphire Styl; Electro-Voice "Aristocrat" Enclosure with E-V's 12TRX-B 12" Three-Way Speaker installed, (enclosure in mahogany, limed oak or walnut veneers—specify when ordering); Plastic Record Changer Cover.

Compact and versatile, the Scott amplifier delivers performance that exceeds the most critical requirements. Full 22-watt output and flat frequency response, guarantees exceptional reproduction of music. Other deluxe features of this carefully engineered unit are record equalization, magnetic inputs selected from front panel, separate bass and treble controls, rumble filter, scratch filter, jacks for tape recording and monitoring, etc.

The renowned Garrard 4-speed record changer, a recognized hi-fi standard, offers precision workmanship throughout, automatic and manual play, etc. Pickering's "Fluxvalve" cartridge, mounted in a Garrard plug-in head, offers 25 millivolt output, low distortion and excellent compliance. E-V's "Aristocrat" corner enclosure achieves an extra octave of bass response by using the walls of the room as an extension of its folded horn; undistorted bass, mid-range and crisp, clean highs are provided by the 3-way construction of the 12TRX-B speaker. For 110-120 v., 60 cycle AC. Wt., 95 lbs.

91 PA 965. Only \$31.60 Down. CASH NET. 316.00

"Space-Saver" Systems With 210-F Amplifier

Phono System

\$549⁵⁰

You Save \$70.07!

- Scott 210-F 36-Watt Amplifier & Case
- Rek-O-Kut L-34 Turntable & 120 Arm
- Pickering 370-1D Cartridge
- E-V "Regency" and 15" Speaker

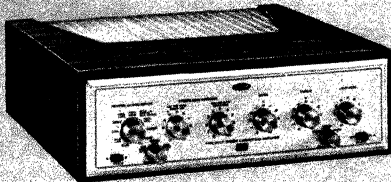

Scott 210-F Amplifier in Case



Rek-O-Kut Turntable
and Arm with Pickering
370-1D Magnetic Cartridge

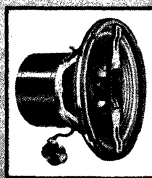
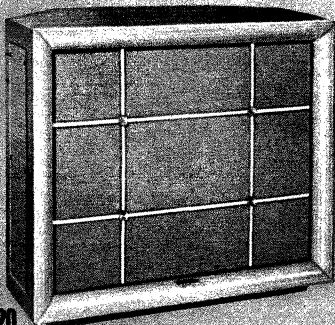

E-V 15TRX 15" 3-Way
Speaker Installed in
"Regency" Enclosure

Space-sparing hi-fi phono system for the audio purist. This array of deluxe units provides superior performance from records, at a saving of \$70.07 over cost of components purchased separately! System includes: Scott 210-F 36-Watt Amplifier & Wood Case (mahogany or blonde veneers—specify when ordering); Rek-O-Kut L-34 Turntable on Base with 120 Pickup Arm, mounted and wired, (base in mahogany, limed oak or walnut veneers—specify when ordering); Pickering 370-1D Magnetic Cartridge, with .001" Diamond Stylus, installed in arm; E-V 15TRX 15" 3-way Speaker installed in "Regency" Enclosure (mahogany, limed oak or walnut veneers—specify when ordering); Plastic Changer Cover.

The powerful Scott amplifier provides outstanding response and control flexibility—performance warrants its connoisseur's "first choice" rating. The professional-quality L-34 turntable, for 33½ and 45 rpm recordings, has a noise level 35 db below average recording level; the 120 pickup arm is also of professional quality. Pickering's 370-1D cartridge features minimum mass and wide response. E-V's 15TRX speaker and "Regency" enclosure provide dazzling sound. For 110-120 v., 60 cycle AC. Shpg. wt., 186 lbs.

91 PA 974. Only \$54.95 Down. CASH NET. 549.50

SYSTEM AS ABOVE, WITH FM-AM TUNER. System as above, but with Scott 330-C FM-AM Stereo Tuner & wood case (not illustrated; see page 40). Case in mahogany or blonde veneers—specify choice. Shpg. wt., 207 lbs.

91 PA 973. You Save \$93.97! NET. 745.50

SYSTEMS FEATURING harman kardon COMPONENTS

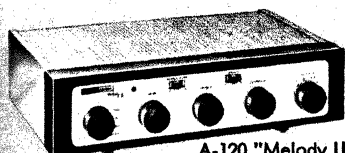

A-120 "Melody II"
20-Watt Amplifier



Garrard RC88-4
Record Changer with
G.E. 4G-052 Cartridge

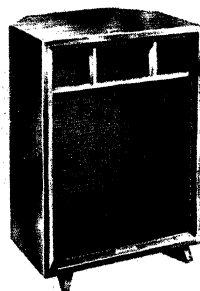

University EN-12
Enclosure with
UXC-123 12" Speaker

T-120 "Rondo"
Basic FM-AM
Tuner



"Space-Saver" Music Systems Featuring Harman-Kardon Components

- Phono System • H-K A-120 "Melody II" 20-Watt Amplifier
\$279⁰⁰ • Garrard RC88-4 Record Changer
 • G.E. Cartridge—Diamond LP Needle
 You Save \$35.32! • University Enclosure & Speaker

Ultra-compact phono system, designed to bring you thrilling reproduction from records, in a small installation and at a large savings. You save \$35.32! System includes: Harman-Kardon A-120 "Melody II" 20-Watt Amplifier; Garrard RC88-4 4-Speed Record Changer with Wood Base (base in mahogany, limed oak or walnut finish—specify choice when ordering); new G.E. 4G-052 Magnetic Cartridge, with .001" Diamond and .003" Sapphire Styli; University EN-12 Rear-Loading Horn Enclosure with UXC-123 12" Speaker installed, (enclosure in mahogany, blonde mahogany or walnut veneers—specify choice when ordering); and Plastic Record Changer Cover. Harman-Kardon's "Melody II" 20-watt amplifier, strikingly styled in black and copper, includes record equalization, 6-pos. loudness control, NARTB-equalized tapehead playback, 3-pos. speaker selector switch, and many other new features.

The matchless Garrard changer features beltless drive, intermixing of records of the same speed, and automatic or manual operation. The new G.E. cartridge is mounted in a Garrard plug-in head, ready for installation. Full range hi-fi reproduction of excellent quality is delivered by the perfectly matched, University combination of EN-12 "cornerless corner" enclosure and UXC-123 12" speaker. System operates from 110-120 v., 60 cycle AC. Shpg. wt., 87 lbs.

91 PA 954. Only \$27.90 Down. CASH NET. 279.00

SYSTEM AS ABOVE, WITH AM-FM TUNER. Complete phono system as above, but with the addition of Harman-Kardon's "Rondo" T-120 FM-AM Basic Tuner. Offers automatic frequency control for "lock-in" tuning of FM stations, cathode follower output, 10-kc whistle filter on AM, weighted flywheel tuning, newest tube types. Styling in attractive black and copper to match the A-120 amplifier. Shpg. wt., 100 lbs.

91 PA 955. You Save \$45.27! NET. 369.00

FM-AM-Phono System with Tuner-Amplifier

- \$413⁰⁰** • H-K "Festival II" Tuner-Amplifier
 You Save \$49.41! • Garrard RC88-4 Changer & Base
 • G.E. Cartridge—Diamond LP Needle
 • E-V SP12 in "Aristocrat" Enclosure

Here's an exceptional value in a top-performing, hi-fi FM-AM-Phono system, specially selected to suit the space requirements of modern apartments and homes. You make a saving of \$49.41 over the total cost of these components if purchased separately! System includes: Harman-Kardon's TA-1040 "Festival II" FM-AM Tuner/40-Watt Amplifier Combination Unit; Garrard RC88-4 4-Speed Record Changer with Wood Base, (base in mahogany, limed oak or walnut finish—specify choice when ordering); new G.E. 4G-052 Magnetic Cartridge, with .001" Diamond and .003" Sapphire Styli; Electro-Voice SP12 12" Speaker installed in "Aristocrat" Enclosure, (enclosure in mahogany, blonde limed oak or walnut veneers—specify choice when ordering); Plastic Record Changer Cover.

The "Festival II" tuner-amplifier unit, compact and styled in H-K's famous copper and black finish, offers such features as inputs for all associated hi-fi accessories, automatic frequency control on FM, variable automatic noise gate, 10-kc whistle filter on AM, tuning meter on FM and AM, record equalization, 6-pos. loudness control, bass and treble tone controls, 3-pos. speaker selector switch, full 40-watt power output, etc. Garrard's RC88-4 changer is internationally known for its smooth operation; G.E. cartridge is mounted in a Garrard plug-in head, ready for installation. E-V's "Aristocrat" and SP12 speaker provide highly pleasing audio reproduction. For 110-120 v., 60 cycle AC. Shpg. wt., 118 lbs.

91 PA 956. Only \$41.30 Down. CASH NET. 413.00

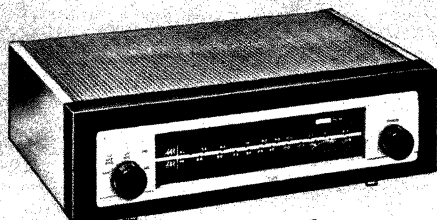

TA-1040 "Festival II"
FM-AM Tuner-Amplifier



Garrard
RC88-4 Changer
with Wood Base
and G.E. 4G-052
Cartridge

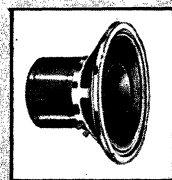
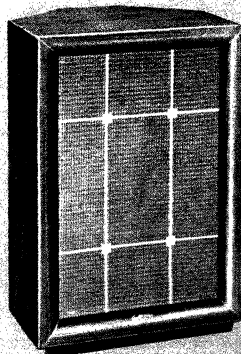

E-V SP12 12" Speaker
installed in E-V
"Aristocrat" Enclosure

See Pages 36-37 For All Harman-Kardon Units

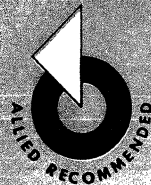

ALLIED "SPACE-SAVER" HI-FI SYSTEMS

FEATURING *Bell* AMPLIFIERS

Bell 2285
"Pacemaker"
10-Watt Amplifier

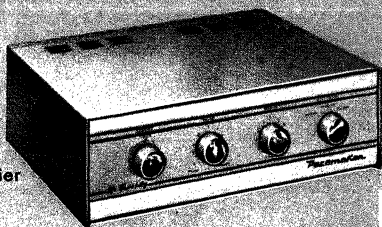

Collaro TC340 Record Changer
with Wood Base and
G.E. 4G-052 Cartridge

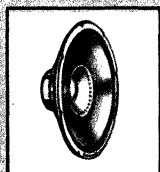
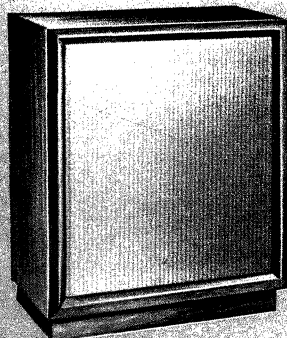

University UXC-122
12" Speaker mounted
in Wellcor Enclosure



New 2315
12-Watt
Amplifier

Webcor 1831-21
Record Changer
with Metal Base and
G.E. 4G-052 Cartridge

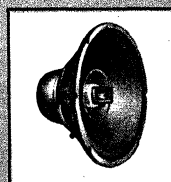
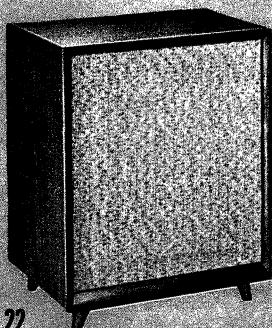

New Jensen CX-120
3-Way, 12" Speaker
in "Ultraflex" Enclosure

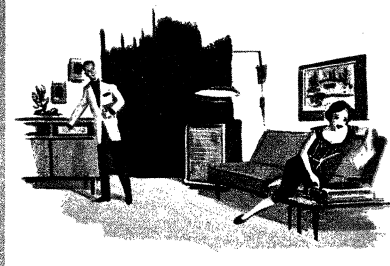

Phono System With "Pacemaker" Amplifier

ONLY

\$144.50

You Save \$38.54!

- Bell 2285 10-Watt Amplifier
- Collaro TC340 Record Changer
- G.E. Cartridge—Diamond LP Needle
- University Speaker in Wellcor Cabinet

Easy on the budget—and easy on the ears! With this low-cost phono system, you can enjoy the listening pleasure of smooth, authentic high-fidelity reproduction from records—at a saving of \$38.54 over the total cost of components purchased separately. System includes: Bell Model 2285 "Pacemaker" 10-Watt Amplifier; Collaro Model TC340 4-Speed Record Changer with Wood Base; new G.E. 4G-052 Magnetic Cartridge with .001" Diamond Stylus and .003" Sapphire Stylus, installed in pickup arm; University UXC-122 12" Speaker in the Wellcor HFC-8-12 Bass Reflex Enclosure; Plastic Record Changer Cover.

The "Pacemaker" amplifier offers a full set of controls including bass and treble, input selector for magnetic phono or tape head, and tuner or TV, and high-impedance output for tape recording. The imported Collaro changer provides highly efficient record changing operation, and the new G.E. cartridge features higher output with wider frequency response. *Changer base and speaker enclosure in mahogany, limed oak or walnut finish—specify choice when ordering.* For 110-120 v., 60 cycle AC. Shpg. wt., 72 lbs.

91 PA 968. Only \$14.45 Down. CASH NET. 144.50

Phono System with 2315 Amplifier

ONLY

\$219.00

You Save \$23.03!

- New Bell 2315 12-Watt Amplifier
- Webcor 1831-21 Record Changer
- G.E. Cartridge—Diamond LP Needle
- New Jensen 12" Speaker & Enclosure

Selected by Allied's experts as a "natural", this compact hi-fi phono system is an outstanding value by any standard of comparison. Loaded with new features, each of these perfectly matched components combines to bring you thoroughly delightful sound from records. Additionally, you save \$23.03 over the total cost of components purchased separately! System includes: New Bell 2315 12-Watt Amplifier; Webcor 1831-21 4-Speed "Magic Mind" Record Changer, with new G.E. 4G-052 Magnetic Cartridge installed in pickup arm, and with Metal Base; new Jensen CX-120 12" 3-Way Speaker installed in Jensen's new BL-812 Bass "Ultraflex", Duct-Loaded Enclosure; and Plastic Record Changer Cover.

The smartly styled 2315 amplifier offers a full array of controls and inputs for all accessory equipment. "Magic Touch" push-pull on-off switch allows you to set the volume you prefer—then turn the amplifier on or off without re-setting controls! Webcor changer has "Magic Mind" record intermixing feature, G.E. cartridge has .001" diamond .003" sapphire styli. Metal base is packed separately. The new Jensen 3-way speaker in the "Ultraflex" enclosure, provides superb reproduction of sound from a unit only 24 1/4 x 19 x 12 3/8" in size! *In mahogany, blonde oak or walnut veneer—specify when ordering.* For 110-120 v., 60 cycle AC. Shpg. wt., 103 lbs.

91 PA 969. Only \$21.90 Down. CASH NET. 219.00

See Page 396 for Allied's Easy Payment Plan

SUPER-VALUE IN HI-FI

Each of the famous-name components in Allied-recommended hi-fi systems, have been carefully selected to match each other in quality for top-notch musical reproduction. Also, in every system, you pocket big savings over the total cost of these components purchased separately.

ALLIED-RECOMMENDED SYSTEMS
FEATURING Sherwood COMPONENTS



Sherwood S-1000 II
 36-Watt Amplifier
 in Metal Case

Sherwood S-2000
 FM-AM Tuner
 in Case

"Space-Saver" Systems With Sherwood Components

ONLY
\$286.50

- New Sherwood 36-Watt Amplifier
- Webcor 4-Speed Record Changer
- G.E. Cartridge—Diamond LP Needle
- University Speaker & Enclosure

You Save \$29.68!

Composed entirely of high-quality components, this hi-fi phono system brings you exciting, living sound—at a saving of \$29.68! Includes: New Sherwood S-1000 II 36-Watt Amplifier; Webcor 1831-21 4-Speed "Magic Mind" Record Changer with Metal Table-Top Base; new G.E. 4G-052 Magnetic Cartridge installed in arm of changer; University UXC-123 12" Speaker installed in University's EN-12 Enclosure; Plastic Changer Cover. The Sherwood amplifier offers complete control facilities; handsome styling includes black "flexitone" case and white leatherette panel. G.E. cartridge has .001" diamond and .003" sapphire styli. Unexcelled sound is provided by UXC-123 12" speaker in the EN-12 enclosure. *Enclosure in mahogany, blonde mahogany or walnut veneers—specify finish when ordering.* Amplifier case packed separately. For 110-120 v., 60 cycle AC. Wt., 98 lbs. 91 PA 971. Only \$28.55 Down. CASH NET. 286.50

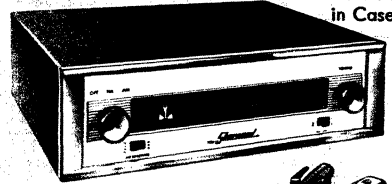

Webcor 1831-21
 Changer with
 Metal Base and
 G.E. 4G-052
 Cartridge

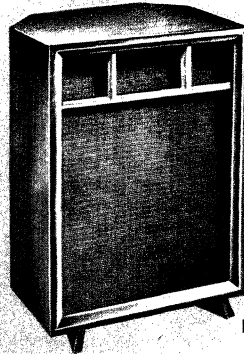

University EN-12
 Enclosure & UXC-123
 12" Speaker

ABOVE SYSTEM WITH FM-AM TUNER. System as above, but includes Sherwood's new S-2000 FM-AM Basic Tuner with handsome metal case. A skillfully engineered unit that provides extraordinary FM-AM reception. Shpg. wt., 120 lbs. 91 PA 970. You Save \$49.93! NET. 410.75

Low-Cost Phono System for Custom Installation

ONLY
\$79.50

- New Grommes 10-Watt Amplifier
- Garrard 4-Speed Record Changer
- New G.E. Magnetic Cartridge
- G.E. Model 850D 8" Hi-Fi Speaker

You Save \$20.36!

Ready for custom installation in cabinetry, wall or closet "built-ins", etc., this array of phono components brings you the utmost value for your hi-fi dollar. You save \$20.36 over the total cost of individual components purchased separately! Carefully selected by Allied's experts, this system includes: New Grommes UJ-6 10-Watt Amplifier; Garrard RC121-4 4-Speed Record Changer (less base); new G.E. 4G-050 Magnetic Cartridge, in plug-in head, ready for mounting in pickup arm; G.E.'s 850D 8" Speaker; Plastic Record Changer Cover.

The "heart" of this fine system is the Grommes amplifier, featuring a response of ± 1 db, 30 to 20,000 cps; RIAA-compensated phono input; bass and treble controls; etc. The renowned Garrard changer has positive intermix of 7", 10" and 12" records of the same speed, and a host of other truly excellent features. G.E.'s new 4G-050 cartridge, with .001" and .003" sapphire styli, offers higher output and wider frequency range. The G.E. 850D speaker is one of the most efficient, 8" hi-fi speakers available—provides extended-range, wide dispersion and excellent tonal quality. System operates from 110-120 v., 60 cycle AC. Shpg. wt., 28 lbs. 91 PA 972. Only \$7.95 Down. CASH NET. 79.50

ALLIED-RECOMMENDED SYSTEM
FEATURING Grommes AMPLIFIER

New Grommes UJ-6
 10-Watt Amplifier

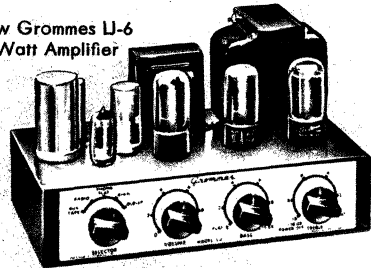

Garrard RC121-4
 Record Changer
 and G.E. 4G-050
 Cartridge

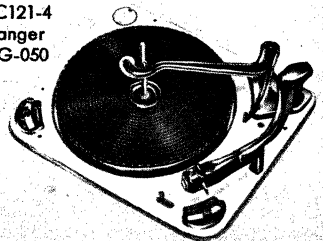

G.E. 850D
 8" Speaker

Allied is Headquarters for High-Fidelity Equipment

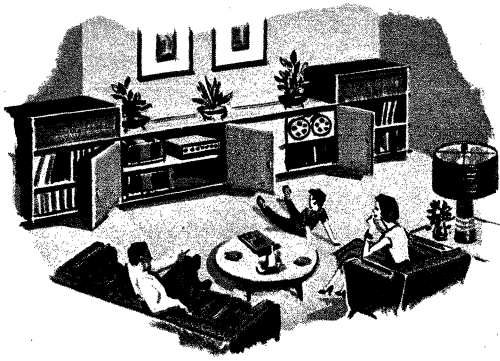

NOW! ENJOY THE WONDER OF

Stereo is the most exciting advance in home entertainment since hi-fi began—it brings you the clearest, most realistic music reproduction you have ever heard! When you listen to a stereo tape recording, you enjoy the jewel-like clarity and dynamic range of high-fidelity, *plus* depth of perspective so remarkably real that you seem to be in the concert-hall itself! The orchestra is spread before you in a panorama of sound, the acoustics of the place-of-performance are preserved, and the sound of each instrument comes clearly and distinctly from its appointed place in the ensemble. The realism of stereo opens the way to a thrilling new world of musical enjoyment for everyone!



Knight KN-700 Stereo Preamp

Pentron TM-4 Stereo Tape Deck

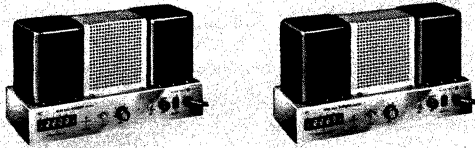

2—Knight KN-632 32-Watt Basic Amplifiers

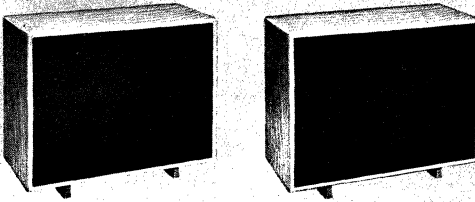

2—Knight KN-1230U Bass Reflex Enclosures with 3-way Speakers

Complete Stereo Tape-Playback System Featuring KNIGHT Stereo Preamplifier

\$498⁵⁰

You Save \$34.95!

- Pentron Stereo Tape Deck
- Knight 32-Watt Basic Amplifiers
- Knight 12" 3-way Speakers
- Efficient Knight Reflex Enclosures

Bring living stereo performances by famous artists into your own home with this complete stereo system—at a special Allied price that saves you \$34.95! Carefully selected by our own audio experts, this system will fully recreate the magnificence of great concert performances, in thrilling, lifelike stereophonic sound!

The system includes: Pentron TM-4 Stereo Tape Deck; Knight KN-700 Stereo Preamp; 2—Knight KN-632 32-Watt Basic Amplifiers; 2—Knight KN-800 12" 3-way Speakers, installed in 2—Knight KN-1230U Bass Reflex Enclosures. The enclosures are unfinished, mahogany veneer, and may be used in upright or lowboy position.

More than 300 stereo tapes and over 1000 monaural tapes are already available, and this system reproduces any of them with breath-taking clarity. For monaural use, you can add a tuner or changer at any time—the Knight stereo preamp has a full set of controls for equalization, scratch and rumble filters, etc.! The new Knight 3-way speakers produce rich, natural sound in the carefully designed enclosures. Tape deck and preamp provide low-distortion signals to the brilliant Knight KN-632 amplifiers—together rated at 64 watts. For 110-120 v., 60 cycle AC. Shpg. wt., 228 lbs. 91 PA 975. *Only \$49.85 Down. CASH NET. 498.50*

Complete Stereo Tape-Playback System Featuring the Bell 3-DT Stereo Amplifier

\$379⁵⁰

You Save \$44.87!

- Bell T-202 Stereo Tape Deck
- Bell 3-DT Stereo Amplifier
- University UXC-122 12" Speakers
- Wellcor HFC8-12 Enclosures



Bell T-202 Stereo Tape Deck

Bell 3-DT Stereo Amplifier

Save \$44.87 on the cost of the components of this high-quality complete stereo system—and enjoy the thrill of stereophonic sound in your own home for far less than you thought possible! Hear the finest in musical entertainment come to life through the magic of stereo—re-created at your command!

High-quality components of this system include: Bell T-202 Stereo Tape Deck; Bell 3-DT Stereo Amplifier in Case; 2—University UXC-122 12" Speakers, installed in 2—Wellcor HFC8-12 Enclosures, in choice of limed oak, mahogany or walnut finish. The entire system will also accommodate a record changer, tuner, or other program source. The stereo amplifier is the equivalent of two high-fidelity amplifiers, each rated at 12 watts. System is for operation from 110-120 volts, 60 cycle AC. Shpg. wt., 133 lbs. *Specify enclosure finish.* 91 PA 976. *Only \$37.95 Down. CASH NET. 379.50*

One Substitution is Allowed in Any Stereo System; Where Two Identical Components are Used Both May Be Substituted.

STEREOPHONIC SOUND IN YOUR HOME AT MODEST COST!

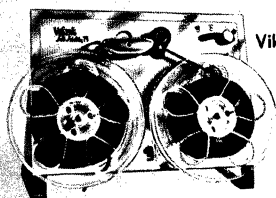

Viking FF75SR Deck

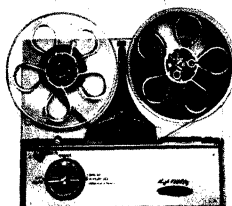

Pentron TM-4 Deck

Bogen ST-10 in case

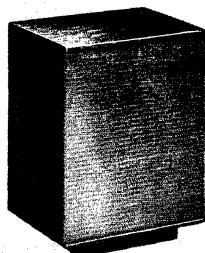
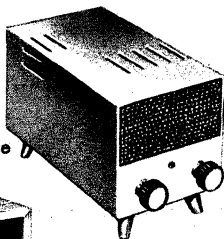

Argos AD-1 with SP12-B

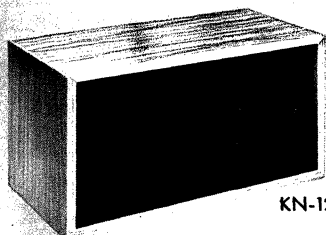

KN-1240 with Diffusicone-8



Knight KN-510 Amplifier

"Add-on" System with Bogen ST-10 Amplifier

\$199⁵⁰

You Save \$21.25!

- Viking FF75SR Stereo Tape Deck
- Bogen ST-10 Stereo "Add-On"
- University 8" "Diffusicone"
- Knight KN-1240 8" Enclosure

Low-Cost "Add-On" Stereo System

\$189⁰⁰

You Save \$22.65!

- Pentron TM-4 Stereo Tape Deck
- Knight KN-510 "Mini-Fi" Amplifier
- Electro-Voice 12" SP12-B Speaker
- Argos AD-1 Enclosure

Use your present hi-fi system as the foundation for a beautifully-performing stereo tape system—at low cost! Allied gives you extra savings, too—\$21.25 off the total cost of the individual components. Everything you need is here: tape deck, stereo preamp with 10-watt amplifier and high-fidelity speaker system. It's compact, too—the entire set of "add-on" components, including speaker enclosure, occupies only 2½ cubic feet!

System includes: Viking FF75SR Stereo Tape Deck; Bogen ST-10 Stereo Preamp/10-Watt Amplifier; University Diffusicone-8 8" Speaker, installed in Knight KN-1240 8" Shelf Enclosure, finished in your choice of mahogany or korina blonde. The system offers excellent reproduction of stereo and monaural tape recordings, when added to your present amplifier and speaker. For 110-120 v., 60 cycle AC. Shpg. wt. 50 lbs. *Specify enclosure finish.* 91 PA 979. Only \$19.95 Down. CASH NET..... 199.50

Add high-quality stereo tape reproduction to your hi-fi system easily and economically with this low-cost "add-on" set of components! If your present hi-fi amplifier has an equalized tape head input, this system is your best buy (otherwise, see systems at left and below). It includes the famous E-V SP12-B 12" speaker, which provides excellent tone quality in the Argos enclosure. The new "Mini-Fi" amplifier sets new standards of performance in a low-cost, 10-watt unit. The tape deck is simple to operate, and of reliable precision construction. Performance of the entire system is superlative.

System includes: Pentron TM-4 Stereo Tape Deck; Knight KN-510 "Mini-Fi" 10-Watt Amplifier; Electro-Voice SP12-B 12" Speaker installed in the Argos AD-1 Enclosure, finished in your choice of mahogany or blonde leatherette. For 110-120 v., 60 cycle AC. 68 lbs. *Specify enclosure finish.* 91 PA 978. Only \$18.90 Down. CASH NET..... 189.00

Deluxe "Add-On" System with KNIGHT Preamp

\$399⁵⁰

You Save \$34.05!

- Bell Stereo Tape Deck
- Knight KN-700 Stereo Preamp
- Knight KN-632 Basic Amplifier
- Jensen H-222 12" Co-ax Speaker

Realize the full possibilities of stereo reproduction by combining your present high-fidelity music system and this superb "add-on" system—at savings of \$34.05, exclusively at Allied! Matched to your high-quality amplifier and speaker, the combined system will vividly recreate—in your own home—the magnificent acoustics of the world's great concert halls, and the excitingly real sound of musical entertainment that only stereo can offer! Even records and broadcasts that are not reproduced in stereo will have a wonderful new quality when played through your new system!

System includes: Bell T-202 Stereo Tape Deck; Knight KN-700 Stereo Preamp.; Knight KN-632 32-Watt Basic Amplifier; Jensen H-222 12" Co-axial Speaker in BL-1215 Enclosure, finished in mahogany, blonde oak or walnut. For 110-120 v., 60 cycle AC. 129 lbs. *Specify finish.* 91 PA 977. Only \$39.95 Down. CASH NET..... 399.50

You May Substitute One Component In Any of the Above "Add-On" Stereo Systems



Bell T-202 Stereo Deck

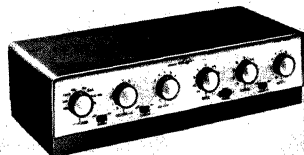

Knight KN-700 Stereo Preamp

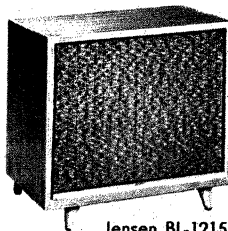

Jensen BL-1215 with H-222

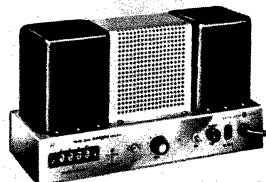

Knight KN-632 Basic Amplifier

ALLIED'S ADVANCED knight® HI-FI

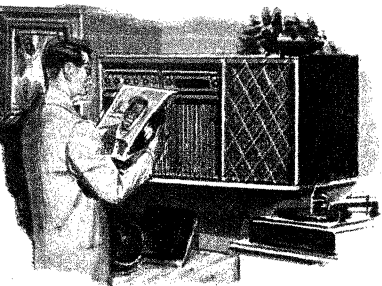

BUILT TO ALLIED'S OWN SPECIFICATIONS TO SAVE YOU MONEY

Knight high-fidelity components are created and designed by Allied and laboratory-checked to confirm that they meet our rigid specifications—and the critical demands of music lovers. *All Knight hi-fi units are unconditionally guaranteed for one year.* For economy and highest quality, Knight equipment leads the field, giving you top performance at lowest cost.



Model KN-530

NEWEST FEATURES FOR TRUE HI-FI PERFORMANCE

"A-B" SPEAKER SWITCH

This convenient control on the front panel of the amplifier enables you to switch either your main speaker system, or an extension speaker, on or off, or to play both speakers together.



RUMBLE AND SCRATCH FILTERS

These switches provide you with ultimate control of recorded or broadcast defects with a minimum loss of musical quality; old, worn records become playable!



VARIABLE LOUDNESS CONTROL

At low volume levels, the human ear is less sensitive to the lowest and highest frequencies; the loudness control compensates for this insensitivity.



TOP FLEXIBILITY

You can use your Knight 30-watt amplifier with a tape deck, complete tape recorder, phono playback units, FM or AM tuner, for hi-fi TV sound, and other applications.



GUARANTEED FOR ONE FULL YEAR

KNIGHT KN-530 Deluxe 30-Watt Hi-Fi Music Amplifier

ONLY
\$94⁵⁰
\$9.45 Down

- Effective Scratch and Rumble Filter Switches
- "A-B" Speaker Selector Switch On Front Panel
- DC on Filaments of Preamp/Tube Tubes
- Accurate, Continuously Variable Loudness Control
- NARTB Equalization for Tape Head Playback

New features—new styling—higher output power, combine to make the new Knight Deluxe 30-watt amplifier the year's outstanding high-fidelity value! It is the finest amplifier in the Knight line, matched in quality, and case and color styling, to the Deluxe FM-AM tuner on the opposite page.

The Knight 30-watt amplifier offers the flexibility necessary to meet the needs of any high-fidelity music system. The new "A-B" speaker selector switch provides for independent playback through either or both of two speaker systems. Scratch and rumble, on records or broadcasts, are effectively suppressed by separate panel switches; hum is reduced to inaudible levels by DC operation of all preamp tube filaments. Equalization controls correct both magnetic and ceramic cartridge inputs. Variable damping permits exact matching of amplifier to any speaker system, while new 6CA7 output tubes provide greater power output at exceptionally low distortion levels; new circuitry prevents overload automatically.

SPECIFICATIONS: All measurements at full 30 watts output. *Frequency Response:* ±0.5 db, from 20 to 40,000 cps. *Harmonic Distortion:* 0.5% at mid-frequencies; never exceeds 1.5% from 30 to 20,000 cps. *Intermodulation:* less than 2% at full rated output. *Hum Level:* 80 db below full output. *Sensitivity (Input required for full output):* 4 mv at Tape Head input; 8 mv at Mag Phono input.

Inputs: G.E. magnetic phono, Pickering magnetic phono, Tuner or Crystal Phono, Ceramic Phono, Tape Head, Tape Amplifier, Microphone; level control on Tuner input. *Controls:* Input Selector/Turnover (Aux, Tape, Tuner, Eur, FFRR, RIAA, Tape Pre, Mic); Rolloff (Eur, FFRR, RIAA, Flat); Bass; Treble; AC Off-On/Volume; Loudness; A-B Speaker Switch; Rumble Filter Switch; Scratch Filter Switch. *Output Imp.:* 4, 8 and 16 ohms. Rich leather-tone finish; brass finish escutcheon. 4x15½x11". U.L. Approved. For 110-120 volts, 50-60 cycle AC. Shpg. wt., 30 lbs.

92 SZ 402. NET. 94.50

CUSTOM INSTALLATION KIT. Special set of six control knobs, for use with above amplifier when custom-mounted in cabinet. Shpg. wt., 5 oz.

94 S 298. NET. 2.45

MUSIC SYSTEM COMPONENTS

FAMOUS FOR QUALITY—GUARANTEED FOR ONE FULL YEAR

Allied—world leader in high-fidelity—presents its own superb Knight components, designed expressly for those who wish to own the finest music reproduction equipment available—at moderate cost. All Knight equipment is covered by the Allied 15-day trial with money-back guarantee (see page 1), in addition to the one-year guarantee.



BEAUTIFUL NEW "SPACE-SAVER" DESIGN

The Deluxe 30-Watt amplifier and Deluxe FM-AM tuner are handsomely styled to match each other, in compact, "Space-Saver" cases.



KN-110

GUARANTEED FOR ONE FULL YEAR

You get more for your Hi-Fi Dollar in this Custom-Quality Tuner

KNIGHT KN-110 Deluxe Basic FM-AM Hi-Fi Tuner

TUNING METER

For precise, distortionless tuning on both FM and AM, there is an accurate tuning meter. With this feature, even weak stations are easy to tune in "right on the nose".



FUNCTION SELECTOR

Clearly marked selector switch turns set on, and chooses AM, FM with AFC, FM without AFC (for tuning weak FM stations near strong ones) and TV (activates TV accessory below).



LOOPSTICK ANTENNA

Fully adjustable, sensitive AM loopstick antenna, rotates for best reception of AM signal from any direction. Makes it easier than ever to get top-notch AM broadcast quality.

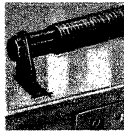

ONLY
\$99⁵⁰
\$9.95 Down

- Tuned RF Stage on FM and AM for High Sensitivity
- AFC Automatically "Locks-In" FM Stations
- Tuning Meter Simplifies Tuning on FM and AM
- Dual Limiters in FM Circuit for Maximum Noise Rejection
- Precision 11-Tube Circuit of Latest Design

True high-fidelity FM reception, plus all the broadcast quality of AM transmissions, are yours with this splendid new Knight "Deluxe" FM-AM tuner. Reception is excitingly clear—you'll find yourself listening to it for hours at a time! The precision tuning meter and AFC—automatic frequency control—make accurate tuning easy; there's no drifting off station, no irritating distortion, simply the cleanest, clearest broadcast reception this side of the transmitter! It's the perfect match, in quality and styling, for the Knight 30-watt amplifier on the opposite page.

Deluxe features include: precision, 3-gang tuning capacitor; separate tuned RF stages for both FM and AM; FM discriminator with dual limiters; 10-kc whistle filter on AM; adjustable loopstick antenna for AM; tuner logging scale for accurate station location; cathode follower with 2 outputs, one with level control for connection to amplifier, one constant-level output for tape recordings; clearly illuminated dial.

SPECIFICATIONS: *Sensitivity:* FM, 2½ microvolts for 20 db quieting, 4 microvolts for 30 db quieting; AM, 5 microvolts for 20 db signal-to-noise ratio. *IF Bandwidth (FM):* 200 kc. *Controls:* Function Selector (Off, AM, FM-AFC, FM, TV) and Tuning. *Distortion:* Less than 2% at 1.5 v. output. 11 tubes, plus rectifier. Size, 4x13½x10". Rich, leather-tone finish. With built-in ferrite AM antenna, FM indoor antenna, and 36" output cable. U.L. Approved. For 110-120 v., 50-60 cycle AC. Shpg. wt. 17 lbs. 92 SX 403. NET..... 99.50

KNIGHT KN-400 TV Audio Tuner—For Hi-Fi TV Sound

ONLY
\$49⁵⁰

Add immeasurably to your TV enjoyment with this hi-fi TV audio tuner—exclusively for use with the Knight Deluxe FM-AM tuner! Most TV sets cannot reproduce the full tonal quality of the sound transmission; the Knight TV audio tuner uses circuitry of the Deluxe tuner to bring you TV sound with thrilling clarity! Rich leather-tone finish. Size, 4x7¼x8½". U.L. Approved. Shpg. wt., 3 lbs. 92 S 407. NET..... 49.50

KNIGHT DELUXE FM-AM TUNER & TV AUDIO TUNER COMBINATION. Wt., 21 lbs. 91 SZ 939. Save \$4.25—Special Combination Price, Only..... 144.75



KN-400

For Money-Saving Systems Using Knight Deluxe Components See Page 7

SUPER-VALUE knight® "BANTAM" HIGH-FIDELITY TWINS

**MORE FOR YOUR MONEY
IN LATEST DESIGN HI-FI**

**GUARANTEED FOR
ONE FULL YEAR**

Brought right up-to-the-minute with latest engineering and design innovations, new Knight "Bantam" hi-fi components now offer you more in power, control flexibility, styling and overall performance, than ever before. They're top hi-fi values!

Created by Allied and built to the highest standards, you can buy these distinguished components with confidence. Always outstanding in performance, *your satisfaction is guaranteed* by lab tests, plus 15-day trial and money-back offer.



New KNIGHT "Bantam" 15-Watt Amplifier

ONLY
\$64⁵⁰
\$6.45 Down

- New Rumble and Scratch Filters
- 3-Pos. Speaker Selector Switch
- NARTB-Equalized Tape Head Input
- Loudness Switch for Tonal Balance
- Latest "Trim-Line" Styling

MODEL KN-515. An excellent choice for the moderate-cost hi-fi system, the new Knight "Bantam" 15-watt amplifier now offers even more in control versatility and dependable operation. Designed and color-styled to perfectly match the "Bantam" basic tuner at right.

SPECIAL FEATURES. Four slide-switches on front panel for Rumble Filter, Scratch Filter, Loudness (converts Volume to Loudness control), and A-B Speaker Selector for multiple speaker systems. Has automatic overload feature—prevents distortion on all inputs regardless of strength of input signal. Also includes equalized tape head input. Two EL84 tubes in output.

Rated Output: 15 watts. *Frequency Response:* ± 0.5 db, 20 to 20,000 cps. *Distortion (at 15 watts):* Harmonic, 0.8% at mid-frequencies—never exceeds $1\frac{1}{2}\%$ from 30-20,000 cps; IM, less than 2%. *Hum:* 75 db below rated output. *Sensitivity:* Magnetic phono, 8 μ v; Tape Preamp, 4 μ v. *Inputs:* Aux, for ceramic phono, etc.; Tuner or Crystal Phono; Tape; high-level Magnetic Phono; low-level Magnetic Phono; Microphone; Tape Preamp. *Controls:* Selector-Equalizer (Aux, Tape, Tuner, Eur, FFRR, RIAA, Tapé-Pre, Mic); Bass; Treble; Off-On-Volume. Variable damping and hum balance controls. *Output Imp.:* 4, 8 and 16 ohms. Brown "Plectone" case with white panel. $3\frac{1}{2} \times 13 \times 10\frac{1}{2}$ ". Requires kit (below) for panel mtg. U.L. Approved. For 110-120 v., 50-60 cycle AC. Shpg. wt., 18 lbs.

92 SX 400. NET..... 64.50

PANEL MOUNTING KIT. Set of 4 knobs, hardware. 6 oz.
94 S 297. NET..... 2.25

New KNIGHT "Bantam" Basic FM-AM Tuner

ONLY
\$74⁵⁰
\$7.45 Down

- Styled to Match "Bantam" Amplifier
- Effortless "Lock-in" FM Tuning
- Tuned RF Stage for FM
- Adjustable AM Loop Antenna
- 10 Kc Whistle Filter

MODEL KN-100. Brand new version of the famous Knight "Bantam" FM-AM Basic Tuner—always a standout value, now better than ever! Carefully matched in size and styling to the new "Bantam" amplifier at left, and "Mini-Fi" amplifier on page 29. A remarkably capable unit, it employs latest circuit advancements for excellent reception of FM and AM broadcasts. Moderately priced, it can also be used with any other hi-fi amplifier having volume and tone controls.

SPECIAL FEATURES. Automatic frequency control (AFC) on FM for effortless, accurate tuning—FM station "locks in" whenever its dial setting is approached. 10-kc whistle filter on AM eliminates adjacent-station whistle. Tuning is simplified by use of temperature-compensated oscillator for drift-free reception. Includes dipole antenna for FM and adjustable loop antenna for best AM reception. 200-kc IF bandwidth on FM for optimum selectivity.

FM Sensitivity: $3\frac{1}{2}$ μ v for 20 db quieting; 6 μ v for 30 db quieting. *AM Sensitivity:* 10 μ v for 20 db signal-to-noise ratio. *Controls:* Selector (Off, AM, FM with AFC, FM without AFC); and Tuning. Tuner output control on rear panel, balances tuner output for best results with hi-fi system amplifier. 8 tubes plus rectifier. In metal cabinet with brown "Plectone" finish, and white panel with brass trim. Does not require shaft extensions for behind panel mounting. Size, $3\frac{1}{2} \times 11\frac{1}{2} \times 9\frac{1}{4}$ " deep. Adjustable loop antenna extends 2" behind cabinet. U.L. Approved. For operation from 110-120 v., 50-60 cycle AC. Shpg. wt., 13 lbs.

92 SX 401. NET..... 74.50

SAVE On This "Bantam" Amplifier & Tuner Combination Offer

BOTH FOR ONLY
\$134⁵⁰

You Save \$4.50

Get these two freshly styled, first-quality components at savings of \$4.50! You need add only a speaker system and a record changer to have a complete hi-fi music ensemble. The metal cabinets which house "Bantam" components have been designed to perfectly match each other in size and appearance. Brown "Plectone" color styling, with white panel and brass trim, blends with any room decor and adds a smart touch to any surroundings. Shpg. wt., 31 lbs.

91 SZ 904. Save \$4.50 on This Combination Offer. ONLY..... 134.50

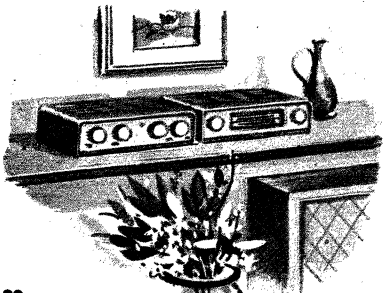

See Page 6 for Money-Saving Hi-Fi Systems Employing Knight "Bantam" Twins

EXCEPTIONAL BUYS IN FAMOUS **knight** HI-FI COMPONENTS

NEW "UNI-FI" TUNER-AMPLIFIER COMBINATION. The perfect replacement unit for obsolete consoles or for use wherever space is at a premium. Add only a speaker system and record changer and you're ready for superb FM-AM-Phono music!

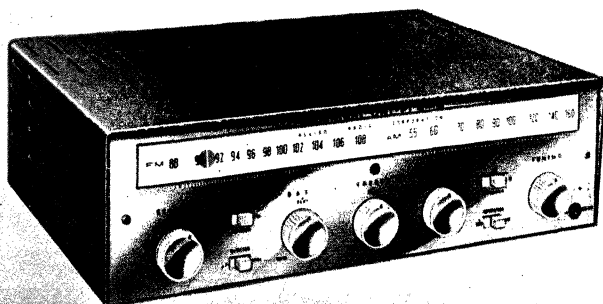

New KNIGHT "Uni-Fi" Tuner-Amplifier

ONLY
\$119⁵⁰

Less Case

- All New FM-AM Tuner-Amplifier Unit
- Add Only Changer & Speaker System
- Smart Styling—Space-Saving Size
- 15-Watt Amplifier Section With Controls
- Offers Many Deluxe Features

MODEL KN-315. New from top to bottom, the Knight "Uni-Fi" gives you a 15-watt amplifier, highly sensitive FM-AM tuner, and versatile preamplifier—on one compact chassis! You need add only a speaker system and record changer to have a complete hi-fi music ensemble.

SPECIAL FEATURES. Full 15-watt output, special switch for converting volume to loudness control, 3-position speaker selector switch for multi-speaker systems, rumble and scratch filters, automatic frequency control on FM with defeat position for tuning in weak stations, two EL84 power output tubes, etc.

Rated Output: 15 watts; 30-watt peaks. **Distortion:** Less than 2% at rated output. **Audio Response:** ± 1 db, 20 to 20,000 cps. **Sensitivity:** FM, 4 μ v for 20 db quieting; AM, 10 μ v at external antenna terminals for 20 db signal-to-noise ratio. **Phono Gain:** 8 millivolts for rated output. **Controls:** Off-On/Volume; Loudness On-Off; Bass; Treble; Selector-Equalizer (Pop, 78, LP, FM with AFC, FM without AFC, AM, Aux.); Rumble and Scratch Filters; Speaker Selector (A, AB, B). **Output Impedances:** 4, 8 and 16 ohms; high-impedance for tape recorder. 12 tubes, plus EZ81 rectifier. Built-in line cord FM antenna; loopstick for AM. $4\frac{1}{4} \times 15 \times 10\frac{1}{2}$ ". Less case. For 110-120 v., 60 cycle AC. Shpg. wt., 18 lbs.

92 SZ 410. NET. 119.50

"UNI-FI" CASE. Attractive brown "Plextone" metal case for above. Size, $4\frac{3}{8} \times 15\frac{1}{8} \times 11\frac{1}{8}$ ". Shpg. wt., 4 lbs.

92 SX 412. NET. 4.50

For hi-fi systems using the "Uni-Fi", see pages 8 and 11.

NEW "MINI-FI" ECONOMY AMPLIFIER. An unsurpassed value, the attractive and compact "Mini-Fi" 10-watt amplifier provides all the controls and features essential to genuine high-fidelity reproduction of sound—at the lowest possible cost.



New KNIGHT "Mini-Fi" 10-Watt Amplifier

ONLY
\$42⁹⁵

- Outstanding Performance and Operation
- NARTB-Equalized Tape Head Input
- Newest Circuitry and Tube Types
- Compact in Size—Fits Anywhere
- Highly Attractive Color Styling

MODEL KN-510. Newest addition to the outstanding Knight line of hi-fi components, the "Mini-Fi" 10-watt amplifier, though small in size and low in cost, is a king-size value! Carefully designed to give you the most for your money, it's perfect for the budget-priced home music system. Offers clean, wide-range response.

SPECIAL FEATURES. Inputs for all accessory equipment including NARTB-equalized tape head playback; bass and treble tone controls; etc. Compact, space-sparing design, suitable for use on shelf, table, etc., or panel mounting. Cabinet is styled in brown "Plextone" and has white panel and brass trim—blends harmoniously with any type of room decor, furniture or cabinetry.

Rated Output: 10 watts; 20-watt peaks. **Distortion (at rated output):** Harmonic, less than 2%; IM, less than 3%. **Response:** ± 1 db, 20 to 20,000 cps at rated output. **Hum:** 65 db below 10 watts. **Sensitivity:** Magnetic phono, 8 millivolts for 10 watts; Tape head, 4 millivolts for 10 watts. **Inputs:** Tape Head, Magnetic Phono, Crystal-Ceramic Phono, Tuner, Auxiliary. **Controls:** Equalizer-Selector (Tape, Magnetic Phono, RIAA, Eur, Radio, Aux); Volume; Bass; Treble; Off-On. Rumble filter on rear panel. **Output Impedances:** 4, 8 and 16 ohms, plus high-impedance for recording. **Tubes:** ECC83, 6BA8A, 2—6V6GT; EZ80 rectifier. $3\frac{5}{8}$ " high (including feet), $11\frac{1}{2}$ " wide, 9" deep. U.L. Approved. For 110-120 v., 60 cycle AC. Shpg. wt., 10 lbs.

92 SX 409. NET. 42.95

For hi-fi systems using the "Mini-Fi", see pages 10-11.

SEE OUR COMPLETE SELECTION OF CHANGERS, SPEAKERS, RECORDERS, ETC.

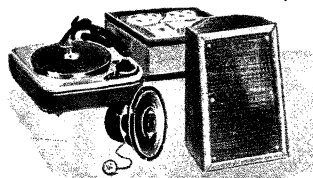

This Catalog contains a complete listing of all of the nationally famous brand-names in high-fidelity components. Record changers, players and turntables; speakers, speaker systems and speaker enclosures; tape recorders and recording equipment; tuners; amplifiers; latest stereo equipment; and related hi-fi accessories—all are included in these pages in a wide range of prices. Make this Catalog your complete buying guide to all of the distinguished products of the leading suppliers in high fidelity. Because we maintain the world's largest stocks of audio components, one order to us will cover all of your high-fidelity needs.

NEW knight HIGH-FIDELITY COMPONENTS

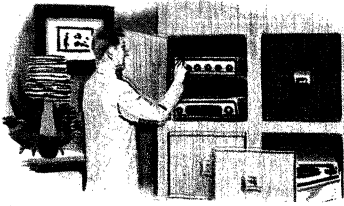

These new Knight high-fidelity components are created and designed by Allied, and precision-built to rigid specifications—your positive assurance of brilliant hi-fi reproduction and the ultimate in dependability. All of the Knight hi-fi components listed on these pages have been closely controlled from their conception, through every step of design and construction, to give you, the customer, maximum value for your hi-fi dollar! As proof-positive of our confidence in Allied's own Knight components, they are all unconditionally guaranteed by us for one full year.



KN-200



KN-632

New KNIGHT FM-AM Tuner-Preamplifier

ONLY
\$139⁵⁰

- Tuning Eye for FM and AM
- 12 Equalization Combinations
- Tuner Filaments Are Off During "Phono" Operation

Model KN-200. A brilliantly styled and engineered combination unit, integrating a deluxe preamplifier section and a highly sensitive FM-AM tuner. A complete hi-fi system control unit and tuner in one case! Use it with any high-quality basic amplifier (such as the Knight 32-watt unit at right) and speaker to have a truly outstanding music system! Best of all, you'll save many dollars by choosing this superb tuner-preamplifier.

Tuner operation is totally independent of preamplifier section—when not in use, tuner tube filaments are switched off, prolonging tube life. The preamplifier section, in addition to controlling volume and tone for the tuner, provides a scratch filter, rumble filter, loudness control switch, bass and treble controls and full equalization for phonograph records. It's functionally styled for easy operation—and strikingly handsome, too.

PREAMPLIFIER SPECIFICATIONS. *Frequency Response:* ± 0.5 db, 20-40,000 cps. *Controls:* Input Selector/Turnover (Aux. Tape, Tuner, Eur, FFRR, RIAA, Tape Pre, Mic); Rolloff (Eur, FFRR, RIAA, Flat); Selector Switch (FM, FM-AFC, AM, Tuner Off); Tuning; Volume; Bass; Treble; Scratch Filter; Rumble Filter; Loudness. *Inputs:* G.E., Pickering, Aux, Ceramic, Tape or Crystal Phono, Tape Pre, Mic. *Outputs* (Impedance 40,000 ohms): Recorder Output, Main Output.

TUNER SECTION SPECIFICATIONS. *FM Sensitivity:* $3\frac{1}{2}$ microvolts provides 20 db quieting. *AM Sensitivity:* 10 microvolts for 20 db signal-to-noise ratio. *IF Bandwidth (FM):* 200 kc. Meets FCC radiation specifications. 10 tubes plus rectifier; EM81 tuning indicator.

No custom mounting accessories required. Deluxe color styling in rich, leather-tone finish, brushed brass and black trim. With FM dipole antenna and 36" output cable. Size, $4\frac{5}{8} \times 13\frac{5}{8} \times 9\frac{3}{4}$ ". For 110-120 v., 50-60 cycles AC. U.L. Approved. Shpg. wt., 15 lbs.
92 SZ 405. NET..... **139.50**

New KNIGHT 32-Watt Basic Amplifier

ONLY
\$74⁵⁰

- Response, 20-40,000 cps ± 0.5 db
- Output Tube Bias and Balance Controls
- Variable Damping Control
- High-Quality Potted Transformers

Model KN-632. Here's a first-quality basic amplifier with power and performance to spare! Built to precision standards, this brand new Knight 32-watt basic amplifier offers just the features you want—at a price that saves you many dollars. Its specifications mean genuine high fidelity—distortion at 32 watts is less than $\frac{1}{2}$ of 1%. Most important, in everyday music listening at ordinary room volume, the response of the Knight 32-watt basic gives you music reproduction with diamond-like clarity. When needed, its ample reserve of power may be depended upon to provide music at concert-hall levels, with equal fidelity.

Design and construction features of the new Knight 32-watt basic amplifier meet the highest standards of electronic practice. It is provided with such refinements as variable damping, output tube bias control, and output tube balance control. The amplifier has a pilot light, auxiliary AC outlet, and a level control; it is safely fused for circuit protection. Attractively finished in rich-looking gold and satin black.

SPECIFICATIONS: *Frequency Response:* ± 0.5 db, 20 to 40,000 cps at 32 watts output. *Harmonic Distortion:* Less than 0.5% at mid-frequencies at 32 watts output—never exceeds 1.5% from 20-20,000 cps. *I.M. Distortion:* Less than 2% at 32 watts output. *Sensitivity:* 0.7 volts input required for 32 watts output. *Hum Level:* 75 db below rated output. *Input Impedance:* 100,000 ohms. *Output Impedances:* 4, 8, 16 ohms. *Size:* $7\frac{1}{8} \times 14\frac{3}{4} \times 5\frac{1}{2}$ " deep. U.L. Approved. For operation from 110-120 volts, 50-60 cycles AC. Shpg. wt., 25 lbs.
92 SZ 404. NET..... **74.50**

FOR STEREO FANS

Two KN-632 basic amplifiers will provide your stereo system with a full 64-watt rated output, at superb specifications. Individual level controls for perfect balancing of two speaker systems. Buy two and save \$10.00! Shpg. wt., 50 lbs.
91 SZ 980. Two KN-632 Basic Amplifiers. ONLY. **139.00**

For top-value high-fidelity music systems combining the new Knight KN-200 Tuner-Preamp with other deluxe components, see page 8; you save on Allied-recommended systems.

See pages 8 and 9 for expert-selected hi-fi systems incorporating the new Knight KN-632 32-watt basic amplifier. These carefully matched systems are "best buys"!

MUSIC COMPONENTS

Pilot

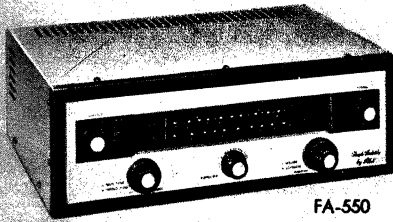

FA-550

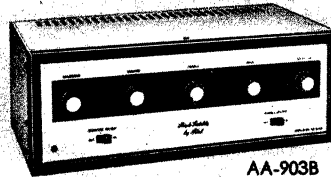

AA-903B

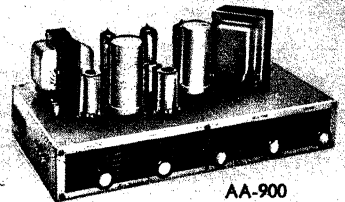

AA-900

FA-550 FM-AM TUNER

ONLY \$159.50

A built-in preamplifier and full set of controls make this unit an excellent companion to any of the basic amplifiers listed below. 2 tape inputs are provided—tape head input permits use with basic tape player mechanism for playback of recorded tapes; other input is used to play back equalized output of tape recorder. **FM Features:** Armstrong dual cascade limiter-discriminator circuit; tuned RF stage for maximum sensitivity and selectivity; AFC with disabling switch; temperature-compensated oscillator to minimize drift; built-in line-cord antenna; shielded to conform to FCC specifications. **Sensitivity:** FM, 2.5 μ v for 20 db quieting; AM, 3 μ v for 1 volt DC at detector. **Hum Level:** 80 db below 1 volt. **Controls:** Selector (Tape Amp, Aux, Phono, Tape Head, AM, FM with AFC, FM without AFC); Bass; Treble; Equalizer (LP, AES, RIAA, NARTB Tape); Off-On/Volume; Loudness Contour and Tuning.

Cathode follower output permits use of long lead between FA-550 and amplifier. Has built-in rumble filter. 10-kc whistle filter with 80 db attenuation. Burgundy-and-brass finish panel may be detached for custom mounting of FA-550. 10 tubes; E8M1 tuning eye; 5Y3GT rectifier. Size: 4 $\frac{3}{4}$ "x14 $\frac{1}{2}$ "x10 $\frac{5}{16}$ ". For 105-120 v., 60 cycle AC. Shpg. wt. 20 lbs.

94 SZ 370. NET.....159.50

AA-902A BASIC AMPLIFIER

A high-quality basic amplifier providing exceptional high-fidelity performance at low cost. Ideal for maximum flexibility of placement in budget hi-fi systems; may be placed out of sight in any convenient, out-of-the-way location, since it has no controls.

Circuitry is based on the Williamson low-distortion design. Compact size of the amplifier chassis facilitates installation in console cabinets when converting to hi-fi. **Rated Output:** 14 watts. **Frequency Response:** ± 1 db, from 20 to 20,000 cps, at 14 watts output. **Harmonic Distortion:** Less than 1% at full rated output of 14 watts. **Intermodulation Distortion:** Less than 1.5% at 14 watts output. **Tube complement:** 6C4, 12AU7, 2-6L6GB; 5Y3GT rectifier. **Speaker Output Impedances:** 4, 8 and 16 ohms.

Rugged construction and high-quality components insure stability of performance. Size, 4 $\frac{3}{4}$ " high, 14 $\frac{1}{2}$ " wide and 4 $\frac{5}{8}$ " deep. For operation from 105-120 volts, 60 cycle AC. Shpg. wt., 14 lbs.

94 SX 326. NET.....49.50

MODEL AA-908 BASIC AMPLIFIER

A carefully-designed power amplifier for use in high-quality music systems, the Pilot AA-908 furnishes a continuous output of 40 watts, and is capable of handling peaks of up to 80 watts. Based upon the famous Williamson low-distortion circuit. Unique 5-position bass emphasis control compensates for speaker characteristics and room acoustics. The output transformer of the AA-908 features interleaved windings and grain-oriented steel laminations for lowest distortion; damping factor of the amplifier is selectable. There is provision for balancing the voltages supplied to the EL34/6CA7 output tubes. The chassis is finished in handsome brushed brass.

AA-903B 14-WATT AMPLIFIER

ONLY \$79.95

A newly-designed 14-watt Williamson-type amplifier with full set of controls. Advanced circuit with latest tube types and design innovations for low distortion, unusually low hum and noise, and exceptional stability. The AA-903B includes a versatile preamp for equalization of all types of recordings, plus an equalized tape head input permitting playback directly from a tape deck. It's a top-rated hi-fi value!

Rated Output: 14 watts. **Frequency Response:** ± 1 db, 20-20,000 cps. **Harmonic Distortion:** Less than 1% at 14 watts. **I.M.:** 1.5% at 14 watts. **Hum:** 80 db below full output. **Inputs:** Radio, Aux, Tape Head, Tape Amp, Phono. **Output Imp.:** 4, 8, 16 ohms. **Controls:** Loudness; Volume; Treble; Bass; Function-Equalization Selector (Radio, Aux, Tape Amp, Tape Head, LP, RIAA, AES, NARTB); Scratch Filter; Rumble Filter.

Tape output jack, independent of volume, loudness and tone controls, on rear panel. Variable input loading for various magnetic phono cartridges assures maximum fidelity with any cartridge. Front panel may be detached for custom installation. DC on preamp filaments for minimum hum. EL84 output tubes. Fully enclosed in case of brushed brass and burgundy finish. Size, 4 $\frac{3}{4}$ "x13 $\frac{1}{2}$ "x9". For 105-120 v., 60 cycle AC. Shpg. wt., 17 lbs.

98 SX 584. NET.....79.95

MODEL AA-410A BASIC AMPLIFIER

The AA-410A is an excellent example of skillful high-fidelity engineering. A perfect companion unit for Pilot's FA-550 described above, or any other high-quality tuner or preamp-equalizer with a full set of controls. Truly a remarkable value, this fine unit features a 20-watt Williamson-type circuit and a deluxe output transformer with interleaved windings.

Rated Output: 20 watts. **Frequency Response:** ± 0.1 db, from 20 to 20,000 cps at rated output. **Harmonic Distortion:** Less than 1% at full rated output of 20 watts. **Intermodulation Distortion:** Less than 1.5% at rated output (50 and 7000 cps, 4:1). **Hum and Noise Level:** 90 db below rated output. **Negative Feedback:** 14 db. **Speaker Output Impedances:** 4, 8 and 16 ohms. Output stage employs 2-6L6GB tubes; transformers are sealed and finished in black enamel. Supplied with removable feet. Overall size, 5 $\frac{3}{4}$ " high, 4" deep, 14 $\frac{1}{2}$ " wide. For operation from 105-120 volts, 60 cycle AC. Shpg. wt. 19 lbs.

94 SX 367. NET.....59.50

MODEL AA-908 BASIC AMPLIFIER

Power Output: 40 watts continuous, 80 watts peak. **Frequency Response:** ± 0.1 db, from 20 to 20,000 cycles, with speaker compensation switch in "FLAT" position. **Harmonic Distortion:** 0.5%. **I.M.:** 0.9% at 40 watts; 0.15% at 10 watts. **Sensitivity:** 0.4 volts input for 40 watts output. Level control attenuator for 6, 12 or 18 db attenuation of input signal. **Hum Level:** 90 db below 40 watts. **Input Impedance:** 470,000 ohms. **Speaker Output Impedance:** 8 and 16 ohms. **Damping Factor:** Choice of 5, 2.5, 1. Size, 6 $\frac{3}{4}$ " high, 12 $\frac{3}{4}$ " wide, 9 $\frac{1}{4}$ " deep. For operation from 105-120 volts, 60 cycle AC. Shpg. wt. 27 $\frac{1}{2}$ lbs.

94 SZ 327. NET.....125.00

NEW AA-900 10-WATT AMPLIFIER

ONLY \$67.50

A new, low-cost Williamson-type amplifier rated at 10 watts output, with full controls for record equalization. Output tubes are rugged, miniature EL84's; total harmonic distortion remains under 1% at full 10 watts output. A front panel switch automatically selects either or both of two speakers.

Rated Output: 10 watts; 20 watts peak. **Frequency Response:** ± 1 db, 20-20,000 cps. **Harmonic Distortion:** Less than 1% at 10 watts output. **I.M.:** 1.5% at 10 watts output. **Hum Level:** 70 db below full output. **Inputs:** Phono, Radio, Tape. **Output Impedance:** 8 ohms. **Controls:** Selector-Equalizer (LP, AES, RIAA, NARTB, Radio, Tape); Speaker Selector Switch; Treble; Bass; Off-On/Volume. Size, 5 $\frac{1}{2}$ "x13 $\frac{1}{4}$ "x7 $\frac{1}{4}$ ".

Front panel plate is easily removed to permit custom installation of amplifier. Case has removable rubber feet to protect furniture. Output transformer has interleaved windings, to improve high frequency characteristics. Bass and treble tone controls provide full 18 db boost or cut at 20 and 20,000 cps. EL84 output tubes.

Only 8 millivolts required in phono channel for full output. Separate accessory AC outlet controlled by amplifier on-off switch, may be used for record changer. For operation from 105-120 volts, 60 cycle AC. Shpg. wt., 11 lbs.

94 SX 325. NET.....67.50

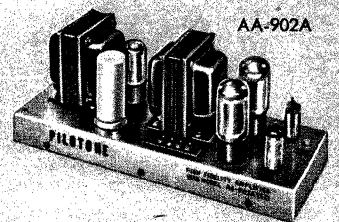

AA-902A



AA-410A

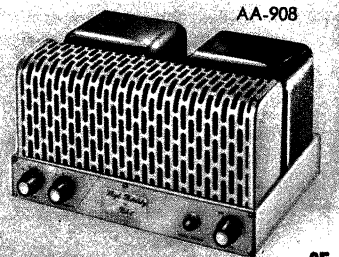

AA-908

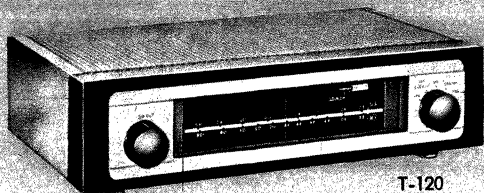

T-120

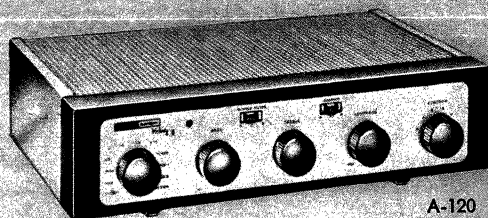

A-120

Harman-Kardon Deluxe "Twin" High-Fidelity Components

T-120 "RONDO" BASIC FM-AM TUNER

ONLY
\$99⁹⁵

Handsomely styled, deluxe quality, basic FM-AM tuner featuring printed circuit wiring and a host of "plus" features that add up to exceptionally fine AM and FM broadcast reception. Makes an ideal companion unit for the A-120 "Melody II" 20-watt high-fidelity amplifier described at right. These two units can be stacked together for an ultra-compact installation only 7" high! Highly sensitive and selective, the T-120 employs Armstrong FM circuitry with limiter and Foster-Seeley discriminator, AFC, and low-noise front end consisting of tuned triode, grounded grid amplifier and triode mixer. A rumble filter is used in the AFC network to eliminate motor noise or rumble originating in the turntable or recordings used by the broadcasting station. AFC defeat position allows tuning weak or distant stations adjacent to strong stations. Counter-weighted tuning mechanism aids accurate station selection. Two cathode follower outputs for amplifier and tape recorder permit use of long leads between components. Unusually attractive contemporary styling—brushed copper escutcheon with matching copper case.

AM Circuit: Up-to-the-minute superhet with automatic volume control; 10-kc whistle filter for suppression of adjacent-station noise and squeal; built-in high-gain ferrite loopstick antenna plus terminal for adding external antenna. **FM Circuit:** Armstrong FM circuit with limiter and Foster-Seeley discriminator; tuned, grounded-grid triode RF amplifier and triode mixer in front end; automatic frequency control circuit with defeat position; rumble filter. **Sensitivity:** FM, 3 μ v for 20 db quieting; AM, 20 μ v. **Selectivity:** FM, 200 kc bandwidth at 6 db down; AM, 8 kc bandwidth at 6 db down. **Controls:** Function (On-Off, FM-AFC, FM, FM-AFC-Filter, AM) and Tuning. 8 tubes plus selenium rectifier. Size, 3 $\frac{1}{4}$ "x12 $\frac{1}{2}$ "x8 $\frac{1}{4}$ ". For 110-120 volts, 50-60 cycle AC. Shpg. wt., 12 lbs.

99 SX 091. NET..... 99.95

A-120 "MELODY II" 20-WATT AMPLIFIER

ONLY
\$99⁹⁵

Improved 20-watt, printed-circuit hi-fi amplifier, designed to match the T-120 or complement any other quality basic tuner. Unusually compact, and providing the utmost in control versatility, the A-120 is a fine choice for even the most elaborate of home music systems. Among its many features, it includes a 3-position speaker switch for versatile operation of systems using two speakers—switch channels music through either speaker alone, or both speakers simultaneously. Other features include: 3-position record equalizer in preamp circuit for proper playback of all records; 6 steps of loudness-contour correction; low-impedance tape output unaffected by controls; equalized tape input for a tape player mechanism; 2-position rumble filter; and exclusive, controlled "H" audio circuit. Highly efficient in operation, this new, 20-watt circuit runs cooler than a conventional 10-watt amplifier, despite its higher power output! Compact styling of the A-120 permits it to be placed almost anywhere, or, if mounted in custom cabinetry, allows "face up" installation.

Rated Output: 20 watts; Peak, 30 watts. **Response:** ± 1 db, 20 to 20,000 cps at full rated output. **Distortion:** Harmonic, less than 0.3%; IM, 1% at 20 watts. **Hum:** Auxiliary and Tuner inputs, -70 db at 20 watts; Magnetic, -60 db at 20 watts. **Inputs:** Magnetic Phono; 2—Auxiliary; Tuner; Tape. **Output Impedances:** 8 and 16 ohms for speakers; low impedance for tape recording. **Controls:** 6-pos. Contour; Loudness; Bass; Treble; Function (LP, RIAA, Eur, Tuner, Aux 1, Aux 2, Tape—15, 7 $\frac{1}{2}$ and 3 $\frac{1}{4}$ ips); 2-pos. Rumble Filter; 3-pos. Speaker Selector. **Tubes:** 2—12AX7, 12AV6, 12AT7, 2—12AB5 power output; 2—6X4 rectifiers. Two convenience AC outlets. Safety interlock AC cord. Size, 3 $\frac{1}{4}$ "x12 $\frac{1}{2}$ "x7 $\frac{1}{4}$ ". Perforated metal cage, styled in brushed copper and black. For 110-120 volt, 50-60 cycle AC. Shpg. wt., 15 lbs.

99 SX 156. NET..... 99.95

Harman-Kardon Low-Cost "Twin" Hi-Fi Components

T-12 "OVERTURE II" FM-AM TUNER

New, and moderately-priced, basic FM-AM tuner delivers top-quality performance. Employs latest printed-circuit wiring techniques. Ideal companion for the A-12 "Prelude II" high-fidelity amplifier (at right). Handsomely styled in copper and black. Features high sensitivity and selectivity, plus wide IF passbands for high-fidelity reception of FM and AM broadcasts. FM circuit employs limiter and Foster-Seeley discriminator; AFC circuit; and low-noise triode RF amplifier and mixer stages. Highly efficient superhet AM circuit offers 8 kc bandwidth (6 db down) and includes built-in ferrite loop antenna.

Sensitivity: FM, 3 μ v for 20 db quieting; AM, 20 μ v. High-impedance output. Professional-type flywheel tuning. 7 tubes plus selenium rectifier. Brushed-copper escutcheon and black matte enclosure. Easy-to-read edge-lighted, slide-rule dial. Size, 3 $\frac{1}{4}$ "x12 $\frac{1}{2}$ "x9". Meets FCC radiation specifications. For operation from 110-120 volts, 50-60 cycle AC. Shpg. wt., 10 lbs.

94 SX 740..... 84.50

A-12 "PRELUDE II" AMPLIFIER

New, A-12 "Prelude II" 12-watt high-fidelity amplifier provides extreme versatility and top-notch performance at exceptionally low cost. An ideal companion for the T-12 tuner (at left). It includes all controls necessary for complete, centralized control in any high-fidelity home music system. Employs latest printed-circuit wiring techniques throughout. Features built-in preamp equalized for tape head and magnetic cartridges; rumble filter; speaker selector.

Rated Output: 12-watts at less than 1% harmonic and 2% IM distortion. **Response:** ± 1 db, 20-25,000 cps at 12 watts. **Hum:** -60 db. **Inputs:** Magnetic phono; Tuner; Tape. **Outputs:** 8 and 16 ohms for speaker; plus output for tape recording. **Controls:** Contour (4-positions); Loudness; Treble; Bass; Function/Equalization (Tuner, Tape, LP, RIAA, RIAA with rumble filter, Eur.); and Speaker Selector. 3 $\frac{1}{4}$ "x12 $\frac{1}{2}$ "x7 $\frac{1}{4}$ ". Copper escutcheon; black matte case. For operation from 110-120 v., 50-60 cycle AC. Shpg. wt. 12 lbs.

94 SX 739. NET..... 59.95

FM-100 "COUNTERPOINT II" BASIC FM TUNER

Custom styled, professional-type basic FM tuner. Represents the successful fulfillment of just one assignment—the most effective reception of the FM broadcast signal. A perfect match for the A-120 hi-fi amplifier (above, right). Outstanding features include: High sensitivity; variable AFC (automatic frequency control) for optimum reception in any area; variable ANG (automatic noise gate—squelch circuit) for reducing noise between stations; rumble filter for suppressing turntable rumble originating at the FM station; tuning meter and flywheel loaded tuning mechanism for simplified tuning;

Armstrong FM circuit with dual limiters (pentode and diode); low noise front-end consisting of tuned triode, grounded-grid RF amplifier and triode mixer. Two outputs—cathode follower and high impedance. **Sensitivity:** 2 μ v for 20 db quieting. **Controls:** Tuning; and concentric AFC Squelch-Power switch. Meter balance, rumble filter, and output level controls on rear panel. 8 tubes; selenium rectifier, and crystal diode. Brushed copper and black styling. 3 $\frac{1}{4}$ "x12 $\frac{1}{2}$ "x7 $\frac{1}{4}$ ". For 110-120 v., 50-60 cycle AC. Shpg. wt. 12 lbs.

99 SX 157. NET..... 99.95

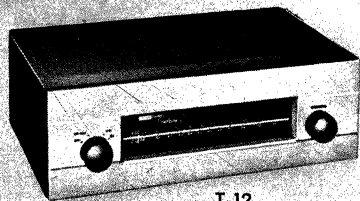

T-12

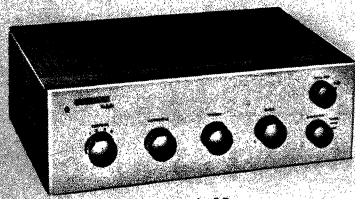

A-12

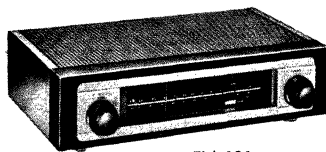

FM-100

MUSIC COMPONENTS

harman kardon

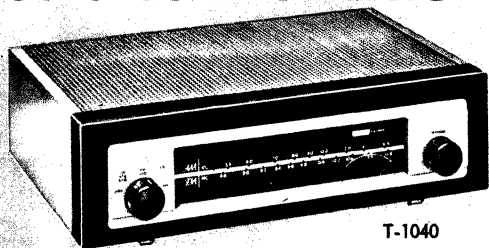

T-1040



A-1040

Harman-Kardon Custom "Twin" High-Fidelity Components

T-1040 "THEME II" BASIC FM-AM TUNER

ONLY
\$140⁰⁰

An outstanding basic FM-AM tuner, worthy of consideration for the finest home music systems. Perfectly matches the A-1040 "Trend II" amplifier (described at right), or any other top-quality hi-fi amplifier with volume and tone controls. Custom features include: Elegant, graceful design and handsome styling; advanced-design; Armstrong FM circuitry with remarkable sensitivity; adjustable automatic frequency control; variable interstation noise gate (ANG); illuminated tuning meter for pin-point accuracy in station selection; rumble filter to eliminate turntable rumble and noise emanating from the FM broadcasting station; superhet AM circuit with tuned RF stage and 10-kc whistle filter; dual cathode follower outputs for amplifier and tape recorder, with adjustable level control—permit the use of long leads between other components. Dimensions of the T-1040 are identical to the A-1040—both units can be stacked to form an attractive, space-saving combination.

FM Circuit: Armstrong FM circuit with double-tuned, dual limiters, Foster-Seeley discriminator, triode-tuned RF amplifier and triode mixer; variable AFC. **AM Circuit:** Broadband superhet with tuned RF stage; 3-stage automatic volume control; 10-kc whistle filter; efficient, built-in ferrite loopstick antenna, plus terminals for adding external antenna. **Sensitivity:** FM, 1.5 μ v for 20 db quieting; AM, 5 μ v. **Hum:** 65 db below 100% modulation. AFC has defeat switch for tuning weak or distant stations. **Controls:** Tuning and Function (On-Off, AM, FM-AFC-ANG, FM-AFC, FM). Other controls include output level, AFC adjustment, automatic noise gate adjustment, meter balance and rumble filter. 11 tubes plus selenium rectifier. Brushed copper escutcheon and enclosure; black panel; edge-lighted, yellow and white dial face. Size, $4\frac{1}{16} \times 13\frac{3}{4} \times 11\frac{1}{2}$ ". For 110-120 v., 50-60 cycle AC. Shpg. wt., 14 lbs.

99 SX 154. NET.....140.00

A-1040 "TREND II" 40-WATT AMPLIFIER

ONLY
\$125⁰⁰

Skilfully designed and highly versatile 40-watt amplifier with controls. Distinctively styled in copper and black to match the T-1040 FM-AM tuner at left; suitable for use with any other top-quality basic hi-fi tuner. Offering unexcelled performance, appearance and audio control, the A-1040 includes this array of notable features: Exclusive controlled "H" circuit employing four 12AB5 output tubes for 40-watt output—generates less heat than a conventional 20-watt amplifier; printed circuit construction; built-in preamplifier with inputs for high, medium and low-level phono cartridges (selector on chassis); auxiliary inputs with level controls; tape input with 3 positions of equalization for basic tape player; tape output ahead of volume and tone controls for recording; 3-position record equalizer; 6-position loudness contour selector; 3-position speaker selector switch for hi-fi systems using 2 speakers—channels music to either or both speakers; variable damping; rumble filter; separate bass and treble controls; etc. Extremely compact in size.

Rated Output: 40 watts at less than 0.3% harmonic and less than 1% IM distortion; 60-watt peaks. **Frequency Response:** ± 1 db, 20 to 20,000 cps at full rated output. **Hum:** Auxiliary and tuner inputs, -70 db at 40 watts; magnetic, -60 db at 40 watts. **Inputs:** Magnetic phono; 2—Auxiliary; Tape; Tuner. **Panel Controls:** 6-position Contour/Loudness; Bass; Treble; Function (LP, RIAA, Eur, Tuner, Aux 1, Aux 2, Tape—15, 7 $\frac{1}{2}$ and 3 $\frac{3}{4}$ ips); 2-position Rumble Filter; 3-position Speaker Selector. **Output Impedances:** 8 and 16 ohms for speakers; low impedance for tape recording. **Tubes:** 2—12AX7, 12AV6, 12AT7, 4—12AB5; 2—EZ81 rectifiers. Two convenience AC outlets. Size, $3\frac{3}{8} \times 13\frac{3}{4} \times 9\frac{3}{4}$ " deep. Brushed copper escutcheon and case; panel edging in black. For 110-120 volt, 50-60 cycle AC. Shpg. wt., 25 lbs.

99 SZ 153. NET.....125.00

Three Harman-Kardon Tuner-Amplifier Combination Units

NEWTA-12 "SOLO II" TUNER-AMPLIFIER

Sensitive FM-AM reception and hi-fi audio from a single, moderately-priced unit. Printed-circuit wiring. Styled in copper and black. **FM:** Armstrong circuit with limiter and Foster-Seeley discriminator; AFC; triode RF amplifier and triode mixer. **AM:** Broadband superhet with AVC and built-in ferrite antenna. **Amplifier:** Two EL84 tubes in output; speaker switch for systems using 2 speakers—channels music to either or both speakers.

Sensitivity: FM, 3 μ v for 20 db quieting; AM, 20 μ v. **Output:** 12 watts at less than 1% harmonic distortion. **Response:** ± 1 db, 20-25,000 cps at 12 watts. **Inputs:** Magnetic phono; Tape; Auxiliary (high impedance). **Output Impedance:** 8 and 16 ohms. **Controls:** Function (AM, FM, FM-AFC, Aux., Phono) Loudness, Treble, Bass, Tuning, Rumble Filter, Contour, Equalizer (LP, RIAA, Eur), and Speaker Selector. 12 tubes plus rectifier. $4\frac{1}{8} \times 14\frac{1}{8} \times 13\frac{1}{2}$ ". Meets FCC radiation specs. For 110-120 volts, 50-60 cycle AC. Shpg. wt., 20 lbs.

94 SZ 741. NET.....139.50

TA-120 "RECITAL II" TUNER-AMPLIFIER

A sensitive FM-AM tuner, an extremely flexible preamplifier, and a 20-watt amplifier on a single chassis, only $4\frac{1}{16}$ " high! **FM:** Armstrong circuit with limiter and Foster-Seeley discriminator; AFC; low-noise, grounded-grid, triode RF amplifier and triode mixer. **AM:** Superheterodyne circuit with AVC and built-in ferrite loopstick antenna. **Amplifier:** Two 12AB5 output tubes. 3-position speaker switch for systems using 2 speakers.

Sensitivity: FM, 3 μ v for 20 db quieting; AM, 20 μ v. **Output:** 20 watts at less than 1% IM and less than 0.3% harmonic distortion. **Response:** ± 1 db 20-20,000 cps at 20 watts. **Inputs:** 1—magnetic phono; 1—auxiliary (high impedance); 1—tape. **Outputs:** 8 and 16 ohms for speakers; plus tape recorder. **Controls:** Tuning; Loudness; Bass; Treble; Function (AM, FM, FM-AFC, Aux. Eur, RIAA, LP, Tape); Contour; Speaker Selector. 13 tubes; plus EZ81 rectifier. $4\frac{1}{16} \times 15\frac{1}{2} \times 14$ ". For 110-120 volts, 50-60 cycle AC. Shpg. wt. 22 lbs.

99 SZ 155. NET.....189.95

TA-1040 "FESTIVAL II" TUNER-AMPLIFIER

Improved custom-quality, hi-fi ensemble—combines features of T-1040 FM-AM tuner and A-1040 40-watt amplifier, on one compact chassis. Uses printed circuit wiring throughout. Features: Variable automatic noise gate to reduce between-station noise on FM; variable automatic frequency control on FM; 6-position loudness contour selector; and tuning meter for easy, accurate tuning of FM and AM. **FM:** Armstrong circuit with dual limiters and Foster-Seeley discriminator. **AM:** Superhet with AVC and built-in ferrite antenna. **Amplifier:** Four 12AB5 output tubes.

Add only a speaker system and a record player to form a complete high fidelity FM-AM-Phono system. **Sensitivity:** FM, 1.5 μ v for 20 db quieting. AM, 5 μ v. **Panel Controls:** Tuning; Contour; Loudness; Bass; Treble; Function (AM, FM, FM-AFC, FM-AFC-Auxiliary Noise Gate, Aux., LP, RIAA, Eur., Tape); Rumble Filter (2-position). **Tubes:** 19, plus 3 rectifiers (1 selenium). Brushed copper enclosure and escutcheon; black panel with edge-lighted dial. Size, $4\frac{5}{16} \times 16\frac{1}{8} \times 14$ ". For 110-120 v., 50-60 cycle AC. Shpg. wt. 30 lbs.

99 SZ 158. NET.....250.00



TA-12



TA-120



TA-1040



80-T

Deluxe High-Fidelity Combination

80-T FM-AM TUNER

\$19950
Less Cabinet

A new high in masterful design, the 80-T FM-AM tuner includes complete, professional audio control facilities. Offers absolute command over listening conditions, extreme sensitivity, and virtually flawless response. Separate tuning meters for FM and AM allow tuning with extreme accuracy. Built-in preamp-equalizer consists of two cascaded triode stages. Six record equalization settings. Fully equalized, separate tape head playback input. Two cathode-follower outputs: 1 for tape recorder (independent of volume and tone controls); 1 for amplifier. DC on all audio tube filaments minimizes hum. Meets FCC radiation specifications.

Sensitivity: FM, 1.5 microvolts for 20 db of quieting; AM, better than 1 microvolt. **Distortion:** Below 0.04% for 1 volt output; 5% for 5 volts output. Hum level completely non-measurable with volume control at minimum (better than 72 db below 2 volts output with control at maximum). **Controls:** AFC, Selector (AM Broad, AM Sharp, FM, Phono, Aux 1, Aux 2); Tuning; Bass; Treble; Tape and Phono Equalization (Eur, AES, RIAA, LP, NAB, 78, Tape); Off-On; Volume; Loudness Balance. 15 tubes; 6X4 rectifier. Brushed brass panel. 6 1/2 x 12 1/4 x 9 1/8". With indoor FM and AM antennas. Less cabinet; see below. For 105-125 v., 50-60 cycles AC. Shpg. wt. 22 lbs.
98 SZ 533. NET. 199.50

WOOD CABINETS FOR 80-T TUNER. Size, 8 1/2 x 13 1/2 x 8 1/2". Shpg. wt., 5 lbs.
98 SX 536. Mahogany. NET
98 SX 537. Blonde. EACH. 17.95

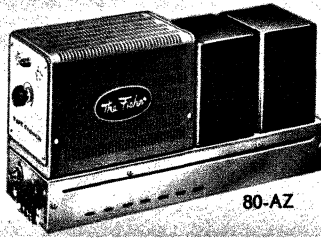

80-AZ

80-AZ 30-WATT BASIC AMPLIFIER

\$9950

A moderately priced unit of conspicuous quality, this superbly designed, 30-watt basic amplifier is the perfect companion to the Fisher Model 80-T FM-AM tuner described at left. Traditional Fisher workmanship and design includes such refinements as the Z-Matic variable damping control for perfect matching of amplifier to your speaker system. Pleasing in appearance, and excellent in design, the 80-AZ handles 60-watt peaks to assure thoroughly authentic reproduction of even the most powerful low-frequency passages.

Three separate feedback loops for low distortion levels and superior transient response. Unique cathode feedback circuit provides triode performance with the efficiency of tetrodes. Output transformer has interleaved windings and a grain-oriented steel core. Ruggedly handsome appearance permits installation on shelf, table-top, etc.; sufficient cable is provided for built-in installation.

Power Output: 30 watts; handles 60-watt peaks. **Distortion:** Less than 0.5% at full rated output; less than 0.05% at 10 watts. **Frequency Response:** Uniform from 10 to 50,000 cps; ±0.1 db from 20 to 20,000 cps. **Hum and Noise:** Better than 95 db below full output. **2 Controls:** Z-Matic and Input Level. **Tubes:** 12AT7, 12AU7A, 2—EL37; 5V4G rectifier. **Output Impedance:** 4, 8 and 16 ohms. Size, 6 1/2 x 15 1/2 x 4 1/2". For operation from 105-125 v., 50-60 cycle AC. Shpg. wt., 23 lbs.
98 SZ 538. NET. 99.50



"500"

NEW "500" FM-AM TUNER-AMPLIFIER

\$24950
Less Cabinet

A modern classic in design and elegant styling, the "500" combines a highly sensitive FM-AM tuner, powerful 30-watt amplifier, and master audio control—on one compact chassis! **FM Section:** Dual triode, cascade circuit with tuned RF stage for extreme sensitivity and maximum signal-to-noise ratio. 3 IF stages followed by a wide-band detector for maximum capture ratio. Highly sensitive; operates on signals as low as 1 microvolt. Includes FM dipole antenna. **AM Section:** Tuned RF stage; efficient ferrite-bar antenna; diode detector circuit for minimum distortion. Sensitivity is better than 3 microvolts for full output.

Professional meter for micro-accurate tuning on both FM and AM, plus flywheel tuning mechanism. **Audio Section:** 4 high-impedance inputs; low-impedance tape recorder output; phono and tape head preamp-equalizer. Response is ±1 db, 16 to 32,000 cps. Harmonic distortion is less than 0.5% at 30 watts; IM, less than 1% at 30 watts. Hum and Noise, —80 db. **Controls:** Tuning; Off-On; Volume-Loudness; Bass; Treble; Selector-Equalizer (AM, FM, AES, RIAA, LP, NAB, Tape, Aux 1, Aux 2). **Output Impedances:** 4, 8 and 16 ohms. 12 tubes; 2 rectifiers; 2 crystal diodes. Size, 6 1/2 x 13 1/2 x 13 1/2". Brushed brass panel. Less cabinet; see below. For 105-125 v., 50-60 cycle AC. Shpg. wt. 26 lbs.
98 SZ 506. NET. 249.50

WOOD CABINETS FOR "500". Size, 9 1/2 x 14 1/2 x 13 1/2". Shpg. wt., 5 lbs.
98 SX 508. Mahogany. NET
98 SX 507. Blonde. EACH. 19.95

NEW FM-90X "GOLD CASCODE" BASIC FM TUNER

ONLY
\$16950
Less Cabinet

Precisely designed for the most exacting FM listener, the new FM-90X is easily one of the finest FM tuners available. Employs a unique gold-cascode RF amplifier tube and highly specialized circuitry to reach the theoretical limits of sensitivity—1/2 microvolt! Two meters, plus the lock-in, drift-free characteristic of its automatic frequency control, assure extremely accurate tuning even by an unskilled user. Outstanding features: Exclusive gold-cascode RF amplifier; silver-shielded front end with dual-triode, cascode-tuned RF stage; 4 IF stages; full, wide-band detector for maximum capture ratio; balanced antenna inputs for maximum signal transfer; variable interstation noise suppressor; etc. **Sensitivity:** Full limiting on signals as low as 1/2 μv; 3/4 μv for 20 db of quieting; 1 1/2 μv for 30 db. **3 Outputs:** Main, Recorder, Multiplex. **2 Controls:** Variable AFC/Off-On & Variable Interstation Muting (dual-concentric); Station Selector. **2 Meters:** Signal-strength, for orienting antenna; Tuning, for center-of-channel. 8 tubes; 4 germanium diodes; 6X4 rectifier. Size, 6 1/2 x 13 1/2 x 8 3/8". Less cabinet; see below. For 105-125 v., 50-60 cycle AC. Shpg. wt., 15 lbs.
99 SX 186. NET. 169.50

WOOD CABINETS FOR FM-90X. Size, 9 1/2 x 14 1/2 x 10". Shpg. wt., 4 1/2 lbs.
94 SX 975. Mahogany. 94 SX 976. Blonde. NET EACH. 17.95

PR-6 LOW-COST PREAMPLIFIER

A self-powered unit of excellent quality and moderate cost. RIAA-equalized for phono; NARTB-equalized for tape head playback. Accommodates any low-level magnetic cartridge, basic tape player mechanism or microphone. Circuit employs two high-gain triode stages. Exclusive feedback design permits the use of long output leads. Fully shielded construction. **Gain:** Phono, 1 volt output for 10 millivolt input; Tape, 1 volt output for 5 millivolts input. **Frequency Response:** ±2 db, 30 to 20,000 cps. **Hum Level:** Better than 60 db below 1 volt on phono and tape; 70 db below 1 v. on mike. Size, 3 1/2 x 3 1/2 x 3 1/2". For 105-125 v., 50-60 cycle AC. Shpg. wt., 1 1/2 lbs.
98 S 528. NET. 10.95

TR-1 TRANSISTOR PREAMP

Hi-fi preamp with RIAA equalization. All-transistor circuitry—no microphonics or hum! Serves as phono or mike preamp—handles all popular magnetic cartridges, including very low-level types, without need for transformer. **Noise:** —65 db. **Controls:** Power-Volume; Input Impedance Selector; Phono or Mike Selector. Permits use of output leads up to 200 ft. Requires battery or AC supply, below, 2x4x4 1/2". 3/4 lb.
94 S 356. NET. 27.50
POWER SUPPLY. For operating TR-1 from 110 v., 60 cycle AC. 2 1/2 x 1 1/2 x 1 1/2". 4 oz.
98 S 517. NET. 4.95
RCA VS304 BATTERY. For TR-1. 3 oz.
80 J 837. NET. 1.05



FM-90X

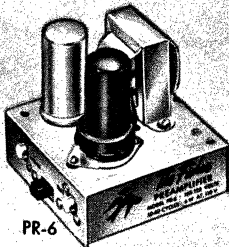

PR-6



TR-1

MUSIC COMPONENTS

FISHER

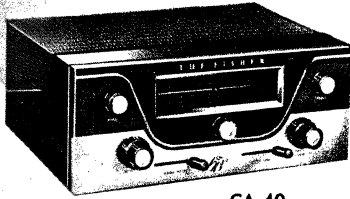

CA-40

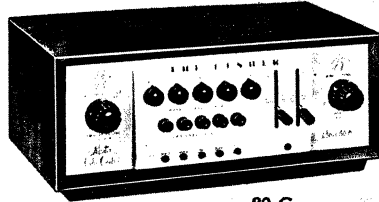

80-C



Series 80

CA-40 MASTER CONTROL AMPLIFIER

\$139⁵⁰

Highly advanced, 25-watt amplifier featuring unique ToneScope. This dramatic innovation provides a visual indication of the actual response curve obtained when bass and treble tone controls are adjusted! Response curve is indicated on an illuminated front panel graph which changes whenever tone controls are re-set. Allows user to pin-point tonal shadings to an unsurpassed degree. Record equalization positions, as they are selected, are also indicated on same panel.

An excellent example of creative engineering, the Model CA-40 also includes these outstanding features: DC filament voltages on all low-level stages for elimination of hum; direct, NARTB-equalized tape head playback and microphone preamplifier; tape recorder output; 6 inputs with input level adjustment; cathode-follower output; and shielded, shock-mounted construction.

Response: ± 0.5 db, from 10 to 90,000 cps. **Harmonic Distortion:** Less than 1% at 25 watts. **Intermodulation:** 1.7% at 20 watts. **Hum and Noise Level:** -90 db on Auxiliary and Tuner inputs; -60 db on magnetic phono input. 0.3 volt on high level and 0.005 volt on low-level inputs produce full 25-watt output. **Output Impedance:** 4, 8 and 16 ohms. **Controls:** Volume-Loudness; Selector-Equalizer (Aux I, Aux II, Tuner, Magnetic Phono, Microphone Tape, Eur, AES, RIAA, LP, NAB); Off-On; Bass; Treble; 3-pos. Rumble Filter; 3-pos. Scratch Filter. Four EL84 tubes in output. Metal cabinet with attractive brass and styrene panel. Size, $5 \times 12 \frac{1}{2} \times 10 \frac{1}{2}$ ". Brass panel. For operation from 105-125 v., 50-60 cycle AC. Shpg. wt., 24 lbs. **98 SZ 516. NET..... 139.50**

80-C MASTER AUDIO CONTROL

\$99⁵⁰

Less Cabinet

Masterfully designed pre-amp-equalizer for controlling any deluxe hi-fi system. Highly flexible, the performance of the 80-C is limited only by the quality of the associated equipment. Hum and distortion are virtually non-existent. Up to 16 combinations of record compensation. NARTB-equalized for tape playback head. Cathode-follower outputs. DC-operated filaments to assure extremely low hum. 4 negative feedback loops. Complete mixing and fading on 2, 3, 4 or 5 channels. High-gain mike preamplifier. Push-button channel selectors.

7 Inputs: 3—high-level (tuner, tape, TV). 1—magnetic phono, 1—constant amplitude phono, 1—microphone, 1—tape-playback. **Panel Controls:** Volume-Loudness/AC Off-On; Volume-Loudness switch; 5 input selector pushbuttons; 4-pos. high-frequency equalization; 4-pos. low-frequency equalization; Bass; Treble. Settings for NARTB tape playback equalization. Each input has level control and indicator light.

Harmonic Distortion: 0.22% at 15v. **IM:** 0.65% at 15 v. **Response:** ± 0.25 db. 20 to 20,000 cps, ± 2 db. 10 to 100,000 cps. **Hum & Noise:** High-level inputs, completely non-measurable with volume control at zero; better than 85 db below 2 volts. Size, $4 \frac{1}{2} \times 12 \frac{1}{2} \times 7 \frac{3}{4}$ ". Less cabinet. For operation from 105-125 v., 50-60 cycles AC. Shpg. wt., 10 lbs. **94 SX 353. NET..... 99.50**

WOOD CABINETS FOR 80-C. Size, $5 \frac{1}{2} \times 8 \times 13 \frac{1}{16}$ ". Shpg. wt., $3 \frac{1}{2}$ lbs. **94 SX 354. Mahogany. NET**
94 SX 355. Blonde. EACH..... 9.95

SERIES 80 BASIC TUNERS

Each of the basic tuners listed below meets FCC radiation specs. Both operate from 105-125 v., 50-60 cycle AC. The AM-80 (not illustrated), is similar in size and appearance to the 80-R.

MODEL 80-R, FM-AM TUNER. Separate front ends for FM and AM; individual tuning meters for FM and AM; cathode-follower output; inputs for Tape, TV, Crystal Phono. Tuned RF stage and two IF stages followed by two cascaded limiters and Foster-Seeley discriminator. Adjustable AFC and adjustable AM selectivity. **Sensitivity:** FM, $1 \frac{1}{2}$ μ v for 20 db of quieting on 72-ohm antenna input; 3 μ v for 20 db quieting on 300-ohm input; AM, less than 1 μ v. 10 kc AM whistle filter. Size, $4 \times 12 \frac{1}{4} \times 8 \frac{3}{4}$ ". Less cabinet. Shpg. wt., 16 lbs. **98 SX 532. NET..... 169.50**

MODEL AM-80 AM TUNER. Designed specifically for use in areas beyond the service of FM stations. Provides the "pulling power" of a professional communications receiver for excellent reception of distant, hard-to-get stations. Three-position adjustable bandwidth for broad, medium and sharp tuning. Relative-sensitivity tuning meter for micro-accurate station selection. Has one tuned RF stage and two IF stages. Built-in 10 kc whistle filter. Cathode follower output. **Sensitivity:** Better than 1 μ v. **Controls:** Off-On/Sensitivity. Bandwidth, Tuning, 7 tubes; 6X4 rectifier. Less cabinet. Shpg. wt., 15 lbs. **98 SX 539. NET..... 119.50**

WOOD CABINETS FOR 80-R, AM-80 AND FM-40. Shpg. wt., $4 \frac{1}{2}$ lbs. **98 SX 518. Mahogany. NET**
98 SX 519. Blonde. EACH..... 17.95

LOW-COST FM-40 BASIC FM TUNER

ONLY
\$99⁵⁰

Less Cabinet

A compact and skillfully designed basic FM tuner, the FM-40 is a superb combination of engineering excellence and brilliant performance at moderate cost. Provides reception that more than fulfills the requirements of the most discriminating FM listener. Circuit employs three IF stages and a cascade RF stage for optimum selectivity, excellent gain and high signal-to-noise ratio. Center-of-channel tuning meter for micro-accurate selection of stations. Flywheel dial mechanism for smooth tuning. **Sensitivity:** 3 microvolts for 20 db quieting and 5 microvolts for 30 db quieting. **2 Outputs:** Main Audio (cathode follower permits using up to 200 feet of cable to amplifier); also Detector Multiplex. **Controls:** Off-On-Volume and Station Selector. Fully shielded and shock-mounted chassis. Accommodates 72 or 300-ohm external antenna—FM folded dipole antenna supplied. 7 tubes; 6X4 rectifier, $4 \times 12 \frac{1}{4} \times 7 \frac{3}{4}$ ". Less cabinet, see listing under AM-80, above right. For 105-125 v., 50-60 cycle AC. Wt., 15 lbs. **98 SX 527. NET..... 99.50**

BASIC AMPLIFIERS

MODEL 55-A 55-WATT. All-triode design, Power Monitor and Z-Matic variable damping. Power Monitor prevents damage to speaker and verifies correct output tube bias. **Output:** Rated, 55 watts; peak, 110 watts. **Response:** ± 0.1 db, 20-20,000 cps; ± 1 db, 5 to 100,000 cps. **Harmonic Distortion:** Less than 1% at 55 watts. **IM:** Below .2% at 50 watts. **Output Impedances:** 8 and 16 ohms. $8 \frac{1}{2} \times 14 \frac{1}{2} \times 11 \frac{1}{8}$ ". For 105-125 v., 50-60 cycle AC. Shpg. wt., 50 lbs. **98 SZ 515. NET..... 169.50**

MODEL 20-A 15-WATT. Not illustrated. Less Power Monitor, Z-Matic feature. **Output:** 15 watts. **Response:** ± 0.1 db, 20 to 20,000 cps. **Harmonic Distortion:** Less than 0.7% at 15 watts. **IM:** 1.5% at 10 watts. **Output Impedances:** 4, 8, and 16 ohms. $6 \frac{3}{4} \times 13 \times 4 \frac{1}{4}$ ". Shpg. wt., 13 lbs. **98 SX 526. NET..... 59.50**

NEW 125-WATT BASIC AMPLIFIER

MODEL 125-A. A superb, laboratory-quality instrument, designed for the finest hi-fi systems. Provides enormous reserve power for present, and any future audio needs. Reproduces the most complex musical passages without coloration or clipping. Drives even the lowest efficiency speaker system to full undistorted output without amplifier overload. Has Power Monitor output meter, calibrated in watts, to indicate correct adjustment of output tube bias, as well as average audio power. Z-Matic variable damping control. Has 2 power supplies. **Response:** ± 0.1 db, 20 to 20,000 cps. **Distortion:** Harmonic, less than 0.6% at 125 watts; IM, less than 1% at 100 watts. **Hum & Noise:** Better than 92 db below full output. **Output Impedances:** 8 and 16 ohms. Size, $8 \frac{1}{2} \times 14 \times 11 \frac{1}{8}$ ". For 105-125 v., 50-60 cycle AC. Shpg. wt., 55 lbs. **99 SZ 227. NET..... 219.50**



FM-40

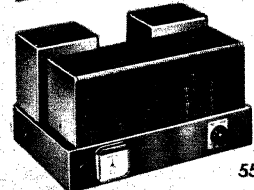

55-A

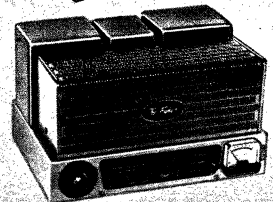

125-A

Express Shipment Recommended for Hi-Fi Equipment

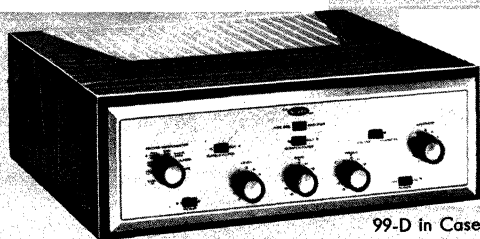

99-D in Case

NEW 99-D DELUXE 22-WATT AMPLIFIER

\$99⁹⁵

Less Case

Important new features make this latest model of the Scott 99 series amplifiers an exceptional choice for the hi-fi music ensemble. Compact and unusually versatile, it's the last word in careful design and outstanding performance. "Green Dot" control settings make the amplifier easy to use. Panel design permits simplified custom installation.

New features include: Front panel speaker-selector switch that lets you select either of two speakers or both speakers at once; new tape recording provisions including front panel monitor-playback switch for use with 3-head recorders; easily accessible tape recorder output and monitoring jacks on rear panel. Also includes 5-pos. record equalizer; rumble and scratch filters; NARTB tape playback channel for connecting tape playback head without external preamp; input selector switch for two magnetic pickups—allows connecting both a record changer and turntable and selecting either without changing connections; etc.

Output: 22 watts; 44-watt peaks. **Response:** Flat from 20 to 30,000 cps. **Harmonic Distortion:** Less than 0.8%. **Hum:** 80 db below rated output. **Output Impedances:** 4, 8 and 16 ohms. DC filament supply on low-level tubes. **Controls:** Selector-Equalizer (Eur 78, Orig. Lon, Orig. AES, RIAA-NARTB, Orig. Col, NARTB Tape, Tuner, Tape); Mag 1 or 2; Rumble Filter; Scratch Filter; Volume-Loudness; Loudness; Input Level; Bass; Treble; Off-On. Two 6L6GB tubes in output. Gold panel, 4 $\frac{3}{4}$ x15 $\frac{1}{2}$ ". Less case; see below. For 105-125 v., 50-60 cycle AC. Shpg. wt., 20 lbs.

94 SZ 582. NET

99.95



210-F in Case

NEW 210-F DELUXE DYNAURAL 36-WATT AMPLIFIER

\$189⁹⁵

Less Case

Completely redesigned, 36-watt amplifier with dynaural noise suppressor. Brand-new features include: Speaker selector switch for choosing between either of two speakers or playing both at once; front panel tape monitor and playback switch; new Dynamic Noise Suppressor with continuous adjustment for rumble and hiss suppression; two magnetic phono inputs switched from front panel, new "cycle-flow" circuitry for low-temperature operation of components; maximum accessibility of all connections. Also has sub-sonic filter to prevent amplifier and speaker overload due to eccentric records and turntable rumble. Tape inputs: NARTB tape input for playback direct from tape heads without external preamp; high-level tape playback channel; monitor provisions for use with 3-head recorders; 2 tape recorder outputs including one before noise suppressor and tone controls, and one after, for recording noisy programs of records.

Output: 36 watts. **Response:** Flat from 19 to 35,000 cps. **Harmonic Distortion:** 0.5%. **Hum:** -80 db. **Inputs:** Mag 1 or 2, Crystal Phono, Tuner, Tape, TV. Tape outputs, Monitor, Level control and Speaker Selector on rear panel. **Controls:** Selector-Equalizer (Eur 78, Orig. Lon, Orig. AES, RIAA-NARTB, Orig. Col, NARTB Tape, Tuner, Tape, TV); Mag 1 or 2; Dynamic Noise Suppressor; Low-Frequency Noise Control; High-Frequency Noise Control; Distortion Filter; Volume-Loudness; Bass; Treble; Loudness; Speaker Selector; Off-On; Tape Monitor. **Output Impedances:** 4, 8, and 16 ohms. Two 6CA7 output tubes. Size, 4 $\frac{3}{4}$ x15 $\frac{1}{2}$ x12 $\frac{1}{2}$ ". Less case; see below. For 105-125 v., 50-60 cycle AC. Shpg. wt., 27 lbs.

94 SZ 583. NET

189.95

330-C BASIC FM-AM STEREO TUNER

Superbly designed, highly sensitive tuner. Has complete and separate AM and FM sections to permit reception of stereo broadcasts. Signal strength meter for simple, accurate tuning. **FM Section:** 2 μ v sensitivity for 20 db quieting; 1 μ v with 72-ohm antenna. Wide-band design; 2 mc detector; automatic gain control. **AM Section:** 1 μ v sensitivity for usable audio output; new, extremely effective detector; 10 kc whistle filter; 4 v. audio output for 100% modulation. **Controls:** FM vernier and quick tuning; AM vernier and quick tuning; Off-On; Selector (FM, AM Wide Range, AM Normal, AM Distance). Separate output jacks for feeding stereo amplifier system or tape recorder. 11 tubes; 2 diodes; 6X5 rectifier. 4 $\frac{3}{4}$ x15 $\frac{1}{2}$ x12 $\frac{1}{2}$ ". Less case; see below. For 105-125 v., 50-60 cycle AC. 17 lbs.

94 SX 584. NET

199.95

331-C FM-AM STEREO TUNER

Includes all of the features of the 330-C FM-AM tuner described at left, plus a complete equalizer and preamplifier. Requires only a basic amplifier (see Model 240 on page 41) and speaker system to make a highly flexible FM-AM installation. By adding another amplifier and speaker system, you can receive stereo FM-AM broadcasts. Inputs include 2 low-level magnetic phono and 2 high-level for tape and TV. Outputs include: Main, Tape Recorder, FM and AM stereo. **Controls:** Selector-Equalizer (Eur 78, Orig. AES, RIAA-NARTB, Orig. Col, NARTB Tape, FM, AM Wide Range, AM Normal, AM Distance, Tape); Bass; Treble; Off-On/Loudness; Volume-Loudness switch; FM and AM Tuning; Mag 1 or 2. 13 tubes. 4 $\frac{3}{4}$ x15 $\frac{1}{2}$ x12 $\frac{1}{2}$ ". Less case; see below. For 105-125 v., 50-60 cycle AC. Wt. 19 lbs.

94 SX 585. NET

259.95

NEW 311-C BASIC FM TUNER

New, greatly improved basic FM tuner with silver-plated front end for high sensitivity. Includes: Automatic gain control; low impedance output to permit connecting cables up to 70 ft. in length; signal strength meter; coarse or fine tuning. Wide-band circuitry consists of 150 kc IF passband, 2 mc detector bandwidth; 2 stages of full limiting; 80 db rejection of spurious response. Separate tape recorder and multiplex output. **Sensitivity:** 2 μ v for 20 db of quieting; 1 μ v with matched 72-ohm antenna. **Max. Audio Output:** 4 v. for 75 kc deviation. **Controls:** Off-On/Level; Tuning; 6 tubes; 2 diodes; 6X4 rectifier. 4 $\frac{3}{4}$ x13 $\frac{1}{4}$ x9 $\frac{3}{4}$ ". Less case; see below. For 105-125 v., 50-60 cycle AC. Shpg. wt., 15 lbs.

94 SX 586. NET

129.95

310-B BASIC FM TUNER

Professional broadcast monitor, basic FM tuner for deluxe hi-fi systems. Wide-band design with 150 kc IF pass band and 2 mc limiters and detector; 3 stages of full limiting. Interstation Noise Suppressor eliminates FM "hiss". Automatic gain control. Signal strength meter. Low-impedance output permits use of long leads. Tape recorder output. **Sensitivity:** 1 $\frac{1}{2}$ μ v on 300-ohm input with 20 db of quieting. 85 db rejection of cross modulation. **Max. Audio Output:** 4 v. for 75 kc deviation. **Controls:** Tuning, Fine Tuning, Level, Noise Suppressor, 9 tubes; 3 diodes; 6X5 rectifier. Size, 4 $\frac{3}{4}$ x13 $\frac{1}{4}$ x9 $\frac{3}{4}$ ". Less case; see below. For 105-125 v., 50-60 cycle AC. 14 lbs.

94 SX 587. NET

169.95

CASES FOR SCOTT UNITS. *Steel, leather finish. †Wood. Av. shpg. wt., 1 $\frac{1}{2}$ lbs.

No.	Type	HWD	Description	For	EACH
94 SX 577	C*	4 $\frac{3}{4}$ x15 $\frac{1}{2}$ x12"	Steel	99-D, 210-F, 300, 330-C, 331-C	9.95
94 SX 578	D*	4 $\frac{3}{4}$ x13 $\frac{1}{4}$ x10 $\frac{1}{2}$ "	Steel	310-B, 311-C, 121-C	9.95
94 SX 580	CWMT†	5 $\frac{1}{8}$ x15 $\frac{1}{2}$ x12 $\frac{1}{2}$ "	Mahogany	99-D, 210-F, 300, 330-C, 331-C	19.95
94 SX 590	DWMT†	5 $\frac{1}{8}$ x13 $\frac{1}{4}$ x9 $\frac{3}{4}$ "	Mahogany	310-B, 311-C, 121-C	19.95
94 SX 581	CWB†	5 $\frac{1}{8}$ x15 $\frac{1}{2}$ x12 $\frac{1}{2}$ "	Blonde	99-D, 210-F, 300, 330-C, 331-C	19.95
94 SX 591	DWB†	5 $\frac{1}{8}$ x13 $\frac{1}{4}$ x9 $\frac{3}{4}$ "	Blonde	310-B, 311-C, 121-C	19.95

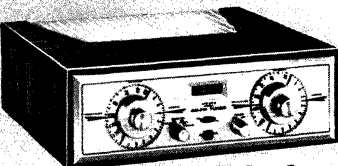

330-C in Case

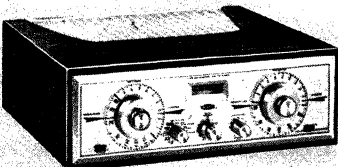

331-C in Case

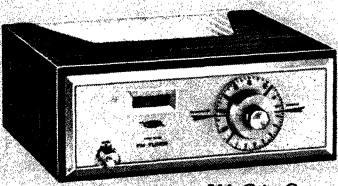

311-C in Case

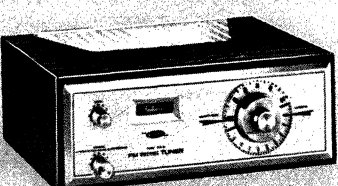

310-B in Case

MUSIC COMPONENTS

H. H. SCOTT, inc.

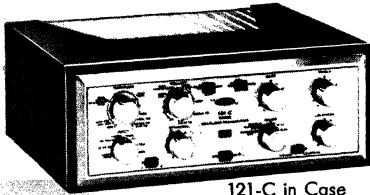

121-C in Case

121-C PREAMP-EQUALIZER

\$169⁹⁵

Less Case

A professional-quality preamp-equalizer, the 121-C offers the audio connoisseur the ultimate in control flexibility. Continuously variable controls provide an infinite number of compensation settings for matching any recording characteristic; provision for 2 magnetic inputs; Dynaural Noise Suppressor with switchable rumble filter to allow scratch suppression only, rumble suppression only, or both together; separate channel for playback direct from tape recorder heads; switch for monitoring right off the tape with 3-head recorders; 2. Cathode-follower outputs; two tape recorder outputs. *Controls:* 8-pos. Input Selector (NARTB Tape, 33 $\frac{1}{2}$, 45, 78, Trans, Tuner, Tape, TV, Extra, Spare); Mag 1 or 2; Dynaural Noise Suppressor; Off-On; Range (Suppressor Off, Rumble Suppressor Only, etc.); Volume-Loudness; Loudness; continuously variable Turnover; continuously variable Roll-off; Rumble Suppression On-Off; Amp/Tape Monitor; Bass; Treble. 6 tubes; 6X4 rectifier. 4 $\frac{1}{2}$ x13 $\frac{1}{2}$ x9 $\frac{3}{4}$ ". Less case; see page 40. For 105-125 v., 50-60 cycle AC. Shpg. wt., 14 lbs. **94 SX 588. NET. 169.95**

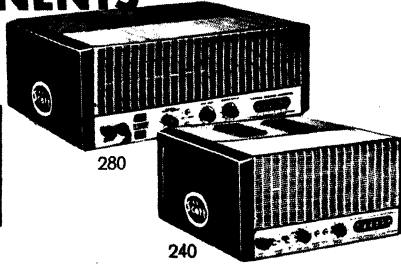

280

240

BASIC AMPLIFIERS

MODEL 280 80-WATT. Fulfills the most demanding requirements of audio perfectionists. Skillfully engineered down to the finest detail. "Dynamic Power Monitor" circuit protects speakers from overload damage. Adjustable damping control for perfect match between amplifier and speaker system. Class "A" circuitry. *Power Output:* Rated, 80 watts; instantaneous peak, 160 watts. *Response:* Flat from 12 to 60,000 cps. Balanced output circuit. *Hum:* 90 db below rated output. *Harmonic Distortion:* Less than 0.5%. *IM (1st order):* Less than 0.1%. *Output Impedances:* 4 to 24 ohms and 70-v. output for PA systems. 4-6CA7's in output. 18x13x6 $\frac{1}{2}$ ". For 105-125 v., 50-60 cycle AC. Shpg. wt., 45 lbs. **94 SZ 570. NET. 229.95**

MODEL 240 40-WATT. *Output:* Rated, 40 watts; 80 watts instantaneous peak. *Response:* Flat from 12 to 60,000 cps. *Harmonic Distortion:* 0.5%. *IM (1st order):* 0.1%. Hum balance and input level adjustment, etc. Variable damping. *Impedances:* 4 to 24 ohms and 70-v. output for P.A. Two 6CA7's. 13x11x6 $\frac{1}{2}$ ". For 105-125 v., 50-60 cycle AC. Wt., 22 lbs. **94 SZ 571. NET. 119.95**

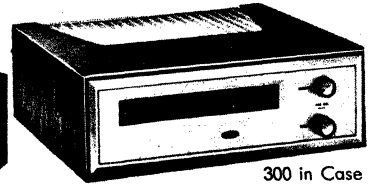

300 in Case

NEW 300 FM-AM BASIC TUNER

\$159⁹⁵

Less Case

Outstanding in performance and workmanship, this new FM-AM basic tuner conforms to Scott's traditional standards of excellence in design. Features absolute freedom from noise, drift and distortion—matches other Scott components.

FM Section: Silver-plated front end for maximum sensitivity; 3 μ v sensitivity on 300-ohm input for 20 db of quieting; 150 kc IF passband assures reception of weak stations without distortion; 2 mc detector bandwidth and temperature-compensated oscillator for drift-free tuning; automatic gain control; 2 stages of full limiting; steep IF response for maximum selectivity. *AM Section:* Separate tuned RF amplifier stage; adjustable AM reception from front panel; 10 kc whistle filter. *Controls:* Selector (FM, AM Normal, AM Wide Range); Tuning. Flywheel tuning and "precision-ray" tuning indicator. *Outputs:* Main, Tape Recorder, Multiplex, 8 tubes; 2 diodes; 6X4 rectifier. Meets FCC radiation specs. 5x15 $\frac{1}{2}$ x12 $\frac{1}{2}$ ". Less case; see page 40. For 105-125 v., 50-60 cycle AC. Shpg. wt., 14 lbs. **94 SX 589. NET. 159.95**

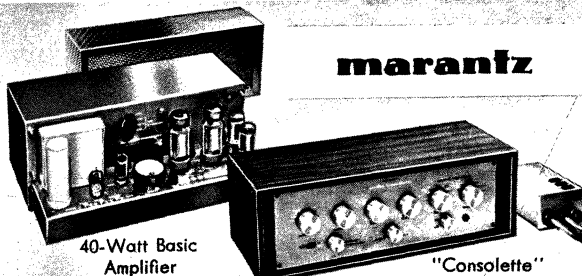

40-Watt Basic Amplifier

"Consolelette"

marantz

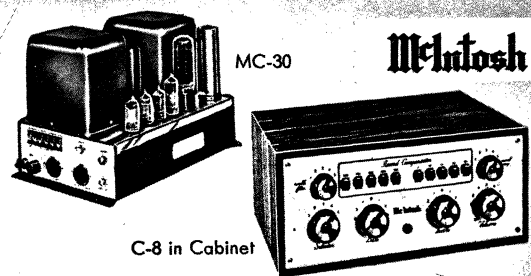

MC-30

C-8 in Cabinet

McIntosh

AUDIO CONSOLETTA PREAMP-EQUALIZER. Superbly designed unit. Employs deposited-carbon resistors, silvered mica capacitors, terminal board construction, etc. 2-piece chassis with separate miniature power supply. Spectacularly low distortion and noise figures. *Hum:* Inaudible at full gain. *Response:* ± 1 db, 20-60,000 cps. *IM Distortion:* 12 v. RMS, 0.5%. *Inputs:* 3—low-level for Mike, low or medium-level Magnetic Cartridges; 4—high-level for Tuner, Tape, TV, Extra. Cathode follower output. Tape recording output unaffected by all controls except record equalizers. *Controls:* 6-pos. Input Selector; Tape-Playback or Monitor; 6-pos. Bass; 6-pos. Treble; Loudness; Bass and Treble Tone; Hi-Frequency Filter; On-Off. 6x17x7 $\frac{1}{2}$ ". For 110-120 v., 50-60 cycle AC. Wt., 13 lbs. **99 SX 168. Mahogany. 99 SX 169. Blonde. NET EACH. 171.00**

40-WATT BASIC AMPLIFIER. Deluxe, 40-watt ultra-linear amplifier. Switch permits 20-watt triode operation to protect low-power speaker systems. Built-in meter and switch for Bias, DC Balance, AC Balance. Variable damping. *Hum:* -90 db. *Response:* ± 1 db, 15-45,000 cps. *Distortion:* Harmonic, under 0.5% to 10 kc; IM, 0.5% at 40 watts. *Output Impedances:* 4, 8, and 16 ohms. 6 $\frac{1}{2}$ x15x9 $\frac{1}{2}$ ". For 110-120 v., 50-60 cycle AC. Shpg. wt. 46 lbs. **99 SZ 006. NET. 198.00**

NEW ELECTRONIC CROSSOVER. Not illustrated. For hi-fi systems using 2 amplifiers. Connects speaker system directly to respective amplifier. A basic 2-channel unit—use one for a 2-way speaker system; use two for 3-way speaker system. *IM:* Less than 0.1%. With separate power supply. Shpg. wt. 8 lbs. **93 SX 532. NET. 90.00**

CABINET FOR ABOVE. Houses 1 or 2 crossovers. 14 $\frac{1}{2}$ x4 $\frac{1}{2}$ x6". 2 lbs. **93 SX 533. Mahogany. 93 SX 534. Blonde. NET EACH. 19.50**

BLANK PANEL. Covers unused section of cabinet when only one crossover unit is employed. Gold finished metal. Shpg. wt., 1 lb. **93 S 535. NET. 3.00**

MC-30 30-WATT BASIC AMPLIFIER. Offers flawless audio reproduction. Special circuit employs "unity coupling" for greater power output without distortion. For use with C-8 preamp (below), or any other quality preamp or tuner with full set of controls. Only 0.5 v. input is required for full 30 watt output. *Response:* ± 0.1 db, 20 to 30,000 cps. *Distortion:* Harmonic, less than $\frac{1}{2}$ % at 30 watts; IM, less than 0.5%. *Hum & Noise:* -90 db. *Output Impedances:* 4, 8, 16 and 600 ohms. 2-1614's in output. Black and chrome styling. 8x13x8". For 110-120 v., 60 cycle AC. Shpg. wt., 36 lbs. **93 SZ 895. NET. 143.50**

MC-60 60-WATT BASIC AMPLIFIER. Similar to above. *IM Distortion:* Less than 0.5% at 60 watts. *Hum:* -90 db. 2-6550 output tubes. 8x14x10". For 110-120 v., 60 cycle AC. Wt., 41 lbs. **93 SZ 899. NET. 198.50**

C-8 AUDIO COMPENSATOR. Highly flexible equalizer-preamp. For use with MC-30, MC-60 basic amplifiers. *Controls:* Rumble Filter; Record Compensator with 10 slide switches; Aural Compensator; Loudness; 5-pos. Input Selector; Bass; Treble; Off-On/Volume. 5 inputs, each with level control. 3 $\frac{1}{2}$ x10x7 $\frac{1}{2}$ ". Less cabinet; see below. Takes power from MC-30 or MC-60. Wt., 7 $\frac{1}{2}$ lbs. **93 SX 898. NET. 88.50**

C-8P SELF-POWERED COMPENSATOR. As above, but self-powered for use with any amplifier. Plugs into AC line. 3 $\frac{1}{2}$ x10x7 $\frac{1}{2}$ ". Less cabinet; see below. For 110-120 v., 60 cycle AC. Wt., 12 lbs. **93 SX 890. NET. 99.50**

C-4P EQUALIZER-PREAMP. With controls. 3 $\frac{1}{2}$ x10x7 $\frac{1}{2}$ ". Less cabinet; see below. For 110-120 v., 60 cycle AC. Wt., 11 lbs. **93 SX 708. NET. 75.50**

WOOD CABINETS. For C-8, C-8P, C-4P preamps. Size, 4 $\frac{1}{2}$ x11 $\frac{1}{8}$ x7 $\frac{1}{2}$ ". Shpg. wt., 1 $\frac{1}{4}$ lbs. **93 SX 898. Mahogany. 93 SX 709. Blonde. NET EACH. 8.00**

Bell

HIGH FIDELITY AMPLIFIERS



2315



2325

NEW MODEL 2315 12-WATT AMPLIFIER

ONLY
\$68⁵⁵

New, completely restyled, ultra-compact 12-watt hi-fi amplifier with controls. Perfect for the moderately priced home music system, this versatile unit offers all the deluxe features of larger amplifiers. Combines smart, low-silhouette styling with outstanding performance. New, "magic touch" control combines on-off switch with loudness control. With the push-pull switch pre-set to the loudness position you prefer, you simply push knob to shut off, or pull the knob to start your system playing—no need to readjust volume or loudness each time you turn on amplifier. Offers unexcelled convenience and ease of operation.

Only 4" high, the Model 2315 can be placed on a table, shelf, mantel, bookcase, etc. Can also be mounted in custom cabinet with only the panel exposed. Continuous strip of light along the control panel functions as a pilot light and illuminates controls in the dark. Handsomely styled in rich, saddle-tan finish, the 2315 blends gracefully with any interior decorative scheme. Other features include: Built-in preamplifier with three positions of record equalization and equalized tape head input; inputs for all associated hi-fi equipment—simply plug in your record player, tape recorder or tuner and connect to speaker system; control versatility allows you complete command over musical reproduction!

Power Output: 12 watts; handles 20-watt peaks. **Frequency Response:** ± 0.5 db, 20 to 20,000 cps. **Distortion:** Harmonic, less than 0.5%; IM, less than 3%. **Hum:** 75 db below 12 watts. **Inputs:** 2—low-level Magnetic or Tape Head, Crystal or Ceramic Phono, high-level Magnetic, Radio Tuner, Auxiliary. **Controls:** "Magic Touch" On-Off-Loudness; Bass; Treble; Level; Selector-Equalizer (Tape, RIAA, 78, Eur, Radio, Aux); Phono/Tape input selector (Low-level Mag, Tape and Ceramic/Crystal; low-level Mag, Tape or high-level Mag). Rumble filter switch. Hum balance adjustment. **Output Impedances:** 4, 8, 16 ohms and recording. **Tubes:** 2—6V6GT, 3—ECC83/12AX7; 5Y3GT rectifier. Two convenience AC outlets. Size, 4x13 $\frac{1}{2}$ x9". For 110-120 volt, 60 cycle AC. Shpg. wt., 15 lbs.

94 SX 736. NET..... 68.55

NEW MODEL 2325 20-WATT AMPLIFIER

ONLY
\$107⁷⁵

All-new exceptionally well-designed, 20-watt amplifier with controls. Offers outstanding Bell quality and precision engineering. The unusual reserve power-handling capacity of the Model 2325, plus highly flexible controls, make it an excellent choice for use with other custom components. Includes the ultra-convenient, single-dial "Magic Touch" control. After setting the loudness control to the desired volume, all you need do is pull the knob to start the music playing, and push it in to stop. There's no further need to readjust the volume or loudness when using the system at another time!

The Model 2325 also includes a 3-position speaker selector switch for hi-fi ensembles using two speaker systems. Switch allows you to play either of the speakers separately, or both together. Other features include separate rumble filter and scratch filter switches, 4 positions of record equalization, equalized tape head input, etc. Space-saving design permits installation anywhere. Low silhouette, with illuminated control panel, adds a dramatic touch to any room. Enclosure is attractively finished in saddle tan; may be dismantled for fast, easy custom installation.

Power Output: 20 watts; handles 40-watt peaks. **Frequency Response:** ± 0.3 db, 20 to 20,000 cps. **Distortion:** Harmonic, less than 0.3%; IM, less than 0.5%. **Hum:** 75 db below 20 watts. **Inputs:** 2—low-level Magnetic or Tape Head, Crystal or Ceramic Phono, high-level Magnetic, Radio Tuner, TV, Auxiliary. **Controls:** "Magic Touch" On-Off-Loudness; Rumble Filter; Scratch Filter; 3-pos. Speaker Selector; Bass; Treble; Level; 8-pos. Selector-Equalizer (Tape, 78, RIAA, LP, Eur, Radio Tuner, TV, Aux); Phono/Tape input selector (low-level Mag, Tape or Ceramic/Crystal; low-level Mag, high-level Mag, or Tape). Tuner input has Level control. Hum balance adjustment. **Output Impedances:** 4, 8 and 16 ohms; high-impedance for tape recording. 2 separate outputs for speakers to be switched. **Tubes:** 3—ECC83, 12AV6, 2—6L6GB; SU4GB rectifier. Size, 4 $\frac{1}{2}$ x16x11". For 110-120 v., 60 cycle AC. Shpg. wt., 24 lbs.

94 SZ 737. NET..... 107.75

MODEL 2360 50-WATT AMPLIFIER

New, 50-watt hi-fi amplifier with controls. Meets the most exacting requirements of the audio perfectionist. Has all the deluxe features of the Model 2325 described above, plus extremely high power-handling capacity (handles 100-watt peaks!). Low-silhouette styling; saddle-tan finish.

Power Output: 50 watts. **Frequency Response:** ± 0.5 db, 20 to 20,000 cps. **Distortion:** Harmonic, less than 0.5%; IM, less than 1%. **Hum:** 75 db below rated output. **Inputs:** 2—low-level Magnetic or Tape Head, Crystal or Ceramic Phono, high-level Magnetic, Radio Tuner, TV, Auxiliary. **Controls:** "Magic Touch" On-Off-Loudness; Rumble Filter; Scratch Filter; 3-pos. Speaker Selector switch; Bass; Treble; Level; Selector-Equalizer (Tape, 78, RIAA, LP, Eur, Radio, TV, Aux). Phono/Tape input selector, etc.

Output Impedances: 8 and 16 ohms; high-impedance for tape recording. **Tubes:** 2—ECC83, 12AV6, 6AN8, 2—6CA7; GZ34 rectifier. Size, 5 $\frac{1}{2}$ x16x11". For 110-120 v., 60 cycle AC. Shpg. wt., 35 lbs.

94 SZ 738. NET..... 156.75

MODEL 3-DT STEREO AMPLIFIER

Dual-channel, hi-fi amplifier for reproduction of binaural records, tapes and broadcasts. Also use as monaural amplifier (utilizing both output channels). Has equalized (NARTB) tape inputs for playing stereo tapes from basic tape mechanism.

Output: 12 watts per channel. Under 0.5% distortion. **Response:** ± 0.5 db, 20-20,000 cps. **Hum:** 70 db below rated output. **Dual Inputs:** Radio, tape, tape preamp, dual aux., magnetic phono. **Dual Outputs:** 4, 8, 16 ohms plus dual tape recording. **Controls:** 4-pos. Selector; 6-pos. Function Switch (Binaural-Monaural-Loudness combinations); Balance (2-channel gain); Gain (both channels simultaneously); Bass, Off-On-Treble. 8x15x11". 10 tubes, rectifier. Less cage, listed below. For operation from 110-120 v., 60 cycle AC. Shpg. wt., 28 lbs.

98 SZ 596. NET..... 146.95

METAL CAGE FOR ABOVE. Distinctively styled in handsome ivory and brown finish. Shpg. wt., 4 lbs.

98 SX 597. NET..... 12.69

MODEL 2285 "PACEMAKER" 10-WATT AMPLIFIER

The Model 2285 10-watt hi-fi amplifier with controls really sets the pace for high performance at low cost! Simply designed, but with a host of desirable features, it includes: Built-in preamp with phono equalized to RIAA curve; separate bass and treble tone controls; 10 watts of full-range, low-distortion power; low-noise ECC83 tubes in preamp section; compact enclosure for use as is, or for quick, easy installation in custom cabinets; non-scratch nylon feet on bottom of enclosure prevent marring or damaging of furniture finishes.

Output: 10 watts; handles 16-watt peaks. **Response:** ± 1 db, 20 to 20,000 cps. **Distortion:** 2% at 10 watts. **Hum:** -65 db. **Inputs:** Magnetic Phono or Tape Head; Radio or TV; Auxiliary (for Crystal or Ceramic Phono). **Controls:** Equalizer-Selector (Aux, Phono—equalized to RIAA curve, Radio); Volume; Bass; On-Off-Treble. **Output Impedances:** 4, 8 and 16 ohms; high-impedance for tape recording. **Tubes:** 2—6V6GT, 2—ECC83; 6XSGT rectifier. 3 $\frac{1}{2}$ x11 $\frac{1}{2}$ x9". For 110-120 v., 60 cycle AC. Wt., 10 lbs.

98 SX 823. NET..... 48.51



2360

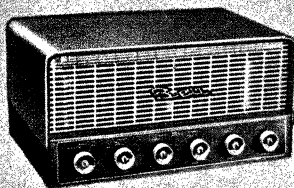

3-DT

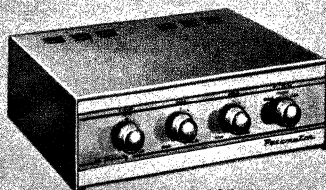

2285

HIGH FIDELITY COMPONENTS

Grommes

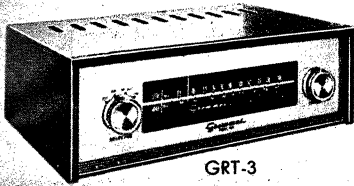

GRT-3

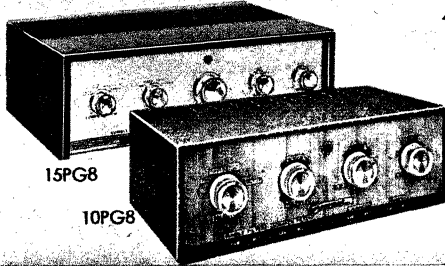

15PG8

10PG8

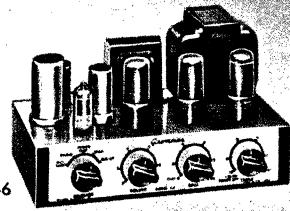

LJ-6

MODEL GRT-3 FM-AM BASIC TUNER

ONLY
\$132⁷⁹

FM-AM basic tuner for use with Grommes amplifiers or any other hi-fi amplifier having a full set of controls. Offers exceptional selectivity and sensitivity. Deluxe features include: Armstrong FM circuit, cascade RF stage, ten tuned IF circuits and two double-tuned Foster-Seeley limiter stages. Assures maximum sensitivity and freedom from interference. Flywheel tuning and FM-AM tuning meter for precise tuning. Cathode follower output permits long leads to amplifier. Uses wide-band, highly sensitive IF coils. AM section includes 10 kc whistle filter. Meets FCC radiation specs. Ultra-compact—finished in handsome charcoal gray and brass.

Sensitivity: FM, better than 1½ microvolts for 20 db quieting; AM, 3 microvolts. *Antenna Inputs:* FM, 300 ohms; AM, built-in ferrite loopstick plus external antenna connection. *Hum:* 65 db below 100% modulation. *Controls:* Tuning and Selector Switch (Off-On-AM, FM with AFC, FM less AFC, 11 tubes; 6X4 rectifier. HWD, 4½x13x8¾". For 110-120 v., 60 cycle AC. Shpg. wt., 16 lbs.
93 SX 540. NET.....132.79

MODEL 15PG8 15-WATT AMPLIFIER

ONLY
\$68¹¹

New 15-watt amplifier employs new feedback circuitry to achieve excellent response with low distortion. Features record compensation; calibrated bass and treble; loudness control; rumble and scratch filters; and 6 inputs, including one for tape head. Charcoal gray and brass styling matches GRT-3 tuner at left. *Output:* 15 watts; peak, 20 watts. *Response:* ±1 db, 30 to 15,000 cps at 15 watts. *6 Inputs:* Auxiliary, Tuner, Tape, Tape Head, Magnetic Phono, Crystal Phono. *Controls:* Selector (Aux, Tuner, Tape, Phono); Record Compensator (500-Flat, RIAA, Early LP, Tape Head); Loudness; Bass; Treble; Rumble Filter; Scratch Filter; Loudness-Off-On; Power-Off-On. *Output Impedances:* 4, 8 and 16 ohms, plus high-impedance for tape recorder. Size, 4½x13x8¾". For 110-120 v., 60 cycle AC. Shpg. wt., 17 lbs.
93 SX 547. NET.....68.11

MODEL 10PG8 10-WATT AMPLIFIER. *Output:* 10 watts; peak, 15 watts. *Response:* ±1 db, 30 to 20,000 cps. 5 inputs. *Output Impedances:* 4, 8 and 16 ohms. 4½x13x6¾". For 110-120 v., 60 cycle AC. 13 lbs.
93 SX 548. NET.....53.90

MODEL LJ-6 10-WATT AMPLIFIER

\$38⁷¹
Less cage

New, economy 10-watt amplifier at tremendous savings. An excellent unit for the budget-priced music installation. Includes built-in preamp compensated for the RIAA curve, separate bass and treble controls, negative feedback and 4 inputs. Unique arrangement of bass control in volume control circuit enables volume control to be used as a loudness control. Extremely compact—can be placed anywhere. In highly-attractive charcoal gray and brass finish.

Output: 10 watts rated, 15 watts peak. *Response:* ±1 db 30-20,000 cps. *Distortion:* 2% harmonic, 3% IM. *Feedback:* 12 db. *Controls:* Selector (Aux, Tuner, Phono Flat, RIAA, Early LP); Volume; Bass (with 15 db boost); Treble (with 18 db attenuation); Off-On. *Hum:* 80 db below output level. *Output:* 4, 8, 16 ohms. *Inputs:* Tuner, Aux., Magnetic phono, Crystal-Ceramic phono. *Tubes:* 2—12AX7, 2—6V6GT, 6X5GT rectifier. Size, 5½x10x6". For operation from 110-120 v., 60 cycle AC. Shpg. wt., 10 lbs.
93 SX 546. NET.....38.71
METAL CAGE FOR ABOVE. Wt., 3 lbs.
93 SX 549. NET.....4.65



S-1000 II
in case



S-2000 in case



S-3000 in case

S-1000 II 36-WATT AMPLIFIER

\$109⁵⁰
Less case

A fine example of functional styling and complete control flexibility. Sherwood's new S-1000 II 30-watt amplifier meets every requirement of the hi-fi music lover. Tastefully styled, it can be placed on tables, shelves or mantel—and is equally simple to build into custom cabinetry. Employs inverse feedback circuitry, and special output transformer to attain undistorted power output (less than 1½% at 36 watts)!

Output: 36 watts; 72-watt peaks. *Response:* ±½ db, 20 to 20,000 cps at 36 watts. *Hum & Noise:* Volume control, -90 db; radio input, -80 db; Phono, -60 db. *Sensitivity:* Radio, 0.3 v.; Phono, 3 microvolts. *6 Inputs:* 2—Magnetic Phono, Tape Head or Mike, 4—Tuner, Tape Recorder, TV, etc. *11 Controls:* Push-button switches for Presence, Scratch Filter, Rumble Filter and Phono Level; slide switches for Tape Monitor and Loudness In-Out; Selector (Tape, Phono, A, B, C); Equalization (LP, Lon, RIAA-AES, Eur, Tape, Mic); Bass; Treble; and Off-On Loudness. *Tubes:* 4—EL84, 2—12AX7/ECC83, 6AQ6, 6BA8A; GZ34 rectifier. White leatherette panel. Size 4x14x10½". Less case, see right. For 110-120 v., 60 cycle AC. Shpg. wt., 23 lbs.
94 SZ 331. NET.....109.50

S-2000 FM-AM BASIC TUNER

\$139⁵⁰
Less case

New, skillfully engineered FM-AM basic tuner—perfectly matches the S-1000 II amplifier described at left. Features highly sensitive circuitry, automatic frequency control on FM, "feather-ray" tuning eye for pin-point FM-AM station selection and directable rod AM antenna.

FM Section: Unusual sensitivity of 0.95 microvolt for 20 db quieting. Circuit employs triode mixer, IF amplifier, 3 cascaded limiters and Foster-Seeley balanced discriminator. Low-noise, balanced antenna input transformer feeds cascade RF amplifier. *AM Section:* 2 microvolt sensitivity at 60% modulation for 0.5 v. output. Superhet circuit, 2 tuned RF circuits, pentagrid mixer, double-tuned IF stage with switched coupling and low-distortion diode detector. 10 kc "bridged-T" whistle filter. *Controls:* Off-On-FM-AM; Tuning; slide switch for AM Wide, AM Narrow; slide switch for FM-AFC On-and-Off. Slide-rule dial with split-shadow tuning indicator. Cathode follower output; FM multiplex output. 10 tubes; 6X4 rectifier, 6BR5/EM80 tuning eye. White leatherette panel. Size, 4x14x10½". Less case, see right. For 110-120 v., 60 cycle AC. Shpg. wt., 18 lbs.
94 SX 332. NET.....139.50

S-3000 BASIC FM TUNER

\$99⁵⁰
Less case

Features the same, extremely sensitive FM circuit employed in the S-2000 tuner; styling matches the S-1000 II amplifier. Outstanding sensitivity makes FM reception practical beyond 100 miles. Highly stable coil design, delayed automatic gain control and Foster-Seeley discriminator, preceded by 3 limiters, assures distortion-free reception. Automatic frequency control for drift-free tuning; disabling switch permits tuning in weak, distant stations. Also has "local-distance" switch and "feather-ray" tuning eye. *Sensitivity:* 0.95 microvolt for 20 db quieting. *Controls:* Off-On; AFC Off-On; Tuning; Sensitivity (Local-Distance). Cathode follower audio output; FM multiplex output. 8 tubes; 6BR5/EM80 split-shadow tuning eye; 6X4 rectifier. White leatherette panel. 4x14x10½". Less case, below. For 110-120v., 60 cycle AC. Wt., 16 lbs.
94 SX 333. NET.....99.50

METAL CASES FOR SHERWOOD UNITS

TYPE B. Black "flextone". Shpg. wt., 3 lbs.
94 SX 334. NET.....5.00
TYPE C. Mahogany leatherette with classic gold tooling. Shpg. wt., 3 lbs.
94 SX 335. NET.....10.00

Letter Z in Stock Number Indicates Express Shipment Only

NEW knight® MONEY-SAVING HIGH-FIDELITY SPEAKERS

MORE FOR YOUR MONEY! Allied's 12" and 15" Knight 3-way high-fidelity speakers offer superb sound reproduction. Each unit is manufactured to the exacting specifications of our audio experts. Allied's great volume of sales enables you to own these remarkable speakers at low cost—dollar for dollar, they are your best buy!

New KNIGHT 12" and 15" 3-Way Precision Speakers

AS LOW AS

\$49⁵⁰

- 3 Independent Radiating Elements for Uniform Response
- Full 1¾-Pound Magnet with High Flux Density
- Genuine Compression-Type Horn-Loaded Tweeter
- Built-in Electrical Crossover; L-Pad Tweeter Control

The hi-fi event of the year! Allied's own 3-way high-fidelity speakers, designed and manufactured to the strictest audio specifications, and brought to you at an outstandingly low price. These speakers are of the new 3-way design, and have a large cone for low frequency reproduction, a specially constructed conical radiator for mid-frequencies, and a built-in compression tweeter for high-frequencies. An L-pad level control, pre-wired to the speakers with a 30" cable, lets you adjust high-frequency response to satisfy personal listening tastes and match room acoustics. Amplifier output wires connect to binding posts on the speaker frame—no soldering is necessary.

Heavy, 1¾-pound magnet insures effective reproduction of even the most thunderous bass passages. The rigid frame used in the Knight 3-way prevents rattling and distortion. A mechanical crossover separates bass from mid-range at 2000 cps; an electrical crossover smooths the transition from mid-range to tweeter at 4000 cps. These speakers are ideal for use in the Klipsch-designed Knight corner enclosures.

MODEL KN-800 12" 3-WAY SPEAKERS. Response, 35 to 15,000 cps. ±3 db; resonant frequency, 50 cps. Impedance, 16 ohms; rated 25 watts program material. Diameter, 12¾"; depth, 9". Shpg. wt., 12 lbs. *Unconditionally guaranteed for one full year.*

81 DX 839. NET..... 49.50

MODEL KN-810 15" 3-WAY SPEAKERS. Response, 30 to 15,000 cps. ±3 db; resonant frequency, 40 cycles. Impedance, 16 ohms; rated 25 watts program material. Diameter, 15½"; depth, 9". Shpg. wt., 15 lbs. *Unconditionally guaranteed for one full year.*

81 DX 840. NET..... 62.50

3-WAY SPEAKERS IN PAIRS. Take advantage of the top quality of these speakers and save even more, by using them in pairs. Uniformity of characteristics make them ideal speakers for use in a stereophonic sound system; each speaker system will then be perfectly matched in response and volume.

2—KN-800 12". Save \$10.00! Wt., 24 lbs.

91 DZ 938. Set of two, ONLY..... 89.00

2—KN-810 15". Save \$15.50! Wt., 30 lbs.

91 DZ 911. Set of two, ONLY..... 109.50

KNIGHT Bass Reflex Lowboy Hi-Fi Speaker Enclosure

AS LOW AS

\$36⁹⁵

KN-1330-U

- Kit or Assembled
- Pre-Glued Cleats
- Lock-Miter Joints
- Tweeter Adapter

The new Knight bass reflex enclosures now feature lock-miter joints, like those on the finest furniture, in both assembled and kit models. It's easier than ever to do a professional job on the kits! Moreover, cleats that hold the front and back panels are already glued in place—the hard part of the job is already done for you! Front panels are cut for a 15" speaker, and supplied with a removable adapter board for a 12" speaker. You even get acoustical insulation, to line the interior, and handsome plastic grille cloth. Exposed surfaces of unfinished models are ¾" mahogany veneer, ready to take a beautiful finish; finished version is done in rich mahogany. Legs may be mounted for low-boy or hi-boy positioning of enclosure. Ideally complements quality furniture of contemporary or any other style.

MODEL KN-1330-U. UNFINISHED KIT. A bass reflex enclosure kit of superior quality throughout. Made entirely of ¾" plywood with mahogany veneer; "snap-in" lock-miter joints. Size, 26" high, 34" wide and 16" deep. Complete with screws, insulation, legs, grille cloth and detailed, illustrated instr. Shpg. wt., 60 lbs.

95 DZ 595. NET..... 36.95

MODEL KN-1230-U. ASSEMBLED, UNFINISHED.

As above, but completely assembled. 61 lbs.

95 DZ 588. NET..... 48.00

MODEL KN-1230-M. ASSEMBLED, FINISHED.

The same enclosure as that listed above, completely assembled and finished in lustrous French mahogany. 62 lbs.

95 DZ 589. NET..... 69.00

KN-1230-U WITH 12" 3-WAY INSTALLED. Assembled and unfinished. Wt., 72 lbs.

94 DZ 793. NET..... 89.50

KN-1230-U WITH 15" 3-WAY INSTALLED. Assembled and unfinished. Wt., 75 lbs.

94 DZ 798. NET..... 99.75

KNIGHT High-Fidelity 8" Speaker Enclosure

ONLY

\$24⁷⁵

- Exceptionally Compact
- Effective Bass Response
- Handsomely Finished
- For Any 8" Speaker

Compact, completely assembled and finished bass reflex enclosures for 8" speakers, available with or without speakers. Carefully computed dimensions provide maximum effective bass response in minimum space; construction of ¾" plywood throughout insures freedom from cabinet rattle. Ideal for any hi-fi system that must occupy as little room as possible—fits shelf, mantel, table-top, etc. All exposed panels are of fine furniture mahogany or korina veneer, hand-rubbed to a high luster; face of enclosure is covered with durable plastic grille cloth. Excellent performance with any quality 8" hi-fi speaker.

MODEL KN-1240-M. MAHOGANY. Compact Knight bass reflex enclosure for 8" speaker as described at left, completely assembled and finished in French mahogany. Size, 11" high, 23¾" wide and 11¾" deep. Shpg. wt., 20 lbs.

95 DZ 616. NET..... 24.75

MODEL KN-1240-B. KORINA BLONDE. As above, but korina blonde finish.

95 DZ 617. NET..... 24.75

ENCLOSURE WITH 8" UNIVERSITY DIFFUSICONE-8 SPEAKER INSTALLED. Enclosure as above, finished in mahogany or blonde, with 2-way University Diffusicone-8 8" speaker installed. Speaker response is 70 to 13,000 cps. Power capacity, 25 watts. Shpg. wt., 24 lbs.

95 DZ 628. Mahogany. NET

95 DZ 629. Korina Blonde. EACH... 46.75

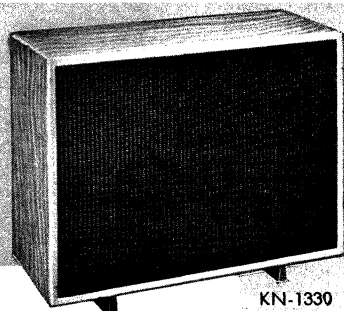
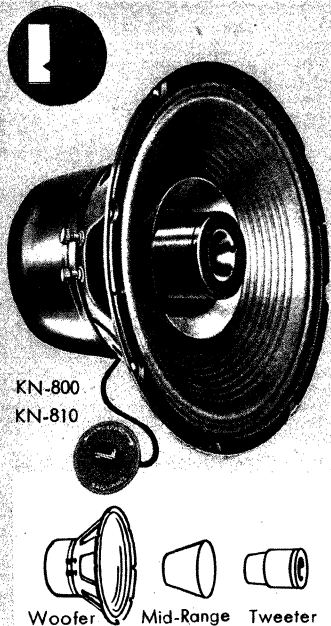

KN-1330

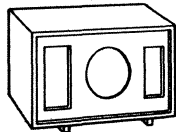

KN-1240

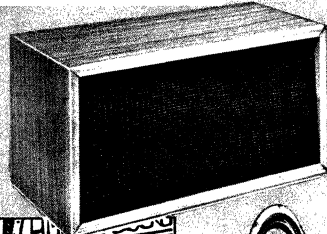

Diffusicone-8

Letter "Z" in Stock Number Indicates Express Shipment Only

SPEAKER ENCLOSURES AND COMPLETE SPEAKER SYSTEMS

HIGHEST QUALITY AT LOW COST. Knight speaker enclosures and enclosure kits have been developed to provide you with the finest possible speaker enclosure at the lowest cost. When used with Knight 3-way speakers, Knight enclosures assure you of true high-fidelity sound reproduction at exceptional savings.

KNIGHT Klipsch-Designed Speaker Enclosures and Kits

AS LOW AS

\$49.50

Prefinished Kit

- Beautiful Hand-Rubbed Furniture Finish
- Klipsch-Licensed Folded Corner Horn Design
- Adapter Board for Additional Components
- "Quik-Craft" Kit Versions Assemble with a Screwdriver

Nowhere will you find value to compare with the precision-designed, handsomely finished Knight-Klipsch corner speaker enclosures. Made throughout with the finest furniture veneers, and hand-worked to a lustrous, rich-looking finish, these enclosures will grace the most distinctive of homes. The efficient folded-horn uses the walls of your room to greatly improve and extend

bass range. "Quik-Craft" Kit versions of the Knight-Klipsch require only a screwdriver for assembly—and like the assembled models, have a fine furniture finish. Lock-miter joints securely seal the horn chamber without glue. An adapter board supplied accommodates tweeters or another speaker. Size: 12" models, A, 10"; B, 6 $\frac{3}{4}$ "; C, 21"; D, 32". 15" models, A, 10"; B, 8 $\frac{1}{2}$ "; C, 24"; D, 32".

Stock No.	Size	Model	Description	Lbs.	NET
94 DZ 768	12"	KN-1200-M	Assembled; Mahogany	45	69.50
94 DZ 769	12"	KN-1200-B	Assembled; Korina Blonde	45	69.50
94 DZ 794	12"	KN-1200-W	Assembled; Walnut	45	69.50
94 DZ 770	12"	KN-1300-M	"Quik-Craft" Kit; Mahogany	43	49.50
94 DZ 771	12"	KN-1300-B	"Quik-Craft" Kit; Korina Blonde	43	49.50
94 DZ 796	12"	KN-1300-W	"Quik-Craft" Kit; Walnut	43	49.50
94 DZ 773	15"	KN-1210-M	Assembled; Mahogany	50	84.50
94 DZ 774	15"	KN-1210-B	Assembled; Korina Blonde	50	84.50
94 DZ 795	15"	KN-1210-W	Assembled; Walnut	50	84.50
94 DZ 775	15"	KN-1310-M	"Quik-Craft" Kit; Mahogany	47	57.50
94 DZ 776	15"	KN-1310-B	"Quik-Craft" Kit; Korina Blonde	47	57.50
94 DZ 797	15"	KN-1310-W	"Quik-Craft" Kit; Walnut	47	57.50

KNIGHT 3-Way Speakers in Knight-Klipsch Enclosures

Get the most in high-fidelity performance from your record player, tuner and amplifier by using a Knight 3-way speaker in a

Knight-Klipsch corner horn enclosure. 12 and 15" Knight 3-way speakers are described on the opposite page. *You Save \$9.50!*

Stock No.	Description	Shpg. Wt., Lbs.	NET EACH
94 DZ 786	12" 3-Way in KN-1200-M	52	
94 DZ 787	12" 3-Way in KN-1200-B	52	109.50
94 DZ 746	12" 3-Way in KN-1200-W	52	
94 DZ 747	15" 3-Way in KN-1210-M	65	
94 DZ 748	15" 3-Way in KN-1210-B	65	137.50
94 DZ 749	15" 3-Way in KN-1210-W	65	

3-WAY SPEAKER AND KNIGHT-KLIPSCH KITS. You save when you use just a bit of time to put together a Knight-Klipsch enclosure kit for your 3-way speaker. A combination of the two units—with your choice of cabinet finish—is available at a special price, offering exceptional savings on both speaker and enclosure.

You need only a screwdriver to assemble

the enclosure and install the speaker. *Be sure to specify mahogany, blonde or walnut finish, when ordering.*

12" 3-WAY & KNIGHT-KLIPSCH KIT. 45 lbs.
91 DZ 937-C. *Save \$9.50!* NET... **89.50**

15" 3-WAY & KNIGHT-KLIPSCH KIT. 50 lbs.
91 DZ 910-C. *Save \$9.50!* NET... **110.50**

KNIGHT Corner Horn Hi-Fi Speaker Enclosures

AS LOW AS

\$29.50

The Knight corner horn enclosure is a versatile, handsomely designed high-fidelity unit especially well-suited for use in budget-priced hi-fi systems. It is available as a kit that can be assembled with a screwdriver, or assembled. Kit versions have pre-glued cleats and are luxuriously pre-finished in your choice of French mahogany, Korina blonde or walnut. The assembled version is available in French mahogany only.

The corner horn enclosure uses the walls of a room as an extension of its self-contained horn, for strengthening the natural bass tones of the music. It may be used with a 12" or 15" speaker, and an adapter board is also provided for mounting tweeters or mid-range components for use in a 2 or 3-way system. It provides excellent performance at moderate cost.

Enclosure parts are of $\frac{3}{4}$ " plywood faced with mahogany veneer on areas which are exposed. Maroon plastic grille cloth is furnished with kit versions of the enclosure. Overall size, A, 35 $\frac{3}{4}$ "; B, 24 $\frac{3}{4}$ "; C, 33 $\frac{3}{4}$ ". Shpg. wt., 30 lbs.

MODEL KN-1220-M. Assembled corner horn enclosure, with French mahogany hand-rubbed finish. Supplied complete with adapter board for additional components; may be used with 12" or 15" speaker.
95 DZ 598. NET..... **39.50**

MODEL KN-1320-M. Mahogany-finished kit.
95 DZ 596. NET..... **29.50**

MODEL KN-1320-B. Blonde-finished kit.
95 DZ 986. NET..... **29.50**

MODEL KN-1320-W. Walnut-finished kit.
95 DZ 881. NET..... **29.50**

KNIGHT-KLIPSCH ENCLOSURE
KN-1200

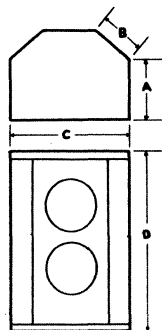
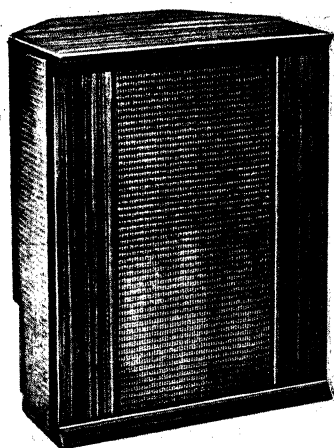

CORNER HORN ENCLOSURE
KN-1220-M

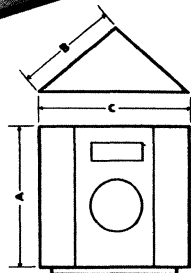
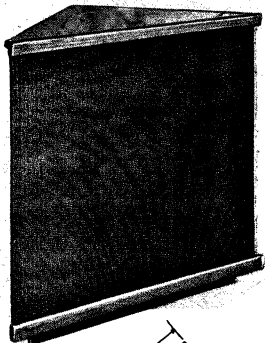

Allied is Headquarters for High-Fidelity Equipment



Electro-Voice HI-FI SPEAKER SYSTEMS

Patrician 4-Way Speaker Systems

Famous as one of the most distinguished of high-fidelity loudspeaker systems, the Patrician by Electro-Voice is offered in a choice of two cabinet styles—the traditional Patrician IV and IVD systems, and the richly modern Patrician 600 and 600D systems. The IVD and 600D systems use the revolutionary "Ionovac" high-frequency unit, in which ionized air replaces the conventional diaphragm (see page 49), while the IV and 600 systems use the new T350 driver with the Avedon Sonophase horn (also on page 49). Other components of Patrician speaker systems are detailed in the listing at the bottom of this page. Beautifully hand-crafted Patrician enclosures are of Klipsch-licensed indirect radiator design; each is carefully assembled from selected hardwood veneers and inlays, and exquisitely finished. Power-handling capacity is 35 watts; 70-watt peaks. Supplied with components installed. Size: (IV and IVD) 62" H. 39" W. 29" D.; (600 and 600D) 58½" H. 38" W. 30" D. *Shipped F.O.B. Chicago or Dowagiac, Mich., whichever is nearer.*

Stock No.	Model	Speaker Pkg.	Finish	Wt., Lbs.	NET
82 DZ 300	IV	103E	Mahogany	390	950.60
82 DZ 301	IV	103E	Limed Oak	390	976.08
82 DZ 302	IV	103E	Walnut	390	976.08
82 DZ 346	IVD	103D	Mahogany	400	1038.80
82 DZ 347	IVD	103D	Limed Oak	400	1064.28
82 DZ 348	IVD	103D	Walnut	400	1064.28
82 DZ 303	600	103E	Mahogany	360	802.62
82 DZ 304	600	103E	Limed Oak	360	821.24
82 DZ 305	600	103E	Walnut	360	821.24
82 DZ 306	600D	103D	Mahogany	370	890.82
82 DZ 307	600D	103D	Limed Oak	370	909.44
82 DZ 308	600D	103D	Walnut	370	909.44

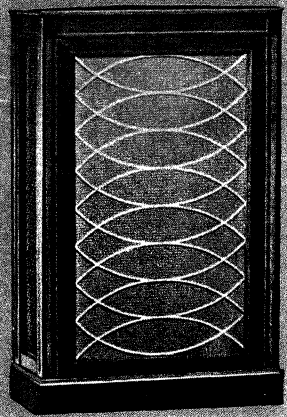

Patrician IV



Patrician 600 and Georgian 600

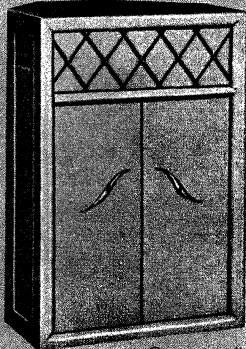

Georgian IV

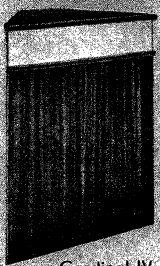

Cardinal IV



115 and 103E



106A and 105E

Georgian 4-Way Speaker Systems

A speaker system of exceptional quality, housed in a Klipsch-licensed "K"-type folded corner horn; offered in traditional Georgian IV exterior design, or new Georgian 600 contemporary styling. Both contain the same speaker package, an outstanding combination of components. The system includes the 15WK special low-frequency speaker, crossing over at 300 cps through the X336 network to the MT30 mid-bass horn assembly (see page 49 for description of this new unit); high frequencies are covered by the newly developed T350 Ultra-Sonax VHF driver, which employs a 2-lb. magnet and an unusually effective horn design. Included are two AT37 controls, for separate adjustment of mid-range and high frequency levels to best suit the acoustics of the room in which the Georgian is placed. The Georgian is supplied with all speaker components mounted and wired. Georgian IV and Georgian 600 are of the same acoustic design, differing only externally. Imp., 16 ohms Capacity, 35 watts. Georgian IV, 53" high, 34" wide, 26" deep; Georgian 600, 48½" high, 28½" wide, 25¾" deep. *Shipped F.O.B. Chicago or Dowagiac, Mich., whichever is nearer.*

GEORGIAN IV (Shpg. wt., 290 lbs.)			GEORGIAN 600 (Shpg. wt., 255 lbs.)		
Stock No.	Finish	NET	Stock No.	Finish	NET
82 DZ 309	Mahogany	548.80	82 DZ 312	Mahogany	480.20
82 DZ 310	Limed Oak	558.60	82 DZ 313	Limed Oak	489.02
82 DZ 311	Walnut	558.60	82 DZ 314	Walnut	489.02

CARDINAL IV SPEAKER SYSTEMS

Quality speaker ensemble for use in superior home music systems; consists of 105E deluxe speaker package in an enclosure acoustically similar to the Georgian above. Uses walls of room as part of folded horn, in place of built-on rear panels. Speaker units include 15WK special 15" woofer; MT30 coaxial mid-range/bass horn and driver; T350 VHF driver; X336 crossover and two AT37 controls. All speakers installed. 45¾" high, 26¾" wide, 23" deep. Shpg. wt., 200 lbs.

Stock No.	Finish	NET
82 DZ 315	Mahogany	416.50
82 DZ 316	Limed Oak	424.34
82 DZ 317	Walnut	424.34

CARDINAL ENCLOSURE ONLY

"K"-type indirect radiator, corner folded horn, less speakers. Shpg. wt., 100 lbs.

Stock No.	Finish	NET
82 DZ 318	Mahogany	161.70
82 DZ 319	Limed Oak	169.54
82 DZ 320	Walnut	169.54

PATRICIAN 115 "K" HORN ONLY

Interior assembly of Patrician enclosure less speaker components. For installation in corner; uses walls of room as part of back-loaded folded horn. Rigidly constructed of heavy lumber, stained matte black. May be painted to match walls or room decor; will not take furniture finish. Accepts 103D or 103E, or similar 4-way system with 18" woofer. Size: 57¾" high, 34¾" wide, 26¾" deep. Shpg. wt., 168 lbs.

81 DZ 775. NET 186.20

GEORGIAN 106A "K" HORN ONLY

Forms complete 4-way speaker system, less furniture cabinet, when used with 105E or similar speaker components package; supplied less speaker components. Matte black stained; will not take furniture finish, but may be painted or concealed behind open-weave drapery. Designed for corner installation; walls of room form part of horn structure. Size: 38½" high, 26¾" wide, 23½" deep. Shpg. wt., 88 lbs.

82 DZ 330. NET 112.70

SPEAKER PACKAGES ONLY. Carefully selected systems of speaker components. Each package includes all driver components, necessary hardware for mounting in enclosure, cable harness and full instructions for mounting. All are intended for use in "K"-type indirect-radiator folded horn enclosures; *also for new E-V phase-loaded enclosures.

Stock No.	Model	Components	Wt., Lbs.	NET
82 DZ 331	117B*	15BWK bass driver; MT30B mid-bass assembly; T35B VHF driver; X336 crossover; 2—AT37 controls	50	147.98
82 DZ 332	105E*	15WK bass driver; MT30 mid-bass assembly; T350 VHF driver; X336 crossover; 2—AT37 controls.	100	240.10
82 DZ 333	105D	Same as 105E, but with T3500 "Ionovac" in place of T350 VHF unit.	113	326.34
82 DZ 334	103E	18WK bass driver; 118B mid-bass dual-driver assembly; T25A HF driver, with 6HD horn; T350 VHF driver; X2635 crossover; 3—AT37 controls.	105	422.38
82 DZ 335	103D	Same as 103E, but with T3500 "Ionovac" in place of T350 VHF unit.	118	509.60

Letter "Z" in Stock Number Indicates Express Shipment Only

HI-FI SPEAKER SYSTEMS



Centurion 4-Way Speaker Systems

SENIOR CENTURION IV. A complete 4-way speaker system installed in the Centurion Klipsch-type enclosure; uses the Electro-Voice 105E deluxe 4-way components package (see page 46). Specialized 15WK 15" woofer is back-loaded by corner folded horn for highly effective bass response. Crossover network X336 directs frequencies above 300 cps to MT30 mid-bass horn assembly. Newly developed T350 Ultra-Sonax VHF driver takes over at 3500 cps, continuing to 21,000 cps. Includes 2—AT37 level controls for "Presence" and "Brilliance" adjustment. Power-handling capacity of entire speaker system is rated at 35 watts in continuous service, and 70 watts on peaks. Impedance: 16 ohms.

Exterior styling of the enclosure is similar to the Georgian, but is on a smaller scale. Size: 42" H, 29" W, 22½" D. Shpg. wt., 163 lbs. In choice of finish (see table below).

CENTURION IV. Same "K"-horn enclosure as above, but with 117B 4-way economy speaker components package installed. Consists of 15BWK bass driver, MT30B mid-bass assembly, T35B Super-Sonax VHF driver, X336 crossover, and 2—AT37 controls for "Brilliance" and "Presence". Power-handling capacity, 20 watts. Shpg. wt. 127 lbs.

Finish	SENIOR CENTURION IV		CENTURION IV	
	Stock No.	NET	Stock No.	NET
Mahogany	82 DZ 321	477.26	82 DZ 324	384.16
Limed Oak	82 DZ 322	484.12	82 DZ 325	391.02
Walnut	82 DZ 323	484.12	82 DZ 326	391.02

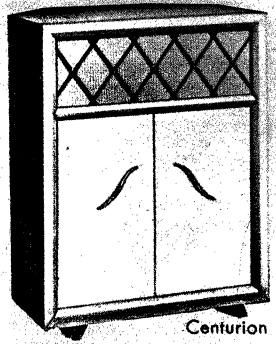

Centurion

Regency Speaker Systems

REGENCY III. Complete 3-way high-fidelity speaker system combining the advantages of folded-horn performance with flexibility of placement. Klipsch-licensed horn design with "built-in" corner allows it to be used against a flat wall or in a corner. In lowbass motif, this highly efficient enclosure enhances any decorative scheme. Speaker components include 15W 15" woofer, T25A HF driver with 8HD horn, T35 VHF driver, X8 and X36 crossovers, and 2—AT37 controls. 16 ohms, 20-30 watts. HWD: 29½x33½x19". Shpg. wt., 135 lbs.

Stock No.	Finish	NET
81 DZ 496	Mahogany	385.14
81 DZ 497	Limed Oak	394.94
82 DZ 327	Walnut	394.94

REGENCY WITH 15TRX. Regency enclosure with popular 15TRX 3-way speaker installed. Provides optimum results when placed either in a corner or against a wall of the room. Offers smooth, extended bass response with clear highs to 15,000 cps. 138 lbs.

Stock No.	Finish	NET
81 DZ 836	Mahogany	273.42
81 DZ 837	Limed Oak	283.22
81 DZ 868	Walnut	283.22

114B SPEAKER PACKAGE. Speaker components used in Regency III speaker system at left. Supplied complete with harness cable, mtg. board, etc. Size (HWD), 26½x32½x13½". Shpg. wt., 107 lbs.

81 DZ 498. NET 260.68

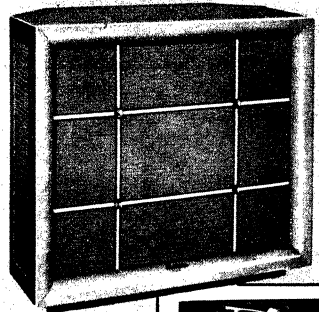

Regency

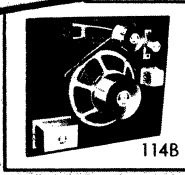

114B

Empire Speaker Systems

EMPIRE IA. 3-way system in attractively designed Empire lowbass enclosure. Compact, highly efficient folded-horn design provides authentic reproduction of bass frequencies; may be used against wall or in a corner. Components in system include 15BW bass driver; T10A HF driver with 8HD diffraction horn; T35B VHF driver with X825 and X36 crossovers and 2—AT37 level controls. Level controls permit adjustment of overall system balance to suit room acoustics. Fine hardwood veneers, hand-rubbed to a lustrous finish, 16 ohms, 15-20 watts. Size (HWD): 29½x32x16". Wt., 80 lbs.

Stock No.	Finish	NET
81 DZ 765	Mahogany	269.50
81 DZ 766	Limed Oak	276.36
82 DZ 328	Walnut	276.36

EMPIRE WITH SP15B. An excellent "starter" system, easily expanded; consists of SP15B 15" Radax speaker installed in Empire enclosure. Other components may be added gradually to expand this system to the 2- or 3-way type. Rear of speaker is coupled to folded horn; "Whizzer" element effectively distributes high frequencies. Wt., 71 lbs.

Stock No.	Finish	NET
81 DZ 832	Mahogany	139.16
81 DZ 833	Limed Oak	143.08
81 DZ 867	Walnut	143.08

116A SPEAKER PACKAGE. Speaker components of Empire IA system at left, with mounting board, etc. HWD, 26½x32½x12½". Shpg. wt. 68 lbs.

81 DZ 771. NET 172.48

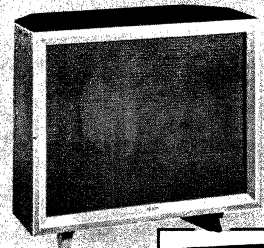

Empire

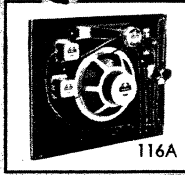

116A

Aristocrat Speaker Systems

ARISTOCRAT III. Deluxe 3-way system in exceptionally compact Aristocrat folded-horn enclosure. Selected speaker components provide unusually fine music reproduction, including extended bass response without booming. Speaker components are 12W 12" bass driver; T25A HF driver with 8HD diffraction horn; improved T35 VHF driver; X8 and X36 crossovers and 2—AT37 level controls. 16 ohms, 15-20 watts. Size (HWD): 29½x19x16½". Shpg. wt., 74 lbs.

ARISTOCRAT III			ARISTOCRAT-12TRXB			ARISTOCRAT-SP12B		
Stock No.	Finish	NET	Stock No.	Finish	NET	Stock No.	Finish	NET
81 DZ 439	Mahogany	305.58	81 DZ 756	Mahogany	135.24	81 DZ 911	Mahogany	104.86
81 DZ 442	Limed Oak	312.62	81 DZ 757	Limed Oak	142.10	81 DZ 912	Limed Oak	111.72
82 DZ 329	Walnut	312.62	81 DZ 865	Walnut	142.10	81 DZ 913	Walnut	111.72

ARISTOCRAT WITH 12TRXB. Top-quality system using highly popular 12TRXB 12" 3-way speaker; adjustable high-frequency control for matching of system to individual room acoustics. Covers entire audible range. Shpg. wt., 58 lbs.

ARISTOCRAT-SP12B. Economy 12" speaker system offering rich, authentic response at low cost. Includes enclosure and SP12B 12" speaker. Shpg. wt., 56 lbs.

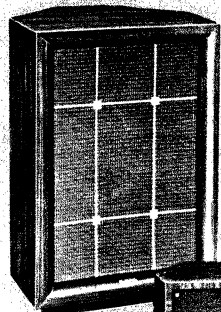

Aristocrat

BARONET WITH SP8B

Extremely compact, Klipsch-licensed corner horn enclosure. Provides excellent sound reproduction. With SP8B 8" speaker installed, bass response extends to 35 cps. Size, 22½x14½x13½". Shpg. wt., 29 lbs.

Stock No.	Finish	NET
81 DZ 754	Mahogany	73.01
81 DZ 755	Limed Oak	76.93
81 DZ 866	Walnut	76.93

BARONET 2-WAY SPEAKER SYSTEM

For exceptional performance where space is limited; includes SP8B 8" speaker, T35B tweeter, AT37 HF control and X36 crossover. Response, 35 cps to beyond audibility. 16 ohms; 15-20 watts. Shpg. wt., 35 lbs.

Stock No.	Finish	NET
81 DZ 872	Mahogany	109.27
81 DZ 873	Limed Oak	113.19
81 DZ 874	Walnut	113.19

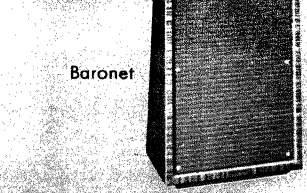

Baronet

For Full Specifications Of Individual Speaker Components, See Pages 48-49

ELECTRO-VOICE HI-FI SPEAKERS AND WOOFERS

Three-Way Speakers

Employ three concentrically mounted sections—Super-Sonax VHF driver, Radax propagator, and large bass cone with heavy magnet, for a superb standard of performance. TRX 3-way speakers deliver vibrant bass, full-bodied mid-range response and ultra-clean treble. Feature concentric mounting of all elements for wide-angle dispersion; adjustable high-frequency level control; electrical crossover network. Edge-wise-wound voice coil design provides 18% more efficiency and lower transient distortion. Excellent for use in custom high-fidelity installations or for modernization of existing systems. All are 16-ohm impedance.

MODEL 15TRX. Electro-Voice's finest 3-way speaker. Custom-engineered in every detail to reproduce with a startling degree of realism. Uses extra-large 5¾ lb. magnet for minimum transient distortion and remarkably clean and distinct bass. Consists of Radax-type 15" speaker with "Whizzer" high-frequency propagator; concentrically mounted T-35 "Super-Sonax" very-high-frequency tweeter; X-36 half-section, constant K crossover network; and the AT-37 HF level control. Uses 2½" aluminum voice coil. Frequencies above 3500 cps are distributed to "Super-Sonax" tweeter by the X36 crossover network. AT-37 level control adjusts tweeter output. Response, ±3½ db, 30-19,000 cps (in Regency or Empire enclosure). Resonance, 35-45 cps. Capacity, 30 watts. Depth behind panel, 9½". 16 ohms. Shpg. wt., 48 lbs.
81 DZ 235. NET.....146.02

MODEL 15TRX-B. Moderate cost 15" speaker similar to model above. Same excellent features, but employs smaller, 1¼ lb. magnet. 3-way concentric-mounted sections for smooth bass, mid-range and treble response. Consists of Radax-type 15" speaker with "Whizzer" high-frequency propagator; T-35B "Super-Sonax" VHF tweeter; HF level control. Mechanical crossover at 2000 cps. Built-in electrical crossover at 3500 cps—feeds to T-35B VHF tweeter. Response, ±3½ db, 30-18,000 cps (in Regency or Empire enclosure). Power handling, 20 watts. Resonance, 38-48 cps. 16 ohms. 7¾" depth. Shpg. wt., 17 lbs.
81 DX 761. NET.....77.42

MODEL 12TRX. 12" speaker. Has same superior design features of Model 15TRX above. Use of Radax-type speaker insures phenomenal bass response; mid-range characteristic provides vivid realism; highest audible frequencies are faithfully reproduced by the T-35 Super-Sonax Very High-Frequency driver. AT-37 HF control compensates for room furnishings—allows matching to room acoustics. Half-section constant-K X-36 crossover network. Response, ±3½ db, 30-19,000 cps (in Aristocrat enclosure). Resonance, 40 cps. 3½ lb. magnet. Power capacity, 25 watts. Depth, 8". 16 ohms. Shpg. wt., 32 lbs.
81 DZ 236. NET.....122.50

MODEL 12TRX-B. Excellent 12" speaker similar to above except 1½ lb. magnet. With Radax principle and 2000 cps first crossover for exceptional bass and mid-range response. 3500 cps built-in electrical crossover feeds the T35B VHF driver for reproduction to beyond the range of audibility. With brilliance control. Resonance, 45 cps. Power handling, 20 watts; 30 watts on peak. Response (in Aristocrat), ±3½ db, 35-15,000 cps. 1¼ lb. magnet. 16 ohms. 6¼" depth. Shpg. wt., 14 lbs.
81 DX 239. NET.....64.68

Low-Frequency Woofers

Featured in E-V speaker systems; all have unusually low cone resonance. Can also be used as woofers in custom 2 and 3-way sound systems. All woofers in this listing are rated at 20-40 watts. Compliance of outer cone rolls and inner spider carefully calculated for maximum extended bass range response. Cones are treated for moisture and fungus resistance. Heavy Alnico V magnets, 15WK, 15BWK and 18WK woofers are recommended for "K" horn and phase-loaded systems only; require sealed cavity behind the driver. *Have 3.2 ohms DC resistance; all others, 16 ohms impedance.

Radax Speakers

Radax principle provides highly efficient and economical method of using two concentrically mounted cones operating from single voice coil. Built-in mechanical crossover from low-frequency cone to high-frequency propagator permits design of each cone for optimum response.

MODEL SP15. Deluxe 15" Radax speaker with special 125 sq. in. bass cone and 2½" aluminum voice coil. Provides exceptionally fine bass, mid-range and treble reproduction. Excellent for custom home music systems. Heavy 5¼ lb. Alnico V magnet for unusually good damping—superb transient response and remarkably distinct bass. Resonance of bass cone, 35-45 cps. Bass cone is directly coupled to "Whizzer" HF radiator. Insures 100° treble dispersion. Frequency response, ±5 db, 30-13,000 cps. Rated, 30 watts. 16 ohms. Crossover, 3000 cps. Requires 13½" dia. baffle opening; 9" depth behind mtg. panel. 41 lbs.
81 DZ 280. NET.....87.22

MODEL SP15-B. 15" Radax speaker similar to above model, except for smaller 1 lb. magnet and 20 watts handling capacity. Response characteristics—30-13,000 cps. Perfect choice for the moderate-cost home hi-fi system. Seamless molded type bass cone directly coupled to "Whizzer" HF radiator. Insures very wide dispersion—extends treble 2 full octaves. Crossover, 3500 cps. Resonance, 38-48 cps. Imp., 16 ohms. Requires 13½" baffle opening; 7¾" depth behind mtg. panel. Shpg. wt., 15 lbs.
81 DX 760. NET.....42.14

MODEL SP12. Popular, moderately-priced 12" speaker. Ideal for hi-fi installations and modernization of older systems. Radax principle uses two cones with single voice coil. 3000 cps built-in mechanical crossover network. Bass cone resonates, 35-45 cps. Incorporates "Whizzer" high-frequency, wide-dispersion radiator for extended treble response. 100° solid angle dispersion. Highly efficient 3 lb. magnet. Response, ±5 db, 30-13,000 cps. 2" aluminum voice coil. Rated, 25 watts. Impedance, 16 ohms. 11" baffle opening; 7¾" depth behind mounting panel. Shpg. wt., 25 lbs.
81 DZ 279. NET.....64.68

MODEL SP12-B. 12" speaker, similar to above, but uses a smaller, 1-lb. magnet. Considered a "best buy" by many authoritative high-fidelity publications, the SP-12-B ranks high on the list of desirable hi-fi components. Power handling capacity, 20 watts. Resonance, 40-50 cps. Response, ±5 db, 30-13,000 cps. 16 ohms impedance. Crossover, 3500 cps. 11" baffle opening; 6" depth behind mounting panel. Shpg. wt., 12 lbs.
81 DX 278. NET.....34.30

MODEL SP8-B. 8" version of above. Excellent for limited space hi-fi applications. Employs same Radax-type construction features—concentric mounting of all elements for extremely smooth reproduction. Low cone resonance of 55-65 cps and "Whizzer" high-frequency propagator provide good overall balance and wide dispersion angle. 1-lb. Alnico V magnet. Power handling capacity, 20 watts. Response, ±5 db, 50-13,000 cps. Crossover, 4000 cps. 16 ohms impedance. 7" baffle opening. 4¾" depth behind panel. Shpg. wt., 9 lbs.
81 D 277. NET.....28.91

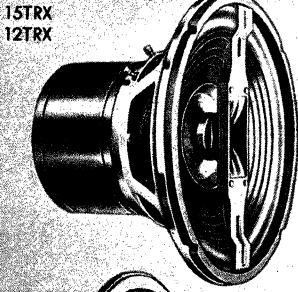

15TRX-B
12TRX-B

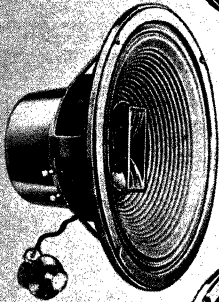

SP15-B
SP12-B

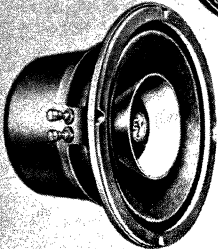
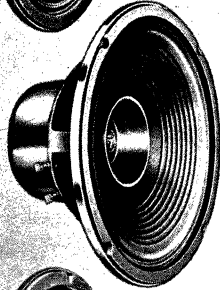

SP8-B

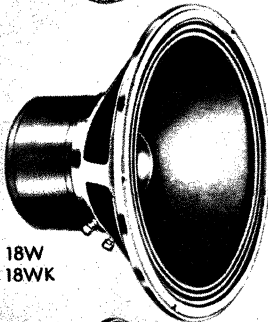

18W
18WK

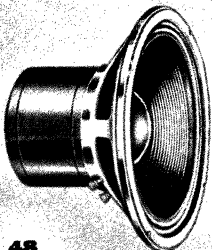

SP15
SP12

E-V HIGH-FREQUENCY COMPONENTS, CROSSOVERS, ETC.

MODEL T35 "SUPER-SONAX" VERY-HIGH FREQUENCY TWEETER. Delivers remarkably clean, extended high-frequency response—3500 to 19,000 cps. Adds at least one more octave of highs. Features wide-angle (180°) dispersion horn; cutoff, 1500 cps. Uses molded-phenolic impregnated, linen diaphragm. Use with X36 crossover and AT37 level control. For systems rated at 20 watts or over. Crossover, 3500 cps. Impedance, 16 ohms. Horn size; 5 1/4" long x 2" wide. Pot size, 2 1/4" dia., 3/4" deep overall. Shpg. wt., 3 lbs.
81 D 434. NET..... 34.30

MODEL T35B VHF TWEETER. Same as T35 above but for systems with speakers rated under 20 watts. Dispersion, 180°; cutoff, 1500 cps. Impedance, 16 ohms. X36 crossover network required. Pot size, 2 1/4" dia.; 3" depth overall. Shpg. wt., 3 lbs.
81 D 432. NET..... 21.56

MODEL AT37 LEVEL CONTROL. 16-ohm L-pad, for adjustment of mid-range and tweeter output. Mahogany finish. 6 oz.
81 D 437. NET..... 3.82

MODEL AT37B LEVEL CONTROL. As above, but for blonde cabinets.
81 D 838. NET..... 3.82

MODEL T10A HIGH-FREQUENCY DRIVER. For ultra-clean, extended response. Use with 8HD or 6HD HF diffraction horn and crossover network. ±5 db. 400-13,000 cps. 20 watts. 16 ohms. 12-oz. magnet. 3 3/4" dia., 3/4" deep. Throat, 7/8". 4 lbs.
81 D 424. NET..... 41.65

MODEL T25A HIGH-FREQUENCY DRIVER. Phenolic-impregnated, linen diaphragm for added strength. Use with 8HD or 6HD horn, plus crossover network. Response, ±5 db. 400-13,000 cps. 30 watts. 16 ohms. 1-lb. magnet. 3 3/4" dia. 4 1/4" deep. Throat dia., 7/8". Shpg. wt., 6 lbs.
81 D 288. NET..... 56.84

MODEL 8HD DIFFRACTION HORN. For use with T10A or T25A drivers. 600 cycle cutoff, 800 cycle crossover frequency. Size, 14 1/2 x 3 3/4 x 7 1/2". Shpg. wt., 4 lbs.
81 D 429. NET..... 17.64

MODEL 6HD DIFFRACTION HORN. Popular horn for T10A and T25A drivers. Utilizes 400 cps cutoff, 600 cps crossover. Size, 19 3/4" x 3 1/2" x 12". Shpg. wt., 6 lbs.
81 DX 491. NET..... 21.56

CROSSOVER NETWORKS. Attenuation, 12 db per octave in 1/2-section types; 6 db in 1/4-section types. 16 ohms. Half-sections, except X425, X825, 1/4; X2635, 1/4 and 1/2.

No.	Type	Crossover	Lbs.	NET
82 D 336	X425	400	4	31.34
81 D 415	X825	800	3	18.62
81 D 293	X8	800	4	31.34
81 D 416	X6	600	7	38.22
81 D 289	X336	300-3500	9	38.22
81 D 436	X36	3500	2	9.31
81 D 404	X2635	200-600-3500	11	73.50

NEW MODEL T350 VERY HIGH FREQUENCY DRIVER. For use in deluxe multi-way speaker systems having extended bass range. Provides extended treble response beyond audibility. Employs diffraction horn principle with special Avedon Sonophase throat design for 180° dispersion pattern. Capacity, 50 watts; handles 100-watt peaks. Impedance, 16 ohms. Frequency response: ±2 db. 2000 to 21,000 cps. Magnet wt., 2 lbs. Recommended crossover, 3500 cps. Horn is 7 1/2" long, 2 7/8" wide. Pot dia., 3 1/4". Overall depth, 4 1/2". Shpg. wt., 9 1/2 lbs.
82 DX 337. NET..... 58.80

NEW MODEL T3500 "IONOVAC" IONIZED AIR, VERY HIGH FREQUENCY DRIVER. For dazzling reproduction of treble frequencies. Employs radical new approach to reproduction of high frequencies. A glowing violet "cloud" of ionized air replaces the speaker diaphragm. This cloud is then modulated by the audio signal, producing rarefaction and compression of the air to form sound. As a result, the reproduced sound is unrestricted by properties of mass—not only does it reproduce audible sounds with amazing clarity, but its smooth, crystal clear high response reaches well into the ultrasonic range! Frequency response: ±2 db, 2000 to 40,000 cps. Recommended crossover, 3500 cps. Dispersion pattern, 180°. Power capacity, 50 watts; handles 100-watt peaks. 16 ohms. Driver assembly, 9x3 1/2 x 7"; electronic unit, 5 1/2 x 5 x 1 3/4". Baffle opening, 1 1/2 x 6". Wt., 22 lbs.
82 DZ 338. NET..... 147.00

NEW MODEL MT300 MID-BASS TREBLE DRIVER ASSEMBLY. Consists of Model 828HF coaxial driver, treble horn, mid-bass horn sections and angle throat. Treble frequencies are emitted from one end—mid-bass frequencies from the other. For use with high-efficiency, full-range speakers and deluxe phase-loaded systems. Response in recommended baffle assembly, 200 to 10,000 cps. Power handling capacity, 30 watts; 60-watt peaks. Impedance, 16 ohms. 3/4-lb. magnet. Size, 21 1/2" long, 6 1/2" high for clearance. Shpg. wt., 7 1/2 lbs.
82 DX 339. NET..... 42.14

NEW MODEL MT30B MID-BASS AND TREBLE DRIVER ASSEMBLY. Similar to MT300 above, but employs Model 828HFB driver unit. For use with medium-efficiency speakers and phase-loaded systems. Capacity, 20 watts; 40-watt peaks. Employs 1/2-lb. magnet. All other specifications are the same as the MT30. Shpg. wt., 7 lbs.
82 DX 340. NET..... 34.30

NEW MODEL 118 MID-BASS DUAL-DRIVER ASSEMBLY. For use in the Patricia and other deluxe speaker systems. Includes two 828HF drivers, two mid-bass horn sections, and all mounting accessories. Response when used in recommended 200-cycle horn, 150 to 1000 cps. Power handling capacity, 30 watts; 60-watt peaks. Impedance, 16 ohms. Size, 21 1/2" long, 6 1/2" high for clearance. Shpg. wt., 14 lbs.
82 DX 341. NET..... 76.44

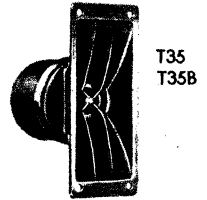

T35
T35B



AT37



T10A
T25A

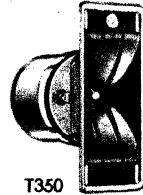

T350

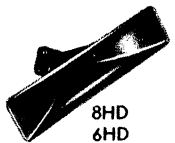

8HD
6HD

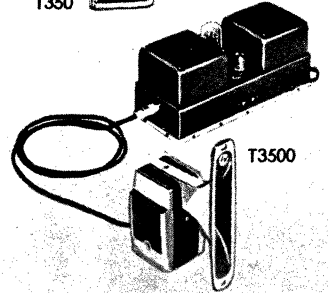

T3500

MT30
MT30B

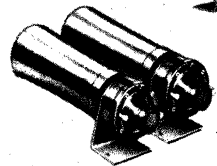

118

MID-RANGE AND HIGH-FREQUENCY COMPONENTS PACKAGES

Stock No.	Type	Description of Components	Wt.-Lbs.	NET
81 D 835	BB1	For use with existing 2-way systems (LF driver with treble driver), and coaxial speakers having 1-2-lb. magnets. Includes T35B VHF driver, X36 crossover, AT37 level control, wiring harness.	5	36.26
81 D 858	BB2	For use with existing 2-way systems (LF driver with treble driver), and coaxial speakers having 3-lb. magnets or greater. Includes T35 VHF driver, X36 crossover, AT37 level control, wiring harness.	5	49.00
81 DX 834	BB3	For existing LF drivers and coaxial speakers having 1-2-lb. magnets. Includes T10A driver, 8HD horn, X825 crossover, AT37 level control, wiring harness.	10	84.28
81 DX 859	BB4	For existing LF drivers and coaxial speakers having 3-lb. magnets or greater. Includes T25A driver, 8HD horn, X8 crossover, AT37 level control, wiring harness.	13	111.72
82 DX 342	BB5	Adds very high frequencies with wide dispersion. For systems having extended bass ranges such as Patricia IV, Georgian IV, Cardinal IV, Sr. Centurion, etc. Includes T3500 UHF driver, X36 crossover, AT37 level control, wiring harness.	13	73.50
82 DZ 343	BB6	Adds very high frequencies through modulation of ionized air stream. Used with deluxe, extended-bass systems such as the Patricia IVD. Includes T3500 "Ionovac" driver and electronic assembly, X36 crossover, AT37 level control, wiring harness.	25	161.21
82 DX 344	BB7	For mid-bass and treble frequencies from 200 to 10,000 cps. Ideal for use with 1 to 2-lb. magnet, full-range drivers such as SP12, SP15, 12TRX B, 15TRX B and medium-efficiency systems. Plans for simple plywood horn extension provided. Includes MT30B driver-horn assembly, X425 crossover, AT37 level control, wiring harness.	14	71.54
82 DX 345	BB8	For mid-bass and treble frequencies from 200 to 10,000 cps. Ideal for use with deluxe full-range drivers having 3-lb. magnets or more, such as SP12, SP15, 12TRX, 15TRX and high-efficiency systems. Plans for simple plywood horn extension are provided. Includes MT30 driver-horn assembly, X425 crossover, AT37 level control, wiring harness.	15	79.38



New E-V Phase-Loaded System and Enclosures with Matching Equipment Consoles

THE "CARLTON" AND "SHERATON" ENSEMBLE

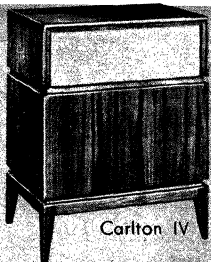

Carlton IV

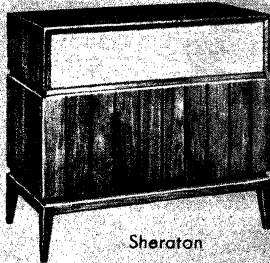

Sheraton

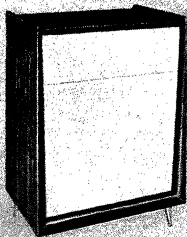

Suzerain

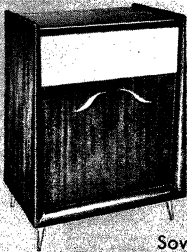

Sovereign

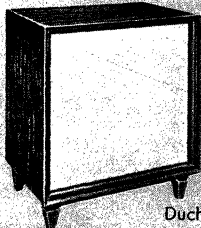

Duchess

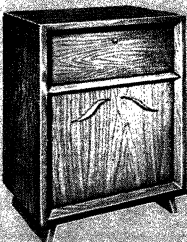

Viscount

CARLTON IV SPEAKER SYSTEM. New, phase-loaded, 4-way speaker system installed in a distinctively styled, contemporary enclosure. Harmonizes beautifully with any modern furnishing mode. *Enclosure available only in complete, phase-loaded system.* Provides unusually clear bass and smooth, resonant-free mid-range and treble.

Employs Model 105E components: Model 15W K 15" "K" type low-frequency driver, crossing over at 300 cps through X336 network to Model MT30 mid-bass horn assembly. Mechanical crossover at 1000 cps.

Model T350 VHF driver takes over at 3500 cps to provide treble response to 21,000 cps. Includes two AT37 level controls for "presence" and "brilliance" adjustment. Components are factory-installed and checked. Available in three lustrous, hand-rubbed veneers. Size: 33½" high, 26¼" wide, 19½" deep. Shpg. wt., 174 lbs.

82 DZ 390. Mahogany. NET..... 351.82
82 DZ 391. Lined Oak. NET..... 356.72
82 DZ 392. Walnut. NET..... 356.72

THE "SUZERAIN" AND "SOVEREIGN" ENSEMBLE

SUZERAIN SPEAKER ENCLOSURE ONLY. Reflecting the attractive, new Scandinavian trend in furniture decor, this magnificently styled enclosure adds a touch of elegance to any room. Carefully designed by audio experts to provide superior sound reproduction, and built by skilled craftsmen, the "Suzerain" demonstrates the perfect blending of creative design—function and style. Exceptionally versatile, it accommodates Electro-Voice phase-loaded, 4-way speaker system components such as Models 105E and 117B, and all 12" or 15" full-range speakers, without the need for cabinet modification. When used with these recommended speaker components, it provides unexcelled reproduction of sound across the entire audio range. Size: 36½" high, 26" wide, 19¾" deep. Shpg. wt., 84 lbs.

82 DZ 396. Mahogany. NET..... 132.30
82 DZ 397. Lined Oak. NET..... 139.16
82 DZ 398. Walnut. NET..... 139.16

"DUCHESS" & "VISCOUNT" ENSEMBLE

DUCHESS SPEAKER ENCLOSURE ONLY. Conveniently compact and with many of the fine touches that distinguish top-quality cabinetry, the "Duchess" provides complete versatility. You can install any E-V 12" or 15" extended-range or 3-way speaker by itself; then later, add tweeters or other speaker components to form a 2 and 3-way direct-radiator speaker system. It easily accepts E-V's phase-loaded, 4-way speaker system components, such as the Model 105E and 117B series without the need for cabinet modification. The "Duchess" is provided with cutouts from which masks may be removed to allow convenient installation of components. Overall size, 29¾" high, 25" wide, 19" deep. Shpg. wt., 60 lbs.

82 DZ 402. Mahogany. NET..... 94.08
82 DZ 403. Lined Oak. NET..... 98.00
82 DZ 404. Walnut. NET..... 98.00

VISCOUNT EQUIPMENT CABINET. Matches the smart, contemporary styling of the "Duchess" enclosure and other excellent E-V enclosures including the "Empire" and "Centurion". Its workmanship is impeccable. Features convenient lift-lid, tilt-out front—either a tuner or an amplifier can be installed on the tilt-out front panel to make all controls readily accessible. Accommodates record changer or turntable, amplifier and tuner. Compartment dimensions: Record Player or Turntable, 24" long, 17" wide, 19" deep overall (adjustable from 3½ to 6" above mounting board); Amplifier-Tuner, 14½" high, 22" wide, 17" deep (mtg. board, 8½x22"). Size is 34½" high, 26" wide, 19¾" deep. Shpg. wt., 88 lbs.

82 DZ 405. Mahogany. NET..... 146.02
82 DZ 406. Lined Oak. NET..... 152.88
82 DZ 407. Walnut. NET..... 152.88

SHERATON EQUIPMENT CABINET. Tastefully styled and functionally designed, console equipment cabinet. Designed to perfectly match the Carlton phase-loaded speaker enclosure. Built by highly skilled wood craftsmen, it forms a fine furniture piece of enduring beauty. Blends with any interior decorative motif. Separate compartments are spacious enough to accommodate almost any assortment of high-fidelity equipment. Has adequate room for amplifier, tuner, turntable or record changer, tape deck—plus record and tape storage facilities.

Compartment dimensions: Record Player, 18" long, 17¼" wide, 9½" overall depth (adjustable from 3½" to 6" above mounting board); Amplifier-Tuner, 13" high, 18" wide, 17¼" overall depth; Tape Deck, 13" high, 18" wide, 17¼" deep; Tape or Record Storage, 13" high, 19" wide, 17¼" deep. Overall size of the Sheraton is 33½" high, 37½" wide, 19½" deep. Shpg. wt., 103 lbs.

82 DZ 393. Mahogany. NET..... 169.54
82 DZ 394. Lined Oak. NET..... 177.38
82 DZ 395. Walnut. NET..... 177.38

SOVEREIGN EQUIPMENT CABINET. A tasteful furniture piece for your home entertainment center, the "Sovereign" is the perfect companion to the "Suzerain" speaker enclosure. Together they form a splendid combination which provides maximum utility and blends beautifully with the most elegant decors. The "Sovereign" features convenient lift-lid, tilt-out front design. The tilt-out front, for tuner or amplifier installation, eliminates stooping by making all controls readily accessible.

Accommodates record changer or turntable, amplifier and tuner. Compartment dimensions: Record Player or Turntable, 24½" long, 17" wide and 9½" deep overall (adjustable from 3½" to 6" above mounting board); Amplifier-Tuner, 14½" high, 23½" wide, 17" deep overall (mounting board 11x 23½"). Overall size, 36½" high, 26" wide, 19¾" deep. Shpg. wt., 84 lbs.

82 DZ 399. Mahogany. NET..... 146.02
82 DZ 400. Lined Oak. NET..... 152.88
82 DZ 401. Walnut. NET..... 152.88



NEW ELECTRO-VOICE PHASE-LOADED ENCLOSURES

A radical departure from conventional speaker enclosure design, E-V's new "Phase-Loaded" enclosures employ a unique acoustic principle to overcome the non-directional characteristic of bass sound. Unlike treble and mid-range tones, which are directional and ordinarily travel along two routes on the way to your ears—*resulting in partial cancellation*. One portion of a bass tone goes directly to your ears from the woofer, while another portion of the same tone travels first to the wall in back of the woofer, and is then reflected to your ears. Since the sound taking this second route travels further, it reaches you later than the sound that comes directly from the woofer—it is *out of phase*. "Phase-Loading" corrects this bass-cancelling time lag by using a specially designed woofer, placed low in a sealed cavity, *facing the wall*. With this unique arrangement, all of the bass is "bounced" back from the wall at the same time, and in phase with mid-range and treble tones—you hear a *perfectly balanced* audio spectrum! With "Phase-Loading", not only are bass tones augmented by 3 times, but you can place the enclosure anywhere along the reflecting wall.

Electro-Voice Speaker Enclosures & Kits



Complete kits for construction of famous Electro-Voice folded-horn speaker enclosures. Economical and easy to assemble, each kit includes clearly written, step-by-step instruction manuals. All lumber parts are cut to exact size on the same precision factory machinery which is used to manufacture completed Electro-Voice cabinets. All exterior surfaces of the enclosure kits are made of clear-grained birch, ready for finishing in the color of your choice. Finishing kits, for obtaining a professional furniture finish, are listed below. Grille cloth, glue, screws and nails are included; less metal trim (see below) and driver components (see pages 48 and 49).

Finished and completely assembled enclosures, also listed in the table below, have approximately the same dimensions as the complete speaker systems shown on pages 46-47. The Regency can be used in a corner or against the wall and accepts 12" or 15" speakers, and 2 and 3-way systems. The assembled Empire accepts phase-loaded and conventional systems, with 12" and 15" speakers—Empire kit is folded horn only. Aristocrat corner enclosure takes any 12" speaker, or Electro-Voice's 2 and 3-way systems. The Baronet accepts Electro-Voice or any other 8" speaker and is designed for corner placement.

ENCLOSURE	UNFINISHED KITS				ASSEMBLED, FINISHED ENCLOSURES								Shpg. Wt., Lbs.
	Stock No.	Model No.	Shpg. Wt., Lbs.	NET EACH	Mahogany		Lined Oak		Walnut				
					Stock No.	NET	Stock No.	NET	Stock No.	NET			
Regency	81 DZ 786	KD4	55	71.54	81 DZ 422	127.40	81 DZ 423	137.20	81 DZ 864	137.20	90		
Empire	81 DZ 787	KD5	45	49.98	81 DZ 769	97.02	81 DZ 770	106.82	81 DZ 863	106.82	56		
Aristocrat	81 DZ 788	KD6	36	38.22	81 DZ 295	70.56	81 DZ 296	77.42	81 DZ 862	77.42	44		
Baronet	81 DZ 789	KD7	15	25.48	81 DZ 418	44.10	81 DZ 419	48.02	81 DZ 861	48.02	20		

MODEL KD1 "PATRICIAN IV" INTERIOR ASSEMBLY KIT. Not illustrated. EV's famous "K" horn, augmented bass section. Scaled up approximately 30% to deliver an added full octave of bass. Low in cost, the KD1 kit offers all the advantages of the Patrician enclosure in a built-in corner installation. Designed for use with the Models 103D or 103E 4-way driver package (page 46).

When completed, the KD1 kit stands 57 7/8" high, 34 1/2" wide and 26 7/8" deep. Kit includes all parts, plus highly detailed but easy-to-follow assembly instructions. All lumber parts are pre-cut—glue, screws and nails are included. Shpg. wt., 150 lbs.
81 DZ 783. NET..... 115.64

FINISHING KITS FOR UNFINISHED ENCLOSURE KITS. Contain stain, filler, sealer, shellac, high-gloss and satin varnishes, finishing paper, brushes and instructions. Blonde kits include bleach. Shpg. wt., 6 lbs.
81 D 844. Model FK10. Walnut.
81 D 845. Model FK20. Mahogany.
81 D 846. Model FK30. Fruitwood.
81 D 847. Model FK40. Cherry.
81 D 848. Model FK50. Golden Oak.
81 D 849. Model FK60. Ebony.
 Above Kits. NET EACH..... **4.90**

ELECTRO-VOICE SPEAKER ENCLOSURE PLANS. Easy-to-follow instruction booklets containing complete plans and list of materials necessary to build any of the E-V speaker enclosures.

The instruction booklets are each divided into five sections. (1) description of the specific enclosure and system, plus performance to be expected; (2) selection of materials, layout and cutting to size; (3) assembling the enclosure; (4) installation of speakers; (5) built-in systems which become part of house. Full construction details include tips on selecting lumber, layout and sawing of parts, and recommended Electro-Voice speakers and other components for your finished enclosure. Also include drawings, photos and hints to simplify building. Postpaid in U.S.A.

Stock No.	Plan	For	NET
38 K 138	1B1	Patrician horn	1.47
38 K 139	1B2	Georgian horn	1.47
38 K 140	1B3	Centurion	.98
38 K 141	1B4	Regency	.98
38 K 142	1B5	Empire	.98
38 K 143	1B6	Aristocrat	.98
38 K 144	1B7	Baronet	.73

DECORATIVE TRIM AND GRILLE KITS. Custom, metal trim and grille sets. Provide a smart, professional appearance for your Electro-Voice enclosure kits—add a distinctive, finished touch.

MODEL AK3. Trim kit for Patrician and Georgian style exteriors. Consists of two decorative handles, 7" long and 1" wide, and modern crossbar grille. Grille is cut to 10" by 29 1/2" size. Attractively finished in brushed and lacquered antique brass. 4 lbs.
81 DX 796. NET..... 11.76

MODEL AK4. Similar to above, but designed for Centurion style exterior. Handles are 5" long and 3/4" wide. Grille is 8" by 25". Shpg. wt., 3 lbs.
81 DX 797. NET..... 8.82

MODEL AK5. For Model KD4 Regency enclosure kit. Consists of lacquered, antique brass finish crossbar grille, 24" by 29 1/2" in size. Shpg. wt., 3 lbs.
81 DX 798. NET..... 5.88

MODEL AK6. Similar to Model AK5 described above, but for use with the Model KD6 Aristocrat enclosure kit. Grille is slightly smaller. Shpg. wt., 3 lbs.
81 DX 799. NET..... 4.70

Electro-Voice High-Fidelity Components

MODEL 3303 STEREO FM-AM TUNER-PRE-AMP. Offers excellent sensitivity, micro-accurate tuning and drift-free operation. Completely independent AM and FM sections, including separate tuning dials, permit reception of stereophonic broadcasts. Other deluxe features are dual signal strength meters, "Magic eye" tuning aid, and preamp. Controls: Selector for Tuner, Tape, TV, Auxiliary and Phono inputs; 3-position Loudness control; 6-position Equalizer (RIAA, LP, Eur-500, Eur-300, 78-500, 78-300); Phono switch (magnetic or ceramic-crystal); Bass; Treble; and Volume. Sensitivity: FM, 1 μ v for 20 db quieting; AM, 1 μ v. 10 kc AM whistle filter.

Preamp section has response of ± 1 db, from 20 to 40,000 cps. Distortion: Harmonic less than 0.2%; IM, less than 0.3%. Rated Output: 1.25 volts from cathode follower output; 0.8 volt from record output jack. 16 tubes, 1 diode, 5Y3GT and 6X4 rectifiers, plus 6AL7 tuning eye. Brown baked enamel with black escutcheon and brushed brass trim. Size: 8 1/4 x 15 x 15 3/4". For 110-120 v., 50-60 cycle AC. Wt., 30 lbs.
94 SZ 306. NET..... 273.91

MODEL 3304 STEREO BASIC FM-AM TUNER Similar to above, but for use with separate preamplifier or amplifier having complete set of controls. Has AFC, volume and FM-AM balanced-level controls. 14 tubes, 3 diodes, 5Y3GT rectifier and 6AL7 tuning eye. Size: 8 1/4 x 15 x 15 3/4". For 110-120 v., 50-60 cycle AC. Shpg. wt., 30 lbs.
94 SZ 307. NET..... 234.71

MODEL A20CL LOWBOY 20-WATT AMPLIFIER. Features "Circulotron Circuit" for superb hi-fi reproduction. All DC is removed from output transformer for extended response with minimum distortion. Output: 20 watts; 40 watts peak. Response: ± 1 db, 20-20,000 cps. Harmonic Distortion: Less than 0.5% at 20 watts; IM: Less than 1% at 20 watts. Hum and Noise: -75 db. Outputs: 4, 8 and 16 ohms for speaker; tape output jack. Controls: Function Selector, Record Compensator; Presence; Loudness; Rumble Filter; Volume; Treble; Bass; Damping. Two 6V6GT's in output. 4 1/2 x 15 x 12". For 110-120 v., 50-60 cycle AC. Wt., 23 lbs.
94 SZ 308. NET..... 122.01

MODEL A15CL 15-WATT LOWBOY AMPLIFIER. Similar to above, but does not have Presence, Loudness and Rumble controls. Two EL84's in output. Shpg. wt., 21 lbs.
94 SZ 309. NET..... 97.51

MODEL PC1 PREAMP-EQUALIZER. Distortion: Less than .03%. Noise Level: -75 db. Controls: Selector (Tuner, Tape, TV, Aux and Phono, plus 4 level controls); 6-pos. Equalizer; Loudness; Rumble Filter; High Frequency Filter; Bass; Treble; Presence; Volume; phono switch; tape recording output jack. Cathode follower output. Size: 4 1/2 x 15 x 8 1/4". For 110-120 v., 50-60 cycle AC. Shpg. wt., 12 lbs.
94 SX 314. NET..... 97.51

MODEL PC2 PREAMP-EQUALIZER. Similar to above, but has same controls as A15CL. Size: 4 1/2 x 15 x 6 1/4". Shpg. wt., 11 lbs.
94 SX 315. NET..... 65.66

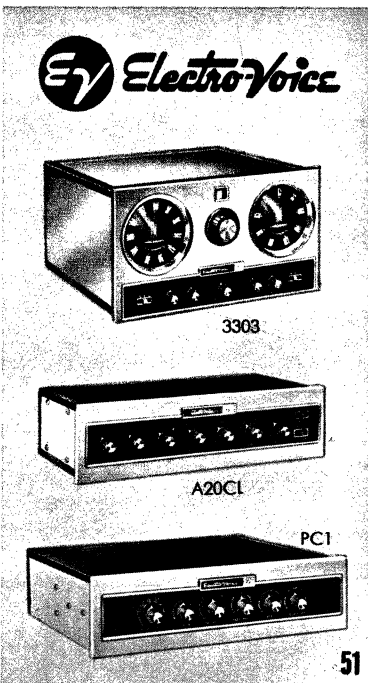

HIGH-FIDELITY SPEAKER SYSTEMS AND ENCLOSURES

EN-12 ENCLOSURES AND COMPLETE SPEAKER SYSTEMS



EN-12

EN-12 ENCLOSURE. Popular "cornerless corner" horn-loaded enclosure, redesigned with attractive new front panel and grille. May be used against a wall or in a corner, with equal effectiveness. Combines the best features of rear horn-loading, phase inversion, and direct radiator design. Speaker mounting board has pre-cut openings and adapter board to allow progressive expansion of speaker system.

Openings permit easy installation of mid-range and high-frequency tweeters. Interior panels are strongly braced for maximum rigidity, to eliminate rattling and "buzzing" at high-amplitude low-frequency signals. For any 12" extended-range speaker; or multiple speaker systems using 12" woofer, H-600 horn with T-30 mid-range or T-50 mid- and high-range driver, and 4401, UXT-5 or HF-206 tweeters. 29½" high, 21½" wide and 15½" deep. Choice of 3 handsome finishes. Shpg. wt., 48 lbs.

81 DZ 822, Mahogany, NET.....74.48
81 DZ 823, Blonde Mahogany, NET..77.91
81 DZ 819, Walnut, NET.....81.83

EN-12 WITH 312 INSTALLED. Folded horn enclosure described at left, with 12" University 312 "Diffaxial" speaker installed. Has 12" bass cone, "Diffusicon" mid-range unit, and HF-206 super-tweeter. 60 lbs.

81 DZ 884, Mahogany, NET.....143.08
81 DZ 885, Blonde Mahogany, NET..146.51
81 DZ 886, Walnut, NET.....150.43

EN-12 WITH UXC-123 INSTALLED. 12" University "Diffaxial" speaker with reciprocating-flare super-tweeter. Reproduces entire musical range with excellent fidelity. Shpg. wt., 55 lbs.

81 DZ 820, Mahogany, NET.....137.20
81 DZ 821, Blonde Mahogany, NET..140.63
81 DZ 887, Walnut, NET.....144.55

EN-12 "SENIOR" 3-WAY SYSTEM. For highest quality performance where space is limited. Uses C12W woofer, H-600/T-30 mid-range combination, and UXT-5 super-tweeter, for superb reproduction. Shpg. wt., 95 lbs.

81 DZ 893, Mahogany, NET.....196.00
81 DZ 894, Blonde Mahogany, NET..200.90
81 DZ 895, Walnut, NET.....204.82

UNIVERSITY EN-15 SPEAKER ENCLOSURE AND SYSTEM

EN-15 ENCLOSURE. Improved version of an advanced design folded-horn enclosure. For use with 12" or 15" speaker. Mounting board is pre-cut for 15" speaker, with removable adapter cut for 12" speaker. For mid-range it accommodates an 8" speaker or the H-600 horn with T-30 driver; for treble, the 4401, UXT-5 or HF-206 tweeter, or the H-600 horn with the T-50 driver. Internal construction is similar to EN-12, combining horn loading, phase inversion and direct radiation. Projects maximum available output of speaker at low frequencies, without screening or blocking radiation of highs. Inclined front panel and unusual shape lend a distinctive appearance to the EN-15 and eliminate resonances. Carefully finished in accordance with the highest standards of furniture manufacture. Choice of 3 finishes. Size: 37" high, 28" wide, 19¼" deep. Shpg. wt., 96 lbs.

81 DZ 914, Mahogany, NET.....122.50
81 DZ 915, Blonde Mahogany, NET..132.30
81 DZ 817, Walnut, NET.....136.71

EN-15 "MASTER" 3-WAY SYSTEM. Provides exceptionally fine music reproduction and occupies relatively small space; tonal range exceeds the limits of human hearing. System includes the effective C15W 15" woofer, T-30 driver unit with H-600 horn for mid-range, and HF-206 Hypersonic tweeter for excellent high-frequency reproduction. N-3 "Acoustic Baton" crossover network with Presence and Brilliance controls permits exact matching of speaker system response to room acoustics. Performance is on a level with systems of considerably greater size and cost; the "Master" system handles up to 50 watts of program material, smoothly reproducing the full sonority of orchestras, large choral groups, etc., as well as solo instruments and the human voice. May be placed in a corner, or against a wall. Size: 37" high, 28" wide, and 19¼" deep. Shpg. wt., 130 lbs.

81 DZ 824, Mahogany, NET.....303.80
81 DZ 825, Blonde Mahogany, NET..313.60
81 DZ 841, Walnut, NET.....318.50

UNIVERSITY "CLASSIC" 3-WAY SPEAKER SYSTEMS

S-8 "CLASSIC." One of the finest speaker systems available, in smart lowboy design enclosure. System includes C15W 15" woofer for extended bass response; Cobreflex-2 mid-range horn with T-30 driver unit for authentic reproduction from 350 to 5000 cycles; HF-206 super-tweeter for reproducing frequencies from 5000 cycles to inaudibility with diamond-like clarity. N-3 "Acoustic Baton" crossover network includes Presence and Brilliance controls, for balancing sound of speaker system to acoustics of room in which it is placed. Enclosure is a highly efficient folded exponential horn, front-loading the 15" woofer for direct projection of bass frequencies toward the listener. Size, 34½" high, 40½" wide, 24¾" deep. Offered in choice of 3 handsome finishes. Shpg. wt., 210 lbs.

81 DZ 826, Mahogany, NET.....465.50
81 DZ 827, Blonde Mahogany, NET..485.10
81 DZ 842, Walnut, NET.....509.60

S-9 EN-CB UTILITY "CLASSIC" SYSTEM. High-quality 3-way speaker components as at left, completely installed and wired inside the unfinished EN-CB utility enclosure. Similar to "Classic," but less base and frame. Constructed of selected ¾" white birch veneer plywood, with lock and miter joints, and braced with heavy glue blocks. May be furniture-finished, painted to match walls, or simply installed behind a partition or wall having a rectangular opening (in custom built-in systems). Supplied with all speaker components already mounted and connected, ready to play. Completely self-contained folded horn permits placement anywhere in a room; operation is entirely independent of corners, walls, etc. Size 40x30x24". Shpg. wt., 185 lbs.

81 DZ 904, NET.....313.60

EN-CB UTILITY "CLASSIC" ENCLOSURE ONLY. Unfinished enclosure, less speakers. Shpg. wt., 142 lbs.

81 DZ 905, NET.....117.60

UNIVERSITY "DEAN" 3-WAY CORNER SPEAKER SYSTEM

Superb 3-way 15" speaker system housed in unusually efficient folded horn enclosure. Cabinet is similar to "Classic," but is specially designed to fit the corner of a room. Built-in front-loaded horn projects sound of C15W woofer outward into room. T-30 mid-range and HF-206 high-frequency components effectively distribute sound through listening area; the entire range of musical tones and overtones is reproduced with great smoothness and clarity. Enclosure workmanship is distinguished; every detail of assembly and finishing testifies to the high standards applied in its manufacture. The T-30 driver unit and Cobreflex horn reproduce mid-range frequencies with ex-

ceptional clarity and smoothness. The HF-206 Hypersonic tweeter is employed to reproduce high frequencies with vivid brilliance and clarity. All components are rigidly mounted in enclosure to thoroughly eliminate vibration or buzzing, even when high-amplitude, very low frequency sounds are played. Overall response of the system extends from 20 cycles to beyond the limits of human hearing. Size: 36½" high, 36" wide, 22" deep. Shpg. wt., 170 lbs.

81 DZ 813, Mahogany, NET.....465.50

81 DZ 814, Blonde Mahogany, NET..485.10

81 DZ 815, Walnut, NET.....509.60

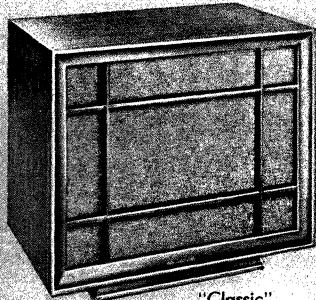

"Classic"

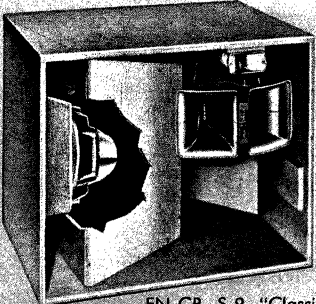

EN-CB S-9 "Classic"

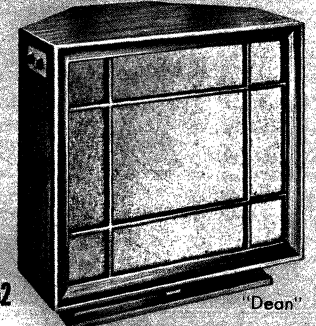

"Dean"

SPEAKER SYSTEMS, KITS AND COMPONENT ASSEMBLIES

UNIVERSITY "TINY-MITE" SPEAKER ENCLOSURES AND SYSTEMS

TM-812 "TINY-MITE" ENCLOSURE. An unusually effective folded-horn design, occupying little more than one square foot of floor space, yet providing powerful bass response. Designed for use with any 12" or 8" speaker; baffle board is cut for 12" speaker, with removable adapter board cut for 8" speaker. Construction is of heavy 3/4" wood, braced to eliminate any trace of vibration or rattling. Interior folded-horn construction operates independently of room placement; enclosure may be used in a corner, against a side wall, on a shelf, etc., without impairment of tonal quality. Surfaces are beautifully finished; precision workmanship throughout. Available in choice of mahogany, blonde mahogany, or walnut finish. Grille cloth has attractive swirl pattern, selected to harmonize with wood finishes. Size, 21" high, 15 1/2" wide, 12 1/2" deep. Shpg. wt., 25 lbs.

95 DZ 104. Mahogany. NET..... 42.73
 96 DZ 107. Blonde Mahogany. NET. 45.57
 81 DZ 818. Walnut. NET..... 47.53

S-37M SYSTEM. Combination of 3-way Model 308 University "Diffaxial" 8" speaker and highly efficient "Tiny-Mite" enclosure listed at left. Speaker is installed, wired and ready to use. Convenient terminal strip on rear of enclosure for easy hook-up to amplifier without opening enclosure. Shpg. wt., 30 lbs.

81 DZ 897. Mahogany. NET..... 83.30
 81 DZ 898. Blonde Mahogany. NET. 86.24
 81 DZ 899. Walnut. NET..... 87.71

"TINY-MITE" WITH UXC-122 INSTALLED. Highly effective system using 12" UXC-122 "Diffaxial" speaker. Delivers music reproduction comparable to considerably larger systems. Exceptionally compact; may be used anywhere in a room, since self-contained folded-horn in enclosure is independent of walls and floor for operation. Shpg. wt., 31 lbs.

81 DZ 568. Mahogany. NET..... 75.07
 81 DZ 569. Blonde Mahogany. NET. 77.91
 81 DZ 888. Walnut. NET..... 79.87

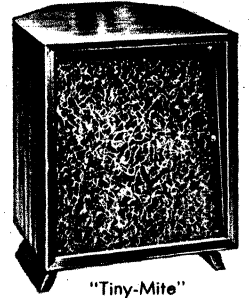

"Tiny-Mite"

UNIVERSITY "COMPANIONETTE" 2-WAY SPEAKER SYSTEM

Tastefully styled 2-way speaker system of excellent tonal quality, designed for limited-space applications as a shelf enclosure; may also be used as an extension speaker to bring music from your central hi-fi system to another part of the house. Enclosure employs "distributed port" construction for smooth, peak-free bass response. Components installed are C8W woofer, 4401 wide-angle tweeter and 2000-cycle crossover network. Response of system extends from deep bass to 15,000 cycles—the practical limit of human hearing.

Only 9 3/4" high, 10" deep and 24" long—perfect for mounting on a book or record shelf. Sturdily constructed to prevent cabinet vibration; handles program material of up to 25 watts. May be mounted on wrought iron legs (available at most hardware stores) as an independent, free-standing unit if desired. Matching grille cloth has attractive swirl pattern. Shpg. wt., 25 lbs.

81 DZ 583. Mahogany. NET..... 60.76
 81 DZ 584. Blonde Mahogany. NET. 62.72
 81 DZ 816. Walnut. NET..... 64.73



"Companionette"

UNIVERSITY "KWIKIT" 12" AND 15" SPEAKER ENCLOSURE KITS

Enclosures of superior acoustic design in kit form, complete with attractive front panel trim and grille cloth. Selected wood panels are cut exactly to size, of 3/4" fully cured lumber, ready for furniture finishing. Rabbeted grooves provide positive air-tight construction for maximum enclosure efficiency. Design combines direct speaker radiation, reflex principle and new rear horn loading construction, to produce uniform response in all parts of the listening area. Self-contained folded horn extends to front of enclosure, projecting low frequencies out into the room. Small slot in base equalizes woofer diaphragm excursions in the compression chamber. "Kwikits" are independent of room placement, and may be used against a flat wall, in a corner, or above floor level. Heavy wood panels provide high rigidity. Exterior and interior parts fit snugly together; smooth, professional finishing is

assured by absence of protruding edges or irregularities in edges of panels. KEN-12 has baffle board for 12" wide-range speaker or woofer; pre-cut for University 4409 or H-600/T-30 mid-range components; and 4401, UXT-5 or HF-206 tweeter. KEN-15 accepts a 15" (or 12" speaker with adapter listed below), and same mid-range and high-frequency components as KEN-12. With grille cloth.

KEN-12. 29 1/2 x 21 1/2 x 15 1/2". Wt., 45 lbs.
 81 DZ 828. NET..... 43.85

KEN-15. 35 1/4 x 29 x 18 1/2". Wt., 70 lbs.
 81 DZ 829. NET..... 58.31

ADAPTER BOARD. Permits mounting 12" speaker in KEN-15. Shpg. wt., 1 1/2 lbs.
 95 DX 579. NET..... 1.19

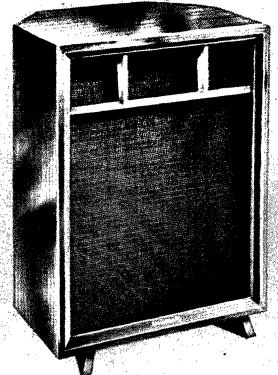

KEN-12

KEN-15

University 2-Way, 3-Way, Mid-Range and High-Frequency Speaker Packages

Carefully matched combinations of speaker components, available in a variety of sizes. Include "add-on" groups of components for modernizing existing installations, and complete sets of components. Especially suited to custom installation in walls or doors, or in specially designed enclosures. Each set includes all necessary drivers and horns, wiring harness, balance controls as indicated, and full instructions for quick, simplified installation.

Each full-range speaker component package offers superior coverage of the audible range, when properly baffled. High frequency and mid-range packages add new brilliance to older high-fidelity systems. Crossover networks are furnished as required, eliminating any necessity for further matching of components. May be used with all high-quality amplifiers and other playback equipment. Binding post terminals for simple installation; no soldering required.

Stock No.	Type	Description	Wt., Lbs.	NET
95 D 109	UN-1	High-Frequency Components Package; HF-206 tweeter, N2B, A8	7	49.93
81 DX 995	UN-2	Mid-Range Components Package; T-30 mid-range driver H-600 reciprocating-flare horn, N2A crossover network, A8 balance control.	8	68.55
81 DX 996	UN-3	Mid- and High-Frequency Components Package; T-30 mid-range driver, H-600 horn, HF-206 super-tweeter, N3 crossover network with controls.	15	106.82
81 DX 997	UN-4	8" Two-Way Components Package; C8W woofer, 4401 tweeter, N1 crossover network with balance control.	8	41.16
81 DZ 998	UN-5	12" Three-Way Components Package; C12W woofer, H-600 horn, T-30 driver, HF-206 super-tweeter, N3 crossover with controls.	17	142.10
81 DZ 999	UN-6	15" Three-Way Components Package; C15W woofer, H-600 horn, T-30 driver, HF-206 super-tweeter, N3 crossover with controls.	22	190.12

FOR FULL DESCRIPTION OF COMPONENTS USED IN PACKAGES ABOVE, SEE PAGE 55

University

HIGH FIDELITY SPEAKERS

Top-quality hi-fi speakers, famous for their authentic reproduction of sound

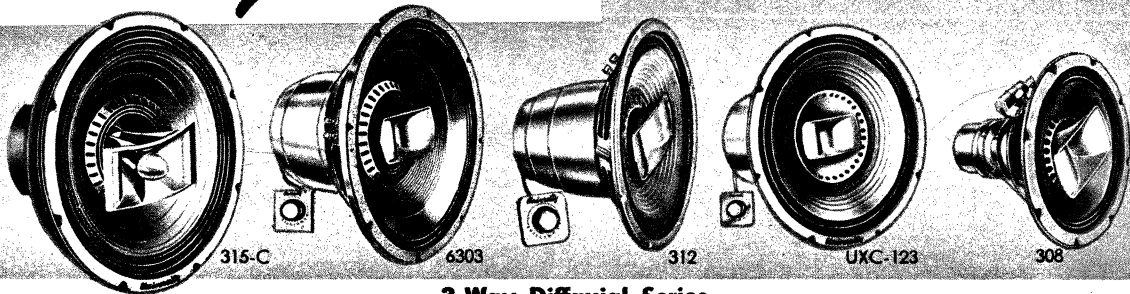

3-Way Diffaxial Series

UNIVERSITY'S DIFFAXIAL DESIGN. Most of the speakers listed below employ University's famous Diffaxial design. This feature assures outstanding tonal balance by providing exceptionally smooth, wide-angle dispersion of treble frequencies. These frequencies are normally projected straight ahead by the loudspeaker; as a result, they are not heard at the proper volume at all points in the room. However, University's Diffaxial speakers overcome this problem by using a special diffusing-type cone (Diffusicone) at the apex of the main cone. The Diffusicone disperses the treble frequencies to provide extremely even distribution throughout the listening area.

MODEL 315-C SUPER 15" DIFFAXIAL. New, greatly improved version of earlier 315. Woofer cone features high excursion, dual-spider piston and anti-breakup, low-resonance diaphragm, for rich natural bass. Multi-element Diffusicone mid-range section, crosses over at 1000 cps. Treble is covered by new, heavy-duty T-50 Hypersonic driver and axially mounted, wide-angle tweeter horn. Response is 25 cps to inaudibility. Includes balance control with tweeter adjustment. Magnet wt., 6½ lbs. Capacity, 50 watts. Impedance, 8-16 ohms. 12" deep. Shpg. wt., 34½ lbs.
81 DZ 947. NET.....152.88

MODEL 6303 15" DIFFAXIAL. Excellent 3-way performance is achieved by using the diffusicone design and coaxially mounted, high-efficiency tweeter. Moderately priced, the 6303 is a fine choice for a custom home music system. Three reproducing elements (15" cone, Diffusicone element and super-tweeter, with new T-50 Hypersonic driver), provide brilliant high-fidelity sound. Frequency response, from 30 cps to beyond audibility.

Mechanical crossover at 1000 cps; electrical crossover network at 5000 cps. Includes brilliance control on 3-ft. cable with brass plate and knob. 2-lb. Alnico V permanent magnet. Power capacity, 30 watts. Impedance, 8-16 ohms. 15½" diameter; 10" deep. Shpg. wt., 12 lbs.
95 DZ 538. NET.....81.34

MODEL 312 12" DIFFAXIAL. Brilliant 12" diffaxial speaker for exceptional, wide-range reproduction. Has 12" woofer, Diffusicone mid-range unit, and HF-206 super-tweeter. Built-in electrical crossover network at 5000 cps. Response, 40 cps to beyond audibility, 25 watts power handling capacity. Impedance, 8-16 ohms. With brilliance control. 36" cable. Size, 12¼" dia. x 8" deep. Shpg. wt., 11 lbs.
95 DX 188. NET.....68.60

MODEL UXC-123 12" DIFFAXIAL. Unusually low in cost, the UXC-123 employs a Diffusicone element and reciprocating-flare super-tweeter, mounted through the center axis of the woofer, to attain true, wide-angle dispersion. Built-in brilliance control for adjustment to room acoustics. Mechanical crossover at 1000 cps; electrical crossover at 5000 cps. 1¼-lb. Alnico V permanent magnet. Power handling capacity, 25 watts. Impedance, 8-16 ohms. Frequency response, 45 to 17,500 cycles. Size, 12¼" diameter; 8¼" deep. Brilliance control comes complete with etched brass mounting plate and knob, wired to 3-ft. cable. Shpg. wt., 9 lbs.
95 DX 585. NET.....62.72

MODEL 308 8" DIFFAXIAL. A very compact, highly efficient Diffaxial speaker. Designed specifically for the smaller hi-fi installation, the 308 is perfect for use where space is at a premium and quality reproduction is desired. Features special-design 8" woofer for excellent bass response. Has Diffusicone mid-range unit, compression type tweeter and built-in 5000-cps electrical crossover. Frequency response, 50-15,000 cps. Impedance 8-16 ohms. Power handling capacity, 25 watts. 8½" diameter; 6¼" deep. Shpg. wt., 5 lbs.
95 D 189. NET.....38.95

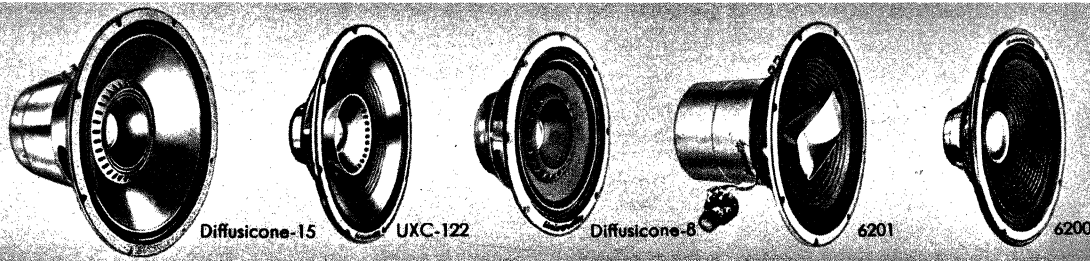

2-Way Diffaxial Series

12" Coaxial Speaker

MODEL DIFFUSICONE-15 15" DIFFAXIAL. Low-cost, 2-way, Diffaxial 15" speaker. Diffusicone element assures wide-angle dispersion of treble frequencies. Horn-loading at the apex of the cone extends mid- and high-frequency response, crossing over mechanically at 1000 cps. Rich, clear bass, without boominess, is provided by the sturdily constructed 15" woofer with specially molded cone. A 1½-lb. Alnico V magnet also contributes to the excellent bass response. Frequency response from 30 to 14,000 cycles. Power capacity, 30 watts. Impedance, 8-16 ohms, 15½" dia.; 7¼" deep. Shpg. wt., 8¼ lbs.
95 DX 539. NET.....44.10

MODEL DIFFUSICONE-12 12" EXTENDED-RANGE DIFFAXIAL. 12" version of above. For the low-cost music installation. Smooth, wide-angle dispersion achieved by patented University diffusicone element. Power handling capacity, 30 watts. Frequency response, 40 to 14,000 cps. Impedance, 8-16 ohms. 24 oz. Alnico V magnet. Depth 4¼"; 12¼" diameter. Shpg. wt., 6 lbs.
95 DX 182. NET.....36.26

MODEL UXC-122 12" DIFFAXIAL. Low-priced 12" Diffaxial speaker. Employs Diffusicone high-frequency element with a 1000-cycle mechanical crossover. Coaxial dual horn-loading at apex of cone extends mid and treble response. Low frequencies are reproduced by specially molded, one-piece woofer diaphragm. Wide angle dispersion achieved by use of a radial projector plus aperture diffraction. Delivers excellent reproduction across entire audio range. Response, 45 to 13,000 cps. Power handling capacity, 25 watts. Impedance, 8-16 ohms. Size, 12¼" diameter; 4" depth. Employs 1-lb. Alnico V permanent magnet. Shpg. wt., 5¼ lbs.
95 DX 584. NET.....32.34

MODEL DIFFUSICONE-8 8" DIFFAXIAL. Low-cost, 2-way 8" speaker. Highly suitable for the smaller hi-fi installation, or where space is at a premium. Diffusicone element provides better-than-average reproduction. Response, 70 to 13,000 cps. Power handling capacity, 25 watts. Impedance, 8-16 ohms. Depth, 3¾". Shpg. wt., 3¼ lbs.
95 D 183. NET.....25.48

MODEL 6201. Highly popular, top-quality 12" hi-fi speaker. True coaxial operation is provided by a compression-type tweeter and 2500-cycle electrical crossover network. Tweeter is axially mounted through the center of the woofer. "W" shape, 1¾-lb. Alnico V magnet and 1-piece molded woofer diaphragm provide exceptionally smooth low-frequency transient response. Includes brilliance control with 3-ft. cable. Excellent frequency response—45 to 15,000 cps. Capacity, 25 watts. Impedance, 8-16 ohms. 8¼" depth. Shpg. wt., 10¼ lbs.
95 DX 176. NET.....50.96

12" Extended-Range Speaker

MODEL 6200. Highly popular 12" speaker. Special, shallow design for flush mounting in ceilings, walls, etc. Excellent for public address use; radio-phonograph replacement, hi-fi systems, etc. Employs duraluminum dome at cone apex. Frequency response, 45-10,000 cps. Impedance, 8-16 ohms. Power handling capacity, 30 watts. Only 4" deep. Shpg. wt., 5¼ lbs.
95 DX 180. NET.....25.48

Low-Frequency Woofers

MODEL C15W 15" WOOFER. Features special-design voice coil permitting greater cone excursion for deep bass. Dual spider piston and 6-lb. magnet assure remarkably clean response from below 25 to 1500 cps. Power handling capacity, 50 watts. Dual impedance voice coil assembly permits use in any system of 4 to 20 ohms. Depth, 10 1/2". Shpg. wt., 26 3/4 lbs.
95 DZ 185. NET. 83.30

MODEL C63W 15" WOOFER. Employs unique, built-in low-pass filter. Permits adjusting treble cut-off point at 700, 2500 or 5000 cps to suit crossover requirements of most tweeters. 1 1/2-lb. magnet. Response, 30 to 6000 cps. Capacity, 30 watts. Includes brilliance control. Impedance, 8 ohms. Depth, 10". Shpg. wt., 10 lbs.
81 DX 563. NET. 48.02

MODEL C12W 12" WOOFER. Features built-in low-pass filter for adjustment of response to 700, 2500 or 5000 cps—suits crossover requirements of most tweeters. Frequency response, 40 to 6000 cps. Power handling capacity, 30 watts. Employs 1 1/2-lb. magnet. Impedance, 8 ohms. 6 1/2" deep. Shpg. wt., 7 1/4 lbs.
95 DX 191. NET. 35.28

MODEL C8W 8" WOOFER. Perfect for use in assembling a high-quality speaker system for use where space is limited. May be used as a low-cost, mid-range speaker in three-way systems. Suitable for crossover up to 5000 cps. Response, 50 to 5000 cps when properly baffled. Power handling capacity, 25 watts. Impedance, 8 ohms. 4 1/4" deep. Shpg. wt., 3 lbs.
95 D 192. NET. 13.23

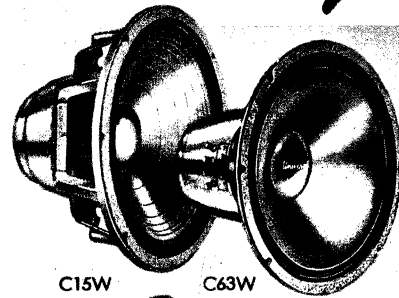

Tweeters, Horns and Drivers

NEW MODEL HF-206 HYPERSONIC TWEETER. For crisp, clear highs. Extends high-frequency response far beyond audible range. Employs improved die-cast aluminum wide-angle, "reciprocating flare" horn for uniform 120° horizontal and 50° vertical dispersion. New driver mechanism handles 25-50 watts of program material. Response, 3500 cps to inaudibility. Requires N-1 or N-2B crossover networks. Impedance, 8 ohms. 6 3/4 x 6 9/16". Shpg. wt., 3 1/2 lbs.
95 D 190. NET. 32.34

MODEL T-30 MID-RANGE AND HIGH-FREQUENCY DRIVER. For use with Cobreflex-2 or H-600 horns. Provides mid-range in 3 and 4-way systems, or serves as tweeter in 2-way systems. Requires N-2A crossover network. Response, 200 to 15,000 cps. Capacity, 50 watts in multi-speaker systems. Impedance, 8 ohms. 1 3/4"-18 throat; 3 1/2" diameter; 3 3/4" deep. Wt., 2 3/4 lbs.
81 D 589. NET. 29.40

NEW MODEL T-50 HYPERSONIC DRIVER. Not illustrated. Heavy-duty driver unit for use with the H-600 horn. Provides response from 600 cps to beyond audibility. Recommended for large theatre and auditorium speaker systems, and deluxe home hi-fi systems. Requires N-2A crossover network. Capacity, 50 watts in multi-speaker systems. Impedance, 8 ohms. 1 3/4"-18 throat; 4 1/4" diameter; 4 1/4" deep. Wt., 5 lbs.
81 D 948. NET. 48.51

MODEL COBREFLEX HORN. Perfect for use as a mid-range horn, in 3-way speaker systems when used with the T-30 driver unit. Its 27" exponentially flared air column permits crossover as low as 350 cps. Twin-flare design for uniform wide-angle dispersion; 120° horizontal and 60° vertical. Aluminum die casting. 1 3/4"-18 throat. 10 1/4 x 18 1/2 x 9 1/4". Shpg. wt., 10 1/4 lbs.
95 DX 184. NET. 22.54

MODEL 4401 TWEETER. A quality tweeter at low cost. Sturdy, one-piece die-cast horn using "reciprocating flare" principle for 120° horizontal and 50° vertical dispersion. Employs efficient driver mechanism and lightweight duralumin voice coil suspension in hermetically sealed unit. Response, 2000 to 15,000 cps. Requires N-1 or N-2B crossover networks. Capacity, 25 watts. Impedance, 8 ohms. Size, 2 3/4 x 6 x 6 1/4". Shpg. wt., 2 lbs.
95 D 167. NET. 17.64

MODEL UXT-5 SUPER TWEETER. A compact, super-tweeter assembly. Unusually smooth response at 5000 cps crossover point, or above. Employs compression driver unit and magnet, coupled to "reciprocating flare" horn, for uniform wide-angle response. Recommended for use with either the N-1 high-pass filter or N-2B crossover network. Response from 4500 to 17,500 cps. 120° horizontal and 50° vertical dispersion. Capacity, 25 watts in 2-way systems, 50 watts in 3-way systems. Impedance, 8 ohms. 4 1/4 x 2 1/2 x 4". Shpg. wt., 1 3/4 lbs.
81 D 564. NET. 20.58

NEW MODEL H-600 MID-RANGE AND HIGH FREQUENCY HORN. Excellent new, 600-cycle cutoff, wide-angle horn. One-piece, die-cast design. Specially designed for professional sound system use or for deluxe home hi-fi systems. Offers outstanding performance at low cost. Combines "reciprocating flare" principle with hemispherical deflection, for uniform sound distribution patterns throughout the audio range from 600 cps to beyond audibility. Accepts any driver unit with standard-size 1 3/4"-18 throat. Recommended for use with N-2A crossover network and the Model T-30 or T-50 driver units. Size, 7 3/4 x 8 3/4 x 4 3/4". Shpg. wt., 2 1/2 lbs.
81 DX 949. NET. 17.64

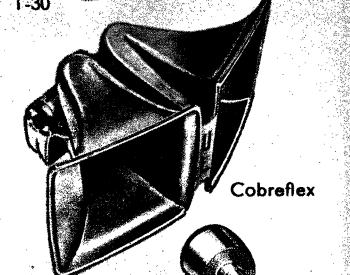
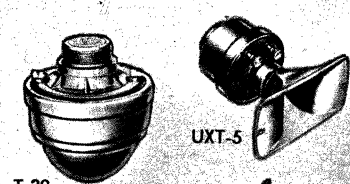
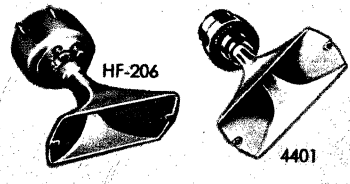
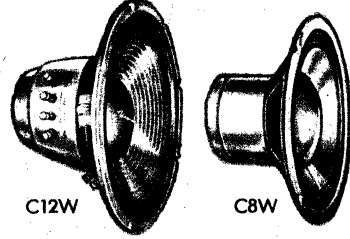

Crossover Networks and Level Control

MODEL N-1 ADJUSTABLE HIGH-PASS FILTER. Adjustable high-pass filter with built-in brilliance control. For dividing audio between woofer and tweeter in 2-way systems. Crossover and impedance combinations: 2500, 5000 and 10,000 cps at 8 ohms; 1250, 2500, 5000 and 10,000 cps at 16 ohms; 5000 and 10,000 cps at 4 ohms. Use with N-2A crossover in 3-way systems. Fits panels to 1". 3 5/8 x 3 1/4 x 3". Shpg. wt., 1 1/4 lbs.
95 D 193. NET. 10.29

MODEL N-2A CROSSOVER NETWORK. For any combination of speakers, in a great variety of voice coil impedances and popular crossover points. Can be used with N-2B for 3-way speaker systems. 6 db, 2-way network. May be used in pairs as 12 db network or singly as 12 db low or high-pass filter. Crossover: 300 or 700 cps at either 8 or 16 ohms; 700 cps at 4 ohms. Size, 3 5/8 x 3 1/4 x 3". Shpg. wt., 2 1/4 lbs.
95 D 194. NET. 17.64

MODEL AP-8 LEVEL CONTROL. Highly efficient attenuator pad for balancing sound according to room acoustics and personal taste. Perfect for use with N-2A and N-2B networks. Polished brass escutcheon marked "presence" on one side, and "brilliance" on other side. Fits panels to 1" in thickness. Impedance: 8-16 ohms. Shpg. wt., 7 oz.
95 D 132. NET. 3.87

MODEL N-2B CROSSOVER NETWORK. For use with any combination of speakers, in varied voice coil impedances and popular crossover points. Can be used with the N-2A for 3-way speaker systems. 6 db, 2-way network. Used in pairs as 12 db network, or singly as 12 db low or high-pass filter. Crossovers: 1250, 2500 and 5000 cps at 8 ohms; 2500 or 5000 cps at 16 ohms; 2500 cps at 4 ohms. 3 5/8 x 3 1/4 x 3". 2 1/4 lbs.
95 D 195. NET. 13.72

MODEL N-3 "ACOUSTIC BATON" 3-WAY CROSSOVER NETWORK. Adjustable network for 3-way speaker systems. Connections for either 350 or 700 cps crossover between mid-range and woofer. Tweeter crossover is 5000 cps. Built-in presence and brilliance controls. Adjustable for vertical or horizontal mounting. Fits panels up to 1" in thickness. Impedance, 8 ohms. Size, 7 x 5 x 3". Shpg. wt., 5 1/2 lbs.
95 D 196. NET. 27.44

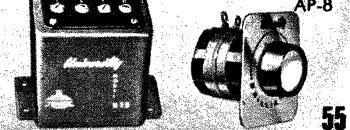
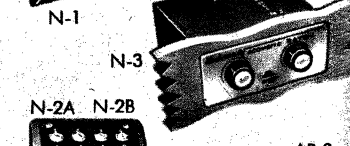
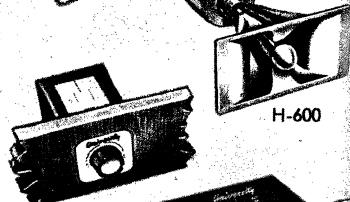



**JAMES B. LANSING
SOUND, INC.**

James B. Lansing High-Fidelity Speakers

FULL RANGE HI-FI SPEAKERS

D130 15" SPEAKER. Heavy-duty, precision built speaker. Provides remarkably distinct bass and extremely smooth, extended treble when used alone. Can also be used as a woofer in two or three-way systems. Response ± 5 db, 30 to 17,000 cps. Capacity, 25 watts. Voice coil diameter, 4". Magnet weight 4 lbs. Free cone resonance, 37 cps. Voice coil impedance, 16 ohms. Depth, 5 1/2". Shpg. wt., 23 lbs.
82 DZ 125. NET.....84.00

D131 12" SPEAKER. One of the finest 12" hi-fi speakers available. Excellent for use alone, or as a woofer in 2 or 3-way systems. Combines excellent design and construction to assure superb reproduction of sound. Response, 30 to 17,000 cps. Capacity, 20 watts. Magnet weight, 4 lbs. Free cone resonance, 39 cps. Voice coil diameter, 4". Impedance, 16 ohms. Depth, 5". Shpg. wt., 21 lbs.
82 DZ 129. NET.....78.00

D123 12" SPEAKER. An extended-range 12" speaker with ultra-shallow frame design. Only 3 5/8" deep, it's perfect for custom in-the-wall mounting, or compact cabinet installation. Response, ± 5 db, 30 to 15,000 cps. Voice coil diameter, 3". Capacity, 20 watts. Free cone resonance, 35 cps. Impedance, 16 ohms. Magnet weight, 1 3/4 lbs. Shpg. wt., 12 lbs.
82 DX 112. NET.....59.40

D208 8" SPEAKER. Same excellent features as the D130 and D131, but for smaller installations. Response, 40 to 13,000 cps. Capacity, 12 watts. Free cone resonance, 55 cps. 2" voice coil. Impedance 8 ohms. 1 lb. magnet. Depth, 2 7/8". Wt., 6 lbs.
82 D 126. NET.....27.90

D216. 8" SPEAKER. Same as D208, but has 16 ohms impedance.
82 D 113. NET.....27.90

WOOFERS, DRIVERS, HORNS AND CROSSOVER UNITS

130A 15" WOOFER. New 15" low-frequency speaker designed to provide clean, distinct reproduction of all audio frequencies below 1500 cps. Highly efficient, the 130A reproduces all bass and mid-range frequencies falling in this range with remarkable fidelity. Matched for use with the Model 175DLH high-frequency, driver-horn-lens assembly. Unique magnet design virtually eliminates stray magnetic fields adjacent to the magnetic pot structure. Rigid, cast aluminum frame. Response, ± 5 db, 30 to 1500 cps. Voice coil diameter, 4". Power handling capacity, 25 watts. Free cone resonance, 36 cps. Magnet weight, 4 lbs. Voice coil impedance, 16 ohms. Depth 5 1/2". Shpg. wt., 23 lbs.
82 DZ 200. NET.....81.00

150-4C 15" WOOFER. New, skillfully designed, low-frequency speaker. Made with an extremely rigid, straight-sided cone, its 4" edgewound, copper ribbon voice coil provides additional rigidity. Its near-ideal piston form assures clean, well-defined bass to 500 cps. Used in some of the finest theatre sound systems, as well as the Hartsfield system (see page 57), the 150-4C is recommended for use with the N500 or N500H crossover network and the Model 375 high-frequency driver. Voice coil diameter, 4". Power handling capacity, 30 watts. Free cone resonance, 30 cps. Magnet weight, 4 3/4 lbs. Voice coil impedance, 16 ohms. Depth, 6". Shpg. wt., 25 lbs.
82 DZ 223. NET.....114.00

075 "RING RADIATOR" HIGH-FREQUENCY TWEETER. Advanced-design, high-frequency driver for reinforcing the performance of extended-range speakers from 2500 cps to the limit of audibility. Adds "brilliance" to Jim Lansing D130, D131, D123 and D208 speakers when used with the Model N2600 dividing network. Renowned for its remarkable presence and exceptional handling of transients, the precisely constructed 075 employs a unique diaphragm structure of hydraulically formed aluminum. Provides ultra-smooth highs. Power handling capacity, 20 watts. Voice coil, 1 3/4" dispersion, 90°. Voice coil impedance, 16 ohms. Baffle hole diameter, 3 3/8"; overall length, 3 1/4". Shpg. wt., 8 lbs.
82 D 118. NET.....59.40

175DLH HIGH-FREQUENCY DRIVER-HORN-LENS ASSEMBLY. Provides highly precise reproduction above 1200 cps; unequalled transient response. Combines a high-frequency driver and an exponential horn, with a true acoustic lens. Consists of 14 separate elements arranged to form a double concave "lens"—refracts sound evenly over a solid 90° angle to all points in the listening area with equal intensity. Perfectly matched to the Jim Lansing Series 130, low-frequency speakers; designed for use with the N1200 dividing network. Power handling capacity, 25 watts. Voice coil impedance, 16 ohms. Horn throat diameter, 1". Mounting hole diameter, 5 3/8"; overall length, 11 1/2". Shpg. wt., 12 lbs.
82 D 130. NET.....123.00

375 HIGH-FREQUENCY DRIVER. For use with the 537-509 and 537-500 horn-lens assemblies. Used in some of the finest theatre sound systems, this high-frequency driver provides highly efficient, smooth response above 300 cps. Voice coil and aluminum diaphragm assembly have a diameter of 4". With so large a piston area, only minimum excursion is needed to reproduce a given frequency at a given level. Power handling capacity, 60 watts. Impedance, 16 ohms. Magnet weight, 9 lbs. Diameter, 7"; depth 5 3/8". Shpg. wt., 31 lbs.
82 DZ 224. NET.....198.00

537-509 HORN-LENS ASSEMBLY. New, exponential horn and "serpentine" acoustical lens assembly (employed in the Hartsfield enclosure—see page 57). Used with the 375 high-frequency driver for ear-level dispersion of treble response. Horn is 12" long, with a 2" round throat, matching the 375 driver. The 9x6" rectangular mouth provides wide horizontal coverage, with narrow vertical coverage, to minimize ceiling and floor reflections. Highs, emanating at ear level, remain unusually clean and are smoothly dispersed over a 90° horizontal angle. Acoustical lens, attached to horn mouth, measures 6 3/4" high, 20" wide and 4 1/2" deep. Shpg. wt., 17 lbs.
82 DX 225. NET.....66.00

537-500 HORN-LENS ASSEMBLY. Round exponential horn and acoustical lens assembly for use with the 375 high-frequency driver. Skillfully designed and precisely constructed, the 537-500 is frequently used for specially built, deluxe theatre sound installations. Provides a unilateral coverage of 70°. Horn length of 12", plus lens diameter of 13 1/2", contribute to the mellowness of treble frequencies transmitted through this assembly. Length, 17". Wt., 37 lbs.
82 DZ 226. NET.....87.00

CROSSOVER NETWORKS. All have nominal impedance of 16 ohms.

N2600. For use with 075 tweeter and D130, D131, D123 and D208 speakers. Crossover, 2500 cps. Includes level control. 3 1/4 x 3 1/4 x 2 3/4". Shpg. wt., 3 lbs.
82 D 199. NET.....24.50

N1200. (Not illustrated.) For use with 175-DLH driver-horn-lens assembly and 130A woofer. Crossover, 1200 cps. With 3-position switch for attenuation control. 4 3/4 x 6 x 6 1/4". Shpg. wt., 9 lbs.
82 D 131. NET.....35.25

N500H. (Not illustrated.) For use with 375 high-frequency driver, 537-509 or 537-500 horn-lens assembly and 150-4C woofer in folded horn enclosures only. Crossover, 500 cps. 3-position switch for attenuation control. 4 3/4 x 6 x 6 1/4". Wt., 10 lbs.
82 D 227. NET.....76.50

N500. (Not illustrated.) Used with same components as N500H network, above. Crossover, 500 cps. Strapping bars for attenuation control (in 1 db steps). Overall size, 6x8x6". Shpg. wt., 16 lbs.
82 DX 228. NET.....84.00

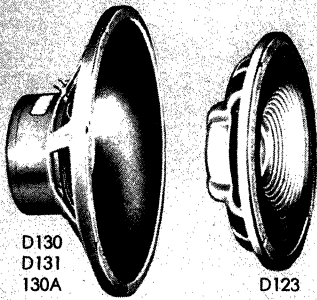

D130
D131
130A



D123

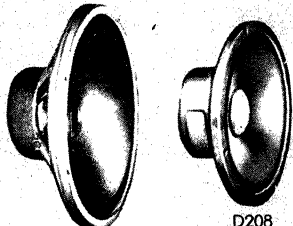

150-4C

D208

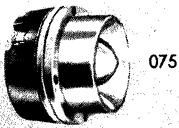

075

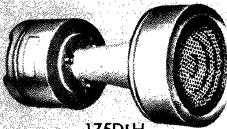

175DLH

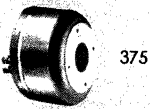

375

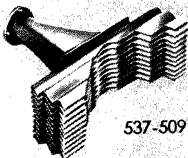

537-509

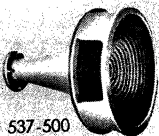

537-500

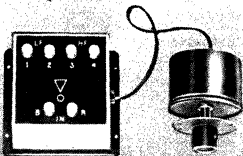

N2600

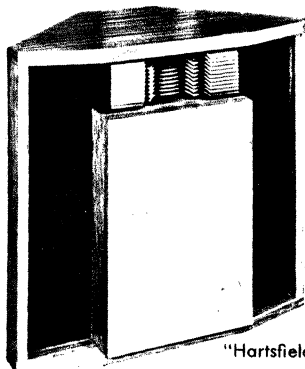

"Hartsfield" D30085



C34

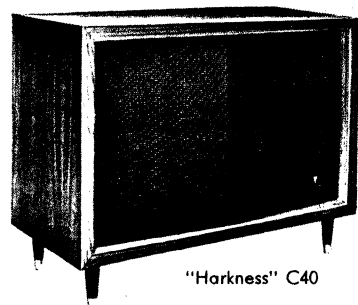

"Harkness" C40

James B. Lansing Speaker Enclosures and Systems

"HARTSFIELD" D30085 SPEAKER SYSTEM. Impressive folded horn corner enclosure speaker system of remarkable fidelity. Employs 150-4C low-frequency driver, 375 high-frequency driver, rectangular exponential horn, N500H dividing network, plus the "serpentine" acoustical lens-horn assembly. Capacity, 60 watts. Impedance, 16 ohms. HWD 45 $\frac{3}{4}$ ", 47", 24 $\frac{1}{2}$ ". Shpg. wt., 250 lbs. *Shipped F.O.B. Chicago or Los Angeles, whichever is nearer.*

- 82 DZ 211. Mahogany. NET... 787.50
- 82 DZ 212. Light Oak. NET... 817.50
- 82 DZ 213. Light Walnut. NET... 817.50

C34 ENCLOSURE ONLY. Rear-loaded, corner horn. Does not require corner placement. Contains, as an integral part of its structure, a 6-ft. exponential folded horn that delivers an extra octave of beautifully defined bass. Premium wood veneers; simple, graceful styling. 39 $\frac{3}{4}$ " high, 23 $\frac{3}{4}$ " wide, 22 $\frac{1}{4}$ " deep. Shpg. wt., 90 lbs.

- 82 DZ 204. Mahogany. NET... 151.00
- 82 DZ 205. Light Oak. NET... 166.00
- 82 DZ 206. Light Walnut. NET... 166.00

D34001 COMPLETE SPEAKER SYSTEM. Includes 130A 15" woofer, 175DLH driver-horn-lens assembly, N1200 dividing network and level control, installed in the C34 enclosure. Capacity, 25 watts. 16 ohms. Shpg. wt., 135 lbs.

- 82 DZ 214. Mahogany. NET... 391.75
- 82 DZ 218. Light Oak. NET... 406.75
- 82 DZ 215. Light Walnut. NET... 406.75

"HARKNESS" C40 ENCLOSURE ONLY. New, solidly built, rear-loading horn enclosure in contemporary low-boy design. Excellent for smaller rooms and apartments; can be placed anywhere. Contains built-in, 6-ft. exponential horn, with mouth area of approximately four square feet. Removable 5" legs. Ht. with legs, 28 $\frac{3}{4}$ "; 37 $\frac{3}{4}$ " wide, 20" deep. Shpg. wt., 90 lbs.

- 82 DZ 201. Mahogany. NET... 151.00
- 82 DZ 202. Light Oak. NET... 166.00
- 82 DZ 203. Light Walnut. NET... 166.00

D40001 COMPLETE SPEAKER SYSTEM. Includes 130A 15" woofer, 175DLH high-frequency driver-horn-lens assembly, N1200 dividing network and level control, installed in the C40 enclosure. Capacity, 25 watts. 16 ohms. Shpg. wt., 135 lbs.

- 81 DZ 919. Mahogany. NET... 391.75
- 82 DZ 216. Light Oak. NET... 406.75
- 82 DZ 217. Light Walnut. NET... 406.75

C37 ENCLOSURE ONLY. Attractively styled, low-boy bass reflex enclosure. Engineered to deliver full-range response when used with recommended Jim Lansing components, below. Its modern styling blends happily with any room decor. 30 $\frac{1}{4}$ " high, 36" wide, 16" deep. Shpg. wt., 69 lbs.

- 82 DZ 116. Mahogany. NET... 115.00
- 82 DZ 207. Light Oak. NET... 123.00
- 82 DZ 169. Light Walnut. NET... 123.00

D37030 COMPLETE SPEAKER SYSTEM. Includes D130 as 15" woofer, 075 "ring radiator" tweeter, and N2600 dividing network with level control, mounted in the C37 reflex enclosure. Shpg. wt., 100 lbs.

- 82 DZ 222. Mahogany. NET... 282.90
- 82 DZ 221. Light Oak. NET... 290.90
- 82 DZ 220. Light Walnut. NET... 290.90

C38 ENCLOSURE ONLY. Space-saving, low-boy bass reflex enclosure. Smart styling and rich, hand-rubbed finish complement any room interior. Compact size allows it to be used almost anywhere. 26" high, 23 $\frac{3}{4}$ " wide, 15 $\frac{1}{8}$ " deep. Shpg. wt., 47 lbs.

- 82 DZ 114. Mahogany. NET... 63.00
- 82 DZ 208. Light Oak. NET... 69.00
- 82 DZ 168. Light Walnut. NET... 69.00

D38002 COMPLETE SPEAKER SYSTEM. Includes Model D123 as 12" woofer, 075 "ring radiator" tweeter, and N2600 dividing network with level control, mounted in the C38 enclosure. Shpg. wt., 68 lbs.

- 82 DZ 108. Mahogany. NET... 206.30
- 82 DZ 219. Light Oak. NET... 212.30
- 82 DZ 210. Light Walnut. NET... 212.30

"HARLAN" C39 ENCLOSURE ONLY. A departure from conventional enclosure design, this most recent and highly versatile, bass reflex corner enclosure features unusually smart, modern styling. Its contoured grille and non-parallel lines and surfaces, contribute to its highly pleasing aspect. Designed to fit snugly in corners, the C39 can accommodate two 12", or two 15" speakers on its baffle! Provides correct acoustic chamber for enhancing the performance of the James B. Lansing D130, D131 and D123 speakers, and the 075 and 175DLH tweeter components listed on page 56. Height with legs, 31 $\frac{1}{8}$ "; width 35 $\frac{1}{2}$ "; depth, 23 $\frac{1}{8}$ ". Shpg. wt., 90 lbs.

- 82 DZ 106. Mahogany. NET... 147.00
- 82 DZ 209. Light Oak. NET... 158.00
- 82 DZ 167. Light Walnut. NET... 158.00

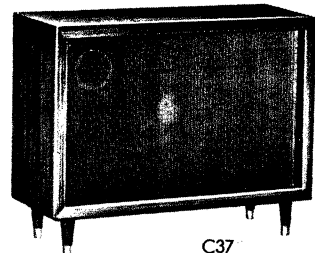

C37

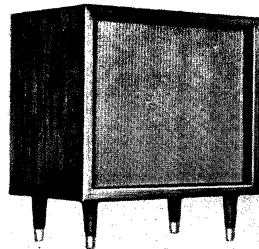

C38

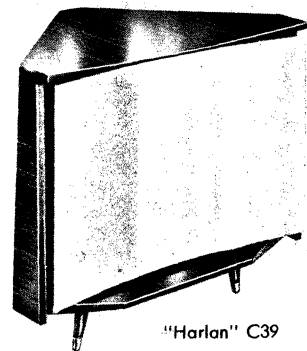

"Harlan" C39

JAMES B. LANSING SPEAKER SYSTEM KITS FOR CUSTOM INSTALLATION

Choice of three matched speaker component packages, for installing in your own custom cabinetry or enclosure, or for building into walls or closets. Provide superb reproduction.

Each component package has a basic speaker, a matching tweeter and a crossover network. For complete description of all James B. Lansing components, see page 56.

Stock No.	Type	Description of Components	Wt., lbs.	EACH
82 DZ 230	002	D123 12" Speaker ■ 075 Tweeter ■ N2600 Crossover	21	143.30
82 DZ 231	030	D130 15" Speaker ■ 075 Tweeter ■ N2600 Crossover	32	167.90
82 DZ 229	001	130A 15" Woofer ■ 175DLH Tweeter ■ N1200 Crossover	44	240.75

HIGH-FIDELITY SPEAKERS

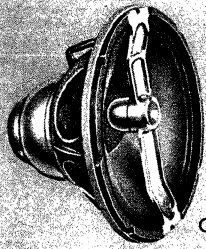

G-610A

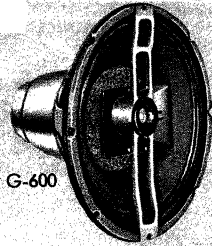

G-600



CX-225
CX-120
CX-255
CX-150

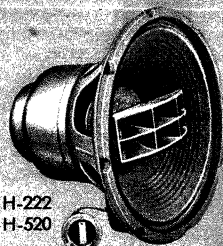

H-222
H-520

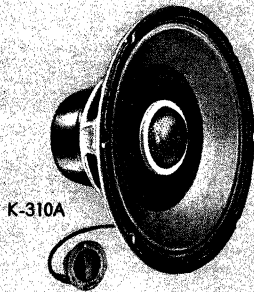

K-310A

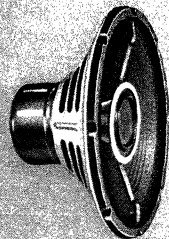

K-210

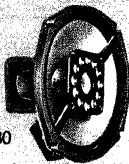

K-80

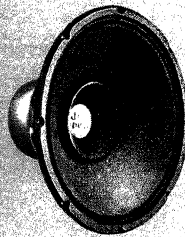

DX-120
DX-150

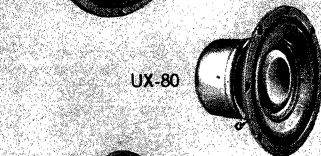

UX-80

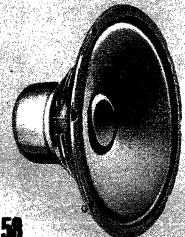

UX-120

Triaxial Speakers

MODEL G-610A 15" TRIAXIAL. An outstanding 3-way speaker. Has three elements, electrically and acoustically independent, built into a single unit, each designed for peak performance in its portion of the audio spectrum. Response, 25 cps to beyond audible range. Employs heavy woofer and two compression driver horn-loaded elements for mid-frequency and high-frequency channels. Includes dual crossover network with wired balance controls. Crossovers at 600 and 4000 cps. Capacity, 40 watts. Impedance, 16 ohms. Magnet weight, 6½ lbs. Depth, 10¾".
82 DZ 170. NET.....252.75

MODEL G-600 15" TRIAX. Embodying the same operating principles as the G-610A, the G-600 is a low-cost version with somewhat lighter construction. Highly efficient woofer employs a 3¼ lb. magnet. Response, 30 cps to beyond audible range. Bore-mounted compression driver for mid-frequencies, has separate horn for 1000-4000 cps range. New super-tweeter handles range from 4000 cps through the upper limits of audability. Has dual crossover network with wired balance controls. Capacity, 35 watts. Impedance, 16 ohms. Depth, 11¼". Shpg. wt., 36¼ lbs.
82 DZ 350. NET.....129.50

Coaxial 3-Element Speakers

MODEL CX-225 12" SPEAKER. Employs three elements for wide-range reproduction. Compression-driver super-tweeter is mounted coaxially inside the cone, and handles the range from 4000 to 15,000 cps. Two cone radiators, driven by the woofer voice coil, reproduce from 30 to 4000 cps. The small diffusion radiator effectively disperses and balances reproduction from 2000 to 4000 cps. Woofer has 45-50 cps resonance. Magnet wt., 1¾ lbs. Capacity, 25 watts. Impedance, 16 ohms. With wired-in high-frequency control. Wt., 10¾ lbs.
82 DX 351. NET.....59.50

MODEL CX-255 15" SPEAKER. An excellent value, this low-cost 15" speaker employs 3-element construction to attain a frequency response from 30 to 15,000 cps. Has woofer cone and smaller diffusion radiator cone, both driven by the voice coil, for 30 to 4000 cps range; coaxially mounted, compression-driver super-tweeter handles the range from 4000 to 15,000 cps. The small diffusion cone covers from 2000 to 4000 cps. Resonance, 45-50 cps. Magnet wt., 1¾ lbs. Power handling capacity, 27 watts. Impedance, 16 ohms. Includes wired-in high-frequency balance control. Shpg. wt., 13½ lbs.
82 DX 352. NET.....76.50

MODEL CX-120 12" SPEAKER. Similar to the Model CX-225, but has 1-lb. magnet. Power handling capacity, 20 watts. Shpg. wt., 9¾ lbs.
82 DX 383. NET.....49.50

MODEL CX-150 15" SPEAKER. As above, but has 1-lb. magnet. Power capacity, 22 watts. Shpg. wt., 12½ lbs.
82 DX 353. NET.....66.50

Coaxial 2-Way Speakers

MODEL H-222 12" SPEAKER. An economical 12" coaxial speaker. Provides unusual clarity of sound and wide range. Compression-driver tweeter is loaded by a 6-cell Hypex horn; insures maximum efficiency and wide-angle dispersion of high frequencies from 2000 to 15,000 cps. Features new, improved electrical crossover network. Tweeter horn passes through the core of a heavy-duty 1¾ lb. magnet. Woofer covers 30 to 2000 cps. Includes high-frequency balance control. Capacity, 25 watts. Impedance, 16 ohms. Depth, 8¼". Shpg. wt., 13 lbs.
82 DX 068. NET.....62.50

"K" SERIES COAXIALS. Low-cost coaxial speakers. Feature electrically and acoustically independent woofer and tweeter units.

MODEL K-310A 15" SPEAKER. Uses direct-radiator cone-type tweeter. With balance control. Magnet wt., ¾ lb. Capacity, 16 watts. Imp., 16 ohms. Wt., 12 lbs.
82 DX 061. NET.....39.75

MODEL K-210 12" SPEAKER. Employs direct radiator tweeter. Magnet wt., ½ lb. Power handling capacity, 14 watts. Impedance, 8 ohms. Shpg. wt., 7 lbs.
82 DX 062. NET.....27.50

MODEL H-520 15" SPEAKER. As above, but larger in size and with 27-watt capacity. Depth 9¾". Shpg. wt., 16 lbs.
82 DX 018. NET.....79.50

MODEL K-80 8" SPEAKER. Employs high-frequency diffraction plate for wide-angle response. Magnet wt., ½ lb. Capacity, 12 watts. Imp., 16 ohms. Wt., 4 lbs.
82 D 354. NET.....16.75

Duax 2-Element Speakers

Budget-priced, DX-series speakers feature two carefully coordinated cones, driven by the same voice coil. The smaller, auxiliary radiator cone helps attain a wider frequency range than single-cone speakers of the same size. Both units listed below have 1-lb. magnets. Resonance, 48-50 cps. Impedance of each, 16 ohms.

MODEL DX-150 15" SPEAKER. Capacity, 22 watts. Depth, 9½". Shpg. wt., 11 lbs.
82 DX 356. NET.....35.50

MODEL DX-120 12" SPEAKER. Power handling capacity, 20 watts. Depth, 7¾". Shpg. wt., 7½ lbs.
82 DX 355. NET.....25.50

Unax Single-Element Speakers

Maximum performance at minimum cost with these low-cost, single-cone UX-series speakers. Cone is specially designed so that center section provides excellent treble response, while the entire cone reproduces lows. Viscous edge damping. Both units have ½ lb. magnets. 8 ohms.

MODEL UX-120 12" SPEAKER. Response, 40-12,000 cps. Capacity, 14 watts. Depth, 8½". Shpg. wt., 5½ lbs.
82 DX 358. NET.....19.50

MODEL UX-80 8" SPEAKER. Response, 50-12,000 cps. Capacity, 12 watts. Depth, 6¼". Wt., 4 lbs.
82 D 357. NET.....14.50

SPEAKER ENCLOSURES AND SYSTEMS

MODEL BL-1215 ENCLOSURE ONLY. A beautiful new enclosure, in contemporary lowboy style. For side-of-wall placement. Interior acoustical design employs new bass-ultraflex, duct-loaded phasing principle with front-opening port—assures excellent bass reproduction. Speaker is fastened to front panel in conventional fashion, but radiation from back of speaker is coupled by large air-chamber through ducts or channels to listening area. Accommodates any 12" or 15" speaker; also has cutouts to permit easy installation of Jensen 2-way or 3-way system kits. Size, 29" high, 30" wide, 19" deep. Shpg. wt., 58 lbs.

82 DZ 359. Mahogany. } NET
82 DZ 360. Blonde Oak. } EACH.. 99.50
82 DZ 361. Walnut.

MODEL BL-1215 ENCLOSURE WITH H-222 12" SPEAKER INSTALLED. Jensen's most popular 12" coaxial speaker, installed in the Model BL-1215 lowboy enclosure, described above. With balance control for adjusting tweeter level. Shpg. wt., 71 lbs.

82 DZ 384. Mahogany. } NET
82 DZ 385. Blonde Oak. } EACH.. 162.00
82 DZ 386. Walnut.

Woofers, Tweeters and Crossover Networks

MODEL P15-LL 15" WOOFER. Low-frequency unit, designed for use in multi-speaker systems. Provides response of 30 to 2000 cps in bass-ultraflex enclosures, bass reflex enclosures, etc. Rated 35 watts. Magnet wt., 3½ lbs. Viscous, edge-damped diaphragm. Resonance, 35-37 cps. Impedance, 16 ohms. Depth, 8¾". Shpg. wt., 18 lbs.

82 DX 365. NET..... 56.80

MODEL P12-NL 12" WOOFER. Ruggedly built, 12" low-frequency unit, specially designed for use in two-way speaker systems. Response, 30 to 2000 cps. Viscous, edge-damped diaphragm. Power handling capacity, 25 watts. Magnet wt., 1¾ lbs. Resonance, 55 cps. Impedance, 16 ohms. Depth, 7". Shpg. wt., 10 lbs.

82 DX 366. NET..... 36.50

MODEL RP-201 MID-RANGE UNIT. Reproduces the range from 600 to 4000 cps as the mid-channel unit in a 3-way speaker system. Compression-type, driver unit is loaded by a cast-aluminum Hypex horn. Has cloth-base, plastic diaphragm for internal damping. Angle of coverage, 115°. Power handling capacity, 35 watts. Recommended for use with Model A-61 network, at right. Impedance, 16 ohms. Size, 4¾" high, 11½" wide, 14" deep. Shpg. wt., 9 lbs.

82 DX 367. NET..... 42.60

MODEL RP-102 TWEETER. Advanced-design, high-frequency unit for use in 2-way speaker systems crossing over at 2000 cps. Response, with A-204 crossover network, 2000 to 15,000 cps. Cast aluminum 6-cell Hypex horn, with cloth-base plastic diaphragm for internal damping. Capacity, 30 watts. Impedance, 16 ohms. Size, 4" high, 7¾" wide, 9¼" deep. Shpg. wt., 6½ lbs.

82 DX 368. NET..... 28.35

MODEL BL-812 ENCLOSURE ONLY. Clean-cut lines and classic styling characterize the BL-812 enclosure. Superior performance is attained through use of the unique bass-ultraflex acoustic design. Sound waves radiating from the back of the speaker are coupled by a large air chamber, through ducts or channels to the listening area. Perfect for use where a larger enclosure cannot be installed. Accommodates any 8" or 12" speaker—also has cutouts to permit installation of Jensen 2-way system kits. Fine hardwood veneers, hand-rubbed to a glistening finish. Size, 24¼" high, 19" wide, 12¾" deep. Shpg. wt., 26 lbs.

82 DZ 362. Mahogany. } NET
82 DZ 363. Blonde Oak. } EACH.. 59.50
82 DZ 364. Walnut.

MODEL BL-812 ENCLOSURE WITH CX-120 12" SPEAKER INSTALLED. Superb coaxial speaker with 3 elements for superior sound reproduction, installed in the Model BL-812 enclosure, described above. With balance control. Shpg. wt., 31 lbs.

82 DZ 387. Mahogany. } NET
82 DZ 388. Blonde Oak. } EACH.. 109.00
82 DZ 389. Walnut.

MODEL RP-103 TWEETER. Quality, low-cost unit. Die-cast horn with plastic diaphragm for internal damping. Response, with A-204 crossover, 2000 to 15,000 cps. Capacity, 20 watts. Impedance, 16 ohms. Size, 3" high, 7¼" wide, 6½" deep. Wt., 2½ lbs.

82 D 369. NET..... 16.50

MODEL RP-302 SUPER TWEETER. Covers range from 4000 cps to beyond audible range. Dispersion, 120°. Recommended for use with A-402 crossover. Capacity, 35 watts. Die-cast horn. Impedance, 16 ohms. Size, 2¾" overall dia.; 3¾" deep. Requires 1¼" dia. baffle cutout. Shpg. wt., 3 lbs.

82 D 370. NET..... 33.60

BALANCE CONTROLS. Adjustable, wire-wound L-pads, with bar knob and brass escutcheon. Mount in 1½" hole. Have 36" leads. Impedance, 16 ohms. Power capacity, 35 watts. Shpg. wt., 12 oz.

MODEL ST-917. For mid-frequencies.

82 D 372. NET..... 5.25

MODEL ST-901. For high-frequencies. 25-watt capacity in 2-way speaker systems.

82 D 371. NET..... 5.00

MODEL A-61 CROSSOVER NETWORK. Two-channel, 600-cycle type with 12 db/octave attenuation. Impedance, 16 ohms. 5¼x6¼x4 3/8". Shpg. wt., 5 lbs.

82 D 373. NET..... 19.75

MODEL A-204 CROSSOVER NETWORK. Two-channel type. High-pass section transmits everything above 2000 cycles; low-pass section, everything below this frequency. 16 ohms. 4½x4½x3¾". Wt., 3 lbs.

82 D 374. NET..... 13.00

MODEL A-402 CROSSOVER NETWORK. As above, but crossover point is 4000 cps. 3 lbs.

82 D 375. NET..... 10.90



BL-1215

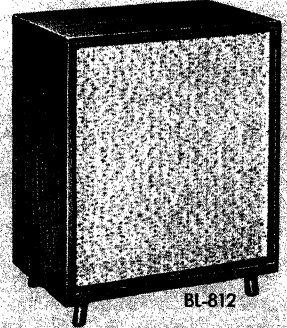

BL-812

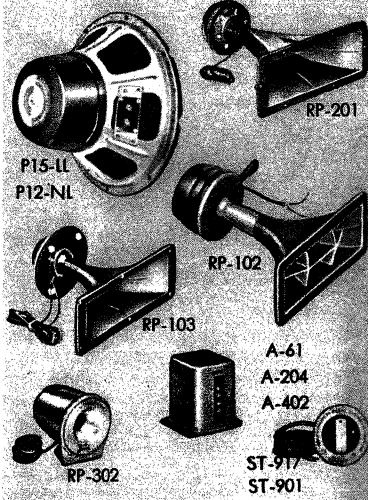

P15-LL
P12-NL

RP-102
RP-103

RP-201
RP-302

A-61
A-204
A-402

ST-917
ST-901

JENSEN SPEAKER COMPONENT KIT PACKAGES

Speaker component kits for mounting into your own enclosure; custom installation in walls, closets, etc.; or for installation in the Model BL-1215 or BL-812 enclosures. Every kit comes complete with all components, crossovers, controls, mounting brackets and wiring, for easy installation.

The BL-1215 enclosure is pre-cut to accommodate any kit listed below; BL-812 can house any kit except KT-31 and KT-32. The modified P15-LL woofer used in the KT-31 is of special design and is not sold separately. Building plans for acoustically correct enclosures included with all component packages.

Stock No.	Model	Description	Components	Shpg. Wt.	NET
82 DZ 376	KT-31	3-way Imperial	Special P15-LL woofer, RP-201 and RP-302 tweeters, A-61 and A-402 crossovers, mid-high-frequency balance controls.	43 lbs.	184.50
82 DZ 382	KT-32	3-way Triplex	P15-LL woofer, RP-201 and RP-302 mid-range and super tweeters, A-61 and A-402 crossover networks, ST-901 and ST-917 mid-range and high-frequency balance controls.	43 lbs.	169.50
82 DZ 377	KT-21	2-way Concerto	P15-LL woofer, RP-102 high-frequency tweeter, A-204 crossover network, ST-901 high-frequency balance control.	29 lbs.	99.50
82 DX 378	KT-22	2-way Concerto	P12-NL woofer, RP-102 high-frequency tweeter, A-204 crossover network, ST-901 high-frequency balance control.	19 lbs.	73.50
82 DX 381	KTX-3	Mid-range kit	RP-201 tweeter, A-61 crossover, ST-917 balance control.	17 lbs.	62.50
82 D 380	KTX-2	Hi-frequency kit	RP-103 tweeter, A-204 crossover, ST-901 balance control.	7 lbs.	32.50
82 D 379	KTX-1	Super tweeter kit	RP-302 tweeter, A-402 crossover, ST-901 balance control.	5 lbs.	43.75

S-1201-A
S-1203-A

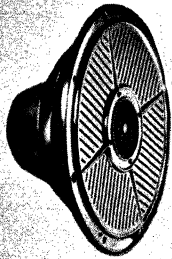
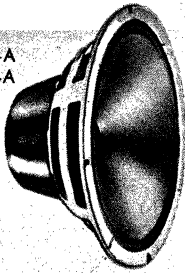

A1-401

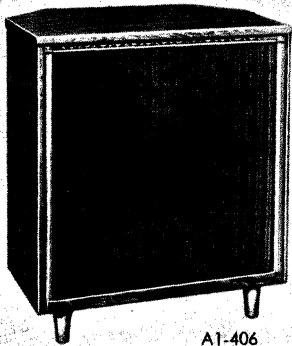

A1-406



850-D

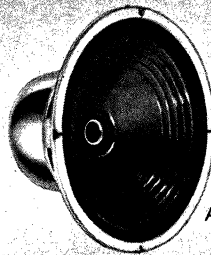

A1-403



A1-404

General Electric Speakers and Components

MODEL A1-401 12" COAXIAL SPEAKER. Advanced-design—provides remarkably smooth, extended response and wide dispersion. Unique slotted baffle plate serves as tweeter baffle and minimizes interference between tweeter and woofer units. 2 3/4" tweeter; built-in mechanical-electrical crossover network. Crossover frequency, 1500 cycles. Response, 40 to 15,000 cycles. Power handling capacity, 25 watts. Impedance, 8 ohms. Total magnet weight of 21.3 oz. 6 1/8" deep. Shpg. wt., 9 lbs.
81 DX 519. NET.....49.25

MODEL S-1201-A 12" SPEAKER. This unusually popular 12" speaker has been highly recommended by nationally known consumer research organizations. Provides very clean, smooth frequency response over the range of 50 to 13,000 cps. Non-warping aluminum-base voice coil. Power handling capacity, 25 watts. Cone resonance, 70 cps. 14.5 oz. magnet. Imp., 8 ohms. Plastic magnet cover. Shpg. wt., 7 lbs.
81 DX 510. NET.....23.27

MODEL S-1203-A SPEAKER. Same as Model S-1201-A described above, but has 9 oz. magnet. Shpg. wt., 6 lbs.
81 DX 513. NET.....17.39

MODEL 850-D SPEAKER. An unusually fine low-cost speaker—ideal for many applications. Excellent for replacement use in radios, TV sets, etc., to improve tonal quality. Also fine choice for limited-space hi-fi systems or for use as hi-fi system extension speaker. Response, 50-12,000 cps. Curvilinear cone. Aluminum-base voice coil. 6.8 oz. magnet. Capacity, 15 watts. Impedance, 8 ohms. Shpg. wt., 3 lbs.
81 D 518. NET.....10.73

MODEL A1-403 12" WOOFER. New, highly efficient 12" woofer—designed to improve reproduction of frequencies below 1500 cycles in a 2 or 3-way speaker system. Has an electro-mechanical filter; requires no crossover network when used with Model A1-404 tweeter (below). Crossover frequency, 1500 cycles. Response, 40-1500 cycles. Capacity, 25 watts. Magnet, 14.5 oz. Impedance, 8 ohms. Wt., 6 1/2 lbs.
81 DX 843. NET.....29.35

MODEL A1-404 TWEETER. New, compact tweeter with 100° dispersion. Matched for use with above or similar woofers in 2-way speaker systems. Response, 1500-15,000 cps. Capacity, 25 watts. Imp., 8 ohms. 4 3/8x2 1/2". Wt., 2 1/2 lbs.
81 D 855. NET.....18.57

MODEL A1-421 CROSSOVER NETWORK. (Not illustrated.) Provides 1500 cycle crossover when used with any 8-ohm tweeter and 8-ohm woofer. (Not required with A1-403, above.) Impedance, 8 ohms. Capacity, 25 watts. 6x4x4". Shpg. wt., 3 lbs.
81 D 856. NET.....13.67

MODEL A1-406 ENCLOSURE. Delivers exceptional performance whether used in corners or placed against wall. Ideal for use with G.E. A1-401, S1201A, S1203A, or other 12" speakers. Features "distributed port" design to achieve highly effective damping and loading of speaker at low frequencies. Beautiful hand-rubbed veneers blend into any furnishing scheme. 1" acoustic lining. Size: 31 1/4" high, 25 3/4" wide, and 18 1/4" deep. Shpg. wt., 49 lbs.
**81 DZ 725. A1-406M. Mahogany.
81 DZ 726. A1-406B. Blonde Oak.
NET EACH.....63.66**



RCA Hi-Fi Speaker Enclosure and Speakers

MODEL 300W1 ENCLOSURE. New, highly versatile custom-convertible speaker enclosure. Features exclusive RCA "bottom-port" with detachable feet to permit use as an infinite baffle, corner driver, or bass reflex enclosure—to suit your room acoustics and personal taste. Ideal for use with either Model 501S1 or 502S1 listed at right—or any 12" speaker. Beautifully styled to blend with the decor of any room; specially constructed to match the furniture arrangement of your choice—against the wall, away from the wall, or in a corner! Use it to suit your room acoustics and your own personal taste. Panels and grille cloth can be removed and interchanged—quickly and easily—to obtain a custom-built appearance.

This smartly styled enclosure has many excellent features to assure top performance: Narrow-width panels to minimize low-frequency cabinet resonances; shallow design that reduces the "Q" of the resonant cavity; and small-grooved edges for reduction of refraction and diffraction effects. All cabinets have mortise-and-tenon joints, glue-block reinforcements and wood-screw clamping for maximum strength and added rigidity. Made of selected hardwoods.

Carefully selected, expertly finished woods assure lasting beauty. Enclosures are available in three popular finishes to complement your home: cherry, blonde, and fruitwood. With 4 properly spaced bolts to fit any 12" speaker having standard RETMA mounting dimensions. Size, 34 3/8x29 1/2x14 1/2". Shpg. wt., 50 lbs.
**81 DZ 965. Cherry Mahog. NET...68.55
81 DZ 966. Blonde Mahog. NET...73.01
81 DZ 967. Fruitwood. NET.....73.01**

MODEL 501S1 12" BIAXIAL SPEAKER. Newly designed, moderately priced 12" hi-fi biaxial speaker. Has a 3" tweeter unit mounted on a specially designed off-axis bracket—provides excellent directivity and smooth response over the entire frequency range of 40 to 18,000 cps. Has excellent transient response because of its inherently good damping. The woofer unit has a copper voice coil and a 1 1/2 ounce Alnico V magnet; the high-frequency section has a 1.47 ounce Alnico V magnet. Highly efficient electro-mechanical crossover network assures a clean, smooth response at crossover frequency. Power handling capacity, 12 watts. Impedance, 8 ohms. Recommended for use with Model 300W1 enclosure listed at left, or such types as bass-reflex, infinite baffle, folded horn, and labyrinth. Requires 10 3/4" baffle opening and 6 1/8" depth behind mounting panel. With 30" cable and 2-terminal connector. Shpg. wt., 7 1/4 lbs.
81 DX 968. NET.....32.83

MODEL 502S1 12" SPEAKER. New, top-quality 12" high-fidelity speaker. Provides smooth, well-balanced tone over the frequency range of 40 to 16,000 cps. Its extended frequency range plus inherently good damping provide exceptionally good transient response. A mechanically terminated cone and the use of low-mass mechanical elements reduce "thumpy" bass. Has an aluminum voice coil and a heavy-duty 1 1/2 ounce Alnico V magnet. Capacity, 12 watts. Impedance, 8 ohms. Requires 10 3/4" baffle opening and 6 3/8" depth behind mounting panel. With 30" cable and 2-terminal connector. Shpg. wt., 6 lbs.
81 DX 969. NET.....24.74

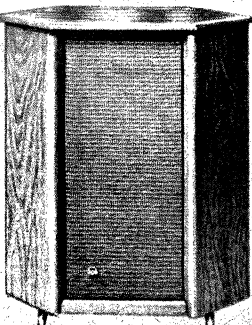

300W1

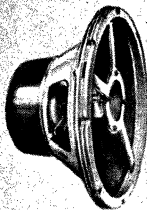

501S1

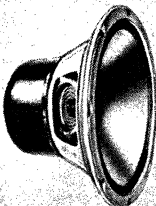

502S1

Bozak High-Fidelity Speaker Components

BOZAK

MODEL E-300 ENCLOSURE. Infinite-baffle speaker enclosure combining extreme versatility, handsome styling, and ready adaptability to present or future speaker components. Ideal for installation of B-207A or both B-207A and B-209 listed below. Available in your choice of 3 highly attractive furniture finishes with harmonizing wrap-around grille cloth. Firmly constructed of selected 3/4" plywood for maximum rigidity.

Baffle board is cut for 12" speaker. A 6" mid-range speaker opening (with removable panel) is also provided. Enclosure is heavily lined with acoustic damping material, plus free-hanging acoustic curtain, to prevent peaking. Size: 30 1/2" high, 24" wide, 17" deep. Shpg. wt., 50 lbs.

81 DZ 094. Mahogany } NET
81 DZ 095. Birch. } EACH.....75.00
81 DZ 096. Walnut. }

MODEL B-207A COAXIAL SPEAKER. This brilliant speaker uses a dual tweeter, the B-200X, mounted inside the B-199A 12" woofer. Designed specifically for infinite baffling, it provides true-pitch bass and clean transients. Listening fatigue is reduced by its near-perfect balance and absence of distortion. Makes an economical installation mounted in a suitable wall, closet door or infinite-baffle enclosure. Frequency response extends from 40 to 16,000 cps. With built-in crossover filter (6 db per octave). Cone resonance, below 40 cycles. Power handling capacity, 15 watts; 30-watt peaks. Impedance, 8 ohms. Cast-aluminum frame fits either 12" or 15" cutouts. Depth behind panel, 7". Shpg. wt., 15 lbs.

81 DX 742. NET.....83.85

MODEL B-209 6" SPEAKER. Excellent 6" speaker for mid-range reproduction. Special felt-paper pulp variable density cone construction combines with rubberized-cloth edge suspension to provide critical damping and superior transient response—extremely smooth from 200 to 3500 cycles. Handles 15 watts; 25 watts peak. Has 1 1/2 lb. Alnico V magnet. Diameter of voice coil, 1 1/2". Requires 5 1/2" baffle opening. Depth behind panel, 3 1/2". Impedance, 8 ohms. Shpg. wt., 7 lbs.

81 D 743. NET.....48.00

MODEL B-199A 12" SPEAKER. (Not illustrated.) Popular 12" bass reproducer for use in high-fidelity 2 and 3-way systems (for infinite baffle mounting only). Low mass variable density cone with rubberized-cloth suspension offers smooth low-frequency response—from 40 to 4500 cps. Has rugged cast-aluminum frame. 1 1/2" ribbon-wound voice coil. Power rating, 15 watts. Impedance, 8 ohms. E-300 enclosure (described at left) recommended. Shpg. wt., 8 lbs.

81 DX 745. NET.....49.50

MODEL N-10102 CROSSOVER NETWORK. (Not illustrated.) New, deluxe convertible crossover network for custom hi-fi use. Ideal 8 or 16 ohm 3-way crossover for use with B-207A (left) and B-209 (listed above). Can easily be converted to accommodate two or four B-207A speakers for excellent sound reproduction. Crossovers, 6 db per octave at 800 and 2500 cycles. Size, 8" wide, 6" deep, and 5 1/2" high. Supplied complete with detailed instructions to simplify installation. Shpg. wt., 5 lbs.

81 D 952. NET.....27.50

E-300

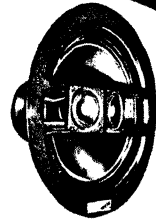
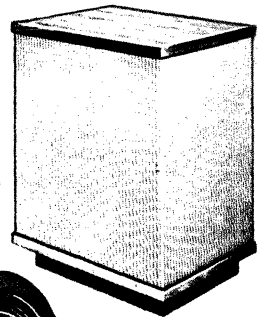

B-207A

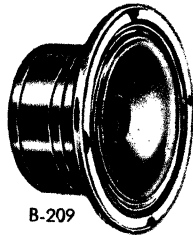

B-209

R-J Speaker Enclosures and Speaker System

FLOOR MODELS. Extremely compact, low-cost, hi-fi 12" speaker enclosures. Top-quality veneers—finished or unfinished. Size (including legs): 20" high, 20" wide and 16" deep. Shpg. wt., 36 lbs.

MODEL F-12-U. Unfinished.

95 DZ 398. NET.....45.50

MODEL F-12-M. Mahogany.

95 DZ 392. NET.....52.50

MODEL F-12-B. Korina Blonde.

95 DZ 394. NET.....57.50

BOOKSHELF TYPES. Small, compact speaker enclosures especially designed for bookshelf installation. Excellent for minimum space applications such as apartment, den, recreation room, etc. Provides maximum bass response despite small size. Ruggedly constructed of carefully selected wood—sanded, ready for finishing with a minimum of effort. Available for two popular speaker sizes.

MODEL S-8-U. FOR 8" SPEAKER. Low-cost, single-shelf type. Measures only 11x23 1/2x10". Shpg. wt., 20 lbs.

95 DX 390. NET.....26.50

CABINET WITH WHARFEDALE SPEAKER. Consists of Model S-8 8", single-shelf speaker enclosure with matched 8" Wharfedale speaker—superb sound and extremely attractive appearance at moderate cost. Excellent for minimum space applications. 10-ohm voice coil impedance. Wt., 25 lbs.

MODEL S-8-MC. Mahogany.

95 DZ 405. NET.....57.50

MODEL S-8-BC. Blonde.

95 DZ 406. NET.....60.00

MODEL S-12-U. FOR 12" SPEAKER. Economy-priced, double shelf type. Size, 24x21x10". Shpg. wt., 31 lbs.

95 DZ 391. NET.....32.50

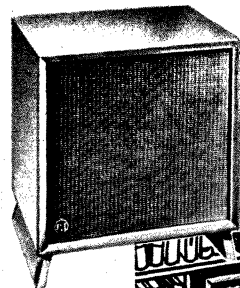

F-12-M
F-12-U
F-12-B

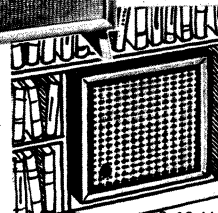

S-12-U



S-8-U

Quam Economy Hi-Fi Speakers and Tweeters

MODEL 8A10X 8" SPEAKER. Excellent 8" extended-range speaker for the limited-budget high-fidelity installation. Ideal for use as an inexpensive remote speaker in home music systems. Frequency response, ±5 db, 60-12,000 cps. Power handling capacity, 10 watts. 1" voice coil diameter. For 7" baffle opening. Depth, 3 3/4". With efficient 10-oz. Alnico V magnet. Impedance, 6-8 ohms. Furnished less pot cover. Shpg. wt., 3 1/2 lbs.

81 D 343. List, \$18.60. NET.....10.94

MODEL 12A6CO 12" COAXIAL SPEAKER. Moderately-priced 12" high-fidelity speaker. Consists of 12" low-frequency unit and 3 1/2" tweeter. Power handling capacity, 14 watts. Response, 50 to 15,000 cps. ±5 db. Has a 6.8 oz. Alnico V woofer magnet. 1.47 oz. tweeter magnet. Voice coil impedance, 6-8 ohms. Shpg. wt., 6 1/2 lbs.

81 DX 318. List, \$30.00. NET.....17.64

MODEL 15A10CO 15" COAXIAL SPEAKER. Has 15" woofer for reproduction of the bass frequencies. High-frequency unit has 5" diameter cone. An ideal low-cost unit for stereo-phonics systems. Power handling capacity, 20 watts. Response over the entire range of 25-15,000 cps. ±5 db. Woofer has 10 oz. Alnico V magnet; tweeter has 1.47 oz. magnet. Voice coil impedance, 6-8 ohms. Depth 7 3/4" behind mounting panel. Shpg. wt., 9 lbs.

81 DX 319. List, \$47.50. NET.....27.93

MODEL 5A15T 5" TWEETER. Exceptionally low-cost 5" tweeter for the budget-minded hi-fi enthusiast. Identical to tweeter used in Model 15A10CO speaker (listed below). Suggested for use with 15" speakers to extend their present range. Frequency response, 2000-12,000 cps, ±6 db. Voice coil impedance, 14 ohms. Power handling capacity, 10 watts to input of speaker system. 1.47 oz. Alnico V magnet. 2 1/8" deep; 4 1/8" mtg. ctrs. Shpg. wt., 1 lb.

81 D 342. List, \$6.50. NET.....3.82

MODEL 3A15T 3 1/2" TWEETER. Same tweeter used in Model 12A6CO, below. Recommended for 12" speakers. Response, 2000-12,000 cps, ±6 db. Voice coil impedance, 14 ohms. Has heavy-duty 1.47 oz. magnet (Alnico V). Power capacity, 10 watts to input of speaker system. Unit is 3 1/2" square; depth 2 1/8". Shpg. wt., 3/4 lbs.

81 D 341. List, \$5.75. NET.....3.38

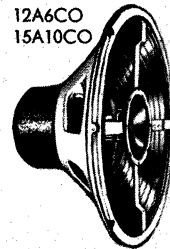

12A6CO
15A10CO

QUAM

8A10X

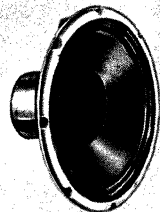

5A15T
3A15T

Allied Supplies Everything for Custom Installation

GARRARD

HI-FI RECORD PLAYING EQUIPMENT



RC-88-4

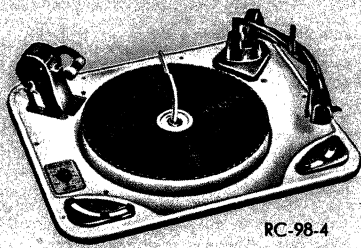

RC-98-4

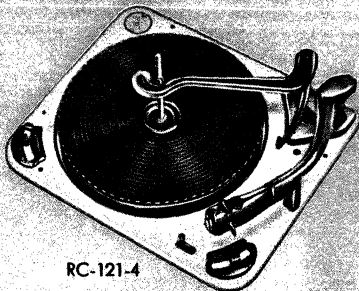

RC-121-4

RC-88-4 "TRIUMPH II" CHANGER

ONLY

Deluxe British-made changer combining the latest design refinements with traditionally precise Garrard craftsmanship. Plays 16 $\frac{2}{3}$, 33 $\frac{1}{3}$, 45 and 78 rpm recordings. Automatic operation is quick and gentle; smooth-acting slide switch converts changer to manual operation instantly. Weighted turntable is covered by protective rubber pad; idler-wheel drive disengages when changer is off. Heavy-duty 4-pole motor and oversize traction wheel for silent, hum-free operation. Size, 15 $\frac{1}{2}$ " W, 13 $\frac{1}{4}$ " D, 3 $\frac{3}{4}$ " below and 5 $\frac{3}{4}$ " above mounting board. Complete with 2 plug-in heads, automatic spindle, spindle for manual play, 45-rpm manual spindle adapter, line cord and plug, output cable and phono plug. Less cartridges and 45-rpm automatic spindle. For 100-130 v., or 200-250 v., 60 cycle AC. Shpg. wt., 16 lbs.

94 RX 950. NET..... 53.41

RC 88-4-050. As above, but with new G. E. 4G-050 magnetic cartridge. Less extra plug-in head.

94 RX 546. NET..... 62.18

RC-88-4-052. As above, but with new G. E. 4G-052 magnetic cartridge. Less extra plug-in head.

94 RX 547. NET..... 72.32

ADVANCED FEATURES

- Four-Speed Operation
- Manual or Automatic Play
- AC and Output Cables
- Smooth, Quiet Operation
- Rugged 4-Pole Motor
- Weighted Turntable

RC-98-4 "CROWN" CHANGER

Luxury changer incorporating all of the features of the RC-88-4 at left, plus separate speed compensation control. Supplied with the RC-98-4 is the Garrard automatic 45-rpm spindle, which converts the changer for playback of 45-rpm records without need for center-hole adapters. Also supplied with standard automatic spindle, manual spindle, and 45-rpm manual spindle adapter. Less cartridges. For 100-130 v., 60 cycle AC. Shpg. wt., 17 lbs.

94 RX 673. NET..... 66.15

RC-98-4-052. Same as above, but with G. E. Type 4G-052 cartridge installed. Less extra plug-in head.

94 RX 545. NET..... 85.06

RC-121-4 "RENOWN" CHANGER

ONLY

Latest version of Garrard's highly popular economy model, which has many of the RC-88-4's fine features; excellent for budget high-fidelity systems or for replacement or modernization purposes. Full manual operation, plus positive automatic intermix of 12", 10" and 7" records of the same speed. Action of changing mechanism is smooth and easy; records slip onto rubber-matted turntable silently and without "jamming", even if oversize. Arm height and stylus pressure are easily adjusted from top of changer. Size, 14 $\frac{1}{2}$ " W, 13" D; requires 4 $\frac{3}{4}$ " above and 3 $\frac{1}{2}$ " below mounting board. Supplied complete with two plug-in heads, line cord and plug, and output cable with phono plug. Less cartridges and automatic spindle. For 100-130 or 200-250 v., 60 cycle AC. Shpg. wt., 14 lbs.

\$41⁶⁵

94 RX 670. NET..... 41.65

RC-121-4-050. As above, but with new G. E. 4G-050 magnetic cartridge installed. Less extra plug-in head.

94 RX 542. NET..... 50.42

RC-121-4-052. As above, but with new G. E. 4G-052 magnetic cartridge installed. Less extra plug-in head.

94 RX 543. NET..... 60.56

COMPLETE GARRARD ACCESSORIES

WOOD BASES FOR RC-88-4 AND RC-98-4. Handsomely finished, sturdy wooden bases. Pre-drilled and cut. Shpg. wt., 4 lbs.

94 RX 744. Mahogany Finish.

94 RX 742. Lined Oak Finish.

94 RX 958. Walnut Finish.

NET EACH..... 4.85

WOOD BASES FOR RC-121-4. Shpg. wt., 4 lbs.

94 RX 745. Mahogany Finish.

94 RX 743. Lined Oak Finish.

94 RX 959. Walnut Finish.

NET EACH..... 4.51

WOOD BASE FOR 301 TURNTABLE. Ebony finish. With level. Shpg. wt., 5 lbs.

96 RZ 914. NET..... 24.01

WOOD BASE FOR TMK-II. Finished in dark brown. Shpg. wt., 4 lbs.

94 RX 957. NET..... 4.07

WOOD MOUNTING BOARDS. Unfinished boards drilled and cut for mounting Garrard units. For use where changers are to be installed in custom cabinets, or to replace old mounting boards when modernizing. Shpg. wt., 1 $\frac{1}{2}$ lbs.

95 RX 666. For RC-88-4, RC-98-4. 1.50

95 RX 667. For RC-121-4. 1.50

96 RX 913. For 301 Turntable. 7.35

94 RX 956. For TMK-II. 1.50

45-RPM AUTOMATIC SPINDLES. For automatic changing of 45-rpm records with large center holes; eliminate need for center-hole adapters for each record. Special revolving collar prevents center-hole wear. Shpg. wt., 10 oz.

95 R 664. For RC-88-4. NET

95 R 665. For RC-121-4. EACH..... 3.43

EXTRA PLUG-IN HEAD. Fits all Garrard RC-80, -90, -88, -98, 121-4 and TMK-II units. Shpg. wt., 6 oz.

56 R 341. NET..... 1.47

REPLACEMENT DRIVE BELTS. Set of 2; For RC-80, RC-90. Shpg. wt., 5 oz.

43 N 402. NET PER SET..... 15c



Model 301



TMK II

301 "PROFESSIONAL" TURNTABLE

ONLY

The finest product of Garrard craftsmanship, this turntable meets the most rigorous standards for professional instruments of its kind. Each Model 301 turntable is supplied with a full report of the factory test of the individual unit. Operates at 33 $\frac{1}{3}$, 45 and 78 rpm speeds; includes plastic stroboscope card to permit exact setting of speed with built-in speed regulator.

\$87²²

An integral lubrication system forces additional lubricant, under pressure, into mechanism at the flick of a knob. A resistor-capacitor network prevents shutoff noise from being transmitted through the system and amplified; a shutoff brake prevents "free wheeling" of turntable after it is switched off. Dynamically-balanced, precision-machined turntable of cast aluminum is entirely non-magnetic. Less than 0.2% wow; flutter is less than .05%. Vibration-proof mounting on special springs.

Size, 16x13 $\frac{3}{4}$ "; requires 2 $\frac{1}{2}$ " above, 3 $\frac{1}{2}$ " below mounting board. For operation from 100-130 or 200-250 v., 60 cycle AC. Shpg. wt., 20 lbs.

96 RZ 912. NET..... 87.22

TMK II MANUAL PLAYER

ONLY

A famous Garrard manual player now including these outstanding features— heavy, rubber-padded steel turntable; new, accurate-tracking pickup arm; safety arm rest and lock for maximum portability. An excellent example of Garrard's renowned rugged construction and precision workmanship. Offers all of the basic record-reproducing features of the automatic changers above, at nominal cost. 4-pole motor is exceptionally smooth and quiet. Live rubber motor mounts for low vibration; highly dependable beltless drive. Motor starts when tone arm is lifted—shuts off automatically at end of record. Size, 14 $\frac{3}{4}$ " W, 12 $\frac{1}{2}$ " D, 3" above and 2 $\frac{1}{8}$ " below mounting board. Less cartridge. With 2 plug-in heads (1 when purchased with cartridge installed). For operation from 100-130 or 200-250 volts, 60 cycle AC. Shpg. wt., 14 lbs.

\$31⁸⁵

94 RX 953. NET..... 31.85

TMK-11-050. As above, with G.E. 4G-050.

94 RX 592. NET..... 40.62

TMK-11-052. As above, with G.E. 4G-052.

94 RX 593. NET..... 50.76

UNEQUALLED FOR VALUE

What goes into a Knight high-fidelity component? *First*, information gained during Allied's long leadership as a supplier of hi-fi units and systems to music-lovers the world over. *Second*, skilled engineering and styling aimed at bringing you the highest quality at the lowest price. *Third*, carefully selected, thoroughly inspected components, assembled to produce the unit *you* want. There's greater value, finer performance in every Knight unit—and you can hear the difference!

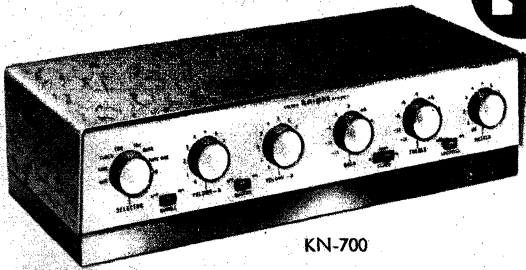

New KNIGHT KN-700 Stereo-Monaural Preamp

ONLY **\$79⁵⁰**

- For Stereo or Monaural Use
- 2-Channel Tape or FM/AM
- Channel "Reverse" Switch
- DC On All Tube Filaments

A superb preamplifier for use with any monaural— or stereo—high-fidelity music system! Start by using it in your present hi-fi system, and add stereo later, or take advantage of the money-saving combination offers at right and on page 24 to start with stereo now— for far less than you thought possible!

The Knight stereo preamp will work perfectly with stereo tapes or phonograph records, and even with stereo broadcasts, already transmitted in some communities. A finger-tip control will instantly switch your entire system to monaural or stereo, and also reverse left and right channels. In addition to independent gain controls, a Master Volume control simultaneously controls both channels. *There is full phono and tape equalization and control for monaural use.*

SPECIFICATIONS: *Frequency Response:* ± 1.0 db, 20 to 20,000 cps. *Hum Level:* 50 db below full output on tape channel; 70 db below output on high-level input. *Sensitivity:* Mag Input, 8 mv for 1 volt output; Tape Head Inputs, 4 mv for 1 volt output. *Controls:* Selector (Aux, Tape Head, Tuner, EUR, FFRR, RIAA, Tape Pre, Mic); Volume "A"; Volume "B"; Bass; Treble, Master Volume; Scratch Filter; Rumble Filter; Loudness Switch; Monaural-Stereo and Channel Reverse Switch. *Inputs:* G.E., Pickering, Ceramic Phono, Aux. A, Aux. B, Tape Head A, Tape Head B, Mic, Tuner, Tape Pre or Crystal. *Outputs:* A & B Recorder Outputs (20,000 ohms impedance), A & B Main Outputs (Cathode Followers). *Size:* 4 $\frac{1}{2}$ x15x7 $\frac{1}{4}$ ".

6-Knob kit required for custom mounting (see below). DC operation of all filaments. Tube complement, 4—ECC83/12AX7, 1—ECC82/12AU7; 2 selenium rectifiers. U.L. Approved. 2 auxiliary AC outlets. For 110-120 volts, 50-60 cycles AC. Shpg. wt., 10 lbs.
92 SX 406. NET. 79.50

CUSTOM MOUNTING KIT. Knobs and hardware to adapt stereo preamp above for mounting in custom cabinet or wall panel, etc. Shpg. wt., 5 oz.
94 S 298. NET. 2.45

See page 9, 24 for superb stereo systems that use the new Knight KN-700 stereo preamp, and offer extra savings!

Allied Is The World's Leading High Fidelity Supplier

Save Money On These KNIGHT Hi-Fi Combination Offers!



STEREO PREAMP WITH BASIC AMPLIFIER

\$139⁵⁰ Begin your hi-fi system with the most modern of components—the new Knight KN-700 Stereo Preamp and the superb new Knight 32-watt Basic Amplifier—at top savings of \$14.05! Use these components as the heart of a fine monaural system now; later, add amplifier-speaker for conversion to thrilling stereophonic sound! See left and page 30 for descriptions of these units. Shpg. wt., 35 lbs.
91 SZ 908. You Save \$14.05! NET. 139.95

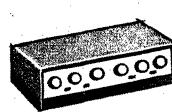

STEREO PREAMP WITH 2 BASIC AMPLIFIERS

\$209⁵⁰ Enjoy the full beauty and realism of stereophonic sound now, with up-to-date Knight components—and save \$19.00! Hear stereo on components designed for stereo, with all of the latest high-fidelity features! Includes KN-700 Stereo Preamp and two KN-632 32-watt Basic Amplifiers. Add tape deck and speakers, and your system is complete! Shpg. wt., 60 lbs.
91 SZ 909. You Save \$19.00! NET. 209.50

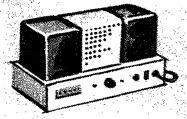

TUNER-PREAMPLIFIER WITH BASIC AMPLIFIER

\$199⁰⁰ Add only a speaker to these fine high-fidelity units and you have a complete music system of top quality—at savings of \$15.00! The Knight KN-200 Tuner-Preamplifier provides excitingly clear reception of both FM and AM broadcasts, together with full controls; the Knight KN-632 32-watt Basic Amplifier is described on the facing page. You'll marvel at its superb reproduction! Shpg. wt., 40 lbs.
91 SZ 905. You Save \$15.00! NET. 199.00

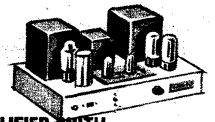

TUNER-PREAMPLIFIER WITH KNIGHT-KIT 25-WATT AMPLIFIER KIT

\$177⁵⁰ Here is the way to the highest savings on your new high-fidelity system: the brilliant new Knight KN-200 Tuner-Preamplifier and the Knight-Kit 25-watt Basic Amplifier Kit. You save \$6.50 over the cost of the two units if purchased separately! The tuner-preamp is fully described on the facing page; see page 215 for the specifications of the remarkable "linear deluxe" basic amplifier. Anyone can assemble this fine unit—and save! Supplied with famous, easy-to-follow Knight-Kit instructions. Shpg. wt., 42 lbs.
91 SZ 907. You Save \$6.50! NET. 177.50



DB130

DELUXE
TWIN'S

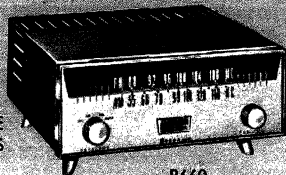

R660

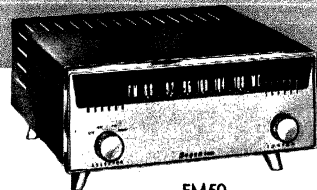

FM50

DB130 35-WATT AMPLIFIER

ONLY \$115.00 This 35-watt amplifier offers exceptional versatility plus full-toned, perfectly-balanced reproduction. Ample inputs for the most elaborate home music entertainment systems. Extremely uniform output, low distortion and high power handling capacity assure faithful sound reproduction. Loudness contour selector assures correct tonal balance even at very low listening levels. Variable damping control provides cleaner bass response by precisely coupling amplifier to speaker system.

Output: 35 watts with 1.5% IM distortion. *Harmonic Distortion:* 0.3% at 35 watts. *Response:* ±0.5 db, 15-30,000 cps. *Hum:* (Below rated output): Magnetic Inputs, -60 db; other inputs, -80 db. *Output Impedance:* 4, 8 and 16 ohms. *Inputs:* High-level magnetic phono, Low-level magnetic phono; Tuner; Tape; Tape monitor; Auxiliary; Crystal phono. *Controls:* On-Off; Loudness-Contour; Bass; Treble; Input Selector (Phono, Radio, Tape, Aux.); 7-pos. Equalizer (Eur 78, U.S. 78, AES, RIAA, COL-LP, NAB, POP); 3-pos. Low Filter; 3-pos. High Filter; Gain; 3-pos. Speaker Selector. Size, 4½x14½x10¼". Less case (see below). For 110-120 v., 60 cycle A.C. Shpg. wt., 24 lbs.

93 SZ 722. NET.....115.00

R660 BASIC FM-AM TUNER

ONLY \$119.50 Moderately priced FM-AM tuner for those desiring a high standard of reception. It's an ideal companion for the DB130 (at left) or any other high-quality amplifier that has tone and volume controls. Extreme sensitivity and high selectivity assure clear reception of even weak or distant stations. Has excellent response characteristic with very low distortion. FM circuit employs dual limiters followed by Foster-Seeley discriminator. AFC (automatic frequency control) circuit assures utmost ease in tuning. AFC can be momentarily switched off to permit tuning weak or distant stations. A tuning meter (indicates signal strength), simplifies tuning of AM as well as FM stations. Cathode-follower output.

Audio Output: 1.5 volts AM and FM. *Sensitivity:* FM (300-ohm input) 5 µv for 30 db quieting; AM 5 µv for 20 db signal-to-noise ratio. *Hum:* 60 db below full output. *Controls:* Selector (Off-On, AM, FM with AFC, FM without AFC); and Tuning. Built-in line cord antenna for FM and ferrite loop for AM. 9 tubes plus rectifier. Meets FCC radiation specs. Size, 4½x11½x10¼" deep. Less case (see below). For 110-120 volts, 60 cycle A.C. Shpg. wt., 13 lbs.

93 SX 720. NET.....119.50

FM50 BASIC FM TUNER

ONLY \$84.50 An exceptionally fine basic FM tuner for high-fidelity music systems. Economically priced, it offers many outstanding features. Can be used with any amplifier that has volume and tone controls. Features extreme sensitivity for clear reception of weak or distant stations. Excellent selectivity eliminates interference from strong or local stations. Limiter and Foster-Seeley discriminator circuits assure high signal-to-noise ratio. AFC (automatic frequency control) for simplified tuning—as dial setting of FM station is approached, AFC takes over and tunes to exact frequency. AFC can be momentarily turned off to permit tuning weak stations. Temperature compensated oscillator plus AFC eliminate drift.

Sensitivity: 300-ohm input, 5 µv for 30 db quieting. *Output:* 1.5 volts. *Controls:* Tuning and Selector (On-Off; FM; AFC-out). *Size:* 4½x11½x10¼". 7 tubes plus rectifier. Built-in line cord antenna provides excellent FM reception in most locations. Attractively styled, brushed gold and white panel; illuminated dial pointer. Meets FCC radiation specifications. Less case (see below). For operation from 110-120 v., 60 cycle A.C. Shpg. wt., 11½ lbs.

93 SX 721. NET.....84.50

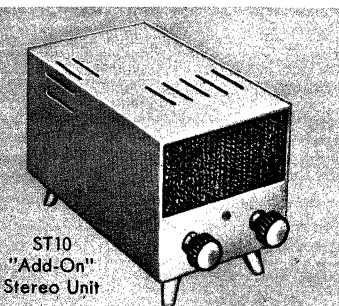

ST10
"Add-On"
Stereo Unit

ST10 "ADD-ON" STEREO AMPLIFIER

Makes it easy to convert your hi-fi system for use with stereophonic sound equipment. Has 2 equalized tape preamps to handle the 2-channel output of a basic stereophonic tape mechanism. The output of 1 preamp is fed into your hi-fi system to provide one channel of sound. Second preamp drives the built-in 10-watt amplifier—you need add only a speaker.

Also has 2 auxiliary inputs for stereo tuner or separate AM and FM tuners. *Response:* ±2 db for 20,000 cps. *Distortion:* 1% at 10 watts. *Inputs:* Tape 1, Tape 2, Aux. 1, Aux. 2. 6½x5½x12". Less case. For operation from 110-120 volts, 60 cycle A.C. Shpg. wt., 11 lbs.

94 S 520. NET.....52.50
94 S 521. Metal Case for ST10. 2 lbs. 8.50

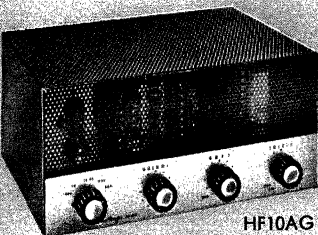

HF10AG

HF10AG "CHALLENGER" 10-WATT AMPLIFIER

Provides true hi-fi performance and control flexibility at low cost! Employs controlled positive feedback circuit for remarkably flat frequency response with low hum and distortion. Has a built-in preamp, separate bass and treble controls, and 2-position record equalizer. *Outputs:* High-imp. tape jack for feeding recorder and 4, 8, 16 ohms for speakers. *Response:* ±1 db, 20 to 20,000 cps. *Distortion:* 1% at 10 watts output.

Hum: -80 db. *Inputs:* Magnetic phono; Crystal phono; Tuner; Aux.; Tape Head. *Controls:* Selector-Equalizer; Volume; Bass; Treble. In ebony-finished metal case, 5½x11½x7¾". For 110-120 v., 60 cycle A.C. 15 lbs.

94 SX 524. NET.....49.10

MODEL HF10A. As above, less case. 10 lbs.
94 SX 523. NET.....44.50



DB110G

DB110G 12-WATT AMPLIFIER

A highly popular unit, the DB110G delivers performance comparable to far more costly amplifiers. Employs controlled positive feedback circuit; built-in preamp with inputs for associated equipment; separate bass and treble controls; 3-pos. record equalizer; hum adjustment control; two 6V6GT power output tubes. *Response:* ±0.5 db, 15 to 30,000 cps. *Distortion:* 0.5% at 12 watts output. *Hum:* -81 db.

Inputs: High and Low-Level Magnetic phono; Mike, Tuner, Aux. *Controls:* On-Off-Volume; Bass; Treble; Selector-Equalizer. *Output Imp.:* 4, 8, 16 ohms. Ebony finished case, 5½x11½x7¾". For 110-120 v., 60 cycle A.C. 15 lbs.

93 SX 875. NET.....64.50

MODEL DB110. As above, less case. 12 lbs.
93 SX 874. NET.....59.95

METAL CASES FOR BOGEN UNITS. Detachable legs. Height with legs, 5¾"; without, 4¾".

Stock No.	Type	Finish	Used With	Size	Shpg. Wt.	EACH
93 SX 723	A	Mahogany	{ R660, FM50, DB115, R620, AM90	12x10½x4¼"	3 lbs.	7.00
93 SX 724	A	Blonde				7.00
93 SX 725	B	Mahogany	{ RR501C, DB130, PR100A	15x10½x4¼"	4 lbs.	7.50
93 SX 726	B	Blonde				7.50
93 SX 727	C	Mahogany	{ RR550	15x11½x4¼"	5 lbs.	8.00
93 SX 728	C	Blonde				8.00

MUSIC COMPONENTS

Bogen

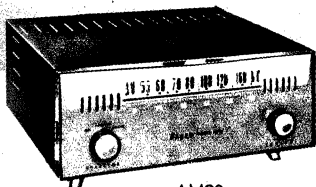

AM90

AM90 BASIC AM TUNER

ONLY
\$74⁵⁰

Top-quality basic AM tuner designed to provide the utmost in reception of standard AM broadcasts. Can be used with any high-fidelity amplifier that has volume and tone controls. Modern superhet circuit with important refinements for greatly improved selectivity and sensitivity.

Tuned RF amplifier provides 3 μ v sensitivity with 20 db signal-to-noise ratio. Choice of wide or narrow passband for excellent reception of local or long-distance stations. Built-in 10-kc filter eliminates adjacent station whistles. Cathode-follower output permits use of long leads between tuner and amplifier. Highly efficient ferrite loop-stick indoor antenna with provision for adding outside antenna. *Output:* 1 volt—ample to drive any high-fidelity amplifier. *Frequency Response:* 30-8500 cps in wide (high fidelity) position; 30-3500 cps in narrow (long range) position. *Controls:* Selector (On-Off, AM Wide, AM Narrow) and Tuning.

Attractive brushed gold and white panel. *Size:* 4 $\frac{1}{2}$ x11 $\frac{3}{4}$ x10 $\frac{1}{4}$ ". 4 tubes plus rectifier. Less case (see listing on page 32). For operation from 110-120 volts, 60 cycle AC. Shpg. wt. 12 lbs.

94 SX 516. NET.....74.50

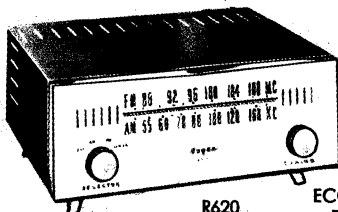

R620

R620 BASIC FM-AM TUNER

ONLY
\$89⁹⁵

The R620 FM-AM high-fidelity tuner offers top-notch coverage of the FM and AM broadcast bands at very moderate cost. Designed for use with the DB115 (at right) or any other high-fidelity amplifier with tone and volume controls. An excellent choice for the budget-conscious high-fidelity enthusiast. Compactly styled to occupy a minimum of space on shelf, table top or bookcase. Triode RF amplifier and triode mixer for excellent signal-to-noise ratio.

AFC (automatic frequency control) circuit assures maximum tuning ease—as dial setting of desired station is approached, AFC takes over and precision tunes to exact frequency then "locks" in. AFC can be turned off to permit easy tuning in of weak or distant stations.

Has built-in line cord FM antenna and loopstick AM antenna; provision for external antenna. *Controls:* Tuning; Selector (Off-On, AM, FM with AFC, FM without AFC). *Sensitivity:* FM, 10 μ v for 30 db signal-to-noise ratio; AM, 5 μ v for 20 db signal-to-noise ratio. 7 tubes plus rectifier. *Size:* 4 $\frac{1}{2}$ x11 $\frac{3}{4}$ x10 $\frac{1}{4}$ ". Less case (see page 32). Meets FCC radiation specs. For 110-120 volts, 60 cycle AC. Wt., 11 lbs.

94 SX 515. NET.....89.95



ECONOMY TWINS

DB115

DB115 15-WATT AMPLIFIER

ONLY
\$79⁹⁵

The DB115 15-watt high-fidelity amplifier is an ideal companion for the R620 or any other basic tuner. Ideal central control—incorporates all necessary controls and ample inputs for a complete home high-fidelity music system. Features wide response with extremely low harmonic and intermodulation distortion. Speaker switch permits use with either of two speaker systems; or both simultaneously. Loudness-contour selector maintains proper tonal balance even at very low volume. Variable damping for optimum speaker performance. Also has rumble and scratch filters.

Power Output: 15 watts. *Response:* ± 0.5 db from 15 to 30,000 cps. *Distortion:* Less than 0.4% at 15 watts. *Hum and Noise:* -60 db, low level input; -90 db, high level input. *Output Impedance:* 8 and 16 ohms. *Controls:* Off-On-Volume; Bass; Treble; Loudness Contour; Equalizer-Input Selector (US 78, RIAA, POP, and NARTB tape equalization—Tuner, Magnetic phono, Tape, Crystal phono, and Auxiliary). Speaker Selector; High Filter; and Low Filter. EL84's in output. 4 $\frac{1}{2}$ x11 $\frac{3}{4}$ x10 $\frac{1}{4}$ ". Less case (see page 32). For operation from 110-120 volts, 60 cycle AC. Shpg. wt. 15 lbs.

94 SX 514. NET.....79.95

RR550 FM-AM TUNER-AMPLIFIER

Deluxe FM-AM tuner-25 watt amplifier combination with built-in preamp—all on a single chassis. The tuner incorporates double limiters, a Foster-Seeley discriminator and AFC. A tuning meter assures pinpoint tuning accuracy. The amplifier delivers a full 25 watts at only 0.3% distortion, with response of ± 0.5 db, from 15 to 30,000 cps. Has 4, 8, and 16 ohm speaker outputs. Extreme versatility is provided by the preamplifier section. It features 3-position loudness control, 5-position record equalizer, high and low frequency filters, separate bass and treble controls, and 5-position input selector. *Sensitivity on FM,* 2.5 μ v for 30 db quieting; *AM,* 5 μ v. *Size:* 4 $\frac{1}{2}$ x14 $\frac{1}{2}$ x11 $\frac{3}{4}$ ". Tuner meets FCC radiation specifications. Less case (see page 32). For operation from 110-120 v., 60 cycle AC. Shpg. wt., 25 lbs.

93 SZ 719. NET.....224.50

PR100A AUDIO CONTROL

Deluxe equalizer-preamplifier, featuring pushbutton operation. 36 positions of equalization. Provisions for binaural connections and control. Inputs for the most elaborate of hi-fi systems. Insignificant IM and harmonic distortion. Hum is inaudible at full gain. *Response:* ± 0.5 db, 10-130,000 cps. *Controls:* Record Equalization, 6-position Low Frequency Turn-over and 6-position High Frequency Roll-off; Bass, +15 to -15 db at 50 cycles; Treble, +15 to -15 db at 15 kc; 5-position Lo-Filter; 5-position Hi-Filter; Volume; Loudness-Contour; Input Selector, Off-On, Monitor, Phono, Radio, Tape, and Auxiliary. *Inputs:* 3—Phono (2—Magnetic; 1—Crystal, Tuner, Tape, Auxiliary, Tape Monitor, and Binaural). *Outputs:* Main, Tape, Binaural. 4 $\frac{1}{2}$ x14 $\frac{1}{2}$ x10 $\frac{1}{4}$ ". Less cabinet (see page 32). For operation from 110-120 v., 60 cycle AC. Shpg. wt., 14 lbs.

94 SX 519. NET.....109.00

RR501C FM-AM TUNER-AMPLIFIER

New, moderately priced tuner-amplifier with built-in equalizer-preamplifier. Consists of a sensitive and selective FM-AM tuner, a high-fidelity 10-watt amplifier, and a preamp with 3 positions of record equalization. Ready to play—you need add only a speaker! *Sensitivity:* FM, 7 μ v for 30 db quieting; *AM,* 5 μ v for 20 db signal-to-noise ratio. *Response:* ± 1 db from 30 to 18,000 cps. *Rated Output:* 10 watts. *Distortion:* 1% at rated output. *Output Impedance:* 4, 8, and 16 ohms. *Controls:* Off-On-Volume; Bass; Treble; Tuning; Equalization-Selector (Pop., 78, LP, FM, AM, Aux); 3-pos. (Speaker) Selector switch; High and Low-Frequency Filters; Loudness. *Size:* 4 $\frac{1}{2}$ x14 $\frac{1}{2}$ x10 $\frac{1}{4}$ ". Tuner meets FCC radiation specifications. Less case (see page 32). For operation from 110-120 v., 60 cycle AC. Shpg. wt., 21 lbs.

94 SZ 522. NET.....134.50

DO70M 70-WATT AMPLIFIER

A basic amplifier, designed to meet the requirements of critical music lovers and audio perfectionists. Uniform output, negligible distortion, and extremely high power capacity assure faithful reproduction of all music. Features variable damping (with light indicator); controlled positive feedback; built-in, 3-position speaker switch; and calibrated output indicator. *Rated Output:* 70 watts. *Harmonic Distortion:* 0.5% at rated output; *IM,* 1.6% at rated output. *Response:* 5 to 100,000 cps. ± 0.5 db. *Hum:* 100 db below rated output. *Sensitivity:* 1 volt for full output. *Damping Factor:* Variable from +0.1 through infinity to -1.5. *Output Impedances:* 4, 8, and 16 ohms. *Tubes:* 6U8, 12B4A, 6CA, and 2-6CA7/EL34; 5U4GB/GZ34 rectifier. Mahogany finished metal case, 4 $\frac{1}{2}$ x15x8 $\frac{1}{2}$ ". For operation from 110-120 v., 60 cycle AC. Shpg. wt., 22 lbs.

94 SZ 517. NET.....129.50



RR550

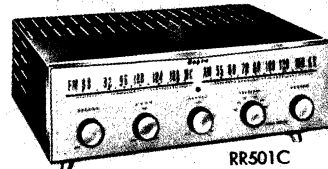

RR501C

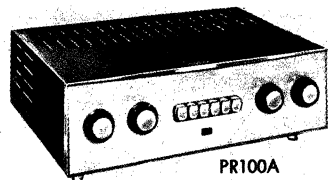

PR100A

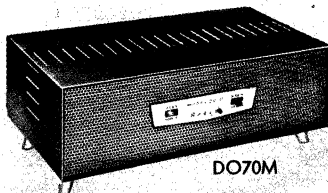

DO70M

Letter Z in Stock Number Indicates Express Shipment Only

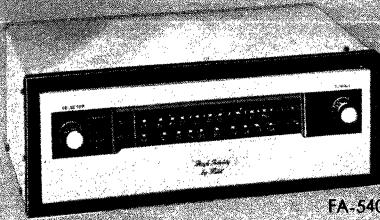

FA-540



AA-920

Deluxe Tuner and Amplifier "Twins"

MODEL FA-540 BASIC FM-AM TUNER

ONLY
\$109⁵⁰

A compact basic FM-AM tuner featuring excellent performance and distinctive appearance, at a moderate price. An ideal companion unit for the AA-920 (at right) or any other hi-fi amplifier having volume and tone controls.

The entire unit is housed in a beautifully styled metal case in burgundy and brushed brass.

Hum Level: 70 db below 1.0 volt. **Maximum Audio Output:** 5 volts. **Output Impedance:** 500 ohms (cathode follower). **Controls:** Selector (Off-On, Aux, AM, FM with AFC, FM without AFC); Tuning. **FM Features:** Automatic frequency control (AFC) for simple, drift-free tuning, with disabling switch for tuning weak stations adjacent to strong stations; temperature-compensated oscillator for maximum stability of tuning; tuned RF amplifier stage for excellent sensitivity and selectivity; 3-gang tuning capacitor; built-in line cord antenna, with 300-ohm terminals to match external dipole. **FM Sensitivity:** 3.0 microvolts for 20 db of quieting. **AM Features:** Tuned RF amplifier stage; 10-kc whistle filter; efficient, built-in ceramic powdered-iron antenna; 3-gang tuning capacitor. **AM Sensitivity:** 3 microvolts for 1 volt DC at detector.

A cathode follower output permits installation of the FA-540 up to 100 feet from the amplifier without deterioration of signal quality. Flywheel tuning for smooth, precise station selection, plus "Beacon" tuning eye provide pin-point accuracy. Tuner can be easily removed from metal case to permit custom installation. FM and AM band calibrations are legibly marked on the illuminated slide-rule dial. A switched input is provided for crystal or ceramic phono or TV sound. 7 tubes, plus EM81 tuning eye and 6X4 rectifier. Size, 4 $\frac{1}{4}$ x13x8 $\frac{1}{2}$ ". For operation from 105-120 volts, 60 cycle AC. Shpg. wt. 14 lbs.

94 SX 369. NET.....109.50

MODEL AA-920 20-WATT AMPLIFIER

ONLY
\$99⁵⁰

High-performance 20-watt amplifier with exceptionally high gain, stability, and freedom from distortion. A built-in preamplifier provides complete control flexibility, including equalization for playback of recorded tapes directly from the tape head. The AA-920 is an excellent choice for use with the FA-540 tuner at left or any high-quality basic tuner.

The output transformer of the AA-920 employs interleaved windings, to minimize leakage inductance and resultant loss of high-frequency response. Tube filaments in the preamplifier section are operated on direct current to assure extremely low hum level. In addition to tape head equalization, an output jack is provided to feed a tape recorder; a full array of inputs accommodates any possible signal source. The burgundy and brushed-brass cabinet finish of the AA-920 adds fresh "new look" styling to any room.

Power Output: Rated, 20 watts; 40 watts peak. **Frequency Response:** ± 1 db from 20 to 20,000 cps. **Hum and Noise Level:** 80 db below full output. **Distortion:** Less than 1% harmonic at 20 watts; 1.5% intermodulation at 20 watts. **Negative Feedback:** 18 db. **Speaker Output Impedances:** 4, 8 and 16 ohms. **Inputs:** Radio, Aux. **Tape Amp—** 470,000 ohms; Magnetic Phono, adjustable from 6800 to 100,000 ohms; Tape Head, 100,000 ohms. 6L6GB output tubes.

Controls: On-Off/Volume; Loudness (Aural Compensation); Selector (LP, AES, RIAA, NARTB, Tape Head, Radio, Aux, Tape Amp); Treble; Bass; 3-position Scratch Filter; 3-position Rumble Filter. Auxiliary AC outlet is controlled by master Off-On switch; may be used to provide power for tuner, record changer, or other accessory. Removable rubber feet and through-chassis mounting hardware, for custom cabinet installation. 4 $\frac{1}{4}$ " high, 13 $\frac{1}{4}$ " wide, 9" deep. For operation from 105-120 volts, 60 cycle AC. Wt., 22 lbs.

94 SZ 371. NET.....99.50

HF-42 TUNER-AMPLIFIER

Compact, smartly styled "all-in-one" chassis with FM-AM tuner, pre-amplifier and 20-watt Williamson-type amplifier. You need only add a record changer and speaker to have a complete home music system. A tape head input permits direct playback of tapes from a tape deck.

Tuner Specs: AFC on FM with defeat switch; "Beacon Eye" tuning indicator; tuned RF stage; 10-kc AM whistle filter; FM sensitivity, 2.5 μ v for 20 db quieting; AM sensitivity, 3 μ v for 1 volt DC at detector. **Amplifier Specs:** Rated output, 20 watts; 1% harmonic distortion and 1.5% IM at 20 watts; response, ± 1 db, 20-20,000 cps; hum, 80 db below 20 watts. **Output impedances:** 4, 8, 16 ohms. **Controls:** Selector (Aux I, Aux II, Phono, AM, FM, FM with AFC); Bass; Treble; Equalizer (LP, NAB, RIAA, AES, Tape); On-Off/Volume; Loudness Contour; Tuning. 6L6GB output tubes; EM81 tuning indicator. 4 $\frac{1}{2}$ x6 $\frac{1}{2}$ x14 $\frac{1}{2}$ x12 $\frac{1}{4}$ ". For 105-120 v., 60 cycle AC. Wt., 30 lbs.

94 SZ 366. NET.....209.50

NEW HF-30 TUNER-AMPLIFIER

New combination unit including high-fidelity FM-AM tuner, preamplifier with controls, and low-distortion 12-watt Williamson-type amplifier in one case. "Beacon" tuning eye simplifies station selection on FM and AM; tuned RF stage on FM and AM for maximum sensitivity. AFC on FM, with disabling switch.

Tuner Specs: (FM) 3 μ v for 20 db quieting. **Bandwidth:** 200 kc. **Overall IM** (antenna to speaker terminals): 1.5% at 10 watts output. (AM) Sensitivity: 3 μ v for 1 v. DC at detector. **Filter:** More than 80 db attenuation at 10 kc; factory set. **Amplifier Specs:** Output: 12 watts. **Harmonic Distortion:** Less than 1%. **Outputs:** 8 and 16 ohms. **Response:** ± 1 db, 20-20,000 cps at 12 watts. **Controls:** Selector (Aux, AM, FM, FM-AFC, Phono); Bass and Treble (calibrated for equalization); Loudness Contour; On-Off/Volume; Speaker Selector; Tuning. EL84 output tubes. 4 $\frac{1}{2}$ x14 $\frac{1}{4}$ x10 $\frac{1}{4}$ ". For 105-120 v., 60 cycle AC. Shpg. wt., 23 lbs.

94 SZ 324. NET.....169.50

FM-530 BASIC FM TUNER

An FM tuner of high quality, specially designed for use with an amplifier having a full set of controls. Many features of the FM-530 are usually found only on much more expensive tuners; it is an ideal tuner for use with an amplifier and speaker system of high quality. Scale calibrations are large and clear; "Beacon" tuning eye, in conjunction with AFC, makes tuning as simple and stable as the electronic art permits. The case, finished in the well-known Pilot burgundy-and-brass combination, may be removed for installation of the tuner in a custom cabinet. Noise level, hum and distortion are well below the threshold of audibility.

Sensitivity: 3.0 microvolts for 20 db of quieting; tuned RF stage. **Hum Level:** 70 db below 1.0 volt. **Maximum Audio Output:** 5 volts. **Distortion:** Less than 0.2% at 1 volt output. **Output Impedance:** 500 ohms (cathode follower). **Selectivity:** 6 db down at 200 kc. **Antenna:** Built-in; terminals for balanced 300-ohm dipole. **Controls:** Selector (Off-On, Aux, FM-AFC, FM without AFC); Tuning. 7 tubes, plus EM81 tuning eye and 6X4 rectifier. Panel finished in brushed brass and deep burgundy. Size, 4 $\frac{1}{4}$ " high, 13" wide, 8 $\frac{3}{4}$ " deep. For operation from 105-120 v., 60 cycle AC. Shpg. wt., 14 lbs.

94 SX 368. NET.....89.50

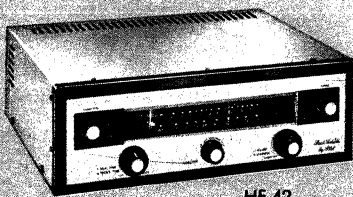

HF-42

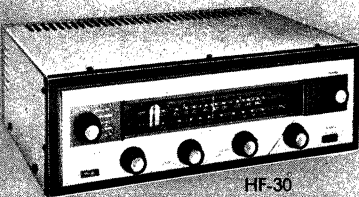

HF-30



FM-530



GENERAL ELECTRIC HI-FI PHONO COMPONENTS

GENERAL ELECTRIC

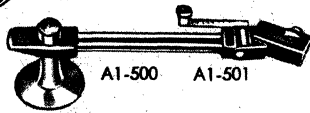

UPX-003B

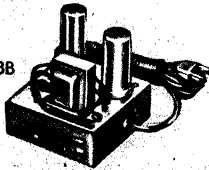

A1-903



A1-203

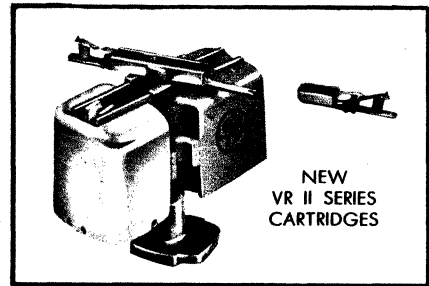
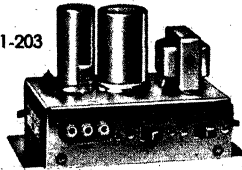

NEW VR II SERIES CARTRIDGES

"BATON" PICKUP ARMS

Precision-engineered 12" and 16" pickup arms; take new G.E. Series VR II magnetic cartridges. Excellent for deluxe hi-fi music systems and for studio use. Made of strong, non-warping, lightweight aluminum. Excellent tracking even on eccentric or warped records. Feature ball-bearing cartridge-head suspension for minimum record wear. Cartridge head tilts up 90° for stylus inspection. RPX-type cartridge plugs into head; new VR II requires A1-504 adapter. Stylus pressure is shown on calibrated scale. Height adjustable to 2".

MODEL A1-500 12" PICKUP ARM. For records up to 12" in diameter. Length, 10 7/8". Shpg. wt., 1 1/2 lbs.
99 R 843. NET..... 26.95

MODEL A1-501 16" PICKUP ARM. For records up to 16". 14 1/8" long. 2 lbs.
99 R 844. NET..... 28.91

A1-903 RUMBLE FILTER

This highly effective rumble filter suppresses or completely eliminates unwanted low-frequency signals in any hi-fi phono system using a G.E. magnetic cartridge. Has single cutoff at 50 cps—extremely effective in filtering out rumble, vibration and spurious sub-audio signals. Simple to install—plugs in between pickup and the preamp stage. Has Off-On switch. Supplied complete with 19" shielded output lead, standard phono plug and mounting bracket for attachment to record changer base, cabinet, or control panel. Size, 2x2 3/4x3 1/2". Shpg. wt., 10 oz.
99 R 865. NET..... 8.33

UPX-003B DUAL-FUNCTION PREAMP

Dual-function high-fidelity modernization component. Permits using hi-fi magnetic phono cartridge with radio-phono or amplifier not equipped with necessary preamp; also permits using a microphone. Two-position switch provides proper equalization for either a mike or G.E. magnetic cartridges. Provides 32 db gain when in "Phono" position; flat (30-15,000 cps) response when on "Mike." 18 db bass boost in record reproduction at 50 cps. Completely shielded. Use up to 25 ft. output cable. With phono-mike input jack, output plug, shielded cable with plug and 6SC7 tube, selenium rectifier. 3 3/4x3 3/4". For operation from 110-120 volts, 60 cycle AC. Shpg. wt., 1 1/2 lbs.
93 S 749. NET..... 10.55

A1-203 "TRANSISTUBE" PREAMP

New, highly versatile transistorized preamplifier for use with all magnetic cartridges. Uses NPN transistor and 12AX7 tube. Unusually low hum and noise level. Sensitivity: 10 millivolt input for 1 volt output. Convenient output level control matches preamp output level to that of tuner. Switch permits adjustment for use with high or low-output magnetic cartridges. Selector switch cuts out equalization network for use with microphone. RIAA equalization for records. Self-contained power supply; does not use batteries. Size, 3 3/4x3 3/4". For operation from 110-120 volts, 50-60 cycle AC. Shpg. wt., 3 1/2 lbs.
81 S 857. NET..... 21.51

NEW G.E. VR II SERIES HI-FI MAGNETIC CARTRIDGES

New variable-reluctance cartridge featuring extended frequency response, special anti-hum coils, higher output than previous types, and new plug-in design. The new VR II cartridge is much smaller than earlier models; fits practically any arm. It is fully shielded in mu-metal, and incorporates coils specially wound to suppress hum.

Increased compliance provides improved tracking, with less record wear. Tracking pressure is only 4 grams, in professional-type arms; 6-8 grams in record changers. Output (nominal) is 22 mv at 10 cm/sec. Extremely smooth frequency response from 20 to 20,000 cycles. Uses independently replaceable "Clip-In-Tip" styli of new design. Fits either standard 1/2" or 3/8" mounting centers; adapter listed below for "Baton" arms. "S"—Sapphire; "D"—Diamond. Shpg. wt., 3 oz.

TRIPLE-PLAY TYPES

Stock No.	Mfr's Type	Stylus Tips	NET
72 R 851	4G-050	S-.001" S-.003"	8.77
72 RC 852	4G-052	D-.001" S-.003"	18.94
72 RC 853	4G-053	D-.001" D-.003"	29.92

SINGLE STYLUS TYPES

Stock No.	Mfr's Type	Stylus Tip	NET
72 R 854	4G-040	S-.003"	6.42
72 R 855	4G-041	S-.001"	6.42
72 RC 856	4G-063	D-.003"	17.18
72 RC 857	4G-061	D-.001"	17.18

G. E. Modernization Assemblies & Styli for RPX Series

REPLACEMENT "CLIP-IN-TIP" STYLI

For stylus replacement in single or triple-play RPX Clip-In-Tip cartridges. Wt., 2 oz.

Stock No.	Mfr's Type	Stylus	Radius
65 RC 992	RPJ-01D	Diamond	.001"
65 RC 993	RPJ-02D	Diamond	.0025"
65 RC 994	RPJ-03D	Diamond	.003"
NET EACH..... 12.00			
65 R 995	RPJ-01S	Sapphire	.001"
65 R 996	RPJ-02S	Sapphire	.0025"
65 R 997	RPJ-03S	Sapphire	.003"
NET EACH..... 1.96			

STYLI MODERNIZATION ASSEMBLIES

For converting G.E. triple-play cartridge types RPX-050, -052, -053, -047 to "Clip-In-Tip". Once installed, only the tips need be replaced when worn. "S"—Sapphire; "D"—Diamond. Shpg. wt., 2 oz.

Stock No.	Type	Stylus Tips	NET
65 R 988	RPJ-010A	S-.001" S-.003"	3.50
65 RC 991	RPJ-012A	D-.001" D-.003"	24.45
65 RC 989	RPJ-013A	D-.001" S-.003"	13.47
65 R 987	RPJ-007A	S-.001" S-.0025"	3.50
65 RC 990	RPJ-011A	D-.001" D-.0025"	24.45

SINGLE-TIPPED REPLACEMENT STYLI

Replacement single-tipped styli for G.E. cartridge types RPX-040, -041, -061, and -063. (These cartridges cannot be converted for use with "Clip-In-Tip" styli.) Shpg. wt., 2 oz.

Stock No.	Mfr's Type	Stylus	Radius
65 R 281	RPJ-005	Sapphire	.001"
65 R 261	RPJ-006	Sapphire	.0025"
65 R 295	RPJ-001	Sapphire	.003"
NET EACH..... 2.06			
99 RC 815	RPJ-004	Diamond	.001"
99 RC 817	RPJ-002	Diamond	.0025"
99 RC 816	RPJ-003	Diamond	.003"
NET EACH..... 12.49			

RPK-009 REPLACEMENT PARTS KIT

For triple-play cartridges. Includes washers, spring and knobs. Shpg. wt., 4 oz.
65 R 971. NET..... 29c

RQB-001 STYLUS BRUSH

Soft bristle brush for cleaning stylus assemblies. Reduces distortion, saves records. 2 oz.
65 R 972. NET..... 10c

REPLACEMENT STYLI FOR VR II SERIES

"Clip-In" replacement styli specially designed for the new VR II cartridge. Consist of precision-ground G.E. diamonds and sapphires mounted on a high-compliance support. Unique construction virtually eliminates response to vertical movement of stylus, greatly reducing noise level on worn or scratched records. Plastic damping blocks suppress needle resonance for smooth, peak-free high frequency response. Av. shpg. wt., 2 oz.

Stock No.	Type	Stylus	Radius	NET
72 R 858	4G-01S	Sapphire	.001"	1.96
72 R 859	4G-02S	Sapphire	.0025"	1.96
72 R 860	4G-03S	Sapphire	.003"	1.96
72 RC 861	4G-01D	Diamond	.001"	12.00
72 RC 862	4G-02D	Diamond	.0025"	12.00
72 RC 863	4G-03D	Diamond	.003"	12.00

A1-504 ADAPTER. Required when mounting new VR II magnetic cartridges in General Electric transcription-type arms, A1-500 or A1-501. Shpg. wt., 5 oz.
72 R 864. NET..... 73c

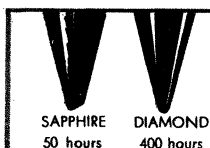

STYLUS FACTS: Magnetic cartridges are supplied with sapphire or diamond styli. Either will outlast the osmium stylus used in ordinary phonographs by many times. This is important, because a worn stylus will seriously damage your records, permanently distorting their sound. In the long run, diamond

styli are most economical. If sapphire styli are used, replace them at the first sign of wear. The diagram at left shows comparative wear of diamond and sapphire styli. It shows that diamond styli last far longer than sapphire styli; taken over a period of a year or so, the cost of diamond styli is considerably lower.

WEBCOR

VERIFIED HIGH-FIDELITY DISKCHANGERS



Model
BR1831-21



Model
BS1842-1

"Imperial" 4-Speed Series 1831 Diskchangers

AS LOW AS

\$42⁶³

- Beautiful New Toned-Gold Finish
- "Magic Mind" Intermixes Records
- Wide Choice of Models
- Plays "Talking Book" Records

New 1958 versions of the world-famous Webcor "Imperial" Diskchanger—featuring precision workmanship, four playing speeds, and the ultra-convenient "Magic Mind" operation. Deluxe styling includes new "Toned-Gold" finish, and attractive, functional placement of controls for simple operation. "Magic Mind" lets you intermix any assortment of 33 $\frac{1}{3}$ and 45-rpm records in 7", 10" and 12" sizes. Changer automatically changes records and changes to 33 $\frac{1}{3}$ or 45 rpm speed. Also intermixes 10" and 12" 78-rpm records automatically. Fourth speed, 16 $\frac{2}{3}$ rpm, is used to play "Talking Book" records manually or automatically.

Other features include automatic motor shut-off after last record; pilot light; powerful 4-pole Rotodyne motor; convenient, top-of-arm stylus pressure adjustment; 9 $\frac{1}{2}$ -inch rubber-matted turntable. Minimum mounting space: 13 $\frac{1}{8}$ " wide, 13 $\frac{3}{8}$ " deep; requires 6 $\frac{1}{2}$ " above, 3" below mounting board. See accessories listed at right below. With phono cable and pin plug, AC cord and plug, and template. Less base. For 110-120 volts, 60 cycle AC. Shpg. wt., 12 lbs.

BR1831-21. "Imperial" Diskchanger with new G.E. 4G-052 magnetic cartridge (.001" diamond, .003" sapphire stylus).
94 RX 960. List Price, \$80.00. NET..... **58.80**

BR1831-1. As above, but with ceramic cartridge (.001" diamond, .003" sapphire stylus).
94 RX 961. List Price, \$75.00. NET..... **55.12**

BR1831-27. As above, less cartridge, but with two plug-in heads. Accommodates any conventional cartridge. See pages 63 and 65-66 for listings of phono cartridges.
94 RX 962. List Price, \$58.00. NET..... **42.63**

Economy 4-Speed Series 1840 Diskchangers

AS LOW AS

\$33⁴⁵

- "Magic Mind" Intermix Feature
- Rubber-Matted Turntable
- Full 4-Speed Operation
- Stylus Pressure Adjustment

Excellent economy version of the "Imperial" series at left. "Magic Mind" feature provides fully automatic intermix of 33 $\frac{1}{3}$ and 45 rpm records of all sizes. Uses exclusive Webcor precision-built motor to assure smooth, constant turntable speeds. Handling of records is gentle and noiseless; stylus pressure may be adjusted for minimum record wear. Turntable is dynamically balanced to eliminate objectionable wow and flutter. Set-down position of pickup arm may be easily adjusted. Four speeds played are 78 rpm, 33 $\frac{1}{3}$ rpm, 45 rpm, and 16 $\frac{2}{3}$ rpm; 16 $\frac{2}{3}$ rpm speed is used for "Talking Book" records. 8-inch turntable is rubber-matted.

Models 1841-1 and 1842-1 have 2-pole motor; other models have a 4-pole motor. All in new "Toned-Gold" color. Size, with base: 10x13 $\frac{1}{2}$ x14 $\frac{1}{8}$ ". Min. mtg. space of models without base: 13 $\frac{1}{8}$ " wide, 13 $\frac{3}{8}$ " deep; require 6 $\frac{1}{2}$ " above, 3" below mounting board. See accessories listed below. With phono cable and pin plug, AC cord and plug. For 110-120 volts, 60 cycle AC. Shpg. wt., less base, 11 lbs.; with base, 15 lbs.

BS1842-1. Economy Diskchanger as described above, with ceramic cartridge and two sapphire styli. On metal base.
94 RX 963. List Price, \$53.75. NET..... **39.50**

BS1842-21. As above, but with new G.E. 4G-050 cartridge (has two sapphire styli).
94 RX 964. List Price, \$58.00. NET..... **42.63**

BR1841-1. Same as Model 1842-1 above, less base.
94 RX 965. List Price, \$45.50. NET..... **33.45**

BR1841-21. Same as Model 1842-21, less base.
94 RX 966. List Price \$49.75. NET..... **36.56**

G.E. UPX-003B PREAMPLIFIER CONVERTS YOUR PHONO OR TV SET FOR USE WITH MAGNETIC CARTRIDGES.

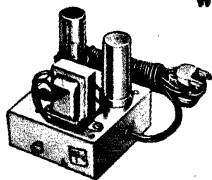

Modernize Your Present
Phonograph with a
Webcor Changer and
Magnetic Cartridge!

If your TV set or radio has a phono input jack, you can easily convert it for use with a Webcor hi-fi Diskchanger and G.E. magnetic cartridge by adding a G.E. UPX-003B preamplifier. Just insert the shielded wire plug from the changer into the socket on the preamp provided for it; then plug the preamp into your radio or TV set in the same way. Connect changer and preamp to 110-volt, 60-cycle AC outlets, and you're all set! The combination will provide record reproduction vastly superior to older equipment; records will last longer, too, thanks to the light stylus pressure required by the G.E. cartridge. It's an excellent way to get started in hi-fi!

All necessary cords and plugs are supplied with the changer and the preamplifier; there's no soldering to be done. The preamp itself is easily hidden out of sight inside TV or radio cabinets, or behind them. In addition, the preamp may be used with a microphone, enabling you to "broadcast" through your radio or TV set. With instructions. Size, 3 $\frac{1}{2}$ x3 $\frac{1}{2}$ x1 $\frac{1}{4}$ ". Shpg. wt., 1 $\frac{1}{2}$ lbs.

93 S 749. NET..... **10.55**

Webcor Diskchanger Accessories



1911 Base



Mounting Board



45-rpm
Spindle



45-rpm
Spider

MODEL 1911 BASE. Highly attractive and durable metal base, finished in rich-looking burgundy. Harmonizes perfectly with new "Toned-Gold" changer finish. Excellent for table-top or shelf use; underside of changer is effectively sealed against dust. Mounting of changer is quick and easy. Shpg. wt., 4 lbs.
95 RX 765. NET..... **5.68**

PRE-CUT MOUNTING BOARD. Pre-cut, heavy plywood mounting board for custom installing Webcor changers. Unfinished; may be stained or finished to match cabinet. Overall size, 16x16x $\frac{3}{4}$ " thick. Shpg. wt., 3 lbs.
95 RX 767. NET..... **1.96**

AUTOMATIC 45 RPM SPINDLE. Automatically changes 45 rpm records without need for individual spider adapters in each record. Easily slips over center spindle of Webcor changers for conversion to fully automatic 45-rpm changing action. Shpg. wt., 8 oz.
94 R 911. NET..... **2.94**

45 RPM SPIDER INSERTS. Lightweight metal inserts, easily snapped into place in large center-hole of 45 rpm records. Small center-hole in adapter permits use of 45 rpm records on any conventional turntable which will operate at 45 rpm speed, but which does not have large spindle. Shpg. wt., package of 10, 6 oz.
96 R 471. Pkg. of 10, NET..... **46c**

Pickering High-Fidelity Components

SERIES 350 "FLUXVALVE" CARTRIDGES

With individual replacement styli. Replaceable stylus, dual-turnover magnetic cartridges—with extremely wide response. For all hi-fi changers and all lightweight transcription arms. Provide the ultimate in record reproduction. Stylus can be quickly and easily changed. Frequency response, ± 2 db from 10 cycles to beyond 30,000 cps. Exceptional compliance and minimum mass assure extremely high tracking accuracy and minimum record and stylus wear. When used with the 190D pickup arm (below, right), tracking force can be as low as two grams. Hermetically sealed. Available with two diamond styli; diamond LP and sapphire standard styli; or single diamond stylus. "S" indicates sapphire tip; "D" indicates diamond. 15 millivolts output. Require preamplifier. Shpg. wt., 3 oz.

Stock No.	Type	Styli	NET
99 RC 847	350DD	D-.001", D-.0027"	54.00
99 RC 848	350DS	D-.001", S-.0027"	42.00
99 RC 899	350D.5D	D-.001", D-.0005"	60.00
99 RC 798	350D0	D-.001"	36.00

NEW 370-1D "FLUXVALVE" CARTRIDGE. Low-cost version of superior Pickering "Fluxvalve" cartridge, with frequency response from 10 to 30,000 cps. Output is 25 millivolts; tracking pressure from 2 to 6 grams, depending upon arm used and type of recording. Supplied with 1-mil diamond stylus for playing microgroove records, but will accommodate any of the styli listed below. Shpg. wt., 3 oz.

99 RC 236. NET 29.85

REPLACEMENT STYLI FOR "FLUXVALVE" 350, 370 AND 194 CARTRIDGES. Ingeniously mounted styli, on specially formed plastic inserts. Easily and quickly changed without tools or disassembly; styli reset perfectly for continued high performance. Shpg. wt., 2 oz.

Stock No.	Type	Tip	NET
99 RC 849	D3510	.001" Diamond	18.00
99 RC 896	D3527	.0027" Diamond	18.00
99 RC 897	S3527	.0027" Sapphire	6.00
99 RC 799	D3505	.0005" Diamond	24.00

Fairchild High-Fidelity Components

MODEL 280A TRANSCRIPTION ARM

Professional-quality pickup arm for use on transcriptions or records—especially in exacting hi-fi installations. Length and shape of arm carefully designed for highest tracking accuracy. Accepts all magnetic cartridges. For recordings to 12" in diameter. Plug-in slide feature for quick cartridge change. Adjustable springs make contact with the cartridge terminals. Springs short when cartridge is removed. Arm is curved and pivoted slightly off center for perfect tracking and minimum record wear. No arm rest required—self-locking stop holds arm securely in place. Height, leveling and stylus pressure is adjustable. Arm drop limit adjustment prevents damaging stylus. Shpg. wt., 6 lbs.

65 R 022. NET 37.50

MODEL 281A. As above but for recordings up to 16" in diameter. Ideal for broadcast transcription use. Shpg. wt., 6 lbs.

65 R 023. NET 39.95

830A EXTRA CARTRIDGE SLIDE-KIT. For insertion of cartridges in 280A and 281A transcription arms. Shpg. wt., 6 oz.

65 R 024. NET 2.35

FAIRCHILD SERIES 412 TURNTABLE

MODEL 412-1. A 33 $\frac{1}{2}$ rpm turntable with superlative specifications at an unusually low price. Uses time-proven belt drive and self-lubricating hysteresis-synchronous motor providing true professional performance. Non-magnetic, dynamically balanced turntable rests on rotating ball-thrust bearing in nylon seat. Advanced motor suspension system eliminates all traces of vibration. Exceeds NARTB specifications by a wide margin. Precision-made throughout. Convertible to 4-speed operation with 412-ED

MODEL 194D ARM AND CARTRIDGE

New "Unipoise" arm of unusually effective design and striking appearance, with integral "Fluxvalve" cartridge. The entire unit is only a fraction of the weight of conventional arms. High compliance of "Fluxvalve" stylus assembly and single friction-free pivot bearing are ideally suited to distortionless tracking of all types of recordings. Frequency response, ± 2 db, 10 to 30,000 cps. Tracking force is easily adjusted through range from 1 to 6 grams.

Supplied with .001" diamond stylus; also accommodates replacement styli listed in column at left. Recommended load resistance for flat response, 27,000 ohms. Easily mounted for use with any high-quality turntable. Supplied with arm rest. Length, 11 $\frac{1}{4}$ ". Shpg. wt., 8 oz.

99 RC 663. NET 59.85

MODEL 190D PICKUP ARM

Outstanding design features assure superb record reproduction. Extremely well balanced. Unusually high tracking accuracy—easily tracks badly warped records. Minimum distortion; minimum record-stylus wear. Safety feature prevents stylus from contacting turntable mat or center pin. Sensitive tracking force adjustment. Height adjustment from $\frac{1}{2}$ " to 2" high. Self-contained levelling screws. Complete with magnetic arm rest. Length, 14 $\frac{1}{2}$ ". Shpg. wt., 2 lbs.

99 R 830. NET 31.50

MODEL 132E RECORD COMPENSATOR

Brings out the full beauty of recorded music. Provides rich, properly balanced reproduction by compensating for recording characteristics used by the various record manufacturers. 6 positions: European 78; London 33 and Old LP; Old Capitol and AES; New AES (RIAA); Maximum Treble and Bass; Noisy Records. With 20" cable, pin plug, and jack; ready for easy plug-in installation between magnetic cartridge and preamp. For panel mounting, 1 $\frac{1}{2}$ x1 $\frac{1}{2}$ x3 $\frac{1}{8}$ " deep. Shpg. wt., 1 lb.

99 R 808. NET 12.00

SERIES 225 "MICRADJUST" CARTRIDGES. Professional-type, moving-coil cartridges. Designed to mount in all changer and transcription arms. Miniature size, only 1 $\frac{1}{2}$ x $\frac{3}{4}$ x $\frac{1}{8}$ ". Provide outstanding frequency range; ± 2 db, 20-20,000 cps. Has exceptionally good tracking ability and low moving mass. Output, 5 millivolts. Impedance, 200 ohms. With diamond stylus. Require preamplifier. Shpg. wt., 4 oz.

Stock No.	Type	Stylus	NET EACH
65 RC 007	225A	.001"	37.50
65 RC 008	225B	.0025"	37.50

MODEL 235 INPUT TRANSFORMER. Provides additional 14 db gain for Fairchild cartridges. 30" cable. Wt., 1 $\frac{1}{2}$ lbs.

65 R 021. NET 11.95

XP-3 CARTRIDGE. New moving-coil cartridge of unusual design. Hand-made by Fairchild's most experienced craftsmen. Features greatly reduced dynamic mass and phenomenal tracking ability—will track 30 cm/sec peak recorded velocity at less than 3 grams. Available with .001" diamond only. Shpg. wt., 4 oz.

65 RC 925. NET 50.00

electronic drive below. For 110-120 v., 60 cycle AC. Shpg. wt., 28 lbs.

99 RZ 205. NET 99.50

412-ED ELECTRONIC DRIVE. Electronic frequency generator; fits 412-1 case. For 110-120 v., 50-60 cycles AC. 15 lbs.

99 RX 206. NET 94.00

FAIRCHILD TURNTABLE BASES. Wt., 5 lbs.

99 RX 207. Mahogany. 99 RX 208. Blonde.

99 RX 209. Walnut. NET EACH ... 31.50

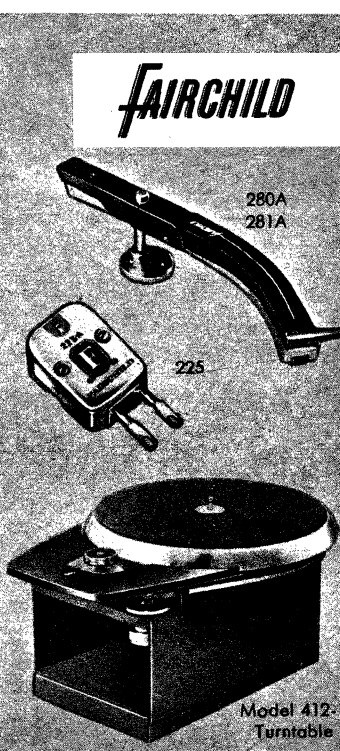
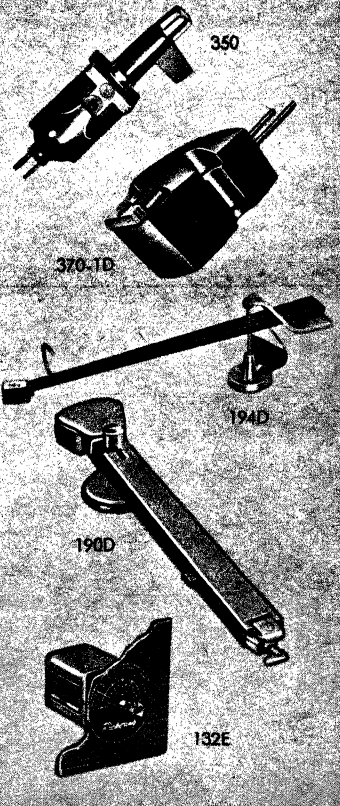

PHONO CARTRIDGES AND PICKUP ARMS

NEW SHURE STUDIO MODEL M-16 DYNETIC ARM AND CARTRIDGE

A Magnificent new pickup arm and cartridge for professional broadcast use and deluxe hi-fi systems. Reproduces recordings with a needle force of only 1 to 2 grams! Takes records to 16" in diameter. Employs M-1 moving magnet cartridge and N-1 diamond stylus for 33 $\frac{1}{3}$ and 45-rpm recordings. Unique moving magnet design provides extreme linearity and freedom from distortion. Arm made of lightweight aluminum in a tapering column; absolutely free of resonance. Jewelled load-bearing pivots throughout. Arm is brought into playing position on any portion of a record by means of a stylus control button which lifts the cartridge. When button is released, the cartridge is lowered, and the stylus gently contacts record grooves with a force of 1 to 2 grams (depending on counterbalance adjustment)—eliminates all chance of damage to record or stylus. *Sensitivity:* Output at 1000 cps, 14 millivolts. *Response:* ± 2 db, 20 to 20,000 cps. Overall length, 14 $\frac{3}{4}$ ". Height adjustment range, 1 $\frac{1}{2}$ ". Includes Model M-1 plug-in cartridge and Model N-1 replaceable diamond stylus with 0.7 mil tip. Shpg. wt., 1 lb.
72 RC 804. NET.....77.91

MODEL M-1 CARTRIDGE ONLY. Plugs in. Includes N-1 LP diamond stylus. Wt., 2 oz.
72 RC 805. NET.....41.16

MODEL N-1 REPLACEMENT DIAMOND STYLUS ONLY. Has 0.7 mil tip. Shpg. wt., 2 oz.
72 RC 806. NET.....19.58

REK-O-KUT PICKUP ARMS

B MODEL 120. Professional-quality arm for use with 12" turntables. Accepts G.E.; Pickering cartridges, etc. "Versa-Twin" bearings result in extreme rigidity combined with smooth lateral movement. Tubular aluminum shape with die-cast aluminum cartridge shell and counterweight. Counterweight rotates to adjust stylus pressure. Also has height adjustment. With one plug-in head. Wt., 2 lbs.
99 RX 862. NET.....26.95

MODEL 160. As above, but 16" in length. Shpg. wt., 2 $\frac{1}{4}$ lbs.
99 RX 863. NET.....29.95

EXTRA PLUG-IN HEAD. Shpg. wt., 6 oz.
99 R 864. NET.....4.95

LIVINGSTON TRANSCRIPTION ARM

C UNIVERSAL MODEL. For use with any cartridge including G. E. triple-play types. Plays recordings up to 16". Features adjustable stylus pressure from 6 to 30 grams. Has precision, ball-bearing pivot; bearings are enclosed for maximum protection. Supplied with hardware for mounting arm and cartridges. Neutral gray finish. Length of arm, 14". Shpg. wt., 2 lbs.
65 R 070. NET.....24.95

B-J PICKUP ARM

D Professional pickup arm for 12" turntables. Unique, tangential tracking minimizes distortion and record wear—no change in angle between cartridge and record grooves throughout entire recording. Twin arms of unequal length co-ordinate to provide low-momentum movement. Tracks under 2 grams. For most hi-fi cartridges. Length, 11 inches. Adjustable height. Less cartridges. Wt., 2 lbs.
99 R 888. NET.....22.50

AUDAX KT-12 PICKUP ARM KIT

E High-quality pickup arm in money-saving kit form. Exactly duplicates the Audax "compass-pivoted" transcription arm, long recognized as an outstanding hi-fi arm. Selector index on back of arm permits instant adjustment for any stylus pressure. Arm plays up to 12" records; can be assembled in minutes using just a nail file or small screwdriver. Accommodates any make of cartridge—wiper-type contacts for simple, positive-contact. Permits stylus-to-groove alignment at a glance. Finger-lift for quick positioning. Shpg. wt., 2 lbs.
72 R 800. NET.....14.55

KT-16 16" PICKUP ARM KIT. As above, but takes records to 16". Wt., 2 $\frac{1}{4}$ lbs.
72 RX 801. NET.....17.55

NEW GARRARD PICKUP ARM

F MODEL TPA10. New, beautifully styled and highly efficient pickup arm. For use with any cartridge. Fully adjustable for length and tracking angle, as well as pressure. Extends to accommodate 16" recordings. Adjustable head for best tracking at any angle. In chrome and white enamel. With fingertip lift. Less cartridge. Shpg. wt., 2 lbs.
72 R 803. NET.....24.01

ELECTRO-SONIC

"CONCERT" CARTRIDGE

G MODEL ESL-C1. Highly recommended, moving coil cartridge for the audio purist. *Response:* 16 to 32,000 cps with virtually unmeasurable IM distortion. Tracks at 3-7 grams. Output impedance, 1.5 ohms. Requires transformer, below. With .001" diamond stylus. $\frac{1}{2}$ " centers. Wt., 2 oz.
65 RC 544. NET.....35.95

MODEL ESL-201M TRANSFORMER. Has 200-ohm output for regular preamps. Wt., 5 oz.
72 R 850. NET.....11.00

MODEL ESL-201F TRANSFORMER. As above, but with filter switch for surface noise.
65 R 546. NET.....15.00

RECOTON "500" CARTRIDGES

H New, improved Model "500" magnetic cartridges. "Back-to-back" turnover type. *Response:* 20-20,000 cps. 555-SDM has mu-metal shield. "D" indicates diamond, "S," sapphire. Shpg. wt., 4 oz.

No.	Type	Styli	List	NET
65 R 002	500-SS	S-.001", S-.003"	\$16.50	9.70
65 RC 003	500-SD	D-.001", S-.003"	31.20	18.35
99 RC 215	555-SDM	D-.001", S-.003"	39.20	23.05

REPLACEMENT STYLI. For above. Wt., 2 oz.

No.	Type	Styli	List	NET
65 RC 004	399D	D-.001"	\$25.00	14.70
65 R 005	399	S-.001"	3.50	2.06
65 R 006	398	S-.003"	3.50	2.06

SHURE CERAMIC CARTRIDGES

J "Music Lovers" dual-stylus, hi-fi cartridges. Include adapter for magnetic phono inputs. *Response:* 30-15,000 cps. Output: Without adapter, 0.4 volt; with adapter, 25 millivolts. Shpg. wt., 4 oz.

TYPE ML44SS. .001", .003" sapphire styli.
65 R 032. NET.....8.20

TYPE ML44DS. .001" diamond, .003" sapphire.
65 RC 028. NET.....22.90

JENSEN ELECTRIC STYLI

TYPE JPS-36. For ML44SS. .001" and .003" sapphire tips. Shpg. wt., 2 oz.

65 R 834. NET.....3.50

TYPE JPS-36SD. For ML44DS. .001" diamond; .003" sapphire. Shpg. wt., 2 oz.

65 RC 144. NET.....17.64

ELECTRO-VOICE CERAMIC CARTRIDGES

K SERIES 80. Ultra-linear. For replacing any high-impedance crystal or ceramic cartridge. *Response:* ± 2.5 db. 20 to 15,000 cps. Output: 500 millivolts. With magnetic phono adapter. *Turnover type. "S" indicates sapphire; "D", diamond. $\frac{1}{2}$ " mounting centers. Av. shpg. wt., 5 oz.

No.	Type	Styli	NET
65 R 426	84S	S-.001"	9.41
65 RC 427	84D	D-.001"	22.64
65 RC 414	86T*	D-.001" S-.003"	33.81

REPLACEMENT STYLI. For above. Wt., 2 oz.

No.	Type	Tip	For	NET
65 R 974	S3	S-.001"	86T	1.47
65 R 973	S1	S-.003"	84S	1.47
65 RC 412	DI	D-.001"	84D, 86T	14.70

SONOTONE CERAMIC CARTRIDGES

L Series "3" cartridges. Output: 0.5 v. *Response:* 20 to 15,000 cps. $\frac{1}{2}$ " or $\frac{3}{8}$ " mtg. ctrs. Shpg. wt., 3 oz.

MODEL 3T-SD. Turnover stylus model with .001" diamond and .003" sapphire tips.

65 RC 948. NET.....14.11

MODEL 3P-1D. .001" diamond stylus only.

65 RC 928. NET.....13.52

REPLACEMENT STYLI. For above.

TYPE N-3T-SD. For 3T-SD cartridge. .001" diamond, .003" sapphire. Wt., 2 oz.

68 RC 315. NET.....10.29

TYPE N-3P-ID. For 3P-ID. .001" diamond.
68 RC 316. NET.....9.70

GRAY HI-FI COMPONENTS

A MODEL HF400 TURNTABLE. Expertly designed, professional 3-speed turntable with 4-pole induction motor. Takes up to 16" recordings. Motor shaft engages turntable rim directly—rim has long-wearing neoprene tire around its outside edge. Entire assembly is mounted on $\frac{1}{4}$ " thick, $19\frac{1}{16}$ " wide and $15\frac{1}{16}$ " deep, steel base plate for absolute rigidity and magnetic shielding. Beautifully balanced, steel turntable, $\frac{3}{8}$ " thick and $11\frac{3}{4}$ " in diameter, weighs 18 lbs. Covered with $\frac{1}{4}$ " thick cork and rubber pad—acts as record cushion and provides magnetic isolation between cartridge and table. Separate cue-light transformer. Brushed aluminum on-off switch also acts as arm rest and cue-light housing. Requires 3" above and $5\frac{1}{2}$ " below mtg. board. With 45 and 78-rpm bushings, and AC line cord. Less base and pickup arm; see below. For 110-120 v., 60 cycle AC. Shpg. wt., 42 lbs.

99 RZ 795. NET. 89.00

MODEL HF500A TURNTABLE. As above, but with hysteresis-synchronous motor.

94 RZ 948. NET. 119.50

MODEL HF504 WOOD BASES FOR GRAY TURNTABLES. Sturdy construction. Size, 7x21x17 $\frac{1}{2}$ ". Shpg. wt., 4 lbs.

94 RX 945. Mahogany. } NET
94 RX 946. Blonde. }
94 RX 947. Walnut. } EACH. 27.50

B MODEL 108C PICKUP ARM. Deluxe high-fidelity pickup arm for transcription-type turntables. Incorporates advanced design and finest quality materials. Features "viscous-damped" (fluid controlled) suspension to provide high tracking accuracy and the utmost in record protection. Regulates vertical and horizontal movement of arm. Minimizes damage to record if arm is dropped. Manually operated setting governs amount of arm damping (speed of arm descent). For records up to 16" in diameter. Constructed of fine cast aluminum. Virtually eliminates arm resonance. Instant cartridge change. Accommodates most magnetic cartridges including Pickering, G.E., and Fairchild. Neutral finish. Light in weight. Shpg. wt., 2 lbs.

99 RX 853. NET. 39.95

AS12 SLIDE KIT. For fitting Pickering 350 and 370 cartridges into above arm. 4 oz.

99 R 889. NET. 3.00

METZNER TURNTABLE WITH ARM

C MODEL 672. New, professional-quality turntable mounted on base and equipped with pickup arm. Its long list of deluxe features includes: Continuously variable speed control from 16 to 83 rpm with exact, marked settings for 16 $\frac{2}{3}$, 33 $\frac{1}{3}$, 45 and 78 rpm speeds; built-in illuminated stroboscope for checking speeds even as a recording is being played; 12" turntable made of precision-machined aluminum, with built-in, retractable 45-rpm hub and non-slip cork pad. *Rumble and Noise*: Better than 50 db below the standard NARTB reference level. *Wow and Flutter*: Less than 0.2%. The highly efficient, 4-pole motor provides direct, center-shaft drive. Employs special anti-vibration mounts for unusually smooth operation. Die-cast aluminum pickup arm, finished in black and satin chrome, is 12" long—takes records up to 16" in diameter. Counterweight adjustment atop cartridge shell, is calibrated from 4 to 14 grams. Arm swings to upright position on pivot for easy cartridge replacement. Takes any standard hi-fi cartridge. Ball-bearing swivel. Base plate is finished in satin chrome, pre-drilled for arm—arm is packaged separately. Wood base is made of 1" thick, laminated hardwood, 6 $\frac{1}{2}$ x16x17 $\frac{1}{2}$ ". Birch finish. For 110-120 v., 60 cycle AC. Shpg. wt., 24 lbs.

72 RZ 811. NET. 97.00

MODEL 60 TURNTABLE ONLY. Base plate and motor assembly. 11 $\frac{3}{4}$ x13 $\frac{1}{4}$ ". Requires 4 $\frac{1}{2}$ " below mtg. base. Shpg. wt., 15 lbs.

72 RX 812. NET. 59.50

MODEL 07 PICKUP ARM ONLY. Wt., 1 lb.

72 RX 814. NET. 22.50

MODEL 002 BASE ONLY. Shpg. wt., 4 lbs.

72 RX 813. NET. 17.50

ACOUSTIC RESEARCH SPEAKER SYSTEMS

D MODEL AR-1. Radically different system featuring air-damped, 12" woofer, plus 8" midrange and high-frequency unit and crossover network. Mounted in a sealed, fiberglass-filled cabinet of braced $\frac{3}{4}$ " hardwood veneer. Dimensions are conveniently small—only 14x11 $\frac{1}{2}$ x25"! Provides extended, ultra-clean bass response; greatly reduces bass harmonic distortion. New principle of operation employs the sealed-in air of the cabinet as a pneumatic spring for the speaker cone during large excursions on very low bass notes—does not use conventional elastic suspension. *Frequency Response*: $\pm 1\frac{1}{2}$ db, 38 to 1000 cps; ± 5 db, 30 to 13,000 cps. *Impedance*: 4 ohms. *Amplifier Power Requirements*: 20 clean watts for moderate level in an average room; at least 30 watts for high levels and large rooms. Shpg. wt., 60 lbs.

82 DZ 033. Mahogany. NET. 185.00

82 DZ 034. Blonde Birch. NET. 185.00

82 DZ 253. Walnut. NET. 194.00

MODEL AR-1W. Same enclosure as above, but less 8" mid-range and treble unit. Employs 12" woofer only. *Manufacturer recommends use of Janszen electrostatic tweeter (described below), in this system. Impedance*: 4 ohms. Shpg. wt., 52 lbs.

82 DZ 043. Mahogany. NET. 145.00

82 DZ 044. Blonde Birch. NET. 145.00

82 DZ 254. Walnut. NET. 154.00

E MODEL AR 2. Low-cost woofer-tweeter system for hi-fi systems in the medium-price range. Employs the same acoustic suspension and pneumatic damping operation as the Model AR-1 above, but requires less power to drive the system—needs only 10 clean watts. Features specially designed 10" acoustic suspension woofer and newly developed tweeter assembly composed of two 5" tweeters. *Does not require the use of a separate tweeter. Frequency Response (at 10 watts)*: ± 5 db, 42 to 14,000 cps, down 10 db at 30 and 16,000 cps. *Dispersion*: 90° horizontal. *Harmonic Distortion (at 10 watts input)*: Under 2% to 60 cps; under 3% to 50 cps. *Impedance*: 8 ohms. Slightly smaller than the AR-1—13 $\frac{1}{2}$ x24x11 $\frac{3}{8}$ ". Shpg. wt., 45 lbs.

82 DZ 038. Mahogany. NET. 96.00

82 DZ 039. Blonde Birch. NET. 96.00

82 DZ 255. Walnut. NET. 102.00

JANSZEN ELECTROSTATIC TWEETER

F Impressive new, electrostatic high-frequency tweeter system. Includes power supply, crossover network, and four plastic radiating elements, all housed in a single hardwood cabinet. Extremely low harmonic and intermodulation distortion.

Unique electrostatic principle of operation completely eliminates the heavy paper cone of conventional speakers. In its place, a micro-thin plastic diaphragm, so low in mass as to be almost imaginary, is suspended between two parallel plates. This push-pull capacitance transducer replaces the ordinary vibrating mechanical system—since the flexible diaphragm is driven uniformly over its entire surface, there is no cone breakup and no uncontrolled excursion. Lack of high-frequency resonances greatly reduces apparent record scratch without attenuating highs.

Employs four separate radiators for vastly improved horizontal and vertical coverage through 120°. *Frequency Response*: 500 cps through 30,000 cps. *Power Handling Capacity*: Up to 60 watts. *Impedance*: 8 ohms. *Electrical Crossover Frequency*: 500 cps. *Recommended for use with the Acoustic Research Model AR-1W Woofer System described above.* Built-in high-pass filter prevents low frequencies from entering tweeter. Size, 7 $\frac{1}{16}$ x21 $\frac{3}{4}$ x12 $\frac{3}{4}$ ". Connects to 110-120 v., 60 cycle AC source. Shpg. wt., 16 lbs.

MODEL 1-30 M. Mahogany. NET. 184.00

MODEL 1-30B. Blonde Birch. NET. 179.00

MODEL 1-30W. Walnut. NET. 188.00

PICKUP ARMS, TURNTABLES AND SPEAKER SYSTEMS

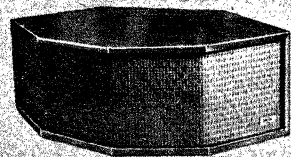
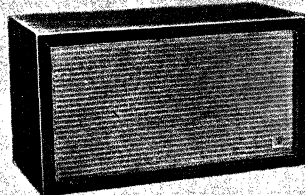
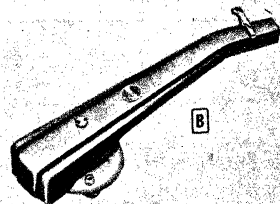

REK-O-KUT

HIGH-FIDELITY COMPONENTS

"Rondine" B-12 with 120 Arm on Rek-O-Kut Base



"Rondine Jr." L-34



"Rondine" B-12



Professional-Quality Rek-O-Kut Turntables

Rondine 12" turntables are widely recognized for their outstanding performance. Precision cast-aluminum construction and advanced-design mechanical filtering reduce noise and distortion to negligible values. Inter-moving parts are case-hardened and ground to micro-finish. Ribbed, rubber turntable mat eliminates record slippage. Permanently affixed strobe disc checks speed. All combine shock mounting and dynamic balance to assure extremely smooth, quiet operation.

"RONDINE JR."—MODEL L-34. Dual-speed, low-priced 33 $\frac{1}{3}$ and 45 rpm turntable. Designed to professional specifications. Ideal for high-fidelity installations as well as commercial radio station use. Noise level 40 db below average recording level for minimum rumble. Quiet, vibration free., constant-speed 4-pole induction motor custom-built to Rek-O-Kut specifications. Idler disengages in off position—prevents flat spots on idler wheel when the turntable is not in use. Has precision-ground and hand-lapped shaft which turns on sturdy ball-thrust bearing. Lathe-turned cast aluminum turntable, lab-tested for perfect balance. Rigid, pressed-steel chassis with attractive silver-tone aluminum finish. Size, 15" wide x 12" deep. Turntable requires 1 $\frac{3}{8}$ " above and 5" clearance below the motor panel. For operation from 110-120 volts, 60 cycle AC. Shpg. wt., 15 lbs.
96 RX 686. NET.....59.95

"RONDINE JR."—MODEL L-37. Same quality construction as Model L-34 turntable described above, but with 33 $\frac{1}{3}$ and 78-rpm speeds. Shpg. wt., 15 lbs.
96 RX 694. NET.....59.95

"RONDINE"—MODEL B-12. Excellent 3-speed turntable. Meets all NARTB standards. Single knob selector, instantly selects speeds of 33 $\frac{1}{3}$, 45, or 78 rpm. Has custom-built 4-pole, induction-type motor. Internal rim drive through special neoprene idler. 45-rpm hub adapter built into turntable center—disappears into table when not in use. Cross-ribbed cast-aluminum turntable, lathe turned and balanced. Turntable shaft of hardened steel, polished and hand-lapped to the bearing well for perfect fit. Noise level is 45 db below average recording level. Requires rectangular cutout 13 $\frac{1}{16}$ x 14 $\frac{13}{16}$ " with clearance of 1 $\frac{1}{2}$ " above and 6 $\frac{1}{2}$ " below motor panel for mounting. Deck is pre-drilled and tapped for Model A-120 arm (right). Turntable includes ribbed rubber mat to assure maximum record traction. For 110-120 volts, 60 cycle AC. Shpg. wt., 19 lbs.
96 RX 688. NET.....84.95

"RONDINE DELUXE"—MODEL B-12H. Professional quality. As above, but has self-lubricating hysteresis motor. Noise level, -55 db. Shpg. wt., 19 lbs.
96 RX 687. NET.....129.95

Rek-O-Kut Pickup Arms

MODEL 120. Professional-type pickup arm for use with 12" turntables. "Versa-Twin" bearings provide ultra-smooth lateral movement and highly accurate tracking. Has height and pressure adjustments. Die-cast aluminum. With one plug-in head, 2 lbs.
99 RX 862. NET.....26.95

MODEL 160. As above but for 12" and 16" turntables. Shpg. wt., 2 lbs.
99 RX 863. NET.....29.95

EXTRA PLUG-IN HEAD. For use in above arms. Shpg. wt., 6 oz.
99 R 864. NET.....4.95

Rek-O-Kut Turntable Bases

Here's a selection of beautifully designed wood turntable bases for mounting Rek-O-Kut turntables. Quality constructed of selected 3/4" solid Walnut or Korina Blonde. Rounded corners are made with mitered, interlocked joints for added firmness. Complete with four special shock mounts. HWD, 6x16 $\frac{1}{2}$ x17". Shpg. wt., 5 lbs.

Stock No.	Finish	Arm	Pre-Cut For	NET EACH
95 RX 716	Walnut	12"	B-12, B-12H	26.95
95 RX 717	Blonde	12"	B-12, B-12H	28.95
95 RX 634	Walnut	12"	L-34, L-37	26.95
95 RX 635	Blonde	12"	L-34, L-37	28.95
94 RX 925	Walnut	16"	B-12, B-12H	32.95
94 RX 926	Blonde	16"	B-12, B-12H	35.95

Professional Record Players

New, moderately-priced professional record player—completely wired, mounted and ready to use. Consists of Model L-34 "Rondine Jr." turntable, Rek-O-Kut Model 120 pickup arm, Wellcor base with handsome veneer, and Pickering 370-1 Dcartridge (see page 65 for specifications of 370-D). Shpg. wt., 21 lbs.

94 RZ 536. Mahogany. } NET
94 RZ 537. Lined Oak. } EACH.....139.95
94 RZ 538. Walnut. }

New, high-quality professional record player. Unit is completely pre-assembled, ready for use. Each player consists of Model B-12 "Rondine" turntable, Model 120 Rek-O-Kut pickup arm, handsome veneer base, and 350-DS Pickering cartridge (for complete specifications of 350-DS Pickering, see page 65). All components are prewired and mounted for your convenience. Shpg. wt., 25 lbs.

94 RZ 539. Mahogany. } NET
94 RZ 540. Lined Oak. } EACH.....175.00
94 RZ 541. Walnut. }

WELLCOR BASES FOR REK-O-KUT TURNTABLES

New, expertly designed turntable bases for use with 12" or 16" pickup arm, made of selected 3/4" hardwoods and fine furniture veneers, hand-rubbed to a lustrous finish. Motor board "floats" on sponge rubber. Mitered joints provide extra firmness and rigidity. Rubber-covered feet prevent marring furniture. Feet are adjustable to permit leveling of base. Height, 6 $\frac{3}{4}$ "; width, 21"; depth, 16 $\frac{3}{4}$ ". Completely pre-assembled. Shpg. wt., 15 lbs.

Stock No.	Finish	Pre-Cut For	NET EACH
94 RX 492	Mahogany		19.50
94 RX 493	Lined Oak	B-12, B-12H	21.75
94 RX 494	Walnut		21.75
94 RX 489	Mahogany		19.50
94 RX 490	Lined Oak	L-34, L-37	21.75
94 RX 491	Walnut		21.75

For money-saving Allied high-fidelity systems using Rek-O-Kut turntables, see pages 19 and 20.

Allied is Headquarters for High-Fidelity Equipment

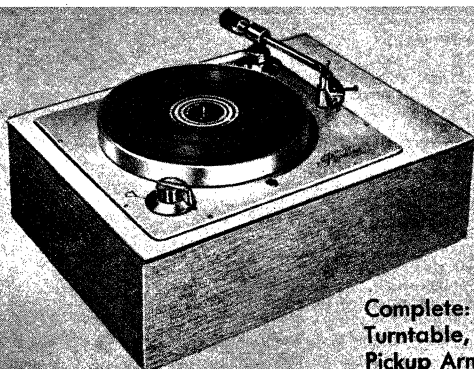

"Rondine" B-12 with 120 Arm on Wellcor Base

Complete: Turntable, Pickup Arm, Base and Cartridge

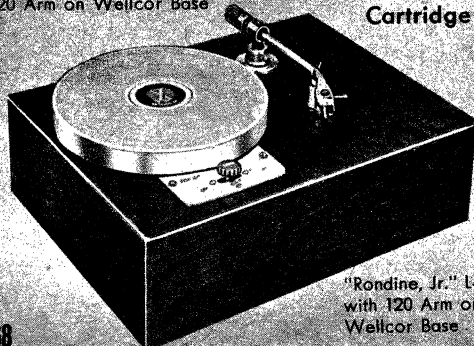

"Rondine Jr." L-34 with 120 Arm on Wellcor Base

LATEST HIGH-FIDELITY RECORD CHANGERS

Collaro



TC-340
"Conquest"



RC-440 "Coronation"



TC-540 "Continental"

"CONQUEST" TC-340 CHANGERS

Economy-priced 4-speed record changer featuring "Sensi-magic" dynamically balanced, transcription-type arm—free of audio spectrum resonances. For automatic record changing, stack 7", 10", and 12" records in order of decreasing size (largest at bottom of each stack)—"Sensi-magic" feature determines record size before setting record down. For turntable operation, simply flip the manual switch—transcription-type arm will provide equally low stylus pressure on first or last record for minimum tracking error. Other deluxe features include: Automatic "muting switch" and a "pop filter"; choice of 78, 45, 33 1/2 and 16 2/3 rpm speeds; 8-second change cycle; heavy-duty 4 pole, shaded pole induction motor; automatic shut-off after final record; heavy, rim-weighted turntable; and removable rubber turntable mat. Will accept all standard hi-fi cartridges. Attractively finished in sea- sand beige and rich, forest brown. Size: 12x13 1/2"; requires 5" above, 2 3/4" below mtg. board. For 110-120 v., 60 cycle AC. Shpg. wt., 15 lbs.

TC-304-E. Less cartridge.
94 RX 404. NET.....36.75

TC-340-GE. Same as above, but with GE-4G-050 dual sapphire cartridge.
94 RX 415. NET.....45.52

TC-340-GED. Same as TC-340-GE above, but with G.E. 4G-052 diamond-sapphire magnetic cartridge.
94 RX 416. NET.....55.69

"CORONATION" RC-440 CHANGERS

Quality 4-speed record changer featuring fully automatic intermixing of 7", 10", and 12" records. Pick-up arm has convenient plug-in head (accepts all standard cartridges). In addition to fully automatic intermix the "Coronation" has a custom micro-finished motor shaft (polished to 6 micro-inches), "muting switch," "pop filter," and an automatic idler disengagement. Handsome maroon and gold finish 12x13 1/2"; requires 5" above, 2 1/4" below mtg. board. For operation from 110-120 v., 60 cycle AC. Shpg. wt., 15 lbs.

RC-440-E. Less cartridge.
94 RX 405. NET.....40.67

RC-440-GE. As above, but with GE-4G-050 dual sapphire cartridge.
94 RX 406. NET.....49.36

RC-440-GED. As above, but with GE-4G-052 diamond-sapphire cartridge.
94 RX 407. NET.....59.61

GPE. Extra plug-in head shell (empty). Shpg. wt., 5 oz.
94 R 949. NET.....83c

"CONTINENTAL" TC-540 CHANGERS

Deluxe 4-speed record changer. Features rapid loading of 7", 10", and 12" records—and automatically intermixes them! Has newly designed, dynamically-balanced, transcription-type arm free of audio spectrum resonances. Other features include: Less than 0.25% flutter; micro-finished motor shaft; 4 speeds—78, 45, 33 1/2, and 16 2/3 rpm; rim-weighted, balanced fly-wheel action; extra heavy-duty 4-pole, shaded-pole motor; manual switch for turntable operation; "muting switch"; "pop filter"; automatic shut-off; removable rubber mat; automatic idler disengagement. Finished in beige and brown. 12x13 1/2". Requires 5" above, 2 3/4" below mtg. board. 110-120 v., 60 cycle AC. WT., 15 lbs.

TC-540-E. Less cartridge.
94 RX 408. NET.....45.57

TC-450-GE. As above, but with GE-4G-050 dual sapphire cartridge.
94 RX 409. NET.....54.34

TC-540-GED. As above, but with GE-4G-052 diamond-sapphire cartridge.
94 RX 410. NET.....64.51

ACCESSORIES FOR COLLARO CHANGERS

BASES. Bases for all Collaro changers. In choice of finishes. Wt., 3 lbs.

Stock No.	Type	Finish	NET
93 RX 513	MT	Mahogany	5.25
93 RX 514	BT	Limed Oak	5.47
93 RX 515	WT	Walnut	5.47

HT MOUNTING BOARD. Unfinished, sanded. For Collaro changers. Wt. 1 1/2 lbs.

91 RX 556. NET.....1.50

GSA 45-RPM SPINDLE ADAPTER. For Collaro changers. Shpg. wt., 8 oz.

95 R 625. NET.....3.23

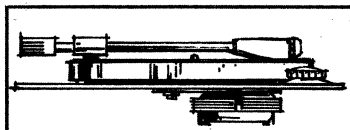

FACTS ABOUT TURNTABLES

The record player is the "origination point" for recorded disc music in your home. It converts mechanical energy into electrical energy (fed into an amplifier). Some high-fidelity enthusiasts prefer the manual professional-type turntable to the record changer. In order to enjoy the extra features of the turntable, many music lovers are willing to change records manually. The turntable features extremely quiet operation and excellent speed regulation. Rumble, or low-frequency noise, is practically eliminated.

The use of the turntable is particularly important for installations which have deluxe speaker systems with exceptionally good response to low notes. Professional turntables are usually supplied less pick-up arm and cartridge. A matching pickup arm should be selected. Since turntable arms do not have to go through the changer cycle, they can be made for lower stylus pressure and longer record wear. Many deluxe installations use both a changer for convenience, and a turntable when the ultimate in performance is desired.

PRESTO QUALITY TURNTABLES

MODEL T-18. 12" turntable for hi-fi and professional use. Constructed of cast aluminum with carefully balanced, weighted turntable. Precision machined and engineered for extremely low levels of wow and flutter. Noise level is better than 40 db below recording level. Has 5-position speed control (45, Off, 33 1/2, Off, 78) for rapid speed selection. Motor is 4-pole, synchronous type with high starting torque. In "off" positions idlers are completely disengaged. Includes permanently attached 45-rpm record adapter disc which conveniently retracts into turntable when not in use. 8x 11 3/4" mounting plate. Mounting space: 14 1/2 x 11 1/8"; requires 3 3/4" below and 2" above base plate. Attractive black panel. For operation from 110-120 volts, 60 cycle AC. Shpg. wt., 16 lbs.

96 RX 918. NET.....75.00

MODEL T-2. New, low-cost, professional-quality turntable. Cast aluminum turntable minimizes speed variations and annoying rumble. Has heavy-duty, 4-pole motor and 3-idler drive system. Quickly changes from 33 1/2 to 45 rpm by flick-shift lever. Has convenient, built-in 45-rpm disc adapter which retracts into turntable when not in use. Mounting plate is 8x11 3/4". Overall size, 14 1/2 x 11 1/8". For operation from 110-120 volts, 60 cycle AC. Shpg. wt., 16 lbs.

98 RX 598. NET.....59.50

BASES FOR PRESTO TURNTABLES

Carefully designed turntable mounting bases. Excellent for shelf, cabinet or table. Shpg. wt., 5 lbs.

95 RX 544. Mahogany. NET.....24.90

95 RX 545. Blonde. NET.....24.90

95 RX 546. Unfinished. NET.....19.95

PRESTO PROFESSIONAL TURNTABLES



T-18

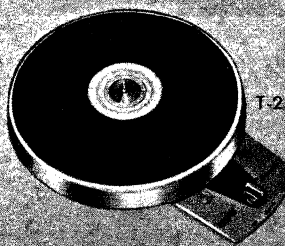

T-2



TRI-O-MATIC



1225A



1200A



920B

SERIES 1200 & 1225 4-SPEED RECORD CHANGERS

Outstanding, 4-speed record changers incorporating features found only in far more expensive units. Modern styling matches any decorating scheme; economically priced to suit any budget.

Play 33 $\frac{1}{3}$, 45, and 78 rpm records automatically. Also include 16 $\frac{2}{3}$ rpm "talking book" speed. Individual records of any speed may also be played manually. Capacity: 12—10", 10—12" and 14—7" records. Have convenient, positive intermix feature of 10—12" and 10" records of the same speed. Exclusive Tri-O-Matic spindle gently lowers records to record shelf. Automatic shutoff; pickup arm comes to rest and motor shuts off after last record is played.

Mechanism is completely jam-proof. Idler disengages in "off" position. Die-cast aluminum pickup arm is rigid, resonance-free and carefully balanced. Constant-speed 2-pole motor provides smooth, quiet operation. White rubber turntable mat prevents record slippage. Styled in antique white with gray trim. Sizes: Less base, 8 $\frac{1}{2}$ x13 $\frac{3}{4}$ x12 $\frac{3}{8}$ ". With base, 8 $\frac{3}{4}$ x13 $\frac{3}{4}$ x12 $\frac{3}{8}$ ". Underwriters' Laboratories Approved. For operation from 110-120 v., 60 cycle AC.

MODEL 1225A—WITH BASE. With Sonotone ceramic cartridge; has 2 sapphire styli. With AC line cord, output cable and plug. Shpg. wt., 14 $\frac{1}{4}$ lbs.
95 RX 631. List, \$49.95. NET..... **39.95**

MODEL 1225A-GE—WITH BASE. As above but with the new G.E. 4G-050 magnetic cartridge; has 2 sapphire styli.
94 RX 944. List \$57.50. NET..... **46.00**

MODEL 1225A-GED—WITH BASE. Same as 1225A, above, but with G.E. 4G-052 magnetic cartridge; 1 diamond, 1 sapphire stylus.
94 RX 967. List, \$73.50. NET..... **58.80**

MODEL 1200A—LESS BASE. With Sonotone ceramic cartridge; 2 sapphire styli. With output cable and plug. Less base and AC cord. Shpg. wt., 11 lbs.
95 RX 630. List, \$46.50. NET..... **37.20**

MODEL 1200A-GE—LESS BASE. As above, but with new G.E. 4G-050 magnetic cartridge.
94 RX 968. List, \$51.50. NET..... **41.20**

MODEL 1200A-GED—LESS BASE. Same as 1200A, but with G.E. 4G-052 cartridge.
94 RX 969. List, \$67.50. NET..... **54.00**

Thorens Changer & Player

CD-43 CHANGER. Carefully engineered, Swiss made, 3-speed record changer. Unique gear-driven turntable features direct-drive, 4-pole induction-type motor—eliminates use of rubber belts, pulleys etc. 4 controls: Record Size Selector; Start-Stop; Repeat; Reject and Pause-Timer (adjusts time lapse between records from 1 to 13 minutes). Can be played manually. Muting switch for silent record change cycle. Base size: 12x15". Requires 3 $\frac{1}{4}$ " below mtg. board; 6" above. With mtg. template, phono cable, 2 plug-in heads. Less cartridge, base (for shelf or table), AC line cord and 45-rpm spindle. No adapter needed to operate from 50 cycle source. For 100-120 v. and 200-250 v., 50-60 cycle AC. Shpg. wt., 24 lbs.
96 RZ 802. NET..... **78.35**

CB-33P PLAYER. A deluxe manual player similar to the CD-43 automatic changer, above. Features direct-drive, 4-pole motor. Automatic shut-off after record is played. Has adjusting screws for keeping stylus perpendicular to record groove, and for adjusting cartridge tracking weight. Includes 2 plug-in shells for accommodating all popular cartridges. Built-in capacitor filters out switch noise. With rubber shock mounts, mounting template. Less base (for shelf or table). Size, 15x12"; requires 3 $\frac{1}{4}$ " below mtg. base. For 110-120 v. and 200-250 v., 50-60 cycle AC. Wt., 17 lbs.
94 RX 974. NET..... **47.04**

THORENS ACCESSORIES

45-RPM SPINDLE. Shpg. wt., 1 lb.
96 R 829. NET..... **5.83**

WOOD BASES. For either CD-43 changer or CB-33P player. Shpg. wt., 5 lbs.
96 RX 808. Mahogany. NET
96 RX 809. Blonde. EACH..... **5.88**

MOUNTING BOARD. Unfinished. For Models CD-43, CB-33P. Shpg. wt., 3 lbs.
96 RX 823. NET..... **2.94**

THREE & FOUR SPEED RECORD CHANGERS

ECONOMY 3-SPEED RECORD CHANGER

MODEL 920B. Economy 3-speed changer on molded plastic base. Plays 78, 33 $\frac{1}{3}$ and 45 rpm records. Positive intermix of ten 10" and 12" records of same speed. Has manual play feature. Automatic shutoff after last record. Size, 12x10x7 $\frac{3}{4}$ ". With dual-stylus, turnover cartridge, 6 ft. AC cord and plug, 4 ft. shielded phono cable and pin plug. For operation from 110-120 v., 60 cycle AC. Shpg. wt., 10 lbs.
95 RX 859. List, \$39.95. NET..... **29.95**

V-M ACCESSORIES

45 RPM SPINDLE. Changes 45 rpm records automatically. For use with all V-M changers listed. Wt., 8 oz.
96 R 329. List, \$2.95. NET..... **2.31**

FIBER SPIDERS. For use with 45 rpm records. Shpg. wt., 3 oz.
96 R 244. NET PER PKG. OF 12..... **25c**

MOUNTING BOARD. Pre-cut, unfinished. 15 $\frac{7}{8}$ x15 $\frac{7}{8}$ ". For 1200A Series. 3 lbs.
95 RX 511. NET..... **1.46**

METAL BASE. For 1200A series. Antique white. Shpg. wt., 3 lbs.
95 RX 510. NET..... **4.15**

Bogen Manual Players

B50-16LC. Latest version of the highly popular, precision-built B50 turntable. Deluxe features include choice of any desired speed, variable from 16 to 86 rpm; has notches for quick, convenient selection of 16 $\frac{2}{3}$ rpm, 33 $\frac{1}{3}$ rpm, 45 rpm, and 78-rpm speeds. Plays all records up to 16" in diameter. Heavy-duty, 4-pole motor. Weighted, balanced, 11 $\frac{3}{4}$ " diameter turntable reduces "wow" to only 1/2%; hum and rumble are also reduced to negligible levels. Pickup arm is made of die-cast metal; ball-bearing mounted. Turntable is covered with serrated rubber pad—reduces dust and dirt, makes cleaning easy. Minimum mounting space: 15" wide, 12" deep; 4" above and 2" below mounting board. Takes conventional phono cartridges. Supplied with plug-in head, vibration insulators and connecting cables. Less base (see below). For 110-120 volts, 50-60 cycle AC. Shpg. wt., 15 lbs.
96 RX 998. NET..... **40.40**

B50-16XD. As above but with new G.E. 4C-052 magnetic cartridge.
95 RX 407. NET..... **59.34**

B20-LC. Popular economy model similar to above. Plays all records up to 12" in diameter at all 4 standard speeds (78, 45, 33 $\frac{1}{3}$ and 16 $\frac{2}{3}$ rpm). Each speed may be varied within a range of 1/2%. Turntable is rubber-covered for record protection. Completely shock-insulated. Supplied with one plug-in head; less cartridge and base (see bases below). Shpg. wt., 15 lbs.
95 RX 945. NET..... **29.95**

BOGEN ACCESSORIES

WOOD BASES. Attractive mahogany wood bases for Bogen manual players, above. Shpg. wt., 5 lbs.
95 RX 949. For B50 players.
95 RX 946. For B20-LC player.
NET EACH..... 4.80

EXTRA PLUG-IN HEAD. Wt., 5 lbs.
96 R 697. NET..... **1.35**

THORENS

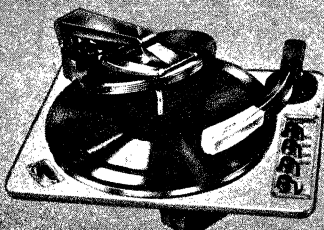

CD-43 Changer

- Intermixes
- Reject & Pause Control
- Noiseless Changing

Bogen



B50-16LC

- Variable Speed
- Shock Insulated

Allied is Headquarters for High-Fidelity Equipment



ENCLOSURES & CABINETS

MODEL 17 EQUIPMENT CABINET. Matches Model 18 enclosure, below. Tuner-amplifier compartment (specify components for free panel cut-out) is (HWD) $11\frac{1}{2} \times 15\frac{3}{4} \times 16"$. Changer compartment (HWD) $11\frac{1}{2} \times 16\frac{3}{4} \times 16"$; has sliding changer drawer. Two compartments below are (HWD) $13\frac{3}{4} \times 16 \times 16"$. 7" tapered brass legs. Overall including legs. (HWD) $32\frac{3}{4} \times 37 \times 18"$. For cutouts, mark order "Special" in place of Stock No. Allow 4 weeks for delivery. Wt., 85 lbs.

94 DZ 912. Mahogany. } NET EACH..... 150.00
 94 DZ 913. Blonde. }
 94 DZ 934. Walnut. }

MODEL 18 SPEAKER ENCLOSURE. Handsomely finished, 6.4 cubic-foot bass reflex speaker enclosure. Styled to match the lowboy design of the Model 17 equipment cabinet, above. Front panel is cut for 15" speaker (an adapter board is supplied for use with 12" speaker), and is covered with woven plastic grille cloth. Interior is lined with acoustic padding. Overall dimensions (HWD): $32\frac{3}{4} \times 37 \times 18"$ including tapered 7" brass legs. Shpg. wt., 70 lbs.

94 DZ 914. Mahogany. } NET EACH..... 82.50
 94 DZ 915. Blonde. }
 94 DZ 935. Walnut. }

MODEL 65 EQUIPMENT AND SPEAKER CABINET. A new combination cabinet with hardwood veneers finished in mahogany, Korina blonde or walnut. Has hinged doors, sliding panel. Slide-mounted record changer drawer and tuner-amplifier compartment each measure (HWD) $10\frac{1}{4} \times 19 \times 15\frac{1}{4}"$. The two compartments below each measure (HWD) $13 \times 19 \times 15\frac{1}{4}"$. Baffle is pre-cut to take either a 12" or 15" speaker. 7" tapered brass legs. Overall size (with legs): $33 \times 60 \times 18"$. Wt., 150 lbs. *Custom cut-out panels prepared at no extra charge if components to be used are specified when ordering. Also available with compartments differently arranged and without speaker enclosure. Cabinets shipped f.o.b. Chicago or Brooklyn, N. Y., whichever is nearer—allow four weeks for delivery.*

94 DZ 916. Mahogany. } NET
 94 DZ 917. Blonde. } EACH..... 240.00
 94 DZ 918. Walnut. }

MODEL 33 EQUIPMENT CABINET. For housing changer, amplifier and tuner. Has hinged, lift top; storage compartment with sliding perforated wood doors and brass pulls. Made of $\frac{3}{4}"$ birch veneers. Available in blonde or mahogany. Unfinished model is smoothly sanded, ready for easy finishing. Compartment sizes (HWD): $32 \times 35\frac{1}{2} \times 16"$; changer, $16\frac{1}{2} \times 14\frac{1}{4}"$; 6" above changer board. Tuner-amplifier, $17\frac{3}{8} \times 14\frac{1}{4}"$; storage, $13 \times 34 \times 15\frac{1}{2}"$. Wt., 74 lbs.

95 DZ 734. Mahogany. } NET
 95 DZ 735. Blonde. } EACH..... 87.00
 95 DZ 736. Unfinished Birch. NET EACH..... 59.40

MODEL 34 BASS REFLEX SPEAKER ENCLOSURE. Matches Model 33 cabinet, above. Pre-cut for 15" speaker. Has adapter for 12" speaker. 6 cu. ft. baffle volume. Mahogany or blonde on birch. Unfinished type is smooth sanded. HWD, $33 \times 35\frac{1}{2} \times 16"$. Wt., 66 lbs.

95 DZ 737. Mahogany. } NET
 95 DZ 738. Blonde. } EACH..... 63.00
 95 DZ 739. Unfinished Birch. NET EACH..... 53.40

MODEL 70 ASSEMBLED EQUIPMENT CABINET. Excellent equipment cabinet for housing tuner, amplifier, record changer. Matches Model 7125 and Model 8125 enclosures below. $\frac{3}{4}"$ fir plywood. Smooth sanded, ready for finishing. Compartment sizes (HWD); Tuner I.D., $20 \times 21\frac{3}{4} \times 15\frac{1}{2}"$; phono I.D., $7\frac{1}{2} \times 21\frac{3}{4} \times 14\frac{1}{2}"$. Overall size (HWD): $33\frac{1}{2} \times 23 \times 16"$. Wt., 35 lbs.

95 DZ 367. NET..... 39.00

MODEL 80 EQUIPMENT CABINET KIT. Same as Model 70, above, but in kit form. Includes all materials, hardware, instructions.

95 DZ 386. NET..... 30.00

MODEL 7125 ASSEMBLED SPEAKER CABINET. Bass reflex type. Pre-cut for 15" speaker. With adapter board for 12" speaker. 6 cu. ft. volume. Unfinished. Size, HWD, $33\frac{1}{2} \times 23 \times 16"$. Wt., 40 lbs.

94 DZ 758. NET..... 30.00

MODEL 8125 SPEAKER ENCLOSURE KIT. Same as Model 7125, above, but in kit form. Pre-cut for 15" speaker. All parts are $\frac{3}{4}"$ fir plywood. Kit includes plastic wood, sandpaper, glue, hardware, grille cloth, insulation and instructions.

94 DZ 759. NET..... 24.00

REBEL K-3 ENCLOSURE KIT. Efficient corner enclosure kit using the famous back-loading, folded-horn principle. Utilizes walls of room as enclosure extension. Bass response extends to 30 cps. Pre-cut for 15" or 12" speakers. Adapter board is supplied for tweeter mounting. All parts are pre-cut from $\frac{3}{8}"$ high-grade birch plywood. Smooth-sanded for easy finishing. Kit includes all parts and full grille front. With instructions. Size, HWD, $36\frac{1}{2} \times 25\frac{3}{4} \times 22\frac{1}{4}"$. 60 lbs.

95 DZ 479. NET..... 54.00

REBEL K-4 ENCLOSURE KITS. Incorporate extremely efficient corner design to assure outstanding bass reproduction. As in the K-3, above, the K-4 uses the walls of the room as the enclosure extension. With 12" or 15" speaker cut-outs. With pre-cut parts, glue, hardware, grille cloth and instructions. Smoothly sanded for easy finishing. HWD: Type K-5, $32 \times 23\frac{3}{4} \times 16\frac{1}{2}"$. Type K-12, $32 \times 21 \times 14\frac{1}{2}"$. Wt.: K-15, 40 lbs.; K-12, 38 lbs.

95 DZ 379. Type K-15. For 15" speakers. NET..... 46.50
 95 DZ 378. Type K-12. For 12" speakers. NET..... 39.00

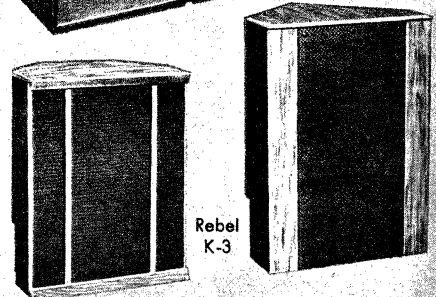
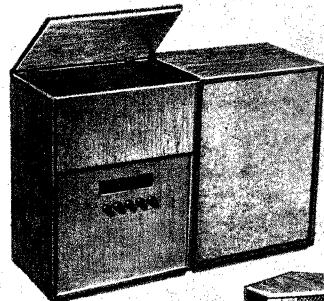
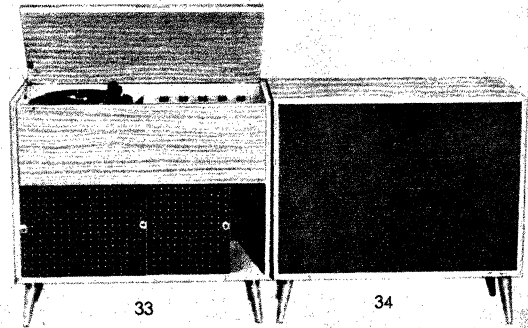
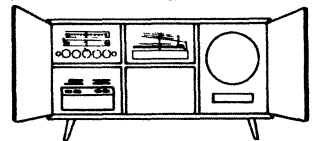
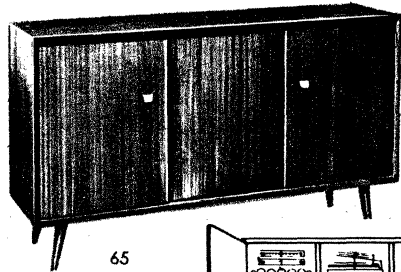
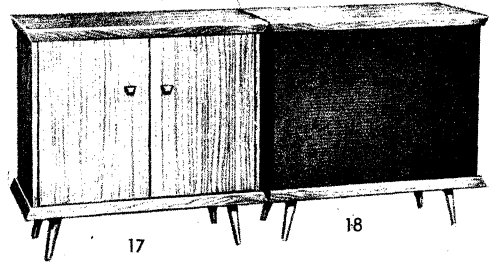

CUSTOM EQUIPMENT CABINETS AND SPEAKER ENCLOSURES

Herman Miller Equipment Storage Cabinet

A beautifully designed cabinet by the famous Herman Miller organization. Has three compartments behind dual doors, and a 3.2-cu. ft. bass-reflex speaker enclosure. Exterior is oil-finished rose-wood, with white lacquered doors, and black porcelain door pulls; grille cloth is natural horsehair. Supplied with round, tapered rose-wood legs, 13 $\frac{3}{4}$ " long. Ample space is provided for a record changer in the largest of the three compartments, 15" high, 15 $\frac{3}{4}$ " wide and 16" deep; space above changer shelf permits easy access to load or unload changer. Tuner and amplifier compartments are both 15" wide and 16" deep; shelf between tuner compartment and amplifier compartment is adjustable. Speaker enclosure is pre-cut for 12" speaker. Size of cabinet, less legs, is 16 $\frac{3}{4}$ " high, 62" wide, and 16 $\frac{1}{2}$ " deep. Height, with legs, 30 $\frac{1}{4}$ ". Shpg. wt., 175 lbs.
81 DZ 892. NET..... 195.00



This Herman Miller cabinet houses a complete hi-fi system. Components sit on shelves—only speaker requires mounting.

River Edge Equipment Cabinets

SERIES 100. A compact, functionally styled cabinet of $\frac{3}{4}$ " birch hardwood, available unfinished in kit or assembled form. Matching legs, listed below, may be used to mount cabinet as free-standing unit. Cabinet is divided into record changer compartment with drawer, and an enclosed compartment with panel for custom installation of tuner, amplifier, etc. Changer compartment has sliding mahogany-finish door, measures 15 $\frac{1}{2}$ " w., 15" d.; 7 $\frac{3}{4}$ " above, 6 $\frac{3}{4}$ " below drawer. Panelled compartment is 14 $\frac{3}{4}$ " h., 16 $\frac{3}{4}$ " w., 15" d. Exterior size (HWD), 16x36x16". Shpg. wt., 50 lbs.
95 DX 719. Series 100 Cabinet Kit. Unfinished. NET..... 39.50
95 DZ 725. Series 100 Cabinet. Assembled, unfinished. NET. 48.50
95 DX 724. Set of 4 Wood Legs. Unfinished; 16" long. NET. .630

MODEL 420G. Tastefully designed chairside cabinet; will accommodate changer, tuner, preamplifier and amplifier. Provides finger-tip control of all high-fidelity components from chairside. Handsome tapered legs have brass ferrules; selected cabinet woods are matched and assembled with care. Record changer compartment has sliding door, for easy access to changer; compartment measures 17x15", 6 $\frac{3}{4}$ " above, 4" below mounting board. Preamp may be mounted face up in compartment, 7 $\frac{3}{4}$ " high, 17" wide, 10" deep. Tuner compartment size (HWD) 9 $\frac{1}{2}$ x17x10 $\frac{1}{2}$ "; amplifier compartment (HWD) 9 $\frac{1}{4}$ x17x7 $\frac{1}{2}$ ". Overall dimensions (HWD), 27 $\frac{1}{2}$ x18 $\frac{1}{2}$ x32". Control panels are easily removable for custom cut-outs. Shpg. wt., 60 lbs.
95 DZ 732. Mahogany. NET..... 89.70
81 DZ 971. Lined Oak. NET..... 98.67
81 DZ 972. Walnut. NET..... 98.67

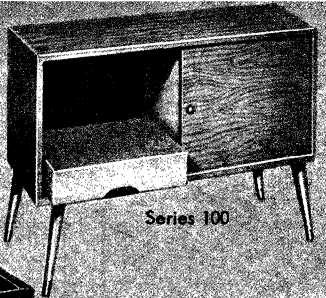

Series 100

Model 420G

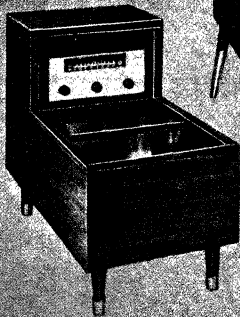

Distinguished River Edge equipment cabinets, designed to harmonize with various furniture styles.

Karlson Speaker Enclosures and Kits

Highly efficient enclosures of unique design, providing a remarkable degree of bass re-inforcement in relatively small volume. A curved, tapered slot in the front of the enclosure aids in achieving a wide-angle, natural-sounding distribution of high and low tones, without pronounced peaks in response. Available unfinished, in kit form or completely assembled.

8K, 12K AND 15K KITS. Save over $\frac{1}{2}$ of the cost of a finished enclosure by assembling a kit! Seasoned lumber used throughout, pre-cut and drilled for quick, easy assembly. Models 15K and 12K are $\frac{3}{4}$ " hardwood, less grille cloth; 8K is $\frac{1}{2}$ " birch veneer plywood, supplied with grille cloth. Use speaker of size indicated in model number. Sizes (HWD): 15K—34 $\frac{1}{2}$ x22 $\frac{1}{2}$ x18"; 12K—24 $\frac{3}{4}$ x16 $\frac{3}{4}$ x13 $\frac{3}{4}$ "; 8K—17 $\frac{1}{4}$ x11 $\frac{3}{4}$ x10". With instructions for assembly and finishing.

8U, 12U, 15U ASSEMBLED ENCLOSURES. As above, but assembled.

Stock No.	Type	Cutout	Wt., Lbs.	NET
81 DZ 715	15K	15"	68	57.00
81 DZ 712	12K	12"	35	42.00
81 DX 706	8K	8"	12 $\frac{1}{2}$	18.60
81 DZ 716	15U	15"	72	87.00
81 DZ 713	12U	12"	42	66.00
81 DX 705	8U	8"	13 $\frac{1}{2}$	26.70

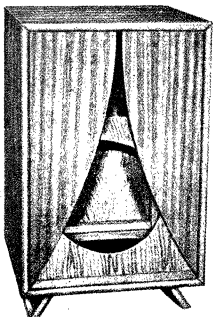

15U 12U 12K 15K

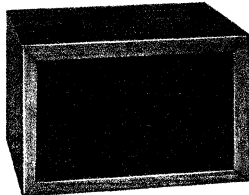

8U 8K

Exceptionally skillful design has made the Karlson a highly popular enclosure; the tapered exponential slot is a Karlson exclusive.

Argos Speaker Enclosures

AD-1. Phase-inverter type enclosures, with "tuned tunnel" design as developed by Jensen Mfg. Co., makers of loudspeakers. Construction permits highly effective smoothing of bass response by reflex method in an enclosure of moderate size. Enclosure is solidly constructed of 5-ply wood, with thick fiber-glass acoustic padding on interior panels. Exterior surface is covered by heavy pyroxylin plastic leatherette, easily cleaned with a damp cloth. Grille fabric is styled to match enclosure covering. Internal capacity, 2.5 cu. ft. Accepts 12" or 8" speaker, and separate tweeter (with adapters supplied). Size (HWD), 23 $\frac{3}{4}$ x19 $\frac{1}{4}$ x13 $\frac{1}{2}$ ". Shpg. wt., 31 lbs.
81 DZ 900. Mahogany Leatherette. NET..... 24.45
81 DZ 901. Blonde Leatherette. EACH..... 24.45

DSE-1. New "Californian" reflex enclosure acoustically designed by Jensen, and produced by Argos. Available in kit form, or completely assembled; both versions are handsomely pre-finished. Top finish is St. Regis "Panelyte," a material which permanently resists burns, stains, etc. Wood trim is solid mahogany. Enclosure interior capacity is 4.3 cu. ft.; performance is excellent with 15" or 12" speaker. Tweeter may also be mounted with adapter supplied. Size (HWD), 29x24x15". Shpg. wt., 43 lbs.
81 DZ 991. Mahogany. NET..... 53.41
81 DZ 992. Blonde. NET..... 53.41
81 DZ 993. Kit, Mahogany. NET..... 39.69
81 DZ 994. Kit, Blonde. NET..... 39.69

Letter "Z" in Stock Number Denotes Express Shipment Only

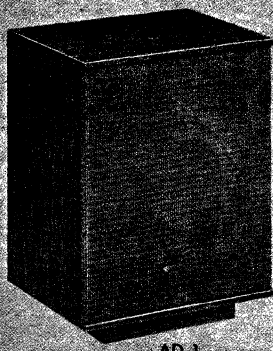

AD-1

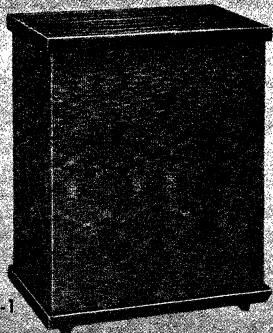

DSE-1

Durably constructed, economical Argos reflex enclosures.



CHFC-12-15

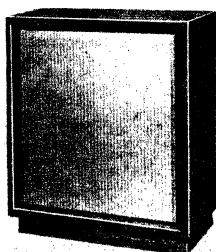

HFC-12-15

HFC-8-12

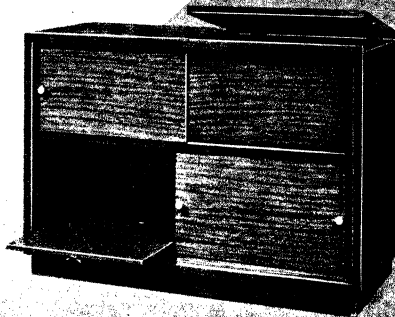

HFEC

Wellcor Hi-Fi Equipment and Speaker Enclosures

CORNER BASS REFLEX

CHFC-12-15. Handsomely finished enclosure for 12" or 15" speaker, designed to fit in a corner. True bass reflex design enhances bass reproduction effectively without decreasing overall efficiency of speaker system; corner placement offers superior distribution of sound throughout the room in which it is placed. Acoustic design permits use in corner or against flat wall without sacrificing correct operation of enclosure.

Front panel is factory-fitted with removable adapter panel permitting use with either 12" or 15" speaker; base of enclosure is removable to gain access to interior for speaker installation, modification, etc. Cabinet interior is acoustically padded, and completely sealed, for efficient performance.

Constructed of 3/4" plywood throughout, for rigidity, with veneer finished in mahogany, blonde or walnut. Size: 27 1/2" high, 24" wide and 16 1/4" deep. Shpg. wt., 40 lbs.

81 DZ 962. Mahogany. NET..... 54.75

81 DZ 963. Blonde. NET..... 60.75

81 DZ 964. Walnut. NET..... 60.75

BASS REFLEX ENCLOSURES

Excellently designed bass reflex enclosures of rigid construction, attractively finished in mahogany, blonde or walnut. Made of seasoned 3/4" plywood throughout, lined with acoustical padding. Base is supplied detached, for mounting enclosure in either high-boy or low-boy position.

MODEL HFC-12-15. Full six-cubic-foot capacity. Speaker mounting board cut for 15" speaker, with removable adapter for 12" speaker. Size: 27 1/2" high, 24" wide, 16" deep. Shpg. wt., 51 lbs.

MODEL HFC-8-12. Over three cubic feet capacity, with all design features of larger model HFC-12-15. Cut for 12" speaker; adapter for 8". 22 1/2"x19 1/4"x13 3/8". 34 lbs.

Stock No.	Model No.	Spkr. Size	Finish	NET
81 DZ 956	HFC-12-15	12" or 15"	Mahogany	54.75
81 DZ 957	HFC-12-15	12" or 15"	Blonde	60.75
81 DZ 958	HFC-12-15	12" or 15"	Walnut	60.75
81 DZ 959	HFC-8-12	8" or 12"	Mahogany	41.25
81 DZ 960	HFC-8-12	8" or 12"	Blonde	44.25
81 DZ 961	HFC-8-12	8" or 12"	Walnut	44.25

EQUIPMENT CABINETS

Model HFEC. A beautiful and exceptionally versatile equipment cabinet, featuring top-quality construction, fresh contemporary styling, and careful furniture finishes in mahogany, walnut or blonde. May be used in two ways: shelves are provided for placement of encased components, and board is also supplied for permanent, custom mounting. Record player compartment will accommodate either professional-type turntable or an automatic record changer. Sliding base in bottom compartment for tape recorder or other accessory equipment. Five completely enclosed compartments for storage of records of all sizes.

Sliding doors throughout provide a functional, smart-appearing frontal design; hinged lid on record player compartment permits easy access. Construction and general appearance matches Wellcor enclosures listed at left. 27x44x21". Wt. 120 lbs.

81 DZ 953. Mahogany. NET..... 108.00

81 DZ 954. Blonde. NET..... 117.00

81 DZ 955. Walnut. NET..... 117.00

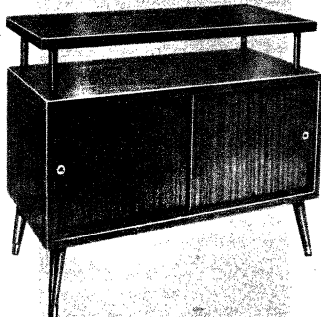

UNIVERSAL RECORD & HI-FI CABINET

Model 20. A beautifully designed example of contemporary furniture, functionally planned to accommodate records and a wide variety of high-fidelity components. Rigidly constructed of beautifully matched panels with durable finish.

The large interior of the cabinet is 13 3/4" high, is convenient storage of records. A smaller sub-compartment holds numerous 45-rpm records, and a third compartment, 6" in height, is a convenient storage space for record cleaning cloths, catalogs, program guides, etc. The large server top is supported on 5-inch spacers, and measures 35 1/2 x 16 1/4"; it is ideal for placement of encased tuner, amplifier and preamp. Overall dimensions of complete unit are 34 1/4 x 36 x 18".

Shipped with legs, spacers and server top unattached; easily set up in minutes. Trim on all models is lustrous polished brass. Shpg. wt., 49 lbs.

81 DZ 989. Mahogany. NET..... 32.50

81 DZ 990. Lined Oak. NET..... 33.95

81 DZ 903. Walnut. NET..... 33.95

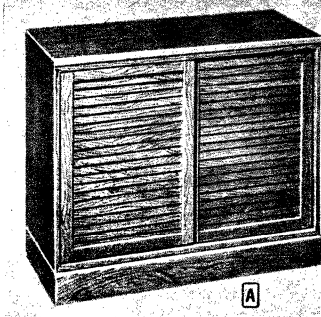

A

Versatile Unfinished Equipment Cabinets

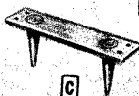

C

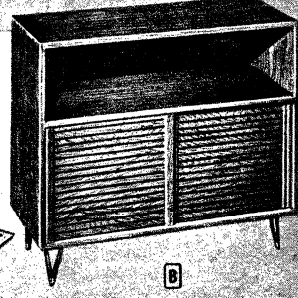

B

LOW-COST UNFINISHED HI-FI EQUIPMENT CABINETS

Attractive cabinets for hi-fi equipment, completely assembled and ready for finishing. Made of clear Ponderosa pine, sanded satin smooth; may be painted, or stained and finished to match any type of furniture. Plenty of room for installation of tuner, amplifier and record player—plus ample record storage space.

A CABINET WITH FULL-LENGTH DOORS. Tastefully designed cabinet with luxurious louvered sliding doors. An excellent unit for budget-priced and limited-space hi-fi installations. Houses all components of a music system (except the speaker) such as changer or turntable on base, tuner, amplifier, albums, etc. Styling easily blends with any interior motif. Wood is richly textured and beautifully grained—ready for fine furniture finishes. Inside of cabinet is divided into two compartments; top compartment: 9 1/4 x 33 3/4 x 14 3/8", bottom compartment: 12 1/2 x 33 3/4 x 14 3/8". Overall size, 24 3/4 x 35 3/8 x 16". Less base, 48 lbs. 95 DZ 508. NET..... 23.90

B Cabinet with Half-Doors. Handsome equipment cabinet with modern, louvered doors covering bottom half of cabinet only. Offers more than adequate space for any combination of high-fidelity components. Bottom half is excellent for record storage. Size and construction features same as full-door version at left. Less legs (see below). Shpg. wt., 47 lbs. 95 DZ 509. NET..... 17.91

Reversible Base. (Shown in Fig. A.) Modern design on one side, traditional on the other. 3 1/2 x 35 3/8 x 16". Shpg. wt., 3 lbs. 95 DX 536. NET..... 4.23

C Modern Round-Leg Base. With brass ferrules. 5 1/4" high, 16" deep. Set of 2. Shpg. wt., 3 lbs. 95 DX 535. NET..... 3.38

Twin Wrought Iron Legs. (Shown in Fig. B.) With lustrous brass ferrules to enhance appearance. 5 1/4" high. Set of 4. Wt., 5 lbs. 95 D 537. NET..... 4.17

Custom Installation Accessories For Built-In Hi-Fi Systems

ACOUSTONE PLASTIC GRILLE CLOTH

A wide selection of grille cloth in beautiful new patterns. Large choice of colors match practically any interior decorating scheme from contemporary to traditional. Made of tough, durable Saran plastic—can be stretched over large openings without sagging. Color-fast patterns will not fade. Acoustone grille cloth has an open weave which permits unrestricted passage of all frequencies. Shpg. wt., per yard, 6 oz.

Description	Type No.	Fig.	Stock No.		NET Per Yd.
			In Lengths Over 1 Yd.	36"x36"	
Mahogany	211	A	86 SX 994	86 SX 976	2.45
Bronze	214	A	86 SX 995	86 SX 977	2.45
Light Blonde	511	A	86 SX 996	86 SX 978	2.45
Gold and Bronze	213	A	86 SX 997	86 SX 979	2.45
Solid Charcoal	452	89 SX 000	86 SX 980	2.45
Black, with gold cobwebs	453	B	89 SX 001	86 SX 986	4.12
Black, with silver cobwebs	462	B	89 SX 002	86 SX 987	4.12
Mahogany, with gold cobwebs	300	B	89 SX 003	86 SX 988	4.12
Blonde, with gold threads	515M	86 SX 998	86 SX 981	3.35
Mahogany, with gold threads	215M	86 SX 999	86 SX 982	3.35
Gold	1011	89 SX 004	86 SX 984	4.12
Bamboo	813	89 SX 005	89 SX 007	3.35
White and gold	617M	89 SX 006	89 SX 008	3.35

PANDANUS GRILLE CLOTH

Imported natural-color, straw fabric. Very attractive. Especially suited for cabinets with modern motif. Available only in 27" widths (minimum order 1 yard.). Shpg. wt., per yard, 6 oz.

86 SX 718. NET PER YARD..... 1.59
86 SX 975. To 10 1/2 yds. PER YARD... 1.59

CUSTOM CHANGER BASES

CABINART MODEL ACC-1 UNCUT. Changer record box with blank top—can be cut to accommodate any make record changer or player. Made of smooth-sanded, ready-to-finish birch wood. Has top-quality, steel ball-bearing phonograph slides, pre-mounted for trouble-free installation in cabinet. Hand-pull insert cut into front panel. Size: 3 1/2" high, 16 1/4" long, 14 1/2" deep. With instructions. Shpg. wt., 8 lbs.

95 RX 556. NET..... 9.90

MODEL ACC-1 PRE-CUT FOR WEBCOR CHANGERS. As above, but pre-cut to accommodate Webcor Model 1831-41 record changers. Shpg. wt. 8 lbs.

95 RX 558. NET..... 9.90

MODEL ACC-1 PRE-CUT FOR GARRARD CHANGERS. Same size as above. Wt. 8 lbs.

95 RX 543. For RC88-4, RC98-4 NET

95 RX 542. For RC121-4..... EACH 9.90

PHONO DRAWER SLIDES

STANDARD DRAWER SLIDES. For installing record changers or turntables in cabinets. Constructed of heavy steel. Slides are 15" long with a normal travel extension of 11". Equipped with ball-bearings for smooth action. Slides can be attached either to bottom or sides of phono drawer or base. Will firmly support phonograph assemblies up to a maximum weight of 50 pounds. Slide brackets have slotted holes to permit leveling after installation. Shpg. wt., 4 lbs.

86 R 195. NET..... 1.90

STANDARD DRAWER SLIDES. As above, but 13" long. Shpg. wt., 4 lbs.

86 R 194. NET..... 1.90

HEAVY-DUTY DRAWER SLIDES. For deluxe installations. 18" long. Normal extension 16". Shpg. wt., 5 lbs.

86 R 199. List, \$7.80. NET..... 3.50

DECORATIVE METAL GRILLE

Adds beautiful decorative touch when used over grille cloth. Excellent for speaker protection.

G-C ORNAMENTAL GRILLE. Heavy metal grille with brushed-brass finish. Diamond pattern, 2 1/8"x7/8". Av. wt. 4 lbs.

86 SX 070. 12x18". NET..... 1.76

86 SX 071. 18x24". NET..... 3.23

86 SX 072. 24x36". NET..... 6.14

ICA MESH GRILLE. Expanded aluminum fine mesh grille. Gold finish. Av. shpg. wt., 1 lb.

86 SX 063. 12x18". NET..... 2.73

86 SX 064. 18x24". NET..... 5.39

86 SX 069. 24x36". NET..... 10.83

FIBERGLAS ACOUSTIC INSULATION

Especially designed to eliminate medium and high frequency reverberation in speaker enclosures. Widely used in bass reflex, folded-horn and infinite-baffle enclosures. In 1" thickness to simplify installation—no need to double up material to obtain proper damping. Eliminates distortion-causing standing waves inside cabinet. Used on all inside portions of cabinet except front panel. Also used as a lining in record-changer compartment—eliminates motor noise, rumble, etc. In convenient 16" width for easy installation. Shpg. wt., 2 lbs.

89 SX 951. 16-Ft. Length. NET..... 2.25

NEW SPEAKER BAFFLE KIT

Versatile, speaker baffle kit—a valuable time and work-saver for anyone who wishes to custom install a hi-fi speaker or 2 or 3-way speaker system in wall or cabinet. Cut for 15" speaker, or may be used with adapter board for installation of 12" speaker. Also has adapter boards for mounting tweeters and to permit use in an infinite baffle or bass reflex enclosure. Sturdy 3/4" plywood. Supplied complete with adapter boards, hardware, easy-to-follow instructions, plus Allied's booklet for building your own bass reflex enclosure. Size, 22x32". Shpg. wt., 12 lbs.

94 DX 799. NET..... 8.95

SPEAKER REDUCER RINGS

Easy-to-use reducing rings for using smaller speakers in larger enclosures. Made of 3/8" plywood and cut to exact size for quick, simplified installation. Four speaker mounting holes drilled. Supplied with speaker mounting nuts, bolts and washers. Less wood screws.

MODEL R-8/12. For mounting 8" speaker in 12" speaker baffle or cabinet. 1 lb.

95 D 578. List, \$2.00. NET..... 89c

Model R-12/15. For mounting 12" speaker in 15" speaker baffle or cabinet. 1 1/2 lbs.

95 DX 579. List, \$2.75. NET..... 1.19

SPEAKER MOUNTING BOLTS

Carriage bolts for mounting speaker to wood panel. Bolt head is flat—when countersunk will not show through grille cloth. Size 1/4x2" long. With square nuts. 4 per pkg. Shpg. wt., 4 oz.

44 N 202. NET PER PKG..... 13c

LEVEL & LEVELING SCREWS

CABINART MODEL ACC-3. Precision, chrome-plated circular level indicator and four adjustable, rubber-tipped leveling screws. Valuable aid for hi-fi enthusiasts. For use with any turntable installed on wood mounting board. Easy to install. Screws mount under base of turntable; level on top. Provide quick adjustment for exact leveling. Shpg. wt., 5 oz.

95 R 555. NET..... 2.40

Complete Electro-Voice enclosure finishing kits are listed on page 51.

High-Fidelity Audio Cables and Connectors

LAB-TRONICS HI-FI CONNECTOR CABLES.

Superior-quality audio connecting cables. Extremely valuable accessories for the installation of hi-fi music system components. Molded-on grippers are attached to plugs for easy removal or insertion. Cables are soldered prior to molding, assuring completely noise-free connections. Molding is of high-impact material; plugs are virtually unbreakable. All cables are shielded, except Figs. C, E, J and K, unshielded. Av. shpg. wt., 5 oz.

Stock No.	Type	Fig.	Description	NET
99 S 855	C101	A	18". Phono pin plug on each end	.61
99 S 856	C102	A	36". As above	.70
99 S 857	C103	A	72". As above	.88
94 S 456	C202	B	36". Phono pin plug and jack	.85
94 S 457	C203	B	72". As above	1.03
94 S 465	P701	C	10". Right angle phone plug and alligator clips	1.79
94 S 470	C106	D	36". Phono pin plug; other end stripped & tinned	.59
94 S 467	C107	D	72". Phono pin plug; other end stripped & tinned	.73
94 S 468	P602	E	10". Right angle phono pin plug and spade lugs.	1.18
94 S 462	C104	F	72". Phono pin plug and right angle shielded phone plug	1.74
94 S 463	C301	G	10". Right-angle shielded phone plug & jack	3.82
94 S 471	C114A	H	72". Straight shld. phone plug; end stripped & tinned	1.65
94 S 464	P601	J	10". Right-angle phono pin plug and alligator clips	1.32
94 S 472	P502	K	20". 2-conductor with spade lugs on each end	1.03
94 S 458	C400	L	Double phono pin jack adapter	.59

LAB-TRONICS MULTI-SPEAKER SWITCH

M MODEL L1601. For selecting any one of 3 speakers, or any combination of them, from a single, convenient location. Can be used with multiple-speaker installations in the home, store, etc. Requires only three wires from the amplifier—common, 8 & 16 ohm (for 16 ohm speakers) or common, 4 & 8 ohm (for 8 ohm speakers). Has screw terminals, no soldering required. Wall plate is brushed brass. Fits in any regular outlet box. Mounting centers, 3 3/4". With wood and machine screws and instructions. Size, 2 3/4 x 4 1/2 x 1 1/2". Shpg. wt., 8 oz.

94 S 450. NET.....5.83

LAB-TRONICS SPEAKER CONTROL

N MODEL 1612. Mounted on wall or cabinet. Has T-pad mounted on brushed brass wall plate. Fits any standard outlet box. Rated 4 watts continuous, 15 watts peak audio. Black molded escutcheon and white knob. 16-ohm control will handle single 16-ohm speaker or two 8-ohm speakers wired in series. 8-ohm control can be used for single 8-ohm speaker, two 16-ohm speakers wired in parallel or two 4-ohm speakers connected in series. Wall plate mounting centers, 3 3/4". Has screw terminals. With wood and machine screws. Size, 2 3/4 x 4 1/2 x 1 1/2". Shpg. wt., 8 oz.

94 S 451. L-1612/8. 8 ohms.
94 S 452. L-1612/16. 16 ohms.
NET EACH.....9.55

VIDAIRE SPEAKER FADER

P MODEL RF-10. For remote control of a speaker in a hi-fi set, radio or TV receiver. Can also be used as an external speaker for "on-the-spot" control. For 4-8 ohm speakers. Gold finished dial plate. With knob, brass screws and installation instructions. Size, 2 1/2 x 2 1/2 x 1 3/4". Shpg. wt., 8 oz.

94 S 473. NET.....1.41

VIDAIRE REMOTE SPEAKER SWITCH

R MODEL MS-6—FOR UP TO 6 SPEAKERS. New, high-quality remote speaker switch. Permits centralized control for as many as six remote speakers. Highly versatile—has six SPDT switches which provide 42 possible operating combinations—any combination of the six speakers can be played, or all can play simultaneously. Easily mounts on panel of hi-fi or public-address system for convenient operation. Designed for use with any size speaker and any speaker impedance. Gold-embossed brass plate blends with any surroundings. Size, 3 1/2 x 2 3/4". With all necessary brass hardware and easy-to-follow instructions. Shpg. wt., 8 oz.

94 S 438. NET.....2.64

S MODEL RS-10—FOR 2 SPEAKERS. Connects remote speaker to radio, TV or hi-fi set. Permits listening enjoyment in any room, porch or patio without "blasting" at source. Has 3 positions—turns on either speaker, or both. Brass plate is gold finished. Complete with knob, brass screws and installation instructions. Size, 2 1/2 x 2 1/2 x 1 3/4". Shpg. wt., 8 oz.

94 S 474. NET.....1.17

MALLORY SPEAKER CONTROLS

T Mallory wire wound T-pads. Excellent for use in multi-speaker systems—regulate volume at one speaker without affecting volume of other speakers. A single T-pad will also control volume in two speakers simultaneously—use 15-ohm pad for two 8-ohm speakers wired in series; use an 8-ohm pad for two 16-ohm speakers wired in parallel, or two 4-ohm speakers connected in series. Will handle up to 15 watts of audio power. Complete with knob and dial plate. Size 1 1/2" dia., 1 1/4" depth. 2" shaft. Shpg. wt., 7 oz.

29 M 871. 8-ohm pad. NET
29 M 872. 15-ohm pad. EACH.....2.76

RCA TUNER-PHONO SWITCH

W A convenient accessory for modernizing amplifiers having insufficient inputs. Has two standard pin-jack inputs for tuner, phono, etc.—just move the slide switch to select either input. Simple, plug-in installation. Output cable has standard pin plug for insertion in amplifier. Size, 4 3/4 x 1 1/2". With complete instructions. Shpg. wt., 6 oz.

69 R506. NET.....3.33

FM TWIN-LINE ANTENNA

X Low cost, folded dipole type indoor antenna designed for FM reception. Eliminates need for outdoor antenna in many locations. Perfect for use where concealed antenna would be desirable, or where outdoor antenna installation is not feasible. Simply place under rug, behind cabinet or in any other out-of-the-way location. Antenna consists of 300 ohm twin-line with copper-covered steel conductors. Has a 6 ft. lead-in wire. Shpg. wt., 6 oz.

92 C 019. NET.....1.26

ROFLEX SHEATHED CABLE

Y For long speaker lines in indoor or outdoor applications. No. 14, 2-conductor solid. Thermoplastic insulated. Min. order 100 ft. Wt., 100 ft., 7 lbs.

47 W 549. PER 100'.....6.47

REMCON REMOTE SWITCH KIT

Z Enjoy the luxury of remote Off-On control of your hi-fi system from any room in the house. Kit consists of control unit (into which hi-fi system is plugged) and three switches with wall plates for standard AC wall boxes. Control unit handles up to 10 amps at 115 v. AC. Wiring to switches carries only 6 volts (supplied by control unit). Parallel wiring—as many switches as desired may be added. With instructions. For 110-120 v., 50-60 cycle AC. Shpg. wt., 1 1/2 lbs.

94 S 435. NET.....9.95

Accessories for Remcon Switch

100' 3-Cond. Cable. 2 lbs.

47 T 360. NET.....2.43

Type S-1 Extra Switch. 4 oz.

94 S 436. NET.....35c

Type PL-1 Extra Wall Plate. 4 oz.

94 S 437. NET.....30c

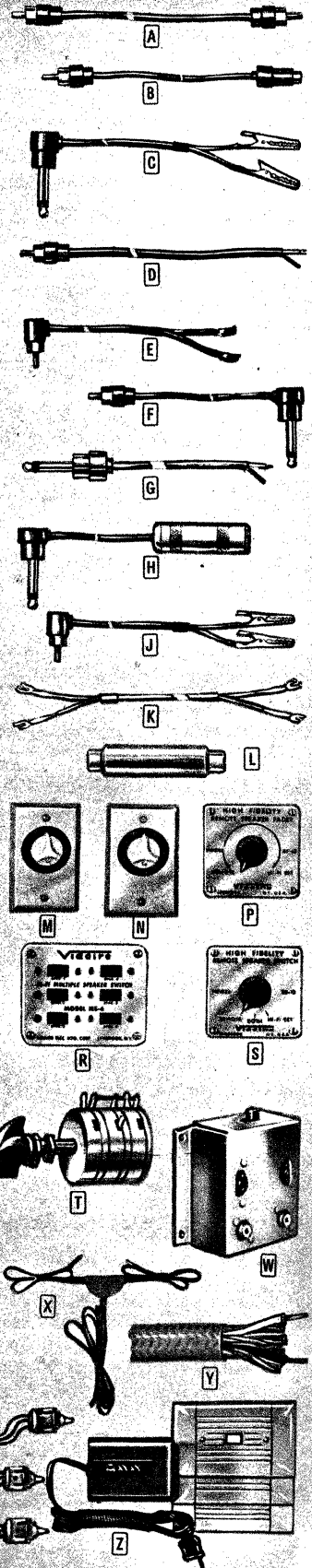

SELECTED RECORD CARE ACCESSORIES

PLASTIC CHANGER COVERS

- A** Useful, decorative, plastic record changer covers. Protect record changers from dust, moisture, etc. In attractive silvery gray. Shpg. wt., 6 oz.
95 R 593. For Garrard RC88-4 and RC98-4 record changers. NET..... **98c**
95 R 594. For V-M, Webcor and Garrard RC121 record changers. NET..... **98c**
95 R 649. For turntables. Cover size, 22x16 $\frac{1}{4}$ x9". NET..... **1.25**

STYLUS INSPECTION MICROSCOPE

- B** Pocket-size stylus inspection microscope. For checking stylus tip to detect imperfections and signs of wear. Approximately 75-power magnification. An easy-to-use "must" item for the serious record collector. Instantly reveals record-damaging imperfections in stylus tip. Has groove for convenient centering of stylus tip in microscope field. Can be used with any stylus. Has sturdy metal barrel; adjustable objective lens. Imported from Japan. Size, 3 $\frac{3}{4}$ " long x $\frac{1}{2}$ " dia. Shpg. wt., 8 oz.
65 RC 440. NET..... **3.00**

PLASTIC DISC COVERS

- C** Protective sleeves for 10" and 12" records. Made of durable polyethylene plastic with thermoseal seams to resist tearing. Prevent scratching of delicate record surfaces; seal out dust and moisture; end finger marking of records. On long playing records, sleeve fits over record and into original record jacket. Shpg. wt., 7 oz.
65 R 515. Pkg. of 15, 10" sleeves.
65 R 516. Pkg. of 12, 12" sleeves.
 NET PER PACKAGE..... **88c**

ANTI-STATIC RECORD CLOTH

- D** 112 square inches of soft, chamois-like lintless fabric, impregnated with chemical compound. Will not fray or dry out. Keeps records free of noise producing dust and electrostatic charge; effectively eliminates static "pops" and "crackles." Leaves no residue—will not harm records or styli. Easy to use—simply wipe record with light pressure and cloth does the rest. Supplied in sealed plastic bag that is ideal for storing cloth. Shpg. wt., 4 oz.
69 R 235. NET..... **59c**

ANTI-STATIC RECORD SPRAY

- E** Easy-to-use, anti-static record spray. Deposits thin anti-static film on record surface. Aids in preventing records from accumulating damaging and noise-producing dust and lint. In handy 6 oz. Aerosol spray can. Shpg. wt., 7 oz.
65 R 525. NET..... **88c**

FOAM RUBBER TURNTABLE MAT

- F** Low-priced, protective foam rubber record player mat. Fits any turntable or record changer. Cushions record drop on automatic record changers. Acts as shock absorber—protects valuable records. 9 $\frac{3}{4}$ " diameter; $\frac{3}{16}$ " thick. Shpg. wt., 4 oz.
65 R 532. NET..... **89c**

FAIRCHILD TURNTABLE PAD

- G** New deluxe foam rubber pad for any record changer or player. Cushions records; reduces magnetic attraction between cartridge and turntable; minimizes record slippage. Cut-out for 45-rpm spindles. 9 $\frac{3}{4}$ " dia.; $\frac{1}{4}$ " thick. Shpg. wt., 4 oz.
94 R 919. NET..... **1.98**

ORTHOSONIC RECORD BRUSH

- H** "Reddi-Sweep," soft camel's hair brush thoroughly cleans record grooves of dust, scrapings. Mounted on plastic stand with height adjustment, brush is positioned to face direction of record revolution. Flip of finger spins brush away. Base of stand has pressure-sensitive material—adheres to any surface. Shpg. wt., 6 oz.
99 R 793. NET..... **4.95**

ANTI-STATIC "ATOMIC JEWEL"

- J** Highly effective static neutralizer. Tiny jewel on clip. Makes records dust-resistant by neutralizing static electric charges which attract dust. Weighs less than $\frac{1}{60}$ of oz. Clips to pickup arm, but does not interfere with tracking. Reduces record noise; increases record and stylus life. Shpg. wt., 2 oz.
96 R 768. NET..... **2.93**

"BALANCED SOUND" KIT

- K** Inexpensive and easy to use, this handy kit contains a quick-reading stylus pressure gauge and a highly accurate turntable level. These two valuable phono accessories are perfect for the serious record collector. Help preserve records—add to the life of styli—improve fidelity. Pressure gauge enables user to quickly determine correct pressure. Level shows slightest tilt in turntable. Shpg. wt., 4 oz.
65 R 527. NET..... **88c**

WALCO TURNTABLE LEVEL

- L** Used for accurate levelling of turntables and record changers; insures correct tracking of lead-in and changer trip grooves, and prevents excessive record and stylus wear caused by lateral resistance of pickup arm. Sturdy hexagonal barrel prevents rolling, assures accurate reading. Attractive gold-finish. Shpg. wt., 4 oz.
69 R 225. NET..... **59c**

"KLEENEEDLE" BRUSH

- M** Automatic record changer needle brush. Brush is positioned to face upward. Whenever pickup arm is cycled, stylus is wiped over brush. Removes accumulations of dust, lint, etc., from stylus tip—minimizes distortion in record reproduction and reduces record and stylus wear. Base has adhesive pad for easy mounting on any surface. Shpg. wt., 4 oz.
96 R 769. NET..... **98c**

RECORD CARE BOOKLET

- N** GUIDE TO THE CARE OF MODERN RECORDINGS. By Karl A. Barleben. Informative booklet thoroughly discusses all aspects of record and stylus care in a clear and interesting manner. Subjects include: Stylus Wear; Dust; Cleaners; Handling of Records; Proper Storage of Records. Size, 5x7 $\frac{3}{4}$ "; 25 pages.
37 K 144. Postpaid in U.S.A..... **25c**

STROBOSCOPIC CARD

- P** Use with any 50 or 60-cycle neon, argon or fluorescent lamp, or low-wattage incandescent lamp. For accurately checking 33 $\frac{1}{3}$, 45 or 78 rpm record speeds. Quickly tells you when equipment needs adjustment. Easy to use—simply place on record changer or turntable as with any record. Turntable is accurately revolving at desired speed when appropriate band of dots appears to be stationary. Shpg. wt., 2 oz.
69 R 511. NET..... **15c**

WALCO RECORD CARE KIT

- R** A complete, easy-to-use record care kit. Contains: 6 oz. can of Stati-Clean, anti-static record spray and cleaner; 2 pkgs. plastic disc covers (12—12" sleeves; 15—10" sleeves); needle brush for cleaning needle tip; and a very informative book, by K. A. Barleben, "Guide to the Care of Modern Recordings." Shpg. wt., 2 lbs.
65 R 526. NET..... **2.91**

CLIP-ON RECORD BRUSH

- S** Soft camel's hair brush for mounting on pickup arm; brushes record ahead of stylus to remove dust from grooves. Selected, lightweight fibers will not scratch record surfaces. Saves stylus and records. Easy to attach—simply clip in place. Does not interfere with tone arm tracking or stylus pressure. Shpg. wt., 3 oz.
69 R 226. NET..... **49c**

Allied is Headquarters for High Fidelity Accessories

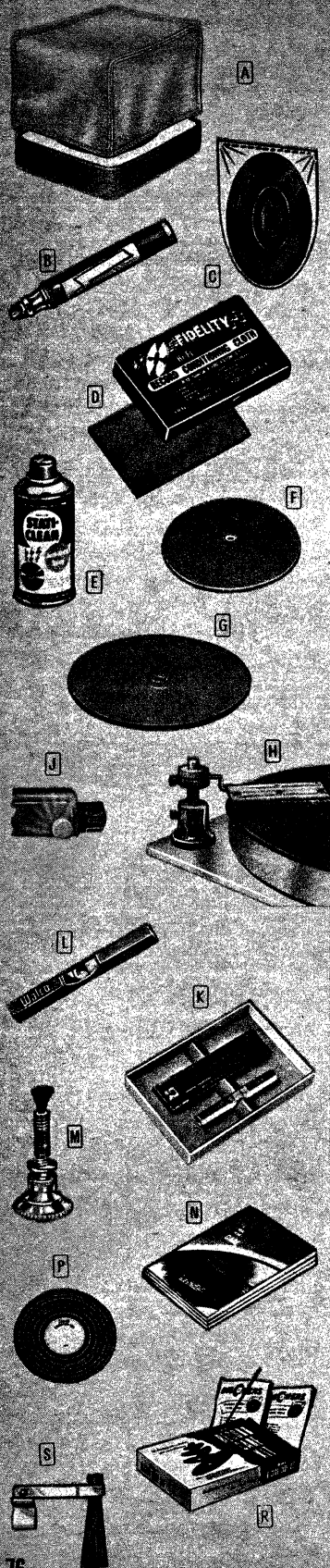

QUALITY PHONOGRAPH ACCESSORIES

RECORD STORAGE CABINET

A UNIVERSAL WOODCRAFTERS, MODEL RD-45. An extra-spacious phonograph table and record storage cabinet with sliding doors, at a remarkably low price. Strongly constructed of $\frac{5}{8}$ " plywood with $\frac{1}{4}$ " tempered masonite doors. Available in highly attractive mahogany or blond finish to blend with any decor. Top surface is large enough to easily accommodate almost any record player or tape recorder. Interior provides space for storing 7", 10" and 12" records.

Has removable dividers for convenient record storage. Divider forms two large compartments which will hold about 100 LP albums. Gracefully tapered legs have solid brass ferrules and gold-flecked levelers. Cabinet stands 27" high. Top surface size: 20 $\frac{1}{4}$ " wide, 22 $\frac{1}{4}$ " deep. Shipped with legs removed—legs quickly and easily fastened without tools. Steel bolts screw into steel sockets for wobble-free support. Shpg. wt., 32 lbs.

92 RZ 850, Mahogany, NET
92 RZ 851, Blonde, EACH..... 18.50

MODEL CRD-45. Same cabinet as above, but with 3" plastic wheels. Wt., 32 lbs.

92 RZ 852, Mahogany, NET
92 RZ 853, Blonde, EACH..... 19.95

RECORD ALBUMS

B STANDARD. Protect your records with this low cost, sturdy 12-pocket album. Wine color fabrikoid cover. With record index. Shpg. wt., $\frac{1}{4}$ lbs.

96 R 850, 10" Size, EACH..... 68c
3 or More, EACH..... 61c

96 RX 851, 12" Size, EACH..... 85c
3 or More, EACH..... 76c

SPANISH-GRAINED. Beautiful maroon leatherette cover. Records are held in 12 heavy Kraft-paper envelopes in binder. Gold stamped back. With handy index. Shpg. wt., 2 lbs.

96 R 856, 10" Size, EACH..... 90c
3 or More, EACH..... 81c

96 RX 857, 12" Size, EACH..... 1.06
3 or More, EACH..... 96c

FOR 7" RECORDS. Holds twelve 7" records, in individual flaps. Covers are bound in attractive simulated leather with gold stamping. Complete with record index. Shpg. wt., 1 lb.

96 R 845, Red, EACH..... 45c
96 R 846, Brown, EACH..... 45c

3 or More, EACH..... 41c

EP AND LP STORAGE BOXES

B Handsome, low-cost storage boxes. For twelve 7" or ten 10" or 12" records in their original jackets. Gold-embossed backs. Perfect for keeping records dust-free. Complete with handy index. Av. shpg. wt., 1 lb.

96 R 884, 7" Size, EACH..... 92c
3 or More, EACH..... 82c

96 R 885, 10" Size, EACH..... 1.25
3 or More, EACH..... 1.13

96 RX 886, 12" Size, EACH..... 1.59
3 or More, EACH..... 1.44

RECORD STORAGE & CARRYING CASES

C 7" & 12" RECORD CASES. Smartly styled record carrying cases for travel or home storage. Extra-strong, light metal construction. 7" case holds 80 records, 12" case holds 36 records. All have comfortable plastic carrying handles and brass plated draw-bolt locks. Each is completely indexed with embossed dividers, index card, numbered identification stickers. Model 46-P has sponge rubber strips for additional record protection. All have rubber feet to protect furniture surfaces. Durable two-tone green and gray baked enamel, wrinkle finish.

MODEL 46-P, 12" Case, Wt., 7 lbs.
95 RX 894, NET..... 4.90

MODEL 49, 7" Case, Shpg. wt., 4 lbs.
96 RX 849, NET..... 3.95

7", 10" & 12" RECORD RACK

D LYRIC MODEL 41 LP-EP RECORD RACK. Handsomely styled, black and brass-plated record rack for LP and EP records. Accommodates sixty 7", 10" or 12" records in jackets. Contemporary styling makes it a highly attractive room accessory, as well as a useful and protective record holder. Five convenient separators. Entire unit is just 11" long—ideal for use where only limited space is available. Has four rubber-tipped legs to prevent marring finish of floor or furniture. Durable all-steel construction. Shpg. wt., 2 $\frac{1}{2}$ lbs.

96 R 848, NET..... 3.45

RECORD HOLDER

E FLAT-TOP RECORD HOLDER. New, low-cost uniquely styled record holder. Accommodates sixty 7", 10" or 12" records with or without jackets. Contemporary flat-top design in attractive brass finish complements any style of room decoration. Compact unit measures only 16 $\frac{1}{2}$ " long—ideal for a large collection of records in mixed sizes that must be stored in a limited space. Holders are of heavy gauge steel construction, spot welded and braced for added rigidity. Each holder is coated with a durable, long-lasting rubber covering for positive record protection. Has handles for easy carrying. Sturdy legs are rubber-tipped to prevent marring or scratching of furniture surfaces. Size, 16 $\frac{1}{2}$ "x 8x5 $\frac{1}{4}$ ". Shpg. wt., 3 lbs.

94 RX 942, NET..... 2.25

RECORD CHANGER CABINET

F MODEL ACC-18 CABINART TABLE-TOP RECORD CHANGER CABINET. Handsome cabinets for table-top or shelf placement of record changers. Sturdily built, with highly attractive mahogany veneer over $\frac{1}{2}$ " birch wood on top and sides. Ebony lift lid. Removable mounting board. Available with mounting boards cut specifically for Garrard changers listed below; also uncut type which may be cut for use with other record changers. Dimensions above mounting board: 6" high, 16" wide, 13" deep. Overall size: 11 $\frac{1}{2}$ " high, 17" wide, 14" deep. Shpg. wt., 17 lbs.

Stock No.	Description
92 RX 801	Uncut
92 RX 802	For Garrard RC88-4, RC98-4
92 RX 803	For Garrard RC121-4
NET EACH..... 27.00	

STYLUS PRESSURE GAUGES

Correct stylus pressure is necessary to assure fine reproduction and minimum stylus and record wear. Insufficient pressure will result in poor tracking, loss of bass response, and often cause the stylus to skip across the record. Excessive pressure will result in shortened stylus and record life, and loss of high-frequency response. The stylus pressure gauges below will allow quick, accurate adjustment for optimum performance.

G WEATHERS STYLUS GAUGE. Accurately measures force with stylus in record groove. Hook gauge under pickup arm, lift, and as sound ceases, gauge shows tracking force. Shpg. wt., 5 oz.
69 R 232, NET..... 2.00

H AUDAX "STYLUS-BALANCE." An accurate method for determining stylus pressure. End of pickup arm is placed on one end of balance arm; weights (supplied) are placed on opposite end. Shpg. wt., 6 oz.
65 R 442, NET..... 4.70

J GARRARD STYLUS PRESSURE GAUGE. Measures weight exerted by a stylus upon a record. Can be used with any pickup arm. Reads 1-15 grams. Red and ivory plastic. Shpg. wt., 5 oz.
96 R 504, NET..... 2.45

K CLARKSTAN STYLUS PRESSURE GAUGE. Handy, sensitive gauge for measuring force exerted by stylus upon a record. For all pickup arms. Gram scale to 28.4. Ounce scale to 4. Shpg. wt., 5 oz.
85 R 029, NET..... 1.47

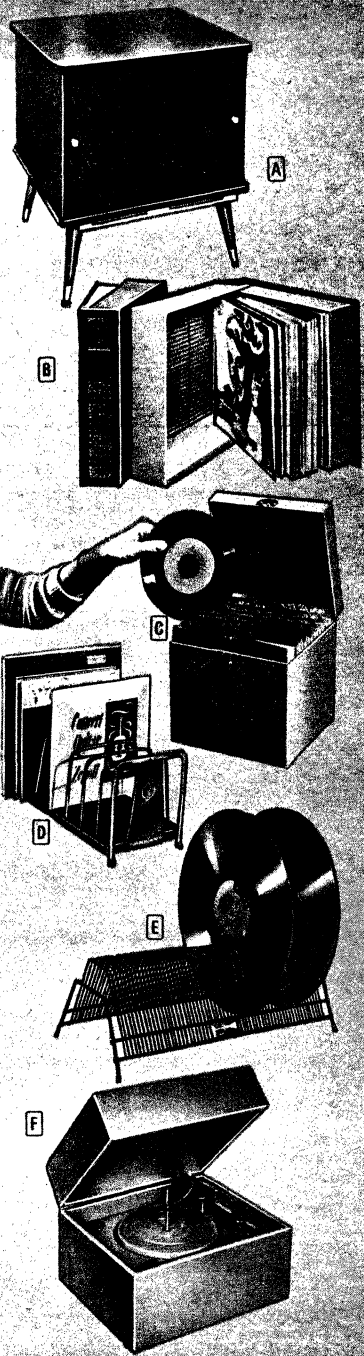

AUTOMATIC PHONOGRAPH VALUES

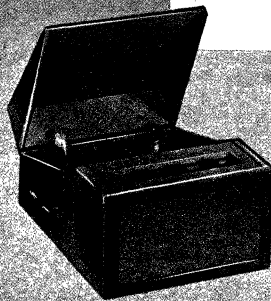

Four Speakers
8-Watt Push-Pull Amplifier



Two Coaxial Speakers
Genuine Leather Covering

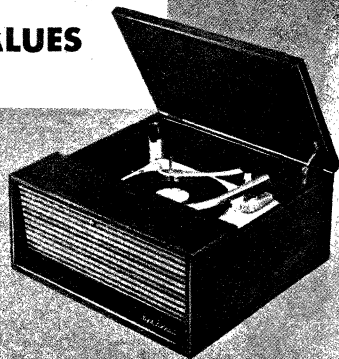

Hand-Rubbed Finish
Modern Styling

Portable Automatic Phono

\$83⁵⁰

Feature-packed, portable automatic phonograph designed to provide clear, natural audio reproduction.

Multiple speakers are employed for extended frequency range and added depth. Utilizes two 6" woofers and two electrostatic tweeters. Mounting of speakers in acoustically balanced enclosure provides smooth, distortion-free bass response and widely-dispersed "highs." Creates rich "room-filling" sound. Use of a powerful 8-watt push-pull amplifier, allows full orchestral passages to be reproduced with amazing realism. Circuit utilizes negative feedback design for greatly reduced distortion and surprisingly clean sound.

Smooth-operating 4-speed record changer provides automatic playing of 7", 10" or 12" records at 16 $\frac{2}{3}$, 33 $\frac{1}{3}$, 45, or 78 rpm speeds. 10" and 12" records of same speed can be intermixed. Automatically shuts-off after last record has been played. Rubber mat on turntable cushions records, prevents damage or slippage. Uses wide-range ceramic cartridge with separate sapphire needles for standard and microgroove records. Cartridge is unaffected by heat or moisture. 45 rpm spindle is supplied.

Separate, continuously variable bass and treble tone controls are mounted on top of cabinet for easy adjustment to suit personal taste and room acoustics. Handsome, luggage-type cabinet is constructed of heavy, laminated wood covered with finest scuff-resistant simulated leather. Matching handle and gold finish speaker grille and cabinet. All vibration-proof hardware. Measures 9" high, 21" wide, and 16" deep. For operation from 110-125 volts, 60 cycle AC. Shpg. wt., 33 lbs.

94 RZ 713. NET.....83.50

Deluxe Portable Phono

\$93⁷⁵

Creatively inspired design and finest-quality components are combined in the superb construction of this

fine automatic portable phonograph. Includes many deluxe features, such as an automatic shut-off which turns off the entire machine (amplifier and turntable) after the last record has been played; jam-proof, record changing mechanism, deluxe styling, etc. Uses two heavy-duty 6" coaxial speakers, angle-mounted in rigidly-braced baffle, for wide sound-coverage and low resonance. Electrical cross-over networks divide sound between coaxial elements for extremely efficient, wide-range reproduction. An external outlet is provided for the addition of a remote speaker.

Deluxe, VM 4-speed automatic changer plays 12", 10", and 7" records at 16 $\frac{2}{3}$, 33 $\frac{1}{3}$, 45 and 78 rpm speeds. Intermixes 10" and 12" records of same speed. Uses heavy-duty, low-torque drive mechanism for constant speed, wow and rumble-free performance. Balanced tone arm is equipped with a high-quality Sonotone ceramic cartridge. Dual sapphire needles for standard and microgroove records. Supplied with 45 rpm spindle. Special compartment stores spindle out-of-way when not in use.

Push-pull, 7-watt amplifier has separate bass, treble, and volume controls for precise adjustment of tonal quality; uses 3 tubes plus selenium rectifier. Cabinet is covered in genuine leather with attractive front-angled, brass-finished speaker grille. Thick-leather carrying strap is securely fastened to side of case. Size: 9 $\frac{3}{4}$ x19 $\frac{3}{4}$ x15 $\frac{3}{4}$ ". For 110-120 volts, 60 cycles AC. Shpg. wt., 25 lbs.

94 RX 939. NET.....93.75

Table-Model Automatic Phono

\$79⁵⁰

Unusually attractive table-model phonograph. Low in cost, it puts a world of listening pleasure at your fin-

ger tips. Hand-crafted cabinet is constructed from carefully selected fine furniture veneers, to form a pleasant addition to the finest decorative ensemble. Reinforced cabinet interior is designed to provide optimum baffle efficiency. Contains a dual speaker system, consisting of a full-toned 6" woofer for bass notes and a 5 $\frac{1}{4}$ " tweeter for treble. Provides rich, clear tonal quality and room filling sound.

Automatic record changer has a heavy-duty motor and smooth-operating changer mechanism. Assures constant speed and low rumble and wow content. Plays 7", 10", or 12" records at 16 $\frac{2}{3}$, 33 $\frac{1}{3}$, 45, and 78 rpm speeds. Will accommodate up to ten 12" records, twelve 10" records, or fourteen 7" records with one loading. Intermixes all size records of same speed. 45 rpm spindle supplied fits into convenient spring holder when not in use. Features automatic shut-off after last record has been played. Motor shuts off and drive wheel is disengaged to prevent flat spots from forming. Wide-range ceramic cartridge is equipped with two sapphire needles for standard and microgroove records. Unaffected by heat, humidity or moisture.

Amplifier has full-range volume control and combined bass and treble control for extreme ease of adjustment. Circuit includes 2 tubes plus rectifier. Size: 9x20x19". For operation from 110-120 volts, 60 cycle AC. In choice of hand-rubbed walnut or limed oak finish. Shpg. wt., 30 lbs.

94 RZ 714. Walnut. NET
94 RZ 715. Limed Oak. EACH..79.50

Deluxe Table-Model Automatic Phonograph

\$96⁷⁵

An up-to-the-minute, table-consolelet phonograph at an unusually low price. Advanced changer mechanism automatically plays 16 $\frac{2}{3}$, 33 $\frac{1}{3}$, 45 and 78 rpm records in 7", 10" and 12" sizes. Has new jam-proof V-M changer mechanism, with positive intermix of 10" and 12" records of the same speed.

Plays any record manually if change cycle is not desired. After last record is played, changer motor automatically shuts off. Features lightweight, die-cast aluminum tone arm with Sonotone turnover ceramic cartridge and .001" and .003" sapphire styli for standard and microgroove records. Balanced turntable and smooth-acting drive mechanism assure quiet, constant-speed operation. Room-filling, true-to-life sound is provided by a top-quality, 4-watt push-pull amplifier and an extended-range system of three speakers.

Employs two 6" woofers for excellent bass and mid-range reproduction; one 4" tweeter for clear, brilliant reproduction of highs. Speakers are mounted in acoustically-matched baffle for added efficiency and improved transient response. Separate bass and treble tone controls allow exact tonal adjustment to suit individual taste and match room acoustics. Controls are recessed to blend with trim phono appearance. The smartly styled wood cabinet is available in either mahogany or blonde genuine wood veneers; hand-rubbed to a lustrous glow. Highly attractive, matching Saran plastic grille cloth; has loose weave for maximum transmission of sound. Includes automatic 45-rpm spindle. Size: 31 $\frac{1}{4}$ x22 $\frac{1}{2}$ x16". Less set of 4 legs (see below). For operation from 110-120 v., 60 cycle AC. Shpg. wt., 64 lbs.

94 RZ 937. Mahogany. NET
94 RZ 938. Blonde. EACH.....96.75

LEGS FOR ABOVE. Set of four, tapered, brass-plated legs for converting to consolette use. 18" long. Shpg. wt., 4 lbs.

95 R 644. NET PER SET.....5.40

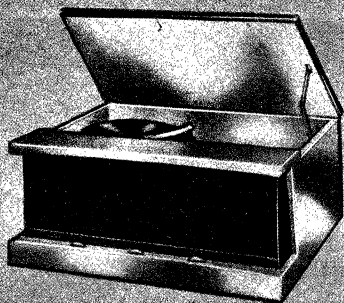

Push-Pull
Amplifier
3 Speakers
Converts to
Consolette

PORTABLE PHONOGRAPH BUYS



Wide-Arc Speaker Grille
Diamond LP Needle

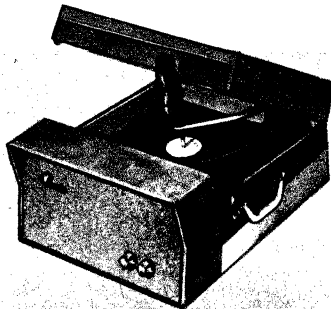

Locked-Seam Construction
Two Heavy-Duty Speakers



Brown-and-Tan Tweed Case
Top-Value Wide-Range Cartridge

Extended-Range Automatic

\$7650

This advanced-design, extended-range portable delivers rich, lifelike sound.

Features triple speaker system mounted in gracefully curved grille, for even sound-dispersion throughout the room. Neat, unusually attractive styling and efficient performance of this fine unit, make it a top value! One 6" woofer and two 4" tweeters are acoustically baffled for optimum bass response and minimum distortion. Case is all wood with locked corner construction. Handsome, luggage tan covering.

Plays ten 12" or twelve 10" records automatically. Intermixes all size records of same speed. 45 rpm spindle included. Plays up to fourteen 45 rpm records with one loading. Shuts off automatically and shifts to neutral position after last record is played. Heavy duty motor and positive drive mechanism assure constant speed at 16 $\frac{2}{3}$, 33 $\frac{1}{2}$, 45, and 78 rpm. Ceramic cartridge has 001" diamond and .003" sapphire needles. Volume, separate bass and treble controls. Size: 8 $\frac{1}{2}$ x17x18 $\frac{1}{4}$ ". For 110-120 volts, 60 cycle AC. Wt., 26 lbs.

94 RZ 716. NET. 76.50

Budget-Priced Automatic

\$5450

Budget-priced 4-speed automatic phonograph—offers features usually found only in high-priced units. You'll

find it easy to carry—easy to play—easy to listen to—and easy on the budget! Plays 16 $\frac{2}{3}$, 33 $\frac{1}{2}$, 45 and 78 rpm records automatically. Rigid, die-cast aluminum tone arm is perfectly balanced for minimum record wear. Sensitive ceramic cartridge has turnover sapphire needles for standard and microgroove records. Jam-proof mechanism plays twelve 10" records, ten 12" records or fourteen 7" records, with intermix of any size records of same speed. 45 rpm spindle included. Motor shuts off after last record is played.

Two 4" speakers are vertically mounted for full, balanced tone. Lightweight cabinet has rugged locked-seam construction. Covered with scuff-resistant two-tone grey leatherette. Heavy-duty, easy-grip handle. Volume control and tone control on outside of case for easy adjustment. Size: 8x14 $\frac{3}{4}$ x17 $\frac{1}{2}$ ". For 110-120 volts, 60 cycles AC. Shpg. wt., 21 lbs.

94 RZ 717. NET. 54.50

Top-Value Automatic

\$3675

A value-packed, 4-speed phonograph offering many deluxe features for smooth, highly convenient operation.

Smooth-acting changer mechanism automatically plays 16 $\frac{2}{3}$, 33 $\frac{1}{2}$, 45 and 78-rpm records. Shuts off automatically after last record plays and intermixes 10" and 12" records of the same speed. Changer has rubber turntable mat for record protection and high-quality 4-pole motor for constant-speed operation. It's an excellent value at this remarkably low price!

Full-toned PM speaker provides plenty of volume for classroom use, parties, etc. Light in weight, it's easy to carry from room to room. Turnover cartridge with separate sapphire stylus for microgroove and standard recordings. Cartridge is heat and humidity-proof. With 45-rpm automatic spindle. Brown-and-tan tweed case with sturdy, balanced-position carrying-handle provides maximum portability. Size: 13 $\frac{1}{4}$ x11 $\frac{1}{2}$ x8 $\frac{1}{2}$ ". For operation from 110-120 v., 60 cycle AC. Shpg. wt., 20 lbs.

98 RZ 599. NET. 36.75

Extended-Range Single-Play Phonograph

\$3330

This popular 4-speed phonograph is easy to carry, easy to play, easy to listen to—and easy on the budget. Rich, lifelike sound is delivered by 2 speakers—a 5 $\frac{1}{4}$ " speaker for bass and a second 4" speaker for wide dispersion of the high notes. Plays 7", 10" and 12" records at 33 $\frac{1}{2}$, 45 and 78 rpm; also plays 16 $\frac{2}{3}$ rpm "talking book" records. Contoured turntable for 45 rpm records prevents record slippage. Heavy flocking assures maximum record protection and constant speed. Has volume and tone controls. Convenient "magic center" for 45's built right in, no spindle changes, can't get lost—with a slight twist it pops up, ready to play. Full-range ceramic cartridge is impervious to heat and moisture and other extremes of temperature—provides extra-long life in hot, humid climates. Has two sapphire needles for standard and microgroove records. Attractive case finished in cadet blue and white leatherette, pyroxylin coated for extra-long life. Size, 13 $\frac{1}{2}$ x11 $\frac{1}{4}$ x8 $\frac{1}{2}$ ". For operation from 110-120 volts, 60 cycle AC. Shpg. wt., 14 lbs.

94 RX 718. NET. 33.30

Top-Value Single-Play Phonograph

\$2350

A world of listening pleasure is yours—at a very low price—with this handsome 4-speed portable phonograph. Plays single records at all 4 speeds—33 $\frac{1}{2}$, 45, 78 and "talking book" 16 $\frac{2}{3}$ rpm. Heavy-duty turntable has built-in adapter for 45 rpm records. Smooth-acting drive mechanism and constant-speed motor assure quiet, true-pitch operation. High-efficiency PM speaker, electrically balanced for finest tone quality. Newly designed amplifier provides plenty of volume. Turnover crystal cartridge and dual sapphire needles for standard and microgroove records. Separate volume and tone controls. Case is attractively styled in red and white leatherette, pyroxylin coated. Size, 7x12 $\frac{1}{2}$ x11 $\frac{1}{2}$ ". For operation from 110-120 volts, 60 cycle AC. Shpg. wt., 10 lbs.

94 RX 941. NET. 23.50

4-Speed "High-Style" Single-Play Phonograph

\$2895

Attractive styling and outstanding performance make this 4-speed phonograph an excellent buy. The luggage-type case is covered in striking red and white polka-dot vinyl plastic. Plays at 33 $\frac{1}{2}$, 45 and 78 rpm speeds, and at 16 $\frac{2}{3}$ rpm for "talking book" records. Heavy-duty turntable has grooved rubber mat to prevent record slippage. Has built-in flip-up 45 rpm adapter. Heavy-duty motor develops smooth, steady power to assure constant speed and quiet operation. High-quality crystal cartridge with dual sapphire needles brings out the full beauty of your records. Twin 4" speakers and powerful amplifier provide ample reserve power and wide dispersion of sound. Speakers are matched and rigidly mounted for low resonance and minimum distortion. Tone and volume controls. 5 $\frac{3}{4}$ x13 $\frac{1}{2}$ x12 $\frac{1}{2}$ ". For operation from 110-120 volts, 60 cycle AC. Shpg. wt., 10 $\frac{1}{2}$ lbs.

94 RX 940. NET. 28.95



HI-FI AND AUDIO TEST RECORDS



Famous Cook High-Fidelity Records

"SOUNDS OF OUR TIMES" SERIES

Famous hi-fi records, noted for their brilliantly realistic sound and off-beat content. All are 99.7% pure vinyl. Precision recording equipment and new "microfusion" process assure less surface noise.

10" 33 1/2 RPM RECORDS

- 1013. ACCORDION POPS CONCERT. Charlie Magnante plays eight "pop" tunes.
- 1041. SPEED THE PARTING GUEST.
- 1056. THE MORELIA CATHEDRAL ORGAN.
- 1057. FOORT POPS. Theater organ music.
- 1070. RAIL DYNAMICS. N. Y. Central.
- 1086. DRUMS OF RODRIGUEZ. Jazz rhythms. Any record above. Shpg. wt., 8 oz.
- 65 RR 600. Specify record No. EA. 3.98

12" 33 1/2 RPM RECORDS

- 1022. HAITI CONFIDENTIAL. Voodoo dancers and music of Haiti.
- 1040. STEEL BAND CLASH. Mambos, sambas, calypsos by Antigua steel bands.
- 1042. STEEL BANDS OF ANTIGUA.
- 1044. THE COMPLEAT IN FIDELITY. Jet plane, engines, 10,000 hens, etc.
- 1059X. INTERMISSION IN THE MOSQUE. Movie-palace organ music.
- 1071. BURLESQUE UNCENSORED. Live show.
- 1083. JAWBONE OF AN ASS. Cuban jazz.
- 1094. SEVEN LAST WORDS (DUBOIS). Willis Page, conducting Boston Chorale.
- 1132. THE JAPANESE KOTO. Imperial Japanese stringed instrument court music.
- 1183. HOT SONGS MY MOTHER TAUGHT ME. Lizzie Miles belting out jazz classics. Any record above. Shpg. wt., 10 oz.
- 65 RR 642. Specify record No. EA. 4.98

New "Talking Book" Records

- Exciting, new 16 2/3-rpm "Audio Book" records. All records are 7" with 1 1/2" diameter center hole. Use .001" stylus. Playing time per record, 50 min.
- C-300. ALICE IN WONDERLAND. 3 records, delightfully read by Marvin Miller and Jane Webb. Wt., 9 oz.
 - 68 RR 403. Specify Book No. NET... 2.62
 - C-305. RIP VAN WINKLE & THE LEGEND OF SLEEPY HOLLOW. Single record, read by Elinor Gene Hoffman. Wt., 3 oz.
 - C-307. GULLIVER'S TRAVELS. Single record, read by Hal Gerard. Wt., 3 oz.
 - 68 RR 404. Specify Book No. EACH... 99
 - GL-601. FAMOUS POEMS. 4 records; 74 poems. Read by M. Miller. 12 oz.
 - GL-602. THE BEST OF MARK TWAIN. 4 records; 17 stories. Read by M. Miller.
 - 68 RR 405. Specify Book No. EACH... 3.28
 - GL-607. COMPLETE SONNETS OF WILLIAM SHAKESPEARE. 3 records; 154 sonnets. Magnificently read by Ronald Colman. Shpg. wt., 9 oz.
 - 68 RR 406. Specify Book No. NET... 2.62
 - R-901. COMPLETE NEW TESTAMENT. Authorized King James Version. 26 records. Shpg. wt., 2 1/2 lbs.
 - R-902. THE OLD TESTAMENT. Authorized Version. 26 records. Shpg. wt., 2 1/2 lbs.
 - 68 RR 401. Specify Book No. EACH... 19.97
 - R-903. COMPLETE NEW TESTAMENT. Catholic Edition. 30 records. Wt., 2 3/4 lbs.
 - 68 RR 402. Specify Book No. NET... 23.30
 - MODEL A-100 16 2/3 RPM ADAPTER. Fits on any record player. Converts 33 1/2 rpm speed to 16 2/3 rpm. Shpg. wt., 1 lb.
 - 68 R 400. NET... 1.40

12" 33 1/2 RPM RECORDS (Cont'd)

- 1185. CALYPSO KINGS AND PINK GIN. Trinidad's top singers hold a revel.
- 1186. MERINGUE. Calypso music recorded at an impromptu Haitian concert.
- 10120. MUSIC BOXES, CAROUSELS & HAND ORGAN. Merry-go-round music.
- 10248. VOICE OF MEXICO. Trio with guitar.
- 10251. KILTS ON PARADE. Scot bagpipes.
- 10271. FIESTA FLAMENCA. Gypsy music.
- 10289. MONTOYA (PATTERNS IN FLAMENCO).
- 10301. THE HARP. Edward and Joseph Vito.
- 10326. CAFE CONTINENTAL. Zither, etc.
- 10350. NICKELODEON & CALLIOPE.
- 10501. PIPE ORGAN IN THE MOSQUE.
- 10523. PERCUSSION AND PEDAL. R. Foort.
- 10545. THE ORGAN AT SYMPHONY HALL.
- 10646. TEMPO VIVACE. Symphonic dances.
- 10657. MOZART SYMPHONY NO. 40 AND BEETHOVEN'S FIFTH SYMPHONY.
- 10889. HORIZONTAL & UPRIGHT. Red Camp.
- 11312. FORGOTTEN PEDAL HARPSICHOORD.
- 11815. CLAMBAKE ON BOURBON ST. Any record above. Shpg. wt., 10 oz.
- 65 RR 642. Specify record No. EA... 4.98

"ROAD RECORDINGS" SERIES

- 12-inch, 33 1/2 rpm recordings made "on location," not studio recorded. **"Duplex" two-track recordings—outside track equalized for monaural playback; both tracks may be used to obtain a stereo effect.
- 5003. CARIBEANA. Calypso music.
 - 5007. *MARIMBA BAND. Mexican music.
 - 5010. *CALLIOPE AND CAROUSEL.
 - 5011. *VOICE OF THE SEA. Surf, foghorns, etc.
 - 5012. OUT OF THIS WORLD. Earthquake.
 - 5014. MARIACHI MUSICAL FROM MEXICO. Any record above. Shpg. wt., 10 oz.
 - 65 RR 620. Specify record No. EA. 4.98

HI-FI TEST RECORDS

COOK AUDIO TEST RECORDS

- SERIES 10, 10", 78 RPM. For checking response of audio playback equipment. "V" groove permits playing entire record with .001" or .003" stylus. Accurately calibrated from 35 to 20,000 cps. 8 oz.
- 65 R 085. NET... 3.98
- SERIES 10-LP. As above, 33 1/2 rpm.
- 65 R 086. NET... 3.98
- SERIES 50NAB. 12". Checks IM distortion in cartridges, amplifiers, speakers. No instruments needed—simply play record and listen. If distortion exceeds 2%, code letter "N" is heard. Under 2%, "A" is heard. 33 1/2 and 78 rpm. Wt., 10 oz.
- 65 R 096. NET... 4.98

CLARKSTAN TEST RECORDS

- STEADY-STATE FREQUENCY RECORDS. Spot frequencies through range of 50 to 10,000 cps for checking 33 1/2 or 78 rpm equipment. Can be re-used.
- TYPE 2001S-2002S. 12" vinylite (2 sides), 33 1/2 rpm. One side NARTB, other side flat. 10 oz.
- 69 R 223. NET... 3.82
- TYPE 102M AUDIO SWEEP FREQUENCY. 12" vinylite (1 side) 33 1/2 rpm. Used with oscilloscope. Sweeps 70-10,000 cps 20 times per NARTB curve. Shpg. wt., 10 oz.
- 69 R 231. NET... 6.47

Audio Fidelity Records

Wide-range, high-fidelity records. Exceptionally clean; fascinating to listen to. All are 12", 33 1/2 rpm.

- 1801. THE BRAVE BULLS! (La Fiesta Brava). "Banda Taurina" of the Plaza Mexico.
- 1802. MARIMBA MAMBO y CHA-CHA-CHA. 6-man marimba, plus orchestra.
- 1810. CHA CHA CHA. Latin rhythms by Pedro Garcia and Del Prado Orch.
- 1814. PATACHOU (Paris c'est une blonde) Vocals in French and English.
- 1815. ACCORDION DE PARIS. Jo Basile & orchestra play nostalgic cafe music.
- 1818. TORERO! (La Fiesta Brava), VOL. 3. Music of the Bullfighting Ring.
- 1819. FIESTA EN ESPANA. Fiery Spanish gypsy music; authentic Flamenco.
- 1821. RENDEZVOUS A PARIS. Jo Basile plays 16 enchanting selections.
- 1822. ROME WITH LOVE. Jo Basile Orch.
- 1823. THE DUKES OF DIXIELAND.
- 1825. MALLET MAGIC. Harry Breuer and his Quintet. Vibes, glockenspiel, etc.
- 1827. HONKY TONK PIANO. Eddie "Pianola" Barnes plays old-time favorites.
- 1828. LEON BERRY AT THE GIANT WURLITZER PIPE ORGAN. Waltzes, "pop" tunes.
- 1830. JOHNNY PULEO AND HIS HARMONICA GANG. Swingtime standards.
- 1840. DUKES OF DIXIELAND. VOL. 2. Sweet Georgia Brown, Blue Heaven, etc.
- 1851. MARCHING ALONG WITH THE DUKES OF DIXIELAND. Bourbon Street Parade, other favorite marches. Any record above. Shpg. wt., 10 oz.
- 65 RR 628. Specify record No. EA. 5.95

"Hi-Fi Record" Records

- Quality of sound reproduction is truly impressive. All are 12", 33 1/2 rpm.
- R-602. BAND WITH A BEAT. Swing orch.
 - R-701. GEORGE WRIGHT PLAYS THE MIGHTY WURLITZER PIPE ORGAN.
 - R-702. GEORGE WRIGHT ENCORES AT THE MIGHTY WURLITZER PIPE ORGAN.
 - R-703. RICHARD PURVIS ORGAN RECITAL IN GRACE CATHEDRAL. Vol. 1.
 - R-707. MORE GEORGE WRIGHT.
 - R-708. GEORGE WRIGHT'S SHOW TIME.
 - R-710. THE GEORGE WRIGHT SOUND.
 - R-712. GEORGE WRIGHT PLAYS THE CONN ELECTRIC ORGAN.
 - R-713. THE GENIUS OF GEORGE WRIGHT.
 - R-801. QUARTERLODEONS. Old-time mechanical pianos, other relics. Any record above. Shpg. wt., 10 oz.
 - 65 RR 623. Specify record No. EA. 4.95

Replica Hi-Fi Records

- Wide-range, distortion-free records. All are 12", 33 1/2 rpm recordings.
- 504. AL MELGARD AT THE CHICAGO STADIUM ORGAN. VOL. 1.
 - 509. BEAST IN THE BASEMENT. Leon Berry.
 - 510. MELGARD AT STADIUM ORGAN. VOL. 2
 - 511. FABULOUS EDDIE OSBORN. VOL. 1.
 - 513. MATINEE. Theatre organ.
 - 518. THIS IS MELGARD.
 - 1001. THE HI-FIMONICS. Harmonica group.
 - 1003. JAZZ. Paul Severson Septet swings.
 - 2501. GLOCKENSPIELS, TRAPS AND PLENTY OF PIPES. VOL. 1. Leon Berry.
 - 2503. GLOCKENSPIELS, TRAPS, ETC. VOL. 2. Any record above. Shpg. wt., 10 oz.
 - 65 RR 624. Specify record No. EA. 4.98

WALSCO REPLACEMENT PARTS

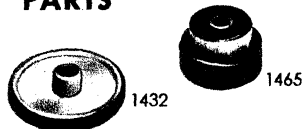

To obtain top performance from your equipment, replace worn belts, pulleys, idlers, etc., with Walasco identical replacements listed below. *How To Order.* The reference list below is arranged alphabetically by manufacturers. It lists model numbers of equipment and Walasco type numbers of available replacement parts. To select the parts needed, check the Walasco type numbers given for your equipment, against the descriptive list at the bottom of the page. When ordering give Allied's Stock No., Walasco type number, and description.

REFERENCE LIST

Mfr. and Models	Walsco Type No.
Admiral 150,160, 161, 161A, 200.....	1432
160A, 170, 170A, 180, 181.....	1434
Collaro RC54, 3RC51, 3RC532.....	1449
Garrard RC80.....	1415 & 1444
T, TA.....	1445
G.E. P-6, P-14, P-15, P-16.....	1432
P-8, P-10, P-17.....	1437
P-12, P-13.....	1433
P-14, P-15, P-16.....	1460, 1461 & 1462
P-17.....	1463, 1464 & 1465
P-15.....	1414 & 1415
Motorola VM3RC.....	1432, 1460, 1461 & 1462
VM4RC.....	1434, 1466, 1467 & 1468
W4RC.....	1437
Pentron CT-1, RWN.....	1410-08
RWN.....	1483
9T-3, 9T-3C, 9T-3M, PB-1, PBA2, HF400, HT225, MP-2, T-90, TM-56, TR-4.....	1409-02 1409-03 & 1483
Philco M-7, M-8.....	1434
M-9C, M-12C.....	1432
M-12C, M-20, M-24A, M-26, M-28.....	1415
RCA RP-168, 190 Series.....	1447
15E, 15E-1.....	1432, 1460, 1461 & 1462
GEMP-1, GEMP-2.....	1433
Silvertone 101, 211, 101, 212, 101, 762, 101, 763, 488, 218.....	1434
101, 761-2, 101, 761-3, 101, 762-2.....	1432
488, 219.....	1414 & 1432
488, 218.....	1461 & 1462
VM 400D, 402D, 404, 405, 800D.....	1433
406, 407, 802, 910, 935, 936.....	1432
100A, 105, 406, 407, 802.....	1414
406, 407, 920, 990.....	1460, 1461 & 1462
920, 990.....	1452
1200.....	1456
Weber 7, 18, 50, 56, 70, 78, 79, 80, 81, 100, 101, 106, 109, 110, 133, 146, 148, 156, 178, 180, 181, 246, 256, 288, 346, 356.....	1437
100, 101, 106, 109, 110, 346, 356.....	1463, 1464 & 1465
210, 2010, 2030, 2110, 2130, 2131, 2132, 2611, 2612.....	1455
135, 136.....	1469
2020, 2021, 2022, 2024.....	1410-21
2611, 2612, 2614, 2615, 2640.....	1410-15

Stock No.	Type	Description	NET
43 N 423	1409-02	Feed Belt	1.47
43 N 427	1410-08	Belt, 2.73" I.D.	.51
43 N 429	1410-15	Belt, 4.86" I.D.	.88
43 N 430	1410-21	Belt, 6.73" I.D.	1.47
43 N 401	1415	Belt, 1/2" O.D.	.15
43 N 402	1415	Belt, 1/4" I.D.	.15
43 N 406	1432	Idler, 2" O.D.	.59
43 N 431	1433	Idler, 2" O.D.	.65
43 N 407	1434	Idler, 2" O.D.	.71
43 N 408	1437	Idler, 2 1/2" O.D.	1.03
43 N 432	1444	Inter-wh. 2" O.D.	1.18
43 N 433	1445	Inter-wh. 2" O.D.	1.18
43 N 412	1447	45rpm Wheel	.65
43 N 434	1449	Idler, 2 1/2" O.D.	1.18
43 N 435	1452	Idler, 1 1/2" O.D.	.59
43 N 436	1455	Roller, 1/2" O.D.	1.35
43 N 437	1456	Wheel, 1 1/2" O.D.	1.79
43 N 413	1460	78 rpm Pulley	.76
43 N 414	1461	45 rpm Pulley	.68
43 N 415	1462	33 1/2 rpm Pulley	.68
43 N 416	1463	78 rpm Pulley	1.47
43 N 417	1464	45 rpm Pulley	1.47
43 N 418	1465	33 1/2 rpm Pulley	1.47
43 N 419	1466	78 rpm Pulley	.73
43 N 420	1467	45 rpm Pulley	.73
43 N 421	1468	3 1/2 rpm Pulley	.73
43 N 422	1469	Turret Drive	.94
43 N 438	1483	Idler, 2" O.D.	.88

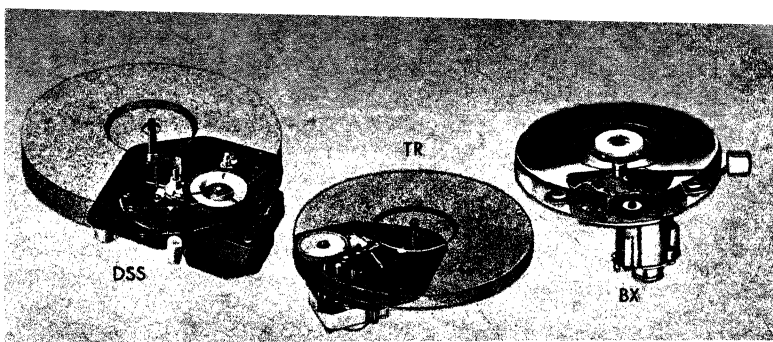

General Industries Phono Motors

MODEL DSS. 3-speed phono motor with 10" turntable. Features 4-pole, shaded-pole motor. For high-fidelity phono systems. For use with all types of phono cartridges, including magnetic. Plays 33 1/2, 45, and 78 rpm records. Turntable is rim driven by idler wheel. Speed selector moves idler wheel to appropriate step on motor shaft for desired speed. Turning speed selector to "off" position automatically turns off motor and disengages the idler wheel from turntable. Other features include: Constant speed; oilless motor and turntable bearings; dynamically balanced rotor. Supplied complete with speed indicator dial, 10" turntable, 45-rpm record adapter, and "On-off" switch. Size, less turntable: 4 1/2 x 6 1/2 x 6 1/8". Requires 2 1/2" below mounting plate. For operation from 110-120 volts, 60 cycle AC. Shpg. wt., 6 1/2 lbs.
85 R 275. List, \$24.50. NET..... 14.70

MODEL SS. 3-speed phono motor with 8" turntable. Induction-type, 2-pole motor features oilless bearings and balanced rotor. Plays 33 1/2, 45 and 78 rpm records. Idler wheel is disengaged in "off" position. With speed indicator dial, turntable, and 45-rpm record adapter. Size, less turntable: 3 1/2 x 4 1/2 x 4 3/4". Requires 2 1/2" below mounting plate. For operation from 110-120 volts 60 cycle AC. Shpg. wt., 4 lbs.
85 R 276. List, \$10.95. NET..... 6.57

MODEL TR. 3-speed phono motor with 9" turntable. Constant-speed, 2-pole motor provides quiet, dependable operation. Speeds of 33 1/2, 45, and 78 rpm from separate pulleys. With speed selector in "off" position, pulleys are disengaged from motor shaft. With speed indicator dial, 45-rpm record adapter, and 9" turntable. Size, less turntable: 3 1/2 x 5 1/2 x 5 3/4". Requires 1 1/2" below mounting plate. For 110-120 volts, 60 cycle AC. Shpg. wt., 4 lbs.
96 R 367. List, \$12.45. NET..... 7.47

BATTERY-OPERATED PHONO MOTORS. New, high-quality phono motors for portable use. Perform on 4 flashlight cells (below)! Have 6" plastic turntable. Constant speed 2-pole motors are rubber grommet mounted for extra cushioning. Enclosed motors have self-lubricated bearings. Type BX has speed shift (lever can be located on either side of turntable) and neutral "off" position. Size, 6 1/2 x 4 1/2 x 2 3/4". Require 2" below mtg. surface. Shpg. wt., 1 lb.

No.	Type	Speeds	NET
85 R 203	BX	45, 33 1/2, 16 2/3 rpm	8.70
85 R 204	BX-45	45 rpm	7.65

TYPE 2 BURGESS BATTERY. For use with above (4 required). Wt., 6 oz.
53 J 009. NET EACH..... 14c

Alliance 3-Speed Phonograph Motor

MODEL JPT8. 3-speed phono motor with 8" turntable. Constant-speed, 2-pole motor. Plays 33 1/2, 45, and 78 rpm records. Speed selector moves idler to position for desired speed. Rubber shock-mounted motor. With 45 rpm record adapter. Mounts in 4 3/8 x 5 1/4" cutout. Requires 2 1/2" below base plate. For operation from 110-120 volts, 60 cycle AC. Shpg. wt., 3 1/2 lbs.
85 R 440. List, \$10.95. NET..... 6.44

MODEL JPQ8. As above, but 4 speeds: 78, 45, 33 1/2, and 16 2/3 rpm.
85 R 442. List, \$11.86. NET..... 6.97

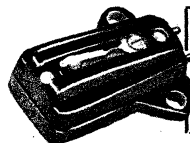
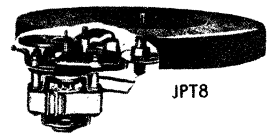

Ronette "Fonofluid" Phono Cartridges

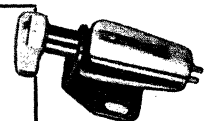

SINGLE-STYLUS CARTRIDGES

MODEL RA-284-OV. Single-stylus crystal cartridge. Replacement for most 45 and 33 1/2 rpm player cartridges. "Fonofluid" construction achieves smooth response from 50 to 9000 cps. 0.7 volts output. Requires 5 grams needle pressure. Supplied complete with hardware and .001" sapphire stylus. 5/8" mtg. centers. Shpg. wt., 4 oz.
65 R 015. List, \$7.25. NET..... 4.26

MODEL RA-395. New, high-output single-stylus crystal cartridge for use with 1 or 2-tube amplifiers. Direct replacement for RCA-type cartridges in 45 and 33 1/2 rpm players. Response from 50 to 4000 cps. Output is 2.2 volts. Requires 12 grams tracking pressure. 5/8" mounting centers. Complete with hardware and .001" sapphire stylus. Shpg. wt., 4 oz.
65 R 079. List, \$7.25. NET..... 4.26

DUAL-STYLUS CARTRIDGES

MODEL TO-284-OV. Dual-stylus, turnover crystal cartridge with .001" and .0025" sapphire tips. "Fonofluid" construction assures excellent reproduction. Response, 50-9000 cps. Stylus pressure 4-6 grams. 0.7 volt output. With hardware. 1/2" mtg. centers. Shpg. wt., 2 oz.
65 R 016. List, \$9.00. NET..... 5.29

MODEL TO-400-OV. New, dual-stylus, turnover cartridge. As above, but front mtg. for automatic changers with narrow tone arms using bar-type knob. 4 oz.
68 R 360. List, \$9.00. NET..... 5.29

MODEL TO-222. Dual-stylus, turnover-type crystal cartridge. Same as RA-395 (left) but has added sapphire stylus for 78 rpm records. 1/2" mtg. center. Shpg. wt., 4 oz.
65 R 968. List, \$9.00. NET..... 5.29

Replacement needles for Ronette cartridges are on page 85

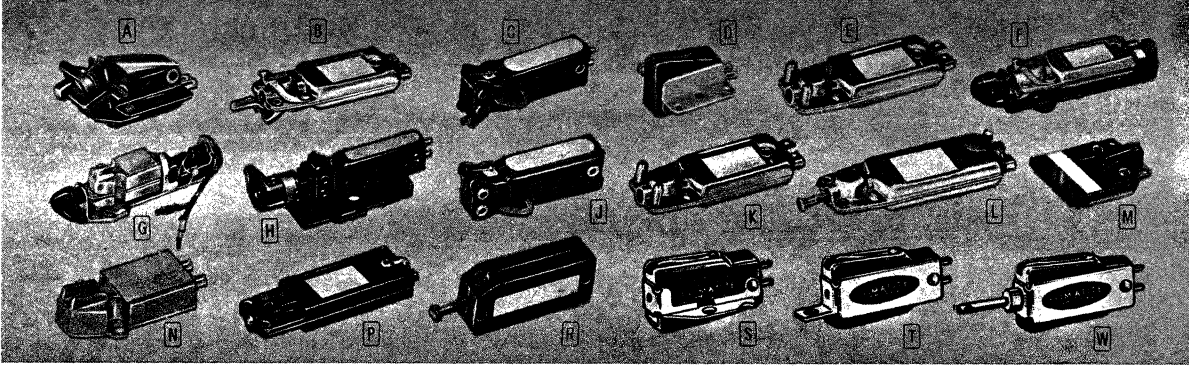

ASTATIC CRYSTAL AND CERAMIC CARTRIDGES

TURNOVER CARTRIDGES

High-quality dual-needle cartridges for 78, 45 and 33 1/2 rpm records. For direct replacement in most popular record players. Types 310-T through 424-TS are new Climatite types; crystals are specially treated to resist heat and humidity. All have sapphire needles; .001" tip for microgroove records and .003" tip for standard records. With bracket (standard 1/2" mounting centers) except *less bracket. *Ceramic type, others are Rochelle-salt crystal. Needle pressure, †6 grams; ‡8 grams; §10 grams. Av. shpg. wt., 4 oz.

Stock No.	Model No.	Fig.	Replaces Astatic Models	Output Volts	Response CPS	List	NET EACH
65 R 240	40-TB†	H	ACD-1 series, ACD-2 series, 11L3	1.0	50-6000	\$ 8.45	4.97
65 R 216	44-TB§	G	CAC-D, 44T series	0.7	30-15,000	10.50	6.17
65 R 576	57-T*†	A	57-TJ series	0.7	30-15,000	9.50	5.59
65 R 236	82-TV†	B	LQD-1 series	1.0	50-7000	9.50	5.59
65 R 029	66-TB§	F	14L3-DMB, 68-T(M)B	3.0	50-5000	9.00	5.29
65 R 013	66-TS§	B	66-T(M)S, 68-TS	3.0	50-5000	8.50	5.00
65 R 577	66-TV**§	B	LT-4D1, 14L3-DM, 15L3-DM, 66-T(M)Y, 68-T(M)Y	3.0	50-5000	8.50	5.00
61 R 300	310-T***	S	3.0	30-11,000	6.95	4.09
61 R 301	310-TB†	W	3.0	30-11,000	7.45	4.38
61 R 302	312-TB†	W	0.75	30-13,000	7.45	4.38
61 R 303	420-TS***	W	3.0	30-11,000	6.95	4.09
61 R 304	422-TS***	W	0.75	30-13,000	6.95	4.09
61 R 305	424-TS***	W	3.0	30-11,000	7.50	4.41

ALL-GROOVE CARTRIDGES

Convenient single-needle cartridges play 78, 45 and 33 1/2 rpm records. All have .002" sapphire needle for both standard and microgroove records, except †.002" osmium needle, glass needle—have screw-type chuck for conventional needle. See page 85 for suitable type. All are designed for 1/2" mounting centers. Model 51-2 fits RCA 45-rpm changer arms. Model 310-2 is for new Astatic "B" arm; crystal is chemically treated to resist heat and moisture. *Has heat and humidity-resistant ceramic element; all others have Rochelle-salt crystal element. Needle pressure, 10 grams, except †6 grams, ‡8 grams. Av. shpg. wt., 4 oz.

Stock No.	Model	Fig.	Replaces Astatic	Volts	CPS	List	NET
65 R 559	16§	E	16L3, 17L3	3.5	50-5000	\$6.00	3.53
65 R 229	22§	K	L-29, L-92-33, 18L3	3.0	50-5000	6.00	3.53
65 R 242	40-†	J	AC-AG series	1.0	50-10,000	6.50	3.82
65 R 571	51-2*†	D	GC-AG series	0.7	30-10,000	7.40	4.35
65 R 091	66-2††	E	LT-2M, LT-5AG, 68-2	3.0	50-5000	7.00	4.12
61 R 306	310-2†	T	14L3-AGM, 15L3-AGM	3.0	30-11,000	6.45	3.79

MICROGROOVE CARTRIDGES

Carefully-constructed microgroove cartridges for dependable performance and very clean reproduction in record changers and players. All are crystal type, except *ceramic type, unaffected by heat and humidity. With .001" sapphire needle for 45 and 33 1/2 rpm records. Model 51-1 fits RCA 45-rpm changer arms. Model 44-1 equalized for Columbia 33 1/2 rpm records; has adapter for RCA 45-rpm changer arms. Model 414-1 used in RCA players. Has specially treated crystal to resist heat and moisture. See page 85 for listings of replacement needles. Needle pressure, 10 grams, except †8 grams, ‡6 grams. Av. shpg. wt., 4 oz.

Stock No.	Model No.	Fig.	Replaces Astatic Models	Output Volts	Response CPS	List	NET EACH
65 R 241	40-1†	C	AC series	1.0	50-10,000	\$6.50	3.82
65 R 245	44-1	N	CAC, 441, QT-33, CQ series	1.0	30-15,000	7.50	4.41
65 R 234	51-1*	D	GC series	0.7	30-15,000	7.40	4.35
65 R 123	66-1	E	LT-1M, 14L3-M, 15L3-M, 68-1	3.0	50-5000	7.00	4.12
61 R 307	414-1†	S	3.0	30-11,000	6.45	3.79

STANDARD-GROOVE CARTRIDGES

Popular Rochelle-salt crystal and ceramic cartridges for 78-rpm changers and players. All are high-output crystal types, except *ceramic type unaffected by heat or moisture. Use .003" needles. With sapphire needle; †osmium. All others are supplied less needle; have screw-type chuck for conventional needle, see page 85. Model 12-U used in Admiral, RCA, and Webster; Model 2 used in Magnavox; 12 in Webster; 402 in Admiral. †Output with condenser, 4.0 volts less condenser. Needle pressure: Models 2 and 4—2 3/4 oz.; Models 6, 24 and 26—1 1/4 oz.; Models 12 and 12-U—1 oz. Model 32—1 1/2 oz.; Model 44-3—10 grams; and Model 402—12 grams. Av. shpg. wt., 4 oz.

Stock No.	Model No.	Fig.	Replaces Astatic Models	Output Volts	Response CPS	List	NET EACH
65 R 158	2	R	B-1, B-2, B-3, B-4	2.5	50-4000	\$7.50	4.41
65 R 156	4	P	L-22A, L-26A, L-27A	1.4	50-4500	5.00	2.94
65 R 153	6	P	L-40A, L-41A	0.6	50-5000	5.00	2.94
65 R 226	12	L	L-10, L-12	4.0	50-5000	4.95	2.91
65 R 227	12-U	L	L-12U	1.25†	50-5000	4.95	2.91
65 R 163	24	P	L-25A, series L-70, L-71, L-75, L-76	1.5	50-4000	5.55	3.26
65 R 165	26	P	L-46A, L-50A, L-72A	3.5	50-4000	6.65	3.91
65 R 231	32	P	L-24A, L-36A, L-82A, L-92, L-92A, 34	3.5	50-5000	5.55	3.26
65 R 198	44-3†	N	Series CAC-78, CQ-78	1.0	30-15,000	7.50	4.41
65 R 149	402*§	M	402-M	0.7	50-10,000	6.90	4.06

NEW HIGH-QUALITY CARTRIDGES

CARTRIDGE-NEEDLE COMBINATION

MODEL 81T. New Astatic "Soundflo" cartridge. Utilizes highly sensitive ceramic element to provide clear, wide-range audio reproduction. Movement is precision engineered for high compliance; permits accurate tracking of wide lateral groove variations. Assures excellent transient response and low distortion. Frequency response extends from 30 to 15,000 cps. Tracking force is 6 grams; assures long needle and record life. Cylindrical shaped housing accommodates "plug-in" replacement cartridge-needle combination, above. Greatly simplifies changing of styli. Flip-over mounting bracket allows quick change to proper styli. Has sapphire .001" stylus for 45 and 33 1/2 rpm, long-play records and sapphire .003" stylus for 78 rpm, standard play-records. Black housing has universal mounting bracket. Shpg. wt., 4 oz.

61 R 308. List, \$4.45. NET..... 2.62

MODEL 81T "PLUG-IN" REPLACEMENT CARTRIDGE. For above. Includes sapphire styli. Shpg. wt., 2 oz.

61 R 309. List \$3.95. NET..... 2.32

SUB-MINIATURE CARTRIDGES

New "Climatec" sub-miniature phono cartridges. Specially designed for original equipment and direct replacement in narrow arm record changers such as V. M., Philco, etc. Model 124TS has small dia. spindle, replaces Philco P122. Specially treated crystal element; resistant to heat and humidity. Model 118TS has 0.75 v. output and a frequency range from 30 to 13,000 cps. Models 120TS and 124TS have 3.0 v. outputs and a frequency range from 30 to 11,000 cps. All track at 8 grams. Highly compliant movements for low "needle-talk" and accurate tracking. Have round flip-over spindles and single screw mounting. Bracket has raised shoulder for snug fit; prevents shifting of needle placement when spindle is rotated. Connecting terminals have flat design for positive, vibration-proof contact. Complete with .001" microgroove and .003" standard sapphire styli. Wt., 3 oz.

61 R 310. Model 118TS Cartridge.

61 R 311. Model 120TS Cartridge.

61 R 312. Model 124TS Cartridge.

List Each, \$6.45. NET EACH..... 3.79

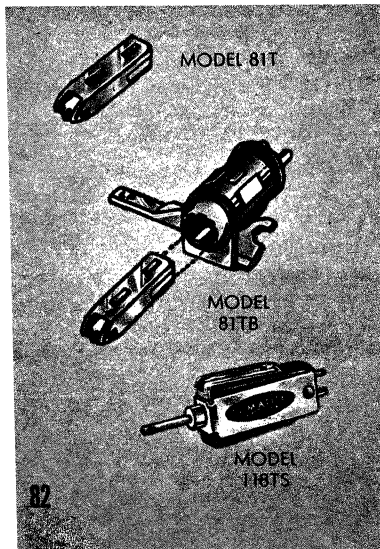

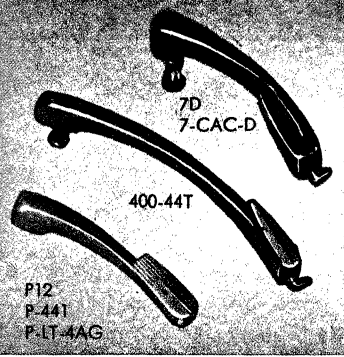

ASTATIC PICKUPS

ARMS WITH TURNOVER CARTRIDGES

Lightweight pickup arms for playing standard or microgroove records. Lever at front of pickup arm selects proper needle for 78, 45, 33 1/3 or 16 rpm records. Adjustable spring permits setting needle pressure for maximum protection of records, proper tracking and long needle life. Models 7D and 7-CAC-D for records up to 12", have threaded bushing 3/4" long, 1/2" dia. Model 400-44T for records up to 16", has threaded bushing 1 1/4" long, 1/2" diameter. Supplied with several spacer washers to permit adjusting height of arm to match that of turntable. All equipped with dual sapphire needles. Av. shpg. wt., 1 1/2 lbs.

Stock No.	Model	Cartridge	List	NET
65 R 220	7D	40-TB	\$15.90	9.35
65 R 219	400-44T	44-TB	25.50	14.99
65 R 218	7-CAC-D	44-TB	16.40	9.64

ARMS WITH CARTRIDGES

Pickups featuring Type P arms for records up to 12" diameter. Arms are made of aluminum-alloy for light weight. All have threaded bushing 3/4" long, 1/2" diameter. Model P-12 supplied less needle; cartridge has screw-type chuck which takes any conventional phono needle, see page 85. Model P-441 has sapphire .001" needle for microgroove records. Model P-LT-4AG has .002" osmium all-purpose needle for standard and microgroove records. Needle pressure can be precisely set by means of adjustable tension spring at rear of arm. With arm rest. Av. shpg. wt., 1 lb.

Stock No.	Model	Cartridge	List	NET
65 R 551	P-12	12	\$ 6.00	3.53
65 R 553	P-441	44-1	10.75	6.32
65 R 554	P-LT-4AG	60-2	9.50	5.59

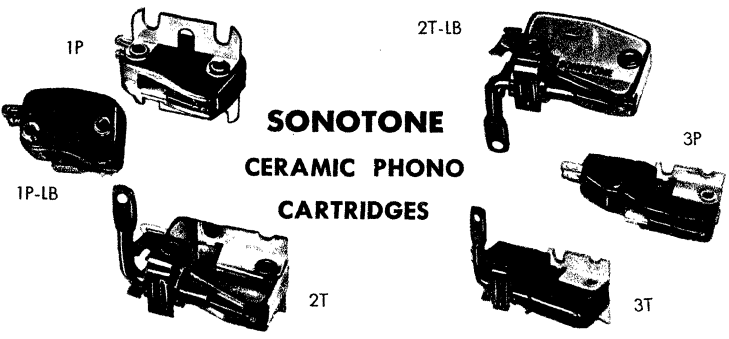

SONOTONE CERAMIC PHONO CARTRIDGES

SINGLE-NEEDLE CARTRIDGES

For exact replacement in many popular phonos. Do not require preamplification or equalization. Ceramic construction provides protection against heat and moisture; also prevents pickup of annoying hum from nearby magnetic fields. Have high compliance for accurate tracking. Sapphire needles, except 1P-1D and 1P-LB-1D which have diamond needles; .001" microgroove; .002" all-purpose (microgroove and standard). 1P-1S, 1P-2S, and 1P-1D have bracket for 1/2" or 5/8" mtg. centers. 1P-LB-1S, 1P-LB-2S, and 1P-LB-1D less bracket for narrow pickup arms. Response, ±3db 30-15,000 cps. Output, 1 v. Needle pressure 8-10 grams. Shpg. wt., 3 oz.

65 R 615.	1P-1S.	.001" tip.	NET	4.41
65 R 523.	1P-2S.	.002" tip.	NET	4.41
61 R 350.	1P-1D.	.001" tip.	NET	12.35
61 R 351.	1P-LB-1S.	.001" tip.	NET	4.41
65 R 843.	1P-LB-2S.	.002" tip.	NET	4.41
61 R 352.	1P-LB-1D.	.001" tip.	NET	12.35

TURNOVER-TYPE CARTRIDGES

High-quality ceramic cartridges. Used as original equipment in many modern phonographs. Will substantially improve sound quality when used in older players. Easily installed; do not require cut-out for turnover mechanism. Models 2T-S and 2T-SD have bracket for 1/2" or 5/8" mtg. centers; 2T-LB-S and 2T-LB-SD less bracket for narrow pickup arms. Response, ±3 db 30-15,000 cps. Output 1 v. Needle pressure, 8-10 grams. Models 2T-S and 2T-LB-S have .001", microgroove and .003", standard sapphire tips; 2T-SD and 2T-LB-SD have .001" diamond and .003" sapphire tips. Shpg. wt., 3 oz.

65 R 533.	Model 2T-S.	NET	5.00
65 RC 844.	Model 2T-SD.	NET	12.94
65 R 528.	Model 2T-LB-S.	NET	5.00
61 R 353.	Model 2T-LB-SD.	NET	12.94

WIDE-RANGE CARTRIDGES

Deluxe, Series "3" cartridges. Provide unusually clean, natural reproduction. Response is within ±1.5 db from 20 to 15,000 cps with a gradual roll-off to 20,000 cps. Lack of resonant peaks and low distortion provide exceptional ease of listening. Highly compliant movement assures accurate tracking and low needle and record wear. Tracking force is only 6 grams. Cartridges are self-equalizing; automatically match modern (RIAA, I.P., NARTB, AES, etc.) recording curves without using external record compensators. Also, have sufficient output (0.5 v.) to eliminate need for preamplification.

Ceramic elements are unaffected by heat or moisture. Have standard 1/2" and 5/8" mounting centers to fit most phonos. Single-needle types: 3P-1S has .001" sapphire stylus; 3P-1D has .001" diamond stylus. Turnover-stylus types: 3T-S has .001" and .003" sapphire styli; 3T-SD has .001" diamond and .003" sapphire styli. Shpg. wt., 3 oz.

65 R 857.	Model 3P-1S.	NET	7.35
65 RC 928.	Model 3P-1D.	NET	13.52
65 R 929.	Model 3T-S.	NET	8.53
65 RC 948.	Model 3T-SD.	NET	14.11

REPLACEMENT NEEDLES

For Sonotone cartridges. S—Sapphire; D—Diamond. Interchangeable types: 3P-1S and 3P-1D; 3T-S and 3T-SD; 2T-S and 2T-SD; 1P-1S, 1P-1D, and 1P-2S. Shpg. wt., 2 oz.

Stock No.	For	Tip	NET
68 R 319	1P-1S	S-.001"	1.47
61 R 354	1P-1D	D-.001"	9.11
65 R 519	1P-2S	S-.002"	1.47
65 R 534	2T-S	S-.001", S-.003"	2.06
65 RC 529	2T-SD	D-.001", S-.003"	9.70
68 R 317	3P-1S	S-.001"	1.76
68 RC 316	3P-1D	D-.001"	9.70
68 R 318	3T-S	S-.001", S-.003"	2.35
68 RC 315	3T-SD	D-.001", S-.003"	10.29

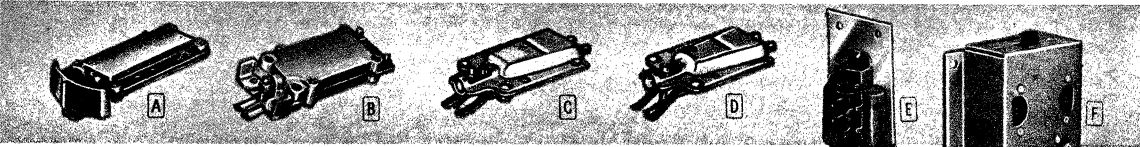

RCA PHONO COMPONENTS

REPLACEMENT CARTRIDGES

All are Rochelle-salt crystal type, except *heat and humidity-resistant ceramic element. All are supplied complete with needle. Needle types: †Sapphire standard, ‡sapphire microgroove, §osmium microgroove, ¶osmium standard and sapphire microgroove, §sapphire standard and microgroove. Av. shpg. wt., 5 oz.

Stock No.	Mfg. Type	Fig.	Used in RCA Models	List Each	NET Each
65 R 269	9890†	A	60U, 70VS, 0-50, R60, R93F, R100, R103S, QU56C, U8, U9, U10, YA21, V100, V101, V105, Radiola 560P	\$7.80	4.59
65 R 270	70338-A†	B	6J, 6JM, 55AU, 62-1, 63E, 63EM, 65AU, 65AUI, 65U, 65UI, 67AV1, 67V1, 75ZU, 77V1, 77V2		
65 R 253	74067††	D	9EY3, 9EY35, 9EY36, 9EYM3, 9YJ, 9YJM, 9TW333, 9TW390, 9W101, 9W102, 9W103, 9W105, 9Y7, 9Y81, 45EY, 45EY1, 45J, 45J2	7.25	4.26
65 R 254	75575††	D	2T81, 4T141, 6T84, 6T86, 7T132, 9T89, 9T147, 9Y510, A82, A101	6.40	3.76
65 R 917	75976†	A	58AV, 58V, 59AV1, 59V1, 66E, 610V1, 610V2, 641TV, 711V1, 711V2, 711V3, QU61, QU62, QU72, QU72A	6.40	3.76
65 R 215	76257§§	C	2ES3, 2ES31, 2ES38, 2JS1, 2S7, 2S10, 2T81, 2U87, 3U55, 4T141, 6T84, 6T86, 6T87, 7T143, 9T89, 9T147, 15E, 21D346, 21D395, 21T342, 21T342	7.50	4.41
65 R 255	77779§			6.75	3.92
65 R 913	100653*†	4ES31Q, 4ES38Q, 4ES10, 6ES4Q, 6ES5, 6HF3, 6HF4, 6HF4Q, 6HF5, 6HF5Q, 6JS1Q, 6JS2Q, 7HFP1, 7HFP1Q	9.50	5.59

PHONO SWITCHES

E Type 240X1 Radio-Phono Switch. For operation of record players through radios that do not have a phono input. Slide switch permits instant change-over from radio to phonograph. Unit is connected between detector and first audio stage in radio. Panel has mounting holes for neat, back-of-the-cabinet installation. With shielded cable, phono plug and complete instructions. Shpg. wt., 6 oz.

69 R 505.	List, \$2.50.	NET	1.47
-----------	---------------	-----	------

F Type 202W1 Record Player Selector Switch. For using either of two record players or changers with one radio or amplifier. Slide switch controls both audio output and motor power. Excellent for radio-phonograph combinations to which an external 45-rpm player has been added. Back-of-cabinet mounting. Complete with plugs and instructions. Shpg. wt., 6 oz.

69 R 506.	List, \$5.65.	NET	3.33
-----------	---------------	-----	------

REPLACEMENT CARTRIDGES

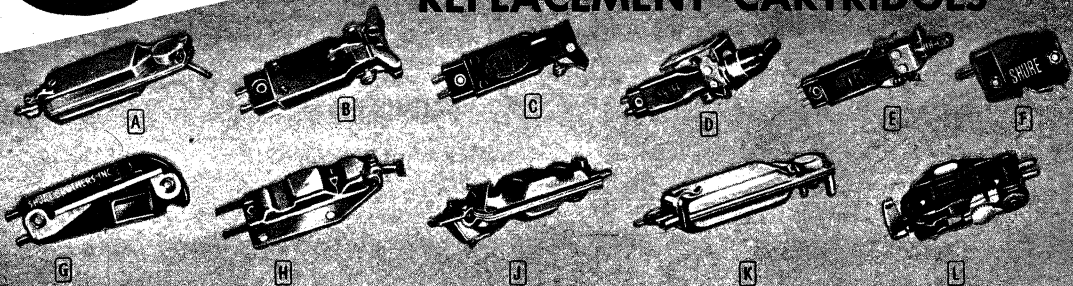

TURNOVER CRYSTAL & CERAMIC CARTRIDGES

An excellent selection of high-quality replacement cartridges for most record changers and players. All are equipped with sapphire needles; .001" needle for microgroove records and .003" needle for 78-rpm records. W9, W22T, W22, and W72 are crystal cartridges. WC10 and WC25 are ceramic type for use in locations where temperature and humidity are high. W9 and WC10 incorporate the newly designed "Twin Lever" needle shift system—flipping the needle lever puts proper needle into playing position—cartridge remains stationary. W9 and W72 are supplied with a "slip-on" capacitor which permits convenient reduction of output voltage to half of that shown. W72 replaces Webster-Electric Type FX and Shpg. W4, F15, F16, F18, F19, F20, and F21 cartridges. Av. shpg. wt., 4 oz.

Stock No.	Model No.	Fig.	Replaces Shure Models	Output Volts	Response, CPS	List	NET EACH
65 R 904	W9	L	Series P7, P8 & P9	3.5	50-10,000	\$ 9.50	5.59
65 R 313	WC10	L	Series P71, P72	0.8	35-12,000	9.50	5.59
65 R 338	W22T	D	P76, P77, P79, PC2, PC4, PC40, PC41	1.2	50-10,000	10.00	5.88
65 R 342	W22	B	Series P72, P76, P77, P79	1.2	50-10,000	9.50	5.59
65 R 902	WC25	E	Series PC42	0.7	50-7,000	9.50	5.59
65 R 911	W72	J	(see above)	3.0	50-5,000	8.50	5.00

SHURE WC20 CARTRIDGE—WITH .0003" STYLUS

F Ceramic cartridge with special .0003" ($\frac{3}{10}$ mil) sapphire needle for playing "Highway Hi-Fi" 16 $\frac{1}{2}$ rpm records. Frequency range, 50-12,000 cps. Low, 6 grams tracking pressure; protects records and assures long stylus life. Output, 0.6 v. Unaffected by heat and moisture. Shpg. wt., 4 oz.
65 R 903. List \$9.50. NET..... 5.59

ALL-GROOVE CARTRIDGES

Single-needle cartridges for playing both standard and microgroove records. All have .002" osmium needles, except Model W26 which has .002" sapphire needle. Needle pressure, 8-9 grams, except W26—4 $\frac{1}{2}$ grams. Shpg. wt., 4 oz.

No.	Model	Fig.	Replaces Shure	Volts	CPS	List	NET
68 R 340	W26	C	W26A, W26B	0.9	50-8000	\$6.50	3.82
65 R 319	WC38	G	PC10, PC13, WC36B	0.9	50-10,000	6.50	3.82
65 R 348	W66B	K	Series P37	2.0	50-4500	7.00	4.12

STANDARD GROOVE CARTRIDGES

Ruggedly-built Rochelle-salt crystal cartridges. Model W78 can be used to increase the volume of many 78 rpm phonographs; supplied with "slip-on" capacitor which permits convenient reduction of output voltage to half of that shown. W68 and W78 are supplied with an extra weight-slug to permit increasing the needle pressure if necessary. All cartridges require 28.5 grams needle pressure, except Model W70 which requires 10-15 grams. W56N is used in Wilcox-Gay disc recorders; supplied with stellite .003" cutting needle and .003" osmium playback needle. Models W68 and W70 are equipped with osmium needles. *Less needle; uses conventional shank type (see next page). W70 replaces Webster-Electric Type CX and the entire C series. Shpg. wt., 4 oz.

Stock No.	Model No.	Fig.	Replaces Shure Models	Output Volts	Response, CPS	List	NET EACH
65 R 349	W56N	A	P86R, W56R, W65R, Series P89	4.3	50-10,000	\$8.50	5.00
65 R 591	W68	K	PP30W, W65B, Series P30, W60, W61	1.6	50-4500	7.50	4.41
65 R 592	W70	H	(see above)	3.8	50-5000	4.95	2.91
65 R 590	W78*	A	Series P35, P87, P88, P90, P92, P93, W42, W56, W58, 99-180, 99-181	4.0	50-6000	5.55	3.26

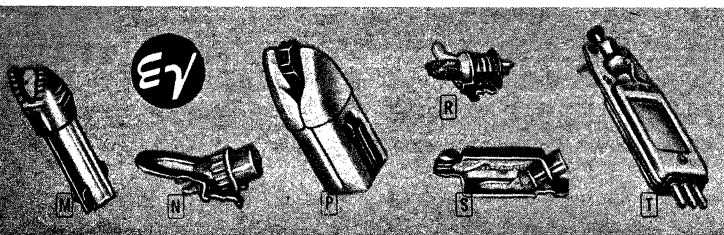

Electro-Voice Replacement Cartridges

POWER POINT TRANSDUCERS

Miniaturized ceramic cartridges. Equipped with two needle tips which are an integral part of the cartridge. Excellent response 20 to 12,000 cps. All, except 76S and 76DS, slip into mechanisms at right. 76S and 76DS replace power points in many Webcor changers. Power Points with two needles of the same size are simply reversed when one needle wears. Mechanisms fit $\frac{1}{2}$ " and $\frac{3}{8}$ " mtg. centers. Output, 1 v. Shpg. wt., 3 oz.

No.	Fig.	Model	Styli	NET
65 R 518	M	51-1	.001" sapphire	3.10
			.001" sapphire	
65 R 444	M	52-2	.002" sapphire	3.10
			.002" sapphire	
65 R 448	M	53-3	.003" sapphire	3.10
			.003" sapphire	
65 R 509	M	56	.001" sapphire	3.10
			.003" sapphire	
65RC464	M	56DS	.001" diamond	16.86
			.003" sapphire	
65 R 598	P	76S	.001" sapphire	3.33
			.003" sapphire	
65RC599	P	76DS	.001" diamond	16.84
			.003" sapphire	

HOLDING MECHANISMS

- N** Model PFT-1. Fixed mount. $\frac{1}{2}$ oz.
65 R 612 NET..... 39c
- S** Model PT-1. Turnover mount. $\frac{1}{2}$ oz.
65 R 613. NET..... 78c
- R** Model PT-2. Turnunder mount. $\frac{1}{2}$ oz.
65 R 614. NET..... 78c

MODEL 60 DUO-VOLT CARTRIDGE

- T** Output: 2 or 4 V. on MG; 3 or 6 V. on std. Response to 6000 cps. $\frac{1}{2}$ " mtg. ctrs. Less std. shank needle. 3 oz.
65 R 422. List, \$4.95. NET..... 2.91

LOW-COST AC-DC PHONO AMPLIFIER

Long narrow chassis makes it perfect for installation in portable record changer case. Off-On/Tone and Volume controls are mounted on 8" extension cables to simplify installation. AC power outlet on chassis for phonograph motor. Chassis is isolated from line. Can be used with crystal or ceramic cartridge. Audio output, 3 watts. Output impedance, 3.2 ohms. With 12SQ7, and 50L6 tubes, 35Z5 rectifier. Size, 8x3 $\frac{1}{2}$ x4". For 110-120 volts, 60 cycle AC, or DC. Shpg. wt., 2 $\frac{1}{2}$ lbs.
83 R 075. NET..... 9.95

SHURE PICKUP ARMS WITH CRYSTAL CARTRIDGES

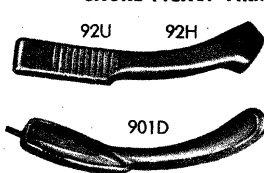

MODEL 92U. With W66B cartridge and all-purpose osmium needle for std. and MG records. Shpg. wt., 9 oz.
65 R 317. List, \$9.75. NET..... 5.73
MODEL 92H. As above, with W78 cartridge for 78 rpm records. Less conventional shank needle. Shpg. wt., 9 oz.
65 R 316. List, \$5.50. NET..... 3.23
MODEL 901D. With W22T cartridge. .001" and .003" sapphire styli. For std. and MG records. Shpg. wt., 1 lb.
65 R 311. List, \$16.25. NET..... 9.55

PHONOGRAPH NEEDLES

knight

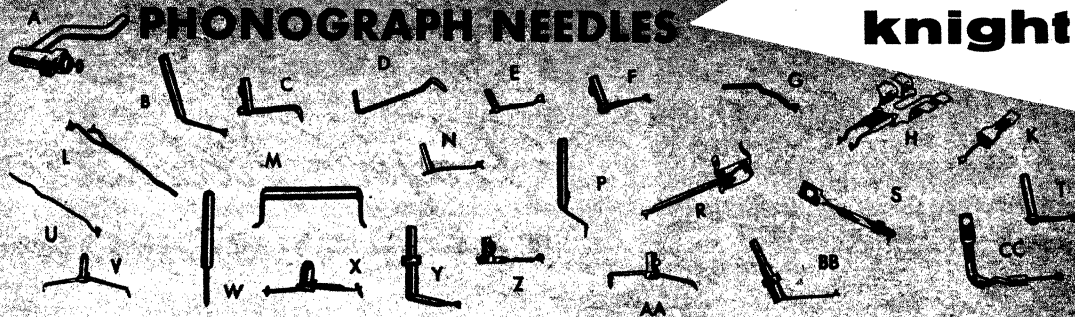

Exact Replacement Needles

Finest quality replacement needles at lowest cost. Precision made from carefully selected materials according to rigid Knight specifications. All needles have sapphire tips, except *osmium. Letters or numbers following the word "Series" in the listings cover all cartridges whose type numbers begin with these letters or numbers—For example: Series U covers U-J, U-M and U-78 cartridges. Type number usually stamped on cartridge. To select needle when cartridge is not listed, match your needle with an illustration and order by Stock No. for that illustration. Be sure to select needle with proper tip radius: Standard, .003"; microgroove, .001" (twin tips are .003" and .001"); all-purpose, .002". Shpg. wt., 2 oz.

FOR ASTATIC CARTRIDGES

Stock No.	Type No.	Fig.	For Cartridge Numbers	Tip	NET
68 R 362	A-67	N	94-TB, 405, 406,	Std.	1.27
68 R 363	A-67LP	N	Series: 62, 64, 66, 68	MG	1.27
68 R 364	A-672	N	Series: 57-T	All	1.27
68 R 365	A-68	A	Series: 55-T, GCD, 409	Twin	1.89
68 R 366	A-71	A		Twin	1.89
68 R 367	A-70*	C	Series: 14L3, 15L3	Std.	.79
68 R 368	A-70LP*	C		MG	.79
68 R 369	A-702	C		All	.79
68 R 370	A-73	B	LT-3D, LT-4, LT-4D, LT-4D1,	Std.	1.27
68 R 371	A-73LP	B	LT-AG	MG	1.27
68 R 372	A-732	B		All	1.27
68 R 373	A-74	D	Series: 402, 51, 53, 59, GC, MG	Std.	1.27
68 R 374	A-74LP	D		MG	1.27
68 R 375	A-742	D		All	1.27
68 R 376	A-75	E	10L3, 11L3, Series AC, ACD,	Std.	1.27
68 R 377	A-75LP	E	40, 41, 42, 90	MG	1.27
68 R 378	A-752	E		All	1.27
68 R 379	A-81	F	SERIES U & 50	MG	1.27
68 R 380	A-81LP	F	Series: CAC, CQ, LQD, QT	Std.	1.27
68 R 381	A-812	F	36, 38, 44, 46, 48; 403J;	All	1.27
68 R 382	CRA-55LP	S	Magnavox 560052		1.27
68 R 379	A-81	F	Series: 310, 312, 414, 420,	MG	1.27
68 R 383	CRA-55	S	422, 424	Std.	1.27
68 R 383	CRA-55	S	Series: 310,312,420,422,424	Std.	1.27

FOR ELECTRO-VOICE CARTRIDGES

Stock No.	Type No.	Fig.	For Cartridge Numbers	Tip	NET
68 R 384	E-90	U	10,12,14,30,32,33,34,36,40,42,	Std.	1.27
68 R 385	E-90LP	U	43,44,46,80,82,84,86,96,	MG	1.27
68 R 386	E-902	U	Admiral 409A13-1	All	1.27
68 R 387	E-91	L	16TT, 22TT	Twin	1.89

FOR MAGNAVOX CARTRIDGES

Stock No.	Type No.	Fig.	For Cartridge Numbers	Tip	NET
68 R 388	M-50	X	560133, 560133-4, 560151-5, 560151-6, 560158-1	Twin	1.89

FOR RONETTE CARTRIDGES

Stock No.	Type No.	Fig.	For Cartridge Numbers	Tip	NET
68 R 383	CRA55	S	Studio O, Studio P, RA-284,	Std.	1.27
68 R 382	CRA-55LP	S	TO-284, Series TO-222, TO-400, 7447, DT-60, RA-395	MG	1.27

FOR PHILCO CARTRIDGES

Stock No.	Type No.	Fig.	For Cartridge Numbers	Tip	NET
68 R 389	M-60LP	Z	45-1609, 45-1612	MG	1.27
68 R 390	PH-12*	AA	76-4649, 425-0014, 425-0009	Twin	1.27

CONVENTIONAL-SHANK PHONO NEEDLES

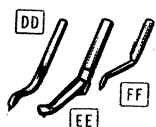

Designed to fit cartridges with screw-type chuck. Needles have "flat side" on shank for proper positioning. *Nylon needles—have flexible nylon material from tip to shank to reduce pickup of record scratch. Sapphire-tipped needles recommended for minimum record wear—tip holds the proper shape much longer than metal types, gives longer playing time at lower cost. Av. shpg. wt., 2 oz.

Stock No.	Type No.	Fig.	Tip material	Tip size	NET
68 R 391	NY-253*	EE	Sapphire	Standard	1.27
68 R 392	J-10	DD	Osmium	Standard	.59
68 R 393	NY-252*	EE	Sapphire	All-purpose	1.27
68 R 394	NY-152*	EE	Osmium	All-purpose	.79
68 R 395	J-152	FF	Osmium	All-purpose	.79
68 R 396	NY-251*	EE	Sapphire	Microgroove	1.27

FOR SHURE CARTRIDGES

Stock No.	Type No.	Fig.	For Cartridge Numbers	Tip	NET
68 R 397	JPS-30	G	P30, P37, P57, P70, P71, P72, P72V, P73, P76, P76V, P77, P79, P81, P81AD, P85, P88, P89, P94, PN30, PC41V;	Std.	1.27
68 R 398	JPS-30LP	G	Philco 35-2671; Series W21, W22, W23, W26, W60, W61, W65, W66, WC22; Admiral 409A11 and 409A13	MG	1.27
68 R 399	JPS-312	G		All	1.27
68 R 320	JPS-32	K	W31AR, W36B, WC24,	Std.	1.27
68 R 321	JPS-32LP	K	WC31AR, WC33B, WC36B, PC9, PC10, PC11, PC40	MG	1.27
68 R 322	JPS-32	K		All	1.27
68 R 323	JPS-35	H	PC2, PC-3, PC-4, PC-5, WC10	Twin	1.89
68 R 324	JPS-36	H	ML-44	Twin	2.54

FOR WEBSTER-ELECTRIC CARTRIDGES

Stock No.	Type No.	Fig.	For Cartridge Numbers	Tip	NET
68 R 332	W-05*	M	Series F14, A4, A5, A6, A7, A8, A1M, A1M-1, A2M, A5M, A6M, A7M, A9M, A9-1, A11, A12M, AM, AM-1, AX (old)	Twin	1.27
68 R 333	W-14	T	Q2, Q3, A9, F7, F7-1, F7-2, F13	Std.	1.27
68 R 334	W-15	T		MG	1.27
68 R 335	W-412*	P	AJ4, C9, C14-2, C14-8, C15-4, C100, C101, CX, F30-1, F30-3, F31-1, F31-2, F31-3, P1-1, P1-3, WS, WX	All	.79
68 R 336	W-422*	W			
68 R 397	JPS-30	G	F10, F11, F11-1	Std.	1.27
68 R 398	JPS-30LP	G		MG	1.27

FOR RCA CARTRIDGES

Stock No.	Type No.	Fig.	For Cartridge Numbers	Tip	NET
68 R 337	M-70	Y	9890, 38598, 99550, 39851, 39919, 70332, 70338, 70339,	Std.	1.27
68 R 339	M-70LP	Y	72551, 74067	MG	1.27
68 R 341	M-74	BB	74625, 75475, 75575,	Std.	1.27
68 R 342	M-74LP	BB	76318, 77779	MG	1.27

FOR SONOTONE CARTRIDGES

Stock No.	Type No.	Fig.	For Cartridge Numbers	Tip	NET
68 R 343	S-60LP	R	Series 3P	MG	1.76
68 R 344	S-61	CC	Series 3T	Twin	2.35
68 R 345	S-63LP	R		MG	1.47
68 R 346	S-632	R	Series 1P	All	1.47
68 R 347	S-66	CC	Series 2T, W-9980; Magnavox 560161-1; RCA 87848	Twin	2.06



QUALITY DIAMOND NEEDLES

NEW LOW PRICES

Diamond needles at a new low price. Provide greatest record protection, and best long-run economy. Retain their proper shape for up to 1,000 hours—20 times as long as sapphire needles. Diamonds listed below fit same cartridges as sapphire equivalents in above tables: i.e., Astatic A-68SD will fit same cartridges as A-68 listed in upper-left-hand table. Any needle with sapphire tip can also be supplied with diamond tip. If diamond equivalent is not listed below, mark order "Special," give Type No. of needle and specify "diamond tip." Single diamond, Net 7.95; diamond sapphire, Net 8.95; dual diamond, Net 15.90. Twin-tip needles below have .001" diamond tip and .003" sapphire tip.

Stock No.	Type No.	Fig.	For	Equivalent, in Table above	NET EA.
68 RC 700	A-68SD	A	Astatic	A-68	8.95
68 RC 701	A-75LPD	F	Astatic	A-75LP	7.95
68 RC 702	A-81LPD	F	Astatic	A-81LP	7.95
68 RC 703	E-90LPD	U	E V	E-90LP	7.95
68 RC 704	M-50SD	X	Magnavox	M-50	8.95
68 RC 705	CRA-55LPD	S	Ronette	CRA-55LP	7.95
68 RC 706	JPS-30LPD	G	Shure	JPS-30LP	7.95
68 RC 707	JPS-36SD	H	Shure	JPS-36	8.95
68 RC 708	M-70LPD	Y	RCA	M-70LP	7.95
68 RC 709	M-74LPD	BB	RCA	M-74LP	7.95
68 RC 710	S-60LPD	R	Sonotone	S-60LP	9.70
68 RC 711	S-61SD	CC	Sonotone	S-61	10.29
68 RC 712	S-66SD	CC	Sonotone	S-66	9.70

NEW knight *High Fidelity* TAPE RECORDER



Model KN-4010
With Microphone, Tape
Take-up Reel,
and "Roving" Speaker

\$129⁹⁵

Complete

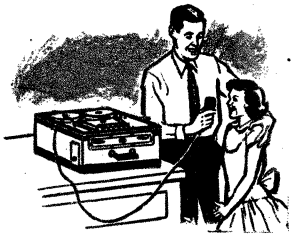

- Transistorized Preamp Lowers Hum and Noise Level
- Digital Tape Index Locates Selections Quickly
- Dual-Speed Operation— $7\frac{1}{2}$ " and $3\frac{3}{4}$ " Speeds

It's easy to make thrilling, lifelike recordings with this remarkable new tape recorder. You'll be delighted with its smooth, effortless push-button operation and the exceptional richness and clarity of its tone. Anyone can be sure of outstanding results—simply press the appropriate push-button and it's at your full command. Five push-buttons let you select Record, Playback, Rewind, and Fast-Forward or Stop. One of the important new highlights of this fine unit is its transistorized preamp which makes possible better-than-ever home recordings by greatly reducing hum and noise. High-frequency AC erase, usually found on more expensive recorders, assures a silent background when re-using tape. Another deluxe feature is the new digital index counter which lets you "pin-point" specific portions of a recording. Included among the array of "plus" features is an automatic safety shut-off, which protects tape by stopping the machine the instant you come to the end of a tape. Also included new, safety interlock to prevent accidental erasure.

OTHER DELUXE FEATURES. Has 8-watt push-pull amplifier and a 3-speaker system featuring 2 built-in speakers—plus a "roving" speaker which adds new depth and realism. A volume control with loudness compensation assures full-range response at any volume level. Dual neon-bulb indicators show when volume is just right for recording.

SUPERIOR SPECIFICATIONS. Response: At $7\frac{1}{2}$ " speed, 65-12,500 cps; at $3\frac{3}{4}$ " speed, 65-8500 cps. Recording Time: (1800-ft. reel): $7\frac{1}{2}$ " speed, 45 min. continuously and $1\frac{1}{2}$ hours overall; $3\frac{3}{4}$ " speed, $1\frac{1}{2}$ hours continuously, 3 hours overall. Wow and Flutter: 0.3% at $7\frac{1}{2}$ " speed. Signal-to-Noise Ratio: 50 db. 8-watt push-pull output stage; ZN132 transistor in preamp. Inputs for recording from mike, radio or TV; separate output for "roving" speaker or any other external speaker. Provision for feeding output from preamp directly to hi-fi system. Case attractively styled in charcoal gray with smart woven Saran center band. Supplied with microphone, roving speaker, 5" reel of tape, and take-up reel. Size, $15\frac{1}{2} \times 14\frac{3}{4} \times 10\frac{1}{2}$ ". Drain, 110 watts. For 110-120 v., 60 cycle AC. Shpg. wt., 40 lbs.

91 RZ 750. Only \$13.00 down. NET.....129.95

DIGITAL INDEX COUNTER

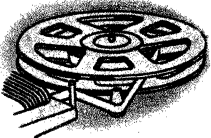

AUTOMATIC SHUT-OFF

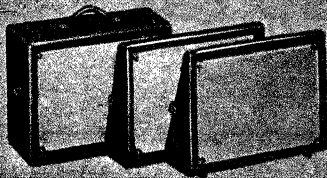

ACCESSORY SPEAKERS

ACCESSORIES FOR KNIGHT TAPE RECORDERS

PATCH CORD. For high-quality recording from radio or TV. Shpg. wt., 1 lb.

94 S 464. NET.....1.32

EXTENSION SPEAKERS. 2—12" PM speakers in two-section case, for P.A. use with KN-4010 recorder. Shpg. wt., 21 lbs.

91 RZ 747. NET.....41.28

CHAIRSIDE REMOTE CONTROL. Off-On-Record; with 18-ft. cable. Plugs into socket on KN-4010. Shpg. wt., 3 lbs.

96 R 636. NET.....6.64

FOOT-PEDAL REMOTE CONTROL. For KN-1010. With 10-ft. cable. 3 lbs.

96 R 638. NET.....9.97

HIGH-QUALITY Knight MAGNETIC RECORDING TAPE

Premium tape at popular prices! The full line of Allied's Knight Recording Tape includes the famous $1\frac{1}{2}$ -mil standard acetate tape; "Plus-Play" 1-mil acetate tape which provides 50% more playing time on standard reels; and our new super-strong Mylar "Plus-Play" 1-mil tape—the most permanent, reliable recording medium that science has yet developed. All Knight recording tape is factory-fresh and splice-free; rigidly controlled manufacturing conditions and strict inspection procedures guarantee that the Knight tape you buy may be used with confidence in the most critical of recording applications. Knight tape is guaranteed to meet exacting government specifications.

MYLAR "PLUS-PLAY". A flawless magnetic coating, bonded to a 1-mil base of tough, long-lasting Mylar (Dupont polyester film). 900 feet on a 5" reel, 1800 feet on a 7" reel; permits up to 3 hours of recording on a 7" reel, at $3\frac{3}{4}$ " speed. Meets professional recording standards—for applications requiring a tape of superior quality.
900-Ft. Shpg. wt., 12 oz.
92 R 939. 5-Up, EA...1.92 1-4, EA...2.19
1800-Ft. Shpg. wt., 12 oz.
92 R 940. 5-Up, EA...3.45 1-4, EA...3.79

ACETATE "PLUS-PLAY". 1-mil tape for all critical recording applications.

900-Ft. (5" REEL). Shpg. wt., 8 oz.

96 R 981. 5-Up, EA...1.69 1-4, EA...1.89

1800-Ft. (7" REEL). Shpg. wt., 8 oz.

96 R 982. 5-Up, EA...2.65 1-4, EA...2.95

STANDARD ACETATE. $1\frac{1}{2}$ -mil, first-quality.

600-Ft. (5" REEL). Shpg. wt., 8 oz.

96 R 698. 5-Up, EA...1.29 1-4, EA...1.42

1200-Ft. (7" REEL). Shpg. wt., 8 oz.

96 R 699. 5-Up, EA...1.78 1-4, EA...1.98

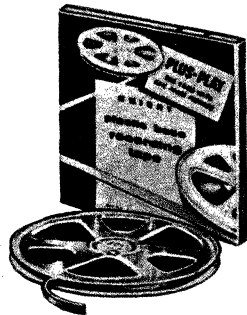

NEW knight KN-4020 DUAL SPEED RECORDER

- Transistor Preamp For Hum-Free Performance
- Dual Speeds—7 1/2" and 3 3/4" Per Second
- Push-Button Automatic Keyboard Control
- Light Weight For Easy Portability

An outstanding tape recorder for all-around use at home, school or office—records up to 3 hours on a single 7" reel of "Plus-Play" tape—exceptionally simple push-button operation assures perfect recordings every time.

Only
\$94⁹⁵

With Mike, Tape
and Extra Reel



Designed for exceptional ease of operation and unusually fine tonal quality, this new Knight tape recorder performs brilliantly in every recording application. The new transistor preamplifier greatly improves tape recordings by reducing hum and microphonics; a high-quality 3-watt amplifier provides excellent tone, and rich, room-filling sound. Compact and lightweight, the new Knight Dual-Speed Tape Recorder can easily be carried from place to place. The push-button keys greatly simplify use—just push down a key for record, play back, rewind, stop or fast-forward operation!

Dual speeds of 3 3/4" and 7 1/2" per second provide for both long playing time, when recording speech or dictation, and best fidelity, for recording music. At the slower speed, up to 3 hours can be recorded on a single 7" reel of "Plus-Play" tape! Any type of program comes through clearly when played back through the carefully designed 4x6" speaker; speaker jack permits playback through an external speaker, if desired. Recordings may be made with the microphone supplied, or from radio or TV.

A new safety interlock on the recording control makes it virtually impossible to erase a recording accidentally, while retaining fully automatic, push-button operation. The volume control is compensated for the varying characteristics of the human ear at different loudness levels; a tone control is provided for exact adjustment of sound quality to match room acoustics or personal preference. The recorder may be used as a P.A. system, too, with speeches or entertainment recorded at the same time. Dual neon-glow level indicators clearly show when the volume is set just right for recording.

SPECIFICATIONS: *Frequency Response:* At 7 1/2" speed, 65-10,500 cps; at 3 3/4" speed, 65-8000 cps. *Recording Time:* (1800-ft. reel) 7 1/2" speed, 45 min. continuously and 1 1/2 hrs. overall; 3 3/4" speed, 1 1/2 hrs. continuously and 3 hrs. overall. *Wow and Flutter:* 0.3% at 7 1/2" speed. *Signal-To-Noise Ratio:* 50 db. Case is attractively finished in charcoal and gray. With mike, 5" reel of tape, 5" take-up reel and instructions. Size, 14x12x10". For 110-120 v., 60 cycles AC. 70 watts. Wt., 29 lbs. 91 RZ 751. Only \$9.50 Down. NET..... 94.95

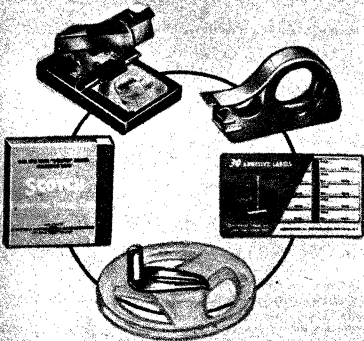

HANDY RECORDISTS' KIT

Contains every accessory needed for cleaning and lubrication of magnetic recording heads and tape, editing, splicing and identification of tapes, plus a time-saving tape threader! Includes: 1 bottle each of "Long-Life" Tape Head Cleaner and "Long-Life" Lubricant Fluid; Robins TS-4JR Tape Splicer; 150-inch Dispenser Roll of Splicing Tape; Robins Tape Threader; 30 Tape Identification Labels; 150-foot Dispenser Roll of Leader Timing Tape.

You'll be able to do professional editing of tapes with the precision-made splicer and the highly effective cleaning solution and lubricant compounds will help keep heads and tape in perfect condition. The adhesive-backed labels adhere to tape reels without need for moistening, and provide a fast, convenient way of marking tapes for identification. Leader and timing tape permits accurate interval timing. Wt., 1 1/2 lbs.

94 R 921. NET..... 7.35



NEW KNIGHT KN-4500 DYNAMIC MIKE

Superlative value in a high-fidelity dynamic microphone—made by one of America's leading manufacturers of broadcast equipment! Ideal for PA and recording applications, the mike may be used on the desk stand supplied, or mounted on any standard floor stand. It comes complete with 10-ft. cable and shielded screw-type mike connector—plus a phone plug adapter that will fit 90% of all home recorders! The new Knight Dynamic microphone will improve the performance of any home recorder with which it is used.

Pickup pattern is all-directional; perfect for recording group entertainment or discussions. Wide-range response, from 60 to 12,000 cps, assures realistic, natural quality of both voice and music. 1 1/2"x7 1/2" long; finished in black and gold. High impedance output. Shpg. wt., 1 1/2 lbs.

94 S 097. NET..... 24.95

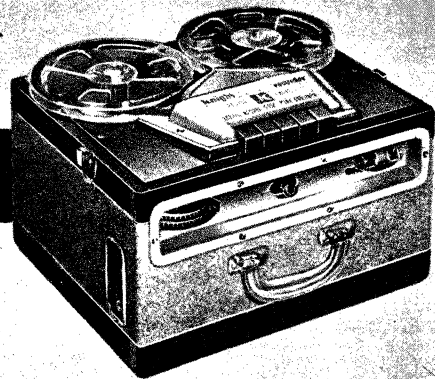

KNIGHT KN-4001 RECORDER

Anyone can afford the new super-value Knight KN-4001 Recorder—and anyone can get clear, top-quality recordings at the push of a button! Plays full-size 7" reels! Includes the same quiet, noise-free transistorized preamplifier as featured in other Knight tape recorders, as well as the positive safety interlock that protects treasured recordings from accidental erasing. Operates at 7 1/2" per second; may be converted to 3 3/4" speed by shifting drive belt inside recorder. 3-watt amplifier provides clear, pleasing sound even at high volume. A speaker jack permits using an external speaker.

Dual neon level indicators make it easy to record. Tone control adjusts playback sound. Charcoal and gray case 10x13 3/4x11 3/4". With microphone, 3" reel of tape and 5" take-up reel. For 110-120 v., 60 cycles AC; 70 watts. Shpg. wt., 29 lbs.

91 RZ 748. NET..... 69.95

Bell

MONAURAL AND STEREO TAPE DECKS AND PREAMPS



T-200

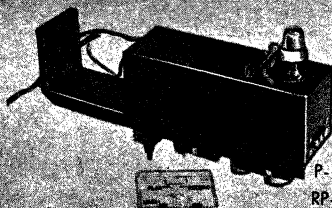

P-100
RP-120

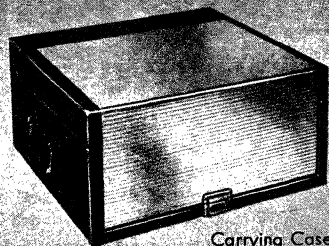

Carrying Case

NEW BELL TAPE DECKS. High-quality tape decks featuring new DC dynamic braking, three 4-pole motors, and operation without belts, pulleys, or clutches. Excellent overall specifications in both stereo and monaural models. All decks accept specially designed Bell preamplifiers, which attach to deck without altering any critical dimensions; ideal for custom installation, especially where record or stereo facilities are to be added later. Positive braking prevents even the thinnest tape from breaking when starting and stopping mechanism. Accepts up to 7" reels.

SPECIFICATIONS: *Frequency Response:* 40 to 10,000 cps ± 2 db; 30 to 15,000 cps ± 4 db (record and playback). *Signal-to-Noise Ratio:* Better than 50 db. *Flutter:* Less than $\frac{1}{4}$ of 1% at $7\frac{1}{2}$ ips. *Overall Distortion:* Less than 1% at maximum indicated recording level. *Controls:* Speed, Play, Rewind, Fast Forward, Stop; Off-On Switch. In-line Staggered Switch on all stereo models. *Speeds:* $7\frac{1}{2}$ and $3\frac{3}{4}$ ips.

Tape lifter removes tape from heads during stop and high speeds. Footage counter operates from take-up reel, and does not introduce wow and flutter. Accommodate 2 amplifiers, Bell models P-100 or RP-120. Charcoal gray base with satin aluminum and embossed gold anodized trim. Size, $15\frac{1}{16} \times 13\frac{3}{16}$; $5\frac{1}{4}$ " below, $1\frac{1}{8}$ " above mounting surface. For 110-120 v., 60 cycle AC. Shpg. wt., 21 lbs.

- MODEL T-200. Monaural record, erase and playback. 91 RZ 764. NET. **97.95**
- MODEL T-201. Stereo playback, both inline and staggered. 91 RZ 765. NET. **107.75**
- MODEL T-202. Mon. record-playback; stereo inline & offset playback. 91 RZ 766. NET. **117.55**
- MODEL T-203. Monaural and stereo record, playback. 91 RZ 767. NET. **137.15**

PREAMPS FOR PLAYBACK AND RECORD-PLAYBACK. Specially designed units which fit Bell tape decks listed at left; knock-outs on deck panels accommodate preamp controls, and preamp becomes an integral part of tape deck assembly. DC is used on all filaments. Both units feature feedback-type, low-frequency equalization for minimum distortion, noise and microphonics from first stage. AC cord of preamp connects to tape deck; on-off switch on deck may be used to control power to preamp. Cathode follower output delivers 15 volts maximum, for playback through any high-fidelity amplifier-speaker system.

MODEL P-100 PLAYBACK PREAMP. Provides NARTB tape equalization and high-gain amplification, with less than 0.1% distortion at 1-volt output. 53 db gain at 1000 cycles; output from maximum-level tape recording, 2.3 volts, when used with Bell tape decks. For operation from 110-120 v., 60 cycles AC. Shpg. wt., $5\frac{3}{4}$ lbs.

91 RX 768. NET. **29.35**

MODEL RP-120 RECORD-PLAYBACK PREAMP. NARTB record and playback equalization; attaches to Bell decks listed at left. 2 inputs: mike and high level (tuner, etc.); require 0.001 and 0.3 volts, respectively, for full recording level. Linear cathode-ray tube indicator for accurate monitoring of recording level. White pilot light indicates "on"; red pilot light for "record". For 110-120 v., 60 cycles AC. Shpg. wt., $9\frac{1}{4}$ lbs.

91 RX 769. NET. **58.75**

CARRYING CASE. Professional-style carrying case for Bell tape transport and preamps. Covered with charcoal gray pyroxylin; contrasting trim. $8\frac{3}{8} \times 17\frac{1}{4} \times 16\frac{1}{2}$ ". Shpg. wt., 13 lbs.

91 RX 770. NET. **29.95**

VIKING

STEREO AND MONAURAL TAPE DECKS AND PREAMPS

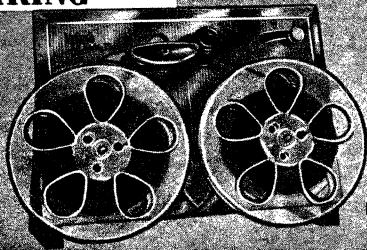

FF75

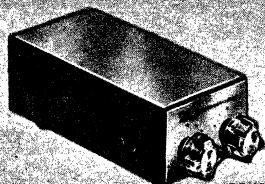

PB60

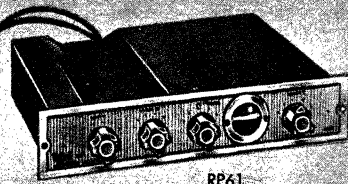

RP61

TAPE DECKS. Well-designed durably constructed transports fitted with precision Dynamu record, playback and erase heads. Ideal for addition of tape playback and/or recording facilities to hi-fi systems. All decks require area $12\frac{1}{8} \times 9\frac{3}{8}$ "; and $1\frac{1}{4}$ " above, $3\frac{1}{2}$ " below mounting board. For 110-120 v., 60 cycles AC.

SPECIFICATIONS: *Frequency Response:* ± 2 db, 30-14,000 cps. *Signal-to-Noise Ratio:* 55 db or better. *Flutter:* 0.2% average. *Long-term Speed Regulation:* Within 0.5%. *Tape Speed:* $7\frac{1}{2}$ ips; convertible to $3\frac{3}{4}$ ips from underside of mounting plate. *Maximum Reel Size:* 7". *Playback Head Output:* 2.5 millivolts. *Gap Width:* 0.00015".

FOR MONAURAL PLAYBACK ONLY. If your hi-fi amplifier has a tape head input, you need only an FF75RSLP deck to add tape to your system. Otherwise add a PB60 preamplifier also.

FOR MONAURAL RECORDING AND PLAYBACK. Use FF75RSLP deck and RP61 record-playback preamplifier with a hi-fi system.

FOR STEREO PLAYBACK ONLY. If your hi-fi amplifier already has a tape head input, use the FF75SR deck and a PB60 preamp; of course, two amplifiers and speaker systems are necessary for stereo. If you own a stereo preamp already, you need add only the FF75SR deck. If your hi-fi system provides no tape preamplification, use the FF75SR deck and two PB60 preamps. These components will also allow you to play monaural tapes.

FOR STEREO RECORDING AND PLAYBACK. Use the FF75SR deck, one RP61 and one RP61S preamplifier. These components also record and playback monaurally. When making stereo recordings, use new or bulk-erased tape (see tape eraser on page 94).

NOTE ON STEREO SYSTEMS. All stereo systems require two complete and independent playback channels: dual preamplifiers equalized for tape playback, dual basic amplifiers and dual speaker systems.

RECORD AND RECORD-PLAYBACK PREAMPLIFIERS. High-fidelity units offering NARTB equalization for both recording and playback.

MODEL PB60 PLAYBACK PREAMP. For use when tape playback is added to a hi-fi system lacking tape head equalization. Two PB60's and the FF75SR deck are used in stereo playback system. Includes power switch on volume control; auxiliary AC outlet from which to operate tape deck; and hum balancing adjustment. Tubes accessible from exterior of case. Response: 30-14,000 cps. ± 2 db. Variable equalization control. Size, $6\frac{5}{8} \times 3\frac{3}{8} \times 2\frac{1}{8}$ ". For 110-120 v., 60 cycle AC.

MODEL RP61 RECORD-PLAYBACK PREAMP. Playback characteristics are the same as those of the PB60 above; also provides fixed equalization during recording, erase bias oscillator and level monitoring indicator. Distortion at full recording level is less than 2%. $12\frac{1}{2} \times 2\frac{1}{8} \times 6\frac{3}{8}$ ". For 110-120 v., 60 cycles AC.

MODEL RP61-S RECORD PLAYBACK PREAMP. For stereo use with RP61; bias furnished by RP61. Otherwise, same as RP61.

Stock No.	Type	Description	Wt., Lbs.	NET
99 RX 491	FF75RSLP	Monaural Tape Deck	11	78.50
95 RX 952	FF75SR	Stereo-Monaural Deck	11	113.00
95 R 953	PB60	Playback Preamplifier	2	29.50
95 R 954	RP61	Record-Play Preamp.	7	77.50
95 R 969	RP61-S	For stereo use with RP61 Preamp	7	77.50

D396 CARRYING CASE. For Viking deck and RP61. 5 lbs.
99 RX 494. NET. **24.50**

PENTRON TAPE DECKS AND PREAMPLIFIERS



TM-1 TAPE DECK. For monaural recording and playback; has single combination half-track record-playback-erase head. Accommodates up to 7" reels; speed change lever on control panel switches from 7½ ips to 3¾ ips instantly. Fast forward and fast rewind, play, record and neutral position are all set by single, easy-grip control knob. Idler-driven capstan drive with 21-ounce spaded for smooth, steady operation. 4-pole shaded-pole induction motor.

SPECIFICATIONS: *Frequency Response:* 40 to 14,000 cps. *Signal-to-Noise Ratio:* 50 to 55 db. *Flutter:* Less than 0.4%, at 7½ ips. Under 1% at 3¾ ips. *Harmonic Distortion:* Less than 2% maximum with NARTB tape and preamp. *Speed Variation:* ±2%. *Fast Forward:* Completely winds 7-inch reel in 75 seconds. *Fast Rewind:* 7-inch reel in 90 seconds. *Mounting Cutout:* 9½x11x7". Two auxiliary AC outlets controlled by power switch on deck panel. Handsome gray and gold finish. For 110-120 v., 60 cycle AC. Shpg. wt., 14 lbs.

91 RX 758. NET. 84.50

TM-4 STEREO TAPE DECK. For stereo recording and playback (inline or staggered) and monaural recording and playback. Requires new or bulk-erased tape for stereo recording (see tape eraser on page 94). Other characteristics and size same as TM-1 deck above. For operation from 110-120 volts, 60 cycle AC. Shpg. wt., 14 lbs.

91 RX 759. NET. 109.95

CA-14 MIKE-PHONO MIXER. 4-Channel mixer with 6 high-impedance inputs; 4 microphone, 2 phono; provides 8 db gain in microphone channels. A virtual necessity when multimicrophone recordings of large groups are made, or for special effects. Response is essentially flat from 20-20,000 cps. Tubes are 2—12AX7. Phono input receptacles on rear of unit; microphone inputs are on front panel; use standard ¼" phone plugs. 1½x6x5x8". For 110-120 v., 60 cycle AC. Shpg. wt., 4 lbs.

93 S 284. NET. 39.95

CA-11 PLAYBACK PREAMP. Playback preamplifier with NARTB equalization. Plays back recordings from any tape deck. Attractive gold-finish front panel with black perforated cage. Has gain control with off-on switch, and hum balance control. *Frequency response:* 20-20,000 cps. *Distortion:* 1% total harmonic. *Signal-to-Noise Ratio:* 50-55 db. *Output Level:* 1 v. rms. *Output Impedance:* 10,000 ohms. *Tubes:* ECC83, 12AU7; 6X5 rectifier. 1½x6x5x8". For 110-120 v., 60 cycles AC. Wt., 5 lbs.

91 RX 760. NET. 39.95

CA-13 RECORD-PLAYBACK PREAMP. Record-playback preamp with illuminated recording level meter, safety interlock "record" push-button, and NARTB equalization for recording and playback of high-fidelity tapes. Handsome black and gold color-scheme matches other Pentron components.

Hum balance control assures minimum hum level after tubes are changed. Dual outputs: one for feeding power amplifier, one for phones. Phone jack for mike input; phono jack for radio/TV input. Power drain is only 20 watts during recording; 15 watts during playback of tapes. *Frequency Response:* 20-20,000 cps. *Signal-to-Noise Ratio:* 50-55 db. *Bias:* 110 v. at 32 kc; push-pull erase oscillator. *Tubes:* ECC83, 2—12AU7, 6C4; 6X4 rectifier. Size, 1½x6x5x8". For 110-120 v., 60 cycle AC. Shpg. wt., 6 lbs.

91 RX 761. NET. 79.95

CA-15 STEREO PLAYBACK PREAMP. Dual channel playback preamp with separate equalization and volume controls for each channel, plus master gain control. Both channels are NARTB equalized. Gold and black finish case, with off-on pilot light.

Response: 20-20,000 cps. *Harmonic Distortion:* Total, 1%. *Signal-to-Noise Ratio:* 55-60 db. *Output Level:* 1 volt rms. *Tubes:* 2—12AU7, 2—12AU7; 6X5 rectifier. For use with Pentron TM-4 or other stereo deck. Size, 1½x6x5x8". For 110-120 v., 60 cycle AC. Shpg. wt., 6 lbs.

91 RX 762. NET. 79.95

COMPLETE MONAURAL RECORDERS INCLUDING STEREO PLAY MODELS

NL-1 "MERCURY". Dual-speed monaural tape recorder with built-in 4-watt amplifier and 6-inch PM speaker; tape deck features automatic braking and precision-built 4-pole, shaded-pole motor, of self-starting induction type. Single rotary control knob sets unit for record, play, fast forward, or fast rewind operation; interlock button prevents accidental recording or erasure. Lever on control panel instantly changes speed from 7½ to 3¾ ips.

SPECIFICATIONS: *Frequency Response:* 40 to 11,000 cps at 7½ ips; 40 to 7000 cps at 3¾ ips. *Controls:* Selector (Play, Record, Forward, Rewind); Interlock; Speed Change Lever; Volume; Tone. *Signal-to-Noise Ratio:* 45 db. *Fast Forward:* (7" reel) 75 seconds. *Rewind:* (7" reel) 90 seconds. *Inputs:* Mike-Mag Phono; Tuner-Aux. *Outputs:* 1—for external amplifier; 1—for external speaker. Neon bulb recording level indicator. Size, 14x17x11". For 110-120 volts, 60 cycle AC. With mike. Shpg. wt., 29 lbs.

91 RZ 752. NET. 109.95

NL-15 STEREO. Same as NL-1 recorder described above, but equipped with inline stereo head, plus preamplifier for feeding second channel. Shpg. wt., 35 lbs.

91 RZ 753. NET. 139.95

FACTS ABOUT STEREO TAPE PLAYBACK

A stereo playback system consists of stereo tape deck, two preamps equalized for tape head, two amplifiers, and two speakers. The Pentron stereo recorders NL-15, NL-25 and NL-35, include a second preamp in addition to the stereo deck and one complete high-fidelity preamp-amplifier-speaker channel. Any one of these three recorders may be used to convert your hi-fi system to stereo, as well as monaural, tape playback. The recorder serves as one channel, and its second preamp and your present hi-fi system as the second channel.

NL-2 "CHAMPION". High-quality dual-speed tape recorder for monaural recording and playback; built-in 5-watt amplifier and woofer-tweeter speaker system, with crossover. Controls and speeds same as "Mercury" model at left, but with separate off-on switch for motor "Magic Eye" level monitor and digital footage counter.

SPECIFICATIONS: *Frequency Response:* 40 to 13,000 cps at 7½ ips; 40 to 7000 cps at 3¾ ips. *Signal-to-Noise Ratio:* 48 db. *Inputs:* 1—high-impedance for microphone or magnetic phono cartridge; 1—high-impedance for radio, TV, crystal or ceramic phono cartridge. *Outputs:* 1—for external amplifier; 1—for external speaker. Size: 14" w., 16¾" d., 10¾" h. For 110-120 v., 60 cycle AC. With mike. Shpg. wt., 33 lbs.

91 RZ 754. NET. 149.95

NL-25 STEREO. As above, but with inline stereo head, plus preamp for second channel. Shpg. wt., 39 lbs.

91 RZ 755. NET. 179.95

NL-3 "ARISTOCRAT". Exceptionally well-designed recorder with many professional features. Automatic shutoff switch stops drive motor if tape breaks or runs out, but does not shut off motor if tape is slack. Professional-type illuminated VU meter and digital footage counter. Has deluxe 10-watt push-pull amplifier with high-quality three-way speaker system consisting of 2 woofers, 6-inch midrange speaker and exponential tweeter. Otherwise same as above.

SPECIFICATIONS: *Frequency Response:* 40-15,000 cps at 7½ ips; 40-7500 cps at 3¾ ips. *Signal-to-Noise Ratio:* 50 db. *Flutter:* Under 0.4% at 7½ ips; under 1% at 3¾ ips. Size, 17½x17¾x11". For 110-120 v., 60 cycle AC. With mike. Wt., 38 lbs.

91 RZ 756. NET. 189.95

NL-35 STEREO. As above, but with inline stereo head, plus preamp for second channel. Shpg. wt., 44 lbs.

91 RZ 757. NET. 219.95

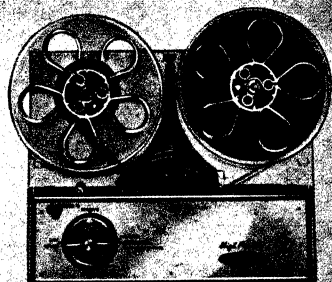

TM Series Deck



CA-13



CA-15



CA-14

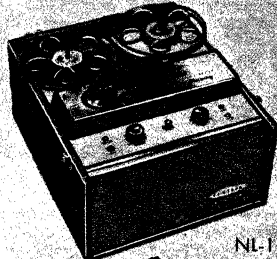

NL-1

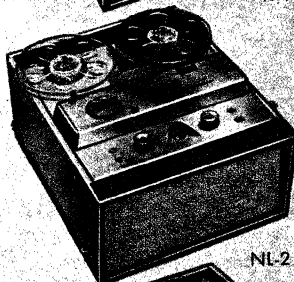

NL-25

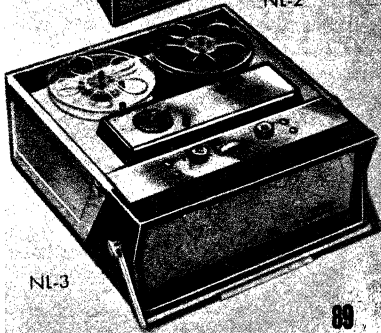

NL-3

Magnecord Professional Recorders

MODEL S36-BX. Dual-speed, full-track tape recorder designed for rack or case mounting. For studio and other professional use or custom hi-fi installation. Has hysteresis synchronous drive motor for close timing accuracy. Knob control with interlock to prevent accidental erasure. Has separate erase and combination record-playback heads. Handles 10 1/2" reels with reel adapter kit listed below.

Operates at 7 1/2" and 15" speed. *Response:* 15", ±2 db from 50-15,000 cps; 7 1/2" ±2 db from 50-10,000 cps. *Recording Time* (1200 ft. reel): 7 1/2", 30 minutes; 15", 15 minutes. *Rewind Time:* 40 sec. for 1200 ft. *Signal-to-Noise Ratio:* 54 db. *Flutter:* less than 0.3% at 15". *2 Inputs:* 1—high impedance mike; (use Shure A86A transformer, page 349 for 50-250 ohms) 1—unbalanced bridge for radio, phono or TV. *2 Outputs:* 1—monitor output on front panel; 1—600 ohm unbalanced output for external amplifier.

Has illuminated VU meter for record and playback, straight loading, printed circuit construction and full track heads. Anodized-aluminum panel with gray trim. Size, 7x19x12". For 110-120 v., 60 cycle AC. Shpg. wt., 45 lbs. **96 R 946. NET. 385.00**

CARRYING CASE. Heavy-duty case for Model S36-BX above. Shpg. wt., 14 lbs. **96 RX 947. NET. 30.00**

10 1/2" ADAPTER KIT. Adapts S36-BX recorder to permit use with 10 1/2" reels. 2 lbs. **96 R 949. NET. 55.00**

MODEL N35-B. New, single-case, dual-track recorder containing tape deck, record-playback preamplifier, and 8-watt power amplifier and speaker; an excellent "on-the-spot" unit for recording and playback. Illuminated VU meter accurately indicates recording level. Phone jack on front panel permits continuous monitoring of program being recorded. Interchangeable capstans for operation at either of two speeds. Furnished with high-impedance microphone. Rugged and stable printed circuit recording amplifier includes NARTB equalization modified for 7 1/2 ips speed. Interlock button prevents accidental tape erasure. Specifications similar to S36 above, but speeds are 7 1/2 and 3 3/4 ips, and has 4-pole shaded-pole motor. Extended frequency response to 12,000 cps for clear, natural recording of speech and music. Dual-track heads permit up to 3 hours of recording on a single 7" reel of "Plus-Play" tape at 3 3/4" speed. High and low-impedance outputs for attachment to external amplifier or speaker system for playback. Self-contained 6x9" oval speaker provides excellent tone quality. Panel size, 8 1/2x15". For 110-120 v., 60 cycle AC. Shpg. wt., 40 lbs. **91 RZ 771. NET. 299.95**

MODEL NS-35-B. As above, with hysteresis-synchronous motor. Shpg. wt., 40 lbs. **91 RZ 772. NET. 349.95**

SERIES P60 PROFESSIONAL UNITS. An integrated series of tape recording components, manufactured to high-precision standards. Conform to critical specifications of the broadcast, studio recording and instrumentation fields. Available with or without cases; all have 19" notched panels for mounting in standard relay racks.

P60-A TAPE DECK. Full-track. For use with P60-C or other professional-quality preamp. *Tape Speed:* 7 1/2x15 ips. *Drive:* Hysteresis-synchronous motor direct drive; individual fast forward and fast rewind motors. *Reel Size:* 10 1/2" NARTB and 7". *Take-Up:* Torque motor. *Controls:* Push-button type (Rewind, Stop, Forward, Fast Forward, Record); Operate/Fast Cue/Manual Cue Switch; 15-7 1/2-Off-On Switch. *Loading:* Deep slot with automatic tape-lifting in rewind and fast forward. *Heads:* Erase, Record, Playback (provides simultaneous record-playback). *Starting Time:* Instantaneous (to normal forward). *Safety Features:* Fail-safe brakes; tape break automatic shut-off. *Frequency Response:* 40 to 15,000 cps ±2 db at 15 ips; 40 to 12,000 cps ±2 db at 7 1/2 ips. *Signal-to-Noise Ratio:* 55 db. *Flutter and Wow:* Less than 0.2% at 15 ips; 0.25% at 7 1/2 ips. *Timing Accuracy:* ±3 seconds in 30 minutes. *Fast Forward and Rewind:* Full 10 1/2" reel in less than 100 seconds. Size, 10 1/2x19x10 1/2". With case. For operation from 110-120 v., 60 cycles AC. Shpg. wt., 50 lbs. **94 RZ 905. NET. 525.00**

P60-BA STEREO DECK. As above, but stereo; for use with 2—P60-C's. **91 RZ 773. NET. 635.00**

P60-AX. Same as P60-A, less case. 50 lbs. **94 RZ 907. NET. 485.00**

P60-BAX. P60-BA less case. 50 lbs. **91 RZ 774. NET. 595.00**

P60-C PREAMP. *Inputs:* 1 microphone high impedance; 1 unbalanced bridge (15 mv for zero level recording). *Playback Output:* Cathode follower, unbalanced. *Noise Level:* 66 db below test level. *Meter:* Bias, Record Level and Playback Level measured on illuminated 4" scale. With case. Size, 5 1/2x19x8 3/4". For 110-120 v., 60 cycle AC. Shpg. wt., 18 lbs. **94 RZ 906. NET. 305.00**

P60-CX. As above preamp, less case. 16 lbs. **94 RZ 908. NET. 265.00**

32X33 TRANSFORMER. Low-Z input. 2 lbs. **94 R 909. NET. 25.00**

32X34 TRANSFORMER. Low-Z output. 2 lbs. **94 R 910. NET. 25.00**

Allied can supply any Magnecord equipment promptly, including the M-90 and P16 broadcast and industrial console units. For prices and free technical planning assistance, write Allied's Audio Division.

Compact and Lightweight Gelo "Hi-Tone" Recorder

MODEL G255-S. Remarkable dual-track 2-speed, precision-made tape recorder imported from Italy. Only 7 1/2 lbs. in weight, it is easily portable in its cordovan leather case. Size is only 5 1/2x9 7/8x5 7/8"; it fits desk drawers, bookshelves, etc. In its strong plastic case are included a playback amplifier and speaker; also has output jack to permit playback through an external amplifier or speaker. Low power drain makes the Gelo ideal for mobile applications.

SPECIFICATIONS: *Speeds:* 1 1/2 ips and 3 3/4 ips. *Frequency Response:* 80-6000 cps at 3 3/4 ips speed; 100-4500 cps at 1 1/2 ips. *Recording Time:* Up to 1 hour in each direction on 1/2-mil tape, at 1 1/2 ips. Uses standard 3" reels, or Gelo 3 1/4" reels (see listing at right). Miniature cathode-ray tube level indicator. Color-coded push-button operation is so simple that a child can safely operate it; plastic deck cover. With microphone and carrying case. For 110 volts, 60 cycle AC. Shpg. wt., 9 lbs. **94 RX 927. NET. 143.95**

M55 MICROPHONE. Concealed microphone in attractively designed desk pen set; high pickup sensitivity. Made of black onyx plastic with transparent base of lucite. Complete with 54" shielded cable, phone plug and an excellent ballpoint pen. 4 1/4" square, 5 1/4" high. 2 lbs. **94 R 928. NET. 24.95**

M50/B85 MIKE AND STAND. Professional type microphone of exceptional sensitivity, handsomely styled. 8 1/2" long, tapering from 1 3/8" to 3/4" diameter. Gray satin finish stand with 360° swivel. Wt., 2 lbs. **94 R 929. NET. 24.95**

9009 RADIO PICKUP. Tapes to output transformer of radio, amplifier, etc. No wiring necessary. Shpg. wt., 1/2 lb. **94 R 930. NET. 6.95**

9010 TELEPHONE PICKUP. Induction type; no wiring necessary. Shpg. wt., 1/2 lb. **94 R 931. NET. 6.95**

1/2-MIL TAPE. 550' on Gelo 3 1/4" reel; 1 hr. 56 min. per reel. Shpg. wt., 4 oz. **92 R 906. NET. 1.62**

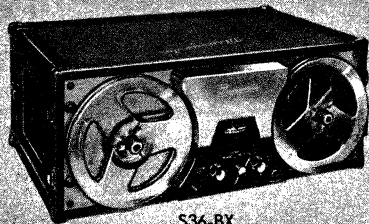

S36-BX

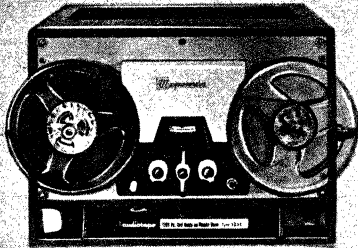

N35-B



P60-BAX with P60-CX



M-90

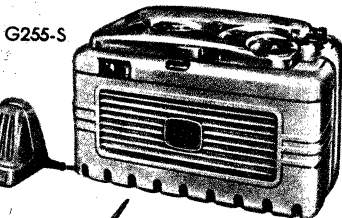

G255-S

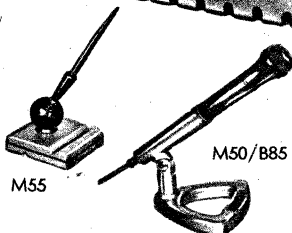

M55

M50/B85

AMPEX

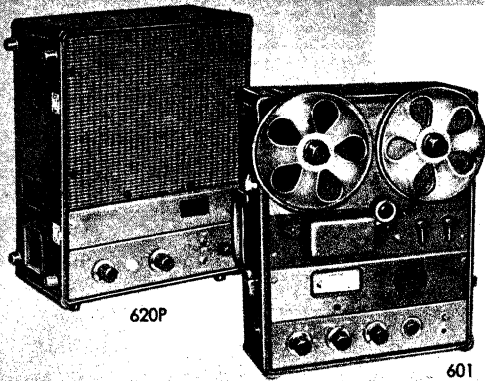

620P

601

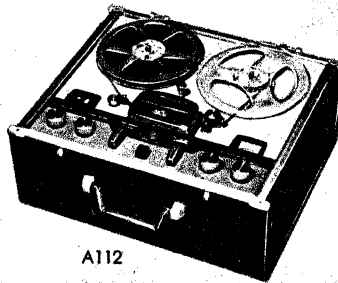

A112

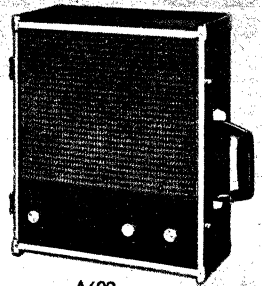

A692

Ampex Stereophonic and Monaural Tape Recorders

MODEL 601 MONAURAL RECORDERS. Combine compact design for practical portability with exceptional Ampex manufacturing precision. New features include provision for low-impedance input and output, faster acceleration to playing speed, illuminating record safety button and new case of rugged Samsonite. Separate record and playback amplifiers; direct-reading illuminated VU meter; simultaneous recording and playback.

SPECIFICATIONS: Speed: 7½ ips. Reel Size: 7" maximum. Response: 30-15,000 cps; Signal-to-Noise Ratio: Over 55 db for full-track; 50 db for half-track. Flutter and Wow: 0.17%. Starting Time: Less than 0.2 second. Fast Forward and Rewind: 90 seconds for full 7" reel. Power Drain: 61 Watts. For 110-120 volts, 60 cycles AC.

95 RZ 978. Dual-Track. 8x13¾x16½". Wt., 35 lbs. NET... **595.00**

95 RZ 979. Full-Track. 8x13¾x16½". Wt., 35 lbs. NET... **595.00**

95 RZ 982. Dual-Track. Less Case. 5x12½x15½". 31 lbs. **545.00**

95 RZ 983. Full-Track. Less Case. 5x12½x15½". 31 lbs. NET **545.00**

MODEL 601-2 STEREOGRAPHIC RECORDER. As above, but with stereo heads (in-line) dual preamps and meters. With case. For 110-120 volts, 60 cycles AC. 8x13x24½". Shpg. wt., 54 lbs.

91 RZ 775. NET... **995.00**

LOW-IMPEDANCE INPUT TRANSFORMER. Plug-in type. ½ lb.

95 R 981. NET... **22.95**

MODEL 620P AMPLIFIER-SPEAKER. 10-watt amplifier and special 8" speaker. Two may be used with 601-2 for stereo. Speaker response 65-10,000 cps. Amplifier response, ±0.5 db, 20-20,000 cps. 13x16x8". For 110-120 v., 60 cycle AC. Shpg. wt., 28 lbs.

95 RZ 980. NET... **169.50**

SERIES "A" HIGH-FIDELITY RECORDERS. Tape deck-preamp units offering latest engineering advancements in the tape recording field, plus renowned Ampex features and high-quality workmanship. Each recorder is housed in an attractive two-tone gray portable case. Accurate footage counter and VU meter.

SPECIFICATIONS: Tape Speeds: 7½ and 3¾ ips. Frequency Response: 30-15,000 cps at 7½ ips. Signal-to-Noise Ratio: 50 db. Reel Capacity: 7". 2 Inputs: High-impedance microphone; radio, TV or phono. Output: Cathode follower. Controls: Selector (Off, Monitor, Single, Stereo*); Listening Volume; Fast Forward-Rewind; Record; Stop; Motor Switch; Recording Volume (Mic); Recording Volume (Tuner-Phono). *On A-122 only. Simultaneous record-monitor feature; push-button speed change; illuminated footage counter. Input channels may be mixed with separate volume controls, for narration during recording. Less mike. For 110-120 volts, 60 cycles AC.

MODEL A-112. MONAURAL RECORDER. Dual-track. Shpg. wt., 35 lbs.

95 RZ 984. NET... **339.50**

MODEL A-122. STEREO PLAYER & MONAURAL RECORDER. Wt., 38 lbs.

99 RZ 699. NET... **495.00**

MODEL A-692 MATCHING AMPLIFIER-SPEAKER. Ingeniously engineered single-case unit, providing substantially flat speaker output, 65-10,000 cps. Styling of case matches recorders listed above; forms an ideal portable high-fidelity tape system when used with A-112, or when two are used with A-122 for stereo. Amplifier Response: ±0.5 db, 20-20,000 cps. Noise Level: -70 db. Controls: Volume, Tone, Raked Output: 10 Watts. Inputs: Tape, Tuner, Phono, TV. 8" PM speaker of special Ampex design. Auxiliary AC outlet. For 110-120 volts, 60 cycle AC. Snpg. wt., 35 lbs.

95 RZ 985. NET... **199.50**

Concertone Portable Recorders

MODEL 22. High-quality drive mechanism with dual-track heads, plus a separate preamp unit. Many professional features, including A-B test fader for comparing signals, provision for cueing and editing, and illuminated, large-scale VU meter. Supplied less cases (see below). Speeds, 7½ and 15 ips. Makes recordings that fully meet critical specifications; response at 15 ips is ±2 db, 50 to 15,000 cps. Units will fit standard 19" equipment racks. Sizes: Drive mechanism, 14x6"; Preamp, 5¼x6". Max. reel size, 10½" (NAB). For 110-120 v., 60 cycles AC. Less case. Shpg. wt., 55 lbs.

95 RZ 991. NET... **495.00**

MODEL 105217 CASE. Portable carrying case for tape transport, or 2 preamps, or preamp and mixer. 15x10¾x20". Wt., 17 lbs.

95 RX 989. NET... **60.00**

MODEL 105245 CASE. Will accommodate one preamplifier or one mixer unit only. Size, 7¼x10¼x20". Shpg. wt., 10 lbs.

95 RX 990. NET... **30.00**

MODEL 31 PROFESSIONAL RECORDING COMBINATION. Dual-speed, full-track tape transport and professional preamp on separate chassis. Precision transport has hysteresis-synchronous drive motor; uses no belts, gears or pulleys. Supplied less cases (will fit cases listed above for Model 22). Response: ±2 db, 40 to 15,000 cps at 15" speed; ±2 db, 50-13,000 cps at 7½" speed. Flutter and Wow: Less than 0.1% at 15" speed. Signal-to-Noise Ratio: 55 db. Rewind and Fast Forward: Average 41 ft./sec for 2500 feet. Both units 19" wide (fit standard racks). Sizes: Drive mechanism, 14" high, 6" deep behind panel; Preamplifier, 5¼" high, 6" deep behind panel. For 110-120 v., 60 cycles AC. Less case. Shpg. wt., 55 lbs.

95 RZ 992. NET... **695.00**

SERIES 60 PROFESSIONAL PORTABLES. Offer lightweight portability and broadcast-quality performance in a single compact unit. Accommodates 10½" NAB reels without adapters; hysteresis-synchronous capstan drive, with separate take-up and rewind motors. VU meter has 3-position switch, to monitor level of input signal, level of taped program (during playback or recording), and bias level. Simultaneous record-playback facility for monitoring.

SPECIFICATIONS: Speeds: 7½ and 15 ips. Frequency Response: (15") ±2 db, 40-15,000 cps; (7½") ±2 db, 40-12,000 cps. Flutter and Wow: (15") 0.15%; (7½") 0.25%. Signal-to-Noise Ratio: 55 db at 15". Inputs: Mic. and Line (both high impedance). Output: Cathode follower; 2 v. into 10,000-ohm load. Timing Accuracy: ±3 seconds in 30 minutes. Controls: Record, Play, Fast Forward, Rewind and Stop (push-buttons); Off-On/Speed; Reel Size (Torque); Line Level; Mike Level; Meter Function; A-B Test. Brushed stainless steel control panel. Supplied less case. Size: 15½x16½x5¼" deep. For 110-120 volts, 60 cycle AC.

MODEL 61. Dual-track monaural record and playback. Shpg. wt., 38 lbs.

91 RZ 776. NET... **495.00**

MODEL 62. Dual-track monaural record and playback, plus stereo playback. 40 lbs.

91 RZ 777. NET... **595.00**

MODEL 63. Dual-track monaural record and playback, plus stereo record and playback. In-line stereo heads. Dual recording preamplifiers. Shpg. wt., 42 lbs.

91 RZ 778. NET... **695.00**

SERIES 60 CASE. Airplane-luggage type case for any of above units. 5 lbs.

91 RZ 779. NET... **60.00**

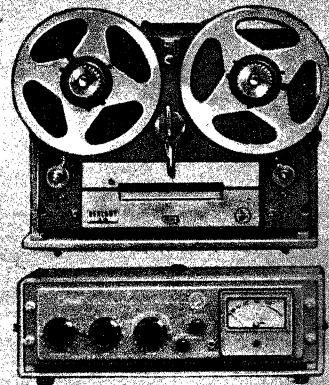

Series 20 and 30

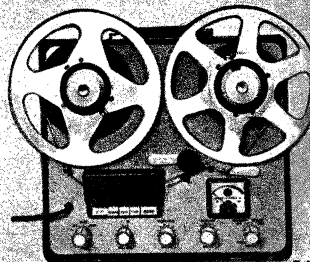

60 Series

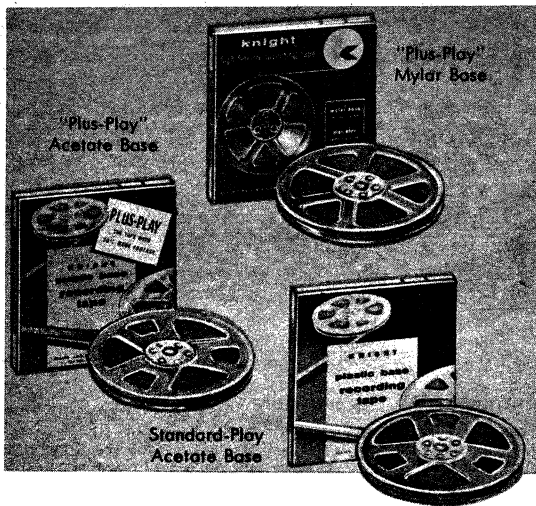

knight®

QUALITY MAGNETIC RECORDING TAPES

New Mylar-Base "Plus-Play" Tape

An ideal combination of qualities: The exceptional toughness and break-resistance of the wonder-plastic, Mylar, plus the extra playing time of Knight "Plus-Play" recording tape—both offered at exceptional savings to you in the new Knight Mylar-base "Plus-Play". It is the most permanent medium yet developed for magnetic recording. Recording characteristics meet the most critical of professional recording requirements and include wide frequency response, extremely low noise level and excellent uniformity of oxide coating. Your cost is far below that of regular recording tapes, at no sacrifice in performance quality!

The remarkable dimensional stability of Mylar, together with its other physical properties, results in an extremely durable bond between oxide and base. The Mylar base is unharmed by heat, cold or humidity. Mylar makes Knight "Plus-Play" indisputably superior to ordinary recording tape; its price makes "Plus-Play" your greatest tape-recording value! *Each reel factory-sealed in cellophane.*

- 92 R 939. 900-ft. Reel. 5" diameter. Shpg. wt., 3/4 lb.
 1 to 4, EACH..... 2.19 5 or More, EACH..... 1.92
 92 R 940. 1800-ft. Reel. 7" diameter. Shpg. wt., 1 1/4 lbs.
 1 to 4, EACH..... 3.79 5 or More, EACH..... 3.45

"Plus-Play" Acetate Base

Within a short time of its release, Knight "Plus-Play" has become one of the most popular recording tapes in America. It's easy to see why—when you buy Knight "Plus-Play," you get superior tape quality, greatly extended playing time (by 50%!) on each reel—plus genuine savings. Knight "Plus-Play" is uniformly red oxide-coated cellulose acetate, only 3/4 as thick as standard tape. With no loss of recording quality, "Plus-Play" is wound 1800 feet to a 7-inch reel—50% more footage than conventional tape. Now you can record entire concerts, conferences or other events on a single reel of tape—at 3 3/4" per second, you get as much as 3 hours of dual-track recording time.

Supplied on transparent molded plastic reels. Shpg. wts.: 900-ft. reel, 3/4 lb.; 1800-ft. reel, 1 1/4 lbs.

- 96 R 981. 900-Ft. Reel. 5" diameter.
 1 to 4, EACH..... 1.89 5 or More, EACH..... 1.69
 96 R 982. 1800-Ft. Reel. 7" diameter.
 1 to 4, EACH..... 2.95 5 or More, EACH..... 2.65

Standard-Play Plastic Base

Knight standard-play, plastic-base tape meets the most critical professional recording requirements, because rigid manufacturing controls protect its high quality. When you use it, you are assured of noise-free reproduction and exceptionally uniform output. The surface upon which the recording is made is precision-coated with pure red oxide, providing excellent high-frequency response and minimum abrasive action on recording heads. You can depend on the quality of Knight recording tape; its performance is easily comparable to other brands of regularly-priced recording tape. It is similar in every respect to tape used throughout the recording industry, and radio and TV work.

Supplied on transparent molded plastic reels. Shpg. wts.: 600-ft. reel, 1/2 lb.; 1200-ft. reel, 1 lb.

- 96 R 698. 600-Ft. Reel. 5" diameter.
 1 to 4, EACH..... 1.42 5 or More, EACH..... 1.29
 96 R 699. 1200-Ft. Reel. 7" diameter.
 1 to 4, EACH..... 1.98 5 or More, EACH..... 1.78



REEVES SOUNDCRAFT

MAGNETIC RECORDING TAPE

RED DIAMOND STANDARD TAPE—1 1/2-MIL ACETATE. Micropolished. Acetate base. Plastic reels except *RETMA fiberglass.

Stock No.	Mfr's. Type	Tape Footage	Reel Size	List	NET
96 R 960	SPN-1	150'	3"	\$0.65	.48
96 R 961	SPN-3	300'	4"	1.25	.92
96 R 962	SPN-6	600'	5"	2.10	1.55
96 R 963	SPN-12	1200'	7"	3.50	2.57
92 R 950	SPN-24RF*	2400'	10 1/2"	8.50	6.24

RED DIAMOND TAPE AND CHEST—TYPE SPNC-7. Five 1200 ft. (7") reels of acetate base tape in storage chest. Shpg. wt., 8 lbs.

- 96 R 964. List, \$17.50. NET..... 12.86

PROFESSIONAL TAPE—1 1/2-MIL ACETATE. Finest quality acetate tape. Micropolished. For professional use. Plastic reels except †RETMA fiberglass (3/16" center opening), †NARTB fiberglass (3" center opening). *NARTB aluminum. Av. shpg. wt., 8 oz.

Stock No.	Mfr's Type	Tape Footage	Reel Size	List	NET
92 R 956	P-12	1200'	7"	\$4.40	3.23
92 R 957	P-24RM*	2400'	10 1/2"	10.25	7.54
92 R 951	P-24RF†	2400'	10 1/2"	10.25	7.54
92 R 958	P-24RF3†	2400'	10 1/2"	10.25	7.54

"PLUS-50" TAPE—1-MIL MYLAR. 50% more footage. Micropolished. "Mylar" base. Plastic reels except *RETMA fiberglass. 8 oz.

Stock No.	Mfr's Type	Tape Footage	Reel Size	List	NET
92 R 952	PL-2	225'	3"	\$1.05	.77
96 R 972	PL-9	900'	5"	3.50	2.58
96 R 973	PL-18	1800'	7"	6.00	4.41
92 R 953	PL-36RF*	3600'	10 1/2"	14.00	10.29

TYPE XP-24 "PLUS 100" TAPE—1/2-MIL MYLAR. Extra-long play tape on Mylar base. Micropolished. Same oxide as "Plus-50". Requires careful handling. 2400', 7" plastic reel. Shpg. wt., 14 oz.

- 95 R 917. List, \$8.50. NET..... 6.24

"PLUS-50" TAPE & CHEST—TYPE PLC-7. Five 1800 ft. (7") reels of "Plus-50" Mylar tape in storage chest. Shpg. wt., 9 lbs.

- 96 R 952. List, \$30.00. NET..... 22.05

LIFETIME TAPE—1 1/2-MIL MYLAR. Mylar base. Micropolished. Plastic reels, except *RETMA fiberglass reel. Av. shpg. wt., 8 oz.

Stock No.	Mfr's Type	Tape Footage	Reel Size	List	NET
96 R 968	L-6	600'	5"	\$3.90	2.86
96 R 969	L-12	1200'	7"	6.30	4.64
92 R 954	L-24RF*	2400'	10 1/2"	13.80	10.14

LIFETIME TAPE & CHEST—TYPE LC-7. Five 1200 ft. (7") reels of Lifetime Mylar base tape in storage chest. Shpg. wt., 8 lbs.

- 96 R 953. List, \$31.50. NET..... 23.16

TAPE CHEST LESS TAPE—TYPE 75TC. Holds five 7" reels. Pull-out drawer compartments. Size, 8x7 3/4x7 1/2". Shpg. wt., 4 lbs.

- 96 R 959. List, \$1.50. NET..... 1.10

TAPE TIMING CHART. Semi-logarithmic tape timing chart. Covers speeds from 1 1/4 to 15", single and dual track. Wt., 6 oz.

- 92 R 955. List, \$1.20. NET..... 88c

audiotape

Recording Tapes and Accessories

STANDARD TAPE—1½-MIL ACETATE. Plastic reels except *NARTB aluminum (3" center opening). Av. shpg. wt., 8 oz.

No.	Type	Footage	Reel	List	EACH	Lot Price
96 R 562	151	150'	3"	\$0.70	.46	.41†
96 R 561	351	300'	4"	1.35	.88	.79†
96 R 560	651	600'	5"	2.25	1.55	1.43†
96 R 356	1251	1200'	7"	3.50	2.40	2.23†
96 R 357	2551R*	2500'	10½"	10.90	7.12	6.41‡

†NET EACH, 10 or more. ‡NET EACH, 5 or more.

"LONGER-RECORDING" TAPE—1-MIL ACETATE. Provides 50% more recording time per reel. Acetate base. Plastic reels except *NARTB aluminum (3" center opening). Av. shpg. wt., 8 oz.

No.	Type	Footage	Reel	List	EACH	Lot Price
92 R 935	941	900'	5"	\$3.50	2.29	2.06†
92 R 936	1841	1800'	7"	5.50	3.60	3.23†
92 R 937	3641R*	3600'	10½"	12.85	8.40	7.56‡

†NET EACH, 10 or more. ‡NET EACH, 5 or more.

"LONGER-RECORDING" TAPE—1-MIL MYLAR. 50% more recording time. Mylar base. On plastic reels except *NARTB aluminum reel (3" center opening). †Plastic reel in self-mailer carton. 12 oz.

No.	Type	Footage	Reel	List	EACH	Lot Price
96 R 838	261‡	225'	3"	\$1.00	.66	.59†
96 R 955	961	900'	5"	3.75	2.45	2.20†
96 R 956	1861	1800'	7"	6.50	4.24	3.82†
96 R 958	3661R*	3600'	10½"	15.00	9.80	8.82‡

†NET EACH, 10 or more. ‡NET EACH, 5 or more.

COLORED BASE TAPE—1½-MIL ACETATE. Colored base recording tape of same high quality as conventional acetate base (above). Ideal for spotting specific selections on one reel; material to be saved, etc. Plastic reels. Shpg. wt., 8 oz.

No.	Green	No.	Blue	Footage	Reel	EACH	10-Up, EA.
96 R 736	651G	96 R 738	651B	600'	5"	1.55	1.43
96 R 737	1251G	96 R 739	1251B	1200'	7"	2.40	2.23

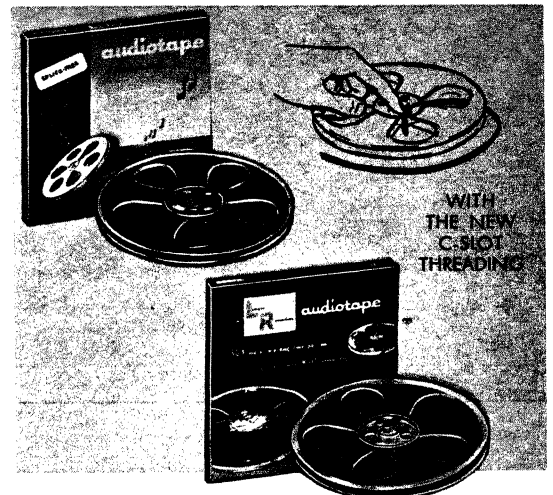

WITH THE NEW C-SHOT THREADING

COLORED PLASTIC REELS. Extremely attractive, colored plastic reels (less tape) available in green, blue, yellow and red as well as standard clear plastic. All are available in 5" and 7" sizes. In boxes. Av. shpg. wt., 4 oz.

Size	Clear	Red	Yellow	Green	Blue	List	EACH	10-Up, EA.
5"	96 R 748	96 R 740	96 R 742	96 R 744	96 R 746	60¢	39¢	35¢
7"	96 R 749	96 R 741	96 R 743	96 R 745	96 R 747	75¢	49¢	44¢

TAPE RECORDER REELS. 10½". With box. *3" center. Wt., 8 oz.

No.	Type	Description	List	1-4, EA.	5-Up, EA.
96 R 358	10RB	NARTB aluminum*			
96 R 997	10FS	Fiberglass, RETMA adapterless ¾" center	\$4.00	2.62	2.35

MYLAR SELF-TIMING LEADER TAPE. 100 ft. of white "Mylar" leader tape. Spaced markings for timing. Shpg. wt., 5 oz.
92 R 938. List, 55¢ NET. 37c

REG. U.S. PAT. OFF.

SCOTCH

BRAND

MINNESOTA MINING

MAGNETIC TAPE

A TYPE 111A STANDARD TAPE—1½-MIL ACETATE. General-purpose acetate base recording tape of high quality. Supplied on high-strength molded plastic reel, except *aluminum NARTB reel (3-inch center opening). Av. shpg. wt., per reel, 8 oz.

Stock No.	Mfr's. Type	Foot-age	Reel Size	List	EACH	Lot Price
96 R 227	111A-1-5	150'	3"	\$.85	.57	.51‡
96 R 343	111A-3	300'	4"	1.50	1.00	.90‡
96 R 226	111A-6	600'	5"	2.25	1.58	1.46‡
96 R 192	111A-12	1200'	7"	3.50	2.45	2.28‡
96 R 313	111A-24R*	2400'	10½"	10.90	7.27	6.54‡

‡NET EACH, 12 or more. †NET EACH, 24 or more.

B TYPE 190A EXTRA-PLAY TAPE—1 MIL ACETATE. Thin acetate base provides 50% more playing time on standard size reels. *NARTB aluminum reel (3" center opening). Av. shpg. wt., 12 oz.

Stock No.	Mfr's. Type	Foot-age	Reel Size	List	EACH	Lot Price
96 R 984	190A-9-100G	900'	5"	\$3.50	2.34	2.10†
96 R 985	190A-18-100G	1800'	7"	5.50	3.67	3.30†
96 R 987	190A-36R-100G	3600'	10½"	12.85	8.57	7.71‡

†NET EACH, 12 or more. ‡NET EACH, 6 or more.

C TYPE 150 EXTRA-PLAY TAPE—1-MIL MYLAR. Extra-strong Mylar plastic base. Plastic reels except *NARTB aluminum 10½" reel (3" center opening). Av. shpg. wt., 12 oz.

Stock No.	Mfr's. Type	Foot-age	Reel Size	List	EACH	Lot Price
92 R 900	150-9	900'	5"	\$4.40	2.93	2.64†
92 R 901	150-18	1800'	7"	7.95	5.30	4.77†
92 R 903	150-36R*	3600'	10½"	17.95	11.97	10.77‡

†NET EACH, 12 or more. ‡NET EACH, 6 or more.

D TYPE 120A-12 HIGH-OUTPUT TAPE—1½-MIL ACETATE. 8 to 12 db higher output. 1200'. Plastic 7" reel. Shpg. wt., 12 oz.
96 R 558. List, \$5.50. NET EACH. 3.67
12 or More, EACH. 3.30

E TYPE 41-½S SPLICING TAPE. Coated one side with non-run adhesive. 150', ½" wide, on handy dispenser. Shpg. wt., 3 oz.
96 R 232. NET. 35c



F TYPE 43P LEADER AND TIMING TAPE—PLASTIC BASE. New leader and timing tape for high-precision editing and protection of start of tapes. Strong plastic base. Marked in 1-second intervals for 3.75", 7.5" and 15" per second. In 150 ft. roll for convenient handling. Shpg. wt., 3 oz.
92 R 905. NET. 57c

EMPTY PLASTIC REELS. Supplied complete with index box. Durably made of molded high-strength plastic, completely transparent. Adequate space provided on each reel for labeling or marking. Av. shpg. wt., 4 oz.

Stock No.	Reel Size	List EACH	1-11, EACH	12 or More Ea.
96 R 237	3"	25¢	17¢	15¢
96 R 349	4"	55¢	37¢	33¢
96 R 236	5"	65¢	44¢	39¢
96 R 194	7"	75¢	50¢	45¢

ONE-REEL MAILING BOXES. Shpg. wt., 3 oz.

Stock No.	Reel Size	List EACH	1-11, EACH	12 or More Ea.
96 R 324	5"	15¢	10¢	9¢
96 R 323	7"	20¢	13¢	12¢
96 R 322	10½"	30¢	20¢	18¢

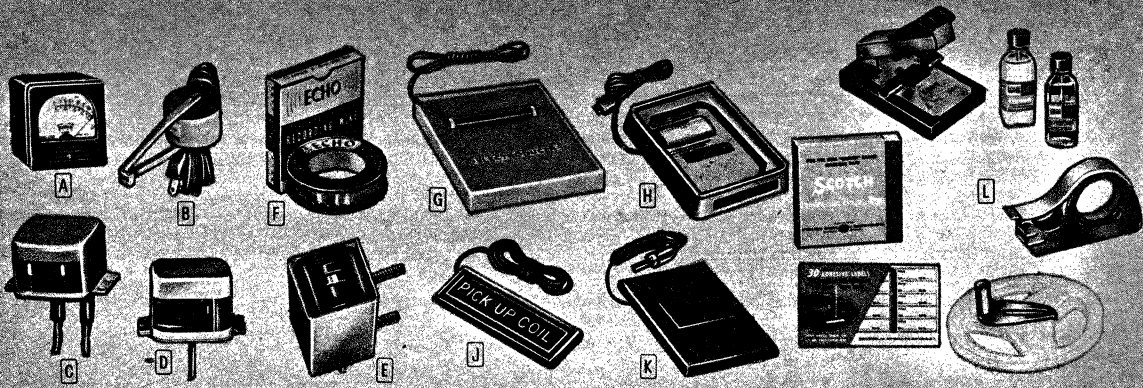

Tape Recording Accessories

A TRIPLETT 327-TC 3" VU METER. Helps visually determine the correct recording level when using most portable tape recorders. Extremely compact—only 3.3x1 3/4" deep. In sturdy black bakelite case equipped with 18" cord, phone plug and jack. Shpg. wt., 2 lbs. 66 R 077. NET..... 22.54

B AUDIOTAPE TYPE 400 HEAD DEMAGNETIZER. For removing magnetism accumulated in recording head. For operation from 110-115 volts, 60 cycle AC. Shpg. wt., 1 lb. 96 R 563. List, \$10.00. NET..... 5.88

SHURE EXACT-REPLACEMENT TAPE RECORDER HEADS. Exact replacement tape recording heads used in many home tape recorders. All Shure heads are stamped with the manufacturer's name and type number, therefore replacements are easily determined in the table below. If in doubt as to the replacement needed, send us the make, model and serial number of your recorder and we'll furnish replacement data. Available in record-playback and record-playback-erase types. Use for replacement or modernization of older tape recorders.

Stock No.	Mfr's Type	Fig.	Coil Impedance	Replaces Older Type	Wt. oz.	List	NET EA.
65 R 366	815†	A	Low	TR5, TR5H	4	15.00	8.82
65 R 584	815H†	C	High	TR5D, TR5K, TR5C	4	15.00	8.82
65 R 588	816†	D	High	TR6C	4	12.00	7.05
96 R 315	817‡	E	Low	TR16A	6	9.00	5.29
65 R 586	TR5B†	C	Low	TR5B	10	17.00	9.99
65 R 413	TR16*	E	High	6	9.00	5.29
65 R 439	TR26	E	High	TR26	6	11.00	6.47

† Upper half track erase, record and playback type.
‡ Upper half-track record and playback only.
* Has Cinch plug and 14" leads.

Wire Recording Accessories

WEBSTER-CHICAGO 2904 WIRE RECORDING HEAD. Not illustrated. Record-playback-erase. Less head cover and mounting screw. Shpg. wt., 11 oz. 96 R 049. List, \$7.50. NET..... 5.88

F ECHO RECORDING WIRE. .0036" stainless steel wire.

Stock No.	Spool Size	Shpg. Wt.	NET EACH
96 R 145	1/4 hour	6 oz.	1.69
96 R 146	1/2 hour	8 oz.	2.56
96 R 147	1 hour	11 oz.	4.25

EMPT METAL SPOOL. Holds 1 hr. wire supply. Shpg. wt., 8 oz. 96 R 044. NET EACH..... 42c

Magnetic Telephone Pickups

High impedance inductor coil units expressly designed to record both sides of a telephone conversation. Requires no electrical or physical connection to the telephone—simply place telephone on pickup. Provides on-the-spot recordings of telephone conversations—eliminates guesswork and misinterpretations. Permits review of older phone messages for technical data, legal specifications, medical discussions, etc. Letters and memoranda may be dictated and recorded for later transcription. Virtually unlimited uses in business, industry and the home. Pickups are plugged into high impedance microphone input of amplifier, tape or recorder—then nothing else to connect. Jones plug on Electro-scriber unit fits most Webcor wire and tape recorders.

G ELECTRO-DUCER TELEPHONE PICKUP. For use with all types of telephones. Has removable coil. Constructed of heavy chip-board. Size: HWD, 1x6 1/2x9 1/2". 12 ft. cable. Wt., 1 1/4 lbs. 99 S 482. List, \$12.50. NET..... 7.35

H ELECTRO-SCRIBER TELEPHONE PICKUP. For standard rectangular-base cradle telephones. Heavy rubber construction. Complete with 8 ft. cable and 3-prong Jones plug. Wt., 1 1/4 lbs. 99 S 489. List, \$12.50. NET..... 7.35

I FOR PUSH-BUTTON PHONES. As above, but specifically for push-button rectangular-base cradle telephones. Shpg. wt., 1 1/4 lbs. 99 S 490. List, \$14.50. NET..... 8.53

J MAGNETIC RECORDING INDUSTRIES VM938 PICKUP. For any telephone. Consists of small coil only, less base. Plastic construction. 1 1/4x3/4x2 1/4". 5 ft. cord, less plug. Shpg. wt., 8 oz. 99 S 478. NET..... 2.98

K KORD-O-KOIL MAGNETIC PICKUP. For cradle telephones only. Size, 5 1/2x3/8x9 1/4". Attractive leatherette finish. Complete with 6 ft. cord and phone plug. Shpg. wt., 1 1/4 lbs. 99 S 486. List, \$10.00. NET..... 5.88

Handy Kit For Tape Recordists

L Everything needed for cleaning and lubrication of magnetic recording and playback heads; also includes valuable aids for editing, splicing and tape identification, plus a time-saving tape threader. Includes: 1 bottle each of "Long Life" Tape Head Cleaner and Lubricant Fluids; Robins TS-4JR Tape Splicer; 150-inch Dispenser Roll of Splicing Tape; Robins Tape Threader; 30 Tape Identification Labels; 150-foot Dispenser Roll of Leader and Timing Tape. The splicer provides every tape recordist with professional-looking, silent, diagonal splices with concave trim. Tape identification labels are on gummed paper, and are self-adhesive. Leader and timing tape permits accurate interval timing and protection of beginning of tapes. Shpg. wt., 1 1/2 lbs. 94 R 921. Complete Kit. NET..... 7.35



M TAPE CARRYING CASE. Holds twelve 7" reels of tape. Sturdily constructed of wood with simulated-leather brown and white covering. Has securely fastened carrying handle and protective feet. Measures only 8 1/2x8 1/2x8 3/4". Wt., 3 1/4 lbs. 96 R 580. List, \$7.95. NET..... 5.95

N TAPE CARRYING CASE. Rugged, lightweight. Kraftboard case holds twelve 7" reels. Styled in textured green. Two clasps securely lock cover. With carrying handle. 8 1/2x8 1/2x8 3/4". Shpg. wt., 2 lbs. 95 RX 714. List, \$2.75. NET..... 1.98

P COUSINO U-3000 TAPE VENDOR. Plays tape-recorded messages continuously. Fits standard recorders. Plays up to 20 min. at 3 3/4"/sec. with Moebius loop. With tape. Clockwise rotation. Shpg. wt., 1 1/2 lbs. 96 R 717. List, \$12.50. NET..... 10.00
96 R 714. As above, but counter-clockwise rotation. NET..... 10.00

R TAPE SPLICER KIT. With plastic splicer, blade, splicing tape. Adhesive backing—adheres to body of recorder. 6 oz. 96 R 718. List, \$1.50. NET..... 1.20

SPLICING TAPE REFILLS. For above, 24 precut pieces. Shpg. wt., 2 oz. 96 R 719. List, 25c. NET..... 20c

S JIFFY RECORDING TAPE SPLICER. For holding recording tape in alignment for cutting and splicing. Shpg. wt., 5 oz. 96 R 379. List, \$2.50. NET..... 1.50

T JIFFY-RASE TAPE ERASER. Efficient bulk tape eraser. Minimizes background noise and distortion. Size, 5" O.D. x 3 1/2" H. For 110-120 v., 50-60 cycle AC. 7 lbs. 96 R 569. NET..... 20.98

W AUDIO DEVICES TYPE 30AL IDENTIFICATION LABELS. Self-adhesive. 1/2x2". Shpg. wt., 4 oz. 96 R 564. PER PKG. OF 30..... 12c

X ROBINS TAPE THREADER. Fits over reel shaft and hub of recorder take-up reel. Turn crank several times—and reel is threaded. For reels to 7". Wt., 2 oz. 96 R 713. NET..... 79c

Y ROBINS TS-4DLX TAPE SPLICER. For rapid tape editing and repairing. Only 2 1/2x4". Consists of snap arms to hold tape in position and double cutting mechanism. Cuts diagonal splice and trims "waist" along sides of splice. With splicing tape and holder. Shpg. wt., 12 oz. 96 R 734. List, \$11.50. NET..... 8.46

ROBINS TS-4 TAPE SPLICER. As above except less splicing tape and holder. Wt., 8 oz. 96 R 319. List, \$8.50. NET..... 6.25

Z ROBINS TS-4JR TAPE SPLICER. Cuts 1/4" tape ends diagonally; gives splice slightly concave trim. No overhang. Uses 1/2" splicing tape. 2x3". Shpg. wt., 7 oz. 95 R 712. List, \$6.50. NET..... 4.78

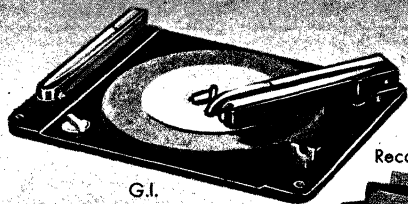
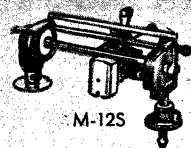
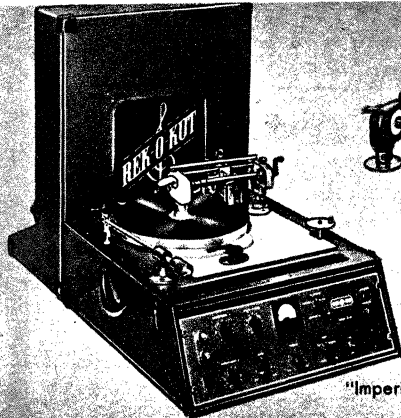

Rek-O-Kut "Imperial" Professional Recorder

Precision Rek-O-Kut disc recorder equipped with the M-12S overhead recording lathe. Unit will accommodate all standard vertical-mounting cutting heads. Supplied with 120-line leadscrew; interchangeable with leadscrews up to 270 lines (see below). Lathe can be hand-cranked for run-in and run-off spiral grooves. Calibrated for critical timing. Model A-160, 16" playback pickup arm accommodates records to 16" in diameter. Supplied complete with new cutting head (Model R-56); frequency response, 50-10,000 cps. Less microphone. Uses standard short-shank cutting needle. For 105-125 v., 60 cycle AC. Shpg. wt., 80 lbs.

95 RZ 742. NET.....599.95

MODEL M-12S OVERHEAD RECORDING LATHE. Used in "Imperial" professional recorder listed above. Interchangeable with M-12 mechanism. Less head. Shpg. wt., 20 lbs.

95 RZ 745. NET.....150.00

MODEL R-56 CUTTING HEAD. For Model M-12S above. Impedance, 8 ohms. Shpg. wt., 1 lb.

95 RC 746. NET.....60.00

MODEL M-12S-210 MICROGROOVE LEADSCREW. For Model M-12S recording lathe. 210 lines per inch. Shpg. wt., 1 lb.

95 R 743. NET.....44.95

MODEL M-12S-240 MICROGROOVE LEADSCREW. As above except 240 lines per inch. Shpg. wt., 1 lb.

95 R 744. NET.....44.95

MODEL TR-43H DUAL-SPEED RECORDING TURNTABLE. Dual speed, 12" aluminum turntable. Plays 33 1/2 and 45 rpm. Tapped for M-12S cutter. With heavy-duty, hysteresis synchronous motor. Includes 78-rpm idler. Less cutter. Shpg. wt., 21 lbs.

91 RZ 749. NET.....149.95

G. I. Recorder-Phono Assembly

MODEL GI-R85L-LP. Low-cost recorder-phono assembly for cutting and playing recordings. Easily mounted in cabinet, carrying case, etc. Cuts discs up to 10" in diameter at 160 lines per inch (std. groove). Two speeds (33 1/2 and 78 rpm., or 45 and 78 rpm. using adapter spring included for that purpose). Weighted pickup arm provides proper needle pressure for both standard and microgroove records. Steel turntable is rim-driven by 4-pole motor. Convenient depth of cut adjustment. An ideal unit for replacement of older disc recorders. Size, Base plate 15" W, 11 1/2" D; height, 6 1/2", 2 3/4" above, 3 7/8" below plate. Requires high-gain amplifier or radio with 3 watts or more output. Cutter head must be connected to high impedance source. Supplied complete with crystal cutting head less cutting needle (requires short shank type) and playback styli. For operation from 110-120 volts, 60 cycle AC. Shpg. wt., 17 lbs.

96 RX 106. List, \$56.50. NET.....33.90

MODEL GI-R85-LP WITH MAGNETIC HEAD. Same as Model GI-R85L-LP described above, but with Astatic 10-ohm magnetic cutting head. Shpg. wt., 18 lbs.

96 RX 703. List, \$58.50. NET.....35.10

Astatic Disc Recording Heads and Needles

TYPE X-26 CRYSTAL. High impedance; response to 6000 cps. Includes flange for Wilcox-Gay, Knight and G.I. recorders. Connects to plate of output tube or 60,000 ohms transformer secondary. Approximate drive voltage required: 150 v. (rms), 1 3/8 x 5/8 x 3/4". With 24" leads. Shpg. wt., 1 lb.

65 R 125. NET.....7.53

TYPE M41-8. MAGNETIC. Impedance, 8 ohms; connects directly to amplifier output. Upper frequency limit, 7000 cps. Drive voltage, 3 v. (rms). Size, 1 3/4 x 1 1/8 x 3/4". 24" leads. Shpg. wt., 1 lb.

65 R 128. NET.....7.53

KNIGHT STEEL CUTTING NEEDLES. Short shank. Has .003" tip. Average cutting life, 20 minutes. Quiet cutting for fine recording. Shpg. wt., 3 oz.

65 R 803. Pkg. of 5. NET.....59c

KNIGHT SAPPHIRE CUTTING NEEDLE. Precision-ground and highly polished. Short shank. Has .003" tip. Av. life, 5 hrs. 2 oz.

65 RC 800. NET EACH.....3.88

Quality Recording Discs for All Purposes

AUDIODISC PROFESSIONAL RECORDING BLANKS

Smooth-coated on both sides of aluminum base. Red Label discs for highest quality work; Yellow Label for general purpose work in studios and schools; Blue Label for home recording. *Large center hole for 45 rpm recordings.

Stock No.	Size	Label	Base	Wt. Ea.	Lbs. Pkg.	Std. Pkg.	NET EACH		
							Single	Lots	Std. Pkg.
69 R 085	7:	Red	.050:	5 oz.	5	25	.91		.82
69 R 069	8:	Red	.040:	5 oz.	5	25	.71		.65
69 R 070	10:	Red	.040:	6 oz.	8 1/2	25	1.01		.91
69 R 071	12:	Red	.050:	9 oz.	13 1/2	25	1.67		1.50
69 RX 072	16:	Red	.050:	1 lb.	25	25	3.01		2.70
69 R 089	8:	Yellow	.040:	5 oz.	5	25	.61		.55
69 R 090	10:	Yellow	.040:	6 oz.	8 1/2	25	.81		.72
69 R 091	12:	Yellow	.050:	9 oz.	13 1/2	25	1.30		1.18
69 RX 092	16:	Yellow	.050:	1 lb.	25	25	2.42		2.18
69 R 065	6 1/2:	Blue	.027:	3 oz.	6 1/2	50	.32		.29
69 R 066	8:	Blue	.027:	4 oz.	7 1/2	50	.46		.41
69 R 067	10:	Blue	.027:	5 oz.	10 1/2	50	.66		.59

REEVES SOUNDRAFT RECORDING DISCS

THE BROADCASTER. For critical recording. Finest physical and sound properties. Made with scrupulous care. Double face.

Stock No.	Size	Wt. Ea.	Std. Pkg.	Lbs. Pkg.	Std. Pkg.	NET EACH		
						Single	Lots	Std. Pkg.
69 R 260	10"	5 oz.	25	8	1	1.11		1.00
69 R 261	12"	8 oz.	25	14	1	1.73		1.56
69 RX 262	16"	16 oz.	25	26	1	3.17		2.86

THE PLAYBACK. Standard broadcast-quality double-faced discs.

Stock No.	Size	Wt. Ea.	Std. Pkg.	Lbs. Pkg.	Std. Pkg.	NET EACH		
						Single	Lots	Std. Pkg.
69 R 263	6 1/2"	3 oz.	25	4	1	.59		.53
69 R 265	10"	5 oz.	25	8	1	1.01		.91
69 R 266	12"	8 oz.	25	14	1	1.67		1.50

THE ADDITION. For recording in the home, Double faced discs.

Stock No.	Size	Wt. Ea.	Std. Pkg.	Lbs. Pkg.	Std. Pkg.	NET EACH		
						Single	Lots	Std. Pkg.
69 R 268	6 1/2"	3 oz.	25	4	1	.52		.47
69 R 270	10"	5 oz.	25	8	1	.81		.73
69 R 271	12"	8 oz.	25	14	1	1.30		1.17

SEMI-PROFESSIONAL & HOME-TYPE RECORDING DISCS

For home, semi-professional and school use. Aluminum base (except paper bond base), cellulose acetate coated. Red Label is semi-professional grade with excellent sound qualities.

Stock No.	Size	Label	Base	Wt. Ea.	Std. Pkg.	Wt. Std. Pkg.	NET EACH		
							Single	Lots	Std. Pkg.
69 R 109	6 1/2"	Orange	†	3 oz.	6	1/2 lb.	25c		15c
69 R 140	6 1/2"	Red	.021"	3 oz.	5	1/2 lb.	30c		27c
69 R 141	8"	Red	.021"	4 oz.	5	3/4 lb.	40c		36c
69 R 142	10"	Red	.021"	4 oz.	5	1 lb.	60c		54c
69 R 143	12"	Red	.021"	6 oz.	5	2 1/2 lbs.	73c		66c
69 R 195	6 1/2"	Purple	.012"	3 oz.	5	1/2 lb.	23c		21c
69 R 196	8"	Purple	.012"	4 oz.	5	3/4 lb.	33c		30c
69 R 197	10"	Purple	.012"	4 oz.	5	1 lb.	47c		42c

RECORD LABELS. Gummied record labels with spaces for title, artist, date, etc. Shpg. wt., per pkg., 2 oz. 50 per pkg.

65 R 520. 4 or more Pkgs., Ea. 31c NET PER PKG. 35c

Disc Cutting Needles

AUDIOPONTS. High-quality recording needles. *For non-professional and Presto Model K recorders. †For professional recorders. 65 R 960 has 87° included angle; 65 R 961, 70°. All .003" except 65 R 966, .001". Shpg. wt., 2 oz.

Stock No.	Mfr's Type	Description	NET EACH
65 R 960*	14	Sapphire, short dural shank	4.85
65 R 967*	20	As above, for microgroove	
65 R 961†	14	Sapphire, long dural shank	
65 R 966†	20	As above, for microgroove	
65 R 962*	202	Sapphire, short brass shank	3.88
65 R 963†	202	Sapphire, long brass shank	
65 R 964*	34	Stellite, short brass shank	1.47
65 R 965†	34	Stellite, long brass shank	

OUTSTANDING SELECTION OF BEST SELLING RECORDED TAPES

Stereo-Inline Recorded Tapes

Stock No.	Tape No.	Mfr.	Description	NET EACH
68 RR 502	ST-6	Bel Canto	TRIBUTE TO VICTOR HERBERT. Stockholm String Orch.	7.96
68 RR 501	ST-7	Bel Canto	POLKA PARTY IN STEREO. Razzberry Reynolds Band.	6.36
68 RR 503	ST-11	Bel Canto	SYMPHONY FOR HUBERT. Hamburg Phil. Orch.	9.56
68 RR 503	ST-11	Bel Canto	ADVENTURES IN EXOTIC LANDS. Paris Theater Orch.	9.56
68 RR 502	ST-13	Bel Canto	OKLAHOMA (Arr. BENNET). New World Theater Orch.	7.96
68 RR 501	ST-14	Bel Canto	SOUTH PACIFIC (Arr. BENNET). New World Theater Orch.	6.36
68 RR 502	ST-17	Bel Canto	WARSAW CONCERTO & RHAPS. IN BLUE. Hamburg Phil. Orch.	7.96
68 RR 503	ST-20	Bel Canto	AROUND THE WORLD IN 80 DAYS. From original film score.	9.56
65 RR 673	22-2	Concertapes	FAVORITE SHOW TUNES NO. 1. Sorkin Strings.	11.95
65 RR 673	22-6	Concertapes	FAVORITE SHOW TUNES NO. 2. Sorkin Strings.	11.95
65 RR 672	101-A	Concertapes	MUSIC OF JOHANN STRAUSS. Sinfonietta, Sorkin cond.	11.95
65 RR 669	501	Concertapes	SOUND IN THE ROUND, VOL. 1. Intro. to stereo.	7.95
65 RR 669	602	Concertapes	GRIEG: PEER GYNT SUITE NO. 1. Sinfonietta, Sorkin.	7.95
65 RR 669	603	Concertapes	TEMPO NUEVO (Latin moods). Concertapes Orch.	7.95
65 RR 669	604	Concertapes	MUSIC OF JOHANN STRAUSS. Sinfonietta, Sorkin cond.	7.95
65 RR 669	608	Concertapes	SWINGIN' EASY. The Moderns.	7.95
64 RR 853	R602	Hi Fi Tapes	BAND WITH A BEAT. Harry Zimmerman Band.	12.95
64 RR 853	R707	Hi Fi Tapes	MORE GEO. WRIGHT. Wurlitzer pipe organ.	12.95
64 RR 853	R708	Hi Fi Tapes	SHOW TIME. Wright playing Wurlitzer organ.	12.95
65 RR 644	AT7-6BN	Livingston	RAMPART RAMBLERS. W. DeParis and New Orleans Band.	9.56
65 RR 605	EM7-6BN	Livingston	RED ONION JAZZ BAND. VOL. 1. All-star group.	9.56
65 RR 604	ES7-6BN	Livingston	RUSTY DEDRICK, TRUMPET WITH RHYTHM AND WINDS.	9.56
65 RR 602	T1062BN	Livingston	ERSKINE BUTTERFIELD—JUST FOR KICKS. Swing.	9.56
65 RR 602	T1081BN	Livingston	BARBARA CARROLL TRIO. Pop. & standard favorites.	9.56
65 RR 602	T1083BN	Livingston	LENNY HERMAN & MIGHTIEST LITTLE BAND. Pops.	9.56
68 RR 510	MDS2-1	Mercury	GREAT SONGS FROM HIT SHOWS. Sarah Vaughan.	10.36
68 RR 510	MDS2-2	Mercury	HAVANA IN HI FI. Richard Hayman.	10.36
68 RR 510	MDS2-3	Mercury	LET'S DANCE. David Carroll.	10.36
68 RR 510	MDS2-6	Mercury	MOODS IN MUSIC. Green and Iles.	10.36
68 RR 511	MDS3-1	Mercury	MUSIC FOR HI-FI BUGS. Pete Rugolo.	10.36
68 RR 512	MDS6-1	Mercury	KODALY & BARTOK. Minneapolis Symphony.	10.36
68 RR 512	MDS6-2	Mercury	CARPENTER: ADV. IN A PERAMBULATOR. Eastman Orch.	10.36
68 RR 512	MDS6-3	Mercury	BIZET: CARMEN. Detroit Symphony, Paray Cond.	10.36
64 RR 864	ST-2001	Omegatape	MISTER ZITHER. A. Karas. Vienna Amusement Orch.	11.95
65 RR 611	ST-7006	Omegatape	THE HI-LO'S IN HI-FI. Hi-Lo's & F. Comstock Orch.	11.95
65 RR 611	ST-7013	Omegatape	OUT OF THIS WORLD. Dick Mark's Quartet— Nan Pastor—The Intervals.	11.95
68 RR 514	RTS-500	Pentape	RIO RHYTHMS. Rhumbas and Mambos.	5.95
68 RR 514	RTS-600	Pentape	MUGGSY SPANIER & HIS ORCHESTRA. Playing Dixieland.	5.95
68 RR 514	RTS-800	Pentape	DUKE ELLINGTON ORIGINALS. Blues.	5.95
68 RR 514	RTS-900	Pentape	CLARK TERRY & HIS ORCHESTRA. Popular favorites.	5.95
65 RR 649	ECS-1	RCA	R. STRAUSS: ALSO SPRACH ZARATHUSTRA. Chi. Symph.	11.96
65 RR 649	ECS-4	RCA	BRAMHS: CONCERTO IN D. Heifetz, Chi. Sym., Reiner.	11.96
65 RR 649	ECS-9	RCA	BARTOK: CONCERTO FOR ORCHESTRA. Chi. Sym., Reiner cond.	11.96
65 RR 649	ECS-15	RCA	OFFENBACK: GAITE PARISIENNE. Boston Pops, Fiedler.	11.96
65 RR 609	FCS-2	RCA	R. STRAUSS: EIN HELDENLEBEN. Chi. Sym., Reiner.	13.56
68 RR 508	A1005	Stereoph'ny	PIANO IN STEREO. Austin Throckmorton.	6.95
68 RR 509	B1215	Stereoph'ny	DOC EVANS PLAYS DIXIE IN STEREO. "Doc" & His Band.	7.95
68 RR 508	A1315	Stereoph'ny	TWIN IVORIES. Austin & Scofield Piano Team.	6.95
64 RR 852	ST-4A	Stereotapes	STAN SELTZER'S STEREO STEINWAY. Pops.	9.56
64 RR 851	ST-5	Stereotapes	JAZZ MYSTERY. Jack Millman Quintet.	6.36
64 RR 880	SWB8001	Sonotape	BACH: 2 FUGUES, D- & C-MINOR. Weinrich, organ.	11.95
64 RR 880	SWB803	Sonotape	STRAVINSKY: LE RAOI DU SOL. Ars Nova, Mandell cond.	11.95
64 RR 880	SWB804	Sonotape	TCHAIKOVSKY: F. L. ORGANO. Owen, organ.	11.95
64 RR 880	SWB806	Sonotape	LEIBERT TAKES RICHMOND. Leibert, organ.	11.95
64 RR 880	SWB8007	Sonotape	SOUNDPROOF! Tomorrow's Sound Today. Ferrante & Teicher.	11.95
64 RR 880	SWB808	Sonotape	CHRISTMAS AT RADIO CITY. Leibert, organ.	11.95
64 RR 880	SWB8012	Sonotape	LEIBERT TAKES A HOLIDAY. Leibert, organ.	11.95
64 RR 880	SWB8014	Sonotape	TCHAIKOVSKY: QUARTER NO. 1. D. Curtis String Quartet.	11.95
64 RR 881	SWB9002	Sonotape	TCHAIKOVSKY: NUTCRACKER BALLET. Rodzinski.	17.95

HOW TO ORDER TAPES

When ordering tapes listed on this page, give both the Stock No. and Tape No. Selections for every taste—classical, popular, and jazz —by the world's leading artists. Tape catalog listed below. All tapes on this page are for 7 1/2" per sec. playback. Stereophonic tapes are for stacked-head machines. If staggered-head tape is desired, write "Special" in place of Stock No., and specify "staggered-head" in description. Allow 2-3 weeks for delivery of staggered-head tapes. Av. shpg. wt., 12 oz.

FREE ALLIED TAPE CATALOG

Up-to-date listing of the tapes in stock. Lists over 200 selections of music and sounds. Frequently revised.
64 R 858.....Free

SAMPLER TAPES

Selections for tape demonstrations.
BEL CANTO DT-27. Monaural.
65 R 617. NET.....2.00
BEL CANTO ST-DX. Stereo.
64 R 878. NET.....3.95
SONOTAPE SWB-DEM. 1. Stereo.
64 RR 882. NET.....6.95
STEREOPHONY C80S. Vol. I. Stereo.
68 RR 507. NET.....4.95
STEREOTAPES ST-1. Stereo.
64 RR 850. NET.....2.00

STEREO TEST TAPES

SONOTAPE SWB-AL-101. For checking head azimuth, speaker locations, frequency response, tape speed, balance, dynamic range, etc. Includes musical selections. Supplied with tuning fork. 7" reel. 12 oz.
64 RR 886. NET.....11.95
STEREOPHONY T-50-S. Checks balance. 5" reel. Shpg. wt., 12 oz.
68 RR 506. NET.....1.98

Monaural Recorded Tapes

Stock No.	Tape No.	Mfr.	Description	NET EACH
65 RR 634	AT-1	Alphatapes	HIGH FIDELITY JAZZ. 6 selections by 6 bands.	3.95
65 RR 634	AT-4	Alphatapes	LATINO. Carlos Molina & His Orchestra.	3.95
65 RR 601	101	Bel Canto	COLOR AND ROMANCE. Monty Kelly & Orchestra.	5.56
65 RR 601	102	Bel Canto	MOODS IN FAR AWAY PLACES. Ray Charles Chorus.	5.56
65 RR 601	103	Bel Canto	THE MIRACLE OF A DREAM. Jay White & His Orchestra.	5.56
65 RR 601	107	Bel Canto	YOUR FATHER'S MOUSTACHE IN HI-FI. A. White & Orch.	5.56
65 RR 601	301	Bel Canto	IN OLD BAVARIA. Polkas, Schernmann & Orch.	5.56
65 RR 601	503	Bel Canto	CHICAGO JAZZ. D. Remington & Chicago Jazz Band.	5.56
64 RR 855	403	Concertapes	TEMPO NUEVO. Latin moods, Concertapes Orch.	3.95
64 RR 855	406	Concertapes	SWINGIN' EASY. The Moderns.	3.95
65 RR 674	481	Concertapes	MUSIC OF JOHANN STRAUSS. Sinfonietta, Sorkin cond.	7.95
65 RR 629	R702	Hi Fi Tapes	GEO. WRIGHT ENCORES. Wright at Wurlitzer Organ.	6.95
65 RR 629	R708	Hi Fi Tapes	GEO. WRIGHT'S SHOW TIME. Wurlitzer Organ.	6.95
65 RR 686	RT-500	Pentapes	RIO RHYTHMS.	3.95
65 RR 686	RT-600	Pentapes	MUGGSY SPANIER & HIS ORCHESTRA. Playing Dixieland.	3.95
65 RR 686	RT-700	Pentapes	HYMNS. Shay Torrent.	3.95
65 RR 686	RT-800	Pentapes	DUKE ELLINGTON ORIGINALS. Blues.	3.95
65 RR 686	RT-900	Pentapes	CLARK TERRY & HIS ORCHESTRA. Popular favorites.	3.95
65 RR 686	RTM-1	Pentapes	MOODS IN MUSIC. Larry Paigs Orchestra.	3.95
64 RR 859	AP-33	RCA	SHALL WE DANCE. Freddy Martin & His Orchestra.	5.56
65 RR 618	BC-11	RCA	RHAPS IN BLUE (Comp.) & GR. CANYON SUITE (Excerpts).	7.16
65 RR 646	BP-2	RCA	WARS FOR RELAY. Melachro String.	7.16
65 RR 646	BP-7	RCA	SOFT AND SWEET. Three Suns with string orch.	7.16
65 RR 646	BP-11	RCA	THE ONE—THE ONLY. Kay Starr.	7.16
65 RR 646	BP-23	RCA	IT'S LOVE. Lena Horne with Lanny Hayton & Orch.	7.16
65 RR 646	BP-46	RCA	ONE NIGHT IN VENICE. Armando & His Orchestra.	7.16
65 RR 646	BP-48	RCA	CALYPSO. Harry Belafonte.	7.16
65 RR 647	CP-10	RCA	BELAFONTE. Harry Belafonte.	8.76
65 RR 647	CP-25	RCA	HI FI AND WIDE. The Three Suns.	8.76

RCA TV Picture Tubes



Fully guaranteed for 1 year. Number prefix in tube type indicates screen size. All tubes have magnetic focus and deflection, except telectrostatic focus and deflection, and telectrostatic focus and magnetic deflection. *Indicates aluminized screens. Department AX3 designates RCA, AX4 Raytheon; AX5 Dumont. Prices include Federal Excise Tax. When ordering, give the complete Stock Number, which consists of the Dept. No. and the Manufacturer's Tube Type. Tubes can be assorted for quantity price. Shipped by express only.

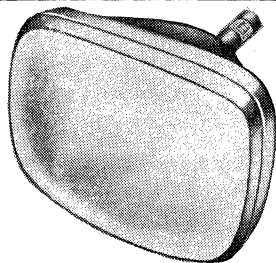

Dept.	Stock No.		List	NET EACH	EACH	
	Type				2-5	6 or More
AX3	5TP4*		\$ 78.25	57.48	54.61	51.74
AX3	7JP4†		29.50	21.71	20.63	19.54
AX3	8DP4†		21.35	15.68	14.90	14.11
AX3	10BP4A		22.50	16.51	15.69	14.87
AX3	10FP4A*		27.35	20.09	19.09	18.08
AX3	12KP4A*		31.75	23.32	22.26	20.99
AX3	12LP4A		27.25	19.94	18.95	17.95
AX4	14ASP4†*		42.00	30.92	29.38	27.83
AX3	14ATP4†*		34.75	25.48	24.21	22.93
AX3	14EP4/14CP4/14BP4		29.25	21.56	20.48	19.40
AX3	14HP4†		29.25	21.56	20.48	19.40
AX3	14QP4A†*		37.95	27.88	26.49	25.10
AX3	14RP4		29.25	21.56	20.48	19.40
AX3	14RP4A*		36.20	26.61	25.28	23.95
AX3	16AP4A		48.25	35.43	33.66	31.89
AX3	16DP4A		45.75	33.66	31.99	30.30
AX3	16GP4B		48.25	35.43	33.66	31.89
AX3	16LP4A		44.50	32.68	31.06	29.42
AX3	16RP4/16KP4		33.25	24.50	23.27	22.05
AX3	16RP4A/16KP4A*		40.75	29.94	28.45	26.95
AX3	16TP4		33.25	24.50	23.27	22.05
AX3	16WP4A		44.50	32.68	31.06	29.42
AX4	16ZP4		44.50	32.68	31.06	29.42
AX3	17AVP4/17ATP4†		35.25	25.82	24.54	23.25
AX3	17AVP4A/17ATP4A†*		42.45	31.21	29.65	28.10
AX3	17BP4†*		40.50	29.74	28.26	26.77
AX3	17BP4A		33.25	24.50	23.27	22.05
AX3	17BP4B*		40.75	29.94	28.45	26.95
AX3	17BVP4†*		47.80	35.13	33.38	31.62
AX3	17BZP4†*		47.65	35.02	33.29	31.54
AX3	17CDP4†*		47.65	35.02	33.29	31.54
AX3	17CP4		43.75	32.14	30.54	28.93
AX3	17GP4†		48.25	35.43	33.66	31.89
AX3	17HP4/17RP4†		35.25	25.82	24.54	23.25
AX3	17HP4B/17RP4B					
AX5	17RP4C†*		42.45	31.21	29.65	28.10
AX3	17K4†		35.75	26.21	24.91	23.60
AX3	17LP4/17VP4†		35.25	25.82	24.54	23.25
AX3	17LP4A/17VP4B†*		42.45	31.21	29.65	28.10
AX3	17QP4		33.25	25.82	24.54	23.25
AX3	17QP4A*		40.75	29.94	28.45	26.95
AX3	17TP4†		43.75	32.14	30.54	28.93
AX3	19AP4B		52.50	38.66	36.73	34.80
AX3	20DP4A/20CP4A		40.25	29.60	28.12	26.64

Dept.	Stock No.		List	NET EACH	EACH	
	Type				2-5	6 or More
AX3	20DP4C/20CP4D*		\$ 48.00	35.28	33.52	31.75
AX3	20HP4A/20MP4A†		42.00	30.92	29.38	27.83
AX3	20HP4D†*		49.80	36.60	34.78	32.95
AX3	21ACP4A/21BSP4*		48.00	35.28	33.52	31.75
AX3	21ALP4A†*		49.80	36.60	34.78	32.95
AX3	21ALP4B†*		49.80	36.60	34.78	32.95
AX3	21AMP4A*		48.00	35.28	33.52	31.75
AX3	21AP4		50.75	37.24	35.38	33.52
AX3	21ATP4†*		49.80	36.60	34.78	32.95
AX3	21ATP4A†*		49.80	36.60	34.78	32.95
AX3	21AVP4/21AUP4†		42.00	30.92	29.38	27.83
AX3	21AVP4B/21AUP4B/21AVP4A/21AUP4A†*		49.80	36.60	34.78	32.95
AX3	21AWP4*		48.00	35.28	33.52	31.75
AX3	21BTP4†*		49.80	36.60	34.78	32.95
AX3	21CBP4A†*		47.50	34.84	33.10	31.36
AX3	21CEP4†*		55.15	40.52	38.50	36.48
AX3	21DFP4†*		52.50	38.66	36.73	34.80
AX3	21EP4A		42.00	30.92	29.38	27.83
AX3	21EP4B*		49.80	36.60	34.78	32.95
AX3	21FP4A†		43.75	32.14	30.54	28.93
AX3	21FP4C†*		51.50	37.88	35.99	34.09
AX5	21KP4A†		54.75	40.18	38.17	36.16
AX3	21MP4†		52.50	38.66	36.73	34.80
AX4	21WP4		40.25	29.60	28.12	26.64
AX4	21WP4A*		45.50	33.52	31.84	30.16
AX3	21YP4†		42.00	30.92	29.38	27.83
AX3	21YP4A†*		49.80	36.60	34.78	32.95
AX3	21ZP4A		40.25	29.60	28.12	26.64
AX3	21ZP4B*		48.00	35.28	33.52	31.75
AX3	24AEP4†*		68.50	50.32	47.81	45.30
AX3	24CP4A*		69.35	50.96	48.41	45.86
AX3	24DP4A/24YP4†*		71.45	52.53	49.90	47.28
AX3	24VP4A*		69.35	50.96	48.41	45.86
AX4	27EP4*		118.75	87.22	82.86	78.50
AX3	27MP4*		163.50	126.47	120.25	113.83
AX4	27RP4*		118.75	87.22	82.86	78.50
AX3	21AXP22†*		160.00	127.40
AX3	21AXP22A†*		160.00	127.40

WESTINGHOUSE 8XP4 8"

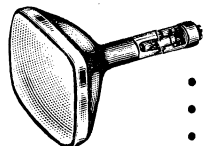

RECEIVER CHECK TUBE

- Fits Most Sets
- Self Focusing
- Saves Time

Here's an extremely versatile 8" rectangular universal picture tube—a great aid in television servicing. An exceptionally valuable, time-saving accessory—permits testing television set without using the original picture tube. Eliminates the necessity for taking the original picture tube to service shop and provides positive substitution test for questionable picture tubes. Lightweight and compact. Can be used in virtually all electromagnetically deflected television sets regardless of the deflection angle. For 53°, 70°, and 90° deflection circuits. No ion trap required. Automatic self-focusing. Ideal for electrostatic or magnetic-focus sets. A "must" for every TV service shop. Shpg. wt., 6 lbs.

AX5 8XP4. NET. 21.56

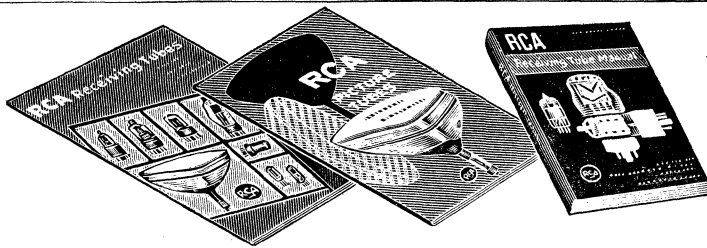

RCA TUBE & SERVICE AIDS

1275-G RECEIVING TUBE CHARACTERISTICS BOOKLET. Helpful guide. No charge with tube order.

37 A 059. Postpaid in U.S.A. 14c

3F37B TUBE MOVEMENT AND INVENTORY GUIDE. No charge with tube order.

37 A 127. Postpaid in U.S.A. 10c

KB-106 PICTURE TUBE CHARACTERISTICS BOOKLET AND REPLACEMENT DIRECTORY. A valuable "must". No charge with tube order.

37 A 141. Postpaid in U.S.A. 12c

RC-18 RCA RECEIVING TUBE MANUAL. Latest edition. Lists characteristics and typical operating conditions of all current RCA receiving type tubes. Includes discussions covering characteristics, applications and installation of electron tubes. No charge with order of 15 tubes.

37K575. Postpaid in U.S.A. 75c

1 picture tube equals 35 receiving tubes on RCA service aids or literature orders.

RCA Receiving Tubes

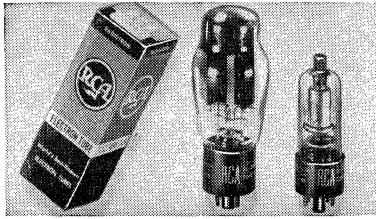

RCA RADIOTRONS—THE GREAT NAME IN ELECTRONIC TUBES. Premium-quality tubes, universally known for their absolutely dependable performance. Purchasers of tubes in quantity lots may obtain RCA service aids, tube literature and promotion displays at no cost—see page 97 of this Catalog. *Not made by RCA—other well-known brands.

GUARANTEED FOR ONE FULL YEAR. You can be sure of complete satisfaction when you order receiving tubes from Allied. We will replace any tube listed on these pages that does not give efficient performance for 12 months from date of purchase. This does not apply to burned-out or broken tubes. Av. shpg. wt. per tube, 4 oz; per 10 tubes, 2½ lbs.

You Save If You Buy More Than 5 Tubes

The first net price column (1 to 5) is for orders of less than 6 tubes. If you buy 6 or more of any one type or assorted types (up to a total of 49), use the second net price column (6 to 49). For 50 tubes and over, use the third price column.

Tube Type	List Price	NET EACH In Quantities of:			Tube Type	List Price	NET EACH In Quantities of:		
		1 to 5	6 to 49	50 or More			1 to 5	6 to 49	50 or More
OZ4	\$1.55	.87	.76	.68	3S4	\$2.30	1.31	1.15	1.03
OZ4G	1.90	1.06	.93	.84	3V4	2.20	1.23	1.08	.97
1A3	2.70	1.51	1.32	1.19	4AU6	1.95	1.09	.96	.86
1A5GT	2.55	1.43	1.25	1.12	4BC5*	2.10	1.17	1.03	.93
1A7GT	2.95	1.65	1.44	1.30	4BC8	3.65	2.04	1.79	1.61
1AD5	3.90	2.18	1.91	1.72	4BN6*	2.80	1.56	1.37	1.23
1AH4*	2.85	1.59	1.40	1.26	4BQ7-A	3.55	1.98	1.74	1.57
1AJ5*	2.90	1.62	1.43	1.29	4BS8	3.65	2.04	1.79	1.61
1AX2	2.70	1.51	1.32	1.19	4BU8*	2.60	1.45	1.27	1.14
1B3GT	2.60	1.45	1.27	1.14	4BX8*	3.45	1.93	1.69	1.52
1C5GT	2.90	1.62	1.43	1.29	4BZ6*	2.10	1.17	1.03	.93
1D8GT*	4.55	2.54	2.23	2.01	4BZ7	3.65	2.04	1.79	1.61
1DN5	2.10	1.17	1.03	.93	4CB6	2.10	1.17	1.03	.93
1E8	4.30	2.40	2.11	1.90	4CY5*	2.50	1.40	1.23	1.11
1G4GT*	2.60	1.45	1.27	1.14	4DT6	1.95	1.09	.96	.86
1G6GT*	3.00	1.68	1.47	1.32	5AM8	2.95	1.65	1.44	1.30
1H4G*	2.35	1.31	1.15	1.03	5AN8	3.20	1.79	1.57	1.41
1H5GT	2.45	1.37	1.20	1.08	5AQ5	2.05	1.15	1.00	.90
1L4	2.35	1.31	1.15	1.03	5AS4A	1.90	1.06	.93	.84
1L6	2.90	1.62	1.43	1.29	5AS8	3.05	1.70	1.49	1.34
1LA4*	3.35	1.87	1.64	1.48	5AT8	2.90	1.62	1.43	1.29
1LA6	3.30	1.84	1.62	1.46	5AU4*	3.15	1.76	1.54	1.39
1LB4	3.55	1.98	1.74	1.67	5AV8	3.20	1.79	1.57	1.41
1LC5	3.15	1.76	1.54	1.39	5AW4*	2.50	1.40	1.23	1.11
1LC6	3.30	1.84	1.62	1.46	5AZ4	2.15	1.20	1.05	.94
1LD5	3.30	1.84	1.62	1.46	5B8*	3.20	1.79	1.57	1.41
1LE3	3.30	1.84	1.62	1.46	5BE8*	2.90	1.62	1.43	1.29
1LG5	3.15	1.76	1.54	1.39	5BK7A	3.20	1.79	1.57	1.41
1LH4	3.15	1.76	1.54	1.39	5BQ7A	3.55	1.98	1.74	1.57
1LN5	3.15	1.76	1.54	1.39	5BR8	3.05	1.70	1.49	1.34
1N5GT	2.90	1.62	1.43	1.29	5BT8	3.10	1.73	1.62	1.37
1Q5GT*	3.05	1.70	1.49	1.34	5CG8	2.90	1.62	1.43	1.29
1R5	2.35	1.31	1.15	1.03	5CL8*	2.90	1.62	1.43	1.29
1S4	2.85	1.59	1.40	1.26	5CM8*	3.20	1.79	1.57	1.41
1S5	2.05	1.15	1.00	.90	5CQ8	3.05	1.70	1.49	1.34
1T4	2.20	1.23	1.08	.97	5CZ5	2.60	1.45	1.27	1.14
1U4	2.20	1.23	1.08	.97	5J6	2.55	1.43	1.25	1.12
1U5	1.95	1.09	.96	.86	5T4	5.45	3.04	2.67	2.40
1V	2.90	1.62	1.43	1.29	5T8	3.15	1.76	1.54	1.39
1V2	1.80	1.01	.88	.79	5U4G*	1.80	1.01	.88	.79
1V6*	3.65	2.04	1.79	1.61	5U4GA*	1.90	1.06	.93	.84
1X2A	2.70	1.51	1.32	1.19	5U4-GB	1.90	1.06	.93	.84
1X2B	2.70	1.51	1.32	1.19	5U8	3.05	1.70	1.49	1.34
2A3	5.10	2.85	2.50	2.25	5V4G	2.80	1.56	1.37	1.23
2A6*	2.85	1.59	1.40	1.26	5V4GA*	2.55	1.43	1.25	1.12
2AF4-A	3.65	2.04	1.79	1.61	5W4GT*	1.75	.98	.86	.77
2B3*	2.60	1.45	1.27	1.14	5X4G	2.25	1.26	1.10	.99
2BN4	2.25	1.26	1.10	.99	5X8	2.90	1.62	1.43	1.29
2CY5	2.60	1.45	1.27	1.14	5Y3GT	1.55	.87	.76	.68
3A2	3.15	1.76	1.54	1.39	5Y4GT	2.05	1.15	1.00	.90
3A3	3.05	1.70	1.49	1.34	5Z3	2.60	1.45	1.27	1.14
3AF4A	3.65	2.04	1.79	1.61	5Z4	3.90	2.18	1.91	1.72
3AL5	1.70	.95	.83	.75	6A3*	4.05	2.26	1.98	1.78
3AU6	1.95	1.09	.96	.86	6A6*	2.85	1.59	1.40	1.26
3AV6	1.60	.89	.78	.70	6A7	3.40	1.90	1.66	1.49
3B2	4.85	2.71	2.38	2.14	6A8	3.30	1.84	1.62	1.46
3BC5	2.10	1.17	1.03	.93	6A8G	3.30	1.84	1.62	1.46
3BN4*	2.20	1.23	1.08	.97	6A8GT	3.30	1.84	1.62	1.46
3BN6	2.70	1.51	1.32	1.19	6AB4	1.85	1.03	.91	.82
3BU8	2.60	1.45	1.27	1.14	6AB5/6NS	3.15	1.76	1.54	1.39
3BY6	2.10	1.17	1.03	.93	6AB7	3.95	2.21	1.94	1.75
3BZ6	2.10	1.17	1.03	.93	6AC5GT	3.45	1.93	1.69	1.52
3CB6	2.10	1.17	1.03	.93	6AC7	3.50	1.96	1.72	1.55
3CF6	2.30	1.29	1.13	1.02	6AD7G	4.65	2.60	2.28	2.05
3CS6	2.20	1.23	1.08	.97	6AF4-A	3.60	2.01	1.76	1.58
3DK6*	2.20	1.23	1.08	.97	6AF6G	3.10	1.73	1.52	1.37
3DT6	1.95	1.09	.96	.86	6AG5	2.20	1.23	1.08	.97
3LF4	3.55	1.98	1.74	1.67	6AG7	3.90	2.18	1.91	1.72
3Q4	2.35	1.31	1.15	1.03	6AH4GT	2.80	1.56	1.37	1.23
3Q5GT	3.10	1.73	1.52	1.37	6AH6	4.20	2.35	2.06	1.85

RCA Receiving Tubes

QUANTITY PRICES ALSO APPLY TO ASSORTED TUBES

Tube Type	List Price	NET EACH In Quantities of:			Tube Type	List Price	NET EACH In Quantities of:		
		1 to 5	6 to 49	50 or More			1 to 5	6 to 49	50 or More
6AH6V*	\$4.20	2.35	2.06	1.85	6CM7	\$2.55	1.43	1.25	1.12
6AJ4*	4.40	2.46	2.16	1.94	6CN7	2.30	1.29	1.13	1.02
6AK5	4.05	2.26	1.98	1.78	6CG8	2.95	1.65	1.44	1.30
6AK6	2.55	1.43	1.25	1.12	6CR6*	2.05	1.15	1.00	.90
6AL5	1.65	.92	.81	.73	6CS6	2.15	1.20	1.05	.94
6AL7GT	5.00	2.79	2.45	2.20	6CS7*	2.60	1.45	1.27	1.14
6AM4	5.35	2.99	2.62	2.36	6CU5	2.10	1.17	1.03	.93
6AM8A	2.90	1.62	1.43	1.29	6CU8	3.30	1.84	1.62	1.46
6AN4	4.55	2.54	2.23	2.01	6CY5*	2.50	1.40	1.23	1.11
6AN8	3.15	1.76	1.54	1.39	6CZ5	2.55	1.43	1.25	1.12
6AQ5A	2.00	1.12	.98	.88	6D6	3.15	1.76	1.54	1.39
6AQ6	1.85	1.03	.91	.82	6DC6	2.55	1.43	1.25	1.12
6AQ7GT	3.05	1.70	1.49	1.34	6DE6	2.20	1.23	1.08	.97
6AR5	2.10	1.17	1.03	.93	6DGGT	2.20	1.23	1.08	.97
6AS5	2.15	1.20	1.05	.94	6DK6*	2.20	1.23	1.08	.97
6AS8	3.05	1.70	1.49	1.34	6DQ5	6.95	3.88	3.40	3.06
6AT6	1.65	.92	.81	.73	6DQ6-A	3.90	2.18	1.91	1.72
6AT8A	2.90	1.62	1.43	1.29	6DS5	2.35	1.31	1.15	1.03
6AU4GTA	3.05	1.70	1.49	1.34	6DT6	1.95	1.09	.96	.86
6AU5GT	3.65	2.04	1.79	1.61	6E5	2.55	1.43	1.25	1.12
6AU6	1.90	1.06	.93	.84	6F5	2.65	1.48	1.30	1.17
6AU6A*	1.90	1.06	.93	.84	6F5GT	2.60	1.45	1.27	1.14
6AU8	3.15	1.76	1.54	1.39	6F6	3.05	1.70	1.49	1.34
6AV5GA	3.55	1.98	1.74	1.57	6F6G	2.70	1.51	1.32	1.19
6AV6	1.60	.89	.78	.70	6F6GT	2.45	1.37	1.20	1.08
6AW8A	3.30	1.84	1.62	1.46	6F7	4.65	2.60	2.28	2.05
6AX4GT	2.45	1.37	1.20	1.08	6F8G	4.30	2.40	2.11	1.90
6AX5GT	2.55	1.43	1.25	1.12	6G6G	3.35	1.87	1.64	1.48
6AX8*	2.90	1.62	1.43	1.29	6H6	2.40	1.34	1.18	1.06
6AZ8	3.55	1.98	1.74	1.57	6J5	2.15	1.20	1.05	.94
6B4G	4.55	2.54	2.23	2.01	6J5GT	2.15	1.20	1.05	.94
6B7*	3.50	1.96	1.72	1.55	6J6	2.55	1.43	1.25	1.12
6B8	3.90	2.18	1.91	1.72	6J6A*	2.55	1.43	1.25	1.12
6BA6	1.90	1.06	.93	.84	6J7	3.05	1.70	1.49	1.34
6BA7	3.15	1.76	1.54	1.39	6J7GT	3.05	1.70	1.49	1.34
6BA8A	3.30	1.84	1.62	1.46	6K5GT*	2.65	1.48	1.30	1.17
6BC4	4.45	2.49	2.18	1.96	6K6GT	2.00	1.12	.98	.88
6BC5	2.10	1.17	1.03	.93	6K7	3.10	1.73	1.52	1.37
6BC7	3.20	1.79	1.57	1.41	6K7GT	2.70	1.51	1.32	1.19
6BC8	3.60	2.01	1.76	1.58	6K8	3.65	2.04	1.79	1.61
6BD4-A	21.50	12.00	10.53	9.48	6L5G*	2.85	1.59	1.40	1.26
6BD6	1.95	1.09	.96	.86	6L6	5.15	2.88	2.52	2.27
6BE6	2.10	1.17	1.03	.93	6L6GB	3.90	2.18	1.91	1.72
6BF5	2.25	1.26	1.10	.99	6L7	3.55	1.98	1.74	1.57
6BF6	1.70	.95	.83	.75	6N7	3.40	1.90	1.66	1.49
6BG6GA	5.55	3.10	2.72	2.45	6N7GT	3.30	1.84	1.62	1.46
6BH6	2.45	1.37	1.20	1.08	6P5GT*	2.45	1.37	1.20	1.08
6BH8	3.15	1.76	1.54	1.39	6Q7	2.90	1.62	1.44	1.30
6BJ6	2.35	1.31	1.15	1.03	6Q7GT	2.55	1.43	1.25	1.12
6BK4	6.35	3.55	3.11	2.80	6R7	3.10	1.73	1.52	1.37
6BK5	2.95	1.65	1.44	1.30	6R8*	3.60	2.01	1.76	1.58
6BK7B	3.15	1.76	1.54	1.39	6S4-A	1.85	1.03	.91	.82
6BL4	5.60	3.13	2.74	2.47	6S7	3.60	2.01	1.76	1.58
6BL7GT	3.55	1.98	1.74	1.57	6S8GT	2.75	1.54	1.35	1.21
6BN4	2.20	1.23	1.08	.97	6SA7	2.60	1.45	1.27	1.14
6BN6	2.70	1.51	1.32	1.19	6SA7GT	2.60	1.45	1.27	1.14
6BN8	2.55	1.43	1.25	1.12	6SB7Y	3.85	2.15	1.89	1.70
6BQ6GTB/6CU6	3.90	2.18	1.91	1.72	6SC7	2.70	1.51	1.32	1.19
6BQ7A	3.55	1.98	1.74	1.57	6SD7GT*	3.35	1.87	1.64	1.48
6BR8	2.95	1.65	1.44	1.30	6SF5	2.30	1.29	1.13	1.02
6BS8	3.50	1.96	1.72	1.55	6SF5GT	2.30	1.29	1.13	1.02
6BU8	2.60	1.45	1.27	1.14	6SF7	3.05	1.70	1.49	1.34
6BV8*	2.80	1.56	1.37	1.23	6SG7	2.95	1.65	1.44	1.30
6BX7GT	3.60	2.01	1.76	1.58	6SH7	3.05	1.70	1.49	1.34
6BY5-GA	3.15	1.76	1.54	1.39	6SJ7	2.45	1.37	1.20	1.08
6BY6	2.10	1.17	1.03	.93	6SJ7GT	2.35	1.31	1.15	1.03
6BY8*	2.55	1.43	1.25	1.12	6SK7	2.40	1.34	1.18	1.06
6BZ6	2.10	1.17	1.03	.93	6SK7GT	2.40	1.34	1.18	1.06
6BZ7	3.60	2.01	1.76	1.58	6SL7GT	2.95	1.65	1.44	1.30
6BZ8/X155*	4.25	2.37	2.08	1.87	6SN7GTA*	2.25	1.26	1.10	.99
6C4	1.65	.92	.81	.73	6SN7GTB	2.35	1.31	1.15	1.03
6C5	2.35	1.31	1.15	1.03	6SQ7	2.10	1.17	1.03	.93
6C5GT	2.15	1.20	1.05	.94	6SQ7GT	2.10	1.17	1.03	.93
6C6	3.15	1.76	1.54	1.39	6SR7	2.35	1.31	1.15	1.03
6C6G	4.30	2.40	2.11	1.90	6SS7	2.70	1.51	1.32	1.19
6CB5A	6.15	3.44	3.01	2.71	6SZ7	2.70	1.51	1.32	1.19
6CB6	2.10	1.17	1.03	.93	6T4	3.60	2.01	1.76	1.58
6CB6A*	2.10	1.17	1.03	.93	6T8	3.15	1.76	1.54	1.39
6CD6GA	5.20	2.90	2.55	2.29	6T8A*	3.10	1.73	1.52	1.37
6CE5*	2.05	1.15	1.00	.90	6U5	2.50	1.40	1.23	1.11
6CF6	2.25	1.26	1.10	.99	6U7G*	2.40	1.34	1.18	1.06
6CG7	2.30	1.29	1.13	1.02	6U8A	2.95	1.65	1.44	1.30
6CG8	2.90	1.62	1.43	1.29	6V3A	3.95	2.21	1.94	1.75
6CH8	3.25	1.82	1.59	1.43	6V6	3.90	2.18	1.91	1.72
6CL6	3.25	1.82	1.59	1.43	6V6GT	2.00	1.12	.98	.88
6CL8*	2.90	1.62	1.43	1.29					
6CM6*	2.45	1.37	1.20	1.08					

RECEIVING TUBES CONTINUED ON NEXT PAGE

RCA Receiving Tubes

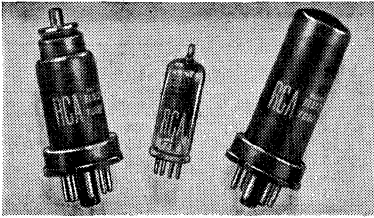

TUBE LISTINGS CONTINUED FROM PAGES 98 AND 99

You Save If You Buy More Than 5 Tubes

The first net price column (1 to 5) is for orders of less than 6 tubes. If you buy 6 or more tubes of any one type or assorted types (and up to a total of 49), use the prices in the second net price column (6 to 49). For 50 tubes and over, use the third price column (50 or More).

Tube Type	List Price	NET EACH In Quantities of:			Tube Type	List Price	NET EACH In Quantities of:		
		1 to 5	6 to 49	50 or More			1 to 5	6 to 49	50 or More
6V8*	\$3.75	2.10	1.84	1.66	12AX4-GTA	\$2.45	1.37	1.20	1.08
6W4GT	2.15	1.20	1.05	.94	12AX7	2.30	1.29	1.13	1.02
6W6GT	2.60	1.45	1.27	1.14	12AZ7	2.60	1.45	1.27	1.14
6X4	1.50	.84	.74	.67	12B4-A	2.55	1.43	1.25	1.12
6X5GT	1.75	.98	.86	.77	12BA6	1.90	1.06	.93	.84
6X8	2.90	1.62	1.43	1.29	12BA7	3.15	1.76	1.54	1.39
6Y6G	2.95	1.65	1.44	1.30	12BD6	1.95	1.09	.96	.86
6ZY5G*	2.55	1.43	1.25	1.12	12BE6	2.00	1.12	.90	.88
7A4	2.60	1.45	1.27	1.14	12BF6	1.70	.95	.83	.75
7A5	2.95	1.65	1.44	1.30	12BH7-A	2.70	1.51	1.32	1.19
7A6	2.55	1.43	1.25	1.12	12BK5*	3.05	1.70	1.49	1.34
7A7	2.65	1.48	1.30	1.17	12BL6	2.05	1.15	1.00	.90
7A8	3.10	1.73	1.52	1.37	12BQ6GTB/12CU6	4.05	2.26	1.98	1.78
7AD7	4.95	2.77	2.43	2.19	12BR7	2.35	1.31	1.15	1.03
7AF7	2.95	1.65	1.44	1.30	12BV7	2.70	1.51	1.32	1.19
7AG7	3.10	1.73	1.52	1.37	12BY7-A	2.80	1.56	1.37	1.23
7AH7	2.95	1.65	1.44	1.30	12BZ7	2.80	1.56	1.37	1.23
7AU7	2.35	1.31	1.15	1.03	12C5/12CU5*	2.10	1.17	1.03	.93
7B4	2.40	1.34	1.18	1.06	12C8	4.40	2.46	2.16	1.94
7B5	2.40	1.34	1.18	1.06	12CA5	2.20	1.23	1.08	.97
7B6	2.65	1.48	1.30	1.17	12CN5*	1.95	1.09	.96	.86
7B7	2.65	1.48	1.30	1.17	12CR6	2.05	1.15	1.00	.90
7B8	2.85	1.59	1.40	1.26	12CU5	2.10	1.17	1.03	.93
7C4*	3.90	2.18	1.91	1.72	12CU6/12BQ6GA*	3.80	2.12	1.86	1.67
7C5	2.55	1.43	1.25	1.12	12CT8*	3.45	1.93	1.69	1.52
7C6	2.65	1.48	1.30	1.17	12CX6*	1.95	1.09	.96	.86
7C7	2.55	1.43	1.25	1.12	12D4*	2.50	1.40	1.23	1.11
7E5*	3.15	1.76	1.54	1.39	12DQ6-A	3.90	2.18	1.91	1.72
7E6*	3.15	1.76	1.54	1.39	12EM6*	2.70	1.51	1.32	1.19
7E7	3.55	1.98	1.74	1.57	12EN6*	2.70	1.51	1.32	1.19
7F7	2.95	1.65	1.44	1.30	12F8	2.45	1.37	1.20	1.08
7F8	3.65	2.04	1.79	1.61	12H6	2.40	1.34	1.18	1.06
7G7	3.20	1.79	1.57	1.41	12J5GT	2.15	1.20	1.05	.94
7H7	3.30	1.84	1.62	1.46	12J7GT	3.05	1.70	1.49	1.34
7J7	4.05	2.26	1.98	1.78	12J8*	3.15	1.76	1.54	1.39
7K7	3.55	1.98	1.74	1.57	12K5	2.55	1.43	1.25	1.12
7L7*	3.35	1.87	1.64	1.48	12K7GT	2.70	1.51	1.32	1.19
7N7	2.70	1.51	1.32	1.19	12K8	3.65	2.04	1.79	1.61
7Q7	3.30	1.84	1.62	1.46	12L6GT	2.20	1.23	1.08	.97
7R7	4.05	2.26	1.98	1.78	12Q7GT	2.55	1.43	1.25	1.12
7V7	3.75	2.10	1.84	1.66	12R5*	2.20	1.23	1.08	.97
7W7	3.75	2.10	1.84	1.66	12S8GT*	2.75	1.54	1.35	1.21
7X7	2.95	1.65	1.44	1.30	12SA7	2.60	1.45	1.27	1.14
7Y4	2.20	1.23	1.08	.97	12SA7GT	2.60	1.45	1.27	1.14
7Z4	2.20	1.23	1.08	.97	12SC7	2.70	1.51	1.32	1.19
8AU8*	3.10	1.73	1.52	1.37	12SF5	2.35	1.31	1.15	1.03
8AW8A	3.35	1.87	1.64	1.48	12SF5GT*	2.15	1.20	1.05	.94
8BA8A*	3.35	1.87	1.64	1.48	12SFT	3.05	1.70	1.49	1.34
8BH8*	3.25	1.82	1.59	1.43	12SG7	2.85	1.59	1.40	1.26
8CG7	2.35	1.31	1.15	1.03	12SH7	3.05	1.70	1.49	1.34
8CM7	2.55	1.43	1.25	1.12	12SJ7	2.45	1.37	1.20	1.08
8CN7*	2.35	1.31	1.15	1.03	12SJ7GT*	2.35	1.31	1.15	1.03
9U8A*	2.90	1.62	1.43	1.29	12SK7	2.40	1.34	1.18	1.06
10C8*	3.25	1.82	1.59	1.43	12SK7GT	2.40	1.34	1.18	1.06
10DE7	2.65	1.48	1.30	1.17	12SL7GT	2.95	1.65	1.44	1.30
12A8GT	3.30	1.84	1.62	1.46	12SN7GT	2.40	1.34	1.18	1.06
12AB5	2.10	1.17	1.03	.93	12SN7GTA*	2.40	1.34	1.18	1.06
12AC6*	1.80	1.01	.88	.79	12SQ7	2.10	1.17	1.03	.93
12AD6	2.10	1.17	1.03	.93	12SQ7GT	2.10	1.17	1.03	.93
12AE6	1.70	.95	.83	.75	12SR7	2.40	1.34	1.18	1.06
12AE7*	2.95	1.65	1.44	1.30	12V6GT	2.00	1.12	.98	.88
12AF6	2.10	1.17	1.03	.93	12W6GT	2.60	1.45	1.27	1.14
12AF6A*	1.80	1.01	.88	.79	12X4	1.50	.84	.73	.66
12AH7GT	3.40	1.90	1.66	1.49	12Z3*	2.60	1.45	1.27	1.14
12AJ6	1.60	.89	.78	.70	14A7	2.65	1.48	1.30	1.17
12AL5	1.70	.95	.83	.75	14AF7	2.95	1.65	1.44	1.30
12AQ5	2.00	1.12	.98	.88	14B6	2.65	1.48	1.30	1.17
12AT6	1.65	.92	.81	.73	14C7	2.65	1.48	1.30	1.17
12AT7	2.85	1.59	1.40	1.26	14F7	2.95	1.65	1.44	1.30
12AU6	1.90	1.06	.93	.84	14F8	3.65	2.04	1.79	1.61
12AU7A	2.30	1.29	1.13	1.02	14Q7	3.30	1.84	1.62	1.46
12AV5GA*	3.60	2.01	1.76	1.58	14R7	4.05	2.26	1.98	1.78
12AV6	1.60	.89	.78	.70	17AX4GT	2.55	1.43	1.25	1.12
12AV7	3.05	1.70	1.49	1.34	17BQ6GTB	4.05	2.26	1.98	1.78
12AW6	2.60	1.45	1.27	1.14	17C5*	2.05	1.15	1.00	.90

RCA Receiving Tubes

QUANTITY PRICES ALSO APPLY TO ASSORTED TUBES

Tube Type	List Price	NET EACH In Quantities of:			Tube Type	List Price	NET EACH In Quantities of:		
		1 to 5	6 to 49	50 or More			1 to 5	6 to 49	50 or More
17DQ6*	3.90	2.18	1.91	1.72	36*	2.90	1.62	1.43	1.29
17H3*	1.85	1.03	.91	.82	37*	1.85	1.03	.91	.82
19*	3.50	1.96	1.72	1.55	38*	2.30	1.29	1.13	1.02
19AU4	3.10	1.73	1.52	1.37	39/44*	2.85	1.59	1.40	1.26
19AU4GTA*	2.95	1.65	1.44	1.30	41	2.55	1.43	1.25	1.12
19BG6-GA	6.00	3.35	2.94	2.65	42	2.40	1.34	1.18	1.06
19C8*	3.35	1.87	1.64	1.48	43	2.60	1.45	1.27	1.14
19J6	2.70	1.51	1.32	1.19	45*	2.15	1.20	1.05	.94
19T8	3.15	1.76	1.54	1.39	47	5.85	3.27	2.87	2.58
19X8	3.35	1.87	1.64	1.48	50A5	2.80	1.56	1.37	1.23
24A	3.05	1.70	1.49	1.34	50B5	2.25	1.26	1.10	.99
25AV5GT*	3.45	1.93	1.69	1.52	50C5	2.00	1.12	.98	.88
25AX4GT	2.80	1.56	1.37	1.23	50C6G	3.35	1.87	1.64	1.48
25BK5*	2.80	1.56	1.37	1.23	50L6GT	2.15	1.20	1.05	.94
25BQ6GT/25CU6	4.10	2.29	2.01	1.81	50X6	2.60	1.45	1.27	1.14
25C5*	2.00	1.12	.98	.88	50Y6GT	2.55	1.43	1.25	1.12
25CD6GB	5.20	2.90	2.55	2.29	50Y7GT	2.25	1.26	1.10	.99
25DN6	5.15	2.88	2.52	2.27	55*	2.30	1.29	1.13	1.02
25L6	4.60	2.57	2.25	2.03	56*	1.90	1.06	.93	.84
25L6GT	2.05	1.15	1.00	.90	57*	2.10	1.17	1.03	.93
25W4GT	2.35	1.31	1.15	1.03	58*	2.10	1.17	1.03	.93
25W6GT*	2.90	1.62	1.43	1.29	70L7GT	6.95	3.88	3.41	3.07
25Z5	2.45	1.37	1.20	1.08	71A*	2.40	1.34	1.18	1.06
25Z6GT	2.45	1.37	1.20	1.08	75	2.60	1.45	1.27	1.14
26*	2.30	1.29	1.13	1.02	76*	1.70	.95	.83	.75
27	2.25	1.26	1.10	.99	77*	2.20	1.23	1.08	.97
30*	2.30	1.29	1.13	1.02	78	2.70	1.51	1.32	1.19
32L7GT*	3.35	1.87	1.64	1.48	80	1.90	1.06	.93	.84
35/51*	2.40	1.34	1.18	1.06	83V	3.80	2.12	1.86	1.67
35A5	2.80	1.56	1.37	1.23	84/6Z4	2.05	1.15	1.00	.90
35B5	2.25	1.26	1.10	.99	85*	2.30	1.29	1.13	1.02
35C5	2.00	1.12	.98	.88	117L7/117M7GT	6.95	3.88	3.41	3.07
35L6GT	2.15	1.20	1.05	.94	117N7GT	7.30	4.08	3.58	3.22
35W4	1.35	.75	.66	.59	117P7GT	7.30	4.08	3.58	3.22
35Y4	2.20	1.23	1.08	.97	117Z3	2.10	1.17	1.03	.93
35Z3	2.20	1.23	1.08	.97	117Z6GT	3.55	1.98	1.74	1.57
35Z4GT	1.70	.95	.83	.75	5642*	2.70	1.51	1.32	1.19
35Z5GT	1.60	.89	.78	.70					

As New Receiving Tubes are Released by Manufacturers, Allied Will Stock Them



SPECIAL AUDIO TUBES

Ideal as replacements for standard tubes in hi-fi equipment. *Directly interchangeable. Others may require slight wiring changes. Guaranteed (except burnouts) for 1 year. Wt., 4 oz.

MULLARD

Stock No.	Tube Type	Equip. Tube	NET EACH
E3-EL34	EL34*	6CA7	3.26
E3-EL34MP	EL34, Matched pr		7.30/Pr.
E3-GZ34	GZ34	SU4GA/B	2.63
E3-EL37	EL37	6L6	2.63
E3-EL37MP	EL37, Matched pr		5.96/Pr.
E3-EZ80	EZ80	6V4	1.25
E3-EZ81*	EZ81*	6BW4	1.25
E3-ECC81	ECC81*	12A7	1.95
E3-ECC82	ECC82*	12AU7	1.78
E3-ECC83	ECC83*	12AX7	1.83
E3-EL84	EL84*	6BQ5	1.80
E3-EL84MP	EL84, Matched pr		4.35/Pr.
E3-EF86	EF86*	6267	2.06
E3-EC90	EC90*	6C4	2.63
E3-EK90	EK90	6BE6	1.65
E3-EB91	EB91*	6AL5	1.35
E3-ECC91	ECC91*	6J6	2.03
E3-EF94	EF94*	6AU6	1.61

RCA

Stock No.	Tube Type	NET EACH
E1-12AV7	12AV7	2.53
E1-1614	1614	2.72
E1-1620	1620	6.36
E1-1621	1621	1.95
E1-1622	1622	2.70
E1-5879	5879	1.75

AMPEREX

Stock No.	Tube Type	Equip. Tube	NET EACH
E4-6CA7	6CA7*	EL34	3.60
E4-EL84	EL84*	6BQ5	1.20
E4-ECC81	ECC81*	12A7	1.71
E4-ECC82	ECC82*	12AU7	1.38
E4-ECC83	ECC83*	12AX7	1.38
E4-EF86	EF86*	6267	1.45

GENALEX

Stock No.	Tube Type	Equip. Tube	NET EACH
E3-KT66	KT66*	6L6	3.50
E3-Z729	Z729	5879	2.99
E3-KT88	KT88		4.50
E3-KT88MP	KT88, Matched pr.		11.00/Pr.

TUNGSO

Stock No.	Tube Type	Equip. Tube	NET EACH
E3-5881	5881*	6L6	3.50

LATEST TRANSISTOR BOOKS

TRANSISTORS AND SEMICONDUCTOR DIODES. By RCA. Provides information on basic characteristics and theory. Many circuit diagrams of receivers, amplifiers, oscillators, etc. Has handy reference directory showing interchangeability of RCA units with those of other manufacturers. 23 pages, 8 1/4 x 11". **39 A 398. Postpaid in U.S.A. 25c**

TRANSISTOR MANUAL. By G.E. Covers principles, construction, specifications and applications. Complete data on all G.E. types. Includes typical circuits. Cross reference chart for transistor radios. 61 pages, 5 1/2 x 8 1/2". **37 K 248. Postpaid in U.S.A. 50c**

28 USES FOR JUNCTION TRANSISTORS By Sylvania. Chapters on Transistorized Amplifiers, Oscillators, Control Devices, etc. Includes elementary theory. 43 pages, 6 x 9". **37 K 121. Postpaid in U.S.A. 25c**

TRANSISTORS—THEORY AND PRACTICE. By Rufus P. Turner. Chapters cover Semiconductor Theory, Transistor Characteristics, Transistor Amplifiers, Oscillators, etc. Illustrated. 144 pages. Size, 5 1/2 x 8 1/2". **37 K 923. Postpaid in U.S.A. 2.00**

TRANSISTORS. Coblenz and Owens. McGraw Hill. Theory and practical applications for engineers, etc. 313 pages, 6 x 9". **37 K 459. Postpaid in U.S.A. 5.88**

TRANSISTOR APPLICATIONS, VOL. I. By Raytheon. 50 practical circuits for receivers, hearing aids, test equipment, etc., using CK722 transistors. 115 pages, 8 1/2 x 11". **37 A 119. Postpaid in U.S.A. 50c**

TRANSISTOR APPLICATIONS, VOL. II. Supplements Vol. I. Many pages of all-new circuits for receivers, amplifiers, test equipment, etc. Also has sections on transistor theory, printed circuits, wiring; especially useful to those who wish to design their own transistorized equipment. 58 pages, 8 1/2 x 11". **37 A 139. Postpaid in U.S.A. 50c**

TRANSISTORS AND THEIR APPLICATIONS. By L. E. Garner, Jr. (Coyne). A practical guide to the uses of transistors. Chapters on transistor characteristics, circuits, components and servicing. Includes a clear and non-mathematical explanation of how transistors work. Illustrated. 105 pages, 5 1/2 x 8 1/2". **38 K 608. Postpaid in U.S.A. 1.50**

FUNDAMENTALS OF TRANSISTORS. By L. Krugman. Explains use of transistors for replacement of vacuum tubes, basic transistor operation, characteristics, etc. Illustrated. 160 pages. Size, 5 1/2 x 8 1/2". **37 K 474. Postpaid in U.S.A. 2.65**

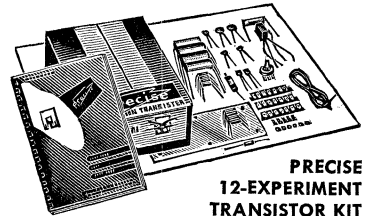

Model T1-K. Fascinating kit for experimenters. Build any of these transistorized circuits: Audio amplifier, multivibrator, audio oscillator, RF oscillator, signal tracer, tuned signal tracer (TRF receiver), etc. Simple, practical approach to understanding transistors and diodes. Learn by using transistors in equipment you build yourself. Basic transistor theory is explained in the 60-page instruction book. Kit includes 2 transistors and germanium diode. Less only headphones and battery, listed below. Shpg. wt., 4 lbs. **83 F 134. NET 14.95**

Battery. For use with above, 4 1/2 volts. Shpg. wt., 1/2 lb. **53 J 035. NET 54c**

Headphones. 2000 ohms. Shpg. wt., 12 oz. **59 J 110. NET 2.00**

MINI-SPRING TUBE HOLD-DOWNS

Hold tubes securely in place. Prevent breakage and assure greater stability. Particularly valuable where tubes are mounted upside down or horizontal; also excellent for portable radios, mobile gear and other equipment subject to vibration and shock. For use with 7 or 9 pin miniature tubes. Mount with nut, bolt, or rivet. Av. shpg. wt., 3 oz. **3 per package.**

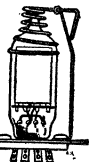

Stock No.	Mfr's Type	Height	For Tubes:	Per Pkg.
41 H 121	562	2 3/8"	6A05, 6X4, 35B5, 35W4, 50B5, etc.	27c
41 H 122	561	1 3/8"	1R5, 6AG5, 6AT6, 6BE6, 6CA, etc.	27c
41 H 123	560	1 1/2"	6AJ5, 6AK5, 6AL5, 6AS6, 6N4, etc.	27c
41 H 124	563	1 3/8"	12A7, 12AU7, etc.	27c

Transistors For Every Use

EXPLANATION OF COLUMN HEADINGS

In the tabular headings, unless otherwise specified, P_r is the Total Power Dissipation in milliwatts; V_c is the Collector Voltage in volts; I_c is the Collector Current in milliamperes. All ratings given, including Cut-Off Frequency, are maximum ratings. Av. shpg. wt., 2 oz.

TEXAS INSTRUMENT TRANSISTORS



Germanium and silicon transistors for every use. Meet rugged commercial and MIL specs. Av. shpg. wt., 2 oz.

A GERMANIUM TRANSISTORS

Stock No.	Type	P_r	V_c	I_c	Cut-Off Freq.	Application	NET EACH	
8 E 110	2N145	65	20	5	NPN; IF amplifier	2.10	
8 E 111	2N146	As above, but 36 db max. gain						2.50
8 E 112	2N147	As above, but 39 db max. gain						2.80
8 E 109	2N172	65	16	5	NPN, converter	2.45	
8 E 104	2N185	150	-20	-150	PNP; audio amplifier	1.50	
8 E 105	2N238	50	-20	-10	PNP; audio amplifier	1.40	
8 E 116	2N248	30	-25	-5	PNP; RF amplifier	3.80	
8 E 106	2N250	25W	-30	-3A	PNP; audio amplifier	5.00	
8 E 107	2N251	25W	60	3A	PNP; highpower mobile	7.50	
8 E 100	2N252	30	-16	-5	PNP; converter	2.25	
8 E 113	2N253	65	12	5	NPN; IF amplifier	1.75	
8 E 114	2N254	65	20	5	NPN; IF amplifier	2.00	
8 E 108	2N291	180	-25	-200	PNP; audio amplifier	1.80	
8 E 101	2N308	30	-20	-5	PNP; IF amplifier	2.10	
8 E 102	2N309	30	-20	-5	PNP; IF amplifier	2.25	
8 E 103	2N310	30	-20	-5	PNP; reflex IF amp.	2.25	
8 E 111	2N325	25	-15	-2	200 mc	PNP; VHF	12.50	
8 E 118	2N30A	150	30	50	2.5 mc	NPN; general purpose	17.88	
8 E 119	201A	150	30	50	3 mc	NPN; general purpose	2.75	
8 E 120	202A	150	30	50	3.5 mc	NPN; general purpose	3.75	
8 E 121	300	150	-30	-50	7 mc	PNP; general purpose	1.20	
8 E 122	301	150	-30	-50	1 mc	PNP; general purpose	1.60	
8 E 123	302	150	-30	-50	1.3 mc	PNP; general purpose	1.90	
8 E 115	800	65	20	5	NPN; photo tube	8.15	

B SILICON TRANSISTORS IN JETEC CAN

8 EC 183	2N332	150	45	25	4 mc	NPN; high gain	11.25
8 EC 184	2N333	150	45	25	5 mc	NPN; high gain	22.50
8 EC 185	2N334	150	45	25	7 mc	NPN; high gain	30.00
8 EC 186	2N335	150	45	25	7 mc	NPN; high gain	30.00
8 EC 187	2N336	150	45	25	7 mc	NPN; high gain	30.00
8 EC 188	2N337	125	40	20	20 mc	NPN; switching	28.80
8 EC 189	2N338	125	40	20	30 mc	NPN; switching	28.80
8 EC 190	2N339	1000	55	60	NPN; audio, servo amp.	22.50
8 EC 191	2N340	1000	85	50	NPN; audio, servo amp.	22.50
8 EC 192	2N341	1000	125	50	NPN; audio servo amp.	24.25
8 EC 193	2N342	1000	60	60	NPN; audio servo amp.	22.50
8 EC 194	2N343	1000	60	60	NPN; audio, servo amp.	34.60
8 EC 195	3N32	150	30	10	4.8 mc	NPN; RF amp.	26.70
8 EC 196	3N33	125	30	10	12.5 mc	NPN; RF amp.	51.00
8 EC 197	3N34	125	30	10	30 mc	NPN; RF amp.	50.00

SILICON TRANSISTORS

8 EC 128	2N117	150	30	25	4 mc	NPN; high gain, lowlevel	11.25
8 EC 129	2N118	150	30	25	5 mc	NPN; high gain, lowlevel	22.50
8 EC 130	2N118A	150	30	25	8 mc	NPN; high gain	30.00
8 EC 131	2N119	150	30	25	5 mc	NPN; high gain, lowlevel	30.00
8 EC 135	2N243	750	60	60	NPN; audio, servo amp.	22.50
8 EC 136	2N244	750	60	60	NPN; audio servo amp.	34.60
8 EC 216	2N389	37.5W	60	-2A	NPN; high power	90.00
8 EC 124	903	150	30	25	4 mc	NPN; high gain	11.25
8 EC 125	904	150	30	25	5 mc	NPN; high gain	22.50
8 EC 126	904A	150	30	25	8 mc	NPN; high gain	30.00
8 EC 127	905	150	30	25	6 mc	NPN; high gain	30.00
8 EC 121	910	150	30	25	7 mc	NPN; high gain	33.00
8 EC 132	951	750	50	60	NPN; audio, servo amp.	22.50
8 EC 133	952	750	80	50	NPN; audio, servo amp.	22.50
8 EC 134	953	750	120	40	NPN; audio, servo amp.	22.50
8 EC 137	970	8.75W + 120	140	NPN; servo amp.	60.00

SYLVANIA TRANSISTORS

2N307. New, low-cost PNP audio power transistor. Collector current 1.0 amp. Output: 1 unit, 2 watts; 2 units, 8 watts. Shpg. wt., 2 oz. **1.50**

2N229. NPN germanium transistor. Ideal for experimenters, hobbyists and designers. Total Current: 40 ma. Total Dissipation: 50 mw. Shpg. wt., 2 oz. **75c**

Stock No.	Type	P_r	V_c	I_c	Current Gain	Cut-Off Freq.	Application	NET EACH
7 E 342	2N34	50	-40	-10	40	PNP; audio amp.	3.00
7 E 341	2N35	50	40	10	40	NPN; audio amp.	1.50
7 E 343	2N36	50	40	10	1.4	NPN; mixer, conv.	2.10
7 E 344	2N94	50	20	50	3.5 mc	NPN; audio amp.	3.73
7 E 346	2N94A	50	20	50	6.0 mc	NPN; audio amp.	5.25
7 E 345	2N95	4 W	30	1.5A	100	0.14 mc	NPN; switching	6.75
7 E 335	2N101	4 W	-30	-1.5A	40	4 mc	NPN; switching	6.75
7 E 336	2N102	4 W	30	1.5A	40	4 mc	NPN; switching	6.75
7 E 339	2N141	4 W	-60	-8A	40	4 mc	NPN; AF, RF amp.	6.75
7 E 349	2N142	4 W	60	8A	40	4 mc	NPN; AF output.	6.75
7 E 389	2N194	50	15	40	15	3 mc	NPN; converter	2.03
7 E 398	2N212	50	10	20	15	NPN; mixer, conv.	1.80
7 E 399	2N213	50	25	50	NPN; audio amp.	1.80	
7 E 863	2N214	125	25	200	100	3 mc	NPN; audio amp.	3.53
7 E 864	2N216	50	15	40	15	3.0 mc	NPN; IF amp.	1.73
7 E 865	2N233	50	10	100	12	NPN; RF amp.	.90
7 E 348	2N242	-45	-2 A	5.0 mc	PNP; audio amp.	3.60

GENERAL ELECTRIC TRANSISTORS

2N107. Low-cost PNP transistor for low-power audio applications, including hearing aid use. With booklet of circuits. Cut-off frequency, 1.0 mc. Collector dissipation, 50 mw at 25° C. Shpg. wt., 2 oz. **1.05**

7 E 442. NET **1.05**

2N170. A rate-grown high-frequency NPN transistor intended for low-power, low-voltage applications. Collector dissipation, 25 mw at 35° C. Cut-off frequency, 2.5 mc. Shpg. wt., 2 oz. **1.26**

Stock No.	Type	P_r	V_c	I_c	Current Gain	Cut-Off Freq.	Application	NET EACH
7 E 443	2N43	150	-45	-50	50	2.5 mc	PNP; audio amp	4.77
7 E 444	2N44	150	-20	-50	22	1 mc	PNP; audio amp.	3.16
7 E 445	2N45	150	-20	-50	12	1 mc	PNP; audio amp.	2.99
7 E 448	2N78	65	15	20	40	6 mc	NPN; IF, RF amp	3.64
7 E 938	2N123	150	-20	-125	50	8 mc	PNP; computer	5.68
7 E 484	2N135	100	20	50	20	3 mc	PNP; RF, IF amp.	2.10
7 E 485	2N136	100	20	50	40	5 mc	PNP; RF, IF amp.	2.51
7 E 486	2N137	100	10	50	60	7 mc	PNP; RF, IF amp.	6.07
7 E 939	2N164A	65	15	20	40	8 mc	NPN; IF amp.	2.02
7 E 940	2N165	55	15	20	72	4 mc	NPN; IF amp.	1.92
7 E 941	2N167	65	30	75	36	8 mc	NPN; computer	6.31
7 E 488	2N168A	65	15	20	40	8 mc	NPN; IF amp.	2.92
7 E 489	2N169	55	15	20	72	4 mc	NPN; IF amp.	1.92
7 E 490	2N169A	55	25	20	72	5 mc	NPN; IF amp.	1.96
7 E 415	2N186A	180	-25	-200	24	3 mc	PNP; audio amp	1.92
7 E 417	2N187A	180	-25	-200	36	1 mc	PNP; audio amp.	1.96
7 E 419	2N188A	180	-25	-200	54	1.2 mc	PNP; audio amp.	1.99
7 E 420	2N189	75	25	50	25	3 mc	NPN; audio driver	1.73
7 E 421	2N190	75	-25	-50	36	1 mc	PNP; audio amp.	1.74
7 E 422	2N191	75	-25	-50	54	1.2 mc	PNP; audio amp.	1.78
7 E 423	2N192	75	-25	-50	75	1.5 mc	PNP; audio amp.	1.84
7 E 942	2N241	100	-25	-200	73	1.3 mc	PNP; audio amp.	1.89
7 E 943	2N241A	180	-25	-200	73	1.3 mc	PNP; audio amp.	2.04
7 E 944	2N265	75	-25	-50	110	1.3 mc	PNP; audio amp.	1.87
7 E 945	2N292	65	15	20	25	5 mc	NPN; IF amp.	1.82
7 E 999	2N293	65	15	20	25	8 mc	NPN; IF amp.	1.99
7 E 946	2N313	65	15	20	25	5 mc	NPN; IF amp.	1.82
7 E 947	2N314	65	15	20	25	8 mc	NPN; IF amp.	1.99
7 E 948	2N315	180	-25	-200	36	3 mc	PNP; audio amp.	1.96
7 E 978	2N320	180	-25	-200	54	1 mc	PNP; audio amp.	1.99
7 E 979	2N321	180	-25	-200	73	1.3 mc	PNP; audio amp.	2.04
7 E 980	2N322	75	-25	-50	36	1 mc	PNP; audio amp.	1.74
7 E 981	2N323	75	-25	-50	54	1.2 mc	PNP; audio amp.	1.78
7 E 982	2N324	75	-25	-50	75	1.5 mc	PNP; audio amp.	1.87
7 E 483	4JD1A17	150	-20	-50	40	1 mc	PNP; computer	5.90
7 E 983	4JD1B3	200	-30	1 A	15-15	3 mc	PNP; symmet. sw.	6.47
7 E 984	4JD1B4	200	-30	1 A	20-20	8 mc	PNP; symmet. sw.	6.87
7 E 986	2N450	150	10	20	15	25 mc	NPN; computer	6.34
7 E 987	2N431	150	15	20	15	25 mc	NPN; computer	11.15
7 E 988	2N432	150	15	20	40	25 mc	NPN; computer	22.54
7 E 989	4JD5A1	250	45	50	NPN; unijunction	15.78

RAYTHEON TRANSISTORS

CK722. PNP transistor. For audio oscillators, preamps; Class B stages. Cut-off, 600 kc. Collector dissipation, 200 mw at 25° C. 2 oz. **99c**

CK768. Low-cost PNP junction transistor for IF and RF use. Cut-off frequency 2.5 mc. Collector dissipation, 120 mw at 25° C. 2 oz. **1.50**

Stock No.	Type	P_r	V_c	I_c	Current Gain	Cut-Off Freq.	Application	NET EACH
5 E 918	2N111A	-6	1	25	3 mc	PNP; IF amp.	1.98
5 E 918	2N112	120	-6	1	30	5 mc	PNP; HF amp.	2.05
5 E 919	2N112A	-6	1	30	20 mc	PNP; HF amp.	7.95
5 E 920	2N114	120	-6	1	65	6 mc	PNP; AF, RF amp.	1.82
5 E 920	2N130A	-6	1	22	6 mc	PNP; AF, RF amp.	2.15
5 E 867	2N131	120	-6	1	45	3 mc	PNP; AF, RF amp.	1.82
5 E 921	2N131A	-6	1	45	3 mc	PNP; AF, RF amp.	2.70

Special Purpose Tubes

Immediate Delivery From Stock. The listing on this and the following pages is a complete selection of tubes for broadcast, industrial and research use. Included are power tubes, rectifiers, cathode-ray, photo-electric and miniature tube types. Almost 700 types of special-purpose tubes are listed, representing the products of leading manufacturers in the electron tube industry (see next page for table of manufacturers). Each tube will provide maximum efficiency and dependable service. Allied supplies all tubes at the lowest current prices from the largest distributor stocks in the country. *MP* after tube type indicates matched pair.

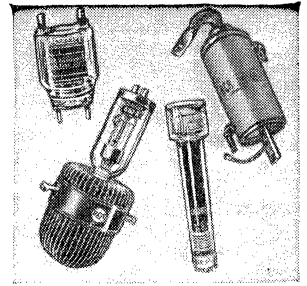

Dept.	Stock No. Tube Type	Mfr.	NET EACH	Dept.	Stock No. Tube Type	Mfr.	NET EACH	Dept.	Stock No. Tube Type	Mfr.	NET EACH
E1	OA2	RCA	1.26	E1	3BP1A	RCA	23.25	E3	EL C6J/F	ELEC	29.40
E1	OA2WA	RCA	3.80	E3	EL 3C	ELEC	11.20	E3	EL C6J/K	ELEC	28.90
E1	OA3	RCA	1.27	E1	3C23	RCA	11.98	E3	EL C6J/KF	ELEC	29.40
E1	OA4G	RCA	1.68	E4	3C23	AMP	11.98	E1	6J4	RCA	4.33
E3	OA5	SYL	7.50	E3	GL 3C23	GE	11.98	E1	6J4-WA	RCA	6.00
E1	OB2	RCA	1.32	3C45	See type 6130		E1	6L4	RCA	7.35
E1	OB2WA	RCA	4.20	E1	3D22A	RCA	21.20	6L6WGA/5932	See type 5932	
E2	OB3	RAY	1.65	E1	3E29	RCA	20.25	E1	65J7Y	RCA	1.45
E1	OC3	RAY	1.27	E3	C3J	CE	12.00	E3	65J7WGT	SYL	2.60
E1	OD3	RCA	1.27	E3	EL C3J	ELEC	15.50	E3	65L7WGT	SYL	3.25
E4	OE3/85A1	AMP	2.50	E1	C3J/5632	RCA	15.50	E2	65N7WGT	RAY	2.60
E4	OG3/85A2	AMP	2.50	E3	EL C3J/A	ELEC	19.80	E3	65U7GT	TUNG	4.25
E2	OY4	RAY	2.79	E1	C3J-A/5684	RCA	17.30	E3	6V6GT	SYL	1.45
E2	OZ4A/CK1003	RAY	.95	E1	3JP1	RCA	27.50	E2	6X4W	RAY	2.00
E2	1AD4	RAY	3.05	E1	3KP1	RCA	24.75	E2	6X5WGT	RAY	2.00
E2	1AE4	RAY	4.50	E1	3KP4	RCA	25.75	E3	7AK7	SYL	7.45
E2	1AG5	RAY	2.05	E3	3NP4	22.50	EZ3	GL 7C29	GE	189.50
E3	EL C1B	ELEC	7.60	E1	3RP1	RCA	17.65	EZ3	GL 7D21	GE	511.00
E3	1B85	VIC	7.50	E3	3X2500A3	EIM	198.00	E3	7JP1/7VP1	SYL	27.75
E3	1B86	VIC	7.50	EZ3	3X2500F3	EIM	198.00	EZ1	7TP4	RCA	68.50
E3	EL 1C	ELEC	9.80	E1	4-65A	RCA	20.00	EZ1	7VP1	RCA	35.00
E1	1C21	RCA	3.85	E3	4-65A	EIM	20.00	E1	8D21	RCA	1500.00
E3	CE 1C/918	CE	2.30	E1	4-125A/4D21	RCA	30.25	EZ3	10NP11	SYL	137.50
E3	1D21/SN4	SYL	6.50	E3	4-125A	EIM	30.25	EZ1	10SP4	RCA	82.25
E3	EL C1J	ELEC	13.40	4-125A/6155	See type 6155		E1	UX CV11	UE	19.00
E3	EL C1J/A	ELEC	15.90	E1	4-250A/5D22	RCA	41.25	E3	12A6	RCA	2.09
E3	EL C1K	ELEC	12.90	E3	4-250A	EIM	41.25	E1	12A7WA	RCA	4.85
E1	C1K/6014	RCA	12.90	4-250A/6156	See type 6156		E1	12A7	RCA	2.53
E1	1P21	RCA	50.00	E3	4-400A	EIM	48.00	E1	12SW7	RCA	1.55
E1	1P22	RCA	15.25	EZ3	4-1000A	EIM	132.00	E1	12SX7GT	RCA	1.75
E1	1P28	RCA	28.95	E3	WL 4B24/3C	WES	10.20	E1	12SY7	RCA	1.70
E1	1P29	RCA	3.80	E2	RK 4D32	RAY	30.95	E3	EL C16J	ELEC	56.90
E1	1P37	RCA	3.45	E1	4E27/8001	RCA	26.00	E1	C16J/5665	RCA	57.90
E1	1P39	RCA	2.15	E1	4E27A/5-125B	RCA	35.75	E3	KY 21A	RAY	25.00
E1	1P40	RCA	3.00	E3	4E27A/5-125B	EIM	40.00	E3	RM 21A	EIM	24.00
E3	CE 1P/40	CE	1.75	E3	ELC4J	ELEC	19.40	E3	CE 23A	CE	2.50
E1	1P41	RCA	3.45	E3	ELC4J/F	ELEC	20.10	E3	25T	EIM	15.00
E1	1P42	RCA	11.65	EZ3	4W20000A	EIM	1850.00	E1	26A6	RCA	3.20
E4	E1T/6370	AMP	16.50	E1	4X150A	RCA	38.95	E1	25A7GT	RCA	7.25
E3	1Z2	CHA	5.70	E3	4X250B	EIM	42.50	E1	26C6	RCA	2.35
E3	2-01C	EIM	15.25	EZ1	4X500A	RCA	121.00	E1	26D6	RCA	3.00
E1	2AP1A	RCA	13.65	EZ3	4X500A	EIM	121.00	E3	FG 27A	GE	40.25
E3	2A515A	THER	7.50	EZ1	5ABP1	RCA	39.75	E3	28D7	SYL	2.85
E1	2BP1	RCA	13.80	EZ1	5ABP7	RCA	42.65	E3	CE 29R	CE	1.86
E1	2BP11	RCA	15.70	EZ1	5ABP11	RCA	43.80	32	See type WL-5558	
E1	2C39A	RCA	22.50	EZ1	5BP1A	RCA	32.75	E3	ECC 32	MULL	3.45
E4	2C39A	AMP	22.50	EZ1	5CP1A	RCA	31.65	E3	EL 34	MULL	3.26
E3	2C39B	EIM	32.15	EZ1	5CP7A	RCA	38.35	E3	EL 34MP	MULL	7.30 pr.
E1	2C40	RCA	26.00	5C22	See type 6279		E3	GZ 34	MULL	2.63
E1	2C43	RCA	23.50	EZ1	5FP4A	RCA	45.70	E3	35T	EIM	20.00
E3	2C51	TUNG	4.15	E1	5R4GY	RCA	1.90	E3	EL 37	MULL	2.63
E3	2C53	13.50	E2	5R4GY	RAY	1.90	E3	EL 37MP	MULL	5.96 pr.
E3	CE 2D	CE	4.56	E3	5R4GYA	GE	1.90	E3	TZ 40	TAY	8.50
E1	2D21	RCA	2.04	E2	5RAWGY	RAY	7.25	FG 57	See type GL 5559	
E4	2D21	AMP	2.90	EZ1	5UP1	RCA	22.65	E4	EFP 60	AMP	8.75
E1	2D21W	RCA	2.90	EZ1	5UP7	RCA	32.00	E2	RK 61	RAY	3.70
E1	2E24	RCA	5.25	E1	6A C7-W	RCA	4.20	E3	KT 66	GEN	3.50
E2	2E26	RAY	3.85	E1	6AG7Y	RCA	2.35	E3	75TL	EIM	28.00
E1	2E26	RCA	3.85	E2	6AJ5	RAY	3.50	E4	75NB3-7	AMP	10.00
E2	2E30	RAY	2.60	E2	6AN5	RAY	3.75	E3	EZ 80	MULL	1.35
E2	2E31	RAY	2.25	E3	6AR6	TUNG	5.75	E3	ECC 81	MULL	1.95
E2	2E32	RAY	2.25	E1	6A56	RCA	3.46	E4	ECC 81	AMP	1.71
E2	2E36	RAY	6.23	E2	6A56	RAY	3.46	E3	EM 81	MULL	2.93
E2	2G21	RAY	4.38	E1	6A57G	RCA	4.45	E3	EZ 81	MULL	1.65
E2	RK 2K25	RAY	30.60	E3	6AU6WA	GE	3.70	E3	FG 81A	GE	27.77
E1	2K26	RCA	48.20	E3	EL 6B	ELEC	13.00	E3	ECC 82	MULL	1.73
E1	2X2A	RCA	2.55	E3	6BF7W	SYL	4.45	E4	ECC 82	AMP	1.38
E1	3A-4	RCA	1.20	E3	EL C6C	ELEC	48.80	E1	83	RCA	1.32
E1	3A5	RCA	1.30	E3	EL 6C	ELEC	19.80	E3	ECC 83	MULL	1.88
E2	3A5	RAY	1.30	E4	6CA7	AMP	3.60	E3	ECC 83	AMP	1.38
E1	3AP1A	RCA	25.50	E3	6C4W	RAY	8.90	E3	EL 84	MULL	1.80
E2	3B4	RAY	2.75	E2	6D4	SYL	2.85	E3	EL 84MP	MULL	4.35 pr.
E3	WL 3B22/1C	WES	9.30	E1	6F4	RCA	7.00	E4	EL 84/6BQ5	AMP	1.20
E3	RK 3B24W	RAY	10.50	E3	EL C6J	ELEC	28.90	E3	ECC 85	MULL	2.17
E3	GL 3B24W	GE	10.55	E1	C6J/5C21	RCA	28.90				
E1	3B25	RCA	6.30	E3	EL C6J/A	ELEC	29.30				
E1	3B28	RCA	6.45	E1	C6J-A/5685	RCA	29.30				

LISTINGS OF SPECIAL PURPOSE TUBES
CONTINUED ON THE FOLLOWING PAGE

Special Purpose Tubes for

Easy to Order—Specify Department and Tube Type. This tabular presentation enables you to locate the tube types you want, quickly and easily. When ordering, give you the full Stock Number, which consists of the Department Number and the Manufacturer's Type Number. The Department Number represents exact location of the tube in Allied stockrooms—speeds up your shipment. Give stock Number thus: E3-1B85. The chart at left shows the full names of the manufacturers whose tubes are listed on these pages. For technical literature, see page 105. You can depend on Allied for prompt shipment of all special purpose tubes.

AMP	Amperex Elect. Corp.
CE	Continental Electric Co.
CHA	Chatham Electronics
EIM	Etzel McCullough
ELEC	Electrons, Inc.
GE	General Electric
GEN	Genalex
MULL	Mullard Products
NAT	Nat'l Electronics, Inc.
RA	Radi Corp. America
RAY	Raytheon Mfg. Co.
SYL	Sylvania Electric
TAY	Taylor Tubes, Inc.
THER	Thermosen, Inc.
TUNG	Tungsol
UE	United Electronics
VIC	Victoren Instrument
WES	Westinghouse

Stock No.		Mfr.	NET EACH	Stock No.		Mfr.	NET EACH	Stock No.		Mfr.	NET EACH
Dept.	Tube Type			Dept.	Tube Type			Dept.	Tube Type		
E3	EF 86	MULL	2.06	E3	NL 760P	NAT	29.40	EZ3	1000T	EIM	137.50
E4	EF 86	AMP	1.45	E1	801A	RCA	9.85	E2	CK 1006	RAY	6.50
E3	KT 88	GEN	4.50	E1	802	RCA	9.85	E2	CK 1020	RAY	10.80
E3	KT 88MP	GEN	11.00 pr.	E1	805	RCA	20.00	E2	CK 1021	RAY	10.80
E3	EC 90	MULL	2.63	E1	807	RCA	2.90	E2	CK 1026	RAY	3.50
E3	EK 90	MULL	1.65	E2	RK 807	RAY	2.90	E2	CK 1034	RAY	8.30
E3	EZ 90	MULL	1.27	E4	807	AMP	2.90	CK 1036	See type CK 6436	
E3	EB 91	MULL	1.35	807W	See type 5933		CK 1037	See type CK 6437	
E3	ECC 91	MULL	2.03	E1	809	RCA	5.65	E2	CK 1038	RAY	8.30
E3	EF 94	MULL	1.61	E1	810	RCA	25.55	EZ3	NL 1051	NAT	65.00
E3	100TH	EIM	20.50	E4	810	AMP	25.55	E3	R 1130B	SYL	19.00
E4	FG 105	AMP	48.00	E1	811A	RCA	5.65	E3	R 1131C	SYL	17.65
E3	172	RCA	71.75	E4	811A	AMP	5.65	E3	1222	SYL	2.45
E3	WL 172	WES	71.75	E1	812A	RCA	5.65	E3	1229	SYL	6.40
E3	T 200	TAY	29.50	E1	813	RCA	22.65	E3	1280	SYL	1.50
E3	CE 203	CE	11.20	E1	814	RCA	23.55	GL 1367	See type 5662	
E3	CE 206	CE	7.86	E1	815	RCA	23.55	E1	1609	RCA	14.50
E3	CE 213A	CE	7.42	E1	816	RCA	2.15	E1	1612	RCA	3.20
E3	GL 242C	GE	15.50	E2	RK 816	RAY	2.15	E1	1613	RCA	2.45
E3	250R	EIM	28.00	E1	828	RCA	27.50	E1	1614	RCA	2.72
EZ3	250TH	EIM	33.00	E4	828	AMP	27.50	E1	1616	RCA	11.35
E4	HF 300	AMP	35.00	E1	829B	RCA	16.25	E1	1619	RCA	3.30
E3	304TH	EIM	60.50	E4	829B	AMP	16.25	E1	1620	RCA	6.36
E3	304TL	EIM	60.50	E1	832A	RCA	14.20	E1	1621	RCA	1.95
E3	SA 309	SYL	18.30	EZ1	833A	RCA	55.00	E1	1622	RCA	2.70
E3	GL 393A	GE	13.25	EZ4	833A	AMP	55.00	E1	1624	RCA	4.00
E3	394A	CHA	7.50	E1	836	RCA	9.00	E1	1625	RCA	2.95
E3	395A	CHA	4.40	E1	837	RCA	7.85	E1	1626	RCA	1.85
E2	QK 404	RAY	74.00	E1	838	RCA	20.00	E1	1629	RCA	1.40
E3	GL 441	GE	4.50	E1	845	RCA	20.85	E1	1631	RCA	3.20
E3	WL 481B	WES	9.00	EZ4	857B	AMP	235.00	E1	1634	RCA	1.55
EZ4	501R	AMP	225.00	E1	865	RCA	14.70	E1	1635	RCA	2.00
E3	502A	GE	2.03	E1	866A	RCA	2.65	EZ1	1850A	RCA	565.00
E1	502A	RCA	2.03	E3	GL 866A	GE	2.65	E1	1946	RCA	10.90
E2	CK 506AX	RAY	2.30	E4	866A/866AX	AMP	2.65	E1	1949	RCA	11.30
E2	CK 510AX	RAY	2.95	E2	RK 866A/866	RAY	2.45	E1	1950	RCA	8.35
E2	CK 512AX	RAY	2.55	E3	866JR	TAY	1.95	E1	2022	RCA	3.45
E2	CK 526AX	RAY	2.76	E1	868	RCA	3.75	E1	2050	RCA	1.85
E2	CK 533AX	RAY	2.52	E3	GL 868/PJ23	GE	3.75	E2	2050	RAY	1.85
E2	CK 534AX	RAY	2.59	EX4	869B	AMP	155.00	E3	2050W	CHA	6.38
E2	CK 536AX	RAY	2.69	E1	872A	RCA	9.35	E2	2051	RAY	1.90
E2	CK 542DX	RAY	5.82	E4	872A/872AX	AMP	9.35	EX4	ZB 3200	AMP	350.00
....	CK 546DX	See type CK6519		E1	884	RCA	1.85	E3	R 4330	SYL	15.35
....	CK 548DX	See type CK6418		E2	884	RAY	1.85	E3	GL 5516	GE	7.95
....	CK 549DX	See type CK6419		E1	885	RCA	2.00	E2	CK 5517	RAY	3.80
EX1	575A	RCA	22.15	EZ4	889A	AMP	230.00	E4	5544	AMP	27.00
E4	575A	AMP	22.15	EZ1	889RA	RCA	360.00	E3	GL 5544	GE	38.41
E1	579B	RCA	16.50	EZ4	889RA	AMP	360.00	E4	5545	AMP	29.40
E3	WL 579B	WES	18.00	EZ1	892	RCA	265.00	GL 5545	See type GL 6807	
E3	592/3-200A3	EIM	37.50	EZ4	892	AMP	265.00	E1	5550	RCA	41.00
E3	NL 604	NAT	10.20	EZ1	892R	RCA	425.00	E4	5550	AMP	41.00
E3	NL 604L	NAT	11.50	EZ4	892R	AMP	425.00	E1	5551A	RCA	65.00
E3	NL 606	NAT	19.80	E1	902A	RCA	18.00	EZ3	WL 5551A/652	WES	65.00
E3	KU 610	WES	27.00	E1	917	RCA	4.95	EZ1	5552A	RCA	99.00
E3	NL 615	NAT	9.75	E1	918	RCA	3.80	EZ4	5552A	AMP	99.00
E3	NL 617	NAT	15.00	E1	919	RCA	4.95	EZ3	WL 5552A/651	WES	99.00
E3	NL 623	NAT	13.35	E1	920	RCA	5.70	EZ1	5553B	RCA	216.00
E3	KU 627	WES	27.00	E1	921	RCA	3.30	EZ3	WL 5553B	WES	216.00
E1	629	RCA	14.30	E1	922	RCA	2.85	EZ4	5553B	AMP	216.00
E4	632B	AMP	28.00	E1	923	RCA	2.85	EZ4	5555	AMP	316.00
E3	WL 632B	WES	28.00	E3	GL 923	GE	2.85	E1	5556	RCA	21.00
E3	NL 635	NAT	12.20	E1	925	RCA	3.20	E1	5557	RCA	9.50
E3	NL 635P	NAT	13.60	E1	926	RCA	3.30	E4	5557	AMP	9.50
E3	NL 649/5834	NAT	9.20	E1	927	RCA	3.75	E3	GL 5557/FG17	GE	9.50
E1	672A	RCA	35.00	E1	928	RCA	4.60	E1	5558	RCA	17.50
E3	WL 672A	WES	38.00	E1	929	RCA	2.00	E3	WL 5558/32	WES	17.50
EX1	673	RCA	22.15	E1	930	RCA	2.85	E1	5559	RCA	23.00
E3	WL 676	WES	58.00	E1	931A	RCA	10.45	E4	5559	AMP	23.00
E1	677	RCA	55.00	E1	934	RCA	3.65	E3	GL 5559/FG57	GE	23.00
E4	678	AMP	47.00	E1	935	RCA	9.95	E1	5560	RCA	28.00
E3	WL 678	WES	47.00	E1	954	RCA	7.40	E4	5560/FG95	AMP	28.00
E3	NL 710/6011	NAT	13.00	E1	955	RCA	4.00	E3	GL 5560/FG95	GE	28.00
E3	NL 714	NAT	9.50	E1	956	RCA	8.25	E1	5563A	RCA	47.00
E3	Z 729	GEN	2.99	E1	957	RCA	5.35	E1	5581	RCA	2.70
E3	NL 740	NAT	19.40	E1	958A	RCA	8.70	E1	5582	RCA	4.95
E3	NL 740P	NAT	20.10	E1	959	RCA	8.90	E1	5583	RCA	4.30
E3	NL 760	NAT	28.90	E1	991	RCA	.87	E1	5584	RCA	5.20

Industry and Broadcast Use

WRITE TO OUR INDUSTRIAL DIVISION FOR QUANTITY PRICES

Dept.	Stock No.	Mfr.	NET EACH	Dept.	Stock No.	Mfr.	NET EACH	Dept.	Stock No.	Mfr.	NET EACH
	Tube Type				Tube Type				Tube Type		
EX4	5604	AMP	570.00	E1	5825	RCA	20.85	E4	6265	GE	4.60
E3	5610	GE	1.05	E2	CK 5829	RAY	4.20	E4	6268	AMP	32.50
E1	5618	RCA	4.93	E1	5840	RCA	7.10	E4	6279	AMP	45.00
E3	GL 5632	GE	13.90	E1	5840A	RCA	7.10	E4	6293	RCA	6.00
E1	5636	RCA	9.15	E3	5841	VIC	6.50	EX1	6326A	RCA	565.00
E1	5636A	RCA	9.15	E3	5844	GE	2.40	E1	6328	RCA	12.15
E2	5651	RCA	1.78	E3	5845	SYL	9.25	E3	6336	CHA	15.75
E1	CK 5651	RAY	1.78	EZ4	5868	AMP	50.00	E3	6336A	CHA	37.50
E2	CK 5651WA	RAY	4.20	E1	5876	RCA	13.55	E1	6342	RCA	72.00
E1	5652	RCA	6.65	E1	5876A	RCA	19.10	E1	6350	RCA	2.40
E1	5653	RCA	1.60	E1	5879	RCA	1.75	E3	6350	SYL	1.95
E1	5654	RCA	3.90	E2	CK 5879	RAY	1.75	E4	6360	AMP	4.00
E2	CK 5654	RAY	3.60	E1	5881	RCA	3.50	E3	6386	GE	8.25
E1	5654/6AK5W	RCA	6.00	E3	5881	TUNG	3.00	E2	CK 6397	RAY	8.30
E2	CK 5654/6AK5W	RAY	3.60	E2	CK 5886	RAY	5.00	E1	6405/1640	RCA	7.30
E1	5654/6AK5W/6096	RCA	6.00	E2	CK 5889	RAY	12.45	E1	6417	RCA	2.37
E3	5662	GE	1.45	E1	5893	RCA	19.40	E2	CK 6418	RAY	3.05
E3	5663	GE	2.10	E4	5894	AMP	22.00	E2	CK 6419	RAY	2.20
EZ3	WL 5668	WES	289.00	E3	GL 5894	GE	22.00	E2	CK 6436/CK 1036	RAY	8.30
E1	5670	RCA	5.05	E3	5896	GE	5.05	E2	CK 6437/CK 1037	RAY	8.30
E3	5670	GE	5.05	E3	5899	GE	7.50	EZ4	6445	AMP	390.00
E2	CK 5670	RAY	5.05	E1	5915	RCA	1.30	EX4	6446	AMP	290.00
E2	CK 5672	RAY	2.45	E3	5932	SYL	11.40	EX1	6448	RCA	4610.00
E1	5675	RCA	13.20	E3	5933/807W	SYL	12.45	E3	6463	GE	2.15
E2	CK 5676	RAY	3.05	E3	WL 5934	WES	18.00	EZ1	6474/1854	RCA	1700.00
E2	CK 5678	RAY	2.45	E1	5963	RCA	1.40	E3	6476	SYL	22.25
E3	5679	SYL	1.35	E1	5964	RCA	1.40	E2	CK 6485	RAY	2.05
E4	5685/C6J	AMP	26.40	E1	5965	RCA	2.15	EX4	6508	AMP	80.00
E1	5686	RCA	3.85	E3	5965	GE	2.40	E2	CK 6519	RAY	3.05
E2	CK 5686	RAY	3.85	E2	CK 5975	RAY	4.20	E1	6524	RCA	15.75
E3	5686	GE	3.85	E2	RK 5976	RAY	74.00	E3	6550	TUNG	4.35
E1	5687	RCA	4.25	E3	5998	TUNG	11.85	E3	6655	RCA	56.25
E3	5687	TUNG	4.25	E1	6005	GE	4.60	E3	6660/6BA6	GE	1.05
E3	GL 5687	GE	4.50	E3	6005	RCA	4.60	E3	6661/6BH6	GE	1.33
E1	5690	RCA	9.65	E4	6007	AMP	1.50	E3	6662/6BJ6	GE	1.27
E1	5691	RCA	8.45	E3	GL 6011	GE	13.00	E3	6663/6AL5	GE	.92
E1	5692	RCA	8.15	E3	WL 6011/710	WES	13.00	E3	6669	GE	1.11
E1	5693	RCA	6.40	E1	6012	RCA	6.25	E3	6677	GE	1.79
E1	5696	RCA	1.90	E3	6014/CIK	NAT	12.90	E3	6679/12AT7	GE	1.54
E2	CK 5702	RAY	4.20	E2	CK 6021	RAY	5.85	E3	6680/12AU7	GE	1.26
E2	CK 5703	RAY	2.35	E2	CK 6029	RAY	5.00	E3	6681/12AX7	GE	1.29
E2	CK 5703WA	RAY	7.50	E1	6072	RCA	5.30	E1	6694A	RCA	5.60
E1	5718	RCA	4.60	E3	6072	GE	4.80	E3	GL 6807	GE	29.30
E1	5718A	RCA	4.60	E1	6073	RCA	3.00	E3	GL 6808	GE	29.40
E1	5719	RCA	3.95	E1	6074	RCA	3.45	EZ1	6810A	RCA	275.00
E1	5719A	RCA	3.95	E4	6076	AMP	275.00	E2	CK 6832	RAY	24.85
E3	GL 5720/FG33	GE	34.75	E1	6080	RCA	6.00	E1	6887	RCA	1.25
E1	5722	SYL	6.40	E1	6080WA	RCA	10.50	E1	6893	RCA	3.85
E1	5725	RCA	3.80	E3	6082	RCA	5.30	E1	6894	RCA	25.00
E2	CK 5725	RAY	3.80	E3	6087	GE	6.40	E1	6895	RCA	25.00
E1	5726	RCA	2.10	E2	CK 6088	RAY	2.75	E1	6957	RCA	3.70
E3	5726	GE	2.10	E1	6101	RCA	7.25	E1	8000	RCA	26.40
E1	5726/6AL5W	RCA	2.10	E1	6101/6J6WA	RCA	7.25	E1	8005	RCA	16.20
E1	5726/6AL5W/6097	RCA	3.45	E2	CK 6111	RAY	6.70	E1	8008	RCA	9.35
E4	5727	AMP	2.90	E2	CK 6112	RAY	6.70	E4	8008	AMP	9.35
E3	5727	GE	2.90	E1	6130/3C45	RCA	17.80	E1	8013-A	RCA	14.45
E1	5727/2D21W	RCA	2.90	E2	CK 6135	RAY	2.60	E1	8020	RCA	24.00
E3	5727/2D21W	GE	2.90	E1	6136	RCA	3.70	E3	GL 8020	GE	24.00
E1	5734	RCA	18.00	E3	6136	GE	3.70	E1	8025A	RCA	21.95
EZ4	5736	AMP	160.00	E1	6146	RCA	4.90	E1	9001	RCA	4.60
EZ3	WL 5736	WES	160.00	E2	CK 6146	RAY	4.90	E1	9002	RCA	3.10
E2	CK 5744	RAY	2.65	E2	CK 6152	RAY	9.15	E1	9003	RCA	4.60
E1	5749	RCA	2.80	E4	6153	AMP	27.50	E1	9004	RCA	3.70
E3	5749	GE	2.80	E1	6156	AMP	37.50	E1	9005	RCA	4.40
E1	5750	RCA	3.90	E1	6159	RCA	4.90	E1	9006	RCA	2.15
E3	5750	GE	3.90	EZ1	6166	RCA	1000.00				
E3	5751	RCA	3.80	E1	6173	RCA	12.10				
E3	5751	GE	3.80	E2	CK 6174	RAY	3.80				
E1	5751WA	RCA	3.80	EZ1	6181	RCA	925.00				
E2	CK 5755	RAY	10.40	E1	6186/6AG5WA	RCA	4.00				
EZ1	5762/7C24	RCA	215.00	E1	6189/12AU7	WA	4.80				
E1	5763	RCA	2.37	E1	6197	RCA	2.55				
E2	CK 5763	RAY	2.37	EZ1	6198	RCA	230.00				
E2	CK 5783	RAY	4.20	E1	6199	RCA	52.50				
E2	CK 5783WA	RAY	8.30	E1	6201	RCA	4.85				
E2	CK 5784	RAY	5.00	E3	6201	GE	4.85				
E2	CK 5785	RAY	5.85	E3	6202	GE	3.70				
E2	CK 5787	RAY	5.00	E1	6205	GE	7.50				
E2	CK 5787WA	RAY	10.80	E1	6211	RCA	2.15				
E1	5814A	RCA	4.15	E1	6217	RCA	72.00				
E3	5814A	GE	3.85	E2	CK 6247	RAY	12.45				
E1	5814WA	RCA	5.10	EZ3	GL 6251	GE	2300.00				
E2	CK 5814A	RAY	3.85	E4	6252	AMP	22.00				
E1	5819	RCA	56.90	E1	6263	RCA	20.00				
EZ1	5820	RCA	1200.00	E1	6263A	RCA	22.40				
E1	5823	RCA	1.57	E1	6264	RCA	20.00				
E3	5824	GE	3.70	E1	6264A	RCA	22.40				

SPECIAL PURPOSE TUBE LITERATURE

RCA PUBLICATIONS

37 A 109. Type 1D-1020A. Interchangeability Directory. Guide to selection of RCA tubes for replacement of non-receiving tubes. No charge.

37 A 159. Type 3F801. User Price Schedule. Six-page folder. Most recent edition is always sent. No charge.

37 A 137. Type CRPD-105. Photosensitive Devices and Cathode-Ray Tubes. Technical information on 106 RCA tubes including single, twin and multiplier phototubes, TV camera tubes, monoscopes, etc. 24 pages. No charge.

37 A 138. Type RIT-104. Receiving-Type Tubes for Industry and Communications. Valuable data on 130 RCA tubes including special red, premium, pencil, computer, glow-discharge, etc. 20 pages. No charge.

37 A 576. Type PG-101-B. Power and Gas Tube Bulletin. Data on more than 150 RCA transmitting, industrial, RF heating, and other special tubes. 24 pages. No charge.

37 A 157. HAM-103B. Latest ratings, technical data and base diagrams for 48 RCA Amateur tubes. 4 pages. No charge.

Diodes, Rectifiers and Photocells

INTERNATIONAL RECTIFIER SELF-GENERATING PHOTO-CELLS

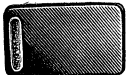

UNMOUNTED



MOUNTED

Self-generating selenium photo-cell sun batteries. Convert light energy into electrical energy with no auxiliary source of voltage. Outputs in average sunlight range from 0.2 to 60 ma. Excellent for use with meters as light measuring devices. Optimum load resistance ranges from 10 to 10,000 ohms. Outputs in table below taken at 100-footcandle illumination with 100-ohm load. Av. shpg. wt., 2 oz.

No.	Type	Size	Style	µa.	NET
7 E 732	A-2M	9/32" dia.	Mounted	13	3.87
7 E 733	A-5	1 1/8" dia.	Mounted	25	1.96
7 E 734	A-10	1 3/8" dia.	Unmounted	50	4.41
7 E 735	A-15	2" dia.	Unmounted	75	5.88
7 E 736	B-2	2 3/32x7/16"	Unmounted	75	.98
7 E 737	B-5	1 7/16x4 1/4"	Unmounted	220	1.96
7 E 738	B-10	1 11/16x7/8"	Unmounted	350	2.45
7 E 739	B-15	1 11/16x1 1/16"	Unmounted	750	5.88
7 E 740	B-10M	1 11/16x7/8"	Mounted	350	6.96

Type B-2M. Self-generating selenium photo-cell sun battery, 2 ma output in average sunlight; 60 µa at 100-footcandles with 55-ohm load. Use with a meter as a light measuring device. Also useful in sun-powered electronic equipment. Mounted. Size, 2 3/32x7/16".
7 E 731. NET.....1.47



CLAIREX PHOTOCELLS

Highly efficient crystal photocell. Extremely sensitive to visible light. Type CL-2 is made of cadmium sulphide; Type CL-3 is made of cadmium selenide and is exceptionally sensitive in the red and near infra-red region of the spectrum. Both types have a maximum rating of 300 volts, AC or DC. Sensitivity of CL-2, 100 µa at 100 footcandles at 10 ms, 1 footcandle at 150 ms. Sensitivity of CL-3, 600 µa at 2 footcandles; time constant, 100 footcandles at 1 1/2 ms, 1 footcandle at 15 ms. Sizes: 1/4x1/2" long. Shpg. wt., 3 oz.

at 2 footcandles; time constant, 100 footcandles at 15 ms. Sizes: 1/4x1/2" long. Shpg. wt., 3 oz.
7 E 881. CL-2. NET
7 E 882. CL-3. EACH.....3.50

HOFFMAN SILICON PHOTOCCELL



Type P-100. Photocell for use in countless photometric applications. Replaces older type selenium cells and operates with greater efficiency. Uses a quarter section of the famous Bell Telephone silicon solar battery. Features high output—in sunlight, 1/2 volt open circuit; 4 mw with 25 ohm load. Sufficient to generate sensitive relay—no auxiliary power needed. Operates on infrared as well as visible light. Amount of generated current depends upon intensity and incident of illumination. Very durable—unaffected by moisture or exposure to weather. Only 1" square, 3/8" thick. Fits standard octal socket. Wt., 4 oz.
77 E 063. NET.....4.00

HOFFMAN SILICON SOLAR CELL



Type S-1A. Silicon junction solar energy converter. Developed by Bell Telephone Labs. Offers countless uses in extremely compact, only 1 1/2" diameter by 3/8" thick—ideal for miniaturized equipment. High output—under direct noon sunlight measures 0.25 volts across 10 ohm load. No auxiliary power source needed. Under optimum conditions will produce up to 35 mw electrical power from solar energy. Will operate on infrared light. High stability and rugged construction—cannot oxidize or corrode. No deterioration due to atmospheric conditions. Completely unaffected by moisture. May be banked in series or parallel arrangements in order to obtain increased voltage or current output. Shpg. wt., 4 oz.
77 E 029. NET.....8.00

PHOTOCCELL-SUN BATTERY HANDBOOK

An excellent handbook for technicians, experimenters and engineers. Thoroughly describes the applications and basic circuits in which photocells and sun batteries can be effectively used. Typical chapters include: Light-Powered Devices, Photometers, Unusual Relays, Light Beam Communication. 9 chapters, 58 pages, 5 1/2x9".
37 K 129. Postpaid in U.S.A.....1.50

SYLVANIA CRYSTAL DIODES

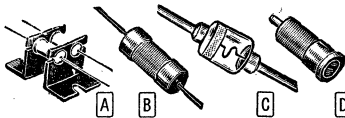

These compact, highly efficient crystal diodes have hundreds of applications. Silicon types are used in radar, industry, and microwave instruments such as test probes, power indicators, etc. Germanium types are used for low-power rectification of frequencies up to 200 mc—have applications as detectors in TV receivers, Amateur communications receivers, transmitters, test and control circuits, standing wave indicators, etc.

GERMANIUM DIODES

A Type 1N35. Consists of two electrically matched 1N34 diodes in mounting bracket. 1 1/2x2 1/4x3/4". Shpg. wt., 4 oz.
7 E 220. NET.....2.25

Stock No.	Mfr's Type	Fig.	*Description	Anode Max. Ma.	NET EACH
7 E 292	1N60	B	Video Detector	50	33c
7 E 436	1N105	B	Video Detector	150	45c

*25 continuous reverse working volts.

"SEALED IN GLASS" DIODES

C Germanium crystal diodes hermetically sealed in moisture-proof glass cartridges—withstanding extended exposure to humidity. Electrically identical to corresponding ceramic types, but smaller and lighter in weight. 1 mmf shunt capacity. All have 50 ma maximum anode current except Type 1N56A, 60 ma. Size, 3/4x1/4". Shpg. wt., 2 oz.

Stock No.	Mfr's Type	Description	Cont. Rev. W.V.	NET EACH
7 E 236	1N34A	General Purpose	60	.47
7 E 426	1N38A	100-Volt Diode	100	.90
7 E 235	1N39A	200 Back Volt Diode	60	4.13
7 E 427	1N54A	High Back-Res.	50	90
7 E 428	1N55A	150-Volt Diode	150	2.03
7 E 237	1N58A	100-Volt Diode	100	1.28
7 E 289	1N56A	High-Cond. Diode	40	1.05

MICROWAVE SILICON DIODES

D Point contact silicon diodes designed for use as non-linear circuit elements in microwave applications—used in UHF-VHF TV converters. Av. shpg. wt., 2 oz.

Stock No.	Mfr's Type	Test Conditions		NET EACH
		Freq. in Mc.	Conversion Loss in db	
7 E 274	1N21B	3050	6.5	1.11
7 E 278	1N23B	9375	8.0	1.13
7 E 279	1N23B	9375	6.5	1.03
7 E 440	1N82	100090

AMPEREX GERMANIUM DIODES

"All glass" point-contact germanium diodes. Hermetically sealed for improved performance. Have high back resistance. Replace most general-purpose, point-contact types. Ratings given are for 25° C. Maximum ratings, peak rectified current, 150 ma; av., rectified current, 50 ma. Shpg. wt., 3 oz.

Stock No.	Type	Peak Inverse DCV	NET
5 E 805	1N34A	75	.66
5 E 806	1N38A	120	1.10
5 E 807	1N54A	75	1.10
5 E 881	1N87	30	.39
5 E 882	1N119	75	1.58

RCA CRYSTAL DIODES

Germanium crystal diodes. Point contact type—designed for use as low-power rectifiers. Small in size, and have great resistance to shock and vibration. Hermetically sealed in glass cartridges—unaffected by moisture. Have low shunt capacity for efficiency in rectifying AC signals. Type 1N34A useful for isolation, clipping, switching, and meter circuits. Types 1N38A and 1N58A have applications in clamping circuits, DC restorer circuits, and high-voltage probes. Type 1N54A can be used for high-voltage probes and high impedance detector circuits. All types have 50 ma. average anode current. Av. shpg. wt., 3 oz.

Stock No.	Mfr's Type	Description	Peak Inv. V.	NET EACH
5 E 870	1N34A	General Purpose	60	.48
5 E 874	1N38A	Large Signal	100	.97
5 E 875	1N54A	High Back-Res.	50	.97
5 E 873	1N58A	Large Signal	100	1.36

G.E. DIODES AND RECTIFIERS

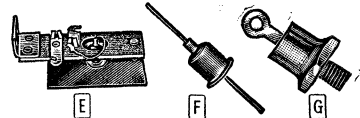

Complete line of general-purpose and special-type G.E. crystal diodes and rectifiers for use in electronic and electrical power circuits requiring detection or rectification. Feature welded joint between platinum whisker and crystal for high strength and rigidity. Withstand shock and vibration. Free from microphonic effects. Low input capacitance for efficient rectification of AC signals. Exceptionally stable in operation. **Explanation of Symbols in Column Heads:** PIV—peak inverse volts; IF—average forward current in ma.; IFM—maximum forward current in ma.

GERMANIUM JUNCTION RECTIFIERS

Alloy junction germanium rectifiers. Extremely low forward resistance and correspondingly high reverse leakage resistance gives these rectifiers an efficiency of over 99%! Applications include signal crops switchboards, computers, magnetic amplifiers, experimental circuits, etc. Feature long life—hermetically sealed construction. Leads attached for soldering to Types 1N315, 1N368, 1N91, 1N92, and 1N93. Types 1N151, 1N152, 1N153 and 1N158 are attached to mounting brackets. Will operate in ambient temperatures up to 65° C, except Type 1N315—designed for high operating temperatures up to 85° C. All specifications given are for operation at 60 cycles, 55° C with resistive load. *Average forward current to average reverse current ratio is 700 at 55° C, 300 at 71° C, and 200 at 85° C. Av. wt., 2 oz.

Stock No.	Mfr's Type	Fig.	PIV	IF	IFM	NET EACH
7 E 479	1N151	E	100	500	1570	2.15
7 E 480	1N152	E	200	500	1570	2.70
7 E 481	1N315*	F	200	100	314	3.00
7 E 496	1N368	F	200	100	310	2.55
7 E 491	1N91	F	100	150	470	1.83
7 E 492	1N92	F	200	300	310	1.90
7 E 493	1N93	F	300	75	250	2.65
7 E 476	1N153	E	300	500	1570	3.60
7 E 495	1N158	E	380	500	1570	5.50

GENERAL-PURPOSE DIODES

Germanium crystal diodes. Hermetically sealed in ceramic cases. Ratings given at 25° C operation. Wt., 2 oz

Stock No.	Mfr's Type	PIV	IF	IFM	NET EACH
7 E 250	1N48	85	50	150	.68
7 E 247	1N51	50	25	100	.47
7 E 249	1N63	125	50	150	2.80
7 E 244	1N65	50	50	150	.68
7 E 395	1N34A	75	50	150	.84

SILICON JUNCTION RECTIFIERS

Alloy junction silicon rectifiers. Designed for maximum forward conduction at high temperatures. No heat dissipators required on axial-lead types (Fig. F). Stud-mounted types (Fig. G) have 10-32x3/8" thread to permit convenient mounting on heat-dissipating plate or fin. Feature low reverse current at maximum temperature—ideal for magnetic amplifiers and other low leakage applications. Minimum forward voltage drop. Operates at ambient temperatures up to 165° C—specifications listed below for operation at 150° C. Av. shpg. wt., 2 oz.

Stock No.	Mfr's Type	Fig.	PIV	IFM	Max. Freq.	NET EACH
7 E 931	1N536	F	50	250	50 kc	2.00
7 E 497	1N537	F	100	250	50 kc	2.05
7 E 498	1N538	F	200	250	50 kc	2.50
7 E 932	1N539	F	300	250	50 kc	3.30
7 E 933	1N540	F	400	250	50 kc	5.00
7 E 930	1N1095	F	500	250	100 kc	7.50
7 E 934	1N1115	G	100	600	100 kc	2.90
7 E 935	1N1116	G	200	600	100 kc	3.90
7 E 936	1N1117	G	300	600	100 kc	4.15
7 E 937	1N1118	G	400	600	100 kc	5.80

GRAYHILL 17-1 DIODE HOLDER

Crystal diode holder with spring tension clip. Loop terminal and spring clip are formed from one piece of phosphor bronze wire, insuring good contact with the diode. Corrosion-resistant gold-plated clip solders easily. Has provision to prevent turning on chassis. Molded phenolic base (MIL-P-14, Type I) (Fig. G). Overall size, 1 1/16x3/8x1/8". Shpg. wt., 2 oz.
45 H 186. NET.....35c

Selenium & Germanium Rectifiers

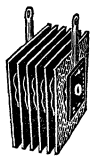

SARKES TARZIAN RECTIFIERS MINIATURE TYPE

"Centre-Kooled" selenium rectifiers—premium quality at low cost. Widely used as replacements in radio and TV sets, intercoms, bias supplies, amplifiers, etc. Also excellent for original equipment. Supply plate, filament and bias voltages directly from power line or from transformer. Maximum rms input volts, 130. Conservatively rated to deliver highly dependable and efficient performance. "Centre-Kooled" design assures cool, stable operation. Maximum inverse peak volts, 380. Approximate internal drop, 5 volts. Av. shpg. wt., 5 oz.

Stock No.	Mfr's Type	DC MA	Size	1 to 4, EACH	5 or More, EACH
4 A 631	50	50	1 3/16 x 2 3/8 x 1 1/2"	.71	.64
4 A 616	65	65	1 1/2 x 1 1/4"	.88	.79
4 A 617	75	75	1 1/2 x 1 3/8"	1.00	.90
4 A 618	100	100	1 1/2 x 1 1/2 x 3/8"	1.21	1.09
4 A 619	100A	100	1 x 1 x 1"	1.06	.95
4 A 620	150	150	1 1/2 x 1 1/4 x 1 1/4"	1.26	1.13
4 A 621	200	200	1 1/2 x 1 1/2 x 1 1/2"	1.68	1.51
4 A 622	250	250	1 1/2 x 1 1/2 x 1 1/2"	1.68	1.51
4 A 685	250A	250	1 1/2 x 1 1/4 x 1 7/8"	1.50	1.36
4 A 623	300	300	1 1/2 x 1 1/2 x 1 1/2"	1.76	1.56
4 A 686	300A	300	1 1/2 x 1 1/2 x 1 1/2"	1.76	1.40
4 A 624	350A	350	1 1/2 x 1 1/2 x 2 3/8"	1.85	1.66
4 A 627	400	400	2 x 2 x 1 1/4"	2.20	1.98
4 A 687	400AD	400	1 1/2 x 1 1/4 x 1 1/4"	2.00	1.80
4 A 625	500	500	2 x 2 x 1 7/8"	2.44	2.20
4 A 688	500AD	500	1 1/2 x 1 1/2 x 1 1/2"	2.18	1.96

FULL-WAVE POWER RECTIFIERS

Single-phase, full-wave selenium rectifier stacks for general-purpose and industrial use. Applications: Electro-plating, motor control, DC filament supplies, battery charging, DC relay supplies, DC supplies for telephone equipment, etc. *Center-tapped. †Bridge-connected. Av. shpg. wt., 10 oz.

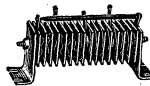

Stock No.	Mfr's Type	Max. Amps.	Max. AC Input V.	DCV Output	Size	NET EACH
4 A 700	*D-10	2	13	6-10	3x2 1/2 x 3"	4.16
4 A 701	*D-12	6	13	6-10	4x2 1/2 x 4"	5.88
4 A 702	*D-14	12	13	6-10	5x2 1/2 x 6"	7.35
4 A 710	*D-16	22.5	13	6-10	4 1/2 x 2 1/2 x 12"	12.84
4 A 703	*D-17	2	26	6-20	3x3 1/2 x 3"	7.10
4 A 704	*D-18	4	26	6-20	4x3 1/2 x 4"	9.36
4 A 705	*D-19	6	26	6-20	4x4x4"	10.04
4 A 706	*D-20	8	26	6-20	5x3 1/2 x 6"	12.20
4 A 707	*D-21	12	26	6-20	5x4x6"	12.49
4 A 708	*D-23	22.5	26	6-20	4 1/2 x 4 1/2 x 12"	22.84
4 A 708	*D-24	2	52	20-40	3x4 1/2 x 3"	12.50
4 A 709	*D-25	4	52	20-40	4x4 1/2 x 4"	17.10
4 A 712	*D-26	6	52	20-40	4x6 1/2 x 4"	18.13
4 A 713	*D-30	22.5	52	20-40	4 1/2 x 6 1/2 x 12"	41.65
4 A 714	*D-39	1	130	60-100	2x5 1/2 x 2"	18.91
4 A 715	*D-40	2	130	60-100	3x8 1/2 x 3"	24.84
4 A 716	*D-45	.5	156	100-120	1.6x6x1.6"	14.06
4 A 717	*D-46	1	156	100-120	2x6x2"	22.05
4 A 718	*D-47	2	156	100-120	3x10 1/2 x 3"	29.01
4 A 719	*D-48	4	156	100-120	4x10 1/2 x 4"	43.21
4 A 720	*D-49	6	156	100-120	4x15 1/2 x 4"	44.88

NEW SILICON RECTIFIERS

Outstanding new development in the field of power conversion and semi-conductors. Especially useful for applications where rectifier may be subjected to extremes of heat and cold—or where high power capacity in a small size unit is required. Thermal range from -55° C. to 100° C. without derating. Forward resistance less than one ohm; reverse resistance in the order of 1000 ohms—gives rectification efficiency greater than 99%. Terminals, Types L, M, and SM; type type; Type F; digitall leads; Type Q; stud—3/8"-24 thread. Note: All AC current ratings are for resistive or inductive loads only. Except Type M (for capacitive loads also). On all other types derate DC current by 20% for capacitive, motor, or battery loads. Type Q current ratings based on proper heat sink design to limit heat of case to 170° C. *Peak inverse voltage. † At 100° C. Av. shpg. wt., 3 oz.

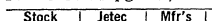

Stock No.	Jetec No.	Mfr's Type	Max. *PIV	RMS Volts	†Max. DC Amps	Overall Size L x Dia.	NET EACH
4 A 731	1N1086	20L	200	140	1.5	1 1/2 x 1/2"	3.72
4 A 732	1N1088	40L	400	280	1.5	1 1/2 x 1/2"	4.51
4 A 733	1N1053	10P1	100	70	1.5	7/16 x 7/16"	1.67
4 A 734	1N1056	30P	300	210	1.5	7/16 x 7/16"	11.29
4 AC 735	1N1078	15Q4	150	105	15	1 1/2 x 3/8 x 1/2"	6.21
4 AC 736	1N1080	30Q4	300	210	15	1 1/2 x 3/8 x 3/8"	22.59
4 A 737	1N1082	20M	200	140	.5	1 1/2 x 1/2"	2.15
4 A 738	1N1084	40M	400	280	.5	1 1/2 x 1/2"	2.88
4 A 739	1N1109	120SM	1200	840	4.25	1 1/2 x 3/8 x 1 3/8"	5.29
4 AC 740	1N1110	160SM	1600	1120	4	2 1/2 x 3/8 x 1 3/8"	7.84
4 AC 741	1N1113	280SM	2800	1960	.325	3 1/2 x 3/8 x 1 3/8"	13.72

SARKES TARZIAN MINIATURIZED SILICON RECTIFIERS

Type M500. Extremely small, clip-in silicon rectifier—perfect for TV replacement and miniaturization uses. Lower voltage drop (only 2 v.) results in increased B+, more drive and sweep voltage, and more anode current for greater clarity. Maximum ratings: AC voltage on picture tube input, 130 v.; peak inv., 400 v.; DC current, 500 ma; peak current, 5000 ma. Shpg. wt., 4 oz.

4 A 697, 1-9, NET EACH..... 2.12
10-24, NET EACH..... 1.90

Type M150. Similar to above but 150 ma. max. current. For replacement use in portable radios, etc. Will replace Sarkes Tarzian Models 65 and 75 selenium rectifiers. In plastic containers complete with one rectifier, two clips, one 10-ohm one-watt resistor, and diagrams.

4 A 696, 10 to 24, EACH..... 1.13 1 to 9, NET EACH..... 1.26

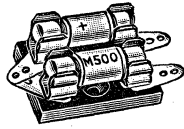

FEDERAL SELENIUM RECTIFIERS MINIATURE TYPE

Top-quality selenium rectifiers at unusually low prices. Ideal for replacement use and for original equipment. Types 1016 and 1017 are bridge-connected. Rated: Max. rms input volts, 25; max. peak inverse volts, 35. Type 1001 rated: Max. rms input volts, 20; max. peak inverse volts, 35. Type 1022: Max. rms input volts, 160; max. peak inverse volts, 460. All other types: Max. rms input volts, 130; max. peak inverse volts, 380; internal drop, 7 volts. Rectifiers with letter A in type no. have locking lug. *Ultra-compact tubular rectifier; enclosed in paper tube. Has 1 1/2" leads for easy installation. Average shpg. wt., 5 oz.

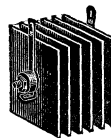

Stock No.	Mfr's Type	DC MA	Size	1 to 4, EACH	5 or More, EACH
4 A 662	1159	20	*1/2" dia. x 3/4"	.88	.79
4 A 606	1002A	65	1x1x3/8"	.88	.79
4 A 679	1386	65	1 1/2 x 1 1/2 x 1 1/2"	.82	.74
4 A 602	1003A	75	1x1x3/4"	1.00	.90
4 A 668	1001	75	1x1x3/8"	.50	.45
4 A 600	1004A	100	1 1/2 x 1 1/2 x 3/4"	1.21	1.09
4 A 661	1101A	100	1x1x1 1/2"	1.03	.93
4 A 603	1005A	150	1 1/2 x 1 1/2 x 1"	1.29	1.16
4 A 604	1006A	200	1 1/2 x 1 1/2 x 1"	1.71	1.54
4 A 607	1028A	250	1 1/2 x 1 1/2 x 1 1/2"	1.71	1.54
4 A 603	1090A	300	1 1/2 x 1 1/2 x 2 1/2"	1.76	1.58
4 A 666	1016	300	1 1/2 x 1 1/2 x 3/2"	1.50	1.35
4 A 612	1023	350	1 1/2 x 1 1/2 x 2 1/2"	2.09	1.88
4 A 615	1130	400	2x2x1 1/4"	2.20	1.98
4 A 665	1022	450	2x2x2 3/8"	3.44	3.10
4 A 611	1179A	500	2x2x2 1/2"	2.44	2.20
4 A 660	1017	600	1 1/2 x 1 1/2 x 3/4"	1.97	1.77

Type 1013 Battery Charger Rectifier. For charging small 2 and 6-volt batteries, such as used in electronic photoflash equipment and self-charging portable radios. Max. rms input volts, 18. Max. DC, 450 ma. Size, 1 1/2 x 1 1/2 x 1/4". Shpg. wt., 4 oz.

4 A 604, NET..... 94c

Type 1512 Battery Charger Rectifier. For trickle charging of 6-volt auto batteries. Also suitable for DC filament supplies. Max. rms input volts, 26. Max. DC, 1800 ma. 4 1/4 x 2 1/8 x 3/8". Shpg. wt., 6 oz.

4 A 664, NET..... 2.18

Federal Miniature Selenium Rectifier Handbook. Valuable handbook for radio-TV servicemen and experimenters. Includes full specifications and circuit applications. 80 pages. 8 1/2 x 4 1/4".

37 K 106, Postpaid in U.S.A..... 50c

HI-DENSITY TYPE RECTIFIERS

New design—extremely compact—selenium rectifiers. Excellent for replacement use and for original equipment. Eliminate installation problems where space is very limited. Maximum rms input volts, 130. Maximum peak inverse volts, 380. Internal drop 7 volts. All have locking lug. Av. shpg. wt., 4 oz.

Stock No.	Mfr's Type	DC MA	Size	1 to 4, EACH	5 or More, EACH
4 A 675	1236A-H	250-300	1 1/4 x 1 1/4 x 1 3/8"	1.56	1.40
4 A 676	1241A-H	350-400	1 1/2 x 1 1/2 x 1 1/2"	2.03	1.83
4 A 677	1237A-H	450-500	1 1/2 x 1 1/2 x 1 3/8"	2.20	1.98
4 A 678	1207A-H	600	1 1/4 x 1 1/4 x 1 3/8"	2.47	2.22

PACKAGED-POWER RECTIFIERS

Exceptionally rugged, high current output type selenium rectifiers. Especially suitable for industrial use but can be used for practically any AC or DC conversion need. Current output on some types as high as 24 amperes. Single phase, full wave bridge type except *single phase full wave center-tap. Ratings shown are for 35° C. ambient temperature. Av. shpg. wt., 8 oz.



Stock No.	Mfr's Type	Max. DC Output		Max. AC Input V.	Size	NET EACH	
		Volts	Amps			1-9	10-24
4 A 781	010*	10	3	13	3x3x1 1/4"	3.53	3.35
4 A 782	12*	10	6	13	3x4x1 1/4"	4.75	4.52
4 A 783	014*	10	12	13	6x5x1 3/4"	6.52	6.19
4 A 784	016	10	24	13	10x6x2 3/8"	12.74	12.10
4 A 785	211	20	3	26	3x3x2 1/16"	6.42	6.10
4 A 786	213	20	6	26	4x4x2 1/16"	8.38	7.96
4 A 787	215	20	12	26	6x5x2 3/8"	12.00	11.41
4 A 788	217	20	24	26	10x6x3 3/8"	24.01	22.81
4 A 789	310	40	3	52	3x3x3 3/8"	11.66	11.08
4 A 790	312	40	6	52	4x4x5 1/8"	15.39	14.62
4 A 791	314	40	12	52	6x5x5 1/4"	22.20	21.09
4 A 792	410	60	2.6	78	3x3x4 1/2"	15.57	14.80
4 A 793	412	60	6	78	4x4x6 3/4"	21.76	20.67
4 A 794	414	60	12	78	6x5x7 1/2"	32.00	30.40
4 A 795	510	80	2.6	104	3x3x5 1/2"	19.55	18.57
4 A 796	512	80	6	104	4x4x8 9/16"	27.29	25.93
4 A 797	514	80	12	104	6x5x9 1/16"	41.70	39.61

Conversion Kit. Exceptionally handy unit for use in TV sets, or any equipment now using selenium or full wave vacuum tube rectifiers. Allows conversion to silicon rectifiers with resulting high efficiency, comparative freedom from breakdown, easier fuse replacement. Excellent for use by TV servicemen for modernization of older model TV sets or other types of electronic equipment. Conversion kit includes 2—M500 silicon rectifiers, dual mounting clip, and all hardware. Shpg. wt., 6 oz.

4 A 699, NET..... 4.59

Single Mounting Clip. Overall size, 3/4 x 1 1/2 x 1/2". Shpg. wt., 2 oz.

4 A 669, NET..... 12c

Dual Mounting Clip. Overall size, 3/4 x 1 1/2 x 1". Shpg. wt., 4 oz.

4 A 670, NET..... 26c

Industrial & Service Items

INTERNATIONAL TELEMETER CORES



375T 180T 100T 80T

New ferrite magnetic memory and switching cores—permanent magnets in which polarity can be reversed by extremely low magnetizing force. Typical applications include use in digital computers, high-speed counters, radiation counters, shift registers, juke boxes, information storage buffers, industrial controls and numerous other similar devices. Types 5011, 5015, 8011, 8015, 10011, 10015, are rectangular hysteresis loop storage cores. Types 180T1, 180T5, 375T1 and 375T5 are ferrite switch cores. Circuits employing these cores are described in the February 1956 issue of Electronics Magazine. Av. shpg. wt., per box, 4 z. 25 cores per box.

Stock No.	Type	O. D.	Switch Time, μ s	PER BOX
9 E 888	375T5	.375"	5	25.00
9 E 889	180T5	.180"	5	25.00
9 E 890	100T5	.100"	5	25.00
9 E 891	80-5	.080"	5	11.25
9 E 892	50T5	.050"	5	11.25
9 E 893	375T1	.375"	1	25.00
9 E 894	180T1	.180"	1	25.00
9 E 895	100T1	.100"	1	11.25
9 E 896	80T1	.080"	1	11.25
9 E 897	50T1	.050"	1	11.25

BARBER-COLMAN BLYM PERMANENT MAGNET DC MOTORS

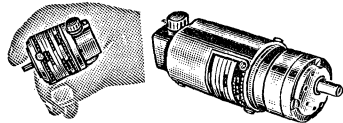

Ideal for many aircraft or industrial equipment applications. Typical uses include: fan and blower drives, rapid transfer switches, and programming devices. Permanent magnet field. Tapered air gap (usually available only on larger motors). Excess armature reaction, for improved performance under varying load conditions. Multi-coat treatment protects armature from moisture, fungus, or salt spray. Brush life at sea level usually exceeds 1000 hours. Motors perform well at high altitudes. Ambient temperature range is -65° F to $+200^{\circ}$ F. Meet performance, environmental, vibration, and shock requirements of AN-M-40 and MIL-M-8609 (S) specs. 24° diam. spline shaft output. Can be used with gear trains listed below. *Pound inches. Av. shpg. wt., 2 lbs.

Stock No.	Type	DC V.	Duty Cycle	HP	RPM	*Torque	EACH
76 P 550	40F-50	26	Continuous	.013	8200	.10	35.28
76 P 551	400-50	26	3 min. on, 7 off	.020	10300	.12	35.28
76 P 552	705-50	26	Continuous	.023	7200	.20	40.18
76 P 553	702-50	26	1.5 min. on, 8.5 off	.054	12300	.28	40.18
76 P 554	901-50	26	2 min. on, 8 off	.090	12600	.40	45.00
76 P 555	40A-50	115	Continuous	.014	10700	.08	44.10
76 P 556	707-50	115	Continuous	.027	7200	.23	44.10

BARBER-COLMAN BYLH GEARTRAINS

For use with the BLYM motors listed above. These geartrains reduce the speed, and increase the torque of the motors by the factor indicated under "gear ratio." Maximum torque of these units is approximately 5 to 10 pound inches. Geartrain fits directly onto motor frame, accepts motor shaft, and delivers power by means of .25" diam. smooth output shaft. All geartrains are 1.38" diam. Lengths range from 1.07" (for 912) to 1.69" (for 919). Av. shpg. wt., 1 lb.

Stock No.	Type	No. Steps	Gear Ratio	NET EACH
76 P 557	922	2	9.5 to 1	20.58
76 P 558	923	3	32.6 to 1	25.48
76 P 559	914H	4	113 to 1	18.62
76 P 560	915A	5	312 to 1	21.56
76 P 561	915B	5	390 to 1	21.56
76 P 562	916A	6	1093 to 1	24.50
76 P 563	917B	7	1767 to 1	27.44
76 P 564	917D	7	4648 to 1	27.44
76 P 565	918B	8	16053 to 1	30.38
76 P 566	919B	9	55440 to 1	33.32

WUERTH SURGISTOR



Type 100-2. A component which combines the functions of a current-limiting resistor and time-delay relay. It is connected directly into the power line circuit of any electronic device. The surgistor limits current until the tube filaments are warm enough to take full voltage. Holds down B plus during warm-up. Specifications: Start res., 100 ohms; normal res., 0.2 ohm; circuit power range, 100-300 watts; time delay, 10 seconds. Shpg. wt., 2 oz.

80 G 144. NET.....1.11

ADC TERMINAL BLOCKS

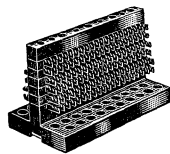

Especially useful in design of telephone circuits, computers, and other applications with very large numbers of circuits. Each unit has a one-piece molded phenolic base. Individual terminal separators are also of molded phenolic. Polished surface makes for easy removal of solder flash after wiring. Terminals are .040 inch plated brass. Rows of terminals are graduated in length, and identified by numbering along the top row. Available with 1-6 rows of 20 terminals per row. Base dimensions: $3 \times 6 \frac{1}{2}$ inches. Height depends on number of rows. Av. shpg. wt., 1 1/2 lbs.

Stock No.	Mfr's Type	Rows of Terminals	No. of Terminals	Height	NET EACH
40 H 694	P1-101	1	20	129/16"	5.40
40 H 695	P1-102	2	40	214/16"	6.53
40 H 696	P1-103	3	60	219/16"	8.10
40 H 697	P1-104	4	80	219/16"	9.60
40 H 698	P1-105	5	100	336/16"	11.03
40 H 699	PJ-106	6	120	358/16"	12.53

EL-TRONICS HUMIDITY SENSER



- Extremely Fast Response
- Highly Stable to 140° F.
- Simplifies Humidity Control

An extremely reliable humidity sensing element. Made of a conducting plastic which changes resistance in the presence of water vapor. Easy to wire in—only 2 connections. Very stable in ambient temperatures to 140° F. Readings are 100% repeatable and accurate within 3%. Fast acting—response in 1 minute for 20% humidity change; 3 minutes for 90% change. Only $\frac{3}{16} \times \frac{1}{16}$; $\frac{1}{16}$ " thick. With specs. relative humidity/resistance graph and sample circuitry. Operates from 6-20 volts AC. Shpg. wt., 2 oz.

7 E 751. NET.....8.00

CLAROSTAT UNIVERSAL RESISTOR TUBES



Clarostat resistor tubes for voltage-reducing applications. For replacement of all AC-DC tubes beginning with letters BK, BL, K, L and M; and corresponding numbers and letters given below. Order tubes according to letter and numeral designation of tube being replaced. For example, to replace a BK-23-A tube, or an M-55-D tube, the Clarostat Type 23-55-A would be used, etc. Shpg. wt., 6 oz.

Stock No.	Mfr's Type	Tube Numbers From:	Ending in Letter:	NET EA.
9 E 853	23-55-A	23 to 55	A, B, C, D	1.62
9 E 855	23-55-F	23 to 55	F, G, H	
9 E 856	60-92-A	60 to 92	A, B, C, D	

JFD TV, ADJUSTABLE AND STEP-DOWN BALLASTS

TV Ballasts. Quality plug-in ballasts for AC-DC TV sets. Perforated shells for maximum dissipation and radiation of heat. Large insulating surfaces and heavy resistance elements provide highly dependable service. Shpg. wt., 6 oz.



No.	Type	For	No.	Type	For	EACH
9 E 860	17A47/0303	Motorola	9 E 862	397022	Emerson	2.94
9 E 861	17A48/4549	Motorola	9 E 863	397023	Emerson	

Adjustable Types. For virtually all replacement needs. 8-prong. 6 oz.

9 E 885. Replaces ballasts beginning with K, L, M, BK, BL, BM having numbers 6-42, ending with A, B, C, D, F, G, or H. NET.....2.06

9 E 886. Replaces ballasts beginning with K, L, M, BK, BL, BM having numbers 45 through 105 and ending with A, B, C, D, F, G, H. S-1, 2 or 3. NET.....2.06

NET.....2.06

AMPERITE REGULATOR TUBES

For Replacement Use in Industrial Electronic Equipment

Amperite regulator tubes have achieved wide acceptance for current-voltage regulating applications in industrial electronic equipment. Built to rigid specifications to assure extremely dependable service. Listed below are special purpose ballast tubes used in original industrial equipment and identified by Amperite type numbers. All units listed below are stocked for prompt delivery. Av. shpg. wt., 4 oz.



Stock No.	Type	EACH	Stock No.	Type	EACH
9 E 981	1H22	1.76	9 E 987	6H6	1.76
9 E 984	3-4		9 E 988	6A4	
9 E 985	6-4		9 E 993	4H4C	
			9 E 999	10-25	

CONSOLIDATED AC-DC RESISTANCE LINE CORDS

Heavily insulated resistance line cords. Have color-coded tinned leads. Supply proper voltage for tubes wired in series across 115 volt lines. 135, 160, 180 and 200 ohm cords can also be used for 1-lamp, 15 and 20-watt fluorescent units. 1' For 3-way battery portables. 6' long. Shpg. wt., 6 oz.

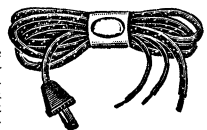

Stock No.	Mfr's Type	Ohms	NET EACH
49 T 522	2401	135	71c
49 T 520	2402	160	
49 T 519	2412	180	
49 T 518	2413	200	
49 T 517	2403	220	
49 T 516	2410	250	71c
49 T 515	2404	290	
49 T 524	2408A	300	
49 T 512	2405	330	
49 T 511	2407	350	
49 T 510	2406A	390	71c
49 T 525	2414A†	560	

Universal Line Cord. Replaces AC-DC cords from 220 to 300 ohms. Easy to install. Just select desired resistance leads; clip off unused leads. For standard three-terminal or pilot bulb tapped cords. Length, 6 ft. Shpg. wt., 5 oz.

49 T 530. NET.....1.68

220-110 V. Step-Down Cord. For operating 110 v. AC-DC radio sets from 220 v. AC-DC. Convenient way to step down 220 volts for sets using 0.15 amp tubes. 500 ohms. 0.2 amps capacity. 5 oz.

49 T 580. NET.....1.32

"MAKE-UR-OWN" RESISTANCE CORDS

Resistance cords for supplying exact line cord resistance need. Shpg. wts., 10', 1/2 lb; 25', 1 lb.

49 W 560. 30 ohms resistance per ft. NET Per Foot.....12c

49 W 570. 60 ohms resistance per ft. NET Per Foot.....24c

IRC Resistors

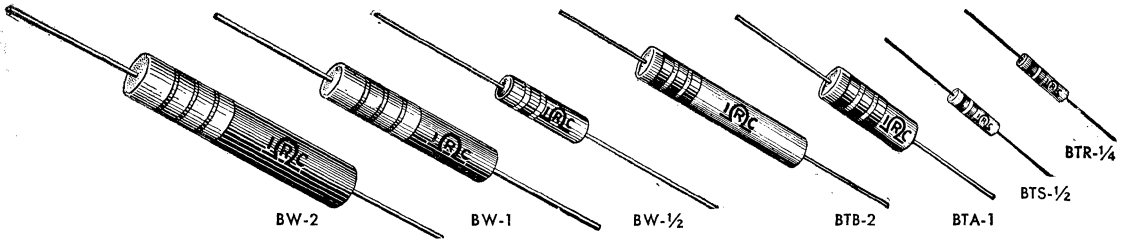

BT AND BW 10% INSULATED TYPES

Type BT Filament Carbon. Exceed rigid MIL - R-11 specifications. Withstand 50-100% overloads for short periods. RETMA-coded. Sizes: BTR, $1\frac{1}{2} \times \frac{3}{32}$ " ; BTS, $1\frac{1}{2} \times \frac{1}{8}$ " ; BTA, $2\frac{3}{32} \times \frac{1}{4}$ " ; BTB, $1\frac{1}{4} \times \frac{1}{4}$ ". Figure in Type No. indicates wattage rating.

Type BW Wire Wound. Will withstand 50% to 100% overloads with little or no resistance change. Values clearly indicated by standard RETMA color coding. Sizes: BW- $\frac{1}{2}$, $\frac{5}{16} \times \frac{3}{16}$ " ; BW-1, $1\frac{1}{4} \times \frac{1}{4}$ " ; BW-2, $1\frac{3}{4} \times \frac{1}{4}$ ". Figure in Type No. indicates wattage rating.

10% RETMA Values—Specify Resistance Wanted

Ohms	Ohms	Ohms	Ohms	Ohms	Ohms	Ohms	Ohms	Ohms	Ohms	Ohms	Ohms
0.27	1.2	5.6	27	120	560	2700	12,000	56,000	0.27 meg	1.2 meg	5.6 meg
0.33	1.5	6.8	33	150	680	3300	15,000	68,000	0.33 meg	1.5 meg	6.8 meg
0.39	1.8	8.2	39	180	820	3900	18,000	82,000	0.39 meg	1.8 meg	8.2 meg
0.47	2.2	10	47	220	1000	4700	22,000	0.1 meg	0.47 meg	2.2 meg	10 meg
0.56	2.7	12	56	270	1200	5600	27,000	0.12 meg	0.56 meg	2.7 meg	12 meg
0.68	3.3	15	68	330	1500	6800	33,000	0.15 meg	0.68 meg	3.3 meg	15 meg
0.82	3.9	18	82	390	1800	8200	39,000	0.18 meg	0.82 meg	3.9 meg	18 meg
1.0	4.7	22	100	470	2200	10,000	47,000	0.22 meg	1.0 meg	4.7 meg	22 meg

TYPE BT 10% CARBON

5-lot price applies to purchase of one resistance value only.

TYPE BW 10% WIRE WOUND

5-lot price applies to purchase of one resistance value only.

Stock No.	Mfr's Type	MIL Equiv.	Values	NET EACH	5 FOR	Stock No.	Mfr's Type	MIL Equiv.	Values (See Chart Above)	NET EACH	5 FOR
1 MM 010	BTR- $\frac{1}{4}$	RC09	10 Ω to 22 megs	10c	39c	1 MM 060	BW- $\frac{1}{2}$	RU-3	0.27 to 820 Ω	20c	.78
1 MM 000	BTS- $\frac{1}{2}$	RC20	10 Ω to 22 megs	10c	29c	1 MM 080	BW-1	RU-4	0.47 to 4700 Ω	30c	1.18
1 MM 020	BTA-1	RC30	10 Ω to 22 megs	15c	44c	1 MM 100	BW-2	RU-6	1 to 8200 Ω	40c	1.57
1 MM 050	BTB-2	RC41	100 Ω to 22 megs	20c	78c						

Industrial Quantities—Substantial Savings

Industrial quantities—to provide tremendous savings on IRC 10% resistors. Supplied in boxes of 100—the minimum quantity of any one value that you may order.

Values may be assorted for 500- and 1000-lot prices—but only in boxes of 100 per value. For example, if you order 1000 resistors, select up to 10 different values.

Type BTS $\frac{1}{2}$ -Watt Carbon

Type BTA 1-Watt Carbon

Stock No.	MIL Equiv.	Values	Lots of 100, Per 100	Lots of 500, Per 100	Lots of 1000, Per 100	Stock No.	MIL Equiv.	Values	Lots of 100, Per 100	Lots of 500, Per 100	Lots of 1000, Per 100
1 MM 001	RC20	10 Ω to 22 megs	4.00	3.00	2.70	1 MM 021	RC30	10 Ω to 22 megs	6.00	4.50	4.00

BT AND BW 5% INSULATED TYPES

Type BT Filament Carbons. Fixed composition, filament carbon 5% resistors. Dependable low-cost units for use in circuits requiring close tolerance values. RETMA color coding. Fully insulated.

Type BW Wire-Wound. Highly stable, low-cost units, completely insulated. Similar in appearance to carbon resistors, but have double width first color code band. Withstand shock, vibration and temperature changes.

5% RETMA Values—Specify Resistance Wanted

Ohms	Ohms	Ohms	Ohms	Ohms	Ohms	Ohms	Ohms	Ohms	Ohms	Ohms	Ohms
0.24	1.1	5.1	24	110	510	2400	11,000	51,000	0.24 meg	1.1 meg	5.1 meg
0.27	1.2	5.6	27	120	560	2700	12,000	56,000	0.27 meg	1.2 meg	5.6 meg
0.30	1.3	6.2	30	130	620	3000	13,000	62,000	0.30 meg	1.3 meg	6.2 meg
0.33	1.5	6.8	33	150	680	3300	15,000	68,000	0.33 meg	1.5 meg	6.8 meg
0.36	1.6	7.5	36	160	750	3600	16,000	75,000	0.36 meg	1.6 meg	7.5 meg
0.39	1.8	8.2	39	180	820	3900	18,000	82,000	0.39 meg	1.8 meg	8.2 meg
0.43	2.0	9.1	43	200	910	4300	20,000	91,000	0.43 meg	2.0 meg	9.1 meg
0.47	2.2	10	47	220	1000	4700	22,000	0.1 meg	0.47 meg	2.2 meg	10 meg
0.51	2.4	11	51	240	1100	5100	24,000	0.11 meg	0.51 meg	2.4 meg	11 meg
0.56	2.7	12	56	270	1200	5600	27,000	0.12 meg	0.56 meg	2.7 meg	12 meg
0.62	3.0	13	62	300	1300	6200	30,000	0.13 meg	0.62 meg	3.0 meg	13 meg
0.68	3.3	15	68	330	1500	6800	33,000	0.15 meg	0.68 meg	3.3 meg	15 meg
0.75	3.6	16	75	360	1600	7500	36,000	0.16 meg	0.75 meg	3.6 meg	16 meg
0.82	3.9	18	82	390	1800	8200	39,000	0.18 meg	0.82 meg	3.9 meg	18 meg
0.91	4.3	20	91	430	2000	9100	43,000	0.20 meg	0.91 meg	4.3 meg	20 meg
1.0	4.7	22	100	470	2200	10,000	47,000	0.22 meg	1.0 meg	4.7 meg	22 meg

TYPE BT 5% FILAMENT CARBONS

5-lot price applies to purchase of one resistance value only.

TYPE BW 5% WIRE-WOUND

5-lot price applies to purchase of one resistance value only.

Stock No.	Mfr's Type	MIL Equiv.	Values	NET EACH	5 FOR	Stock No.	Mfr's Type	MIL Equiv.	Values	NET EACH	5 FOR
1 MM 015	BTR- $\frac{1}{4}$	RC09	10 Ω to 22 megs	20c	.78	1 MM 065	BW- $\frac{1}{2}$	RU-3	0.24 Ω to 820 Ω	40c	1.57
1 MM 005	BTS- $\frac{1}{2}$	RC20	10 Ω to 22 megs	20c	.78	1 MM 085	BW-1	RU-4	0.47 Ω to 5100 Ω	45c	1.76
1 MM 025	BTA-1	RC30	10 Ω to 22 megs	30c	1.18	1 MM 105	BW-2	RU-6	1.0 Ω to 8200 Ω	60c	2.35
1 MM 035	BTB-2	RC41	100 Ω to 22 megs	40c	1.57						

IRC Resistors

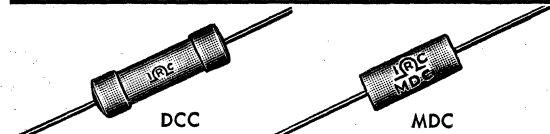

PRECISION 1% RESISTORS

Film-type carbon resistors for circuits requiring high voltage ratings and low noise levels. "MD" types are sealed in a molded plastic case; "DC" types are unmolded. Wattage rating is indicated by last letter of type designation: B (1/4 watt), C (1/2 watt), F (1 watt) or H (2 watts). Both molded and unmolded types meet MIL 10509B specs. Ratings are for 70° F for molded and 40° C for unmolded. Write for larger quantity prices. Specify values when ordering. Shpg. wts.: 1/2 watt, 3 oz.; 1 watt, 4 oz.; 2 watts, 6 oz.

Ohms	Ohms	Ohms	Ohms	Ohms	Megs	Megs	Megs
51	330	1800	9100	50,000*	.30	1.6	6.2
56	360	2000	10,000	51,000	.33	1.8	6.8
62	390	2200	11,000	56,000	.36	2.0	7.5
68	400*	2400	12,000	62,000	.39	2.2	8.2
75	430	2500*	13,000	68,000	.43	2.4	9.1
82	470	2700	15,000	75,000	.47	2.5	10.0
91	500*	3000	16,000	82,000	.47	2.7	11.0
100	510	3300	18,000	91,000	.50†	3.0	12.0
110	560	3600	20,000	.11 meg	.51	3.3	13.0
120	620	3900	22,000	.11 meg	.56	3.6	15.0
130	680	4000*	24,000	.12 meg	.62	3.9	16.0
150	750	4300	25,000*	.13 meg	.68	4.0*	18.0
160	820	4700	27,000	.16 meg	.75	4.3	20.0
180	910	5000*	30,000	.16 meg	.82	4.7	22.0
200	1000	5100	33,000	.18 meg	.91	5.0	24.0
220	1100	5600	36,000	.20 meg	1.0	5.1	27.0
240	1200	6200	39,000	.22 meg	1.1	5.6	30.0
250*	1300	6800	40,000*	.24 meg	1.2		
270	1500	7500	43,000	.25 meg*	1.3		
300	1600	8200	47,000	.27 meg	1.5		

Stock No.	Type	MIL Type	Values	NET EACH	
				1-24	25-99
1 MM 490	DCC	RN20X	51 ohms to 2 megs except * or †	39¢	31¢
1 MM 450	DCF	RN25X	100 ohms to 5 megs	59¢	47¢
1 MM 452	DCF	RN25X	5.1 meg to 10 megs	65¢	52¢
1 MM 470	DCH	RN30X	200 ohms to 10 megs except *	71¢	56¢
1 MM 471	DCH	RN30X	11 megs to 30 megs	76¢	62¢
1 MM 465	MDB	RN65B	51 ohms to 1 meg except * or †	59¢	47¢
1 MM 455	MDC	RN70B	51 ohms to 2 megs except * or †	59¢	47¢
1 MM 460	MDF	RN75B	100 ohms to 5 megs	71¢	56¢
1 MM 461	MDF	RN75B	5.1 meg to 10 megs	98¢	78¢

WIRE-WOUND PRECISION RESISTORS



WW2J



WW5J



WW4J

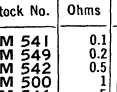

WW10J

Extremely dependable precision resistors widely used in instruments, calibrated controls, etc. All except WW10J are wound with adjacent sections in opposite directions to minimize coupling effects. Tolerance is ±1%. All have lug terminals, except WW10J, which has wire terminals.

Type WW2J. 1 Watt. Enamelled windings on ceramic forms. Maximum volts, 2000. Lug terminals. Size, 5/8x2 1/2". Shpg. wt., 3 oz.

Type WW4J. 1/2 Watt. Special impregnated for complete humidity protection, as on others of series. Max. volts, 700. Size, 5/8x1". Shpg. wt., 3 oz.

Type WW5J. 1/2 Watt. Similar to type WW4J, but rated at 1000 volts maximum. Tolerance is ±1%. Size, 5/8x1 1/2". Shpg. wt., 3 oz.

Type WW10J. 0.15 Watt. Extremely small wire-wound resistors. 2" wire leads. Maximum volts, 200. Size, 9/32x1 1/2". Shpg. wt., 2 oz.

TYPE WW4J			TYPE WW10J		
Stock No.	Ohms	NET EACH	Stock No.	Ohms	NET EACH
2 M 541	0.1	1.29	2 M 515	10000	1.59
2 M 549	0.2				
2 M 542	0.5				
2 M 500	1				
2 M 546	5				
2 M 501	10	2.06	2 M 518	20000	
2 M 502	25				
2 M 503	50				
2 M 504	100				
2 M 505	200				
2 M 506	250	2.32	2 M 516	12500	
2 M 543	300				
2 M 507	500				
2 M 508	1000				
2 M 509	1500				
2 M 510	2000	2.56	2 M 517	15000	
2 M 511	2500				
2 M 547	3000				
2 M 548	3500				
2 M 512	4000				
2 M 513	5000	2.82	2 M 519	22500	
		3.32	2 M 520	30000	
		3.79	2 M 521	40000	
		1.59	2 M 522	50000	
2 M 514	7500	1.59	2 M 523	60000	
			2 M 524	75000	
			2 M 525	100000	
			2 M 526	125000	
			2 M 527	150000	
			2 M 528	175000	
			2 M 529	200000	
			2 M 530	225000	
			2 M 531	250000	
			2 M 532	300000	
			2 M 533	400000	
			2 M 534	500000	
			2 M 535	600000	
			2 M 536	750000	
			2 M 537	1000000	
			2 M 538	1500000	
			2 M 539	2000000	
			2 M 540	2500000	
			2 M 541	3000000	
			2 M 542	4000000	
			2 M 543	5000000	
			2 M 544	6000000	
			2 M 545	7500000	
			2 M 546	10000000	
			2 M 547	15000000	
			2 M 548	20000000	
			2 M 549	25000000	
			2 M 550	30000000	
			2 M 551	40000000	
			2 M 552	50000000	
			2 M 553	75000000	
			2 M 554	100000000	
			2 M 555	150000000	
			2 M 556	200000000	
			2 M 557	250000000	
			2 M 558	300000000	
			2 M 559	400000000	
			2 M 560	500000000	
			2 M 561	750000000	
			2 M 562	1000000000	
			2 M 563	1500000000	
			2 M 564	2000000000	
			2 M 565	2500000000	
			2 M 566	3000000000	
			2 M 567	4000000000	
			2 M 568	5000000000	
			2 M 569	6000000000	
			2 M 570	7500000000	
			2 M 571	10000000000	
			2 M 572	15000000000	
			2 M 573	20000000000	
			2 M 574	25000000000	
			2 M 575	30000000000	
			2 M 576	40000000000	
			2 M 577	50000000000	
			2 M 578	60000000000	
			2 M 579	75000000000	
			2 M 580	100000000000	
			2 M 581	150000000000	
			2 M 582	200000000000	
			2 M 583	250000000000	
			2 M 584	300000000000	
			2 M 585	400000000000	
			2 M 586	500000000000	
			2 M 587	600000000000	
			2 M 588	750000000000	
			2 M 589	1000000000000	
			2 M 590	1500000000000	
			2 M 591	2000000000000	
			2 M 592	2500000000000	
			2 M 593	3000000000000	
			2 M 594	4000000000000	
			2 M 595	5000000000000	
			2 M 596	6000000000000	
			2 M 597	7500000000000	
			2 M 598	10000000000000	
			2 M 599	15000000000000	
			2 M 600	20000000000000	
			2 M 601	25000000000000	
			2 M 602	30000000000000	
			2 M 603	40000000000000	
			2 M 604	50000000000000	
			2 M 605	60000000000000	
			2 M 606	75000000000000	
			2 M 607	100000000000000	
			2 M 608	150000000000000	
			2 M 609	200000000000000	
			2 M 610	250000000000000	
			2 M 611	300000000000000	
			2 M 612	400000000000000	
			2 M 613	500000000000000	
			2 M 614	600000000000000	
			2 M 615	750000000000000	
			2 M 616	1000000000000000	
			2 M 617	1500000000000000	
			2 M 618	2000000000000000	
			2 M 619	2500000000000000	
			2 M 620	3000000000000000	
			2 M 621	4000000000000000	
			2 M 622	5000000000000000	
			2 M 623	6000000000000000	
			2 M 624	7500000000000000	
			2 M 625	10000000000000000	
			2 M 626	15000000000000000	
			2 M 627	20000000000000000	
			2 M 628	25000000000000000	
			2 M 629	30000000000000000	
			2 M 630	40000000000000000	
			2 M 631	50000000000000000	
			2 M 632	60000000000000000	
			2 M 633	75000000000000000	
			2 M 634	100000000000000000	
			2 M 635	150000000000000000	
			2 M 636	200000000000000000	
			2 M 637	250000000000000000	
			2 M 638	300000000000000000	
			2 M 639	400000000000000000	
			2 M 640	500000000000000000	
			2 M 641	600000000000000000	
			2 M 642	750000000000000000	
			2 M 643	1000000000000000000	
			2 M 644	1500000000000000000	
			2 M 645	2000000000000000000	
			2 M 646	2500000000000000000	
			2 M 647	3000000000000000000	
			2 M 648	4000000000000000000	
			2 M 649	5000000000000000000	
			2 M 650	6000000000000000000	
			2 M 651	7500000000000000000	
			2 M 652	10000000000000000000	
			2 M 653	15000000000000000000	
			2 M 654	20000000000000000000	
			2 M 655	25000000000000000000	
			2 M 656	30000000000000000000	
			2 M 657	40000000000000000000	
			2 M 658	50000000000000000000	
			2 M 659	60000000000000000000	
			2 M 660	75000000000000000000	
			2 M 661	100000000000000000000	
			2 M 662	150000000000000000000	
			2 M 663	200000000000000000000	
			2 M 664	250000000000000000000	
			2 M 665	300000000000000000000	
			2 M 666	400000000000000000000	
			2 M 667	500000000000000000000	
			2 M 668	600000000000000000000	
			2 M 669	750000000000000000000	
			2 M 670	1000000000000000000000	
			2 M 671	1500000000000000000000	
			2 M 672	2000000000000000000000	
			2 M 673	2500000000000000000000	
			2 M 674	3000000000000000000000	
			2 M 675	4000000000000000000000	
			2 M 676	5000000000000000000000	
			2 M 677	6000000000000000000000	
			2 M 678	7500000000000000000000	
			2 M 679	10000000000000000000000	
			2 M 680	15000000000000000000000	
			2 M 681	20000000000000000000000	
			2 M 682	25000000000000000000000	
			2 M 683	30000000000000000000000	
			2 M 684	40000000000000000000000	
			2 M 685		

Resistors

IRC WIRE-WOUND POWER RESISTORS

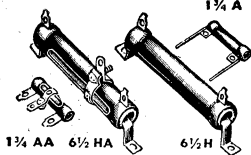

Large, non-porous ceramic cores, and thick cement coatings. All have lugs, and types 1 1/4 A and 2 D, also have tinned 1/4" leads. Units of 25 watts and higher include mounting brackets. All have $\pm 10\%$ tolerance except fixed types in 50 ohms and higher, which are $\pm 5\%$. **NOTES ON ADJUSTABLE TYPES:** Units of 25 watts and higher have silver contacts. Wattage rating applies only if total resistance is used. Where range of values is given in individual listings, consult table for specific values available; e.g., 1 to 1000 means all values listed in table between and including 1 and 1000. *Specify resistance value when ordering.* Av. shgp. wt., 10-50 watts, 4 oz.; 100-200 watts, 1 lb.

STOCK RANGES—SPECIFY RESISTANCE VALUE

Ohms	Ohms	Ohms	Ohms	Ohms	Ohms	Ohms	Ohms
1†	25†	350*§	1250*	3500§	8500*§	30,000*	
2†*	50†	400	4000†	9000*§	40,000*		
3†§	75†	500†	1500†	4500*§	10,000†	50,000*	
5†	100†	600*†§	1750*§	5000†	12,000*§	100,000*	
7.5*§	150†	750†	2000†	6000*	12,500*§		
10†	200†	800†	2250*§	7000*	15,000		
15§	250†	1000†	2500†	7500*§	20,000		
20*§	300†	1200*	3000†	8000*	25,000		

FIXED POWER RESISTORS

1 1/4 A (AB)—10 WATT

In resistances above to 25,000 ohms, except 2 and 3 ohms. 1 3/4 x 3/4".

Stock No.	Ohms	NET EACH
I MM 120	1 to 1000	.47
I MM 121	1200 to 5000	.53
I MM 122	6,000 to 10,000	.59
I MM 123	12,000 to 20,000	.65
I MM 124	25,000	.71

2 D (DG)—20 WATT

Available in resistances above to 50,000, except those marked §. 2 x 3/8".

Stock No.	Ohms	NET EACH
I MM 140	1 to 1000	.62
I MM 141	1200 to 5000	.65
I MM 142	6000 to 10,000	.71
I MM 143	15,000 and 20,000	.76
I MM 144	25,000 to 40,000	.88
I M 145	50,000	1.03

4 1/2 E (EP)—50 WATT

Available only in resistances indicated below. Size, 4 1/2 x 3/4".

Stock No.	Ohms	NET EACH
I MM 160	1 and 2	1.47
I MM 161	5, 10, 25, 50, 75, 100, 200, 250, 500, 1000	1.06
I MM 162	1500, 2000, 2500, 3000, 4000, 5000	1.12
I MM 163	6000 and 10,000	1.23
I M 168	100,000	2.06

6 1/2 H (HA)—100 WATT

Available only in resistances indicated below. Size, 6 1/2 x 1 1/8".

Stock No.	Ohms	NET EACH
I MM 300	5, 10, 25, 50, 75, 100, 150, 250, 500, 750, 1000	1.56
I MM 301	1250, 1500, 2000, 2500, 3000, 5000,	1.65
I M 302	7500	1.76

ADJUSTABLE POWER RESISTORS

1 1/4 AA (ABA)—10 WATT

Available in resistances to 10,000 marked † on above table. Size, 1 3/4 x 3/8".

Stock No.	Ohms	NET EACH
I MM 200	1 to 1000	.94
I MM 201	1500 to 5000	1.00
I MM 202	7500 and 10,000	1.06

2 1/2 DA (DHA)—25 WATT

In resistances above, except those marked *. Size, 2 1/2 x 3/8".

Stock No.	Ohms	NET EACH
I MM 220	1 to 1000	1.21
I MM 221	1500 to 5000	1.23
I MM 222	7500 and 10,000	1.29
I MM 223	15,000 and 20,000	1.35
I M 224	25,000	1.47

4 1/2 EA (EPA)—50 WATT

Available only in resistances indicated below. Size, 4 1/2 x 3/4".

Stock No.	Ohms	NET EACH
I MM 240	10, 25, 50, 75, 100, 150, 200, 250, 500, 750, 1,000	1.53
I MM 241	1500, 2000, 2500, 3000, 4000, 5000	1.59
I M 242	10,000	1.71
I MM 243	15,000 and 20,000	1.82
I MM 244	25,000, 30,000, 40,000	2.00
I M 245	50,000	2.12
I M 247	100,000	2.53

6 1/2 HA (HAA)—100 WATT

Available only in resistances indicated below. Size, 6 1/2 x 1 1/8".

Stock No.	Ohms	NET EACH
I MM 260	100, 200, 400, 500, 750, 1000	2.32
I MM 261	1500, 2000, 2500, 3000, 5000	2.38
I M 262	10,000	2.50
I MM 263	15,000 and 20,000	2.65
I M 264	25,000	2.82
I M 265	50,000	2.94
I M 267	100,000	3.20

10 1/2 HA (HOA)—200 WATT

Available only in resistances indicated below. Size, 10 1/2 x 1 1/8".

Stock No.	Ohms	NET EACH
I MM 340	10, 25, 50, 100, 250, 500, 1000	2.82
I MM 341	1500, 2000, 2500, 5000	2.88
I M 342	10,000	3.06
I M 345	50,000	3.35
I M 347	100,000	3.67

EXTRA SLIDERS FOR ADJUSTABLE RESISTORS

2 M 604.	For 2 1/2 DA.	NET EACH.....	18c
2 M 605.	For 4 1/2 EA.	NET EACH.....	18c
2 M 600.	For 1 1/4 AA.	NET EACH.....	26c
2 M 603.	For 6 1/2 HA and 10 1/2 HA.	NET EACH.....	26c

CONTINENTAL CARBON NR & NA $\pm 1\%$ PRECISION RESISTORS

NR-25 1-watt resistors have metallic resistance film formed on surface of low-loss ceramic tubes. Hermetically sealed with smooth, uniform vitreous enamel coating. Hollow body for withstanding temperatures to 400° F. Rating, 500 v. No. 18, 1 1/2" tinned copper leads. Size, 1/4" dia., 1 1/2" long. NA-15, 1/2-watt precision resistors are available in values (listed in table below) up to 1.0 meg. Have No. 20, 1 1/2" tinned copper leads. Rating, 350 v. Size, 1/2" dia., 1 1/2" long. Shgp. wt., 2 oz.



Ohms	Ohms	Ohms	Ohms	Ohms	Ohms	Ohms	Megs
1	150	2000	5500	15,000	85,000	400,000	1.0
5	200	2500	5950	20,000	90,000	450,000	1.5
10	300	2950	7450	25,000	100,000	490,000	2.0
15	400	3500	8500	30,000	150,000	500,000	2.5
20	500	4000	8950	40,000	200,000	600,000	3.0
25	1000	4450	9950	50,000	240,000	750,000	3.5
50	1450	4950	10,000	60,000	250,000	800,000	4.0
100	1500	5000	13,500	75,000	300,000	900,000	5.0

NR-25 1-WATT

2 MM 300. 1 ohm—1.0 megohm. Specify value. NET EACH..... 59c
25 or more of one value, EACH..... 41c

2 MM 301. 1.5—5.0 megohms. Specify value. NET EACH..... 76c
25 or more of one value, EACH..... 55c

NA-15 1/2-WATT

2 MM 350. 1 ohm—1.0 megohm. Specify value. NET EACH..... 47c
25 or more of one value, EACH..... 33c

$\pm 1\%$ AEROVOX CARBOFILM PRECISION RESISTORS

For circuits requiring accuracy and stability. Carbon deposited on ceramic rod. Silver-plated contacts. Size and voltage ratings: CP-1/2 watt, 1 3/4" x 1 1/8", 1500 v.; CPL-1/2 watt, 1 3/4" x 1 1/8", 2000 v.; CP-1 watt, 1 3/4" x 1 1/8", 2500 v.; CP-2 watt, 1 3/4" x 2 1/8", 6000 v. Av. wt., 2 oz.

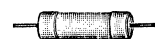

Ohms	Ohms	Ohms	Ohms	Ohms	Ohms	Megs	Megs
100	510	2700	12,000	68,000	390,000	2.2	10.0
110	560	3000	15,000	75,000	430,000	2.4	12.0
120	620	3300	18,000	82,000	470,000	2.7	15.0
130	680	3600	20,000	91,000	510,000	3.0	18.0
150	750	3900	22,000	100,000	560,000	3.3	20.0
180	820	4300	24,000	110,000	620,000	3.6	22.0
200	910	4700	27,000	120,000	680,000	3.9	25.0
220	1000	5100	30,000	150,000	750,000	4.3	27.0
240	1100	5600	33,000	180,000	820,000	4.7	33.0
270	1200	6200	36,000	200,000	910,000	5.1	36.0
300	1300	6800	39,000	220,000	1.0 meg	5.6	39.0
330	1500	7500	43,000	240,000	1.1 megs	6.2	43.0
360	1800	8200	47,000	270,000	1.2 megs	6.8	47.0
390	2000	9100	51,000	300,000	1.5 megs	7.5	50.0
430	2200	10,000	56,000	330,000	1.8 megs	8.2	100.0
470	2400	11,000	62,000	360,000	2.0 megs	9.1

SPECIFY RESISTANCE VALUE

All are $\pm 1\%$ tolerance, except * $\pm 2\%$.

Type CP-1/2. 1/2-watt. 100 ohms to 4.7 megohms. NET EACH..... 38c

Type CPL-1/2. 1/2-watt. 5.1 megohms to 7.5 megohms. NET EACH..... 44c

Type CP-1. 1-watt. 100 ohms to 1.0 megohm. NET EACH..... 56c

Type CP-1. 1-watt. 1.1 megohms to 4.7 megohms. NET EACH..... 59c

Type CP-1. 1-watt. 5.1 megohms to 15 megohms. NET EACH..... 65c

Type CP-2. 2-watt. 100 ohms to 10 megohms. NET EACH..... 71c

Type CP-2. 2-watt. 12 megohms to 20 megohms. NET EACH..... 76c

Type CP-2. 2-watt. 22 megohms to 27 megohms. NET EACH..... 1.03

Type CP-2. 2-watt. 33 megohms to 50 megohms. NET EACH..... 1.18

Type CP-2*. 2-watt. 100 megohms only. NET EACH..... 2.94

ALLIED BARGAIN RESISTOR ASSORTMENT

Servicemen—here's a useful assortment of 100 high quality carbon resistors at a money-saving low price! An excellent selection of most-often-used values, all in 1/2-watt and 1 watt sizes. All resistors are brand new and have tinned copper leads. Non-insulated types. Shgp. wt., 12 oz.



58 M 086. NET..... 95c

ALLIED'S COLOR-CODE GUIDE

An "instant-reference" color-code guide for resistors. Code colors may be set to show corresponding resistance values, or resistance values set to show corresponding code colors. Size, 2 3/4 x 3/4". Includes tolerance code and listing of RETMA-JAN $\pm 10\%$ standard stock values. (Supplied at no charge with order for 20 or more resistors.) Shgp. wt., 2 oz.



Resistors and Controls

OHMITE AXIAL-LEAD WIRE-WOUND RESISTORS



Axial-lead, ceramic-core resistors. Covered with vitreous enamel to withstand high temperature. Resistance wire and terminals welded to end caps to assure excellent stability and minimum noise. Tolerance: $\pm 5\%$ for values over 50 ohms; $\pm 10\%$ for values less than 50 ohms. Wattage ratings based on temperature rise to 300°C. $1/2$ " leads. Av. shgp. wt., 4 oz.

Ohms	Ohms	Ohms	Ohms	Ohms	Ohms	Ohms	Ohms
1.0	12	75	350	900	2250	7000	18,000
1.5	15	100	400	1000	2500	7500	20,000
2.0	20	125	450	1100	3000	8000	22,500
3.0	25	150	500	1200	3500	9000	25,000
4.0	30	200	600	1250	4000	10,000	
5.0	35	225	700	1500	4500	12,500	
7.5	40	250	750	1750	5000	15,000	
10.0	50	300	800	2000	6000	17,500	

3 WATTS

- 1 to 1000 Ohms. Size, $3/16 \times 1/4$ " dia. Specify value. **50¢**
- 2 MM 090. NET EACH
- 1100 to 5000 Ohms. Size, $3/16 \times 1/4$ " dia. Specify value. **53¢**
- 2 MM 095. NET EACH
- 6000 to 10,000 Ohms. Size, $3/16 \times 1/4$ " dia. Specify value. **56¢**
- 2 MM 110. NET EACH

5 WATTS

- 1 to 1000 Ohms. Size, $1/16 \times 1/2$ " dia. Specify value. **53¢**
- 2 MM 115. NET EACH
- 1100 to 5000 Ohms. Size, $1/16 \times 1/2$ " dia. Specify value. **56¢**
- 2 MM 130. NET EACH
- 6000 to 10,000 Ohms. Size, $1/16 \times 1/2$ " dia. Specify value. **59¢**
- 2 MM 135. NET EACH
- 12,500 to 20,000 Ohms. Size, $1/16 \times 1/2$ " dia. Specify value. **71¢**
- 2 MM 145. NET EACH
- 22,500 to 25,000 Ohms. Size, $1/16 \times 1/2$ " dia. Specify value. **73¢**
- 2 MM 146. NET EACH

SPRAGUE "KOOLOHM" WIRE-WOUND RESISTORS



Feature high-voltage insulated resistive wire windings; will withstand 10,000 volts from surface of jacket to resistance element. KT types are inductively wound; NIT types have non-inductive winding. Ceramic jackets and special end-seals provide complete protection against high humidity and heat—ceramic coating insulation withstands temperatures to 1000°C. Accuracy within 3%. Av. shgp. wt., 2 oz.

SPECIFY VALUES DESIRED

Ohms	Ohms	Ohms	Ohms	Ohms	Ohms	Ohms
5	50	400	1250	5000	12,000	30,000
10	75	500	1500	6000	14,000	35,000
15	100	600	1750	7500	15,000	40,000
20	150	700	2000	8000	17,500	50,000
25	200	800	2500	9000	20,000	60,000
30	250	900	3000	10,000	25,000	70,000
40	300	1000	4000			

TYPE 5KT—5 WATT— $1/32 \times 1/2$ "

No.	Ohms	EACH	No.	Ohms	EACH
MM 640	5 to 1000	38¢	M 645	20,000	56¢
MM 641	1250 to 5000	41¢	M 646	25,000	65¢
MM 642	6000 to 10,000	47¢	M 647	30,000	71¢
MM 643	14,000	53¢	M 649	35,000	82¢
MM 644	15,000	56¢	M 648	40,000	88¢

TYPE 10KT—10 WATT— $1/32 \times 1/2$ "

No.	Ohms	EACH	No.	Ohms	EACH
MM 660	5 to 1000	44¢	M 666	30,000	.76
MM 661	1250 to 5000	47¢	M 658	35,000	.89
MM 662	6000 to 10,000	53¢	M 667	40,000	.97
MM 663	12,000 to 17,500	59¢	M 668	50,000	1.06
MM 664	20,000	65¢	M 669	60,000	1.18
MM 665	25,000	71¢	M 659	70,000	1.29

TYPE 5NIT—5 WATT— $1/32 \times 1/2$ "

No.	Ohms	EACH	No.	Ohms	EACH
MM 670	5 to 1000	59¢	M 672	2500 to 4000	.76¢
MM 671	1250 to 2000	68¢	M 673	5000	.76¢

TYPE 10NIT—10 WATT— $1/32 \times 1/2$ "

No.	Ohms	EACH	No.	Ohms	EACH
MM 680	5 to 1000	59¢	M 683	5000 to 6000	.76
MM 681	1250 to 2000	68¢	M 684	7500 to 9000	.85
MM 682	2500 to 4000	73¢	M 685	10,000	1.12



OHMITE TYPE FR FUSE RESISTOR

A highly dependable $7/16$ -ohm fuse resistor. May be used to replace many fuse resistors used in television circuits. $1/2$ " tinned wire leads make replacement application easy and quick. Supplied with convenient, plug-in bakelite mounting strip—or can be wired directly into circuit of TV set. Widely used in sets employing series-string filament circuits. Length, $1 1/8$ ". Shgp. wt. 3 oz. **2 M 063. NET. 38¢**

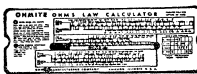

HANDY OHM'S LAW CALCULATOR

Easy-to-use calculator. Solves problems in Ohm's Law and DC power. Shows power, voltage and current when resistance is known. By setting to two known values resistance can be determined. Also has parallel resistance calculator. Size, 9×3 ". Shgp. wt., 3 oz. **2 M 780. NET. 25¢**
2 M 781. Deluxe Plastic Model. NET. 1.50

BOURNS "TRIMPOT" SUBMINIATURE POTENTIOMETERS

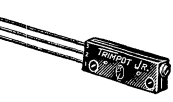
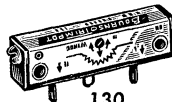

Precision-made, multi-turn miniature potentiometers used to control all types of electronic circuits. Widely used in airborne and instrumentation equipment. Ideal for use in printed circuits and a wide variety of portable and mobile applications. Highly resistant to vibration, shock and violent acceleration; all units are specially sealed to be splash, sand and dust-proof. Self-locking adjustment holds any setting under extreme conditions. Interchangeable mounting for easy substitution in experimental circuits. All except Model 120-15 are wire-wound; all except Model 220-1 have 25-turn screwdriver adjustment. Model 130 has solder lug connectors; all others have wire leads. Units mount easily in stacked assemblies—twenty Model 120 "Trimpots" fit into a $1/2$ -inch cube! All metal parts are fully corrosion-resistant; contacts and collector strips are platinum alloy. Units are 100% inspected; Total Resistance Tolerance: $\pm 10\%$, except Model 120-15, $\pm 20\%$. Features of various models are briefly explained below. Av. shgp. wt., 2 oz. **Write for larger quantity prices and complete specifications.**

Model	Size HxWxL	Max. Oper. Temp. °C.	Diss. Watts	Features
120-1	$5/16 \times 1/4 \times 1/4$ "	105	0.25	Standard "Trimpot." Carbon element for infinite resolution.
120-15	$5/16 \times 1/4 \times 1/4$ "	95	0.20	Solder lug connectors. "Trim-R" variable resistor; two leads.
130	$5/16 \times 1/4 \times 1/4$ "	105	0.25	
132	$5/16 \times 1/4 \times 1/4$ "	105	0.25	
160	$3/8 \times 1/4 \times 1/4$ "	175	0.6	High temperature model. Humidity-proof; exceeds MIL-E-52724 10-day test.
230	$3/8 \times 3/16 \times 1/32$ "	135	0.4	For moderately "hot" applications. Micro-miniature, "Trimpot, Jr.," humidity-proof; 15-turn adjustment; wiper idles at element ends.
263-1	$5/16 \times 1/4 \times 1/4$ "	135	0.4	
220-1	$5/16 \times 1/16 \times 1$ "	175	2.0	

RESISTANCES AVAILABLE—SPECIFY WHEN ORDERING

Ohms	Ohms	Ohms	Ohms	Megohms	Megohms
10	200	5,000	30,000	.1	.4
20	500	10,000	40,000	.15	.5
50	1000	20,000	50,000	.2	.75
100	2000	25,000*	75,000	.3	1.0

When Ordering—Specify Stock No., Model No., and resistance.

Stock No.	Model	Resistances Available (See Table Above)	1-9, EACH	10-24, EACH	25-49, EACH
31 M 380	120-1	10 to 10,000	4.86	4.50	4.05
31 M 381	120-1	20,000	6.48	6.00	5.40
31 M 382	120-15	20,000 to 1.0 meg	4.86	4.50	4.05
31 M 383	130	10 to 10,000	4.86	4.50	4.05
31 M 384	130	20,000	6.48	6.00	5.40
31 M 385	132	20,000	5.94	5.50	4.95
31 M 386	132	25,000	5.94	5.50	4.95
31 M 387	132	50,000	7.56	7.00	6.30
31 M 388	230	10 to 10,000	7.94	5.50	4.95
31 M 389	230	10 to 10,000	7.02	6.50	5.85
31 M 390	230	20,000	8.64	8.00	7.20
31 M 394	263-1	20,000	7.56	7.00	6.30
31 M 395	220-1	100 to 10,000	8.64	8.00	7.20
31 M 396	220-1	20,000	10.26	9.50	8.55

"TRIMPOT" MOUNTING ACCESSORIES

Stock No.	Accessory	1-24, EACH	25-99, EACH
31 M 391	End Mounting Brackets	20¢	15¢
31 M 392	Side Mounting Brackets	20¢	15¢
31 M 393	2-5x1 1/2" Machine Screws	2¢	1 1/2¢

G-C GLO-BAR THERMISTORS

Popular thermistors used in series-string filament circuits of G.E., Motorola, Sears, and other TV sets. A necessary service replacement item. *Matched pair; replace G.E. filament resistors. Av. wt., 1 oz.



Stock No.	Type	Ohms		NET EACH	
		Hot	Cold	1-9	10 or More
2 M 066	9214	20	250	.79	.72
2 M 067	9215	75	75	.79	.72
2 M 068	9216	35	260	.83	.74
2 M 069	9217	35	460	.83	.74
2 M 070	9268	43	125	1.00	.90
2 M 071	9269	9	200	1.09	.98
2 M 072	9135*	40	375	1.41	1.27

G-C TV FUSE-SISTORS

Reliable, low-cost replacement units for series-string TV tube circuits. Replace similar units in Raytheon, RCA, Motorola, Sylvania, Zenith and other TV receivers. All units are less than an inch in length; tinned leads for quick and easy installation. Av., shgp. wt., 1 oz.

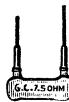

Stock No.	Type	Ohms	List	1-9, EACH	10 or More, EACH
2 M 073	9276	5.6	.65	38¢	.44
2 M 074	9207	7.5	.65	38¢	.44
2 M 075	9277	9.0	.65	38¢	.44
2 M 076	9278	22.0	.65	38¢	.44

Type 9279 Fuse-Sistor Kit. Contains one each of above. **2 M 077. List, \$2.50. NET. 1.47**

Ohmite Controls

WIREWOUND INDUSTRIAL RHEOSTATS

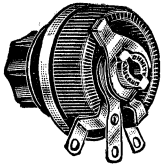

Quality vitreous-enamelled wirewound rheostats. Provide extremely smooth, highly dependable control of industrial and other electronic devices. Resistance wire is wound on a solid ceramic core and each turn is permanently bonded in place by vitreous enamel. The core and base are also bonded by vitreous enamel. A pivoted universal-action-mounted contact brush rides over a smooth, flat surface to assure perfect contact at all settings. Copper-graphite contact brush, except *silver-

graphite contact brush. Ratings indicated are at full setting. U.L. Approved. Types H, J, K and L mount on panels up to 1/4" thick; Type N on panels up to 1 1/4" thick. Specifications: Type H, dia. 1 3/8", depth behind panel 1 3/8"; Type J, dia. 2 3/8", depth behind panel 1 3/8"; Type K, dia. 3 3/8", depth behind panel 1 3/8"; Type L, dia. 4", depth behind panel 2"; Type N, dia. 6", depth behind panel 2 3/8". Complete with fluted, plastic knob. Av. shpg. wt., 10 oz.

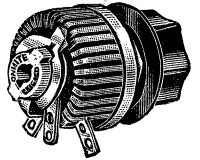

25 WATT—TYPE H

No.	Type	Ohms	EACH	No.	Type	Ohms	EACH
74 M 320	0140*	1	4.53	74 M 341	0152	125	4.03
74 M 321	0141	2		74 M 348	0153	175	
74 M 337	0142	3		74 M 329	0154	250	
74 M 322	0143	6		74 M 342	0155	350	
74 M 336	0144	8	4.03	74 M 330	0156	500	4.53
74 M 323	0145	10		74 M 331	0157	750	
74 M 325	0146	15		74 M 332	0158	1000	
74 M 325	0147	25		74 M 333	0159	1500	
74 M 339	0148	35	4.76	74 M 334	0160	2500	4.76
74 M 326	0149	50		74 M 335	0161	3500	
74 M 340	0150	75		74 M 336	0162	5000	
74 M 327	0151	100					

150 WATT—TYPE L

No.	Type	Ohms	EACH	No.	Type	Ohms	EACH
74 M 450	0524*	0.5	9.58	74 M 463	0537	150	9.06
74 M 451	0525*	1		74 M 464	0538	200	
74 M 452	0526*	2		74 M 465	0539	250	
74 M 453	0527*	3		74 M 466	0540	350	
74 M 454	0528*	5	9.06	74 M 467	0541	500	9.58
74 M 455	0529*	7.5		74 M 468	0542	750	
74 M 456	0530	10		74 M 469	0543	1250	
74 M 457	0531	15		74 M 470	0544	1800	
74 M 458	0532	25	9.06	74 M 471	0545	2250	10.11
74 M 459	0533	35		74 M 472	0546	3000	
74 M 460	0534	50		74 M 473	0547	4500	
74 M 461	0535	75		74 M 474	0548	7500	
74 M 462	0536	100		74 M 475	0549	10,000	

50 WATT—TYPE J

No.	Type	Ohms	EACH	No.	Type	Ohms	EACH
74 M 350	0308*	0.5	5.06	74 M 359	0321	150	4.53
74 M 351	0309*	1		74 M 360	0322	225	
74 M 352	0310*	2		74 M 361	0323	300	
74 M 353	0311	4		74 M 362	0324	500	
74 M 367	0312	6	4.53	74 M 371	0325	800	4.76
74 M 354	0313	8		74 M 363	0326	1000	
74 M 355	0314	12		74 M 372	0327	1600	
74 M 368	0315	16		74 M 364	0328	2500	
74 M 356	0316	22	5.06	74 M 373	0329	3500	5.06
74 M 369	0317	35		74 M 365	0330	5000	
74 M 357	0318	50		74 M 374	0331	8000	
74 M 358	0319	80		74 M 366	0332	10,000	
74 M 370	0320	125					

300 WATT—TYPE N

No.	Type	Ohms	EACH	No.	Type	Ohms	EACH
74 M 476	0650*	1	13.64	74 M 487	0661	100	13.64
74 M 477	0651*	2		74 M 488	0662	150	
74 M 478	0652*	3		74 M 489	0663	200	
74 M 479	0653*	4		74 M 490	0664	300	
74 M 480	0654*	5	13.64	74 M 491	0665	400	13.64
74 M 481	0655*	7.5		74 M 492	0666	700	
74 M 482	0656*	10		74 M 493	0667	900	
74 M 483	0657*	15		74 M 494	0668	1200	
74 M 484	0658	25	9.06	74 M 495	0669	1500	9.06
74 M 485	0659	50		74 M 496	0670	1750	
74 M 486	0660	75		74 M 497	0671	2500	

100 WATT—TYPE K

No.	Type	Ohms	EACH	No.	Type	Ohms	EACH
74 M 380	0440*	0.5	7.59	74 M 399	0452	200	7.09
74 M 393	0441*	1		74 M 400	0453	300	
74 M 381	0442*	2		74 M 401	0454	400	
74 M 382	0443*	3		74 M 387	0455	500	
74 M 394	0444*	5	7.09	74 M 402	0456	750	7.59
74 M 395	0445	7.5		74 M 388	0457	1000	
74 M 383	0446	10		74 M 403	0458	1500	
74 M 397	0447	16		74 M 404	0459	2000	
74 M 384	0448	25	8.06	74 M 389	0460	2500	8.58
74 M 385	0449	50		74 M 390	0461	5000	
74 M 398	0450	75		74 M 391	0462	7500	
74 M 386	0451	100		74 M 392	0463	10,000	

Type 5000 Dial Plate. For Type H, J, K and L. 2 3/8" diameter. Hand-somely finished with bright figures and lines on etched black background. 0-100 scale. Shpg. wt., 2 oz.

74 M 405. NET. 18c

Type 5001 Dial Plate. For Type N. 5 1/2" dia. 0-100. 3 oz.

74 M 407. NET. 76c

TANDEM COUPLING KITS

Kits for assembling Ohmite rheostats in tandem, formerly available only in made-to-order assemblies. Rheostats are mounted colinear, so that both are operated with a single knob. Each kit consists of a steel "H" frame, mica washer, coupling, Allen wrench, and complete instructions for assembly. Rheostats are joined together by means of a coupling fastened to the shaft of the rear unit with a socket set screw. Large frame (No. 6532) is designed for Models K and L rheostats, and will accommodate Model H or J in the rear position. Maximum panel thickness when using standard Ohmite knobs, 1/4". Frame is 2 3/8" long and 1 1/4" wide. Small frame (No. 6532) is designed for Models H and J, and will accommodate Model K or L in the rear position. Maximum panel thickness, 3/8". Frame is 2 3/8" long and 1 1/4" wide.

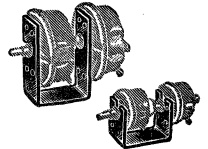

No. 6532 Tandem Coupling Kit. Shpg. wt., 4 oz.

74 M 408. NET. 1.79

No. 6533 Tandem Coupling Kit. Shpg. wt., 5 oz.

74 M 409. NET. 2.23

OHMITE "AB" POTENTIOMETERS

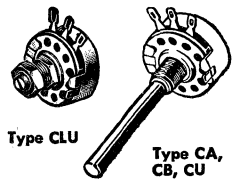

The Ohmite "AB" type potentiometer is a high-quality two-watt variable resistance control unit designed especially for industrial laboratory, TV service and other uses where reliability is particularly important. Features molded resistor element construction for exceptionally high safety factor. For complete protection this resistor element is sealed in a metal enclosure to make each unit dust-proof and splash-proof. Carbon sliding contact and terminals imbedded in the resistor element assure smooth, noise-free operation.

Size of double units, 1 1/4" dia. x 3/8". Size of single units, 1 1/4" dia. x 1 3/8". Mount in 3/8" hole on panels up to 1/4" thick. Types CU, CCU, CA and CB have 2" standard 1/4" round shafts; Type CLU has locking nut and slotted shaft for screw driver adjustment. Type number prefix indicates taper for potentiometer. CU, CCU and CLU types have linear taper; CA types, clockwise logarithmic taper; CB types, counterclockwise logarithmic taper; All ±10% tolerance, except *±20%. Av. shpg. wt., 5 oz.

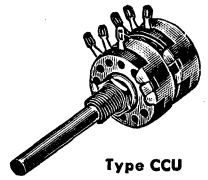

TYPES CA, CB, CU—WITH 2-INCH SHAFT

No.	Type	Ohms	EACH	No.	Type	Ohms	EACH
28 M 500	CU5001	50	1.91	28 M 512	CB5021	50,000	2.20
28 M 501	CU1011	100		28 M 513	CU1041	100,000	1.91
28 M 502	CU2511	250		28 M 514	CA1041	100,000	2.20
28 M 503	CU5011	500		28 M 515	CU2541	250,000	1.91
28 M 504	CU1021	1000	2.20	28 M 516	CA2541	250,000	2.20
28 M 505	CU2521	2500		28 M 517	CU5041	500,000	1.91
28 M 506	CU5021	5000		28 M 518	CA5041	500,000	2.20
28 M 507	CU1031	10,000		28 M 519	CU1052	1 Meg*	1.91
28 M 508	CB1031	10,000	2.20	28 M 520	CA1052	1 Meg*	2.20
28 M 509	CU2531	25,000		28 M 521	CU2552	2.5 Meg*	1.91
28 M 510	CB2531	25,000		28 M 522	CA2552	2.5 Meg*	2.20
28 M 511	CU5031	50,000		28 M 523	CU5052	5 Meg*	1.91

Type CS-1 SPST Switch. For AB potentiometers. Wt., 3 oz.

28 M 524. NET. 65c

TYPE CLU—WITH LOCKING SHAFT

No.	Type	Ohms	EACH	No.	Type	Ohms	EACH
28 M 525	CLU5001	50	2.50	28 M 533	CLU2531	25,000	2.50
28 M 526	CLU1011	100		28 M 534	CLU5031	50,000	
28 M 527	CLU2511	250		28 M 535	CLU1041	.1 Meg	
28 M 528	CLU5011	500		28 M 536	CLU2541	.25 Meg	
28 M 529	CLU1021	1000	2.50	28 M 537	CLU5041	.5 Meg	2.50
28 M 530	CLU2521	2500		28 M 538	CLU1052	1.0 Meg*	
28 M 531	CLU5021	5000		28 M 539	CLU2552	2.5 Meg*	
28 M 532	CLU1031	10,000		28 M 540	CLU5052	5.0 Meg*	

TYPE CCU DUALS

No.	Type	Ohms	EACH	No.	Type	Ohms	EACH
28 M 541	CCU1031	10,000	5.73	28 M 545	CCU2541	250,000	5.73
28 M 542	CCU2531	25,000		28 M 546	CCU5041	500,000	
28 M 543	CCU5031	50,000		28 M 547	CCU1052	1 Meg*	
28 M 544	CCU1041	100,000					

Ohmite and IRC Controls

OHMITE TYPE AS MINIATURE POTENTIOMETERS



- Smallest Molded Composition Potentiometers
- Screwdriver Slotted
- No Rivets or Soldered Parts
- Made to Rigid Specifications
- Synthetic-Resin Sealed

New, linear-taper, miniature potentiometers combining exceptional reliability and extremely small size. Maximum continuous power rating is 0.5 watt. Only 1/2" in diameter—ideal for lightweight, miniaturized assemblies. Molded composition resistance and collector tracks (bridged by a molded composition brush) assure long life. Greater cross-section of resistor track lowers current density—gives excellent performance in excess of 50,000 operation cycles. Terminals are molded directly into control elements for trouble-free connections. Enclosures are sealed with synthetic resin to keep out dust, moisture and fungus. Terminals are goldplated for easy soldering, even after long storage. Have screwdriver-slotted, locking-type shafts. Rated at 350 $\frac{1}{2}$ " dia.; 1/4" long. Shaft: 1" long. Meet QQ-M-151, MIL-R-94A and RETMA specifications. Types 3613, 3614 and 3615 have $\pm 20\%$ tolerance; others are $\pm 10\%$. Shpg. wt., 2 oz.

Stock No.	Mfrs. Type	Ohms	NET EACH
28 M 580	3601	100	5.00
28 M 581	3602	250	
28 M 582	3603	500	
28 M 583	3604	1K	
28 M 584	3605	2.5K	
28 M 585	3606	5K	5.00
28 M 586	3607	10K	
28 M 587	3608	25K	
28 M 588	3609	50K	
28 M 589	3610	.1 meg	
28 M 590	3611	.25 meg	5.00
28 M 591	3612	1.0 meg	
28 M 592	3613	1.5 meg	
28 M 593	3614	2.5 meg	
28 M 594	3615	5.0 meg	

IRC CONTROLS

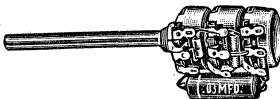

TYPE LC-1 LOUDNESS CONTROL

Easily installed, loudness-type volume control. Permits complete listening pleasure during periods when amplifier volume must be kept low. Replaces conventional volume control in amplifier, radio or phono. Automatically compensates for reduced response of the ear to bass and treble frequencies at low volume. Audio output can be reduced to nearly whisper level and yet retain almost perfect tonal balance. Has input resistance of 5 megohms. Insertion loss is only 6 db. Space required behind panel: With switch 2 3/8", without switch, 1 3/4". With instructions, less AC switch (may be used with Type 76-1 or 76-2 switch, next column). Shpg. wt., 4 oz.
30 M 595, List, \$7.95. NET.....6.44

TV SIGNAL ATTENUATOR



Type QJ-3. Economically priced L-pad television signal attenuator. For use with sets having 300-ohm twin line antenna input. Minimizes interstation interference, definition loss and sound bars caused by excessive signal strength. Diminishes buzz or hum due to high signal level in intercarrier systems. Reduces overloading effects in strong signal area. In many cases, corrects or reduces horizontal or vertical jitters in picture; also picture and sound "break-over." Very useful device for the TV serviceman to simulate fringe-area signals when shop is located near powerful local station. A nearly constant 300-ohm load is maintained on antenna lead-in to minimize ghosts caused by mismatch of antenna lead to receiver. Easily mounted on cabinet or chassis. Slotted shaft for screwdriver adjustment. Supplied with mounting bracket and instructions. 7/8" diameter, 1" deep. Shaft: 1/4" diameter, 1/2" long. Shpg. wt., 3 oz.
29 M 915, List, \$3.65. NET.....2.15

IRC Q CONTROLS WITH UNIVERSAL SHAFTS

Handle over 90% of all radio and television control applications. Knurled, flatted and slotted. 3" universal shaft can be cut down to meet most applications. 1 1/2" dia., 1/4" long bushing. Use with "M" multi-sections (page 118) for ganged controls. * Includes 270-ohm, 1/2-watt fixed bias resistor. Less switch. See attachable switches and taper explanations below. Av. shpg. wt., 4 oz.

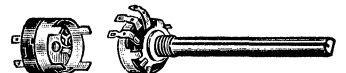

No.	Type	Ohms	Taper	No.	Type	Ohms	Taper
30 M 395	Q11-201	250	A	30 M 318	Q13-128	100K	C
30 M 300	Q11-103	500	A	30 M 388	Q11-228	125K	A
30 M 377	Q11-105	750	A	30 M 875	Q11-328	150K	C
30 M 441	Q17-105	750	P	30 M 444	Q13-328	150K	C
30 M 301	Q11-108	1000	A	30 M 374	Q11-229	200K	A
30 M 379	Q17-108	1000	Q	30 M 319	Q11-130	250K	A
30 M 874	Q17-110	2000	Q	30 M 320	Q13-130	250K	C
30 M 442	Q11-109	1500	A	30 M 445	Q11-131	300K	A
30 M 380	Q17-109	1500	Q	30 M 876	Q11-132	350K	A
30 M 302	Q11-110	2000	A	30 M 321	Q13-132	350K	C
30 M 373	Q13-111	2500	C	30 M 322	Q11-133	500K	A
30 M 381	Q17-111	2500	Q	30 M 323	Q13-133	500K	C
30 M 303	Q11-112	3000	A	30 M 324	Q14-133	500K	D
30 M 382	Q17-112	3000	Q	30 M 327	Q17-133	500K	Q
30 M 304	Q11-114	5000	A	30 M 398	Q11-134	600K	A
30 M 383	Q13-114	5000	C	30 M 390	Q11-136	750K	A
30 M 384	Q17-114	5000	Q	30 M 325	Q11-137	1 meg	A
30 M 305	Q11-115	7500	A	30 M 326	Q13-137	1 meg	C
30 M 306	Q11-116	10K	A	30 M 327	Q14-137	1 meg	D
30 M 307	Q13-116	10K	C	30 M 877	Q17-137	1 meg	Q
30 M 308	Q14-116*	10K	D	30 M 328	Q11-138	1.5 meg	A
30 M 385	Q17-116	10K	Q	30 M 329	Q11-139	2 meg	A
30 M 309	Q11-119	20K	A	30 M 330	Q13-139	2 meg	C
30 M 310	Q16-119	20K	Spec.	30 M 399	Q17-139	2 meg	Q
30 M 311	Q11-120	25K	A	30 M 331	Q11-239	2.5 meg	A
30 M 443	Q13-120	25K	C	30 M 332	Q11-140	3 meg	A
30 M 312	Q13-120*	25K	D	30 M 333	Q13-140	3 meg	C
30 M 313	Q11-121	30K	A	30 M 446	Q17-140	3 meg	Q
30 M 396	Q11-122	35K	A	30 M 334	Q11-141	5 meg	A
30 M 314	Q11-123	50K	A	30 M 287	Q12-141	5 meg	Spec.
30 M 315	Q13-123	50K	C	30 M 392	Q13-141	5 meg	C
30 M 316	Q14-123*	50K	D	30 M 393	Q17-141	5 meg	Q
30 M 387	Q11-125	75K	A	30 M 394	Q11-142	7.5 meg	A
30 M 317	Q11-128	100K	A	30 M 335	Q11-143	10 meg	A

NET EACH.....82c

IRC TAPPED Q CONTROLS WITH UNIVERSAL SHAFTS

No.	Type	Megs	Taps, Ohms	Taper	No.	Type	Megs	Taps, Ohms	Taper
30 M 378	Q17-105X	750†	250	Spec.	30 M 347	Q17-137X	1.0	35K	Spec. H
30 M 878	Q17-105X	2K†	250/500	Spec.	30 M 346	Q13-137X	1.0	250K	Spec. H
30 M 879	Q13-118X	15K†	10K	Spec.	30 M 348	Q17-137XX	1.0	50K/100K	Spec. H
30 M 386	Q13-118XX	15K†	5K/10K	Spec.	30 M 349	Q18-137X	1.0	100K	Spec. H
30 M 288	Q17-118X	15K†	5K	Spec.	30 M 350	Q18-137XX	1.0	250K/5 Meg	Spec. H
30 M 447	Q17-118XX	15K†	5K-10K	Spec.	30 M 351	Q19-137X	1.0	5 Meg	Spec. H
30 M 389	Q17-328XX	.15	19K/38K	Spec.	30 M 352	QVC-539X	1.0	.5 meg	Spec. H
30 M 337	Q18-130X	.25	60K	H	30 M 391	Q13-138X	1.5	.25 meg	Spec. H
30 M 336	Q13-130X	.25	125K	Spec.	30 M 392	Q19-138X	2.0	50K	Spec. H
30 M 338	Q18-130XX	.25	60K/120K	Spec.	30 M 355	Q17-139X	2.0	150K	Spec. H
30 M 339	Q17-132X	.35	35K	Spec.	30 M 357	Q18-139XX	2.0	250K/.5 Meg	Spec. H
30 M 340	Q18-132X	.35	75K	H	30 M 354	Q13-139XX	2.0	.5Meg/1Meg	Spec. H
30 M 342	Q17-133X	.5	25K	Spec.	30 M 353	Q13-139X	2.0	.5 meg	H
30 M 343	Q18-133X	.5	50K	Spec.	30 M 356	Q18-139X	2.0	1 Meg	Spec. H
30 M 341	Q13-133X	.5	125K	H	30 M 448	Q13-140X	3.0	900K	Spec. H
30 M 344	Q19-133X	.5	250K	Spec.	30 M 449	Q18-140X	3.0	1.5 Meg	Spec. H
30 M 345	Q18-133XX	.5	100K/200K	Spec.					

NET EACH.....1.21

TYPE 76 ATTACHABLE SWITCHES FOR Q CONTROLS

Blue bakelite enclosure. Easily and quickly attached. U.L. Approved. Shpg. wt., 2 oz.
30 M 359, Type 76-1. SPST. NET
30 M 591, Type 76-2. DPST. EACH..38c

EXPLANATION OF TAPERS

- Taper A.** Linear.
- Taper C.** Logarithmic curve for audio circuit control or antenna shunt control.
- Taper D.** Tapered at both ends to provide control of grid bias and antenna circuit. Used where control of grid bias is of prime importance in controlling gain.
- Taper H.** Tapped logarithmic curve. Audio level control for automatic bass compensation.
- Taper P.** Semi-logarithmic curve with reverse taper. For use in contrast and picture control circuits in television.
- Taper Q.** Same applications as Taper P above, but has slightly steeper curve.

IRC TYPE Q CONTROL KIT

Assortment No. 9. An assortment of versatile Type Q Volume Controls plus switches and shafts, in a handsome metal cabinet. These units are carefully selected and will handle over 90% of all AM, FM and TV standard control replacements.

Contains 18 controls, 6 switches and 5 special shafts, as follows: 1—Q11-116 (10,000 ohms), 1—Q11-123 (50,000 ohms), 1—Q13-123 (50,000 ohms), 1—Q11-128 (100,000 ohms), 1—Q13-128 (100,000 ohms), 1—Q11-130 (250,000 ohms), 1—Q13-130 (250,000 ohms), 1—Q11-133 (1/2 meg), 2—Q13-133 (1/2 meg), 1—Q13-133X (1/2 meg), 1—Q11-137 (1 meg), 1—Q13-137 (1 meg), 1—Q13-137X (1 meg), 1—Q13-137X (2 meg), 1—Q13-139X (2 meg), 1—Q18-139X (2 meg), 6—Type 76-1 SPST switches, 1—Q shaft, 1—CQ shaft, 2—HQ shaft, and 1—NQ shaft. Cabinet is included at no extra charge. Contains drawers for shafts, switches and spare parts. Convenient hinged metal panel keeps contents of drawers dust-free. An excellent addition to the well-equipped servichop.
30 M 297, NET.....21.64

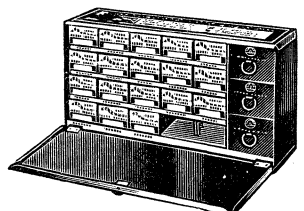

IRC Controls

INDUSTRIAL CONTROLS

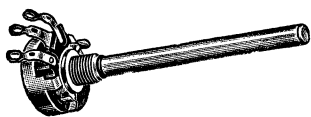

PQ



RQ
RQL



M

These versatile industrial-type controls have a smooth carbon base element and "two-finger" wiper arm of thin, high-stress alloy—assures good contact and low noise for years of service. Type M multi-sections can easily be added to either PQ, RQ or RQL types; Permit exact "tailoring" of dual, triple and quadruple units to meet individual requirements. Special-purpose controls can be made up by using a Type PQ, RQ or RQL with several M multi-sections and a Type 76 switch (listed below). Types PQ, RQ and RQL have a 3/4" threaded bushing. Body diameter less terminals is 1 1/4" maximum; body diameter including terminals is 1 3/4" maximum; depth behind panel, 3 3/4". Each Type M multi-section adds 1/2" to depth. Type PQ, RQ, RQL and M sections feature 300 degree arc of rotation—with or without switch. Power rating is 1/2 watt, 500 volts maximum.

PQ types have a round fixed shaft, 3" long, 1/4" diameter. Shaft can be cut to any desired length with a hacksaw. Where a longer shaft is required, use the extension fittings on page 160. RQ and RQL types have a short shaft with a screwdriver slot for use where adjustment is semi-permanent; shaft extends 1/4" beyond threaded bushing. Types RQ, RQL are the same except RQL has split bushing and locking nut—for permanent, vibration-proof settings. Tolerance of all types is ±10%. All have terminals that are tinned for easy soldering and firmly riveted to the body of the control. Terminals may be bent for a variety of applications without causing noise in the circuit. Ground plate on Types PQ, RQ, and RQL has two locating tabs either or both of which may be bent down if not needed. Av. shpg. wt., 4 oz.

Mfr's Type	Ohms	Taper	Stock No. PQ	Stock No. RQ	Stock No. RQL	Stock No. M
11-103	500	A	30 M 510	30 M 542	29 M 271	30 M 592
11-108	1000	A	30 M 511	30 M 543	29 M 272	30 M 574
11-110	2000	A	30 M 512	30 M 544	29 M 273	30 M 593
11-112	3000	A	30 M 513	30 M 545	29 M 274	30 M 598
11-114	5000	A	30 M 514	30 M 546	29 M 275	30 M 575
11-115	7500	A	30 M 515	30 M 547		
11-116	10K	A	30 M 516	30 M 548	29 M 276	30 M 576
13-116	10K	C	30 M 517	30 M 549		
14-116	10K	D	30 M 518	30 M 550		
17-116	10K	Q	30 M 519	30 M 551	29 M 277	30 M 599
11-119	20K	A	30 M 520	30 M 552	29 M 278	30 M 577
11-120	25K	A	30 M 521	30 M 553		
14-120	25K	D	30 M 522	30 M 554	29 M 279	30 M 596
11-121	30K	A	30 M 523	30 M 555	29 M 280	30 M 578
11-123	50K	A	30 M 524	30 M 556	29 M 281	
13-123	50K	C				
14-123	50K	D	30 M 525	30 M 557		
11-128	100K	A	30 M 526	30 M 558	29 M 282	30 M 579
13-128	100K	C	30 M 527	30 M 559		30 M 580
11-129	200K	A	30 M 375	30 M 376	29 M 283	
11-130	250K	A	30 M 528	30 M 560	29 M 284	30 M 581
13-130	250K	C	30 M 529	30 M 561	29 M 285	30 M 582
11-133	500K	A	30 M 530	30 M 562	29 M 286	30 M 583
13-133	500K	C	30 M 531	30 M 563	29 M 287	30 M 584
11-137	1.0 meg	A	30 M 532	30 M 564	29 M 288	30 M 585
13-137	1.0 meg	C	30 M 533	30 M 565	29 M 289	30 M 586
11-138	1.5 meg	A	30 M 534	30 M 566	29 M 290	
13-138	1.5 meg	C				30 M 499
11-139	2.0 meg	A	30 M 535	30 M 567	29 M 291	30 M 587
13-139	2.0 meg	C	30 M 536	30 M 568	29 M 292	30 M 588
11-239	2.5 meg	A	30 M 537	30 M 569	29 M 293	
11-140	3.0 meg	A	30 M 538	30 M 570	29 M 294	
13-140	3.0 meg	C	30 M 539	30 M 571		30 M 594
17-140	3.0 meg	A				30 M 597
11-141	5.0 meg	A	30 M 540	30 M 572	29 M 295	30 M 589
11-143	10.0 meg	A	30 M 541	30 M 573	29 M 296	30 M 590

PQ, RQ and M Controls. NET EACH.....1.32
 RQL Controls. NET EACH.....1.53

EXPLANATION OF TAPERS

- Taper A.** Linear curve for uniform resistance change.
- Taper C.** Logarithmic curve for audio circuit control or antenna shunt control.
- Taper D.** Tapered at both ends to provide control of grid bias or antenna circuit. Used where control of the grid bias is of prime importance in regulating the gain.
- Taper Q.** Logarithmic curve with reverse taper for TV contrast and picture control.

TYPE 76 ATTACHABLE SWITCHES FOR Q, PQ, RQ, RQL AND M CONTROLS

Can be easily attached to control by bending down four metal tabs. Switch housing is made of arc-resistant material. Terminals are hydraulically staked—no openings for solder to run into switch. Contacts are silver-plated alloy—maintains low contact resistance to assure long life. Type 76-1 handles up to 5 amps at 125 v. Type 76-2 rated at 1 amp at 125 v. Shpg. wt., 2 oz.
 30 M 359, Type 76-1, SPST. NET
 30 M 591, Type 76-2, DPST. EACH.....38c

TYPE HV-15 FOCUS CONTROL

Carbon control especially designed for high-voltage control with TV picture tubes requiring electrostatic focus. Resistance, 15 megohms. Rated at 2 watts. Linear taper characteristic. Equipped with 3" long "Knob Master" shaft—knurled, flatted and grooved to fit most knob requirements without any modification except cutting to length. Size, 2 1/4" dia., 2 3/4" depth. Shpg. wt., 4 oz.
 30 M 274. NET EACH.....1.94

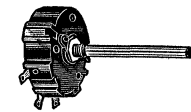

Type HV-25. Same as focus control above, but 25 megohms resistance.
 30 M 286. NET EACH.....1.94

UNIVERSAL WIRE-WOUND CONTROLS

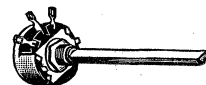

Rugged 4-watt controls. Replace Types W, WK, 4WK and 4WS. Have linear taper, except *left-hand logarithmic taper for TV focus and *right-hand logarithmic taper for picture contrast. Rotation, 300°. Size: 1 1/4" dia., 2 3/4" deep; threaded bushing is 3/8" dia. and 3/4" long. Nickel-plated brass shafts, 1/4" dia. Type WP has round shaft, 3" long. Type WPK has 3" long "Knob Master" shaft—fits a wide variety of knobs. Type WPS has 3/2" long shaft, knurled at end and slotted. Type WM multi-sections can be attached to all controls. Shpg. wt., 4 oz.

WPK CONTROLS

Type	Ohms	Type	Ohms
WPK-10	10	WPK-1350R	1350†
WPK-20	20	WPK-1500	1500
WPK-30	30	WPK-1500L	1500*
WPK-50	50	WPK-2000	2000
WPK-100	100	WPK-2000L	2000*
WPK-200	200	WPK-2250L	2250*
WPK-250	250	WPK-2500	2500
WPK-300	300	WPK-2500R	2500†
WPK-400	400	WPK-3000	3000
WPK-500	500	WPK-4000L	4000*
WPK-600	600	WPK-5000	5000
WPK-650	650	WPK-5000L	5000*
WPK-750	750	WPK-6000	6000
WPK-750L	750*	WPK-6000L	6000*
WPK-750R	750†	WPK-7500	7500
WPK-1000	1000	WPK-7500L	7500*
WPK-1350	1350	WPK-10000	10,000

Specify Type No. and Ohms.
 30 MM 216. NET EACH.....97c

WPK-12500	12,500	WPK-20000	20,000
WPK-15000	15,000	WPK-25000	25,000

Specify Type No. and Ohms.
 30 MM 199. NET EACH.....1.21

WPS CONTROLS

Type	Ohms	Type	Ohms
WPS-25	25	WPS-2000	2000
WPS-40	40	WPS-2250	2250
WPS-60	60	WPS-2250L	2250*
WPS-250	250	WPS-2500	2500
WPS-500	500	WPS-3000	3000
WPS-500L	500*	WPS-4000	4000
WPS-1000	1000	WPS-4000L	4000*
WPS-1500	1500	WPS-5000	5000

Specify Type No. and Ohms.
 30 MM 217. NET EACH.....97c

WP CONTROLS

Type	Ohms	Type	Ohms
WP-2	2	WP-200	200
WP-3	3	WP-250	250
WP-5	5	WP-300	300
WP-6	6	WP-400	400
WP-8	8	WP-500	500
WP-10	10	WP-750	750
WP-15	15	WP-1000	1000
WP-20	20	WP-1500	1500
WP-25	25	WP-2000	2000
WP-30	30	WP-2500	2500
WP-40	40	WP-3000	3000
WP-50	50	WP-4000	4000
WP-60	60	WP-5000	5000
WP-75	75	WP-7500	7500
WP-100	100	WP-10000	10,000

Specify Type No. and Ohms.
 30 MM 215. NET EACH.....97c

WM MULTISECTION CONTROLS

Ruggedly constructed 4-watt "add-on" control sections. Can be attached to the WPK, WPS or WP controls, listed above, to form dual control units. All have linear taper, except *Type WM-7500L which has left-hand logarithmic taper for TV focus. Rotation, 300°. Multisection adds 5/8" to depth. Shpg. wt., 2 oz.

Type	Ohms	Type	Ohms
WM-50	50	WM-2000	2000
WM-100	100	WM-2500	2500
WM-200	200	WM-3000	3000
WM-250	250	WM-5000	5000
WM-500	500	WM-7500L	7500*
WM-1000	1000	WM-10000	10,000
WM-1500	1500		

Specify Type No. and Ohms.
 30 MM 860. NET EACH.....97c

SWITCHES FOR ABOVE CONTROLS

Easily attached switches for all of above controls. Shpg. wt., 2 oz.
 30 M 218, Type 76-11, SPST. NET
 30 M 219, Type 76-12, DPST. EACH. 38c

Mallory Controls

SERIES U MIDGETROL CONTROLS

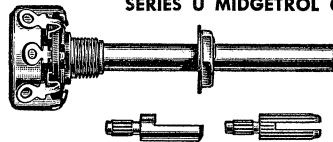

For audio, tone and similar control circuits in home receivers, audio amplifiers, portables, TV sets, and industrial electronic equipment. Available in a full line of resistances, tapers, and taps. Round, hollow shaft—easily cut to desired length. Two spline-shank knob adapters furnished with each Midgetrol—see illustration above. With nut and lock washer, 1/8" dia. brass shaft, 2 3/8" long, 1/4" dia. Less switch (see below). Shpg. wt., 3 oz.

No.	Type	Ohms	Taper	No.	Type	Ohms	Taper
29 M 714	U-1	100	4	29 M 763	U-35	50K	4
29 M 715	U-2R	500	2	29 M 764	U-36	75K	1
29 M 709	U-2	500	4	29 M 765	U-39	100K	1
29 M 716	U-75TL	750	2	29 M 766	U-40	100K	2
29 M 796	U-3	1K	2	29 M 767	U-41	100K	4
29 M 785	U-4	1K	4	29 M 795	U-415	125K	4
29 M 797	U-5	1500	2	29 M 768	U-42	150K	1
29 M 710	U-5L	1500	4	29 M 769	U-43	200K	4
29 M 786	U-6	2K	4	29 M 770	U-44	250K	1
29 M 798	U-7	2500	2	29 M 771	U-45	250K	2
29 M 787	U-8	3K	4	29 M 772	U-46	250K	4
29 M 717	U-9	3K	2	29 M 773	U-48	500K	1
29 M 751	U-12	5K	1	29 M 774	U-50	500K	4
29 M 752	U-14	5K	4	29 M 775	U-51	750K	1
29 M 753	U-18	10K	1	29 M 776	U-52	1 Meg	2
29 M 754	U-19	10K	4	29 M 773	U-53	1 Meg	1
29 M 755	U-20	10K	4	29 M 777	U-54	1 Meg	4
29 M 756	U-21	15K	1	29 M 778	U-55	1.5 Meg	4
29 M 757	U-22	15K	2	29 M 790	U-55	2 Meg	1
29 M 758	U-24	20K	1	29 M 781	U-56	2 Meg	4
29 M 783	U-26	20K	4	29 M 784	U-255	2.5 Meg	4
29 M 759	U-28	25K	2	29 M 779	U-57	3 Meg	1
29 M 712	U-28A	25K	1	29 M 782	U-59	3 Meg	4
29 M 760	U-29	25K	4	29 M 780	U-65	5 Meg	1
29 M 761	U-33	50K	1	29 M 788	U-67	5 Meg	4
29 M 762	U-34	50K	2	29 M 789	U-82	10 Meg	4

NET EACH.....82c

TYPE UT SINGLE-TAPPED MIDGETROLS

Same as U-types above, but tapped for tone compensation.

No.	Type	Ohms	Tap	No.	Type	Ohms	Tap
29 M 718	UT-153	15K	10K	29 M 806	UT-443	1 Meg	450K
29 M 802	UT-420	250K	50K	29 M 807	UT-450	2 Meg	125K
29 M 803	UT-425	350K	70K	29 M 808	UT-448	2 Meg	250K
29 M 816	UT-429	500K	50K	29 M 809	UT-452	2 Meg	400K
29 M 804	UT-427	500K	100K	29 M 863	UT-449	2 Meg	600K
29 M 860	UT-430	500K	150K	29 M 810	UT-451	2 Meg	900K
29 M 805	UT-431	500K	225K	29 M 817	UT-457	3 Meg	900K
29 M 861	UT-440	1 Meg	200K	29 M 711	UT-461	3.2 Meg	300K
29 M 862	UT-438	1 Meg	300K				

NET EACH.....1.21

TYPE UDT DOUBLE-TAPPED MIDGETROLS

No.	Mfr's Type	Ohms	Taps	EACH
29 M 988	UDT-283	500K	100K/200K	1.21
29 M 989	UDT-289	1 Meg.	250K/500K	
29 M 990	UDT-291	1.5 Meg.	225K/500K	
29 M 991	UDT-295	2.25 Meg	500K/300K	
29 M 992	UDT-296	2.25 Meg	500K/1 Meg.	
29 M 919	UDT-303	3.3 Meg.	300K/1.5 Meg.	

TYPE SU INSULATED-SHAFT MIDGETROLS FOR TV

Size and basic construction are the same as Midgetrols listed above, except the SU type control has a 1/4" dia., fixed knurled and slotted phenolic shaft protruding 1/4" beyond bushing. Meet exact physical and electrical requirements for special applications. Linear taper. With hex nut, Shpg. wt., 3 oz.

No.	Mfr's Type	Ohms	No.	Mfr's Type	Ohms
29 M 646	SU-6	1.5K	29 M 828	SU-46	250K
29 M 647	SU-8	3K	29 M 814	SU-50	500K
29 M 822	SU-14	5K	29 M 829	SU-55	1 Meg
29 M 826	SU-20	10K	29 M 830	SU-56	2 Meg
29 M 812	SU-29	25K	29 M 833	SU-565	2.5 Meg
29 M 827	SU-35	50K	29 M 831	SU-59	3 Meg
29 M 813	SU-41	100K	29 M 815	SU-67	5 Meg

NET EACH.....82c

SWITCHES AND ACCESSORIES FOR MIDGETROLS

"Push-on, stay-on" switches for Midgetrols. Shpg. wt., 2 oz.
 29 M 620. US-26 SPST Switch. NET.....38c
 29 M 621. US-26T SPST Switch. With dummy terminal. NET.....47c
 29 M 622. US-27 DPST Switch. NET.....38c
 29 M 623. US-28 SPDT Switch. NET.....47c
 29 M 985. DS-36 Special 3" Extension Shaft. For tubular shaft. Midgetrols above; TV and industrial 2-watt potentiometers at right. Also couples front and rear sections together. Shpg. wt., 2 oz. NET.....29c
 29 M 882. DS-37 3/8" Diameter Shaft. For use with round-shaft Midgetrols to accommodate knobs requiring 3/8" shaft. Wt., 2 oz. NET.....29c
 29 M 987. EB-214 Special Bushing. Dimensions: 1/2"-28 thread, 2 3/8" long with .403" milled flat. Shpg. wt., 2 oz. NET.....53c

EXPLANATION OF TAPERS

Taper No. 1: For use in audio or antenna shunt circuits.
 Taper No. 2: For series circuits or cathode output controls.
 Taper No. 4: Linear. For voltage control.

DUAL CONCENTRIC MIDGETROLS FOR TV

Exact replacements in over 90% of all television sets and auto radios. Each dual Midgetrol is composed of a front and a rear section—each ordered separately. Necessary hardware is supplied with front section. Diameter: only 1 1/8". Hardware supplied with each front section includes one inner shaft, one bakelite spacer, one coupling cup, and two shaft ends each fitting 1/8" and .202 RETMA knobs. Uses Midgetrol switches (see below left). Depth without switch: 1 1/8"; with switch, 1 3/8". Instructions included. Shpg. wt., front section, 5 oz.; rear, 4 oz.

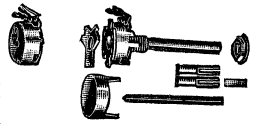

TYPE UF CARBON FRONT SECTIONS

Stock No.	Mfr's Type	Ohms	Taper	Stock No.	Mfr's Type	Ohms	Taper
29 M 636	UF62R	600	2	29 M 937	UF54L	50K	4
29 M 648	UF13R	1000	2	29 M 938	UF753L	75K	4
29 M 926	UF13R	1000	4	29 M 939	UF15A	100K	1
29 M 649	UF152R	1500	2	29 M 940	UF15L	100K	2
29 M 819	UF152L	1500	4	29 M 941	UF254A	250K	4
29 M 652	UF23R	2000	2	29 M 919	UF254L	250K	1
29 M 918	UF23L	2000	4	29 M 942	UF55A	500K	1
29 M 653	UF252R	2500	2	29 M 943	UF55R	500K	2
29 M 736	UF252L	2500	4	29 M 944	UF55L	500K	4
29 M 654	UF33R	3000	2	29 M 945	UF16A	1 Meg	1
29 M 737	UF33L	3000	4	29 M 946	UF16L	1 Meg	1
29 M 929	UF53R	5000	2	29 M 733	UF155A	1.5 Meg	4
29 M 930	UF53L	5000	4	29 M 667	UF155R	1.5 Meg	2
29 M 931	UF73R	7000	2	29 M 667	UF155L	1.5 Meg	4
29 M 666	UF14R	10K	2	29 M 947	UF26A	2 Meg	1
29 M 932	UF14L	10K	4	29 M 948	UF26L	2 Meg	4
29 M 933	UF233R	25K	2	29 M 740	UF255L	2.5 Meg	4
29 M 934	UF233L	25K	4	29 M 741	UF46A	4 Meg	1
29 M 935	UF34A	35K	1	29 M 936	UF54A	50K	1
29 M 936	UF54A	50K	1	30 M 012	UF106L	10 Meg	1

NET EACH.....1.29

TYPE WF WIRE-WOUND FRONT SECTIONS

1 1/4" dia. Tapped: *250 ohms; †500 ohms; ‡2000 ohms.

Stock No.	Mfr's Type	Ohms	NET	Stock No.	Mfr's Type	Ohms	NET
29 M 794	WF32	300	1.35	29 M 744	WF23	2000	1.35
29 M 742	WF751	750	1.35	29 M 793	WF252-T23	2500†	1.62
29 M 668	WF751-T52	750†	1.62	29 M 996	WF252	2500	1.35
29 M 993	WF751-T251	750*	1.62	29 M 997	WF33	3000	1.35
29 M 994	WF13	1000	1.35	29 M 998	WF53	5000	1.35
29 M 743	WF152	1500	1.35	29 M 999	WF73	7000	1.35

TYPE UR CARBON REAR SECTIONS

Stock No.	Mfr's Type	Ohms	Taper	Stock No.	Mfr's Type	Ohms	Taper
29 M 951	UR13L	1000	4	29 M 962	UR254A	250K	1
30 M 011	UR152L	1500	4	29 M 963	UR254L	250K	4
29 M 954	UR23L	2000	4	29 M 746	UR354A	350K	1
29 M 673	UR352R	3500	2	29 M 964	UR55A	500K	1
29 M 745	UR352L	3500	4	29 M 965	UR55L	500K	4
29 M 955	UR53R	5000	2	29 M 966	UR16A	1 Meg	1
29 M 956	UR53L	5000	4	29 M 967	UR16L	1 Meg	4
29 M 956	UR14R	10K	2	29 M 968	UR26A	2 Meg	1
29 M 957	UR14L	10K	4	29 M 969	UR26L	2 Meg	4
29 M 958	UR233L	25K	4	29 M 747	UR355L	2.5 Meg	4
29 M 959	UR54L	50K	4	29 M 747	UR36A	3 Meg	1
29 M 960	UR15R	100K	2	30 M 013	UR56L	5 Meg	4
29 M 961	UR15L	100K	4				

NET EACH.....65c

2-WATT TV AND INDUSTRIAL CONTROLS

Two-watt wirewound potentiometers designed especially for replacement of television controls. Also excellent for use as voltage dividers and bias controls. Insulated contact arm type, linear taper. Special dual contactor mechanism. 900 volts AC insulation between resistance element and chassis. 207° rotation. Taper 4. 1 1/2" in diameter. Knurled stub shaft has screwdriver slot. *Center-tapped. 3/8" bushing. Shpg. wt., 4 oz.



No.	Type	Ohms	NET	No.	Type	Ohms	NET
29 M 835	R20L	20	.82	29 M 842	R1000L	1000	91c
29 M 836	R20CT*	20	1.21	29 M 843	R1500L	1500	91c
29 M 837	R25L	25	.82	29 M 844	R2500L	2500	91c
29 M 838	R30L	30	1.21	29 M 845	R3000L	3000	91c
29 M 839	R30CT*	30	1.21	29 M 845	R5000L	5000	91c
29 M 840	R50L	50	.82	29 M 692	R7500L	7500	97c
29 M 864	R100L	100	.82	29 M 693	R10ML	10,000	97c
29 M 841	R250L	250	.82	29 M 694	R15ML	15,000	97c
29 M 834	R500L	500	.82	29 M 695	R20ML	20,000	97c

THEATER SPEAKER CONTROLS

Precision units developed especially as controls in drive-in theater speaker installations. Withstand extremes of temperature and humidity. TSA-10 is an L-pad with 10-ohm input and 4-ohm output. TSA-35 is a 35-ohm series-type potentiometer. TSA-6 is a 6-ohm shunt-type attenuator. 1 1/8" dia. cases. Shafts are 1/2" long; *steel (knurled), †brass. Shpg. wt., 4 oz.

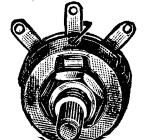

No.	Mfr's Type	Description	EACH
29 M 847	*TSA-10	L-pad	1.29
29 M 848	*TSA-35	Potentiometer	.97
29 M 849	†TSA-6	Shunt-type Attenuator	.97

Industrial & Special Controls

MALLORY CONTROLS

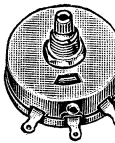

"M" AND "MT" WIRE WOUND CONTROLS

For industrial and laboratory use as bias controls and voltage dividers. Also for T replacement. 4 watts. Arm insulated from shaft. 294° rotation. Knurled 1/4" shaft is 3/8" long; has screwdriver slot and is hollow to accept DS-36 and DS-37 extension shafts (see page 120). MT types are center-tapped T units. 1 1/2" dia. x 3/8". Mount in 3/8" hole. Linear taper. Shpg. wt., 4 oz.

POTENTIOMETERS

No.	Type	Ohms	EA.	No.	Type	Ohms	EA.
29 M 424	M1PK	1		29 M 410	M400PK	400	
29 M 425	M3PK	3		29 M 411	M500PK	500	97c
29 M 426	M6PK	6		29 M 412	M600PK	600	
29 M 427	M10PK	10		29 M 413	M1MPK	1000	
29 M 428	MT10PK	10	1.29	29 M 431	M15MPK	1500	
29 M 400	M15PK	15		29 M 414	M2MPK	2000	
29 M 401	M20PK	20	97c	29 M 432	M2.5MPK	2500	
29 M 429	MT20PK	20	1.29	29 M 415	M3MPK	3000	1.09
29 M 402	M25PK	25		29 M 416	M4MPK	4000	
29 M 403	M30PK	30	97c	29 M 417	M5MPK	5000	
29 M 430	MT30PK	30	1.29	29 M 418	M10MPK	10000	
29 M 404	M40PK	40		29 M 419	M15MPK	15000	
29 M 405	M50PK	50		29 M 420	M20MPK	20000	1.29
29 M 406	M60PK	60		29 M 421	M25MPK	25000	
29 M 407	M75PK	75	97c	29 M 422	M50MPK	50000	
29 M 408	M100PK	100		29 M 423	M70MPK	70000	1.56
29 M 409	M200PK	200		29 M 433	M75MPK	75000	
				29 M 434	M100MPK	100000	2.26

RHEOSTATS

Have open or "off" position counter-clockwise.

No.	Type	Ohms	Amps	No.	Type	Ohms	Amps
29 M 451	M05RK	1/2	2.80	29 M 459	M20RK	20	.45
29 M 452	M1RK	1	2.00	29 M 460	M25RK	25	.40
29 M 453	M2RK	2	1.40	29 M 461	M30RK	30	.37
29 M 454	M3RK	3	1.15	29 M 462	M40RK	40	.32
29 M 455	M4RK	4	1.00	29 M 463	M50RK	50	.28
29 M 456	M6RK	6	.82	29 M 464	M60RK	60	.26
29 M 457	M10RK	10	.63	29 M 465	M75RK	75	.23
29 M 458	M15RK	15	.52	29 M 466	M100RK	100	.20

NET EACH..... 82c

29 M 651. Type 395 Dial Plate. For "M" Controls. 2 oz. NET... 15¢

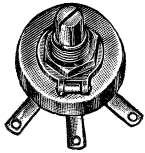

"C" WIREWOUND CONTROLS

Ideal for limited-space applications. Conservatively rated to dissipate 2 watts. Contact arm grounded to shaft. 266° effective electrical rotation. 1 1/8" dia. x 7/8" deep. 1/4" shaft, slotted 3/4" x 1/8" deep, extends 3/8" from bushing. Hexagon nut furnished. Use dial plate 34 B 622, listed below. Linear taper. Av. shpg. wt., 4 oz.

POTENTIOMETERS

No.	Type	Ohms	Amps	No.	Type	Ohms	Amps
29 M 720	C6P	6	.58	29 M 725	C40P	40	.22
29 M 721	C10P	10	.45	29 M 726	C50P	50	.22
29 M 722	C15P	15	.37	29 M 727	C100P	100	.14
29 M 723	C20P	20	.32	29 M 728	C200P	200	.1
29 M 724	C30P	30	.26	29 M 729	C400P	400	.07

NET EACH..... 97c

29 M 730. C1MP | 1000 | .045 | 29 M 731 | C3MP | 3000 | .025

NET EACH..... 1.09

29 M 732. C5MP | 5000 | .02 | 29 M 734. C10MP | 10000 | .014

29 M 733. C6MP | 6000 | .018 | 29 M 735. C15MP | 15000 | .011

NET EACH..... 1.29

RHEOSTATS

No.	Type	Ohms	Amps	No.	Type	Ohms	Amps
29 M 700	C6R	6	.58	29 M 704	C30R	30	.26
29 M 701	C10R	10	.45	29 M 705	C40R	40	.22
29 M 702	C15R	15	.37	29 M 706	C50R	50	.2
29 M 703	C20R	20	.32	29 M 707	C100R	100	.14

NET EACH..... 82c

34 B 622. Type 393 Dial Plate. For "C" controls. 2 oz. NET... 15¢

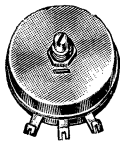

"E" WIREWOUND POTENTIOMETERS

Ruggedly constructed, heavy-duty, wire-wound potentiometers. Conservatively rated to dissipate 7 watts. For industrial, laboratory production control and research applications. Contact arm grounded to shaft. 295° effective electrical rotation. 2 5/8" dia. x 3 3/4" deep. 1/4" shaft slotted 3/4" x 1/8" deep, extends 1/2" from bushing. Mount in 3/8" hole. Hexagon nut furnished. Use dial plate 29 M 650, listed below. Linear taper. 6 oz.

No.	Type	Ohms	Amps	NET
29 M 480	E5MP	5000	.042	2.47
29 M 481	E10MP	10,000	.03	2.62
29 M 482	E20MP	20,000	.021	2.70
29 M 483	E25MP	25,000	.019	2.76
29 M 484	E50MP	50,000	.0135	2.79
29 M 485	E75MP	75,000	.011	2.88
29 M 486	E100MP	100,000	.009	2.94
29 M 487	E125MP	125,000	.0085	2.96
29 M 488	E150MP	150,000	.0078	3.00

29 M 650. Type 399 Dial Plate. For "E" Controls. 2 oz. NET... 15¢

SPEAKER CONTROLS

Constant-load attenuator pads. Widely used to control the level of low-impedance audio circuits in sound systems. Rated at 4 watts, continuous DC; 15 w. peak audio. Have 2" shafts. Bushing size: 3/8 x 3/8" diameter. Supplied with bar knob, 0-10 dial plate and wiring instructions. Av. shpg. wt., 7 oz.

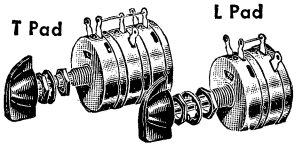

T Pad Attenuators. Present constant source impedance as well as constant load at all control settings. Size: 1 1/8" dia., 1 1/8" deep.

L Pad Attenuators. Present a constant load impedance at all control settings. Size: 1 1/8" dia., 1 1/8" deep.

Ohms	Stock No.	Type	Stock No.	Type
2	29 M 868	T2	29 M 883	L2
4	29 M 869	T4	29 M 884	L4
6	29 M 870	T6	29 M 885	L6
8	29 M 871	T8	29 M 892	L8
15	29 M 872	T15	29 M 886	L15
50	29 M 873	T50	29 M 887	L50
100	29 M 865	T100	29 M 920	L100
200	29 M 874	T200	29 M 888	L200
500	29 M 876	T500	29 M 889	L250
600	29 M 866	T600	29 M 890	L500
1000	29 M 867	T1000	29 M 921	L600
2000	29 M 877	T2000	29 M 922	L1000
3000	29 M 878	T3000	29 M 891	L2000
4000			29 M 923	L3000
			29 M 708	L4000

"T" Pads. NET EACH... 2.76 | "L" Pads. NET EACH... 2.44

VOLUME CONTROL ACCESSORIES

*Couples 1/4" shafts to 1/8" or 1/4" x 3/8" shafts. *Bushings for panel mounting. 1" extends beyond center of control 3/8" away from mounting surface. Av. shpg. wts.: Brackets, 3 oz.; shafts, couplers and bushings, 1 1/4 oz.



No.	Type	Fig.	Description	EACH
29 M 676	RB249	A	Mtg. bracket. Mtg. Ctrs. 2 1/2"	24¢
29 M 675	RB248	A	Mtg. bracket. Mtg. Ctrs. 1 1/4"	21¢
29 M 661	EB247†	C	Extender	18¢
29 M 665	178	E	Wrench for 1/2"-3/16" v.c. hex nuts	44¢
29 M 655	RS242	F	Ext. shaft, 4x1/4x1/2" flat.	56¢
29 M 656	RS243	F	Ext. shaft, 4x1/4x3/2" flat.	
29 M 657	RS244	F	Ext. shaft, 4x3/16x3/4" flat.	79¢
29 M 658	RS245	F	Ext. shaft, 2x1/4" with 3/32" slot.	
29 M 672	EC240*	B	Coupling	56¢
60 H 390	UB241‡	D	Bushing	9¢

G. W. BORG "MICROPOTS" AND "MICRODIALS"

Model 205 "Micropots." High-precision, turn linear potentiometers. Widely used in electronic instruments, industrial and aircraft controls, electronic computers, radar and sonar gear, etc. Resistance is directly proportional to the shaft rotation. Extremely high accuracy. Wire and terminals are imbedded firmly within the housing. Smooth action and low uniform torque. Anti-backlash spring in contact guide. Fine resolution. Mechanical and electrical rotation, 3600°. Linearity, 0.1%. Torque, not over 1.5 inch-oz. running; not over 3 inch-oz. starting. Power dissipation, 5 watts @ 40° Centigrade. Shaft extension length, 7/8". Life is more than 1 million revolutions. Av. shpg. wt., 1 1/2 lbs.

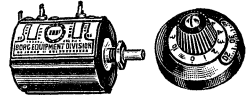

Stock No.	Ohms	Stock No.	Ohms	Stock No.	Ohms
29 M 680	100	29 M 683	5000	29 M 686	50K
29 M 681	500	29 M 684	10K	29 M 687	100K
29 M 682	1000	29 M 685	20K		

NET EACH..... 15.00

Ten-Turn "Microdials." For use with above. Have 2 concentrically mounted dials—one for counting increments of each turn and the other for counting turns. Built-in fingertip brake. May be locked in any position. For panels, parts for life against dust, dirt and moisture. Indexing chrome dial. Type 1327 has dull black cover and dull black dial. Overall diameter, 1 3/4". Overall depth, 1 3/8". Shpg. wt., 4 oz.

29 M 696. MODEL 1320. NET

29 M 697. MODEL 1327. EACH..... 5.85

MODEL 1307 DIRECT READING MICRODIAL

For use with Micropots listed above. Three digit readings allow extremely accurate indexing. Designed for rapid operation—may be hand or servo-operated at speeds up to 100 rpm. Rotation is continuous in either direction. Built-in, finger-tip brake—may be locked in any position. Designed for wide-angle reading. Rigid shaft connection eliminates possibility of backlash or lost motion. Knob is finished in black, with brake panel in satin chrome. Neoprene seal protects all working parts for life against dust, dirt and moisture. Indexing accuracy, 1 part in 1000. Size, 1 3/8 x 2" diameter. Shpg. wt., 4 oz.

29 M 678. NET..... 14.55

SELECTOHM POTENTIOMETER

100,000 ohm, 25 watt, calibrated, wire-wound potentiometer of laboratory quality. An ideal precision resistance substitute for use as a decade box, voltage divider or a bridge circuit component. Very useful for determining the value of a burned-out resistor. Dial calibrated in 200 divisions. 15.8 m capacity - 6" x 3 3/4". Shpg. wt., 2 lbs.

84 M 323. NET..... 9.80

Cornell-Dubilier Capacitors

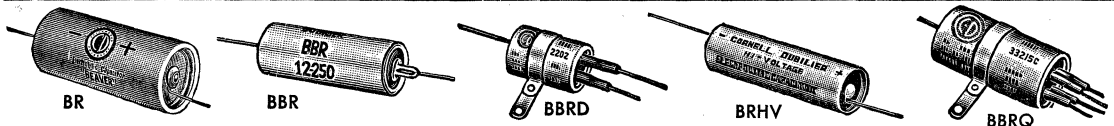

"BLUE BEAVER" TUBULAR ELECTROLYTICS

"Blue Beaver" tubular electrolytic capacitors are specifically designed for service replacement applications. All are sealed in aluminum cans for protection against heat and humidity. Have wax-impregnated cardboard outer sleeves. Single-section Type BR has solid, tinned-copper leads with negative terminal grounded to can. Type BBR is a miniature version of Type BR, for limited-space applications. Type BRHV is similar to Type

BR, but is designed for filter applications in higher-voltage power supplies. Surge voltage of Type BRHV is 150 volts above working voltage. Types BBRD, BBRQ, and BBRQ have 7" flexible vinyl covered leads with color coded positive and common negative. All "Blue Beavers" are rated for operation up to 85° C., except 500-volt types, which are for up to 65° C. Av. shpg. wt., 4 oz.

TYPE BR SINGLE SECTION

Radio and TV replacement units. Ideal for bypass, filter, etc. Hermetically sealed.

Stock No.	Type	Mfd	W.V.	Size	NET
19 L 285	500-6	500	6	1 1/2 x 1 1/2	.91
19 L 286	1000-6	1000	6	1 1/2 x 2 1/2	1.12
19 L 287	2000-6	2000	6	1 1/2 x 2 1/2	1.35
19 L 288	2500-6	2500	6	1 1/2 x 2 1/2	1.50
19 L 273	5001	500	15	1 1/2 x 2 1/2	1.03
19 L 274	10001	1000	15	1 1/2 x 2 1/2	1.35
19 L 284	20001	2000	15	1 1/2 x 2 1/2	1.88
19 L 270	2502	250	25	1 1/2 x 1 1/2	1.00
19 L 271	5002	500	25	1 1/2 x 2 1/2	1.35
19 L 147	1005	100	50	1 1/2 x 2 1/2	.82
19 L 148	1505	150	50	1 1/2 x 2 1/2	.91
19 L 149	2505	250	50	1 1/2 x 2 1/2	1.03
19 L 269	5005	500	50	1 1/2 x 2 1/2	1.41
19 L 272	2515	25	150	1 1/2 x 1 1/2	.73
19 L 045	3015	30	150	1 1/2 x 1 1/2	.76
14 L 046	4015	40	150	1 1/2 x 1 1/2	.79
14 L 047	5015	50	150	1 1/2 x 1 1/2	.82
14 L 046	6015	60	150	1 1/2 x 1 1/2	.86
14 L 039	8015	80	150	1 1/2 x 2 1/2	.94
14 L 056	10015	100	150	1 1/2 x 2 1/2	1.03
14 L 057	15015	150	150	1 1/2 x 3 1/2	1.12
14 L 033	1625	16	250	1 1/2 x 1 1/2	.76
14 L 034	2025	20	250	1 1/2 x 1 1/2	.79
19 L 142	3025	30	250	1 1/2 x 1 1/2	.85
14 L 035	4025	40	250	1 1/2 x 2 1/2	.91
19 L 143	5025	50	250	1 1/2 x 2 1/2	1.00
19 L 144	6025	60	250	1 1/2 x 2 1/2	1.06
19 L 021	835	8	350	1 1/2 x 1 1/2	.71
14 L 022	1235	12	350	1 1/2 x 1 1/2	.76
14 L 023	1635	16	350	1 1/2 x 1 1/2	.82
14 L 018	2035	20	350	1 1/2 x 1 1/2	.85
14 L 019	3035	30	350	1 1/2 x 2 1/2	.97
14 L 026	4035	40	350	1 1/2 x 2 1/2	1.03
19 L 141	5035	50	350	1 1/2 x 2 1/2	1.09
14 L 008	145	1	450	1 1/2 x 1 1/2	.65
14 L 009	245	2	450	1 1/2 x 1 1/2	.65
14 L 010	445	4	450	1 1/2 x 1 1/2	.68
14 L 011	845	8	450	1 1/2 x 1 1/2	.73
14 L 012	1045	10	450	1 1/2 x 1 1/2	.76
14 L 013	1245	12	450	1 1/2 x 1 1/2	.79
14 L 014	1645	16	450	1 1/2 x 2 1/2	.82
14 L 015	2045	20	450	1 1/2 x 2 1/2	.91
14 L 016	3045	30	450	1 1/2 x 2 1/2	1.00
14 L 017	4045	40	450	1 1/2 x 2 1/2	1.06
14 L 004	6045	60	450	1 1/2 x 2 1/2	1.38
14 L 005	8045	80	450	1 1/2 x 3 1/2	1.65
14 L 015	450	4	500	1 1/2 x 1 1/2	.71
14 L 016	850	8	500	1 1/2 x 1 1/2	.73
14 L 010	1250	12	500	1 1/2 x 2 1/2	.82
19 L 141	1650	16	500	1 1/2 x 2 1/2	.88
14 L 002	2050	20	500	1 1/2 x 2 1/2	.94
14 L 003	3050	30	500	1 1/2 x 2 1/2	1.03

TYPE BBR SINGLE SECTION

Miniaturized units for hearing aids, transistor radios, low-voltage circuits, etc. Hermetically sealed. Grounded negative lead.

Stock No.	Type	Mfd	W.V.	Size	NET
19 L 200	25-3	25	3	3/8 x 1 1/4	.50
19 L 201	6-5	50	5	3/8 x 1 1/4	.50
19 L 202	5-6	5	6	3/8 x 1 1/4	.47
19 L 203	25-6	25	6	3/8 x 1 1/4	.50
19 L 204	50-6	50	6	3/8 x 1 1/4	.56
19 L 205	100-6	100	6	3/8 x 1 1/4	.71
19 L 206	250-6	250	6	3/8 x 1 1/2	.79
19 L 207	100-15	100	15	3/8 x 1 1/2	.73
19 L 216	10-25	10	25	3/8 x 1 1/2	.59
19 L 217	20-25	20	25	3/8 x 1 1/2	.59
19 L 218	25-25	25	25	3/8 x 1 1/2	.59
19 L 219	50-25	50	25	3/8 x 1 1/2	.65
19 L 208	100-25	100	25	3/8 x 1 1/2	.79
19 L 209	1-50	1	50	3/8 x 1 1/2	.53
19 L 210	2-50	2	50	3/8 x 1 1/2	.53
19 L 211	4-50	4	50	3/8 x 1 1/2	.59
19 L 222	5-50	5	50	3/8 x 1 1/2	.59
19 L 223	10-50	10	50	3/8 x 1 1/2	.59
19 L 224	25-50	25	50	3/8 x 1 1/2	.62
19 L 212	10-90	10	90	3/8 x 1 1/2	.65
19 L 213	16-90	16	90	3/8 x 1 1/2	.65
19 L 214	4-150	4	150	3/8 x 1 1/2	.59
19 L 215	6-150	6	150	3/8 x 1 1/2	.59
19 L 226	10-150	10	150	3/8 x 1 1/2	.62
19 L 227	12-150	12	150	3/8 x 1 1/2	.65
19 L 248	16-150	16	150	3/8 x 1 1/2	.68
19 L 225	20-150	20	150	3/8 x 1 1/2	.71
19 L 227	4-250	4	250	3/8 x 1 1/2	.59
19 L 228	8-250	8	250	3/8 x 1 1/2	.68
19 L 229	12-250	12	250	3/8 x 1 1/2	.73

TYPE BBRD DUAL SECTION

Sealed in aluminum tube; wax-impregnated cardboard outer sleeve. Common negative lead.

Stock No.	Type	Mfd	W.V.	Size	NET
19 L 220	2202	20-20	25	1 1/2 x 1 1/2	.82
19 L 250	115	10-10	50	1 1/2 x 1 1/2	.82
19 L 251	2115	20-10	150	1 1/2 x 1 1/2	.91
19 L 252	2215	20-20	150	1 1/2 x 1 1/2	.97
19 L 253	3215	30-20	150	1 1/2 x 1 1/2	1.00
19 L 254	3315	30-30	150	1 1/2 x 1 1/2	1.06
19 L 255	4215	40-20	150	1 1/2 x 1 1/2	1.03
19 L 256	4315	40-30	150	1 1/2 x 2 1/2	1.06
19 L 257	4415	40-40	150	1 1/2 x 2 1/2	1.09
19 L 258	5315	50-30	150	1 1/2 x 2 1/2	1.15
19 L 259	5515	50-50	150	1 1/2 x 2 1/2	1.23
19 L 260	8415	80-40	150	1 1/2 x 2 1/2	1.32
18 L 609	0183.7	100-50	150	1 x 3	1.76
18 L 288	101015	100-100	150	1 1/2 x 3 3/8	1.88
18 L 610	0196	200-5	150	1 x 3 3/8	1.56
18 L 611	0576	60, 125, 200	250	1 x 3	1.91
19 L 289	8025	8-8	250	1 1/2 x 1 1/2	.94
19 L 261	16825	16-8	250	1 1/2 x 2 1/2	1.00
19 L 262	16025	16-16	250	1 1/2 x 2 1/2	1.06
19 L 263	2225	20-20	250	1 1/2 x 1 1/2	1.09
19 L 296	3325	30-30	250	1 1/2 x 2 1/2	1.32
19 L 294	74225	75-20	250	1 1/2 x 2 1/2	1.53
18 L 612	0242	30-10	250	1 x 3	1.50
18 L 613	0246	120-80	250	1 1/2 x 3 1/2	2.35
18 L 614	0286	150-100	300	1 1/2 x 3 1/2	3.09
18 L 615	0334	140-5	350	1 1/2 x 4 1/2	2.44
19 L 265	8045	8-8	450	1 1/2 x 1 1/2	1.00
19 L 266	16845	16-8	450	1 1/2 x 2 1/2	1.18
19 L 267	16045	16-16	450	1 1/2 x 2 1/2	1.32
19 L 268	2245	20-20	450	1 1/2 x 3 1/2	1.47
19 L 297	3345	30-30	450	1 1/2 x 3 1/2	1.76
19 L 291	4445	40-40	450	1 1/2 x 4 1/2	2.00
18 L 616	0646	20, 100, 450	250	1 x 2 1/2	1.29
18 L 617	0652	40, 50, 150	250	1 x 2 1/2	1.76
18 L 618	0702	80, 100, 450	250	1 1/2 x 3 1/2	1.68
18 L 619	0707	30, 50, 450, 200	1 1/2 x 2 1/2	1.68	

TYPE BBRQ TRIPLE SECTION

Stock No.	Type	Mfd	W.V.	Size	NET
19 L 230	22215	20-20-20	150	1 1/2 x 3 1/2	1.29
19 L 231	32215	30-30-30	150	1 1/2 x 3 1/2	1.38
19 L 232	33315	30-30-30	150	1 1/2 x 2 1/2	1.38
19 L 233	42215	40-20-20	150	1 1/2 x 1 1/2	1.32
19 L 234	43215	40-30-20	150	1 1/2 x 2 1/2	1.38
19 L 235	44215	40-40-20	150	1 1/2 x 2 1/2	1.38
19 L 236	44415	40-40-40	150	1 1/2 x 2 1/2	1.44
19 L 298	84215	80-40-20	150	1 1/2 x 3 1/2	1.62
18 L 620	0126.5	150-150-150	150	1 1/2 x 4 1/2	2.79
19 L 237	2215C	20-20-20	150, 25	1 1/2 x 1 1/2	1.21
19 L 238	3315C	30-30-20	150, 25	1 1/2 x 2 1/2	1.29
19 L 239	4215C	40-20-20	150, 25	1 1/2 x 1 1/2	1.26
19 L 240	4315C	40-30-20	150, 25	1 1/2 x 1 1/2	1.29
19 L 241	4415C	40-40-20	150, 25	1 1/2 x 2 1/2	1.29
19 L 242	4415X25	40-40-25	150, 10	1 1/2 x 2 1/2	1.53
19 L 243	5315C	50-30-20	150, 25	1 1/2 x 1 1/2	1.38
19 L 244	5515C	50-50-20	150, 25	1 1/2 x 1 1/2	1.42
19 L 299	5315C25	50-30-25	150, 25	1 1/2 x 3 1/2	1.87
19 L 245	8415C	80-40-20	150, 25	1 1/2 x 2 1/2	1.56
19 L 246	3215C10	30-20-100	150, 25	1 1/2 x 2 1/2	1.38
19 L 275	5315X20	50-30-200	150, 10	1 1/2 x 2 1/2	1.50
19 L 276	5315C10	50-30-100	150, 25	1 1/2 x 2 1/2	1.44
19 L 277	8215C10	80-20-100	150, 25	1 1/2 x 2 1/2	1.62
19 L 278	2225C	20-20-20	250, 25	1 1/2 x 2 1/2	1.32
19 L 279	4225C	40-20-20	250, 25	1 1/2 x 2 1/2	1.50
19 L 280	4425C	40-40-20	250, 25	1 1/2 x 2 1/2	1.71
19 L 281	74125	75-40-10	250	1 1/2 x 3 1/2	2.03
19 L 282	04185	40-40-40	300	1 1/2 x 3 1/2	2.70
18 L 622	0196	120-40-10	300	1 1/2 x 3 1/2	2.85
18 L 623	0733	80-10-100	300, 50	1 1/2 x 3 1/2	2.38
18 L 624	0235	60-60-5	350	1 1/2 x 3 1/2	2.50
18 L 625	0878	140-5, 200	350, 200	1 1/2 x 4 1/2	3.94
18 L 622	16745	16-16-16	450	1 1/2 x 3 1/2	1.82
19 L 283	2245C	20-20-20	450, 25	1 1/2 x 3 1/2	1.71
18 L 626	141	30, 50, 100	450, 150, 25	1 1/2 x 3	2.18
18 L 627	1238	5, 80-40	450, 400	1 1/2 x 3 1/2	2.68

TYPE BBRQ QUADRUPLE SECTION

Stock No.	Type	Mfd	W.V.	Size	NET
19 L 291	42215C	40-20-150	20, 25	1 1/2 x 2 1/2	1.68
19 L 292	52215C	50-30-150	20, 25	1 1/2 x 2 1/2	1.79
19 L 293	44315C	40-40-150	20, 25	1 1/2 x 2 1/2	1.76
19 L 294	55515C	60-50-150	20, 25	1 1/2 x 3 1/2	2.03
19 L 290	33215C	30-30-150	150, 25	1 1/2 x 2 1/2	1.71
18 L 620	0789.4	140-5, 200, 150	300		

Mallory Capacitors



FP AND WP ELECTROLYTIC CAPACITORS

For use in filter circuits, audio by-pass circuits and TV applications. Capacitors feature complete stability under heavy ripple current, high surge voltages and high temperatures. Units are encased in compact, rubber-sealed aluminum cases. FP types have the exclusive Mallory Fabricated Plates—anodes specially constructed of metalized cotton gauze. WP types have

etched-plate anodes. Special internal design lowers RF impedance and permits a minimum of coupling between plates. Up to 150 WVDC, capacity tolerance is -10% to +100%. Above 150 WVDC, tolerance is -10% to +50%. Can is negative except *. Insulating washer supplied. For mounting hardware, see page 138. Av. shpg. wt., 6 oz.

SINGLE SECTION

Stock No.	Mfr's Type	Mfd	DC Wkg. Volts	Size	NET EACH
18 L 471	FP171	10	500	1x2"	.94
18 L 472	FP173	20	500	1x2"	1.09
18 L 473	FP175	30	500	1x2 1/2"	1.18
18 L 474	FP177	40	500	1x3"	1.47
18 L 475	FP187	90	500	1 1/2x3"	2.06
17 L 360	FP142	10	450	3/4x2"	.91
17 L 364	FP143	15	450	1x2"	1.00
17 L 361	FP144	20	450	1x2"	1.06
17 L 367	FP145	30	450	1x2 1/2"	1.15
17 L 362	FP146	40	450	1x2 1/2"	1.21
18 L 469	FP148	60	450	1 1/2x2 1/2"	1.69
17 L 368	FP149	80	450	1 1/2x2 1/2"	1.75
18 L 470	FP150	100	450	1 1/2x3"	2.03
17 L 370	FP137	50	350	1x2 1/2"	1.23
18 L 468	FP137.4	50	350	1x3"	1.29
17 L 371	FP140	125	350	1 1/2x3"	2.32
18 L 465	FP128	80	300	1x3"	1.50
18 L 466	FP129.1	100	300	1x3"	1.71
18 L 467	FP131	150	300	1 1/2x3"	2.06
18 L 713	FP121	120	200	1 1/2x2"	1.38
17 L 372	FP115	50	150	1x2"	.97
17 L 373	FP116	100	150	1x2 1/2"	1.18
18 L 463	FP116.5	120	150	1x3"	1.21
17 L 799	FP117	150	150	1x3"	1.26
18 L 464	FP118	200	150	1 1/2x2 1/2"	1.44
17 L 836	FP119	300	150	1 1/2x3"	1.65
17 L 350	WP065	500	50	1 1/2x2"	1.56
17 L 258	WP068	1500	50	1 1/2x4"	2.26
17 L 257	WP052	40	25	3/4x2"	.79
18 L 350	WP027	50	25	1x2 1/2"	1.50
17 L 352	WP059	1000	25	1 1/2x2"	1.50
17 L 353	WP039	1000	15	1 1/2x2 1/2"	1.59
17 L 354	WP041	2000	15	1 1/2x2 1/2"	2.03
17 L 256	WP042	3000	15	1 1/2x3"	2.06

TRIPLE SECTION (cont'd)

Stock No.	Mfr's Type	Mfd	DC Wkg. Volts	Size	NET EACH
18 L 487	FP384.14	5-100-200	475-300-150	1 1/2x4"	3.03
17 L 857	FP377	40-40-40	450	1 1/2x4"	2.88
17 L 858	FP378	80-40-20	450	1 1/2x4"	3.18
17 L 665	FP375.8	10-10-10	450	1x2 1/2"	1.55
17 L 666	FP376.1	15-15-10	450	1x3"	1.33
17 L 667	FP376.3	20-10-10	450	1x3"	1.71
17 L 668	FP376.5	20-20-20	450	1 1/2x2 1/2"	2.12
17 L 669	FP376.8	40-40-10	450-450	1 1/2x3"	2.44
17 L 855	FP375	40-40-100	450-450-200	1 1/2x4"	2.91
17 L 853	FP366	20-10-50	450-450-50	1x3"	1.68
17 L 597	FP345.2	10-10-20	450-450-25	1x2"	1.41
17 L 598	FP345.5	15-15-40	450-450-25	1x2 1/2"	1.62
17 L 599	FP345.8	20-20-20	450-450-25	1x3"	1.79
18 L 444	FP346	20-40-10	450-450-25	1 1/2x3"	2.32
18 L 360	FP341	40-90-50	450-150-150	1 1/2x3"	2.35
18 L 486	WP334.6	20-500-500	450-25-25	1 1/2x3"	3.15
18 L 717	FP333.85	100-10-80	400-400-350	1 1/2x4"	3.59
18 L 485	FP332.4	100-100-10	350	1 1/2x4"	4.00
17 L 428	FP330.5	10-10-10	350	1x2"	1.41
17 L 429	FP330.7	30-20-10	350	1x3"	1.91
17 L 427	FP330.3	20-10-5	350-350-250	1x2"	1.50
18 L 718	FP330.23	40-30-400	350-350-50	1 1/2x4"	3.32
17 L 719	FP329.1	20-40-150	350-350-25	1x2 1/2"	1.53
18 L 484	FP329.5	20-20-20	350-350-25	1x2"	1.65
17 L 386	FP328	15-10-20	350-350-25	1x2"	1.87
17 L 346	FP331	30-30-20	350-300-25	1x3"	1.85
18 L 720	FP326.74	140-10-200	300-300-150	1 1/2x4"	3.23
18 L 721	FP326.7	140-100-60	300-300-50	1 1/2x4"	3.50
17 L 846	FP335	100-60-20	300-250-250	1 1/2x3"	2.88
18 L 483	FP326.3	100-200-60	300-150-150	1 1/2x4"	3.20
17 L 425	FP320	40-20-20	250	1 1/2x2"	1.94
17 L 358	FP319	80-40-20	250-150-50	1 1/2x2 1/2"	1.71
17 L 289	FP311.2	20-20-20	150	1x2"	1.35
17 L 337	FP311.4	40-20-20	150	1x2 1/2"	1.41
17 L 338	FP311.5	40-40-40	150	1x3"	1.53
18 L 722	FP311.66	70-15-15	150	1x2 1/2"	1.59
17 L 339	FP311.7	80-40-20	150	1 1/2x2"	1.71
17 L 340	FP311.9	120-120-40	150	1 1/2x3"	2.38
17 L 787	FP306	40-20-20	150-150-25	1x2"	1.35
17 L 788	FP307	40-20-20	150-150-25	1x2 1/2"	1.47
17 L 768	FP310	40-40-20	150-150-25	1x2 1/2"	1.41
17 L 438	FP309	50-30-10	150-150-25	1x2 1/2"	1.59
17 L 344	FP311	50-50-20	150-150-25	1x3"	1.56
17 L 844	FP314	40-40-20	150-150-25	1x3"	1.65
18 L 723	FP302.5	80-60-250	150-150-10	1x2 1/2"	2.00
17 L 357	WP520	40-40-40	25	1x2"	1.26
18 L 724	WP300	20-500-1000	16	1 1/2x2"	2.47

QUADRUPLE SECTION

Stock No.	Mfr's Type	Mfd	DC Wkg. Volts	Size	NET EACH
18 L 462	FP495	40-40-8-8	500	1 1/2x4"	3.35
18 L 459	FP474.5	20-20-10-10	475	1 1/2x2 1/2"	2.56
18 L 460	FP475	20-20-20-20	475	1 1/2x3"	3.06
18 L 461	FP475.5	40-10-10-10	475	1 1/2x3"	2.73
18 L 462	FP474	10-10-10-10	450	1 1/2x3"	2.06
17 L 984	FP476	40-10-10-10	475	1 1/2x3"	3.00
18 L 369	FP456	25-20-40-100	475-450-300-50	1 1/2x3"	2.91
18 L 725	FP451.3	10-14-140-100	475-300-300-50	1 1/2x4"	3.20
17 L 422	FP434	10-10-10-10	450	1 1/2x2"	1.97
17 L 423	FP444	20-20-20-20	450	1 1/2x3"	2.76
17 L 893	WP433.6	5-5-5-5	450	1 1/2x2"	1.76
17 L 894	FP434.5	20-10-10-10	450	1 1/2x2"	2.18
17 L 896	FP444.8	30-30-20-20	450	1 1/2x3"	3.06
17 L 897	FP445	35-35-10-10	450	1 1/2x3"	2.70
17 L 899	FP447	40-40-20-20	450	1 1/2x4"	3.26
17 L 887	FP430.2	40-20-20-25	450-450-450-25	1 1/2x3"	2.70
17 L 872	FP436	40-20-20-40	450-450-450-25	1 1/2x3"	2.73
17 L 449	FP429	40-30-10-20	450-450-450-25	1 1/2x3"	2.65
17 L 888	FP430.6	40-40-40-40	450-450-450-25	1 1/2x4"	3.23
17 L 886	FP428.4	40-40-30-30	450-450-350-350	1 1/2x4"	3.47
17 L 885	FP427.5	10-10-60-100	450-450-200-50	1 1/2x2 1/2"	2.26
17 L 834	FP413X	40-40-40-20	450-450-25-25	1 1/2x2"	2.03
18 L 726	FP420.7	100-10-30-20	450-300-300-150	1 1/2x3"	3.00
18 L 494	FP420.45	40-80-100-25	400-350-200-50	1 1/2x4"	3.56
18 L 727	FP420.33	30-10-5-100	350-350-350-200	1 1/2x2 1/2"	2.59
18 L 493	FP420.28	140-20-10-100	350-350-350-50	1 1/2x4"	3.56
18 L 492	FP419.87	40-20-20-50	350-350-350-25	1 1/2x2 1/2"	2.50
18 L 365	FP419.3	40-40-20-20	350-350-350-25	1 1/2x3"	3.93
18 L 258	FP419.67	60-100-60-140	300-350-200-75	1 1/2x3"	3.25
18 L 491	FP419.65	160-60-10-14	305-300-300-300	1 1/2x4"	3.76
18 L 490	FP419.55	200-20-20-20	300	1 1/2x4"	3.79
18 L 489	FP419.37	150-30-30-150	300-300-300-50	1 1/2x4"	3.59
18 L 729	FP418.7	140-10-10-100	300-300-150-50	1 1/2x4"	3.91
17 L 868	FP419	200-10-100-20	300-250-50-25	1 1/2x4"	2.41
17 L 746	FP412.2	40-40-50-80	250-250-150-50	1 1/2x2 1/2"	2.41
17 L 730	FP412	100-80-60-40	150-150-150-75	1 1/2x3"	2.73
18 L 730	FP411.8	200-200-100-10	150-150-150-25	1 1/2x4"	3.50
17 L 447	FP409	40-40-30-20	150-150-150-25	1 1/2x2"	1.82
18 L 488	FP409.6	50-10-40-50	150-150-150-25	1 1/2x2"	1.85
17 L 716	FP409.4	50-20-20-20	150-150-150-25	1 1/2x2"	2.06
18 L 362	FP410	50-50-20-20	150-150-150-25	1 1/2x2 1/2"	2.09
17 L 717	FP411	80-40-30-100	150-150-150-25	1 1/2x2 1/2"	2.18
17 L 718	FP411.3	80-40-40-20	150-150-150-25	1 1/2x2 1/2"	2.06
17 L 729	FP411.7	125-125-40-100	150-150-150-25	1 1/2x4"	2.85
17 L 715	FP408	60-40-20-20	150-150-150-10	1 1/2x2"	2.03
17 L 714	FP405	20-20-160-40	150-150-25-25	1 1/2x2"	1.88

TRIPLE SECTION

Stock No.	Mfr's Type	Mfd	DC Wkg. Volts	Size	NET EACH
17 L 713	FP398	10-40-40	500-450-450	1 1/2x3"	2.44
17 L 864	FP394	10-10-10	475	1x3"	1.59
17 L 865	FP396	30-30-20	475	1 1/2x3"	2.62
17 L 698	FP396.2	40-10-10	475	1 1/2x2 1/2"	2.26

Centralab Ceramic Capacitors

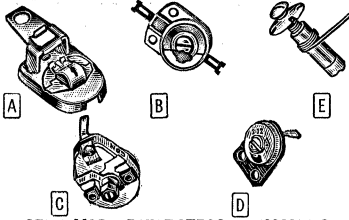

CERAMIC—DIELECTRIC TRIMMERS

Full capacity range with 180° rotation. 600 working v. DC. Power factor less than 0.2% at 1 mc. Type numbers followed by N indicate negative temperature coefficient; Z, zero temp. coef. Silver stator and rotor fired to ceramic. Av. shpg. wt., 1 oz.

A Type 820. Ceramic base. $\frac{5}{16} \times 2 \frac{1}{2} \times 2 \frac{1}{2}$ "

No.	Type	Mmf	1-24, EA.	25-49, EA.
L 381	820-D	1-3.5	7lc	59c
L 382	820-A	2.5-6		
L 383	820-B	5-20		
L 384	820-C	7-35		

B Type 822. Steatite base. $2 \frac{7}{32} \times 2 \frac{1}{2} \times 2 \frac{1}{2}$ "

No.	Type	Mmf	1-24, EA.	25-49, EA.
L 123	822-AN	8-50	88c	73c
L 124	822-BN	7-45		
L 125	822-CN	4.5-25		
L 127	822-AZ	4.5-25	88c	73c
L 128	822-BZ	2.5-13		
L 129	822-CZ	2-7.5		

C Type 823. Steatite base. $1 \frac{1}{2} \times 1 \frac{1}{2} \times 2 \frac{1}{2}$ "

No.	Type	Mmf	1-24, EA.	25-49, EA.
L 510	823-AN	20-125	2.06	1.71
L 511	823-BN	10-100		
L 512	823-DN	8-50		
L 513	823-AZ	12-60		
L 514	823-BZ	10-50		
L 515	823-DZ	6-25		

D Type 827. Phenolic base. $1 \frac{7}{8} \times 3 \frac{3}{4}$ "

No.	Type	Mmf	1-24, EA.	25-49, EA.
L 516	827-A	2.5-7	73c	61c
L 517	827-B	3.5-12		
L 518	827-C	6-30		
L 519	827-D	7-35		

E Type 829. Tubular ceramic. $\frac{7}{32} \times 3 \frac{3}{4}$ "

No.	Type	Mmf	1-24, EA.	25-49, EA.
L 400	829-3	5-3	29c	25c
L 401	829-4	1-4	29c	25c
L 402	829-6	1-6	29c	25c
L 403	829-7	1-7.5	35c	29c
L 404	829-10	1.5-10	35c	29c

CERAMIC CAPACITOR KITS

200 assorted capacitors in 4-drawer steel cabinet. All popular values—quantity of each value is selected according to the frequency of use. All capacitors are in clearly marked envelopes. Listing shows the types and quantity included in each kit. Cabinet size, \$8 6x6x4". All are 1000 WVDC, except *600 WVDC. Shpg. wt., 8 lbs.

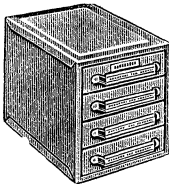

Mmf	DK	DDK	MDK	Mmf	DK	DDK	MDK
3.3	5	5	5	270	5	5	5
* 5	5	5	5	330	5	5	5
10	* 5	5	5	390	* 5	5	5
15	* 5	5	5	470	* 5	5	5
20	5	5	5	500	15	10	10
25	* 5	5	5	680	* 5	5	5
33	* 5	5	5	800	...	5	5
47	* 5	5	5	820	...	5	5
50	* 5	5	5	1000	15	10	10
56	* 10	10	10	1500	10	10	10
75	* 5	5	5	2000	* 5	5	5
100	* 15	10	10	2500	...	5	5
200	* 5	5	5	3300	...	5	5
150	* 5	5	5	4700	* 5	5	5
180	* 5	5	5	5000	* 15	15	10
220	* 5	5	5	10000	* 15	15	10
250	* 10	10	10	20000	...	5	5

DK-200 Kit. 200 Type D6, ceramic tubular capacitors. 27 values, 5-10,000 mfm.
58 L 451 Kit. List, \$40.00. **NET..... 23.52**
DDK-200 Kit. 200 Type DD, ceramic disc capacitors. 30 values, 3.3-20,000 mfm.
58 L 453 Kit. List, \$40.00. **NET..... 23.52**
MDK-200 Kit. 200 Type MD, molded disc ceramic capacitors. 32 values, 5-10,000 mfm.
58 L 452 Kit. List, \$50.00. **NET..... 29.40**

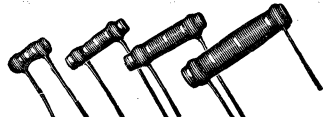

BC TUBULAR D-6 HI-KAPS

Compact, moisture-proof Hi-Kaps for use in bypass and coupling circuits. High mechanical strength plus small size—ideal replacements for mica and paper capacitors. Ceramic construction assures long life—withstanding vibration and high temperatures. Leads are 1 1/2" long. 600 wkg. v. DC. 1500 v. flash test. Tolerance: ±10%, except § ±20%; *Guaranteed minimum value. Av. shpg. wt., 2 oz.

Stock No.	Type	Mmf	Size
L 545	030	3	1/4 x 1/2"
L 546	050	5	
L 547	100	10	
L 548	120	12	
L 549	150	15	
L 550	180	18	
L 551	200	20	
L 552	220	22	
L 553	250	25	
L 554	270	27	
L 555	330	33	
L 556	390	39	
L 557	470	47	
L 558	500	50	
L 559	560	56	
L 560	680	68	
L 561	750	75	
L 562	820	82	
L 563	910	91	
L 564	101	101	
L 565	121	120	
L 566	151	150	
L 567	181	180	
L 568	201	200	
L 569	221	220	
L 570	251	250	
L 571	271	270	
L 572	301	300	
L 573	331	330	
L 574	391	390	
L 575	401	400	
L 576	471	470	
L 577	501	500	
L 578	561	560	
L 579	601	600	
L 580	681	680	
L 581	751	750§	
L 582	821	820§	
L 583	102	1000§	
L 584	122	1200§	
L 585	152	1500§	
L 586	182	1800§	
L 587	202	2000§	
L 588	222	2200§	
L 589	252	2500§	
L 590	272	2700§	
L 591	302	3000§	
L 592	332	3300§	
L 593	402	4000§	
L 594	472	4700§	
L 595	502	5000§	
L 596	562	5600§	
L 597	682	6800§	
L 598	752	7500§	
L 599	103	10,000§	

1 to 24, EACH..... 12c
 25 to 49, EACH..... 10c



FEED-THRU HI-KAPS

Tiny ceramics, designed for single-hole mounting. Permit convenient feeding of leads through chassis or shields and at the same time provide exceptionally effective RF by-passing. Special construction virtually eliminates lead inductance. Ratings, 500 WVDC. FT has 12-28 mounting nut; MFT has 1/4" dia. flange, mounts in 5/8" dia. hole and is attached by soldering to chassis. Tolerance: *±20%; -20 to +50%; § ±10%; *guaranteed minimum value. Av. shpg. wt., 2 oz.

No.	Type	Mmf	1-24, EA.	25-49, EA.
L 390	FT-500	* 500	59c	49c
L 391	FT-1000	*1000		
L 392	FT-1500	*1500		
L 393	FT-1800	*1800		
L 394	FT-2300	†2300		

No.	Type	Mmf	1-24, EA.	25-49, EA.
L 488	MFT-50	§ 50	29c	24c
L 489	MFT-100	§ 100		
L 490	MFT-500	§ 500		
L 491	MFT-1000	§ 1000		

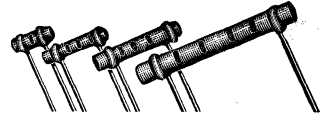

TYPE TC TEMPERATURE COMPENSATING CAPACITORS

Comply with JAN-C-20A specs. Type TCZ is negative-positive-zero (NPO); capacity remains essentially constant over a wide temperature range (-20° C. to +85° C.). Type TCN changes capacity with temperature and has a negative coefficient; N750, or 750 parts/million/°C. A variety of other coefficients may be achieved by hooking up both types in parallel. DC voltage rating, 600; surge, 1200. *Tolerance. Av. shpg. wt., 2 oz.

TC CAPACITOR SIZES

TYPE TCZ		TYPE TCN	
Cap. Mmf	Size	Cap. Mmf	Size
0.5 to 24	1/2 x 3/8"	3.3 to 62	1/2 x 3/8"
25 to 56	1/2 x 1 1/8"	68 to 160	1/2 x 1 1/8"
62 to 100	1 5/8 x 1 1/8"	180 to 270	1 5/8 x 1 1/8"
110 to 150	3/32 x 1 1/4"	300 to 430	3/32 x 1 1/4"
160 to 300	9/32 x 1 1/8"	470 to 750	9/32 x 1 1/8"

TYPE TCZ NEGATIVE-POSITIVE-ZERO (NPO)

No.	Mmf	Tol.*	No.	Mmf	Tol.*
L 200	.5	±.25 mmf	L 221	.47	±2%
L 201	.68		L 493	.50	
L 202	1.0		L 222	.51	
L 203	1.5		L 223	.56	
L 204	2.2	L 224	.62		
L 205	3.3	L 225	.68		
L 206	4.7	±.5 mmf	L 226	.75	
L 207	6.8		L 227	.82	
L 208	10		L 228	.91	
L 209	12		L 229	1.00	
L 210	15	L 230	1.10		
L 211	18	L 231	1.20		
L 212	20	L 232	1.30		
L 213	22	±2%	L 233	1.50	
L 214	24		L 234	1.60	
L 215	25		L 235	1.80	
L 215	27		L 236	2.00	
L 216	30	L 237	2.20		
L 217	33	L 238	2.40		
L 218	36	L 239	2.70		
L 219	39	L 240	3.00		
L 220	43				

1 to 24, NET EACH..... 29c
 25 to 49, EACH..... 25c

TYPE TCN—NEGATIVE (N750)

No.	Mmf	Tol.*	No.	Mmf	Tol.*
L 241	5	±.5 mmf	L 270	.91	±2%
L 250	10		L 271	1.00	
L 251	12	±2%	L 272	1.10	
L 252	15		L 273	1.20	
L 253	18		L 274	1.30	
L 254	20		L 275	1.50	
L 255	22		L 276	1.60	
L 256	24		L 277	1.80	
L 257	25		L 278	2.00	
L 257	27		L 279	2.20	
L 258	30		±5%	L 280	2.40
L 259	33			L 281	2.70
L 260	36	L 282		3.00	
L 261	39	L 283		3.30	
L 262	43	L 284		3.60	
L 263	47	L 285		3.90	
L 264	51	L 286		4.30	
L 264	51	L 287		4.70	
L 265	56	L 288		5.10	
L 266	62	L 289		5.60	
L 267	68	L 290	6.20		
L 268	75	L 291	6.80		
L 269	82	L 292	7.50		

1 to 24, NET EACH..... 29c
 25 to 49, EACH..... 25c

DF FLAT PLATE HI-KAPS

For use as bypass and filter capacitors. Unusually thin. 600 working volts DC; 1200 volts DC test. Tolerance, guaranteed minimum value except *±80%, -20%. Size of DF-104, DF-105, 1 1/2 x 1 1/8 x 1/8". Size of DF-503, DF-403, DF-303, 1 1/4 x 1 1/8 x 1/4". Shpg. wt., 3 oz.

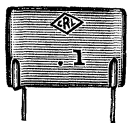

No.	Type	Mmf	1-24, EA.	25-49, EA.
L 245	DF-104*	.1	47c	39c
L 246	DF-753	.075	47c	39c
L 247	DF-503	.05	41c	34c
L 248	DF-403	.04	41c	34c
L 249	DF-303	.03	41c	34c

Ceramic Capacitors & Modules



CENTRALAB TYPE MD MOLDED DISC CERAMIC HI-KAPS

Low-inductance molded discs for bypass, coupling and general applications in high-frequency circuits. Completely insulated with "Centratheene." Electrical properties constant to 3000 mc. Insulation resistance, 300,000 megohms. Breakdown voltage to ground, 3000 volts DC. Can be placed against chassis or next to high-voltage leads without danger of flashover or breakdown. Capacity, tolerance and voltage ratings labeled on each unit. Fungus resistant. Will not become brittle at -55° C. Unaffected by ozone, salt water or any solvent at room temperature. 100% flash tested at double rated voltage. For operation to 85° C. Values to .005 mfd. rated 1000 WVDC; others rated 600 WVDC. No. 22 tinned copper leads, 1 1/2" long. Tolerance, 10% except *20%; †20%; ‡+80%. †GMV (guaranteed minimum value). Size: values through 2000 mfd., 1/2" dia. 3/4"; 2200 mfd. and over, 1 1/4" dia. x 3/4". Av. shgp. wt., 2 oz.

Stock No.	Mfr. Type	Mfd.	Stock No.	Mfr. Type	Mfd.
L 300	050	.000005	L 327	391	.00039
L 301	100	.00001	L 328	401	.0004
L 302	120	.000012	L 329	471	.00047
L 303	150	.000015	L 330	501	.0005
L 304	180	.000018	L 331	561	.00056
L 305	200	.00002	L 332	601	.0006
L 306	220	.000022	L 333	681	.00068
L 307	250	.000025	L 334	751	.00075
L 308	300	.00003	L 335	820	.00082
L 309	330	.000033	L 336	102	.00102
L 310	390	.000039	L 337	122	.00122
L 311	470	.000047	L 338	152	.00152
L 312	500	.00005	L 339	182	.00182
L 313	560	.000056	L 340	202	.00202
L 314	680	.000068	L 341	222	.00222
L 315	750	.000075	L 342	252	.00252
L 316	820	.000082	L 343	272	.00272
L 317	101	.0001	L 344	302	.00302
L 318	121	.00012	L 345	332	.00332
L 319	151	.00015	L 346	402	.00402
L 320	181	.00018	L 347	472	.00472
L 321	221	.00022	L 348	502	.00502
L 322	221	.00022	L 349	562	.00562
L 323	251	.00025	L 350	682	.00682
L 324	271	.00027	L 351	752	.00752
L 325	301	.0003	L 352	103	.0103
L 326	331	.00033			

1 to 24, NET EACH.....15c
25 to 49, EACH.....12c

CENTRALAB HI-KAP KITS

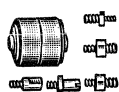

TYPE TV-207. Highly efficient, universal-type high-voltage capacitor kit. Ideal for television receiver applications. Provides maximum coverage with a minimum of inventory—excellent for service shops. Kit consists of 1 Type TV-20 "Hi-Vo Kap" ceramic capacitor and complete set of attachable terminals. Capacitor is rated 500 mfd at 20,000 working volts DC. Terminal set has 1 each—slotted rod, 3/8" thread short male and 3/4" long male; 2 each 3/8" thread female tap and 3/4" male thread. Terminals set without air gap—eliminates internal corona. Shgp. wt., 5 oz.

|| L 016, NET.....1.09
TVK-5-50. Larger version of above. Contains 5 TV-20 "Hi-Vo Kaps" and 50 terminals (10 each, of 5 types). Shgp. wt., 1 lb.
|| L 017, NET.....5.39

850S HIGH-VOLTAGE CERAMICS



High-quality ceramic capacitors for RF power circuits. Designed for transmitters, induction heaters, diathermy units, and similar applications. Has negative temperature coefficient of 750 parts/million/°C., except *zero temperature coefficient. Contains silver electrodes fired to ceramic. Low power factor. =10% tolerance. With 6-32 mounting screw, 3/8x1/4" dia. (†Type 858S, same size and style, HI-K dielectric =20% tolerance). Av. shgp. wt., 2 oz.

Stock No.	Mfr's Type	Mmf.	WVDC
L 100	850S-25Z	25*	7500
L 101	850S-50Z	50*	7500
L 102	850S-50N	50	7500
L 103	850S-75N	75	7500
L 104	850S-100N	100	5000
L 107†	858S-500	500	5000
L 108†	858S-1000	1000	5000

1 to 4, NET EACH.....2.65
5 to 9, EACH.....2.38
10 to 24, EACH.....2.20

CENTRALAB DD DISC CERAMICS



Rugged disc ceramic capacitors. Excellent for bypass-coupling in high-frequency circuits. All are rated 1000 working volts DC; except †600 volts. Sizes range from 1/4" to 3/4" dia. Tolerance =20% except †±.5 mmf, *±10% and ‡GMV (guaranteed minimum value). **±20%, †80%. All units are U.L. Approved for AC lines except †. Av. shgp. wt., 2 oz.

No.	Type	Mmf.	Av.	Type	Mmf.
L 406	3R3†	3.3	L 428	301	300
L 407	050†	5	L 429	331	330
L 520	060†	6	L 533	351	350
L 408	6R8†	6.8	L 534	361	360
L 521	7R5†	7.5	L 430	391	390
L 522	080†	8	L 535	401	400
L 409	100†	10	L 431	471	470
L 523	120†	12	L 432	501	500
L 410	150†	15	L 433	561	560
L 524	180†	18	L 536	601	600
L 411	200†	20	L 434	681	680
L 525	220†	22	L 435	751	750
L 526	240†	24	L 436	801	800
L 527	250†	25	L 537	821	820
L 412	270†	27	L 437	102	1000
L 528	300†	30	L 538	122	1200
L 413	330†	33	L 539	132	1300
L 414	390†	39	L 543	152	1500
L 415	470†	47	L 540	162	1600
L 416	500†	50	L 541	182	1800
L 417	560†	56	L 439	202	2000
L 418	680†	68	L 542	222	2200
L 419	750†	75	L 543	252	2500
L 529	820†	82	L 544	272	2700
L 530	910†	91	L 440	302	3000
L 420	101*	100	L 600	332	3300
L 421	121*	120	L 601	332	3900
L 422	131*	130	L 602	402	4000
L 423	151*	150	L 603	432	4300
L 423	181*	180	L 441	472	4700
L 424	201*	200	L 037	502S	5000
L 425	221	220	L 604	562S	5600
L 532	241	240	L 605	682S	6800
L 426	251	250	L 606	752S	7500
L 427	271	270	L 455	103S	10,000

1 to 24, NET EACH.....12c
25 to 49, EACH.....10c

No.	Type	Mmf.	No.	Type	Mfd
L 106	1032	.01	L 042	2033	.02
L 442	5022	.005			

1 to 24, NET EACH.....18c
25 to 49, EACH.....15c

DD16 1600 VOLTS BUFFER CAPACITORS

No.	Type	Mfd.	1-24, EA.	25-49, EA.
L 456	302S	.003		
L 370	402S	.004		
L 371	502S	.005		
L 372	602S	.006	21c	18c
L 457	702S	.007		
L 373	752S	.0075		
L 374	802S	.008		
L 375	103S	.01		
L 376	153**	.015	35c	29c

TYPE DD30 3000 VOLTS

No.	Type	Mmf.	No.	Type	Mmf.
L 607	250	25	L 617	221	220
L 608	390	39	L 618	251	250
L 609	470	47	L 619	271	270
L 610	500	50	L 620	471	470
L 611	560	56	L 621	501	500
L 612	680	68	L 622	102	1000
L 613	820	82	L 623	152	1500
L 614	101	100	L 624	202	2000
L 615	151	150	L 625	302	3000
L 616	181	180	L 626	502	5000

1 to 24, NET EACH.....24c
25 to 49, EACH.....20c

TYPE DD60 6000 VOLTS

No.	Type	Mmf.	No.	Type	Mmf.
L 462	250	25			
L 466	390	39			
L 467	470	47			
L 468	500	50			
L 469	560	56			
L 470	680	68			
L 472	820	82			
L 473	101	100			
L 474	151	150			
L 476	181	180			
L 478	221	220			
L 479	251	250			
L 480	271	270			
L 485	471	470			
L 486	501	500			
L 445	102	1000			
L 447	152	1500			
L 448	202	2000			

1 to 24, NET EACH.....29c
25 to 49, EACH.....24c

CENTRALAB LOW-VOLTAGE CAPACITORS

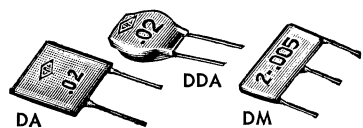

New, extremely compact high-capacity low-voltage ceramic capacitors. Designed especially for transistor circuits and other subminiature applications. Ideal for use in coil assemblies, pocket radios, hearing aids, and portable or airborne equipment, etc.—wherever space is at a premium. Ruggedly constructed to resist effects of heat, moisture, and vibration. Type DA is 1/2x1/2x3/16" thick; capacity tolerance is -20%, +100%; all units are rated at 30 WVDC. Type DDA is 3/4" diameter x 3/16" thick; capacity tolerance is -30%, +80%; all units are rated at 75 WVDC. Type DM is 1/2x3/8x3/16" thick; capacity tolerance is *-20% +50% and †-20% +80%; all units are rated at 150 WVDC. Av. shgp. wt., 2 oz.

TYPE DA			NET EACH	
Stock No.	Mfr's Type	Mfd.	1-24	25-49
L 627	203	.02	24c	20c
L 628	503	.05	38c	31c
L 629	104	.1	56c	47c

TYPE DDA				
L 630	503	.05	29c	24c
L 631	104	.1	53c	44c

TYPE DM				
L 632	101*	.0001	21c	17c
L 634	201*	.0002	21c	17c
L 634	301*	.0003	21c	17c
L 635	501*	.0005	21c	17c
L 636	102*	.001	21c	17c
L 637	202*	.002	26c	22c
L 638	302†	.003	26c	22c
L 639	502†	.005	26c	22c
L 640	103†	.01	38c	32c
L 641	2-502†	2x.005	38c	32c

AEROVOX STANDARD CIRCUIT MODULES

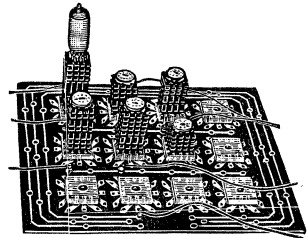

Modules are an entirely new concept in electronic circuitry assembly! They are complete and extremely compact standard basic circuits consisting of miniaturized components including capacitors, resistors, etc. mounted on stacked wafers. Will save hours of time and effort for design engineers and others who require basic circuit elements for quick production and testing of prototype and experimental electronic developments. They eliminate the need for designing, building and bother of setting up such circuits. Easily inserted into breadboard; can be conveniently moved about or removed when needed. Av. shgp. wt., 1 lb.

No.	Type	Description	NET
12 L 676	P1001	Video Limiter	8.08
12 L 677	P1002	Low-Level Cathode Follower	7.74
12 L 678	P1003	Dual Cathode Follower	8.08
12 L 679	P1004	Cascade Intermediate Video Amplifier	10.39
12 L 680	P1005	Triode Video Driver Amplifier	12.89
12 L 681	G1001	PRF Multivibrator	5.00
12 L 682	R1001	DC Regulator = 300 v.	20.68
40 H 404	MBB-12	12-Pin. Breadboard Phenolic Socket	17.64
40 H 405	MBB-1		1.47
12 L 683	A1001	Low-Level Lin. Amp.	5.15
12 L 684	A1002	Inter. Lin. Amp.	5.15
12 L 685	A1003	Phase Inverter-Driver Linear Amplifier Flip-Flop, 1 Meg.	4.16
12 L 686	C1002		14.26
12 L 687	P1006	Dual High-Level Cathode Follower	5.29
12 L 688	R1002	DC Regulator = 150v.	10.49
12 L 689	T1001	VTD Multivibrator	8.59
12 L 690	T1002	Phantastron Delay	5.00

Aerovox Module Catalog. 37 L 136, Free with your Next Order.

Printed Circuits and Capacitor Hardware

SPRAGUE BULPLATE PRINTED CIRCUITS



The new, quality-constructed line of Sprague Bulplate printed circuits offers the radio-television serviceman a time-saving electronic aid. Each printed circuit unit consists of a self-contained, extremely compact "package" containing capacitors, resistors and, in certain units, inductance. With these units, there is no need to waste time on excessive wiring and unwiring operations or in tracing circuitry for faulty components—simply replace the entire circuit section with a Bulplate unit.

A moisture sealed, shock-resistant ceramic base firmly holds the printed circuit wiring and all components in place. Capacitors are rated at 500 v. DC, 1000 v. test, while the maximum voltage to be applied across the resistors is 250 v. DC; except D-C where all elements are rated at 100 v. DC. Av. shpg. wt., 2 oz.

18 L 860. New Printed Circuit Guide No. K-350. An informative catalog listing complete information on Sprague's Bulplate printed circuits. Contains diagrams of all circuits listed below. Includes replacement information on sets produced by leading radio and television manufacturers. **NO CHARGE** when requested with your next order.

Stock No.	Mfr's Type	Description	NET EA.
18 L 861	D-1	Diode Filter	.35
18 L 862	D-2	Diode Filter	.35
18 L 863	D-3	Diode Filter	.35
18 L 864	DP-1	Detector Pentode Coup.	.73
18 L 865	DT-1	Audio Output	.59
18 L 866	DT-2	Audio Output	.68
18 L 867	DT-3	Audio Output	.59
18 L 868	DT-4	Audio Output	.68
18 L 869	DT-5	Audio Output	.68
18 L 870	DT-6	Audio Output	.68
18 L 871	F-1	Decoupling Filter	.50
18 L 872	F-2	Decoupling Filter	.50
18 L 873	P-1	Pentode Coupling	.53
18 L 874	P-2	Pentode Coupling	.53
18 L 875	P-3	Pentode Coupling	.59
18 L 876	PB-1	Special	.44
18 L 877	PB-2	Special	.44
18 L 878	PB-3	Special	.44
18 L 879	PB-4	Special	.59
18 L 880	ST-1	Sync Takeoff Network	.73
18 L 881	ST-2	Sync Takeoff Network	.73
18 L 882	ST-3	Sync Takeoff Network	.73
18 L 882	T-1	Triode Coupling	.44
18 L 883	T-2	Triode Coupling	.44
18 L 884	T-3	Triode Coupling	.41
18 L 885	T-4	Triode Coupling	.41
18 L 886	T-5	Triode Coupling	.44
18 L 887	V-1	Vertical Integrator	.65
18 L 888	V-2	Vertical Integrator	.73
18 L 889	V-3	Vertical Integrator	.65
18 L 890	V-4	Vertical Integrator	.65
18 L 891	V-5	Vertical Integrator	.65

CENTRALAB PACKAGED ELECTRONIC CIRCUITS (PEC)

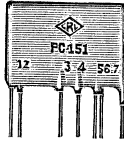

Complete, printed electronic circuits—with resistors, capacitors, and in some cases, inductance. Ideal for the replacement of entire circuit sections in radio and TV sets. The printed-circuit wiring and all components are bound to a ceramic base and sealed against moisture, temperature change and physical shock. Av. shpg. wt., 2 oz.

18 L 893. PC-4 Printed Circuit Guide. Contains complete data on all Centralab PEC units. Includes PEC replacement guide for radio and TV sets listed by 130 manufacturers. **NO CHARGE** when requested with your next order.

No.	Type	Description	EA.
11 L 147	PC-50	Filipee	35¢
11 L 148	PC-51	Filipee	35¢
11 L 167	PC-52	Filipee	35¢
11 L 150	PC-70	Triode Couplate	41¢
11 L 152	PC-80	Triode Couplate	44¢
11 L 153	PC-81	Triode Couplate	44¢
11 L 165	PC-84	Triode Couplate	44¢
11 L 154	PC-90	Pentode Couplate	53¢
11 L 155	PC-91	Pentode Couplate	53¢
11 L 166	PC-92	Pentode Couplate	59¢
11 L 156	PC-100	Vertical Integrator	65¢
11 L 157	PC-101	Vertical Integrator	73¢
11 L 356	PC-104	Vertical Integrator	65¢
11 L 357	PC-105	Vertical Integrator	65¢
11 L 358	PC-106	Vertical Integrator	59¢
11 L 168	PC-110	Filipee	44¢
11 L 158	PC-150	Audet Output Stage	59¢
11 L 159	PC-154	Audet Output Stage	59¢
11 L 360	PC-157	Audet Output Stage	59¢
11 L 361	PC-158	Audet Output Stage	68¢
11 L 362	PC-159	Audet Output Stage	68¢
11 L 171	PC-160	Pendet	73¢
11 L 172	PC-165	Pendet	79¢
11 L 368	PC-260	Sync Takeoff Couplate	73¢
11 L 369	PC-262	Sync Takeoff Couplate	73¢
11 L 380	PC-263	Sync Takeoff Couplate	73¢
18 L 894	PC-264	Sync Takeoff Couplate	59¢
18 L 895	PC-308	Horizontal Oscillator	59¢
18 L 896	PC-309	Retrace Suppression	59¢
18 L 897	PC-310	Audio Couplate	59¢
18 L 898	PC-311	Vertical Feedback	59¢
18 L 899	PC-312	Vertical Integrator	59¢
18 L 900	PC-313	Audet	59¢
18 L 901	PC-314	Retrace Suppression	59¢
18 L 902	PC-315	Audet	59¢
18 L 903	PC-316	Sync Takeoff Couplate	59¢
18 L 904	PC-317	Audio Couplate	59¢
18 L 905	PC-318	Pendet	89¢
18 L 906	PC-319	Phase Comparator	73¢
18 L 907	PC-326	Filipee	59¢
18 L 908	PC-327	Pendet	73¢
18 L 909	PC-330	Sync Takeoff	73¢
18 L 910	PC-331	Audet-Output Stage	59¢

CENTRALAB COMPONENTS

TRANSISTOR AMPLIFIER

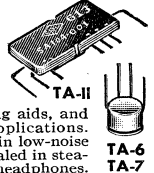

Ultra-miniature amplifiers—stamp or pencil-eraser size! Circuit includes transistors, capacitors, resistors, etc. For computers, pocket-size radios or recorders, hearing aids, and other ultra-miniature applications. Specially designed high-gain low-noise transistors hermetically sealed in stearite base. Output will drive headphones.

Type TA-6. 1-stage. Response: 250-20,000 cps \pm 3 db. **Gain:** 21 db at 1 kc. **Input Imp.:** 1000 ohms. **Supply Voltage:** 1.345 v.; 5 ma drain. **Output:** $\frac{1}{8}$ mw. $\frac{1}{2}\%$ dia. 3 oz. **11 L 377. 1 to 4, NET EACH..... 9.80**
5 to 9, EACH..... 8.82

Type TA-11. 4-stage. Response: 400-20,000 cps \pm 5 db. **Gain:** 75 db at 1 kc. **Input Impedance:** 1000 ohms. **Supply Voltage:** 1.3-1.5 v.; 4 ma drain. **Output:** 1 milliwatt. Size, $\frac{1}{2}\times\frac{1}{2}\times\frac{1}{8}$ " Shpg. wt., 4 oz. **11 L 378. 1 to 4, NET EACH..... 29.40**
5 to 9, EACH..... 26.46

Type TA-7. New, Single stage for output stage use. Response: \pm 3 db, 250-20,000 cps. **Gain:** 26 db at 1 kc. **Input Impedance:** 500 ohms. **Supply Voltage:** 1.3 to 1.5 v.; 2 ma drain. **Output:** 1 mw @ 1% distortion or $\frac{1}{2}$ mw @ 2% distortion. $\frac{1}{2}\times\frac{1}{2}$ " dia. 3 oz. **18 L 911. 1 to 4, NET EACH..... 9.80**
5 to 9, EACH..... 8.82

AMPEX AUDIO AMPLIFIER



3 stage. Operates on 22 $\frac{1}{2}$ v. 3" battery. Response, 200-8000 cps. Gain of 4500 at 1 kc. PC-201 complete with tubes: One CK548DX; two CK512-AX. Wt., 8 oz. PC-200 same but less tubes. Wt., 4 oz. B16-228 volume control and switch for use with either Ampeg unit. $\frac{3}{8}$ " dia. $\frac{1}{2}$ " deep with knob. Instructions. Wt., 3 oz.

11 L 160. Type PC-201. NET..... 14.70
11 L 159. Type PC-200. NET..... 8.82
30 M 419. Type B16-228. NET..... 2.35

AEROVOX RIGHT-ANGLE TUBE SOCKETS



Space-saving sockets permit horizontal placement of tubes. For use with printed circuits. Allow extremely compact chassis layout. Socket prongs insert easily into punched circuit board holes. Silver plated contacts. Molded Alloy 430 body. Meets MIL spec. $\frac{3}{16}\times\frac{3}{16}\times\frac{3}{8}$ " 5 oz. **40 H 406. Type RA9A. 9-Pin. NET..... 97c**
40 H 403. Type RA7A. 7-Pin. NET..... 81c

CAPACITOR HARDWARE

MALLORY MOUNTING HARDWARE

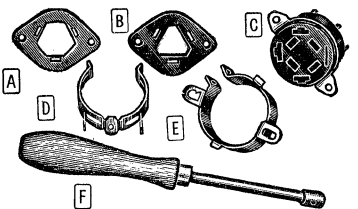

No.	Type	Fig.	Size	NET
17 L 531	PS-4	C	1"	.41
17 L 532	VR-6	C	1 $\frac{1}{8}$ "	.59
17 L 413	VR-3	E	1 $\frac{1}{2}$ to 1 $\frac{1}{4}$ "	.09
17 L 414	VR-4	E	1 $\frac{1}{2}$ to 1 $\frac{1}{8}$ "	.12
17 L 415	VR-6	E	1 $\frac{1}{2}$ to 1 $\frac{1}{8}$ "	.15
17 L 416	VR-8	E	2 to 2 $\frac{1}{2}$ "	.18
17 L 412	TH-25	D	1 $\frac{1}{2}$ to 1 $\frac{1}{8}$ "	.06
17 L 417	MW-100	F	Mtg. Wrench	1.03

Stock No.	Mfrs. Type	Fig.	Size	Per Pkg. of 3	
18 L 414	MP-2	A*	3/4"	9c	
18 L 415	MP-4	A*	1"		
18 L 416	MP-6	A*	1 3/8"		
18 L 417	BP-2	B†	3/4"		
18 L 418	BP-4	B†	1"		
18 L 419	BP-6	B†	1 3/8"		
18 L 420	TH-13	D	3/8"		
18 L 421	TH-15	D	1/2 to 9/8"		9c
18 L 422	TH-17	D	5/8 to 1 1/8"		
18 L 423	TH-19	D	3/4 to 1 3/8"		
18 L 424	TH-21	D	7/8 to 1 5/8"		

A complete assortment of the most commonly used mounting hardware for electrolytic capacitors. Consists of the finest materials to assure rigid, highly dependable mounting. Designed to simplify installation and save valuable time. Excellent for use in television and radio service shops, industrial applications and production runs of electronic equipment. For Mallory Type FP or WP capacitors use MP, BP, PS and MW-400 units listed at left. For Type TC, FP, WP and other tubular capacitors use VR brackets for vertical mounting, or TH spring clips for horizontal mounting. *Metal. †Phenolic. Av. shpg. wt., 3 oz.

No.	Type	Description	Size	EACH
18 L 406	115-1	Top cap	1 3/8"	12c
18 L 407	116-1	Top cap	2"	
18 L 408	118-1	Bottom cap	2"	
18 L 409	119-1	Bottom cap	2 1/2"	
18 L 410	121-1	Bracket	1 3/8x3 1/4"	21c
18 L 411	122-1	Bracket	1 3/8x4 1/4"	
18 L 412	123-1	Bracket	2x3 1/8"	
18 L 413	124-1	Bracket	2x4 1/8"	

No.	Type	Size	EACH
17 L 510	CE-1	3/4x2"	6c
17 L 511	CE-3	1x2"	
17 L 512	CE-5	1 1/2x2"	
17 L 513	CE-5	1 1/2x2"	
17 L 514	CE-6	1 1/2x3 1/2"	
17 L 515	CE-7	1x2 1/2"	9c
17 L 516	CE-8	1x4"	
17 L 517	CE-9	1 1/2x2 1/2"	
17 L 518	CE-10	1 3/8x2 1/4"	

C-D MOUNTING HARDWARE

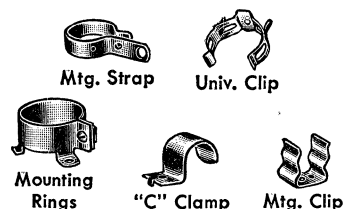

Stock No.	Description	Pkg.
19 L 478	Mtg. Ring; 1 1/4" dia. cans	.23
19 L 479	Mtg. Ring; 1 3/8" dia. cans	.23
19 L 480	Mtg. Ring; 1 1/2" dia. cans	.25
19 L 481	Mtg. Clip; 3/4" dia. cans	.35
19 L 482	Mtg. Clip; 1" dia. cans	.35
19 L 483	Mtg. Clip; 1 1/8" dia. cans	.35
19 L 484	"C" Clamp; 5/8-3/4" cans	.35
19 L 485	"C" Clamp; 7/8-1" cans	.35
19 L 489	Mtg. Strap; I.D. 3/8"	.17
19 L 491	Mtg. Strap; I.D. 3/8"	.17
19 L 492	Mtg. Strap; I.D. 7/8"	.17

UNIVERSAL CLIPS

19 L 493	For 3/8-7/8" dia. cans	.35
19 L 494	For 1/2-3/4" dia. cans	.35
19 L 495	For 5/8-1 1/4" dia. cans	.35
19 L 496	For 3/4-1 3/8" dia. cans	.35
19 L 497	For 7/8-1 3/8" dia. cans	.35
19 L 498	For 1-1 1/8" dia. cans	.35
19 L 499	For 1 1/8-1 7/8" dia. cans	.35

Stancor Transformers

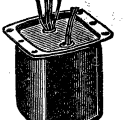
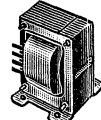
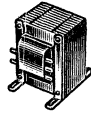
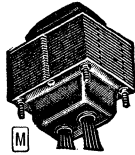
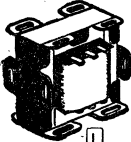
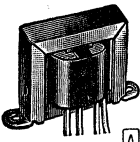

POWER TRANSFORMERS

8400 Series—For 6.3 Volt Tubes. All have center-tapped 6.3 v. winding except PS-8415 and PA-8421. *For 6AX5, 6X4, 6X5 or sel. rect.

All are Fig. M, except type PC is Fig. C and Type PS is Fig. A. †Has extra winding: 6.3 v. @ 3A. not C. T. Pri., 117 volts, 60 cycle AC.

Stock No.	Mfr's Type	Plate		Rect.		Fil.		Overall Size	Wt. Lbs.	1-9 EA.	10-24 EA.
		VCT	Ma	V	A	V	A				
64 G 162	PS-8415	125	15	*	...	6.3	.6	2 3/4 x 1 3/4 x 2 1/2"	3/4	2.06	1.85
64 G 078	PA-8421	125	50	*	...	6.3	2.0	2 1/4 x 3 3/4 x 2 1/2"	1 1/2	3.43	3.09
64 G 216	PS-8416	250	25	*	...	6.3	1.0	2 9/16 x 2 1/2 x 1 3/4"	1	2.59	2.32
64 G 077	PC-8418	450	5	*	...	6.3	2.5	3 9/16 x 2 7/8 x 2 1/2"	2 1/4	4.27	3.85
64 G 154	PM-8401	470	40	*	...	6.3	2.0	2 1/2 x 2 1/2 x 3 3/4"	2 1/4	4.41	3.97
64 G 176	PC-8401	470	40	*	...	6.3	2.0	3 9/16 x 2 3/8 x 2 3/8"	2 1/4	4.41	3.97
64 G 175	PM-8402	480	50	*	...	6.3	2.0	2 1/2 x 2 1/4 x 3 3/4"	2 1/4	4.90	4.41
64 G 177	PC-8402	480	55	*	...	6.3	2.0	3 1/4 x 2 3/8 x 2 3/8"	2 1/4	4.90	4.41
64 G 175	PM-8419	480	70	*	...	6.3	3.0	2 7/8 x 2 1/2 x 3 3/4"	2 3/4	4.90	4.41
64 G 215	PC-8419	480	70	*	...	6.3	3.0	3 1/8 x 2 1/2 x 2 7/8"	2 1/4	4.90	4.41
64 G 171	PM-8403	500	70	*	...	6.3	2.5	3 1/4 x 2 1/4 x 3 3/4"	3 1/4	5.49	4.94
64 G 178	PC-8403	500	70	*	...	6.3	2.5	3 9/16 x 2 3/8 x 3 1/8"	3 1/4	5.49	4.94
64 G 179	PC-8404	520	90	*	...	6.3	3.0	3 5/8 x 3 x 3 1/2"	4	6.17	5.56
64 G 160	PM-8404	520	90	*	...	6.3	3.0	2 7/8 x 3 3/8 x 3 5/8"	4	6.17	5.56
64 G 172	PC-8405	540	120	*	...	6.3	3.5	3 1/2 x 3 1/2 x 3 3/4"	4 1/2	6.82	6.14
64 G 183	PC-8405	540	120	*	...	6.3	3.5	4 x 3 1/4 x 3 1/2"	4 1/2	6.82	6.14
64 G 155	PM-8407	650	55	*	...	6.3	2.0	2 1/2 x 3 x 1 1/2"	3 1/4	4.96	4.47
64 G 157	PC-8406	650	40	*	...	6.3	2.0	2 1/2 x 3 x 3 1/2"	2 1/2	4.51	4.06
64 G 156	PM-8406	650	40	*	...	6.3	2.0	3 1/2 x 2 3/8 x 3 1/2"	2 1/4	4.51	4.06
64 G 184	PC-8407	650	55	*	...	6.3	2.0	3 9/16 x 2 5/8 x 3 1/2"	3 1/2	4.96	4.47
64 G 164	PC-8408	680	70	*	...	6.3	2.5	3 3/8 x 3 5/8 x 3 3/4"	4	5.62	5.06
64 G 156	PM-8408	680	70	*	...	6.3	2.5	2 7/8 x 3 3/8 x 3 3/4"	4	5.62	5.06
64 G 158	PC-8409	700	90	*	...	6.3	3.0	2 7/8 x 3 3/8 x 3 3/4"	4 1/2	6.27	5.64
64 G 185	PC-8409	700	90	*	...	6.3	3.0	3 5/8 x 3 x 3 1/2"	4 1/2	6.27	5.64
64 G 159	PM-8410	720	120	*	...	6.3	3.5	3 1/8 x 3 3/4 x 3 3/4"	5 1/2	6.92	6.23
64 G 186	PC-8410	720	120	*	...	6.3	3.5	4 x 3 1/4 x 3 3/4"	5 1/2	6.92	6.23
64 G 173	PM-8411	750	150	*	...	6.3	4.5	3 7/8 x 3 1/2 x 4 1/2"	5 1/2	8.29	7.47
64 G 187	PC-8411	750	150	*	...	6.3	4.5	4 9/16 x 3 5/8 x 4 1/2"	5 1/2	8.29	7.47
64 G 161	PM-8412	800	200	*	...	6.3	5.0	3 3/4 x 4 1/2 x 3 7/8"	8 1/4	9.34	8.41
64 G 163	PC-8412	800	200	*	...	6.3	5.0	4 x 4 x 3 3/4"	8 1/4	9.34	8.41
64 G 169	PC-8414 †	1200	200	*	...	6.3	3.0	4 1/4 x 4 3/4 x 4 1/2"	8 1/2	11.78	10.61

All ratings are with maximum DC in winding. All are Fig. A mounting type, except *Fig. L, †Fig. TD, ‡Fig. C, †Fig. NV. All are rated 1500 v. rms. except **2000, ††3000.

Stock No.	Type	Hys.	Ma.	Ohms	Size	Lbs.	1-9 EA.	10-24 EA.
64 G 057	C1001 ††	10.5	110	225	2 5/8 x 4 x 2 1/4"	2 1/2	2.91	2.62
64 G 056	C1002	15.0	75	400	2 1/4 x 3 3/4 x 2 1/4"	1 1/2	1.73	1.91
64 G 055	C1003	16.0	50	580	2 x 3 1/4 x 1 3/4"	1 1/2	1.13	1.56
64 G 055	C1000	3.5	50	225	1 5/8 x 2 7/8 x 1 1/2"	3/4	1.40	1.26
64 G 075	C1279	8.5	50	400	1 5/8 x 2 7/8 x 1 1/2"	3/4	1.40	1.29
64 G 067	C1355 *	8.0	75	290	2 1/8 x 2 5/8 x 1 3/4"	1 1/2	1.99	1.79
64 G 063	C1410 †††	4.0	175	100	1 5/8 x 2 3/8 x 1 1/2"	2 1/2	4.12	3.70
64 G 466	C1411 †††	4.5	200	80	3 3/8 x 3 x 3 1/4"	3 1/2	4.66	4.20
64 G 455	C1412 †††	4.0	250	60	3 5/8 x 3 x 3 1/4"	4 1/2	6.82	6.14
64 G 068	C1420 †	16.0	80	360	3 9/16 x 2 5/8 x 2 5/8"	2 1/2	3.53	3.18
64 G 465	C1421 †††	7.0	140	165	3 3/4 x 2 5/8 x 2 5/8"	2 1/2	4.02	3.62
64 G 058	C1515	20.0	15	900	1 5/8 x 2 3/8 x 1 1/2"	1	1.44	1.29
64 G 050	C1706	4.5	50	300	1 5/8 x 2 3/8 x 1 1/2"	3/4	1.21	1.09
64 G 051	C1707	7.0	50	550	1 5/8 x 2 3/8 x 1 1/2"	3/4	1.27	1.15
64 G 052	C1708	13.0	65	500	2 x 3 1/4 x 1 3/4"	1	1.99	1.79
64 G 053	C1709	8.0	85	250	2 x 3 1/4 x 2 1/2"	1 1/4	2.22	2.00
64 G 054	C1710	7.0	150	200	2 3/8 x 4 x 2 1/4"	2 1/4	3.23	2.91
64 G 069	C1721 †††	8.5	200	120	3 7/8 x 3 1/8 x 3 3/8"	4 1/2	5.64	5.09
64 G 059	C1722 †††	8.5	300	80	4 5/8 x 3 3/8 x 3 1/2"	7 1/2	9.37	8.44
64 G 059	C2303 **	2.5	130	100	2 x 3 1/4 x 1 3/4"	1 1/2	2.03	1.82
64 G 060	C2304	2.3	150	60	2 x 3 1/4 x 1 3/4"	1 1/2	2.09	1.88
64 G 061	C2305 †	5.0	100	300	2 1 1/8 x 2 3/4 x 2 3/8"	1 1/2	3.07	2.76
64 G 064	C2308 †††	8.0	300	80	4 3/4 x 4 x 3 7/8"	7 3/4	9.47	8.53
64 G 457	C2309 **	3.0	150	90	2 1/4 x 3 3/4 x 2 1/4"	1 3/4	2.52	2.26
64 G 505	C2325	2.0	200	60	3 3/4 x 2 1/4 x 2 1/4"	2	2.52	2.26
64 G 520	C2326	1.0	300	43	3 3/4 x 2 1/4 x 2 1/4"	1 3/4	2.84	2.55
64 G 073	C2327	1.5	200	85	1 5/8 x 2 7/8 x 1 1/2"	3/4	1.60	1.44
64 G 458	C2328	.8	375	25	2 1/2 x 3 3/4 x 2 1/2"	1 1/2	3.30	2.97
64 G 459	C2334	.8	300	60	2 5/8 x 2 1/4 x 2 1/4"	2 1/2	2.77	2.50

SELENIUM RECTIFIER TRANSFORMERS

††† Versatile multi-tap transformers for low voltage, high current applications. All units are designed for a nominal input of 117 volts 50-60 cycle AC. With wiring chart.

Stock No.	Mfr's Type	Rectifier Circuit	Range of AC Volts	Max. DC Output Resistive Load	Max. DC Output Capacitive Load	Size	Wt. Lbs.	1-9 EA.	10-24 EA.
64 G 372	RT-201	C.T. (Bridge)	11.7 to 29.4 11.1 to 28.5	11.2v. @ 2.0 amps 23.0v. @ 1.25 amps	13.8v. @ 2.0 amps 30.0v. @ 1.25 amps	3 5/8 x 2 1/2 x 3 3/8"	2 1/2	4.73	4.26
64 G 373	RT-202	C.T. (Bridge)	12.0 to 29.8 11.0 to 29.8	11.1v. @ 4.0 amps 24.3v. @ 2.0 amps	14.0v. @ 4.0 amps 33.0v. @ 2.0 amps	3 3/8 x 2 1/2 x 3 1/2"	4	6.27	5.64
64 G 374	RT-204	C.T. (Bridge)	11.7 to 29.2 11.6 to 29.2	12.0v. @ 8.0 amps 24.0v. @ 4.0 amps	13.5v. @ 8.0 amps 32.0v. @ 4.0 amps	4 x 3 1/4 x 4 1/4"	6 1/4	7.90	7.11
64 G 375	RT-206	C.T. (Bridge)	12.0 to 29.7 12.0 to 29.7	11.5v. @ 12.0 amps 24.0v. @ 6.0 amps	14.4v. @ 12.0 amps 32.0v. @ 6.0 amps	4 1/4 x 3 1/8 x 5 1/8"	9 1/4	10.52	9.47
64 G 376	RT-208	C.T. (Bridge)	12.1 to 29.2 12.1 to 29.2	11.4v. @ 15.0 amps 23.7v. @ 8.0 amps	14.8v. @ 15.0 amps 31.5v. @ 8.0 amps	4 3/4 x 3 1/8 x 5 1/4"	12 1/2	12.44	11.20
64G378	RT-2012	C.T. (Bridge)	21.1 to 29.0 12.0 to 29.0	11.4v. @ 22.5 amps 23.5v. @ 12.0 amps	13.3v. @ 22.5 amps 30.0v. @ 12.0 amps	5 3/4 x 4 1/2 x 6 3/8"	21	19.30	17.38
64G377	RT-408	Bridge	25.0 to 53.5	44.0v. @ 8.0 amps 63.0v. @ 12.0 amps	60.0v. @ 8.0 amps 83.0v. @ 12.0 amps	5 3/4 x 4 1/2 x 7 1/2"	27	27.75	24.99
64G379	RT-412	Bridge	25.0 to 53.0	43.5v. @ 12.0 amps	60.0v. @ 12.0 amps	7 1/2 x 5 1/8 x 6 1/4"	34	37.55	33.81

POLY-PEDANCE MODULATION TRANSFORMERS

† Multi-tapped, modulation transformers for transmitting use. Primary and secondary each will match loads from 2,000 to 20,000 ohms.

Type A-3893. Max. DC, pri. and sec., 180 ma. each. 4x3 1/4 x 1 1/2". Shpg. wt., 7 lbs.
64 G 478 1 to 9, NET EACH **12.90**
10 to 24, EACH 11.61
Type A-3894. Rated 225 watts. Max. DC, primary and secondary 225 ma. each. Size, 4 3/4 x 4 1/4 x 4 1/4". Shpg. wt., 10 lbs.
64 G 488. 1 to 9, NET EACH **15.58**
10 to 24, EACH 14.02

TUBE CHECKER TRANSFORMER

Type P-1834-3. Multiple-secondary transformer. Pri.: 125/115/105 v., 60 cycles. Secondary output volts: 1.1/1.4/1.5/2.0/2.5/3.0/3.3/5.0/6.3/7.0/7.5/12.5/30/35/50/70/85/110/117. Size, 2 5/8 x 4 x 2". "A" style mounting. With data sheet. Shpg. wt., 2 1/2 lbs.
64 G 139. 1 to 9, NET EACH **9.27**
10 to 24, EACH 8.35

AUDIO INPUT TRANSFORMERS

†† For single plate to push-pull grids except *single plate to single grid; for 7000-20,000 ohm plate impedances. All others, 7000-15,000 ohm plate impedance. Max. pri. DC, 10 ma.

Type A-52-C. 1:2 ratio. Size, 1 3/8 x 2 3/8 x 1 1/2". Shpg. wt., 3/4 lbs.
64 G 079. 1 to 9, NET EACH **1.79**
10 to 24, EACH 1.62
Type A53*. 1:3 ratio. Size, 1 3/8 x 2 3/8 x 1 1/2". Shpg. wt., 3/4 lbs.
64 G 090. 1 to 9, NET EACH **1.73**
10 to 24, EACH 1.56
Type A-53-C. 1:3 ratio. Size, 1 3/8 x 2 3/8 x 1 1/2". Shpg. wt., 1 lb.
64 G 081. 1 to 9, NET EACH **1.76**
10 to 24, EACH 1.59
Type A-53-C. 1:3 ratio. Size, 1 3/8 x 2 3/8 x 1 1/2". Shpg. wt., 3/4 lbs.
64 G 082. 1 to 9, NET EACH **1.99**
10 to 24, EACH 1.79

DRIVER TRANSFORMERS

†† Single plate (10,000 ohms primary impedance) to push-pull grids.

Type A-4713. 2:1 primary to 1/2 secondary ratio; 3 ma. max. in primary. Size, 1 5/8 x 2 3/8 x 1 1/2". Shpg. wt., 1 lb.
64 G 076. 1 to 9, NET EACH **1.96**
10 to 24, EACH 1.76
Type A-4723. 3:1 primary to 1/2 secondary ratio; 30 ma. max. in primary. Size, 1 5/8 x 2 3/8 x 1 1/2". Shpg. wt., 1 lb.
64 G 038. 1 to 9, NET EACH **1.96**
10 to 24, EACH 1.76
Type A-4752. 2:1.5/1:1 primary to 1/2 secondary ratio; 40 ma. max. in primary. Size, 2 x 3 1/4 x 3/4". Shpg. wt., 1 1/2 lbs.
64 G 039. 1 to 9, NET EACH **2.87**
10 to 24, EACH 2.59

INTERCOM AND TRANSCEIVER TRANSFORMERS

††† Type A-3833. For transceiver applications. 200 and 5K-ohm pri. for carbon mike; sec., 60K. 1 5/8 x 2 1/8 x 1 1/2". Shpg. wt., 1 lb.
64 G 031. 1 to 9, NET EACH **2.81**
10 to 24, EACH 2.53

††† Type A-4744. For intercom use; voice coil to grid input. 4-ohm pri., sec., 25K. 1 1/2 x 2 3/8 x 1 1/2". Shpg. wt., 3/4 lb.
64 G 030. 1 to 9, NET EACH **1.83**
10 to 24, EACH 1.65

Type A-8090. Matches line to voice coil. Has 45-50 ohm pri., sec., 3-4, 6-8. Maximum watts, 3. Size, 1 3/8 x 2 3/8 x 1 1/2". (Not illustrated.) Shpg. wt., 3/4 lb.
64 G 459. 1 to 9, NET EACH **1.67**
10 to 24, EACH 1.50

Type A-8091. Matches line to voice coil. 45-50 ohm pri., sec., 3-4, 6-8. Max. watts, 8. 1 3/8 x 2 3/8 x 1 1/2". (Not illustrated.) Wt. 1 lb.
64 G 490. 1 to 9, NET EACH **1.83**
10 to 24, EACH 1.65

Knight and Stancor Transformers

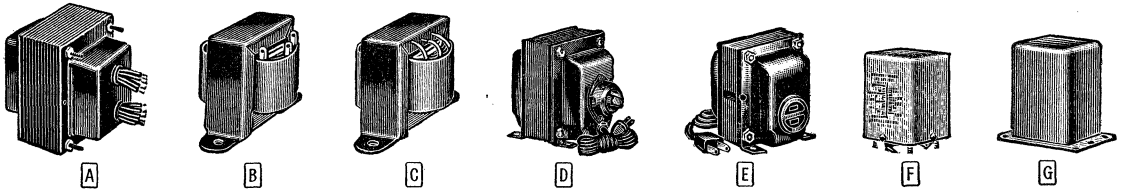

KNIGHT QUALITY TRANSFORMERS

An excellent selection of economy-priced, high-quality Knight transformers. All are carefully assembled of quality components and fully meet Allied's rigid standards for performance and dependability of

REPLACEMENT POWER TRANSFORMERS

A C 62 G 008 is Fig. C; all others Fig. A. Recommended for radio set replacement, kit building, etc. Fully shielded; heavy duty 5" flexible coated leads. All plate and Fil. 1 windings center-tapped. All have 110-120 volt, 50-60 cycle primaries.

Stock No.	Plate Volts	Rect. Ma.	Fil. 1 V	Fil. 1 A	Mtg. Ctrs.	Wt., Lbs.	1-9, EACH	10-24, EACH
62 G 008	250	25	5	1.0	2 3/8"	1	2.54	2.24
62 G 034	480	40	5	2	2x2 1/2"	3	3.47	3.09
62 G 041	650	40	5	2	2x2 1/2"	3	3.83	3.45
62 G 042	650	70	5	3	2x2 1/2"	5	4.65	4.17
62 G 043	700	90	5	3	2 1/2 x 2 1/2"	5 3/4	4.78	4.30
62 G 044	700	120	5	3	2 1/2 x 3 1/8"	7	5.52	5.97
62 G 045	750	150	5	3	2 1/2 x 3 1/8"	7 1/4	6.33	5.69
62 G 053	800	200	5	6	3x3 3/4"	10	7.65	6.89

UNIVERSAL OUTPUTS

B CT primary. 6 taps on secondary. Match single or push-pull tubes to speaker voice coil.

Stock No.	Impedances	Watts	Mtg. Ctrs.	Wt., Lbs.	1-9, EACH	10-24, EACH
62 G 023	Pr. 14,000 ohms.	4000	4	2"	1	1.56
62 G 021	Sec., VC	8	3	2 3/8"	1	1.65
62 G 022		18	3	2 3/8"	1 1/4	2.21

70.7 VOLT LINE-TO-VOICE COIL OUTPUTS

B Secondaries: 4, 8, 16 ohms, except *3.2-4, 6-8.

Stock No.	Watt Taps	Watts	Mtg. Ctrs.	Wt., Lbs.	1-9, EACH	10-24, EACH
62 G 081	5, 2.5, 1.25, .62, .31	*5 Max.	2"	3/4	1.79	1.60
62 G 077	10, 5, 2.5, 1.25, .62	10 Max.	2 3/8"	1	2.04	1.84
62 G 078	18, 9, 4.5, 2.25, 1.12, .56	18 Max.	2 3/8"	1 1/4	2.80	2.51
62 G 079	24, 12, 6, 3, 1.5, .75	24 Max.	3 1/8"	1 3/4	3.39	3.04

STANDARD OUTPUTS

C For coupling plate of output tube to the speaker voice coil. Designed specifically for class A amplifiers. Shpg. wt., 3/4 lb.

Stock No.	Primary Imp.	Ma.	Sec. Imp.	Audio Watts	Size	1-9, EACH	10-24, EACH
62 G 064	5,000	40	3.2	3	1 1/2 x 1 1/2 x 1 1/8"	.89	.80
62 G 063	2,500	50	3.2	3	1 1/2 x 1 1/2 x 1 1/8"	.89	.80
62 G 063	8,000	20	3.2	3	1 1/2 x 1 1/2 x 1 1/8"	.89	.80
62 G 065	2,000	50	3.2	5	1 3/8 x 2 1/2 x 1 1/8"	1.00	.88

AUDIO TRANSFORMERS

C *Single or double-button. Shpg. wt., 1 lb.

Stock No.	Description	Ctrs.	1 to 9, EA.	10-24, EA.
62 G 025	*Carbon mike to grid	2 3/8"	2.07	1.88
62 G 062	1:3 Single plate to single grid	2"	1.52	1.37

On 25 or more transformers—write for quantity prices.

operation. Recommended for replacement applications and installation in new equipment. A fine low-cost line of transformers for use by radio-TV servicemen, Amateurs, experimenters, students and hobbyists.

FILTER CHOKES

C Excellent for receivers, low power transmitters, etc.

Stock No.	Hys.	Ma.	Ohms	Ctrs.	Lbs.	1-9, EA.	10-24, EA.
62 G 135	5.5	50	330	2"	1 1/2	1.11	1.00
62 G 136	8.5	50	400	2 3/8"	1	1.22	1.10
62 G 137	16	50	550	2 1/2"	1 1/2	1.37	1.24
62 G 138	15	75	400	3 1/8"	1.83	1.65	1.65
62 G 139	10.5	110	220	3 1/2"	2 1/2	2.44	2.20

FILAMENT TRANSFORMERS

C Primaries, 105-125 volts, 50-60 cycle AC.

Stock No.	Volts	Amps	Size	Lbs.	1-9, EA.	10-24, EA.
62 G 028	5	6	2 1/4 x 3 1/2 x 1 1/8"	2 1/4	2.89	2.59
62 G 029	6.3	3	1 3/8 x 2 1/2 x 1 1/8"	1 1/4	1.65	1.48
62 G 031	6.3	3	2 x 3 1/4 x 1 1/8"	1 3/4	2.47	2.23

VARIABLE VOLTAGE AND ISOLATION TRANSFORMERS

D Variable Voltage and Isolation Transformer. Rated 150 watts. Delivers 115 v. from 90-250 v., 50-60 cycle AC input. With 6-ft. cord and plug. Mtg. centers, 3x3 1/4". Shpg. wt., 9 lbs. 1 to 9, NET EACH **13.88**

D Variable Voltage Transformer. 150 watts. Tests for possible failure in radio by voltage overload method. 7-tap switch calibrated in output volts, 90-150 (10-volt steps). For 115 v., 50-60 cycle AC. 6-ft. cord, plug, output receptacle. Mtg. ctrs., 2 1/2 x 3 3/4". Wt., 6 1/2 lbs. 1 to 9, NET EACH **12.07**

E Isolation Transformer. Reduces shock hazard by isolating test units, or equipment under test, from line. For 115 volts, 50-60 cycle AC. With 6-ft. cord, plug and output receptacle. 62 G 086, 100 Watt. 4 1/4 x 3 3/8 x 3 3/4". 7 lbs. 1-9, EA. **11.74**
 62 G 087, 250 Watt. 4 3/8 x 3 3/8 x 4 7/8". 12 1/2 lbs. 1-9, EA. **19.05**
 10-24, EACH **17.13**

230-TO-115 VOLT AUTOTRANSFORMERS

E Well-built step-down transformers for reducing 220-250 volts, 50-60 cycles AC to 110-125 volts. For operating tape recorders, radios, amplifiers, household appliances, etc. Shielded construction. Smooth black enamel finish. With 8-ft. cord and plug. Female outlet on case.

Stock No.	Watts	Size	Lbs.	1-9, EACH	10-24, EACH
62 G 510	80	3 1/2 x 2 1/2 x 3 3/8"	4	5.55	4.99
62 G 511	150	3 7/8 x 3 3/8 x 3 3/8"	6	7.63	6.86
62 G 512	250	4 5/8 x 3 1/2 x 4 3/8"	9 1/4	10.02	9.02
62 G 513	500	4 5/8 x 3 1/2 x 6 3/8"	11	12.74	11.48

HIGH-FIDELITY OUTPUT TRANSFORMERS

Designed for ultra-linear Williamson-type amplifiers. All flat from 6-90, 0 cps. *Rated Watts from 6-30, 00 cps. All have 4, 8 and 16 ohm outputs. †Max. allowable DC current in each half of primary.

Stock No.	Fig.	Watts	P-P Imp.	Ma.	Size	Wt., Lbs.	1-9, EA.	10-24, EA.
62 G 082	F	24*	8000	60	2 7/8 x 3 1/2 x 3 3/8"	5	8.08	7.27
62 G 083	G	12*	6000	75	3 1/4 x 3 1/2 x 4 1/4"	6	15.81	14.23

STANCOR TRANSISTOR TRANSFORMERS

A new line of transformers designed for use in transistor circuits. These units feature small size and weight, very important for miniaturized or portable equipment. Allied will stock new transistor components as they become available. *Max. pri. DC (for each half if primary has center tap). †Type TA-14 has 2 secondaries, 16 ohms series, 4 ohms parallel. ††Type TP-1 is for bridge rectifier power supplies; has 117 volt 60 cycle primary and 2 secondaries, each supplying 13 or 18 volts at 900 ma.

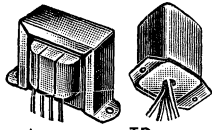

Stock No.	Mfr's Type	Application	Pri. Imp.	Sec. Imp.	*Ma.	Pri. Sec.	Sec. Res.	Watts	Size	Fig.	Shpg. Wt.	1-9, EACH	10-24, EACH
63 G 952	TA-1	Input	600 CT	10	20	42	8	.05	1 3/8 x 1 1/2 x 1 1/8"	A	1 oz.	1.89	1.71
63 G 953	TA-2	Interstage	100 CT	10	100	4	4	.25	1 1/8 x 2 1/8 x 1 3/8"	A	3 oz.	1.89	1.71
63 G 954	TA-3	Interstage	100	1000 CT	100	5.8	4.5	.05	1 3/8 x 2 1/8 x 1 3/8"	A	3 oz.	2.48	2.23
63 G 955	TA-4	Interstage	500 CT	5000 CT	12	37	250	.03	1 3/8 x 2 1/8 x 1 3/8"	A	2 oz.	4.69	4.22
63 G 956	TA-5	Driver	1000	200 CT	10	400	115	.05	1 3/8 x 1 1/2 x 1 1/8"	A	2 oz.	5.32	4.79
63 G 957	TA-6	Driver	2000	200 CT	5	720	115	.05	1 3/8 x 1 1/2 x 1 1/8"	A	5 oz.	1.89	1.71
63 G 958	TA-7	Driver	100	100 CT	100	12	12	.5	1 3/8 x 1 1/2 x 1 1/8"	A	1 oz.	4.24	3.82
63 G 959	TA-8	Output	9800	15	2	640	2	.05	1 3/8 x 2 1/8 x 1 3/8"	A	1 oz.	4.86	4.37
63 G 960	TA-9	Output	1000 CT	4/8/16	10	120	3.5	.2	3/4 x 1 1/2 x 3/4"	A	1 oz.	5.32	4.79
63 G 961	TA-10	Output	2000 CT	4/8/16	10	250	4	.2	3/4 x 1 1/2 x 3/4"	A	1 ib.	2.74	2.47
63 G 962	TA-11	Output	48 CT	8/15	275	5	1.5	.5	2 3/8 x 1 1/2 x 1 1/8"	A	4 oz.	1.89	1.71
63 G 963	TA-12	Output	20 CT	8	500	.55	3.5	10	1 3/8 x 1 1/2 x 1 1/8"	TD	1 1/2 lb.	4.02	3.62
63 G 964	TA-13	Driver	200 CT	400 CT	10	6	3 1/2 x 1 1/2 x 2 5/8"	TD	6 1/2 lb.	9.40	8.46
63 G 965	TA-14	Output	24 CT	16/4CT	200	10	4 1/4 x 4 3/8 x 3 3/8"	TD	2 1/2 lb.	4.86	4.37
63 G 966	TP-1	Power	3 3/8 x 2 1/2"

On 25 or more transformers—write for quantity prices.

STANCOR AIR CONDITIONER AUTOTRANSFORMERS

Type PSU-2000. For use with home air conditioners having 1/2 to 1-hp. motors. (1/2 to 1-ton units.) Converts 208-volt unit to 230-volt line. Converting a 230-volt unit to 208-volt line is done by a simple change inside the outlet box. Supplied with line cord, standard 250-volt polarized plug, and receptacle. Rated at 2.3 KVA. Size, 3 1/2 x 6 1/2 x 3 3/4". Shpg. wt., 9 lbs. 1 to 9, NET EACH **14.45**
 10 to 24, EACH **13.00**



Type PSU-3000. Similar to PSU-2000, but designed for larger air conditioners. Supplies enough power to drive a 1 to 2-hp. motor of the type used in 1 to 2 ton conditioners. Converts 208-volt unit to 230 volts, or 230-volt unit to 208. Size 4x6x4 1/2". Shpg. wt., 10 lbs. 1 to 9, NET EACH **16.26**
 10-24, EACH **14.63**

UTC Transformers

Designed specifically for Amateur and P. A. amplifier service. Vacuum-impregnated and compound-filled.

Case	Height	Width	Depth	Shpg. Wt.
G-2	2 1/2"	3 3/4"	1 1/2"	1 1/2 lbs.
G-3	2 1/2"	3 3/4"	2 1/2"	2 lbs.
G-4	2 1/2"	4 1/4"	3 1/4"	3 lbs.
G-5	3 3/4"	3 3/4"	4 1/2"	4 1/2 lbs.
G-7	4 3/8"	4 3/8"	5 1/2"	8 lbs.
G-8	4 3/8"	5 3/8"	5 3/8"	12 lbs.
G-9	5 1/8"	5 3/8"	6 3/8"	21 lbs.
G-10	5 7/8"	6 1/4"	6 3/4"	24 lbs.
G-11	5 7/8"	6 1/4"	7 3/8"	31 lbs.
G-12	10 1/4"	7 3/8"	9 1/4"	52 lbs.

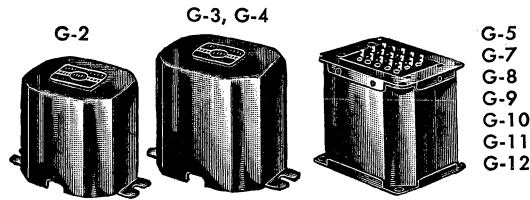

UNIVERSAL DRIVERS

Stock No.	Mfr's Type	Application	Case	1-24, EA.	25 or More, EACH
62 G 761	S-8	Single driver plate to PP grids	G-3	6.47	5.50
62 G 762	S-9	PP pl. to grids of class B tubes	G-4	8.23	7.00
62 G 763	S-10	12AU7 or similar tubes to 5881 or 6L6's, self or fixed bias.	G-3	6.47	5.50

UNIVERSAL OUTPUTS—TO LINE AND VOICE COIL

Secondary impedances: 500, 15, 8, 2 ohms.

Stock No.	Type	Primary Ohms	Watts	Case	1-24, EA.	25 or More, EACH
62 G 764	S-14	2500, 4000, 7000, 10,000	10	G-2	6.47	5.50
62 G 765	S-15	PP tubes: 4000, 5000, 10,000	12	G-2	7.06	6.00
62 G 766	S-16	PP 3000, 6000, 9000-10,000	30	G-4	8.23	7.00
62 G 767	S-17	PP 3800, 4500-5000	55	G-5	9.70	8.24

SINGLE-SECONDARY FILAMENT TRANSFORMERS

All primaries tapped at 105, 115 Volts, 50-60 cycles. *Tapped sec.

Stock No.	Type	Secondary (CT)	Ins. V.	Case	1-24, EA.	25-Up, EA.
62 G 703	S-53	2.5V @ 10A	1500	G-3	5.88	5.00
62 G 704	S-54	5V @ 4A	2500	G-3	5.59	4.75
62 G 705	S-55	6.3V @ 3A	1500	G-3	5.29	4.50
62 G 707	S-57	2.5V @ 10A	10000	G-5	8.82	7.50
62 G 708	S-58	2.5V @ 20A	10000	G-5	9.41	8.00
62 G 709	S-59	5V @ 13A	5000	G-5	8.82	7.50
62 G 710	S-60	5V @ 22A	10000	G-7	12.94	11.00
62 G 711	S-61*	7.5, 6.3V @ 10A	3000	G-5	10.00	8.50
62 G 712	S-62	10V @ 10A	3000	G-5	9.11	7.75
62 G 713	S-63*	14.12, 11V @ 10A	5000	G-7	12.94	11.00

MULTIPLE-SECONDARY FILAMENT TRANSFORMERS

Primary tapped 105, 115 volts, 50/60 cycles. Insulation, 3000 v., except S-71, 10,000 v. and S-72, 5000 v. All in G-5 case except *G-7 case.

Stock No.	Mfr's Type	Fil. I CT	Fil. 2 CT	Fil. 3 CT	1-24, EA.	25 or More, EACH
62 G 715	S-65	2.5V @ 5A	5V @ 4A	6.3V @ 3A	9.70	8.24
62 G 717	S-67	5V @ 6A	6.3V @ 5A	7.5V @ 5A	9.70	8.24
62 G 718	S-68	5V @ 3A	6.3V @ 4A	7.5V @ 5A	10.00	8.50
62 G 720	S-70	6.3V @ 5A	6.3V @ 5A	2.5V @ 12A	10.00	8.50
62 G 721	S-71*	2.5V @ 6A	2.5V @ 6A	5V @ 6A	14.70	12.49
62 G 722	S-72	5V @ 3A	5V @ 6A	5V @ 6A	10.58	9.00

FILTER, SWINGING AND AUDIO CHOKES

Stock No.	Mfr's Type	Henrys	Ma	Ohms	Insul.	Case	1-24, EA.	25 or More, EACH
62 G 776	S-23	300	5	5000	1500 V.	G-2	4.41	3.75
62 G 775	S-24	500 CT	3	6000	1500 V.	G-2	5.00	4.25
62 G 725	S-25	30	30	800	1500 V.	G-2	3.82	3.25
62 G 727	S-26	12	60	250	1500 V.	G-2	3.82	3.25
62 G 728	S-27	25	75	350	1500 V.	G-4	5.00	4.25
62 G 729	S-28	20	100	350	1500 V.	G-4	5.88	5.00
62 G 730	S-29	6	175	90	1500 V.	G-4	5.00	4.25
62 G 731	S-30	4/20	175	90	1500 V.	G-4	5.00	4.25
62 G 732	S-31	6	225	100	2700 V.	G-5	6.76	5.75
62 G 733	S-32	4/20	225	100	2700 V.	G-5	6.76	5.75
62 G 751	S-33	8	300	100	4000 V.	G-7	9.11	7.75
62 G 734	S-34	4/20	300	100	4000 V.	G-7	9.11	8.00
62 G 735	S-35	8	400	60	5000 V.	G-8	11.76	10.00
62 G 736	S-36	4/20	400	60	5000 V.	G-8	11.76	10.00
62 G 737	S-37	8	550	60	6000 V.	G-8	14.70	12.49
62 G 738	S-38	4/20	550	60	6000 V.	G-8	14.70	12.49

PLATE TRANSFORMERS—115 V., 50-60 CYCLES

Stock No.	Type	Sec. VCT	DC Ma	Case	1-24, EA.	25 or More, EA.
62 GZ 744	S-44	1150/550	500	G-9	23.52	19.99
62 G 745	S-45	1800/1500	200	G-8	20.58	17.49
62 GZ 746	S-46	2000/1500	300	G-9	23.52	19.99
62 GZ 748	S-47	3000/2500/2000	300	G-10	32.34	27.49
62 GZ 749	S-48	3000/2500/2000	500	G-11	38.22	32.49
62 GZ 750	S-49	4200/3600/3000	300	G-11	35.28	29.99
62 GZ 700	S-50	6000/15000	300	G-12	58.80	49.98

UNIVERSAL MODULATION TRANSFORMERS

Stock No.	Type	Audio Power	Case	1-24, EA.	25 or More, EACH
62 G 771	S-18	12 watts	G-3	7.06	6.00
62 G 772	S-19	30 watts	G-4	9.11	7.75
62 G 773	S-20	55 watts	G-5	14.70	12.49
62 G 774	S-21	110 watts	G-7	20.58	17.49
62 GZ 775	S-22	250 watts	G-9	32.34	27.49

MICROPHONE CABLE TRANSFORMER

Type MC-2. Connects low-impedance microphone to high-impedance input on amplifier or tape recorder. Allows microphone cable to be extended several hundred feet without loss of frequency response. Primary imp.: 30-50 and 200-250 ohms. Secondary to grid. Response, 40-12,000 cps. 1 1/2" dia., 2 1/2" long. Wt. 12 oz.
 62 G 819, 1 to 24, NET EACH.....11.76
 25 or More, EACH.....10.00

POWER TRANSFORMERS—115 V., 50-60 CYCLES

All Fil. 2 windings are center tapped.

Stock No.	Type	Sec. VCT	Rec. Fil.	Fil. 1	Fil. 2	Case	1-24, EA.	25 or More, EA.
62 G 739	S-39	980/800 @ 175 ma	5V, 3A	2.5 VCT, 6A	6.3V, 4A	G-7	16.17	13.75
62 G 740	S-40	1050/850 @ 250 ma	5V, 3A	6.3 VCT, 3A	6.3V, 3A	G-7	17.64	14.99
62 G 741	S-41	1200 @ 200 ma	5V, 3A	7.5V tapped 6.3V, 3A	6.3V, 2A	G-7	17.64	14.99
62 G 742	S-42	1200/1050 @ 300 ma	5V, 6A	7.5V tapped 6.3V, 3A	6.3V, 3A	G-8	19.11	16.25

LINE-TO-SPEAKER TRANSFORMERS

Stock No.	Type	Watts	Primary	Sec.	Case	1-24, EA.	25 or More, EA.
62 G 769	S-12	15	1500, 2000	2, 4, 8, 15	G-2	5.29	4.50
62 G 770	S-13	30	4000	15	G-4	7.64	6.50

OUNCER AUDIO UNITS

Weigh only 1 ounce—for all compact applications. Response characteristics are: ±1 db 30-20,000 cps, except 0-14, 0-15, and units carrying DC, which are for voice from 150 to 4,000 cps. Maximum operating level, 0 db. Sealed in aluminum housings, 7/8" dia., 1 1/4" high. Mount by two 2-56 screws on 1/16" centers opposite terminals. Shpg. wt., 4 oz.

Stock No.	Type	Primary Impedance	Sec. Imp.	1-24, EA.	25 or more, EA.
62 G 780	0-1	50, 200-250, 500-600	50,000	7.64	6.50
62 G 781	0-2	50, 200-250, 500-600	50,000 CT	7.64	6.50
62 G 782	0-3	7.5-30	50,000	7.35	6.25
62 G 783	0-4	15,000	60,000	6.47	5.50
62 G 784	0-5	15,000 DC in Pri.	60,000	6.47	5.50
62 G 785	0-6	15,000	95,000 CT	7.35	6.25
62 G 786	0-7	15,000 DC in Pri.	95,000 CT	7.35	6.25
62 G 787	0-8	15,000	(50, 200-250, 500-600)	7.64	6.50
62 G 788	0-9	15,000 DC in Pri.	(50, 200-250, 500-600)	7.64	6.50
62 G 789	0-10	30,000 plate to plate	(500-600)	8.23	7.00
62 G 790	0-12	50, 200-250		7.64	6.50
62 G 793	0-13	AUDIO choke: 300 hys. at 0 DC; 50 hys. at 3 ma DC, 6000 ohms.		6.17	5.25
62 G 791	0-14	200	1/2 megohm	7.35	6.25
62 G 792	0-15	15,000	1 megohm	7.35	6.25
62 G 794	0-16	250 CT	50,000	10.00	8.50
62 G 493	0-18	10,000/2500	2000/500	8.23	7.00
62 G 494	0-19	10,000/2500	4000/1000	8.23	7.00
62 G 495	0-20	1500 CT	500/125	8.23	7.00
62 G 496	0-21	2000 CT; 4000 CT	8; 16	7.64	6.50
62 G 492	0-17	Mumetal Shield; fits any Ouncer unit		1.47	1.25

SUB AND SUB-SUBOUNCER TRANSFORMERS

"Tiny" transformers for miniature equipment. Frequency response, ±3 db from 200 to 5000 cps. Sub-ouncers size 3/16"x3/16"x7/16". Weight, 1/4 oz. Sub-ouncers size 1/8"x3/16"x5/16". Weight, 1/4 oz. Fixed imp. ratio; 1250:1 for SO-1 and SSO-1; 1:50 for SO-3 and SSO-3. *SO-5, 2675 ohms DC resistance; SSO-5, 4400 ohms. Wt., 2 oz.

SUB-OUNCER TRANSFORMERS

Stock No.	Type	Use	Pri. Imp.	Pri. DC	Sec. Imp.	1-24, EA.	25-Up, EA.
62 G 210	†SO-1	Input	200, 50	0	250K, 62.5K	2.94	2.50
62 G 211	SO-2	Audio 1:3	10,000	0-2.5 ma	90K	2.94	2.50
62 G 212	†SO-3	PI to line	10K, 25K	3, 1.5 ma	200, 500	2.94	2.50
62 G 213	SO-4	Output	30K, 10K	1 ma	50	2.94	2.50
62 G 214	SO-5	Reactor	50 hys @ 100,000	1 ma DC*	60	2.94	2.50
62 G 215	SO-6	Output	100,000	.5 ma	60	3.82	3.25
62 G 216	SO-7	†Transformer Interstage	20K, 30K	.5 ma	800, 1200	2.94	2.50
62 G 217	SO-8	†Transformer to PP sec.	10K	1 ma	2000 CT	3.53	3.00
62 G 218	SO-9	†Transformer to VC	500 CT	0	3.2	3.53	3.00
62 G 497	SO-10	†Transformer to VC	2K CT	4	2	3.53	3.00

SUB-SUBOUNCER TRANSFORMERS

Stock No.	Type	Use	Pri. Imp.	Pri. DC	Sec. Imp.	1-24, EA.	25-Up, EA.
62 G 236	†SSO-1	Input	200, 50	0	250K, 62.5K	4.41	3.75
62 G 237	SSO-2	†Input Interstage	10,000	0-2.5 ma	90K	4.70	4.00
62 G 238	†SSO-3	PI. to line	10K, 25K	3, 1.5 ma	200, 200	3.82	3.25
62 G 239	SSO-4	Output	30,000	1 ma DC*	50	3.82	3.25
62 G 240	SSO-5	Reactor	50 hys @ 100,000	1 ma DC*	60	3.82	3.25
62 G 241	SSO-6	Output	100,000	.5 ma	60	3.82	3.25
62 G 235	SSO-7	†Transformer	10K, 20K	.5 ma	800, 1200	2.94	2.50
62 G 229	SSO-8	†Transformer to PP sec.	10K	1	2000 CT	3.82	3.25
62 G 234	SSO-9	†Transformer to VC	10K	2	16	2.94	2.50
62 G 246	SSO-10	†Transformer to VC	10K	2	3.2	2.94	2.50
62 G 247	SSO-11	†Transformer Output	500	3.5	50	2.94	2.50
62 G 248	SSO-12	†Transformer Output	1000	3.5	50	2.94	2.50
62 G 249	SSO-13	†Crystal to Transistor	1200	3	50	2.94	2.50
62 G 498	SSO-14	†Crystal to Transistor	200K	0	1000	4.41	3.75
62 G 499	SSO-15	†Interstage	10K CT	2	200 CT	4.70	4.00
			25K CT	2	500 CT	4.70	4.00
			20K CT	1	800 CT	4.70	4.00
			30K CT	1	1200 CT	4.70	4.00

UTC Transformers

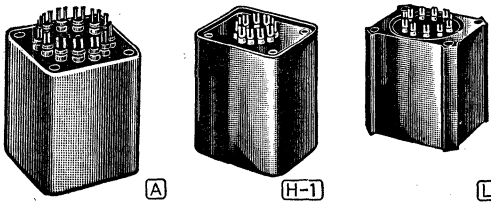

CASE DIMENSIONS

Case	Height	Width	Length	Mounting	Shpg. Wt.
H-1	3 1/8"	1 1/2"	2 3/8"	15x2x1 1/8"	2 1/2 lbs.
A	2"	1 1/2"	1 1/2"	15x2x1 1/8"	1 1/2 lbs.
LS-1	3 1/4"	2 1/2"	3 1/8"	1 1/2x2 3/8"	3 1/2 lbs.
LS-2	4 3/8"	3 1/2"	4 7/8"	2 1/2x3 1/8"	8 lbs.
LS-3	4 1/8"	5 1/2"	5 1/8"	4 3/8x5 1/2"	16 lbs.

TYPE HA HIPERM-ALLOY TRANSFORMERS

Lightweight audio transformers for compact, portable applications. All have Hiperm-Alloy core. Hum-balanced coil, die-cast case reduces hum. Uniform frequency response.

PLATE-TO-LINE TRANSFORMERS

Six secondary taps cover 50, 125-150, 200, 250, 333, 500-600 ohms. = 1 db from 30-40,000 cps. Maximum unbalanced DC in primary: HA-113, 0 ma.; HA-133, 8 ma.; HA-114, 1 ma. In H-1 case. *Imp. in ohms.

Stock No.	Type	Application	*Pri.	dbm	1-24, EA.	25 or More, EA.
62 G 816	HA-113	Plats to mult. line	15K	+21	17.64	14.99
62 G 866	HA-113	Plats to mult. line	15K	+22	20.58	17.49
62 G 817	HA-114	PP plates to line	30K	+23	20.58	17.49

TYPE LS LINEAR STANDARD TRANSFORMERS

Type LS units fulfill the most critical specifications established for broadcast equipment. Each is guaranteed to meet or exceed the frequency response indicated. All have Hiperm-Alloy cores, plus multiple-section, inter-leaved windings in a semitoroidal coil structure. Special winding methods and insulations assure minimum leakage reactance and distributed capacitance. Minimum hum pickup is achieved by the use of a high-conductivity outer case and hum-balancing coil structure.

INTERSTAGE AUDIO TRANSFORMERS

Designed for coupling single plates to PP grids. LS-19: = 1 db, 20-20,000 cps; relative hum, -50 db. LS-21: = 1 db, 10-20,000 cps; relative hum, -74 db. Maximum level: +20 dbm. Primary impedance, 15,000 ohms; for coupling single plate to PP grids. LS-1 case.

No.	Type	Sec. Imp., Ohms	1-24, EA.	25 or More, EA.
62 G 835	LS-19	95,000. Ratio, 1 1/2:1	17.64	14.99
62 G 837	LS-21	135,000. Ratio, 3:1	17.64	14.99

OUTPUT TRANSFORMERS

= 1 db, 7-50,000 cps, except +10-50,000 for push-pull output tubes. LS-35 and LS-36 are hi-fi types; LS-35: for class AB feedback; 43% screen tap; LS-36: for class AB₁ feedback; 40% screen tap. All in LS-2 case, except *in LS-3 case.

Stock No.	Mfr's Type	Pri. Imp., Ohms	Sec. Imp., Ohms	Watts	1-24, EACH	25 or More, EA.
62 G 845	LS-52	8000	(1, 2, 2.5, 5, 10, 15, 20, 30, 50, 100, 200, 300, 500, 1000)	20	20.58	17.49
62 G 847	LS-55	5000, 3000	(1, 2, 2.5, 5, 10, 15, 20, 30, 50, 100, 200, 300, 500, 1000)	20	23.52	19.99
62 G 849	LS-58*	2500, 1500	(1, 2, 2.5, 5, 10, 15, 20, 30, 50, 100, 200, 300, 500, 1000)	40	49.98	42.48
62 G 850	LS-61	1000, 6000	(1, 2, 2.5, 5, 10, 15, 20, 30, 50, 100, 200, 300, 500, 1000)	20	23.52	19.99
62 G 851	LS-61L	9000	(1, 2, 2.5, 5, 10, 15, 20, 30, 50, 100, 200, 300, 500, 1000)	30	35.28	29.99
62 G 846	LS-54	8000	(1, 2, 2.5, 5, 10, 15, 20, 30, 50, 100, 200, 300, 500, 1000)	20	17.64	14.99
62 G 848	LS-57	5000, 3000	(1, 2, 2.5, 5, 10, 15, 20, 30, 50, 100, 200, 300, 500, 1000)	20	17.64	14.99
62 G 855	LS-63	10,000, 6000	(1, 2, 2.5, 5, 10, 15, 20, 30, 50, 100, 200, 300, 500, 1000)	20	17.64	14.99
62 G 871	LS-35*	5000	(1, 2, 2.5, 5, 10, 15, 20, 30, 50, 100, 200, 300, 500, 1000)	35	23.52	19.99
62 G 872	LS-65*	3300	(1, 2, 2.5, 5, 10, 15, 20, 30, 50, 100, 200, 300, 500, 1000)	60	41.16	34.99

MIXING TRANSFORMERS

For mixing low-impedance mike, pickup or multiple line to multiple line. Maximum unbalanced DC in primary: LS-30, 5 ma.; LS-30X, 1 ma. Primary and secondary have 6 taps: 50, 125-150, 200, 250, 333, 500-600 ohms. In LS-1 case.

Type LS-30. Maximum level, +23 dbm. Relative hum-pickup reduction compared to uncased type, -74 db. = 1 db, 7-50,000 cps. **22.05**

Type LS-30X. Maximum level, +20 dbm. Multiple alloy shield gives relative hum-pickup reduction of -92 db. = 1 db, 20-20,000 cps. **23.52**

HIGH-LEVEL MATCHING TRANSFORMER

Type LS-33. Primary 50, 125, 200, 250, 333, 500-600 ohms. Secondary, 1, 2, 2.5, 5, 7.5, 10, 15, 20, 30, 50, 125, 200, 250, 333, 500-600 ohms. Max. level 20 watts. Response = 1 db, 10-40,000 cps. In LS-2 case. **20.58**

LOW-IMPEDANCE-TO-GRID TRANSFORMERS

LS-10, LS-10X to single grid; others to PP grids. Relative hum-pickup reduction compared to uncased type, -72 db; fextcept, -92 db. Primary impedance 50, 125-150, 200, 250, 333, 500-600 ohms. *Total impedance, both sections. In LS-1 case. = 1 db, 20-20,000 cps.

Stock No.	Type	*Sec. Ohms	Max. Level	1-24, EA.	25 or More, EA.
62 G 829	LS-10	60,000	+19 dbm	20.58	17.49
62 G 830†	LS-10X	50,000	+17 dbm	20.58	17.49
62 G 831	LS-12	120,000	+19 dbm	24.70	20.99
62 G 867†	LS-12X	80,000	+17 dbm	23.52	19.99

PLATE-TO-LINE TRANSFORMERS

LS-50, single plate to multiple line. LS-51, for push-pull low-level plates to multiple line. Secondary impedances: 50, 125-150, 200, 250, 333, 500-600 ohms. In LS-1 case. = 1 db, 10-40,000 cps.

Stock No.	Type	Pri. Ohms	Max. Level	1-24, EA.	25 or More, EA.
62 G 843	LS-50	15,000	+23 dbm	20.58	17.49
62 G 844	LS-51	30,000	+24 dbm	26.46	22.49

VARIATR VOLTAGE CONTROLS



Type V-1. Autotransformers with single layer coil. Coil is designed so that top portion of every turn is exposed and may be used as a tap of the winding. A special non-fusing contact can be moved to any position on the winding, permitting the exact voltage desired to be obtained. Maximum current available from 0-20 volts and 95-130 volts. From 20-95 volts current capacity tapers off (60% maximum at 65 volts). Rated at 5 amps, 570 watts. Output is independent of load. Size, 4 7/8x3 3/4". For 110-120 volts 50-60 cycle. Shpg. wt., 12 lbs.

62 G 201, 25 or More, EACH...16.66. 1 to 24, EACH...19.60

Model V-1-M. As above, but 0-150 v. meter. 4 7/8x3 3/4", 14 lbs.

62 G 202, 25 or More, EACH...29.15. 1 to 24, EACH...34.30

INTERSTAGE AUDIO TRANSFORMER

Type HA-106. Incorporates Hiperm-Alloy nickel iron core structure and hum balanced coils. Designed to match a single plate to push-pull grids. Has split secondary. Primary impedance, 15,000 ohms. Secondary impedance, 135,000 ohms. Turns ratio, 3:1 overall. Response: from 30-20,000 cps. = 1 db. Max. level, +20 dbm. In H-1 case.

62 G 813, 25 or More, EACH...15.75. 1 to 24, NET EACH...18.52

ULTRA-COMPACT HIGH-FIDELITY AUDIOS

Max. level, +15 dbm, except +1+30 dbm. *Multiple alloy shield. Response: A-10, A-12, = 2 db, 20-20,000 cps; A-11, = 2 db, 50-20,000 cps; A-16, A-18, A-19, A-25, = 2db, 40-20,000 cps; A-20, = 1 db, 10-50,000 cps; A-24, A-26, = 2 db, 20-40,000 cps; A-21, = 2 db, 30-30,000 cps; A-15, A-22, A-23, 2 db, 40-10,000 cps. Alt fit Mumetal "slip-on" shield (last listing in table). In A case. Av. shpg. wt., 1 1/2 lbs.

Stock No.	Mfr's Type	Pri. Imp., Ohms	Sec. Imp. Ohms	1-24, EA.	25 or More, EA.
62 G 820	A-10	50, 125-150, 200-250, 300, 500-600	50K	12.94	11.00
62 G 821	A-11*	50, 100, 200	80K P.P.	11.76	10.00
62 G 822	A-12	Same as A-10	80K 2 sect.	11.76	10.00
62 G 864	A-15†	10K-2.5K	500-2K	9.70	8.25
62 G 824	A-16	15K	60K 2:1	9.70	8.25
62 G 825	A-18	15K (Split)	80K P.P. 2.3:1	11.76	10.00
62 G 826	A-19	15K—8 ma DC	80K P.P. 2.3:1	11.76	10.00
62 G 827	A-20	Same as A-10	Same as Pri.	14.11	12.00
62 G 828	A-21*	50, 200-500, 500-600	Same as Pri.	11.76	10.00
62 G 868	A-22†	500	125-500, split	9.70	8.25
62 G 873	A-23†	500	4-16, split	9.70	8.25
62 G 777	A-24	15K	As A-10 pri.	12.64	10.75
62 G 778	A-25	15K—8 ma DC	As A-10 pri.	11.76	10.00
62 G 779	A-26	30K P. to P.	As A-10 pri.	12.94	11.00
62 G 874	A-33	Mumetal shield; for any of above		2.65	2.25

"DOTS" TRANSISTOR TRANSFORMERS

Deci-Ouncer-Transformers (DOTS). Miniature transistor transformers weighing only 1/16 of an ounce. Low distortion, high efficiency and excellent response. Moisture-proof case has firmly anchored leads, with plastic insulation. Especially suitable for printed circuits. 5/8" dia., 1 3/4" long. Shpg. wt., 1 oz.

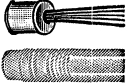

Stock No.	Mfr's Type	Application	Primary Ohms	Secondary Ohms	1-24, EA.	25 or More, EA.
62 G 686	DO-T1	Interstage	20K-30K	800-1200	5.88	5.00
62 G 687	DO-T2	Output	500-600	50-60	5.29	4.50
62 G 688	DO-T3	Output	1K-1.2K	50-60	5.29	4.50
62 G 689	DO-T4	Output	600	3:2	5.29	4.50
62 G 690	DO-T5	Output	1.2K	3:2	5.29	4.50
62 G 691	DO-T6	Output	10K	3:2	5.88	5.00
62 G 692	DO-T7	Input	200K	1K	6.47	5.50
62 G 693	DO-T8	Reactor	3.5 hrs. @ 2 ma DC		4.70	4.00
62 G 694	DO-T9	Out. Drive.	10K-12.5K	500-600	6.47	5.50
62 G 695	DO-T10	Driver	10K-12.5K	1.2K-1.5K	6.47	5.50
62 G 696	DO-T11	Driver	10K-12K	2K-2.5K	6.47	5.50
62 G 697	DO-T12	S/PP Output	150-200	12-16	5.59	4.75
62 G 698	DO-T13	S/PP Output	300-400	12-16	5.59	4.75
62 G 699	DO-T14	S/PP Output	600-800	12-16	5.88	5.00
62 G 876	DO-T15	S/PP Output	800-1070	12-16	5.88	5.00
62 G 877	DO-T16	S/PP Output	1K-1.33K	12-16	5.88	5.00
62 G 878	DO-T17	S/PP Output	1.5K-2K	12-16	5.88	5.00
63 G 087	DO-T18	S/PP Output	7.5K-10K	12-16	6.17	5.25
63 G 089	DO-T19	Output	600	600	5.88	5.00
63 G 088	DO-T20	Output	500	600	5.88	5.00
63 G 090	DO-T21	Output	900	600	5.88	5.00
63 G 091	DO-T22	Output	1.5K	600	5.88	5.00
63 G 092	DO-T23	Interstage	20K-30K	800-1.2K	6.78	5.75
63 G 093	DO-T24	Input	200K	1K	7.35	6.25
63 G 094	DO-T25	Interstage	10K-12K	1.5K-1.8K	7.06	6.00

UTC Transformers and Inductors



CGE-1A



CG, CVP, CVM

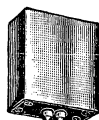

M

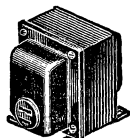

R-88

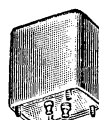

BMI



VIC



HVC

TRANSFORMERS, TOROIDS, FILTERS, VOLTAGE CONTROLS, INDUCTORS

COMMERCIAL GRADE COMPONENTS

FIXED-IMPEDANCE & VARIMATCH AUDIO OUTPUT TRANSFORMERS

Designed for industrial and commercial use where dependable operation is essential. Windings are vacuum impregnated and entire unit is sealed with a special compound. Will withstand extremes of climate. Response of all units $\pm 1\frac{1}{2}$ db from 40 to 10,000 cps. P-P pri. imp. of CG-15 8000 ohms; CG-16 3000 and 5000 ohms; have 1.5, 3, 5, 8, 16, 200 and 500 ohm taps on secondary. CVP-1 and CVP-2 are Varimatch type. Will match any tubes to line or voice coil. Pri. imp.: 3000, 5000, 6000, 7000, 8000, 10,000, 14,000 ohms. Sec. imp.: 1.5, 3, 5, 8, 16, 50, 200, 500 ohms. All units require $2\frac{1}{2}$ " mounting hole, except *3" hole. Shpg. wt. and size: $3\frac{1}{4} \times 3 \times 3\frac{1}{4}$, $3\frac{1}{2}$ lbs.; except * $4\frac{1}{2} \times 3\frac{3}{4} \times 3\frac{3}{4}$, 6 $\frac{1}{2}$ lbs.

Stock No.	Mfr's Type	Watts	Typical Tubes	1-24, EACH	25-Up, EACH
62 G 922	CG-15	20	6A05, 6V6, 6F6 triode	11.76	10.00
62 G 923	CG-16	20	2A3, 6AS7G, 6L6, 6080	11.76	10.00
63 G 067	CVP-1	12	2A3, 6AQ5, 6V6, 25L6	12.94	11.00
63 G 068	*CVP-2	30	2A3, 6L6, 807, 5881, 6V6	14.11	11.98

VARIMATCH MODULATION UNITS

Match any modulator tubes to any RF load. Vacuum impregnated and sealed against moisture. Primary imp., from 500 to 20,000 ohms; secondary imp., from 30,000 to 500 ohms. Maximum audio ratings: CVM-0 12 w., CVM-1 30 w., CVM-2 60 w. *Maximum watts. Shpg. wt.: CVM-0 $3\frac{1}{2}$ lbs.; CVM-1, 6 $\frac{1}{2}$ lbs.; CVM-2, 11 lbs.

Stock No.	Mfr's Type	Class C Input*	Size	1-24, EACH	25-Up, EACH
63 G 069	CVM-0	25	3" x 3 $\frac{3}{4}$ "	10.29	8.75
63 G 070	CVM-1	60	3 $\frac{3}{4}$ x 4 $\frac{1}{2}$ "	13.52	11.49
63 G 071	CVM-2	125	4 $\frac{1}{2}$ x 5 $\frac{1}{2}$ "	17.64	14.99

TYPE R VOLTAGE BOOSTERS

For TV or air conditioner when line voltage is low. Give 10% boost. Operate from 95 to 110 volts 50 to 60 cycles. With line cord and receptacle. Wts., R-87 2 lbs., R-88 12 lbs.

Stock No.	Mfr's Type	Rating	Size	1-24, EACH	25-Up, EACH
62 G 752	R-87	3A, 350W	$3\frac{3}{4} \times 2 \times 2\frac{3}{4}$	5.28	5.00
62 G 753	R-88	18A, 2KW	$3\frac{3}{4} \times 4\frac{1}{2} \times 4\frac{1}{2}$	17.05	14.49

FEEDBACK OUTPUT TRANSFORMERS

Hi-fi units. Sec. imp.: 4, 8, 16 ohms, 70 volt. Pri. imp.: CG-20 5000CT, 43% screen taps; CG-21 3300CT, 40% screen taps. Size and wt.: CG-20 $3\frac{3}{4} \times 4\frac{1}{2}$ " 7 $\frac{1}{2}$ lbs.; CG-21 $4\frac{1}{2} \times 5\frac{1}{2}$ " 11 lb.

Stock No.	Mfr's Type	Watts	Typical Tubes	1-24, EACH	25-Up, EACH
62 G 102	CG-20	25	EL-34's in AB	14.70	12.49
62 G 103	CG-21	50	6550's in AB	23.52	19.99

INPUT, INTERSTAGE, MIXING AND LOW-LEVEL OUTPUT TRANSFORMERS

A new line of transformers designed for a wide variety of applications. Shpg. wts.: CG-132, 1 lb.; CG-133, 1 $\frac{1}{2}$ lbs.; CG-134, $\frac{1}{2}$ lb.; CG-235, $\frac{1}{2}$ lbs.; CG-141 $\frac{1}{2}$ lb.

Stock No.	Mfr's Type	Application	1-24, EACH	25-Up, EACH
62 G 104	CG-132	1 plate to 2 grids	9.70	8.25
62 G 105	CG-133	2 plates to 2 grids	10.29	8.75
62 G 106	CG-134	Line to 1 grid	8.82	7.50
62 G 107	CG-235	Line to 1 or 2 grids	11.76	10.00
62 G 108	CG-141	PP plates to line	8.82	7.50

FILTER CHOKES

Inductance shown is at rated DC ma. Shpg. wts.: CG-40, 5 lbs.; CG-48C, 2 $\frac{1}{2}$ lbs.; CG-102, 11 lbs.; CG-108, 22 lbs.

Stock No.	Mfr's Type	Hys.	DC Ma.	DC Ohms	1-24, EACH	25-Up, EACH
62 G 109	CG-40	10	200	110	7.94	6.75
62 G 111	CG-48C	75	50	2200	7.35	6.25
62 G 112	CG-102	12	250	100	12.94	11.00
62 G 113	CG-108	10	500	52	26.46	22.49

TYPE M TOROIDS

Coils conform to MIL-T-27 specifications. Inductance is virtually independent of frequency, temperature and vibration. Extremely low hum pickup. Very high Q available. Typical Q values: MQE-7 max. Q 130 @ 8 kc; MQA-10 150 @ 5 kc; MQB-5, 250 @ 3 kc and 50 @ 250 cycles. Lab. adjusted to 1% tol. DC currents shown will drop coil inductance 5%. Shpg. wts., MQE 2 oz.; MQA, 4 oz.; MQB 14 oz.

TYPE MQE— $1\frac{1}{4} \times 1\frac{1}{2} \times 1\frac{1}{2}$ "

Stock No.	Mfr's Type	Inductance	Max. Ma.	1-24, EACH	25-Up, EACH
62 G 945	MQE-1	7 mhy	135	7.06	6.00
62 G 946	MQE-2	12 mhy	100	7.35	6.25
62 G 947	MQE-3	20 mhy	80	7.64	6.50
62 G 948	MQE-4	30 mhy	65	7.64	6.50
62 G 949	MQE-5	50 mhy	50	7.94	6.75
62 G 975	MQE-6	70 mhy	40	8.23	7.00
62 G 976	MQE-7	100 mhy	35	8.23	7.00
62 G 977	MQE-8	150 mhy	30	8.53	7.25
62 G 978	MQE-9	.25 hy	22	8.53	7.25
62 G 979	MQE-10	.4 hy	17	8.82	7.50
62 G 980	MQE-11	.6 hy	14	8.82	7.50
62 G 981	MQE-12	.9 hy	12	9.11	7.75
62 G 982	MQE-13	1.5 hy	9	9.70	8.25
62 G 983	MQE-14	2 hy	8	10.58	9.00
62 G 984	MQE-15	2.8 hy	7.2	11.76	10.00

TYPE MQA— $1\frac{1}{2} \times 2 \times 1\frac{1}{2}$ "

Stock No.	Mfr's Type	Inductance	Max. Ma.	1-24, EACH	25-Up, EACH
62 G 985	MQA-1	7 mhy	250	7.35	6.25
62 G 986	MQA-2	12 mhy	200	7.64	6.50
62 G 987	MQA-3	20 mhy	150	7.94	6.75
62 G 988	MQA-4	30 mhy	125	8.23	7.00
62 G 989	MQA-5	50 mhy	100	8.53	7.25
62 G 990	MQA-6	70 mhy	80	8.82	7.50
62 G 991	MQA-7	120 mhy	60	9.11	7.75
62 G 992	MQA-8	.2 hy	50	9.41	8.00
62 G 993	MQA-9	.3 hy	40	9.70	8.25
62 G 994	MQA-10	.5 hy	30	10.00	8.50
62 G 995	MQA-11	.7 hy	25	10.29	8.75
62 G 996	MQA-12	1 hy	20	10.58	9.00
62 G 997	MQA-13	1.5 hy	17	10.88	9.25
62 G 998	MQA-14	2.5 hy	13	11.17	9.50
62 G 999	MQA-15	4 hy	10	11.76	10.00
62 G 967	MQA-16	6 hy	9	12.64	10.75
62 G 968	MQA-17	10 hy	7	13.52	11.49
62 G 969	MQA-18	15 hy	5	14.70	12.49
62 G 970	MQA-19	22 hy	4	17.64	14.99

TYPE MQB— $2\frac{1}{2} \times 2 \times 1\frac{1}{2}$ "

Stock No.	Mfr's Type	Inductance	Max. Ma.	1-24, EACH	25-Up, EACH
62 G 953	MQB-1	10 mhy	400	12.64	10.75
62 G 954	MQB-2	30 mhy	250	12.94	11.00
62 G 955	MQB-3	70 mhy	170	13.23	11.25
62 G 956	MQB-4	120 mhy	120	13.52	11.49
62 G 957	MQB-5	.5 hy	60	13.82	11.75
62 G 958	MQB-6	1 hy	40	14.11	11.98
62 G 959	MQB-7	2 hy	30	14.41	12.25
62 G 962	MQB-8	3.5 hy	22	14.70	12.49
62 G 963	MQB-9	7.5 hy	16	15.59	13.25
62 G 964	MQB-10	12 hy	11	16.46	13.99
62 G 965	MQB-11	18 hy	9	17.64	14.99
62 G 973	MQB-12	25 hy	8	18.82	15.99

LOW-FREQUENCY HIGH "Q" COILS

Specially constructed coils of laminated permalloy to provide high Q at low frequencies. Q of 45 at 100 cycles. Exceptional temperature stability. Inductance values laboratory adjusted to 2% tolerance at 1 volt, 60 cycles. Very low hum pickup assured by heavy Hi-permalloy shielding and laminated structure. Two identical windings brought out to 4 terminals permit series, parallel or center-tapped or transformer type connections. Requires $1\frac{1}{2}$ " dia. cutout. $2\frac{1}{2}$ " dia. x $2\frac{1}{2}$ ". Shpg. wt., 1 lb.

Stock No.	Mfr's Type	Series Hy.	Parallel Hy.	1-24, EACH	25-Up, EACH
62 G 896	MLQ-1	10	2.5	20.58	17.49
62 G 897	MLQ-2	20	5	20.58	17.49
62 G 898	MLQ-3	200	50	20.58	17.49
62 G 899	MLQ-4	400	100	22.34	18.99

UNIVERSAL INTERSTAGE EQUALIZER

Type CGE-1A. Tone equalizer. Matches source of up to 20K ohms to load of 500K ohms or more. Continuously variable equalization over 30 db range at either end of audio spectrum, with only 18 db insertion loss. $2\frac{1}{2}$ " deep, $2\frac{3}{8} \times 3\frac{1}{2}$ " panel. Shpg. wt. 2 lbs.

62 G 875.1 to 24, NET EACH.....21.46
25 or More, EACH.....18.25

TYPE HVC VARIABLE INDUCTORS

Wide-range, stable, high-Q units. Hermetically sealed. Meet MIL-T-27A specs. *Adjustable by set screw from $\pm 200\%$ to $\pm 70\%$ of mean value. Size, $1\frac{1}{2} \times 2\frac{1}{2} \times 1\frac{1}{2}$ ". Shpg. wt. 3 oz.

Stock No.	Mfr's Type	Mean Hys.*	Max. Ma.	1-24, EACH	25-Up, EACH
62 G 114	HVC-1	.005	100	8.82	7.50
62 G 115	HVC-2	.015	60	8.82	7.50
62 G 116	HVC-3	.040	40	8.82	7.50
62 G 117	HVC-4	.1	30	8.82	7.50
62 G 118	HVC-5	.25	20	8.82	7.50
62 G 119	HVC-6	.6	15	8.82	7.50
62 G 121	HVC-7	1.5	10	9.41	8.00
62 G 122	HVC-8	4.0	7	9.41	8.00
62 G 123	HVC-9	10	5	9.41	8.00
62 G 124	HVC-10	25	3.5	9.70	8.24
62 G 126	HVC-11	60	2	10.58	9.00
62 G 127	HVC-12	150	1.5	11.76	10.00

TYPE VIC VARIABLE INDUCTORS

*Adjustable from +85% to -45% of mean value. Mtg. ctrs., $1\frac{1}{2} \times 2\frac{1}{2} \times 1\frac{1}{2}$ ". Shpg. wt., 6 oz.

Stock No.	Mfr's Type	Mean Hys.*	Max. Ma.	1-24, EACH	25-Up, EACH
62 G 900	VIC-1	.0085	75	6.47	5.50
62 G 901	VIC-2	.013	60	6.47	5.50
62 G 902	VIC-3	.021	50	6.47	5.50
62 G 903	VIC-4	.034	40	6.47	5.50
62 G 904	VIC-5	.053	35	6.47	5.50
62 G 905	VIC-6	.084	30	6.47	5.50
62 G 906	VIC-7	.13	25	6.47	5.50
62 G 907	VIC-8	.21	21	6.76	5.75
62 G 908	VIC-9	.34	18	6.76	5.75
62 G 909	VIC-10	.54	15	6.76	5.75
62 G 910	VIC-11	.85	12	6.76	5.75
62 G 911	VIC-12	1.3	10	7.06	6.00
62 G 912	VIC-13	2.2	8	7.06	6.00
62 G 913	VIC-14	3.4	7	7.06	6.00
62 G 914	VIC-15	5.4	6	7.35	6.25
62 G 915	VIC-16	8.5	5	7.35	6.25
62 G 916	VIC-17	13.	4	7.35	6.25
62 G 917	VIC-18	21.	3.5	7.64	6.50
62 G 918	VIC-19	33.	3	7.64	6.50
62 G 919	VIC-20	52.	2	8.23	7.00
62 G 920	VIC-21	83.	1.5	8.82	7.50
62 G 921	VIC-22	130.	1	11.76	10.00

INTERSTAGE AND LINE FILTERS

First letter in Type No. indicates function: B—bandpass; H—high-pass; L—low-pass. Last letter: I—Interstage (10,000 ohms); L—line (500/600 ohms). Shielded; reduce hum pickup to 150 mv per gauss at 60 cps. Hermetically sealed. Size, $1\frac{1}{2} \times 1\frac{1}{2} \times 1\frac{1}{2}$ ". except $1\frac{1}{2} \times 1\frac{1}{2} \times 2\frac{1}{2}$ ". Av. shpg. wt. 9 oz.

Stock

Thordarson Transformers

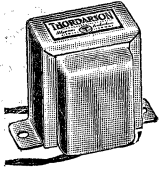

FGV

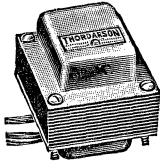

AGF



GGV

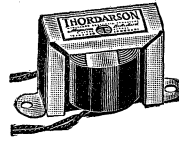

BAH



BAV

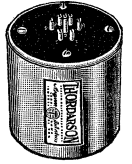

RTV

UNIVERSAL-MOUNT POWER TRANSFORMERS

AGF High quality, universal-mount power transformers. Easy to install—adjustable brackets permit flush, vertical or horizontal mounting. RETMA color-coded. 117-volt,

50-60 cycle primaries. All Fil. 1 windings center-tapped. *Has additional 2.5-volt, 3.5-ampere, center-tapped winding. †Has additional 2.5-volt, 5-ampere, center-tapped winding.

Stock No.	Mfr's Type	Plate		Rect.		Fil. 1		Mtg. Ctrs.	Wt., Lbs.	NET EACH	
		Volts	Ma	V	A	V	A			1 to 9	10 to 24
63 G 700	22R00	500 CT	40	5	2	6.3	2.0	2x2 1/2"	2 1/2	4.88	4.39
63 G 701	22R01	550 CT	50	5	2	6.3	2.5	2x2 1/2"	3	5.88	5.29
63 G 702	22R02	600 CT	70	5	2	6.3	3.0	2x2 1/2"	3 1/4	7.03	6.32
63 G 703	22R04	600 CT	70	5	2	6.3	3.5	2 1/2 x 2 1/2"	3 3/4	6.85	6.14
63 G 704	22R05	600 CT	120	5	3	6.3	5.0	2 1/2 x 3 1/2"	5 1/2	7.50	6.74
63 G 705	22R06	650 CT	150	5	3	6.3	5.0	3x3 3/4"	6 1/4	8.76	7.89
63 G 706	22R07	700 CT	200	5	3	6.3	6.0	3x3 3/4"	8 1/2	11.44	10.29
63 G 708	22R09	550 CT	50	5	2	2.5	7.5	2x2 1/2"	3	5.88	5.29
63 G 709	22R10*	650 CT	85	5	2	2.5	9.0	2 1/2 x 3 1/2"	4 3/4	8.36	7.53
63 G 710	22R11†	650 CT	120	5	3	2.5	12.5	2 1/2 x 3 1/2"	6 1/4	7.50	6.74

UPRIGHT-MOUNT POWER TRANSFORMERS

GGV Upright-mount power transformers designed for dependable service. All units have 117 volt, 50-60 cycle primaries. Fil. 1

windings CT. Standard RETMA color-coded leads; ends stripped and tinned for easy soldering. *Additional 6.3 volt, 3-amp CT winding.

Stock No.	Mfr's Type	Plate		Rect.		Fil. 1		Mtg. Ctrs.	Wt., Lbs.	NET EACH	
		Volts	Ma	V	A	V	A			1 to 9	10 to 24
63 G 711	22R30	550 CT	50	5	2	6.3	2.5	2x2 1/2"	3 1/2	6.12	5.51
63 G 712	22R31	720 CT	80	5	2	6.3	2.5	2x2 1/2"	5 1/2	6.67	7.80
63 G 713	22R32*	720 CT	110	5	2	6.3	2.0	2 1/2 x 2 1/2"	6 1/4	10.76	9.68
63 G 713	22R33	750 CT	160	5	3	6.3	5.0	3x2 1/2"	9	11.44	10.29
63 G 715	22R34	770 CT	225	5	3	6.3	5.0	3x3 3/4"	11 3/4	13.05	11.75
63 G 716	22R35	800 CT	340	5	6	6.3	7.0	3x4 1/2"	13	15.99	14.40
63 G 719	22R36	1200 CT	200	5	3	6.3	5.0	3x3 3/4"	8 1/2	11.76	10.58

"ECONOMY SERIES" POWER TRANSFORMERS

Low-cost, high quality power transformers. Designed for general replacement. Types ending with U are for upright mounting (Fig. GGV). Others have adjustable brackets to permit

flush, vertical or horizontal mounting (Fig. AGF). Both types have 110-120 volt, 50-60 cycle primaries. Fil. 1 windings are center-tapped. All units are RETMA color-coded.

Stock No.	Mfr's Type	Plate		Rect.		Fil. 1		Mtg. Ctrs.	Wt., Lbs.	NET EACH	
		Volts	Ma	V	A	V	A			1 to 9	10 to 24
63 G 319	24R00	480 CT	40	5	2	6.3	2.0	2x2 1/2"	2	4.41	3.97
63 G 320	24R00-U	480 CT	40	5	2	6.3	2.0	2x1 3/4"	2	4.41	3.97
63 G 321	24R01	650 CT	40	5	2	6.3	2.0	2x1 3/4"	2 3/4	4.50	4.05
63 G 322	24R01-U	650 CT	40	5	2	6.3	2.0	2x1 1/4"	2 3/4	4.50	4.05
63 G 323	24R02	700 CT	70	5	2	6.3	2.5	2 1/4 x 2 1/4"	4	5.62	5.06
63 G 324	24R04	700 CT	90	5	3	6.3	3.5	2 1/4 x 2 1/4"	4 1/4	6.53	5.87
63 G 325	24R04-U	700 CT	90	5	3	6.3	3.5	2 1/4 x 2 1/4"	4 1/4	6.53	5.87
63 G 326	24R05	700 CT	120	5	3	6.3	4.7	2 1/2 x 3 1/2"	5 3/4	6.91	6.21
63 G 327	24R05-U	700 CT	120	5	3	6.3	4.7	2 1/2 x 3 1/2"	5 3/4	6.91	6.21
63 G 328	24R06	750 CT	150	5	3	6.3	4.7	2 3/4 x 3 3/4"	6 1/2	8.17	7.35
63 G 329	24R06-U	750 CT	150	5	3	6.3	4.7	2 3/4 x 3 3/4"	6 1/2	8.17	7.35
63 G 330	24R07	800 CT	200	5	3	6.3	5.0	3x3 3/4"	9 1/2	9.32	8.39
63 G 331	24R07-U	800 CT	200	5	3	6.3	5.0	3x3 3/4"	9 1/2	9.32	8.39

MODULATION TRANSFORMERS

Stock No.	Mfr's Type	Fig.	Watts	Primary Ohms	Secondary Ohms	Mtg. Ctrs.	Wt., Lbs.	NET EACH	
								1 to 9	10 to 24
63 G 801	21M52	FGV	10	10K CT	3K, 3.75K, 4.5K	2 3/8"	1 1/2	4.50	4.05
63 G 615	21M53	BAH	10	10K CT	3K, 3.75K, 4.5K	2 7/8"	1 1/2	3.91	3.52
63 G 615	21M68	BAV	10	10K CT	4K, 5K, 7.5K, 10K, 12K	2 7/8 x 2 1/8"	1 1/2	3.59	3.22
63 G 612	21M67	GGV	25	10K CT	3K, 5K, 6.5K, 8K	2x1 1/8"	2 3/4	5.41	4.87
63 G 802	21M54	GGV	25	6.6K CT	4K	2x2"	3 1/4	6.53	5.87

Multi-Match Type. Universal modulation transformers—have taps to permit proper im-

pedance match between modulator output tubes and RF amplifier load. Split secondary.

Stock No.	Mfr's Type	Fig.	Watts	Prim. Ma. Each Side	Sec. Ma.	Ser. Par.	Mtg. Ctrs.	Wt., Lbs.	NET EACH	
									1 to 9	10 to 24
63 G 812	21M61A	GGV	60	125	125	125	2 3/4 x 2 1/2"	6 1/2	14.38	12.94
63 G 813	21M62A	GGV	125	210	160	320	3 1/4 x 3 1/2"	15	18.29	16.45

FILTERING AND COUPLING CHOKES

20C58 is speech-frequency tuned audio choke for impedance coupling. 20C50 is plate im-

pedance coupling choke. Others for both input and smoothing use. *Inductance at rated ma.

Stock No.	Mfr's Type	Fig.	*Hys.	Rated Ma.	Res. Ohms.	Insul. Test.	Mtg. Ctrs.	Wt., Lbs.	NET EACH	
									1 to 9	10 to 24
63 G 725	20C50	BAH	350	5	5500	2000	2 7/8"	1 1/2	3.50	3.15
63 G 726	20C51	BAH	35	15	1850	1200	2"	3/4	1.38	1.24
63 G 727	20C52	BAH	8	40	450	1200	2"	3/4	1.23	1.11
63 G 728	20C53	BAH	12	80	375	2000	2 7/8"	1 1/2	2.06	1.85
63 G 729	20C54	GGV	8	150	145	2700	1 3/4 x 2"	3/4	4.09	3.67
63 G 730	20C55	GGV	6	200	75	2700	2x2 1/4"	3/4	5.09	4.58
63 G 731	20C56	GGV	8	250	60	3500	3x2 1/2"	6 3/4	8.26	7.44
63 G 733	20C58	BAH	0.75	10	30	1100	2 3/8"	3/4	2.55	2.12

OSCILLOSCOPE TRANSFORMER

GGV Type 22R40. For use in oscilloscopes, CRT applications and test equipment. Primary, 117 volts, 60 cycles. Plate, 1800 volts AC at 2 ma. Rectifier filament, 2.5 volts at 1.8 amps. Filament 1, 6.3 volts at 0.6 amps; tapped at 2.5 volts, 2.1 amps. Overall size: 3 3/4 x 3 1/4 x 4-hole mounting; mtg. centers, 2 1/2 x 2 1/2". Shpg. wt., 3 1/2 lbs.
63 G 717, 1 to 9, NET EACH.....13.05
10 to 24, EACH.....11.75

UNIVERSAL TV POWER TRANSFORMER

AGF Type 26R00. Extremely versatile, high-quality replacement unit for power transformers in over 2000 popular television sets. Ideal stock-item for TV service-shops—helps keep down inventory. Multi-tapped 295-ma secondary. Primary: 117 volts, 50-60 cycles AC. Tapped high-voltage secondary: 850 volts center-tapped, 720 volts center-tapped, 600 volts center-tapped. Filament windings: Two 5-volt @ 3 and four 6.3-volt @ 3 amperes. Dual electrostatic shielding. Universal mounting for ease of installation. Overall size: 3 3/4 x 4 1/2 x 4 1/2". Shpg. wt., 11 lbs.
63 G 820, 1 to 9, NET EACH.....17.96
10 to 24, EACH.....16.17

PLATE TRANSFORMERS

GGV Primaries for 115 volts, 50-60 cycles. Excellent for use in transmitter, RF amplifier and modulator power supplies. All units listed are static shielded.

Type 21P87. Has tapped primary to provide choice of two output voltages. Delivers either 1670 volts CT or 1312 volts CT at 200 ma, depending upon primary tap used. Secondary, 835-650-0-650-835 volts @ 220 ma. Mounting centers, 3 3/4 x 3". Overall size: 4 5/8 x 3 7/8 x 4 1/4". Shpg. wt., 10 lbs.
63 G 657, 1 to 9, NET EACH.....12.73
10 to 24, EACH.....11.46

Type 21P89. Secondary, 550-0-550 volts @ 175 ma. Mounting centers, 3x2 1/2". Size, 3 7/8 x 3 3/4 x 4 1/4". Shpg. wt., 6 1/2 lbs.
63 G 658, 1 to 9, NET EACH.....9.82
10 to 24, EACH.....8.84

Type 21P93. For two full-wave rectifier systems, or one rectifier at combined current output. Secondary, 500-0-500 volts @ 95 ma or 1075-0-1075 @ 125 ma. Mtg. centers, 3 5/8 x 3". Size, 4 5/8 x 3 7/8 x 4 1/4". Shpg. wt., 10 lbs.
63 G 660, 1 to 9, NET EACH.....19.58
10 to 24, EACH.....17.62

DUAL TONE CONTROL COMPONENTS

Type 20C74. Reactor. For tone compensating systems to boost or attenuate bass or treble independently. Similar to Fig. RTV above, but wire leads. Use with R1068X listed below. Hum-bucking. Inductance, 22 hrs. DC resistance, 220 ohms. 2x1 1/2" dia. Wt., 12 oz.
63 G 734, 1 to 9, NET EACH.....7.94
10 to 24, EACH.....7.14

Type R1068X. Dual Control. Use with reactor above. Size, 1 1/2" dia. x 1 1/4" overall length. Shaft, 3/8" long. With hardware and diagram. Two required for complete bass-treble system. Shpg. wt., 8 oz.
63 G 165, 1 to 9, NET EACH.....4.12
10 to 24, EACH.....3.70

TUBE-TO-LINE TRANSFORMERS

Low-level tube-to-line transformers for a wide variety of applications. Units listed are rated at three watts. Primary may be used with single or push-pull plates. Frequency response, 60-15,000 cps.

GGV Type 22S90. Tube-to-line audio output transformer. Primary, 20,000 ohms center-tapped. Secondary, 125, 200, 500, 600 ohms @ 10 ma. Mounting center, 2 3/8". Overall size, 2 3/8 x 2 1/2 x 1 1/2". Shpg. wt., 1 lb.
63 G 740, 1 to 9, NET EACH.....3.76
10 to 24, EACH.....3.39

BAH Type 22S91. Tube-to-line audio output transformer. Primary, 20,000 ohms center-tapped. Secondary, 125, 200, 500, 600 ohms @ 10 ma. Mounting center, 2 7/8". Overall size, 2x3 1/2 x 2". Shpg. wt., 1 lb.
63 G 611, 1 to 9, NET EACH.....3.23
10 to 24, EACH.....2.91

Thordarson Transformers



CAV



BAH



BAV



BHH

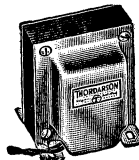

GGV

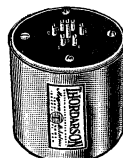

RAV, RTV

OUTPUT TRANSFORMERS

Compact, high-grade output transformers—for output to line or voice coil, etc. All are similar to Fig. BAH except *Fig BHH and*Fig. GGV Av. shpg. wt., 2 1/2 lbs.

Stock No.	Type	Primary	Secondary	Watts	Ctrs.	1-9, EA.	10-24, EA.
63 G 775	22S45	1500-3000	3.2-4	5	2"	2.44	2.20
63 G 776	22S46	2000-3000	3.2-4	5	1 1/2"	2.76	2.49
63 G 777	22S47	6000-7000 CT	3.2-4	5	2 1/2"	2.62	2.35
63 G 778	22S48	12,000-16,000 CT	3.2-4	5	2 3/4"	1.94	1.74
63 G 779	22S56	8000/10,000 CT	3.2-4, 6-8	10	2 1/2"	3.26	2.94
63 G 780	*22S58	5,000/7,000 CT	3.2-4, 6-8	8	2 1/2"	2.20	1.98
63 G 781	22S60	2500/4000 CT	3.2-4, 6-8	10	2 1/2"	3.09	2.77
63 G 782	*22S62	Univ. Plate	1-30	8		3.20	2.88
63 G 783	*22S64	10,000 CT	15, 250, 500	25	1 1/2 x 2"	5.88	5.29
63 G 784	*22S66	8000 CT	3.2-4, 6-8	25	1 1/2 x 2"	6.14	5.53
63 G 785	*22S68	6500 CT	15, 250, 500	25	1 1/2 x 2"	6.47	5.82
63 G 786	*22S70	5000 CT	3.2-4, 6-8	25	1 1/2 x 2"	5.23	4.71
63 G 790	*22S78	3300 CT	3.2-4, 6-8	60	2 1/2 x 2 1/2"	9.82	8.84
63 G 788	*22S74	Universal CT	1 to 30	25	3 1/2"	5.44	4.89
63 G 796	22S86	Universal CT	3.2-4, 6-8	3	2"	2.26	2.04
63 G 797	22S87	Universal CT	3.2-4, 6-8	6	2 1/2"	2.94	2.65
63 G 798	22S88	Universal CT	3.2-4, 6-8	8	2 1/2"	2.94	2.65
63 G 799	*22S93	9500 CT	15-16	10	1 1/2 x 2"	7.05	6.32
63 G 774	*22S95	5,000 CT	3.2-4, 6-8,	15	1 1/2 x 2"	7.70	6.93
		3,000 CT	15-16				
63 G 799	*22S97	6,000 CT	3.2-4, 6-8	25	1 1/2 x 2"	7.32	6.59
63 G 772	24S60	4000/7000/8000/10,000/14,000 CT	0.1-30	4	2"	1.88	1.70
63 G 773	24S61	4000/7000/8000/10,000/14,000 CT	0.1-30	8	2 1/2"	2.20	1.98

FILAMENT TRANSFORMERS

Primaries for 117 v. 50-60 cycle AC, except 26F65 6.3 v., 21F26 115-230 v. All have 2500 v. insulation, except 21F02 and 21F05 10,000 v., 21F26 8500 v., 21F27 3000 v., 26F65 5000 v., *1 secondary. *Tapped primary.

Stock No.	Type	Fig.	Volts	Amps	Ctrs.	Lbs.	1-9, EA.	10-24, EA.
63 G 665	21F00	BAV	2.5 CT	10	2 3/4"	1	2.35	2.12
63 G 666	21F01	BAV	2.5 CT	10	2 3/4"	1 1/2	4.12	3.70
63 G 667	21F02	CAV	2.5 CT	10	2x1 3/4"	2 1/2	4.62	4.16
63 G 668	21F03	BAV	5 CT	3	2 1/2"	1 1/2	3.26	2.94
63 G 669	21F04	CAV	5 CT	8	2x1 1/2"	3	5.56	5.00
63 G 681	21F05	CAV	5 CT	3	2x1 1/2"	2 1/2	5.70	5.14
63 G 682	21F06	CAV	5 CT	13	2x2"	3 1/2	4.82	4.34
63 G 671	21F07	CAV	5 CT	21	2 1/2 x 2 1/2"	5 1/2	9.14	8.23
63 G 672	21F08	BAV	6.3 CT	1	2"	1	1.88	1.70
63 G 604	21F09	BAH	6.3 CT	1.2	2 1/2"	1	1.88	1.70
63 G 673	21F10	BAH	6.3 CT	3	2 1/2"	1	3.04	2.73
63 G 674	21F11	CAV	6.3 CT	6	1 1/2 x 2"	2 1/2	4.06	3.66
63 G 675	21F12	CAV	6.3 CT	10	2x2"	3	5.56	5.00
63 G 676	21F13	BAH	*6.3/7.5/2.5	2.5	2 1/2"	1 1/2	3.22	2.92
63 G 677	21F15	BAV	7.5 CT	4	2 1/2"	2	4.09	3.67
63 G 678	21F16	CAV	7.5 CT	8	2 1/2"	3 1/2	5.88	5.29
63 G 682	21F17	CAV	7.5 CT	12	2 1/2 x 2 1/2"	5	7.50	6.74
63 G 679	21F18	CAV	10 CT	5	1 1/2 x 2"	2 1/2	5.88	5.29
63 G 680	21F19	CAV	*10 or 11 CT	12 or 11	2 1/2 x 2 1/2"	6	9.61	8.65
63 G 605	21F26	7.5 CT	5	3 1/2 x 4 1/4"	15	25.96	23.36
63 G 606	21F27	BAH	25.0 CT	.6	2 1/2"	1 1/2	3.26	2.94
63 G 746	26F60	BAH	6.3 CT	1.2	2 1/2"	1 1/2	2.44	2.20
63 G 607	26F65	BAH	6.3 CT	1.2	2 1/2"	1 1/2	2.68	2.41
63 G 608	26F66	5 CT	15	2x2 1/2"	3 1/2	6.65	6.16

CLASS "B" AND "AB" DRIVERS

For use in modulators or high-powered audio amplifiers. *Indicates single plate to PP grids. Others can be used as single or PP plates to PP grids.

Stock No.	Mfr's Type	Fig.	Max. Ma DC	Pri. to Sec.	Mtg. Ctrs.	Wt., Lbs.	1-9, EA.	10-24, EA.
63 G 690	20D75*	BAH	5	2.4:1	2"	1	2.76	2.49
63 G 691	20D76*	BAH	15	5.2:1	2"	1	2.76	2.49
63 G 692	20D77*	FGV	30	2.5:1	2 1/2"	1	4.23	3.81
63 G 693	20D78	GGV	40	4.0:1	1 3/4 x 2 1/2"	3	5.97	5.37
63 G 694	20D79	FGV	30	5.2:1	2 1/2"	2	5.03	4.53
63 G 609	20D87	BAH	30	5.2:1	2 1/2"	1 1/4	4.90	4.41

UNIVERSAL LINE-TO-VOICE COIL

Secondary taps marked with impedance values. *A-9 marked for 70-v. power distribution service.

Stock No.	Mfr's Type	Pri. Imp.	Sec. Imp.	Watts	Ctrs.	Wt., Lbs.	1-9, EA.	10-24, EA.
63 G 791	22S80	500, 600		8	3 1/2"	2 1/2	3.91	3.52
63 G 792	22S82			25	3 1/2"	2 1/2	3.53	3.18
63 G 793	22S83	2000/1500/1000/500	3.2, 8, 16	15	3 1/2"	2 1/2	3.91	3.52
63 G 794	22S84			5	2 1/2"	2 1/2	3.4	3.07
63 G 795	22S85			3	2 1/2"	2 1/2	3.76	3.39
63 G 744	24S66	2000, 1500, 1000, 500	3.2, 8	10	2"	1 1/2	2.73	2.46
63 G 745	24S62*	3000, 2500, 2000, 1500, 1000, 500	.06, 48	10	3"	2 1/2	4.23	3.81

TRANSISTOR TRANSFORMERS

BAH Transistor Transformers. High-quality transistor transformers designed for input, bridging, interstage and output applications. Many of the units listed can be used for various applications. Need not necessarily be used at their stated impedance—they may be used efficiently at any practical impedance, provided that the ratio of the windings is maintained. All leads are RETMA color-coded. *300 mw, 1 1/2" mtg. centers; all other types, 150 mw, 1 3/8" mtg. centers Applications: A—input; B—bridging; D—driver; IS—interstage; O—output. Av. shpg. wt., 2 oz.

Stock No.	Mfr's Type	Turns Ratio	Impedance		Application
			Winding 1	Winding 2	
63 G 228	*TR-1	1.00:1	500 CT	500 CT	B, D, IS
63 G 229	TR-2	1.23:1	5000 CT	7500 CT	B, D, IS
63 G 230	TR-3	1.41:1	5000 CT	10000 CT	D, IS
63 G 231	TR-4	1.73:1	1500	500 CT	D, IS, O
63 G 232	TR-5	1.81:1	490 CT	150 CT	D, IS
63 G 233	TR-6	1.83:1	10000	3000 CT	D, IS
63 G 234	TR-7	2.24:1	10000	2000 CT	D, IS
63 G 235	*TR-8	2.45:1	48 CT	8 or 4	O
63 G 236	TR-9	2.45:1	5000	30000 CT	A, IS
63 G 237	TR-10	3.00:1	5000 CT	45000	A, IS
63 G 238	TR-11	3.16:1	500 CT	50	D, O
63 G 239	TR-12	3.16:1	100 CT	10 CT	D, O
63 G 240	TR-13	4.00:1	5000 CT	80000	A, IS
63 G 241	TR-14	4.08:1	20000	1200	A, IS
63 G 242	TR-15	4.47:1	3000	15	O
63 G 243	TR-16	5.00:1	400 CT	16	O
63 G 244	TR-17	5.00:1	20000	800 CT	A, D, IS, S
63 G 245	TR-18	5.00:1	500 CT	16.4	O
63 G 246	TR-19	6.04:1	400 CT	16	O
63 G 247	TR-20	6.22:1	650 CT	16.8	O
63 G 248	*TR-21	6.33:1	160CT	8 or 4	O
63 G 249	*TR-22	7.07:1	400 CT	8 or 4	O
63 G 257	TR-23	7.07:1	10000	200 CT	D, O
63 G 258	*TR-24	8.17:1	100000	1500 CT	A, IS
63 G 259	TR-25	8.66:1	15000	200 CT	IS, O
63 G 260	TR-26	10.0:1	50000	500 CT	A, D, O
63 G 261	TR-27	12.5:1	500 CT	3.2	O
63 G 262	*TR-28	14.1:1	200000	1000	A
63 G 263	TR-29	15.6:1	825 CT	3.4	O
63 G 264	TR-30	15.8:1	50000	200 CT	A, O
63 G 265	TR-31	20.0:1	49000	100	A, O
63 G 266	TR-32	25.5:1	9800	15	A, O
63 G 267	*TR-33	35.4:1	250000	200 CT	A
63 G 268	TR-34	40.8:1	50000	30 CT	A
63 G 269	*TR-35	44.7:1	100000	50	A
63 G 271	*TR-36	50.0:1	500000	200 CT	A

1 to 9, NET EACH 3.26
10-24, EACH 2.94

AUDIO INPUT TRANSFORMERS

All are electrostatically shielded except Types 20A10 and 20A01. Types 20A00 and 20A04 have a frequency response of 250-3500 cps; Type 20A01 has a frequency response of 60-7500 cps and highly effective hum-bucking construction. Av. shpg. wt., 1 lb.

Stock No.	Mfr's Type	Fig.	Turns Ratio	Application	Mtg. Ctrs.	1-9, EA.	10-24, EA.
63 G 760	20A00	BAH	1:10	Line or mic to sgl. or PP grids.	2"	3.26	2.94
63 G 761	20A01	FGV	1:20	Line or mic to sgl. grid.	2 1/2"	4.26	3.83
63 G 764	20A04	BAH	1:80	Voice coil or mic to grid.	2"	1.82	1.64
63 G 610	20A10	BAH	1:20	Line or mic to sgl. grid.	2"	2.94	2.65
63 G 616	20A11	BAH	1:20	Line or mic to sgl. or PP grids.	2 1/2"	3.09	2.77

AUDIO INTERSTAGE TRANSFORMERS

Primary current, 8 ma. Type 20A25 has hum-bucking construction. Types 20A24 and 20A25 have split secondary winding. Type 20A29 is also applicable for high-impedance output mixing and can be connected as a driver with 2:1 ratio. Av. shpg. wt., 1 1/4 lbs.

Stock No.	Mfr's Type	Fig.	Ratio	Application	Mtg. Ctrs.	1-9, EA.	10-24, EA.
63 G 750	20A16	BAH	1:2	Sgl. plate to sgl. or PP grids.	2"	1.76	1.59
63 G 751	20A17	RAV	1:2	Sgl. plate to sgl. or PP grids.	1 1/2"	5.23	4.71
63 G 752	20A19	BAH	1:3	Plates to grids, sgl. or PP	2 1/2"	1.94	1.74
63 G 753	20A22	BAH	1:3	Sgl. plate to sgl. or PP grids.	2 1/2"	2.47	2.22
63 G 754	20A23	FGV	1:3	Sgl. plate to sgl. or PP grids.	2 1/2"	4.90	4.41
63 G 755	20A24	FGV	1:3	Plates to grids, sgl. or PP	2 1/2"	4.00	3.60
63 G 756	20A25	RTV	1:1.41	Plates to grids, sgl. or PP	1 1/2"	8.03	7.22
63 G 748	20A29	BAV	1:1.1	Univ. car radio interstage	2"	2.35	2.12

"ECON

Transformers

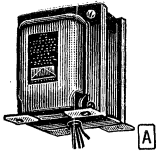

TRIAD TRANSFORMERS

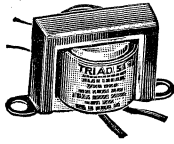

A Combined plate and filament transformers. Gray enamel finish. Copper foil shields. *All CT.

Stock No.	Mfr's Type	Plate Supply Volts	Filaments			Size (HWD)	Wt., Lbs.	1-4, EA.	5-24, EA.
			V	A	V*				
64 G 936	R-3A	500CT	20	...	6.3	2 1/2"x2 1/2"x2 1/2"	1 1/4	4.95	4.45
64 G 976	R-4A	500CT	40	...	6.3	2 1/2"x2 1/2"x2 1/2"	1 1/4	4.95	4.45
64 G 977	R-5A	500CT	65	...	6.3	2 3/4"x2 1/2"x2 1/2"	2 1/4	5.73	5.16
64 G 978	R-7A	600CT	50	2	6.3	2 3/4"x2 1/2"x2 1/2"	2 1/4	6.15	5.53
64 G 979	R-9A	600CT	75	5	6.3	3 3/4"x3 3/4"x3 3/4"	3 1/4	7.14	6.43
64 G 976	R-11A	700CT	90	5	6.3	3 5/8"x3 5/8"x3 5/8"	4 1/4	8.07	7.26
64 G 987	R-14A	700CT	125	5	6.3	4 5/8"x3 1/2"x1 1/2"	6	9.27	8.34

B Low-cost replacement transformers. Type A-1X transformer is input type for line or microphone to grid. A-21X, transceiver type for single button microphone and plate to grid. A-81X, driver type. A-31X, interstage type for plate to single or push-pull grids. Frequency response, 300-3000 cps.

Stock No.	Mfr's Type	Pri. Imp. Ohms	Turns Ratio	Size	Wt., Lbs.	1-4, EA.	5-24, EA.
64 G 934	A-21X	100 & 10,000		1 3/8"x2 1/2"x1 1/4"	1/2	2.31	2.08
64 G 991	A-31X	10,000	1:3	1 3/8"x2 1/2"x1 1/4"	1/2	2.16	1.94
64 G 993	A-81X	15 ma. in Pri.	2.66:1 1/2 sec.	1 3/8"x2 1/2"x1 1/4"	1/2	2.07	1.86

FILAMENT TRANSFORMERS

All 1500 test v. except *2000 volts.

Stock No.	Mfr's Type	Fig.	Secondary		Size (HWD)	Wt., Lbs.	1-4, EA.	5-24, EA.
			Volts	Amps				
64 G 953	F-13X	B	6.3	1.2	1 1/2"x2 1/2"x1 1/4"	1/2	2.04	1.84
64 G 954	F-14X	B	6.3CT	1.6	1 1/2"x2 1/2"x1 1/4"	1/2	2.22	2.00
64 G 955	F-16X	B	6.3CT	3	1 1/2"x3 1/4"x2"	1 1/4	3.18	2.86
64 G 956	F-18A	A	6.3CT	6	3 3/4"x2 1/2"x2 1/2"	2 1/2	5.64	5.08
64 G 957	F-21A	A	6.3CT	10	3 3/4"x3 3/4"x2"	3 1/4	6.96	6.26
64 G 958	*F-22A	A	6.3CT	20	4 3/4"x4 3/4"x2"	7	9.90	8.91
64 G 959	F-25X	B	12.6CT	1.5	1 1/2"x3 1/4"x2"	1 1/4	3.51	3.16
64 G 974	F-40X	B	24CT	1	1 1/2"x3 1/4"x2"	1 1/4	3.39	3.05
64 G 935	F-23U	...	10CT	7	3 3/4"x2 1/2"x3 3/8"	4	6.87	6.18

MODULATION TRANSFORMERS

B Tube to RF load. Frequency response, 300 to 3000 cps. Primary impedance, 10,000 CT. Sizes: Type M-1X is 1 3/8"x2 1/2"x1 1/4"; Type M-3X is 2 1/4"x3 1/2"x2 1/2".

Stock No.	Mfr's Type	Secondary Imp.	Audio Watts	Wt., Lbs.	1-4, EACH	5-24, EACH
64 G 939	M-3X	3000/5000/8000	20	1 1/2	4.47	4.02

ALTEC-LANSING PEERLESS OUTPUT TRANSFORMERS



High-quality audio output transformers designed for exceptionally true high-fidelity performance. All units feature high power handling capacity throughout wide frequency range. Each transformer is constructed of the finest material to insure superior response. Available in three power ratings for desired output. Frequency response, =1 db, 20-30,000 cps; at rated power output response is less than 3 db down at 25 cps. All have tapped primaries offering choice of 2 impedances. Type S-510-F is 2 1/2" high, 2 3/4" deep and 2 1/2" wide. Type S-526-F is 4 1/2" high, 3 1/4" deep and 2 3/4" wide. Type S-542-F is 5 1/2" high, 3 3/4" deep and 3 1/4" wide. 7" leads extend from two grommet holes.

Stock No.	Mfr's Type	P-P Pri. Imp.	Sec. Imp.	Watts	Wt., Lbs.	NET EA.
63 G 832	S-526-F	6600/5000	16, 8, 4	20	3 1/4	15.88
63 G 833	S-542-F	5000/4000	16, 8, 4	40	6	18.82

THORDARSON-MEISSNER CONTROL TRANSFORMERS

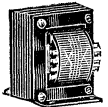

New, extremely versatile control transformers designed for a wide variety of industrial applications. Ideal for automation equipment, operation of relays, and pilot lamp circuits. Two-section secondary windings permit series or parallel operation. All primary windings designed to operate from either 115 volts or 230 volts, 50-60 cycles AC. Ruggedized construction throughout provides the high dependability required in industrial applications. Type 23V50 is 2 3/8"x2 1/2"x2 1/2"; type 23V51 is 3 5/8"x3 3/4"x2 1/4"; type 23V52 is 3 1/2"x3 3/4"x2 1/2"; type 23V53 is 3 3/4"x2 1/2"x3 3/8"; type 23V54 is 4 1/4"x3 1/2"x3 1/2".

Stock No.	Mfr's Type	Secondary		Mtg. Ctr.	Wt., Lbs.	1-9, EACH	10-24, EACH
		Parallel	Series				
63 G 179	23V50	6V. @2A.	12V. @1A.	2 1/2"	3/4	3.53	3.18
63 G 180	23V51	6V. @4A.	12V. @2A.	2 1/2"	1 1/2	5.29	4.76
63 G 181	23V52	12V. @4A.	24V. @2A.	3 1/4"	3 1/2	7.06	6.35
63 G 182	23V53	12V. @8A.	24V. @4A.	2 3/4"x2 1/4"	3 1/2	9.41	8.47
63 G 183	23V54	12V. @16A.	24V. @8A.	2 1/2"x2 3/4"	8	12.94	11.64

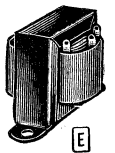
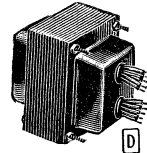
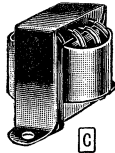

MERIT TRANSFORMERS

UNIVERSAL LINE TRANSFORMERS

For line-to-voice coil. *For 70.7 v. line; rated power furnished on lowest tap; others reduce power in steps of 3 db. Av. shpg. wt., 8 oz.

Stock No.	Mfr's Type	Fig.	Primary Impedance	Sec. Imp.	Av. Wtts.	Size	NET EACH
62 G 450	A-3005	C	500	3.2-6.8	5	1 1/2"x2 1/2"x1 1/2"	1.79
62 G 451	A-3013*	E	1K-2K-4K-8K-16K	3.5, 7	5	1 1/2"x2 1/2"x1 1/2"	2.50
62 G 452	A-3014*	E	500-1K-2K-4K-8K	4.8-16	10	1 1/2"x2 1/2"x1 1/2"	2.70

POWER TRANSFORMERS

For 115V., 50-60 cycles AC. *Fig. C, for TV boosters—others are Fig. D, except Fig. E. †Center-tapped filament winding. ‡Has rectifier socket. RETMA color-coded leads.

Stock No.	Mfr's Type	Plate Volts	Ma	Fil.		Mtg. Ctrs.	Wt., Lbs.	NET
				V	A			
62 G 190	P-3059	720 CT	250	5	2	6.3	2.7	
62 G 193	P-3067	800 CT	220	5	3	6.3	3	3x3 3/4"
62 G 140	P-3069†	700 CT	225	5	3	6.3	3	3x3 3/4"
62 G 273	P-2952	700 CT	90	5	3	6.3	2.7	3x3 3/4"
62 G 272	P-2951	650 CT	70	5	3	6.3	3.5	2x2 1/2"
62 G 257	P-3045*	120	50	2	2	6.3	2	3 1/8"
62 G 145	P-3046*	150	25	1	1	6.3	.5	2"
62 G 281	P-3048	700 CT	90	5	3	6.3	4.7	2x2 1/2"
62 G 282	P-2953	520 CT	120	5	3	6.3	4.7	2 1/2"x3 1/2"
62 G 283	P-3148§	520 CT	90	5	3	6.3	4.7	2x2 3/8"

FILTER CHOKES

C 2000-volt insulation, except *1500 volts.

Stock No.	Mfr's Type	H. y.s.	Ma.	Ohms	Size	Wt., Lbs.	NET EA.
62 G 179	C-2999	1.5	200	90	1 1/2"x2 1/2"x1 1/2"	3/4	1.65
62 G 180	C-2995	8.0	100	375	2x3 1/2"x1 1/2"	1 1/2	2.12
62 G 181	C-2996	1.0	300	60	2 1/2"x3 1/2"x2 1/2"	1 1/2	2.44

GRAMER-HALDORSON TRANSFORMERS

New, high-quality miniature audio transformers designed for transistor-powered applications. Excellent replacements for use in standard or printed circuits. Extremely lightweight.

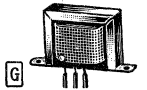

150-MILLIWATT SERIES

F All types described below are 2 1/2" high, 1 1/2" wide and 3/8" deep. Mounting tab centers are 1 3/8". Av. shpg. wt., 2 oz.

Stock No.	Type	Application	Pri. Impedance	Sec. Impedance
62 G 460	GH100	Input	30 CT Ohms	50K Ohms
62 G 461	GH101	Interstage	100 CT Ohms	10 CT Ohms
62 G 462	GH102	Output	350 CT Ohms	4, 12, Ohms
62 G 463	GH103	Output	500 CT Ohms	4, 18, 16 Ohms
62 G 464	GH104	Interstage	500 CT Ohms	50 Ohms
62 G 465	GH105	Output	600 CT Ohms	4, 8, 16 Ohms
62 G 466	GH106	Interstage	500 CT Ohms	50K Ohms
62 G 467	GH107	Output	825 CT Ohms	4, 8, 16 Ohms
62 G 468	GH108	Output	1250 Ohms	4, 12 Ohms
62 G 469	GH109	Interstage	1200 Ohms	20K CT Ohms
62 G 470	GH110	Interstage	1500 Ohms	500 CT Ohms
62 G 471	GH111	Output	2500 Ohms	4, 16 Ohms
62 G 472	GH112	Interstage	5K CT Ohms	7500 CT Ohms
62 G 473	GH113	Interstage	5K CT Ohms	10K CT Ohms
62 G 474	GH114	Interstage	5K CT Ohms	80K CT Ohms
62 G 475	GH115	Output	10K CT Ohms	4, 8, 16 Ohms
62 G 476	GH116	Interstage	10K Ohms	200 CT Ohms
62 G 477	GH117	Interstage	10K Ohms	2K CT Ohms
62 G 478	GH118	Interstage	10K Ohms	3K CT Ohms
62 G 479	GH119	Output	400 CT Ohms	1 Ohms
62 G 480	GH120	Interstage	500 CT Ohms	150 CT Ohms

NET EACH.....3.33

300-MILLIWATT SERIES

G All types described below are 1 3/8" high, 1 1/2" wide and 3/8" deep. Mounting centers are 1 3/8". Av. shpg. wt., 3 oz.

Stock No.	Type	Application	Pri. Impedance	Sec. Impedance
62 G 481	GH1	Output	48 CT Ohms	4, 8, 16 Ohms
62 G 482	GH2	Output	100 CT Ohms	4, 8, 16 Ohms
62 G 483	GH3	Output	160 Ohms	4, 8, 16 Ohms
62 G 484	GH4	Output	400 CT Ohms	4, 8, 16 Ohms
62 G 485	GH5	Output	500 CT Ohms	4, 8, 16 Ohms
62 G 486	GH6	Output	700 CT Ohms	4, 8, 16 Ohms
62 G 487	GH7	Output	1K Ohms	4, 8, 16 Ohms
62 G 488	GH8	Output	2500 Ohms	4, 8, 16 Ohms
62 G 489	GH9	Output	3K Ohms	4, 8, 16 Ohms
62 G 490	GH10	Interstage	100K Ohms	1500 CT Ohms
62 G 491	GH11	Input	1K CT Ohms	200K CT Ohms

NET EACH.....3.33

Quality Voltage Controls

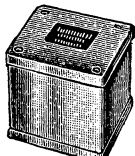
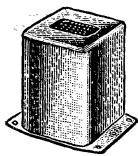

TO-300 TO-330

ACROSOUND 300 SERIES HI-FI OUTPUT TRANSFORMERS

Model TO-300. High-fidelity output transformer. Designed for use with Ultra-Linear Acrosound and Williamson-type amplifier circuits. Provides 20 watts undistorted power from 20 to 30,000 cps; 40 watts undistorted from 30 to 20,000 cps. Recommended for type KT66, 807, 1014, 6L6 or 5881 tubes. Primary impedance: 6600 ohms. Secondary impedance: 4, 8, 16 ohms. Frequency response, ± 1 db, 10-100,000 cps. Permissible feedback, 30 db. Maximum DC per primary, 75 ma. Primary shunt inductance, 150 henries minimum. 10° color-coded leads. Seamless steel case. Gray finish. Size, $4\frac{1}{4} \times 3\frac{3}{4} \times 3\frac{1}{4}$ ". Shpg. wt., 7 lbs. **63 G 993. NET.....24.75**

Model TO-310. High-fidelity output transformer. Excellent for converting push-pull 6V6's or EL84's to Ultra-Linear operation. Although recommended for 12-watt circuits, will deliver 10 watts undistorted power from 20 to 30,000 cps; 20 watts undistorted from 30 to 20,000 cps. Primary impedance, 8000 ohms. Primary shunt inductance, 85 henries minimum. All other specifications same as TO-300, above. Size, $4\frac{1}{4} \times 3\frac{3}{4} \times 3\frac{1}{4}$ ". Shpg. wt., 6 lbs. **63 G 994. NET.....18.75**

Model TO-305. Ideal for amplifiers where high-output impedances are required for multiple speakers, telephone lines, broadcast equipment, etc. Same specifications as TO-300 above, but has 4, 8, 16, 125 and 500-ohm output impedances. Size, $4\frac{1}{4} \times 3\frac{3}{4} \times 3\frac{1}{4}$ ". Shpg. wt., 8 lbs. **63 G 995. NET.....30.75**

Model TO-315. High-fidelity output transformer. Matches push-pull type 6V6 tubes for Ultra-Linear operation. Ideal for use in remote amplifier to feed long line or where high-output impedances are needed. Has 4, 8, 16, 125 and 500 ohm output impedances. Other specifications are same as TO-310 above. Size, $4\frac{1}{4} \times 3\frac{3}{4} \times 3\frac{1}{4}$ ". Shpg. wt., 7 lbs. **63 G 996. NET.....24.75**

Model TO 330. For Ultra-Linear operation in Williamson-type circuits. For push-pull 6550's, EL-34's, 6CA7's, KT38's, or push-pull parallel KT66's, 6L6's, 807's, etc. in fixed-bias operation. Provides 50 watts undistorted power from 20 to 30,000 cps; 100 watts undistorted from 30 to 20,000 cps. Primary impedance, 3800 ohms. Secondary impedance, 4, 8, 16 ohms. Response, ± 1 db., 10-100,000 cps. Permissible feedback, 30 db. Max. DC in primary, 150 ma. Fully potted. Gray finish. Holes for bottom mounting. 10° leads. Size, $5\frac{1}{4} \times 4 \times 4\frac{5}{8}$ ". Shpg. wt., 14 lbs. **63 G 997. NET.....39.75**

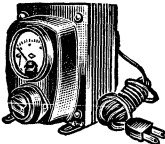
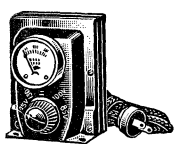

T10306 T8394M

ACME VARIABLE VOLTAGE ADJUSTERS

Highly efficient, constant-duty voltage regulators. Used as step-up or step-down transformers to correct for either low or high line voltage. Easily adjusted by manually turning 7-position rotary switch until built-in voltmeter reads 115 volts output. Type T8394M has input switch positions for 95, 100, 105, 110, 115, 120, 125 volts, at 50-60 cycles. Type T10306 is for 65, 75, 90, 100, 115, 130 and 145 volts. Features simple, "plug-in" installation, (built-in AC receptacle and 8 ft. line cord) ideal for localities with fluctuating voltage supplies, to assure correct performance of electrical appliances. Also for the radio serviceman for over-voltage testing—speeds location of intermittent troubles.

Type T8394M. Especially designed for use with television sets. Rated, 300 watts. Size, $4\frac{3}{4} \times 4 \times 5$ ". Shpg. wt., 9 lbs. **62 G 514. NET.....11.55**

Type T10306. Rated, 150 watts. Size, $4\frac{3}{4} \times 3\frac{1}{2} \times 5\frac{1}{2}$ ". Shpg. wt., 7 lbs. **62 G 501. NET.....14.33**

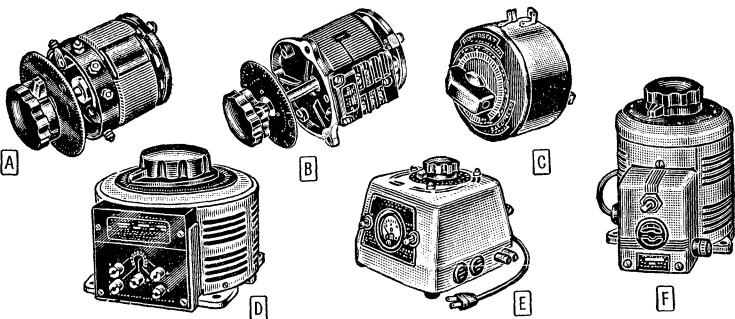

"SUPERIOR" VARIABLE VOLTAGE CONTROLS POWERSTAT VARIABLE AUTOTRANSFORMERS

Delivers adjustable output voltage from AC line—output variable from zero to above line voltage. Negligible voltage change from no load to full load. Current ratings apply over full range of output voltage. Zero waveform distortion. Rated for 50° C. temperature rise under full load. *For 110-120 v. AC inputs. †For 240 volt inputs. For 50-60 cycles, except \$60 cycles only. 2PF-136 has standard 2-blade plug and receptacle. 3PF-136 has 3-blade plug and receptacle; third wire is connected to transformer frame. Gang assemblies: 1156-2P and 1256-2P consist of two paralleled units operated

from a common shaft. 1156-3P and 1256-3P consist of three units operated from a common shaft. 1156-3Y consists of three units operated from a common shaft, wired for three-phase wye-connected operation. Sizes shown on gang types are height and diameter. Mountings: P, panel; and U, general utility. Sizes shown: P types, distance back of panel and diameter; U types, overall height and diameter. Types 2PF10, 116 and 216 have on-off switch, line cord and plug, fuse and output receptacle. 116, 105-135 v. and 225-255 v. output for line-voltage correction.

Stock No.	Mfr's Type	Fig.	OUTPUT		Mtg.	Size	Wt., Lbs.	NET EACH
			Volts	Amps				
62 G 536	10*§	A	0-132	1.25	0.165	P 2 1/2 x 2 1/2 x 3 1/2"	2 1/2	8.50
62 G 575	2PF10*§	C	0-132	1.0	0.132	U 3 1/2 x 3 1/2"	3 1/2	16.50
62 G 531	20*§	A	0-140	3.0	0.42	P 3 1/2 x 3 1/2"	6	12.50
62 G 525	116*§	F	0-140	7.5	1.0	U 6 1/2 x 4 5/8"	12	24.00
62 G 524	116U*	B	0-140	7.5	1.0	P 4 7/8 x 4 5/8"	11	18.00
62 GZ 543	136*	D	0-140	20.0	2.8	U 6 1/2 x 7 3/4"	25	50.00
62 GZ 576	LW136*†	D	0-30	25.0	0.75	U 6 1/2 x 7 3/4"	25	80.00
62 GZ 545	2PF-136*	0-140	20.0	2.8	U 6 1/2 x 7 3/4"	26	65.00
62 GZ 546	3PF-136*	0-140	20.0	2.8	U 3 1/2 x 3 1/2"	26	65.00
62 G 547	145*§	A	0-140	45.0	0.40	U 8 1/2 x 1 1/2"	11	11.00
62 G 527	216†	F	0-280	3.0	0.84	U 6 1/2 x 4 5/8"	12	26.00
62 G 573	216U†	B	0-280	3.0	0.84	P 4 7/8 x 4 5/8"	11	20.00
62 GZ 544	236†	D	0-280	9.0	2.5	U 6 1/2 x 7 3/4"	25	50.00
62 GZ 530	1256†	0-280	28.0	7.8	U 8 1/2 x 1 1/2"	80	118.00
62 GZ 537	1156-2P*	0-140	90.0	12.6	U 17 7/8 x 1 1/2"	170	269.00
62 GZ 538	1156-3P*	0-140	135.0	18.9	U 25 7/8 x 1 1/2"	295	418.00
62 GZ 539	1256-2P†	0-280	56.0	15.7	U 17 7/8 x 1 1/2"	170	269.00
62 GZ 540	1256-3P†	0-280	84.0	23.5	U 25 7/8 x 1 1/2"	295	418.00
62 GZ 541	1156-3Y†§	0-280	45.0	21.8	U 25 7/8 x 1 1/2"	280	394.00

MODEL UCIM VOLTBOX

For industrial and electrical, chemical and physics laboratory installations and radio-TV servicing. Provides AC source for variable AC voltage testing. Has a variable voltage transformer, voltmeter, fuse, line switch, two five-way binding posts and three output receptacles. Continuously adjustable output voltage up to 17% above line voltage to all output receptacles and binding posts. Rated at 7.5 amp. Input 120 v. 50-60 cycles. Output 0-140 volts. $3 \times 8 \times 6$ ". Shpg. wt., 17 lbs. **62 GX 533. NET.....65.00**

Model UC2M. As above but for 240 volts input. Output, 0-280 volts at 3 amps. **62 GX 542. NET.....70.00**

OTHER "SUPERIOR" EQUIPMENT

Allied can supply Superior Powerstat equipment for commercial, industrial, laboratory and special-purpose applications. Available on special order are motor-driven, oil-cooled, explosion-proof powerstats and powerstat line correctors; Stabiline automatic voltage regulators, including instantaneous electronic and electro-mechanical regulators; Varicell DC power supplies; etc. Stabiline regulators are ideal for voltage regulation in radio and TV stations. When ordering special items be sure to mark order "Special" and give manufacturer's type number, voltage and current as well as all information required for motor drive, etc. Allow four weeks for delivery. Write for free Bulletin (No. 37 G 102).

RAYTHEON VOLTAGE REGULATORS

Stabilize Varying Line Voltages to Within $\pm 1/2\%$

Fully automatic magnetic-type AC line voltage stabilizers. For applications requiring accurate voltage stabilization. Maintain absolutely constant output of 115 volts within 1/2% despite input voltage fluctuations as great as 15%. Quick response corrects for fluctuations so rapidly that no indication can be noticed on an ordinary AC voltmeter. Can be used in parallel for greater power-handling capacity where load is greater than rated capacity of single unit. Require no adjustment. *Case has flat top instead of style illustrated. †In 2 sections, mounted as single unit. For 95-130 v., 60 cycle AC. Available in ratings to 2000 watts on special order.

No.	Type	Watts	Size	Mtg. Ctrs.	Wt.	NET
62 G 675	VR-6110*	15	5 1/4 x 2 1/4 x 3 1/4"	5 1/8"	6 lbs.	16.00
62 G 676	VR-6111	30	7 1/2 x 3 3/8 x 4 1/8"	6 7/8 x 2 1/4"	7 lbs.	18.00
62 G 677	VR-6112	60	7 1/2 x 3 3/8 x 4 7/8"	6 7/8 x 2 1/4"	10 lbs.	25.00
62 G 678	VR-6113	120	7 1/2 x 3 3/8 x 5 1/8"	6 7/8 x 2 1/4"	17 lbs.	33.00
62 GZ 679	VR-6114	250	12 3/8 x 5 x 7 5/8"	11 3/8 x 3 1/2"	29 lbs.	52.00
62 GZ 680	VR-6115	500	12 3/8 x 5 x 9 1/8"	11 3/8 x 3 1/2"	52 lbs.	81.00
62 GZ 681	VR-6116†	1000	14 1/8 x 1 3/8 x 9 5/8"	12 7/8 x 1 1/8"	128 lbs.	135.00

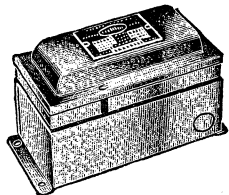

CONNECTING ASSEMBLIES FOR VOLTAGE REGULATORS

Type 51-590G1. Cord, plug, socket and mounting plate assembly for VR-6111, VR-6112, VR-6113. Shpg. wt., 2 lbs. **62 G 684. NET.....2.25**

Type 51-590G2. Cord, plug, socket and mounting plate assembly for VR-6114 and VR-6115. Shpg. wt., 2 lbs. **62 G 685. NET.....3.00**

Chicago Transformers

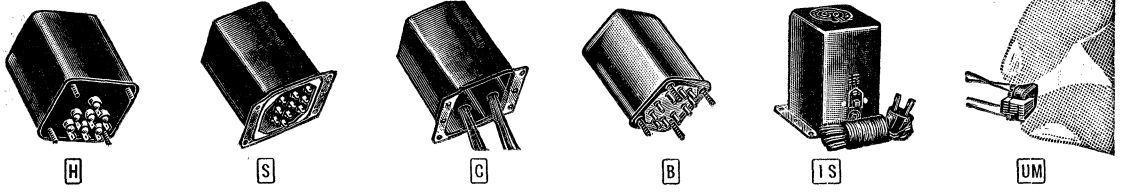

Case No.	Depth	Width	Height	Case No.	Depth	Width	Height	Case No.	Depth	Width	Height
12	2 1/4"	2 1/4"	2 1/4"	16	2 7/8"	2 1/4"	3 1/2"	20	3 1/8"	3 5/8"	4 5/8"
13	2 1/4"	2 1/4"	2 1/4"	17	2 7/8"	2 1/4"	3 1/2"	21	3 1/8"	3 5/8"	4 1/4"
14	2 1/4"	2 1/4"	3 1/8"	18	3 1/2"	3"	3 7/8"	22	4 1/8"	4 1/8"	5 5/8"
15	2 1/2"	2 3/8"	3 3/8"	19	3 1/2"	3"	4 1/4"	24	5 5/8"	4 3/8"	6 1/8"

TRANSFORMERS AND CHOKES

A complete selection of power transformers, filament transformers and filter chokes designed for electronic equipment. All units have high-grade magnet wire coils wound on non-aging silicon-steel cores. All have one-piece, steel cases for electrostatic and magnetic shielding, plus high moisture resistance. Types PSC, PSR, and RS (Fig. 5) are semi-sealed

units with steel base covers fitted with phenolic terminal boards and numbered solder lugs. Types PCC, PCR, and RC (Fig. C) are compound-sealed units with fiberboard base covers and 10° color-coded leads. *Have extra filament winding; †Has extra filament winding; ‡ at 2 amps. All units have 117 volt, 50-60 cycle primaries.

POWER TRANSFORMERS FOR CAPACITOR INPUT FILTERS

Stock No.	Mfr's Type	Case No.	1-9 EA.	10-24 EA.	25-49 EA.	Stock No.	Mfr's Type	Case No.	1-9 EA.	10-24 EA.	25-49 EA.	Plate			Rect.			Fil.		Wt. Lbs.
												VCT	Ma	A	VCT	A	VCT	A		
64 G 706	PCC-40	16	5.00	4.85	4.59	64 G 707	PSC-40	17	8.67	8.41	7.97	450	40	5	2	6.3	2	3 3/4	3 3/4	
64 G 614	PCC-55	16	5.38	5.22	4.94	64 G 607	PSC-55	17	9.11	8.84	8.37	540	55	5	2	6.3	2	3 3/4		
64 G 708	PCC-60	18	6.17	5.99	5.67	64 G 709	PSC-60	19	9.70	9.41	8.91	600	60	5	2	6.3	3	4 1/2	4 1/2	
64 G 615	PCC-70	18	6.62	6.41	6.08	64 G 608	PSC-70	19	10.29	9.98	9.45	670	70	5	2	6.3	3	4 1/2		
64 G 616	PCC-85	20	7.64	7.41	7.02	64 G 609	PSC-85	20	10.97	10.63	10.07	660	85	5	2	6.3	3	6		
64 G 617	PCC-105	20	8.29	8.04	7.61	64 G 610	PSC-105	20	11.61	11.26	10.67	690	105	5	2	6.3	3.5	6 1/2	9 1/2	
64 G 618	PCC-120	22	9.32	9.03	8.56	64 G 611	PSC-120	22	12.23	11.86	11.23	750	120	5	3	6.3	4	9 1/2		
64 G 619	*PCC-150	22	10.67	10.35	9.80	64 G 612	*PSC-150	22	16.17	15.68	14.85	740	150	5	3	6.3	4	11 1/2	12 1/2	
64 G 620	*PCC-200	22	12.44	12.06	11.42	64 G 613	*PSC-200	22	17.20	16.67	15.80	770	200	5	3	6.3	4.5	12		
64 G 617	†PCC-250	24	15.32	14.85	14.07	64 G 614	†PSC-250	24	21.46	20.81	19.71	800/160	250	5	3	6.3	7	15		

POWER TRANSFORMERS FOR CHOKE INPUT FILTERS

Stock No.	Mfr's Type	Case No.	1-9 EA.	10-24 EA.	25-49 EA.	Stock No.	Mfr's Type	Case No.	1-9 EA.	10-24 EA.	25-49 EA.	Hys.	Ma.	Ohms	Test Volts	Wt. Lbs.		
64 G 637	PCR-55	16	5.59	5.42	5.13	64 G 629	PSR-55	17	9.26	8.98	8.51	755	5	2	6.3	2	3 3/4	
64 G 638	PCR-70	18	6.32	6.13	5.81	64 G 630	PSR-70	19	10.14	9.83	9.32	800	70	5	2	6.3	3	4 1/2
64 G 640	PCR-105	20	7.85	7.61	7.21	64 G 632	PSR-105	21	11.76	11.40	10.80	900	105	5	2	6.3	3.5	6 1/2
64 G 641	*PCR-120	22	8.79	8.52	8.07	64 G 633	*PSR-120	22	12.49	12.11	11.48	1000	120	5	3	6.3	4	9 1/2
64 G 643	*PCR-200	22	11.47	11.12	10.53	64 G 635	*PSR-200	22	18.52	17.96	17.01	1040	200	5	3	6.3	4.5	12 1/2
64 G 644	*PCR-300	24	17.93	17.39	16.47	64 G 636	*PSR-300	24	26.17	25.37	24.03	1100/740/150	300	5	6	6.3	5	17 1/2

FILTER CHOKES

Stock No.	Mfr's Type	Case No.	1-9 EA.	10-24 EA.	25-49 EA.	Stock No.	Mfr's Type	Case No.	1-9 EA.	10-24 EA.	25-49 EA.	Hys.	Ma.	Ohms	Test Volts	Wt. Lbs.
64 G 669	RC-1540	12	2.50	2.42	2.30	64 G 657	RS-1540	12	3.53	3.42	3.24	15	40	475	2500	1 1/2
64 G 670	RC-1055	12	2.91	2.82	2.67	64 G 658	RS-1055	13	3.91	3.79	3.59	10	55	230	2500	1 3/4
64 G 671	RC-1835	12	3.06	2.96	2.81	64 G 659	RS-1555	13	4.12	3.99	3.78	15	55	420	2500	2
64 G 672	RC-1085	14	3.45	3.33	3.16	64 G 660	RS-1085	15	4.12	3.99	3.78	10	85	175	2500	2 1/2
64 G 673	RC-1585	14	3.70	3.59	3.40	64 G 661	RS-1585	15	4.97	4.82	4.56	15	85	285	2500	2 3/4
64 G 674	RC-8105	16	4.11	3.99	3.78	64 G 662	RS-8105	17	5.59	5.42	5.13	8	105	100	2500	3 3/4
64 G 675	RC-12105	16	4.32	4.19	3.97	64 G 663	RS-12105	17	5.59	5.42	5.13	12	105	170	2500	4
64 G 676	RC-8150	18	5.67	5.50	5.21	64 G 664	RS-8150	19	6.47	6.27	5.94	8	150	100	2500	5 1/4
64 G 677	RC-12150	18	5.73	5.56	5.27	64 G 665	RS-12150	19	6.67	6.47	6.13	12	150	150	2500	5 1/2
64 G 678	RC-8200	20	6.67	6.47	6.13	64 G 666	RS-8200	21	7.64	7.41	7.02	8	200	85	2500	7
64 G 679	RC-12200	20	6.76	6.56	6.21	64 G 667	RS-12200	21	8.08	7.84	7.43	12	200	140	2500	7
64 G 680	RC-8300	22	9.35	9.06	8.59	64 G 668	RS-8300	22	11.61	11.26	10.67	8	300	60	3500	12 1/2

FILAMENT TRANSFORMERS

H Hermetically sealed filament transformers. Built to rigid specifications. Meet all MIL-T-27 requirements. All have 115-230 v., 50-60 cycle primaries. 2500 v. insulation.

Stock No.	Mfr's Type	Sec. V./CT	Amps	Case No.	Wt. Lbs.	1-9 EA.	10-24 EA.
64 G 721	FH-615	6.3	1.5	12	1	7.94	7.70
64 G 722	FH-63	6.3	3	14	2	9.38	9.09
64 G 693	FH-61	6.3	5.5	16	3	10.91	10.57
64 G 695	FH-610	6.3	10	19	5	15.43	14.96

S Semi-sealed, 115-230 v., 50-60 cycle primaries. 2500 v. insulation.

Stock No.	Mfr's Type	Sec. V./CT	Amps	Case No.	Wt. Lbs.	1-9 EA.	10-24 EA.
64 G 686	F-54	5	4	15	2 1/4	6.38	6.18
64 G 688	F-58	5	10	17	3 1/4	10.88	10.55
64 G 692	F-530	5	30	22	10 1/2	16.61	16.10
64 G 723	F-615	6.3	1.5	12	1	5.14	4.99
64 G 724	F-63	6.3	3	14	2	6.17	5.99
64 G 694	F-65	6.3	5.5	17	3	7.50	7.27
64 G 696	F-610	6.3	10	19	5	10.29	9.98
64 G 698	F-104	10.0	4	17	3 1/4	8.23	7.98

ISOLATION TRANSFORMERS

IS For faster, safer, easier servicing of AC-DC equipment. Chassis ground is isolated from line ground, eliminating shock hazard. Primary slide switch selects high, medium and low secondary voltages. 8' line cord, female output receptacle. Primary volts, 105/115/125; secondary volts, 125/115/105. For 50-60 cycle AC operation.

Stock No.	Mfr's Type	Watts Cont.	Case No.	Wt. Lbs.	1-9 EA.	10-24 EA.
64 G 726	IS-50	50	21	5	8.08	7.84
64 G 727	IS-100	150	24	8 1/2	11.61	11.26
64 G 728	IS-150	200	24	12	13.82	13.40
64 G 729	IS-250	250	24	18 1/4	16.32	15.82

OUTPUT TRANSFORMERS

B Full-frequency-range outputs. Typical response, ±0.5 db, 30-20,000 cps. *Indicates extra 150/4 ohm secondary. All except BO-12 and BO-13 have split, balanced secondary with CT.

Stock No.	Mfr's Type	Pri. Ohms	Sec. Ohms	Watts	Case No.	Wt. Lbs.	1-9 EA.	10-24 EA.
62 G 522	BO-1	15K	600/150	0.22	14	2 1/4	9.97	9.66
64 G 734	BO-2	20K	600/150	1	16	3	13.23	12.83
64 G 738	BO-9*	5K/3K	600/16/8	15	20	6	16.90	16.39
64 G 747	BO-12	10K	600/16/8	10	22	9	17.49	16.96
64 G 748	BO-13	10K	16/8/4	20	21	7	17.49	16.96

Type BO-14 "Super-Range" 100-Watt Output Transformer. Designed for use with Tungsol 6550's in pentode or triode amplifier circuits (Radio & TV News, November, 1955). 8 and 16 ohm plus 70.7 v. outputs. Similar to Fig. C. 8x5 1/2x6". Shpg. wt., 21 lbs.

64 GZ 775, 1 to 9, NET EACH 38.95

10 to 24, NET EACH 37.76

PA OUTPUT TRANSFORMERS

C Type PCO-150. 15-watt output transformer for public address amplifiers. Primary impedance, 10,000 ohms CT; secondary, 600/150/16/8/4 ohms, plus tertiary winding for 10% feedback. Primary rated 200 ma maximum DC. Has 10° color-coded leads. Case No. 19. Shpg. wt., 5 lbs.

64 G 395, 1 to 9, NET EACH 7.35

10 to 24, NET EACH 7.13

TRANSISTOR TRANSFORMERS

UM Ultra-miniature audio transformers for transistor applications below 1 mw level. Wound on nylon bobbins with nickel-steel laminations. Actual wt., 1/10 oz. Size, 3/8x3/8x3/8". Shpg. wt., 2 oz.

Stock No.	Mfr's Type	Application	Impedance		DC Resistance		1-9 EA.	10-24 EA.
			Pri.	Sec.	Pri.	Sec.		
64 G 237	*UM-110	Interstage	20K	1K	1675	285	5.59	5.42
64 G 238	UM-111	Output/Matching	1K	50/60	120	9	3.82	3.71
64 G 239	UM-112	Mic. input	200K	1K	4K	195	6.17	5.99
64 G 240	UM-113	Interstage	20K	1K	1350	205	4.26	4.13

Special-Purpose Transformers

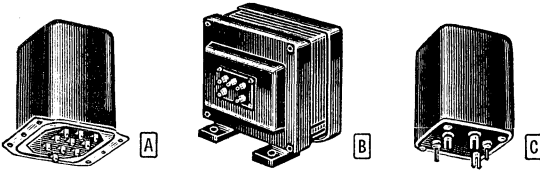

CHICAGO TRANSFORMERS

MULTIPLE FILAMENT TRANSFORMERS

A Primaries tapped for 105, 115 or 125v., 50-60 cycle AC. Insulation, 2500 v. except F8, 5000 v. All secondaries have CT except *.

Stock No.	Mfr's Type	Fil. 1	Fil. 2	Fil. 3	Case No.	Wt. Lbs.	1-9, EACH	10-24, EACH
63 G 154	F1	*5V @ 2A	6.3V @ 2.5A	15	2 1/2	9.70	9.22
63 G 155	F2	*5V @ 2A	12.6V @ 1.25A	15	2 1/2	9.70	9.22
63 G 156	F3	*5V @ 3A	6.3V @ 5A	17	3 1/2	10.14	9.63
63 G 157	F4	*5V @ 3A	6.3V @ 3A	18	4 1/4	11.61	11.03
63 G 158	F5	*5V @ 3A	6.3V @ 1A	18	4 1/4	11.76	11.17
63 G 159	F6	6.3V @ 3A	6.3V @ 3A	17	3 1/2	10.14	9.63
63 G 160	F7	6.3V @ 6A	6.3V @ 6A	21	6 1/2	12.05	11.46
63 G 161	F8	5V @ 3A	5V @ 3A	21	7	12.64	12.01

PLATE TRANSFORMERS

B Primaries for 115-230 v., 50-60 cycle AC.

Stock No.	Type	VCT	Ma.	Size	Lbs.	1-9, EA.	10-24, EA.
63 G 162	P45	1350/1150	250	5 1/2 x 4 1/8 x 4 3/16"	12	14.99	14.25
63 G 163	P67	1800/1470	250	5 1/2 x 4 1/8 x 4 3/16"	13	16.46	15.84
63 GZ 164	P1512	3420/2860	300	7 x 7 1/2 x 7 3/8"	43	52.63	50.00
63 GZ 184	P2520	5640/4520	300	8 1/2 x 8 1/8 x 8 1/4"	71	74.97	71.23

FILTER REACTORS

Stock No.	Mfr's Type	Hys.	Ma.	Ohms	Insul.	Size	Wt. Lbs.	1-9, EACH	10-24, EACH
63 GZ 185	R105	10	500	40	9000	7 x 7 1/2 x 7 3/8"	35	39.10	37.15
63 GZ 186	R103	10	300	40	7500	7 1/16 x 5 1/4 x 8 1/4"	22	19.11	18.16

AUDIO TRANSFORMERS

C Size of each transformer, 2x1 1/2 x 1 1/2". Shpg. wt., 10 oz.

Stock No.	Mfr's Type	Description	1-9, EACH	10-24, EACH
63 G 187	WF20	Pri.:50,125/150,200,250,333,500/600 Sec.:50,000	11.47	10.90
63 G 188	WF21	Pri.:50,200,500. Sec. Imp.:50,000	12.23	11.62
63 G 189	WF22	Pri.:50,125/150,200,250,333,500/600 Sec.:80,000 overall in two sections.	11.47	10.90
63 G 190	WF28	Pri.:15,000. Sec. Imp.:80,000 overall. Pri.:30,000 Plate to Plate.	10.70	10.16
63 G 191	WF36	Sec.:50,125/150,200,250,333,500/600	11.47	10.90
63 G 192	WF30	Pri.:50,125/150,200,250,333,500/600 Sec.:50,125/150,200,250,333,500/600	11.47	10.90

STANDARD ELECTRIC

ADJUST-A-VOLT VARIABLE AUTOFORMERS



Type 100BU Autoformer. For low-power equipment—tube testers, power supplies, model railroad controls, etc. Has special sliding brush and low-resistance alloy-plated brush track—allows high initial surge current and temporary overloads. Permits smooth control of output voltage from 0 to 132 volts. Mounts on any panel up to 1/4" thick. Max. load, 165 VA. For 110-120 volts, 50-60 cycle AC. Size, 2 1/8" dia. x 2 3/8", 2" dial, calibrated 0-100%. Shpg. wt., 2 lbs. **62 G 583. NET..... 8.33**

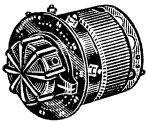

Type 300BU Autoformer. Ideal for light control, small ovens, speed regulation of brush-connected AC motors, etc. Several units can be ganged for operation from the same shaft. Unit is easily set and has dial plate for clockwise or counterclockwise operation. Specially designed brush and alloy-plated brush track eliminate arcing. Can be wired to deliver either 0-115 volts or 0-135 volts. Maximum load, 400 VA. Maximum current, 3.3 amperes. For operation from 110 to 120 volts, 50-60 cycles AC. 3 1/4" diameter x 3 1/8" depth behind panel. 4" dial. Wt., 6 lbs. **62 G 580. NET..... 12.25**

TYPE 500B AND 500BU AUTOFORMERS

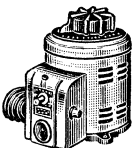

For laboratory and industrial voltage control. Type 500B is cased, 6 1/2 x 4 5/8" dia. Supplied with line cord, plug, receptacle, pilot light, on-off switch and fuse. Constructed of die-cast aluminum, finished in gray wrinkle. Type 500BU is uncased, designed for panel mounting—supplies pilot light voltage; adjustable shaft length. Size: 5 5/8" dia. For 115 v., 60 cycle AC input. Av. shpg. wt., 12 lbs.

Stock No.	Mfr's Type	Output			NET EACH
		Volts	Amperes	KVA	
62 G 581	500B	0-135	7.5	1.0	22.54
62 G 582	500BU	0-115/0-135	7.5	1.0	17.64

TYPE 1500B VARIABLE AUTOFORMER

Sturdy, highly dependable autoformer for 2 KVA power applications. Ideal for theatrical lighting control and other heavy-duty operation. Rotor and frame of die-cast aluminum. Several units can be ganged to the same shaft—can be used in series or parallel. Voltage output range is 0-135 v. Maximum current output is 15 amperes. Has 115 v., 60 cycle AC input, 30-60 oz. driving torque. 8 1/2 x 5 1/2 x 1 1/8" dia. Wt., 25 lbs. **62 GZ 589. NET..... 45.08**

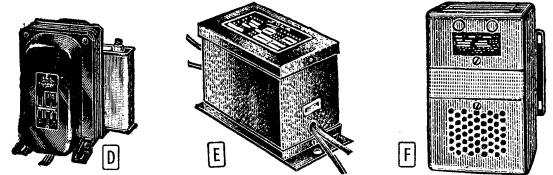

SOLA CONSTANT-VOLTAGE TRANSFORMERS

POWER TRANSFORMERS

D Replace ordinary power transformers. Stabilize plate and filament voltages within ±3% with line variations from 100-130 volts. With Pyranol oil-filled input filter condenser and mounting bracket. For 100-130 volts, 60 cycles AC only.

Type 7104. DC input to filter, 275 v @ 50 ma. Fil., 6.3 v CT @ 2 1/2 A; 5 v @ 2A. Size, 4 1/8 x 3 1/8 x 3 1/8". Shpg. wt., 6 lbs. **62 G 669. NET..... 12.00**

Type 7106. Same as above, but delivers 385 volts DC to filter @ 110 ma. Filaments, 6.3 v CT @ 3A; 5 v @ 2A. 75 VA. Size, 4 1/8 x 4 1/8 x 3 1/8". Shpg. wt., 9 lbs. **62 G 670. NET..... 15.00**

Type 7107. As above, but 380 v DC to filter @ 250 ma. Fil., 6.3 v @ 4A; 6.3 v @ 8A (unreg.); 5 v @ 3A. 210 VA. 7x5x4 1/2". Wt., 19 lbs. **62 G 671. NET..... 27.00**

TV VOLTAGE REGULATORS

Type 7202. Reduces flicker in television screens due to changes in line voltage. For any TV set with power consumption between 165 and 285 watts. Output voltage, ±3%, with line variations up to 30%. Turns on and off with TV. Size, 9 1/8 x 4 1/2 x 7 1/4". For operation from 95-130 v., 60 cycle AC. Shpg. wt., 26 lbs. **62 GZ 667. NET..... 32.00**

Type 7201. For 110 to 175-watt sets. Shpg. wt., 19 lbs. **62 G 631. NET..... 29.60**

TYPE CV TRANSFORMERS

Static-magnetic voltage regulators. Designed to provide constant output voltage within ±1%, even with line voltage changes (transient or continuous) of up to ±15%. No manual adjustment necessary—regulation is fully automatic. Adjusts quickly to changes—usually within a time range of 1.5 cycles or less. Current-limiting characteristic protects transformer and load equipment from excessive current. *Has Pyranol oil-filled capacitor with mounting bracket. †Uses new low stray-field design—suitable for use as internal component. Input voltages listed below for 60 cycle AC. 25 and 50 cycle units available on special order. Write for quotation, giving full details about your requirements.

Stock No.	Mfr's Type	Fil.	Input Voltages	Output Voltage	Cap. VA	Wt. Lbs.	NET EACH
62 G 650	30488	E	95-130	6.0	15	6	16.00
62 G 649	30492	E	95-130	6.3	15	6	16.00
62 G 656	30498	E	95-130	115	15	6	16.00
62 G 619	30885	E	95-130	115	60	13	25.00
62 G 620	30886	E	95-130	115	120	19	33.00
63 G 193	20-04-030**	D	95-130/190-260	6.3	30	6	16.00
63 G 194	20-04-065**	D	95-130/190-260	6.3	60	7	20.00
63 G 195	20-04-095**	D	95-130/190-260	6.3	90	11	24.00
63 GZ 196	20-04-113**	D	95-130/190-260	6.3	120	20	31.00
63 GZ 197	20-04-116**	D	95-130/190-260	6.3	150	23	35.00
62 GZ 660	20-13-125†	...	95-130	118	250	30	52.00
62 GZ 661	20-13-150†	...	95-130	118	500	40	81.00
62 GZ 662	20-13-210†	...	95-130	118	1000	115	135.00
62 GZ 663	30811	...	95-130	115	2000	205	245.00
62 GZ 624	30888	...	95-130	115	2000	205	245.00

HARMONIC-FILTERED REGULATING TRANSFORMERS

Similar to Fig. F. Provide harmonic-neutralized, stabilized source of voltage. For any equipment affected by harmonics from power source. Less than 3% harmonic content in output. Regulated sine wave output constant within ±1%. Types 23-13-060, 23-13-112 with power cord and receptacle; others have knockout boxes. For 60 cycle AC voltages.

Stock No.	Mfr's Type	Pri. V.	Secondary Voltage	Cap. VA	Wt. Lbs.	NET EACH
62 GZ 517	23-13-060	95-130	115	60	35	35.00
62 GZ 518	23-13-112	95-130	115	120	45	44.00
62 GZ 646	23-13-125	95-130	118	250	32	70.00
62 GZ 647	23-13-150	95-130	118	500	47	105.00
62 GZ 648	23-13-210	95-130	118	1000	80	175.00
62 GZ 642	5010	95-125	115	2000	320	310.00

CONSTANT-VOLTAGE DC POWER SUPPLIES

Compactly built DC power supplies with regulated output. Use high-capacitance filter, germanium rectifier and constant-voltage transformer. Output is constant within ±1% with line voltage changes of ±10%. Ripple less than 1% (rms), except *½%. Units can be series-wired for higher output voltage. Input and output connections made at terminal strip. All supplies are assembled on 5 1/4 x 19" rack panels. Depth 9 3/4". Chassis have vent holes. For 100-130 v., 60 cycles AC.

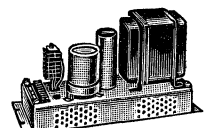

Stock No.	Mfr's Type	Output Ratings			Efficiency % (approx.)	Wt. Lbs.	NET EACH
		Watts	Volts	Amps			
62 GZ 636	28156	144	24	6.0	72	45	145.00
62 GZ 637	28120	192	48	4.0	77	45	135.00
62 GZ 638	28152	250	125	2.0	82	55	145.00
62 GZ 639	28106	300	150	2.0	80	50	145.00
62 GZ 640	*28193	200	200	1.0	76	45	140.00
62 GZ 641	*28192	250	250	1.0	81	55	150.00

J. W. Miller Coils and Chokes

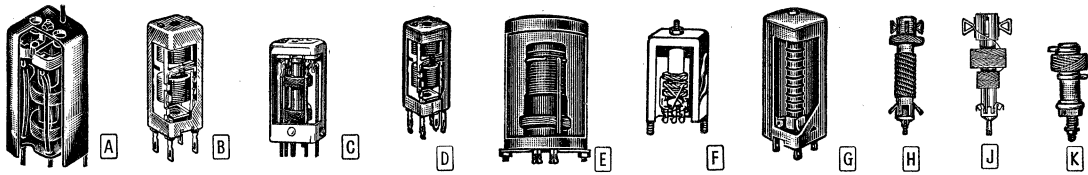

IF TRANSFORMERS, RF AND BROADCAST COILS

REPLACEMENT 455 KC IF TRANSFORMERS

A Double-tuned air-core, universal input, interstage or output transformers. Universal wound primary and secondary tuned by mica insulated compression-type trimmers. RETMA leads. Size, $1\frac{1}{2} \times 1\frac{1}{2} \times 2\frac{1}{2}$ ". Wt., 4 oz.

No.	Type	Use	EA.
60 H 739	512-C1	Input IF	1.53
60 H 740	512-C2	Interstage IF	
60 H 741	512-C3	Full-wave output IF	
60 H 512	512-C4	Half-wave output IF	

MINIATURE IF TRANSFORMERS

B Molded plastic frame with built-in capacitors. Tunable powdered iron cores. *Built-in diode filter capacitors. Aluminum shielded $\frac{3}{4}$ " sq. x 2". With mtg. hardware. Wt., 4 oz.

No.	Type	Freq.	Use	Net
60 H 727	12-C1	455 kc	IF Input	1.35
60 H 728	12-C2	455 kc	IF Output	1.35
60 H 787	12-C6	455 kc	IF Output*	1.44
60 H 716	12-C7	455 kc	Input (Batt.)	1.35
60 H 717	12-C8	455 kc	Output (Batt.)	1.35
60 H 718	12-C9	455 kc	Input (AC-DC)	1.35
60 H 719	12-C10	455 kc	Output (AC-DC)	1.35
60 H 729	12-H1	262 kc	IF Input	1.53
60 H 731	12-H2	262 kc	IF Output	1.53
60 H 788	12-H6	262 kc	IF Output*	1.62
60 H 732	1463	10.7 mc	Input or Inter.	1.68
60 H 733	1464	10.7 mc	Discriminator	2.00
60 H 734	1465	10.7 mc	Ratio Detect.	2.00
60 H 789	6203	4.5 mc	Input or Inter.	1.68
60 H 790	6204	4.5 mc	Discriminator	2.00
60 H 791	6205	4.5 mc	Ratio Detect.	2.00

MIDGET IF TRANSFORMERS

C Air-core mica trimmer tuned IF's. Excellent gain and selectivity. 6-32 spade-bolt mtg. $1\frac{1}{2} \times 1\frac{1}{2} \times 2$ ". *With filter. Wt., 4 oz.

No.	Type	Freq/cy	Use	EA.
60 H 735	112-C1	455 kc	Input	1.47
60 H 736	112-C2	455 kc	Interstage	
60 H 737	112-C3	455 kc	CT Output	
60 H 738	112-C4	455 kc	Output	
60 H 855	112-H1	262 kc	Input	1.53
60 H 856	112-H2	262 kc	Interstage	
60 H 857	112-H3	262 kc	CT Output	
60 H 858	112-H4	262 kc	Output	
60 H 859	112-H6	262 kc	Output*	1.65

SUBMINIATURE 455 KC IF TRANSFORMERS

D Extremely small IF coils with excellent gain and bandwidth characteristics. Ferrite shell cores provide high efficiency. Mica trimmer tuned primary and secondary. Only $\frac{1}{2}$ " square by $1\frac{1}{2}$ " high. Shpg. wt., 3 oz.
60 H 860. Type 10-C1. Input. NET
60 H 861. Type 10-C2. Output. EA...1.53

455 KC IF TRANSFORMERS

D Subminiature IF transformers for Raytheon types CK 760 and CK761 transistors. Primary impedance, 25 K ohms; secondary impedance, *600 ohms, †1000 ohms. Size, $\frac{3}{8}$ " sq. x $\frac{3}{8}$ " high. Av. shpg. wt., 3 oz.
60 H 802. Type 3-C1*. Input. NET
60 H 803. Type 3-C2†. Output. EA...2.20

DELUXE BANK-WOUND COILS

E Shielded antenna RF and bandpass coils. Cover 540-1740 kc with 365 mmf capacitor. Two-bank Litz secondaries. High impedance primaries. $1\frac{1}{8} \times 3$ ". Shpg. wt., 4 oz.
60 H 783. Type 242-A. Ant. NET
60 H 784. Type 242-RF. RF. EACH 1.18
60 H 797. Type 242-BF. Bandpass. NET 1.03

UNIVERSAL ADJUSTABLE BROADCAST BAND COILS

F Compact, variable-inductance iron-core coils for replacement use. Shielded type. Used with 250-450 mmf capacitor. Oscillator coils have tapped secondary. Size: $1\frac{1}{2} \times 1\frac{1}{2} \times 2\frac{1}{2}$ ". Av. shpg. wt., 5 oz. *1F frequency.

No.	Type	Use	KC Range	EACH
60 H 748	73-A	Antenna	500-1800	1.68
60 H 749	73-RF	RF	500-1800	
60 H 752	73-OSC	Oscillator	*100-550	

MINIATURE RF COILS

G Shielded iron-core coils for compact receivers. For 365 mmf tuning capacitors. $\frac{3}{4}$ " sq. x 2". *Requires series pad. Wt., 4 oz.

No.	Type	Use	KC Range	EACH
60 H 798	X-121-A	Antenna	140-425	1.29
60 H 795	X-121-RF	RF	140-425	
60 H 782	X-121-C	Osc.	*120 mmf	
60 H 706	A-121-A	Antenna	540-1700	1.09
60 H 707	A-121-RF	RF	540-1700	
60 H 708	A-121-C	Osc. 455 kc	*400 mmf	
60 H 709	A-121-H	Osc. 262 kc	*600 mmf	

HIGH "Q" BROADCAST RF COILS

H High-efficiency, unshielded, iron-core coils. For replacement purposes or for new receiver design. Adjustable core for tracking desired frequency range. Range indicated obtained using 365 mmf variable capacitor. Coils mount in $\frac{1}{4}$ " hole. *Padder values shown are for 455 kc IF. Size: $\frac{3}{4} \times 2$ ". Shpg. wt., 4 oz.

No.	Type	Use	KC Range	EACH
60 H 862	A-5495-A	Antenna	550-1700	1.23
60 H 863	A-5495-RF	RF	550-1700	
60 H 864	A-5495-C	Std. Osc.	*400 mmf	
60 H 865	A-5496-C	Tapped Osc.	*400 mmf	

MINIATURE ADJUSTABLE RF COILS

J Variable-inductance RF coils. Use with tuning capacitors of 250 to 450 mmf capacity. Type 70-OSC coil has tapped secondary. 70 series installed self-supported. 71-OSC has 2-tap primary. Both track 100 to 550 kc IF. Max. size: $\frac{3}{4} \times 1\frac{1}{2}$ " high. Av. shpg. wt., 4 oz.

No.	Type	Use	KC Range	NET
60 H 866	70-A	Antenna	540-1600	.88
60 H 867	70-RF	RF	540-1600	.88
60 H 868	70-OSC	Osc.	540-1600	.88
60 H 869	71-OSC	Osc.	500-1800	1.18

ADJUSTABLE CERAMIC RF INDICATORS

K Small, adjustable coils for the most exacting requirements. Silicone-impregnated ceramic forms. Tuned by powdered iron core. Types 4502 to 4506 are single-layer wound. Types 4507 to 4509 are twin-pi wound. Others are honeycomb wound. Mount in $\frac{3}{8}$ " hole. Form size: $\frac{1}{4} \times \frac{1}{2}$ " high. Av. shpg. wt., 2 oz.

No.	Type	Microhenries	NET
60 H 870	4500	Form only	.88
60 H 871	4502	1.0-1.6	1.18
60 H 872	4503	1.6-2.8	1.23
60 H 873	4504	2.8*	1.29
60 H 874	4505	5-9	1.35
60 H 875	4506	9-16	1.41
60 H 876	4507	RF 16-24	1.47
60 H 877	4508	24-35	1.47
60 H 878	4509	35-60	1.47
60 H 879	4511	60-120	1.47
60 H 880	4512	110-200	1.53
60 H 881	4513	190-330	*4.03
60 H 882	4514	320-500	1.53

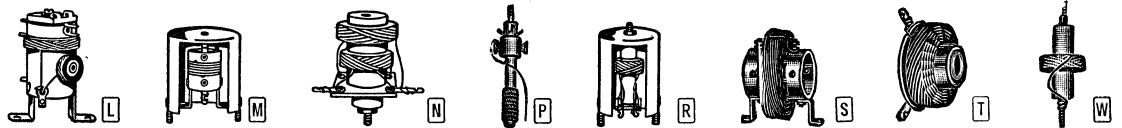

COILS AND CHOKES

CAPACITY-OPERATED RELAY COIL

L For alarm systems, window displays, etc. With diagram $\frac{1}{2} \times \frac{1}{2}$ " high. Wt., 4 oz.
60 H 589. Type 695. NET...1.71

BANDPASS COUPLING COIL

M Negative mutual coupling coil for hi-IFTR receivers. $1\frac{1}{2} \times 2$ ". Shpg. wt., 4 oz.
60 H 761. Type EL-56. NET...79c

MIDGET OSCILLATOR COILS

N Cover 540-1600 kc with 365 mmf capacitor. Series 5480 for pentagrad converters. 5481 series have single tapped coil for 6SA7 and similar tubes. Size: 1×1 ". Shpg. wt., 4 oz.

No.	Type	IF	Padder	EACH
60 H 742	5480-K	175 kc	.001 mfd	73c
60 H 884	5480-H	262 kc	.0006 mfd	
60 H 743	5480-C	455 kc	.0004 mfd	
60 H 744	5481-C	455 kc	.0004 mfd	
60 H 885	5481-H	262 kc	.0006 mfd	

FERRITE ANTENNA COIL

P Cover 540-1700 kc with capacitors having 350 to 450 mmf. Adjustable core. Mount in $\frac{3}{8}$ " hole. $\frac{3}{4} \times 2\frac{1}{4}$ ". Shpg. wt., 4 oz.
60 H 883. Type 6300. NET...73c

ANTENNA AND RF COILS

R Untuned. Broadly self-resonant from 540 to 1700 kc. No tuning capacitor needed. Can. $2\frac{1}{2} \times 1\frac{1}{2}$ ". Shpg. wt., 4 oz.
60 H 758. Type 472-UA. Ant. NET...1.32
60 H 759. Type 472-UT. RF. NET...1.62

DUO-LATERAL FILTER CHOKES

S Effective line filters. Duo-lateral wound for low distributed capacity. Ideal for use in AC lines to filter RF or noise pulses from Amateur or commercial transmitters; from power supplies, sign flashers, diathermy equipment, farm lighting plants, signal systems, oil burners and all types of intermittent switching systems. Type 7825 is $1\frac{1}{2} \times 1\frac{1}{4}$ " wound on bakelite form. Types 7826 and 7827 are $2\frac{1}{2} \times 4$ ", wound on ceramic forms.

No.	Type	Amps	Ohms	Oz.	Mh	NET
70 H 185	7825	2	.7	5	.600	1.18
60 H 886	7826	5	.28	10	.570	2.85
60 H 887	7827	10	.15	16	.370	3.20

CENTER TAPPED CHOKE

T Duo-lateral wound, single-section RF chokes. Ceramic dowels. 20 mh. 100 ohms. $1\frac{1}{2}$ " sq. $1\frac{1}{8}$ " high. Shpg. wt., 4 oz.
60 H 588. Type 691T. NET...71c

VIDEO PEAKING & FILAMENT CHOKE COILS

W Type 6175 is filament choke. Reduces stray coupling, feedback, etc. Others are video peaking coils for proper bandwidth and wave shape of video signals. Coils without shunt resistor wound on plastic forms; shunt types wound on resistor. * $\frac{7}{8} \times \frac{3}{4}$ " dia.; all others, $\frac{3}{8} \times \frac{3}{8}$ " dia. Av. shpg. wt., 2 oz.

Stock No.	Mfr's Type	μ hs.	Shunt	NET EACH
60 H 792	6172	73	None	35c
60 H 889	6153	120	None	
60 H 793	6173	250	22 K	
60 H 794	6174	500	None	29c
60 H 776	6175*	0.8	None	
60 H 898	6152	20	None	
60 H 777	6176	36	None	
60 H 778	6177	93	None	35c
60 H 779	6178	120	22 K	
60 H 780	6179	180	39 K	
60 H 781	6180	180	None	
60 H 890	6154	200	None	
60 H 782	6181	250	None	35c
60 H 891	6155	300	None	

Coils, Transformers & Antennas

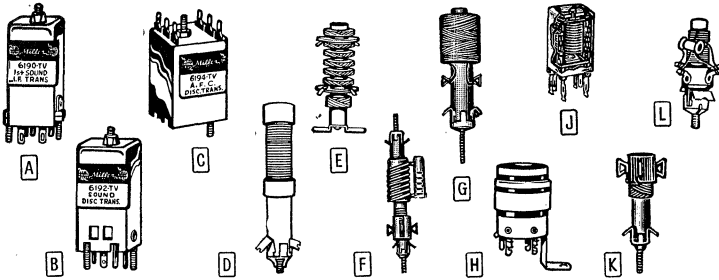

J. W. MILLER COILS, INDUCTORS & TRANSFORMERS

SOUND IF TRANSFORMERS

A Permeability tuned. 6190 and 6191 for 21.25 mc in TV sets with separate picture and sound IF channels. 1466 for 4.5 mc in sets with inter-carrier system. Provide high gain and adequate bandwidth for high-fidelity sound. Primary adjustable from top of aluminum can; secondary from bottom. Has spade bolt mounting. * $7/8 \times 2 1/4$ " high. $1 1/8 \times 1 1/8 \times 2 1/8$ " high. Shpg. wt., 5 oz.

Stock No.	Mfr's Type	Description	NET EACH
60 H 762	6190*	1st IF sound	1.41
60 H 763	6191*	2nd IF sound	1.41
60 H 764	1466†	Sound Trap, 4.5mc	.73
60 H 705	1470†	Sound Trap, 4.5mc	.73

SOUND DETECTOR AND OSCILLATOR TRANSFORMERS

B Quality TV components. Types 6192 and 6184 for TV receivers with separate 21.25 mc sound IF channel. Types 1467 and 1468 are for 4.5 mc IF in sets using inter-carrier sound system; Type 6192 and Type 1467 are the Foster-Seely type and are normally preceded by one or two limiter stages. Type 6184 and Type 1468 are for use in ratio detector circuits. Type 6182 has tapped coil for horizontal oscillator Synchro-Hi circuit. Type 6183 dual windings for Sync. Frequency and Phase circuit. Aluminum shields with 6-32 spade bolt mounting. Sizes: $1 1/8 \times 1 1/8 \times 2 1/2$ " and $1 1/8 \times 1 1/8 \times 2 1/8$ ". $1 1/8 \times 1 1/8 \times 2 1/2$ ". Shpg. wt., 5 oz.

Stock No.	Mfr's Type	Description	NET EACH
60 H 765	6192*	Discriminator	1.76
60 H 766	6184*	Ratio detector	1.94
60 H 764	6182*	Hor. Osc.	1.32
60 H 759	6183*	Hor. Osc.	1.62
60 H 767	1467†	Discriminator	1.76
60 H 768	1468†	Ratio detector	1.94

HORIZONTAL OSCILLATOR AFC DISCRIMINATOR TRANSFORMER

C Type 6194. For horizontal oscillator circuits using synchro-lock automatic frequency control system. Two coupled permeability tuned windings: One, tapped, for use in horizontal blocking oscillator tank circuit; the second, center-tapped for phase discrimination. Housed in aluminum shield with adjustment for horizontal frequency at top and horizontal phase at bottom. 6-32 spade bolt mounting. $1 1/8 \times 1 1/8 \times 2 1/2$ " high. Shpg. wt., 5 oz.

60 H 769. NET.....1.62

HORIZONTAL LINEARITY AND WIDTH CONTROL

D Iron-core variable inductance coils for horizontal sweep circuits. *Have AGC winding. Mounting clip fits $3/8$ " hole. 6300 series are $1 1/2 \times 2 1/4$ " long on phenolic forms. 6100 series are $3/8 \times 2 1/2$ " long on bakelite forms. Shpg. wt., 4 oz.

Stock No.	Mfr's Type	Millihenries	NET EA.
60 H 770	6195	.185-1.000	.73
60 H 771	6196	.054-.045	.65
60 H 897	6196-A	.054-.50 tapped	.73
60 H 772	6197	.550-2.300 tapped	.73
60 H 773	6198	.170-.0610	.65
60 H 774	6199-A	1.300-4.100 tapped	.76
60 H 775	6199-B	.500-1.700	.73
60 H 826	6313	.5-5	1.88
60 H 827	6312	.2-1.8	1.06
60 H 828	6315	4.0-30	1.06
60 H 829	6316*	4.0-30	1.32
60 H 830	6317*	3.2-9	1.32
60 H 831	6318	2-3	1.32
60 H 832	6319	15.0-60	.88
60 H 833	6320	2-3 tapped	.88
60 H 834	6321	1.0-5 tapped	.88
60 H 835	6322	1.5-10	1.03
60 H 836	6323	.5-5 tapped	.88
60 H 898	6324	60-130 tapped	1.32

HIGH VOLTAGE RF POWER SUPPLY TRANSFORMERS

E Type 4525. RF power supply transformer for TV receivers, scopes. Up to 5,000 v. DC. Size, $3 3/4 \times 1 1/4$ " Wt., 4 oz.

60 H 754. NET.....4.85

Type 4526. Up to 10,000 v. DC. (30,000 in rectifier-triplex circuit). Size, $6 \times 2 1/4$ " diameter. Shpg. wt., 4 oz.

60 H 757. NET.....8.08

20 MC RANGE PICTURE IF COILS

F Popular shielded and unshielded permeability tuned TV IF transformers, single and bifilar wound. Type 6247 has single tuned circuit and cathode trap. Type 6248 employs single winding. Types 6251 and 6252 are shielded. Unshielded coils have mounting clip for $3/8$ " hole. Maximum dimensions: $3/4$ " O.D. by $2 1/2$ " long. *Bifilar wound. Av. shpg. wt., 5 oz.

Stock No.	Mfr's Type	IF Mc	Trap Mc	NET EA.
60 H 840	6245	25.5	27.25	1.47
60 H 841	6246	22.0	21.20	1.47
60 H 842	6247	21.25	1.47
60 H 843	6248	24.588
60 H 844	6249*	21-2588
60 H 845	6250*	25-2988
60 H 846	6251*	21-25	1.32
60 H 847	6252*	25-29	1.32
60 H 848	6253*	21-30	20-23	1.62
60 H 849	6254*	22-32	24-29	1.62

SYNC STABILIZER (RINGING) COIL

G Type 6210. Has bakelite form with $7/8$ " mounting clip. 16-42 mh range. Size, $3/4 \times 2 1/2$ ". Shpg. wt., 2 oz.

60 H 820. NET.....1.32

TYPE 20 ECONOMY TRF COILS

H Unshielded tuned RF coils for AM broadcast band, 540 to 1750 kc. For use with 365 mmf variable capacitor. L mtg. bracket. Low impedance primary on adjustable sleeve over secondary. $1 1/8 \times 2$ " high. Shpg. wt., 3 oz.

60 H 753. 20-A. Antenna Coil. NET.....56c

60 H 590. 20-RF. RF. Coil. NET.....56c

TRANSISTOR IF TRANSFORMERS

J Type 2041. High-quality IF transformer for miniature transistor receivers. Designed for use with transistor types CK760 and CK761. Frequency, 455 kc. Primary 25,000 ohms; secondary 600. Replaces Automatic No. EX03015. Size, $3/8$ " high $\times 1 1/2$ " sq. Shpg. wt., 2 oz.

60 H 896. NET.....1.76

Type 2042. Miniature IF transformer same as above, except has 25,000-ohm primary and 1000-ohm secondary windings.

60 H 973. NET.....1.76

TRANSISTOR OSCILLATOR COIL

K Type 2020. For receivers with transistor oscillator. Supplies local oscillator energy to the mixer stage. Use with a 365 mmf variable capacitor. Intermediate frequency 455 kc. With clip for mounting in $3/8$ " diameter hole. Size, $1 1/8 \times 3/8$ " dia. Shpg. wt., 3 oz.

60 H 895. NET.....1.32

Type 2022. Similar to above, except for use with variable capacitor 78-100 mmf max.

60 H 974. NET.....1.32

SUBMINIATURE TRANSISTOR OSC. COIL

L Type 2021. Shielded oscillator coil for use in converter circuits using one transistor for oscillator, mixer. Use with variable capacitor having maximum capacity of 100 mmf. Size, $3/8$ " high $\times 3/8$ " sq. Shpg. wt., 2 oz.

60 H 975. NET.....1.62

MILLER LOOP ANTENNAS

FERRITE ROD ANTENNA

Type 705A. Newly developed rod loop antenna for universal replacement use. Uses a highly efficient design for outstanding performance. Improves reception of distant stations. Extremely easy to adjust. Simply slide the coil along the ferrite rod to peak the antenna. Completely non-directional—it allows convenient placement of the set in any desired position. Equally good reception from any direction. Replaces any loop antenna. Size, $3/4 \times 9 1/2$ ". Shpg. wt., 5 oz.

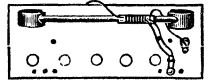

60 H 893. NET.....1.62

TRANSISTOR LOOP ANTENNA



Type 2000. Loop antenna specially designed for transistor receivers. Features a fixed inductance loop with a large pick up field to insure adequate signal to the first stage. Inductor is tapped to match the 600 ohm input impedance of the transistor. Frequency range is 540-1650 kc when used with a 365 mmf variable capacitor. Slender styling for compact installation. Size $1 1/4 \times 9 1/2$ ". Shpg. wt., 3 oz.

60 H 894. NET.....1.62

TRANSISTOR ANTENNA RODS

Type 2001. Miniature antenna rod for use where space is limited. Matches 600 ohm input impedance.

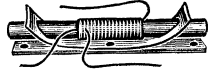

Has inductance of 240 microhenries. Use with any variable capacitor having maximum capacity of 365 mmf. $3/4 \times 3 3/4$ ". Wt., 4 oz.

60 H 976. NET.....1.47

Type 2003. As above but, 700 microhenries. Use with 125 mmf capacitor.

60 H 977. NET.....1.47

STRIP TRANSISTOR ANTENNA RODS

Type 2004. Antenna coil wound on flat ferrite strips.

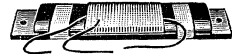

Extremely sensitive—signal pickup compares favorably to that of larger rods. Has inductance of 240 microhenries. For use with capacitor having maximum capacity of 365 mmf. Size, $1/4 \times 3 3/4$ ". Shpg. wt., 4 oz.

60 H 978. NET.....1.47

Type 2005. As above, but 700 microhenries. Use with 125 mmf capacitor.

60 H 979. NET.....1.47

SUB-MINIATURE ANTENNA ROD

Type 2002. Sub-miniature transistor antenna coil. Adjustable from 35 to 300 microhenries. Hi-Q coil tunes with variable capacitor having maximum capacity of from 300 to 500 mmf. Antenna is supplied with short length of wire for additional signal pickup. Mounts in $3/8$ " hole, or may be mounted on sturdy bracket supplied. Matches 600 ohm input impedance. Size, $1/2 \times 2 1/2$ ". Shpg. wt., 3 oz.

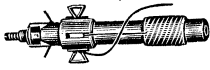

60 H 980. NET.....88c

VOKER IF COIL KIT

Model IF-5000. Set of precision-built IF coils and transformers for building your own 6-transistor superheterodyne radio. Ideal for schools, labs, hobbyists and experimenters. Kit includes: Converter-Stage, 455-kc IF Transformer; 455-kc Intermediate IF Transformer; 455-kc Output IF Transformer; 455-kc Autodyne Oscillator Coil. Kit is supplied complete with easy-to-follow circuit schematic and parts list. Also includes list of names of G.E., Raytheon, General Transistor and RCA transistors to which kit units are matched. All IF transformers are vacuum impregnated for time and temperature stability, and for protection from humidity and dust. Shpg. wt., 6 oz.



60 H 099. NET.....5.26

Meissner IF's and Coils

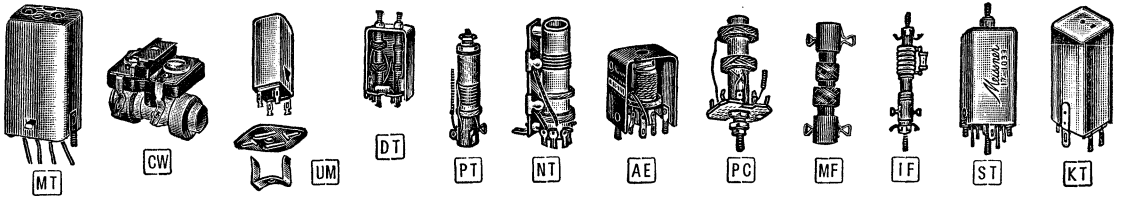

IF TRANSFORMERS

LOW-COST PLASTICS

MT Low-cost IF's. Air core except, iron core. Double-tuned trimmers. $2\frac{1}{2} \times 1\frac{1}{4} \times 1\frac{1}{4}$ " *; $\$1\frac{1}{2} \times 1\frac{1}{8} \times 2\frac{1}{2}$ ". *Bandwidth in kc. Wt., 6 oz.

Stock No.	Mfr's Type	Use	Frequency Range, kc	Selectivity*		NET EACH	
				2X	10X		
60 H 192	16-6649	Input	140-200	6.0	17.5	1.56	
60 H 193	16-6651	Output	140-200	11.5	29.5	1.56	
60 H 194	16-6652	Input	200-310	9.5	24.7	1.41	
60 H 195	16-6654	Output	200-310	20.5	52.1	1.41	
60 H 196	16-6658	Input	400-550	18.8	46.6	1.41	
60 H 197	16-6659	Interstage	400-550	12.5	33.0		
60 H 198	16-6660	Output	400-550	17.5	50.5		
60 H 070	16-6666	Input	400-600	14.1	37.5		
60 H 071	16-6667	Output	400-600	18.0	49.5		1.41
60 H 139	16-6669	Input	380-600	11.2	30.0		1.47
60 H 144	16-6663	Output	380-600	11.2	30.0	1.47	

STANDARD GENERAL REPLACEMENTS

MT Replacements for most receivers. Double-tuned mica trimmers. Size, $3 \times 1\frac{1}{8} \times 1\frac{1}{8}$ ". *Bandwidth in kc. at 2X and 10X down. Av., 4 oz.

Stock No.	Mfr's Type	Use	Frequency Range, kc	Selectivity*		NET EACH
				2X	10X	
60 H 077	16-5700	Input	121-234	6.5	17.7	1.62
60 H 080	16-5712	Input	425-500	11.1	27.7	1.47
60 H 081	16-6133	Interstage	435-1000	14.5	36.5	1.62
60 H 082	16-5714	Output	425-500	12.3	37.2	1.47
60 H 079	16-3731	Output CT	121-255	9.8	23.2	1.47
60 H 083	16-3736	Output CT	255-550	23.2	60.0	1.62

HIGH-Q IRON-CORE REPLACEMENTS

Same as above, except coils have Hi-Q powdered iron cores. *Bandwidth in kc. $1\frac{1}{8} \times 1\frac{1}{8} \times 1\frac{1}{8}$ ". *For battery radios. Wt., 5 oz.

Stock No.	Mfr's Type	Use	Frequency Range, kc	Selectivity*		NET EACH
				2X	10X	
60 H 81	16-5740	Input	360-600	8.4	20.0	2.06
60 H 190	16-5742	Output	360-600	13.8	38.0	1.76
60 H 199	16-6668	Input	350-550	22.5	54.3	1.76
60 H 103	16-6669	Output†	350-550	12.5	38.0	1.76
60 H 104	16-6678	Input/Output	375-550	16.6	41.1	1.76

"CARTWHEEL" IF TRANSFORMER

CW 60 H 095. Type 16-6661. Input, interstage or output. Freq. range, 380-600 kc. $1\frac{1}{8} \times 1\frac{1}{8} \times 1\frac{1}{8}$ ". Dual trimmers. Wt., 5 oz. NET.....1.41

¾" PERMEABILITY TUNED IF's

UM Tuned at top and bottom by adjustable iron cores. Silvered mica condensers. Size, $2 \times \frac{3}{4} \times \frac{3}{4}$ ". With mtg. plates. *Bandwidth in kc. at 2X and 10X down. †With diode filters. Shpg. wt., 4 oz.

Stock No.	Mfr's Type	Use	Frequency Range, kc	Selectivity*		NET EACH
				2X	10X	
60 H 152	16-6758	Input/Output	400-500	28	60	1.29
60 H 153	16-6770	Output	400-550	30	65	1.35
60 H 157	16-6754†	Output	245-275	18	45	1.53
60 H 154	16-6752	Input	245-275	12	35	1.47

TWEET FILTER OUTPUT IF TRANSFORMER

MT Type 16-6670. Frequency, 456 kc. $2\frac{1}{2} \times 1\frac{1}{4} \times 1\frac{1}{4}$ ". RETMA color-coded leads, 4" long. Shpg. wt., 4 oz.

60 H 145. NET.....1.76

AM-FM IRON CORE IF

DT Type 16-6675. Has a 455 kc AM and 10.7 mc FM transformer. Each circuit tuned by powdered iron cores. $2\frac{1}{2} \times 1\frac{1}{8} \times 1\frac{1}{8}$ ". Wt., 7 oz.

60 H 068. NET.....2.94

10.7 MC FM IF TRANSFORMERS

Permeability tuned. Stable shunt capacities. For replacement use or new equipment. Shpg. wt., 5 oz.

No.	Type	Fig.	Description	Mounting	Size	EACH
60 H 069	17-3487	ST	Ratio Det., 400 KC, P-P	1½"	1½x1½x2½"	1.94
60 H 077	16-6665	ST	Input or interstage	1½"	¾x¾x1¾"	1.82
60 H 098	17-3484	ST	Discrim., 400 KC, P-P	1½"	1½x¾x1¾"	1.94
60 H 158	16-3487	UM	Input or interstage	Var. ¾x1½"	¾x¾x2"	1.62

ADJUSTABLE INDUCTANCE SHORTWAVE COILS

PT Adjustable Hi-Q iron cores. Tune with 292 mfd condenser. Universal replacements. Single ¼" hole mounting. $\frac{3}{4} \times 1\frac{1}{4}$ ". Shpg. wt., 4 oz.

No.	Type	Coil type	Freq. Range	Dimensions	EACH
60 H 146	14-1061	Antenna	1.7-5.3 mc	¾x1¾"	1.76
60 H 147	14-1062	R.F.	1.7-5.3 mc		
60 H 148	14-1063	Osc. (for 6SA7)	1.7-5.3 mc		

MULTIPLE-BAND COILS

NT Engineered for custom set builders, experimenters, etc. For use with 456 kc IF. Single bracket mounting. Shpg. wt., 5 oz.

No.	Type	Coil type	Frequency	Size	EACH
60 H 149	14-2860	Antenna	530-1660 kc, 5.8-19 mc	1x1½x3¼"	2.94
60 H 124	14-2862	Osc.	530-1660 kc, 5.8-19 mc	1x1½x2¼"	

RF, ANTENNA AND TV COILS

REPLACEMENT COILS

Air-core type. High-impedance primary. Litz wire secondary. Tune 545-1620 kc, with 360 mfm tuning condenser. *Shielded. 1456 kc IF frequency; 350 mfm padder required. Shpg. wt., 5 oz.

No.	Type	Fig.	Function	Size	EACH
60 H 000	14-1010	NT	Antenna	1¼x2½"	1.18
60 H 001	14-1011	NT	RF	1¼x2½"	
60 H 005	14-1004*	AE	Antenna	1¾x1¾x2½"	
60 H 006	14-1005*	AE	RF	1¾x1¾x2½"	
60 H 075	14-2436*	AE	Antenna	1¾x1¾x2"	
60 H 076	14-2437*	AE	RF	1¾x1¾x2"	1.18
60 H 161	14-4034†	PC	Oscillator	1x1½"	
60 H 166	14-4243*†	AE	Oscillator	1½x1½x1¾"	1.03
60 H 150	14-1022	NT	Antenna	¾x2½"	
60 H 151	14-1023	NT	RF	1¾x2½"	

MINIATURE IRON-CORE COILS

MF Permeability-tuned broadcast coils. Track with all commonly used tuning capacitors. With leads. Shpg. wt., 3 oz.

No.	Type	Use	For	Size	EACH
60 H 167	14-1071	Ant.	AC sets	1½x1¾"	1.03
60 H 168	14-1072	RF	AC sets	1½x1¾"	
60 H 169	14-1073	Osc.	AC sets	1x¾"	
60 H 183	14-1074	Osc.	Batt. sets	1x¾"	

PENTAGRID OSCILLATOR BROADCAST COILS

PT Type 14-1033. Tapped type for 6SA7, 12SA7, etc. 456 kc. Single ¼" hole mtg. ¾" dia. 1" long. Use 420 mfm padder. Wt., 4 oz.

60 H 170. NET.....1.03

Type 14-1053. Oscillator coil. 455 kc. Same as above but requires cut section padder. 162 mfm. Single ¼" hole mounting. ¾" dia. Wt., 4 oz.

60 H 118. NET.....1.03

UNIVERSAL ADJUSTABLE INDUCTANCE COILS

†For battery-operated sets. *For IF frequencies between 175 and 520 kc. Single-hole mounting. Screwdriver adj. Broadcast band. Wt., 5 oz.

Type 15-2866. Adjustable Wave Trap. Not illustrated. 456 kc. 4 oz.

60 H 126. NET.....1.18

TV IF TRANSFORMERS

Replacement units for TV receivers. Permeability tuned. Mounting centers: *1½; †single ¾" hole; †1½; †clip. ST type primary turns from top; secondary from bottom. Shpg. wt., 6 oz.

No.	Type	Fig.	Function	Freq. Mc.	Size	EACH
60 H 129	17-1033†	ST	Ratio Det.	4.5	1½x1½x2"	1.94
60 H 056	17-1034*	ST	Sound IF	4.5	1½x¾x¾"	1.06
60 H 133	17-3483*	ST	Ratio Det.	4.5	1½x1½x2½"	1.94
60 H 057	17-3486†	UM	Discriminator	4.5	2x¾x¾"	1.94
60 H 053	19-1021†	IF	Tunable Choke	21.25	¾x1½"	.71

½" PERMEABILITY TUNED IF's

KT New, sub-miniature IF's with the same performance characteristics as larger units. Widely used in AC-DC receivers. *Bandwidth in kc at 2X and 10X down. ½" mtg. centers. Shpg. wt., 2 oz.

Stock No.	Mfr's Type	Use	Frequency	Selectivity*		Size	EACH
				2X	10X		
60 H 048	16-6800	Input-Inter	465 kc	16	34	1½x½x1½"	1.47
60 H 049	16-6801	Output	465 kc	18	38	1½x½x1½"	

MINIATURE ADJUSTABLE PEAKING COILS

Adjustable inductance coils. For exact adjustment of frequency response in video amplifiers. Mount by leads. Powdered iron cores. Wt., 4 oz.

No.	Type	Fig.	Inductance Range	Size	EACH
60 H 034	19-1920	MF	65-115 Microhenries	1x1½"	59¢
60 H 035	19-1921	MF	115-195 Microhenries		59¢
60 H 036	19-1922	MF	195-325 Microhenries		59¢
60 H 037	19-1923	MF	325-500 Microhenries		73¢

PHONO-OSCILLATOR COIL

Type 17-9373. For use in building either wireless or direct connected phono-osc. units. Permits record reproduction through any radio receiver. Knob adjustment allows selection to clear frequency. $3\frac{1}{2} \times 1\frac{1}{8} \times 1\frac{1}{8}$ ". Shpg. wt., 4 oz.

60 H 096. NET.....2.20

BFO COIL

Type 17-6753. Beat frequency oscillator coil. For receivers having IF's between 290 and 650 kc. Supplies "beat" note necessary to receive CW. $3 \times 1\frac{1}{8} \times 1\frac{1}{8}$ ". Shpg. wt., 6 oz.

60 H 230. NET.....2.94



RF Chokes—Transistor IF's and Coils

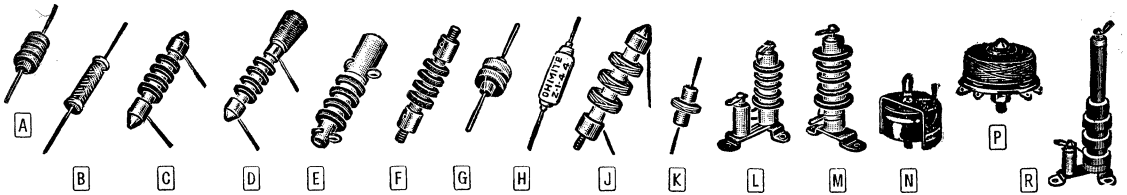

POPULAR RF CHOKES FOR EVERY PURPOSE

Chokes below may be used in transmitters, receivers, test equipment, etc. 71 H 160 is recommended for transmitters with plate supply of up to 3,000 volts modulated or 4,000 volts unmodulated. It may be used on all bands from 80 through 10 meters. R-33 series chokes are two-section; R-50 series chokes are 3 and 4-section. 71 H 149 choke is hermetically sealed in glass. National suffix "U" following type number indicates removable stand-off insulator at

one end. National chokes wound on isolantite forms; Meissner, on specially treated dowels, except *iron-core type. †Shielded. The four highest frequency Ohmite chokes are wound on low power factor plastic cores; the other three units are wound on steatite tubes. Millen and National current ratings are maximum ma. ‡Mounted on standoff insulator for vertical mounting. †Millihenries. **Microhenries. Av. shpg. wt., 2 oz.

Stock No.	Mfr.	Type	Fig.	±Mh	Ma	Ohms	NET
60 H 795	J.W. Miller	4532	F	1	5	200	21 .53
60 H 825	ICA	277	C	2.5	150	32	.39
71 H 150	National	R-100	C	2.5	125	50	.82
71 H 189	National	R-100	C	5	75	50	.40
71 H 188	National	R-100	C	10	75	50	.40
71 H 152	National	R-300	C	1	300	10	.44
71 H 513	National	R-100U	D	2.5	125	50	.48
71 H 1869	National	R-100U	D	5	75	50	.48
71 H 1873	National	R-100U	D	10	75	50	.48
71 H 533	National	R-300U	D	1	300	10	.48
71 H 1618	National	R-100S	E	2.5	125	50	.48
71 H 788	National	R-100S	E	5	75	50	.48
71 H 1629	National	R-100S	E	10	75	50	.48
71 H 1793	National	R-300S	E	1	300	10	.48
71 H 174	National	R-100ST	F	2.5	125	50	.46
71 H 197	National	R-100ST	F	10	75	50	.46
71 H 164	National	R-300ST	F	2.5	300	10	.46
71 H 159	National	R-33	G	10**	100	1.0	.40
71 H 598	National	R-33	G	50**	100	4.0	.40
71 H 163	National	R-33	G	100**	100	5.5	.40
71 H 148	National	R-33	G	1**	100	.06	.40
71 H 149	National	R-33	G	750**	100	17	.40
71 H 198	National	R-50	G	2.5	100	41.5	.40
71 H 250	National	R-50	A	.5	100	16.2	.40
71 H 251	National	R-50	A	1.	100	22	.40
71 H 252	National	R-50-I	A	10	100	30	.61
71 H 253	National	R-60	B	2**	170040
71 H 155	National	R-154	L	1	600	6	2.01
71 H 156	National	R-154U	M	1	600	6	1.61
71 H 160	National	R-175A	M	R	800	6	3.56
60 H 126†	Meissner	19-5584	N	5	5	20	62 .76
60 H 277†	Meissner	19-5588	N	8	0	30	77 .76
60 H 30†	Meissner	19-5592	N	30	0	165	.88
60 H 031†	Meissner	19-5594	N	60	0	16	318 1.18
60 H 032†	Meissner	19-5596	N	80	0	16	342 1.18
60 H 010	Meissner	19-1994	P	2.5	20	40	.53
60 H 011	Meissner	19-4551	P	5.5	20	57.5	.53
60 H 012	Meissner	19-2078	P	8	20	75	.53
60 H 013	Meissner	19-8770	P	10	20	82.5	.53

Stock No.	Mfr.	Type	Fig.	±Mh	Ma	Ohms	NET
60 H 014	Meissner	19-1995	P	1.0	20	108	.53
60 H 015	Meissner	19-2330	P	30.0	20	159	.76
60 H 016	Meissner	19-3247	P	60.0	20	258	.82
60 H 017	Meissner	19-2709	P	80.0	16	372	.82
60 H 040*	Meissner	19-6834	P	2.5	20	22.5	.68
60 H 041*	Meissner	19-6840	P	10.0	20	51.4	.85
60 H 042*	Meissner	19-6842	P	30.0	20	114	1.00
60 H 043*	Meissner	19-6844	P	60.0	12.5	247.5	1.16
60 H 044*	Meissner	19-6846	P	80.0	15	258	1.29
60 H 045*	Meissner	19-6848	P	125.0	20	330	1.62
72 H 040	Millen	34100	D	2.5	250	52.5	.48
72 H 073	Millen	34101	I	2.5	250	52.5	.42
72 H 067	Millen	34103	J	2.5	250	52.5	.42
72 H 076	Millen	34106	C	1	300	13.5	.42
72 H 004	Millen	34140	1.4	500	6.25	1.14
72 H 134	Millen	34300-100	K	100**	250	6.7	.42
72 H 135	Millen	34300-250	K	250**	250	11	.42
72 H 186	Millen	34300-25	K	25**	250	3.1	.42
72 H 187	Millen	34300-50	K	50**	250	4.7	.42
72 H 188	Millen	34300-300	K	300**	250	10.1	.42
72 H 189	Millen	34300-500	G	500**	250	19.8	.42
72 H 190	Millen	34300-1000	G	1000**	250	19	.42
72 H 191	Millen	34210	10	175	63	.69
72 H 192	Millen	34225	25	75	159	.84
72 H 193	Millen	34280	80	75	336	.96
72 H 194	Millen	1300-100	B	100**	50	4.0	.42
72 H 195	Millen	1300-250	B	250**	50	6.2	.42
72 H 196	Millen	1300-500	B	500**	50	12.8	.42
72 H 197	Millen	1300-1000	B	1000**	50	20.3	.42
72 H 198	Millen	1300-2500	B	2500**	50	37.2	.42

Stock No.	Mfr.	Type	Fig.	**uh	Ma	Mc	NET
74 M 410	Ohmite	Z-460	H	0.2	1000	320-520	.29
74 M 411	Ohmite	Z-235	H	0.84	1000	160-350	.29
74 M 412	Ohmite	Z-144	H	1.8	1000	80-200	.29
74 M 413	Ohmite	Z-50	H	7.0	1000	35-110	.29
74 M 414	Ohmite	Z-28	21	600	20-60	.47
74 M 415	Ohmite	Z-14	44	600	7-35	.53
74 M 416	Ohmite	Z-7	84	1000	3-20	1.21

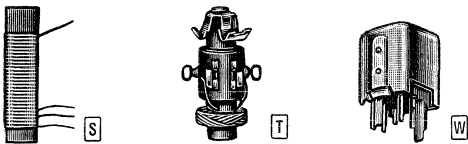

MEISSNER TRANSISTOR COILS AND IF'S

Transistor Antenna and Oscillator Coils. For broadcast frequencies. Can be used with most transistors. Antenna coils have high Q for maximum signal pickup—external antenna usually not required. Wt., 3 oz.

Stock No.	Mfr's Type	Fig.	Function	Capacitor MMF	Inductance, UH	Size	NET EACH
60 H 950	14-9003	S	Antenna	98	880	5/2x3/4x2 1/2"	1.47
60 H 951	14-9003	T	Antenna	365	240	1 1/2x2 1/2"	1.47
60 H 952	14-9004	T	Oscillator	365	140	1 1/2x2 1/2"	1.18
60 H 953	14-9005	S	Antenna	123	667	5/2x3/4x3 3/8"	2.18
60 H 954	14-9006	Oscillator	78	248	1/2x1/2x2 1/2"	2.94
60 H 955	14-9009	Antenna	165	506	3/4x2 1/2"	1.76
60 H 956	14-9010	T	Oscillator	82	262	9/16x1 1/4"	1.18
60 H 957	14-9011	Antenna	73	1125	3/4x5"	1.76
60 H 958	14-9012	Oscillator	59	346	1/2x3/4"	1.47
60 H 959	14-9013	Antenna	123	667	5/8x5"	1.44
60 H 960	14-9014	T	Oscillator	98	207	1 1/8x3/8"	1.18
60 H 961	14-9015	T	Antenna	100-365	200-900	3/4x2"	1.03

Transistor IF Transformers. Compact, high-quality units designed for input, interstage and output use. Ideal for printed circuits. Permeability tuned. All units 1/2" sq. Applications: A—input; IS—interstage; O—output. Shpg. wt., 3 oz.

Stock No.	Type	Frequency	Pri. Imp.	Sec. Imp.	Height	Application	NET
60 H 962	16-9001	262 KC	20000	600	3/4"	A, IS, O	2.94
60 H 963	16-9002	455 KC	25000	600	3/4"	A, IS, O	1.65
60 H 964	16-9003	455 KC	10000	500	3/4"	A, IS	2.94
60 H 965	16-9004	455 KC	10000	1500	3/4"	O	2.94
60 H 966	16-9007	455 KC	80000	25	3/4"	A	2.94
60 H 967	16-9008	455 KC	30000	25	3/4"	IS	2.94
60 H 968	16-9009	455 KC	30000	1000	3/4"	O	2.94
60 H 969	16-9012	455 KC	25000	250	3/4"	A	2.94
60 H 970	16-9013	455 KC	20000	150	3/4"	IS	2.94
60 H 971	16-9014	455 KC	20000	1000	3/4"	O	1.65

IRC INSULATED HF CHOKES

Insulated wire-wound chokes for use in receivers, transmitters and other high frequency circuitry. Compact size simplifies installation; wide choice of inductances. All are fully insulated in molded phenolic housings against high humidity, abrasion and physical damage. 1000 volts insulation breakdown to ground. Color coded. All values are RETMA preferred and have ±10% tolerance. Type CLA units have resistance tolerance of ±20%, except 0.47, 0.56, 0.68 and 1.0 micro-henry units which are ±30%. CL-1 units are ±20%, except 0.47, 0.82 and 1.0 microhenry units which are ±30%. "Q" rises with frequency. CLA, 3/2x3/4" dia.; CL-1, 1 1/4x1/4" dia. Wt., 2 oz.

Stock No.	Mfr's Type	Micro-henries	DC Ohms	Resonant Freq. (Mc.)	1-99, EACH	100 or More, EACH
74 M 420	CLA	0.47	0.22	305	2lc	12 1/2c
74 M 421	CLA	0.56	0.26	275		
74 M 422	CLA	0.68	0.37	250		
74 M 424	CLA	1.0	0.66	205	2lc	12 1/2c
74 M 425	CLA	1.2	0.68	190		
74 M 426	CLA	1.5	0.94	170		
74 M 427	CLA	1.8	1.3	155	2lc	12 1/2c
74 M 428	CLA	2.2	1.8	140		
74 M 429	CLA	2.7	2.0	125		
74 M 430	CLA	3.3	2.8	115	2lc	12 1/2c
74 M 431	CL-1	0.47	0.14	330		
74 M 434	CL-1	0.82	0.29	250		
74 M 435	CL-1	1.0	0.33	225	2lc	12 1/2c
74 M 437	CL-1	1.5	0.56	185		
74 M 438	CL-1	1.8	0.77	170		
74 M 439	CL-1	2.2	0.87	150	2lc	12 1/2c
74 M 440	CL-1	2.7	1.2	135		
74 M 441	CL-1	3.3	1.7	125		
74 M 442	CL-1	3.9	2.3	115	2lc	12 1/2c
74 M 443	CL-1	4.7	2.5	105		
74 M 444	CL-1	5.6	3.4	95		
74 M 445	CL-1	6.8	4.7	86	2lc	12 1/2c
74 M 446	CL-1	8.2	5.2	79		
74 M 447	CL-1	10.0	7.5	71		

Shields, Caps, Coil Forms, Capacitors

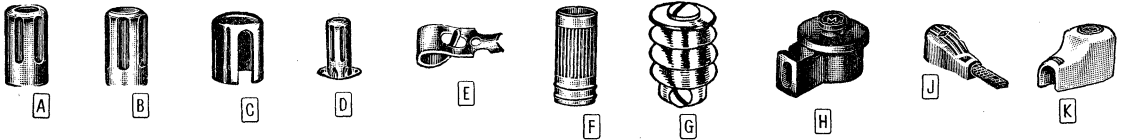

RECEIVING AND TRANSMITTING GRID CAPS AND SHIELDS

RECEIVING TUBE GRID CAPS AND SHIELDS

A complete selection of grid caps and shields for receiving-tube tubes. Shields are sturdily constructed of durable, lightweight aluminum, accurately formed to assure easy installation. Used extensively for shielding high-gain RF and audio amplifier tubes to reduce microphonics, eliminate inter-stage interference, etc. Also used to shield oscillator and converter tubes to avoid radiation. Tube caps provide positive, dependable contact. Av. shpg. wt., per pkg., 3 oz.

Stock No.	Fig.	Description and Application	Quan. Per Pkg.	NET Per Pkg.
42 H 510	A	Goat G1332-3 tube shield for GT tubes. 2 7/8" high, 7/8" hole.	4	19¢
42 H 511	B	Goat G1332-5A. Same as 42 N 510, but with closed top.	4	19¢
42 H 513	C	H. H. Smith 537 metal tube grid shield. Slot for grid lead.	2	21¢
42 H 512	D	Goat G1700 tube shield for miniature T5 1/2 with G1710-B base. .865"x1 1/8".	3	20¢
42 H 514	E	National Type 24. For standard tubes, 3/8" dia. grid caps.	5	23¢
42 H 515	E	National Type 8. For octal tubes, 1/4" diameter grid caps.	5	23¢
42 H 507	F	Goat G1222K tube shield for all GT types. 1 1/4" dia., 2 5/8" high.	4	19¢
42 H 509	F	Goat G1222L tube shield for loktal type tubes. 1 3/8" dia., 2 5/8" high.	4	19¢
42 H 508	(Not illustrated). Goat G1004 ground clip for grounding shields on octal tubes.	10	9¢
42 H 506	(Not illustrated). Goat G1307-2 double clip for octal base tubes (fits on tube socket).	5	14¢

AMPHENOL COIL FORMS



Low-loss, miniature transparent polystyrene coil forms. Excellent for receivers, low-power transmitters, VHF equipment, etc. All are plug-in type except #19. Type 24 has raised hole in center of base for mounting with self-tapping screw. Prongs of plug-in types are spaced to fit Amphenol Series 78S standard and miniature sockets (page 160). Coils can be coated after winding with Amphenol "912" cement, listed on page 332. Rigidly anchored prongs; sturdy construction. Av. shpg. wt., 2 oz.

Stock No.	Mfr's Type	Description	1-99 100-249 250-200			
			EACH	EACH	EACH	
71 H 723	24-5H	5-Prong Min.	1 1/2"x1 3/4"	24¢	20¢	18¢
71 H 711	24-6H	6-Prong Min.	1 1/2"x1 3/4"	24¢	20¢	18¢
71 H 713	24-4P	4-Prong Std.	2 1/4"x1 1/2"	24¢	20¢	18¢
71 H 714	24-5P	5-Prong Std.	2 1/4"x1 1/2"	24¢	20¢	18¢
71 H 724	24-6P	6-Prong Std.	2 1/4"x1 1/2"	24¢	20¢	18¢
71 H 712	24	Coil Form only*	1 1/2"x3/4"	9¢	7 1/2¢	7¢

CAMBRIDGE THERMIONIC CERAMIC SLUG-TUNED COIL FORM KIT



This kit of ceramic, slug-tuned coil forms meets almost every slug-tuned coil requirement encountered by development labs, engineers, Amateurs and experimenters. Includes 15 coil forms (3 each of 3 different types), 19 powdered iron slugs, 5 silver-plated brass slugs, and complete set of mounting hardware. Coils covering 200 kc to 200 mc can be wound with coil forms and slugs supplied. Forms are silicone-impregnated ceramic. Powdered iron slugs are color-coded. All coil forms included in kit incorporate the "Permaton" slug locking feature. Diameter of forms

ranges from 3/8" to 1/2"; overall mounted heights from 1 1/2" to 1 1/8". Shpg. wt., 13 oz. 72 H 280. NET.....11.76

SLUG-TUNED COILS



For broadband RF amplifiers, TV traps, HF circuits, etc. Bodies of LS3, LSM and LS4 are HF paper base phenolic; PL55 and PL56 are ceramic. LS3 has larger slug, greater bandpass. LS4 for larger inductance and Q. Tunable from either end; locking nut. LSM, 2 3/8"x1/4" dia.; LS3, 1 1/2"x3/8" dia.; LS4, 2x1/2" dia.; PL55, 1 1/8"x3/8" dia.; PL56, 2 3/8"x1/4" dia. Shpg. wt., 4 oz.

Stock No.	Mfr's Type	Description	1-9, EACH	10 or More, EACH
72 H 294	LS3	Coil Form	.81	.73
72 H 295	LS3	1 Mc Coil	1.23	1.11
72 H 296	LS3	5 Mc Coil	1.18	1.06
72 H 297	LS3	10 Mc Coil	1.13	1.02
72 H 298	LS3	30 Mc Coil	1.11	1.00
72 H 299	LS3	60 Mc Coil	1.11	1.00
72 H 282	LSM	Coil Form	.81	.73
72 H 283	LSM	1 Mc Coil	1.23	1.11
72 H 284	LSM	5 Mc Coil	1.18	1.06
72 H 293	LSM	10 Mc Coil	1.13	1.02
72 H 286	LSM	30 Mc Coil	1.11	1.00
72 H 287	LSM	60 Mc Coil	1.11	1.00
72 H 288	LS4	Coil Form	1.08	.97
72 H 289	PL55	Coil Form	.96	.86
72 H 292	PL56	Coil Form	.88	.79

TRANSMITTING TUBE CAPS

Popular-type heat dissipating connectors, plate and grid caps for transmitting tubes. Heat dissipating connectors provide large metal surface area for rapid radiation of heat; have machine screw for secure connection. Millen 36011 cap is for mobile or industrial use where a tighter-than-normal grip is required; self-locking, with snap-button release. *For wire leads. All others are cap type. Av. shpg. wt., 3 oz.

Stock No.	Fig.	Description and Application	Quan. Per Pkg.	NET Per Pkg.
42H 093*	G	Eimac HR-3 heat dissipating cap for 35T, 250TH, etc., .070" hole.	1	60¢
42H 096	G	Eimac HR-6 heat dissipating cap for 4-250A, 304TH, etc., .359" hole.	1	80¢
73H 000*	G	Bud TC-488 heat dissipating cap for HK24. .052" hole.	1	47¢
73H 001*	G	Bud TC-489 heat dissipating cap for 35T, HK54, etc., .072" hole.	1	53¢
73 H 002	G	Bud TC-1920 heat dissipating cap for 100T, 80T, etc., .375" hole.	1	59¢
73 H 003	G	Bud TC-1921 heat dissipating cap for 866, 1125, etc., .570" hole.	1	64¢
72 H 082	H	Millen 36011 industrial snap-action plate cap. 3/8".	1	69¢
71 H 246	J	National SP9-P ceramic insulated grid and plate cap. 3/8".	1	24¢
42 H 518	E	National 12 transmitting grid and plate cap. 3/8".	3	29¢
72 H 069	K	Millen Type 36002 steatite tube cap, 3/8".	1	24¢
72 H 140	K	Millen Type 36004 steatite tube cap, 1/4".	1	24¢
72 H 068	K	Millen 36001 steatite plate cap for 866, etc., 3/8".	1	24¢

JFD PISTON-TYPE VARIABLE TRIMMER CAPACITORS

Variable trimmer capacitors with spring-loaded piston. Smooth action—no backlash. Insulation resistance, 10,000 megohms. Class dielectric—operates efficiently up to 125°C., quarter—150°C. Dielectric strength, 1,000 volts/1" long. Mounts in .257" round or "D" hole. Shpg. wt., 5 oz.



Stock No.	Type	Mmf	1-24, EACH	25-99, EACH
16 H 005	VC2†	0.7-4.5	3.30	2.97
16 H 000	VC5†	0.5-5.0	3.60	3.24
16 H 001	VC1†	1-10	4.05	3.64
16 H 006	VC11†	1-10	4.50	4.05
16 H 007	VC12†	10-20	5.25	4.72
16 H 008	VC19*	0.5-8.0	1.95	1.75
16 H 009	VC3*	0.7-8.0	1.50	1.35
16 H 010	VC4*	1-18	1.95	1.75
16 H 011	VC5*	1-18	2.25	2.02
16 H 012	VC6*	1-18	1.80	1.62
16 H 013	VC6*	1-18	1.95	1.75
16 H 014	VC7*	2-30	2.25	2.02
16 H 002	VC11G*	0.7-12.0	2.10	1.89
16 H 015	VC11GRB*	0.7-10	2.10	1.89
16 H 016	VC11GRB*	0.7-10.0	1.80	1.62
16 H 017	VC11GRC*	0.7-10.0	2.10	1.89
16 H 018	VC13G*	1-10	.90	.81
16 H 004	VC30G*	1-30	2.40	2.16

Write for quantity prices on 100 or more JFD capacitors

ICA COIL FORMS & COIL SETS

Rim-Type Coil Forms. Low-loss forms with high dielectric strength. Molded rim handle. Prongs fit standard sockets. 1 1/4" dia., 2 1/4" high. Wt., 2 oz.



Stock No.	Mfr's Type	Prongs	1-9, EACH	10 or More, EACH
60 H 700	1108B	4	37¢	33¢
60 H 701	1113B	5	40¢	36¢
60 H 702	1114B	6	40¢	36¢

Plug-In Coil Sets. Precision-made coils on bakelite forms. Use with 140 or 150 mmf. capacitor. Two windings: 1—grid; 1—tickle or antenna. Fit 4-prong tube sockets. 1 1/4"x2 1/4". Shpg. wt., 8 oz.

Stock No.	Mfr's Type	Description	1-9 Sets, PER SET	10 or More Sets, PER SET
60 H 680	1471	(Set of 4) Short-Wave. 1380 kc—31.5 mc	2.69	2.42
60 H 681	1473	(Set of 2) Broadcast. 545 kc—1580 kc	2.16	1.94

AMPEREX VACUUM CAPACITORS

For industrial RF applications. Provide extremely high stability in critical bypass, coupling and neutralizing circuits. Can be used as plate tank capacitor. Break-down voltage of all capacitors rated at 32 kv maximum. Size, 2 1/2"x3/2". Av. shpg. wt., 10 oz.



Stock No.	Type	Mmf	NET
42 H 075	VC-25	25	23.25
42 H 076	VC-50	50	27.50
42 H 077	VC-100	100	33.00

Millen Components

MINIATURIZED COUPLINGS

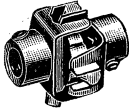

These miniaturized couplings are designed for use in compact equipment and for limited space applications. M003 is solid brass. M006 (illustrated) is universal joint style made of nickel plated brass with stearite insulation and spring fingers. M008 is an insulated coupling with brass inserts. 39003 is solid brass for 1/4" shafts; all others are for 1/8" shafts. Av. shgp. wt., 2 oz.

Stock No.	Type	Description	NET
72 H 172	M003	Solid brass coupling	30c
72 H 170	M006	Univ. joint coupling	75c
72 H 171	M008	Insulated coupling	48c
72 H 090	39003	Solid brass coupling	24c

FLEXIBLE COUPLINGS



Popular 39000 series of flexible couplings. Designed to provide higher flexibility, no backlash, high break-down voltages, smaller diameter and accurate alignment. 39006 for "out-of-line" shaft operation. 39016 has insulating barrier diaphragm.

All are for use with 1/4" shafts. Av. shgp. wt., 2 oz.

Stock No.	Type	Description	E.A.
72 H 034	39001	Insulated universal joint	48c
72 H 176	39002	Insulated	
72 H 054	39005	Universal joint	
72 H 094	39006	Insulated slide action	
72 H 175	39016	Insulated barrier	

DRIVE MECHANISMS



Type 10000 Worm Drive. A ruggedly constructed drive mechanism offering a 16-to-1 step-down ratio. Cast-aluminum frame drilled for secure mounting on panel or chassis base. Spring-loaded split gears for smooth operation and minimum backlash.

1/4" left and right hand shafts. 3.2x2 3/8". Shgp. wt., 6 oz.
72 H 173. NET..... 9.75

Type A012 Right-Angle Drive. Compact single-hole bushing mount type drive mechanism. Has 1-to-1 ratio. 1/8" left and right-hand drives can be used together. 1 1/4x1 1/4x3/8". Shgp. wt., 4 oz.
72 H 174. NET..... 3.90

MOLDED COIL FORMS



Type 45004. Molded-mica, phenolic base type coil forms. Four-prong type. For shortwave receivers and low-power transmitters. Size: 1" diameter; 1 1/2" winding length; 2 3/8" overall. Shgp. wt., 2 oz.

72 H 124. NET..... 51c

Type 45005. Same as 45004, but has 5 prongs. Shgp. wt., 2 oz.
72 H 125. NET..... 51c

Type 45000. As above, without prongs. Screw mounting. Shgp. wt., 2 oz.
72 H 128. NET..... 39c

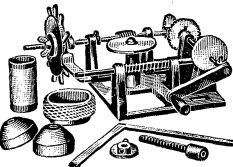

MORRIS COIL WINDER

You'll be able to wind efficient, commercial-honeycomb, spiderweb and solenoid coils with this very versatile, but economical coil winder. It's a real time saver for the Amateur and experimenter and gives your work a more professional appearance. Just set up the winder for the type of coil you require and turn the handle—dial indicator counts the turns for you. May be used for winding RF coils, oscillator coils, loop antennas, coils for low-power transmitters, chokes, filter inductors, parasitic suppressors, TVI traps, etc. Handles up to No. 16 wire, making it suitable for almost all coil requirements in receivers, test equipment and small transmitters. Unit is supplied with two-piece wood spool for holding honeycomb and solenoid coils, plus cast pegholders and four 6 1/2" wooden pegs for spiderweb coils. Winder is mounted on rugged cast-iron base with holes for bench mounting. With extension shaft for winding solenoid coils up to 3 1/4" long. Less wire and forms. Base size, 4x3 1/2". Shgp. wt., 3 lbs.
83 P 520. NET..... 4.95

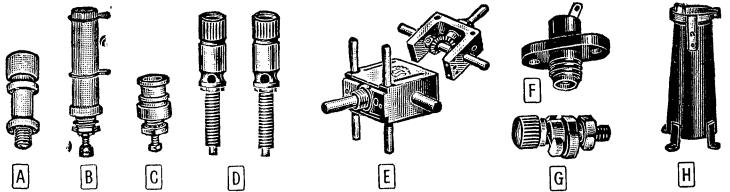

"DESIGNED FOR APPLICATION" COMPONENTS Precision Components for Finest Performance

Famous Millen components for use in original equipment and for replacement purposes in existing equipment. Made to exacting specifications to assure extremely dependable service in all industrial, Amateur and experimental applications. Type 10008 instrument dial (not illustrated) has logging scale spread over 180 degrees. In 69000 series slug-tuned coil forms, copper slug decreases inductance as slug is turned into coil; iron slug increases inductance.

Series 80000 CRT bezels have satin-black finish, neoprene cushions and green lucite filters. 37200 Series binding posts, plates and plugs provide a number of combinations to meet the most varied requirements. For extensive listings of Millen high-quality RF chokes, see page 155. *Items not illustrated. Coil dimensions are winding lengths. Refer to manufacturers' index on page 400 for the many other Millen products listed in this Catalog.

Stock No.	Mfr's Type	Fig.	Description	NET EACH
72 H 046	10008	*	Instrument Dial, 3 1/2" dia., 0-100.....	2.40
72 H 085	10012	E	Right Angle Drive.....	4.53
72 H 087	10050	G	Dial Lock.....	.54
72 H 099	10061	*	Shaft Lock, for 3/8" Bushing; 1/4" shafts.....	.45
72 H 088	10062	*	Shaft Lock with Knurled Nut.....	.54
72 H 162	32150	*	Insulated Feed-Through Bushing, 1/4", Pkg. of 5.....	.30
72 H 036	37001	F	High Voltage Terminal and Thru-Bushing, Black.....	.45
72 H 037	37001	F	High Voltage Terminal and Thru-Bushing, Red.....	.48
72 H 260	40305	*	5-Prong Steatite Coil Plug.....	.69
72 H 261	41305	*	5-Prong Steatite Jack Bar for above.....	.84
72 H 056	37201	*	Bakelite Discs (2) for 37222 below.....	.24
72 H 057	37202	*	Bakelite Plates (2) for 37222 below, Black.....	.36
72 H 138	37212	*	Double Banana Plug, Black.....	.78
72 H 059	37222	D	Binding Posts (2) for 37212 above.....	.60
72 H 163	37302	*	Steatite Terminal Strip, 2 Terminals.....	.75
72 H 164	37303	*	Steatite Terminal Strip, 3 Terminals.....	.84
72 H 165	37304	*	Steatite Terminal Strip, 4 Terminals.....	.96
72 H 166	37305	*	Steatite Terminal Strip, 5 Terminals.....	1.14
72 H 167	37306	*	Steatite Terminal Strip, 6 Terminals.....	1.23
72 H 139	37412	*	300 ohm Transmission Line Plug.....	.24
72 H 129	39023	*	Insulated Shaft Extension.....	1.35
72 H 130	69041	C	Ceramic Slug-tuned Coil Form, 1 1/2x1 1/2", Copper Slug.....	.96
72 H 131	69043	A	Ceramic Slug-tuned Coil Form, 1 1/2x1 1/2", Iron Core.....	.84
72 H 084	69045	B	Ceramic Slug-tuned Coil Form, 1 1/2x1 1/2", Copper Slug.....	1.05
72 H 132	69046	*	Ceramic Slug-tuned Coil Form, 1 1/2x1 1/2", Iron Core.....	1.05
72 H 161	69047	*	Ceramic Slug-tuned Coil Form, 1 1/2x1 1/2", Copper Slug.....	1.05
72 H 163	69048	*	Ceramic Slug-tuned Coil Form, 1 1/2x1 1/2", Iron Core.....	1.05
72 H 150	69042	H	Nicoloi Shield for 2AP1 and 2BP1 2" CR Tubes.....	6.63
72 H 151	80043	*	Nicoloi Shield for use with either 3AP1 or 3BP1 3" CR Tubes.....	7.62
72 H 177	80055	*	Nicoloi Shield for 5CP1.....	13.41
72 H 153	80072	*	Bezel, Cushion and Filter for 2" CR Tube.....	1.44
72 H 154	80073	*	Bezel, Cushion and Filter for 3" CR Tube.....	4.35
72 H 155	80075	*	Bezel, Cushion and Filter for 5" CR Tube.....	8.40

VARIABLE CAPACITORS



Series 20000 Ultra-Midgets. Top-quality, steatite-insulated variables. All are single-bearing type with .015" air gap (rated 600 volts peak), except *double-bearing type with .045" air gap (rated 1400 volts peak). All have 1/4" round shafts, 1" long. 3/16"-32 thread mounting bushing. Lengths given include shaft. Av. shgp. wt., 5 oz.

Stock No.	Mfr's Type	Max. Mmf.	Min. Mmf.	Overall Length	NET EACH
72 H 030	20015	20	2.8	1 1/2x2 1/2"	1.77
72 H 044	20025	28.5	3.0	2 1/2x2 1/2"	1.86
72 H 032	20050	56	3.5	2 3/4x2 1/2"	2.04
72 H 033	20100	111	5.2	2 3/4x3 1/2"	2.43
72 H 045	21935*	39.5	6.7	3 3/4x2 1/2"	2.08

33087 TUBE BASE CLAMPS



Sturdily made, polished spring steel tube base clamps. Hold tubes in sockets and protect against damage from sudden jarring and shock. Excellent for use in mobile equipment and for reducing vibration of oscillator tubes. Shgp. wt., 2 oz.

Stock No.	Mfr's Type	Diameter	NET EACH
72 H 178	33087A	1.125"	36c
72 H 179	33087B	1.165"	
72 H 180	33087C	1.250"	
72 H 181	33087D	1.275"	
72 H 182	33087E	1.375"	
72 H 183	33087F	1.156"	
72 H 184	33087I	1.000"	

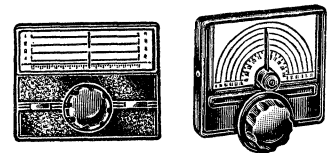

MULTI-SCALE DIALS

J Type 10035 Multi-Scale Dial. An exceptionally handsome, deluxe-type illuminated slide-rule dial. Ideal for home-built Amateur communications receivers, VFO's, etc. Two built-in pilot lights provide even illumination over dial. Unit is entirely self-contained. Large finger-grip knob control. Has 12 to 1 drive ratio. Has 4 blank scales for calibration and one 0-100 logging scale. Cardboard scale supplied can be used on both sides. Clear plastic full-view dial window. Ample panel space provides room for 2 small controls. Escutcheon removable without disturbing the mechanism, for easy scale calibration. Escutcheon size 8 1/2x6 1/2". Attractive black finish. Shgp. wt., 2 1/2 lbs.
72 H 123. NET..... 7.26

K Type 10039 Midget Panel Dial. Economy model. Excellent for small transmitters, receivers and measurement equipment. Drive ratio is 8 to 1. Totally self-contained mechanism eliminates back-of-panel interference; quick, easy installation. Compact design. Comfortable, finger-grip knob. Has 5 blank scales for calibration and one 0-100 logging scale. Easily calibrated without disturbing mechanism. Black finish. Size, 4x3 1/2". Shgp. wt., 13 oz.
72 H 050. NET..... 3.24

National Components

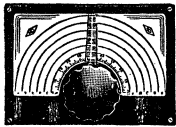

ACN

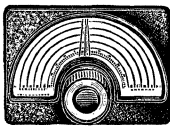

ICN



SCN



MCN

CALIBRATED AND UNCALIBRATED DIALS

VERNIER DIALS FOR INDIVIDUAL CALIBRATION

Popular blank dials. Feature the famous "Velvet Vernier" with 5:1 drive ratio. Pointers are clear plastic, with centered hairlines and pinholes for easy, accurate calibration of each scale.

All have one 0-100 logging scale. Black, wrinkle-finished escutcheons. Clear-view plastic windowns. With instructions, extra scales, hardware, and hub for 1/4" shafts.

Type ACN. The famous original of this type. Large-size vernier dial. 5" high, 7 1/4" wide. Shpg. wt., 1 1/4 lbs.
71 H 090. NET.....7.04

Type SCN. Intermediate size vernier dial, 4 7/8" high, 1 1/4" wide. Ideal for use where space is limited. Shpg. wt., 1 lb.
71 H 088. NET.....6.47

Type ICN. Large, illuminated vernier dial, 5 1/2" high, 7 1/4" wide. Lights in upper corners. With standard bayonet sockets and mounting screws. Less lamps. Shpg. wt., 1 1/4 lbs.
71 H 087. NET.....6.90

Type MCN. Small size vernier dial, only 2 3/4" high, 3 7/8" wide. Perfect for mobile gear and other small units. Mechanism extends 1/4" below frame. Shpg. wt., 10 oz.
71 H 089. NET.....3.99

CALIBRATED DIALS

Famous National top-quality dials—outstanding favorites for smooth performance and dependability. Recommended for all types of equipment. We can supply any National dial promptly—specify type number for models not listed. *Not illustrated.



Stock No.	Type	Fig.	Description	Wt., Oz.	EA.
71 H 072	AM-2	*	Ratio 5:1. 180° Rotation. Scale, 0-100. 3" dia.....	10	3.93
71 H 073	AM-3	*	Ratio 5:1. 180° Rotation. Scale, 100-0. 3" dia.....	10	3.93
71 H 074	AM-4	*	Ratio 5:1. 270° Rotation. Scale, 150-0. 3" dia.....	10	4.31
71 H 077	AM-5	*	Ratio 5:1. 360° Rotation. Scale, 200-0. 3" dia.....	10	3.93
71 H 078	AM-6	*	Ratio 5:1. 270° Rotation. Scale, 0-150. 3" dia.....	10	4.43
71 H 067	BM-1	A	Ratio fixed. 180° Rotation. 0-100-0. 3" dia.....	10	4.88
71 H 068	BM-2	A	Ratio fixed. 180° Rotation. 0-100. 3" dia.....	10	4.64
71 H 069	BM-5	A	Ratio fixed. 360° Rotation. 200-0. 3" dia.....	10	4.64
71 H 091	K	C	ODD vernier drive. 180°. Scale, 0-100. 3 1/2" dia.....	12	1.73
71 H 063	N-5	C	Vernier reader. Planetary 5:1. 200-0. 4" dia.....	12	6.41
71 H 083	NPW-O	B	Precision type; drive shaft perpendicular to panel	3 lbs.	20.45

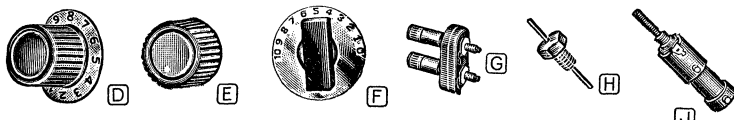

EQUIPMENT DESIGN COMPONENTS

An excellent selection of top-quality components, including terminals, knobs, connectors, coil forms, etc. Used in transmitters, receivers, test equipment, etc. *Not illustrated.

Stock No.	Mfr's Type	Fig.	Description	1-24, EACH	25 or More, EACH
71 H 064	AN	*	Vernier Mechanism; 5:1 ratio. 1/4" shaft.....	3.02	2.71
71 H 167	FWA	*	Binding Post. Takes wire, lugs, etc.....	.60	.54
71 H 166	FWC	*	Insulator for FWA. Mica-Bakelite. (Pr.).....	1.10	.99
71 H 173	FWH	G	Terminal Strip—Binding Post.....	.87	.78
71 H 176	FWJ	*	Terminal Strip—As FWH, for jacks only.....	1.56	1.40
71 H 157	FWT	*	Plug for FWH and FWJ terminal strips.....	.35	.31
71 H 208	HR	E	Knob, Black, HRS Type; white dot.....	.35	.31
71 H 209	HR	E	Knob, Gray; same as above.....	.47	.47
71 H 204	HRE	*	Lever Knob; bright zinc alloy.....	.66	.59
71 H 086	HRK	*	Knob, Black. 2 3/8" dia. Set screw; for 1/4" shaft.....	.28	.24
71 H 071	HRP-P	D	Bar knob with pointer. 1 1/4 x 1/2" dia.....	.58	.52
71 H 058	HRS-3	D	Knob, Black; 1 1/2" dia. chrome. 0-10; 300°.....	.58	.52
71 H 059	HRS-3	D	Knob, Gray; as above.....	.58	.52
71 H 218	HRS-4	*	Knob, Black; as HRS-3, one pointer line.....	.58	.52
71 H 219	HRS-4	*	Knob, Gray. As HRS-3, one pointer line.....	.86	.77
71 H 056	HRT	*	Knob, Black; chrome trim. 2 1/8" dia.....	.86	.77
71 H 057	HRT	*	Knob, Gray; chrome trim. As above.....	2.85	2.57
71 H 082	O	*	Dial, nickel-silver. 0-100; 180°; 3 1/2" dia.....	.48	.43
71 H 085	ODD	*	Vernier drive unit for Type O dial.....	2.07	1.86
71 H 199	OSR	*	100 kc. Osc. Coil. For superregens.....	.69	.62
71 H 070	F	H	Dial, silver; 0-10; 180°; 1 1/2" dia.....	.07	.06
71 H 116	TPB	F	Threaded Polystyrene Bushing.....	1.04	.93
71 H 228	XR-50	J	Coil Form, iron-slug tuned. Mica-bakelite.....	1.32	1.19
71 H 229	XR-60	*	Coil Form, iron-slug tuned. Ceramic.....	.87	.78
71 H 239	XR-91	*	Coil Form, iron-slug tuned. Ceramic.....	.14	.13
71 H 122	XS-6	*	Stearite Bushing.....		

Write For Quantity Prices

MULTI-BAND TANK ASSEMBLIES

TYPE MB-40SL

TYPE MB-150

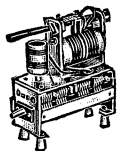

Low-power version of MB-150 at right. Excellent for final tank in low-power transmitters or for grid circuit in transmitter using MB-150 in final. Has same frequency coverage. Shielded swinging link minimizes harmonics. Handles up to 40 watts with output link loaded; 20 watts no load. Size, 5 1/2 x 2 1/4 x 6 1/4".

Shpg. wt., 1 1/4 lbs.
71 H 045. NET.....17.75

Tunes all frequencies from 80 through 10 meters with no coil change. Constant L/C ratio maintained on all bands. Rated at 150 watts; handles 1500 v. peaks. Consists of 3 coils, 4-gang tank condenser, RF choke. For balanced or single-ended amplifiers. Size, 8 1/4 x 3 x 9".

Shpg. wt., 4 lbs.
71 H 046. NET.....21.56

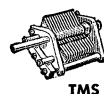
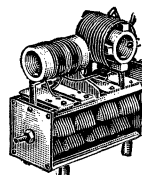

TMS



TMC

TM TRANSMITTING CAPACITORS

Compact, rigid construction. Steatite insulation. Provisions for panel, chassis or standoff insulator mounting. Air Gap and Peak Voltage: TMS types, .026", 1000 volts; TMC types, .077", 3000 volts. Lengths: *3"; †3" to 6"; ‡4 3/8" to 9 1/4". 180° rotation. Av. shpg. wt., 1 lb.

TYPE TMS—SINGLE STATOR*

Stock No.	Mfr's Type	Max. Mmf	Min. Mmf	NET EACH
71 H 000	TMS-100	100	9.5	5.48
71 H 001	TMS-150	150	11	6.02
71 H 002	TMS-250	250	13.5	7.01
71 H 003	TMS-300	300	15	6.81

TYPE TMS—DOUBLE STATOR*

Stock No.	Mfr's Type	Max. Mmf	Min. Mmf	NET EACH
71 H 004	TMS-50D	50-50	6-6	6.09
71 H 005	TMS-100D	100-100	7-7	6.05
71 H 013	TMS-125D	125-125	8-8	7.50

TYPE TMC—SINGLE STATOR†

Stock No.	Mfr's Type	Max. Mmf	Min. Mmf	NET EACH
71 H 015	TMC-50	50	10	7.17
71 H 016	TMC-100	100	13	8.61
71 H 017	TMC-150	150	17	9.23
71 H 018	TMC-250	250	23	13.11

TYPE TMC—DOUBLE STATORS‡

Stock No.	Mfr's Type	Max. Mmf	Min. Mmf	NET EACH
71 H 020	TMC-50D	50-50	9-9	5.64
71 H 021	TMC-100D	100-100	11-11	11.61
71 H 022	TMC-200D	200-200	18.5-18.5	18.66

TYPE ST CAPACITORS

Top-quality, dependable units with straight-line wavelength plates. 180° rotation. Steatite insulation. *Airgap, .026", 1000 volts peak. All others have air-gap of .018", 600 volts peak. All have threaded bushing for easy panel mounting. Av. shpg. wt., 7 oz.

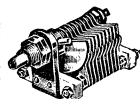

SINGLE BEARING

Stock No.	Mfr's Type	Max. Mmf	Min. Mmf	NET EACH
71 H 030	STHS-15	15	3	3.09
71 H 031	STHS-25	25	3.25	3.20
71 H 032	STHS-50	50	3.5	3.24

DOUBLE BEARING

Stock No.	Mfr's Type	Max. Mmf	Min. Mmf	NET EACH
71 H 033	ST-35*	35	6	4.65
71 H 034	ST-50*	50	7	4.83
71 H 035	ST-75*	75	8	5.34
71 H 036	ST-100*	100	9	4.88
71 H 037	ST-140*	140	10	6.51
71 H 038	ST-150*	150	10.5	7.28
71 H 039	STH-200	200	12	11.79
71 H 040	STH-250	250	13.5	5.99
71 H 041	STH-300	300	15	7.62
71 H 042	STH-335	335	17	7.01

SPLIT STATOR DOUBLE BEARING

Stock No.	Mfr's Type	Max. Mmf	Min. Mmf	NET EACH
71 H 043	STD-50*	50-50	5-5	7.50
71 H 044	STDH-100	100-100	5.5-5.5	6.21

UM MINIATURE CAPACITORS

180° rotation. Straight-line capacity plates. .017" air gap, 600 volts peak. 1/4" diameter shafts; protrude to permit ganging. Exceptionally low minimum capacity. Ceramic base for 4-hole mounting or single 3/8" hole. Size, 1 1/2 x 1/2 x 3/8". Wt., 5 oz.

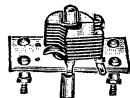

Stock No.	Mfr's Type	Max. Mmf	Min. Mmf	NET EACH
71 H 275	UM-15	15	1.5	1.17
71 H 276	UM-35	35	2.5	1.32
71 H 277	UM-50	50	3	1.43
71 H 278	UM-75	75	3.5	1.67
71 H 279	UM-100	100	4.5	1.84

RIGHT-ANGLE DRIVE

Type RAD. For front panel control of variable capacitors, switches, potentiometers, etc., positioned at right angles to the panel. Use of a right-angle drive often permits more compact parts layout and efficient utilization of space. Die-cast zinc housing and gears. Drive unit is 1/2 x 1 1/2 x 2" long with a 2 1/2 x 1/4" removable shaft. May be used to drive two units. Shpg. wt., 6 oz.
71 H 014. NET.....4.31

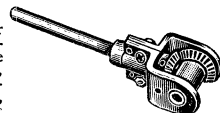

Variable Capacitors

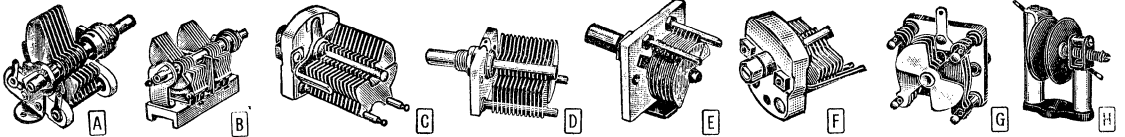

HAMMARLUND CAPACITORS FOR AMATEUR, INDUSTRIAL AND MILITARY APPLICATIONS

TYPE MC

A Siliconized steatite base, nickel-plated brass plates. Panel or chassis mounting. *Straight-line capacity characteristic; others have mid-line capacity characteristic. Air gap: M and S types, .0245"; MX and SX types, .0175". Tested at 1000 v. and 1750 v. (60 cycle rms) respectively. Capacity increases with clockwise rotation. All capacitors have rotor stop. Shpg. wt., 10 oz.

Stock No.	Mfr's Type	Max. Mmf	Min. Mmf	NET EACH
72 H 425	*MC-20-S	20	5.5	2.64
72 H 426	*MC-35-S	35	6.0	2.79
72 H 427	*MC-50-S	50	6.5	2.88
72 H 428	MC-50-M	50	6.3	2.88
72 H 429	*MC-75-S	80	8.0	3.06
72 H 430	*MC-75-M	80	7.3	3.06
72 H 431	*MC-100-S	100	8.3	3.15
72 H 432	MC-100-M	100	7.7	3.15
72 H 433	MC-140-M	140	9.0	3.39
72 H 434	*MC-140-S	140	10.0	3.39
72 H 435	MC-200-M	200	10.3	3.63
72 H 436	MC-250-M	250	12.0	3.87
72 H 437	MC-325-M	320	13.5	4.23

DOUBLE-SPACED MC's

Stock No.	Mfr's Type	Max. Mmf	Min. Mmf	NET EACH
72 H 451	*MC-20-SX	20	6.8	2.82
72 H 452	*MC-35-SX	32	8.5	2.97
72 H 453	*MC-50-SX	32	7.8	2.97
72 H 454	*MC-50-SX	53	11.5	3.15
72 H 455	*MC-50-MX	53	10.5	3.15
72 H 456	*MC-100-SX	100	16.5	3.93

TYPE MCD DUALS

B Panel-mount type. Steatite base; nickel-plated brass plates. Tested at 1000 v. *Straight-line capacity characteristic; others mid-line capacity characteristic. Shpg. wt., 11 oz.

Stock No.	Mfr's Type	Max. Mmf	Min. Mmf	NET EACH
72 H 465	MCD-50-M	50	5.5	4.44
72 H 466	MCD-100-M	100	6.3	4.69
72 H 467	*MCD-100-S	100	7.0	4.89
72 H 468	MCD-140-M	140	7.8	5.28

DOUBLE-SPACED DUALS

Stock No.	Mfr's Type	Max. Mmf	Min. Mmf	NET EACH
72 H 469	MCD-35-MX	31	6.0	4.62
72 H 470	*MCD-35-SX	31	6.8	4.62

E. F. JOHNSON CAPACITORS



MINIATURE VARIABLES

For VHF and UHF use. Low-loss steatite insulation. Mount in 1/4" panel hole; 3/8x3/8" panel mtg. space. Slotted shaft takes 3/8" knob. 1250 volts approximate peak break-down. Nickel-plated. Av. shpg. wt., 2 oz.

SINGLE

Stock No.	Mfr's Type	Max. Mmf	Min. Mmf	No. of Plates	NET EACH
75 H 175	5M11	5.0	1.5	5	1.00
75 H 176	9M11	8.7	1.8	9	1.05
75 H 177	15M11	14.2	2.3	15	1.20
75 H 178	20M11	19.6	2.7	21	1.35

BUTTERFLY

Stock No.	Mfr's Type	Max. Mmf	Min. Mmf	No. of Plates	NET EACH
75 H 179	3MB11	3.1	1.5	7	1.40
75 H 180	5MB11	5.1	1.8	13	1.60
75 H 181	9MB11	8.0	2.2	22	1.80
75 H 182	11MB11	10.8	2.7	31	2.00

TYPE "R" VARIABLES

For transmitting and receiving. Have .024" airgap; .023" plates. Av. shpg. wt., 1 lb.

Stock No.	Mfr's Type	Max. Mmf	Min. Mmf	No. of Plates	NET EACH
75 H 053	20R12	20	5	3	2.25
75 H 054	35R12	35	6	5	2.35
75 H 055	50R12	50	6.5	7	2.45
75 H 056	75R12	80	8	11	2.60
75 H 057	100R12	102	8.5	14	2.75
75 H 058	140R12	140	13.5	19	2.95

TYPE MAPC

C Midget padding, trimming and general-purpose capacitors. Similar to APC, but smaller. Ideal for small space applications. Gap, .0135". Rotors and stators are nickel-plated brass. Nickel-plated beryllium copper wiper contact. Tapped (4-40 thread) brass studs in steatite base permit mounting without grounding rotor. Tested at 600 volts rms, 60 cps. Size: 25/32" wide, 1/4" high. Slotted shafts for screwdriver or hex wrench. Shpg. wt., 4 oz.

Stock No.	Mfr's Type	Max. Mmf	Min. Mmf	NET EACH
72 H 208	MAPC-15	15	2.3	1.10
72 H 209	MAPC-25	25	2.6	1.15
72 H 210	MAPC-35	35	2.9	1.20
72 H 211	MAPC-50	50	3.2	1.20
72 H 212	MAPC-75	75	3.9	1.45
72 H 213	MAPC-100	100	4.5	1.65

TYPE HFA

D Sturdy capacitors, similar to HF, but larger plates and wider air gaps. For general-purpose and transmitting applications. Single-hole panel mounting. Also bracket for base mounting. End letter A in type no. denotes .02" air gap. B—.03". E—.07"; 800, 1200 and 1750 test volts respectively. Shpg. wt., 1 lb.

Stock No.	Mfr's Type	Max. Mmf	Min. Mmf	NET EACH
72 H 224	HFA-10B	9	2.3	2.40
72 H 225	HFA-15B	16	2.6	2.60
72 H 226	HFA-25B	25	3.0	2.80
72 H 227	HFA-50B	50	4.3	3.10
72 H 228	HFA-100B	100	7.5	4.10
72 H 229	HFA-100A	102	4.5	2.95
72 H 232	HFA-140A	145	6.0	3.40

TYPE MAC

(Not illustrated.) Extremely small variables; excellent as VHF trimmers. Steatite base; only 3/8x3/8". Screwdriver adjustment. Threaded sleeve for panel mounting. Shpg. wt., 4 oz.

Stock No.	Mfr's Type	Max. Mmf	Min. Mmf	NET EACH
72 H 255	MAC-5	5.0	1.4	1.00
72 H 256	MAC-10	8.7	1.7	1.05
72 H 257	MAC-15	14.2	2.2	1.20
72 H 258	MAC-20	19.6	2.7	1.35

BUD VARIABLE CAPACITORS

"MC" MIDGETS

Sturdy midget capacitors with excellent mechanical and electrical characteristics. Have bob front, top and rear bearings. Single and double-bearing types; *double-bearing types. Mount in 3/8" hole. Cadmium-plated brass rotor and stator plates, semi-circular in shape, are electro-soldered to their respective rods. Steatite insulation. All units have .024" airgap. Shpg. wt., 7 oz.

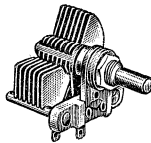

Stock No.	Mfr's Type	Max. Mmf	Min. Mmf	No. of Plates	NET EACH
61 H 142	1850*	15	3	3	1.78
61 H 143	1852*	33	4	5	1.84
61 H 144	1853*	50	5	7	2.43
61 H 145	1858*	100	7	14	2.65
61 H 146	1856*	140	7	19	2.72
61 H 147	1858*	190	9	27	2.94
61 H 148	1859*	235	10	33	3.38
61 H 149	1860*	300	12	43	3.67
61 H 150	1870	15	3	3	1.76
61 H 151	1872	33	4	5	1.84
61 H 152	1873	50	5	7	1.91
61 H 154	1875	100	7	14	2.06
61 H 155	1876	140	8	19	2.35

MIDGET TRIMMER

TYPE MT-833. For antenna coupling, interstage coupling and receiver tracking applications. Max. capacity 36 mmf.; min., 3 mmf. Has ceramic base. Shpg. wt., 4 oz.



TYPE HF

E Ideal for tuning or trimming critical high-frequency circuits. Insolentite insulation *Double-spaced units. Shpg. wt., 6 oz.

Stock No.	Mfr's Type	Max. Mmf	Min. Mmf	NET EACH
72 H 215	HF-15	17.5	2.8	1.05
72 H 216	HF-35	36	3.2	1.20
72 H 217	HF-50	52	3.7	1.30
72 H 218	HF-100	102	5.3	1.55
72 H 219	HF-140	142	6.3	1.90
72 H 220	*HF-15-X	15	3.6	1.30
72 H 221	*HF-30-X	30	5.2	1.40

HFD SPLIT-STATOR

Stock No.	Mfr's Type	Max. Mmf	Min. Mmf	NET EACH
72 H 230	HFD-50	52	3.6	2.70
72 H 231	HFD-100	102	5.0	3.35
72 H 232	HFD-140	142	6.0	4.05
72 H 233	*HFD-15-X	16	3.8	2.70
72 H 234	*HFD-30-X	28.5	5.0	3.30

TYPE APC

F Compact high-quality variables. Insolentite base. Screwdriver or hex-wrench adjustment. Shpg. wt., 4 oz.

Stock No.	Mfr's Type	Max. Mmf	Min. Mmf	NET EACH
72 H 250	APC-25	25	3.0	1.35
72 H 251	APC-50	50	3.0	1.35
72 H 252	APC-75	75	4.6	1.70
72 H 253	*APC-100	100	5.5	1.85
72 H 254	APC-140	140	6.7	2.05

BFC BUTTERFLY TYPES

G Straight-line capacity type; 90° minimum to maximum. Spacing, .03". Tested at 1200 v. rms., 60 cycles between rotor and each stator. Tapped (6-32 thread) studs in steatite base permit mounting capacitor without grounding the rotor. Silver contact. Shpg. wt., 1 lb.

No.	Type	Max.	Min.	NET
72 H 262	BFC-12	14.5	3.4	1.95
72 H 263	BFC-25	27.3	4.8	2.25
72 H 264	BFC-38	40.1	6.2	2.50

NEUTRALIZING CAPACITOR

H Type N Z-10. Rated, 3000 v. AC peak. Fine adjustment. Capacity, 2.3-10 mmf. 2 1/2"x 1 1/2"x2 1/2". Shpg. wt., 1 lb.

72 H 249, NET 5.50

CARDWELL CAPACITORS

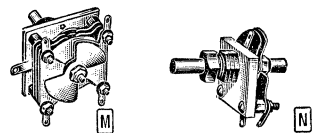

VHF BUTTERFLY CAPACITORS

M 90° capacitors with butterfly rotor plates. Electrical symmetry; low inductance; no moving contacts. Insolentite insulation. Removable plates. Air gap, .030". Shpg. wt., 10 oz.

Stock No.	Mfr's Type	Max. Mmf	Min. Mmf	NET EACH
75 H 001	PL-6076	5	1.5	1.58
75 H 002	PL-6077	7	2.0	1.65
75 H 003	PL-6078	13	3.0	2.40
75 H 004	PL-6113	13	10.4	1.88

TRIM-AIR MIDGETS

N Universal mounting. Insolentite insulation. Shaft has rear extension for ganging; except *. Air gap, .02"; others .03". Shpg. wt., 7 oz.

Stock No.	Mfr's Type	Max. Mmf	Min. Mmf	NET EACH
75 H 010	PL-6000	10	1.2	1.13
75 H 011	PL-6001	15	1.5	1.42
75 H 012	PL-6002	25	2.0	1.65
75 H 013	PL-6003	35	2.5	1.88
75 H 014	PL-6004	50	2.8	1.95
75 H 015	PL-01+	75	2.7	1.80
75 H 016	PL-0174	100	3.0	2.40
75 H 017	*PL-0181	140	3.0	3.15

Coils, Capacitors & Accessories

RECEIVER-TYPE VARIABLE CAPACITORS TRF TYPE CAPACITORS

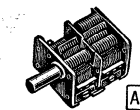

A 2-Gang. For use in superhets without RF stage or in 2-stage TRF receivers. Each section has 29 plates. Range of 12.5 to 452.3 mmf. Counter-clockwise rotation. With trimmers for each section. End plates slotted to permit easy tracking adjustments. Spring brass wipers. Requires series padder for oscillator use. Has $\frac{3}{8}$ " dia. shaft. Use with shaft extender No. 60 H 366 (below) for conversion to $\frac{1}{4}$ " shaft. See pages 152 to 155 for details. Size, $1\frac{1}{2} \times 1\frac{1}{2} \times 2\frac{1}{2}$ ". Shpg. wt., 10 oz. **1.08**
60 H 059, 1 to 9, EACH.....

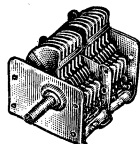

B 2- and 3-Gang Capacitors. Compact TRF variable capacitors. Have trimmers on side of frame. Outer rotor plates are slotted for tracking adjustment. Tapped holes in frame provide secure mounting. Range: 10 to 365 mmf. Shaft diameter, $\frac{3}{8}$ ". 2 gang: $2\frac{1}{2} \times 1\frac{1}{2} \times 1\frac{1}{2}$ ". 3 gang: $3\frac{1}{2} \times 1\frac{1}{2} \times 1\frac{1}{2}$ ". Av. shpg. wt., each, 6 oz.
60 H 725, 2-gang, 1 to 9, EACH..... **1.04**
10 to 49, EACH..... .94
60 H 726, 3-gang, 1 to 9, EACH..... **1.60**
10 to 49, EACH..... **1.44**

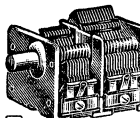

C Two-section superhet variable. 19-plate oscillator section with 170.7 max.—8.7 min. mmf.; has one 2-17 mmf. trimmer. 27-plate RF section with 431 max.—11.0 min. mmf.; has one 2-17 mmf. trimmer. Provides 455 kc frequency difference in combination with oscillator coil and loop antenna, below. Counter-clockwise rotation. $1\frac{1}{2} \times 1\frac{1}{2} \times 2\frac{1}{2}$ ". Shaft, $\frac{1}{4}$ " dia. $\frac{3}{4}$ " long. Shpg. wt., 10 oz.
61 H 065, 1 to 9, EACH..... **1.02**
10 to 49, EACH..... .92
55 H 507, Oscillator Coil. Shpg. wt., 4 oz. NET..... .36
51 C 040, Loop Antenna. Shpg. wt., 8 oz. NET..... .53



D Midget Superhet. Miniature size without sacrifice of performance makes these 2-gang variables perfect for portable and midget sets. Capacity: RF section, 10.5 to 364 mmf, 27 plates; osc. section, 7.6 to 132.6 mmf, 15 plates. Capacity increases with counter-clockwise rotation. For use with 455 kc IF. With trimmers. Size, $1\frac{1}{4} \times 1\frac{1}{2} \times 1\frac{1}{2}$ ". $\frac{1}{4}$ " dia. shaft extends 1" beyond frame. Ball-bearing mounted shaft. Shpg. wt., 6 oz.
61 H 008, 1 to 9, EACH..... **1.01**
10 to 49, EACH..... .91
61 H 011, Smaller version of above. RF sec., 10.8 mmf to 221.6 mmf. Osc. sec., 8.5 mmf to 97.3 mmf. $1\frac{1}{2} \times 1\frac{1}{2} \times 1\frac{1}{2}$ ". Shpg. wt., 5 oz.
1 to 9, EACH..... **.92c**
10 to 49, EACH..... **.83c**



E Midget TRF. 33-plate, single-gang capacitor. Variable from 15 to 409 mmf. $\frac{1}{4}$ " diameter shaft. Size: $1\frac{1}{4}$ " deep, $1\frac{1}{2}$ " wide, $1\frac{1}{4}$ " high. Shaft extends $\frac{3}{4}$ " beyond frame. Shpg. wt., 5 oz. **.73c**
61 H 009, 1 to 9, EACH.....
10 to 49, EACH..... **.66c**

On 50 or more capacitors—write for quantity prices.

TRIMMERS AND PADDERS



Mica trimmer and padder capacitors. Treated for resistance to humidity. Low-loss ceramic base. Adjusting plates rigidly constructed to permit bending soldering lugs without affecting capacity. Size, $\frac{1}{32} \times \frac{3}{4} \times \frac{3}{8}$ ". Mtg. ctrs., $\frac{1}{32}$ ". Ranges below are mmf. from 3 turns open trimmer to tight setting. Av. shpg. wt., 2 oz.

Stock No.	Mmf	1 to 9, EACH	10 to 49, EACH
60 H 347	1.5-15	15c	14c
60 H 340	2-30	13c	12c
60 H 341	4-80	13c	12c
60 H 342	9-180	15c	14c
60 H 343	25-280	18c	16c
60 H 344	45-380	20c	18c
60 H 345	70-480	22c	20c
60 H 346	100-580	24c	22c
60 H 348	140-680	29c	26c
60 H 349	170-780	30c	27c

Write for Quantity prices.

PANEL BEARING ASSEMBLY



For use with rigid or flexible couplings for mounting volume controls, etc., away from the panel. Made of brass. Take panels up to $\frac{1}{8}$ " thick. For standard $\frac{1}{4}$ " shafts. Supplied with 2 fiber insulating washers. Shpg. wt., 3 oz.

60 H 385. Overall length 3". NET..... **.32c**
60 H 386. Overall length 6". NET..... **.38c**
60 H 390. Bearing only. NET..... **.9c**

E. F. JOHNSON FLEXIBLE SHAFTS

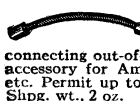

Non-rusting phosphor-bronze flexible shafts with $\frac{1}{8}$ " hubs. Ideal for connecting out-of-line shafts together. Handy accessory for Amateurs, experimenters, labs, etc. Permit up to 90 degrees angular control. Shpg. wt., 2 oz.

73 H 290, 115-253. Length 3". NET..... **.50c**
73 H 291, 115-254. Length 6". NET..... **.75c**

160



SHAFT FITTINGS

Couplings for extending shafts of controls, switches, capacitors, etc., or for ganging units, even when shafts are not same diameter. Insulated types are of black phenolic. Extenders are for decreasing or increasing shaft diameter and for extending shaft length. 60 H 366 has $\frac{3}{8}$ " opening, $\frac{1}{4}$ " shaft. Shaft length on all extenders, $\frac{3}{8}$ "; overall length, $1\frac{1}{8}$ ", 4 oz.

Brass	Insulated	Kind	Size
60 H 360	60 H 350	Coupling	$\frac{1}{4}$ to $\frac{1}{4}$ "
60 H 361		Coupling	$\frac{3}{8}$ to $\frac{3}{8}$ "
60 H 362	60 H 352	Coupling	$\frac{1}{2}$ to $\frac{1}{2}$ "
60 H 365	60 H 355	Ext.	$\frac{1}{4}$ to $\frac{1}{4}$ "
60 H 366		Ext.	$\frac{3}{8}$ to $\frac{1}{2}$ "

1 to 9, EACH..... **1.6c**
10 to 49, EACH..... **1.4c**

Write for quantity prices.

HAMMARLUND COUPLINGS

Type FC-465. Insulated coupling for providing flexible linkage between angularly misaligned shafts. Maximum torque is limited only by holding power of set screws. For $\frac{1}{4}$ " shafts. Shaft clearance, $\frac{3}{32}$ ". Flash voltage, 6000 v. Size, $1\frac{1}{4} \times 1\frac{1}{2}$ ". Shpg. wt., 3 oz. **75c**
NET.....



Type FNC-465. As above, but non-insulated type. Has durable, plated-metal construction. $1\frac{1}{4} \times 1\frac{1}{2}$ ". Shpg. wt., 3 oz.
72 H 497. NET..... **.75c**

INSULATED COUPLING

For coupling drive shafts to condensers, gang switches, etc. Bakelite insulation. Hubs drilled to fit $\frac{1}{4}$ " shafts; set-screws hold rigidly. Shpg. wt., 2 oz.
60 H 395. NET..... **.53c**



LOW-LOSS CERAMIC COUPLING

Similar to above, but has ceramic insulation to permit use in high-voltage applications. Excellent for transmitters, etc.
60 H 396. NET..... **.57c**

Lowest Prices—Highest Quality—Best Service

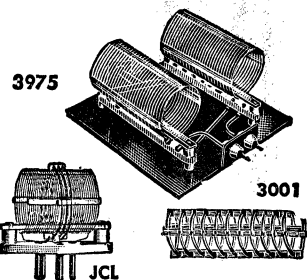

B&W AMATEUR COILS 75 WATT "JUNIORS"

Rated, 75 watts—850 DC volts. Tune with 15 mmf to 100 mmf. Supplied in fixed-end (JEL), fixed-center (JCL) or variable-center (JVL) link types. All fit standard 5-prong tube sockets. $3\frac{1}{2} \times 1\frac{1}{2}$ ". Shpg. wt., 5 oz.

Band	JEL	JCL	JVL	EACH
160	75 H 320	75 H 330	75 H 340	1.65
80	75 H 321	75 H 331	75 H 341	
40	75 H 322	75 H 332	75 H 342	
20	75 H 323	75 H 333	75 H 343	
15	75 H 349	75 H 354	75 H 355	
10	75 H 324	75 H 334	75 H 344	
6	75 H 444	75 H 445	75 H 446	

25 WATT "BABY" PLUG-IN COILS

Very compact coils for exciters and low-power transmitters. Only $1\frac{1}{4} \times 1\frac{1}{2}$ ". MC—center tap, no link. MEL—end link. MCL—center link. Tune with 50 mmf (except 100 mmf for 160M). Fit standard 5-prong sockets. Wt., 3 oz.

Band	MC	MEL	MCL	EACH
160	75 H 380	75 H 300	75 H 310	1.26
80	75 H 359	75 H 301	75 H 311	
40	75 H 370	75 H 302	75 H 312	
20	75 H 371	75 H 303	75 H 313	
15	75 H 358	75 H 357	75 H 356	
10	75 H 372	75 H 304	75 H 314	

MINIDUCTOR COIL STOCK

Easily cut polystyrene-insulated, air-wound coils for RF use. 1" diameter coils are 3" long, all others 2". Av. shpg. wt., 5 oz.

4 Turns Per Inch				8 Turns Per Inch			
Dia.	No.	Type	NET	No.	Type	NET	NET
$\frac{1}{2}$ "	75 H 305	3001	36c	75 H 306	3002	36c	
$\frac{3}{8}$ "	75 H 309	3005	45c	75 H 316	3006	45c	
$\frac{1}{4}$ "	75 H 319	3009	54c	75 H 325	3010	54c	
$\frac{1}{8}$ "	75 H 328	3013	60c	75 H 329	3014	60c	
16 Turns Per Inch				32 Turns Per Inch			
$\frac{1}{2}$ "	75 H 307	3003	36c	75 H 308	3004	36c	
$\frac{3}{8}$ "	75 H 317	3007	45c	75 H 318	3008	45c	
$\frac{1}{4}$ "	75 H 326	3011	54c	75 H 327	3012	54c	
$\frac{1}{8}$ "	75 H 335	3015	60c	75 H 336	3016	60c	

2" & 2 1/2" DIA. COIL STOCK

For buffer and final tank coils, etc. *Turns per inch. All 10" long.

Stock No.	Type	Dia.	Wire	*TPI	Wt., Oz.	NET EACH
75 H 406	3900	2"	#14	8	9	1.50
75 H 407	3905-1	2 1/2"	#12	6	13	
75 H 408	3906-1	2 1/2"	#14	8	12	
75 H 409	3907-1	2"	#16	10	8	

TYPE 3975 BALUN ANTENNA COILS

Bifilar inductors for efficiently matching 75-ohm unbalanced output to 75 or 300-ohm balanced transmission lines. Cover 80 through 10 meters without tuning or switching. Excellent for use with transmitters having Pi-networks. Rated, 250 watts input. Shpg. wt., 12 oz. Two required.
75 H 594. NET EACH..... **3.75**

B&W "CC-50" COAXIAL CONNECTOR

Provides weatherproof cable connection to half-wave doublet antenna; also serves as center inductor. Antenna elements connect to forged steel eye-bolts. Internal soldering connections for coax cable. Includes cement, eye-bolts, rubber sleeve, screws, 2 housing sections, and instructions. Shpg. wt., 1 lb.
75 H 593. NET..... **5.85**



Dials and Accessories, Coils

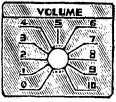

CRONAME ANODIZED ALUMINUM DIAL PLATES

A Attractive aluminum dial plates with etched black scales. Available in a large variety of designations. Excellent for installers, hobbyists and experimenters. Size, $2\frac{3}{16} \times 2\frac{3}{8}$, with $\frac{1}{2}$ " center hole. Shpg. wt., 2 oz.

Stock No.	Mfr's Type	Description
55 H 160	448	Treble 0-10
55 H 161	447	Bass, 0-10
55 H 137	429	Treble, 5-0-5
55 H 136	428	Bass, 5-0-5
55 H 164	416	Microphone, 1, 0-10
55 H 165	417	Microphone, 2, 0-10
55 H 126	415	Microphone, 0-10
55 H 170	413	Master Gain, 0-10
55 H 124	412	Gain, 0-10
55 H 127	422	Gain, 5-0-5
55 H 123	411	Tone, 0-10
55 H 124	426	Volume, 0-10
55 H 125	414	Record, 0-10
55 H 135	427	Fader, 5-0-5
55 H 138	430	Expansion, 0-10
55 H 139	446	Phono, 0-10
55 H 131	423	Increase, with arrow
55 H 172	410	No title, 0-10

1 to 9, NET EACH.....50¢
10 or More, EACH.....34¢

CRONAME ROUND DIAL PLATES

B Diameter, $1\frac{1}{4}$ ". Easy-to-read aluminum scale with black background. Type 25 has clockwise arrow labeled "Volume." Type 569 graduated 0-100 over 180° clockwise. Type 905 graduated 0-100 over 270° clockwise. Use with $1\frac{1}{4}$ " bar knobs. Shpg. wt., 2 oz.

Stock No.	Type	1-9, EA.	10-Up, EA.
55 H 141	25	37¢	33¢
55 H 140	569	37¢	33¢
55 H 108	905	27¢	24¢

CRONAME "ON-OFF" SWITCH PLATE

Economy-priced "Off-On" switch plates. Etched aluminum with black background. Has polished aluminum letters and border. Size, $1\frac{1}{2} \times 1\frac{1}{4}$ ". Shpg. wt., 2 oz.

60 H 338, 1 to 9, NET EACH.....17¢
10 or More, EACH.....15¢

G-C DIAL POINTERS

Will fit most radio sets. Can be cut shorter for small dials.

Type 6810. Kit of 10 pointers in plastic case. Shpg. wt., 4 oz.
60 H 449 NET.....1.91

Type 6802, 5" rotary for $\frac{1}{4}$ " shaft. Gold and red. Shpg. wt., 2 oz.
60 H 446, NET EACH.....24¢

Type 6801, 3" rotary for $\frac{1}{4}$ " shaft. Gold. Shpg. wt., 2 oz.
60 H 445, NET EACH.....24¢

Type 6804, 2" slide pointer. White enamel. Shpg. wt., 2 oz.
60 H 448, NET EACH.....24¢

Type 6803, 2 $\frac{1}{2}$ " slide pointer. Red translucent. Shpg. wt., 2 oz.
60 H 447, NET EACH.....24¢

3-IN-1 RADIO TUNER

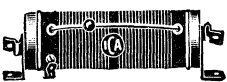

ICA No. 93. Functions as antenna tuner, wave trap or aerial eliminator. Operates on any broadcast or short-wave receiver. When used as antenna tuner, improves reception of weak signals. When used as a wave trap, minimizes interference from strong local stations. Materially improves reception when used with outdoor antenna. Quick, easy installation. Shpg. wt., 5 oz.
70 C 395, List, \$1.00, NET.....59¢

CRONAME HIGH-QUALITY TUNING ASSEMBLIES

CROFLEX "TAILORED TO THE CHASSIS" UNITS

"Croflex" dials are "tailored" to fit any average chassis. The tuning knob can be located at either end of the dial or along its lower edge. Simply drill a hole for the knob shaft, and attach the knob shaft assembly. Condenser pulley furnished with each tuner slips onto condenser shaft and is connected to dial mechanism by drive cable. Take clockwise or counter-clockwise capacitor with $\frac{1}{4}$ " shaft. Have modern "3-dimension" edge-lighted glass scales, calibrated horizontally. With gold-bronze finished aluminum escutcheon and two clip-on miniature base, screw-type pilot light sockets (less bulbs).

Type CR-1, AM-Shortwave. Small-size tuning assembly. Requires $1\frac{1}{2} \times 6\frac{3}{4}$ " cutout. Pointer travels $3\frac{3}{4}$ ". Tuning ratio of 9 to 1. Dial scale calibrated for 550-1700 kc broadcast and 6-18 mc shortwave bands. Also has 0-100 logging scale. Shpg. wt., 1 lb.
55 H 317, NET.....6.44

Type CR-1A AM-FM. Same as CR-1 but with dial scale calibrated for 550-1700 kc AM broadcast and 88-108 mc FM broadcast band. Shpg. wt., 1 lb.
55 H 318, NET.....6.44

Type CR-1B AM Broadcast. Same as above but with dial scale calibrated for 550-1700 kc band only. Shpg. wt., 1 lb.
55 H 319, NET.....6.44

Type CR-2 AM-Shortwave. Medium-size tuning assembly. Requires $1\frac{1}{2} \times 6\frac{3}{4}$ " cutout. Pointer travels $6\frac{3}{4}$ ". Tuning ratio 17 to 1. Scale calibrated for 550-1700 kc broadcast and 6-18 mc shortwave band. Has 0-100 logging scale for accurate resetting and station logging. Shpg. wt., $\frac{1}{4}$ lbs.
55 H 322, NET.....7.06

Type CR-2A AM-FM. Same as CR-2 but with dial scale calibrated for 550-1700 kc AM broadcast band and 88-108 mc FM broadcast band. Shpg. wt., $\frac{1}{4}$ lbs.
55 H 323, NET.....7.06

Type CR-2B AM Broadcast. As above but calibrated for 550-1700 kc band only. $\frac{1}{4}$ lbs.
55 H 324, NET.....7.06

Type CR-3 AM-Shortwave. Large-size tuning assembly. Requires $2 \times 8\frac{1}{2}$ " cutout. Pointer travels $7\frac{1}{2}$ ". Tuning ratio of 18 to 1. Dial scale calibrated for 550-1700 kc broadcast and 6-18 mc shortwave band. Also has 0-100 logging scale. Shpg. wt., $\frac{1}{2}$ lbs.
55 H 325, NET.....9.76

Type CR-3A AM-FM. Same as CR-3 but with dial scale calibrated for 550-1700 kc AM broadcast band and 88-108 mc FM broadcast band. Shpg. wt., $\frac{1}{2}$ lbs.
55 H 326, NET.....9.76

Type CR-3B AM Broadcast. As above but calibrated for 550-1700 kc AM band only. $\frac{1}{2}$ lbs.
55 H 327, NET.....9.76

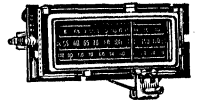

CR-1



CR-2A



CR-3A

AMPHENOL "TUNING EYE" ASSEMBLIES



Type 58-MEA

-6. Tuning eye indicator. For use in custom-built AM or FM chassis and tuners, test instruments, etc. Takes 6-prong indicator tubes (6E5, 6U5, etc.). Easily installed in any set having Automatic Volume Control. Less tube. With hood escutcheon. Shpg. wt., 6 oz.

45 H 855, 1 to 99, NET EACH.....1.12
100 to 249, EACH.....93¢

250 or More, EACH.....85¢

Type 58-MEA-8. Same as indicator described above, but for octal-type magic eye tubes (6AD6-G, 6AF6-G, 6AL7-GT, etc.) Less tube. Shpg. wt., 6 oz.

45 H 856, 1 to 99, NET EACH.....1.53
100 to 249, EACH.....1.27

250 or More, EACH.....1.18

WALSCO DIAL ACCESSORIES



Thrifty Dial Cord

An economical and convenient supply of dial cord. Contains 200 ft. of the most popular dial cord types; 50 ft. of Type 652—Medium; 100 ft. of Type 656—Special Thin; and 50

ft. of Type 654—Standard. Dustproof, dispenser-type box. Shpg. wt., $\frac{1}{4}$ lbs.
86 N 053, NET.....4.95

Popular Dial Cord Spools. Covers 80% of the replacement demand. Have fiberglass or linen core; pre-stretched. Nylon-braided sleeves. Av. shpg. wt., 4 oz.

No.	Type	Dia.	Strgth.	Lgth.	EA.
60 N 490	652-Med.	.040"	35 lbs.	25 ft.	.88
60 N 491	652-Med.	.037"	15 lbs.	25 ft.	
60 N 492	654-Std.	.032"	20 lbs.	25 ft.	
43 N 197	652-Med.	.040"	35 lbs.	100 ft.	2.91
43 N 195	656-Thin	.025"	15 lbs.	100 ft.	
43 N 196	654-Std.	.032"	20 lbs.	100 ft.	

ILLUMINATIC COIL STOCK

New, high-quality air-wound coil stock for a wide variety of Amateur, experimental, and laboratory applications. Excellent for use in tuned circuits of transmitters, receivers, VFO's, converters, and other types of radio frequency equipment. Each coil comes in a convenient 1' length. May be tapped or easily cut to any desired length to provide the exact inductance required. Available in choice of four wire sizes (Nos. 12, 14, 16 and 18) and six diameters ($\frac{1}{4}$ ", $\frac{1}{2}$ ", $1\frac{1}{4}$ ", 2", $2\frac{1}{2}$ ", and 3") to meet most requirements. All coils are constructed of finest quality tinned copper wire to assure easy soldering and efficient performance. Polystyrene supporting strips provide strength and rigidity—excellent physical stability for frequency determining circuits. *Turns per inch.

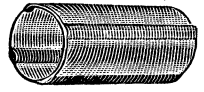

Stock No.	Type	Dia.	*TPI	Wire Size	Wt. Oz.	NET EACH
72 H 312	1006T	$1\frac{1}{4}$ "	6	14	5	1.45
72 H 313	1008T	$1\frac{1}{4}$ "	8	16	5	1.45
72 H 314	1010T	$1\frac{1}{4}$ "	10	18	5	1.45
72 H 315	1206T	$1\frac{1}{2}$ "	6	14	5	1.55
72 H 316	1208T	$1\frac{1}{2}$ "	8	16	5	1.55
72 H 317	1210T	$1\frac{1}{2}$ "	10	18	5	1.55
72 H 318	1406T	$1\frac{3}{4}$ "	6	14	5	1.65
72 H 319	1408T	$1\frac{3}{4}$ "	8	16	5	1.65
72 H 326	1410T	$1\frac{3}{4}$ "	10	16	5	1.75
72 H 327	1606T	2"	6	14	9	1.65
72 H 328	1608T	2"	8	14	9	1.75
72 H 329	1610T	2"	10	16	9	1.75
72 H 330	2006T	$2\frac{1}{2}$ "	6	12	13	1.90
72 H 331	2008T	$2\frac{1}{2}$ "	8	14	13	1.90
72 H 332	2010T	$2\frac{1}{2}$ "	10	16	13	1.90
72 H 333	2406T	3"	6	12	17	2.85
72 H 334	2408T	3"	8	14	17	2.85
72 H 337	2410T	3"	10	14	17	2.85

E. F. JOHNSON ROTARY INDUCTORS

Smooth-operating rotary inductors—ideal for tank circuits in multi-band transmitters. Variable-pitch windings for improved efficiency at high frequencies. All are rated at 3 amps. Av. shpg. wt., $\frac{1}{2}$ lbs.

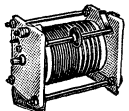

Stock No.	Mfr's T	Size	Max. μ h	NET EACH
60 H 372	229-201	$4\frac{3}{8} \times 2\frac{1}{2} - 2\frac{1}{2} \times 2$	10	9.50
60 H 373	229-202	$5\frac{1}{2} \times 2\frac{1}{2} - 2\frac{1}{2} \times 2$	15	10.50
60 H 374	229-203	$7\frac{1}{2} \times 2\frac{1}{2} - 2\frac{1}{2} \times 2$	25	11.50

Molded Knobs—Speaker Repair Service

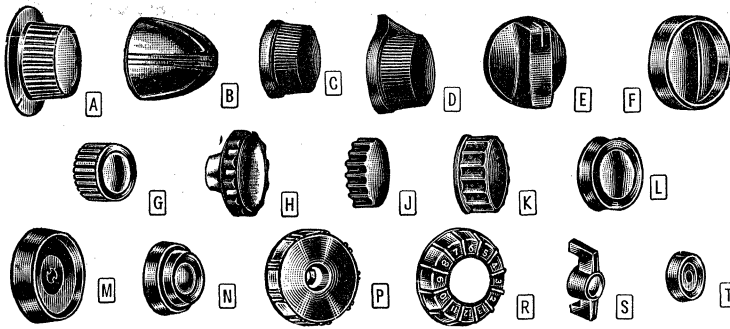

POPULAR MOLDED KNOBS FOR EVERY REPAIRMENT

A wide selection of handsomely styled plastic knobs. For replacement use on majority of radios and TV sets. Figs. B and C are excellent for small radios. *For knurled shafts only; other types are equipped with setscrews to permit use with either round or flatted shafts. Figs. F, G and L have rich, contrasting gold-metal inlays. All knobs are for use with standard 1/4" shafts. Simple to install. Av. shpg. wt., 3 oz.

Stock No.	Fig.	Dia.	Color	NET EA.	10 or More, EA.	Stock No.	Fig.	Dia.	Color	NET EA.	10 or More, EA.
55 H 031	A	1 1/2"	Black	12c	11c	54 H 980	K	1 1/8"	Walnut	10c	9c
55 H 032	B	1 1/2"	Red	12c	11c	54 H 981	J	1 1/8"	Ivory	10c	9c
55 H 022	A	7/8"	Black	8c	7c	54 H 982	J	1"	Walnut	10c	9c
55 H 025	B	3/4"	Black	8c	7c	54 H 983	J	1 1/8"	Ivory	10c	9c
55 H 027	B	3/4"	Walnut	8c	7c	55 H 024	H	7/8"	Black	10c	9c
55 H 028*	B	3/4"	Walnut	5c	4c	55 H 050	H	1 1/8"	Black	14c	13c
55 H 029	B	3/4"	Ivory	10c	9c	55 H 018	E	1 1/8"	Black	10c	9c
55 H 043*	C	1 1/8"	Black	5c	4c	55 H 019	E	1 1/8"	Red	10c	9c
55 H 035	C	1 1/8"	Black	6c	5c	54 H 960*	F	1 1/8"	Walnut	24c	22c
55 H 036	C	1 1/8"	Walnut	6c	5c	54 H 964*	G	1 1/8"	Walnut	17c	15c
55 H 023	D	1 1/8"	Black	10c	9c	54 H 965*	G	1 1/8"	Ivory	17c	15c
55 H 040	D	1 1/8"	Black	6c	5c	54 H 962*	L	1 1/2"	Walnut	23c	21c
55 H 042*	D	1 1/8"	Black	5c	4c						

TELEVISION REPLACEMENT KNOBS

For television receivers using dual-type controls and tuners manufactured by Standard Coil, Sarkes-Tarzian, etc. May be used on practically all popular TV sets, such as RCA, Bendix, Westinghouse, Admiral, etc. Made of molded plastic; have walnut pattern with attractive gold-finish inlay on face. *For 1/4" knurled shaft. 1 1/4" flatted shaft. 1 1/2" flatted shaft. 1.263" keyway shaft. **3/8" flatted shaft. Av. shpg. wt., 2 oz.

No.	Fig.	Dia.	Use	EACH	No.	Fig.	Dia.	Use	EACH
54 H 966*	L	1 1/8"	Front dual	26c	54 H 974**	P	2 5/8"	Rear dual	26c
54 H 967†	L	1 1/8"	Front dual	29c	54 H 973†	R	2 1/4"	Front dual	73c
54 H 968†	L	1 1/8"	Front dual	29c	54 H 971†	S	2"	Front dual	53c
54 H 969†	M	1 1/8"	Rear dual	17c	54 H 972**	T	1 1/2"	Rear dual	17c
54 H 970†	N	1 1/8"	Comb. dual	44c					

FLUTED KNOBS

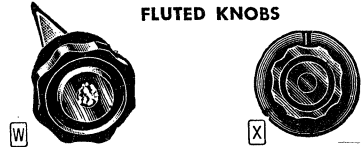

Made of high-quality bakelite. All types have metal inserts. Set screw mounting for use on 1/4" round or flatted shafts. *Types with pointer. Av. shpg. wt., 4 oz.

Stock No.	Fig.	Dia.	1-9, EA.	10 or More, EA.
55 H 085*	W	1 1/8"	30c	27c
55 H 088*	W	1 1/8"	30c	27c
55 H 086*	W	1 1/8"	32c	29c
55 H 087*	W	2 1/8"	44c	39c
55 H 095*	W	1 1/8"	20c	18c
55 H 094	W	1 1/8"	20c	18c
55 H 095	W	1 1/8"	22c	20c
55 H 097	W	2 1/8"	44c	39c
55 H 092	X	1 1/8"	36c	32c
55 H 090	X	2 1/8"	44c	39c



ICA DIALS

Y Type 2164. Miniature. Chrome-silver dials with black etched numerals and black knob. 10-0 in 180° rotation. 1 1/8" dia. Set screw bushing for standard 1/4" shafts. Shpg. wt., 3 oz. **55 H 340. NET.....69c**
Y Type 2165. As above but 10-0 in 270°. **55 H 341. NET.....74c**

Z Precision Vernier. Have chrome-silver dial plates. Black numerals and calibrations. 0 to 100 in 180° or 325°. Dial sets to a fraction of division. Flanged knob. For 1/4" shafts. Av. shpg. wt., 7 oz.

Stock No.	Type	Dia.	Degrees	NET
55 H 350	2170	2 3/8"	325	1.47
55 H 351	2171	2 3/8"	180	1.47
55 H 352	2168	4"	325	1.96
55 H 353	2169	4"	180	1.96

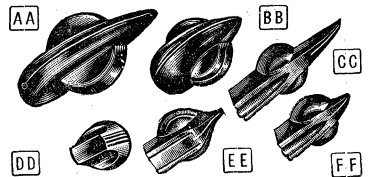

POINTER AND BAR KNOBS

Molded of high-quality plastic. Fit 1/4" round or flat shafts. Slotted set screws. Figs. AA, BB and DD are Croplastic types by Croname. *Brass inserts. 1 1/8" diameter recess in rear for close panel mounting. All black, except \$red. Shpg. wt., 2 oz.

Stock No.	Fig.	Size	NET EACH		
			1-24	25-99	100-UP
55 H 065*	AA	2 1/2"	44c	39c	36c
55 H 063*	BB	1 1/2"	28c	25c	24c
55 H 067*	DD	1 1/2"	35c	31c	29c
55 H 074	EE	1 1/2"	7c	6c	5 1/2c
55 H 072	FF	1 1/2"	7c	6c	5 1/2c
55 H 078*	FF	1 1/2"	11c	10c	9c
55 H 073*	FF	1 1/2"	8c	7c	6 1/2c
55 H 071*	CC	2"	15c	13c	12c
55 H 070	CC	2"	14c	12c	11c
55 H 079*	CC	2"	18c	16c	15c

LEVER-TYPE KNOB

Black bakelite knob with brass insert. Fit 1/4" shafts. With set screw. 1 1/2" long. Shpg. wt., 2 oz. **55 H 006. 1 to 24, NET EACH.....15c**
25 or More, NET EACH.....13c

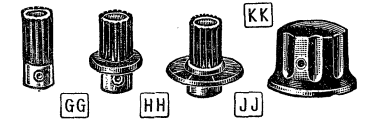

MILLEN MINIATURE KNOBS

Black plastic knobs with brass inserts for 1/8" dia. shafts. Overall ht.: A006 and A007, 1/2"; A018 and A019, 3/8". Shpg. wt., 4 oz.

No.	Type	Fig.	Size	NET
72 H 271	A006	KK	3/4" dial dia.	42c
72 H 272	A007	JJ	3/8" dial dia.	42c
72 H 273	A018	HH	1/2" dial dia.	39c
72 H 274	A019	GG	1/4" dial dia.	36c

CHROME-PLATED BRASS KNOB

Brass knob with handsome chrome plating. Perfect replacement for knobs on most auto radios. Set screw permits use on 1/4" round or flatted shafts. Ideal for volume and tuning control shafts. Shpg. wt., 4 oz. **56 H 751. NET EACH.....32c**

POMONA SOCKET SAVER

Protects tube tester sockets from wear caused by repeated tube insertions and does away with time consuming socket replacement. Prevents contact sockets from developing loose, worn contacts which cause inaccurate test readings. No wiring is necessary—the socket saver easily plugs into the original socket. An excellent tube tester accessory, available for 7, 8 and 9-pin sockets. Av. shpg. wt., 3 oz. **40 H 668. SS-7. For 7-pin min. sockets.**
40 H 669. SS-8. For 8-pin oct. sockets.
40 H 678. SS-9. For 9-pin min. sockets.
NET EACH.....1.91

ALLIED OFFERS COMPLETE SPEAKER REPAIR SERVICE

HI-FI SPEAKER REPAIR SERVICE

Your valuable hi-fi speakers can be completely rebuilt by skilled technicians, using exact replacement parts. For just a fraction of the original cost any hi-fi speaker can be reconed with a matching high-fidelity cone and voice coil.

The repaired speaker will meet all specifications for high-fidelity performance, and will be fully restored to top-notch condition. Just pack your speaker carefully and ship it to us by insured parcel post or Railway Express. Send remittance, including postage, with your order. Allow 30 days for delivery. Service includes replacing cone, gasket, voice coil, spider and dust cover.

8" Hi-Fi Speaker. Repair Service.....	7.50
12" Hi-Fi Speaker. Repair Service.....	11.25
15" Hi-Fi Speaker. Repair Service.....	15.00

STANDARD SPEAKER REPAIR SERVICE

Skilled technicians will completely rebuild your old speakers for the small charges listed below. Service covers general-purpose speakers including radio, TV and phonograph types. Ship speaker to us prepaid and send remittance (including postage) with order. Allow 30 to 45 days for delivery. Additional charges for field coil repair or replacement are as follows: \$1.25 for 4" to 9" speakers; \$2.25 for 10" to 12" speakers. Field coils welded into speaker frames cannot be repaired or replaced.

Speaker Size	Complete Repair Service	Speaker Size	Complete Repair Service
4" to 6"	1.55	14" to 15"	3.85
6 1/2" to 9"	2.25	5"x7" oval	2.25
10"	3.05	5"x7" oval	2.25
11" to 12"	3.05	6"x9" oval	2.55

Custom-Designed Auto Antennas

"TENNA" AUTO RADIO ANTENNAS

WARD AUTO RADIO ANTENNAS

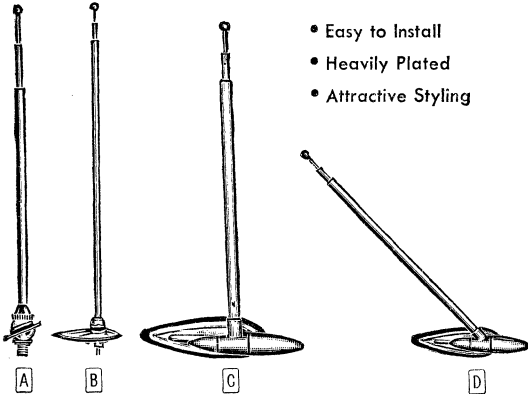

- Easy to Install
- Heavily Plated
- Attractive Styling

TOP-COWL AND FENDER MOUNTS

- A Model MH-57-C/54.** New, low-cost top-cowl antenna. Fits any model of car. Easily, quickly installed with a minimum of work. Features ball and rocker mounting base for rigid support. 3-section mast extends to 57". Chrome-plated to resist the effects of weather, grit and dirt. Easy to clean; simply wipe with a soft cloth. With 54" insulated cable and all necessary connections. Shpg. wt., 12 oz. **91 CX 356. List, \$3.73. NET..... 2.43**
- B Model NT-3.** New, high-quality smartly styled antenna for top-cowl mounting. Has three telescoping sections which extend to 57"; lowers to 23". Handsome "tear-drop" base complements flowing lines of all cars. Speedy, effortless installation. Attractive chrome finish for lasting beauty. Supplied complete with 48" cable. Shpg. wt., 1 1/4 lbs. **91 CX 357. List, \$4.70. NET..... 2.55**
- C Model JA-5.** New, top-quality vertical-mast "bullet" antenna for top-cowl or side-cowl mounting. Three sections; extends to 57". Features attractive, "bullet" design above base for added car beauty. Chrome-plated for lasting brilliance. Easy to install. Includes 48" cable and all necessary connectors. Fits any car. Shpg. wt., 13 oz. **91 CX 358. List, \$6.03. NET..... 4.03**
- D Model JA-6.** New, top-quality slanted-mast "bullet" antenna. Excellent for top-cowl or side-cowl mounting. 3-sections extend to 57". Bullet-type ornament above base has sleek appearance. Glistening chrome finish resists effects of weather; provides lasting beauty. Includes 48" cable. Fits all cars and station wagons. Shpg. wt., 13 oz. **91 CX 359. List, \$6.03. NET..... 4.03**

REAR-MOUNT ANTENNAS

Rear-Fin or Trunk Mounting

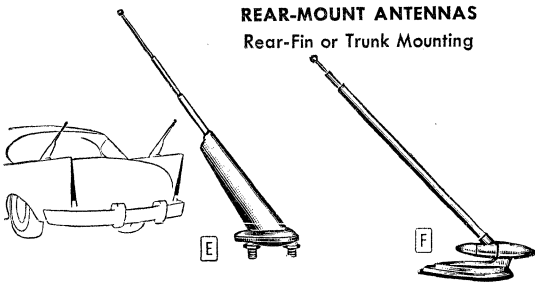

- E Model TRM-27—Single Antenna.** Beautiful 4-section rear-fin antenna. Features swept-back styling to give all cars a "sleek-line" appearance. Designed for superior performance and long, dependable service. Has chrome-plated tubing. Telescopes from 10" to 27". Includes low-loss 15-ft., shielded cable. Complete with adapters to fit both high-crown and flat-surface fenders. Shpg. wt., 1 1/4 lbs. **92 C 193. List, \$7.60. NET..... 5.11**
- Model TRMT-A—Dual Antennas.** As above, but for installing on both rear fenders. Complete with line-clips. Shpg. wt., 2 lbs. **92 C 194. List, \$14.82. NET PER PAIR..... 9.96**
- F Model JA-1—Single Antenna.** New 3-section "bullet" antenna for rear-mount installation. Gives any car an "in-motion" appearance. Durable, highly attractive chrome plating. Extends to 27". Efficient, low-loss, 15-ft. cable assures excellent reception. Includes adapters to fit contours of any car. Shpg. wt., 1 lb. **91 CX 360. List, \$7.85. NET..... 5.27**
- Model TJA-3—Dual Antennas.** As above, but for installing on both rear fenders. Complete with line-clips. Shpg. wt., 2 lbs. **91 CX 361. List, \$15.48. NET PER PAIR..... 10.39**

AUTO LEAD-IN EXTENSIONS

New, high "O" lead-in extension cables. Low-loss, high-quality coaxial type with polyethylene insulation; fully shielded and covered with waterproof vinylite. All cables have male and female pin-plug fittings. Shpg. wt.: LE-18, 3 oz.; LE-36, 4 oz.; LE-54, 5 oz.; LE-144, 8 oz.

No.	Type	Length	EA.	No.	Type	Length	EA.
91 C 362	LE-18	18"	.54	91 C 364	LE-54	54"	1.08
91 C 363	LE-36	36"	.75	91 C 365	LE-144	144"	2.13

SIDE-COWL MOUNTS

- G Model SC-6 "Air Queen."** Chrome-plated brass, side-cowl antenna. 3 sections—extends to 66". Low-loss 2-stanchion mount with bakelite and chrome insulators. New positive shielding eliminates use of shield can. Detachable 36" polyethylene insulated, vinylite covered, high "Q" lead-in. Includes complete conversion kit to permit simplified installation on irregular type car bodies. Shpg. wt., 1 lb. **97 CX 215. List, \$5.45. NET..... 3.20**
- H Model SC-8 "Long Ranger."** Popular side-cowl antenna in low signal areas. Four telescoping sections. Extends to 100". 2-stanchion mount has smartly designed insulators with chrome caps. 36" vinylite-covered high "Q" lead-in is polyethylene insulated. Complete conversion kit for irregular type car bodies. Shpg. wt., 1 1/4 lbs. **97 CX 216. List, \$7.65. NET..... 4.50**

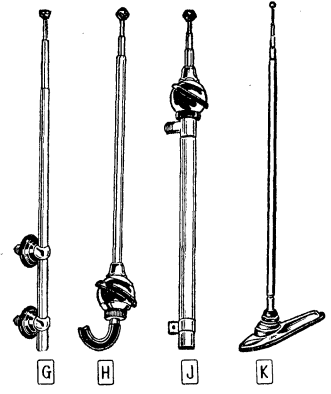

TOP-COWL AND FENDER MOUNTS

- H Model TCF-3C.** A top-notch antenna that offers deluxe appearance and fine performance. Has popular "Eight Ball" design for simplified installation on top cowl. Will fit any type of car perfectly. 3 sections—extends to 56". Constructed of chrome-plated brass tubing; 54" lead-in. With instructions and hardware. Shpg. wt., 1 lb. **97 CX 213. List, \$5.90. NET..... 3.47**
- H Model FTB-3.** An excellent buy in an economy model, top-cowl antenna. Fits any model of car. Quickly, easily installed from outside of car. 3 sections—telescopes to 56". Chrome-plated; resists dust, grit and humidity. Has "Eight Ball" mounting insulator. With 54" high "Q" lead-in and coaxial-type connector. Shpg. wt., 1 lb. **92 CX 001. List, \$3.95. NET..... 2.32**
- J Model DCF-3A.** "Phantom" type antenna with split-ball design for top-cowl or fender mounting. 3 sections—telescopes from 3 1/2" to 56". Constructed of chrome-plated brass tubing. 54" lead-in is vinylite covered. Complete with coaxial lead connector. Mounting bracket supplied. Shpg. wt., 1 1/4 lbs. **97 CX 222. List, \$7.95. NET..... 4.67**
- K Model TF-56MO.** New antenna with "tear-drop" mount. For top-cowl or fender installation. Quickly, easily mounts from outside of car. Features handsome, swept-back styling. Constructed of gleaming, chrome-plated brass tubing for handsome appearance. Three telescoping sections extend from 22" to 56". 54" polyethylene-insulated lead-in is vinylite covered. Good sensitivity for low signal areas. Complete with mounting instructions and all necessary hardware. Shpg. wt., 1 1/4 lbs. **91 CX 366. List, \$4.28. NET..... 2.52**

NEW REAR-FIN ANTENNA

- Model TFL-1 "Sparkle."** New rear-fin antenna designed to give a "custom touch" to any car. Features handsome, swept-back styling. Constructed of the finest materials to assure long, dependable service; heavily chrome-plated to retain its gleaming finish against effects of weather, road-grime, dirt, etc. Three telescoping sections extend to 27". A built-in capacitor in the lead-in improves reception in weak-signal areas. Supplied complete with 15-ft. cable and all connections. Shpg. wt., 1 1/4 lbs. **91 CX 367. List, \$8.50. NET..... 5.00**

ANTENNA LEAD EXTENSION

- Type C-8.** 12' shielded extension cable for Ward auto radio antennas. For use with Models TCF-3C, DCF-3A, TF-56MO, and other fender-mounting models. Shpg. wt., 5 oz. **49 C 555. List, 90c. NET..... 53c**

"DURA-RAMIC" AUTO ANTENNAS

- Model TGF-1.** Colorful auto antennas—constructed of opaque, corrosion-proof fiberglass. Extremely flexible. The antenna elements are completely imbedded in protective fiberglass. Excellent sensitivity in low-signal areas. Electrically equivalent to the best metallic-type antennas. Feature "Eight-Ball" top cowl mounting. Can be adjusted to any desired angle. Will fit any car perfectly. Supplied with 54" vinylite covered, shielded lead-in. Length, 36". In 7 attractive opaque colors. Shpg. wt., 1 lb. **92 CX 002. Red. 92 CX 006. White.**
92 CX 003. Blue. 92 CX 007. Yellow.
92 CX 004. Green. 92 CX 009. Chrome.
92 CX 005. Brown.
List, \$5.95. NET EACH..... 3.50
- Type C-42.** 15' shielded extension cable; built-in capacitor provides improved sensitivity. Permits rear mounting of "Dura-Ramic" antenna (noted above) or any Ward cowl antenna. Shpg. wt., 1/2 lb. **49 C 556. List, \$5.50. NET..... 3.23**

Vibrators—Auto Accessories



Mallory precision vibrators, backed by years of outstanding performance, offer the dependability, the long life and the trouble-free service required for all vibrator applications. These carefully designed, precision units provide the lowest cost-per-hour of actual use. Their springs are fabricated of

MALLORY REPLACEMENT VIBRATORS

high-grade clock-spring steel; held in perfect alignment by a rugged frame. 105-strand lead wire virtually defies vibration—connections stay firmly intact. If Mallory type number is not known write to Allied, stating make, model, tube line-up of set, or part number of the original vibrator—we will recommend the correct Mallory replacement. Average shpg. wt., 8 oz.

Stock No.	Mfr's Type (Old)	Mfr's Type (New)	Volts	Size	List	NET EACH
56 P 000	4-4	4-4	6	1 1/2x2 1/2"	\$2.50	1.47
56 P 154	12-3	12-3	12	1 1/2x2 1/2"	2.45	1.44
56 P 155	12-4	12-4	12	1 1/2x2 1/2"	2.45	1.44
56 P 042	273C	273C	6	2x4 1/2"	9.15	5.38
56 P 054	294	294	6	1 1/2x3 1/4"	4.90	2.88
56 P 120	509P	509P	6	1 1/2x2 1/2"	4.15	2.44
56 P 157	576	1806/576	6	1 1/2x3 1/4"	7.70	4.53
56 P 156	G567G	G1801/G567C	12	1 1/2x3 1/4"	9.95	5.85
56 P 077	716	716	6	1 1/2x3 1/4"	7.70	4.53
56 P 080	G725C	1801S/725C	6	1 1/2x3 1/4"	8.55	5.03
56 P 080	G725C	G1801S/G725C	12	1 1/2x3 1/4"	9.95	5.85
56 P 082	742	1801/742	6	1 1/2x2 7/8"	7.70	4.53
56 P 123	W759	W1802/W759	4	1 1/2x2 1/2"	8.25	4.85
56 P 085	825C	825S/825C	6	1 1/2x3 1/4"	6.90	4.06
56 P 110	826C	1603S/826C	6	1 1/2x3 1/4"	6.35	3.73
56 P 086	F826C	F826S/F826C	32	1 1/2x3 1/4"	7.70	4.53
56 P 111	G826C	G1603S/G826C	12	1 1/2x3 1/4"	7.70	4.53
56 P 092	854	854	6	1 1/2x3 1/4"	4.90	2.88
56 P 113	859	1601/859	6	1 1/2x2 1/2"	4.70	2.76
56 P 132	G859	G1601/G859	12	1 1/2x2 1/2"	4.70	2.76
56 P 118	W859	W1601/W859	4	1 1/2x2 1/2"	4.90	2.88

Stock No.	Mfr's Type Old	Mfr's Type (New)	Volts	Size	List	NET EACH
56 P 094	870	870	6	1 1/2x2 7/8"	\$4.90	2.88
56 P 133	G883	G1602/G883	12	3 1/4x1 1/2"	4.70	2.76
56 P 121	903M	903M	6	1 1/2x2 1/2"	3.60	2.12
56 P 157	1604	1604	6	1 1/2x2 1/2"	4.90	2.88
56 P 159	1701	1701	6/12	1 1/2x2 1/2"	9.60	5.64
56 P 160	1751	1751	6	1 1/2x2 1/2"	9.80	5.76
56 P 161	1832	1832	6	1 1/2x2 1/2"	9.70	5.70
56 P 127	T4002	T4002	2	1 1/2x1 1/2x2 1/8"	10.70	6.29
56 P 128	T4003	T4003	2	1 1/2x2 1/2"	9.80	5.76
56 P 135	4501	1501/4501	6	1 1/2x2 1/2"	6.35	3.73
56 P 140	M4501	M1501/M4501	24	1 1/2x2 1/2"	6.90	4.06
56 P 141	4512	1512/4512	6	1 1/2x2 1/2"	6.90	4.06
56 P 142	4513	1513/4513	6/12	1 1/2x2 1/2"	6.90	4.06
56 P 143	4514	1514/4514	6	1 1/2x2 1/2"	6.90	4.06
56 P 144	G4548	G1801/G4548	12	1 1/2x3 1/4"	8.55	5.03
56 P 145	G4549	G1801/G4549	12	1 1/2x3 1/4"	8.55	5.03
56 P 131	G4501	G1501/G4501	12	1 1/2x2 1/2"	6.90	4.06
56 P 137	4506	1808/4506	6	1 1/2x3 1/4"	7.70	4.53
56 P 138	4548	1807/4548	6	1 1/2x3 1/4"	7.70	4.53
56 P 139	4549	1801/4549	6	1 1/2x3 1/4"	7.70	4.53

12-VOLT VIBRATORS

Popular Mallory replacement vibrators for 12-volt applications. Type 12-3 has 3-pin base; Type 12-4, 4-pin base. Size, 1 1/2x2 1/2". Shpg. wt., 8 oz.

- Type 12-3. Replaces Mallory G682.
- 56 P 154. 5-Up, EA...1.30 1-4, EA...1.44
- Type 12-4. Replaces Mallory G659.
- 56 P 155. 5-Up, EA...1.30 1-4, EA...1.44

TYPE 4-4 6-VOLT VIBRATOR

One of the most popular replacement vibrators for 6-volt automobile radios. Replaces Type 4-4 vibrators. Each unit is individually tested under load conditions for output, starting voltage, etc. Used as original equipment in many auto radios. Fits standard 4-prong socket. 1 1/2x2 7/8". Shpg. wt., 5 oz.

- 56 P 000. 1 to 4, NET EACH.....1.47
- 5 or more, EACH.....1.32

TYPE GC7 GROUND CUP

Efficient, ground cup noise suppressor. For use with any 1 1/2-inch diameter vibrator. Effectively eliminates radio interference caused by vibrator hash. Provides an excellent low-impedance connection between the shield can of the vibrator and the car frame. Fits most auto radios in present-day use. Easy to install. Shpg. wt., 2 oz.

- 56 P 151. NET.....26c

MALLORY AUTO NOISE SUPPRESSORS

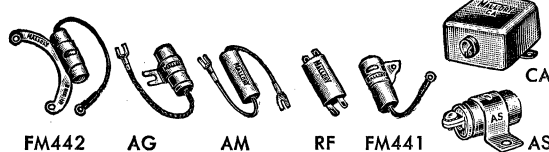

These ruggedly built capacitors are designed to prevent interference with radio reception caused by generators, vibrators, switches and other spark-producing devices within the auto, marine or aircraft equipment. All units are wax impregnated. AG types are well protected from moisture, but are not hermetically sealed. AS types are enclosed in metal cases with screw terminals and hermetically sealed—provide low RF impedance, recommended for extreme climate conditions. Both AG and AS types are designed for noise suppression use on generators, ammeters, and many other types of electrical equipment where there is contact spark or noise radiation.

Type AG442 also used in midjet aircraft motors. Type AG453 has shielded lead. Types FM441 and FM442 for Ford generators. Type AM454 for ammeter and gauges—has waxed-paper case, can be held in place with Mallory TH-17 clip (see Page 138). Types RF480 and RF481 used for vibrator hash and general noise suppression (have very low RF impedance)—both have waxed-paper case. Type RF481 requires Mallory TH-19 mounting clip (see Page 138). CA275X, hermetically sealed bath-tub type is used for general noise suppression in marine and aircraft equipment. Av. shpg. wt., 3 oz.

Stock No.	Mfr's Type	Mfd.	Wkg. Volts	Size	NET EACH
17 L 681	RF481	0.5	50	3/4x1 3/8"	.53
17 L 728	CA275X	4.0	50	2x2x1"	1.76
17 L 677	FM441	0.5	100	1 1/8x1 1/8"	.50
17 L 680	RF480	0.5	100	1 3/16x1 1/16"	.47
17 L 721	AS125	0.01	100	1 1/8x1 3/8"	.71
17 L 720	AG442	0.05	100	3/8x1 1/4"	.47
17 L 670	AG443	0.05	100	7/16x1 3/8"	.59
17 L 722	AS125	0.1	100	1 1/8x1 3/8"	.82
17 L 723	AS165	0.25	100	3/4x1 1/2"	.88
17 L 724	AS185	0.5	100	1x1 1/2"	1.03
17 L 678	FM442	0.5	200	1 1/8x1 1/8"	.38
17 L 676	AM454	0.5	200	1 1/8x2"	.38
17 L 675	AG453	0.5	200	3/4x2"	.88
17 L 674	AG444	1.0	200	1x2 3/8"	.53
17 L 671	AG444	0.25	200	5/8x1 3/4"	.53
17 L 673	AG451	0.5	200	3/4x2"	.38

ANTI-STATIC POWDER

Anti-static powder minimizes car radio static noise caused by tires, brake drums and wheels. Only one packet needed per tire. Use injector below. Shpg. wt., 2 oz. 5 per pkg.

- 56 B 687. NET PER PKG.....41c
- Static Powder Injector. Holds 1 packet of powder. Easy to use—one end of injector screws onto tire valve; other end attaches to air hose. Powder is blown in as tire is inflated. Shpg. wt., 10 oz.
- 56 B 686. NET.....75c

CORNELL-DUBILIER INVERTER VIBRATORS

Heavy-duty vibrators for Cornell-Dubilier "Powercon" amplifiers. Also replace vibrators in many mobile amplifiers. Rugged construction assures years of service. All are dust-protected. Vibrators with VB and VC in Type No. are mounted in sponge rubber for minimum noise and maximum stability. Vibrators with VD in Type No. are less sponge rubber; have liner for greater heat dissipation. *Tandem types have higher power handling capacity; have two 6-pin plugs on case. Av. shpg. wt., 1 lb.



Stock No.	Mfr's Type	Volts	Used in "Powercon" Models	NET EACH
82 P 753	6VB6H	6	6DC6, 6*110DH6, 6RS, 6S8, 6SW8	7.94
82 P 759	6V06H	6	6SH15 6SW15	13.82
82 P 775	2529	6	6SP2, 6LM3	2.44
82 P 776	2531	6	6M4	4.53
82 P 777	2563	6	6/12DS, 6L6, 12L8	6.09
82 P 782	12VB6H	12	12DC6, 12R8, 12S10, 12SW10	7.94
82 P 783	*12VD6H	12	12DC12, 12H15, 12RU15 12SH20, 12SW15	13.82
82 P 779	2530	12	12SP2, 12LM4	2.44
82 P 780	2532	12	12M6	4.53
82 P 787	110VB6H	110	110H25, 110S15, 110SW15, 220H25, 220S15	7.94
82 P 788	*110VD6H	110	110H35, 110RT35, 110SH40, 110SW35, 220SH40	13.82
82 P 784	2533	110	110LM5	2.44
82 P 785	2565	110	110M7	6.09

C-D 12-VOLT & "AUTRONIC EYE" VIBRATORS

Cornell-Dubilier replacement vibrators for use in late model automobiles and in "Autronic Eye" circuits. Sturdily constructed to provide long, trouble-free service. Mounted in sponge rubber for quiet operation. Built to withstand severe road-shock and vibration. Individually tested under actual operating conditions. Shpg. wt., 8 oz.

- Type 6326. For 12-volt operation in Chrysler Crown Imperial cars and Philco radio Models 822 and 823. Has 4-pin base. Size, 1 1/2x2 7/8".
- 56 P 265. List \$4.50. NET.....2.65
- Type 6330. For 12-volt operation in Delco radio Models 8550 and 1220155, Oldsmobile, Buick, Cadillac and GMC trucks. Has 3-pin base. Size, 1 1/2x3 1/8".
- 56 P 266. List, \$4.90. NET.....2.88
- Type 6370. For 12-volt operation in "Autronic Eye" circuits, and Guide Lamp unit, No. 5943300. 4-pin base. Size, 1 1/2x3 1/8".
- 56 P 267. List, \$4.70. NET.....2.76
- Type 5370. For 6-volt operation in Guide Lamp unit, No. 5943336. Supersedes No. 5520-4. Has 4-pin base. Size 1 1/2x3 1/4".
- 56 P 268. List, \$4.90. NET.....2.88

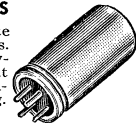

FUSE HOLDERS

Metal container. Fits 1/4" 3AG fuses. Has spring-loaded contacts for firm, sure contact. Designed for quick access and simplest possible fuse replacement. Does not require additional support bracket. Die-stamped for easy identification. Size, 2 1/2x3/8". Shpg. wt., 2 oz.

- 41 B 735. NET EACH.....13c
- 10 or More, EACH.....12c



All-Purpose Tube Sockets

WAFER-TYPE SOCKETS

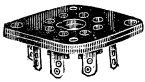

Sturdily constructed, laminated-bakelite tube sockets. All have 1/2" mtg. centers except * which has 1" centers. Av. shpg. wt., 2 oz.

Stock No.	Prongs	NET EACH		
		1-9	10-49	50-99
40 H 224	4	7¢	6¢	5 1/2¢
40 H 225	5	8¢	7¢	6 1/2¢
40 H 226	6	9¢	8¢	7¢
40 H 227	7 (small)	10¢	8 1/2¢	7 1/2¢
58 H 004*	7 (min.)	6¢	5¢	4 1/2¢
40 H 228	Octal	7¢	6¢	5 1/2¢

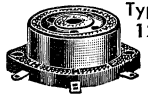

Type 12



Type 49

EBY SOCKETS

Above-Chassis Type. One-piece molded bakelite construction, for top-of-chassis or panel mounting. Contact designations molded in base. Mounting centers, 1 1/8". Shpg. wt., 2 oz.

Stock No.	Type	Prongs	1-9	10-49
			EACH	EACH
40 H 254	12-4	4	29¢	26¢
40 H 255	12-5	5	30¢	27¢
40 H 256	12-6	6	32¢	29¢
40 H 261	12-7-N-O	7L & 7S	34¢	31¢
40 H 258	12-8	Octal	36¢	32¢

TV Tube Socket Type 49-13DD. All-molded bakelite, duo-decal TV tube socket for magnetic or electrostatic focusing tubes. 12" leads. Shpg. wt., 4 oz.
40 H 291. 10-49, EA... 42¢, 1-9, EA... 47¢

EBY CRT TEST SOCKET ADAPTER

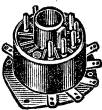

TV picture tube socket adapter, easy to install or remove. External lugs permit checking all CRT pin voltages while set is in operation. No wiring or soldering required. Wt., 3 oz. Shpg. wt., 4 oz.
40 H 273. 1-9, EACH... 94¢
10-49, EACH... 84¢

JAMES MILLEN TUBE SOCKETS



Recommended for UHF use. Higher steatite body gives longer leakage path between contacts. Mounting centers, 1 1/4". Shpg. wt., 4 oz.

Stock No.	Type	Prongs	EACH
72 H 061	33005	5	
72 H 062	33006	6	
72 H 063	33007	7	
72 H 064	33008	8	

NATIONAL SOCKETS



Type CIR. Ruggedly dependable, low-loss steatite sockets for VHF or UHF use. Universal mtg. ring permits installation in any of 6 positions to permit convenient wiring. Mtg. ctrs. 1 1/2".

Mounting plates are nickel-plated brass; contacts are silver-plated phosphor bronze. 4 oz.

Stock No.	Prongs	1-24	25-99	100-199
		EACH	EACH	EACH
71 H 100	4	60¢	54¢	50¢
71 H 101	5	69¢	62¢	57¢

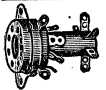

SOCKET-TURRETS

Components mount on mica-filled phenolic form. Turrets are 1/2" diam. Octal units mount in 1" hole; miniatures, 3/8" hole. Av. shpg. wt., 3 oz.

2 1/2" Turrets. Has 9 terminals in two rings, spaced 1 3/8" apart.

Stock No.	Type	Socket	1-19, EA.	20-49, EA.	50-99, EA.
40 H 211	10-0-9T	Octal	59¢	53¢	49¢

2" Turrets. 9 terminals in two rings, spaced 1" apart.

40 H 212	8-0-9T	Octal	56¢	50¢	46¢
40 H 217	8-M-9T	7-Pin Min.	65¢	58¢	54¢
40 H 213	8-N-9T	9-Pin Noval	65¢	58¢	54¢

1 1/2" Turrets. Have 6 terminals in one ring only.

40 H 218	6-0-6T	Octal	50¢	45¢	41¢
40 H 213	6-M-6T	7-Pin Min.	59¢	53¢	49¢
40 H 234	6-N-6T	9-Pin Noval	59¢	53¢	49¢

Shield Bases. For miniature sockets above. Fasten above chassis on socket mtg. centers. Use with standard bayonet type shield. Shpg. wt., 2 oz.

Stock No.	Type	Description	1-19, EA.	20-49, EA.	50-99, EA.
40 H 235	S7	For 7-pin sockets	9¢	8¢	7 1/2¢
40 H 236	S9	For 9-pin sockets	9¢	8¢	7 1/2¢

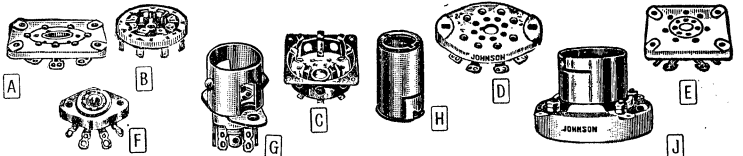

E. F. JOHNSON TUBE SOCKETS

SPECIAL SOCKET TYPES

A Type 122-244. 4-pin steatite for "super jumbo" tubes. Takes 8008, BR6, SC22, 5C22, GL146, GL152, GL159, GL169, RO585, RH507, SR50, SR53, SK60. Shpg. wt., 1/2 lb.
73 H 997. NET... 1.60

A Type 122-275. Steatite socket for giant 5-pin base tubes. Takes 4-125A, 4-250A, RK28, RK48, 125M, 803. Shpg. wt., 10 oz.
73 H 998. NET... 1.90

B Type 124-109. 8-pin socket of Kel-F plastic for UHF high power tubes. 8—12" holes on 1 1/8" circle. Shpg. wt., 1/2 lb.
40 H 299. NET... 5.00

C Type 122-101. 7-pin steatite with base shield and retainer springs. For use with 4-65A, 826, 829, 832, etc. Provision for isolating grid leads. Shpg. wt., 1/2 lb.
73 H 245. NET... 2.35

MINIATURE SERIES

F Type 120-267. 7-pin steatite socket with silver-plated contacts. For 9000 series and miniature tubes 1R5, 1S5, 6CB6, etc. 3/8" mtg. hole. Shpg. wt., 3 oz.
40 H 290. NET... 4.1¢

G Type 120-277. As above, but metal mtg. frame and shield base. Shpg. wt., 3 oz.
73 H 186. NET... 5.9¢

H Type 133-278-6 Shield. For use with Type 120-277 socket. With spring. Cadmium-plated. Height 1 3/8". Shpg. wt., 3 oz.
73 H 244. NET... 1.5¢

H Type 133-278-8 Shield. As above but 2 1/4" high. Shpg. wt., 3 oz.
73 H 187. NET... 1.8¢

STANDARD WAFERS

D Steatite wafer sockets for receiving and low-power transmitting tubes. Cadmium-plated contacts. Size, 2 5/8" x 1 1/8". 1 3/4" Mtg. centers. Shpg. wt., 4 oz.

Stock No.	Mfr's Type	Prongs	NET
73 H 238	122-224	4	69¢
73 H 239	122-225	5	76¢
73 H 240	122-226	6	80¢
73 H 241	122-227	7	90¢
73 H 243	122-228	Octal	97¢

JUMBO WAFERS

E Type 122-237. Steatite wafer for 813, 8001, 3D22, 4E27, HK257. 2 5/8" square. 4 mounting holes, 1 7/8" between centers. Shpg. wt., 1 1/2 lb.
73 H 188. NET... 1.20

Type 122-247. Same steatite "giant" 7-pin wafer socket as above, but with etched aluminum base shield. For tubes 825, 826, etc. Shpg. wt., 1 1/2 lb.
73 H 189. NET... 1.45

BAYONET SOCKETS

J Type 123-209. For tubes with 4 prong "UX" bases 852, 860, 866 tubes, etc. 4 mtg. holes. 2 3/8" centers. Shpg. wt., 10 oz.
73 H 195. NET... 1.50

J Type 123-211. Porcelain base socket for use with "jumbo" type, 4-pin tubes. Takes 211, 872 tubes, etc. Mounting centers are spaced 2 1/8". Shpg. wt., 1 lb.
73 H 191. NET... 1.95

ELCO JAN-TYPE MINIATURE SOCKETS AND SHIELDS

The JAN miniature sockets and shields listed below are manufactured in accordance with military standards and are warranted to comply with JAN-S28 A and JAN-S28 A1 specifications. Bayonet-type locking shields and sockets. Highest quality materials and workmanship used in the construction. Write for quantity prices on 100 or more. Shpg. wt., 3 oz.

Stock No.	JAN No.		Description	1-9, EACH	10-49, EACH	50-99, EACH
	S-28 A	S-28 A1				
40 H 263	TSE 7T 102	TS 102C01	7-Pin Shield Base, Ceramic	26¢	24¢	22¢
40 H 264	TSE 7T 101	TS 102P01	7-Pin Shield Base, Mica-filled	20¢	18¢	17¢
40 H 265	TSE 9T 102	TS 103C01	9-Pin Shield Base, Ceramic	30¢	27¢	25¢
40 H 266	TSE 9T 101	TS 103P01	9-Pin Shield Base, Mica-filled	22¢	20¢	18¢
40 H 267	TSF OT 101	TS 102U01	7-Pin Tube Shield, 1 3/8"	12¢	11¢	10¢
40 H 268	TSF OT 102	TS 102U02	7-Pin Tube Shield, 1 3/8"	12¢	11¢	10¢
40 H 269	TSF OT 103	TS 102U03	7-Pin Tube Shield, 2 1/4"	14¢	13¢	12¢
40 H 270	TSF OT 104	TS 103U01	9-Pin Tube Shield, 1 1/2"	14¢	13¢	12¢
40 H 271	TSF OT 105	TS 103U02	9-Pin Tube Shield, 1 1/2"	14¢	13¢	12¢
40 H 272	TSF OT 106	TS 103U03	9-Pin Tube Shield, 2 3/8"	18¢	16¢	15¢
40 H 286	TSB 8T 102	TS 101C01	Octal, Saddle, Ceramic	40¢	36¢	33¢
40 H 287	TSB 8T 101	TS 101P01	Octal, Saddle, Mica-filled	26¢	24¢	22¢

ELCO SERIES 3300 TRANSISTOR SOCKETS

For 3-pin transistors with in-line pins, or 3 and 4-pin transistors with pins on 200° diam. circle of any configuration. Conform to MIL-P-14. Gold-flashed beryllium copper contacts. Av. shpg. wt., 2 oz.

Stock No.	Type	Description	1-9, EA.	10-49, EA.	50-99, EA.
41 H 092	3301	Saddle Mounting	26¢	23¢	21¢
41 H 093	3304	Mounting Ring Type	19 1/2¢	17¢	15 1/2¢
41 H 094	3305	Printed-Circuit Type	23¢	20¢	18¢
41 H 095	757	Ring Only for 3304	2 1/2¢	2¢	1 1/2¢

VECTOR SOCKETS

PLUG-IN UNITS

Consist of standard tube socket, tubular terminal post, octal plug and shield can. Can sizes: B10M and B10N, 1.37" square, 2.5" long; C10M and C10N, 2" square, 2.5" long. Av. shpg. wt., 5 oz. each.

Stock No.	Type	Description	1-19, EA.	20-49, EA.	50-99, EA.
40 H 237	B10M	7-pin Miniature	1.71	1.54	1.42
40 H 238	B10N	9-pin Noval	1.73	1.56	1.44
40 H 241	C10M	7-pin Miniature	2.06	1.85	1.71
40 H 239	C10N	9-pin Noval	2.09	1.88	1.73

TUBE ADAPTER TEST KIT

Type T-789. Ideal for making voltage, resistance and wave form measurements from tube side of electronic equipment chassis without removing components or disassembling unit. Set contains 1—7-pin, 1—9-pin miniature, and 1 octal adapter in plastic carrying case. To use, adapters are simply inserted between tube and tube socket. 1/2" diam. holes in recessed tabs for test prod. points. Adapters will fit into tube shield bases. Shpg. wt., 6 oz.

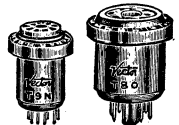

40 H 210. NET... 6.17

Amphenol Sockets

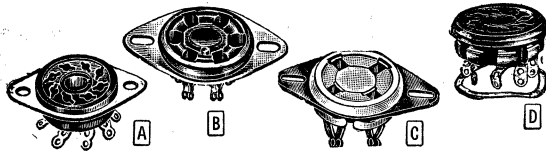

POPULAR STANDARD SOCKETS

A Type MIP. Bakelite body with molded-in steel plate. *Require 1 1/4" hole; mounting centers, 1 5/8". All others have 1 1/2" mounting centers. †Requires 1 3/32" hole; ‡1 5/32" hole. †Mica-filled bakelite. Av. shpg. wt., 4 oz.

Stock No.	Mfr's Type	Prongs	1-99, EACH	100-249, EACH	250-Up, EACH
40 H 024	77MIP4‡	4	.09	.077	.069
40 H 025	77MIP5‡	5	.10	.076	.077
40 H 026	77MIP6‡	6	.11	.098	.088
40 H 027	77MIP7S‡	7 Small	.12	.107	.096
40 H 029	77MIP7L†	7 Large	.12	.105	.094
40 H 028	77MIP8‡	Octal	.10	.085	.076
40 H 026	88-8*	Octal	.11	.095	.085
40 H 030	88-8X*	Loctal	.14	.118	.106
40 H 034	77MIP8T‡	8	.12	.102	.092
40 H 032	77MIP9‡	9	.12	.10	.09
40 H 033	77MIP11‡	11	.13	.11	.099

B Type RS. Has removable mounting plate. 40 H 009 mounts in from 1 1/2 to 1 3/4". Av. shpg. wt., 4 oz.

40 H 004	78RS4	4	.11	.097	.087
40 H 005	78RS5	5	.12	.105	.094
40 H 006	78RS6	6	.13	.112	.101
40 H 007	78RS7S	7S	.14	.117	.105
40 H 009	78RS7L	7L	.18	.155	.14
40 H 008	78RS8	Octal	.13	.11	.099
40 H 010	78RS8L	Loctal	.17	.147	.132
40 H 012	78RS9	9	.13	.115	.103

C Type RSS. Ultra-low-loss teatite sockets. Excellent for use in high-frequency transmitting equipment, etc. All are universal type; have removable mounting plate with slotted holes 1 1/2 to 1 3/4". Mounting hole, 1 1/4" except 40 H 079, which requires 1 1/4". Av. shpg. wt., 5 oz.

40 H 074	49RSS4	4	.28	.245	.221
40 H 075	49RSS5	5	.29	.255 <td>.23</td>	.23
40 H 076	49RSS6	6	.31	.27	.243
40 H 077	49RSS7S	7 Small	.35	.30	.27
40 H 079	49RSS7L	7 Large	.34	.295	.266
40 H 078	49RSS8	Octal	.29	.225	.22

D Type S. High-dielectric molded bakelite body. Units are the same as type RS, but without mounting plate; mount with retainer ring, supplied. All sockets require 1 1/4" hole, except 40 H 059, which requires 1 3/4" hole. Av. shpg. wt., 4 oz.

40 H 054	78S4	4	.08	.07	.063
40 H 055 <td>78S5</td> <td>5</td> <td>.09</td> <td>.078</td> <td>.07</td>	78S5	5	.09	.078	.07
40 H 056 <td>78S6</td> <td>6</td> <td>.10</td> <td>.085</td> <td>.077</td>	78S6	6	.10	.085	.077
40 H 057 <td>78S7S</td> <td>7 Small</td> <td>.10</td> <td>.09</td> <td>.081</td>	78S7S	7 Small	.10	.09	.081
40 H 059 <td>78S7L</td> <td>7 Large</td> <td>.14</td> <td>.122</td> <td>.117</td>	78S7L	7 Large	.14	.122	.117
40 H 058 <td>78S8</td> <td>Octal</td> <td>.10</td> <td>.085</td> <td>.077</td>	78S8	Octal	.10	.085	.077
40 H 062 <td>78S9</td> <td>9</td> <td>.11</td> <td>.098</td> <td>.088</td>	78S9	9	.11	.098	.088
40 H 060 <td>78SSL</td> <td>Loctal</td> <td>.14</td> <td>.117</td> <td>.105</td>	78SSL	Loctal	.14	.117	.105

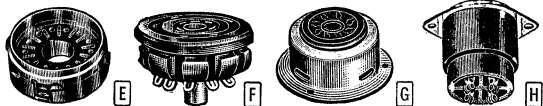

E Type 59-402 Television Tube Socket. Duodecal socket for cathode-ray tubes. Has 12 prongs equally spaced on a 1.063" diameter circle. Body constructed from low-loss bakelite insulating material. Has removable cap, which fits over terminals to provide protection from shock Hazard. Shpg. wt., 5 oz.

40 H 100, 1-99, NET EACH68
100-249, EACH58
250-Up, EACH52

F Type "S" Miniature Sockets. Have high-dielectric, molded bakelite insulating material. Mount in standard 1 1/4" chassis hole with retainer ring supplied. Av. shpg. wt., 5 oz.

Stock No.	Type	Pins	1-99, EA.	100-249, EA.	250-Up, EA.
40 H 113	78-A7P	7	.22	.185	.166
40 H 114	78-A9P	9	.26	.225	.203

G Type 23-1S ACS Socket Shells. Lightweight aluminum shell for type "RSS," "RS," and "S" sockets, except 78S7L, 78RS7L, and 49RSS7L. Permits extension of sockets 1 1/8" above or below chassis surface. Body dia., 1 1/8". Mounts in 1 1/4" hole. Less socket. Shpg. wt., 5 oz.

40 H 127, 1-99, NET EACH10
100-249, EACH086
250-Up, EACH077

H Type 77A-4T High-Voltage 4-Contact Safety Socket. For high-voltage, small-base 2X2A rectifier tubes. Takes all 4-pin types with 1.156" base dia., such as 2X2A. Requires 1 1/2" dia. hole. Shpg. wt., 5 oz.

40 H 147, 1-99, NET EACH44
100-249, EACH375
250-Up, EACH338

Barrier-Type Industrial Octal Sockets. Max. RETMA working voltage, 2,000 DC. Bronze cloverleaf contacts. Rated 8 amps each contact. Inter-electrode capacitance, 2.6 mmf. Eight screw terminals. Insulating barriers. Top mounting. *Includes 4 molded-in threaded inserts for use as tie points. Size: 3/4x1 1/2x2 3/4". Mtg. ctrs., 1 1/16". Shpg. wt., 8 oz.

Stock No.	Type	1-49, EACH	50-149, EACH	150-Up, EACH
40 H 180	146-103	.96	.82	.73
40 H 181	146-104*	.25	1.07	.96

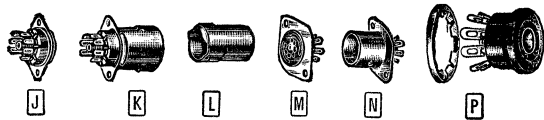

MINIATURE SOCKETS AND SHIELDS BAKELITE AND STEATITE SOCKETS

High-grade miniature sockets and shields. 147 series mount in 5/8" chassis hole; 7/8" mtg. ctrs., with 1/8" screw holes. 59 series mount in 3/4" chassis hole and have 1 1/8" mtg. ctrs. with .095" rivet holes. *Steatite. †Black bakelite. ‡Mica-filled bakelite. Av. shpg. wt., 5 oz.

J WITHOUT TUBE SHIELD BASE

Stock No.	Mfr's Type	Prongs	1-99, EACH	100-249, EACH	250-Up, EACH
40 H 191	†147-500	7	.15	.125	.113
40 H 192	†147-501	7	.24	.205	.185
40 H 199	†147-505	7	.15	.125	.113
40 H 193	†59-409	9	.20	.17	.153
40 H 167	†59-410	9	.20	.17	.153

K WITH TUBE SHIELD BASE

40 H 194	†147-905	7	.21	.18	.162
40 H 195	†147-925	7	.26	.225	.203
40 H 175	†147-913	7	.27	.188	.169
40 H 176	†59-407	9	.27	.24	.216
40 H 196	†59-406	9	.24	.21	.189

L TUBE SHIELDS

FOR 7-PRONG SOCKETS

Stock No.	Type	Height	1-99, EA.	100-249, EA.	250-Up, EA.
40 H 197	5-401	1 3/8"	.08	.073	.066
40 H 198	5-402	1 3/4"	.09	.076	.068

FOR 9-PRONG SOCKETS

Stock No.	Type	Length	1-99, EA.	100-249, EA.	250-Up, EA.
40 H 188	5-405	1 1/2"	.09	.075	.068
40 H 189	5-408	1 5/8"	.10	.09	.081
40 H 190	5-409	2 3/8"	.11	.098	.088

7- AND 9-PIN "ETHYLON-A" SOCKETS

Molded of low-loss "Ethylon-A" high "Q" insulating material. For use where temperature is below 125°F. Sockets without shield base are "Zip-In" type; require special keyed hole. 7-pin sockets with shield base require 7/32" holes; 9-pin, 1/8" holes. Av. shpg. wt., 5 oz.

M WITHOUT TUBE SHIELD BASE

Stock No.	Type	Prongs	1-99, EA.	100-249, EA.	250-Up, EA.
40 H 184	59-357	7	.15	.125	.113
40 H 185	59-359	9	.20	.17	.153

N WITH TUBE SHIELD BASE

40 H 186	59-367	7	.21	.18	.162
40 H 187	59-369	9	.36	.31	.27

RETAINER RING SOCKETS

P Mount in 5/8" round or "D" shaped hole with retainer ring provided. May be used with 91-MPM plugs (page 168). Av. shpg. wt., 5 oz.

BLACK BAKELITE

Stock No.	Mfr's Type	No. Prongs	1-99, EACH	100-249, EACH	250-Up, EACH
40 H 131	78-SSS	3	.07	.063	.056
40 H 115	78-S4S	4	.07	.063	.056
40 H 122	78-S5S	5	.10	.09	.081
40 H 130	78-S6S	6	.11	.095	.085
40 H 120	78-7P	7	.11	.12	.108

MICA-FILLED

40 H 124	78-7PT	7	.13	.127	.114
----------	--------	---	-----	------	------

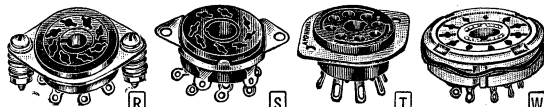

SPECIAL OCTAL AND MAGNAL SOCKETS

R Type 77-MIP8FK Floating Octal. Live-rubber grommets in enlarged mounting holes of sturdy steel plate. Mounts in 1 1/4" hole with two 1/4" holes on 1 1/2" centers. With grommets, mtg. screws, nuts and washers. Shpg. wt., 5 oz.

40 H 043, 1-99, NET EACH21
100-249, EACH18
250-Up, EACH162

S Type 168-015 Saddle Octal. Designed for below-chassis mounting. Steel plate is molded directly into bakelite body. For 1" hole; 3/4" mtg. holes on 1 1/8" ctrs. Shpg. wt., 5 oz.

40 H 118, 1-99, NET EACH09
100-249, EACH075
250-Up, EACH067

T Type 59-355 "Ethylon-A" Octal. Molded of low-loss "Ethylon-A" insulating material. High "Q" factor. For applications where temperature does not exceed 125°F. May be mounted above or below chassis. Requires 1 1/8" diameter hole; two 3/32" mounting holes on 1 1/2" centers. Shpg. wt., 5 oz.

40 H 182, 1-99, NET EACH20
100-249, EACH17
250-Up, EACH153

W Type 49-SS11L Magnal. Has 1 1/8" pin circle to accept 11-prong cathode-ray tubes. Constructed from low-loss steatite. Steel retaining ring for quick assembly. Requires 1 1/8" mounting hole. Shpg. wt., 7 oz.

40 H 090, 1-99, NET EACH61
100-249, EACH52
250-Up, EACH47

Sockets, Plugs, Connectors

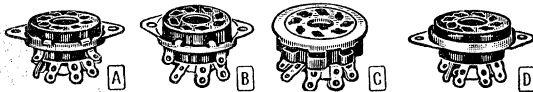

SPECIAL-VALUE OCTAL SOCKETS

An excellent selection of octal sockets. Recommended for receiving and low-power transmitting equipment. All have high-quality phenolic insulated bases, except Fig. C, which has a low-loss ceramic base. Figs. A, B, and D have tinned steel saddles; A and B saddles are equipped with ground lugs. Fig. A is designed for below chassis mounting. Figs. B and D mount from top of chassis. Fig. C mounts from top of chassis with spring retainer ring. Socket contacts are made of cadmium-plated brass. Av. shpg. wt., 4 oz. per pkg. **3 sockets per pkg.**

Stock No.	Fig.	Mtg. Centers	Mtg. Hole Req.	1-4 Pkgs. PER PKG.	5-9 Pkgs. PER PKG.	10 or More Pkgs. PER PKG.
41 H 524	A	1 1/2"	19/32"	23¢	20¢	18¢
41 H 525	B	1 3/8"	1 1/8"	22¢	20¢	18¢
41 H 526	C	1 3/8"	1 1/8"	62¢	56¢	49¢
41 H 527	D	1 3/8"	1 1/8"	22¢	20¢	18¢

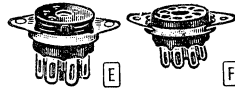

MINIATURE SOCKETS

Special values in high-quality miniature receiving tube sockets. Top and bottom-mounting types. Available with either general-purpose phenolic or mica-filled phenolic insulated bases. Mica-filled types are ideal for low-loss RF use. All sockets have cadmium-plated brass contacts, and have cadmium-plated steel saddles.

BOTTOM MOUNTING TYPE

Miniature-type sockets for below-chassis mounting. 7-pin types require 3/4" mounting hole; mounting centers are 7/8" apart. 9-pin types require 1 1/8" mounting hole; mounting centers are 1 1/8" apart. Av. shpg. wt., 4 oz. per pkg. **3 per pkg.**

Stock No.	Pins	Fig.	Base	1-4 Pkgs. PER PKG.	5-9 Pkgs. PER PKG.	10 or More Pkgs. PER PKG.
41 H 528	7	E	Phenolic	22¢	20¢	18¢
41 H 529	7	E	Mica-Filled Phenolic	28¢	25¢	22¢
41 H 530	9	F	Phenolic	29¢	26¢	23¢
41 H 531	9	F	Mica-Filled Phenolic	34¢	31¢	27¢

TOP-MOUNTING TYPE

Miniature type sockets for top-of-chassis mounting. 7-pin types require 5/8" mtg. hole; mtg. centers are 7/8" apart. 9-pin types require 63/64" mtg. hole; mtg. centers are 1 1/8" apart. Both types have shielded base. Shpg. wt., 2 oz. per pkg. **3 per pkg.**

Stock No.	Pins	Fig.	Base	1-4 Pkgs. PER PKG.	5-9 Pkgs. PER PKG.	10 or More Pkgs. PER PKG.
41 H 532	7	E	Phenolic	25¢	23¢	20¢
41 H 533	7	E	Mica-Filled Phenolic	31¢	28¢	25¢
41 H 534	9	F	Phenolic	29¢	26¢	23¢
41 H 535	9	F	Mica-Filled Phenolic	34¢	31¢	27¢

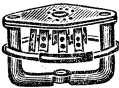

RAY-PAR ANTI-CORONA SOCKETS

Octal socket for 1B3 high-voltage rectifier tube. Corona ring minimizes breakdown. Laminated bakelite. Mounts on insulator or on high-voltage filter capacitor with screw type terminal. Shpg. wt., 3 oz. **40 H 446. NET. .44¢**

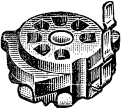

ELCO SOCKETS FOR PRINTED CIRCUITS

These new sockets have been designed specifically for use with printed circuits. Permit quick, simplified connections to printed-circuit boards. Extremely compact and rugged. Available in choice of 7, 8 and 9 miniature, or octal types. All sockets are bottom-solder type and have mica insulation, tinned brass contacts, and ground lug. Wt., 3 oz.

Stock No.	Type	Pins	7	8	9	1-9, EA.	10-49, EA.	50-99, EA.	100-up, EA.
41 H 550	645	Octal	11¢	10¢	9¢	8 1/2¢			
41 H 551	612	Octal	35¢	31¢	28¢	26¢			
41 H 552	653	9	16¢	14¢	13¢	12¢			

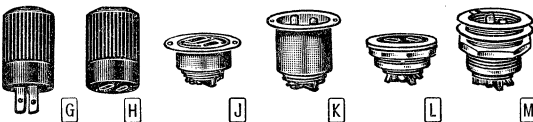

HART AND HEGEMAN MIDGET CONNECTORS

Midget bakelite 2-prong cord connectors and receptacles. Rated 10 amps, 250 volts. 1-inch hole required for all receptacles. 3/8" contact spacing. Terminals are exposed, threaded cover. *With plate for screws. †With plate and lock ring. ‡Fits all receptacles listed in table below. Av. shpg. wt., 3 oz.

Stock No.	Type	Fig.	Description	EACH
52 N 721	80324	G	Male cable connector.	.70
52 N 722	80325	H	Female cable connector.	.70
52 N 723	80332	Cord connector.	1.02
52 N 724	80330	Terminal cover.	.78
52 N 725	80326*	J	Female flush receptacle.	.84
52 N 726	80328*	K	Male flush receptacle.	.84
52 N 727	80327†	L	Female flush receptacle.	1.02
52 N 728	80329†	M	Male flush receptacle.	1.02
52 N 729	80331†	Female flush receptacle, recessed.	1.02

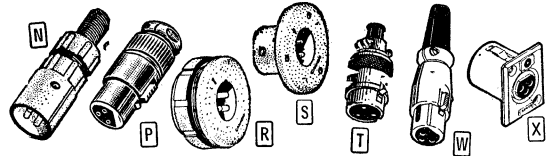

CANNON PLUGS AND RECEPTACLES

TYPE XL CONNECTORS

Small 3 and 4 contact connectors. First No. in type column indicates No. of contacts. *Grip and strain relief spring, shown in Fig. N. †Steel shell cable clamp, shown in Fig. P. Rating: 15 amp, 3 contact; 10 amp, 4 contact. Working voltage, 250. Av. shpg. wt., 4 oz.

STRAIGHT CORD PLUGS

Stock No.	Type	Fig.	Description	1-24, EA.	25-99, EA.
40 H 714	XL-3-12*	N	Male (pin insert)	.88	.79
40 H 713	XL-3-11*	Female (socket insert)	.91	.82
40 H 788	XL-3-11SC†	P	Female (socket insert)	2.00	1.79
40 H 789	XL-3-12SC†	Male (pin insert)	1.97	1.76
40 H 794	XL-4-11*	Female (socket insert)	1.26	1.14
40 H 795	XL-4-12*	N	Male (pin insert)	1.18	1.06
40 H 796	XL-4-11SC†	P	Female (socket insert)	2.35	2.12
40 H 797	XL-4-12SC†	Male (pin insert)	2.26	2.04

CHASSIS MOUNT RECEPTACLES

40 H 716	XL-3-14	S	Male (pin insert)	.71	.64
40 H 715	XL-3-13	Female (socket insert)	.91	.82
40 H 798	XL-4-14	S	Male (pin insert)	1.00	.90
40 H 799	XL-4-13	Female (socket insert)	1.26	1.14

PANEL MOUNT RECEPTACLES

40 H 718	XL-3-14N	R	Male (pin insert)	.85	.76
40 H 717 <td>XL-3-13N</td> <td>.....</td> <td>Female (socket insert)</td> <td>.91</td> <td>.82</td>	XL-3-13N	Female (socket insert)	.91	.82
40 H 754	XL-4-14N	R	Male (pin insert)	1.15	1.03
40 H 600	XL-4-13N	Female (socket insert)	1.26	1.14

TYPE P CONNECTORS

3-contact receptacles and cable connectors for audio circuits. For any size wires up to No. 10. 15 amp contact capacity. Black phenolic insulation. Plugs have steel shells and zinc cable clamps. Av. wt., 4 oz.

40 H 707	P3-13	Panel mount, female (socket)	3.15	2.83
40 H 757 <td>P3-14</td> <td>.....</td> <td>Panel mount, male (pin)</td> <td>1.65</td> <td>1.48</td>	P3-14	Panel mount, male (pin)	1.65	1.48
40 H 724	P3-CG-11S	T	Cable plug, female (skt)	3.70	3.33
40 H 701	P3-CG-12S	Cable plug, male (pin)	3.03	2.72
40 H 709	P3-35	Wall receptacle, female for 40 H 701	5.38	4.84

TYPE XLR AUDIO CONNECTORS

New Cannon audio connectors with clamp and resilient socket insulator. Satin nickel finish. Av. shpg. wt., 3 oz.

40 H 790	XLR-3-11C	W	Female (socket insert)	1.26	1.14
40 H 791	XLR-3-12C	Male (pin insert)	.94	.84
40 H 792	XLR-3-31	X	Female (socket insert)	1.23	1.11
40 H 793	XLR-3-32	Male (pin insert)	.76	.69

Manufacturers and industrial—write for special prices on Cannon Plugs and Receptacles in quantities of 100 or more.

CINCH-JONES RECEPTACLES

TYPE 8PB 8-CONTACT PLUG

For making up to 8 connections between chassis. Molded black bakelite. Fits any octal socket. Use with 16F shield, (below). Shpg. wt., 2 oz.

40 H 846, 1-24, NET EACH. .22¢
25-99, EACH. .19¢ 100 or More, EACH. .18¢

Type 11PB 11-Contact Plug. Same as above, but with 11 contacts. Molded black bakelite. Fits 11-contact socket, Type 11RB listed below. Use with type 16F snap-on shield. Shpg. wt., 2 oz.

40 H 847, 25-99, EA. 21 1/2¢ 100 or More, EA. 20¢ 1-24, EA. .24¢

TYPE 16F STEEL SNAP-ON SHIELD

Cadmium-plated, durable steel shield. Designed to snap on 8PB and 11PB sockets. For use with extension cables. Rubber grommet with 2 5/8" hole protects cable. Shpg. wt., 2 oz.

40 H 848, 25-99, EA. 25¢ 100 or More, EA. 24¢ 1-24, EA. .28¢

TYPE 11RB 11-CONTACT SOCKET

For use with 11PB 11-contact plug (above). Molded from high-dielectric, black bakelite. Hot solder-dipped tinning on brass contact terminals for quick, positive solder connections. Can be mounted on 1/8" thick chassis using retaining ring. Can also be used with 16F snap-on shield (above) on extension cables. Shpg. wt., 2 oz.

40 H 849, 25-99, EA. 25¢ 100 or More, EA. 24¢ 1-24, EA. .28¢

H. H. SMITH TV COAX CABLE CONNECTORS

Low-cost solderless coaxial cable connectors for use with RG-59/U and other 1/4" diameter cable. Low-loss insulation. Silver-plated for high conductivity. Av. shpg. wt., 2 oz.

Y	Male Connector. For below.
40 H 300, 10-49, EA. .42¢	50 up, EA. 38¢ 1-9, EA. .47¢
Z	Female Receptacle. 5/8" threaded stem. Chassis type.
40 H 301, 10-49, EA. .42¢	50 up, EA. 38¢ 1-9, EA. .47¢
AA	Cable Junction. Feed-through. Both ends fit 40 H 300.
40 H 302, 10-49, EA. 53¢	50 up, EA. 48¢ 1-9, EA. .59¢

Amphenol Connectors and Plugs

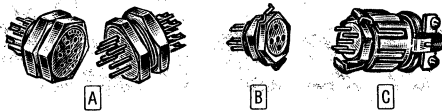

MINIATURE RACK PANEL & CABLE CONNECTORS

Miniature type connectors designed especially for interconnection of miniature electronic equipment. Molded of Blue Amphenol 1-501 dielectric. Silver base plated, gold finished contacts will not tarnish. All hardware is solid nickel-plated brass. Three types available, all interchangeable. Hex nut type, Fig. A has threaded body for mounting to panel. Requires 3/4" dia. mounting hole. This type also available with a locking clip (Fig. B) for mating with the hood and cable clamp type where a locking feature is desirable. Fig. C shows the hood and cable clamp type. Cable clamp takes strain off cable, prevents broken connections. Overall diameter, hex nut type only 3/8"; cable clamp type, 3/4". Overall length, cable clamp type, 1 1/4". Av. shpg. wt., 5 oz.

MALE CONNECTORS

Stock No.	Mfr's Type	Con-tacts	Fig.	Description	NET EACH	
					1-99	10-49
40 H 632	126-010	5	A	Hex nut type, for panel mtg.	.76	.58
40 H 634	126-191	7	A	Hex nut type, for panel mtg.	1.14	.85
40 H 636	126-012	9	A	Hex nut type, for panel mtg.	.98	.73
40 H 644	126-217	5	C	Hood and cable clamp type	1.38	1.04
40 H 646	126-195	7	C	Hood and cable clamp type	1.52	1.15
40 H 648	126-220	9	C	Hood and cable clamp type	1.59	1.20
40 H 638	126-216	5	B	Hex nut type, with locking clip	.82	.62
40 H 640	126-197	7	B	Hex nut type, with locking clip	.98	.73
40 H 642	126-219	9	B	Hex nut type, with locking clip	1.04	.78

FEMALE CONNECTORS

Stock No.	Mfr's Type	Con-tacts	Fig.	Description	NET EACH	
					1-99	10-49
40 H 633	126-011	5	A	Hex nut type, for panel mtg.	1.20	.90
40 H 635	126-192	7	A	Hex nut type, for panel mtg.	1.71	1.28
40 H 637	126-013	9	A	Hex nut type, for panel mtg.	2.07	1.55
40 H 645	126-223	5	C	Hood and cable clamp type	1.79	1.34
40 H 647	126-196	7	C	Hood and cable clamp type	2.29	1.72
40 H 649	126-222	9	C	Hood and cable clamp type	2.65	1.99
40 H 639	126-218	5	B	Hex nut type, with locking clip	1.26	.95
40 H 641	126-198	7	B	Hex nut type, with locking clip	1.73	1.30
40 H 643	126-221	9	B	Hex nut type, with locking clip	2.12	1.59

MINIATURE CABLE CONNECTORS

Standard plugs of durable bakelite construction. For use as chassis or panel connectors. Prongs securely fastened to body. Use adapter plate listed below for replacement mounting in present equipment. With mounting ring for 1 1/4" holes except *1.328" keyed hole. 9 and 11-prong plugs have guide post and aligning key. Av. shpg. wt., 2 oz.

No.	Type	Fig.	1-49, EA.	50-149, EA.	150-Up, EA.
40 H 320	91-MPP3L	D	27¢	24¢	21¢
40 H 571	91-MPP3S	D	27¢	24¢	21¢
40 H 321	91-MPP4L	D	29¢	24¢	23¢
40 H 572	91-MPP4S	D	27¢	24¢	21¢
40 H 325	91-MPM3L	E	24¢	21¢	19¢
40 H 573	91-MPM4S	E	23¢	20¢	18¢
40 H 326	91-MPM4L	E	24¢	21¢	19¢
40 H 574	91-MPM4S	E	23¢	20¢	18¢
40 H 570	91-MPM5L	E	26¢	23¢	20¢
40 H 328	91-MPM6L	F	27¢	24¢	21¢
40 H 330	78-PCG3	F	16¢	13 1/2¢	12¢
40 H 331	78-PCG4	F	16¢	13 1/2¢	12¢
40 H 332	78-PCG5	F	18 1/2¢	15 1/2¢	14¢
40 H 333	78-PCG6	F	19¢	16¢	14¢



TYPE CP PLUGS

Standard plugs of durable bakelite construction. For use as chassis or panel connectors. Prongs securely fastened to body. Use adapter plate listed below for replacement mounting in present equipment. With mounting ring for 1 1/4" holes except *1.328" keyed hole. 9 and 11-prong plugs have guide post and aligning key. Av. shpg. wt., 2 oz.

No.	Mfr's Type	Prongs	1-99, EA.	100-249, EA.	250-Up, EA.
40 H 015	86-CP4	4	11¢	9 1/2¢	8 1/2¢
40 H 016	86-CP5	5	12¢	10¢	9¢
40 H 017	86-CP6	6	12¢	11¢	10¢
40 H 018	86-CP7*	7-Large	15¢	12 1/2¢	11¢
40 H 019	86-CP7S	7-Small	14¢	11 1/2¢	10¢
40 H 020	86-CP8	8-Octal	14¢	11 1/2¢	10¢
40 H 021	86-CP9	9	13¢	11¢	9 1/2¢
40 H 022	86-CP11	11	14¢	12¢	11¢

Adapter Plate. Nickel plated steel. For use with all Type CP plugs above except 86-CP7L. 1 1/2" to 1 3/4" centers. Shpg. wt., 2 oz.
40 H 023. NET

TYPE 71 PLUGS

Compact, efficient, high-dielectric plugs. Ideal for all plug-in connections where space is limited. Excellent for transmitters, receivers, intercoms, etc. Body is made of high quality bakelite. Molded ring allows firm, non-slip finger grip. Securely anchored, nickel-plated brass prongs; deeply recessed to prevent shorts caused by pulled back insulation. Easily soldered. Contacts are polarized to assure proper connection. For cables with up to six conductors. Fit Amphenol 78-S series miniature sockets on page 166. Av. shpg. wt., 2 oz.

No.	Mfr's Type	Prongs	NET EACH		
			1-99	100-249	250-Up
40 H 177	71-3S	3	6 1/2¢	5 1/2¢	4¢
40 H 169	71-4S	4	7¢	6¢	4¢
40 H 149	71-5S	5	9¢	7 1/2¢	7¢
40 H 179	71-6S	6	10¢	8 1/2¢	7 1/2¢

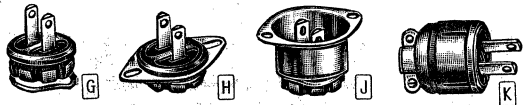

AC PLUGS AND RECEPTACLES

U. L. Approved. All are rated at 15 amps, 110 v., or 10 amps, 250 v. High-dielectric black bakelite. Fig. G mounts with retainer ring. Requires 1 1/2" hole. Fig. H has mtg. plate. Requires 1 1/4" hole, mtg. centers, slotted 1 1/2" to 1 3/4". Fig. J is recessed type. Requires 1 3/4" hole, mtg. centers, 1 1/2". Fig. K is shielded type with clamp. *For standard or polarized plugs. All are 2 pole except † 3 pole. Av. shpg. wt., 3 oz.

RETAINER RING TYPE

Stock No.	Mfr's Type	Fig.	Description	NET EACH		
				1-99	100-249	250-Up
40 H 675	61-M	G	Male Standard	29¢	17¢	15¢
40 H 676	61-MP	G	Male Polarized	29¢	17¢	15¢
40 H 081	60-M	G	Male Polarized†	25¢	21 1/2¢	19¢
40 H 677	61-F	G	Female Universal*	19¢	16¢	14 1/2¢
40 H 082	60-F	G	Female Polarized†	22¢	19¢	17¢

WITH SEPARATE MOUNTING PLATE

Stock No.	Mfr's Type	Fig.	Description	NET EACH		
				1-99	100-249	250-Up
40 H 680	61-M1	H	Male Standard	23¢	19¢	17¢
40 H 681	61-MP1	H	Male Polarized	23¢	19 1/2¢	17 1/2¢
40 H 083	60-M1	H	Male Polarized†	27¢	23 1/2¢	21¢
40 H 682	61-F1	H	Female Universal*	23¢	19¢	17¢
40 H 084	60-F1	H	Female Polarized†	24¢	21¢	19¢

WITH BELOW-SURFACE SHELL

Stock No.	Mfr's Type	Fig.	Description	NET EACH		
				1-99	100-249	250-Up
40 H 685	61M10	J	Male Standard	29¢	24¢	22 1/2¢
40 H 689	61F10	J	Female Universal*	29¢	25¢	23¢
40 H 687	61F10	J	Female Universal*	29¢	24 1/2¢	22¢

SHIELDED CABLE TYPE

Stock No.	Mfr's Type	Fig.	Description	NET EACH		
				1-99	100-249	250-Up
40 H 690	61M11	K	Male Standard	33¢	27¢	24¢
40 H 691	61MP11	K	Male Polarized	33¢	27¢	24¢
40 H 692	61F11	K	Female Universal*	31¢	26¢	24¢
40 H 693	60M11	K	Male Polarized†	39¢	32¢	28¢

Type 61-MIP-61F. Female receptacle. Same as Fig. H above except has molded-in plate. Two mounting holes on 1 1/2" centers. Takes all standard or polarized 2-pole plugs. High-dielectric, black, bakelite insulation. Shpg. wt., 3 oz.

40 H 085, 1-99, NET EACH..... 19¢
100 to 249, EACH..... 16¢. 250 or More, EACH..... 14¢

Type 61-61. Shell only. Converts all Fig. G male plugs and female receptacles to Fig. J, for recessed mounting. Shpg. wt., 2 oz.
40 H 086, 1 to 99, NET EACH..... 8¢
100 to 249, EACH..... 7¢. 250 or More, EACH..... 6¢

MULTI-WIRE CONNECTORS

Matching Amphenol male and female cable connectors. Take cables up to 7/8" O.D. Male types can be plugged into chassis-mounted tube sockets. Size, 1 1/2"x1 1/2". Av. shpg. wt., 3 oz.

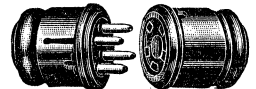

MALE

Stock No.	Mfr's Type	Prongs	NET EACH		
			1-99	100-249	250-Up
40 H 524	78-PP4	4	17¢	14 1/2¢	13¢
40 H 525	78-PP5	5	18¢	15¢	14¢
40 H 526	78-PP6	6	19¢	16¢	14¢
40 H 527	78-PP7S	7S	20¢	16 1/2¢	15¢
40 H 528	78-PP8	8 octal	19¢	16¢	14¢
40 H 516	78-PP9	9	21¢	17¢	15 1/2¢
40 H 517	78-PP11	11	22¢	18 1/2¢	16 1/2¢

FEMALE

Stock No.	Mfr's Type	Con-tacts	NET EACH		
			1-99	100-249	250-Up
40 H 504	86-PM4	4	21¢	17 1/2¢	16¢
40 H 505	86-PM5	5	22¢	17 1/2¢	16¢
40 H 506	86-PM6	6	22¢	18 1/2¢	17¢
40 H 507	86-PM7S	7S	23¢	19¢	17¢
40 H 508	86-PM8	8	22¢	18¢	16¢
40 H 512	86-PM9	9	22¢	18 1/2¢	17¢
40 H 513	86-PM11	11	23¢	19 1/2¢	17 1/2¢

Amphenol Cable Clamp, Type 79-CC4. For use with above connectors. Relieves strain on soldered connections. Shpg. wt., 5 oz.
40 H 670, 1-49, NET EACH..... 5¢
50 to 149, EACH..... 4¢. 150 or More, EACH..... 3 1/2¢

SOCKETS AND PLUGS

Single-contact sockets and plugs. Molded bakelite bodies. Sockets mount in 3/8" hole. Supplied with Amphenol 2-11 retainer ring. Contacts recessed 1/8" to prevent shorts and possibility of shock from exposed metal. Shpg. wt., 1 oz.

Stock No.	Mfr's Type	Description	NET EACH		
			1-99	100-249	250-Up
41 H 152	71-1L	Plug, Red. For 3/8" socket.			
41 H 154	71-1L	Plug, Black. Same as above.	.03	.025	.023
41 H 156	71-1L	Plug, Red. For 1/2" socket.			
41 H 157	71-1M	Plug, Black. Same as above.			
41 H 158	71-1S	Plug, Red. For 3/8" socket.	.03	.025	.023
41 H 159	71-1S	Plug, Black. Same as above.			
41 H 160	78-1L	Socket, Red. For 3/8" plug.			
41 H 161	78-1L	Socket, Black. Same as above.	.05	.043	.039
41 H 162	78-1M	Socket, Red. For 1/2" plug.			
41 H 163	78-1M	Socket, Black. Same as above.			
41 H 164	78-1P	Socket, Red. Std. 080° phone tip.			
41 H 165	78-1P	Socket, Black. Same as above.			
41 H 166	78-1S	Socket, Red. For 3/8" plug.	.05	.043	.039
41 H 167	78-1S	Socket, Black. Same as above.			

Amphenol Connectors

RF CABLE CONNECTORS

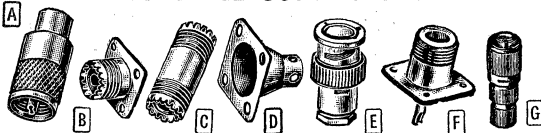

Type "83" Coaxial Cable Connectors. Meet government specs. *Polystyrene insulation. †Mica-filled insert. ‡For twin coax RG-22/U and RG-22A/U cable. Av. shpg. wt., 3 oz.

UHF Small Single Contact. Popular connectors for any RF application.

Stock No.	Military No.	Mfr's Type	Fig.	Description	NET EACH	
					1-9	10-49
40H 357	UG-106/U, M-360	83-1H	D	For RG/U 8, 9, 10, 11, 12, 13, 63	.21	.16
40H 360	UG-175/U	83-185	Reducing Adapter for RG/U 29, 55	.21	.16
40H 359	UG-176/U	83-168	Reducing Adapter for RG/U 59, 62	.18	.14
40H 351	UG-177/U	83-765	D	For RG/U 29, 55, 58A	.26	.20
40H 373	UG-203/U, 49482	83-776	A	For RG/U 29, 55, 58A, 59, 62, 63, 71	1.03	.77
40H 356	UG-365/U, PL-274	83-1F*	Feed-Through Connector	1.94	1.46
40H 353	UG-646/U, M-359	83-1AP*	Right Angle Plug Adapter	1.47	1.11
40H 354	M-358, 49199	83-1T*	"T" Adapter	1.97	1.48
40H 355	PL-258, 49191	83-1J*	C	Straight Adapter	1.00	.75
40H 350	PL-259, 49190	83-1SP†	A	For RG/U 8, 9, 10, 11, 12, 13	.71	.53
40H 372	PL-259A, 49195	83-1SPN	A	For RG/U 8, 9, 10, 11, 12, 13, 63, 65	.97	.73
40H 352	SO-239 49194	83-1R†	B	Receptacle Chassis Type	.73	.55
40H 358	83-1AC	83-1AC	Cap and Chain	.53	.40

UHF Small Twin Contact. For use with 2-conductor coax cables.

Stock No.	Military No.	Mfr's Type	Fig.	Description	NET EACH	
					1-9	10-49
40H 361	UG-102/U, PL-284	83-22SP†	A	Straight plug	1.00	.75
40H 362	UG-103/U, SO-264	83-22R†	B	Chassis receptacle	.79	.60
40H 374	UG-104/U, PL-293	83-22AP†	Right-angle adapter	1.88	1.41
40H 511	UG-105/U, PL-285	83-22J	C	Straight Adapter	1.18	.88
40H 518	PL-275	83-22F	Straight Bulkhead Adapter	2.20	1.66

Solderless Type UHF Plug Connectors.

Stock No.	Military No.	Mfr's Type	Fig.	Description	1-9	10-49
40H 509	83-850	Plug for RG/U 11	1.35	1.02
40H 510	83-851	G	Plug for RG/U 8, 9, 10, 11, 12, 13, 63, 65	1.09	.81

BNC Type Connectors. Small lightweight, weatherproofed connectors. Low voltage, single contact types for use with 50 ohm RG-55/U and RG-58/U cables except *for use with 70 ohms RG-59/U, RG-62/U and RG-71/U. Av. shpg. wt., 3 oz.

Stock No.	Military No.	Mfr's Type	Fig.	Description	NET EACH	
					1-9	10-49
40H 391	UG-88/U	31-002	E	Plug	1.15	.86
40H 393	UG-89/U	31-005	Jack	1.23	.93
40H 396	UG-260/U	31-012*	E	Plug	1.26	.95
40H 397	UG-261/U	31-015*	Jack	1.29	.99
40H 395	UG-262/U	31-011*	Panel Jack	1.35	1.02
40H 392	UG-290/U	31-003	Receptacle	1.09	.77
40H 399	UG-291/U	31-001	Panel Jack	1.29	.97
40H 394	UG-306/U	31-009	Right Angle Adapter	3.09	2.31
40H 398	UG-657/U	31-102	Receptacle	1.62	1.22
40H 490	CW-123/U	31-006	Cap and Chain	.50	.37
40H 491	CW-155/U	31-007	Cap	.35	.26
40H 492	UG-274/U	31-008	T Adapter	3.18	2.37
40H 493	UG-273/U	31-028	BNC to UHF Adapter	2.00	1.50
40H 494	UG-492A/U	31-220	Adapter	3.06	2.29

Type N Connectors. Low voltage. 50 ohms except *70 ohms. 3 oz.

Stock No.	Military No.	Mfr's Type	Fig.	Description	NET EACH	
					1-9	10-49
40H 313	UG-21B/U	82-61	Plug for RG/U 8, 9, 10	1.85	1.39
40H 314	UG-22B/U	82-62	Panel Jack for RG/U 8, 9, 10	1.68	1.25
40H 315	UG-23B/U	82-63	Jack for RG/U 8, 9, 10	1.41	1.06
40H 312	UG-58/U	82-24*	F	Receptacle	1.21	.90
40H 316	UG-94A/U	82-84*	Plug for RG/U II, 12, 13	2.15	1.61
40H 519	UG-107A/U	82-36	T Adapter	5.32	3.99
40H 520	UG-27A/U	82-64	Right-Angle Adapter	3.59	2.69
40H 521	UG-29A/U	82-65	Straight Adapter	1.65	1.23
40H 522	UG-30/U	82-66	Bulkhead Adapter	2.32	1.74
40H 523	UG-96A/U	82-90*	Panel Jack for RG/U, 11, 12	2.00	1.50
40H 529	UG-58A/U	82-97	F	Receptacle	1.26	.95
40H 528	UG-107B/U	82-102	T Adapter	4.15	3.11
40H 559	UG-167A/U	82-104	Plug for RG/U 17, 18	5.35	4.02
40H 560	UG-1185/U	82-312	Plug, RG/U 8, 9, 10, 87A,	3.88	2.91
40H 561	UG-1185/U	82-313	Jack, 115, 115A	3.35	2.52
40H 562	UG-1187/U	82-314	Panel Jack	3.50	2.63

Type HN Connectors. High voltage. 50 ohms. Av. shpg. wt., 3 oz.

Stock No.	Military No.	Mfr's Type	Fig.	Description	NET EACH	
					1-9	10-49
40H 375	UG-59A/U	82-38	Plug for RG/U 8, 9, 10	2.44	1.83
40H 317	UG-59B/U	82-80A	Plug for RG/U 8, 9, 10	3.38	2.54
40H 318	UG-560/U	82-805	Receptacle	3.03	2.27
40H 563	UG-1213/U	82-320	Plug	6.47	4.85
40H 514	UG-1214/U	82-321	Jack	6.12	4.61
40H 515	UG-1215/U	82-324	Panel Jack	6.47	4.85

Type C and LC Connectors. Shpg. wt., 3 oz.

Stock No.	Military No.	Mfr's Type	Fig.	Description	1-9	10-49
40H 488	UG-154/U	82-59	Plug for RG/U 17, 18	11.32	8.49
40H 489	UG-573A/U	82-530	Plug for RG/U 8, 9, 10	3.47	2.61

SUBMINAX RF CONNECTORS

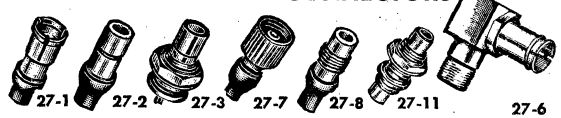

SUBMINIATURE RF CONNECTORS

Subminiature RF connectors for use with Amphenol subminiature coaxial cable. Feature high efficiency, plus space-saving design. Use screw-on types with each other; push-on connectors only with push-on types; 75-ohm and 50-ohm types cannot be inter-mixed. Plugs fit jacks, bulkhead jacks or receptacles. For cables use plugs and jacks. Use bulkhead jacks for chassis or panel mounting if internal wiring is coax; use receptacles if internal wiring is non-coax. Feed-through types are for permanent feed-through connection. All connectors have gold-plated bodies and contacts. Shpg. wt. 3 oz.

50 OHM PUSH-ON

Stock No.	Mfr's Type	Description	For Amphenol Cables	NET EACH	
				1-9	10-49
40H 470	27-1	Plug	21-598 (RG-174/U)	.91	.69
40H 495	27-6	Right-Angle Plug	21-598 (RG-174/U)	2.79	2.10
40H 471	27-2	Jack	21-598 (RG-174/U)	.91	.69
40H 472	27-3	Receptacle94	.71
40H 473	27-4	Jack, Bulkhead	21-598 (RG-174/U)	1.09	.81
40H 474	27-5	Feed-Through	1.47	1.11
40H 044	27-10	Jack, Hermetic	2.65	1.99
40H 045	27-801	Terminator 521-596	21-598 (RG-174/U)	.62	.46

50 OHM SCREW-ON

Stock No.	Mfr's Type	Description	For Amphenol Cables	NET EACH	
				1-9	10-49
40H 475	27-7	Plug	21-598 (RG-174/U)	.82	.62
40H 476	27-8	Jack	21-598 (RG-174/U)	.88	.67
40H 477	27-9	Receptacle	21-598 (RG-174/U)	.94	.71
40H 478	27-10	Jack, Bulkhead	1.00	.75
40H 479	27-11	Feed-Through	1.62	1.22
40H 480	27-12	Receptacle, Hermetic	21-598 (RG-174/U)	2.20	1.66
40H 046	27-25	Right-Angle Plug	2.35	1.76
40H 046	27-28	Adapter, Submin-BNC	2.94	2.20
40H 047	27-800	Receptacle, prntd-crct73	.55

75 OHM PUSH-ON

Stock No.	Mfr's Type	Description	For Amphenol Cables	NET EACH	
				1-9	10-49
40H 481	27-13	Plug	21-597	1.12	.84
40H 497	27-18	Right-Angle Plug	21-597	3.00	2.25
40H 457	27-14	Jack	21-597	1.12	.84
40H 458	27-15	Receptacle	1.12	.84
40H 459	27-16	Jack, Bulkhead	21-597	1.47	1.11
40H 460	27-17	Feed-Through	1.56	1.17

75 OHM SCREW-ON

Stock No.	Mfr's Type	Description	For Amphenol Cables	NET EACH	
				1-9	10-49
40H 461	27-19	Plug	21-597	1.03	.77
40H 498	27-25	Right-Angle Plug	21-597	2.59	1.94
40H 462	27-20	Jack	21-597	1.00	.75
40H 463	27-21	Receptacle	1.09	.81
40H 464	27-22	Jack, Bulkhead	21-597	1.32	.99
40H 465	27-23	Feed-Through	1.59	1.20
40H 466	27-24	Receptacle, Hermetic	2.41	1.81

CRIMPING TOOLS FOR SUBMINAX CONNECTORS

Stock No.	Mfr's Type	Description	For Amphenol Cables	Wt. Oz.	NET EACH
40H 467	27-900	Crimp Tool	21-598 (RG-174/U)	12	12.25
40H 468	27-901	Crimp Tool	21-597	12	12.25
40H 469	27-902	Adapter for 27-901	For connectors 27-13, 27-14	4	1.37

MULTI-CONTACT PLUGS AND SOCKETS

Versatile, shielded connectors with 11, 15 and 20 contacts. Two-types—cable and chassis. May be combined for "pull-out" rack mounting, inter-connecting several units, and mounting conductors. Mica-filled phenolic plastic has high impact strength, low loss and low shrinkage. Non-rotating contacts are silver-plated with "00002" hard gold shell. Plating gives improved appearance, makes soldering easier and faster—no pre-tinning of solder cups is required. All have eyelets inserted in mounting holes for added strength, and a locking barrier to prevent accidental shorting. Rated at 900 v., 60 cycles, AC. *Insert only; all others with can. Cable type, 4 oz., chassis type, 2 oz.

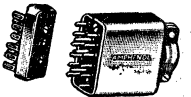

Stock No.	Mfr's Type	Total Contacts	Contacts		Description	NET EACH	
			No. 16	No. 20		1-9	10-49
40H 530	126-804*	11	2	9	Chassis plug	1.04	.78
40H 531	126-805*	11	2	9	Chassis socket	.82	.62
40H 532	126-809*	11	2	9	Cable plug	1.65	1.23
40H 533	126-808	11	2	9	Cable socket	1.41	1.06
40H 534	126-151*	15	3	12	Chassis plug	1.26	.95
40H 535	126-150*	15	3	12	Chassis socket	.87	.66
40H 536	126-152	15	3	12	Cable plug	1.91	1.43
40H 537	126-153	15	3	12	Cable socket	1.52	1.15
40H 538	126-806*	20	4	16	Chassis plug	1.79	1.34
40H 539	126-807*	20	4	16	Chassis socket	1.47	1.11
40H 540	126-811	20	4	16	Cable plug	2.26	.92
40H 541	126-810	20	4	16	Cable socket	2.53	1.68

Amphenol AN Connectors



AN 3100A



AN 3101A



AN 3102A



AN 3106A



AN 3106B



AN 3108A

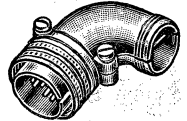

AN 3108B

AN OR MS MARKING—MEET ARMY-NAVY SPECIFICATIONS

Amphenol "AN" connectors for use in aircraft and other critical applications. The connectors you receive will have either the "AN" markings or the government's new "MS" markings—connectors with the same numerical designations are identical in every respect whether marked "AN" or "MS". **Explanation of type nos.:** E.g., Type 3102A-20-7P. Letter "A" after first 4 digits indicates solid shell (letter "B" would mean split shell), "20" indicates shell size in 16ths of an inch; "20" means 20/16, or 1 1/4". The final letter "P" indicates male contacts (pins); type numbers ending in "S" indicate female contacts (sockets). Av. shpg. wt., 6 oz.

ALLIED STOCKS ALL AMPHENOL AN CONNECTORS

Allied can supply any Amphenol Type AN (MS) connector directly from stock. Only the most popular types are listed below. To order any type not listed, give complete Amphenol Type No. and description. Write for special prices on quantities of 50 or more of any one type.

Size 8S

Stock No.	"AN" Type	Contacts	NET
39H 700	3102A-8S-1P	1	.54
39H 701	3106A-8S-1P	1	.75
39H 702	3108A-8S-1P	1	1.16
39H 703	3102A-8S-1S	1	.53

Size 10S

Stock No.	"AN" Type	Contacts	NET
39H 704	3102A-10S-2P	2	.44
39H 705	3102A-10S-2S	1	.44
39H 706	3106A-10S-2S	1	.64
39H 707	3108B-10S-2S	1	.93

Size 10SL

Stock No.	"AN" Type	Contacts	NET
39H 708	3106A-10SL-4S	2	.86
39H 709	3106A-10SL-3P	3	.69
39H 710	3101A-10SL-3P	3	.73
39H 711	3101A-10SL-3S	3	.57
39H 712	3106A-10SL-3S	3	.75
39H 713	3102A-10SL-4P	4	.47
39H 714	3108A-10SL-4S	2	1.30
39H 715	3108B-10SL-4S	2	1.03

Size 12SL

Stock No.	"AN" Type	Contacts	NET
39H 716	3106A-12SL-84S	4	2.40

Size 12S

Stock No.	"AN" Type	Contacts	NET
39H 717	3102A-12S-3P	2	.44
39H 718	3106A-12S-3P	2	.75
39H 719	3108A-12S-3P	2	1.16
39H 720	3102A-12S-3S	2	.71
39H 721	3102A-12S-3S	2	.47
39H 722	3106A-12S-3S	2	.78
39H 723	3108A-12S-3S	2	1.30
39H 724	3108B-12S-3S	2	1.05
39H 725	3102A-12S-4P	1	.46
39H 726	3106A-12S-4S	1	.78
39H 727	3108B-12S-4S	1	1.05

Size 14S

Stock No.	"AN" Type	Contacts	NET
39H 729	3102A-14S-1P	3	.62
39H 730	3106A-14S-1P	3	.93
39H 731	3102A-14S-1S	3	.66
39H 732	3106A-14S-1S	3	.96
39H 733	3108A-14S-1S	3	1.52
39H 734	3108B-14S-1S	3	1.10
39H 735	3102A-14S-2P	4	.93
39H 737	3106A-14S-2P	4	1.25
39H 738	3108A-14S-2P	4	1.49
39H 739	3108B-14S-2P	4	.93
39H 740	3101A-14S-2S	4	.96
39H 741	3102A-14S-2S	4	.71
39H 742	3106A-14S-2S	4	1.01
39H 743	3108A-14S-2S	4	1.34
39H 744	3108B-14S-2S	4	1.15
39H 746	3102A-14S-4S	4	.56
39H 747	3101A-14S-5P	5	1.00
39H 748	3102A-14S-5P	5	.73
39H 749	3106A-14S-5P	5	1.05
39H 750	3108A-14S-5P	5	1.00
39H 751	3102A-14S-5S	5	.76
39H 752	3106A-14S-5S	5	1.08
39H 753	3108B-14S-5S	5	1.40
39H 754	3108A-14S-5S	5	1.64
39H 755	3108B-14S-5S	5	1.21
39H 756	3102A-14S-6P	6	.83
39H 757	3106A-14S-6S	6	1.15
39H 758	3108B-14S-6S	6	1.27
39H 759	3102A-14S-7P	3	.62
39H 760	3106A-14S-7P	3	.93
39H 761	3101A-14S-7S	3	.91

Size 14S (cont'd)

Stock No.	"AN" Type	Contacts	NET
39H 762	3102A-14S-7S	3	.66
39H 763	3106A-14S-7S	3	.96
39H 764	3108A-14S-7S	3	1.52
39H 765	3108B-14S-7S	3	1.10
39H 766	3101A-14S-9P	2	.83
39H 767	3102A-14S-9P	2	.57
39H 768	3106A-14S-9P	2	.88
39H 769	3102A-14S-9S	2	.61
39H 770	3106A-14S-9S	2	.91
39H 771	3108B-14S-9S	2	1.05

Size 16

Stock No.	"AN" Type	Contacts	NET
39H 772	3106A-16-10P	3	1.18
39H 773	3101A-16-11P	2	1.01
39H 774	3102A-16-11S	2	.62
39H 775	3106A-16-11S	2	1.22
39H 776	3106A-16-12P	1	1.44

Size 16S

Stock No.	"AN" Type	Contacts	NET
39H 777	3101A-16S-1P	7	1.10
39H 778	3106A-16S-1P	7	.78
39H 779	3108B-16S-1P	7	1.15
39H 780	3108B-16S-1P	7	1.45
39H 781	3102A-16S-1S	7	1.01
39H 782	3102A-16S-1S	7	.76
39H 783	3106A-16S-1S	7	1.13
39H 784	3106B-16S-1S	7	1.52
39H 785	3108B-16S-1S	7	1.44
39H 786	3102A-16S-5P	3	.59
39H 787	3106A-16S-5S	3	1.05
39H 788	3106A-16S-6P	3	1.01
39H 789	3102A-16S-8P	5	.75
39H 790	3106A-16S-8S	5	.75
39H 791	3102A-16S-8S	5	1.11

Size 18

Stock No.	"AN" Type	Contacts	NET
39H 792	3102A-18-1P	10	1.10
39H 793	3106A-18-1P	10	1.54
39H 794	3108A-18-1P	10	.96
39H 795	3100A-18-1S	10	1.40
39H 796	3102A-18-1S	10	1.18
39H 797	3106A-18-1S	10	1.62
39H 798	3106B-18-1S	10	2.14
39H 799	3108A-18-1S	10	2.62
39H 800	3108B-18-1S	10	2.04
39H 801	3102A-18-3P	2	.73
39H 802	3106A-18-3S	2	1.35
39H 803	3102A-18-4P	4	.78
39H 804	3106A-18-4P	4	1.22
39H 805	3102A-18-4S	4	.88
39H 806	3106A-18-4S	4	1.32
39H 807	3102A-18-8P	8	1.03
39H 808	3106A-18-8P	8	1.47
39H 809	3102A-18-8S	8	1.20
39H 810	3106A-18-8S	8	1.64
39H 811	3102A-18-9P	7	1.00
39H 812	3106A-18-9P	7	1.44
39H 813	3100A-18-9S	7	1.37
39H 814	3106A-18-9S	7	1.59
39H 815	3102A-18-11P	5	1.53
39H 816	3106A-18-11P	5	1.47
39H 817	3102A-18-12P	6	1.34
39H 818	3102A-18-12S	6	1.03
39H 819	3106A-18-12S	6	1.47
39H 820	3102A-18-15S	4	2.68
39H 821	3102A-18-16S	1	1.10

Size 20

Stock No.	"AN" Type	Contacts	NET
39H 822	3102A-20-4P	4	.98
39H 823	3106A-20-4S	4	1.78
39H 824	3102A-20-7P	8	1.08
39H 825	3106A-20-7P	8	1.64
39H 826	3101A-20-7S	8	1.60

Size 20 (cont'd)

Stock No.	"AN" Type	Contacts	NET
39H 827	3102A-20-7S	8	1.20
39H 828	3106A-20-7S	8	1.74
39H 829	3102A-20-9P	8	1.18
39H 830	3106A-20-11P	13	1.86
39H 831	3102A-20-11S	13	2.33
39H 832	3102A-20-15P	7	1.22
39H 833	3106A-20-15P	7	1.78
39H 834	3102A-20-15S	7	1.78
39H 835	3102A-20-16P	9	1.06
39H 836	3106A-20-16P	9	1.62
39H 837	3102A-20-18P	9	1.21
39H 838	3102A-20-18S	9	1.40
39H 839	3102A-20-27P	14	1.40
39H 840	3106A-20-27P	14	1.96
39H 841	3106B-20-27P	14	2.33
39H 842	3108B-20-27P	14	2.42
39H 843	3100A-20-27S	14	1.70
39H 844	3102A-20-27S	14	1.07
39H 845	3106A-20-27S	14	2.07
39H 846	3106B-20-27S	14	2.38
39H 847	3108A-20-27S	14	3.18
39H 848	3108B-20-27S	14	2.47
39H 849	3102A-20-29P	17	1.59
39H 850	3106A-20-29P	17	2.14
39H 851	3102A-20-29S	17	1.60
39H 852	3106A-20-29S	17	2.16

Size 22

Stock No.	"AN" Type	Contacts	NET
39H 853	3102A-22-5P	6	1.08
39H 854	3106A-22-5P	6	2.22
39H 855	3100A-22-14P	19	2.01
39H 856	3102A-22-14P	19	1.69
39H 857	3106A-22-14P	19	2.35
39H 858	3108B-22-14P	19	2.76
39H 859	3100A-22-14S	19	2.27
39H 860	3102A-22-14S	19	1.89
39H 861	3106A-22-14S	19	2.77
39H 862	3106B-22-14S	19	3.07
39H 863	3108A-22-14S	19	3.74
39H 864	3108B-22-14S	19	2.97
39H 865	3106A-22-18P	8	1.94
39H 866	3102A-22-18S	8	1.30
39H 867	3102A-22-19P	14	1.50
39H 868	3102A-22-19S	14	1.57
39H 869	3106A-22-23P	8	2.53
39H 870	3102A-22-23S	8	1.99
39H 871	3102A-22-23S	8	1.83

Size 24

Stock No.	"AN" Type	Contacts	NET
39H 872	3106A-24-5P	16	2.32
39H 873	3102A-24-5S	16	1.88
39H 874	3106A-24-5S	16	2.62

Amphenol Connectors

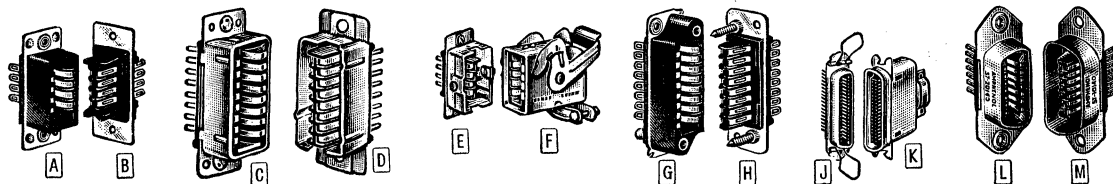

BLUE RIBBON CONNECTORS

Amphenol Type 26 Blue Ribbon connectors for heavy-duty operation. Provide an excellent solution to multi-circuit connection, switching and re-routing problems. Unique, self-cleaning spring contacts maintain continuity even under conditions of severe vibration. Do not require visual alignment—ideal for use in hidden, hard-to-reach locations. Positive polarization prevents mis mating of connectors. Feature low insertion and withdrawal force, but provide exceptionally firm, positive contact. Exclusive spring-tension contacts are heavily silver base plated and gold finished; will not tarnish or corrode. Plug contacts are supported

their full length on the dielectric. Dielectric configuration makes it impossible to overstress or fatigue contacts and individual protective barrier between each spring member insures proper spacing. Bodies are diallyl phthalate blue dielectric and meet government specifications. Have high insulation resistance and stability. Mounting plates are made of corrosion-resistant stainless steel and are molded into the body. 4301 Series has end cable outlet; 4501 Series has side cable outlet. S in Type No. indicates socket contacts; P indicates plug contacts. For wire size up to No. 16. Rated 5 amperes at 600 v., DC. Av. shgp. wt., 5 oz.

TYPE 26 BARRIER POLARIZATION TYPES

Contacts	(B) MALE				(A) FEMALE			
	Stock No.	Mfr's Type	NET EACH		Stock No.	Mfr's Type	NET EACH	
			1-9	10-49			1-9	10-49
8	40 H 542	182	1.02	.76	40 H 543	183	1.64	1.22
8	40 H 660	4100-8P			40 H 665	4200-8S	1.57	1.18
16	40 H 661	4100-16P	1.78	1.34	40 H 666	4200-16S	2.25	1.70
24	40 H 662	4100-24P	2.13	1.60	40 H 666	4200-24S	2.71	2.04
32	40 H 663	4100-32P	2.51	1.88	40 H 667	4200-32S	3.20	2.40

TYPE 26 BARRIER POLARIZED CONNECTORS WITH KEYPED SHELLS

Contacts	(D) MALE				(C) FEMALE			
	Stock No.	Mfr's Type	NET EACH		Stock No.	Mfr's Type	NET EACH	
			1-9	10-49			1-9	10-49
8	40 H 650	4101-8P	1.88	1.41	40 H 671	4201-8S	2.16	1.62
16	40 H 651	4101-16P	2.82	2.12	40 H 672	4201-16S	2.94	2.20
24	40 H 652	4101-24P	3.25	2.45	40 H 673	4201-24S	3.51	2.63
32	40 H 653	4101-32P	3.74	2.81	40 H 674	4201-32S	4.10	3.07

TYPE 26 BARRIER POLARIZED CONNECTORS WITH KEYPED LATCH SHELLS

Contacts	(E) PLUGS				(F) MATING RECEPTACLES			
	Stock No.	Mfr's Type	NET EACH		Stock No.	Mfr's Type	NET EACH	
			1 to 9	10 to 49			1 to 9	10 to 49
8	40 H 610	4301-8S	5.44	4.09	40 H 618	4401-8P	2.92	2.19
8	40 H 614	4501-8P	4.93	3.63	40 H 619	4401-8S	3.53	2.65
16	40 H 611	4301-16S	6.23	4.90	40 H 620	4401-16P	3.86	2.89
16	40 H 615	4501-16P	6.06	4.55	40 H 621	4401-16S	4.33	3.25
24	40 H 612	4301-24S	7.38	5.54	40 H 622	4401-24P	4.31	3.23
24	40 H 616	4501-24P	6.79	5.10	40 H 623	4401-24S	4.90	3.67
32	40 H 613	4301-32S	8.26	6.19	40 H 630	4401-32P	4.79	3.60
32	40 H 617	4501-32P	7.55	5.66	40 H 631	4401-32S	5.49	4.12

PRINTED CIRCUIT CONNECTORS AND PLUGS

Series 143 Printed Circuit Connectors. High-quality connectors for use in printed circuit networks. Printed circuit board acts as male part of connector. Ideal for use in computers, telephone equipment, military gear, etc. Specially designed to resist set or over-stress—even after repeated insertions. Blue dielectric, gold-plated contacts. All units accept .061" to .071" printed circuit boards. Av. shgp. wt., 2 oz.

Stock No.	Mfr's Type	Contacts	NET EACH	
			1-9	10-49
40 H 503	143-010-01	10	1.15	.86
40 H 500	143-015-01	15	1.54	1.16
40 H 501	143-018-01	18	1.68	1.25
40 H 502	143-022-01	22	2.00	1.50

Series 133 Printed Circuit Plugs. New selection of dependable plugs and adapters. Recommended for use with standard 143 series printed circuit connectors listed at left. Have molded diallyl phthalate body, molded nylon guide pins, brass cadmium-plated end caps and brass contacts with gold over albaloz plating. Average voltage rating 2300 v. rms at 50 cps; current rating exceeds or surpasses any printed circuit wiring board requirement. All units are polarized. Av. shgp. wt., 2 oz.

Stock No.	Mfr's Type	Contacts	NET EACH	
			1-9	10-49
41 H 085	133-010-21	10	1.80	1.35
41 H 086	133-015-21	15	2.11	1.59
41 H 087	133-018-21	18	2.35	1.76
41 H 088	133-022-21	22	2.57	1.93

SERIES 165 AN-TYPE CONNECTORS

The Amphenol Series 165 electrical connectors feature compact design and complete dependability. Two sizes are available—a small size with 5, 9 or 12 contacts and a large size with 11, 14 or 24 contacts. All connectors are available with either male or female inserts installed in plug or receptacle. Connectors remain waterproof whether mated or apart. Bronze contacts are gold-plated over a silver base and shells are made of aluminum. Small receptacles mount in 1 1/8" hole and are secured through 4, 125" equally spaced holes on the flange. Flange is only 1/8" square. Large receptacles mount in 1 1/8" hole and are secured through 4, 125" equally spaced holes on a 1 1/2" square flange. Plugs are approximately 3/16" long. Small sized plug is 3/8" diameter and large sized plug is 1/2" diameter. All are rated at 500 volts rms except *600 volts rms. All plugs have built-in, strain-relief, cable clamps. Av. shgp. wt., 3 oz. Quantity prices on 50 or more of any type—write for prices.

SMALL SHELL—5 No. 20 AWG				
Stock No.	Type No.	Contacts and Ampere Rating	Description	NET EACH
40 H 595	165-33	*5 @ 7.5	Male Plug	3.14
40 H 596	165-34	*5 @ 7.5	Female Plug	3.53
40 H 597	165-35	*5 @ 7.5	Male Receptacle	2.40
40 H 598	165-36	*5 @ 7.5	Female Receptacle	2.82
SMALL SHELL—9 No. 20 AWG				
40 H 579	165-13	9 @ 7.5	Male Plug	3.26
40 H 580	165-14	9 @ 7.5	Female Plug	3.88
40 H 581	165-15	9 @ 7.5	Male Receptacle	2.56
40 H 582	165-16	9 @ 7.5	Female Receptacle	3.18
SMALL SHELL—12 No. 20 AWG				
40 H 575	165-9	12 @ 7.5	Male Plug	3.40
40 H 576	165-10	12 @ 7.5	Female Plug	4.21
40 H 577	165-11	12 @ 7.5	Male Receptacle	2.71
40 H 578	165-12	12 @ 7.5	Female Receptacle	3.51

Large receptacles mount in 1 1/8" hole and are secured through 4, 125" equally spaced holes on a 1 1/2" square flange. Plugs are approximately 3/16" long. Small sized plug is 3/8" diameter and large sized plug is 1/2" diameter. All are rated at 500 volts rms except *600 volts rms. All plugs have built-in, strain-relief, cable clamps. Av. shgp. wt., 3 oz. Quantity prices on 50 or more of any type—write for prices.

LARGE SHELL—4 No. 16 & 7 No. 20 AWG				
Stock No.	Type No.	Contacts and Ampere Rating	Description	NET EACH
40 H 583	165-17	4 @ 17; 7 @ 7.5	Male Plug	4.48
40 H 584	165-18	4 @ 17; 7 @ 7.5	Female Plug	5.36
40 H 585	165-19	4 @ 17; 7 @ 7.5	Male Receptacle	2.96
40 H 586	165-20	4 @ 17; 7 @ 7.5	Female Receptacle	3.77
LARGE SHELL—14 No. 16 AWG				
40 H 591	165-29	14 @ 17	Male Plug	4.64
40 H 592	165-30	14 @ 17	Female Plug	5.73
40 H 593	165-31	14 @ 17	Male Receptacle	3.07
40 H 594	165-32	14 @ 17	Female Receptacle	4.16
LARGE SHELL—24 No. 20 AWG				
40 H 587	165-25	24 @ 7.5	Male Plug	5.34
40 H 588	165-26	24 @ 7.5	Female Plug	6.84
40 H 589	165-27	24 @ 7.5	Male Receptacle	3.77
40 H 590	165-28	24 @ 7.5	Female Receptacle	5.25

Cinch-Jones Terminals & Fanning Strips

FANNING STRIPS

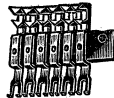

For neat, highly dependable terminal wiring. Insure correct, positive firm connections. Ideal for cable or harness wiring. These units simplify assembly—connections can be made before putting strip into assembly. Facilitate disconnecting sub-assemblies for servicing. Last letter in Type No. indicates right or left mounting hole position. Laminated bakelite. Terminals made of .032" thick brass. Av. shgp. wt., 3 oz.

Series 160L. Fit Series 140 barrier terminals at right. Terminals are mounted on $\frac{3}{8}$ " bakelite, $\frac{1}{2}$ " wide and on $\frac{3}{8}$ " centers.

Stock No.	Mfr's Type	Term.	NET EACH		
			1-24	25-99	100-499
41 H 808	2-160L	2	8¢	7¢	6½¢
41 H 809	3-160L	3	12¢	11¢	10¢
41 H 812	4-160L	4	15¢	13¢	12½¢
41 H 813	5-160L	5	19¢	17¢	16¢
41 H 814	6-160L	6	23¢	21¢	20¢
41 H 817	8-160L	8	30¢	28¢	26¢
41 H 818	10-160L	10	37¢	34¢	32¢
41 H 819	12-160L	12	45¢	40¢	38¢

Series 160R. Fit Series 140 barrier terminals at right. Terminals are mounted on $\frac{3}{8}$ " bakelite, $\frac{1}{2}$ " wide and on $\frac{3}{8}$ " centers.

Stock No.	Mfr's Type	Term.	NET EACH		
			1-24	25-99	100-499
40 H 956	2-160R	2	8¢	7¢	6½¢
40 H 957	3-160R	3	12¢	11¢	10¢
40 H 958	4-160R	4	16¢	14¢	12½¢
40 H 959	5-160R	5	19¢	17¢	16¢
40 H 960	6-160R	6	23¢	21¢	20¢
40 H 961	8-160R	8	30¢	28¢	26¢
40 H 962	10-160R	10	37¢	34¢	32¢
40 H 963	12-160R	12	45¢	40¢	38¢

Series 161L. Fit Series 141 barrier terminals at right. Terminals are mounted on $\frac{1}{2}$ " bakelite, $\frac{5}{8}$ " wide and on $\frac{1}{2}$ " centers.

Stock No.	Mfr's Type	Term.	NET EACH		
			1-24	25-99	100-499
41 H 822	2-161L	2	8¢	7½¢	7¢
41 H 823	3-161L	3	13¢	11¢	10½¢
41 H 824	4-161L	4	16¢	14¢	13¢
41 H 827	5-161L	5	20¢	18¢	16½¢
41 H 828	6-161L	6	24¢	22¢	20¢
41 H 829	8-161L	8	30¢	27¢	26¢
41 H 832	10-161L	10	38¢	34¢	32½¢
41 H 833	12-161L	12	45¢	40¢	38½¢

Series 161R. Fit Series 141 barrier terminals at right. Terminals are mounted on $\frac{1}{2}$ " bakelite, $\frac{5}{8}$ " wide and on $\frac{1}{2}$ " mounting centers.

Stock No.	Mfr's Type	Term.	NET EACH		
			1-24	25-99	100-499
40 H 964	2-161R	2	8¢	7½¢	7¢
40 H 965	3-161R	3	13¢	11¢	10½¢
40 H 966	4-161R	4	16¢	14¢	13¢
40 H 967	5-161R	5	20¢	18¢	16½¢
40 H 968	6-161R	6	24¢	22¢	20¢
40 H 969	8-161R	8	30¢	27¢	26¢
40 H 970	10-161R	10	38¢	34¢	32½¢
40 H 971	12-161R	12	45¢	40¢	38½¢

Series 162L. Fit Series 142 barrier terminals at right. Terminals are mounted on $\frac{3}{8}$ " bakelite, $\frac{5}{8}$ " wide and on $\frac{3}{8}$ " centers.

Stock No.	Mfr's Type	Term.	NET EACH		
			1-24	25-99	100-499
41 H 834	2-162L	2	10¢	9¢	8½¢
41 H 843	3-162L	3	14¢	13¢	11½¢
41 H 844	4-162L	4	17¢	15¢	14½¢
41 H 845	5-162L	5	21¢	19¢	17½¢
41 H 846	6-162L	6	25¢	23¢	21½¢
41 H 847	8-162L	8	32¢	29¢	27½¢
41 H 848	10-162L	10	40¢	36¢	34¢
41 H 849	12-162L	12	47¢	42¢	40¢

Series 162R. Fit Series 142 barrier terminals at right. Terminals are mounted on $\frac{3}{8}$ " bakelite, $\frac{5}{8}$ " wide and on $\frac{3}{8}$ " centers.

Stock No.	Mfr's Type	Term.	NET EACH		
			1-24	25-99	100-499
40 H 972	2-162R	2	10¢	9¢	8½¢
40 H 973	3-162R	3	14¢	13¢	11½¢
40 H 974	4-162R	4	17¢	15¢	14½¢
40 H 975	5-162R	5	21¢	19¢	17½¢
40 H 976	6-162R	6	25¢	23¢	21½¢
40 H 977	8-162R	8	32¢	29¢	27½¢
40 H 978	10-162R	10	40¢	36¢	34¢
40 H 979	12-162R	12	47¢	42¢	40¢

CABLE CLAMPS



Cable clamps for fanning strips above. Made of nickel-plated brass, with 6-32 round head screws. Serve as strain relief and anchor cable securely. Sizes shown are I.D. Shgp. wt., 2 oz.

Stock No.	Mfr's Type	Size	NET EACH		
			1-24	25-99	100-499
41 H 852	CC-161-4	$\frac{1}{2}$ "			
41 H 853	CC-161-6	$\frac{3}{8}$ "	8¢	7½¢	7¢
41 H 854	CC-161-8	$\frac{1}{2}$ "			
41 H 857	CC-161-10	$\frac{3}{8}$ "	8¢	7½¢	7¢
41 H 858	CC-161-12	$\frac{3}{8}$ "			
41 H 859	CC-161-14	$\frac{3}{8}$ "			

SERIES 2000 TERMINAL STRIPS



Terminals are made of .019" brass, tin-plated, and spaced on $\frac{3}{8}$ " centers. Molded bakelite insulation. Mounting brackets are made of cadmium-plated steel. Mounting holes at each end of bracket. Av. shgp. wt., 2 oz.

Stock No.	Mfr's Type	Term.	Mtg. Ctrs.	NET EACH		
				1-24	25-99	100-499
41 H 687	2002	2	1"	6¢	5½¢	5¢
41 H 688	2003	3	1½"	6¢	6¢	6¢
41 H 689	2004	4	1½"	8¢	7¢	6½¢
41 H 690	2005	5	1½"	9¢	8¢	7½¢
41 H 691	2006	6	2¼"	10¢	9¢	8¢
41 H 693	2008	8	2½"	11¢	10¢	9½¢
41 H 695	2010	10	3½"	13¢	12¢	11¢
41 H 697	2012	12	4½"	15¢	14¢	12½¢

BARRIER TERMINALS



Barriers between each terminal provide increased insulation. Excellent for industrial and experimental applications. Barriers follow edge of strips and terminate at base. Make a long leakage path and prevent direct shorts caused by frayed wires at the terminals. Base is molded bakelite, with mounting holes at ends. Eyelets and binder screws of nickel-plated brass; terminals of hot tin-finish brass. Barrier-type terminals and fanning strips, when used together, insure positive contact and firm connections. No. 140 terminal strips have 5-40x $\frac{3}{16}$ " binder head screws, $\frac{1}{4}$ " metal-to-metal spacing. No. 141 terminal strips have 6-32x $\frac{1}{4}$ " binder head screws, $\frac{3}{16}$ " metal-to-metal spacing. No. 142 terminal strips have 8-32x $\frac{3}{16}$ " binder head screws, $\frac{3}{16}$ " metal-to-metal spacing. Av. shgp. wt., 5 oz.

Series 140. Metal-to-metal spacing over bakelite $\frac{1}{4}$ ". Base $\frac{7}{8}$ " wide x $\frac{3}{8}$ " high. $\frac{3}{8}$ " centers. Use with Series 160 fanning strips.

Stock No.	Mfr's Type	Term.	NET EACH		
			1-24	25-99	100-499
41 H 580	1-140	1	.09	.08	.075
41 H 800	2-140	2	.14	.13	.12
41 H 801	3-140	3	.20	.18	.165
41 H 803	4-140	4	.24	.23	.21
41 H 807	5-140	5	.30	.28	.25
41 H 802	6-140	6	.34	.31	.30
41 H 581	7-140	7	.40	.36	.34
41 H 804	8-140	8	.45	.41	.39
41 H 582	9-140	9	.51	.45	.43
41 H 805	10-140	10	.56	.50	.48
41 H 583	11-140	11	.61	.55	.52
41 H 806	12-140	12	.66	.60	.56
41 H 584	13-140	13	.72	.64	.61
41 H 585	14-140	14	.77	.69	.66
41 H 586	15-140	15	.82	.74	.70
41 H 587	16-140	16	.87	.78	.75
41 H 588	17-140	17	.92	.83	.79
41 H 589	18-140	18	.98	.88	.83
41 H 590	19-140	19	1.03	.93	.88
41 H 591	20-140	20	1.08	.97	.92
41 H 592	21-140	21	1.14	1.02	.97

Series 141. Metal-to-metal spacing over bakelite $\frac{3}{8}$ ". Base $1\frac{1}{8}$ " wide x $\frac{1}{2}$ " high. $\frac{1}{2}$ " centers. Use with Series 161 fanning strips.

Stock No.	Mfr's Type	Term.	NET EACH		
			1-24	25-99	100-499
41 H 835	2-141	2	.19	.17	.16
41 H 836	3-141	3	.24	.22	.21
41 H 837	4-141	4	.31	.28	.27
41 H 842	5-141	5	.37	.35	.33
41 H 838	6-141	6	.44	.40	.38
41 H 839	8-141	8	.58	.52	.50
41 H 840	10-141	10	.72	.65	.61
41 H 841	12-141	12	.84	.78	.74
41 H 876	14-141	14	.98	.88	.82
41 H 877	16-141	16	1.12	1.01	.95
41 H 878	18-141	18	1.24	1.12	1.07
41 H 879	20-141	20	1.38	1.24	1.18

Series 142. Metal-to-metal spacing over bakelite $\frac{5}{8}$ ". Base $1\frac{1}{8}$ " wide x $\frac{1}{2}$ " high. $\frac{3}{8}$ " centers. Use with Series 162 fanning strips.

Stock No.	Mfr's Type	Term.	NET EACH		
			1-24	25-99	100-499
41 H 670	2-142	2	.22	.20	.18
41 H 671	3-142	3	.30	.28	.26
41 H 672	4-142	4	.38	.34	.33
41 H 673	5-142	5	.46	.42	.39
41 H 674	6-142	6	.54	.49	.46
41 H 676	8-142	8	.71	.64	.60
41 H 678	10-142	10	.87	.78	.75
41 H 680	12-142	12	1.04	.94	.88
41 H 881	13-142	13	1.12	1.01	.95
41 H 882	14-142	14	1.20	1.08	1.02
41 H 883	15-142	15	1.28	1.16	1.11
41 H 884	16-142	16	1.36	1.22	1.16
41 H 886	17-142	17	1.44	1.29	1.23

ADAPTER SOLDER TERMINALS

Adapt barrier strips (listed above) to permit top-side or underside solder connections. Type $\frac{3}{4}$ W permits top-side soldering to barrier terminals; Type Y is for underside solder connections. Made of brass; hot-tin finish. Assure positive solder connections. Fasten securely under binder head screws. Av. shgp. wt., per 10, 3 oz.

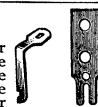

TYPE $\frac{3}{4}$ W				TYPE Y			
Stock No.	Mfr's Type	For Series	Pkg. of 10	Stock No.	Mfr's Type	For Series	Pkg. of 10
41 H 887	$\frac{3}{4}$ W-140	140	29¢	41 H 891	Y-140	140	29¢
41 H 888	$\frac{3}{4}$ W-141	141	34¢	41 H 892	Y-141	141	34¢
41 H 889	$\frac{3}{4}$ W-142	142	42¢	41 H 893	Y-142	142	42¢

SERIES 170 TERMINAL STRIPS

Terminal strips with extra-heavy solder terminals. Ideal for industrial users, experimental labs, etc. Black molded bakelite insulation, $\frac{3}{8}$ " wide, $\frac{1}{4}$ " thick. Terminals are mounted on $\frac{3}{8}$ " centers. Mounting holes are $\frac{3}{8}$ " from center of end terminals. Terminals are .032" brass, tin plated. Double-notched solder terminals for rapid soldering or wrap-around connections. Compact, sturdy units. Av. shgp. wt., 5 oz.



Stock No.	Type	Term.	NET EACH		
			1-24, EA.	25-99, EA.	100-499, EA.
40 H 990	1-170	1	14¢	13¢	12½¢
40 H 991	2-170	2	19¢	17¢	15½¢
40 H 992	3-170	3	22¢	20¢	18¢
40 H 993	4-170	4	26¢	23¢	21¢
40 H 994	5-170	5	29¢	26¢	25¢
40 H 995	6-170	6	33¢	30¢	28¢
40 H 996	7-170	7	36¢	33¢	31¢
40 H 997	8-170	8	39¢	35¢	34¢
40 H 998					

Cinch-Jones Plugs and Sockets

SERIES 300 PLUGS & SOCKETS

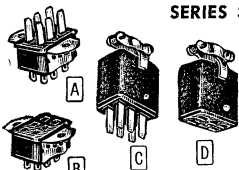

Compact units rated 730 volts rms at 10 amps. Metal caps; bakelite body. Phosphor-bronze socket contacts engage both sides of plug contacts. Units are polarized; plugs with 24 or more contacts have positioning pin. Plug contacts are 3/32" wide by 3/64" thick. *Round shell; others rectangular. Av. shpg. wt., 3 oz.

TYPE AB FOR CHASSIS MOUNTING

A PLUGS

Contacts	Stock No.	Type	1-24, EA.	25-99, EA.	100-499, EA.
2	40 H 870*	P-302-AB	.19	.17	.16
3	40 H 871	P-303-AB	.24	.23	.20
4	40 H 872	P-304-AB	.25	.23	.22
6	40 H 873	P-306-AB	.31	.28	.27
8	40 H 874	P-308-AB	.37	.34	.32
10	40 H 875	P-310-AB	.42	.38	.365
12	40 H 876	P-312-AB	.48	.43	.405
15	40 H 816	P-315-AB	.63	.57	.535
18	40 H 817	P-318-AB	.78	.71	.665
21	40 H 818	P-321-AB	.98	.88	.835
24	40 H 819	P-324-AB	1.19	1.07	1.01
27	40 H 820	P-327-AB	1.40	1.26	1.19
30	40 H 821	P-330-AB	1.61	1.45	1.36
33	40 H 822	P-333-AB	1.80	1.63	1.53

B SOCKETS

Contacts	Stock No.	Type	1-24, EA.	25-99, EA.	100-499, EA.
2	40 H 880*	S-302-AB	.21	.19	1.75
3	40 H 881	S-303-AB	.24	.23	.21
4	40 H 882	S-304-AB	.27	.24	.235
6	40 H 883	S-306-AB	.34	.31	.31
8	40 H 884	S-308-AB	.43	.39	.365
10	40 H 885	S-310-AB	.51	.46	.43
12	40 H 886	S-312-AB	.59	.53	.505
15	40 H 864	S-315-AB	.71	.66	.62
18	40 H 865	S-318-AB	.88	.79	.75
21	40 H 866	S-321-AB	1.09	.98	.925
24	40 H 867	S-324-AB	1.29	1.17	1.10
27	40 H 868	S-327-AB	1.50	1.35	1.27
30	40 H 869	S-330-AB	1.71	1.54	1.46
33	40 H 877	S-333-AB	1.92	1.72	1.63

TYPE CCT WITH CABLE CLAMP

C PLUGS

Contacts	Stock No.	Type	1-24, EA.	25-99, EA.	100-499, EA.
2	40 H 802*	P-302-CCT	.43	.39	.37
3	40 H 803	P-303-CCT	.46	.42	.395
4	40 H 804	P-304-CCT	.51	.45	.43
6	40 H 806	P-306-CCT	.56	.50	.475
8	40 H 808	P-308-CCT	.62	.56	.525
10	40 H 810	P-310-CCT	.69	.62	.585
12	40 H 812	P-312-CCT	.75	.68	.64
15	40 H 813	P-315-CCT	.98	.88	.835
18	40 H 807	P-318-CCT	1.19	1.07	1.01
21	40 H 809	P-321-CCT	1.40	1.25	1.19
24	40 H 811	P-324-CCT	1.66	1.49	1.40
27	40 H 813	P-327-CCT	1.87	1.69	1.59
30	40 H 814	P-330-CCT	2.18	1.96	1.85
33	40 H 815	P-333-CCT	2.33	2.10	1.98

D SOCKETS

Contacts	Stock No.	Type	1-24, EA.	25-99, EA.	100-499, EA.
2	40 H 852*	S-302-CCT	.44	.40	.375
3	40 H 853	S-303-CCT	.48	.43	.405
4	40 H 854	S-304-CCT	.54	.46	.435
6	40 H 856	S-306-CCT	.59	.53	.50
8	40 H 858	S-308-CCT	.69	.62	.58
10	40 H 860	S-310-CCT	.76	.69	.65
12	40 H 862	S-312-CCT	.87	.78	.745
15	40 H 850	S-315-CCT	1.09	.98	.925
18	40 H 851	S-318-CCT	1.29	1.17	1.10
21	40 H 855	S-321-CCT	1.50	1.35	1.25
24	40 H 857	S-324-CCT	1.77	1.60	1.50
27	40 H 859	S-327-CCT	1.98	1.78	1.65
30	40 H 861	S-330-CCT	2.28	2.06	1.94
33	40 H 863	S-333-CCT	2.44	2.20	2.07

SUB-MINIATURE SOCKETS

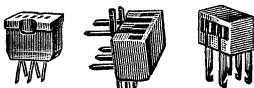

Used extensively for miniature radios and transmitters, hearing aids and other electronic equipment employing subminiature tubes. Molded from mica-filled low-loss bakelite. Silver-plated beryllium copper contacts. 4-prong tubes and G.E. transistors G11 and G11A fit 2H5 socket. All 3/32" deep. Shpg. wt., 2 oz.

Stock No.	Type	Contacts	1-9, EA.	10-49, EA.	50-99, EA.
40 H 294	2H3	3	.20	.18	.165
40 H 245	2H5	5	.27	.24	.23
40 H 247	2H7	7	.30	.27	.24
40 H 242	8SM	8	.52	.47	

Transistor Types. 5-contact sockets for transistors. Use type 5PC for printed circuits and 5WC for wired circuits. Av. shpg. wt., 2 oz.

Stock No.	Type	Size	1-9, EA.	10-49, EA.	50-99, EA.
40 H 249	5WC	3/8x7/32x1 1/4"	.39	.35	.32
40 H 252	5PC	3/4x1 1/4x5/16"	.46	.42	.39
40 H 253		1 1/2x3/8x5/16"	1.48	1.33	1.22

SERIES 400 AND 2400 PLUGS & SOCKETS

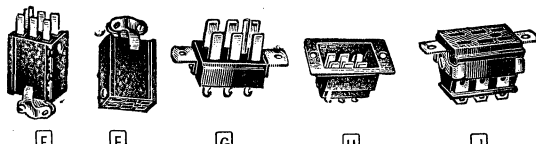

Heavy-duty multiple-circuit type plugs and sockets. Series 400 rated at 1100 rms volts, 15 amps; series 2400 rated at 1700 rms volts, 15 amps. All have polarizing pins. Plug contact prongs are 1/4" wide by 1/16" thick. Bodies bakelite. Phosphor-bronze socket contacts engage both sides of flat plug contact prongs to minimize contact resistance. Series 2400 improved design offers longer leakage path permitting use on higher operating voltages. 2400 series plugs and sockets can be mated with 400 series. They are interchangeable mechanically, differing only in voltage ratings. Cap or panel mounting. *Similar to Fig. J. †Type DB recessed plugs take Type CCT (Fig. F) sockets. Av. shpg. wt., 5 oz.

TYPE CCT WITH CABLE CLAMP

E PLUGS

Contacts	Stock No.	Type	1-24, EA.	25-99, EA.	100-499, EA.
2	40 H 910	P-402-CCT	.73	.66	.62
4	40 H 911	P-404-CCT	.89	.80	.755
6	40 H 912	P-406-CCT	1.04	.94	.885
8	40 H 913	P-408-CCT	1.19	1.07	1.01
10	40 H 914	P-410-CCT	1.34	1.21	1.14
12	40 H 915	P-412-CCT	1.49	1.34	1.27
2	40 H 833	P-2402-CCT	.90	.81	.765
4	40 H 834	P-2404-CCT	1.01	.91	.86
6	40 H 836	P-2406-CCT	1.14	1.02	.975
8	40 H 837	P-2408-CCT	1.25	1.13	1.07
10	40 H 838	P-2410-CCT	1.38	1.24	1.18
12	40 H 839	P-2412-CCT	1.52	1.34	1.30

F SOCKETS

Contacts	Stock No.	Type	1-24, EA.	25-99, EA.	100-499, EA.
2	40 H 920	S-402-CCT	.78	.71	.67
4	40 H 921	S-404-CCT	.99	.89	.84
6	40 H 922	S-406-CCT	1.20	1.08	1.03
8	40 H 923	S-408-CCT	1.40	1.26	1.20
10	40 H 924	S-410-CCT	1.62	1.45	1.38
12	40 H 925	S-412-CCT	1.81	1.63	1.55
2	40 H 840	S-2402-SB*	.70	.63	.595
4	40 H 841	S-2404-SB*	.82	.74	.70
6	40 H 842	S-2406-SB*	.95	.85	.81
8	40 H 843	S-2408-SB*	1.08	.95	.925
10	40 H 844	S-2410-SB*	1.22	1.10	1.09
12	40 H 845	S-2412-SB*	1.35	1.22	1.15

TYPE AB FOR CHASSIS MOUNTING

G PLUGS

Contacts	Stock No.	Type	1-24, EA.	25-99, EA.	100-499, EA.
2	40 H 890	P-402-AB	.46	.41	.395
4	40 H 891	P-404-AB	.57	.51	.485
6	40 H 892	P-406-AB	.69	.62	.59
8	40 H 893	P-408-AB	.78	.71	.665
10	40 H 894	P-410-AB	.89	.80	.755
12	40 H 895	P-412-AB	.98	.88	.835

J SOCKETS

Contacts	Stock No.	Type	1-24, EA.	25-99, EA.	100-499, EA.
2	40 H 900	S-402-AB	.52	.47	.445
4	40 H 901	S-404-AB	.69	.62	.58
6	40 H 902	S-406-AB	.83	.74	.715
8	40 H 903	S-408-AB	.98	.88	.835
10	40 H 904	S-410-AB	1.15	1.03	.975
12	40 H 905	S-412-AB	1.28	1.17	1.10

TYPE DB RECESSED FOR CHASSIS MOUNTING†

Contacts	Stock No.	Type	1-24, EA.	25-99, EA.	100-499, EA.
2	40 H 950	P-402-DB	.57	.51	.485
4	40 H 955	P-404-DB	.73	.66	.62
6	40 H 951	P-406-DB	.89	.80	.755
8	40 H 952	P-408-DB	1.04	.93	.885
10	40 H 953	P-410-DB	1.20	1.08	1.025
12	40 H 954	P-412-DB	1.35	1.22	1.15

SERIES 101 PLUG AND SOCKET

Low-loss plug and socket for high-frequency RF use. For coax or shielded 1-conduct. Cadmium-plated brass; prong, contacts, silver-plated. Shpg. wt., 4 oz.

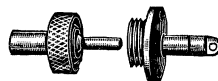

Stock No.	Type	Description	1-24, EA.	25-99, EA.	100-499, EA.
40 H 825	P-101	1/4" Plug, Length 1 1/4"	.63	.57	.54
40 H 835	S-101	Socket, Dia., 7/8"	.41	.37	.35

SERIES 202 PLUGS AND SOCKETS

Cadmium plated brass plugs and sockets. Type P-202-CCT is polarized. Knurled nut, Type S-202-B socket mtg. holes, No. 30 drill on 1" centers. All units have 3/16"-27 thread; shpg. wt. of 3 oz. Type P-202-CCT and S-202-CCT-THR with cable clamp.



Stock No.	Type	Fig.	Description	1-24, EA.	25-99, EA.	100-499, EA.
40 H 980	P-202-CCT	K	Plug, 2 contact	.58	.52	.495
40 H 982	S-202-B	L	Socket, base mounting	.69	.62	.58
40 H 981	S-202-CCT-THR	M	Socket, extension	.78	.71	.665

2R2 CHASSIS TYPE AC SOCKET

Molded bakelite units for chassis mounting. Solder lug terminals. For 10 amps, 250 volts, or 15 amps, 125 volts, 2 screw mounting, 3/8x3/4" mounting hole. Overall size, 1 1/2x1/2". Shpg. wt., 2 oz.



40 H 830, 1-9, NET EACH	1.3 1/2	50-99, EACH	1.24
-------------------------	---------	-------------	------

Switchcraft Plugs and Jacks

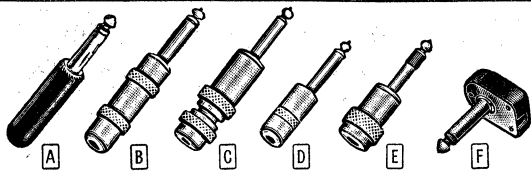

"LITTEL-PLUGS" PHONE PLUGS

Small-size phone plugs; fit standard 1/4" phone jacks, except *Type S-250, 206" sleeve for S-11 "Littel-Jax" and †Type R280 which has short sleeve for Revere recorders. Plugs with solder terminals feature built-in cable clamp; others do not include cable clamp. Metal (shielded) handles are nickel-plated brass; plastic handles are durable "Tenite." Handles are 1 1/8" long; 1/2" dia. Av. shgp. wt., 4 oz.

Stock No.	Mfr's Type	Fig.	Cond.	Handle Color	Terminals	NET EACH
41 H 553	240	A	2	Black	Screw	44¢
41 H 554	244	A	2	Red	Screw	44¢
41 H 614	250	A	2	Black	Solder	41¢
41 H 614	S250*	A	2	Black	Solder	44¢
41 H 612	255	A	2	Red	Solder	41¢
41 H 555	260	A	3	Black	Screw	71¢
41 H 616	267	A	3	Black	Solder	62¢
41 H 613	280	B	2	Metal	Solder	59¢
41 H 556	R280†	B	2	Metal	Solder	73¢
41 H 617	297	B	3	Metal	Solder	76¢

STANDARD PHONE PLUGS

Standard-size 1/4" phone plugs. Metal (shielded) or black bakelite handles; 2 1/8" long, 1 1/8" dia., except †Type 170 is similar to 70, but has 2-piece handle with cable clamp for 1/4" cable. No. 190A is similar to 90, but has same handle as 170. Av. shgp. wt., 5 oz.

Stock No.	Mfr's Type	Fig.	Cond.	Handle Color	Terminals	NET EACH
41 H 557	40	A	2	Black	Screw	.44
41 H 558	60	A	3	Black	Solder	.62
41 H 559	70	B	2	Metal	Screw	.71
41 H 560	90*	E	3	Metal	Solder	.76
41 H 561	160*	C	2	Metal	Screw	.53
41 H 562	170	C	2	Metal	Screw	.97
41 H 563	190A	C	3	Metal	Solder	1.15

"LUG-PLUG" PHONE PLUGS

Low-cost, two-conductor, 1/4" phone plugs, similar to "Littel-Plugs," above. Have solder terminals. Exterior parts bright nickel plated. Red or black "Tenite" handles are 1 1/8" long, 1/2" dia., except *Type 380 which has metal (shielded) handle 1" long. Av. shgp. wt., 4 oz.

Stock No.	Mfr's Type	Fig.	Handle Color	Terminals	NET EACH
41 H 564	350	A	Black	Screw	32¢
41 H 565	355	A	Red	Screw	32¢
41 H 566	380*	D	Metal	Screw	41¢

FLAT PHONE PLUGS

1/4" phone plugs featuring flat, space-saving handles. Ideal for applications where conventional plugs would protrude too far and interfere with operation of equipment, prevent installation in tight quarters, etc. Easily removable plastic handle. Screw terminals on Types 220 and 225 will accept standard phone tips. Terminals and body are mechanically interlocked. Shgp. wt., 4 oz.

Stock No.	Mfr's Type	Fig.	Cond.	Handle Color	Terminals	NET EACH
41 H 621	220	F	2	Black	Screw	53¢
41 H 567	225	F	2	Red	Screw	53¢
41 H 568	230	F	3	Black	Screw	76¢
41 H 569	235	F	3	Red	Screw	76¢

MILITARY-TYPE "LITTEL-PLUGS" AND EXTENSION JACK

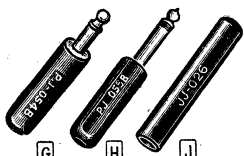

Meet exacting industrial and military requirement. Plugs are made in accordance with MIL-P-642A specs. Type 820 extension jack is designed to meet MIL-J-641A specs. Highest quality materials and advanced molding technique provide firm internal interlock; parts will not shift in position. Black plastic handle. Extension jack; fits Type 430 "Littel-Plug." All have screw terminals. Av. shgp. wt., 5 oz.

Stock No.	Mfr's Type	Fig.	Cond.	JAN Type	Old S. C. No.	NET EACH
41 H 570	430	G	2	PI-054B	PI-54	.82
41 H 618	440	C	2	PJ-055B	PI-55	.82
41 H 612	480	H	3	PJ-068	PI-68	2.12
41 H 619	820	J	2	JJ-026	JK-26	1.18

ADAPTER/CONNECTOR

Type 44. Adaptors Amphenol Type 75-MCIF or 75-MCIF-A connectors for use with standard 1/4" 2-conductor phone jacks. Sleeve tip and body are machined from brass; bright nickel-plated finish. Shaft is 1 1/8" long. Shgp. wt., 3 oz.
41 H 657, NET... 29¢

JACK SCHEMATIC DIAGRAMS

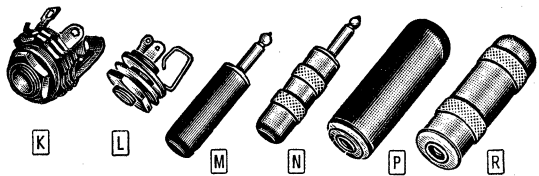

"LITTEL-JAX" PHONE JACKS

Take standard 1/4" phone plugs, except *S-11 which takes S-250 "Littel-Plug" and †C-12B which takes 480 Military-type "Littel-Plug." Jacks are 3/4" dia., 1 1/2" overall, and have a 3/8" dia. threaded shank, 3/8" long. SCC indicates single closed circuit; OC indicates open circuit. Av. shgp. wt., 3 oz.

Stock No.	Mfr's Type	Diagram	Cond.	Circuit	JAN Type	NET
41 H 622	11	I	2	OC		24¢
41 H 623	C-11	I	2	OC	JJ-034	35¢
41 H 607	S-11*	I	2	OC		26¢
41 H 624	12A	II	2	SCC		26¢
41 H 631	C-12A	II	2	SCC	JJ-089	44¢
41 H 632	12-B†	III	3	OC		32¢
41 H 633	C-12B†	III	3	OC	JJ-033	41¢
41 H 634	13B	IV	3	SCC		44¢

"TINI-JAX" SUB-MINIATURE PHONE JACKS

Extra-small 2-conductor jacks for "Tini-Plugs," 2 1/2" long; fit 1/4" hole. OC, open circuit; CC, closed circuit. Av. shgp. wt., 2 oz.

Stock No.	Mfr's Type	Diagram	Cond.	Circuit	NET
41 H 516	41	I	2	OC	26¢
41 H 517	42A	I	2	CC	26¢

"TINI-PLUGS" SUB-MINIATURE PHONE PLUGS

For use with "Tini-Jax," 1 1/8" overall length, 2-conductor. Handles are "Tenite" plastic or nickel-plated brass. Shgp. wt., 2 oz.

Stock No.	Mfr's Type	Fig.	Terminals	Handle	NET
41 H 518	740	M	Screw	Black	44¢
41 H 519	745	M	Screw	Red	44¢
41 H 520	750	M	Solder	Black	41¢
41 H 521	755	M	Solder	Red	41¢
41 H 522	770	N	Screw	Shielded	62¢
41 H 524	780	N	Solder	Shielded	59¢

"EXTENSION JAX" CABLE EXTENSION JACKS

Extension cable jacks; fit standard 1/4" plugs. 1 1/8" O.D.; 3 1/2" long. Black handles are durable plastic "Tenite," shielded handles are nickel-plated brass. All are open circuit type. Av. shgp. wt., 3 oz.

Stock No.	Type	Fig.	Cond.	Terminals	Handle	NET
41 H 571	80	P	2	Screw	Black	.68
41 H 718	88	P	2	Solder	Black	.59
41 H 572	120	R	2	Screw	Shielded	.91
41 H 717	1230	R	3	Screw	Shielded	1.15

"MT-JAX" SWITCHBOARD-TYPE JACKS

Meet Mil. specifications. 3/8" wide, 3/8" long. Fit 1 1/2" hole. SCC, single closed circuit; OC, open circuit. Shgp. wt., 3 oz.

Stock No.	Type	Diag.	Cond.	Circuit	JAN Type	NET
41 H 603	MT-331	I	2	OC	JJ-086	.88
41 H 604	MT-332A	II	3	SCC	JJ-024	1.00
41 H 606	MT-332B	III	3	OC	JJ-022	1.00

JACK PANELS

Black phenolic strip panels, reinforced with steel. Brackets are slotted for 19" relay racks. *Equipped with military type MT-332A jacks listed above; have telephone type T-332A (same as MT-332A, but non-Mil. version).

Stock No.	Type	Rows	Jacks	H. W. D.	Shgp. Wt.	NET
41 H 452	1232A	Single	12 pair†	1 1/4" x 1 9/16"	4 lbs.	26.46
41 H 453	1332A	Single	12 pair*	1 1/4" x 1 9/16"	4 lbs.	32.34
41 H 454	2432A	Double	24 pair†	2 1/8" x 1 9/16"	5 lbs.	44.10
41 H 457	2532A	Double	24 pair*	2 1/8" x 1 9/16"	5 lbs.	55.86
41 H 458	2632A	Double	52†	1 1/4" x 1 9/8"	6 lbs.	49.98
41 H 459	2732A	Double	52*	1 1/4" x 1 9/8"	6 lbs.	64.68

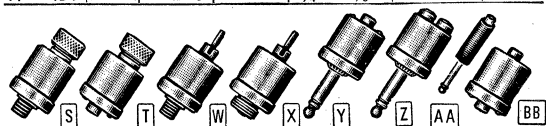

AUDIO ADAPTERS

For quick adaptation of plug to fit other type of jack on recorders, amplifiers, etc. 345 and 347 are similar to 343, but without internal resistor. 347 has metal handle. *Dia. is sleeve I.D. or plug O.D. Wt., 6 oz.

Stock No.	Mfr's Type	Fig.	Input		Output		NET
			Description	*Dia.	Description	*Dia.	
41 H 636	332	S	Phone jack	1/4"	Fem. mike conn.	1.03	
41 H 637	334	T	Phone jack	1/4"	Fem. mike conn.	.85	
41 H 638	336	W	Phone jack	1/4"	Phone plug	.85	
41 H 639	338	X	Male mike conn.	5/8"-27	Phone plug	.85	
41 H 609	342	...	Post/Banana jack	1/8"	Phone plug	1.53	
41 H 640	343	AA	Phone jack	1/4"	Phone plug	1.15	
41 H 645	344	Y	Phone jack	1/4"	Phone plug	.85	
41 H 649	346	Z	Tip jacks	Phone plug	1.26	
41 H 608	348	BB	Phone jack	1/4"	Phone plug	.82	
40H 382	345	AA	Phone jack	1/4"	Phone plug	.78	
40H 383	347	AA	Phone jack	1/4"	Phone plug	.96	

Plugs, Jacks and Jack Panels

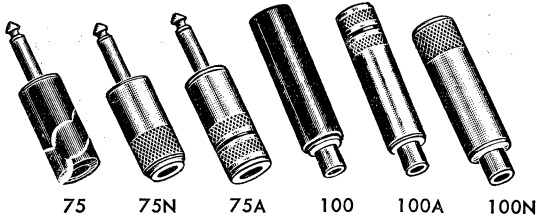

MALLORY PLUGS AND JACKS

STANDARD PHONE PLUGS

Standard 1/4", 2 and 3-conductor, phone plugs for use with headphones, handsets, microphones, and for numerous other audio applications. Fit standard 1/4" phone jacks. 2-conductor plugs have built-in tie-cord anchor for terminal strain relief. Type 75A and 76A have a cable clamp built into the handle to provide terminal strain relief. Shielded handles are nickel-plated brass with knurling for sure grip; others are molded phenolic. Screw-type terminals accommodate either tip jacks or wire. *Type 76 and 76A (not illustrated) similar to 75 and 75A. Av. shpg. wt., 3 oz.

Stock No.	Mfr's Type	Cond.	Terminals	Handle		NET EACH
				Type	Length	
41 H 641	75	2	Screw	Phenolic	1 1/2"	.44
41 H 640	75N	2	Screw	Shielded	1 1/2"	.65
41 H 937	75A	2	Screw	Shielded	1 1/2"	1.03
41 H 941	*76	3	Solder	Phenolic	1 3/8"	.65
41 H 942	*76A	3	Solder	Shielded	1 1/8"	1.15

STANDARD EXTENSION JACKS

Type 100. 2-conductor, fiber handle extension jack for standard 1/4" phone plugs. Length, 3 1/4". Screw terminals. Shpg. wt., 4 oz. 41 H 938. NET.....82c

Type 100N. 2-conductor extension jack with shielded, nickel-plated brass handle. For standard 1/4" phone plugs. Screw terminals. Length, 3 3/8". Shpg. wt., 6 oz. 41 H 939. NET.....1.06

Type 100A. 2-conductor extension jack with shielded, nickel-plated brass handle and built-in cable clamp. Screw terminals. For standard 1/4" phone plugs. Length, 3 1/8". Shpg. wt., 5 oz. 41 H 940. NET.....1.47



LONG-FRAME STANDARD PHONE JACKS

Industrial-type, long-frame jacks offering a variety of switch combinations. All take standard 1/4" phone plugs. Types Nos. 1, 2, 2A, and 5 (Fig. A) are 3/8x1 1/8x3/8" wide. Mount in panels up to 1/4" thick by means of 3/8" diameter threaded shank. XP types (Fig. B) are 3/2x2 3/8x3/8" wide. Have 7/8" diameter smooth shank 3/8" long and mount with screw and nut. *Column headed "Cond." indicates number of conductors in mating plug. †Diagram indicates switching arrangement (shown in column at right). Av. shpg. wt., 4 oz.

Stock No.	Type	*Cond.	Circuit	†Diagram	NET
34 H 440	1	2	Open	I	44c
34 H 441	2	2	Shorting	VII	56c
34 H 442	2A	2	Closed	II	56c
41 H 055	5	2	Closed & Transfer	IX	88c
34 H 445	XP1	2	Open	I	62c
41 H 644	XP2B	2	Closed	II	73c
34 H 446	XP3B	2	Transfer	VIII	88c

AUDIO DEVELOPMENT JACK PANELS, PLUGS AND PATCH CORDS

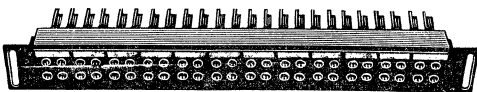

BROADCAST TYPE JACK PANELS

Professional-quality jack panels for use in broadcast stations, paging systems, theaters, recording studios, and in any other installation requiring efficient distribution, switching and control of audio signals. Easily inserted card strips. Bakelite panels fit standard 19" relay rack. Type PJ340. Double row jack panel complete with 52 (26 pairs) closed circuit jacks. Width, 1 3/4". Shpg. wt., 5 lbs. 86 HX 804. NET.....49.50

Type PJ341. Double row jack panel complete with 48 (24 pairs) closed circuit jacks. Width, 2 1/8". Shpg. wt., 5 lbs. 86 HX 802. NET.....42.75

Type PJ343. Single row jack panel complete with 24 (12 pairs) closed circuit jacks. Width, 1 3/4". Shpg. wt., 3 1/4 lbs. 86 HX 803. NET.....25.13

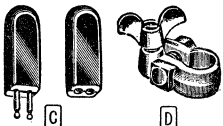

MINIATURE PLUG-JACK

C 1 3/8" long, 1/2" wide, 3/8" thick. Two-conductor type. Black bakelite case. Shpg. wt., 3 oz. 43 H 260. Plug. NET.....47c
43 H 261. Jack. NET.....65c

BATTERY BINDING POST

D Universal storage battery binding post. Shpg. wt., 5 oz. 41 H 785. NET EACH.....56c

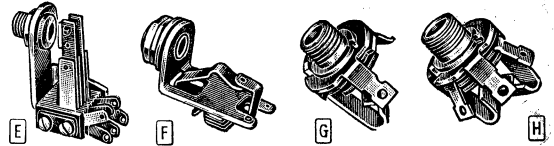

MALLORY STANDARD PHONE JACKS

JUNIOR PHONE JACKS

E Compact "Junior" jacks for standard 1/4" phone plugs. Require only 1 1/2" behind panel. Cadmium-plated frames with nickel-plated brass shank, springs, and mounting hardware. 3/8" diameter threaded shank for mounting in panels up to 1/4" thick. Silver contacts. *Column head "Cond." indicates number of conductors in mating plug. Av. shpg. wt., 3 oz.

Stock No.	Type	*Cond.	Circuit	Diagram	NET
41 H 054	701	2	Open	I	44c
41 H 058	702B	3	Open	III	56c
41 H 052	703	2	Open	V	59c
41 H 059	703B	3	Closed-Transfer 1	IV	59c
41 H 060	704B	3	Closed-Transfer 2	VI	68c

MIDGET AND INFANT PHONE JACKS

F Extremely small "Midget" and "Infant" type jacks for limited-space applications. All take 1/4" phone plugs. "Midget" type jacks require only 1 1/2" mounting space behind panel; "Infant" type requires only 7/8" behind panel. Cadmium-plated steel frames with nickel-plated brass shank, springs, and mounting hardware. 3/8" threaded shank for mounting in panels up to 1/4" thick. *Column headed "Cond." indicates number of conductors in mating plug. All are "Midget" type except A-1 "Infant" type jack. (†Not illustrated). Av. shpg. wt., 2 oz.

Stock No.	Type	*Cond.	Circuit	Diagram	NET
41 H 050	†A-1	2	Open	I	38c
41 H 051	A-2	2	Shorting	VII	47c
41 H 053	A-2A	2	Closed	II	56c
41 H 056	A-3A	2	Closed-Transfer 1	VIII	65c

MILITARY-TYPE SC JACKS

Type SC phone jacks are commercial equivalents of military types complying with JAN-J-641 specification. Both require 7/8" mounting space behind panel. Type SC-1A has 3/8" diameter threaded shank, 3/8" long. Type SCA-2B has 5/8" diameter threaded shank, 3/8" long. Av. shpg. wt., 2 oz.

G Type SC-1A. Equivalent to military jack No. JJ-034. Open circuit. 2-conductor jack, see Diagram I. Takes all standard 1/4" plugs including Mallory 75; Western Electric Nos. 47A and 47B; Nos. PL-47, PL-48, PL-53, PL-148, PL-153, PL-125, PJ-055, PJ-155, PJ-634, PJ-636, and PJ-047. 41 H 642. NET.....35c

H Type SCA-2B. Equivalent to military jack No. JJ-033. Open circuit, 3-conductor jack, see Diagram III. Takes all 3-conductor plugs with .206" diameter sleeves, including Western Electric 109; Military Nos. PL-68, PL-168, PJ-068, PJ-168, and PJ-309. 41 H 643. NET.....41c

JACK SCHEMATIC DIAGRAMS

Diagrams below illustrate circuits of jacks listed on pages 174-176.

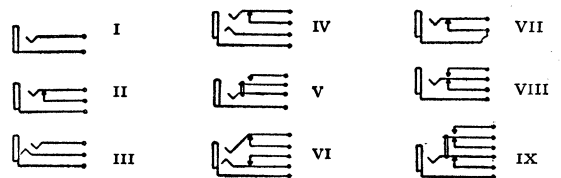

PATCH CORD SETS

One Patch Cord and two Double Plugs. Tinned-copper, 2-conductor, insulated wire. Heavy braid overall. Bakelite and brass plugs. Have polarizing identifications. Wt., 9 oz.

41 H 661. Type PJ12. Patch Cord Set. 2-ft. long. NET.....7.41
41 H 662. Type PJ13. Patch Cord Set. 3-ft. long. NET.....7.59
41 H 664. Type PJ15. Patch Cord Set. 5-ft. long. NET.....8.07
41 H 666. Type PJ1. Double Plug Only. NET.....2.76

Replacement Cords. Same fine quality 2-conductor cords as used on patch cord sets above. Insulated tinned copper. Heavy protective braid. Fit all makes of standard plugs. Av. shpg. wt., 6 oz.

41 H 667. Type PJ22. Replacement Cord. 2-ft. long. NET.....1.65
41 H 668. Type PJ23. Replacement Cord. 3-ft. long. NET.....1.74
41 H 669. Type PJ24. Replacement Cord. 4-ft. long. NET.....1.80
41 H 659. Type PJ25. Replacement Cord. 5-ft. long. NET.....1.89

GENERAL RADIO DOUBLE PLUG

Type 274-MB. Dual plug for standard banana jacks. Molded as a unit on 3/4" centers. Recessed top forms double jack, allowing units to be used in tandem. Banana plug prongs. Holes in body accept phone tips or wires up to No. 12; terminal screws clamp conductors securely. Body of plug is constructed of durable, black polystyrene for high insulation resistance. 15 amp rating. DC leakage resistance 100 million megohms. 1 1/8" W., 1 1/8" L. Shpg. wt., 3 oz. 41 H 242. NET.....65c

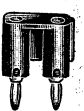

Plugs, Jacks and Test Lead Accessories

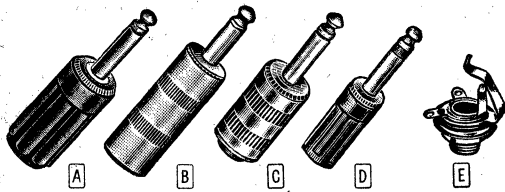

ICA PHONE PLUGS AND JACKS STANDARD 2-CONDUCTOR PHONE PLUGS

Selection of standard 2-conductor phone plugs for a wide variety of applications. Choice of handle sizes for practically any space requirement. All sleeves fit standard 1/4" phone jacks. Molded plastic handles are ribbed to provide a sure grip. Shielded plugs have nickel-plated brass handles. *Screw-type terminals of Type 24B and 24R can also be used with 1 or 2 pairs of phone tips. Av. shgp. wt., 3 oz.

Stock No.	Mfr's Type	Fig.	Terminals	Handle Color	Dimensions	1-9 EACH	10 or More, EA.
41 H 600	24B	A	*Screw	Black	3/4 x 1 1/2"	38c	34c
41 H 601	24R	A	*Screw	Red	3/4 x 1 1/2"	38c	34c
41 H 605	25	B	Screw	Shielded	1 1/4 x 2"	65c	58c
41 H 610	27	C	Screw	Shielded	1 1/4 x 1 1/2"	53c	48c
41 H 625	29B	D	Solder	Black	3/4 x 1"	37c	33c
41 H 626	29R	D	Solder	Red	3/4 x 1"	37c	33c

STANDARD PHONE JACKS

Miniature phone jacks for standard 1/4" phone plugs. Have 3/8" threaded shank, 3/8" long. Overall length, 1". *Page 175. Wt., 3 oz.

Stock No.	Mfr's Type	Cond.	Circuit	*Diagram	1-9 EACH	10 or More, EACH
41 H 627	1870	2	Open	I	29c	26c
41 H 628	1871	2	Closed	VII	33c	29c
41 H 629	1872	3	Open	III	39c	35c

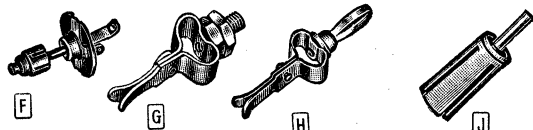

PHONO PIN PLUG & JACK—TEST CLIPS

F Shielded Phono Pin-Plug and Jack. For auto radios, record players, etc. Pin plug fits standard phono jack on radio. Pin dia. 1/8", length, 3/8". Single prong jack on 1/2" bakelite disc. 1/16" mtg. centers. Av. wt., 1 oz. 3 per package.

46 H 212. Pin Plug, 10 or More Pkgs., Per Pkg. 13c. Per Pkg. 14c
46 H 213. Pin Jack, 10 or More Pkgs., Per Pkg. 18c. Per Pkg. 20c

G Grayhill Type 2-0 Test Clip. Spring clip with 8-32x3/8" mounting stud for test panels or board. 1 1/2" long. Shgp. wt., 2 oz.

45 H 182. NET. 20c
H Grayhill Type 2-1 Test Clip. As above, but with banana plug for mounting in standard banana jacks. 1 1/2" long. Shgp. wt., 2 oz.

45 H 183. NET. 34c
J H. H. Smith No. 1200 Motorola Type Plug. Antenna lead in plug designed for connecting coaxial lead in antenna wire to auto radio. Split brass shell has serrated edge to provide secure ground connection. Pin dia. 1/4". Shgp. wt., 2 oz.

41 H 152. 10 or More, EACH... 7c. 1 to 9, NET EACH... 8c

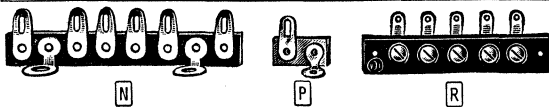

STANDARD BAKELITE TIE-POINTS

N Terminals riveted to 1/8" thick bakelite on 3/8" centers. *Have one mounting lug; others have two. Mounting centers, 4-terminal, 1 7/8"; 6-terminal, 1 7/8". Av. shgp. wt., per pkg., 1/2 lb. 10 per pkg.

Stock No.	Term.	1-9 Pkgs. PER PKG.	10 Pkgs & Up. PER PKG.	Stock No.	Term.	1-9 Pkgs. PER PKG.	10 Pkgs & Up. PER PKG.
41 H 500	2*	17c	15c	41 H 503	5*	22c	20c
41 H 501	3*	20c	18c	41 H 504	6	51c	46c
41 H 502	4	30c	27c				

SINGLE-LUG TIE-POINT

P Tinned solder lug. Very convenient for keeping wiring neat and rigid. Reduces possibility of shorts from loose wires coming in contact with each other. Riveted to 1/8" thick, high-quality bakelite. One mounting lug. Shgp. wt., per pkg., 4 oz. 10 per pkg.

41 H 515. 1 to 9 Pkgs., PER PKG. 14c
10 or More Pkgs., PER PKG. 13c

TERMINAL STRIPS

R Excellent for cabled sub-assemblies, to simplify chassis removal. 1/8" thick bakelite terminal strips. Cadmium-plated screw terminals and tinned solder lugs. Av. shgp. wt., per pkg., 1/2 lb. 8 per pkg.

Stock No.	Term.	1-9 Pkgs. PER PKG.	10 Pkgs & Up. PER PKG.	Stock No.	Term.	1-9 Pkgs. PER PKG.	10 Pkgs & Up. PER PKG.
41 H 505	2	29c	26c	41 H 508	5	69c	62c
41 H 506	3	44c	40c	41 H 509	6	82c	74c
41 H 507	4	59c	53c				

SWITCHCRAFT

"Mini-Mix" Audio Mixers

Miniature, 2-input audio mixers. Small, inexpensive units for greatly increasing the flexibility of recording equipment. Accommodate 2 high-impedance inputs. Allow mixing of 2 mikes, contact mike and record player, etc. 2 1/4 x 1 1/4 x 1 1/4". Wt. 4 oz.

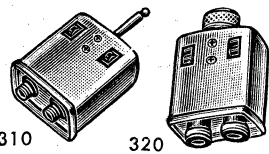

Stock No.	Type	Description	NET
41 H 953	310	Has phono jack inputs with phono plug output. Fits std. jacks. Connect directly to equipment—no external cables needed.	4.67
41 H 699	8266	Recessed jack adapter. For 310 above. w/1-ft., 2-cond. cable.	2.20
41 H 954	320	Mixer. Has microphone connector inputs, and outputs with standard microphone connectors.	4.67
41 H 658	315	Mixer. Has phone jack inputs with mike connector output mating with std. mike connectors or No. 44 Adapter.	4.67
41 H 686	325	Mixer. For use with recorders and amplifiers using Jones-type connectors. Fits recessed connectors on Webcor tape recorders, etc.	5.85

TELEX SUBMINIATURE JACKS AND PLUG

Type 9231 Plug. Extremely small phone-type plug for 2-conductor cable up to .150" diameter. 1 1/2" by 1/4" diameter. Shgp. wt., 2 oz.
59 J 243. NET. 35c
Type 8870 Jack. Closed circuit jack for plug above. Mounts in 3/8" hole. Shgp. wt., 2 oz.
59 J 242. NET. 24c
Type 9240 Jack. Open circuit jack for Type 9231 plug listed above. Mounts in 3/8" hole. Shgp. wt., 2 oz.
59 J 254. NET. 24c



H. H. SMITH ALLIGATOR CLIPS

Steel alligator clips. Insulated handles except phone tip or banana plugs. Wt., per 10, 5 oz.

Stock No.	Type	Color	Description	1-9, EA.	10-49 EA.	50-UP, EA.
41 H 300	304	Red	With tip jack adapter.	32c	29c	26c
41 H 305	304	Black	With tip jack adapter.	32c	29c	26c
41 H 168	305	Red	With comb. tip & banana jack.	38c	34c	31c
41 H 169	305	Black	With comb. tip & banana jack.	38c	34c	31c



GRAYHILL INSULATED TEST CLIPS

Completely insulated clips. Molded phenolic insulation. Silver contact points. Contact resistance 0.0015 ohms. Shgp. wt., 2 oz.
45 H 180. Type 16-B Black. NET. 83c
45 H 181. Type 16-R Red. EACH. 83c



NU-WAY SNAPS, STUDS AND LUGS

Make and break contacts for temporary or permanent connections. A quick, simple way to join wires together. Snaps may be cascaded together for multiple connections—wires are secured by clamping terminal prongs over stripped wire and soldering. Nickel-plated brass. Fig. K has solder lug; Fig. L has hole for 6-32 screw. 100, 12 oz. 100 per pkg.

Stock No.	Fig.	Description	Size	1-9 Pkgs. PER PKG.	10 Pkgs. or More, PER PKG.
44 H 450	K	Snaps for lugs and studs.	7/16" D x 3/8" L	7.20	5.00
44 H 452	L	Stud for panel or chassis mtg.	6-32x1/2"	4.30	3.00
44 H 451	M	Lug for flush mounting.	1/2x3/16x3/4"	4.30	3.00

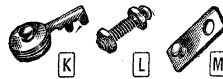

MINIATURE TIE-POINTS

S Consist of .025" tinned brass terminals on 1/8" thick laminated phenolic. Ground lug included. Av. shgp. wt., per pkg., 8 oz. 10 per pkg.

Stock No.	Term.	1-9 Pkgs. PER PKG.	10 Pkgs & Up. PER PKG.	Stock No.	Term.	1-9 Pkgs. PER PKG.	10 Pkgs & Up. PER PKG.
41 H 510	2	15c	13c	41 H 513	5	30c	27c
41 H 511	3	21c	19c	41 H 514	6	35c	31c
41 H 512	4	25c	22c				

HEAVY-DUTY SCREWS

T Black 3/32" bakelite. Cadmium-plated screw terminals. Tinned lugs, for antenna-ground connection on receivers, etc. Av. wt., 4 oz.

Stock No.	Terminals	1-9, EA.	10-UP, EA.	Stock No.	Terminals	1-9, EA.	10-UP, EA.
41 H 875	2	14c	13c	41 H 895	6	27c	24c
41 H 880	3	17c	15c	41 H 897	7	31c	28c
41 H 885	4	19c	17c	41 H 898	8	34c	31c
41 H 890	5	24c	22c				

TERMINALS—CONNECTORS

Av. shgp. wt., per pkg., 4 oz. 10 per pkg.

Stock No.	Fig.	Description	1-9 Pkgs. PER PKG.	10 or More PER PKG.
41 H 757	W	Single hole fuse mount. For 1/4" diameter fuses.	12c	11c
41 H 767	X	Terminal lugs.	40c	36c
41 H 777	Y	Black, insulated pin-plug.	71c	64c

H. H. Smith Plugs and Jacks

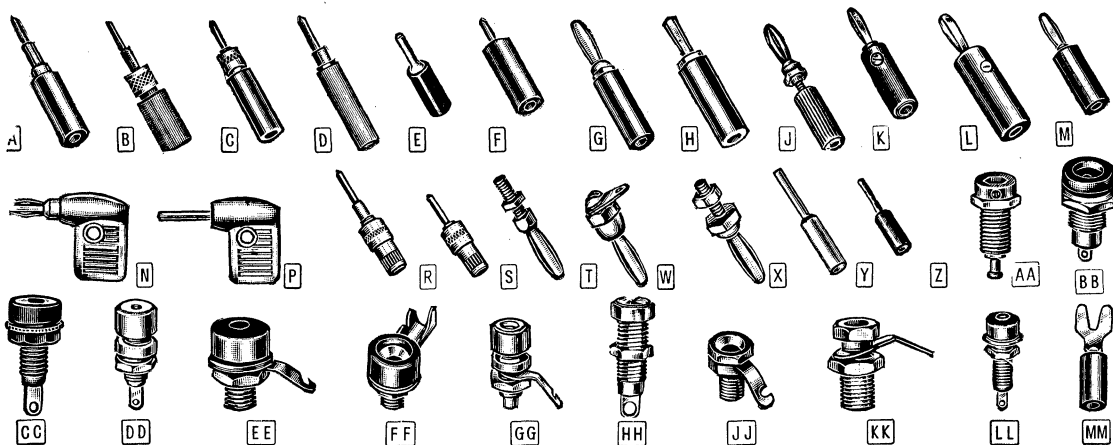

TIP PLUGS, BANANA PLUGS AND MATCHING JACKS

INSULATED TIP PLUGS

A Type 229 Heavy Duty Phone Tip Plug. Molded bakelite handle. One-piece, nickel-plated brass construction for heavier-current use. $2\frac{1}{4}$ " long. Shpg. wt., 3 oz.
 41 H 536. Red 1-9
 41 H 537. Black NET EACH
 41 H 538. Yellow
 41 H 539. Green 15c
 41 H 540. Blue
 50-99, EA. 12c 10-49, EA. 13c

B Type 200 "Senior" Solderless Phone Tip Plug. Knurled nut tightens against wire, making soldering unnecessary. Plug is made of nickel-plated brass; bakelite handle. $2\frac{1}{4}$ " long. Shpg. wt., 3 oz.
 41 H 250. Red 1-9
 41 H 255. Black NET EACH
 41 H 415. Yellow
 41 H 416. Green 15c
 41 H 417. Blue
 50-99, EA. 12c 10-49, EA. 13c

C Type 201 "Junior" Solderless Phone Tip Plug. Has same tightening assembly in body of plug as Type 200, above. Bakelite handle; nickel-plated brass. $2\frac{1}{4}$ " long. Shpg. wt., 3 oz.
 41 H 542. Red 1-9
 41 H 543. Black NET EACH
 41 H 544. Yellow
 41 H 545. Green 15c
 41 H 546. Blue
 50-99, EA. 12c 10-49, EA. 13c

D Type 270 Subordinate Phone Tip. $\frac{1}{4}$ " O.D. bone fiber handle. Nickel-plated brass tip. $1\frac{3}{8}$ " overall length. 2 oz.
 41 H 547. Red 1-9
 41 H 548. Black NET EA. 13c
 50-99, EA. 11c 10-49, EA. 12c

E Type 237. For standard tip jacks. $1\frac{1}{2}$ " long. 3 oz.
 41 H 260. Red 1-9
 41 H 261. Black NET EA. 10c
 50-99, EA. .8c 10-49, EA. .9c

F Type 203 Short Phone Tip Plug. Shoulderless tip permits insertion all the way up to insulated handle. Handle is molded bakelite. Nickel-plated brass tip. $1\frac{1}{2}$ " long. Shpg. wt., 3 oz.
 41 H 575. Red 1-9
 41 H 576. Black NET EACH
 41 H 577. Yellow
 41 H 578. Green 12c
 41 H 579. Blue
 50-99, EA. 10c 10-49, EA. 11c

NON-INSULATED TIP PLUGS

R Type 105 "Senior" Solderless Phone Tip Plug. Has knurled nut for fastening wire. $1\frac{1}{2}$ " long. Shpg. wt., 2 oz.
 41 H 240. 1-9, NET EACH. 10c
 50-99, EA. .8c 10-49, EA. .9c

S Type 106 "Junior" Solderless Phone Tip Plug. As above, but $1\frac{3}{8}$ " long. 2 oz.
 41 H 230. 1-9, NET EACH. 10c
 50-99, EA. .8c 10-49, EA. .9c

Y Type 123 Heavy-Duty Cord Tip. Fits standard phone tip jacks. $1\frac{1}{2}$ " long. Shpg. wt., 2 oz.
 41 H 125. 1-9, NET EACH. 3c
 50-99, EA. .2c 10-49, EA. 2c

NON-INSULATED TIP PLUG

Z Type 108 Standard Cord Tip. For instruments, test panels, headphones, etc. Length, $1\frac{1}{2}$ ". Shpg. wt., 2 oz.
 41 H 200. 1-9, NET EACH. 2c
 50-99, EA. .1c 10-49, EA. .1c

MOLDED METER PLUGS

N Type 255 Banana-Type Meter Plug. Four-leaved phosphor bronze spring; nickel-plated. Tip is $1\frac{1}{2}$ " long. Wt., 2 oz.
 41 H 467. Red 1-9
 41 H 468. Black NET EA. 35c
 50-99, EA. 29c 10-49, EA. 31c

P Type 235 Meter Tip Plug. Molded in two halves for easy assembly with screw and nut. Nickel-plated tip is $1\frac{1}{2}$ " long. 2 oz.
 41 H 203. Red 1-9
 41 H 204. Black NET EA. 26c
 50-99, EA. 22c 10-49, EA. 24c

BANANA PLUGS

G Type 212 Insulated, Spring Tip. Molded Bakelite handle. Wire can be soldered to brass stud supplied, or directly into plug. Length, $1\frac{1}{8}$ ". Shpg. wt., 2 oz.
 41 H 593. Red 1-9
 41 H 594. Black NET EACH
 41 H 595. Yellow
 41 H 596. Green 21c
 41 H 597. Blue
 50-99, EA. 17c 10-49, EA. 19c

H Type 253 Insulated, Split Tip. Nickel-plated, cross-slotted tip. Wire can be soldered to brass stud supplied or directly into plug. Length, $1\frac{1}{2}$ ". Shpg. wt., 2 oz.
 41 H 428. Red 1-9
 41 H 427. Black NET EACH
 41 H 067. Yellow
 41 H 068. Green 18c
 41 H 069. Blue
 50-99, EA. 15c 10-49, EA. 16c

J Type 236 Insulated, Spring Tip. Tenite handle. Silver-plated tip. Fits all standard banana jacks. Four leaved spring provides lasting contact. Has curved contact area to assure high current handling capacity. Length, $1\frac{1}{2}$ ". Shpg. wt., 2 oz.
 41 H 407. Red 1-9
 41 H 408. Black NET EA. 29c
 50-99, EA. 24c 10-49, EA. 26c

K Type 204 Insulated, Spring Tip. Solderless; has set screw in bakelite handle. Nickel-plated tip. Length, $1\frac{1}{4}$ ". Wt., 2 oz.
 41 H 405. Red 1-9
 41 H 410. Black NET EACH
 41 H 402. Yellow
 41 H 403. Green 18c
 41 H 404. Blue
 50-99, EA. 15c 10-49, EA. 16c

L Type 213 Insulated, Split Tip. Solderless; set screw in handle. Length, $1\frac{1}{8}$ ". Shpg. wt., 2 oz.
 41 H 425. Red 1-9
 41 H 430. Black NET EACH
 41 H 412. Yellow
 41 H 413. Green 18c
 41 H 414. Blue
 50-99, EA. 15c 10-49, EA. 16c

BANANA PLUGS

M Type 211 Insulated, Spring Tip. Nickel-plated brass tip. Wire can be soldered to brass stud supplied, or directly into plug. Length, $1\frac{1}{2}$ ". Shpg. wt., 2 oz.
 41 H 462. Red 1-9
 41 H 463. Black NET EACH
 41 H 464. Yellow
 41 H 465. Green 18c
 41 H 466. Blue
 50-99, EA. 15c 10-49, EA. 16c

T Type 103 All-Metal, Spring Tip. Has solder lug. Four-leaved spring. Body and tip are nickel-plated. $6-32 \times \frac{3}{8}$ " stud. Length, $1\frac{1}{2}$ ". Shpg. wt., 2 oz.
 41 H 400. 1-9, NET EACH. 15c
 50-99, EA. 12c 10-49, EA. 13c

W Type 100 All-Metal, Spring Tip. As above, but internal threads permit use on all size panels. Length, $1\frac{1}{2}$ ". Shpg. wt., 2 oz.
 41 H 488. 1-9, NET EACH. 15c
 50-99, EA. 12c 10-49, EA. 13c

X Type 102 All-Metal, Spring Tip. Nickel plated, one-piece construction. $6-32 \times \frac{3}{8}$ " stud. Length, $1\frac{1}{2}$ ". Shpg. wt., 2 oz.
 41 H 489. 1-9, NET EACH. 15c
 50-99, EA. 12c 10-49, EA. 13c

TIP JACKS

AA Type 1505 Miniature Nylon Tip Jacks. Silver-plated, beryllium copper contact. Fits $\frac{1}{4}$ " hole; panels to $\frac{1}{2}$ " thick. Overall size, $2\frac{1}{2} \times \frac{3}{8}$ " dia. Wt., 2 oz.
 41 H 495. Red 1-9
 41 H 496. Black NET EACH
 41 H 497. Yellow
 41 H 498. Green 29c
 41 H 499. Blue
 50-99, EA. 24c 10-49, EA. 26c

BB Type 240 Nylon Tip Jack. Completely insulated; phosphor bronze contact. $1\frac{1}{2} \times \frac{3}{8}$ " dia. Shpg. wt., 2 oz.
 41 H 012. Red 1-9
 41 H 013. Black NET EACH
 41 H 014. Yellow
 41 H 015. Green 18c
 41 H 016. Blue
 50-99, EA. 15c 10-49, EA. 16c

CC Type 202 Insulated Tip Jack. Body is nickel-plated brass. Mounts in $\frac{5}{16}$ " hole in panels up to $\frac{3}{8}$ " thick. Size, $1\frac{1}{2} \times \frac{3}{8}$ " O.D. Shpg. wt., 2 oz.
 41 H 110. Red 1-9
 41 H 115. Black NET EACH
 41 H 432. Yellow
 41 H 433. Green 13c
 41 H 434. Blue
 50-99, EA. 11c 10-49, EA. 12c

DD Type 241 Insulated Tip Jack. Molded nylon head and insulating washer. Nickel-plated brass body. Mounts in $\frac{5}{16}$ " hole. Shpg. wt., 2 oz.
 41 H 025. Black 1-9
 41 H 026. Yellow NET EACH
 41 H 027. Green 18c
 41 H 028. Blue
 50-99, EA. 15c 10-49, EA. 16c

TIP JACK

HH Type 107 Non-Insulated Tip Jack. $\frac{1}{4}$ " mtg. hole; $\frac{3}{8}$ " max. panel thickness. Has phosphor-bronze spring contact. Shpg. wt., 2 oz.
 41 H 100. 1-9, NET EACH. 10c
 50-99, EA. .8c 10-49, EA. .9c

BANANA JACKS

EE Type 205 Insulated Banana Jack. With solder lug and removable insulated top. Requires $\frac{3}{16}$ " hole; for panels to $3\frac{1}{2}$ " long. Shpg. wt., 2 oz.
 41 H 475. Red 1-9
 41 H 480. Black NET EACH
 41 H 422. Yellow
 41 H 423. Green 13c
 41 H 424. Blue
 50-99, EA. 11c 10-49, EA. 12c

FF Type 219 Insulated Banana Jack. Has molded plastic head. Recessed body assures snug contact. Fits $\frac{3}{16}$ " mtg. hole; $\frac{3}{8}$ " max. panel thickness. Shpg. wt., 2 oz.
 41 H 033. Red 1-9
 41 H 034. Black NET EACH
 41 H 035. Yellow
 41 H 036. Green 15c
 41 H 037. Blue
 50-99, EA. 12c 10-49, EA. 13c

GG Type 221 Insulated Banana Jack. Molded nylon head and insulating washer. $\frac{3}{16}$ " mtg. hole; $\frac{3}{8}$ " max. shpg. wt., 2 oz.
 41 H 042. Red 1-9
 41 H 043. Black NET EACH
 41 H 044. Yellow
 41 H 045. Green 18c
 41 H 046. Blue
 50-99, EA. 15c 10-49, EA. 16c

JJ Type 101 Non-Insulated Banana Jack. Has brass tinned lug. $\frac{1}{4}$ " mtg. hole; $\frac{7}{16}$ " max. panel thickness. Shpg. wt., 2 oz.
 41 H 047. 1-9, NET EACH. 10c
 50-99, EA. .8c 10-49, EA. .9c

KK Type 109 Non-Insulated Banana Jack. $\frac{1}{4}$ " mtg. hole; $\frac{3}{8}$ " max. thickness. Shpg. wt., 2 oz.
 41 H 470. 1-9, NET EACH. 10c
 50-99, EA. .8c 10-49, EA. .9c

COMBINATION JACK

LL Type 206 Insulated Combination Jack. Will accommodate all standard phone tip or banana plugs. Nickel-plated brass body. Mounts in $\frac{5}{16}$ " hole; panels up to $\frac{1}{2}$ " thick. Length, $1\frac{1}{2}$ ". Shpg. wt., 2 oz.
 41 H 130. Red 1-9
 41 H 135. Black NET EACH
 41 H 137. Yellow
 41 H 138. Green 16c
 41 H 143. Blue
 50-99, EA. 13c 10-49, EA. 14c

INSULATED SPADE LUG

MM Type 218 Phone Tip to Spade Lug Adapter. Has tip jack in rear of handle to allow insertion of phone tip. $\frac{1}{2}$ " wide steel hot-tinned lug. $.030$ " thick for extra durability. Size: $1\frac{1}{16}$ " long, $\frac{3}{16}$ " O.D. Shpg. wt., 2 oz.
 41 H 048. Red 1-9
 41 H 049. Black NET EA. 11c
 50-99, EA. .9c 10-49, EA. 10c

Alligator Clips, Binding Posts

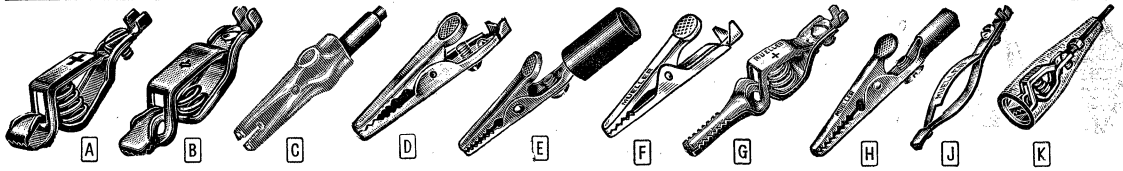

MUELLER UNIVERSAL CLIPS AND FLEXIBLE INSULATORS

A wide variety of clips for positive, highly dependable electrical contact. For batteries, high-frequency equipment, experimental setups, transmitting apparatus, electroplating, and countless other applications.

MESH TEETH TEST CLIPS

A For general purpose applications. *Solid Copper. †Solid bronze. ‡Cadmium-plated steel. †Insulation-piercing needle for quick wire contact. Av. shgp. wt., 3 oz.

Stock No.	Mfr's Type	Amps	Size	NET EACH			
				1-9	10-99	100-499	500-Up
45 N 000	‡45	5	1 1/2"	.07	.05	.042	.04
45 N 005	*45C	10	1 1/2"	.13	.09	.078	.072
45 N 010	‡48B	10	2"	.10	.07	.06	.056
45 N 078	*48C	10	2"	.14	.098	.084	.08
45 N 087	†50C	10	2 1/4"	.24	.18	.15	.14

LEAD-PLATED BATTERY CLIPS

A For moderately-heavy current work, including battery charging, electroplating, and light welding. Lead-plated steel for complete protection and long life. Av. shgp. wt., 4 oz.

Stock No.	Mfr's Type	Amps	Size	1-9	10-99	100-499	500-Up
45 N 020	24A	25	2 7/8"	.20	.14	.12	.12
45 N 030	21A	50	4 1/2"	.35	.24	.22	.21
45 N 040	11A	100	6"	.98	.69	.59	.56

SOLID COPPER CLIPS

A Heavy-duty, high-conductivity, solid copper clips. Shgp. wts.: 24C 3 oz.; 21C, 5 oz.; 11C, 8 oz.; 33C, 1 lb.

Stock No.	Mfr's Type	Amps	Size	1-9	10-99	100-499	500-Up
45 N 025	24C	50	2 7/8"	.33	.24	.20	.19
45 N 022	21C	100	4 1/2"	.86	.61	.52	.49
45 N 045	11C	200	6"	1.67	1.17	1.00	.95
45 N 050	33C	300	7 3/4"	3.18	2.23	1.91	1.82

3-SIDED MESH TEETH CLIPS

B ‡Cadmium-plated steel; *solid copper. Jaws open 5/8". Meshing teeth on 3 sides of each jaw. Shgp. wt., 2 oz.

Stock No.	Mfr's Type	Amps	Size	1-9	10-99	100-499	500-Up
45 N 015	‡27	20	2 3/4"	.12	.08	.07	.066
45 N 097	*27C	40	2 3/8"	.20	.14	.12	.112

INSULATED ALLIGATOR CLIPS

C ‡Cadmium-plated steel; *solid copper. Completely insulated with vinyl plastic to provide excellent protection against shocks and shorts. Shgp. wt., 3 oz.

Stock No.	Mfr's Type	Amps	Size	1-9	10-99	100-499	500-Up
45 N 140	‡63	5	2 1/8"	.27	.20	.17	.16
45 N 141	*63C	10	2 1/8"	.29	.21	.18	.17

70 SERIES ALLIGATOR CLIPS

D Streamlined, simplified design. No. 70 is cadmium-plated steel, with solder connection; No. 70S is cadmium-plated steel, with screw connection. No. 70CS is made of solid copper and has screw connection. Av. shgp. wt., 3 oz.

Stock No.	Mfr's Type	Amps	Size	1-9	10-99	100-499	500-Up
45 N 170	70	5	1 1/16"	.07	.044	.038	.036
45 N 171	70S	5	1 1/16"	.08	.05	.044	.04
45 N 172	70CS	10	1 1/16"	.11	.075	.064	.06

Quality springs maintain firm grip for low resistance. Lead-plated clips resist battery acid. Solid copper types have low resistance and are non-magnetic. Slip-on insulators (Fig. K) are listed for all types.

INSULATED BARREL ALLIGATOR CLIPS

E Made of cadmium-plated steel, except *solid copper. Jaws open 5/8". Av. shgp. wt., 2 oz.

Stock No.	Mfr's Type	Size	Description	NET EACH			
				1-9	10-99	100-499	500-Up
45 N 070	60HS	2 1/2"	Red handle	.14	.095	.08	.076
45 N 075	60HS	2 1/2"	Black handle	.14	.095	.08	.076
45 N 090	*60CHS	2 1/2"	Red handle	.16	.11	.096	.092
45 N 095	*60CHS	2 1/2"	Black handle	.16	.11	.096	.092

CROCODILE CLIPS

G *Solid copper; ‡cadmium-plated steel. †Phone tip on one jaw. Av. shgp. wt., 2 oz.

Stock No.	Mfr's Type	Size	Description	1-9	10-99	100-499	500-Up
45 N 060	‡85	2 1/2"	Screw Connection	.08	.058	.048	.044
45 N 062	*85C	2 1/2"	Screw Connection	.16	.11	.098	.092
45 N 098	†85T	2 1/2"	Tip-Clip	.21	.15	.126	.12

ALLIGATOR CLIPS

H Steel, except *Solid copper. †Solder type; "S"-screw type. Slim jaws for close work. Jaws open 3/8". Shgp. wt., 2 oz.

Stock No.	Mfr's Type	Size	Description	1-9	10-99	100-499	500-Up
45 N 200	†60	2"	Fit banana plugs	.07	.05	.044	.04
45 N 065	60S	2"	Fit banana plugs	.08	.058	.048	.044
45 N 080	*60CS	2"	Fit banana plugs	.12	.084	.072	.068

NON-FERROUS R.F. TEST CLIP

J Phosphor bronze clip with brass screw. Ideal for tapping small transmitter coils; also for work in crowded chassis. Shgp. wt., 2 oz.

Stock No.	Mfr's Type	Size	Description	1-9	10-99	100-499	500-Up
45 N 055	88	1 1/16"	Ideal for coils	.22	.15	.13	.124

"MINI-GUARD" CLIPS

F Miniaturized—3/8" jaw opening, 1/16" O.D. tip. ‡Cadmium-plated steel; *solid copper. Shgp. wt., 2 oz.

Stock No.	Mfr's Type	Amps	Size	NET EACH			
				1-9	10-99	100-499	500-Up
45 N 142	‡30	5	1 1/8"	.07	.044	.038	.036
45 N 143	*30C	10	1 1/8"	.08	.056	.048	.044

SLIP-ON INSULATORS FOR CLIPS

K Tough, flexible plastic. High dielectric strength; resistant to oils and grease. Covers entire clip except for end of nose. Av. shgp. wt. per pkg., 5 oz. 2 insulators per pkg.; one red, one black.

Stock No.	Mfr's Type	For Use With	NET PER PKG.			
			1-4	5-49	50-249	250-Up
45 N 167	13	Series 11	1.51	1.06	.90	.86
45 N 164	23	Series 21	.94	.67	.57	.53
45 N 163	24	Series 24	.47	.33	.278	.262
45 N 166	29	Series 27	.31	.22	.192	.18
45 N 144	32	Series 30	.22	.152	.126	.12
45 N 162	35	Series 33	5.06	3.53	3.04	2.88
45 N 160	47	Series 45	.14	.096	.08	.076
45 N 161	49	Series 48, 50	.20	.14	.112	.108
45 N 165	62	Series 60, 70	.14	.096	.08	.076
45 N 168	87	Series 85	.14	.096	.08	.076
45 N 169	93	Series 88	.20	.14	.12	.116



SPRING CLIPS AND BINDING POSTS

FAHNSTOCK SPRING CONTACT CLIPS

Positive contact clips. *Made of bronze. All others brass. Av. shgp. wt., per pkg., 3 oz. 10 clips per pkg.

Stock No.	Mfr's Type	Fig.	Length	Width	Max. Wire	Mtg. Hole	NET PER PKG.		
							1-9	10-99	100-Up
41 H 700	2	L	1"	3/8"	#10	#8	.12	.11	.10
41 H 702	3	L	1 1/16"	3/8"	#10	#8	.17	.15	.14
41 H 705	5	M	3/4"	5/16"	#10	#8	.10	.09	.08
41 H 707*	15	M	1/2"	7/16"	#16	#4	.19	.17	.16
41 H 704	9	N	2 1/8"	3/8"	#10	#8	.51	.46	.42
41 H 710	9C	N	1 3/8"	3/8"	#10	#8	1.50	1.35	1.24
41 H 715	18	N	1 1/2"	5/8"	#14	#6	.50	.45	.41
41 H 708*	36	P	1 3/8"	3/8"	#10	#8	.55	.50	.46
41 H 709	45	R	1 1/2"	3/8"	#12	#6	.17	.15	.14

SUPERIOR BINDING POSTS

S Take spade lugs, banana plugs (have jack in top), clip leads, and up to No. 12 wire. 30 amps, 1000 volts. For panels 1/2" to 1/4". Insulated with nylon plastic; all-metal components recessed. 1 3/4"x1 1/4". Wt., 4 oz.

Stock No.	Type	Color	1-99, EACH	100 or More, EACH
41 H 172	DF30YC	Yellow	40c	34c
41 H 173	DF30GNC	Green		
41 H 174	DF30WC	White		
41 H 177	DF30BC	Black		
41 H 178	DF30RC	Red		

ICA BINDING POSTS

T Molded bakelite. 3/16" diameter head with threaded insert. Nickel-plated 8-32 screw and knurled locking nut. Length overall, 1 1/8". Shgp. wt., 2 oz.

Stock No.	Mfr's Type	Size	Description	1-9	10-99	100-499	500-Up
41 H 369	Black	41 H 370, Red.					
50-99, EACH	...13c	10-49, EACH	...14c	1-9, NET EACH	...16c		

H. H. SMITH BINDING POSTS

All posts rated 2000 volts. 30 amps. Type 267 is "standard" type, requires solder lug for connection to post; Type 257 uses direct wrap-around solder connection. 260 is completely insulated; 220 is grounding type, requires fiber washers for insulation. Av. shgp. wt., 2 oz.

Stock No.	Mfr's Type	Fig.	Dia.	Length	Description	NET EACH		
						1-9	10-49	50-Up
41 H 368	257R	W	1 1/16"	1 1/8"	Red	35c	31c	28c
41 H 367	257B	W	1 1/16"	1 1/8"	Black			
41 H 386	267R	X	1 1/16"	1 1/8"	Red			
41 H 387	267B	X	1 1/16"	1 1/8"	Black			
41 H 330	220R	Y	1/2"	1 1/4"	Red	18c	16c	15c
41 H 335	220B	Y	1/2"	1 1/4"	Black	18c	16c	15c
41 H 388	260B	Z	1 1/2"	1 1/2"	Red	24c	22c	20c
41 H 389	260B	Z	1 1/2"	1 1/2"	Black	24c	22c	20c

AA Type 110 Post. For heavy-duty use and low-resistance connections. Nickel-plated brass 3/16" dia. 1 1/8" long. Wt., 2 oz. 41 H 371. 50-Up, EA. 12c 10-49, EA. 13 1/2c 1-9, NET EA. 15c

Insulators, Plugs, Jacks and Adapters

FAMOUS E. F. JOHNSON QUALITY PRODUCTS

INSULATORS

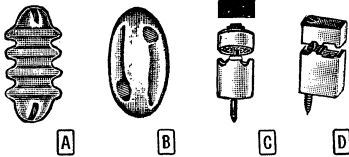

ANTENNA INSULATORS

- A** 51 C 223. Glazed porcelain insulator, 2 1/2" long. Shpg. wt., 2 oz. 4 per pkg. **21c**
10 or More Pkgs., Per Pkg. **19c**
- B** 51 C 224. White porcelain strain insulator, 1 3/4" dia. Wt., 2 oz. 4 per pkg. **29c**
10 or More Pkgs., Per Pkg. **26c**
- C** 51 C 225. Standard nail knob. 1 3/4 x 1 1/8" dia. Shpg. wt., 4 oz. 4 per pkg. **17c**
10 or More Pkgs., Per Pkg. **15c**
- D** 51 C 226. Porcelain insulator for 300 ohm twin-lead. Shpg. wt., 5 oz. 4 per pkg. **26c**
10 or More Pkgs., Per Pkg. **24c**

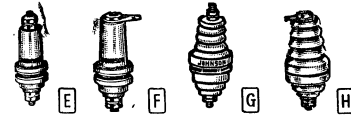

Thru-Panel Insulators. High mechanical strength; long leakage path. White glazed porcelain, except fsteatite. *Have Type 108-740 jack, listed below. Shpg. wt., 12 oz.

Stock No.	Mfr's Type	Fig.	Top Ht.	Panel Hole	Hard-ware	NET E.A.
73 H 225	135-40-2	E	1 1/4"	7/16"	10-32	.35
73 H 226	135-40-2	F	1 1/4"	7/16"	*	.45
73 H 227	135-42-2	F	1 1/4"	7/16"	10-32	.45
73 H 228	135-42-2	F	1 1/4"	7/16"	10-32	.45
73 H 229	135-44-1	E	3/4"	5/16"	6-32	.27
73 H 230	135-45-1	G	1 1/4"	1/2"	10-32	.47
73 H 231	135-45-2	H	1 3/8"	1/2"	*	.57
73 H 233	135-46	E	2 1/4"	1 1/16"	1/4-20	1.30
73 H 235	135-47	E	4"	3 1/2"	1/4-20	1.85
73 H 223	135-48	G	2"	1 1/16"	10-32	.70
73 H 224	135-48-2	H	2"	1 1/16"	*	.83

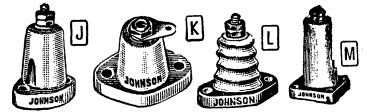

Stand-Off Insulators. High-glass porcelain (except fsteatite). Ideal for transmitter applications, etc. Feature long leakage path, low capacity and freedom from moisture absorption. Heavy breakage-resistant bases. Nickel-plated brass hardware. Types 65, 65-2, 68, 68-2 are ribbed; others have drawn bases. †Have jacks as listed below. †Like Fig. L but square base. Av. shpg. wt., 1 lb.

Stock No.	Mfr's Type	Fig.	Body Ht.	Hard-ware	NET
73 H 120	135-208	J	1 1/4"	10-32	25c
73 H 121	135-20-2	K	1 1/4"	740†	30c
73 H 122	135-228	J	1"	8-32	19c
73 H 123	135-22	K	1"	740†	25c
73 H 129	135-24	J	5/8"	6-32	15c
73 H 125	135-60	*	4 1/2"	1/4-20	98c
73 H 123	135-62	*	2 3/4"	1/4-20	60c
73 H 127	135-65	L	1 3/8"	10-32	30c
73 H 128	135-65-2	L	1 3/8"	740†	39c
73 H 129	135-66	M	2 3/4"	1/4-20	87c
73 H 130	135-66-2	M	2 3/4"	760†	98c
73 H 131	135-67	M	4 1/2"	1/4-20	98c
73 H 136	135-68	*	2"	10-32	46c
73 H 137	135-68-2	*	2"	740†	54c

NATIONAL STAND-OFF INSULATORS



Molded steatite insulators for use in RF circuits. Glazed to prevent moisture absorption. Base and terminal assembly removable to form single-screw type pillar mount. Av. shpg. wt., 3 oz.

Stock No.	Mfr's Type	Body Ht.	Dia.	NET EACH
71 H 125	GS-1	1 3/4"	1 1/2"	27c
71 H 126	GS-2	2 1/4"	1 1/2"	35c
71 H 127	GS-3	2 3/4"	3/4"	69c

LAB-TRONICS JACK ADAPTERS AND CONNECTORS

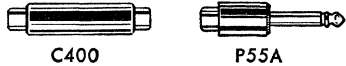

Type C400 Double ended Phono Pin Jack. Allows rapid connection of any two lines having phono pin plug ends. Shpg. wt., 2 oz. 71 H 288. NET **59c**

Type P55A Adapter. Standard phone plug, with standard phono pin jack on opposite end. Allows connection of standard phono pin plug into standard phone jack. Shpg. wt., 2 oz. 71 H 289. NET **73c**

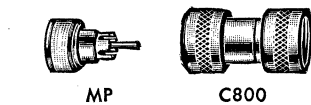

Type MP Microphone Connector Adapter. Has standard microphone connector on one end and a standard phono pin plug on the other end. Handy for all installers of public address and hi-fi equipment, repair departments, labs, etc. Shpg. wt., 2 oz. 71 H 290. NET **59c**

Type C800 Microphone Cable Connector. For use where splicing microphone lines is necessary. Connects two cables equipped with male or female microphone connectors. 4 oz. 71 H 291. NET **59c**



Type E1106. 6-ft. shielded cable with mike connector at one end; other end stripped and tinned. Shpg. wt., 1 lb. 71 H 292. NET **1.21**

Type E1110. As above, but 10-ft. Wt., 1 lb. 71 H 293. NET **1.59**



Type E906. 6-ft. shielded cable with mike connectors on both ends. Shpg. wt., 1 lb. 71 H 294. NET **1.47**

Type E912. As above, but 12-ft. Wt., 1 lb. 71 H 295. NET **2.06**

Type E925. As above, but 25-ft. Wt. 2 lbs. 41 S 911. NET **3.44**



Lead-in Bushings. Have many applications in transmitter and antenna installations. Ideal as power supply and high voltage terminals. 50, 51, 52, 55 are steatite, with nickelled brass rod and nuts; 53 and 54 are porcelain, less hardware. Av. shpg. wt., 8 oz.

Stock No.	Mfr's Type	Fig.	Top Ht.	Max. Dia.	Panel Hole	NET E.A.
73 H 160	135-50	S	1/2"	3/4"	1 1/2"	33c
73 H 161	135-51	S	1 1/8"	1 1/4"	2 1/2"	54c
73 H 162	135-52	S	1 3/8"	1 3/4"	1 3/2"	79c
73 H 163	135-53	P	1 1/4"	2 1/2"	1 7/8"	29c
73 H 164	135-54	N	4"	3 1/2"	2 1/16"	79c
73 H 165	135-55	R	1/4"	3/4"	1 1/2"	31c

Ultra-Steatite Cone Insulators. Smooth, non-ribbed high grade steatite insulators. Ideal for mounting coils, capacitors, etc. Threads tapped directly into the steatite. Width shown is max. (Base) With screws, washers. Wt., 5 oz.

Stock No.	Mfr's Type	Height	Width	NET EACH
73 H 150	135-500	5/8"	5/8"	.23
73 H 151	135-501	1"	3/4"	.31
73 H 152	135-502	1 1/2"	1"	.51
73 H 153	135-503	2"	1 1/8"	.71
73 H 154	135-504	3"	1 1/2"	1.20

PLUGS AND JACKS



NON-INSULATED PLUGS AND JACKS

Positive contact. Banana type plugs have nickel-silver springs; jacks are nickelled brass with phosphor bronze spring sleeves. Type 771 plugs have long screw for mounting on ceramic or steatite plug-in coil forms. Supplied with all hardware. Av. shpg. wt., 2 oz.

Stock No.	Type	Fits	Lgth.	NET
73 H 200	108-740	750, 750-2, 753	5/8"	12c
73 H 201	108-750	740	1 1/8"	13c
73 H 202	108-750-2	740	1 1/2"	14c
73 H 203	108-753	740	1 5/16"	14c
73 H 204	108-760	770, 771	1"	31c
73 H 205	108-770	760	1 2 3/32"	30c
73 H 206	108-771	760	1 1/8"	34c



NYLON TIP JACKS

Low loss nylon insulated .081" tip jacks. Silver-plated beryllium copper contacts. Body threaded 7/8"-32; single nut mounting. D.C. breakdown voltage 11,000 volts. Length 2 3/32". Diameter 3/8". Shpg. wt., 2 oz.

Stock No.	Mfr's Type	Color	EACH
73 H 250	105-601	White	25c
73 H 251	105-602	Red	
73 H 252	105-603	Black	
73 H 253	105-604	Green	
71 H 254	105-605	Blue	
71 H 255	105-607	Yellow	

NYLON BANANA JACKS AND PLUGS

Compact, high voltage insulated, plugs and jacks. Molded of tough low-loss nylon. Retain low-loss qualities through wide temperature range and high humidity. Plugs have one piece nickel-plated brass body and pin; nickel silver springs. Solderless connection takes up to No. 16 wire. Voltage breakdown of jacks, 11,000 v. Jacks mount in 1/4" hole. 2 oz.

Stock No.	Type	Fig.	Color	Length	EACH
71 H 266	108-901	T	White	1 3/8"	14c
71 H 267	108-902	T	Red	1 3/8"	
71 H 268	108-903	T	Black	1 3/8"	
71 H 269	108-904	T	Green	1 3/8"	
71 H 270	108-907	T	Yellow	1 3/8"	
71 H 271	108-301	W	White	1 3/8"	21c
71 H 272	108-302	W	Red	1 3/8"	
71 H 273	108-303	W	Black	1 3/8"	
71 H 274	108-304	W	Green	1 3/8"	
71 H 287	108-307	W	Yellow	1 3/8"	

NYLON TIP PLUGS

Nylon insulated solderless tip plugs. Fit all standard tip jacks. No metal surfaces exposed when inserted. Withstand high voltages. Current rating 10 amps. Pin size, 3/8" long; .081" diameter. Body, 7/8" long; 3/8" diameter. Wt., 2 oz.

Stock No.	Mfr's Type	Color	NET EACH
71 H 256	105-301	White	16c
71 H 257	105-302	Red	
71 H 258	105-303	Black	
71 H 259	105-304	Green	
71 H 264	105-305	Blue	
71 H 265	105-307	Yellow	

Belden Cable and Wire



SHIELDED MICROPHONE CABLE SINGLE CONDUCTOR—FOR HIGH-IMPEDANCE MIKES

No. 25, tinned, stranded conductor; 3x33 copper and 4x33 steel wire. Covered with cellulose acetate yarn braid, polyethylene insulation, tinned copper shield and chrome plastic jacket. *Rubber insulation and black rubber jacket. Lengths under 100 ft. available only in spool sizes listed below.

Mfr's Type	15 ft. Spool		25 ft. Spool		50 ft. Spool		100 ft. Spool		Over 100 ft.	
	Stk. No.	NET	Stk. No.	NET	Stk. No.	NET	Stk. No.	NET	Stk. No.	Per 100'
8401	47 T 561	.81	47 T 562	1.18	47 T 563	2.30	47 T 560	4.21	47 W 564	4.21
8410*	47 T 447	1.32	47 T 448	2.06	47 T 449	3.82	47 T 446	7.20	47 W 444	7.20
8411	47 T 601	.64	47 T 602	.99	47 T 603	1.71	47 T 600	3.14	47 W 604	3.14

TWO-CONDUCTOR—FOR LOW-IMPEDANCE MIKES

Shielded cable. 8422 is No. 22 stranded (16x34) tinned copper, polyethylene insulation, chrome plastic jacket. 8412 is No. 20 stranded (26x34) cotton wrap, rubber ins., black rubber jacket. 8428 is heavy-duty studio cable, No. 18 stranded (41x34), cotton wrap, black rubber jacket. Lengths under 100 ft. available only in spool sizes listed below.

Mfr's Type	15 ft. Spool		25 ft. Spool		50 ft. Spool		100 ft. Spool		Over 100 ft.	
	Stk. No.	NET	Stk. No.	NET	Stk. No.	NET	Stk. No.	NET	Stk. No.	Per 100'
8428	47 T 465	1.71	47 T 466	2.79	47 T 467	5.29	47 T 454	10.29	47 W 468	10.29
8412	47 T 457	1.42	47 T 458	2.30	47 T 459	4.21	47 T 453	8.08	47 W 464	8.08
8422	47 T 451	1.08	47 T 452	1.67	47 T 455	3.09	47 T 450	5.94	47 W 456	5.94

Unshielded, Weatherproof 2-Cond. Cable. For intercoms, speaker extensions, etc. 8205 is No. 22 stranded (7x30), rubber ins., black cotton braid; 8204 is No. 18 (16x30), rubber ins., white cotton braid.

Mfr's Type	O. D.	Wt., 100 ft.
8205	.165"	2 lbs.
8204	.220"	3 lbs.

MULTIPLE-CONDUCTOR MIKE AND POWER CABLE

For microphone and interconnecting power cable requirements. No. 20 stranded (26x34), tinned copper conductor, and color-coded conductors. Types 8423, 8424, 8425, 8426, 8427, and 8418 have cotton wrap, rubber insulation, rayon braid, tinned copper braid shield, and black rubber outer jacket. Types 8403, 8404, and 8405 have polyethylene insulation, rayon, tinned copper braid shield, and chrome vinyl plastic jacket. Types 8405, 8404, 8423, and 8424 for all low-impedance mikes; all others for general interconnecting power cable uses. Lengths under 100 ft. available only in spool sizes listed below.

Mfr's Type No.	Conductors	Mmf. per foot	15 ft. Spool		50 ft. Spool		100 ft. Spool		Over 100 ft.	
			Stk. No.	NET	Stk. No.	NET	Stk. No.	NET	Stk. No.	Per 100'
8423	3	85	47 T 461	1.62	47 T 462	4.80	47 T 460	8.82	47 W 463	8.82
8403	3	45	47 T 554	1.47	47 T 555	3.67	47 T 557	7.35	47 W 558	7.35
8404	4	42	47 T 559	1.70	47 T 565	4.41	47 T 566	8.82	47 W 567	8.82
8424	4	95	47 T 471	1.86	47 T 472	5.39	47 T 470	10.29	47 W 473	10.29
8425	5	58	47 T 481	2.06	47 T 482	6.42	47 T 480	12.64	47 W 483	12.64
8405	5	42	47 T 568	1.91	47 T 569	5.44	47 T 572	10.88	47 W 573	10.88
8426	6	60	47 T 491	2.65	47 T 492	7.89	47 T 490	15.14	47 W 493	15.14
8407	6	56	47 T 507	2.57	47 T 510	8.53	47 T 510	16.56	47 W 509	16.56
8418	8	64	48 T 834	2.89	48 T 835	8.77	48 T 836	16.86	48 W 837	16.86



MULTI-CONDUCTOR RUBBER SERVICE CORDS

2-Conductor. Stranded copper wire, cotton wrap, Rubber ins.; 1/2" black rubber jacket. 8452 and 8478, No. 18 stranded (41x34), 8472, No. 16 stranded (65x34). *SV. †SJ. Lengths under 100 ft. available only in spool sizes listed below.

Mfr's Type	O. D.	25 ft. Spool		50 ft. Spool		100 ft. Spool		Over 100 ft.		Lbs., 100 ft.
		Stk. No.	NET	Stk. No.	NET	Stk. No.	NET	Stk. No.	Per 100'	
8452*	.245"	47 T 411	1.42	47 T 412	2.40	47 T 410	4.26	47 W 413	4.26	5
8478†	.299"	47 T 401	1.62	47 T 402	2.79	47 T 400	5.14	47 W 404	5.14	5 1/2
8472†	.325"	47 T 406	1.91	47 T 407	3.38	47 T 403	6.32	47 W 408	6.32	5 1/2

3, 4 & 5-Conductor. Excellent for use in extension speakers, public address systems, test equipment, remote control circuits, press-to-talk intercom circuits, etc. Uniform quality. Bare copper flexible stranding; cotton wrap; rubber insulation; color-coded conductors; black rubber jacket. Av. shgp. wt., per 100-ft. spool. 5 1/2 lbs. Lengths under 100 ft. available only in spool sizes listed below.

Mfr's Type	Cond.	Wire Size	15 ft. Spool		50 ft. Spool		100 ft. Spool		Over 100 ft.		Type	O. D.
			Stk. No.	NET	Stk. No.	NET	Stk. No.	NET	Stk. No.	Per 100'		
8453	3	18 (41x34)	47 T 421	1.17	47 T 422	2.94	47 T 420	5.39	47 W 423	5.39	8453	.265"
8454	4	18 (41x34)	47 T 431	2.24	47 T 432	5.53	47 T 430	6.57	47 W 433	6.57	8454	.265"
8455	5	3-22(16x34) 2-18(41x34)	47 T 441	1.37	47 T 442	3.92	47 T 440	7.30	47 W 443	7.30	8455	.280"

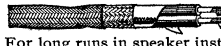

SHIELDED PA AND SOUND SYSTEM CABLE

For long runs in speaker installations. 8208 and 8209 are 2-cond., 8206, 1-cond.; 8735, 3-cond. All have No. 18 stranded copper conductor (except 8735), cotton or paper wrap, rubber insulation (except 8735), and copper braid shield. 8735 is No. 22 stranded (7x30) and has plastic insulation. 8209 in white weatherproof cotton outer jacket; 8208, 8735 chrome vinyl plastic; 8206 in copper braid. Lengths under 100 ft. available only in spool sizes listed below.

Mfr's Type	O. D.	15 ft. Spool		50 ft. Spool		100 ft. Spool		Over 100 ft.		Lbs., 100 ft.
		Stk. No.	NET	Stk. No.	NET	Stk. No.	NET	Stk. No.	Per 100'	
8206	.155"	47 T 831	.71	47 T 832	1.91	47 T 830	3.38	47 W 833	3.38	2
8208	.260"	47 T 852	1.15	47 T 853	3.18	47 T 851	5.83	47 W 854	5.83	4
8209	.258"	47 T 847	1.08	47 T 848	3.04	47 T 850	5.59	47 W 849	5.59	3 1/2
8735	.195"	48 T 872	.85	48 T 873	2.25	48 T 876	4.21	48 W 874	4.21	3



COPPER BRAID SHIELDING AND BONDING CABLE

Flexible, braided and tinned copper for shielding and bonding. Braided in tubular form for slip-on installation over wires. Av. shgp. wt., per 50 ft., 1 1/2 lbs. Lengths under 50 ft. available only in 10 ft. spools.

Mfr's Type	I. D.	Stranding	10 ft. Spool		50 ft. Spool		100 ft. or more	
			Stk. No.	NET	Stk. No.	NET	Stk. No.	Per 100'
8660	1 1/8"	96x34	49 T 351	.41	49 T 350	1.32	49 W 352	2.51
8668	1 1/8"	120x34	49 T 356	.51	49 T 355	1.76	49 W 357	3.35
8661	3/8"	192x34	49 T 361	.56	49 T 360	2.16	49 W 362	4.00
8669	1 1/2"	336x34	49 T 366	1.11	49 T 365	5.14	49 W 367	9.41
8662	25/32"	576x34	49 T 381	1.40	49 T 380	6.47	49 W 382	12.94

JUKE BOX CABLE



Mfr's Type	O. D.	Wt., 100 ft.
8783	.240"	3 lbs.
8782	.058"x.115"	4 lbs.
8785	.195"x.300"	4 lbs.
8786	.195"x.300"	2 1/4 lbs.

High-quality speaker and control cable for all juke box applications.

All have vinyl-plastic inner insulation; chrome vinyl plastic outer jacket. Type 8782 parallel is No. 24 stranded (7x32) for speaker cable; 1 bare cond., 1 tinned copper cond. Others for use as juke box control cable. 8783 is 3-cond. color-coded, 1—No. 20 (26x30), 2—No. 16 (26x30). Type 8785 oval is 5-cond. color-coded. No. 22 stranded (7x30) tinned copper with copper braid shield over 3 conductors, twisted pair unshielded. 8786 oval is 6-cond. color-coded, 2—No. 22 (7x30), 4—No. 24 (7x32) tinned copper braid shield over 4 conductors; twisted pair unshielded.

Stock No.	Mfr's Type	NET Per ft.	NET Per 100 ft.	Wt., 100 ft.
48 W 867	8783	5¢	4.26	4 lbs.
48 W 868	8782	1 1/2¢	.91	10 oz.
48 W 869	8785	6¢	5.14	3 lbs.
48 W 864	8786	8¢	6.47	3 lbs.

CATHODE-RAY TUBE CABLE

Type 8869. High voltage cable for C.R. tubes, power supplies and other applications. High dielectric strength, corona resistance and minimum surface leakage. No. 20 single conductor stranded (7x28) tinned copper, with white flame retardant polyethylene insulation. .035" thick. 108" O.D. 10,000 volts. Shgp. wt., 100 ft., 1 1/4 lbs. Available only in lengths shown below.

47 T 893.	25 ft. Spool.	NET.....	67c
47 T 895.	100 ft. Spool.	NET.....	1.71
Type 8868.	As above but with .065" insulation, white with red stripe; rated at 20,000 volts. .168" O.D. Shgp. wt., 100 ft., 2 3/4 lbs.		
47 T 897.	25 ft. Spool.	NET.....	1.00
47 T 896.	100 ft. Spool.	NET.....	3.02

DUPLEX LIGHTING CABLE

Weatherproof 2-cond. stranded copper wire. Outer jacket is chrome vinyl plastic. One brown and one red conductor parallel in plastic vinyl oval sheathing. Av. wt., 100 ft., 5 lbs. Type 8677, No. 16 (19x29), O.D., .164"x.108".

47 T 405.	PER FOOT.....	6c
100 ft. or more,	PER 100 FT.....	5.39
Type 8675, No. 14 (19x27), O.D., .189"x.326".		
47 W 415.	PER FOOT.....	8c
100 ft. or more,	PER 100 FT.....	7.15
Type 8673, No. 12 (19x25), O.D., .214"x.384".		
47 W 425.	PER FOOT.....	12c
100 ft. or more,	PER 100 FT.....	9.95

SHIELDED GRID WIRE

Type 8885. No. 20 single stranded (10x30) tinned copper, .015" rubber insulation. Cellulose acetate yarn braid, fungus-resistant lacquer coating, tinned copper braid shield. Used in circuits where shielded grid return is required and to shield a circuit conductor from stray fields. Break-down voltage, 4000 volts. O.D., .117". Shgp. wt., 100 ft., 2 lbs. Lengths under 100 ft. available only in spool sizes listed below.

47 T 791.	15 ft. Spool.	NET.....	59c
47 T 792.	25 ft. Spool.	NET.....	96c
47 T 793.	100 ft. Spool.	NET.....	2.94
47 W 790.	Over 100 ft.,	PER 100 FT.....	2.94

PHONO PICKUP ARM CABLE

Type 8430. New, phono pickup arm cable of exceptional flexibility. Lightweight has minimum effect on tracking pressure. No. 32 stranded (7x40) copper conductor with .009" vinyl plastic insulation. Red and black twisted pair; O.D., .055".

47 T 614.	10-ft. Spool.	Wt., 4 oz.	NET .35¢
47 T 615.	25-ft. Spool.	Wt., 4 oz.	NET .50¢
47 T 616.	250-ft. Spool.	Wt., 8 oz.	NET .3.38
Type 8431.	No. 24 stranded (16x36) tinned copper, rubber covered, tinned copper shield, brown cotton. Extremely limp and flexible. O.D., .095". Shgp. wt., 100 ft., 1 lb.		
47 T 611.	10 ft. Spool.	NET.....	50c
47 T 612.	25 ft. Spool.	NET.....	.99¢
47 T 610.	100 ft. Spool.	NET.....	3.09
47 W 613.	Over 100 ft.,	PER 100 FT.....	3.09

Belden Cable and Wire

3 & 4-CONDUCTOR INTERCOM CABLE



Type 8734. No. 22 tinned, stranded copper (7x30) with plastic insulation; 3 cond.; 1 tinned copper shield, 2 unshielded. Chrome vinyl plastic jacket overall. For station-to-station and extension wiring. 190° O.D. Shpg. wt., 100 ft. 2 3/4 lbs.
48 W 875. PER FOOT..... 5c
100 ft. or more, PER 100 FT..... 3.67

Type 8732. No. 22 tinned, stranded copper (7x30) with polyethylene insulation. 4 conductors; 1 pair tinned copper braid shield, 1 pair unshielded. Chrome vinyl plastic jacket. Oval. 174"x.276" O.D. Wt., 100 ft., 3 lbs.
48 W 897. PER FOOT..... 5c
100 ft. or more, PER 100 FT..... 4.41

Mfr's Type	O. D.	Wt., 100 ft.
*8443	.146"	2 lbs.
*8444	.164"	2 1/2 lbs.
*8445	.176"	3 lbs.
*8446	.218"	4 lbs.
*8447	.236"	4 1/2 lbs.
*8448	.241"	4 1/2 lbs.
*8449	.251"	5 lbs.

VINYL-COVERED PLASTIC-INSULATED CABLE

For permanent installation of speakers, control and intercom circuits, and other applications requiring highly durable, lightweight cable. Conductors are tinned copper, flexible, stranded wire, with color-coded, plastic insulation; chrome vinyl plastic jacket overall. *All conductors are No. 22 stranded (7x30). †Have two conductors of No. 18 stranded (16x30); the others are No. 22 stranded. Lengths under 100 ft. available only in spool sizes listed below.



Mfr's Type	Cond.	15 ft. Spool		25 ft. Spool		100 ft. Spool		Over 100 ft.	
		Stk. No.	NET	Stk. No.	NET	Stk. No.	NET	Stk. No.	Per 100'
*8443	3	47 T 361	.81	47 T 360	2.43	47 W 362	2.43
*8444	4	47 T 371	.96	47 T 370	2.94	47 W 372	2.94
*8445	5	47 T 381	1.14	47 T 380	3.63	47 W 382	3.63
*8446	6	47 T 311	1.03	47 T 310	5.24	47 W 312	5.24
*8447	7	47 T 321	1.13	47 T 320	5.83	47 W 322	5.83
*8448	8	47 T 331	1.18	47 T 330	6.47	47 W 332	6.47
*8449	9	47 T 341	1.27	47 T 340	6.76	47 W 342	6.76

SHIELDED P.A. AND SOUND SYSTEM CABLE



For public address and intercom use. All have inner insulation of vinyl plastic except 8432 and 8433 (rubber) and 8799 (cotton braid). Outer jackets of chrome vinyl plastic, except cotton braid shield; 8432 and 8433 are No. 20 stranded (10x30); 8789, 8790 and 8791 are No. 18 stranded (7x26); 8799 is No. 18 solid (for PA and broadcast use).

Stock No.	Mfr's Type	Cond.	O. D.	Lbs., 100 ft.	PER FOOT	100 Ft. For
48 W 884	8432*	2	.225"	3 1/2	7c	5.98
48 W 886	8433*	3	.230"	5 1/2	9c	7.45
48 W 814	8779*	2	.225"	4 1/2	8c	6.17
48 W 815	8780*	2	.260"	5	8c	6.17
48 W 865	8789*	2	.205"	3	5c	4.41
48 W 803	8790	2	.225"	5	5 1/2c	4.56
48 W 804	8791	3	.230"	5 1/4	7c	5.73
48 W 885	8799*	2	.165"	3	6c	4.85

UNSHIELDED P.A. AND SOUND SYSTEM CABLE

For PA, intercom, speaker extension, alarm systems, etc. All are No. 19 solid copper conductor except 8762; 8762 is No. 20 stranded (7x28). All have vinyl plastic insulation. 8486, 8487 and 8762 have chrome Polyethylene outer jacket; no outer jacket on others. 8762 has spiral-wrapped, aluminum shield over copper ground wire and twisted pair.

Stock No.	Mfr's Type	Cond.	O. D.	Lbs., 100 ft.	PER FOOT	100 Ft. For
48 W 878	8482	2	.115"	3 1/2	1 1/2c	1.25
48 W 879	8483	3	.132"	1 1/4	2c	1.76
48 W 805	8486	2	.162"	3 1/2	2c	1.85
48 W 806	8487	3	.170"	2 1/2	3c	2.34
48 W 809	8762	2	.160"	2	4c	3.23
48 W 816	8460	2	.175"	2 1/2	3c	3.35
48 W 817	8461	2	.195"	3	3c	3.97
48 W 818	8470	2	.195"	2 3/4	3 1/2c	2.79
48 W 819	8471	2	.246"	4	4 1/2c	3.82

2-CONDUCTOR BROADCAST AUDIO CABLE

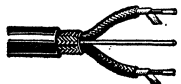

All have tinned, solid-copper conductors. 8436, 8437 and 8440 have No. 22 solid copper ground wire parallel to twisted pair under copper spiral-wrapped shield (8437, copper braid shield). All others have 2 conductors under copper braid shield. Outer jackets: Type 8436-67 8437, black vinyl plastic; 8438 and 8439, copper braid; 8440, chrome vinyl plastic. Type 8438 and 8440 have waxed cotton braid over cotton wrap; 8436 and 8439, cellulose-acetate yarn braid over cellulose-acetate yarn wrap; 8437, waxed cotton braid over cellulose-acetate yarn wrap.

Stock No.	Mfr's Type	Gauge	O. D.	Lbs., 100 ft.	PER FOOT	100 Ft. For
48 W 859	8436	22	.180"	2	5 1/2c	4.56
48 W 886	8437	22	.222"	3 1/2	6c	4.95
48 W 887	8438	20	.140"	2 3/4	5c	4.07
48 W 888	8439	20	.150"	2 3/4	5 1/2c	4.70
48 W 889	8440	22	.185"	3	5c	4.41

RG HIGH-FREQUENCY CABLE



All cables have low-loss, flexible, polyethylene plastic inner jacket, covered with copper braid shield. All have black vinyl plastic outer jacket overall, except RG-9/U has gray plastic jacket and silver-coated copper conductor; RG-54A/U and RG-71/U have polyethylene plastic outer jacket. Impervious to acids, alkalis, oils and gasoline. RG-8/U and RG-9/U are medium-sized video and communications cable. RG-11/U is medium-sized 75-ohm video and communications cable. RG-58/U is ideal for radio-frequency transmission, video test equipment, etc. *Solid copper; all others stranded. See page 169 for connectors.

Stock No.	RG No.	Mfr's Type	Imp.	Mmf/ft	O. D.	Lbs., 100 ft.	Per Ft.	100 Ft. For
47 W 511	8/U	8237	52	29.5	.405"	12	16c	13.38
47 W 512	9/U	8242	51	30.0	.420"	15 1/2	33c	27.64
47 W 513	11/U	8238	75	20.5	.405"	11	15c	12.49
47 W 514	54A/U	8238	53	26.5	.250"	3	10c	8.67
47 W 516	58/U	8240*	53.5	28.5	.195"	3	7c	5.68
47 W 517	58A/U	8259	50	29	.195"	3 1/2	7c	5.68
47 W 552	59/U	8241*	73	21	.242"	4	8c	6.17
47 W 518	62/U	8254*	93	13.5	.242"	4	9c	7.20
47 W 519	71/U	8257*	93	13.5	.250"	4 1/2	14c	11.61

PAIRED VINYL-COVERED CABLE

For intercom and telephone wiring. No. 22 solid tinned copper; color-coded vinyl plastic insulation. Conductors are cabled in twisted pairs; chrome vinyl plastic overall.



Stock No.	Mfr's Type	Conductors	O. D.	Shpg. Wt., 100 ft.	PER FOOT	100' or more PER 100'
48 W 890	8740	2	.140"	1 1/4 lbs.	2c	1.76
48 W 891	8741	4	.191"	2 1/2 lbs.	3 1/2c	2.89
48 W 892	8742	6	.226"	3 1/2 lbs.	5c	3.82
48 W 893	8743	12	.281"	4 1/2 lbs.	7c	5.44
48 W 894	8744	18	.330"	6 1/2 lbs.	9c	7.79
48 W 898	8753	22	.370"	8 lbs.	13c	10.88
48 W 895	8745	30	.400"	10 lbs.	17c	14.21
48 W 896	8746	54	.520"	17 lbs.	30c	24.99

2-CONDUCTOR SHIELDED INTERCOM CABLE

All have vinyl plastic insulation, jackets; except 8738, 8758 have copper braid jackets. Tinned conductors. *Tinned copper shield. Black/Red coding. 8737 is No. 22 stranded (7x30); 8758, 8759 are No. 20 stranded (7x28); 8738, 8739 are No. 22 solid.



Stock No.	Mfr's Type	O. D.	Shpg. wt., 100 ft.	PER FOOT	100' or more PER 100'
48 W 877	8737*	.166"	3 1/2	4c	3.53
48 W 882	8738	.130"	2	3c	2.50
48 W 801	8758	.165"	2 1/2	4c	3.09
48 W 802	8759*	.185"	2 3/4	5c	3.82
48 W 883	8739*	.156"	2 1/4	3 1/2c	2.89

TV CAMERA CABLE

Type 8280. 28-conductor TV camera cable. All conductors, plastic-insulated color-coded. Highest performance with black-and-white color. Has 4 No. 18 conductors; 21 No. 22 conductors in groups of 7 each; 3 coaxial cables (Nom. Imped. 51 ohms); paper separator, tinned copper braid shield; chrome plastic jacket .750" O.D. Wt., 100 ft. 35 lbs.



47 W 575. NET PER FT.....70¢ 100' or More, PER 100...58.80

NEW 75-OHM VIDEO CABLE

Type 8281. New coaxial video cable for black-and-white or color transmission. Single No. 20 solid copper conductor and polyethylene insulated. Has tinned copper, double braid shield and brown polyethylene jacket, .310" O.D. av. wt., 100-ft. coil, 8 lbs.
 48 W 813. NET PER FT.....19¢ 100' or More, PER 100...16.17



POPULAR ANTENNA WIRE

High conductivity copper antenna wire. Ideal for all receiving and transmitting antenna requirements. Maximum tensile strength assures minimum stretch. *Nylclad insulation protects wire from corrosion. Supplied only in coil lengths listed below. Av. shpg. wt., per 100-ft. coil, 1 lb.



STRANDED BARE COPPER

Type 8000—7x22			Type 8002—7x24		
No.	Spool	NET	No.	Spool	NET
47 T 680	50 ft.	.81	47 T 654	50 ft.	.59
47 T 681	75 ft.	1.1	47 T 655	75 ft.	.73
47 T 682	100 ft.	1.40	47 T 656	100 ft.	.96
47 T 683	1,000 ft.	13.23	47 T 657	1,000 ft.	8.82

*SOLID NYLCLAD COPPER

Type 8008 No. 12			Type 8009 No. 14		
47 T 670	100 ft.	2.28	47 T 740	100 ft.	1.62
47 T 735	200 ft.	4.26	47 T 741	500 ft.	6.61
47 T 736	500 ft.	9.55			

NEW WIRE MARKERS

New Stran Code adhesive markers provide efficient method of wire and cable identification. Consist of 33 numeral markers (3/16" x 1/2") per card in numerical sequence from 1 through 33. On vinyl impregnated cloth or .003" soft aluminum. Pressure sensitive adhesive. Heat resistant—Card size: Cloth, 2x9"; aluminum, 1 1/2x6 3/4". Shpg. wt., 3 oz. Write for quantity prices on 50 or more cards.
 49 T 898, Cloth. PER CARD, 1-9.....23¢ 10-49.....21¢
 49 T 899, Aluminum. PER CARD, 1-9.....21¢ 10-49.....19¢

Belden Cable and Wire

TYPE MIL-W-76A SRIR THERMOPLASTIC HOOK-UP WIRE

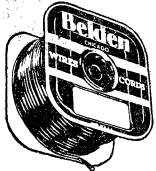

A general-purpose, heavy-duty, thermoplastic-insulated hook-up wire for critical electronic applications. Insulation is rated at 1000 volts rms. Made to conform to stringent government specifications. Feature extremely high dielectric strength, excellent stability at high temperatures and extremely low moisture absorption. Has high flame and fungi resistance. Vinyl thermoplastic insulation (0.016" thick) is virtually impervious to damage from solvents. Supplied in popular lengths on durable spools for most convenient storage and use. Nominal diameters: Type 8530, .059"; Type 8524, .064";

Type 8529, .066"; Type 8523, .072". All are tinned copper conductors. No. 22 stranded is 7x30; No. 20 stranded is 10x30. Av. shpg. wt., 25-ft. spool, 6 oz. Av. Shpg. wt., 100-ft. spool, 1 1/4 lbs. Av. shpg. wt., 1000-ft. spool, 14 lbs.

25-FOOT SPOOLS

Color	Type 8530 22 Solid	Type 8524 22 Stranded	Type 8529 20 Solid	Type 8523 20 Stranded
Black	47 T 390	47 T 377	47 T 337	47 T 315
Brown	47 T 391	47 T 378	47 T 338	47 T 316
Red	47 T 392	47 T 379	47 T 339	47 T 317
Orange	47 T 393	47 T 383	47 T 343	47 T 318
Yellow	47 T 394	47 T 384	47 T 344	47 T 319
Green	47 T 395	47 T 385	47 T 345	47 T 325
Blue	47 T 396	47 T 386	47 T 346	47 T 326
Violet	47 T 397	47 T 387	47 T 347	47 T 327
Gray	47 T 398	47 T 388	47 T 348	47 T 328
White	47 T 399	47 T 389	47 T 349	47 T 329

NET EACH 32c 37c 35c 38c

Hook-Up Wire Kits. Each kit contains six, 25-ft. spools of No. 20 hook-up wire. Type 8850 kit contains Type 8529 solid (.066" O.D.). Type 8857 kit contains Type 8523 stranded (.072" O.D.). Both are for general-purpose use, and have thermoplastic insulation. Colors: Black, Blue, Green, Red, White, Yellow. Shpg. wt., 3 lbs.

49 T 848. Type 8856 Kit. NET.....2.12
49 T 849. Type 8857 Kit. NET.....2.29

100-FOOT SPOOLS

Color	Type 8530 22 Solid	Type 8524 22 Stranded	Type 8529 20 Solid	Type 8523 20 Stranded
Black	49 T 800	49 T 820	49 T 810	49 T 830
Brown	49 T 801	49 T 821	49 T 811	49 T 831
Red	49 T 802	49 T 822	49 T 812	49 T 832
Orange	49 T 803	49 T 823	49 T 813	49 T 833
Yellow	49 T 804	49 T 824	49 T 814	49 T 834
Green	49 T 805	49 T 825	49 T 815	49 T 835
Blue	49 T 806	49 T 826	49 T 816	49 T 836
Violet	49 T 807	49 T 827	49 T 817	49 T 837
Gray	49 T 808	49 T 828	49 T 818	49 T 838
White	49 T 809	49 T 829	49 T 819	49 T 839

NET EACH 76c 88c 88c 1.03

1000-FOOT SPOOLS

Color	Type 8530 22 Solid	Type 8524 22 Stranded	Type 8529 20 Solid	Type 8523 20 Stranded
Black	49 T 850	49 T 870	49 T 860	49 T 880
Brown	49 T 851	49 T 871	49 T 861	49 T 881
Red	49 T 852	49 T 872	49 T 862	49 T 882
Orange	49 T 853	49 T 873	49 T 863	49 T 883
Yellow	49 T 854	49 T 874	49 T 864	49 T 884
Green	49 T 855	49 T 875	49 T 865	49 T 885
Blue	49 T 856	49 T 876	49 T 866	49 T 886
Violet	49 T 857	49 T 877	49 T 867	49 T 887
Gray	49 T 858	49 T 878	49 T 868	49 T 888
White	49 T 859	49 T 879	49 T 869	49 T 889

NET EACH 4.56 5.88 5.73 7.06



NYLCLAD HEAVY MAGNET WIRE

Type HNC. This heavy-duty Nylonclad copper magnet wire combines the most desirable features of Formvar wire with the toughness and solvent resistance of nylon enamel. Unexcelled for difficult and exacting windings of any type. Outstanding features: Withstands winding abuse and forming operations; resists solvent action of all types of thinners; resists softening and brittleness at extreme temperatures; infinite moisture resistance.

Stk. No.	1/2 lb. Spool			1 lb. Spool			
	Size	Feet	NET	Stk. No.	Size	Feet	NET
48 T 036	14	40	.61	48 T 086	14	80	1.15
48 T 037	16	63	.61	48 T 087	16	126	1.15
48 T 038	18	100	.62	48 T 088	18	199	1.18
48 T 039	20	157	.65	48 T 089	20	315	1.22
48 T 040	22	250	.68	48 T 090	22	501	1.28
48 T 041	24	396	.76	48 T 091	24	793	1.35
48 T 042	26	630	.84	48 T 092	26	1200	1.49
48 T 043	28	995	.84	48 T 093	28	1990	1.62
48 T 044	30	1570	.93	48 T 094	30	3140	1.81
48 T 045	32	2440	.97	48 T 095	32	4880	1.91
48 T 046	34	3930	1.11	48 T 096	34	7860	2.20
48 T 047	36	6200	1.29	48 T 097	36	12400	2.50
48 T 048	38	9700	1.70	48 T 098	38	19400	3.50
48 T 049	40	16050	2.62	48 T 099	40	32100	5.50

Type 8817. 5x44 stranded Celanamel with one nylon varnish. For rewinding antenna primaries, hand-winding RF coils, and similar applications. Outside diameter; .008". 100 ft. spool. Shpg. wt., 2 oz.

48 T 981. NET.....24c

HIGH TEMPERATURE THERMOPLASTIC HOOK-UP WIRE

Type B Mil-W-16878-B. For general-use of up to 212 degrees Fahr., and up to 600 volts rms. Vinyl thermoplastic insulation (0.010") resists damage from solvents. All are stranded tinned copper conductors. Where color is shown as "Wh/Red", indicates white body color and color of striping. Nominal diameters: Type 8501, .068" (7x26); Type 8502, .058" (7x28); Type 8503, .050" (7x30); Type 8504, .044" (7x32). Av. shpg. wt., 100-ft. spool, 1/2 lb.; 1000-ft. spool, 4 1/4 lbs.



100-FOOT SPOOLS

Color	Type 8501 18 Stranded	Type 8502 20 Stranded	Type 8503 22 Stranded	Type 8504 24 Stranded
Wh/Black	47 T 306	47 T 354	47 T 367	47 T 417
Wh/Brown	47 T 307	47 T 355	47 T 368	47 T 418
Wh/Red	47 T 308	47 T 356	47 T 369	47 T 419
Wh/Orange	47 T 309	47 T 357	47 T 373	47 T 424
Wh/Yellow	47 T 313	47 T 358	47 T 374	47 T 426
Wh/Green	47 T 314	47 T 359	47 T 375	47 T 427
Wh/Blue	47 T 335	47 T 363	47 T 376	47 T 428
Wh/Violet	47 T 336	47 T 364	47 T 409	47 T 429
Wh/Gray	47 T 352	47 T 365	47 T 414	47 T 434

NET EACH 1.38 1.20 1.12 1.09

White 47 T 353 47 T 366 47 T 416 47 T 435

NET EACH 1.29 1.11 1.03 1.00

1000-FOOT SPOOLS

Color	Type 8501 18 Stranded	Type 8502 20 Stranded	Type 8503 22 Stranded	Type 8504 24 Stranded
Wh/Black	47 T 436	47 T 479	47 T 497	47 T 536
Wh/Brown	47 T 437	47 T 484	47 T 498	47 T 537
Wh/Red	47 T 438	47 T 485	47 T 503	47 T 538
Wh/Orange	47 T 439	47 T 486	47 T 504	47 T 539
Wh/Yellow	47 T 469	47 T 487	47 T 506	47 T 543
Wh/Green	47 T 474	47 T 488	47 T 524	47 T 544
Wh/Blue	47 T 475	47 T 489	47 T 526	47 T 545
Wh/Violet	47 T 476	47 T 494	47 T 528	47 T 546
Wh/Gray	47 T 477	47 T 495	47 T 529	47 T 547

NET EACH 11.12 9.41 8.33 7.89

White 47 T 478 47 T 496 47 T 534 47 T 553

NET EACH 10.24 8.53 7.45 7.01

CELLULOSE ACETATE HOOK-UP WIRE

Single, tinned copper conductor, with heavy cellulose acetate yarn wrap and cellulose yarn braid. Fungus and flame resistant. Lacquer coating. Breakdown voltage, 1000 volts AC. DC insulation resistance is 200 megs or better. Stranded type conductor (Type 8943) is No. 20 (10x30) with O.D. of .076". Solid type conductor (Type 8944) has O.D. of .072". Av. shpg. wt., 12 oz. per 100 ft.



Type 8941—20 Solid

Coil	Red	Black	Blue	Green	Yellow	EACH
25 Ft.	48 T 331	48 T 330	48 T 332	48 T 333	48 T 334	.46
100 Ft.	47 T 920	47 T 921	47 T 922	47 T 923	47 T 924	1.47
1000 Ft.	48 T 351	48 T 350	48 T 352	48 T 353	48 T 354	11.40

Type 8864 Assorted Wire Kit. Contains six, 25-ft. Spools of Type 8941 hook-up and lead-wire. Spools are one each: Black, Blue, Green, Red, White and Yellow. Shpg. wt., 1 lb.

48 T 846. NET.....2.74

Type 8943—20 Stranded

Coil	Red	Black	Blue	Green	Yellow	EACH
25 Ft.	48 T 361	48 T 360	48 T 362	48 T 363	48 T 364	.47
100 Ft.	47 T 940	47 T 941	47 T 942	47 T 943	47 T 944	1.47
1000 Ft.	48 T 381	48 T 380	48 T 382	48 T 383	48 T 384	12.20

Type 8865 Assorted Wire Kit. Contains six, 25-ft. spools of Type 8943 hook-up and lead wire. Spools are one each: Black, Blue, Green, Red, White and Yellow. Shpg. wt., 1 lb.

48 T 847. NET.....2.82

TYPE 8945—18 SOLID

47 T 900. Red.	} 100-Ft. Spools
47 T 901. Black.	
47 T 902. Blue.	
47 T 903. Green.	
47 T 904. Yellow.	

TYPE 8947—18 STRANDED

47 T 910. Red.	} 100-Ft. Spools
47 T 911. Black.	
47 T 912. Blue.	
47 T 913. Green.	
47 T 914. Yellow.	

TYPE 8942—16 STRANDED

47 T 916. Black	} 100-Ft. Spools
47 T 917. Red	
47 T 918. Green	

TYPE 8938—14 STRANDED

47 T 935. Red	} 100-Ft. Spools
47 T 936. Black	

RUBBER-COVERED LEAD-IN

Type 8200. Flexible No. 18 tinned copper wire, stranded (7x27), with .040" live rubber insulation. Overall diameter, .126". Av. shpg. wt., 100-ft. spool, 1 1/2 lbs.

47 T 745. 100-ft. Spool. NET 1.47. 47 T 746. 500-ft. Spool NET 5.83

INDOOR AERIAL WIRE

Type 8014. Extra flexible. No. 25 stranded (13x36), tinned copper conductor, with chrome vinyl plastic insulation. O.D., .044". Shpg. wts.: 25-ft. Spool, 2 oz.; 500-ft. spool, 2 lbs.

47 T 930. 25-ft. Spool. NET 29c. 47 T 933. 500-ft. Spool. NET 2.60

Electrical Accessories

BELDEN REPLACEMENT CORDS



Type 1765B. SP-1. 6-Foot Replacement Cord. No. 18 wire. Brown, rubber-covered cord. Extra-flexible. Supplied with Belden unbreakable, soft rubber plug on one end; other end stripped. Ideal cord for electric clocks, lamps, fans, radio sets and other small electrical appliances. U.L. Approved. Shpg. wt., 6 oz.
49 T 211. NET.....**25c**

Type 1735K. SP-1. Same as above, but 12 feet long. Shpg. wt., 8 oz.
49 T 236. NET.....**49c**

Type 1750K. SJ. 10-Foot Replacement Cord. No. 16 wire. For washing machines, heavy home workshop tools, etc. With soft, unbreakable rubber plug. One end is stripped and tinned, ready for easy attachment. Black rubber. U.L. Approved. Shpg. wt., ¾ lb.
49 T 213. NET EACH.....**79c**

Type 1754K. SJ. 8-Foot Replacement Cord. No. 18 wire. Specially designed for refrigerators, small home workshop tools, etc. Type SJ black rubber cord, unbreakable rubber plug. U.L. Approved. Shpg. wt., ½ lb.
49 T 215. NET EACH.....**59c**

Type 1749K. SV. 6½-Ft. Replacement Cord. No. 18 wire. Type SV cord used in mixers, sewing machines, small appliances, etc. Gray rubber. Unbreakable plug. U.L. Approved. Shpg. wt., ½ lb.
49 T 212. NET EACH.....**46c**

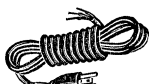

Type 1766B. SJ. 8-Foot Appliance Grounding Cord. No. 18 wire. Used for tools, neon signs and other small appliances requiring grounding. Type SJ flexible 3-conductor black rubber cord with unbreakable, 3-prong rubber plug. One end is stripped and tinned, ready for easy attachment. U.L. Approved. Shpg. wt., ½ lb.
49 T 219. NET EACH.....**73c**

ber plug. Opposite end stripped and tinned, ready for easy attachment. U.L. Approved. Shpg. wt., ½ lb.
49 T 219. NET EACH.....**73c**

HEAVY-DUTY EXTENSION CORDS

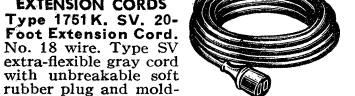

Type 1751K. SV. 20-Foot Extension Cord. No. 18 wire. Type SV extra-flexible gray cord with unbreakable soft rubber plug and mold-on rubber connector. Specially designed for use on vacuum cleaners and other small appliances and tools such as soldering irons, grinders, polishers, etc. In natural gray; will not mark or stain floors. Handsomely styled to match the finest appliances or electric tools. Convenient, safe and dependable to use. Cr. prongs insure long service life. Rubber covered. U.L. Approved. Shpg. wt., 1 lb.
49 T 214. NET EACH.....**1.19**

Type 1756K. SJ. 10-Foot Extension Cord. No. 16 wire. For general-purpose use. Unbreakable rubber plug and connector. U.L. Approved. Black rubber. Shpg. wt., 1 lb.
49 T 216. NET EACH.....**1.01**

Type 1791K. SJ. 50-Foot Extension Cord. No. 16 wire. For general-purpose use. Unbreakable rubber plug and connector. U.L. Approved. Black rubber. Shpg. wt., 3¾ lbs.
49 T 217. NET EACH.....**3.68**

Type 1792K. SJ. 100-Foot Extension Cord. No. 16 wire. Extra-flexible, black rubber. Same uses as above. U.L. Approved. Unbreakable plug. Shpg. wt., 6½ lbs.
49 T 218. NET EACH.....**6.28**

Type 1795-K. SJO. 25' Extension Cord. 2-conductor. 2-way service block. Black neoprene; resists oil, etc. U.L. Approved. Shpg. wt., 2¼ lbs.
47 T 242. NET.....**3.49**

Type 1790-K. SJO. Same cord as above, but 50'. Shpg. wt., 4¼ lbs.
47 T 243. NET.....**5.31**

RACINE CORD'N REEL

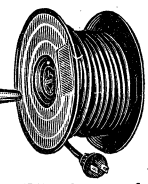

Extension cord and storage reel with built-in electrical outlet. Designed to permit unwinding only as much cord as is needed during use. Has service outlet built into reel hub to furnish current for appliance or tool to be used. Excellent for use with shop tools, lawn mowers, floor Sanders, etc. Heavy-duty, U.L. Approved, rubber-covered cords.

Model 1825. 25' SV type, No. 18 2-conductor cord. Capacity, 7 amps. Shpg. wt., 2 lbs.; 3.40
46 N 954. NET.....

Model 1850. As above, but 50'. Wt., 3 lbs. 5.12
46 N 958. NET.....

Model 1650. 50' SJ type, No. 16 2-conductor cord. Capacity, 10 amps. Shpg. wt., 4 lbs. 7.38
46 N 959. NET.....

CORDOMATIC DROP-LIGHT REELS

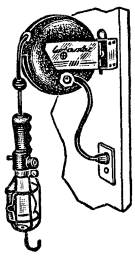

Unique, self-winding drop light. Provides light where you want it. Cord is out of the way when light no longer needed. No. 18, 2-conductor cord, covered with tough, neoprene insulation. Crack-proof handle with built-in outlet and toggle switch. Chrome reflector has swing-open bulb guard. Steel housing is equipped with universal mounting bracket. Extremely dependable spring mechanism operates like a window shade. Does not include bulb. U.L. Approved.

Model 700. 20' cord. Shpg. wt., 7 lbs. 4.65
46 NX 976. NET.....

Model 800. 30' cord. Shpg. wt., 8 lbs. 18.57
46 NX 977. NET.....

Model 900. 40' cord. Shpg. wt., 9 lbs. 22.47
46 NX 978. NET.....

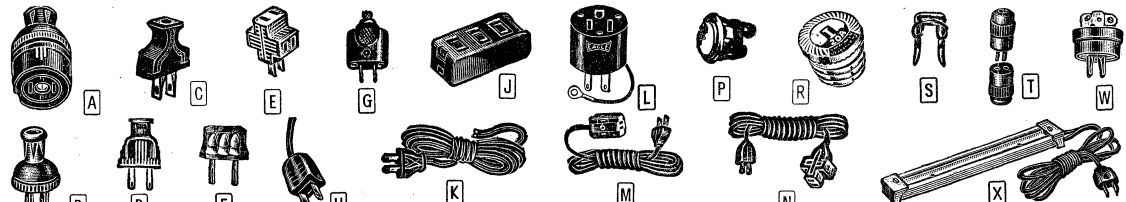

VALUES IN HANDY ELECTRICAL ACCESSORIES

A Line Cord Receptacle. Rubber pull-handle receptacle. Dia., 1¼". 15 amps at 125 v. Shpg. wt., 3 oz.
52 N 603. EACH.....**26c**

B Rubber-Handle Plug. Unbreakable soft-rubber. Approved for power tools. Excellent for use with 52 N 603, above, for line cord extensions. Shpg. wt., 2 oz.
52 N 602. EACH.....**8c**

C Bakelite Plug Cap. With convenient finger-grip. Cap size, 1½x1¼x¾" deep. Brown finish. Shpg. wt., 2 oz.
52 N 600. EACH.....**8c**

D Flat Rubber Plug. Non-breakable mold-on rubber plug cap. Because of their narrow construction, these caps are ideal for use with multiple AC receptacles similar to Fig. 1 above. Easily disassembled. Screw terminal wiring. Rated 15 amps at 125 v.; 10 amps at 250 v. Shpg. wt., 3 oz.
52 N 641. EACH.....**10c**

E Rubber Cube Tap. Spring-action, 3-way outlet of one-piece, soft rubber. U. L. Approved. Shpg. wt., 4 oz.
52 N 609. EACH.....**23c**

F Continental Adapter. Male-female adapter. Permits using standard flat-prong American plugs in Continental Europe outlets designed for round prongs. Wt., 2 oz.
49 N 536. NET.....**29c**

G Fused Plug. Protects equipment. Small fuses for each side of line. fit snugly in cylindrical receptacles—blown fuse easily removed for quick replacement. Interchangeable with any standard AC plug. Supplied less 3AG cartridge fuses. (See pages 190, 191 for fuses.) Shpg. wt., 3 oz.
52 N 648. EACH.....**33c**

H Academy Automatic Plug. No wire stripping. Just insert through cap. Sure-grip "needles" on prongs make positive connection through insulation. For POSJ cable only. Shpg. wt., 3 oz.
52 N 607. NET EACH.....**12c**

J Academy 3-Way Outlet. No wire stripping—insert cord, close case. 15 amps/125 v. or 10 amps/250 v. Shpg. wt., 5 oz.
52 N 622. Mahogany plastic. NET EACH. **20c**
52 N 619. White plastic.

K 6-Ft. Replacement Cord Set. Heavy rubber-covered cord firmly secured in sturdy molded plug. Brown. Wt., 5 oz.
49 T 230. 10 or More, EA. **19c. EA. 21c**

L Parallel Ground Adapter. Adapts 3-prong plugs for use in standard 2-prong AC outlets. Rated at 15 amps, 125 v. Has 3" wire with grounding lug. Shpg. wt., 3 oz.
52 N 669. NET EACH.....**25c**

M Cube Tap Extension. 3-way extension tap. Rated at 15 amps 125 volts; 10 amps 250 volts. With 6-foot cord and bakelite plug cap. Shpg. wt., 7 oz.
52 N 605. 10 or More, EA. **33c. EA. 37c**

N Rubber Cube Tap Extension. An all-rubber, solderless, 3-way extension cord set. Consists of 9-ft. cord, cube tap and plug. Shpg. wt., 8 oz.
52 N 608. EACH.....**59c**

O 6-Ft. Extension. Same as above, but with 6-ft. cord.
52 N 621. EACH.....**50c**

P Flush-Mount Pushbutton Switch. Pearl button. Brass contacts. Screw terminals. Switch is provided with spring clasps for mounting in ¾" hole on panels to 1/8" thick. Shpg. wt., 2 oz.
55 B 196. 10 or More, EA. **26c. EA. 29c**

R Plug Fuses. U.L. Approved. Clear view—easily seen when blown. Shpg. wt., 8 oz. 5 per box.

52 B 170. 10 Amps.....	} PER BOX	25c
52 B 171. 15 Amps.....		
52 B 172. 20 Amps.....		
52 B 173. 25 Amps.....		
52 B 174. 30 Amps.....		

S Insulated Staples. Saddle-type, drive-in staples. With fiber insulation. Shpg. wt., 5 oz. 100 per box. **21c**
NET PER BOX.....
52 N 030. 10 or More Boxes, PER BOX **19c**

T Morse Midget Cord Connector. 2-contact pull-apart type. For AC-DC cords, phono motors, pilot lights, etc. Consists of plug and receptacle. 1½" long and ¾" dia. Shpg. wt., 2 oz.
52 N 626. 10 or More, EA. **44c. EA. 49c**

W Cord Clamp Plug. Two-wire bakelite plug cap with cord clamp attachment riveted on. Cord clamp is adjustable to all wire sizes and provides absolute strain relief; wire cannot slip out of clamp—clamp will not move. Spring-action prongs. Highly dependable. Brown. Shpg. wt., 4 oz.
52 N 604. 10 or more, EACH **31c. EA. 35c**

X Tap-A-Line Outlet. Multiple outlet tap. Up to 8 AC line cords can be plugged into this outlet strip. Cord clamp is adjustable to all wire sizes and provides absolute strain relief; wire cannot slip out of clamp—clamp will not move. Spring-action prongs. Highly dependable. Brown. Shpg. wt., 2½ lbs.
52 N 636. NET.....**1.47**
2-Ft. Tap-A-Line. As above, but 2 ft. long. Shpg. wt., 2½ lbs.
52 NX 637. NET.....**2.40**

Test Leads—Wire & Cable

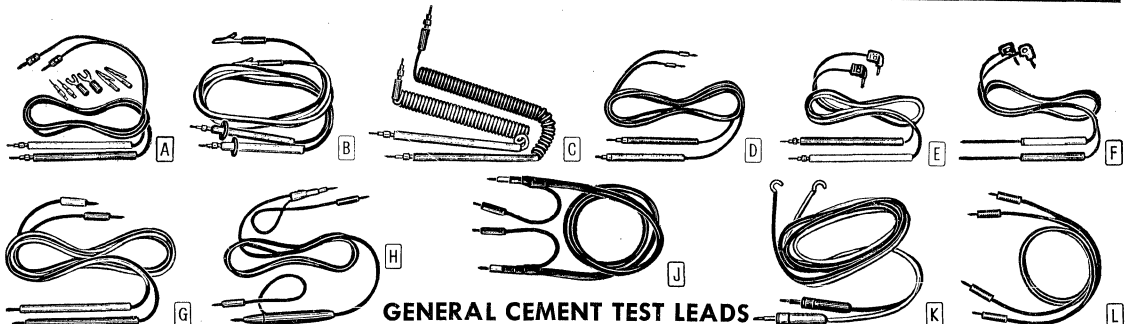

GENERAL CEMENT TEST LEADS

A Type 8463. With Interchangeable Connectors. 50' leads have 6' unbreakable plastic prods, one red, one black; with pointed phone tips. Instrument ends come with banana plugs. Supplied with spade lugs, pointed phone tips, and alligator clips, all of which are interchangeable with the banana plugs. 6000-volt insulation. Shpg. wt., 4 oz.
42 N 350. NET PER PAIR.....1.76

Type 8464. With Interchangeable Connectors. Same as above except prod ends are equipped with needle point chucks and needle point tips for piercing insulation.
42 N 351. NET PER PAIR.....1.76

B Type 9102. HV Test Leads. 48" long, flexible, heavy-duty, rubber-covered leads, 1/4" thick. One red, one black. Pointed phone tip prods; alligator clip ends. Special finger-guard prod handles. 5' long. 22,000-volt breakdown at 60 cycles. Shpg. wt., 4 oz.
42 N 352. NET PER PAIR.....2.94

Type 9101. As above, but with spade lug ends.
42 N 353. NET PER PAIR.....2.94

Type 9100. As above, but with phone tip ends.
42 N 354. NET PER PAIR.....3.53

C Type 9301. Stretch Leads. No-kink-no-tangle test leads. 9' coil extends to 6 feet. 6' Tenite prod handles. Pointed phone tips both ends. Shpg. wt., 4 oz.
42 N 355. NET PER PAIR.....2.91

D Type 9190. Slender Pencil. 5' long test prods made of durable Tenite with 50' kinkless leads. Have pointed phone tips on prod end; plain phone tips on connector end. Shpg. wt., 4 oz.
42 N 356. NET PER PAIR.....73c

E Type 8459. 6000v Insulation. 6' durable Tenite prods with pointed phone tips. Angle phone tips on connector ends. 50' leads. Shpg. wt., 4 oz.
42 N 358. NET PER PAIR.....1.23

Type 5050. Same as Type 8459 above but equipped with all-metal connector ends with pointed phone tips instead of the angle phone tips. Shpg. wt., 4 oz.
42 N 357. NET PER PAIR.....1.09

Type 8461. Same as Type 5050 but prods have needle tip chuck and needle points for piercing insulation. Shpg. wt., 4 oz.
42 N 359. NET PER PAIR.....1.15

Type 8462. Same as Type 8461 above but equipped with angle phone tips on connector ends instead of the pointed phone tips. Shpg. wt., 4 oz.
42 N 360. NET PER PAIR.....1.32

F Type 8465. Long Needle. Same as Type 8462 but prod tips are 4' lengths of stiff pointed No. 16 wire. Also prod handles are 4' long. Excellent for those hard-to-reach places. 50' leads—6000-volt breakdown, insulation. Shpg. wt., 4 oz.
42 N 361. NET PER PAIR.....1.23

KLIPZON TEST PRODS AND LEADS

G Prods equipped with clip-tip which holds on to wire, lug, etc., leaving both hands free. 4 3/4" handles. Leads. Av. wt., 4 oz.

Stock No.	Type	Description	PR.
42 N 362	5608	Klipzon tips both ends	1.91
42 N 363	5609	Klipzon tips and plain phone tip connectors	1.47
42 N 364	5610	Klipzon phone tip prods; banana plug connectors.	1.91

CRYSTAL PROBES FOR VOM & VTVM

H Permit measurement of RF on DC meter. Klipzon tips on both ends.

Stock No.	Type	Description	WT.	EACH
42 N 365	5611	For Standard VOM	4 oz.	4.26
42 N 366	5612	For VTVM. Shielded	6 oz.	4.26

J Type 5613. Low Capacity. For audio or RF work. Low loss. Shpg. wt., 4 oz.
42 N 367. NET EACH.....2.91

K Type 5614. Heavy Duty. 4' leads. Large size Klipzon tips on prod end; Spade lugs on connector end. Shpg. wt., 4 oz.
42 N 368. NET PER PAIR.....2.50

KLIPZON JUMPER LEADS
 L 2 wire leads with Klipzon phone-tip miniprods at each end. Average shpg. wt., 4 oz.

Stock No.	Type	Color	Length	PER PAIR
42 N 369	5634	Red	12"	59c
42 N 370	5635	Black	12"	59c
42 N 371	5636	Red	24"	65c
42 N 372	5637	Black	24"	65c

BELDEN TEST PROD WIRE
 Rubber-covered, designed for high-voltage testing applications. "Limpt" type, No. 18 stranded (65x36) tinned conductor. Type 8898 is 230' O.D.; working voltage, 10,000. Type 8899 is 140' O.D.; working voltage, 5000. Shpg. wt. per 100': 8898, 4 lbs.; 8899, 2 lbs. Lengths under 100' available only in 10- and 25-ft. spools.

TYPE 8898				TYPE 8899			
Stock No.	Color	Length	NET	Stock No.	Color	Length	NET
47 T 811	Red	10 ft. spool	.56	48 T 911	Red	10 ft. spool	.41
47 T 812	Black	10 ft. spool	.56	48 T 901	Black	10 ft. spool	.41
47 T 801	Red	25 ft. spool	1.15	48 T 912	Red	25 ft. spool	.73
47 T 802	Black	25 ft. spool	1.15	48 T 902	Black	25 ft. spool	.73
47 T 810	Red	100 ft. spool	3.38	48 T 910	Red	100 ft. spool	2.25
47 T 800	Black	100 ft. spool	3.38	48 T 900	Black	100 ft. spool	2.25
47 W 813	Red	Over 100'	3.38	48 W 913	Red	Over 100'	2.25
47 W 803	Black	PER 100'	3.38	48 W 903	Black	PER 100'	2.25

AMPHENOL RG COAXIAL CABLE

Meets rigid commercial and military standards. Polystyrene inner jacket covered by copper shield. Tough vinyl or polyethylene outer jacket. Max. RF power at 30 mc: RG-8/U, 2000 watts; RG-11/U, 4000 watts; RG-59/U, 680 watts; RG-58/U, 430 watts. RG-22/U is 2-conductor.

Stock No.	RG	Imp.	Mmf Per Ft.	O.D.	Lbs. 100'	1-99 Ft. PER FT.	100-499 Ft. PER FT.	500-999 Ft. PER FT.
49 W 460	8/U	52.0	29.5	.405	12	1.30	1.18	1.18
49 W 465	9/U	51.0	30.0	.420	15 3/4	2.87	2.59	2.30
49 W 470	11/U	75.0	20.5	.405	11	1.19	1.07	1.07
49 W 465	22/U	95.0	16.0	.405	10 1/2	1.63	1.47	1.30
49 W 480	54A/U	58.0	26.5	.250	4 1/2	.083	.075	.075
49 W 485	58/U	53.5	28.5	.195	3	.051	.046	.046
49 W 487	58A/U	50	29.0	.195	3 1/2	.051	.046	.046
49 W 490	59/U	73.0	21.0	.195	4 1/2	.056	.050	.050
49 W 488	62/U	93	13.5	.242	4 1/2	.061	.055	.055
49 W 489	71/U	93	13.5	.242	4 1/2	.108	.098	.098

AMPHENOL MINIATURIZED COAXIAL CABLE

For use in miniaturized equipment. Copperweld center conductor, stranded 7x.0063" except* 7x.0056". Copper shield. Vinyl plastic jacket. Av. wt., 100', 1 1/2 lbs.

Stock No.	Mfr's Type	Imp. Ohms	Mmf Per Ft.	O.D.	1-99 Ft. PER FT.	100-499 Ft. PER FT.	500-999 Ft. PER FT.
W 473	21-598	50	30	.100"	.049	.044	.044
W 472	21-597*	75	20	.140"	.052	.048	.048

GENERAL CEMENT NE-O-LITE

Neon glow type tester for indicating voltages from 60 v. AC and 90 v. DC to 500 v. AC-DC. Excellent for finding "hot" AC leads, checking fuses and spark plugs, appliance repair, etc. Neon bulb is mounted in insulating holder. 5' insulated leads with phone tip ends. Ideal for home handyman. Shpg. wt., 3 oz.
78 N 055. NET EACH.....35c
10 or More, EACH.....31c



CABLE LACING CORD

Genuine waxed linen twine. Hard-twist gray 8-cord; 50-lb. test. For binding cables in switchboards, transmitters, etc. 1-lb. spool, approx. 450 yds.; 1/2-lb. spool, approx. 225 yds. Shpg. wts.: 1-lb. spool, 1 1/4 lbs.; 1/2-lb. spool, 3/4 lb.
49 T 245. 1-lb. Spool. NET.....3.08
49 T 246. 1/2-lb. Spool. NET.....1.58

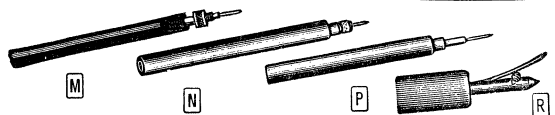

TEST PRODS

M ICA Type 302. Lucite. Red and black, high dielectric lucite prods for precision measurements. Threaded female insert; needle chucks on ends. Length with plugs, 5 7/8". Low loss; rated 10 kv. Wt., 3 oz.
42 N 114. NET PER SET.....97c

N H. H. Smith Type 303. Solderless Test Prod. Threaded prod with 5 1/2" long plastic handle. Nickel plated phone tip. Wire fits through handle, wraps around screw portion. Shpg. wt., 4 oz.
42 N 110. Red. 42 N 111. Black. NET EACH PROD.....29c

N H. H. Smith Type 318. Phone Needle Test Prod. Brass nickel-plated body with steel, nickel-plated needle. Removable chuck for replacing broken needles. Red or black molded plastic handle. Overall length 6 1/2". Shpg. wt., 3 oz.
42 N 373. Red. 42 N 374. Black. NET EACH PROD.....32c

P H. H. Smith Type 329. Heavy-duty Test Prod. Threaded type. Extra sturdy brass, nickel-plated tip with red or black molded plastic handle. Overall length, 6 1/4". Shpg. wt., 3 oz.
42 N 375. Red. 42 N 376. Black. NET EACH PROD.....32c

G-C KLIPZON MINIPRODS

R Type B Self-Gripping Tips. No. 5621. Clip to any terminal, lug, etc., and stay there! Needle points for piercing insulation. Solderless connection inside 1 1/2" plastic handle. Shpg. wt., 2 oz.
42 N 271. Red. 42 N 272. Black. NET EACH TIP.....26c

Type A Prod Set. No. 5608. 48" red and black, rubber leads; Type B tips on end; self-gripping tips with 4 3/4" handles on other end. 6 oz.
42 N 270. NET PER SET.....1.91

Dialco Pilot Light Assemblies

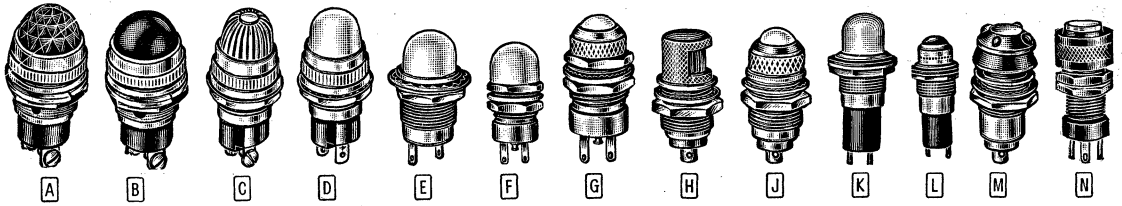

NEW OIL-TIGHT SERIES

A complete selection of heavy-duty, industrial-type pilot light assemblies. Feature totally enclosed construction, fully gasketed to make them impervious to oil, water, and dust. One-piece, solid brass mounting bushing. Chrome finish. Glass lens gives omni-directional (180°) light spread. High-impact phenolic insulation. Rugged terminals. Caps unscrew from front panel for easy lamp replacement. With mounting hardware; less lamp. Av. shpg. wt., 3 oz.

1" MOUNTING HOLE TYPES

Series 103-3101. For use with G56 screw-base lamp. Size, 1 1/2" x 1 1/2". Screw-type terminals. *Indicates frosted lens.

A	Stock No. (Faceted)	Mfr's Type	B	Stock No. (Dome)	Mfr's Type	Color
	52 E 885	-1331	52 E 892	-1211*	Red	
	52 E 886	-1332	52 E 892	-1212*	Green	
	52 E 887	-1333	52 E 893	-1213*	Amber	
	52 E 888	-1334	52 E 895	-1214*	Blue	
	52 E 889	-1335	52 E 896	-1235	White	
	52 E 890	-1336	52 E 897	-1216*	Yellow	
	52 E 891	-1337	52 E 898	-1217*	Clear	

1 to 9, NET EACH 2.20
10 or More, EACH 1.98

Series 103-3502. As above, but for 656 bayonet base lamp. *Indicates frosted lens.

A	Stock No. (Faceted)	Mfr's Type	B	Stock No. (Dome)	Mfr's Type	Color
	52 E 839	-1331	52 E 846	-1211*	Red	
	52 E 840	-1332	52 E 847	-1212*	Green	
	52 E 841	-1333	52 E 848	-1213*	Amber	
	52 E 842	-1334	52 E 849	-1214*	Blue	
	52 E 843	-1335	52 E 850	-1235	White	
	52 E 844	-1336	52 E 878	-1216*	Yellow	
	52 E 845	-1337	52 E 880	-1217*	Clear	

1 to 9, NET EACH 2.20
10 or More, EACH 1.98

1 1/8" MOUNTING HOLE TYPES

Series 125-408. New pilot light assemblies for use with NE-51 neon lamps. Built-in resistor. Fluted lens type have screw terminals; plain lens type have solder terminals. Size, 1 1/8" x 2 3/4".

C	Stock No. (Fluted)	Mfr's Type	D	Stock No. (Plain)	Mfr's Type	Color
	52 E 823	-1191	52 E 828	-1131	Red	
	52 E 824	-1193	52 E 829	-1133	Amber	
	52 E 825	-1197	52 E 830	-1137	Clear	

1 to 9, NET EACH 1.94
10 or More, EACH 1.74

Series 125-410. Same as above, but for use with low-voltage T-3 1/4 miniature, bayonet-base lamp. *Indicates frosted lens.

Stock No. (Fluted)	Mfr's Type	Stock No. (Plain)	Mfr's Type	Color
52 E 831	-1191	52 E 862	-1111*	Red
52 E 832	-1192	52 E 863	-1112*	Green
52 E 869	-1193	52 E 864	-1113*	Amber
52 E 834	-1194	52 E 865	-1114*	Blue
52 E 835	-1195	52 E 866	-1135	White
52 E 836	-1196	52 E 867	-1116*	Yellow
52 E 837	-1197	52 E 868	-1117*	Clear

1 to 9, NET EACH 1.94
10 or More, EACH 1.74

Series 103-3114. Dome lens pilot light assemblies for use with candlebase screw-base NE-45 neon lamp. Built-in resistor. Size, 1 1/2" x 2 1/2". *Indicates frosted lens.

Stock No.	Type	Color
52 E 881	-1231	Red
52 E 882	-1233	Amber
52 E 883	-1195	Yellow
52 E 884	-1237	Clear
52 E 889	-1217*	Clear

1 to 9, NET EACH 2.20
10 or More, EACH 1.98

MODEL 1316-L ADAPTER SET

Gasketed reducer for adapting any 1" Dialco pilot light assembly to 1 1/8" hole. Impervious to oil, water, and dust. 2 oz.

52 E 833, NET 73¢

NEW SUBMINIATURE SERIES

Extremely compact pilot light assemblies for use with tiny T-1 1/4 bulbs (voltages from 1.3 to 28). Caps unscrew from front of panel for easy lamp replacement. Permanent isolation from ground assured by military-grade phenolic material. All connections, lamp, and socket are completely insulated from the bushing and panel. Ruggedly constructed of brass and are finished in black nickel. Size, 1/2" x 1/4". Supplied with lockwasher and nut. Less lamp. Av. shpg. wt., 2 oz.

2-TERMINAL PLASTIC DOME TYPES

Series 101-5030 Front Mount and 101-3830 Back Mount. Front mount pilot lights (Fig. E) require 1/32" panel clearance; back mount (Fig. F) pilot lights require 1/16" clearance hole. Tinned solder terminals.

E	Stock No. (Front)	F	Stock No. (Back)	Mfr's Type	Color
	52 E 513		52 E 521	-951	Red
	52 E 514		52 E 522	-952	Green
	52 E 515		52 E 523	-973	Amber
	52 E 516		52 E 524	-975	White

1 to 9, NET EACH 1.24
10 or More, EACH 1.12

2-TERMINAL DIMMER TYPES

Series 108-3830 Blackout Type and 1012-3830 Polaroid Type. New, mechanical and polaroid assemblies. Polaroid type gives reduced intensity at all settings; mechanical type varies opening size to complete blackout. Require 1/32" mtg. hole. Frosted lenses, except *unfrosted. Solder terminals.

Stock No. (Blackout)	Stock No. (Polaroid)	Mfr's Type	Color
52 E 508	52 E 528	-111	Red
52 E 509	52 E 529	-112	Green
52 E 510	52 E 530	-113	Amber
52 E 517	52 E 534	-113*	White
52 E 519	52 E 543	-117*	Clear

1 to 9, NET EACH 1.92
10 or More, EACH 1.73

2-TERMINAL NON-DIMMING TYPES

Series 111-3830. New, non-dimming assemblies for general purpose use. Have metal lens holders and glass lenses. Require 1/32" mounting hole. All have frosted lenses except *unfrosted. Solder terminals.

Stock No.	Mfr's Type	Color	1-9, EACH	10 or More, EACH
52 E 569	-111	Red	1.56	1.40
52 E 570	-112	Green		
52 E 571	-113	Amber		
52 E 572	-135*	White		
52 E 573	-117	Clear		

1-TERMINAL LIGHT SHIELD TYPES

H New, one terminal units for grounded circuits. Meet MIL-L-7806-A specifications. Opening on side of assembly emits light on panel—ideal for dials, instruments control panels, etc. Movable contact is made solid brass; spring does not carry current. Require 1/32" diameter mounting hole.

Type 4-1930. With soldering terminal.
52 E 544, 10 or More, EA. 1.43 1-9, EA. 1.59

Type 4-1830. With binding screw terminal.
52 E 549, 10 or More, EA. 1.43 1-9, EA. 1.59

1-TERMINAL NON-DIMMING TYPES

J Series 8-1830 With Binding Screw and Series 8-1930 With Soldering Terminal. Meet MIL-L-7806-A specifications. All have frosted lenses except *unfrosted.

Stock No. (Screw)	Stock No. (Solder)	Mfr's Type	Color
52 E 423	52 E 433	-111	Red
52 E 424	52 E 434	-112	Green
52 E 425	52 E 435	-113	Amber
52 E 426	52 E 436	-114	Blue
52 E 427	52 E 437	-115	White
52 E 428	52 E 438	-116	Yellow
52 E 429	52 E 439	-117	Clear

1 to 9, NET EACH 1.24
10 or More, EACH 1.12

NEON PANEL ASSEMBLIES

K Series 952208. Enclosed neon pilot light assemblies. Built-in 36,000 ohm 1/4 watt resistor. For NE-51 neon lamps in 105-125 v. circuits. Plastic cap, bakelite body. 2 1/8" long. 1 1/8" mtg. hole. Less NE-51 (see listing on page 188). U.L. Approved. Shpg. wt., 3 oz.

Stock No.	Mfr's Type	Cap Color	NET EACH
52 E 581	931	Red	68c
52 E 582	933	Amber	
52 E 583	935	White	
52 E 584	937	Clear	

REPLACEMENT PLASTIC CAPS FOR ABOVE

Stock No.	Mfr's Type	Color	1 to 9, EACH	10 or More, EACH
52 E 565	95-931	Red	15c	13c
52 E 566	95-933	Amber		
52 E 567	95-935	White		
52 E 568	95-937	Clear		

LOW VOLTAGE ENCLOSED SIGNAL ASSEMBLIES

L Series 812210. Aviation type signal assemblies with smooth-faced jewels in 1/2" nickel-brass holder. Take miniature bayonet base lamp, replaceable from front of unit. (See page 188 for bulb listing.) 2 1/4" long. Require 1/8" mounting hole. For panels up to 3/8" thick. Less lamp. U.L. Approved. Shpg. wt., 3 oz.

Stock No.	Mfr's Type	Cap Color	NET EACH
52 E 589	111	Red	56c
52 E 590	112	Green	
52 E 591	113	Amber	
52 E 592	135	White	

REPLACEMENT JEWEL CAPS ONLY FOR ABOVE

Stock No.	Mfr's Type	Color	NET EACH
52 E 535	81-111	Red	16c
52 E 536	81-112	Green	
52 E 537	81-135	White	
52 E 538	81-113	Amber	

PLATE LIGHTING ASSEMBLIES

New, sub-miniature plastic plate lighting units. Designed for MIL-P-7788 plastic plate panels; on qualified products list OPL-7800 as per military drawing MS25010-1A to 8A. Require 1/32" mounting hole. With lockwasher and nut. Less lamp (T-1 1/4). Wt., 2 oz.

M Series TT61 (Solder Type) and TT62 (Screw Type) Edge Light Assemblies. Red units conform to MS25010-2A and -4A.

Stock No. (Solder)	Stock No. (Screw)	Mfr's Type	Lens Color
52 E 463	52 E 478	—B7	Red
52 E 464	52 E 479	—B7	Clear

1 to 9, NET EACH 67¢
10 or More, EACH 60¢

M Series TT-61 (Solder Type) and TT62 (Screw Type) Top Light Assemblies. Red units conform to military standard number MS25010-6A and 8A. Shpg. wt., 2 oz.

52 E 551	52 E 553	-R1	Red
52 E 552	52 E 554	-C7	Clear

1 to 9, NET EACH 67¢
10 or More, EACH 60¢

PRESS-TO-TEST LIGHT TYPES

N Series VM-911M. New, press-to-test indicator assemblies. Feature built-in bulb-testing device and optional shutter dimming construction. Has 3 soldering terminals; 2 for normal circuit and 1 for test circuit. Units are completely enclosed. Provide 180° daylight beam; "halo" light for night. Require 1/32" mtg. hole. Size, 3/8" x 1/8". Less lamp (T-1 1/4). 1 oz.

Dimmer		Non-Dimmer		Lens Color
Stock No.	Mil. No.	Stock No.	Mil. No.	
52 E 415	MS25041-1	52 E 456	MS25041-5	Clear
52 E 416	MS25041-2	52 E 457	MS25041-6	Red
52 E 417	MS25041-3	52 E 458	MS25041-7	Green
52 E 418	MS25041-4	52 E 459	MS25041-8	Amber

1 to 9, NET EACH 2.
10 or More, EACH 1

Dialco Pilot Light Assemblies

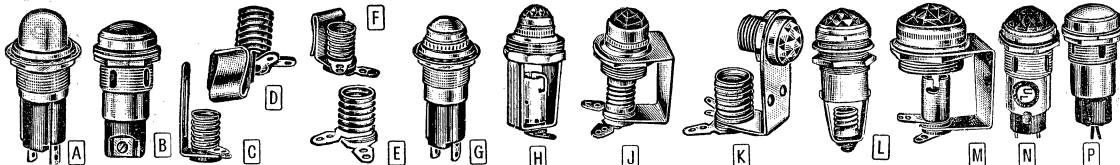

NEON INDICATOR LIGHTS

A Series 95408X. Enclosed neon indicator lights. Have built-in, 56,000-ohm, 1/2-watt resistor. For NE-51 neon lamps in 105-125 v. circuits. Insulated in molded bakelite of MIL-M-14 grade. Plastic head gives 180° light spread. Size, 2 1/8" long, 1 1/4" mtg. hole. Meets MIL-L-3661 and CSA requirements. U.L. Approved. Less lamp (see page 188). 3 oz.

Stock No.	Mfr's Type	Cap Color	NET EACH	10 or More, EACH
52 E 504	931	Red	1.19	1.07
52 E 505	933	Amber		
52 E 506	935	White		
52 E 507	937	Clear		

Replacement Plastic Caps for Above

Stock No.	Mfr's Type	Cap Color	NET EACH	10 or More, EACH
52 E 565	95-931	Red	15c	13c
52 E 566	95-933	Amber		
52 E 567	95-935	White		
52 E 568	95-937	Clear		

JEWEL CAP ASSEMBLIES

B Series 31914. For NE-45, -57, -58, etc. Candelabra screw base neon lamps. 115 v., 2 1/2" long. 1" mtg. hole. Neon removable from front. Less lamp (see page 188). U.L. Approved. Shpg. wt., 4 oz.

Stock No.	Mfr's Type	Jewel Color	NET EACH	10 or More, EACH
52 E 559	111	Red	1.03	93c
52 E 560	113	Amber		
52 E 562	137	Clear		

Replacement Jewel Caps for Above

Stock No.	Mfr's Type	Cap Color	NET EACH	10 or More, EACH
52 E 575	31-111	Red	35c	31c
52 E 576	31-113	Amber		
52 E 578	31-137	Clear		

PILOT LIGHT SOCKETS

Popular Dialco assemblies. Cadmium plating on all brackets. Terminal lugs of tinned brass to facilitate rapid soldering. Coil spring construction on all bayonet type sockets. Supplied with high-grade insulating washers. See page 188 for complete selection of miniature screw lamps (for Series 500), bayonet lamps (for Series 700), and candelabra lamps (for Series 600). Av. shpg. wt., per 5, 6 oz. 5 per pkg.

MINIATURE SCREW

Stock No.	Mfr's Type	Fig.	Per Pkg.	5 Pkgs. or More, Per Pkg.
52 E 400	501	F	36c	32c
52 E 401	507	E	28c	25c
52 E 402	504	D	36c	32c
52 E 410	505	C	34c	31c

MINIATURE BAYONET (Not illustrated.)

Stock No.	Mfr's Type	Per Pkg.	5 Pkgs. or more, Per Pkg.
52 E 404	701	39c	35c
52 E 405	704	36c	28c
52 E 403	704	36c	35c
52 E 406	705	39c	35c

CANDELABRA SCREW—115 VOLTS

Stock No.	Mfr's Type	Fig.	Per Pkg.	5 Pkgs. or More, Per Pkg.
52 E 407	601	F	45c	41c
52 E 408	604	D		
52 E 409	605	C		

PILOT LIGHT LENS CAPS

All-purpose 3/4", 1/2", and 1 1/2" diameter smooth jewels in polished nickel-plated brass holders for up to 3/8" panels. Require 1/16", 7/64" and 3/32" holes, respectively, for mounting. Shpg. wt., 2 oz. Deduct 10% for 10 or more.

Size	Red	Green	Amber	EA.
3/4"	52 E 444	52 E 445	52 E 446	24c
1/2"	52 E 490	52 E 491	52 E 492	13c
1 1/2"	52 E 447	52 E 448	52 E 449	20c

HALF INCH ENCLOSED TYPE INDICATOR LIGHTS

G Series 81410X. New aviation-type socket shell with smooth-faced jewels in 1/2" nickel-brass holder. Take miniature bayonet base lamp, replaceable from front. 2 1/4" long, 1 1/4" mtg. hole. Fits panels up to 3/8" thick. Less lamp (see page 188). U.L. Approved. Shpg. wt., 3 oz.

Stock No.	Mfr's Type	Cap Color	NET EACH	10 or More, EACH
52 E 530	111	Red	1.19	1.07
52 E 531	112	Green		
52 E 532	135	White		
52 E 533	113	Amber		

Replacement Jewel Caps for Above

Stock No.	Mfr's Type	Cap Color	NET EACH	10 or More, EACH
52 E 535	81-111	Red	16c	14c
52 E 536	81-112	Green		
52 E 537	81-135	White		
52 E 538	81-113	Amber		

HALF-INCH OPEN TYPES

H Series 857B. Requires an 1 1/4" mtg. hole. 1 1/2" lens. 2" long. Tinned solder terminals. For panels up to 1/4" thick. With mounting washer. Less lamp. Uses type 44, 47 or 51 listed on page 188. Shpg. wt., 4 oz.

Stock No.	Mfr's Type	Jewel Color	NET EACH	10 or more, EACH
52 E 545	431	Red	44c	40c
52 E 546	432	Green		
52 E 547	433	Amber		
52 E 548	434	Blue		

MINIATURE TYPE

J Series 810. Screw and bayonet types. 1/2" jewel. Require an 1 1/4" mtg. hole. Use miniature bulbs. Tinned lugs. For PA equipment, recorders, etc. *Indicates bayonet base. Less lamp; see page 188. Shpg. wt., 2 oz.

Stock No.	Mfr's Type	Jewel Color	NET EACH	10 or more, EACH
52 E 450	M-431	Red	32c	29c
52 E 451	M-432	Green		
52 E 452	M-433	Amber		
*52 E 453	B-431	Red		
*52 E 454	B-432	Green		
*52 E 455	B-433	Amber		

K Series 610, 610, and 710. Open-type visual indicators. Choice of miniature screw, bayonet or candelabra. Faceted jewels. Lug terminals. Require 7/8" mounting hole. Less lamp (see page 188). Shpg. wt., 2 oz.

Series 510 Miniature Screw Type

Stock No.	Mfr's Type	Jewel Color	NET EACH	10 or more, EACH
52 E 475	431	Red	21c	19c
52 E 476	432	Green		
52 E 477	433	Amber		

Series 610 Candelabra Screw Type

Stock No.	Mfr's Type	Jewel Color	NET EACH	10 or more, EACH
52 E 540	431	Red	21c	19c
52 E 541	432	Green		
52 E 542	433	Amber		

Series 710 Miniature Bayonet Type

Stock No.	Mfr's Type	Jewel Color	NET EACH	10 or more, EACH
52 E 480	431	Red	21c	19c
52 E 481	432	Green		
52 E 482	433	Amber		

ONE-INCH ENCLOSED TYPES

N Series 313101. 115-volt, enclosed pilot lamp assembly. Black bakelite and brass. Has faceted jewel in chrome-plated holder. Candelabra screw socket. 1" mounting hole. Shpg. wt., 4 oz. *Not recommended for neon; all others for neon or incandescent. Underwriters' Laboratories Approved.

Stock No.	Mfr's Type	Jewel Color	NET EACH	10 or More, EACH
52 E 460	431	Red	1.03	93c
52 E 461	432	Green*		
52 E 462	433	Amber		
52 E 510	437	Clear		
52 E 511	434	Blue*		
52 E 512	435	White		

ASSEMBLIES WITH WIRE LEADS

P Series 312901. Enclosed assembly. With 6" wire leads. Solid brass. Has friction-fit, chrome-plated cap. 1" mtg. hole. U.L. Approved. Less S6 candelabra screw-base lamp (see page 188). Shpg. wt., 4 oz.

Stock No.	Mfr's Type	Jewel Color	NET EACH	10 or More, EACH
52 E 485	111	Red	1.13	1.02
52 E 486	112	Green		
52 E 487	113	Amber		
52 E 488	117	Clear		

Replacement Jewel Caps for Above

Stock No.	Mfr's Type	Jewel Color	NET EACH	10 or More, EACH
52 E 575	31-111	Red	35c	31c
52 E 596	31-112	Green		
52 E 576	31-113	Amber		
52 E 578	31-117	Clear		

ONE-INCH OPEN TYPES

L Series 75. 115-volt open-type pilot lamp assembly with faceted jewel in chrome-plated brass holder. Candelabra screw socket. Solid brass construction. Friction-fit chrome-plated cap. 1" mounting hole. Less lamp. Shpg. wt., 5 oz.

Stock No.	Mfr's Type	Jewel Color	NET EACH	10 or More, EACH
52 E 500	C-431	Red	70c	63c
52 E 501	C-432	Green		
52 E 502	C-433	Amber		

MINIATURE SOCKETS

M Series 910. Open type with chrome-plated brass jewel holders. 1 1/2" long. 1" mounting hole. Excellent for power panels, test instruments, etc. Less bulb. Shpg. wt., 3 oz.

MINIATURE BAYONET TYPE

Stock No.	Color	NET EACH	10 or More EACH
52 E 420	Red	61c	55c
52 E 421	Green		
52 E 422	Amber		

MINIATURE AND CANDELABRA SCREW

Color	Miniature Screw	Candelabra Screw	NET EACH	10 or More, EACH
Red	52 E 430	52 E 440	58c	52c
Green	52 E 431	52 E 441		
Amber	52 E 432	52 E 442		

SITTLER PANEL LAMP



Type 211007 Neon Indicating Lamp. Easily mounted panel lamp. Starting voltages of 65 v., AC-90 v., DC. Rated at 1/25 watt. Bulb leads securely soldered to switchboard slide-type base. Compact and sturdy. Shpg. wt., 2 oz. 52 E 380. NET.....40c

COLE-HERSEE DASH LAMP ASSEMBLY



Nickel-plated. Socket takes No. 51 or 55 bulb (see page 188). 3/8" mtg. hole. Securely soldered 12" leads. Easy to install on dashboards, panels, etc. Less switch and bulb. Shpg. wt., 2 oz. 52 E 633. NET.....44c

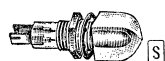

DRAKE NEON INDICATING LIGHTS
R Type 110 "Flushite." Neon light in translucent plastic base. For 110-125 v. AC-DC. 1/2x1 1/8x3/8". 1 1/2" mtg. cntrs. Wt., 2 oz. 78 E 061. EA....43c. 10, EACH.....39c
S Type 105 "Post-Lite." Panel lights for 65-130 v. AC or 90-130 v. DC. 2 1/4" long. Require 1/2" mtg. hole. With mtg. nut. 2 oz. 78 E 062. EA....58c. 10, EACH.....52c

PILOT BULB REMOVER

Designed to expedite installation or removal of miniature and candelabra lamps. High-grade rubber. Wt., 2 oz. 52 E 550. NET.....26c

General Electric Lamps—Sockets

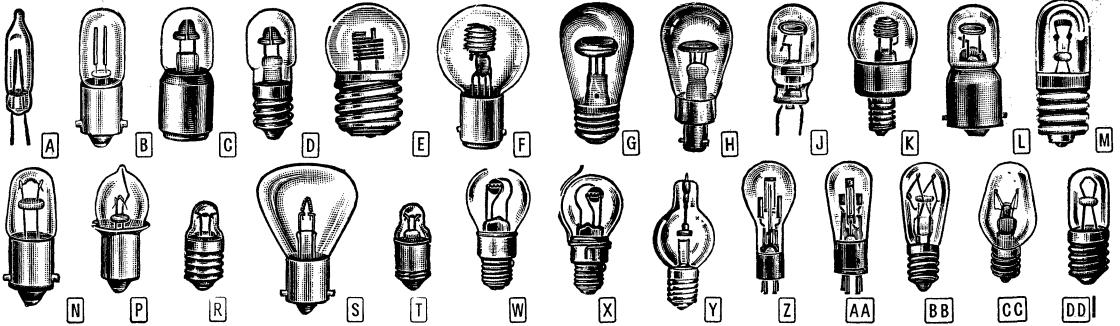

NEON, ARGON AND MINIATURE LAMPS

NEON GLOW LAMPS

For 105-600 volt operation except types marked † which are for 210-600 v. ‡Indicates DC only. S.C. stands for single contact; D.C., double contact; Sk., skirted. Screw types have series resistor in base—for 105-125 v. operation; others require external resistor. AC starting voltage shown. DC starting voltage is 40% higher. †Red sprayed. Av. shpg. wt. 1 lamp, 3 oz.; box of 10, 5 oz.

Stock No.	Mfr's Type	Fig.	Watts	AC Volts	Bulb Style	Base	NET EACH	10 or more, Each
52 E 370	NE-2	A	1/25	65	T-2	Wire Term.	.10	.08
52 E 374	NE-53	J	1/25	65	T-3 1/4	S.C. Bay. Min.	.21	.18
52 E 375	NE-7	J	1/4	55	T-4 1/4	Wire Term.	.73	.58
52 E 361	NE-57	D	1/4	55	T-4 1/2	Cand. Screw	.99	.82
52 E 812	NE-48	C	1/4	65	T-4 1/2	D.C. Bay. Cand.	.70	.58
52 E 807	NE-45	D	1/4	65	T-4 1/2	Cand. Screw	.85	.71
52 E 822	NE-21	L	1/4	55	T-4 1/2	S.C. Bay. Cand.	.95	.77
52 E 362	†NE-18	C	1/4	65	T-4 1/2	Cand. Screw	.95	.77
52 E 826	†NE-56	C	1/4	87	T-4 1/2	D.C. Bay. Cand.	.63	.51
52 E 827	NE-17	C	1/4	55	T-4 1/2	D.C. Bay. Cand.	.90	.74
52 E 360	†NE-56	E	1	60	G-10	Edison	1.25	1.05
52 E 80	NE-30	K	1	60	G-10	Edison	1.20	1.00
52 E 809	NE-31	E	1	60	G-10	Sk. Cand. Screw	2.99	2.50
52 E 814	NE-32	F	1	60	G-10	D.C. Bay. Cand.	1.20	1.00
52 E 805	NE-34	G	2	60	S-14	Edison	1.85	1.54
52 E 803	†NE-34	G	2	60	S-14	Edison	1.97	1.65
52 E 816	NE-36	H	2	60	S-14	Sk. D.C. Bay. Cand.	2.40	2.04
52 E 805	NE-40	G	3	60	S-14	Edison	2.70	2.26
52 E 816	NE-42	H	3	60	S-14	Sk. D.C. Bay. Cand.	2.65	2.20

ARGON GLOW LAMPS

Characterized by small size and low operating temperature. Produce a pale blue-violet light—near-ultraviolet radiation. Clear glass. *Av. life, 1000 hours; fav. life, 3000 hrs. Av. wt., 1 lamp, 3 oz., box of 10, 5 oz.

52 E 811	†AR-3	D	1/2	80	T-4 1/2	Cand. Screw	.85	.68
52 E 820	†AR-1	H	2	65	S-14	Sk. D.C. Bay. Cand.	2.20	1.78
52 E 810	†AR-1	G	2	65	S-14	Edison	1.90	1.53

AC-DC PILOT LAMPS

Rated at 1500 hours, average use. Have clear glass envelopes except † white glass. Ideal for use behind small panel openings, as indicator lamps, etc. *Candelabra screw base. †Double contact candelabra bayonet base. ‡Herzog tubular lamp—all others, G.E. Av. wt., 4 oz.

Stock No.	Type	Fig.	Volts	Watts	EACH	10-UP, EA.
52 E 349	*S6	BB	115	6	.22	.20
52 E 352	†G56	BB	115	6	.30	.27
52 E 354	*S6	BB	115	3	.35	.31
52 E 353	†G56	BB	230	10	.52	.47
52 E 355	*C7	CC	115-125	7	.20	.18
52 E 356	†C7	CC	115-125	7	.26	.23
52 E 351	*C7	CC	115-125	10	.26	.23
52 E 350	†C7	DD	120	4	.39	.35

SOCKETS FOR NEON, ARGON AND PILOT LAMPS



*Hard rubber insert in metal shell. Av. shpg. wt., 3 oz.

Stock No.	Fig.	Description	EACH	10-UP, EA.
52 E 850	EE	Edison	.13	.12
52 E 858	EE	Miniature screw	.14	.13
52 E 855	FF	Candelabra screw	.45	.41
52 E 852	EE	Candelabra screw	.14	.13
52 E 853*	GG	Double-contact, bay. candelabra	.29	.26
52 E 856	HH	Double-contact, bay. candelabra	.62	.56
52 E 857	HH	Single-contact, bay. candelabra	.59	.53

LAMP SOCKET REDUCERS



Receptacle opening receives base of bulb; other end fits into socket desired. Enables user to convert to most commonly-used types of bulb bases. Positive contact. Av. shpg. wt., 2 oz.

Stock No.	Fig.	Description	NET
52 E 606	JJ	Edison-to-Candelabra	16¢
52 E 639	KK	Candelabra-to-Miniature	14¢
52 E 634	KK	Intermediate-to-Candelabra	7¢
52 E 638	LL	Edison-to-Intermediate	15¢

GENERAL-PURPOSE MINIATURE LAMPS

All are miniature, except: *Midget flanged type; †pre-focused candelabra type; ‡has screw terminals, sealed beam type. Under **Amps**, c.p. means candlepower. Abbreviations under **Base** mean: S. C., F.—single contact, flanged; D. C., F.—double contact, flanged; S. C., Bay.—single contact, bayonet; D. C., Bay.—double contact, bayonet. Under **Bulb Style**, G—globes; T—tubular; B—lemon shape; TL—Lens end, tubular (pre-focus type); FE—flat end; RP—reflector, pear shape; S—as in Fig. R; PAR—parabolic. Shpg. wts.: 1 lamp, 2 oz.; box of 10, 4 oz.

Stock No.	Mfr's Type	Fig.	Volts	Amps	Base	Bulb Style	NET EA.	10 or More, EA.	100 or More, EA.
52 E 344	PR-2	P	2.4	0.50	S. C., F.	B-3 1/2	.20	.14	.13
52 E 345	PR-3	P	3.6	0.50	S. C., F.	B-3 1/2	.20	.14	.13
52 E 337	PR-4	P	2.3	0.27	B-3 1/2	B-3 1/2	.25	.18	.16
52 E 338	PR-9	P	2.7	0.15	S. C., F.	B-3 1/2	.20	.14	.13
52 E 387	PR-12	P	5.95	0.50	S. C., F.	B-3 1/2	.20	.14	.13
52 E 304	PR-13	P	4.75	0.50	S. C., F.	B-3 1/2	.20	.14	.13
52 E 300	13	..	3.7	0.30	Screw	G-3 1/2	.17	.12	.11
52 E 301	14	..	2.5	0.30	Screw	G-3 1/2	.17	.12	.11
52 E 303	27	..	4.9	0.30	Screw	G-4 1/2	.17	.12	.11
52 E 302	31	..	6.2	0.30	Screw	G-4 1/2	.20	.14	.13
52 E 305	40	M	6-8	0.15	Screw	T-3 1/4	.15	.10	.09
52 E 306	41	M	2.5	0.50	Screw	T-3 1/4	.15	.10	.09
52 E 307	42	M	3.2	0.35	Screw	T-3 1/4	.20	.14	.13
52 E 308	43	M	2.5	0.50	Bayonet	T-3 1/4	.15	.10	.09
52 E 309	44	N	6-8	0.25	Bayonet	T-3 1/4	.15	.10	.09
52 E 310	45	N	3.2	0.35	Bayonet	T-3 1/4	.15	.10	.09
52 E 311	46	M	6-8	0.25	Screw	T-3 1/4	.15	.10	.09
52 E 312	47	N	6-8	0.15	Bayonet	T-3 1/4	.15	.10	.09
52 E 313	48	M	2.0	0.06	Screw	T-3 1/4	.15	.10	.09
52 E 314	49	N	2.0	0.06	Bayonet	T-3 1/4	.15	.10	.09
52 E 315	50	..	6-8	1 c. p.	Screw	G-3 1/2	.15	.10	.09
52 E 316	51	N	6-8	1 c. p.	Bayonet	G-3 1/2	.15	.10	.09
52 E 369	53	..	14.4	1.2	Bayonet	G-3 1/2	.15	.10	.09
52 E 320	55	N	6-8	2 c. p.	Bayonet	G-4 1/2	.15	.10	.09
52 E 660	57	..	12-16	2 c. p.	Bayonet	G-4 1/2	.15	.10	.09
52 E 322	63	..	6-8	3 c. p.	S. C. Bay.	G-6	.20	.14	.13
52 E 321	81	..	6-8	6 c. p.	S. C. Bay.	G-6	.25	.18	.16
52 E 323	82	..	6-8	6 c. p.	D. C. Bay.	G-6	.25	.18	.16
52 E 325	112	R	1.2	0.22	Screw	TL-3	.17	.12	.11
52 E 327	136	..	1.3	0.60	Screw	G-4 1/2	.17	.12	.11
52 E 330	222	R	2.2	0.25	Screw	TL-3	.17	.12	.11
52 E 331	223	..	2.2	0.25	Screw	FE-3 1/2	.17	.12	.11
52 E 333	224	T	2.15	0.22	Special	TL-2 1/4	.17	.12	.11
52 E 334	233	..	2.2	0.27	Screw	G-3 1/2	.17	.12	.11
52 E 339	248	..	2.5	0.80	Screw	G-5 1/2	.20	.14	.13
52 E 319	313	N	28	0.17	Bayonet	T-3 1/4	.35	.26	.23
52 E 323	327	..	28	0.04	S. C. Mid.*	T-1 1/4	.90	.66	.59
52 E 377	328	..	6	0.20	S. C. Mid.*	T-1 1/4	.70	.51	.46
52 E 378	425	..	5	0.50	Screw	G-4 1/2	.17	.12	.11
52 E 658	428	..	12.5	0.25	Screw	G-4 1/2	.17	.12	.11
52 E 332	432	..	18.0	0.25	Screw	G-4 1/2	.17	.12	.11
52 E 332	433	..	18	0.25	Bayonet	G-4 1/2	.17	.12	.11
52 E 342	605	..	6.1	0.50	Screw	G-4 1/2	.17	.12	.11
52 E 650	1133	S	6-8	32 c. p.	S. C. Bay.	RP-11	.40	.29	.26
52 E 651	1188	S	6-8	50/32 c. p.	D. C. Bay.	RP-11	1.00	.72	.65
52 E 379	1323	..	6.2	4.30	S. C. Pref.†	RP-11	1.00	.72	.65
52 E 659	1446	..	12	0.20	Screw	G-3 1/2	.17	.12	.11
52 E 341	1447	..	18.0	0.15	Screw	G-3 1/2	.20	.14	.13
52 E 661	1449	..	14	0.20	Screw	G-3 1/2	.17	.12	.11
52 E 662	1458	..	20	0.25	Bayonet	G-3 1/2	.17	.12	.11
52 E 653	1477	DD	24	0.17	Screw	T-3	.40	.27	.24
52 E 324	1487	DD	12-16	0.20	Screw	T-3 1/4	.20	.14	.13
52 E 655	1488	N	14	0.15	Bayonet	T-3 1/4	.20	.14	.13
52 E 340	1490	N	3.2	0.16	Bayonet	T-3 1/4	.15	.10	.09
52 E 656	1493	..	6.5	2.75	D. C. Bay.	S-8	1.00	.70	.63
52 E 326	1768	..	6	0.20	Midget Screw	T-1 1/4	.75	.52	.47
52 E 657	1815	N	12-16	0.20	Bayonet	T-3 1/4	.20	.14	.13
52 E 324	1820	..	28	1.0	Bayonet	T-3 1/4	.40	.29	.26
52 E 343	1829	..	28.0	0.07	Bayonet	T-3 1/4	.35	.25	.22
52 E 383	4512	..	4.7	0.50	S. C. Term‡	PAR-25	2.50	1.77	1.59
52 E 384	4548	..	4.7	0.50	S. C. Term‡	PAR-36	2.50	1.77	1.59

TUNGAR BULBS

General Electric tungar bulb type rectifiers for replacement purposes. High-quality units. Used in battery-charging equipment. Gas-filled thermionic-emission types. Av. shpg. wt., 1 1/4 lbs.

No.	Type	Fig.	Amps	NET	No.	Type	Fig.	Amps	NET
9 E 900	12X825	W	2	4.41	9 E 904	189049	Y	6	4.77
9 E 901	206501	X	2	4.41	9 E 905	217283	Y	15	9.19
9 E 906	20X672	W	5	5.52	9 E 907	16X897	Z	2	12.13
9 E 903	189048	Y	6	4.77	9 E 908	45X674	AA	6	4.70

Photoflash Components

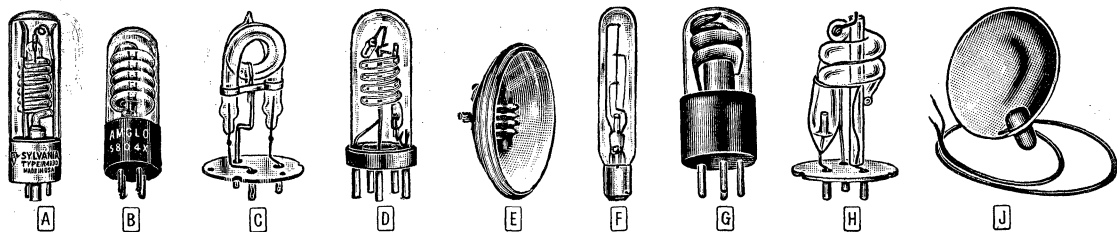

ELECTRONIC FLASH TUBES AND REFLECTORS

SYLVANIA R4330

A Flash tube for high-speed photo equipment. High-voltage discharge type. 100 watt seconds; 2250 volts; flash duration, 1/5000 second. Over 30,000 flashes. Wt., 1 lb. **E3-R4330**. List, \$23.75. **NET.....15.35**

AMGLO FLASH TUBES

B For high-speed photo units. Flash duration, 1/10,000 second. Gas-filled design with open-end spiral feature gives long life. May be used for color work without filter. High-intensity, blue-white light. Color temperature, 6500° Kelvin. *Relay type; all others are trigger type. Shpg. wt., 1 lb.

Stock No.	Mfr's Type	W-S	Operating Voltage	Cap., Mfd	NET EACH
78 E 655	78R9D	200	2000-2500	15-80	14.70
78 E 652	54R4*	200	2250-2850	15-80	14.70
78 E 653	56122	150	450-900	300-1400	12.74
78 E 658	5804*	110	2250-2850	15-32	13.72
78 E 662	HD-2-0	200	300-2000	1500	8.82

G.E. FLASH TUBES

Used in amateur and professional photography, and solving research and industrial problems. Provide flashes of exceedingly high intensity for a short duration, ranging from 1/1,000 to 1/1,000,000 second. Same tube can be flashed repeatedly—tens of thousands of times. Standard equipment in many units and popular for the home kit builder and experimenter. Tubes are helix-coiled, xenon-filled. *60 watt incandescent modeling lamp fits inside Type FT-403. †Similar to Fig. D, but has 3-pin base. Av. shpg. wt., 1 lb.

Stock No.	Type	Fig.	W-S	Volts	Mfd	NET
52 E 389	FT-218	C	200	1000	400	9.10
52 E 375	FT-118	C	125	500	1000	7.90
52 E 364	FT-214	D	200	2000	100	21.50
52 E 376	FT-220	E	200	2000	100	23.00
52 E 359	FT-403	F	480	2000	240	24.50
52 E 363	60T6½/1*	F	120	2.10
73 H 998	122-275		Socket for FT-214			1.90

SPRAGUE & KEMLITE COMPONENTS

For use in two low-cost, portable, dry-cell powered photoflash units. Schematics, parts listings and instructions in Sprague Booklet C-703 below. Two models—one using Kemlite DX flashtube (same as FA-100), and one using Kemlite DW-2 flashtube (same as FA-104). For synchro shutters or solenoid synchronization.

Uses two 450 volt capacitors (listed below) and five 90 volt Burgess N60 batteries (listed page 284). Flashes faster than 1/1000 second. Light output of 100 w.s. Flashtubes are Kemlite; reflectors and adapter are Sprague. All other parts available from Allied. Write for free parts list. Av. shpg. wt., 1 lb.

Stock No.	Type	Fig.	Descrip.	W-S	V.	NET
78 E 700	DX	G	Flash Tube	100	450	9.95
78 E 710	DW-2	H	Flash Tube	150	500	5.95
78 E 703	FA-101	J	Reflector for DX			2.69
78 E 704	FA-105	J	Reflector for DW-2			3.43
78 E 702	FA-102		Adapt. for Ed. bases			2.55

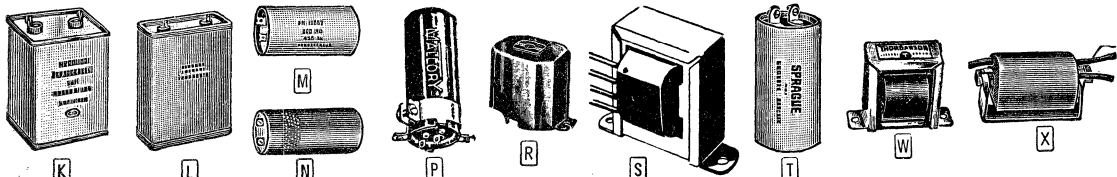

BUILD YOUR OWN HIGH-SPEED PHOTOFLASH UNITS WITH THESE ESSENTIALS

C-D CAPACITORS

K High-Voltage Oil-Filled Types. Cornell-Dubilier high-dielectric photoflash capacitors. Impregnated and filled with Dykanol "G" to assure top dependability.

TYPE GKGT—2000 VOLT DC WORKING

Stock No.	Type	Mfd.	W-S	Lbs.	EACH
14 L 480	1A01	25	50	4½	11.17

TYPE GKGT—2500 VOLT DC WORKING

14 L 481	1A02	12	50	4¾	10.00
14 L 483	104	32	100	6	21.76

M Low-Voltage Types. Type FB10063 has aluminum can with cardboard sleeve. Type FW10005 has bakelite case.

Stock No.	Mfr's Type	Mfd	Volts	W-S	Lt. Wb.	NET EACH
14 L 841	FB10063	200	450	20	1¼	4.03
14 L 842	FW10005	200	500	25	1¼	6.17

ILLINOIS UMC CAPACITORS

N Highly efficient, dependable capacitors. All units have very low leakage current. Av. shpg. wt., 1¾ lbs.

Stock No.	Type	Mfd	W-S	Volts	NET
10 L 679	52545A	525	53	450	13.23
10 L 581	60045	600	60	450	17.64
10 L 578	100030A	1000	45	300	17.64
10 L 582	165030	1650	75	300	23.52

Illinois Electronic Flash Handbook. Handbook and construction manual. Covers 4 photoflash units; battery and battery-AC types. **37 L 191**. Postpaid in U.S.A.50¢

RECTIFIERS AND VIBRATORS

Type 1013. Fed. Tel. & Radio Rectifier. For storage battery chargers. Output, 700 ma at 18v. Shpg. wt., 4 oz. **4 A 604**. **NET.....94¢**

Type W1601/W859. Mallory Vibrator. Interrupter type. 4 prong base. Replaces type W659. Shpg. wt., 8 oz. **56 P 118**. **NET.....2.88**

Type FA-106. Sprague Vibrator. (Same as Oak V6815). For photoflash equipment. 4 volts; 4 amp. 2½x1½". Shpg. wt., 8 oz. **78 E 706**. **NET.....8.33**

SPRAGUE CAPACITORS AND RELAYS

L Type PQ Capacitors. Combine maximum dependability with very compact size. Rated, 2500 v., except Type 425 (4000 v.).

Stock No.	Type	Mfd	W-S	Lbs.	NET
15 L 730	2510	10	31	1¾	10.00
15 L 732	2525	25	78	4¼	15.58
15 L 733	2535	35	109	6	19.11
15 L 729	425	25	200	7¼	24.99

Type FA-103. Sprague Delay Relay. For 2-25 microsecond delay synchronization for operation with 3 to 4½-volt cell flashguns. Shpg. wt., 8 oz. **78 E 701**. **NET.....3.43**

MALLORY LOW-VOLTAGE CAPACITOR

P Type HC 45003. An excellent low-voltage electrolytic for use in photoflash units. Capacity, 300 mfd at 450 volts working. Size, 2½x4¾". Shpg. wt., 1 lb. **17 L 820**. **NET.....6.17**

UTC TRANSFORMERS

R Type PF-1. Primary for 115 v., 50-60 cycle. Secondary supplies 2200 v. DC when used with proper rectifier, and condensers up to 100 mfd. Transformer is compound-sealed in 2½x2¾x2½" case. Shpg. wt., 2½ lbs. **62 G 230**. **NET.....8.23**

Type PF-3. Trigger transformer for electronically fired circuit. Shpg. wt., 6 oz. **62 G 232**. **NET.....5.88**

STANCOR TRANSFORMERS

S Model P-6425. Photoflash power transformer for AC electronic photoflash units. Exact replacement in the Heiland Research Photoflash unit. The comparatively low output voltage (450 v.), permits lower construction cost, simplicity in design and a greater safety factor. Has a 105/115/125 volt primary. Charges 1050 mfd. capacitor to 450 volts DC, through a half-wave selenium rectifier. 2½x6 2½x2". Mtg. centers, 2½". With diagram. Shpg. wt., 2 lbs. **64 G 445**. **NET.....3.43**

Type P-6426. Trigger coil for P-6425 transformer. ¾" long, ¾" diameter. Replaces G.E. 36 G 41 trigger coil. Shpg. wt., 3 oz. **64 G 144**. **NET.....1.64**

T Type FF-1 525 Mfd. Capacitor. 450 volts DC working. Low-leakage electrolytic for dry battery photoflash service. Nominal rating 53 w.s. Shpg. wt., 1¼ lbs. **15 L 725**. **NET EACH.....13.23**

C703 Electronic Flash Handbook. Contains photos, drawings and instructions for building two battery-operated, high-speed electronic flash units as well as an AC-operated unit. A handbook for the amateur or professional photographer. 15 pages. Size, 8½x11". **37 K 078**. Postpaid in U.S.A.35¢

Type 2T-M-55 Molded Tubular Capacitor. 200 v. at .05 mfd. ¾x1¼". Shpg. wt., 8 oz. **15 L 121**. **NET.....15¢**

THORDARSON TRANSFORMERS

W 22 R42. Open frame type with leads. Pri.: 117 v., 60 cycle, AC. Sec. for supply delivering 2250 volts DC at 1.5 ma.; Sec. No. 2, 2.5 volts AC at 1.75 amps. Size, 4x2½x2½"; 3¾" mtg. centers. Shpg. wt., 2 lbs. **63 G 720**. **NET.....6.47**

W 22 R43. Pri.: 117 volts, 60 cycle, AC or 4-volt vibrator. Sec., 1100 volts AC at 1.5 ma. Delivers 2250 volts in voltage doubler circuit. Size, 4x2½x2¾"; 2½" mtg. centers. Shpg. wt., 1½ lbs. **63 G 721**. **NET.....8.17**

X Type 22 R41. Power transformer. Pri., 4 volts from vib. at 115 cyc. or higher. Sec., 450 volts DC or 900 volts DC at 15 ma. Mtg. ctrs., 2½". Overall size, 2½x2½x2½". Shpg. wt., 1¼ lbs. **63 G 723**. **NET.....3.26**

X Type 22 R44. Ignition transformer. For high-pressure 3-electrode tubes. Pri., 200 volt DC discharge from .25 to 5 mfd. condenser. Sec. 15,000 v. peak. Size, 2½x1½x1½". Shpg. wt., 8 oz. **63 G 722**. **NET.....4.90**

Thordarson Booklet "Universal Power Pack for High-Speed Electronic Photoflash Tubes". Shows how to build your own reliable high-speed photoflash tube power pack. For amateur and professional photographers. Versatile—may be operated from 117 v. A.C. or from self-contained batteries. Booklet includes complete circuit diagram and detailed parts list. 8 pages. Size, 7x9¾". **37 K 028**. **NET**. Postpaid in U.S.A.15¢

Potter and Brumfield and Sigma Relays

POTTER AND BRUMFIELD RELAYS

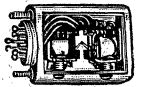
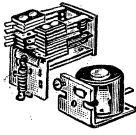

NEW GP "PIC & BUILD" SERIES

Flexibility—keynote of Potter & Brumfield's new "Pic & Build" series of separate coils and switches! Units available can be combined to produce twenty different relays, each easily converted to an alternative sensitivity or switching arrangement in minutes. Perfect for prototypes, testing relay requirements, or school use. Size of assembled relay and general specifications same as GA series on Page 193. Av. shpg. wt., 4 oz.

Stock No.	Mfr's Type	Item	NET EACH			
			1-24	25-50	51-74	75-99
76 P 333	GPA	6v.AC Coil	1.55	1.47	1.39	1.24
76 P 334	GPA	24v.AC Coil	1.55	1.47	1.39	1.24
76 P 335	GPA	115v.AC Coil	1.55	1.47	1.39	1.24
76 P 336	GPA	230v.AC Coil	2.00	1.90	1.80	1.60
76 P 337	GPD	6v.DC Coil	2.00	1.90	1.80	1.60
76 P 338	GPD	12v.DC Coil	2.00	1.90	1.80	1.60
76 P 339	GPD	24v.DC Coil	2.00	1.90	1.80	1.60
76 P 340	GPD	110v.DC Coil	3.00	2.85	2.70	2.40
76 P 341	GPD	2500-ohm Coil	1.45	1.37	1.30	1.16
76 P 342	GPD	10,000-ohm Coil	2.10	1.90	1.80	1.60
76 P 343	GP11	DPDT Switch	1.60	1.52	1.44	1.38
76 P 344	GP17	4PDT Switch	2.80	2.66	2.52	2.24

TYPE PC INTERMITTENT RELAY

Conventional armature, pulse-operated relay. Armature and pusher assembly operate phenolic rocker switching from one contact pile to the other on alternate pulses. Pulses may be as short as 30 millisecond periods. Gold-plated silver contacts, rated 5 amps. 115 v. AC, resistive. Size: 1 3/4 x 2 1/2 x 2 3/4". For operation from 50-60 cycle AC, except *DC. Shpg. wt., 10 oz.



Stock No.	Mfr's Type	Action	Coil Volts	NET EACH			
				1-24	25-50	51-74	75-99
76 P 501	PC11A	DPDT	115	5.25	4.98	4.72	4.20
76 P 500	PC17A	4PDT	115	7.25	6.88	6.52	5.80
76 P 502	PC11A	DPDT	24	5.25	4.98	4.72	4.20
76 P 503	PC17A	4PDT	24	7.25	6.88	6.52	5.80
76 P 504	PC11A	DPDT	6	5.25	4.98	4.72	4.20
76 P 505	PC17A	4PDT	6	7.25	6.88	6.52	5.80
76 P 506	PC11D*	DPDT	24	5.10	4.84	4.59	4.08
76 P 507	PC17D*	4PDT	24	7.10	6.74	6.39	5.68

TYPE KB LATCHING RELAYS

Ideal for memory work and overload applications. One coil operates relay to set latch; other coil releases it. Operates on momentary impulse to either coil. Release and trip coils must be used with same voltage. Size: 2 1/2 x 1 1/2 x 2 3/4" high. Mounts with 2 — 3/32" holes on 1 1/2" centers. Contacts rated at 5 amperes.*60 cycle. Molded phenolic insulating barrier. Shpg. wt., 10 oz.

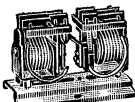

Stock No.	Mfr's Type	Action	Coil Volts	NET EACH			
				1-24	25-50	51-74	75-99
75 P 124	KB17A	4PDT	115 AC*	9.90	9.40	8.91	7.92
75 P 125	KB17A	4PDT	24 AC*	9.90	9.40	8.91	7.92
75 P 126	KB17A	4PDT	6 AC*	9.90	9.40	8.91	7.92
75 P 127	KB17D	4PDT	110 DC	10.20	9.69	9.18	8.16
75 P 128	KB17D	4PDT	24 DC	9.00	8.55	8.10	7.20
75 P 129	KB17D	4PDT	6 DC	9.00	8.55	8.10	7.20

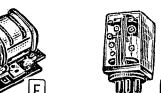
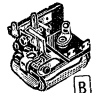

A Series 4F. Plate circuit relay for any 20 mw. sensitivity application. SPDT contacts rated 2 amps. 1 1/2 x 1 1/2 x 1 1/2". Wt. 2 1/4 oz.

Stock No.	Mfr's Type	Ohms	Ma. DC	NET
76 P 377	4F-1000-S/SIL	1000	4.5	5.50
76 P 378	4F-2500-S/SIL	2500	3.0	5.50
76 P 379	4F-5000-S/SIL	5000	2.0	5.75
75 P 285	4F-8000-S/SIL	8000	1.6	6.00

B Series 5F. Rugged SPDT DC relay withstands 10 G shock. 5 mw. sensitivity. Contacts rated 1 amp. 1 3/4 x 1 3/8 x 1 1/8". Wt., 5 oz.

Stock No.	Mfr's Type	Ohms	Ma. DC	NET
76 P 380	5F-1000-S/SIL	1000	2.3	7.50
76 P 381	5F-2500-S/SIL	2500	1.4	7.50
76 P 382	5F-5000-S/SIL	5000	1.0	8.00
76 P 383	5F-10,000-S/SIL	10,000	0.7	8.75

C Series 11F. Small, low-cost DC relay. 50 mw. sensitivity; SPDT contacts rated 1 amp. 1 3/2 x 1 1/2 x 1 1/2" high. Shpg. wt., 1 oz.

Stock No.	Mfr's Type	Ohms	Ma. DC	NET
75 P 068	11F-1000-G/SIL	1000	7.0	1.50
75 P 069	11F-2300-G/SIL	2300	4.6	1.50
75 P 074	11F-6000-G/SIL	6000	2.9	1.70
75 P 075	11F-9000-G/SIL	9000	2.4	1.85

D Series 22. Hermetically sealed; only 1" sq. by 1 3/4" high. SPDT; 20 mw. *DPDT; 40 mw. Contacts rated 2 amps. Wt., 3 oz.

Stock No.	Mfr's Type	Ohms	Ma. DC	NET
76 P 384	22RCC-1000-G/SIL	1000	4.5	16.00
76 P 385	22RCC-2500-G/SIL	2500	2.8	16.50
76 P 386	22RCC-5000-G/SIL	5000	2.0	17.00
76 P 387	22RCC-8000-G/SIL	8000	1.6	17.50
76 P 388	22RCC-1000-G/SIL*	1000	6.3	17.50
76 P 389	22RCC-2500-G/SIL*	2500	4.0	18.00
76 P 390	22RCC-5000-G/SIL*	5000	2.8	18.50
76 P 391	22RCC-8000-G/SIL*	8000	2.3	19.00

E Series 41. Exceptionally quiet, sensitive relay. SPDT contacts rated *2; †5 amps. Sensitivity, 40 mw. 2 1/4 x 1 1/4 x 1 1/2". 3 oz.

Stock No.	Mfr's Type	Volts (AC) (DC)	Ma. (DC)	NET
75 P 076	41FZ-10-ACG/SIL	6 v. †	3.50
76 P 392	41FZ-35-ACG/SIL	6 v. *	3.50
76 P 077	41FZ-200-ACG/SIL	24 v. †	3.50
76 P 393	41FZ-500-ACG/SIL	24 v. *	3.50
76 P 078	41FZ-5000-ACG/SIL	115 v. †	3.65
76 P 394	41FZ-10000-ACG/SIL	115 v. *	3.85
76 P 079	41FZ-12000-ACG/SIL	230 v. †	4.15
76 P 395	41F-5-S/SIL	5 ohms	90	3.50
76 P 396	41F-50-S/SIL	50 ohms	30	3.50
76 P 397	41F-200-S/SIL	200 ohms	15	3.50
76 P 398	41F-1000-S/SIL	1K ohms	6.5	3.50
76 P 399	41F-5000-S/SIL	5K ohms	3.0	3.65
76 P 400	41F-10000-S/SIL	10K ohms	2.0	3.85

F Series 42. DPDT relay with octal plug-in base and dust cover. Octal base provides for quick interchangeability. Operates under 0.2 watt DC and under 0.5 VA AC. Contacts rated 5 amps at 28 v. DC or 115 v. AC. 1 1/2" sq. x 2 1/8" high. Shpg. wt., 4 oz.

Stock No.	Mfr's Type	Volts (AC) (DC)	Ma. (DC)	NET
76 P 401	42R02-8-ACG/SIL	6 v.	7.75
76 P 402	42R02-50-ACG/SIL	12 v.	7.75
76 P 403	42R02-200-ACG/SIL	24 v.	7.75
76 P 404	42R02-4000-ACG/SIL	115 v.	7.75
76 P 405	42R02-12000-ACG/SIL	220 v.	8.50
76 P 406	42R02-5-G/SIL	5 ohms	200	7.75
76 P 407	42R02-50-G/SIL	50 ohms	65	7.75
76 P 408	42R02-200-G/SIL	200 ohms	32	7.75
76 P 409	42R02-1000-G/SIL	1K ohms	14	7.75
76 P 410	42R02-5000-G/SIL	5K ohms	6.5	8.00
76 P 411	42R02-10000-G/SIL	10K ohms	4.5	8.25

G 26F-8000-CDS/PAL Relay. Similar to 4F series 8000-ohm relay listed in left-hand column, but slightly lighter and with somewhat greater sensitivity. Allows circuits to be adjusted so as to draw less plate current, for longer tube or battery life. Ideal for use in radio-controlled devices. SPDT; palladium contacts rated at 0.5 amp @ 28 v. DC or 115 v. AC. 8000 ohm coil. Operating current, 0.7 ma. Pull-on, drop-out current difference, 0.2 ma. Shpg. wt., 7 oz.

75 P 284. NET..... 8.50

Relays and Contact Protectors

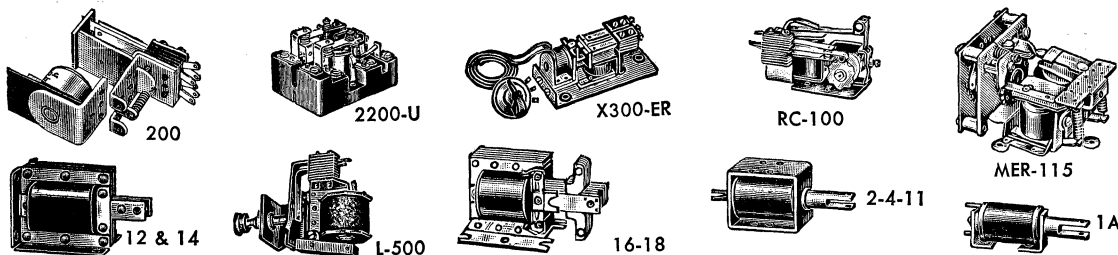

GUARDIAN RELAYS & SOLENOIDS

2200-U POWER RELAYS

DPDT power relay featuring interchangeable coils. Relay may be modified by inserting replacement coil of another voltage. For motor starting, heater loads and other heavy-duty uses. Contacts rated at 25 amps, continuous duty, 230 v. AC with 75% power factor load. Operating power requirement, 9.5 va; coil drain, approx. .080 amps at 115 v., 60 cycles. 3/8x2 1/2x2 3/8". Av. shpg. wt., relays, 12 oz.; coils, 6 oz.

Volts AC	Relays					Replacement Coils				
	Stock No.	1-24, EACH	25-49, EACH	50-99, EACH	50-99, EACH	Stock No.	1-24, EACH	25-49, EACH	50-99, EACH	50-99, EACH
6	75 P 083	6.00	5.40	5.10	5.10	75 P 087	2.05	1.84	1.74	
74	75 P 084	6.00	5.40	5.10	5.10	75 P 088	2.05	1.84	1.74	
115	75 P 085	6.00	5.40	5.10	5.10	75 P 089	2.05	1.84	1.74	
230	75 P 086	6.25	5.62	5.31	5.31	75 P 090	2.20	1.98	1.87	

INDUSTRIAL SOLENOIDS

Intermittent-duty solenoids are for applications that do not require energization of coil for more than 5 consecutive minutes with sufficient time between cycles for cooling. Continuous-duty solenoids are not to exceed a temperature rise of 85° C. Lift obtained during "cold" operation. Sizes and shpg. wts.: 1A—1 1/2x1 3/4x1 3/8"; 5 oz. 2—1 5/8x1 9/16x1 1/8"; 10 oz. 4—1 3/4x2 1/8"; 15 oz. 11—1 3/4x1 9/16x1 1/8"; 8 oz. 14—2 1/8x2 1/8x1 1/8"; 19 oz. 16—1 1/2x1 1/2x1 1/8"; 8 oz. 18—2 1/8x2 1/8x1 1/8"; 1 lb. *Intermittent. †Continuous. All for 110-120 v., 60 cyc. AC but: †DC; †230 v. AC.

Stock No.	Type	Ohms	Amps	Stroke	Lift	1 to 24, EA.	25 to 49, EA.	50 to 99, EA.
75 P 890	1A*	300	.17	3/8-1/2"	8	2.48	2.23	2.10
75 P 891	1A†	675	.07	3/8-1/2"	3	2.48	2.23	2.10
75 P 154	2*	60	50	3/8-1/2"	27	2.90	2.61	2.46
75 P 155	2†	166	155	3/8-1/2"	10	2.90	2.61	2.46
75 P 892	4*	37	64	3/8-1 1/8"	24	3.13	2.82	2.66
75 P 893	4†	133	14	3/8-1 1/8"	6	3.13	2.82	2.66
75 P 828	12*	100	27	3/8-1 1/8"	32	3.98	3.49	3.29
75 P 829	12†	150	15	3/8-1 1/8"	22	3.98	3.49	3.29
76 P 318	11 1/2†	4.5	1.35	3/8-1"	21	3.08	2.67	2.61
76 P 319	11 1/2†	80	.30	3/8-1"	21	3.08	2.67	2.61
75 P 894	14*	11	1.4	3/8-1 1/2"	110	5.61	5.05	4.76
75 P 895	14†	18	.52	3/8-1 1/2"	65	5.61	5.05	4.76
76 P 320	16 1/2†	355	10	3/8-1 1/2"	60	3.65	3.28	3.10
75 P 156	16*	41	540	3/8-1 1/2"	80	3.48	3.13	2.95
75 P 885	16†	85	21	3/8-1 1/2"	60	3.48	3.13	2.95
75 P 157	18*	8.2	1.45	3/8-1"	340	4.88	4.39	4.14
75 P 886	18†	20	.39	3/8-1"	145	4.88	4.39	4.14
76 P 321	18 1/2†	78.2	.20	3/8-1"	145	5.10	4.59	4.33

MER-115 MIDGET STEPPING RELAY

Electrical-reset stepping relay with 21 active positions; resets from external control or own contacts. Contacts rated 1 amp at 115 v., 60 cycle, non-inductive. Stepping and reset coils 115 v., 60 cycle AC. Minimum set pulse, 50 ms; reset, 10 ms. 3/4x2 3/8x3/4". Shpg. wt., 13 oz. 75 P 282, 1 to 24, NET EACH.....9.96 50 to 99, EACH.....9.40

AMPERITE THERMOSTATIC DELAY RELAYS

Hermetically sealed in glass envelope with octal base. Heater draws 2 watts and may be operated continuously. Contacts: SPST, 3 amps at 115 v. AC, 1 amp at 220 v. AC. Voltage Breakdown: Contacts, 1000 v.; Heater-to-Contact, 1500 v., except* 250 v. and 500 v. for delays of 10 sec. or less. Ambient temperatures from -55° to +70° C. Size, Dia., 1 3/8"; Height less Prongs, 2 7/8". Av. shpg. wt., 4 oz. Be sure to specify type number as well as stock number.

Delay Seconds	Type No. Normally Open		Type No. Normally Closed	
	6.3 v. AC-DC	115 v. AC-DC	6.3 v. AC-DC	115 v. AC-DC
2*	6N02	115N02	6C2	115C2
5*	6N05	115N05	6C5	115C5
10*	6N010	115N010	6C10	115C10
15*	6N015	115N015	6C15	115C15
20	6N020	115N020	6C20	115C20
30	6N030	115N030	6C30	115C30
45	6N045	115N045	6C45	115C45
60	6N060	115N060	6C60	115C60
75	6N075	115N075	6C75	115C75
90	6N090	115N090	6C90	115C90
120	6N0120	115N0120	6C120	115C120
150	6N0150	6C150
180	6N0180	6C180

75 PP 295, NET EACH.....2.35

Miniature Relays. All types above also available in miniature size, 9-pin, 3/4x2 3/8". 3 oz. When ordering, specify type no., adding letter "T", following type number. Example: 6N02T. 75 PP 296, NET EACH.....2.35

Allied also stocks a complete selection of Amperite Regulator Tubes for industrial applications. See page 110 for listing.

UNIVERSAL "200" SERIES

Universal interchangeable parts for assembling custom relays. Listings include AC, DC, and plate coils, and switch contact assemblies. Complete relay requires one coil and one contact assembly. For additional contacts use the contact switch parts kit. Contact ratings given are at 115 v., 60 cycle AC, non-inductive load. Use two 6-32 screws for mounting. Overall size: With standard contact assembly 2 1/4x1 1/2x1 3/4"; midget contact assembly, 2 1/8x1 1/8x1 1/2". Av. shpg. wt., 4 oz.

Stock No.	Volts	AC Coil Types			DC Coil Types				
		1 to 24, EACH	25 to 49, EACH	50 to 99, EACH	Stock No.	Volts	1 to 24, EACH	25 to 49, EACH	50 to 99, EACH
75 P 709	6	1.63	1.47	1.38	75 P 713	6	1.63	1.47	1.38
75 P 710	12	1.63	1.47	1.38	75 P 714	12	1.63	1.47	1.38
75 P 711	24	1.63	1.47	1.38	75 P 715	24	1.63	1.47	1.38
75 P 712	115	2.04	1.84	1.73	75 P 716	32	1.63	1.47	1.38
75 P 888	230	2.69	2.42	2.28	75 P 717	110	2.04	1.84	1.73

75 P 779, Type 200-5000 D, 5000-ohm plate coil, 1-24, EACH.....2.10
25-49, EACH.....1.89 50 to 99, EACH.....1.78

CONTACT SWITCH ASSEMBLIES

Stock No.	Mfr's Type	Description	1 to 24, EACH	25 to 49, EACH	50 to 99, EACH
75 P 707	200-1	SPDT contact assembly, 8 amps.	1.33	1.20	1.13
75 P 708	200-2	DPDT contact assembly, 8 amps.	1.81	1.63	1.53
75 P 724	200-4	DPDT contact assembly, 12.5 amps.	2.10	1.89	1.78
75 P 718	200-M1	SPDT midget contact assembly, 8 amps.	1.24	1.12	1.05
75 P 719	200-M2	DPDT midget contact assembly, 8 amps.	1.63	1.47	1.38
75 P 826	200-M5	APDT midget contact assembly, 8 amps.	2.70	2.43	2.29

Type 200-M3, Switch parts. For adding poles to 200-M1 and 200-M2. 75 P 725, 25-49, EA., 1.21 50-99, EA., 1.13 1-24, EA., 1.34
Type 200-3, Switch parts for adding poles to 200-1 and 200-2. 75 P 730, 25-49, EA., 1.21 50-99, EA., 1.13 1-24, EA., 1.34

LOCKING RELAYS

Locking relays for break-in control; phone to CW switching etc. Momentary energization locks contacts. Each impulse reverses contacts. 1/4" silver contacts are rated 12.5 amps; handle 1500-watt non-inductive load at 60 cycle AC; 1000-watt inductive load at 60 cycle AC. Overall size, 2 1/4x2 3/8x3/4". Av. shpg. wt., 12 oz.

Stock No.	Type	Contacts	Volts	1 to 24, EA.	25 to 49, EA.	50 to 99, EA.
75 P 727	RC-100-AR	4PST	115	5.96	5.36	5.06
75 P 827	RC-100-BR	SPDT & DPST	115	6.21	5.59	5.27
76 P 322	RC-100-CR	SPDT	115	5.75	5.17	4.88
75 P 887	RC-100-GR	DPDT	115	5.83	5.25	4.95

OVERLOAD RELAYS

Relays protect against surges, or continuous overload. X-300-ER has remote electrical reset and overload adjustment; *adjustable from 250-milliamp to 3000 v. ins. Aux. contacts for pilot light indicates "overload" or "clear" position. L-500 has manual reset. Contacts rated 1500 w. non-inductive; 1 kw inductive; at 115 v., 60 cycles; 2000 v., ins.

Stock No.	Type	Ma.	Size	Lbs.	1 to 24, EA.	25 to 49, EA.	50 to 99, EA.
75 P 640	X-300-ER	250-750*	4 3/4x1 5/8x2 1/8"	1 1/4	7.69	6.92	6.53
75 P 726	L-500	500	1 3/4x2 3/8x3/4"	1/4	8.92	8.03	7.58

LEDEX 12-POSITION RELAY

Consists of master switch and solenoid-activated slave switch. Slave switch may be installed at any convenient, remote location. Master switch mounts directly on panel, etc. Just turn master switch to any desired position—slave switch moves to identical position. 5-conductor cable used between master and slave. Perfect for remote switching of TV antennas, control circuits, meter switching, etc. Both master and slave are supplied on handy demonstration board. Comes completely wired with selenium-rectifier power supply and line cord for plugging in to outlet. For 95-130 v., 50-60 cycle AC. Shpg. wt., 3 lbs. 75 P 243, NET.....16.50

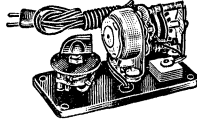

FEDERAL CONTACT PROTECTORS

Effective protection for relay contacts controlling inductive circuits. Suppress arcing and RF transients to prevent erosion of contact surfaces. Consist of selenium rectifier cells back-to-back in one small tubular unit. For relays operating up to 40 times per sec. and drawing up to 600 ma at 150 v., AC or DC. Pigtail leads. Wt., 6 oz.

Stock No.	Type	Max. V	Max. Ma	Min. V.	Size	NET
76 P 323	8A2PS2	52	200	27 AC	2 5/8x3 3/4"	1.06
76 P 324	15A2PS2	52	400	27 AC	1 1/2x3 3/4"	1.32
76 P 325	15A3PS2	66	500	45 AC	1 1/2x3 3/4"	1.45
76 P 326	8A5PS5	130	200	105 AC	2 5/8x3 3/8"	1.67
76 P 327	15A5PS5	130	400	105 AC	1 1/2x3 3/8"	2.08
76 P 328	8A2PS1	44	200	23 DC	2 3/8x3 3/4"	.99
76 P 329	8A2HS1	44	200	23 DC	3 3/8x1 1/2"	2.60
76 P 330	15A2PS1	44	500	23 DC	1 1/2x3 3/4"	1.23
76 P 331	15A2HS1	44	500	23 DC	3 3/8x1 1/2"	2.86
76 P 332	8A3PS2	66	250	45 DC	2 5/8x3 3/4"	1.17

Relays and Electric Counters

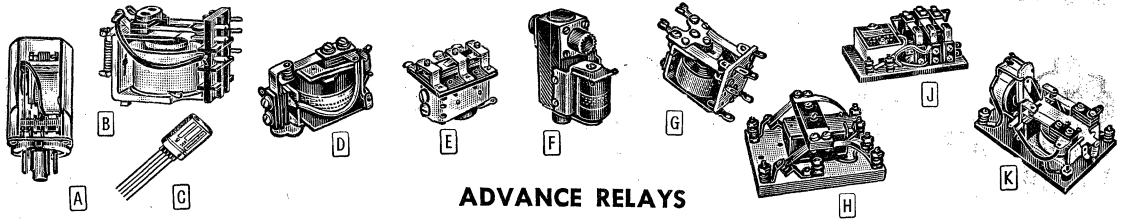

ADVANCE RELAYS

A B Type GH General-Purpose Midget Relays. Precision-built midget relays. Types GHP, GHE, and GHH have dust-proof, clear polystyrene covers and octal bases, except $\frac{1}{2}$ -pin base (Fig. A). Types GHA, GHB, and GHS are open with solder type terminals (Fig. B). Types GHB and GHH rated 10 amps at 115 v. AC with resistive load; GHP, GHE, GHA, and GHS rated 5 amps at 115 v. AC with resistive load. Types GHE and GHS are current actuated and can be used as phase circuit relays. All others are voltage actuated. Size: Types GHA, GHB, and GHS, $1\frac{1}{2} \times 1\frac{1}{2} \times 1\frac{1}{4}$ " others are $1\frac{1}{2} \times 2$ square by $2\frac{1}{2}$ " above chassis. Av. shpg. wt., 4 oz.

Stock No.	Mfr's Type	Volts	Action	1-24, EA.	25-49, EA.	50-99, EA.
76 P 447	GHA/1C/6VA	6 v. AC	SPDT	2.88	2.40	2.16
76 P 460	GHB/1C/6VA	6 v. AC	DPDT	3.10	2.62	2.83
76 P 451	GHA/2C/6VA	6 v. AC	DPDT	3.48	2.90	2.61
76 P 470	GHB/2C/6VA	6 v. AC	DPDT	3.75	3.13	2.81
76 P 481	GHH/2C/6VA	6 v. AC	DPDT	6.09	5.08	4.57
76 P 482	GHP/2C/6VA	6 v. AC	DPDT	5.64	4.70	4.23
76 P 455	GHA/3C/6VA	6 v. AC	3PDT	3.87	3.23	2.90
76 P 473	GHB/3C/6VA	6 v. AC	3PDT	4.17	3.48	3.13
76 P 459	GHA/1C/6VD	6 v. DC	SPDT	2.85	2.38	2.14
76 P 461	GHB/1C/6VD	6 v. DC	DPDT	3.18	2.65	2.39
76 P 476	GHB/2C/6VD	6 v. DC	DPDT	3.42	2.85	2.57
76 P 464	GHA/3C/6VD	6 v. DC	3PDT	3.57	2.98	2.68
76 P 462	GHB/2C/6VD	6 v. DC	3PDT	3.87	3.23	2.90
76 P 462	GHA/2C/12VD	12 v. DC	DPDT	3.18	2.65	2.39
76 P 465	GHB/3C/12VD	12 v. DC	3PDT	3.57	2.98	2.68
76 P 448	GHA/1C/24VA	24 v. AC	SPDT	2.88	2.40	2.16
76 P 483	GHP/1C/24VA	24 v. AC	SPDT	5.10	4.25	3.83
76 P 452	GHA/2C/24VA	24 v. AC	DPDT	3.48	2.90	2.61
76 P 471	GHB/2C/24VA	24 v. AC	DPDT	3.75	3.13	2.81
76 P 484	GHH/2C/24VA	24 v. AC	DPDT	6.09	5.08	4.57
76 P 485	GHP/2C/24VA	24 v. AC	DPDT	5.64	4.70	4.23
76 P 456	GHA/3C/24VA	24 v. AC	3PDT	3.87	3.23	2.90
76 P 486	GHB/3C/24VA*	24 v. AC	3PDT	4.17	3.48	3.13
76 P 466	GHA/1C/24VD	24 v. DC	SPDT	2.85	2.38	2.14
76 P 467	GHA/2C/24VD	24 v. DC	DPDT	3.18	2.65	2.12
76 P 473	GHB/2C/24VD	24 v. DC	DPDT	3.42	2.85	2.57
76 P 466	GHA/3C/24VD	24 v. DC	3PDT	3.57	2.98	2.68
76 P 479	GHB/3C/24VD	24 v. DC	3PDT	3.87	3.23	2.90
76 P 449	GHA/1C/115VA	115 v. AC	SPDT	2.88	2.40	2.16
76 P 487	GHP/1C/115VA	115 v. AC	SPDT	5.10	4.25	3.83
76 P 453	GHA/2C/115VA	115 v. AC	DPDT	3.48	2.90	2.61
76 P 472	GHB/2C/115VA	115 v. AC	DPDT	3.75	3.13	2.81
76 P 488	GHH/2C/115VA	115 v. AC	DPDT	6.09	5.08	4.57
76 P 489	GHP/2C/115VA	115 v. AC	DPDT	5.64	4.70	4.23
76 P 457	GHA/3C/115VA	115 v. AC	3PDT	3.87	3.23	2.90
76 P 475	GHB/3C/115VA	115 v. AC	3PDT	4.17	3.48	3.13
76 P 490	GHP/3C/115VA*	115 v. AC	3PDT	6.99	5.83	5.24
76 P 459	GHA/1C/220VA	220 v. AC	SPDT	3.30	2.75	2.48
76 P 454	GHA/2C/220VA	220 v. AC	DPDT	3.48	3.40	3.06
76 P 450	GHA/3C/220VA	220 v. AC	3PDT	4.41	3.68	3.31

Stock No.	Mfr's Type	Ohms	Ma.	Action	1-24, EA.	25-49, EA.	50-99, EA.
76 P 467	GHS/2C/2500D	2500	10.0	DPDT	3.75	3.13	2.81
76 P 468	GHS/2C/5000D	5000	7.2	DPDT	4.20	3.50	3.15
76 P 469	GHS/2C/10000D	10000	5.0	DPDT	4.65	3.88	3.49
76 P 491	GHE/2C/2500D	2500	10.0	DPDT	5.88	4.90	4.41
76 P 492	GHE/2C/5000D	5000	7.2	DPDT	5.97	4.98	4.48
76 P 493	GHE/2C/10000D	10000	5.0	DPDT	6.48	5.40	4.86

C Type NM Ultra-Miniature DC Relays. Hermetically sealed in transformer-type nitrogen-filled case. Ideal for computers, missiles, printed circuits, etc. Vibration resistance, 10G up to 500 cps; shock to 50G, SPDT contacts rated at $\frac{1}{4}$ amp, 28 v. DC. $1\frac{1}{2} \times \frac{3}{8} \times \frac{3}{16}$ ". Wt., 3 oz.

Stock No.	Type	Ohms	Ma.	1-24, EA.	25-49, EA.	50-99, EA.
76 P 195	NM/1C/50	50	44			
76 P 196	NM/1C/200	200	22			
76 P 197	NM/1C/500	500	14	24.00	20.00	18.00
76 P 198	NM/1C/1K	1000	10			
76 P 199	NM/1C/2K	2000	7			

Industrial users—write for quantity prices on relays in lots of 100 or more.

D Type PC Power-Control Relays. Contacts rated 15 amps, at 115 v. AC non-inductive. DC type draws 2½ watts. AC coils 4-7 VA. Mount by 2, 6-32 holes on 2" ctrs. SP units: $1\frac{1}{2} \times 1\frac{1}{2} \times 2\frac{1}{2}$ "; DP units: $1\frac{1}{2} \times 1\frac{1}{2} \times 2\frac{1}{2}$ "; 3P unit: $1\frac{1}{2} \times 2\frac{1}{2} \times 3$ ". Av. shpg. wt., 8 oz.

Stock No.	Type	Action	Coil Volts	NET EACH		
				1-24	25-49	50-99
76 P 200	PC/1C/115VA	SPDT	115 v. AC	3.51	2.93	2.64
76 P 202	PC/2C/115VA	DPDT	115 v. AC	4.80	4.00	3.60
76 P 203	PC/3C/115VA	3PDT	115 v. AC	6.75	5.62	5.06
76 P 494	PC/4C/115VA	4PDT	115 v. AC	8.88	7.40	6.66
76 P 495	PC/2C/24VA	DPDT	24 v. AC	4.80	4.00	3.60
76 P 496	PC/4C/24VD	4PDT	24 v. DC	4.68	3.90	3.51
76 P 208	PC/1C/6VA	SPDT	6 v. AC	3.51	2.93	2.64
76 P 216	PC/1C/6VD	SPDT	6 v. DC	3.39	2.83	2.55

E Type SO Sensitive Relays. Extremely sensitive, adjustable, SPDT DC relays. Feature sensitivity and versatility equal to relays costing three times as much. Standard adjustment is 10 mw, can be adjusted to as low as 2 mw. Max. coil rating, 3 watts. Contacts rated 1.5 amps, 28 v. DC., 115 v. AC resistive. Size, $1\frac{1}{2} \times 1\frac{1}{2} \times 1\frac{1}{4}$ ". Av. shpg. wt., 3 oz.

Stock No.	Mfr's Type	Ohms	Ma.	1-24, EA.	25-49, EA.	50-99, EA.
76 P 261	SO/1C/4000D	4000	1.6	4.80	4.00	3.60
76 P 262	SO/1C/6500D	6500	1.25	5.04	4.20	3.78
76 P 263	SO/1C/10,000D	10,000	1	5.31	4.43	3.98

F Type CB Coaxial Relays. For use with 52-ohm RG cables at RF outputs of up to 800 watts on lines with low SWR. SWR of less than 1.08: 1.00 at 150 mc. SPDT internal contacts directly connected to Amphenol 83-1R connector. *SPDT with external DPDT contacts for auxiliary circuits. $3\frac{1}{2} \times 1\frac{1}{4} \times 3\frac{1}{2}$ ". Shpg. wt., 11 oz.

Stock No.	Mfr's Type	Action	Coil Volts	NET EACH		
				1-24	25-49	50-99
76 P 250	CB/1C/6VD	SPDT	6 v. DC	10.80	9.00	8.10
75 P 645	CB/1C/115VA	SPDT	115 v. AC	12.15	10.12	9.11
76 P 252	CB/1C2C/6VD	SPDT*	6 v. DC	13.89	11.57	10.41
76 P 254	CB/1C2C/115VA	SPDT*	115 v. AC	14.85	12.37	11.13

G Type AM2C/115VA Midget Antenna Relay. Compact, DPDT antenna relay. Highly efficient, yet inexpensive. Well insulated for RF applications—silicone glass material is used to insulate armature and contact assemblies. Can be used for transmitters with up to 170 watts input. Elements spaced to maintain impedance of 300-ohm twin line. For 115 v., 60 cycle AC. Single 6-32 mounting. $1\frac{1}{4} \times 1\frac{1}{2} \times 1\frac{1}{8}$ ". Shpg. wt., 6 oz.

75 P 644, 1-24, NET EACH..... 4.82
25-49, EACH.....3.85 50-99, EACH..... 3.46

H Type AT/2C/115VA Heavy-Duty Antenna Relay. For continuous heavy-duty RF transmitter antenna changeover applications. Primarily designed for fixed-station use. Conservatively rated at 1 KW RF. Low-loss steatite insulation. Smooth-wiping DPDT $\frac{1}{4}$ " silver contacts, rated at 10 amps, 115 v. AC non-inductive, or 1 kw RF, 115 v. AC coil. Size, $1\frac{1}{4} \times 2\frac{1}{2} \times 3\frac{1}{2}$ ". Shpg. wt., 14 oz.

75 P 641, 1-24, NET EACH..... 9.09
25-49, EACH..... 7.58 50-99, EACH..... 6.82

J Type DM/2C/115VA Time Delay Relay. Provides adjustable 5-60 sec. delay. Excellent for use in pre-heating tube filaments, specialized lighting circuits, photographic controls, protection applications, etc. DPDT $\frac{1}{4}$ " silver contacts, rated at 15 amps, 115 v. AC or 26.5 v. DC non-inductive. Recycling time: 8-10 times delay period. Coil for operation from 115 v., 60 cycle AC. Size, $1\frac{1}{2} \times 2\frac{1}{2} \times 3\frac{1}{2}$ ". Shpg. wt., 12 oz.

75 P 642, 1-24, NET EACH..... 14.88
25-49, EACH..... 12.40 50-99, EACH..... 11.16

K Type LE Latching Relays. For industrial and power-control applications—eliminates undesired continuous current consumption by the duty coil. Positive locking. Has reset coil. $\frac{1}{4}$ " contacts rated for 15 amps at 115 v. AC or 26.5 v. DC non-inductive. $2\frac{3}{8} \times 2\frac{1}{2} \times 3\frac{1}{2}$ ". Wt., 1 lb.

Stock No.	Type	Action	Volts	1-24, EA.	25-49, EA.	50-99, EA.
76 P 497	LE/2C/115VA	DPDT	115 v. AC	11.25	9.38	8.44
76 P 498	LE/2C/24VD	DPDT	24 v. DC	10.74	8.95	8.05

PRODUCTION INSTRUMENT CO. ELECTRIC COUNTERS

Mercury Moderate-Duty Counters. Small, low-cost electric counters for coin-operated equipment and industrial equipment. Can be actuated by any switch or relay which has a min. closed period of .04 sec. and max. open period of .06 sec. Tested at 600 counts per minute. All are completely enclosed in tamper-proof case with plastic window. Model MDB-S4 counts to 4 digits. Overall size, $1\frac{1}{2} \times 2\frac{1}{2} \times 1\frac{1}{2}$ " mfg. centers, $1\frac{1}{2} \times 2\frac{1}{2} \times 1\frac{1}{2}$ ". Model MEA-N5 counts 5 digits. Overall size, $2\frac{1}{2} \times 1\frac{1}{2} \times 2\frac{1}{4}$ " mfg. centers, $1\frac{1}{2} \times 1\frac{1}{2}$ ". Model MDA-S4 counts 5 digits. Overall size, $2\frac{1}{2} \times 1\frac{1}{2} \times 2\frac{1}{4}$ " mfg. centers, $1\frac{1}{2} \times 1\frac{1}{2}$ ". Power required, 3 watts. For 60 cycle AC. Av. shpg. wt., 1 lb.

L MDB-S4 PANELMOUNT (RESET)

Stock No.	Mfr's Type No.	Volts	NET EACH
77 P 044	MDB-S4-6A	6 v. AC	
77 P 049	MDB-S4-24A	24 v. AC	14.75
77 P 049	MDB-S4-115A	115 v. AC	

M MEA-N5 (NON-RESET)

Stock No.	Mfr's Type No.	Volts	NET EACH
77 P 032	MEA-N5-6A	6 v. AC	4.40
77 P 033	MEA-N5-115A	115 v. AC	4.40

N MDA-S4 (RESET)

Stock No.	Mfr's Type No.	Volts	NET EACH
77 P 042	MDA-S4-6A	6 v. AC	
77 P 043	MDA-S4-24A	24 v. AC	14.00
77 P 043	MDA-S4-115A	115 v. AC	

P "Super Wizard" ECS-9 Counter. 6-digit industrial type for continuous, heavy-duty use. Min. "make" .024 sec. min. "break" .036 sec.—up to 1000 counts per min. Completely enclosed. Resets to zero with complete turn of knob. Power, 5 watts. For 115 v., 60 cycle AC. $3\frac{1}{2} \times 1\frac{1}{2} \times 5\frac{1}{2}$ ". Wt., 3 lbs.

77 P 036, NET..... 38.50

Industrial Relays

AGASTAT TIME DELAY RELAYS

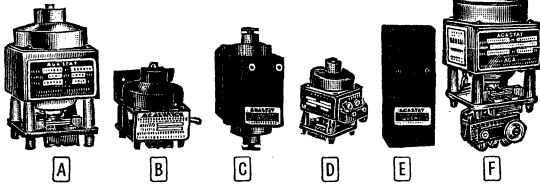

Precision time-delay relays. Provide adjustable delays—down to 1/10th second, or delays up to 5 minutes, varied by outside screw adjusted timing head. For vertical operation only. Consist of sealed timing head, solenoid assembly, snap-action switch with fine silver contacts, and screw terminals. Contact ratings based on 115 v., 60 cycle resistive loads. *DB suffix indicates double-break type with 15 amp contact rating; SB indicates single-break, with 8 amp rating. "Use" column numbers mean that delay starts when (1) coil is energized, (2) coil is de-energized, (3) lever is released manually, (4) coil is energized and de-energized, (5) delay starts on main contacts when coil is energized, but no delay on auxiliary SPDT contacts; main contacts transfer at end of time delay. (6) Instant transfer on main and aux. contacts when energized. Instant retransfer on aux.; adjustable time delay on main when de-energized. (7) Depressing lever starts time delay, after which contacts are automatically energized. Contacts reset to normal when lever is released. NE-13 is double-throw type for adjustable delay in both directions. NEL-11QT is remote push-button type with hold-in switch. All relays listed may be mounted from front or back. NET relays provide 2-step delay; first delay period from 0 to 15 sec.—2nd period from .01 sec. to 5 min. NET-15Q, NET-16Q, NET-25Q and NET-26Q consist of standard Agastat plus SPDT aux. switch at bottom of terminal block. NEU-11QT is U.L. Approved. Types G, GY and GZ are general-purpose enclosures similar to NEA. Type 1: 1/2" for NEL-11QT. GZ for NE-13. G for all others. Coil voltages are 50-60 cycle AC. Av. size, 2 1/2" x 2 1/4" x 3/4", except 1 1/2" x 2 1/8" x 5/8". Av. shpg. wt., 2 1/4 lbs.

Stock No.	Mfr's Type	Fig.	Use	Contacts*	Coil Volts	NET EACH	2-U. EACH
76 P 428	NE-11QT	A	1	SPDT-DB	115	33.00	29.70
76 P 429	NE-12QT	A	1	DPDT-SB	115	34.06	30.65
76 P 430	NE-11QT	A	1	SPDT-DB	230	33.00	29.70
76 P 431	NE-12QT	A	1	DPDT-SB	230	34.06	30.65
76 P 432	NE-11QT	A	1	SPDT-DB	440	33.00	29.70
76 P 433	NE-12QT	A	1	DPDT-SB	440	34.06	30.65
76 P 434	NE-21QT	A	2	SPDT-DB	115	33.00	29.70
76 P 435	NE-22QT	A	2	DPDT-SB	115	34.06	30.65
76 P 436	NE-21QT	A	2	SPDT-DB	230	33.00	29.70
76 P 437	NE-22QT	A	2	DPDT-SB	230	34.06	30.65
76 P 438	NE-21QT	A	2	SPDT-DB	440	33.00	29.70
76 P 412	NM-12QT	B	7	DPDT-SB	Manual	21.81	19.63
76 P 439	NM-21QT	B	3	SPDT-DB	Manual	20.81	18.73
76 P 440	NM-22QT	B	3	DPDT-SB	Manual	21.81	19.63
75 P 747	NED-13	C	4	SPDT-DB	115	60.95	54.85
75 P 748	NED-14	C	4	DPDT-SB	115	61.95	55.75
76 P 413	NEH-22Q	F	6	DPDT-SB	115	39.36	35.42
76 P 441	NEL-11QT	D	5	SPDT-DB	115	39.36	35.42
76 P 442	NET-11QT	F	1	SPDT-DB	115	36.18	32.56
76 P 443	NET-15QT	F	1	SPDT-DB	115	42.90	38.61
76 P 444	NET-16QT	F	1	DPDT-SB	115	43.90	39.51
76 P 445	NET-25QT	F	2	SPDT-DB	115	42.90	38.61
76 P 446	NET-26QT	F	2	DPDT-SB	115	43.90	39.51
76 P 739	G	E	Enc.	5.00	4.50
76 P 248	GY	E	Enc.	6.00	5.40
75 P 249	GZ	E	Enc.	6.00	5.40

BARBER-COLMAN TYPE "O" ULTRA-SENSITIVE RELAYS



Ultra-sensitive, DC-polarized relays. Feature extremely high sensitivity. Ideal for use wherever power supply is limited. Will operate for years with mercury cells. Widely used in plate circuits. High-speed response; can be operated in excess of 100 cps. Fine silver contacts are SPDT, with floating neutral position. Polarity of signal determines which contact closes. Sensitivity is adjustable for precise setting. Two Alnico magnets are used for polarizing field. Balanced armature is mounted on torsional supports in air gap, assuring high resistance to physical shock. Normal tolerance on pull-in current at 75° F. is ±25%; from -65° to +160° F., ±60%. All have octal plug-in bases for chassis installation. 1 9/16" x 3/16" x 1 1/4". Shpg. wt., 10 oz.

SINGLE COIL

Stock No.	Mfr's Type	Coil Ohms	Pull-in Volts	Pull-in Amps	Pull-in μ Watts	NET
75 P 250	AYLZ-2542S	215	.154	.00071	109.6	18.00
75 P 252	AYLZ-2804S	7950	.930	.00012	108.8	18.00
76 P 418	AYLZ-2841S	7950	.694	.000076	45.9	22.00
76 P 419	AYLZ-3165S	560	2.38	.00043	101.2	18.00
76 P 411	AYLZ-3428S	215	.100	.00046	46.3	22.00
75 P 255	AYLZ-4436S	13	.035	.00267	92.4	18.00
76 P 420	AYLZ-4538S	2300	.499	.00022	95.3	18.00
76 P 414	AYLZ-4525S	13	.023	.00173	39.1	22.00
76 P 416	AYLZ-4529S	560	.155	.00028	42.8	22.00
76 P 417	AYLZ-4531S	2300	.325	.00014	45.9	22.00

DOUBLE COIL

Stock No.	Mfr's Type	Coil Ohms	Pull-in Volts	Pull-in Amps	Pull-in μ Watts	NET
76 P 427	AYLZ-3078S	940	.494	.00053	260.0	19.00
75 P 253	AYLZ-3188S	5	.033	.00667	222.2	19.00
75 P 251	AYLZ-3192S	3800	1.000	.00026	263.0	19.00
75 P 254	AYLZ-3353S	240	.240	.00100	240.0	19.00
76 P 425	AYLZ-3428S	3800	.650	.00017	111.1	23.00
76 P 426	AYLZ-4443S	95	.146	.00154	224.7	19.00
76 P 421	AYLZ-4534S	5	.022	.00433	93.7	23.00
76 P 422	AYLZ-4538S	95	.086	.00102	95.0	23.00
76 P 423	AYLZ-4539S	240	.056	.00065	101.4	23.00
76 P 424	AYLZ-4540S	940	.322	.00034	110.0	23.00

EBERT MERCURY-PLUNGER RELAYS

Ideal for industrial applications where extreme dependability is required. Mercury contacts are hermetically sealed in tempered glass and are unaffected by dust, moisture etc. Actuating coil operates from 115 v., 60 cycle AC. 60 cycle AC contact ratings: 35 amperes at 115 v., 25 amperes at 230 DC contact ratings: 12 amperes or 1/2 HP at 120 V., 7 amperes or 1/2 HP at 220. EM-1 and EM-4 are rated at 2 HP at 115 and 230 v., 60 cycle AC. EM-2 is rated at 1 HP at 115 and 230 v., 60 cycle AC. NO indicates normally open; NC normally closed. 35 millisecond "make" and 55 millisecond "break." Wt., 2 lbs. Shipped by express only.



Stock No.	Mfr's Type	Contacts	Size	NET EA.
75 P 950	EM-1	SPST-NO	5x2 3/8 x 2 1/2"	12.65
75 P 951	EM-2	SPST-NO	5 1/2 x 2 3/8 x 2 1/2"	14.02
75 P 952	EM-4	DPST-NO	5x3 3/8 x 2 1/2"	20.90

EBERT HEAVY-DUTY MERCURY-PLUNGER RELAYS

Heavy duty mercury relays, similar to above. Types HD-1 and HD-2 are rated at 60 amps for 115 volts AC and 35 amps for 230 volts AC. 60 cycle. DC rating is 12 amps at 120 volts and 7 amps at 240 volts. Type HD-4 2-pole relay: Each tube controls 60 amps at 115 volts AC and 35 amps at 230 v. AC, 60 cycles. DC rating for each tube is 12 amps at 120 volts and 7 amps at 230 volts. Type HD-7 3-pole relay. Each of the 3 tubes can control up to 60 amps at 115 volts AC and 35 amps at 230 v. AC, 60 cycles. DC rating for each tube is 12 amps at 120 volts and 7 amps at 220 volts. All Underwriter's Laboratories Approved. NO indicates normally open; NC, normally closed. Shipped by express only.

No.	Type	Description	Size	Lbs.	NET
75 P 232	HD-1	Single pole, NO	2 1/2 x 5 3/4 x 3 3/8"	2	14.30
75 P 233	HD-2	Single pole, NC	2 1/2 x 5 3/4 x 3 3/8"	2	15.68
75 P 234	HD-4	2-pole, both NO	2 1/2 x 6 x 3 1/2"	2	26.40
75 P 235	HD-4	2-pole, both NC	2 1/2 x 6 x 3 1/2"	2	29.70
75 P 236	HD-4	2-pole, 1 NO/1 NC	2 1/2 x 6 x 3 1/2"	2	28.05
75 P 237	HD-7	3-pole, all NO	3 1/2 x 6 1/2 x 4"	3	35.20
75 P 238	HD-7	3-pole, all NC	3 1/2 x 6 1/2 x 4"	3	40.70
75 P 239	HD-7	3-pole, 2 NO/1 NC	3 1/2 x 6 1/2 x 4"	3	37.40
75 P 241	HD-7	3-pole, 1 NO/2 NC	3 1/2 x 6 1/2 x 4"	3	39.05

EBERT MINIRELAY

Extremely compact in size. Meets critical space requirements and is capable of handling load capacities nearly twice that of ordinary armature-type mechanical relays of equal size. Rated at 20 amps or 1.5 HP at 115 volts, 50-60 cycles. In either normally open (NO) or closed (NC) types. Hermetically sealed, mercury-to-mercury contacts. "Make" and "break," 45 ms. Actuating coil operates from 115 v., 60 cycle AC. Size, 3/8" x 1 7/8" x 1 1/2". Shipped by express only.



Stock No.	Mfr's Type	Contacts	Wt., Oz.	NET EA.
75 P 258	M R-10	SPST-NO	8	8.25
75 P 259	M R-12	SPST-NO	8	9.08

EBERT SPST MICRELAY

Highly sensitive relay for handling high-power, high-current loads. Uses a 2D21 thyatron to control a built-in mercury-plunger relay. Actuated by control signals as low as 3 μa. For control circuits, 1 to 10 megohms impedance. Contacts: Standard Type—35 amps, 115 v. AC; 25 amps, 230 v. AC and 12 amps, 120 v. DC. Heavy-Duty Type—60 amps at 115 v. AC, 35 amps at 230 v. AC. Provide normally open operation. 5x3 1/2 x 4". Shpg. wt., 8 1/2 lbs. Express only. For 115/230 v., 60 cycles.



75 P 256	Standard Type, NET	41.25
75 P 257	Heavy-Duty Type, NET	43.00

DOW-KC COAXIAL ANTENNA RELAYS

Type DKC-G. Precision-built coaxial antenna relays. Re-designed magnet provides thrust pressure in excess of 200 grams—prevents intermittent failure in closing of receiver circuit. Shielded magnet. AC type completely free of hum or chatter. Contacts rated 1000 watts. Negligible change in SWR up to 300 mc. Built-in automatic receiver antenna shorting device. Grounds contact leading to receiver before tongue makes contact with transmitter—prevents r.f. from reaching receiver circuit. Breakdown voltage: over 1000 volts rms. Takes SPDT switch (included in illustration) listed below, for operating B+ of receiver. Connectors, relay tongues and brass parts are silver plated. Size: 4 1/4 x 2 3/4 x 1 1/8". Shpg. wt., 9 oz.

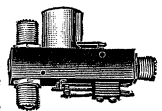

75 P 148	For 110 v. AC, NET	11.50
75 P 147	For 6 v. DC, NET	10.50

SPDT Switch. For above relays. Actuated by plunger on relay. 2 oz. 75 P 799. NET..... 1.00

Type DKM. Smaller coaxial 6 v. DC relay without external SPDT switch and receiver shorting device. For mobile use. 3 1/4 x 2 1/2". Wt., 7 oz. 75 P 149. NET..... 9.50

Type DKF-2 Connector. Double male. For mounting relays directly to output of transmitter. Designed for UHF. Heavy silver plating. Recommended for indoor use. Non-locking type. Shpg. wt., 6 oz. 75 P 136. NET..... 1.85

12VDC Coil, Model DK C-M. 12 volt relay coil for converting DKM 6 volt DC relay or DKC-G 6 and 110 volt AC relays for 12 volt DC use. Ideal for the new 12 v. automotive systems. Shpg. wt., 3 oz. 75 P 138. NET..... 2.00

Interference Filters

PLUG-IN TYPE FILTERS

Easy Installation at Radio, TV, Appliance



CORNELL-DUBILIER "QUIETONE" FILTERS

A Type IF-18. Highly effective all-wave capacitive-inductive type of filter for suppression of severe interference. Used where ventilating or air conditioning units, washing machines, or machine tools interfere with reception on radio or TV. Bakelite case, 6x3¼x2½", with line cord and plug attached. Binding post for attachment of ground wire, if used. Rated at 115 volts, AC-DC, 5 amps. Shpg. wt., 4 lbs.
70 B 120. List, \$9.20. **NET**..... 5.41

B Type IF-19. Effective capacitive-inductive type filter for use where interference is severe. Used to eliminate interference from electric fans, diathermy machines, neon signs, etc. Mounting holes for permanent attachment to baseboard, back of receiver or any convenient location. Terminal for ground connection. Rated 115 volts AC-DC, 5 amps. Bakelite case, 4x2¼x2¼". Shpg. wt., 1½ lbs.
70 B 121. List, \$7.70. **NET**..... 4.53

C Type IF-4. Plug-in, cylindrical filter for suppression of medium-intensity interference produced by fluorescent lights, electric shavers and similar devices. Well-suited for use with small receivers such as AC-DC midget sets, portable TV sets, etc. Filter plugs directly into wall; appliance or receiver plugs into filter. Rated 115 volts, AC-DC, 5 amps. 1½" diameter and 2" long. Shpg. wt., 5 oz.
70 B 125. List, \$1.25. **NET**..... 73c

C Type IF-6. Convenient plug-in filter for elimination of moderate interference. Especially suitable for suppression of interference caused by fluorescent lights, electric shavers, and similar devices. Connects between power line and appliance, or between power line and receiver. Rated at 115 volts, AC-DC, 5 amps. Size, 1½" diameter, 2" long. Shpg. wt., 6 oz.
70 B 126. List, \$1.95. **NET**..... 1.15

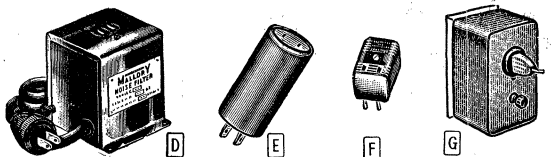

MALLORY INTERFERENCE FILTERS

D Type LC5. Capacitive-inductive filter for eliminating extreme forms of interference. Has terminal for grounding to motor or frame of appliance. Rated 110-220 volts, AC-DC, 5 amps. In rectangular housing with mounting flanges. Size, 2½x6x3½". Shpg. wt., 1¼ lbs.
70 B 328. List, \$11.25. **NET**..... 6.61

D Type LC10. Heavy-duty capacitive-inductive interference filter for elimination of extreme interference. Similar to above, but rated for use with appliances and motor-driven equipment drawing up to 10 amps. Size, 2½x6x3½". Shpg. wt., 2½ lbs.
70 B 320. List, \$15.00. **NET**..... 8.82

E Type X3. Capacitor-type filter for use at radio or appliance. For suppression of light interference from small fans, food mixers, etc. Plugs into AC or DC outlet; has receptacle for appliance plug. Rated 110-220 v., AC-DC, 5 amps. 1½" dia. x 2¾". Shpg. wt., 5 oz.
70 B 331. List, \$1.80. **NET**..... 1.06

F Type X6. Single capacity filter of special low-impedance design for light interference. Housed in molded plastic case, for use on line cord plug of appliance causing interference. Rated at 125 volts, AC or DC, 15 amps. Size, 1¼x2x1". Shpg. wt., 6 oz.
70 B 332. List, \$1.60. **NET**..... 94c

SPRAGUE "FILTEROL" TYPE F-400

G Effective filter for suppression of moderate interference, with built-in screw for attachment directly to any standard duplex wall outlet. Most effective when used at appliance, but may also be used at receiver. Rated 105-125 v., AC-DC, 5 amps. 4½x2¾x2½". Wt., 3½ lbs.
70 B 095. **NET**..... 7.30

WIRED-IN TYPE FILTERS

For Installation at Appliance

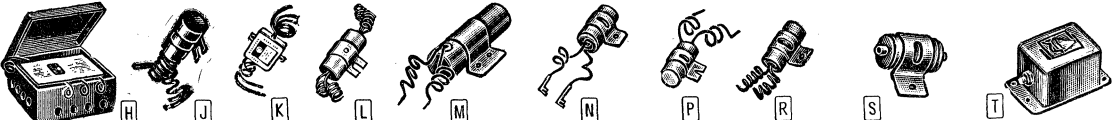

CORNELL-DUBILIER "QUIETONE" FILTERS

H Type IF-7A. For installation at appliance. Capacitive-inductive type filter for suppression of severe interference. Attaches to oil burners, electric motors in dishwashers, disposal units, washing machines, home workshop tools, etc. For single-phase 110-220 volt AC or DC. Rated 5 amps. Size, 6x6x4". Shpg. wt., 9 lbs.
70 B 124. List, \$13.75. **NET**..... 8.08

J Type IF-24. Exceptionally compact unit for wiring to appliances causing light to moderate interference in broadcast or TV receivers. Ideal for elimination of fluorescent light interference. Dual capacitive filter unit effectively suppresses buzzing introduced through power line. For 115 v., AC or DC. Shpg. wt., 8 oz.
70 B 122. List, \$1.25. **NET**..... 73c

K Type IF-64. General-purpose capacitive-inductive filter for use where moderate interference is present. For circuits drawing 2 amps. or less from power line. Miniature size permits installation on almost any appliance or fluorescent fixture causing interference. Rated 110-220 volts. AC or DC. Shpg. wt., 8 oz.
70 B 114. List, \$2.50. **NET**..... 1.47

SPRAGUE INTERFERENCE FILTERS

Type IF. Compact multi-section interference filters for suppressing man-made radio and TV interference. Small and completely self-contained. For use on motors, thermostats, arcing devices, etc. up to 220 volts, AC or DC. Easily installed. Av. shpg. wt., 8 oz.

Stock No.	Mfr's Type	Fig.	Size	Sections	List	NET EACH
70 B 100	IF-15	N	1x2¾"	Triple	\$2.60	1.53
70 B 104	IF-11	M	1½x5½"	Dual	7.80	4.59
70 B 105	IF-21	R	1x2¾"	Dual	1.75	1.03
70 B 113	IF-S1	P	¾x2½"	Single	1.15	.68
70 B 112	IF-37	R	1x2½"	Triple	2.25	1.32

Filterol Types. Designed for connection in series with power supply lines of interference-producing industrial devices. A three-terminal network of matched, specially designed chokes and coils are inside the case, which functions as one of the terminals. The filter selected should have a higher rating than the continuous current rating of the device with which it is to be used. Type 4 utilizes "By-pass" capacitor, providing exceptionally strong attenuation at frequencies above 5 megacycles. All have convenient single-hole mounting; types 1, 2 and 3 are drilled for mounting at either side. Av. shpg. wt., 1 lb.

Stock No.	Type	Fig.	Amps	Volts	Size	List	NET
70 B 091	1	T	1	115	¾x1¼x1¾"	\$13.50	7.94
70 B 092	2	T	10	115	1½x2x2"	14.80	8.70
70 B 093	3	T	35	115	1½x2¾x3½"	27.40	16.11
70 B 094	4	S	20	115	1" dia.x1¾" long	3.05	1.79

MALLORY DUAL CAPACITY FILTER

L Type W7SP. Dual capacity filter designed for mounting directly on appliance causing interference. Suppresses interference caused by drink mixers, electric drills, calculating and bookkeeping machines, cash registers, etc. Size, ¾" diameter, 2" long. With 6" insulated leads. For 110-220 volts, AC or DC. Shpg. wt., 4 oz.
70 B 325. List, \$1.80. **NET**..... 1.06

MEISSNER FILTERS AND WAVE TRAPS

LINE FILTER

Type 15-7515. Inductive-capacitive type filter which filters both sides of the line. For most radios and phono combinations, food mixers, electric shavers, vacuum cleaners, etc. For use at source of interference. Rated at 110 volts, AC or DC. Handles up to 3 amps. Size, 4½x3½x2". Shpg. wt., 8 oz.
60 B 242. List, \$15.00. **NET**..... 8.82



WAVE TRAPS

Tunable resonant circuits for suppression of interference with TV or FM reception; connect between antenna transmission line and receiver. When selecting, choose type whose range includes frequency of interfering signal. All are designed for use with receivers having the following balanced or unbalanced antenna inputs: 50, 72, 300, 400 and 500 ohms. "Tune out" unwanted signals emanating from taxicab, Amateur, commercial telephone and other transmitters. Size, 4½x3x2". Shpg. wt., 4 oz.
60 B 203. Type 15-7510. 6-13 mc. **60 B 209.** Type 15-7513. 54-108 mc.
60 B 204. Type 15-7511. 13-27 mc. **60 B 210.** Type 15-7514. 108-216 mc.
60 B 208. Type 15-7512. 27-54 mc.
List, \$6.00. NET EACH..... 3.53



MILLER TV AND FM WAVE TRAPS

High-Q series-resonant wave traps for the elimination of interference and undesirable images in TV and FM receivers. Tune to the frequency of the interfering signal to reduce herringbone patterns, streaks, or tearing of the picture. With FM receivers, greatly reduce cross-talk from strong interfering station. Size, 1½" wide x 1½" long x 3¾" high. Shpg. wt., 13 oz.



Stock No.	Type	Range	List Each	NET EACH
60 H 211	6163	150-250 mc.	\$4.40	2.59
60 H 212	6164	75-150 mc.		
60 H 213	6165	40-80 mc.		
60 H 214	6166	20-40 mc.		

Arrow-Hart & Hegeman Switches

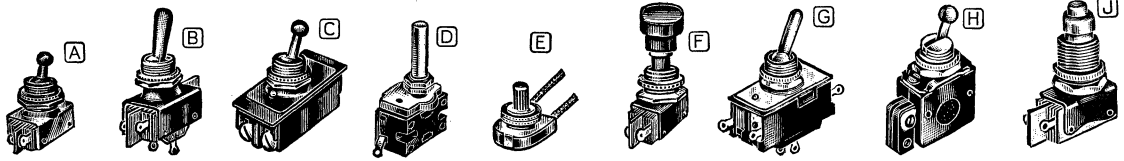

A-H&H SWITCHES FOR MOTORS, ELECTRONIC EQUIPMENT AND APPLIANCES

BALL HANDLE TOGGLE SWITCHES

A Quality Arrow-Hart and Hegeman ball handle toggle switches. Underwriters' Laboratories Approved. Built for long, dependable service. SPST type rated at 3 amps, 250 volts. All others 3 amps at 125 volts or 1 amp at 250 volts. 34 B 127 is momentary-contact type. All have bakelite insulation. Shank, $1\frac{1}{2}$ " diameter. Supplied with mounting nuts. Solder lug terminals. Shpg. wt., each, 2 oz.; per 20, 2 lbs.

Stock No.	Mfr's Type	Type	Shank Length	1-9, EACH	10-99, EA.	100 or More, EA.
34 B 100	20994-BF	SPST	$1\frac{3}{32}$ "	.46	.41	.33
34 B 101	21515-BD	SPST	$1\frac{3}{32}$ "	.56	.50	.42
34 B 102	21615-BD	SPST	$1\frac{3}{32}$ "	.56	.52	.42
34 B 103	20994-CS	SPST	$1\frac{5}{32}$ "	.46	.41	.33
34 B 110	21350-B	SPDT	$1\frac{3}{32}$ "	.58	.52	.42
34 B 111	80023-B	SPDT	$3\frac{3}{4}$ "	.69	.62	.50
34 B 112	21661-B	SPDT	$1\frac{3}{32}$ "	.71	.64	.52
34 B 127	21827-B	SPDT	$1\frac{3}{32}$ "	.79	.71	.50
34 B 120	20902-AM	DPST	$1\frac{3}{32}$ "	.83	.75	.60
34 B 122	20902-Q	DPST	$1\frac{3}{32}$ "	.95	.85	.68
34 B 130	20905-Z	DPDT	$1\frac{3}{32}$ "	.95	.85	.68
34 B 131	20905-BT	DPDT	$1\frac{3}{32}$ "	1.06	.95	.76
34 B 132	20905-C	DPDT	$1\frac{3}{32}$ "	1.09	.98	.78
34 B 133	21350-BF	SPDT	$1\frac{3}{32}$ "	.58	.52	.42
34 B 133	20902-N	DPST	$1\frac{5}{32}$ "	.83	.75	.60
34 B 134	20905-BX	DPDT	$1\frac{5}{32}$ "	.95	.85	.68

BAT HANDLE TOGGLE SWITCHES

B Ruggedly built A-H and H bat handle toggle switches. Underwriters' Laboratories Approved. All have bakelite insulation. Silver-plated lug terminals. Shank, $1\frac{1}{2}$ " diameter, $1\frac{1}{2}$ " long. Supplied with mounting nuts. Shpg. wt., each, 2 oz.; per 20, 2 lbs.

Stock No.	Mfr's Type	Type	Amps.	Volts	1-9, EACH	10-99, EA.	100 or More, EA.
34 B 195	20994-EW	SPST	3	125	.52	.47	.38
34 B 196	21350-BP	SPDT	3	125	.64	.58	.46
34 B 197	20902-DN	DPST	3	125	.90	.81	.65
34 B 198	20905-GA	DPDT	3	125	1.06	.95	.75

POWER TYPE TOGGLE SWITCHES

C Compact, toggle-operated power switches for motors and appliances. All rated 6 amps at 250 volts; 12 amps at 125 volts; 34 B 136 is also rated 1 HP, 250 volts. U.L. Approved. Bakelite case. Screw terminals. Shank, $1\frac{1}{2}$ " dia. $3\frac{1}{2}$ " long. With mtg. nuts. Shpg. wt., 2 oz.; per 20, 2 lbs.

Stock No.	Mfr's Type	Type	1-9, EACH	10-99, EACH	100 or More, EACH
34 B 135	80607	SPST	88c	79c	63c
34 B 136	80600	DPST			
34 B 137	80618	SPDT			

ROTARY SWITCHES

D Positive contact. U.L. Approved. All switches 125/250 volts. Threaded shank, $1\frac{1}{2}$ " dia., $3\frac{1}{2}$ " long. Shaft, $1\frac{1}{4}$ " dia., $7\frac{1}{8}$ " long. Wt., 2 oz.

Stock No.	Mfr's Type	Type	Amps	1-9, EACH	10-99, EACH	100 or More, EA.
34 B 141	81715-G	SPST	6/3	1.12	1.01	.81
34 B 142	81721-G	SPDT	6/1	1.24	1.12	.90
34 B 143	81724-G	DPST	6/3	1.52	1.37	1.10
34 B 144	81727-G	DPDT	6/3	1.63	1.47	1.18

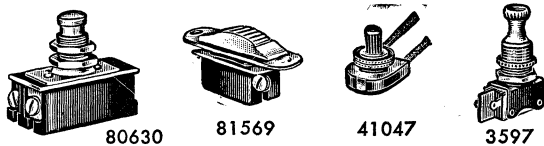

GENERAL-PURPOSE SWITCHES

Type 80630 Push-Button Switch. Momentary contact. DPST, normally open. Can be used as interlock in heavy-duty applications. Metal button. 6 amp, 250 v.; 12 amp, 125 v. U.L. Approved. Screw terminals. Size, $1\frac{1}{2}$ "x $1\frac{1}{2}$ ". Sleeve length $3\frac{1}{2}$ " dia., $1\frac{1}{2}$ " Wt., 2 oz.; per 20, 1 1/2 lbs. 34 B 152, 100 or More, EA., .92¢. 10-99, EA., 1.17¢. EACH, 1.30

Type 81569 Slide Switch. SPST. Indicating switch, screw terminals. Requires $1\frac{1}{2}$ "x $3\frac{1}{2}$ " cutout for mounting. 3 amp at 250 v.; 6 amp at 125 v. Size, $2\frac{1}{4}$ "x $3\frac{1}{4}$ ". Bakelite case. Shpg. wt., 2 oz.; per 20, 1 1/4 lbs. 4 B 153, 100 or More, EA., .60¢. 10-99, EA., .75¢. EACH, .83c

41047 Rotary Canopy Switch. Rated 1 amp, 250 v.; 3 amp, 125 v. SPST, $5\frac{1}{8}$ " stem; $3\frac{1}{2}$ " dia. Deluxe brass finish; metal handle. 6" leads. wt.; each, 2 oz.; per 20, 1 1/4 lbs. .65, 100 or More, EA., .40¢. 10-99, EA., .44¢. EACH, .48c

3597 Push-Pull Midget Switch. SPST. Metal button, laminated. Solder lug terminals. 3 amps at 250 volts. U.L. Approved. $1\frac{1}{2}$ " mtg. hole. Size, $1\frac{1}{2}$ "x $1\frac{1}{8}$ ". Wt., 2 oz.; per 20, 1 1/4 lbs. 100 or More, EA., .54¢. 10-99, EA., .67¢. EACH, .74c

CANOPY-TYPE ROTARY SWITCH

E Type 41044, 3 amps, 125 volts; 1 amp, 250 volts. U.L. Approved. Bakelite base. Threaded shank, $3\frac{1}{2}$ " dia. $5\frac{1}{8}$ " long. Fluted shaft, $7\frac{1}{2}$ " dia., $5\frac{1}{4}$ " long. 6" wire leads. With mtg. nuts. Shpg. wt., 2 oz. 34 B 147, 100 or More, EA., .24¢. 10-99, EA., .26¢. EACH, .29c

PUSH-BUTTON SWITCHES

F Type 86710-C. SPST push-button switch with snap-on bakelite button in red or black. Press button to close circuit; press to open. Rated at 3 amps, 250 volts; 6 amps, 125 volts. U.L. Approved. Threaded shank, $1\frac{1}{2}$ "x $3\frac{1}{8}$ " long. With mtg. nuts. Shpg. wt., each, 2 oz.; per 20, 1 1/4 lbs. 34 B 161, Red. 34 B 162, Black. 100 or More, EA., .70¢. 10-99, EA., 88¢. EA., .98c

Type 86710. Same as type 86710-C push-button switch above, but less snap-on bakelite button. Shpg. wt., 2 oz. 34 B 160, 100 or More, EA., .59¢. 10-99, EA., .74¢. EA., .82c

Type 3391-G.L. Momentary contact. SPST normally open. 1 amp, 125 v. AC. U.L. Approved. Threaded shank, $1\frac{1}{2}$ "x $3\frac{1}{8}$ ". With mtg. nuts, lugs and bakelite button. Shpg. wt., each, 2 oz.; per 20, 1 1/4 lbs. 34 B 159, 100 or More, EA., .48¢. 10-99, EA., .60¢. EA., .67c

INDUSTRIAL TYPE SWITCHES

Underwriters' Laboratories Approved. All have $1\frac{1}{2}$ " shank diameter, except 34 B 107, $3\frac{1}{4}$ " diameter. With mounting nuts.

BAT HANDLE TOGGLE SWITCHES

G Shank lengths: $1\frac{1}{2}$ ", except $*1\frac{1}{2}$ ". 34 B 103 is center-off type. Screw terminals except 34 B 103 with lug terminals. Shpg. wt., 4 oz.

Stock No.	Mfr's Type	Type	Amps	Volts	1-9, EACH	10-99, EA.	100 or More, EA.
34 B 109	80607-BJ	SPST	12/6	125/250	.88	.79	.63
34 B 106	80602-CA	DPST	15/10	125/250	1.53	1.38	1.10
34 B 103	82024-D*	DPDT	6/3	125/250	1.37	1.23	.99

BALL HANDLE TOGGLE SWITCHES

H 34 B 104 has $1\frac{1}{2}$ " shank length. 34 B 107 has $3\frac{1}{8}$ " shank length and has center-off position. Screw terminals. Shpg. wt., 7 oz.

Stock No.	Mfr's Type	Type	Amps	Volts	1-9, EACH	10-99, EA.	100 or More, EA.
34 B 104	80323-BU	SPDT	10/5	125/250	.71	.64	.51
34 B 107	80638	DPDT	10/5	125/250	4.20	3.76	3.02

PUSH-BUTTON SWITCHES

I Momentary contact. Metal base, and $3\frac{1}{8}$ " shank length. *Two-circuit type. Same as 3392 but with black bakelite button. Shpg. wt., 3 oz.

34 B 118	3392	SPST	3	250	.89	.80	.64
34 B 119	3392*	SP	1	125	.84	.78	.64
34 B 124	3392-AE§	SP2	1	125	.81	.73	.59

34 B 125, Type 3391-194 R. Red button for 3392-AE. NET 34 B 126, Type 3391-194 B. Black button for 3392-AE. EACH, .15c

INDICATING SWITCH PLATES

Type 20590-1. For Toggle Switches. Nickel-plated brass stamping. Keved to fit switch shank. Reads "On-Off". For $1\frac{1}{2}$ " dia. shank. Shpg. wt., per pkg. of 2, 2 oz. 34 B 157, Pkg. of 2, .8c

50 Pkgs. or More, Per Pkg., .6¢
Forward-Reverse Plate. As above, but reads: "For-Rev." 34 B 166, Pkg. of 2, .7¢
 50 pkgs. or More, Per Pkg., .6¢

For Toggle or Rotary Switches. $1\frac{1}{2}$ " diameter polished aluminum plate for use with toggle or rotary switches. Has $1\frac{1}{2}$ " hole. Etched on black background. Shpg. wt., 2 oz. 34 B 151, 1-19, NET EACH, .39c
 20-99, EACH, .36¢

LOCK SWITCH

Type 81715-L. Lock switch with key. SPST 3 amps at 250v.; 6 amps at 125v. Sleeve dia. $1\frac{1}{2}$ ". Fits panels to $3\frac{1}{2}$ " thick. Size, $1\frac{1}{2}$ "x $1\frac{1}{2}$ ". Switch must be open to remove key. Wt., 2 oz. 34 B 156, 1-9, EACH, .144
 10-99, EA., .130
 100 or More, EA., .104
 34 B 128, Extra key for above. Shpg. wt., 2 oz. NET, .15¢
 Type 81715-LE. As above, but key removable in open or closed pos. 34 B 158, 1-9, EACH, .144
 10-99, EA., .130
 100 or More, EA., .104

STEVENS-WALDEN SPINTITE SWITCH WRENCHES

Specially designed spintite wrenches for easy installation of toggle switches. Features a very deep recess to accommodate even bat-handle type toggle switches. Knurled surface is tapered to accommodate different-sized ring nuts. Has wood handle. Shpg. wt., 6 oz. Type 3480. For A-H switches only. 46 N 056, EACH, 2.42
 Type 3481. For Cutler Hammer switches. 46 N 167, NET EACH, 2.42

Cutler-Hammer Toggle Switches

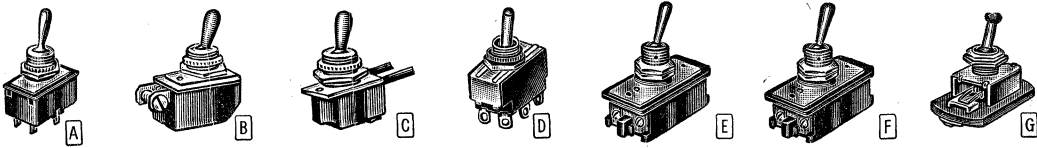

DEPENDABLE TOP-QUALITY SWITCHES

STANDARD AC-DC TYPE

Phenolic case. Solder lug terminals, 1/8" dia. threaded stem. Stem length, 1 1/2", except *1 1/2" and †1/4". U.L. Approved. Use with on-off plate at right below. Av. shpg. wt., 3 oz.

Stock No.	Mfr's Type No.	Type	Fig.	Amperes		NET EACH	10-99, EACH	100 or More, EACH
				125V DC	250V AC			
34 B 500	8280-K16	SPST	A	3	.50	.42	.34
34 B 507	8280-K14†	SPST	A	3	.50	.42	.34
34 B 528	8381-K8	SPST	A	3	.57	.48	.38
34 B 501	8282-K14	SPDT	A	3	.64	.54	.43
34 B 521	8282-K12†	SPDT	A	3	.64	.54	.43
34 B 502	8360-K7	DPST	A	3	.90	.77	.61
34 B 529	8360-K6†	DPST	A	3	.90	.77	.61
34 B 530	8363-K6†	DPDT	A	3	1.04	.88	.70
34 B 531	8363-K7	DPDT	A	3	1.04	.88	.70
34 B 549	8280-K15*	SPST	A	3	.50	.42	.34
34 B 783	8290-K15*	SPST	C	3	.61	.52	.41
34 B 784	8290-K16	SPST	C	3	.61	.52	.41
34 B 785	8295-K7*	SPST	B	3	.61	.52	.41
34 B 786	8295-K8	SPST	B	3	.61	.52	.41
34 B 787	8381-K7*	SPST	A	3	.57	.48	.38
34 B 788	8391-K7*	SPST	C	3	.68	.58	.46
34 B 789	8391-K8	SPST	C	3	.68	.58	.46
34 B 790	8396-K7*	SPST	B	3	.68	.58	.46
34 B 791	8396-K8	SPST	B	3	.68	.58	.46
34 B 792	8370-K7	DPST	A	3	.98	.83	.66
34 B 793	8372-K7	DPST	B	3	1.19	1.01	.80
34 B 794	8373-K8*	DPDT	A	3	1.12	.95	.76
34 B 795	8375-K7	DPDT	3	1.44	1.22	.98

AIRCRAFT TYPE

☐ Suitable for aircraft requirements. Meet JAN-S-23 specifications. Solder terminals, 1/8" threaded stem, 1 1/2" long. Size 1 1/4" x 5/8". *Have center-off position. Tested 10,000 operations at maximum ratings indicated. Av. shpg. wt., 3 oz.

Stock No.	Mfr's Type No.	Gov't No.	Type	Amperes		NET EA.	10-99, EA.	100 or More, EA.
				25V DC	125V AC			
34 B 551	8803-K6	ST42A	SPST	20	8	.85	.72	.57
34 B 552	8816-K5	ST42D	SPDT	20	8	1.02	.87	.70
34 B 553	8802-K6*	ST42E	SPDT	20	8	1.02	.87	.70
34 B 554	8823-K5	ST52K	DPST	30	20	1.02	.87	.70
34 B 555	8823-K5	ST52N	DPDT	30	20	1.16	.99	.78
34 B 692	8805-K5	ST42F	SPDT	20	8	1.12	.95	.76
34 B 693	8815-K6*	ST42H	SPDT	20	7	1.12	.95	.76
34 B 694	8817-K5	ST42C	SPDT	20	7	.94	.80	.64
34 B 695	8818-K5*	ST42G	SPDT	20	7	1.12	.95	.76
34 B 696	8819-K5	ST42B	SPDT	20	7	.94	.80	.64
34 B 697	8827-K5	ST52M	DPST	20	12	1.16	.99	.78
34 B 698	8829-K5	ST52L	DPST	20	12	1.16	.99	.78
34 B 699	8831-K5	ST52P	DPDT	20	12	1.34	1.14	.91
34 B 712	8833-K3*	ST52T	DPDT	20	12	1.34	1.14	.91
34 B 713	8835-K3*	ST52S	DPDT	20	12	1.34	1.14	.91

HEAVY-DUTY AC TYPE

Slow-make, slow-break mechanism for long dependable use. 1/2" diameter threaded stem, 1 1/2" long. *Center off. †Screw terminals; others have solder lug terminals. All have nominal rating of 10 amps at 250 v. AC and 15 amps at 125 v. AC. U.L. Approved. Av. shpg. wt., 3 oz.

Stock No.	Mfr's Type No.	Type	Fig.	NET EACH	10-99, EACH	100 or More, EACH
34 B 591	7500-K14†	SPST	J	.57	.48	.38
34 B 592	7502-K13†*	SPDT	H	.68	.58	.46
34 B 536	7505-K4	SPDT	H	.55	.47	.37
34 B 593	7504-K4†	SPDT	H	.68	.58	.46
34 B 537	7511-K4	DPST	J	.74	.63	.50
34 B 594	7560-K5†	DPST	J	.91	.77	.62
34 B 538	7565-K5	DPDT	H	.84	.71	.57
34 B 595	7564-K6†	DPDT	H	1.10	.94	.74
34 B 539	7563-K4*	DPDT	H	.84	.71	.57
34 B 596	7562-K4*†	DPDT	H	1.10	.94	.74
34 B 543	7611-K2	3PST	K	1.58	1.34	1.07
34 B 597	7610-K2†	3PST	K	1.83	1.56	1.24
34 B 523	7613-K2*	3PDT	1.94	1.65	1.31
34 B 598	7612-K2*†	3PDT	2.33	1.98	1.58
34 B 796	7503-K13*	SPDT55	.47	.37
34 B 797	7561-K4	DPST	J	.74	.63	.50
34 B 798	7615-K2	3PDT	1.94	1.65	1.31
34 B 799	7614-K2†	3PDT	2.33	1.98	1.58

AC-DC INDUSTRIAL TYPE

☐ Standard-duty switches. Bakelite case. 1/2" threaded stem, 1 1/2" long except *, 1 1/2" long stem. Screw terminals. Underwriters' Laboratories Approved. Av. shpg. wt., 3 oz.

Stock No.	Mfr's Type No.	Type	Amperes		NET EACH	10-99, EACH	100 or More, EACH
			125 V	250 V			
34 B 545	7320-K3	DPST	12	6	.96	.82	.65
34 B 520	7321-K3	SPST	12	6	.96	.82	.65
34 B 516	7360-K8	DPST	15	10	1.67	1.42	1.13
34 B 517	7402-K4	DPST	1 1/2 hp	20	2.34	1.99	1.58
34 B 714	7361-K5	SPST	15	10	1.67	1.42	1.13
34 B 715	8690-K2	DPDT	15	10	3.66	3.11	2.47
34 B 716	7320-K2	DPST	12	6	.96	.86	.65
34 B 717	8680-K1*	DPDT	10	5	3.02	2.57	2.04
34 B 718	7360-K7*	DPST	15	10	1.67	1.42	1.13
34 B 719	7402-K3*	DPST	1 1/2 hp	20	2.34	1.99	1.58

STANDARD AC TYPE

☐ All rated at 6 amps at 125 v. and 3 amps at 250 v. Solder lugs, except *screw type terminals. †Center "Off" positions. Threaded stem dia., 1/2"; stem length, 1 1/2". U.L. Approved. 3 oz.

Stock No.	Mfr's Type No.	Type	NET EACH	10-99, EACH	100 or More, EACH
34 B 641	7580-K6	SPST	43¢	37¢	29¢
34 B 642	7581-K6*†	SPDT	56¢	48¢	38¢
34 B 643	7360-K6†	SPDT	47¢	40¢	32¢
34 B 644	7582-K4*	SPDT	56¢	48¢	38¢
34 B 645	7582-K6	SPDT	47¢	40¢	32¢
34 B 646	7590-K4*	DPST	76¢	65¢	51¢
34 B 647	7590-K6	DPST	64¢	54¢	44¢
34 B 648	7591-K4*†	DPDT	90¢	77¢	61¢
34 B 649	7591-K6†	DPDT	72¢	61¢	49¢
34 B 689	7592-K4*	DPDT	90¢	77¢	61¢
34 B 690	7592-K6	DPDT	72¢	61¢	49¢

CENTER-OFF TYPE

☐ Type 7140-K6. SPDT switch with center-off position. 3 amps at 125 volts AC and 10 amps at 24 volts DC. Screw terminals. Threaded stem diameter, 1/2"; stem length, 1 1/2". U.L. Approved. 3 oz.
 34 B 522, NET EACH.....43¢
 10-99, EACH. 37¢. 100 or More, EACH.....29¢

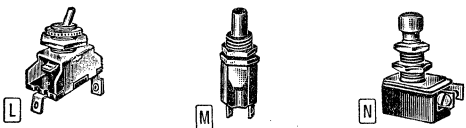

SPST MIDGET TYPE

☐ Type 8098-K3. Midget switch. 3 amps at 125 volts AC, 0.75 amps at 125 volts DC, and 6 amps at 24 volts, DC. Screw terminals. Threaded stem diameter, 1/2"; stem length, 1 1/2". Shpg. wt., 2 oz.
 34 B 510, EACH.....40¢
 10-99, EACH. 34¢. 100 or More, EACH.....27¢

PUSH-BUTTON AC-DC TYPE

☐ Push-button type switches to control current by opening or closing door. Momentary contact type. Stem length, 1 1/2". Solder lug terminals. *Normally-open type; †normally-closed type. U.L. Approved. Av. shpg. wt., 3 oz.

Stock No.	Mfr's Type No.	Type	Amperes		NET EACH	10-99, EACH	100 or More, EACH
			125 V	250 V			
34 B 548	8411-K4	SPST*	.75	.25	36¢	31¢	24¢
34 B 547	8411-K8	SPST†	.75	.25	25¢	21¢	17¢
34 B 549	8440-K2	SPST*	3	1	73¢	62¢	50¢

☐ Type 7208-K4 AC-DC Push-Push On-Off Switch. Push-button switch. For control of current by alternate impulses. With SPST action. Rated at 3 amps, 250 volts; 6 amps, 125 volts. With screw type terminals. 1/2" diameter threaded stem; 1 1/2" long. U.L. Approved. Shpg. wt., 2 oz.
 34 B 519, EACH.....78¢
 10-99, EACH. 66¢. 100 or More, EACH.....53¢

Type 7196-K1 Momentary Type Normally Open Switch. (Not illustrated). SPST action. Rated at 3 amps, 250 volts AC or DC; 6 amps, 125 volts AC or DC. With screw terminals. Threaded stem diameter, 1/2"; stem length, 1 1/2". U.L. Approved. Shpg. wt., 4 oz.
 34 B 691, EACH.....1.10¢
 10-99, EACH. 87¢. 100 or More, EACH.....

ON-OFF PLATE

Type 827-228F3. For Cutler-Hammer toggle switches. Wt., 2 oz.
 34 B 504. Per Pkg. of 2.....

Toggle and Rotary Switches



JBT ROTARY SWITCHES

Sturdy rotary selector switches. Current-carrying capacity, 1 amp; momentary, 5 amps. Rated 1000 rms volts, contact-ground. With knob. Av. shgp. wt., 6 oz.

CONTINUOUS-ROTATION SWITCHES

Continuous rotation type, except *6-pole, double throw. Type MS-14 has 13 circuits and 1 "off" position per deck. Angular indexing, 25°, 43°. MS-20 has up to 19 circuits and 1 "off" position per deck.

Stock No.	Mfr's Type	Gangs	Total Poles	Pos. per Pole	Shorting or Non-Shorting	Depth	EACH
34 B 950	MS-14-1	1	1	14	N-S	1 3/4"	1.96
34 B 951	MS-14-1S	1	1	14	S	1 3/4"	2.00
34 B 952	MS-14-2	2	2	14	N-S	1 1/2"	2.50
34 B 953	MS-14-2S	2	2	14	S	1 1/2"	2.60
34 B 954	MS-14-3	3	3	14	N-S	1 1/4"	3.04
34 B 955	MS-14-4	4	4	14	N-S	1 3/4"	3.97
34 B 956	MS-14-6	6	6	14	N-S	2 3/8"	5.78
34 B 957	MS-20-1	1	1	20	N-S	1 3/4"	2.50
34 B 958	MS-20-1S	1	1	20	S	1 3/4"	2.55
34 B 959	*MS-20-1-6	1	6	2	N-S	1 3/4"	3.18
34 B 960	MS-20-2	2	2	20	N-S	1 1/2"	3.18
34 B 961	MS-20-2S	2	2	20	S	1 1/2"	3.28
34 B 962	MS-20-2-6	2	12	2	N-S	1 1/2"	3.59
34 B 963	MS-20-3	3	3	20	N-S	1 1/2"	4.21
34 B 964	MS-20-4	4	4	20	N-S	1 3/4"	5.24
34 B 965	MS-20-6	6	6	20	N-S	2 3/8"	7.40



LAMINATED ROTARY SWITCHES

14 and 20-position type instrument switches. Both types include "off" position. Continuous rotation. Current ratings (not make or break): normal, 1 amp; momentary 5 amps. Supplied with knob. *Complete shorting, all positions shorted except one in use.

Stock No.	Mfr's Type	Gangs	Total Poles	Pos. per Pole	Shorting or Non-Shorting	Depth	EACH
34 B 258	SS-14-1	1	1	14	N-S	1 3/4"	1.86
34 B 259	SS-14-1A	1	2	5	S	1 3/4"	2.00
34 B 260	SS-14-1S	1	1	14	S	1 3/4"	1.91
34 B 261	SS-14-1CS	1	1	14	*	1 3/4"	2.30
34 B 262	SS-14-2	2	2	14	N-S	1 1/2"	2.30
34 B 263	SS-14-2A	2	4	5	N-S	1 1/2"	2.60
34 B 264	SS-14-2S	2	2	14	S	1 1/2"	2.40
34 B 265	SS-14-2CS	2	2	14	*	1 1/2"	3.18
34 B 266	SS-14-3	3	3	14	N-S	1 1/2"	2.74
34 B 267	SS-14-3S	3	3	14	S	1 1/2"	2.82
34 B 268	SS-14-6	4	6	14	N-S	1 3/4"	3.58
34 B 269	SS-14-6S	4	6	14	S	1 3/4"	3.66
34 B 270	SS-20-1	1	1	20	N-S	1 3/4"	2.40
34 B 271	SS-20-1A	1	2	6	N-S	1 3/4"	2.55
34 B 272	SS-20-1S	1	1	20	S	1 3/4"	2.45
34 B 273	SS-20-2	2	2	20	N-S	1 1/2"	2.99
34 B 274	SS-20-2S	2	2	20	N-S	1 1/2"	3.09
34 B 275	SS-20-3	3	3	20	N-S	1 1/2"	3.92
34 B 276	SS-20-4	4	4	20	N-S	1 3/4"	4.85
34 B 277	SS-20-6	6	6	20	N-S	2 3/8"	6.81

ETCHED DIAL PLATES. For the JBT rotary switches listed above. Raised bright metal numerals are easy to read against the dull black finish of the dials. Diameter, 2 3/4". Shgp. wt., 1 oz.

Stock No.	Mfr's Type	Calibration	Angular Indexing	EACH
34 B 960	EP-13	Off thru 13	25°, 43°	23c
34 B 961	EP-14	1 thru 14	25°, 43°	
34 B 962	EP-19	Off thru 19	18°, 30°	
34 B 963	EP-20	1 thru 20	18°	



OHMITE POWER TAP SWITCHES

All-ceramic, power tap switches, non-shorting, single-pole type. The 111 is rated at 10 amps, 150 volts, AC. Dia., 1 1/4". The 212 is rated at 15 amps, 150 volts, AC. Dia., 2 1/4". Model 312 is rated at 25 amps, 300 volts, AC. 150 v. between taps. Dia. 3 3/8". *Two-in-tandem types; rated same as single types. Shgp. wt., 111, 5 oz.; 212, 10 oz.; 312, 1 lb. All are U.L. Approved.

MODEL 111				MODEL 212			
Stock No.	Taps	Rotation	NET EA.	Stock No.	Taps	Rotation	NET EA.
34 B 226	2	30°	2.65	34 B 237	2	30°	6.56
34 B 223*	3	30°	10.29	34 B 234*	2	30°	18.35
34 B 227*	2	60°	2.65	34 B 238*	3	60°	6.56
34 B 222*	3	60°	10.29	34 B 232*	3	60°	18.35
34 B 228	4	90°	2.65	34 B 239	4	90°	6.56
34 B 221*	4	90°	10.29	34 B 322*	4	90°	18.35
34 B 229	5	120°	2.70	34 B 240	5	120°	6.82
34 B 220*	5	120°	10.50	34 B 241*	6	150°	6.82
34 B 230	6	150°	2.70	34 B 321*	6	150°	18.87
34 B 231	7	180°	2.82	34 B 242	7	180°	7.09
34 B 232	8	210°	2.82	34 B 320*	7	180°	19.40
34 B 233	9	240°	2.94	34 B 243	8	210°	7.09
34 B 234	10	270°	2.94	34 B 244	9	240°	7.32
34 B 235	11	300°	3.03	34 B 245	10	270°	7.32
				34 B 246	11	300°	7.59
				34 B 247	12	330°	7.59

MODEL 312

34 B 280	2	30°	9.58	34 B 274	8	210°	10.11
34 B 279	3	60°	9.58	34 B 273	9	240°	10.35
34 B 278	4	90°	9.58	34 B 272	10	270°	10.35
34 B 277	5	120°	9.82	34 B 271	11	300°	10.58
34 B 276	6	150°	9.82	34 B 270	12	330°	10.58
34 B 275	7	180°	10.11				

See page 203 for 30° type switch plates.

CARLING SWITCHES

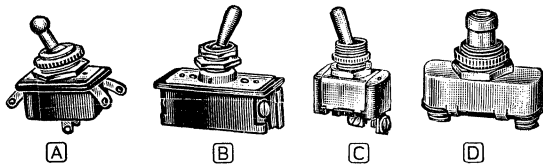

AC-DC TOGGLE SWITCHES

A Bat type toggle switches, 1 1/4" long. All have 1 1/2" stem lengths. With lug terminals, except Type 111-16-73 which has wire leads. Stem dia., 1 1/2"-32 thread. Shgp. wt., 2 oz.

Stock No.	Mfr's Type	Action	Amperes		1-9, EACH	10-99, EA.	100 or More, EA.
			125 V	250 V			
34 B 175	110-73	SPST	6	3	.39	.35	.28
34 B 177	112-73	SPDT	3	1	.46	.41	.33
34 B 178	216-73	DPST	3	1	.62	.56	.45
34 B 179	316-73	DPDT	3	1	.71	.64	.51
34 B 180	111-16-73	SPST	6	3	.42	.38	.30

HEAVY-DUTY AC-DC TOGGLE SWITCHES

B Particularly suitable for breaking heavy line current. For motors, appliances, etc. Bat type toggle, 2 1/2" long. Stem length, 1 1/2". Stem dia., 1 1/2"-32 thread. With screw terminals. Shgp. wt., 2 oz.

34 B 181	2DK25	DPST	12	6	.83	1.75	.60
34 B 182	EK55	DPST	15	10	1.32	1.19	.95

HEAVY-DUTY AC TOGGLE SWITCHES

C Bat handle toggle switches, 1 1/4" long. Bakelite base with metal covering for added strength. Stem length, 1 1/2". Stem dia., 1 1/2"-32 thread. *Screw-type terminals with No. 6-32 binding-head screws. All others with solder lugs. †One side normally on; other side momentarily on; no center position. ‡Both sides momentarily on; center off. †One side momentarily on; center off. Shgp. wt., 3 oz.

34 B 183	2FA53-73	SPST	15	10	.49	.44	.35
34 B 385	2FA54-73*	SPST	15	10	.54	.49	.39
34 B 386	2FB34-73*	SPDT	15	10	.65	.58	.46
34 B 184	2FC53-73*	SPDT	15	10	.54	.49	.39
34 B 387	2FC54-73*	SPDT	15	10	.65	.58	.46
34 B 186	6FB53-73	SPDT†	15	10	.62	.56	.45
34 B 388	6FC54-73*	SPDT‡	15	10	.71	.64	.51
34 B 187	2GK53-73	DPST	15	10	.77	.71	.51
34 B 389	2GK54-73*	DPST	15	10	.86	.77	.62
34 B 188	2GL-53-73	DPDT	15	10	.81	.73	.58
34 B 390	2GL-54-73*	DPDT	15	10	1.03	.93	.74
34 B 167	2GM53-73	DPDT	15	10	.81	.73	.58
34 B 391	2GM54-73*	DPDT	15	10	1.03	.93	.74
34 B 392	6GM58-73*	DPDT†	15	10	1.16	1.04	.83

PUSH-BUTTON SWITCHES

D Heavy-duty, push-type momentary contact switches. Rated 10 amps, 125-250 v. AC. N.o., normally open; n.c., normally closed. Screw terminals. 1 1/2" dia. stem; 3/8" long. Shgp. wt., 3 oz.

Stock No.	Mfr's Type No.	Action	1-9, EACH	10-99, EA.	100 or More, EA.
34 B 398	172	SPST, n.o.	57c	51c	41c
34 B 397	170	SPST, n.c.			

TYPE 110-5P PUSH-BUTTON SPST AC-DC SWITCH

Push-on, push-off switch. Handles AC-DC loads up to 4 amps, 125 volts, and 3 amps at 250 volts. Screw type terminals. Stem length, 3/8". Stem dia., 1 1/2"-32 thread. Size, 1 1/2"x2 1/2"x7/8". Shgp. wt., 2 oz.

34 B 168, 1-9, EACH..... 92c
10-99, EA..... 83c 100 or More, EACH..... 66c

TYPE 600C HEAVY-DUTY 20 AMP. AC-DC SPST TOGGLE SWITCH

For high-current applications. Handles loads up to 20 amps at 125 volts AC-DC, or 10 amps at 250 volts. Stem length, 3/8". Stem dia., 1 1/2"-32 thread. Single hole mounting. Screw type terminals. Size, 1 1/2"x2 1/2"x1 1/8". Shgp. wt., 2 oz.

34 B 169, 1-9, EACH..... 62c
10-99, EA..... 56c 100 or More, EACH..... 45c

MOMENTARY SPST AC-DC TOGGLE SWITCH

Type 110-M-N-93. With trigger-bat handle, 1 1/2". For many industrial applications. Normally open. Lugs are silver-plated. AC-DC rating; 6 amps, 125 volts; 3 amps, 250 volts. Stem length, 1 1/2". Stem dia., 1 1/2"-32 thread. Shgp. wt., 3 oz.

34 B 149, 1-9, EACH..... 68c
10-99, EA..... 61c 100 or More, EACH..... 49c

AMPHENOL TAP SWITCHES

8-position, single-pole, continuous rotary switches. Type 36-1 has markings 1-2-3-4-5-6-7-8 for general purpose use. Type 36-2 has impedance markings 0-2-4-8-16-250-500 for use as an output impedance selector. Set-screw in the side of the switch locks the switch-arm in any position. Require 1 1/2" mounting hole. Saddles have 3/8" holes on 1 1/2" mtg. centers. Shgp. wt., 5 oz.

Stock No.	Mfr's Type	Description	1-99, EA.	100-249, EA.	Over 250, EA.
34 B 090	36-1	Numerals 1-8	.67	.56	.50
34 B 091	36-2	Impedance Markings	.67	.56	.50

Mallory Switches

CERAMIC-SECTION SELECTOR SWITCHES

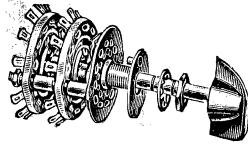

Multi-contact ceramic-section circuit selector switches. Minimize RF losses in high frequency circuits and eliminate effects of moisture absorption. Adjustable stop permits selecting number of positions desired, from 2 to maximum of unit. All are non-shorting (break before make). Silver plated, double-wiping, self-cleaning contacts to insure low contact resistance over an extended temperature range. Maximum non-breaking current, resistive load, 10 amps. 2 gang spaced $\frac{1}{2}$ " ; 3 gang, 1". 30° indexing; $\frac{1}{4}$ " base diameter; use plates below, at right. With 2" grooved shaft, knob, and mounting hardware. *Additional "Off" position. Shpg. wt., 7 oz.

Stock No.	Mfr's Type	Gangs	Total Poles	Positions per Pole	NET EACH
34 B 327	172C	1	1	11	1.94
34 B 328	173C*	1	2	5	
34 B 329	174C*	1	3	3	
34 B 331	176C	2	2	11	2.76
34 B 332	177C*	2	2	5	
34 B 333	178C*	2	3	3	
34 B 335	180C	3	3	11	3.53
34 B 336	181C*	3	2	5	

160C CERAMIC-SECTION "HAMBAND" SWITCHES

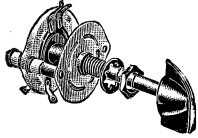

Four-position, continuously rotating switches for band switching. Rated for use in plate circuits up to 1,000 volts DC with power up to and including 100 watts. Impregnated magnesium-silicate ceramic provides low losses at high frequencies. Low-resistance, self-cleaning, silver-plated contacts. 90° indexing. Complete with 2" grooved shaft, $\frac{3}{8}$ " bushing, knob, nut and washer. Non-shorting. Shpg. wt., 8 oz.

Stock No.	Mfr's Type	Gangs	Total Poles	Positions per Pole	NET EACH
34 B 337	161C	1	2	4	1.76
34 B 338	162C	2	2	4	2.50
34 B 339	163C	3	3	4	3.23
34 B 340	164C	4	4	4	3.97
34 B 341	165C	5	5	4	4.70

Type 488 Dial Plate. For 160C switches, above. Shpg. wt., 2 oz.
34 B 688. NET.....12c

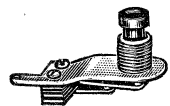

MINIATURE PUSH-BUTTON SWITCHES

A wide selection of push-button switches. Eight circuit combinations. *Locking type. All others are non-locking; contact is made only when button is depressed. Have alloy contact springs and fine-silver contacts to assure excellent electrical characteristics. Steel switch frame is cadmium plated. Mfg. bushing is aluminum. Mount in single hole, $\frac{7}{16}$ " diameter, on panels up to $\frac{1}{4}$ " thick. Mtg. depth is $\frac{7}{16}$ " minimum (Type 1011) and $\frac{3}{4}$ " maximum (Type 1018). Voltage breakdown, 500 v. DC. Shpg. wt., 3 oz.

Stock No.	Type	Description	NET
34 B 432	1011	SPST—Make	.56
34 B 433	1012*	SPST—Break	.56
34 B 434	1013	SPDT	.65
34 B 435	1014	DPST—Make 2	.71
34 B 436	1015	DPST—Break 2	.71
34 B 437	1016	DPDT	.85
34 B 438	1017	DPB—Make 2, Break 1	.85
34 B 439	1018	DPDT—Make before break	1.18

LEVER-ACTION SWITCHES

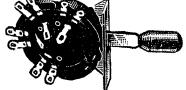

Positive-indexing, lever action switches— with shorting or non-shorting contacts. Indexing in 2, 3 or 4 positions with 20° spacing between positions. Types 6142, 6143 and 6243 have mounting brackets with round holes spaced for $\frac{1}{8}$ " centers. 5124 and 5224 have elongated mounting holes in the brackets, spaced $2\frac{3}{8}$ " to $2\frac{3}{4}$ " apart. Phenolic resin insulation. Can be mounted in multiples with $\frac{3}{4}$ " spacing between levers on conventional rack and panel installations. Maximum non-breaking current resistive load, 5 amps. For PA, test equipment and industrial applications. With knob and hardware. Shpg. wt., 4 oz.

SHORTING		NON-SHORTING		Poles	Positions Per Pole	NET EACH
No.	Type	No.	Type			
34 B 382	5124	34 B 383	5224	2	4	1.12
34 B 365	6142			4	2	.97
34 B 366	6143	34 B 368	6243	4	3	.97

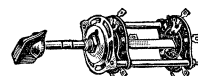

"HAMSWITCH" TYPE 1511

Two-section, 5-position switch; 1 pole per section. Non-shorting type. Excellent for switching meter circuits. $2\frac{1}{4}$ " spacing between sections. Rated at 1000 volts AC (rms) or 1500 volts DC. 60° indexing between positions. With brass bushing $\frac{3}{8}$ " long, $\frac{3}{8}$ " dia. and $2\frac{1}{2}$ " long, $\frac{1}{4}$ " dia. shaft is grooved at popular lengths for easy cutting. Complete with knob, nut and lock washer. Shpg. wt., 6 oz.

34 B 318. NET.....2.20

TYPE 13124L 24-POINT TAP SWITCH

Single circuit, 24 position, non-shorting switch. Continuous rotation. $\frac{3}{4}$ " bushing. 2" grooved shaft. Useful in test equipment. 15° indexing between positions. With knob, dial plate and hardware. 6 oz.
34 B 295. NET.....2.26

TYPE 1200L & 1300L MULTI-GANG SWITCHES

Versatile multi-gang switches for servicing and industrial applications. Have 1 fixed and 1 adjustable stop, silver-plated contacts, solid silver rotor contact slugs and phosphor-bronze springs. 3- and 4-gang spaced 1"; all others $\frac{1}{2}$ ". 2" notched shaft. Shorting-type make before break. Require $\frac{7}{16}$ " mtg. hole. With bar knob and hardware, less mtg. plate. Use 34 BB 600 plates below. *With additional "off" positions with all circuits open. Av. Shpg. wt., 8 oz.

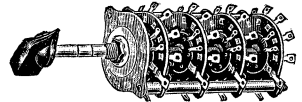

Shorting		Non-Shorting		Gangs	Total Poles	Pos. per Pole	NET EACH
Stock No.	Type	Stock No.	Type				
34 B 201	1211L	34 B 251	1311L	1	2	11	1.71
34 B 202	1215L*	34 B 252	1315L*	1	3	5	
34 B 203	1213L*	34 B 253	1313L*	1	4	3	
34 B 204	1212L*	34 B 254	1312L*	1	4	2	2.12
34 B 206	1221L	34 B 256	1321L	2	2	11	
34 B 207	1225L*	34 B 255	1325L*	2	4	5	
34 B 208	1223L*	34 B 258	1323L*	2	6	3	
34 B 209	1222L*	34 B 259	1322L*	2	8	2	
34 B 211	1231L	34 B 261	1331L	3	3	11	2.65
34 B 212	1235L*	34 B 262	1335L*	3	6	5	2.65
34 B 214	1241L	34 B 264	1341L	4	4	11	3.12
34 B 215	1245L*	34 B 265	1345L*	4	8	5	3.12
34 B 216	1251L	34 B 266	1351L	5	5	11	3.35
34 B 217	1256L	34 B 267	1356L	5	10	6	3.70
34 B 218	1261L	34 B 268	1361L	6	6	11	3.94
34 B 219	1266L	34 B 269	1366L	6	12	6	4.50

3100J & 3200J SINGLE GANG SWITCHES

Compact, enclosed, low-voltage switches. Have 2" notched shaft bushing, $\frac{3}{4}$ " long. With bar knob and nut. All $1\frac{1}{16}$ " base dia. types have adjustable stops. For band switching, etc. Use plates listed below. Shpg. wt., 4 oz.

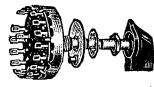

Shorting		Non-Shorting		Poles	Positions	Base Dia.	NET EACH
Stock No.	Type	Stock No.	Type				
34 B 300	3115J	34 B 350	3215J	1	5	$1\frac{1}{16}$ "	82c
34 B 301	3112J	34 B 351	3212J	1	12	$1\frac{1}{16}$ "	
34 B 302	3122J	34 B 352	3222J	2	2	$1\frac{1}{16}$ "	
34 B 303	3121J	34 B 353	3221J	2	3	$1\frac{1}{16}$ "	
34 B 304	3126J	34 B 354	3226J	2	6	$1\frac{1}{16}$ "	.85
34 B 305	3134J	34 B 355	3234J	3	4	$1\frac{1}{16}$ "	
34 B 306	3142J	34 B 356	3242J	4	2	$1\frac{1}{16}$ "	
34 B 307	3143J	34 B 359	3243J	4	3	$1\frac{1}{16}$ "	
34 B 308	3117J	34 B 358	3217J	1	17	$1\frac{1}{16}$ "	
34 B 309	3129J	34 B 359	3229J	2	9	$1\frac{1}{16}$ "	
34 B 310	3136J	34 B 360	3236J	3	6	$1\frac{1}{16}$ "	
34 B 311	3163J	34 B 361	3263J	3	3	$1\frac{1}{16}$ "	

TYPE 3122 TV ANTENNA SWITCH

New, high-quality antenna switch designed for applications where 2 separate antennas are used with 1 set. Just turn the switch to select desired antenna. Easily mounts on TV rear safety panel. $\frac{1}{4}$ " dia.; shaft, $1\frac{1}{8}$ ", solder terminals. With bar knob and all mounting hardware. Shpg. wt., 4 oz.
34 B 296. NET.....1.12

TYPE 1400L CIRCUIT OPENING SWITCH

Opens any one of 12 "lines" for insertion of current reading meter while "through" circuit is maintained on other 11 lines. Multiplying resistors can be wired so that when switch opens line, resistor is inserted in circuit. For test sets, tube checkers, etc. Shaft, $\frac{1}{4}$ " dia.; length, 2". With bar knob, dial plate and hardware. Shpg. wt., 6 oz.
34 B 290. NET.....3.82

DIAL PLATES

Types 372 to 390 for switches 1200L, 1300L and $1\frac{1}{16}$ " base 3100J and 3200J. Others for $1\frac{1}{16}$ " base 3100J and 3200J. Etched aluminum. Black background. $1\frac{1}{16}$ " dia. $\frac{7}{16}$ " hole. Shpg. wt., 2 oz.



30° SPACING FOR $\frac{1}{4}$ " BASE SWITCHES

Type	Marking	Type	Marking
372	1 to 2	384	Off 1 to 4
373	1 to 3	385	Off 1 to 5
374	1 to 4	386	Off 1 to 6
375	1 to 5	387	Off 1 to 7
376	1 to 6	388	Off 1 to 8
377	1 to 7	389	Off 1 to 9
378	1 to 8	390	Off 1 to 10
379	1 to 9		
380	1 to 10		
381	1 to 11		
382	1 to 12		
383	Off 1 to 3		

20° SPACING FOR $1\frac{1}{16}$ " BASE SWITCHES

Type	Marking	Type	Marking
453	1 to 3	474	Off 1 to 4
454	1 to 4	475	Off 1 to 5
455	1 to 5	476	Off 1 to 6
456	1 to 6	477	Off 1 to 7
457	1 to 7	478	Off 1 to 8
458	1 to 8	479	Off 1 to 9
459	1 to 9	480	Off 1 to 10
460	1 to 10	481	Off 1 to 11
461	1 to 11	482	Off 1 to 12
462	1 to 12	483	Off 1 to 13
467	1 to 17	484	Off 1 to 14
473	Off 1 to 3	486	Off 1 to 16

34 BB 600, Specify Type. 34 BB 650, Specify Type. NET EACH.....12c

34 B 670. Type 369. 0-100 plate for volume control.
34 B 620. Type 391. Increase type plate for vol. control. } NET
34 B 622. Type 393. 0-10 plate for rheostats and pots. } EACH...15c
34 B 624. Type 396. 0-10 plate for wire-wound controls. }
34 B 623. Type 394. 1-24 position. 15° opening. NET.....12c

RB254 UNIVERSAL MOUNTING BRACKET

"L" shaped Universal Mounting Bracket for baseboard or rear support mounting of all Mallory circuit selector switches, volume controls and jacks. Shpg. wt., 2 oz.
34 B 420. NET.....15c

General Purpose Switches

SWITCHCRAFT SWITCHES

LEVER-TYPE SWITCHES

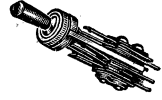

Ultra-compact lever action switches. Silver contacts, rated at 3 amps, 120 volts, non-inductive load. Length, 3 1/4"; width 3/4". $\$$ n.o. means normally open; n.c., normally closed. *3-position type. †Types 3034 and 3034L are operated to close either of two circuits keeping the other open. ‡Types 3035 and 3035L are operated to open one of two circuits keeping other closed. Require 1/2" mtg. hole. Shpg. wt., 3 oz.

Spring Return		Locking		Action $\$$		NET EACH
Stock No.	Type	Stock No.	Type	Poles	Diag.	
34 B 465	3001	34 B 471	3001L	SPST, n.o.	I	1.15
34 B 454	3002	34 B 455	3002L	SPST, n.c.	II	1.15
34 B 466	3003	34 B 472	3003L	SPDT	III	1.32
34 B 467	3004	34 B 473	3004L	DPST, n.o.	IV	1.47
34 B 456	3005	34 B 457	3005L	DPST, n.c.	V	1.47
34 B 468	3006	34 B 474	3006L	DPDT	VI	1.62
34 B 485	3009	34 B 484	3009L	3PDT	VII	2.00
34 B 469	*3033	34 B 475	*3033L	SPDT, n.o.	VII	1.47
34 B 458	*3034	34 B 459	*3034L	DP 2-Ckt \ddagger	VIII	1.53
34 B 464	*3035	34 B 477	*3035L	DP 2-Ckt \ddagger	IX	1.53
34 B 478	*3036	34 B 476	*3036L	DP 2-Ckt	X	1.71
34 B 470	*3037	34 B 479	*3037L	DPDT, n.o.	XI	1.73



"T-SWITCHES"

New, high-quality long frame switches designed for communication equipment. Series 11000 (push-button) and 11200 (2-position turn-button) are available in spring-return or locking types. Welded cross-bar palladium contacts are rated at 3 amperes AC non-inductive load, 300 watts maximum. Tempered nickel silver springs assure long life. Meet military requirements. Insulation is XXXP paper base phenolic spacers and tubing in stack assembly (Mil type PBE-P per Mil-P-3115A). Require 2 1/2" rear panel mounting space. Cadmium plated steel frame, screws and hardware. Complete with black plastic knob and nickel plated brass bushing. Shpg. wt., 3 oz.

Spring Return		Locking		Action		NET EACH
Stock No.	Mfr's Type	Stock No.	Mfr's Type	Poles	Diag.	
34 B 804	11003	34 B 805	11003L	SPDT	III	2.35
34 B 806	11006	34 B 807	11006L	DPDT	VI	2.94
34 B 808	11006D	34 B 809	11006DL	DPDT	2-XII	2.94
34 B 810	11008	34 B 811	11008L	4PST	4-I	3.29
34 B 812	11012	34 B 813	11012L	3PDT	3-III	4.00
34 B 814	11203	34 B 815	11203L	SPDT	III	2.35
34 B 816	11203D	34 B 817	11203DL	SPDT	XII	2.35
34 B 818	11204	34 B 819	11204L	DPST	2-I	2.65
34 B 825	11206	34 B 826	11206L	DPDT	VI	2.94
34 B 827	11206D	34 B 828	11206DL	DPDT	2-XII	2.94
34 B 829	11212	34 B 830	11212L	4PDT	4-III	4.00



"TINI-SWITCHES"

New, subminiature push-button switches for limited space applications. Ideally suited for use in microphones, radio and automotive test instruments, inter-communication systems, electro-therapy equipment, etc. Quality constructed throughout. 3/4" threaded shank; 1 1/4" long. For low-level currents only. Require 3/8" behind panel. *n.o. means normally open; n.c., normally closed. Shpg. wt., 3 oz.

Stock No.	Type (Red)	Stock No.	Type (Black)	Action*		NET EACH
				Poles	Diag.	
34 B 831	951	34 B 834	961	SPST n.o.	I	53¢
34 B 832	952	34 B 835	962	SPST n.c.	II	53¢
34 B 833	953	34 B 836	963	SPDT	III	59¢

NEW STACK SWITCH KIT



Model K-101. Kit of component parts for assembling or repairing stacking switches. Designed to speed the assembly of engineering samples in the lab, aid maintenance men in the field, and save time in general replacement. Ideal for mechanical engineers and coin-making in vending. Used in relays, remote control units, electronic organs, etc. Kit consists of 74 springs in 9 different thicknesses, over 115 phenolic spacers and insulators in 7 variations of design, hard-rubber insulating tubing, two different sets of stack assembling pins, two roller assemblies, assorted contacts, etc.

switches is supplied in one package. Shpg. wt., 1 1/2 lbs. 34 B 837 NET.....9.70

SWITCHCRAFT SCHEMATIC DIAGRAMS

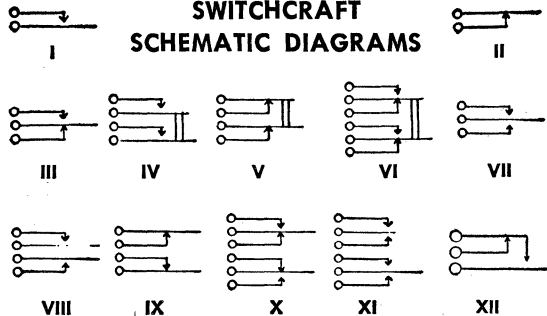

TELEVER TYPE SWITCHES

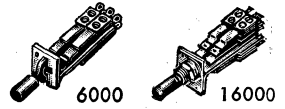

A rugged telephone-type lever switch. Nylon rollers actuate nickel-silver springs. Palladium contacts rated at 3 amps, 120 v. AC (non-inductive). Series 16000 has 1/2"-32 thread single hole mounting. Series 6000 tapped for 3-48 screws; standard telephone mtg. ctrs., 1/2x1 1/8". *3-position type. †One each side. ‡Two each side. §Four each side. With insulating black knob. All units have stainless steel pivot pins; solder lug terminals. Available in locking or non-locking types. Shpg. wt., 6 oz.

6000 SERIES

Spring Return		Locking		Action		NET EACH
Stock No.	Type	Stock No.	Type	Poles	Diag.	
34 B 726	6006	34 B 734	6006L	DPDT	VI	2.94
34 B 729	60012	34 B 737	*60012L	4PDT	4 sec. III	4.00
34 B 739	*6036	34 B 742	*6036L	2-Ckt. Tr.	X	2.94
34 B 740	*60312	34 B 744	*60312L	4PDT	14 sec. III	4.00
34 B 741	*60324	34 B 745	*60324L	8PDT	§8 sec. III	5.88

16000 SERIES

Spring Return		Locking		Action		NET EACH
Stock No.	Type	Stock No.	Type	Poles	Diag.	
34 B 853	16006	34 B 854	16006L	DPDT	VI	2.94
34 B 855	16006D	34 B 856	16006DL	DPDT	2 sec. XII	3.29
34 B 857	16008	34 B 858	16008L	4PST	4 sec. I	3.29
34 B 859	160024	34 B 860	160024L	8PDT	8 sec. III	5.88
34 B 861	*16036	34 B 862	*16036L	2-Ckt. Tr.	X	2.94
34 B 863	*16036D	34 B 864	*16036DL	DPDT	12 sec. XII	3.29
34 B 865	*160312	34 B 866	*160312L	4PDT	14 sec. III	4.00
34 B 867	*160316	34 B 868	*160316L	8PST	§8 sec. I	5.17
34 B 869	*160324	34 B 869	*160324L	8PDT	§8 sec. III	5.88

Type 530 Escutcheon. For Series 6000 Telever switches. 3 oz. 34 B 486. NET.....35¢

NON-LOCKING PUSH-BUTTON TYPE SWITCHES

FF Switches. Flat frame construction provides frame adaptable spring stack of contacts. Simple, direct action movement. Conventional spring stack assembly with bakelite spacers. Silver contacts rated at 3 amperes, 120 volts AC. One-piece, black knob and shaft. 3/8" diameter threaded shank, 3/4" long. With locknut and washer. $\$$ n.o. means normally open. n.c. means normally closed. Shpg. wt., 3 oz.

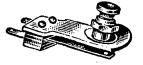

Stock No.	Mfr's Type	Button Color	Action $\$$		NET EACH
			Poles	Diag.	
34 B 994	1001	Black	SPST n.o.	I	.62
34 B 995	1002		SPST n.c.	II	.62
34 B 996	1003		DPST	III	.71
34 B 997	1004		DPST n.o.	IV	.76
34 B 998	1005	Black	DPST n.c.	V	.76
34 B 999	1006		DPDT	VI	.91
34 B 969	1009		3PDT	1.23

Little Switches. For limited space applications. One piece black or red, button and shaft. Nickel silver spring contacts. Spring sections are insulated. 3/8" threaded shank, 3/4" long. Recommended for low-level currents only. With mtg. hdwe. Shpg. wt., 3 oz.



Stock No.	Type	Color	Action	NET EACH	
				I	II
34 B 944	101	Red	SPST n.o.	I	.53
34 B 945	102		SPST n.c.	II	.53
34 B 946	103		SPDT	III	.59
34 B 947	201	Black	SPST n.o.	I	.53
34 B 948	202		SPST n.c.	II	.53
34 B 949	203		SPDT	III	.59

EAGLE KNIFE SWITCHES

New, low-cost knife switches. Recommended for compact applications. All units are rated at 25 amperes, 125 volts AC. Available in bakelite or porcelain base as shown. Shpg. wt., 5 oz.

Stock No.	Action	Base	Size	NET EACH		
				1-9	10-99	Over 100
34 B 884	SPST	Bakelite	1 1/2x1"	20¢	18¢	16¢
34 B 886	SPDT	Bakelite	2 1/2x1 1/2"	23¢	21¢	18¢
34 B 887	DPST	Bakelite	1 1/2x1 1/2"	33¢	29¢	25¢
34 B 888	DPDT	Bakelite	2 1/2x1 1/2"	38¢	34¢	29¢
34 B 889	SPST	Porcelain	3 1/2x1 1/2"	25¢	22¢	19¢

FOOT SWITCHES

A General Control Type MA. SPDT foot-switch with removable front plate. Efficient control for industrial operations. Set for 4 1/2 lbs. BX connector. Spring return. Rated: 10 amps at 125 v., and 5 amps at 250 v. AC. Fast operation—minimum fatigue. Shpg. wt., 1 1/4 lbs. 78 B 374. NET.....4.60

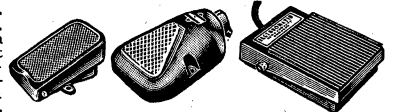

B General Control Type MI-25. Foot-operated, SPDT treadle-type switch. First press transfers contacts; second press restores to original position. Set for 5 lbs. pressure. BX connector. Rated: 12 amps at 125 v., 6 amps at 250 v. AC. Shpg. wt., 3 1/2 lbs. 78 B 370. NET.....11.25

Type MI-23. As above, but spring return. Rated: 10 amps at 125 v., 5 amps at 250 v. AC. Shpg. wt., 3 1/2 lbs. 78 B 371. NET.....9.80

C Lectromatic Model 1011. Off-On foot switch for use in home workshops, factories, etc. Saves time; increases work output. Operates power tools, photo enlargers and floodlights, etc. Rated 10 amps. at 115 v. 4 1/2x3 1/2". Shpg. wt., 1 lb. 78 B 382. NET.....5.48

Special Purpose Switches

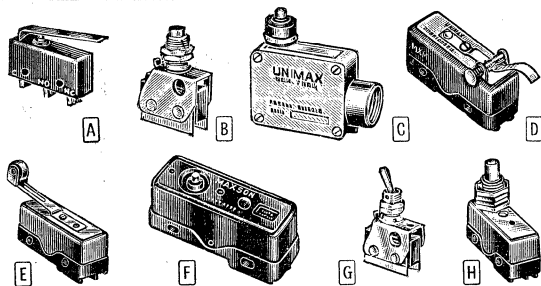

UNIMAX SNAP-ACTION SWITCHES

Exceptionally efficient snap-action switches for wide variety of industrial and laboratory uses. Highly dependable switch actuators are attached to stainless steel "Adaptaplates," except actuators in switch cover. Rated 5 amp, 125v DC and 20 amps, 125, 250, or 480v, 60 cycle non-inductive AC. All switches SPDT. UL, CSA Approval. Military versions conform to JAN-S-63, MIL-S-6743 and MIL-S-6744. Metal clad units allow direct wiring into standard electrical conduit systems. Sizes: (1) 1 $\frac{1}{2}$ "x $\frac{7}{8}$ "x $\frac{1}{16}$ "; (2) 2 $\frac{1}{2}$ "x1 $\frac{3}{8}$ "x $\frac{1}{16}$ "; (3) 2 $\frac{3}{4}$ "x1 $\frac{3}{8}$ "x $\frac{1}{16}$ "; (4) 2 $\frac{1}{2}$ "x1 $\frac{1}{2}$ "x $\frac{1}{16}$ "; (5) 2 $\frac{3}{4}$ "x1 $\frac{1}{2}$ "x $\frac{1}{16}$ "; (6) 3x2 $\frac{3}{4}$ "x1". Av. shpg. wt., 3 oz.

Stock No.	Mfr's Type	Fig.	Actuator and Operating Force	Overall Size	NET EACH		
					1-9	10-19	20-49
34 B 750	*2HB-1	F	Basic pin type; 9-13 oz.	1	1.37	1.23	1.10
34 B 751	2HB-1	E	Leaf spring type; 5-5 max.	1	1.47	1.32	1.18
34 B 752	2HBW-1	E	Same with roller; 5 oz. max.	2	1.91	1.71	1.53
34 B 755	*2HBT-1	F	Leaf spring, hinged; 1-2 oz.	1	1.71	.54	1.37
34 B 759	*2HBA-1	...	Same with roller; 1-3.5 oz.	3	2.16	.94	1.72
34 B 764	2HBM-1	D	Safety interlock; 10 oz. max.	4	2.50	2.24	2.00
34 B 722	2HBV-1	...	Pre-stressed, hinged; 10 oz.	1	1.71	.54	1.37
34 B 753	2HBQ-1	...	Plunger, small; 9-13 oz.	5	1.67	.50	1.33
34 B 754	2HBV-1	C	Plunger, large; 9-13 oz.	2	3.09	2.79	2.47
34 B 721	KEB2HB-5	H	Ball plgr, metal clad; 9-24 oz.	6	5.44	4.89	4.35
34 B 781	KEJ2HB-5	G	Plunger, metal clad; 9-13 oz.	6	4.23	3.79	3.37

Type USM Subminiature. Snap action, compact, fully enclosed SPDT switch. Rated 5 Amps, 125/250v non-inductive AC. UL & CSA Approval. USM5 conforms to applicable military spec. Operating force, 7 oz. Size: $\frac{5}{32}$ "x $\frac{1}{2}$ "x $\frac{3}{4}$ ". Supg. wt., 2 oz.

Stock No.	Mfr's Type	Pin	1-9	10-19	20-49
34 B 846	USM	Pin	1.37	1.23	1.10
34 B 847	USM-5	Pin (Military)	1.42	.27	1.14
34 B 848	USM-L	Leaf, Spring	1.47	1.32	1.18
34 B 849	USMW	Leaf, Spring roller	1.91	1.63	1.45
34 B 896	USMJ	Plunger, Panel Mount	4.46	4.01	3.57
34 B 897	USM5-J	Plunger, Panel Mt. (Military)	4.51	4.06	3.61
34 B 898	USMB-1	Toggle	3.67	3.30	2.94

UNIMAX DESIGN KIT

Unimax kit of standard interchangeable parts. Contains two Type 2HB-1 basic switches, one Type 2HBT-23-1 switch, 3 different "Adaptaplates," spring leaf, leaf and roller, roller assembly, 12 screws and 12 rivets. Simplifies choice of switch styles to suit any need. Permits assembly of exact switch required. Shpg. wt., 12 oz. **3.77**



GRAYHILL MINIATURE SWITCHES

Series 4000. Non-snap, momentary contact, normally open, SPST switches. Very smooth action. Housing and button constructed of molded phenolic. Rated @ 1/2 amp, 115 v. AC (non-inductive). (When used @ 1 amp, life is about 100,000 operations.) Requires single hole panel mount. Bushing is 3/8" long; 1/32"-32 thread. Solder type 3/8" terminals. Body, 5/8"x5/8". Shpg. wt., 4 oz.

Series 2000. As above, except snap type, rated @ 10 amps, 115 v. AC (non-ind.). Body dia., 7/8". With 2 hex nuts. Shpg. wt., 4 oz.

Stock No.	Type	Color	Stock No.	Type	Contacts
34 B 870	4001	Red Button	34 B 872	2201	Normally open
34 B 871	4002	Black Button	34 B 873	2202	Normally closed

Type 4000, NET EACH 69¢ **Type 2000, NET EACH** 1.81

Series 23-1. Tiny push-button switch designed for long life. Momentary contact. SPST, non-snap action switch. Solder type terminals. Rating, 1/4 amp, 115 v. AC, non-inductive. Normally open. Length, 1 3/8"; diameter at widest point, 1/2". 3/16"-32 thread. Shpg. wt., 2 oz. **83¢**

SINGLE-DECK MINIATURE ROTARY TAP SWITCHES

Series 5000. Extremely well-built to withstand heavy use. Housed in high arc-resistant molded Melamine. Contacts and rotor are silver-plated for maximum efficiency. Rated to carry 5 amp running current at 115 v. AC—break up 1 amp, non-inductive. All are single-pole non-shorting type. All switches have stops. Mount in 3/8"-diameter hole. Size, 1 1/2" dia. x 1 1/2". Shpg. wt., 5 oz.

Stock No.	Type	Pos.	EACH	Stock No.	Type	Pos.	EACH
34 B 875	5001-2	2	1.27	34 B 893	5001-6	6	1.47
34 B 876	5001-3	3	1.32	34 B 894	5001-7	7	1.52
34 B 891	5001-4	4	1.37	34 B 895	5001-8	8	1.57
34 B 892	5001-5	5	1.42	34 B 878	5001-10	10	1.67

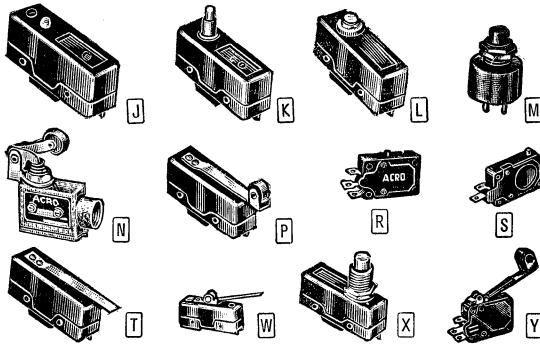

ACRO SNAP-ACTION SWITCHES

Positive snap-action switches, precision made for laboratory and industrial requirements. Snap-action switches are ideal for use in safety, limiter, counting, signaling and many other applications. Lightweight "Rolling Spring" and its friction-free action assure extra long life and dependability. Resilient, high-conductivity beryllium copper blades. Enclosed types have thermosetting plastic cases. In listing below NC means normally closed; NO normally open. Ampere ratings given at 125 volts. Type 1C2MD1-2AXX-A22 and 2C2MD1-2AXX-A24 are light pressure switches—particularly suitable for use in coin-operated devices such as juke boxes, pinball machines, etc. All have solder lug terminals. Sizes: 1—1 1/4"x1 1/4"x1/8"; Wx2 1/2"H. 2—1 1/4"x1 1/4"x3/16"; H. 3—2 1/4"x1 1/4"x3/16"; H. 4—1 1/4"x1 1/4"x1/8"; Wx1 1/4"H. 5—2 1/4"x1 1/4"x1/8"; Wx1"H. 1—Operating Force Oz., 1—Pre-Travel, Max., Inches. All switches SPDT except figure M which is SPST. *Operating force in grams. †With wire leaf actuator; ‡With mounting bracket; §With flat leaf actuator. Write for special prices on switches in quantities of 50 or more. Wt., 4 oz.

Stock No.	Mfr's Type	Fig.	I	II	Size	Amps	NET EACH		
							1-9	10-19	20-49
35 B 013	RD-5L	...	4-5	1/16	1	10	1.55	1.39	1.23
35 B 014	RD-2M	...	4-5	1/16	1	10	1.98	1.78	1.59
35 B 016	TD-48L	W	12	3/32	1	10	1.98	1.78	1.59
35 B 009	1MD1-1A	R	3-6	1/32	2	10	1.42	1.27	1.14
35 B 018	2MD1-1A	R	6-10	1/32	2	10	1.42	1.27	1.14
35 B 019	2MD3-1A	R	6-10	1/32	2	10	1.42	1.27	1.14
35 B 020	1C2MD1-2AXX	S	12*	.040	2	3	1.42	1.27	1.14
35 B 021	2C2MD1-2AXX	S	15*	.040	2	3	1.42	1.27	1.14
35 B 024	1C2MD1-2AXX-A22	R†	2.5*	.070	3	3	1.71	1.54	1.37
35 B 028	3D05-5P	M	10-15	.040	3	12	1.71	1.54	1.37
35 B 029	3D05-5P	M	10-15	.070	3	12	1.71	1.54	1.37
35 B 030	2C2MD1-2AXX-A24	R‡	33-34*	.040	2	3	1.71	1.54	1.37
35 B 031	M-S1-POBDR	R	3-6	.188	2	10	.68	.61	.55
35 B 008	1MD1-1A-18M	R†	3-6	1/32	2	10	1.81	1.63	1.44
35 B 038	1MD1-1A-18M	Y	3-6	1/32	2	10	2.01	1.80	1.61

10-AMP TYPES—WITH MICRO EQUIVALENTS

Stock No.	Mfr's Type	Micro Equiv.	Fig.	I	II	Size	Amps	NET EACH		
								1-9	10-19	20-49
35 B 280	S-RD-7PN-1S	BZE-2RN	...	9-24	.078	5	5.39	4.85	4.31	
35 B 281	S-RD-8PQ2-1S	BZE-2RQ2	N	10-18	3/64	5	7.25	6.53	5.80	
35 B 282	S-RD-8PR-1S	BZE-2RQ9	...	9-13	.025	5	7.25	6.53	5.80	
35 B 283	S-RD-8PQ1-1S	BZE-2RQ3	...	9-13	.025	5	4.16	3.74	3.33	
35 B 285	RD-1A-1S	BZ-2R-A2	J	8-10	1/16	4	1.37	1.23	1.10	
35 B 286	RD-1A-1S	BZ-2RL-A2	K	8-10	1/16	4	1.67	1.50	1.33	
35 B 287	RD-5L-1S	BZ-2RL-A2	P	4-5	1/16	4	1.47	1.32	1.18	
35 B 288	RD-1P-1S	BZ-2RQ1-A2	X	8-10	1/16	4	3.04	2.73	2.43	
35 B 289	RD-70-1S	BZ-2RD-A2	L	8-10	1/16	4	1.67	1.50	1.33	
35 B 290	RD-10-1S	BZ-2RS-A2	K	8-10	.03	4	1.67	1.50	1.33	
35 B 291	RD-1W28-1S	BZ-2RW2-A2	...	3.5	.28	4	2.16	1.94	1.72	
35 B 292	RD-24P0-1S	BZ-2RQ181-A2	...	9-13	.03	4	5.59	5.03	4.47	
35 B 293	RD-LW228-1S	BZ-2RW822-A2	...	6	1.56	4	2.16	1.94	1.72	
35 B 294	RD-LW8-1S	BZ-2RW80-A2	...	2.5	.406	4	1.67	1.50	1.33	

FEDERAL SWITCHES

ANTI-CAPACITY TYPE

Quick make-and-break type, positive-action switches. All normally open. Lever action is cam-roller type, with graphite-impregnated bearing turning on tool-steel axles. Blades are silver-plated phosphor bronze with pure silver contacts. Molded bakelite insulation; chrome faceplate. 2 1/2"x5 3/4". Av. wt., 5 oz.

Stock No.	Mfr's Type	Action	NET EACH
34 B 480	1427	DPST	2.79
34 B 481	1425	DPDT	2.79
34 B 482	1424	4PDT	2.86
34 B 483	12494	8PDT	6.20

ECONOMY AC-DC SLIDE SWITCHES

Cadmium-plated steel housing. Size, 3 1/2"x5 1/2"x1 1/2" long. Mounting centers, 1 1/4". Type S-110-S is heavy duty; 6 amps at 125 volts; 3 amps at 250 volts. Type SS-6 has 3/8" bevel trigger with prong guide, solder lug terminals, spring return. Type S-110-S has screw terminals; all others have hot-tinned solder lugs for easy soldering. For special prices for quantities over 50, write for quotation. U.L. Approved. Av. shpg. wt., 3 oz.

Stock No.	Mfr.	Mfr's Type	Action	Amps.	NET EACH	10-24 EACH	25-49 EACH
34 B 491	Wirt	SW724	SPDT	0.75	22¢	20¢	18¢
34 B 492	Wirt	SW725	DPST	0.75	22¢	20¢	18¢
34 B 148	Carling	S-110-S	SPST	10	48¢	43¢	39¢
34 B 421	Carling	S-516	SP2 Cir.	3	57¢	51¢	46¢
34 B 422	Carling	S60A	SPST	4	11¢	10¢	9¢
34 B 423	Carling	S60B	SPDT	4	12¢	11¢	10¢
34 B 424	ICA	1260	DPDT	4	24¢	22¢	20¢
34 B 496	Stackpole	SS-6	3PDT	.05	30¢	27¢	24¢

Industrial Time Switches

INDUSTRIAL TIMER CORPORATION



SERIES CM CAM RECYCLING TIMERS

Motor driven timers specifically designed for repeating a definite electrical Off-On cycle continuously. A complete timer unit consists of a Series CM chassis-mounted foundation unit, heavy-duty synchronous motor, cam activated single-pole double-throw switch, and gear and rack assembly. The gear and rack assembly determines the overall time of one full Off-On cycle e.g., CM-4 will provide overall time cycles of from 40 seconds to 6 minutes, depending on which gear and rack assembly it is used with. Cams have single screw adjustment for setting "On" or "Off" cycle up to 98% of complete time cycle. Synchronous motor assures precise repetition of time cycle under continuous, industrial use. All gear and rack assemblies in the listing below are of standard construction to permit changing overall time cycle simply by changing the gear and rack assembly. The SPDT switch is totally enclosed and dust-proof. Contacts are rated 10 amps at 115 v., or 220 v. non-inductive. Size, 2 1/4 x 2 1/4 x 3 1/4". For operation from 110-120 v., 60 cycle AC.

TO ORDER: Locate overall time cycle desired in the table below and order both the gear and rack assembly and the CM foundation unit indicated. Av. shpg. wt., complete, 4 lbs.

SERIES CM FOUNDATION UNITS

Stock No.	Type	Stock No.	Type	Stock No.	Type	NET EA.
78 B 450	CM-2	78 B 453	CM-6	78 B 455	CM-10	14.75
78 B 451	CM-4	78 B 454	CM-8	78 B 456	CM-12	
78 B 452	CM-5					

GEAR-AND-RACK ASSEMBLIES

Stock No.	Mfrs Type	*Overall Time Cycles Available						
		CM-2	CM-4	CM-5	CM-6	CM-8	CM-10	CM-12
78 B 472	E-12	10S	40S	2M	3M20S	20M	2H	8H
78 B 470	D-12	12S	48S	2M24S	4M	24M	2H24M	3H36M
78 B 468	C-12	15S	60S	3M	3M	30M	3H	12H
78 B 466	B-12	20S	80S	4M	6M40S	40M	4H	16H
78 B 467	B-15	25S	100S	5M	8M20S	50M	5H	20H
78 B 457	A-12	30S	2M	6M	10M	60M	6H	24H
78 B 471	D-36	36S	144S	7M12S	12M	72M	7H12M	28H48M
78 B 458	A-16	40S	160S	8M	13M20S	80M	8H	32H
78 B 469	C-34	42.5S	170S	7M30S	14M10S	85M	8H30M	34H
78 B 459	A-18	45S	3M	9M	15M	90M	9H	36H
78 B 460	A-20	50S	200S	10M	16M40S	100M	10H	40H
78 B 461	A-24	60S	4M	12M	20M	2H	12H	48H
78 B 462	A-28	70S	280S	14M	23M20S	2H20M	14H	56H
78 B 463	A-30	75S	5M	15M	25M	2H30M	15H	60H
78 B 464	A-32	80S	320S	16M	26M40S	26M	16H	64H
78 B 465	A-36	90S	6M	18M	30H	3H	18H	72H

*S—Seconds M—Minutes H—Hours
NET EACH.....1.25

SERIES PC PERCENTAGE TIMERS

Accurate motor driven, recycling timer. Useful for control of pumps, blowers, oil burners, stokers, etc. Heavy-duty synchronous motor drives a cam-operated snap-action switch. Controls any electrical circuit of 15A or less. Percentage calibrated dial for adjustments allows precise setting of "ON" time from 3% to 100% of overall time cycle. At full-on setting switch is closed continuously. Mechanism is completely enclosed; protected from dust and dirt. For panel mounting in 3" hole. Flange has 3 mounting holes spaced 120°. For 110-120 v., AC. Wt., 2 lbs.

78 B 493, PC-30S.	30-second maximum cycle.	NET EACH..... 25.50
78 B 494, PC-60S.	60-second maximum cycle.	
78 B 495, PC-15M.	15-minute maximum cycle.	
78 B 496, PC-30M.	30-minute maximum cycle.	

SERIES S SIGNALLING TIMER

Motor-driven, manual-set timer with 2 AC outlets. Designed to give visual and audible signal at completion of selected time interval. Setting timer for any part of time cycle lights lamp and powers one outlet. On completion of cycle, lamp is turned off, a buzzer sounds, and a 10 amp SPDT switch transfers power to the other outlet. Buzzer sounds until turned off manually or timing interval is again started. 5x5x3" metal case. With AC cord. For 110-120 v., 60 cycle AC. Shpg. wt., 3 lbs.

78 B 477, S-1H.	1-hour maximum cycle.	NET EACH..... 24.00
78 B 478, S-3H.	3-hour maximum cycle.	

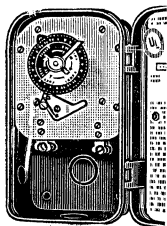

Model W-22. New, completely automatic electrical switch. Ideal for control of apartment lights, water heaters, etc. Convenient manual switching will not interfere with automatic operation. Minimum "ON" period, 1/2 hr.; max. 23 hours. Synchronous, self-starting motor. Snap-action silver-to-silver contacts; spring-temper, phosphor-bronze blades. DPST. Contacts rated 30 amps, at 120-240 v. Has 1/2" and 3/4" knockouts in bottom, sides and back. Indoor cabinet for wall mounting. Hammerloid enamel finish. Size, 4 1/2 x 4 1/2 x 4 1/2". U.L. Approved. For 110-125 v., 60 cycle AC. Neutral tap for 3-wire, 250 v. circuits. Wt., 5 lbs.
78 B 390, List, \$15.50. NET..... 11.40

Model W-33. As above but DP, 2-circuit time switches in one. Will control 2 separate circuits independently or simultaneously by setting trippers for desired schedule. Provides 8 different combinations of 2-circuit control; may be set to operate both circuits simultaneously as a DPST switch.
78 B 391, List, \$20.00. NET..... 14.70

206

Lowest Prices—Highest Quality—Best Service

SERIES H AND SF DELAY TIMERS

Dependable automatic reset timers. Useful for any operation requiring a fixed or adjustable delay between the closing of one circuit and the closing or opening of another. SPDT switch has contacts rated 10 amps at 115v. AC with non-inductive load. Suitable for pre-heating transmitter tube filaments, vending machines, store displays, etc. Both H and SF series available in four models providing maximum time cycles from 15 seconds to 5 minutes. All have clutches as integral part of motor. Series H is for front of panel mounting; Series SF for back of panel. Underwriters' Laboratories Approved. Sizes: H Series, 3 7/8 x 3 3/8 x 3 1/2"; SF Series, 2 3/4 x 3 1/2 x 2 3/8". For operation from 110-120 volts, 60 cycle AC. Shpg. wt., 1 1/2 lbs.



78 B 485, H-16S.	15-second maximum cycle.	NET..... 22.00
78 B 485, H-1M.	1-minute maximum cycle.	
78 B 487, H-3M.	3-minute maximum cycle.	
78 B 488, H-5M.	5-minute maximum cycle.	
78 B 481, SF-15S.	15-second maximum cycle.	
78 B 482, SF-1M.	1-minute maximum cycle.	
78 B 483, SF-3M.	3-minute maximum cycle.	
78 B 484, SF-5M.	5-minute maximum cycle.	

SERIES PAB INSTANT RESET TIMERS

Extremely accurate automatic reset timers designed specifically for heavy-duty use in industrial process control applications. Feature instant reset adjustment. Electrically operated clutch drives actuating arm to dial setting selected and automatically releases. Spiral spring resets arm in split second. Output terminals can be wired for circuit transfer applications. Switch contacts rated 15 amps at 115 v. AC with non-inductive load. Metal enclosure has 1/2" knockouts for use with rigid or flexible conduit. 7x5x4". For 110-120 v., 60 cycle AC. Shpg. wt., 4 lbs.



78 B 489, PAB-60S.	60-second maximum cycle.	NET EACH... 45.50
78 B 490, PAB-30M.	30-minute maximum cycle.	
78 B 491, PAB-60M.	60-minute maximum cycle.	

SERIES P AUTOMATIC RESET TIMERS

Portable, motor-driven timer with automatic reset. Operates by built-in pushbutton switch that actuates timer for each cycle. On completion of a cycle, lapsed time indicator automatically resets and unit is ready to start another cycle when pushbutton is pressed. Receptacle for plugging in remote starting switch is provided. Has standard AC receptacle for plugging in load. Load switch contacts are rated 15 amps at 115 v. AC with non-inductive load. Built-in toggle switch is provided for closing load circuit continuously when timed operation is not required. Completely portable, unit is supplied with AC cord and is housed in metal case with keyhole slots for wall mounting. 5x5x3". For operation from 110-120 v., 60 cycle AC. Shpg. wt., 3 lbs.



78 B 473, P-4R.	15-second maximum cycle.	NET EACH..... 27.00
78 B 474, P-1M.	1-minute maximum cycle.	
78 B 475, P-3M.	3-minute maximum cycle.	
78 B 476, P-5M.	5-minute maximum cycle.	

MULTI-CAM TIMER KIT

Basic construction kit. Developed for applications requiring design flexibility, either in the construction of standard multi-cam timers or experimental devices. Consists of all parts required to assemble four Multi-Cam Timers. Especially suitable for design engineers and laboratory technicians. Components may be used to construct units that will be used for short periods; for test or other purposes. Includes all parts necessary to make one each of the following: 3-switch timer; 6-switch timer; 9-switch timer and 12-switch timer. Design of case and trays allows easy reinsertion of all parts in their proper positions. Supplied complete with case and trays for motors, switches, cams, etc. For operation from 115 v., 60 cycle AC. Shpg. wt., 27 lbs.
78 BX 492, NET..... 295.00



RELIANCE HEAVY-DUTY TIME SWITCHES

TYPE W—30 AMP

Model W-22. New, completely automatic electrical switch. Ideal for control of apartment lights, water heaters, etc. Convenient manual switching will not interfere with automatic operation. Minimum "ON" period, 1/2 hr.; max. 23 hours. Synchronous, self-starting motor. Snap-action silver-to-silver contacts; spring-temper, phosphor-bronze blades. DPST. Contacts rated 30 amps, at 120-240 v. Has 1/2" and 3/4" knockouts in bottom, sides and back. Indoor cabinet for wall mounting. Hammerloid enamel finish. Size, 4 1/2 x 4 1/2 x 4 1/2". U.L. Approved. For 110-125 v., 60 cycle AC. Neutral tap for 3-wire, 250 v. circuits. Wt., 5 lbs.
78 B 390, List, \$15.50. NET..... 11.40

Model W-33. As above but DP, 2-circuit time switches in one. Will control 2 separate circuits independently or simultaneously by setting trippers for desired schedule. Provides 8 different combinations of 2-circuit control; may be set to operate both circuits simultaneously as a DPST switch.
78 B 391, List, \$20.00. NET..... 14.70

"BADGER" 50 AMP

Model M1. Heavy duty time switch for dependable control of substantial loads. Self-starting, synchronous motor maintains accurately timed intervals. Automatically controls on and off periods of illuminating, flood lights, air conditioning units, etc. Minimum "ON" period, 1/2 hour; maximum, 23 1/2 hours. Can be switched on or off manually if desired, at any time during cycle without interfering with automatic operation. Plunger action, copper-to-copper SPST contacts. Contacts rated at 50A at 120 to 240 v. Steel cabinet. 18 gauge. Cabinet finished in Hammerloid enamel. Has 3/4" and 1" knockouts in bottom, sides, and back. U.L. Approved. For 110-125 v., 60 cycle AC. Size: 5 1/2 x 10 x 4 1/2" deep. Shpg. wt., 10 lbs.
78 B 392, List, \$22.00. NET..... 15.09

Model M2. Same as above except switch has DPST contacts. Neutral tap for 3-wire, 240 v. circuits.
78 B 393, List, \$24.00. NET..... 16.46

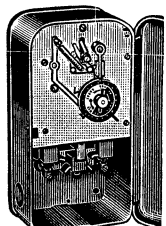

Industrial-Type Time Switches

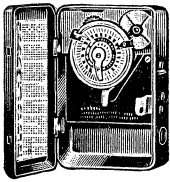

T101



T185



T171



P101

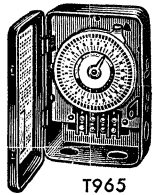

T965

TYPE T101 TIME SWITCH

Inter-Matic SPST time switch turns equipment "on" and "off" once in 24 hours. With extra trippers (see bottom of next column) will operate up to 12 times a day. Trippers can be added without removing the dial. Minimum time between settings is 1 hour. Manual operation does not interfere with settings. 35 amp contacts will handle a 4000 watt load at 125 v., 60 cyc. Gray steel case with knockouts. Size 5x3x7/8". U.L. Approved. For 105-125 volts, 60 cycle AC. Shpg. wt., 4 lbs.
78 B 322. List, \$10.95. NET.....7.12

Type T103. As above, but DPST.
78 B 321. List, \$12.95. NET.....8.42

Adapter Kit. Handy adapter kit makes the above units portable. Consists of 6 ft. cord, plug, etc. 15 amperes. Shpg. wt., 1 lb.
78 B 323. NET.....1.12

TYPE T185 TIME SWITCH

Unusually versatile switch that provides up to 14 complete "on-off" cycles. Each cycle is independently controlled and can vary from 5 to 60 min. Minimum interval between cycles, 1 1/2 hrs. Can be used as SPST normally open; SPST normally closed; or SPDT. Perfect for any application requiring more than one "on-off" cycle in a 24-hour period. Each cycle is easily adjusted for minutes desired; set screw on tripper selects any period from 5-60 min. Trippers are easily changed or added. Large, silver, snap-action contacts; rated 35 amps, 125 volts, AC. Synchronous timing motor is slow-speed, high-torque type. Gray steel case, 7 3/4x5x3". With 3 trippers (for 3 "on-off" cycles). For 110-120 volts, 60 cycle AC. Shpg. wt., 4 lbs.
78 B 313. List, \$16.95. NET.....11.02

Extra Trippers. For above. One tripper required for each "on-off" cycle added. Shpg. wt., 4 oz.
78 B 336. NET EACH.....49¢

"SKIPPER" TIME SWITCHES

Permits "skipping" control cycle on Saturdays, Sundays, holidays, etc. The "Skipper" has 2 dials: A time dial and a day dial. To skip any days, small skipping screws are inserted into the proper holes in the day dial. "On" and "off" trippers are set in the usual manner on the time dial. Special "cutout" tripper advances day dial every 24 hours. From 1 to 12 on and off operations per day can be obtained by adding extra trippers. Timing range: Minimum "on" or "off" time, 1 hour; maximum, 23 hours. Switch may be turned on or off manually—regardless of the time settings. Automatic reset resumes time cycle. Silver, snap-action switch contacts are rated 35 amps at 125 volts (4000 watts). Drawn steel case. Attractive light gray finish. Furnished with three skipping screws, one set of "on and off" trippers and instructions. Extremely simple installation. Air conditioner plugs into unit; unit plugs into electrical outlet. Operates on 110-120 volts, 60 cycle AC. U.L. Approved. Size 7 3/4x5x3". Shpg. wt., 4 lbs.

Type T171. SPST. Skips "on" cycle.
78 B 315. List \$16.95. NET.....11.02

Type 173. DPST. Skips "on" cycle.
78 B 316. List, \$18.95. NET.....12.32

Type T175. SPDT. Skips either "on" or "off" cycle.
78 B 317. List, \$18.95. NET.....12.32

TRIPPERS AND SKIPPING SCREWS
Type 107T19A. On-Cutout Trippers. For "Skipper" types only. Shpg. wt., 3 oz.
78 B 319. NET EACH.....20¢

Type 79T2. Skipping Screws. For "Skipper" types only. Shpg. wt., 2 oz.
78 B 308. Pkg. of 3, EACH PKG.....12¢

Type 107T8A. Set of "On and Off" Trippers. For all Inter-Matic switches (except T185). Shpg. wt., 2 oz.
78 B 324. NET PER SET.....26¢

Other Inter-Matic Time Switches on page 208

TYPE P101 TIME SWITCH

Portable time, SPST plug-in time switch. Simple to install. Improved version carries a much heavier load than earlier models. Will handle any appliance that plugs into regular outlets. Provides many uses in the shop, store, or home. Easily set for from 1 to 12 on-off operations per day. Minimum "on" or "off" time, 1 hr.; maximum, 23 hrs. Controls lamps, signs, electric roasters, radio, TV sets, communications equipment, etc. Precision-built. Finest quality materials. Can be used with up to twelve extra trippers. May also be manually operated. Capacity: 10 amps at 125 volts (1250 watts). Size, 5x3x7/8". For 105-125 v., 60 cycle AC. Shpg. wt., 4 lbs.
78 B 314. List, \$12.95. NET.....8.42

TYPE T965 TIME SWITCHES

An unusually flexible program timer for use where many "on" and "off" operations are needed. Provides up to 96 operations in a 24 hour period. Minimum "on" or "off" period is 15 minutes. Can be used for 24 hour control of heating, ventilating and air conditioning systems. Ideal for programming industrial music systems. Schedule is easily set by depressing trippers located on dial face. Trippers are permanently attached—cannot be misplaced. Dial face is yellow and black for excellent visibility in poorly lighted locations. Entire mechanism is removable when mounting the case. Setting one lever releases mechanism; no screws or nuts to remove. 2 knockouts on bottom of case permit neat installation and rapid cable attachment. Large terminal screws on bakelite board allow easy hookup. Switch is SPST type with contacts rated to handle 20 amperes. Will repeat timing cycles without resetting. Synchronous timing motor is low speed, high torque type. Size: 7 7/8x5x3". Shpg. wt., 3 lbs.

Type T965. 105-125 v., 60 cycle AC.
78 B 395. List \$37.50. NET.....27.57

Type T966. 210-250 v., 60 cycle AC.
78 B 396. List \$38.50. NET.....28.38

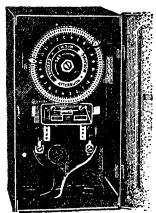

1191

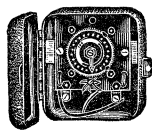

948

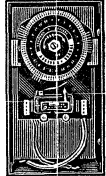

801



919

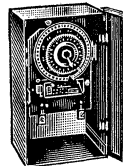

24H61191

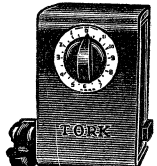

2925-P

MODEL 1191—"LITTLE GIANT"

Automatically turns electrical equipment "on" and "off" at any pre-set time, once every 24 hours. For use in stores, offices and homes. On-off dial calibrated in 15 minute intervals. 45 minutes required between settings. Handles 35 amps at up to 3300 watts lighting load (4000 watts heating load) or 1 h.p. single phase motor. Manual operation if desired. Reliable Telechron clock motor. Heavy-duty, lug-type terminals take up to #6 wire. Steel case. Size, 8 1/2x4 3/4x4 1/4". For 110-120 volts, 60 cycle AC. Shpg. wt., 5 lbs.
78 B 302. List, \$13.95. NET.....9.07

MODEL 948—"THE TORKMASTER"

Automatically turns electrical equipment "on" and "off" once over a 24-hour period. Two hours required between settings. Dial calibrated in 15-minute intervals. Switch is single pole with current rating of 30 amps. Ideal for window lights, display signs, porch lights, hallways, yard lights, oil burners, coal stokers, defrosters, pumps and many other shop and home applications. Switch may be opened by hand without disturbing pre-set adjustments. With conduit knockout holes. Housed in blue-gray finished steel case with hinged cover. Has Telechron motor; precision timing gears. Size, 5 1/4x4 3/8x3 1/2". For operation from 110-125 volts, 60 cycle AC. Shpg. wt., 3 lbs.
78 B 308. List, \$10.95. NET.....7.12

TORK SWITCHES—INTERVAL TIMERS

MODEL 801 PROGRAM TIMER

Highly versatile unit. Has a total of 40 tabs for "on" or "off" intermittent operation. Easily adjusted. Tabs can be inserted at any quarter-hour period. Allows almost any desirable timing combination for 15 minutes or longer. Adjoining tabs keep operation continuous. Timer has 10 ampere single-pole switch. Provides a multitude of timed operations for stores, offices, shops and the home. Ideal for controlling fans, heating systems, lights or signs, etc. Size, 8 1/2x4 3/4x4 1/4". For 110-120 volts, 60 cycle AC. Shpg. wt., 5 lbs.
78 B 337. List, \$19.95. NET.....12.97

MODEL 919—PORTABLE PLUG-IN

Portable, 24-hour, plug-in time switch—fully automatic. Operates air conditioners up to 1/2 ton, burglar alarms, bedside radios, etc. Simple turn of dial to set "on" time. On-off levers for manual use. Adjustable "off" tripper. Minimum time between settings, 45 min, 15 min. each. Capacity, 15 amps, 1650 watts. Size, 5 1/2x4 1/4". For 110-120 v., 60 cycle AC. Shpg. wt., 3 1/2 lbs.
78 B 304. List, \$13.95. NET.....9.07
Model 1919C. As above, but can control 3/4 or 1-ton air conditioners having 7-prong plug.
78 B 360. List, \$19.95. NET.....12.97
Extra Trippers. For above. Pair, 3 oz.
78 B 309. NET PER PAIR.....35¢

MODEL 24H61191 TIMER

Extremely versatile, heavy-duty, SPST 24-hour time switch. Provides up to 24 hourly "on" cycles. Each "on" cycle is adjustable from 2 to 55 minutes in duration—may be set in 1-minute steps. Has many applications in the store, home and farm. Use to control poultry feeders, well pumping, crop curing, television, lawn sprinkling, stokers, etc. Contacts rated at 30 amps. Steel case. Size 8 1/2x4 3/4x4 1/4". With 24 hourly actuating screws. 110-120 volts, 60 cycle AC. 5 lbs.
78 B 359. List, \$24.95. NET.....16.22

2925-P MODELS

Single set interval timers. Can be manually set for any interval less than stated maximum settings. Provide automatic time control for a wide variety of household appliances such as toasters, waffle irons, mangles, roasters, coffee-makers, etc. All are 15 amp capacity, single pole normally open. Has Telechron motor, with receptacle. White enameled finish. Size, 4 1/2x3 1/2x3 1/2". With core and plug. For operation from 110-120 v., 60 cyc. AC. Shpg. wt., 2 lbs.
Model 2925-4P. Max. setting, 4 hrs.
78 B 347. List, \$15.95. NET.....10.36
Model 2925-12P. Maximum setting, 12 hours.
78 B 348. List, \$15.95. NET.....10.36
Model 2925-24P. Maximum setting, 24 hours.
78 B 349. List, \$15.95. NET.....10.36

Clock Timers and Foot Switches

INTERMATIC CLOCK TIMERS FOR HOME, OFFICE & SCHOOL



A

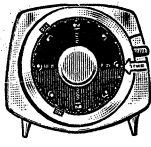

B

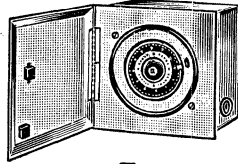

C

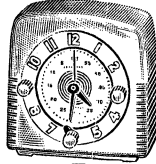

D



E

MODEL RC 2021-4 UNMOUNTED TIME SWITCH

A Automatically turns on radios, television sets, toasters, coffee-makers and other electrical devices—at any pre-set time within a 12-hour period. Also serves as an accurate, highly attractive time-piece. Converts any radio to a modern clock-radio—an excellent musical alarm. An ideal service replacement for clock-radios. May be installed in a small case with an AC outlet and line cord for use with appliances anywhere in the house. All controls, off-automatic-on, time adjust and timer set, conveniently located on chrome outer dial face. Easy to install. Requires $3\frac{1}{2}$ " diameter hole; overall size, $3\frac{1}{2} \times 3\frac{1}{2} \times 1\frac{1}{8}$ " deep. Built-in single-pole switch handles up to 15 amps, 1650-watt load. Mounting centers, $3\frac{1}{4}$ ". U.L. Approved. For operation from 110-120 volts, 60 cycle AC. Shpg. wt., 1 lb.
78 B 399. List, \$9.00. 1 to 5, NET EACH..... **6.44**
 6 or More, EACH..... **5.93**

MODEL A-211 "TIME-ALL"

B Time control switch for office, store or home. Ideal for converting radios to clock-radios, controlling lights or appliances, etc. Has manual control with automatic reset. Permits manual control without automatic reset, for continuous "off" or "on." To revert to control cycle, release manual control from "permanent" position. Min. "on" time, 15 min.; max., 23 hrs., 45 min. Plug-in receptacle for equipment to be controlled. Size, $5 \times 4 \times 2\frac{1}{2}$ ". Handles 15 amps, 1650-watt load. With 6-ft. cord, plug, instructions. For 110-120 v., 60 cycle AC. Shpg. wt., 2 lbs.
78 B 311. List, \$11.95. NET..... **7.97**

Model A-221. (Not illustrated). Same as above, but handles 7 amps, 875 watts. Shpg. wt., 2 lbs.
78 B 397. List, \$9.95. NET..... **6.64**

NEW MODEL T-1101 "LAMP-LYTER" WALL-MOUNTED TIMER

C Electrical time control switch for flush-mounting in walls or hi-fi cabinets. Finished in semi-gloss beige. Can be used to turn lights or appliances off when departing and on when returning. Has automatic reset. Manual control located on outside of door. Hinged $6\frac{1}{2} \times 6\frac{1}{2}$ " door securely latched by magnet. Min. "on" time, 30 min.; max., 23 hrs., 30 min. Inset junction box, $5 \times 5 \times 2\frac{3}{8}$ " deep; combination $\frac{1}{2}$ " and $\frac{3}{4}$ " conduit knockouts on sides, top, and bottom. SPST switch rated at 15 amps, 1650 watts. For 110-120 v., 60 cycle AC. Shpg. wt., 4 lbs.
78 B 398. List, \$21.95. NET..... **14.27**

MODEL A-301 "TIME-MINDER"

D Combination electric clock and signal timer. Can be set to time any pre-set interval from 1 min. to 4 hrs. Pleasant toned buzzer sounds at end of interval and keeps going until turned off manually. Timer is accurate within seconds and easily set with large, easy-to-read pointer. Spruce green plastic case. Clock and timing interval are both set from front panel. No installation is necessary—just plug the timer in and it's ready to go. U.L. Approved. Has 6-ft. cord and plug. Size, $4\frac{1}{2} \times 4\frac{3}{4} \times 2\frac{1}{4}$ ". For operation from 110-120 v., 60 cycle AC. Shpg. wt., 2 lbs.
78 B 342. List, \$8.95. NET..... **6.56**

MODEL A-401 "CLOCK-TIMER"

E Combination clock and automatic time switch. Turns appliances on at any pre-set time, then turns them off automatically. Minimum interval, 15 min., maximum, $5\frac{1}{2}$ hrs. Also permits manual operation. Plug-in receptacle for appliance to be controlled. Capacity: 15 amps at 1650 watts. All controls on front panel. In green plastic case. With 6-ft. cord and plug. $4\frac{3}{4} \times 4\frac{1}{2} \times 2\frac{1}{4}$ ". U.L. Approved. For 110-120 v., 60 cycle AC. Shpg. wt., 2 lbs.
78 B 343. List, \$11.95. NET..... **8.77**

MONTGOMERY MODEL M-24 PROGRAM CLOCK

Ideal for schools, industrial and service organizations. Provides dependable automatic control and operation of buzzers, bells or horns, on a 24-hour schedule. Permits manual operation at any time for special program schedules, personnel paging or sounding emergency alarm, without affecting accuracy of pre-set schedule. Eliminates clock watching and button pushing. Program schedules can easily be set or changed by inserting pins in desired time slots of 24-hour mechanism. Program disks have 288 time slots—permit actuating signal at up to 5 minute intervals. Duration of signal is adjustable from 4 to 20 seconds. Program mechanism is automatically set to correct time by turning the clock hands—assures perfect synchronization. Switch for automatic silencing of signals during any days or nights of the week. Single-circuit timer contacts rated at 10 amperes. Gray enameled steel case. $11 \times 8 \times 4$ ". For 110-120 volts, 60 cycle AC. Shpg. wt., 12 lbs.
78 BX 351. NET..... **87.71**

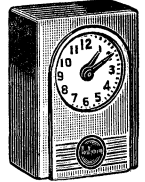

STEP-ON SWITCHES

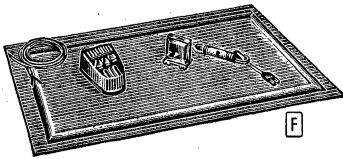

F

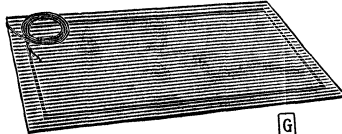

G



H

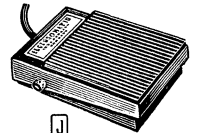

J

"SWITCHMAT" STEP-ON SWITCHES

F "Announcemat" Chime Alarm. Low-cost, practical alarm system for stores, offices, homes and industry. Signals the presence of visitors or intruders. Even the step of a small child on any part of the Switchmat sounds the alarm. Rugged Switchmat is $\frac{5}{8}$ " thick, heavily ribbed brown vinyl plastic.

Completely protected—sealed between layer of plastic and rubber. Resistant to cleaning and sweeping compounds, oils, acids and most chemicals. Lies completely flat on floor—will not slip or slide even on polished floors. No installation problems—simply plugs into wall outlet. Can be quickly and safely installed by anyone. Switchmat operates on extremely low voltage supplied by transformer which is included.

Complete with 18×30 " commercial-type Switchmat, transformer with 6-ft. cord and plug, 25 ft. low-voltage cable and chime signal alarm. For 110-120 v., 60 cycle AC. Shpg. wt., 13 lbs.
78 BX 358. NET..... **23.96**

G Industrial "Switch-Mat" Switch. Stepping on Switchmat closes circuit which may be used to ring bells, turn on lights, actuate electric counters, open doors, etc. Attractive vinyl plastic carpet conceals SPST switch (normally off). Waterproof. Controls 110-volt circuit with non-inductive loads up to 100 watts. Can be used to control loads of up to 1,000 watts when used with Switchmat control box listed below. Brown color; choice of two sizes, $\frac{5}{8}$ " thick. Both are supplied with 6' leads.
78 BX 355. 14×23 ". $6\frac{1}{2}$ lbs. NET.. **15.20**
78 BX 356. 18×30 ". 10 lbs. NET.... **21.60**

H Control Box. Relay control unit for Switchmat or other switch. Handles up to 1,000 watts at 110-120 v., 60 cycles AC. Provides 6 v. AC for switch circuit. Outlets for normally "on" and normally "off" operation. With plug, socket and 6' cord. $3 \times 4 \times 5$ ". For operation from 110-120 volts, 60 cycle AC. Shpg. wt., $2\frac{1}{2}$ lbs.
78 B 357. NET..... **12.40**

LECTROMATIC FOOT SWITCH

J Model 1011. Snap-action foot switch. Provides a faster, more efficient means of switching electric motors and machines on and off. Ideal for starting and stopping a wide variety of power tools, riveting and welding equipment; operating relays, solenoids, etc.; controlling photographic, medical, and communications equipment, etc.

Promotes greater safety because operator can instantly stop machine by merely releasing pressure on foot switch (faster than reaching for a hand switch). Saves time and extra hand movement; increases work output. Easy to install—just plug device to be controlled into the special socket and plug switch cord into AC wall socket. Normally-open switch is rated at 10 amps, 115 v. Housed in durable metal case; with anti-skid pad on bottom, rubber foot tread on top. Complete with 6-ft. cord and combination plug-receptacle. Overall size, $4\frac{1}{4} \times 3 \times 1\frac{1}{2}$ ". Shpg. wt., 1 lb.
78 B 382. NET..... **5.48**

Build Your Own Quality Electronic Equipment at Big Savings

BUILD ALLIED'S OWN knight®-kits

and get the most for your money

Knight-Kits are available *only* from Allied. Creatively engineered and styled by top-notch professionals, these famous kits incorporate every desirable feature that 37 years of experience in kit design can provide. Progressive in every way, while retaining traditionally high standards of quality, more new Knight-Kits are continuously being released, than any other brand. You can always look to Allied for the latest and best in money-saving Knight-Kits.

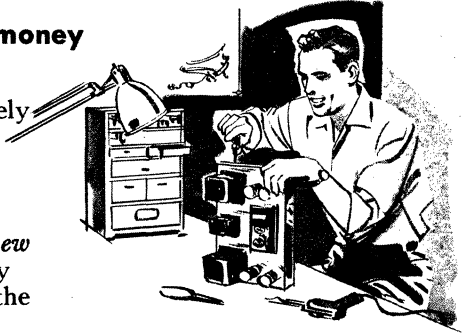

here's why you get more for your money in knight-kits

AHEAD OF THE FIELD WITH MORE, NEWER FEATURES

Wide use of printed circuit boards and transistors; ultra-new, printed circuit switches; newest premium-type tubes and circuitry; smart, modern styling—these and other features put Knight-Kits far in front!

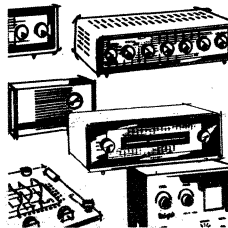

THERE IS A MONEY-SAVING KNIGHT-KIT FOR EVERY NEED

It pays to check these super-value kits before you buy. For example, in high fidelity and test equipment, you can *save up to half of the cost* of equivalent factory-built units, when you buy Knight-Kits!

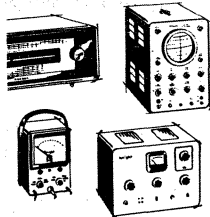

PEAK PERFORMANCE AND YEARS OF SERVICE

You get performance *plus!* All circuits are designed to operate well within rated limits for *every* part—rigid quality control assures you of trouble-free operation and years of service from *any* Knight-Kit you choose.

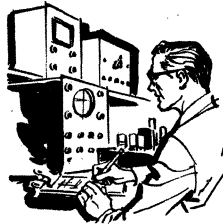

KNIGHT-KITS ARE EASIEST TO ASSEMBLE—BY FAR!

No technical experience is required to assemble Knight-Kit equipment. Carefully written instruction manuals, with "Step-and-Chek" directions and "Wall-Size" pictorial diagrams, make assembly remarkably easy.

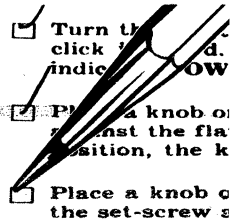

YOU DO THE EASY BUILDING —AND EARN BIG SAVINGS!

When you choose famous Knight-Kits, *you save* because our giant buying power makes it possible to present these kits at lowest cost—and in addition, *you save* because you do the assembly yourself.



YOU GET THE FINEST PREMIUM-QUALITY PARTS

Only the finest, *brand-new* parts are used in Knight-Kits. *Cadmium-plated* steel chassis—*extra-strong* steel cases and panels—*solid bakelite* knobs plus *spring-loaded*, disappearing handles on test units for easy stacking.

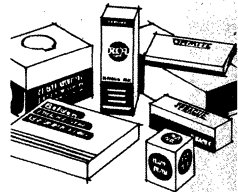

® Registered Trade-Mark of Allied Radio Corp.

EASY PAYMENT PLAN FITS YOUR BUDGET

Knight-Kit electronic kits and accessory equipment may be purchased under our Easy Payment Plan—the most liberal plan in electronics. Your order need total only \$45.00 or more, and a down payment of only 10% is required—you then complete the balance in small easy-on-the-budget monthly payments. Carrying charges are low and there's no "red tape"—no finance companies to deal with. If the balance is paid within 60 days, carrying charges are refunded in full. For complete Easy Pay Plan details, see page 396.

MONEY-BACK GUARANTEE

Your purchase price is refunded in full if your Knight-Kit does not meet our published specifications for performance. When you build a Knight-Kit, you can always be sure of outstanding value.

See the Following 27 Pages for a Complete Selection of Famous Knight-Kit Equipment

BUY WITH CONFIDENCE

knight-kits

are backed by ALLIED—

America's Pioneer in Electronic Kits

Backed by Allied's 37 years in the electronics industry, the name of Knight-Kit on electronic kits has come to mean the mark of incomparable quality and dependability. Only Allied, with its unlimited buying power, can offer expertly engineered kits at unbeatably low prices. To assure you of top performance, each new Knight-Kit must pass Allied's rigid standards for day-in, day-out operation. Every kit goes through many stages of development and is thoroughly field tested. It is no wonder that experienced technicians and engineers, as well as students, look to Knight-Kits for the latest design and unsurpassed performance.

KNIGHT-KITS are easiest to build—you do the easy, satisfying assembly and SAVE

Whether you're a beginner, or have years of electronic experience, you'll find that it's really fun to build a Knight-Kit. All the hard work has already been done—many kits have printed circuitry and our latest exclusive printed-circuit switches. You'll have only the highest praise for Knight-Kits, in ease of assembly and outstanding quality and low cost.

IT'S LIKE HAVING A GOOD INSTRUCTOR AT YOUR SIDE

- Turn the knob clockwise. Place indicator on POWER.
- Place a knob on the flat side position, the knob.
- Place a knob on the set-screw again.

"STEP-AND-CHECK" INSTRUCTIONS. No experience is needed to assemble any Knight-Kit. Clearly written "Step-and-Check" instructions tell you when and how to mount each part; tell you exactly when to solder. As each step is completed, check it off—you know just what you've done every step of the way.

KING-SIZE DIAGRAMS. Wall-size pictorial diagrams are another reason Knight-Kits are so easy to assemble. Every kit contains at least one "King-Size" picture diagram—you don't have to know how to read schematic symbols. Diagrams may be tacked over your work table for convenient reference.

CLEARLY MARKED PARTS. Resistors are neatly mounted on cards with identifying symbols (no need to know color-coding)—capacitors have plainly marked values—wires are pre-cut to size, pre-stripped and colored for easy selection. Everything you need is included—there's nothing else to buy, not even solder!

Knight-Kits ARE IDEAL FOR SCHOOL USE

Schools everywhere use Knight-Kits for easier, more effective electronics instruction. Knight-Kits maintain a high level of class interest and make the job of teaching easier. Give every student a chance to produce something he can point to with pride. Knight-Kit offers hi-fi units, lab kits, Amateur gear and test equipment. Allied offers special arrangements on large-quantity purchases. Let us know your requirements—address our Commercial Division.

SENSATIONAL NEW EASY-TO-BUILD

Hi-Fi knight-kits

now everyone can afford true hi-fi comparable to the best

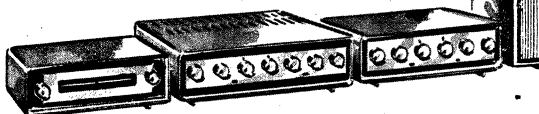

A COMPLETE LINE OF ALL-NEW MATCHED HI-FI COMPONENT KITS

Now you can build your own professionally styled hi-fi equipment at tremendous savings. Painstaking design and highest quality components guarantee exceptional performance and dependability comparable to the finest factory-built units. Enjoy the best in hi-fi music reproduction for less. You're sure to find just the components you want in the complete listings offered.

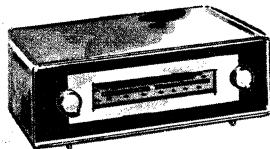

FIRST TRULY CUSTOM-STYLED HI-FI KITS

Knight-Kit hi-fi components are designed to take their place alongside the finest of home furnishings. Beautiful as well as functional, Knight-Kit hi-fi units are as easy to look at as they are to use. Highest-quality materials and workmanship insure that they will stay that way!

BUILD YOUR OWN COMPLETE HI-FI MUSIC SYSTEM—SAVE UP TO 50%

Now, with Knight-Kits anyone can afford to bring breathtaking new musical adventures into his home. Knight-Kits offer a hi-fi music system to fit any budget—a system that's right for you. Build with Knight-Kits and save up to 50%.



FM-AM Tuner or FM Tuner + 18 W. Amp. + Speaker



FM-AM Tuner or FM Tuner + 30 W. Amp. + Speaker



FM-AM or FM Tuner + Preamp + 25 W. Amplifier + Speaker

BUILD YOUR OWN KNIGHT-KIT HI-FI—IT'S COMPARABLE TO THE VERY BEST—AND YOU SAVE MONEY!

See Pages 12 and 13 for Complete Hi-Fi Systems Featuring Knight-Kit Units

knight-kits

are exclusive with ALLIED

NEW MONEY-SAVING HI-FI AMPLIFIER KIT

Last Word in Professional Performance and Styling

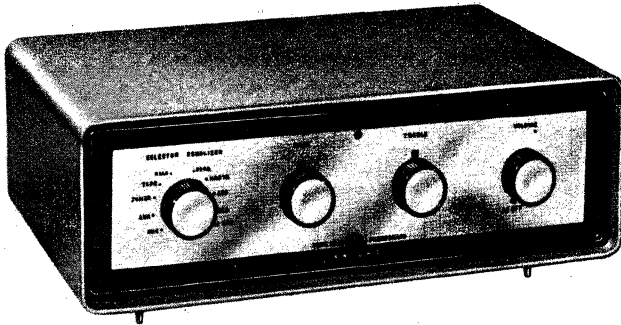

KNIGHT-KIT 18-Watt Complete Amplifier Kit

ONLY
\$39⁹⁵

- New, RCA 6973 High-Fidelity Audio Tubes
- Only 0.5% Distortion at Full 18 Watts
- Exclusive Printed Circuit Switches
- Two Printed Circuit Boards
- Response, ± 1 db, 20 to 30,000 cps

The new Knight-Kit 18-watt high-fidelity amplifier kit provides brilliant performance and custom styling at exceptionally low cost. Here is an amplifier designed to bring flawless high fidelity sound into your home at half the cost of comparable commercially assembled units—an excellent unit around which a fine home music system can be built. Delivers a full 18-watts output at only .5% distortion using the new 6973 high fidelity output tubes—designed by RCA for unparalleled high-fidelity sound reproduction. Construction is simplified through use of a Knight-Kit exclusive printed circuit switch and two printed circuit boards—most of the wiring has already been done for you. With the Knight-Kit "Step-and-Chek" instructions you'll find this amplifier fun to build—even if you have no previous electronic experience.

SPECIFICATIONS: *Frequency Response:* ± 1 db, 20 to 30,000 cps at rated output. *Distortion:* Only .5% at 18 watts. *Hum & Noise Level:* Better than 60 db below 18 watts. *Sensitivity* (tape head and magnetic cartridge): 5 mv for 18 watts output. *Inputs:* Microphone; Auxiliary; Tuner; Tape player; Magnetic (GE, Pickering); Ceramic; Tape Head. *Controls:* Selector-Equalizer (Mic, Aux, Tuner, Tape, Magnetic, Ceramic, Tape Head Equalization—RIAA, FFRR, NARTB, AES, RCA, 500 cps, COL); Bass Boost and Attenuate; Treble Boost and Attenuate; Off-On/Volume. *Output Impedance:* 4, 8, or 16 ohms. *Tubes:* 1—ECC83/12AX7 preamplifier-equalizer driver and tone control driver, 1—ECC83/12AX7 voltage amplifier and phase inverter, 1—ECC83/12AX7 push-pull driver, 2—6973 push-pull power output amplifiers; 1—EZ81 rectifier.

Complete with all parts, wire and solder, tubes, deluxe cabinet and step-by-step instructions. Size, 4x13x8". For operation from 110-120 v., 50-60 cycle AC. Shpg. wt., 15 lbs.

83 YX 786. NET.....39.95

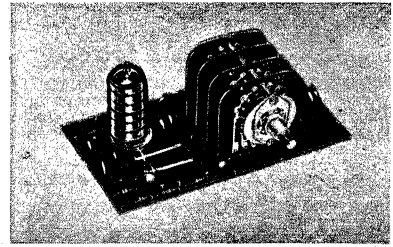
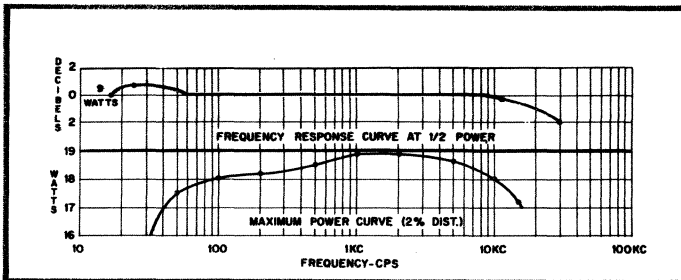

PRINTED CIRCUIT SWITCHES

Another Knight-Kit first! This exclusive Knight-Kit development simplifies kit construction—eliminates critical switch wiring, one of the major stumbling blocks encountered by the inexperienced kit builder.

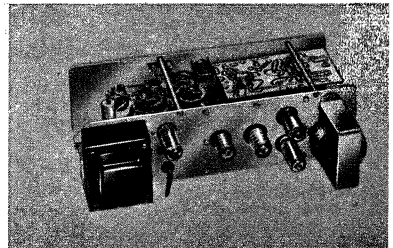

2 PRINTED CIRCUIT BOARDS

All the critical, complex wiring is already completed. Two printed circuit boards contain the wiring for all tubes except the rectifier. With 90% of the wiring completed, assembly time is reduced to a minimum.

PROOF OF SUPERIOR Knight-Kit PERFORMANCE

The frequency response and power curves at left, graphically illustrate the superiority of Knight-Kit hi-fi components. Before you buy, compare these curves with other kits or assembled units. You'll agree that Knight-Kits are the finest values available anywhere.

HI-FI knight-kits EQUAL TO THE BEST

NEW

ASSEMBLE IT
YOURSELF AND SAVE!

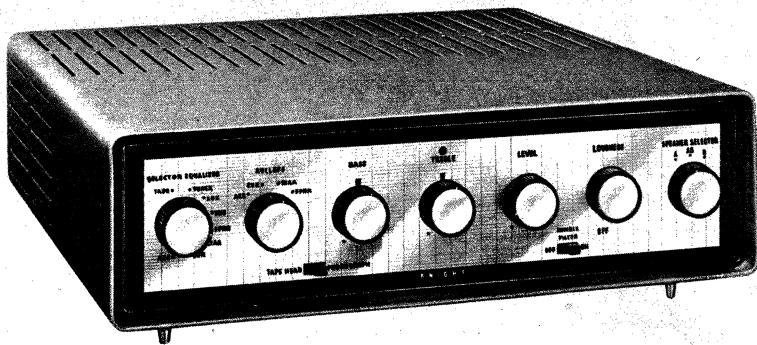

KNIGHT-KIT 30-Watt High-Fidelity Amplifier Kit

NET
\$76⁹⁵

- Exclusive Printed Circuit Switches—3 Printed Circuit Boards
- 8 Different Inputs plus A-AB-B Speaker Selector
- Record Equalization Within 1/2 db of Recommended Settings
- Frequency Response, ±0.5 db from 15 to 100,000 cps

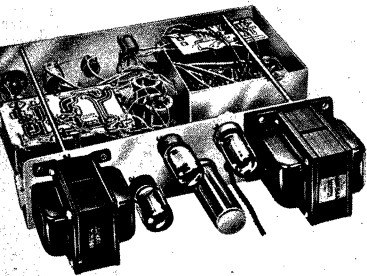

3 PRINTED CIRCUIT BOARDS. Assembly is quick and easy the Knight-Kit way—printed circuits trim wiring to a minimum and eliminate errors—you'll get perfect results.

Entirely new in concept and design, the Knight 30-watt amplifier is the finest complete hi-fi amplifier you can buy in kit form! It is exceptionally easy to assemble, and its superb specifications put it in a class by itself; its performance matches that of commercially assembled units costing up to twice as much. Every necessary control is provided in the preamplifier section, including 16 combinations of equalization, each accurate within 1/2 db of the record manufacturer's actual recording curve. Components are of the finest quality, and include easy-to-solder printed circuit boards, exclusive printed circuit switches, premium 12AY7 tube and oversized transformers. Damping factor is continuously variable from -4 to +35.

SPECIFICATIONS: *Power Amplifier Response:* ±0.5 db, 15 to 100,000 cps at 30 watts output. *Harmonic Distortion:* 0.55% at mid-frequencies; never exceeds 1% from 20 to 40,000 cps at 30 watts. *I.M.:* 0.74% at 20 watts. *Hum and Noise:* Better than 60 db below 30 watts at all high-gain inputs; 75 db at all low-gain inputs. *8 Inputs:* Tape Head, Tape Preamp, G.E. and Pickering Cartridges, Ceramic Cartridge, Microphone, Auxiliary, Tuner (with level set control). *Tubes:* 12AY7, 4—ECC82/12AU7, 2—5881; GZ34 rectifier. *Controls:* Input Selector-Turnover (Tape, Tuner, Mic, Aux, FFRR, RIAA, Eur, AES); Rolloff (AES, Eur, RIAA, FFRR); Bass (±15 db at 20 cps); Treble (±15 db at 20 kc); Level; Off-On/Loudness (continuously variable); A-AB-B Speaker Selector (impedances may be mixed without mismatch); Tape-Phono Switch; Rumble Filter Switch. *Output Impedances:* 8 and 16 ohms. Balance adjustment is provided for output tubes. DC on all preamp filaments. All specifications absolutely guaranteed.

You'll find the Knight-Kit 30-watt amplifier easy to assemble, even if you have never built an electronic kit before. The 3 printed circuit boards and exclusive Knight-Kit printed circuit switches make assembly easy, because most of the wiring is already done! Step-by-step instruction manual is thoroughly illustrated, and nontechnical. In addition to the manual, there are wall-size picture-diagrams to make every step completely clear.

Size, 4 1/4 x 15 x 15". Includes French gray cabinet; control panel is finished in bright aluminum and ebony. With tubes, wire, solder and all parts. For 110-120 v., 50-60 cycles AC. Shpg. wt., 32 lbs.

83 YZ 762. NET **76.95**

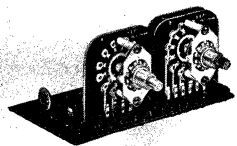

EXCLUSIVE PRINTED CIRCUIT SWITCHES. An important Knight-Kit development that makes short work of the most tedious part of amplifier kit building—assembling equalization circuits.

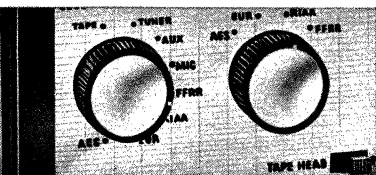

ACCURATE EQUALIZATION. By laboratory measurement, within 1/2 db of manufacturer's recording curves—better than all but the most expensive of assembled amplifiers!

**IDEAL FOR USE WITH
Knight-Kit TUNERS!**

Use the Knight-Kit 30-watt amplifier as the heart of a hi-fi system; it's a perfect match, in quality and styling, to the Knight-Kit FM tuner, or the FM-AM tuner listed on the opposite page.

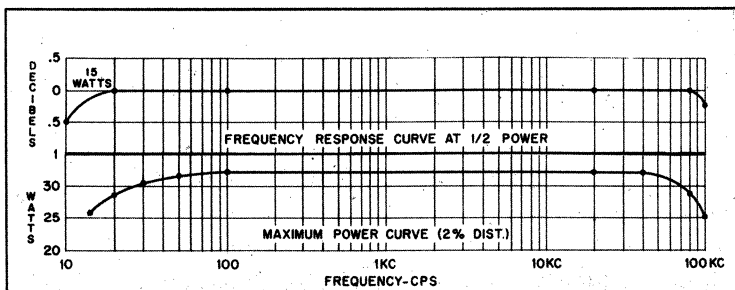

LOW COST HI-FI ANYONE CAN AFFORD!

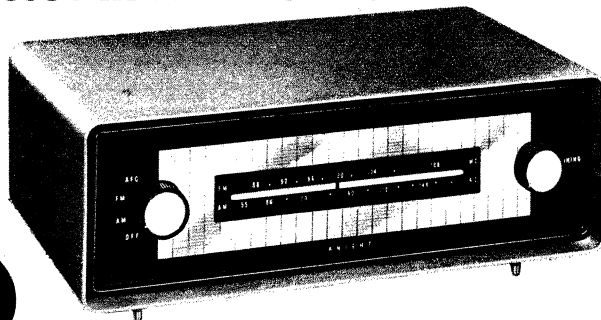

TRUE HI-FI
RECEPTION

NEW

Top-Performing KNIGHT-KIT Hi-Fi FM-AM Tuner Kit

NET

\$49⁹⁵

- Modern Printed Circuit—Most of the Wiring Is Already Done
- Exceptional Sensitivity—2.5 μ v for 20 db Quieting On FM
- Flywheel Tuning Plus AFC—Locks In Stations Automatically
- Completely Pre-Aligned—No Further Adjustment Necessary

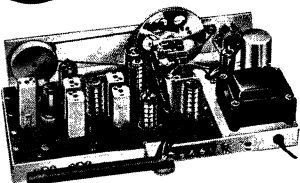

ADVANCED CIRCUIT WITH AFC. Effortless, drift-free FM tuning is assured by Automatic Frequency Control—it "locks in" stations, keeps them tuned electronically!

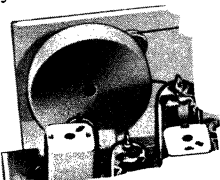

EASY FLYWHEEL TUNING. A gentle touch moves the neon glow tuning pointer to the station you select, smoothly and quietly.

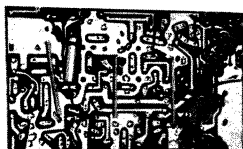

PRINTED CIRCUIT WIRING. The tuner of the future—today! Except for power leads, all wiring is done for you on the printed circuits.

Easy to look at—easy to use—here's a high fidelity tuner with every feature required for top performance on both FM and AM! You'll be proud to place it where everyone can see its smart contemporary styling. It's easy to assemble, too; the entire unit has been carefully designed for quick, easy construction. Superior performance, advanced design and elementary, step-by-step assembly make it the greatest tuner value ever!

A tuned RF stage on FM provides high sensitivity—2.5 microvolts for 20 db quieting. Wide-range, flat frequency response guarantees true high-fidelity FM reception that vividly re-creates the full sonority of broadcast music. The built-in ferrite antenna may be rotated to improve reception of a favorite AM station that may be very weak. Smooth, professional flywheel tuning enables you to glide from station to station, effortlessly; automatic frequency control (AFC) locks in FM stations, eliminating distortion due to mis-tuning. AFC defeat switch helps tune weak stations. Cathode follower output, with extra output jack for convenient "off-the-air" recording directly from the tuner.

The Knight-Kit FM-AM tuner is styled to take its place alongside the very finest high-fidelity equipment; it is completely enclosed in a beautiful French gray case, supported on tapered, chrome-finished feet. Centered on the ebony-and-aluminum control panel is an easy-to-read slide rule scale; stations are located by the self-illuminated neon glow pointer, as it moves across the scale with jewel-like orange brilliance.

FM SPECIFICATIONS: Sensitivity: 2.5 μ v for 20 db quieting. Hum and Noise: -60 db. IF Bandwidth: 200 kc at 50% down on curve. Frequency Response: ± 0.5 db, 20-20,000 cps. Distortion: Under 0.6%. **AM SPECIFICATIONS:** Sensitivity: 3 μ v for 10 db signal-to-noise ratio. IF Bandwidth: 8 kc at 50% down on curve. Frequency Response: 20 to 8000 cps.

Most of the wiring is already done on the single large printed circuit board; pre-aligned RF and IF sections mean that you can play the tuner—without further adjustment—as soon as assembly is complete! Simple, non-technical instructions take you through the entire assembly, a step at a time. Everything is supplied—all parts, pre-cut wire, solder, output cable, and the attractive French gray steel cabinet. Size, 8x4 $\frac{1}{4}$ x13 $\frac{1}{4}$ ". For 110-120 v., 50-60 cycles AC. Shpg. wt., 12 lbs.

83 YX 787. NET..... 49.95

SAVE ON COMPLETE SYSTEMS FEATURING FAMOUS Knight-Kits!

See pages 12 and 13 of this catalog for Allied-selected home music systems featuring easy-to-build Knight-Kits. You'll save many dollars by assembling components yourself—and save even more by selecting a complete system at Allied's special system price! Top engineering and brilliant Knight-Kit styling bring you unmatched value!

Knight-Kit MONEY-BACK GUARANTEE

Every Knight-Kit is absolutely guaranteed to meet or exceed its published performance specifications, or your money is refunded.

knight-kit HI-FI BASIC FM TUNER KIT



NEW

- Hi-Fi Response—20 to 20,000 cps, 0.6% Distortion
- Automatic Frequency Control "Locks-In" on Station
- 4-Microvolt Sensitivity for 20-db Quieting
- Printed Circuit Wiring—Critical Wiring is Completed
- Pre-Adjusted RF and IF Coils—No Need for Alignment
- Beautifully Styled Metal Cabinet with Tapered Legs

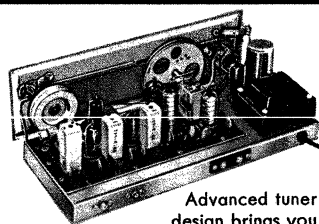

Advanced tuner design brings you superb FM reception.

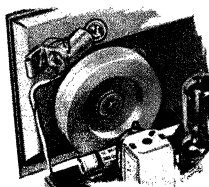

Flywheel tuning permits velvet-smooth station selection over entire bandwidth.

Printed circuit cuts wiring time, prevents errors.



NET
\$38⁹⁵

A notable achievement in creative engineering, distinctive design and impressive performance, the Knight-Kit Basic FM Tuner Kit is not only the best-looking tuner kit that money can buy—but the only FM tuner kit with all these deluxe features: Superb styling,

which is both attractive and functional; printed circuit for ease of assembly; automatic frequency control, for "lock-in" tuning of stations, with disabling feature for tuning in weak stations adjacent to strong stations; pre-adjusted RF coils on rigid forms to eliminate any need for adjustment; IF's pre-adjusted so accurately that they need no further adjustment; front ventilation, an integral part of panel design—no unsightly perforations in the top or at the sides of the cabinet.

Magnificently styled to more than hold its own with even pre-wired tuners costing much more, the Knight-Kit tuner is unlike any other unit available! You'll be proud of its beautiful appearance—and pleased with its brilliant performance. It's an ideal companion unit for the Knight-Kit 18 or 30 watt amplifiers, or any other amplifier with input selector switch and volume control. Its smart gray cabinet has a polished aluminum panel with ebony black trim. A brightly glowing neon bulb serves as both tuning pointer and pilot light—moves across the tuning scale like a gleaming orange jewel. Cabinet rests on chrome finished, tapered legs. The printed circuit board clearly indicates placement of basic components.

SPECIFICATIONS. *Sensitivity:* 4 μ v for 20 db quieting. *Output:* 2 volts at 1000 μ v input. *IF Bandwidth:* 200 kc. *Audio Response:* 20-20,000 cps with only 0.6% distortion. *2 Output Jacks:* One for amplifier, the other for tape recorder; cathode follower permits use of long interconnecting cables. *Controls:* Tuning; Off-FM, FM with AFC. *Tubes:* 6BQ7A, 6BA7, 12AT7, 2—6AU6, 6AL5, 12AU7; 6X4 rectifier. Cascode broadband RF amplifier. 4x13x8". With all parts, wire and solder, and cabinet. For operation from 110-120 v., 50-60 cycle AC. Shpg. wt., 12 lbs.

83 YX 751. NET..... **38.95**

knight-kit 25-WATT

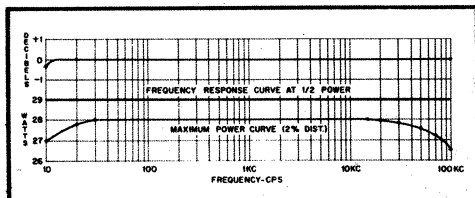
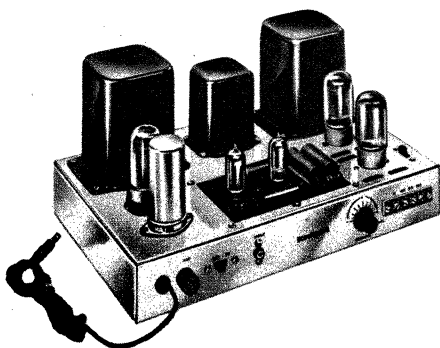

Here's Proof of Superb Hi-Fi Performance

Shield cover, finished in satin black, offers striking contrast to gleaming chrome chassis of amplifier.

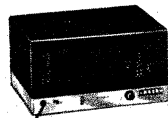

REVOLUTIONARY knight-kit PREAMP KIT



PRINTED CIRCUIT SWITCHES. Another Knight-Kit first! An exclusive development that cuts assembly time.

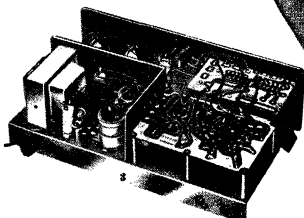

2 PRINTED CIRCUIT BOARDS. Eliminate complex wiring—reduce assembly time. 90% of wiring already is completed.

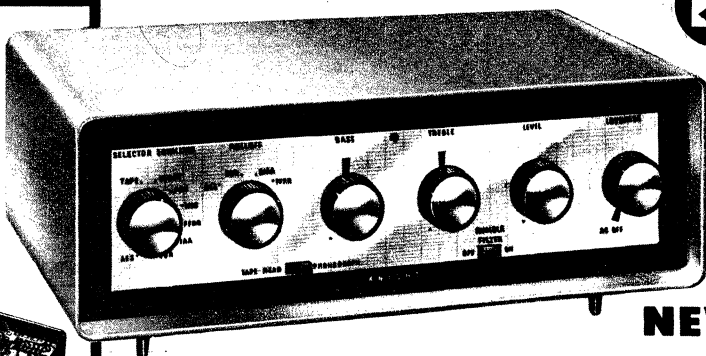

NEW

- Exclusive Knight-Kit Printed Circuit Switches
- Record Equalization within 1/2 db of Manufacturer's Curves
- Continuously Variable Loudness and Level Controls
- DC On Filaments for Hum-Free Performance
- 8 High Level and Low Level Inputs Including Tape Head
- Deluxe Styling—Matches Any Decorating Scheme

BASIC AMPLIFIER KIT

- Printed Circuit Wiring Board
- Response, ± 0.5 db, 10-120,000 cps
- Linear-Deluxe Williamson-Type Circuit

NET
\$44⁵⁰

An exceptional amplifier at a modest price! The outstanding Knight-Kit 25-Watt Basic Amplifier delivers performance equal to units costing twice as much. Williamson-type circuit delivers over 25

watts of virtually flawless output for truly life-like reproduction. Designed for use with any tuner or preamplifier having a full set of controls (for volume, tone and record equalization).

DELUXE FEATURES. Custom-quality, potted, output transformer for superior response; printed circuit board for easy assembly; balance control for precise adjustment of output tubes; damping control variable from -4 to $+35$ to assure optimum performance with any speaker—prevents low-frequency distortion caused by over-damping or underdamping in speaker systems.

SPECIFICATIONS. *Rated Output:* 25 watts. *Response:* ± 0.5 db, 10-120,000 cps at 20 watts. *Harmonic Distortion:* 0.15% at 25 watts. *IM:* 1% at 20 watts. *Output Imp.:* 4, 8, 16 ohms. *Tubes:* 2—ECC82/12AU7, 2—5881; GZ34 rectifier.

Styled in black and chrome. With all parts, tubes, wire, solder and instructions. Less cover (below). For 110-120 v., 50-60 cycle AC. Size, 6 $\frac{1}{4}$ x14x9". Shpg. wt., 25 lbs.

83 YZ 755. NET. 44.50

METAL COVER FOR ABOVE. Black finish—contrasts beautifully with gleaming chrome chassis of amplifier. Shpg. wt., 3 lbs.

83 YX 759. NET. 4.25

NET
\$39⁹⁵

The new Knight-Kit preamplifier is truly an exceptional high-fidelity instrument, equal in component quality and engineering design to the most advanced high-fidelity sound reproducing equipment available today! Never before has so versatile a preamplifier-equalizer kit been offered at this low price. It provides precise equalization—*guaranteed within 0.5 db of manufacturer's curves*—more accurate than all but the most expensive factory-built preamplifiers.

Printed circuit switches, an exclusive Knight-Kit development—make possible ease of assembly never before achieved in a kit of this kind. *All wiring in the new Knight-Kit preamplifier is on two printed circuit boards*, except for the power supply and control leads. Other features include: Cathode follower output; separate output to recorder, independent of tone and volume controls; continuous loudness and level controls; 16 equalization combinations; two AC convenience outlets for use with associated equipment. In metal cabinet finished in attractive French gray; front panel is ebony with aluminum trim.

SPECIFICATIONS. *Frequency Response:* ± 0.5 db, 10-40,000 cps. *Harmonic Distortion:* Less than 0.15% at 1 v. output; less than 0.25% at 3 v. output. *Hum Level:* 60 db below 3 v. at high-gain inputs; 80 db below 3 v. at low-gain inputs. *8 Inputs (figures denote sensitivity in millivolts for 1 v. output):* Tape Head (2 mv); G.E. Phono (2 mv); Picking Phono (5 mv); Ceramic (150 mv); Mic. (24 mv); Aux. (400 mv); Tape Pre-amp (125 mv); Tuner (125 mv). *Level adjustment for Tuner input. Controls:* Selector-Equalizer (Tape, Tuner, Aux, Mic, FFRR, RIAA, Eur, AES); Rolloff (AES, EUR, RIAA, FFRR); Bass; Treble; Level; Off-On/Loudness; Tape Head-Phono; Rumble Filter On-Off. *Tubes:* 12AY7, 2—ECC82/12AU7.

Complete with all parts, tubes, wire, solder, and easy-to-follow instructions. Size, 13x4 $\frac{1}{2}$ x8". For 110-120 volts, 50-60 cycle AC. Shpg. wt., 12 $\frac{1}{2}$ lbs.

83 YX 754. NET. 39.95

The Knight-Kit 25-Watt Amplifier and Preamp Kits are Featured in an Allied Hi-Fi System—See Page 13 **215**

TOP VALUES IN CUSTOM QUALITY knight-kit HI-FI AMPLIFIERS



KNIGHT-KIT 20-Watt Hi-Fi Amplifier Kit

NET
\$35⁷⁵

- Chrome and Black Styling
- Response, ± 1 db, 20-20,000 cps
- Distortion, 1% at 20 Watts
- With Built-In Preamp

This easy-to-build, versatile amplifier is an excellent foundation unit for starting a top-performing hi-fi system. Extremely wide response and very high power capacity guarantee brilliant reproduction.

Frequency Response: ± 1 db, 20 to 20,000 cps at 20 watts. *Rated Output:* 20 watts. *Distortion:* 1% at 20 watts. *Hum and Noise Level:* Tuner input, 90 db below 20 watts; Phono input 72 db below 20 watts. *4 Inputs:* Magnetic phono, microphone, crystal phono or recorder, and tuner. *Sensitivity:* Tuner input, 0.6 volt for 20 watts output; Magnetic Phono, .007 v. for 20 watts output. *Output Impedances:* 4, 8, 16 and 500 ohms. *Controls:* Bass, On-Off-Treble, Volume, Selector. *Tubes:* 1—12AX7, 2—12AU7, 2—6L6G; 5V4G rectifier. Record compensation positions for 78 rpm and micro-groove records. Smart chrome and black styling. *Size:* 7x13x8 $\frac{3}{4}$ ". With all parts, tubes, wire, solder, and deluxe chrome-plated chassis. Less enclosure (below). For 110-120 v., 50-60 cycle AC. Wt., 23 lbs.

83 YZ 750. NET. 35.75

CHROME-PLATED METAL CONTROL PANEL. For installing above in cabinet. Shpg. wt. 6 oz.

83 Y 752. NET. 1.40

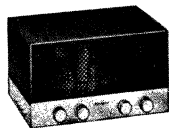

METAL ENCLOSURE FOR ABOVE. Black finish contrasts beautifully with chrome chassis of amplifier. Size, enclosure plus amplifier, 7 $\frac{1}{2}$ x13x8 $\frac{3}{4}$ ". Shpg. wt., 3 lbs.

83 YX 758. NET. 4.15



DELUXE
CHROME-
PLATED
CHASSIS

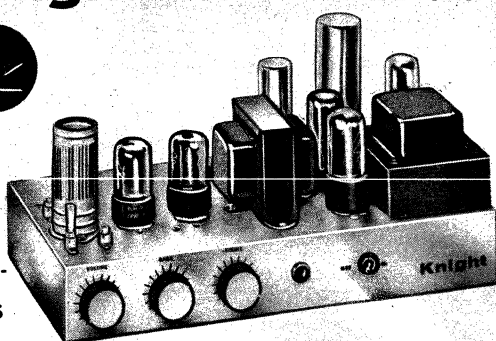

KNIGHT-KIT 10-Watt Hi-Fi Amplifier Kit

NET
\$23⁵⁰

- Ideal for Low-Cost Home Music Systems
- Response, ± 1 db, 30-20,000 cps
- Separate Bass and Treble Tone Controls
- Fine Fidelity, Very Low Distortion

The Knight-Kit 10-watt high-fidelity amplifier kit provides wide response and smooth reproduction at exceptionally low cost. Construction is greatly simplified by an easy-to-follow manual, complete with schematic diagrams and clear illustrations—anyone can easily assemble this fine amplifier.

Frequency Response: ± 1 db, 30-20,000 cps at 10 watts. *Harmonic Distortion:* Less than 0.5% at 10 watts. *Inter-modulation Distortion:* Less than 1.5% at 10 watts output. *Controls:* Volume, Bass, Treble, and Off-On. With input for crystal phono or tuner. Chassis is punched for preamp kit below (for use with magnetic cartridges). Matches 8 ohm speakers. *Tubes:* 2—6SN7GT, 2—6V6GT, 5Y3GT rectifier. Kit is complete with tubes, all parts, wire, solder, and chrome-plated chassis. Less only preamp parts and black finished enclosure (below). *Size:* 7x13x6" deep. For operation from 110-120 v., 50-60 cycle AC. Shpg. wt., 14 lbs.

83 YX 753. Net. 23.50

EQUALIZED PREAMP KIT. For use with above. Includes 6SL7 tube and all parts (no chassis; wired into amplifier chassis). Shpg. wt., 1 lb.

83 Y 235. NET. 3.10

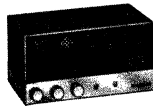

METAL ENCLOSURE FOR ABOVE. Attractive black finish contrasts with the chrome chassis of amplifier. Size, enclosure plus amplifier, 7 $\frac{1}{2}$ x13x6". Shpg. wt., 3 lbs.

83 YX 757. NET. 3.95

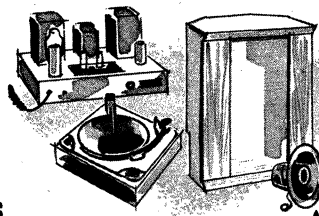
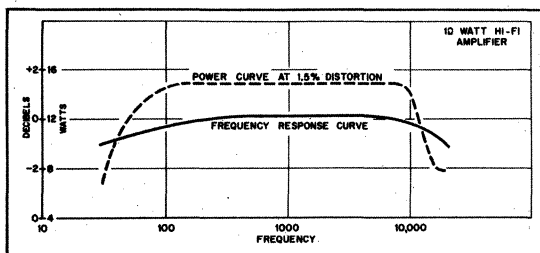
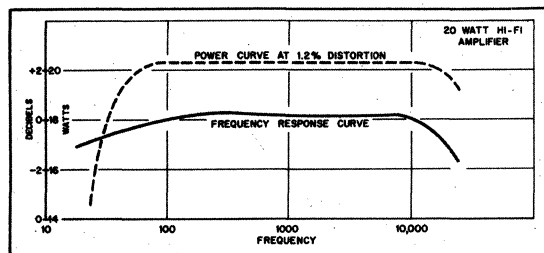

CHOOSE FROM OUR NEW SELECTION OF KNIGHT-KIT HI-FI SYSTEMS

Be sure to see pages 12 and 13 for a selection of complete high-fidelity systems featuring Knight-Kit components. Each system brings you genuine hi-fi at unsurpassed savings: You save because the cost of these systems is far less than the total cost of components purchased separately—and you save by doing the easy assembly yourself. No previous experience is necessary when you build Knight-Kit hi-fi components.

Allied is Headquarters for High-Fidelity Equipment

SAVE MONEY! BUILD YOUR OWN **knight-kit** SPEAKER SYSTEM

EASY TO ASSEMBLE. No experience is required to assemble Knight-Kit speaker system kits. Illustrated, clearly written instructions make assembly a marvel of simplicity. Build any system in minimum time—you'll be proud of the results.

COMPLETE. You'll find everything you need in a Knight-Kit speaker system kit—highest-quality speakers, pre-finished cabinetry work, all hardware, acoustic material and easy-to-follow instructions. There's nothing else to buy.



12" WOOFER

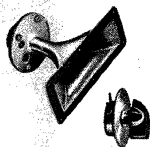

TWEETER WITH CONTROL

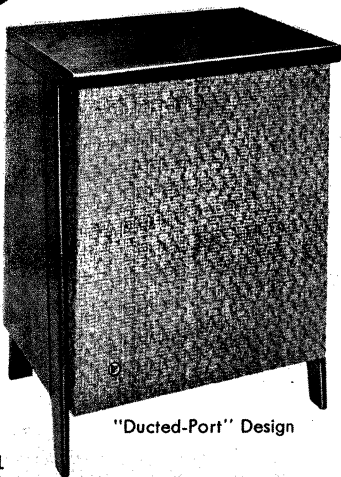

"Ducted-Port" Design

CORNER FOLDED-HORN

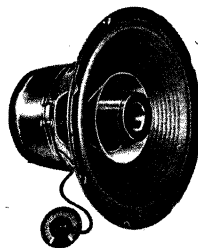

Knight 3-WAY SPEAKER

- Woofer
- Mid-Range Cone
- Tweeter

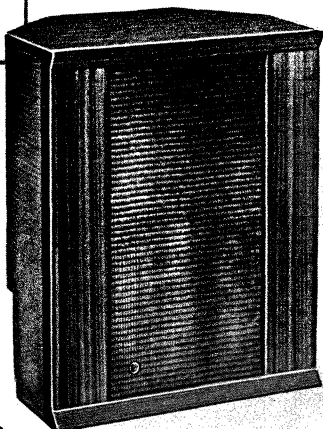

Easy Assembly—With Just a Screwdriver.

KNIGHT-KIT Economy 2-Way Speaker System

NET
\$49⁹⁵

- Response, 45-14,000 cps
- 12" Woofer
- Horn-Type Tweeter
- Only 7 Pieces to Assemble

Introducing the new Knight-Kit 2-way speaker system kit—pre-finished, and complete with Jensen 12" woofer and Jensen compression-type tweeter—at remarkably low cost. Absolutely no furniture finishing is required—all parts have been pre-finished by expert cabinet craftsmen in full-grained, high-luster blonde or mahogany. You do the easy part—just assemble only 7 pieces, mount the speaker components, and enjoy rich, thrilling sound! Special, Jensen-engineered baffle features "ducted-port" construction to bring out the full beauty of bass notes. A genuine L-pad tweeter control permits easy adjustment of tweeter for best tonal balance. The assembled unit offers a frequency response of 45 to 14,000 cps. Grille-cloth has neutral-tan background with gold-metallic threading—and comes pre-fitted on the front panel! Beautifully styled to complement the decor of any home. Includes high-quality Jensen 12" woofer, Jensen compression-type tweeter, pre-finished wood parts (with grille-cloth installed), acoustic material, glue, hardware and step-by-step instructions. 26x19x14". *Specify blonde or mahogany when ordering.* Shpg. wt., 33 lbs.

83 YZ 789. NET.....49.95

KNIGHT-KIT Deluxe 3-Way Speaker System

NET
\$89⁵⁰

- You Save \$9.50
- Famous Knight 3-Way Speaker
- Knight "Quik-Craft" Corner Enclosure
- Choice of 3 Finishes

An outstanding value in a deluxe, 3-way high-fidelity speaker system—the new Knight "Quik-Craft" KN-1300 corner folded-horn enclosure kit and high-quality Knight 12" 3-way speaker. Assembling the enclosure is simplicity itself—all you need is a screwdriver; there's no gluing, sanding, drilling or sawing! There's no finishing to do, either—all exposed surfaces are finished in hand-rubbed Korina blonde, mahogany or walnut. The speaker is of the new 3-way type—it has a 12" cone for bass, a specially designed conical radiator for mid-frequencies and a built-in compression-type tweeter (with wired level control and calibrated dial) for highest frequencies. The woofer magnet weighs a full 1 3/4 pounds for solid bass response. Unexcelled efficiency of the enclosure and superb performance of the speaker combine to cover the whole spectrum of audible sound—from 35 to 15,000 cps, ±5 db; and you save \$9.50 on the regular price of the two units! Includes 3-way speaker, pre-finished panels, grille cloth, hardware, accessories and instructions. 32x21x14 1/2". *Specify Korina blonde, mahogany or walnut when ordering.* Shpg. wt., 44 lbs.

91 DZ 937C. NET.....89.50

SEE OUR WIDE SELECTION OF FAMOUS-NAME HI-FI COMPONENTS

In addition to kits, Allied also offers you the world's largest selection of factory-built hi-fi components, including speakers and enclosures, changers, record players and recorders. Make it a must to study pages 26 through 96—you'll find an outstanding array of expertly selected, top-performing units. Allied's staff of audio specialists will be glad to help you select the components which best suit your individual needs.

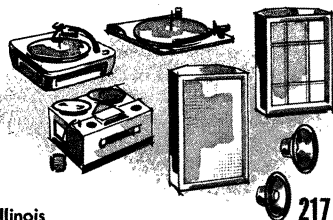



NEWEST knight[®]-kits FOR HOBBYISTS

Always the first choice of hobbyists and experimenters, new *transistor* Knight-Kits are now more popular than ever before. Fun to build and enjoyable to use, the latest electronic advances are always incorporated into Knight-Kit circuitry and design.

Ease of construction is a hallmark of Knight-Kits. You need only a screwdriver, soldering iron and pliers. No special tools or skills are required. Parts fit together with ease, and detailed instructions are marvelously clear—you can't go wrong!

EASY-TO-BUILD, TRANSISTORIZED POCKET RADIO

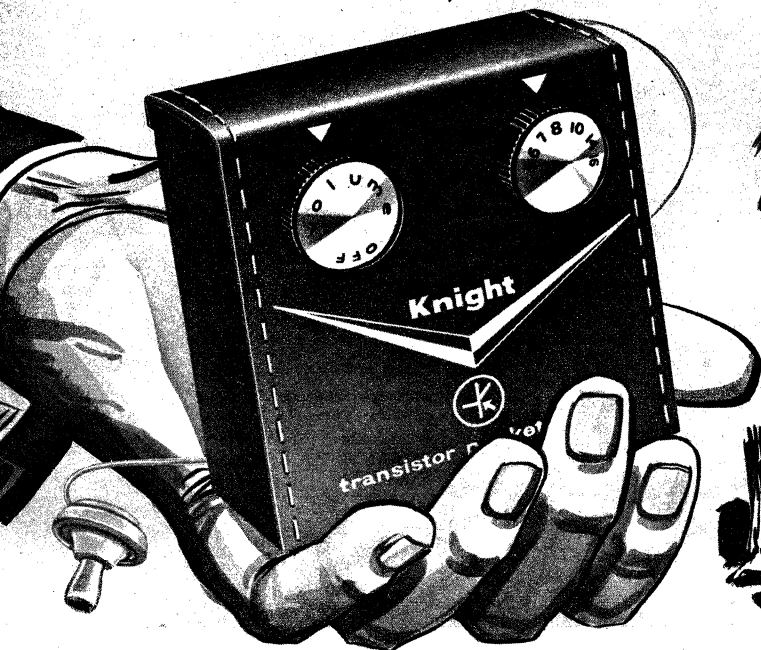

COMPLETE WITH BUILT-IN EARPHONE, ANTENNA AND CASE



A MARVEL OF COMPACTNESS

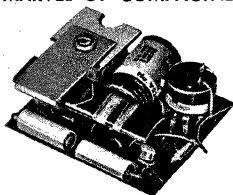

CHASSIS VIEW

KNIGHT-KIT 2-Transistor Pocket Radio Kit

ONLY

\$14⁶⁵

- Receives Local Stations Loud and Clear
- Employs Newest Printed Circuit Board
- Operates from Built-In Loop Antenna
- Plays for Months from Single Battery

You'll be delighted with the performance of this outstanding pocket radio! The miniature dynamic earphone, patterned after professional hearing-aid types, provides exceptionally good tonal quality. The two low-drain transistors will enable you to operate it for months and months from its long-life, alkaline-cell battery.

You'll enjoy building this extremely efficient, 2-transistor pocket radio—and your enjoyment will be doubled when you start listening to its crystal-clear, local broadcast reception wherever you go. Compact and portable, it fits easily into your pocket and button-down flap allows it to be suspended from your belt. Only 4" high, 3³/₄" wide, and 1³/₄" deep! You'll find hundreds of uses for this precisely designed, low-cost pocket radio—perfect for baseball and football games, picnics, hikes and many other outdoor activities, as well as private listening indoors.

Employs an extremely efficient, reflex-type, 2-transistor circuit that actually does the work of 3 transistors! It's complete with everything you need—there's nothing else to buy. Works from a built-in, high-gain ferrite core antenna—no external antenna is needed to pick up local stations! You'll get months and months of service from the new-type alkaline battery, since transistors require an incredibly small amount of power.

Other important features of the pocket radio include the use of an air-dielectric, variable capacitor for smooth, accurate tuning. The printed circuit board, with all critical wiring already completed, simplifies assembly, reduces building time, and almost completely eliminates chance of wiring error. Everything you need, down to the finest detail, is supplied. "Step-and-Chek" instructions are marvelously clear and won't let you go wrong. Even with no previous building experience, the entire radio can be assembled in just one evening—it's ready for use the instant you finish!

Only two controls: On-Off-Volume and Tuning. Carrying weight is only 11 ounces! Handsome tan carrying case is plastic-impregnated and styled to resemble leather. Size, 4" high, 3³/₄" wide, 1³/₄" deep. Kit includes two transistors, carrying case, earphone with 3-ft. cord, battery, wire, solder, all parts, and easy-to-follow instructions. Shpg. wt. 1¹/₂ lbs.

83 Y 262. NET. 14.65

NEW

TRANSISTORIZED PORTABLE SUPERHET RECEIVER

Easiest-to-Build for Thrilling Radio Reception Anywhere

Knight-Kit's newest portable superhet receiver! Up-to-the-minute circuitry employs 5 transistors and push-pull audio output stage for excellent reception of broadcast stations, and remarkably clear tonal quality. Printed circuit for easy assembly. It's a top value!

Highly attractive and compact carrying case, made of durable, impact-resistant extruded plastic, is color-styled in eye-pleasing ivory and gold. Gold finished end plate has convenient, pull-out carrying handle. Plastic tuning dial has gold insert. Plastic tuning dial has gold insert.

CLASS B PUSH-PULL AUDIO OUTPUT STAGE AND BIG 3 1/2" SPEAKER

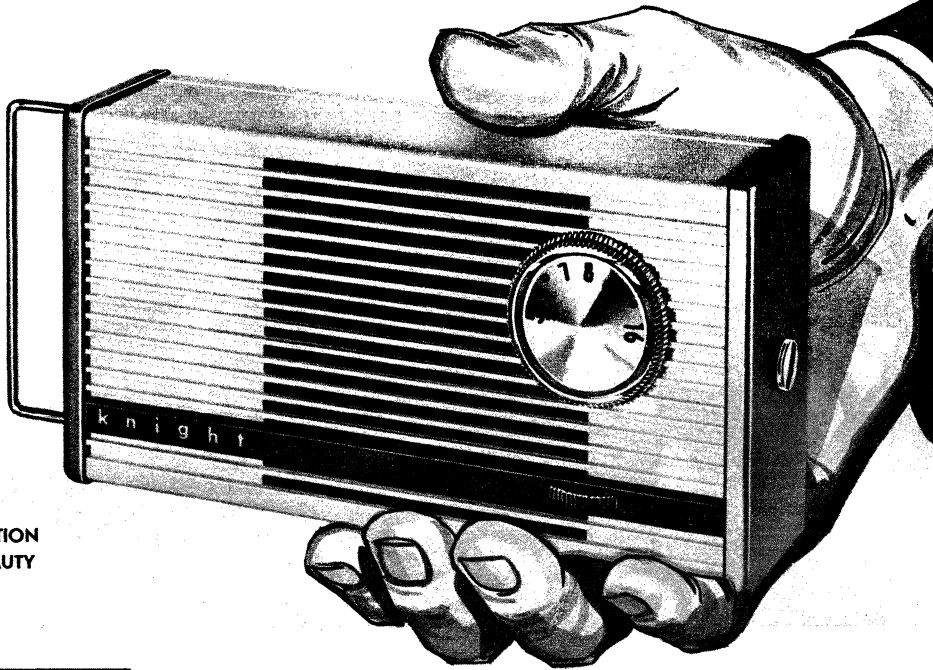

QUALITY REPRODUCTION
WITH STRIKING BEAUTY

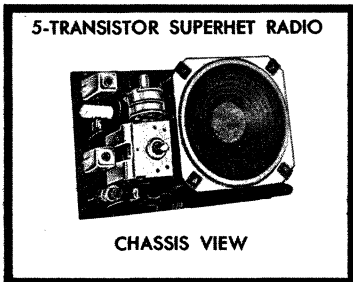

5-TRANSISTOR SUPERHET RADIO

CHASSIS VIEW

New KNIGHT-KIT 5-Transistor Superhet Radio Kit

ONLY
\$29⁹⁵

- Extra-Sensitive, 5-Transistor Superhet
- Uses Texas Instrument Co. Transistors
- Printed Circuit for Easy Building
- Average Battery Playing Life, 200 Hours

Excellent design and efficient circuitry are combined in this handsome, new portable radio kit. Ultra-simple chassis layout, plus use of printed circuit board, provide the utmost in accessibility to all parts and battery—and make assembly unusually easy for almost anyone. No technical skill is required—you can build it in one evening!

A convincing example of elegant, functional styling and precise design, the new Knight-Kit 5-Transistor Superhet Radio Kit easily ranks with the best of battery-operated portable radios. Among its many excellent features, you'll find: *A big 3 1/2" speaker*, larger than is ordinarily used in portable radios of this type; *premium-quality transistors and component parts*, your assurance of a finished radio kit equivalent in performance to more expensive, pre-wired units; *Class B push-pull audio output stage*, for clear voice and music reproduction and extremely low battery drain; *built-in, high-gain ferrite loopstick antenna*, for top-notch broadcast reception; *phone jack output*, for private listening if desired.

In a matter of hours, and using only the simplest of tools, you can build yourself a smooth-operating, professionally styled portable radio that will give you *up to 200 hours of playing time*, from just a single, 9-volt battery, which is also included!

The orderly layout of parts, as well as the trim styling of the carrying case, reflects the painstaking care that has gone into the design of the Knight-Kit 5-transistor portable superhet radio. Its smart appearance and highly dependable operation, will make you proud to own it, and equally proud to have built it yourself. Carrying weight of the finished kit is only 22 ounces, and its pull-out, end-handle will enable you to carry it comfortably anywhere.

The printed circuit board simplifies and speeds building, and eliminates chance of wiring error. Two controls: Off-On-Volume and Tuning. Volume control is a handy, recessed thumbwheel. Handsome ivory and gold styling is accented by the use of ebony black panel trim. Size: 3 3/4" high, 7 1/2" wide, 1 3/4" deep. With all parts, wire, solder, battery and instructions. 2 lbs.

- 83 Y 766. NET. 29.95
- EARPHONE FOR ABOVE. For private listening. 5 oz.
- 59 J 147. NET. 3.17

EXCITING NEW TRANSISTORIZED knight-kits

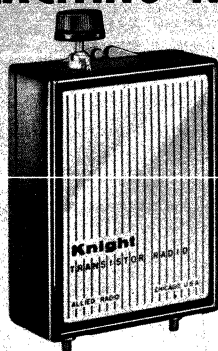

NEW

WITH PLASTIC CASE

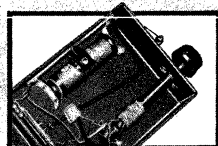

FASCINATING HOBBY KIT

- Uses High-Efficiency Transistor
- Exceptionally Sensitive Reception
- Operates From Single Penlight Cell
- Has High-Impact Plastic Case
- Operates Indoors or Outdoors

HEADPHONES AND ANTENNA KIT



Headphones and complete antenna kit are available as accessory items for Knight-Kit transistor radios and crystal set. Antenna kit includes 50 feet of copper wire, 25 feet of lead-in, insulators, lead-in strip, and ground clamp.

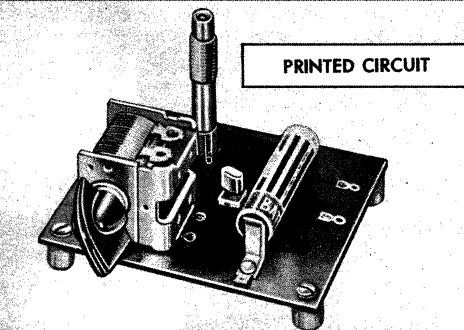

PRINTED CIRCUIT

KNIGHT-KIT Printed-Circuit Transistor Radio Kit

NET

\$3⁹⁵

- Outstanding Kit Value
- Printed Circuit Mounting Board
- High-Efficiency Transistor
- Operates on Single Penlight Cell

An amazing radio—small enough to fit into the palm of your hand—and it operates for months and months on just one penlight battery! This popular kit introduces you to the latest marvels of electronics—the transistor and the printed circuit—and delivers excellent headphone reception on the entire AM band. The transistor is highly efficient—uses remarkably little current—lasts indefinitely—and is extremely small in size. The printed circuit eliminates wiring—makes assembly the last word in simplicity. Kit includes specially designed coil for exceptionally good sensitivity and selectivity. A ball bearing variable capacitor assures smooth, effortless tuning. With all parts, transistor, battery, solder, etc. Less headphones (4000 ohms or more) and antenna, above right. Size, $3\frac{1}{2} \times 3\frac{3}{8} \times 3"$. Shpg. wt., 1 lb.

83 Y 765. NET. 3.95

KNIGHT-KIT "Trans-Midge" 1-Transistor Radio Kit

NET

\$2⁴⁵

Here's a tiny, 1-transistor radio kit that's just slightly larger than a pack of cigarettes! Designed to provide a fascinating, fun-filled evening for both experienced and beginning kit builders.

You'll be amazed at how easily it goes together and you'll enjoy its exceptionally fine performance. Small enough to fit easily into the palm of your hand, this efficient radio will give clear reception throughout the standard AM broadcast band. Using a high-efficiency transistor, the "Trans-Midge" has excellent selectivity and displays remarkable sensitivity—pulls in stations loud and clear. Requires external antenna.

Features of this expertly engineered little radio include: Efficient, slug-tuned coil for high sensitivity and excellent separation of stations; external knob to permit tuning in stations without opening the case; low-drain transistor which operates for months and months on the single penlight cell supplied; durable, positive-locking, red plastic case. Highest-quality parts are used.

Supplied complete with plastic case, all parts, transistor, wire, solder, battery and step-by-step instructions. Less headphones and antenna kit (see below). Size, $3\frac{3}{8} \times 2\frac{3}{8} \times 1\frac{1}{8}"$. Shpg. wt., 8 oz.

83 Y 767. NET. 2.45

59 J 149. 4000-Ohm Headphones. $1\frac{1}{4}$ lbs. NET. 2.15

83 C 100. Antenna Kit. $1\frac{1}{2}$ lbs. NET. 1.03

Popular KNIGHT-KIT Crystal Set Kit

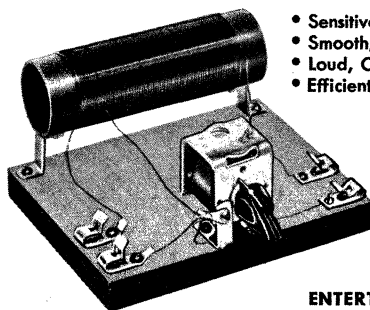

- Sensitive Crystal Diode
- Smooth, Easy Tuning
- Loud, Clear Reception
- Efficient "Hi-Q" Coil

ENTERTAINING EDUCATIONAL

NET

\$2¹⁵

This famous, feature-packed Knight-Kit crystal set kit is acclaimed everywhere for its outstanding performance and remarkably low cost. Delivers

loud, clear reception of local broadcast stations. Circuit employs a fixed-type germanium crystal diode detector of the type used in high frequency detecting equipment. Crystal is preset and does not require adjustment. Kit includes coil form and wire for winding efficient "Hi-Q" coil. Complete with all parts, detailed instructions, wire, solder and baseboard. Less headphones and antenna kit. Shpg. wt., 1 lb.

83 Y 261. NET. 2.15

59 J 110. 2000-Ohm Headphones. $1\frac{1}{4}$ lbs. NET. 2.00

83 C 100. Antenna Kit. $1\frac{1}{2}$ lbs. NET. 1.03

HAVE FUN WITH FASCINATING, INSTRUCTIVE KNIGHT-KIT HOBBY KITS

Fun to build and enjoyable to use! That's why Knight-Kits are the first choice of hobbyists and experimenters. You learn more with Knight-Kits because the latest advances in electronics are always incorporated in every circuit.

With Knight-Kits you're always assured of outstanding performance and top value. Construction is simplicity itself—no special equipment or tools are required. Parts fit together easily, and detailed instructions are marvelously clear.



ENTIRE BOARD IS A
PRINTED CIRCUIT

AN ELECTRONIC MARVEL!

knight-kit 10-CIRCUIT TRANSISTOR LAB KIT

... you go from one exciting project to another... each circuit has a practical use... each circuit helps teach you how transistors work...

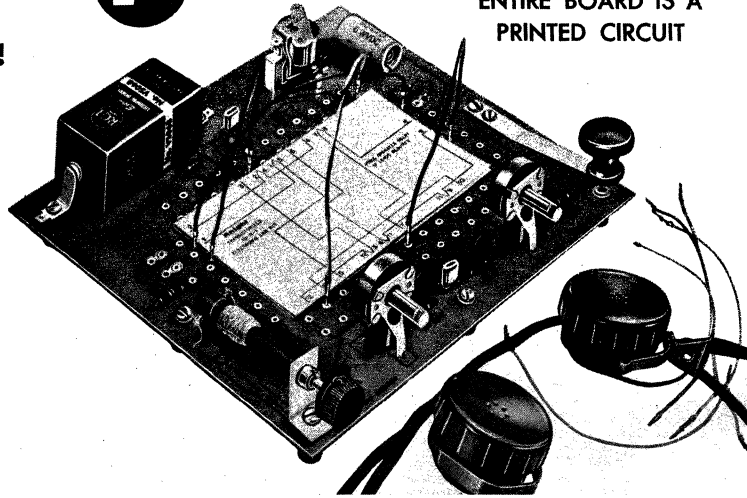

IT'S EASY TO ASSEMBLE

SOLDER THE BASIC PARTS IN PLACE... THEN CHANGE FROM ONE CIRCUIT TO ANOTHER BY MERELY PLUGGING IN THE PROPER LEADS.

BUILD ANY ONE OF THESE WONDERFUL PROJECTS:

- 2-Stage AM Radio
- Photoelectric Relay
- Wireless Broadcaster
- Code Practice Oscillator
- Electronic Switch
- 2-Stage Audio Amplifier
- Capacity-Operated Relay
- Electronic Timer
- Voice-Operated Relay
- Electronic Flasher

The KNIGHT-KIT 10-Circuit transistor lab kit is an ideal supplement to school electronic courses.

Remarkable Transistor Lab Value For Hobbyists

NET
\$15⁷⁵

Amazing, versatile Knight-Kit 10-Circuit Transistorized Electronic Lab—one of the most rewarding kits ever designed. It's unexcelled in simplicity of construction—truly a marvel of ingenious kit design! One side of the printed circuit board is screen-printed to indicate where all components go—after you solder these basic parts in place, you change from one circuit to the next by merely inserting "plug-in" leads into the proper jacks on the board—no additional soldering! Jacks are already mounted and "plug-in" leads of uniform length already have plugs permanently fastened on the ends. You learn how transistors operate by "plugging in" any one of 10 circuits that really work! An AM radio that gives loud, clear headphone reception—a wireless broadcaster that lets you "broadcast" to any nearby radio—a versatile electronic switch of many uses—a capacity-operated relay that may be used as a burglar alarm, etc.

This top-value kit is supplied complete—you get dual headphones (also serve as mike), "plug-in" circuit leads, guide cards, two transistors, solder, relay and photocell—everything you need, with nothing else to buy! You'll be delighted with the big, easy-to-understand instruction manual that comes with this kit. It tells you exactly what to do to complete initial wiring—then gives you an understanding of transistors by explaining just how each of the 10 circuits works. The perfect kit for the beginner—student—hobbyist—or experimenter. Uses for the circuits in the Transistorized Electronic Lab are limited only by the imagination! Battery-powered. With battery and solder. Shpg. wt., 3 lbs.

83 Y 299. NET.....15.75

SPECIAL GUIDE CARDS FOR EACH EXPERIMENT

Simply place these guide cards on the board, and plug in the circuit leads where indicated to get a working circuit! Holes for "plug-in" leads are number-coded—it's easy—it's fun—it's practical!

EACH CIRCUIT IS CLEARLY EXPLAINED

Written in easy-to-follow terms, the instruction manual not only tells you exactly what to do to build the basic chassis, but also fully explains the operation of the transistors in each circuit.

Allied is Headquarters for Builders and Experimenters

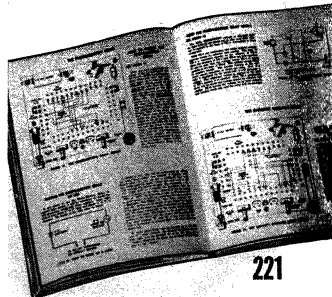
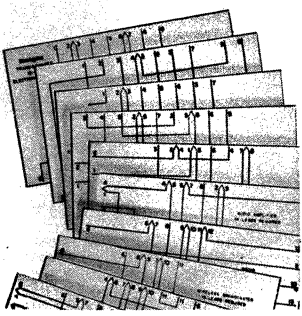

HIGH-PERFORMANCE knight-kit RADIO RECEIVER KITS



YOU'LL BE PROUD OF THE SET YOU BUILD

Using your radio is twice as much fun when you've built it yourself; and famous Knight-Kit illustrated instructions make it easy! Everything is clearly explained.



LISTEN TO SHORT-WAVE!

Listening to short-wave stations from all parts of the world is fun! You'll hear foreign broadcasts, amateurs all over the world, ships at sea, police, aircraft, etc.

EXCITING 2-BAND RECEIVER KIT



ALL-WAVE RADIO RECEPTION

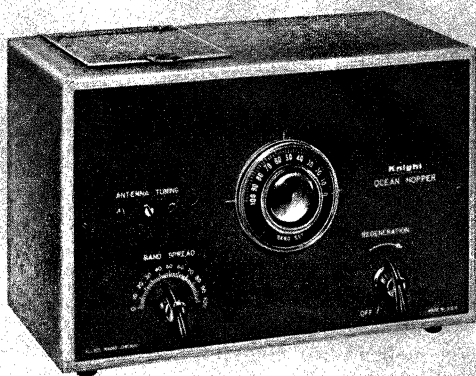

KNIGHT-KIT "Space Spanner" Receiver Kit THRILLING WORLD-WIDE 2-BAND RECEPTION

NET
\$15⁹⁵

- Sensitive Regenerative Circuit
- Broadcast and Short-Wave Reception
- Bandswitching From Front Panel
- Built-In PM Speaker

Imagine the thrill of hearing broadcasts from overseas on a precision short-wave receiver you've built yourself! Then, just flip a switch to tune in the ball game on your favorite local broadcast station! The sensitive "Space Spanner" circuit—acclaimed by thousands of enthusiastic owners—tunes short-wave from 6.5 to 17 megacycles, bringing you the 40 and 20 meter Amateur bands, International bands, plus maritime, police and aircraft communications and the National Bureau of Standards transmissions. Standard broadcast coverage is complete, from 540 to 1700 kilocycles. Building the "Space Spanner" is an ideal way to learn about radio—and an economical way to own a fine receiver.

You'll enjoy working from the clear, detailed instructions supplied with your "Space Spanner"; big pictures show you where to put every part, and there's even an 8-page section that explains the principles of radio, and shows how to get the most from your "Space Spanner". The radio itself is loaded with features: headphone connectors, speaker cut-out switch, 50C5 beam power output stage, 4" PM speaker, and 6 controls (Bandspread, Main Tuning, Antenna Trimmer, Bandswitch, Regeneration and Volume). Less cabinet (below). With wire, solder, etc. Size, 7x10½x6". For 110-120 v., 50-60 cycle AC or DC. 4½ lbs. 83 Y 243. NET.....15.95

CABINET FOR "SPACE SPANNER". Smart-looking gray cabinet with durable pyroxylin covering. Shpg. wt., 2lbs. 83 Y 247. NET.....2.90

ANTENNA KIT. For use with "Space Spanner" and "Ocean Hopper" receivers. 50' antenna wire, 25' lead-in, insulators, etc. Shpg. wt., 1½ lbs. 83 C 100. NET.....1.03

KNIGHT-KIT "Ocean Hopper" Receiver Kit BROADCAST, LONG-WAVE AND SHORT-WAVE COVERAGE

NET
\$11⁹⁵

- Full Frequency Coverage
- Simple, Sensitive Circuit
- Easy to Assemble
- Convenient Bandspread

Easy to build and fun to use, this top performing regenerative receiver is truly worthy of its name! It puts a world of listening pleasure at your fingertips—literally hopping oceans to bring in crisp, clear reception from all corners of the earth. The exceptionally wide tuning range of the "Ocean Hopper", using the coils listed below, covers from 155 kilocycles to 35 megacycles, including virtually every type of radio transmission: marine, aircraft, distress call channels, standard broadcast, direction finding, Amateur, frequency standard, International broadcast, police and fire departments, etc. A large main tuning knob and electrical bandspread help to make tuning simple and precise.

Front panel controls include Main Tuning, Bandspread, Antenna Trimmer and Off-On/Regeneration. Tubes are a 12AT6 detector and 50C5 audio output stage; 35W4 rectifier. Kit is supplied with coil to cover standard broadcast band, wire, solder, and easy-to-follow, step-by-step instructions. Less extra coils (below), headphones, speaker, and cabinet. Size, 6x9½x5". For 110-120 v., 50-60 cycle AC, or DC. Shpg. wt., 5 lbs. 83 Y 740. NET.....11.95

CABINET FOR "OCEAN HOPPER". Shpg. wt., 1½ lbs. 83 Y 746. NET.....2.90
PLUG-IN COILS. Shpg. wt., each, 2 oz.
 83 Y 741. Long Wave. 155-470 kc. NET.....79c
 83 Y 742. Short Wave. 1.65-4.1 mc }
 83 Y 743. Short Wave. 2.9-7.3 mc. } NET
 83 Y 745. Short Wave. 7-17.5 mc. } EACH.....65c
 83 Y 744. Short Wave. 15.5-35 mc. }

HEADSET. High-quality 2000-ohm dual headset, for "Ocean Hopper" or "Space Spanner". Inside terminals; with 4½-ft. cord. Shpg. wt., 12 oz. 59 J 110. NET.....2.00

IT'S FUN TO DO!



You'll point with pride to this smart-looking, high-performance table model radio when you've built it! It's so easy, anyone can do it—and it's fun!

BUILD A BROADCAST BAND SUPERHET



KNIGHT-KIT "Ranger II" AC-DC Radio Kit TOP-PERFORMING BROADCAST BAND RECEIVER

NET
\$1725

- Highly Efficient Superhet Circuit
- Rich Tonal Quality
- Smart, Modern Plastic Cabinet
- Crystal-Clear Instructions

Here's a remarkably fine table radio in kit form. High-quality parts and expert circuit design give outstanding superhet performance on the broadcast band.

Can be assembled with no previous radio experience. The clear, step-by-step instructions and giant-sized diagrams make construction easy and fun. An excellent aid to understanding radio. No special tools or instruments required. The entire job can be done with a soldering iron, screwdriver, and pliers. Construction of this quality radio will reward the builder with years of dependable service—and the pride that comes from building a working radio receiver himself.

Covers 540 to 1680 kc for reception of the entire broadcast band and exciting police calls. Fine quality Alnico V speaker and acoustically designed cabinet for clear, full tone. Sensitive superheterodyne circuit includes automatic volume control to reduce blasting and fading. Cadmium-plated steel chassis. Ball bearing tuning condenser for smooth operation. Smart brown plastic case, with handsome gold mesh grille insert.

Tubes: 12SA7GT—mixer; 12SK7GT—IF amplifier; 12SQ7GT—detector-AVC-audio; 50L6GT—audio output. Rectifier is a 35Z5GT. Efficient loop antenna for maximum sensitivity. With wire and solder, tubes, cabinet, speaker, all parts, and hardware. Size 6" high, 9" wide and 5" deep. For operation from 110-120 volts. 50-60 cycle AC or DC. Shpg. wt. 8 lbs.
83 Y 735. NET..... 17.25

AN IDEAL KIT FOR SCHOOL USE

Students develop a keen interest and learn more about electronics when they have the opportunity to build a working radio themselves! Schools are invited to inquire about quantity purchase prices for the easy-to-build "Ranger II" and other kits.

NEW knight-kit PHOTOELECTRONIC RELAY SYSTEM

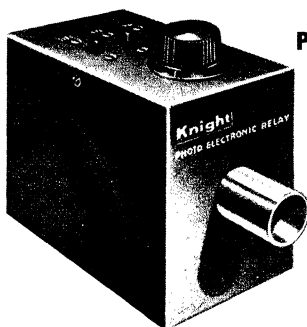

Photoelectronic Relay Unit

A versatile, light-controlled switching device of many uses.



Interruption of light striking the relay unit can be used as a burglar alarm, to sound chime, turn on lights, etc.

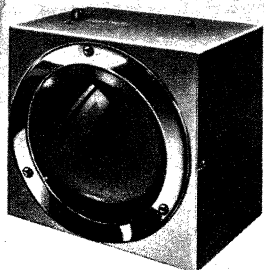

Light Source with Deep Red Filter

Low-Cost Photoelectronic Relay System

NET
\$1350

Now you can build your own ultra-sensitive photoelectronic relay at very low cost. It's fun to build—and you'll find dozens of uses for it in automatic control of lights, door openers, burglar alarms, counting devices, etc. Ideal for turning on house or store lighting each evening at dusk. Employs new, highly sensitive cadmium-selenide photocell in a thyatron circuit that permits operation up to 250 ft. from Knight-Kit light source, below. Selectable operation: "Trip" for burglar alarm—provides continuous ringing of alarm even though intruder steps out of beam; and "Auto" if relay is to operate each time beam is broken—for chimes, counting devices, turning on lights, etc. Supplies 6.3 v. AC at 0.6 amps for alarm, counter, etc. With wire, solder, and all parts. Size, 5x3x5". For 105-120 v., 50-60 cycle AC. Shpg. wt., 2½ lbs.
83 Y 702. NET..... 13.50

LIGHT SOURCE KIT ONLY. With bulb and dark red filter. Size, 6x6x4". For 110-120 v., 50-60 cycle AC. Shpg. wt., 3½ lbs.
83 Y 703. NET..... 6.75

CHIME. For use with above relay. 2 lbs.
77 P 035. NET..... 2.58

Easy-to-Follow Instructions

POPULAR LOW-COST Knight-Kits FOR EXPERIMENTERS

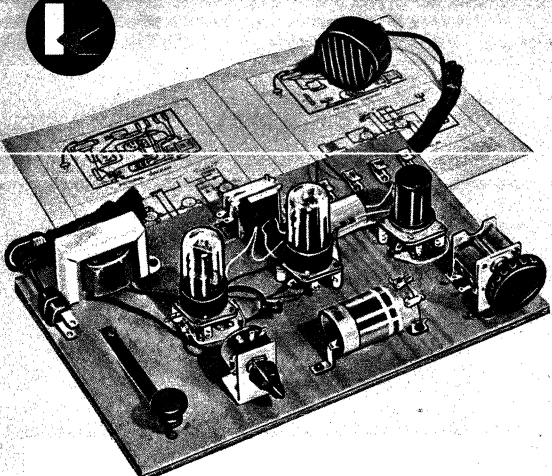

BUILD ANY ONE OF THESE TEN PROJECTS

- Home "Broadcast" Station
- Wireless Phono Oscillator
- Code Practice Oscillator
- Capacity-Operated Relay
- Phono or Mike Amplifier
- Broadcast Receiver
- Photo Relay
- Electronic Switch
- Signal Tracer
- Electronic Timer

BUILD ANY OF THESE FASCINATING PROJECTS

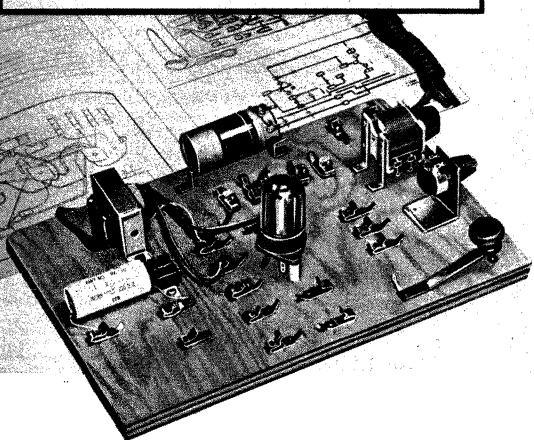
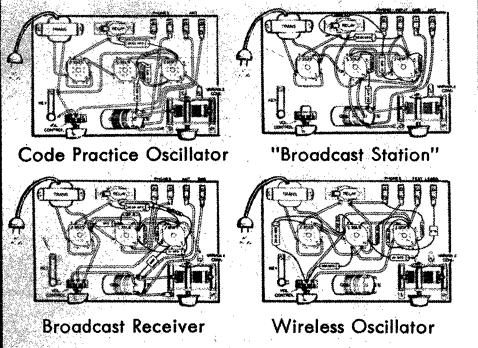

BUILD ANY ONE OF THESE SIX PROJECTS

- Standard Broadcast Receiver
- Wireless "Home Broadcaster"
- Code Practice Broadcaster
- Code Practice Oscillator
- Single Sine Wave Generator
- Signal Tracer

Famous KNIGHT-KIT 10-in-1 Electronic Lab Kit

NET \$12⁶⁵ Have fun—while you learn the basic elements of electronics—by working on the 10 carefully selected circuits in this fascinating and practical kit. With the "10-in-1" you'll be able to quickly and easily build any one of 10 circuits that really work, and then change from one circuit to another whenever you wish. Low-voltages throughout—it's safe to build and operate—and the only tools needed are a soldering iron, screwdriver and pliers.

Build what you want for fun as well as practical applications. The broadcast receiver provides sensitive headphone reception of the AM broadcast band; the "wireless" phono oscillator permits you to play records through your radio from anywhere in the house; the code practice oscillator enables you to "send" code through your headphones or radio; the photo relay operates electrical appliances when actuated by light; the capacity-operated relay is excellent for use as a burglar alarm; the signal tracer is used to service radios by tracing the signal through the circuit, etc.

Complete kit includes: 12SF5, 35L6GT tubes and 35Z5GT rectifier; mike; power transformer; relay; capacitors; resistors; mounting board; hardware; wire and solder; and a 12-page instruction manual. Less headphone, phototube and phototube socket. For 110-120 v., 50-60 cycle AC. Shpg. wt., 5 lbs. 83 Y 265. NET.....12.65

KNIGHT-KIT 6-in-1 Electronic Lab Kit

NET \$8⁴⁵ Here's a smaller version of the famous "10-in-1" radio lab kit, described above. Contains an excellent selection of 6 useful circuits. Valuable as an introduction into the field of electronics. Features special time-saving design for quick, easy change from one circuit to the next. Safety engineered—uses a specially constructed power transformer—no dangerous high voltages. After basic wiring is completed, circuits can be changed without any soldering. Code practice oscillator permits "sending" code through your radio for group code instruction or for practice use with headphone; single sine wave generator (1700 cps) is excellent for checking audio circuits in radios, amplifiers, etc. Includes 6SN7 tube, selenium rectifier, power transformer, all parts, mounting board and complete easy-to-follow instructions. Less headphone (also serves as microphone). For operation from 110-120 v., 50-60 AC. Shpg. wt. 3 lbs. 83 Y 770. NET.....8.45

ACCESSORIES FOR ELECTRONIC LAB KITS

- HEADPHONE.** Single type, 1000-ohm headphone. For use with either kit. Shpg. wt., 8 oz. 59 J 112. NET.....1.08
- ANTENNA KIT.** For use with receiver circuits of either kit. Includes 50-ft. of antenna wire, lead-in, insulators, and hardware. Shpg. wt. 1½ lbs. 83 C 100. NET.....1.03
- PHOTOTUBE.** For use in photo relay circuit of the 10-in-1 lab kit. Shpg. wt., 5 oz. 77 P 003. NET.....2.50
- 4-PRONG TUBE SOCKET.** Bakelite socket for phototube, above. Shpg. wt., 2 oz. 40 H 024. NET.....9c

LOW-COST, EASY-TO-BUILD INTERCOM SYSTEM
For Home, Office or Factory 2-Way Communication

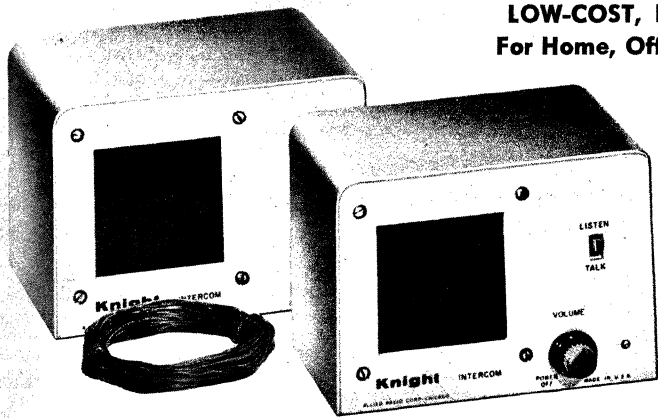

KNIGHT-KIT 2-Way Intercommunication System Kit

NET
\$14⁷⁵

- Low Cost—Easy-to-Assemble
- With 50-ft. Cable
- Handsome Metal Cabinets
- High Gain—Clear Tone

Efficient, versatile 2-station intercom kit consisting of a Master and a Remote unit—at remarkably low cost! Has high gain and plenty of volume—responds to even a whisper—person at remote unit can answer from across the room. Hundreds of uses in the home, office, school, shop, etc. Use it as a step-saving means of communication between house and garage, backyard, attic or basement, “baby sitter” (picks up the slightest sound) for the children’s room, etc. In the office, factory or store, use it for rapid control of operations between widely separated departments. Provides private or non-private operation at the flick of a switch. In non-private position Master can “listen in” on Remote. Master unit has a “press-to-talk” switch; Remote unit has a “talk-listen” switch. Switch on Remote can be left in “talk” position to permit continuous listening-in by Master unit.

Master can communicate with Remote regardless of position of switch on Remote unit and can handle up to three Remote units in parallel. Combination volume control and on-off switch, plus pilot light, on Master.

Only the Master station need be connected to an AC or DC power source; Remote station can therefore be located at any desired spot. Kit has a high-gain, 2-stage amplifier and 4” PM speakers. The audio amplifier uses a 12AV6 voltage amplifier and 50C5 power amplifier; rectifier is a 35W4. In antique white. With parts, tubes, 50-ft. cable, hook-up wire, solder, and easy-to-follow instructions. Size each unit, 4¾x6½x4¾”. For 110-120 v., 50-60 cycle AC, or DC. Shpg. wt., 8 lbs.

- 83 Y 295. NET.....14.75
- EXTRA REMOTE STATION KIT. Less cable. 3 lbs.
- 83 Y 296. NET.....3.75
- EXTRA CABLE. Shpg. wt., 100 ft., 2½ lbs.
- 49 W 604. NET PER FOOT.....3c

KNIGHT-KIT High-Speed Electronic Photoflash Kit

NET
\$28⁵⁰

- 1/700th-of-a-Second Flash
- 50 Watt/Seconds
- Daylight Spectral Quality
- Ideal for Color and B & W

The feature-packed Knight-Kit electronic flash gun kit is perfect for indoor, outdoor, black-and-white, and color photography. Quality-engineered and proven acceptance—provides excellent service and reliable performance for the economy-minded photography enthusiast. The bulb gives over 10,000 flashes at just a fraction of a cent per flash! No more bulky, costly flashbulbs—no more lost shots—no more misfires. Freezes fastest action with 1/700-second flash. Light approaches daylight in spectral quality—permits using daylight-type color film indoors. Film guide number on average black and white film (ASA 80) is 200; for color film (ASA 10) guide number is 45. Output is full 50 watt-seconds.

Features include: Xenon-filled reflector-bulb assembly; self-contained trigger transformer; pre-assembled reflector-bulb socket; and heavy-duty, plastic-impregnated case. Each kit comes complete with universal mounting bracket that fits all cameras, all parts, case, pre-cut wire, solder, and step-by-step instructions with clearly illustrated diagrams. Ideal for use with “X” or “O” shutters only. Requires sync cable (obtainable from any photo supply dealer) and either battery or AC power supply (below). Shpg. wt., 4 lbs.

- 83 Y 244. NET.....28.50
- AC POWER SUPPLY KIT. Shpg. wt., 2 lbs.
- 83 Y 246. NET.....3.75
- BATTERY. Burgess U-200. Shpg. wt., 1 lb.
- 80 J 626. NET.....7.70

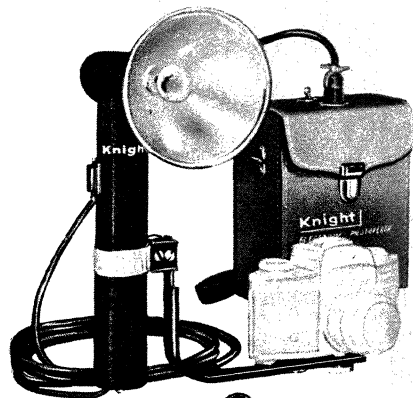

AC Power Supply



A perfect flash each time—no misfires—no lost shots. Economical—a fraction of a cent per flash.

Knight-Kits Have Easy-to-Follow Instructions

LOW-COST knight-kits FOR HOME ENTERTAINMENT

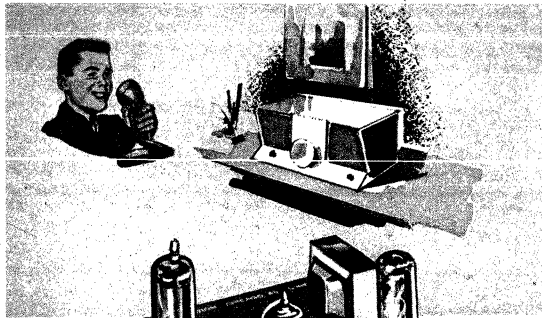

A WORLD OF FUN
Broadcasts Phono
or Mike Through
any AM Radio

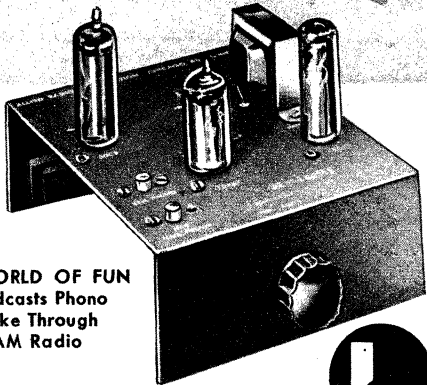

KNIGHT-KIT Wireless Broadcaster Kit

NET
\$950

- Broadcasts Clear Signal
- Use with Phono or Mike
- High Gain Stage with Equalizer
- No Connections to Radio

Set up your own "broadcast" station. Use the Knight-Kit Wireless Broadcaster with mike or phono to make announcements or play music through one or more standard radios in the house—without any need for direct connection to the sets! May be used with crystal cartridge, magnetic cartridge, or mike (crystal or high-impedance dynamic). Has Class A Heising modulator and inverse feedback—puts out a clear, full-toned signal. Volume may be controlled at broadcaster or at any radio picking up its signal. Broadcaster is continuously adjustable from 600 to 1600 kc—can easily be tuned to any clear frequency on your set.

High-gain stage with equalizer permits using magnetic cartridge without external preamp; equalizer may be disconnected for use with mike. Tubes: 12AX7, 2—50C5. With selenium rectifier. Kit is supplied complete with tubes, chassis, all parts, wire, solder and easy-to-follow instructions. Size, $4\frac{1}{2} \times 5 \times 6$ ". For 110-120 volts, 50-60 cycle AC, or DC. Shpg. wt., 3 lbs.

83 Y 705. NET. 9.50

KNIGHT CRYSTAL MIKE. Quality mike for use with above. With 5-ft. cable. Shpg. wt., 1 lb.

99 S 519. NET. 2.95

**BROADCASTS RECORDED
MUSIC THROUGH ANY
RADIO**

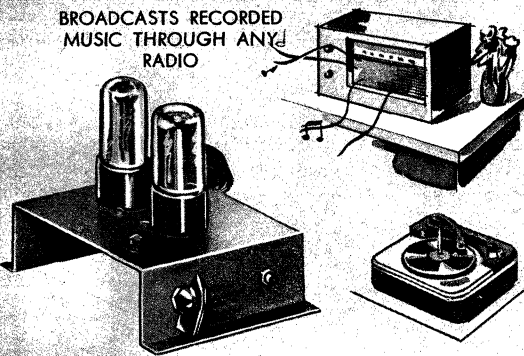

KNIGHT-KIT Phono Oscillator Kit

NET
\$585

- Extremely Low Cost
- "Broadcasts" Up to 50 Feet
- No Connections to Radio
- For Any Crystal Phono

The popular, easy-to-build Knight-Kit economy-model phono oscillator. Use this top-performing kit with any crystal phono for "broadcasting" recorded music to any standard radio set up to 50 feet away. Requires no direct connection to radio set. Compact phono oscillator kit may be easily installed in the phonograph cabinet or mounted behind a wooden panel. Operates on any frequency between 600 and 800 kc. Delivers excellent tonal quality. Has controls for adjustment of modulation level and selection of clear frequency on radio set.

Uses 50L6GT tube as a modulated oscillator and also 35Z5GT rectifier. Kit is supplied complete with all parts, wire, solder, tubes, and easy-to-follow assembly instructions. Instructions include schematic and pictorial diagrams—can quickly and easily be wired from pictorial diagram alone. Size, $4\frac{1}{4} \times 4\frac{1}{4} \times 4\frac{1}{2}$ ". For operation from 110-120 volts, 50-60 cycle AC, or DC. Shpg. wt. 2 lbs.

83 Y 760. NET. 5.85

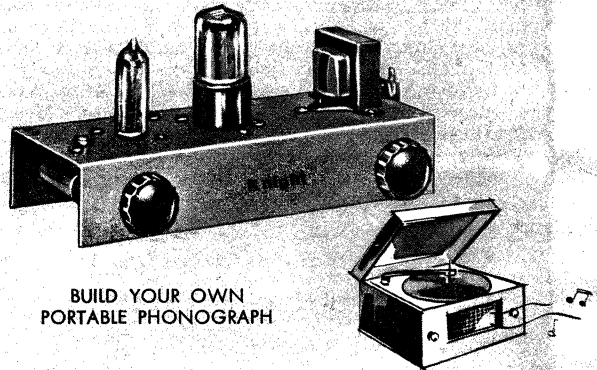

**BUILD YOUR OWN
PORTABLE PHONOGRAPH**

KNIGHT-KIT Low-Cost Phono Amplifier Kit

NET
\$945

- Excellent Tonal Quality
- Compact Size
- Built-In Tone Control
- Ideal for Portable Phonos

Here's a low-cost, unusually compact phono amplifier that delivers excellent tonal quality. Presents unusual specifications in a moderately priced package. Excellent for building a low priced portable phonograph—any record changer and speaker are all that is needed. Compact chassis fits most portable phono cabinets. Works equally well with crystal or ceramic cartridges.

Auxiliary AC socket, controlled by amplifier "Off-On" switch, is provided for connecting record changer. Provides full output with less than .25 volt input—plenty of volume. 8 db of inverse feedback for low distortion and hum levels. Tone control permits adjustment of high frequency response and balance. Matches any 3- to 4-ohm speaker. Tubes: 1—12AU6, 1—50L6. Selenium rectifier. Size: $4\frac{1}{2} \times 7 \times 4$ " deep. Highly attractive blue wrinkle finish. Kit is supplied complete with tubes, all parts, wire, solder, and easy-to-follow instructions. For 110-120 v., 60 cycle AC. Shpg. wt., 3 lbs.

83 Y 790. NET. 9.45

Low-Cost KNIGHT-KIT Battery Charger Kit

NET
\$875

Here's a battery charger kit at unusually low cost. Charges 6-volt storage batteries. Operation of unit is self regulating—charging rate tapers from 4 to 2 amperes. Pilot light indicates correct connection of cables to battery; lights if cables are connected correctly. Transformer is fused for extra protection against line surges. With

all parts, DC leads, battery clips, wire, solder, and instructions. 3 $\frac{3}{8}$ x 6 $\frac{1}{2}$ x 5". For 110-120 v., 60 cycles AC. Shpg. wt., 14 lbs.
83 Y 780. NET..... 8.75

"A" SUPPLY ADAPTER KIT. Filters output of charger to permit use as 6.3-volt, 4-amp DC filament supply, etc. Shpg. wt., 6 oz.
83 Y 782. NET..... 1.90

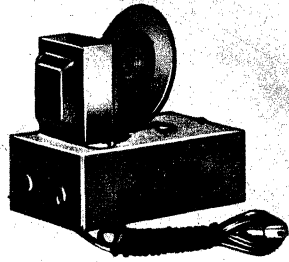

For Proof of KNIGHT-KIT Superiority—Examine Our Instruction Manuals

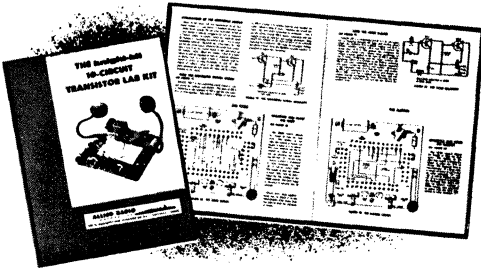

ONLY
10c

SEE THE DESIGN QUALITY FOR YOURSELF

Complete, easy-to-follow instruction manuals for famous Knight electronic kits—identical to manuals supplied with kits. Offer an inexpensive preview of any kit. Contain breakdown of equipment, construction notes, technical hints, operating data, plus parts lists. Include comprehensive schematic and pictorial diagrams. Each manual includes all essential data, fully keyed with helpful cross references. No wiring experience or knowledge of schematics is necessary to follow these manuals.

- 38 K 166. RF Signal Generator.
- 38 K 169. Audio Generator.
- 38 K 196. TV-FM Sweep Generator.
- 38 K 170. Signal Tracer.
- 38 K 167. 5' Wide Band Oscilloscope.
- 38 K 097. 5' General-Purpose Oscilloscope.
- 38 K 183. VOM; 1,000 ohms-per-volt.
- 38 K 168. VOM; 20,000 ohms-per-volt.
- 38 K 163. 6-Volt Battery Charger.
- 38 K 098. 6-12 Volt Battery Eliminator.
- 38 K 099. Scope Voltage Calibrator.
- 38 K 148. Capacitance Substitution Box.
- 38 K 147. Resistance Substitution Box.
- 38 K 199. Transistor Checker.
- 38 K 184. Resistance-Capacitance Tester.
- 38 K 188. In-Circuit Capacitor Checker.
- 38 K 928. Flyback Checker.
- 38 K 185. Vacuum-Tube Voltmeter.
- 38 K 172. AC-DC Phono Amplifier.
- 38 K 162. Phono Oscillator.
- 38 K 178. Wireless Broadcaster.
- 38 K 197. 2-Station Intercom.
- 38 K 044. "10-in-1" Lab.
- 38 K 164. "6-in-1" Lab.
- 38 K 295. 10-Circuit Transistor Lab.

- 38 K 165. Tube Tester.
- 38 K 050. Crystal Set.
- 38 K 176. "Ranger II" Superhet Radio.
- 38 K 942. 5-Transistor Superhet Radio.
- 38 K 936. 2-Transistor Pocket Radio.
- 38 K 943. "Trans-Midge" 1-Transistor Radio.
- 38 K 195. Printed Circuit 1-Transistor Radio.
- 38 K 096. Electronic Photoflash.
- 38 K 934. Photoelectronic Relay.
- 38 K 935. Light Source.
- 38 K 198. RF Z-Bridge.
- 38 K 296. 100-Kc Crystal Calibrator.
- 38 K 146. Transistor Code Practice Oscillator.
- 38 K 161. "Ocean Hopper" Receiver.
- 38 K 187. "Space Spanner" Regenerative Receiver.
- 38 K 944. Amateur Communications Receiver.
- 38 K 180. Amateur Variable Frequency Oscillator.
- 38 K 095. Amateur 50-Watt CW Transmitter.
- 38 K 937. Hi-Fi Preamplifier.
- 38 K 145. 25-Watt Basic Hi-Fi Amplifier.
- 38 K 939. 30-Watt Hi-Fi Amplifier.
- 38 K 190. 20-Watt Hi-Fi Amplifier.
- 38 K 940. 18-Watt Hi-Fi Amplifier.
- 38 K 059. 10-Watt Hi-Fi Amplifier.
- 38 K 941. Hi-Fi FM-AM Tuner.
- 38 K 126. Hi-Fi FM Tuner.

ANY KNIGHT-KIT MANUAL. Postpaid in U.S.A. NET EACH.....

10c

KNIGHT-KITS are Available Only at Allied

Money-Saving Tools and Supplies for Kit Builders

- A** WEN MODEL 199 SOLDER GUN. Efficient, lightweight, 120-watt soldering gun. Long-life, steel-nose tip. Heats in 2 $\frac{1}{2}$ seconds. For 110-120 v., AC. Shpg. wt. 2 $\frac{1}{4}$ lbs.
46 N 358. NET..... 5.83
- B** 47 $\frac{1}{2}$ -WATT UNGAR SOLDERING PENCIL. For printed-circuit soldering. Pyramid-type tip, molded plastic handle, flexible cord. For 110-120 volts. AC or DC. Wt., 6 oz.
47 N 095. NET..... 3.67
- C** KRAEUTER 6" PLIERS. Precision, long-nose pliers. Simplifies work on crowded chassis. Has side cutters. Shpg. wt., 10 oz.
46 N 449. NET..... 1.76

- D** XCELITE R 146 6" SCREWDRIVER. $\frac{1}{4}$ "-dia. chrome-vanadium steel shaft and plastic handle. Overall length, 10". Shpg. wt., 6 oz.
45 N 796. NET..... 72c

- KESTER ROSIN-CORE SOLDER. Handy tin of solder. Compounded of highest grade tin and lead. Plastic rosin filled. Non-corrosive. Wt., 3 oz.
46 N 900. NET..... 17c

- G.C. PRINT-KOTE SOLDER. For use in printed circuits. Wt. 3 oz.
43 N 026. NET..... 44c

- WIRE KIT. Package of five, 5-ft. lengths of No. 20 solid hookup wire. In 5 different colors. Wt., $\frac{1}{2}$ lb.
48 T 198. NET..... 55c

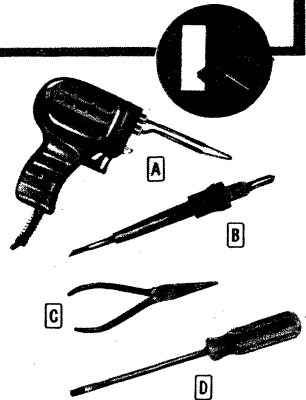

SEE PAGES 228-236
FOR COMPLETE LISTINGS
OF KNIGHT-KIT AMATEUR
AND TEST EQUIPMENT

QUALITY knight-kits FOR THE RADIO AMATEUR



YOU GET MORE FOR YOUR HAM DOLLAR IN EVERY WAY

There are no finer values for the Amateur station than Knight-Kit equipment. These outstanding kits are designed to the highest standards of Amateur performance by skilled engineers, who are themselves licensed Amateurs with a thorough understanding of your needs and problems. When you outfit your station with Knight-Kits you can be sure of equipment that's designed for maximum efficiency, versatility and operating ease—plus the ultimate in dependability. Nowhere can you find greater value.

NEW

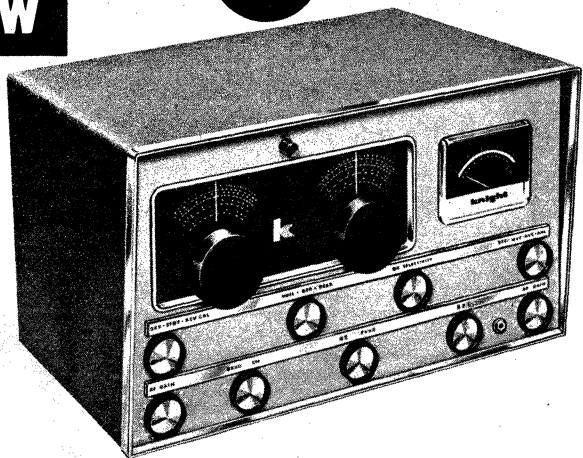

New KNIGHT-KIT Deluxe All-Band Amateur Receiver

NET
\$104⁵⁰
\$10.45 Down

Here's one of the most sensational values ever offered in a communications receiver! The new Knight-Kit receiver offers high selectivity, sensitivity and stability to meet the needs of all Amateurs. Has an array of features, many of which are found only in receivers costing much more. Uses printed circuitry throughout, including the revolutionary Knight-Kit printed circuit bandswitch, to make assembly remarkably easy. Covers 540 kc to 31 mc in 4 ranges;

calibrated electrical bandspread on the 80-10 meter Amateur bands; slug-tuned hi-Q coils; continuous B+ applied to HFO—lets you switch from standby to receive with no drift; B+ to HFO is voltage regulated; built-in Q-multiplier peaks desired signal or nulls interference; delayed AVC; provision for Knight-Kit crystal calibrator (below). Sensitivity: 1.5 μ v for 10 db signal-to-noise ratio. Selectivity: Variable from 300 cps to 4.5 kc at 6 db down. Exalted BFO injection.

TUBES: 6BZ6 RF amp.; 6BH8 mixer and HF osc.; 6AZ8 1st IF and 1st audio; 6AZ8 2nd IF and S-meter amp.; 6BC7 delayed AVC, 2nd det., and noise limiter; 6AW8 audio output and BFO; 12AX7 Q-multiplier; 6X4 rectifier; OB2 voltage regulator.

CONTROLS: Main tuning, bandspread tuning, band selector, Q-multiplier selectivity, Q-multiplier tune, null-off-peak, BFO pitch, RF gain, AF gain, BFO-MVC-AVC-ANL, off-stby-recv-cal, antenna trimmer; also includes headphone jack.

With tubes, all parts, wire, solder, instructions and sturdy metal cabinet. Less phones, 8-ohm loudspeaker and S-meter. 10x10x16 $\frac{1}{2}$ ". For 110-120 v., 50-60 cycle AC. Shpg. wt. 23 lbs.

83 YZ 726. NET..... 104.50

83 Y 727. S-METER KIT FOR ABOVE. Shpg. wt., 1 lb. NET..... 9.50

PROFESSIONAL QUALITY AMATEUR RECEIVER

- Tunes 540 kc to 31 mc
- Printed Circuit Bandswitch
- Built-In Q-Multiplier
- 300 cps to 4.5 kc Selectivity
- 1.5 μ v Sensitivity
- Printed Circuitry Throughout
- Vernier Dials—No Strings
- Constant-Running HFO
- $\frac{1}{16}$ " Cold-Rolled Steel Chassis

WORTHY OF THE ADVANCED HAM

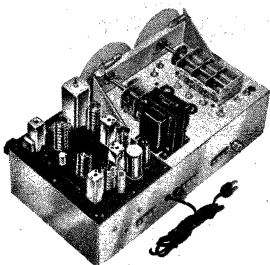

2 Printed Circuit Boards. Critical wiring is already completed. Eliminates problems of "lead-dress"—greatly simplifies assembly, reduces wiring time and eliminates costly wiring errors.

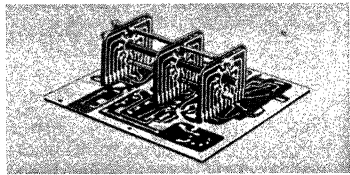

Printed Circuit Bandswitch. Another Knight-Kit exclusive! The printed circuit bandswitch, used for the first time in any communications receiver regardless of cost, assures exact reproduction of laboratory model and cuts assembly time.

NEW KNIGHT-KIT 100 kc Crystal Calibrator Kit

NET
\$10⁵⁰

Crystal frequency standard at very low cost. Gives marker every 100 kc up to 32 mc. An Amateur "must" for marking band edges. Mounting flanges permit installation in, or in back of, receiver cabinet. Measures only 1 $\frac{1}{2}$ x1 $\frac{1}{2}$ x3". Requires 6.3 v. at 0.15 amp and 150-300 v. DC at 3-6 ma. Trimmer for zero-beating with WWV; On-Off switch. With tube, crystal, all parts, wire, solder, and instructions. 1 lb.

83 Y 256. NET..... 10.50

NEW

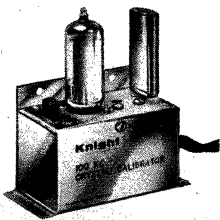



Component layout is skillfully engineered for high efficiency.

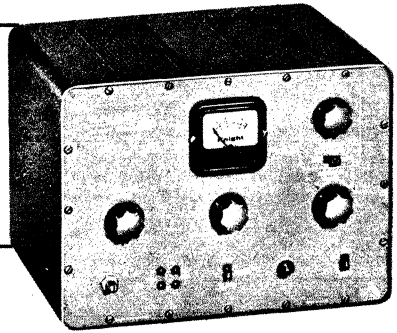

KNIGHT-KIT Low-Cost VFO Kit

NET
\$28⁵⁰

- Exceptional Stability
- Compact Design
- Excellent Keying
- TVI Suppression

WITH BUILT-IN POWER SUPPLY

A deluxe, high-quality VFO kit at an incomparably low price. Calibrated for 80, 40, 20, 15, 11 and 10 meters; output on 80 and 40 meters. 40-volt output on 80 meters and 20-volt output on 40 meters is more than adequate to excite oscillator stage of any transmitter. An ideal companion to the Knight-Kit 50-watt transmitter at right. Drift-free, series-tuned Clapp oscillator uses 1% silver mica capacitors. Tank coil is wound on heavy ceramic form. Features TVI suppression; vernier drive. Frequency stability is achieved by careful design and rigid mechanical construction. Two chassis design keeps heat from oscillator circuit. Voltage regulated for stable output. Tubes: 6BL6, 6AK6; 6X4 rectifier, 0A2 regulator. With all parts, tubes, wire, solder, and instructions. Gray and blue steel cabinet, 6x6x8³/₄". For 110-120 volts, 50-60 cycle AC. Shpg. wt., 11 lbs.
 83 Y 725. NET.....28.50

Special Value KNIGHT-KIT 50-Watt CW Transmitter Kit

NET
\$38⁹⁵

- Ideal Transmitter for the Novice Amateur
- Long-Life Transmitting Tubes—Effective TVI Suppression
- Convenient Bandswitching—80 through 10 meters
- Efficient Pi-Network Antenna Coupler

Here's a low-cost 50-watt transmitter kit that features high-quality transmitting components throughout. Uses the popular 807 tube in the final, ceramic coil forms, double-spaced tank capacitor and heavy copper-finish chassis aids TVI suppression. Ideal as a "first rig" for the Novice because assembly is simplicity itself. Excellent, too, as a low-power standby rig for the advanced Amateur. The Knight-Kit transmitter kit is a completely self-contained, bandswitching CW transmitter that can be operated crystal-controlled or with a VFO such as the Knight-Kit VFO at left.

OUTSTANDING CIRCUIT. Features a 6AG7 as a modified-Pierce tuned-plate oscillator-multiplier when crystals are used; as a buffer-multiplier when used with a VFO. 50 watts input to an 807 final. 5U4G rectifier. Transmitter is completely shielded in rugged metal cabinet for TVI suppression. Firm metal-to-metal seals are provided at all junctions. Filtering and bypassing of AC, keying, meter and heater circuits are provided. Pi-section antenna output permits operation with any type of antenna. Matches antenna impedances from 50 to 2000 ohms. Eliminates need for external type of antenna tuner. Other features include: Bandswitching on all bands; cathode keying of oscillator and final; metering of final plate and grid circuits; provisions for external modulator; and power plug for supplying voltages to VFO and other accessories. In addition to the final plate and grid current meter, the front panel includes the following controls: Oscillator Tuning; Antenna Loading; Grid-Plate Meter switch; and Off-On switch. Key jack, VFO and crystal sockets are also on front panel.

Kit is supplied complete with all parts, tubes, wire and solder. Assembly is simple with the step-by-step instructions included. Less crystal and key. 8¹/₂x10¹/₂x8¹/₄". For 110-120 v., 50-60 cycle AC. Wt., 18 lbs.
 83 YX 255. NET.....38.95



KNIGHT-KIT RF Z-Bridge Kit

NET
\$5⁸⁵

- For Measuring SWR
- Reads Antenna Impedance
- For 20-400 Ohm Lines
- Coaxial Input, Output

An excellent value in a high-efficiency, low-cost RF Z-bridge kit. Now every Amateur can achieve peak antenna efficiency—inexpensively. Completely eliminates guesswork—accurately measures Standing Wave Ratio (SWR) from 1 mc to 150 mc. Also for measuring impedance on frequencies up to 100 mc. Use your own VOM as a null indicator. For sharpest null indications a 5,000 ohm/v or better VOM is recommended. Has low-loss coaxial input and output connectors. Can be used with transmission lines having characteristic impedances between 20 and 400 ohms. Two convenient meter inputs for metering both input voltage and bridge voltage. Accurately calibrated dial gives direct impedance reading. Kit includes 1% precision resistor for calibration use and plasticized chart for converting meter reading to standing wave ratio. Size, 2¹/₂x3¹/₂x4". With all parts, SWR chart, wire, solder, and instructions. Less meter. Wt., 1¹/₂ lbs.
 83 Y 253. NET.....5.85



KNIGHT-KIT Transistor Code Practice Kit

NET
\$3⁹⁵

- Transistorized Circuit
- Extremely Compact
- Operates for Months On Penlight Cell

Advanced-design code practice oscillator at unusually low cost. Excellent for the beginner, or for the experienced Amateur who wants to improve his "fist." Uses transistor circuit—powered by a single penlight cell! Amazingly low current consumption—one battery operates unit for months. 500 cps tone. Has output jacks for standard headphone tips; screw type terminals for key. Housed in bakelite case with aluminum panel. With parts, battery, wire, solder, and instructions. Less phones, key. 2³/₈x3³/₄x1¹/₂". Shpg. wt., 1 lb.
 83 Y 239. NET.....3.95

45-RPM CODE COURSE RECORD. Wt., 4 oz.
 77 S 641. NET.....98c

QUALITY knight-kit TEST INSTRUMENTS

YOU DO THE EASY ASSEMBLY AND SAVE OVER 50%



MORE FOR YOUR MONEY. You get more for your money when you buy Knight-Kit test equipment kits. Highest-quality components, professionally styled cabinets and panels, many important "plus" features and genuine ease of assembly assure you of equipment equal to or better than factory-wired units costing at least twice as much! Build any Knight-Kit test instrument—you'll be proud of the results.

TOP PERFORMANCE. You can be sure of top performance and advanced design when you build Knight-Kit test equipment kits. Expert engineering, careful quality control through every stage of development, and long, rigid field testing assure you of the ultimate in reliability and operating ease. Feature for feature, Knight-Kit test instruments are equal or superior to factory-built equipment costing far more.



Knight-Kit SCOPES SAVE YOU MONEY



Knight-Kit scopes feature printed circuit boards and a laced wiring harness to simplify assembly and assure maximum operating efficiency.

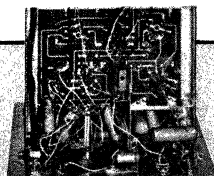

KNIGHT-KIT 5" General-Purpose Oscilloscope Kit

NET
\$42⁰⁰

- Phantastron Linear Sweep Generator
- Printed Circuit Board Speeds Assembly
- Excellent Sensitivity—25 mv/inch
- Retrace Blanking on all Ranges

Feature for feature the world's best oscilloscope kit value. This 5" general-purpose scope delivers performance equal to or better than factory-wired units several times its price—defies comparison with other scope kits at anywhere near its price. The ideal choice for radio-TV servicing, audio work and hundreds of other uses—meets at least 90% of all oscilloscope requirements.

Up-to-the-minute circuit design featuring a printed circuit wiring board and a laced wiring harness to reduce wiring to a minimum. Directly coupled positioning controls assure fast positioning of trace—free of overshoot.

Other important features include: Blanking circuit to eliminate retrace lines on all ranges; frequency-compensated vertical input attenuator; internal and external, positive and negative synchronization; Phantastron linear sweep generator; and high 2nd-anode voltage for high-intensity trace. Vertical sensitivity is 3 times that of similarly priced scope kits!

SPECIFICATIONS: *Vertical Response:* ± 3 db, 3 cps to 1.5 mc; ± 6 db to 2.5 mc. *Vertical Sensitivity:* .025 rms v/inch. *Sweep:* 15-150,000 cps in 4 ranges. *Horizontal Sensitivity:* .07 rms v/inch; response of horizontal amplifier is down only 3 db at 200 kc (1000 cycle reference). *Vertical Input Impedance:* 3.3 megs shunted by 45 mmf. *Calibrating Voltage:* 1-volt peak-to-peak, square wave (voltage regulated)—applied by push-button switch.

Supplied complete with all tubes including 5" CRT, chassis, printed circuit board, laced wiring harness, rugged steel case with convenient disappearing handle (permits stacking of other test equipment units on top of scope), graph screen, all parts, wire and solder, and easy-to-follow "Step-and-Chek" instructions with pictorial and schematic diagrams. Case has handsome blue finish; panel is finished in gray. Size, $9\frac{1}{2} \times 13\frac{3}{4} \times 17\frac{3}{4}$ ". For operation from 110-120 volts, 50-60 cycle AC. Shpg. wt., 26 lbs.

83 YZ 146. NET. 42.00

KNIGHT-KIT RF Demodulator Probe Kit

Use with Knight-Kit oscilloscopes to permit observation of modulation envelopes of amplitude modulated RF carriers at frequencies up to 250 mc. Complete with all parts, 4-ft. shielded cable, wire, solder, and instructions. Wt., 2 lbs.
83 Y 148. NET. 3.45



KNIGHT-KIT Low-Capacity Probe Kit

For use with Knight-Kit oscilloscopes when observing high-impedance, high-frequency, or broadband circuits. Prevents overload and distortion of audio, video, sweep or sync signals. 12 mmf input. With solder, all parts, cable. 2 lbs.
83 Y 147. NET. 3.45



PROVEN ACCEPTANCE

Service shops, labs, and production lines rely on the versatility and outstanding performance of the Knight-Kit wide band scope—a marvel of engineering skill.

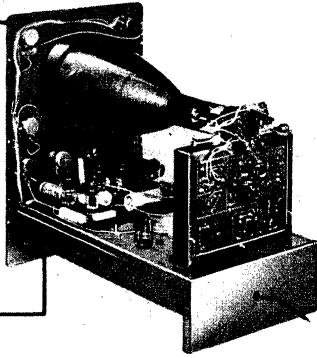

KNIGHT-KIT 5" Wide-Band Oscilloscope Kit

NET
\$69⁰⁰

- Two Printed Circuit Boards Greatly Speed Assembly
- 5-mc Bandwidth—Ideal for Color TV Servicing
- High Vertical Sensitivity—25 mv/inch
- Exceptionally Wide Sweep Range—15 to 600 Kc

An outstanding value in a highly efficient, printed circuit, 5" oscilloscope featuring wide-band design. Its performance is equal to or better than commercially wired oscilloscopes costing far more. Wiring this fine Knight-Kit instrument is simplicity itself—two printed circuit boards cut assembly time to a minimum by eliminating a large percentage of the circuit wiring. Also includes a laced wiring harness to further simplify assembly. Single-chassis construction and careful placement of components allow use of shortest possible lead lengths to assure maximum operating efficiency.

This exceptionally fine instrument is ideal for color TV servicing and many other high-frequency applications. In addition to its great utility as a servicing instrument, the Knight-Kit wide-band scope will perform hundreds of jobs—on a par with factory-built units—in the laboratory, on the production line, and in the maintenance shop. Notable among its fine array of features are its extremely wide sweep range, wide frequency response, and very high sensitivity.

Cathode-follower vertical and horizontal inputs assure minimum circuit loading. Has 5UP1 cathode ray tube; interchangeable with other 5UP type tubes for scope photography and many other specialized laboratory applications. 2nd anode voltage of 1400 volts provides high intensity trace. Uses push-pull vertical and horizontal amplifiers to assure minimum waveform distortion. Excellent synchronization on complex waveforms is achieved by oscilloscope's positive and negative locking. Provides faithful square-wave response.

Many other important features make this scope an extremely valuable lab instrument. Has frequency-compensated input attenuator. The Z-axis input permits intensity modulation of trace. One volt peak-to-peak calibrating voltage. Uses internal astigmatism control for precision adjustment of symmetry. Retrace lines are effectively eliminated by blanking circuit. Directly coupled positioning controls permit fast, overshoot-free positioning of trace.

SPECIFICATIONS: *Vertical Response:* ± 3 db, 5 cps to 5 mc; only 1 db down at 3.58-mc color burst frequency. *Vertical Sensitivity:* .025 rms v/inch. *Input Impedance:* 2.9 megs and 20 mmf. *Horizontal Amplifier:* 0.6 rms v/inch; Response, down only 3 db at 600 kc, 4 db at 1 mc; Sweep range exceptionally wide, from 15 to 600,000 cps. Locks in at frequencies as high as 9 mc.

Supplied complete with all tubes including CRT, all parts, punched chassis, blue case with disappearing handle and gray panel, pre-cut wire, and solder. CRT tube is shaded and protected by molded rubber mount. Green plastic graph screen. Assembly is simplified with step-by-step instructions, giant-size pictorial diagrams and schematics. Size, $14\frac{1}{2} \times 9\frac{1}{2} \times 16$ " deep. For 110-120 volts, 50-60 cycle AC. Shpg. wt., 40 lbs.

83 YZ 144. NET..... **69.00**

Probes for use with the Knight-Kit Wide-Band Oscilloscope are described on the preceding page.



KNIGHT-KIT Voltage Calibrator Kit for Scopes

NET
\$12⁷⁵

This easy-to-assemble calibrator permits using any scope as a precision peak-to-peak AC voltmeter—tremendously increases scope versatility. Puts a true square-wave voltage on scope screen. Has range switch and calibrated potentiometer to permit selecting any voltage between .01 and 100 volts, in 4 ranges. Fifth position of range switch feeds external signal directly to scope for instant comparison. Voltage regulator tube provides extremely high stability; output voltage stays constant with a power line variation from 80 to 135 volts. Accuracy of $\pm 6\%$ on all ranges. Shunt capacitance is only 15 mmf. Use any 20,000 ohms/volt VOM or a VTVM for initial calibration. Direct coupling of output provides ground reference for DC scopes. Handsome blue metal case with gray panel. Size, $7\frac{3}{4} \times 5\frac{1}{4} \times 4\frac{3}{16}$ ". Supplied complete with pre-cut wire; solder; giant-size pictorial diagrams; schematics; and easy-to-follow, step-by-step instructions. For operation from 110-120 volts, 50-60 cycle AC. Shpg. wt., 5 lbs.

83 Y 136. NET..... **12.75**

knight-kits GIVE YOU MORE FOR YOUR MONEY

KNIGHT-KIT Printed-Circuit VTVM Kit

NET **\$24⁹⁵**

- 200 μ a Movement, 4 1/2" Meter
- Reads AC Peak-to-Peak
- Balanced-Bridge, Push-Pull Circuit
- 1% Film-Type Resistors

Here's a top buy in an extremely stable and highly accurate VTVM. Wiring and assembly are greatly simplified—the entire chassis is a printed circuit board. Performance is equal to factory-wired instruments costing much more. An outstanding choice for radio-TV service shop, lab, Amateur use, etc. Uses low-leakage type switches; film-type, 1% precision resistors. Balanced-bridge, push-pull circuit permits switching to any range without re-adjusting zero set. Has zero-center scale and direct-reading db scale; polarity reversing switch.

SPECIFICATIONS: *Input Resistance:* 11 megohms. *DC and AC rms volts:* 0-1.5-5-15-50-150-500-1500. *AC Peak to Peak Volts:* 0-4-14-40-140-400-1400-4000. *Resistance:* 0-1000-10K-100K ohms; 1-10-100-1000 megohms. *Decibels:* -10 to +5. *Response:* 30 cycles to 3 mc.

With tubes, blue case, gray front panel, battery, all parts, pre-cut wire, solder, test leads and easy-to-follow instructions. Size, 7 3/4 x 5 1/4 x 4 3/16". For 110-120 v., 60 cycle AC. Shpg. wt., 6 lbs.

83 Y 125. NET..... 24.95



Accessory Probe Kits for KNIGHT-KIT VTVM

HIGH-VOLTAGE PROBE KIT. Extends DC voltage range to 50,000 v. Shpg. wt., 1 1/2 lbs.
83 Y 126. NET..... 4.75

HIGH-FREQUENCY PROBE KIT. Extends AC range of VTVM to 250 mc. Shpg. wt., 1 1/2 lbs.
83 Y 127. NET..... 3.45

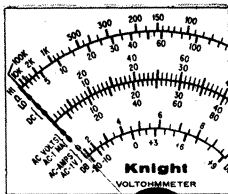
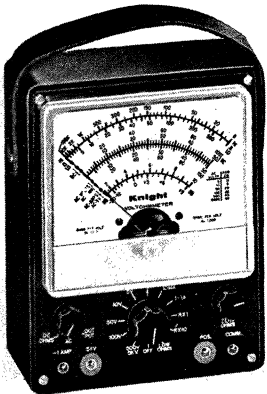
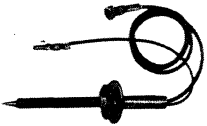

Has 4 1/2-inch meter with large, easy-to-read scales.

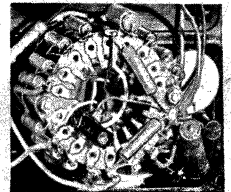
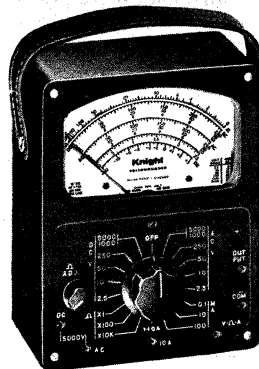

Single range-function switch speeds assembly and simplifies operation.

KNIGHT-KIT 1000 Ohms/Volt VOM Kit

NET **\$16⁹⁵**

- 38 Ranges
- 1% Precision Resistors
- Versatile and Accurate
- 400- μ a, 4 1/2" Meter

Another great value in an easy-to-build Knight-Kit instrument kit! This 38-range VOM kit provides exceptional accuracy. Separate scales for AC and DC voltage and current, decibels and resistance. 1% precision resistors are used as shunts and multipliers. 3-position function switch and 12-position range switch. 4 1/2" 400-microamp meter. Black bakelite case.

SPECIFICATIONS. Ranges: AC, DC and output volts, 0-1-5-10-50-100-500-5000 (with sensitivity of 1000 ohms-per-volt); Resistance, 0-1000-100,000 ohms and 0-1 megohm (center scale readings of 60, 150 and 1500 ohms); Current, AC or DC, 0-1-10-100 ma and 0-1 amp; Decibels, from -20 to +69 in six ranges. Size, 6 3/4 x 5 1/4 x 3 3/4". With all parts, battery, test leads, pre-cut wire and solder. Shpg. wt., 2 1/2 lbs.
83 Y 128. NET..... 16.95

KNIGHT-KIT 20,000 Ohms/Volt VOM Kit

NET **\$29⁵⁰**

- 32 Ranges
- 1% Precision Resistors
- Single Range-Function Switch
- 4 1/2" 50- μ a Meter

This Knight-Kit VOM offers outstanding quality and performance. Carefully engineered circuit employs 1% precision multipliers. Has 4 1/2" meter; movement accurate within 2% of full scale deflection. 50-microamp meter sensitivity provides 20,000 ohms-per-volt input resistance on DC to assure accurate measurements in critical circuits. Front panel "zero adjust" control. Single switch for selection of function and range.

SPECIFICATIONS. Ranges: AC, DC and output volts, 0-2.5-10-50-250-1000-5000; Resistance, 0-2000-200,000 ohms and 0-20 megohms; DC ma, 0.1-10-100; DC amps, 0-1-10; Decibels, -30 to +63 in six ranges. Moisture resistant film-type resistors. Black bakelite case. Size, 6 3/4 x 5 1/4 x 3 3/4". With all parts, test leads, batteries, wire and solder. Shpg. wt., 5 lbs.
83 Y 140. NET..... 29.50

VERSATILE TOP-VALUE TUBE TESTER



The one-piece 10-lever function switch simplifies and speeds assembly—entire bank of switches can be installed in a matter of minutes.

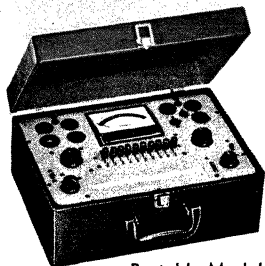

Portable Model

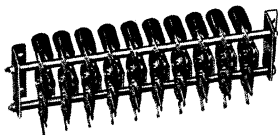

Counter Model

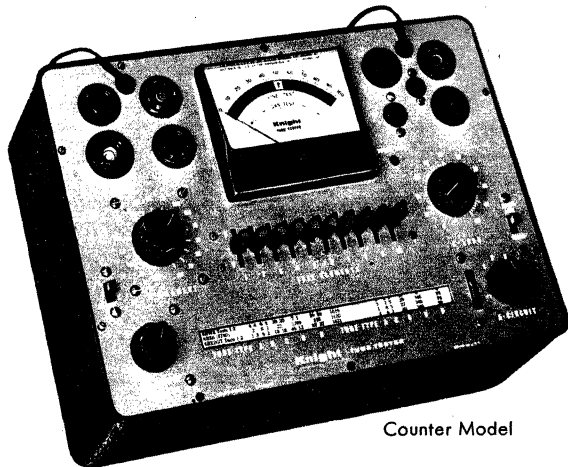

KNIGHT-KIT Low-Cost Tube Checker—With 16 Filament Voltages

\$29⁷⁵

Counter Model

- Large "Good-?-Replace" Meter
- Tests Series-String TV Tubes
- 600 Tube Types Listed
- Designed to Stay Up-To-Date

This expertly designed tube checker kit has now been improved for completely up-to-date coverage of tube types. Includes provision for checking *series-string TV tubes*. Tests 4, 5, 6, and 7-pin large, regular and miniature types, octals, loctals, 9-pin miniatures and pilot lamps. Tube performance is measured by the amount of cathode emission. Easy-to-read $4\frac{1}{2}$ " square meter has three-color "GOOD-?-REPLACE" scale. Also provides tests for shorts, open elements, cathode-to-filament leakage, and heater continuity.

Provides continuity check for other components, electrical appliances, motors, etc. Has line-voltage indicator and line-adjust control to compensate for line voltage variations; may be adjusted from the front panel—assures greater test accuracy and correct voltage for each tube test. Choice of 16 filament voltages from 0.63 to 117 volts to check virtually all receiving tubes. With adapter listed at right, tester checks TV picture tubes without removal from set.

Special circuit features assure years of dependable service without obsolescence. Blank panel socket accommodates future tube types. Universal-type selector switches permit setting up for any new tube pin connections without wiring changes. Single-unit, pre-assembled 10-lever function switch simplifies and speeds assembly. Illuminated roll chart lists 600 tube types. With all parts, wire and solder. $5 \times 14 \times 10$ ". For 110-120 v., 50-60 cycle AC. Shpg. wt., 14 lbs.

83 YX 143. NET. 29.75

PORTABLE MODEL TUBE CHECKER KIT. With covered plywood case; $6\frac{1}{2} \times 14\frac{1}{2} \times 10\frac{1}{2}$ ". Shpg. wt., 15 lbs.

83 YX 142. NET. 34.75

MODERNIZATION KIT. For earlier models of Knight-Kit Tube Checker Kit with 14 filament voltages. Includes new chart, transformer, switch and panel plate to bring earlier checker up-to-date. Shpg. wt., 3 lbs.

83 Y 701. NET. 7.45



TV PICTURE TUBE ADAPTER. Valuable service aid—ready to use. Permits testing TV picture tubes with Knight-Kit Tube Checker. Shpg. wt., 1 lb.

83 Y 141. NET. 4.25

KNIGHT-KIT Transistor & Diode Checker Kit



- Checks Gain Ratio of Transistors
- Checks Germanium and Silicon Diodes

NET **\$8⁵⁰**

The ever-increasing use of transistors and diodes makes this highly versatile checker an extremely valuable test instrument. Ideal for servicemen, engineers

and experimenters. Checks the leakage-to-gain ratio and noise level of all types of junction, point contact and barrier transistors. Checks the forward and reverse current conduction of germanium and silicon diodes, and selenium rectifiers. Useful for continuity and short checks. Features spring-return leakage-gain switch, calibration control and separate sockets for PNP and NPN-type transistors. Bakelite case. With all parts, $22\frac{1}{2}$ v. battery, wire, solder. Size, $5 \times 3 \times 2$ ". Shpg. wt., $2\frac{1}{2}$ lbs.

83 Y 149. NET. 8.50

KNIGHT-KIT Capacitor Checker Kit



- "In-Circuit" Checker
- "Magic-Eye" Indicator
- 20 mmf to 2000 mfd
- Perfect for Servicemen

NET **\$12⁵⁰**

An invaluable aid to speedy servicing—at only one-third the cost of factory-wired units! Feature for feature, the world's finest economy-priced capacitor

checker kit. Has widest range—20 mmf to 2000 mfd—through use of exclusive resonant circuit that tunes out test cable capacity. The "magic-eye" indicator shows opens and shorts (not leakage). Checks by-pass, blocking, coupling and filter capacitors. Tests opens and shorts on any capacitor of 20 mmf or over—even if capacitor is in parallel with a resistance as low as 50 ohms! With tubes, wire, solder and easy-to-follow instructions. $7\frac{3}{4} \times 5\frac{1}{4} \times 5$ ". For 110-120 v., 50-60 cycle AC. Shpg. wt., 5 lbs.

83 Y 119. NET. 12.50

SUPERIOR VALUES IN knight-kit TEST INSTRUMENTS

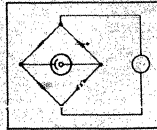

Measurements are made by the laboratory-type balanced bridge method!

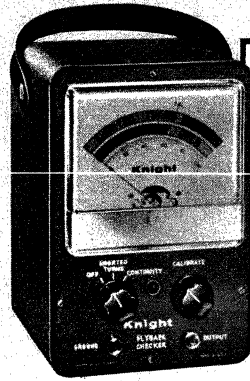

NEW

Widest-Range Flyback Checker Kit Available

Permits TV technicians to determine the condition of flyback transformers and deflection yokes.

KNIGHT-KIT Resistor-Capacitor Tester Kit

- NET **\$19.50**
- Shows Capacitance, Resistance
 - Indicates Power Factor
 - Balanced-Bridge Circuit
 - Tests Capacitors at Rated Voltage

An extremely useful instrument—skillfully engineered for top-notch performance in the service shop and laboratory. Measures resistance and capacitance by the highly dependable bridge method; checks for opens and shorts in paper, mica and ceramic capacitors; and indicates the power factor of electrolytics. Its large, easy-to-read dial, used in conjunction with the “magic eye” null indicator, shows resistance and capacitance at a glance. The “magic eye” is also used in testing for opens, shorts, intermittents, and in checking power factor. Capacitors are tested at actual working voltages.

SPECIFICATIONS. Test Voltages: 50, 150, 250, 350 and 450 volts. Capacity Ranges: 10 mmf to .005 mfd, .001 to 0.5 mfd, 1 to 50 mfd, and 20 to 1000 mfd. Resistance Ranges: 100 to 50,000 ohms and 10,000 ohms to 5 megohms. Accuracy: $\pm 10\%$. Power Factor Range: 0–50%. Uses 6E5 “magic eye”; 6X4 rectifier.

In portable metal case with blue-wrinkle finish. Size, 7x10x5". With tubes, solder, pre-cut wire and instructions. For operation from 110-120 volts, 50-60 cycle AC. Shpg. wt. 10 lbs.

83 Y 124. NET.....19.50

Low-Cost KNIGHT-KIT Flyback Checker Kit

- NET **\$19.50**
- Widest Range in Its Field
 - Exceptional Accuracy
 - Large 4½-Inch Meter
 - Invaluable For TV Servicing

Race through TV deflection circuit repairs—for bigger-than-ever servicing profits—with the new Knight-Kit Flyback and Yoke tester! Use it to check instantly on the condition of all types of horizontal output transformers and deflection yokes, as well as linearity and width coils in TV sets. Provides an accurate check of any standard unit. Positively indicates the presence of shorted turns for any coil with a “Q” greater than 1, and an inductance between .003 henry and 2 henries. Determines the continuity of any circuit with a resistance between 0 and .5 megohms. Checks a wider range of inductances than any other similar unit! 4½-inch meter with 400 microamp movement provides clear readings and high accuracy. Circuit uses 6S4A tube in pulsed oscillator arrangement. Self-contained power supply is of isolation transformer type, for full safety during servicing of any type of TV set. Durable metal case, 7¾x5½x5", has leather handle. Supplied complete with all parts, test leads, solder, wire, 6S4A tube, step-by-step instructions, etc. For operation from 110-120 v., 50-60 cycle AC. Shpg. wt., 6 lbs.

83 Y 118. NET.....19.50

KNIGHT-KIT Resistance Substitution Box Kit

NET **\$5.95**

Find the correct resistance value required in a circuit—in minutes—with this convenient resistance substitution box. Saves time in radio and TV servicing as well as in equipment design. Low resistance range: 15 ohms to 10K. High resistance range: 15K to 10 megohms. Slide switch selects either range. Accuracy is within $\pm 10\%$. 18-position rotary switch permits rapid setting to exact value needed. Switch has extra wafer to simplify wiring. All parts mount in compact case of bakelite with clearly calibrated aluminum panel; size, 5x3x2". Supplied complete with all parts, hardware, 18" leads, heavy-duty insulated alligator clips, solder, wire and easy-to-follow, step-by-step instructions. Shpg. wt., 2 lbs.

83 Y 139. NET.....5.95

KNIGHT-KIT Capacitance Substitution Box Kit

NET **\$5.95**

Cuts time and effort in finding correct values for replacement of badly damaged, illegible capacitors. Substitutes a wide range of RETMA values. Ideal for laboratory and service shop. Has 18 standard capacitor values from .0001 mfd to .22 mfd. Accuracy of $\pm 20\%$. All values are 600 volts, except .15 and .22 which are 400 volts. An 18-position switch permits fast, convenient selection of values. In sturdy bakelite case with attractive anodized aluminum panel. Size, 5x3x2". Kit is supplied complete with all parts, 18" leads, insulated alligator clips, solder, wire and step-by-step instructions. Shpg. wt., 2 lbs.

83 Y 138. NET.....5.95

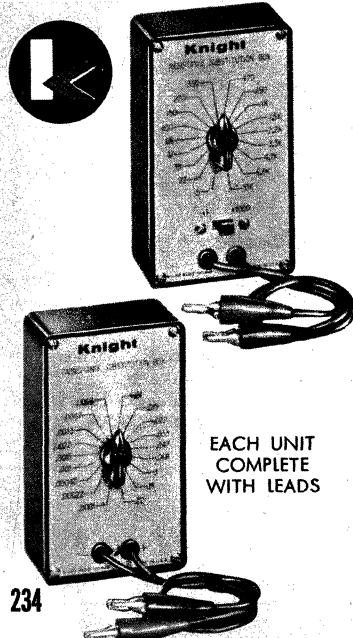

EACH UNIT COMPLETE WITH LEADS

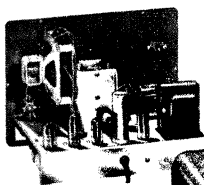

The finest sweep generator kit available anywhere—build it yourself—save up to half the cost of a comparable unit!



KNIGHT-KIT TV-FM Linear Sweep Generator

NET
\$43⁷⁵

- Extreme Linearity
- Fundamentals to 250 mc
- Output Flat Within 1 db
- Electronic Blanking
- Quick, Easy Assembly

An outstanding, low-cost instrument for TV and FM alignment—provides sweep linearity on a par with costly laboratory instruments. Covers 300 kc to 250 mc on fundamentals. Delivers up to 0.15 v. and has coarse and fine attenuators for precise output adjustment. The skillfully engineered sweep circuit provides output which is constant within 1 db over the swept range, on all bands. Step-down dial drive mechanism gives smooth-as-velvet tuning action. Large, clearly calibrated dial is easy to read on all ranges. Circuit utilizes electronic retrace blanking, and a highly effective automatic gain control to keep output voltage constant over swept range. Sweep width is continuously variable from 0 (no sweep) to full 13 megacycles. Built-in crystal marker and input for external marker—built-in and external marker can be mixed. The Knight-Kit signal generator (at right) is an excellent variable marker for use with this unit. With all parts, tubes, pre-cut wire, test cable, solder, and instructions. Less crystal (below). 8½x12x7½". For 110-120 v., 60 cycle AC. Shpg. wt., 16 lbs.

83 YX 123. NET.....	43.75
99 S 286. 4.5-mc Crystal. NET.....	4.80
99 S 143. 5.0-mc Crystal. NET.....	3.95
99 S 145. 10.7-mc Crystal. NET.....	3.95

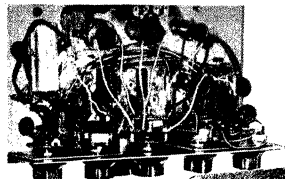

A top-quality signal generator at only one-third the cost of similar wired units; features high-precision coils!



KNIGHT-KIT RF Signal Generator Kit

NET
\$19⁷⁵

- Precision-Wound Coils
- No Calibration Required
- Output to 112 mc on Fundamentals
- Modulated or Unmodulated Output
- 400-Cycle Sine Wave Output

Build this wide-range, extremely stable RF signal generator and save two-thirds the cost of a comparable wired instrument. You can quickly build it without difficulty; easy, fully illustrated Knight-Kit instructions enable you to get the job done in the least amount of time. The large, semi-circular dial is calibrated clearly; the signal generator's range is covered in five separate bands, permitting close accuracy in the setting of individual frequencies. You'll find that it's an ideal instrument for alignment of RF and IF stages in radio and TV sets, and for trouble-shooting audio equipment. Also serves as a TV marker generator when used with sweep generator listed at left. Delivers output on fundamentals from 160 kc all the way out to 112 mc; provides useful harmonic output to 224 mc. Output can be modulated at 400 cycles—has built-in sine-wave audio oscillator with output jack for 400-cycle output. Features the high-stability Colpitts circuit. Convenient jack for external modulation. Maximum audio output 10 volts. RF output, over 0.1 volt on all ranges. Step and continuous-type attenuator controls permit precise adjustment of output. With all parts, tubes, wire, solder and instructions. 7x10x5". For operation from 110-120 volts, 50-60 cycle AC. Shpg. wt. 11 lbs.

83 Y 145. NET..... 19.75

KNIGHT-KIT 6V-12V Battery Eliminator

NET
\$32⁹⁵

- Most Power Per Dollar!
- Continuously Variable Output Voltage
- Delivers 15A at 6V—10A at 12V
- May Be Used as Battery Charger



Make short work of auto radio servicing with this high-current unit! Also great for mobile gear!

This heavy-duty DC power supply is ideal for testing auto radios, as well as Amateur and commercial mobile radio equipment. Continuously variable output from 0 to 15 volts at higher current than any similarly priced battery eliminator kit. Handles current requirements of any 6 or 12-volt radio. Dual filter for low-ripple output. Can be used to charge any 6 or 12-volt battery overnight. Low in price—high in performance—the Knight-Kit battery eliminator is a test and service instrument that will quickly pay for itself.

Provides DC output at 0-8 volts or 0-15 volts. Continuous current rating: 15 amps at 6 volts, 10 amps at 12 volts. Intermittent current rating: 17.5 amps at 6 volts, 12.5 amps at 12 volts. Two meters provide current and voltage readings. Meter ranges: 0-15 volts DC; 0-20 amps DC. Portable metal case with blue-wrinkle finish and disappearing handle. 9x12½x7¾". With all parts, wire, solder and instructions. For 110-120 v., 50-60 cycle AC. Shpg. wt. 18 lbs.

83 YX 129. NET..... 32.95



YOU SAVE MORE ON EASIEST -TO-BUILD knight-kits

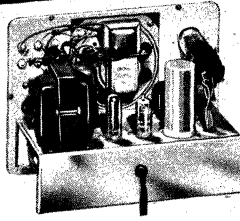
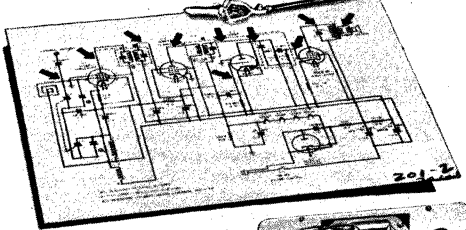

For extremely fast, convenient signal tracing by aural and visual methods. Exceptionally high amplification. Gain of 91,000.

KNIGHT-KIT High-Gain Signal Tracer Kit

NET
\$26⁵⁰

- Gain of 91,000
- Built-in Wattmeter
- Measures Stage Gain
- Reveals "Dead" Stage

For speedier servicing and bigger profits, use the Knight-Kit high-gain signal tracer. This easy-to-build, extremely worthwhile unit will save you work and trim valuable time from hundreds of servicing jobs—once you've used this outstanding, trouble-shooting instrument, you'll wonder how you ever got along without it.

It's ideal for servicing radios, TV sets and amplifiers—checks RF, IF, video and audio circuits. Employs pentode front-end for remarkably high amplification—has gain of 91,000—the highest in its price class. "Magic eye" tube with calibrated attenuators clearly indicate signal presence and permit stage-by-stage gain measurements all the way from the antenna to the speaker. Only 6 mmf input capacitance. In addition to "magic eye" indicator, has built-in 4" PM speaker for audible signal tracing, or use as a general-purpose audio amplifier. 2-position RF-AF probe supplied permits complete testing versatility; one position of probe is for checking RF, IF and video stages; other for checking audio.

Noise test—applies DC to volume controls for amplification of noise characteristic. Built-in wattmeter is calibrated from 25 to 1000 watts—wider range than any other kit. Has provision for external oscilloscope or VTVM. Binding posts provide 280 v. B+ for external uses; permit easy output transformer or speaker check in audio amplifiers. Attractively finished blue wrinkle case has contrasting gray panel. Size, 7x10x5". With disappearing carrying handle. With all parts, tubes, probe, pre-cut wire and solder, instructions, pictorial and schematic diagrams. Tubes: 6AU6 high-gain amplifier, 6AV6 amplifier and wattmeter rectifier, 6V6GT power amplifier; 6E5 "magic eye"; 6X4 rectifier. For 110-120 volts, 50-60 cycle AC. Shpg. wt. 12 lbs.

83 Y 135. NET.....26.50



For Precise Testing of Audio Equipment

KNIGHT-KIT Audio Generator Kit

NET
\$31⁵⁰

- Latest Circuit Design
- Less Than .25% Distortion
- 600-Ohm Output
- Range: 20 cps to 1 mc.

The Knight-Kit audio generator kit features an up-to-date circuit developed by the U.S. Bureau of Standards. Its excellent specifications and low cost make it ideal for critically precise testing of high-fidelity amplifiers, tone control circuits, speakers, or any application requiring calibrated, continuously variable audio signals. Performance equals or surpasses far costlier factory-built units. Operates into high impedance or 600-ohm standard broadcast line. Low distortion even at high output into either high-impedance or 600 ohms. Ideal for checking speaker response. Offers the flat response of a lab standard.

SPECIFICATIONS: Uses 6CB6 Bridge-T type R-C oscillator. *Frequency Range:* 20 cps to 1 mc in 5 ranges. *Output Voltage:* 10 v., ±1 db to 1 mc. *Output Impedance:* 600 ohms. *Distortion:* Less than .25% from 100 cps through the audible range into high impedance; less than .5% when driving 600 ohm load at maximum output.

Supplied complete with all parts, tubes (6CB6, 2—6CL6; 5Y3GT rectifier), pre-cut wire, solder and step-by-step instructions plus pictorial and schematic diagrams. Attractive blue metal case, 8½x11x7½", with light gray front panel. For operation from 110-120 v., 50-60 cycles AC. Shpg. wt., 16 lbs.

83 YX 137. NET.....31.50

KNIGHT-KIT MONEY-BACK GUARANTEE

Your purchase price is refunded in full if your Knight-Kit does not meet our published specifications for performance.

FOR EVERYTHING IN TEST EQUIPMENT . . . LOOK TO ALLIED THE WORLD'S LARGEST SUPPLIER OF QUALITY TEST INSTRUMENTS

COMPLETE STOCKS. Make Allied your one, dependable source for test equipment. When you order from Allied, you draw on the world's largest stocks—your assurance of extremely fast, highly efficient service.

EASY TERMS. Use our Easy Payment Plan to order all the test units you need. Only 10% down—complete the balance in convenient monthly payments. Full details on page 396.

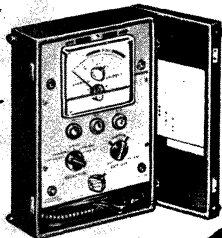
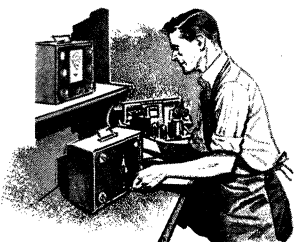

400

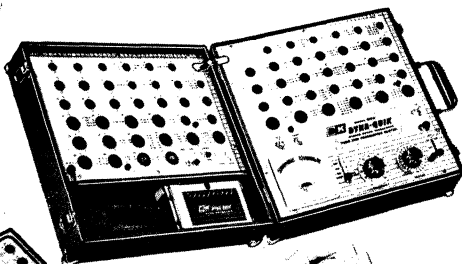

650

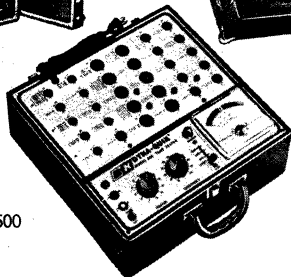

500

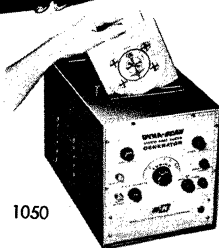

1050

B&K TEST EQUIPMENT



NEW MODEL 675 AUTOMATIC TUBE & TRANSISTOR TESTER

JUST INSERT A CARD AND TEST

- Dynamic Mutual Conductance Tester
- Tests Each Tube Section Separately
- Checks Average Set in Minutes

Portable, card-controlled "Dyna-Quik" dynamic mutual conductance tester. Card automatically selects socket connections for quick, accurate test. Reduces switching—saves servicing time. Utilizes only 60 cards for testing over 500 tube types—over 95% of all popular TV tubes. Easily kept up-to-date by adding new cards. Checks each section of multi-section type tubes separately. Complete, accurate tube test in seconds! Tests for shorts, grid emission and probable tube life. $4\frac{1}{2}$ " meter has "Good-Bad", 0-6000-18,000 μ hos scales. 7 and 9-pin min. tube pin straighteners. Automatic line compensation. Tests Ico and forward gain ratio of junction, point contact, and barrier transistors; F/B ratio of germanium, silicon and selenium diodes. $15\frac{1}{2} \times 12\frac{1}{2} \times 6\frac{1}{2}$ ". With cards and index. For 105-125 v., 60 cycle AC. Shpg. wt., 14 lbs.

87 FX 284. NET. 166.55

MODEL 400 REJUVENATOR-TESTER

Unique TV picture tube rejuvenator-tester. Checks tube while still in set. Detects opens between base pins and elements; shorts, leakage between elements. Checks cathode emission, grid bias cut-off voltage. Repairs shorts between elements, open connections to elements, and restores weak emission. Predicts probable tube life. $4\frac{1}{4}$ " meter. In portable, leatherette-covered case. $5 \times 7\frac{1}{2} \times 11\frac{1}{4}$ ". For operation from 105-125 v., 60 cycle AC. Shpg. wt., $8\frac{1}{2}$ lbs.

84 FX 643. NET. 58.75

MODEL C40 COLOR ADAPTER. Adapts Model 400 and earlier Model 350 for testing and rejuvenating 110° and color picture tubes. Shpg. wt., 1 lb.

87 F 279. NET. 9.75

MODEL 500 TUBE TESTER

Portable, "Dyna-Quik" dynamic mutual conductance tester. Requires a minimum of switching—no roll chart! Fast and accurate. Tests over 95% of all popular TV receiving tubes including 600-ma. series-string types. Includes grid emission and gas test. 7 and 9-pin min. tube pin straighteners. "Good-Bad". 0-6000-18,000 μ hos scales. Automatic line compensation. $15\frac{1}{8} \times 14\frac{1}{2} \times 5\frac{3}{4}$ ". For operation from 105-125 v., 60 cycle AC. Shpg. wt., $12\frac{1}{2}$ lbs.

84 FX 644. NET. 107.75

ADAPTERS. For use with B&K 500.

Stock No.	Model	For Testing	Lbs.	EACH
84 F 646	B50	$1\frac{1}{2}$, 3-volt tubes	1	4.85
87 F 292	L55	Loctals	$\frac{1}{2}$	4.85
87 F 291	R56	35Z5, 35W4	$\frac{1}{2}$	3.87

MODEL 650 TUBE & TRANSISTOR TESTER

New, highly versatile portable "Dyna-Quik" dynamic mutual conductance tester. Tests transistors and virtually all popular TV receiving tubes. Checks each section separately—requires very little switching. $4\frac{1}{2}$ " meter; "Good-Bad". 0-6000-18,000 μ hos scales. 7 and 9-pin min. tube pin straighteners and 16 spare sockets mounted on panel. Automatic line compensator. Detects shorts, grid emission, probable tube life, and gas. Tests Ico and forward gain ratio of junction, point contact, and barrier transistors; F/B ratio of germanium, silicon and selenium diodes. $15\frac{3}{4} \times 15 \times 6\frac{1}{2}$ ". For 105-125 v., 60 cycle AC. 22 lbs.

87 FZ 280. NET. 166.55

1050 VIDEO & AUDIO GENERATOR

New, unique "Dyna-Scan" flying spot scanner produces test patterns on color or black-and-white TV sets. Useful for broadcasting picture or message in closed-circuit or community antenna TV systems. 6-color display for testing color circuits. Audio section provides modulated or unmodulated TV audio signal. Complete with 3 test patterns and blank transparency. $10\frac{3}{4} \times 9\frac{1}{2} \times 6\frac{1}{2}$ ". With 6-ft. RF cable. For 110-120 v., 60 cycle AC. Shpg. wt., 30 lbs.

87 FZ 281. NET. 254.75

MODEL 1000. As above, but black-and-white only and less audio. 34 lbs.

87 FZ 252. NET. 195.95

ADAPTERS. For use with Model 1000.

Stock No.	Model	Description	Lbs.	EACH
87 F 282	C15	6-color display	1	19.55
87 F 283	S16	Audio carrier	1	29.35

LABORATORY AND INDUSTRIAL TEST EQUIPMENT

MODEL 750 TEST EQUIPMENT CALIBRATOR. Combination voltage, resistance, and frequency standard. Quickly checks the accuracy of any test instrument. Provides the following voltages $\pm 1\%$ or better: DC—2, 5, 25, 100 and 300; AC—5, 25, 100, 1000 and 300. Resistances: 10, 100, 1000, 10,000, 100,000 ohms and 10 megs. Built-in crystal oscillator generates harmonics well over VHF region; tone generator for use alone or for modulating oscillator. $8\frac{3}{4} \times 8 \times 5\frac{1}{2}$ ". With 5-mc crystal. For 110-120 v., 60 cycle AC. Wt., 8 lbs.

87 F 253. NET. 53.85

NEW MODEL 150 TRANSISTOR TESTER. Accurately measures grounded emitter current gain of all transistors, including power types. Uses 1-ic signal for true small signal measurement. Meter reads 0-50, 0-200 T; 0-200—Ico; 0-20 ma for power transistors; and 20-80% diode front-to-back ratio. Special circuitry prevents damage to test instrument and transistor. Tests power transistors at 100 ma forward current. Bias adjustment; choice of 4 collector voltages; mercury cell power supply (cells included). Size, $14 \times 8\frac{1}{2} \times 7\frac{3}{4}$ ". Shpg. wt., 11 lbs.

87 FX 288. NET. 117.10

750



150





TEST EQUIPMENT

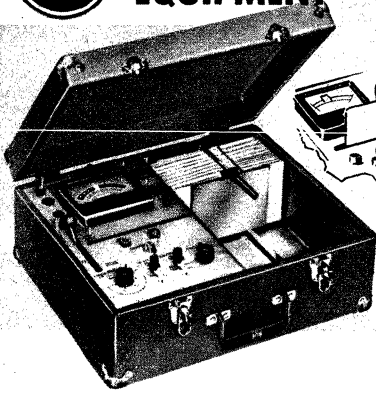

NEW AUTOMATIC TUBE TESTER INSERT CARD—TEST TUBE!

MODEL WT-110A. Highly dependable, exceptionally versatile portable tube tester. Designed to save valuable time—simply insert pre-punched card into tester! Card automatically sets up all filament, bias signal, plate, and screen voltages under heavy load conditions. Tests transconductance, gas, shorts and twin tube balance. Tests each section of multi-section tubes. Easy-to-read meter registers "RENEW—?—GOOD". Two gold-plated printed circuit boards set up a combination of 15 to 20 circuits which permit: Socket connections up to 10 pins, 220 combinations of heater voltage, 10 bias voltages, 5 plate voltages, 11 values of cathode resistors, 2 screen voltages, and 50 quality sensitivity ranges. Warranty includes free subscription that supplies card settings for each new tube as it is announced. 241 pre-punched vinyl plastic cards (covering 95% of tubes) supplied with each tester. In $7\frac{1}{4} \times 14\frac{1}{2} \times 17\frac{1}{2}$ " carrying case. With master card for punching blanks (below) and test card. For 105-125 v., 60 cycle AC. Shpg. wt., 28 lbs.

- 87 FZ 075. NET.....199.50
- WG-325. 24 blank cards for replacement or new tube types. Wt., 1 lb.
- 87 F 076. NET.....1.50
- WG-326. Card Hand Punch. Wt., 1 lb.
- 87 F 078. NET.....5.95

VTVM & VOM PROBES

- WG-299B DC/AC-OHMS PROBE. With shielded cable and coaxial connector. Switch selects function. Shpg. wt., 1 lb.
- 87 F 058. NET.....8.75
- WG-299C DC/AC-OHMS PROBE. As above, but for WV-87B. Shpg. wt., 1 lb.
- 87 F 077. NET.....8.75
- WG-301A CRYSTAL DIODE PROBE. Slips on WG-299A, B or C. Extends RF range to 250 mc. Shpg. wt., 8 oz.
- 87 F 052. NET.....7.75
- WG-264 CRYSTAL DIODE PROBE. As above, but for WG-218 probe. Wt., 12 oz.
- 84 F 084. NET.....7.75
- WG-290 HIGH-VOLTAGE PROBE. Adapts VOM's and VTVM's to read to 50,000 v. DC. Less multiplier (below). With shielded cable and phone tips. Shpg. wt., 1 lb.
- 84 F 076. NET.....7.15
- WG-289 HIGH-VOLTAGE PROBE. As above, but has coaxial connector. Wt., 1 lb.
- 84 F 077. NET.....7.15
- MULTIPLIERS. For WG-290 & WG-289. 2 oz.
- 84 F 079. WG-206. 1090 meg.
- 84 F 080. WG-207. 991 meg.
- 84 F 081. WG-208. 400 meg.
- 84 F 082. WG-209. 480 meg.
- 84 F 083. WG-210. 900 meg.
- NET EACH.....2.80

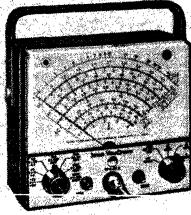
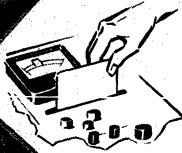

WV-98A

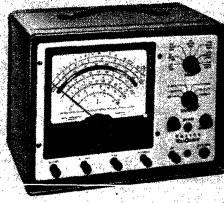

WV-87B



WV-77C

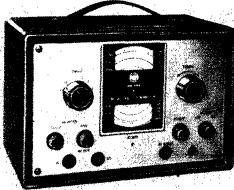

WR-49B

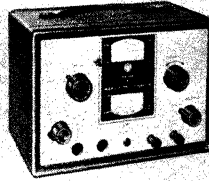

WA-44B

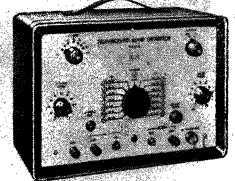

WR-69A

WV-98A SENIOR VOLTOHMYST

Has $6\frac{1}{2}$ " meter, accuracy improved to $\pm 3\%$, and single-unit DC-AC-Ohms probe with built-in selector switch. Excellent for measurement of complex TV waveforms—reads peak-to-peak voltages to 4200 volts. 7 ranges for each function. Reads AC rms and DC to 1500 volts. Measures resistance from 0.2 ohms to 1000 megohms. AC input impedance of 0.83 megohm and 70 mmf to 1.5 megohms and 60 mmf. Input resistance on DC is 11 megohms. Size, $6\frac{1}{2} \times 7 \times 3\frac{3}{4}$ ". With WG-299B probe. For 105-125 volts, 50-60 cycle AC. Shpg. wt., 7 lbs.

87 F 050. NET.....79.50

WV-77C JUNIOR VOLTOHMYST

Improved model of the popular WV-77B-VTVM. Features WG-299B DC/AC-Ohms probe with built-in selector switch. Redesigned front panel with easy-to-read $4\frac{1}{2}$ " meter. 5 ranges on all functions. Reads AC rms and DC to 1200 volts. Accuracy on AC and negative DC volts is $\pm 5\%$; on positive DC volts, $\pm 3\%$. Measures resistance from 0.2 ohms to 1000 megohms. AC input impedance 0.2 megohms and 75 mmf to 2 megohms and 50 mmf. Input resistance is 11 megohms. Size, $8 \times 5\frac{1}{2} \times 4\frac{1}{2}$ ". Complete with WG-299B probe. For 105-125 volts, 50-60 cycle AC. Shpg. wt., 5 lbs.

87 F 051. NET.....59.50

WV-87B MASTER VOLTOHMYST

New, deluxe VTVM with $7\frac{1}{2}$ " mirrored-scale meter. Reads peak-to-peak to 4200 volts. Response: 30 cps-3 mc. Has zero-center for FM discriminator alignment. Reads DC current to 15 amps. Measures DC voltage to 1500 in 7 ranges. Reads AC rms to 1500 volts; AC input impedances from 0.83 meg and 85 mmf to 1.5 meg and 75 mmf. DC resistance to 1000 megs in 7 ranges. Accuracy, $\pm 3\%$ of full scale for DC; $\pm 3\%$ of full scale for AC. $10 \times 13\frac{1}{2} \times 7$ ". With WG-299C probe and cables. For 105-125 volts, 50-60 cycle AC. Wt., 9 lbs.

87 FZ 066. NET.....137.50

WR-49B RF SIGNAL GENERATOR

New, accurate RF signal generator. Continuous coverage from 85 kc-30 mc. in 6 ranges, all on fundamentals. Excellent for aligning AM and FM receivers. Dial calibration accurate within 1%. Built-in 400-cycle oscillator for internal or external modulation. Attenuator for positive control of RF level. Approximate range: 2000 to 1. Cathode-follower output stage isolates oscillator from effects of load; assures high stability. RF output voltages at least 0.05 v. rms and 0.01 v. rms at high and low connectors respectively. With cable. Size: $7\frac{1}{2} \times 10\frac{1}{2} \times 6$ ". For operation from 105-125 v., 50-60 cycle AC. Shpg. wt., 10 lbs.

87 FZ 079. NET.....79.50

WA-44B AUDIO SIGNAL GENERATOR

For measuring intermodulation, response, input and output impedances, resonant frequency of speakers, etc. 4 ranges: 11-110 and 110-1100 cps; 1.1-11 and 11-100 kc. Has separate 60-cycle, variable-amplitude output. Cathode-follower output. "Hi" and "Lo" outputs: 0-2.5 and 0-15 volts (rms). Frequency stability, 3%. Response, ± 1 db (1100 cps reference). Total harmonic distortion, 2% (max.) from 30 cps to 15 kc. Hum level, 0.1% or less. Size, $7 \times 10\frac{1}{2} \times 6$ ". For operation from 105-125 v., 50-60 cycle AC. Shpg. wt., 12 lbs.

87 FZ 053. NET.....107.50

WR-69A TV-FM SWEEP GENERATOR

New sweep generator provides test and alignment signals for TV video, IF, and RF channels 2-13—plus IF and RF signals for FM radio. Continuous IF coverage from 50 kc to 50 mc. Pre-set switch for channels 2-13. Sweep width, 12 mc, continuously variable. Output flat within 0.1 db per mc of sweep width. Fundamental oscillator output on TV channels; filtered beat-frequency fundamental output on IF/VF range. Output, 1 volt RMS or better at all frequencies. Blanking circuit. Size: $10 \times 13\frac{1}{2} \times 7\frac{1}{4}$ ". With cables. For 105-125 volts, 50-60 cycle AC. Shpg. wt., 17 lbs.

87 FZ 070. NET.....295.00

OTHER RCA INSTRUMENTS

- WR-70A RF-IF-VF-MARKER ADDER. For RF, IF and video sweep-alignment of black-and-white and color sets. 4 differently shaped markers. Use with marker and sweep generators. Marker signal is added after sweep passes through receiver—eliminates distortion of marker or sweep curve. 0-60 db attenuation of IF sweep signal for IF or video alignment. $10\frac{1}{2} \times 7\frac{1}{2} \times 6\frac{1}{4}$ ". For 105-125 v., 50-60 C. AC. 12 lbs.
- 87 FX 055. NET.....97.50
- WG-295B VIDEO MULTIMARKER. For use with sweep generator on black-and-white and color sets. Checks response of chrominance bandpass filter, and alignment of I and Q filters. 7 simultaneous absorption-type markers (mc): 0.5, 1.5, 2.5, 3, 3.58, 4.1, and 4.5. Size: $5 \times 2\frac{3}{4} \times 2\frac{1}{2}$ ". Wt., 1 lb.
- 87 F 054. NET.....32.50
- WG-307A TV BIAS SUPPLY. New. For black-and-white and color TV. 3 output voltages for RF, IF and AGC adjustable from 0 to 15 v.; 1 output, 100 v., for chrominance circuitry. Size: $2\frac{1}{2} \times 3 \times 5\frac{1}{4}$ ". For 105-125 v., 50-60 cycles AC. Wt., 2 lbs.
- 87 F 067. NET.....22.50
- WG-304A RF MODULATOR. Crystal-type mixer. For use with WR-69A and WR-99A to check TV response from antenna to picture tube. $1\frac{1}{2} \times 6 \times 2\frac{1}{8}$ ". Wt., 1 lb.
- 87 F 057. NET.....28.50



WR-61B



WR-46A

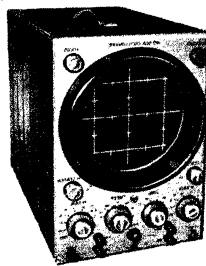

WO-56A



WO-88A



WR-99A

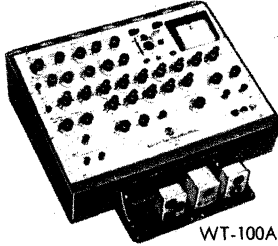

WT-100A

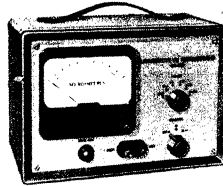

WV-84B

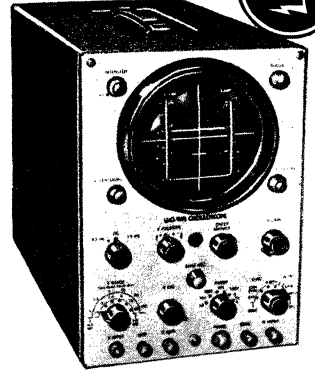

WO-91A 5" OSCILLOSCOPE



WR-61B COLOR-BAR GENERATOR

For checking color TV sets, and for adjusting color phasing and matrixing. Produces 10 bars of different colors, simultaneously. Provides picture-carrier, color-subcarrier and sound-carrier frequencies on channel 3. Luminance signals at edges of bars for checking registration of luminance and chrominance signals. "Sync level Pedestals" for checking signal ratio through the three chrominance channels to indicate potential troubles. Size: 9 3/4 x 13 1/2 x 7 1/2". For operation from 105-125 volts, 50-60 cycle AC. Shpg. wt., 18 lbs.

87 FZ 065. NET 259.50

WR-46A DOT-BAR GENERATOR

This dot-bar-crosshatch generator features a high level video output for driving the picture tube directly; or, the video amplifier of color or black-and-white receivers. Provides interlaced pattern of small dots and a choice of vertical or horizontal bars and a crosshatch. Vertical bars adjustable from 8 to 26 bars—15 horizontal bars only 2 lines wide. Fully adjustable video output voltage. Direct sync from TV signal allows convergence adjustment independent of receiver characteristics. Polarity reversal switch. With all leads and cables. 10x13 1/2 x 8". For 110-120 v., 60 cycle AC. 20 lbs.

87 FZ 056. NET 179.50

NEW WR-99A MARKER-GENERATOR

Crystal-calibrated marker-generator for aligning TV sets and other electronic equipment in the 19-216 mc range. Crystal calibrator provides 240 check points for accurate calibration at 1 or 10 mc intervals. Modulation frequencies: 1, 10, 4.5 mc, 600 cycles. Sound and picture carrier markers available simultaneously. Output: At least 0.1v. rms on all frequencies. Double-shielded oscillator for reduced leakage. 10x13 1/2 x 7 1/2". For operation from 105-125 v., 50-60 cycle AC. Shpg. wt., 18 lbs.

87 FZ 069. NET 242.50

WR-25A TV ISOTAP

Isolation and autotransformer. For checking TV sets at high, medium and low voltage. Selects 105-130 volts in 5-volt steps. Outputs: 105, 115 and 130 v. @ 500 VA from autotransformer winding; 105, 115 and 130 v. @ 275 VA from isolated secondary. 5x5 1/2 x 4 3/8". For 50-60 cycle AC. With 5 ft. line cord. Wt., 15 lbs.

62 G 516. NET 22.00

PROBES FOR RCA OSCILLOSCOPES

WG-300A DIRECT/LOW-CAPACITANCE PROBE. With switch, cable and coaxial connector. Shpg. wt., 1 lb.

87 F 059. NET 14.25

WO-56A TV FM-AM OSCILLOSCOPE

Big 7" screen. DC or AC input. Frequency-compensated, voltage-calibrated attenuators. Vertical response flat, within 2 db, to 500 kc, useful beyond 2 mc. Input impedance: One megohm, 75 mmf with direct probe 9.5 mmf with low-capacity probe. Sensitivity: 10.6 rms mv/inch or 30 mv. p-to-p using direct probe; 106 rms mv/inch or 300 mv. p-to-p, using low-capacitance probe. Sweep: Variable, 3-30,000 cps with fast retrace and preset fixed positions for TV-vertical (30 cps) and TV-horizontal (7875 cps). Has peak-to-peak calibrating voltage source. 13 1/2 x 9 x 16 1/2". With WG-300A probe. 7VP1 CRT. For 105-125 v., 50-60 cycle AC. Shpg. wt., 38 lbs.

84 FZ 085. NET 289.50

LAB ACCURACY INSTRUMENTS

WT-100A MICRO-MHO-METER. Laboratory-quality tube testing instrument for production line and laboratory use. Check general-purpose and industrial-type receiving tubes and low-power transmitting tubes. Measures control grid-to-plate and suppressor grid-to-plate transconductance with better than 5% accuracy. Regulated power supply for DC voltages. Measures individual electrode currents, AC heater currents, voltage drop across electron tubes, dry-disc rectifiers and crystal diodes. Blue-gray case. Size: 8x18 1/2 x 23 1/2". For 105-125 v., 50-60 cycle AC. Shpg. wt., 110 lbs.

84 FZ 021. NET 785.00

INDUSTRIAL SOCKETS. Heavy-duty type for production line testing. Av. wt., 1 lb.

WG-233A. 7-pin. miniature socket. 87 F 061. NET 25.00

WG-234A. 8-pin octal socket. 87 F 062. NET 25.00

WG-235A. 9-pin noval socket. 87 F 063. NET 25.00

WG-236A. Kit of plug-in socket parts for WT-100A (less sockets and with unpunched cover plate). Shpg. wt., 1 lb. 84 F 064. NET 15.00

WV-84B DC MICROAMMETER. New, battery-operated DC microammeter. Reads from .0002 to 1000 microamperes in 6 ranges. Reads current below 1-billionth amp. Voltage drop at full scale 1/2 volt, all ranges. Meter protected against burnout. With batteries. 9 1/2 x 6 1/4 x 5 3/4". Shpg. wt., 10 lbs. 87 F 074. NET 110.00

5" wide-band oscilloscope for black-and-white and color TV servicing. Features: Dual-band response; wide-band position flat within ±1 db from 10 cps to 4.5 mc and narrow-band position flat within -6 db from 10 cps to 1.5 mc, and voltage-calibrated, frequency-compensated 3-to-1 step attenuator. Removable, multi-scale graph screen. Vertical polarity reversal switch. Preset vertical and horizontal sweep positions. Built-in calibration for peak-to-peak voltage measurements. Plus or minus internal sync selector. Positive-lock internal sync. Sensitivity is 0.05 volt peak-to-peak per inch (0.018 volt rms) in narrow-band position and 0.150 volt peak-to-peak per inch (0.053 volt rms) in wide-band position. Vertical input impedance 75 mmf and 1 meg direct, and 11 mmf and 10 meg low-capacity position, with WG-300A probe supplied. Type 5UP1 CRT. Size: 13 1/2 x 9 x 16 1/2". For operation from 105-125 v., 50-60 cycle AC. Shpg. wt., 33 lbs.

84 FZ 049. NET 239.50

WO-88A OSCILLOSCOPE

Popular priced 5" oscilloscope featuring a direct-coupled, push-pull vertical amplifier to provide flat response within 3 db from 0-500,000 cps—excellent reproduction of square waves and sync pulses. Sensitivity: vertical with direct probe, 25 rms millivolts/inch; vertical with low-capacitance probe, 0.25 rms volts/inch. Impedance: Vertical direct probe, 1 meg and 75 mmf; vertical with low-capacitance probe, 10 megs and 9.5 mmf; horizontal, 2.2 meg and 55 mmf. Sweep: variable from 15-30,000 cps. Frequency-compensated step attenuator. Green graph screen is calibrated for peak-to-peak voltage. Excellent shielding throughout. Housed in blue Hammeroid case. Size, 13 1/2 x 9 x 16 1/2" deep. Supplied complete with WG-300A direct/low-capacitance probe, ground lead, alligator clip and instructions. For 105-125 volts, 50-60 cycle AC. Shpg. wt., 32 lbs.

84 FZ 089. NET 179.50

WG-388A WIDE-BAND MODIFICATION KIT. To adapt WO-88A scopes for color television use. Includes all parts and instructions for modification. No special tools required. Provides wide and narrow-band operation from DC to 4.5 mc. Sensitivity: 700 mv peak-to-peak per inch with direct probe. Shpg. wt., 1 lb.

84 F 006. NET 5.95

HICKOK

**TEST EQUIPMENT
FOR SERVICE, INDUSTRIAL
AND LABORATORY USE**

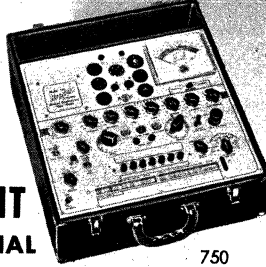

750

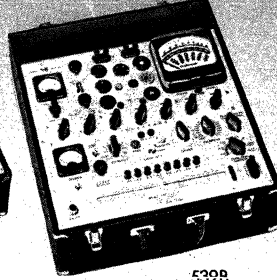

539B

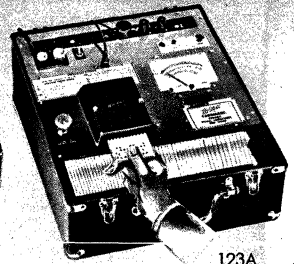

123A



NEW MODEL 6000 TUBE TESTER

- Speedy Transconductance Readings
- 1-2-3 Push-Button Operation Saves Time
- New Socket-Plate Design

Dynamic mutual conductance tester. Features accurate, high-speed testing. Roll chart groups most commonly-used tubes separately—minimizes time-wasting searching! Constant line voltage indication for quick adjustment. All shorted elements indicated and identified at the same time without rotary switching. One-button grid current test measures gas content accurately in micro-amps. Filament continuity check made instantly before warm-up. Socket plate design permits plug-in socket replacement or change without re-wiring. 5" meter has 0-3000-6000-15,000 micromhos and "REPLACE—?—GOOD" ranges. 16 $\frac{1}{2}$ x7 $\frac{1}{2}$ x11 $\frac{1}{4}$ ". For 110-120 v., 50-60 cycle AC. Shpg. wt., 21 lbs.

87 FZ 181. NET.....182.25

MODEL 6005 TUBE TESTER AND VOM. Same as above, but with built-in 20,000 ohm-per-volt multimeter. Shpg. wt., 22 lbs.

87 FZ 182. NET.....224.00

CRT TESTER ADAPTER. For use with all Hickok tube testers to test picture tubes. With cable, plug, and dual socket. Shpg. wt., 1 lb.

84 F 184. NET.....10.25

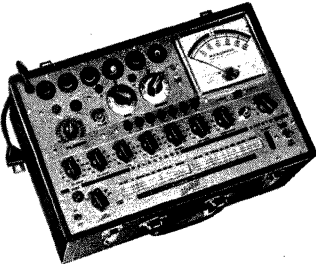

MODEL 600A TUBE TESTER

Dynamic mutual conductance type—checks tubes under simulated operating conditions. Tests all the latest tube types including min., sub-min., and 600 ma series heater types. Has these outstanding features: easily portable; tests for gas content; reads directly in micromhos; applies separate voltage to each element; easily detects hard-to-locate weak tubes. Predicts probable tube life. Easy-to-read triple-scale 5" lucite-case meter has ranges of 0-3000-6000-15,000 micromhos and "REPLACE—?—GOOD". Red leatherette-covered case. Size: 16 $\frac{1}{2}$ x7 $\frac{1}{2}$ x11 $\frac{1}{4}$ ". For 110-120 volts, 50-60 cycle AC. Shpg. wt., 21 lbs.

84 FZ 185. NET.....166.00

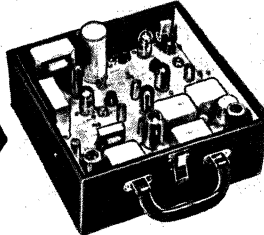

660

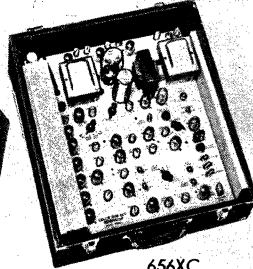

656XC

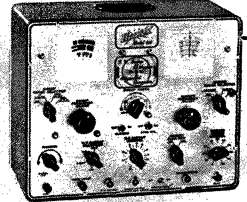

615

MODEL 539B TUBE TESTER

Laboratory-type dynamic mutual conductance tube tester. Accurately measures mutual conductance under simulated operating conditions. Tests all receiving-type tubes, voltage regulators, selenium and germanium diodes.

Uses 3 meters. Micromhometer with 8 ranges; 60,000-30,000-15,000-6000-3000-600 micromhos; Rectifier Diode Range; Voltage Regulator Range. Separate AC meter for line voltage check and separate DC voltmeter for grid bias readings. Bias control has vernier adjustment. Choice of 4 AC signals (2.5, 5, 1, 2.5 v.). Reads leakage up to 50 megohms. Permits tube matching; tests future life of tube, noise and gas content. Has choice of low or normal plate and screen voltages. Black leatherette-covered portable case. Size: 16 $\frac{1}{2}$ x18 $\frac{1}{2}$ x7 $\frac{1}{2}$ ". For operation from 110-125 volts, 50-60 cycle AC. Shpg. wt., 39 lbs.

84 FZ 608. NET.....392.95

MODEL 750 TUBE TESTER

Portable dynamic mutual conductance tester for accurately testing all types of radio and TV receiving tubes—including the 600 ma series-string types. Also checks ruggedized types used by airlines, hearing aid tubes and voltage regulator tubes—accurate DC voltmeter measures 0-200 volts; DC milliammeter, 0-200 ma. Permits matching of tubes such as 6SN7 for critical circuits. 5" meter reads 0-1500-3000-6000-15,000-30,000 micromhos—also 0-200 v. DC and 0-100 ma DC scales. Has two "Replace-Good" ranges. Tests for shorts, gas, noise, and gives probable tube life. Provides a choice of two plate and screen voltages and four AC signal voltages—as low as .25 volt. Leatherette-covered case. Size: 18 $\frac{1}{2}$ x16 $\frac{1}{2}$ x7 $\frac{1}{2}$ ". For operation from 110-125 v., 50-60 cycle AC. Shpg. wt., 24 lbs.

84 FZ 633. NET.....257.25

MODEL 660 DOT-BAR GENERATOR

New, portable white dot-bar color-display generator designed for "on-the-spot" adjustment of color TV receivers. All frequencies generated are crystal-controlled and locked together for extreme stability—reduces possibility of alignment error. Features switch selection of RF output up to .05 v. on TV channels 2 to 6, 300 white dots, less those in blanking; 20 vertical and 15 horizontal white crosshatch lines, less those in blanking. Color display pattern; crystal accurate in sequence of red, blue and green. RF modulated (60%) by all video outputs. Housed in sturdy, black leatherette, portable case. With 2 crystals, output cable and instructions. Size, 10 $\frac{1}{2}$ x10 $\frac{1}{2}$ x5 $\frac{1}{4}$ ". For operation from 105-125 v., 50-60 cycle AC. Shpg. wt., 20 lbs.

87 FZ 175. NET.....243.00

MODEL 123 AUTOMATIC TUBE TESTER

Automatic dynamic mutual conductance precision tester. Uses perforated vinyl cards which slide in easily to instantly trip automation circuit. One card sets up entire circuit for testing each function of tube—automatically, without roll charts. Ideal for fast, accurate laboratory or industrial use.

Features: Automatic short test; direct-reading leakage check; sensitive gas test; 0.22 v. rms grid signal variable voltages for each tube element. "Knee test" quickly evaluates tube's ability to perform in TV sweep circuit. 5" meter. With 500 cards covering all popular tube types and metal rack for easy filing. In ventilated, counter-type steel case. 16 $\frac{1}{2}$ x18 $\frac{1}{2}$ x7 $\frac{1}{2}$ ". For 110-120 v., 60 cycle AC. Shpg. wt., 51 lbs.

87 FZ 179. NET.....470.00

MODEL 123A. As above, but in portable case with filing rack. Shpg. wt., 56 lbs.

87 FZ 183. NET.....470.00

656XC TV COLOR BAR GENERATOR

Highly accurate, white dot crosshatch and color bar generator, for color TV servicing. Supplies the same type of color signal that is transmitted over the air; a self-checking, standard 100% fully saturated NTSC color bar pattern. Crystal-controlled 3.58 mc color burst. Provides signals for demodulator alignment; I. Q. and R-Y and B-Y signals. Video output, 0-2 volts p-to-p open circuit. RF output, modulated with color bar pattern, on channels 2 to 6. Produces white dot crosshatch: 20 vertical and 15 horizontal, less those in blanking; 300 dots, less those in blanking; also provides vertical and horizontal lines. Sound carrier for setting local oscillator. Leatherette-covered carrying case. Size, 7 $\frac{1}{2}$ x16 $\frac{1}{2}$ x18 $\frac{1}{2}$ ". For operation from 110-120 volts, 60 cycle AC. Shpg. wt., 42 lbs.

87 FZ 176. NET.....495.00

615 SWEEP & MARKER GENERATOR

Combination sweep and marker generator for visual alignment of TV receivers. Continuous IF coverage from 0 to 50 mc. Fine tuning adjustment pinpoint frequency. Sweep width variable from 0 to 15 mc. Marker frequencies: 2.5 to 5.5 mc; 19 to 50 mc; 54 to 108 mc; all on fundamentals—108 to 216 mc on harmonics. Built-in 4.5-mc crystal provides dual markers for IF or RF alignment; and 4.5-mc signal for intercarrier sound alignment. 900-cycle internal modulator for both marker and crystal oscillators. Built-in retract blanking panel-controlled for zero reference. External sweep variable phasing (170°) for use with scopes without variable phasing. Size, 13 $\frac{1}{2}$ x16 $\frac{1}{2}$ x8". For 110-120 volts, 50-60 cycle AC. Shpg. wt., 39 lbs.

87 FZ 177. NET.....299.00

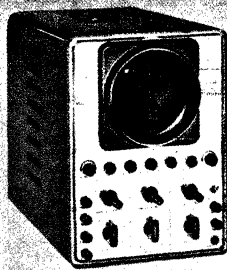

675A

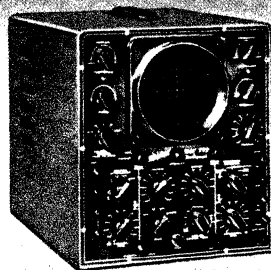

770

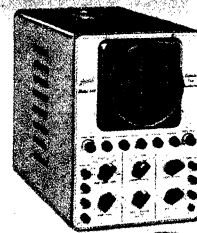

685

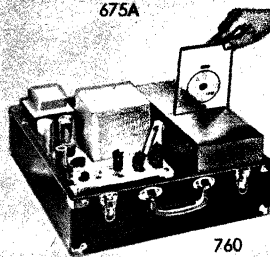

760

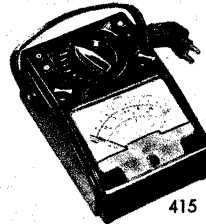

415

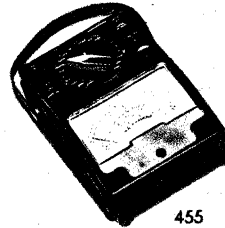

455

HICKOK

TEST EQUIPMENT QUALITY INSTRUMENTS

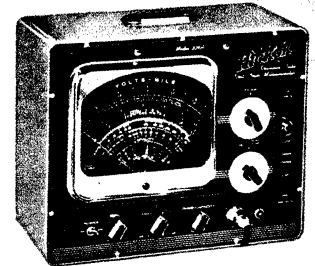

MODEL 209A VTVM

- Light Loading—Only 7 mmf.
- Flat Response to 300 mc.
- Big, Zero-Center 9" Meter

Professional-quality VTVM and capacitance checker. Large, zero-center 9" meter. Flat response from 30 cps to 300 mc. Input impedance: DC, 12 megs.; AC, 12 megs shunted by 7 mmf (3 megs on 1200 v. scale). Ranges: AC-DC volts, 0-3-12-30-120-300-1200; DC current, 0-3-12-30-120-300-1200 ma; Resistance, .1 ohm to 10,000 megs in 8 ranges; capacitance; 1 mmf. to 1000 mfd. in 7 ranges; inductance, 50 mh to 1000 henries (with conversion chart provided); db, -20 to +25 in 3 ranges; AC peak-to-peak, 0-3-12-30-120-300. 13/4x16x4x7". With AC and DC probes, test leads. For 105-125 v., 50-60 cycle AC. Shpg. wt., 25 lbs.

84 FZ 136. NET. 140.25

PR-30KVA PROBE. For above. Extends range to 30 KV DC. Shpg. wt., 1 1/2 lbs.

84 F 149. NET. 14.35

MODEL 675A WIDE-BAND SCOPE

Wide-band, high sensitivity, 5" oscilloscope for color TV as well as FM and AM use. Features 4.5-mc bandwidth and 20 rms mv/inch vertical sensitivity. Illuminated, calibrated screen with astigmatic focus provides exceptional trace detail. Vertical response within 3 db from 1 cps to 4.5 mc—flat through 3.58-mc color burst frequency. Excellent pulse response with a rise time of .08 microseconds. Switch for reversing polarity of vertical trace. Built-in voltage calibrator. Horizontal response within 3 db from 1 cps to 450 kc—sensitivity is 250 rms mv/inch. Sweep frequency, 10 cps to 100 kc. Has input for intensity modulation. 13x10x16". For operation from 110-120 v., 50-400 cycle AC. Shpg. wt., 43 lbs.

84 FZ 634. NET. 278.25

NEW MODEL 685 INDUSTRIAL SCOPE

5" oscilloscope for industrial or laboratory use. DC or AC input. Illuminated, calibrated screen backed with green filter reduces incidental reflections for accurate measurements. Astigmatic focus control provides sharp, undistorted trace. Excellent pulse response with rise time of approx. 0.5 microseconds.

Vertical frequency response, 0 to 750 kc within 3 db. Sensitivity is 20 rms mv/inch. Input impedance, 1 megohm, 40 mmf. Horizontal amplifier response is within 3 db from 0 to 750 kc—sensitivity of 30 rms mv/inch. Sweep frequency, 1 cps to 100 kc in 5 calibrated ranges, with fine tuning vernier control of 10 to 1 ratio. Includes provision for even lower sweep frequencies with external capacitors (not supplied). Choice of recurring or triggered sweep functions; internal or external locking. Has input for intensity modulation. Size, 17 1/2 x 9 3/4 x 13 1/4". For 105-125 v., 50-400 cycle AC. Shpg. wt., 46 lbs.

87 FZ 184. NET. 345.00

MODEL 770 LABORATORY SCOPE

Wide-band, 5" oscilloscope for professional use including color TV servicing. Dual bandwidth for flat response and maximum sensitivity. *Wide band:* Frequency response 0 to 5 mc within 3 db; vertical sensitivity, 35 rms mv/inch. *Narrow band:* Frequency response, 0 to 2.5 mc, 3 db down;—sensitivity, 10 rms mv/inch. Horizontal response,—3 db from 0 to 500 kc—sensitivity, 75 rms mv/inch. Sweep frequency from 2 to 30,000 cps. 14x12x18". For operation from 110-120 v., 50-400 cycle AC. Shpg. wt., 60 lbs.

84 FZ 606. NET. 398.00

MODEL 34 DEMODULATOR PROBE. Extends RF range to 500 mc. Shpg. wt., 1 1/2 lbs.

84 F 138. NET. 5.75

MODEL TYP-1 PROBE. Low impedance for reduced loading. Shpg. wt., 2 lbs.

84 F 162. NET. 11.50

NEW MODEL 760 VIDEO SCANNER

A complete cable-connected TV transmitting station. Instantly scans and produces a video or RF signal from slide. Extremely useful for TV servicing; can also be used by dealers for projecting information on TV sets in the store. Reproduces your own test patterns, pictures, messages, advertising displays, paging, etc., in any closed-circuit or community antenna TV system. Will operate any black-and-white or color TV receiver. Enables rapid frequency response analysis of picture definition capabilities.

RF output, 100,000 microvolts—enough to drive several receivers simultaneously. Video output, 2 volts peak-to-peak; choice of positive or negative output. Variable sync level; permits test of how well a TV receiver locks-in on high or low sync levels. Completely crystal controlled. Supplied with bar, dot, standard test pattern, and transparent blank slides. Size, 19 1/2 x 17 x 8 1/4". For 105-125, 50-60 cycle AC. Shpg. wt., 50 lbs.

87 FZ 185. NET. 299.90

MODEL 415 VTVM

Compact vacuum tube voltmeter. Ideal for radio-TV servicing and industrial laboratory use. Features modern "laydown" design. Ranges: AC (rms) and DC volts, 0-1.5-15-50-150-500-1500. Zero center DC ranges for instant polarity identification. DC input impedance is 13.3 megohms. AC input capacity is 10 megohms shunted by 150 mmf.; frequency response, 50 cps to 2.5 mc. Ohmmeter is readable from 0.2 ohms to 2000 megohms. Resistance ranges: 0-2000-20,000-200,000 ohms and 0-2-200-2000 megohms. Center-scale reading, 10 ohms. With test leads. Requires no batteries. 3x5 7/8 x 8 1/4". For 110-120 v., 50-60 cycle AC. Shpg. wt., 6 lbs.

87 F 178. NET. 82.00

MODEL 455 INDUSTRIAL VOM

Compact, portable VOM. Rugged design withstands hard use. Unique overload circuit cut-out and fuse system protects meter and components against burn-out on any function including ohms. Single switch selects function and range. Sensitivity: 20,000 ohms-per-volt AC-DC. Ranges: AC-DC v., 0-3-12-30-120-600-1200; resistances, 0 to 100 megs in 4 ranges—5 ohms center scale; current, 0-50 ua, 0-1-10-100-1000 ma, 0-10 amps. 3x5 7/8 x 8 1/4". With test leads. Less batteries. Shpg. wt., 5 1/2 lbs.

84 F 609. NET. 66.50

CARRYING CASE. Durable neoprene; houses Model 455 or 415 plus leads. 1/2 lb.

84 F 635. NET. 9.00

JERROLD

704B Portable VHF Field Strength Meter



Extremely versatile, portable VHF field strength meter. Useful for field intensity surveys, checking per cent of AM and FM modulation, locating and measuring noise and losses, testing antenna color response, calibrating signal generators, adjusting traps, and numerous other applications. Continuously tunable, 54-220 mc, ±1 1/2 db accuracy. Sensitivity, 5 μv. Ranges: 0-300-1000-3000-10,000-30,000 μv RF; with built-in attenuator, measures 0.1-3-1-3 v. RF. Db meter scale and dbj scale on range switch for easy conversion to dbj (gain). Bandwidth, 600 kc at 3 db down. 12x12 3/4 x 8". For operation from 105-125 v., 50-60 cycle AC. Shpg. wt., 24 lbs.

87 FZ 293. NET. 365.00

TRIPLITT

TEST EQUIPMENT

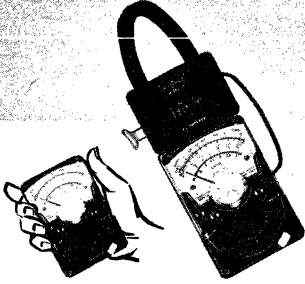

NEW MODEL 310-10 WITH ADAPTER

Versatile, miniature combination VOM and AC ammeter clamp-on adapter. Clamp-on jaws of ammeter adapter fit around any single conductor to permit direct reading of C-6-12-30-60-120-300 amps AC, without breaking circuit or piercing the insulation. Adapter securely locks to VOM body; can be left on permanently while using VOM ranges, or removed. VOM ranges: DC volts, 0-3-12-60-300-1200 at 20,000 ohms/volt; AC volts, 0-3-12-60-300-1200 at 5000 ohms/volt; DC μ a, 0-600; DC ma, 0-6-60-600; ohms, 0-20,000-200,000; megohms, 0-2-20. Size, $8\frac{1}{2} \times 3\frac{1}{4} \times 1\frac{1}{4}$ ". With batteries, leads. Wt., $3\frac{3}{4}$ lbs.
66 F 588. NET. 48.02

MODEL 310 VOM ONLY. Miniature, hand-sized VOM with 18 ranges. Same as above, but without AC ammeter clamp-on adapter. $4\frac{1}{4} \times 2\frac{3}{4} \times 1\frac{1}{4}$ ". Shpg. wt., 1 lb.
84 F 674. NET. 33.81

MODEL 379 LEATHER CARRYING CASE. Holds Model 310-10. Shpg. wt., 8 oz.
66 F 590. NET. 5.39

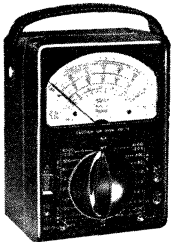

MODEL 630 VOM

Popular, accurate VOM. $5\frac{1}{2}$ " meter with $4\frac{3}{8}$ " scale. Ranges: DC and AC volts, 0-3-12-60-300-1200-6000, DC at 20,000 ohms/volt, AC at 5000 ohms/volt; DC current, 0-60 microamps, 0-1.2-12-120 ma, and 0-12 amps; resistance, 0-1000-10,000 ohms and 0-1-100 megs; db, -30 to +70 in 7 ranges; output v., 0-3-12-60-300-1200-6000. $7\frac{1}{2} \times 5\frac{1}{2} \times 3\frac{1}{2}$ ". With batteries, leads. Shpg. wt., 6 lbs.
84 F 568. NET. 43.61

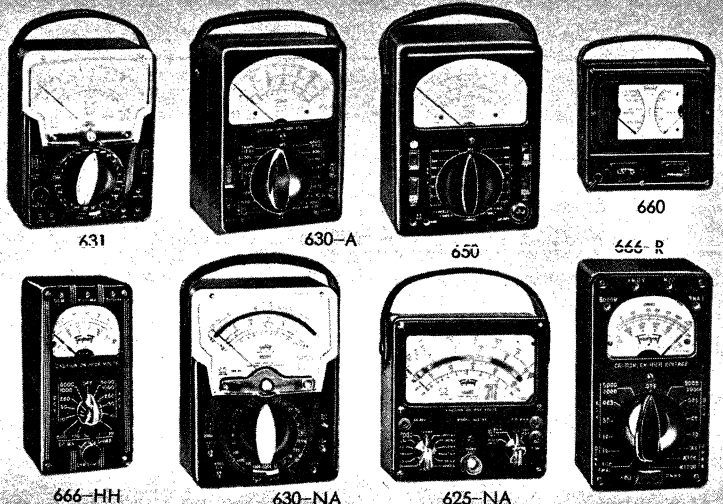

MODEL 631 VTVM-VOM

Battery-operated, 34-range VTVM and VOM. Easy-to-read VTVM ranges: 0-1.2-6-30-120 DC volts; 11 megohms input impedance. VOM ranges: DC volts, 0-3-12-60-300-1200 at 20,000 ohms/volt; AC volts, and audio output/volts, 0-3-12-60-300-1200 at 5000 ohms/volt; DC microamperes, 0-60; DC ma, 0-1.2-12-120-1200 at 250 mv; DC amps, 0-12 at 250 mv; db, -30 to +56; ohms, 0-1500-15,000; megohms, 0-1.5-150. $3\frac{7}{8} \times 5\frac{1}{2} \times 7\frac{1}{2}$ ". With batteries and 48" leads with alligator clips. Shpg. wt., 5 lbs.
84 F 546. NET. 63.21

MODEL 650 VTVM

Highly accurate VTVM. Ranges: DC volts, 0-1-5-10-50-100-500-1000; AC volts, 0-1-5-10-50-100-500; resistance, 0-1000 megohms in six ranges, $7\frac{1}{2} \times 5\frac{1}{2} \times 3\frac{3}{4}$ ". With 2 alligator clips, AC-RF probe, ohms-DC probe and battery. For 110-120 volts, 60 cycle AC. Shpg. wt., 8 lbs.
84 F 558. NET. 87.71
H. V. PROBE. 0-50,000 v. DC. Wt., 8 oz.
84 F 564. NET. 14.21
MODEL 659 LEATHER CARRYING CASE. Shpg. wt., $1\frac{1}{2}$ lbs.
84 F 559. NET. 10.29

MODEL 666-HH VOM

Accurate, low-cost VOM. 400 microampere meter movement. Ranges: AC-DC volts, 0-10-50-250-1000-5000 at 1000 ohms per volt; DC ma, 0-10-100-500; ohms, 0-2000-400,000. With battery and 48" leads. Plastic case. $5\frac{7}{8} \times 3\frac{1}{16} \times 2\frac{9}{16}$ ". 4 lbs.
84 F 555. NET. 26.95

MODEL 625-NA VOM

Wide-range VOM. Large mirror scale. DC volts, 0-1.25-5-25-125-500-2500 at 20,000 ohms/volt and 0-2.5-10-50-250-1000-5000 at 10,000 ohms/volt; DC current, 0-50 μ a, 0-1-10-100-1000 ma, and 0-10 amps; resistance, 0-2000-200,000 ohms, 0-40 megs. AC volts, 0-2.5-10-50-250-1000-5000 at 10,000 ohms/volt, $5\frac{1}{2} \times 2\frac{1}{2} \times 6\frac{7}{8}$ ". With batteries and leads. Wt., 6 lbs.
84 F 575. NET. 53.41
MODEL 629 CASE. Leather case with handle. Shpg. wt., 1 lb.
84 F 561. NET. 7.06

MODEL 630-A VOM

Laboratory type, highly accurate VOM. Features unit construction; series ohmmeter circuits; special $\frac{1}{2}$ % resistors for greater accuracy; long, mirrored meter scales for reduced parallax. Accuracy: $1\frac{1}{2}$ % on ohms and 0-1200 DC volts; $\frac{4}{5}$ % on 6000 DC volts and all AC ranges. Ranges: DC and AC volts 0-3-12-60-300-1200-6000 (DC at 20,000 ohms per volt, AC at 5000 ohms per volt); DC current, 0-60 microamps, 0-1.2-12-120 milliamperes, and 0-12 amps; resistance, 0-1000-10,000 ohms, and 0-1-100 megohms; db, -30 to +70 in 7 ranges; output volts, 0-3-12-60-300-1200-6000. $5\frac{1}{2}$ " meter with $4\frac{3}{8}$ " scale. $7\frac{1}{2} \times 5\frac{1}{2} \times 3\frac{3}{8}$ ". Complete with batteries and 48" leads. Shpg. wt., 6 lbs.
84 F 574. NET. 53.41

MODEL 660 LOAD-CHEK

Wattmeter-voltmeter. Detects overloads and underloads. Load-Chek shows if power drawn from line exceeds or is less than the proper value. Power cord of unit under test plugs into receptacle on Load-Chek. Two 3" meters provide simultaneous wattage and voltage readings. Two watt-meter ranges. Toggle switch changes watt scale. Ranges: 0-500-1000 AC-DC watts; 0-150 AC-DC volts. Black plastic case. Size, $6 \times 5\frac{1}{2} \times 2\frac{1}{2}$ ". Shpg. wt., 4 lbs.
84 F 537. NET. 33.81

MODEL 630-NA VOM

Offers unusually high accuracy. 70 ranges: $\pm 1\frac{1}{2}$ % on DC to 1200 v.; $\pm 3\%$ on AC to 1200 v. Features: DC volts: 8 ranges to 6000 (10,000 ohms/v.); 8 ranges to 3000 (20,000 ohms/v.). AC volts: 6 ranges to 6000 (5000 ohms/v.); 6 ranges to 3000 (10,000 ohms/v.). DB: -30 to +70 in 12 ranges. DC microamps: 1 range to 120 (240 mv); 2 ranges to 600 (120 mv). DC milliamps: 4 ranges to 1200 (240 mv); 3 ranges to 600 (120 mv). DC amps: 1 range to 12 (240 mv); 1 range to 6 (120 mv). Resistance: 3 ranges to 100,000 ohms; 3 ranges to 100 megohms. Output: All 12 AC volt ranges, $7\frac{1}{2} \times 5\frac{1}{2} \times 3\frac{1}{16}$ ". Mirror scale. With leads, batteries. Shpg. wt., 6 lbs.
84 F 512. NET. 73.01

MODEL 666-R VOM

Compact VOM. Single range-function switch and ohms adjust. 1000 ohms/volt sensitivity. Has 3" meter. Ranges: DC and AC volts, 0-10-50-250-1000-5000; DC ma, 0-10-100; DC amps, 0-1; ohms, 0-3000-300,000; megs., 0-3. Black plastic case, $5\frac{7}{8} \times 3\frac{1}{16} \times 2\frac{9}{16}$ ". With batteries, 48" test leads. Shpg. wt., 4 lbs.
84 F 557. NET. 28.91
MODEL 669 CASE. Cowhide case for Model 666R or 666-HH. Wt., 1 lb.
84 F 560. NET. 5.98
MODEL 669-RL CASE. Leather case for Model 666-R. Shpg. wt., 1 lb.
84 F 547. NET. 6.47

ACCESSORIES FOR TRIPLITT 630, 630-A, 630-NA & 631 VOM'S

HIGH-VOLTAGE PROBE. For 630, 630-A or 631. Extends DC range to 30 kv. Polystyrene insulation. Shpg. wt., 8 oz.
84 F 544. NET. 14.21

MODEL 639 CASE. Durable leather carrying case for 630, 630-A, 630-NA, or 631. Meter can be used without removal from case. Shpg. wt., $1\frac{1}{2}$ lbs.
84 F 569. NET. 9.21

MODEL 639-P CASE. As above, with sponge rubber padding. $1\frac{3}{4}$ lbs.
84 F 562. NET. 14.60

TESTER STAND. Holds above meters at 45° angle. Shpg. wt., 1 lb.
84 F 573. NET. 49c

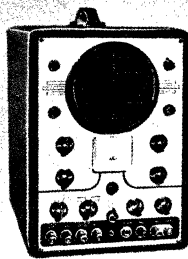

3441-A

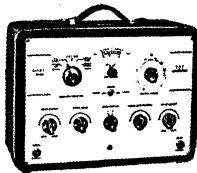

3438

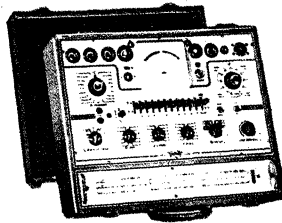

3423

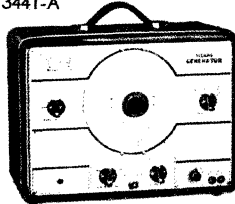

3432-A

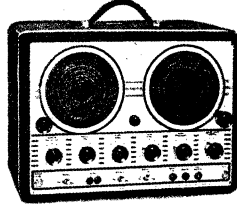

3434-A

MODEL 3441-A TV-FM OSCILLOSCOPE

Wide-range 5" TV-FM oscilloscope. Suitable for color TV. Push-pull vertical and horizontal output amplifiers. 4.5 megacycle bandwidth, usable to 9 mc. Vertical sensitivity: 10 rms mv/inch maximum. Horizontal response, 20 cps to 150 kc. Peak-to-peak, 2 3/8" voltmeter reads 0-1000 volts in 8 ranges. Phased 60-cycle horizontal sweep and return trace eliminator for use with sweep generators. Phone jack on panel for audio check of waveform under observation; for audio circuit tracing. Variable sawtooth output from 10 to 60,000 cycles. With coaxial cable. Size: 15 1/2 x 11 1/2 x 11 1/2". For 110-120 volts, 50-60 cycle AC. Shpg. wt., 42 lbs.

84 FZ 530. NET..... 244.51

9989 CRYSTAL PROBE. For use with above. Shpg. wt., 8 oz.

84 F 545. NET..... 10.29

MODEL 3432-A SIGNAL GENERATOR

Quality signal generator for AM-FM radio, black-and-white and color TV servicing. Covers complete range from 160 kc to 110 mc (220 mc using harmonics) with no skips in frequency. 6 3/4" etched dial. Jacks provided for either internal modulation or audio output. Internal modulation variable 0-100% at 400 cps. Ranges selected by 7-position switch. Coaxial output cable. Size: 15 1/2 x 11 1/2 x 6 1/4". For 110-120 v., 50-60 cycle AC. Shpg. wt., 12 lbs.

84 FZ 677. NET..... 97.51

MODEL 3438 DOT GENERATOR

High-quality dot-bar generator for checking video, RF, IF, sync and color circuits. Provides standard vertical and horizontal sync pulses; horizontal bars (480-600 cps) and vertical bars (189 kc, crystal-controlled); white dot pattern; and square block cross hatch. Crystal controlled accuracy for varying colors through approx. 330° of the color spectrum with any combination of the function selector. Will produce red, blue and green color spectrum and colors corresponding to R-Y, B-Y, I and Q axis. Has both positive and negative video outputs. Completely self-contained. 6 1/4 x 11 1/2 x 15 1/2". For 110-120 v., 50-60 cycle AC. Shpg. wt., 16 lbs.

84 FZ 598. NET..... 224.91

MODEL 3434-A TV-FM GENERATOR

For TV and FM receiver servicing. Continuous tuning to 243 mc. Regulated power supply for greater oscillator stability. Sweep center frequency: 0-60, 60-120 and 120-243 mc. Sweep width: 0.1 to 12 mc, continuously variable. Marker frequencies: 3.5-4.9, 19.5-29.3, 29-48.6 (fundamentals); 48.6-243 mc on harmonics. Crystal frequency: to 20 mc on fundamentals; harmonics to 216 mc (crystals not supplied). Modulation: 600 cycles in both crystal and marker frequencies. Crystal and variable marker permits simultaneous presentation of two markers. 15 1/2 x 11 1/2 x 8 1/4". For 110-120 v. 50-60 cycle AC. Shpg. wt., 27 lbs.

84 FZ 534. NET..... 234.71



TEST EQUIPMENT

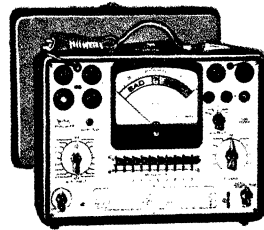

MODEL 3413-B TUBE TESTER

An extremely versatile tube tester. Checks all radio receiving tubes, including series-string types, ballasts, miniatures, and hearing aid types. Dual-sensitivity, neon-type short test. Checks TV picture tubes when used with T-2247-BV adapter listed below. Shows shorts, open circuits and condition of tube elements, connections, taps, etc. Provides continuity test for electrical appliances, motors, etc. 6" meter with 3-color scale. Accurate BAD—?—GOOD tests. Built-in, Speed-Roll chart; Line voltage compensator; Counter-portable case; handle and removable cover. Size, 15 1/2 x 11 1/2 x 6 1/2". For operation from 110-120 volts, 50-60 cycle AC. Shpg. wt., 28 lbs.

84 FZ 591. NET..... 77.91

T-2247-BV ADAPTER. Adapts models 3413-B and 3423 for picture tubes. Shpg. wt., 1 lb. 84 F 539. NET..... 5.29

MODEL 3423 TUBE TESTER

Accurate, versatile tube tester. Tests by proportional mutual conductance method—simulates actual tube operating conditions. Tests receiving tubes, subminiatures, ballasts, low-power transmitting types, etc. Includes tests for series-string tubes. Reads mutual conductance directly in microhmhos; also BAD—?—GOOD scale. Checks pilot lamps and continuity of motors, etc. Checks for shorts and leakage between elements. Indicates gassy and noisy tubes. Filament voltage adjustable from 0.63 to 117 in 19 steps. Size, 14 3/4 x 18 25/32 x 6 1/2". For 110-120 v., 50-60 cycle AC. Shpg. wt., 24 lbs.

84 FZ 541. NET..... 195.51

Sprague Quality Test Equipment

MODEL KT-1 CAPACITOR CHECKER

An up-to-the-minute capacitor tester. Permits checking capacitors while they are wired into the equipment being serviced. No unsoldering is necessary—not even when capacitor is wired in parallel with a resistor. Instantly checks for direct short, open or intermittent conditions in all types of capacitors. Bypass, coupling, and blocking capacitors from 30 mmf. to 2000 mmf. can be checked even when wired in parallel with resistances as low as 60 ohms. Capacitors between .1 mfd. and 2000 mfd. can be checked even when wired in parallel with resistances as low as 2 ohms. Sturdy steel case with medium gray wrinkle finish. Size, 9x6x5 1/4". For 110-120 v., 50-60 cycle AC. Shpg. wt., 7 lbs.

84 FX 005. NET..... 33.81

NEW MODEL TO-5 TEL-OHMIK

Multi-purpose bridge-type capacitor analyzer. Quickly detects open, shorted, or intermittent capacitors. Provides an accurate, multi-range capacitance and power factor measuring bridge; an insulation resistance checker for paper, mica, and ceramic capacitors; a leakage current indicator for electrolytics (tests at rated voltages); and a turns ratio scale to measure turns ratio of power and audio transformers. Measures capacitance from 1 mfd. to 2000 mfd. in 5 ranges; electrolytic leakage from 0-60 ma in 2 ranges; power factor of electrolytics to 55% in 3 ranges. Up to 600 volts DC for electrolytic test. Size, 8 7/8 x 14 3/8 x 6 1/8". For 110-120 v., 50-60 cycle AC. Shpg. wt., 12 1/2 lbs.

66 FX 591. NET..... 82.22

NEW MODEL LF-1 TRANSIMULATOR

Unique transistor circuit simulator. Simulates any 1-transistor amplifier stage, AC or DC, except high-power audio stages. Useful for testing experimental circuits quickly and easily—without time-consuming soldering or messy breadboards. Excellent for lab and quality control applications—predicts transistor performance in various types of circuits. Includes all variable components necessary for an RC amplifier. With 5-way binding posts for transformer cou-

pling and metering circuits. Has self-contained separate bias and load battery supplies, negative or positive voltages. Can be used with PNP, NPN junction or surface barrier transistors; common or grounded emitter, base or collector. For circuits using more than one transistor. Transimulators may be cross-coupled. Less batteries (requires 8—RCA V5035 cells; see page 286). 5 1/2 x 14 3/4 x 8 1/2". Wt., 11 1/2 lbs.

66 FX 592. NET..... 77.91

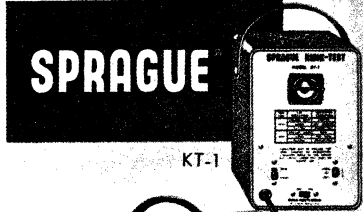

KT-1

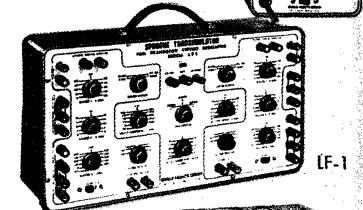

LF-1



TO-5

Express Shipment Recommended for Test Equipment

Simpson

TEST EQUIPMENT

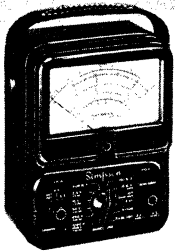

MODEL 260 VOM

Extremely popular, time-tested, VOM. Provides great versatility and dependable performance at moderate cost. 29 ranges. DC sensitivity, 20,000 ohms per volt. AC sensitivity, 1,000 ohms per volt. Ranges: AC and DC volts; 0-2.5-10-50-250-1,000-5,000. Output volts; 0-2.5-10-50-250. DC current; 0-100 microamps. 0-10-100-500 ma and 0-10 amps. Resistance; 0-2,000 ohms (12 ohms center), 0-200,000 ohms (1200 ohms center), and 0-20 megohms (120,000 ohms center). Decibels; -12 to +55 db in 5 ranges. Bakelite case. 5 1/4 x 7 x 3 1/4". With batteries and test leads. Shpg. wt., 5 lbs.

84 F 780. NET. 43.07

MODEL 260 RT. As above, but in convenient "roll top" safety case. Size: 6 1/2 x 9 x 4 3/4". Shpg. wt., 9 lbs.

84 F 779. NET. 48.95

HIGH-VOLTAGE PROBE. Extends DC range to 25,000 volts. Shpg. wt., 8 oz.

84 F 771. NET. 9.75

TYPE 8375 SPARE TEST LEADS. With alligator clips and elbow terminals. Shpg. wt., 1 lb.

87 F 106. NET. 1.22

MODEL 390 VOLT-AMP-WATTMETER

Measures power consumption of any 60 cycle AC appliance, radio or TV. Speeds trouble-shooting. Ranges: AC volts, 0-150 and 0-300; amps, 0-3 and 0-15; watts, 0-300, 0-600, 0-1500 and 0-3000. Has 3" meter. Size: 5 7/8 x 3 x 2 1/2". Supplied with break-in plug and leads. Shpg. wt., 4 lbs.

84 F 788. NET. 43.07

MODEL 370. AC AMMETER. (Not illus.) Ranges: 0-1.2-5-5-10-25 amperes. Built-in current transformer. 3" meter. 3 x 5 7/8 x 2 1/2". Less leads. For 60 cycle AC. Wt., 3 lbs.

84 F 794. NET. 21.51

MODEL 379. BATTERY TESTER. (Not illus.) Tests radio and hearing aid batteries from 1.5 to 90 volts. Makes test under load conditions for accurate indication of battery's condition. 3" dial. With needle-type prods. Size: 3 x 5 7/8 x 2 1/2". Shpg. wt., 3 lbs.

84 F 764. NET. 24.45

MODEL 372 OHMMETER

An accurate, wide-range ohmmeter that easily fits into pocket or tool box. Features exceptionally small size and 5-range flexibility—an excellent instrument for field servicing applications. Employs a special 3" meter. Basic movement has a sensitivity of 85 microamperes. Ranges; 0-500 (5 ohms center), 0-5000 (50 ohms center), 0-50,000 (500 ohms center), 0-5 megohms (50,000 ohms center), 0-50 megohms (500,000 ohms center). Supplied complete with batteries and test leads. Size: 3 x 5 7/8 x 2 1/2". Shpg. wt., 3 lbs.

84 F 796. NET. 27.39

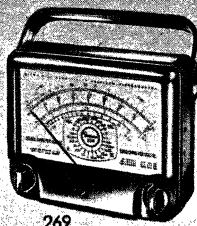

269



355

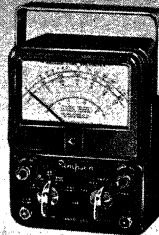

303



382



390



372

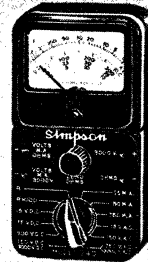

240

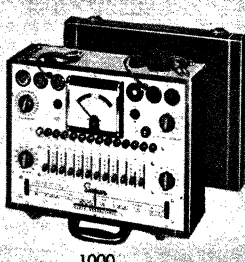

1000

MODEL 362 LOW-OHMMETER

(Not illus.) Highly-accurate readings between 0.1 and 25 ohms. Ranges: 0-5 ohms and 0-25 ohms. Ideal for checking motor armatures and fields; switch and relay contact resistances; shorts in TV and radio wiring. With calibrated test leads. Size: 3 x 5 7/8 x 2 1/2". Shpg. wt., 3 lbs.

87 F 107. NET. 24.45

MODEL 269 MICROAMMETER VOM

Sensitive, 100,000 ohms/volt multimeter. Battery-operated; 33 ranges; 7" dial; 2 controls. Ranges: DC current, 0-16-160 microamps. 0-1.6-16-160 milliamps and 0-1.6-16 amps. DC volts, 0-1.6-8-40-160-400-1600-4000 (100,000 ohms/volt); AC volts, 0-3-8-40-160-800; output volts, 0-3-8-40-160; resistance, 0-2000-20,000-200,000 ohms. 0-2-20-200 megohms, 8 x 6 x 3". Test leads. 4000-v. DC probe and batteries. 6 lbs.

84 F 726. NET. 86.24

HI-VOLTAGE PROBE. Extends DC range of Model 269 to 40,000 volts. 2 lbs.

84 F 742. NET. 12.25

MODEL 262. Similar to above, but resistance ranges, 0-500-5000-50,000-500,000 and 0-5-50-megohms; DC current, 0-80-160 ma.; 1.6-16-160 ma and 0-1.6-16 amps. Wt., 6 lbs.

84 F 727. NET. 58.31

HI-VOLTAGE PROBE. Extends DC range of Model 262 to 40,000 volts. Wt., 2 lbs.

84 F 743. NET. 12.25

MODEL 5262 CARRYING CASE. Vinyl case for 269 and 262. 7 x 8 x 4". Shpg. wt., 2 lbs.

84 F 728. NET. 9.75

MODEL 355 MIDGETESTER

Miniature, highly accurate VOM. Fits in palm of hand. 10,000 ohm/volt sensitivity on AC and DC. Accuracy: ±3% on DC; ±5% on AC. 100 microamp, self-shielded and shock-proof meter movement. Handy ohms zero-adjust thumbwheel on side of case. Ranges: AC and DC volts, 0-3-12-60-300-1200. Resistance; 0-10,000-100,000 ohms. 0-1-10 megs. Function and range selection by insertion of leads. Size: 2 3/4 x 4 1/2 x 1". Supplied complete with batteries and test leads. Shpg. wt., 2 lbs.

84 FC 734. NET. 34.25

TYPE 6355 CASE. For above. High quality, black leather with zipper. Shpg. wt., 3 oz.

84 F 741. NET. 2.89

MODEL 8600 SPARE TEST LEADS. 1 lb.

87 F 108. NET. 1.71

MODEL 240 HAMMMETER

Popular, low-cost VOM. Sensitivity, 1000 ohms/v on AC and DC. DC volts, 0-3000. AC volts, 0-3000; DC ma. 0-750; ohms, 0-3000-300,000. Bakelite case. 3 x 5 7/8 x 2 1/2". With battery, leads. Shpg. wt., 3 lbs.

84 F 787. NET. 28.37

MODEL 303 VTVM

Compact, accurate VTVM. Ranges: AC and DC volts, 0-1.2-12-60-300-1200; AF volts, 0-1.2-12-60, flat to 100 kc; resistance, 0-1000-100,000 ohms and 0-1-10-1000 megs. Also reads decibels from -20 to +63 in 5 ranges. Large 4 1/2" dial scale with easy-to-read calibrations. Bakelite case, 7 x 5 1/4 x 3 1/4". With DC and AC-Ohms probe; less RF probe. For operation from 110-120 volts, 60 cycle AC. Shpg. wt., 6 1/2 lbs.

84 F 712. NET. 66.64

MODEL 303 RT. As above, but in "roll top" case. Shpg. wt., 8 lbs.

84 F 725. NET. 74.48

HV PROBE. Extends DC volts range to 30,000 volts. Shpg. wt., 1 lb.

84 F 715. NET. 9.75

RF PROBE. Measures RF volts. 1 lb.

84 F 716. NET. 7.35

CASES FOR MODELS 260 AND 303

Eveready type permits using meter in case. Av. shpg. wt., 2 lbs.

84 F 721. Eveready Case. NET. 9.55

84 F 782. Standard Case. NET. 7.59

MODEL 382 ANALYZER

In-circuit horizontal system analyzer and capacitance checker. Only plate cap of output tube need be removed for tests! Checks High-Z systems on good-bad scale; Checks Low-Z system on comparative logging scale. Tests any transformer or yoke winding for continuity; tests transformers and yokes for opens. Checks individual windings on flyback system for shorts or partial shorts. Measures capacitance and checks for opens in any capacitor of horizontal system. Direct-reading from 10 mmf to 0.1 mfd (checks any capacitor in chassis falling in this range). 4 1/2" meter. With test leads. Size: 7 3/4 x 7 1/4 x 1 1/2". For 110-120 v., 50-60 cycle AC. Shpg. wt., 12 lbs.

87 FX 103. NET. 68.55

MODEL 1000 TUBE TESTER

Accurate, plate-conductance tube tester. Tests all receiving tubes, including 9-pin miniature and sub-miniatures with a linear and circular base arrangement. Tests are made under conditions simulating actual use.

4 1/2" dial indicates percentage of rated plate conductance for an accurate indication of tube condition. Also provides quick, dependable short and leakage tests—shows exact resistance values of shorts and interelement leakage. Each tube element is individually connected to the correct voltage tap—insures against tube damage during testing. Size, 15 3/4 x 11 3/4 x 6". For operation from 110-120 v., 60 cycle AC. Shpg. wt., 19 lbs.

84 FX 723. NET. 132.30

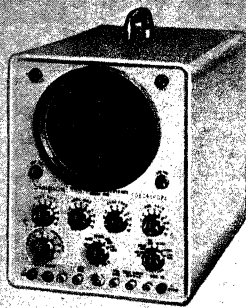

458

MODEL 458 COLORSCOPE

7" dual bandwidth, oscilloscope. For black-and-white and color TV. Vernier and compensated decimal step attenuator. Horizontal sweep to 50 kc for expansion of high-frequency waveform detail and color burst. Intensity modulation input. Graph screen. Frequency response: Wide-band, ± 2 db to 5 mc; narrow band, ± 1 db, 10 cycles to 200 kc. Deflection sensitivity: Wide band, 25 mv rms/inch; narrow band, 10 mv rms/inch. Calibrating voltage, 6.3 volts rms. 100% response at 3.58-mc color burst. $13\frac{3}{4} \times 11 \times 17\frac{1}{4}$ ". For operation from 110-120 v. 50-60 cycle AC. Shpg. wt., 32 lbs.

84 FZ 631. NET 225.35

87 F 104. TYPE 0740 VOLTAGE DOUBLER PROBE. Wt., 1½ lbs. NET 10.73

87 F 105. TYPE 0741 LOW CAPACITANCE PROBE. Wt., 1½ lbs. NET 9.75

87 F 109. TYPE 0742 100:1 VOLTAGE DIVIDER PROBE. Wt., 1½ lbs. NET 9.75

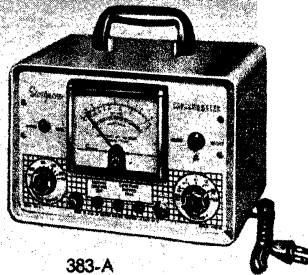

383-A

MODEL 383-A CAPACOHMMETER

"In-or-out-of-circuit" capacitor leakage tester. Indicates leakage and measures capacitance of paper, mica or ceramic capacitors. Permits checking capacitors while they are wired into the equipment being serviced by means of special pulsing circuit. No unsoldering is necessary—not even when capacitor is wired in parallel with a resistor. Pulse test quickly detects "borderline" capacitors.

Easy-to-read 4½" meter. Indicates leakage in ohms—checks for direct short, open, or intermittent conditions in all types of bypass, coupling and blocking capacitors from 10 mmf to 10 mfd. Also detects leaks in wiring, sockets, transformers, etc. and measures distributed capacity to ground. No need for adjustment of bridge circuit and balancing controls. All measurements made under load conditions. Size: $8\frac{3}{4} \times 11\frac{3}{4} \times 8\frac{1}{2}$ ". With test leads. For 110-120 volts, 60 cycle AC. Shpg. wt., 11 lbs.

84 FX 630. NET 88.15

Simpson

TEST EQUIPMENT

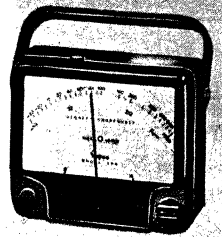

388-3L

MODEL 388-3L THERM-O-METER

Thermocouple thermometer. For gases, liquids or solids. Reads—50° to 1000° F, on 7" scale. Has 7½-ft. general-purpose interchangeable probe (Type 0190), with provisions for 3 probes. Allows temperature readings in 3 different areas by rotating switch. Size: $6\frac{1}{2} \times 2\frac{1}{2} \times 1\frac{1}{2}$ ". With battery. Shpg. wt., 6 lbs.

84 F 744. NET 63.21

MODEL 388. As above, but with provisions for one probe only. Shpg. wt., 6 lbs.

84 F 738. NET 58.31

TYPE 0187 SURFACE TEMP. PROBE. For 388-3L and 388 above. Shpg. wt., 1 lb.

84 F 745. NET 6.81

TYPE 0190 GENERAL-PURPOSE PROBE. For 388-3L and 388. Shpg. wt., 1 lb.

84 F 746. NET 4.85

TYPE 5262 CASE. For 388, 388-3L. 5 oz.

84 F 728. NET 9.75

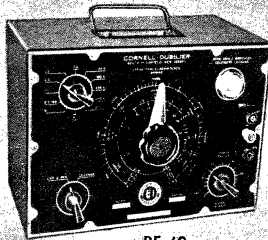

BF-60

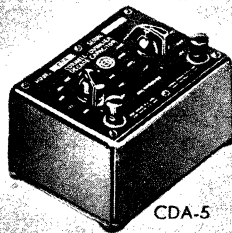

CDA-5

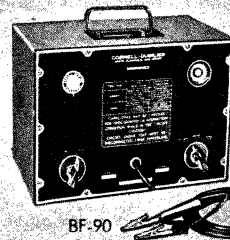

BF-90

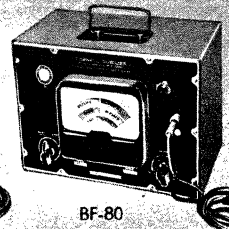

BF-80

Cornell-Dubilier Test Instruments

BF-60 CAPACITOR-RESISTOR BRIDGE

Precision instrument for industrial and electronic labs. Checks for opens, shorts, intermittents, capacity and power factor of electrolytics as well as insulation resistance of papers, micas and ceramics. Measures capacity between wires and shielding, transformer windings, wires in cables, etc. Capacity ranges are: 10 mmf-.005 mfd, .001-5 mfd, .1-50 mfd, 20-1000 mfd. Resistance ranges: 100-50,000 ohms and 10,000 ohms to 5 megohms. Hammered-enamel finish. Size: $5\frac{1}{2} \times 7 \times 10$ ". For 110-125 volts, 50-60 cycle AC. Shpg. wt., 10 lbs.

84 FX 457. NET 42.85

RESISTANCE DECADES

Provide a rapid and dependable source of resistance for substitution purposes. Each of the instruments below permits a possible selection of 110 resistance values. Series connected, they cover a range from 1 ohm to 1,111,110 ohms in steps of 1 ohm. Each box utilizes 2 rotary-type switches with 11 positions for quick change in resistance values. Heavy-duty, insulated binding posts. Black enamel finish. Less leads. $3\frac{3}{4} \times 5 \times 3\frac{3}{4}$ ".

Stock No.	Mfr's Type	Range Ohms	Ohms/Step	NET EACH
84 F 615	RDA	1-110	1	11.91
84 F 616	RDB	100-11,000	100	12.25
84 F 617	RDC	10,000-1,100,000	10,000	12.25

CAPACITOR DECADES

Provide accurate standards over a wide range of capacity. Rated at 600 volts DC and 220 volts AC. May be used singly or in groups of two or more decades. With calibration chart giving exact capacity values for all scale markings, extending use to more precise measurements. Types CDA-5, CDB-5 and CDC-5, $\pm 5\%$ tolerance; CDD-3 and CDC-3, $\pm 3\%$ tolerance. Type CDA-5 has mica dielectric capacitors; all others have oil-impregnated paper capacitors. Shpg. wt., 4 lbs.

Stock No.	Mfr's Type	Range Mfd	Mfd./Step	NET, EACH
84 F 452	CDA-5	.0001-.011	.0001	11.12
84 F 453	CDB-5	.01-1.1	.01	11.12
84 F 455	CDB-3	.01-1.1	.01	13.23
84 F 454	CDC-5	1.0-10	1.0	19.55
84 F 456	CDC-3	1.0-10	1.0	21.56

MODEL BF-90 "HANDICHECK" CAPACITOR CHECKER

Quickly checks capacitors without removing them from the circuit by means of a 60-cycle circuit incorporating an electron-ray indicator tube. Checks capacitors from 30 mmf to 2000 mfd or open, short or intermittent conditions even if connected in parallel with a resistance as low as 50 ohms. Capacitors from .1 mfd to 2000 mfd can be checked for short circuits. Size: $7 \times 10 \times 5\frac{1}{2}$ ". With leads and test clips. For 110-125 volts, 60 cycle AC. Shpg. wt., 8 lbs.

84 FX 619. NET 34.50

BF-80 FLYBACK-YOKE CHECKER

For rapidly locating defects in flyback transformers and yokes. Employs an oscillator circuit incorporating a 6V6 tube. Extremely sensitive—detects short circuited vacuum tube elements and windings. Will detect a single shorted turn. Also indicates open circuits in transformers, yokes, coils and switches. 4½" microammeter; 50 microamp full-scale sensitivity. Meter scale indicates "GOOD" and "REPLACE"; scale is also numbered for quantitative readings. Sturdy metal case; recessed carrying handle. $5\frac{1}{2} \times 7 \times 10$ ". With test leads. For operation from 110-125 v., 60 cycles AC. Shpg. wt., 9½ lbs.

84 FX 618. NET 46.45

BF-70 CAPACITANCE-RESISTANCE ANALYZER

Accurately checks capacitors and resistors. Wien bridge circuit assures permanent accuracy; readings not affected by line voltage variations. Measures capacity from .00001 to 2000 mfd in 4 ranges. Checks power factor of electrolytics from 0 to 50%. Indicates insulation resistance of paper, mica, and ceramic capacitors. Built-in VOM for leakage measurement. VOM ranges: DC volts, 0-15-150-750; DC ma, 0-1.5-15-75; DC resistance, 2.5-2500 ohms, 250-250,000 ohms, 250,000 ohms to 25 megs. Metal case. Gray enamel finish. $11 \times 10 \times 5\frac{1}{2}$ ". For operation from 110-125 v., 50-60 cycle AC. Shpg. wt., 11 lbs.

84 FX 613. NET 71.50

PRECISION TEST EQUIPMENT

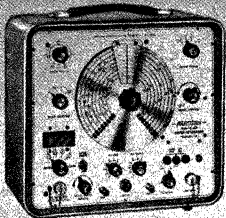

E-400

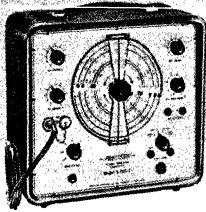

E-200C

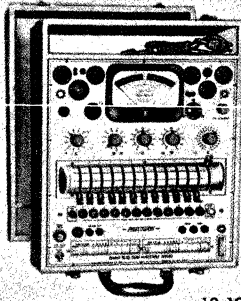

10-12-P

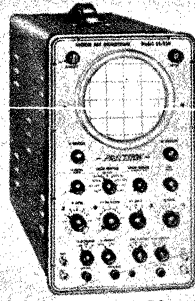

ES-550

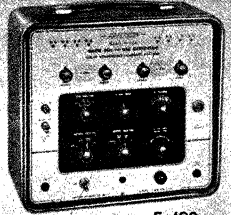

E-420

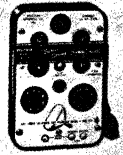

SS-10

MODEL E-200-C DELUXE SIGNAL-MARKER GENERATOR

- For Lab & Serviceshop
- 9 Easy-Reading Bands
- Accuracy to 1%

Highly sensitive, deluxe-signal-marker generator. Valuable aid for television alignment and servicing of AM and FM sets. 9 bands: 88 kc to 240 mc; to 60 mc on fundamentals. Accuracy to 1%. Outputs: Unmodulated RF; 400-cycle modulated RF; and 400-cycle sine wave. Control for variable internal modulation, 0-100%. 6 1/2" direct reading dial with 0-100 vernier scale. Supplies 0-50 volts AVC-AGC voltage. Handsome blue-gray finish. With coax cable, "LO-HI" connectors, and illustrated manual "Servicing by Signal Substitution". Deluxe hooded cabinet, 11 1/2 x 13 x 6 5/8". For 110-120 v., 50-60 cycle. Shpg. wt., 17 lbs. 87 FZ 000. NET..... 93.10

MODEL ES-550 DELUXE 5" OSCILLOSCOPE

Excellent for servicing and lab work, including color TV; provides 5-mc bandwidth. Push-pull vertical amplifier has 10 mv/inch sensitivity; response within 1 db, 10 cps to 3.5 mc; (3 db at 5 mc). Push-pull horizontal amplifier rated 100 mv/inch sensitivity; response within 1 db, 20 cps to 1 mc (3 db at 2 mc). Sweep frequency, 10 cycles to 100 kc; also 30 and 7875 cycles synchronized sweep. Negative and positive internal sweep. Vertical pattern reversal switching. Direct reading, peak-to-peak voltage calibrator. 8 1/4 x 14 1/2 x 18 1/2". For 110-120 volts, 50-60 cycle AC. Wt., 47 lbs. 87 FZ 002. NET..... 230.30

MODEL SP-5 PROBE SET, 4 probes (high-Z low-capacity, crystal, isolating, shielded); coax cables; connectors. For use with above scope. Shpg. wt., 3 lbs. 84 F 491. NET..... 25.97

MODEL E-400 DELUXE SWEEP GENERATOR

Deluxe portable sweep generator for television and FM servicing. Frequency range is 3-900 mc; to 240 mc on fundamentals; saves time on front-end alignment—read directly on panel dial. Has narrow and wide-band sweep—frequency widths: 0-1 mc and 0-15 mc. Built-in base-line reference. Self-contained multiple crystal marker-calibrator. Supplied with 2 crystals (2 mc and 4.5 mc). Special socket accommodates 4 crystals. Full vision, 6 1/2-inch dial. Phasing control. Internal retrace blanking circuit simplifies alignment—eliminates return traces. Supplied complete with test cables, tubes, comprehensive instruction manual, and 2 crystals. In custom-styled, handsome blue-gray, hooded steel cabinet; two-color satin brushed aluminum panel and contrasting dark blue control knobs. Deluxe cabinet, 11 1/2 x 13 x 6 5/8". For operation from 110-120 volts, 50-60 cycle AC. Wt., 24 lbs. 87 FZ 001. NET..... 156.80

MODEL E-420 DELUXE DOT AND BAR GENERATOR

Highly versatile white-dot and bar generator for color TV adjustment. Ideal unit for checking color convergence and vertical and horizontal linearity. Has separate controls to adjust the number and thickness of both vertical and horizontal bars. Provides direct video and modulated TV channel outputs. Has RF channel selector for channels 2 to 6. Generates: White dots, vertical and horizontal bars and cross-hatch pattern. Number and size of dots can be varied. In beautiful, custom-styled, blue-gray, hooded steel cabinet and four-color, satin-brushed aluminum panel with contrasting dark blue control knobs. With cables and instructions. Size, 13 x 11 1/2 x 6 1/2". For operation from 110-120 volt, 60 cycle AC. Shpg. wt., 19 lbs. 87 FZ 021. NET..... 147.00

MODEL 10-12-P DELUXE ELECTRONIC TUBE TESTER

Here's a deluxe tube tester—ideal for use as a portable or counter-type unit. Dynamically checks mutual conductance plus other characteristics of modern radio and television tubes including sub-miniatures and acorns; wired to handle tubes up to 12 pins. Built-in stainless steel pin straighteners. Has direct facilities for battery (A, B, and C dry batteries under load conditions), ballast, pilot bulb and capacitor testing. Large, easy-to-read 5 1/4" meter; accuracy within 2%. Double-window, roll chart has space for adding new tube data. Convenient portable model in hardwood case. Handsome, two-color, satin-brushed aluminum panel and contrasting dark blue control knobs. Hardwood cabinet has convenient tool compartment and hinged, removable cover. Size, 17 1/4 x 13 3/4 x 6 3/4". For 110-120 volts, 50-60 cycle AC. Shpg. wt., 24 lbs. 87 FZ 009. NET..... 126.42

MODEL PTA CATHODE-RAY-TUBE ADAPTER. For all Precision tube testers. Wt., 1 lb. 84 F 492. NET..... 7.59

MODEL SS-10 FILAMENT & CONTINUITY TESTER

Handy, compact, battery-operated tube tester. Highly versatile—designed to test for burned-out tube filaments, fuses, and pilot lamps (both bayonet and screwbase). Also checks for continuity in transformer windings, appliances, etc. Has test sockets for octal, locial, and miniature 7 and 9 pin tubes. Also tests filaments in television picture tubes. Built-in tube pin straighteners for miniature 7 and 9 pin tubes. Includes internal battery life test. Custom-molded case with gold and black anodized panel. Supplied complete with batteries. Size, 5 1/2 x 3 1/2 x 1". Shpg. wt., 1 lb. 87 F 026. NET..... 6.37

660

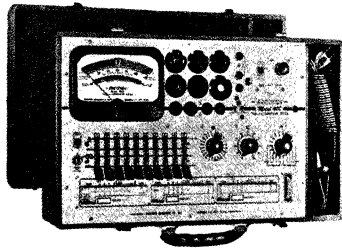

- Easy-to-Read 5 1/4" Meter
- ±2% Accuracy
- Tests Modern TV, FM, & AM Tubes
- Picture Tube Beam Current Test

MODEL 660 TUBE AND TRANSISTOR TESTER

Introducing an all-new, highly versatile tube and transistor tester. Has provisions for measuring the reverse current between collector and base with emitter open (Icbo), shorts and leakage on all RF, audio, power and tetrode transistors—both NPN and PNP types. Also provides cathode conductance test for receiving type tubes. Has special circuit for testing picture producing beam current on all TV picture tubes when used with Model PTA Cathode Ray Adapter (above, right column). Rugged 24-position rotary selector switch controls filament voltages from 3/4 to 117 volts. 5 1/4" meter; accuracy to ±2%. Smooth action, 3-window roll chart has "Tube Finder" feature. Leatherette-covered carrying case with handy tool compartment. 18 x 10 1/2 x 6 1/2". For operation from 110-120 v., 50-60 cycle AC. Shpg. wt., 16 lbs. 87 FX 028. NET..... 97.51

MODEL 640 CATHODE CONDUCTANCE TUBE TESTER

New, moderately priced cathode conductance tube tester. Checks for merit, leakage and short tests on TV, FM and AM tubes. Designed to test each section of multi-section and ballast resistor-type tubes. Smooth-action, 24-position rotary switch controls filament voltages from 3/4 to 117 volts—reduces obsolescence as new tubes are released. Has handy built-in 7 and 9-pin straighteners. Easy-to-read 5 1/4" meter accurate to ±2%.

High-speed, 3-window roll chart saves valuable time—locates desired reference easily, quickly with "Tube Finder" feature. Comes complete with leatherette-covered, solidly constructed carrying case. Attractive, etched, satin-brushed aluminum panel. 18 x 10 1/2 x 6 1/2". For 110-120 v., 50-60 cycle AC. Shpg. wt., 16 lbs. 87 FX 027. NET..... 77.91

PRECISION TEST EQUIPMENT

98-MCP

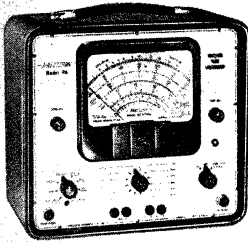

MODEL 98-MCP DELUXE VTVM

Economically priced, highly accurate, deluxe laboratory type VTVM. Has an easy-to-read 7" meter with 200-microampere sensitivity; accuracy $\pm 2\%$. Ranges: Zero-center DC, AC rms and DC volts, 0-1.2-6-12-60-300-1200. P-P AC volts, 0-3.2-16-32-160-800-3200. Zero-center DC input resistance, 26.6 megohms. Resistance, 0-1000-100,000 ohms; 0-1-10-100-1000 megohms. DC current, 0-300 microamperes; 0-1.2-6-30-120-600 ma; 0-1.2-12 amps. 6 db ranges, -20 to +63 db. In custom-styled, hooded metal cabinet with brushed aluminum panel. Size, $11\frac{1}{2} \times 13 \times 6\frac{3}{8}$ ". Supplied complete with 3-way probe and instruction manual. For operation from 110-120 volts, 60 cycle AC. Shpg. wt., 18 lbs.
87 FZ 014. NET.....117.11

MODEL TV-8 SUPER-HIGH VOLTAGE PROBE. Excellent accessory for Model 88 or 98 VTVMs. Extends DC voltage range to 60,000 v. Shpg. wt., 2 lbs.
84 F 681. NET.....14.45

MODEL RF-10A HIGH-FREQUENCY PROBE. For above VTVM. Extends response to 300 mc. Shpg. wt., 2 lbs.
84 F 419. NET.....14.11

MODEL 110 MULTIMETER

Highly useful, expertly constructed pocket-size VOM. Combines full-range instrument performance with small-sized convenience. Valuable aid to the radio-TV serviceman. Easily fits into tube caddy or tool kit—"on-hand" at all times. Ideal for field use, service calls, etc. Ranges: DC volts, 0-1.5-6-30-150-600-3000 (20,000 ohms per volt); AC volts, 0-1.5-6-30-150-600-3000 (5000 ohms per volt); DC current, 0-0-600-600 microamps and 0-6-60-600 ma; resistance, 0-2000-200,000 ohms and 0-20 megohms; db, from -20 to +70. $3\frac{1}{2}$ " meter with long, easy-reading scales; sensitivity 50 microamps. Full scale accuracy $\pm 2\%$. Supplied complete with vinyl-plastic cover; heavy-duty, banana-plug test leads; and batteries. Size, $5\frac{3}{8} \times 3\frac{1}{2} \times 1\frac{1}{16}$ " deep. Shpg. wt., 3 lbs.
87 F 023. NET.....33.81

MODEL 107 ULTRA-COMPACT PORTABLE TUBE TESTER

- Provides Thorough Checking of Wide Range of Tube Types
- Extremely Compact; Weighs Only 11 $\frac{1}{4}$ Lbs.
- Simple, Fast, Accurate Operation For Positive Checking

Remarkably compact, precision tube tester, Provides all essential tests for wide range of tube types, including sub-miniature types. "Good-?Bad" meter shows results of dynamic mutual conductance test and cathode emission test; electron-eye indicates "control-grid-emission" test. Also checks for filament continuity, element leakage, open elements, and gassiness. Only $6 \times 9 \times 13\frac{1}{2}$ "! Weight is only a fraction over 11 pounds! Handy "flip-chart" tube index. For 110-120 volts, 60 cycle AC. Shpg. wt., 14 $\frac{1}{2}$ lbs.
87 FX 295. NET.....136.71

MODEL GCT-5 GRID CIRCUIT TUBE TESTER

Exceptionally lightweight, highly compact, grid circuit tube tester. Has 7 wired sockets for testing receiving type tubes with filament voltages from 3 to 12 volts. Check: Control grid emission; grid-to-cathode shorts; cathode-to-heater shorts; gassy tubes. Has "Magic Eye" Bad-OK-Bad indicator. Size, $6\frac{1}{2} \times 6\frac{1}{2} \times 2\frac{1}{2}$ ". For operation from 110-120 volts, 50-60 cycle AC. Shpg. wt., 4 lbs.
84 F 639. NET.....29.35

Express Shipment Recommended for Test Equipment



110

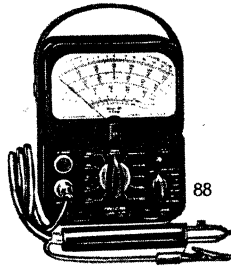

88

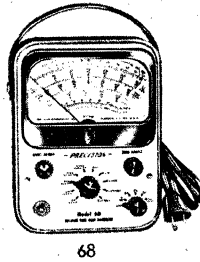

68

MODEL 68 VTVM

Highly dependable AC-operated VTVM for all radio and television servicing requirements. Accurate, and versatile—has many uses for inspection work and other industrial applications. Has 5 zero-center ranges for FM discriminator balancing, voltage polarity determinations, etc. Large, $5\frac{1}{4}$ " wide-angle meter with 400 microampere sensitivity. Accuracy, $\pm 2\%$. Multiplier resistors are rated within $\pm 1\%$. High input resistance of 13.3 megohm on DC ranges. DC volts, 0-3-12-60-300-1200. Resistance 0-1000-100,000 ohms; 0-1-100-1000 megohms. AC volts, 0-3-12-60-300-1200. Peak-to-Peak volts, 0-8-32-160-800-3200.

Convenient, built-in carrying strap. Hand-some blue-gray ripple steel cabinet with brushed aluminum panel. Overall size, $5\frac{7}{8} \times 7\frac{3}{4} \times 3\frac{1}{4}$ ". Supplied complete with battery and convenient 3-way coaxial probe. For operation from 110-120 volts, 60 cycle AC. Shpg. wt., 9 lbs.
87 F 018. NET.....53.41

MODEL 88 VTVM

Highly sensitive vacuum tube voltmeter for laboratory and service-shop use. Employs full-bridge VTVM circuit with 1% multipliers and shunts for extremely accurate readings. Extra-large, wide-angle $5\frac{1}{4}$ " meter with easy-to-read, 3-color scales. 200 microamp sensitivity, $\pm 2\%$ accuracy. Reads AC rms in 6 ranges: 0-1.2-6-12-60-300-1200 volts. 6 peak-to-peak AC volt ranges: 0-3.2-16-32-160-800-3200. 5 resistance ranges: 0-1000-10,000 ohms; 0-1-100-1000 megohms. 6 zero-center DC ranges: 1200-300-60-12-6-1.2-0-1.2-6-12-60-300-1200 volts with $26\frac{2}{3}$ meg input resistance. Also 6 -DC volt and 6 +DC volt ranges: 0-1.2-6-12-60-300-1200, with $13\frac{1}{3}$ meg input resistance. In compact, custom-molded phenolic case; with convenient, sure-grip carrying strap. Overall size, $5\frac{3}{8} \times 7 \times 3\frac{1}{8}$ ".

Complete with detachable AC line cord. internal ohmmeter battery, three-way coaxial VTVM probe. For operation from 110-120 volts, 50-60 cycle AC. Wt., 8 lbs.
84 F 680. NET.....73.01



120

MODEL 120 MULTI-RANGE TESTER

- Low-Cost, Highly Versatile
- 20,000 Ohms/Volt DC Sensitivity
- Covers 36 Ranges

Highly sensitive VOM. Has more ranges than most meters of its type and size. Ranges: AC, DC, and output volts, 0-1.2-3-12-60-300-600-120C-6000 with 5000 ohms per volt on AC and 20,000 ohms per volt on DC; DC current, 0-60-300 μ a, 0-1.2-12-120-600 ma, 0-12 amps; resistance, 0-200-2000-200,000 ohms, 0-2-20 meg; 8 db ranges, -20 to +77. $5\frac{1}{4}$ " meter. Complete with batteries and test leads. Size, $5\frac{3}{8} \times 7 \times 3$ ". Shpg. wt., 5 lbs.

84 F 490. NET.....44.05

MODEL LC-3 LEATHER CASE. For Model 120. Top-grain cowhide. Shpg. wt., 3 lbs.

84 F 496. NET.....9.31

MODEL TV-2B HV PROBE. For Model 120. Extends DC range to 30,000 v. Wt., 2 lbs.
84 F 495. NET.....14.45

MODEL ST-1 RETRACTABLE STAND. For Models 88, 120. Convenient 45-degree table mount. Shpg. wt., 1 lb.

87 F 020. NET.....98c

MODEL 78 BATTERY VTVM

Battery powered VTVM—can be used anywhere. $5\frac{1}{4}$ " meter—rated at 100 microampere sensitivity, $\pm 2\%$ accuracy. Multipliers rated for $\pm 1\%$ accuracy. High input resistance—13.3 megohms on all DC ranges. Extra-high input impedance on AC ranges —8 megohms, 67 mmf. Ranges: Resistance, 0-1000-10,000 ohms; 0-1-100-1000 megohms. Zero-center DC volts, 0-1.5-6-30-150-600-1500. AC volts (rms), 0-3-12-60-300-1200. Resistors are deposited-film and wire-wound types. Blue-gray ripple case, $5\frac{7}{8} \times 7\frac{3}{4} \times 3\frac{1}{2}$ ". Complete with batteries and probe. Shpg. wt., 9 lbs.

87 F 019. NET.....61.25

MODEL TV-4 HIGH-VOLTAGE PROBE. For Models 68 or 78 VTVM's listed in center column and above. Extends DC voltage range to 60,000 volts. Shpg. wt., 2 lbs.
84 F 445. NET.....14.45

SECO TEST EQUIPMENT

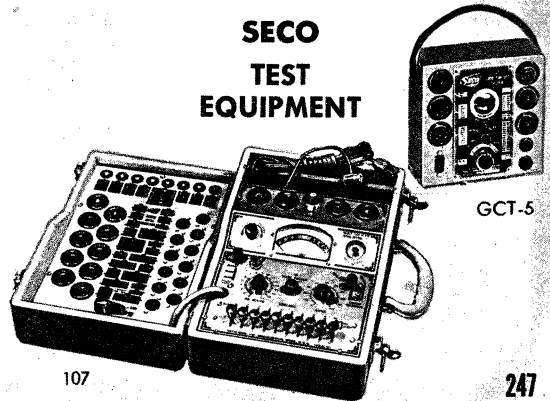

GCT-5

precise

TEST EQUIPMENT

111-K

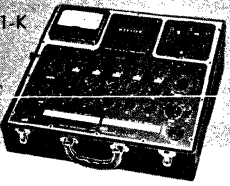

MODEL 111-K TUBE TESTER KIT

Advanced-design tube tester kit. Checks emission and mutual conductance separately. Tests all receiving tubes; also tests CRT's with PTA-K adapter. Features rotary tube switches; gas check; single-switch short check; latest type roll chart. Filament current and tube bias measured on the meter. Has spare switch for future tube types. Steel cabinet with aluminum panel. Size, 14x16x6". Less solder. For 110-120 v., 60 cycle AC. Shpg. wt., 25 lbs.
83 FZ 133. NET.....79.95

MODEL 111W. As above, but factory-wired.
84 FZ 692. NET.....139.95

MODEL PTA-K. CRT ADAPTER KIT. For above. Shpg. wt., 2 lbs.
84 F 693. NET.....2.95

MODEL PTA-W. As above, but factory-wired.
84 F 694. NET.....4.25

630-KA SIGNAL GENERATOR KIT

RF-AF-TV signal generator and marker kit. Reaches 110 mc on fundamentals; 330 mc on harmonics. Pre-assembled and calibrated RF heads; audio of 20-20,000 cycles; cathode follower output; variable percent modulation; external modulation; speech amplifier; crystal marker; RF and AF stand-by; Wien bridge AF osc.; Colpitts RF osc.; filtered line; separate RF section; coax fittings. Other features include constant output impedance; vernier tuning on RF and AF, plus complete shielding. Steel cabinet. Size, 8x11x5". With all parts and instructions, less solder. For 110-120 v., 60 cycles AC. Shpg. wt., 11 lbs.
83 FX 130. NET.....38.95

MODEL 630-W. As above, but factory-wired
84 FX 497. NET.....53.95

MODEL 9071-K VTVM KIT

Deluxe VTVM kit designed to meet industrial specifications. Features: Voltage regulation; 7 1/2" meter, precision 1% resistors, zero alignment scale for FM and TV discriminators, and burnout-proof circuit. Ranges: DC and AC volts, 0.5-25-250-500-1000 (25 megs input imp. on DC); ohms, 0-1000-10,000; megohms, 0-1-10-1000; db, -20 to +55. Separate 5-volt AC scale for accuracy on low voltages. Steel cabinet; etched panel, 12x8 1/2x5". With test leads, battery and instructions; less solder. For 110-120 v., 60 cycle AC. Wt., 11 lbs.
83 FZ 902. NET.....35.95

MODEL 912A RF PROBE. For use with above. Extends frequency range up to 250 megacycles. Shpg. wt., 1/2 lb.
87 F 260. NET.....4.25

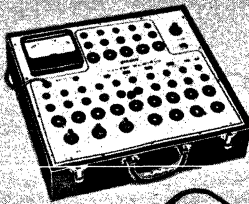

116-K

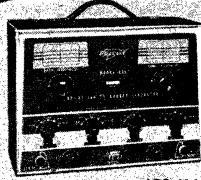

630-KA

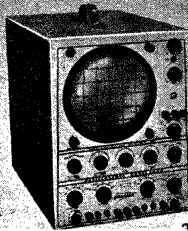

300-K

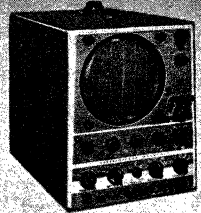

308-K

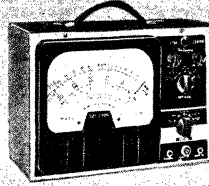

9071-K

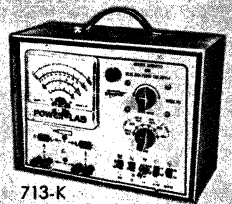

713-K

MODEL 116-K TUBE TESTER KIT

Accurate, ultra-fast tube tester kit for simplified testing of all receiving-type tubes and transistors. Unique, multiple-socket design and Tube Bank Switch permit comparison tests on up to 5 similar tubes in 20 seconds. Makes emission, mutual conductance, gas, life, and short tests. Function switch permits checking individual sections of multisection tubes. Employs emission test for power tubes and mutual-conductance test for IF amplifiers—fool proof method of determining a tube's efficiency. Simple to operate—has only 3 basic knobs. May be modified to measure filament current. Chart in cover lists all tubes, including the new 600-ma series-strand types, and gives switch settings. Handsome, ruggedly constructed wood carrying case; etched panel, 7 1/2x16 1/2x14 1/2". Easy-to-follow instructions. With all parts; less solder. For operation from 110-120 volts, 60 cycle AC. Shpg. wt., 16 lbs.
83 FZ 104. NET.....69.95

MODEL 116W. As above, but factory wired.
84 FZ 695. NET.....119.95

MODEL 300-K 7" SCOPE KIT

High-quality 7" scope kit. Vertical response, ±3 db up to 5 megacycles with sensitivity of 10 millivolts. Frequency-compensated vertical and horizontal stepping attenuators. Push-pull DC amplifiers; push-pull horizontal. Astigmatic focus control. Linear square wave calibrator with pot. Electronic magnifier circuit allows any portion of signal to be magnified up to 10 times. Screen is edge lighted—may be switched on or off. 5-way binding posts for easy hookup. Has plug gate and sawtooth outputs on front panel. Bridge type positioning on vertical and horizontal does not vary tube characteristics. Extra-heavy, fused power supply. Steel cabinet, 11x14x17". With all parts; less solder. For 110-120 v., 60 cycle AC. Shpg. wt., 35 lbs.
83 FZ 131. NET.....99.95

MODEL 960 CAPACITY ATTENUATOR PROBE. For Model 300 and 308 scopes. Range, through 100 mc. Input capacity, 7 mmf. Shpg. wt., 1 1/2 lbs.
84 F 691. NET.....5.95

MODEL 713-K POWER LAB KIT

New, extremely versatile bench power supply—ideal for service shops and labs. Combines variable low and high-voltage AC and DC supplies, a wattmeter, voltmeter, AC and DC ammeter, and an isolation transformer in one compact unit. Performs function of 11 different pieces of equipment. DC power available is 0-30 v. at 10 amps and 110-180 v. at .75 amps. (1 amp intermittent). AC power available is 0-24 v. at 20 amps; 90-140 v. at 10 amps (1000 watts continuous) and 20 amps (2000 watts intermittent) (no isolation) and 90-140 v. at 3 amps, 300 watts (with isolation). Meter reads AC and DC current to 20 amps, AC and DC voltage to 180 v. and power to 2000 watts. Size, 12x8 1/2x5 1/4". For 110-120 v., 60 cycle AC. Shpg. wt., 22 lbs.
83 FZ 904. NET.....62.95

MODEL 713-W. Same as unit described above, but factory-wired.
87 FZ 266. NET.....79.95

MODEL 711-K KIT. Similar to 713-K, but provides isolation to 100 watts. Shpg. wt., 15 lbs.
83 FX 903. NET.....49.95

MODEL 711-W. Same as unit described above, but factory-wired.
87 FZ 265. NET.....64.95

MODEL 308-K 8 1/2" SCOPE KIT

Unusually fine, easily assembled, 8 1/2" scope kit at very moderate cost. Many deluxe features; excellent for any radio-TV servicing or laboratory application. Edge-illuminated 8 1/2" screen and magnifier positioner permit extremely accurate waveform analysis. A 3rd anode intensifier ring, as well as a separate HV supply provide increased picture sharpness and tracing speed. Has push-pull inputs for internally mixing 2 signals or observing push-pull waveforms. Exceptional vertical response; ±1.5 db to 5 mc. Sensitivity, 10 mv/inch. Return trace eliminator. Linear sweep, 1 cycle to 80 kc. Square-wave calibrator with pot. External, internal negative or positive sync, or internal 60 or 120 cycle sync. Steel cabinet, 11x14x19". With all parts, wire, tubes and instructions; less solder. For 110-120 volts, 60 cycle AC. Shpg. wt., 36 lbs.
83 FZ 132. NET.....129.50

CHICAGO INDUSTRIAL TEST EQUIPMENT

MODEL 431A VOM

Accurate 18-range volt-ohmmeter. Has 860 µa meter movement. Ranges: AC-DC volts, 0-15-30-150-300-1500-3000 (at 1000 ohms per volt); DC current, 0-1.5-150 ma and 0-7.5 amps; resistance, 0-10,000-100,000 ohms 0-1 meg. (center scale readings, 50, 600 and 6000 ohms). Gray hammerloid case. Size, 6 1/2x3 1/4x5 3/4". Supplied complete with penlight cells, carrying strap and leads. Shpg. wt., 3 1/2 lbs.
84 F 309. NET.....19.11

MODEL 312 VOM

Pocket-size, 6-function VOM. 2" meter. Reads: DC volts, 0-25-50-125-250. AC volts, 0-25-50-125-250. DC ma, 0-50. AC ma, 0-50. Resistance, 100,000 ohms full scale, with 1600 ohms half-scale reading. Capacitance, .05-15 mfd. Resistance ranges operate from AC power—no batteries required. In sturdy bakelite case, 3 1/2x2 1/4x1 1/4". Less test leads. For operation from 110-120 v., 60 cycles AC. Shpg. wt., 1 1/4 lbs.
84 F 306. NET.....8.82

For Soldering Irons and Guns, See Pages 311-315



312



431-A

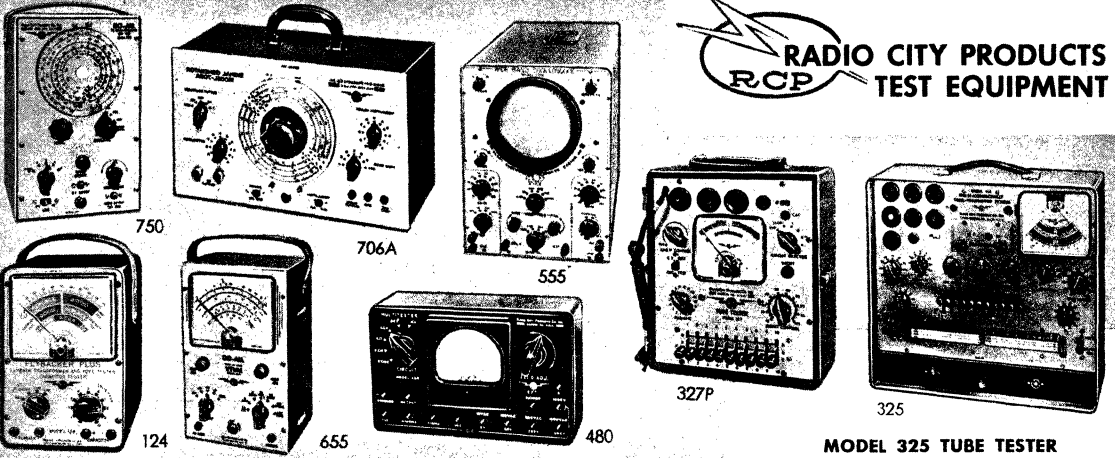

MODEL 124 FLYBACKER

An extremely valuable, versatile TV test unit. Tests capacitors, flyback transformers and yokes without disconnecting them from the circuit. Shows leakage and shorts in all capacitors; tests for continuity in all flyback transformers, deflection yokes, width coils, solenoids, relays, etc. Instantly shows up a single shorted turn in a flyback transformer or yoke. Tests high-impedance sections of all transformers. Over 200 volts applied to components under test. 5 easy-to-read scales, 4 illuminated GOOD-BAD scales—calibrated direct reading numbered scale for transformers. In steel case. 10x6x5". For operation from 105-125 volts, 50-60 cycle AC. Shpg. wt., 8 lbs.

84 F 625. NET.....41.94

MODEL 750 GENERATOR

Combination signal, marker and pattern generator. Covers all UHF-VHF channels for FM and TV receiver servicing. Checks and aligns front ends, sound IF's and picture traps, linearity, sync circuits, sweep circuits, focus and deflection. Accuracy of 0.5%. All VHF frequencies are covered on fundamental. Ranges: 9-11, 21-47, 54-220, 465-690 and 650-900 mc. RF's and IF's are clearly calibrated on large etched dial. Provides horizontal or vertical bars or cross-hatch pattern on all channels. Internal modulation: 360 cps and 141.75 kc. Provides unmodulated carrier signal. 4 1/2" dial. With leads and instructions. 10 1/4x6 1/2x5 3/8". For operation from 105-125 volts, 60 cycle AC. Shpg. wt., 10 lbs.

84 FX 338. NET.....77.91

MODEL 706A RF SIGNAL GENERATOR

High-quality performance, construction and appearance. Special electron-coupled circuit design, permeability adjusted coils, and air trimmer capacitors assure stability and constancy of calibration. Accurate within 1% of calibration adjustment. Ladder-type step attenuator consisting of a multiplier and fine attenuator control. Planetary drive for vernier tuning without backlash. Covers 150 kc to 220 mc in eight ranges. Six fundamental ranges through 55 mc. 400 cycle audio at 50 ohms for external use. Thorough shielding of all critical circuits. For operation from 105-125 v., 50-60 cycle AC. Size, 15x9x7". Shpg. wt., 14 lbs.

84 FX 331. NET.....66.15

MODEL 655 DO-ALL VTVM

4 1/2" meter reads peak-to-peak and rms waveshapes. 7 ranges on all functions. DC volts, 0-1.5-5-15-50-150-500-1500. Input resistance, 11 megohms. Accuracy on DC ranges ±3%. AC voltage ranges: peak-to-peak, 0-4.2-14-42-140-420-1400-4200; rms, 0-1.5-5-15-50-150-500-1500. Accuracy on AC ranges ±5%. Response: 30 cps to 3 mc for 1.5, 5, 15, 50, 150 and 500 volt ranges (voltage source having low impedance output). Resistance ranges: 0-1000-10,000 ohms, 0-0.1-1-10-100-1000 megohms. Center scale: 10, 100, 1000, 10,000 ohms and 0.1, 1, 10 megohms. Balanced bridge-type circuit. With test leads. Size, 10x6x5". For operation from 105-125 volts, 50-60 cycle AC. Shpg. wt., 8 lbs.

84 F 324. NET.....58.31

MODEL HVMP-2 HIGH VOLTAGE MULTIPLIER PROBE. For use with above. Extends DC volts range to 30 KV. Shpg. wt., 1 lb.

84 F 622. NET.....8.77

MODEL 555 OSCILLOSCOPE

Wide-band 5-inch oscilloscope for black-and-white and color TV servicing. Push-pull, 3-stage vertical amplifier has 25 mv/inch sensitivity; frequency response up to 4 mc. Horizontal amplifier rated at 0.3 volts/inch sensitivity; frequency response up to 700 kc. Features: Multivibrator-type sweep generator; compensated stop attenuator, Z-axis modulation, internal and external sweep synchronization; built-in 60 cycle phasing with adjustable front panel control; retrace blanking; built-in spot size control and versatile 5-way binding posts. Metal cabinet. Size: 9 1/2x12 1/2x18". For operation from 105-125 volts, 50-60 cycle AC. Shpg. wt., 23 lbs.

87 FZ 202. NET.....87.71

MODEL 480 VOM

1000 ohm-per-volt, multitester. 3" square meter. Bakelite case and panel. DC voltage ranges: 0-5-50-250-500-1000 volts. AC readings at 0-10-100-500-1000 volts. Output voltage readings over same ranges as AC. Milliammeter reads 0-1-10-100 ma and 0-1 ampere. Ohmmeter has 4 resistance ranges: 0-10,000-100,000 ohms, 0-1 megohm and 0-10 megohms external. Decibel meter reads from -10 to +55 db. 7x4 3/8x2 5/8". With batteries. Shpg. wt., 2 1/4 lbs.

84 F 621. NET.....15.63

MODEL 325 TUBE TESTER

Dynamic mutual conductance tester for accurately checking tubes and transistors. Tests all N-P-N or P-N-P transistors, all radio and TV receiving tubes—including hearing aid and magic eye types, pilot lights, and many industrial and transmitting types. Checks tubes under actual operating conditions—adjustable controls for heater, plate, screen and grid voltages simulate actual tube operation. Tests for shorts and leakage between each element. Also tests picture tubes when used with Model PTA CRT adapters, below.

Illuminated 4 1/2" meter indicates "GOOD-?-REPLACE" plate conductance, grid conductance, and transistor gain. Lever switches prevent obsolescence. Transistor current gain is measured under full load by a unique constant-current bridge circuit. Separate controls for transistor tests; special diode limiter protects meter against shorted transistors. Safety buttons protect meter against misuse. Easy-to-read, fast-action roll chart. Built-in pin straighteners for 7 and 9-pin tubes. Housed in an attractive steel cabinet with etched aluminum panel—ideal for counter or portable use. Size, 15 1/4x14x5 3/8". For 105-125 v., 50-60 cycle AC. Shpg. wt., 17 lbs.

84 FX 682. NET.....127.35

MODEL 327P TUBE TESTER

A modern, accurate tube tester. Checks all tubes currently used in radio and TV receivers. Will check transmitting, hearing aid, ballast, gaseous rectifier and tuning indicator types. Checks tubes for emission and shorts. Slide-lever switches permit fast, easy testing. Will also check both black-and-white and color tubes with CRT adapters listed below. Dim or weak black and white tubes can be reactivated with this tester. "Finger-flip" tube index—permits rapid insertion of new tube data. 3-color meter provides POOR-?-GOOD tests. CRT scale indicates DIM-BRIGHT readings. In handsome oak combination counter-portable case. Size, 9 1/2x11x5 1/2". For operation from 105-125 volts, 50-60 cycle AC. Shpg. wt., 11 lbs.

84 FX 339. NET.....50.91

MODEL PTA-1 CRT ADAPTER. For black and white. Shpg. wt., 2 lbs.

84 F 627. NET.....3.87

MODEL PTA-2 CRT ADAPTER. For color sets. Shpg. wt., 2 lbs.

84 F 628. NET.....9.75

PRECISION SIGNAL TRACER

MODEL 202. All-purpose signal tracer for servicing radio, television, TV, audio, and electronic equipment. For quick checking all stages from antenna to speaker or picture tube. Also checks mikes, transformers, etc. Locates intermittents, open circuits, hum, noise and distortion. Provides both visual and aural tracing with sensitive "magic-eye" and built-in 5" speaker. RF response to 300 mc. 3-stage preamplifier. Preamp provides voltage gain of 400 for scope or VTVM. Audio input flat from 2 cps to 200 kc. Selector switch for using instrument as RF probe, audio probe, noise test, or wattmeter. Size: 7 1/2x10 1/2x6 1/2". For operation from 110-120 volts, 60 cycle AC. Shpg. wt., 11 lbs.

84 FX 197. NET.....36.75

MODEL B RF DEMODULATOR-AMPLIFIER PROBE. For use with Model 202 Signal Tracer described above. Shpg. wt., 1 lb.

87 F 258. NET.....7.35

202



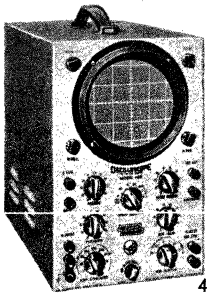

460-K

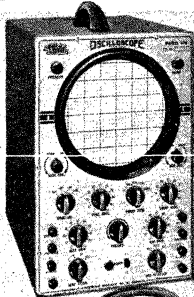

470-K

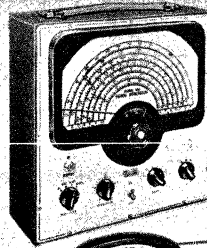

315-K

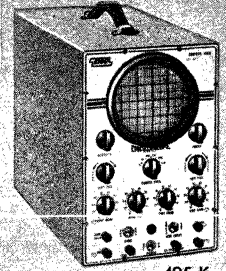

425-K

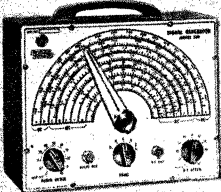

320-K

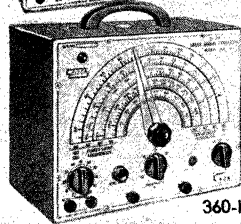

360-K

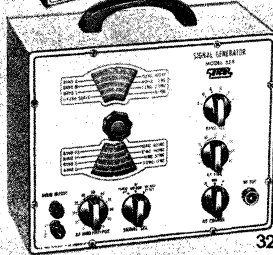

324-K

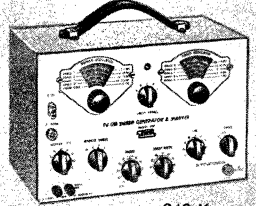

368-K

MODEL 460-K 5" OSCILLOSCOPE KIT

Wide-band scope for lab and color TV use. Response flat from DC to 4.5 mc—usable to 10 mc. Accurately reproduces 3.58-mc color TV sync burst; 4-step attenuator in both DC and AC position. Vertical sensitivity 25 mv/inch. Built in voltage calibrator. Full-screen DC vertical positioning and 2X full-screen horizontal positioning. Automatic sync limiter and amplifier eliminates sync voltage adjustment. Sweep: 10 tps to 100 kc, plus low frequency sweep with external capacitor. Graph screen has variable illumination. Push-pull vertical amplifier, voltage regulated. Cathode follower inputs. With all tubes, CRT, all parts, instructions. 13x8 1/2x16". Less solder. For 105-125 v., 50-60 cycle AC. Shpg. wt., 26 lbs.

83 FZ 193. NET.....79.95
 MODEL 460. As above, but factory-wired.
 84 FZ 668. NET.....129.50

MODEL 470-K 7" OSCILLOSCOPE KIT

Push-pull amplifiers and cathode follower inputs to both vertical and horizontal sections. Wide-range sweep frequency generator (15 cps to 100 kc). Intensity modulation, external sync inputs, saw-tooth and line frequency outputs—all on front panel. Internal voltage calibrator. Frequency response: Vertical amplifier, flat within ±2 db from 10 cps to 1 mc with sensitivity of .01 volt rms/inch; horizontal amplifier, ±2 db from 10 cps to 500 kc with sensitivity of .3 volt rms/inch. Input impedance: Vertical, 3 megs and 35 mmf; horizontal, 1 meg and 40 mmf. Graph screen, 15x15x10". With all tubes and parts. Less solder. For 105-125 v., 50-60 cycle AC. Shpg. wt., 35 lbs.

83 FZ 174. NET.....79.95
 MODEL 470. As above, but factory-wired.
 84 FZ 343. NET.....129.50

OSCILLOSCOPE TV PROBES

For signal and waveform tracing, alignment applications and other test procedures. Probes are fully shielded. Rugged terminal board mounting of parts. All have swivel-action, shock-mounted construction. Av. shpg. wt., 5 oz.
 MODEL PSD-K. Demodulator Probe Kit.

83 F 180. NET.....3.75
 MODEL PSD. As above, but factory wired.
 84 F 653. NET.....5.75
 MODEL PD-K. Direct Probe Kit.
 83 F 181. NET.....2.75
 MODEL PD. As above, but factory wired.
 84 F 654. NET.....3.95
 MODEL PLC-K. Low Capacity Probe Kit.
 83 F 182. NET.....3.75
 MODEL PLC. As above, but factory wired.
 84 F 655. NET.....5.75

MODEL 425-K 5" OSCILLOSCOPE KIT

For AM, FM and TV. Push-pull outputs in horizontal and vertical amplifiers for balanced deflection. Sensitivity, .05 to 1 rms volt/inch. Range, 5 cps to 500 kc, usable to 2.5 mc. Input imped. 1 megohm. Wide-range multi-vibrator sweep circuit, 15-75,000 cps. Provision for external sync. Z-modulation and direct input to CR tube plates. Calibrating voltage terminal on panel. Graph screen. Uses: 3-6SN7, 2-6J5, 5BP1 Cathode Ray tube, 2-5V3GT. With tubes, portable case, all parts, wire, instructions, and operating manual. Less solder. 8 1/2x17x13". For 105-125 v., 50-60 cycle AC. Shpg. wt., 30 lbs.

83 FZ 155. NET.....44.95
 MODEL 425. As above, but factory-wired.
 84 FZ 392. NET.....79.95

MODEL 368-K SWEEP & MARKER GENERATOR KIT

Sweep generator and marker for highly accurate alignment of FM, color and black-and-white TV. Covers 3 to 216 mc in 5 ranges. Variable frequency marker provides output from 2 to 75 mc on fundamentals; to 225 mc on harmonics. Sweep width is variable from 0-30 mc. Supplied with built-in 4.5-mc crystal marker for oscillator. Provides dual markers for RF or IF alignment. Provision for adding external marker. Continuously variable sweep and marker attenuators. Has retrace blanking. Output impedance, 50 ohms. Edge-lit hairlines for high tuning accuracy. 6:1 vernier tuning mechanism. Tubes used: 12AT7, 12AV7, 12AX7, 6AU6, 12B4, 6x4 rectifier, selenium bias rectifier. 8 3/4x13 1/2x 7 1/4". With all tubes, parts and instructions. Less solder. For 105-125 v., 50-60 cycles AC. Shpg. wt., 16 lbs.

83 FX 950. NET.....69.95
 MODEL 368. As above, but factory-wired.
 87 FX 225. NET.....119.95

MODEL 360K SWEEP GENERATOR KIT

Every advanced feature needed for quick, easy, and accurate alignment of TV or FM receivers. Use for video IF alignment and response curve adjustment, sound IF and sound detector adjustment. Covers 500 kc to 228 mc. Variable sweep, 0-30 mc. Crystal marker oscillator with variable amplitude. Provision for injection of external marker. Phase control. 8 1/2" vernier tuning dial. Center of each TV channel is marked on front panel. Uses 6C4, 2-6J5, 7193; 6X5GT rectifier. With tubes, parts, instructions. Less 5-mc crystal and solder. 10x8x 6 3/4". For 105-125 v., 50-60 cycle AC. Shpg. wt., 12 lbs.

83 F 159. NET.....34.95
 MODEL 360. As above, but factory-wired.
 84 FX 342. NET.....49.95

MODEL 324-K

RF SIGNAL GENERATOR KIT

Provides modulated or unmodulated RF signal. For signal tracing and IF-RF alignment of AM, FM, TV receivers. Has expanded frequency range of 6 fundamental bands: 150-400 kc, 400-1200 kc, 1.2-3.5 mc, 3.5-11 mc, 11-37 mc and 37-145 mc. One harmonic band covers 111-435 mc. Calibration accuracy is ±1.5%. Output impedance, 50 ohms. Internal modulation of 400 cps variable from 0 to 50%; can be used for audio testing. Input has gain control for use with external modulator. Colpitts RF oscillator is directly modulated by cathode follower. Fine and coarse RF attenuators. With tubes and all parts. Less solder. 8x10x4 3/4". For 105-125 v., 50-60 cycle AC. Shpg. wt., 10 lbs.

83 F 192. NET.....26.95
 MODEL 324. As above, but factory-wired.
 84 F 666. NET.....39.95

MODEL 315-K DELUXE

RF SIGNAL GENERATOR KIT

For AM, FM, TV servicing. 1% accuracy from 75 kc to 150 mc. 9" illuminated dial. Vernier tuning. Provision for external modulation. Internal 400-cps sine wave generator with attenuator for RF modulation and external audio testing. Uses: 7F7, 6C4; VR150, and 6X5 rectifier. 12x13x7. Less solder. For operation from 105-125v., 50-60 cycle AC. Shpg. wt., 20 lbs.

83 FZ 162. NET.....39.95
 MODEL 315. As above, but factory-wired.
 84 FZ 395. NET.....59.95

MODEL 320-K

RF SIGNAL GENERATOR KIT

Well-designed circuit uses a stable Hartley oscillator. Covers 150 kc to 34 mc on fundamentals—to 102 mc on harmonics. 400-cps modulation. Has 9" dial calibrated in 7 bands. Complete with tubes, portable case, parts, shielded cable, instructions, etc. Less solder. 10x8x4 3/4". For 105-125 v., 50-60 cycle AC. Shpg. wt., 10 lbs.

83 F 154. NET.....19.95
 MODEL 320. As above, but factory-wired.
 84 F 394. NET.....29.95

MODEL 322-K RF GENERATOR KIT

Accurate 150 kc to 34 mc generator. Individual calibration for each of 5 bands. Switch selects pure RF, modulated RF or pure 400 cycle AF. Shielded RF and AF attenuators. With 6SN7; 6X5 rectifier. Steel case, 10x8x4 3/4". Instructions. Less solder. For 105-125 v., 50-60 cycle AC. Shpg. wt., 10 lbs. (Not illustrated.)

83 F 168. NET.....23.95
 MODEL 322. As above, but factory-wired.
 84 F 396. NET.....34.95

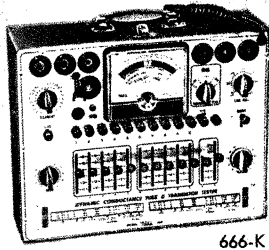

666-K

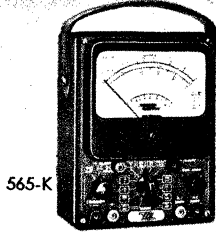

565-K



536-K

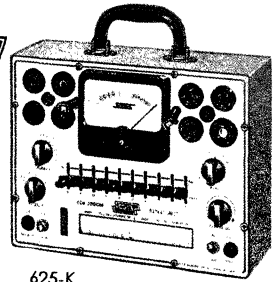

625-K

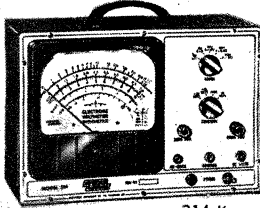

214-K

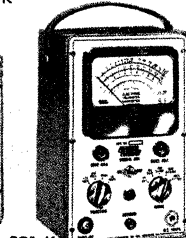

221-K



232-K

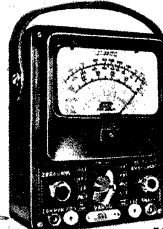

556-K

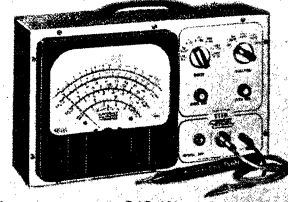

249-K

**MODEL 536-K
STANDARD MULTIMETER KIT**

Ideal low-cost unit for servicemen. 31 ranges. 3" meter. Ranges: AC and DC volts: 0-1-5-10-50-100-500-5000 at 1000 ohms/volt; resistance, 0-500, 0-100,000 ohms. 0-1 meg; AC and DC current, 0-1-10 ma and 0-0.1-1 amps; 6 decibel ranges, -20 to +69 db. With bakelite case, wire, battery and instructions. Less leads and solder. Size: 6 1/4 x 3 3/4 x 2". Shpg. wt., 3 lbs.

83 F 171. NET.....12.90

MODEL 536. As above, but factory-wired.

84 F 345. NET.....14.90

MODEL 526-K KIT. As above, but with 1% resistors. Shpg. wt., 3 lbs.

83 F 166. NET.....13.90

MODEL 526. As above, but factory-wired.

84 F 390. NET.....16.90

**MODEL 565-K 20,000 OHMS-PER-VOLT
MULTIMETER KIT**

Has 31 ranges: DC, AC and output volts, 0-2.5-10-50-250-1000-5000 (DC at 20,000 ohms per volt, AC at 1000 ohms per volt); DC current, 0-100 microamps. 0-10-100-500 ma. and 0-10 amps; resistance, 0-2000-200,000 ohms and 0-20 megohms. Five db ranges, -12 to +55. 4 1/2" meter. 6 3/4 x 5 1/4 x 3". With batteries, all parts, wire, instructions. Less leads, solder. Wt., 4 lbs.

83 F 172. NET.....24.95

MODEL 565. As above, but factory-wired.

84 F 346. NET.....29.95

MODEL 555-K KIT. Same as 565-K above, but with 1% resistors. Wt., 4 lbs.

83 F 167. NET.....29.95

MODEL 555. As above, but factory-wired.

84 F 391. NET.....34.95

VTVM PROBE KITS

Av. shpg. wt. 1 lb.

83 F 188. Model PTP-25-K. Peak-to-peak probe kit. NET.....4.95

84 F 661. Model PTP-25. As above, but factory wired. NET.....6.95

83 F 189. Model PRF-25-K. RF Probe Kit. NET.....3.75

84 F 662. Model PRF-25. As above but factory wired. NET.....4.95

83 F 196. Model PRF-11K. RF Probe Kit. NET.....3.75

83 F 197. Model PRF-11. As above but factory wired. NET.....4.95

MODEL HVP-2 HIGH VOLTAGE PROBES. For adapting VTVM units to read up to 30,000 volts. Factory-wired and tested.

84 F 663. For Models 214, 221. NET 4.95

84 F 669. For Models 232, 249. NET 4.95

**MODEL 232-K
VACUUM-TUBE VOLTMETER KIT**

A high-quality, moderately-priced service instrument. Balanced-bridge circuit provides accuracy and stability. Meter movement protected against burn-out. Easy-to-read 4 1/2" scale. 1% multiplier resistors. Easily calibrated without removal from case. "Uni-Probe" provides convenient high impedance input. Half turn of probe tip selects DC or AC/ohms. Measures peak-to-peak or rms values of AC waves. Ranges: p-p volts, 0-4-14-42-140-420-1400-4200 volts; DC/rms volts, 0-1.5-5-15-50-150-500-1500 volts; resistance 0 to 1000 megohms in 7 ranges. Has zero-center scale for TV and FM discriminator alignment. Tubes: 12AU7, 6AL5, selenium rectifier. Size: 7x4x5". Less solder. For 105-125 volts, 50-60 cycle AC. Shpg. wt., 7 lbs.

83 F 186. NET.....29.95

MODEL 232. As above, but factory-wired.

84 F 659. NET.....49.95

MODEL 249-K DELUXE

VACUUM-TUBE VOLTMETER KIT

All of the features of model 232-K (above) plus the extra convenience and readability of its big 7 1/2" meter. An ideal bench instrument for a lab or shop. Size: 8 1/2 x 13 x 5". Less solder. Shpg. wt., 9 lbs.

83 F 187. NET.....39.95

MODEL 249. As above, but factory-wired.

84 F 660. NET.....59.95

MODEL 221-K

VACUUM-TUBE VOLTMETER KIT

An easy-to-build, sensitive VTVM for making measurements in high-resistance circuits. 20 ranges, with DC input resistance of 25 megohms. 4 1/2" meter is protected against burnout. Includes zero center for alignment of FM and TV discriminators. Dual-triode balanced bridge, 1% multiplier resistors. Ranges: AC-DC volts, 0-5-10-100-500-1000; extends to 30,000 volts and 200 mc with HVP-2 and PRF-25 probes; resistance, 0-1000 ohms 0-1-10-100-1000 megohms; db -20 to +55. Tubes used: 6H6, 6SN7, and 6X5 rectifier. With leads, less solder. 6x9 1/2 x 5". For 105-125 volts, 50-60 cycle AC. Shpg. wt., 10 lbs.

83 F 152. NET.....25.95

MODEL 221. As above, but factory-wired.

84 FX 389. NET.....39.95

MODEL 214-K DELUXE

VACUUM-TUBE VOLTMETER KIT

All the versatility and performance-proven features of Model 221, plus the extra convenience and legibility of its big 7 1/2" meter. 13 1/4 x 9 x 6". Shpg. wt., 11 lbs.

83 FX 170. NET.....34.95

MODEL 214. As above, but factory-wired.

84 FX 344. NET.....54.95

MODEL 625-K TUBE TESTER KIT

Short and open test for each element. Full-visibility, bakelite-cased meter. Easy to read Replace-Weak-Good scale. An overload bulb indicates transformer overload and also serves as fuse. Rugged steel case. Illuminated, "speed-roll" chart—speeds location and setting up. Lever-action switches for individual testing of every tube element. Knock-out for addition of new socket. Handsome three-color panel. 4 1/2" meter. Less solder. For 105-125 v., 60 cycle, AC. 12 1/2 x 9 1/2 x 4 1/4". Shpg. wt., 12 lbs.

83 FX 161. NET.....34.95

MODEL 625. As above, but factory-wired.

84 FX 397. NET.....49.95

MODEL L-1. Lid (cover) for 625-K or 625.

83 F 880. NET.....3.98

666-K TUBE & TRANSISTOR TESTER KIT

This versatile tester indicates mutual conductance, plate conductance and peak emission capability of tubes—also measures transistor collector current and shows current amplification factor. Ten 6-position switches plus 2 lever switches permit simultaneous selection of any one of 4 combinations of 3 plate, 3 screen and 3 ranges of control grid voltages. 200 µa meter provides direct readings of leakage up to 20 megohms; 5 ranges of meter sensitivity. 12x15x4 1/2". Less solder. For 105-125 v., 50-60 cycle AC. Shpg. wt., 18 lbs.

83 FX 198. NET.....69.95

MODEL 666. As above, but factory-wired.

87 FX 226. NET.....109.95

MODEL CRA PICTURE TUBE ADAPTER

(Not illus.) Adapts 625 and 666 tube testers for checking all sizes of TV picture tubes. Measures cathode emission. Tests for filament continuity, shorts between elements. With standard 12-pin socket, octal connector and 4-ft. cable. Wt., 2 lbs.

84 F 348. NET.....4.50

NEW MODEL CRA-110. Same as above but with eight 8-contact socket for checking 110 deg. deflection tubes. Shpg. wt., 1 lb.

83 F 879. NET.....3.95

**MODEL 556-K STANDARD
MULTIMETER KIT—WITH 4 1/2" METER**

Has 400-microamp movement. 38 full-scale ranges: DC, AC and output volts, 0-1-5-10-50-100-500-5000 (at 1000 ohms per volt); AC and DC current, 0-1-10 ma and 0-0.1-1 amp; resistance, 0-500-100,000 ohms and 0-1 megohm. Six db ranges, -20 to +69. Accuracy, DC ±3%, AC, ±5%. With case, wire, battery and instructions. Less leads and solder. 6 3/4 x 5 1/4 x 3". Wt., 4 lbs.

83 F 173. NET.....16.90

MODEL 556. As above, but factory-wired.

84 F 347. NET.....23.50



TEST EQUIPMENT

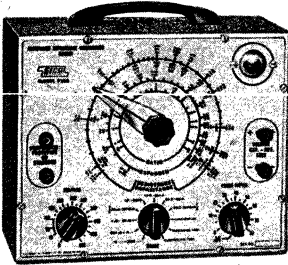

MODEL 950B-K RESISTANCE-CAPACITANCE BRIDGE KIT

A precision instrument for the laboratory or service shop. This unit provides for quick, accurate tests of component values. Combines a resistance-capacitance bridge and R-C-L comparator in one unit.

Measures and tests resistors from 0.5 ohm to 500 megohms in 4 ranges, and capacitors from 10 mmf to 5000 mfd in 4 ranges. One direct-reading scale gives both resistance and capacitance values. A ratio scale is provided for comparison of resistance, capacitance, or inductance values to any external standard. Reads ratios from .05 to 20 (400 to 1.) Substitution boxes and decades, also listed on this page, make good external standards. "Magic eye" tube serves as null indicator. Continuously variable 0-500 volt DC source permits checking capacitors under rated voltage. Tests capacitors for shorts, leakage, and (in the case of electrolytics) power factor. 6" dial. Tubes: 1-1629, 1-6X5 (rectifier). Transformer-type power supply provides line isolation. Satin finished etched aluminum panel gray-wrinkle case, 10x8x4 $\frac{3}{4}$ ".

With case, panel, parts, tubes, wire, and instructions. Less solder and leads. For operation from 105-125 volts, 50-60 cycle AC. Shpg. wt., 10 lbs.

83 F 164. NET. 19.95

MODEL 950B. As above, but factory-wired.
84 F 387. NET. 29.95

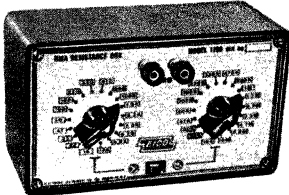

MODEL 1100-K RESISTANCE SUBSTITUTION BOX KIT

A handy, versatile, time-saving instrument with a wide variety of applications. Helps to determine the value of an unmarked or illegible resistor. With a circuit in operation, resistance values can be changed to give optimum performance. In servicing or development, several Model 1100's give the flexibility needed to change circuit values quickly. Easy to use—simply disconnect one end of the resistor in question, and attach the substitution box with test leads. The best resistance value can then be selected by adjusting the box. This value of resistance can then be wired into the circuit. Resistance range from 15 ohms to 10 megs in decade multiples of 15, 22, 33, 47, 68 and 100 ohms. 36 RETMA 1-watt 10% resistors. 5-way jack-top binding posts for connecting any type test leads. Black bakelite case, with 2-color etched aluminum panel. 3 $\frac{3}{4}$ x6 $\frac{1}{2}$ x3 $\frac{1}{2}$ ". Less solder and leads. Shpg. wt., 2 lbs.

83 F 179. NET. 5.95

MODEL 1100. As above, but factory-wired.
84 F 652. NET. 9.95

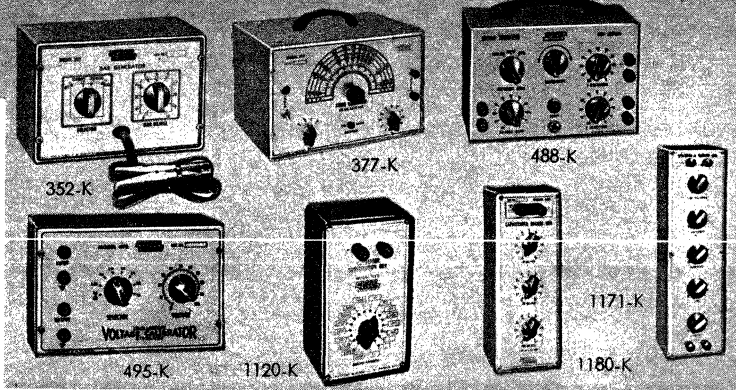

MODEL 352-K BAR GENERATOR KIT

For adjusting vertical and horizontal linearity. A valuable instrument for use in shop and on service calls. Produces 16-23 vertical and 13-22 horizontal bars when connected to antenna terminals (number of bars is adjustable). Since bars will be equally spaced on a correctly adjusted set, a quick indication is obtained of the picture linearity of TV set under test. Also indicates vertical and horizontal sync circuits. Video carrier oscillator is tunable over channels 2-6. 3-way antenna clip. Less solder. Size, 7 $\frac{1}{2}$ x5x4 $\frac{1}{2}$ ". For operation from 110-120 v., 50-60 cycle AC. Shpg. wt., 4 lbs.

83 F 178. NET. 14.95

MODEL 352. As above, but factory-wired.
84 F 651. NET. 19.95

MODEL 377-K AUDIO GENERATOR KIT

Provides sine and square waves. 1% resistors in Wien bridge-type oscillator circuit. Sine wave: 20-200,000 cps in 4 bands, ± 1.5 db. from 60-150,000 cps, less than 1% distortion. Square wave: 60-50,000 cps in 4 bands, 5% tilt at 50 cps, 5% rounding at 50,000 cps. Output (sine or square wave): 10 volts across rated load of 1000 ohms. Cathode follower output. Hum less than 0.4% of rated output. Calibration accuracy $\pm 3\%$ or 1 cps, whichever is greater. 6 $\frac{1}{2}$ " dial has 0-100 reference scale. 7 $\frac{1}{8}$ x11 $\frac{1}{8}$ x7 $\frac{1}{8}$ ". With tubes, wire and instructions. Less solder and leads. For 105-125 v., 50-60 cycle AC. Wt., 14 lbs.

83 FX 169. NET. 31.95

MODEL 377. As above, but factory-wired.
84 FX 349. NET. 49.95

MODEL 488-K ELECTRONIC SWITCH KIT

Allows simultaneous observation of two patterns on the screen of a scope. Amplitudes of two patterns are separately adjustable by gain controls in each channel. Patterns may be superimposed or separated with positioning control. Switching rates: Low range, 10-100 cps; mid-range, 50-400 cps; high range 250-2000 cps, all continuously variable. Freq. resp. 0-30,000 cps 2 db; usable to 300,000 cps. With tubes, instructions; less solder and leads. For operation from 105-125 v., 50-60 cycle. Size, 6x8x6". Shpg. wt., 7 lbs.

83 F 185. NET. 23.95

MODEL 488. As above, but factory-wired.
84 F 658. NET. 39.95

MODEL 495-K SCOPE VOLTAGE CALIBRATOR KIT

Injects a calibrated, semi-square wave on the scope screen for comparison with any waveform. Ranges: 1, 10 and 100 volts peak-to-peak. Continuously calibrated output from 0 to 100 volts. Uses 1% decade attenuator resistors. Switch permits transfer of signal under observation directly to scope. Calibrator can be permanently connected to scope. Regulated power supply. 5x7 $\frac{1}{2}$ x4". Less solder and leads. For 105-125 v., 50-60 cycle. Shpg. wt., 4 lbs.

83 F 176. NET. 12.95

MODEL 495. As above, but factory-wired.
84 F 384. NET. 17.95

MODEL 1120-K CAPACITOR SUBSTITUTION BOX KIT

For rapidly substituting a wide range of RETMA capacitance values. A time-saving instrument for laboratory and serviceshop use. Provides capacitance values from 0.0001 to 0.22 microfarads in 18 steps. Determines values needed for optimum performance, or values of badly damaged or otherwise illegible capacitors. Can be used with Model 1100 Resistance Substitution Box to determine the best values for differentiating, integrating, and other wave shaping R-C circuits. 18-position rotary switch. Accuracy, $\pm 10\%$. Most of capacitors rated at 600 v.; others 400 v. 5-way jack-top binding posts take any type of test lead. Black bakelite case; attractive two-color etched aluminum panel. Size, 3 $\frac{3}{4}$ x6 $\frac{1}{2}$ x3 $\frac{1}{2}$ ". Supplied complete with all parts and instructions; less solder and leads. Shpg. wt., 2 lbs.

83 F 191. NET. 5.95

MODEL 1120. As above, but factory-wired.
84 F 665. NET. 9.95

MODEL 1171-K RESISTANCE DECADE BOX KIT

An excellent unit for use in general design and development work. Can be used as a known resistor with Model 950B or any other bridge, for ohmmeter calibration, determination of meter multiplier resistance values. Also makes a very accurate resistance substitution box. Supplies resistance values from 0 to 99,999 ohms in 1-ohm steps with 5 decades with $\frac{1}{2}\%$ accuracy. Uses $\frac{1}{2}$ 1-watt resistors. Has 5 separate 10-position switches. Ideal low-cost unit for the experimenter and builder. Comparator position and binding posts for instant substitution of actual equivalent component. Satin finish deep-etched aluminum panel. Heavy-gauge steel cabinet with gray wrinkled finish. Size: 3 $\frac{1}{2}$ x12x3". Less solder, leads. Shpg. wt., 3 lbs.

83 F 165. NET. 19.95

MODEL 1171. As above, but factory-wired.
84 F 388. NET. 24.95

MODEL 1180-K DECADE CAPACITOR BOX KIT

For general design and development work. Useful in every laboratory as tuned circuit elements, bridge impedances, filter elements or components of any circuit where a wide range of capacitance is necessary. Permits rapid determination of proper capacitance values. Range: 100 mmf to .111 mfd in steps of 100 mmf; voltage rating 350 volts DC continuous, 500 volts intermittent. Mica capacitors are $\pm 1\%$. Zero capacitance approx. 7 mmf. Positive detent, ceramic wafer switches. 5-way jack-type binding posts take any type of test lead. Low-loss lucite terminal board. Satin finish etched aluminum panel with gray wrinkled steel case. Size: 9x3 $\frac{1}{2}$ x3". With panel, case, parts, and instructions. Less solder and leads. Shpg. wt., 3 lbs.

83 F 183. NET. 14.95

MODEL 1180. As above, but factory-wired.
84 F 656. NET. 19.95



TEST EQUIPMENT



944-K

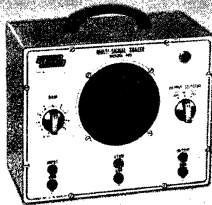

145-K

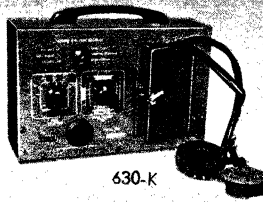

630-K



584-K

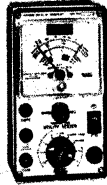

540-K

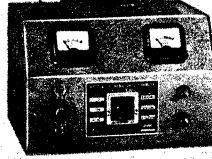

1050-K

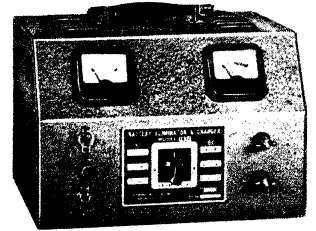

NEW MODEL 1060-K DELUXE BATTERY ELIMINATOR KIT

MODEL 944-K FLYBACK TESTER KIT

Very useful for color or monochrome TV servicing. Spotting a defective flyback transformer or yoke—formerly a very difficult job—becomes quick and easy with this instrument. Also checks continuity of yokes, speakers, etc. Provides positive check of all types of flybacks and yokes. Operating on the extremely sensitive grid-dip principle, it shows even 1 shorted turn. Separate calibration for air-core and iron-core flybacks for more accurate testing. Has easy-to-read 4 1/2" meter with 3 separate colored scales. Satin finish aluminum panel. Gray wrinkle steel case with convenient carrying strap. Size, 8 1/2 x 5 x 5". Less solder. For operation from 105-125 v., 50-60 cycle AC. Shpg. wt., 5 lbs.

83 F 184. NET..... 23.95

MODEL 944. As above, but factory-wired.

84 F 657. NET..... 34.95

MODEL 584-K BATTERY TESTER KIT

Designed for quick testing of all portable radio "A" and "B" batteries in or out of the receiver. Tester provides correct current drain for accurate measurement. Will also test lantern batteries, and can be adapted to test other types. A rotary switch selects the voltage of the battery under test, and inserts the proper resistors in series and shunt with the meter. Therefore the battery's internal resistance reduces its terminal voltage exactly as occurs when the battery is in service. Test switch positions (volts): 1.5, 4.5, 6.0, 7.5, 9.0, 22.5, 45, 67.5, 75, 90, plus a spare position. Has 3 1/2" meter; calibrated: Good, Usable and Bad. Rugged, high-impact black bakelite case and deep-etched aluminum panel with satin finish. Size, 6 1/2 x 3 3/4 x 2". Less solder. With test leads. Shpg. wt., 2 lbs.

83 F 195. NET..... 9.95

MODEL 584. As above, but factory-wired.

84 F 671. NET..... 12.95

MODEL 540-K "REDI-TESTER" KIT

A very useful device for simplified repair work on home appliances and for checking automobile electrical systems. It is a combination AC/DC voltmeter, ammeter, ohm meter, wattmeter, and leakage tester. A rotary switch range selector provides easier, surer, and faster operation than comparable units. The instruction book contains an introduction to electricity, complete operating instructions, and procedures for common repair jobs. This versatile tester locates defects in irons, refrigerators, electric blankets, house wiring, furnace control systems, heaters, fans, etc. Will also check auto batteries, regulators, starters, ignition coils, direction signals, horns, switches, etc.

Ranges: AC-DC volts, 0-7.5, 15, 150, 300. Current (AC or DC), 0-15 amps. Resistance, 0-1000 ohms. Leakage test of capacitors above .0005 mfd and resistors between 1000 and 2 megohms. 3 1/2" meter. Has handsome, etched aluminum panel and black bakelite case. With leads. Less solder. Size, 6 1/2 x 3 3/4 x 3 1/2". Shpg. wt., 3 lbs.

83 F 199. NET..... 12.95

MODEL 540. As above, but factory-wired.

84 F 667. NET..... 15.95

MODEL 1050-K 6-12 VOLT BATTERY ELIMINATOR KIT

Work bench supply for 6 or 12 v. auto radios. Can be used as battery eliminator or charger. 2 DC ranges: 0-8 v. at 10 amps continuous, 20 intermittent; 0-16 v. at 6 amps continuous, 12 amps intermittent. Separate ammeter (0-20 amps) and voltmeter (0-20 v.). With steel case, parts, and instructions. Less solder. For 105-125 volts, 50-60 cycle AC. Size: 8 3/4 x 10 1/2 x 7 3/4". Shpg. wt. 15 lbs.

83 FX 175. NET..... 29.95

MODEL 1050. As above, but factory-wired.

84 FX 341. NET..... 38.95

MODEL 1055-K. An L-C filter for 1050 or any similar unit. Gives extra filtering needed for transistor auto radios. Size: 5 x 4 x 5 3/4". Shpg. wt., 7 lbs.

83 FX 877. NET..... 11.95

MODEL 1055. As above, but factory-wired.

83 FX 878. NET..... 15.95

MODEL 630-K CATHODE RAY TUBE CHECKER KIT

Tests television picture tubes in the set or the shipping carton—speeds servicing, saves time. Indicates shorted or open elements in the electron gun assembly. Can be used with any cathode ray tube having either electrostatic or magnetic deflection and focus.

Uses balanced bridge circuit to measure peak beam current (which is proportional to screen brightness). Neon lamp acts as a sensitive bridge balance indicator. Balancing control dial is calibrated to indicate tube condition directly. Supplied with two test sockets, each with 2 1/2 ft. of cable, for duodecal (12-pin) and diheptal (14-pin) tubes. Adapter cables plug into an octal socket on the panel. Cables are stored in case. Less solder. 6 1/2 x 9 1/2 x 3". For 105-125 volts, 50-60 cycle AC. Shpg. wt., 6 lbs.

83 F 177. NET..... 13.95

MODEL 630. As above, but factory-wired.

84 F 650. NET..... 18.95

MODEL 145-K MULTI-SIGNAL TRACER KIT

A useful aid to the serviceman and experimenter. Provides a quick method for locating the source of trouble in any radio, television set or audio amplifier. RF probe incorporates a germanium crystal diode with response to over 200 mc. Probe can be used for stage-by-stage check of IF, RF, video and audio circuits. Front panel jacks for external oscilloscope or VTVM—permits visual signal tracing. Built-in 4 1/2" PM speaker and audio amplifier with volume control; can also be used as a low-power utility sound system for phonograph, intercom, public address, etc. Supplied with tubes, RF probe, and speaker. Less solder. Aluminum panel is handsomely styled, satin finished. For operation from 105-125 volts, 50-60 cycle AC. Size, 8 x 10 x 4 3/4". Shpg. wt., 11 lbs.

83 F 158. NET..... 19.95

MODEL 145. As above, but factory-wired.

84 F 385. NET..... 28.95

A rugged, powerful unit for operating any auto radio, including transistor models. Combines Model 1050-K battery eliminator and 1055-K filter (at left) in a single unit. Fits conveniently on the work bench or wall. Can be used as a battery charger or eliminator. An excellent addition towards a well-equipped service shop.

Features: 2 DC ranges with extra filtering and continuous adjustment by a variac; separate voltmeter and dual range ammeter for simultaneous readings; heavy duty selenium rectifiers; fused primary; automatic reset overload relay in secondary; strong, well ventilated steel case.

Specifications: Low range, 0-8 v., 10 amps continuous, 20 amps intermittent, 0.3% ripple at 2 amps, 1.5% at 10 amps; high range, 0-16 v., 6 amps continuous, 12 amps intermittent, 1.5% ripple at 2 amps, 2% at 6 amps; voltmeter range, 0-20 v.; ammeter, 0-10, 0-20 amps. For 105-125 v., 50-60 cycle AC. Size: 8 3/4 x 10 1/2 x 7 3/4". With case, parts, and instructions. Less solder. Shpg. wt., 19 lbs.

83 FX 875. NET..... 38.95

MODEL 1060. As above, but factory-wired.

83 FX 876. NET..... 47.95

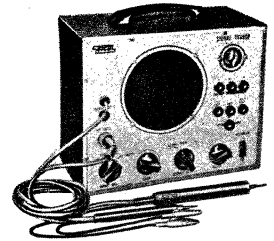

MODEL 147-K DELUXE SIGNAL TRACER KIT

Versatile transformer-operated instrument. High and low-gain RF channels with internal wide-frequency range demodulator permits direct observation of actual transmitted signal. Has output for connection to VTVM or oscilloscope. May be connected as substitute speaker, output transformer, or amplifier. Heavy filtering and hum-balance control. Both visual and aural monitoring of all RF and AF channels—magic eye and 5" PM speaker. Calibrated wattmeter circuit indicates wattage consumption in unit under test. Has noise localizer circuit. Fully shielded RF crystal and audio probes. Tubes: 6K6, 6SQ7, 6SJ7, 1629 ("magic eye"); also 6x5 rectifier. Handsome, satin-finish etched aluminum panel, gray wrinkled steel case. Supplied with probes and easy-to-follow assembly instructions. Less solder. For operation from 105-125 volts, 50-60 cycle AC. Size, 9 x 10 x 5". Shpg. wt., 10 lbs.

83 F 190. NET..... 24.95

MODEL 147. As above, but factory-wired.

84 F 664. NET..... 39.95

SELECTED TEST EQUIPMENT



A

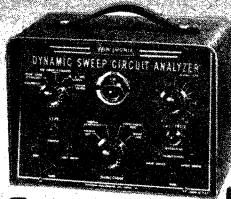

C



E

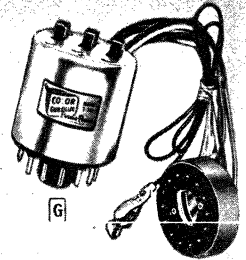

G

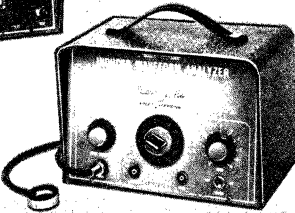

D

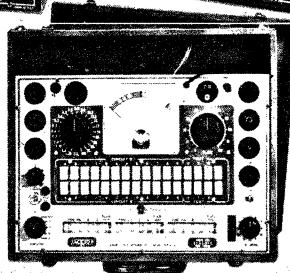

F

Wintronix Test Equipment

A MODEL 825 DYNAMIC AGC CIRCUIT ANALYZER. New unit pinpoints troubles in the AGC circuit of a TV set. Provides RF at the frequency of channel 2 or 3, with 15 kc sync pulse modulating signal. Also supplies AGC bias from +1 to -15 v. DC for insertion into set under test. Checks for continuity of AGC circuit; monitors DC value of AGC voltage and p-p value of gate pulse. Adjustable for signal ranges of 0 to 100,000 μ v. $4\frac{1}{2}$ " meter. Scales: 15-0-15 v. DC; 300-0-300 v. DC; 0-250 v. rms AC; 0-800 v. p-p AC; 0-10 megohms. Size: $7 \times 10\frac{1}{2} \times 6$ ". For 105-125 v., 50-60 cycle AC. Shpg. wt., 12 lbs.
87 FX 240. NET. 79.95

B MODEL 850 INDUCED WAVEFORM ANALYZER. New unit for use with oscilloscope. Trace and view RF, composite video, sound IF, sync, deflection, or audio signals in any TV from top of chassis. Simply slip over tube of stage to be checked and view waveform on scope. Tuned input tests: TV channels 2-13; 40 mc IF; 21 mc IF; 3.58-4.5 mc IF; audio, video. Built-in high-gain, low-noise amplifier. With probe and attachments for any size receiving tube, including multi-section types, and instruction book showing correct waveforms. Size: $7 \times 10\frac{1}{2} \times 6$ ". For operation from 105-125 v., 50-60 cycle AC. Shpg. wt., 12 lbs.
87 FX 239. NET. 169.95

C MODEL 820 DYNAMIC SWEEP CIRCUIT ANALYZER. Uses signal substitution to localize troubles in deflection circuits. Tells whether loss of raster is due to faults in sweep circuits or high-voltage components. Provides 15 kc sawtooth for hor. def. tube grid, square wave for plate circuit, and 60 cycle sawtooth for vert. circuit. Checks flyback and yoke for even 1 shorted turn. Use with 915/960 (below) to service sync circuits. With leads. $10 \times 13\frac{1}{2} \times 9$ ". For 105-125 v., 50-60 cycle AC. Shpg. wt., 10 lbs.
84 FX 637. NET. 69.95

MODEL 915/960 SYNC PULSE ADAPTER. For above. Provides positive or negative, horizontal or vertical sync pulses. $4 \times 2\frac{1}{2} \times 1\frac{1}{4}$ ". Shpg. wt., $1\frac{1}{2}$ lbs.
84 F 638. NET. 14.95

Jackson Test Equipment

D MODEL 648A DYNAMIC TUBE TESTER. Gives correct voltage for every available or presently planned tube type, 3-column roll chart with middle column in inverted order speeds location of set-up data for any tube. Data for newly announced tubes published monthly in PF Reporter. Sequence switching with push-buttons makes set-up time less than the warm-up time of most tubes. Separate loads or voltages are applied to each tube element. Checks inter-element leakage at any value from 250K to 2 megohms. Life line indicator tells when good tube is nearing the end of its life. Meter reads good-bad and per cent of relative transconductance. Portable case with tough gray and green plastic finish. Size: $16\frac{1}{2} \times 13\frac{1}{2} \times 6$ ". For operation from 110-120 v., 60 cycle AC. Shpg. wt., 23 lbs.
87 FZ 130. NET. 127.35

MODEL 710 SELENIUM TESTER. (Not illus.). Accurately tests all selenium rectifiers rated from 20-650 ma. Variable voltage range from 25-300 volts AC. "Good—Replace" meter dial. $3\frac{1}{4} \times 7\frac{1}{4} \times 4\frac{1}{4}$ ". For 110-120 volts, 50-60 cycle AC. Shpg. wt., 5 lbs.
84 F 458. NET. 28.91

Barker & Williamson Test Equipment

E MODEL 200 AUDIO OSCILLATOR. RC type for making frequency response, distortion, and other audio measurements. Ranges: 30-300, 300-3000, 3000-30,000 cps. Output: 10 volts into 500-ohm load. Less than 1% rms harmonics from 30-15,000 cps, with 500-ohm load. Response: Better than ± 1 db from 30-15,000 cps. Calibration accuracy, 3% of scale reading. $13\frac{1}{4} \times 7\frac{1}{4} \times 9\frac{1}{2}$ ". For operation from 105-125 volts, 50-60 cycles AC. Shpg. wt., 17 lbs.
84 FX 482. NET. 138.00

F MODEL 400 DISTORTION METER. Measures low-level audio voltages, noise and harmonic content, and amplifier gain. Ranges: Distortion meter, 30 to 15,000 cps on fundamentals, to 45,000 cps on harmonics; voltmeter and db meter, 30 to 45,000 cps. Sensitivity: Noise and distortion, 0.3 volts minimum input; voltmeter, 0.3, 0.1, 0.03, .01 and 0.003 volts for full scale readings. Size: $13\frac{1}{4} \times 7\frac{1}{4} \times 9\frac{1}{2}$ ". $4\frac{1}{2}$ " meter. For operation from 105-125 volts, 50-60 cycle AC. Shpg. wt., 17 lbs.
84 FX 483. NET. 168.00

Perma Power Color Gun Killer

G MODEL T-101. Invaluable aid in color adjustment. Put between color picture tube and socket. Slide switches permit guns to be turned on or off as desired. Permits purity adjustment without changing balance or other controls. Size: $1\frac{1}{2} \times 2 \times 5\frac{1}{2}$ ". Shpg. wt., 8 oz.
87 F 241. NET. 2.91

Pyramid "Snap Around" AC Volt-Ammeters

Amprobes measure current without breaking the circuit or the insulation of conductors. Press trigger to open probe jaws, then close them around conductor. Meter instantly gives correct reading. One-hand operation. Jaws fully insulated. Dustproof D'Arsonval movements, precision balanced, 1% resistors. Accuracy, $\pm 3\%$ of full scale. Voltage measured with new safety test leads which automatically insulate plugs when test lead is removed. Units are designed for 60-cycle operation, and will give dependable results from 50 to 70 cps. Current readings tend to be low if frequency is low, or high if frequency is high.

K MODEL RS-1. New multi-range Amprobe. Recessed range selector permits selection of any one of 4 current and 2 voltage ranges by flick of the thumb. Only one scale visible at a time. Pointer-lock locks needle in position when reading is taken in difficult locations. 2.36 " dial with close magnifying dial window. Ranges: Amps: 0-5-15-40-100; Volts: 0-150-600 AC. Impact-proof case has non-slip ribbing. Printed-circuit design and shielded-core magnet movement. Supplied with test leads and storage case for easy carrying. Shpg. wt., 2 lbs.
87 F 268. NET. 39.85

H AMPROBE JUNIORS. Small versions of Amprobe "snap around" meters. Convenient 1.8-inch scale. Plastic case and window are molded in one piece. With test leads for making voltage measurements. Less carrying case (listed below). Size: $2\frac{1}{2} \times 4\frac{3}{4} \times 1\frac{3}{8}$ ". Shpg. wt., 1 lb.

Stock No.	Model	Amps	Volts
84 F 369	10	0-10	0-125-250
84 F 373	25	0-25	0-125-250
84 F 374	50	0-50	0-125-250
84 F 379	100	0-100	0-125-250
84 F 897	525	0-25	0-150-600
84 F 898	550	0-50	0-150-600
84 F 899	500	0-100	0-150-600

NET EACH. 19.85

MODEL P-1 LEATHER CARRYING CASE. Fits Amprobe Juniors above. Wt., 12 oz.
84 F 488. NET. 2.85

J MODEL A-40 ENERGIZER. This 3-function Amprobe accessory serves as a "split" plug to divide 2 cond. cords at the outlet. Increases ammeter sensitivity 10X. Test jacks permit measuring line voltage under load. Supplied with leather carrying case. Shpg. wt., 8 oz.
84 F 489. NET. 3.75

SELECTED TEST EQUIPMENT

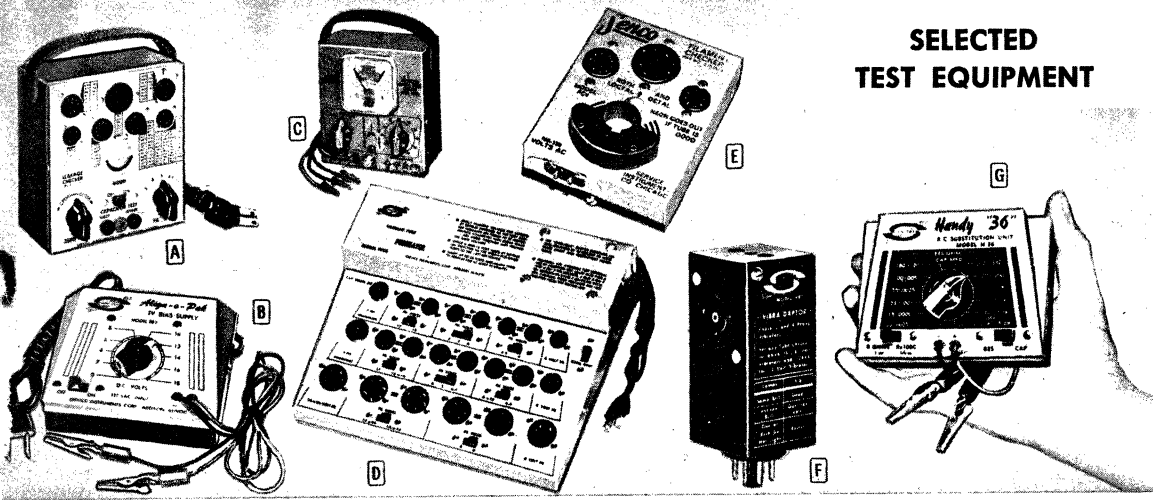

Scencore Test Equipment

A MODEL LC-2 TUBE & CAPACITOR CHECKER KIT. Versatile checker for detecting leakage in capacitors or between tube elements. Tube numbers printed on panel for quick testing. Indicates grid-to-cathode leakage in tubes up to 100 megohms; heater-to-cathode leakage up to 50,000 ohms. Can detect control grid currents as low as 0.5 microamps. Tests capacitors by applying 50 volts. Indicates leakage up to 50,000 ohms in electrolytic capacitors and up to 100 megohms in paper types. With leads. 5½x5x2½". For 110-120 v., 50-60 cycle AC. Shpg. wt., 3 lbs.
83 F 901. NET.....19.55

MODEL LC-2. As above, but factory-wired.
87 F 250. NET.....24.45

B MODEL BE-3 TV BIAS SUPPLY. Completely isolated variable voltage bias supply. Provides all DC battery voltages for TV alignment—especially useful for AGC trouble-shooting. Output, 0 to 18 volts DC, pos. or neg., with AC ripple of less than 0.1%. Includes 28' leads. 2½x4x4". For 110-120 v., 60 cycle AC. Shpg. wt., 2 lbs.
84 F 696. NET.....7.69

C MODEL TDC-22 TRANSISTOR & DIODE CHECKER. Battery-operated. Tests 10 opens, shorts, leakage, and current gain in transistors; forward and reverse current ratio in diodes. Has 3 leads with miniature clips for in-circuit testing. With battery. 4½x5x2¼". Shpg. wt., 2 lbs.
87 F 254. NET.....15.63

D MODEL FP-22 PREHEATER. Quickly locates gassy or intermittent tubes. Provides filament voltages up to 35 v., including values for 450 and 600 ma tubes. Quick-heat switch applies 10% overvoltage for speed. Size: 3x10½x9". For 110-120 v., 50-60 cycle AC. Shpg. wt., 5 lbs.
87 F 274. NET.....18.57

E MODEL FC-4 FILAMENT CHECKER. Locates bad tubes in series filament TV sets. TV power cord is plugged into checker. Tube in question goes into one of 4 sockets. If neon lamp goes out, filament is good. Checks voltage (100-600 v.) and continuity. With leads. 3¼x4x1½". For 110-120 v., AC or DC. Shpg. wt., 1 lb.
84 F 697. NET.....2.89

F MODEL VB-2 "VIBRA-DAPTOR". Permits any tube tester to check vibrators. Plug VB-2 into tube tester, and set for 6AX4 for 6-volt vibrators or 12AX4 for 12-volt vibrators. Also operates with LC-2 (described at left)—use 6SN7 connections. Has sockets for 3- or 4-prong vibrators. Two lamps on the adaptor indicate condition of the vibrator. Vibrator is good if lamps glow evenly, bad or questionable otherwise. Uses 2 #51 lamps, recessed for protection. Steel body with instructions screened on front. 3¼x1½x1¼". Shpg. wt., 5 oz.
87 F 278. NET.....2.69

G MODEL H-36 SUBSTITUTION UNIT. Handy for lab, shop, or outside service. 3-pole, 12-position switch selects any one of 36 components. Has 12—1-watt resistors, 10 to 5K ohms; 12—½-watt, 10K to 5.6 megs; 10—600 v. capacitors, 100 mmf. to .5 mfd; 1 ea. 10 and 40 mfd. 450 v. electrolytics. Simply insert R or C value into circuit with test leads. If a part is already in the circuit, disconnect one end. With leads and case. Size: 2x4¼x3¼". Shpg. wt., 2 lbs.
87 F 269. NET.....12.49

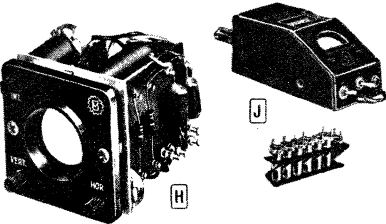

Millen Test Equipment

H MODEL 90901 1" SCOPE. For Amateur or industry. Use as: Modulation indicator, null indicator. Lissajous screen, etc. Controls: Intens., Vert. Ctr., Hor. Ctr. Sens.; Vert., rms v/mm; Hor., 2.5 rms v/mm. Requires 600-950 v. DC @ 3.2 ma. and 6.3 v. @ 0.6 a. 2½x2¾x4½". Wt., 2 lbs.
84 F 907. NET.....38.25

J MODEL 90651 GRID DIP METER. Useful as oscillator, detector, wavemeter, etc. 2" meter. 7 direct reading freq. scales and 0-100 scale. Plug-in coils supplied cover 1.7 to 300 mc. 7x3¾x3¾". For 110-120 v., 50-60 cycle AC. Terminals for battery operation. Shpg. wt., 3½ lbs.
84 F 962. NET.....61.50

LOW FREQUENCY COILS FOR GRID DIP METER

No.	Type	Range KC	EACH
84 F 966	46702	925-2000	6.72
84 F 967	46703	500-1050	
84 F 968	46704	325- 600	
84 F 972	46705	220- 350	

MODEL 46721 PROBE. For above. Wt., 6 oz.
84 F 996. NET.....1.95

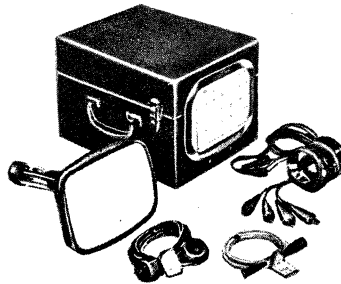

Telematic 8" "Tele-Check"

MODEL CR-117. Portable CRT substitution unit. Saves time and trouble by quickly locating and identifying CRT or yoke troubles. Completely self-focusing; no ion trap needed. Works with either electrostatic or electromagnetic focusing TV sets. Can be used with any 52°, 66°, 70°, or 90° deflection yokes. 6-foot CRT extension lead permits convenient placement. Universal yoke is interchangeable with yoke of set under repair. Horizontal and vertical lines on front plate help in making accurate picture adjustments. In leatherette covered carrying case with plastic handle. Supplied with leads and plastic face plate, less CRT. Requires an 8AXP4 picture test tube. Size: 12x11½x15". Shpg. wt., 9 lbs.
87 FX 296. NET.....26.95

MODEL CR-118. As above, but with 8AXP4. Shpg. wt., 11½ lbs.
87 FX 297. NET.....44.95

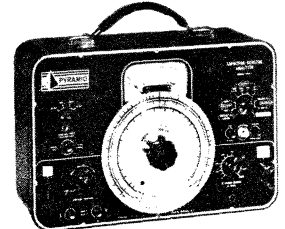

Pyramid Model CRA-2 Capacitor-Resistor Analyzer

Extremely versatile capacitor-resistor analyzer. Ideal for the lab, serviceman and engineer. Makes "In-Circuit" checks to quickly locate open and shorted capacitors. Also measures resistance, capacitance, power factor, leakage and insulation resistance. The analyzer contains a combination Wien and Wheatstone bridge circuit for quick, accurate capacitance (10 mmf to 2000 mfd), resistance (100 ohms to 25 megohms), and power factor (0-65%) measurements. 4½" meter reads leakage current (0-50 ma) and insulation resistance (5-20,000 megohms). Rotary switch permits rapid selection of desired test function and range; meter also indicates test voltage applied by built-in power supply (adjustable from 0-600 volts). Can be used in any application where a capacitance bridge is needed. Black enamel case with leather handle. Size: 14x9¼x5½". Complete with leads and instruction manual. For operation from 110-120 volt, 50-60 cycle AC. Shpg. wt., 15 lbs.
84 FX 642. NET.....92.50



**EMICO
PANEL
METERS**



Sturdy panel meters. Black enamel steel cases. Have screw terminal binding posts and lugs for soldered connections. Model NF-2C (round); Flange, 2 1/4"; overall depth, 1 1/4". Model RF-2C (square); Flange, 2 1/4"; overall depth 1 3/4". With mounting bracket. Both types mount in 2 1/8" hole. 5% accuracy. Av. shpg. wt., 9 oz.

DC MILLIAMMETERS

Model NF-2C				Model RF-2C				
Ma	Stock No.	1-24, EA.	25-49, EA.	50-99, EA.	Stock No.	1-24, EA.	25-49, EA.	50-99, EA.
0-1	67 F 609	3.52	3.18	3.00	67 F 614	3.58	3.22	3.04
0-10	67 F 600	2.06	1.85	1.75	67 F 615	2.11	1.89	1.79
0-20	67 F 601				67 F 616			
0-30	67 F 602	1.71	1.54	1.46	67 F 617	1.81	1.63	1.54
0-50	67 F 603				67 F 618			
0-100	67 F 604				67 F 619			
0-150	67 F 605				67 F 620			
0-200	67 F 606	1.71	1.54	1.46	67 F 621	1.81	1.63	1.54
0-300	67 F 607				67 F 622			
0-500	67 F 608				67 F 623			

DC VOLTMETERS

Volts	Stock No.	1-24, EA.	25-49, EA.	50-99, EA.	Stock No.	1-24, EA.	25-49, EA.	50-99, EA.
0-3	67 F 630				67 F 635			
3-0-3	67 F 631	1.71	1.54	1.46	67 F 636	1.81	1.63	1.54
0-10	67 F 632				67 F 637			

DC AMMETERS

Amps.	Stock No.	1-24, EA.	25-49, EA.	50-99, EA.	Stock No.	1-24, EA.	25-49, EA.	50-99, EA.
0-10	67 F 650				67 F 656			
3-0-3	67 F 651	1.71	1.54	1.46	67 F 657	1.81	1.63	1.54
20-0-20	67 F 652				67 F 658			
30-0-30	67 F 653				67 F 659			

AC AMMETERS

Amps.	Stock No.	1-24, EA.	25-49, EA.	50-99, EA.	Stock No.	1-24, EA.	25-49, EA.	50-99, EA.
0-5	67 F 646	2.84	2.56	2.42	67 F 648	2.94	2.65	2.50
0-10	67 F 647				67 F 649			

AC MILLIAMMETERS

Ma	Stock No.	1-24, EA.	25-49, EA.	50-99, EA.	Stock No.	1-24, EA.	25-49, EA.	50-99, EA.
0-500	67 F 640	1.71	1.54	1.46	67 F 643	2.94	2.65	2.50

AC VOLTMETERS

Volts	Stock No.	1-24, EA.	25-49, EA.	50-99, EA.	Stock No.	1-24, EA.	25-49, EA.	50-99, EA.
0-15	67 F 665	2.84	2.56	2.42	67 F 670	2.94	2.65	2.50
0-150	67 F 666	3.43	3.09	2.92	67 F 671	3.53	3.18	3.00
0-300	67 F 667	4.02	3.62	3.42	67 F 672	4.07	3.66	3.46

Write for Prices on Quantities of 100 or More Emico Panel Meters

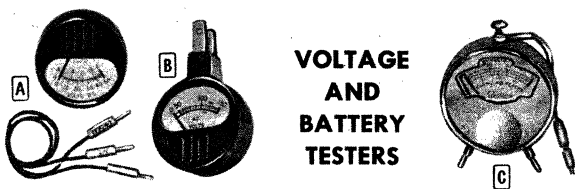

**VOLTAGE
AND
BATTERY
TESTERS**

EMICO HEARING AID BATTERY TESTER

A 2" DC voltmeter. Designed to check hearing aid batteries. Separate ranges for "A" and "B" types assure reliable, accurate readings. "A" scale reads 0-2 volts in .1-volt divisions; "B" scale reads 0-50 volts in 2-volt divisions. Meter movement housed in durable metal case. Will not drain batteries. Supplied complete with test leads. Shpg. wt., 8 oz.
67 F 627. NET..... 2.94

EMICO AC VOLTAGE TESTER

B Handy, low-cost, AC line-voltage tester. Gives accurate, instantaneous check at receptacle. Has 2-prong male plug to fit conventional outlets—no test leads are required. Features convenient 90-degree swivel head for easier reading at angle. Range: 0-150 volts. Scale has 5-volt graduations between 50 and 150 volts. Meter size: 2". Damped movement. Overall accuracy: 5% of full scale. Black metal case. Shpg. wt., 8 oz.
67 F 626. NET..... 2.94

STERLING BATTERY TESTERS

C Accurate battery testers in sturdy, watch-type nickel-finished cases. For checking hearing aid batteries, "B" batteries, dry cells, etc. All are designed to correctly load small batteries. Handy pocket size. White dial face with easy-to-read scales. Size, 2 1/4" dia., 3/4" thick. Av. shpg. wt., 6 oz.

TYPE 31A HEARING AID BATTERY TESTER. For testing 22 1/2, 30 or 45-volt "B" and 1 1/2-volt "A" batteries. Scales: 0-50 volts, 0-2 volts. With plug and flexible leads.
78 F 031. NET..... 2.50

FOR PORTABLE BATTERIES

- TYPE 37A. 0-2-50 volts.
- 78 F 024. NET..... 2.20
- TYPE 38A. 0-2-100 volts.
- 78 F 025. NET..... 2.35
- TYPE 39A. 0-2-150 volts.
- 78 F 026. NET..... 2.35
- TYPE 40A. 0-10-150 volts.
- 78 F 027. NET..... 2.50

FOR DRY CELL BATTERIES

- TYPE 24. Meter scale: 0-35 amperes.
- 78 F 028. NET..... 1.79
- TYPE 34C. Meter scale: 0-50 volts.
- 78 F 029. NET..... 2.09
- TYPE 45. Meter scales: 0-35 amperes and 0-50 volts.
- 78 F 030. NET..... 2.77

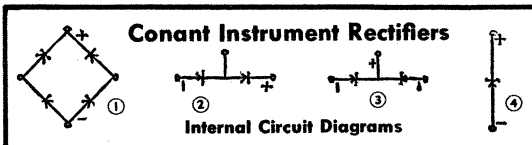

Copper-oxide rectifiers for relay and meter circuits and replacement purposes. Easy to select correct replacement—body color indicates circuit type. Maximum AC input, all units, 5 volts. Series 500: For up to 30 ma max. Reverse voltage: 2.25 DC. Frequency response: 0-1 mc. Diameter .500" with .166" center hole. 0.038" thick. Copper oxide with pure silver face. 3" lead wires. Phillips head 6-32 mounting stud. Synthetic lacquer-enamel finish. Series 160: For up to 5 ma max. Reverse voltage: 2.25 DC. Frequency response: 0.75 mc. Diameter: 0.166"; .038" thick. Copper-oxide with pure silver contact face. 3" lead wires. Two holes for No. 2 mounting screw. Sealed in housing with polystyrene base; moisture-proofed. Series 160-C: Same as Series 160 except stack is housed in welded brass case. Has convenient, clip-type mount. Synthetic lacquer finish. Av. shpg. wt., 5 oz.

Stock No.	Type	Series	Body Color	Internal Circuit	No. of Term	For-ward DC MA	Av. Output DC MA	NET EACH
68 F 041	M	500	Yellow	1	4	60	30	2.06
68 F 043	HS	500	Red	2	3	60	30	1.50
68 F 047	T	500	Red	3	3	60	30	1.50
68 F 042	H	500	Green	4	2	60	30	1.18
68 F 040	B	160	Yellow	1	4	10	5	2.06
68 F 044	BHS	160	Black	2	3	10	5	1.50
68 F 046	BT	160	Red	3	3	10	5	1.50
68 F 037	BH	160	Green	4	2	10	5	1.18
68 F 038	B-C	160-C	Yellow	1	4	10	5	2.06
68 F 045	BHS-C	160-C	Black	2	3	10	5	1.50
68 F 048	BT-C	160-C	Red	3	3	10	5	1.50
68 F 049	BH-C	160-C	Green	4	2	10	5	1.18

INSTRUMENT RECTIFIERS. By H. B. Conant. Includes graphs, curves, plus other helpful data.
37 K 170. NET..... 15c

RADIOACTIVE MATERIAL

Radioactive source for testing radioactivity detectors. Will give a positive indication if the detection unit is operating correctly. Radioactivity is at a perfectly safe level. Excellent for classroom use. Embedded in plastic disc, 2" in diameter. Shpg. wt., 3 oz.
77 P 069. NET..... 69c

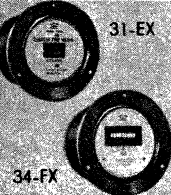

31-EX

**JBT
METERS**



23-JP-1

MODEL 31-EX ELAPSED TIME METER

Records operating time of AC equipment in .1 hour steps to 9999.9 hours, then automatically resets. Self-starting synchronous motor. Flange, 3 1/2". Mounts in 2 3/4" hole; overall depth, 3 3/4". For 110-120 v., 60 cycle AC. Shpg. wt., 1 1/4 lbs.
66 F 689. NET..... 15.63

MODEL 34-FX FREQUENCY METER

Vibrating reed frequency meter. Measures AC frequency from 56-64 cycles in 1-cycle steps. ±0.3% accuracy at 77° F. For 100-130 volts. Flush mounting. Flange, 3 1/2"; body, 2 1/8"; overall depth, 3 3/4". Shpg. wt., 12 oz.
66 F 685. NET..... 26.70

MODEL 23-JP-1 TEMPERATURE METER

Accurate, portable temperature meter. Tests oven thermostats in appliances. 2 3/8" scale reads from 0-650° F. in 10° divisions. Automatically compensated for ambient temperature changes. Meter is mounted on a black metal panel. With attached 5 1/2-ft. calibrated thermocouple, clip, and convection shield. Black top-grain leather case, 4 1/2 x 2 3/4 x 1 1/4". Shpg. wt., 2 1/4 lbs.
66 F 688. NET..... 25.48



BENCH-TYPE METER CASE

Compact, sloping-front metal case with rounded corners. Top binding posts. Size, 3 3/4 x 4"; 2 3/4" dia. hole. Less meter. Shpg. wt., 1 lb.
66 F 506. NET..... 1.29

METER DIMENSIONS

*Round †Rectangular

Mfr's Type	Flange	Body Dia.	Depth	Scale
221-PL*	2 1/16"	2 1/8"	1"	2.197"
227-PL†	2 1/8 x 2 3/8"	2 1/8"	1 1/2"	2.197"
231-PL*	2 1/16"	2 1/8"	1"	1.92"
237-PL†	2 1/8 x 2 3/8"	2 1/8"	1 1/2"	1.92"
321-PL*	3 1/2"	2 3/4"	1"	3.11"
327-PL†	3 3/4 x 3 1/8"	2 3/4"	1 3/4"	3.11"
331-PL*	3 1/2"	2 3/4"	1"	2.65"
337-PL†	3 3/4 x 3 1/8"	2 3/4"	1 3/4"	2.65"
341-PL*	3 1/2"	2 3/4"	1"	3.11"
347-PL†	3 3/4 x 3 1/8"	2 3/4"	1 3/4"	3.11"
420-PL†	4 3/4 x 4 3/4"	2 3/4"	1 1/2"	4.14"
130-PL†	4 3/4 x 4 3/4"	2 3/4"	1 1/2"	3.6"
40-PL†	4 3/4 x 4 3/4"	2 3/4"	1 1/2"	4.14"



PANEL METERS

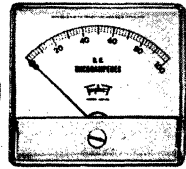
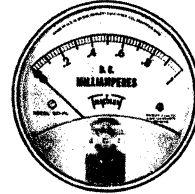

2 1/2" and 3 1/2"
Round

4 1/2"
Rectangular

TYPE PL PLASTIC-FRONT PANEL METERS

Advanced-design panel meters with wrap-around fronts of clear, unbreakable plastic. Have many advantages over conventional style panel meters. Full open dial provides much longer, more readable scale in same size case. Attractive design enhances appearance of test instruments and panels. All have stud mountings. Raised plastic "coverglass" allows full natural lighting from top, sides, and bottom. Durable, white enamel finish metal meter faces with black scales and characters.

Accuracy within $\pm 2\%$ on full scale. DC types have D'Arsonval movements with extra-light moving coil. AC types have air-damped, iron-vane movements. All types have selected jewel bearings, highly polished and specially-treated pivots. Mounting template provided with each meter for accurately determining necessary cut-out. Spade-type pointers; molded zero adjusters; and ceramic pointer stops. Av. shpg. wt., 1 1/2 lbs. Be sure to include Range and Model Number on all meter orders.

AC MILLIAMMETERS

Range	331-PL 3 1/2" Rnd.	NET EACH			337-PL 3 1/2" Rect.	NET EACH			430-PL 4 1/2" Rect.	NET EACH		
		1-9	10-24	25-49		1-9	10-24	25-49		1-9	10-24	25-49
0-100	66 F 863	10.78	9.70	9.16	66 F 864	10.78	9.70	9.16	66 F 854	11.37	10.23	9.66

AC VOLTMETERS

Range	231-PL 2 1/2" Rnd.	NET EACH			237-PL 2 1/2" Rect.	NET EACH			331-PL 3 1/2" Rnd.	NET EACH			337-PL 3 1/2" Rect.	NET EACH			430-PL 4 1/2" Rect.	NET EACH		
		1-9	10-24	25-49		1-9	10-24	25-49		1-9	10-24	25-49		1-9	10-24	25-49		1-9	10-24	25-49
0-50	66 F 825	11.17	10.05	9.50	66 F 826	11.17	10.05	9.50	66 F 859	10.78	9.70	9.16	66 F 780	10.78	9.70	9.16	66 F 799	11.37	10.23	9.66
0-150									66 F 860	11.66	10.50	9.92	66 F 781	11.66	10.50	9.92	66 F 888	12.25	11.02	10.42
0-300									66 F 861	12.74	11.47	10.83	66 F 782	12.74	11.47	10.83	66 F 889	13.33	12.00	11.33

AC AMMETERS

Range	231-PL 2 1/2" Rnd.	NET EACH			237-PL 2 1/2" Rect.	NET EACH			331-PL 3 1/2" Rnd.	NET EACH			337-PL 3 1/2" Rect.	NET EACH			430-PL 4 1/2" Rect.	NET EACH		
		1-9	10-24	25-49		1-9	10-24	25-49		1-9	10-24	25-49		1-9	10-24	25-49		1-9	10-24	25-49
0-5	66 F 828				66 F 784				66 F 855				66 F 787				66 F 892			
0-10	66 F 829				66 F 783				66 F 856				66 F 788				66 F 893			
0-25	66 F 833	10.19	9.17	8.66	66 F 785	10.19	9.17	8.66	66 F 857	10.78	9.70	9.16	66 F 789	10.78	9.70	9.16	66 F 858	11.37	10.23	9.66
0-30	66 F 835				66 F 792				66 F 858				66 F 790				66 F 862			
0-50	66 F 832				66 F 785				66 F 859				66 F 791				66 F 866			

DC MILLIAMMETERS

Range	221-PL 2 1/2" Rnd.	NET EACH			227-PL 2 1/2" Rect.	NET EACH			321-PL 3 1/2" Rnd.	NET EACH			327-PL 3 1/2" Rect.	NET EACH			420-PL 4 1/2" Rect.	NET EACH		
		1-9	10-24	25-49		1-9	10-24	25-49		1-9	10-24	25-49		1-9	10-24	25-49		1-9	10-24	25-49
0-50	66 F 812	10.19	9.17	8.66	66 F 814	10.19	9.17	8.66	66 F 843	10.78	9.70	9.16	66 F 793	10.78	9.70	9.16	66 F 878	11.37	10.23	9.66
0-100	66 F 813	10.58	9.53	9.00	66 F 815	10.58	9.53	9.00	66 F 844	11.17	10.05	9.50	66 F 794	11.17	10.05	9.50	66 F 879	11.76	10.58	10.00
0-200	66 F 827	10.58	9.53	9.00	66 F 851	10.58	9.53	9.00	66 F 845	11.17	10.05	9.50	66 F 795	11.17	10.05	9.50	66 F 778	11.76	10.58	10.00
0-300	66 F 839	10.58	9.53	9.00	66 F 853	10.58	9.53	9.00	66 F 846	11.17	10.05	9.50	66 F 796	11.17	10.05	9.50	66 F 779	11.76	10.58	10.00
0-500	66 F 849	10.58	9.53	9.00	66 F 854	10.58	9.53	9.00	66 F 847	11.17	10.05	9.50	66 F 797	11.17	10.05	9.50	66 F 882	11.76	10.58	10.00

DC VOLTMETERS

1000 OHMS PER VOLT—FILM-TYPE MULTIPLIER RESISTORS

Range	221-PL 2 1/2" Rnd.	NET EACH			227-PL 2 1/2" Rect.	NET EACH			321-PL 3 1/2" Rnd.	NET EACH			327-PL 3 1/2" Rect.	NET EACH			420-PL 4 1/2" Rect.	NET EACH		
		1-9	10-24	25-49		1-9	10-24	25-49		1-9	10-24	25-49		1-9	10-24	25-49		1-9	10-24	25-49
0-50	66 F 804	10.98	9.88	9.33	66 F 805	10.98	9.88	9.33	66 F 834	11.47	10.32	9.75	66 F 806	11.47	10.32	9.75	66 F 872	12.05	10.85	10.25

DC AMMETERS

Range	221-PL 2 1/2" Rnd.	NET EACH			227-PL 2 1/2" Rect.	NET EACH			321-PL 3 1/2" Rnd.	NET EACH			327-PL 3 1/2" Rect.	NET EACH			420-PL 4 1/2" Rect.	NET EACH		
		1-9	10-24	25-49		1-9	10-24	25-49		1-9	10-24	25-49		1-9	10-24	25-49		1-9	10-24	25-49
0-5	66 F 822	10.98	9.88	9.33	66 F 830	10.98	9.88	9.33	66 F 855				66 F 880				66 F 885			
0-10	66 F 823	10.98	9.88	9.33	66 F 831	10.98	9.88	9.33	66 F 856	11.47	10.32	9.75	66 F 881	11.47	10.32	9.75	66 F 886	12.05	10.85	10.25

DC MICROAMMETERS

Range	221-PL 2 1/2" Rnd.	NET EACH			227-PL 2 1/2" Rect.	NET EACH			321-PL 3 1/2" Rnd.	NET EACH			327-PL 3 1/2" Rect.	NET EACH			420-PL 4 1/2" Rect.	NET EACH		
		1-9	10-24	25-49		1-9	10-24	25-49		1-9	10-24	25-49		1-9	10-24	25-49		1-9	10-24	25-49
0-50	66 F 807	15.09	13.58	12.83	66 F 809	15.09	13.58	12.83	66 F 836	15.58	14.02	13.24	66 F 873	15.58	14.02	13.24	66 F 874	16.17	14.55	13.74
0-100	66 F 808	13.23	11.91	11.25	66 F 810	13.23	11.91	11.25	66 F 837	3.72	3.35	3.16	66 F 876	3.72	3.35	3.16	66 F 875	4.31	3.88	3.66
0-200	66 F 809	11.37	10.23	9.66	66 F 838	11.37	10.23	9.66	66 F 838	1.96	1.76	1.66	66 F 877	1.96	1.76	1.66	66 F 871	2.55	2.28	2.16

DB METER

Decibel meter, 6 milliwatts, 5% accuracy. Has internal resistance of 5000 ohms. 1.73 volts at zero db. 3 1/2" round.

Stock No.	Type	Range	Calibration	NET EACH		
				1-9	10-24	25-49
66 F 811	321-PL	+6 to -10db	for 500 ohm line	15.68	14.11	13.33

VOLUME UNIT METER ("A" SCALE)

Volume unit meter. 3900 ohms impedance. Steady state reference, 1 milliwatt. For 600-ohm line. Also has 0-100% scale.

Stock No.	Type	Description	Range	NET EACH		
				1-9	10-24	25-49
66 F 897	321-PL	3 1/2" Round	-20 to +3	19.31	17.38	16.41

THERMO-AMMETERS (RF)

Range	341-PL 3 1/2" Rnd.	NET EACH			347-PL 3 1/2" Rect.	NET EACH			440-PL 4 1/2" Rect.	NET EACH		
		1-9	10-24	25-49		1-9	10-24	25-49		1-9	10-24	25-49
0-5	66 F 818	11.86	10.67	10.08	66 F 817	11.86	10.67	10.08	66 F 819	12.45	11.20	10.58

TRIPLET PANEL METERS

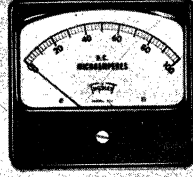
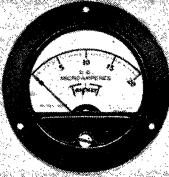

227T
237S

Round

420
430

METER DIMENSIONS

ROUND FLUSH MOUNTING

Model No.	Flange	Body Dia.	*Depth	Scale Length
221T	2 1/4"	2 7/8"	1 3/4"	1.76"
231S	2 1/4"	2 7/8"	1 3/4"	1.58"
321T	3 1/2"	2 3/4"	1 3/4"	2.49"
331S	3 1/2"	2 3/4"	1 3/4"	2.22"
361	3 1/2"	2 3/4"	1 3/4"	2.22"

RECTANGULAR FLUSH MOUNTING

Model No.	Flange	Body Dia.	*Depth	Scale Length
227T	2 3/4" x 2 3/4"	2 3/8"	1"	1.76"
237S	2 3/4" x 2 3/4"	2 3/8"	1"	1.58"
327T	3 3/4"	2 3/4"	1 1/4"	2.49"
337S	3 3/4"	2 3/4"	1 1/4"	2.22"
420	4 5/8" x 4 3/8"	2 3/4"	1 1/4"	4.06"
430	4 5/8" x 4 3/8"	2 3/4"	1 1/4"	3.6"

GLASS-FRONT PANEL METERS

SPECIFICATIONS. Accuracy, within 2% of full scale. DC meters have D'Arsonval moving coil movements. AC meters have double, iron repulsion-type movements. Jeweled bearings and hardened alloy steel pivots. Metal dial faces, finished in white enamel, will not warp, crack or discolor under normal conditions. Have molded zero-adjusters and cushioned ceramic pointer stops.

All parts are heat-treated to eliminate strains and stresses, and to assure accurate alignment. Rigidity and alignment of bearing supports provide protection against vibrations. Steel parts are rustproofed. Black bakelite cases. Av. shpg. wt., 1 1/2 lbs. When ordering include Range and Model No. of meter. *Indicates overall depth but does not include terminals.

DC MILLIAMMETERS

Range	221T 2 1/2" Rnd.	227T 2 1/2" Rect.	1 to 9 EACH	10 to 24 EACH	25 to 49 EACH	327T 3" Rect.	321T 3 1/2" Rnd.	1 to 9 EACH	10 to 24 EACH	25 to 49 EACH	420 4 1/2" Rect.	1 to 9 EACH	10 to 24 EACH	25 to 49 EACH
0-1	66 F 150	66 F 170				66 F 120	66 F 100				66 F 136			
0-1.5	66 F 151	66 F 171	9.70	8.73	8.25	66 F 121	66 F 101	10.29	9.26	8.75	66 F 196	11.37	10.23	9.66
0-3	66 F 165	66 F 185				66 F 118	66 F 115				66 F 197			
0-5	66 F 152	66 F 172				66 F 122	66 F 102				66 F 137			
0-10	66 F 153	66 F 173	9.70	8.73	8.25	66 F 123	66 F 103	10.29	9.26	8.75	66 F 138	11.37	10.23	9.66
0-15	66 F 154	66 F 174				66 F 124	66 F 104				66 F 139			
0-25	66 F 155	66 F 175				66 F 125	66 F 105				66 F 140			
0-50	66 F 156	66 F 176	10.09	9.08	8.58	66 F 126	66 F 106	10.68	9.61	9.07	66 F 141	11.76	10.58	10.00
0-75	66 F 166	66 F 186				66 F 119	66 F 116				66 F 198			
0-100	66 F 157	66 F 177				66 F 127	66 F 107				66 F 142			
0-150	66 F 158	66 F 178	10.09	9.08	8.58	66 F 128	66 F 108	10.68	9.61	9.07	66 F 143	11.76	10.58	10.00
0-200	66 F 159	66 F 179				66 F 129	66 F 109				66 F 144			
0-250	66 F 160	66 F 180				66 F 130	66 F 110				66 F 145			
0-300	66 F 161	66 F 181	10.09	9.08	8.58	66 F 131	66 F 111	10.68	9.61	9.07	66 F 146	11.76	10.58	10.00
0-400	66 F 167	66 F 187				66 F 135	66 F 117				66 F 199			
0-500	66 F 162	66 F 182				66 F 132	66 F 112				66 F 147			
0-750	66 F 163	66 F 183	10.09	9.08	8.58	66 F 133	66 F 113	10.68	9.61	9.07	66 F 148	11.76	10.58	10.00
0-1000	66 F 164	66 F 184				66 F 134	66 F 114				66 F 149			

AC MILLIAMMETERS

Range	231S 2 1/2" Rnd.	237S 2 1/2" Rect.	1 to 9 EACH	10 to 24 EACH	25 to 49 EACH	337S 3" Rect.	331S 3 1/2" Rnd.	1 to 9 EACH	10 to 24 EACH	25 to 49 EACH	430 4 1/2" Rect.	1 to 9 EACH	10 to 24 EACH	25 to 49 EACH
0-10	66 F 570	66 F 580				66 F 490	66 F 470				66 F 496			
0-15	66 F 571	66 F 581	9.70	8.73	8.25	66 F 491	66 F 471	10.29	9.26	8.75	66 F 446	11.37	10.23	9.66
0-25	66 F 572	66 F 582				66 F 488	66 F 476				66 F 447			
0-50	66 F 573	66 F 583				66 F 492	66 F 472				66 F 448			
0-100	66 F 574	66 F 584				66 F 493	66 F 473				66 F 497			
0-200	66 F 575	66 F 585	9.70	8.73	8.25	66 F 489	66 F 477	10.29	9.26	8.75	66 F 449	11.37	10.23	9.66
0-250	66 F 576	66 F 586				66 F 494	66 F 474				66 F 498			
0-500	66 F 577	66 F 587				66 F 495	66 F 475				66 F 499			

DC AMMETERS

Range	221T 2 1/2" Rnd.	227T 2 1/2" Rect.	1 to 9 EACH	10 to 24 EACH	25 to 49 EACH	327T 3" Rect.	321T 3 1/2" Rnd.	1 to 9 EACH	10 to 24 EACH	25 to 49 EACH	420 4 1/2" Rect.	1 to 9 EACH	10 to 24 EACH	25 to 49 EACH
0-1	66 F 510	66 F 525	9.70	8.73	8.25	66 F 450	66 F 440	10.29	9.26	8.75	66 F 460	11.37	10.23	9.66
0-2	66 F 511	66 F 526	10.49	9.44	8.92	66 F 451	66 F 441	10.98	9.88	9.33	66 F 461	12.05	10.85	10.25
0-5	66 F 512	66 F 527	10.49	9.44	8.92	66 F 452	66 F 442	10.98	9.88	9.33	66 F 462	12.05	10.85	10.25
0-10	66 F 513	66 F 528	10.49	9.44	8.92	66 F 540	66 F 560	10.98	9.88	9.33	66 F 465	12.05	10.85	10.25
0-15	66 F 514	66 F 529	10.49	9.44	8.92	66 F 453	66 F 443	10.98	9.88	9.33	66 F 463	12.05	10.85	10.25
0-30	66 F 515	66 F 530	10.49	9.44	8.92	66 F 541	66 F 561	10.98	9.88	9.33	66 F 466	12.05	10.85	10.25
0-50	66 F 516	66 F 531	10.49	9.44	8.92	66 F 542	66 F 562	10.98	9.88	9.33	66 F 467	12.05	10.85	10.25
0-100	66 F 518	66 F 533	17.25	15.52	14.66	66 F 543	66 F 563	17.84	16.05	15.16	66 F 468	18.91	17.02	16.08
0-200	66 F 519	66 F 534	17.25	15.52	14.66	66 F 544	66 F 564	17.84	16.05	15.16	66 F 469	18.91	17.02	16.08
0-300	66 F 520	66 F 535	18.72	16.85	15.92	66 F 545	66 F 565	19.31	17.38	16.41	66 F 470	20.38	18.37	17.33
0-500	66 F 521	66 F 536	23.52	21.17	19.39	66 F 546	66 F 566	24.11	21.70	20.49	66 F 459	25.19	22.67	21.41

AC AMMETERS

Range	231S 2 1/2" Rnd.	237S 2 1/2" Rect.	1 to 9 EACH	10 to 24 EACH	25 to 49 EACH	337S 3" Rect.	331S 3 1/2" Rnd.	1 to 9 EACH	10 to 24 EACH	25 to 49 EACH	430 4 1/2" Rect.	1 to 9 EACH	10 to 24 EACH	25 to 49 EACH
0-1	66 F 340	66 F 350				66 F 320	66 F 300				66 F 330			
0-2	66 F 341	66 F 351	9.70	8.73	8.25	66 F 321	66 F 301	10.29	9.26	8.75	66 F 331	11.37	10.23	9.66
0-3	66 F 342	66 F 352				66 F 322	66 F 302				66 F 332			
0-5	66 F 343	66 F 353				66 F 323	66 F 303				66 F 333			
0-10	66 F 344	66 F 354				66 F 324	66 F 304	10.29	9.26	8.75	66 F 334	11.37	10.23	9.66
0-15	66 F 347	66 F 357				66 F 328	66 F 308	10.29	9.26	8.75	66 F 338	11.37	10.23	9.66
0-25	66 F 345	66 F 355	9.70	8.73	8.25	66 F 325	66 F 305	10.29	9.26	8.75	66 F 335	11.37	10.23	9.66
0-50	66 F 346	66 F 356				66 F 326	66 F 306	10.29	9.26	8.75	66 F 336	11.37	10.23	9.66
0-75	66 F 346	66 F 356				66 F 327	66 F 307	11.86	10.67	10.08	66 F 337	12.94	11.65	11.00

DC MICROAMMETERS

Range	221T 2 1/2" Rnd.	227T 2 1/2" Rect.	1 to 9 EACH	10 to 24 EACH	25 to 49 EACH	327T 3" Rect.	321T 3 1/2" Rnd.	1 to 9 EACH	10 to 24 EACH	25 to 49 EACH	420 4 1/2" Rect.	1 to 9 EACH	10 to 24 EACH	25 to 49 EACH
0-20	66 F 054	66 F 015	17.25	15.52	14.66	66 F 059	66 F 049	17.84	16.05	15.16	66 F 065	18.91	17.02	16.08
0-50	66 F 055	66 F 016	14.60	13.14	12.42	66 F 060	66 F 050	15.09	13.58	12.83	66 F 066	16.17	14.55	13.75
0-100	66 F 056	66 F 017	12.74	11.47	10.83	66 F 061	66 F 051	13.23	11.91	11.25	66 F 067	14.31	12.88	12.16
0-200	66 F 057	66 F 018	10.88	9.79	9.25	66 F 062	66 F 052	11.47	10.32	9.75	66 F 068	12.54	11.29	10.66
0-500	66 F 058	66 F 019	10.39	9.35	8.83	66 F 063	66 F 053	10.88	9.79	9.25	66 F 069	11.96	10.76	10.16

TRIPLET PANEL METERS

DC VOLTMETERS

1000 OHMS PER VOLT—WITH CARBON, FILM-TYPE RESISTORS

Economical units. For applications where high humidity is not encountered. †Meters with external resistors.

Range	221T 2 1/2" Rnd.	227T 2 1/2" Rect.	1 to 9, EACH	10 to 24, EACH	25 to 49, EACH	327T 3" Rect.	321T 3 1/2" Rnd.	1 to 9, EACH	10 to 24, EACH	25 to 49, EACH	420 4 1/2" Rect.	1 to 9, EACH	10 to 24, EACH	25 to 49, EACH
0-10	66 F 903	66 F 923				66 F 943	66 F 963				66 F 983			
0-15	66 F 904	66 F 924	10.49	9.44	8.92	66 F 944	66 F 964	10.98	9.88	9.33	66 F 984	12.05	10.85	10.25
0-25	66 F 905	66 F 925				66 F 945	66 F 965				66 F 985			
0-50	66 F 906	66 F 926				66 F 946	66 F 966				66 F 986			
0-100	66 F 907	66 F 927				66 F 947	66 F 967				66 F 987			
0-150	66 F 908	66 F 928				66 F 948	66 F 968				66 F 988			
0-200	66 F 909	66 F 929	10.49	9.44	8.92	66 F 949	66 F 969	10.98	9.88	9.33	66 F 989	12.05	10.85	10.25
0-250	66 F 910	66 F 930				66 F 950	66 F 970				66 F 990			
0-300	66 F 911	66 F 931				66 F 951	66 F 971				66 F 991			
0-500	66 F 912†	66 F 932†	10.98	9.88	9.33	66 F 952	66 F 972	11.56	10.40	9.83	66 F 992	12.64	11.38	10.75
0-750	66 F 913†	66 F 933†				66 F 953	66 F 973				66 F 993			
0-1000	66 F 914†	66 F 934†				66 F 954†	66 F 974†				66 F 994†			
0-2000	66 F 915†	66 F 935†				66 F 955†	66 F 975†				66 F 995†			
0-3000	66 F 916†	66 F 936†	13.03	11.73	11.08	66 F 956†	66 F 976†	13.62	12.26	11.57	66 F 996†	14.70	13.23	12.49
0-4000	66 F 917†	66 F 937†				66 F 957†	66 F 977†				66 F 997†			
0-5000	66 F 918†	66 F 938†				66 F 958†	66 F 978†				66 F 998†			

1000 OHMS PER VOLT—WITH WIRE-WOUND MULTIPLIER RESISTORS

Have moisture-resistant, vacuum-sealed, wire-wound resistors. †Have external resistors.

Range	221T 2 1/2" Rnd.	227T 2 1/2" Rect.	1 to 9, EACH	10 to 24, EACH	25 to 49, EACH	327T 3" Rect.	321T 3 1/2" Rnd.	1 to 9, EACH	10 to 24, EACH	25 to 49, EACH	420 4 1/2" Rect.	1 to 9, EACH	10 to 24, EACH	25 to 49, EACH
0-1	66 F 900	66 F 920				66 F 940	66 F 960				66 F 980			
0-3	66 F 739	66 F 750	10.49	9.44	8.92	66 F 762	66 F 742	10.98	9.88	9.33	66 F 770	12.05	10.85	10.25
0-5	66 F 740	66 F 751				66 F 763	66 F 743				66 F 771			
0-10	66 F 741	66 F 752				66 F 764	66 F 744				66 F 772			
0-25	66 F 743	66 F 754	12.84	11.55	10.92	66 F 765	66 F 747	13.33	12.00	11.33	66 F 773	14.41	12.97	12.25
0-50	66 F 744	66 F 755				66 F 766	66 F 748				66 F 774			
0-100	66 F 745	66 F 756	13.33	12.00	11.33	66 F 767	66 F 749	13.92	12.52	11.83	66 F 775	14.99	13.49	12.75
0-150	66 F 746	66 F 757				66 F 768	66 F 750				66 F 776			
0-300	66 F 748	66 F 759	16.27	14.64	13.83	66 F 769	66 F 751	16.86	15.17	14.33	66 F 777	17.93	16.14	15.25
0-500	66 F 749†	66 F 760†	18.23	16.41	15.49	66 F 770†	66 F 752†	18.72	16.85	15.92	66 F 778	19.80	17.82	16.83

AC VOLTMETERS

Range	231S 2 1/2" Rnd.	237S 2 1/2" Rect.	1 to 9, EACH	10 to 24, EACH	25 to 49, EACH	337S 3" Rect.	331S 3 1/2" Rnd.	1 to 9, EACH	10 to 24, EACH	25 to 49, EACH	430 4 1/2" Rect.	1 to 9, EACH	10 to 24, EACH	25 to 49, EACH
0-3	66 F 259	66 F 279				66 F 218	66 F 209				66 F 239			
0-5	66 F 250	66 F 270	9.70	8.73	8.25	66 F 220	66 F 210	10.29	9.26	8.75	66 F 230	11.37	10.23	9.66
0-10	66 F 251	66 F 271				66 F 221	66 F 211				66 F 231			
0-15	66 F 252	66 F 272				66 F 222	66 F 212				66 F 232			
0-25	66 F 253	66 F 273				66 F 223	66 F 213				66 F 233			
0-50	66 F 254	66 F 274	9.70	8.73	8.25	66 F 224	66 F 214	10.29	9.26	8.75	66 F 234	11.37	10.23	9.66
0-100	66 F 255	66 F 275				66 F 225	66 F 215				66 F 235			
0-150	66 F 256	66 F 276	10.68	9.61	9.08	66 F 226	66 F 216	11.17	10.05	9.50	66 F 236	12.25	11.02	10.41
0-250	66 F 260	66 F 280	11.17	10.05	9.50	66 F 219	66 F 210	11.76	10.58	10.00	66 F 240	12.84	11.55	10.92
0-300	66 F 257	66 F 277	11.76	10.58	10.00	66 F 227	66 F 217	12.25	11.02	10.41	66 F 237	13.33	12.00	11.33
0-500	66 F 258	66 F 278	15.39	13.85	13.08	66 F 228	66 F 218	15.97	14.38	13.58	66 F 238	17.05	15.35	14.49

VOLUME UNIT METERS

Highly damped meters for broadcast monitoring, public address or communications systems. "A" scale: 20 to 30 volume units on top of arc; 0-100% modulation on bottom of arc. Have D'Arsonval elements with Alnico-V magnets. Sensitive rectifiers operate under wide frequency variations. Steady state ref., 1 mw. Zero adjustment. Internal impedance, 3900-ohms. For 600-ohm lines. Metal dial is yellow with black and red lettering. In rugged black cases of molded bakelite. *Illuminated.

327T 3" Rect.	1 to 9, EACH	10 to 24, EACH	25 to 49, EACH
66 F 075	18.72	16.85	15.92
66 F 076*	20.48	18.43	17.41

420 4 1/2" Rect.	1 to 9, EACH	10 to 24, EACH	25 to 49, EACH
66 F 071	23.52	21.17	20.00
66 F 072*	26.75	24.07	22.75

DECIBEL METERS (+6 to -10 db)

Power level indicators. For measuring sound or noise level in broadcasting, public address and recording systems. Read up 6 and down 10 db. Zero db is 1.73 volts. Calibrated for use with 500-ohm line. Reference level is 6 milliwatts. Internal resistance is 5000-ohms. White enameled metal dial with black lettering. In black bakelite molded cases. *Illuminated.

327T 3" Rect.	1 to 9, EACH	10 to 24, EACH	25 to 49, EACH
66 F 263	14.99	13.49	12.75
66 F 264*	16.95	15.25	14.42

420 4 1/2" Rect.	1 to 9, EACH	10 to 24, EACH	25 to 49, EACH
66 F 265	16.76	15.08	14.25
66 F 266*	18.03	16.23	15.35

DC MILLIVOLTMETERS

Range	327T 3" Rect.	321T 3 1/2" Rnd.	1 to 9, EACH	10 to 24, EACH	25 to 49, EACH	420 4 1/2" Rect.	1 to 9, EACH	10 to 24, EACH	25 to 49, EACH
0-50	66 F 078	66 F 088	10.29	9.26	8.75	66 F 098	11.37	10.23	9.66
0-100	66 F 079	66 F 089				66 F 099			

ZERO-CENTER DC MICROAMMETERS

Range	327T 3" Rect.	321T 3 1/2" Rnd.	1 to 9, EACH	10 to 24, EACH	25 to 49, EACH	420 4 1/2" Rect.	1 to 9, EACH	10 to 24, EACH	25 to 49, EACH
50-0-50	66 F 086	66 F 084	13.23	11.91	11.25	66 F 094	14.31	12.88	12.16
100-0-100	66 F 087	66 F 085	11.47	10.32	9.75	66 F 095	12.54	11.29	10.66

TYPE 361 WATTMETERS

For shop, field and laboratory. Use as appliance tester, wattmeter, voltmeter, ammeter, etc. Accuracy guaranteed within 2% for either DC or single-phase AC to 133 cps.

Stock No.	Watts	Volts	Amps	1 to 9, EACH	10 to 24, EACH	25 to 49, EACH
66 F 286	0-150	150	1			
66 F 285	0-300	150	2	23.52		
66 F 287	0-750	150	5			20.00

PRECISE MULTI-RANGE PANEL METER KITS

Versatile, new, multi-range panel meter kits. Lets you choose from 4 to 18 different meter ranges using only one meter movement! Features interchangeable dial faces which slide in or out easily, and plug-in shunt or multiplier resistors. Each kit is supplied complete with high-quality, jeweled D'Arsonval meter movement, precision resistors, 4 1/2" mirror scales, inserts, meter case (4 1/2" x 4 3/4") and full instructions. Shpg. wt., 1 1/4 lbs.

Stock No.	Type	Ranges	EACH
83 F 958	DC Volts; 1000 ohm/volt; .05 v. to 1000 v.	18	29.95
83 F 959	DC Volts; 20,000 ohm/volt; .1 v. to 1000 v.	18	35.95
83 F 960	AC Volts; 1000 ohm/volt; 1 v. to 1000 v.	16	35.95
83 F 961	DC Amp.; .05 to 1 amp.	6	14.95
83 F 962	DC μa.; 50 μAmp. to 400 μAmp.	4	18.95
83 F 963	AC Amp.; .001 to 1 amp.	10	29.95

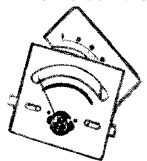



RECTANGULAR MODELS

3 1/2" 4 1/2"

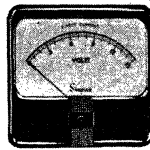

Simpson PANEL METERS

NEW WIDE-VUE METERS



An excellent selection of high quality panel meters. Spade type pointers move through a wide scale arc of 100°. New, "Wide-Vue" meters (listed below) have longer scales for maximum readability; self-shielded meter movements. Models 27, 29, 37 and 39 have D-Arsonal movements. Models 57 and 59 have iron-vane movements. 27, 37 and 57 are 3 1/2" meters; 29, 39 and 59 are 4 1/2" meters. Polished and shock-mounted jewels. Accuracy: ±2%. DC voltmeters, 1000

ohms/volt movement. Scale length: 27, 37, 49 and 57, 29%, 29, 39, 49 and 59, 39%; 1327, 3 1/4"; 1329, 3 3/8". Size: 27, 37, 47 and 57, 3 1/2" high x 3" wide. 29, 39, 49 and 59, 4 1/4" high x 4 1/2" wide; 1327, 3 1/4" square; 1329, 4" high x 4 1/8" wide. All require 2 3/4" diameter mounting holes. Recessed zero adjustments. Housed in rugged, black molded bakelite cases. With mounting hardware and template. Shpg. wt., 1 lb. Include Range and Model No. on all orders.

DC MILLIAMMETERS

Table with columns for Model 27 and Model 29, listing Stock No., NET EACH (1-9, 10-24, 25-Up), Range, and Stock No. for each model.

AC MILLIAMMETERS

Table with columns for Model 57 and Model 59, listing Stock No., NET EACH (1-9, 10-24, 25-Up), Range, and Stock No. for each model.

AC VOLTMETERS

Table with columns for Model 57 and Model 59, listing Stock No., NET EACH (1-9, 10-24, 25-Up), Range, and Stock No. for each model.

DC VOLTMETERS

*0-1000 to 0-5000 types are supplied with external multiplier resistor.

Table with columns for Model 27 and Model 29, listing Stock No., NET EACH (1-9, 10-24, 25-Up), Range, and Stock No. for each model.

AC AMMETERS

Table with columns for Model 57 and Model 59, listing Stock No., NET EACH (1-9, 10-24, 25-Up), Range, and Stock No. for each model.

RF AMMETERS

Table with columns for Model 37 and Model 39, listing Stock No., NET EACH (1-9, 10-24, 25-Up), Range, and Stock No. for each model.

RECTIFIER TYPE VOLTMETERS 1000 OHMS PER VOLT

Table with columns for Model 47 and Model 49, listing Stock No., NET EACH (1-9, 10-24, 25-Up), Range, and Stock No. for each model.

VU METERS

Volume unit meters for power amplifiers and broadcast equipment. Scales show level both in VU and percentage modulation. D'Arsonal movement. Highly damped. Accuracy, ±5%. Dials have 100° arc VU scale A, -20 to +3. 3900 ohm internal impedance across 600-ohm lines (zero reference, 1 milliwatt). Model 47 has 29% scale; case size, 3 1/2"x2 1/4" deep (mounts in 2 3/4" hole). Model 142 has 3 1/2" scale; case size, 4 1/4"x1 1/8" deep (mounts in 3 1/4" hole). *Illuminated, 2 3/4" deep. Have bakelite case. Av. shpg. wt., 1 1/4 lbs.

Table with columns for Model 47 and Model 49, listing Stock No., Model, NET EACH (1-9, 10-24, 25-Up).

MODEL 27 DC GALVANOMETERS

500-0-500 MICROAMP. Scale, 50-0-50. Approximate internal resistance, 46 ohms. 3 1/2" rectangular case. Wt., 1 lb. 67 F 591, 25-Up, EA. 9.00 10-24, EA. 9.53 1-9, EA. 10.58

75-0-75. MICROAMP. Scale, 50-0-50. Approximate internal resistance, 2000 ohms. 3 1/2" rectangular case. Wt., 1 lb. 67 F 592, 25-Up, EA. 10.62 10-24, EA. 11.24 1-9, EA. 12.49

WIDE-VUE PANEL METERS

AC AND DC VOLTMETERS

Table with columns for Model 1327-3 1/2" and Model 1329-4 1/2", listing Stock No., NET EACH (1-9, 10-24, 25-Up), Range, and Stock No. for each model.

AC AND DC AMMETERS

Table with columns for Model 1327-3 1/2" and Model 1329-4 1/2", listing Stock No., NET EACH (1-9, 10-24, 25-Up), Range, and Stock No. for each model.

DC MILLIAMMETERS

Table with columns for Model 1327-3 1/2" and Model 1329-4 1/2", listing Stock No., NET EACH (1-9, 10-24, 25-Up), Range, and Stock No. for each model.

DC MICROAMMETERS

Table with columns for Model 1327-3 1/2" and Model 1329-4 1/2", listing Stock No., NET EACH (1-9, 10-24, 25-Up), Range, and Stock No. for each model.

PHAOSTRON TEST EQUIPMENT AND METERS



666

MODEL 666 VOM

Features signal light (105-125 v. operated) to show overload or incorrect polarity. Fused to protect against burnouts. Large, 4 7/8" color-coded scales are illuminated. Anti-magnetic, chrome and black metal case. 43 ranges. Sensitivity: 20,000 ohms-per-volt DC; 2,000 ohms-per-volt AC. AC current ranges: 0-1.5-5-15-50-150-500-1500 ma and 0-15 amps. DC current ranges: 0-50-150-500 microamps. 0-1.5-15-50-105-500-1500 ma and 0-15 amps. Resistance: 0-1000-100,000 ohms, 0-1-10 megohms, AC and DC volts; 0-1.5-5-15-50-150-500-1500 volts, 6 decibel ranges: -10 to +56 db. With probes, batteries, power cord, carrying case. Plugs into 105-125 v. AC or DC outlet for illumination of meter. Size, 6 1/2 x 7 1/2 x 3 3/4". Shpg. wt., 6 1/2 lbs.
87 F 275. NET..... 63.21

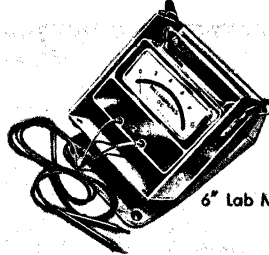

6" Lab Meter

PORTABLE 6" LAB STANDARD METERS

Extremely accurate, portable secondary-standard meters. Metal-cased with double-shielded meter movements for excellent protection from stray magnetic fields. Overload network prevents burnouts. Zero adjust. Accuracy, ±1/2%, except *±1%. Scale size, 4.37". With leather case, test leads. † Range switch. 3 3/4 x 6 3/4 x 1 1/2". Shpg. wt., 5 lbs.

Description	Stock No.	NET
DC Milliammeter, 0-1.....	67 F 733	58.80
AC Voltmeter, 0-150*.....	67 F 736	58.80
DC Current Meter: 0-50-150-500 microamps; 1.5-5-15 milliamps†.....	67 F 737	137.20
DC Voltmeter, 0-1.5-15-10-50†.....	67 F 738	91.14
DC Voltmeter, 0-5-15-50-150-500-1500†.....	67 F 739	91.14

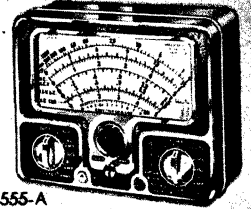

555-A

MODEL 555-A MULTITESTER

Highly-accurate multimeter. Very large (4 7/8") meter scale, yet it's ultra-compact. Extremely rugged, anti-magnetic, black metal case. Color-coded meter scale. Sensitivity: 20,000 ohms-per-volt DC. AC current ranges: 0-1.5-5-15-50-150-500-1500 ma and 0-15 amps. DC current ranges: 0-50-150-500 microamps; 0-1.5-5-15-50-150-500-1500 ma and 0-15 amps. Resistance: 0-1000-100,000 ohms; 0-10 megohms, AC, DC volts: 0-1.5-5-15-50-150-500-1500 volts, 6 decibel ranges: -10 to +56. Meter movement protected to 1000 times overload. With probes and batteries. 6 1/2 x 4 3/8 x 2 1/4". Shpg. wt., 5 lbs.

84 F 684. NET..... 44.05
MODEL 555-CC CARRYING CASE. Wt., 6 oz.
84 F 686. NET..... 7.79

Phaostron Custom Panel Meters

High quality, metal-cased panel meters. Carefully designed for long service and reliable performance. Precision-cast, anti-magnetic drawn steel cases shield meter movements from stray magnetic fields. Permit mounting on bakelite or steel panels without calibration. Accuracy under constant use and high shock and vibration conditions is positively assured. Large, easy-to-read scales with clear increments and numerals. 6" meters have mirrored scales. All have insulated zero-adjust screws. Accuracy: 6" instruments, 1%; others, 2%. Shock-mounted jewels and polished pivots. Sizes: (6" rect.) 4 1/2" high, 6" wide, 2 1/2" deep; (4 1/2" rect.) 4 3/8" high, 5" wide, 2 1/4" deep; (3 1/2" rect.) 3 3/8" high, 3 3/4" wide, 2 1/4" deep; (3 1/2" round) 3 1/2" dia., 2" deep; (3 1/2" square) 3 1/2" square, 2" deep; (2 1/2" round) 2 1/2" dia., 2" deep; (2 1/2" square) 2 1/2" square, 2" deep. 6" instruments have 100° scale arc, except 20 microampere type, which has 60° arc. 20 and 30 microampere 2 1/2" and 3 1/2" meters have 60° arc. Av. shpg. wt., 1 1/4 lbs.

DC MILLIAMMETERS

Range	2 1/2" Rd.	2 1/2" Sq.	3 1/2" Rd.	3 1/2" Sq.	3 1/2" Rect.	4 1/2" Rect.	6" Rect.	
0-1	67 F 750	67 F 760	67 F 770	67 F 780	67 F 790	67 F 704	67 F 720	
0-5	67 F 751	67 F 761	67 F 771	67 F 781	67 F 791	67 F 756	67 F 766	
0-10	67 F 752	67 F 762	67 F 772	67 F 782	67 F 792	67 F 757	67 F 767	
0-50	67 F 753	67 F 763	67 F 773	67 F 783	67 F 793	67 F 705	67 F 721	
0-100	67 F 754	67 F 764	67 F 774	67 F 784	67 F 794	67 F 706	67 F 722	
0-500	67 F 755	67 F 765	67 F 775	67 F 785	67 F 795	67 F 707	67 F 723	
1-9, EA.	10.88		11.71		12.49		18.23	
10-24, EA.	9.79		10.53		11.24		16.41	
25-Up, EA.	9.25		9.96		10.62		15.49	

DC VOLTMETERS

Range	2 1/2" Rd.	2 1/2" Sq.	3 1/2" Rd.	3 1/2" Sq.	3 1/2" Rect.	4 1/2" Rect.	6" Rect.	
0-10	68 F 100	68 F 110	68 F 120	68 F 130	68 F 140	67 F 709	67 F 725	
0-15	68 F 101	68 F 111	68 F 121	68 F 131	68 F 141	67 F 758	67 F 768	
0-50	68 F 102	68 F 112	68 F 122	68 F 132	68 F 142	67 F 710	67 F 726	
0-150	68 F 103	68 F 113	68 F 123	68 F 133	68 F 143	67 F 711	67 F 727	
0-300	68 F 104	68 F 114	68 F 124	68 F 134	68 F 144	67 F 712	67 F 728	
0-500	68 F 105	68 F 115	68 F 125	68 F 135	68 F 145	67 F 713	67 F 729	
1-9, EA.	11.95		12.79		13.62		19.31	
10-24, EA.	10.75		11.51		12.26		17.38	
25-Up, EA.	10.16		10.87		11.58		16.41	

DC AMMETERS

Range	2 1/2" Rd.	2 1/2" Sq.	3 1/2" Rd.	3 1/2" Sq.	3 1/2" Rect.	4 1/2" Rect.	6" Rect.	
0-1	68 F 106	68 F 116	68 F 126	68 F 136	68 F 146	67 F 759	67 F 769	
0-10	68 F 107	68 F 117	68 F 127	68 F 137	68 F 147	67 F 708	67 F 724	
0-50	68 F 108	68 F 118	68 F 128	68 F 138	68 F 148	67 F 706	67 F 786	
1-9, EA.	10.88		11.71		12.49		18.23	
10-24, EA.	9.79		10.53		11.24		16.41	
25-Up, EA.	9.25		9.96		10.62		15.49	

DC MICROAMMETERS

Range	2 1/2" Rd.	2 1/2" Sq.	1-9, EA.	10-24, EA.	25-up, EA.	3 1/2" Rect. 1-9, EA.	10-24, EA.	25-up, EA.	4 1/2" Rect 1-9, EA.	10-24, EA.	25-up, EA.	6" Rect. 1-9, EA.	10-24, EA.	25-up, EA.
0-20						67 F 954	20.92	18.84	17.79	67 F 746	22.05	19.85	18.75	67 F 796
0-50	67 F 961	67 F 971	16.32	14.69	13.87	67 F 955	17.93	16.14	15.25	67 F 700	19.06	17.16	16.20	67 F 716
0-100	67 F 962	67 F 972	14.16	12.75	12.03	67 F 968	15.78	14.20	13.42	67 F 701	16.86	15.17	14.33	67 F 717
0-200	67 F 963	67 F 973	11.96	10.76	10.15	67 F 969	13.62	12.26	11.58	67 F 777	14.70	13.23	12.49	67 F 787
0-500	67 F 964	67 F 974	11.42	10.28	9.71	67 F 970	13.03	11.73	11.08	67 F 778	14.16	12.75	12.03	67 F 788
50-0.50	67 F 965	67 F 975	14.16	12.75	12.03	67 F 978	15.78	14.20	13.42	67 F 779	16.86	15.17	14.33	67 F 789
100-0.100	67 F 966	67 F 976	11.96	10.76	10.15	67 F 979	13.62	12.26	11.58	67 F 702	14.70	13.23	12.49	67 F 718
500-0.500	67 F 967	67 F 977	10.88	9.79	9.25	67 F 988	12.50	11.25	10.62	67 F 703	13.62	12.26	11.58	67 F 719

VOLUME UNIT METER—SCALE A

[67 F 946] 67 F 947] 20.14] 18.13] 17.12] 67 F 999] 21.76] 19.58] 18.49] 67 F 715] 22.83] 20.55] 19.41] 67 F 731] 27.49] 24.74] 23.37



3 1/2", 4 1/2", 6", Rectangular



2 1/2", 3 1/2" Round

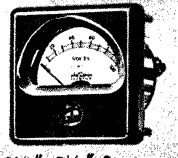

2 1/2", 3 1/2" Square

Industrial buyers—depend on Allied to fill your needs for meters and instruments in industrial quantities. For quantity prices on the equipment you require, call or write Allied's Industrial Division—you can depend upon a prompt quotation and fast, efficient service.

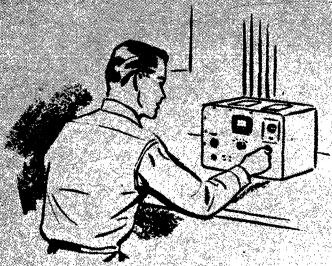

There's More For The Amateur At Allied

- We're Trading High
- Easiest Payment Terms
- Money-Back Guarantee
- World's Largest Stocks
- Fastest and Best Service
- Staff of Experienced Amateurs

• GIANT TRADE-INS

Allied is making bigger and better trade-in deals than ever. Now's the time to cash in on our "king-size" trade-in allowances for your old receiver or transmitter and bring your "shack" right up to date with the latest transmitting and receiving equipment. Just drop a card to Allied's Ham Shack—tell us the unit you'd like to trade and the new gear you want. You'll agree that Allied is "trading high" when you receive our offer. Do business with Allied and enjoy the latest in Amateur gear.

• ONLY 10% DOWN

You can bring your "Shack" right up to date without straining your budget when you buy from Allied. Order new Amateur equipment on our Easy Payment Plan—there's no red tape—and no finance companies to deal with. Pay only 10% down and the balance in small, easy-on-the-budget monthly payments. If you have Amateur equipment to trade, it should cover the down payment and you can pay the balance while enjoying the latest gear. For full details on Allied Easy Payment Plan, see page 396.

• 15-DAY TRIAL

Order Amateur equipment on our regular terms and try it under your own operating conditions. If within 15 days you're not completely satisfied with the performance of the equipment, return it and we will refund your full purchase price, less transportation charges. Allied's money-back guarantee, which applies to all factory-built units, offers you complete protection. In addition, this Guarantee is further backed by the standard RETMA Warranty against defects in materials and workmanship.

knight-kits FOR THE AMATEUR

Amateurs Get More For Their Money With KNIGHT-KITS

New! KNIGHT-KIT Amateur Communications Receiver

\$104⁵⁰

- Covers 540 kc to 31 mc in Four Bands
- New Printed Circuit Switches for Ease of Assembly
- Extremely High Sensitivity—1.5 Microvolts

Revolutionary new Amateur communications receiver kit. Employs printed circuitry in every stage—even has printed circuit switches! Makes possible quick and easy assembly; virtually eliminates wiring errors. Absence of lead "dress" variations gives positive assurance that every kit must equal or surpass specifications. Covers 540 kc to 31 mc in four bands; electrical bandspread calibrated for Amateur bands. Sensitivity, 1.5 μ v for 10 db SNR. Selectivity, 300 cps-4.5 kc at 6 db. Includes: AVC; ANL; antenna trimmer; variable BFO; Q multiplier; constant-running, voltage-regulated HF oscillator. Coaxial input. Has phone jack. Knight-Kit 100-kc Crystal Calibrator can be mounted inside cabinet; controlled from front panel. Provision for "S" meter. Less 8-ohm speaker. 7 tubes. VR and rectifier. Complete with all parts, tubes, wire, solder, and instructions. For 110-120 v., 50-60 cycle AC. 10x10x16 $\frac{1}{2}$ ". Shpg. wt., 23 lbs.

83 YZ 726. NET. 104.50

"S" Meter Accessory Kit. For above receiver. Shpg. wt., 1 lb.

83 Y 727. NET. 9.50

KNIGHT-KIT 50-Watt Transmitter

\$38⁹⁵

- Ideal For The Novice
- Bandswitching—80-10 Meters
- Effective TVI Suppression
- Pi Antenna Coupler

Bandswitching transmitter kit for 80, 40, 20, 15 and 11-10 meters. Rated at 50 watts—up to 60 watts input on 80 and 40 meters. 6AG7 oscillator; 807 final. Built-in pi-section coupler. Other features include: Ceramic-insulated final tank capacitor; preassembled switches; pre-wound parasitic chokes; ceramic coil forms; RF-type coax connector; crystal and VFO socket on front panel; accessory power take-off jack; fused power transformer; pilot light; copper-finished steel chassis; steel cabinet; with effective TVI suppression. Controls: Oscillator Tuning; Bandswitch; Final Amplifier Tuning; Antenna Loading; Grid-Plate Meter Switch; Off-On Switch. With tubes, all parts, wire, solder and instructions. 8 $\frac{1}{2}$ x10 $\frac{1}{2}$ x8 $\frac{1}{4}$ ". For 110-120 v., 50-60 cycle AC. Shpg. wt., 19 lbs.

83 YX 255. NET. 38.95

KNIGHT-KIT VFO KIT. Deluxe VFO at an incomparably low price. Calibrated for 80, 40, 20, 15, 11 and 10 meters; output on 80 and 40 meters. 40-volt output on 80 meters and 20-volt output on 40 meters is more than adequate to excite oscillator stage of any transmitter. An ideal companion to the Knight-Kit 50-watt transmitter, above.

Complete with built-in, transformer-type power supply. Features extremely high stability, oscillator keying for fast break-in, and compact construction. Drift-free, series-tuned Clapp oscillator uses 1% silver mica capacitors. Tank coil wound on ceramic form; padders are air dielectric. Plugs into crystal socket of transmitter. Features: TVI suppression; vernier drive; plenty of bandspread. Two-chassis design keeps heat from oscillator circuit. Voltage regulated for stable output. Tubes: 2—6BH6; 6X4 rectifier, OA2 regulator. 6x6x8 $\frac{3}{4}$ ". With all parts, tubes, wire, solder and step-by-step instructions with pictorial and schematic diagrams. For 110-120 volts, 50-60 cycles AC. Shpg. wt., 11 lbs.

83 Y 725. NET. 28.50

KNIGHT-KIT RF Z-BRIDGE KIT. Get peak efficiency from your antenna. Measures SWR from 1-150 mc; line impedance from 20-400 ohms on frequencies to 100 mc. Any sensitive VOM can be used as null indicator for adjusting antenna network. Jacks for checking input and bridge voltages; impedance-calibrated dial. 1% calibrating resistor, plasticized SWR chart. With all parts, wire, solder and instructions. Size, 2 $\frac{1}{2}$ x3 $\frac{1}{2}$ x4". Wt., 2 lbs.

83 Y 253. NET. 5.85

KNIGHT-KIT 100-KC CRYSTAL CALIBRATOR KIT. Crystal frequency standard at very low cost. Gives marker every 100 kc up to 35 mc. An Amateur "must" for marking band edges. Mounting flanges permit installation inside of or on back of receiver cabinet. Requires 6.3 v. at 0.15 amps and 150-300 v. DC at 3-6 ma—easily obtainable from any receiver. Trimmer for beating with WWV; Off-On switch. With all parts, tube, crystal, wire, solder and instructions. Size, 1 $\frac{1}{2}$ x1 $\frac{1}{2}$ x3". Shpg. wt., 1 lb.

83 Y 256. NET. 10.50

NEW

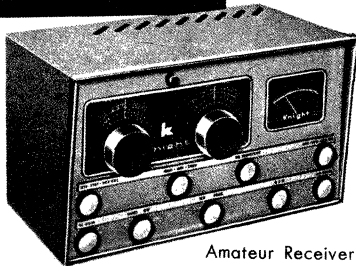

Amateur Receiver



50-watt CW Transmitter



VFO

100-Kc Crystal Calibrator



RF Z-Bridge

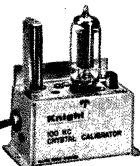



AMATEUR GEAR

NEW!



KWS-1



75A-4

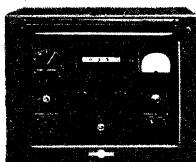

SC-101

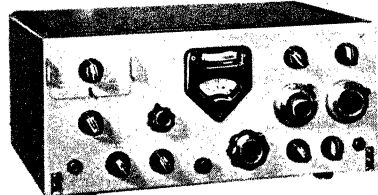

KWM-1 Unique in Design
No "Zeroing In"

KWS-1 TRANSMITTER

Bandswitching Amateur transmitter for SSB, CW, and AM. Covers 80-75, 40, 20, 15, 11 and 10 meters. 1 kw P.E.P. on SSB, 1 kw on CW. AM emission is carrier plus one sideband; equivalent to 1 kw with a narrow-bandwidth receiver. VFO has dial calibration of 1 kc per division. Extreme stability—uses low-frequency VFO and crystal-controlled mixer stages. Pi-L output network—52 ohms RF impedance. High impedance mike input. Voice-operated or push-to-talk keying. Mechanical filter on SSB provides 50 db rejection of unwanted sideband, limits audio to 3000 cps. Balanced modulator, mechanical filter reduce carrier 60 db. Linear RF power amplifier uses two 4X250B's in class AB1. RF feedback for improved linearity. All power supplies are housed in cabinet which serves as transmitter base. Size, transmitter, 10 1/2 x 17 3/8 x 15 1/2" deep; power supply section, 30 x 17 3/8 x 15 1/2" deep. For 110-120 v., 50-60 cycle AC. Shpg. wt., 210 lbs.
98 SZ 774. NET.....2095.00

75A-4 RECEIVER

Top-performing receiver for AM, CW, SSB and RTTY. Covers Amateur bands only—160 through 10 meters. Double conversion gives image rejection of 50 db or more. Precision dial calibration and high stability are provided by the hermetically sealed VFO and crystal-controlled second HFO. Very fast acting AVC requires no carrier—ideal for SSB. Separate SSB detector for minimum intermodulation distortion. Desired signal can be moved within the bandwidth without a change in CW beat note—pushing nearby interference off edge of band. Bridged-T rejection notch filter; Built-in 100 kc crystal calibrator. With 3.1 kc mechanical filter; sockets for 2 additional filters. Sensitivity, 1 μv for 6 db SNR. Less speaker. For 110-120 v., 50-60 cycle AC. 10 1/2 x 17 3/8 x 15 1/2". 70 lbs.
98 SZ 767. NET.....695.00

270G-3 10" SPEAKER IN CABINET. For above receiver. Shpg. wt., 34 lbs.
97 SZ 776. NET.....22.00

SC-101 STATION CONTROL. Control system. Has 10" speaker, beam indicator, SWR meter and directional coupler, 24-hr. clock, lamp, phone patch, control circuit supply, synchro control, 6-antenna remote selector and wiring duct with harness for all station components. Cabinet, 15 1/2 x 12 1/2 x 9 1/2". For 110-120 v., 50-60 cycle AC. Wt., 75 lbs.
94 SZ 876. NET.....695.00

312A-1 SPEAKER/CONTROL. Metal cabinet with 10" speaker and lamp only. Size, 14 3/4 x 12 x 10 3/4". Shpg. wt., 35 lbs.
94 SZ 871. NET.....39.50

NEW KWM-1 TRANSCEIVER

New mobile or fixed transceiver for 20, 15 or 10 meters. Has husky 200 watts P.E.P. input on SSB or CW. Revolutionary in concept, it employs commonly-tuned circuits—no "zeroing in"—transmitting frequency is always same as receiving frequency! Dual-conversion receiver with 100-kc crystal calibrator. Mechanical filter for use in both reception and transmission. Voice control or push-to-talk; break-in CW keying. Sidetone CW monitor. Antenna input/output, 50 ohms unbalanced. Antenna changeover relay. 600-ohm phone patch. Less speaker, power supply. 6 1/4 x 14 x 10". 22 lbs.
94 SZ 877. NET.....770.00

94 SZ 870. 312B-1 MATCHING SPEAKER. For fixed stations. Size, 6 1/4 x 7 5/8 x 10". Shpg. wt., 7 lbs. NET.....25.00

94 SZ 878. 516E-1 POWER SUPPLY. For 12 v. DC. 4 1/2 x 5 x 9". Wt., 18 lbs. NET... 248.00

94 SZ 879. 516F-1 POWER SUPPLY. For 115 v. AC. 6 1/4 x 7 5/8 x 10". 29 lbs. NET... 130.00

MECHANICAL FILTERS. For optimum selectivity. Plug into 75A-4. Av. wt., 2 lbs.
94 SC 875. F4551-05. 500 cps. NET... 54.75
94 SC 872. F4551-15. 1.5 kc. NET... 54.75
94 SC 873. F4551-21. 2.1 kc. NET... 45.00
94 SC 874. F4551-60. 6.0 kc. NET... 45.00

Lakeshore INDUSTRIES HAM RADIO EQUIPMENT

A P-400GG LINEAR AMPLIFIER. Companion power amplifier for Phasemaster II. 575 watts P.E.P.; 200 watts on AM, PM or CW input. Bandswitching on 80-10 meters. Full output with only 20 watts P.E.P. drive. 4-position meter switch: Grid, plate, power in, power out. Extremely stable grounded-grid triode circuitry. Coaxial input and output. Pi antenna network. Switching circuit prevents applying HV before filaments. 9 1/4 x 19 1/4 x 11 1/8". For 110-120 v., 50-60 cycle AC. Shpg. wt., 50 lbs.
83 SZ 863. NET.....269.50

C BANDHOPPER. All-band VFO for phasing-type exciters using 9-mc SSB generation. Perfect for use with Phasemaster II. Covers 160, 80, 40, 20, 15 and 10. Extremely high stability is obtained by heterodyning on high bands—eliminates multiplying VFO drift. Stability: ±100 cps or better after warm-up. Anti-backlash dial. Voltage-regulated. 9 1/4 x 17 1/4 x 11 1/8". For 110-120 v., 50-60 cycle AC. Shpg. wt., 22 lbs.
94 SZ 897. NET.....139.50

B PHASEMASTER II. 9-mc phasing-type transmitter-exciter for AM, PM, CW, and SSB with selectable sidebands. 100 watts P.E.P. input on SSB; 50 watts AM, PM, or CW. Bandswitching from 160 through 10 meters. TVI suppression; CW break-in; power socket for external VFO; built-in low-pass audio filter; coaxial and balanced antenna connectors. Uses multi-band tank circuits. Pi-network output matches 50-500 ohm loads. Uses 12AX7 speech, 12AT7 balanced modulator, 12BH7 AF driver and 9-mc crystal oscillator. 6BA7 mixer. 6CL6 buffer, 6146 amplifier, 12AT7 anti-trip, 12AX7 voice control; 2—5Y3GT and 6AL5 rectifiers. 9 1/4 x 19 1/4 x 11 1/8". For 110-120 v., 50-60 cycle AC. 37 lbs.
83 SZ 862. NET.....329.50

D TIME-MASTER. Continuous gong timer—reminds the Amateur to identify his station every 10 minutes, as required by FCC. A particularly useful accessory for SSB stations. Gives a pleasantly-toned gong every 10 minutes, without resetting. Plastic case. 4 1/2 x 2 1/2 x 2 3/4". For 110-120 v., 50-60 cycle AC. Shpg. wt., 2 lbs.
83 S 860. NET.....7.95

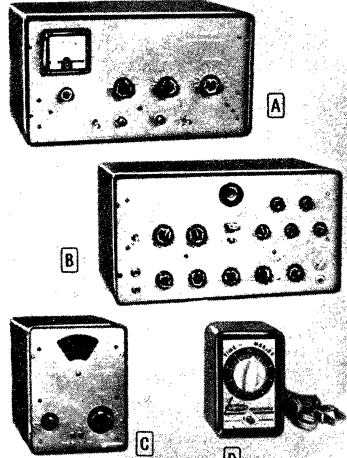

hallicrafters

THE RADIO MAN'S RADIO

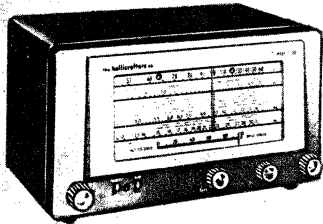

S-38D LOW-COST RECEIVER

Famous Amateur-SWL receiver. Features sensitive voice and code reception. Tunes the standard AM broadcast band and all short wave frequencies to 32 mc, for police, aircraft, Amateur, foreign and domestic short-wave and ship-to-shore transmissions. Easy-to-read, slide rule type dial.

4-BAND COVERAGE. 4-position range selection switch. Range 1, 540 to 1650 kc; Range 2, 1650 kc to 5.1 mc; Range 3, 5 to 14.5 mc; Range 4, 13 to 32 mc. Separate bandspread dial simplifies tuning the crowded short-wave bands.

AC-DC SUPERHET CIRCUIT. High sensitivity superhet circuit employs four tubes and rectifier. 5" PM speaker gives excellent tonal quality. 2 watts audio output. Tip jacks for headphone reception. Standby-receive switch for use when transmitting. AM-CW switch for reception of code or AM phone. Gray steel cabinet with attractive silver frame trim. Size, 12 $\frac{1}{2}$ x7x7 $\frac{3}{4}$ ". For operation from 105-125 volts DC, or 50-60 cycle AC. (See 220 volt adapter cord, below). Shpg. wt., 13 lbs.
98 SX 709. NET. 49.95

S-38D in Furniture Finishes

These latest models of the popular S-38D receiver are available in either mahogany or blonde furniture finish. Metal cabinets have lustrous, high-gloss over simulated fine wood grain. Shpg. wt., 13 lbs.

S-38DM. Mahogany finish. **54.95**
94 SX 805. NET.

S-38DB. Blonde finish. **54.95**
94 SX 806. NET.

220-VOLT ADAPTER CORD. Permits 220 v. AC-DC operation of S-38 receivers. 5 oz. **49 T 580. NET. 2.54**

**MAKE ALLIED YOUR
AMATEUR HEADQUARTERS**

Allied offers the Amateur every buying advantage. Select the equipment you want from the largest and most complete stocks of Amateur equipment in the world and be sure of prompt, efficient service. Amateurs everywhere rely on Allied's famous "Ham-to-Ham" service—our staff of experienced Amateurs will be glad to answer any questions you may have regarding installation or operation of your equipment. And Allied's "King-Size" trade-in offers and Easy Payment Plan make it easy to own the latest in station equipment.



S-53A

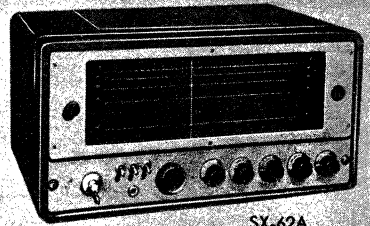

SX-62A

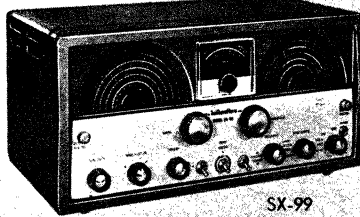

SX-99

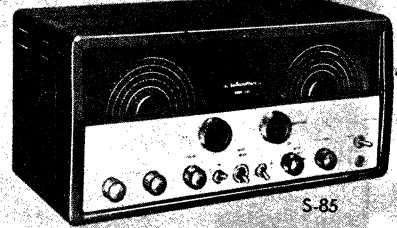

S-85

POPULAR S-53A RECEIVER

A highly sensitive and selective receiver at low cost. Covers: 6 Amateur bands, Police, Aircraft, Marine, Foreign and domestic shortwave broadcasts and standard broadcast programs. Has high signal-to-noise ratio. Built-in 5" PM speaker.

TUNES TO 54.5 MC. Range 1, 540-1630 kc; Range 2, 2.5-6.3 mc; Range 3, 6.3-16 mc; Range 4, 14-31 mc; Range 5, 48-54.5 mc. Provides excellent Amateur 6-meter reception on Range 5. Edge-illuminated slide-rule dial. Panel controls: Main Tuning, Bandspeed, Bandswitch, Volume-On-Off, Sensitivity-Phono, Standby, Tone, Automatic Noise Limiter, and Phone-Code switch. Electrical bandspeed control simplifies tuning on crowded bands. Speaker-Headphone switch, headphone and phono jacks on rear panel.

MODERN SUPERHET CIRCUIT. Uses: 1—6C4 osc. (temperature-compensated for minimum drift), 1—6BA6 mixer, 2—6BA6 IF's, 1—6H6 detector-AVC-noise limiter, 1—6SC7 BFO-1st AF, 1—6K6GT output (2.5 watts), Rectifier is 5Y3GT. 5" PM speaker. Satin black steel cabinet with brushed chrome trim. Size, 12 $\frac{1}{2}$ x7x7 $\frac{3}{4}$ " deep. Piano-hinge top. For 105-125 volts, 50-60 cycles AC. Shpg. wt., 20 lbs.
97 SZ 573. NET. 89.95

TOP-VALUE SX-99 RECEIVER

An outstanding value in a medium-priced communications receiver. Offers features usually found only in high priced communications receivers. Crystal filter—Calibrated electrical bandspeed—"S" meter. Also separate RF and AF gain controls.

FREQUENCY COVERAGE. Full coverage of all frequencies from 540 kc to 34 mc in 4 ranges; the standard AM broadcast band plus 3 short-wave ranges. Provides reception of broadcasts from all over the world.

FEATURES: Bandspeed dial calibrated for 80, 40, 20, 15, 11 and 10 meter Amateur bands for excellent tuning accuracy; "S" meter is calibrated in units of 6 db to S9 and in db above S9 for accurate signal reports; Crystal filter for razor-sharp selectivity; RF stage and two IF stages for very high sensitivity; Terminals for 3.2-ohm or 500-ohm speaker. Separate BFO with pitch control; automatic noise limiter and 3-position tone control. 7 tubes; plus rectifier.

CONSTRUCTION: The SX-99 has the famous Hallicrafters precision construction and expert craftsmanship—known the world over. Use of high-quality components assures years of dependable performance. Steel cabinet is finished in gray and black with brushed chrome trim. 8 $\frac{1}{2}$ x18 $\frac{1}{2}$ x11" deep. For 105-125 volts, 50-60 cycles AC. Less speaker (see R-46B matching speaker on page 265). Shpg. wt., 36 lbs.
98 SZ 714. NET. 149.95

SX-62A ALL-WAVE RECEIVER

The SX-62A offers peak performance on AM broadcast, short wave and hi-fi FM. Precision built to meet the most exacting standards—incorporates every modern refinement in all-wave receiver engineering. Six ranges: 540-1620 kc; 1620 kc-4.9 mc; 4.9-15 mc; 15-32 mc; 27-56 mc (AM-FM); 54-109 mc (AM-FM). Beautifully styled.

HIGH-FIDELITY AUDIO. Push-pull 6V6 output furnishes 10 watts of audio power. Four-position tone control; phono jack.

FOR SWL'S AND DX FANS. Red dots identify proper settings of controls for AM and SW reception; green dots for FM. Wide-vision slide-rule dial. 60-to-1 ratio tuning knob. 500-kc calibrating crystal, with dial pointer for pin-point reset accuracy. Has BFO for reception of code signals.

MODERN CIRCUIT. Three IF and two RF stages provide maximum usable sensitivity. Crystal filter provides 6-step selectivity. Separate RF and AF gain controls; AVC; BFO; ANL; temperature-compensated, voltage-regulated oscillator. 300-ohm antenna input. 3.2, 8 and 500 ohm outputs.

Black steel cabinet with gray panel. Size, 10 $\frac{1}{2}$ x20x16". Less speaker. (See R-46B, p. 265.) For 105-125 volts, 50-60 cycles AC. Shpg. wt., 77 lbs.
97 SZ 540 NET. 349.95

FAMOUS S-85 RECEIVER

Popular S-85 communications receiver. Supersedes the renowned S-40 series. Completely restyled for improved operating ease and greater tuning accuracy. Puts worldwide communications at your finger tips. Tunes from 540 kc to 34 mc continuously in 4 ranges.

FEATURES: Bandspeed dial calibrated for 80, 40, 20, 15, 11 and 10 meters. RF amplifier; 2—IF amplifiers; BFO with variable pitch control; automatic noise limiter; 3-position tone control; built-in 5" PM speaker; 4 tuning ranges—standard broadcast plus 3 shortwave.

TUBES USED: 6SG7 RF amplifier, 6SA7 converter, 2—6SK7 IF amplifiers, 6SC7 BFO and audio amplifier, 6K6GT audio output, 6H6 ANL-AVC detector; rectifier is 5Y3GT.

FRONT PANEL CONTROLS: Sensitivity, band selector switch, volume, main tuning, bandspeed AVC on-off, noise limiter on-off, AM-CW, tone (high-medium-low) and AC on-off, pitch control, standby-receive. Panel jack for headphones.

Steel cabinet finished in gray and black. 8 $\frac{1}{2}$ x18 $\frac{1}{2}$ x10". For 105-125 v. 50-60 cycle AC. Shpg. wt., 36 lbs.

98 SZ 711. NET. 119.95
S-86. Same as S-85 in design and appearance, but for 105-125 v. DC or 50-60 cycle AC. Shpg. wt., 32 lbs.
98 SZ 712. NET. 119.95

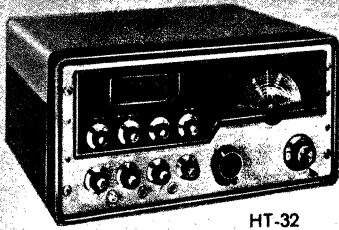

HT-32



HT-33

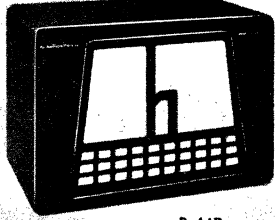

R-46B



SX-101

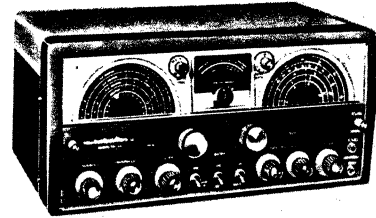

SX-100 SELECTABLE RECEIVER

HT-32 TRANSMITTER

New, high-efficiency transmitter-exciter for SSB-AM, or CW operation. Used alone, the HT-32 with 144 watts P.E.P. input, is an excellent, completely self-contained transmitter for the 80, 40, 20, 15, 11 and 10 meter Amateur bands. As an exciter, the HT-32 is ideal for use with the HT-33 power amplifier (at right), or any other similar unit.

FEATURES: New piezo-electric sideband filters; new, extremely stable bridged-tee modulator develops almost perfect sideband modulation; precision gear-driven VFO reads directly in kilocycles to within 300 cycles of reference point; distortion products down 30 db; carrier suppressed 50 db; unwanted sideband down 50 db; full voice control; clean, break-in keying; 52-ohm pi-network output for harmonic suppression.

TUBE FUNCTIONS: 12AX7 speech amplifier; 12AU7 speech amplifier and 4.95-mc carrier osc.; 12AX7 voice control and 1st anti-trip amplifier; 6AL5 voice control and anti-trip diodes; 12AT7 relay tube 2nd anti-trip amplifier; 12AU7 diode modulator; 6AH6 4.95-mc amplifier; 12AT7 sideband switching oscillator; 6AH6 1st mixer; 6AU6 9-mc amplifier; 6BA4 crystal oscillator; 6AH6 2nd mixer; 6AH6 3rd mixer; 6CB6 VFO; 12BY7 driver amplifier; two parallel 6146's in final; 5R4GY HV rectifier; 5V4 LV rectifier; OA2 voltage regulator.

CONTROLS: Operation (Power Off, Standby, Mox, Cal, Vox); Audio Level; RF Level; Final Tuning; Function (Upper Sideband, Lower Sideband, DSB, CW); Meter Compression; Calibration Level; Driver Tuning; Band Selector; VFO.

Ruggedly constructed steel cabinet is handsomely finished in gray and black with brushed chrome trim. Size, 10 1/4 x 20 x 17". For operation from 105-125 volts, 50-60 cycles AC. Shpg. wt., 86 lbs.
94 SZ 807. NET..... 675.00

R-46B MATCHING SPEAKER

10" PM-type speaker in handsome cabinet to match Hallicrafters receivers. Has power handling capacity more than adequate for even the SX-62A and provides excellent tonal quality. Also a fine companion unit for use with the SX-96, SX-99, SX-100, SX-101, or any other receiver having 3.2-ohm output impedance. Features heavy-duty construction throughout; has rugged steel frame to maintain precise voice coil alignment; also Alnico V magnet and high-quality seamless-type cone. Frame is pre-drilled to permit mounting of output transformer, if desired. Speaker cabinet is of sturdy metal and finished in black with smart, contrasting satin-chrome trim. All seams are spot-welded for high strength. Four rubber feet prevent marring of desk, table or receiver top. Size, 10 7/8 x 15 x 8 1/2". Supplied complete with 5-ft. 2-conductor cable. Shpg. wt., 15 lbs.
98 SX 758. NET..... 17.95

HT-33 LINEAR AMPLIFIER

A kilowatt of flexible, efficient table-top performance is yours with the new, ultra-compact HT-33 linear amplifier. A perfect mate to the HT-32 (at left) or any other low-power transmitter.

FEATURES: Covers 80, 40, 20, 15, 11 and 10 meter Amateur bands; 52-ohm pi-network output for efficient harmonic suppression; built-in TVI suppression includes filtered control leads; one knob bandswitching; ceramic tubes.

CIRCUIT: Two parallel-connected 4CX300A power tetrodes in class AB₁; two 866A rectifiers; two OB2 voltage-regulators; one OA2 voltage regulator. 52-ohm coax input. Bandswitch simultaneously selects proper grid and plate tank inductances. Large meter measures plate and screen current.

SPECIFICATIONS: Power Input, 1000 watts SSB and CW; 700 watts AM. Power Output, 625 watts P.E.P. with 8 watts P.E.P. drive; 575 watts CW with 6.5 watts drive; 285 watts AM with 6 watts drive.

CONTROLS: Band Selector, Grid Tuning, Plate Tuning, Power Off-On, Tune-Operate, High Voltage, Off-On, Meter (plate and screen).

Beautifully finished satin-black steel cabinet with chrome trim. 20x12 3/8 x 16 1/4". For 105-125 v., 50-60 cycle AC. Wt., 123 lbs.
94 SZ 808. NET..... 775.00

SX-101 AMATEUR RECEIVER

The SX-101 is a super-deluxe communications receiver incorporating every essential for first-class coverage of the Amateur bands. A dual-conversion, selectable-sideband receiver, it has 1- μ v sensitivity on all bands and 5 steps of selectivity from 500 to 5000 cps. 7 bands cover: 1.8-2.0 mc; 3.5-4.0 mc; 7.0-7.3 mc; 14.0-14.4 mc; 21.0-21.5 mc; 26.95-27.35 and 28.0-29.7 mc. 10-mc position for zero-beating crystal calibrator with WWV.

DELUXE FEATURES: Crystal-controlled 2nd conversion oscillators; Tee-notch filter; gear drive tuning mechanism with 50:1 ratio; vernier dial-pointer adjustment; 100-kc crystal calibrator; Individually illuminated band scales; dual-scale S meter with zero point independent of sensitivity control — functions with AVC off or on; direct-coupled series noise limiter.

CONTROLS: Tuning; Pointer Reset; Antenna Trimmer; Tee-Notch frequency; Tee-Notch Depth. Sensitivity; Band Selector; AC Off/On-volume; Selectivity; BFO Pitch; Response (Upper or Lower-Sideband and Tone); AVC Off-On; BFO Off-On; ANL Off-On; Marker (crystal calibrator) Off-On; Standby-Receive.

Circuit employs 14 tubes plus voltage regulator and rectifier. Size, 10 1/2 x 20 x 16". Less speaker; See R-46B matching speaker, at left. For 105-125 volts, 50-60 cycle AC. Shpg. wt., 85 lbs.
94 SZ 802. NET..... 395.00

The SX-100 communications receiver offers an array of outstanding features. In addition to selectable sideband operation and double conversion, it features a 50-kc "Tee-Notch" system of selectivity. Covers 538 to 1530 kc and 1720 kc to 34 mc in 4 ranges.

OTHER FEATURES: 100-kc crystal calibrator; logging scale and gear drive on main and band-spread tuning; and crystal controlled 2nd conversion oscillator.

TUBES AND FUNCTIONS: 6CB6 RF amplifier, 6AU6 1st mixer, 6C4 HF oscillator, 6BA6 1650-kc IF, 6BA6 2nd mixer, 12AT7 dual crystal 2nd conversion oscillator, 6C4 50-kc IF, 6BA6 50-kc IF, 6BJ7 detector-AVC-ANL, 6SC7 1st audio and BFO, 6K6GT audio output, 6AU6 100-kc calibrator; 5Y3-GT rectifier and OA2 voltage regulator.

CONTROLS: Antenna trimmer, Notch Frequency, Notch Depth, Calibrator Off-On, Sensitivity, Band Selector, Volume, Tuning, AVC Off-On, Noise Limiter Off-On, Bandsread, Selectivity, Pitch, Reception, Standby, Headphone Jack; 3.2-ohm output.

Black cabinet with satin-chrome trim. Size, 8 1/2 x 18 3/8 x 10 5/8". For 105-125 v., 50-60 cycle AC. Less speaker. (See R46B below left.) Shpg. wt., 43 lbs.

98 SZ 769. NET..... 295.00

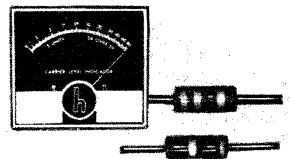

"S" METER KIT

A handsome, easily installed "S" meter for panel mounting. For use with Hallicrafters S-40B, S-20R, S-40A, SX-62, S-77, S-77A, etc., as well as communications receivers of other manufacturers. Can be installed in any RF or IF stage with AVC action. Rugged, attractively styled 3" square meter has black dial with easy-to-read white translucent markings with provision for internal back lighting. Two scales; reads in microvolts from 0 to 20,000; "S" units to S9 at mid-scale and then in db up to 50 db over S9. Essential to the Amateur operator and SWL for giving accurate signal strength reports — aids in receiver tuning. Requires 2 3/4" diameter round hole for meter barrel and four 1/8" holes for mounting studs. Can be separately mounted in individual meter case (see page 296). Kit consists of 0.5 milliamperere meter, 500-ohm potentiometer for electrical zero-set, one 82-ohm 1/2-watt 10% resistor, one 330-ohm 1/2-watt 10% resistor, and complete installation instructions covering all recent Hallicrafters communications receivers. Shpg. wt., 1 lb.
97 S 740. NET..... 10.90



FAMOUS NATIONAL RECEIVERS



NC-109



NC-300



RDF-66

NC-66

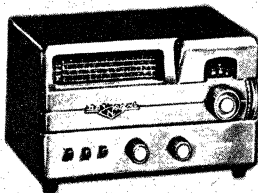

SW-54

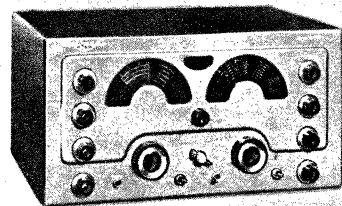

NC-183D

NEW NC-66 AND RDF-66

Versatile 3-way portable receiver covers Amateur, marine, and shortwave bands—operates on AC, DC or from its own, self-contained batteries. Five bands provide continuous coverage from 150 kc. to 23 mc.; long-scale electrical bandspread permits tuning and logging with great accuracy. Compact case—beautifully styled—also includes two antennas: highly sensitive ferrite loop for DF (see below) and broadcast bands, plus a telescoping whip antenna for ham and shortwave bands. Easy to carry anywhere; it's even been salt-spray tested!

Built-in fixed-tuned CW oscillator for code reception. Quality 5" PM speaker is housed behind front panel; phone jack on front panel automatically cuts out speaker when phones are used. Dial calibrations are exceptionally clear, with Amateur and shortwave bands plainly marked in color. Low filament-voltage tubes provide nearly instantaneous warm-up. Tube lineup: 1U4 RF, 1L6 converter, 1U4 CW oscillator/IF amplifier, 1U5 2nd detector/AVC/1st audio amplifier, 3V4 audio output; selenium rectifier. Chrome-trimmed case measures 9 1/4" x 12 3/4" x 10". For operation from 110-120 volts, 50-60 cycle AC, or DC, or batteries (supplied less battery, see listing below). Shpg. wt., 16 lbs.

94 SX 832. NET.....129.95

BATTERY FOR NC-66. Shpg. wt., 6 1/2 lbs.
80 J 616. NET.....4.80

RDF-66 DIRECTION FINDER. A modern, efficient, radio direction finding instrument designed for use with the NC-66 receiver. Provides a simple, accurate means of navigation for pleasure craft and small fishing vessels. Built-in tuning meter assures pinpoint accuracy; positive one-null indication. Size, 7x8 1/2x10". Takes power from NC-66. Shpg. wt., 8 lbs.

94 SX 836. NET.....39.95

LOW-COST SW-54 RECEIVER

A smart, ultra-compact communications receiver at low cost. Perfect for the beginning Amateur or short wave listener; a real DX-getter. Provides sensitive, selective reception over a full range of frequencies from 540 kc to 30 mc. Receives standard AM broadcasts, ships, aircraft and Amateur signals. Single knob drives separate main tuning and bandspread dials; all important channels are clearly marked on the well-illuminated main tuning dial. Bandspread dial simplifies tuning of crowded shortwave bands; has 0-100 logging scale which makes it easy to reset dial. Receives voice or code.

Built with the same precision and ruggedness that has made National communications receivers world-famous. Modern superheterodyne circuit uses 12BE6 converter, 12BA6 CW oscillator/IF amplifier, 12AV6 2nd detector/1st audio amplifier/AVC, 50C5 audio output, and 35Z5 rectifier. Built-in 5-inch PM speaker provides clear, intelligible reproduction of voice and music; pin jacks on rear permit use of headphones for late listening, or greater clarity under conditions of strong interference. A convenient switch cuts out the speaker when headphones are being used.

Easy-to-read slide-rule scale is indirectly illuminated; four bands are used to cover operating range. Band A covers 540-1600 kc.; Band B, 1.6 mc to 4.7 mc; Band C, 4.6 mc to 14.5 mc; Band D, 12-30 mc. Attractively designed cabinet maintains professional appearance, yet looks handsome; knobs and switches are spaced for easy, accurate operation without crowding. Controls: Main-Bandspread tuning, Off-On, Volume, Receive-Standby, Band Selector, AM-CW Switch, Speaker-Headphones Switch. Cabinet is 7x11x7", finished in National gray enamel. For 110-120 v., 50-60 cycle AC. Shpg. wt., 15 lbs.

97 SX 711. NET.....59.95

NEW NATIONAL NC-109

Low-price, general coverage receiver for AM, CW or SSB reception. Incorporates exclusive "Microtome" crystal filter, which provides five degrees of selectivity, in addition to normal bandwidth for voice. Sharp phasing notch over 60 db deep for effective interference rejection. Separate product detector for excellent reception of single side-band and CW signals. Input for phono or crystal calibrator.

Covers 540 kc to 40 mc in four bands. Calibrated electrical bandspread for Amateur 10, 11, 15, 20, 40 and 80 meter bands. Indirectly illuminated lucite dial is designed for legibility; amateur and shortwave bands are clearly marked. "S" meter on front panel for signal strength indication and more accurate tuning. Gang-tuned RF amplifier stage, plus two IF and two AF stages. Stability is increased by separate HF oscillator tube; ceramic oscillator coil forms and temperature compensation further improve stability. Separate RF and AF gain controls.

Tube lineup: 6BA6 RF amp., 6BE6 frequency converter, 6C4 HF oscillator, 6BA6 1st IF amplifier, 6BA6 2nd IF amplifier, 6BE6 product detector, 6AL5 detector, AVC and ANL, 12AT7 1st AF amplifier and BFO/S meter amplifier, 6AQ5 AF output, 5Y3GT rectifier and OB2 voltage regulator.

Controls: Main tuning; bandspread tuning; antenna trimmer; band selector switch; RF gain control; AC Off-On and AF gain control; stand-by switch; mode selector switch (ANL, AM, CW, SSB and ACC); tone control; BFO pitch; selectivity; phasing. Size, 10x16 1/4x10 1/2" deep. Less speaker. For 110-120 volts, 50-60 cycle AC. Shpg. wt., 35 lbs.

94 SZ 834. NET.....199.95

94 SX 835. NTS-1. Matching 8" speaker.
Shpg. wt., 10 lbs. NET.....17.50

NATIONAL NC-300

Designed specifically for Amateur band coverage, the superb NC-300 provides the ultimate in flexibility and outstanding performance. Covers 7 Amateur bands, from 160 through 10 meters, with dial scales for 50, 144 and 220 mc plug-in converters (below). Double conversion: 2215 kc 1st IF and 80 kc 2nd IF, with three positions of selectivity, 8 kc, 3.5 kc, and 0.5 kc. Separate linear detector for optimum SSB performance. Crystal filter for heterodyne elimination. Foot-long slide-rule dial spreads out each band to 2 kc per division, or less. Sensitivity: 1 μ v or better on all bands. HF and LF oscillators are temperature-compensated and rock-stable. Inertia tuning mechanism, fast-acting "S" meter, separate RF and IF gain controls. Less speaker (below). For operation from 110-120 volts, 50-60 cycle AC. Size, 11 1/4x19 1/2x15". Shpg. wt., 60 lbs.

98 SZ 730. NET.....399.00

6-METER CONVERTER. Covers 49.5-54.5 mc. Shpg. wt., 2 lbs.

83 S 870. NET.....41.95

2-METER CONVERTER. Covers 143.5 to 148.5 mc. Shpg. wt., 2 lbs.

83 S 871. NET.....43.95

1 1/4-METER CONVERTER. Covers 220 to 225 mc. Shpg. wt., 2 lbs.

83 S 872. NET.....45.95

100-KC CRYSTAL CALIBRATOR. Wt., 1 lb.

83 S 873. NET.....21.95

NC-300TS SPEAKER. Efficient 8-inch speaker in two-tone gray cabinet to match NC-300. Shpg. wt., 10 lbs.

98 SX 782. NET.....19.95

NATIONAL NC-183D

Double-conversion communications receiver superseding the renowned NC-183. Features razor-sharp selectivity, extreme sensitivity and "solid-as-a-rock" stability. Covers 540 kc to 31 mc and 47-55 mc in 5 ranges; calibrated electrical bandspread for 80-75, 40, 20, 15, 11-10 and 6 meter Amateur bands. Bi-metallic tuning capacitor automatically compensates for temperature change.

Double-conversion above 4.4 mc, with 3 IF stages and 16 tuned circuits. Single conversion below 4.4 mc. Six selectivity positions; 5 crystal and 1 non-crystal. Selectivity is 80 cycles at 6 db and 7.0 kc at 60 db. Better than 1 1/2 μ v sensitivity.

Two RF stages; amplified and delayed AVC; noise limiter; and push-pull 8-watt audio. Has edge-lighted lucite dials; auxiliary power socket; phono input; and 500/8 ohm output. 15 tubes plus VR and rectifier. Gray cabinet. 10 1/4x19 1/4x16 3/4". For 110-120 or 220-240 volts, 50-60 cycle AC. Less speaker. Shpg. wt., 65 lbs.

97 SZ 666. NET.....449.00

MATCHING SPEAKER. 10" PM speaker in matching cabinet. Wt., 10 lbs.

97 SX 663. NET.....19.95

HAMMARLUND QUALITY RECEIVERS



NC-188

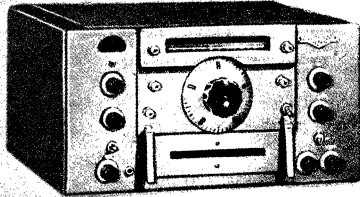

HRO-60

NATIONAL NC-188

New general-coverage receiver featuring excellent design and construction combined with new, modern styling. Continuous coverage from 540 kc to 40 mc, AM, SSB or CW. Calibrated bandspread for Amateur 10, 11, 15, 20, 40 and 80 meter bands; separate tuning capacitors, knobs and scales for general coverage and bandspread. Large, easy-to-read 12-inch slide-rule dial with combination edge and back-lighting; large tuning knobs. Sensitivity: Under 2.5 μ v required for 10-to-1 signal-to-noise ratio. Built-in "S" meter on front panel.

Tube lineup: 6BA6 RF amplifier, 6BE6 frequency converter, 6C4 HF oscillator, 2-6BA6 IF amplifiers, 6AL5 detector/AVC/ANL, 12AT7 1st AF and BFO, 6AQ5 AF output; 5Y3GT rectifier. Antenna input, 50-300 ohms, balanced or unbalanced. Handsome two-tone gray wrinkle finish.

Oscillator is temperature compensated and ventilated for maximum stability. Separate antenna trimmer on front panel. Series-type automatic noise limiter. BFO provided for reception of CW and SSB signals. Separate RF and AF gain controls. Noise limiter switch. Size: 10" high, 16 $\frac{3}{4}$ " wide, and 10 $\frac{7}{8}$ " deep. Less speaker. For 110-120 v., 50-60 cycle AC. Wt., 35 lbs.

94 SZ 833. NET.....159.95

94 SX 835. NTS-1. Matching 8" Speaker. Shpg. wt., 10 lbs. NET.....17.50

NATIONAL HRO-60

The latest version of the great HRO receivers. The HRO-Sixty provides virtually image-free reception, has superb "weak-signal" sensitivity, plus remarkable selectivity and stability. Plug-in coil units supplied provide general coverage from 50 kc to 54 mc or bandspread on 80, 40, 20, 15, 11-10 and 6 meter Amateur bands.

Dual conversion above 7 mc; 2 RF stages. Sensitivity: 1 μ v or better for 6 db S/N ratio. 1990 kc 1st IF, 456 kc 2nd IF. 12 permeability-tuned IF circuits plus 6-step crystal filter. Selectivity variable from 80 cycles to 3.5 kc at 6 db points. Virtually drift-free. Adjustable ANL, phono input, auxiliary power socket, provision for crystal calibrator or NFM adapter (below). 15 tubes plus rectifiers and regulators. 19 $\frac{3}{4}$ x10 $\frac{1}{2}$ x17 $\frac{1}{2}$ ". For 115/230 volts 50-60 cycle AC. 84 lbs. With coils, less speaker (below).

97 SZ 722. NET.....645.00

MATCHING 10" SPEAKER. Wt., 10 lbs.

97 SX 663. NET.....19.95

HRO-60-XCU-2. Crystal calibrator.

97 S 717. NET.....27.50

NFM-83-60. NFM adapter.

97 S 719. NET.....31.95

HRO-60-AC. 21-21.5 mc coil.

97 S 789. NET.....37.50

HRO-60-E. 900-2050 kc coil.

98 S 048. NET.....37.50

HRO-60-F. 480-960 kc coil.

98 S 049. NET.....37.50



HQ-100



HQ-110

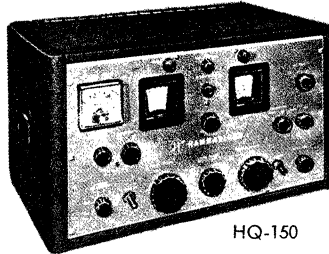

HQ-150

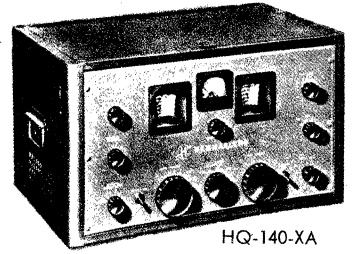

HQ-140-XA

NEW HAMMARLUND HQ-100

New, advanced-design communications receiver at moderate cost. Covers 540 kc to 30 mc in 4 bands. Features include: "Auto-Response" circuit which adjusts audio bandwidth for best reception of signal being received; "Q" multiplier selectivity position for selectivity variable from 100 cps to 3 kc; high sensitivity—less than 2 μ v signal for 10 to 1 S/N ratio; voltage regulated, temperature compensated HF oscillator for extra stability; calibrated electrical bandspread; built-in clock with automatic timer; and built-in "S" meter.

Tube lineup: 6BZ6 RF, 6BE6 mixer, 6C4 HF osc., 2-6BA6 IF's, 6AL5 det./ANL, 12AX7 audio amp/Q-mult./BFO, 6AQ5 audio out.; 5Y3 rectifier, OB2 voltage regulator. Range: 540 kc to 30 mc in 4 bands. Size, 9 $\frac{7}{8}$ x16 $\frac{1}{4}$ x9 $\frac{1}{8}$ ". For 110-120 v., 50-60 cycle AC. Shpg. wt., 35 lbs.

94 SZ 829. NET.....179.00

94 SZ 827. HQ-100, Less clock. NET 169.00

MATCHING 6x9" SPEAKER. For HQ-100 & HQ-110. 10 lbs.

94 SX 828. NET.....14.95

HAMMARLUND XC-455 CRYSTAL-CONTROLLED BFO. For single-signal CW. Wt., 1 lb.

94 S 824. NET.....15.95

HAMMARLUND HQ-150

Precision Hammarlund receiver packed with features, including built-in Q multiplier and built-in crystal calibrator. The HQ-150 provides high selectivity and outstanding stability. Provides continuous coverage from 540 kc to 31 mc in six ranges. Calibrated electrical bandspread for the Amateur 80, 40, 20, 15 and 10 meter bands. Famous Hammarlund crystal filter for sharp selectivity. Six different bandwidth positions may be selected: 1 crystal "off" position, 3 phone crystal positions, and 2 CW positions. Fast acting AVC on RF, two IF stages.

Series-type noise limiter greatly minimizes ignition and other pulse-type noise; has negligible effect on modulation of phone signals. Antenna trimmer permits peaking RF stage for highest gain.

Tube lineup: 6BA6 RF amp., 6BE6 mixer, 6C4 HF oscillator, 3-6BA6 IF amp., 6AL5 2nd detector/AVC/ANL, 12AY7 BFO-audio, 6V6GT audio output; 5U4G rectifier, VR105 regulator, 6BZ6 calibrator. Two-tone gray cabinet. 11x20 $\frac{1}{4}$ x13 $\frac{1}{2}$ ". Less speaker. For 110-120 v., 50-60 cycle AC. Wt., 80 lbs.

94 SZ 825. NET.....294.00

MATCHING 8" PM SPEAKER. 12 lbs.

97 SX 757. NET.....14.50

HAMMARLUND HQ-110 RECEIVER

The new HQ-110 Amateur band receiver offers outstanding coverage of 160, 80, 40, 21, 15, 10, and 6 meters. Deluxe features include: linear detector for top-notch CW and SSB reception; 100-kc crystal calibrator; "Q" multiplier for high selectivity; "S" meter for "on-the-nose" tuning; antenna trimmer; voltage regulated, temperature compensated HF oscillator; dual conversion from 6 to 40 meter bands; 9 tuned circuits in IF strip; "auto-response" adjusts bandwidth for optimum reception; and automatic clock-timer. 10-tube circuit plus rectifier and VR tube.

Controls: Function Switch, Tuning Range Switch, MAN-AVC Switch, Pitch Control, Calibration Set, Tuning Control, Antenna Trimmer, Selectivity Control, Sensitivity Control, Audio Gain Control, and Frequency control. Frequency Control peaks the selectivity curve to the left or right over the pass band of the IF amplifier, permitting accurate control of selectivity. Size: 9 $\frac{7}{8}$ " high, 9 $\frac{1}{8}$ " deep and 16 $\frac{1}{4}$ " wide. Less speaker. For 110-120 v., 50-60 cycle AC. Shpg. wt., 36 lbs.

94 SZ 822. NET.....239.00

94 SZ 821. HQ-110, Less clock. NET 229.00

HAMMARLUND HQ-140-XA

Up-to-date version of the world-famous HQ-140—provides Amateurs, commercial radio operators and shortwave listeners with all of the advantages of modern professional design and reliability. Covers 540 kc to 31 mc in 6 ranges. Crystal filter provides high selectivity required to separate signals on crowded bands. "S" meter reads to 20 db over S9. Sensitivity, 1 μ v for 10 db signal-to-noise ratio. Electrical bandspread is calibrated for Amateur 80, 40, 20, 15 and 10 meter bands, 3 watts audio output. Six selectivity positions from 8 kc to 600 cycles. Separate HF oscillator and mixer, 3 stages of IF amplification, and self-adjusting noise limiter. Drift is less than 0.01%.

Tube lineup: 6BA6 RF, 6C4 oscillator, 6BE6 mixer, 3-6BA6 IF's, 6AL5 2nd detector/AVC/ANL, 12AU7 1st audio/BFO, 6V6GT/G audio output; 5U4GB rectifier, and OC3/VR105 voltage regulator, 3 phone crystal positions, 2 CW crystal positions, and one crystal "off" position.

Two-tone gray cabinet with large and conveniently positioned controls. Size, 11x20 $\frac{1}{4}$ x13 $\frac{1}{2}$ " deep. For operation from 110-120 volts, 50-60 cycle AC. Less speaker (see below). Shpg. wt., 75 lbs.

99 SZ 123. NET.....249.50

MATCHING 8" PM SPEAKER. 12 lbs.

97 SX 757. NET.....14.50



JOHNSON AMATEUR EQUIPMENT

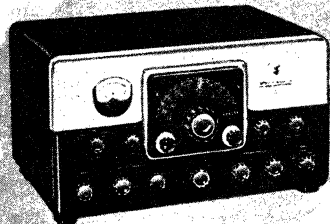

VIKING "FACEMAKER" SSB TRANSMITTER MODEL 240-301-2. Completely self-contained AM-CW-SSB transmitter of 90 watts input—enough to pack a real on-the-air signal or to drive any amplifier. Band-switched, 80 through 10 meters, VFO controlled, with VFO always in the 3-4 mc range for maximum stability on all bands. Five crystals provide heterodyning frequencies to reach the desired bands. SSB is generated by phasing method, with upper sideband or lower sideband at the flick of a switch. Final amplifier is a 6146 with pi-network tank for loading flexibility and harmonic suppression. Break-in keying with excellent waveform makes for tops in CW operating. Audio system takes hi-Z mikes. Has up-to-the-minute VOX and anti-trip circuits for full voice-operated phone operation; audio output can be used to feed higher-power amplifier for high-power AM phone. Husky triple-section power supply provides high and low voltages as well as control voltages for an external high-power amplifier. Meter on panel for grid and plate current, modulation and carrier balance. Controls: Carrier Insert, Balance Modulator, Carrier Balance, Bandswitch, Exciter, Tuning, Amplifier Tuning, Fine Coupling, Auxiliary Coupling, Audio Gain, Meter Operate, VFO. Tubes: 5-12AT7, 12AU7, 6AL5, 6BE6, 3-6AU6, 6CL6, 6146, 12BH7, 5U4G, 5R4GY rectifiers; OA2, 2-OB2 voltage regulators. With crystals; less mike and key. For 110-120 volts, 50-60 cycle AC. 11 $\frac{1}{2}$ x21x14 $\frac{1}{2}$ ". Shpg. wt., 73 lbs.
94 SZ 850. NET..... 495.00



VIKING "6N2" TRANSMITTER. MODEL 240-201-2. Efficient, compact VHF transmitter offering instant bandswitching coverage of 6 and 2 meters. Makes use of the existing power supplies and audio of the Amateur's low-frequency transmitter. Requires 6.3 v. at 3.5 amps, 300 v. DC at 70 ma, 300-750 v. DC at 200 ma, plus 30 or more watts of audio. Viking "Ranger" or Viking I or II are ideally suited as power sources. Input power at full voltage: 150 watts CW or FM, 100 watts AM phone. Built-in crystal oscillator for 8 to 9-mc crystals, or may be driven by 8-9 mc VFO. Final amplifier uses 5894 dual tetrode, with dual-band tank circuit, silver plated for highest efficiency. Parallel lines used on 2 meters. Extremely flexible link coupling output. All circuits metered for quick tune-up. TVI-suppressed. Tubes: 6U8 osc-doubler, 6360 tripler-driver, 5894 final, 6AQ5 clamper. Size: 13 $\frac{1}{2}$ x8 $\frac{3}{8}$ x8 $\frac{1}{2}$ ". Less crystal, key, and microphone. Shpg. wt., 14 lbs.
94 SZ 851. NET..... 169.50

MODEL 240-201. As above, but in kit form.
83 SZ 844. NET..... 129.50

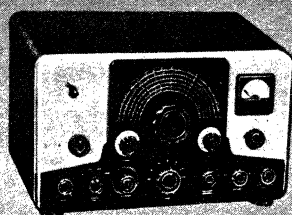

"Ranger"



Viking 500

VIKING "RANGER" TRANSMITTER. MODEL 240-161-2. Latest model of this extremely popular, phone-CW transmitter. Highly effective TVI suppression. Input to final is 75 watts on CW; 65 watts on AM phone. Offers single-knob bandswitching on 160, 80-75, 40, 20, 15, and 11-10 meters. Frequency selection with built-in VFO, or crystals. Pi-network output matches 50-500 ohm loads; tunes out large amounts of reactance. Time-sequence (grid-block) keying provides excellent keying characteristic and allows quick, clean break-in operation. The built-in VFO is temperature-compensated for high stability. Separate, accurately calibrated VFO bandspread scales for each band—9" of dial scale on 10 meters. A 6-to-1 planetary drive mechanism allows accurate tuning with velvet smooth control, 100% AM modulation; response limited to 250-3000 cycles for maximum communication effectiveness. Full meter switching for accurate tune-up. Tubes: 6AU6 VFO, 6CL6 crystal oscillator, 6CL6 buffer, 6146 final, 6AQ5 clamper, 12AU7 keyer, 12AX7 speech amplifier, 12AU7 audio driver, 2-1614 modulators; OA2 voltage regulator, 5R4GY, 6AL5 and 6AX5 rectifiers. Less crystal, key and mike. Size: 15x11 $\frac{1}{2}$ x9". For 105-125 v., 50-60 cycle AC. Shpg. wt., 54 lbs.
99 SZ 036. NET..... 329.50

MODEL 240-161. As above, but in kit form.
99 SZ 037. NET..... 229.50

VIKING "FIVE HUNDRED" TRANSMITTER. MODEL 240-500-2. A full half-kw all-band rig for tops in Amateur enjoyment. CW input is 600 watts, SSB (with auxiliary exciter) is 500 watts PEP. Transmitter is in two units—all controls are in RF section, receiver-size for convenience. Power supply and modulators are in second cabinet. All exciter stages gang-tuned to highly-stable VFO; safety and protective features include cabinet interlocks, voltage failure protection, fuses, time delay. Final amplifier operates into very efficient pi-L network for extreme harmonic suppression. Two meters provide complete monitoring of all transmitter functions. Audio system includes phone patch and low-level clipping. Complete filtering and shielding insure against TVI. Time-sequence keying for fast CW break-in. Tubes: 6AU6 VFO, 6CL6 buffer, 6CL6 multiplier, 5763 RF driver, 4-400A final, 807 clamper, 12AU7 keyer, 12AX7 speech amplifier, 6AL5 audio clipper, 6B4G audio driver, 2-811A modulators. 6AX5GT bias rectifier, 5U4G low voltage rectifier, 2-866/866A high voltage rectifiers, VR-105 and 4-VR-150 final screen voltage regulators, OA2 VFO voltage regulators. Size: RF unit, 11 $\frac{1}{2}$ x21x14 $\frac{1}{4}$ ". Power unit, 10 $\frac{1}{2}$ x20 $\frac{3}{8}$ x15 $\frac{3}{4}$ ". Less mike, key, and crystals. For 115 v. or 230 v., 50-60 cycle AC. Wt., 200 lbs.
94 SZ 854. NET..... 949.50

MODEL 240-500. As above, but in kit form.
83 SZ 846. NET..... 749.50

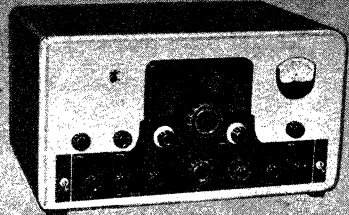

"Valiant"



Viking Navigator

VIKING "VALIANT" TRANSMITTER. MODEL 240-104-2. A husky and compact all-band transmitter. 200 watts input on AM phone, 275 watts CW. Bandswitching from 160 through 10 meters. Can be used with auxiliary SSB exciter for 275 watts SSB power. Retains the famous Johnson features—extra-stable VFO, TVI suppression, time-sequence keying. In addition, audio clipping and filtering provide maximum "punch" through QRM. Can easily be used for driver for kilowatt amplifier, or power source for VHF transmitters. Final amplifier operates into very efficient pi-network antenna output designed to match 50-600 ohm loads; tunes out large amounts of reactance. VFO and modulator screens are voltage regulated. Tubes: 6AU6 VFO, 6CL6 crystal oscillator/VFO isolator, 5763 RF driver, 3-6146 final amplifier, 12AU7 keyer, 6AQ5 clamper, 12AX7 speech amplifier, 6AL5 audio clipper, 6C4 audio amplifier, 12AU7 audio driver, 2-6146 modulators, 2-866A high-voltage rectifiers, 5V4G low-voltage rectifier, 6BY5CA bias rectifier, 2-VR105 modulator screen voltage regulators, and OA2 VFO voltage regulator. Size: 11 $\frac{1}{2}$ x21x14 $\frac{1}{4}$ ". Less crystal, key and mike. For operation from 105-125 v., 50-60 cycle AC. Shpg. wt., 85 lbs.
94 SZ 853. NET..... 439.50

MODEL 240-104. As above, but kit form.
83 SZ 845. NET..... 349.50

VIKING "NAVIGATOR" TRANSMITTER. MODEL 240-126-2. New transmitter-exciter for the Novice or advanced Amateur who desires a flexible, low-power CW rig. 40 watts input. Bandswitching coverage of the 160, 80, 40, 20, 15, 11 and 10 meter bands. Built-in, highly stable VFO features time-sequenced keying for chirp-free, clean, crisp signals. Transmitter may be crystal-controlled—has front-panel provision for 2 crystals. TVI suppression includes filtering and bypassing; aluminum cabinet effectively shields unit. Wide-range pi-network antenna coupler matches transmission line impedances for 50-600 ohms. Accurate meter on front panel can be switched to read final grid and plate currents.

TUBE COMPLEMENT: 6AU6 VFO, 6CL6 crystal-oscillator/buffer-doubler; 6146 final amplifier; 12AU7 time-sequence keyer; 6X4 bias rectifier; 5U4 high voltage rectifier; OA2 regulator.

CONTROLS: Operate (Off, Tune, Standby, Trans); Oscillator (C1, C2, VFO, Zero); Crystals; Bandswitch; Exciter, VFO; Final; Coupling; Meter switch (Grid Plate).

Aluminum cabinet measures 13 $\frac{1}{4}$ x9 $\frac{1}{2}$ x10 $\frac{1}{4}$ ", and is attractively finished in maroon and gray. Completely factory-wired and tested. With tubes; less crystals and key. For operation from 110-120 v., 50-60 cycle AC. Shpg. wt., 27 lbs.
94 SZ 857. NET..... 199.50

MODEL 240-126-1. As above, but kit form.
83 SZ 892. NET..... 149.50

JOHNSON AMATEUR EQUIPMENT

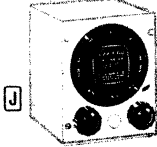
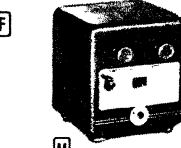
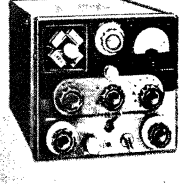
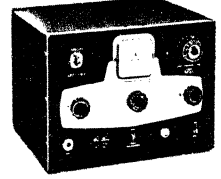
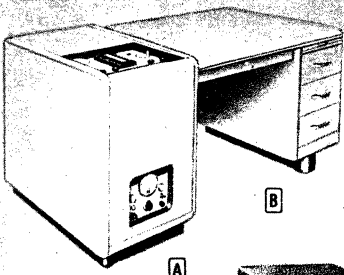

A VIKING "KILOWATT" POWER AMPLIFIER. MODEL 240-1000. Superbly engineered 1000-watt amplifier for use with CW exciter, AM audio driver, or SSB exciter. Provides continuous coverage from 3.5 mc to 30 mc; pi-network output is designed to match antenna loads from 50 to 500-ohms. Unit is mounted in pedestal with convenient desk-top controls; completely enclosed—no internal adjustments or coil changing. Safety features include: Key-operated main switch; interlocks. Excitation requirements: 30 watts RF; 10 watts audio for AM; 2-3 watts P.E.P. for SSB. Two 4-400A in RF amplifier; two 810 modulators. Size, $29\frac{1}{2} \times 19\frac{1}{4} \times 32\frac{3}{4}$ ". Completely wired and lab-tested. Write for brochure. For 210-240 v., 50-60 cycle AC. Shpg. wt., 500 lbs.

99 SZ 035. NET. 1595.00

B 251-101 MATCHING DESK TOP, BACK, AND 3-DRAWER PEDESTAL. Specify right or left-hand pedestal when ordering. Width (with amplifier) $63\frac{1}{2}$ ". Net. f.o.b. Chicago or Corry, Pa., whichever is nearer. Shpg. wt., 155 lbs.

99 SZ 034. NET. 132.00

250-29 POWER REDUCER. Permits using 100-150 watt transmitters to excite Viking "Kilowatt." $3\frac{1}{2} \times 2\frac{1}{2}$ " dia. 1 lb.

99 S 015. NET. 13.95

C MOBILE TRANSMITTER KIT. MODEL 240-141. Up to 60 watts input on all bands, 75 through 10 meters. Bandswitched and gang-tuned—all stages ganged to one tuning knob for maximum tuning ease. Separate PA trimmer permits greater frequency shift without readjusting antenna loading. Has 4-position crystal selector with extra position for VFO; 52-ohm output. Requires 300-600 v. DC at 200-240 ma and 6 or 12 v. for heaters. Less tubes and mike. $7\frac{1}{8} \times 6\frac{1}{8} \times 10\frac{1}{8}$ ". Wt., 16 lbs.

98 S 056. NET. 107.00

MOBILE VFO KIT. MODEL 240-152. For above. With tubes. $4 \times 4 \times 5\frac{1}{2}$ ". 4 lbs.

99 S 018. NET. 33.95

240-152-2 VFO. As above, but wired.

99 S 019. NET. 52.50

D VFO KIT. MODEL 240-122. Extremely stable VFO. Designed specifically for use with Viking I or II transmitter, but can be used with any other transmitter. For 160, 80-75, 40, 20, 15, 11 and 10 meters. Output frequency ranges: 1.75-2 mc for 160-40 meters; 7-7.425 mc for 40-10 meters; 6.7-7 mc for 11 meters. Output: 5.5 to 8 volts. Housed in maroon and gray aluminum case. Has 4 rubber feet to protect desk or table top. Requires 250-300 volts DC at 15 ma, and 6.3 volts at 0.3 amp. Kit is supplied complete with easy-to-follow instructions; 6AU6 osc.; OA2 voltage regulator; RF output and power cables. Size, $7 \times 6\frac{1}{8} \times 6\frac{1}{8}$ ". Shpg. wt., 7 lbs.

99 S 013. NET. 45.50

MODEL 240-122-2. As above, but wired.

99 SX 014. NET. 69.75

E LOW-PASS FILTER. MODEL 250-20 Effective TVI filter with 4 shielded sections. For any Amateur transmitter. Handles 1 kilowatt, 100% modulated. 75 db or more attenuation of harmonic and spurious frequencies above 54 mc—insertion loss is less than 0.25 db. Teflon insulated fixed capacitors. Durable aluminum filter case is designed for easy accessibility. Coax connectors for input and output connections. Completely wired and accurately pre-tuned. Impedance: 52 ohms. Size, $9 \times 2\frac{3}{8}$ " dia. Shpg. wt., 3 lbs.

98 S 055. NET. 14.95

F CRYSTAL CALIBRATOR. MODEL 250-28. Accurate and stable 100-kc crystal standard small enough to be mounted inside receiver cabinet. Produces 100-kc. check points up to 55 mc. Gives pin-point accuracy for checking frequency of your own as well as other stations. With 6BH6 tube, hermetically sealed crystal, and power cable and extension leads. $3\frac{3}{8} \times 2\frac{1}{2} \times 1\frac{1}{2}$ ". Requires 6.3 v. @ .15 amp and 150-300 v. DC @ 2 ma. Shpg. wt., 1 lb.

99 S 039. NET. 17.95

G STANDING WAVE RATIO BRIDGE. MODEL 250-24. A valuable aid in the adjustment of antenna coupler and transmission line for maximum efficiency. Helps to minimize standing wave ratio to assure effective operation of low-pass filter. 52 ohm input (can be changed by replacing resistor). Supplied complete with coax connectors and color coded phone tip jacks for connection of 0-1 ma meter (not supplied). Size, $2\frac{3}{8} \times 4\frac{1}{2}$ ". Shpg. wt., 1 lb.

99 S 028. NET. 9.75

H SIGNAL SENTRY. MODEL 250-25. For monitoring of phone or CW transmissions on all bands. Requires no tuning. Can also be used as code practice oscillator. Plug provided fits headphone jack of receiver; headphones plug into jack on Signal Sentry. RF probe coupled loosely to transmitter provides signal. Mutes receiver output; an ideal keying monitor for break-in operation. Requires 250 v. DC at 5 ma., 6.3 v. at 0.6 amp. Size, $3\frac{7}{8} \times 3\frac{5}{8} \times 3\frac{3}{4}$ ". Uses 12AX7 and 12AU7. All cables and connectors included. Shpg. wt., 3 lbs.

99 S 017. NET. 22.00

J 2-METER VFO KIT. MODEL 240-132. New 2-meter VFO. Replaces 8 mc crystals in 2-meter transmitters, including those using over-tone oscillators. 6BH6 series-tuned oscillator is temperature compensated and extremely stable. Has OA2 voltage regulator. Output frequency range is 7.995 to 8.235 mc. Accurately calibrated, edge-lighted lucite dial reads 144 to 148 mc. Requires 250-325 volts DC at 10 ma, and 6.3 volts at .3 amp. With tubes, power cable and plug, and full instructions. Housed in attractive maroon and gray cabinet. Size, $4 \times 4 \times 5\frac{1}{2}$ ". Shpg. wt., 4 lbs.

83 S 849. NET. 29.50

240-132-2. As above, but wired.

94 S 856. NET. 46.50

"ADVENTURER" 50-WATT CW TRANSMITTER KIT. MODEL 240-181. Here is the ideal rig for the Novice Amateur, as well as confirmed "Brass Pounders" who want a compact low-power CW transmitter. 50 watts input to an 807 amplifier. Uses 6AG7 crystal oscillator and 5U4G rectifier.

FEATURES: Bandswitching on 80, 40, 20, 15, and 11-10 meters; grid and plate metering; crystal and VFO inputs; shielding and filtering for TVI suppression; wide-range pin-network output permits the use of even the simplest antennas—provides up to 30 db harmonic attenuation. Receptacle on rear of chassis permits using built-in power supply (450 volts DC at 150 ma and 6.3 volts at 2 amps) with other equipment such as a VFO, modulator, etc. Power supply is fused to provide protection from overloads. Oscillator and final amplifier are keyed simultaneously. Keying is crisp and clean. Meter switch selects 807 grid or plate current.

CONTROLS: Oscillator tuning, band selector, plate tuning and output coupling. Jacks for key, VFO and crystal.

With tubes and easy-to-follow instructions; less key and crystal. Size, $7\frac{3}{8} \times 10\frac{3}{8} \times 8\frac{1}{8}$ ". For operation from 105-125 v., 50-60 cycle AC. Shpg. wt., 16 lbs.

99 SZ 024. NET. 54.95

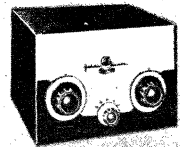

"MATCHBOX" ANTENNA COUPLERS

MODEL 250-23. Performs all transmission line matching and switching functions required in low or medium-power stations. For the 80-10 meter Amateur bands. Matches balanced antennas from 25 to 1200 ohms and unbalanced or single wire-antennas from 25 to 3000 ohms. Nominal input impedance 52 ohms, rated at 275 watts. Built-in transmit-receive relay. Has adjustment for matching antenna to receiver. Coaxial input and 7-terminal receiver and relay strip. Maroon and gray metal cabinet. $9\frac{1}{2} \times 10\frac{1}{2} \times 7\frac{1}{2}$ ". Shpg. wt., 11 lbs.

99 SX 026. NET. 54.95

KILOWATT "MATCHBOX" MODEL 250-30. Similar to above, but rated at 1000 watts. Handles unbalanced lines from 50 to 1200 ohms, balanced lines from 50 to 2000 ohms. Includes time-delay system for relay, providing "fast-make, slow-break" action. $17\frac{1}{2} \times 12\frac{1}{2} \times 10\frac{1}{2}$ ". Wt., 27 lbs.

99 SZ 016. NET. 124.50

T-R SWITCH. MODEL 250-39. New. Switches antenna from receiver to transmitter electronically. Rated at 4000 watts peak power. Uses 6BL7 (supplied) for improved receiver isolation. Broadband printed circuit requires no tuning. Coax fittings. Has nylon tip-jack for connecting scope to internal RF probe. $4\frac{3}{8} \times 4\frac{3}{8} \times 5\frac{1}{8}$ ". For 110-120 v., 50-60 cycle AC. Wt., 5 lbs.

94 S 858. NET. 25.00

Central Electronics, Inc.



Central Electronics SSB Units

A MODEL 100V EXCITER. New, voice-controlled, bandswitching exciter. Output: SSB, 100 watts P.E.P.; CW, PM or FSK, 100 watts; AM, 35 watts. Covers 80, 40, 20, 15 and 10 VFO has direct-reading 1-kc calibration on all bands; remainder of unit is broadbanded and requires no tuning. Choice of sideband. Built-in 2° scope monitors RF output, TVI suppressed. Two 6550's in output. Gray cabinet. 18x18 $\frac{3}{4}$ x15". For operation from 110-120 v., 50-60 cycle AC. Shpg. wt., 70 lbs.

94 SZ 892. NET. 595.00

B MODEL 20-A EXCITER. Efficient, voice-controlled all-band SSB exciter. 20 watts peak output. Choice of either sideband. Covers 160 through 10 meters. Also operates AM, PM, or CW. Over 40 db unwanted sideband suppression. Requires VFO or crystal. Surplus BC-458 is ideally suited. (See below.) Completely bandswitching. Provides blocking bias for external amplifier during reception. 14 $\frac{1}{2}$ x10x8 $\frac{3}{4}$ ". For 110-120 v., 50-60 cycle AC. 34 lbs.

83 SZ 811. NET. 279.50

MODEL 20-A EXCITER KIT. As above, but in kit form.

83 SZ 810. NET. 219.50

458-K CONVERSION KIT. Converts surplus BC-458 to VFO for use with 20-A exciter. Contains dial, all components. 2 lbs.

83 S 815. NET. 17.50

QT-1 ANTI-TRIP UNIT. Plugs into 20-A. Prevents loud signals, heterodynes, from tripping break-in circuit. Shpg. wt., 2 lbs.

83 S 812. NET. 12.50

C MODEL 600L BROADBAND LINEAR AMPLIFIER. 500-watt DC input linear amplifier. Bandswitching from 160-10 meters. Has single 813 in Class A₂. Only 8 watts rms required to drive amplifier to 500 watts input. Amplifier is broadband and does not require tuning. Relay trigger tube provides automatic load mismatch protection. Large meter reads power input, RF amperes, reflected power and grid current. Built-in SWR bridge. TVI suppressed. Output matches any unbalanced 52 or 72 ohm antenna system without loading controls. Size, 18x18 $\frac{3}{4}$ x15"D. Gray steel cabinet. For 110-120 v., 60 cycles AC. Shpg. wt., 117 lbs.

83 SZ 816. NET. 495.00

MODEL GC-1 GATED-COMPRESSION AUDIO AMPLIFIER. Gated-compression amplifier eliminates continual adjustment of receiver gain to boost weak signals or cut down strong signals. For CW, AM, and SSB. Change in output is less than 3 db for signal variations up to 40 db. Connects between speaker voice coil and secondary of receiver output transformer. 4 tubes plus rectifier. 9 $\frac{1}{2}$ x6 $\frac{1}{4}$ x14 $\frac{1}{2}$ ". For 110-120 v., 50-60 cycle AC. Shpg. wt., 17 lbs.

83 SX 865. NET. 59.50

MODEL GC-1 AMPLIFIER KIT. As above, but in kit form.

83 SX 866. NET. 49.50

D MODEL MM-1 MULTIPHASE RF ANALYZER. Extremely versatile RF analyzer consists of a compact 3" oscilloscope with built-in low-distortion audio oscillator. Designed for maximum convenience in analyzing transmitter RF systems. Furnishes patterns for monitoring speech (without 60 cycle double-trace); for aligning phasing type SSB exciters; for evaluating high-level AM systems; for analyzing SSB overall performance. Can be used with transmitters from 5 watts to 5 kw at frequencies from 1 to 200 mc. Gray steel cabinet, 9 $\frac{1}{2}$ x6 $\frac{1}{4}$ x14 $\frac{1}{2}$ ". For 110-120 v., 50-60 cycle AC. Wt., 19 lbs.

94 SX 893. NET. 129.50

MODEL MM-1 RF ANALYZER KIT. As above, but in kit form.

83 SX 867. NET. 99.50

MODEL B SIDEBAND SLICER. For converting receivers with 450 to 500 kc IF's for selective SSB reception. Either sideband selected with flip of switch. Has built-in Q multiplier. Size, 5 $\frac{1}{2}$ x8 $\frac{3}{4}$ x13". For 110-120 v., 60 cycle AC. Shpg. wt., 17 lbs.

83 SX 817. NET. 99.50

Harvey-WELLS

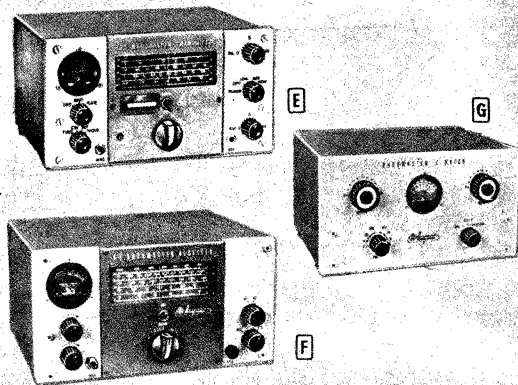

Harvey-Wells Quality Ham Gear

E MODEL T-90 90-WATT TRANSMITTER. Compact, bandswitching and TVI-suppressed 75-watt AM phone and 90-watt CW transmitter. Built-in VFO using stable, voltage-regulated and temperature-compensated circuits. For 80, 40, 20, 15, 11 or 10 meters. Provides VFO tuning without carrier on. Selector switch allows metering of important circuits. Takes carbon or crystal mike; provision for push-to-talk. Size, 6 $\frac{3}{4}$ x12 $\frac{3}{4}$ x10 $\frac{1}{2}$ " deep. Less power supply, crystals, key and mike. Shpg. wt., 18 lbs.

99 SX 041. NET. 179.50

99 SZ 043. APS-90 115-Volt AC Power Supply. For above. Shpg. wt., 35 lbs. NET.

99 SZ 044. VPS T-90 Mobile Supply. For 6 or 12-volt DC. Shpg. wt., 21 lbs. NET.

89.50

F R9 RECEIVER. Companion to the T-90 transmitter. Covers 80, 40, 20, 15, 11 and 10 meter bands. Double-conversion on all bands. All coils slug tuned for high Q. Less speaker (below). 6 $\frac{3}{4}$ x12 $\frac{3}{4}$ x10 $\frac{1}{2}$ ". For 110-120 v., 50-60 cycle AC. Wt., 18 lbs.

99 SX 042. NET. 149.50

VPS-R9 MOBILE POWER SUPPLY. 6 or 12 v. DC. With cable and connector. 6 $\frac{3}{4}$ x7 $\frac{1}{2}$ x4 $\frac{3}{4}$ ". Shpg. wt., 12 lbs.

99 SX 045. NET. 30.50

FS-1 MATCHING SPEAKER. For fixed-station use. Shpg. wt., 5 lbs.

99 SX 046. NET. 11.50

MS-1 MATCHING SPEAKER. For mobile use. Shpg. wt., 3 lbs.

99 SX 047. NET. 8.25

G Z-MATCH. Antenna matcher, 50-ohm dummy load, SWR and power indicator. Tunes 3.5-30 mc. Matches 10-2500 ohms. For 50-ohm lines. Uses M. C. Jones Micro-Match coupler. Built-in meter. 500 w. max. transmitter input. 6 $\frac{3}{4}$ x12 $\frac{3}{4}$ x11 $\frac{1}{2}$ ". 16 $\frac{1}{4}$ lbs.

99 SX 050. NET. 89.00

Sonar Marine Equipment

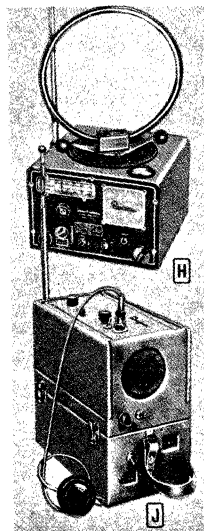

H SONAFINDER DF4X DIRECTION FINDER. Highly-accurate navigational aid and all-purpose receiver. Covers 3 bands: Beacon, Broadcast, Marine. Includes 1 crystal-controlled channel for monitoring 2182 kc channel or any other frequency between 2 and 3 mc. 12" loop can be remotely located. Sense antenna gives one-null indications. 7 tubes, built-in noise limiter, 4" PM waterproof speaker. Requires 2-B30 and 1-8F batteries (see page 284). 10 $\frac{1}{2}$ x11x7 $\frac{1}{2}$ ". Less batteries. Shpg. wt., 18 lbs.

83 SX 839. NET. 179.95

I MODEL M35W 35-WATT MARINE RADIO-TELEPHONE. Crystal-controlled. Range 25-150 miles. 35 watts input. Covers five channels plus broadcast band—2 ship-to-ship, 2 ship-to-shore and emergency frequency 2182 kc. Has push-to-talk, noise limiter, modulator and RF indicator. Crystals supplied for 2182 kc, and a ship-to-ship frequency. With 6 v. rechargeable battery, antenna, mike. 12x7 $\frac{1}{4}$ x12 $\frac{1}{2}$ ". Wt., 40 lbs.

83 SZ 836. NET. 339.50

MODEL M35W FOR GREAT LAKES OPERATION. As above, but for 2003-kc Great Lakes ship-to-ship frequency.

83 SZ 847. NET. 339.50

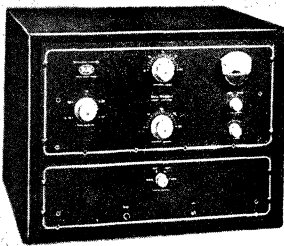

B&W

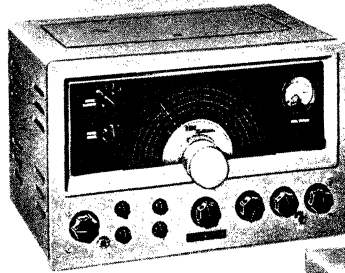
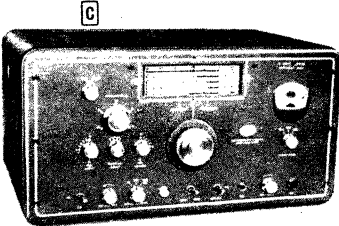
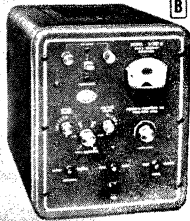

RME

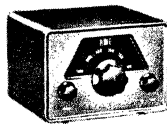

Barker & Williamson Amateur Gear

A L-1000-A AMPLIFIER. Here is a completely self-contained (including power supply) kilowatt amplifier in desk-top size. A full "gallon" of SSB input; 875 watts CW. Uses pair of 813's with pi-network tank for precise adjustment and loading. Input circuit is broadbanded to eliminate grid tuning. Simply set bandswitch, apply drive, tune and load final, and you're on the air! Requires approximately 80 watts drive, easily supplied by the 5100B transmitter. Output network matches 50-75 ohm loads. Meter reads amplifier grid or plate currents. Uses 4—816 rectifiers in bridge circuit. Controls: Band Selector; Amplifier Tuning; Amplifier Loading; Grid-Plate Meter; Bias Adjust; and Off-On Tune-Operate switch. For 110-120 v., 50-60 cycle AC. 16x21x15". Shpg. wt., 110 lbs.

94 SZ 880. NET..... 460.00

B MODEL 515B-B SSB GENERATOR. Companion unit to the 5100B transmitter, the 515B-B provides highest quality SSB transmission with a new high in operating convenience. Bandswitching from 80 through 10 meters. AM, CW and SSB can be selected by a switch on the 5100B panel. Operating power is obtained from the 5100B or any other suitable transmitter. Voice-operated control and speaker anti-trip are built-in. Tubes: 2—12AT7, 6CL6, 6V6; 4—12AT7, 6AL5. 75-ohm unbalanced output. Requires 6.3 v. @ 3.2 amp., and 250 v. DC @ 130 ma. Size, 11½x10x14¾". Shpg. wt., 27 lbs.

97 SZ 607. NET..... 265.00

C 5100B TRANSMITTER. A self-contained 150-watt all-band transmitter of superior performance. Operates on 80-75, 40, 20, 15, 11 and 10 meters with built-in VFO or with crystal control. With SSB generator (above) the 5100B produces clean SSSC transmission. VFO dial can be read to 1 kc on all bands. 80-meter crystals can be used, making the rig useful to the Novice Amateur. Final amplifier is two 6146's in parallel, feeding a pi-network tank. Another pair of 6146 tubes in AB₂ provide modulation, and can be used to drive a higher-power modulator. Multiplier and driver stages are ganged for fast simplified tune-up. Grid-block CW keying is clean, crisp. Has built-in filtering for TVI reduction. Tubes: 6BH6, 2—6BJ6, 5—6SQ5, 6U8, 4—6146, 5U4GB, 2—SR4GV, OD3. For 110-120 v., 50-60 cycle AC. Size, 11½x22x14¾". Shpg. wt., 88 lbs.

97 SZ 606. NET..... 475.00

D 600 GRID-DIP METER. A valuable instrument in any ham shack or laboratory. Covers 1.75 to 260 mc in 5 ranges, with color-coded plug-in coils. Can be used as grid-dip meter, absorption wavemeter, auxiliary signal generator, etc. Size, 3x3x7". With rack for holding unused coils. For operation from 110-120 v., 50-60 cycle AC. Shpg. wt., 3 lbs.

84 S 487. NET..... 39.75

E 380-B TR SWITCH. Provides fully automatic electronic antenna changeover. Handles up to 1 kw in 52 or 75-ohm lines only. Ideal for SSB, AM and CW. Requires Amphenol 83-1T fitting. Size, 3⅞x3½x5". Shpg. wt., 2 lbs.

98 S 775. NET..... 23.70

2Q4 AUDIO PHASE-SHIFT NETWORK. For use in phasing-type SSB generators. Will split any audio signal in the 300-3000 cps range into two components, equal in amplitude, but 90° ± 1.5° out of phase with respect to each other. Extremely compact—mounted in octal-based shell no larger than a 6J5. Ideal for the "build-it-yourself" SSB ham. Shpg. wt., 1 lb.

99 S 122. NET..... 4.65

550-A COAXIAL SWITCH. Five-position switch permitting selection of one of five coaxial circuits. Handles up to 1 kw RF, AM modulated. Shpg. wt., 2 lbs.

97 S 608. NET..... 8.25

551-A COAXIAL SWITCH. (Not illus.) For switching devices in and out of coaxial line. 2 positions. Shpg. wt., 2 lbs.

97 S 591. NET..... 7.95

F MODEL 4350A RECEIVER. New, dual-conversion receiver designed specifically for Amateur-band coverage. Offers many deluxe features usually found only in higher-priced units. Extremely high sensitivity and selectivity, plus exceptional ease of tuning. Covers 160, 80-75, 40, 20, 15 and 11-10 meters; frequency ranges: 1.8-2, 3.5-4, 7-7.3, 14-14.35, 21-21.5 and 27-29.7 mc.

Features include: 2 microvolt sensitivity for 10 db signal-to-noise ratio; 100-kc crystal calibrator; 4 positions of selectivity (3 positions with crystal filter; one non-crystal position); up to 35 db of notch rejection with crystal filter; drift of only 0.01% for first 20 minutes with practically zero drift after warm-up; temperature compensated components and rugged mechanical construction for excellent stability. Large 8½" evenly graduated dial has differential mechanism which provides choice of 75:1 or 1:1 tuning ratio. Has "S" meter; two coaxial jacks for Model 4301 SSB adapter (below); terminals for transmitter relay and break-in circuits.

Controls: Tuning, AF gain, BFO pitch, BFO injection, antenna trimmer, calibration adjust, band selector, RF gain, function (CW, AGC, SSB/AGC, SSB/MGC), standby switch, crystal selectivity switch, crystal phasing/rejector, ANL off-on. Tubes: 6BZ6, 3—6U8, 2—6CB6, 6T8, 6AQ5; 5Y3GT rectifier and OA2 regulator. Gray cabinet. 10x16½x10". For operation from 110-120 v., 50-60 cycle AC. Shpg. wt., 36 lbs.

94 SZ, 889. NET..... 249.00

MODEL 4302 MATCHING SPEAKER. PM speaker in handsome case to match 4350A receiver. 10x8½x5½". Shpg. wt., 6 lbs.

99 SX 049. NET..... 17.50

G MODEL 4301 SIDEBAND DETECTOR-SELECTOR. Sideband detector-selector for outstanding, easy-to-tune SSB reception. Plugs directly into the RME Model 4350A receiver listed above. Easy to connect to other receivers.

Contains built-in power supply feeding extremely stable BFO, balanced detector circuit, accurate phase shift network, and adder and subtractor circuits. Front panel control selects upper or lower sideband, double-sideband exalted carrier reception or normal receiver operation. Switching between upper and lower sideband is instantaneous and provides 40 db suppression of unwanted sideband. Improves the selectivity and signal-to-noise ratio for SSB, AM or CW reception. Housed in handsome metal cabinet. Size, 10x8½x10". With all cables for connection to RME 4350A. For 110-120 volts, 50-60 cycle AC. Shpg. wt., 16 lbs.

99 SX 023. NET..... 75.00

H MODEL DB23 PRESELECTOR. This broadband preselector tremendously boosts the gain and signal-to-noise ratio of Amateur receivers. Covers 80-75, 40, 20, 15, and 11-10 meter bands. Average overall gain, 25 db. Improves signal-to-noise ratio to better than 7.5 db over that of the receiver alone. Allows optimum use of crystal filters. Input circuits accurately match any standard antenna. Operation is simple—broadband circuit requires no tuning. Controls: Off-On, Band Selector and Antenna Peaking. Tubes: 3—6J6's plus rectifier. Unit is completely self-contained. Handsome steel cabinet is finished in blue-gray to match RME equipment. Size, 5x7½x6⅞". For operation from 110-120 volts, 50-60 cycle AC. Shpg. wt., 6½ lbs.

98 S 751. NET..... 49.50

WE'RE TRADING HIGH

Shopping for a big trade-in on your old receiver or transmitter? Be sure to drop a card to Allied. Tell us the make and model of the unit you'd like to trade and the equipment you want. You'll not only get a King-Size trade-in offer, but you may be able to use our Easy Pay Plan. Your old equipment should more than cover the down payment and you can pay the balance while enjoying the latest in station gear.

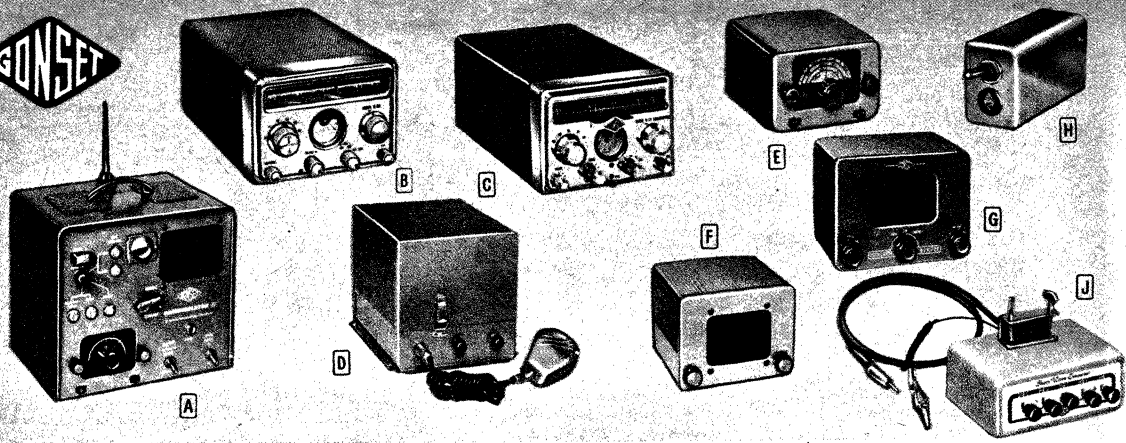

FAMOUS GONSET HIGH-QUALITY COMMUNICATIONS EQUIPMENT

COMMUNICATOR TRANSCEIVERS

- A** NEW MODEL 3136 COMMUNICATOR III. Complete 6-meter station in one portable case. Operates from 110-120 v., 50-60 cycle AC, or 6 or 12 v. DC. Highly selective receiver covers 49-54 mc; includes cascade RF stage, AVC, 3 IF stages, noise limiter, squelch, and 4" speaker. Transmitter: 5-7 watts AM output; ganged tuning; uses 8-mc crystals. With 19" whip; less crystals and mike. $10\frac{1}{4} \times 11\frac{1}{2} \times 7\frac{1}{8}$ ". Shpg. wt., 23 lbs.
92 SZ 304. NET. 269.50
- MODEL 3133 COMMUNICATOR III. As above, but for 2 meters. Uses 8-mc crystals.
92 SZ 305. NET. 269.50
- MODEL 3212 LINEAR AMPLIFIER. For use with Model 3136. Provides carrier output of 50-60 watts. $10\frac{1}{2} \times 10\frac{1}{4} \times 11"$. 30 lbs.
92 SZ 306. NET. 169.50
- MODEL 3211 LINEAR AMPLIFIER. As above, but for use with Model 3133.
92 SZ 307. NET. 169.50

MOBILE RECEIVER

- B** MODEL 3046. Deluxe 6-band mobile receiver for really outstanding Amateur reception. Covers 80-75, 40, 20, 15 and 10 meters, plus 540-2000 kc for broadcast and 160 meters. Double conversion on all bands, and three tuned input circuits on high bands for excellent image rejection. High sensitivity, steep skirt selectivity and rugged stability for top AM, CW, and SSB performance. Highly intelligible speech quality results from virtually flat-topped IF response with 3.5 kc bandwidth at 6 db down. Front panel includes "S" meter, antenna trimmer, BFO pitch, audio and RF gain controls. Less power supply and speaker. $4\frac{1}{2} \times 6\frac{1}{2} \times 9"$. Shpg. wt., 9 lbs.
83 S 831. NET. 209.50
- MODEL 3069 POWER SUPPLY AND SPEAKER. 3-way power supply for G-66 receivers. For 12 v. DC or 115 v., 60 cycle AC. Built-in speaker. $4\frac{1}{2} \times 6\frac{1}{2} \times 4\frac{5}{8}$ ". 8½ lbs.
83 S 832. NET. 44.50

MOBILE CONVERTERS

- E** MODEL 3030 "SUPER SIX." Mobile converter covering 75, 40, 20, 15, 11 and 10 meters, plus 19 and 49 meter SW bands. Excellent signal-to-noise ratio. Controls: Antenna Trimmer, On-Off, Band Selector, RF gain, Oscillator Compensator, and hi-lo antenna impedance switch. Output, 1430 kc. With cables. Gray metal case. $5\frac{1}{4} \times 3\frac{1}{2} \times 5\frac{1}{4}$ ". Requires 80-135 v. DC at 10 ma., and 6 v. at 0.9 amp. Shpg. wt., 5 lbs.
84 S 913. NET. 57.50
- F** MODEL 3002 3-30 MC CONVERTER. Continuous coverage from 3 to 30 mc in 3 ranges. Has high sensitivity on short whip antenna. Excellent for all-band mobile installations. Requires 135 v. DC at 10 ma and 6 volts at 0.75 amps. Output 1500 kc. With cables. $5\frac{1}{4} \times 3\frac{1}{2} \times 5\frac{1}{4}$ ". 5 lbs.
84 S 954. NET. 49.50

FM TUNERS AND ACCESSORIES

- E** FM TUNERS. For mobile or fixed installations. Include squelch circuit. Easily connected to AM receiver. Require 150 v. DC at 14 ma; 6.3 v. at 1.8 amp. Size, $5\frac{1}{4} \times 3\frac{1}{2} \times 5\frac{1}{4}$ ". *Less speaker. Shpg. wt., 5 lbs.
83 S 822. Type 3009. 30-40 mc.
83 S 823. Type 3010. 40-50 mc.
84 S 925. *Type 3011. 88-108 mc.
83 S 824. Type 3012. 152-162 mc.
NET EACH. 69.50

- F** MODEL 3034 AUDIO AMPLIFIER, POWER SUPPLY & SPEAKER. For any Gonset tuner. For 6v. DC. $6\frac{1}{8} \times 7 \times 6\frac{1}{4}$ ". 8 lbs.
83 S 826. NET. 47.50

MONITOR & CODE PRACTICE

OSCILLATOR

- G** MODEL 3022 MONITONE. Combination code practice oscillator and phone or CW monitor. Transformer-type power supply. Has built-in speaker and provision for headphones. Separate tone and volume controls. Uses RF pickup link to monitor transmitter keying. $5\frac{1}{4} \times 6\frac{1}{2} \times 4\frac{1}{4}$ ". For 110-120 v., 50-60 cycle AC. Wt. 4 lbs.
83 S 829. NET. 22.50

CLIPPER NOISE LIMITER

- H** MODEL 3001. Greatly reduces ignition and similar types of interference. Easily installed on any receiver having diode second detector. $2\frac{1}{2} \times 4\frac{1}{2} \times 1\frac{1}{2}$ ". 2 lbs.
60 S 596. NET. 9.95

NEW PUSH-BUTTON CONVERTER

- J** MODEL 3128. New, ultra-compact, push-button converter for world-wide shortwave reception in your car. Can be used with any 12 v. auto radio that can be manually tuned. Quickly and easily installed—no internal connections to car radio. Just plug patch cable into antenna receptacle and clip power lead to 12 v. DC. Four push-buttons select 49, 31, 19 and 13 meter bands for day and night shortwave reception. Fifth button is for standard broadcast band. Size, $2\frac{1}{2} \times 5\frac{1}{2} \times 4\frac{1}{2}$ ". Shpg. wt., 2 lbs.
92 S 303. NET. 29.95

G-77 MOBILE TRANSMITTER

- C** **D** MODEL 3116. New, 5-band bandswitching transmitter (Fig. C), complete with built-in VFO and separate mobile power supply (Fig. D). Covers 80-75, 40, 20, 15, 10 meters. Power input up to 60 watts on AM phone or CW. Final is type 6146 with a pi-network output. Switch for crystal-controlled or VFO operation. Drum-type VFO dial exposes only band in use. Driver-multiplier stages ganged with oscillator for single-knob exciter control. Heavy-duty, vibrator power supply operates from 6 or 12 v. DC—may be mounted in auto trunk. Transmitter features: 40-to-1 bandspread ratio; press-to-talk system; built-in antenna relay; metering of final and modulator; VFO-crystal switch. Size: Transmitter, $4\frac{1}{2} \times 6\frac{1}{2} \times 9"$; power supply, $7\frac{1}{4} \times 7\frac{1}{2} \times 9"$. Shpg. wt., 32 lbs.
83 SZ 848. NET. 289.50



ALL-TRANSISTOR RADIO RECEIVER

MODEL TCR-2. Versatile new, transistorized portable receiver. A complete broadcast receiver, with a 5-transistor circuit and built-in speaker for full-toned output with plenty of volume. Can be used in the home, in a car, or as a personal portable. A perfect companion unit for the ATC-1 (at right), for Amateur use. Ideal for a quick and easy mobile installation, or for portable or emergency use. The TCR-2 is provided with an input matching network terminating in an auto-type jack at rear of receiver. Provides optimum coupling to the ATC-1 for reception of 80, 40, 20, 15 and 10-meter Amateur bands. Operates for up to 200 hours from a single battery. Size, only $3\frac{1}{4} \times 4\frac{3}{4} \times 4\frac{1}{8}$ ". Less battery. Shpg. wt., $3\frac{1}{2}$ lbs.
99 S 174. NET. 39.95

TYPE 2N6 BATTERY. For use with above. Shpg. wt., 5 oz.
80 J 684. NET. 1.30

Regency
Tiny Team



AMATEUR BAND CONVERTER

MODEL ATC-1. Unique, transistorized ham band converter! Entirely self-contained and self-powered, this tiny converter provides amazing performance on AM, CW and SSB in the 80, 40, 20, 15, and 10 meter bands. Operates with any set; portable, AC-DC or mobile; provided with cable for instant connection to Model TCR-2 matching receiver. Includes modified Q multiplier. Powered by three penlight cells; total drain only 0.6 ma! Has drum-type slide rule dial, break-in jack, high-Q permeability-tuned coils. Uses SB-100 transistor as converter, and 2N169A multiplier and BFO, with variable injection. Employs CK706 clamper to prevent damage to transistors. Less penlight cells. $3\frac{1}{4} \times 4\frac{3}{4} \times 4\frac{1}{8}$ ". Wt., $2\frac{1}{2}$ lbs.
99 S 167. NET. 79.50

TYPE Z PENLIGHT CELL. For above. Three required. Wt., each, 2 oz.
53 J 031. NET EACH. 9c

Quality Mobile Equipment

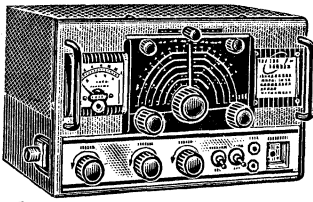

A

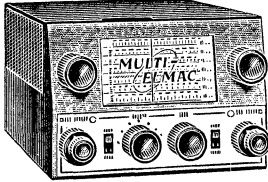

B

MULTI-ELMAC GEAR

A Model AF-67 Trans-Citer. Highly versatile, low-powered transmitter for fixed-station or portable use. Also excellent as exciter and speech amplifier for high-power amplifier. Power input, 60 watts on AM, CW or NBFM. Bandswitching on 160, 80-75, 40, 20, 15 and 11-10 meters for convenient all-band operation.

Built-in, temperature-compensated VFO. Provision for crystal operation, Pi-network output, 5-circuit metering. Tubes: 6146 power amplifier, 6AQ5 driver, 6AG5 multiplier, 6AK6, oscillator, 6BJ6 reactance modulator, OB2 voltage regulator, 6AU6 speech amplifier, 12AU7 speech driver, 2-5881 modulators. Controls: Power Off-On, Bandswitch, Final Loading, Plate Tuning, Grid Drive, VFO Spotting switch, VFO Freq., VFO-Xtal. Meter switch, Audio Gain. Rear apron has: AM-NBFM-CW switch, High-Low Impedance Mike switch, power connections.

Requires 475 v. DC at 170 ma and 225 v. DC at 60 ma. Filaments require 6 or 12 v. DC or AC. Simple jumper connection used to change from 6 to 12 volt operation. Size, 7x11½x1¼". Shpg. wt., 20 lbs.

98 SZ 091. NET. 177.00

PS-2V 115V. AC Power Supply. For AF-67. Shpg. wt., 30 lbs.

98 SZ 760. NET. 49.50

CFS-1 Connecting Cable. Connects PS-2V and AF-67. Shpg. wt., 8 oz.

98 S 761. NET. 4.75

B PMR-7 Receiver. A double-conversion superhet for outstanding mobile reception. Sensitivity exceeds that of many fixed-station receivers. Covers 160, 80-75, 40, 20, 15 and 10-meter bands and 540-1650 kc. Slide-rule dial has scales for each band.

First IF is 2238 kc. for extreme image rejection. Second oscillator is crystal controlled for maximum stability. Second IF is 262 kc. HF oscillator is voltage regulated. Includes adjustable squelch circuit which operates on ¼µv signal. Built-in noise limiter, variable BFO, variable BFO injection. RF gain control, delayed AVC. Antenna input for 50 to 75-ohm coax line. All coils are individually shielded for maximum stability and freedom from interaction. Slide-rule dial is illuminated; headphone jack on rear of chassis. Filaments operate from either 6 or 12 volts.

Tubes: 6BZ6 RF amplifier; 6BE6 1st oscillator; 6C4 first converter; 6BA6 1st IF amplifier; 6X8 2nd converter and crystal oscillator; 6BJ6 2nd IF amplifier; 6BJ7 detector-AVC-ANL; 6AN8 1st audio & squelch, 6AQ5 output, 12AU7 BFO and isolation amplifier. Size, 4½x7x9½". Shpg. wt., 11 lbs.

83 S 842. NET. 159.00

Model PSR-612 Power Supply. For above. Input: 6 or 12 volts DC. Size, 4½x4½x9½". Shpg. wt., 10 lbs.

83 S 843. NET. 34.00

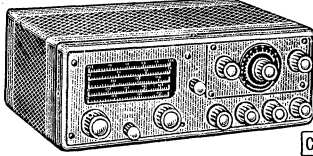

C

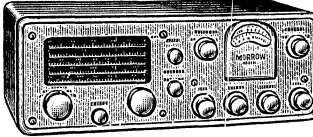

D

NEW "FALCON" RECEIVER

C Superb new dual-conversion superhet receiver for 80-75, 40, 20, 15 and 10 meters. Also available with built-in broadcast tuner (see below). Outstanding sensitivity and selectivity; improved noise limiter effectively suppresses pulse noise interference. Sensitivity: 1µv for 14 db signal-to-noise ratio on 10 meters. Selective band pass: Narrow, 2.8 kc; wide, 9.2 kc at 6 db down. Power requirements: 270 v. @ 70 ma; see power supplies listed below. Size, 4½x11½x7¼". Less speaker. Wt., 11 lbs.

94 SZ 847. NET. 169.00

"Falcon" With BCT Built-In Tuner. Includes broadcast band coverage. Shpg. wt., 12 lbs.

94 SZ 848. NET. 189.00

MBR-5 RECEIVER

D Excellent 80-10 meter dual conversion superhet; 0.5 µv sensitivity on all bands. For SSB, AM, CW. Oscillators are temperature and voltage compensated; second osc. crystal controlled. Built-in 100-kc crystal calibrator; highly effective squelch circuit. Illuminated "S" meter—may be used as field-strength meter for transmitter tune-up. Less speaker and power supply. Size, 4x11¾x6½". Shpg. wt., 15 lbs.

84 SZ 917. NET. 224.50

ACCESSORIES FOR MORROW GEAR

RVP-250 Power Supply. For MBR-5 Receiver or low-voltage supply for MB-560-A. 6/12 v. DC input. 8x5x3¾". Wt., 15 lbs.

84 S 919. NET. 39.95

SH-7 Speaker and Case. For MBR-5. Metal case; hammertone enameled. Wt., 4 lbs.

84 S 920. NET. 11.50

RTS-600-S AC Power Supply and Speaker. Input, 110 v., 60 cycle AC; supplies power for receiver and transmitter. 5x7" speaker. Shpg. wt., 25 lbs.

94 SZ 849. NET. 107.50

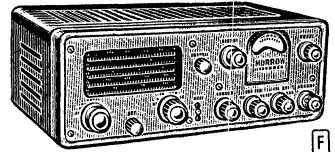

F

MORROW MOBILE EQUIPMENT



E

5BR-2 MOBILE CONVERTER

E Superior mobile converter for 80-75, 40, 20, 15, and 10 meters. Separate, individually-tuned coils on each band. Each band is spread over the full length of the slide-rule dial. Temperature compensated. 10 high-Q RF and mixer coils; 5 adjustable oscillator coils. Requires 200-225 volts DC at 20 ma and 6 or 12 volts for filaments. Steel case, 4x5½x7". Supplied complete with mounting bracket, shielded cable, plug. Shpg. wt., 10 lbs.

99 S 133. NET. 79.95

MB-560-A TRANSMITTER

F Highly popular, all-band, mobile transmitter. 90 watts input on CW; 60 watts input on AM phone. Covers 80-75, 40, 20, 15 and 10 meters. Pi-network output separately tuned in final stage. Built-in VFO. Special 2-section tuning capacitor allows bandspreading on 20, 15 and 10 meters. Completely TVI suppressed. Takes carbon, dynamic or crystal mike. All stages are gang-tuned. Relay switches antenna and mutes receiver during transmission. Requires 6 or 12 v. DC for filaments and 250 v. DC at 75 ma and 300-600 v. DC at 200 ma. 4½x11¾x7¼". Wt., 17 lbs.

84 SZ 918. NET. 214.50

JAMES POWER SUPPLIES

G Model C-1050 Mobile Supply. Dual-vibrator mobile power supply for both transmitter and receiver. Provides high and low transmitter voltages in addition to receiver "B" voltage. Adjustable tap provides any combination of three voltages from 150 to 450. Typical combination: Transmitter, 450 volts at 170 ma and 225 volts at 60 ma. Oversize filters assure hash-free receiver voltage. Includes receiver muting relay for automatic receiver control during transmitting periods. Tap allows connecting an external relay for switching antenna from transmitter to receiver. Has standard TV-type selenium rectifiers and standard 4-prong 6-volt vibrators. For 6 or 12 volts DC. 6½x10x6". Wt., 13 lbs.

80 S 156. NET. 48.95

83 SX 112. Above, in kit form. NET. 39.15

H New Model C-1470 Mobile-Fixed Supply. Heavy-duty power supply for mobile or fixed use. Powers both transmitter and receiver. Works from 12 v. DC, or 110-120 v., 50-60 cycle AC. May be used for AC operation of mobile equipment when car is parked convenient to power outlet. Delivers filtered receiver power of 200 or 250 v. at 100 ma. Transmitter voltages: 150 or 225 v. at 70 ma, simultaneously with 400 or 500 v. at 200 ma. 95 watts of DC power available. Uses TV-type selenium rectifiers for high efficiency (60-70%). Has control relay for receiver muting while transmitting. With vibrators, fuses, 12-v. adapter plug, AC cord and plug. 6½x10x6½". Shpg. wt., 17 lbs.

80 SX 159. NET. 68.55

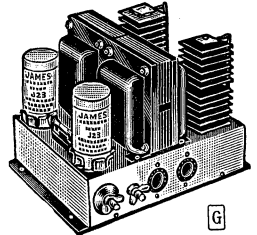

G

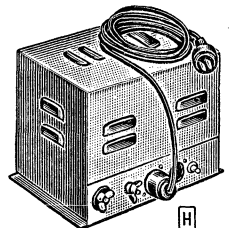

H

Selected Values In Amateur Equipment

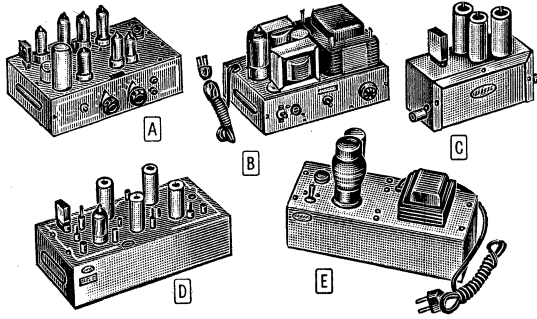

TECRAFT VHF EQUIPMENT

A TR-20/50 Transmitter. 20-25 watt transmitter for the 6-meter band. Uses 8-mc crystals in Pierce oscillator—eliminates tricky overtone circuits. No frequency multiplication in final stage—reduces radiated harmonics. Has 6AU6 oscillator, 5763 buffer-doubler, 6360 amplifier, 12AX7 speech, 2—6AQ5 modulators. Requires 6.3 v. @ 3.89 amp and 250 v. DC @ 1/4 amp. Matches 52 or 72-ohm coaxial lines. Size, 9 1/2 x 5 1/2 x 5 1/2". With crystal. Shpg. wt., 5 lbs.
83 S 856. NET.....**59.95**

TR-20/144 Transmitter. Same as above, but for 2 meters—has additional 5763 buffer-multiplier.
83 S 854. NET.....**59.95**

PT R-2 Power Supply. For above transmitters, and also the TFC converters. Delivers continuous 6.3 volts @ 6 amps, 6.3 volts @ 4 amps, and 250 volts DC @ 1/4 amp. Has send-receive switch for disabling transmitter or receiver at appropriate times. Size, 5 1/4 x 9 1/2 x 6". For 110-120 v., 60 cycle AC. Shpg. wt., 17 lbs.
83 S 855. NET.....**39.95**

C M-6 6-Meter Converter. The "Mini-Verter" for 6 meters. A natural for mobile use. Chassis is only 2 1/4 x 5 x 2 1/4", excluding tubes and crystal. Uses wide-band circuit to achieve 1-mc. coverage of the 6-meter band. Tune broadcast receiver from 550 kc to 1550 kc to cover 50-51 mc. Crystal-controlled oscillator provides extreme stability. Requires 6.3 v. @ 3/4 amp and 100 v. DC @ 8 ma. Shpg. wt., 3 lbs.
83 S 852. NET.....**25.95**

CC-5-144 2-Meter Converter. 2-meter cascode converter. Provides 30 db gain sensitivity: 1 μ v for 6 db SNR. Noise figure: 4 db. Has 6-mc passband, 6 db points; may be peaked to favor any portion of band. Has 6BZ7 RF amp, 2—6CB6, and 2—6J6. IF output frequency: 14-18 mc, crystal controlled. Requires 6.3 v. @ 2.4 amps and 150-250 v. DC @ 43 ma maximum. Can be used in any position. 14-18 mc. output. With tubes and crystal. Size, less tubes: 9 1/2 x 3 x 4 1/2". Wt., 3 1/2 lbs.
83 S 850. NET.....**42.50**

CC-1-144. As above, but Deluxe model with 36 db gain.
83 S 857. NET.....**44.95**

CC-5-50 6-Meter Converter. As above, but 6 meters. (50-54 mc).
83 S 851. NET.....**42.50**

CC-50. As above, but 6-meter Deluxe model with 36 db gain.
83 S 858. NET.....**44.95**

P-1 Power Supply. For Tecraft converters above. Provides plate and filament power. Delivers 6.3 v. AC @ 3 amps and 200 v. DC @ 50 ma. Size, 5 1/2 x 9 1/2 x 5 1/2". For operation from 110-120 v., 50-60 cycle AC. Shpg. wt., 6 lbs.
83 S 853. NET.....**17.95**

TMC GPR-90 RECEIVER

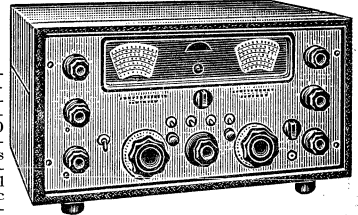

A precision-built communications receiver designed for the most discriminating user. Continuously tunable from 540 kc to 31 mc in six accurately-calibrated bands with full electrical bandwidth. Employs dual conversion above 5.4 mc for improved image rejection of better than 60 db. Sensitivity: less than 5 μ v from 540 kc to 1500 kc; extremely high sensitivity of 1 μ v on higher bands at 10 db. S/N ratio. Exceptional selectivity—variable in 6 steps from 250 cps to 5 kc. Includes accurate 100-kc crystal calibrator. Uses front-end grounded-grid RF amplifier above 3.3 mc for improved image rejection and S/N ratio.

Tube complement: 6AB4 RF amplifier, 6CB6 RF amplifier, 6AU6 1st converter, 6AU6 HFO, 6BE6 2nd converter/HFO, 4—6BA6 IF amplifiers, 6AL5 detector/noise limiter, 6AG5 BFO, 12AX7 AVC/audio amplifier, 6V6 audio output, 6CB6 calibrator; 5U4G rectifier and OA2 VR.

Includes highly effective ANL; calibrated "S" meter; antenna trimmer; crystal phasing; dial locks. Fast-acting AVC keeps output constant even with severe fading of the input signal. Features a variable bandwidth audio filter; power take-off socket for accessories; input for emergency power; utility AC outlet; audio input for SSB and IF output for SSB filter; phono input jack with phono off-on switch. 2 watts audio output. Output impedances: 4, 8, 16, and 600 ohms. Size, 10x20x15". Less speaker. For 105-125 v., 50-60 cycle AC. Shpg. wt., 63 lbs.
94 S2 895. NET.....**495.00**

Matching Speaker. For GPR-90 receiver. Shpg. wt., 11 lbs.
83 SX 891. NET.....**16.50**

NEW HAMMARLUND HC-10 CONVERTER

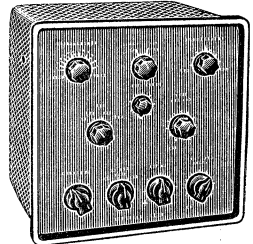

Unique converter provides dual conversion operation for increased selectivity and higher gain with any superhet having an IF between 450 and 500 Kc. Basically an IF and audio system with all the electrical and mechanical aids for the ultimate in SSB/CW and AM/MCW operation. Compact and completely self-contained—all connections are plug-in type except speaker. Choice of either one or both sidebands simultaneously. 60-Kc IF has 3 positions of selectivity from 1 to 3 kc on either sideband; 4 positions from .5 to 6 kc on both sidebands. Has bifilar T-trap slot filter with 60 db suppression of co-channel interference. Vernier passband tuning, \pm 3 kc. Combination noise limiter and squelch control. Linear product detector for CW and SSB reception. BFO has linear range of \pm 2 kc. Fast-attack, 3-speed delayed AVC circuit. Manual volume control. AC power take-off for receiver. 9 tubes plus rectifier. Less speaker. Size, 9 1/2 x 9 1/2 x 7 1/2". For operation from 105-125 v., 50-60 cycle AC. Shpg. wt., 17 lbs.
94 SX 823. NET.....**149.00**

Additional Hammarlund equipment listed on page 267.

AMATEUR ACCESSORIES

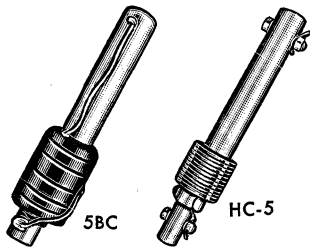

GENERAL CRYSTAL ALL-BAND ANTENNAS AND COILS

All-band loading coils and antennas. Permit operation on 80 through 10 meters with one 109-ft. dipole and untuned feeder. SWR is 3:1 or better when operated within 100 kc of resonance. Peaked for either CW or phone bands as indicated below. *Transmitter input.

Coil Sets. Complete with instructions.

Stock No.	Type	Application	Wt.	Per Pr.
83 S 888	5BC-F	*1/4 kw phone	2 lbs.	12.50
83 S 889	5BC-C	*1 kw CW	2 lbs.	12.50
83 S 886	HC-5F	*1 kw phone	3 lbs.	19.95

Complete Antennas. Wired and tested. Include copeland wire, all insulators, coil set, 88-ft. 72-ohm twin lead. Overall length of dipole, 111 ft. Peaked for phone bands.
Type 5BA-F, 1/4 kw input. Wt., 10 lbs. **27.50**
92 C 233. NET.....
Type HA-5F, 1 kw input. Wt., 11 lbs. **33.95**
92 C 226. NET.....

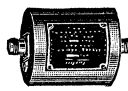

M. C. JONES MICROMATCH COUPLER AND INDICATOR

Model 261.1 Antenna Coupler. For use with Model 262 indicator for measuring RF power and VSWR. Rated for 1 kw at 1:1 VSWR. 52-ohm, coaxial UHF type connectors. Range: 5-220 mc. Loss: less than 0.1 db power loss. Size, 3x4 3/4". Shpg. wt., 1 lb.
99 S 117. NET.....**22.50**

Model 262 Indicator. Measures relative power, forward or reflected; 0-10-100-1000 watts. 4 1/4 x 9 1/2 x 4 9/16". Shpg. wt., 2 lbs.
99 S 118. NET.....**14.50**

LAKESHORE TONEMASTER

Completely self-contained, self-powered audio sine wave generator—ideal for making the two-tone test in SSB transmission. Completely portable—uses a tiny P-N-P type transistor and two penlight batteries. Off-On/Output control. Max. output, over 1 v. rms. Less batteries. 4 1/2 x 2 1/2 x 2 1/2". Shpg. wt., 2 lbs.
83 S 861. NET.....**12.95**

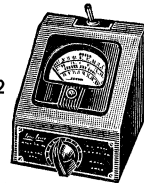

MOSLEY 3-BAND "TRAP-MASTER"

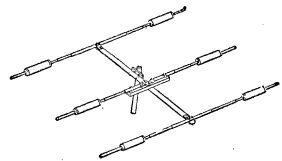

Model TA-33. Precision-tuned and matched three-element, rotary beam array. Provides outstanding performance on 10, 15, and 20-meter Amateur bands—without switching! Weighs only 40 lbs., assembled. Rated for 1 kw phone transmitter input power. Has up to 8 decibels forward gain with 25 decibels front-to-back ratio at 1.5:1 SWR.

Exclusive Mosley trap design provides exceptional stability and power-handling capacity. Resonant circuits of traps are enclosed in oversize aluminum element sections. Weather and dirt-proof. Streamlined design offers minimum wind resistance. Tuned for broadband response characteristics—gives excellent results over full bandwidth. For use with Type RG-8/U coaxial cable.

Double thickness aluminum element center sections. One-piece, 1 1/2-inch diameter, 14-foot aluminum boom. No bracing required. Maximum element length, 28 feet. Turning radius, 15 1/2 feet. Supplied complete with all necessary mounting hardware and instructions, ready for assembly. Heavy-duty, universal mast mounting plate fits masts with up to 1 1/2 inches outside diameter. Shpg. wt., 53 lbs.
92 S2 360. NET.....**99.75**

Amateur Antennas and Accessories

JOHNSON VIKING "MATCHSTICK" ANTENNA

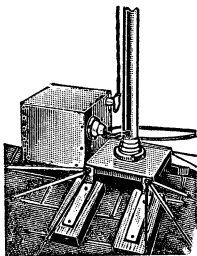

New, vertical antenna for 80-75, 40, 20, 15 and 11-10 meters. Features motor-driven, remote-controlled switch for matching antenna length to band selected. Vertical radiator is 35 feet long; made of durable, hard-tempered, 2" dia. aluminum. Accurately pre-adjusted at factory. Low SWR on all bands—less than 2 to 1. Impedance is 52 ohms. For transmitter inputs up to 1 kw. With base, base insulator, matching unit, control cable and nylon guy ropes. Less control cable and radials. Control box size, 3 1/2 x 3 3/4 x 3 3/4". For 110-120 volts, 60 cycles AC. Shpg. wt., 47 lbs.

92 SZ 234, NET.....129.50

Control Cable For "Matchstick". Connects to terminal strip provided on rear of control box. Belden #8742. Wt., 3 1/2 lbs. per 100'. 48 W 892. PER FT. 5¢ PER 100 FT...3.82

"E-Z WAY" TILT-OVER TOWER

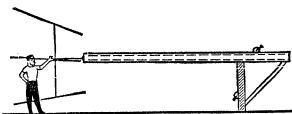

Model GPRBS 50-60. Here's a tower that really goes up to snag the DX, but which can be cranked down and laid over on its side for work on the antenna. Made of cylindrical steel rod and structural pipe to give the greatest strength. Height, 65 ft. Mounts in a single, 5-ft. deep hole without concrete. Requires no guy wires. Will support a 3-element 20-meter "Minibeam" or a 2-element 40-meter "Minibeam" in winds up to 50 miles per hour. Tower is electrically welded and galvanized to insure resistance to corrosion. Tower locks into position at any height up to maximum of 65 ft. Provision for installing rotator; specify type of rotator to be used, and the proper mount will be supplied. Furnished complete with ground post, crank-up mechanism for raising or lowering tower, mast and full instructions. Shpg. wt., 480 lbs.

92 SZ 246, NET.....260.00

NOTE: Shipped F.O.B. Tampa, Florida, or Chicago, whichever is nearer. E-Z Way tower is also available under Allied's Easy Payment Plan. On cash orders, please send full remittance—no C.O.D. shipments. Allied can supply E-Z Way towers in other sizes, including the largest tower, 120 feet in height. Write for further information and literature concerning these models.

CD AMATEUR ROTATORS

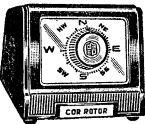
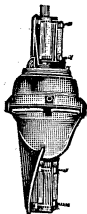

Brand-new, heavy-duty rotator with control unit designed for exacting Amateur applications. Solenoid-operated electric brake locks rotator in any position. Takes wind or racking load from gear train or motor when rotator is at rest. Rotator delivers 360 inch-pounds torque. For masts from 3/4" to 2" O.D. For control cable (listed below) see page 181. For 110 v., 60 cycle AC. Shpg. wt., 23 lbs.

Model HAM-A. Stops at pre-set direction. Use Belden #8447 cable. 92 SX 356, NET.....97.51

Model HAM-M—Meter Type. Control button is depressed until setting is correct. Use Belden #8448 cable or equivalent. 92 SX 357, NET.....97.51

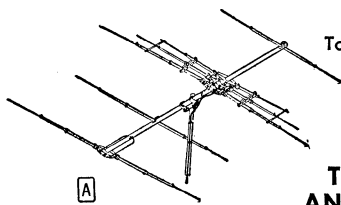

A New Telrex Model TB-2E-10-15-20 "Tri-Band". 2-element, wide-spaced antenna featuring single transmission line and excellent operation on 10, 15 and 20 meters without switching. Front-to-back ratio is 19 db, or better, on each band. Standing wave ratio is 1.2 to one, or better, on each band. Factory precision tuned and adjusted for direct 52 ohm coaxial feed or through a 1/1 broadband "balun". Will handle at least 2.5 kw on all bands; 1.2 kw when used with "balun". Longest element length, 32' 10". Boom is 2" in diameter and 16 ft. long. Turning radius is 18 ft. Equipped with heavy-duty gusset mounting plate for mounting 2" O.D. mast support. Ruggedly built of heavy-gauge aluminum and steel; designed to withstand winds of hurricane velocity. Shpg. wt., 50 lbs.

92 SZ 358, NET.....158.00

B Series 56 Rotaries. New, precision-tuned and matched arrays; designed to meet rigid commercial specifications, but priced for the Amateur. Series 56 units all include stainless steel fastenings; taper-swaged elements insulated from the boom by molded phenolic brackets; hairpin-resonated and coaxial-balun-matched arrays for superb performance. Highest gain per element and best signal-to-noise and signal-to-interference ratios ever achieved in a unit of this kind for Amateur communications. With extra-heavy gusset plate mounting for easy attachment to 2" O.D. mast. Pre-tuned, matched, and ready to assemble.

Model 15M56-67 2-Element—15 Meters. "Deluxe Super Minibeam". 4.8 db gain over tuned half-wave dipole; 14 db front-to-back ratio. Boom length, 6' 10"; longest element length, 18' 9". Shpg. wt., 22 lbs.

92 SZ 270, NET.....80.00

Model 20M56-79 2-Element—20 Meters. "Super Mini-Beam". 4.8 db gain over tuned half-wave dipole; 14 db front-to-back ratio. Boom length, 10'; longest element length, 29'. Shpg. wt., 26 lbs.

92 SZ 271, NET.....89.00

Model 20M56-112 3-Element—20 Meters. Deluxe medium-spaced array. 8.7 db gain over half-wave tuned dipole; 24 db front-to-back ratio. Boom length, 18'; longest element, 32' 8". Shpg. wt., 43 lbs.

92 SZ 272, NET.....130.00

Rugged,
Top-Performing
Units

TELREX ANTENNAS

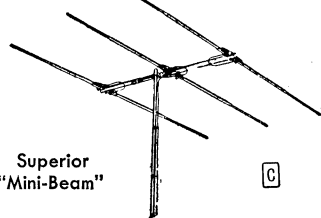
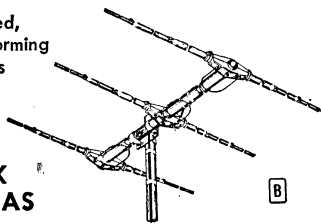

C Model 1030-S 3-Element—10 Meters. High efficiency, "Super Mini-Beam". Ideal for installations where space is restricted. 7.5 db gain over tuned half-wave dipole; 21 db front-to-back ratio. Boom length, 9'; longest element length, 13' 7". Wt., 9 lbs.

92 SZ 251, NET.....36.50

Model 2M3C 3-Element—2 Meters. 9.4 db gain over tuned half-wave dipole; 18 db front-to-back ratio. Boom length, 34"; length of longest element, 3' 6". Will mount on 1" or 1 1/2" O.D. mast. Shpg. wt., 2 1/4 lbs.

92 SZ 219, NET.....5.95

Model 2M6C 6-Element—2 Meters. Optimum-spaced 12.7 db gain over tuned half-wave dipole. Front-to-back ratio, 22 db. Boom length, 8' 6"; length of longest element, 3' 6". Shpg. wt., 4 lbs.

92 SZ 273, NET.....12.50

Model 6M3D 3-Element—6 Meters. Optimum-spaced 8.8 db gain over tuned half-wave dipole antenna; front-to-back ratio, 26 db. Boom length, 6'. Longest element, 8' 8". Shpg. wt., 7 lbs.

92 SZ 250, NET.....16.25

Model 6M6C 6-Element—6 Meters. 12.7 db gain over half-wave dipole; 22 db front-to-back ratio. Boom length, 23' 4"; longest element, 8' 8". Shpg. wt., 20 lbs.

92 SZ 252, NET.....57.50

TELREX R100S ROTATOR AND DIRECTION-CONTROL SYSTEM

One of the finest medium-duty rotators available for Amateur use. Powered by two reversible shaded-pole motors, spur-gear driven to provide high torque. Rotates up to 3 bays of 3-element "Super-Minibeams" on one mast. Heavy-duty gearing eliminates possibility of gear damage. For 110-120 v., 60 cycle AC. Size, 12 3/4 x 4 1/4 x 5". Less connecting cable (see below). Shpg. wt., 11 lbs.

92 SX 274, NET.....99.75

Belden Type 8453 Power Cable. For use with above rotator. Shpg. wt., 3 1/4 lbs. per 100'

47 T 420, NET PER 100-ft. Spool.....5.39

Direction-Control Indicator Box. Consists of selsyn drive, mounting plate, terminal board, and color-compass indicator box containing control switch, transformer and mating selsyn. Less cable (see below). Shpg. wt., 7 1/2 lbs.

92 S 359, NET.....59.00

8-Conductor Control Cable. 22-gauge conductors, for up to 100 ft. between units. Shpg. wt., 3 1/2 lbs. per 100'

47 T 586, NET PER 100-ft. Spool.....4.73

4-Conductor Cable. 20-gauge conductors; use doubled for greater than 100-ft. distances between units. Shpg. wt., 2 3/4 lbs. per 100'

97 T 365, NET PER 100-ft. Spool.....2.70

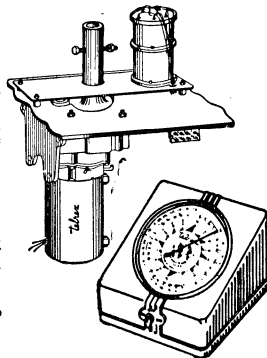

Has Two Reversible
Shaded Pole Motors

AMPHENOL FOLDED DIPOLES

Folded-dipole antenna kits for transmitting and receiving on individual bands. Precisely cut to provide top performance on the four most popular Amateur bands. Excellent broadband characteristics. Antenna sections use high-strength, weather-resistant 300-ohm twin-line with copper-clad steel conductors. May be cut to match short-wave, FM or other bands. Supplied with T-block assembly and 75 feet of standard 300-ohm twin-line for use as feeder.

No.	Type	Band	Feet	Wt., Lbs.	EACH
98 S 318	139-010	10	18	2	5.24
98 S 319	139-020	20 or 15	35	3	5.88
98 S 320	139-040	25-40	70	4	7.64
98 S 321	139-080	80	135	5	11.02

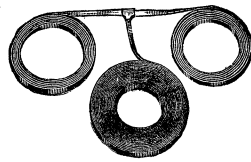

Mobile Antennas & Conelrad Equipment

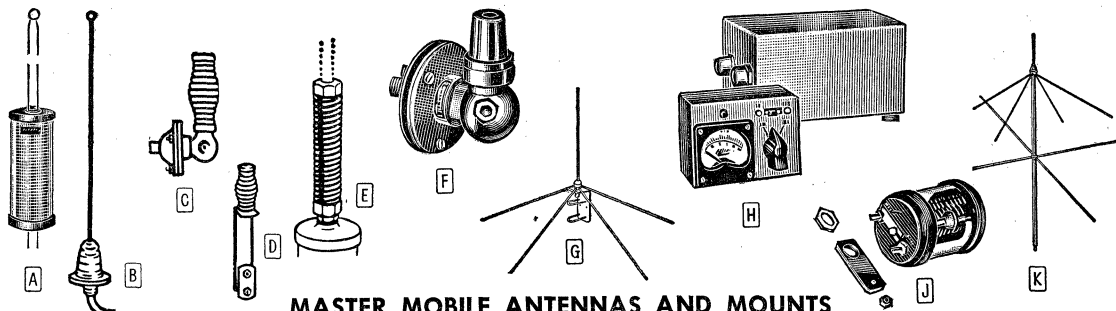

MASTER MOBILE ANTENNAS AND MOUNTS

A 88-60 MOBILE ANTENNA. High-gain whip antenna supplied in two sections to permit all-band operation; comes apart to allow insertion of Ultra-Hi-Q 80, 40 or 20 meter loading coil or "All Bander" 666 coil. Serves as a 10-meter antenna when used without coils. Has 3/8" threaded stud to fit mounts listed below. Length, 108". Supplied less mount and coils. Shpg. wt., 6 lbs.
98 SX 359, NET..... 9.70

ULTRA-HI-"Q" ANTENNA COILS. Newly developed coils for use with mobile antennas. Feature extremely high "Q"—measured by manufacturer at well over 515! Windings are air-spaced. Weather-sealed. Shpg. wt., 1 lb.
80 METER COIL, 2 1/2 x 8". 5.14
92 S 352, NET..... 5.14
40 METER COIL, 2 1/2 x 5". 5.14
92 S 353, NET..... 5.14
20 METER COIL, 2 1/2 x 3". 5.14
92 S 354, NET..... 5.14

"ALL BANDER" 666 COIL, Hi-"Q" variable antenna coil; tunes from 10 to 75 meters. May be used with Master Mobile 88-60 listed above, or other mobile antennas. Size, 1 3/4 x 2 3/4". Shpg. wt., 1 1/2 lbs.
97 S 167, NET..... 14.65

B 97 SX 148, 113 VHF ROOF-TOP ANTENNA. For 140-165 mc. Mounts in 3/8" hole. 10' coax cable. 1 lb. NET..... 3.88

92 SX 355, 613 VHF ROOF-TOP ANTENNA. As above, but deluxe model with positive-lock coax connector. NET..... 4.85

97 SX 149, 114 COAXIAL ANTENNA. For 140-165 mc. 10' coax cable. 5 lbs. NET..... 9.75

97 SZ 155, 100-965 96" WHIP ANTENNA. Stainless steel. 3/8" threaded stud. Less mount. Shpg. wt., 2 lbs. NET..... 5.14

97 SX 166, 100-60S 60" WHIP. As above, but 60" long. Shpg. wt., 2 lbs. NET..... 4.85

97 SX 154, 92 18" WHIP EXTENSION, 3/8" threaded stud on one end and collet at other. Shpg. wt., 1 lb. NET..... 3.43

98 SZ 302, 9-96T LOW-COST 96" WHIP. Cadmium-plated. 3/8" threaded stud. Less mount. Shpg. wt., 3 lbs. NET..... 3.67

92 S 223, MODEL 10-H "TENAHOLD". Ties down end of whip to clear garage roofs, etc. Fastens to car gutter. Wt., 3 oz. NET..... 98¢

BODY AND BUMPER MOUNTS. For antennas with 3/8" threaded stud. Choice of 7 models (below and above right). Av. shpg. wt., 3 lbs.

C 97 S 151, MODEL 232C. Double-taper spring swivel-base body mount; with coax fitting. NET..... 8.57

97 S 157, MODEL 232XC. Heavy-duty version of 232C. NET..... 9.65

98 S 304, MODEL 232 XSSC. Heavy-duty stainless steel version of 232C. NET..... 14.65

98 S 300, MODEL 132JC. Economy version of 232C. NET..... 5.07

D 98 S 301, MODEL 140J. Economy bumper mount. NET..... 4.09

97 S 160, MODEL 140X. Heavy-duty bumper mount. NET..... 7.79

E 92 S 224, MODEL 321 SWIVEL-BASE BODY MOUNT. Same as 232C, below left, but less spring. NET..... 7.79

E 92 S 222, "MASTER-FLEX-R". Strain-relief spring. Mounts above coil; supports top of whip. 4 1/2 x 7/8". Shpg. wt., 1 lb. NET..... 1.91

G 98 SX 356, MODEL GP-4 "GROUND PLANE". 2-meter antenna. 4 droop-type radials. Impedance, 52 ohms. Coax cable connector. Shpg. wt., 1 lb. NET..... 5.83

H MODEL 2495-6 "MASTER-MATCH-ER". Remote tuner for any mobile, loaded whip from 160-10 meters. Dashboard control of inductance for peaking antenna to any frequency in an Amateur band. Field strength meter on dash unit. Inductor box, 6 1/4 x 4 1/4 x 4 1/4". Dash unit 4 1/2 x 3 1/4 x 2 3/4". For 6 v. DC. Shpg. wt., 2 lbs.
92 S 220, NET..... 24.45

MODEL 2495-12. As above, but for 12v. DC.
92 S 221, NET..... 24.45

J MODEL 825 MICRO-Z-MATCH. A micrometer matching inductor for matching any coaxial cable to any mobile antenna. Mounts on standard coax fitting (Requires 83-1T "T" adapter). Permits adjustment to minimum SWR. 4 microhenries inductance; silver-plated coil and roller contacts. With coax adapter. Shpg. wt., 2 lbs.
92 S 225, NET..... 7.79

K MODEL 300 "MASTER PLANE". A highly effective 2-meter antenna. Features 4 drooping and 4 straight radials for low-angle of radiation. With 3-ft. mast and coax connector. Impedance, 52 ohms. Shpg. wt., 3 lbs.
98 SX 357, NET..... 12.69

JOHNSON "WHILOAD 6" COIL

MODEL 250-26. Bandswitching loading coil for 10-meter mobile whip antennas. Provides operation on 10-meters through 75-meter bands. Calibrated dial scale makes it easy to set coil accurately. Designed for high "Q". Permanently protected against damage and weathering by sturdy Fiberglass housing. Shpg. wt. 3 lbs.
98 S 396, NET..... 16.95

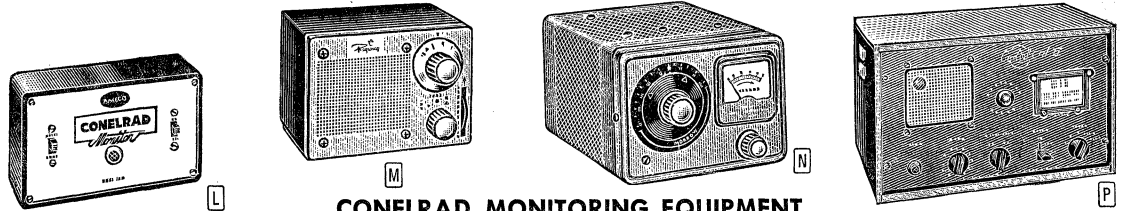

CONELRAD MONITORING EQUIPMENT

L Ameco Model CD-1. New, low-cost Conelrad. Converts any completely self-contained single 12AU7 dual-triode functions as trigger tube and tone generator. Broadcast station carrier removes AVC from trigger-tube causing tone generator to produce constant-frequency audio note as alarm signal. No broadcast signal is heard during monitoring periods. Function switch on front panel mutes radio for monitoring or allows normal operation for broadcast listening. Has separate On-Off switch. Quickly installed—simply solder leads of connecting cable (supplied) to AVC, 1st audio grid and B+ (requires 150 v. at 1 ma). Built-in filament transformer supplies 6.3 volts to 12AU7. Easily modified for mobile use. Housed in attractive copper and black case. With tube, cable, instructions. Size, 6 1/4 x 3 3/4 x 2". For 110-120 v., 50-60 cycle AC. Shpg. wt., 2 1/2 lbs.
94 S 888, NET..... 14.95

M Regency Model CD-2 Transistorized Conelrad Monitor. A new, completely self-contained monitor and broadcast receiver. Ideal for fixed, portable or mobile use. Powered by only two batteries, the three-transistor TRF circuit provides over 500 hours of operation in the "C-D" monitoring position. Has built-in ferrite loopstick for use in strong signal areas, antenna jack for use with external antenna. Regeneration adjustable for maximum sensitivity. Off/Radio/C/D switch selects desired function. Built-in 3" PM speaker is muted in "C-D" position; audio note is produced only when broadcast carrier is interrupted. Gray-wrinkle aluminum case, bright aluminum front panel. Less batteries; requires 1 of each type listed below. 4 3/4 x 3 1/4 x 4 1/4". Shpg. wt., 2 1/2 lbs.
99 S 174, NET..... 29.50
53 J 031, Burgess Z cell, 3 oz. NET..... .09
80 J 684, Burgess 2N6, 5 oz. NET..... 1.30

N Morrow Model CM-1 Conelrad Monitor. New, high-performance monitor. Designed for rugged, four-tube, sensitive 4-tube superhetrodyne broadcast band receiver not required—sensitive 4-tube superhetrodyne circuit provides both visual and audible alarm indications; covers 550-1700 kc. Unit qualifies for Commercial applications through use of built-in DC amplifier and relay circuit for external alarm (tube and relay not supplied). S-meter permits visual monitoring with audio gain turned down; built-in 4" PM speaker provides audible signal. Has range of up to 200 miles with antenna supplied. Calibrated dial indicates Conelrad frequencies. Gray-hammerloid metal cabinet. 5 7/8 x 4 1/2 x 8". For 110-120 v., 50-60 cycle AC. Shpg. wt., 6 1/4 lbs.
94 S 845, NET..... 39.50

Relay for Above. Potter-Brumfield Type SM5LS. SPDT. Wt., 5 oz.
75 P 949, NET..... 7.00

P Kaar Model 117R905 Conelrad Monitor. The new, Conelrad II is a precision engineer superhetrodyne receiver designed for 24-hour automatic monitoring. For radio stations, hospitals, industry—wherever continuous operation is important. Monitors any one of 5 pre-set channels including 640 and 1240 kc. Loss of broadcast carrier automatically lights red indicator lamp, connects 5" PM speaker for listening to Conelrad messages and activates external alarm system. Features: Fail-safe circuit activates alarm for immediate attention if major component or tube fails; separate inputs for high-and low-Z antennas; audible and visual monitoring. **Alarm Sensitivity:** 5 microvolts. **Selectivity:** 6 db down at +3 kc; 40 db down at +1 kc. **Output:** 2 watts. **Controls:** Off-On Volume; External Alarm Off-On; Monitor Aural Silent-Rest; Channel Selector. 7 tubes plus rectifier. Metal cabinet. 15x9x10 1/2". Less external alarm. For 110-120 v., 50-60 cycle AC. Shpg. wt., 2 1/2 lbs.
94 SZ 890, NET..... 140.00

SELECTION OF QUALITY CRYSTALS

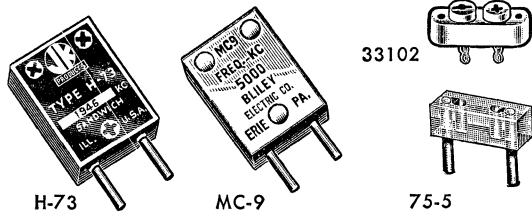

JAMES KNIGHTS "STABILIZED CRYSTALS"

Unaffected by moisture, dust particles, vibrations. X-ray oriented, optically lapped and stabilized to insure high activity. Wt., 3 oz.

- TYPE H-73 AMATEUR CRYSTALS.** Pressure-mounted. Pin spacing, .486" (approx. 1/2"). Pin diameter, .093". In black phenolic holder. Only 1 1/2 x 3/16 x 1/16". Specify frequency. Supplied ±5 kc (except *±30 kc) of frequency specified. Tolerance, ±.03%.
- 99 SS 253. 1.8 to 2.0 mc.....
 - 99 SS 266. 3.5 to 4.0 mc.....
 - 99 SS 254. 6.25 to 6.8 mc (for mult. to 6 or 11 meters).....
 - 99 SS 267. 7.0 to 7.5 mc.....
 - 99 SS 259. 8.0 to 8.222 mc (for multiplication to 2 meters).....
 - 99 SS 296. 8.34 to 9.0 mc (for multiplication to 6 meters).....
 - 99 SS 255. 13.48 to 13.615 mc (for mult. to 11 meters)*.....
 - 99 SS 268. 14.0 to 14.8 mc*.....

EACH

2.95

TYPE H-73 NOVICE CRYSTALS. Specify frequency. ±5 kc.

- 99 SS 294. 80 meters. 3.7 to 3.75 mc.....
- 99 SS 295. 40 meters. 7.15 to 7.2 mc.....

EACH

2.95

TYPE H-73 CRYSTALS—EXACT FREQUENCY. As above, but cut to exact frequency specified. From 1.8 to 2 mc only. Available on special order only. Allow 30 days for delivery. Specify frequency.

99 S 257. NET..... 4.80

H-73 AMATEUR CRYSTALS. Pin spacing, .486". Pin diameter, .050". 3/4 x 3/4 x 1/4". For oscillators with low crystal current. Special order only—allow 30 days for delivery. Specify frequency.

99 S 263. 21 to 40 mc. (Supplied ±15 kc.). NET..... 4.95

99 S 264. Over 40 to 54 mc. (Supplied ±25 kc.). NET..... 5.95

TYPE H-93 FREQUENCY-STANDARD CRYSTALS. 2" by 1 1/8" dia. Tolerance, ±.005%. Spacing, .486". Pin diameter, .093". Wire-mounted, silver-plated crystal.

99 S 284. 100 kc..... NET

99 S 287. 1000 kc..... EACH.... 6.95

TYPE H-7 AIRCRAFT CRYSTAL. 3023.5 kc, ±.005%. Pin spacing, .486". Pin diameter, .093". Size: 1 1/8 x 3/16 x 7/16".

99 S 289. NET..... 4.95

TYPE H-17L TV ALIGNMENT CRYSTAL. 4.5 mc, ±.005%. Pin spacing, .486". diameter, .093". Size: 3/4 x 2 3/32 x 9/16".

99 S 286. NET..... 4.80

TYPE H-17L RADIO CONTROL CRYSTAL. 3rd overtone type. 27.255 mc, ±.03%. Construction similar to H-17L above.

99 S 258. NET..... 4.95

BLILEY SPECIALIZED SERVICE CRYSTALS

TYPE MC-9 ALIGNMENT CRYSTALS. For use as marker in sweep generators or for calibration purposes. Phenolic holder, 1 1/4 x 3/16 x 1/16". Tolerance, ±.02%. Pin spacing, .486" (1/2"); diameter, .093". Pressure-mounted crystal; acid-etched. Shpg. wt., 3 oz.

99 S 143. 5.0 mc..... NET

99 S 145. 10.7 mc..... EACH.... 3.95

TYPE MC-7 SHIP-TO-SHORE CRYSTALS. Available from 2.0 to 3.5 mc. Tolerance, ±.02% from 0° to 50° C. Holder measures 1 3/4 x 1 1/8 x 2 1/32". Pin spacing is .750" (3/4"). Pin diameter is .125" (1/8"). Specify frequency or location of shore station. Available on special order only. Allow 30 days for delivery. Shpg. wt., 3 oz.

99 S 165. NET..... 7.50

MILLEN CRYSTAL SOCKETS & MOSLEY ADAPTERS

TYPE 33102 SOCKET. Low-loss steatite socket for crystal holders with .486"-spaced pins of .093" diameter. Phosphor-bronze contacts. Tinned lugs. 2-screw mounting. Shpg. wt., 2 oz.

72 H 035. NET..... 36c

TYPE 33302 SOCKET. Same as above, but for .050" dia. pins.

72 H 075. NET..... 24c

TYPE 33002 SOCKET. Same as 33102, but for holders with 3/4" pin spacing and .125" pin diameter. Shpg. wt., 2 oz.

72 H 029. NET..... 36c

TYPE 75-5 ADAPTER. Adapts 3/4"-spaced holders to .486" sockets. Polystyrene base with phosphor-bronze contacts. Wt., 2 oz.

72 C 707. NET..... 35c

TYPE 5-75 ADAPTER. Adapts .486"-spaced holders to 3/4" sockets.

72 C 708. NET..... 35c

QUALITY FREQUENCY METERS

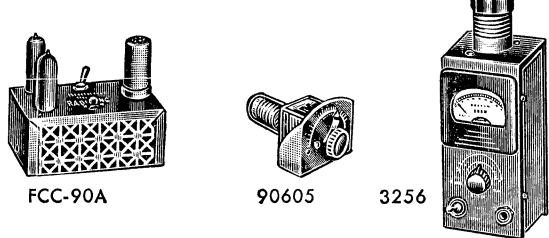

BUD FCC-90A FREQUENCY CALIBRATOR. Quickly establishes band edges when used with communications receiver. Consists of 100-kc crystal oscillator and trimmer condensers. With built-in power supply. Produces 100-kc signals across all Amateur bands through 30 mc. No extra wiring is necessary. Output lead attaches to antenna post of receiver. With on-off switch, standby switch, 50C5 tube and 35W4 rectifier. Includes 100-kc crystal. For 105-125 volts. AC or DC. 5 1/4 x 3 x 2 1/4". Shpg. wt., 2 lbs.

73 S 043. NET..... 19.11

MILLEN ABSORPTION FREQUENCY METERS. Indicate frequency, harmonics, parasitics, etc. Can be easily "poked" into small corners. 2 3/8 x 1 7/8 x 4". Shpg. wt., 10 oz.

Stock No.	Mfr's Type	Range, Mc.	EACH
72 S 142	90605	3-10	7.50
72 S 143	90606	9-23	
72 S 144	90607	23-60	
72 S 145	90608	50-140	

TRIPLETT 3256 ABSORPTION FREQUENCY METER. Bandswitching—covers 80, 40, 20, 15 and 10 meters. Checks fundamental frequency of oscillating circuits, parasitic oscillations, harmonics, neutralization, standing wave ratio, spurious RF, and AM modulation. Germanium crystal and DC milliammeter. Direct panel calibration. Gray enamel finish. Case, 7 1/2 x 2 1/2 x 2 1/4". Shpg. wt., 1 lb.

66 F 005. NET..... 19.11

STATION ACCESSORIES

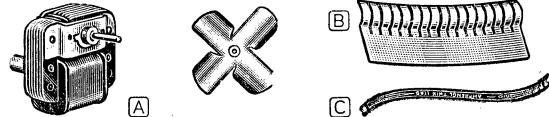

A TUBE COOLING MOTOR AND FAN. Extends tube life by keeping envelope and seals cool. Permits more complete shielding of RF amplifiers, etc., without depending on convection cooling. Shaded-pole induction motor, 2400 rpm. 2 1/8 x 2 1/8 x 2 1/8". 4-blade fan, dia., 2 1/2". For operation from 110-120 volts, 50-60 cycle AC. Shpg. wt., 1 1/4 lb.

72 P 715. NET..... 2.99

B EIMAC CONTACT FINGER STOCK. Silver-plated alloy stripping. Has excellent electrical contact—prevents RF leakage from doors on equipment cabinets. Secured either mechanically or by soldering. Shpg. wt., 12 oz.

42 P 086. 3' long; 1 7/32" wide. NET..... 4.95

42 P 087. 3' long; 3 1/32" wide. NET..... 5.40

42 P 088. 3' long; 1 1/16" wide. NET..... 6.00

C AMPHENOL TYPE 214-076 TRANSMITTING TWIN-LINE. 300-ohm air-core tubular, 7/26 copper conductors. Rated 1 kw RF. Shpg. wt., 100 ft., 3 1/2 lbs. 100 ft. minimum.

49 T 416. 100-ft. coil. NET..... 6.23

49 W 409. Over 100 ft. Per 100 ft..... 6.23

AMPHENOL 214-023 TRANSMITTING TWIN-LINE. 75 ohm. Handles up to 1 kw RF power. Propagation factor, 71%. Attenuation: 1.40 db per 100 ft. at 28 mc. Shpg. wt., 100 ft., 4 lbs.

49 W 495. NET PER FOOT..... 7c

PENNWOOD 24-HOUR STATION CLOCK

MODEL 100-J-24 1/4. Numeral type, 24-hour station clock. Ideal for Amateur stations, commercial stations, or short wave listeners—wherever 24-hour time is preferred. Clearly shows exact time at a glance—reduces chance of error in time calculations. Separate numerals for hours, minutes and seconds—scale for seconds calibrated in 5-second intervals. Employs a self-starting synchronous motor. Housed in handsome ivory plastic case. Size, 4 x 7 3/4 x 4". For 110-120 v., 60 cycle AC. Shpg. wt., 4 lbs.

78 B 341. NET (Including excise tax)..... 15.84

MODEL 100-J-24H 1/4. As above, but ebony plastic case.

78 B 340. NET (Including excise tax)..... 14.85

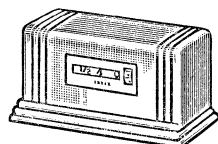

Amateur Keys and Equipment

JOHNSON SPEED-X KEYS AND BUZZERS

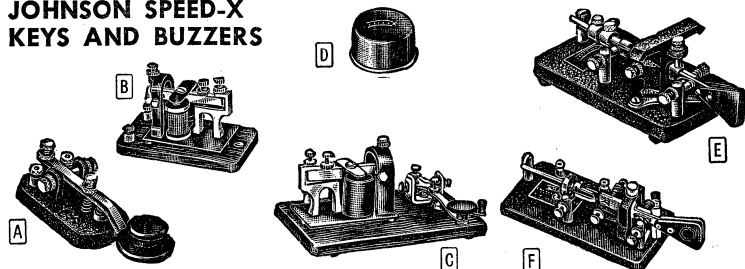

A Heavy-Duty Model 114-320. Deluxe key built to very rigid specifications for smooth, comfortable sending. Large, chrome-plated key arm suspended from hardened steel bearings. $\frac{1}{4}$ " silver contacts. Adjustable spacing and tension. Heavy brass connector concealed under base. Black die-cast base. Shpg. wt., 2 lbs.
76 S 058. NET.....4.70

B Model 114-112 Telegraph Sounder. High-quality brass telegraph sounder. Designed for instant response. Brass sounder provides strong, clear signal. Steel bar frame with black enamel finish. Brass bridge and adjustment screws with lacquer finish. Black lacquered steel sounder plate. On mahogany finished wood base. Non-slip rubber mounting feet. Sounder has 4 ohms resistance. Brass binding posts for convenient connection. Shpg. wt., 3 lbs.
76 S 067. NET.....9.95

C Learner Model 114-110 Key. Moderately priced telegraph sounder, complete with smooth operating key. An excellent unit specially designed, for Morse-code sending and receiving practice. Rugged, dependable construction, throughout. Provides clear easy-to-read signal. Has steel sounder plate. Brass sounding bar. Bridge has black enamel finish. Mahogany finished wood base. Brass binding posts. Sounder resistance is 4 ohms. Shpg. wt., 2 lbs.
76 S 066. NET.....14.95

D Model 114-400 High-Frequency Buzzer. Use with hand key for code practice. A very effective low-cost unit. Ample volume for several listeners. Screw adjustment provides variable tone. Requires 3 v. battery. Shpg. wt., 5 oz.
76 S 060. NET.....1.85

E Model 114-500 Deluxe Semi-Automatic Key. A smooth operating key with $\frac{1}{8}$ " contacts. Vibrator arm, posts, circuit closing switch, and all machine parts are chrome plated. Adjustable from lowest to highest speeds. Mounted on black steel wrinkle base. Size, $6\frac{1}{4} \times 3\frac{1}{2} \times 1\frac{1}{2}$ ". 5 lbs.
76 S 068. NET.....17.95

Model 114-501 Key. As above but with $\frac{1}{4}$ " contacts and chrome base. 5 lbs.
76 S 069. NET.....20.65

F Model 114-520 Semi-Automatic Key. A semi-automatic key for smooth, effortless radiotelegraph sending. Contact spacing and sliding weight easily adjustable to desired sending speed. Ruggedly constructed for long dependable use. Has $\frac{1}{8}$ " silver contacts. All hardware is heavily chrome plated. Die-cast base finished in black wrinkle enamel. Rubber feet prevent marring finished surfaces and also keep "bug" stationary. Shpg. wt., 4 lbs.
76 S 065. NET.....13.95

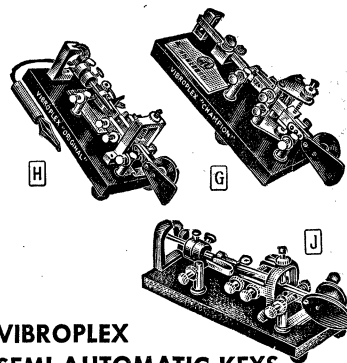

VIBROPLEX SEMI-AUTOMATIC KEYS

G "Champion." Inexpensive, semi-automatic key for radio and telegraph use. Carefully designed for smooth, easy operation. Mechanism is chrome plated; base is grey crackle finish. Supplied less cord and wedge. Shpg. wt., 4 lbs.
76 S 036. NET.....15.95

H "Original." A precision-built, semi-automatic key for all speeds. Minimum effort for smooth, rapid sending. Preferred and used by veteran operators. Chrome-plated mechanism. Grey finish cast-iron base. Supplied complete with cord and wedge. Shpg. wt., 5 lbs.
76 S 035. NET.....19.95

Deluxe "Original." Like above, but jeweled bearings, chrome-plated base. Wt., 5 lbs.
76 S 038. NET.....23.95

Carrying Case. Fits all Vibroplex keys except "Blue Racer." Shpg. wt., 2 lbs.
76 S 037. NET.....6.75

J "Blue Racer" Standard. Small and lightweight. Precision construction throughout for extremely smooth operation. Chrome-plated mechanism. Grey base. With cord and wedge. Shpg. wt., 4 lbs.
76 S 045. NET.....19.95

"Blue-Racer" Deluxe. As above, but jeweled bearings, chrome base. 4 lbs.
76 S 046. NET.....23.95

BELL MODEL CM-1 CARBON MICROPHONES

Model CM-1 Microphone. Deluxe, hand-held communications-type carbon mike. Response, 200-4000 cps. Single-button carbon with 85-ohm resistance. DPST push-to-talk switch for mike circuit and external relay. Black plastic case and 4-ft. cord. Supplied with mounting bracket. Shpg. wt., 1 1/2 lbs.
94 S 898. NET.....7.79

Model CM-1 With Retractable Cord. As above, but with coiled cord that extends to 5-ft. Shpg. wt., 1 1/2 lbs.
94 S 899. NET.....9.75

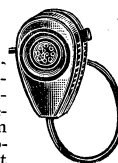

MILLEN ANTENNA BRIDGE

Model 90672. Accurate and sensitive impedance bridge. Measures impedances from 5 to 500 ohms at radio frequencies up to 200 mc. Based on unit described in August, 1955 QST. Special differential capacitor provides high accuracy. Can be used to measure radiation resistance, receiver input impedance, SWR, etc. Skillfully engineered for permanency of calibration and convenient use. Clearly calibrated. Designed for use with source of RF such as Millen Model 90651 Grid-dip Meter (listed on page 255). $3\frac{1}{8} \times 3\frac{1}{2} \times 5\frac{1}{8}$ ". Shpg. wt., 2 1/2 lbs.
83 S 834. NET.....45.00



AMATEUR TVI FILTERS

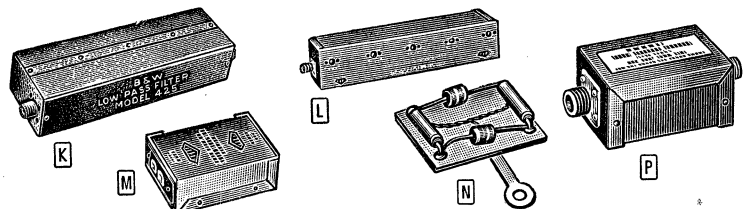

K B & W 425 Low-Pass Filter. 52 ohms. 1 kw RF. 2 "M"-derived end sections; 4 constant-K center sections. 85 db attenuation on TV channels. $11\frac{1}{2} \times 2\frac{1}{2}$ ". 1 1/2 lbs.
77 S 613. NET.....14.85

Model 426. As above, but for 72-ohm lines.
77 S 614. NET.....14.85

L Bud LF-601 Low-Pass Filter. For 52 or 72-ohm lines. Handles 1 kw of RF. Cutoff: 42 mc. Minimum attenuation of 85 db above 54 mc, 93 db above 70 mc. $12\frac{1}{2} \times 2\frac{1}{2} \times 2\frac{1}{4}$ ". Shpg. wt., 2 1/2 lbs.
73 S 047. NET.....20.58

M Bud HF-600 High-Pass Filter. High-pass filter for TV set. Rejects signals below 42 mc. Reduces interference from low-frequency sources. For 300-ohm line. $3\frac{1}{4} \times 2\frac{1}{8} \times 1\frac{1}{8}$ ". Shpg. wt., 6 oz.
73 S 046. NET.....5.15

N Ameco HP-45 High-Pass Filter. Attenuates all signals below 45 mc. Reduces TV interference. 40 db attenuation at 14 mc and below; 20 db attenuation at 10 meters. Uses balanced constant-K circuit. For use with 300-ohm twin line. Size, $1\frac{1}{8} \times 1\frac{1}{8} \times 3\frac{1}{4}$ ". Extremely simple to install. Attached at TV set. Complete with easy-to-follow instructions. Shpg. wt., 3 oz.
77 S 673. NET.....95c

P Ameco LN-2 Low-Pass Filter. Handles up to 200 watts RF. For 52 to 72-ohm coaxial cable. Has 2—SO-239 connectors, bracket, and full instructions. In aluminum case, $4\frac{5}{8} \times 2\frac{3}{8} \times 1\frac{3}{4}$ ". Shpg. wt., 1 lb.
77 S 675. NET.....3.75

Type LN-1 Low-Pass Filter. As above, but has RCA-type phono jacks.
77 S 674. NET.....2.25

Values for Beginning Amateurs

Knight-Kit CODE PRACTICE OSCILLATOR KIT



Advanced-design code practice oscillator kit at a very low price. Ideal for the beginner just learning the code—and for the experienced Amateur who wants to improve his "fist." Employs transistor circuit—and is powered by a single penlight battery! Amazingly low current consumption. One battery can operate the unit continuously for several months! Provides a very clear, crisp tone of approximately 500 cps. Has output jacks for standard headphone tips; screw type terminals for connecting key. Housed in compact, black bakelite case with anodized aluminum front panel. Complete unit measures only 2 1/2 x 3 1/2 x 1 1/2". With all parts, wire and solder, instructions. Less earphones and key. Shpg. wt., 1 lb.

83 Y 239. NET.....3.95



ALLIED'S OWN AMERICAN BELL QUALITY HEADPHONES

Lightweight headphones at very moderate cost. Feature excellent tonal fidelity and sensitivity. Have adjustable flexible headbands for wearing comfort. Hy-flex Alnico magnets for high efficiency, durability, and sustained power. Well-insulated solenoid coils are firmly mounted in headphone shell. Internal terminal connections. Cap and case are durable, molded bakelite. Supplied with 4 1/2-ft. extra-flexible cord of mercerized cotton-covered tinsel. Standard phone tip terminals.

Standard Dual Headphones. Double headband with firmly gripping yokes: 2000 ohms Shpg. wt., 1 lb. 59 J 110. NET.....2.00
Single Headphone. (Not illustrated). Dependable economy-priced phone. 1500 ohms. Shpg. wt., 8 oz. 59 J 113. NET.....1.15

HOOK-UP ACCESSORIES

Standard Phone Plug. For attaching keys and headphones to Bud and ICA code practice oscillators at right. Shpg. wt., 3 oz. 41 H 641. NET.....44c
Cable. Extension cord for keys. Shpg. wt., 5 ft., 2 oz. 48 W 805. NET PER FOOT.....2c

AMATEUR BOOKS

SO YOU WANT TO BE A HAM. (Howard Sams publication). By Robert Hertzberg. Excellent information for those interested in Amateur radio and who would like to get started in this fascinating hobby. Provides the reader with an understanding of the licensing regulations governing Amateurs, and how to get your license. Covers learning the code, popular types of Amateur transmitting and receiving equipment, antennas, operating practices, and presents the various phases of Amateur activities. 186 pages. 5 1/2 x 8 1/2". 37 K 446. Postpaid in U.S.A.....2.50

GATEWAY TO AMATEUR RADIO. A valuable set of four A. R. R. L. books for the Novice. *How to Become a Radio Amateur.* Tells how to get on the air, obtain a license. Also covers the construction of receivers, transmitters, and operating practices. 148 pages. *Learning the Radio-Telegraph Code.* Covers sending and receiving. Excellent for class study and home training. 48 pages. *License Manual.* Covers FCC exams, answers to probable exam questions on: Novice Technician, Conditions, etc. 111 pages. *Operating an Amateur Radio Station.* Valuable information on correct operating procedures, including network operation. 10 pages. Size, 6 1/2 x 8 1/2". 37 K 566. Postpaid in U.S.A.....1.50

RADIO AMATEUR'S LICENSE MANUAL. Standard reference for the Amateur radio enthusiast preparing for his Amateur license. Covers FCC exams for all Amateur licenses. Contains up-to-date government regulations, answers to probable license exam questions, and valuable information about regulations affecting Amateurs. 6 1/2 x 9 1/2". 111 pages. 37 K 555. Postpaid in U.S.A.....50c

MAKE ALLIED YOUR SUPPLY HEADQUARTERS

Beginners in Amateur Radio—you can't do better than to make Allied your supply headquarters. When you deal with Allied, you not only choose from the world's finest array of equipment, but you profit by personalized service from Allied's staff of experienced Amateurs. Allied's Amateurs have studied your needs and carefully selected a group of beginners items that will make the road to your Amateur license short and smooth. All of these items are grouped together on this single page for your shopping convenience. You'll find code practice equipment to fit any budget; low-cost, high-quality headphones; hook-up accessories; plus books that make it easy and enjoyable in preparing for the written portion of the license exam. And remember—if you have any problems, either now, or after you get on the air, Allied's friendly Amateur staff stands ready to assist you—just drop a card or letter to Allied's Ham Shack for expert, practical advice.

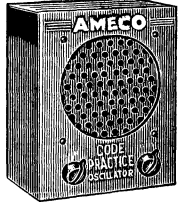
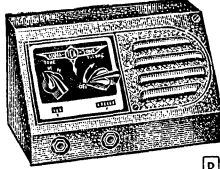

CODE PRACTICE OSCILLATORS

A Bud CPO-128A Codemaster. High-quality code practice oscillator with built-in 4" PM speaker. Earphones and keys may be paralleled for group instruction. Volume and pitch controls. External speaker may be plugged into headphone jack; both headphone and key jacks take standard phone plugs listed at left. Can be used as CW monitor by adding RF pickup link. Gray hammertone. 6 1/2 x 5 1/2 x 3 1/2". For 110-120 v., AC or DC. Shpg. wt., 5 lbs. 73 S 044. NET.....18.75

Bud CPO-130A Codemaster. (Not illustrated.) Has same features as CPO-128 Codemaster, but less built-in speaker. Size, 4 1/2 x 5 1/2 x 3 1/2". Shpg. wt., 4 1/2 lbs. 73 S 045. NET.....16.17

C Ames CPS-WT Code Practice Oscillator. A deluxe practice oscillator with a built-in 4" PM speaker. Produces a loud and clear tone with ample volume for group use. Built-in click filter provides smooth, clickless and chirp-free operation. Variable tone and volume controls to suit the individual listener. An ideal unit for code class use—headphones and keys can be paralleled for group listening and individual keying. Can easily be converted to an excellent CW keying monitor. Gray hammertone finish. Has rear-mounted screw terminal strip. Size, 6 1/2 x 5 x 3 1/2". For 110-120 v., AC or DC. Shpg. wt., 3 lbs. 77 S 629. NET.....14.95

B ICA 4300 Audio Oscillator. Deluxe code practice set. Excellent as CW keying monitor and audio source for transmitter modulation tests. Has volume control and 3-position tone switch. Built-in speaker. Both headphone and key jacks take standard phone plugs listed at left. Keys and headphones can be connected in parallel for class instruction. 8 1/2 x 4 1/2 x 4 1/4". For 105-125 v., AC or DC. Shpg. wt., 3 1/2 lbs. 73 S 430. NET.....15.43

ICA 4301 Audio Oscillator. (Not illustrated.) Designed primarily for class and radio club use. Incorporates the deluxe features of Model 4300, but without speaker. 4 1/2 x 4 x 4". For 105-125 v., AC or DC. Shpg. wt., 3 lbs. 73 S 431. NET.....14.55

Jackon 562 Code Practice Oscillator. Low-cost transistor code oscillator for self-practice, teaching or monitoring. For use with external magnetic phones and key. Employs p-n-p junction transistor. With tone adjustment. Less battery. 6 1/2 x 3 3/4 x 2". Shpg. wt., 2 lbs. 77 S 640. NET.....7.79

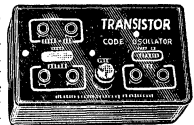

Battery for Above. 1 1/2 v. Wt., 3 oz. 53 J 009. NET.....14c

CODE COURSE RECORDS



Allied Code Course. "Eye-Ear" method of learning code at home—eye follows the letters as the ear hears the sounds. Consists of five 10" high-quality, 78 rpm break-resistant records recorded on each side. Can be played on any 78 rpm phonograph. Speed steadily progresses from 2 to 15 wpm in 10 lessons. Includes sturdy record album and instructions. Shpg. wt., 6 lbs. 77 S 643. NET.....5.95

Ameco Code Courses. Three courses: *Jr. Code Course*—5 records (10 sides). Code speeds from start to 1 1/2 wpm. *Advanced Code Course*—6 records (12 sides). Speeds from 8 1/2 to 18 wpm. *Senior Code Course*—11 records (22 sides total). Speeds from start to 18 wpm. All courses include 28-page manual with FCC-type exams. Jr. and Senior Courses include record album. 10" 78 rpm or 7" 45 rpm records.

JUNIOR CODE COURSES

77 S 616. 78 rpm. 4 lbs. NET.....7.95
77 S 647. 45 rpm. 1 1/2 lbs. NET.....6.95

ADVANCED CODE COURSES

77 S 619. 78 rpm. 4 lbs. NET.....6.95
77 S 648. 45 rpm. 2 lbs. NET.....5.95

SENIOR CODE COURSES

77 S 617. 78 rpm. 4 lbs. NET.....12.95
77 S 649. 45 rpm. 7 lbs. NET.....11.95

JOHNSON SPEED-X KEYS

Standard Model 114-310. Precision-built, moderately priced key. Excellent for code practice and for use with transmitters. Heavy die-cast base is durably finished in handsome black wrinkle enamel; mechanical parts are nickel-plated. 1/4" silver contacts. Dual adjustments for tension and contact spacing. Smooth adjustable bearings. Has two holes in base for securing to table-top. Includes provision for plugging in semi-automatic keys. Shpg. wt., 2 lbs. 76 S 055. NET.....3.10



Practice Model 114-300. A well-built, low-cost general purpose key. Ideal as a code practice key for the beginner. Brown molded phenolic base and knob. Equipped with adjustable key arm, spring and smooth action bearings—easily adjusted tension and contact spacing. 1/4" silver contacts. Nickel-plated machined parts. Has holes for stationary mounting. With beginners code card. Shpg. wt., 8 oz. 76 S 053. NET.....2.25



Model 114-450 Buzzer Code Practice Set. Economy-priced code practice system. Consists of key and constant, high-frequency buzzer mounted on brown bakelite base. Screw adjustment provides variable tone. Key has silver contacts. Can be used individually or in pairs for code practice. Requires 3 v. DC (2 1 1/2 v. batteries). Size of base, 4x9". Shpg. wt., 2 lbs. 76 S 059. NET.....4.90

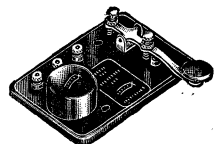

Industrial Communication Equipment

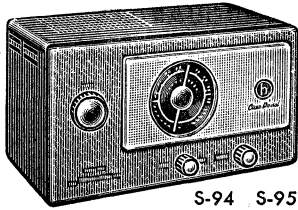

S-94 S-95

hallicrafters FM RECEIVERS

- High-Performance Receivers for Commercial Use
- Receive Police Calls, Fire Trucks, Taxis, Etc.
- Excellent signal-to-noise Ratio
- Compact—Easy to Install and Operate
- Choice of Standard or Deluxe Models

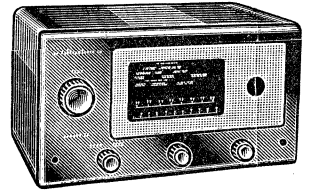

SX-104 SX-105

"CIVIC PATROL" RECEIVERS. Two high-performance FM receivers for excellent reception on public service or commercial frequencies. Model S-94 provides full coverage of all frequencies from 30 to 50 mc. Model S-95 covers all frequencies between 152 and 173 mc. Both models are carefully designed to assure exceptionally high sensitivity throughout their tuning range. These compact, easy-to-operate units cover police, fire, taxicab, inter-city bus, railroad, private telephone mobile, and other industrial and emergency-service communications.

FEATURES. Advanced circuit design assures minimum drift, high signal-to-noise ratio and exceptional sensitivity. Circuit refinements include: Low-noise, grounded-grid RF amplifier; 2 IF stages; separate high-gain DC amplifier for squelch system; and wide-range antenna input impedance for excellent results with any type antenna. Designed for low oscillator radiation. Adjustable, built-in, relay-type squelch system silences entire audio system until signal is received—permits quiet standby operation. Built-in 5" PM speaker. Audio output, 1.5 watts.

CONTROLS AND CONNECTIONS. Controls: Tuning; Off-On/Volume; Squelch-Off. Phone tips jacks are provided for headphone operation. Switch selects speaker or headphone output. Terminals for single or twin lead antenna (external antenna supplied). Dial is calibrated in megacycles and service channels.

Circuit employs 8 tubes plus selenium rectifier. In professional-type gray steel cabinet with silver trim and panel. Size, 7" high, 12 7/8" wide, and 7 1/4" deep. For 110-120 volts, 50-60 cycle AC, or DC. Shpg. wt., 12 1/2 lbs.

MODEL S-94. For 30 to 50 mc FM coverage. 98 SX 708. NET. **59.95**

MODEL S-95. For 152 to 173 mc FM coverage. 98 SX 721. NET. **59.95**

DELUXE "CIVIC PATROL" RECEIVERS. These outstanding new FM receivers cover the same frequencies as the S-94 and S-95 (described at left), but they incorporate many deluxe extras for improved performance and operating convenience.

DELUXE FEATURES. Choice of crystal controlled (fixed frequency) or tunable operation by means of front panel selector switch. In fixed frequency use the receiver is "locked in" to the frequency determined by the crystal employed. Tuned RF stage assures extreme sensitivity. Carrier-operated relay with external switch contacts for connecting warning light or buzzer system to alert operator when signal is received. Dual, edge-lighted, slide-rule dial.

OTHER FEATURES. Built-in squelch for quiet standby operation. High stability in tunable position—no drift in crystal position. High signal-to-noise ratio. Low oscillator radiation. Wide-range antenna input impedance for excellent results with all types of antennas. Built-in 5" PM speaker. Over 3 watts of audio.

CONTROLS. Front panel controls include: Tuning; Selector switch (tunable—crystal); Squelch-Off/On; Off/On-Volume. Headphone jack with built-in speaker cutout switch.

Circuit employs 9 tubes plus rectifier. Gray steel cabinet. Size, 7x12 7/8x7 3/4". For 110-120 volts, 50-60 cycle AC. Less crystal. Shpg. wt., 18 1/2 lbs. *Crystal for fixed frequency operation available on special order at \$5.29 each for the SX-104 and \$7.72 each for the SX-105. Specify receiving frequency required. Allow 3 weeks for delivery.*

MODEL SX-104. For 29 to 50 mc coverage. 94 SX 803. NET. **89.95**

MODEL SX-105. For 152 to 173 mc coverage. 94 SX 804. NET. **89.95**

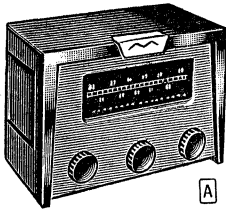

A

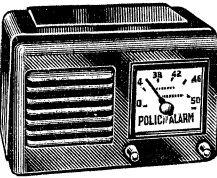

B

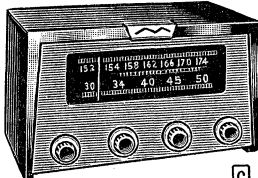

C

MONITORADIO FM RECEIVERS

A MODEL MR-10. Deluxe FM receiver for outstanding coverage of the 152-174 mc band. Excellent for monitoring use in emergency commercial or industrial communications; assures an effectively coordinated overall communications network. Features include: Transformer-type power supply; tuned RF stage for better image rejection; built-in electronic squelch (adjustable from front panel) for absolute quieting; built-in 5" PM speaker; provision for adding external speaker; 4 microvolt sensitivity for 20 db quieting; illuminated slide-rule dial. 7 tubes; 6X4 rectifier. Metal cabinet. 7 7/8x11 1/4x6 1/2". For operation from 110-120 v., 50-60 cycle AC. Shpg. wt., 14 lbs. 99 SX 002. NET. **64.50**

MODEL MR-33. Same as above, but for 30-50 megacycle FM coverage. 99 SX 003. NET. **64.50**

C MODEL DR-200 2-BAND FM RECEIVER. Excellent for central installations with very weak outlying stations. Ranges: 30-50 mc and 152-174 mc. Dual-conversion and separate front-end range. Provision for 2 crystal-controlled receiving frequencies (less crystals); one in each range. Squelch circuit. Sensitivity for 20 db quieting; 30-50 mc, 1 μ v.; 152-174 mc, 2 μ v. 14 tubes; 5Y3GT rectifier. Brown cabinet with gray panel. 8x11 1/4x9 1/2". Less speaker (see below). For 110-120 v., 60 cycle AC. Shpg. wt., 21 lbs. *Crystals for fixed-frequency reception with the DR-200 are available on special order at \$11.95 each. Specify desired receiving frequency. Allow 3 weeks for delivery.* 97 SZ 939. NET. **149.95**

MODEL DRS-1 6" SPEAKER IN METAL ENCLOSURE. With cable. 8x7 1/2x7 1/2". 5 3/4 lbs. 97 SX 949. NET. **14.95**

MODEL CA-2 COAXIAL ANTENNA. Use with DR-200 for 30-50 mc reception. 1 lb. 99 SX 000. NET. **5.00**

B MODEL PR-31 "POLICE-ALARM". Low-cost, quality-built FM receiver for dependable reception of police dispatches, fire, emergency service, etc., operating on frequencies between 30 and 50 mc. Employs superhet circuit with ratio detector; offers quiet operation of receiver under "signal" conditions. Temperature compensated to minimize frequency drift. Sensitivity is better than 10 microvolts for 50 milli-watts output. 100-kc selectivity. Built-in 5" PM speaker. 5 tubes plus 35W4 rectifier. Antenna impedance, 72 ohms. In attractively styled plastic cabinet. Size, 7x10 1/2x6 1/2". For operation from 110-120 v., 50-60 cycle AC, or DC. Shpg. wt., 5 lbs. 97 SX 907. NET. **49.95**

MODEL PR-9. As above, but for 152-174 mc coverage, and includes 14" indoor antenna. 97 SX 908. NET. **49.95**

MODEL A-30 WHIP ANTENNA. For use with the Model DR-200 or the MR-10 receiver for optimum 152 to 174 mc FM reception. Adjustable base. 3 chrome-plated sections; extends to 86". Less cable. Use 72-ohm coaxial cable. Shpg. wt., 1 lb. 99 SX 001. NET. **6.50**

NEW

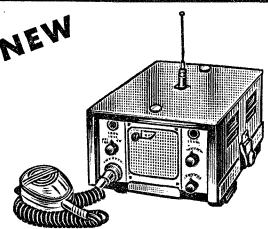

KAAR "IMP" RADIOTELEPHONE

MODEL TR-426. New, highly versatile, low-power industrial mobile phone unit. Designed for communication in and about any plant. It's perfect for use on lift trucks and runabout, cranes, and other mobile units. Helps boost payload of any vehicle by eliminating wasteful "deadhead" trips. Average transmitting range, 2 miles. Consists of a complete transmitter and receiver in one compact case. Ruggedly built and easily installed, the "Imp" has hundreds of uses in construction fields, airports, rail yards, loading docks, warehouses, etc.

Unit operates from 6 or 12-v. battery or 110-120 v. AC source. Any "Imp" can be used as a fixed or mobile station. Crystal-controlled transmitter section operates on 154.57 mc. Receiver section is fixed-tuned to this frequency—no tuning required; has adjustable squelch circuit. Includes: Transmitter-receiver unit; shock mount base; cable for 6 or 12-v. DC operation; cable for 110-120 v. AC operation; carbon mike with switch and antenna. 5 1/4x12 1/2x8 1/4". Shpg. wt., 24 lbs. *Requires FCC permit—application form included in carton.* 99 SZ 009. NET PER UNIT **360.00**

Telex Headphones and Accessories

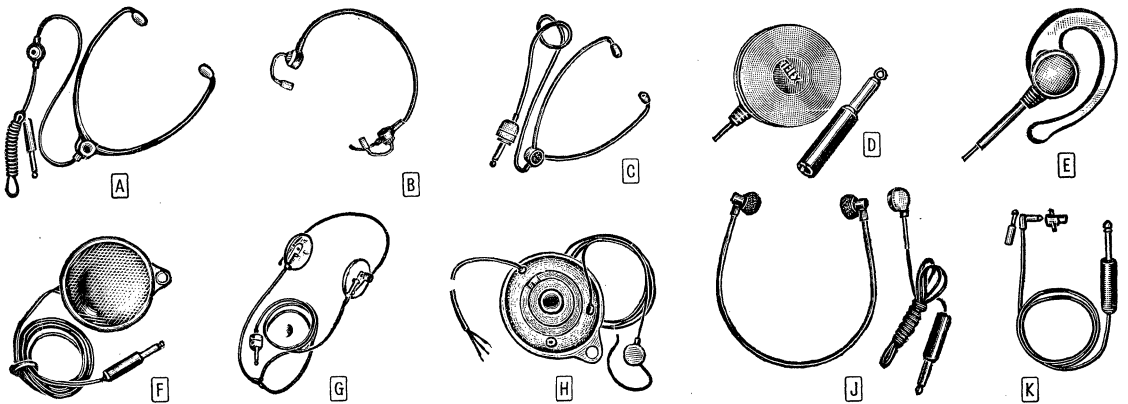

Famous, lightweight Telex headsets—used throughout the world on all types of audio equipment requiring private, continuous listening. Telex headsets are manufactured with the finest materials, and incorporate the most recent engineering advances in the field.

Suitable for all applications requiring comfort, sensitivity and durability in a headset; ideal for communications work, offices, hospitals. Amateur radio, hard-of-hearing, and other uses. Matching cords are listed for those headsets supplied without cords.

LIGHTWEIGHT MONOSET

A Exceptionally comfortable, lightweight headphones, designed to eliminate fatigue and strain when headphones must be worn continuously for long periods. Total weight is only 1.2 ounces. Magnetic type receiver for clarity and ruggedness under even severe use; housing is molded of rigid, easy-to-clean tenite plastic. White plastic ear plugs remove easily for cleaning. Less cord. Shpg. wt., 8 oz.

59 J 281. Model 4626. 2000 ohms.
59 J 280. Model 4601. 128 ohms.
List Each, \$9.00. NET EACH..... 5.29

WITH CORD. Monosets as above, with 5-foot cord and standard plug. Shpg. wt., 12 oz.
59 J 222. Model 4625. 2000 ohms.
59 J 223. Model 4600. 128 ohms.
List Each, \$12.50. NET EACH..... 7.35

TWINSET

B An important innovation in headset design—nothing touches the ears with the Telex Twinset! Sensitive receivers rest lightly at the temples; tubular "pipes" send sound directly into ears. Perfect for long, fatigue-free listening; weighs only 1.6 ounces. Approved by the Civil Aeronautics Authority. Supplied with two extra eartips. Less cord. Shpg. wt., 8 oz.

59 J 285. Model 3776. 1000 ohms.
59 J 286. Model 3781. 64 ohms.
List Each, \$17.50. NET EACH..... 10.29

WITH CORD. Twinsets as above, with 5-foot cord and plug. Shpg. wt., 12 oz.

59 J 224. Model 3775. 1000 ohms.
59 J 225. Model 3791. 64 ohms.
List Each, \$21.00. NET EACH..... 12.35

HI-FI DYNASET

C Model 6701. Under-the-chin dynamic headset of superior quality. Receiver consists of a tiny, 3/4"-diameter 6-ohm loud-speaker built into the plug. Extremely sensitive; frequency response extends from 50 to 8000 cycles at 25 mw. Speaker diaphragm directs sound, through 60-inch flexible tubing, into headset. Light gray finish. Shpg. wt., 6 oz.

59 J 239. List, \$14.75. NET..... 8.67

PILLOW SPEAKER

D Exceptionally small; for radio and TV listening through a pillow without disturbing others. For home or institutional use. Red waterproof plastic. 5/8x2 1/4" dia. Less cord. Shpg. wt., 6 oz.

59 J 290. Model 4531. 2000 ohms.
59 J 291. Model 4501. 128 ohms
List Each, \$7.20. NET EACH..... 4.23

WITH CORD. Pillow speakers as above, with 5-foot cord and plug. Shpg. wt., 10 oz.

59 J 226. Model 4530. 2000 ohms.
59 J 227. Model 4500. 128 ohms.
List Each, \$10.70. NET EACH..... 6.29

MIDGET EARSET

E Extremely lightweight individual earsets—weigh only 1/2 ounce! Carefully designed holder is scientifically contoured to fit the ear comfortably. Unit utilizes high-quality receiver which reproduces speech with great clarity and fidelity; frequency response is from 50 to 4000 cycles. Available with metal ear bow also, where extreme ruggedness is desired. With or without cord and plug. Wt., 5 oz. without cord, 6 oz. with cord and plug.

LESS CORD

Stock No.	Type	Description	Ohms
59 J 228	18050	Plastic ear bow	15
59 J 265	18051	Plastic ear bow	128
59 J 267	18053	Plastic ear bow	1000
59 J 229	18137	Plastic ear bow	2000
59 J 237	9376	Metal ear bow	15
59 J 274	9329	Metal ear bow	128
59 J 273	9336	Metal ear bow	1000
59 J 244	18139	Metal ear bow	2000

List Each, \$6.50. NET EACH..... 3.82

WITH CORD

Stock No.	Type	Description	Ohms
59 J 202	18134	Plastic ear bow	15
59 J 203	18056	Plastic ear bow	128
59 J 204	18058	Plastic ear bow	1000
59 J 207	18138	Plastic ear bow	2000
59 J 208	18092	Metal ear bow	15
59 J 209	9334	Metal ear bow	128
59 J 211	9335	Metal ear bow	1000
59 J 212	18140	Metal ear bow	2000

List Each, \$10.00. NET EACH..... 5.88

DYNAMIC PILLOW SPEAKER

F Model 8110. An under-the-pillow loud-speaker with great power-handling ability; provides exceptionally clear, natural tone without any disturbance to others who may be sleeping nearby. Ideal for institutional use, or private listening at home to radio or TV set. 3.2 ohm voice coil matches most small radios and portable TV sets. With 5-foot cord and standard phone plug. 3 3/4" dia. 1 1/8" thick. Wt., 6 oz.

59 J 276. List, \$10.20. NET..... 6.00

MODEL 8130. As above, but 10,000 ohms.

59 J 277. List, \$12.10. NET..... 7.12

MUFF-TYPE HEADSET

G Sensitive headset with plexiglas ear cushions for comfort. Cushions and receivers are mounted on stainless steel headband; weight 1.6 ounces. Receiver is housed in special molded plug—directs sound through flexible tubing to ears. Complete with tubing and plug. Shpg. wt., 6 oz.

59 J 213. Model 18078. 15 ohms.

59 J 279. Model 8825. 128 ohms.

59 J 283. Model 9316. 2000 ohms.

List, \$18.45. NET EACH..... 11.14

USEFUL TV "LISTENER"

H Model 9900. Use wherever individual listening is desired—ideal for families with children, hard-of-hearing, etc. Can be used by 2 people at the same time. Has volume control for earset; switch on control unit turns TV speaker on or off. 3 1/2x1". Control unit is equipped with 10' cord; earset, 4' cord. Shpg. wt., 8 oz.

59 J 263. List, \$16.25. NET..... 9.55

TELE-FI HEADSET

J New, lightweight headset is ideal for applications where clarity and intelligibility of speech are important. Unique design provides a delay of 1 millisecond between earpieces; resultant sound greatly enhances clarity of speech. Excellent for secretaries, switchboard operators, TV monitors, etc. Receiver may be detached from dual set and mounted on plastic ear bow in seconds, for one-ear use. Feather-light unit weighs only 1/2 ounce. With cord and plug. Shpg. wt., 6 oz.

59 J 214. Model 18135. 15 ohms.

59 J 257. Model 18035. 128 ohms.

59 J 258. Model 18020. 1000 ohms.

59 J 217. Model 18160. 2000 ohms.

List Each, \$12.35. NET EACH..... 7.26

CORD AND MINIATURE PLUG

K MODEL 9200. 5-ft. cord with 90° plug. Length of plug, 3/4". Dia., 3/16". For computers, dictating machines, and similar equipment. Shpg. wt., 5 oz.

59 J 252. List, \$3.15. NET..... 1.85

CORDS, EXTRA TIPS AND ACCESSORIES

*Has built-in volume control. 4 oz.

No.	Description	For Use With	NET
59 J 270	Type 3280 standard cord	All Telex sets except Dynaset and Midget Earset	2.06
59 J 272	*Volume control cord w/5,000 ohm pot.	59 J 224 59 J 285	5.82
59 J 245	*Volume control cord w/20,000 ohm pot.	59 J 222, 59 J 226 59 J 281, 59 J 290	5.82
59 J 246	*Volume control cord w/1,000 ohm pot.	59 J 280, 59 J 265 59 J 286, 59 J 291 59 J 223, 59 J 203 59 J 225, 59 J 227	5.82
59 J 297	Type 18036 Plastic Earframe	59 J 265, 59 J 267 59 J 203, 59 J 204	.47
59 J 269	Type 8555 5-ft. Extension Cord.	All Telex units except Dynaset	2.06
59 J 242	Type 8570 Panel Mounted Jack	59 J 252 Cord/Plug	.24
59 J 243	Type 9231 Miniature Straight Plug	59 J 252 Cord/Plug	.35
59 J 254	Type 9240 Jack	TV "Listener"	.24
59 J 253	Type 9241 standard w/stand-ard phone plug	59 J 203, 59 J 204 59 J 209, 59 J 211 59 J 265, 59 J 267 59 J 273, 59 J 274	2.06
59 J 295	Ear Tips	All Twinsets	.09
59 J 296	Ear Tips	All Monosets	.09

American Bell & Cannon Headphones

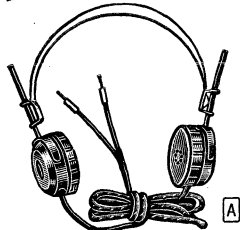

ALLIED'S OWN AMERICAN BELL HEADPHONES

Exceptionally sensitive headphones at remarkably low cost. For communications use, short-wave listening, code practice or class use. Produced by one of America's leading manufacturers. Noted for their remarkable tonal fidelity and sensitivity. Lightweight. Have adjustable flexible headbands to provide utmost wearing comfort and long life. Hy-flux Alnico magnets for high efficiency, durability, and sustained power. Solenoid coils are well insulated and firmly mounted

STANDARD DUAL HEADSETS

A Have double headband with firmly gripping, easily adjustable yokes. 1 7/8" diaphragm. Cords are cotton-covered tinsel. Shpg. wt., 1 1/4 lbs.

59 J 110, 2000 Ohms. NET.....	2.00
59 J 111, 3000 Ohms. NET.....	2.08
59 J 149, 4000 Ohms. NET.....	2.15
59 J 141, 11 Ohms. NET.....	2.00

INSTITUTIONAL DUAL HEADSETS

Especially designed for schools, hospitals and other institutions where dependable, lightweight headphones are essential. Also ideal for use with crystal sets, battery radios and low-cost hearing aids. Every feature required for institutional use has been incorporated: Durable bakelite cases and caps which are easily cleaned; inside terminal connections, to prevent tampering; diaphragm is 1 1/8" in diameter; Hyflux Alnico permanent magnets assure excellent sensitivity. Provide crisp, clear reproduction of voice and music. 4 1/2-ft. braided cord. Comfortable, vinyl-plastic headband is easily adjustable. Shpg. wt., 1 1/4 lbs.

59 J 100, 2000 Ohms. NET.....	2.12
59 J 101, 3000 Ohms. NET.....	2.20

AMERICAN BELL

Quality, lightweight earpieces; ideal for use with portable equipment. Replace earpieces used in popular transistor radios indicated in table below. Supplied in individual plastic box, complete with 3-ft. cord. Shpg. wt., 5 oz.



Stock No.	For Use With
59 J 147	Regency, Admiral, Motorola, Roland, Zenith, Gambles, Philco, Trav-Ler, Hoffman, Airline (1100, 1102, 1106), Western Auto
59 J 148	RCA and Arvin
59 J 109	Magnavox, Sonora, Bulova, Spartan, Sylvania
59 J 142	G. E. 5-Transistor
59 J 145	G. E. 6 and 7-Transistor, Emerson
59 J 133	Westinghouse, Airline 1108
59 J 116	Dewald
NET EACH.....	3.17



in headphone shell. Internal terminal connections. Cap and case are durable, molded bakelite. All headphones are supplied with 4 1/2 foot extra-flexible cord of mercerized cotton-covered tinsel. With standard phone tip terminals. Ideal for use with crystal or battery sets, Amateur and commercial communications receivers. Available in single or dual types; low-impedance models may be inserted in audio circuits directly at loudspeaker tap.

SINGLE HEADPHONES

B Dependable, economy-priced single phones. Suitable for hard-of-hearing installations, receivers, crystal sets, Geiger counters, etc. Diaphragm is 1 1/8" in diameter. Has spring-metal headband which is permanently attached to back of case. Equipped with 4 1/2-ft. cotton covered cord. Shpg. wt., 8 oz.

59 J 112, 1000 Ohms. NET.....	1.08
59 J 113, 1500 Ohms. NET.....	1.15

HEADPHONE REPLACEMENT PARTS

Replacement parts for the American-Bell headphones listed on this page. Made to the same high standards as the original parts to assure maximum efficiency.

DIAPHRAGM. Shpg. wt., 2 oz.	
59 J 104. Pkg. of 2.....	13c
BAKELITE CAP. Shpg. wt., 2 oz.	
59 J 106. NET EACH.....	10c
DOUBLE HEADBAND. Less yokes. 6 oz.	
59 J 107. NET EACH.....	50c
YOKE. For headband above. 3 oz.	
59 J 108. NET EACH.....	10c

TRANSISTOR RADIO EARPIECES

SEPARATE EARPIECE, Receiver and comfortable earpiece. Equipped with cord but less plug. Impedance, 8000 ohms. Excellent tonal quality. Shpg. wt., 4 oz.

59 J 119. NET.....	3.93
--------------------	------

EARPIECES FOR TV

For private listening to TV sets. Two models listed below; one is equipped with plug to fit Emerson sets; the other for Motorola. Provide crisp, clear reproduction. Very light in weight and exceptionally comfortable. May be worn for hours without fatigue. Shpg. wt., 5 oz.

59 J 117. For use with Emerson TV sets. NET EACH.....	3.50
59 J 123. For use with Motorola TV sets. NET EACH.....	4.00

EARPIECES WITH PL-55 PLUGS

High-sensitivity ear pieces. Supplied complete with standard PL-55 plug attached. 5-ft. cord. Shpg. wt., 5 oz.

59 J 166, 15 ohms	59 J 134, 2000 ohms
59 J 124, 120 ohms	59 J 167, 8000 ohms
59 J 131, 1000 ohms	
NET EACH.....	3.50

CANNON-BALL RADIO HEARING AID

Popular, low-priced hearing aid for any radio set or TV set, easily attached to any loudspeaker. Excellent for private listening, or listening at late hours without disturbing others. Employs a specially-constructed low-impedance headphone which matches the output of radio or TV set. Built-in selector control switch permits listening with speaker only, headphone only, or both speaker and headphone simultaneously. Supplied complete with control box, connecting cables for attachment to speaker, and attachment of headphone to control box, instructions and diagram. Shpg. wt., 1 lb.

59 J 118. NET.....	3.38
--------------------	------

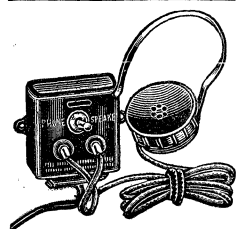

C. F. CANNON HEADPHONES AND ACCESSORIES

BRANDES BS-2 "SUPERIOR" PHONES. A high-quality, ruggedly-built, 2000-ohm headset which has been a favorite for years. Outside terminal type; metal cases, bakelite caps. Diaphragm diameter is 2 1/8". Has double coils, one in each receiver. Flexible metal headband. Easily adjustable for maximum comfort. 4 1/2-foot cord. Shpg. wt., 1 1/4 lbs.



59 J 130. NET.....	2.44
--------------------	------

BRANDES "ADMIRAL" PHONES. Similar to above but with inside terminals.

59 J 135. BA-2. 2000 ohms. NET.....	2.44
59 J 136. BA-3. 3000 ohms. NET.....	2.73
59 J 137. BA-5. 5000 ohms. NET.....	3.53

REPLACEMENT CAPS AND DIAPHRAGMS. For "Superior" and "Admiral" phones, above.

59 J 138. Caps. Wt., 2 oz. EACH.....	21c
59 J 140. Diaphragms. 2 oz. Pkg. of 2.....	13c

CANNON-BALL "MASTER" PHONES. High-quality headset for communications and general-purpose applications. Cases are metal, with bakelite caps. Terminals are inside of case for maximum safety from tampering. Chrome steel magnets produce strong field, and resist corrosion. With cord. Wt., 1 1/4 lbs.

59 J 215. MC-2. 2000 ohms. NET.....	2.44
59 J 125. MC-3. 3000 ohms. NET.....	2.65
59 J 126. MC-5. 5000 ohms. NET.....	3.38



CANNON-BALL CC-2 "CHIEF" PHONES. Sensitive and practical headset for all general use. Inside terminal connections. 2 1/8" diaphragms; bakelite case and cap. Vinyl plastic covered headband. 2000 ohms. With 4 1/2-ft. cord. Shpg. wt., 1 1/4 lbs.

59 J 172. NET.....	2.28
--------------------	------



REPLACEMENT CAPS AND DIAPHRAGMS. For "Master" and "Chief" phones, above.

59 J 127. Caps. Wt., 2 oz. EACH.....	21c
59 J 129. Diaphragms. 2 oz. Pkg. of 2.....	13c

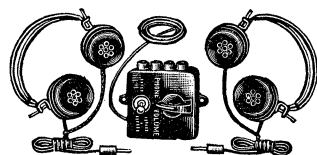

CANNON TV HEADPHONE KIT

High-quality listening device to aid hard-of-hearing, or provide private, "silent" listening when others might be disturbed by loudspeaker operation. Volume control and Speaker-Phones switch on control box. Supplied with 15-ft. cord, and two pairs of headphones. Shpg. wt., 3 lbs.

59 J 175. NET.....	9.70
--------------------	------

SINGLE HEADSET KIT. Same kit as above, but with only one pair of phones. 2 lbs.

59 J 176. NET.....	6.61
--------------------	------

CONTROL BOX ONLY. Shpg. wt., 9 oz.

59 J 177. NET.....	4.41
--------------------	------

11-OHM DUAL HEADSET. Shpg. wt., 1 1/4 lbs.

59 J 141. NET.....	2.00
--------------------	------

Headphones and Accessories

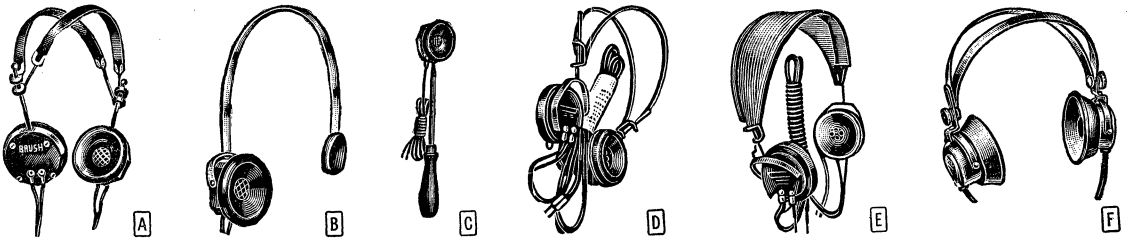

BRUSH QUALITY HEADPHONES

A BA-200 Headphones. Very sensitive headphones with high impedance (45,000 ohms at 1000 cps.). Frequency response, 100 to 8000 cps. Cone type diaphragm. Molded plastic case shaped for maximum comfort. Require small DC blocking condenser for DC circuits. With 5-ft. cord and headband. Wt. 2 lbs.
59 J 151. List \$21.50. NET.....12.64

Model BA-200B Headphones. Like BA-200 above; but equipped with cord wired for binaural use. Impedance, 90,000 ohms (at 1000 cps). Shpg. wt., 2 lbs.
59 J 152. List \$23.45. NET.....13.79

B BA-201 Headphone. Similar to model BA-200 but, single headphone. 90,000 ohms (1000 cps). Shpg. wt., 1 lb.
59 J 156. List \$13.40. NET.....7.88

C Lorgnette BA-202 Phone. For group hearing aid systems. Extends to 17". 90,000 ohms. With 5-ft. cord. Shpg. wt., 1 lb.
59 J 157. List \$16.80. NET.....9.88

Hi-Fi Headsets. Double headphone sets that feature uniform frequency response, low distortion, and excellent bass response. Lightweight for maximum comfort. Impedance indicated is at 1000 cps. *For binaural use. Average shpg. wt., 3 lbs.

Stock No.	Type	Impedance	Response	List	NET
59 J 158	BA-205	75,000 ohms	100-10,000 cps	\$33.00	19.40
59 J 153	*BA-205B	150,000 ohms	100-10,000 cps	35.00	20.58
59 J 163	BA-206	50,000 ohms	60-8000 cps	34.65	20.37
59 J 154	*BA-206B	100,000 ohms	60-8000 cps	36.60	21.52

MYTRON HEADPHONES

D N-98 Headphones. Designed for general laboratory use where high impedance and sensitivity are necessary. Have a frequency response of from 60 to 10,000 cps. Impedance at 1000 cps. is in excess of 50,000 ohms. Phones employ crystal elements for high sensitivity. Blocking capacitor required in presence of DC. With 5 1/2 ft. flexible cord attached. Shpg. wt., 1 lb.
59 J 186. NET.....7.20

E N-130 Headphones. Extended frequency headphones, similar to model N-98 above; designed for high fidelity listening. Match impedances from 3.2 to 16 ohms, with minimum distortion. Response of from 60 to 13,000 cps. Has soft rubber ear cushions and cushioned headband. Blocking capacitor required in presence of DC. With 5 1/2 ft. cord. Shpg. wt., 1 lb.
59 J 187. NET.....8.03

BRITISH INDUSTRIES TYPE K HEADPHONES

F Professional-type, high-fidelity dynamic headphones for broadcast use, monitoring, etc. Can be connected to any sound system, amplifier, radio, phonograph, recorder, or similar equipment. Headphones are actually 2 miniature high-fidelity loudspeakers—remarkable tonal fidelity and sensitivity. Uses moving-coil type armature assemblies for maximum response and fidelity; bachelized conical diaphragm; flux density, 6000 lines. Headbands and receiver cases are constructed of highly-polished dural for long life. Headbands are adjustable. Response: 50-10,000 cps. Rubber ear cushions; 6 1/2 ft. cord. 52 ohms impedance. Shpg. wt., 1 1/2 lbs.
59 J 337. NET.....28.95

600-OHM HI-FI HEADPHONES. As above, but 600 ohms.
59 J 338. NET.....34.50



HEADPHONE CORDS

Copper inner conductor covered with woven cotton braid. For phones on this page and pages 279, 281 and 282. All cords have 2 phone tips at one end; *terminals at opposite end of cord. Shpg. wt., 2 oz.

4 1/2 Ft. Double Cords

No.	*Terminals	For Use With	EACH
59 J 220	Eyelet type. For inside terminals.	59 J 100, -101, -110, -111, -125, -126, -172, -135, -136, -137, -215 59 J 130	50c
59 J 205	Eyelet type.	Govt. and military types 59 J 070	50c
59 J 206	Has phone tips on both ends		
59 J 002	Small blunt tips		

5 Ft. Double Cords

59 J 006	Large blunt tips	59 J 020, -021	54c
59 J 181	Eyelet type	59 J 151, -158, -163	

6 Ft. Double Cords

59 J 004	Eyelet type	59 J 000, -001	58c
59 J 007	Large blunt tips	59 J 040	

8 Ft. Double Cords

59 J 221	Eyelet type	Same as type 59 J 220 above	75c
59 J 218	Eyelet type	59 J 130	
59 J 219	Has phone tips on both ends	Govt. and Military type	

Single Cords

59 J 200	4 ft. cord with eyelet type	59 J 112, -113	33¢
59 J 003	4 1/2 ft. cord with small blunt tips	59 J 072	33¢
59 J 182	6 ft cord with eyelet type	59 J 157	50¢

ICA RUBBER PHONE CUSHION



Type 195. Rubber cushions slip over phones for maximum comfort. Do not interfere with reception. Shpg. wt., 6 oz.
59 J 122. NET PER PAIR 1.00
10 or More Pairs, EACH 90c

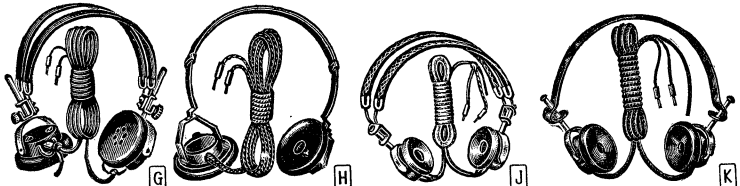

TRIMM HEADPHONES AND ACCESSORIES

G "Military" Type. Constructed to meet military headphone specifications. Impedance, 20,000 ohms; DC resistance, 2,000 ohms. Metal shell with bakelite cap. 6 ft. cord. Inside terminals. Leather-covered headband. Shpg. wt., 1 1/2 lbs.
59 J 040. NET.....11.76
59 J 042. Extra Diaphragms. EACH.. 15c

H "Featherweight" Type. Weigh less than 5 ounces. Black bakelite caps and shells. Forged magnets; pole pieces of permalloy. Impregnated coils. Supplied with flexible 6-ft. moisture-proof cord. Choice of high or low impedances. Shpg. wt., 9 oz.
59 J 000. Standard. 4000 ohms.
59 J 001. Special. 24,000 ohms.
NET EACH.....6.47
59 J 045. Extra Diaphragms. EACH... 15c
59 J 013. Replacement Caps. EACH... 44c

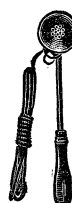

"Lorgnette" Type Earphone. Same construction as "Featherweight" phones above. Excellent for use in churches, and small theaters. Earphone size, 2 1/2" dia. x 3/4" thick. Handle extends to 14". Impedance, 4500 ohms; DC resistance, 1000 ohms. Supplied with flexible, braided 6-ft. cord. Shpg. wt., 10 oz.
59 J 036. NET.....4.85

J "Professional" Type. Magnetic headphones for general use. Bakelite caps and shells. Forged magnets of chrome steel, impregnated coils. 5-ft. cord. Inside terminals. Have plastic-covered headband. Shpg. wt., 1 1/4 lbs.
59 J 020. 3000 ohms. NET
59 J 021. 4000 ohms. EACH.....3.41
59 J 030. Replacement Caps. EACH... 38c
59 J 031. Extra Diaphragms. EACH.... 12c

K Acme "Deluxe" Type Headphones. Sensitive headphones designed for every use. 2000 ohm impedance. Sturdily constructed for dependable performance under all conditions. 4 1/2-ft. cord. Shpg. wt., 8 oz.
59 J 070. NET.....2.12

Extra Diaphragms. For above. 2 oz.
59 J 012. EACH.....12c

Individual Volume Control. Consists of phone jack and volume control mounted in compact box. Ideal for group hearing aid systems in theaters, churches, schools, etc. Resistance: 10,000 ohms. Size: 3 3/4 x 2 1/2 x 1 1/2". Shpg. wt., 1 lb.
59 J 056. Brown wrinkle.
59 J 057. Ivory wrinkle.
NET EACH.....2.59



Burgess Batteries

BURGESS PORTABLE RADIO BATTERIES



All Burgess batteries are carefully manufactured to assure peak performance from battery-operated electronic equipment. The selection of power-packed Burgess batteries listed below covers types for virtually all portable radio needs. Latest "Featherweight" hearing-aid batteries are also listed. Because of Allied's extremely rapid turn-

over, you are always assured of factory-to-you freshness. If you are not able to find the batteries which you require, give the make and type number of the original batteries, make and model number of your set, and we will supply the Burgess equivalents. *Standard type number assigned by National Electronic Distributors Association.



PORTABLE "A" BATTERIES

Stock No.	Burgess Type	Std. Pkg.	List Price	NET EACH		Volts	Size	Shpg. Wt., Lbs.	* NE DA No.	Replaces	
				Single Lots	Std. Pkg.					Eveready	RCA
53 J 069	2D	1	\$0.7553	1 1/2	2 3/4 x 1 1/2 x 2 3/16"	1/2	18	720	VS069
53 J 063	2R	48	.20	.14	.13	1 1/2	2 3/4 x 1 1/2 x 1/4"	1/2	13	950	VS036
53 J 003	2F	1	.8559	1 1/2	2 1/2 x 1 3/4 x 1/4"	3/4	11	W353	VS141
53 J 005	4F	6	1.35	1.05	.95	1 1/2	2 5/8 x 2 5/8 x 4 3/4"	1 1/2	4	742	VS004
53 J 045	5R	12	1.12	.11	.09 1/2	1 1/2	2 1/2 x 1 3/4 x 1/4"	1/2
80 J 629	6F	1	1.95	1.37	1 1/2	4 3/4 x 2 3/4 x 4 1/4"	2 1/4	5	743	VS007
53 J 046	8R	24	.50	.38	.35	1 1/2	3 1/2 x 1 1/2 x 1/4"	1/4	23	960P	VS070
53 J 006	8F	1	2.35	1.65	1 1/2	3 2/3 x 2 2/3 x 5 1/2"	3	17	741
53 J 047	9R	12	.17	.13	.12	1 1/2	1 6/8 x 3/8 x 1/4"	1/4	1015E
80 J 641	21R	12	.40	.31	.28	1 1/2	4 1/8 x 1 1/4"	1/2	20	964	VS236
53 J 070	D3	6	.90	.69	.63	4 1/2	3 7/8 x 1 5/8 x 2 1/4"	3/4	19	726	VS072
80 J 624	F3	6	1.05	.81	.74	4 1/2	4 1/4 x 1 3/4 x 1/4"	1 1/4	3	736	VS067
53 J 013	G3	6	1.10	.85	.77	4 1/2	3 1/2 x 1 7/8 x 1 1/4"	1 1/4	7	746	VS002
53 J 011	74PI	6	1.35	.95	.95	6	2 1/2 x 2 1/2 x 4 1/8"	1 1/2	6	744	VS009
53 J 001	2F4	1	2.95	2.07	6	4 x 2 1/2 x 5 7/8"	2 1/2	1	718	VS010
80 J 625	Z4	1	.9063	6	1 3/4 x 1 3/8 x 2 3/8"	1/4	2	724	VS068
53 J 042	B5	6	1.50	1.16	1.05	7 1/2	3 2/3 x 2 1/8 x 2 1/2"	1 1/2	8	713	VS129
53 J 043	C5	6	1.35	1.05	.95	7 1/2	2 7/8 x 1 7/8 x 3 1/2"	1 1/2	9	717	VS065
53 J 071	T5	3	1.38	1.06	.96	7 1/2	2 1/2 x 2 1/2 x 2 2/3"	1 1/2	10	W360
53 J 049	S7	1	.9865	1 1/2	6 1/8 x 1 5/8"	1/4

PORTABLE "B" BATTERIES

Stock No.	Burgess Type	Std. Pkg.	List Price	NET EACH		Volts	Size	Shpg. Wt., Lbs.	* NE DA No.	Replaces	
				Single Lots	Std. Pkg.					Eveready	RCA
80 J 535	A30	2	3.05	2.33	2.12	45	3 9/16 x 2 1/4 x 4 5/8"	1 3/4	206	W359	VS014
80 J 536	B30	2	3.85	2.97	2.70	45	4 1/8 x 2 1/2 x 5 5/8"	2 1/4	207	484	VS012
80 J 537	Z3	2	3.75	2.93	2.74	45	3 1/2 x 2 1/8 x 4 1/4"	1 1/2	205	482	VS013
80 J 546	M30	6	3.15	2.43	2.21	45	5 1/2 x 1 3/4 x 3 1/2"	2	202	482	VS013
80 J 539	W30PI	1	3.33	2.33	45	2 1/2 x 1 1/2 x 3 2/3"	3/4	733
80 J 545	XX30	6	2.45	1.89	1.72	45	2 1/2 x 3 1/2 x 3 2 1/2"	3/4	201	455	VS055
80 J 646	U30	1	2.50	1.75	45	1 3/4 x 1 9/8 x 3 1/2"	3/4	213	315	VS086
80 J 645	P45M	6	4.00	3.03	2.75	67 1/2	1 2/3 x 1 x 5 5/8"	3/4	211M	477	VS215
80 J 631	K45	6	3.15	2.43	2.21	67 1/2	2 1/4 x 1 1/2 x 3 1/4"	1/2	203	457	VS082
80 J 544	XX45	6	3.50	2.70	2.45	67 1/2	2 3/4 x 1 1/2 x 3 3/8"	3/4	200	460	VS016
80 J 642	P45	6	3.10	2.39	2.17	67 1/2	1 2/3 x 1 x 5 5/8"	3/4	211P	477	VS218
80 J 692	UX45	1	2.95	2.07	67 1/2	1 3/4 x 1 3/8 x 3 3/8"	1/2	416
80 J 613	XX50	6	3.95	3.05	2.77	75	1 2/3 x 1 1/8 x 6 3/8"	1 1/4	212	437	VS217
80 J 693	N60X	1	4.25	2.97	2.70	90	1 7/8 x 1 1/8 x 7 7/8"	1 1/8	495	VS012
80 J 665	P60	6	3.75	2.89	2.63	90	1 2/3 x 1 7/8 x 7 7/8"	1	214	479	VS216
80 J 582	N60	6	4.25	3.28	2.93	90	3 1/8 x 1 3/4 x 3 3/8"	1	204	490	VS090
80 J 588	XX69	1	5.65	3.96	103 1/2	1 1/2 x 1 1/2 x 1 3/4"	1 1/4	217	W361

COMBINATION "AB" PACKS FOR PORTABLES

Stock No.	Burgess Type	Std. Pkg.	List Price	NET EACH		Volts	Size	Shpg. Wt., Lbs.	* NE DA No.	Replaces	
				Single Lots	Std. Pkg.					Eveready	RCA
80 J 594	2TXX40	1	5.04	3.38	1 1/2, 60	2 1/3 x 2 1/4 x 1 1/2 x 7 5/8"	1 1/2	412	W370
80 J 551	4GA42	1	7.35	4.95	1 1/2, 63	9 1/4 x 2 1/2 x 4 3/4"	4	407	W366	VS053
80 J 555	61A60	1	7.15	4.80	1 1/2, 90	9 3/8 x 2 1/2 x 4 1/4"	4 1/2	410	W369	VS054
80 J 676	4T260	1	5.75	4.03	1 1/2, 90	7 3/8 x 2 1/2 x 3 3/4"	4	424	729	VS064
80 J 615	TSZ50	1	6.25	4.38	6, 7 1/2, 75	8 1/2 x 3 1/2 x 2 3/8"	4	403	755	VS050
80 J 675	TSZ50P	1	6.25	4.38	7 1/2, 75	8 1/2 x 3 1/2 x 2 3/8"	3 1/2	431	785	VS060
80 J 614	TOZ60	1	6.75	4.73	7 1/2, 90	2 3/4 x 8 1/8 x 3 1/4"	4 1/2	405	756	VS057W
80 J 584	FOA60	1	7.25	5.08	7 1/2, 9, 90	9 3/8 x 2 1/2 x 4 3/8"	6	401	753	VS019
80 J 585	G6M60	1	7.85	5.50	7 1/2, 9, 90	10 3/4 x 3 1/2 x 4 1/2"	6	402	754	VS018
80 J 643	TOZ60P	1	6.85	4.80	9, 90	2 3/4 x 2 3/4 x 1 3/8"	4 1/2	428	727	VS059
80 J 644	FOA60P	1	6.85	5.00	9, 90	6 7/8 x 2 3/4 x 4 1/4"	4 1/2	406	757	VS038
80 J 570	G6B60	1	7.75	5.43	9, 90	1 3/4 x 2 1/2 x 3 1/2 x 4 1/2"	7	400	752	VS047

FARM RADIO PACKS

Stock No.	Burgess Type	Std. Pkg.	List Price	NET EACH	Volts	Size	Shpg. Wt., Lbs.	* NE DA No.	Replaces
80 JX 572	17GD60	1	9.65	7.21	1 1/2, 90	15 1/4 x 4 3/8 x 7 1/4"	20	413	759
80 J 635	4SD60	1	9.65	7.21	1 1/2, 90	10 1/4 x 4 3/8 x 6 1/4"	15	414	758
80 J 636	S6D60	1	12.50	8.75	7 1/2, 9, 90	9 7/8 x 4 1/8 x 7 1/8"	17	415	776

TRANSISTOR PORTABLE RADIO BATTERIES

Stock No.	Burgess Type	Std. Pkg.	List Price	NET EACH		Volts	Size	Shpg. Wt., Lbs.	Zenith	Replaces		Acous-tion
				Single Lots	Std. Pkg.					Sono-tone	Ever-eady	
80 J 689	NE	48	.12 1/2	.09	.08	1 1/2	1 1/4 x 7/8"	1/4	E340E	
80 J 691	D6PI	1	1.65	1.16	3, 6, 9	7 7/8 x 1 7/8 x 2 1/8"	1 1/2	1601	2506	VS301	
80 J 683	4D4	1	3.95	2.76	6	7 3/8 x 2 1/2 x 1 3/8"	2 1/2	1400	274	
80 J 690	A4	1	1.0060	6	2 1/2 x 1 3/8 x 1 3/8"	1/4	
80 J 679	XX9	1	1.3595	9, 13 1/2	1 3/8 x 1 3/8 x 2 1/8"	3/4	1900	239	VS304	
80 J 666	D6	1	1.65	1.16	9	3 5/8 x 2 x 2 3/8"	1	1603	276	VS306	
80 J 684	2N6	1	1.85	1.16	9	2 3/8 x 1 3/8 x 1 3/8"	1/4	1602	246	VS305	
80 J 664	2U6	1	1.65	1.16	9	1 1/8 x 3/8 x 1 1/8"	1/4	1604	276	
53 J 086	P6	1	1.1077	9	3 1/2 x 3 1/2 x 1 1/2"	1/4	1600	226	VS300	
80 J 696	C6X	1	1.60	1.10	9	2 3/8 x 1 1/2 x 6 1/8"	3/4	2356	

"FEATHERWEIGHT" "B" BATTERIES—INCLUDING HEARING AID TYPES

Stock No.	Burgess Type	Std. Pkg.	List Price	NET EACH		Volts	Size	Shpg. Wt., Lbs.	Zenith	Replaces		Acous-tion
				Single Lots	Std. Pkg.					Sono-tone	Ever-eady	
53 J 072	XX15	1	\$1.80	1.27	22 1/2	1 1/2 x 1 3/8 x 3 3/8"	4	425P	922	22EW
53 J 073	XX22	1	2.05	1.44	33	2 1/2 x 3 1/2 x 3 1/2"	6	433P	930	33EW
53 J 074	XX30PI	1	2.50	1.75	45	2 1/2 x 3 1/2 x 4 1/2"	12	455P	230	945	45EW
53 J 075	K20	1	1.95	1.37	30	2 2/3 x 1 1/2 x 1 1/4"	3
53 J 076	U10	1	1.1581	15	1 x 3/8 x 1 1/4"	2	411	211	311	711G
53 J 077	U15	1	1.50	1.05	22 1/2	1 x 3/8 x 1 1/4"	2	412	212	312	712H
53 J 078	U20	1	1.75	1.23	30	1 x 3/8 x 2 1/8"	2	413	213	313	713G
53 J 080	Y10	1	1.1581	15	1 3/8 x 1 3/8 x 1 3/8"	3	504E	Z5	315	715G
53 J 081	Y15	1	1.50	1.05	22 1/2	1 3/8 x 1 3/8 x 1 3/8"	3	505E	Z6	322	722G
53 J 079	Y20	1	1.85	1.30	30	1 3/8 x 1 3/8 x 1 3/8"	3	506E	Z7
53 J 084	Y20S	1	1.85	1.30	30	1 3/8 x 1 3/8 x 2 3/8"	3	507E	Z7

Burgess Batteries



STANDARD DRY BATTERIES

Suitable for all radio and laboratory requirements. Allied's stock of Burgess batteries is always fresh, assuring you of full-rated efficient service. Burgess quality construction and insulators allow use of very active ingredients, providing maximum useful life. Letters following battery type numbers denote terminals: F.—plus; S.C.—spring clips; Others—w/ screw terminals except *spring clips where S.C. is not included in Type No.; \$heavy-duty, industrial type.

"A" BATTERIES

Stock No.	Burgess Type	Volts	Size	Shpg. Wt. Lbs.	Std. Pkg.	NET EACH	
						Single Lots	Std. Pkg.
53 J 036	2FBP	1 1/2	2 1/2 x 3 1/2 x 4 1/2	1 1/2	5	.81	.74
80 J 62	2BBP	2 1/2	4 1/2 x 2 1/2 x 2 1/2	1 3/4	6	1.16	1.05
53 J 023	44	1 1/2	1 2/8 dia. x 4 3/8	3/4	195
53 J 017	2FH	3	2 1/2 x 2 1/2 x 4 1/2	1 1/2	5	1.03	.94
53 J 018	F2BP	3	2 1/2 x 1 1/2 x 4 1/2	1	5	.81	.74
80 J 591	B2BP	3	1 5/8 x 1 3/8 x 2 1/4	1/4	6	1.03	.94
80 J 604	2Z2PI	3	1 3/2 x 1 1/2 x 2 1/2	1/4	12	.62	.56
53 J 038	422	3	2 3/4 x 1 1/2 x 2 1/2	1/4	10	.46	.42
53 J 037	2F2BP	3	5 1/2 x 1 1/2 x 4 3/4	1 1/2	1	2.23
53 J 035	432	4 1/2	2 1/2 x 1 1/2 x 2 1/2	1/4	10	.54	.49
53 J 085	532	4 1/2	2 1/2 x 2 1/2 x 2 1/2	1/4	152
53 J 016	F4BP	6	2 5/8 x 2 3/8 x 4	1 1/2	165

"B" BATTERIES

Stock No.	Burgess Type	Volts	Size	Shpg. Wt. Lbs.	Std. Pkg.	NET EACH	
						Single Lots	Std. Pkg.
80 J 511	5156PI	22 1/2	4 3/4 x 2 3/8 x 2 5/8	1 3/4	1	2.02
80 J 512	4156SC	22 1/2	4 1/2 x 2 1/8 x 2 3/8	1 3/4	5	2.22	2.02
80 J 510	4156SC	22 1/2	3 1/2 x 2 1/8 x 2 3/8	1 3/4	1	1.61
80 J 501	21308SC	45	8 1/2 x 4 1/2 x 7 3/4	13	1	4.45
80 J 504	10308PI	45	8 1/2 x 4 1/2 x 7 3/4	11 1/2	1	4.00
80 J 505	10308SC	45	8 1/2 x 4 1/2 x 7 3/4	11 1/2	1	4.00
80 J 507	2308SC	45	8 1/2 x 2 1/2 x 7 1/8	8	1	3.19
80 J 508	5308	45	4 1/2 x 2 1/2 x 5 1/8	3	1	2.64
80 J 519	W30BPX	45	3 x 1 1/2 x 3 3/8	3/4	1	2.00
80 J 524	Z30NX	45	1 7/8 x 3 1/2 x 4 1/8	1 1/2	5	2.61	2.37
80 J 634	Z60BP	90	3 3/4 x 2 1/2 x 5 1/8	2 1/4	1	8.90
80 J 626	U-200	300	2 3/4 x 2 3/8 x 3 3/8	1	1	7.70

"C" BATTERIES

Stock No.	Burgess Type	Volts	Size	Shpg. Wt. Lbs.	Std. Pkg.	NET EACH	
						Single Lots	Std. Pkg.
80 J 515	5360	4 1/2	2 1/8 x 2 1/8 x 2 1/8	1 1/4	10	.69	.63
80 J 513	2370PI	4 1/2	4 1/2 x 1 3/4 x 2 6/8	1 1/4	5	1.16	1.05
80 J 593	2370	4 1/2	3 1/2 x 1 3/4 x 2 1/8	1 1/4	5	1.01	.92
80 J 514	5540	7 1/2	4 x 1 3/4 x 2 3/4	1 1/2	5	1.12	1.02
80 J 521	W5BP	7 1/2	2 3/8 x 2 1/2 x 1 3/8	3/4	6	1.47	1.34
80 J 516	B5P	7 1/2	4 3/4 x 2 1/2 x 2 3/8	1 1/4	1	1.94
80 J 623	A9BP	13 1/2	2 3/8 x 2 3/8 x 2 1/8	1 1/2	1	2.94

No. 6 LINE

Stock No.	Burgess Type	Volts	Size	Shpg. Wt. Lbs.	Std. Pkg.	NET EACH	
						Single Lots	Std. Pkg.
80 J 638	6	1 1/2	2 1/2 x 6 5/8	1 3/4	12	.77	.70
80 J 639	6*	1 1/2	2 1/2 x 6 5/8	2 1/4	12	.77	.70
80 J 644	6	1 1/2	2 1/2 x 6 5/8	2	12	.88	.80
80 J 640	S461	6	10 1/2 x 2 3/4 x 7 1/8	8 1/2	6	3.19	2.90

FLASHLIGHT BATTERIES

These top-quality, long-life cells deliver highly dependable performance in all popular sizes of flashlights. All are double-protected against leakage—sealed in plastic and steel on the outside and chrome protected on the inside. Curbs harmful internal action for new, longer life. Type 1—for baby tubular flashlights; Type 2—for standard flashlights; Type Z—for standard penlights; Type 7—for slim penlights; Type N—for miniature and novelty lights.



Stock No.	Burgess Type	Size	Wt. Oz.	Std. Pkg.	NET EACH		
					LIST	Single Lot	Std. Pkg.
53 J 009	2	2 3/8 x 1 2/4	6	50	20c	14c	13c
53 J 029	1	1 1/4 x 5/8	4	12	20c	14c	13c
53 J 031	Z	1 3/8 x 3/8	3	12	12 1/2c	9c	8c
53 J 082	N	1 1/4 x 7/16	3	24	12 1/2c	9c	8c
78 J 243	7	1 1/4 x 1 3/8	2	12	12 1/2c	9c	8c

IGNITION AND TELEPHONE BATTERIES

Famous "Metalclad" weather-resistant batteries. *Have strap-handle for easier carrying. Designed for emergency illumination, portable lighting, alarm systems. Used by railroads, police, fire departments and emergency crews. Dependable, leakproof metal container. Types 4F2H and 4FH recommended for general ignition, telephone and lantern service as well as electronic devices, etc.



Stock No.	Burgess Type	Volts	Size	Shpg. Wt. Lbs.	Std. Pkg.	NET EACH	
						Single Lots	Std. Pkg.
53 J 033	4F6H*	9	8 1/2 x 3 3/4 x 5 1/8	9	1	4.30
80 J 601	4F5H*	7 1/2	7 7/8 x 3 3/4 x 5 1/8	7 1/2	1	3.67
53 J 025	4F4H*	6	6 3/4 x 2 1/2 x 4 1/8	6 1/4	1	2.90
80 J 027	4F2H	6	3 3/4 x 2 1/4 x 5 1/8	3	1	1.26
53 J 024	4FH	1 1/2	2 5/8 x 2 3/8 x 4	1 1/2	12	.77	.70

LANTERN BATTERIES

For use with railroad-type lanterns. Type F4H has durable and positive coispring contacts—a favorite of railroadmen.

Stock No.	Burgess Type	Volts	Size	Wt. Lbs.	Std. Pkg.	NET EACH	
						Single	Pkg
53 J 027	4F2H	3	3 3/4 x 2 1/4 x 5 1/8	2 3/4	1	1.26
53 J 028	F4H	6	2 5/8 x 2 3/8 x 3 1/8	1 1/2	12	.72	.65
53 J 016	F4BP	6	2 5/8 x 2 3/8 x 4	1 1/2	165

PHOTO-FLASH BATTERIES

*Designed for high initial current discharge.

Stock No.	Type No.	Volts	Size	Std. Pkg.	Wt.	NET EACH		Replaces Eveready
						Single	Pkg.	
53 J 039	220s	1 1/2	2 25/64 x 1 1/32	12	6 oz.	.14	.13	850
53 J 040	120s	1 1/2	1 15/64 x 1 1/32	12	4 oz.	.14	.13	835
53 J 041	920s	1 1/2	1 31/64 x 3 3/64	24	4 oz.	.11	.10	815
53 J 044	U15PF8	2 1/2	3 1/2 x 2 1/2 x 1 3/8	1	4 oz.	1.05	412
80 J 678	U160	240	2 7/8 x 1 3/4 x 4 3/8	1	3/4 lb.	5.56	491
80 J 626	U200	300	2 3/4 x 2 3/8 x 3 3/4	1	1 lb.	7.70
80 J 677	XX150	225	4 1/4 x 2 3/8 x 4 3/8	1	2 1/2 lb.	6.96	667
80 J 544	X60	60	2 1/2 x 1 1/2 x 3 3/8	6	1 lb.	2.70	2.48	667
80 J 632	D4	6 3/4	3 1/4 x 1 3/8 x 3 1/8	6	1 lb.	3.28	2.98	490
53 J 070	D3	4 1/2	3 1/8 x 1 5/8 x 2 1/8	6	3/4 lb.	6.69	6.63	726
80 J 631	K45	6 3/4	2 1/4 x 1 1/2 x 2 1/2	6	1 lb.	2.43	2.21	457
80 J 546	M30	45	3 1/4 x 1 3/4 x 5 1/2	6	2 lbs.	2.43	2.21	482
53 J 081	Y15PF	22 1/2	1 1/2 x 1 1/2 x 2 1/2	1	3 oz.	1.05	505
53 J 076	U10	15	1 1/2 x 3 3/4 x 1 7/8	1	2 oz.81	411
53 J 078	U20	30	1 1/2 x 3 3/4 x 2 1/8	1	2 oz.	1.23	413
53 J 080	Y10PF	15	1 1/2 x 3 3/4 x 2 3/8	1	3 oz.81	504
80 J 681	N150	225	3 5/8 x 2 1/2 x 4 3/8	1	1 1/2 lb.	5.56	492
80 J 682	U320	510	2 1/2 x 1 1/2 x 3 3/8	1	1 1/2 lb.	11.16	497

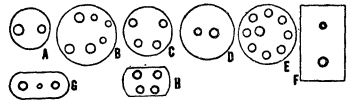

PLUGS FOR BATTERIES

*With 3 small prongs only. †5 prongs, 5 Fahnestock clips. ‡3 prongs. 1 oz. 2 per pkg.

Stock No.	Fig.	For Burgess Battery	For RCA Battery	Per Pkg.
54 J 021	A	2F4, F4PI,	VS009	9c
54 J 022	B*	XX15, XX22, XX30PI	11c
54 J 023	C	6TA60, 4SD60 4T260, 1VGD60	VS054	11c
54 J 024	D	2F, 4F, 6F, 8F, 2D, 8R	VS004, VS069, VS070, VS141	9c
54 J 026	G	B3, F3 G3	VS067, VS072	9c
54 J 027	H	B-5, C-5, I-5	VS065	9c
54 J 028	G	2TX40, 4GA42	11c
54 J 031	E	FS660, GG660 SD660, TS250, T6260	VS018, VS019, VS050, VS057W	19c
54 J 034	B	A30, B30, M30, W30PI, Z30	VS012, VS013, VS014, VS015	9c
54 J 036	†	5156PI	VS030	30c
54 J 035	§	2370PI	20c
54 J 067	Male snap-on	8c
54 J 068	Female snap-on	8c
54 J 037	U30	VS086	72c

EVEREADY NO. 6

DRY CELL

Standard No. 6 dry cell. Supplies 1 1/2 volts. For industrial use, annunciator and signal systems, battery-operated ignition systems, farm lanterns, etc. Size, 6x2 1/2" diameter. Equipped with screw terminals. Case is insulated. Shpg. wt., 2 lbs. **80 J 767. NET EACH.....77c**



Lots of 12, EACH.....70c

EVEREADY GEIGER COUNTER 300 VOLT BATTERY

Type 493. A very compact, highly dependable power source. Especially designed for low-drawn, high-voltage applications such as: Geiger counters, photoflash units (gas discharge type), multiplier-photo cells, and small lightweight insulation testers. Supplies 300 volts. Size: 2 1/4 x 2 3/8 x 3 3/8". Shpg. wt., 1 1/4 lbs. **80 J 759. NET EACH.....7.70**

SWITCHBOARD TESTING BATTERY

Type 766T. 22 1/2-volt battery for switchboard testing. Replaces Burgess Type 2156 and RCA Type VS137 batteries. Size, 6 1/4 x 4 1/8 x 3 1/8". Shpg. wt., 4 lbs. **80 J 674. NET.....3.10**

WILLARD RECHARGEABLE BATTERIES

Compact rechargeable wet batteries. Excellent for portable equipment. Non-spill construction. In lightweight polystyrene containers immune to corrosion. Fibrite insulation retards plate shedding. Built-in charge indicator. For 2-volt power supplies, but can be connected in series for higher voltages. Shipped wet. Express only.



Type 25-2. For Portable Radios. Supplies 2 volts for 21 ampere-hours. Plug-in terminals. Original equipment in GE Models 250 and 260. Size, 6x2 1/2 x 2 3/4". Wt., 3 1/4 lbs. **98 J 023. List, \$11.15. NET.....8.08**

Type ER 6-2B For Photo-Flash. Supplies 2 volts for 6 ampere-hours. 125 to 250 flashes per cycle of charge. Gives maximum peak current for positive bulb flash and split-second shutter synchronization. Has plain post terminals. 1 1/4 x 2 3/8 x 4 1/4". Shpg. wt., 1 1/2 lbs. **98 J 024. List, \$7.55. NET.....5.52**

Type ER-34-2. For Portable Radios. Supplies 2 volts for 34 ampere-hours. Battery has plain posts. Original equipment in RCA radio model 65BR9. Length, 4 1/2"; width, 3 1/8"; height, 4 1/2". Shpg. wt., 3 1/4 lbs. **98 J 025. List, \$14.85. NET.....10.78**

RCA Batteries



RCA RADIO, TRANSISTOR & INDUSTRIAL BATTERIES

RCA batteries are scientifically designed to give maximum performance. The extensive selection of long-life RCA batteries in the listing below covers types for hundreds of industrial applications and virtually all portable radios in use today. If you cannot determine which batteries you require, give us the make and type number of the original

batteries, plus the make and model number of your set. Because of our rapid stock turnover, you can always be sure of fresh batteries when you order from Allied. *Standard number assigned by National Electronic Distributors' Assn. †Sealed in steel. ‡Other voltage taps: 1 1/2, 3, 4 1/2, 6, 10. †Other voltage taps: 3, 4 1/2, 6, 9, 10 1/2, 16 1/2.



PORTABLE "A" BATTERIES

Stock No.	RCA Type	Std. Pkg.	List Price	NET EACH		Volts	Size	Wt. Each Lbs.	*NEIDA No.	Interchangeable with	
				Single Lots	Std. Pkg.					Burgess	Eveready
80 J 947	VS034	12	1.25	.09	.08	1 1/2	3/16x2"	1/4	15	ZR	915
80 J 903	VS036†	48	.20	1.35	.125	1 1/2	1 3/16x2 3/8"	1/2	13	2R	950
80 J 948	VS035†	23	.20	1.35	.125	1 1/2	1x1 1/8"	1/4	14	1	935
80 J 897	VS074	24	1.25	.09	.08	1 1/2	7/16x1 1/4"	2	24	4	912
80 J 901	VS004	6	1.35	1.05	.95	1 1/2	4 1/16x2 3/8x2 3/8"	1 1/2	4	7F	742
80 J 904	VS073	24	1.25	.09	.08	1 1/2	7/16x1 3/8"	1/6	910	N	W463
80 J 912	VS236†	12	.40	.31	.28	1 1/2	1 3/8x4 3/8"	1/2	20	21R	964
80 J 966	VS069	6	.75	.58	.53	1 1/2	2 9/16x1 1/2x2 7/8"	3/4	18	2D	720
80 J 967	VS072	12	1.10	.69	.63	4 1/2	3 1/8x1 1/2x2 1/8"	1	19	D3	726
80 J 900	VS002	6	1.10	.85	.77	4 1/2	4 1/16x1 3/8x4"	1 1/4	7	G3	746
80 J 963	VS067	6	1.05	.81	.74	4 1/2	4x1 3/8x4 1/8"	1	3	F3	736
80 J 902	VS009	6	1.35	1.05	.95	6	3 1/8x2 5/8x2 5/8"	1 1/2	6	F4P1	744
80 J 962	VS068	12	.90	.69	.63	6	1 3/8x1 1/2x2 3/8"	1/4	2	Z4	724
80 J 962	VS065	12	1.35	1.05	.95	7 1/2	3 1/8x2x2 3/8"	1 3/4	9	C5	717

PORTABLE "B" BATTERIES

80 J 913	VS084	20	1.50	1.16	1.05	22 1/2	1x5/8x2"	1/4	215	U15	412
80 J 969	VS086	6	2.50	1.93	1.75	45	1 1/16x3/16x3 9/16"	1/4	213	U30	415
80 J 905	VS012	6	3.85	2.97	2.70	45	4 3/8x2 3/8x5 1/8"	3	207	B30	484
80 J 906	VS013	6	3.15	2.43	2.21	45	3 3/8x1 1/8x5 1/8"	2	202	M30	482
80 J 907	VS014	6	3.05	2.33	2.12	45	3 1/8x2 1/4x4 3/8"	1 3/4	206	A30	W359
80 J 908	VS015	10	3.95	3.04	2.76	22 1/2-45	3x2 1/4x4"	1 1/2	205	Z30	738
80 J 910	VS055	6	2.45	1.89	1.72	45	2 1/8x1 3/8x1 1/8"	3/4	211	XX30	455
80 J 999	VS218	6	3.10	2.39	2.17	67 1/2	5 7/8x1 1/8x2 1/8"	1	201	P45	471
80 J 909	VS016	6	3.50	2.70	2.45	67 1/2	2 3/4x1 3/8x3 3/4"	1	200	XX45	467
80 J 932	VS216	6	3.95	2.98	2.71	67 1/2	5 9/16x1 1/2x1 1/8"	1	211	P45	477
80 J 889	VS082	6	3.15	2.43	2.21	67 1/2	2 1/4x1 3/8x2 1/8"	3/4	203	K45	457
80 J 898	VS215	24	3.50	2.70	2.45	67 1/2	1 29/32x1 5/16"	5/8	211M	P45M	477
80 J 968	VS217	6	3.95	3.05	2.77	75	1 1/8x1 3/8x6 1/4"	1	212	XX50	437
80 J 911	VS090	6	4.25	3.28	2.98	90	3 1/16x1 3/8x3 3/4"	1	204	N60	490
80 J 984	VS219	12	3.75	2.89	2.63	90	1 1/2x1 1/2x7 1/2"	1	214	P60	479

PORTABLE "AB" BATTERIES

80 J 921	VS050	1	6.25	4.38	4.38	6-7 1/2-75	8 9/16x2 3/8x3 1/4"	4	403	TSZ50	755
80 J 896	VS060	6	6.25	4.82	4.38	7 1/2-75	3 1/8x2 3/8x8 9/16"	3 1/2	431	TSZ50P	785
80 J 916	VS019	1	7.25	5.08	5.08	7 1/2-90	4 3/8x2 3/8x9 3/4"	6	401	FGA60	753
80 J 933	VS057W	1	6.75	4.73	4.73	7 1/2-90	8 1/16x2 3/8x3 3/4"	4	405	TGZ60	756
80 J 920	VS047	1	7.75	5.43	5.43	9-90	1 3/8x2 3/8x4 3/8"	8	400	G6B60	752
80 J 928	VS058	1	6.85	4.80	4.80	9-90	9 1/2x2 3/8x4 3/8"	5	406	FGA60P	757
80 J 888	VS059	1	6.85	4.80	4.80	9-90	8 1/16x2 3/8x3 3/4"	5	428	TGZ60P	757

INDUSTRIAL BATTERIES

80 J 993	VS070	20	.50	.39	.35	1 1/2	1 5/16x4 1/8"	1/2	23	8R	1060
80 J 879	VS006C	12	1.05	.77	.70	1 1/2	2 3/8x3 3/8"	2 1/2	914	6CL	67L
80 J 986	VS101	5	1.05	.81	.74	1 1/2	2 3/8x1 3/8x4 3/8"	1	700	22F BP	W354
80 J 957	VS106	10	1.05	.77	.70	1 1/2	2 1/16x2 1/16x4 3/8"	1 1/2	900	4FH	735
80 J 959	VS130	5	1.32	1.01	.92	1 1/2-3-4 1/2	3 1/8x1 1/8x3"	1	712	370ST	761T
80 J 892	VS134	10	.60	.46	.42	3	1 1/16x3/4x2 9/16"	1 1/2	704	422	750
80 J 985	VS100	5	1.05	.81	.74	3	2 9/16x1 3/8x4 3/8"	1	701	F2BP	W352
80 J 937	VS028	5	.90	.69	.63	4 1/2	2 9/8x1/2x2 1 1/2"	1 1/2	714	5360	781
80 J 987	VS133	5	.75	.57	.52	4 1/2	3 1/16x1 3/8x2 3/8"	1 1/2	706	532	703
80 J 942	VS039	4	4.35	3.19	2.90	6	10 3/8x2 1/8x7 7/8"	11	907	S461	1461
80 J 992	VS040C	10	.98	.72	.65	6	2 1/16x2 1/16x4 5/16"	1 1/4	908	F4H	767
80 J 950	VS040S	10	.98	.72	.65	6	2 1/16x2 1/16x4 5/16"	1 1/4	913	F4BP	767
80 J 939	VS029	5	1.47	1.12	1.02	7 1/2	2 1/8x1 1/8x3 3/8"	1 1/2	713	S40	773
80 J 890	VS083	20	1.15	.89	.81	7 1/2	1 1/2x2x3 1/4"	1 1/2	208	U10	411
80 J 960	VS131	5	2.90	2.22	2.02	22 1/2	4 3/8x2 1/2x3 3/4"	2	708	5156SC	778
80 J 951	VS102	5	2.35	1.77	1.61	22 1/2	3 3/8x2 1/8x2 3/4"	1 1/4	710	4156	763
80 J 952	VS112	5	3.75	2.90	2.64	22 1/2-45	5 7/8x2 5/8x4 1/8"	3 3/4	709	5308	W376
80 J 988	VS114	5	3.40	2.61	2.37	22 1/2-45	3x1 1/8x4 1/8"	2	711	Z30NX	W350
80 J 871	VS026	6	4.55	3.51	3.19	22 1/2-45	8 1/16x3 3/8x7 3/8"	7 1/2	717	2308PI	485
80 J 873	VS127W	5	6.30	4.85	4.41	22 1/2-45	8x4x7 3/8"	11	724	10308SC
80 J 996	VS157	5	6.35	4.90	4.45	22 1/2-45	8 1/8x4 5/8x7 1/8"	12	715	2130BSC	794
80 J 914	VS085	20	1.75	1.35	1.23	30	2 9/16x3/8x1 1/2"	1 1/4	210	U20	413
80 J 989	VS093	1	11.00	7.70	7.70	300	2 9/8x2 3/8x3 3/8"	1 1/4	722	U200	493

TRANSISTOR BATTERIES

The RCA batteries listed below are engineered specifically for use in transistorized radios—all combine extremely compact size, light-

weight and exceptionally long service life. All RCA battery types will provide extra listening hours from your radio.

Stock No.	RCA Type	Std. Pkg.	List Price	NET EACH		Volts	Size	Wt. Each Lbs.	*NEIDA No.	Interchangeable with	
				Single Lots	Std. Pkg.					Burgess	Eveready
80 J 846	VS313	20	.75	.56	.51	1.4	3/16x1 1/4"	1/16	216
80 J 991	VS301	12	1.65	1.28	1.16	3, 6, 9	2 3/4x1 1/8x8"	1 1/2	1601	D6P1	2506
80 J 949	VS400	10	2.65	1.98	1.80	4	1 3/8x2 1/8"	1/4	1300	E233
80 J 841	VS308	12	1.28	.99	.90	4	1 1/16x3 1/8"	1/8	1302
80 J 844	VS311	12	1.10	.85	.77	4	1 1/32x3 3/4"	1/32	1301
80 J 840	VS307	12	1.44	1.11	1.01	5 1/2	1 9/32x3 1/2"	3/8	1402
80 J 843	VS310	12	1.20	1.00	.91	5 1/2	1 1/4x3 1/2"	1/2	1401
80 J 845	VS312	12	2.75	2.04	1.85	8	1x1 1/8"	2 1/8	1600	216
80 J 961	VS300	6	1.75	1.35	1.23	9	1 3/8x3 1/2"	1/4	1600	P6	226
80 J 838	VS305	12	1.85	1.43	1.30	9	2 3/4x1 3/8x1 3/8"	1/4	1602	2N6	246
80 J 839	VS306	6	1.65	1.28	1.16	9	3 3/4x2 1/2x2 9/16"	1	1603	D6	276
80 J 842	VS309	12	1.61	1.24	1.13	9	1 29/32x3 5/8"	1/16	1606
80 J 847	VS314	12	1.10	.85	.77	9	1x1 1/8"	1/8	1600	226
80 J 837	VS304	12	1.35	1.05	.95	9, 13 1/2	2 3/4x1 1/8x1 3/8"	1/4	1900	XX9	239

Mallory Batteries, Power Supplies & Rectifiers



MERCURY TRANSISTOR RADIO BATTERIES

Mercury batteries for radio and instrument applications. For direct replacement of zinc-carbon types. Provide longer service and greater shelf life. Av. shgp. wt., 8 oz.

Stock No.	Mfr's Type	Size	Volts	Std. Pkg.	NET EACH	
					Single	Std. Pkg.
80 J 780	RM-411R	1x1 7/32x1 13/32"	1.50	12	1.65	1.50
80 J 781	RM-412R	1x1 7/32x1 15/32"	22.5	12	2.11	1.92
80 J 782	RM-413R	1x1 7/32x2 1/8"	30.0	12	2.50	2.27
80 J 783	RM-415R	1x1 7/32x1 1/2"	45.0	6	3.47	3.15
80 J 727	ZM-9	1 7/8x1 1/2"	1.5	20	.56	.51
80 J 787	TR-145R	3/8x1 1/2"	7 1/2	10	1.60	1.45
80 J 725	TR-146R	1x1 1/2x1 15/16"	9.0	12	2.04	1.85
80 J 849	TR-233R	1x1 3/16"	4.0	10	1.98	1.80
80 J 788	TR-246R	1 5/8x2 3/4"	9	10	2.20	2.00

MERCURY "A" BATTERIES

Extremely long shelf life and uniform discharge voltage. Resistant to humidity. With 1/2" tab on positive terminal. Shgp. wt., 2 oz.

Stock No.	Mfr's Type	Size (Dia. x Ht.)	Volts	Std. Pkg.	NET EACH	
					Single	Std. Pkg.
80 J 878	RM1R	5/8x3/8"	1.34	20	.40	.36
80 J 879	RM3R	1x5/8"	1.34	20	.55	.50
80 J 880	RM4R	1 7/8x5/8"	1.34	20	.72	.65
80 J 881	RM12R	3/8x1 1/8"	1.34	10	.85	.77
80 J 740	RM4RT†	1 1/8x1 1/8"	1.34	20	.77	.70
80 J 741	RM4ZR	1 3/8x1 1/2"	1.34	20	.64	.58
80 J 784	RM42R	3/8x2 1/2"	1.34	10	2.04	1.85
80 J 742	RM42RT†	7/8x2 3/8"	1.34	10	1.87	1.70
80 J 743	RM400R	7/8x2 1/2"	1.34	50	.88	.82
80 J 884	RM401R	7/8x1 1/2"	1.34	20	.55	.52
80 J 744	RM450R	3/8x3/8"	1.34	40	.33	.30
80 J 882	RM502R	1 3/8x1 1/8"	1.34	10	.64	.58
80 J 883	RM625RT†	5/8x1 5/8"	1.34	40	.39	.35
80 J 745	RM601R	5/8x1 1/8"	1.34	10	.56	.51
80 J 746	RM625R	5/8x1/4"	1.34	40	.31	.28
80 J 747	RM630R	5/8x1/4"	1.34	40	.31	.28
80 J 748	RM640R	5/8x7/16"	1.34	20	.35	.32

MERCURY TRANSISTOR POWERPAKS

Transistor batteries for replacement or original equipment applications. Used in portable radios, instruments, etc. Av. shgp. wt., 3 oz.

Stock No.	Mfr's Type	Size	Volts	Std. Pkg.	NET EACH	
					Single	Std. Pkg.
80 J 789	TR-113R	2 1/2x2 1/2"	4.0	10	1.01	.92
80 J 790	TR-114R	2 1/2x1"	5.0	10	1.34	1.22
80 J 728	TR-115R	2 1/2x1 1/2"	6.5	10	1.67	1.52
80 J 729	TR-132R	2 1/2x1 1/2"	2.5	10	.92	.84
80 J 730	TR-133R	2 1/2x1 1/2"	4.0	10	1.30	1.18
80 J 731	TR-134R	2 1/2x2 1 3/4"	5.0	10	1.68	1.53
80 J 732	TR-135R	2 1/2x3 3/8"	6.5	10	2.04	1.85
80 J 733	TR-136R	2 1/2x3 3/8"	8.0	10	2.53	2.30
80 J 734	TR-140R	1 1/2x1 1/2"	1.3	10	1.22	1.12
80 J 735	TR-152R	1 1/2x1 1/8"	2.5	20	.79	.72
80 J 791	TR-153R	1 1/2x1 2 3/8"	4.0	20	1.01	.92
80 J 792	TR-162R	2 1/2x2 3/8"	4.0	10	.84	.76
80 J 793	TR-163R	2 1/2x1 1 1/8"	4.0	10	1.21	1.10
80 J 794	TR-164R	2 1/2x1 2 5/8"	5.0	10	1.49	1.35
80 J 795	TR-165R	2 1/2x2 1/8"	6.5	10	1.80	1.64

GRID BIAS CELLS

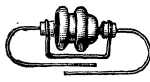

Used to bias class A audio tubes; and RF, IF, and AVC stages. Can be stacked using bias cell clips listed below. Accuracy: ±10%. Size, 1 1/8x3/8". Wt., 2 oz.

Stock No.	Mfr's Type	Volts	List	NET EACH
9 M 948	BC-3	1 1/2	60c	40c
9 M 949	BC-5	1 3/4	60c	

BIAS CELL CLIPS

Stock No.	Mfr's Type	Used With	Capacity	List	NET EA.
9 M 952	GB-15		2-cell	40c	26c
9 M 953	GB-16	BC-3 or BC-5	4-cell	40c	
9 M 954	GB-17		1-cell	40c	

DRY-DISC RECTIFIERS



Magnesium-copper sulphide rectifiers. Single-phase, full-wave bridge type. All metal. Unaffected by temperature extremes (-90° to +265°F.). Constant output without adjustments. "Self-heating" rectifying film. †At full load. Type of mounting: †Insulated bolt; ‡grounded foot; §insulated stud. J suffix indicates universal design for all types of mounting.

Stock No.	Mfr's Type	Max. ACV Input	DC Volts Output†	Cont. Duty Amps	Size H. W. D.	Replacement in Equipment	Wt. Lbs.	List	NET EACH
56P 174	IB4R*	3.2	1.7	1.5	3/8x9/16x1"	GTC Battery Eliminator	3/4	\$2.90	1.89
56P 175	IB8R*	6.4	3.4	1.5	3/8x9/16x1 1/8"	GTC Battery Eliminator	3/4	3.45	2.25
56P 176	IB12R*	9.7	5.0	1.3	3/8x9/16x1 1/4"	Electric Fence Supplies	3/4	3.15	2.25
56P 179	IB12L5*	9.7	5.0	4.5	2 5/8x2 1/2x2 1/2"	Mallory 6AC4-2 Charger	7/8	7.10	4.65
56P 180	IB12C5*	9.7	5.0	5.3	2 5/8x2 1/2x3"	Mallory 6AC6-3 Charger	7/8	8.95	5.85
56P 170	IB12C11*	9.8	5.1	3.2	1 5/8x1 1/2x2 3/4"	Mallory 3C 6A04 Booster	3/4	7.25	4.74
56P 177	IS16CB7*	12.8	6.6	6.0	3x2 1/2x3 3/8"	Mallory 5555B, 6AC6, IS16CB7M	1 1/2	10.20	6.65
56P 181	IS16B75*	12.8	6.5	8.3	3x2 1/2x5 1/2"	6-AC-10-2, 107, IS16B7M	2	13.60	8.89
56P 182	IS16B85*	12.7	6.4	11.6	4 1/2x3 1/2x5 1/2"	Mallory 6AC10	3	15.50	10.13
56P 171	F16C3†	13.0	6.8	3.9	2 1/8x1 3/4x3"	Mallory 5535	1	8.85	5.77
56P 184	F20C7†	16.0	8.4	4.8	3 3/8x2 1/2x3 3/8"	ATR Battery Eliminators	1	12.75	8.32
56P 186	IS24C7J§	19.4	10.1	4	3 3/8x2 1/2x4 3/4"	Mallory 12-AC-5-2	2 1/2	12.60	8.23



IB8R

NEW MA-6 FILTER PACK

Model MA-6 Filter Pack. Designed for use with 12RS60DF or other similarly rated bench power supplies where additional filtering is required. Particularly accurate-reading ammeter which is placed in the circuit by depressing the automatic spring return switch located on the front panel. Matches the 12RS60 in appearance. Housed in handsome Hammertone case. Size, 4 1/2x5 3/4x6 1/2". Shgp. wt., 3 1/2 lbs. 80 P 292. NET. 17.15

Model A-4 Filter Pack. Similar to model MA-6; but provides filtering for output currents up to 4 amperes. Does not have meter or push-button switch. Size, 4 1/4x5 1/4x4 1/4". Shgp. wt., 3 1/2 lbs. 80 P 293. NET. 10.53

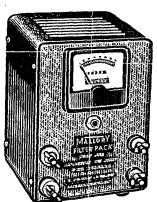

6 AND 12-VOLT BATTERY CHARGERS

Highly efficient selenium-rectifier battery chargers. May also be used as power supplies for electroplating, model trains, telegraph systems, vending machines, relays, solenoids, etc. Charging rate decreases as battery becomes charged, except with 6SAC4. Equipped with socket for use with R675 charging cord below. All have DC cord with vibrator clips. Pilot light on all units except 6SAC4. Pilot light dims as battery becomes charged and blinks if charger connections are reversed or reversed. For 6 v. batteries except #12 v. For 105-125 v. 60 cycle AC.

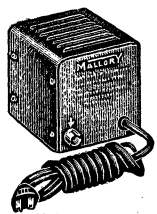

Stock No.	Mfr's Type	DC Amps Max/Taper	Max DC Amps Continuous	Sizes H. W. D.	Wt. Lbs.	List	NET EACH
80 P 066	6SAC4	4 4 3	3	4 1/2x4 1/2x4 1/2"	5 1/4	\$19.95	13.03
80 P 093	6SAC6	6 4 4	5	6 1/2x4 1/2x4 1/2"	6	22.95	14.99
80 P 094	6SAC10	10 7 8	8	7 1/2x6 1/2x5 1/2"	9	33.95	22.18
80 P 087	12SAC5*	5 3 4	4	7 1/2x6 1/2x5 1/2"	9	33.95	22.18

Type R675 Charging Cord with Universal Lighter Plug. For charging of cigarette lighter socket. Complete with 6-ft. cord. Shgp. wt., 6 oz. 52 P 643. List, \$2.25. NET. 1.47

TYPE VP VIBRAPACKS

PORTABLE AND MOBILE HIGH-VOLTAGE DC POWER SUPPLIES

Mallory vibrapacks provide high-voltage DC from low-voltage storage batteries. Excellent as source of "B" power for portable radios, transmitters and receivers, mobile P.A. systems, etc. Have filter for vibrator hash. All are tube-rectifying types for use in circuits where self-bias is obtained through a resistor or choke between B-negative and ground. VP6-260, VP12-260 and VP24-260 can be converted to 200 v. DC output at 60 ma with simple wiring change. All require external filter circuit. Size, 5 1/2x3 1/4x4 1/4".

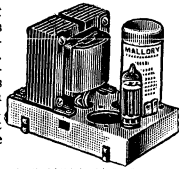

Stock No.	Mfr's Type	Input VDC	Output VDC	Max. Ma.	Wt. Lbs.	List	NET EACH
80 P 118	VP6-260	6	260	60	5	\$28.95	17.02
80 P 119	VP12-260	12	260	60	5	28.95	17.02
80 P 133	VP24-260	24	260	60	6	30.95	18.20
80 P 116	VP6-325	6	325	100	6	29.95	17.61
80 P 117	VP12-325	12	325	100	6	29.95	17.61
80 P 134	VP24-325	24	325	100	6	32.95	19.37

POWER SUPPLIES

12RS60DF BENCH POWER SUPPLY

Dual-range power supply for servicing car, truck and transistor radios. Range "A" supplies 0-16 v. at 6 amps continuously, or 14 amps intermittently. Range "B" provides 0.8 v. at 10 amps continuously or 20 amps intermittently. 2 1/4" voltmeter and ammeter; ranges: 0-10 v. DC and 0-20 amps DC. Provision for plugging in external ammeter. Includes built-in filter pack similar to Type MA-6—provides filtered output up to 6 amps at less than 0.5% ripple; 6 volts at less than 1 v. rms ripple; 12 volts at less than 0.5 v. rms ripple. With automatic overload protection. Size, 6 1/2x10 1/2x5 1/2". For 110-120 v., 60 cycle AC. Shgp. wt., 12 1/2 lbs. 80 PX 291. NET. 58.75

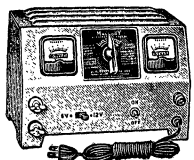

12RS14D "RECTOPOWER" SUPPLY

Efficient versatile power supply. Provides filtered and continuously adjustable power for electronic equipment operating on 6 or 12 volts. Supplies 6 volts at 25 amps continuous or 40 amps intermittent; 12 volts at 14 amps continuous or 20 amps intermittent. Automatic voltage regulating system maintains constant output under varying load. Includes DC voltmeter and DC ammeter. Overload protection. Has large-capacity electrolytic capacitors that provide power storage for operation of vibrator powered equipment. Uses selenium rectifiers. Size, 11x10 1/2x8 1/4". For 110-120 volts, 60 cycle AC. Shgp. wt., 35 lbs. 80 PZ 132. NET. 136.73

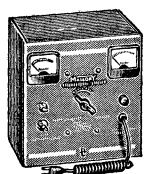

Converters and Power Supplies

ATR INVERTERS AND POWER SUPPLIES

DC TO AC UNIVERSAL INVERTERS

New, universal inverters for operating 110-v., 60 cycle AC equipment from DC voltages in autos, buses, trucks, boats, trains, planes and DC districts. Designed especially for standard 110-volt AC tape recorders, TV sets, radios, PA systems, electric razors, test equipment, etc. Units are carefully engineered and ruggedly constructed to provide long life operation. All feature complete RF interference suppression and exceptional frequency stability. Have operating efficiency in excess of 75%. Four-point voltage regulator corrects output voltage for minimum and maximum loads, and also helps compensate for input voltages lower or higher than normal. Inverters are recommended for use with loads in excess of 70%. Built-in toggle switch selects most efficient operation for use with TV sets or tape recorders. Inverters are not recommended for use with large motor driven appliances such as refrigerators, washing machines, etc. All have On-Off switches. Housed in attractive gray Hammerloid metal cabinet with convenient leather carrying strap. Sizes: Standard Model RSF, 8 1/2"x9 1/2"x5 1/4"; Heavy-Duty Model RHG, 6 1/4"x11 1/4"x8 1/2"; Extra-Heavy-Duty Model HSJ, 6 1/2"x12 1/2"x8 1/2". With battery clips for instant connection to power source. Models with "P" suffix equipped with adapter cord for use in auto cigarette lighter receptacles. *Recommended for 24 volt battery operation. *Before ordering, check wattage of equipment with which inverter will be used.*

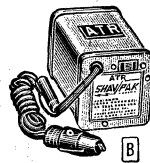
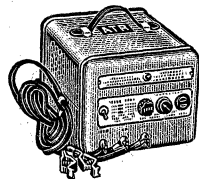

having power factors in excess of 70%. Built-in toggle switch selects most efficient operation for use with TV sets or tape recorders. Inverters are not recommended for use with large motor driven appliances such as refrigerators, washing machines, etc. All have On-Off switches. Housed in attractive gray Hammerloid metal cabinet with convenient leather carrying strap. Sizes: Standard Model RSF, 8 1/2"x9 1/2"x5 1/4"; Heavy-Duty Model RHG, 6 1/4"x11 1/4"x8 1/2"; Extra-Heavy-Duty Model HSJ, 6 1/2"x12 1/2"x8 1/2". With battery clips for instant connection to power source. Models with "P" suffix equipped with adapter cord for use in auto cigarette lighter receptacles. *Recommended for 24 volt battery operation. *Before ordering, check wattage of equipment with which inverter will be used.*

6-12 V. DC POWER SUPPLIES

A Type 610C-ELIF. Features either 6 volts @ 10 amperes continuous, or 12 volts @ 6 amperes continuous. Has voltmeter and ammeter. Toggle switch selects 6 or 12 volts output. 8-position voltage selector control. For 105-125 v., 50-60 cycle AC. Gray steel case, 6 1/2"x9 1/2"x8 1/2". Shpg. wt., 22 lbs. **80 PZ 243, NET.....42.95**

A Type 620C-ELIT. Heavy-duty model. Uses dual rectifier—full wave assures noiseless operation. Rated output: 6 volts at 20 amperes or 12 volts at 10 amperes. Has voltmeter and ammeter. Gray steel case with handle. 8-position voltage selector control. Size, 6 1/2"x12 1/2"x8 1/2". For 105-125 volts, 50-60 cycle AC. Shpg. wt., 33 lbs. **80 PZ 234, NET.....59.95**

NEW SHAV-PAKS

B Miniature inverters especially designed to operate standard AC electric shavers from 6 and 12-volt storage batteries in autos, buses, trucks, boats and planes. Ideal for salesmen, sportsmen. Plugs into cigarette lighter receptacle. Both 6 and 12-volt models provide 115 volts 60 cycle AC output at 15 watts. In attractively finished Hammerloid steel case. 4 1/2"x2 3/4". Wt., 2 1/2 lbs.

MODEL 6-SPB. For 6-volt operation. **81 P 944, List, \$9.95. NET.....6.63**
MODEL 12-SPB. For 12-volt operation. **81 P 945, List, \$9.95. NET.....6.63**

NEW BATTERY CHARGER

Model 612CA6. Charges 6 or 12-volt storage batteries through cigarette lighter receptacle of any vehicle. 6 amp charge rate tapers to 3 amp. Circuit-breaker eliminates need for fuses. For use in negative and positive-ground vehicles. Has On-Off and Voltage Selector switches. Full-wave selenium rectifier. 8 1/2"x5 1/2"x3 3/4". For 110-120 v., 50-60 cycle AC. Shpg. wt., 8 lbs. **81 P 946, List, \$27.95. NET.....20.96**

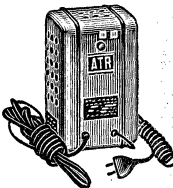

Stock No.	Mfr's Type	Input DC Volts	Output 60 Cycle	Watts		Wt., Lbs.	List	NET EACH
				Cont.	Inter.			
81 PZ 922	6U-RSF	6	110 v.	80	100	22	\$75.00	50.00
81 PZ 923	6U-RSF-P	6	110 v.	80	100	22	75.00	50.00
81 PZ 924	6U-RHG	6	110 v.	125	150	27	89.95	59.97
81 PZ 925	6U-RSJ	6	110 v.	150	175	37	125.00	83.34
81 PZ 926	12U-RSF	12	110 v.	100	125	22	75.00	50.00
81 PZ 927	12U-RSF-P	12	110 v.	100	125	22	75.00	50.00
81 PZ 928	12U-RHG	12	110 v.	150	175	37	89.95	59.97
81 PZ 929	12U-HSJ	12	110 v.	200	250	37	125.00	83.34
81 PZ 930	28U-RSF*	28	110 v.	100	125	22	89.95	59.97
81 PZ 931	28U-RHG*	28	110 v.	150	175	27	105.75	70.50
81 PZ 932	28U-HSJ*	28	110 v.	200	250	37	145.00	96.67
81 PZ 933	32U-RSF	32	110 v.	100	150	22	89.95	59.97
81 PZ 934	32U-RHG	32	110 v.	180	200	30	105.75	70.50
81 PZ 935	32U-HSJ	32	110 v.	225	325	37	145.00	96.67
81 PZ 936	50U-RSF	50	110 v.	100	150	22	89.95	59.97
81 PZ 937	110U-RSF	110	110 v.	150	250	22	75.00	50.00
81 PZ 938	110AU-RHG	110	110 v.	250	325	27	89.95	59.97
81 PZ 939	110BU-RHG	110	110 v.	350	400	30	105.75	70.50
81 PZ 940	110U-HSJ	110	110 v.	400	600	37	145.00	96.67

PORTABLE PLUG-IN TYPE INVERTERS

Lightweight inverters for operating 110 v. AC equipment from DC voltage sources. Feature excellent frequency stability and high efficiency. 6 and 12-volt units plug into cigarette lighter receptacle of any vehicle; others are equipped with standard 2-prong plugs. All are designed especially for use with dictating machines; record players, electric razors, test equipment, etc. Not recommended for tape recorders and large motor driven appliances such as refrigerators, washing machines, etc. Gray Hammerloid case with leather carrying strap. Sizes: DME, 5 1/4"x4 1/4"x2 3/4"; RME and RMF, 8 3/4"x8x3 3/4". *Recommended for 24-volt operation. *Check wattage rating of equipment before ordering.*



Stock No.	Mfr's Type	Input DC Volts	Output 60 Cycle	Watts		Wt., Lbs.	List	NET EACH
				Cont.	Inter.			
80 P 246	6DME	6	110 v.	30	40	5	\$19.95	13.30
80 P 289	6C-DME	6/12	110 v.	30	40	5	23.50	15.67
80 P 247	6-RMF	6	110 v.	60	80	12	45.00	30.00
81 P 941	6C-RMF	6/12	110 v.	60	80	12	49.50	33.00
80 P 249	12-DME	12	110 v.	40	50	5	19.95	13.30
80 P 266	12T-RME	12	110 v.	90	125	12	42.50	28.33
81 P 942	28-RME*	28	110 v.	80	100	12	57.50	38.34
81 P 943	32-RME	32	110 v.	80	100	12	57.50	38.34
80 P 218	110-RME	110	110 v.	100	150	12	47.50	31.67

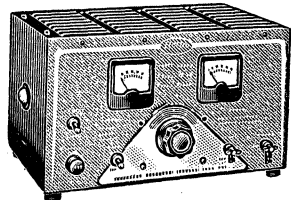

D-612T

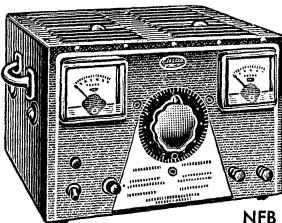

NFB

ELECTRO-PRODUCTS POWER SUPPLIES

MODEL D-612T DC POWER SUPPLY 6 AND 12 VOLT, 10 AMP

Designed for servicing transistor auto sets as well as 6 and 12-volt tube-vibrator types. Also suitable for servicing transistor radios. Two ranges, both continuously variable: 0-8 volts and 0-16 volts, 10 amperes continuous duty up to 12 volts. Up to 20 amperes intermittent duty. Less than 0.5% ripple up to 6 amperes and less than 2% ripple at 10 amperes. Choke-input filter circuit; four bridge-type selenium rectifiers; 10,000 mfd. capacitor. Two panel meters provide constant check on output voltage and current. On-Off switch and 0-8 and 0-16 volt selector switch. Readily accessible fuseholder on panel. Patented conduction cooling provides large margin of safety. Built to withstand high overloads. Rugged 18-gauge steel cabinet with baked-on blue Hammerloid finish. Supplied with terminal connector clips. Size, 12x7x8 1/2". For 105-125 v., 50-60 cycle AC. Shpg. wt., 22 lbs. **80 PZ 283, NET.....44.95**

MODEL NFB POWER SUPPLY 32-VOLT, 15 AMP

Filtered DC power unit for continuous heavy-duty operation. Output continuously variable, 0-32 volts for loads to 15 amperes and 0-40 volts for loads to 5 amp. 2% D'Arsonval movement meters. Ripple: Less than 0.75% @ 15 amp. Filter circuit consists of two chokes and three 2000 mfd., 50 volt capacitors. Regulation: 16% no load to full load. Circuit breaker for overload protection. Variable voltage transformer provides smooth increment control. 5-way output terminals; carrying handles on sides. Power drain; 730 w., with 32-volt, 15 ampere output. Bridge-type germanium rectifiers. Blue Hammerloid steel cabinet. 14 1/4"x14 1/4"x9 3/4". For 105-125v., 50-60 cycle AC. Shpg. wt., 36 lbs. **80 PZ 282, NET.....195.00**
Model NFB-R. Same as NFB unit above, but for rack mounting. Has 1 1/2" steel panel 19x10 1/2". Shpg. wt., 100 lbs. **80 PZ 290, NET.....225.00**

CARTER CONVERTERS

Super Converters For Tape & Wire Recording

Rotary converters specially designed to operate tape and wire recorders from a DC power source. Dependable construction features cross-stacked armature laminations for reduction of eddy current and hysteresis losses. Heavy, triple-insulated magnet wire assures protection from winding shorts. Have power factor of 85 to 100%. Average efficiency, 60%. All have single-phase output only, with approximately 20% regulation, no load to full load. Output: 115 volts 60 cycle AC. Supplied complete with plug-in AC receptacle and DC connecting cord. Size, 5x8 1/4"x4 1/2". Shpg. wt., 15 lbs.

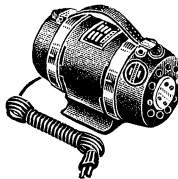

Type B1080CBW. 12 volts DC to 115 volts AC, 80 watts. Designed for all mobile applications—ideal for railroad and marine use. Features slip-proof ventilated construction. Extra-long-life brushes. 70% power factor up to 80 watts for operating most recorders. Easily carried from place to place; provided with extra-strong leather strap. **80 P 058, List \$108.00. NET.....79.38**

Type B1010CBW4. 12 v. DC to 115 v. AC. 130 watts. Size, 5x8 1/4"x4 1/2". Shpg. wt., 15 lbs. **80 P 059, List, \$123.00. NET.....90.40**

Type A1010CBW4. Same as above, but 6 v. input. Shpg. wt., 15 lbs. **80 P 069, List, \$123.00. NET.....90.40**

Converters and Chargers

NEW PERMA-POWER A-400 POWER SUPPLY

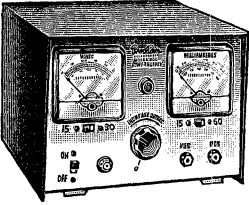

Exceptionally precise, versatile power supply for testing, servicing and operating all types of low power transistorized equipment, including radios, phonographs, etc. Continuously variable output uses autotransformer control; two voltage ranges for exact setting of voltage required. Continuous current monitoring of single transistor or entire set. Meters provide laboratory accuracy; have precision D'Arsonval movement. Input Voltage: 115 v., 50-60 cycles. Output Voltage: 0-15 and 0-30 volts DC. Output Current: 0-15 and 0-60 ma. Ripple less than 0.002%. Size, 10x6½x5¼" deep. Shpg. wt., 16 lbs. **80 P 191, NET.....63.21**

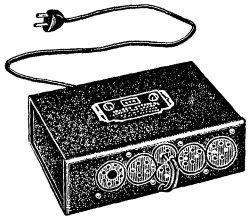

PERMA-POWER 1½-VOLT RADIO BATTERY ELIMINATOR

Model "A". Converts battery-operated radios and other appliances requiring low power for operation from 110 volts AC house current. Uses efficient selenium rectifiers; output is well-filtered direct current. Maintains rated power under widely varying tube loads. "A" power: 1.35 volts to 1.5 volts DC, depending upon current drain; "B" power: 90 volts DC at 13 milliamperes. Will operate any 4, 5 or 6-tube radio with filaments designed for 1.5-volt battery operation. Fits easily in back of case of battery radios, as well as in battery compartments of most portables. Extremely compact—2½" high, 6¾" wide and 4½" deep. Variety of sockets permit use with most portable radios. Fully automatic operation, noiseless and interference-free. Shpg. wt., 4 lbs. **80 P 176, List, \$18.95. NET.....11.14**

CORNELL-DUBILIER DC TO AC CONVERTERS

The famous line of Cornell-Dubilier "Powercon" DC to AC converters. Efficient vibrator-type recommended for operating AC appliances from DC power sources. All units have well-regulated output of 110 volts, 60 cycle AC. Feature improved RF filtering. Now have a higher rating for intermittent overloads. Wattage figures for intermittent use are rated for power factors from 70-100%. Superior filtering assures output free of "hash". Model 12SS14 comes in case of size indicated, providing room for 12 v. battery (supplied less battery). Frequency stability regardless of load. Instant starting under load—no warm-up period needed. Output has complete RF filtering for clear TV, short-wave, AM and FM broadcast reception. Choice of 17 sizes for wide variety of applications. *For small portable types. Converters listed according to inputs: 6 volt battery, 12 volt battery or 110 volts DC. Models 110H25 and 110H35 are approved for TV sets and are TRI-proofed.

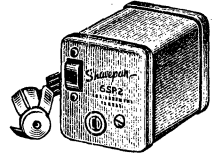

Stock No.	Mfr's Type	Typical Applications	Input V. DC		Watts Cont. Inter.		Size	Wt., Lbs.	List	NET
			V.	DC	Cont.	Inter.				
80 P 300	6SP2	Electric shaver	6	20	20	20	2½x2½x3¾"	2	\$13.40	7.88
80 P 301	6L6	Phono motor, amplifier	6	60	80	80	5½x6¼x8"	12	64.50	37.93
80 P 302	6S8	Radio, phono, recorder	6	80	100	100	5½x6¼x9"	14	77.50	45.57
80 PZ 303	6H10	Radio, recorder, PA	6	112	125	125	6½x7½x11"	20	89.95	52.89
80 PZ 304	6SH15	Radio, recorder, PA	6	150	175	175	8½x9½x13"	35	124.50	73.21
80 P 263	6/12D6	Dictating Machines*	6/12	60	75	75	5½x7½x6¼"	11½	50.00	29.40
80 P 305	12SP2	Electric shaver	12	20	20	20	2½x2½x3¾"	2	13.40	7.88
80 P 306	12M6	Radio, phono, amplifier	12	60	80	80	4½x3½x65½"	6	34.50	20.29
80 P 307	12L8	Radio, phono, recorder	12	80	100	100	5½x6¼x9"	12	44.95	26.43
80 P 308	12S10	Radio, recorder, PA	12	100	125	125	5½x6¼x9"	14	72.50	42.63
80 PZ 199	12SS14	TV, recorder, PA	12	140	175	175	9½x9½x14"	60	77.91
80 PZ 309	12H15	Radio, recorder, PA	12	150	175	175	6½x7½x11"	20	99.50	58.51
80 PZ 198	12SH20	TV, recorder, PA	12	200	250	250	8x½x11"	35	129.50	76.15
80 P 310	110LM5	Phono, amplifier	110	50	60	60	3½x3x1¾"	4	28.50	16.76
80 P 311	110L10	Radio, recorder, PA	110	100	150	150	4½x3x1¾"	12	5.00	3.81
80 PZ 312	110H25	TV, recorder, PA	110	250	325	325	6½x7½x11"	20	89.50	52.63
80 PZ 313	110H35	TV, recorder, PA	110	350	450	450	6½x7½x11"	20	135.00	79.38

TERADO 6 AND 12 V. DC TO 110 V. AC CONVERTERS

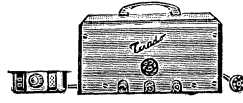

50153

Convenient DC-to-AC converters for operating various 110-volt AC electrical devices from automobile batteries. Each converter is equipped with a plug which fits the automobile cigarette-lighter socket, except for models marked "T", which clip directly to the battery terminals with clips provided. All units provide a completely filtered output, permitting convenient operation of radios, tape recorders, soldering irons, incandescent lights, electric razors, etc. For all makes of cars. Check wattage requirements of equipment, and voltage of auto battery, before selecting converter.

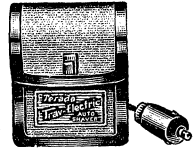

A-1215

Stock No.	Mfr's Type	Input DC Volts	Output V., 60 cycles	Watts		Size	Wt., Lbs.	NET
				Cont.	Inter.			
80 P 194	A-615	6	110	10	15	2x3x4"	2	7.77
80 P 196	A-1215	12	110	15	20			7.77
80 P 272	6-1160	6	110	35	40	2½x2½x4½"	3¼	13.17
80 P 273	12-1160	12	110	40	50			13.17
80 P 270	6-71160	6	110	60	75	8x5x4"	8	28.17
80 P 271	12-71160	12	110	75	85			28.17
80 P 276	6-81160†	6	110	75	100	6x5x4"	9	38.97
80 P 277	12-81160†	12	110	100	125			38.97
80 P 287	A-5585	6	110	55	75	6x5x4"	9	32.97
80 P 197	M-5585†	12	110	85	110			32.97
80 P 197	M-5585†	6	110	55	75	4x5x6"	9	31.17
80 P 197	M-5585†	12	110	85	110			31.17
80 PZ 193	50153	12	110	175	200	6x6x11"	24	59.97

SCHAUER QUALITY BATTERY CHARGERS

CX-2 10-AMPERE CHARGERS

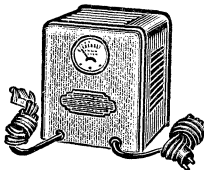

Dependable, safe chargers utilizing the finest available materials and components; designed especially to re-charge heavy-duty batteries as used in trucks, tractors and farm and mobile equipment. 10 ampere charging rate permits over-night charging of most batteries. Ideal for quick charging during intervals when equipment is not in use, but must be ready in a hurry. Widely used for re-charging taxicab batteries, or other vehicle batteries which are required to power other electronic equipment in addition to automotive requirements. Rate of charging is automatically controlled for full protection of batteries; charging rate gradually is decreased as batteries approach full charge. Has accurate ammeter, which indicates exact rate of charge. Supplied with cords and clips. 7¼x6½x6". For operation from 110-115 v., 60 cycle AC. Shpg. wt., 10 lbs.

Type CX-2. For 6-volt batteries. **80 P 163, List, \$26.95. NET.....17.83**

Type CX-2-12. For one 12-volt or two 6-volt batteries in series. Otherwise as above. **80 P 164, List, \$32.95. NET.....21.80**

AX-612 4-AMPERE CHARGER

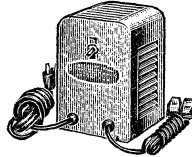

which provides instantaneous and full automatic protection against short circuits and overloads. Has full-wave charging output for higher efficiency operation. Rectifiers are selenium for long, efficient service. 4-ampere charging rate tapers to 2-amperes as the battery becomes fully charged. Has clip terminals. Quickly connected—no need to disconnect the battery or remove it from car. Size, 4¼x4¼x6¼". For operation from 110-115 v. 60 cycle AC. Shpg. wt., 4¼ lbs. **80 P 284, List, \$19.95. NET.....13.20**

AX-2 4-AMPERE CHARGER

Highly efficient, 6-volt, overnight battery charger. Has a tapered 4-amp. to 2-amp. charging rate. Includes full-wave charging output which makes possible higher efficiency of operation. Rectifiers are selenium for dependable service. Equipped with built-in "Charger Guard." Pays for itself in longer battery life and protection from battery failure. With cables and clips. Size, 4¼x4¼x6¼". For 110-115 v. 60 cycle AC. Shpg. wt., 4 lbs. **80 P 161, List, \$13.95. NET.....9.23**

BX-612 6-AMPERE CHARGER

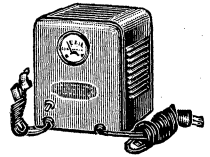

Dependable 6-ampere, 6-volt and 12-volt battery charger. Charges the average battery overnight. Has a selector switch for changing from 6-volt to 12-volt operation. Equipped with built-in "Charger-Guard" which protects unit against damage to another. Has ammeter to indicate exact charging rate of battery. For autos equipped with public address systems, two-way radios, etc.—this unit is ideal for restoring battery to full-charge overnight. Equipped with "Charger Guard" which protects unit against damage from short circuits and overloads. Supplied complete with cords, battery clips and operating instructions. Steel case. Size, 6¼x6¼x7¼". For operation from 110-115 v., 60 cycle AC. Shpg. wt., 8 lbs. **80 P 285, List, \$28.95. NET.....19.16**

BX-2 6-AMPERE CHARGER

High-quality 6-volt, 6-amp battery charger. Fully charges the average run-down battery in 7 to 9 hours. For autos equipped with two-way radio communication, etc. Equipped with "Charger Guard" for protection against overloads and short circuits. Ammeter indicates charging current. Supplied complete with cable and battery clips. Steel case size, 7¼x6¼x7¼". For operation from 110-115 v., 60 cycle AC. Shpg. wt., 8 lbs. **80 P 162, List, \$19.95. NET.....13.20**

Fluorescent Fixtures — Lanterns

MITCHELL FLUORESCENT FIXTURES

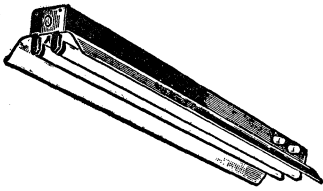

INDUSTRIAL FIXTURES

An excellent selection of efficient, low-cost fluorescent fixtures. Ideal for industrial use, workbench, stock room, service shop, etc. Provides non-glare light with even diffusion and high illumination. Virtually eliminates shadows. Power factor corrected to reduce inductive effects. Constructed of heavy-gauge pressed steel. Reflectors are finished in high-gloss white enamel for maximum lighting efficiency and easy cleaning. Reflector is easily removed for cleaning. See page 291 for fluorescent lamps.

STANDARD FIXTURE

Model 2098. 48" Standard Fixture. Uses two 48" Type T-12, 40-watt fluorescent lamps. Made of heavy-gauge pressed steel, finished in a high-gloss gray enamel for easy cleaning and maximum light reflection. Power factor corrected to reduce inductive effects. Supplied with brackets for hanging from ceiling and knock-outs to permit flush or stem mounting. Fixtures may be hung on chains, flush-mounted separately, or mounted end-to-end in a continuous row. Starters located on side for easy replacement without removing lamps or reflector. 48 1/2 x 11 1/2 x 5 3/4". With reflector, starters and ballasts. Less lamps and chains, U.L. Approved. For 105-125 volts, 60 cycles AC. Shpg. wt., 17 lbs.
91 RZ 260, List, \$15.45. NET EACH... 9.43
3 or More, EACH..... 8.70

RAPID-START FIXTURE

Model 2098 RS. Same as Model 2098 standard fixture, described above, but rapid-start type. For operation from 105-125 volts, 60 cycle AC. Shpg. wt., 17 lbs.
91 RZ 315, List, \$17.20. NET EACH... 11.18
3 or More, EACH..... 10.32

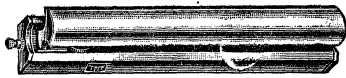

WALL BRACKET

Model 704. Extremely well-constructed fluorescent wall bracket for general-purpose use in shop, store or home. Has handy flush-type electrical outlet on side panel—permits operation of small electrical appliances, such as shavers, mixers, etc. Utilizes maximum radiation from a single 15-watt fluorescent lamp. Attractive triple-chrome finish provides long wear and smart appearance. Convenient rotary type on-off switch. 20x2 1/2 x 2". With starter. For 110-120 v., 60 cycle AC. Wt. 3 lbs.
91 RX 286, List, \$5.96. NET EACH... 4.58
3 or More, EACH..... 4.24

Model 705. As above, but has adjustable shade for directing light. Wt. 3 1/2 lbs.
91 RX 287, List, \$8.25. NET EACH... 5.36
3 or More, EACH..... 4.95

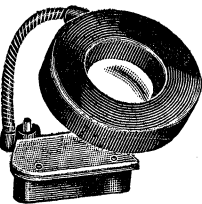

"STRAT-O-LITE" INSPECTION LAMP

A carefully designed, easy-to-use, industrial-type magnifier. Has built-in fluorescent lamp for excellent illumination. An ideal unit for close inspection of small-sized objects. Has 4 1/2" dia. x 9" focal length lens centered in 360° black shield; provides shadow-free, perfectly enlarged vision. Adjustable arm and swivel joints permit adjustment to any combination of height, angle, magnification. With instant-start fluorescent circle lamp. For 110-120 v., 60 cycle AC. Wt., 11 lbs.
91 RX 350, NET..... 29.95

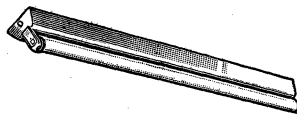

FLUORESCENT STRIP LIGHTS

Efficient fluorescent strip lights—specially designed for end-to-end continuous lighting installations. Each unit has provision for secure locking to adjacent units. Attractive, modern design; tapered lines and rounded corners. Install anywhere. White, baked enamel finish. With starters. Less lamps. For 110-120 v., 60 cycle AC. U.L. Approved. See page 291 for listings of fluorescent lamps.

1 LAMP—20 WATT 24"

Model 316. Single light strip. Normal power factor. Perfect for salesrooms, corridors. Shpg. wt., 4 lbs.
91 RX 195, List, \$4.24. NET EACH... 2.76
3 or More, EACH..... 2.54

1 LAMP—40 WATT 48"

Model 318. Single strip for 40-watt lamp. Designed to give good lighting in large rooms. Normal power factor. Shpg. wt., 6 lbs.
91 RX 196, List, \$7.06. NET EACH... 4.59
3 or More, EACH..... 4.24

2 LAMP—80 WATT 48"

Model 265. Double light strip. High power factor. Provides maximum illumination using two 48" tubes. Shpg. wt., 8 lbs.
91 RX 197, List, \$13.71. NET EACH... 8.91
3 or More, EACH..... 8.23

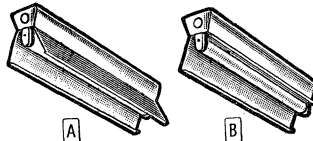

REFLECTORS FOR STRIP LIGHTS

Streamlined reflectors for fluorescent strip lights above. Provide maximum lighting efficiency. For symmetrical reflection when strip lights are paired or banked, use one asymmetric reflector on each side. Constructed of heavy-gauge steel with white "Glazename" finish.

REFLECTORS FOR 20-WATT (24") STRIPS

A Model 570. Symmetric type. Two-sided units. Length 24". Wt. 2 lbs.
91 RX 191, List, \$3.11. NET..... 2.18
3 or More, EACH..... 2.02

B Model 571. Asymmetric type. For close-to-wall mounting. Length, 24 inches. Shpg. wt., 1 1/2 lbs.
91 RX 192, List, \$3.11. NET..... 2.18
3 or More, EACH..... 2.02

REFLECTORS FOR 40-WATT (48") STRIPS

A Model 572. Symmetric type. Length, 48". Shpg. wt., 4 lbs.
91 RX 193, List, \$4.39. NET..... 3.07
3 or More, EACH..... 2.85

B Model 573. Asymmetric type. Length, 48". Shpg. wt., 3 lbs.
91 RX 194, List, \$4.39. NET..... 3.07
3 or More, EACH..... 2.85

BURGESS QUALITY LANTERNS AND FLASHLIGHTS

RADAR BEARCAT LANTERN

Model TW9. New focusing lantern puts light where you need it—near or far. Wide-angle or pinpoint light with type of built-in focusing ring. Has steelclad battery and waterproof switch for safe, efficient outdoor use—in any weather. Powerful light beam can be seen for one-half mile. Two insulated knurled nuts hold battery—a low quick, easy battery changing. Red, baked enamel finish. Size, 8 5/8 x 5 1/4 x 4 3/4" (including battery). With Type TW1 6 v. battery. Shpg. wt., 4 1/2 lbs.
78 J 227, List, \$6.95. NET..... 4.34

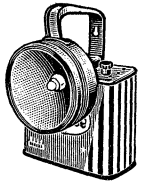

"RADAR-LITE" LANTERN

Model TW7. Outstanding new portable lantern with super-intensity lamp. Completely leakproof and weatherproof. Simple to operate and convenient to carry. Battery can be replaced in seconds—two insulated knurled nuts hold battery firmly to head assembly. 9 1/4 x 5 1/4 x 2 3/4" (including battery). With TW1 6 v. battery. Wt. 4 1/2 lbs.
80 J 686, List, \$8.95. NET..... 5.53



Model TW7

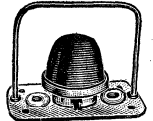

Model TW34

Model TW7. Outstanding new portable lantern with super-intensity lamp. Completely leakproof and weatherproof. Simple to operate and convenient to carry. Battery can be replaced in seconds—two insulated knurled nuts hold battery firmly to head assembly. 9 1/4 x 5 1/4 x 2 3/4" (including battery). With TW1 6 v. battery. Wt. 4 1/2 lbs.
80 J 686, List, \$8.95. NET..... 5.53

TW34 Flasher Light. Similar construction to "Radar Lamp," above—attaches to top of TW1 battery. Provides red light which flashes on and off. Chrome plated. 4x2 3/4 x 5 1/8". Less battery. Shpg. wt., 1 lb.
80 J 687, List, \$3.95. NET..... 2.53

RL22 Storage Bracket. Bracket with spring clips to hold "Radar Lamp" (above) to floor or wall of car, or truck. Wt., 1 lb.
80 J 688, List, \$1.50. NET..... 1.00

"RADAR-LITE" LANTERN

Model TW3. Superpower, all purpose lantern. Sealed beam lamp develops 40,000 candlepower. Automatic red flashing signal on movable arm, swings 90°. Battery is lantern body—can be installed in seconds. Convenient to carry. Chrome handle. 11 1/4 x 9 3/4 x 3 1/2". Lamp, 4 3/4" dia. With TW1 6 v. battery. Wt. 6 lbs.
78 J 270, List, \$12.45. NET..... 7.48

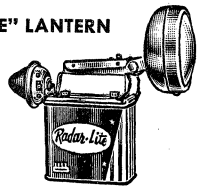

Model TW4. As above, but less flasher.
78 J 228, List, \$9.95. NET..... 6.06

TW1 Battery. For TW3, TW4, TW7, TW9, TW34. Wt., 3 1/2 lbs.
80 J 680, List, \$2.45. NET..... 1.63

FLASHLIGHTS

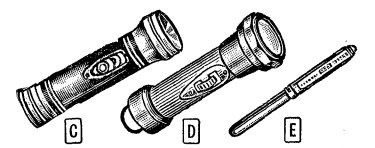

C Model 255. New, two-cell flashlight. Ribbed metal case in gleaming chrome finish. Has 3-position switch, pre-focused lamp. Less two No. 2 cells. Shpg. wt., 3/4 lbs.
78 J 218, List, \$1.89. NET..... 1.26

D Model 350. New two-cell flashlight. Fiber barrel with rubber cushioned head, end cap. Pre-focused and weatherproof. Uses two No. 2 cells. With lamp. Less batteries. 1 lb.
78 J 229, List, \$1.90. NET..... 1.28

Model 460. As above, but uses three No. 2 cells and PR3 lamp. Less batteries. 1 1/4 lbs.
78 J 235, List, \$2.15. NET..... 1.44

E Type 152 Penlight. Duo-Tone and chrome finish. Uses two No. 7 cells. With No. 224 bulb. Less batteries. Wt. 5 oz.
78 J 245, List, 88c. NET..... 59c

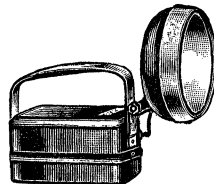

"LIFETIME" ALL-PURPOSE LANTERN

Model 501S. Features powerful, sharp focus, sealed-beam lamp. May be hand-held, hung on wall or set on flat surface. Lamp fully adjustable through 180-degree swivel. Lamp and handle fold down for easy storage. 3-way switch for off-on-manual-flash operation. Excellent as an emergency lamp or as trouble light for servicemen, motorists, etc. Uses one 6-v. lantern battery (Burgess F4H listed below). In bright red baked enamel with chrome trim. Less battery. 5x3x2 3/4". Lamp 4" dia. Shpg. wt., 4 lbs.
78 J 222, NET..... 3.28

53 J 028, F4H Battery. Wt. 1 1/4 lbs. NET 72c

Desk Lamps & Fluorescent Fixtures

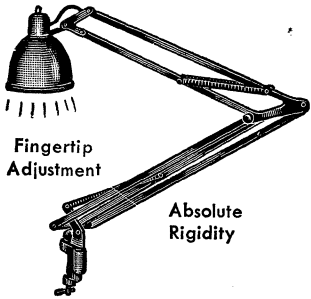

Fingertip Adjustment
Absolute Rigidity

LUXO ADJUSTABLE LAMP

Model L-1A. All-Angle Adjustable Lamp. The Luxo lamp, made in Sweden, is famous for its construction and flexibility. The perfect lamp for a service bench. Swings from a straight vertical position to within a few inches of the floor. May be raised, lowered, or turned with a touch of the fingers. Has two extension arms, 45" long. Swivel joints are spring-loaded; knurled nut controls overall tension. Porcelainized shade has large vents at top for heat dissipation. On-Off switch. Supplied with clamp for easy attachment to bench table, etc. Dove gray. U.L. Approved. Uses standard light bulb. Less bulb. Shpg. wt., 5 lbs.
91 RX 296. List \$21.95. NET.....16.46

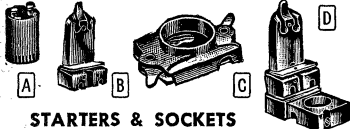

STARTERS & SOCKETS

High-quality starters and sockets for all types of fixtures. *For Circline fixtures. Av. wt., 3 oz.

A STARTERS

Stock No.	Mfr's Type	Watts	Each	Lots of 10, EA.
78 R 850	FS2	14, 15, 20	20¢	18¢
78 R 851	FS4	30 or 40	20¢	18¢
78 R 854	*FS12	32	28¢	25¢

B LAMPHOLDER SOCKETS

Stock No.	Watts	Color	Each	Lots of 10, EA.
78 R 860	14, 15, 20	Black	15¢	13¢
78 R 861	30 or 40	White	17¢	15¢

C STARTER SOCKETS

Standard Dual-Loc remote starter socket
78 R 858. 1 to 9. NET EACH.....14c
10 or More, EACH.....13c

D STARTER SOCKET & LAMPHOLDERS

Stock No.	Watts	Color	Each	Lots of 10, EA.
78 R 865	14, 15, 20	Black	38¢	34¢
78 R 866	30 or 40	White	40¢	36¢

DUPLEX STARTER

Features handy "pilot-light." Shows when starter is operating and the lamp is dead. Plastic case. *Circline Lamp; †Circlarc. Shpg. wt., 2 oz.



Stock No.	Mfr's Type	Watts	Each	Lots of 10, EA.
78 R 855	FS-22	14-15-18*-20-22†	28¢	25¢
78 R 856	FS-42	13-30-40		

STANDARD AND CIRCLINE FLUORESCENT LAMPS

Highest-quality fluorescent lamps in all popular sizes for industrial and home use. Provide a non-glare light from entire surface with even diffusion and high illumination. White lamps provide a light which approximates that of incandescent lighting. Daylight lamps provide light with a slightly bluish tint approximating natural daylight. Cool-white lamps are 4500° Kelvin. *Circline lamps; size shown is diameter of lamp circle. Lamp life is approximately 2000 hours. †Rapid start lamps.

Stock No.	Type	Watts	Size	Color	Std. Pkg.	Wt. Lbs.	NET EACH	Std. Pkg. EA.
91 R 521	T5	6	9"	White	24	1/2	1.35	1.08
91 R 511	T12	14	15"	Cool-white	24	1	1.00	.80
91 R 500	T8	15	18"	Daylight	24	1	1.05	.84
91 R 514	T12	15	18"	Cool-white	24	1	1.00	.80
91 RX 502	T12	20	24"	Daylight	24	1 1/2	1.05	.84
91 R 535	T9*	22	8"	Cool-white	24	1 1/2	3.50	2.80
91 R 516	T9*	30	12"	Cool-white	24	1 1/2	3.50	2.80
91 RX 538	T10S*	40	16"	Warm-white	12	1 3/4	4.70	3.76
91 R 534	T12S	42	48"	Cool-white	24	2	3.30	3.04
91 RX 506	T12	40	48"	Daylight	24	2	1.25	1.00

FLEXO ADJUSTABLE LAMPS

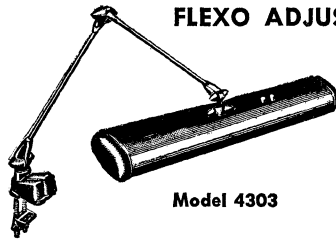

Model 4303

MODEL 4303 ALL-PURPOSE LAMP

A well-designed all-purpose lamp. Head tilts vertically 180° and turns 300° on its axis. Upper elbow swings in 160° vertical arc; lower elbow swings in 110° vertical arc. Extends to 36". Spring-controlled swivel joints. Push-button on-off switch. Easily installed—two bolts clamp base firmly to surfaces up to 3" thick. Bolts removable for screw mounting. Statuary bronze finish. Requires two T8, 15-watt lamps. For 105-125 v., 60 cycle AC. U.L. Approved. Less lamps (below). Shpg. wt., 10 lbs.
91 RX 225. List, \$20.95. NET.....15.40
3 or More, EACH.....14.38

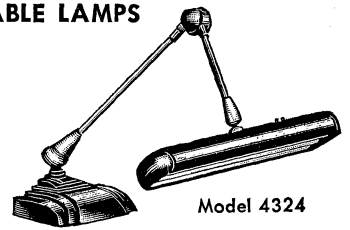

Model 4324

MODEL 4324 PORTABLE DESK LAMP

Portable desk model. Similar to Model 4303 (left) but with weighted base. For desks where screw clamp cannot be used. Raises and lowers, extends and tilts in any direction. Stays in position. Ideal for fine precision work, service bench use, industrial assembly lines, etc. Gives a light without glare or shadows. Attractive streamline base design has pen and pencil grooves. Double arm extends 32". U.L. Approved. For 105-125 volts, 60 cycle AC. Less lamps (see listing below). Shpg. wt., 23 lbs.
91 RZ 226. List, \$28.95. NET.....21.28
3 or More, EACH.....19.86

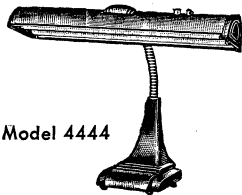

Model 4444

MODEL 4444 "FLEXARM" TWIN-LIGHT

An extremely versatile flexible-arm desk lamp. Gooseneck permits shade adjustment from 8" to 14". Sturdy metal base. Heavy gauge steel shade, 2 1/2 x 4 1/2 x 18". White enamel porcelain reflector. Push-button on-off switch. Requires two T8, 15-watt fluorescent lamps. Finished in royal statuary bronze. U.L. Approved. For 105-125 v., 60 cycle AC. Less lamps (see listing below). Shpg. wt., 10 lbs.
91 RX 146. List, \$14.95. NET.....10.95

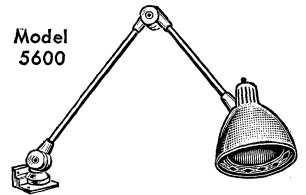

Model 5600

MODEL 5600 "COOL-SHADE" LAMP

New, low-cost fully adjustable incandescent bench lamp. Provides fingertip control and absolute rigidity in any position. Shade has large vents for air circulation and heat dissipation. Swivels at base, and is entirely spring-controlled in base, middle joint and shade. Maximum extension, 42". Convenient on-off switch. Shade dia., 5 1/2"; 7" deep. With brackets. Less bulb. Gray. Wt., 3 1/2 lbs.
91 RX 142. List, \$11.95. NET.....8.77

MITCHELL CIRCLINE FLUORESCENT FIXTURES

CHROME SINGLE-LIGHT FIXTURE

Model 865C. Low-cost, chrome-plated fluorescent fixture with "instant-start" feature. Provides clear, glareless illumination—equivalent in light produced to a 100-watt incandescent bulb. An excellent lighting fixture for use in average-size kitchens, basement work areas, small offices, dens, etc. Handsome chrome finish complements any room. Lamp is held securely in place by tempered, spring-steel clips. Supplied complete with 12" diameter, 32-watt Circline lamp. Includes knock-out for convenient installation of pull-chain switch, if desired. Underwriters Laboratories' Approved. For operation from 110-120 volts, 60 cycle AC. Shpg. wt., 9 lbs.
91 RX 279. NET EACH.....8.26
3 or More, EACH.....7.51

CHROME-PLATED 2-LIGHT FIXTURES

Model 841C. Chrome-plated 2-lamp fluorescent fixture in attractive circular design. Improved light diffusion. With 12" dia. 32-watt dia. 22-watt rapid-start lamps, hardware and glass pendant. For 110-120 v., 60 cycle AC. U.L. Approved. Shpg. wt., 11 lbs.
91 RX 262. NET.....13.35
3 or More, EACH.....12.14

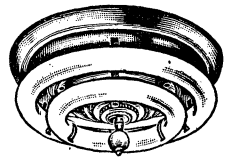

CHROME-PLATED 3-LIGHT FIXTURE

Model 847C. Deluxe model fluorescent fixture with three self-starting lamps and full chrome plating for high illumination. Pan diameter, 16 1/2". Complete with 40-watt, 32-watt, 22-watt lamps and mounting hardware for quick,

easy installation. Has knock-out. For operation from 110-120 volts, 60 cycle AC. U.L. Approved. Shpg. wt., 15 lbs.
91 RX 241. NET.....21.60
3 or More, EACH.....19.64

ADVANCE FLUORESCENT BALLASTS

For all popular fixtures. Normal power factor types are 55-65% corrected. High power factor types are 90-100% corrected. L-32 is for standard Circline; LQ-312 is for quick-start Circline. U.L. Approved. For 105-125 volts, 60 cycle AC.



1-LAMP BALLAST—NORMAL POWER FACTOR									
Stock No.	Mfr's Type	Lamp Watts	Size	Mfg. Ctrs.	Wt. Lbs.	NET EACH			
78 R 889	L-115	15	4 1/2 x 2 1/2	35%	1	.90			
78 R 891	L-120	20	4 1/2 x 2 1/2	35%	1	.90			
78 R 893	L-140	40	6 1/2 x 1 1/2 x 6 1/2	6"	3	1.75			
78 R 894	L-132	32	6 1/2 x 1 1/2 x 6 1/2	6"	2 1/4	1.70			
78 R 895	LQ-132	32	6 1/2 x 2 1/2 x 1 1/2	6"	3 1/4	2.75			
2-LAMP BALLAST—NORMAL POWER FACTOR									
78 R 898	L-220	20	6 1/2 x 2 1/2	55%	1 1/2	1.75			
2-LAMP BALLAST—HIGH POWER FACTOR									
78 R 896	S-240	40	11 3/4 x 3 1/2 x 1 1/2	11 1/2"	4 1/2	4.75			
78 R 897	BRSH-240	40	9 1/2 x 2 3/8 x 1 1/2	8 1/2"	4 3/4	5.65			

Bud Relay Racks and Cabinets

STURDY RELAY RACKS FOR ALL PURPOSES

DELUXE ENCLOSED RACKS

A Ruggedly constructed racks. 16-gauge steel with 1/4" panel supports. Have sturdy bottom supports for fastening casters directly to base. All have chassis-type base. Wrinkle finish, except *Hammerstone finish. Drilled and tapped for 19" panels. With all necessary hardware.

Overall Size	Panel Height	Mfr's Type	Gray Wrinkle	Black Wrinkle	Wt., Lbs.	NET EACH
47 1/2" x 22 x 1 1/8"	42"	CR-1771	98 PZ 843	86 PZ 816	95	44.59
66 1/2" x 22 x 1 1/8"	61 1/4"	CR-1772	98 PZ 844	86 PZ 817	122	55.86
82 1/2" x 22 x 1 1/8"	77"	CR-1773	98 PZ 845	86 PZ 818	150	66.88
42 1/2" x 22 x 1 1/8"	36 3/4"	CR-1774	98 PZ 808	86 PZ 819	90	39.44
66 1/2" x 22 x 2 1/2"	61 1/4"	CR-2072	*98 PZ 868	86 PZ 832	150	78.01
82 1/2" x 22 x 2 1/2"	77"	CR-2073	*98 PZ 869	86 PZ 833	175	92.69

SUPER-DELUXE ENCLOSED CABINET RACKS

(Not illustrated.) Styling similar to deluxe cabinet racks above, but feature adjustable panel mounting supports; can be positioned from 1" to 6" behind the cabinet front, at 1" intervals. Front and rear doors. 16-gauge steel with 1/4" panel supports. Welded bottom supports permit fitting casters directly to base. Attractive wrinkle finish. With hardware.

Overall Size	Panel Height	Mfr's Type	Gray Wrinkle	Black Wrinkle	Wt., Lbs.	NET EACH
42 1/2" x 22 x 1 1/8"	36 3/4"	CR-2174	98 PZ 856	86 PZ 834	108	56.45
47 1/2" x 22 x 1 1/8"	42"	CR-2175	98 PZ 857	86 PZ 836	117	63.45
66 1/2" x 22 x 1 1/8"	61 1/4"	CR-2172	98 PZ 858	86 PZ 857	146	81.92
82 1/2" x 22 x 1 1/8"	77"	CR-2173	98 PZ 859	86 PZ 858	191	98.34

OPEN RELAY RACKS

B Have chassis-type base, except * has 1/4" iron angles and brackets to permit bolting unit to floor. Durable wrinkle finish.

Overall Size	Panel Height	Mfr's Type	Gray Wrinkle	Black Wrinkle	Wt., Lbs.	NET EACH
35 3/8" x 20 x 2 1/2"	31 1/4"	RR-1263	98 PZ 840		38	19.01
70 3/8" x 20 x 2 1/2"	66 1/2"	RR-1264	98 PZ 841		53	21.66
72 1/4" x 20 3/8" x 1 3/8"	66 1/2"	*RR-1265	98 PZ 809		100	47.86
40 5/8" x 20 x 2 1/2"	36 3/4"	RR-1363	86 PZ 859		37	19.19
75 5/8" x 20 x 2 1/2"	71 3/4"	RR-1364	86 PZ 877		46	21.97
81 5/8" x 20 x 2 1/2"	77"	RR-1366	86 PZ 878		48	26.17

DESK-TYPE RACKS

Overall Size	Panel Height	Mfr's Type	Gray Hammerstone	Black Wrinkle	Wt., Lbs.	NET EACH
24 x 20 1/2 x 12"	21"	RR-1248	86 PZ 879	98 PZ 848	15	8.08
31 x 20 1/2 x 12"	28"	RR-1249	86 PZ 880	98 PZ 849	17	10.00

ADD-A-RACK SERIES

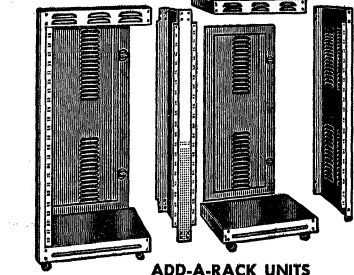

ADD-A-RACK UNITS

For addition of rack cabinets to deluxe, enclosed racks (Fig. A, above). Consist of four sections: Top, bottom, door and coupling panel. Replace either side panel of deluxe racks with coupling panel; add new top and

bottom; attach original side panel to new top and bottom. Placing new door on back completes assembly. RC775 casters (listed below) fit these racks. Same sizes and construction as deluxe racks. With hardware.

Black Wrinkle	Type	Used with	Wt., Lbs.	NET	Gray Wrinkle	Type	Used with	Wt., Lbs.	EACH
86 PZ 806	AR-1775	CR-1771	77	42.81	98 PZ 817	AR-1775	CR-1771	77	42.81
86 PZ 807	AR-1776	CR-1772	110	53.24	98 PZ 818	AR-1776	CR-1772	100	53.24
86 PZ 808	AR-1777	CR-1773	127	65.22	98 PZ 819	AR-1777	CR-1773	127	65.22
86 PZ 805	AR-1778	CR-1774	75	38.71	98 PZ 816	AR-1778	CR-1774	75	38.71
86 PZ 814	AR-2276	CR-2072	130	74.40	86 PZ 809	AR-2276	CR-2072	130	74.40
86 PZ 815	AR-2277	CR-2073	150	90.65	86 PZ 813	AR-2277	CR-2073	150	90.65

RELAY RACK ACCESSORIES

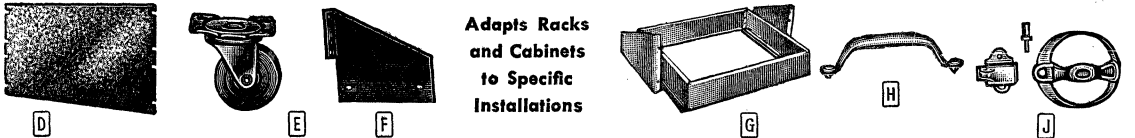

Adapts Racks and Cabinets to Specific Installations

STANDARD RACK PANELS

D Sturdy high quality rack panels. Standard notching fits cabinet, open, and desk type racks. All are 19" wide and 1/8" thick. Choice of steel or aluminum in black or gray wrinkle.

Height	Steel			Aluminum		
	Black	Gray	Lbs.	Black	Gray	Lbs.
1 1/4"	98 PX 723	98 PX 738	2	98 PX 864	98 PX 895	1
3 1/2"	98 PX 724	98 PX 739	3	98 PX 865	98 PX 896	2
5 1/4"	98 PX 725	98 PX 740	4	98 PX 866	98 PX 897	2
7 1/4"	98 PX 726	98 PX 741	6	98 PX 867	98 PX 898	2
8 3/4"	98 PX 727	98 PX 742	7	98 PX 868	98 PX 899	3
10 1/2"	98 PX 728	98 PX 743	8	98 PX 868	98 PX 877	3
12 1/4"	98 PX 729	98 PX 744	9	98 PX 889	98 PX 878	4
14"	98 PX 733	98 PX 745	10	98 PX 890	98 PX 879	4
15 1/2"	98 PX 734	98 PX 749	13	98 PX 891	98 PX 861	5
17 1/2"	98 PX 735	98 PX 749	13	98 PX 892	98 PX 862	5
19 1/2"	98 PX 736	98 PX 748	14	98 PX 893	98 PX 863	6
21"	98 PX 737	98 PX 749	15	98 PX 894	98 PX 803	7

CHASSIS SUPPORTING ANGLES

Type SA-1349. Relay rack chassis runners 14 1/2" long, 3" wide. Afford ample support for a standard 19" width chassis or shelves below. Black finish. Shpg. wt., 5 lbs.
86 P 235. NET PER PAIR.....1.96

HEAVY-GAUGE STEEL RACK SHELVES

Slide in from rear of cabinet. Require chassis support angles above. Black crackle finish.

No.	Type	H.W.D.	Lbs.	NET
86 PX 231	CB-1976	1x19x15"	7	3.04
86 PX 232	CB-1977	1x19x12"	6	2.30

STEEL DOOR RACK PANEL

Type PE-616. 1/4" high-grade sheet steel. Black wrinkle enamel. Door opening, 15 1/2" x 7 1/4". Size, 19x12 1/2". Shpg. wt., 10 lbs.
86 P 175. NET.....6.54

SWIVEL TRUCK CASTERS

E RC-7766. Heavy-duty type, for relay racks. Will carry 400 pounds. Hard rubber. Ball-bearing mounted. Wt., 10 oz.
86 P 264. NET EACH.....88c

CHASSIS MOUNTING BRACKETS

F Mount against rack. Heavy-gauge steel, cut away to provide clearance for flush mounting of chassis. Black enamel finish. For chassis 3" high, except *for 4" chassis.

No.	Type	Ht.	Depth	Lbs.	PAIR
86 P 219	MB-458	6 1/2"	8"	2	1.95
86 P 220	MB-448	6 1/2"	10"	3	1.18
86 P 211	MB-459	6 1/2"	11"	3	1.30
86 P 221	MB-440	6 1/2"	12"	3	1.54
86 P 222	MB-450	8 1/2"	13"	3	1.77
86 P 223	MB-451	8 1/2"	13"	4	1.83

RELAY RACK SLIDE DRAWER

G SD-1717. Sliding drawer for any standard rack or cabinet. Excellent for record player, portable typewriter base, and writing table. Can't fall out or tilt. Slides easily on ball bearings. Supports 50 lbs. Stop screw on slide rail prevents drawer from falling out. Light gray finish. Less drawer plate. Wt. 5 lbs.
86 PX 256. NET.....11.20

TP-1718 Drawer Plate. For above. May be attached to bottom or top of drawer. Size, 16 1/2" x 14". Shpg. wt., 1 1/4 lbs.
86 PX 257. NET.....2.04

UTILITY HANDLES

H Handles provide sufficient strength and comfortable hand grip. Made of aluminum tubing; have etched aluminum finish. 2 each.

No.	Type	Length	Mtg. ctr.	EACH
86 P 849	UH-70A	5 1/2"	4 3/8"	35c
86 P 899	UH-71A	3 1/2"	3 1/4"	29c

HANDLE CATCH SET

J CL-7777. Handsome plunger type handle and catch set. Used on all Bud cabinet and relay racks. Handle is chrome-plated cast aluminum. Snap is spring type. Wt., 1/4 lb.
86 P 848. NET.....1.07

TRIANGULAR PANEL BRACKETS

Panel-mounted chassis support. Heavy steel.

No.	Type	Ht.	Depth	Lbs.	PAIR
86 P 226	MB-1266	5"	5"	1	.90
86 P 227	MB-1267	7"	7"	2	1.05
86 P 228	MB-1268	9"	9"	2	1.24

Bud Metal Products

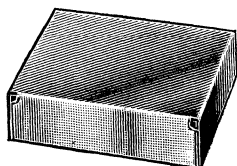

STANDARD CHASSIS BASES

High-quality, sturdily constructed chassis bases. Available in zinc-plated and black-wrinkle steel, and lightweight aluminum types. Carefully formed, one-piece construction; corners are reinforced and spot-welded. The four sides are folded at the bottom to provide additional strength; bottom fold also permits easy addition of bottom plate. Aluminum types are spot-welded with government approved equipment; same as used for welding aluminum aircraft parts. Steel chassis gauges: *No. 22; †No. 20; ‡No. 18. Aluminum chassis gauges (aluminum gauge): †No. 18; **No. 16; ††No. 14. Less bottom plates. AC-403; 2x9½x5".

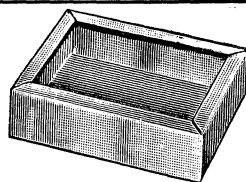

H.W.D. Inches	Black-Wrinkle Steel				Zinc-Plated Steel				Aluminum			
	Stock No.	Type	Lbs.	NET	Stock No.	Type	Lbs.	NET	Stock No.	Type	Lbs.	NET
2x6x4	80 P 456	CB-628*	1	.93	86 P 277	CB-629*	1½	1.15	86 P 930	AC-431†	¾	1.08
2x7x5	80 P 457	CB-644*	1	1.20	86 P 905	CB-645*	1½	1.45	86 P 112	AC-402†	¾	1.08
2½x9½x5	80 P 458	CB-788*	1¾	1.05	86 P 906	CB-776*	1½	1.47	86 P 113	AC-403†	¾	1.13
3x6x4									86 P 932	AC-430†	¾	1.15
3x7x5									86 P 933	AC-429**	1	1.22
3x9½x5	80 P 459	CB-604*	1½	1.12	86 P 271	CB-605*	1½	1.61	86 P 114	AC-421†	1	1.44
3x10x5									86 P 127	AC-404†	1	1.60
3x13x5	80 P 460	CB-755†	1¾	1.54	86 P 907	CB-756†	2	1.80	86 P 934	AC-422†	1	1.62
3x14x6												
3x17x6	80 P 461	CB-789*	1½	1.05	86 P 272	CB-1191†	1¾	1.31	86 PX 935	AC-433**	1½	2.51
2x7x7	80 P 462	CB-700*	1½	1.22	86 P 273	CB-1192†	1¾	1.39	86 P 115	AC-405†	¾	1.40
2x9x7	80 P 463	CB-752*	1½	1.27	86 P 274	CB-1193†	1¾	1.47	86 P 116	AC-406†	¾	1.23
3x11x7	80 P 464	CB-792†	1¾	1.37	86 P 275	CB-793†	2	1.80	86 P 117	AC-407†	¾	1.55
3x12x7									86 P 118	AC-408†	¾	1.71
2x13x7	80 PX 465	CB-646†	2	1.33	86 P 276	CB-1194†	2¼	1.71	86 P 119	AC-409†	1	1.64
2½x13½x5	80 PX 466	CB-647†	2	1.49	86 P 908	CB-1198†	2	1.86	86 PX 936	AC-411**	1¾	2.29
3x15x7	80 P 467	CB-649†	1¾	1.55	86 PX 909	CB-1189†	2¼	2.11				
3x15x8½	80 P 468	CB-665†	2½	1.96	86 PX 910	CB-666†	2¼	2.37	86 PX 937	AC-432**	1½	2.28
3x17x4	80 P 469	CB-1068†	2½	1.57	86 PX 911	CB-1066†	2½	1.88				
2½x17x7	80 PX 470	CB-648†	2½	1.73	86 PX 912	CB-1199†	2¾	2.08				
3x17x7	80 PX 471	CB-757†	1¾	1.88	86 PX 913	CB-758†	2	2.25	86 PX 938	AC-423**	1¾	2.69
2½x10x8	80 PX 472	CB-701†	2	1.51	86 P 914	CB-702†	2¼	1.76				
2½x12x8	80 PX 473	CB-703†	2½	1.54	86 P 915	CB-704†	2¾	1.96	86 P 939	AC-424**	1¾	2.05
3x12x8	80 PX 474	CB-759†	1¾	1.62	86 P 916	CB-760†	2	2.04				
2x17x8	80 PX 475	CB-650†	2½	1.49	86 PX 917	CB-774†	2¾	2.04	86 PX 940	AC-425**	1¾	2.29
3x17x8	80 PX 476	CB-651†	3¼	1.80	86 PX 918	CB-775†	3¼	2.29	86 PX 120	AC-412**	2	2.51
3x12x10	80 PX 477	CB-652†	1	1.67	86 P 919	CB-1195†	3½	1.95	86 P 121	AC-413**	2	2.78
3x14x10	80 PX 478	CB-653†	4	1.77	86 P 920	CB-779†	4½	2.13	86 P 941	AC-414**	2	2.78
3x15x8½	80 P 479	CB-654†	3¾	1.74	86 PX 278	CB-769†	3½	2.10	86 PX 942	AC-415**	1½	2.63
2x17x10												
3x17x10	80 PX 480	CB-636†	4	1.78	86 PX 921	CB-1196§	5½	2.67	86 PX 943	AC-416**	2¼	2.94
3x17x10	80 PX 481	CB-655§	5	2.21	80 PX 385	CB-637†	4	2.29				
3x23x10	80 PX 482	CB-656§	5	2.50	86 PX 922	CB-1197§	6	3.00	86 PX 122	AC-426††	2½	3.24
2x17x11	80 PX 483	CB-657§	4½	2.06	86 PX 923	CB-770§	4¾	2.45	86 PX 123	AC-417††	3	3.89
3x17x11	80 PX 484	CB-658§	4½	2.41	86 PX 266	CB-771§	4¾	3.06				
2x17x12	80 PX 485	CB-663§	4½	2.12	86 PX 925	CB-661§	4¾	2.55	86 PX 128	AC-418††	3	4.00
3x17x12	80 PX 486	CB-664§	5½	2.53	86 PX 268	CB-662§	5½	3.10	86 PX 944	AC-419††	3	3.27
2x17x13	80 PX 487	CB-659§	5	2.53	86 PX 269	CB-772§	5½	3.25	86 PX 124	AC-420††	3	4.07
3x17x13	80 PX 488	CB-660§	5½	2.98	86 PX 270	CB-773§	6	3.40	86 PX 25	AC-427††	3¾	4.25
4x17x10	80 PX 489	CB-640§	6½	2.51	86 PX 926	CB-641§	7	3.02	86 PX 126	AC-428††	4	4.50
4x17x13	80 PX 490	CB-642§	7½	3.43	86 PX 927	CB-643§	8	4.12				
5x17x10	80 PX 491	CB-623§	7½	3.92	86 PX 928	CB-624§	8	4.70				
5x17x13	80 PX 492	CB-625§	8	4.31	86 PX 929	CB-626§	8½	5.19				

BOTTOM PLATES FOR CHASSIS BASES

Bottom plates to fit the chassis bases listed above. In zinc-plated or black ripple heavy-gauge steel plate and aluminum. Four raised bosses in corners to prevent marking and scratching of table-tops or shelves. Drilled for use with No. 6 self-tapping screws.

Size	Lbs.	Black Wrinkle			Zinc Plated			Aluminum			
		Stock No.	Type No.	NET	Stock No.	Type No.	NET	Stock No.	Type No.	Lbs.	NET
5x7"	1	80 P 386	BP-705	.49	80 P 406	BP-706	.68	80 P 426	BPA-1589	½	.71
5x9½"	1¼	80 P 387	BP-680	.55	80 P 407	BP-667	.67	80 P 427	BPA-1590	¾	.73
5x10"	1¼	80 P 388	BP-536	.52	80 P 408	BP-538	.61	80 P 428	BPA-1591	¾	.73
7x7"	1½	80 P 389	BP-681	.81	80 P 409	BP-668	.78	80 P 429	BFA-1592	¾	.75
7x9"	1½	80 P 390	BP-682	.81	80 P 410	BP-669	.78	80 P 430	BFA-1593	¾	.78
7x11"	1½	80 P 391	BP-683	.95	80 P 411	BP-670	1.05	80 P 431	BFA-1594	¾	.88
7x12"	1½	80 P 392	BP-537	.79	80 P 412	BP-539	.98	80 P 432	BPA-1595	1	.95
7x13"	1½	80 P 393	BP-684	.90	80 PX 413	BP-671	1.18	80 PX 433	BFA-1596	1	1.12
5x13½"	1½	80 PX 394	BP-685	.74	80 PX 414	BP-672	.98				
4x17"	2	80 PX 395	BP-1069	.82	80 PX 419	BP-1067	1.05				
7x17"	2	80 PX 396	BP-686	.88	80 PX 416	BP-673	1.20				
8x10"	1¾	80 P 400	BP-707	.90	80 P 417	BP-708	1.03				
8x12"	2	80 P 397	BP-709	1.04	80 P 418	BP-710	1.31				
8x17"	2½	80 PX 398	BP-687	.93	80 PX 419	BP-674	1.34				
10x12"	2	80 PX 399	BP-688	.93	80 PX 420	BP-675	1.37				
10x14"	2	80 PX 401	BP-517	1.22	80 PX 421	BP-514	1.30				
10x17"	2½	80 PX 402	BP-689	1.18	80 PX 422	BP-676	1.41				
11x17"	2	80 P 403	BP-690	1.19	80 PX 423	BP-677	1.41				
11x17"	2½	80 PX 404	BP-691	1.24	80 PX 424	BP-678	1.41				
13x17"	2¾	80 PX 405	BP-692	1.44	80 PX 425	BP-679	1.96	80 PX 434	BPA-1597	1¼	1.49
								80 PX 435	BFA-1598	1¼	2.03

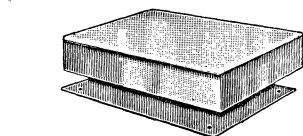

HEAVY-DUTY CHASSIS BASES

Ruggedly constructed chassis bases for heavy duty applications. Formed of one-piece heavy ¼" steel. Corners are spot welded and sides are folded over at bottom. Electro-zinc plated. Supplied complete with bottom plates and mounting screws.

Stock No.	Type	H.W.D.	Lbs.	NET
86 PX 240	CB-1765	3x17x 8"	8	4.51
86 PX 242	CB-1767	3x17x11"	9½	5.07
86 PX 243	CB-1768	2x17x13"	10	5.39
86 PX 244	CB-1769	3x17x13"	10½	5.71
86 PX 946	CB-1770	4x17x13"	11½	6.52

OPEN-END CHASSIS

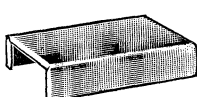

Open-end, heavy-gauge aluminum chassis. Have U-shaped construction with ends folded over ¾" to provide additional strength. Available in a wide variety of sizes to accommodate nearly every construction requirement. Will provide excellent fit when used with Bud cabinets listed on page 294. Natural aluminum finish. Av. shpg. wt., 1½ lbs.

Stock No.	Type	H.W.D.	NET
80 P 437	CB-30	1½x7x5"	.85
80 P 438	CB-41	1½x7x7"	1.08
80 P 440	CB-996	1½x9x5½"	.98
80 P 441	CB-976	1½x9x7½"	1.22
80 P 443	CB-997	1½x11x7"	1.15
80 P 444	CB-998	1½x13x7"	1.39
80 P 436	CB-38	2x8x7"	.90
80 P 439	CB-39	2x8x7"	1.02
80 P 442	CB-40	2x10x7"	1.22

MINIATURE ALUMINUM CHASSIS

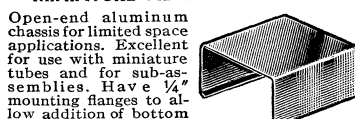

Open-end aluminum chassis for limited space applications. Excellent for use with miniature tubes and for sub-assemblies. Have ¼" mounting flanges to allow addition of bottom plate. Natural aluminum finish. Av. shpg. wt., ¼ lbs.

Stock No.	Type	H.W.D.	For Cabinet	NET
80 P 446	CB-1624	1x3½x1½"	CU-883	37c
80 P 452	CB-1617	1x3½x4"	C-1602	40c
80 P 448	CB-1626	1x4½x2½"	CU-728	40c
80 P 453	CB-1618	1x4½x4"	C-1603	49c
80 P 454	CB-1619	1x5¼x4"	C-1604	49c
80 P 455	CB-1620	1x6¼x4"	C-1605	49c
80 P 445	CB-1623	1¼x2¼x2½"	34c
80 P 450	CB-1628	1x6¼x3"	C-995	40c
80 P 449	CB-1627	1½x4½x3¾"	CU-729	49c
80 P 451	CB-1629	1½x4½x5¾"	CU-1098	50c
80 P 447	CB-1625	2x4½x3¾"	C-1788	44c

Bud Metal Products

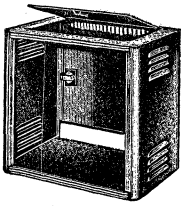

DELUXE CABINET RACKS

Attractive, ruggedly constructed 16-gauge steel cabinet racks. Have welded joints. Ideal for commercial broadcast stations, Amateur transmitters, sound or test equipment, etc. Cabinets have rounded corners and smart, red inlaid chrome trim. All have recessed, hinged top doors, equipped with smooth-operating snap locks. Adequate ventilation is provided by means of lowered sides and a 2 1/2" opening in the bottom of the back, extending the entire width of the cabinet. Models CR-1727, CR-1728, CR-1743, CR-1744 and CR-1745 have back doors with snap locks. Models CR-1739, CR-1740, CR-1741 and CR-1742 have welded back panels. All panel mountings are drilled for standard RETMA notched panels and tapped for 10-32 screws. Supplied with panel mounting screws. Units are 1 3/4" in depth and 22" wide. Wrinkle finish.

Ht.	Panel Space	Stock No.		Mfr's. Type	Wt. Lbs.	NET EACH
		Gray	Black			
10 3/4"	8 3/4"	86 PZ 729	98 PZ 835	CR-1741	28	14.60
12 1/2"	10 1/2"	86 PZ 730	98 PZ 804	CR-1740	30	16.66
14 1/2"	12 1/2"	86 PZ 731	98 PZ 836	CR-1742	32	17.61
15 3/4"	14"	86 PZ 893	86 PZ 894	CR-1739	34	19.19
19 1/2"	17 1/2"	86 PZ 732	98 PZ 837	CR-1743	38	22.86
33 1/2"	31 1/2"	86 PZ 895	86 PZ 896	CR-1728	39 1/2	27.93
28 1/2"	26 1/4"	86 PZ 733	98 PZ 838	CR-1744	48	26.29
21 1/2"	21"	86 PZ 897	86 PZ 898	CR-1727	52	24.50
36 1/2"	35"	86 PZ 734	98 PZ 839	CR-1745	60	29.40

STREAMLINED CABINETS

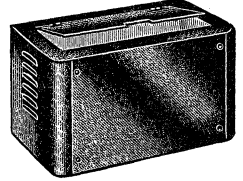

Handsome, sturdily constructed cabinets, featuring rounded corners. Recessed hinged top, plus 3/4" opening in rear permit easy access to tubes, terminals, etc. Front panel fastens with self tapping screws. Side louvers provide ample ventilation. Excellent for Amateur receivers, transmitters, VFO's, test equipment, etc. Available in a choice of sizes to accommodate a variety of equipment. Durable black-wrinkle enamel finish.

Stock No.	Mfr's. Type	Size H.W.D.	Wt., Lbs.	NET EACH
80 PX 314	C-1789	8x10 1/2 x 8 1/4"	5 3/4	3.84
80 PX 315	C-1746	8x12 1/2 x 8 1/4"	6	4.73
80 PX 316	C-1747	8x14 1/2 x 8 1/4"	6 1/2	5.14
80 PX 317	C-1748	8x16 1/2 x 8 1/4"	7 3/4	5.39
80 PX 318	C-1790	8x18 1/2 x 8 1/4"	7 3/4	5.92
80 PX 319	C-1730	12x20 1/2 x 12"	15	10.73

METAL UTILITY CABINETS



General-purpose cabinets for all types of electronic equipment. In welded steel or high-grade sheet aluminum construction for rigidity. Two removable sides for easy, quick access to interior. Sides attached to flange of cabinet frame with self-tapping screws. Excellent for building receivers, monitors, frequency meters, VFO's, transmitters, etc. Well adapted for shielding of high-gain pre-amplifier stages, RF sections and other special circuits. Steel cabinets in black-wrinkle or gray Hammertone finish—aluminum cabinets have natural aluminum finish.

Size, H.W.D.	Stock No. (Steel)		Mfr's. Type	Wt., Lbs.	NET EACH	Stock No. Aluminum	Mfr's. Type	Wt., Lbs.	NET EACH
	Black Wrinkle	Gray Hammertone							
4x4x2"	86 P 200	80 P 332	CU8893	1 1/4	1.02	86 P 735	AU-1083	1 1/4	1.26
4x5x3"	86 P 201	80 P 333	CU7728	1 1/4	1.12	86 P 736	AU-1028	1 1/4	1.34
6x5x4"	86 P 202	80 P 334	CU1079	2 1/2	1.35	86 P 737	AU-1029	1 1/2	1.64
6x6x6"	86 P 203	80 P 335	CU1098	3	1.83	86 P 738	AU-1039	3/4	1.86
9x6x5"	86 P 204	80 P 336	CU1099	4	2.04	86 P 739	AU-1040	1	2.30
10x8x7"	86 P 205	80 P 337	CU879	5	2.94				
10x10x8"	86 P 207	80 P 339	CU880	8	3.53				
12x7x6"	86 P 206	80 P 338	CU1124	5	2.88				
12x11x8"	86 P 208	80 P 340	CU881	9	4.05				
15x9x7"	86 P 209	80 P 341	CU882	9	4.22				

DELUXE STREAMLINED CABINETS

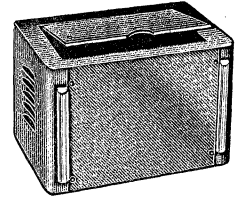

Bud's deluxe, streamlined equipment cabinets feature strikingly smart, gray-wrinkle finish, plus chrome stripping to enhance their appearance. Include hinged door, convenient opening at rear for easy access to terminals, as well as all of the other fine constructional features offered in the cabinets listed above. Give a handsome, factory-built look to any electronic equipment—excellent for housing Amateur transmitters and receivers, laboratory equipment, and for hundreds of other applications where appearance and rugged, functional design are of prime importance.

Stock No.	Mfr's. Type	Size H.W.D.	Panel Size	Wt., Lbs.	NET EACH
80 PX 320	C-1791	8x10 1/2 x 8 1/4"	8 x 8"	5 3/4	5.73
80 PX 321	C-1781	8x12 1/2 x 8 1/4"	8x10"	6	5.80
80 PX 322	C-1782	8x14 1/2 x 8 1/4"	8x12"	6 1/2	6.12
80 PX 323	C-1783	8x16 1/2 x 8 1/4"	8x14"	7 1/2	6.54
80 PX 324	C-1792	8x18 1/2 x 8 1/4"	8x16"	7 3/4	7.18
80 PX 325	C-1731	12x20 1/2 x 12"	12x18"	15	13.06

ALUMINUM MINIBOXES

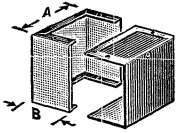

Two-piece boxes with handsome gray Hammertone or natural aluminum finish—offered in a wide selection of sizes to accommodate literally thousands of electronic devices. Particularly suited for housing above-chassis or below-chassis sub-assemblies—also excellent for complete, self-contained units where highly effective shielding as well as protection from dust and dirt is desired. May be used for phono amplifiers, VHF and UHF converters, low-pass TVI filters, test and measurement units, etc. Valuable for experimenters, Amateurs and laboratory use. Two-piece construction permits installation of a greater number of components than would be possible in a conventional box; also permits exceptionally easy access to circuitry for servicing or wiring modifications. Flanges assure extremely low RF leakage and also strong, easy to cut and drill. Stock up on several of these mini-boxes. Be ready for any small construction project.

Provide high rigidity. Self-tapping screws (supplied) hold sections firmly together. Made of high-quality aluminum; strong, easy to cut and drill. Stock up on several of these mini-boxes. Be ready for any small construction project.

Size AxCx B	Wt., Lbs.	Gray Hammertone	Mfr's. Type	NET EACH	Natural Aluminum	Mfr's. Type	NET EACH
2 3/4 x 2 1/2 x 1 3/8"	1/2	80 P 342	CU-2100	.80	80 P 360	CU-3000	.59
3 1/4 x 2 1/2 x 1 1/8"	1/2	80 P 343	CU-2101	.85	80 P 361	CU-3001	.59
4x2x2 3/4"	1/2	80 P 344	CU-2102	.88	80 P 362	CU-3002	.62
4x2 1/2 x 1 3/8"	1/2	80 P 345	CU-2103	.96	80 P 363	CU-3003	.80
4 1/4 x 2 1/4 x 1 1/2"	1/2	80 P 346	CU-2104	1.15	80 P 364	CU-3004	.83
5x2 1/2 x 2 1/4"	1/2	80 P 347	CU-2105	1.24	80 P 365	CU-3005	.95
5x4x3"	3/4	80 P 348	CU-2106	1.10	80 P 366	CU-3006	.93
6x5x4"	1	80 P 349	CU-2107	1.78	80 P 367	CU-3007	1.18
7x5x3"	1	80 P 350	CU-2108	1.81	80 P 368	CU-3008	1.29
8x6x3 1/2"	1 1/4	80 P 351	CU-2109	2.19	80 P 369	CU-3009	1.94
10x2x1 1/2"	3/4	80 P 352	CU-2113	1.35	80 P 373	CU-3013	1.22
10x6x3 1/2"	1 1/2	80 P 352	CU-2110	2.69	80 P 370	CU-3010	2.13
12x2 1/2 x 2 1/4"	1	80 P 356	CU-2114	1.58	80 P 374	CU-3014	1.20
12x7x4"	1 1/2	80 P 353	CU-2111	3.17	80 P 371	CU-3011	2.71
17x5x4"	2 1/2	80 P 354	CU-2112	3.72	80 P 372	CU-3012	3.15

MINIATURE UTILITY CABINETS WITH ATTACHED CHASSIS

Sturdily-made, unusually compact, steel utility cabinets with a built-in chassis attached to the front panel; eliminate need for installing separate chassis. Excellent for construction of equipment using miniature tubes or transistors. Especially suitable for standing-wave bridges, frequency meters, small transistorized receivers, code practice oscillators, detection boxes, crystal sets, and many other types of small, self-contained units. Removable front and rear panels fastened with self-tapping screws permit easy access to components and provide maximum layout flexibility. Built-in chassis is securely fastened in place. Panels fit snugly against flanges of case to assure extremely low RF leakage and protect components from dust. Professionally finished in handsome, durable, black-wrinkle enamel.

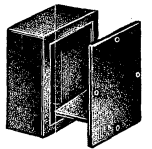

Stock No.	Mfr's. Type	Cabinet H.W.D.	Chassis H.W.D.	Wt., Lbs.	NET EACH
80 P 326	C-1793	4x4x2"	1x3 3/8 x 1 7/8"	3/4	1.31
80 P 327	C-1794	4x5x3"	1x4 3/8 x 2 7/8"	1	1.45
80 P 328	C-1785	5x4x3"	1 1/4 x 3 3/8 x 2 3/4"	1 1/2	1.59
80 P 330	C-1797	5x5x4"	1 1/4 x 5 x 3 3/8"	1 3/4	1.88
80 P 329	C-1798	6x5x4"	1 3/4 x 4 x 3 3/8"	1 3/4	1.67
80 P 331	C-1786	6x6x6"	1 3/4 x 4 x 5 3/8"	2 3/4	2.13

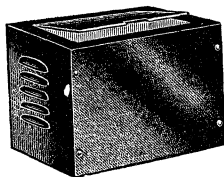

INSTRUMENT AND RECEIVER CABINETS

High-quality, moderately priced steel cabinets. Offered in a wide selection of sizes to accommodate many different types of electronic equipment. Particularly suitable for housing Amateur communications receivers, transmitters, signal generators, etc. Each unit has smooth-working, recessed hinged cover to permit easy access for tube replacement, circuit alignment, etc. Front panel is held securely in place with 4 self-tapping screws. Panel extends full width of cabinet—provides maximum space for installation of controls. Louvers on each side of cabinet assure ample ventilation of circuitry. Rugged construction throughout. Durable, highly attractive, black-wrinkle enamel finish.

Stock No.	Mfr's. Type	Height	Width	Depth	Wt., Lbs.	NET EACH
80 P 378	C-973	7"	8"	8"	5 1/2	3.29
80 P 379	C-993	7"	10"	8"	5 1/2	4.24
80 P 380	C-994	7"	12"	8"	5 1/2	4.49
80 PX 381	C-995	7"	14"	8"	5 1/2	4.82
80 PX 382	C-1190	8"	16"	8"	7	6.62
80 PX 383	C-975	9"	15"	11"	8	6.78
80 PX 384	C-999	12"	18"	12"	15	9.72

Bud Foundation Cabinets and Chassis

STEEL CARRYING CASES

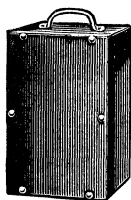

These attractive carrying cases are suitable for a great variety of uses. Cases are carefully designed in correct proportions to provide maximum useful mounting area. Front and back panels are removable. Have easy-grip handles, firmly fastened to the top of each case. Welded steel construction assures maximum strength. Carrying cases all available in either black wrinkle or gray hammertone finish.

H.W.D.	Type	Black	Gray	Lbs.	NET
9x6x5"	CC-1095	80 P 798	80 P 813	3 3/4	2.61
6x9x5"	CC-1091	80 P 799	80 P 814	3 3/4	2.61
12x7x6"	CC-1096	80 PX 808	80 PX 816	4	3.67
7x12x6"	CC-1092	80 PX 809	80 PX 817	4	3.67
15x7 1/2x7"	CC-1097	80 PX 810	80 PX 818	5	4.09
10x10x8"	CC-1100	80 PX 811	80 PX 819	5	4.25
9x15x7"	CC-1093	80 PX 812	80 PX 815	5	5.14

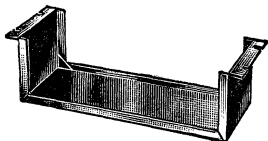

PANEL-MOUNTING CHASSIS

Open-side chassis for std. 19" mounting. Made of .062" aluminum with reinforced corners. 1" flange on ends, with 4 elongated holes for mounting. Front flange has standard panel notching. All other edges have 3/8" flanges. Etched aluminum finish. All models are 17" wide, excluding flange, and 5 1/2" deep.

Stock No.	Type	Height	Lbs.	NET
86 PX 185	CB-1370	1 3/8"	1 1/2	1.99
86 PX 186	CB-1371	1 1/2"	1 1/2	2.29
86 PX 187	CB-1372	1 3/4"	2 1/4	2.94
86 PX 188	CB-1373	2 1/4"	2 1/4	2.94
86 PX 189	CB-1374	3 3/8"	3 3/4	3.34
86 PX 190	CB-1375	10 1/2"	3 1/2	3.76
86 PX 191	CB-1376	12 1/2"	3 1/2	4.12
86 PX 192	CB-1377	14"	3 1/2	4.44

SLOPING PANEL UTILITY CABINETS

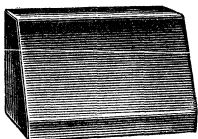

Sloping panel utility cabinets featuring attractive, modern design. Units are similar in appearance to the Sloping Panel Utility Box, with the exception of their opening placement.

Utility cabinets are recommended for installations that require an opening in the bottom of the enclosure, rather than in the back. They are typically used as control panels, microphone mixers, attenuators, etc. Adequate space is provided to allow proper ventilation when used with most small chassis. Height on all units is 4 1/4", depth 4". All cabinets have durable black wrinkle enamel finish.

Stock No.	Width	Type	Lbs.	NET
80 P 718	4"	C-1578	3/4	1.20
80 P 719	5"	C-1579	3/4	1.37
80 P 796	6"	C-1580	1	1.44
80 P 797	7"	C-1581	1	1.51

SLOPING PANEL CABINETS



Very attractive, professionally styled, sloping panel steel cabinets. Hinged top for easy access to tubes and other top-of-chassis components. Removable front panel. Excellent for amplifiers, oscillators, test instruments, power supplies, etc. Handsome black-wrinkle finish.

Stock No.	Type	H. W. D.	Lbs.	NET
86 P 900	C-1584	6 1/2 x 7 1/2 x 7 3/8"	3	3.23
86 P 901	C-1585	6 1/2 x 9 1/2 x 7 3/8"	4 1/2	4.07
86 P 902	C-1586	6 1/2 x 11 1/2 x 7 3/8"	4 1/2	4.07
86 P 903	C-1892	8 x 13 1/2 x 8 1/2"	5 3/4	4.89
86 P 904	C-1893	10 x 18 1/2 x 10 1/2"	9	6.85
86 P 968	C-1587	8 x 8 1/2 x 8"	3 1/4	3.91
86 P 969	C-1588	8 x 10 1/2 x 8"	3 3/4	4.32
86 P 970	C-1894	8 x 14 1/2 x 8"	4 1/2	4.69
86 P 971	C-1896	9 x 18 1/2 x 8 1/2"	7 1/2	6.70

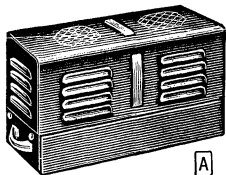

AMPLIFIER FOUNDATIONS

Modern appearance and rigid construction are primary features in these popular amplifier foundations. Each unit consists of a well ventilated, removable top cover, solidly mounted on a chassis. Sturdy, easy-grip handles are provided for increased portability.

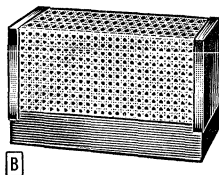

STREAMLINED FOUNDATIONS

These amplifier foundations are recommended for installations which require extra pleasing appearance in an amplifier and similar equipment. Foundation covers are designed with louvered sides and perforated tops, to provide proper ventilation and attractive styling.

Polished chrome handles are solidly fitted to each end of chassis to allow safe, convenient movement. All chassis are 3" high. Streamlined foundations are available in either black wrinkle or gray wrinkle enamel finish, with complementary chrome trim.

H.W.D.	Type	Black Wrinkle	Gray Wrinkle	Lbs.	NET
9x10 1/2 x 5"	CA1750	80 PX 493	80 PX 497	4 3/4	5.96
9x12 1/2 x 7"	CA1751	80 PX 494	80 PX 498	5	7.03
9x17 1/2 x 7"	CA1752	80 PX 495	80 PX 499	8	7.43
9x17 1/2 x 10"	CA1753	80 PX 496	80 PX 496	9	8.08

STANDARD FOUNDATIONS

Standard amplifier foundations. Ideal units for most amplifier requirements. Foundations consist of regular chassis with ruggedly constructed metal covers. Solid pieces are used on ends of each cover to provide firm bracing and allow a snug fit to chassis. Entire side and top area between ends, enclosed by heavy-

gauge metal screening; will provide excellent ventilation and proper tube protection. Extreme regularity of pattern and long clean lines provide a neat, functional appearance. Smooth, easy-grip metal handles are attached to the chassis. Units are available in black wrinkle finish only.

Stock No.	Type	H.W.D.	Chassis Ht.	Lbs.	NET
80 PX 697	CA-699	8 3/4 x 9 3/8 x 5 1/8"	2 1/2"	3	4.90
80 PX 698	CA-1125	8 3/4 x 13 3/8 x 5 3/8"	2 1/2"	4 3/4	5.62
80 PX 699	CA-1126	8 3/4 x 17 1/8 x 7 3/8"	2 1/2"	6	6.37
80 PX 656	CA-1128	8 3/4 x 12 1/2 x 10 1/8"	3 3/8"	7	6.61

MINIATURE AMPLIFIER FOUNDATION

Type CA-1754. An extremely compact, sturdily built amplifier foundation. Designed expressly to meet the requirements of builders employing miniature tubes, transistors, capacitors, small transformers, and other miniaturized components. Excellent for small, portable-type public address amplifiers, recording preamplifiers, etc. Chassis, which is an integral part of the unit, is only 2" high, 7" wide, and 5" deep. With foundation cover fastened in place, entire unit stands only 6" high! Removable cover includes a carrying handle for comfortable hand grip and convenient carrying. Cover is heavily perforated to allow sufficient ventilation of amplifier or other apparatus.

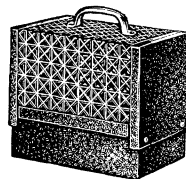

Entire unit is made from cold rolled steel; welded construction assures maximum strength, rigidity and full protection for components. Foundation cover is securely fastened to the chassis sides by means of four self-tapping screws. Has durable, highly attractive, black wrinkle enameled finish. Shpg. wt., 2 lbs. **3.92**
86 P 214. NET.....

"PRESTIGE" STEEL CABINETS

Stock cabinets of advanced design suitable for housing highly quality instruments. Specially engineered to provide versatile convenient usage. Hinged cover swings back completely for easy access to interior of cabinet. Covers are available solid or perforated; have added reinforcement for perforated style. Entire cover may be removed if desired. Grommeted finger holes are provided for quick, easy lifting. Cover opens tightly closed by means of pressure fasteners. Cabinet can be comfortably and safely carried by use of two deeply recessed handle slots, designed to prevent contact with equipment housed within. Each cabinet includes two supporting channels which can be moved from side to side to accommodate chassis of different widths or mounting platforms. Height of channels permits free flow of cooling air around components, and provides easy removal of entire cabinet contents through front opening. Accommodates standard size relay rack panels. Sturdily built of 16-gauge steel. Has rubber feet. Finished in durable gray hammertone. Overall width: 21 1/2"; overall depth, 14 7/8". Clear inside depth, 13 1/8". Rear opening, 18x3". Cover opening, 21 1/2 x 12 3/4".

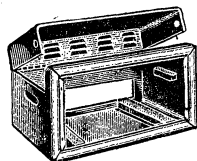

Stock No.	Type	Cover	Height	Panel Space	Lbs.	EACH
86 PZ 644	C-1440	Solid	9 1/2"	7"	21	24.65
86 PZ 645	C-1441	Solid	11 1/4"	8 3/8"	23	26.21
86 PZ 646	C-1442	Solid	13 1/4"	10 1/2"	25	29.66
86 PZ 647	C-1550	Perforated	9 1/2"	7"	20	26.66
86 PZ 648	C-1551	Perforated	11 1/4"	8 3/8"	22	28.62
86 PZ 649	C-1552	Perforated	13 1/4"	10 1/2"	24	31.07

SLOPING PANEL UTILITY BOXES

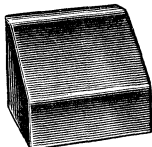

Sloping panel utility boxes are carefully designed to provide streamlined appearance and maximum useable space. Will conveniently house a small amplifier, oscillator test equipment, etc. Opening is located in rear of box; has 3/8" flange to permit simplified back cover mounting. Rigid construction assures proper support and protection for components. All units are 4" high, 4 1/4" deep. Finished in black wrinkle enamel.

Stock No.	Mfr's Type	Width	For Chas. No.	Lbs.	NET EA.
80 P 657	C-1602	4"	CB-1617	1/2	1.20
80 P 672	C-1603	5"	CB-1618	1/2	1.37
80 P 673	C-1604	6"	CB-1619	1	1.44
80 P 717	C-1605	7"	CB-1620	1	1.51

ALUMINUM METER CASES

Lightweight aluminum meter cases. Sturdy, well-built units available for either 2" or 3" meters. Have sloping front with rounded top corner. Excellent as "S" meter case for use with Amateur receivers, compact measurement equipment, etc. Case has no magnetic effect. Supplied less terminal feed-through insulators. Model CMA-2065 is for use with 2" meters; CMA-2066 is for use with 3" meters. Attractive, natural aluminum finish. Size: 4 1/4" high, 4" wide, 4" deep. Shpg. wt., 1/2 lb.

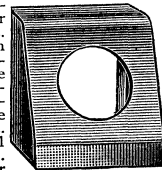

Stock No.	Mfr's Type	Hole Dia.	NET EACH
86 P 778	CMA-2065	2.334"	1.26
86 P 779	CMA-2066	2.835"	1.26

ICA Metal Products

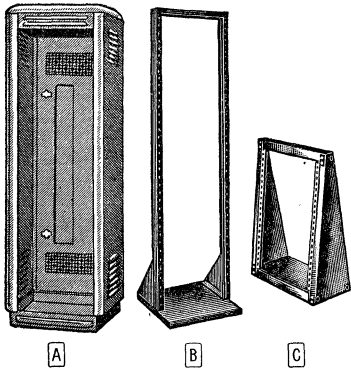

Depend on ICA cabinets and racks for sturdy construction, easy installation of equipment and handsome, professional appearance.

STURDY RELAY RACKS FOR ALL PURPOSES

DELUXE ENCLOSED RACK CABINETS

A Well-built, modern transmitter and public address equipment racks. Heavy-duty construction. Deluxe enclosed cabinets are made of $\frac{1}{8}$ " cold rolled steel with $\frac{1}{8}$ " pressed steel panel mounting angles. Screen ventilators on rear door and louvers on sides at top and bottom. Attractive, blue-gray and black ripple finish. Pre-drilled for standard 19" panels; tapped for 10-32 screws. Racks are shipped knocked down. With hardware.

Blue - Gray	Black	Type	Overall Size, H. W. D.	Panel Space	Wt., Lbs.	NET
98 PZ 880	86 PZ 950	3865	43 $\frac{1}{2}$ x22x18"	36 $\frac{1}{4}$ x19"	81	47.99
98 PZ 881	86 PZ 951	3866	67 $\frac{1}{2}$ x22x18"	61 $\frac{1}{2}$ x19"	116	59.68
98 PZ 882	86 PZ 952	3867	83 $\frac{1}{2}$ x22x18"	77x19"	133	71.17

OPEN-FACE RELAY RACKS

B Open-faced racks, made of tough, durable 11-gauge steel. Vertical and top cross-brace sections welded for added strength and rigidity. Designed for public address units, various types of Amateur transmitters, laboratory test and measurement equipment, etc. Base depth, 22". Accurately drilled mounting holes. Finished in attractive black ripple. Shipped knocked down; includes all necessary rack screws and cup washers.

Stock No.	Type	Overall Size, H. W. D.	Panel Space	Wt., Lbs.	NET
98 PZ 885	3912	73 $\frac{1}{2}$ x20x20 $\frac{3}{4}$ "	71 $\frac{3}{4}$ x19"	58	23.34
98 PZ 886	3913	38 $\frac{1}{2}$ x20x18 $\frac{1}{2}$ "	36 $\frac{3}{4}$ x19"	46	20.02

TABLE-MOUNT RELAY RACKS

C Table-type racks with chassis-type base. All panel mounting angles are pre-drilled for standard RETMA 19" panels and are tapped for 10-32 screws. Heavy-duty construction with one-piece base. Finished in black ripple. Shipped knocked down; with all necessary hardware.

Stock No.	Type	Overall Size, H. W. D.	Panel Space	Wt., Lbs.	NET
98 PZ 883	3910	25x21x12"	21x19"	17	12.18
98 PZ 884	3911	32x21x12"	28x19"	20	13.96

DELUXE SLOPING PANEL CABINETS

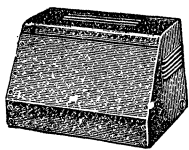

Top has rounded corners and chrome trim. Rear and side panels louvered for ventilation. Opening at rear for cable connections. Front panel is removable; chassis can be attached to it and used as one unit. Blue-gray ripple finish. For amplifiers, ham gear, intercoms, etc. Less chassis, see next column.

Stock No.	Mfr's Type	Size, H. W. D.	Wt., Lbs.	Use Chassis	NET EACH
86 PX 320	3990	8x8x8"	5	86 P 464	4.23
86 PX 321	3991	8x10x8"	6	86 P 473	4.69
86 PX 322	3992	8x14x8"	7	86 P 466	5.07
86 PX 323	3993	12x18x12"	14	86 P 429	9.49

SLOPING PANEL CABINETS

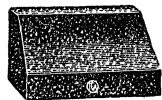

Professional-type steel cabinets with streamlined sloping panel. Ruggedly built, small and compact, they are ideally suited for any type of equipment which is to be used on top of an operating desk or work bench. For speakers, meters, small receivers, intercoms, etc. With rounded corners. Finished in handsome, blue-gray ripple enamel. Less rear cover. See below.

Stock No.	Type	H. W. D.	Lbs.	NET
86 P 380	3905	4 $\frac{1}{2}$ x4 $\frac{1}{2}$ x4 $\frac{1}{2}$ "	1 $\frac{1}{2}$	1.11
86 P 381	3906	4 $\frac{1}{2}$ x7 $\frac{1}{2}$ x6x4 $\frac{1}{2}$ "	2	1.85

CABINET REAR COVERS

Stock No.	Mfr's Type	For Cabinet	Size	Wt., Lbs.	NET EACH
86 P 678	4155	86 P 380	4 $\frac{1}{2}$ x4 $\frac{3}{8}$ "	6	34¢
86 P 679	4156	86 P 381	4 $\frac{1}{2}$ x7 $\frac{1}{2}$ "	8	47¢

DELUXE METER CASES

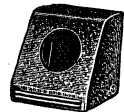

Inexpensive meter case. Designed to harmonize with modern, streamlined equipment. Finished in blue-gray ripple enamel, trimmed with an attractive chrome band. Neat rounded top. Extremely compact—easily placed with any equipment. Available for provides maximum meter visibility. Excellent for "S" meters, various types of ultra-compact test units, etc. Dependable heavy-gauge pressed steel construction for maximum strength and durability. Overall size, 4 $\frac{1}{2}$ " high by 4 $\frac{1}{4}$ " wide by 4 $\frac{1}{4}$ " deep. Shpg. wt., 1 $\frac{1}{4}$ lbs.

Type 3995. 2 $\frac{3}{8}$ " hole. For 2 $\frac{1}{2}$ " round or rectangular meters. 86 P 390. NET1.06

Type 3996. 2 $\frac{1}{8}$ " hole. For use with 3" rectangular or 3 $\frac{1}{2}$ " round meters. 86 P 391. NET1.06

ALUMINUM CHASSIS BASES

High-quality aluminum chassis bases; ruggedly constructed for general-purpose use. Easily punched and drilled. Carefully formed of one-piece 16 gauge aluminum. Have reinforced welded corners. Sides have folded lips on the bottom for added strength and rigidity. Lips are drilled to permit using chassis bottom plates listed below.



Stock No.	Type	H. W. D.	Lbs.	NET
86 P 463	29002	3x 9 $\frac{1}{2}$ x5"	1	1.66
86 P 462	29003	3x13x5"	1 $\frac{1}{2}$	1.86
86 P 468	29004	3x10x5 $\frac{1}{2}$ "	1 $\frac{1}{8}$	1.33
86 P 448	29034	3x14x 6"	1 $\frac{3}{8}$	2.50
86 P 464	29005	2x 7x 7"	$\frac{7}{8}$	1.37
86 P 473	29006	2x 9x7"	1	1.66
86 P 474	29007	2x11x7"	1 $\frac{1}{4}$	1.78
86 P 465	29008	3x12x7"	1 $\frac{1}{4}$	1.97
86 P 466	29009	2x13x7"	1 $\frac{1}{8}$	1.88
86 P 489	29011	3x17x7"	1 $\frac{3}{4}$	3.10
86 P 427	29012	3x12x8"	1 $\frac{1}{2}$	2.34
86 P 432	29013	2x17x8"	1 $\frac{3}{4}$	2.79
86 P 467	29014	3x17x8"	1 $\frac{7}{8}$	2.95
86 P 449	29015	3x12x10"	1 $\frac{7}{8}$	2.72
86 P 428	29016	3x14x10"	1 $\frac{1}{8}$	3.30
86 P 429	29017	3x17x10"	2	3.55
86 P 430	29025	4x17x10"	2 $\frac{3}{8}$	4.09
86 P 433	29018	3x23x10"	2 $\frac{1}{2}$	4.14
86 P 468	29019	2x17x11"	1 $\frac{1}{8}$	3.41
86 P 469	29020	3x17x11"	2 $\frac{1}{4}$	4.15
86 P 434	29022	3x17x12"	2 $\frac{3}{8}$	4.40
86 P 470	29023	2x17x13"	2 $\frac{1}{8}$	3.75
86 P 471	29024	3x17x13"	2 $\frac{1}{2}$	4.65
86 P 431	29026	4x17x13"	2 $\frac{3}{4}$	5.16

Volume Control Bracket. Punched right-angle bracket. For above-chassis mounting of volume controls. Shpg. wt., 3 oz. 43 N 620. NET.....6¢

BOTTOM PLATES FOR CHASSIS BASES

Sturdy bottom plates for use with the chassis bases listed above. Made of high-quality aluminum. Close fit provides excellent shielding of sub-chassis circuitry; protects components from dirt and dust. Have four raised bosses to prevent corners from marring table-tops or shelves. Easily mounted in place with No. 6 self-tapping screws.

Stock No.	Type	Size	Lbs.	NET
86 P 580	8702	5x13"	$\frac{1}{2}$.95
86 P 581	8725	5 $\frac{1}{2}$ x10"	$\frac{1}{2}$.87
86 P 582	8723	7x 7"	$\frac{1}{2}$.87
86 P 583	8703	7x 9"	$\frac{1}{2}$.90
86 P 584	8704	7x11"	$\frac{1}{2}$	1.02
86 P 585	8705	7x12"	$\frac{3}{4}$	1.10
86 P 586	8706	7x13"	$\frac{3}{8}$	1.28
86 P 587	8708	7x17"	$\frac{7}{8}$	1.34
86 P 588	8712	8x12"	$\frac{7}{8}$	1.26
86 P 589	8713	8x17"	1	1.39
86 P 591	8716	10x14"	$\frac{7}{8}$	1.33
86 P 592	8717	10x17"	1 $\frac{1}{4}$	1.71
86 P 593	8718	10x23"	1 $\frac{1}{4}$	2.08
86 P 594	8727	11x17"	1 $\frac{1}{8}$	2.08
86 P 595	8719	12x17"	1 $\frac{1}{8}$	2.22
86 P 596	8720	13x17"	1 $\frac{1}{2}$	2.33

RELAY RACK ACCESSORIES

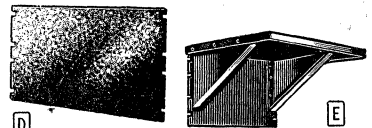

D Series 3600 RS. Handsome relay rack panels with standard RETMA notching. Width 19"; $\frac{1}{8}$ " thick. Support up to 200 lbs. *Also notched to fit Western Electric type racks. Crackle finish.

Black	Gray	Height	Lbs.	NET
*86 PX 101	*86 PX 130	13 $\frac{1}{4}$ "	2	.80
*86 PX 102	*86 PX 131	3 $\frac{1}{2}$ "	3	.90
*86 PX 103	*86 PX 133	5 $\frac{1}{4}$ "	4	1.08
*86 PX 104	*86 PX 134	7"	6	1.21
*86 PX 105	*86 PX 135	8 $\frac{3}{4}$ "	7	1.44
*86 PX 106	*86 PX 136	10 $\frac{1}{2}$ "	9	1.77
*86 PX 107	*86 PX 137	12 $\frac{1}{4}$ "	10	2.38
*86 PX 108	*86 PX 138	15 $\frac{3}{4}$ "	12	2.59
*86 PX 109	*86 PX 139	17 $\frac{1}{2}$ "	13	2.99
*86 PX 110	*86 PX 140	19 $\frac{1}{4}$ "	14	3.32
*86 PX 111	*86 PX 141	21"	15	3.66

D Series 8600 RS. Lightweight relay rack panels made of hard aluminum. Easy to drill; excellent rigidity RETMA notching. Size, $\frac{1}{8}$ " thick, 19" wide; heights given below. *Also notched to fit Western Electric type racks.

Black	Gray	Height	Lbs.	NET
*86 PX 400	*86 PX 450	13 $\frac{1}{4}$ "	1	1.12
*86 PX 401	*86 PX 451	3 $\frac{1}{2}$ "	2	1.36
*86 PX 402	*86 PX 452	5 $\frac{1}{4}$ "	2	1.88
*86 PX 403	*86 PX 453	7"	2	2.35
*86 PX 404	*86 PX 454	8 $\frac{3}{4}$ "	3	2.82
*86 PX 405	*86 PX 455	10 $\frac{1}{2}$ "	3	3.53
*86 PX 406	*86 PX 456	12 $\frac{1}{4}$ "	4	4.12
*86 PX 407	*86 PX 457	14"	4	4.73
*86 PX 408	*86 PX 458	15 $\frac{3}{4}$ "	5	5.25
*86 PX 409	*86 PX 459	17 $\frac{1}{2}$ "	5	5.81
*86 PX 410	*86 PX 460	19 $\frac{1}{4}$ "	6	6.38
*86 PX 411	*86 PX 461	21"	7	6.85

RELAY RACK BRACKETS

E Heavy-duty, triangular design brackets. For reinforcing racks and for mounting of panels, shelves, chassis, etc. Black wrinkle finish.

Stock No.	Mfr's Type	Base	Wt., Lbs.	NET, Per Pair
86 P 335	3950	5"	$\frac{1}{2}$.88
86 P 336	3951	8"	1	1.02
86 P 337	3952	11"	1 $\frac{1}{4}$	1.22

CHROME HANDLES

For cabinet, chassis, etc. Chrome finished. With mtg. screws. Shpg. wt., 4 oz.



Type 3500. 4" long, 1 $\frac{1}{8}$ " wide, 2 $\frac{3}{4}$ " mtg. ctrs. 42 H 520. EACH. .63¢
Type 3501. 6 $\frac{1}{2}$ " L, $\frac{5}{8}$ " W, 4 $\frac{1}{8}$ " mtg. ctrs. 42 H 521. NET EACH.....83¢

Builders' Supplies

POPULAR ICA BUILDERS' SUPPLIES

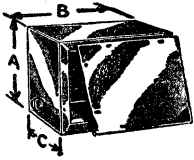

UTILITY CABINETS

Popular utility cabinets for amplifiers, monitors, input stages, meters, transceivers, etc. Excellent for the Amateur, experimenter and builder. Removable front and back covers may be fastened to cabinet with self-tapping screws provided. Available in steel with black ripple finish, aluminum with gray Hammertone finish and natural aluminum. Shipped knocked down. Supplied complete with hardware.

BLACK RIPPLE STEEL

Stock No.	Mfrs. Type	AxBxC	Wt., Lbs.	NET
86 P 350	3810	4x4x2"	1 1/4	.95
86 P 351	3811	5x4x3"	1 1/2	1.06
86 P 358	3812	6x4x5"	2 1/2	1.32
86 P 352	3800	6x6x6"	3	1.44
86 P 353	3801	6x9x5"	4	2.07
86 P 354	3802	7x10x8"	5	2.45
86 P 355	3804	8x12x11"	8	3.98
86 P 356	3803	10x10x8"	8	3.00

AxBxC	Wt. Lbs.	Gray Hammertone			Natural Aluminum		
		Stock No.	Type	NET	Stock No.	Type	NET
4x4x2"	1/2	86 P 304	29810	1.26	86 P 960	29840	1.22
5x4x3"	3/4	86 P 305	29811	1.45	86 P 961	29841	1.34
6x4x5"	1 1/2	86 P 306	29812	1.82	86 P 962	29842	1.64
6x6x6"	1 1/2	86 P 307	29800	2.00	86 P 963	29843	1.86
6x9x5"	1 3/4	86 P 308	29801	2.79	86 P 964	29844	2.45

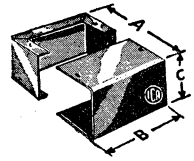

"FLEXI-MOUNT" ALUMINUM CASES

Two-piece aluminum cases designed especially to provide a maximum degree of accessibility. "Flexi-mount" cases offer the solution to numerous builder's problems demanding installation of many elements in a limited space. Excellent for oscillators, phono preamps, mike mixers, amplifiers, sub-assemblies, etc. Formed of 16-gauge aluminum. Supplied with hardware.

Size AxBxC	Wt. Lbs.	Gray Hammertone			Natural Aluminum		
		Stock No.	Type	NET	Stock No.	Type	NET
1 1/2x2 1/4x2 1/2"	3/8	86 P 435	29435	.82	86 P 835	29335	.68
1 1/2x3 1/4x2 1/2"	1/2	86 P 436	29436	.82	86 P 836	29336	.68
1 1/2x4 1/4x2 1/2"	1/2	86 P 437	29437	.84	86 P 837	29337	.71
2 1/4x4 1/2x2 1/2"	1/2	86 P 438	29438	1.08	86 P 838	29338	.92
2 1/4x5 1/2x2 1/2"	5/8	86 P 439	29439	1.12	86 P 839	29339	.99
3x5x4"	3/4	86 P 440	29440	1.22	86 P 840	29340	1.07
2 1/8x5 1/4x3"	5/8	86 P 441	29441	1.22	86 P 841	29341	1.10
4x6x5"	1	86 P 442	29442	1.56	86 P 842	29342	1.35
3x7x5"	1 1/8	86 P 443	29443	1.90	86 P 843	29343	1.49
3 1/2x8x6"	1 1/4	86 P 444	29444	2.49	86 P 844	29344	2.23
3 1/2x10x6"	1 1/2	86 P 445	29445	3.09	86 P 845	29345	2.45
4x12x7"	2	86 P 446	29446	3.64	86 P 846	29346	3.12
4x17x5"	2 1/4	86 PX 447	29447	4.28	86 PX 447	29347	3.62

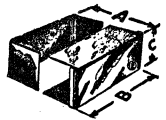

"CHANNEL-LOCK" ALUMINUM BOXES

Two-piece, 16-gauge aluminum boxes with special "Channel-lock" feature for snug fit. Readily assembled and disassembled. Ideal for oscillators, power supplies, amplifiers, etc.

NATURAL ALUMINUM

Stock No.	Type	Size, AxBxC	Shgp. Wt.	NET
86 P 850	29200	1 1/2x4x2 1/2"	8 oz.	.89
86 P 851	29205	2 1/8x5x2 1/4"	10 oz.	1.24
86 P 852	29210	2 1/8x5 1/4x3"	10 oz.	1.36
86 P 853	29215	5x6x4"	12 oz.	1.16
86 P 854	29220	5x6x4"	1 lb.	1.27
86 P 855	29225	2 1/8x10x4"	1 lb.	2.48

Size AxBxC	Shgp. Wt.	Black Wrinkle		Gray Hammertone		NET EACH
		No.	Type	No.	Type	
1 1/2x4x2 1/2"	8 oz.	86 P 314	29300	86 P 324	29400	1.03
2 1/4x5x2 1/2"	10 oz.	86 P 315	29305	86 P 325	29405	1.40
2 1/8x5 1/4x3"	10 oz.	86 P 316	29310	86 P 326	29410	1.53
5x6x4"	12 oz.	86 P 317	29315	86 P 327	29415	1.30
5x6x4"	1 lb.	86 P 318	29320	86 P 328	29420	1.49
2 1/2x10x4"	1 lb.	86 P 319	29325	86 P 329	29425	2.69

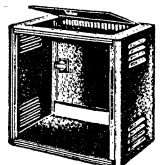

DELUXE CABINET RACKS

Heavy-gauge steel equipment cabinet racks with handsome professional appearance. For P.A. equipment, Amateur transmitters, test equipment, etc. Have modern rounded corners, chrome trim and side louvers. Notched for standard RETMA 19" panels or Western Electric panels. Equipped with nickel-plated brass snap locks on hinged doors. Models 3880, 3885, 3881 and 3886 have door on top only; Models 3882, 3883 and 3884 have doors on top and rear. Shipped assembled.

Stock No.	Black	Blue-Gray	Type	Overall Size H.W.D.	Panel Height	Wt. Lbs.	NET
							EACH
98 PZ 870	86 PZ 953	3880		10 1/2x21 3/4x15 1/4"	8 3/4"	29	14.60
98 PZ 875	86 PZ 954	3885		12 1/4x21 3/4x15 1/4"	10 1/2"	30	16.66
98 PZ 871	86 PZ 955	3881		14x21 3/4x15 1/4"	12 1/4"	32	17.61
98 PZ 876	86 PZ 956	3886		15 3/4x21 3/4x15 1/4"	14"	34	19.19
98 PZ 872	86 PZ 957	3882		19 1/4x21 3/4x15 1/4"	17 1/2"	36	22.86
98 PZ 873	86 PZ 958	3883		28 3/4x21 3/4x15 1/4"	26 1/4"	60	26.29
98 PZ 874	86 PZ 959	3884		36 3/4x21 3/4x15 1/4"	35"	60	29.40

"SPECIFIC" MODEL C-100 SPEED CHASSIS

Versatile chassis for lab and experimental use. Has tapped holes for a variety of plates listed below. Perfect for temporary experimental circuits.



With 4 tie-point strips; 3 insulated, 1 grounded. Sturdily constructed of cadmium-plated 20-gauge steel. Size: 5" high, 16 1/2" wide, 5 1/4" deep. Shgp. wt., 1 3/4 lbs. **4.85**

MOUNTING PLATES. Cadmium-plated, 20-gauge steel. Quickly and easily installed or removed from Speed Chassis. Pre-punched for sockets and other parts. 4 3/8" deep. Av. shgp. wt., 2 oz.

Stock No.	Description	Width	NET
86 P 681	Single 7-pin min. socket.....	1 1/8"	20c
86 P 682	Double 7-pin min. socket.....	1 1/8"	24c
86 P 692	Single 7-pin Vector socket.....	1 1/8"	34c
86 P 693	Double 7-pin Vector socket.....	1 1/8"	39c
86 P 694	Triple 7-pin Vector socket.....	1 1/8"	44c
86 P 683	Single 9-pin min. socket.....	1 1/8"	23c
86 P 684	Double 9-pin min. socket.....	1 1/8"	27c
86 P 695	Single 9-pin Vector socket.....	1 1/8"	34c
86 P 696	Double 9-pin Vector socket.....	1 1/8"	39c
86 P 697	Triple 9-pin Vector socket.....	1 1/8"	44c
86 P 685	Single octal socket 1 1/2" ctrs.....	2 1/8"	25c
86 P 686	Double octal socket 1 1/2" ctrs.....	2 1/8"	30c
86 P 687	Single octal socket 1 3/4" ctrs.....	2 1/8"	25c
86 P 699	Double octal socket 1 3/4" ctrs.....	2 1/8"	30c
86 P 687	Universal transformer (2 supplied)	2 1/8"	54c
86 P 688	Volume control.....	1 1/8"	34c
86 P 689	Blank.....	1 1/8"	15c
86 P 690	Blank.....	1 1/8"	15c
86 P 691	Blank.....	2 1/8"	15c

DUMONT UNIVERSAL CIRCUIT BREADBOARD

Type K-100. Time saver for engineers and experimenters. Consists of a 3x4x12" steel frame with end plates punched for controls, 16 phenolic 4x2" sub-chassis, two 9-terminal strips, and 20 double-ended terminals. Sub-chassis includes 4 single and 4 double-hole types for 7 or 9-pin miniature sockets, 4 single-hole types for octal, loctal, etc., sockets and 4 utility chassis with holes for mounting terminals or parts. Shgp. wt., 2 lbs.

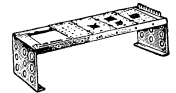

86 P 794. NET..... **12.25**

"UNICHASSIS" EXPERIMENTAL CHASSIS

All-metal "breadboard type" chassis permits rapid assembly of circuits. 8 holes for miniature and 8 for standard sockets cut in two sections of chassis top. Angled at 45 degrees to permit using large tubes or other components. Heavy components can be mounted on lower shelf. Made of heavy-gauge aluminum alloy. 22 rubber covered No. 18 leads in lengths from 6" to 42". With assorted connectors. Size, 11x7 1/2x8 1/4". Shgp. wt., 3 1/2 lbs.

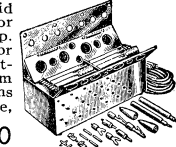

86 PX 575. NET..... **19.50**

PLASTIC CASES AND PANELS

Sturdy, molded, black plastic cases and panels. Recessed corner bosses for flush mounting panels. Bosses are pre-drilled for 3/8" self-tapping screws. Av. shgp. wt., cases: 1 1/2 lbs.; panels: 1 lb.

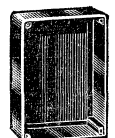

CASES

Stock No.	Size	1-9, EA.	10 or More, EA.
86 P 286	6 1/4x3 3/4x2"	.88	.79
86 P 287	6 1/8x5 1/2x2 1/8"	1.28	1.16

MATCHING PANELS

Stock No.	Panel Size	1-9, EACH	10 or More, EACH
86 P 288	6x3 1/2"; for BC-138	.55	.49
86 P 289	6 1/2x5"; for BC-140	.73	.66

ICA UTILITY CABINETS WITH BUILT-IN CHASSIS

Multi-purpose small cabinets ideal for VFO assemblies, pre-amplifiers and units requiring enclosed cabinets. Front and rear panels are attached by self-tapping screws. Built-in chassis is welded to front panel. Constructed of sturdy steel in black ripple finish. Accurately formed for perfect fit. Handy for the Amateur, builder and experimenter.

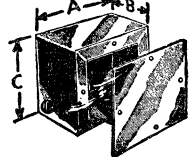

Stock No.	Mfr's. Type	Cabinet Size AxBxC	Chassis Size AxBxC	Wt. Lbs.	NET EACH
86 P 416	3816	4x2x4"	2 7/8x1 7/8x1"	1 1/8	1.31
86 P 417	3817	4x3x5"	2 7/8x2 7/8x1"	1 1/2	1.45
86 P 418	3818	5x3x4"	3 7/8x2 7/8x1 1/4"	1 1/2	1.59
86 P 419	3819	4x5x6"	2 7/8x4 7/8x1 3/4"	2 1/4	1.67
86 P 421	3821	6x5x4"	4 7/8x4 7/8x1 3/4"	2 1/4	1.88
86 P 423	3823	6x6x6"	4 7/8x5 7/8x1 3/4"	3 1/2	2.13

ICA SPEAKER CASES

Type 3988 Composite. A neat looking, smartly styled cabinet designed to house either a 4 or 5-inch speaker. Skillfully fabricated of extra-heavy, 20-gauge sheet steel. Cabinet is beautifully finished in a blue-gray ripple and has attractively embossed grille. Unit is provided with a removable back plate for faster assembly. Keyhole slots on back plate permit convenient wall hanging. Size: 7" high, 7" wide, 4" deep. Shgp. wt., 3 lbs.



86 P 394. NET..... **3.68**



RIDER PUBLICATIONS AND SERVICE MANUALS

LATEST RADIO AND TELEVISION PUBLICATIONS

TV MANUFACTURERS' RECEIVER-TROUBLE CURES. VOLUME 1. TV receiver troubles and cures as specified by set makers. Includes improvements used in later runs. Describes solutions to manufacturers problems. Complete details on TV sets from Admiral to DuMont. 115 pages. 8½x5½".

37 K 502. Postpaid in U.S.A. 1.76

VOLUME 2. Covers 11 TV manufacturers from Emerson to Jackson. Over 100 pages.

37 K 503. Postpaid in U.S.A. 1.76

VOLUME 3. Trouble cures for receivers from Kaye-Halbert to Philco. Over 120 pages.

37 K 504. Postpaid in U.S.A. 1.76

VOLUME 4. For servicing receivers from Philharmonic to Shaw. Over 120 pages.

37 K 505. Postpaid in U.S.A. 1.76

VOLUME 5. Continuation of series from Spartan to Zenith. Over 120 pages.

37 K 506. Postpaid in U.S.A. 1.76

VOLUME 6. 12 TV manufacturers from Admiral to Firestone. 120 pages.

37 K 316. Postpaid in U.S.A. 1.76

VOLUME 7. Covers TV sets from G.E. to Raytheon. 120 pages.

37 K 416. Postpaid in U.S.A. 1.76

VOLUME 8. New coverage. From RCA to Zenith. 120 pages.

37 K 318. Postpaid in U.S.A. 1.76

TECHNICIAN'S GUIDE TO TV PICTURE TUBES. By Ira Remer. Picture tube servicing guide for the TV serviceman. Covers care, handling, replacement, maintenance and repair of picture tubes. 160 pages. Illustrated. Size, 5½x8½".

37 K 475. Postpaid in U.S.A. 2.35

TELEVISION—HOW IT WORKS. By J. Richard Johnson. 2nd edition. Comprehensive, basic text fully explaining the "hows" of TV operation. Follows the progress of the received TV signal from the antenna to the picture tube and speaker. Includes discussion of antennas, video amplifiers, kinescopes, FM, sweep circuits, synchronization, etc. Leather-finish cover. 352 pages, illustrated. 5½x8½".

37 K 317. Postpaid in U.S.A. 4.51

FM TRANSMISSION AND RECEPTION. By John F. Rider and Seymour D. Uslan. 2nd Edition. Covers FM broadcasting, including police and Amateur equipment. Explains theory and servicing of FM receivers. Typical chapters: Transmitters of Today; FM Receiving Antennas; Alignment of FM Receivers. Cloth bound. 460 pages. 8½x5½".

37 K 628. Postpaid in U.S.A. 4.85

BROADCAST OPERATOR'S HANDBOOK. 2nd Edition. By Harold E. Ennes, Engineer, WIRE. Discusses every phase of broadcast operating practice. Typical chapters: Remote Versus Studio Pickups; Measuring Noise and Distortion; Emergency Shutdowns. 440 pages. Size, 8½x5½".

37 K 623. Postpaid in U.S.A. 5.29

TV SWEEP ALIGNMENT TECHNIQUES. By Art Liebscher. Written by a test equipment specialist. All phases of TV sweep alignment. Detailed instructions on the new "Supermark" method of sweep alignment. Includes uses for standard test equipment. Profusely illustrated with sweep-curve pictures taken from actual jobs using test equipment set-ups and techniques. Helpful for servicing in UHF areas. Over 120 pages. 5½x8½".

37 K 531. Postpaid in U.S.A. 2.06

TV AND ELECTRONICS AS A CAREER. By Ira Kamen and Richard H. Dorf. Written for those already in electronics as well as young people just planning a career. Top authorities explain career opportunities. Gives full details of jobs and opportunities in radio and television broadcasting, manufacturing and servicing. 326 pages. 5½x8½".

37 K 549. Postpaid in U.S.A. 2.45

TV REPAIRS QUESTIONS AND ANSWERS. A practical series of question- and answer-books on troubles and repair of TV sets. Series follows correct receiver signal sequence. Fully illustrated. 5½x8½".

VOLUME 1. FRONT ENDS. 128 pages.

38 K 920. Postpaid in U.S.A. 2.06

VOLUME 2. VIDEO CIRCUITS. 128 pages.

37 K 428. Postpaid in U.S.A. 2.06

VOLUME 3. SYNC. & SWEEP CIRCUITS. 128 pages.

37 K 429. Postpaid in U.S.A. 2.06

VOLUME 4. DEFLECTION & H-V CIRCUITS. 128 pages.

37 K 264. Postpaid in U.S.A. 2.06

VOLUME 5. SOUND & L-V CIRCUITS. 120 pages.

37 K 265. Postpaid in U.S.A. 2.06

HOW TO INSTALL TV ANTENNAS. By Samuel L. Marshall. Clearly written book on how to make professional antenna installations. Based on the author's personal experiences, the book describes best installation methods currently used. Chapters include: Antenna Fundamentals; VHF Antennas, Installation Materials, etc. Illustrated. 124 pages. Size, 5½x8½".

38 K 635. Postpaid in U.S.A. 2.45

HOW TO USE METERS. By John F. Rider. Written for the service technician, the TV and radio student, and Amateurs. Thoroughly covers panel-type volt-ohm-milliammeters, vacuum tube voltmeters, and variations of these basic types. Comprehensively illustrated. Over 140 pages. Size, 5½x8½".

37 K 532. Postpaid in U.S.A. 2.35

OBTAINING AND INTERPRETING TEST SCOPE TRACES. By John F. Rider. Contains over 500 actual photographs of test scope traces. Complete instructions on use of scopes and interpretation of traces. Indispensable for servicing TV, FM and AM radio receivers, audio systems, etc. Specific test equipment set-ups are shown with each application. Over 140 pages. Size, 5½x8½".

37 K 533. Postpaid in U.S.A. 2.35

TV TROUBLESHOOTING AND REPAIR GUIDE BOOK VOL. 1. By R. G. Middleton. Thorough presentation of typical television troubles and their cures. Tells how to recognize trouble symptoms through the use of patterns from TV picture tubes and waveforms from scopes. Includes valuable data on troubleshooting with test equipment and scopes, visual troubleshooting techniques and troubleshooting charts. Profusely illustrated. 200 pages. Size, 8½x11".

37 K 768. Postpaid in U.S.A. 3.82

TV TROUBLESHOOTING AND REPAIR GUIDE BOOK VOL. 2. By R. G. Middleton. A practical reference for the TV serviceman. Contains highly valuable service information: Troubleshooting front ends; servicing the video IF strips; faults in video amplifiers; trouble analysis in sound IF and detector systems; etc. 160 pages. 8½x11".

37 K 779. Postpaid in U.S.A. 3.23

TUBE SUBSTITUTION GUIDE

Lists substitutes for over 2500 receiving tubes. Gives ratings and wiring changes, RETMA color codes, transformer and capacitor substitutions, etc. Complete data on filament wiring of all TV sets in Rider TV Manuals 1 to 5 (page 299). Has tube base diagrams and characteristics chart. 224 pages. 8½x11".

37 K 648. Postpaid in U.S.A. 2.94

15T SUPPLEMENT. Lists additional 750 tube replacements. Includes section on TV tubes. 44 pages. Size, 8½x11".

37 K 548. Postpaid in U.S.A. 97¢

2ND SUPPLEMENT. 134 picture tube and 190 receiving tube substitutions. 48 pages. Size, 8½x11".

37 K 547. Postpaid in U.S.A. 97¢

3RD SUPPLEMENT. 200 picture tube and 80 receiving tube substitutions. 68 pages. Size, 8½x11".

37 K 583. Postpaid in U.S.A. 1.32

COLOR TELEVISION BOOKS

INTRODUCTION TO COLOR TV. 2ND EDITION. By M. Kaufman and H. Thomas. Revised, up-to-date edition of a TV best-seller. Full information on latest large-screen picture tubes, simplified set circuitry, etc. Illustrated. 208 pages, 5½x8½".

37 K 524. Postpaid in U.S.A. 2.65

HIGHLIGHTS OF COLOR TV. By John R. Locke, Jr. An easy-to-understand introduction to color TV for those who are familiar with black and white TV. 48 pages. 8½x5½".

37 K 937. Postpaid in U.S.A. 97¢

COLOR TV DICTIONARY. By J. R. Johnson. Complete explanation of color TV terms with their definitions. Ideal for anyone interested in color TV. 72 pages. 50 illustrations. Size, 5½x8½".

37 K 112. Postpaid in U.S.A. 1.22

COLOR TV RECEIVER PRACTICES. By Hazeltine Corp. Analyses and explanations of color TV circuits. 240 pages, 5½x8½".

37 K 419. Postpaid in U.S.A. 4.41

GENERAL TECHNICAL BOOKS

RIDER'S INTRODUCTION TO PRINTED CIRCUITS. By Robert L. Swiggert. Construction, design and characteristics of printed circuits as used in various types of electronic equipment. Covers modules, etched circuits, etc. 101 pages. Size, 5½x8½".

37 K 244. Postpaid in U.S.A. 2.65

PICTURE BOOK OF TV TROUBLES. VOL. 1. Picture-tube displays and waveforms clearly show trouble symptoms. Covers horizontal AFC-oscillator circuits, pulse-width phase detectors, etc. 70 pages. 5½x8½".

37 K 217. Postpaid in U.S.A. 1.32

VOL. 2. Covers vertical sweep-deflection circuits, vertical retrace blanking, trouble-shooting of vertical sweep systems, etc. 96 pages.

38 K 636. Postpaid in U.S.A. 1.76

VOL. 3. Covers video IF and video amplifiers. Includes impedance-coupled and transformer-coupled IF amplifiers, 90 pages.

37 K 424. Postpaid in U.S.A. 1.76

VOL. 4. Covers automatic gain control systems. Includes delayed AGC circuits, and keyed AGC systems. 86 pages.

37 K 425. Postpaid in U.S.A. 1.76

VOL. 5. Covers horizontal and high-voltage circuits. Includes separate secondary, direct drive, autotransformer, etc. 108 pages.

37 K 213. Postpaid in U.S.A. 1.76

VOL. 6. Covers horizontal and vertical sync circuits. Includes common and dual channel circuits, clippers, etc. 120 pages.

37 K 214. Postpaid in U.S.A. 1.76

VOL. 7. Covers sound circuits and L-V power supplies. Includes Foster-Seely FM circuits, ratio detectors, etc. 64 pages.

37 K 221. Postpaid in U.S.A. 1.47

HOW TO USE TEST PROBES. By A. Ghirardi and R. Middleton. Covers all types of test probes used with VOM's, VTVM's and scopes. Tells what probe to use, where to use it and how to use it. Step-by-step explanations. Includes resistive H-V DC probe, capacitance divider, H-V AC probe and others. 172 pages. Size, 5½x8½".

37 K 216. Postpaid in U.S.A. 2.84

ADVANCED TELEVISION SERVICING TECHNIQUES. Practical, advanced TV servicing course. Divides receiver into major sections. Teaches troubleshooting section-by-section. Explains component problems. 176 pages. Size, 8½x11".

37 K 311. Postpaid in U.S.A. 3.53

ADVANCED TELEVISION SERVICING TECHNIQUES—LABORATORY WORKBOOK. By RETMA. Companion book for use with advanced TV Servicing Techniques listed above. Familiarizes students with all types of test equipment. 32 pages. 8½x11".

37 K 314. Postpaid in U.S.A. 93¢

ENERGY. By Sir Oliver Lodge. Contains no mathematics, yet easily conveys complex ideas to reader. Includes fundamentals of energy and work, terrestrial energy, laws, etc. Well illustrated. 64 pages. 5½x8½".

37 K 266. Postpaid in U.S.A. 1.22

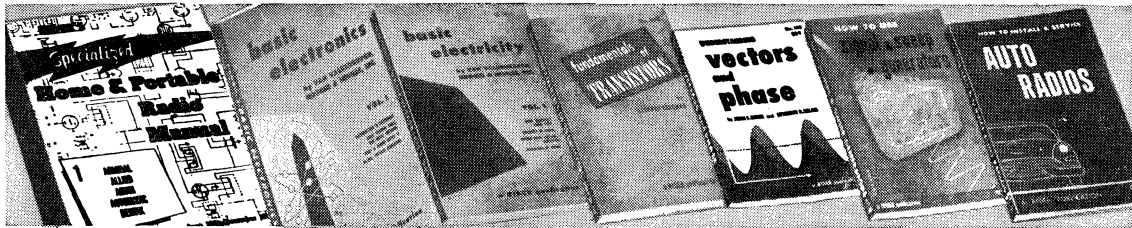

RIDER PUBLICATIONS AND SERVICE MANUALS

RADIO MANUALS

Specialized Home and Portable Radio Manuals. More service profits with popular Rider radio manuals! Fully approved and authorized by the receiver manufacturers who prepared the original information. Covers sets produced from *June 1951* through *December 1953*. Data includes clear schematic diagrams, voltage measurements, trimmer locations, tube layouts, dial stringing data, chassis views, complete parts list, etc. With durable soft cover. Size, 8½x11".

Vol. 1. Covers Admiral, Allied, Arvin, Automatic and Bendix sets. 96 pages.
38 K 900. Postpaid in U.S.A. 1.62

Vol. 2. Covers Bogen, Capehart-Farnsworth, CBS, Crosley. 96 pages.
38 K 901. Postpaid in U.S.A. 1.62

Vol. 3. Covers sets made by DeWald, Emerson, Fada, Firestone. 96 pages.
38 K 902. Postpaid in U.S.A. 1.62

Vol. 5. Covers Jewel, Magnavox, Meck, Mitchell, Montgomery Ward sets. 96 p.
38 K 904. Postpaid in U.S.A. 1.62

Vol. 6. Covers sets made by Motorola, Olympia, Packard. 96 pages.
38 K 905. Postpaid in U.S.A. 1.62

Vol. 7. Covers Philco only. 192 pages.
38 K 906. Postpaid in U.S.A. 2.35

Vol. 8. Covers RCA sets only. 96 pages.
38 K 907. Postpaid in U.S.A. 1.62

Vol. 9. Covers Radio Craftsmen, Raytheon, Sears Roebuck, Sentinel, Setchell-Carlson, Sonora. 96 pages.
38 K 908. Postpaid in U.S.A. 1.62

Vol. 10. Covers sets made by Spiegel, Stewart Warner, Stromberg-Carlson, Sylvania, Tele-King, Trav'ler. 96 pages.
38 K 909. Postpaid in U.S.A. 1.62

AUTO RADIO MANUALS

Specialized Auto Radio Manuals. A specialized series of manuals devoted to servicing information on auto radios for any make of car or truck produced from 1950 through 1954. Clear illustrations guide you every step of the way. Data includes: Noise suppression, tube layout, schematic diagrams, voltage measurements, push-button setups, alignment data, dial stringing, trimmer locations, installation instructions, chassis layouts, and complete parts list. All have soft covers.

Volume 1. Ford, Lincoln and Mercury autos. 208 pages. 8½x11".
38 K 950. Postpaid in U.S.A. 2.94

Volume 2. Buick, Cadillac and Oldsmobile autos. 200 pages. 8½x11".
38 K 951. Postpaid in U.S.A. 2.94

Volume 3. Chevrolet, Pontiac, GMC and Chevrolet trucks. 128 pages. 8½x11".
38 K 952. Postpaid in U.S.A. 1.76

Volume 5. Henry-J, Hudson, Kaiser-Frazer, Nash, Packard, Studebaker and Willys. 208 pages. 8½x11".
38 K 954. Postpaid in U.S.A. 2.94

Volume 6. Motorola data for any 1948 to 1954 car or truck. 208 pages. 8½x11".
38 K 955. Postpaid in U.S.A. 2.94

Volume 7. Automatic, Spiegel, Firestone and Montgomery Ward radios for all cars. 208 pages. 8½x11".
38 K 956. Postpaid in U.S.A. 2.94

TELEVISION MANUALS

Factory-authorized service data on TV receivers, kits, boosters. With schematics, alignment charts, test patterns, parts lists. All are 8½x11". Postpaid in U.S.A.

No.	Vol.	Covers	EACH
90 KX 045	20	Aug. 56-Dec. 56	23.52
90 KX 044	19	May 56-Aug. 56	19.40
90 KX 043	18	Jan. 56-Apr. 56	19.40
90 KX 042	17	Aug. 55-Dec. 55	23.52
90 KX 041	16	Apr. 55-July 55	
90 KX 037	12	Mar. 53-July 53	

GENERAL TECHNICAL PUBLICATIONS

HOW TO LOCATE AND ELIMINATE RADIO AND TV INTERFERENCE. By Fred D. Rowe. Chapters include: Interference Locating Equipment; Locating the Source; Noise Filters; etc. 5½x8½". 128 pages.
37 K 510. Postpaid in U.S.A. 1.76

HOW TO INSTALL AND SERVICE AUTO RADIOS. By Jack Darr. Gives information on antenna installations; vibrator testing; noise suppression; tools, parts, and equipment needed; etc. 5½x8½". 120 pages.
37 K 512. Postpaid in U.S.A. 1.76

HOW TO TROUBLESHOOT A TV RECEIVER. By J. Richard Johnson. Written expressly for the newcomer. Explains picture patterns, schematics, trouble symptoms, etc. Illustrated. 128 pages. 5½x8½".
37 K 309. Postpaid in U.S.A. 1.76

TV FIELD SERVICE MANUALS. By Harold Alsberg. For the serviceman. Include tube locations, trouble symptoms, adjustments, etc. Each volume covers 7 years production. Soft cover, spiral binding. Illustrated. 5½x8½".

Vol. 1. Covers TV sets by Admiral, Artone, AMC, Air King, Air Marshall, Allied, Andrea, Arvin and Automatic. 120 pages.
37 K 511. Postpaid in U.S.A. 2.06

Vol. 2. Covers TV sets by Bendix, Capehart, CBS-Columbia, Crosley and Dumont. 160 pages.
38 K 997. Postpaid in U.S.A. 2.35

Vol. 3. Complete service data on TV receivers by Emerson and Fada. 121 pages.
37 K 315. Postpaid in U.S.A. 2.06

Vol. 4. Service data on TV receivers by G.E., Hallicrafters and Hoffman. 151 pages.
37 K 426. Postpaid in U.S.A. 2.35

Vol. 5. Complete service data on TV receivers by Motorola and Philco. 137 pages.
37 K 427. Postpaid in U.S.A. 2.35

RADIO TROUBLESHOOTING GUIDEBOOK. Vol. 1. By John F. Rider and J. R. Johnson. Discusses every type of AM and FM receiver. Part I: Superhets, both AM and FM. Part II: Fundamental Troubleshooting. Illustrated. 140 pages. 5½x8½".
37 K 933. Postpaid in U.S.A. 2.35

FUNDAMENTALS OF TRANSISTORS. By Leonard Krugman. Explains use of transistors for direct replacement and as supplement to vacuum tubes. Text deals with basic operation, characteristics, performance, and application. Written in a pleasant easy to understand style. Chapters include: Basic Semiconductor Physics, Transistors and Their Operation, The Grounded Base Transistor, Grounded Emitter and Grounded Collector Transistors, Transistor Amplifiers, Transistor Oscillators, Transistor High-Frequency and other applications. Illustrated. 144 pages. Size, 5½x8½".
37 K 474. Postpaid in U.S.A. 2.65

SERVICING TV VERTICAL AND HORIZONTAL OUTPUT SYSTEMS. By Harry Thomas. A complete explanation of how vertical and horizontal output systems function. Over 176 pages. 5½x8½".
37 K 509. Postpaid in U.S.A. 2.35

HOW TO USE SIGNAL AND SWEEP GENERATORS. By J. Richard Johnson. Explains applications of signal generators used in FM, AM radio and TV servicing. 144 pages. Illustrated. 5½x8½".
37 K 306. Postpaid in U.S.A. 2.06

UNDERSTANDING VECTORS AND PHASE. By John F. Rider and S. D. Usilan. Covers scalars, vectors, vector analysis and their application. 160 pages. 5½x7¼".
37 K 928. Postpaid in U.S.A. 97c

SPECIALIZED HI-FI AM-FM TUNER MANUAL. An informative, factory-accurate manual. Thoroughly covers the 20 most popular brands of AM and FM high-fidelity tuners. Provides the serviceman with comparative specifications, characteristics, and information on adjustments, servicing, etc. Covers 1950-1955. Full-page photos clearly identify all components. 192 pages. 8½x11".
37 K 417. Postpaid in U.S.A. 3.43

BASIC ELECTRONICS. By Van Valkenburgh, Nooger and Neville, Inc. Prepared for the U.S. Navy—over 25,000 trainees have learned basic electronics this easy way. Consists of 5 volumes. Each page covers a complete idea with illustrations—over 1700 drawings!
Vol. 1: Diodes and Power Supplies; **Vol. 2:** Amplifiers and Oscillators; **Vol. 4 and 5:** Transmitters and Receivers. 9x6".
38 K 631. Postpaid in U.S.A. 9.80

As above, but cloth bound.
37 K 268. Postpaid in U.S.A. 11.27

BASIC ELECTRICITY. As above, but covering electricity. Vol. 1: DC and Meters; Vol. 2: DC Circuits, Ohm's and Kirchoff's Laws, and Electric Power; Vol. 3: Inductance, Capacitance, Reactance and AC Meters; Vol. 4: Impedance, Resonance, and Transformers; Vol. 5: Generators, Motors, Alternators and Power Control Devices.
38 K 621. Postpaid in U.S.A. 9.80

As above, but cloth bound.
37 K 269. Postpaid in U.S.A. 11.27

BASIC SYNCHROS AND SERVOMECHANISMS. By Van Valkenburgh, Nooger and Neville. Exceptionally well written and easy to understand. Used in U.S. Navy's electronics training program. Explains in detail and illustrates the basic principles of servos and synchros; also includes typical applications. Set of two volumes. 272 pages. 6x9".
37 K 508. Postpaid in U.S.A. 5.39

BASIC VACUUM TUBES AND THEIR USES. By J. F. Rider and H. Jacobowitz. Basic information on vacuum tubes, presented with a minimum of mathematics. Begins with elementary electron behavior; proceeds to advanced and specialized vacuum tubes. 200 pages. Size, 5½x8½".
38 K 921. Postpaid in U.S.A. 2.94

ELECTRONIC TECHNOLOGY SERIES. A thorough coverage of fundamentals and applications of electronic theory. Each book is profusely illustrated. The complete series will total 36 volumes and Allied will make available each new title as it is published. All are 6x9".
Postpaid in U.S.A.

Table with 3 columns: No., Title, EACH

No.	Title	EACH
37 K 113	RC and RL Time Constant	.88
38 K 922	FM Limiters and Detectors	.88
37 K 418	Frequency Modulation	.88
37 K 233	Crystal Oscillators	1.22
37 K 234	AM Detectors	1.22
37 K 235	Limiters and Clippers	1.22
37 K 236	Multivibrators	.88
37 K 237	RF Transmission Line	1.22
37 K 238	Amplitude Modulation	1.22
37 K 239	Blocking Oscillators	1.22
37 K 240	Wave Propagation	1.22
37 K 241	Superhet Converters & IF Amplifiers	.88
37 K 242	Inverse Feedback	.88
37 K 246	L-C Oscillators	1.22
37 K 247	Resonant Circuits	1.22
37 K 267	Antennas	1.47

ARITHMETIC FOR ENGINEERS. 5th edition. By C. B. Clapham. Covers fundamentals of mathematics, including slide rules, verniers, micrometers. Clearly written in a style which stimulates interest. 1,950 problems with answers. 558 pages; cloth bound. Size, 5½x8½". Diagrams, illustrations, etc.
37 K 243. Postpaid in U.S.A. 6.37

TRANSISTOR ENGINEERING REFERENCE HANDBOOK. By H. E. Marrows. Unique text embraces entire field from structure and fabrication to directory of transistor and component manufacturers. Four indexed sections. 288 pages. Illustrated. Cloth bound. Size, 9x12".
37 K 270. Postpaid in U.S.A. 9.75

SPECIALIZED TAPE RECORDER MANUAL. Vol. 1. Complete servicing information on 12 different brands of tape recorders manufactured from 1950 through 1954. Includes operation, adjustments, trouble diagnosis and repair of RCA, Bell & Howell, Columbia, Pentron, V-M, Webeor, Wilcox-Gay, etc. 288 pages. Size, 8½x11".
38 K 930. Postpaid in U.S.A. 4.41

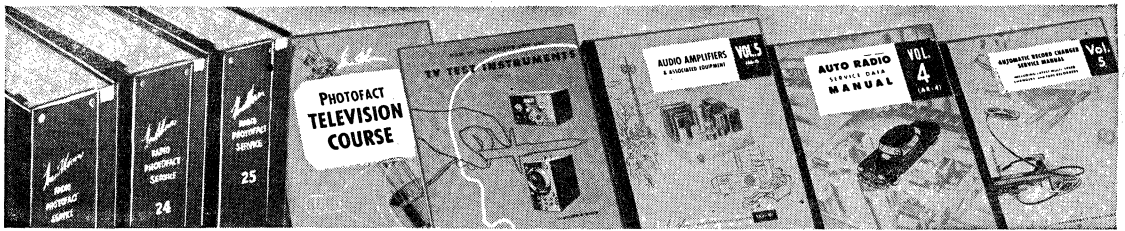

HOWARD W. SAMS RADIO-TV SERVICE PUBLICATIONS

PHOTOFACT SERVICE MANUALS AND FOLDER SETS

AUDIO AMPLIFIER MANUALS

"Pay-as-You-Profit Plan." The Photofact Manuals and Folder Sets listed below may be purchased on Sams' Time Payment Plan. This liberal "Pay-as-you-Profit" plan requires only a small down payment and no carrying charge or interest is added to the price. The down payment starts as low as \$10.00.

The balance can be completed in as many as 24 monthly payments. To qualify under this plan, a minimum order of 50 Folder Sets or a minimum order of 4 Manuals is required. Only Photofact Folders already published may be ordered under this plan. Write to Allied for further details.

Bound volumes of Photofact Folder Sets covering all types of audio equipment, including hi-fi amplifiers, public address amplifiers, pre-amplifiers, and tuners. Invaluable to the audio engineer, sound technician, serviceman, custom installer and experimenter. Each volume includes schematic diagrams complete with recommended voltage and resistance measurements at various points in the circuits. Detailed alignment instructions with provisions for use of oscilloscope (desired patterns are shown) or VTVM. Standard replacement parts are easily found through Sams' easy-to-use interchangeability charts. Profusely illustrated with front, top and bottom photographs. Photos are keyed to show exact locations and enable easy identification of each component. All controls clearly labelled. Dial stringing guides included. Page size, 8½x11". Postpaid in U.S.A.

PHOTOFACT SERVICE MANUALS

Photofact Service Manuals are compact and convenient binders consisting of 10 Folder Sets. These Manuals contain complete information on the servicing of radios, television sets, and other equipment produced up to the present. They are assembled as numbered volumes with each volume covering a particular time period.

No.	Vol.	Folder Sets	Period
38 K 864	40	391-400	10/57-1/58
38 K 865	38	381-390	6/57-10/57
38 K 862	38	371-380	3/57-6/57
38 K 861	37	361-370	1/57-3/57
38 K 860	36	351-360	10/56-1/57
38 K 859	35	341-350	7/56-10/56
38 K 634	34	331-340	5/56-7/56
38 K 633	33	321-330	2/56-5/56
38 K 632	32	311-320	12/55-2/56
38 K 637	31	301-310	10/55-12/55
38 K 630	30	291-300	7/55-10/55
38 K 629	29	281-290	5/55-7/55
38 K 628	28	271-280	1/55-4/55
38 K 627	27	261-270	12/54-3/55
38 K 626	26	251-260	9/54-12/54
38 K 625	25	241-250	6/54-9/54
38 K 624	24	231-240	12/53-5/54
38 K 584	23	221-230	8/53-12/53
38 K 583	22	211-220	5/23-8/53
38 K 575	21	201-210	2/53-5/53
38 K 574	20	191-200	11/52-2/53
38 K 573	19	181-190	7/52-11/52
38 K 572	18	171-180	4/52-7/52
38 K 571	17	161-170	1/52-4/52
38 K 570	16	151-160	11/51-1/52
38 K 569	15	141-150	8/51-10/51
38 K 563	14	131-140	4/51-8/51
38 K 562	13	121-130	1/51-4/51
38 K 561	12	111-120	10/50-1/51
38 K 560	11	101-110	7/50-10/50
38 K 559	10	91-100	3/50-7/50
38 K 558	9	81-90	12/49-3/50
38 K 557	8	71-80	10/49-12/49
38 K 556	7	61-70	5/49-10/49
38 K 555	6	51-60	12/48-5/49
38 K 554	5	41-50	7/48-12/48
38 K 553	4	31-40	1/48-7/48
38 K 552	3	21-30	7/47-1/48
38 K 551	2	11-20	1/47-7/47
38 K 550	1	1-10	Postwar-1/47

PHOTOFACT FOLDER SETS

Each set consists of individual folders describing numerous radio receivers, TV sets, record changers, amplifiers, etc. Each Folder contains complete servicing data presented in an easy-to-use manner. Numerous photographs with keyed components for instant identification and location of all parts. Parts replacement for most parts is made easy by interchangeability charts showing direct replacements available from standard manufacturers.

All Folder Sets In Stock. We stock all Sets from No. 1 up, and supply all new Folder Sets promptly upon publication. For complete TV set coverage, rely on new Photofact Folders. Use free Index listed below to determine the Folder Set you require, or write Allied, giving make and model number of receiver.

When ordering, be sure to specify Stock No. (38KK500) and Folder Set No., (or make and Model No. of receiver).

38 KK 500. EACH FOLDER SET.1.95
Postpaid in U.S.A.

PRODUCTION CHANGES. A-340. Changes made by manufacturers in models covered in Folder Sets 301 through 340.
37 K 359. Postpaid in U.S.A.1.95

PRODUCTION CHANGES. A-300. Changes made by manufacturers in models covered in Folder Sets 251 through 300.
38 K 618. Postpaid in U.S.A.1.95

PRODUCTION CHANGES. A-250. Changes made by manufacturers in models covered in Folder Sets 201 through 250.
38 K 640. Postpaid in U.S.A.1.95

PRODUCTION CHANGES. A-200. Changes made by manufacturers in models covered in Folder Sets 1 through 200.
38 K 616. Postpaid in U.S.A.1.95

BINDER FOR FOLDER SETS. Hard-bound; in durable black leatherette. Prevents misplacing or damaging of individual folders. Holds 10 sets. 9½x11½x6". 4 lbs.
38 K 549. NET.3.50

FREE CUMULATIVE INDEX. Tells you instantly which Folder Set contains the data you want. Lists sets by make and model.
38 K 576.FREE

Any of above Service Manuals.
NET EACH. Postpaid in U.S.A.23.00

TELEVISION BOOKS

HOW TO UNDERSTAND AND USE TV TEST INSTRUMENTS. TN-1. By Milton S. Kiver. Revised and enlarged to include latest data on instruments for servicing color TV. Basic explanations of each instrument's operation. Describes the function of each control and shows how to adjust properly for best results. Shows how to use each instrument in TV servicing. Contains a complete discussion of the alignment of FM and TV sets. Typical instruments covered: Vacuum Tube Voltmeters, AM Signal Generators, Sweep Signal Generators, Oscilloscopes. 208 pages. Profusely illustrated. Size, 8½x11".
38 K 587. Postpaid in U.S.A.3.50

UHF ANTENNAS, CONVERTERS, TUNERS. UHF-1. By Milton S. Kiver. Newest book on UHF by this popular author. Shows how to get satisfactory UHF reception. Divided into 5 sections covering: Necessary information and characteristics of UHF antenna arrays; problems involved in transmission lines and signal gain. Tells antenna best suited for any given location or condition. Outlines proper antenna installation. Gives full analysis of popular UHF converters and tuners. 136 pages. Size, 5½x8½".
38 K 604. Postpaid in U.S.A.1.50

LOW POWER TELECASTING. OH-2. By H. E. Ennes. Basic planning considerations useful for any TV station. Includes: Conversion of AM towers; "economy" TV antenna data; design and operation of TV transmission equipment; station layouts. 112 pages. Illustrated. Size, 6x9".
37 K 360. Postpaid in U.S.A.2.95

PRINCIPLES AND PRACTICES OF TELECASTING OPERATIONS. OH-1. By H. E. Ennes. For the engineer, production man, operations director, technician, etc. Over 450 illustrations. 596 pp. 6x9".
37 K 473. Postpaid in U.S.A.7.95

PHOTOFACT TELEVISION COURSE. TV-1. H. W. Sams' popular and invaluable Photofact television course. Profusely illustrated and packed with valuable data. Gives a complete, clear understanding of modern TV principles, operation, and practice. Supplies information invaluable to television servicemen and technicians. Typical chapters: Magnetic Control of the Electron Beam; Deflection Systems—Commercial Applications; Sawtooth Generators; Sync Pulse Separation and Use; DC Restoration; Intercarrier Sound System, etc. With glossary. 216 pages. 8½x11".
38 K 580. Postpaid in U.S.A.3.00

No.	Vol.	Period Covered	EACH
37 K 361	AA-8	1955-1956	3.95
37 K 352	AA-7	1955	3.50
37 K 353	AA-6	1953-1954	3.95
38 K 617	AA-5	1952-1953	3.95

AUTO RADIO MANUALS

These manuals provide complete coverage of auto radio receivers. Indispensable for rapid servicing. Offer full servicing information and alignment instructions. Replacement of parts is simplified through the use of the interchangeability charts which show standard replacements available from various manufacturers. Numerous photographs with keyed components are included; permit identification and location of all parts. Give schematic diagrams with normal voltage and resistance readings. Dial cord stringing diagrams are also provided. 8½x11". Postpaid in U.S.A.

No.	Vol.	Period Covered	EACH
37 K 362	AR-6	1955-1956	3.95
38 K 641	AR-5	1951-1955	3.95
38 K 612	AR-4	1953	3.00
38 K 603	AR-3	1950-1952	3.00
38 K 602	AR-2	1949-1950	3.00
38 K 597	AR-1	1946-1948	4.95

RECORD CHANGER AND TAPE RECORDER MANUALS

It's easy to service record changers and tape recorders with these information-packed manuals. Includes multi-speed automatic record changers; wire, tape and disc recorders; turn-over pickups; dual-track heads; etc. Give complete description including specifications of each unit, full operating instructions for every function, and complete parts lists. Lists possible troubles and ways to correct them. Procedures for disassembly and inspection are also outlined in detail. Exploded views show exact placement of all mechanical parts. Include schematic diagrams of all electrical circuitry. Many valuable hints on lubrication, cleaning, adjustment. 8½x11". Postpaid in U.S.A.

No.	Vol.	Period Covered	EACH
37 K 363	CM-9	1956	3.95
37 K 356	CM-8	1955-1956	3.95
37 K 354	CM-7	1954-1955	3.00
38 K 614	CM-6	1953-1954	3.00
38 K 615	CM-5	1951-1952	3.00
38 K 582	CM-4	1950-1951	3.00
38 K 567	CM-3	1949-1950	3.00

DIAL CORD STRINGING GUIDES

Popular, time-saving aids for radio and television servicemen. The only manuals devoted to the baffling problems of stringing radio and TV set dial cords. Cover both permeability-tuned and capacity-tuned sets. Clear, easy-to-follow illustrations. Size, 5½x8½".

No.	Vol.	Period Covered
37 K 364	DC-6	mid 1955-mid 1957
37 K 355	DC-5	1953-1955
38 K 611	DC-4	1951-1953
38 K 610	DC-3	1950-part 1951
38 K 568	DC-2	1947-Oct. 1949
38 K 564	DC-1	1938-1946

Any of the above Stringing Guides.
NET EACH. Postpaid in U.S.A.1.00

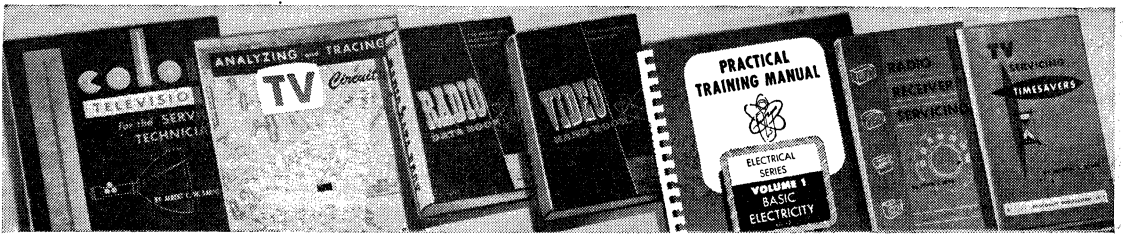

HOWARD W. SAMS RADIO-TV SERVICE PUBLICATIONS

TV TUBE LOCATION GUIDES. These books tell you the position and function of every tube in hundreds of popular TV sets. Include clear, accurate diagrams of each receiver. Volumes 4, 5 and 6 include a "tube failure check chart," which lists the most likely tube failures for no sweep or sync, loss of picture or sound and power supply failure. Each volume beginning with No. 2 indexes the sets in the previous volumes. $5\frac{1}{2} \times 8\frac{1}{2}$ ".

Stock No.	Type	Volume	Period
38 K 858	TGL-6	6	1955-1956
38 K 857	TGL-5	5	1953-1954
38 K 806	TGL-4	4	1952-1953
38 K 601	TGL-3	3	1951-1952
38 K 856	TGL-2	2	1950-1951
38 K 855	TGL-1	1	1948-1950

NET EACH. Postpaid in U.S.A. 2.00

KEY CHECK POINTS IN TV RECEIVERS. A compilation of proved, time-saving servicing information based on careful analysis of TV sets. This practical book tells how to make quick tests at key points to localize the trouble; how to check over-all performance of the set to insure against call-backs. Also describes other general TV servicing applications. Illustrated. Size, $5\frac{1}{2} \times 8\frac{1}{2}$ ".

KCP-1, Volume 1. 182 pages. For sets produced in late 1951 and early 1952.

37 K 218. Postpaid in U.S.A. 2.00

KCP-2, Volume 2. 184 pages. For sets produced in late 1952 and early 1953.

37 K 259. Postpaid in U.S.A. 2.00

COLOR TV FOR THE SERVICEMAN. 38-1. By A. C. W. Saunders. Explains basic relationship and composition of color signal. Describes the operation of the color picture tube and complete receiver, and alignment procedures for several commercial TV sets. Based on Photofact TV Courses. Easy to understand with many illustrations and definitions. An excellent short-course in color TV for the busy serviceman. Paper bound. 110 pages, Size, $8\frac{1}{2} \times 11$ ".

38 K 639. Postpaid in U.S.A. 2.50

SERVICING AND CALIBRATING TEST EQUIPMENT. TEK-1. Tells you how to keep your test equipment in working order, how to determine proper operation, calibration procedures. Quickly show you how to check instrument accuracy, how to service test equipment. Many other time-saving tips. Profusely illustrated. 145 pages. Size, $5\frac{1}{2} \times 8\frac{1}{2}$ ".

37 K 260. Postpaid in U.S.A. 2.75

TV SERVICING GUIDE. SGS-1. A quick reference guide showing how to use proper trouble-shooting technique as a basis for diagnosing TV symptoms. Includes trouble-shooting and servicing hints for locating and curing trouble in each section of TV set. Illustrated. 132 pages. Size, $8\frac{1}{2} \times 11$ ".

37 K 261. Postpaid in U.S.A. 2.00

RADIO RECEIVER SERVICING. RS-1. By J. Frye. For radio service technicians. Deals mainly with AC, AC-DC sets and the 3-way portable. Gives step-by-step directions for servicing and includes many practical short cuts. Covers basic troubles (dead set, intermittent, no station separation, etc.). Illustrated. 186 pages. Size, $5\frac{1}{2} \times 8\frac{1}{2}$ ".

38 K 623. Postpaid in U.S.A. 2.50

ANALYZING AND TRACING TV CIRCUITS. JA-1. By Milton S. Kiver. Starts with fundamental electronic concepts (amplification, positive and negative voltages, bias, etc.). Shows operation of a TV receiver by means of block diagrams and schematics. Discusses TV receivers stage-by-stage. Illustrated. 140 pages. Size, $8\frac{1}{2} \times 11$ ".

38 K 613. Postpaid in U.S.A. 3.00

ATOMIC RADIATION DETECTION AND MEASUREMENT. ADR-1. By Harold S. Renne. A guide for Civil Defense personnel, engineers, students and prospectors. Contains photos, diagrams and schematics of many commercial instruments. Typical chapters: Atomic Structure; Atomic Radiation and its Effects; Commercial Geiger Counters; etc. 200 pages. Size, $5\frac{1}{2} \times 8\frac{1}{2}$ ".

38 K 638. Postpaid in U.S.A. 3.00

RADIO DATA HANDBOOK. BB-1. A handbook by Wm. F. Boyce and Jos. J. Roche. An authoritative source of information on radio and electronics. Extremely helpful in the solution of everyday problems in fundamentals, vacuum tubes, basic circuits, receivers, transmitters, sound systems, power supplies, antennas, testing and aligning, etc. Dozens of tables, charts, graphs, etc. with useful mathematical formulas. Over 1200 illustrations. 900 pages. Size, $4\frac{3}{4} \times 7$ ".

37 K 740. Postpaid in U.S.A. 4.95

VIDEO HANDBOOK. BB-2. A valuable reference book. Clearly written and profusely illustrated. The 14 sections cover the entire TV field, including: Design, construction, production and servicing. Widely used by students, engineers and industrial technicians. Illustrated. 892 pages. Size, $3\frac{1}{2} \times 7$ ".

37 K 739. Postpaid in U.S.A. 5.95

FUNDAMENTALS OF COLOR TV. BA-1. By W. Boyce. A complete explanation of all phases of color television. Written in simple understandable terms with photographs, block diagrams and schematics. Discusses: Structure of Color Television Tubes, Compatibility, Methods of Transmission and Reception, Circuit Analysis of Color TV Circuits, etc. 224 pages. Size, $5\frac{1}{2} \times 8\frac{1}{2}$ ".

38 K 619. Postpaid in U.S.A. 2.00

TV SERVICING TIMESAVERS. JC-1. By Milton S. Kiver. Written especially for the television serviceman. Some of the 51 "Time-saver Tips" are: Causes and Cures for the Narrow Picture, Tuner Sensitivity—How to Increase It, Vertical Retrace Blanking, Checking Horizontal Output Transformers, Touch-Up Alignment and Remedy to a Corona Problem—plus many other valuable tips. 97 illustrations. 124 pages. Size, $5\frac{1}{2} \times 8\frac{1}{2}$ ".

38 K 645. Postpaid in U.S.A. 1.50

TV SERVICING SHORT-CUTS. TK-1. By Milton S. Kiver. A pocket-size book that gives professional service techniques. Typical case histories. Shows how to quickly solve commonly recurring TV service problems. Trouble symptoms outlined, followed by a step-by-step explanation of how the trouble was localized and tracked down. Detailed discussions as to how a particular trouble can be located and solved in any TV set. Shows how to apply the proper servicing techniques to all TV sets. Over 100 pages. Size, $5\frac{1}{2} \times 8\frac{1}{2}$ ".

38 K 588. Postpaid in U.S.A. 1.50

SERVICING TV IN THE CUSTOMER'S HOME. TC-1. By Milton S. Kiver. Thoroughly describes vital tests which can be made in the customer's home, using only a VTVM or a good VOM and probes. Discusses audio section tests, checking the vertical system, analyzing picture distortion, focusing, purpose of the test pattern, oscillator adjustment, etc. Four chapters; numerous diagrams and pattern photos. 96 pages. Size, $5\frac{1}{2} \times 8\frac{1}{2}$ ".

38 K 586. Postpaid in U.S.A. 1.75

COLOR TV TRAINING MANUAL. TVC-1. By the H. W. Sams staff. A comprehensive manual to train the service technician for a future in color TV service work. Fully describes the science of color, the requirements and make-up of the composite color signal, color circuits, servicing procedure and many other subjects. Includes complete picture tube photos for alignment and trouble shooting. Over 300 illustrations with 40 pages in full color. 260 pages. Size, $8\frac{1}{2} \times 11$ ".

37 K 220. Postpaid in U.S.A. 6.95

SERVICING AGC SYSTEMS. AGC-1. By H. Carter and T. Lesh. Covers: Theory of AGC Circuits, Commercial AGC Circuits and Trouble Shooting. Discusses the three types of AGC circuits—simple rectifier type, amplified type and keyed. 132 pages. Size, $5\frac{1}{2} \times 8\frac{1}{2}$ ".

38 K 646. Postpaid in U.S.A. 1.75

SERVICING TV SWEEP SYSTEMS. SSD-1. Explains the operation, circuit function and variations of different types of vertical and horizontal sweep systems used in most TV receivers. Describes methods of analyzing circuits and trouble-shooting. Gives service hints of particular troubles. The construction of transformers, coils and deflection yokes is also discussed. Fully illustrated. 212 pages. Size, $5\frac{1}{2} \times 8\frac{1}{2}$ ".

38 K 647. Postpaid in U.S.A. 2.75

BASIC ELECTRICITY. ED-12. By H. W. Sams Staff. Latest release in the educational series of training manuals. Text material is laid out in 35 profusely illustrated lessons. 264 pages. Size, $8\frac{1}{2} \times 11$ ".

38 K 854. Postpaid in U.S.A. 5.00

BASIC RADIO MANUAL. ED-1. By H. W. Sams. A text designed for both instructor and student. Includes discussion of basic theories, definitions, modern components. Gives review questions and step-by-step lab jobs. 248 pages. Size, $8\frac{1}{2} \times 11$ ".

38 K 609. Postpaid in U.S.A. 5.00

BASIC TELEVISION MANUAL. ED-21. In two parts. Covers all phases and basic theory of TV set operation and design, from the cathode-ray tube to the antenna. Second section covers actual projects which demonstrate theory explained in first section. 312 pages. Size, $8\frac{1}{2} \times 11$ ".

37 K 219. Postpaid in U.S.A. 5.00

AUTO RADIO REMOVAL BOOKS. Step-by-step instructions for removal of radios, power supplies and speaker units from American cars. For each auto covered, books list tools required; show phantom view of dash panel with mounting nuts and bolts, cables, antenna and speaker leads; and include photo of radio being removed. Summary of servicing procedures aids in determining if removal is necessary. $5\frac{1}{2} \times 8\frac{1}{2}$ ".

ARR-56. Covers all 1956 autos. 104 pages.

37 K 262. Postpaid in U.S.A. 2.95

ARR-55. Covers all 1955 autos. 104 pages.

37 K 263. Postpaid in U.S.A. 2.95



P. H. BRANS BOOKS

HOW TO LISTEN TO THE WORLD. Helps short-wave listeners to get the best out of their receivers, antennas. Profusely illustrated with useful drawings and tables. Chapters include fundamentals of short waves, antennas, shack arrangements, how to identify languages, differences in time, abbreviations, QSL, bureaus, etc. 54 pages. $6\frac{1}{2} \times 8\frac{1}{2}$ ".

37 K 571. Postpaid in U.S.A. 60c

WORLD'S RADIO TUBES. "Vade Mecum" Latest edition by P.H. Brans. New simplified style. Lists receiving and transmitting tubes of all types, U.S. and foreign, in numerical and alphabetical order. Gives replacements and other interchangeable information. In English, French, German, Dutch and Swedish. Book marker enumerates tube symbols, abbreviations and their meaning in English. Size, $8\frac{1}{2} \times 11$ ". Paper bound. 816 pages.

37 K 673. Postpaid in U.S.A. 5.00

WORLD'S TELEVISION TUBES. By P. H. Brans. Covers all generally available television or special-purpose tubes throughout the world. Presents a wealth of information to technicians, engineers and other specialists in the electronics field. First section of the book presents complete characteristics of all types of TV picture tubes and cathode-ray tubes. The following sections deal with special-purpose tubes including: Crystal devices, thyratrons, ignitrons, senditrons, magnetrons, klystrons, coaxial velocity modulators, etc. 244 pages, profusely illustrated. $8\frac{1}{2} \times 11$ ".

37 K 435. Postpaid in U.S.A. 5.00

WORLD'S EQUIVALENT RADIO TUBES. By P. H. Brans. Quick reference for possible tube changes or substitutions of domestic, foreign, forces and most foreign radio tubes. Tables give maximum practical information in simple, understandable form. Contains valuable data for radio builders, experimenters. 303 pages. Size, $8\frac{1}{2} \times 11$ ".

37 K 350. Postpaid in U.S.A. 5.00

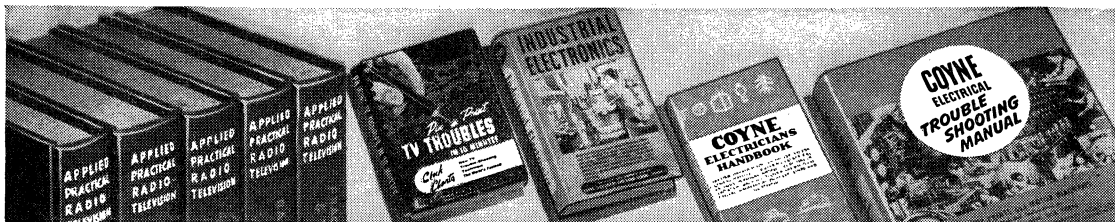

COYNE SHOP-TESTED MANUALS

APPLIED PRACTICAL RADIO-TV MANUALS

Coyne Practical Television Servicing and Trouble Shooting Manuals are compiled and written by the staff of one of the largest electrical and electronic schools in the country today. Most of the leading television manufacturing companies have cooperated in the preparation of these volumes. Extremely valuable for reference and instruction.

VOLUME 1. APPLICATION OF RADIO AND TV PRINCIPLES. Presents the principles of construction, operation, and testing of radio and television equipment in a simple, easy-to-follow manner. Numerous photos, charts and diagrams. 299 pages. 5 1/2 x 8 3/4".
37 K 466. Postpaid in U.S.A. 3.25

VOLUME 2. RADIO, TELEVISION AND FM RECEIVERS. A practical reference book on many phases of radio and television. Written in simple language. Contains hundreds of illustrations, charts, and diagrams. 403 pages. 5 1/2 x 8 3/4".
37 K 467. Postpaid in U.S.A. 3.25

VOLUME 3. RADIO AND TELEVISION CIRCUITS. Explains how various radio and television parts fit into complete circuits. Methods of trouble-shooting are explained in clearly written text with many diagrams. 336 pages. 5 1/2 x 8 3/4".
37 K 468. Postpaid in U.S.A. 3.25

VOLUME 4. LATEST TESTING INSTRUMENTS FOR SERVICING RADIO-TELEVISION. Explains how to use modern radio, TV, and electrical testing equipment. Covers methods of servicing, construction, and many other jobs. 350 pages. 5 1/2 x 8 3/4".
37 K 469. Postpaid in U.S.A. 3.25

VOLUME 5. PRACTICAL TV SERVICING AND TROUBLE-SHOOTING MANUAL. Tells how to spot TV trouble quickly and how to repair, adjust, and align all models in step-by-step detail. Covers UHF channels and color systems. 390 pages. 5 1/2 x 8 3/4".
37 K 470. Postpaid in U.S.A. 4.25

SET OF 5 VOLUMES. Includes 1 each of the above volumes on Applied Practical Radio-TV Practice.
37 K 471. Postpaid in U.S.A. 15.00

TECHNICAL DICTIONARY. CTB-100. Handy dictionary for use by anyone in the electronics field. Contains over 4,000 definitions of Radio, TV, Electronic, Electrical and Radar terms. Includes data section with charts, graphs, diagrams and symbols. 160 pages. 5 1/2 x 8 1/2".
37 K 463. Postpaid in U.S.A. 2.00

PRACTICAL HANDBOOKS

TRANSISTOR CIRCUIT HANDBOOK. Reference book covering almost every application involving transistors. 430 pages. 6x9".
37 K 258. Postpaid in U.S.A. 4.95

PIN-POINT TV TROUBLES. Valuable aid listing remedies for nearly 700 TV troubles. 299 pages. 6x8 1/4".
37 K 249. Postpaid in U.S.A. 3.95

ELECTRICAL TROUBLE-SHOOTING MANUAL. Contains over 600 commercial diagrams. Covers basic electricity, transformers, AC & DC motors, all types of controls including refrigeration, generators and converters. 626 pages. 8 1/2 x 11".
90 K 055. Postpaid in U.S.A. 6.95

INDUSTRIAL ELECTRONICS. A simplified instruction and reference book. Explains various types of equipment and their use. Chapters include: Electronic Tubes and Their Work; Resistors for Control of Potential; etc. 468 pages. 5x7 1/4".
37 K 895. Postpaid in U.S.A. 3.75

TRANSISTORS. By L. E. Garner, Jr. Valuable information includes discussion of transistor action, characteristics, circuits, components, care and servicing reference data and latest experimental work. Paper bound. Illustrated. 105 pages. 5 1/2 x 8 1/4".
38 K 608. Postpaid in U.S.A. 1.50

ELECTRICIAN'S HANDBOOK. A practical reference and data book. Includes the latest code requirements, building codes, rules, tables, charts, testing guides, and sizes of wire for certain jobs; full data on motors, transformers, circuit breakers and hundreds of other subjects of value to every electrician. In a handy pocket-size book for "on-the-job" use. Illustrated. 348 pages. 7 1/2 x 4 1/4".
37 K 896. Postpaid in U.S.A. 2.75

COYNE TV CYCLOPEDIA. Full coverage of television in straightforward practical form. The various phases of TV, such as circuits, adjustments, typical troubles, etc., are all organized in alphabetical order for quick reference. Methods of testing and adjustment derived from service literature of more than 70 manufacturers. Photos of typical abnormal test patterns with cause and cure. Over 450 illustrations, 727 pages. Size, 5 1/2 x 8 1/4".
37 K 707. Postpaid in U.S.A. 5.95

TV & RADIO HANDBOOK. Lists formulas, charts, circuits, emergency repair data, definitions and designs, and many other aids to the radioman. Includes chapters on Mathematics, Circuits, Capacitors and Capacitances, Reactances and Energy Losses, Amplifiers, Meters and Measurements, etc. Fully illustrated. 375 pages. 4 1/2 x 7 1/4".
37 K 898. Postpaid in U.S.A. 2.75

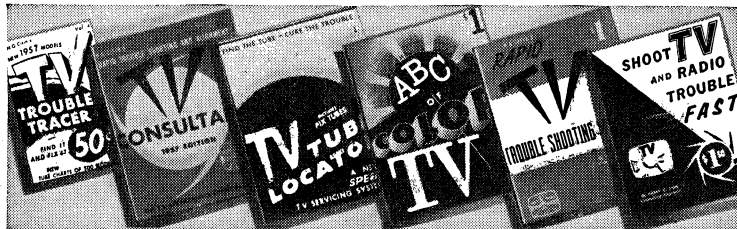

CISIN PUBLICATIONS

THE ABC OF COLOR TV. By H. G. Cisin. Thoroughly covers color TV fundamentals, including basic color principles, the ABC's of color transmission, color television reception, and color picture tubes. Discusses the "I" and "Q" signals and their applications. Includes block diagrams of transmitting and receiving equipment. 25 pages, 8 1/2 x 11".
37 K 345. Postpaid in U.S.A. 1.00

RAPID TV TROUBLE SHOOTING METHOD. By H. G. Cisin. Extremely rapid method of TV servicing in which the trouble is recognized, classified, and located in logical procedure. Code numbers are assigned to each observable defect. Through special charts, the code numbers reveal the specific circuit at fault. 100 rapid checks. 23 pages. 8 1/2 x 11".
37 K 346. Postpaid in U.S.A. 1.00

SHOOT TV AND RADIO TROUBLE FAST. By H. G. Cisin. Enables the serviceman to diagnose and locate radio faults rapidly through logical interpretation of trouble symptoms. For each trouble, a series of checks is listed. Sections on rapid TV and radio service, and a section on the servicing of printed circuits. 40 pages. Size, 8 1/2 x 11".
37 K 347. Postpaid in U.S.A. 1.50

TV AND RADIO TUBE SUBSTITUTION GUIDE. Lists substitute radio-TV tubes which can be used without wiring changes. Also picture tube section covering substitutions, dimensions, ion traps, etc. A highly useful booklet. 22 pages. 5 1/2 x 8 1/4".
37 K 349. Postpaid in U.S.A. 50c

TV TROUBLE TRACER. By H. G. Cisin. A greatly simplified method of TV servicing. Locate and correct TV tube troubles using the unique step-by-step procedure outlined in these extremely helpful manuals. Each volume contains trouble indicating tube location guides for hundreds of different television receivers. 48 pages. 5 1/2 x 8 1/2".
37 K 341. Volume 1, 1952.
37 K 342. Volume 2, 1953.
343. Volume 3, 1954.
37 K 344. Volume 4, 1955.
37 K 348. Volume 5, 1956.
37 K 338. Volume 6, 1957.

PER VOLUME. Postpaid in U.S.A. 50c

TV CONSULTANT. By H. G. Cisin. TV trouble shooting and rapid alignment servicing book. No theory—no math—no formulas. Practical information on UHF; Rapid TV Alignment; Use of Test Instruments, etc. Illus. 135 rapid checks. 69 pages. 8 1/2 x 11".
37 K 522. Postpaid in U.S.A. 2.00

TV TUBE LOCATOR. By H. G. Cisin. A valuable aid for the TV serviceman. Contains charts showing the locations of all tubes in hundreds of TV sets. Each tube is coded to identify its function in the circuit. A table of common picture and raster troubles is included, to further speed and simplify TV service. Size, 8 1/2 x 11".

Volume 1. 1947 to 1954 models. 25 pp.
37 K 328. Postpaid in U.S.A. 1.00

Volume 2. 1955 to 1957 models. 34 pp.
37 K 329. Postpaid in U.S.A. 1.50

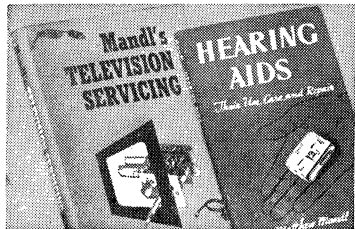

MACMILLAN PUBLICATIONS

TV AND FM ANTENNA GUIDE. By E. M. Noll and M. Mandl. Combines an up-to-date text on antenna theory with reference handbook on antennas and allied equipment. Includes: Commercial models, special types of antennas for special locations, antennas for fringe areas, and newer types. 279 illustrations. 311 pages. Size, 6 1/4 x 9 1/2".
37 K 792. Postpaid in U.S.A. 5.14

HEARING AIDS, THEIR USE, CARE AND REPAIR. By M. Mandl. Provides information needed by users, prospective purchasers, dealers and servicemen for selection and maintenance of modern hearing aids. Explains principles and operation of various models—clearly describes adjustments and repairs. 90 illus. 158 pages. 5 1/2 x 8 3/4".
37 K 793. Postpaid in U.S.A. 3.43

MANDL'S TELEVISION SERVICING. Revised edition. By M. Mandl. Detailed and illustrated trouble-shooting procedures on today's TV sets. Latest circuits explained. Includes special servicing techniques for VHF, UHF and color TV. Over 300 illustrations. 450 pages. Size, 9 1/4 x 6 1/4".
37 K 791. Postpaid in U.S.A. 6.37

RADIO AND TV MATHEMATICS. By Bernhard Fischer. Solutions to nearly 400 problems encountered in transmitters, receivers, television, industrial and other electronics circuits. Includes mathematical problems from the Study Guide of the FCC. 484 pages. Size, 5 1/2 x 8 1/2".
37 K 788. Postpaid in U.S.A. 6.61



AUDEL'S PUBLICATIONS

PRACTICAL ELECTRICITY. Simplified reference book containing complete practical information on the laws of electricity. An ideal reference book for maintenance engineers, electricians, students. Chapters cover: Maintenance, AC motors, armature winding and repair, house lighting, power wiring, cable splicing, meters, transformers, elevators, bells, sign flashers, ignition, radio principles, etc. 2600 illustrations. 1320 pages. Size, 5x6 $\frac{1}{4}$.
37 K 487, Postpaid in U.S.A. 4.90

WIRING DIAGRAMS FOR LIGHT AND POWER. Data and diagrams for all types of electrical apparatus. Valuable guide to house wiring, relays, motors, switchboards. 304 pages. Size, 4 $\frac{3}{4}$ x6 $\frac{3}{4}$.
37 K 625, Postpaid in U.S.A. 1.96

HOME APPLIANCE SERVICE GUIDE. By Edwin Anderson. Practical, easy-to-understand guide for electric, gas and mechanical appliance trouble-shooting. Thoroughly covers basic principles, servicing, operation and repair of almost all home appliances. Hundreds of large, easy-to-follow illustrations. Tells how to locate appliance troubles and includes detailed disassembly and reassembly procedure. Gives up-to-date testing methods. Perfect for home or serveshop. 864 pages. 500 illustrations. 5x8 $\frac{1}{2}$.
37 K 485, Postpaid in U.S.A. 5.88

TELEVISION SERVICE MANUAL. By E. P. Anderson. Practical information on installing, trouble-shooting, and repairing TV sets. Useful for all TV servicemen. 17 chapters include: Placement of Receivers; Adjustment; Interference Traps; Single and Master Antenna Systems; Transmission Lines; TV Broadcasting; Typical Receiver Circuits; Picture Tubes, etc. Covers color TV. Useful tables and data. Over 225 illustrations and diagrams. 480 pages. Size, 7 $\frac{1}{2}$ x5 $\frac{1}{2}$.
37 K 706, Postpaid in U.S.A. 2.94

RADIOMAN'S GUIDE. A valuable, clearly written book covering home, automotive, commercial, aircraft, and marine radio equipment. Excellent for radiomen and service shop. Also covers radio compasses, radio beacons, automatic radio alarms, radio control systems, and public address systems. Typical chapters: Radio Fundamentals and Ohm's Law; Measuring Instruments; Power Supply Units, etc. Illustrated. 1088 pages. 5x6 $\frac{1}{2}$.
37 K 808, Postpaid in U.S.A. 4.90

THE GERNSBACK LIBRARY

TRANSISTORS—THEORY AND PRACTICE. By Rufus P. Turner. Elementary discussion of transistor theory and operation for practical electronic workers. Tells in simple language how transistors work and what their circuits are like. Chapters include: Semi-Conductor Theory, Transistor Characteristics, Equivalent Circuits, Transistor Amplifiers, Oscillators, Triggers and Switches, etc. 144 pages. 5 $\frac{1}{2}$ x8 $\frac{1}{2}$.
37 K 923, Postpaid in U.S.A. 2.00

TRANSISTOR TECHNIQUES. New practical handbook on transistors for the technician and experimenter. Gives scores of hints on how to use transistors in modern electronic equipment. Covers testing, performance, construction, measurements, etc. of this electronic marvel. Profusely illustrated. 96 pages. Size, 5 $\frac{1}{2}$ x8 $\frac{1}{2}$.
37 K 332, Postpaid in U.S.A. 1.50

TV—IT'S A CINCH. By E. Aisberg. Originally published in French, the unorthodox, humorous style of this book has made it a favorite of teachers and students alike. Hundreds of helpful, amusing sketches. Covers TV transmitters, receivers. 224 pages. 5 $\frac{1}{2}$ x8 $\frac{1}{2}$.
37 K 333, Postpaid in U.S.A. 2.90

TELEVISION TECHNOTES. An excellent reference book written specifically for television technicians. Contains hundreds of actual case histories of troubles found in scores of models. Lists specific troubles in actual sets and tells how to correct them. Compiled from reports of practicing service technicians in the field and from manufacturers' bulletins. Includes many diagrams. 128 pages. 5 $\frac{1}{2}$ x8 $\frac{1}{2}$.
37 K 773, Postpaid in U.S.A. 1.50

THE VTVM. By Rhys Samuel. Operation of the VTVM, its probes and meter scales, FM-AM alignment, signal tracing, finding causes of hum, etc. 224 pages. 175 illustrations. 5 $\frac{1}{2}$ x8 $\frac{1}{2}$.
37 K 498, Postpaid in U.S.A. 2.50

RADIO & TV TEST INSTRUMENTS. For the radio-TV technician who wants to build his own test equipment. Covers all types of units used in servicing. Over 100 illustrations. 128 pages. 5 $\frac{1}{2}$ x8 $\frac{1}{2}$.
37 K 787, Postpaid in U.S.A. 1.50

RADIO CONTROL HANDBOOK. By H. G. McEntee. Detailed information for controlling model planes, trains and boats. Covers receivers, transmitters. 192 pages. 175 illustrations. 5 $\frac{1}{2}$ x8 $\frac{1}{2}$.
37 K 534, Postpaid in U.S.A. 2.25



SUPREME RADIO AND TV PUBLICATIONS

RADIO DIAGRAM MANUALS

Speed up repairs by keeping these manuals always on hand. They contain specific service instructions, diagrams, and other helpful data on most popular radio sets. Include service hints and short cuts, alignment data, etc. Cover all types of transistor sets, portables, auto radios, FM sets, record changers, Hi-Fi, etc. Size, 8 $\frac{1}{2}$ x11".
Postpaid in U.S.A.

Stock No.	Vol.	Year	Pages	NET
37 K 332	17	1957	192	2.50
37 K 497	16	1956	192	2.50
37 K 834	15	1955	160	2.00
37 K 939	14	1954	160	2.50
37 K 912	13	1953	192	2.50
37 K 819	12	1952	192	2.50
37 K 818	11	1951	192	2.50
37 K 812	10	1950	192	2.50
37 K 869	9	1949	160	2.50
37 K 849	8	1948	192	2.00
37 K 847	7	1947	192	2.00
37 K 846	6	1946	192	2.00
37 K 839	5	1942	192	2.00
37 K 831	4	1941	192	2.00
37 K 830	3	1940	208	2.00
37 K 829	2	1939	192	2.00
37 K 828	1	1926-38	240	2.50

INDEX. Covers Radio Manuals 1-17 and Television Manuals TV-2-TV-13. Sets listed by manufacturer and model number.
37 K 809, Free Upon Request

TELEVISION SERVICING COURSE. Compiled by M. Beitman. Practical home-study television training course. Well-illustrated lessons on circuits, adjustments, picture faults, servicing shortcuts, UHF, alignment, antenna problems, how to use test equipment, picture analysis, etc. Many practical service hints. 922 pages. Size, 8 $\frac{1}{2}$ x11".
37 K 927, Postpaid in U.S.A. 3.00

HOW TO MODERNIZE RADIOS FOR PROFIT. Shows how to improve early model radios by adding new features. Articles include: Improving the Old Cabinet; New Cabinet Ideas; Adding Extra Speakers; Using Modern Tubes; Adding a Tuning Eye; Audio Circuit Improvements; Adding an IF Stage; Push-Button Tuning; Removing Interference at the Source; Removing Interference at the Set; etc. With illustrations and step-by-step instructions. Size, 8 $\frac{1}{2}$ x11".
37 K 838, Postpaid in U.S.A. 1.00

TELEVISION SERVICE MANUALS

Complete servicing information on all popular television sets. Contain test patterns, waveforms, alignment data, voltage charts, service hints, recommended changes, and many diagrams on extra-large, easy-to-follow double-sized blueprints. Speed television servicing. Cardboard covers open flat, 8 $\frac{1}{2}$ x11". \$Also includes 8 or more 8 $\frac{1}{2}$ x15" blueprints. *Early models. †Additional models. **Postpaid in U.S.A.**

Stock No.	Vol.	Year	Pages	NET
37 K 319	TV-13†	1957	192	3.00
37 K 483	TV-12*	1957	192	
37 K 486	TV-11	1956	192	
37 K 507	TV-10†	1955	192	
37 K 924	TV-9*	1955	192	3.00
37 K 926	TV-8	1954	192	
37 K 924	TV-6	1953	192	
37 K 903	TV-5	1952	192	3.00
37 K 889	TV-5	1951	192	
37 K 876	TV-48	1950	144	
37 K 875	TV-38	1949	192	
37 K 855	TV-28	1948	144	

PRACTICAL RADIO AND ELECTRONICS COURSE. A three-volume home study course in one book. Consists of 35 lessons including fundamentals of radio and electronics, receivers, transmitters, test equipment and other equipment. 268 pages. 8 $\frac{1}{2}$ x11".
37 K 841, Postpaid in U.S.A. 3.95

ANSWER BOOKLET. Contains answers to the self-testing questions in above book. 32 pages. Size, 5 $\frac{1}{2}$ x8 $\frac{1}{2}$.
37 K 845, Postpaid in U.S.A. 25c

SIMPLIFIED RADIO SERVICING BY COMPARISON METHOD. Shows new shortcut technique for locating faults. Utilizes only a volt-ohmmeter. Point-to-point circuit cross reference. Over 1,000 service hints. 26 circuits. 92 pages. 8 $\frac{1}{2}$ x11".
37 K 836, Postpaid in U.S.A. 1.50

RADIO MATHEMATICS. Discusses simple mathematics in connection with meter scales, Ohm's Law, capacity, inductance, etc. Ideal for the beginner. 32 pages. 8 $\frac{1}{2}$ x5 $\frac{1}{2}$.
37 K 811, Postpaid in U.S.A. 25c

RADIO SERVICING COURSE BOOK. 22 lessons. Completely revised. Chapters on use of test equipment, signal tracing, alignment, AVC, etc. New FM data and extra-profit ideas. Includes transistors, hi-fi, PA, tube data and business hints. 192 pages. 8 $\frac{1}{2}$ x11".
37 K 824, Postpaid in U.S.A. 2.50



BASIC RADIO COURSE. By J. T. Frye. Covers radio completely, from Ohm's Law to servicing methods. Chapters include: The Electron Theory; Reactance, Impedance, etc. 176 pages. 5 $\frac{1}{2}$ x8 $\frac{1}{2}$.
37 K 727, Postpaid in U.S.A. 2.25

TV REPAIR TECHNIQUES. Gives the service technician causes and cures of many tough TV repair jobs. Written by practicing service technicians. Thoroughly illustrated. 128 pages. 5 $\frac{1}{2}$ x8 $\frac{1}{2}$.
37 K 598, Postpaid in U.S.A. 1.50

RADIO & TV HINTS. A storehouse of shortcuts for the practicing technician. Hundreds of methods for adding speed and efficiency. Gathered by the editors of *Radio-Electronics* from suggestions by radio-TV service men. 112 pages. Illustrated. 5 $\frac{1}{2}$ x8 $\frac{1}{2}$.
37 K 774, Postpaid in U.S.A. 1.00

RADIO TUBE FUNDAMENTALS. By G. J. Christ. Explains what radio tubes are and how they work in circuits. Covers tube elements, voltage amplification, oscillation, etc. 96 pages. 5 $\frac{1}{2}$ x8 $\frac{1}{2}$.
37 K 761, Postpaid in U.S.A. 1.00

MODEL CONTROL BY RADIO. By Edward L. Safford, Jr. Tells how to control toy trucks, model planes, etc. by radio. Gives theory and practical construction data. 112 pages. 5 $\frac{1}{2}$ x8 $\frac{1}{2}$.
37 K 726, Postpaid in U.S.A. 1.00

THE OSCILLOSCOPE. By George Zwick. A straightforward, how-to-do-it book that tells service technicians how to get the most out of the oscilloscope. 192 pages. 174 illustrations. 5 $\frac{1}{2}$ x8 $\frac{1}{2}$.
37 K 546, Postpaid in U.S.A. 2.25

PROBES. By B. Zucconi and M. Clifford; probe manufacturer and engineer. Specifically for the serviceman. Tells how to use probes for TV, radio, and audio. 224 pages. 220 illustrations. 5 $\frac{1}{2}$ x8 $\frac{1}{2}$.
37 K 488, Postpaid in U.S.A. 2.50

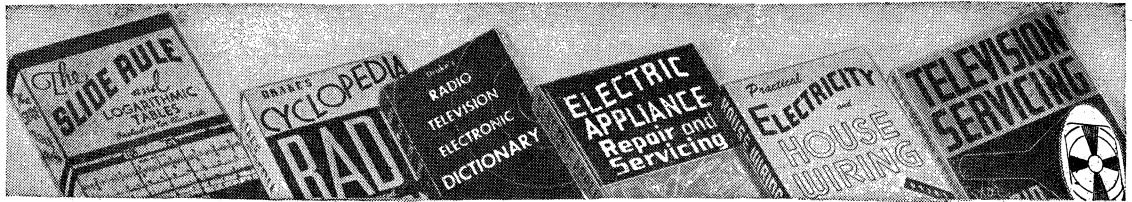

DRAKE PUBLICATIONS

TV SERVICING FOR RADIO MEN. By H. P. Manly. Newest edition—contains a tremendous amount of information condensed into minimum space. Simplifies TV circuits into general types easily understandable by any radio man. Covers alignment, adjustments, trouble shooting, etc. Chapters include: The RF Section or Front End; The Video IF Amplifier; Video Detector and Video Amplifier; Instruments for Alignment; Alignment of Video IF and Traps; Sound Section and Its Alignment; Front-End Alignment; Intercarrier Sound; Sweep Oscillators; etc. Over 400 pages. 318 illustrations. Size, 5½x8".
37 K 661. Postpaid in U.S.A. 3.00

CYCLOPEDIA OF RADIO AND ELECTRONICS. By Harold P. Manly and L. O. Gorder. Standard reference and instruction book for radio men. Covers radio, sound systems, television, photoelectricity, electronic tubes, microwaves, frequency modulation, electronics in industry, etc. Contains simple, easy-to-follow explanations, with reference to related articles. 967 illustrations, charts and graphs. 822 pages. 6x9".
37 K 652. Postpaid in U.S.A. 4.50

ELECTRIC APPLIANCE REPAIR AND SERVICING. By Harold P. Manly. An instruction book on the maintenance and repair of electric home appliances, using the simplest testing apparatus and hand tools. One-third of the book is devoted to general servicing methods for all appliances; the remainder gives specific instructions for handling individual appliances. Typical chapters: Installing Signals and Alarms; Electric Toasters, Percolators, and Waffle Irons; Electric Flatirons, Roasters and Ranges; Electric Motors and Wiring; Food Mixers, Sewing Machines and Vacuum Cleaners; Electric Refrigerators. 250 pages, 5x7½". 188 illustrations.
37 K 662. Postpaid in U.S.A. 2.25

RADIO-TV ELECTRONIC DICTIONARY. By Harold P. Manly. This completely revised edition has the latest terms covering photoelectricity; audio systems; radio transmission and reception; electricity and magnetism. Emphasis is given to definitions on black-and-white TV; color TV; high-fidelity systems, and transistors. Contains over 3000 terms and 549 illustrations. 320 pages. Size, 6x9".
37 K 499. Postpaid in U.S.A. 3.00

PRACTICAL ELECTRICITY AND HOUSE WIRING. By H. P. Richter. A practical book of instruction covering in detail every branch of electrical work as applied to the wiring of small buildings. Includes basic circuits, wiring methods, polarizing, conduit, fuses, wire sizes, switches. Underwriters' and the National Electrical Codes, etc. Typical chapters: Wiring with Armored Cable; Circuit Breakers and Circuits; Wiring with Conduit; Polarizing and Grounding; Appliances—Home Repairs. 277 illustrations. 313 pages, 5x7½".
37 K 651. Postpaid in U.S.A. 2.25

THE SLIDE RULE AND LOGARITHMIC TABLES. By J. S. Clark, M. E. Explains the use of the slide rule for all purposes as employed by draftsmen, engineers, electricians, mechanics, etc. Partial contents: Slide Rule Principles; Use of the Slide Rule; Polyphase Slide Rules; Circular Slide Rules; Calculations Involving Angles; Using Tables of Logarithms; Operation of Logarithms; Trigonometric Logarithms; Four Place Logarithmic Tables; Ten Place Logarithmic Tables; etc. Cloth bound. Contains 222 pages. Illustrated. Size, 5¼x7¼".
37 K 578. Postpaid in U.S.A. 2.00

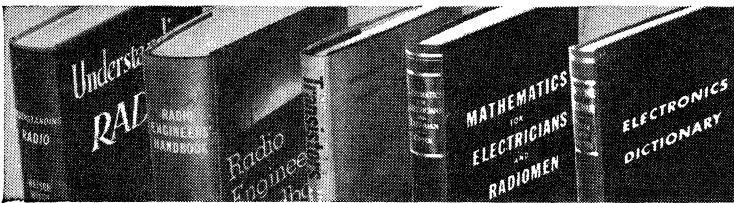

McGRAW-HILL PUBLICATIONS

UNDERSTANDING RADIO. 2nd Edition. By Watson, Welch and Eby. Simplified introduction to practical radio. Clearly written and well illustrated. Chapters include: Radio Waves and Wave Travel; Principles of the Vacuum Tube; Radio-Telephone Transmitters; Antennas; Frequency Modulation; Oscillators; Superheterodyne Receivers; Wave-Form Pictures; Power Supplies; Public Address Amplifiers; Crystal Detector Receiver; Resonance and Tuning. 536 illustrations. 732 pages, 6x9".
37 K 688. Postpaid in U.S.A. 6.86

TRANSISTORS. By A. Coblenz and H. Owens. Covers transistors from manufacture through circuit design. Explains both point-contact and junction-type transistors of the silicon and germanium type. Chapters include: Holes and the Transistor; The Electron; Nature of Semi-Conductors; Electronics of Transistors; Small-Signal Parameters; Grounded Emitter and Grounded Collector Connections; Cascading Transistors; Switching Circuits. Illustrated. 313 pages. Size, 6x9".
37 K 459. Postpaid in U.S.A. 5.88

TELEVISION FUNDAMENTALS: THEORY, CIRCUITS & SERVICING. By Fowler and Lippert. Simple, non-mathematical presentation of the basic principles of television. Covers all elements of the receiver system, from antenna to picture tube. Typical chapters: The Picture Tube; Video Detector and Amplifier Circuits; Sweep Generators; Synchronization; Receiving Antennas and Their Installation; Test Equipment and Alignment. Fully illustrated. 524 pages. Size, 6x9".
37 K 798. Postpaid in U.S.A. 6.86

TELEVISION AND RADIO REPAIRING. By John Markus. A practical "how-to-do-it" manual. Discusses troubles in power supplies, resistors, capacitors, speakers, tuning devices, etc. How to test, repair and replace components. Only a minimum of theory needed. 556 pages. 229 illustrations. 6x9".
37 K 518. Postpaid in U.S.A. 7.79

ELEMENTS OF RADIO SERVICING. 2nd Edition. By W. Marcus and A. Levy. Easy-to-read presentation of the theory and procedures of radio servicing. Many examples used to simplify explanations. Includes details on using the sweep generator and oscilloscope for servicing. Chapters on: Servicing Procedure; Alignment of a Superheterodyne Receiver; Multimeters; Signal Generator Applications; Auto Radio Installation; AC/DC Power Supply; Servicing AM-FM Receiver; IF Amplifier Service; Service Bench. 480 illustrations. 557 pages. Size, 6x9".
37 K 990. Postpaid in U.S.A. 5.88

MATHEMATICS FOR ELECTRICIANS AND RADIOMEN. By N. M. Cooke, Lt. Commander, U.S. Navy. Teaches elementary algebra; quadratic equations; logs; trig; plane vectors; and elementary vector algebra as applied to electricity and radio. 3,000 problems and answers. Typical chapters: Exponents and Radicals; Simultaneous Linear Equations; Charts, Tables, etc. 604 pages, 6x9".
37 K 691. Postpaid in U.S.A. 5.39

HANDBOOK OF INDUSTRIAL ELECTRONIC CIRCUITS. By Markus and Zelfuff. Invaluable reference manual on 433 industrial electronic circuits. Excellent for engineers, technicians, etc. Diagrams included. Chapters cover circuits on: Capacitance control, counting, electronic switching, motor control, timing, multivibrators. 272 pages, 8½x11".
37 K 655. Postpaid in U.S.A. 7.35

RADIO ENGINEERS' HANDBOOK. By F. E. Terman. A wealth of technical information for solving practical radio problems. Typical chapters: Fundamental Components of a Radio System; Circuit Elements; Resonant Circuits and Circuit Analysis; Fundamental Properties of Vacuum Tubes; Vacuum Tube Amplifiers; Oscillators; Power Amplifiers; Propagation of Radio Waves; Power Supply Systems; Antennas. 1,019 pages, 6x9".
37 K 975. Postpaid in U.S.A. 11.76

ELECTRONICS DICTIONARY. By Cooke and Markus. Definitions of almost 6500 terms in addition to a complete listing of common abbreviations. A condensed library of technical knowledge. Ready reference data at your fingertips. Indispensable for the instructor and technical writer. Recommended for the student and technician. A worthwhile addition to your book shelf. 433 pages. Size, 5¾x8¾".
37 K 983. Postpaid in U.S.A. 6.37

REPAIRING RECORD CHANGERS. By Eugene Ecklund. Clearly explains how to service record changer mechanisms. Well-illustrated to show operation and repair of pickups; needles; record changing actings; motors; drives; tripping, dropping and shutoff mechanisms. Chapters cover: Handling Record Changer Service Calls; Service Bench Setup; Special 45-rpm Changers and Spindles; Amplification and Compensation; Cycling the Pickup Arm; Record Dropping Mechanisms; Fault Location and Tests; Magnetic Tape Recorders. 278 pages, 6x9".
37 K 423. Postpaid in U.S.A. 5.83

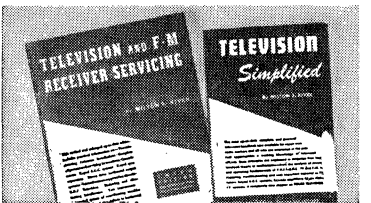

VAN NOSTRAND BOOKS

THE DESIGN OF SWITCHING CIRCUITS. By W. Keister, A. E. Ritchie, and S. H. Washburn, of the Bell Telephone Labs Technical Staff. Covers basic techniques of switching circuit design, such as telephone switching circuits, digital computers, large control systems, as well as simple control circuits. More than 400 illustrations and charts. 576 pages. Size, 6x9".
37 K 989. Postpaid in U.S.A. 8.57

CAPACITORS: THEIR USE IN ELECTRONIC CIRCUITS. By M. Brotherton. Tells how to choose and use capacitors for electronic circuits. Discusses voltage and temperature limitations of mica, paper, ceramic and electrolytic capacitors. Explains dielectric absorption and dielectric polarization effects. 107 pages. Size, 6x9".
37 K 482. Postpaid in U.S.A. 3.43

THE RADIO MANUAL. By Sterling and Monroe. Fourth Edition. Begins with elementary electric and radio theory and progresses to advanced study. Detailed explanations are given. Diagrams cover all types of modern radio equipment. Typical chapters: Elementary Electricity and Magnetism; Motors and Generators; The Electron Tube; Amplifiers and Oscillators; Amplitude Modulation; Frequency Modulation Systems; Radio Frequency Measurements and Monitors; Transmitters; Television; Marine Radio; etc. 820 pages, cloth bound. Size, 7½x10".
37 K 669. Postpaid in U.S.A. 12.49

TV AND FM RECEIVER SERVICING. By Milton S. Kiver. Extensive coverage of problems encountered by the serviceman. Chapters on: Antenna System; Receiver Installation; TV Test Equipment; Using Test Patterns; UHF TV; Deflections Systems; RF Stages; Video Amplifiers; FM and TV Receiver Alignment; FM Receiver Servicing. Paper bound. Illustrated. 320 pages, 8½x11".
37 K 913. Postpaid in U.S.A. 4.51

TELEVISION SIMPLIFIED. By Milton S. Kiver. Fifth Edition. Completely revised and enlarged. Contains all the latest developments. Covers the new sensitive camera tube, the intercarrier sound system, and color television. Easy-to-read chapters explain circuit analysis and operating fundamentals of frequency modulation on through to the theory, operation and repairing of television receivers. Includes a special chapter on understanding basic principles of television. Well illustrated. 608 pages. Size, 6x9".
37 K 907. Postpaid in U.S.A. 6.81

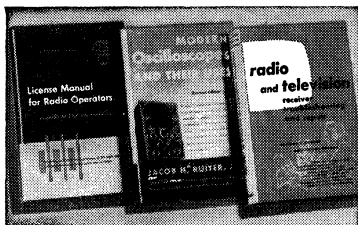

RINEHART BOOKS

LICENSE MANUAL FOR RADIO OPERATORS. By J. Richard Johnson. A thorough explanation of all eight elements covered in the FCC Study Guide. Recommended for those preparing for FCC Commercial Radiotelephone and Radiotelegraph License examinations. Well-illustrated question and answer text. Each of the eight elements is covered in a separate chapter. Data in appendix covers international communications Treaties, Laws and Regulations. 142 illustrations. 448 pages. Size, 6½x9½".

37 K 448. Postpaid in U.S.A. 5.00

PRACTICAL TELEVISION SERVICING. By J. R. Johnson and J. H. Newitt. Includes: Common Troubles in TV Receivers; Antennas and Wave Propagation; Synchronizing and Sweep Circuits; Color Television; Case Histories; Test Equipment and Alignment. Clearly written text is very well illustrated. 334 pages. Size, 6x9".

37 K 734. Postpaid in U.S.A. 4.00

BASIC ELECTRONIC TEST INSTRUMENTS. By Rufus Turner. Written for servicemen. Covers the design, function and operation of test equipment of all types. Contains 171 illustrations, including schematic diagrams of typical test equipment circuits. 272 pages. Size, 6x9".

37 K 778. Postpaid in U.S.A. 4.95

TROUBLESHOOTER'S HANDBOOK. By A. A. Ghirardi. Third revised and enlarged edition. A practical handbook, packed with valuable servicing hints. Covers 4820 models (202 brands) of home and auto radios. Gives IF alignment peaks of 20,816 superhet receivers. Other sections: Trouble-Shooting Reminder Charts, Electrical Wiring Diagrams of 88 Automobiles, Vibrator Buffer-Capacitor Replacement Chart, etc. 744 pages, 8½x11".

37 K 731. Postpaid in U.S.A. 6.95

PIX-O-FIX TV TROUBLE FINDER GUIDE, VOLS. I AND II. By A. Ghirardi. Clever way of handling TV service. Simply dial guide until TV screen photo appears in window. Identifies hundreds of TV troubles, gives remedies. A unique trouble-shooting aid. Size, 5½x7½".

37 K 574. Postpaid in U.S.A. 2.00

MODERN OSCILLOSCOPES AND THEIR USES. Revised Edition. By Jacob H. Ruiter, Jr., Dumont Labs. Comprehensive book on oscilloscopes. Contains useful information on theory and applications of scopes. 390 illustrations. 368 pages, 6x9½".

37 K 757. Postpaid in U.S.A. 6.50

RADIO AND TELEVISION RECEIVER CIRCUITRY AND OPERATION. By Alfred A. Ghirardi. Covers modern radio and TV receivers. Based upon years of experience and hundreds of talks with servicemen. With this book servicemen can trace trouble with a minimum of time and effort, repair sets promptly and efficiently. A valuable addition to the service technician's library. 400 illustrations, 669 pages. Size, 6½x9½".

37 K 728. Postpaid in U.S.A. 6.75

RADIO AND TELEVISION RECEIVER TROUBLE-SHOOTING AND REPAIR. By A. A. Ghirardi and J. R. Johnson. Complete, easily understood course in servicing TV, FM and AM radios and record players. An excellent book for the experienced serviceman as well as the beginner. 417 illustrations. 820 pages. Size, 6x9".

37 K 759. Postpaid in U.S.A. 7.50

Combination Offer: Radio and TV Receiver Circuitry and Operation plus Radio and TV Receiver Troubleshooting and Repair at a savings.

37 K 762. Postpaid in U.S.A. 13.00

SYLVANIA TUBE MANUAL

SYLVANIA MANUAL OF ELECTRONIC TUBES. Latest edition. Over 1000 tube types, including new color TV tubes, kinescopes, series-string types, and diodes. Loose-leaf binder opens flat for convenience; also permits adding new data at any time. 504 pages. Size 9½x5½".

37 K 132. Postpaid in U.S.A. 2.00

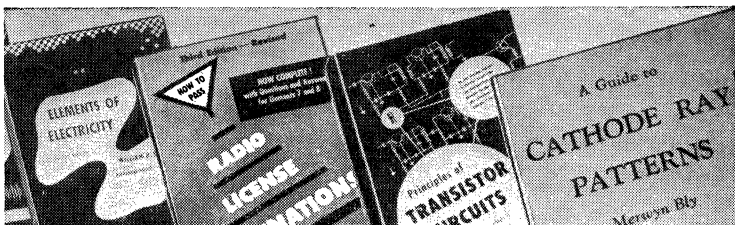

WILEY RADIO AND ELECTRONICS PUBLICATIONS

PRINCIPLES OF RADIO. By Henney and Richardson. 6th Edition. Covers electrical fundamentals and radio theory. Includes laboratory experiments. Chapters on: Direct Current Circuits; Production of Current; Inductance; Capacitance; Properties of Coils and Condensers; Rectifiers and Power Supplies; Detection; Receiver Systems; Antennas and Electromagnetic Radiation; Frequency Modulation; etc. Illustrated. 655 pages, 5½x8".

37 K 860. Postpaid in U.S.A. 6.61

ELEMENTS OF ELECTRICITY. By W. H. Timbie. Fourth Edition. Ideal first text for radio training courses. Typical chapters: Ohm's Law; Magnets and Magnetism; The Generator; Inductance; Capacitance; Alternating Currents; Measurement of Resistance; Electric Motors; The Generator; etc. Illustrated. 631 pages, 5½x8¾".

37 K 863. Postpaid in U.S.A. 6.37

TRANSISTOR AUDIO AMPLIFIERS. By Richard F. Shea. An excellent practical reference book for the engineer, technician and experimenter. Contains detailed specifications on over 20 transistors. Clearly written and includes many illustrations. Explains transistor operating curves, signal-to-noise ratio, input and output impedances, high-temperature operation. Chapter on practical amplifier design covers: hearing aids; phonograph amplifier; electronic megaphone; high-power audio amplifier. Typical chapters: Transistor Parameters; Basic Amplifier Design; Coupled Stages; etc. 219 pages, Size, 6x9".

37 K 422. Postpaid in U.S.A. 6.86

HOW TO PASS RADIO LICENSE EXAMINATIONS. By Charles E. Drew. 3rd revised edition. An excellent guide for all radiomen interested in broadcasting, television, marine, or other fields of transmission and reception. Covers subjects generally included on commercial radio operator license exams. Question-and-answer chapters. 407 pages, 6½x9¾".

37 K 858. Postpaid in U.S.A. 6.37

MICROWAVES AND RADAR ELECTRONICS. By Pollard and Sturtevant. Explains the essential facts about microwave circuits by use of electromagnetic principles. Covers microwave developments completely. Chapters include: Electromagnetic Fields and Microwaves; Servo-mechanisms and Computers; etc. 426 pages, 5½x8¾".

37 K 884. Postpaid in U.S.A. 7.59

PRINCIPLES OF TRANSISTOR CIRCUITS. By R. F. Shea. Written by combination of nine G.E. transistor experts. Covers theory, circuits, stabilization amplifier design, etc. Material published for first time. Cloth binding. 535 pages, 9½x6½".

37 K 988. Postpaid in U.S.A. 12.49

RCA SERVICE DATA BOOKS

PRACTICAL COLOR TELEVISION FOR THE SERVICE INDUSTRY. (Revised edition.) By RCA Service Co. An extremely valuable book for TV servicemen, engineers and technicians. Thoroughly covers: Color principles, transmission, test equipment, RCA color TV receiver, intercom, short-wave reception, servicing, alignment, and other subjects vital to color TV. Includes glossary. Profusely illustrated. 84 pages. Size, 8½x11".

37 K 173. Postpaid in U.S.A. 2.00

RADIOTRON DESIGNERS HANDBOOK. New Fourth Edition. Edited by F. Langford-Smith and a staff of 33 author-engineers. The most comprehensive volume ever published covering the design of radio and audio circuits and equipment. Written for design engineers, students and service technicians interested in basic and advanced principles of circuit design. Contains 1000 illustrations, and a 7000-item cross-reference index. 1500 pages, 5½x8¾".

37 K 597. Postpaid in U.S.A. 7.00

RCA TUBE MANUAL. RC-18. Latest revised edition. Full technical data on all current receiving tubes and kinescopes including color and black and white. Has schematics on AM and FM radios, intercom, short-wave receivers, amplifiers, treble and bass control stage, voltmeter, etc. Also explanation of electron tube characteristics, interpretation of operating curves, etc. 352 pages, 5½x8¾".

37 K 575. Postpaid in U.S.A. 75c

PHOTOELECTRICITY AND ITS APPLICATION. By Zworykin and Ramberg. A complete survey of the entire field of photoelectricity, covering basic principles, methods of preparation, photocell circuits and application of photoelectric devices. Typical chapters: The Multiplier Phototube; The Photovoltaic Cell; etc. 494 pages, Size, 6x9½".

37 K 883. Postpaid in U.S.A. 9.80

A GUIDE TO CATHODE RAY PATTERNS. By Merwin Bly. Handy reference book of cathode ray pattern types encountered in the course of laboratory and test bench work. Written to aid the oscilloscope operator in correctly interpreting all basic oscilloscope patterns. 154 illustrations of typical cathode-ray patterns. 29 pages, 8½x10¾".

37 K 856. Postpaid in U.S.A. 2.45

GIANT BRAINS. (Machines That Think.) By G. Berkeley. A fascinating discussion of mechanical "brains"—machines that store and transfer information. Clearly written in easy-to-understand terms. It shows the complete development of a simple "brain." Explains operation of punch card machines, differential analyzers, sequence-controlled calculator, etc. Typical chapters include: Accuracy; Reasoning; Speed—5000 Additions A Second; Social Control. 270 pages, 5x8".

37 K 460. Postpaid in U.S.A. 4.90

INDUSTRIAL ELECTRONICS REFERENCE BOOK. Compiled by Electronics Engineers of the Westinghouse Electric Corporation. An exhaustive, authoritative digest of the marked advances in the field of industrial electronics since 1940. Expressly written to aid technicians in judging the possibilities and limitations of electronic devices accurately, as well as to design successful equipment of their own. Presents basic theory and application principles of new industrial electronic equipment. 680 pages, 8½x11¾".

37 K 877. Postpaid in U.S.A. 17.64

ELECTRICAL ENGINEERS HANDBOOK VOLUME 2. (Communications—Electronics.) By Harold Pender and Knox McIlwain. Enlarged Fourth Edition. Excellent reference. 54 page index. Includes sections on: Electron Tubes; Optics; Electro-Optical Devices; FM; Mathematics, Units and Symbols; Transmission Circuits; TV; Telephony; etc. Illustrated. 1618 pages, Size, 5x8".

37 K 867. Postpaid in U.S.A. 9.80

ELECTRONICS FOR INDUSTRY. By Waldemar Benz. A practical, non-mathematical, explanation of electronics for engineers. Places emphasis on the application of electronic principles to industrial equipment. Chapters include: Electron Escape From Solids; Three-Element Pliotrons; Two-Element Tubes; Thyratrons; etc. 501 pages, 5x8".

37 K 887. Postpaid in U.S.A. 6.86

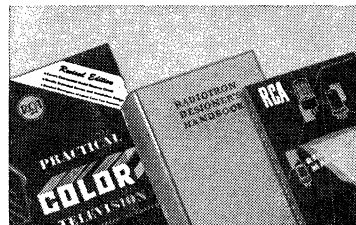

TRANSMITTING TUBE MANUAL. TT-4. Latest edition. Contains technical data and operating characteristics of curricula of available transmitting and high voltage rectifier tubes. Includes section covering power tube fundamentals, construction and materials, applications, design considerations, etc. Circuit diagram section graphically illustrates practical uses of transmitting tubes in oscillators, power amplifiers, dielectric and induction heating circuits, etc. Profusely illustrated. 256 pages. Size, 5½x8¾".

37 K 222. Postpaid in U.S.A. 1.00

Additional RCA literature on page 97. Popular RCA replacement components are listed on page 390. Make Allied your headquarters for RCA parts.

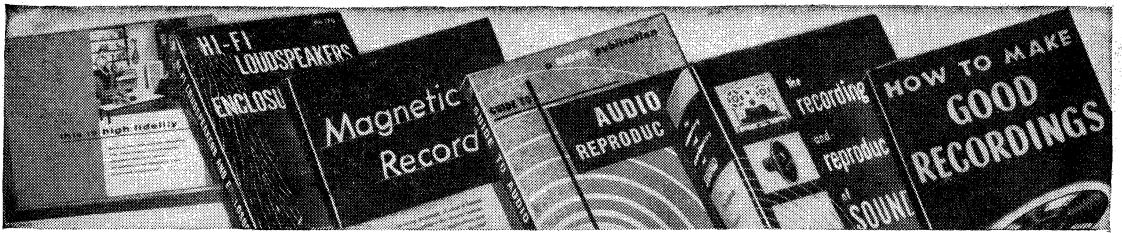

HI-FI AUDIO AND RECORDING BOOKS

ALLIED HI-FI BOOKLETS

THIS IS HIGH FIDELITY. Published by Allied. This clearly written booklet takes the "mystery" out of high-fidelity. It supplies much useful information and tells how to choose different music systems, how to select properly matched components, and how to get more for your hi-fi dollar. Very well illustrated. 16 pages. 11x8 1/2".

39 K 000. Postpaid in U.S.A. 10c

BUILT-IN HOME HI-FI SYSTEMS. By Allied's experts on high-fidelity installation. This booklet contains highly useful data for homeowners and others planning built-in hi-fi systems. Contents includes: Wiring your home for an entire hi-fi system; artist's sketch of layout; block diagrams and illustrations of speaker, TV, radio and phono sections; entire electrical layout, etc. 15 pages. 8 1/2 x 11".

39 K 012. Postpaid in U.S.A. 10c

BASS REFLEX CABINET PLANS. Unusually thorough booklet on the construction of the popular bass reflex speaker enclosure. For either a 12" or 15" speaker. Clearly written and highly readable, the booklet tells you what lumber to buy, how to lay out and cut the lumber, how to assemble the enclosure, and how to apply a furniture finish. Profusely illustrated. 10 pages. 8 1/2 x 11".

39 K 013. Postpaid in U.S.A. 10c

LOUDSPEAKER BOOKS

LOUDSPEAKERS. By G. A. Briggs (Wharfedale Speakers). 4th edition. Non-technical book covering the field of sound reproduction. Contains an excellent guide for the proper selection of speakers and the construction of baffles. Typical chapters include: Development of Loudspeakers; Chassis or Cone Housing; Impedance; Response Curves; Resonance and Vibration, etc. 92 pages. 8x5".

37 K 325. Postpaid in U.S.A. 1.57

HI-FI LOUSPEAKERS AND ENCLOSURES. By Abraham B. Cohen (Rider). A clear, well-organized book for either the hi-fi enthusiast or the technician. First section deals with the basic principles of loudspeakers, multi-speaker design, cross-over networks, etc. Second section analyzes the characteristics of baffles and enclosures and supplies data on building and evaluation of performance. The third section discusses the room as part of the acoustic circuit and includes hints on enclosure placement. Appendix consists of 18 complete plans for the construction of typical enclosures. Profusely illustrated. 360 pages. 5 1/2 x 8 1/2".

38 K 924. Postpaid in U.S.A. 4.60

"HIGH FIDELITY MAGAZINE" BOOKS

THE HIGH FIDELITY READER. Edited by R. H. Hoopes, Jr. (Hanover House). Consists of 26 interesting and informative articles taken from *High Fidelity Magazine*. Tells how to judge and select hi-fi equipment, make minor repairs and adjustments, assemble a complete system, etc. Written in a simplified and non-technical manner. Chapters include: Read Well Before Shopping, by Roy F. Allison; Tape, Discs and Coexistence, by David Sarsar; Are High Frequencies Necessary? by F. A. Kuttner; etc. An Audio Lexicon of terms used in hi-fi. 254 pages. 5 1/2 x 8 1/2".

37 K 212. Postpaid in U.S.A. 3.50

HIGH FIDELITY RECORD ANNUAL OF 1965. Edited by R. Gelatt (Lippincott). Top music critics evaluate significant new recordings and also discuss the artists. An excellent guide for the hi-fi enthusiast. Includes detailed information on all types of records—vocal, chamber, orchestral, speeches, drama and poetry. Based on reviews from *High Fidelity Magazine* from July, 1954 through June, 1955. First of a superbly written series of annual books. 352 pages. Size, 6x8 1/2".

37 K 421. Postpaid in U.S.A. 4.95

BUILDING YOUR RECORD LIBRARY. By R. Hoopes, Jr. (McGraw-Hill). How to build a hi-fi collection—considers budget as well as personal preferences. Written by 17 record reviewing experts on the staff of *High Fidelity Magazine*. Features 28 chapters which cover different categories of music and discuss the best records in each category. Chapters include: Bach, by Nathan Broder; Piano Music, Organ Music, by Raymond Erickson. 247 pages. 5 1/2 x 8 1/2".

38 K 851. Postpaid in U.S.A. 3.95

RECORDING BOOKS

YOUR TAPE RECORDER. By Robert and Mary Marshall. How to select and get the most out of your tape recorder. Written from the practical viewpoint, it describes the best type of recorder for different applications. Includes detailed directions for making the best recordings under various conditions, such as orchestra recordings, church services for shut-ins, and home recordings. Charts show correct microphones to use and type of playback equipment needed. Specs on 53 recorders. Over 100 illustrations. 288 pages. 8 1/2 x 5 1/2".

37 K 484. Postpaid in U.S.A. 4.85

TAPE RECORDERS AND TAPE RECORDING. By Harold D. Weiler. An extremely useful book for the amateur and semi-professional recordist. Gives the answer to virtually every tape recording problem in practical, easy-to-understand language. Contains numerous tables and charts—more than 100 illustrations. Typical chapters: Microphones and Tape Recording, Tape Recording and Room Acoustics, Recording from Records, Radio and TV, Tape Recorders—Theory and Practice, Tape Recorder Maintenance. 13 chapters, 192 pages. 8 1/2 x 5 1/2".

38 K 124. Postpaid in U.S.A. 2.95

HOW TO SERVICE TAPE RECORDERS. By C. A. Tuthill (Rider). All phases of servicing tape recorders. Subjects include: Operation of the recording head; types of electronic circuits; kinds of drive mechanisms used; troubleshooting—and how to service many types of tape recorders, with practical examples. Discusses general maintenance of recorder mechanisms as well as the requirements for a tape recorder repair shop. 176 pages. 5 1/2 x 8 1/2".

37 K 998. Postpaid in U.S.A. 2.84

RECORDING AND REPRODUCTION OF SOUND. 2nd ed. Dr. Oliver Read (Edward W. Sams, Pub.). Complete authoritative coverage of the entire subject of audio; how to get the most out of recording equipment; how to test amplifier performance. Chapters on Behavior of Sound Waves; Basic Recording Methods; Lateral Disc and Microgroove Recording; Magnetic Recorders—tape, wire and film; Loudspeakers and Enclosures; Public Address Systems; AM and FM Tuners, 700 illustrations. 800 pages. 6x9".

38 K 585. Postpaid in U.S.A. 7.95

MAGNETIC RECORDING. By S. J. Begun (Murray Hill). A comprehensive book on magnetic recording. Chapters on History of Magnetic Recording, Fundamentals of Magnetism, Theory of Magnetic Recording, Components, Recording Equipment, Instrumentation and Magnetic Recording Measurements, Industrial Applications. More than 130 diagrams and illustrations. 242 pages. 6 1/2 x 9".

37 K 729. Postpaid in U.S.A. 5.00

HOW TO MAKE GOOD RECORDINGS. (Audio Devices, Inc.) Detailed book covering basic techniques of the art. Covers every phase of disc recording. Tells the whole story in non-technical terms. Includes selection of equipment, common recording difficulties and their remedies, school recording problems, etc. 128 pages. 86 illustrations. Size, 6 1/2 x 8".

37 K 641. Postpaid in U.S.A. 1.45

TAPE RECORDERS—HOW THEY WORK. By Charles G. Westcott (Howard W. Sams). A detailed treatment of tape recording technique and tape recorder equipment. Serves as guide for purchasing and operating a tape recorder. Topics include: Magnetic recording theory, characteristics of tape, how a recorder operates, motor-drive mechanism, motors, volume indicators, bias oscillators, etc. Illustrated. 176 pages. 5 1/2 x 8 1/2".

38 K 642. Postpaid in U.S.A. 2.75

HOW TO SELECT AND USE YOUR TAPE RECORDER. By David Mark (Rider). All the facts needed for an intelligent selection of a tape recorder and how to get the most use from it. Written in clear, easy-to-read manner—with a minimum of technical language. Chapters include: Selecting the Tape Recorder, How a Tape Recorder Works, How to Make a Recording on Tape, Using a Tape Recorder in the Home, Using a Tape Recorder in Business, Using a Tape Recorder in Professional Service, How to Select a Tape Recorder. A Buyer's Guide lists over 80 kinds of tape recorders. 152 illustrations. 148 pages. 5 1/2 x 8 1/2". Soft cover.

38 K 825. Postpaid in U.S.A. 2.95

HI-FI BUILDERS BOOK

THE SATURDAY REVIEW HOME BOOK OF RECORDED MUSIC AND SOUND REPRODUCTION. 2nd edition. E. C. Canby, C. G. Burke, and I. Kolodin. (Prentice Hall). 3 sections, each prepared by a hi-fi expert associated with *The Saturday Review*. First part discusses records—"from studio to store". Second part supplies money-saving pointers on home equipment. Last part of book deals with music discrimination and appreciation. 339 pages. 6 1/2 x 9 1/2".

37 K 480. Postpaid in U.S.A. 4.95

HIGH FIDELITY HOME MUSIC SYSTEMS. W. R. Wellman (Van Nostrand). An expertly written book of practical hints and money-saving suggestions on the selection of hi-fi components. Considers such factors as budget, room layout and personal taste. Detailed drawings simplify construction of custom cabinets. Also shows how to convert radios and phonographs for hi-fi reproduction. Chapters include: Loudspeakers, Loudspeaker Enclosures, Record Players, Radio Tuners, etc. 177 pages. 5 1/2 x 8 1/4".

37 K 438. Postpaid in U.S.A. 4.41

HIGH-FIDELITY SIMPLIFIED. By H. D. Weiler (Rider). Presents in clear form what you need to know to enjoy Hi-Fi. Will guide the reader in selecting the best equipment with least expense. Includes the following chapters: Sound; Acoustics; Electronics and Music; The Hi-Fi Loudspeaker; Loudspeaker Enclosures; etc. 208 pages. 5 1/2 x 8 1/2". Soft cover.

37 K 769. Postpaid in U.S.A. 2.45

HOME MUSIC SYSTEMS. By Edward Tatnall Canby (Harper & Bros.). Written by record columns for *Hanover House* and *Audio Engineering* magazines. A layman's guide on how to purchase and assemble parts for home hi-fi music systems. Shows how to get the most out of each dollar spent for high-fidelity. Written in straightforward, easy-to-follow style. Explains principles of various types of hi-fi equipment. 500 pages, including 4 pages of illustrations and diagrams. Size: 8 1/2 x 11".

37 K 947. Postpaid in U.S.A. 3.95

GUIDE TO AUDIO REPRODUCTION. D. Fiedelman (Rider). A complete explanation of the reproduction of sound. Discusses all phases of audio reproduction systems. Covers design, construction, assembly, and testing of the systems as a whole and the components which comprise it. Chapters include: Hi-fidelity reproduction of sound, input and pick-up units, audio amplifier theory, A-F networks and corrective circuits, loudspeakers and enclosures, magnetic recording, measurement of quality of audio reproduction, etc. 240 pages with over 160 illustrations. 5 1/2 x 8 1/2". Soft cover.

37 K 308. Postpaid in U.S.A. 3.43

SOUND REPRODUCTION. (3rd Ed.) G. A. Briggs (Wharfedale Speakers). Recommended by a leading national research organization. Provides a comprehensive technical coverage of the entire field. Has 28 chapters, including the following: Cone Resonances, Room Acoustics, Response Curves, Crossover Networks, Interference, Magnetic Recording, etc. Amply illustrated. 368 pages. 5 1/2 x 8 3/4".

37 K 326. Postpaid in U.S.A. 3.43

HIGH FIDELITY TECHNIQUES. John H. Newitt (Rinehart Books). An unusually comprehensive book for the hi-fi enthusiast and technician. Topics covered include: Ear cost considerations; properties of sound; reverberation; response; speakers; enclosures; crossover networks; distortion; special hi-fi circuits; binaural effects; amplifiers; tuners; record players; etc. 494 pages. 6x9 1/4".

37 K 351. Postpaid in U.S.A. 7.50

UNDERSTANDING HIGH FIDELITY. By L. Biancoli and L. H. Bogen (Bogen). Chapters on: Musical Sounds; Elements of a High-Fidelity System; How to Conduct a Listening Test; etc. 56 pages. 6x9".

37 K 211. Postpaid in U.S.A. 25c

THE 3RD AUDIO ANTHOLOGY. Edited by C. G. McProud. Consists of selected articles which have appeared in *Audio Magazine*. Presents many suggestions and ideas for improving hi-fi systems. Chapters include: Improved Phonograph Compensation Circuits, by R. H. Brown; Flexible Tone Control Circuit, by Basil T. Barber. 124 pages. 8 1/2 x 11 1/4".

37 K 337. Postpaid in U.S.A. 2.50



LATEST HIGH-FIDELITY BOOKS

HIGH FIDELITY—A PRACTICAL GUIDE. By Charles Fowler (Audiocom). An extremely well written book, this guide to hi-fi makes plain every aspect of high fidelity. It explains in clear, non-technical language, just how to evaluate, buy and operate hi-fi equipment. Covers speakers, enclosures, room acoustics, amplifiers, control units, tuners, etc. 100 illustrations. 140 pages. 6x8 1/4".
38 K 125. Postpaid in U.S.A. 4.85

HOW TO MAKE GOOD TAPE RECORDINGS. By C. J. LeBel (Audio Devices). A complete handbook of tape recording. Contains a wealth of practical information for professional as well as beginning tape recordists. Chapters include: How a Tape Recorder Works, Selecting a Recording Tape, Tape Editing, Binaural or Stereophonic Recording, etc. Profusely illustrated. 150 pages. 5 1/2 x 7 3/4".
38 K 933. Postpaid in U.S.A. 1.50

HANDBOOK OF SOUND REPRODUCTION. By Edgar M. Villchur (Radio Magazines, Inc.). A practical, well-written book for those who want to learn more about hi-fi at a technical level. Equivalent to a study of several texts on acoustical engineering, but presented clearly so that the layman and the high fidelity enthusiasts, can learn easily. Illustrated. 218 pages. 6 1/4 x 9 1/4".
37 K 209. Postpaid in U.S.A. 6.50

ATTENUATORS, EQUALIZERS AND FILTERS. AET-1 (Same). This clearly-written book thoroughly describes the design, application and theory of operation of every type of attenuator, equalizer and wave filter used in recording and reproducing equipment. Helps both audio engineer and hi-fi enthusiast to a better understanding of audio equipment. 176 pages. Size, 5 1/2 x 8 1/4".
37 K 357. Postpaid in U.S.A. 2.75

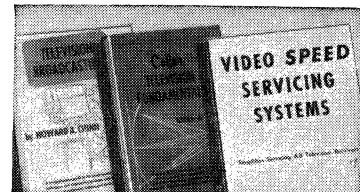

TV DATA-SERVICE BOOKS

TELEVISION BROADCASTING. By Howard Chinn (McGraw-Hill). Practical, technical guide to equipment, systems, facilities, engineering practices, and operating techniques of television broadcasting. Typical chapters: Image Orthicon Camera, Field Pickup Techniques; Field Equipment; Studio Equipment; Studio Lighting; Staging; Camera Technique; etc. 695 pages. Size, 6x9".
37 K 948. Postpaid in U.S.A. 9.80

COLOR TELEVISION FUNDAMENTALS. (McGraw-Hill). Handy reference for TV serviceman and technician. Shows how to install and service color TV receivers. Also covers the basic theory in easy-to-understand terms. Chapters on Color Fundamentals, NTSC Color TV System, 3-gun Receiver in Block Form, 3-Gun Receiver Circuits, Narrow-Band Color Receivers, TV Receivers. 312 pages. 6x9".
37 K 462. Postpaid in U.S.A. 5.88

VIDEO SPEED SERVICE SYSTEMS, VOL. 2. (Cowan Pub. Corp.). Consists of more than 220 pages, ring-hole punched, in binder. Based on service case histories from files of manufacturers and distributors of TV sets. Full of information on over 25 top TV brands. 600 different data sheets; over 2500 TV models. Size, 9x12".
37 K 521. Postpaid in U.S.A. 2.95

THE WHYS AND WHEREFORES. By L. O. Gorder. Non-technical introduction to television. Very clear, highly readable. Helps the serviceman to better understand TV. Chapters: The Transmitter, The Transmission Medium, The Receiver, The Test Pattern, The Television Antenna, etc. Has service notes and glossary. 113 pages. 5 1/2 x 8 1/2".
37 K 796. Postpaid in U.S.A. 98c

HI-FI HANDBOOK, HFB-1 (Same). A comprehensive book for the beginner, audiophile and technician interested in hi-fi design and installation. Covers loudspeakers, baffles, enclosures, amplifiers, preamplifiers, controls, etc. Helpful hints on speaker locations, program sources, selection of equipment and many other interesting hi-fi subjects. Profusely illustrated. 240 pages. 5 1/2 x 8 1/4".
37 K 358. Postpaid in U.S.A. 3.00

JENSEN SPEAKER SYSTEM PLANS. Especially written for the Hi-Fi enthusiast who wants to build his own loudspeaker enclosure. Gives detailed construction plans on 8 enclosures—ranging from the "Imperial" folded horn to the "Duette" cabinet. Tells how to dress up completed enclosures. Includes complete parts lists and many excellent illustrations. 36 pages. Size, 8 1/2 x 11".
37 K 128. Postpaid in U.S.A. 50c

GUIDE TO THE CARE OF MODERN RECORDINGS. By Karl A. Barleben (Walco). An informative booklet which thoroughly discusses all aspects of record and stylus care in a clear interesting manner. Subjects covered include: Stylus Wear; Dust; Cleaners; Handling of Records; Proper Storage of Records. An important addition to any Hi-Fi library. 25 pages. Size, 5x7 3/4".
37 K 144. Postpaid in U.S.A. 25c

MAINTAINING HI-FI EQUIPMENT. By Joseph Marshall (Gernsback). A clearly written, much-needed handbook for servicing and trouble-shooting of hi-fi components. Chapters include: High-Fidelity Standards, Test Instruments, High-Fidelity Circuits, Preliminary Diagnosis, Distortion, Bass and Treble Faults, Audio Troubles, etc. Illustrated. 224 pages. Size, 5 1/2 x 8 1/4".
38 K 932. Postpaid in U.S.A. 2.90

SERVICING RECORD CHANGERS. (Gernsback). This new book discusses every functional assembly as a unit so that even if you are a beginner, in no time at all you will know how to service all types of record changers. Chapters include: Change Cycle, Trip Mechanism, Setdown Index, etc. Line drawings illustrate intricate mechanisms. 224 pages. Size, 5 1/2 x 8 1/4".
37 K 271. Postpaid in U.S.A. 2.90

HIGH-FIDELITY. (Gernsback). An information-packed book that is written for those who want to build and experiment with hi-fi equipment. Discusses design, construction and measurements. Chapters include: Audio Feedback Design, by G. F. Cooper; Crossover Networks, by N. H. Crowhurst; Audio Waveform Analysis, by J. D. Ledbetter and E. J. Thompson; etc. 128 pages. 5 1/2 x 8 1/4".
37 K 786. Postpaid in U.S.A. 1.50

BASIC AUDIO COURSE. By Donald Carl Hoefler (Gernsback). A basic text that provides easy-to-understand explanations of all the important points in the field of audio reproduction. Avoids the use of higher mathematics. Chapters include: The Nature of Sound, Audio Frequency Amplifiers, Distortion and Noise, Loudspeaker Systems, etc. Illustrated. 223 pages. 5 1/2 x 8 1/4".
38 K 926. Postpaid in U.S.A. 2.75

HIGH FIDELITY CIRCUIT DESIGN. By Norman Crowhurst and George F. Cooper (Gernsback). This new book takes the guesswork out of high-fidelity circuit design. Shows you how to plan circuits intelligently before you actually begin construction. Chapters include: Feedback Effects, Analysis and Design, Attenuators, Speaker Systems, Test Equipment, etc. 304 pages. 8 5/8 x 5 3/4".
37 K 272. Postpaid in U.S.A. 5.95

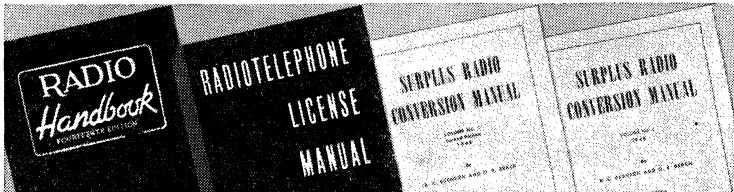

EDITORS AND ENGINEERS PUBLICATIONS

COMMUNICATIONS BOOKS

RADIO HANDBOOK. 14th edition. Complete volume on radio practice. This extremely valuable text on radio technique and theory deserves a place on every reference shelf. An unusually comprehensive handbook for Amateurs, engineers, radiomen and technicians. Tells how to design, construct and operate Amateur transmitting and receiving equipment. Contains valuable reference data. Text is thoroughly supplemented with hundreds of pictures, diagrams and charts. Covers basic electricity, AC and DC circuits, vacuum tubes and amplifiers, receiver fundamentals; generation of RF, AM and FM, transmitter design and adjustment, radiation and propagation, antennas, high frequency arrays, TVI and BCI, mobile equipment, power supplies, test units and radio math. Covers latest equipment—does not duplicate 13th edition. Includes schematics. Hard cover. 768 pages. Size, 6x9".
37 K 556. Postpaid in U.S.A. 7.50

RADIO-TELEPHONE LICENSE MANUAL. Valuable manual that contains all the information necessary to obtain any commercial radio-telephone license. Complete list of questions and answers. Covers: Questions on Basic Law; Basic Operating Practice; Basic Radiotelephone; Advanced Radiotelephone. Unusually complete appendix includes: Formulas and Problems; recommended FCC publications; Laws and Regulations; "Q" Signals; Miscellaneous Abbreviations. Complete information for anyone interested in radiotelephone communication. Paper bound. Includes many diagrams. 200 pages. 6x9 1/2".
37 K 784. Postpaid in U.S.A. 3.75

SURPLUS CONVERSION MANUALS

VOLUME 1. By R. C. Evenson and O. R. Beach. Devoted entirely to conversion data on surplus military equipment—no theory included. Contents: BC-221 Frequency Meter; BC-342, BC-312 and BC-348 Receivers; BC-412 Radar Oscilloscope (Conversion for Television Receiver and Test Scope); BC-645 Transmitter/Receiver (to 420 mc); BC-645 Receiver (Conversion to Auto Receiver); SCR-374N Receiver (Conversion to 10-Meter Receiver); and many other money-saving conversions. This volume also includes: Electronic Surplus Index, Cross Index of Army-Navy tubes versus Commercial types, Amateur Frequency Allocation Chart, and other valuable information on surplus gear. 112 pages, with schematics and photographs. Size, 6 1/2 x 9 1/4".
37 K 320. Postpaid in U.S.A. 2.50

VOLUME 2. Provides data on additional surplus units, by the same authors as noted above. Ideal for both Amateur and commercial use, this book is easy to understand and to use. Table of Contents: BC-454 or ARC-5 Receivers (Conversion to 28 mc); AN/APS-13 Transmitter/Receiver (Conversion to 420 mc); BC-457 or ARC-5 Transmitter (Conversion to 28 mc); BC-357 Marker Receiver (Conversion to Capacity Relay); BC-946B Receiver (Conversion to High-Fidelity Tuner); BC-375 Transmitter (Conversion for use with External VFO); TA-12B, TA-12C Transmitters; AN/ART-13 Transmitter (Conversion to AC Power and 28 mc); AVI-112A Transmitter for Aircraft. Includes: Coil winding data, power charts, illustrations, schematics, plus other useful information. 126 pages, 6 1/2 x 9 1/4".
37 K 321. Postpaid in U.S.A. 2.50

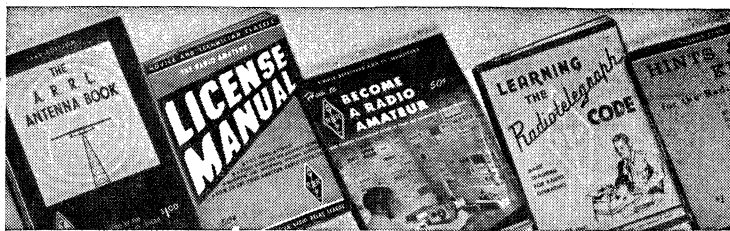

A. R. R. L. PUBLICATIONS

RADIO AMATEUR'S HANDBOOK. Latest edition. The Ham's "Bible"—world-wide standard text of Amateur and high-frequency communications. Wide in scope—covers all phases of theory, construction of station equipment, and operating practices. Revised to include the latest data on basic electricity and radio, HF, VHF, and UHF equipment, radiotelephony and CW, antennas, workshop practices, vacuum-tube data, etc. Chapters include: Electrical Laws and Circuits; Keying and Break-In; Power Supplies; High-Frequency Receivers; UHF and Microwaves; High-Frequency Transmitters; and Measuring Equipment; Mobile Equipment; etc. Latest edition always shipped. 764 pages. $6\frac{1}{2} \times 9\frac{1}{2}$ ". Paperbound. **37 K 550. Postpaid in U.S.A. 3.50**

THE MOBILE MANUAL FOR RADIO AMATEURS. By the staff of the A.R.R.L. A valuable sourcebook of basic information for the mobile enthusiast. Compilation of the most popular articles on mobile radio which have appeared in QST magazine. Articles include: 1-Tube, 75-Meter Mobile Converter; Simple Crystal-Controlled Converters, Bandswitching Mobile Converter, Mobile SSB Receiver for 80 and 40 Meters, Two-Band Mobile Transmitter, "Mighty Mo," "Mighty Mo Sr.," 80 and 40 on Wheels, etc. Contains latest material on power supplies, including 12-volt systems, data on mobile antennas, etc. Valuable hints and kinks for mobile operators. Profusely illustrated. Size, $6\frac{1}{2} \times 9\frac{1}{2}$ ". 352 pages. **37 K 573. Postpaid in U.S.A. 2.50**

RADIO AMATEUR'S LICENSE MANUAL. Enlarged edition. A standard reference for the Amateur radio enthusiast in preparation for his Amateur license. Covers FCC examinations for Novice, Technician, Conditional, General, and Extra Class licenses. Contains up-to-date government regulations, answers to probable license examination questions, and valuable information about regulations affecting Amateurs. Typical chapters: The Novice License, The Technician License, the Conditional Class License, the General Class License, The Extra Class License, Examinations by Mail. Covers FCC Rules and International Regulations. $6\frac{1}{2} \times 9\frac{1}{2}$ ". 111 pages. **37 K 555. Postpaid in U.S.A. 50c**

GATEWAY TO AMATEUR RADIO. Set of four A.R.R.L. books for the Novice. *How to Become a Radio Amateur.* Tells how to get on the air, obtain a license. Also covers the construction of receivers, transmitters, and operating practices. 148 pages. *Learning the Radiotelegraph Code.* Covers sending and receiving. Excellent for class study and home training. 48 pages. *License Manual.* Covers FCC exams. Answers to probable exam questions on: Novice, Technician, Conditional, etc. 111 pages. *Operating an Amateur Radio Station.* Valuable information on properly operating an Amateur station. Correct operating procedures, including network operation. 16 pages. Size, $6\frac{1}{2} \times 8\frac{1}{2}$ ". **37 K 566. Postpaid in U.S.A. 1.50**

HINTS AND KINKS. Presents hundreds of the best ideas developed by ingenious Amateurs to solve problems encountered in modern radio construction and experimenting. Useful and time-saving ideas range from short-cuts in soldering and assembly in hard-to-reach corners to clever methods of testing with simple instruments. An invaluable collection of ideas which have everyday application. Chapters cover the workshop, the receiver, the transmitter, the phone rig, the power supply, the antenna system, test equipment, etc. A handy book that quickly pays for itself. 128 pages. Size, $6\frac{1}{2} \times 9\frac{1}{2}$ ". **37 K 552. Postpaid in U.S.A. 1.00**

A COURSE IN RADIO FUNDAMENTALS. A study guide, examination book, and laboratory manual with text based on the latest edition of the Radio Amateur's Handbook (listed above). Contains 36 study assignments to provide a thorough foundation in radio theory. Assignments are arranged in logical order to give the reader a practical course in electronic and radio fundamentals. Each chapter is followed by questions and answers. Typical chapters include: Electricity and Magnetism; Ohm's Law; Resonant Circuits; Vacuum-Tube Fundamentals; Modulation; Receivers; Antennas, etc. Numerous experiments to illustrate principles are included. 103 pages. Size, $6\frac{1}{2} \times 9\frac{1}{2}$ ". **37 K 564. Postpaid in U.S.A. 1.00**

ANTENNA BOOK. Latest edition of invaluable and well-known antenna guide. An authoritative and thorough volume covering antenna theory and wave propagation, transmission lines, and the construction of various types of popular antennas for Amateur frequencies. Discusses and describes single- and multi-wire doublets, "V"-beams and rhombics, broadside, collinear and end-fire arrays, and parasitic antennas. Chapters include: Multi-element Directive Arrays; Multiband Antennas; Antennas for the Meter Band; Direction Finding; Antennas for Mobile Use; etc. Many useful tables and illustrations. 344 pages. Size, $6\frac{1}{2} \times 9\frac{1}{2}$ ". **37 K 556. Postpaid in U.S.A. 2.00**

LEARNING THE RADIOTELEGRAPH CODE. Trains students to handle code skillfully and with accuracy, both in sending and receiving. Employs a system of instruction which quickly brings the student an understanding of this new "language." Excellent for home study, particularly if a mechanical code device is not available. Covers the mechanics of code; element and letter sounds; sending methods, including key adjustment and special characters, etc. Chapters include: High-Speed Operation; Operating on the Air; Code Practice; Class Instruction, etc. 48 pages. Size, $6\frac{1}{2} \times 9\frac{1}{2}$ ". **37 K 562. Postpaid in U.S.A. 50c**

HOW TO BECOME A RADIO AMATEUR. Latest edition. Widely accepted as the standard elementary Amateur guide. Tells what Amateur radio is, the Amateur bands, learning the code, how radio works, and how to get started. Includes instruction for building a 2-tube receiver and 1-tube transmitter. In addition to more elaborate equipment. Describes simple meter equipment for the Novice, and explains the various types of antennas used in Amateur work. Covers the steps required to obtain an Amateur license, and includes a chart showing the currently-available Amateur bands. 148 pages. $6\frac{1}{2} \times 9\frac{1}{2}$ ". **37 K 551. Postpaid in U.S.A. 50c**

SINGLE SIDEBAND FOR THE RADIO AMATEUR. Best of SSB articles appearing in QST magazine, including those of a general nature, plus dozens of construction and theoretical articles. Covers design of SSB generators of filter and phasing type, linear amplifiers for SSB use, receiving equipment for SSB, and SSB detection principles. A discussion of voice-control systems and anti-trip devices is included. Typical articles: The Product Detector; Crystal Lattice Filters; Audio Phasing Networks; Linear Amplifier Design; Power-Supply Regulation; etc. 176 pages. $6\frac{1}{2} \times 9\frac{1}{2}$ ". **37 K 545. Postpaid in U.S.A. 1.50**

AMATEUR RADIO MAP OF THE WORLD. Very popular map, used by Amateurs and short wave listeners everywhere. Completely revised and up-to-the-minute in every detail. Made by Rand-McNally to A.R.R.L. specifications. Includes all data required by the Amateur and SWL—particularly valuable for the DX enthusiast. In six colors. Shows distances between large cities, Amateur station prefixes for all countries, time zones around the world, DX zones, and call areas. Very large size (30x40") makes it unusually easy to locate stations you hear or work. **98 KX 498. Postpaid in U.S.A. 2.00**

MINILOG. 60-page Amateur Radio Station logbook. Ideal for mobile work; assures compliance with FCC regulations. 4x6". **37 K 560. Postpaid in U.S.A. 30c**

AMATEUR STATION LOGBOOK. 36 log pages, 36 blank pages, "O" line, message number sheet. Spiral bound, $8\frac{1}{2} \times 11$ ". **37 K 558. Postpaid in U.S.A. 50c**

A. R. R. L. MESSAGE BLANKS. Handy pad of 70 blanks. $5\frac{1}{2} \times 8\frac{3}{8}$ ". **37 K 559. Postpaid in U.S.A. 35c**

LIGHTNING CALCULATOR. TYPE A. Solves problems of frequency, inductance, coil winding, etc. Size, $8\frac{1}{2} \times 11$ ". **37 K 553. Postpaid in U.S.A. 1.25**

LIGHTNING CALCULATOR. TYPE B. Solves problems of voltage, current, resistance, and power. Size, $8\frac{1}{2} \times 11$ ". **37 K 554. Postpaid in U.S.A. 1.25**

AMATEUR BOOKS

RADIO AMATEUR CALL BOOK. Directory of Amateurs everywhere. Lists station call letters, names and addresses of Amateurs in the U.S.A., Canada, and foreign countries. New table of great-circle bearings from U.S. cities, and table of Amateur call-sign prefixes for foreign countries. Handy station accessory. Published quarterly. The current issue is always shipped. Size, $11\frac{1}{4} \times 8\frac{3}{8}$ ". **37 K 670. Postpaid in U.S.A. 4.50**

BINDER FOR ABOVE. Pyroloxin-coated fabricoid binder for Call Book. Metal clasps hold book; ring for walk hook. **37 K 479. Postpaid in U.S.A. 4.00**

RADIO AMATEUR'S MOBILE HANDBOOK. By W. S. Orr, W6SAI. (Cowan.) A comprehensive treatment of material useful to the mobile Amateur. Covers automotive electrical systems, proper battery care, types of mobile power supplies, including several popular war-surplus dynamos. Discusses mobile receiving systems, and noise silencing devices including the "TNS". Covers mobile transmitters, mobile antennas, and test equipment. Features a section of "hints & kinks" to aid the mobile Amateur in getting the most from his equipment. $6\frac{1}{2} \times 9\frac{1}{2}$ ". 166 pages. **37 K 519. Postpaid in U.S.A. 2.95**

WORLD RADIO HANDBOOK. Latest edition. By O. Johansen of Copenhagen, Denmark. Standard for reference by shortwave listeners for ten years. Complete listings of all broadcasting stations on the shortwave bands for the whole world. Includes a listing of stations in the medium- and long-wave bands for Europe, North Africa, and the Near East. Shows, with musical notes, the interval signals of most stations, in addition to identification announcements. Also has listing of all foreign television stations, and includes frequency and transmission system. 168 pages. $6\frac{1}{2} \times 8\frac{1}{2}$ ". **37 K 570. Postpaid in U.S.A. 2.00**

THEORY COURSE. (Publisher, Ameco.) A detailed instructional course in radio theory, especially designed to prepare the student for an Amateur radio operator's license. Provides all the necessary material for the Novice Class and General Class examinations. Course consists of 14 lessons, beginning with the elements of electricity, and progressing through vacuum-tube theory, and actual transmitting and receiving equipment. Also included is a list of approximately 400 questions and answers typical of those found in the FCC examinations. 294 pages, $6\frac{1}{2} \times 9\frac{1}{2}$ ". **37 K 569. Postpaid in U.S.A. 3.95**

RADIO AMATEUR DX GUIDE. By C. O. Stimpson (Radio Amateur Call Book). Contains a wealth of information for the DX operator or shortwave listener. Includes an international DX log, a listing of great-circle bearings within the continental United States, time zones throughout the world, a list of international "O" signals. Also includes the official countries list of the A.R.R.L., World-wide Amateur QSL bureaus are shown, in addition to a Field Day log, Radio Amateur prefix maps, and other helpful information. Paper bound. 64 pages, $8\frac{3}{4} \times 12$ ". **37 K 914. Postpaid in U.S.A. 1.50**

RADIO AMATEUR QUESTION AND ANSWER LICENSE GUIDE. (Ameco.) Provides all of the technical information the student must have in order to pass the FCC examinations for the Novice, Technician, and General Class licenses. The questions are of the multiple-choice type, similar to those used by the FCC. Typical schematic diagrams are shown, and two sample FCC-type examinations are included, on which the student may grade himself with the answers provided. Paper cover, $6\frac{1}{2} \times 9\frac{1}{2}$ ". 32 pages. **37 K 567. Postpaid in U.S.A. 50c**

Gibson Radio Rule

Handy, 6" stencil-type plastic radio rule. Contains cut-outs for drawing all commonly used radio symbols: Circuits, tubes, meters, coils, transformers, etc. Invaluable for students, engineers, technicians, Amateurs and anyone else engaged in drawing circuit diagrams. Complete with cover and directions. 2 oz. **37 K 215. NET. 73c**

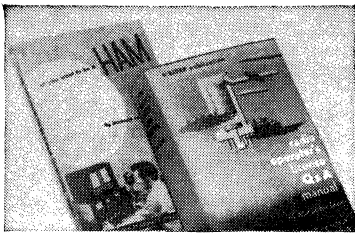

AMATEUR BOOKS

MOSLEY QSO INDEX. A handy Amateur station accessory which permits the Amateur operator to keep a record of each of his contacts. The index is arranged according to districts and letters of the worked station. Enables the Amateur to quickly determine whether a given station has been previously worked, and the name of the operator of the other station. 20 pages. Size, 8 1/2 x 11".
37 K 431. Postpaid in U.S.A. 98c

BEAM ANTENNA HANDBOOK. By William S. Orr, W6SAI. A "must" for any Amateur who has or is building a beam. Complete and authoritative volume on parasitic antennas. Discusses wave propagation, ionosphere characteristics, sun-spots, angle of radiation, and ground reflections. Covers antenna principles, the parasitic director and reflector, antenna height, transmission lines, and matching devices. Provides a wealth of design information for beam antennas, including all-metal arrays, antenna construction and evaluation, antenna installation, and test equipment. Indexed. 128 pages. Size, 5 1/2 x 8 1/2".
37 K 411. Postpaid in U.S.A. 2.70

SINGLE SIDEBAND TECHNIQUES. By Jack N. Brown, W3SHV. A complete volume covering the theory, operation, and construction of SSB equipment. A simple, straightforward introduction to the principles of SSB precedes the description of the filter and phasing methods of generating the SSB signal. Construction of both types of generators is described. Also covers linear amplification theory, including a high-power linear amplifier. Discusses balanced modulators and phase-shift networks. A 35-watt SSB transmitter is completely described, with much useful data on the alignment of SSB equipment. Also covers the design of an antenna T-R switch, and the use of the oscilloscope in SSB monitoring. Indexed. 112 pages. 6 1/2 x 9 1/2".
37 K 529. Postpaid in U.S.A. 1.50

HAM'S INTERPRETER. By OH2SQ. An easily understood booklet for the Amateur "DXer." Provides radiotelephone phrases in English, French, Spanish, Italian, German, Swedish, and Finnish. Includes pronunciation of the alphabet in all seven languages, and lists common radiotelephone terms in all languages. Also includes sample short QSO in all 7 languages. 37 pages. Size, 5 1/2 x 8 1/2".
37 K 572. Postpaid in U.S.A. 75c

COMMERCIAL Q & A BOOKS

SO YOU WANT TO BE A HAM. (Howard Sams publication). By Robert Herzberg. Excellent information for those interested in Amateur radio and who would like to get started in this fascinating hobby. Provides the reader with an understanding of the licensing regulations governing Amateurs, and how to get your license. Covers learning the code, popular types of Amateur transmitting and receiving equipment, antennas, operating practices, and presents the various phases of Amateur activities, such as "ragchewing", DX, experimenting, etc. 186 pages. 5 1/2 x 8 1/2".
37 K 446. Postpaid in U.S.A. 2.50

RADIO OPERATOR'S LICENSE Q & A MANUAL. (Rider Publication). By Milton S. Kaufman. Revised and enlarged 6th edition. A standard reference manual and study guide for those preparing for FCC commercial operator licenses. Contains questions and answers to past FCC exams, plus latest revisions of Elements I and II. Essential to the preparation for Commercial, Broadcast, and Television Station Operator's Licenses. Based on the latest Study Guide and releases from the FCC. With appendices. 766 pages. Size, 5 1/2 x 8 1/2".
37 K 638. Postpaid in U.S.A. 6.47

RADIO OPERATING QUESTIONS AND ANSWERS. (McGraw-Hill Pub.). By J. L. Horning. For those preparing to take radio operator license examinations. Latest, up-to-the-minute 12th edition. Includes all FCC examination elements. An indispensable reference for new license applicants, or those applying for endorsements for existing licenses. Over 2000 questions and answers on theory, apparatus, circuits, laws and regulations. Full list of contents: Basic Radio Laws, Basic Theory and Practice; Radio-Telephone; Advanced Radio-Telegraphy; Operating Abbreviations, etc. 571 pages. Size, 5 1/2 x 8". Illustrated.
37 K 685. Postpaid in U.S.A. 5.88

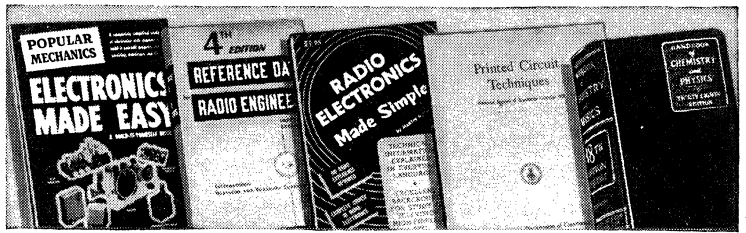

PRACTICAL REFERENCE BOOKS

RADIO-ELECTRONICS MADE SIMPLE. By Martin Schwartz. (American Electronics Company publication.) Provides reader with basic understanding of elementary radio-electronic principles. Especially useful for beginners. 14 chapters dealing with current tubes, power supplies, transmission and reception, antennas, magnetism, etc. Special sections on radio abbreviations, symbols, and formulas. Complete index for easy cross-reference. 191 pages. Illustrated. 6x9".
37 K 245. Postpaid in U.S.A. 1.95

PRINTED CIRCUIT TECHNIQUES. By Clelio Brunetti and Roger W. Curtis. A general treatise on printed circuit techniques published by the United States Department of Commerce. Chapters include: Painting; Spraying; Chemical Deposition; Vacuum Processes; Die-Stamping; Dusting; Performance; Applications. Informative introduction traces history of printed circuit. Extensive bibliography supplies important sources for additional references and information. Illustrated. Many graphs and tables. Includes charts. 43 pages. 8x10 1/4".
37 K 893. Postpaid in U.S.A. 40c

RADIO-ELECTRONIC MASTER. (United Catalog Publishers.) New 1958 edition (22nd). Official catalog of the radio, television and electronics industry. Large, hard-bound volume lists over 85,000 items produced by major manufacturers of standard brands. Each item is fully described, with specifications and prices. Thousands of illustrations. Catalog is divided by product and is fully indexed by manufacturer and product. Over 1400 pages. Size, 8x11 1/2".
37 K 204. Postpaid in U.S.A. 3.50

REFERENCE DATA FOR RADIO ENGINEERS. Fourth edition. By International Telephone and Telegraph Corporation. A complete-in-one-volume reference designed to save time for radio engineers seeking electronic data. Supplies basic information for classroom, research, development, production, and operation. Deals with transistor circuits, nuclear physics, feedback control systems, modern network filter design, TV pickup tubes, patent practices, etc. 1121 pages. 5 1/2 x 8 1/2".
37 K 449. Postpaid in U.S.A. 6.00

ELECTRONICS MADE EASY. By L. Stern. (Popular Mechanics.) Excellent reference and build-it-yourself guide for the beginner and experimenter. Explains basic electronic theory and includes illustrations to demonstrate the various principles. Also covers high-fidelity and transistors. Presents 23 construction projects in detail, including: Crystal set; 1, 3, and 5-tube radio; short wave converter; intercom system; photoelectric eye; test units; 10- and 25-watt hi-fi amplifiers, etc. Glossary of terms. 192 pages. 6 1/2 x 9 1/2".
38 K 127. Postpaid in U.S.A. 2.95

HANDBOOK OF CHEMISTRY AND PHYSICS. By Hodgman and Lange. 38th edition. The standard manual in every laboratory. A complete reference manual containing formulas and tables for literally every technical field. Includes chemical formulas, charts and descriptions of the elements, physical data on hundreds of compounds, electrical characteristics of all metals and semi-conductors, mathematical charts and tables, conversion of units, etc. Over 3000 pages. 4 3/4 x 7".
37 K 331. Postpaid in U.S.A. 12.00

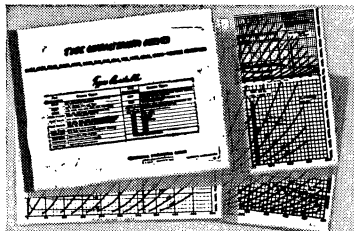

TUBE CURVES

By Technical Publishing House. 20-sheet graph pack of tube characteristics. Include plate, screen, positive grid, mu, Gm, and Rp curves; plus physical and electrical data for all equivalent tube types. Graphs have 1, 2, or 5 units per scale division for simplified readings. 8 1/2 x 11". Postpaid in U.S.A.

Stock No.	Tube Types (and Equivalents)
39 K 200	12AU7, 5814, 5963, 6C4, 6135, 6189, 6100.
39 K 201	12AT7, 6AB4, 6201, 12AZ7
39 K 202	12AX7, 6AV6, 6BK6
39 K 212	6AQ5, 6005, 6VGGT, 6CM6, 6C5, 5871, 6287, 5992 (triode) As above, pentode connected
39 K 203	6SN7, 6J5, 6CG7, 1633, 7A4, 5692, 7N7, 12G4, 12H4
39 K 205	6SL7, 6SU7GT, 5691, 7F7, 6188
39 K 206	6L6, 5932, 1631, 5881 (triode) As above, pentode connected
39 K 207	5965, 6829
39 K 208	5687
39 K 209	5751
39 K 210	5718
39 K 213	6211
39 K 214	6350
39 K 215	6AK5, 5654, 5702WA, 6CK605CX (pent.) As above, but triode connected
39 K 217	6AU6, 12AU6, 6136 (pentode) As above, but triode connected
39 K 218	6CL6, 6197, 6677 (pentode) As above, but triode connected
39 K 221	12AV7, 6072
39 K 222	2C51, 5670, 6385
39 K 223	6A57, 6080, 6082

Above charts. NET EACH. 89c



PRENTICE-HALL BOOKS

TELEVISION SERVICING. By W. H. Buchsbaum. A manual for TV servicemen written by the Chief Engineer of Vision Research Laboratories. No knowledge of higher math is needed. Excellent for self-teaching or for classroom use. Divided into three sections. Section 1 covers general television theory; Section 2, the installation and alignment of TV receivers; Section 3, trouble-shooting. Well illustrated. 416 pages. Size, 6x9".
37 K 945. Postpaid in U.S.A. 5.95

BASIC MATHEMATICS FOR TELEVISION AND RADIO. Second edition. By George F. Maedel. A popular and valuable book for the radio and television engineer or student. All material is presented in a manner designed to meet the specialized requirements of the radio and TV field. Explains the proper use of mathematics in the technology of radio and television. 411 pages. Size, 6x9".
37 K 949. Postpaid in U.S.A. 4.75

TRANSISTOR ELECTRONICS. By Lo, Endres, Zavels, Waldhauer, and Cheng. An authoritative and comprehensive volume on semiconductor electronics. Written by scientists and engineers who are foremost in the field. An essential book for anyone working with transistors. Thoroughly covers theory of operation, and discusses practical applications. 521 pages. 5 1/2 x 8 1/2".
37 K 420. Postpaid in U.S.A. 12.00

ELEMENTS OF RADIO. By A. Marcus and Wm. Marcus. Prepared under the direction of Dr. Ralph E. Horton. New Third Edition. A simplified, practical course on the essentials of radio theory. Each chapter concludes with a number of problems for the student to solve. Includes over 500 diagrams and drawings, plus a complete glossary of terms. Indexed. 800 pages. Size, 5 1/2 x 8".
37 K 940. Postpaid in U.S.A. 6.60

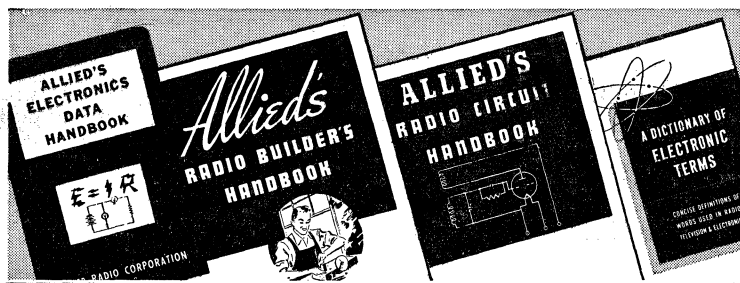

ALLIED'S OWN RADIO PUBLICATIONS

ALLIED'S ELECTRONICS DATA HANDBOOK. By Nelson M. Cooke, Lieutenant Commander, U. S. Navy (Ret.). Completely revised edition of Allied's former Radio Data Handbook. Contains a comprehensive listing of formulas, data, standards, tables and charts used in solution of everyday problems encountered in radio and electronics. A practical reference book for students, servicemen, engineers, instructors, etc. Filled with essential information. Contents include Log and Trig tables, RETMA color codes for chassis wiring, math constants, decibel ratios, speaker matching formulas, coil winding formulas, fundamental algebraic formulas, attenuator network formulas, abbreviations, symbols, tube data, etc. 64 pages. Size, 6x9".
37 K 398. Postpaid in U.S.A. 35c

ALLIED'S RADIO CIRCUIT HANDBOOK. Compiled especially for training classes. Consists of most popular radio circuit diagrams. Aids students in understanding basic principles of radio by knowledge of how radio circuits operate. Illustrates and explains fundamental circuits and their applications in complex radio design. Begins step-by-step progress from 2-tube set to 5-tube superhet and a variety of other radio and electronic circuits. Contents include Ticker Coil Oscillator, Hartley Oscillator, AC-DC Power Supply, Power Amplifier, Audio Phase Inverter, 3-Way Portable Receiver, Electronic Photoflash, etc. 32 pages. 8 1/2 x 11".
37 K 753. Postpaid in U.S.A. 25c

A DICTIONARY OF ELECTRONIC TERMS. Don't guess the meaning of that term! Look it up in Allied's dictionary and be sure. Completely revised, with clear, concise definitions of more than 3500 terms used in Television, Radio, Electronics and Nucleonics. Edited by Gordon R. Partridge, Ph. D., Purdue University. Includes over 125 illustrations and diagrams. Appendix covers RETMA color code, schematic symbols, etc. For engineers, servicemen, students, instructors, hobbyists—everyone in electronics should have a copy. 79 pages. Size 6x9".
37 K 756. Postpaid in U.S.A. 25c

ALLIED'S RADIO BUILDER'S HANDBOOK. For classroom or home study. Explains radio set parts and functions, magnetism, resistance, electron theory, inductance and reactance, capacitance, how to read schematic diagrams, etc. Easily built projects permit application of radio theory to actual use. Includes: receivers; transmitters; amplifiers; phonoscissors, etc. 32 pages. 8 1/2 x 11".
37 K 750. Postpaid in U.S.A. 25c

Complete Set of Four Allied Books Shown Above. Radio's greatest book value. Buy the complete set and save. Practical books for the instructor, student, serviceman, technician, or engineer.
37 K 399. Postpaid in U.S.A. 1.00

SLIDE RULE CALCULATORS

Allied Radio-Parallel-Resistance Series-Capacitance Calculator. For rapidly obtaining answers to everyday problems in parallel-resistance and series capacitance. Simple to use. Enlarged scales. 3 1/2 x 21 1/2".
37 K 960. Postpaid in U.S.A. 35c

Allied Radio Coil Winding Calculator. Provides coil winding data without mathematical calculation. Covers series or parallel RF resonance, winding RF coils, etc. Accurately calibrated. In envelope. 4 1/2 x 6 7/8".
37 K 955. Postpaid in U.S.A. 50c

Shure Reactance Slide Rule. For computing capacitive or inductive reactance, dissipation factor, "Q" of inductances and AF-RF resonant frequency problems. Five scales. Size 8 1/2 x 3 1/2".
37 K 950. Postpaid in U.S.A. 50c

Ohmite Ohm's Law Calculator. Single setting gives power, voltage and current when resistance is known. Gives unknown resistance with single setting of any two known values. With slide rule scales and parallel resistance calculator. Cardboard. Size, 9x3".
2 M 780. Postpaid in U.S.A. 25c
2 M 781. Plastic Model. Postpaid 1.50

Gordon Rotary Beam Antenna Calculator. For frequencies from 10-30 mc. Tells length of driven element, reflector and director; element spacing; boom length. Reads decimal fractions of ft. With resonance calculator.
37 K 951. Postpaid in U.S.A. 1.00

SCHOOLS, COLLEGES, LIBRARIES, BOOK STORES—WRITE FOR QUANTITY PRICES ON ALLIED PUBLICATIONS

POPULAR Knight-Kit INSTRUCTION MANUALS

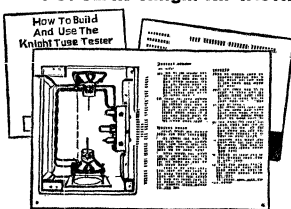

Complete, easy-to-follow instruction manuals for Allied's exclusive Knight-Kit electronic kits. Offer a preview of any Knight-Kit. Contains detailed construction notes, technical hints, operating data and comprehensive pictorial and schematic diagrams—exactly as included with each Knight-Kit. Prepared by skilled technical writers. Tell you all you'll want to know about these famous kits—

and they're "proof positive" that anyone can put these kits together, even without previous experience. Manuals cover complete Knight-Kit line for servicemen, radio Amateurs, hi-fi music lovers, experimenters, and students.

- 38 K 165. Tube Tester
- 38 K 166. RF Signal Generator
- 38 K 167. 5" Wide-Band Oscilloscope
- 38 K 097. General-Purpose Oscilloscope
- 38 K 168. VOM; 20,000 ohms per volt
- 38 K 183. VOM; 1,000 ohms per volt
- 38 K 169. Audio Generator
- 38 K 170. Signal Tracer
- 38 K 196. TV-FM Sweep Generator
- 38 K 163. Battery Charger
- 38 K 148. Capacitance Substitution Box
- 38 K 147. Resistance Substitution Box
- 38 K 098. 6-12 Volt Battery Eliminator
- 38 K 099. Voltage Calibrator
- 38 K 198. RF Z-Bridge
- 38 K 199. Transistor Checker
- 38 K 185. VTVM
- 38 K 184. Resistance-Capacitance Tester
- 38 K 188. In-Circuit Capacitor Checker
- 38 K 928. Flyback Checker
- 38 K 296. 100-Kc Crystal Calibrator
- 38 K 172. AC-DC Phono Amp
- 38 K 162. Phono Oscillator
- 38 K 145. 25-Watt Basic Amplifier
- 38 K 937. Hi-Fi Pre-amplifier
- 38 K 939. 30-Watt Hi-Fi Amp

- 38 K 190. 20-Watt Hi-Fi Amp.
- 38 K 140. 18-Watt Hi-Fi Amp.
- 38 K 059. 10-Watt Hi-Fi Amp.
- 38 K 941. Hi-Fi AM-FM Tuner
- 38 K 126. Hi-Fi FM Tuner
- 38 K 050. Crystal Set
- 38 K 161. "Ocean Hopper" Receiver
- 38 K 044. "10-in-One" Lab
- 38 K 176. "6-in-One" Lab
- 38 K 178. "Ranger II" Superhet Radio
- 38 K 178. Wireless Broadcaster
- 38 K 180. Amateur Variable Frequency Oscillator
- 38 K 187. "Spanner" Receiver
- 38 K 146. Transistor Code Practice Oscillator
- 38 K 095. 50-Watt Transmitter
- 38 K 197. 2-Station Intercom
- 38 K 942. 5-Transistor Superhet
- 38 K 936. 2-Transistor Pocket Radio
- 38 K 943. "Trans-Midge" 1-Transistor Radio
- 38 K 195. Printed Circuit 1-Transistor Radio
- 38 K 944. Auto Receiver
- 38 K 295. 10-Circuit Transistor Lab
- 38 K 096. Electronic Photoflash
- 38 K 934. Photoelectronic Receiver
- 38 K 935. Light Source

EACH, Postpaid in U.S.A. 10c

See pages 209-236 of this Catalog for complete listings of famous Knight-Kits.

"TEKNI-CALS" INSTRUMENT AND PANEL DECALS

Extremely versatile water transfer decal sets. Wide selection covers practically any application. Permit exact marking and tiling on Amateur, professional and industrial equipment. Excellent for engineering and classroom demonstrations—simplifies understanding of specific-part uses. Adhere to any clean surface. Easily photographed—contrasting design and colors of each decal is ideal for color or black and white photography. Packaged in handy, easy-to-use book form; each book protected by dust-free polyethylene storage bag. Set titles are alphabetically indexed. When title is removed, remaining decals are not disturbed. Av. shpg. wt., 5 oz.



Aircraft Set. Specialized to the needs of aircraft owner, repair man or mechanic. Titles for instrument panel, cabin and electrical circuits. Contains over 1200 titles, marks and specialized indications. For all types of aircraft: 1/8", 1/4" and 1/2" white markings.
37 K 969. NET 2.35

Meter Dial Face Sets. New meter dial faces for voltmeters, ohmmeters, ammeters, milliammeters, microammeters, etc. Complete with scales for setting up new meters and repairing old equipment. Black on white background.
38 K 107. For 2" meters. NET 1.75
38 K 108. For 3" meters. NET 1.85

General-Purpose Instrument and Workshop Decals.

- 37 K 968. Television, White
- 37 K 966. Receivers, White
- 38 K 112. Instruments, Black
- 38 K 132. Communications, Black
- 37 K 965. Transmitter, White
- 37 K 954. Alphabet & Nos., Gold
- 37 K 956. Alphabet & Nos., Black
- 37 K 957. Alphabet & Nos., White
- 38 K 115. VTVM, Black
- 38 K 116. VTVM, White
- 37 K 962. Instruments, White
- 37 K 958. Oscilloscope, Black
- 37 K 964. Oscilloscope, White
- 37 K 961. Vacuum Tubes, White
- 37 K 959. Workshop, Black
- 38 K 137. Workshop, White
- 38 K 130. Audio, White
- 38 K 131. Audio, Gold

Dial Sets. Over 200 dial decals. Includes markings such as switch points, circles, faders, gain, etc.
38 K 133. Black on white. 37 K 963. White on black. NET EACH 1.50

Service Sets. Contains 2 sheets of front panel markings and titles for TV and radio receivers plus intercom sets. Includes volume control and bandswitch dials, arrows, channel switch markings, etc.
38 K 134. White. 38 K 135. Black. 38 K 136. Gold. NET EACH 40c

High-Fidelity Audio Sets. Over 1000 marks, symbols and titles for such amplifiers, filters, recorders, players, speakers, etc. Include various speeds for turn recorders; record equalization; etc. Include white.
38 K 109. Gold 38 K 110. Black. 38 K 111. White. NET EACH 1.50

Series Numerals. Numerals 3/16" high, numbered from 1 to 2500 consecutively. Ideal for equipment production run numbering switches, identifying components and other controls. Excellent for all-around use.
38 K 113. Black. 38 K 114. White. NET EACH 1.85

Soldering Guns and Solder

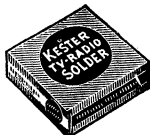

KESTER SOLDERS

Highest quality solder for all applications. Flux filling flows easily. Makes soldering jobs neater and quicker. Shpg. wts.: Handy coil, 3 oz.; 1-lb. spools, 1 1/4 lbs.; 5-lb. spools, 6 lbs.

ROSIN CORE 3/32" SOLDER

Plastic rosin filled. The most efficient solder for all radio and electrical work. Eliminates possibility of corrosion or leakage. Makes perfect connections with minimum work. 40% tin and 60% lead.

46 N 901. 1-lb. Spool. NET.....1.10
46 N 902. 5-lb. Spool. NET.....5.30

ROSIN CORE 1/16" SOLDER

Thin solder, plastic rosin filled. For delicate soldering where only the smallest amount of solder is desired. 40% tin and 60% lead.

46 N 930. 1-lb. Spool. NET.....1.13
46 N 931. 5-lb. Spool. NET.....5.45

"RESIN FIVE" 5-CORE SOLDER

Features "Resin 5" flux—non-corrosive and non-conductive. Makes soldering easier and faster. Handy coil, 1/4" dia.; spool, 3/32" dia. 40% tin and 60% lead.

46 N 900. Handy Coil. NET.....17c
46 N 916. 1-lb. Spool. NET.....1.10

Printed-Circuit Solder—60/40 Type. Compounded of 60% tin; 40% lead. For copper-clad printed circuits. 1/4" dia.

46 N 926. 1-lb. Spool. NET.....1.47

ACID CORE SOLDER

Acid core solder for all general soldering other than electrical connections. 1/8" dia. Acid flux saves time; makes a lasting job. 40% tin and 60% lead.

46 N 905. Handy Coil. NET.....17c
46 N 906. 1-lb. Spool. NET.....1.10
46 N 907. 5-lb. Spool. NET.....5.30



SOLDERING PASTE

Specially processed for finer, more even distribution of fluxing ingredients. Permits a clean, non-corrosive solder job. Convenient 2-oz. cans. Shpg. wt., 5 oz.

46 N 915. 10 for 1.05. NET.....12c



KESTER TINNING BLOCK

Cleans and tins soldering irons quickly. Replaces salt ammoniac. Will not crumble or cause any corrosion on work. Shpg. wt., 1 1/4 lbs.

46 N 922. NET.....65c



ERSIN MULTICORE SOLDER

New 5-core solder for high-speed, precision soldering. Melts rapidly with less heat. Pure high-grade tin, lead and non-corrosive Ersin flux. Shpg. wts.: 1-lb. spool, 1 1/4 lbs.; 7-lb. spool, 8 1/2 lbs.

14 Gauge (.080"). 40/60 Multicore Solder.

46 N 995. 1-lb. Spool. NET.....1.37

46 N 996. 7-lb. Spool. NET.....9.31

16 Gauge (.064"). 40/60 Multicore Solder.

46 N 991. 1-lb. Spool. NET.....1.39

46 N 992. 7-lb. Spool. NET.....9.45

Service Pak. 17-ga., 50/50 5-core solder.

46 N 997. NET EACH.....50c

BLONDE TAPE SOLDER

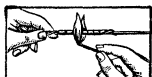

Use It
With a Match

Tape of pure 40/60 tin lead solder, impregnated with rosin flux. Just use a match, candle, cigarette lighter or torch for rapid soldering. Solders copper, brass, tin or anything for which regular solder is used. Tape is wrapped around wires to be joined or metal to be bonded, and heat is applied. Flux is activated at 190 degrees and dissipates at 210 degrees—forms a bond that will not corrode. Has same protective qualities as bar or spool solder. 28" long—enough for 100 connections. Wound on convenient, compact card. Shpg. wt., 2 oz.

46 N 979. List, 25c. NET.....17c

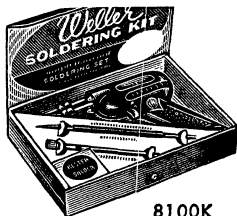

8100K

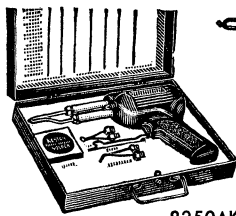

8250AK

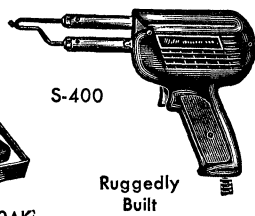

S-400

Ruggedly
Built

WELLER INSTANT-HEAT "SOLDERLITE" KITS AND GUNS

8100K MEDIUM-DUTY KIT—100 WATTS

Complete kit with everything needed for general, medium-duty soldering. Ideal for servicemen, craftsmen and hobbyists. Kit includes Model 8100, 100-watt solder gun, handy soldering aid tool (for holding wire in place while soldering), solder brush (for cleaning solder joints) and a coil of rosin-core solder. Gun delivers large volume of heat; reaches full operating heat in 5 seconds. Two built-in spotlights focus light directly on work—eliminate shadows. Has trigger switch for instant on-off operation. Easily reaches into crowded chassis wiring. Rugged, black plastic housing. For operation from 110-120 v., 60 cycle AC. Shpg. wt., 3 lbs.

46 N 640. List, \$7.95. NET.....5.83
3 or More, EACH.....5.19

8250AK HEAVY-DUTY KIT—250 WATTS

Extremely versatile, heavy-duty kit. Includes: Model 8250A 250-watt heavy-duty solder gun (with trigger-switch control, pre-focused dual spotlights, chisel-point tip, black plastic housing); 1 coil of Kester acid-core solder for metal work (use rosin core solder listed at left, for radio, TV and electrical wiring); 1 tip for general work; 1 smoothing tip for heat-sealing and mending plastic articles; 1 cutting tip for plastic tile and putty removal; 1 wrench for quick, easy interchange of tips. Complete with sturdy metal case. Size: 2 1/4 x 1 1/4 x 8 1/8". Gun is for operation from 110-120 volts, 60 cycle AC. Shpg. wt., 7 1/2 lbs.

46 N 677. List, \$14.95. NET.....10.99
3 or More, EACH.....9.71

MEDIUM-DUTY GUNS

Model S-400—135 Watts. Single-heat type. Specially designed for home crafter and all hobby uses. When used with cutting and smoothing tips listed below, it performs a wide variety of household functions including furniture repair, cutting plastic wall and tile, etc.

Shpg. wt., 3 lbs.

46 N 643. List, \$12.15. NET.....8.77
3 or More, EACH.....7.89

Model D-440—100-150 Watts. Dual-heat type. Shpg. wt., 3 lbs.

46 N 644. List, \$14.90. NET.....10.73
3 or More, EACH.....9.65

VERSATILE ACCESSORY TIPS

46 N 681. Type 6110. Cutting Tip. For S-400, D-440, and 8100. 3 oz. NET.....35c

46 N 682. Type 6120. Smoothing Tip. For S-400, D-440, and 8100. NET.....35c

46 N 683. Type 6130. Cutting Tip. For S-500, D-550 and 8250A. 3 oz. NET.....35c

46 N 684. Type 6140. Smoothing Tip. For S-500, D-550 and 8250A. 3 oz. NET.....35c

CHISEL-POINT TIPS

46 N 574. Type 7136. For 8100, S-400, D-440. Wt., 3 oz. 2 per Pkg. PER PKG. 25c

46 N 573. Type 7250. For 8250A, S-500, D-550. Wt., 3 oz. 2 per Pkg. PER PKG. 35c

46 N 579. Type 7300. For use only in older models S-107 and D-207. Not interchangeable with tips used in guns listed above. Wt., 3 oz. 2 per Pkg. PER PKG.....25c

HEAVY-DUTY GUNS

Ideal for production line use, service shop, home workshop, etc. Air-cooled transformers, pre-focused dual spotlights. Easily replaced tips. Rugged, high-impact, shatter-proof plastic housing. All have convenient pistol-type grip with on-off switch.

Model 8250A—250 Watts. Single-heat type. For all-purpose use. Shpg. wt., 4 lbs.

46 N 678. List, \$12.95. NET.....9.52
3 or More, EACH.....8.47

Model S-500—250 Watts. Single-heat type. Shpg. wt., 3 3/4 lbs.

46 N 642. List, \$13.50. NET.....9.75
3 or More, EACH.....8.77

Model D-550—200-275 Watts. Dual-heat type. Shpg. wt., 3 3/4 lbs.

46 N 641. List, \$16.25. NET.....11.71
3 or More, EACH.....10.53

SOLDER GUN REPLACEMENT PARTS

46 N 625. No. 7325 Tip Nut. For Models S-107, D-207, WS-100, WD-135, S-400 and D-440. Shpg. wt., 3 oz. NET EACH.....15c

46 N 626. No. 7323 Single Heat Switch. For all single-heat models. Shpg. wt., 3 oz. NET EACH.....1.22

46 N 627. No. 7324 Dual Heat Switch. For all dual-heat models. Shpg. wt., 3 oz. NET EACH.....1.37

46 N 630. No. 7417 Tip Nut. For WS-200, WD-250, S-500, D-550. Shpg. wt., 3 oz. NET EACH.....15c

KWIKHEAT THERMOSTAT-CONTROLLED SOLDERING IRONS

Thermostatically controlled, industrial soldering irons. Available in lightweight (150-watt) or heavyweight (225-watt) size, both of these deluxe irons include many highly desirable features: Quick-heating (only 90 seconds!); core assembly and outer shell of stainless steel; handles of high-impact phenolic, ribbed internally to allow circulation of air—handle is cool at all times; quickly interchangeable tips made of forged tellurium copper alloy, plated to resist corrosion and flaking; quickly replaceable heating element; light in weight and perfectly balanced for tireless soldering; U.L. Approved.

The built-in, bi-metallic thermostat automatically maintains a constant temperature, delivering fast heat when required, or conserving power during standby periods. New high temperature metals are incorporated in the thermostats, which are preset at the factory and sealed for protection. With 6-ft. cord and unbreakable molded plug. For operation from 100-125 v., 60 cycle AC.

A Model 200, 150-Watt. Kwikheat Jr. for light-duty continuous use. Length, with tip, 12 3/4". Shpg. wt., 12 oz.

46 N 634. NET.....6.38
3 or more, EACH.....5.66

Type 2051 Replacement Tip. 3/8" body, 1/4" shank, chisel point. 4" long. 4 oz.

46 N 633. NET.....68c

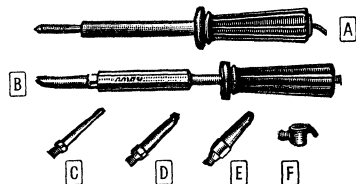

B Model 300. A highly efficient, 225-watt soldering iron for heavy-duty continuous use. Ideal for servicemen, home craftsmen, production line—for any job where soldering is required. Provides quick heating—only 90 seconds to full operating temperature. Uses any of 4 tips listed below. With tip (Fig. D). Length, 13". U.L. Approved. For 110-125 v., 60 cycle AC. Shpg. wt., 1 lb.

46 N 560. NET.....9.94
3 or More, EACH.....8.82

INTERCHANGEABLE TIPS FOR MODEL 300

No.	Fig.	Description	NET
46 N 561	C	Small taper point	1.20
46 N 562	D	Gradual taper point	1.24
46 N 566	E	Heavy, with chisel tip	1.31
46 N 566	F	Melting pot; holds 1 oz.	1.24

Soldering Guns

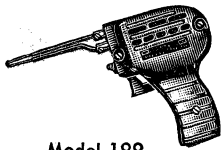

Model 199

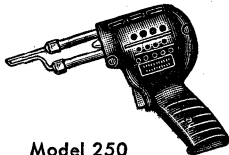

Model 250

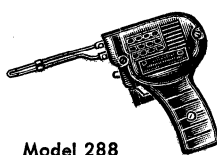

Model 288

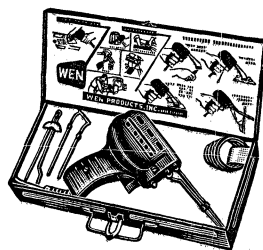

FAMOUS WEN SOLDERING GUNS

MODEL 199—120 WATTS

Extremely popular, low-cost soldering gun. Heats in just 2½ seconds. Excellent balance for faster, easier soldering. Efficiency comparable to guns of much higher wattage ratings. Has steel nose long-life tip. Spotlight focuses on work. Rated at 120 watts. Lightweight; only 1½ lbs., for use over long periods of time without fatigue. Heat and shock resistant cherry-red plastic handle. Overall length less tip, 5", 6' cord. Underwriters' Laboratories Approved. For operation from 110-120 volts, 60 cycle AC. Shpg. wt., 2¼ lbs.
46 N 358. List \$7.95. NET.....5.83

REPLACEMENT TIPS

Stock No.	Mfr's Type	Description	NET EACH
46 N 359	19-B-4	Standard Tip	35¢
46 N 328	19-C-1	Plastic Cutting Tip	42¢

MODEL 250—250 WATTS

Heavy-duty soldering gun at low cost. Rated at 250 watts. Heats in 3 seconds. Excellent for radio-TV repair work and provides plenty of heat for heavy soldering jobs. Perfectly balanced for ease of handling. Straight-line design and built-in spotlight for illuminating work area. Nickel-plated corrosion-resistant tip. Heat and shock resistant. Underwriters' Laboratories Approved. For operation from 110-120 volts, 60 cycles AC. Length, 6½". Shpg. wt., 5 lbs.
46 N 325. List, \$12.95. NET.....9.52

REPLACEMENT TIPS

Stock No.	Mfr's Type	Description	NET EACH
46 N 326	25-A-4	Standard Tip	11¢
46 N 327	25-X-20	Feraloy Tip	35¢
46 N 330	25-C-1	Plastic Cutting Tip	35¢

WEN SOLDERING GUN KIT

Highly versatile, all-purpose solder gun kit. Includes the Model 199 120-watt gun, one 5-ft. roll of rosin-core solder, three different tips for a wide variety of jobs, plus an attractively styled heavy-gauge metal kit box. Gun reaches soldering temperature in just 2½ seconds after squeezing trigger.

Well-balanced, pistol-grip handle assures fatigue-free operation. Single trigger automatically controls heat and built-in spotlight. Pre-focused spotlight assures shadow-free working area. Gun is extremely light in weight; only 1½ lbs. Valuable for medium and light-duty soldering jobs in both radio and TV repair and home workshop. Handsome, cherry-red, heat and shock-resistant plastic housing.

Tips include: Model 19-B-4 long-nosed standard tip for repair of household wiring, radio and TV, appliances, lamps, automobile wiring, hobbycraft uses, etc.; Model 19-F-33 flat iron tip specially designed for removing dents and repairing scratches in furniture or woodwork, heat-sealing of wax paper packages and plastic bags, etc.; Model 19-C-1 cutting tip for making any type of cut in plastic, rubber or asphalt tile, softening and removal of hardened putty, fusing and cutting of thermoplastic material, etc.

Gun operates from 110-120 v., 60 cycle AC and is U.L. Approved. Shpg. wt., 4 lbs.
46 N 319. List \$9.95. NET.....7.31

MODEL 288 200-WATT HEAVY-DUTY GUN

Economy-priced, heavy-duty 200-watt soldering gun. Delivers large volume of heat for all types of heavy-duty work; special tip design also makes this an excellent gun for a wide variety of delicate, light-duty jobs. Valuable tool for radio and TV repair and electrical wiring. Versatile gun for home workshop. Reaches maximum working heat in less than five seconds. "Feather-touch" trigger and pistol grip design permits effortless operation over long periods of time. Long-reach tip assures easy

access to those difficult-to-reach places. Silver-plated connectors assure positive electrical contact. Built-in spotlight focuses directly on work; eliminates shadow. Spotlight goes on and off with gun. Entire housing made of high-impact, shatterproof plastic. Lustrous ebony-black finish. Length with tip, 9½"; less tip, 4½". U.L. Approved. 110-120 v., 60 cycle AC. Shpg. wt., 3½ lbs.
46 N 324. List, \$9.95. NET.....7.31
46 N 331. Extra Tip. Wt., 3 oz. NET....41¢

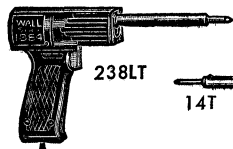

238LT



14T

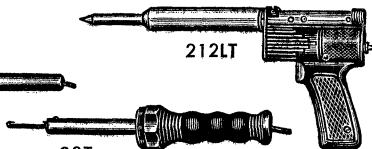

212LT



38T



Slim 5" Barrel

WALL "THERMOSTATIC ACTION" SOLDERING TOOLS

"TRIG-R-HEAT" SOLDERING GUNS

Wall "Trig-R-Heat" guns feature thermostatic action and lightweight, transformerless design. Just squeeze the trigger and the tip heats in seconds to the proper soldering temperature. Unique thermostatic action assures quick heating and higher wattage for heavier soldering jobs; thermostatic action also automatically takes over for light soldering jobs. Guns are perfectly balanced and light in weight for tireless handling and continuous, fatigue-proof operation. Narrow, 6½" barrel provides unusually good reach into tight or crowded places; a valuable time saver.

All guns have interchangeable tip-element assemblies. Steel-clad tips assure long service life. Tip-element assemblies are quickly and easily changed by means of plug-in, one-screw installation. Black plastic housing. For operation from 110-120 volts, AC or DC.

Model 212LT. Wattage range, 300-650. ½" steel-clad tip. Built-in 7-watt spotlight controlled by a separate, rear-mounted switch. Shpg. wt., 1½ lbs.
46 N 848. NET.....11.07

Model 214LTN. Similar to above, but employs ¼" tip. Wattage range, 150-400. Less spotlight. Shpg. wt., 1¼ lbs.
46 N 889. NET.....9.77

Model 238LT. Designed for lighter soldering applications. Wattage range, 75-150. Employs ¼" steel-clad tip. Built-in 7-watt spotlight controlled by a separate, rear-mounted switch. Shpg. wt., 1 lb.
46 N 853. NET.....5.13

Model 238T. Same soldering gun as described above, but less spotlight and rear-mounted switch. Shpg. wt., 1 lb.
46 N 846. NET.....4.77

SOLDERING IRONS

Thermostatic action soldering irons. Excellent for delicate soldering operations, yet built to withstand "production line punishment." Ideal for all general-purpose applications. All models meet government specifications. Thermostatic action assures quick heating and higher wattage for heavier soldering jobs; thermostatic action also takes over to reduce wattage for light soldering jobs. Wattage control action prevents tipburning and maintains optimum heat. Have rugged, precision-wound elements. U.L. Approved. For operation from 110-120 volts, AC or DC. *Pencil types.

Stock No.	Mfr's Type	Watts	Tip	Lgth	Wt.	NET E.A.
46 N 851	18T*	25 to 85	¼"	7"	7 oz.	4.09
46 N 852	14T*	40 to 125	½"	8"	7 oz.	4.73
46 N 854	38T	80 to 200	¾"	12½"	2 lbs.	5.88

REPLACEMENT TIPS

*Walloy-Red tips for production line use.

Stock No.	Size	For	Wt.	NET EACH
46 N 874	¼"	18T	2 oz.	.73
46 N 875	½"	14T	2 oz.	1.18
46 N 876	¾"	38T	3 oz.	1.32
46 N 877	½"	18T	2 oz.	1.36
46 N 872	¼"	14T	2 oz.	.33
46 N 855	¾"	38T	3 oz.	.53

TIP-ELEMENT ASSEMBLIES

Either type fits any of the guns listed at left. Quickly and easily interchanged with plug-in and 1-screw installation. Steel clad.

Stock No.	Watts	Tip	Wt.	NET EACH
46 N 870	150-400	¼"	12 oz.	3.32
46 N 846	300-650	½"	1 lb.	5.32

GREGG MODEL G-250-A 250-WATT SOLDER GUN

New, heavy-duty 250-watt solder gun featuring unique, single-barrel design. Delivers large volume of instant heat for most heavy-duty applications. Slim, probe-type 5" barrel easily reaches into tight places; permits critical work with minimum danger of damage to other components and insulation. An excellent gun for working on crowded chassis and miniaturized units. Efficient, built-in transformer brings gun to full working heat in only 2 seconds; no time is lost waiting for "warm-up."

Built-in spotlight focuses directly on work for excellent visibility; illuminates the deepest area for greater soldering accuracy. Gun has features that permit use over long periods of time without strain or fatigue; well-balanced design for ease of handling; lightweight construction; comfortable pistol-grip handle and soft-action trigger control. Rugged, heavy-duty housing is constructed of high-impact plastic; built to withstand plenty of punishment and continuous usage.

Supplied complete with 2 interchangeable tips — 1 pencil-point tip, excellent for delicate jobs; and 1 chisel tip for heavier soldering jobs. Desired tip type can easily be changed in a matter of seconds; no need for fumbling with set screws, wrenches, or additional tools of any kind. Simply screw tip into head of probe-type barrel—you're ready to start soldering. For operation from 110-120 volts, 60 cycle AC. Shpg. wt., 3 lbs.
46 N 834. NET.....11.62

REPLACEMENT TIPS

High-quality replacement tips for Gregg Model G-250-A solder gun, listed above. Shpg. wt., 6 oz. 2 per pkg.

Stock No.	Mfr's Type	Description	NET EACH PER PKG.
46 N 973	5211	Pencil Point	35¢
46 N 974	5212	Chisel Type	35¢

Soldering Pencils and Irons

UNGAR SOLDERING EQUIPMENT

HEAVY-DUTY SOLDERING KIT



Complete extra-duty soldering kit and continuity tester. Kit includes a No. 2036 heavy-duty soldering unit (825° F) for radio, TV, and electrical appliance repair, and a No. 535 precision soldering unit (650° F) for printed circuits and miniature parts repair. Soldering units screw into socket of soldering pencil handle. Units are interchangeable to suit specific applications. Molded plastic handle with cork grip and flexible lightweight cord. Kit also includes a circuit tester with adapter and leads; trouble light; a roll of solder; 20 assorted terminal connectors; 1 sheet emery paper; roll of electrical insulating tape; and illustrated instruction booklet. All parts store in carton when not in use. Underwriters' Laboratories Approved. For operation from 110-120 volts, AC or DC. Wt. 1 lb.

46 N 657, NET EACH.....4.49
6 or More, EACH.....3.99

SOLDERING AND BURNING KIT



Soldering and burning set for hobbyists. Includes #776 heat element, 6 assorted tips (cutting, soldering, embossing tile, etc.), 5 sheets of metal foil, abrasive paper, and instructions. U.L. Approved. For operation from 110-120 v., AC or DC. Shpg. wt., 1 lb.

46 N 604, NET.....2.70
6 or More, EACH.....2.25

REPLACEMENT ELEMENT AND TIPS. For above set. Av. shpg. wt., 2 oz.

Stock No.	Mfr's Type	Description	NET EACH
46 N 498	121	Tile Cutter	18c
46 N 664	936	Pyramid Tip	18c
46 N 668	123	Brass Tip	12c
46 N 669	122	Knife Tip	18c
46 N 667	267	Heat Element	75c



SOLDERING PENCILS

Small, lightweight soldering pencils. Excellent for almost all soldering jobs including production line, kit assembly, and printed-circuit soldering. Interchangeable element-tips. Molded plastic handle, perfectly balanced. Flexible lightweight tinsel cord; form-fit cork grip. Ceramic insulation. Length, 7". U.L. Approved. For 110-120 v., AC or DC.

No. 776, Cord and handle. Less tip and element. Shpg. wt., 5 oz.
46 N 591, NET EACH.....1.18
10 or more, EACH......95c

With Element-Tip. Soldering pencil with No. 776 cord and handle and No. 536 standard element-tip. 23½ watts. Shpg. wt., 6 oz.
46 N 580, NET EACH.....2.16
10 or more, EACH.....1.75

With 37½-Watt Element-Tip. Soldering pencil with No. 776 cord and handle and No. 1236 production element-tip. Wt., 8 oz.
46 N 591, NET EACH.....2.35
10 or more, EACH.....1.91

No. 880, New cord and handle for "Super Hi-Heat" element-tips. Same as No. 776, except with special metal heat reflector and high-temperature insulation. Less tip and element. Shpg. wt., 5 oz.

47 N 094, NET EACH.....1.57
10 or more, EACH.....1.27

With 47½-Watt Element Tip. Soldering pencil with No. 880 cord and handle and No. 4036 heavy-duty element-tip. Wt., 1 lb.
47 N 095, NET EACH.....3.92
10 or more, EACH.....3.18

STANDARD ELEMENT-TIPS

For use with No. 776 handle above. High-strength ceramic insulation. *23½-watt types; heat to 650-700° in 1 minute. †37½-watt, 800° units; excellent for use in production soldering. Av. shpg. wt., 3 oz.

Stock No.	Fig.	Mfr's Type	Descrip.	1-9, EACH	10-Up, EACH
46 N 582	F	536*	Pyramid	98c	79c
46 N 585	E	539*	Pyramid		
46 N 592	F	1236†	Pyramid	1.18	96c
46 N 593	E	1239†	Chisel		

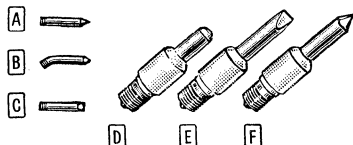

INTERCHANGEABLE TIPLETS

Designed especially for elements below. 1½" dia. 1" long; threaded to fit 535, 1235 or 4035 elements. Use 776 cord and handle. All tiplets are interchangeable, so a single element can do the work of three points. PL types are iron plated for easier tinning and longer life. Av. shpg. wt., 2 oz.

Stock No.	Fig.	Mfr's Type	Descrip.	1-9, EACH	10-Up, EACH
46 N 606	A	331	Pencil		
46 N 607	B	332	Offset	16c	13c
46 N 608	C	333	Chisel		
46 N 495	A	PL331	Pencil		
46 N 496	B	PL332	Offset	47c	38c
46 N 497	C	PL333	Chisel		

ELEMENTS

For tiplets above. Type 535 is 23½-watt element; Type 1235, 37½-watts; Type 4035, 47½-watts. Av. shpg. wt., 1 oz.

Stock No.	Fig.	Mfr's Type	Descrip.	1-9, EACH	10-Up, EACH
46 N 605	D	535	Element	.98	.79
46 N 609	D	1235	Element	1.18	.96
46 N 622	D	4035	Element	2.35	1.91

"SUPER HI-HEAT" ELEMENT-TIPS

47½-watt, one-piece element-tips for extra-heavy-duty service and production line soldering. 850-1000 degree heat. Use with No. 880 cord and handle described at left. Specially processed iron plating resists pitting and oxidation and eliminates need for filing. #¼" chisel. †¾" chisel. Av. shpg. wt., 12 oz.

Stock No.	Fig.	Mfr's Type	Descrip.	1-9, EACH	10-Up, EACH
46 N 647	E	4033*	Chisel		
46 N 648	F	4036	Pyramid	2.35	1.91
46 N 649	E	4039†	Chisel		

DRAKE GENERAL-PURPOSE AND INDUSTRIAL IRONS

Heating Elements Made of High-Grade Nichrome Wire

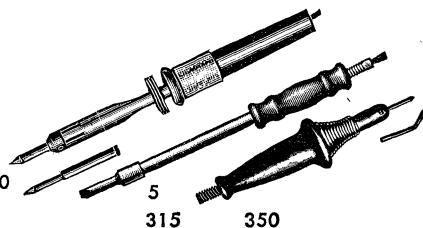
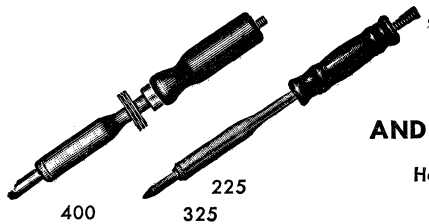

High-quality, dependable soldering irons. Ruggedly built and perfectly balanced. Heating elements are of the finest grade nichrome wire. Comfortable, fitted handles, thermally insulated to assure cool operation. Metallic parts are blue finished. A wide selection of models to cover every application, from printed circuits to production line.

MODEL 400 INDUSTRIAL—60 WATTS

A small, industrial, continuous-duty 60-watt soldering iron for close, delicate work. Only 9" long with ¼" pyramid tip. Weighs only 8 ounces. Baffle plates radiate heat away from handle. Complete with 6-ft. heater cord, plug and stand. Shpg. wt., 14 oz.
46 N 538, List, \$6.50. NET.....3.82

STANDARD MODELS

Model 225—80 Watts. A general-purpose 80-watt soldering iron. For medium duty. Element is nichrome, wound on amber mica. Overall length 13½" including ¾" adjustable pyramid tip supplied. Complete with 6-ft. cord, plug and stand. Shpg. wt., 1¼ lbs.
46 N 522, List, \$6.00. NET.....3.53

Model 325—100 Watts. Lightweight, general-purpose iron—provides plenty of heat for virtually all soldering jobs. Nichrome element, on amber mica. 13" overall length; with ¾" adjustable pyramid tip. 6-ft. cord, plug and stand supplied. Shpg. wt., 1¼ lbs.
46 N 523, List, \$6.50. NET.....3.82

ECONOMY MODELS

Model 5—40 Watts. Low-cost, light-duty soldering iron. Overall length, 10". Supplied with ¼" pencil tip (screw-on type). Complete with 6-ft. cord, plug, and stand. Shpg. wt., 10 oz.
46 N 505, List, \$2.10. NET.....1.23

Model 315—80 Watts. Quick-heating, general-purpose soldering iron. Excellent for light-duty applications in radio-TV servicing, garages, etc. Has screw-on type ¾" pyramid tip, length, 11½". Complete with 6-ft. cord, plug and stand. Shpg. wt., 12 oz.
46 N 521, List, \$2.80. NET.....1.65

Industrial model is designed for use in production lines, shops, etc. Standard models are for medium-duty and general radio-TV work. "Pee-Wee" and Midget irons useful for fine work such as soldering voice coil leads, meter connections, crystal pickups, etc. U.L. Approved. For 110-120 v., AC or DC. Replacement tips for all types listed below.

MODEL 350 MIDGET—35 WATTS

A compact, high-quality midget soldering iron for delicate work. Rated at 35 watts for continuous duty. Supplied with two tips—½" straight tip, and extra tip bent at 45 degrees. 7" long. With 6-ft. cord, rubber plug and stand. Shpg. wt., 13 oz.
46 N 539, List, \$6.00. NET.....3.53

MODEL 360 "PEE-WEE"—35 WATTS

A 35-watt iron for delicate work. Only 7½" long—small enough to easily fit in the serviceman's tool kit. Extremely light in weight and easy to handle. Supplied with ¾" and ¼" pyramid tips; 5-ft. cord, plug and stand. Cork insulator on handle; heat-radiating baffles on element keep handle cool. Shpg. wt., 8 oz.
46 N 532, List, \$5.50. NET.....3.23

REPLACEMENT TIPS

Exact duplicate replacement tips for all Drake general-purpose, midget and industrial model soldering irons listed above and at right. Made of high-quality copper. *Set of two tips.

Stock No.	For Use With Model No.	Description	Wt., Oz.	NET EACH
46 N 537*	5	½" pencil, straight	3	44c
46 N 535	225, 325, 326, 625	¾" pyramid	6	44c
46 N 514	315	¾" pyramid	6	53c
46 N 533*	360	¾" pyramid	2	18c
46 N 513	400	¼" pyramid	2	29c
46 N 547*	350	½" pencil, straight	2	15c
46 N 548*	350	½" pencil, 45°	2	15c

Soldering Irons and Pots

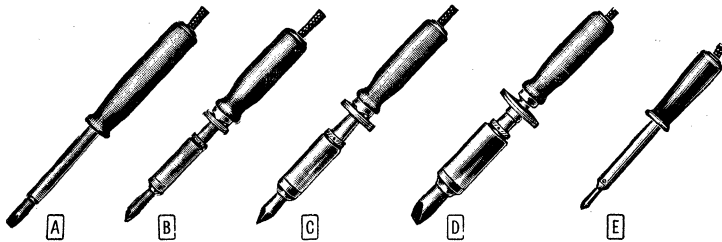

AMERICAN BEAUTY SOLDERING IRONS

Wide selection of popular American Beauty soldering irons—includes a model to fit any soldering application. Special, iron-plated tips are available for all models; greatly reduce pitting and redressing. A great time-saver on production lines and in service shops—saves cost of frequent tip replacements. Casing and body of one-piece, seamless steel. Lightweight wood handles are cool and shatterproof; coated with durable rubberoid for extra comfort. With super-flexible 6-ft. heater cords to withstand repeated kinking, twisting and bending. Rated to withstand an insulation breakdown test of 1100 volts.

MODEL 3128—60-WATT

A Designed for light work. Uses $\frac{1}{8}$ " tip, making it handy for working in hard-to-get-at spots. With tip and stand. For 110-120 volts, AC or DC. Shpg. wt., 1 lb.
46 N 674, NET 4.05
6 or more, EACH 3.89

Type 3728. $\frac{3}{8}$ " solid copper replacement tip for Model 3128 iron. Shpg. wt., 3 oz.
46 N 675, NET 30¢

Type 3728-IP. $\frac{1}{4}$ " iron-plated tip for Model 3128 iron. Shpg. wt., 2 oz.
46 N 820, NET 57¢

Type 9272. Replacement Element. For Model 3128, 60-watt element. Mica insulation. Includes handle-spring, tube and terminal assembly. Shpg. wt., 6 oz.
46 N 670, NET 2.19

MODEL 3138—100-WATT

B Length 12 $\frac{3}{4}$ " $\frac{3}{8}$ " tip. Polished chrome plated metal parts. Has cooling baffle. With stand and tip. For 110-120 volts, AC-DC. Shpg. wt., 2 $\frac{1}{4}$ lbs.
46 N 655, NET 6.44
6 or more, EACH 6.16

Type 3738. $\frac{3}{8}$ " solid copper replacement tip for Model 3138 iron. Shpg. wt., 4 oz.
46 N 656, NET 42¢

Type 3738-IP. $\frac{3}{8}$ " iron-plated tip for Model 3138 iron. Shpg. wt., 5 oz.
46 N 821, NET 69¢

Type 9273. Replacement element for Model 3138 iron. Shpg. wt., 1 lb.
46 N 666, NET 2.66

MODEL 3118 "BANTAM"—30-WATT

E Dependable 30-watt iron for light-duty soldering. For continuous or intermittent use. $\frac{1}{8}$ " copper tip. Only 6 $\frac{1}{2}$ oz. Nickel-chromium element, mica insulated. For 110-120 v. AC or DC. Shpg. wt., 1 $\frac{1}{2}$ lbs.
46 N 890, NET 3.68
6 or more, EACH 3.52

MODEL 3158—200 WATTS

C For medium-heavy factory and production work. Also excellent for maintenance of industrial electronic equipment. Length, 13 $\frac{3}{4}$ "; tip dia., $\frac{5}{8}$ "; weight, 28 oz. With cord, stand and tip. For 110-120 volt AC-DC operation. Shpg. wt., 3 lbs.
46 N 650, NET 7.52
6 or more, EACH 7.20

D Excellent heavy-duty soldering iron. Ideal for service and production work. Standard equipment in factories and shops. Length 14 $\frac{3}{4}$ "; tip dia., $\frac{7}{8}$ "; net wt., 2 $\frac{1}{2}$ lbs. With cord, stand and tip. For 110-120 volts AC or DC. Shpg. wt., 4 lbs.
46 N 671, NET 9.93
6 or more, EACH 9.51

REPLACEMENT TIPS AND ELEMENTS

For Model 3158 iron. Tips are $\frac{5}{8}$ ". Element is made of chrom-ni. wire on mica insulated steel rod. Shpg. wt., 1 lb.

Stock No.	Mfr.'s Type	Description	NET EACH
46 N 652	3758	Copper tip	.98
46 N 822	3758-IP	Iron-plated tip	1.35
46 N 665	9275	Element	3.53

MODEL 3178—300 WATTS

REPLACEMENT TIPS AND ELEMENT

For Model 3178 iron. Shpg. wt., 1 lb.

Stock No.	Type	Description	NET
46 N 672	3778	$\frac{1}{4}$ " Copper tip	1.92
46 N 823	3778-IP	$\frac{1}{4}$ " Iron-plated tip	2.37
46 N 673	9277	Element	4.79

MODEL 3178—300 WATTS

Excellent heavy-duty soldering iron. Ideal for service and production work. Standard equipment in factories and shops. Length 14 $\frac{3}{4}$ "; tip dia., $\frac{7}{8}$ "; net wt., 2 $\frac{1}{2}$ lbs. With cord, stand and tip. For 110-120 volts AC or DC. Shpg. wt., 4 lbs.
46 N 671, NET 9.93
6 or more, EACH 9.51

MODEL 3118 "BANTAM"—30-WATT

Model 3120. Same as 3118, but $\frac{3}{8}$ " tip.
46 N 891, 6 or more, EA.... 3.52 **EA.**... 3.68
Type 3718 Tip. For Model 3118 iron.
46 N 884, NET 16¢
Type 3720 Tip. For Model 3120 iron.
46 N 885, NET 20¢

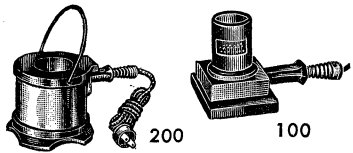

DRAKE SOLDER POTS

Model 200—300 Watts. Heavy-duty production type solder pot. Designed for continuous duty. Excellent for dip soldering wires, plugs, coils and printed circuits. Large well, 2 $\frac{1}{2}$ " in diameter x 2" deep holds up to 2 lbs. of solder. Special nichrome heating element for maximum heat transfer. With detachable cord and plug set. Extension lip to prevent hot solder from damaging cord plug. Convenient handle for easy carrying—even when hot. For 110-120 v., AC or DC. Shpg. wt., 6 lbs.
46 N 555, List, \$12.00, NET 7.06

Model 100—150 Watts. Ideal solder pot for general light-duty work. Excellent for tinning stranded wires, component leads, plugs and assemblies, etc. Heating element is genuine nickel-chromium, precision-wound on ceramic core. Well, 1 $\frac{1}{2}$ " diameter by 1" deep. Holds 1 lb. of solder. With cord. For 110-120 volts, AC or DC. Shpg. wt., 3 lbs.
46 N 556, List, \$9.50, NET 5.59

QUALITY SOLDER POTS

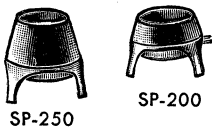

LECHTROM SOLDER POTS

High-quality solder pots designed to withstand rigor of continuous operation. Excellent for use in tinning small wires and leads, RF coils, plugs and assemblies, etc. Ideal for radio, motor, and other electrical equipment shops where individual solder melting pots are used for dipping. Particularly recommended for production line use. Sturdily constructed. Made of cast iron, mounted on cadmium-plated steel stands. Sizes—SP-200: 2 $\frac{3}{4}$ " ht., 2 $\frac{3}{8}$ " dia., $\frac{7}{8}$ " cup depth; SP-250: 3 $\frac{1}{2}$ " ht., 2" dia., 1 $\frac{3}{4}$ " cup depth. Complete with 6 foot detachable cord. For 110 volt operation, AC or DC.

Stock No.	Type	Capac.	Watts	Wt.	NET
46 N 880	SP-200	1 $\frac{3}{4}$ lbs.	200	3 $\frac{1}{4}$ lbs.	4.98
46 N 881	SP-250	2 lbs.	250	3 $\frac{1}{2}$ lbs.	4.98

Replacement Nickel-Chrome Elements.
 Shpg. wt., 3 oz.
46 N 882, Type A. For SP-200. **NET** .. 1.42
46 N 883, Type B. For SP-250. **NET** .. 1.42

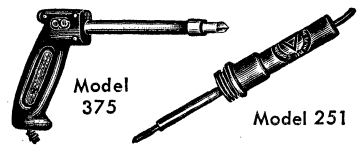

LENK SOLDERING IRONS

ECONOMY PISTOL GRIP SOLDERING IRON

Model 375. Popularly priced, all-purpose, 80-watt pistol grip soldering iron. Designed for efficient, long-lasting use. An excellent iron for servicemen, hobbyists, home owners and mechanics. Cool, convenient pistol grip handle is perfectly balanced for easier soldering with less fatigue. Has highly dependable, heavy-duty heating element. Heavy chrome-plated barrel. Tip diameter, $\frac{3}{8}$ ". Underwriters' Laboratories Approved. For operation from 110-120 volts AC or DC. Wt., 1 $\frac{1}{4}$ lbs.
46 N 638, NET EACH 2.57

REPLACEMENT TIP

For use with Model 375, above. Tip diameter, $\frac{3}{8}$ ". Shpg. wt., 1 $\frac{1}{4}$ lbs.
43 N 714, NET 48¢

PENCIL TYPE IRONS

Model 251 Pencil Type 25-Watt Soldering Iron. $\frac{1}{8}$ " dia. tip. Light-weight, compact, and extremely sturdy. Weighs only 4 oz. Ideal for tight-chassis jobs; perfect for production line use and printed circuits. Copper tip is nickel plated. Construction features silver nichrome element, Madagascar mica, and a brass core. Tiny stainless steel barrel and small tip permit easy access to tight spots or crowded chassis wiring. For operation from 110-120 volts AC or DC. Shpg. wt., 8 oz.
46 N 940, NET EACH 4.41

Type 256. Same solder iron as Model 251 described above, but for heavier work. Rated at 40 watts. Shpg. wt., 8 oz.
46 N 941, NET EACH 4.41

REPLACEMENT TIPS

$\frac{1}{8}$ " Tip. Replacement tip for Models 251 and 256 soldering irons, above. Size, $\frac{1}{8}$ " dia. by 3" long. Shpg. wt., 3 oz.
46 N 942, NET 33¢

$\frac{1}{4}$ " Tip. For applications requiring larger tip area for above soldering irons. Increases versatility of pencil irons. Shpg. wt., 3 oz.
46 N 946, NET 48¢

LENK BLOW TORCH

Model 108. Handy, small-size alcohol torch for light jobs. A valuable aid for the average home or light service work. Easily fits into coat pocket or tool chest. Copper heat conductor attached to wick insures instant starting. Curved nozzle on power tube is positioned over top of flame tube. Screw caps on top and bottom of flame tube permit quick filling and prevent leakage. Double barrel, self-generating. Both tubes made of heavy nickel-plated steel for long-lasting service. Screw-on cap protects nozzle when not in use. Burns either commercial or denatured alcohol. Economical fuel consumption. Overall size, 5 $\frac{1}{2}$ x2x1". Shpg. wt., 1 lb.
43 N 701, NET 2.06



AMERICAN BEAUTY "475" TEMPERATURE REGULATING STAND

Thermostatically controlled to maintain soldering iron temperature—even while the iron is connected to current and not in actual use. Merely set thermostat for any heat you desire. Eliminates heat variations and overheating. Increases soldering iron element life, particularly when iron must be used continuously without oxidation of soldering iron tip. Perfect for production line and service bench. Molded plastic body. Soldering iron cradle is tough copper alloy—permits maximum transmission of heat from soldering iron to thermostat of stand. Has heater cord and plug-in receptacle. For use with soldering irons from 80 to 660 watts input. Less iron. Shpg. wt., 2 $\frac{1}{2}$ lbs.
46 N 658, NET 5.25



Power Tool Kits—Soldering Accessories

ORYX MINIATURE SOLDERING IRONS

Extremely Light in Weight

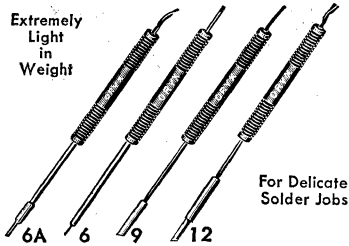

For Delicate Solder Jobs

¼-OUNCE SOLDERING IRONS

Perfect for the most delicate soldering—printed circuits, TV tuners, sub-miniature wiring, hearing aids, etc. Quick heating, low-voltage design. Operate from 6-v. AC or DC. Use with step-down transformer (below) or other 6-v. source. All are ¼ oz. and 6" long, *except ¾ oz. and 7¼" long. All have replaceable tips, (except fixed tip). Tips are described in the replacement table (below). *Develops 813° F for high-temperature applications. Av. shpg. wt., 2 oz.

Stock No.	Model	Tip Type	Watts	1-11, EACH	12 or More, EACH
46 N 817	76	fixed	6	4.85	4.36
46 N 818	6A	B	6	4.85	4.36
46 N 819	9-6	A	8.3	4.85	4.36
46 N 828	811	D	10	6.81	6.32
46 N 828	12-6	C	12	4.85	4.36
46 N 830	*18	F	18	7.35	6.91

REPLACEMENT TIPS

Precision replacement tips for all Oryx soldering irons except Model 6. Tips are made of a special copper alloy and are nickel plated to minimize the need for tinning and dressing. Tips D, E and G also have a pure nickel end for extra long life. Av. shpg. wt., 2 oz.

Stock No.	Type	For Model	Dia.	EACH
46 N 831	A	6A, 9-6	5/32"	.49
46 N 843	B	6A, 9-6	3/32"	.49
46 N 844	C	12-6	3/16"	.49
46 N 845	D	11	3/16"	1.76
46 N 845	E	11	3/16"	1.76
46 N 898	F	18	3/16"	1.22
46 N 899	G	18	3/16"	1.81

STEP-DOWN TRANSFORMER

For use with the Oryx soldering irons listed above. Has holder on top for soldering iron. Rated at 18 watts. With 4½-ft. AC cord. Size, 2¼x2¼". For operation from 110-120 v., 60 cycle AC. Shpg. wt., 2 lbs.
46 N 923. NET.....4.85



WALSCO MASTER PRINTED CIRCUIT REPAIR KIT

Model 12-K. Save time and minimize replacement of printed circuit components with this handy, versatile, repair kit. The Walsco 12-K Master Repair Kit is supplied with all the materials required for completing several printed circuit repair jobs. An extremely valuable outfit for the radio-TV service-shop, laboratory, as well as for use by Amateurs, experimenters, or anyone working with printed circuits. Permits quick, simplified repair jobs on resistors, capacitors, coils, wiring, tube sockets, lugs, copper foil, etc.

Kit includes: foil, solder washers; solder; "solder ease" tool for tightening contacts, etc.; fiberglass brush for removing excess solder; 6-oz. spray can of silicone resin lacquer; solvent for removing surplus solder; tweezers; practice wiring board; and an Ungar soldering iron with special tip. With instructions. 7x12½x3½". Shpg. wt., 1 lb.
46 N 465. List, \$13.25. NET.....7.79

DORMEYER "MATCHED CRAFT" TOOL SET

MODEL 5-3901 HOME WORKSHOP

- U. L. Approved Power Drill
- 1000 Home and Shop Uses

Complete, 50-piece home workshop set. Drills, saws, polishes, grinds, sands, etc., and contains everything the home craftsman or serviceman could ask for—at an unusually low price!

Workshop includes: The Model 5-2102 ¼" drill; horizontal drill stand; stationary drill press; nine 4" sanding discs (60 grit); six 4" sanding discs (120 grit); 4" sandpaper pattern; 3" buffing wheel; 4" rubber backing pad; 3" grinding wheel; set of seven assorted steel drill bits; 6-piece arbor set in plastic case; Model 110 saw attachment with rip fence—converts drill to highly useful 4" power saw; 4" combination saw blade; sturdy, tilting saw table with miter gauge and rip fence—miters, levels, crosscuts and rips; and rugged steel carrying case.

Model 5-2102 ¼" drill included in the set, is an indispensable home and shop tool. Has geared chuck to securely grip drill bits and attachments. Precision cut, hardened steel gears, in super-torque drive, deliver more "twisting power" at drill point. Comfortable, extra-long pistol grip provides easier handling and safety. Built-in switch lock; locks drill "on" or releases instantly. Self-lubricating bearings; smooth-operating motor powers all attachments with ease. No-load speed, 1800 rpm. Die-cast, polished aluminum housing.

The U.L. Approved drill operates from 110-120 v., AC or DC. Shpg. wt., 23 lbs.
46 NZ 396. NET.....34.95

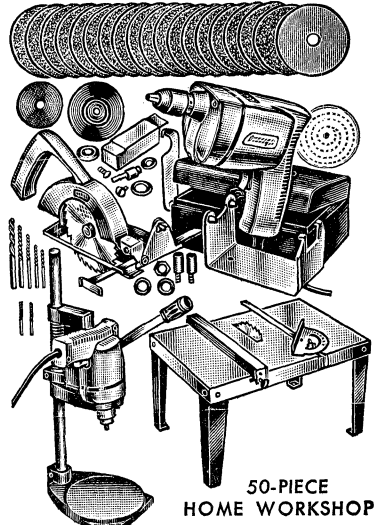

50-PIECE HOME WORKSHOP

POPULAR THOR ¼" DRILL KITS

Give Years of Dependable Service

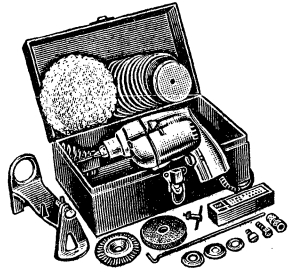

MODEL 201-JK DRILL KIT

Highly useful electric drill kit. Features powerful ¼" electric drill and all the accessories needed for home or shop use. Kit includes: Model 201-¼" electric drill; 7 assorted drill bits; handy Speed Stand for mounting drill horizontally on workbench; grinding wheel; wire scratch brush; cloth buff; 10 sanding discs; 4½" wool polishing bonnet; 4" rubber backing plate for sanding discs and bonnet; steel paint stirrer; adapters, flanges, etc. The 201-J drill has a no-load speed of 2400 rpm; full-load speed, 1500 rpm. Other features of this excellent power drill include: Geared chuck with key; momentary contact switch with locking pin; air-cooled, specially-wound high-torque motor; polished, die-cast aluminum housing. Steel carrying case. U.L. Approved. Drill operates from 110-120 volts, AC or DC. Shpg. wt., 8½ lbs.
46 N 369. List, \$27.95. NET.....19.16

MODEL 100-K DRILL KIT

The new "Speed Drill" kit is a complete basic workshop including a carefully selected set of high-quality attachments in a rugged steel carrying case. Kit features: Model 100 electric drill with ¼" gear-type chuck. Has heavy-duty bearings and momentary-contact switch with locking pin. Highly practical, the case can be used for a handy storage bin, or easily carried to site of work. Contains accessories that enable you to quickly perform a large variety of jobs. Kit includes: 7 chrome alloy bits (¼" to ½"); 4½" lamb's wool polishing bonnet; sturdily constructed mounting stand; 10 sanding discs; 4" rubber backer; wire brush; linen buffer; paint stirrer; grinding wheel; generous supply of polishing compound; all adapting hardware; and a heavy-gauge, 8¼" long carrying case. For operation from 110-120 volts, AC-DC. Shpg. wt., 11 lbs.
46 N 534. List, \$35.00. NET.....24.00

THOR IMPACT WRENCH WITH 6 SOCKETS

MODEL 56K. New, heavy-duty ½" square-drive impact wrench with six of the most commonly used hex sockets. A tool of a thousand uses, the Model 56 impact wrench is perfect for production assembly work, automobile repair, maintenance of trucking fleets, servicing road-building equipment, maintenance of military vehicles, etc. The power of the rugged Model 56 impact wrench can easily be converted to drill into steel, wood, stone or concrete; it taps, drives and extracts studs. Fingertip reversing button allows speedy setting and removal of nuts; driving and removing of screws; and, with chuck (listed below), converts into a powerful electric drill with ½" diameter capacity. Well-balanced pistol-grip handle minimizes fatigue. Soft-touch, instant trigger-action reduces strain on any job. Speed (forward and reverse), 1900 rpm.; Blows per minute, 1900. Complete with six sockets (sizes ½", ¾", 5/8", 1¼", 3/4" and 3/8"); 15-ft., 3-conductor cable; and 3-prong plug and adapter with grounding wire. Length, 9½". U.L. Approved. For 110-120 v., 60 cycle AC. Shpg. wt., 9 lbs.
46 N 793. List, \$94.50. NET.....69.15

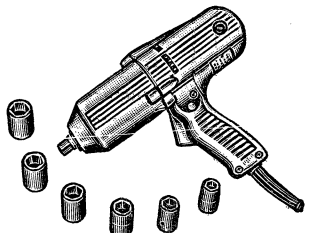

MODEL C558. Gears, 3-jaw chuck for converting Model 56K impact wrench to drill. Holds drill bits, reamers, taps, etc., to ½" dia. Shpg. wt., ¾ lb.
46 N 794. List, \$9.50. NET.....6.82

For complete selection of Thor power tools, see pages 316, 318 and 319.

Electric Drills—Bits

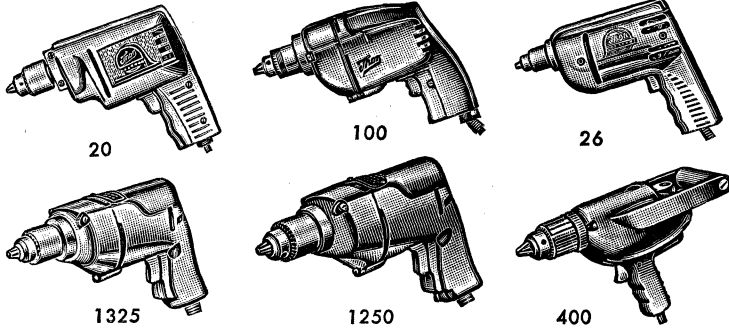

THOR QUALITY ELECTRIC DRILLS

1/4" DRILLS

Model 20. An excellent buy in an efficient 1/4" electric drill. For servicemen, hobbyists, etc. Gear-type chuck takes shanks up to 1/4" diameter. Drills holes to 1/4" diameter in steel, and to 1/2" diameter in hardwood. Self-aligning, ball-thrust bearings assure smooth operation. Has locking pin on momentary-contact trigger switch. No-load speed, 2400 rpm; full-load speed, 1500 rpm. 7" long. U.L. Approved. For operation from 110-120 volts, AC or DC. Shpg. wt., 3 1/4 lbs.
50 N 009, List, \$18.95. NET.....12.95

Model 100. Powerful 1/4" electric drill. Designed for rugged use. Series-wound universal motor develops high torque. Reliable 3-jaw geared chuck with tightening key. Chuck takes drill shanks up to 1/4" diameter. Speed: 2000 rpm no-load, 1200 rpm full-load. Trigger-type, momentary action switch with locking pin. Ball-bearing on chuck spindle; oilless bronze elsewhere. No-load speed, 1000 rpm; full-load speed, 650 rpm. Length, 9 1/2". Polished, cast aluminum housing. 6-ft., 3-conductor cord. U.L. Approved. For operation from 110-120 v., AC or DC. Shpg. wt., 5 lbs.
46 N 370, List, \$25.00. NET.....17.15

3/8" DRILL

Model 1325. New, heavy-duty 3/8" drill ideally suited for home, farm, and industrial work. Has 3/4" geared chuck with key. Momentary-contact trigger switch with locking pin. Ball-bearing on chuck spindle; oilless bronze elsewhere. No-load speed, 1000 rpm; full-load speed, 650 rpm. Length, 9 1/2". Polished, cast aluminum housing. 6-ft., 3-conductor cord. U.L. Approved. For operation from 110-120 v., AC or DC. Shpg. wt., 5 lbs.
46 N 998, List, \$39.50. NET.....28.90

Model 26. New, power-packed 1/4" drill featuring ball-bearing design for ultra-smooth operation. Excellent for wide variety of jobs—maintenance, farm, garage, etc. 1/4" geared chuck with key. Has anti-friction, heavy-duty thrust ball bearing on spindle. Die-cast, all-aluminum housing. Speed: 2200 rpm no-load, 1400 rpm full-load. Trigger type switch with convenient locking pin. Length, 9". Equipped with 10-ft., 3-conductor cord. U.L. Approved. For 110-120 v., AC or DC. Shpg. wt., 5 lbs.
46 N 999, List, \$29.95. NET.....20.55

Model 1250. Heavy-duty 1/4" drill with extra-rugged motor. Designed to give years of service under the most severe conditions. Features sealed, anti-friction, ball-thrust and needle-spindle bearings. Gear-type chuck takes up to 1/4" diameter shanks. Drills holes to 1/4" diameter in steel, 1/2" in hardwood. No-load speed, 2000 rpm; full-load, 1300 rpm. Length, 9", 10-ft., 3-conductor cord. U.L. Approved. For 110-120 volts, AC or DC. Shpg. wt., 5 lbs.
46 N 454, List, \$44.00. NET.....32.14

1/2" DRILL

Model 400. Power and performance are combined in this heavy-duty 1/2" drill. Aluminum housing. Removable side-handle for close drilling. Heavy-duty radial and end-thrust ball bearings on spindle. Other bearings, self-aligning bronze. No-load speed, 650 rpm; full-load, 425 rpm. 1/2" geared chuck with key. Momentary contact switch with locking pin. 3-wire line cord. U.L. Approved. For 110-120 volts, AC or DC. Shpg. wt., 11 lbs.
46 N 455, List, \$39.50. NET.....27.10

WEN QUALITY DRILLS

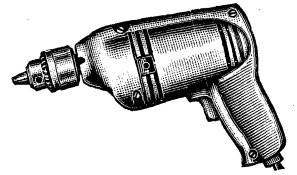

MODEL 707 3/8" DRILL

Powerful 3/8" drill for less than the cost of many 1/4" drills. Has power to spare. Ideal tool for automobile body shops, construction work, home workshop, etc. Uses helical gears for very quiet operation. 3/8" geared, Jacobs-type chuck with key; takes drill shanks to 3/8" diameter. Drills holes to 3/8" diameter in steel, to 3/4" in hardwood. No-load speed, 1100 rpm; full-load speed, 800 rpm. Ideal for tough drilling jobs. Can be used with carbon steel bits for regular work; with masonry bits to drill stone, marble or concrete. Overall length, 9". U.L. Approved. For operation from 110-120 volts, AC or DC. Shpg. wt., 4 1/4 lbs.
46 N 458, List, \$26.95. NET.....19.81

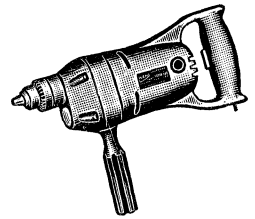

NEW MODEL 808 3/8" DRILL

Unique, extremely versatile, 2-speed drill featuring dual power take-offs. Simply insert chuck into high-speed power take-off for effortless drilling through steel, wood, aluminum, brass, or copper; insert chuck into low-speed power take-off for drilling through such materials as masonry and concrete. Extra grip-handle included for maximum ease of handling at either speed. Squeeze-type switch with "lock-on" button; comfort-grip "D"-type handle. High speed, 3000 rpm; low speed, 1000 rpm. Overall length, 12 1/4"; 6-ft. heavy-duty rubber-covered cord. U.L. Approved. For 110-120 v., AC-DC. Shpg. wt., 5 lbs.
46 N 947, List, \$29.95. NET.....22.01

CENTURY "MAGIC BLACK" MECHANICS' HI-SPEED DRILL SETS

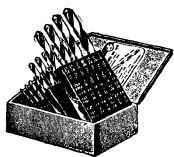

13-Drill Set

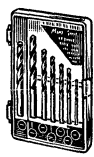

7-Drill Set



5-Drill Set



Features
"Magic Black"
Tempering
Treatment



Drill Only

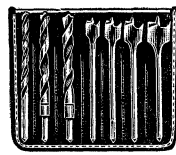

Auger Bit Set

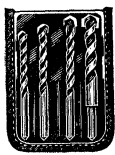

Masonry Set

Complete assortment of top quality drill bits. Feature "Magic Black" tempering treatment; insures extra wearing qualities and makes drill bits stay sharp longer. "Quick-Cut" point (on 3/8" and larger) greatly reduces load on electric drill. Four cutting edges instead of two, eliminate "walk" and "wander," give twice the penetration with half the pressure.

5-Drill Set. Includes 5 drills, 1/4" to 1/2" in 1/8" graduations. Have 1/4" diameter shanks. With handy, indexed container of transparent plastic; drill bits are easily visible for quick selection. Shpg. wt., 1 lb.
46 N 785. NET.....6.90

7-Drill Set. 7 drills, 1/8" to 1/4" in 1/2" graduations. Shank sizes same as drill diameters. Supplied in handy, hinged, clear plastic container. All units are conveniently indexed so that desired drill bit can be located immediately. Shpg. wt., 6 oz.
46 N 784. NET.....2.86

13-Drill Set. Includes 13 drills, 1/16" to 1/2" in 1/16" graduations. Packed in Huot Index Drill Case. Opens like a book with every drill instantly accessible and identified. Case size, 4 3/4"x2 3/4". Shpg. wt., 9 oz.
46 N 782. NET.....5.37

15-Drill Set. 15 quality drills, 1/16" to 1/2" in 32nds. Sizes over 1/4" have 1/4" shank. Huot Case has space for 14 more drills in 1/16" graduations. Case, 7x4x1 3/8". Shpg. wt., 3 lbs.
46 N 786. NET.....16.63

60-Drill Set. Complete assortment of 60 drills, in drill sizes 1 to 60. Packed in a steel Huot Index Drill Case for protection and maximum accessibility. Case opens like book for quick selection of desired bit. Size of case, 4 3/8"x3 3/8"x 2 1/8". Shpg. wt., 1 1/4 lbs.
46 N 717. NET.....21.90

SPECIAL-PURPOSE DRILL SETS

4-Piece Masonry Drill Set. 1/4", 3/8", 3/4" and 1/2" shanks fit standard 1/4" electric drills. Carbide tips for drilling concrete, bricks and plaster. In plastic roll. Shpg. wt., 5 oz.
46 N 718. NET.....3.17

7-Piece Auger Bit Set. 1/4" to 1" in 8ths. Have 1/4" shanks to allow use in standard 1/4" electric drill. In convenient, space-saving plastic roll. Shpg. wt., 11 oz.
46 N 719. NET.....3.65

Chrome Steel Drill Bit Set. Set of 5 chrome-alloy steel bits for electric drills. For use on aluminum and other soft metals, wood and plastic. Sizes, 1/4", 3/8", 3/4", 1/2" and 1/4". Have 1/4" shanks to fit all standard drills. In hinged, clear plastic box. Shpg. wt., 1 lb.
46 N 787. NET.....2.90

"MAGIC BLACK" INDIVIDUAL DRILLS

High-speed drill bits in sizes from 1/16" to 1/2". Drills are machined from solid tungsten-molybdenum stock. Feature "Magic Black" super-hard temper. Drills are individually packaged in plastic cylinders. Sizes over 1/4" have 1/4" shank. Av. shpg. wt., 3 oz.

Stock No.	Size	NET	Stock No.	Size	NET
46 N 723	1/16"	.19	46 N 734	1 1/2"	.56
46 N 724	3/16"	.22	46 N 735	1 3/4"	.61
46 N 725	1/4"	.24	46 N 737	1 1/2"	.81
46 N 726	5/16"	.24	46 N 739	3/8"	.94
46 N 727	3/8"	.26	46 N 741	1 1/8"	1.14
46 N 728	1/2"	.28	46 N 743	3/4"	1.32
46 N 729	5/8"	.32	46 N 745	1 1/4"	1.59
46 N 730	3/4"	.34	46 N 747	7/8"	1.87
46 N 731	7/8"	.44	46 N 749	1 1/8"	2.05
46 N 732	1 1/8"	.48	46 N 781	1/2"	2.34
46 N 733	1 1/4"	.53			

Power Drill Accessories

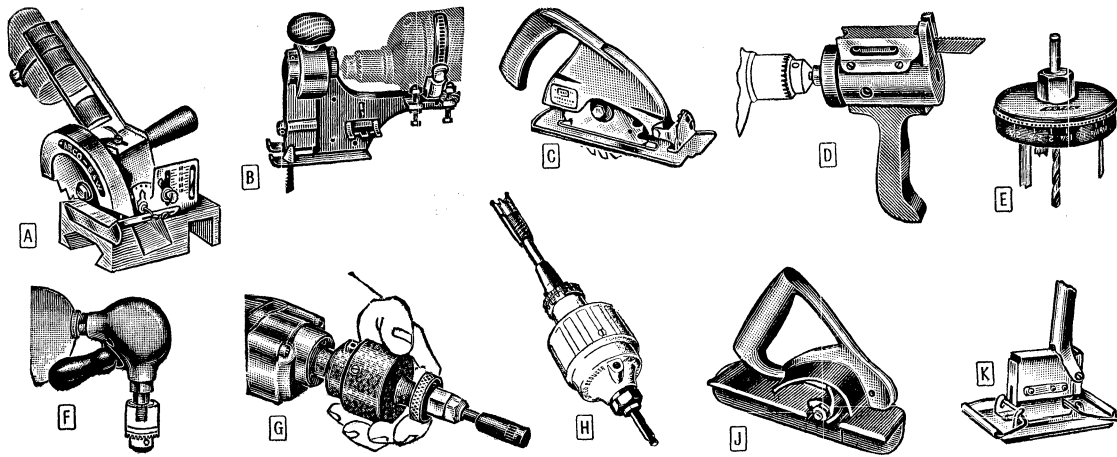

SHOP ATTACHMENTS FOR ELECTRIC DRILLS

Convert your portable power drill into a complete home workshop—and at a fraction of the cost of equivalent power tools. There's no fuss or bother—accessories listed below are designed to attach easily and quickly. You can use your drill as a power saw, a power screwdriver, a power planer, a sander or even as a power buffer and polisher.

You can drive wood, machine or sheet metal screws; cut holes in chassis bases, panels, ceilings or floors; drill between joists or shelves; plane across, with or against wood grain; cut plastics or metals; polish and sand; etc. These precision-made attachments guarantee excellent results. All are ruggedly built and designed for years of highly dependable service.

ARCO 456 SAW

A New, high-quality saw attachment designed to convert any 1/4" electric drill into a multi-purpose power saw. Has features normally found in power saws costing many times more. Has "Dado-Arbor" that swivels saw blade to cut any groove up to 1/2" wide by 1/2" deep in one cut; arbor easily removed when saw is to be used for accurate straight or angle cutting. Simple to attach. Adjustable for straight-cutting to depth of 1 3/4"; rip gauge and bevelling rip gauge from 0 to 45°. Includes sight for accurate cutting along guide lines. Gear case contains self-lubricating, lifetime bearings. Rugged, right-angle steel gear drive. Has extra-broad base for steadier rest and exceptional ease of handling. Includes safety yoke. Can be used with one hand. An excellent choice for the budget-wise serviceman, home hobbyist, carpenter or mechanic. Supplied complete with 5" Arco Safcut™ blade. Wt., 4 lbs. 50 N 000, List, \$12.95. NET..... 8.63

"ARCO-SAW" REPLACEMENT BLADES

High-quality 5" replacement blades for Arco 456. Tempered tool steel; 3/8" bore. Wt., 1/4 lb.

Stock No.	Mfr's Type	Description	EA.
50 N 001	250T	Safcut blade	1.33
50 N 002	252T	Crosscut blade	
50 N 003	253T	Rip blade	
50 N 004	255T	Combination blade	

BABCO JIGSAW ATTACHMENT

B Converts any electric drill for use as a portable jigsaw, hacksaw, keyhole or coping saw. Makes curved or straight cuts in wood, metal or plastic. Double-cam drive for smooth action; air piston blower removes particles. Includes 6 assorted blades and T Bar. Shpg. wt., 3 lbs. 46 N 385, List, \$11.95. NET..... 8.78

JIGSAW BLADES

Made of special long-life alloy saw blade steel. *Not for metal. Number after dash in Type No. indicates teeth/inch. Sizes: †3/4x3"; ‡9/16x3". Av. wt., 3 oz.

Stock No.	Mfr's Type	Description	EA.
46 N 386	201-6†	For general roughing	24¢
46 N 387	201-14†	For starting cut	24¢
46 N 388	203-6‡	For moderate contours	24¢
46 N 389	203-14‡	Contours in light metals	24¢
46 N 390	204-6*‡	Very close contours	29¢
46 N 391	205-10*‡	For stationary jigsaw	13¢

PET SAW ATTACHMENT

C Quickly converts any electric drill into a fast-cutting power saw. Valuable for custom installers, home craftsmen, etc. Can be used for mitering, grooving, dado cutting, pruning and general maintenance work. Attaches easily. Vertical cutting capacity to 1"; adjustable from 90° to 45°. With 4" combination rip and crosscut blade. Size, 1 1/4"x2 3/4"x5 1/2". Shpg. wt., 2 1/2 lbs. 46 N 279, List, \$7.50. NET..... 5.51

ROTEX B-22 SABRE SAW

D Highly useful attachment for 1/4" electric drills. Does the work of scroll saws, jigsaws, crosscut saws, rip saws, coping saws and bandsaws. Valuable for custom installers, home craftsmen, hobbyists, mechanics, etc. Exceptionally easy to handle. Cuts metals, wood, plastics, etc. Smooth, highly dependable operation. Blade locks in place to handle all work accurately and dependably. Lightweight design for effortless operation; aluminum die-cast one-piece case. Pistol-grip handle permits use of tool in almost any position. Complete with 3 blades: wood, steel, and scroll. Shpg. wt., 2 lbs. 45 N 869, List \$12.95. NET..... 9.52
Model SSB-30, Extra Set of 3 Blades. 5 oz. 45 N 871, List, \$1.00. NET..... 73¢

ROTEX B-50 HOLE SAW

E Adjustable hole-saw attachment featuring unique dial adjustment. Greatly increases usefulness of any 1/4" electric drill or drill press. Valuable aid to the hobbyist, serviceman, home craftsman, etc. Easily cuts holes from 1/4" to 2 1/2" in 1/4" steps, cleanly and without ragged edges. Just dial the size you want and start cutting! Sturdily constructed of heavy gauge steel for rugged use. Rabbeting or planing can be done by simply removing starter drill. Will cut to 1 1/8" depth. Shpg. wt., 1 1/2 lbs. 45 N 879, NET..... 5.11

BABCO 741 RIGHT-ANGLE DRIVE

F Right-angle drive unit for use with electric drills. A low-cost accessory that greatly increases the versatility of any electric drill. Unusually handy for drilling in confined spaces, such as between joists or shelves, crowded radio and TV chassis, etc. Highly recommended for radio-TV servicemen. Amateurs, electricians, plumbers, home owners, etc. Angle head fits the hand for easy guiding of drill and exerting pressure. Easy to attach. Chuck is unscrewed from electric drill and screwed on right-angle drive unit. Drive unit (3/8"-2 female threaded) is then screwed on to drill spindle. Provides choice of 2 speed ratios—halves drill speed for sanding wood or polishing painted surfaces; doubles speed for efficient sanding of metal surfaces. Shpg. wt., 1 lb. 46 N 268, List, \$4.49. NET..... 3.30

BABCO 825 5-1 SPEED REDUCER

G New, high-quality instantly reversing 5-to-1 speed reducer to fit any 1/4" electric drill or any drill press. Drives or removes up to No. 14 screws or nuts. Provides tremendous torque increase. For assembly of right or left-hand threaded parts, masonry drilling, drilling holes in wood, etc. Has 1/4" tap capacity; reversing feature makes this an excellent tool for hole tapping. Complete with 1/2" adapter, 1/4" adapter, screwdriver bit with fender sleeve for medium size slotted screws, sleeves to adapt collet chuck of speed reducer to fit tap sizes from 3/16" to 1/4", and sleeves to fit most popular slotted and Phillips screwdriver bits. Shpg. wt., 1 lb. 50 N 005, NET..... 10.99

BABCO 820 5-1 SPEED REDUCER

H New, economy-priced speed reducer for all 1/4" electric drills. Ideal for the hobbyist, electrician, home craftsman, mechanic, plumber, carpenter, general maintenance work, etc. 5-to-1 gear reduction produces large torque increase; provides more power at slower speed. Excellent tool for a wide variety of jobs: Drives up to No. 14 screws; drills up to 1 1/2" holes in masonry; drills large holes in wood; handles numerous assembly operations with ease. Has convenient grip-type hand clutch control; clutch is easily engaged or disengaged while drill is running. Simply grip the speed reducer, the clutch engages, and the working tool starts; release grip on the speed reducer to stop the working tool instantly (speed reducer will revolve freely when grip is released). Compact, lightweight design for fatigue-free operation. Quality constructed. Supplied complete with screwdriver bit with fender sleeve, 3/8" to 3/4" x24-thread adapter, 3/8" x24-thread to 1/2" x20-thread adapter, and 1/4" plain shaft to 3/8" x24-thread adapter. Wt., 1 1/2 lbs. 50 N 006, NET..... 7.31

ROTEX "ROTO-PLANE" ATTACHMENT

J Precision planer attachment for use with any 1/4" electric drill. Ideal for home craftsmen, carpenter, hobbyists, etc. Planes at any angle; easily glides with, across, or against grain of wood. Depth of cut is completely adjustable (0° to 1/16"). Guide edge provides automatic planing at a true 90 degrees—simplifies wood jointing. Diagonal shearing action eliminates deflections from knots, etc. Specially designed, double-flute steel cutter is deep hardened and precision ground. Planing width, 1 1/8". Entire unit is lightweight and perfectly balanced for fatigue-free handling. Has die-cast aluminum housing. With heavy-duty, permanently oil-impregnated bearings. Attractive baked hammerhead finish. With instructions. Shpg. wt., 3 lbs. 45 N 872, List, \$11.95. NET..... 8.78

ROTEX B-28 HACKSAW SANDER

K Excellent value in a work-saving two-in-one drill attachment. Use it with any 1/4" electric drill and you have a power hacksaw or sander. Highly versatile tool to provide a variety of applications for the home and workshop. Excellent for hobbyists, handymen, "do-it-yourself mechanics", etc.; saves hours of tedious work. Use as a sander for jobs ranging from general roughing to fine piano finishing. Easily converts to a hack-saw in a few seconds (fine or coarse blam for use on most cutting jobs. Sanding surface covers 3" by 5" to make any sanding job easy. Compact design allows easy access to those difficult-to-reach places. Constructed of rigid steel and aluminum for long, dependable service. Lightweight and perfectly balanced for effortless handling over long periods of time. Comfortable grip fits the hand for smooth control. Convenient, self-tightening clamp pulls and tightens sandpaper and locks into position. Comes complete with assorted sandpaper sheets of various grits, felt polishing pad, and pack of hack-saw blades. Shpg. wt., 2 lbs. 45 N 898, NET..... 7.31

Power Saws and Grinders

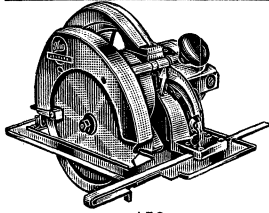

450

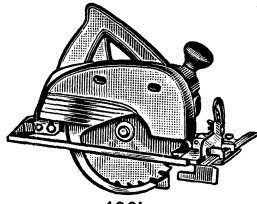

620L

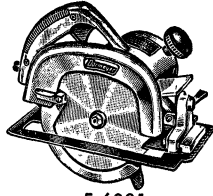

5-6001

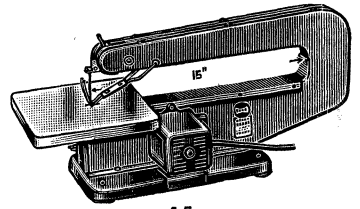

15

HIGH-QUALITY POWER SAWS

NEW THOR SPEEDSAW

Model 450. New, heavy-duty, power hand saw with all the requirements for trade use by carpenters and contractors. A fine addition to either a professional or a home craftsman tool kit. Rugged 1¼-hp (9 ampere) motor has no-load speed of 5500 rpm. Automatic blade guard with lifter handle for plunge cuts. Spring-loaded, ball-bearing mounted blade guard exposes only portion of blade required while cutting. Large 6½" blade cuts to 2½" depth at 90°; 1½" at 45°—cuts "2-by-4" at 45°. Minimum depth of cut, ½". Graduated angle adjustment easily adjusts to any angle between 90° and 45°. Momentary trigger switch with guard. With combination (rip and cross-cut) blade, 10-ft. cord with ground wire, and adjustable rip guide. For operation from 110-120 v., AC or DC. U.L. Approved. Shpg. wt., 15 lbs.

46 NX 788. List, \$49.95. NET.... 34.25
Extra Blade. Combination rip and cross-cut. 6½" dia. Shpg. wt., 10 oz.
50 N 007. NET.....1.84

SHOPMATE POWER SAW

Model 620L. New, lightweight, ruggedly constructed power hand saw. Exceptionally safe and easy to use. Features safety clutch to eliminate "kick-back" and reduce motor overloading if blade becomes jammed. Motor has precision-balanced armature for vibration-free performance. 6¼" blade cuts to 2½" depth at 90°; 1½" at 45°—will cut a dressed "2-by-4" at 45°. Motor speed: No load, 4700 rpm; full load, 3200 rpm. Rated at 7 amperes. Easily adjusts to any angle between 90° and 45°. Safety guard exposes blade only during cutting operation. Die-cast, aluminum alloy housing assures long service life. Complete with combination blade, 10-ft. cord with ground wire, and adjustable rip guide. For operation from 110-120 v., AC or DC. U.L. Approved. Shpg. wt., 14 lbs.

46 NX 242. List, \$48.88. NET.... 35.93
Extra Blades. 6¼" dia. Av. wt., 10 oz.
46 N 282. Combination. NET.....1.84
46 N 283. Cross-cut. NET.....1.84
46 N 284. Hollow-ground. NET.....3.86

DORMEYER POWER SAW

Model 5-6001. Power hand saw for the home craftsman, carpenter, custom installer, etc. Powerful motor (6½-ampere capacity) has no-load speed of 5500 rpm. Motor has self-lubricating sleeve bearings, plus ball thrust bearing on armature shaft to eliminate end-play. 6½" combination blade cuts to 2½" depth at 90°; 1½" at 45°—cuts 2" lumber at 45° angle. Has fingertip adjustment for bevel angle and depth of cut. Easily adjusts for any angle between 90° and 45°. Flat pedestal base for standing saw. Automatic telescoping guard exposes only portion of blade required while cutting. Plastic clip-on shield deflects chips. Satin-finished aluminum housing. Complete with heavy-duty cord and adjustable rip guide. U.L. Approved. For 110-120 v., AC or DC. Shpg. wt., 16 lbs.

46 NX 392. List, \$39.95. NET.... 32.95
Extra Blades. 6½" dia. Av. wt., 10 oz.
46 N 397. Combination. NET.....2.10
46 N 398. Cross-cut. NET.....2.25
46 N 399. Hollow-ground Rip. NET....2.25

DREMEL MOTO-JIG SAW

Model 15. This efficient fast-cutting tool will outcut and outperform heavier jig saws selling for far more! Perfect for the serviceman, home craftsman, wood-working hobbyist, etc. Saws through wood up to 1¾" thick. Has plenty of power for big jobs. Large 15" throat. Powerful rotary motor. No stalling or burning out. Saw blade turns to any direction—cuts stock of any length. Exclusive "Rocker-Action" eliminates the wear and tear on blades and the wasted power associated with conventional jig saws. With 4 blades—ready to use. Table tilts to 45°—can move up or down. U.L. Approved. Size, 8x23x9½" high. Complete with instructions. For 110-120 volts, 60-cycle AC. Shpg. wt., 14 lbs.

46 NX 379. List, \$29.95. NET.... 23.48
Extra Saw Blades. Pkg. of 12. Wt., 1 lb.
46 N 376. NET PER PKG.....47c

WEN PORTABLE SABRE SAW

Model 505. Versatile power saw—8 saws in one! Does the work of a rip-saw, coping-saw, band-saw, cross-cut saw, scroll-saw, jig-saw, hack-saw and keyhole saw! Rotary motor; 2650 strokes per minute under load. Length of stroke, 5/8". Cuts through ½" cold-rolled steel, 2x4" lumber, plaster, hard rubber, leather, etc. Fan clears work area. Makes straight, curved, circular or intricate design cuts. Vibration-free. Overall length, 6¾". With 3 blades; coarse, medium and fine. U.L. Approved. For 110-120 v., AC or DC. Shpg. wt., 4 lbs.

46 N 362. List, \$29.95. NET.....22.01

ACCESSORIES FOR 505 POWER SAW

Saw Table. With protractor, jointer, circle cutter, rip fence and 5 blades. All steel. 15x15x7½". Shpg. wt., 12 lbs.

46 NX 339. List, \$12.95. NET.....9.52

Extra Set of 3 Blades. Same as those included with 505 saw (coarse, medium and fine). Shpg. wt., 4 oz.

46 N 363. List, \$1.20. NET.....88c

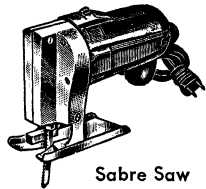

Sabre Saw

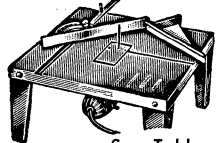

Saw Table

THOR HIGH-QUALITY GRINDERS

Keeps Your Tools Sharp for Maximum Efficiency

HEAVY-DUTY SPEEDGRINDER

Model 128. This new bench grinder is ideal for all heavy-duty grinding applications in maintenance and repair shops, garages, model shops, home workshops, etc.

Specially designed, adjustable tool rests with built-in angle guides, allow fast and accurate sharpening of drills, chisels, planes and a variety of other cutting tools. Lightweight, die-cast aluminum housing allows convenient operation anywhere, or it may be permanently attached to bench or service truck. Rubber feet protect work surface, absorb vibration and prevent "walking." A ruggedly built, highly dependable unit, it soon pays for itself in time-saving elimination of hand sharpening—keeps all your tools keen-edged, ready to use. Transparent protective shield included.

Has two grinding wheels: 1—46 grit and 1—75 grit. Wheel size: 6x3x½". Powerful motor is ¼-hp. induction-type. No-load speed, 3450 rpm. Self-aligning, oil-less bearings. Slide-type, On-Off switch is located on top of housing. Overall length, 16". For 110-120 v., 60 cycle AC only. Shpg. wt., 24 lbs.

46 NZ 468. List, \$32.50. NET.....23.78

HIGH-QUALITY BENCH GRINDER

Model 117. A high-quality power bench grinder—ideal for the small shop, garage, or home work bench. Widely used by model makers, hobbyists, "do-it-yourself" enthusiasts, schools, etc. Designed for medium or light work loads, it outperforms homemade bench grinders in efficiency and is easily portable. Light in weight, it is particularly useful where part is too heavy to be carried to grinder.

Rubber feet prevent furniture marring; can be secured to bench or table-top if desired. Has two grinding wheels: 1—60 grit for coarse grinding, and 1—120 grit for smooth grinding. Wheels are 4½x3½" with ¾" center hole. Dependable, 1/15-hp motor. Speed: 3400 rpm no-load. Body is one-piece cast aluminum with attractive blue-wrinkle finish. Motor, shaft and bearings are completely housed by case which also provides integral wheel guards and tool rests. Slide switch is conveniently located between wheels. Has self-aligning, oil-less bronze bearings. With 6-foot, heavy-duty 2-conductor cord. Height, 6"; width, 8"; depth, 6¾". For operation from 110-120 volts, 60 cycle AC only. Shpg. wt., 8 lbs.

46 N 373. List, \$16.50. NET.....12.07

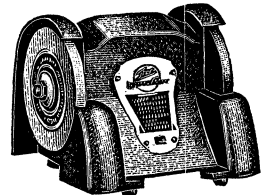
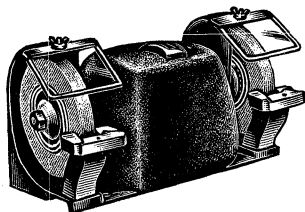

Power Sanders and Tool Kits

HIGH-QUALITY POWER SANDERS & SANDER KITS

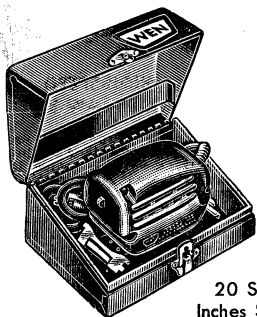

20 Square
Inches Sanding
Surface

WEN POWER SANDER KITS

Model 404. Heavy-duty kit for rough sanding or for fine finishing. 20 sq. in. of sanding surface. Vibrator motor; 14,400 strokes per min. Self-tightening clamp pulls, tightens paper and locks it into position. Size of sander, 6 $\frac{1}{2}$ x3 $\frac{1}{4}$ x4"; weighs only 3 $\frac{3}{4}$ lbs. With 15 assorted sheets of sandpaper, 2 polishing cloths and steel carrying case. For operation from 110-120 volts, 60 cycle AC. Shpg. wt., 6 $\frac{1}{2}$ lbs.

46 N 329. List, \$19.95. NET.....14.66

Model 303. Smaller, lightweight version of above—for rough or fine sanding. Has 13 $\frac{3}{4}$ -sq. in. surface; weighs 2 $\frac{1}{2}$ lbs.; size is 5 $\frac{5}{8}$ x2 $\frac{1}{2}$ x3 $\frac{1}{16}$ ". With 12 sheets assorted sandpaper, 2 polishing cloths, metal case. For operation from 110-120 v., 60 cycle AC. Shpg. wt., 3 $\frac{1}{2}$ lbs.

46 N 323. List, \$16.95. NET.....12.46

- Make Any Sanding Job Easy
- Save Hours of Sanding Time
- Feature Rugged, Powerful Motors

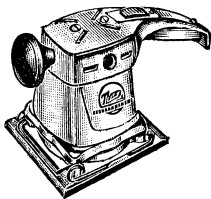

Powerful,
Heavy-Duty
Motor

NEW THOR SPEED SANDER

Model 16. Powerful, heavy-duty sander. Features rugged, 6200-rpm series-wound AC-DC motor. Has cooling slots in top and sides of housing plus sealed and shielded ball bearings for smooth operation and long life. For hundreds of sanding jobs around home or shop. Lightweight (only 5 lbs.) and well-balanced, it is ideal for tireless vertical or overhead sanding. Easily does in minutes sanding jobs that would require many hours of hard work. $\frac{3}{16}$ " orbital motion for attractive French finishing. Sanding surface: 4 $\frac{1}{2}$ x5 $\frac{1}{8}$ "; requires 4 $\frac{1}{2}$ x6 $\frac{1}{2}$ " sandpaper. Convenient Off-On slide switch on handle. Durable cast aluminum body. Overall size: Height, 5 $\frac{1}{4}$ "; width, 4 $\frac{1}{2}$ "; length, 9 $\frac{1}{2}$ ". With 10-ft., Type SJ 3-conductor cord. For operation from 110-120 volts, AC or DC. Shpg. wt., 8 lbs.

47 N 097. List, \$39.95. NET.....27.40

Features
Orbital
Motion

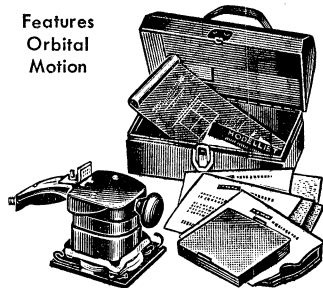

THOR SPEED SANDER KIT

Model 15TK. Versatile kit featuring the 15T sander—makes any sanding job easy. Orbital motion creates beautiful French finish. Sands, finishes and polishes vertically or horizontally. The 15T can be used with either dry or wet abrasives. Has powerful 2-pole, 3450-rpm induction motor. Convenient push-button switch on handle. Rugged cast-aluminum body. Sanding area: 4 $\frac{1}{2}$ x5 $\frac{1}{8}$ " with $\frac{3}{16}$ " orbit; paper size, 4 $\frac{1}{2}$ x6 $\frac{1}{2}$ "; size of sander, 4 $\frac{3}{4}$ x4 $\frac{1}{2}$ x9". Includes: 18 assorted abrasive sheets; 2 free-abrasive felt pads; 1 neoprene contour pad (for curved surfaces); 1 lamb's wool polishing cover; steel storage-carrying case. For 110-120 v., 60 cycle AC. Shpg. wt., 10 lbs.

46 N X 467. List, \$34.95. NET....23.92

Model 15T Sander Only. 7 lbs.

46 N 375. List, \$24.95.....17.12



BURGESS V-760 TOOL KIT

Marking, engraving and craftsman's kit. For industrial identification, servicing, and general hobbyist applications. Uses include jewelry engraving, instrument marking, stencil cutting, embossing, etc. Includes Vibro-Tool (7200 strokes per min.), ten all-purpose attachments and steel case. Illustrated instruction booklet. For 110-120 volts, 60 cycle AC. Shpg. wt., 3 $\frac{1}{2}$ lbs.

46 N 290. List, \$14.95. NET.....9.77

THOR G-A-K TOOL KIT

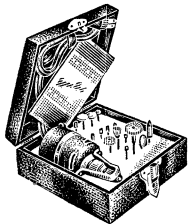

This 28-piece power tool kit has thousands of uses in the shop and home. Includes the Speedway Speed-Grinder; has powerful 20,000 rpm motor, self-aligning oil-less bronze bearings and slide-type switch. Includes: 4—grinding stones; 4—cutting burrs; 3—brushes; 1—scratch brush; 1—polishing

tool; 2—mandrels; 12—sanding discs. Complete with wood case, and instruction manual. For operation from 110-120 volts, AC or DC. Shpg. wt., 2 $\frac{1}{2}$ lbs.

46 N 365. List, \$16.95. NET.....12.40

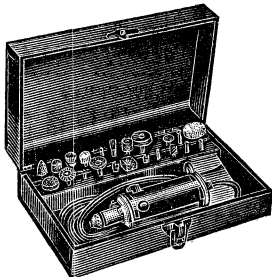

VERSATILE MOTO-TOOL KIT NO. 1

- Pocket-Size Machine Shop
- Thousands of Uses

The Moto-Tool Kit No. 1 is expressly designed for light-capacity grinding, polishing, drilling, reaming, sharpening, carving, routing, engraving, etc. Moderately priced, this power tool kit has thousands of uses around the home and workshop. Provides remarkable handling ease. Works well in wood, metal, plastics, leather, glass, etc.

A popular favorite with model makers, hobbyists, lab technicians and students in school shops. The numerous practical attachments supplied with this kit make it possible to do precision jobs in minutes; speeds the completion of difficult jobs that formerly took hours with hand tools. Entire kit is contained in attractive, blue-enamelled metal case, 3x9 $\frac{1}{4}$ x5 $\frac{1}{2}$ ".

Wrenchless collet chuck for quick, easy changing of attachments; insures positive locking of replacement tools. Chuck lock-pin disengages automatically. Oil-less, self-aligning bearings, mounted in felt oil retainers, assure smooth, dependable operation. Complete with 34 practical accessories. For 110-120 volt, AC or DC operation. Shpg. wt., 3 $\frac{1}{2}$ lbs.

46 N 377. List, \$21.50. NET.....16.86

DREMEL ELECTRIC POWER TOOLS

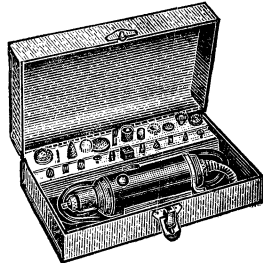

POWERFUL MOTO-TOOL KIT NO. 2

- Rugged Construction
- Speeds Production

Moto-Tool Kit No. 2 offers a more powerful tool intended for industrial and other heavy-duty jobs. Features a sturdy, 27,000-rpm rotary motor—operates dependably under long periods of continuous use. A great time-saver in the tool room, industrial lab, production line, etc. Widely used by technicians, tool-and-die makers, machinists, hobbyists, etc. Works well in wood, metal, plastics, leather, glass, etc. A true precision instrument.

Motor employs a dust filtered, air cooling system. The wide assortment of attachments in this kit includes emery wheel points, wire and fibre bristle brushes, mandrels, drum sander and a variety of high-speed steel cutters. Collet chuck with unique lock pin, makes it easy to quickly change attachments. Self-aligning bearings are mounted in felt oil retainers—require minimum oiling. Moto-Tool No. 2 is lightweight and easy to manipulate. Fits comfortably in the hand—weighs only 13 oz.

Kit comes complete in attractive, gray-enamelled metal box. Size, 3x9 $\frac{1}{4}$ x5 $\frac{1}{2}$ " deep. With instructions. For 110-120 volts, AC or DC. Shpg. wt., 4 lbs.

46 N 378. List, \$27.50. NET.....21.49

Quality Tools

BURGESS DELUXE SPRAY GUN OUTFIT

- Complete, Ready to Use
- Nothing Else to Buy

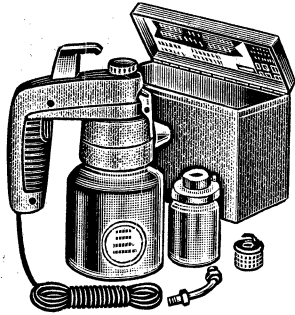

Model VS-700-UL. New, multi-purpose spray kit designed to handle a variety of jobs. With this kit, anyone can do a professional-quality paint job. Sprays paints, varnishes, shellacs, lacquers, insecticides, enamels, garden sprays, mothproofers, oils, chemicals, deodorants, etc. Excellent for painting new work (indoors and outdoors), re-finishing and touch-up, rust-proofing, stenciling, etc. Perfect for use in home or shop. Has long-lasting jewel nozzle for trouble-free operation. Self-contained heavy-duty power unit and pump assembly—no compressor needed. Convenient adjuster knob regulates heavy or extra-light spray. Variable directional nozzle adaptor permits spraying up or down while holding sprayer level—a time-saving feature for spraying ceilings and difficult-to-reach places. A special "fogging" nozzle shoots an extra-fine mist stream when used with mothproofers and insecticides. Rust-proof housing made of handsome gray hammer-finish molded plastic with contrasting metal bands. Fast-action trigger switch permits long periods of fatigue-free operation.

Handy, out-of-the-way hook mounted on housing for wall-mount storage. 25-ounce graduated aluminum jar holds large amount of spray-liquid and is easily refilled. Specifications of spray gun: weight, 2 lbs., 12 oz.; 9 1/2" high; 6 3/4" deep; 4" wide. No need to dismantle for cleaning—simply spray solvent through gun and it's automatically clean! Handy 4-ounce additional container easily replaces large jar for touch-up and other small jobs. 15-foot extension cord permits convenient wide-area coverage. Gun assembly has removable paint strainer over intake tube—keeps out paint lumps and dirt. A detailed instruction book carefully explains how to use the spray-gun to best advantage when painting, etc.

Attractive steel carrying case with easy-grip handle and safety clasp. Spray kit includes: Spray gun with AC cord attached, 25-oz. all-aluminum jar, 4-oz. auxiliary touch-up jar, 15-ft. AC extension cord set, variable direction nozzle adaptor, full set of spare parts including strainer attachment, special "fogging" nozzle, steel carrying case and complete instruction book. Size of carrying case, 9x12x5". For operation from 110-120 v., 50-60 cycle AC. Shpg. wt., 8 lbs. **19.97**

Model VS-651-UL. Spray Gun Only, With Glass Jar. Shpg. wt., 3 1/2 lbs. **8.63**
46 N 928. NET.....

BABCO SANDING AND POLISHING KIT

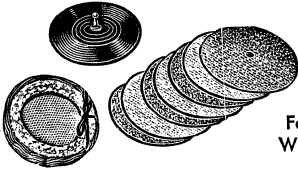

For Use With Any Drill

Model 407. Complete sanding and polishing kit for any electric power drill. Handy for the home craftsman, hobbyist, etc. It sands, smooths-buffs and polishes with assorted sanding discs and a lambswool bonnet. Includes a 5" rubber backing pad (fits into chuck of drill), 6" lambswool bonnet and 7 assorted sandpaper discs in gradations of coarse, medium and fine. Quickly and easily attaches to drill. With instructions. An excellent value in a versatile, time-saving outfit. Shpg. wt., 10 oz. **14.3**

46 N 364. List, \$1.95. NET.....

ROTEX ATTACHMENTS

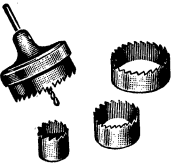

Holesaw Attachment. Versatile holesaw attachment for all 1/4" electric hand drills. An indispensable, time-saving tool for home craftsmen, custom lift installers, hobbyists, carpenters, servicemen, etc. Easily cuts through any 3/4" stock, wood, plastic

or metal. Ideally suited for effortless cutting of holes for chassis work; custom radio television and high-fidelity installation; running pipe and conduit; setting locks; cabinet work; instrument panel work; decorative installations; and 10001 other uses. Smoothly cuts 1", 1 1/2", 2", and 2 1/2" holes. Easy-to-change steel cutting blades; simply loosen set screw in arbor, slip desired size blade in, and tighten set screw—cutting blade is locked securely in place. No need to detach arbor from drill. Supplied complete with light, rugged aluminum arbor and a set of four top-quality, high-carbon steel blades. Shpg. wt., 1 lb. **4.37**

45 N 873. List, \$5.95. NET.....



Roto Bench Stand. Rugged, heavy-aluminum horizontal drill stand for any electric drill. Time-saving aid for home craftsmen, experimenters, hobbyists, etc. Ideally suited for farm maintenance, auto repair shops, radio-TV service shops, light chassis manufacturing, building maintenance, home workshop and many other applications. Simplifies use of drill attachments. Specially designed to minimize shake or shimmy. Holds drill firmly in place on workbench for polishing, grinding, buffing, burnishing, wire-brushing, drilling, etc. Adds a variety of new uses to any electric drill and accessories. Easy to install. Simply screw two heavy-duty bolts (supplied with unit) through holes of bench stand and into workbench. Clamp attachment easily engages or disengages drill. Provides long, dependable service. Shpg. wt., 1 lb. **2.17**

45 N 874. List, \$2.95. NET.....

NEW ARCO SCREW-DRILLS

Combination pilot hole drill and countersink. Drills proper size hole for wood-screws indicated; also drills countersinks. Adjust to length of screw. Vanadium steel bit; 1/4" shank. *Wood-screw size. 2 oz.

No.	Type	*For
50 N 010	1106	#6
50 N 011	1108	#8
50 N 012	1110	#10
50 N 013	1112	#12

1 to 5, EACH..... **73c**
6 or More, EACH..... **64c**
50 N 014. Set of 4 drills above. Wt., 6 oz.
6 or More Sets, PER SET. 2.42. PER SET..... **6.29**

G-H DRILL GRINDING TOOL

Model 825. Exceptionally useful grinding attachment by General Hardware. Perfect for repointing and sharpening of drills. Designed to handle the following drill sizes: 1/8" to 3/4"; No. 30 to No. 1; A to Z; and 3.0 to 19.0 millimeter. Fully adjustable. Ruggedly constructed for long, dependable service. Shpg. wt., 2 lbs. **4.25**

KNEISLEY MINIATURE DRILL SET

Type KS-1115 Carbon Drill Set. 20 drills—No. 61 through No. 80 (.039" to .0135"). An indispensable set for extremely fine drilling jobs. Hardened by unique method, assuring precision production. Finest grade carbon steel used. Set includes 4-jaw chuck with 1/4" shank for using drills in standard chucks. Molded lucite case. Shpg. wt., 6 oz. **5.84**

46 N 799. NET.....

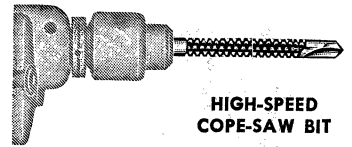

HIGH-SPEED COPE-SAW BIT

A remarkably versatile, all-purpose bit for use with any 1/4" or 1/2" electric drill, including drill presses. It drills, saws and reams in practically any material. Use it for angle iron, pipe, wood, plastics, sheet metal, radio chassis, rack panels, etc. Actually takes the place of many more costly tools—saves money—saves space—take it anywhere. An extremely helpful tool for use by the radio-TV serviceman, custom installer, woodworker, electrician, repairman, and hobbyist.

Easy to use since it drills its own starter hole. Cuts circles, ovals, squares, scrolls and all types of unusual-shape holes. Very useful for working on objects too large to put on a jig-saw. Also excellent for making cutouts in record changer mounting boards, speaker enclosures and custom equipment panels.

Made of finest abrasive-resistant steel to assure long life. Flutes are designed for non-clogging operation at high speed. The three models listed below have cutting edges especially shaped for the recommended material to be cut. Shpg. wt., 3 oz.

46 N 795. All-Purpose Bit.
46 N 796. Wood Bit. **NET**
46 N 797. Heavy-Metal Bit. EACH..... **1.77**

MILLERS FALLS DRILL BITS

High-speed power bits for drilling large holes in hard and soft woods, plastics, etc. Plywood, etc. Bits will cut through wire nails without damage. Designed for use with any 1/4" electric drill. Shanks are 1/4", milled for standard three-jawed chucks. Finely tempered high speed steel—holds edges ten times longer than ordinary tool steel. Cut fast and clean, even when cutting on an angle. Bits are easily resharpened on a grinding wheel. Depth of cut, 5"—ideal for boring through floors or partitions. Overall length of bits, 6 1/2".



No. 8004 Power Bit Set. Set of 4 bits in convenient plastic roll. Sizes: 1/2", 5/8", 3/4" and 1". Shpg. wt., 3/4 lb. **3.75**

46 N 366. List, \$5.25. NET.....

No. 8006 Power Bit Set. Set of 6 bits in plastic roll. Sizes: 3/8", 1/2", 5/8", 3/4", 7/8" and 1". Shpg. wt., 1 lb. **5.12**

46 N 367. List, \$7.80. NET.....

MILLERS FALLS COUNTERSINK

Model 710. Made of fine-grade high-speed steel. For use in any material ordinarily machinable with a high-speed cutter. Cuts fast and clean in soft steel, iron, wood and similar materials. Has 5 carefully ground flutes for fast cutting at 82° angle for wood and machine screws. Shank, 1/4". Fits any brace or drill. Overall length of unit is 2 1/2". Shpg. wt., 6 oz. **1.22**

46 N 156. List, \$1.65. NET.....

GENERAL HARDWARE AUTOMATIC CENTER PUNCH

Model 79. Hand pressure on handle triggers powerful spring, which drives punch. Perfect for accurate center punching in tight spots. Extremely valuable aid to the builder. Simply turn top of handle to adjust tension for light or heavy punch. Size, 1/2" dia. x 5". Replaceable point. Shpg. wt., 5 oz. **3.10**

46 N 195. NET.....

46 N 196. 79P. Extra point. NET..... **31c**

GENERAL HARDWARE SELF-CENTERING PUNCH

Model 806. For use with hardware having counter-sunk mounting holes—hinges, switch plates, etc. Tapered end of punch fits into hole and automatically locates correct center. Just tap plunger pin and work is accurately marked. Made of cadmium-plated steel; plunger pin is tempered-steel. A handy, time-saving tool for the serviceman, repairman, builder, etc. Shpg. wt., 2 oz. **38c**

46 N 218. NET.....

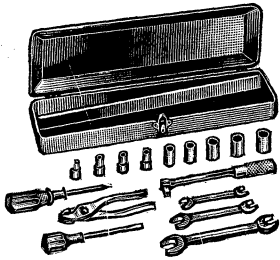

"HANDYMAN SPECIAL" TOOL KIT

A versatile, 17-piece tool kit—efficiently handles up to 95% of all home and automotive repairs. All tools are made of selected alloy steels, hot-forged by special processes for extra tough jobs. Brightly polished, heavy chrome-plated finish withstands rough handling—gives more than adequate protection from rust. Built to meet government specifications.

Kit includes a total of nine sockets: Two 6-point sockets—fit 1/4", 3/16" hex nuts; and seven 12-point sockets—fit 3/8", 1/2", 5/8", 3/4", 7/8", 1" hex nuts. Kit also includes three double-end wrenches, 3/8" and 1/2" and 3/4" and 1/2" and 3/4" utility pliers; one 3/4" Phillips screwdriver; one 3/4" flat screwdriver; and one 3/8" square drive Flex-handle socket driver.

Socket walls are straight and extra thin for those hard-to-get-at places. Complete with sturdy, oversize steel chest which is large enough to accommodate additional tools. Shpg. wt., 5 lbs.
46 NX 499, NET.....8.24

STEVENS-WALDEN TOOL SETS



"SPINTITE" SET 3800B15

Deluxe 15-piece radio and electrical set. Includes 7 hex wrenches in following sizes: 3/16", 1/8", 5/16", 3/8", 1/2", and 5/8"; three screwdrivers; one combination reamer and awl; and one universal handle which holds all tool shafts. Also includes 6" long-nose pliers, 5" diagonal cutters, and insulated screwdriver and wrench. Supplied complete with leatherette tool roll. Shpg. wt., 2 1/4 lbs.
46 N 055, NET.....12.90



"MIGIT" RADIO WRENCH SET

Model 3100C14. This compact, 14-piece socket set will cover almost all hex-head bolt and nut sizes encountered in radio-television servicing. A highly valuable wrench set for repairmen, technicians, etc. Universal joint handle with sliding "T" bar, and one straight spin type amber plastic handle. Eight hex sockets, 3/16" to 7/8"; 3 double-square sockets. Chrome-plated tools; bright enamel-finished case. Shpg. wt., 1 1/2 lbs.
46 N 165, NET.....6.47

HUOT DRILL CASES

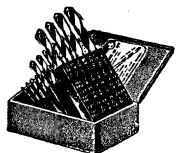

Sturdy drill cases for compact storage and quick, convenient selection of the right drill for the job. Ideal for shop, school or home. Prevents misplacing drill bits and protects them from dirt and moisture. Holds drill bits securely even when bits are shortened by long use. Cases are made of heavy gauge steel. Index clearly shows drill sizes. Supplied less drills.

60-Drill Capacity. Sizes, 1-60. For most-frequently-used small drill bits. Decimal equivalents and machine screw tap information included on case. Size, 3 1/4"x4 1/2"x1". Shpg. wt., 1 lb.
46 N 790, NET.....1.84

15-Drill Capacity. Sizes, 1/16" to 1/2" in 1/32" steps. 4x1 1/2". Shpg. wt., 2 lbs.
46 N 716, NET.....1.84

13-Drill Capacity. Sizes, 1/16" to 1/4" in 1/64" steps. 2 1/16"x4 3/8"x3/8". Shpg. wt., 1 lb.
44 N 842, NET.....81¢

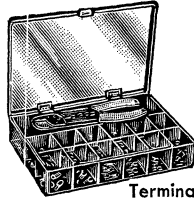

Terminal Kit

A-MP TERMINALS AND TOOLS

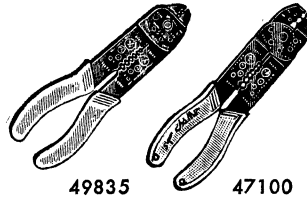

49835

47100

A-MP TERMINAL KIT

Terminal kit containing an assortment of the 12 most popular terminals for general wiring. 240 insulated, solderless terminals are supplied plus the heavy-duty "Super Champ" crimping and wiring tool described below. Compartmented plastic box makes it easy to quickly select the proper terminal—also shows at a glance when it is time to order more. Assortment includes ring, spade-butt and nylon closed-end connectors. For all wire sizes from 10 to 22 and most often used stud sizes. A complete outfit, invaluable for general wiring. Box size, 9 1/2"x10 1/2"x2". Shpg. wt., 2 lbs.
45 N 322, NET.....17.95

"SUPER CHAMP" CRIMPING TOOL

Type 47100. Versatile hand tool for electricians, maintenance men, etc. Crimps insulated solderless terminals, shears machine screws, measures stud sizes, cuts and strips wire. Shears machine screws: 4-40, 6-32, 8-32, 10-32 and 10-24. Separate notches strip insulation from #18, #16, #14 and #12 AWG wire. Measures stud (machine screw) sizes: 4, 6, 8, 10, 12, 1/4", 3/8" and 3/4". Designed for heavy-duty use—made of hardened tool steel, has insulated yellow plastic handles for a secure and comfortable grip. Shpg. wt., 1 lb.
45 N 321, NET.....3.95

Type 49835. Same as above, but for crimping non-insulated terminals.
44 N 453, NET.....3.95

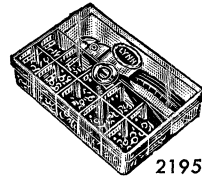

2195

TYPE 2195 SERVICE KIT

Contains: \$5.00 worth of solderless terminals in assorted sizes in addition to the new, Type 1902 crimping-cutter tool described below. A wide variety of terminals for making virtually any type of lug connection likely to be encountered in radio or TV work; includes new "lightning spade" and hook-type terminals. A full range of sizes is provided. Clear plastic container supplied with kit. 8 3/4"x6 1/4"x1 3/4". Shpg. wt., 2 lbs.
44 N 479, NET.....8.72

NEW TYPE 1902 CRIMPER-CUTTER TOOL

Versatile crimping and bolt cutter tool for electricians, maintenance men, etc. Neatly crimps solderless terminals; shears machine screws in sizes 4-40, 6-32, 8-32, 10-32, 10-24, #12, #14, and #10 AWG wire. Tempered steel jaws with red plastic shock-proof handles. Shpg. wt., 1 lb.
44 N 843, NET.....3.87

MOODY WRENCH AND SCREWDRIVER SETS



TYPE SC-5. Contains 5 interchangeable hardened steel blades in sizes .100", .080", .070", .055" and .040". Insert quickly and firmly into chuck. Excellent for kit and model building; repairing radios, appliances, cameras, etc. Complete set of five blades, handle and plastic base with transparent dust cover. Shpg. wt., 8 oz.
43 N 859, List, \$1.50, 1-11, EA. 1.03
12 sets or more, EACH.....93¢

TYPE PA-5. Combination Phillips Head Screw Set and Allen Head Wrench Set. Contains No. 0 and No. 1 Phillips type driver and Nos. 4, 6, and 8 Allen type wrench. With handle, stand and cover. Shpg. wt., 7 oz.
43 N 857, List, \$2.50; 1-11, EACH.....1.84
12 sets or more, EACH.....1.66

GENERAL WIRING TERMINALS

Provide positive contact without wire fracture. Inside of connector ribbed for firm grip on wire. Eliminate soldering. Simple crimping operation provides extremely strong, neat, vibration-proof connections. Wire sizes clearly marked on each terminal. *Insulated terminals—plastic outer sleeves. Wire size, 14 to 16, except #16 to 22. Shpg. wt., 8 oz. 100 per pkg.

Stock No.	Fig.	Mfr's No.	Type	Stud Size	PER PKG.
45 N 301	A	34149**	Ring	8-10	5.34
45 N 302	A	34142**	Ring	4-6	5.34
45 N 303	B	34070**	Butt	6.41
45 N 304	A	34158*	Ring	4-6	5.34
45 N 305	A	34161*	Ring	8-10	5.34
45 N 306	C	34165*	Spade	4-6	5.34
45 N 307	C	34167*	Spade	8-10	5.34
45 N 308	B	34071*	Butt	6.41
45 N 323	C	34153**	Spade	5-6	5.34
45 N 310	D	33214*	Ring	8-10	3.73
45 N 311	D	34194*	Ring	4-6	3.73
45 N 312	E	31818*	Butt	3.98
45 N 313	D	34197	Ring	4-6	3.73
45 N 314	D	33217	Ring	8-10	3.27
45 N 315	F	33477	Spade	4-6	4.16
45 N 316	F	33219	Spade	8-10	4.16
45 N 317	G	31762*	Knife	7.21
45 N 318	G	31763*	Knife	7.21
45 N 319	H	34846	Shur-Plug	2.03
45 N 320	36840*	Recep.	6.20

LYNN SERVICE KIT, TOOL AND TERMINALS

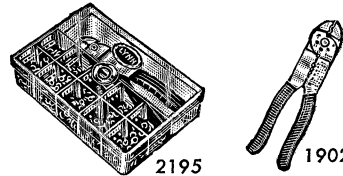

2195

1902



Extra Terminals. Popular sizes of Lynn terminals. Av. shpg. wt. per pkg., 3 oz. *Used in Type 2195 kit to left.

Stock No.	Fig.	Mfr's No.	Type	Wire Size	Stud Size	Pkg. Qua.
44 N 476	J	2300*	Ring	22-16	4-6	41
44 N 481	J	2301*	Ring	22-16	4-6	41
44 N 482	J	2302*	Ring	22-16	8-10	41
44 N 487	J	2400*	Ring	16-14	4-6	41
44 N 475	J	2401*	Ring	16-14	4-6	41
44 N 486	J	2402*	Ring	16-14	8-10	41
44 N 487	J	2403	Ring	16-14	12-1/4	32
44 N 488	J	2502	Ring	12-10	8-10	32
44 N 490	2503	Ring	12-10	12-1/4	24
44 N 489	2600*	Stud	22-16	4-6	45
44 N 492	K	2601*	Spade	16-14	4-6	41
44 N 493	K	2602*	Spade	16-14	8-10	41
44 N 494	K	2702	Spade	12-10	8-10	32
44 N 495	L	2802	Flag	22-16	8-10	41
44 N 496	L	2902	Flag	16-14	8-10	41
44 N 432	M	3101	Butt	22-16	52
44 N 433	M	3102	Butt	16-14	52
44 N 434	M	3103	Butt	12-10	41
44 N 499	N	3300*	Hook	22-16	45

NET PER PKG.....98¢

MAGNETIC SOCKET WRENCH SET

Type BW-5. Moody kit containing five tiny, interchangeable socket wrenches with magnetized swivel-top handle. Magnetized handle provides easy means for removing or inserting nuts in recessed, hard-to-get-at places. Particularly suitable for close work in crowded radio or television chassis. An indispensable tool kit for radio-TV servicemen, electricians, home craftsmen, etc.

Socket wrench sizes: 3/16" hex, 1/8" hex, 1/4" hex, 3/8" hex, 1/2" hex, and 5/8" hex. Wrenches and handle of tough, heat-treated and rust-proof steel. Kit supplied in transparent plastic container, with attractively colored plastic base. Shpg. wt., 5 oz.
43 N 862, List, \$3.95, NET.....2.90

Xcelite Nutdrivers & Screwdrivers

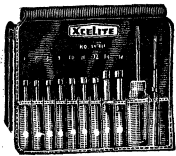

99PR



77

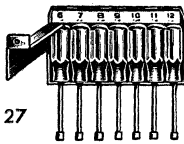

127

HEX NUT DRIVER SETS

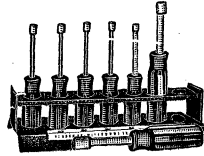

137

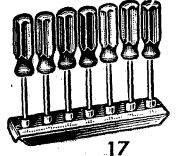

17

MODEL 99PR MULTI-PURPOSE NUT & SCREWDRIVER SET

A complete 12-piece tool set in a durable plastic kit that rolls up for convenience. Consists of 9 nut drivers, double-ended standard screwdriver shaft, double-ended Phillips screwdriver shaft, and rugged plastic handle. All blades and shafts are chromium plated. Nut driver sizes: $\frac{1}{16}$ ", $\frac{1}{8}$ ", $\frac{3}{16}$ ", $\frac{1}{4}$ ", $\frac{5}{16}$ ", $\frac{3}{8}$ ", $\frac{1}{2}$ ". Screwdriver blades: $\frac{3}{16}$ " and $\frac{1}{2}$ ". No. 1 and No. 2 Phillips. Shpg. wt., 2 lbs.

Model 99X10 Extension, 8" extension for above. Chrome finish. Wt., 5 oz. 45 N 787. List, \$1.45. NET

Model 99-39 Reamer, $\frac{1}{4}$ to $\frac{1}{2}$ " reamer fits 99PR above. Will accommodate $\frac{3}{4}$ " rod to apply torque. Shpg. wt., 5 oz. 45 N 788. List, \$2.60. NET

MODEL 77 NUT DRIVER SET

A handy 7-piece set of hex nut drivers in a convenient, roll-up carrying case. An indispensable tool set for the radio-TV serviceman and the experimenter or builder. Color-coded handles for easy identification. Shafts are hollowed to an average depth of $\frac{1}{4}$ " to permit tightening nuts on long screws. Socket sizes range from $\frac{3}{16}$ " to $\frac{1}{2}$ " steps. Shockproof handles are fluted for sure grip and firmly secured to polished steel shafts. Overall length 6". Shpg. wt. 2 lbs.

46 N 337. List, \$8.90. NET

MODEL 127 NUT DRIVER SET

Color-coded plastic handles indicate socket sizes instantly. Sockets are deep enough to handle two nuts. Depth of shaft hole, $\frac{1}{4}$ ". Includes 7 wrenches, sizes $\frac{3}{16}$ " to $\frac{1}{2}$ " in $\frac{1}{32}$ " steps. Sturdy metal holder in red wrinkle finish. Can be permanently fastened to wall for added convenience. Size, $7\frac{1}{2} \times 7\frac{1}{2} \times 1\frac{1}{4}$ ". Shpg. wt., 2 1/4 lbs.

45 N 735. List, \$8.90. NET

MODEL 137 NUT DRIVER SET

Consists of seven nut drivers and a stand-up rack for holding tools in place when not in use. Ideal for serviceman's bench or workshop. Sizes: $\frac{3}{16}$ ", $\frac{1}{4}$ ", $\frac{5}{16}$ ", $\frac{3}{8}$ ", $\frac{1}{2}$ " and $\frac{5}{8}$ ". Large handles insure non-slip gripping. Handle colors include black, red, yellow, green, blue, and brown. Shafts are polished steel. Shpg. wt., 3 lbs.

45 N 734. List, \$10.25. NET

MODEL 17 NUT DRIVER SET

Consists of the seven most commonly used nut driver sizes in radio-tube servicing. A valuable addition to any work bench. With durable amber plastic handles and highly polished, tough alloy steel shafts. Sizes: $\frac{3}{16}$ ", $\frac{1}{4}$ ", $\frac{5}{16}$ ", $\frac{3}{8}$ ", $\frac{1}{2}$ " and $\frac{5}{8}$ ". Set includes metal rack for holding nut drivers upright when not in use. Shpg. wt., 2 1/2 lbs.

45 N 733. List, \$8.25. NET

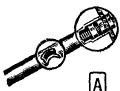

A

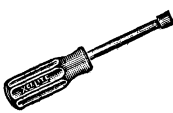

B

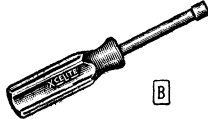

C

XCELITE HEX NUT DRIVERS

Xcelite's famous line of quality nut drivers. These tools have become standard in the electronics industry, and are offered in a wide range of sizes and styles for every application.

Made to exacting specifications, the Xcelite nut drivers employ shafts of highly-polished chrome-vanadium electric furnace steel. Handles are of rugged Xcelite plastic, with shafts permanently molded in place—will not work loose. Sockets are precision formed and have no burrs—fit nuts and screw hex heads snugly. Socket wells are deep enough to handle two nuts simultaneously.

All Xcelite nut drivers have color-coded handles for identification of size at a glance. Fig. A shows types having a hollow shaft, for tightening nuts on long screws; Fig. B is standard type. Fig. C is stubby type for use where space is limited. Type HS-18 fits $\frac{3}{16}$ " volume control nuts. Shpg. wt., 6 oz., except S-8, S-10, S-12, which are 5 oz.

Stock No.	Mfr's Type	Fig.	Nut Size	Handle	Length	NET
45N 779	HS-8	A	$\frac{1}{4}$ "	Red	6"	.81
45N 780	HS-10	A	$\frac{5}{16}$ "	Amber	6"	.81
45N 781	HS-11	A	$\frac{1}{2}$ "	Green	6"	.81
45N 782	HS-12	A	$\frac{3}{8}$ "	Blue	6"	.81
45N 783	HS-14	A	$\frac{7}{16}$ "	Brown	7"	.93
45N 784	HS-16	A	$\frac{1}{2}$ "	Red	7"	.96
45N 785	HS-18	A	$\frac{3}{16}$ "	Orange	7"	.99
45N 786	HS-20	A	$\frac{3}{8}$ "	Amber	7"	1.14
45N 813	6	B	$\frac{3}{16}$ "	Black	6"	.66
45N 814	7	B	$\frac{1}{4}$ "	Brown	6"	.66
45N 815	8	B	$\frac{1}{4}$ "	Red	6"	.66
45N 816	9	B	$\frac{5}{16}$ "	Orange	6"	.66
45N 817	10	B	$\frac{3}{8}$ "	Amber	6"	.66
45N 818	11	B	$\frac{1}{2}$ "	Green	6"	.66
45N 819	12	B	$\frac{3}{8}$ "	Blue	6"	.66
45N 857	S-8	C	$\frac{1}{4}$ "	Red	3 1/2"	.54
45N 858	S-10	C	$\frac{5}{16}$ "	Amber	3 1/2"	.54
45N 859	S-12	C	$\frac{3}{8}$ "	Blue	3 1/2"	.54

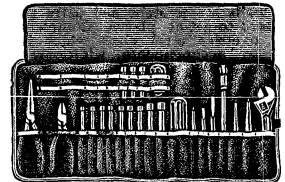

XCELITE SERVICE MASTER KIT

Type 99SM Service Master Kit. Extremely versatile set of quality tools. Includes complete assortment of wrenches, pliers, drivers, and reamers; with handles and extension. Will meet almost every service need. Set contains: No. 52C long nose pliers; No. 55C diagonal pliers; No. 46, 6" adjustable wrench; Nos. 99-6, -7, -8, -9, -10, -11, -12, -14, and -16, $\frac{3}{16}$ " through $\frac{1}{2}$ " regular nut drivers; Nos. 99-S8, -S10, and -S12, $\frac{1}{4}$ ", $\frac{3}{16}$ " and $\frac{1}{2}$ " stubby nut drivers; Nos. 99-811 and -812, $\frac{3}{16}$ " and $\frac{1}{2}$ " slotted screwdrivers; No. 1 Phillips screwdriver; No. 99-38 and -39, $\frac{1}{8}$ "- $\frac{3}{8}$ " and $\frac{1}{4}$ "- $\frac{1}{2}$ " reamers; No. 99X10, 8" extension; No. 99-1 and -3, regular and stubby handles. All tools have highly polished nickel chrome finish. A convenient roll-up kit, made from durable, soft material, is included. Kit contains a separate pocket for each tool. Shpg. wt., 2 3/4 lbs.

43 N 884. List, \$33.50. NET

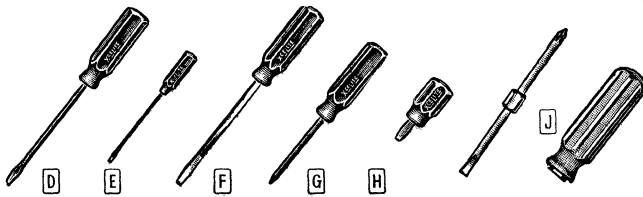

D Round Shaft. Available in lengths from $4\frac{1}{4}$ " to 12".

Stock No.	Mfr's Type	Shaft Size		Overall Length	Shpg. Wt.	NET
		Dia.	Length			
43 N 845	R-182	$\frac{1}{8}$ "	2"	$4\frac{1}{2}$ "	3 oz.	.33
43 N 846	R-184	$\frac{1}{8}$ "	4"	$6\frac{1}{2}$ "	3 oz.	.36
43 N 847	R-186	$\frac{1}{8}$ "	6"	$8\frac{1}{2}$ "	4 oz.	.39
43 N 848	R-188	$\frac{1}{8}$ "	8"	$10\frac{1}{2}$ "	4 oz.	.48
45 N 795	R-144	$\frac{1}{4}$ "	4"	8"	6 oz.	.69
45 N 796	R-146	$\frac{1}{4}$ "	6"	10"	6 oz.	.72
45 N 797	R-148	$\frac{1}{4}$ "	8"	12"	7 oz.	.78

E Set-Screw Types. Precision-ground, narrow-blade screwdrivers designed to fit set-screws. Have pocket clips.

43 N 830	R-3323SS	$\frac{3}{16}$ "	3"	5"	2 oz.	.27
43 N 831	R-184SS	$\frac{1}{8}$ "	4"	6"	2 oz.	.27

F Square Shaft. Available in lengths from $7\frac{3}{4}$ " to 18".

43 N 829	S-3164	$\frac{3}{16}$ "	4"	$7\frac{3}{4}$ "	4 oz.	.63
43 N 832	S-144	$\frac{1}{4}$ "	4"	8"	6 oz.	.75
43 N 833	S-146	$\frac{1}{4}$ "	6"	10"	6 oz.	.78
43 N 834	S-148	$\frac{1}{4}$ "	8"	12"	7 oz.	.90
43 N 837	S-388	$\frac{3}{8}$ "	8"	$12\frac{3}{8}$ "	1 lb.	1.26
43 N 838	S-3812	$\frac{3}{8}$ "	12"	18"	1 1/4 lb.	1.83

G Phillips Screwdrivers. Alloy steel. *Stubby type.

Stock No.	Mfr's Type	Shaft		Overall Length	Shpg. Wt.	NET
		Tip	Length			
43 N 876	X-101	No. 1	3"	6 1/2"	5 oz.	.63
43 N 877	X-108	No. 1	6"	10"	5 oz.	.69
43 N 878	X-102	No. 2	4"	7 1/2"	6 oz.	.81
43 N 879	X-1020	No. 2	10"	13 1/2"	8 oz.	1.08
43 N 881	X-103	No. 3	6"	10"	10 oz.	1.08
43 N 882	SX-101	No. 1	*	2 1/2"	5 oz.	.60
43 N 883	SS-102	No. 2	*	3 1/2"	5 oz.	.66

H Stubby Screwdriver $\frac{1}{4}$ " square shaft, polished blade. Ideal for work in cramped space.

43 N 844	S-141	Regular	$1\frac{1}{4}$ "	$3\frac{1}{4}$ "	5 oz.	.51
----------	-------	---------	------------------	------------------	-------	-----

J Combination Blade Screwdrivers.

Stock No.	Mfr's Type	Blade Combination	Overall Length	Shpg. Wt.	NET
45 N 746	CR1	$\frac{3}{16}$ " Regular #1 Phillips	7"	4 oz.	1.29
45 N 747	CR2	$\frac{1}{4}$ " Regular #2 Phillips	7"	5 oz.	1.29
45 N 748	CR3	$\frac{3}{16}$ " Regular #3 Phillips	7"	10 oz.	1.29



TK-5

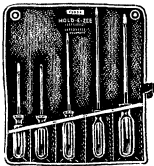

RT-52

"HOLD-E-ZEE" SCREWDRIVERS AND SCREWDRIVER KITS

TK-5 Kit. New, versatile, top-quality screwdriver kit. Especially recommended for the "do-it-yourself" enthusiast, mechanic, and car owner. Kit includes 5 automatic-grip screwdrivers: one each—TR-4, PR-4, TS-4, PS-4, and TH-6 (see table below for specifications). Screwdrivers feature convenient, spring-steel gripper that holds screws for starting in difficult-to-reach places. Shock-resistant, comfort-grip handles have exclusive "lock-blok" construction to prevent blade from twisting. Blades are tempered, chrome-vanadium steel. With handy roll pouch. Wt., 1½ lbs. **43 N 971. List, \$5.25. NET.....3.86**

RT-52 Kit. Handy new kit similar to above, but recommended for electronic use. Includes one each: TR-4, PR-4, TR-6, TR-8, and TS-7 (see listing below). Shpg. wt., 1¼ lbs. **43 N 972. List, \$4.50. NET.....3.31**

"HOLD-E-ZEE" SCREWDRIVERS

A wide selection of new, high-quality self-grip screwdrivers. Durable, hexagonal blade shafts of tempered, chrome-vanadium steel. Handles of impact-resistant plastic. *For Phillips head and Reed & Prince type screws. PR-4 fits No. 1 to No. 8 screws; PS-4 fits No. 6 to No. 16. †Stubby type.

SLOTTED SCREW TYPE

Stock No.	Type	Hex.	Blade	Oz.	NET
43 N 973	TR-4	5/32"	4"	3	.59
43 N 974	TR-6	5/32"	6"	3	.63
43 N 975	TR-8	5/32"	8"	3	.67
43 N 976	TC-2†	7/32"	1 3/4"	4	.67
43 N 977	TS-4	7/32"	4"	4	.67
43 N 978	TS-7	7/32"	7"	5	.70
43 N 979	TH-6	5/16"	6"	6	1.11

*RECESSED TYPE

43 N 980	PR-4	5/32"	4"	3	.70
43 N 981	PS-4	7/32"	4"	4	.77

WALSCO HEX AND SPLINE WRENCH SET

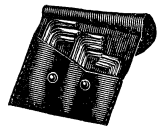

Handy set with 11 hex and spline wrenches in sizes most often used in radio. Contains 7 hex (Allen) and 4 spline (Bristol) keys for No. 2 to 3/8" screws. Finest carbon steel. In attractive leatherette case. Shpg. wt., ½ lb. **46 N 166. NET.....1.32**

ALLEN SCREW KEY WRENCH SET



6 L-shaped wrenches to fit 7 popular-sized Allen-head screws: Nos. 4, 5, 6, 8, 10, 1/4", and 3/8". Made of "Alloyen" steel with leatherette case which fits into pocket. Shpg. wt., 3 oz. **46 N 072. NET EACH...71c**
12 sets or more, EACH...64c



INSULATED MAGNETIC SCREWDRIVERS

Made by craftsmen in U.S. zone of Germany. Tough steel, full rubber-insulated shock-proof blade. Feature magnetic tip to hold and guide screws through shield holes or other tight places; excellent for retrieving small screws or nuts which have been accidentally dropped into crowded part of chassis. Parallel-ground tip follows screw heads into deep holes. Molded bakelite handle with screw cap. 1/8" tip. Excellent for trimmer adjustment, TV, etc.

Stock No.	Length	Blade	Oz.	NET
43 N 867	5 1/2"	2 1/2"	1 1/4	19c
43 N 868	7 1/4"	4"	2	29c
43 N 869	9 1/2"	5 1/2"	2 1/2	39c

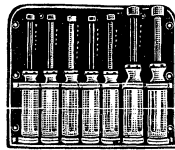

K-7

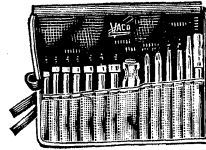

RT-14

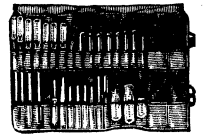

TV-27



ZSX-61



ZB-50

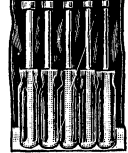

K-505

VACO TIME-SAVING SERVICE TOOL SETS

INSULATED HEX NUT DRIVER SET

Type K-7. Set includes 7 hex-nut drivers with color-keyed shafts. Permits immediate selection of correct hex driver for the job. Completely insulated, all-hollow shafts. Sure-grip handles; extra-hard sockets. In convenient, plastic tool roll with individual holders marked for size and color. Shaft length, 3". For hex-nut sizes: 3/16", 1/4", 5/16", 1/2", 3/8", 7/16", 1/2". Shpg. wt., 1 1/2 lbs. **43 N 906. List, \$9.00. NET.....7.06**

HANDY COMBINATION KIT

Type RT-14. All blades fit the shock-proof Amberyll handle provided. Kit includes: Handle; 6" extension piece; 7 nut drivers, sizes 3/16", 1/4", 5/16", 1/2", 3/8", 7/16", 1/2"; 2 Phillips drivers, No. 1 and No. 2; and 3 regular drivers, sizes 1/8", 3/16", and 1/4". All drivers are of high-quality chrome-alloy steel. With 1/4-section leatherette tool roll. Shpg. wt., 1 1/2 lbs. **45 N 829. List, \$10.50. NET.....8.23**

27-PIECE TV AND RADIO KIT

Type TV-27. Includes: 1 medium and 1 heavy-duty handle; #1 and #2 Phillips bits; 1/8", 3/16", and 1/4" regular bits; 6" bit extension; 3/16", 1/4", 5/16", 1/2", 3/8", 7/16", and 1/2" hex-nut bits; 1 medium and 1 small offset regular screwdriver; 1/4" stub; 3/8" pocket-clip; #1 Phillips; 1/8" screw-holding; 1/8" insulated-blade; 3/16" screw-holding; 3/16" insulated-blade screwdrivers; 3/16" metal-tip aligner; 1/8"x10" non-magnetic adjuster; 3/32" fiber television aligner. Shpg. wt., 2 1/2 lbs. **45 N 831. List, \$23.30. NET.....18.27**

BERYLLIUM-COPPER SCREWDRIVERS

For adjusting PM focus units on TV sets. Extra-long sizes permit back-of-the-set adjustments without removing the back cover. Quickly make close tolerance adjustments. Non-magnetic; do not affect picture. Nearly as hard as steel. Provide long service without buckling or shearing. Will not "give."

Stock No.	Type	Lgth.	Blade	Oz.	NET
43 N 896	VB26	8 3/4"	6x1/8"	3	.92
43 N 897	VB48	11 5/8"	8x1/4"	4	2.22
43 N 898	VB210	12 3/4"	10x3/8"	4	1.02

INSULATED BLADE SCREWDRIVER

Type VR261. Blade is heavily coated with break-resistant plastic of high dielectric strength. Precision built for perfect balance. Smooth Amberyll handle with fluted sides for comfortable grip. Unusually strong vanadium steel blade. Handle diameter and length, 3/4"x3 1/2"; blade diameter and length, 1/8"x6". Overall length, 9". Shpg. wt., 3 oz. **43 N 861. NET.....66c**



OFFSET SCREWDRIVERS

Forged from a steel bar; heat-treated and tempered, with screwdriver at each end.

A For Phillips screws, sizes 1 to 9. 4 1/2" long. Shpg. wt., 4 oz. **45 N 835. NET.....47c**

B For standard screws. 3/8" blades. 4 1/2" long. Shpg. wt., 4 oz. **43 N 843. NET.....53c**

WRENCH SET

Type ZSX-61. Handy 7-piece wrench set. All shafts are made of high-quality, oil-tempered chrome alloy steel, plated in rust-proof cadmium. Kit consists of one each—1x3 3/8" Amberyll handle with clutch, 1/4" hex nut wrench shaft, 3/8" hex nut wrench shaft, 1/2" hex nut wrench shaft, 3/8" hex nut wrench shaft, and extension shaft. Wrench shafts are 3" long. Leatherette tool roll included. Shpg. wt., 1 lb. **45 N 828. List, \$5.55. NET.....4.35**

SCREWDRIVER KIT

Type ZB-50. Features 5 detachable blades. All the screwdrivers ordinarily needed—in one compact unit. Very strong, oil-tempered, chrome vanadium steel. Has 1x3 3/8" Amberyll handle with clutch. Blades: 1/8"x4", 1/4"x5", Phillips No. 1 and No. 2, 4", Leatherette tool roll. Shpg. wt., 8 oz. **43 N 875. List \$3.68. NET.....2.88**

NUT DRIVER KIT

Type K505. New, 5-piece set of high-quality nut drivers. Recommended for mechanics, car-owners, maintenance men, etc.—ideally suited for use in shop or home. Perfect for radio-television servicemen. Comfort-grip handles constructed of insulated, shock-resistant Tenite. Has 3 1/4" all-hollow, heavy-duty steel shafts—easily fits long bolt extensions. Specially treated sockets assure long-wearing use. Kit includes five popular nut-driver sizes: 3/16", 1/4", 5/16", 1/2", and 3/8". Comes complete with convenient, individually pocket-marked plastic bag for quick identification and storage. Shpg. wt., 8 oz. **43 N 982. List, \$4.60. NET.....3.61**

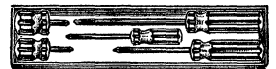

PHILLIPS SCREWDRIVER SET

Type P550. Set contains five of the most popular Phillips screwdrivers. A necessary time-saving aid for the radio-television serviceman, auto-mechanic, custom installer, etc. Designed to handle most-common applications quickly and efficiently. Easy-grip handles are constructed of shock-proof Amberyll. Long-wearing blades are made of tough, wear-resistant vanadium steel. Sold as complete kit only. Shpg. wt., 1 1/2 lbs.

Type	Overall	Blade	For Screws
P1	6 1/2"	3/16"x3"	No. 4 and smaller
P2	7 1/2"	1/4"x4"	No. 5 to No. 9
P3	10"	5/16"x6"	No. 10 to No. 16
P5	3 3/8"	1/4"x1 3/4"	No. 5 to No. 9
P6	3"	3/16"x1 1/4"	No. 4 and smaller

43 N 880. Complete kit. NET.....4.20

JEWELER'S SCREWDRIVER SET

Type S-600. Made by General Hardware. Handy set of 6 quality screwdrivers. Handles are precision made of top steel tubing. Each tool has a swivel head, replaceable blade and nickel-plated body. Tempered blades held firmly in place by threaded chucks. Chucks are grooved for identification. Overall length, 3 3/4". Blades: No. 0, .100"; No. 1, .080"; No. 2, .07"; No. 3, .055"; No. 4, .040"; No. 5, .025"; Shpg. wt., 5 oz. **43 N 855. NET.....3.20**

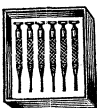

Quality Pliers and Wrenches

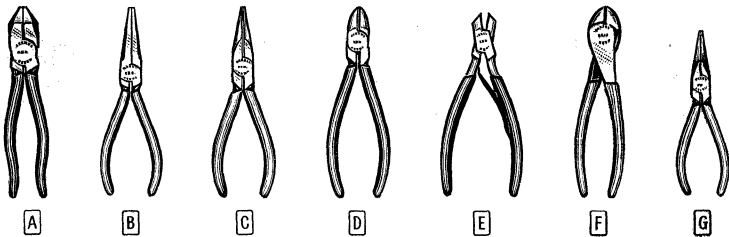

KRAEUTER HIGH QUALITY TOOLS "INDUSTRIAL LINE" PLIERS

A complete selection of famous Kraeuter professional-quality pliers. Designed for radio-TV, manufacturing, construction, and many other applications requiring pliers of the highest quality. Hammer-forged from high-grade tool

steel, individually fitted, tempered, and tested. Most types are available in both removable plastic cushion-grip handles with polished heads, or in a hard chrome finish. Assure long life under hardest use. Av. wt., 10 oz.

Cushion-Grip Handle—Polished Head				All Chrome			
Stock No.	Fig.	Type	Description	NET	Stock No.	Type	NET
46 N 408	A	1801	8½" Side-Cutting Pliers	3.31	46 N 442	1831	2.31
46 N 400	A	1830	6½" Side-Cutting Pliers	2.14	46 N 443	1662	2.36
46 N 413	B	1741	6" Long Flat Nose Pliers	1.91	46 N 444	1672	2.06
46 N 401	C	1661	6" Needle Nose Side Cutter	2.31	46 N 445	4601-5	2.17
46 N 404	C	1671	6" Needle Nose (No cutter)	1.91	46 N 446	4601-6	2.43
46 N 402	D	4501-5	5" Diagonal Cutters	2.02	46 N 447	1664	2.54
46 N 403	D	4501-6	6" Diagonal Cutters	2.28			
46 N 419	G	1663	6" Nose-Cutting Pliers	2.39			
46 N 414	E	2612	6½" Notched Diag. Cutters	2.69			
46 N 410	F	4610	7" Extra-Heavy Diag. Cutters	2.28			

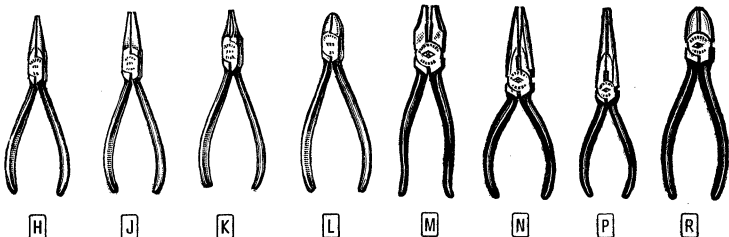

JEWELERS' PRECISION PLIERS

Precision-made pliers for work on miniaturized electronic assemblies and all types of delicate mechanisms. Widely used by hobbyists, experimenters, watchmakers, etc. Drop-forged from high-quality tool steel and polish finished. Av. shpg. wt., 5 oz.

Stock No.	Fig.	Type	Description	NET
46 N 415	H	83	4½" Chain-Nose Pliers	2.14
46 N 416	J	84	4½" Flat-Nose Pliers	2.20
46 N 417	K	85	4½" Round-Nose Pliers	2.20
46 N 418	L	81	4½" Diag. Cutting Pliers	2.20

HORSEHILL ECONOMY PLIERS

Famous Kraeuter pliers at an economy price. For radio, TV, and electrical work. All are forged from quality carbon steel. Semi-polished heads and black handles. Type 1780 has extra-long jaws. Av. shpg. wt., 10 oz.

Stock No.	Fig.	Type	Description	NET
46 N 448	M	1380	6½" Side-cutting pliers	1.84
46 N 449	N	1860	6" Chain-nose with cutters	1.76
46 N 431	R	4600	5" Diagonal cutting pliers	1.55
46 N 432	R	4600	6" Diagonal cutting pliers	1.76
46 N 433	P	1780	7" Chain-nose with cutters	2.14

KRAEUTER JEWELERS' PLIER SETS



Type 89. Set consists of 3 jewelers' precision pliers for close, accurate work on miniature mechanical and electronic equipment. Most often used types for wiring and assembling. Set includes 1—Type 81 diagonal cutting pliers, 1—Type 84 flat-nose pliers, 1—Type 83 chain-nose pliers.

All are drop-forged from high-quality tool steel. Heat treated to withstand shock and abuse. Polished to a gleaming finish. Excellent for the well-equipped service shop, home workshop, electronics laboratory, etc. Each precision tool is 4½" long. Supplied in black zipper case. Shpg. wt., 1 lb.
46 N 435. NET..... 8.02



Type 90. Complete set of 5 jewelers' precision pliers in durable black zipper storing case. Contains every popular type pliers. Used extensively for delicate, precision work by hobbyists, experimenters, watchmakers, etc. Set consists of 1—Type 81 diagonal cutters, 1—Type 82 end cutters, 1—Type 83 chain-nose pliers, 1—Type 84 flat-nose pliers, and 1—round-nose pliers. High-quality tool steel, heat treated and polished to assure long, dependable service. Each precision tool is 4½" long. Case size, 9¼" wide, 5¾" high, 1¼" lbs.
46 N 423. NET..... 13.41

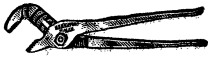

KRAEUTER 10" JOINT PLIERS

Type 710. Extremely versatile, slip-joint pliers. Drop-forged tool steel. Five parallel adjustments from ¾" to 1½". "T" section for added strength in lower jaw. Milled teeth assure firm, non-slip gripping. Polished finish. 10" long. Shpg. wt., 10 oz.
46 N 421. NET..... 2.20

PATTERN SNIPS

Type K-13. Combination pattern snips. Designed to cut either curved or straight lines in sheet metal, plastics, rubber, leather, etc. Hundreds of uses. Ideal for use in shop and home. Drop forged from high-quality steel. Carefully heat-treated. Blades stay sharp and have uniform shearing action over their entire length. Rated to cut 26 gauge cold-rolled sheet steel. Highly polished blades; black enameled handles. Pocket sized—only 7" long, 1¾" cut. Shpg. wt., 10 oz.
46 N 422. NET..... 1.40

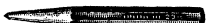

OCTAGON CENTER PUNCH

Type 23. Heavy-duty octagon center punch. Forged of high-quality carbon steel. Heat-treated, tempered and accurately ground. Black enamel finish, polished point. Size: 4½x ¾". Shpg. wt., 5 oz.
46 N 412. NET..... 44c

DB-76

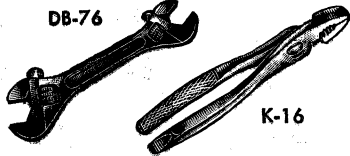

K-16

DIAMOND CALK TOOLS

TYPE DB-76 ADJUSTABLE WRENCH

Double-ended, adjustable wrench. Drop forged "Diamalloy" tool steel. Carefully machined to close tolerances for smooth dependable service. Finished in chrome nickel with highly polished heads and satin finished handle. Capacities are ½" and ¾". 1½" jaws are ¼" at tip with ¾" maximum head thickness; ¾" jaws are ½" at tip with 1½" maximum head thickness. Length, 6". Shpg. wt., 6 oz.
45 N 770. NET..... 2.65

TYPE K-16 SLIP-JOINT PLIERS

Slip-joint combination pliers with convenient wire cutting groove. Excellent for all general purpose work. Precision milled jaws provide a firm, non-slip grip on large or small objects of any shape. Knurled handles for secure hand hold. Length, 6". Shpg. wt., 10 oz.
46 N 460. NET..... 85c

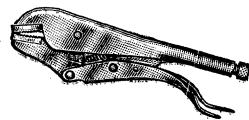

"TRU-CUT" LOCK WRENCH

Type 10-DC. Rugged, heavy-duty tool. Applies tremendous pressure with minimum effort—up to 1000 lbs. Non-slip grip holds objects of any shape. Can be used as quick-clamp, pipe wrench, toggle press, or hand vise. Finger-tip release opens wrench instantly. Knurled-head adjustable bolt sets tool for sizes up to 1½". Nickel-plated hardened steel. 10" long. Shpg. wt., 1¼ lbs.
46 N 434. NET..... 1.72

ADEL METAL "NIBBLING" TOOL

"Nibbles" holes, slots or openings in sheet metal. A real time-saver; leaves smooth, flat edge on holes. Easily munches 18-gauge steel, or aluminum and other soft metals up to ¼" thick. Minimum hole size, ¼" diameter. Durable construction; easy to use. Shpg. wt., 8 oz.
43 N 863. NET..... 3.77



WALSCO PROTECTO-TUBE

Type 18-K. Synthetic plastic high-voltage tubing for insulating the handles of pliers, screwdrivers, etc. Tubing is applied by treating with expanding solution which swells tubing for application to tool handles. Tubing then shrinks and remains firmly in place. Contains 12 ft. of tubing and expanding solution. Shpg. wt., 12 oz.
43 N 132. NET..... 1.06



VLČEK PANEL BAR WRENCH SETS

Type X2564. 5-piece open-end wrench set. Made of finest tempered carbon steel. 10 openings, ¾" to ¾" marked on wrench. Velco finish resists rust. Shpg. wt., ¾ lb.
46 N 265. NET..... 1.38

Type X2567. 5-piece large wrench set. As above but ¾" to ¾" openings. Wt., 1¼ lbs.
46 N 266. NET..... 1.73



L. B. MILLER "MAGMICK JR."

A very useful tool when working in restricted space. Consists of permanent magnet mounted on a swivel-joint extension handle. Retrieves nuts, bolts, etc. in hard-to-reach places. Indispensable when working on miniaturized units, in corners, etc. 10" long. Wt. 6 oz.
46 N 084. NET..... 1.20

Quality Tools

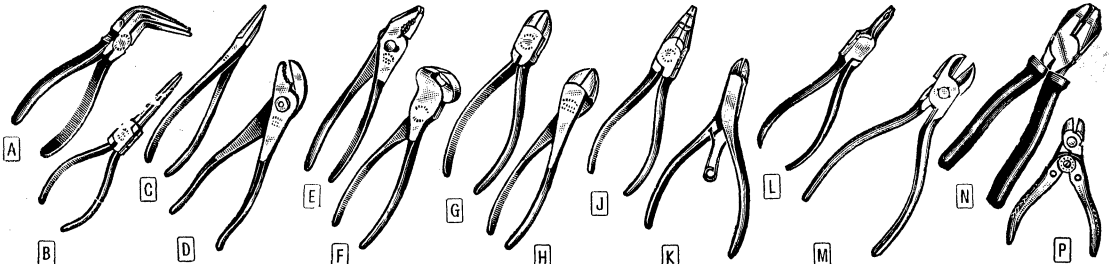

UTICA HIGH-QUALITY CUTTERS, PLIERS AND SNIPS

All types of electrical wiring, repair work and assembly jobs are easier with fine-quality tools. Utica supplies a wide variety of pliers, cutters and snips that are ideal for use by manufacturers, servicemen, Amateurs, experimenters—any who insist upon tools offering the utmost in smooth action, dependability and long life under the hardest use. Precise, scientifically controlled heat treating and hardening of the finest tool

steels assure superior and uniform quality. Precision-fit joints provide free, positive action under all conditions of operation. Accurate, easy cutting and gripping are assured by careful alignment of jaws and cutting edges. Handles on all types are of proper size and shape for completely comfortable grip and balance. Use Utica tools and add power to your hands. Av. shpg. wt., 10 oz.

No.	Fig.	Type	Description	EACH
46 N 476	A	888	6" Curved Needle Nose Pliers	2.50
46 N 475	B	777	6" Long Needle Nose Pliers	2.17
46 N 477	C	82	8" Assembly Pliers, Needle Nose	2.27
46 N 480	D	523	7" Angle Nose Gripping Pliers	1.90
46 N 479	E	512	8" Heavy-Duty Bent Nose Slip Joint Pliers	3.05
46 N 474	F	260	7" End Cutting Nippers	2.78
46 N 470	G	45	6" Aviation Diagonal Cutters	2.65

No.	Fig.	Type	Description	EACH
46 N 471	H	40	7" High Leverage Diagonal Pliers	2.39
46 N 478	J	2291	6" Insulation Stripping Pliers	2.47
46 N 425	K	101	4 1/2" Midget, Scissors-Type Snips	2.55
46 N 426	L	896	6" Cutting and Stripping Pliers	2.87
46 N 427	M	241N	5" Cushion Throat Side Cutters	3.23
46 N 489	N	3950	6" Linemen's Side Cutters	3.21
46 N 466	P	470-5	5" Printed Circuit Cutting and Crimping Pliers	3.23

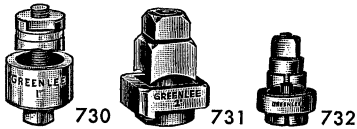

GREENLEE CHASSIS PUNCHES

Series 730. Permit easy, rapid cutting of round holes in metal chassis for sockets, switches, controls and other equipment. Cuts through metals up to 1/8" thick. Just turn cap screw to cut hole—can be operated with ordinary wrench. No reaming or filing required. All punches require 3/8" hole for lead screw, except 1/4" hole, and 1 3/4" hole. Av. shpg. wt., 1 1/2 lbs.

No.	Size	NET	No.	Size	NET
46 N 1698	1/2"	2.29	46 N 002†	1 3/4"	2.86
46 N 1778	3/4"	2.29	46 N 175	1 1/4"	2.65
46 N 000	1 1/8"	2.29	46 N 176	1 3/8"	3.00
46 N 170	3/4"	2.29	46 N 180	1 1/2"	3.39
46 N 001	1 3/8"	2.29	46 N 011†	1 5/8"	3.97
46 N 171	7/8"	2.29	46 N 110†	1 3/4"	4.50
46 N 172	1"	2.51	46 N 111†	1 7/8"	5.60
46 N 178	1 1/8"	2.65	46 N 116†	2"	6.04
46 N 173	1 1/4"	2.65	46 N 181†	2 1/4"	6.57
46 N 179	1 3/8"	2.65	46 N 209†	2 5/8"	11.02
46 N 174	1 1/2"	2.65			

Replacement Cap Screws. For round hole punches listed above. Av. shpg. wt., 4 oz.

- 46 N 182. 1/2" screw for 1/2" and 3/8" punches. NET.....26¢
- 46 N 183. 3/8" screw for 1 1/8", 3/4", 1 3/8", and 7/8" punches. NET.....26¢
- 46 N 168. 3/8" screw for 1" to 1 1/2" punches (except 1 3/8"). NET.....30¢
- 46 N 299. 3/4" screw for 1 1/2", 1 5/8" and 1 3/4" punches. NET.....39¢
- 46 N 343. 3/4" screw for 1 7/8" to 2 5/8" punches. NET.....53¢

- Series 731 Square Punches. Cut holes in metal up to 1/8" thick. Require 1/2" hole. Shpg. wt., 2 lbs.
- 46 N 269. For 1/2" hole. NET.....3.66
- 46 N 276. For 5/8" hole. NET.....3.78
- 46 N 277. For 3/4" hole. NET.....3.78
- 46 N 278. For 1" hole. NET.....4.94

Series 732 Key Punches. Cut holes for keyed sockets. Require 1/2" hole except 3/4" hole. Av. shpg. wt., 1 1/2 lbs.

No.	Size	NET	No.	Size	NET
46 N 214	1 1/2"	4.32	46 N 189	1 1/4"	4.67
46 N 184	1 3/8"	4.10	46 N 193	1 1/4"	4.94
46 N 186	1 1/4"	4.41			

HANDY STEEL TWEEZER

Handy Steel Tweezer. Finely tempered, nickel-plated steel tweezers. Size, 6 1/2" long. For all types of delicate work. Holds wires, nuts, screws, etc. Easy to hold. Shpg. wt., 4 oz.

46 N 095. NET.....53¢



UTICA ADJUSTABLE WRENCHES

Type 91 Adjustable Wrench. Thin pattern design. Easily slip into tight places. Drop-forged from tough alloy steel. Thumb-screw adjustment holds jaws firmly. Chrome finished head. *Tip thickness.

Stock No.	*Thick-ness	Size	Jaw Open	Shpg. Wt.	NET EACH
46 N 481	1/8"	4"	1/2"	2 oz.	1.75
46 N 482	3/16"	6"	3/4"	4 1/2 oz.	1.75
46 N 483	1/4"	8"	1"	8 oz.	2.03
46 N 484	9/16"	10"	1 1/8"	1 lb.	2.61
46 N 485	1 1/2"	12"	1 1/2"	1 1/2 lbs.	3.61

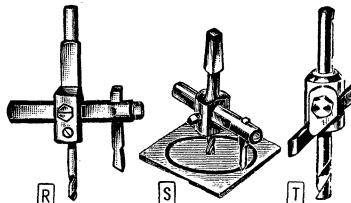

ALL-PURPOSE CIRCLE CUTTERS

Cut holes accurately in wood, sheet metal, plastics, etc. Round shank type for use in drill press; square shank type for hand brace. Drill acts as center pilot, keeping cutter in alignment. Horizontal cross-bar and cutting bits are instantly adjustable. Shpg. wt., 8 oz.

No.	Fig.	Shank	Hole Size	NET
45 N 600	R	Round 1/4"	7/8" to 4"	1.69
45 N 602	S	Square	1" to 5 1/2"	2.10
45 N 603	R	Round 3/8"	1" to 5 1/2"	2.10

Replacement Cutter Blades. For above. Hardened tool steel. Shpg. wt., 4 oz.

45 N 610. NET EACH.....53¢

CLARK HOLE CUTTER

Type 100. Cuts holes 5/8" to 1 1/2" in dia., in metals up to 1/8" thick. 1/4" pilot drill with 1/2" round shank for electric drills. Fully adjustable. Shpg. wt., 5 oz.

45 N 620. NET.....3.67

ICA 775 COMBINATION SHANK

Circle cutter for cutting smooth, accurate holes from 1 1/2" to 8" in dia. in chassis metals, panels, bakelite, wood, etc. Rugged 3/8" sq. cutting bar will not twist. 3/8" hexagon shank. Complete with removable 3/8" pilot drill. Shpg. wt., 1 lb.

45 N 604. NET.....2.94

777 Replacement Blade. For above. Made of hardened tool steel. Shpg. wt., 4 oz.

45 N 605. NET.....73¢



UTICA STRAIGHT CUT TIN SNIPS

Type 270. High-quality tin snips for straight cutting, medium-duty applications. 7" length. Sturdy tempered, forged steel construction. Cutting edge holds sharpness. Powerful, lever action makes cutting easier and faster. Ring-type handles provide firm, comfortable grip. Shpg. wt., 12 oz.

46 N 490. NET.....1.66

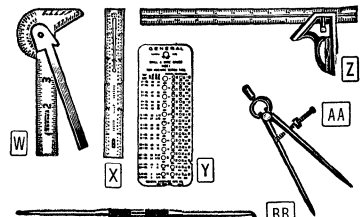

CHASSIS LAYOUT TOOLS

W Multi-purpose Steel Rule. Can be used as 4" scale in 32nds and 64ths, drill point gauge, square, bevel protractor, center finder, circle divider, tap-drill table. Made of stainless steel. In leather case. Shpg. wt., 4 oz.

46 N 153. NET.....1.26

X 6" Steel Rule and Wire Gauge. Made of stainless steel. Front graduated in 32nds and 64ths, also B. & S. wire gauge. Back has decimal equivalents. Identifies No. 8 to 20 wire. Shpg. wt., 2 oz.

46 N 061. NET.....41¢

Y Drill and Steel-Wire Gauge. For gauging machine screw taps, sizes 1 to 60. Indicates decimal equivalents. Lists taps with tap-drill and body-drill sizes, 1/4-28 to 2-56. Made of heavy-gauge steel, specially hardened and tempered. Shpg. wt., 5 oz.

46 N 060. NET.....1.26

Z Combination Steel Rule. 12" etched-steel combination square. Graduated on both sides in 32nds, 16ths, and 8ths. Head has thumbscrew for locking. 45 degree angle for bevel cuts. Shpg. wt., 1 3/4 lbs.

46 N 154. NET.....1.40

AA Steel Dividers. Stiff tempered, bow spring and tapered fulcrum spoon to assure rigidity and accurate measuring. Needle points are replaceable. Split adjusting nut permits quick, easy adjustment. Length, 6". Shpg. wt., 6 oz.

46 N 089. NET.....2.45

BB 9" Scriber. Two-point machinist's scriber with knurled finger-hold. Wt., 3 oz.

46 N 197. NET.....37¢

12" Stainless Steel Bench Rule. (Not illustrated.) Has two sides graduated in 8ths, 16ths, 32nds, and 64ths. 7/8" wide. Shpg. wt., 2 oz.

46 N 088. NET.....65¢

Quality Tools

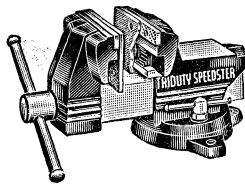

665A

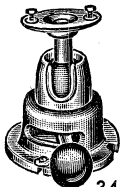

343

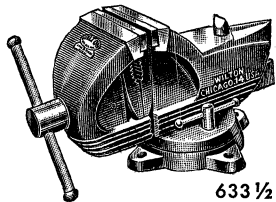

633 1/2

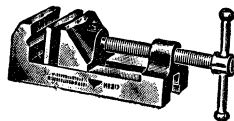

217

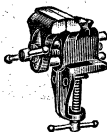

149

SHOP AND BENCH VISES

WILTON VISES

Model 665A Vise. Versatile new tool for the home workshop. Three rapid-acting vises—woodworking, metal working and pipe vise all rolled into one. Removable fiber-board jaw faces clamp wood without marring, 5" wide serrated steel jaws provide powerful grip for metal jobs. Built-in pipe jaws hold pipes of 1/4" to 2 1/2" dia. Jaws are 3 1/4" deep. Max. jaw opening 5 1/2". Swivel base. Enamel finish. Shpg. wt., 35 lbs.
46 NZ 953. NET.....17.64

Model 343 "Junior" Pow Rarm. Light-duty positioner for small electronic assemblies or parts. Provides a second pair of hands for production workers, servicemen or home craftsmen. Supports work firmly in any desired position. Body is cast aluminum and cadmium-plated steel. Capacity, 24 lbs. Base diameter, 4 1/4". Shpg. wt., 4 1/2 lbs.
46 N 857. NET.....13.80

Model 633 1/2 Vise. Ruggedly constructed "Shop-King" utility vise. A fine value for the home workshop. Suitable for all types of metal work. Equipped with removable pipe jaws, hardened serrated top jaws, wire cut-off tool and swivel base. Jaws open to a maximum of 4". Jaw width, 3 1/2". Pipe jaws will accept pipes from 1/4" to 1 1/2" in diameter. Smooth action opening and closing controlled by slide-bar which can be spun with one hand. Swivel base allows unit to be swung to any desired position and locked there. Base has four built-in lugs for secure mounting on any flat surface. Vise has attractive bright red enamel finish. Shpg. wt., 20 lbs.
46 NZ 866. NET.....9.33

Model 634 Vise. As above, but 4" jaw. Opens to 4 1/2". Shpg. wt., 30 lbs.
46 NZ 867. NET.....13.56

MILLERS FALLS NO. 217 VISE

For holding work on drill-press bed or work bench. Radiomen find it perfect for holding parts to be soldered or drilled. 2 3/4" wide jaws have parallel faces, extend to 3 1/4". Removable swivel jaw is provided for holding odd-shaped parts. Fine thread on screw gives excellent leverage. Shpg. wt., 5 lbs.
46 N 064. NET.....8.06

BRINK & COTTON NO. 149 VISE

Compact clamp vise ideally suited for radio work. Securely holds small parts for soldering, filing, cutting, etc. Smooth, easy action. Can be clamped to bench or table up to 2" thick. Jaws are 1 3/4" wide, open to 1 3/4", and are machined to meet squarely for a firm grip. Shpg. wt., 2 1/4 lbs.
46 N 015. NET.....1.76



614V



21

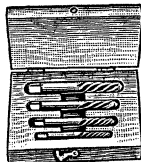

20

HENRY HANSON ACE TOOLS

TAP AND DIE SET

Model 614V. Ace "Super" tap and die set. A highly versatile tap and die outfit for radiomen, mechanics, hobbyists, and repairmen. Includes a complete set of popular size taps, dies and accessories. Consists of 39 pieces, each in its own easy-to-reach compartment. Ranges cover all average needs. Contains 1 each tap and die; 4-36, 6-32, 8-32, 10-24, 10-32 and 12-24 (Machine Screw Standard) 1/4-20, 3/8-18, 1/2-16, 7/8-14 and 1 1/2-13 NC (U.S. Standard), 1/2-28, 3/8-24, 1/2-24, 7/8-20 and 1 1/2-20, NF (S.A.E. Standard), 1/4" pipe. Includes die stock, tap and reamer wrench, "T" tap wrench, screw-driver and screw pitch gauge. Dies are V-notch adjustable. Set is complete with attractive, lightweight, green plastic carrying case—combines all the advantages of the conventional wooden box, but is much lighter, smaller, and more durable. Shpg. wt., 4 lbs.
46 N 245. NET.....21.38

SCREW EXTRACTOR SET

Model 20. For removing broken screws, bolts, studs and pipes that cannot be taken out by regular methods. Extremely useful tool for machinists, auto mechanics, steamfitters, etc. A hole is drilled into the broken piece, using the correct drill size marked on the extractor. Counter-clockwise turning of the extractor wedges it into the hole and removes the broken piece on its own threads. No damage to the threaded hole results. Set contains 4 extractors in hinged-cover, polished hardwood box. Will remove screws with diameters from 5/32 to 3/8". Will also remove 1/8" and 1/4" pipe. Extractors are tough alloy steel. Shpg. wt., 1 lb.
46 N 264. NET.....1.58

RADIO TAP AND DIE SET

Model 21. 12-piece set covering basic threads most frequently used in radio work. An excellent, low-cost set for the radio serviceman, hobbyist, experimenter, or engineer. Includes 1 each plug tap and die, sizes 6-32, 8-32, 10-24, 12-24, 1/4-20. Dies are solid type, 1" dia. High carbon, tempered steel assures long tap life. Tap wrench is finished in cadmium plating. Cover of case has index showing correct tap drill size to use with each tap. In mahogany box. Shpg. wt., 3 lbs.
46 N 025. NET.....6.38

INDIVIDUAL TAPS AND DIES

High-quality taps and solid dies for all-purpose use. Tough carbon steel. Right-hand thread. Shpg. wt., 2 oz.

Size	Tap	EACH	Die	EACH
4-36	46 N 700	26¢	46 N 706	37¢
6-32	46 N 701	26¢	46 N 707	37¢
8-32	46 N 702	26¢	46 N 708	37¢
10-32	46 N 703	30¢	46 N 710	37¢
10-24	46 N 703	30¢	46 N 709	37¢
1/4-20	46 N 705	34¢	46 N 711	37¢

Tap Wrench. "T" handle tap wrench for above taps. Sliding bar handle with spring tension gives plenty of leverage. Can be adjusted for one or two hand operation. Shpg. wt., 4 oz.
46 N 713. NET.....4.5¢

Die Stock. Plain die stock for above dies. Set-screw holds die in stock. Rugged construction for long life. Shpg. wt., 8 oz.
46 N 714. NET.....53¢



REAR CONTROL TV TUNING AID

Highly useful fingertip tuning aid for remote adjustment of TV rear panel controls. A tool-kit "must" item for the serviceman or technician. Has sturdy clip at one end of cable; small knob at other end for tuning. No mirrors needed. Simply attach clip to any rear mounted control—bring the cable around to front of television receiver and make adjustments while observing results directly on television screen. Shpg. wt., 8 oz.
46 N 248. NET.....2.98

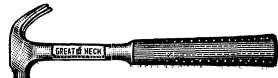

GREAT NECK CLAW HAMMER

Model R-16C. Deluxe, well balanced claw hammer. One-piece construction eliminates possibility of head loosening. Precisely tempered claws split to fine point for easily pulling small nails. Mirror-polished, hardened head cannot loosen. Has rubber cushioned handle for secure grip and excellent shock absorption. Highest quality forged tool steel construction. Overall length, 13". Shpg. wt., 1 1/2 lbs.
45 N 848.....3.19

G.C. CHASSIS CRADLE

Features easy-to-handle "Speed Clamps" that hold the work securely. A valuable accessory for the serviceman, builder and experimenter. Eliminates fumbling with makeshift setups to hold bulky chassis—prevents breakage of tubes or other above-chassis parts and equipment. Job is quickly and easily clamped into position. Complete 360 degree rotation permits tilting work to the most convenient angle. Fine for working on power supplies, TV sets, transmitters, record changers, etc. All-steel construction. Size, 24" long, 14" high, 12 1/2" wide. Shpg. wt., 7 lbs.
86 NX 034. NET.....7.35

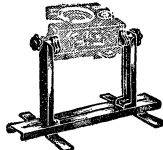

JFD "REPAIRACK"

Model 79-3. Sturdy, cast-iron rack for supporting chassis. Securely holds any chassis of up to 200 lbs. Full 360-degree rotation permits positioning work to any convenient angle. Designed to accommodate practically any chassis up to 32" in length. Greatly simplifies servicing jobs on large, heavy chassis. Allows faster, more efficient repair work. Separate chassis clamps on each side have thumb-screws that provide safe, positive holding action. Cast-iron construction for maximum rigidity and dependable, trouble-free service. Finished in durable black crackle lacquer. A "must" for the busy TV and radio serviceman's bench; will pay for itself in time saved. Maximum size, 32" long, 14 3/4" high, 15" wide. Shpg. wt., 18 lbs.
86 NX 038. NET.....19.80

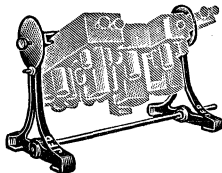

CLAUSS INDUSTRIAL SCISSORS

Type 925. Electricians' scissors. Made of finest cutting steel. Nickel plated for long service. Lgh. of cut, 1 3/4". Ideal for cutting tape, rubber, etc. 5" long. Shpg. wt., 3 oz.
45 N 896. NET.....1.70

Type 926BS. Same as above, but one blade is serrated.
45 N 897. NET.....1.88

Type 4217 Industrial Shears. Not illus. For shg. use. 7" long. Length of cut, 3 1/4". 5 oz.
46 N 305. NET.....3.19

Type 4218. As above, but 8" long; 4" cut. 6 oz.
46 N 304. NET.....3.57

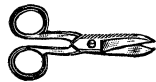



**G-C
SPEEDEX
WIRE
STRIPPERS**

766K



766

Efficient tools for automatically stripping insulation from all wires neatly and quickly. Narrow plier-grip handles. Ruggedly built and precision-made for uniform results. A valuable time-saving tool for servicemen, electricians, production lines, etc.

Deluxe Models. Equipped with "delayed return action" to prevent crushing of fine stranded wires. Easy to use. Just insert wire into jaws and squeeze handles. Has hardened steel cutting blades. Shpg. wt., 1 1/4 lbs.
46 N 225, Type 766. For 12 to 20 wire.
46 N 226, Type 766A. For 14 to 30 wire.
NET EACH.....4.85

Standard Models. Same design as above, but without "delayed return action." A smooth-operating, highly efficient tool for very moderate cost. Hardened blades. Shpg. wt., 1 1/4 lbs.
46 N 003, Type 733. For 12 to 20 wire.
46 N 004, Type 733A. For 14 to 30 wire.
NET EACH.....3.88

Type 766K Kit. A complete, versatile kit to fill most service and production line needs. Contains the Deluxe Wire Stripper described above and 7 different size hardened steel blades. For wire sizes from No. 8 up to No. 30. A practical addition to tool box. Shpg. wt., 2 1/4 lbs.
46 N 229, NET.....10.14

G-C TYPE 757 5-IN-1 STRIPPER



Extremely compact wire stripper. This handy, multi-purpose tool belongs in every radio and TV serviceman's tool kit. It can be used as a wire stripper, cutter, scraper, winder, and as a screwdriver. Strips insulation easily without cutting wire. Shpg. wt., 3 oz.
43 N 905, NET.....29c

MPC WIRE STRIPPER



An easy-to-use spring-steel, wire stripper and cutter. Has screw for adjusting cutting blade gap for any size wire to No. 12. Length, 5 3/8". Shpg. wt., 5 oz.
46 N 036, NET.....66c

K. MILLER 101-S STRIPPER AND CUTTER

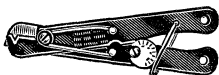

Combination wire stripper and cutter. Easily adjusted to strip insulation from any wire up to No. 8, solid or stranded. Calibrated adjustment permits convenient resetting to exact jaw opening required for any wire. Hardened steel blades. Ring lock holds blades closed when not in use. 5" long. Shpg. wt., 4 oz.
46 N 246, NET.....1.17

WALSCO "TWISTO" WIRE STRIPPER



Type 592-00. Wire stripper for rapid removal of toughest insulation. Can be inserted into chassis without removing wire. Adjustment for wire sizes 12 to 22. Built-in stop for production stripping. Spring steel blades. 4 1/2" long. Shpg. wt., 8 oz.
46 N 440, List, \$4.50, NET.....2.65

592-03, Replacement Blades. Wt., 2 oz.
46 N 441, List, \$1.00, NET PER SET.....59c

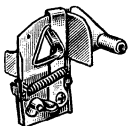

BLONDER-TONGUE S-1 WIRE STRIPPER

Amazingly simple rotary cable stripper. Strips insulated wire, cable and non-metallic tubing. Also excellent for cutting coaxial cable outer covering, shield- ing and inner insulation. Ideal for TV and radio servicemen. Razor blade is easily replaced. Has scale stamped on handle for measuring stripping length. Shpg. wt., 8 oz.
46 N 232, NET.....1.85

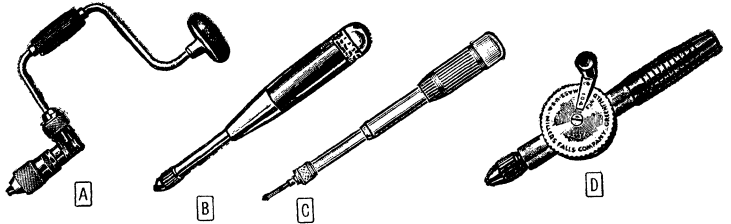

MILLERS FALLS HAND DRILLS AND BRACE

A Model 1708 Brace. Low-priced brace for square shank bits. Has adjustable forward-reverse ratchet control for use in limited space. Barber chuck with alligator jaws. 8-inch sweep. Ball bearing head mount. Hardwood head and handle. Shpg. wt., 2 1/2 lbs.
46 N 043, List, \$5.98, NET.....4.49

B Model 100 Automatic Drill. Push-type drill with multiple-toothed spiral mechanism and internal spring return. Top part of handle is rounded to fit comfortably into the hand. Hollow red plastic handle stores 8 fluted-shank drills (supplied), 1/8" to 1 1/4". Shpg. wt., 1 1/2 lbs.
46 N 038, List, \$5.75, NET.....4.30

C Model 170 Automatic Drill. Has convenient, quick-action chuck. Locks or releases with slight forward thumb pressure. Serrated, red plastic handle has 4 compartments—holds up to 12 drill bits. Complete with 4 drills: 3/8", 7/8", 1 1/8" and 1 3/8". 10 1/4" long. Shpg. wt., 3/4 lb.
46 N 307, List, \$4.00, NET.....3.00

D Model 104 Hand Drill. Latest drill design. Frame is die-cast aluminum; handle is made of break-proof plastic. 3-jaw chuck. Takes drills up to 1/4" in diameter. Hollow handle stores 8 drills (supplied), 1/8" to 1 1/4". Length, 12 3/4". Shpg. wt., 1 1/4 lbs.
46 N 042, List, \$7.94, NET.....5.96

HANSON ECONOMY HAND DRILL

An exceptionally well-balanced, inexpensive hand drill with knurled, hardened steel chuck. Will take drill bits up to 1/4" in diameter. Hardwood handle, with screw-on cap; has convenient storage space for extra drills. Has wooden side knob. Drill can be used with carbon steel or high-speed steel drill bits for drilling through wood, metal or plastic. All wooden parts are lacquer-finished. Overall length, 13 1/2". Shpg. wt., 1 1/4 lbs.
46 N 030, NET.....1.65

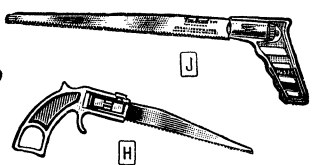
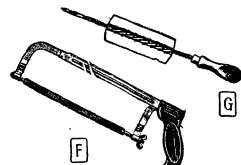
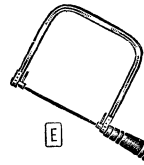

ALL-PURPOSE HAND SAWS

E Coping Saw. Excellent, all purpose coping saw. Natural hardwood, lacquered handle. Special ratchet locks blade in position. Supplied with 6 1/2" blade. Throat depth, 4 3/4". Shpg. wt., 3/4 lb.
45 N 878, NET.....49c

Type 124, Replacement Blades. Wt., 2 oz.
45 N 876, Pkg. of 2, PER PKG.....10c

F Pistol-Grip Hacksaw. Adjusts for 8 to 12" blades. Supplied with 10" blade. Shpg. wt., 1 1/2 lbs.
46 N 090, NET.....1.11

Replacement Blade Set. Contains 1 fine and 1 coarse blade, both 10". Shpg. wt., 3 oz.
46 N 091, NET, PER SET OF 2.....18c

G Stickback Drillsaw. Drills its own starting hole, then saws any shape in plywood, plaster, etc. Tip is gimlet; main blade has sharp spiral toothing. In 7" and 13" sizes.

46 N 148, 3/8" Drillsaw, 7" L. 6 oz. **NET 1.60**
46 N 149, 3/8" Drillsaw, 13" L. 12 oz. **NET 2.60**

H Forsberg V-35 Four-Way Keyhole Hacksaw. Handy lightweight saw for all general purpose work. Cuts metal, wood, plaster, conduit, etc. Blade is 7 1/2" long, 24 teeth/inch—can be faced in 4 directions. Wt., 6 oz.
46 N 341, NET.....29c

Extra Keyhole Saw Blades. Wt., 2 oz.
46 N 342, NET EACH.....12c

J Millers Falls Model 525 Keyhole Hacksaw. Cuts metal, wood, plaster, etc. Has removable, 11 3/4" blade; 10 teeth per inch. Blade can be rotated and locked in any of 8 positions for easier odd-angle cuts. Handle fits blades below. Shpg. wt., 9 oz.
46 N 102, NET.....1.65

Metal-Cutting Blade. 24 teeth per inch. Shpg. wt., 3 oz.
46 N 103, NET.....44c

Wood-Cutting Blade. 7 teeth per inch. Shpg. wt., 3 oz.
46 N 104, NET.....44c

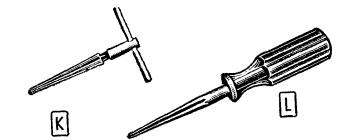

HAND-HELD REAMERS

K Henry Hanson Type 120. For enlarging holes in chassis, panels and other materials. T-Handle provides firm grip for heavy work; can be easily removed for use in drill chuck. Precision machined of hardened carbon steel. Point, 1/8" dia.; shank, 1/2" dia.; 5 1/2" long. Shpg. wt., 9 oz.
46 N 243, NET.....94c

L Master Reamer. Tapered reamer for quickly and easily enlarging undersize holes. Reamer is graduated in width from 1/8" tip to 3/8". Made of finest tool steel, hardened and carefully ground. Has unbreakable plastic handle. A very handy tool for the radio and TV repairman, experimenter, electrician, etc. Length, 8". Shpg. wt., 6 oz.
46 N 244, NET.....88c

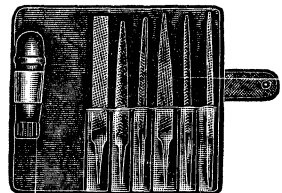

MINIATURE FILE KIT

Contains six files and durable amber plastic handle. Length of files, 4". Made in Western Germany. Includes: one equaling file (flat, single cut) with square edge; one half-round file, double cut; one three-square file, (triangular, double cut); one flat, taper file (double cut); one round (rat-tail, single cut) tapered file; and a tapered square (4-sided, double cut) file. Plastic handle contains built-in collet-type chuck, securely grips file tang. Files are quickly and easily interchangeable. Durable, attractive red plastic roll case with snap-type fastener. Shpg. wt., 5 oz.
46 N 340, NET.....1.32

Quality Tools

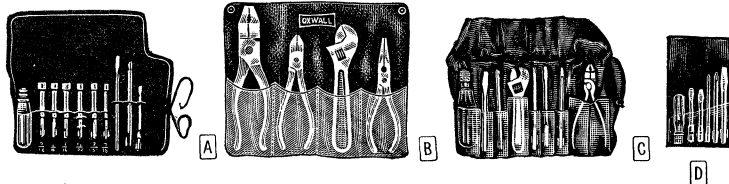

ECONOMY TOOL SETS

COMBINATION DRIVER SET

A A complete nut and screwdriver set, in a handy pocket-sized roll. Multi-purpose, 10-piece tool set contains 6 nut driver blades, 3 screwdriver blades and a clear amber plastic handle with an aluminum adjustable screw chuck. Blades are made of hardened and tempered tool steel, nickel plated to prevent rusting. Nut driver blades are for hex sizes $\frac{3}{16}$ ", $\frac{1}{4}$ ", $\frac{5}{16}$ ", $\frac{1}{2}$ ", $\frac{3}{8}$ ", $\frac{7}{16}$ ". 3 screwdriver blades: 1 large and 1 small standard screwdriver blade and 1 Phillips screwdriver blade. Plastic roll case has tie string. Shpg. wt., 1 lb.

46 N 463. NET.....1.55

4-PIECE TOOL SET

B Quality, drop-forged, imported tool steel. Ground and polished handles; pliers have knurled handles. An excellent set for the service shop or garage. Contains: 1, 7" lineman's slip-joint pliers; 1, 5 1/2" long nose pliers; 1, 5 3/4" diagonal side cutters; 1, 6" adjustable wrench. Each tool kept in place in its own transparent compartment. Heat-sealed plastic roll-up holder. Case no. 007. Shpg. wt., 2 lbs.

42 N 507. NET.....2.82

10-PIECE RATCHET SOCKET SET



Ratchet set with 8 heavy-duty sockets. 3 1/2" extension bar for hard-to-reach places. 3-position ratchet; right, rigid, or left. Five 6-point sockets for hex nut sizes: $\frac{3}{16}$ ", $\frac{7}{32}$ ", $\frac{1}{4}$ ", $\frac{9}{32}$ " and $\frac{5}{16}$ ". Three 12-point sockets: $\frac{1}{2}$ ", $\frac{5}{8}$ " and $\frac{3}{4}$ ". Length, 6 1/2" plus 3 1/2" extension. Unbreakable, amber plastic handle. Shpg. wt., 1 lb.

46 N 464. NET.....1.09

FLEXIBLE-DRIVE SOCKET SET

For use around corners and out-of-the-way places. Shaft of laminated steel wires. Thick cadmium plating. Shockproof amber handle. 8 3/4" overall. Includes 6 hex sockets, sizes: $\frac{1}{4}$ ", $\frac{5}{16}$ ", $\frac{1}{2}$ ", $\frac{3}{8}$ ", $\frac{7}{16}$ ", $\frac{1}{2}$ ". With handy wood case. Shpg. wt., 10 oz.

46 N 067. NET.....1.96

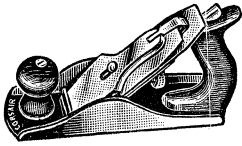

GREAT NECK PLANE

Model C-4 Corsair. Excellent value in a new to quality smooth plane. An extremely valuable time-saving tool for the home craftsman, woodworker, do-it-yourself enthusiast, etc. Ideal for a wide variety of general repair and maintenance jobs. Parts are made of high-quality, hardened and tempered alloy tool steel. Razor-sharp, 2-inch tempered steel cutter. Designed to provide rigid, vibration-free performance over long periods of use. Easy-grip handle knob is made of genuine kiln-dried hardwood, finished in attractive mahogany.

Lever cap is nickel-plated. The frog is fully adjustable to the entire width of the mouth. Bottom and sides of plane are machined and polished for maximum accuracy. Conveniently located brass screw permits easy adjustment of cutting blade. Expertly balanced for fatigue-free operation. 9 inches long. A "must" for every tool chest. Shpg. wt., 4 lbs.

45 N 849. NET.....3.37

8-PIECE TOOL SET

C Handy 8-piece combination wrench, plier and screwdriver set. Ideal for the serviceman, Amateur or hobbyist. Provides most of the smaller tools needed for repairs on appliances, table radios, etc. Contains following tools: 4" adjustable wrench; 4 3/4" combination pliers; 3 screwdriver blades measuring $\frac{1}{2}$ "x $\frac{3}{16}$ ", $\frac{3}{16}$ "x $\frac{3}{16}$ ", $\frac{1}{4}$ "x $\frac{1}{4}$ "; 2 Phillips screwdriver blades, #1 ($\frac{3}{16}$ "x $\frac{3}{16}$ ") and #2 ($\frac{1}{4}$ "x $\frac{5}{16}$ "). Shock-proof, amber plastic handle with adjustable chuck. Roll-up plastic holder. Shpg. wt., 2 lbs.

46 N 233. NET.....2.05

5-IN-1 SCREWDRIVER SET

D Screwdriver set containing five most-commonly-used screwdriver types. Interchangeable blades are easily inserted into aluminum screw chuck of the shock proof, unbreakable amber plastic handle. Hardened and tempered tool steel blades are nickel plated. Set contains: $\frac{3}{16}$ "x $\frac{3}{4}$ " cabinet blade; $\frac{3}{16}$ "x $\frac{3}{2}$ " cabinet blade; Phillips No. 1 ($\frac{3}{16}$ "x $\frac{1}{4}$ ") blade; Phillips No. 2 ($\frac{1}{4}$ "x $\frac{1}{4}$ ") blade. $\frac{1}{4}$ "x $\frac{1}{4}$ " keystone blade; plastic handle. Includes plastic roll-up holder with handy tie string. Shpg. wt., 8 oz.

46 N 096. NET.....64c

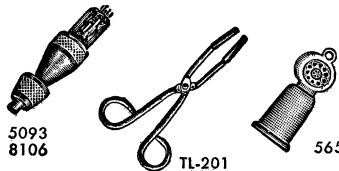

5093
8106

TL-201

565

TUBE PULLERS & STRAIGHTENER

G-C Type 5093. Compact tube puller. Aluminum body with rubber cup; for 7-pin miniature tubes. Shpg. wt., 2 oz.

46 N 094. NET.....1.06

G-C Type 8106. As above, for 9-pin tubes.

46 N 155. NET.....1.06

G-C Type TL-201. Scissors-type tube puller with rubber tips. Unusually handy tool. Shpg. wt., 12 oz.

46 N 092. NET.....97c

Walsco Type 565 "Straight 'N' Pull." 3 tools in one. Straightens 7 or 9 pin miniature tube pins; pulls tubes. Extremely helpful where pins have been bent by removal or insertion of tube. Shpg. wt., 3 oz.

42 N 016. NET.....97c

G-C PIN STRAIGHTENERS

Type 5191. Precision-built steel die. For 7-pin miniature tubes. Shpg. wt., 6 oz.

46 N 227. NET.....73c

Type 8105. As above, for 9-pin tubes.

46 N 228. NET.....73c

Type 8655. Not illustrated. For both 7 and 9-pin miniature tubes. Shpg. wt., 6 oz.

46 N 230. NET.....1.47

G-C "SPEEDEX" FUSE PULLERS

New, low-cost fuse pullers designed for quick removal of cartridge-type fuses. Provide maximum safety and ease of operation. Features non-slip construction. Laminated insulation of high dielectric material prevents shock from dangerous high voltages.

Model 5525. Midget size. For $\frac{1}{4}$ " to $\frac{1}{2}$ " fuses. Shpg. wt., 6 oz.

45 N 836. NET.....41c

Model 5526. Handy pocket-size puller. For $\frac{1}{2}$ " to $1\frac{1}{2}$ " fuses. Shpg. wt., 7 oz.

45 N 837. NET.....97c

ARROW GUN TACKERS

Model T-32. Easy-action stapling tool for tacking down 300-ohm twin-lead, intercom cable and other light nailing jobs. "Squeeze grip" for convenient, rapid, accurate operation. Just hold tacker against surface and squeeze—staple goes in wherever a tack can be driven. Easy to use. Chrome-plated steel. Shpg. wt., 2 lbs.

46 N 062. NET.....8.74

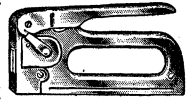

T-32-1/4" Staple Clips. For T-32. Length, 1/4". Package of 5000 staples. Shpg. wt., 1 lb.

47 N 096. NET.....1.87

T-32-3/8" Staple Clips. For T-32. Length 3/8". Package of 5000 staples. Shpg. wt., 1 lb.

46 N 063. NET.....2.08

Model T-25 Low-Voltage Wire Tacker. Tacks down any wire up to 1/4" in diameter. Shpg. wt., 2 lbs.

46 N 491. NET.....12.49

T-25-3/8" Staple Clips. For T-25. 3/8" long. 5000 staples to package. Shpg. wt., 1 lb.

45 N 790. NET.....3.33

T-25-7/8" Staple Clips. For T-25. 7/8" long. 5000 staples to package. Shpg. wt., 1 lb.

46 N 492. NET.....3.33

T-25-5/8" Staple Clips. For T-25. 5/8" long. 5000 staples to package. Shpg. wt., 1 lb.

45 N 791. NET.....3.74

Model T-50 General-Purpose Tacker. All-purpose—tacks down any wire up to 3/8" in dia. Shpg. wt., 1 1/2 lbs.

46 N 292. NET.....10.41

T-50-3/8" Staple Clips. For T-50. 3/8" long. 5000 staples to package. Shpg. wt., 1 lb.

45 N 792. NET.....2.29

T-50-1/4" Staple Clips. For T-50. 1/4" long. 5000 staples to package. Shpg. wt., 1 lb.

45 N 793. NET.....2.08

T-50-5/8" Staple Clips. For T-50. 5/8" long. 10,000 staples to package. Shpg. wt., 1 lb.

45 N 794. NET.....4.59

T-50-3/4" Staple Clips. For T-50. 3/4" long. 5000 staples to package. Shpg. wt., 1 lb.

46 N 294. NET.....2.92

Model T-75 Tacker. For non-metallic, sheathed cable up to 1/2" in diameter. Shpg. wt., 2 1/2 lbs.

46 N 493. NET.....12.49

T-75-3/8" Staple Clips. For T-75. 3/8" long. 1000 staples to package. Shpg. wt., 1 1/4 lbs.

45 N 798. NET.....1.88

T-75-5/8" Staple Clips. For T-75. 5/8" long. 1000 staples to package. Shpg. wt., 1 1/4 lbs.

45 N 799. NET.....1.88

T-75-7/8" Staple Clips. For above. 7/8" long. 1000 staples to package. Shpg. wt., 1 1/4 lbs.

46 N 494. NET.....2.08



MILLERS FALLS UTILITY KNIFE

Model U-333. Versatile utility knife of 1000 uses in shop or home. Neatly cuts rubber, veneer, gaskets, linoleum, upholstery, etc. Die-cast, 2-section handle contains 4 extra razor-sharp blades, .018" thick. Each blade has 3 positioning notches for exposing longer or shorter cutting edge. Blades are end-to-end reversible—a total of 10 keen cutting edges. Sturdy, rounded handle provides a sure, comfortable grip. Hole at end for convenient hanging. 5" long. With 5 blades. Shpg. wt., 1/2 lb.

46 N 308. NET.....73c

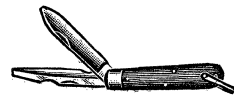

CAMILLUS ELECTRICIAN'S KNIFE

Model 229. Rugged, versatile knife. Excellent for use by the electrician, serviceman or handyman. Two blades: Combination screwdriver-cutter-stripper-scraper; spear-shaped, 5/8" knife blade. Brass locking bar positively prevents screwdriver blade from closing accidentally. Each blade is 2 1/2" long; of carefully tempered, high-quality steel. Black plastic, full-grip handle. Shpg. wt., 5 oz.

45 N 895. NET.....1.56

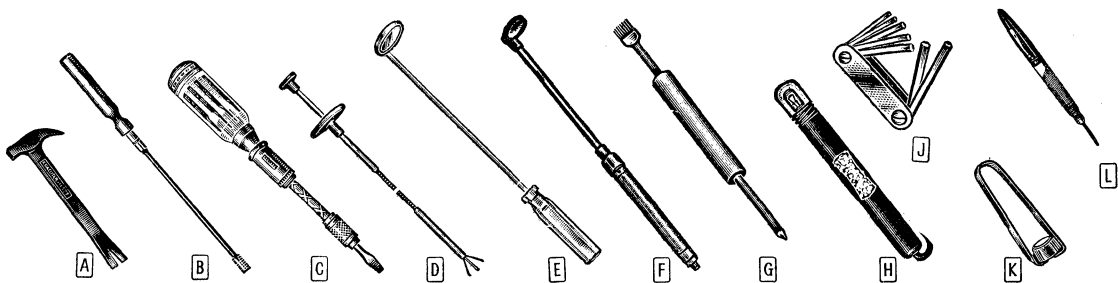

ALL-PURPOSE SERVICING TOOLS

- A All-Steel Utility Hammer.** Claw handle for pulling nails, dismantling cabinets, etc. Made of finest hardened and tempered steel—withstands roughest use. Excellent for use in workshop or home. Ideal size for carrying in tool box or belt. Length, 9½". Shpg. wt., 1½ lbs.
43 N 900. NET.....83c
- B Hunter TV-12 Tuning Slug Retriever.** Retrieves Standard Coil slugs without removing chassis from cabinet. Automatic holding mechanism. 11" L. Wt., 9 oz.
42 N 012. NET.....2.20
- Type TV-16.** As above but 15" long.
42 N 013. NET.....2.92
- Type TV-20.** As above but 20" long.
46 N 452. NET.....3.67
- C Mansco Speedriver.** Spiral ratchet-action automatic screwdriver. Transparent plastic handle holds interchangeable bits—permits user to quickly and easily select the right one. With 5 bits; ¼" and ⅜" screwdrivers; 3 wood drills. Overall length, 10". Shpg. wt., 10 oz.
42 N 017. NET.....2.72
- D Miller 345 Pick-Up Tool.** Invaluable for the serviceman. Press button to open claws—release to close over object. Flexible 14" shaft. Shpg. wt., 1 lb.
42 N 014. NET.....89c

- E G-C 5090 Inspection Mirror.** For inspecting parts, connections, etc. in tightly wired radio and TV sets, auto radios, etc. Handy for reading parts numbers and inspecting solder and wire connections in out-of-sight places. 8" length allows user to get into crowded chassis with ease. Indispensable for radio and TV servicemen, Amateurs, experimenters, etc. Mirror dia., 1". Shpg. wt., 5 oz.
42 N 121. NET.....35c
- F G-C 8725 Illuminated Inspection Mirror.** Permits inspection of parts otherwise hidden from sight. Consists of anodized aluminum flashlight with 6" lucite rod and 1" hinged-mounted mirror. Plastic housing prevents shocks. Locking switch allows one-hand operation. With bulb. Requires 2 penlight cells (below). 12¼". Shpg. wt., 6 oz.
42 N 130. NET.....1.91
- Burgess Type Z Cell.** 1½-volt cell for use with 42 N 130, above. Shpg. wt., 3 oz.
53 J 031. NET EACH.....9c
- G G-C 9088 Soldering Aid Tool.** A "must" for easier soldering. One end has a stiff wire brush for cleaning wire and terminals before soldering; other end is specially shaped to hold wires securely during soldering. Solder will not stick to chrome-tipped, probe end of tool. Especially handy for printed circuit repairs, neat solder connections, etc., 8" long. Shpg. wt., 4 oz.
42 N 001. NET.....97c

- H G-C 705 Handy Trouble Light.** No radio-TV serviceman or technician should be without this handy light. Illuminates dark corners in chassis—excellent for visual inspection of components in cabinets, etc. Casts light without glare; small size won't get in the way. With bulb and 5½-ft. cord. For 110-120 v., AC or DC. Shpg. wt., ½ lb.
42 N 120. NET.....1.32
- J Pocket Hex Key Wrench Set.** Hardened nickel-chrome alloy steel wrenches. Fitted in a steel frame like pocket-knife blades. Each wrench can be used independently in most suitable position. In popular sizes from .050" to ¾". Nickel-plated steel frame. Handy, plastic carrying case. Shpg. wt., 4 oz.
42 N 002. NET.....1.62
- K Knob-Puller.** A very helpful tool kit item. Knob-puller easily removes all types of hard-to-grip, push-on knobs. Simply place blades in back of knob, close handles, and pull forward. Prevents damaging either knob or cabinet. Shpg. wt., 4 oz.
46 N 077. NET.....29c
- L Pres-To-Oiler.** Press on plunger to release one drop of oil. Prevents over-oiling. Transparent fountain-pen reservoir holds oil supply. Also ideal for dispensing radio and TV chemicals in hard-to-reach places. Contains oil—ready to use. Shpg. wt., 3 oz.
46 N 065. NET.....95c



MILLERS FALLS TORPEDO LEVEL

Model 590. Accurate, lightweight level with one 45° plumb, one 90° plumb and one level. Molded, high-strength, glossy black bakelite body. Top plate of heavy, polished "nickeloid"; sets flush with body to protect the level glass. Plumbs and level vial are of highly visible cat's-eye type. Impervious to moisture; unaffected by changes in temperature. Bottom has V-groove running its entire length. Size, 9x1¼x¾". Shpg. wt., 7 oz.
46 N 309. NET.....1.87



EXACT "HANDLEVEL"

Model PL-24. Here's an exceptionally fine value in a new, quality-constructed level. A very dependable aid for anyone doing construction or repair jobs—excellent for use by carpenters, custom hi-fi installers, cabinet-makers, "do-it-yourself" enthusiasts, etc. Provides highly accurate leveling in both horizontal and vertical positions. The easy-to-handle, 24" long frame is made of rugged, lightweight, die-cast aluminum. Features shock-proof Pyrex vials which are permanently sealed in plastic inserts. Vials are large and easy to sight. Size: 24" long, 1½" thick, 1½" wide. Shpg. wt., 1½ lbs.
46 NX 927. NET.....2.25

STEEL TAPE RULES

Retracting, steel rules in choice of 6, 8 or 12 ft. lengths. Right-angle, square-corner case permits accurate inside or outside measurements. Die-cast case is finished in attractive, heavy chrome plated enamel face, black numerals. Av. wt. ¼ lb.

46 N 298, 6 ft. NET.....58c
46 N 321, 8 ft. NET.....77c
46 N 322, 12 ft. NET.....1.17



ACU-MATH SLIDE RULES

- M Model 1311 Professional 10" Slide Rule.** Extremely accurate, high-quality 10" slide rule. Deluxe features include: White nitrate plastic sheet face, bonded to corrosion-resistant magnesium core; stainless steel brackets; crystal-clear lucite cursor; inlaid calibrations and numerals; Trig and Log Log numerals in red. Scales on one side; LL01, L, K, A, B, T, ST, S, D and LL1. Other side: LL02, LL03, DF, CF, C1F, C1, C, D, LL3, and LL2. Supplied complete with sheath and instruction booklet. Shpg. wt., 1 lb.
46 N 333. NET.....12.95
- N Model 1211 5" Pocket Slide Rule.** Precision-made, highly readable pocket slide rule. Employs same quality construction features as the Model 1311 above, but with fewer scales. Perfect low-cost rule for the student. Scales on one side; K, A, B, C1, C, D and L; S and T on other. Fluid-action, slide assembly; clear lucite cursor. Inlaid, permanently accurate calibrations are quickly and easily read. Supplied complete with handsome leather sheath and easy-to-follow instruction book. Shpg. wt., 5 oz.
46 N 332. NET.....4.50

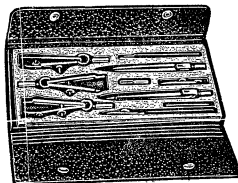

12-PIECE DRAFTING SET

An amazingly low-priced, 12-piece drafting set. Heavily nickel-plated brass instruments, in durable, velvet-lined pocketbook case. Imported from Western Germany, this exceptional, value-packed drafting set is perfect for students, engineers, beginning draftsmen, hobbyists, model makers, custom installers, etc. Also makes an excellent "second set."

Includes: 3½" bow compass with pencil; 3¼" bow compass with pen; 3¼" bow divider; 4¾" divider; 4¾" compass with removable arm; extra handle for pen and pencil parts of compass; 4½" ruling pen; 2" ruling pen head; 2" ruling pencil head; metal capsule with spare leads; and screwdriver. Ruling pen heads, divider tips and pencil leads are removable. With fine, side-screw adjustment.

The excellent workmanship of the instruments in this drafting set compares very favorably with many higher-priced outfits—an outstanding value. Size of pocketbook case, 8½ x 4½". Shpg. wt., 1 lb.
46 N 382. NET.....2.48

HANSON TYPE 100RS 1" MICROMETER

An economically priced, precision-made micrometer. Has full-range accuracy of .0005". An excellent, thoroughly dependable instrument for the home craftsman, Amateur and experimenter. A valuable aid for grinding quartz crystals, precise measurement of metal thickness, etc. Carefully designed to assure minimum frame distortion. Employs smooth-operating, screw-type anvil to permit simplified zero adjustment. Includes spring-friction stop for improved accuracy. Spindle moves in a steel bushing which is firmly fixed in frame of instrument to preserve high accuracy. Frame, thimble and ratchet are fully chrome-plated to inhibit rust. Each 100RS micrometer is pre-tested and factory adjusted using gauge block standards. Shpg. wt., 7 oz.
46 N 249. NET.....2.77



Steel Cabinets—Stands—Trucks

EQUIPTO STORAGE CABINETS



No. 8. 8-Drawer Cabinet. General-purpose storage cabinet. Excellent for storing small parts, hardware, tools, supplies, merchandise, etc., in workshops, stores, offices, or anywhere that an attractive, durable storage rack is required. Parts with loose wire ends are kept completely safe from accidental damage. Especially suited for radio-TV servicemen. Heavy-duty, welded steel frame holds 8 drawers on 2 levels. Each drawer has 2 centers, adjustable on 1" centers, making a total of 24 compartments. Drawers are made of heavy steel, with full-size handles and slot holders for label cards. Durable baked olive-green enamel finish. Drawer size, 3 1/8" high, 5 5/8" wide and 11" long. Cabinet size, 10" high, 25 1/2" wide and 12" deep. May be placed on shelf or stacked. Shpg. wt., 32 lbs.

- 86 NZ 012, NET.....15.95**
Type 8505 Drawer. Same type drawer as in cabinet above. Popular for use as parts trays on open shelving. With handle. Less dividers (below). Shpg. wt., 2 1/2 lbs.
86 N 869, NET.....90c
Type 8720 Cross Dividers. For type 8505 drawer above. Fit grooves die-pressed into drawer sides. Slant top for easy labeling. Shpg. wt., 6 oz. 5 per package.
86 N 872, PER PKG.....50c

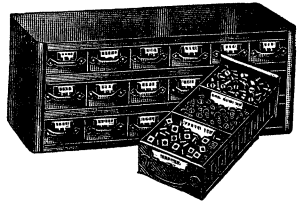

No. 11. 18-Drawer Cabinet. For storing small parts. Each drawer is equipped with two adjustable cross dividers. Drawers have large convenient handles. Instant-visibility label holders on drawers and dividers. Heavy-duty all-steel frame. Olive-green finish. Drawer size, 11x5 3/8x3 1/8". Overall size, 34" wide, 13 3/4" high, and 12" deep. Units fit on 1 1/2" shelf and may be stacked for greater storage space. Shpg. wt., 62 lbs.

86 NZ 011, NET.....27.90
No. 22. 18-Drawer Cabinet. As above, except 18" deep, and with 17x5 3/8x3 1/8" drawers. Shpg. wt., 95 lbs.
86 NZ 099, NET.....37.90
Type 8711 Lengthwise Divider. For No. 8505 drawer, use in No. 8 and No. 11 cabinets. Length, 11". Shpg. wt., 9 oz. 5 per pkg.
86 N 871, PER PKG.....50c
Type 8720 Cross Divider. For drawers of No. 11 or No. 22 cabinet listed above. Shpg. wt., 6 oz. 5 per pkg.
86 N 872, PER PKG.....50c

EQUIPTO COMBINATION AND "LITTLE GEM" CABINETS

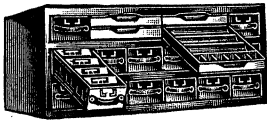

No. 12. Combination Cabinet. For small and medium-sized parts. Cabinet combines the features of Equipto Standard Drawer Units with the safety and convenience for tiny parts storage of "Little Gem" Drawers at right. Label holders on each drawer for quick identification of parts. Includes 14 standard drawers with 3 compartments each and 4 "Little Gem" drawers with 12 compartments each. Size: 34x13 1/4x11 1/2". Olive-green finish. Shpg. wt., 68 lbs.

- 86 NZ 096, NET.....39.30**



"Little Gem" Cabinets. For small parts. May be used individually or stacked. Units lock firmly together when stacked. Large, built-in handle. Drawer stop prevents accidental spilling. Dividers instantly adjustable on 1/2" centers. Dividers fit tight to embossed bottom—no creeping of parts under dividers. 12 compartments per drawer—up to 28 with extra dividers. No seams, sharp edges, slots or holes to catch or damage parts. 1 1/2"x11" label holder on front of drawer. 3/8"x1" label holder in overhang of each compartment. Olive green baked enamel finish. Size of each drawer: 11" long, 11" wide, and 1 1/2" high.

- No. 1. 2-Drawer Cabinet.** With dividers providing for 24 compartments. Size: 3 1/2x11x11". Shpg. wt., 7 lbs.
86 NX 065, NET.....6.95
No. 2. 4-Drawer Cabinet. With dividers for 48 compartments. Size: 6 1/2x11x11". Shpg. wt., 15 lbs.
86 NX 066, NET.....13.90
No. 3. 6-Drawer Cabinet. 72 compartments. Safe storage for thousands of parts. Size: 9 1/2x11x11". Shpg. wt., 23 lbs.
86 NX 067, NET.....20.85
No. 8730. Extra Drawer Dividers. Can be added to each drawer to provide up to 28 compartments per drawer. Easily adjustable. Size: 1 1/2x2 3/4x1 1/2". Shpg. wt., 1/4 lb. each. 5 per pkg.
86 N 068, PER PKG.....50c

NEW BENCH AND CABINET COMBINATION

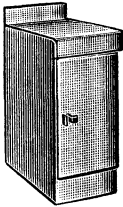

No. 233. All-steel combination workbench and storage cabinet for limited space applications. A compact "workshop" that is ideal for home, shop, or laboratory. Work surface area is 28x15". Raised rail at rear of work surface prevents work or tools from dropping behind cabinet. Storage cabinet is equipped with a removable shelf. Door is reinforced with steel box frame around all four sides. Smooth operating hinges are tamper-proof while door is closed. Door is equipped with an easy-operating latch and a heavy-duty tamper-proof hatch for padlocking if desired. Size, 34" high, 15" wide, and 28" deep. Olive-green finish. Shpg. wt., 60 lbs.

- 86 NZ 157, NET.....42.30**

EQUIPTO STEEL STANDS AND TRUCKS

CHASSIS AND TEST UNIT STANDS

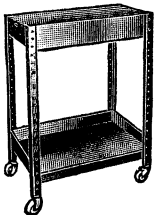

Convenient stands for radio and television chassis, industrial electronic equipment, and test instruments. Excellent for use in service shops, labs and factories. Ideal for moving chassis to service bench. Also excellent for bringing test instruments to industrial equipment. Unusually rugged construction; withstand constant use and maximum weight loads. Can be used in narrow aisles. Convenient bottom shelf provides handy storage space for small tools, extension cords and other accessories. Heavy steel with olive-green enamel finish. Solid rubber wheels, 2 1/2" diameter. Size, 18" wide, 24" in length. Height: With wheels, 34"; without wheels, 31".

No.	Type	Description	Wt., Lbs.	NET
86 NZ 087	710	With wheels	35	15.13
86 NZ 088	711	With wheels, wood top	40	16.63

STURDY STEEL TRUCKS



Stock handling carts for a wide variety of jobs. Heavy steel construction with round beaded edges for strength and rigidity. Easy rolling, 5" diameter solid rubber-tired wheels. Wheels are stationary in front, swivel in rear. Design for use in narrow aisles between rows of shelving or any general trucking use. Durable olive green baked enamel finish. Top tray may be inverted to make flat surface. Trays are 4" deep. Will safely handle loads up to 600 lbs. Paper-carrying shelf (86 N 093) listed in table below, fastens to push bar.

No.	Type	Description	Wt., Lbs.	NET
86 NZ 090	150	36" high, 24" wide, 36" long	68	39.90
86 NZ 092	145	36" high, 16" wide, 30" long	49	29.90
86 N 093	146	Paper-carrying shelf; 8 1/2x11"	5	2.50

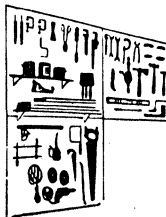

ABACUS PIN-UP BOARD

Provides 12 Sq. Ft. of Storage Space

Model 102. Four separate squares of perforated hardboard, each 18x24". Provide 12 square feet of storage space. A convenient and attractive way to store tools and a great variety of other small accessories. Pin-up rack includes 62 specially designed fixtures for hanging saws, hammers, planes, etc. Includes four, 4-oz. nail and screw jars, two shelf brackets, screwdriver holder. Hardboard is of 1/4" thickness—forms an unusually tough and durable surface. Dual suspension brackets. Board can be painted to suit any interior motif or decorating scheme. Complete with hooks, mtg. screws, spacers and installation instructions. Shpg. wt., 15 lbs.
86 NX 178, List, \$7.98, NET.....5.87

VIS-A-PART BOARDS

Stores Small Parts

Convenient wallboard for storage of small parts. Keeps parts in sight for immediate selection. Consists of attractive masonite board with up to 24 glass storage jars. Jars easily slide in or out of holder clips with one simple motion. Parts are always within easy reach. Masonite board is pre-punched to permit hanging on any wall. Perfect for use in the radio-TV service shop, machine shops or home workshops.

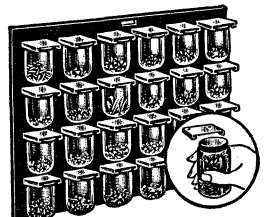

- 12-Jar Type.** Size, 18x8 3/4". Shpg. wt., 4 1/2 lbs.
86 NX 246, List, \$3.25, NET.....1.91
24-Jar Type. Size, 18x18". Shpg. wt., 9 lbs.
86 NX 245, List \$6.00, NET.....3.53
Replacement Jars. For above. Wt., 2 oz.
46 N 207, NET EACH.....8c
Holder Clips. Same type of holder clips used in boards listed above. For use on walls, boards, and screw mounting. Wt., 2 oz.
46 N 204, Pkg. of 2, Per Pkg.....20c

Tool Boxes—Parts Containers

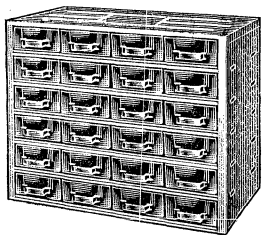

UNION "STACKMASTER" HEAVY STEEL CABINETS

New, ruggedly constructed multi-drawer cabinets for general storage of small items. Ideal units for the home workshop, radio and TV service shops, factory, office, lab, etc. Feature convenient "Lok-Tabs" that enable cabinets to be stacked in any direction—permits expansion of storage space as need arises. Cabinets can be quickly and easily detached from one another to provide any desired arrangement as additions are made. Cabinet frame is made of heavy-gauge welded steel. Clear, all-plastic drawers have built-in index cardholder and removable partitions. Special safety-stop on drawers prevent accidental spilling of small parts. All drawers are 5 1/2" long, 2 3/4" wide, 1 1/4" deep. Cabinet frames finished in handsome silver Dentone baked enamel.

Model U-24. 24-drawer cabinet. Size, 11x6x12 1/2". Shpg. wt., 9 lbs.
86 NX 783. NET.....3.29

Model U-12. 12 drawer cabinet. Size, 5 1/2x6x12 1/2". Shpg. wt., 6 lbs.
86 N 784. NET.....3.75

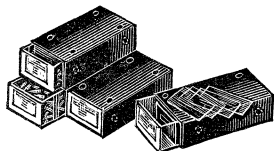

PLASTIC PARTS DRAWERS

The convenient way to store small parts for easy identification and withdrawal. Designed to display their contents and to make the most of all possible storage space. Consist of transparent drawers in steel shells which snap together to form strong steel cabinets. Each drawer shell has prongs and slots for secure interlock with other units on top, bottom, or side. May be stacked around existing fixtures to utilize all available space. Drawers may be subdivided into compartments with plastic dividers. Units snap together easily—require no tools. Shells are finished in gray. Furnished with one plastic divider and one name card. Overall size: 6" long, 3 1/8" wide, 1 7/8" deep. Shpg. wt., ea. 12 oz., per doz., 5 1/2 lbs.
86 N 024, 1 to 11. NET EACH.....54c
12 or More, EACH.....49c

Extra Dividers. Available only in packages of 7. Shpg. wt., per package, 12 oz.
86 N 193. Pkg. of 7.....22c

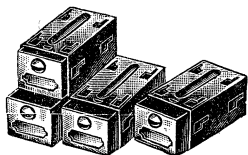

DIXIE INTERLOCKING DRAWERS

Small steel trays for storage of all types of radio-TV hardware and small parts. May be used separately or ganged together to form space-saving cabinets. Each unit interlocks with others at top, sides and bottom. Drawers may be assembled to fit irregularly shaped spaces unsuited to other cabinets or arranged for best utilization of available space. Each unit measures 2 1/2x2 1/4x5". Label holders make it easy to identify contents. Shpg. wt., each 10 oz., per dozen 8 lbs.
86 N 023. NET EACH.....42c
10 or More, EACH.....38c

Dividers. For use with Dixie drawers, above. Shpg. wt., per pkg., 4 oz.
86 N 179. Pkg. of 3.....10c

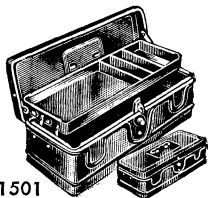

1501

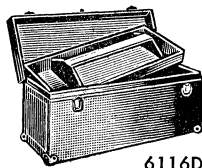

6116DB
6119

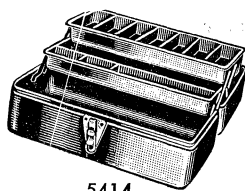

5414

QUALITY STEEL UTILITY CHESTS

HAMILTON UTILITY BOX

Model 1501. Sturdily constructed, drawn-metal tool and general-utility box. Extremely compact and easy to carry—fits airplane. Excellent for the radio and TV serviceman, kit builder, experimenter, mechanic and home craftsman. Easily accommodates a soldering iron, screwdriver, pliers, wrenches, test leads, etc. Handy cantilever tray has three compartments: 1—2 3/8x6", 1—1 7/8x6", 1—9/16x6". Compartments are extremely handy for the storage of hardware and miscellaneous small parts, such as resistors, capacitors, screws, etc.

Case has full-drawn, seamless, rounded corners with a smooth operating, snap-type lock. Lock also has eye for padlock insertion if desired. Cover has positive latching action when closed—prevents accidental spilling of contents. Folding, fingertip handle is securely attached to cover. Entire construction of box assures extra strength and complete rigidity. Ruggedly built to last for years. An excellent value. Handsomely finished in high-gloss green baked enamel. Overall size, HWD: 4 1/2x6 1/4x14 1/2". Shpg. wt., 3 lbs.
86 N 156. NET.....1.50

UNION "SUPER STEEL" TOOL CHESTS

Sturdy steel chests with removable tray. Has two heavy-duty drawbolts plus center padlock eye. Continuous hinge welded to cover and case. Heavy-duty steel handle. Blue, hard-baked enamel interior. Exterior has silver gray hammertone finish.

Type 6116DB. 16x7x7". Wt., 6 1/2 lbs.
86 NX 018. NET.....4.70

Type 6119. Same as above, but overall size is 19x7x7". Wt., 7 lbs.
86 NX 017. NET.....5.02

UNION WATERTIGHT TOOL BOX

Type 5414. Ruggedly constructed, watertight utility chest with two cantilever-mounted trays. Large tray capacity makes it ideal for storing tools or small parts. Upper tray is divided into seven equal compartments; lower tray contains one full length, one 2/3 length and two smaller compartments. Full-grip steel handle. Finished in green hard-baked enamel; green enamel interior. 7 1/4" wide, 7" high and 14 1/2" long. Shpg. wt., 5 lbs.
86 N 045. NET.....3.32

"QUA-DROR" ALL STEEL STORAGE CABINET

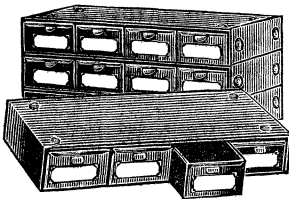

Compact, four-drawer, three-way interlocking cabinets. The ideal solution for storage of small parts, tools, etc. Perfect for limited-space applications. Extremely handy for the radio and television serviceman, mechanic, hobbyist, home craftsman, etc. Each cabinet is a complete unit with four, individual, one-piece drawers. Cabinets can be stacked either vertically or horizontally and locked together. No limit to the number of cabinets you can attach. Can be quickly, simply detached for re-arrangement in any desired pattern. Excellent for stacking on workbench or table. Frames have countersunk locking devices on top and both ends. Each drawer is complete with metal snap-in separators for up to four individual compartments. Separators will not shift or slide—each is completely rigid. Drawers have folded, reinforced corners with strong tubular and folded sides. Made of rugged, one-piece, steel frame—will not warp or bend even if dropped. Each has safety-stop to prevent accidental spilling of parts—drawers cannot fall out. Have easily replaced, identifying label. Drawer contents can be identified instantly. Individual drawer size, HWD, 1 7/8x2 1/4x5 3/8". Cabinet size, HWD, 1 3/4x11 1/2x7". Handsomely finished in attractive, neutral gray. Shpg. wt., 1 1/2 lbs.
86 N 781. NET.....1.42

"HAZ-BIN" SMALL PARTS STORAGE CABINETS

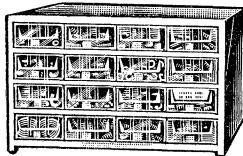

Beautifully Styled—Clear Plastic Drawers

Space-conserving cabinets for parts and hardware storage. Offered in an excellent selection of sizes to accommodate virtually all storage requirements. Ruggedly made and unusually handsome in appearance. Excellent for the radio-TV serviceman, store, home workshop, etc. Clear plastic drawers, 1 1/8x2 1/4x5 3/8", are separated into three sections by removable dividers. Contents are protected from dust and are always clearly visible to permit easy identification. Index cards are supplied to fit slots on front of drawers. Cylindrical stub handles provide easy grip without blocking view of index cards. Back-stop prevents accidental pull-out of drawers; contents cannot spill. Additional cabinets can be attached to back, side or top, can be wall-mounted or placed on any level surface. Rubber feet prevent marring or scratching of tabletop or shelf. Durable, welded all-steel cabinets; attractive, baked-on, silver-gray Hammertone finish.

Stock No.	Mfr's Type	No. Draw.	H. W. D.	Wt. Lbs.	NET EACH
86 NX 047	-16	16	8 1/2x12 1/2x6"	8	6.95
86 NX 143	-20	20	10 1/2x12 1/2x6"	9	7.95
86 NX 144	-24	24	12x12 1/2x6"	10	9.95
86 NX 048	-32	32	15 1/2x12 1/2x6"	13	12.95
86 NZ 039	-64	64	15 1/2x25 1/2x6"	25	24.95

UNION MODEL 410 4-DRAWER STEEL CHEST

Sturdy all-steel chest for keeping often-used parts within handy reach. Can be used for storing all types of radio and TV hardware, resistors, capacitors, small tools, nails, screws, and hundreds of other small parts. Excellent for the home workshop, repair-shop, hobbyist, experimenter, etc. Has four easy-slide drawers, each 2x9x11 1/2". Each drawer has removable dividers—enough supplied to make anywhere from 2 to 12 compartments per drawer. Drawers also have label holders for quick, easy identification of contents.

Safety drawer-stop prevents contents of drawers from being accidentally spilled. Cabinet and drawers are constructed of heavy, non-warp steel. Cabinets can easily be stacked for greater storage area—indentations on cabinet hold feet of cabinet above—prevents slipping or falling of stacked units—use on work bench, table, etc. Each drawer has convenient, sturdy pull-out handle. Attractively finished in durable, silver-gray finish. Overall size, 10x10x11 1/2". Shpg. wt., 10 1/2 lbs.
86 NX 019. NET.....4.97

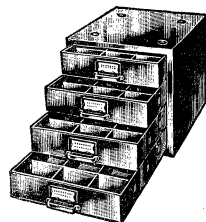

With Removable Dividers

Workshop Aids, Plastic Stock, Hardware

STURDI-BILT "DROPTOP" SET

Model DT 200TR. Here's an exceptionally valuable workshop aid—provides 1296 square inches of tool rack area plus swing-away work table. Work space when and where you need it—provides maximum utility for limited-space areas. Tool rack mounts flush against wall; solidly built work table folds conveniently out of way when not in use! Tool rack panel can be easily removed from frame for cleaning.

Accepts standard tool hooks to accommodate an entire large-size tool set in convenient, easy-to-reach form. Ideal for hanging wrenches, screw and nut drivers, and other workshop tools in neat, orderly fashion. Massive work-table top measures 60x24x1 1/2" thick; constructed of kiln-dried lumber strips, side by side, bonded between layers of high-density wood and smooth, hard plastic. Rugged, yet smart in appearance.

Complete "Droptop" Work Center includes folding table, tool rack (48x27"), brackets and hardware. Can be easily set-up in a few minutes. Attractive tan finish. Shpg. wt., 67 lbs.

46 NZ 929. NET 27.00

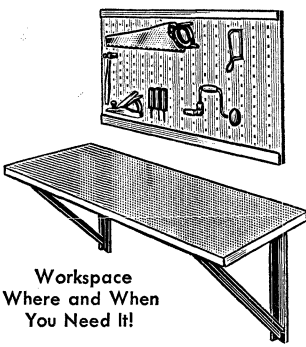

Workspace
Where and When
You Need It!

G-C 8943 "TUX" TOOL HOLSTER

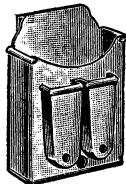

A perfect accessory for servicemen, electricians, and repairmen. Excellent for service calls and antenna installations; the required tool is always available. Attaches to belt. Has two narrow compartments and one full-size compartment. Plenty of room for carrying most needed tools, such as wrench, pliers, wire-cutter, tube puller, screwdrivers, alignment tools, file, etc. Made of tough, flexible polyethylene

plastic. Holds its shape. Shpg. wt., 6 oz. 46 N 345. NET 2.32

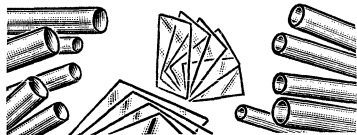

POLYSTYRENE SHEETS, RODS AND TUBING

Polystyrene sheets, rods and tubing. Ideal for AC, DC and RF applications as well as VHF, UHF and SHF. Excellent material for insulators, coil forms, shields, etc. Extremely low-loss factor at ultra-high frequencies. High dielectric strength. Excellent arc resistance and insulating properties. No moisture absorption. Highly stable under varying climatic conditions. Transparent except tubing, which has satin finish.

POLYSTYRENE SHEETS

Stock No.	Size	Thick-ness	Shpg. Wt.	1-9, EA.	10-49, EA.
71 H 865	12x12"	1/8"	8 oz.	4.07	3.66
71 H 866	12x12"	3/32"	10 oz.	4.70	4.23
71 H 867	12x12"	1/8"	12 oz.	5.39	4.85
71 H 868	12x12"	3/16"	1 lb.	7.01	6.31
71 H 869	12x12"	1/4"	1 1/2 lbs.	7.99	7.19
71 HX 870	12x24"	1/8"	1 lb.	7.64	6.88
71 HX 871	12x24"	3/16"	1 1/4 lbs.	8.97	8.07
71 HX 872	12x24"	1/4"	1 1/2 lbs.	10.39	9.35
71 HX 873	12x24"	3/8"	2 lbs.	12.89	11.60
71 HX 874	12x24"	1/2"	3 lbs.	15.34	13.81

12" POLYSTYRENE RODS

Stock No.	Dia.	Shpg. Wt.	1-9, EACH	10-49, EACH
71 H 875	1/8"	2 oz.	.03	.02
71 H 876	3/16"	3 oz.	.07	.06
71 H 877	1/4"	5 oz.	.12	.11
71 H 878	3/8"	6 oz.	.18	.16
71 H 879	1/2"	6 oz.	.25	.22
71 H 880	5/8"	6 oz.	.47	.42
71 H 881	3/4"	8 oz.	.71	.64
71 H 882	7/8"	8 oz.	.98	.88
71 H 883	1"	8 oz.	1.39	1.25
71 H 884	1 1/8"	8 oz.	1.86	1.67

12" TUBING (Satin Finish)

Stock No.	O. D.	I. D.	Shpg. Wt.	1-9, EACH	10-49, EACH
71 H 885	1/4"	3/16"	2 oz.	.10	.09
71 H 886	3/8"	1/2"	3 oz.	.14	.13
71 H 887	1/2"	3/4"	3 oz.	.18	.16
71 H 888	5/8"	3/4"	3 oz.	.25	.22
71 H 889	3/4"	5/8"	4 oz.	.31	.28
71 H 890	1"	3/4"	6 oz.	.39	.35
71 H 891	1 1/8"	1"	6 oz.	.55	.49

Write for prices on larger quantities.

332

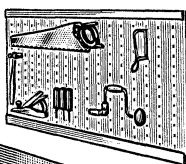

JIFFY TOOL RACK

Lightweight steel tool rack. Holds an amazingly large number of tools in a very small space. Uses only 2x12" of wall space yet it neatly holds all your small tools within easy reach. Right-angle shape. Bottom half, for flush wall mounting, has 9 hooks for general utility use. Upper half of rack has 10 holes and 10 recesses. The holes provide convenient, rust-proof storage space for screwdrivers, files, inspection mirrors and other small tools. The recesses are useful for mounting pliers, wrenches, shears, etc. Constructed of rigid, durable steel. Shpg. wt., 5 oz. 46 N 779. NET 49c

BARGAIN HARDWARE KIT

Save on this amazingly low-priced assortment of rivets, rubber grommets, nuts, screws, lock washers, right-angle brackets, soldering lugs, spade bolts, self-tapping screws, eyelets, and other radio hardware. Includes nickel and cadmium-plated, and solid aluminum pieces. In convenient transparent plastic container. Shpg. wt., 1 1/4 lbs. 44 N 315. NET 97c

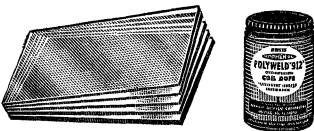

AMPHENOL POLYSTYRENE SHEET STOCK & CEMENT

Extremely low-loss, 4x8" polystyrene sheets. Excellent for use in AC, DC and RF applications including VHF, UHF and SHF. Perfect where safe, clear insulation is needed. High dielectric strength. Colorless; does not deteriorate under adverse climatic conditions. Retains original dimensions—does not stretch or warp. No moisture absorption. Also fine for dial and gauge glass use. Easy to cut and fit to any size. Can be drilled and tapped.

Stock No.	Mfr's Type	Size	Shpg. Wt.	NET EA.
71 H 738	19-0628	4x8x1/8"	3 oz.	20c
71 H 739	19-0938	4x8x3/32"	4 oz.	24c
71 H 746	19-1258	4x8x1/2"	5 oz.	37c
71 H 749	19-1878	4x8x3/8"	6 oz.	46c
71 H 748	19-2508	4x8x1/4"	8 oz.	50c

POLYWELD "912" CEMENT

Type 53-912-2. Securely bonds or "welds" polystyrene sheets. Rapid drying. Ideal for coil coating where polystyrene forms are used. Has negligible loss factor. With brush applicator. 2 oz. bottle. Shpg. wt., 3 oz. 43 N 139. NET 35c

AMPHENOL CEMENT THINNER

Type 53-916-2T. For thinning Polyweld cement listed above. Does not change loss factor of cement. Rapid acting. Extends useful life of cement. 2 oz. bottle. Shpg. wt., 3 oz. 43 N 141. NET 35c

VLCHEK PLASTIC BOXES

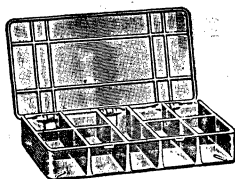

For Storing Small Parts

Clear plastic storage boxes. Individual compartments for neat, visible arrangement of parts.

Type P250. One-compartment utility box. Overall size, 6 1/2x4x1 1/8". Shpg. wt., 6 oz. 44 N 362. NET 38c

Type P212. 5 compartments. 4 are 1 1/2x2 3/8" plus 1 1/2x3 3/8" center compartment. Overall size, 7x3 1/2x1 3/8". Shpg. wt., 1/2 lb. 44 N 356. NET 37c

Type P203. 6 compartments, each 1 1/4x4 1/4". Overall size, 8 1/4x4 1/4x1 1/4". Wt., 3/4 lb. 44 N 357. NET 51c

Type P210. 9 compartments. 8 are 1 1/2x1 1/2". Center compartment, 1x3 3/8". Overall size, 7x3 1/2x1 3/8". Shpg. wt., 1/2 lb. 44 N 355. NET 37c

Type P201. 12 compartments. Has four 2x1 1/2" compartments; two 1 1/4x4"; six 1 1/4x1 1/4". Overall size, 8 1/4x4 1/4x1 1/4". Shpg. wt., 3/4 lb. 44 N 358. NET 52c

Type P612. 12 compartments. Has 6—1 1/4x2"; 6—1 1/4x4 1/4". Overall size: 10 3/4x6 5/8x1 3/4". Shpg. wt., 1 1/4 lbs. 44 N 354. NET 1.22

Type P618. 18 compartments, each 1 1/4x2". Overall size, 10 3/4x6 5/8x1 3/4". Wt., 1 1/4 lbs. 44 N 359. NET 1.29

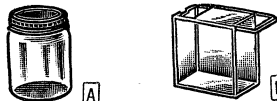

STORAGE CONTAINERS

A Glass Jar. Ideal storage container for miscellaneous small parts. Complete with metal screw cap for keeping items free from dust and moisture. Size, 2 1/2" high; 2" in diameter. Shpg. wt., 7 oz. 44 N 500. 12 or more, EA. .50. EACH... 6c

B Plastic Container. Transparent plastic container with sliding lid. Useful for storing resistors, capacitors, nuts, screws, washers, etc. Size, 2 1/2x1 1/2x2 1/2". Shpg. wt., 3 oz. 44 N 501. Pkg. of 12... 2.27. EACH... 21c



NEW G-C HOME-SHOP ASSORTMENTS

Handy assortments of most-often-needed hardware. Provide many hard-to-get screws, springs, solder lugs, nuts, and bolts often needed by experimenters and servicemen. Packed in sturdy light weight plastic storage containers. Contents can be quickly identified from any angle. Have tight-sealing, hinged covers to keep out dirt and moisture.

No. 9116 Solder Lug Assortment. Includes generous quantity of different size solder lugs. For all types of electrical connections—particularly suited for radio chassis, control panels, test instruments, laboratory equipment, etc. Shpg. wt., 1 1/2 lbs. 43 N 370. NET 97c

No. 9117 Screw and Nut Assortment. Contains various size screws, nuts and bolts. Ideal addition to the tool box for repair jobs. Popular sizes used for mounting terminal strips, transformers, tube sockets, relays, switches, etc. Shpg. wt., 1 1/2 lbs. 43 N 371. NET 97c

No. 9118 Spring Assortment. Package of different type springs for use with dial cords, push-buttons, etc. Includes both extension and compression springs. Shpg. wt., 1 1/2 lbs. 43 N 372. NET 97c

Depend on Allied for Complete Stocks, Low Prices, Friendly Service

Radio-TV Hardware

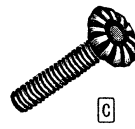
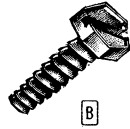
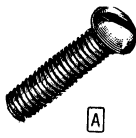
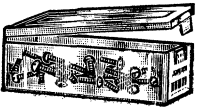

Hardware for all purposes, in popular sizes and quantities. Each 32c quantity comes in a handy transparent plastic container with sliding lid.

Needed items are easy to find—protected against loss—kept free of dust. All nickel-plated except Fig. C (brass finish). Size, 2 1/2 x 2 1/2 x 1 1/2".

A Round Head Screws. General-purpose type in most sizes required for repair and construction jobs in radio, television and electronics. Plated steel. Shpg. wts.: 3 oz.; 14 oz.; and 5 lbs.

Size	32¢ container		Gross Pkg.		1000 Lot Pkg.	
	No.	Quan.	No.	NET	No.	NET
4-36x1/4"	44 N 502	40	44 N 741	.57	44 N 742	3.40
4-36x3/8"	44 N 503	35	44 N 744	.62	44 N 745	3.68
4-36x1/2"	44 N 504	35	44 N 747	.62	44 N 748	4.28
6-32x1/4"	44 N 505	40	44 N 703	.73	44 N 704	3.74
6-32x3/8"	44 N 506	30	44 N 711	.73	44 N 712	4.35
6-32x1/2"	44 N 507	30	44 N 716	.85	44 N 717	5.12
8-32x1"	44 N 508	30	44 N 721	.98	44 N 722	7.68
6-32x1 1/4"	44 N 509	30	44 N 726	1.18	44 N 727	7.05
8-32x1 1/2"	44 N 518	30	44 N 738	.81	44 N 739	4.89
8-32x3/4"	44 N 519	25	44 N 753	.88	44 N 754	5.26
8-32x1/2"	44 N 529	25	44 N 756	.95	44 N 757	5.71
8-32x3/8"	44 N 535	25	44 N 761	1.10	44 N 762	6.55
8-32x1"	44 N 546	20	44 N 768	1.25	44 N 769	7.50
10-32x1 1/2"	44 N 548	20	44 N 777	1.12	44 N 778	6.73
10-32x1"	44 N 549	20	44 N 780	1.31	44 N 781	7.88
10-32x1 1/4"	44 N 553	17	44 N 783	1.47	44 N 784	8.86

C Ornamental Head Screws. For use on panels, etc. Shpg. wts. 4 oz.; 13 oz.; 6 lbs.

Size	32¢ container		Gross Pkg.		1000 Lot Pkg.	
	No.	Quan.	No.	NET	No.	NET
6-32x 3/4"	44 N 573	25	44 N 671	1.26	44 N 672	7.54
8-32x1 1/4"	44 N 575	12	44 N 677	1.87	44 N 678	11.24

D Binding Head Machine Screws. For general machine shop use. Plated. Shpg. wts.: 4 oz.; 7 oz.; 2 1/2 lbs.

Size	32¢ container		Gross Pkg.		1000 Lot Pkg.	
	No.	Quan.	No.	NET	No.	NET
6-32x1/4"	44 N 576	35	44 N 690	.63	44 N 694	3.74
6-32x3/8"	44 N 577	35	44 N 691	.66	44 N 696	3.97
6-32x1/2"	44 N 684	.81	44 N 622	3.06
8-32x3/8"	44 N 686	.99	44 N 624	3.70
8-32x1/2"	44 N 687	1.05	44 N 625	3.96

B Self-Tapping Screws. Flat-slotted type. Ideal for panel and rack mounting. No tapping of metal required. Plated steel. Hex head—with deep screwdriver slot. Shpg. wts.: 4 oz.; 12 oz.; and 4 1/2 lbs.

Size	32¢ container		Gross Pkg.		1000 Lot Pkg.	
	No.	Quan.	No.	NET	No.	NET
4x1/2"	44 N 564	35	44 N 803	1.14	44 N 804	6.82
6x1/2"	44 N 565	30	44 N 808	1.14	44 N 809	6.82
6x1"	44 N 566	25	44 N 813	1.25	44 N 814	7.54
8x1"	44 N 567	15	44 N 817	1.46	44 N 818	6.91
10x1 1/2"	44 N 569	15	44 N 833	2.06	44 N 834	12.30

E Hex Nuts. Plated steel. Shpg. wts.: 4 oz.; 8 oz.; 3 lbs.

Size	32¢ container		Gross Pkg.		1000 Lot Pkg.	
	No.	Quan.	No.	NET	No.	NET
4-36x1/4"	44 N 584	30	44 N 906	.77	44 N 907	4.66
4-36x3/8"	44 N 579	30	44 N 910	.85	44 N 911	5.12
8-32x3/8"	44 N 915	.86	44 N 916	5.15
10-32x3/8"	44 N 585	30	44 N 918	1.13	44 N 919	6.80
6-32x1/4"	44 N 586	30	44 N 937	.81	44 N 953	4.86
8-32x1/4"	44 N 587	30	44 N 938	.86	44 N 954	5.15

F Split Lockwashers. Tempered steel. Wts.: 2 oz.; 4 oz.; 2 lbs.

# 6 screw	44 N 588	65	44 N 662	.54	44 N 663	3.20
# 8 screw	44 N 589	55	44 N 665	.44	44 N 666	2.65

G Internal Star Lockwashers. Shpg. wts.: 2 oz.; 4 oz.; 1 1/4 lbs.

# 6 screw	44 N 597	60	44 N 923	.54	44 N 924	3.2
# 8 screw	44 N 598	60	44 N 928	.54	44 N 929	3.51
#10 screw	44 N 599	60	44 N 933	.59	44 N 934	3.51



Solder Lugs. Sturdy, tinned solder lug units. Easily accommodate all screw numbers given below; No. 8 holes also take No. 6 screws. Shpg. wts.: 2 oz.; 4 oz.; 1 lb.

Size	32¢ container		Gross Pkg.		1000 Lot Pkg.	
	No.	Quan.	No.	NET	No.	NET
# 8, Fig. H.	44 N 603	30	44 N 636	1.24	44 N 637	8.04
# 8, Fig. J.	44 N 604	30	44 N 639	1.41	44 N 640	8.43
#10, Fig. K.	44 N 605	30	44 N 642	1.73	44 N 643	10.44
# 8, Fig. L.	44 N 607	30	44 N 645	1.74	44 N 646	10.49
# 8, Fig. M.	44 N 608	30	44 N 648	1.01	44 N 649	6.15



R Snap Hole Plugs. Fill hole size listed. 3 oz.; 1 1/4 lbs.; 10 lbs.

Size	32¢ container		Gross Pkg.		1000 Lot Pkg.	
	No.	Quan.	No.	NET	No.	NET
1/4"	44 N 659	8	44 N 286	4.65
3/8"	44 N 679	8	44 N 289	4.65
1/2"	44 N 689	6	44 N 292	5.38	44 N 293	32.25
3/4"	44 N 699	5	44 N 295	7.42	44 N 296	45.65
1"	44 N 707	5	44 N 298	9.81	44 N 299	61.04

S Screen-Vent Snap Hole Plug. Shpg. wts.: 1 1/4 lbs.; 10 lbs.

1"	44 N 394	35.23	44 N 395	211.38
----	-------	----------	-------	----------	--------

T Cable Clamps. Fit cable sizes below. Wts.: 3 oz.; 12 oz.; 5 lbs.

1/2-3/8"	44 N 708	25	44 N 333	1.16	44 N 334	6.92
3/8-1/2"	44 N 713	20	44 N 336	1.30	44 N 337	7.84
1/2-3/4"	44 N 732	15	44 N 339	2.45	44 N 342	14.68
3/4-1"	44 N 733	15	44 N 344	1.49	44 N 345	8.94

W Rubber Feet. Take screws, nails, etc. For wood or metal cabinets. Shpg. wts.: 3 oz.; 9 oz.; 4 1/4 lbs.

3/8" O.D.	44 N 763	8	44 N 154	1.08	44 N 155	6.44
5/8" O.D.	44 N 764	6	44 N 157	2.61	44 N 158	15.61

HANDY PLASTIC BOXES OF MOST-OFTEN NEEDED SERVICING HARDWARE

Most-often-needed hardware used in radio, TV and electronics—packaged in handsome plastic boxes. No loss or spillage.

Stock No.	Description	Quan.*
43 N 332	Extra small size escutcheon and wood screws.	25
43 N 302	Wood screws w/round and countersunk heads.	25
43 N 300	1/4-1" mach. screws w/round & flat heads: Nos. 6, 8, 10.	35
43 N 301	Nos. 2 & 4 screws & nuts.	35
43 N 305	3/4-1 1/4" ornamental screws: 6-32 & 8-32.	20
43 N 304	Nickel-plated rack screws & cup washers.	15
43 N 303	Sheet metal screws, ast.—6, 8, 10. Round, hex-slotted & unslotted.	25
43 N 318	Phono needle set screws—2-56, 2-64, 1-72.	12
43 N 329	Spade bolts, #6 hole size.	12
43 N 306	Assorted set screws—6-32, 8-32, 10-32.	15
43 N 322	Self-locking speed nuts.	30
43 N 331	Internal lockwashers, tempered. No. 2 to 3/8".	50
43 N 307	Machine screw nuts—6-32, 8-32, 10-32.	30
43 N 308	Hex & ring mounting nuts. Used on controls, switches, etc.	15
43 N 330	Insulating washers. Nos. 6 to 3/8".	35
43 N 312	Steel washers for 4, 6, 8, 10, 1/4" screws.	80
43 N 313	Rings & C-washers for 3/16-1/4" shafts.	25
43 N 316	Snap-hole plugs—1/4" to 1".	6
43 N 317	Asst. ventilating hole plugs.	3
43 N 341	TV cord rivets, 1/16-3/16" diam., w/washers.	50

All items are precision-made from high-quality materials to insure dependable service. All are assortments. Av. shpg. wt., 4 oz.

Stock No.	Description	Quan.*
43 N 319	Terminal & solder lugs. Tinned brass, #6-10.	30
43 N 342	Metal spacers. For #6 & 8 screws.	12
43 N 343	Insulated spacers for #6 & 8 screws.	12
43 N 321	Twin lead wiring nails.	35
43 N 320	Cotter & hairpins.	50
43 N 323	Cable clamps w/mounting hole. for 1/2 to 3/8" dia. cables.	20
43 N 310	Large size expansion springs.	10
43 N 311	Small size expansion springs.	10
43 N 327	Rubber feet w/wood screws.	10
43 N 337	Small-size dial drive springs.	8
43 N 338	Large & small dial drive springs.	5
43 N 339	Cord strain relief for POSJ type wire.	5
43 N 339	Radio knob springs.	18
43 N 344	Allen wrench set, 4 hex: for #4 to 10 set screws, #2-6 cap screws.	Set of 4
43 N 315	Rubber chassis mounts.	10
43 N 345	Spline wrenches for set screws to 1/4" & cap screws to No. 8.	Set of 4
43 N 314	Rubber grommets. For cables & metals to 1/8".	15
43 N 335	Standard thin dial cord.	10 ft.
43 N 336	Standar dial cord.	10 ft.

*Approximate quantities.
NET PER BOX..... 32c

*Approximate quantities.
NET PER BOX..... 32c

Chemicals & Printed Circuit Kits

FAMOUS, HIGH-QUALITY G-C CHEMICALS, PAINTS & KITS



CABINET REPAIR KIT

Type 901. An extremely convenient, practical cabinet repair kit. Valuable aid for radio and television service shops, furniture stores, custom installation shops, offices, etc. Ideal for do-it-yourself enthusiasts, home craftsmen, cabinet-makers, custom installation crews, maintenance men, etc. Includes all the materials needed for turning out highly professional cabinet refinishing jobs. Use it for repairing dents, scratches or nicks on wood, plastic or bakelite cabinets, knobs, metal escutcheons, etc. Consists of an assortment of 10 shades of shellac sticks, bottles of light and dark oil stain, metal shading varnish, polish, Magic Scratch Remover, alcohol lamp, alcohol, spatula, touch-up brushes, steel wool, sandpaper and wiping cloth. In handy metal box for convenient storage. With complete instructions. Shpg. wt., 3 lbs.
43 N 115. List, \$8.50. NET..... 5.00



PRINTED CIRCUIT KIT

Type 680. Complete printed circuit repair kit for quickly and easily making repair jobs on printed circuits. Simplifies replacement of soldered components in printed circuits and permits repairing of sockets, lugs, copper foil, etc.

A valuable service aid—used to repair any printed circuit or printed circuit wiring in modern television receivers, radios, hearing aids, electronic devices, etc. A "time-saver" for every radio-TV serviceman.

Complete kit includes: Silicone resin lacquer (for applying a protective coating on parts, connection points, etc. after repairing), solvent (for dissolving surplus silicone resin and use as thinner), ¼ oz. of pure silver print (for repairing and replacing of printed circuit wiring, touching up circuit parts, rivets, eyelets, etc.), solder probe tool (for tightening up contacts, etc.), stainless-steel brush and scraper (for removing silicone resin before repairing), special printed circuit solder, and complete, easy-to-follow instruction manual. Shpg. wt., 1 lb.
46 N 247. List, \$9.75. NET..... 5.73

SILICONE RESIN SPRAY

Type 14-6. Use this clear, silicone resin after repairing or replacing parts in printed circuits. Forms a protective coating which prevents shorts and arcing. Insulates, waterproofs and provides barrier against dust. Application is simple—pressing of button at top of can releases a spray. Used by manufacturers to assure dependable performance of printed circuits. Dries rapidly and requires no baking. Spray can. Contents 6 oz. Shpg. wt., 10 oz.
43 N 027. List, \$3.25. NET..... 2.38



PRINTED CIRCUIT PAINT

Type 21-2. This is the same pure silver compound used by manufacturers in printed circuit designs. Use it to repair all printed circuits and to touch up circuits around eyelets, rivets, and other parts. Handy for servicemen, experimenters and engineers. Comes with handy brush-in-cap. Shpg. wt., 4 oz.
43 N 159. List, \$7.75. NET..... 4.56



"SPRA-KOAT" PAINTS

Wrinkle Finish. Air drying wrinkle varnish. For hobbyists, servicemen, etc. Provides finish comparable to professional oven baked jobs. Perfect for chassis, panels and racks. Makes connection board and bakelite panels appear as wrinkle finish steel panels. Available in black or gray. Contents, 16 oz. Shpg. wt., 1 ½ lbs. In convenient, ready to use, hand-squeeze spray can.
43 N 028. Type 60-12. Black.
43 N 029. Type 60-13. Gray.
NET EACH..... 1.99



Telephone Black and Gray. A satin-finish enamel. Telephone black is perfect for power control and meter panels. Telephone gray gives professional appearance to test equipment, etc. Dries quickly after spraying. Provide moisture resistance. For wood or metal. Contents, 16 oz. Shpg. wt., 1 ½ lbs.
43 N 033. Type 62-12. Black.
43 N 034. Type 62-13. Gray.
NET EACH..... 1.99

Hammer Finish. For applying professional hammer finish to panels, racks, chassis and instrument cases. Protects metal from moisture. Perfect for refinishing scratched and scarred metal surfaces. Air-dries quickly. Contents, 16 oz. Shpg. wt., 1 ½ lbs.
43 N 035. 84-12. Blue.
43 N 035. 83-12. Brown. NET
43 N 037. 85-12. Silver. EACH..... 1.99

SPRA-KLEEN CONTACT CLEANER

Type 8666. Efficient cleaner for electrical contact surfaces. Removes noise due to dust, dirt and corrosion. No need to dismantle chassis—cleaner is simply sprayed on contacts or control and mechanism is worked a few times. Spray cleaner on contacts, controls, relays, switches and on sliding contact devices. In handy 6 oz. aerosol spray can. Shpg. wt., 10 oz.
43 N 025. NET..... 88c



CONTROL GUN

Type 9280. Handy device for cleaning and lubricating volume controls. For use with Type 65-16 Control Kleener, listed below. 7/4x3/4". Shpg. wt., 8 oz.
43 N 045. List, \$6.25. NET..... 3.67

Type 9282. Control Gun Adapter. Use with Type 9280 Gun. For extra long shanks.
43 N 062. List, 75¢. NET..... 44¢

Type 9281. Control Gun Adapter. Converts gun to fit special size auto radio controls.
43 N 063. List, 75¢. NET..... 44¢

CONTROL KLEENER

Type 65-16. Highly effective lubricating and cleaning compound for use with Type 9280 Control Gun, above. Quickly restores controls to like-new condition. A "must" for every radio and TV serviceman. In 16-oz. bottle. Shpg. wt., 1 ½ lbs.
43 N 046. List, \$3.25. NET..... 1.91

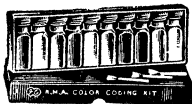

RETMA COLOR-CODING KIT

Type 677. Complete kit of all standard RETMA colors: Black, brown, red, orange, yellow, green, blue, purple, gray and white. Shpg. wt., 1 ½ lbs.
43 N 112. NET..... 1.26



LUMINOUS LITE-KOAT KIT

Type 184-0. A long-life non-poisonous luminous coating that emits light in the dark. Coating absorbs light in daytime and glows in dark. Shpg. wt., 2 ¼ lbs.
43 N 111. NET..... 2.20



DIAL LITE COLORING KIT

Type 66-5. Long-lasting bright colors for coloring bulbs. Instant drying. Colors: Red, green, blue, amber and solvent. Bulbs may be colored by dipping. Shpg. wt., 4 oz.
43 N 110. NET..... 59c



SCRATCH STICKS

For repairing scratches on wood. Wt., 5 oz.
43 N 113. Type 909-M. Mahogany.
43 N 368. Type 909-W. Walnut.
43 N 369. Type 909-I. Oak.
NET EACH..... 35c

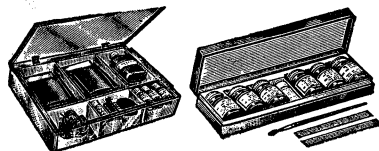

PRINTED CIRCUIT KITS AND COMPONENTS

E Techniques Kit. With this complete kit, it's a very simple matter to set up operating prototypes of many different kinds of printed circuits. These prototypes provide a practical method for determining the efficiency, economy, and compactness in specific electronic applications. Contains all materials required for producing etched circuits. It includes: 7 single-sided, copper-clad laminates; 5 double-sided, copper-clad laminates; 17 assorted tube sockets; roll of tape resist; 1 bottle of liquid resist; photographic resist; etchant; terminals; layout paper; sample of etched process; instructions, etc. In convenient plastic box, with hinged lid. Size, 9 1/2 x 13 1/2". Shpg. wt., 9 1/2 lbs.
43 N 067. NET..... 27.00

F Micro Circuit Kit. This printed circuit kit permits you to create all kinds of miniature-sized electronic equipment. Make resistors, capacitors, connecting wires and many other components. Kit also allows you to paint your own radio circuit and make rapid, easy repairs on existing printed circuits. Special materials supplied with kit include: Brush; silver conducting paint; low, medium, high and very high resistance paints; insulating lacquer; solvent; brush cleaner; the manual, "Design and Repair of Printed Circuits," plus other informative literature. An extremely useful kit for the experimenter, hobbyist, technician, engineer and serviceman. In handy plastic case with hinged lid. Shpg. wt., 1 3/4 lbs.
43 N 070. NET..... 10.24

G Kepro Professional Kit. Etched circuit kit. Permits production of printed circuits of commercial quality. For experiments, creating circuit prototypes, etc. A negative of the desired layout can be produced photographically, or manually with the negative materials supplied. A sensitized sheet of copper-clad XXXP phenolic is exposed through the prepared negative, then developed and etched. Kit contains: 2 sheets of 1/8" copper-clad phenolic 6x3"; 2 pieces negative mask; 1 printing frame glass; 2 printing frame clamps; 1 bottle developer; 2 bottles etching solution; aluminum developing tray; 1 polystyrene etching tray; 1 cleaning pad; and a set of complete, easy-to-follow instructions. Shpg. wt., 2 1/2 lbs.
43 N 068. NET..... 5.29

H Kepro Standard Kit. This low-cost etching kit is supplied complete with all the materials needed for manually producing etched copper circuits. Permits quick, easy preparation of many types of experimental circuits and aids in the design of miniaturized electronic equipment. Simple to use—just draw the desired circuit on the copper clad XXXP phenolic using the etch-resistant coating supplied. Excess (unprotected) copper is removed with etching solution. Kit contains: 2 sheets of 1/8" copper-clad phenolic 6x3"; 1 bottle etch-resistant solution; 1 etching tray; 1 bottle etching solution; 1 cleaning pad; 1 brush; and instructions. Complete with convenient plastic case. Shpg. wt., 1 1/2 lbs.
43 N 069. NET..... 3.38

Chemicals and Paints

KRYLON PLASTIC SPRAYS



Hard, waterproof coating of tough Acrylic Crystal Clear spray. High dielectric strength of coating is highly effective in preventing corona and arcing. When sprayed on the bell part of metal picture tubes, minimizes the accumulation of dust. Eliminates arcing when sprayed on high voltage leads and connections. Excellent for use on radio-TV antennas—prevents rusting and pitting and makes antennas salt-spray and chemical resistant. In ready to use, hand-size spray can. 16 oz. Shpg. wt., 1 1/2 lbs.

43 N 133. Clear. NET.....1.27

KRYLON ENAMEL SPRAYS

Highly attractive, non-fading, enamel sprays. Excellent for either interior or exterior use—provide a handsome, durable finish. Available in a wide variety of colors. Extremely quick drying—dries in 3 minutes. Non-clogging spray valve. 16-oz. can. Shpg. wt., 1 1/4 lbs.

- | | |
|--------------------------|-----------------|
| 43 N 134. Bright Silver. | } NET EACH 1.19 |
| 43 N 137. Touch-up White | |
| 43 N 138. Glossy Black | |
| 43 N 106. Flat Black | |
| 43 N 053. Light Gray | |
| 43 N 108. Machine Gray | |
| 43 N 109. Bright Gold | |
| 43 N 107. Hunter Green | |
| 43 N 054. Chrome Yellow | |
| 43 N 055. Regal Blue | |
| 43 N 056. Flat Red | |
| 43 N 044. O. D. Khaki | |
| 43 N 043. Int'l. Orange | |
| 43 N 059. Flat White. | |
| 43 N 064. Bright Copper | |

INSL-X E-33 TOOL DIP

A red liquid plastic that hardens into a tough, insulating coating when applied to handles of pliers, wrenches and other tools used in electrical work. Minimizes shock hazard. Dielectric strength, 1500 v. per mil. Simple applications; remove cap from container and dip handle of tool into liquid; may be dipped repeatedly if heavier coating is desired. Dries in 24 hours. Resists acids, alkalis or other corrosive compounds. Shpg. wt., 6 oz. can, 10 oz.; 32 oz. can 2 1/4 lbs.



Stock No.	Contents	NET EACH	24 or More, EACH
42 N 400	6 oz.	.79	.71
42 N 401	32 oz.	2.83	2.55

INSL-X E-16 INSULATING SPRAY

Electrical insulation in handy spray can. Has non-clogging spray valve. Insulates parts, wiring, tools, etc. Has same insulating properties as above. Dielectric strength, 800-1200 volts per mil. 12-oz. can. Shpg. wt., 1 1/2 lbs.

Stock No.	Color	Contents	NET EACH	24 or more, EACH
42 N 402	Clear	12 oz.		
42 N 403	Aluminum	12 oz.	1.19	1.07
42 N 404	Black	12 oz.		

QUIETROLE CLEANER AND LUBRICANT

Radio-TV general purpose lubricant and cleaner. Eliminates noise from TV front-end tuners and volume-tone controls without removal from chassis. Non-inflammable and non-corrosive liquid; remains effective indefinitely. Also recommended for use on switches, pushbuttons, bearings, dial shafts, contacts, etc. An indispensable tool box item for the radio-TV serviceman. Shpg. wts.: 2-oz. bottle, 7 oz.; 4-oz. bottle, 1 1/4 oz. *With eye dropper.

43 N 102. *2-oz. bottle. NET.....1.66
43 N 103. 4-oz. bottle. NET.....2.49

EMC TAPE RECORDER CLEANER AND LUBRICANT

This new combination package consists of one bottle of cleaner plus one bottle of lubricant. Specially compounded to reduce wear and friction on all magnetic tape recorders. Minimizes "wow" and tape "squeal" and reduces effects of humidity on tape. Brush-in-cap permits easy application. Complete with instructions. Wt. 1/2 lb.

94 R 920. NET.....1.50

WALSCO RADIO AND TV CHEMICALS

Pliobond Cement. No. 67. Strong synthetic rubber-base cement. Adheres permanently to any material. Perfect for rubber, wood, metals, plastics, etc. Dries rapidly to form a waterproof, chemical-resistant bond. Shpg. wts.: 2-oz. bottle, 1/2 lb.; 8-oz. bottle, 1 1/4 lbs.
43 N 210. 2-oz. bottle. NET.....4.4c
43 N 211. 8-oz. bottle. NET.....1.12

Glyptal Varnish. No. 134. A new, outstanding insulating varnish originally developed by G.E. Resists heat, oils and acid. High arc resistance makes it ideal for electrical and electronic applications. Shpg. wts.: 2-oz. bottle, 1/2 lb.; 8 oz. bottle, 1 1/4 lbs.
43 N 212. 2-oz. bottle. NET.....56c
43 N 293. 8-oz. bottle. NET.....1.62

Chlorothene Solvent. No. 113. Powerful solvent for cleaning any electronic component, switch, chassis, etc. Excellent for use by servicemen. Similar in action to carbon tetrachloride, but non-toxic. Shpg. wts.: 4-oz. bottle, 3/4 lb.; 16-oz. bottle, 1 1/2 lbs.
43 N 294. 4-oz. bottle. NET.....56c
43 N 295. 16-oz. bottle. NET.....1.29

Bakelite Cement. No. 66. A special adhesive for phenolics (bakelite). Forms permanent bond between phenolic plastic items, or between phenolics and wood, metal, etc. Bond does not deteriorate with age. Shpg. wts.: 2-oz. bottle, 1/2 lb.; 16-oz. bottle, 1 1/4 lbs.
43 N 296. 2-oz. bottle. NET.....50c
43 N 297. 16-oz. bottle. NET.....2.68

Rust-De-Solve. No. 109-02. Excellent, quick-acting, rust solvent. Instantly removes rust from heavily rusted bolts, nuts and other metal parts. Particularly useful in radio-TV servicing and TV antenna maintenance work—also for automotive repair and metal work.
2 oz. bottle. Shpg. wt., 6 oz.
43 N 298. NET.....35c

Carbon Tetrachloride. No. 111. Dissolves dirt and grease. Non-explosive and non-inflammable 4 oz. bottle. Shpg. wt. 12 oz.
43 N 154. 4-oz. bottle. NET.....53c
43 N 114. 1-gal. can. Wt., 14 1/2 lbs.....5.00

"No-Ox." No. 100. Fast-acting, chemical contact and control cleaner. Cleans, protects and lubricates. Shpg. wts.: 1-oz. bottle, 1/4 lb.; 2-oz. bottle, 1/2 lb.
43 N 121. 1-oz. bottle. NET.....65c
43 N 128. 2-oz. bottle. NET.....94c

Scratch Removing Polish (Dark). No. 231. For walnut, mahogany, etc. Removes scratches as it polishes. 4 oz. bottle. Wt., 12 oz.
43 N 165. NET.....38c

Scratch Polish (Light). No. 232. As above, but light shade for maple, oak, etc. 4 oz.
43 N 175. NET.....38c

Anti-Corona Lacquer. No. 195. Fast-drying, high-dielectric lacquer. A thin layer (.01") withstands over 15 KV. Prevents corona, arcing in HV supplies, when applied to sharp corners, wires, lugs, etc. 4 oz. bottle. Wt., 6 oz.
43 N 145. NET.....71c

Cap Needle Injector. No. 989. Surgical-grade needle with oil-resistant neoprene bulb—attached to bakelite bottle cap. Permits easy application of Contactene or Dial Oil to bandswitches, volume controls, etc., without disassembling Shpg. wt., 2 oz.
43 N 198. NET.....44c

Radio Cement. No. 50. Vibration-proof cement. Shpg. wts.: 4-oz. bottle, 3/4 lb.; 8-oz. bottle, 1 1/4 lbs.; 16-oz. bottle, 2 lbs.
43 N 155. 4-oz. bottle. NET.....65c
43 N 166. 8-oz. bottle. NET.....1.12
43 N 156. 16-oz. bottle. NET.....2.15

"NO NOISE" SOLUTION



Remarkably effective chemical formula for cleaning, lubricating and protecting: TV front-ends, controls, switches, etc. In 6 oz. aerosol spray can 2 oz. bottle is complete with dropper. Shpg. wts. is exceedingly simple—just make a few electrical connections and brush surface to be plated with metal compound. Includes 1 oz. metal cleaner, 1 oz. metal polish, plating compound 5/8" brush wires and clips, and polishing stick. Requires 2 or 3 No. 6, 1 1/2-volt cells (see page 285). Shpg. wt., 1 lb.

MERIX ANTI-STATIC SOLUTION



Prevents accumulation of static charges on smooth-surfaced substances such as plastics, metals, records, recording discs, etc. Treated surfaces become static-free and no longer attract dust or lint. Removes static-caused crackling noise on all types of records. Single bottle treats approximately 400 records. Non-inflammable. Can be safely used on face of TV tube. 4 oz. plastic bottle. Shpg. wt., 8 oz.
43 N 144. NET.....69c



Walscolub B. No. 22. A radio lubricant that prevents corrosion. Eliminates noise on switches. etc. 1 1/4 oz. tube. Wt., 5 oz.
43 N 124. NET.....53c

Tunerlub. No. 26. Prevents noisy operation of TV tuning units, etc. Cleans and protects contacts from oxidation. 1 1/4 oz. tube.
43 N 126. NET.....53c

"Lubriplate." No. 23. For phonograph motors, record changers. Superior to ordinary greases. 2 oz. tube. Shpg. wt., 6 oz.
43 N 125. NET.....53c

No-Slip. No. 260. Greatly increases the friction of pulley cords and belts. Stops any slippage. 2 oz. bottle. Shpg. wt., 6 oz.
43 N 167. NET.....44c

Radio Dial Oil. No. 27. A light-bodied lubricating oil for all electronic and electrical applications. Free of corrosive acids. Prevents rusting. 2 oz. bottle. Shpg. wt., 6 oz.
43 N 172. NET.....35c

Polystyrene Cement. No. 57. For bonding Polystyrene parts, coating coils. Brush-in-cap 4 oz. bottle. Shpg. wt., 12 oz.
43 N 174. NET.....71c

Super Polish. No. 230. Removes old polish, grease or dirt from cabinets. Forms hard, high-gloss film. 8-oz. bottle. Wt., 1 1/4 lbs.
43 N 179. NET.....53c

Insulating Varnish. No. 190. Fast drying; for coils, transformers, solenoids, motors, etc. 2 oz. bottle. Shpg. wt., 6 oz.
43 N 173. NET.....44c

Plastic Cement. No. 40. Repairs plastic knobs and cabinets. Also cements metal, glass. Brush-in-cap, 2-oz. bottle. Wt., 6 oz.
43 N 171. NET.....44c

Vinylite Cement. No. 55. A highly flexible cement with excellent adhesive qualities. For porous and non-porous materials—metals, paper, plastics, etc. 2 oz. bottle. Wt., 6 oz.
43 N 169. NET.....44c

Rubber Cement. No. 56. For cementing rubber parts to metal or wood. Brush-in-cap, 4 oz. bottle. Shpg. wt., 12 oz.
43 N 176. NET.....71c

Cement Solvent and Thinner. No. 201. Loosens cement. Shpg. wts.: 4-oz. bottle, 3/4 lb.; 8-oz. bottle, 1 1/4 lbs.; 16-oz. bottle, 2 lbs.
43 N 157. 4-oz. bottle. NET.....56c
43 N 163. 8-oz. bottle. NET.....73c
43 N 158. 16-oz. bottle. NET.....1.17

Contactene. No. 80. Cleaning fluid for switch or relay contacts. Shpg. wts.: 2-oz. bottle, 1/2 lb.; 4-oz. bottle, 3/4 lb.; 8-oz. bottle 1 1/4 lbs.
43 N 160. 2-oz. bottle. NET.....44c
43 N 161. 4-oz. bottle. NET.....65c
43 N 178. 8-oz. bottle. NET.....1.12

RAPID "BRUSHPLATER"

For quick, easy electro-plating of small metal items such as hardware, trim, metal knobs, etc. Plating process is exceedingly simple—just make a few electrical connections and brush surface to be plated with metal compound. Includes 1 oz. metal cleaner, 1 oz. metal polish, plating compound 5/8" brush wires and clips, and polishing stick. Requires 2 or 3 No. 6, 1 1/2-volt cells (see page 285). Shpg. wt., 1 lb.



Stock No.	Mfr's Type	Plating Compound	NET EACH
43 N 080	200	Nickel	1.47
43 N 081	202	Cadmium	
43 N 082	204	Copper	
43 N 083	205	Brass	
43 N 084	206	Silver	1.83
43 N 085	207	24 K Gold	3.67

G-C TV Alignment Tools

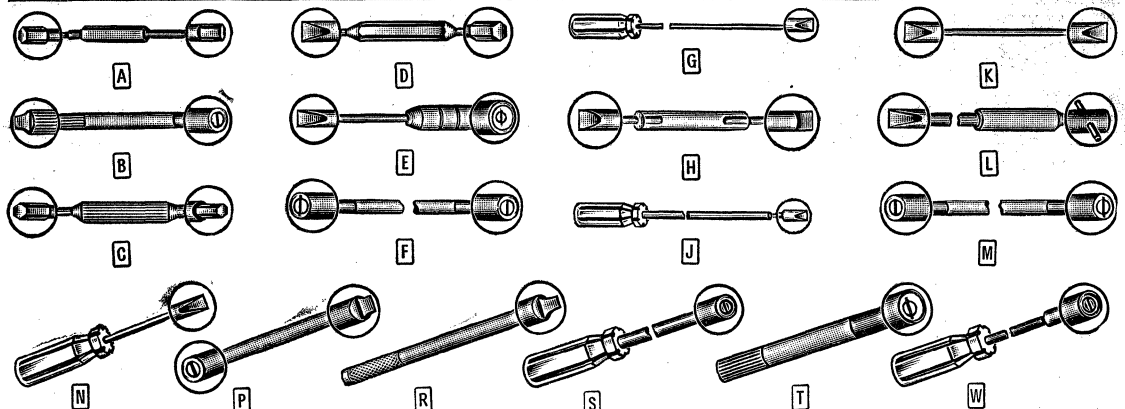

A No. 8606 Hex Wrench. New, 5" all-nylon hex wrench for alignment of Zenith, Admiral and other TV and radio sets. One end undercut for reaching bottom slug of iron coils. Ends are .100" across flat. Shpg. wt., 3 oz. 42 N 377. NET.....44c

B No. 8276 Duplex Aligner. New, utility alignment tool for TV trimmers and IF transformers. Made of Butyrate plastic with thin steel tips. One end recessed; other end projected. Size: 6x7/2". Shpg. wt., 3 oz. 42 N 378. NET.....47c

C No. 9091 .125" Hex Tool. New, all-nylon tool to fit cores with .125" hex opening. Both ends are usable, with one end undercut to reach bottom slug without turning top. Length, 5 in. Shpg. wt., 3 oz. 42 N 379. NET.....44c

D No. 8282 Wrench and Aligner. New, molded all-plastic tool for Zenith television receivers. One end has .100" dia. hex wrench; the other end has .109" dia. screwdriver. Length: 5 7/8". Shpg. wt., 3 oz. 42 N 380. NET.....32c

E No. 8275 Zenith Universal Aligner. New tool for Zenith and other TV sets. 1/8" fiber screwdriver on one end; recessed steel tip on other end. Plastic handle: 1/4" dia. Length: 5". Shpg. wt., 3 oz. 42 N 381. NET.....47c

F No. 8271 Core Aligner. New plastic tool for sets using Stackpole or other stud-type non-slotted cores. Milled steel insert on one end; thin screwdriver blade on other end. 6x3/2" dia. Shpg. wt., 3 oz. 42 N 382. NET.....53c

H No. 5097 K-Tran Tool. New, plastic alignment tool for K-Tran and IF transformers. 2 screwdriver tips—3/8" fiber and 1/8" metal. Length, 6". Shpg. wt., 3 oz. 42 N 383. NET.....56c

G No. 8988 "X57 Plastic Long Slim" Screwdriver. New, rugged, flexible plastic screwdriver for hard-to-reach places. Tip can be re-ground. Shaft dia.: 1/8"; blade length: 12"; overall: 14 1/2". Shpg. wt., 3 oz. 42 N 384. NET.....88c

G No. 8989 "X57 Plastic Long Slim" Screwdriver. Same as No. 8988 above, except blade length: 16"; overall length: 18 1/2". Shpg. wt., 3 oz. 42 N 385. NET.....1.18

J No. 8607 Nylon Long-Reach TV Aligner. Useful new long-reach alignment tool with replaceable nylon tip. Insulated metal shaft for sturdiness. Shaft Diameter: .195"; overall length: 12 1/4". Shpg. wt., 4 oz. 42 N 386. NET.....1.06

No. 8608-E Replacement Tip for Above. Nylon tip replacement for No. 8607 Alignment Tool. Shpg. wt., 3 oz. 42 N 387. NET.....18c

K No. 8728-A Long Reach TV Alignment Screwdriver. Very thin, new, 1/8" diameter screwdriver. Made of rugged bone fiber—can be re-ground if necessary. Length: 7". Handy for all TV work. Shpg. wt., 3 oz. 42 N 388. NET.....26c

K No. 8728 Long Reach TV Alignment Screwdriver. Similar to above, but 12" long. Shpg. wt., 3 oz. 42 N 389. NET.....41c

K No. 8729 Long Reach TV Alignment Screwdriver. As above, but 16" long for extra-long reaches. Shpg. wt., 3 oz. 42 N 390. NET.....53c

L No. 8274 Long Reach TV Aligner. New, fiber alignment tool for RCA or sets having nested iron cores, and RCA front end adjustments. 9" long; 1/8" dia. Shpg. wt., 3 oz. 42 N 391. NET.....71c

M No. 8721 Long Reach Duplex Aligner. Here's a new, 2-in-1 plastic aligner. For No. 4 and No. 6 studs, color-coded for quick identification. Recessed steel tips. 9" long; 7/2" dia. Shpg. wt., 3 oz. 42 N 392. NET.....73c

M No. 8722 Long Reach Duplex Aligner. As above, except 7" long. Also color-coded for size of ends. Shpg. wt., 3 oz. 42 N 393. NET.....62c

N No. 8195 TV Channel Tuning Tool. New design for TV receiver channel tuning. Has non-metallic 1/8" blade. Overall length: 7 1/4". Shpg. wt., 3 oz. 42 N 394. NET.....65c

P No. 8277 "Shorty" Duplex TV Aligner. New aid for close-quarter trimmer and IF tuning. 7/2" plastic with steel tips; one recessed end, one projected end 2 1/2" long. Shpg. wt., 3 oz. 42 N 395. NET.....47c

R No. 5000 Alignment Screwdriver. New, plastic screwdriver with low inductance metal tip. Rugged, all-around alignment tool. Size: 1/4" dia.; 6" long. Shpg. wt., 3 oz. 42 N 396. NET.....26c

S No. 8273 All-Purpose TV Aligner. New, general-use tool for IF alignment. All-plastic, with recessed steel tip. 8" long; 7/2" dia. Shpg. wt., 3 oz. 42 N 397. NET.....65c

T No. 8196 TV and FM Tuning Tool. Special new short tool with recessed steel tip. Size: 3/2" shaft diameter; 2 1/2" long. Ideal for work in cramped spaces. Shpg. wt., 3 oz. 42 N 398. NET.....35c

W No. 8272 TV IF Oscillator Aligner. Ideal new tool for IF and oscillator tuning. With plastic handle and steel shaft. 6 1/2" long; 1/4" tip diameter. Shpg. wt., 3 oz. 42 N 399. NET.....1.03

TOP-QUALITY ALIGNMENT TOOL KITS

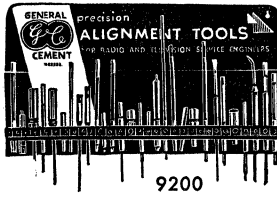

9200

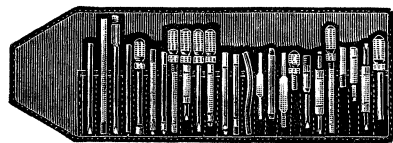

8283

X Type 9200 Panel Kit. A convenient, wall-mounting kit of most-needed alignment tools. Contains 27 different tools for all popular makes of TV sets. Each tool has separate slot identified by shape and size number. Correct tool may be selected at a glance. All tools in this kit are selected to cover most alignment jobs on all popular radio and TV sets. The finest materials are used throughout—low-loss plastics, tips of hardened spring steel, and extra-hard bone fiber that can be re-ground as tool wears.

Includes: Alignment screwdrivers in various lengths, special short tools, alignment wrenches, channel tuners, core aligners, oscillator adjustment tools, trimmer and IF aligners, solder probe tool, stainless steel brush and scraper, nylon replacement tip, special hex tools, etc. Tools are stored in a handsome three-color steel panel, drilled for two-hole mounting. Shpg. wt., 3 lbs. 42 N 341. List, \$25.50. NET.....14.99

Type 8283 Master Deluxe TV Tool Kit. A complete service alignment tool kit for television repair work. Contains 25 high-quality alignment tools not over 9" long. Flexible tool-case has heavily stitched edges and fold-over flap to prevent loss of tools. Kit is easily carried. Includes: TV K-Tran tool, TV Core Aligner, TV Long Reach Aligner, TV Flexible Wand, TV Short Tool for IF, etc. Leatherette roll case. Shpg. wt., 1 lb. 42 N 005. List, \$20.85. NET.....12.26

Type 8280 Deluxe Television Alignment Tool Kit. Handy roll-type durable leatherette case with 16 specially engineered TV tools. The steel tips are all extra thin and are made of the best grade of hardened spring steel of accurate dimensions and high durability. Case lies flat when opened. Includes TV "Shorty", Duplex Aligner, TV Tuning Wand, TV Core Aligner, TV Oscillator Tool, TV Long Reach Aligner, etc. Shpg. wt., 3 oz. 42 N 006. List, \$12.90. NET.....7.59

WALSCO TEL-A-TURN ALIGNMENT TOOLS

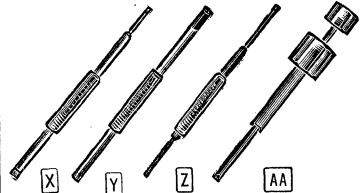

X No. 2587 Tel-A-Turn Screwdriver. New, tuning tool of tough fiberglass. Automatically counts turns. Standard tip on one end, small 7/8" tip on other end. Shpg. wt., 3 oz. 42 N 342. NET.....97c

Y No. 2586 Tel-A-Turn IF Aligner. New, fiberglass tuning tool that automatically counts turns. One end fits #4 stud, the other fits #6 stud. Shpg. wt., 3 oz. 42 N 343. NET.....97c

Z No. 2588 Tel-A-Turn Hex Aligner. Valuable new tool of fiberglass that automatically counts turns. One end is .100" hex, the other end is .125" hex. Shpg. wt., 3 oz. 42 N 344. NET.....97c

AA No. 2589 Concentric Color-TV Tool. New non-conductive tool for concentric color-TV control shafts. Separate knobs for outer and inner controls. Shpg. wt., 3 oz. 42 N 345. NET.....1.17

You Get More in the All-New **knight**[®] P.A. Line

SUPREMACY IN PERFORMANCE AND VALUE

®Registered Trade-Mark
of Allied Radio Corp.

LATEST TRIUMPH IN
ALLIED'S 37 YEARS OF
EXPERIENCE IN SOUND...

knight PUBLIC ADDRESS

more in performance,
output, styling and
rugged year-in, year-out
operating dependability ...

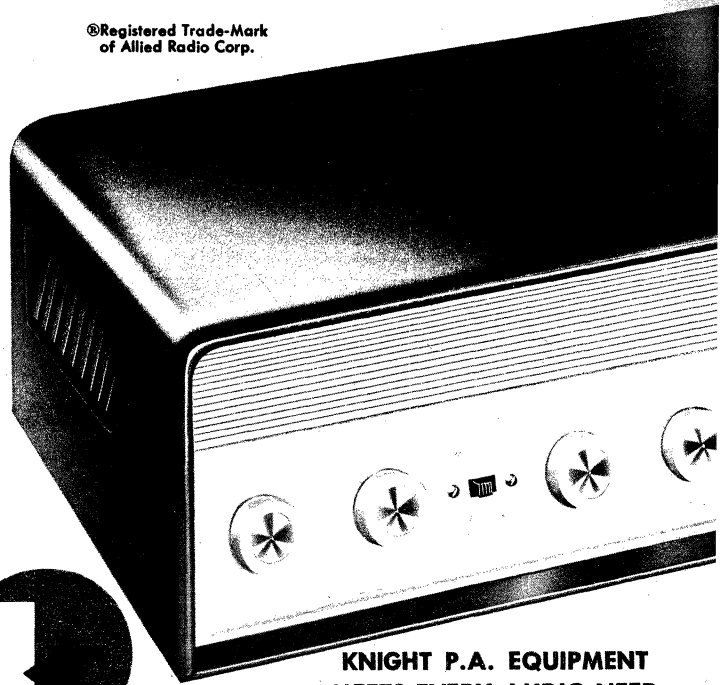

UNDERWRITERS' APPROVED

Knight P.A. amplifiers, from 16 to 60 watts (and our 60-watt power booster too!), fully meet stringent Underwriters' Laboratories specifications for complete operating safety.

BUY ON OUR EASY TERMS

The finest Sound Equipment in the P.A. field is readily available to you on our Easy Payment Plan. You pay just 10% down, and the balance in convenient monthly payments. Full Easy Pay details are on page 396.

SAVE ON A COMPLETE SYSTEM

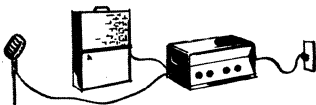

The cost of a complete Knight Sound System is always less than the total cost of individual components purchased separately! Additionally, only top-quality, nationally known parts and component products are used in the makeup of our P.A. systems.



FULL YEAR GUARANTEE

All Knight amplifiers are guaranteed for one full year against defects in material and workmanship. Skillfully engineered and conservatively rated, they can be run 24 hours a day.







FREE CONSULTING SERVICE

Our Audio experts are always ready to help you. Give us approximate audience figures, area coverage dimensions, noise level, and a rough sketch of area to be covered. Careful recommendations are promptly made.

15-DAY TRIAL OFFER WITH MONEY BACK GUARANTEE

We guarantee absolute satisfaction or your money back. Order any Knight Sound System you want, either for cash or on our Easy Payment Plan. Test it out for yourself, under your own operating conditions. If, after 15 days, it is not everything we claim it to be—send it back. We'll refund every penny of the purchase price, less only transportation charges!

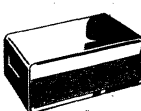
KNIGHT P.A. EQUIPMENT MEETS EVERY AUDIO NEED

-  **8** WATT Amplifier and Systems
-  **16** WATT Amplifier and Systems
-  **25** WATT Amplifier and Mobile Systems
-  **32** WATT Amplifier and Systems
-  **60** WATT Amplifier and Systems
-  **60** WATT Power Booster

EXCLUSIVE NEW FEATURES

Compact, new design with handsome "Tri-Tone" styling ... Latest Tube Types and Circuitry ... Phono Fader Control ... Trumpet Protector Switch ... Multi-Impedance Terminal Strip ... and more!

THERE IS A KNIGHT AMPLIFIER FOR EVERY SOUND COVERAGE NEED

YOU GET SUPREME QUALITY. Ceaseless research, engineering skill, and 37 years of experience in Sound, go into every Knight P.A. amplifier. Rugged and reliable, they're presented for use only after they fulfill our very highest standards—your absolute assurance of top performance.

CHECK THESE SUPERIOR FEATURES

Trumpet Protector Switch

NEW. Unique feature, controlled by fingertip slide switch, protects trumpets from low-frequency burn-out by blocking frequencies which could harm the voice coil.

Phono Fader Control

NEW. Valuable P.A. feature! By turning the Phono Fader knob either to the left or to the right, you can increase or decrease the volume of either phono input. Returning knob to center cuts out both phono inputs.

Impedance Selector

NEW. Specially designed to add greatly to the ease and speed with which you can change your speaker arrangement. Use either speaker jacks or screw terminals for fast, easy setup of equipment.

Magnetic Phono Input

Pioneered by Knight! Magnetic input for hi-fi phono cartridges offers you unexcelled voice and music reproduction from records. Sets a pace-making standard of realism for P.A. sound equipment.

Rack Mounting Feature

NEW. U-pan assemblies, for mounting 32 and 60-watt amplifiers, booster and all associated equipment in rack panels, are available. Handsome, brushed chrome front panels are listed on page 345.

With Record Player

Increase the versatility of your P.A. system at small additional cost, by ordering your Knight amplifier with 4-speed record player already installed. You'll be equipped to play any and all records.

GUARANTEED FOR ONE FULL YEAR

Knight engineering provides amplifiers using tubes employed at proper rating, not peak, to give you guaranteed usable power with minimum distortion. Rugged and reliable, Knight amplifiers are guaranteed for one full year against defects in material and workmanship!



New KNIGHT 32-Watt P.A. Amplifier

ONLY
\$58.50

Less Record Player

- Fresh, New Styling—Attractive and Functional
- Loaded with New P.A. Convenience Features
- 32 Watts of Power, For 90% of P.A. Needs
- Always a "Best Buy"—Now Better Than Ever

MODEL KN-3032. An outstanding P.A. value, and rapidly becoming our best-seller, the new Knight 32-Watt Amplifier is a triumph of flawless design and skillful engineering. Its highly attractive, ultra-compact styling features a tilted control panel for operator convenience; handsome, new cabinet with new deep-well hand grips for safer, easier carrying; new "tri-tone" color styling in light brown hammerloid with aqua-and-white front panel; control knobs in gleaming white plastic with gold inlay. Adaptable to every P.A. use, the 32-watt amplifier is a "natural" for auditoriums, clubs, lodges, schools, etc. It's perfect for music, paging, general coverage under high-noise conditions, and other P.A. uses.

Eloquent testimony of its supremacy lies in such features as: New phono fader control permits selection of either of 2 high-level program sources (tape recorder, changer or tuner) and phono, with volume control of each from a single knob; new tape output jack for recording your own P.A. broadcasts; new output terminal strip which greatly simplifies speaker hook-up; new trumpet protector feature—protects trumpets from low-frequency burnout. Speaker output taps of 4, 8, 16, 250 and 500 ohms, as well as 70.7-v. output, permit use of up to 32 speakers! **Power Output:** Full 32 watts of usable power. **Response:** ± 2 db, 30 to 20,000 cps. Hum is inaudible; 78 db below rated output. **5 Inputs:** 2—Mic, 2—Phono, 1—Magnetic Phono. **Controls:** Mic (2), Phono Fader, Off-On/Tone, Mic/Magnetic Phono switch. **Tubes:** 2—ECC83/12AX7, 6AV6, 2—6L6GB; 5U4GB rectifier. Size, $6\frac{1}{2} \times 15\frac{1}{2} \times 11"$. With complete set of input plugs. Less player. U.L. Approved. For operation from 110-120 v., 60 cycle AC. Shpg. wt., 26 lbs.

93 SZ 507. Only \$5.85 Down. CASH NET. 58.50

MODEL KN-3132 32-WATT AMPLIFIER WITH RECORD PLAYER INSTALLED. Shpg. wt., 28 lbs.

93 SZ 740. Only \$7.78 Down. CASH NET. 77.75

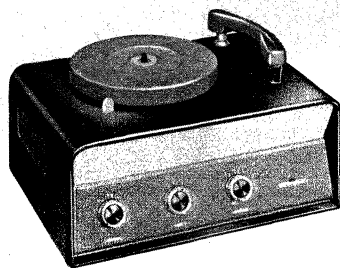

New KNIGHT 16-Watt P.A. Amplifier

\$46.50

Less Record Player

- For General Use in Medium-Duty Applications
- Topnotch Design—Dependable Performance
- Premium-Quality Input and Output Tubes

MODEL KN-3016. Designed with the user in mind, the excellent, new Knight 16-watt P.A. Amplifier offers efficient design, quality construction and guaranteed performance. It's perfect for smaller auditoriums, halls and lodges, church or school recreation rooms, etc. Deluxe features include: Tape output jack for recording your own P.A. broadcasts; phono fader control; terminal strip for quick easy setting up, and other custom features.

Power Output: Full 16 watts of usable power. **Frequency Response:** ± 2 db, 40 to 15,000 cps. Hum is inaudible; 72 db below rated output. **3 Inputs:** Mic, 2—Phono. **Controls:** Mic, Phono Fader, Off-On/Tone. **Output Impedances:** 4, 8, 16, 250 and 500 ohms, as well as 70.7-v. output—permits use of up to 16 speakers. **Tubes:** 6AV6, ECC83/12AX7, 2—6V6GT; 5Y3GT rectifier. Size, $6\frac{1}{2} \times 15\frac{1}{2} \times 11"$. Enclosure in light brown hammerloid; aqua-and-white panel. With complete set of input plugs. Less record player. U.L. Approved. For 110-120 v., 60 cycle AC. Shpg. wt., 25 lbs.

93 SZ 505. Only \$4.65 Down. CASH NET. 46.50

MODEL KN-3116 16-WATT AMPLIFIER WITH RECORD PLAYER INSTALLED. Shpg. wt., 28 lbs.

93 SZ 737. Only \$6.58 Down. CASH NET. 65.75

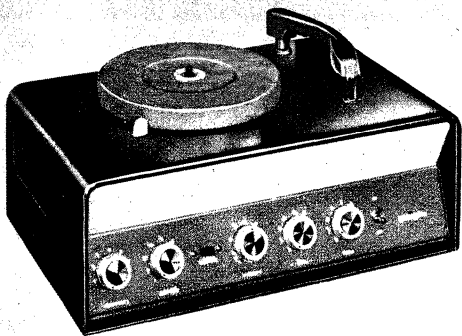

New KNIGHT 60-Watt P.A. Amplifier

ONLY

\$84⁰⁰

Less Record Player

- New Styling—Traditional Ruggedness
- Tremendous Power—Minimum Distortion
- Conservatively Rated, Long-Life Components
- Includes Every Desirable P.A. Feature

MODEL KN-3060. Designed by experts to give you the most for your P.A. dollar, the new Knight 60-watt Amplifier is perfect for stadiums, industrial plants, raceways, carnivals, church tower chime systems, schools—wherever maximum coverage is necessary. Although compact in size, there's hardly a big job it cannot do—and with the aid of the 60-watt power booster described below, its P.A. uses are practically limitless! Offering remarkable versatility, it employs every feature that professional soundmen have found desirable. Employs latest tubes and circuitry for peak performance and extremely dependable operation. Tape output jack allows you to make high-quality tape recordings of all program material going through your P.A. system. Trumpet protector switch protects your trumpets by blocking frequencies which could harm the voice coil. Phono fader control provides smooth transition from one phono input to the other with center-off position. Magnetic input for G.E. cartridges allows you to plug a hi-fi record changer or player directly into the amplifier. New terminal strip for utmost ease in speaker hook-up. New, heavy-duty transformers for long life.

Power Output: Full 60 watts of usable power. Hum is inaudible; 71 db below rated output. **Frequency Response:** ±2 db, 20 to 20,000 cps. **Inputs:** 2—Mic, 2—Phono, 1—Magnetic Phono. **Controls:** Mic (2), 1—Phono Fader, Bass, Treble, Mic/Mag switch, Off-on. **Tubes:** 2—ECC83/12AX7, 6C4, 2—6CA7/EL34, 5Y3GT, 5U4GB rectifiers. **Output Impedances:** 4, 8, 16, 250 and 500 ohms, plus 70.7-v. output. **Size:** 6⁷/₁₆x17¹/₄x10³/₄". Light brown hammerloid and aqua-and-white color styling. With set of plugs. Less record player. U.L. Approved. For 110-120 v., 60 cycle AC. Shpg. wt., 37 lbs.

93 SZ 508. Only \$8.40 Down. CASH NET. 84.00

MODEL KN-3160 60-WATT AMPLIFIER WITH RECORD PLAYER INSTALLED. Shpg. wt., 39 lbs.

93 SZ 741. Only \$10.45 Down. CASH NET. 104.50

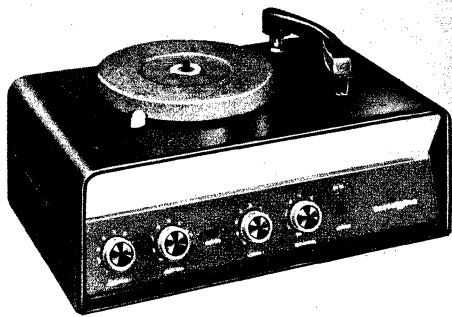

New KNIGHT 25-Watt Mobile Amplifier

ONLY

\$106⁵⁰

Less Record Player

- Use Indoors From 110-Volt AC Power
- Use Outdoors From 6 or 12-V Battery
- Exclusive Phono Fader Control
- New Trumpet Protector Switch

MODEL KN-3025. Wherever you use the new Knight 25-watt Mobile Amplifier, you'll applaud its remarkable versatility! Rugged and dependable, this new amplifier operates anywhere—indoors or outdoors—from either 6 or 12-volt storage batteries, or 110 volts AC. Its unique circuit lets you switch instantly from battery to AC operation by simply changing plugs on the rear of the amplifier. It's ideal for use in cars, trucks or boats; in theatres, at carnivals, outdoor athletic events, political rallies, emergency paging use—or any other mobile or stationary application where areas up to 85,000 square feet must be covered. Additionally, it employs all of the deluxe features found on larger Knight amplifiers: Tape output jack for recording your own P.A. broadcasts; trumpet protector switch to block frequencies which could harm trumpet voice coils; input voltage switch for instant choice of 6V, 12V or 110V operation; convenient terminal strip for quickly setting up or changing speaker arrangement; battery "saver" switch; "tri-tone" styling; etc.

Power Output: Full 25 watts of usable power. **Frequency Response:** ±2 db, 40 to 20,000 cps. Hum is inaudible; 75 db below rated output. **Inputs:** 2—Mic, 2—Phono, 1—Magnetic Phono. **Output Impedances:** 4, 8, 16, 250 and 500 ohms, plus 70.7-v. output. **Controls:** 2—Mic, Phono Fader, Off-On/Tone, Standby switch, Mic/Mag switch. **Tubes:** 3—ECC83/12AX7, 2—6L6GB; 2—6X5GT rectifiers. **Size:** 6⁷/₁₆x16¹/₄x10³/₄". Light brown hammerloid cabinet with aqua-and-white panel. With complete set of plugs. Less record player. U.L. Approved. Operates from 6 or 12 volts DC, or 110-130 volts, 60-cycle AC. Shpg. wt., 34 lbs.

93 SZ 506. Only \$10.65 Down. CASH NET. 106.50

MODEL KN-3125 25-WATT AMPLIFIER WITH RECORD PLAYER INSTALLED. Shpg. wt., 37 lbs.

93 SZ 738. Only \$12.65 Down. CASH NET. 126.50

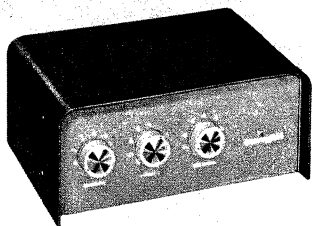

New KNIGHT 8-Watt P.A. Amplifier

ONLY

\$32⁵⁰

- Compact—Remarkably Versatile
- Perfect for Smaller P.A. Installations
- Microphone, Phono and Tone Controls
- Up-to-the-Minute in Styling and Design

MODEL KN-3008. Small in size, but with a large "voice", the new Knight 8-Watt P.A. Amplifier is an unbeatable value. You'll find hundreds of uses for this little "powerhouse"—at carnivals, bazaars, amusement parks; sales demonstrations and auctions; small clubs, classrooms, churches, stores, cafes, rumpus rooms (plug in a record player for parties); etc. Tape output jack allows recording your own P.A. broadcasts; phono fader control gives you single-knob volume control over two phono inputs. **Output:** Full 8 watts of usable power. Hum is inaudible; 62 db below rated output. **Response:** ±2 db, 70 to 10,000 cps. **Output Impedances:** 4 and 8 ohms. **Inputs:** 1—Mic, 2—Phono. **Controls:** Mic, Phono Fader, Off-On/Tone **Tubes:** ECC83/12AX7, 6L6GB, 5Y3GT rectifier. Pleasingly trim appearance. Enclosure styled in light brown hammerloid; panel in light green. **Size:** 4¹/₂x10³/₄x7³/₈". For 110-120 v., 60 cycle AC. Shpg. wt., 12 lbs.

93 SX 504. CASH NET. 32.50



NEW KNIGHT 60-Watt Power Booster

ONLY **\$69⁵⁰**

- Adds 60 Watts of Step-Up Power to Your Amplifier
- Use Any Number for Unlimited Extra Power
- Easily Installed in Cabinet, Relay Rack, etc.

MODEL KN-3061. Step up your P.A. system by a full 60 watts of distortion-free audio power with this versatile, new booster-amplifier! For use with any of the new Knight amplifiers or practically any other P.A. amplifier that delivers 0.4 volt or more at its speaker terminals. Attached in minutes. Tremendously boosts area coverage, provides husky power reserve and overcomes high noise. Perfect for use in sports arenas, stadiums, tracks, or large auditoriums. Can be added to church P.A. system to provide the extra power needed for a chime or carillon installation.

Output: Full 60 watts of usable power. **Hum:** —71 db. **Response:** ±2 db, 20 to 20,000 cps. **Input for 60-Watt Output:** 0.4 volt. **Output Impedances:** 4, 8, 16, 250 and 500 ohms; plus 70.7-v. output. **Controls:** Off-On and Volume. Trumpet protector switch; tape output jack. **Tubes:** ECC83/12AX7, 6C4, 2—6CA7/EL34, 5Y3GT, 5U4GB rectifiers. 7¹/₂x15x8¹/₈". For 110-120 v., 60 cycle AC. Shpg. wt. 24 lbs.

93 SZ 694. Only \$6.95 Down. CASH NET. 69.50

knight 32-WATT COMPLETELY PORTABLE PUBLIC ADDRESS SYSTEMS



Knight Portable Public Address Systems are carefully designed to meet the needs of specific applications; your satisfaction is insured by Allied's 15-day trial plan, with money-back guarantee!

ONE YEAR GUARANTEE



TRAVELING DANCE BANDS

Knight Portable Systems pack away easily, occupying no more space than an instrument or two. They're rugged, and easy to set up or put away; operation is simple!

KNIGHT Deluxe 32-Watt All-Portable Sound System

Less Record Player
\$154⁵⁰

Save Up To \$27.89!

This new, high-quality, portable P.A. system meets 90% of all portable P.A. needs—and saves you up to \$27.89 over the total price of the individual components if purchased separately. Two balanced carrying cases contain the entire system, making it easy to transport and set up in a jiffy. The system is offered with or without record player, and with your choice of either of two excellent microphones.

SYSTEM INCLUDES: New Knight 32-Watt Amplifier, with or without Top-Mounted 4-Speed Record Player; Electro-Voice Model 664 Dynamic Microphone or wide-range Astatic Model 788 Dynamic Microphone; Microphone Cable; exceptionally compact Atlas CS-33 Microphone Floor Stand; and Two Heavy-Duty 12" Speakers, each rated at 25 watts, installed in a Carrying Case that comes apart to form two separate baffles for the speakers within. Wood cases have durable plastic brown-tweed finish—green grille. Speaker Case, 19½x16x17"; Amplifier Case, 11½x17x12". Record player operates at 16⅔, 33⅓, 45, 78 rpm; has dual sapphire styli. Systems less record player are for 110-120 v., 50-60 cycle AC; with player, 60 cycle AC only.

WITH E-V 664 MIKE, LESS RECORD PLAYER. Includes P.A. components listed above, with E-V 664 mike; less record player for amplifier. Shpg. wt., 96 lbs.
92 PA 656. Save \$27.89! NET..... 154.50

WITH E-V 664 MIKE AND RECORD PLAYER. Greatly increases versatility of P.A. system; permits playing of any recording at any speed. Ceramic cartridge used provides excellent, wide-range reproduction. Especially useful to schools and churches. Shpg. wt., 100 lbs.
92 PA 756. Save \$27.89! NET..... 173.75

WITH ASTATIC 788 MIKE, LESS RECORD PLAYER. P.A. components listed above, with Astatic 788 mike; less record player for amplifier. Shpg. wt., 96 lbs.
92 PA 655. Save \$24.65! NET..... 154.50

WITH ASTATIC 788 MIKE AND RECORD PLAYER. Same as above but with 4-speed player mounted on amplifier. Ceramic cartridge, installed in player, is unaffected by heat and humidity. Ideal for outdoor dances, institutional use, or general P.A. work indoors or out. Wt., 100 lbs.
92 PA 755. Save \$24.65! NET..... 173.75

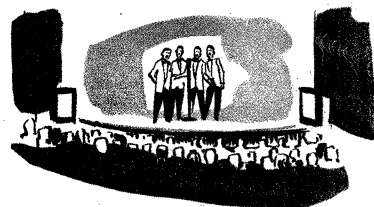

THEATER GROUPS

Use a Knight Portable System for musical background, sound effects, or announcements. Wide coverage and clear reproduction bring the show to the entire audience!

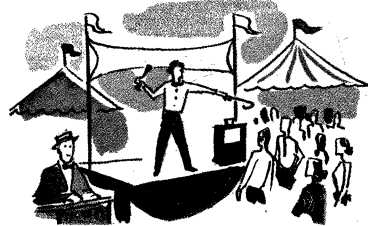

BAZAARS—CARNIVALS—FAIRS

Set it up in minutes—a Knight portable System adapts to any job, big or small. Afterwards, it's quickly stored, ready for its next job.

KNIGHT Standard 32-Watt Portable System

\$124⁵⁰

Less Record Player
You Save \$14.80

A complete, one case 32-watt portable P.A. system, packed with exclusive Knight features! Sets up quickly to provide truly superior P.A. performance; when the job is done, pick it up and pack it away easily—in one case! There are no loose items to carry around, yet everything you need is in the case: speakers, microphone, amplifier, cable—even a 4-speed record player, if desired!

SYSTEM INCLUDES: Knight 32-Watt Amplifier, with or without the Top-Mounted 4-Speed Record Player; Electro-Voice 951 Microphone; Mike Cable; convenient Knight Floor Mike Stand; and two powerful Knight 12" P.A. Loudspeakers. Single case becomes two separate baffles when opened. For 110-120 v., 60 cycle AC.

LESS RECORD PLAYER. Shpg. wt. 73 lbs.
92 PA 654. Only \$12.45 Down. CASH NET..... 124.50

WITH RECORD PLAYER. Shpg. wt., 75 lbs.
92 PA 754. Only \$14.38 Down. CASH NET..... 143.75

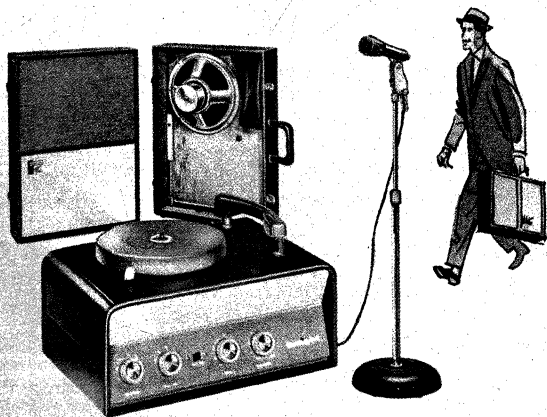

knight 32-WATT P.A. SYSTEMS FOR INDOOR OR OUTDOOR USE

Only components of the highest quality are used in Knight Public Address Systems. U.L. Approved and fully guaranteed, they are definitely your best buy in public address equipment.

U. L. APPROVED

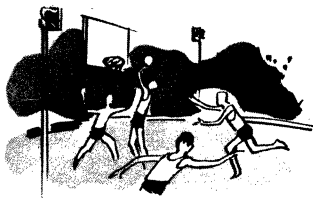

GYMNASIUMS

Teams and crowds are easy to control, misunderstandings are eliminated, and there's more enjoyment for everybody—when you use this powerful, top-performing system.

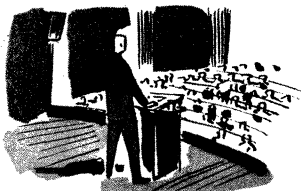

AUDITORIUMS

No more straining in the back rows to hear what the lecturer is saying! Effectively placed speakers (Allied will help you plan) bring the program to every listener!



OUTDOOR RINKS

Skating or dancing are more fun when you hear music and announcements clearly and plainly, through a Knight public address system!



KNIGHT 32-Watt Permanent Installation P.A. System

AS LOW AS
\$129.50

Less Record Player

An excellent system for medium-power applications—perfect for moderate-size auditoriums, schools, churches and meeting halls. Components are selected to provide dependable service under the most exacting conditions.

Accessory top-mounted record player operates at 4 speeds, features sapphire styli and ceramic cartridge which is unaffected by temperature and humidity. On 92 PA 659 you save \$34.34 over the total cost of individual items—and you pocket big savings on the other systems too. **Basic system includes: Knight 32-Watt Amplifier; Shure 55S Microphone; Microphone Cable.** Choose any of three speaker systems: "A" for best music reproduction; "B" for deep penetration; "C" for best wide-angle coverage. Systems without record player are for 110-120 v., 50-60 cycles AC; those with player are for 60 cycle AC only.

WITH WALL BAFFLES (A), LESS RECORD PLAYER. P.A. System as listed above, including two heavy-duty 12" FM speakers in wall baffles. Speakers are fused to prevent accidental damage due to overloading. Baffles are attractively finished in walnut. Supplied with 30-ft. speaker cables and plugs. Shpg. wt., 72 lbs.
92 PA 657. *Save \$22.44!* NET.....**129.50**

WITH WALL BAFFLES (A) RECORD PLAYER. System as described above, but with 4-speed record player mounted on amplifier case. Shpg. wt., 75 lbs.
92 PA 757. *Save \$22.44!* NET.....**148.75**

WITH UNIVERSITY TRUMPETS (B), LESS RECORD PLAYER. Main system as described, using 2 University PH trumpets, and MA-25 drivers. Shpg. wt., 75 lbs.
92 PA 658. *Save \$19.90!* NET.....**164.50**

WITH UNIVERSITY TRUMPETS (B) AND RECORD PLAYER. 78 lbs.

92 PA 758. *Save \$19.90!* NET.....**183.75**

WITH ELECTRO-VOICE PROJECTORS (C), LESS RECORD PLAYER. Main system as described, with 2—Electro-Voice 848 CDP projectors. Especially suited to outdoor installations where wide-angle coverage is required; may be used equally well indoors. Fully weather-proof and virtually indestructible. Sound may be concentrated in a given direction by simple adjustment of the speaker mount. Shpg. wt., 75 lbs.

92 PA 659. *Save \$34.34!* NET.....**169.50**

WITH ELECTRO-VOICE TRUMPETS (C) AND RECORD PLAYER. High-quality system, as listed above, plus 4-speed record player. Shpg. wt., 78 lbs.

92 PA 759. *Save \$34.34!* NET.....**188.75**

Important Accessories for Your P.A. System

D BOGEN B50-16XD RECORD PLAYER. Continuously variable speed from 15 to 83 rpm. With G.E. 4G-052 magnetic cartridge and portable case. *See page 70.* For 110-120 v., 60 cycle AC. Wt., 26 lbs.
94 RZ 943. NET.....**79.06**

E V-M 4-SPEED CHANGER ON BASE. Greatly improves tonal quality of music played through your P.A. system. Includes G.E. 4G-050 (twin sapphire) magnetic cartridge. For 110-120 v., 60 cycle AC. 15 lbs.
94 RX 944. List, \$57.50. NET.....**46.00**

F KNIGHT "BANTAM" FM-AM TUNER. Excellent, economical way to add the richness of high-fidelity FM-AM programming to your P.A. system. *See page 28.* For 110-120 v., 50-60 cycle AC. Shpg. wt., 13 lbs.
92 SX 401. NET.....**74.50**

G KNIGHT KN-4020 TAPE RECORDER. Your "Best Buy" in an efficient tape recorder; record announcements, programs, etc. *Described on page 87.* 29 lbs.
91 RZ 751. NET.....**94.95**

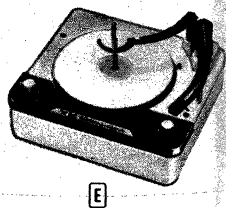

See Page 396 for Allied's Easy Pay Plan

knight® 60-WATT SUPER-POWER P. A. SYSTEMS & BOOSTER PACKAGES

Tremendous sound coverage, rugged construction, absolutely dependable operation under any conditions, and deluxe styling—are yours when you choose any of the Knight 60-Watt Super-Power P.A. Systems. For blanket coverage of large areas or overcoming high-noise levels you cannot do better!

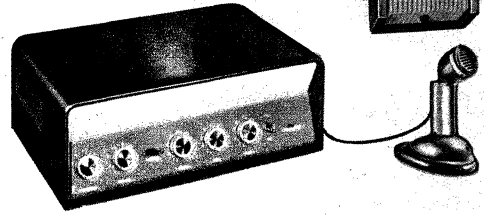
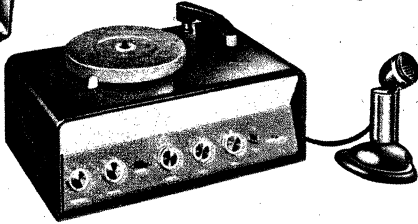
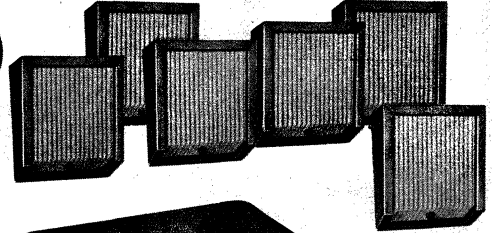
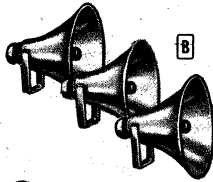

New KNIGHT 60-Watt Deluxe Trumpet System

\$239⁹⁵

Less Record Player

Designed for any "big job" in Public Address, the new Knight 60-Watt Deluxe Trumpet System provides highly effective sound dispersion over large areas. Suitable for indoor or outdoor use, its 3 sound projectors provide excellent all-angle coverage and are made of virtually indestructible and weatherproof fiberglass. The Shure "Dispatcher" microphone employed in the system, made especially for P.A. use, delivers crisp, clear reproduction of voice and music.

System includes: New Knight 60-Watt Amplifier, U.L. Approved for operator safety; Shure Model 520SL Controlled Reluctance Mike on Stand (heat and humidity-proof, with grip-to-talk, slide-to-lock switch); three Electro-Voice Model 84BCDP Diffraction Projectors (Fig. A); three E-V Model 876 Line-Matching Transformers, with screw terminals. Less speaker cable, see page 180. For 110-130 v., 60 cycle AC. *You save \$31.45 on these systems!*

92 PA 660. Less Record Player. Wt., 102 lbs. NET..... **239.95**
 92 PA 760. With Record Player. Wt., 104 lbs. NET..... **260.45**

60-WATT SYSTEM WITH UNIVERSITY TRUMPETS. Same system as above but with 3 University PH trumpets (Fig. B) with SA-30 drivers. SA-30 drivers have built-in line-matching transformers with screw terminals. *You save \$23.47 on these systems!*

92 PA 661. Less Record Player. Wt., 94 lbs. NET..... **224.95**
 92 PA 761. Record Player. Wt., 96 lbs. NET..... **245.45**

New KNIGHT 60-Watt Paging System

ONLY

\$199⁵⁰

When you need a "big voice" for indoor paging—in a large office, industrial plant, stadium, auditorium or any other large indoor area—you'll get dependable performance from this new, Knight 60-watt paging system!

Ready for quick, simple installation, it employs 6 speaker-baffles, each with separate volume control, for highly efficient sound dispersion and excellent penetrating power. System includes: New Knight, U.L. Approved, 60-Watt Amplifier; Shure Model 520SL Microphone on Stand; 6 Pre-Wired Speaker-Baffle Combination Units.

Sloping front baffles are made of wood and attractively finished in lustrous mahogany, with matching plastic grille cloth. Each baffle contains a heavy-duty 8" speaker; each has a separate volume control to permit controlling sound level at the speaker. Pre-wired transformer in every speaker-baffle is ready to connect to the 70.7-volt output of the 60-watt amplifier. No soldering is required—a screwdriver is all you need to connect your speaker cable to the terminals on the baffle. Additional speaker-baffle units (up to 30), can be added to the system at any time. Add an FM-AM tuner, record player or tape recorder for background music, recording your own programs, etc. Less speaker cable (see page 180). System operates from 110-130 v., 50-60 cycle AC. Shpg. wt. 80 lbs. *You save \$10.04 on this system!*

92 PA 697. Only \$19.95 Down. CASH NET..... **199.50**

Boost Your Sound Coverage with These KNIGHT 60-Watt P.A. Power Packages

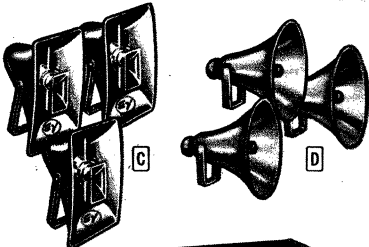

ONLY
\$199⁵⁰

With E-V Projectors

Extra power without distortion! Add real "muscle" to your present P.A. installation with this new Knight 60-watt power booster package. Includes: New, U.L. Approved Knight 60-watt Power Booster-Amplifier; 3 Electro-Voice Model 84BCDP Diffraction Projectors (Fig. C), with 3 E-V Model 876 Line-Matching Transformers. Package can be easily added to your present P.A. system or added to any of the P.A. systems described

above. Provides greatly extended sound coverage. Can be used indoors or outdoors—can be located thousands of feet from present amplifier with negligible loss. E-V projectors provide wide-angle coverage and are excellent for concentrating sound toward your audience. Line matching transformers are quickly fastened to the back of the projectors and are pre-set for perfect impedance match. Less speaker cable. For operation from 110-130 v., 50-60 cycle AC. Shpg. wt., 84 lbs. *You save \$31.40 on this system!*

92 PA 698. Only \$19.95 Down. CASH NET..... **199.50**

SYSTEM AS ABOVE WITH UNIVERSITY TRUMPETS. Includes Knight 60-watt booster-amplifier with 3 University Model PH trumpets (Fig. D), and 3 Model SA-30 drivers. University trumpets are renowned for their long "throw" and deep penetration. Driver units have built-in line-matching transformers with screw terminals. Shpg. wt., 84 lbs. *You save \$18.02 on this system!*

92 PA 699. Only \$18.99 Down. CASH NET..... **189.90**

knight® 25-WATT UNIVERSAL 6V-12V-110V MOBILE SOUND SYSTEMS

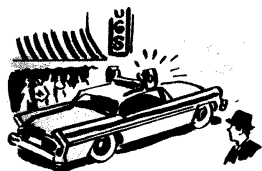

For Cars, Trucks, etc.



Safety While Driving



110-Volt AC Use

Take sound everywhere, with any of the new Knight 25-watt mobile P.A. systems listed below! Ruggedly built, they provide the utmost in dependable operation from cars, trucks or boats. Cover up to 85,000 sq. ft.—more than enough for any "big crowd" event. Quickly and easily set up for 110-volt AC use in rental installations.



Knight mobile systems use either a "3rd hand" mike-holding accessory or a neck-suspended lavalier cord for unobstructed vision, free use of hands.

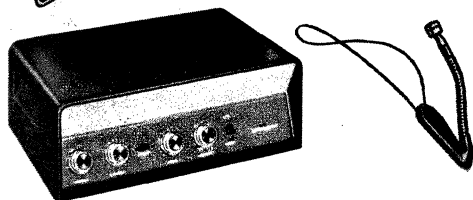
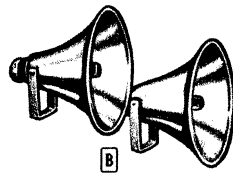
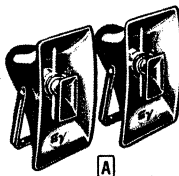

New KNIGHT Standard Mobile P.A. System

\$149⁵⁰

Less Record Player

An excellent value, this low-cost sound system is sure to win acclaim for its clear "sound-casting", all-around ruggedness and unusual versatility. The new Knight standard 25-watt mobile system operates from either 6 or 12-volt storage batteries on cars, trucks and boats—or from 110-volt AC. Unique circuit lets you switch instantly from battery to AC operation by simply changing plugs on the rear of the amplifier. Highly suitable for any number of applications, it's especially recommended for: Carnivals, outdoor athletic events, political rallies, auction sales, advertising promotions, etc.

System includes: New Knight 25-Watt Amplifier, U.L. Approved for operating safety and offering an array of P.A. features; one Electro-Voice Model 848CDF Diffraction Projector, made of weatherproof fiberglass; Turner Model 82-3H crystal microphone, with "third hand" mike holder for suspending mike from neck. Mike itself is fitted onto a flexible gooseneck for positioning at correct distance from mouth. Both hands remain free for driving and vision is unobstructed. The Knight 25-watt amplifier features smart, contemporary "tritone" color styling, tape output jack, input voltage switch, phonofader control, trumpet protector switch and other features that add to its flexibility of operation. Current-saving standby switch assures minimum battery drain. With cables and plugs. For 6 or 12 volts DC, or 110-130 v., 60 cycle AC. Shpg. wt., 52 lbs. *You save \$17.02 on either of these systems!*
92 PA 662. Only \$14.95 Down. CASH NET.....149.50

SYSTEM AS ABOVE, WITH RECORD PLAYER. Wt., 56 lbs.
92 PA 762. Only \$16.95 Down. CASH NET.....169.50

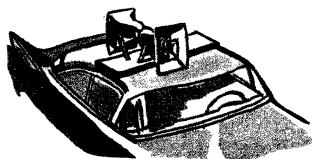

Car-Top Speaker Platform

Exceptionally sturdy, weather-resistant and heavily varnished wood platform for mobile speaker installations. Easily supports even the largest speakers. Attaches by four non-slip vacuum cups. Fits roof contour of any car. Secured with straps and anchored by rubber-insulated clips to raingutter over car doors. Easily and quickly installed or removed. 7½x46". Shpg. wt., 9 lbs.
93 DX 220. NET.....6.45

New KNIGHT Deluxe Mobile P.A. System

\$214⁸⁵

Less Record Player

Combining power with unusual versatility of operation, the new Knight deluxe 25-watt mobile P.A. system gives you everything you need for truly dependable, mobile or stationary P.A. service. Sets up in a jiffy and operates anywhere, indoors or outdoors, from any 6 or 12-volt DC, or 110-volt AC source. Works equally well from cars, trucks, buses, as well as in offices, plants, theaters, etc. With an area coverage of up to 85,000 square feet, you can direct sound ahead or behind in mobile applications, or aim it toward your audience when used indoors. Makes a perfect sound system for any group or organization now renting Public Address equipment.

System includes: New Knight 25-Watt Mobile Amplifier, with or without 4-speed record player installed atop its cabinet; two Electro-Voice Model 848CDF Diffraction Projectors (Fig. A); Shure Model 535 Dynamic Microphone with 20-ft. cable and connector. The temperature and humidity-proof Model 535 dynamic mike is specially designed for P.A. use, and can be used for hand-held, desk or floor stand operation; lavalier cord allows suspension from neck for free use of hands. Complete with 50 ft. of speaker cable. System operates from 6 or 12-volt DC or 110-130 v., 60 cycle AC. *You save \$24.05 on either of these systems!*

92 PA 627. Less Record Player. Wt., 73 lbs. NET.....214.85
92 PA 718. With Record Player. Wt., 76 lbs. NET.....234.85

25-WATT SYSTEM WITH UNIVERSITY TRUMPETS. As above, but with 2 University PH trumpets (Fig. B) and MA-25 drivers, instead of E-V projectors. *You save \$19.51 on these systems!*
92 PA 628. Less Record Player. Wt., 72 lbs. NET.....199.95
92 PA 719. With Record Player. Wt., 75 lbs. NET.....219.95

Use a Tape Recorder with KNIGHT Mobile Systems



KNIGHT "SUPREME VALUE" TAPE RECORDER. Add extra usefulness to your P.A. system! Enables you to record your own programs, announcements, etc., and play them back through P.A. system. Can be used for P.A. and recording simultaneously with patch cord, below. Need not be kept perfectly level; bumps and jarring do not affect sound. Requires converter for mobile use; see below. *Fully described on page 87.* Wt., 29 lbs.
91 RZ 751. NET.....94.95

99 S 856. Patch Cord. 36" long. 1 lb. NET.....70c

CARTER CONVERTERS. Operate tape recorders from a DC power source, such as an automobile battery. Output: 115 volts, 60 cycle AC. No filtering is required. Include DC connecting cord and plug-in AC receptacle. Size, 5x8¼x4½". Shpg. wt., each, 15 lbs.
80 P 059. Type B1010CBW4. For 12-volt DC input. NET.....90.40
80 P 069. Type A1010CBW4. For 6-volt DC input. EACH.....90.40

knight 16-WATT SOUND SYSTEMS FOR EVERY APPLICATION



These handy, single-case systems are the most convenient portable sound systems ever designed! Everything is in a single case—there's nothing extra to carry or keep track of—the height of functional design!

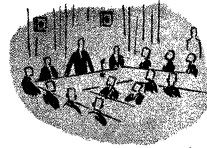

Knight 16-Watt sound systems are ideal for auctioneers, salesmen, demonstrators, etc. The perfect answer to all modest P.A. requirements!

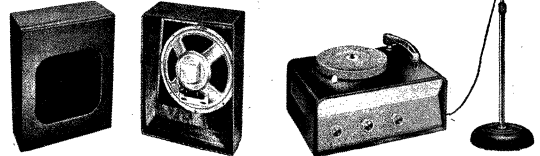

KNIGHT 16-Watt Deluxe Portable P.A. System

ONLY
\$94⁵⁰

Less Record
Player

Here's a deluxe, portable 16-watt sound system that offers you plenty of power, maximum convenience and top dependability. You save \$11.68 over the cost of the individual components purchased separately! System includes: Knight KN-3116 16-Watt Amplifier with 4-Speed Phono Top; 2—12" Heavy-Duty Quam P.A. Speakers; 3-Section Microphone Stand; Astatic M332 Microphone; Combination Speaker and Amplifier Case.

The new Knight 16-Watt amplifier features low-noise ECC-83 input tubes, and a convenient tape recorder output, which may be used to record programs while the P.A. system is in use. The case comes apart to form two independent baffles for the speakers. For 110-120 volts, 60 cycles AC. Shpg. wt., 75 lbs.

92 PA 752. NET. **113.75**
LESS PHONO TOP. Shpg. wt., 72 lbs.
92 PA 652. NET. **94.50**

KNIGHT 16-Watt System with Wall-Mount

ONLY
\$89⁵⁰

Less Record
Player

You'll find exceptional value in this Knight 16-watt sound system for permanent installation. Although moderately priced, it offers outstanding performance, exceptional operating convenience and rugged dependability.

The 16-watt system easily covers audiences of up to 2000 persons, and areas of up to 10,000 square feet. As many as 15 additional speakers can be added without impairing the response of the amplifier. Additionally, you save \$13.72 over the cost of individual components purchased separately! The system includes: Knight KN-3116 16-Watt Amplifier with 4-Speed Phono Top; Knight 3-Section Microphone Stand; Astatic M332 Microphone; 2—12" Quam Heavy-Duty P.A. Speakers; 2—Argos Wall Baffles. For 110-130 v., 60 cycles AC. Wt., 63 lbs.

92 PA 753. NET. **108.75**
LESS PHONO TOP. As above system, but less 4-speed record player. Shpg. wt., 60 lbs.
92 PA 653. NET. **89.50**



KNIGHT 8-Watt "Little Giant" Public Address Systems

- Functional New Design
- 1-Year Guarantee
- Tape Output Jack
- Quality "Slim-X" Mike
- Ideal for Background Music
- Easy to Use!

8-WATT SYSTEM WITH WALL-MOUNT SPEAKER

\$55⁵⁰
You Save
\$4.93

Ideal for smaller permanent sound installations, the Knight "Little Giant" permanent system is highly recommended for clubs and lounges, waiting rooms, classrooms, stores, cafes, etc. Surprisingly powerful, it combines low initial cost with economical service and thoroughly dependable operation. System includes: Knight KN-3008 8-Watt Amplifier; Quam 8" Heavy-Duty P.A. Speaker; Argos 8" Wall Baffle; Slim-X Microphone with Stand. For operation from 110-120 volts, 50-60 cycles AC. Shpg. wt., 23 lbs.

92 PA 651. NET. **55.50**

8-WATT ALL-PORTABLE SOUND SYSTEM

\$62⁵⁰
You Save
\$5.10

Light in weight, and easy to set up anywhere, this 8-watt "Little Giant" sound system is a giant buy—you save \$5.10 over the cost of individual components purchased separately! Everything you need fits into the single, compact case—Knight KN-3008 8-Watt Amplifier; Quam 8" Heavy-Duty PM Speaker; Slim-X Mike; New Speaker-Amplifier Carrying Case; Microphone Stand.

It's the practical P.A. system for use in schools or other institutions where a number of groups must share the use of a single system. The new amplifier provides for tape recording while the amplifier is being used for a program. For 110-120 v., 50-60 cycles AC. Shpg. wt., 28 lbs.

92 PA 650. NET. **62.50**

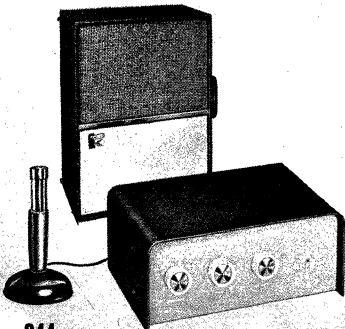

Write to Our Sound Division for Free Consultation Service

NEW knight INDUSTRIAL SOUND EQUIPMENT AND RACK PANEL KITS

New Knight P.A. and industrial sound equipment brings you extra value in every unit . . . extra versatility for every type of program and application . . . and handsome new styling!

Designed especially for the new series of Knight sound equipment, rack panel mounting kits permit a neater, more functional installation of your sound system than ever before!

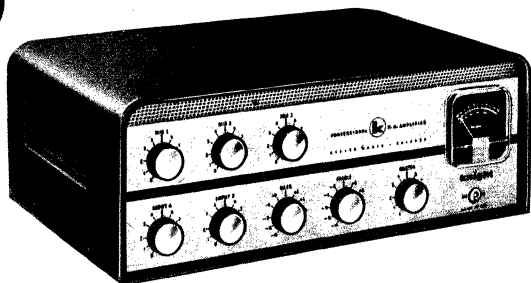
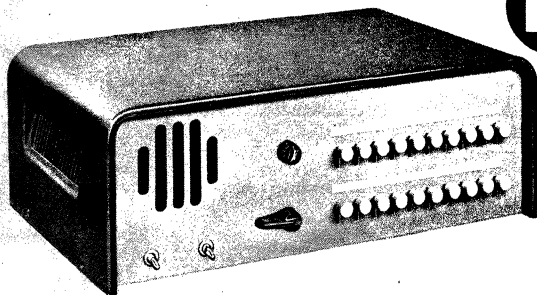

KNIGHT Control Unit for Paging and Intercom

NET
\$77.50

A new, exceptionally versatile control unit providing complete switching between control location and up to 40 stations, in any combination, for talking, listening, or transmission of program material; it may be used with any P.A. amplifier. As supplied, the unit will handle 20 stations; Adapter panel permits the addition of 20 more keys. Controls include a volume control, talk-listen-program switch, and an "all-call" switch. The self-contained speaker may be used as a microphone; a jack is provided for an external microphone with switch. Applications include school, hospital and factory intercommunication systems. The control unit itself requires no power, and connects to the input and output of any associated amplifier. Size, 9x17 $\frac{1}{4}$ x7". Shpg. wt., 11 $\frac{1}{2}$ lbs.

93 SX 056. NET. 77.50

EXTRA 20-KEY PANEL. For control unit above. 1 $\frac{3}{4}$ lbs.

93 SX 057. NET. 29.50

New KNIGHT 35-Watt Deluxe Amplifier

NET
\$109.75

Model KN-3035. A P.A. amplifier of exceptional versatility, suited to the most demanding of applications. The unusually impressive array of features includes remote mixing of 3 microphones, plug-in transformers for conversion of mike inputs to low impedance, VU meter with range switch, output impedance selector socket, output tube balancing control, and full 35 watts output at only 2% distortion. Other specifications include: *Hum*: -71 db. *Response*: ± 2 db, 20-20,000 cps. *Inputs* (6): 3 mikes, 2 phonos, 1 magnetic. *Controls*: 3—mike volume, 2—phono volume, bass, treble, master volume, mike-magnetic switch, on-off switch. *Output Impedances*: 4, 8, 16, 143 (70 v), 250 and 500 ohms. *Tubes*: 3—ECC83, 12AU7, 2—EL34 (output); 5U4GB rectifier. Rugged, all-metal black case with brushed chrome front panel. Size, 6 $\frac{1}{8}$ x17 $\frac{1}{4}$ x10 $\frac{3}{4}$ ". U. L. Approved. For 110-120 volts, 50-60 cycles AC. Shpg. wt., 28 $\frac{1}{2}$ lbs.

93 SX 055. NET. 109.75

Rack Mounting Panel Kits for KNIGHT P.A. Equipment

Give your P.A. equipment professional appearance and centralization by mounting Knight P.A. components in standard relay racks; everything you need is in these new panel kits! All panels are handsomely finished in brushed chrome, easy to keep clean and new-looking. When your Knight units are mounted in this way, they will make an integrated package, easily installed as a single unit, in a few square feet of floor space. Full ventilation is provided for all units. Matching brushed chrome blank panels are also available.

Each kit includes a brushed chrome dress panel, U-pan assembly, a full set of knobs (black with chrome insert to match panel), and hardware. See pages 292 and 296 for listing of standard relay racks.

Stock No.	Description	Height	Wt., Lbs.	NET
93 SX 058	For KN-3035 Amplifier	7"	6 $\frac{3}{4}$	14.95
93 SX 059	For KN-3032 Amplifier	7"	7 $\frac{1}{2}$	14.38
93 SX 060	For KN-3060 Amplifier	7"	7 $\frac{1}{2}$	14.55
93 SX 061	For KN-3061 Booster	8 $\frac{3}{4}$ "	7 $\frac{1}{2}$	14.10
93 SX 062	For KN-110 Deluxe Tuner	7"	6 $\frac{1}{2}$	11.60
93 SX 063	Phono Drawer on Slides	10 $\frac{1}{2}$ "	14	19.65
93 SX 064	Blank Panel	3 $\frac{1}{2}$ "	3	5.40
93 SX 065	Blank Panel	5 $\frac{1}{4}$ "	3 $\frac{1}{2}$	5.85
93 SX 066	Blank Panel	7"	4 $\frac{1}{4}$	6.50
93 SX 067	Blank Panel	8 $\frac{3}{4}$ "	4 $\frac{3}{4}$	6.90

ACCESSORIES FOR KNIGHT KN-3035 AMPLIFIER

PLUG-IN LO-Z TRANSFORMER. 50-600 ohms input. 1 lb.

93 S 068. NET. 13.50

REMOTE CONTROL UNIT. For use with Model KN-3035 amplifier only. Handles 3 microphones. Size, 5x2 $\frac{1}{4}$ x1". Shpg. wt., 1 $\frac{1}{2}$ lbs.

93 S 070. NET. 12.75

See Pages 348 through 359 for Listings of Microphones and Speakers for Use With Knight P.A. Systems.



Bogen

FLEX-PAK

PUBLIC ADDRESS



"Deluxe" LX Series

- Flexibility Permits Use In Any Installation
- Remote Control Feature Adds Convenience
- Handy "Pencil-In" Identification Strips
- Constant-Voltage Taps



"Superb" L Series

EXCEPTIONAL FLEXIBILITY. Many accessories permit almost any type of installation: "Deluxe" series may be remotely controlled with accessory and has anti-feedback control, an exclusive Bogen feature. All units have plug-in sockets for low-impedance transformers; pencil-in identification strips for gain controls; constant-voltage output taps for use with 70.7-volt transformers.

EXCEPTIONAL QUALITY. Controlled positive feedback, plus screen regulation for higher output at lower distortion levels; XL-311 Cannon microphone connectors used throughout; new functional modern styling; easy attachment of accessories without tools; correct compensation for use with phono cartridges; speech filters for highest clarity.

"DELUXE" 30 AND 60-WATT FLEX-PAK AMPLIFIERS

These are the two brilliant leaders of Bogen's new "Flex-Pak" series: a distinguished group of units that bring new versatility and electronic refinements to the P.A. field. Incorporated in the "Deluxe" amplifiers are such features as anti-feedback control, constant-voltage output taps, four independently controlled microphone channels (one convertible to phono) and built-in circuitry for adaptation to remote control of gain at distances up to 2,000 feet. The anti-feedback control minimizes feedback noise without compromising tone or reducing gain. Constant-voltage output taps eliminate calculations to determine correct line-to-voice coil transformers. The circuitry is modern: screen regulation in the output stage provides higher power with greater efficiency; controlled positive feedback provides high output with minimum distortion. Handsome case is finished in black and gray. Handy identification strips above each gain control may be marked in pencil; they are easily erased when the set-up is changed.

Frequency Response: ± 1.5 db, 20-20,000 cps. **Hum Level:** 60 db below rated output. **Controls:** 4—Gain; Mic.-Phono switch; 2—Speech Filters; Off-On-Treble; Bass; Anti-Feedback. **Size:** $5\frac{1}{2} \times 16\frac{1}{4} \times 13$ ". For operation from 110-120 volts, 50-60 cycles AC.

LX60 60 WATT AMPLIFIER. Power Output: 60 watts at less than 2% distortion; 90 watts peak. **Tubes:** 2—6AV5GA, 3—12AX7, 2—6U8, 6CM7; 3—5Y3GT rectifiers. **Output Impedances:** 4, 8, 16 ohms, balanced 25-volt line, 70-volt line. Shpg. wt., 37 lbs.

91 SZ 710. List 259.50. NET. **155.70**

LX30 30 WATT AMPLIFIER. Power Output: 30 watts at less than 2% distortion; 45 watts peak. **Tubes:** 2—6AV5GA, 3—12AX7, 6CG7, 2—6U8; 2—5Y3GT rectifiers. **Output Impedances:** 4, 8, 16 ohms, balanced 25-volt line, 70-volt line. Shpg. wt., 31 lbs.

91 SZ 711. List 209.50. NET. **125.70**

"SUPERB" 30 AND 60-WATT FLEX-PAK AMPLIFIERS

The two amplifiers of the "Superb" group are ideal for high-quality P.A. work requiring unusual flexibility and excellent performance at moderate cost. They include many of the outstanding features of the "Deluxe" amplifiers at the left, and provide three independently controlled microphone channels, one of which is convertible to phono. Controlled positive feedback, screen regulation in the output stage, and constant-voltage output taps are also provided. The handsomely designed cases of these amplifiers are black and gray; control panel markings are in red and black. A convenient leather carrying handle, easily removed, is attached to the side of the case with thumbscrews. No tools are needed for maintenance of Flex-pak amplifiers; the cage-type cover can be quickly removed after four thumbscrews are loosened. Pencil-in, erase-out labels are permanently bonded to the amplifier control panels above each gain control. The phono input is equalized for all types of cartridges.

Frequency Response: ± 2 db, 20-20,000 cps. **Hum Level:** 60 db below rated output. **Controls:** 3—Gain; Mic.-Phono switch; Speech Filter; Off-On-Treble; Bass. **Size:** 60-watt, $5\frac{1}{2} \times 16\frac{1}{4} \times 13$ "; 30-watt, $5\frac{1}{2} \times 14\frac{1}{2} \times 13$ ". For 110-120 v., 50-60 cycles AC.

L60 60-WATT AMPLIFIER. Power Output: 60 watts at less than 2% distortion; 90 watts peak. **Tubes:** 4—6AV5GA, 2—12AX7, 6U8, 6CM7, 6AU6; 3—5Y3GT rectifiers. **Output Impedances:** 4, 8, 16 ohms, balanced 25-volt line, 70-volt line. Shpg. wt., 37 lbs.

91 SZ 713. List 189.50. NET. **113.70**

L330 30-WATT AMPLIFIER. Power Output: 30 watts at less than 2% distortion; peak, 45 watts. **Tubes:** 2—6AV5GA, 2—12AX7, 6AU6, 6CG7, 6U8; 2—5Y3GT rectifiers. **Output Impedances:** 4, 8, 16 ohms, balanced 25-volt line, 70-volt line. Shpg. wt., 29 lbs.

91 SZ 712. List 149.50. NET. **89.70**

"FLEX-PAK" ACCESSORIES FOR ALL P.A. APPLICATIONS

L AND LX SERIES PHONO TOPS. Precision-quality phono attachments, supplied in kit form. Kit includes phono top, mounting brackets and hardware. Easily attached to cases of "Flex-Pak" amplifiers; no tools needed. All have Ronette turnover cartridge; 4-speed models also have variable speed control. For 110-120 v., 60 cycle AC.

STANDARD MODELS. 3-speed manual phono tops. Shpg. wt. 5 lbs.

MODEL LPA-3. For L-330 amplifier. 91 SX 714. List 39.00. NET. **23.40**

MODEL LPB-3. For LX60, LX30, L60 or LOM. 91 SX 716. List 39.00. NET. **23.40**

DELUXE MODELS. 4-speed, vibration-isolated phono tops. Shpg. wt., 6 lbs.

MODEL LPA-4. For L330 amplifier. 91 SX 715. List 62.50. NET. **37.50**

MODEL LPB-4. For LX60, LX30, L60 or LOM. 91 SX 717. List 62.50. NET. **37.50**

"CONTROL-GUARD" LOCKING PLATES. For locking "Flex-Pak" control settings.

LOCKING PLATES FOR WALL-MOUNTED UNITS. Shpg. wt., 3 lbs.

MODEL LK-3. For L330. 91 SX 720. List 8.50. NET. **5.10**

MODEL LK-4. For LX60, LX30, L60, LOM. 91 SX 721. List 9.50. NET. **5.70**

LOCKING PLATES FOR REGULAR UNITS. Shpg. wt., 2 lbs.

MODEL LK-1. For L330. 91 SX 718. List 6.95. NET. **4.17**

MODEL LK-2. For LX60, LX30, L60, LOM. 91 SX 719. List 7.50. NET. **4.50**

LWM WALL MOUNTING KIT. Keep your equipment ready when needed, yet safely and neatly out of the way when not in use. For use with all "Flex-Pak" units, except KO series. Equipment may be set any angle. Shpg. wt., 3 lbs.

91 SX 722. List 12.50. NET. **7.50**

RACK PANEL MOUNTING KITS. For mounting "Flex-Pak" units on standard 19" electronic equipment racks. *Specify amplifier for which kit is being ordered.* Shpg. wt., 6 lbs.

91 SX 723. For LX, L, LOM. NET. **11.70**

91 SX 724. For K and KO. NET. **8.91**

91 SX 727. For L-330 only. NET. **11.70**

PLUG-IN MIKE TRANSFORMERS. Especially designed for simple, plug-in connection to Bogen "Flex-Pak" amplifiers and preamplifier; permit use of low-impedance mikes far from amplifier. An ideal solution to the problems created when a long line must be run from amplifier set-up to microphone; transformers permit microphone leads hundreds of feet long. Available in 50, 200 or 500 ohms impedance. Octal base plugs into corresponding socket on "Flex-Pak" unit. Hermetically sealed and fully shielded to prevent hum pickup or deterioration.

MODEL T-155. 200 ohms. Shpg. wt., 1 lb. 99 S 184. List 17.50. NET. **10.50**

MODEL T-156. 500 ohms. Shpg. wt., 1 lb. 91 S 725. List 20.00. NET. **12.00**

MODEL T-157. 50 ohms. Shpg. wt., 1 lb. 91 S 726. List 20.00. NET. **12.00**

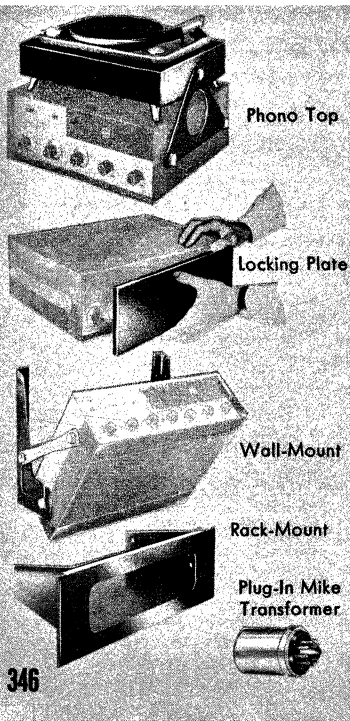

EQUIPMENT FOR EVERY SOUND NEED

Bogen FLEX-PAK

- EASY TO SERVICE
- EASY TO INSTALL
- EASY TO CARRY

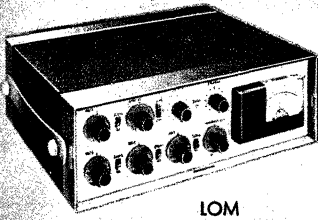

LOM

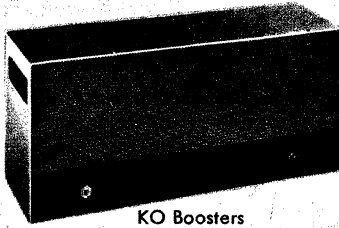

KO Boosters

LOM PREAMP-CONTROL UNIT

A superbly engineered instrument for critical P.A. applications, or high-quality, professional recording on location. Five independently controlled microphone inputs are provided, one convertible to a phono cartridge input. An accurate level meter permits continuous monitoring of the combined output of all channels in use. Built-in sockets accept plug-in low impedance transformers listed on opposite page, for use with extra-long microphone leads. Output is high impedance, or may be easily converted to low impedance with T-165 600-ohm transformer, for remote broadcast or recording work. Hi-Z output for connection to boosters like KO series at right.

Output: 30 milliwatts at less than 2% distortion; 6 milliwatts at less than 0.5% distortion. **Peak Output:** 45 milliwatts. **Controls:** 5—Gain; 4—Speech Filter; Microphone-Tuner-Phono; Bass; Treble; Off-On-Master Gain. **Tubes:** 3—12AX7, 6CG7, 6AU6, 6BF6; 6X4 rectifier. **Frequency Response:** ±1 db, 20-20,000 cps. **Hum:** 60 db below rated output. For 110-120 volts, 50-60 cycles AC. Size, 5¼x16¼x13". Shpg. wt., 21 lbs.

99 SZ 183. List 177.50. NET. 106.50

T 165 OUTPUT TRANSFORMER. Converts output impedance to 600-ohm broadcast standard. Shpg. wt., 1 lb.

91 S 700. List 17.50. NET. 10.50

KO POWER BOOSTERS

Powerful new P.A. boosters to increase system power as much as 100 watts by the addition of a single unit. All three models feature controlled positive feedback; distortion is less than 2% at rated output. May be used with plug-in transformers for conversion to balanced low-impedance line input. When combined with the LOM mixer-preamp at left, any of these boosters makes a superb P.A. system. All are adaptable to rack panel mounting, with kit listed on opposite page. **Response:** ±1 db, 20-20,000 cps. **Hum:** 80 db below rated output. **Overall dimensions:** 7¼x17¼x6¼". For 110-120 volts, 50-60 cy. AC.

MODEL KO-30. **Power Output:** 30 watts; peak, 45 watts. **Output Impedance:** 4, 8, 16 ohms, 25, 70-volt line. 21 lbs.

91 SZ 701. List 108.75. NET. 65.25

MODEL KO-60. **Power Output:** 60 watts; peak, 110 watts. **Output Impedance:** 2.5, 10 ohms, 25, 70-volt lines. Shpg. wt., 23 lbs.

91 SZ 702. List 167.50. NET. 100.50

MODEL KO-100. **Power Output:** 100 watts; peak, 150 watts. **Output Imp. (Ohms):** 1.6, 6.25 (25 v.), 49 (70 v.). 31 lbs.

91 SZ 703. List 215.75. NET. 129.45

T-161 INPUT TRANSFORMER. For conversion of KO boosters to 500-ohm input impedance. Shpg. wt., 1 lb.

99 S 185. List 15.00. NET. 9.00

No tools are needed to inspect, clean or maintain Bogen "Flex-Pak" amplifiers. Just loosen four thumb-screws and you have complete and convenient access to the chassis.

Accessory wall-mount bracket makes a handsome, functional installation possible for any "Flex-Pak" unit; easily accessible when needed—folded back when not in use.

Flex-Pak units are as portable as small luggage; convenient carrying handles are provided at the side of each unit, for maximum ease of portability. They're light, too!

Convenient write-in space over each gain control prevents errors in balance adjustment and volume setting. Markings are easily erased whenever necessary.

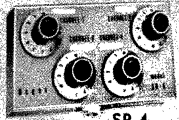
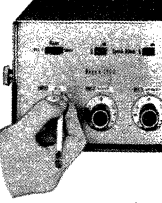
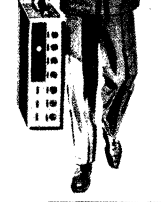
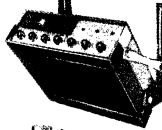

SR-4
Remote
Control Unit



RP-2
Preamp-Mixer
with Cage

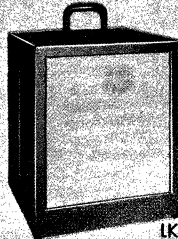

LK-12

REMOTE CONTROL ACCESSORIES AND CARRYING CASES

REMOTE MICROPHONE GAIN CONTROLS. For LX "Deluxe" amplifiers; provide remote control of gain for either two or four channels. Will mix or fade channels up to 2000 ft.

SR-2 TWO-CHANNEL REMOTE CONTROL. Less cable (see below). Shpg. wt., 2 lbs.

91 S 704. List 11.25. NET. 6.75

CABLE FOR SR-2. 3-conductor unshielded. Shpg. wt. 2 lbs. per 100 ft.

47 W 362. NET, PER 100' 2.43

SR-4 FOUR-CHANNEL REMOTE CONTROL. Less cable (see below). Shpg. wt., 3 lbs.

91 S 705. List 16.50. NET. 9.90

CABLE FOR SR-4. 5-conductor unshielded. Shpg. wt. 2½ lbs. per 100 ft.

47 W 382. NET, PER 100' 3.63

CARRYING CASES WITH AND WITHOUT SPEAKERS. Specially made carrying cases are available for transportation of "Flex-Pak" amplifier units and accessories, or for conversion of systems utilizing "Flex-Pak" amplifiers to complete portability. Model LK-12S, containing two 12" speakers, may be combined with the Model L330 30-watt amplifier to make an excellent, lightweight P.A. system; easily carried anywhere, it makes an ideal system for outdoor, mobile or "last-minute" situations. Cases separate into two halves; each half contains a speaker with its own baffle. Durably constructed for long service under rugged conditions. Size, 19½x16½x15".

MODEL LK-12 CARRYING CASE. Holds L330 30-watt "Flex-Pak" amplifier. Space is provided for installation of 12" speakers, if desired, but case is supplied less speakers. Shpg. wt., 20 lbs.

91 DZ 708. List 37.50. NET. 22.50

MODEL LK-12S CARRYING CASE WITH SPEAKERS. As above, but with two Jensen P12S speakers installed. With 25-ft. cable and plugs. Shpg. wt., 25 lbs.

91 DZ 709. List 76.50. NET. 45.90

TAKE ADVANTAGE OF OUR SPECIAL BOGEN CUSTOM INSTALLATION SERVICE

Allied specialists are ready to help you choose the equipment which will best suit your P.A. system requirements. Bogen will pre-assemble your custom sound system, supplying all necessary interconnecting cable; and your system will arrive ready for installation.

All Bogen equipment so supplied by the Custom Division is factory tested to insure perfect performance. Units may be ordered mounted on standard electronic equipment racks, or on shock-proof isolation bases, if desired. Any Bogen amplifier may be ordered for photocell input for theater installations, through the Custom Division. Special audio and radio distribution systems of this kind have been specially developed for industry, hotels, public buildings, and military installations. Submit complete specifications to Allied for prompt service.

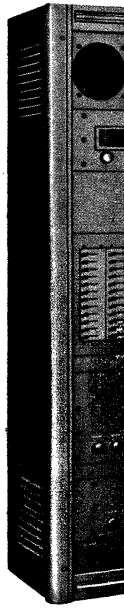

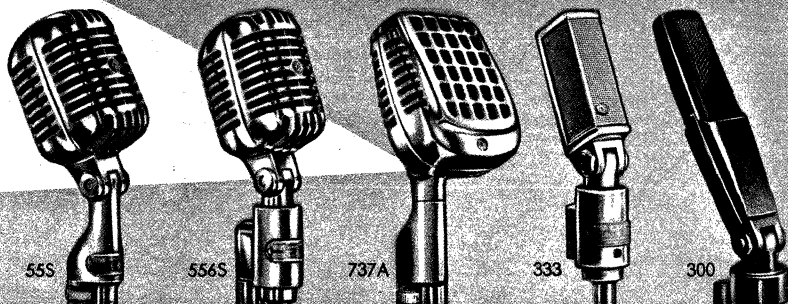
SHURE**MICROPHONES FOR EVERY PURPOSE****CARDIOID-PATTERN MICROPHONES**

A cardioid microphone (also called Unidirectional) has a heart-shaped pickup pattern. It is far more sensitive at its front than rear; front-to-rear sensitivity ratio is 7 to 1. Permits a P.A. system to be operated at a higher volume before acoustic feedback occurs.

"UNIDYNE" DYNAMIC MICROPHONE

MODEL 555. Rugged, cardioid dynamic microphone designed to withstand severe mechanical shock as well as heat and moisture. Cardioid feature permits placement of microphone at a distance from performer 75% greater than all-directional microphones. An excellent choice as a singer's or announcer's microphone. Response from 50 to 15,000 cps. Switch selects impedances of 35-50 ohms, 150-250 ohms, and high impedance. Output is -60.5 db at high impedance. Swivel mounting. Satin chrome finish. $\frac{5}{8}$ "-27 thread. Detachable, 18-ft., 2-conductor shielded cable. Size, $4\frac{1}{2}$ "x $3\frac{1}{8}$ ". Shpg. wt., $4\frac{1}{4}$ lbs.

99 S 395. List, \$83.00. NET. **48.80**

MODEL 556S. Deluxe version of above. Constructed and tested within extremely close tolerances to give improved frequency response and directivity. Smooth response from 40 to 15,000 cps. Live rubber isolation unit in stand connector deadens vibrations from floor. Shpg. wt., $4\frac{1}{2}$ lbs.

99 S 396. List, \$135.00. NET. **79.38**

"MONOPLEX" CRYSTAL MICROPHONE

MODEL 737A. High output, cardioid, crystal microphone. Cardioid features (above) make this a superior, moderate cost microphone in P.A. and tape recording applications. Head tilts to change pickup to all-directional. Crystal element is sealed against adverse effects of moisture. Output is -53 db, high impedance. Response: 60 to 10,000 cps. Satin chrome finish. $\frac{5}{8}$ "-27 thread. Detachable, 15-ft. shielded cable. Size, $4\frac{3}{4}$ "x $2\frac{1}{8}$ ". Shpg. wt., $2\frac{1}{4}$ lbs.

99 S 380. List, \$46.00. NET. **27.05**

**UNI-DIRECTIONAL RIBBON MIKES**

MODEL 333. An ultra-cardioid microphone made to extremely rigid tolerances and designed for the ultimate in wide response and directional characteristics. Ribbon element. Response: ± 2.5 db from 30 to 15,000 cps. Minimizes pickup of moving props, scuffing feet, and other background noises. Has Voice-Music switch; also 3-position switch to select 50, 150 or 250-ohm, impedance. Output, -60 db. Has wind and blast filter, and live rubber isolation unit in stand connector. $\frac{5}{8}$ "-27 thread. Non-reflecting bronze finish. $3\frac{9}{16}$ "x $1\frac{1}{2}$ "x $\frac{1}{4}$ ". With detachable, 20-ft., 2-conductor shielded cable. Wt., 4 lbs.

99 S 456. List, \$250.00. NET. **147.00**

MODEL 330. New "Unitron" mike, similar to above. Less Voice-Music switch; satin-chrome finish. Shpg. wt., 4 lbs.

94 S 090. List, \$120.00. NET. **70.56**

**BI-DIRECTIONAL MICROPHONES**

Figure "8" pattern permits picking up sound from front and rear while rejecting sound from the sides. Ideal for radio and recording studios and for fixed installations on lecterns, pulpits, speaking platforms, etc.

"CONCERT-LINE" RIBBON MICROPHONES

MODEL 300. Deluxe Bi-directional microphone. Shock mount; Voice-Music switch. Response, ± 2.5 db from 40 to 15,000 cps. 30-50 ohms, 150-250 ohms and high impedance. Output is -57 db at high impedance. Bronze finish. $\frac{5}{8}$ "-27 thread. Detachable, 18-ft., 2-conductor shielded cable. $6\frac{1}{2}$ "x $1\frac{1}{2}$ "x $\frac{3}{32}$ ". Shpg. wt., $3\frac{3}{4}$ lbs.

99 S 397. List, \$150.00. NET. **88.20**

MODEL 315. As above, but less rubber shock mount and Voice-Music switch. Frequency response, 50-12,000 cps. Output, -57 db. Satin-chrome finish. Shpg. wt., $3\frac{3}{4}$ lbs.

99 S 398. List, \$89.50. NET. **52.63**

**"SONODYNE" DYNAMIC MICROPHONE**

MODEL 51. For tape recorder and public address use. Immune to effects of temperature and humidity. Frequency response of 60 to 10,000 cps for outstanding reproduction of music. Multi-impedance; 35-50 ohm, 150-250 ohm, and high impedance, selected by screw-driver adjustment. Output, -52 db. Satin chrome finish. $\frac{5}{8}$ "-27 thread. Swivel mount. Detachable, 15-ft., 2-conductor shielded cable. $5\frac{1}{16}$ "x $3\frac{1}{2}$ "x $\frac{7}{8}$ ". Wt., $3\frac{1}{2}$ lbs.

99 S 378. List, \$49.50. NET. **29.11**

MODEL 707A CRYSTAL MICROPHONE

Popular, low-cost, semi-directional microphone. Used extensively for Amateur radio communications, home recorders, low-cost public address systems and paging systems. Response from 30 to 7000 cps. Output is -50 db, high impedance. Gray enamel finish with chrome trim. $\frac{5}{8}$ "-27 thread. Size, $2\frac{5}{8}$ " dia., $3\frac{1}{4}$ " long. 7-ft. cable. Shpg. wt., 2 lbs.

99 S 361. List, \$19.50. NET. **11.47**

MODEL 520 "GREEN BULLET." Controlled-magnetic version of above. Practically immune to temperature conditions. Response, 100 to 9000 cps. Output, -52.5 db; high impedance. Green enamel with chrome trim. $\frac{5}{8}$ "-27 thread. Size, $2\frac{5}{8}$ " diameter, $3\frac{1}{4}$ " long. 7-ft. cable attached. Shpg. wt., $1\frac{1}{2}$ lbs.

99 S 383. List, \$22.50. NET. **13.23**

MODEL 708A "STRATOLINER"

Semi-directional crystal microphone for public address, home recording, paging, etc. Particularly good for voice. Response, 60-10,000 cps. Output, -51 db. High impedance. Gray finish. $\frac{5}{8}$ "-27 thread. 7-ft. cable. $2\frac{5}{8}$ " dia., 4" long. Wt. 2 lbs.

99 S 363. List, \$31.00. NET. **18.23**

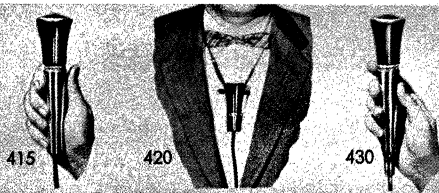
**MODEL 415 "COMMANDO"**

New, slim-grip, controlled-magnetic, high impedance microphone. Has all-directional pick-up pattern. Excellent for use in public address systems, home recording, etc. Frequency response from 60 to 10,000 cps. Output level is -55 db. Rugged, die-cast metal case is satin-chrome finished for lasting beauty. Impact-resistant polystyrene cap is non-reflecting gray. With $\frac{5}{8}$ "-27 swivel stand adapter, and 7-ft., single-conductor, non-detachable shielded cable. $6\frac{1}{16}$ " long, diameter of head, $1\frac{1}{4}$ "; diameter of handle, $1\frac{1}{8}$ ". Wt. 1 lb.

94 S 085. List, \$27.50. NET. **16.17**

MODEL 420 "COMMANDO"

New, low-cost controlled-magnetic lavalier microphone. All-directional pickup pattern. Especially suited for public address at auctions, demonstrations, etc., where freedom of hands is essential. Frequency response from 60 to 10,000 cps. Output is -55 db. Dual impedance; 150- to 250 ohms and high impedance. Gray finish polystyrene case. 18-ft., 2-conductor, non-detachable shielded cable, and lavalier cord with clip. $3\frac{11}{16}$ "x $1\frac{1}{8}$ ". Shpg. wt., $\frac{1}{2}$ lb.

94 S 086. List, \$30.00. NET. **17.64**

MODEL 430 "COMMANDO"

New, deluxe, controlled-magnetic microphone with press-to-talk switch. All-directional pick-up pattern. Ideal for P.A., recording, intercommunication, etc. Response, 60-10,000 cps. Output, -55 db. Dual impedance; 150- to 250 ohms and high impedance. Satin-chrome, die-cast metal case; non-reflecting gray polystyrene cap. Detachable, 15-ft. 2-conductor shielded cable. Size, $6\frac{1}{16}$ " long; diameter of head, $1\frac{1}{4}$ "; diameter of handle, $1\frac{1}{8}$ ". With cover plate (may be attached for continuous "On" operation), $\frac{5}{8}$ "-27 swivel adapter. Shpg. wt., $1\frac{1}{2}$ lbs.

94 S 087. List, \$38.50. NET. **22.64**

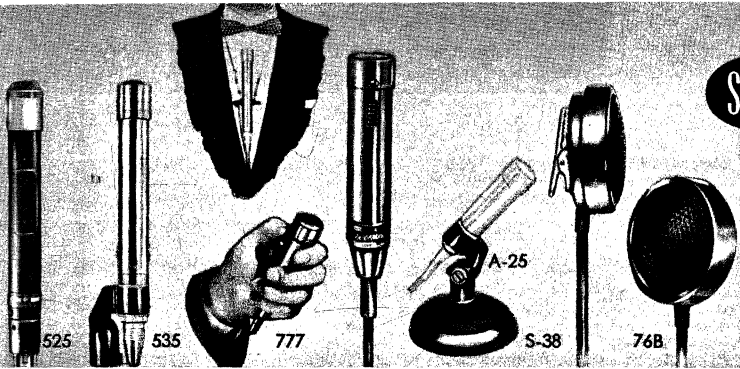

SHURE

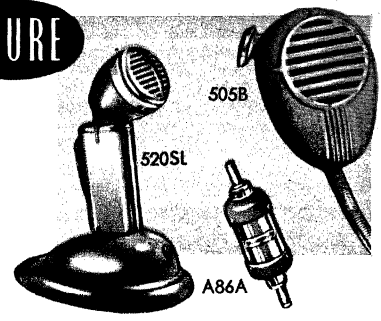

ALL-DIRECTIONAL MICROPHONES

Respond equally well to sounds from all directions (360°) in a plane perpendicular to the axis of the microphone. Ideal for soloists, groups, orchestras, choirs, and stage productions. Small diameter makes them especially suitable for use where microphone must be hand held; or for lavalier use (suspended from neck). All-directional microphones are also called omni-directional.

MODEL 525 STUDIO MICROPHONE

All-directional, professional dynamic microphone. Dynamic range of 125 db. Response, ±2.5 db from 40 to 15,000 cps. Switch selects impedance of 50, 150 and 250 ohms. Output, -61 db at all impedances. Case is bronze; head is beige. With neckcord for lavalier use, belt-clip, A-25 swivel adapter for 5/8"-27 thread stands, and detachable 20-ft. 2-conductor shielded cable. 8 1/2" long and 1 1/8" diam. Shpg. wt., 3 1/4 lbs.
99 S 454. List, \$200.00. NET.....117.60

MODEL 535 "SLENDYNE" MICROPHONE

Moderately-priced, all-directional dynamic microphone. Especially suitable for public address applications. 60-13,500 cps. Built-in switch for selecting output impedances of 50-250 ohms, and high impedance. Output, -61 db. With lavalier cord and swivel adapter. 5/8"-27 thread. Detachable, 18-ft., 2-conductor shielded cable. 1 1/8" diameter and 7 1/2" long. Wt., 3 lbs.
99 S 657. List, \$72.50. NET.....42.63

MODEL 76B LAPEL MICROPHONE.

All-directional crystal microphone designed for clear speech reproduction. Has alligator clip for attaching microphone to lapel. Cable can be used to suspend mike around the neck—"lavalier" style. 40-6000 cps. Output, -57 db, high impedance. Gray. With 20-ft. cable. 2 3/4" dia., 3/4" thick. Wt., 1 lb.
99 S 372. List, \$29.00. NET.....17.05

MODEL 777 "SLIM-X" MICROPHONE

Multiple-purpose crystal microphone. Can be worn as a lavalier, hand-held or mounted on floor or desk stand (see S-38 and A-25 below). For P.A. use, singers, etc. In vertical position pickup pattern is all-directional. Response, 60-10,000 cps. Output, -62 db. High impedance. Satin chrome finish. Detachable, 7-ft. cable. With neck-strap and holder for 5/8"-27 thread stands. Size, 4 3/8"x1". Shpg. wt., 1 lb.
99 S 616. List, \$25.00. NET.....14.70

MODEL 777S. Same as above, but with Off-Off switch. Shpg. wt., 1 lb.

99 S 617. List, \$27.00. NET.....15.88

S-38 BASE. For above. Wt., 1 1/2 lbs.

94 S 038. List, \$4.50. NET.....2.65

MODEL A-25 SWIVEL ADAPTER. Fits S-38 stand above. 5/8"-27 thread. Swings 90° in vertical plane. Wt. 8 oz.

94 S 039. List, \$5.50. NET.....3.23

Communications Microphones

MODEL 520SL "DISPATCHER." Ruggedly built, controlled-magnetic microphone. Designed to handle the most severe field requirements of paging and dispatching systems. Supplied with base. Includes soft-action grip-to-talk, slide-to-lock switch bar that operates microphone and relay circuits. Response, 100-9000 cps. Output, -52.5 db. High impedance. Chrome and green finish. 7-ft., 2-conductor shielded cable. 9 1/2" high; 5" base. Shpg. wt., 5 lbs.
99 S 388. List, \$42.50. NET.....24.99

MODEL 505B "RANGER." Rugged, controlled-magnetic mike for mobile police, fire, Amateur and taxi communications. Die-cast case fits into the palm. DPST leaf switch controls mike and relay circuits. Gives excellent voice reproduction. 100-9000 cps. Output, -50 db at 250 ohms. Blue-gray wrinkle finish. With mounting bracket and 5-ft. 4-cond. cable. Size, 3 1/4"x2 3/4"x1 1/8". Shpg. wt., 1 1/4 lbs.
99 S 392. List, \$32.00. NET.....18.81

MODEL 505C. Similar to above, but high impedance. Output, -50.5 db. With 5-ft. 3-cond. (one cond. shielded) cable.
99 S 389. List, \$32.00. NET.....18.81

MODEL A86A MICROPHONE TRANSFORMER. For running lines from low-impedance microphones to high-impedance inputs. Matches 35-50 or 150-250 ohms. ±1 db, 20-20,000 cps. 2 1/2"x1 1/2". Wt., 2 lbs.
41 S 917. List, \$17.50. NET.....10.29

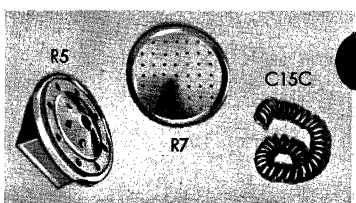

SHURE



710S
510S

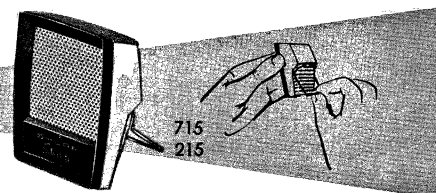

715
215

MODEL R5 MICROPHONE CARTRIDGE. High-impedance, controlled-magnetic type. Response, 100-9000 cps. Output, -51.5 db. Fits Shure mikes: 505, 510 and 520. May be used for modification of almost any crystal microphone to magnetic type. Depth 27/32"; dia. with mtg. ring, 2 1/4"; dia. less ring, 1 1/8". Shpg. wt., 4 oz.
41 S 934. List, \$11.00. NET.....6.47

MODEL R7 MICROPHONE CARTRIDGE. High-impedance crystal type. High output and very smooth response. Response, 50-10,000 cps. Output, -50 db. Used in Shure 707A, 708A and most other Shure crystal mikes. Size; Depth, 3/8"; diameter with rubber mounting ring, 2 3/16"; diameter less ring, 1 1/4". Shpg. wt., 5 oz.
41 S 945. List, \$8.25. NET.....4.85

MODEL C15C RETRACTING MICROPHONE CORD. Heavy, rubber-covered 4-conductor (not shielded) cable for use in mobile transmitters, etc. Extends to length of 6-ft.; only 1-ft. long when retracted. Color-coded wires with tinned ends. Replaces cables in the following Shure mikes: CB10, CB10B, CB10D, CB10F, CB12, CB12A, CB12C, CB15, CB15B, CB15C, CB15D, and all "100" series. Shpg. wt., 1/2 lb.
41 S 932. List, \$6.25. NET.....3.67

MODEL 710S "REX." Low-cost, semi-directional crystal microphone for home tape recorders, Amateur radio, etc. Response, 60-9000 cps. Output is -50 db. high impedance. Off-On switch. 7-ft. cable. Hand-some burgundy-red metallic finish. Size, 3 7/32"x2 1/16"x1 1/8". 5/8"-27 thread adapter. Shpg. wt., 1 1/4 lbs.
99 S 387. List, \$14.00. NET.....8.23

MODEL 710A "REX." Same as Model 710S microphone described above, but without Off-On control switch.
99 S 386. List, \$12.00. NET.....7.05

MODEL 510S "HERCULES." Semi-directional controlled-magnetic microphone for use in areas where heat and humidity are high. Ideal for public address, home recording, etc. Excellent for both indoor and outdoor use. Response, 100-7000 cps. Output is -52.5 db. high impedance. Off-On switch. 7-ft. cable. Green metallic finish. Size, 3 7/32"x2 1/16"x1 1/8". 5/8"-27 thread adapter. Shpg. wt., 1 1/2 lbs.
99 S 385. List, \$19.00. NET.....11.11

MODEL 510C "HERCULES." Same as microphone described above, but without Off-On control switch.
99 S 384. List, \$17.00. NET.....9.99

MODEL 715 "STARLITE." New, high output crystal microphone featuring smart, ultra-modern design. Has a semi-directional pickup pattern and smooth response. Ideal for Amateur communications, home recording of voice and music, and inexpensive paging, intercom or public address systems. Comfortably fits in palm of hand. Has a retractable, built-in wire stand that easily converts microphone into a self-supporting unit for table-top or desk. Extremely lightweight; only 3 1/2 ounces. Output, -50 db, high impedance. Frequency response, 60-10,000 cps. Handsomely styled, impact-resistant, polystyrene case with two-tone finish; gray front and black back; black grille. Overall size, 3 3/32"x2 3/16"x1 9/32". 5-ft., single-conductor shielded cable. Shpg. wt., 1 1/2 lbs.
94 S 089. List, \$8.00. NET.....4.70

MODEL 215 "STARLITE." New, modernistic ceramic microphone. Practically immune to moisture and high temperatures. Semi-directional pickup pattern; provides smooth response. Features built-in wire stand described above. Output, -56.5 db. Response, 60-10,000 cps. Black front, gray back. Polystyrene case. Overall size, 3 5/32"x2 3/16"x1 1/8". With 5-ft. single-conductor shielded cable. Shpg. wt., 1 1/2 lbs.
94 S 088. List, \$8.00. NET.....4.70

Electro-Voice

MICROPHONES FOR BROADCAST AND TV APPLICATIONS

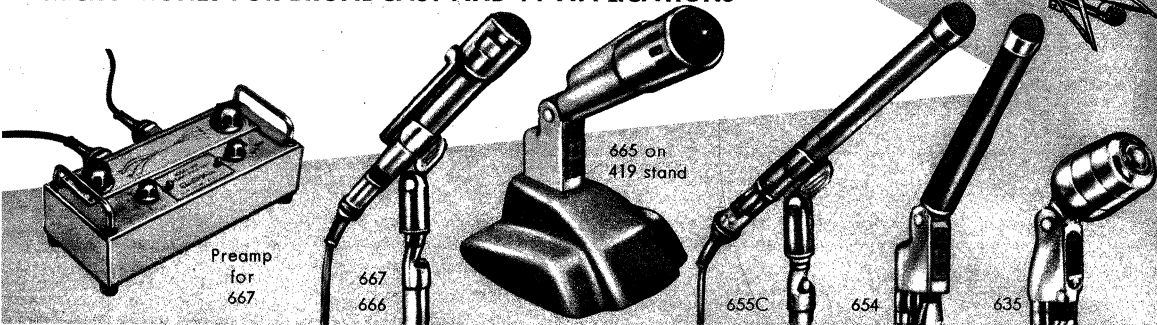

Variable "D" Cardioid Dynamic Mikes

MODEL 667. Widely used in network TV, the Model 667 is ideal for all applications requiring critically uniform frequency response, high resistance to shock, or where high ambient noise or severe reverberation exists. It is supplied with a special transistor preamplifier providing twenty frequency response characteristics, individual bass and treble control, and four levels of attenuation. Sound enters three apertures in the microphone case, and is then combined in such a way as to assure extremely smooth frequency response and total absence of "proximity effect." Response is uniform, 35 to 16,000 cycles. Output level, variable, -30 to -48 db. Designed to work into 250, 150 or 50 ohm circuits. Noise level is -123 dbm; dynamic range at maximum gain setting is 120 db. Microphone is 1 3/4 x 7 1/2"; preamp, 9 x 3 7/8 x 3 1/2". Supplied with 50-ft. and 20-ft. broadcast-type cables and connectors, 1/2" pipe thread with 3/8"-27 adapter. Shpg. wt., 4 lbs.

94 SC 093. List, \$600.00. NET. **352.80**

MODEL 666. Superior dynamic microphone for important broadcast and TV applications; variable "D" construction produces effective cardioid pattern—discriminates against unwanted sound from sides and rear. Response is substantially flat from 30 to 16,000 cps; average front-to-back ratio, 24 db. Output level, -55 db; adjustable to 50, 150 or 250 ohms, 1 3/4 x 7 1/2". Supplied complete with clamp-on adapter for 1/2" and 5/8"-27 stands and detachable 20-ft., 3-conductor shielded cable. Shpg. wt., 1 lb.

99 S 593. List, \$255.00. NET. **149.94**

MODEL 366. BOOM SHOCK MOUNT. For 666 or 667. Wt., 12 oz.

94 S 057. List, \$40.00. NET. **23.52**

MODEL 524 WIND SCREEN. For 666 or 667. Minimizes wind effect during boom movement or when mike is used outdoors. Wt., 2 oz.

94 S 083. List, \$8.00. NET. **4.70**

MODEL 665. Similar in design and function to Model 666 mike, but for less exacting applications. Response, 40 to 15,000 cps. Output, -55 db. Recessed switch permits quick selection of 50 or 250 ohms. Dia., 1 1/8"; 7 3/8" long, 18-ft., 3-conductor shielded cable and adapter for 1/2" and 5/8"-27 stands. Shpg. wt., 2 lbs.

99 S 530. List, \$150.00. NET. **88.20**

Famous "Slim Trim" Dynamic Studio Mikes

MODEL 655C. Pencil-slim, dynamic mike for highest quality professional recording and broadcasting. Wide frequency response, all-directional pickup range, and lightweight (only 7 oz.), make it ideal for TV staging and audience participation. Breath-mast filter head. Response is essentially flat from 40 to 20,000 cps. Output level, -55 db. Quickly changed impedances of 50, 150 and 250 ohms (connected for 50 ohms when shipped) on terminal board in case. Cast aluminum case is non-reflecting gray. Dia., 1 1/8"; 10 3/8" long. With clamp-on adapter for 1/2" and 5/8"-27 stands; detachable, 20-ft., 3-conductor, shielded cable. Shpg. wt., 1 1/4 lbs.

99 S 579. List, \$200.00. NET. **117.60**

MODEL 654. Moderately priced mike, similar to 655C, but for less critical applications. All-directional. Response, 50 to 15,000 cps. Output, -55 db. Switch selects 50 or 250-ohm impedances. Diameter, 1 3/8"; 10 1/16" long, 5/8"-27 thread. With detachable, 18-ft., 3-conductor shielded cable. Shpg. wt., 1 1/4 lbs.

99 S 583. List, \$100.00. NET. **58.80**

RUGGED TV & BROADCAST DYNAMIC MIKE

MODEL 635. Sturdily built and low in price, the Model 635 has a reputation as a studio "workhorse." Response is uniform, 40 to 15,000 cps. Level, -55 db. Recessed switch selects 50 or 250-ohm impedances. Cast zinc, chrome-plated case. 5/8"-27 thread. Dia., 2"; 6 1/4" long. With detachable, 18-ft., 3-cond. shielded cable. Shpg. wt., 1 3/4 lbs.

99 S 327. List, \$82.00. NET. **48.22**

DESK STANDS FOR PROFESSIONAL MICROPHONES

MODEL 419. Illustrated above with 665 mike. For use with 665, 664 and 654 microphones. Shpg. wt., 3 lbs.

94 S 082. List, \$10.00. NET. **5.88**

MODEL 420. Similar to 419 desk stand, with clamp for mounting 666, 655C, 646 and 647 microphones. Shpg. wt., 4 lbs.

94 S 056. List, \$20.00. NET. **11.76**

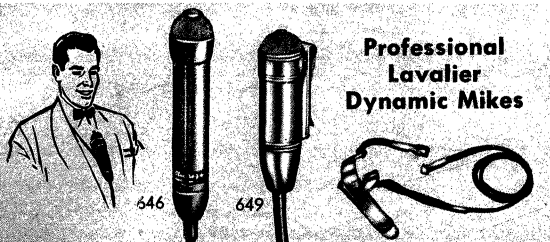

Professional Lavalier Dynamic Mikes

MODEL 646. All-directional, TV and broadcast dynamic mike. This unusually small, 7-oz. mike can be hung from neck, hand-held, used in desk stand or suspended from boom. Particularly suitable wherever concealment of mike, mobility, or freedom of hands is desired. Response from 50 to 10,000 cps. Recessed screw in grille permits adjustment of high-frequency response to suit special applications. Output level, -57 db. Lathe-turned aluminum case in non-reflecting gray. Dia., 1"; 6 1/4" long. With 30-ft. cable, carrying bag, neck cord, belt clip. Shpg. wt., 1 lb.

99 S 584. 50-Ohm Impedance. List NET

99 S 537. 250-Ohm Impedance. Each, \$147.50. EACH. **86.73**

MODEL 649. An ultra-small lavalier mike—only 3/4" in diameter and 2 1/8" long. Weighs only 2 ounces! Response, 60 to 10,000 cps. Output, -62 db. Choice of 50, 150 or 250 ohm impedances on terminal board inside mike case (connected for 50 ohms when shipped). All other specs same as Model 646. Shpg. wt., 3/4 lb.

99 S 536. List, \$115.00. NET. **67.62**

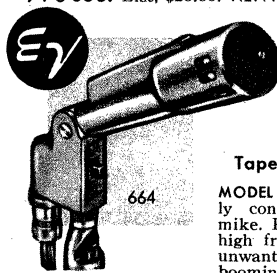

Variable "D" Dynamic Microphone

For Finer Public Address, Tape Recording & Communications Use

MODEL 664. Skillfully designed and ruggedly constructed, uni-directional dynamic mike. Picks up from front only—provides high front-to-back discrimination against unwanted sounds, without close-talking boominess. Employs variable "D" (variable distance) construction to produce cardioid pattern. Highly useful for PA applications in locations where ambient noise and severe reverberations exist. Gives distinct, natural reproduction of voice and music—increases working distance from microphone—provides greater protection against feedback problems. Equipped with a "pop-proof" wire mesh grille, the 664 minimizes wind and breath blasts—excellent for outdoor public address use in fixed or mobile installations. Diaphragm is shielded from dust and magnetic particles.

Rugged construction and use of non-metallic diaphragm permits smooth response over a wide frequency range. Withstands high humidity, temperature extremes and severe mechanical shock.

Virtually indestructible under normal use. Can be used on floor or desk stand, or carried in the hand. Frequency response from 40 to 15,000 cps. Output level, -55 db. Has 150-ohm and high-impedance output. Supplied wired for high impedance. 5/8"-27 thread. Cast zinc case, finished in glistening chrome. Complete with on-off switch; and detachable, 18-ft., 2-conductor cable. Diameter, 1 7/8"; 7 3/8" long. Shpg. wt., 2 lbs.

99 S 531. List, \$85.00. NET. **49.98**

Electro-Voice

QUALITY MICROPHONES FOR P.A. AND GENERAL-PURPOSE USE

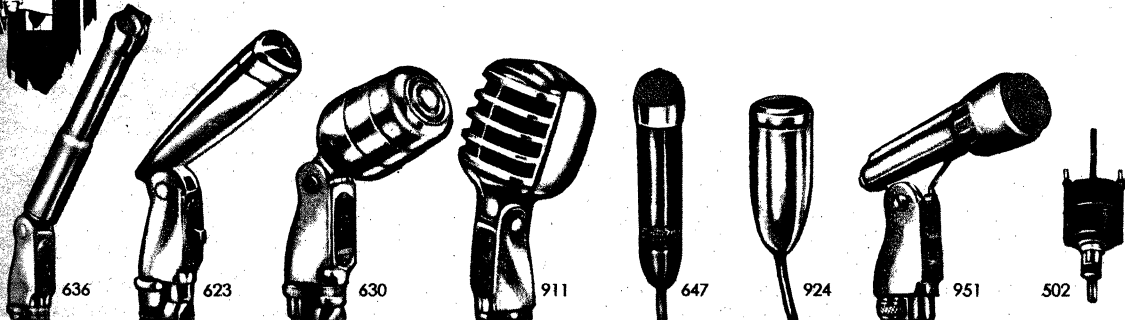

All-Directional Microphones

MODEL 636 "SLIMAIR" DYNAMIC. A very fine all-directional mike for tape recording. Provides excellent reproduction of individual and group singers and speakers; choirs, orchestras, etc. Also can be used for public address—"baton" styling does not hide the speaker's face. Wire mesh blast-filter permits outdoor use. 90° swivel. Response, substantially flat from 60 to 15,000 cps. 150-ohm or high impedance (connected for high-impedance output when shipped). Output level, -55 db. Chrome-plated steel case. 1 1/8" dia., 10 1/4" long. 3/8"-27 thread. On-off switch. With detachable, 18-ft. 2-conductor shielded cable. Shpg. wt., 2 lbs.

99 S 581. List, \$72.50. NET..... 42.63

MODEL 636G. As above, but finished in gold.

99 S 591. List, \$77.50. NET..... 45.57

MODEL 623 SLIM DYNAMIC. Low-cost, all-directional dynamic mike. Ideal for P.A. recording and communication use. Slim size makes it inconspicuous and easy to handle. Smooth response from 60 to 12,000 cps. Output level, -56 db. Choice of 150-ohm or high-impedance output (connected for high-impedance when shipped). On-off switch. Chrome-plated. Dia., 1 5/8"; 7 1/2" long. 5/8"-27 thread. With detachable, 18-ft., 2-cond. shielded cable. Shpg. wt., 2 lbs.

99 S 595. List, \$57.00. NET..... 33.52

MODEL 630 HIGH-OUTPUT DYNAMIC. All-directional mike designed for public address, dispatching call systems, industrial applications, recording and general communications service. Uniform response from 60 to 11,000 cps. Output level, -55 db. Choice of 250-ohm or high-impedance output. 250-ohm mike supplied with detachable 18-ft., 2-cond. shielded cable; high-impedance mike with detachable 18-ft., single-cond. shielded cable. Chrome-plated. On-off switch. Dia., 2"; 6 1/4" long. 5/8"-27 thread. Shpg. wt., 2 lbs.

99 S 347. 250-Ohm Impedance. List NET

99 S 336. High-Impedance. Each, \$52.50 EACH..... 30.87

MODEL 911 "MERCURY" CRYSTAL. For low-cost P.A. applications, home recording, Amateur communications, etc. All-directional pickup pattern becomes slightly directional with increased frequency. Response, 50 to 9000 cps. Output level -50 db. High-impedance output. Chrome-plated case, 2 3/8x3 1/2x6 3/4" long. 5/8"-27 thread. With 18-ft. detachable cable. Shpg. wt., 2 1/2 lbs.

99 S 554. List, \$32.50. NET..... 19.11

Mobile Communication and Intercom Microphones

MODEL 606 DIFFERENTIAL DYNAMIC. For intercom use. Close-talking, noise-cancelling. Head is fixed at 22° angle. Response, flat from 100 to 5000 cps. Output level at 1/2", -55 db. High impedance. Chrome-plated case. 2x3 1/4x2 1/2". 5/8"-27 thread. With detachable 18-ft. cable. Wt., 2 lbs.

99 S 564. List, \$52.50. NET..... 30.87

MODEL 648 DYNAMIC. Extremely versatile, all-directional microphone. For broadcast, TV, intercom, paging or P.A. use. Built-in connector and mating 3/8"-27 threaded adapter allow mounting on rigid or flexible booms, desk or floor stand. Response is uniform from 50 to 10,000 cps. Output, -58 db. Impedance, 250 ohms. Aluminum case; non-reflecting gray. Dia., 1"; 6 1/8" long. With adapter and 2 wrenches. Less cable. Shpg. wt. 1/2 lb.

99 S 539. List, \$56.00. NET..... 32.93

MODEL 448 SWIVEL BOOM MOUNT. For use only with Model 648 mike. Holds mike 11 1/8" off mounting surface. Male connector matches connector on mike. 62° elbow bend. Extends 4" below mounting surface. 2 1/2" diameter mounting base. Chrome-plated. Shpg. wt., 1 1/2 lbs.

99 SX 540. List, \$24.00. NET..... 14.11

MODEL 600D DYNAMIC. Extra-rugged, hand-held microphone for mobile P.A. and communication use. Semi-directional pickup pattern. Response is flat from 100 to 7000 cps. Output level, -55 db. High impedance. Has press-to-talk switch for mike and relay control. Black phenolic case, 2 1/2x2x4". 5-ft. cable. Wt., 10 oz.

99 S 323. List, \$47.50. NET..... 27.93

MODEL 210KK SINGLE-BUTTON CARBON. Similar in appearance to the Model 600D but single-button carbon. Provides highly intelligible speech transmission for mobile communication use. Output level, -50 db. Black phenolic case. With 5-ft. coiled cable. Shpg. wt., 1 lb.

99 S 589. List, \$35.00. NET..... 20.58

MODEL 205KK DIFFERENTIAL CARBON. Close-talking, noise-cancelling, single-button carbon mike. Provides maximum intelligibility under high noise conditions. Blastproof, waterproof, and shock-resistant. Response, when held close to sound source, 100 to 4000 cps. Output level at 1/4", -50 db. Press-to-talk switch. Black phenolic case, 2 1/2x2 1/2x4". With mounting bracket, 5-ft. coiled 3-cond. cable. Shpg. wt., 1 lb.

99 S 590. List, \$45.00. NET..... 26.46

New Crystal Cardioid

MODEL 951. Excellent crystal microphone using exclusive variable "D" principle to achieve cardioid directivity and uniform frequency response. Designed to fulfill requirements of wide-range reproduction under a wide variety of P.A. applications; pop-proof wire mesh grille minimizes wind and breath noises. Uniform polar response makes it highly suitable for noisy locations, or where much echo is present. Response, 50 to 11,000 cps. Output level, -55 db. Handsome satin-chrome finish, die-cast zinc case. Size, 1 3/4x5 1/8". With 18 ft., shielded, single-conductor cable. Shpg. wt., 1 1/2 lbs.

94 S 092. List, \$49.50. NET..... 29.11

Lavalier Microphones

MODEL 647 DYNAMIC. Small, ruggedly designed all-directional mike for general P.A. use. Extremely versatile—can be hand-held, suspended from neck, used on desk stand or suspended from boom. Excellent wherever concealment, mobility or free use of hands is desired. Peak-free response from 60 to 10,000 cps. Output level, -57 db. 150-ohm or high impedance. Black aluminum with chromium trim. Dia., 1"; 5" long. Supplied complete with neck cord, belt clip, 2 wrenches and detachable, 18-ft. 2-conductor cable. Shpg. wt., 1 1/4 lbs.

99 S 538. 150-Ohm Impedance. List, NET

99 S 585. High-Impedance. Each, \$82.50 EACH..... 48.51

MODEL 924 CRYSTAL. Ultra-small, all-directional mike for P.A., home recording, paging and Amateur radio use. Response, 60 to 8000 cps. Output, -60 db. High-impedance. Chrome-plated. 1 1/2" dia., 3 1/2" long. With neck cord, clip, 18-ft. cable. 12 oz.

99 S 094. List, \$20.00. NET..... 11.76

MODEL 418 DESK STAND. Similar to Model 419 illustrated on opposite page. For 951, 911, 636, 635, 630 and 623 microphones. Cast iron, gray finish. Shpg. wt., 4 lbs.

94 S 059. List, \$10.00. NET..... 5.88

MODEL 502 MATCHING TRANSFORMER. Allows connecting long-line, low-impedance mikes to amplifiers with high-impedance input. Supplied complete with connector and 2-ft. single cond. cable. Shpg. wt., 1 lb.

94 S 084. List, \$17.50. NET..... 10.29

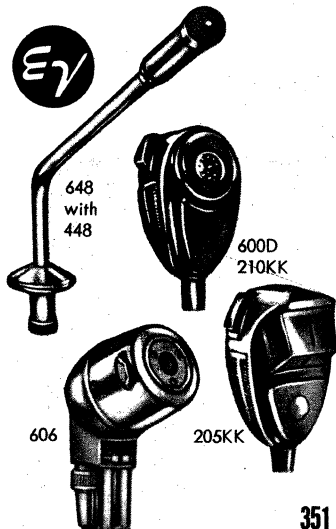

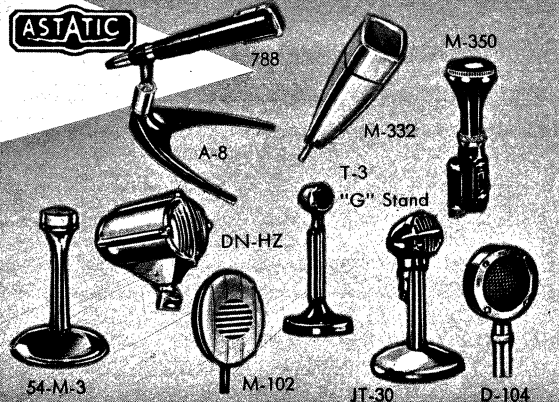

Famous Astatic Microphones

"FUTURA" SERIES DYNAMICS. Beautifully designed dynamic microphones with all-directional pickup; ideal for TV applications. Exceptionally rugged and heat-resistant. Supplied with 20-ft. cable and 5/8"-27 thread adapter for mounting microphone on stand.

- 99 S 413. MODEL 788. "METRO". Response, 50-13,000 cps. Impedance and level: 150 ohms, -58 db; high impedance, -55 db. Off-On switch. 8 3/8"x1 1/8". Wt., 12 oz. List, \$79.50. NET..... 46.74
- 99 S 414. MODEL 888. "TEMPO". Response, 50-15,000 cps. Impedance and level: 50 ohms, -57 db; 200 ohms, -58 db; hi-Z, -56 db. Size, 9 1/8"x1 1/4". Shpg. wt., 1 1/2 lbs. List, \$110.00. NET..... 64.68
- 99 S 416. MODEL 988. "VOGUE". Exceptionally uniform response, 40-20,000 cps. Output impedances: 50, 150 and 250 ohms. Size, 9 1/2"x1 9/32". Shpg. wt., 1 1/2 lbs. List, \$150.00. NET..... 88.20

A-8 DESK STAND. Die-cast aluminum; 5/8"-27 thread. 1 1/2 lbs. 94 S 031. List, \$8.25. NET..... 4.85

NEW SLIM CRYSTAL MICROPHONES. Low-cost mikes for hi-fi tape recording. P.A. work, etc. High impedance; uniform response, 30-15,000 cps. With 8-ft. lavalier cord and 5/8"-27 stand adapter.

94 S 091. MODEL M-332. All-directional; output, -57 db. Size, 1 1/4"x1 1/4"x4 1/2". Shpg. wt., 1 lb. List Price, \$17.90. NET..... 10.53

94 S 094. MODEL M-332-S. Same specifications as above, but with built-in Off-On switch. List Price, \$19.90. NET..... 11.70

POPULAR GENERAL-PURPOSE MIKES. *Has Off-On switch. †Includes stand. All are high-impedance.

Stock No.	Type	Element	Response	Wt. Lbs.	List	NET
99 S 304	DN-HZ	Dynamic	50-7,000	2 1/2	\$29.50	17.35
99 S 419	M-350-S*	Dynamic	50-10,000	1	42.70	25.11
99 S 418	M-350	Dynamic	50-10,000	1	39.95	23.49
99 S 302	JT-30†	Crystal	30-10,000	2 1/2	16.95	9.97
99 S 422	JT-30C†	Ceramic	30-8,000	2 1/2	16.15	9.50
99 S 426	54-M-3†	Crystal	30-10,000	2	14.95	8.79
99 S 442	M-102	Crystal	30-10,000	1 1/2	8.00	4.70
99 S 443	M-101	Ceramic	30-8,000	1 1/2	7.50	4.41
99 S 300	T-3	Crystal	30-10,000	2	27.35	16.08
99 S 309	D-104	Crystal	30-7,500	1 3/4	29.95	17.61

MODEL "G" STAND. For T-3, D-104 mikes. 6-ft. cord. 2 1/4 lbs. 94 S 011. List, \$24.95. NET..... 14.67

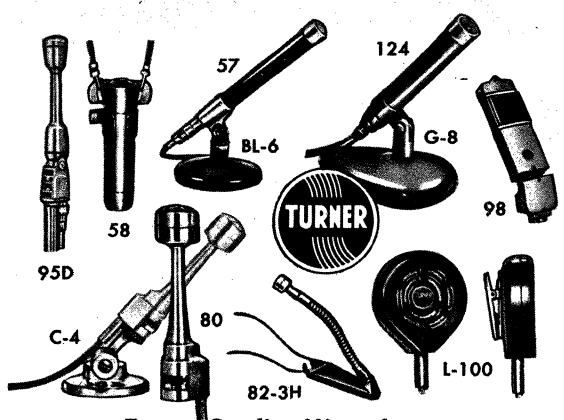

Turner Quality Microphones

99 S 526. MODEL 95D DYNAMIC. All-directional, 100-10,000 cps. High impedance. 7 3/4"x1 1/8". 1 1/4 lbs. List, \$37.50. NET..... 22.05

99 S 505. MODEL 57 DYNAMIC. All-directional. Response, 50-13,000 cps. Impedance selectable. 150 ohms or high impedance. 8 3/4"x1 1/8". Shpg. wt., 3 lbs. List, \$65.00. NET..... 38.22

99 S 503. MODEL 58 DYNAMIC. Response, 60-13,000 cps. All-directional. Weighs only 3 3/8 oz. 150 ohms and hi-Z selectable. 4x1" diameter. Shpg. wt., 1 1/4 lbs. List, \$57.00. NET..... 33.52

99 S 509. MODEL 98 DYNAMIC. Response, 65-11,000 cps. Cardioid pattern minimizes feedback. High impedance. Front-to-back ratio, 20 db. 6 1/2"x1 3/4"x1". Wt., 2 lbs. List, \$59.50. NET..... 34.99

99 S 507. MODEL 124 DYNAMIC. Lightweight, all-directional; response, 50-13,000 cps. High impedance. Gun-metal finish. 1 5/16"x6 1/2". Shpg. wt., 1 1/4 lbs. List, \$49.00. NET..... 28.81

94 S 095. MODEL 142 DYNAMIC. Low-cost lavalier. All-directional. 70-12,000 cps. High-Z. 4x1" dia. 1 1/4 lbs. List, \$45.00. NET..... 26.46

POPULAR MIKE STANDS. All desk-type, except "3rd Hand" holder, as supplied with Model 82-3H mike.

Stock No.	Mfrs. Type	For Use With	Wt., Lbs.	List	NET
99 S 504	C-4	Model 58	3/4	\$5.75	3.38
99 S 506	BL-6	Model 57	1	7.50	4.41
99 S 508	G-8	Model 124	1	8.00	4.70
99 S 518	G-7	Model 98	1	8.00	4.70
94 S 080	3-H*	Model 80	1	5.00	2.94

99 S 525. MODEL 80 CRYSTAL. Response, 80-7000 cps; all-directional. Size, 4 1/4"x3/8". Shpg. wt., 9 oz. List, \$15.95. NET..... 9.38

99 S 529. MODEL 82-3H CRYSTAL. Model 80 mike on special "hands free" chest holder. Flexible gooseneck on holder, fully adjustable. Shpg. wt., 1 1/2 lbs. List, \$22.75. NET..... 13.38

99 S 527. MODEL L-100 CRYSTAL. Response, 50-10,000 cps; all-directional. 2x1 1/8". Shpg. wt., 1/2 lb. List, \$12.50. NET..... 7.35

94 S 096. MODEL 141 CRYSTAL. Response, 60-10,000 cps; all-directional. 3 3/4" long. Wt., 3/4 lb. List, \$13.50. NET..... 7.94

Electro-Voice Low-Cost Mikes

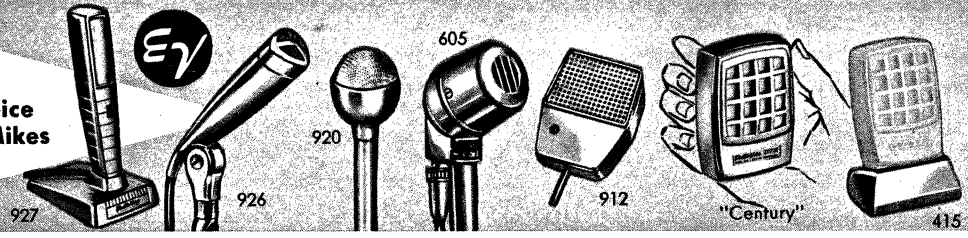

MODEL 927 CRYSTAL. Response, 60-8000 cps; with removable desk stand. High impedance. Output level, -50 db. All-directional response, tending to directional at high frequencies. 7 7/8"x1 1/4"x1 1/4". 5-ft. cable. Shpg. wt., 1 1/2 lbs. 99 S 532. List, \$22.50. NET..... 13.23

MODEL 926 CRYSTAL. Response, 60-8000 cps. Rising frequency characteristic for crisp reproduction of speech. 6 3/4"x1 5/16". 18-ft. cable. Shpg. wt., 1 1/2 lbs. 99 S 596. List, \$29.50. NET..... 17.35

MODEL 920 "SPHEREK" CRYSTAL. 60-7000 cps; all-directional. Minimum breath "pop". Output, -50 db. Size, 2 1/4" diameter. 18-ft. cable. Shpg. wt., 1 lb. 99 S 578. List, \$27.50. NET..... 16.17

MODEL 605 DYNAMIC. Rugged, all-directional microphone; 65-8000 cps. Size, 2x3 3/4" long. 18-ft. cable. Shpg. wt., 1 lb. 99 S 592. List, \$32.50. NET..... 19.11

MODEL 912 CRYSTAL. Plastic-cased; safe for use with AC-DC units. Response, 70-7000 cps. 5-ft. cable. Wt., 1 lb. 99 S 598. List, \$10.00. NET..... 5.88

"CENTURY" SERIES. Popular for home recording, paging and P.A. Inner element insulated for safe use in AC-DC circuits. 5/8"-27 stand adapter; 5-ft. cable. 1 lb.

MODEL 915 "CENTURY". Moisture-sealed crystal; output, -50 db. Response, 60-7000 cps. 3x2 3/4"x1". 99 S 567. List, \$13.00. NET..... 7.65

MODEL 915-S "CENTURY". Same as Model 915 above, but equipped with Off-On "slide-to-talk" switch. 99 S 582. List, \$15.00. NET..... 8.82

MODEL 715 "CENTURY". Ceramic element. Heat and humidity resistant; 60-7000 cps. Output, -59 db. High impedance. 99 S 586. List, \$13.00. NET..... 7.65

MODEL 615 "CENTURY". Dynamic type. For rugged use; response, 80-8000 cps. High impedance; output, -55 db. 99 S 549. List, \$25.50. NET..... 15.00

MODEL 415 DESK STAND. For "Century" microphones. Holds mike at 15° tilt for desk use. Shpg. wt., 6 oz. 94 S 050. List, \$1.75. NET..... 1.03

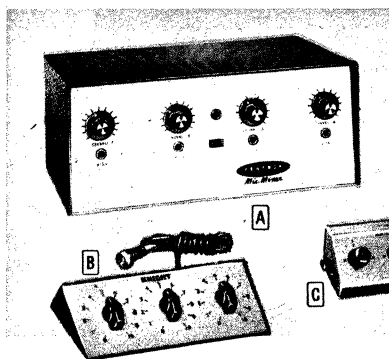

Quality Microphone Mixers

- A** **PENTRON CA-14 ELECTRONIC MIXER.** Professional-type mixer for amplifiers or tape and disc recorders. 8 db gain on mike inputs compensates for insertion losses; gain is -22 db on phono inputs. May be used to blend four independent channels. 6 high-impedance inputs: 4 for microphone and 2 for phono. Response, 20-20,000 cps. 8x6x5". For 105-125 v., 60 cycle AC. Wt., 5 lbs.
93 S 284. NET. 39.95
- B** **KNIGHT COMPACT MICROPHONE MIXER.** Adds new versatility to any P.A. system at modest cost; permits mixing of three high-impedance microphones or other signal sources, or converts amplifier or recorder with single mike input for use with three microphones, each with its own separate gain control. May be used to mix sound effects and music with dialogue for movies, special effects, or tape recorded sales presentations. Exceptionally compact design. Measures only 1½x3½x7¾". Shpg. wt., 1 lb.
93 S 282. NET. 8.82
- C** **KNIGHT TRANSISTOR MICROPHONE MIXER.** For feeding up to three microphones into a single microphone input of amplifier or recorder. Includes three controls for individual gain adjustment of each mike. Doubles mike output level; may be used up to 25 ft. from amplifier or recorder. Power is provided by miniature mercury batteries, which provide extremely long service. Compact case easily fits into small area; perfect for mobile operation. Supplied complete with batteries and output cable with screw-on microphone connector. Size, 1x3x8". Shpg. wt., 1 lb.
93 S 283. NET. 14.95

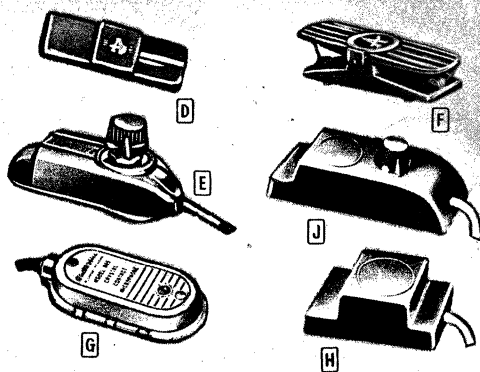

Contact-Type Microphones

- Contact mikes permit amplification of sound from a single instrument, by attaching directly to its sounding board or body. Excellent supplementary microphones for recording or amplification of solo piano, cello, guitar and similar instruments.
- D** **AMPERITE MODEL SKH.** Hi-Z magnetic; response, 40-9000 cps. Output, -40 db. ¼x3x1". 12-ft. cable. Shpg. wt., 10 oz.
99 S 406. List, \$12.00. NET. 7.06
- E** **AMPERITE MODEL KKH.** As above, but has volume control.
99 S 408. List, \$18.00. NET. 10.58
- F** **FOOT VOLUME CONTROL.** For all models. Shpg. wt., 1 lb.
41 S 900. List, \$18.00. NET. 10.58
- G** **E-V MODEL 805.** 100-5000 cps. Hi Z. 15-ft. cable. 10 oz.
99 S 319. List, \$20.00. NET. 11.76
- H** **KNIGHT CONTACT MICROPHONE.** An unusual value in a wide-response contact microphone; response, 50-10,000 cps. High-impedance magnetic type. With 12-ft. cable. Shpg. wt., 1 lb.
99 S 517. NET. 5.95
- J** **As above, but with built-in volume control.**
99 S 516. NET. 7.50
- MODEL 75-MC-1P PHONE PLUG ADAPTER FOR KNIGHT MICROPHONES.** Shpg. wt., 2 oz.
41 H 962. NET. 30c
- KONTAK STRAP.** (Not illus.) For flat-top guitars. Wt., 4 oz.
41 S 902. NET. 59c

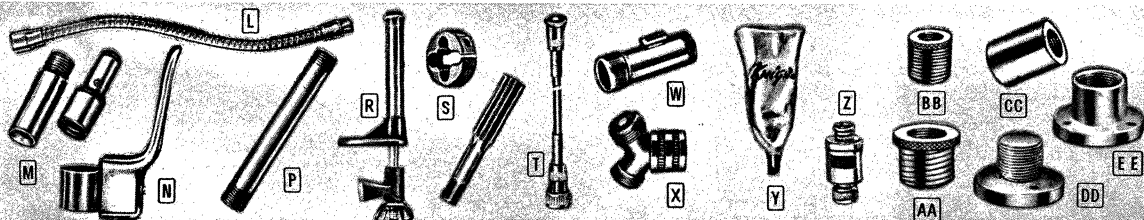

Microphone Accessories

- L** **ATLAS GN-13 FLEXIBLE GOOSE NECK.** For any mike stand or fixture. Provides complete flexibility of mike positioning. ¾"-27 male and female threads. 13" long. Wt., 1 lb.
94 S 027. List, \$2.75. NET. 1.62
- M** **MODEL GN-19 FLEXIBLE GOOSE NECK.** 19". 1½ lbs.
94 S 075. List, \$3.75. NET. 2.20
- N** **ATLAS SO-1 SNAP-ON MIKE ATTACHMENT.** Shpg. wt., 1 lb.
94 S 017. List, \$2.75. NET. 1.62
- P** **ATLAS CH-1 CABLE HANGER.** Fits on all stems, ¾" to 1¼" diameter. Easily attached and removed by 1" screw. Durable chromium finish. Shpg. wt., ½ lb.
94 S 076. List, \$2.50. NET. 1.47
- R** **ATLAS AD7 EXTENSION ROD.** Rigid, lightweight tubing 3" long. Precision-threaded at each end with ¾"-27 male thread. Shpg. wt., 3 oz.
41 S 913. List, 60c. NET. 35c
- P** **ATLAS ADB EXTENSION ROD.** 6" long. Shpg. wt., 4 oz.
41 S 907. List, 70c. NET. 41c
- R** **ATLAS BC-1 BRACKET CLAMP.** 6" stem. Shpg. wt., 1 lb.
94 S 028. List, \$3.50. NET. 2.06
- ATLAS SW-1 GYROMATIC SWIVEL.** (Not illustrated.) Locks microphone at any desired angle. 4½" long. Shpg. wt., 1½ lbs.
94 S 067. List, \$4.00. NET. 2.35
- S** **MIKE STAND THREADING TOOLS.** For tapping stands, tubing, microphone fittings, connectors, etc., with standard ¾"-27 thread. Easy for anyone to use. Shpg. wt., 5 oz.
46 N 187. Tap. NET. 3.53
46 N 188. Die. NET. 4.70
- T** **EXTENSION CORD.** 25-ft. cable with 75MC1F, 75MC1M connectors. Shpg. wt., 2 lbs.
41 S 911. NET. 3.44
- W** **AMPHENOL 75-MC1S SWITCH.** Push-to-talk switch with lock. Requires no soldering; standard threads. Wt., 6 oz.
41 H 950. NET. 1.09
- X** **"Y" TYPE MIKE CONNECTOR.** 2 males, 1 female. 2 oz.
41 H 996. NET. 97c
- Y** **"SAVE-UR-MIKE" COVER.** Plastic-coated celanese. 2 oz.
41 S 995. NET. 69c
- Z** **SWITCHCRAFT MODEL 329 MIKE VOLUME CONTROL.** For high-impedance microphones having single-conductor detachable cable. Screws in between mike and cable. Shpg. wt., 6 oz.
41 H 946. NET. 4.09
- ATLAS MIKE STAND ADAPTERS.** Wt., 2 oz. except *, 6 oz.
- | Stock No. | Type | Fig. | Description | NET |
|-----------|-------|------|--|-----|
| 41 S 928 | AD1 | AA | For adapting RCA mikes. ½" male to ¾"-27 female. | 50c |
| 94 S 060 | AD2 | BB | ¼" pipe female to ¾"-27 male. | 35c |
| 94 S 061 | AD3 | CC | ¼" pipe female to ¾"-27 female. | 35c |
| 94 S 062 | AD4 | BB | ¾" long. ¾"-27 male thread. | 18c |
| 94 S 063 | AD5 | CC | ¾"-27 to ¾"-27 female coupling. | 35c |
| 94 S 066 | AD10 | BB | Adapts W.E. mikes. ¾"-24 female to ¾"-27 female. | 71c |
| 41 S 906 | AD11* | EE | Mike base flange. Female. ¾"-27. | 35c |
| 41 S 905 | AD12* | DD | Mike base flange. Male. ¾"-27. | 35c |

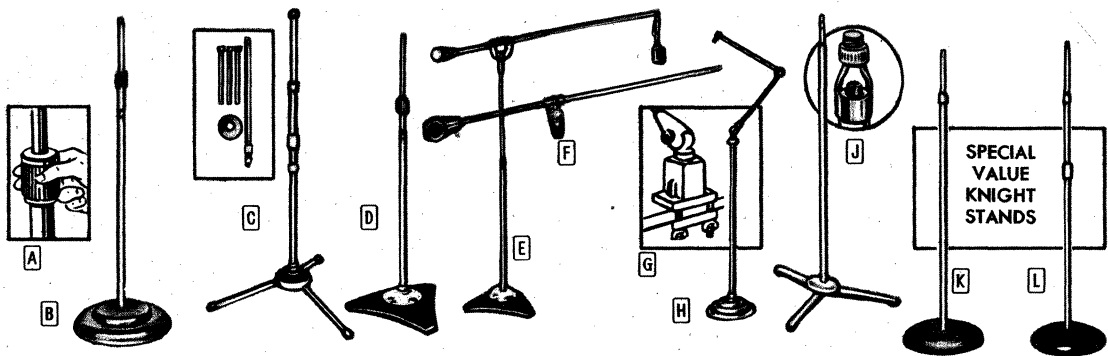

Quality Microphone Floor Stands and Booms

A B ATLAS MS-11C FLOOR STAND. Low-cost microphone stand with high-quality features. Equipped with "Full Grip" clutch mechanism—allows stand to be quickly and quietly adjusted to any height from 35" to 65". Excellent for use in school auditoriums, etc., where the microphone must be easily positioned to the proper height for different users. "Full Grip" clutch eliminates jamming, slipping or sudden dropping. Rugged base includes self-leveling, shock-absorbing pads. Reinforced with three "anti-tip" points in base for added rigidity. Handsome chrome-plated base and stand; retains lasting beauty. Base diameter, 10". $\frac{5}{8}$ "-27 thread. Shpg. wt., 12 lbs.
94 SX 012. List, \$13.00. NET..... 7.64

C ATLAS CS-33 DEMOUNTABLE FLOOR STAND. Three-section microphone stand designed for both fixed and portable applications. Fully collapsible for transporting within amplifier or speaker carrying case. Requires no tools for assembly or demounting. Legs are held in place with "finger-operated" spring lock and can be quickly removed. Adjustable from 26" to 64". Fully collapsed size, 22 $\frac{1}{2}$ ". Self-leveling legs tipped with rubber—prevent skidding. Attractive chrome-plated finish. $\frac{5}{8}$ "-27 thread. Shpg. wt., 4 lbs.
94 SX 016. List, \$11.75. NET..... 6.91

D ATLAS MS-25 "AIR-LOCK" FLOOR STAND. Features "air-lock" cushioning of telescoping section. Controlled escape of air allows only slow, quiet collapse into lower section. Microphone stand extends from 37" to 66". Heavy base is 17" dia.; provides firm support for boom arm attachment. Will not tip even with a heavy microphone. Chrome-plated stem. Gray-finished base. $\frac{5}{8}$ "-27 thread. Shpg. wt., 20 lbs.
94 SZ 029. List, \$24.00. NET..... 14.12

E ATLAS BS-36 PROFESSIONAL BOOM STAND. Similar to Model MS-25 above, but with removable 62" boom arm. Gyromatic swivel joint at end of boom allows microphone to hang in the proper position regardless of how the boom arm is moved. Has "snap-on" hangers for attaching cable to stand. Vertical height adjustable from 48" to 72". Shpg. wt., 33 lbs.
94 SZ 021. List, \$60.00. NET..... 35.28

F ATLAS BB-1 "BABY BOOM" ATTACHMENT. Quickly converts any floor stand having a $\frac{5}{8}$ "-27 thread to a boom-type stand. Permits a quick, fixed positioning of microphone anywhere within a 5-ft. circle. Heavily chrome-plated boom attachment is 32" long. Gray crackle-finish fittings. Counterbalance weight can be adjusted easily for use with any mike. Shpg. wt., 4 $\frac{1}{2}$ lbs.
94 SX 019. List, \$7.50. NET..... 4.41

H FLEKO MODEL 3 MIKESTER. Has a sturdy 40" floor stand and two 18" easy-action swinging arms. Arms can be adjusted to firmly hold the microphone at any angle or distance, up to 36" in any direction. Weighted, anti-tip cast-iron base; diameter, 13 $\frac{1}{2}$ ". Stem finished in gray enamel. Suitable for mikes weighing up to 4 lbs. $\frac{5}{8}$ "-27 thread. Shpg. wt., 28 lbs.
94 SZ 043. List, \$32.50. NET..... 19.11

G FLEKO MODEL 1 MIKESTER. Similar to above, but less 40" floor stand. Has two bolts; unit may be clamped or screw-mounted to any surface up to three inches thick. Shpg. wt., 4 $\frac{3}{4}$ lbs.
94 SX 044. List, \$14.00. NET..... 8.23

J E-V 425 FLOOR STAND. Features single-button control of shaft height. When button is released, shaft locks automatically. Shaft can be rotated without any adjustment. Adjustable from 37" to 66". Legs fold back for storing and carrying. Satin chrome finish. Die-cast base has 17" spread. $\frac{5}{8}$ "-27 thread. Shpg. wt., 9 lbs.
94 SX 049. List, \$30.00. NET..... 17.64

KNIGHT FLOOR STAND VALUES

K THREE-SECTION MODEL. A compact stand—carrying height only 25". Ideal for portable applications. Two smooth-operating clutches provide adjustment from 25" to 61". Stem is heavily chrome-plated for long wear. Sturdy, cast-iron base has 10" dia., and gray, wrinkle finish. Standard $\frac{5}{8}$ "-27 thread. Shpg. wt., 10 lbs.
94 SX 001. NET..... 7.35

L ECONOMY MODEL. As above, but two-section type. Adjustable from 35" to 64". Shpg. wt., 10 $\frac{1}{2}$ lbs.
94 SX 004. NET..... 5.85

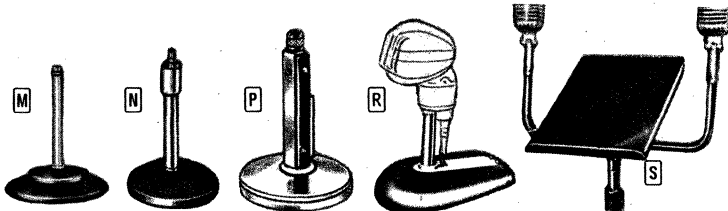

Microphone Desk and Banquet Stands and Chest Holder

M ATLAS DS-5 DESK STAND. Low-cost desk stand. Chrome-plated stem, 4" high. Cast-iron base; 6" diameter. Rubber base pads prevent marring of table or desk. $\frac{5}{8}$ "-27 thread. Shpg. wt., 2 lbs.
94 S 077. List, \$3.00. NET..... 1.76

N ATLAS DS-7 ADJUSTABLE DESK STAND. Height adjustable from 8" to 13". Uses full-sized clutch mechanism for quick, smooth change of stand height. 2-section stem uses $\frac{3}{4}$ " and $\frac{5}{8}$ " tube combination. All tubular sections finished in chrome. Gray crackle base, 6" diameter. Rubber base pads prevent scratches. Standard $\frac{5}{8}$ "-27 thread. Shpg. wt., 3 lbs.
94 S 014. List, \$5.00. NET..... 2.94

P E-V 428 TOUCH-TO-TALK STAND. Deluxe, versatile microphone desk stand with touch-to-talk feature. Has 6 $\frac{1}{2}$ " touch-to-talk bar on side of stem with locking button at top. Slight pressure will close circuit. SPDT switch for controlling relay or shorting out microphone. Switch assembly removable from base. Satin chrome finish; gray plastic switch lever. Stem height, 7". Sturdy die-cast base; dia., 5 $\frac{1}{2}$ ". $\frac{5}{8}$ "-27 thread. Shpg. wt., 2 lbs.
94 S 053. List, \$17.50. NET..... 10.29

R ATLAS DS-10 DESK STAND. Modern, functional design. Cable concealed in slot underneath center section of chrome trim. Space under base for on-off or press-to-talk switch. Gun-metal enamel finish. Rubber pads prevent marring of table-top or desk. $\frac{5}{8}$ "-27 thread. Shpg. wt., 1 $\frac{1}{2}$ lbs.
94 S 073. List, \$5.00. NET..... 2.94

S ATLAS TB-1 DUPLEX MIKE MOUNT. For use with any floor stand or TS-7 stand below. Quickly, easily mounted—no extra connectors needed. Permits use of 2 mikes on a single stand with proper spacing to keep the speaker "on the mike." Convenient desk attachment holds written material for ready reference during the speech; attachment is removable. Ideal for public speakers, lecturers, etc. Finished in chrome and cadmium plating. 9x11" desk of molded composition; handsome black finish. $\frac{5}{8}$ "-27 thread. Shpg. wt., 2 $\frac{1}{2}$ lbs.
94 S 072. List, \$10.00. NET..... 5.88

ATLAS TS-7 BANQUET STAND. For use with TB-1 duplex mount, above. Ideal for speakers' table. Chrome-plated. Height: Extended, 17 $\frac{1}{2}$ "; closed, 10 $\frac{1}{2}$ ". All chrome. Base dia., 10". Wt., 11 lbs.
94 S 074. List, \$10.00. NET..... 5.88

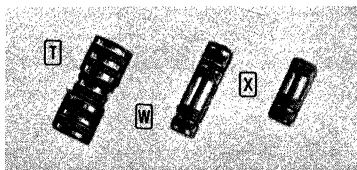

SWITCHCRAFT SOLDERLESS MICROPHONE CABLE CONNECTORS

W TYPE 2501FL. Single-contact connector with female coupling ring. Built-in cable clamp relieves strain on terminal connections. No soldering required—just insert cable and secure wire and braid to screw terminals. Fits male mike connectors. Shpg. wt., 6 oz.
41 H 986. NET..... 1.32

X TYPE 2501FS. Same as above, but less cable clamp. Shpg. wt., 5 oz.
41 H 987. NET..... 97c

T TYPE 2501FT. Double-female connector for single-conductor microphone cables. Provides convenient means of connecting 2 cables terminated in male mike connectors. Precision made for accurate fit. Shpg. wt., 2 oz.
41 H 998. NET..... 47c

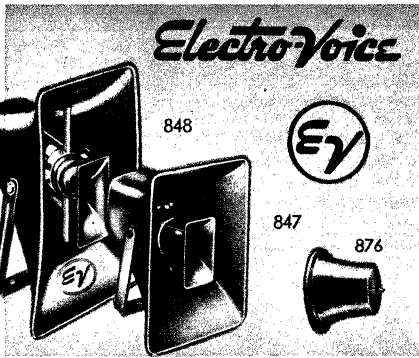

ELECTRO-VOICE 25-WATT PROJECTOR

MODEL 848 CDP. Unique coaxial projector with single driver. Features: Virtually indestructible spun fiberglass construction; greater coverage; wide, smooth frequency response for full range sound reproduction. Two horns are employed; large horn for low frequencies—200-1000 cps; small horn for highs—1000-10,000 cps. Low-end response is augmented by 100 cps horn taper, insuring at least one-half octave added bass. Horns are coupled to opposite sides of driver diaphragm, and provide exceptionally wide-angle dispersion. Maximum polar coverage, 120°. Power handling capacity, 25 watts. Impedance, 16 ohms. Weatherproof, splash-proof and blast-proof. Finished in gray. 20 1/2"x10 1/2" mouth; 20" deep. Wt., 17 lbs. 81 DZ 490. List, \$75.00. NET. 44.10

ELECTRO-VOICE 12-WATT PROJECTOR

MODEL 847 CDP. Smaller version of above. Has two coaxially mounted diffraction horns coupled to opposite sides of driver diaphragm for highest efficiency and wide-range response. Provides 120° distribution at all frequencies from 300 to 10,000 cps. Power capacity, 12 watts. Impedance, 16 ohms. Weatherproof, splashproof and blast-proof. 1500 cps crossover. Finished in attractive gun-metal gray. Size: 11 1/4"x7 3/4" mouth; 10 7/8" deep. Complete with mounting bracket and instructions. Shpg. wt., 7 lbs. 81 DX 851. List, \$46.33. NET. 27.24

MODEL 879 JOINING KIT. For assembling two or more. Model 848 projectors in multiple arrays. One kit required for each additional projector. Shpg. wt., 1 lb. 81 D 495. List, \$2.75. NET. 1.62

ELECTRO-VOICE TRANSFORMERS

MODEL 876. Mounts on rear of Model 848 projector. Pri. taps for 25, 10, 5, and 2.5 watts with 70-v. line. Imp. taps of 45, 200, 500, 1000, and 2000 ohms. 3 1/2"x5 1/4" dia. Shpg. wt., 3 lbs. 81 D 492. List, \$16.50. NET. 9.70

MODEL 877. As above, but with thermal bimetallic relay for overload protection. 3 1/2"x5 1/4" dia. Shpg. wt., 3 lbs. 81 D 493. List, \$17.50. NET. 10.29

MODEL 870. For use with Model 847 CDP above. Primary taps for 12, 8, 4, 2, and 1 watt with 70-volt line; impedance taps for 500, 2500, 5000, and 45 ohms. 2 1/2"x2 1/2"x3". Shpg. wt., 2 lbs. 81 D 852. List, \$12.00. NET. 7.06

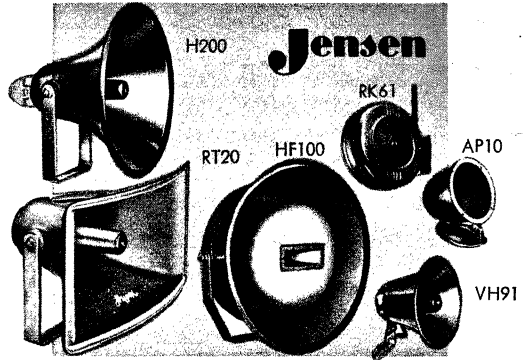

NEW JENSEN HIGH-QUALITY TRUMPETS

MODEL H-200. Popular 20" projector horn for commercial sound work. Maximum angle coverage, 85°. 41" air column. Response, 150-10,000 cps. Mouth diameter, 20 3/8"; length, 14 1/8". All-metal construction. Handsome beige finish. Less driver (listed below). Shpg. wt., 12 3/4 lbs. 93 DZ 524. List, \$31.00. NET. 18.23

MODEL RT-20. Rugged, high-power rectangular horn; excellent for car-top and rental service. Covers 80° sound angle. 41" air column. Response, 140-10,000 cps. 26x13 1/2" mouth; 16 5/16" long. Fiberglass-reinforced plastic construction; virtually indestructible. Handsome tan finish. Less driver. Shpg. wt., 15 lbs. 93 DZ 525. List, \$46.50. NET. 27.34

NEW JENSEN DRIVERS AND STACKING HARDWARE

DRIVERS. High-quality drivers for Models H-200 and RT-20 above.

No.	Type	Watts	Ohms	Resp., CPS	Length	Dia.	Lbs.	EACH
93D526	D-30	30	16	75-7000	4 1/16"	4 1/2"	3 1/2	16.17
93D527	DD-100	100	8, 32	75-10000	5 5/16"	8 1/2"	8	56.74

STACKING HARDWARE. For stacking Model RT-20.

No.	Type	Application	Lbs.	NET EACH
93 D 528	MA-3	Horizontal	2 3/4	3.12
93 D 529	MA-4	Vertical	2	2.70

NEW PROJECTORS—COMPLETE WITH DRIVERS

MODEL VH-91. Excellent for speech. 15 watts. 300-7000 cps. 8 ohms. Dispersion, 100°. 8 3/8" mouth dia. Length, 7 3/4". With mtg. brackets. Metal; tan finish. Wt., 3 3/8 lbs. 95 D 035. List, \$35.80. NET. 21.05

MODEL HF-100. Hi-f response; 60-15,000 cps. Rated 30 watts. Imp., 16 ohms. Dispersion, 120°. 24 3/8" mouth dia. Length, 11 3/8". With bracket. Plastic and aluminum, tan finish. Wt., 30 lbs. 81 DZ 951. List, \$129.50. NET. 77.70

"SPEECH MASTER" SPEAKERS

MODEL AP-10. 5" PM speaker in metal enclosure. Rated, 5 watts. Imp., 4 ohms. 6 3/4" high. With 36" cord. Wt., 6 lbs. 82 D 040. List, \$19.30. NET. 11.35

MODEL RK-61. New, 2-direction 6" speaker in metal case. 8 watts. Imp., 4 ohms. 8x3 1/4". With 24" cable. Tan. Wt., 3 1/2 lbs. 93 D 531. List, \$12.60. NET. 7.41

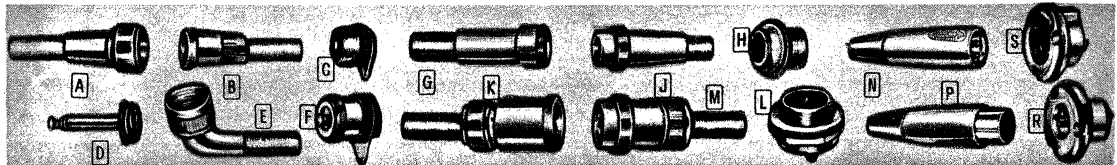

Amphenol Microphone Connectors

SERIES 75. SINGLE-CONTACT TYPES. Standard connectors. 5/8"-27 threads; 3/8" mounting holes. Av. shpg. wt., 3 oz.

Stock No.	Type	Fig.	Description	NET
41 H 958	*75-MC1F	A	Combination cable plug & jack	31c
41 H 955	*75-MC1M	B	Cable plug	21c
41 H 965	*75-PC1M	C	Chassis receptacle, non-shorting	23c
41 H 962	*75-MC1P	D	Phone plug adapter	30c
41 H 959	*75-MC1FA	E	90° angle cable jack	63c
41 H 967	*75-CL-PC1M	F	Chassis receptacle, closed circuit	33c

SERIES 91. 3- AND 4-CONTACT TYPES. Microphone connectors for portable equipment. Polarized. Clamps eliminate stress on soldered connections. *3-contact type. †4-contact type. Shpg. wt., 3 oz.

Stock No.	Type	Fig.	Description	NET
41 H 970	*91-MC3F	K	Female cable jack	54c
41 H 972	*91-PC3F	L	Female chassis receptacle	61c
41 H 971	*91-MC3M	M	Male cable plug	64c
41 H 977	*91-MC4F	K	Female cable jack	67c
41 H 978	*91-PC4F	L	Female chassis receptacle	52c
41 H 976	*91-MC4M	M	Male cable plug	66c

SERIES 80. SINGLE AND DOUBLE-CONTACT TYPES. For shielded cables, etc. Center contacts are pin and socket type. *Single-contact type. †Double-contact type is polarized. Av. shpg. wt. 3 oz.

Stock No.	Type	Fig.	Description	NET
42 H 084	*80-F	G	Female cable jack	40c
42 H 080	*80-C	H	Female chassis receptacle	37c
42 H 081	*80-M	J	Male cable plug	47c
42 H 082	*80-MC2F	G	Female cable jack	43c
42 H 085	*80-PC2F	H	Female chassis receptacle	40c
42 H 083	*80-MC2M	J	Male cable plug	47c

"QWIK" SERIES 91. 3- AND 4-CONTACT TYPES. Push together; released by slight pressure on lock button. Gold-plated (over silver) bronze contacts. Polarized. Satin-nickel plated, zinc-alloy shells. *3-contact type. †4-contact type. Av. shpg. wt., 3 oz.

Stock No.	Type	Fig.	Description	NET
42 H 065	*91-853	N	Male cable plug	1.06
42 H 066	*91-854	P	Female cable plug	1.23
42 H 067	*91-855	R	Male chassis receptacle	1.67
42 H 068	*91-856	S	Female chassis receptacle	1.47
42 H 069	*91-857	N	Male cable plug	1.00
42 H 070	*91-858	P	Female cable plug	1.35
42 H 071	*91-859	R	Male chassis receptacle	1.72
42 H 072	*91-860	S	Female chassis receptacle	1.57

TYPE 75-CCCI CAP AND CHAIN. (Not illustrated.) For dust-sealing of chassis-mounted, Series 75 and 80 receptacles. Shpg. wt., 3 oz. 40 H 381. NET. 24C



**TRUMPETS & DRIVERS
FOR
VOICE AND MUSIC**

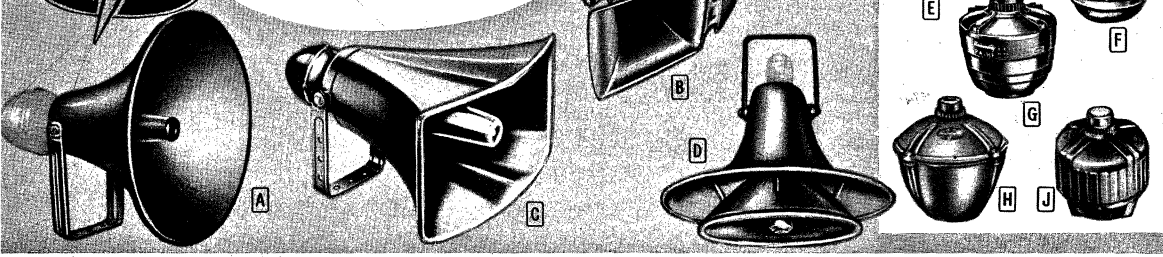

University Weather-Proof Reflex Trumpets & Heavy-Duty Drivers

A Model GH has 85-cps cutoff for music. Models LH and PH have higher cutoff for general use. Model SMH for voice only. With "U" mtg. bracket, less driver.

No.	Type	Dia.	Length	Low Cutoff	Lbs.	List	EACH
95 DZ 158	GH	30 3/8"	27 7/8"	85 cps	22	\$65.00	38.22
95 DZ 155	LH	25 3/4"	19"	120 cps	16 1/2	44.50	26.17
95 DZ 156	PH	20 1/4"	15 3/4"	150 cps	11 3/4	31.00	18.21
95 DX 157	SMH	16 1/2"	12"	200 cps	8	26.00	15.29

B COBRAFLEX-2 WIDE-ANGLE REFLEX TRUMPET. Provides 120° horizontal sound pattern. 250-cps cutoff. For voice only. With swivel-joint bracket. 9 1/4 x 18 1/2 x 10 1/4" dia. Less driver. 10 1/4 lbs.

C MODEL CLH WIDE-ANGLE TRUMPET. Features 4 1/2-ft. air column. 120-cps cutoff. 21 1/2 x 11 9/16 x 20 1/16" dia. Less driver. 15 lbs.

D MODEL RPH TRUMPET. For ceiling use; 360° coverage. 140 cps cutoff. 4-ft. air column. 25 3/16" dia. Less driver. 19 lbs.

E MODEL RLH. As above, with 5-ft. air column. 25 lbs.

PMA ADAPTER. Attachable to "U" bracket for mounting trumpets on 1/2" pipe fittings. Shpg. wt., 3/4 lb.

95 D 160. List, \$2.00. NET. 1.18

HEAVY-DUTY DRIVER UNITS. PM dynamic type, hermetically sealed units for any trumpet listed at left, or other trumpets. Breakdown and weatherproof. Thread, 1 1/8"-18. MA-25 is designed for use with high cut-off frequency trumpets. SA-HF has higher frequency response. SA-30 and PA-50 have built-in, multi-impedance line transformers with power taps. Impedances: SA-30, 45, 165, 250, 500, 1000, 2000 ohms; 30, 20, 10, 5 and 2.5 watt 70-v. line power taps; PA-50, 165, 250, 500, 1000, 2000 ohms, 50, 30, 20, 10, 5 and 2.5 watt 70-v. line power taps.

No.	Type	Fig.	Range, CPS	Watts	Ohms	Lbs.	List	EACH
81 D 573	MA-25	E	85-6500	25	16	3 3/4	\$27.50	16.17
81 D 571	SA-HF	F	80-10,000	30	16	4 1/2	36.00	21.17
81 D 079	PA-HF	G	70-10,000	50	16	7	47.50	27.93
93 D 377	PA-50	H	70-10,000	50	16	6 1/2	57.50	33.81
81 D 582	SA-30	J	90-10,000	30	16	5 1/4	47.50	27.93

2YC "Y" CONNECTOR. Permits connection of two driver units to any trumpet listed on this page. Shpg. wt., 1 lb.

95 D 159. List, \$12.00. NET. 7.06

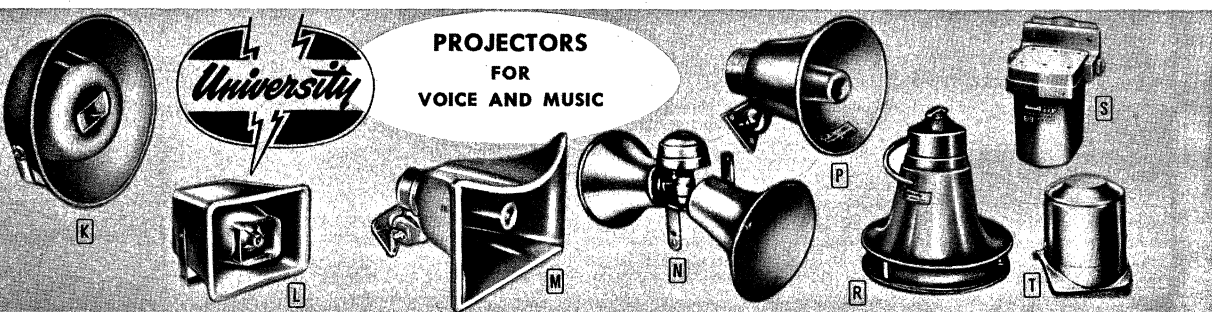

**PROJECTORS
FOR
VOICE AND MUSIC**

K FULL-RANGE, WEATHERPROOF COAXIAL SPEAKERS. Exceptionally fine weatherproof coaxial speakers. Full-range voice and music reproduction; high intelligibility; wide dispersion. For bandshells, stadiums, auditoriums, and other indoor or outdoor applications. Special woofer speaker cone is built into an infinite rear baffle chamber—works in conjunction with large folded horn to provide optimum loading of speaker for clean, highly efficient bass response. Have coaxially mounted tweeters.

MODEL BLC. 70-15,000 cps. 2000-cycle crossover. Dispersion, 120°. 25 watts. Imp., 8 ohms. 22 1/2 x 9". Shpg. wt., 21 lbs.

MODEL WLC. Larger version of above. 50-15,000 cps. Dispersion, 90°. 30 watts. Imp., 8 ohms. 33 1/2 x 20". Shpg. wt. 72 lbs.

MODEL MLC LOW-POWER SPEAKER. New version of the BLC. For low-level speaker distribution, or to cover medium size areas. Excellent for voice and music. Ideal for general-purpose, indoor or outdoor P.A. applications. Response, 150-15,000 cps. Dispersion, 120°. Capacity, 15 watts. Imp., 8 ohms. 12 3/4 x 9 1/2 x 10 3/8". Shpg. wt., 10 lbs.

MODEL CIB WIDE-ANGLE SPEAKER. Uniform frequency response. Perfect for paging, announcing, etc. Steel reinforced fiberglass bell. Capacity, 15 watts. 300 to 13,000 cps. Horizontal dispersion, 120°; vertical, 60°. Imp., 8 ohms. 7 3/8 x 14 x 12". Shpg. wt., 5 1/2 lbs.

CMIL. As above, but 5-watt capacity; 400 to 13,000 cps. Size, 6 1/2 x 9 1/2 x 8 7/16". Shpg. wt., 4 lbs.

N 2WP 2-WAY SPEAKER. Dual horns, 180° opposed for economical coverage of two oppositely located areas. Excellent for use in school or hospital corridors, railroad stations, loading ramps, etc. Use with single MA-25, SA-HF, SA-30 or PA-50 driver. Dispersion, 120° each horn. Power and impedance ratings depend on type of driver used. With adjustable bracket. 20 1/2 x 8" dia. Shpg. wt., 4 lbs.

P MODEL IB8 GENERAL-PURPOSE SPEAKER. Reflex-type with built-in 15-watt driver unit. Compact and highly efficient, it offers maximum speech intelligibility in high-noise areas. 90° dispersion angle. Range, 300-13,000 cps. Input impedance, 8 ohms. Size, 8 1/2" bell dia. x 9" long. Shpg. wt. 4 lbs.

MODEL MIL LOW-POWER SPEAKER. Similar to IB8, above. For low-power systems. Reflex-type 5-watt driver. Range, 400-13,000 cps. Dispersion, 120°. Imp., 8 ohms. 7 x 6 3/4" dia. Shpg. wt. 3 3/4 lbs.

MODEL IBR RADIAL SPEAKER. 12 watts. 360° coverage. 300-10,000 cps. 8 ohms. Size, 11 x 9 3/4" dia. With ceiling ring. 5 1/4 lbs.

MODEL CTR TRANSFORMER HOUSING. New, weatherproof housing. For transformers 2 1/4 x 2 1/4 x 2 1/4" max., and mtg. ctrs. 1 1/2 to 2 3/4". Shpg. wt. 2 lbs.

MODEL PB-1 TRANSFORMER HOUSING. New, weatherproof transformer housing for use with Model MIL, CMIL, IB and CIB speakers. Constructed of durable die-cast aluminum. Offers complete weather protection for any transformer similar to Fig. E, p. 148, with 2" mounting centers and not exceeding 1 1/2 x 1 1/2 x 1 3/8". Size, 3 3/8" high, 2 3/8" dia. Shpg. wt., 1 lb.

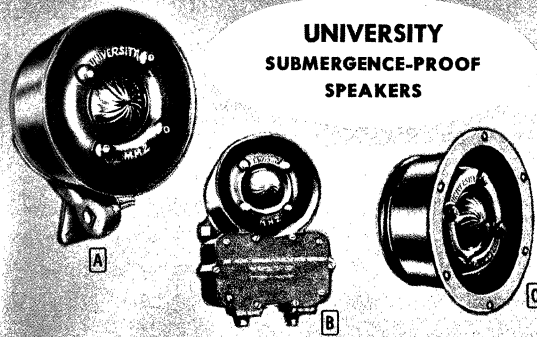

**UNIVERSITY
SUBMERGENCE-PROOF
SPEAKERS**

**IMMUNE TO SALT SPRAY, GASES, STEAM, FUNGI AND
ALL HARMFUL DIRT AND DUST**

Submergence-proof speakers for applications demanding ruggedness and immunity to salt spray, gases, live steam, dirt, dust and fungi. All will function under water, drain automatically, and continue to provide uninterrupted service. For use in locations where severe climatic conditions are likely to be met. Have built-in hermetically sealed drivers. MM-2 and MM-2L mount with adjustable swivel brackets (supplied). MM-2F has flange for wall or ceiling mounting. MM-2TC is for wall mounting; has provision for transformer and attenuator. All rated at 15 watts except MM-2L which is 25 watts. Impedance, 16 ohms. Size: MM-2, 4 3/4 x 6" O.D.; MM-2F, 3 3/4 x 7 1/4" O.D.; MM-2L, 5 x 7 1/4" dia.; MM-2TC, 10 x 6 1/2 x 4 1/8".

Stock No.	Mfr's Type	Dispersion Angle	Response, CPS	Fig.	Wt. Lbs.	List	NET EACH
81 D 097	MM-2	150°	300-6,000	A	5 1/4	\$46.00	27.05
81 D 099	MM-2F	150°	300-6,000	C	5 1/4	46.00	27.05
81 D 087	MM-2L	120°	250-10,000	—	6 3/4	52.00	30.58
81 D 098	MM-2TC	120°	300-6,000	B	8 1/2	70.00	41.16

BULKHEAD ADAPTERS. For wall mounting MM-2 or MM-2L. ST is weather-proof transformer housing. SB is ring shape less housing. Model SB, 5 1/8" dia.; Model ST, 5 7/8 x 9 3/4 x 3 1/8" dia. 1 lb.
81 D 088. SB. NET.....1.76 81 D 089. ST. NET.....7.35

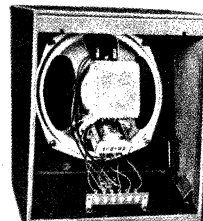
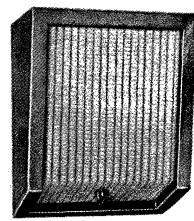

**Knight
EXTENSION
SPEAKER-BAFFLE
COMBINATIONS**

- Ideal For Extending Home Sound Systems
- Excellent For Use in Schools, Plants, Offices, etc.
- Volume Control For Individual Control Of Sound Level
- Built-in High-Quality Speaker For Voice and Music

NEW 8-OHM SPEAKER-BAFFLE COMBINATION

New, ready-to-use, speaker-baffle combination for extending sound coverage of existing sound systems. Excellent for all indoor installations including public address systems in schools, industrial plants, large offices, auditoriums, stores, etc. Pre-wired volume control permits controlling sound level at speaker—a very desirable feature in multiple speaker systems where a variety of sound levels must be maintained. Attractive, sloping-front baffle features rugged, deluxe-quality construction. Baffle is made of 1/4" and 1/2" veneered woods. Rabbeted construction is featured throughout with liberal use of glue blocks for additional strength. Attractive, plastic grille cloth matches lustrous mahogany finish of baffle but does not affect sound dispersion. Built-in heavy-duty 8" speaker has 4.64 oz. Alnico V magnet to assure highly efficient reproduction of voice and music. Has high-quality seamless speaker cone. Voice coil impedance is 8 ohms; power handling capacity is a full 10 watts. Hanging the baffle is as easy as hanging a picture—slots are provided at the rear of baffle for screws or nails. The speaker and volume control leads are pre-soldered—a screw-driver is the only tool required to connect your speaker cable to the terminals on the baffle. Size, 11 x 9 1/2 x 6 1/8". Shpg. wt., 6 lbs.
93 D 704. NET.....14.88

SPEAKER-BAFFLE COMBINATION FOR 70.7-VOLT SPEAKER SYSTEMS

A high quality speaker-baffle combination similar to the deluxe combination above, but with built-in transformer for use with 70.7-volt speaker distribution systems. Ideal for building an efficient sound distribution system, or for increasing the versatility of a system at low cost. Simply determine wattage rating need for each room—add ratings together—choose an amplifier with a rating which is at least equal to the total rating of the speaker load. Features pre-wired volume control for individual sound level adjustment. Built-in 8" speaker features seamless cone selected for optimum frequency response. Has highly efficient Alnico V magnet. Transformer is mounted directly on sturdy, warp-free speaker frame. Excellent for all indoor installations. Has screw-type terminals for quick, easy installation. Terminals are marked for 10, 5, 2.5, 1.25, and 0.62 watt output. Mahogany finish; matching plastic grille. Easily mounted on any wall. Shpg. wt., 7 lbs.
93 D 703. NET.....16.59

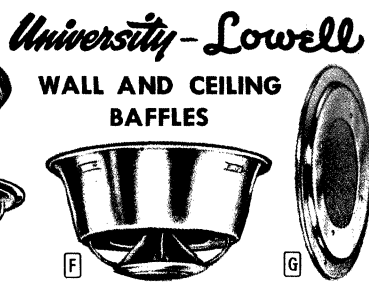

**University-Lowell
WALL AND CEILING
BAFFLES**

D FLUSH-MOUNTING BAFFLE ENCLOSURES. For mounting AL and RS baffles, below. CP types for new construction; have steel can and plaster ring. All have sound deadening material. Shpg. wt.: CP6 and XCP6, 3 1/2 lbs. each; CP8 and XCP8, 4 1/4 lbs. each; CP1012 and XCP1012, 7 1/2 lbs. each.

Stock No.	Type	Description	NET
95 DX 235	CP6	For AL6A, RS6A. 7" I.D. x 4" x 1 1/4" O.D.	4.28
95 DX 236	CP8	For AL8A, RS8A. 8 1/2" I.D. x 4 1/4" x 1 3/8" O.D.	5.29
95 DX 237	CP1012	For AL12A, RS12A. 12 1/2" I.D. x 7" x 1 7/8" O.D.	7.25
95 DX 232	XCP6	For AL6A, RS6A. 7" dia. x 4" deep.	3.77
95 DX 233	XCP8	For AL8A, RS8A. 8 1/2" dia. x 4 1/4" deep.	4.73
95 DX 234	XCP1012	For AL12A, RS12A. 12 1/2" dia. x 7" deep.	6.39

WALL AND CEILING BAFFLES. Aluminum with 1/2" mtg. flange. Have satin finish. RS types for recessed wall mounting; AL for recessed ceiling mounting; BL for non-recessed ceiling mounting. All except BL types require baffle enclosures, above.

Stock No.	Type	Fig.	Description	Lbs.	NET
95DX240	RS6-A	G	For 6" speakers. 10 x 7 1/16".	1	2.94
95DX238	RS8-A	G	For 8" speakers. 12 3/8 x 1 1/2".	1	3.26
95DX239	RS12-A	G	For 12" speakers. 16 1/2 x 1 1/2".	1 3/4	4.47
95DX226	AL6-A	E	For 6" speakers. 10 1/2" dia.	1 1/2	4.41
95DX227	AL8-A	E	For 8" speakers. 12 3/8" dia.	1 3/4	7.14
95DX228	AL12-A	E	For 12" speakers. 16 3/4" dia.	3 1/4	9.00
95DX223	BL6-A	F	For 6" speakers. 7 1/4 x 12 1/4" dia.	3 3/4	7.64
95DX224	BL8-A	F	For 8" speakers. 8 1/2 x 14 1/4" dia.	4	12.94
95DX225	BL12-A	F	For 12" speakers. 9 1/4 x 18 3/8" dia.	6 3/4	15.88

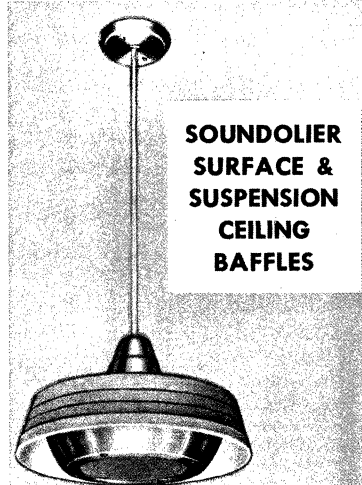

**SOUNDOLIER
SURFACE &
SUSPENSION
CEILING
BAFFLES**

SOUNDOLIER WIDE-ANGLE CEILING BAFFLES. Bass reflex design for full-range sound. Models 210 for surface mounting; Models 310 for suspension mounting. Size: Model 210-8, 4 x 14 1/4" dia.; Model 210-12, 7 9/32 x 18 5/16" dia.; Model 310-8, 8 5/16 x 14 1/8" dia.; Model 310-12, 11 9/32 x 18 5/16" dia.
MODEL 210-8. For 8" speakers. 4 lbs. 12.94
93 DX 271. NET.....
MODEL 210-12. For 12" speakers. 7 lbs. 15.88
93 DX 272. NET.....
MODEL 310-8. For 8" speakers. 4 3/4 lbs. 17.64
93 DX 273. NET.....
MODEL 310-12. For 12" speakers. 7 3/4 lbs. 21.76
93 DX 274. NET.....
MODEL 335 HANGERS. For models 310, above. With canopy and swivel.
93 DX 275. 335-2. 24". 3/4 lb. NET...1.76
93 DX 276. 335-3 36". 1 1/4 lbs. NET 2.06

WALL & CORNER BAFFLES

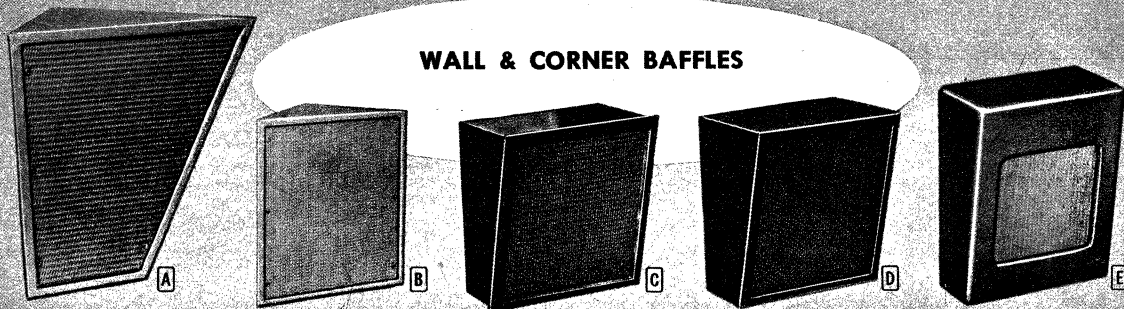

ARGOS BASS REFLEX CORNER BAFFLES. Handsomely styled, low in cost and extremely versatile bass reflex enclosures for 8" or 12" speakers. Incorporate true bass reflex design for rich, full-toned musical reproduction. Excellent for music distribution systems, extension speakers for hi-fi systems. P.A. use, etc. Simple, quick installation—speaker bolts are already installed and other necessary hardware is included. Acoustically padded. Rigidly constructed of reinforced plywood and hardboard, covered with plastic-coated fabric in simulated wood finish. Attractive plastic, matching grilles.

A SLANTING BAFFLES. Designed to utilize the walls and ceiling for extending bass frequency response of any speaker. Slanting panel aims sound downward.

MODEL SCB-8. For use with 8" speaker. Size, HWD: 15x21x10". Shpg. wt., 5 lbs.
95 DX 580. Mahogany. NET
95 DX 581. Blonde. EACH **7.74**

MODEL SCB-12. For use with 12" speaker. Size, HWD: 21¼x21x10½". Shpg. wt., 9 lbs.
95 DX 582. Mahogany. NET
95 DX 583. Blonde. EACH **10.73**

B NON-SLANTING BAFFLES. For corner, ceiling-hung, or wall installation. Mounting position may be selected to suit individual requirements.

MODEL CB-8A. For use with 8" speaker. Size, HWD: 14x12¼x6". Shpg. wt., 4½ lbs.
95 DX 445. Mahogany. NET
95 DX 446. Blonde. EACH **7.26**

MODEL CB-12A. For use with 12" speaker. Size, HWD: 20¼x18x9". Shpg. wt., 9 lbs.
95 DX 447. Mahogany. NET
95 DX 448. Blonde. EACH **10.29**

C ARGOS DELUXE WOOD WALL BAFFLES. Feature rugged plywood construction; solid oak or walnut front frames. Excellent for all indoor installations, paging systems, etc. Easily installed—speaker bolts are already mounted and other necessary hardware is included. Attractive plastic grilles.

MODEL DWB-8. For 8" speaker. 10½x9¾x6½". Shpg. wt., 3 lbs.
95 DX 400. Walnut. NET
95 DX 401. Lined Oak. EACH **5.88**

MODEL DWB-12. For 12" speaker. 14x13¼x9". Shpg. wt., 5 lbs.
95 DX 402. Walnut. NET
95 DX 403. Lined Oak. EACH **8.23**

D ARGOS WALL BAFFLES. Made of wood and hardboard; finished in durable plastic-coated fabric with simulated wood grain finish. Attractive plastic grilles. Complete with wall-mounting bracket and speaker mounting hardware.

Stock No.		Model No.	Size, HWD	Speaker Size	Wt., Lbs.	NET EACH
Mahog.	Blonde					
95 D 435	95 D 436	WB-4/5A	6 x 6 x 4"	4-5"	1½	2.74
95 D 437	95 D 438	WB-6A	8½ x 7½ x 5"	6"	2	3.37
95 D 439	95 D 440	WB-8A	10½ x 9¾ x 6½"	8"	3	3.97
95 DX 441	95 DX 442	WB-10A	12¼ x 10½ x 7¾"	10"	4	4.70
95 DX 443	95 DX 444	WB-12A	14¼ x 13¼ x 9"	12"	5	5.44

E ECONOMY BAFFLES. For all indoor installations, paging systems, etc. Wall-mounting type. Made of strong plywood, covered with dark brown leatherette. Flocked brown screen grille. Less all mounting hardware.

8" SPEAKER BAFFLE. Size, 11x9¾x6". Shpg. wt., 4 lbs.
93 DX 522. NET **2.78**

12" SPEAKER BAFFLE. Size, 17x13¾x8". Shpg. wt., 6 lbs.
93 DX 520. NET **3.57**

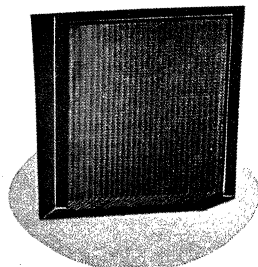

WELLCOR WALL BAFFLES

All-wood lock-corner construction. Mounting hardware is installed; speaker hardware also included. Wood finish baffles have natural plywood exterior; leatherette-covered baffles have pyroxylin-coated fabric.

FOR 8" SPEAKERS. 11x9¾x6½". 3½ lbs.
MODEL FWB-8M. Mahogany wood finish.
93 DX 750. List, \$10.20. NET **6.12**
MODEL FWB-8B. Blonde wood finish.
93 DX 776. List, \$11.02. NET **6.48**
MODEL LCWB-8M. Mahogany leatherette.
93 DX 778. List, \$6.80. NET **4.00**
MODEL LCWB-8B. Blonde leatherette.
93 DX 752. List, \$6.80. NET **4.00**
FOR 12" SPEAKERS. 16¼x13¾x9". 5½ lbs.
MODEL FWB-12M. Mahogany wood finish.
93 DX 751. List, \$14.03. NET **8.42**
MODEL FWB-12B. Blonde wood finish.
93 DX 777. List, \$15.42. NET **9.07**
MODEL LCWB-12M. Mahogany leatherette.
93 DX 779. List, \$9.35. NET **5.50**
MODEL LCWB-12B. Blonde leatherette.
93 DX 753. List, \$9.35. NET **5.50**

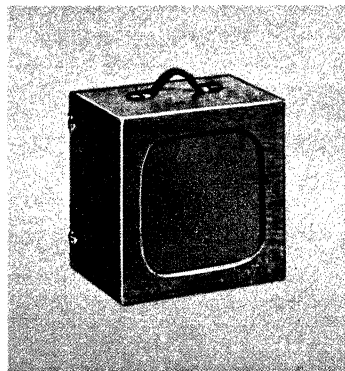

PORTABLE SPEAKER CASES

Exceptionally well-built carrying cases. For portable sound systems where a means of carrying additional speakers is desired. Constructed of plywood covered with dark brown leatherette. Have speaker openings of harmonizing brown flocking on rigid metal screen. Removable covers fitted with trunk-type clasps; leather carrying handles.

SINGLE SPEAKER CASE. Will accommodate one 12-inch speaker. Inside dimensions: 12¼x12¼x9½". Shpg. wt., 9 lbs.
93 DX 601. NET **7.25**

DUAL SPEAKER CASE. Will accommodate two 12-inch speakers. Divides into two convenient separate units which serve as baffles. Rugged plywood construction with tough, durable dark brown leatherette covering. Inside dimensions: 20¼x16x12¼x9½". Shpg. wt., 25 lbs.
93 DX 600. NET **9.49**

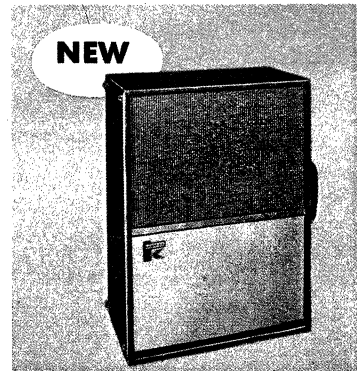

Knight SPEAKER-AMPLIFIER CASES

Ruggedly built combination speaker-amplifier cases. Expressly designed for the new Knight 8, 16, or 32-watt amplifiers. Provision is made for securely housing mike, stand and cable. Sturdy lock-corner plywood construction. Attractive blue-green and ivory leatherette covering with matching plastic grille. Interior has cable windup brackets, mike pocket, clasp and screw mount for mike stand and base. Leather carrying handles.

LARGE CASE. For system using Knight 16 or 32-watt amplifier and two 12" speakers. HWD: 24½x18x11". Wt., 25 lbs.
93 DX 767. NET **17.96**

SMALL CASE. For system with Knight 8-watt amplifier and one 8" speaker. Size (HWD): 14x12x8½". Shpg. wt., 9 lbs.
93 DX 768. NET **9.95**

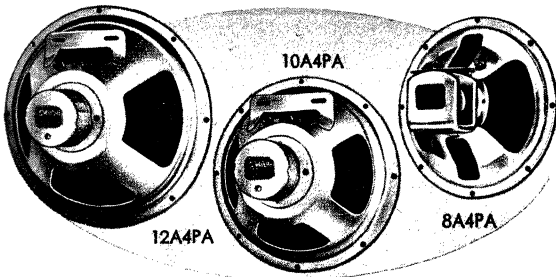

Quam Heavy-Duty P.A. Speakers

These heavy-duty permanent magnet speakers are specifically designed to deliver highly dependable service in public address installations. Offer high power handling capacity, excellent tonal quality, and rugged construction throughout. Complete dust-proofing and rigid welding assure permanent alignment of integral parts. Quam speakers feature two exclusive engineering developments. One is the U-shaped field coil pot feature which provides an unbroken flux path of sufficient cross section to carry the full energy of the magnetic field. The second feature is Quam's Adjust-A-Cone suspension consisting of a clamping ring securely fastening the spider to the basket by means of two machine screws rather than cement, as in other speakers. This assures precision centering of the voice coil. Also use high-quality Alnico V magnets. Pot material is selected for low carbon content and high magnetic properties. Basket is finished in durable baked aluminum enamel. Have convenient bracket for mounting of matching transformer. All have 6-8 ohm voice coils.

Stock No.	Mfr's Type	Size	Max. Watts	Magnet Wt., Oz.	Wt., Lbs.	NET EACH
81 D 061	8A21PA	8"	8	2.15	1½	4.82
81 D 062	8A31PA	8"	10	3.16	2½	5.41
81 D 335	8A4PA	8"	12	4.64	2¾	6.00
81 D 336	8A6PA	8"	12	6.8	3¼	7.11
81 D 063	10A31PA	10"	12	3.16	2¾	6.32
81 D 394	10A4PA	10"	14	4.64	3¼	6.88
81 D 395	10A6PA	10"	14	6.8	3½	8.00
81 D 064	10A10PA	10"	20	10.0	3½	10.58
81 DX 065	12A31PA	12"	12	3.16	3¾	6.82
81 DX 337	12A4PA	12"	15	4.64	4	7.44
81 DX 338	12A6PA	12"	15	6.8	4¾	8.53
81 DX 340	12A10PA	12"	25	10.0	4¾	11.17

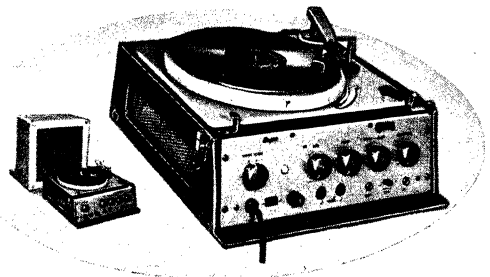

Bogen VP-17X Transcription Player

Portable, variable speed transcription player. Has built-in 10-watt amplifier, plus microphone input with separate gain control—makes an excellent portable P.A. system. An extremely versatile combination of player, amplifier, and speaker in a portable unit. Useful for instruction, calisthenics, etc. Has outstanding Bogen B50-16 turntable—features continuously variable speed from 16 to 86 rpm. Plays all records up to 16" dia., with splendid sound quality and minimum record wear. Speed adjustment is accomplished through a precision cone drive, regulated by a single lever with lock-in positions for accurate, instantaneous selection of conventional speeds (78, 45, 33½ and 16½ rpm).

Incorporates heavy-duty 4-pole motor, weighted (3¼ lbs.) and balanced turntable; reduces wow, hum and rumble to negligible values—wow to under 0.5%! Die-cast pick-up arm has ball-bearing mount and "Feather-Drop" action to protect record and stylus; equipped with G. E. variable reluctance cartridge with dual sapphire stylus. With built-in compensated preamplifier for cartridge.

12" heavy-duty Alnico V speaker is mounted in removable lid of carrying case; has 25 ft. of cable. Provides sufficient coverage for moderate-size gymnasium or auditorium—has 2 jacks for external speakers. Separate bass and treble controls are provided, as well as an effective scratch and noise filter. Attractive, compact carrying case is constructed of ¾" plywood, and is adequately shock-mounted. Expanded metal speaker grille; covered in two-tone luggage-type fabric.

Output: 10 watts with less than 3% harmonic distortion. *Res. p. n. s. e.* Mike, ±1½ db, 50-10,000 cps; Phono and Radio, ±1½ db, 40-12,000 cps. *H. u. m.*: 60 db below 10 watts. *T. o. n. e C. o. n. t. r. o. l.*: +15 db at 100 cps; -23 db at 10,000 cps. *C. o. n. t. r. o. l. s.*: Mike gain, phono gain, treble, bass, off-on. *S. i. z. e.*: 12½x17x16¼". For 110-120 v., 50-60 cycle A. C. Shpg. wt., 40 lbs.

95 RZ 959. List, \$181.90. NET. 136.43

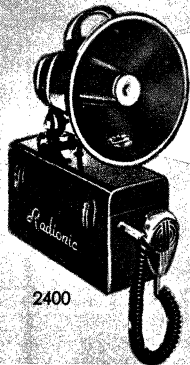

2400

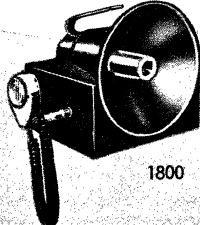

1800



PP-1



PP-2

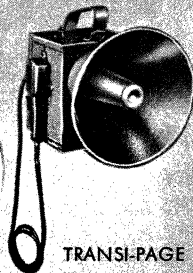

TRANSI-PAGE

Battery-Powered Portable P.A. Systems

IRWIN PORTABLE P.A. SYSTEMS

MODEL 2400 "ULTRASONIC". Self-contained portable P.A. system. Easily transmits ¼ mile. Instant operation. Average battery life, 6-12 months. Supplied with case, speaker, mike, 8-ft. coiled cord and plug, and four 6-volt batteries. Has carrying handle and adjustable shoulder strap. Weather and rust-proof. Case size, 10½x6x4¼". Shpg. wt., 15 lbs.
93 SX 886. List, \$99.50 NET. 66.33

MODEL 1800. New, compact, lightweight portable P.A. system. Voice range of this weatherproof unit is ¼ mile. Approx. battery life, 6-9 months. Complete with self-contained speaker, mike, 8-ft. coiled cord and plug, adjustable carrying strap, carrying handle, and two 9-volt batteries (Burgess Type D6). Push-to-talk button. Case, 9½x9½x8¼". Shpg. wt., 9 lbs.
93 SX 761. List, \$89.50 NET. 59.95

UNIVERSITY "POWR-PAGES"

MODEL PP-1. Hand-held, portable power megaphone. Range of up to ¼ mile! Weatherproof speaker has locking swivel bracket. Mike has 11-ft. cable with push-to-talk, "Powr-Saver" switches for longer battery life. Less batteries. Wt., 8 lbs.
93 SX 781. NET. 68.35

BATTERY, 7 required. Ea., 6 oz.
53 J 009. NET EACH. 14c

MODEL PP-2. Lightweight, self-powered P.A. system. Has range of up to ¼ mile. Weighs only 4½ lbs. with batteries (not included). Push-to-talk switch. Has jack to permit use with external 6-volt or 12-volt DC supply. Shpg. wt., 4¾ lbs.
93 SX 780. NET. 63.70

PENLIGHT BATTERY, 6 required. Each, 2 oz.
53 J 031. NET EACH. 9c

NEW IRWIN "TRANSI-PAGE"

MODEL TP-1200. Transistorized, battery-powered portable P.A. system. Uniquely designed portable paging unit—first of its type to employ electronic amplification. Utilize 3 transistors for a husky 5 watts output. Features remarkable tonal quality and clarity. Exceptionally good sound coverage—excellent for emergency use, large gatherings, etc. Low battery drain circuit has extremely long battery life of up to 500 actual operating hours. Use of dynamic mike instead of conventional carbon mike provides exceptionally clear reproduction. Mike has push-to-talk switch. Volume control on unit. Supplied with mike, coiled cord and plug, self-contained speaker, two 6-volt batteries (Burgess Type 4F) and adjustable leather carrying strap. Large 8" trumpet; housing, 7¾x5¾"; overall length (incl. trumpet), 11". Wt., 7 lbs.
93 SX 771. List, \$165.95. 99.50

QUALITY REPLACEMENT SPEAKERS

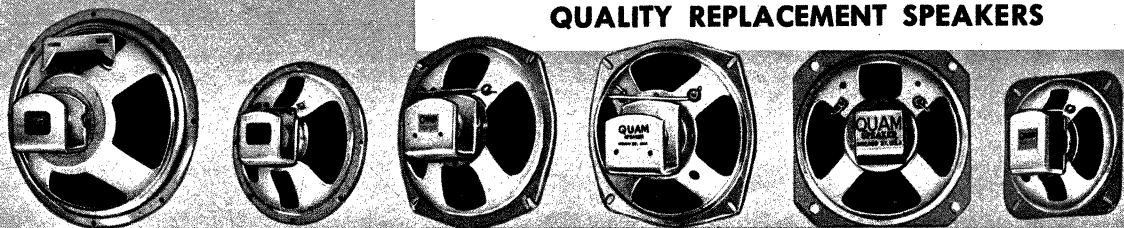

Famous Quam Adjust-A-Cone Speakers

Quam speakers feature two exclusive engineering developments. One is the U-shaped field coil pot feature which provides an unbroken flux path of sufficient cross section to carry the full energy of the magnetic field. The second feature is the Quam Adjust-A-Cone suspension consisting of a clamping ring securely fastening the spider to the basket by means of

two machine screws rather than cementing. This assures precision centering of the voice coil. With Alnico V magnets in the PM units. Pot material is selected for low carbon content and high magnetic properties. 3 1/2" to 6 1/2" units have a universal mounting bracket which may be attached to any two of the four mounting holes in the pot.

PERMANENT MAGNET SPEAKERS

Quam permanent magnet speakers are dependable, quality units for replacement in receivers, phonographs, etc. Built to RETMA standard dimensions. Fully dustproofed and finished in baked aluminum enamel. All models use Alnico V magnets and have 3.2-ohm voice coils. All 3 1/2" to 6 1/2" speakers have 4 holes in pot for easy mounting.

Stock No.	Mfr's Type	Size	Max. Watts	Magnet Weight	Wt., Lbs.	NET EACH
81 D 066	25A07	2 1/2"	2.0	.65 oz.	1/2	2.35
81 D 346	3A07	3 1/2"	2.5	.68 oz.	1/2	2.35
81 D 309	4A06	4"	2.5	.58 oz.	1/2	1.73
81 D 320	4A07	4"	3.0	.68 oz.	1/2	2.35
81 D 321	4A1	4"	3.0	1.0 oz.	3/4	2.50
81 D 322	4A15	4"	3.0	1.47 oz.	3/4	2.76
81 D 347	46A07	4x6"	3.5	.68 oz.	3/4	2.62
81 D 371	46A1	4x6"	3.5	1.0 oz.	1	2.79
81 D 372	46A15	4x6"	3.5	1.47 oz.	1	3.03
81 D 323	5A07	5"	3.5	.68 oz.	3/4	2.47
81 D 324	5A1	5"	3.5	1.0 oz.	1	2.62
81 D 325	5A15	5"	3.5	1.47 oz.	1	2.85
81 D 803	52A1	3 1/2"	4.0	1.0 oz.	1	2.73
81 D 317	52A21	5 1/2"	4.0	2.15 oz.	1 1/4	3.35
81 D 348	57A1	5x7"	5.0	1.0 oz.	1	3.17
81 D 334	57A15	5x7"	5.0	1.47 oz.	1	3.41
81 D 339	57A21	5x7"	5.0	2.15 oz.	1 1/4	3.79
81 D 326	6A1	6 1/2"	5.0	1.0 oz.	1	2.82
81 D 327	6A15	6 1/2"	5.0	1.47 oz.	1	3.06
81 D 328	6A21	6 1/2"	5.0	2.15 oz.	1 1/4	3.44
81 D 332	6A31	6 1/2"	6.0	3.16 oz.	1 1/2	3.97
81 D 373	69A2	6x9"	8.0	1.4 oz.	1 1/2	4.41
81 D 374	69A3	6x9"	10.0	3.2 oz.	1 3/4	5.26
81 D 375	7A21	7"	6.0	1.4 oz.	1	4.26
81 D 387	7A31	7"	9.0	3.16 oz.	2	5.00
81 D 329	8A21	8"	7.0	2.15 oz.	1 1/2	4.23
81 D 330	8A31	8"	9.0	3.16 oz.	2 1/4	5.00
81 D 388	10A31	10"	9.0	3.16 oz.	2 3/4	6.17
81 D 804	10A4A	10"	10.0	4.64 oz.	3 1/4	6.88
81 D 805	10A6A	10"	12.0	6.8 oz.	3 1/2	8.00
81 DX 333	12A31	12"	10.0	3.16 oz.	3 3/4	6.67
81 DX 806	12A4A	12"	12.0	4.64 oz.	4	7.44
81 DX 807	12A6A	12"	14.0	6.8 oz.	4 1/2	8.53

OUTDOOR SPEAKERS

Speakers have exclusive Humi-Gard cone of plastic impregnated synthetic fiber fabric. Greatly outlast ordinary moisture-proofed cones yet provide the response of an untreated paper cone. Air gap surfaces are enameled and cadmium-plated. Voice coil impedance, 3.2 ohms. You can save by buying in large quantities. Write for quotations.

Stock No.	Mfr's Type	Size	Max. Watts	Magnet	Wt., Lbs.	NET EA.
81 D 308	3A07OT	3 1/2"	2.5	.68 oz.	1/2	2.35
81 D 393	4A1OT	4"	3	1.0 oz.	1/2	2.50
81 D 306	5A1SOT	5"	3.5	1.47 oz.	1	2.85
82 D 260	6A1SOT	6"	5	1.47 oz.	1 1/4	3.06

ELECTRO-DYNAMIC SPEAKERS

Field coils made from carefully tested materials. 3.2-ohm voice coil impedance. Wattage ratings are conservative. 4", 5", 6 1/2" and 4x6" speakers have 4 tapped holes in coil pot for chassis mounting plus universal mounting brackets. †Equipped with hum-bucking coils.

Stock No.	Mfr's Type	Size	Field Ohms	Max. Watts	Wt., Lbs.	NET EA.
81 D 350	4E45	4"	450†	3.0	1	3.09
81 D 375	46E45	4x6"	450†	3.5	1 1/4	3.67
81 D 352	5E45	5"	450†	3.5	1	3.23
81 D 353	5E10	5"	1000	3.5	1	3.23
81 D 356	6E6V	6 1/2"	6-V.	5.0	1 1/2	3.82
81 D 357	6E10	6 1/2"	1000	5.0	1 1/2	3.82
81 D 378	69E6V	6x9"	6-V.	8.0	2	4.41
81 D 368	7E6V	7"	6-V.	7.0	2	4.41
81 D 361	8E10	8"	1000	7.0	1 1/2	4.41
81 DX 364	12E10	12"	1000†	12.0	5	8.23

INTERCOM SPEAKERS

PM type speakers designed for exact replacement in intercommunication systems. Voice coil impedance is 45 ohms.

Stock No.	Mfr's Type	Size	Magnet	Shpg. Wt.	NET
81 D 808	3A07Z45	3 1/2"	.68 oz.	1/2 lb.	2.50
81 D 809	4A1Z45	4"	1.0 oz.	3/4 lb.	2.85
81 D 810	5A1Z45	5"	1.0 oz.	1 lb.	2.76

See page 359 for listings of Quam PA speakers.

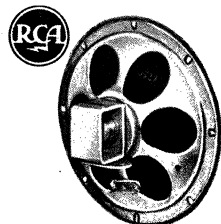

RCA "Gold Label" PM Speakers

High-quality RCA dynamic speakers for replacement or original equipment purposes. All have felted cones and powerful Alnico V magnets. 4", 4x6" and 5" types have mounting brackets for transformer and speaker. Voice coils have impedance of 3.2 ohms, except †12 ohms and †6-8 ohms. †Include leads for Ford, Mercury and Lincoln cars.

Stock No.	Type	Size	Watts	Magnet	Lbs.	EACH
81 D 126*	222S1	2 1/2"	1/4	1 oz.	1/2	3.46
81 D 456*	214S1	2x3"	3/8	1 oz.	1/2	2.79
81 D 119	216S1	3"	2	1.47 oz.	1	2.44
81 D 127	231S1	3"	2	1.47 oz.	1	5.56
81 D 128	223S1	4"	3	0.68 oz.	1	2.47
81 D 457	304S2	4"	3	1 oz.	1	2.55
81 D 462	404S2	4"	3	1.47 oz.	1	2.71
81 D 129	227S1	4x6"	3	1 oz.	1 1/2	2.65
81 D 452	246S2	4x6"	3	0.68 oz.	1 1/2	2.47
81 D 453	446S2	4x6"	3	1.47 oz.	1 1/2	2.79
81 D 120	205S2	5"	3	0.68 oz.	1	2.47
81 D 137	228S1	5"	3	1 oz.	1	2.56
81 D 451	405S2	5"	3	1.47 oz.	1	2.80
81 D 121	217S1	5 1/2"	4	1 oz.	1 1/2	2.69
81 D 138	233S1	5 1/2"	6	2.15 oz.	2	3.79
81 D 139	232S1	5x7"	7	3.16 oz.	2	4.12
81 D 141	229S1	6"	4	1 oz.	2	2.88
81 D 142	224S1	6"	5	1.47 oz.	2	3.09
81 D 125	230S1	6 1/2"	6	3.16 oz.	2	3.97
81 D 124	238S1	6x9"	6	2.15 oz.	2	4.59
81 D 459	257S1	5x7"	6	1.47 oz.	1 1/4	3.38
81 D 143*	235S1	6x9"	8	2.33 oz.	2	5.29
81 D 466	208S2	8"	8	2.15 oz.	2 1/4	4.23
81 D 460†	208S4	8"	8	2.15 oz.	2 1/4	4.41
81 D 144	224S1	8"	8	3.16 oz.	2 1/4	4.97
81 D 145	234S1	8"	9	6.8 oz.	2 1/2	6.53
81 DX 146	236S1	10"	7	2.15 oz.	4	6.12
81 DX 147	237S1	10"	8	3.16 oz.	4	6.12
81 DX 467†	215S1	10"	10	6.8 oz.	4 1/2	7.79
81 DX 454	112S1	12"	12	2.15 oz.	4	6.17
81 DX 148	226S1	12"	12	2.9 oz.	4 1/2	6.35
81 DX 455	412S6	12"	12	6.8 oz.	4 1/2	8.08
81 DX 458†	412S7	12"	12	6.8 oz.	4 1/2	8.82

Jensen "Concert Series" PM Speakers

Top performing PM dynamic speakers. Excellent units for replacement use or as original equipment. 5" and larger provide for mounting matching transformers on frames. Supplied with new, high-energy DP-Alnico V magnets. Cones are selected for maximum frequency response characteristics. Voice coil impedance is 3.2 ohms, except †16 ohms for Regency and other transistor radios, and †, 8 ohms.

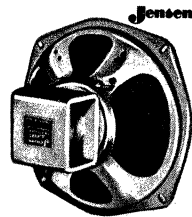

Stock No.	Mfr's Type	Size	Magnet Weight	Watts	Wt., Lbs.	NET EACH
82 D 171*	P275-Y	2 3/4"	0.65 oz.	.15	1/4	3.67
82 D 271	P4-W	4"	1.0 oz.	2.0	1 1/2	2.47
82 D 272	P5-W	5"	1.0 oz.	2.5	1 3/4	2.68
82 D 176	P5-V	5"	1.47 oz.	3.5	1 3/4	2.95
82 D 273	P6-W	6"	1.0 oz.	3.0	2	2.85
82 D 179	P6-V	6"	1.47 oz.	4.0	2	3.12
82 D 181	P6-T	6"	3.16 oz.	6.0	2	4.59
82 D 195	P69-V	6x9"	1.47 oz.	5.0	2 1/2	4.41
82 D 183	P8-U	8"	1.73 oz.	6.0	2 1/2	4.50
82 D 184	P8-T	8"	2.5 oz.	7.0	2 3/4	5.23
82 D 185	P8-S	8"	4.64 oz.	8.0	3 1/4	6.67
82 D 187	P10-T	10"	2.5 oz.	8.0	5	6.32
82 D 188†	P10-S	10"	4.64 oz.	9.0	5	8.44
82 DX 190	P12-T	12"	2.5 oz.	9.0	5	6.32
82 DX 191†	P12-S	12"	4.64 oz.	10.0	6	9.24
82 DX 270	P314-T	14x3"	3.16 oz.	7.5	2	7.50

JENSEN SPEAKER VOLUME CONTROLS

L-pads for volume control at individual speakers—no effect on volume of other speakers in system. Smooth, gradual control. Excellent for use in PA, intercom and home music systems. With knob and on-off dial. Shpg. wt., 5 oz.

Stock No.	Type No.	Ohms	Watts	NET
33 M 942	ST-760	3-4	5	1.97
33 M 940	ST-276	6-8	5	1.76
33 M 941	ST-411	6-8	15	2.76
33 M 938	ST-837	15-16	15	2.76
33 M 939	ST-761	500-600	15	3.65

Knight QUALITY SPEAKERS & GRILLES

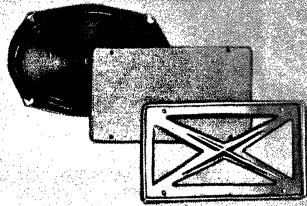
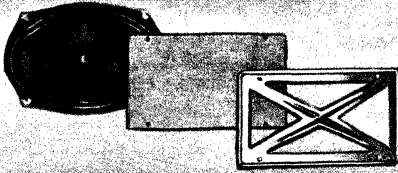
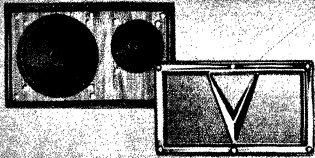

KNIGHT Rear-Deck Auto Speaker Kits

NEW DELUXE DUAL-SPEAKER KIT

\$1145

One of the finest rear deck speaker kits available, this distinctively styled unit features two separate speakers.

Provides unusually rich and thrilling auto radio sound; makes it possible for all passengers in car to enjoy enhanced musical reproduction. Consists of a 4" speaker and a 6" speaker, mounted side-by-side on a baffle board. 4" speaker serves as an efficient tweeter for reproducing treble notes. 6" speaker is used as a woofer for bass response. A highly efficient, built-in high-pass filter, mounted on the baffle board, distributes highs and lows to the proper speaker.

The smartly styled grille, in a choice of two attractive finishes, adds a distinctive touch to any car interior. Easy to install, the kit includes a dash-mounted, three-way switch for instant selection of radio-mounted speaker only, rear-deck dual speakers only, or all speakers together. Grille size, 7x11 1/2". Supplied complete with switch, wire, all hardware and easy-to-follow instructions—everything needed for a quick, simple installation. Shpg. wt., 3 lbs.

81 D 130. Chrome Grille.
81 D 131. Gray Grille.
NET EACH..... **11.45**

NEW EXTENDED-RANGE SPEAKER KIT

As Low As \$539

New, high-quality extended-range speaker kit for rear deck mounting. Duo-type speaker, with specially designed, high-frequency cone mounted at its center, provides balanced reproduction of bass and treble. Offers much richer tonal quality and sound dispersion than conventional, single-cone speakers. The duo-speaker employs the natural baffle of the automobile body to deliver pleasingly smooth reproduction throughout the audio range. Handsomely styled grille, available in choice of two finishes, adds a touch of beauty to any car interior.

A dash-mounted, 3-way switch, permits playing the radio-mounted speaker only, duo-speaker only, or all speakers simultaneously. Allows all passengers to hear radio broadcasts at a comfortable listening level—eliminates need for turning up front-seat volume. Kit includes switch, wire, all hardware and complete instructions.

Stock No.	Size	Grille	Lbs.	EACH
81 D 132	5x7"	Gray	2	5.39
81 D 133	5x7"	Chrome	2	5.55
81 D 135	6x9"	Gray	2 1/2	5.71
81 D 134	6x9"	Chrome	2 1/2	5.88

STANDARD REAR-DECK SPEAKER KITS

As Low As \$375

A value-packed luxury item at remarkably low cost. These economically priced, rear-deck speaker kits are

ready for quick, trouble-free installation in any car. Provide outstanding sound and add immensely to the listening pleasure of all the passengers in your car, without the need for turning up car radio volume to annoying loudness. Assure excellent tonal quality and greatly improved sound distribution.

Dash-mounted, 3-way control switch permits operation of front speaker only, rear speaker only, or both speakers together. Speakers are top-quality, Alnico V P M type with handsome, protective grille. Kits are available in two popular speaker sizes. Contain everything needed for a neat, custom installation. Your choice of two attractive finishes. Kits include: Grille, pre-wired 3-way switch, all wires and hardware, mounting template and complete instructions—nothing else to buy.

Stock No.	Size	Grille	Lbs.	EACH
81 D 558	5x7"	Gray	2	3.75
81 D 559	5x7"	Chrome	2	3.92
81 D 501	6x9"	Gray	2 1/2	4.49
81 D 502	6x9"	Chrome	2 1/2	4.65

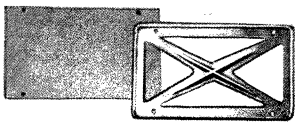

Knight SPEAKER GRILLES ONLY

Distinctive, chrome finish speaker grilles for either 5x7" or 6x9" rear deck speakers. Attractive and durable chrome finish stays bright after years of wear. Include all mounting hardware. Av. shpg. wt., 1 lb.

FOR 6x9" SPEAKER.
82 D 251. NET..... **1.07**
FOR 5x7" SPEAKER.
82 D 252. NET..... **.97c**

QUAM REAR-DECK KITS

A MODEL AS-3. Complete rear-deck speaker kit with Quam 5x7" "Adjust-A-Cone" speaker; 3/4" voice coil, 1.47 oz. Alnico V magnet. Fader control for exact adjustment of balance between front and rear speakers. Kit also supplied with flocked grille, baffle plate, hardware and wire. Shpg. wt., 2 1/4 lbs.
81 D 140. NET..... **7.03**

B MODEL AS-2. Same as above, but with 6x9" speaker having 1" voice coil, 2.15 oz. Alnico V magnet, and sponge rubber gasket. Shpg. wt., 3 1/2 lbs.
81 D 390. NET..... **8.20**

Top Buys in Coaxial Speakers

C Outstanding values for economy-minded music lovers. Dependable, high-quality, 8", 12" and 15" coaxial speakers. Ideal for use in economy hi-fi systems, as extension speakers in recreation room and den, and for improving the tone of radios and phonographs. Unusually good high-frequency response and faithful bass reproduction. Have 6-8 ohm impedance and "Alnico V" magnets. Tweeters mounted on cross bars attached to speaker frames. Built-in crossover networks.

AS LOW AS \$628

8" COAXIAL SPEAKER. 8" cone; has 2.15 oz. magnet. 2 3/4" tweeter with .68 oz. magnet. Rated at 8 watts. Range: 70-12,000 cycles. Crossover: 3000 cycles. Shpg. wt., 3 lbs.

81 D 607. NET..... **6.28**

12" COAXIAL SPEAKER. 12" cone; has 6.8 oz. magnet. 5" tweeter with 1 oz. magnet. Rated at 15 watts. Range: 55-12,000 cycles. Crossover: 2000 cycles. Shpg. wt., 8 lbs.

81 DX 638. NET..... **9.95**

15" COAXIAL SPEAKER. 15" cone; has 6.8 oz. magnet. 5" tweeter with 1.47 oz. magnet. Power handling capacity: 20 watts. Delivers outstanding bass response. Range: 45-12,000 cycles. Crossover frequency: 1800 cycles. Shpg. wt., 11 lbs.

81 DX 608. NET..... **15.27**

Replacement Speaker Values

Excellent quality permanent magnet speakers at very low prices. Actually cost less than the price of a re-coning job. Designed for universal replacement use—also recommended for installation in original equipment. They're real money savers for radio and TV servicemen, Amateurs and "do-it-yourself" fans. Ideal replacements for speakers in home radio receivers, auto radios, portables, phonographs and intercommunication equipment. Provide full tonal response for very smooth reproduction of voice and music. Built to RETMA standard dimensions—rugged construction throughout. Rigid frame construction assures permanent alignment of integral parts. Magnet and voice coil are precision centered. 4" and 5" speakers have four holes in pot for easy mounting; furnished with universal mounting bracket. All speakers are fully dust-proofed. Voice coil impedance, 3.2 ohms. *Extended range.

AS LOW AS \$140

Stock No.	Fig.	Size	Magnet Wt.	Max. Watts	Wt., Lbs.	NET EACH
81 D 616	E	4" square	.68 oz.	3.0	1/2	1.40
81 D 617	D	5"	.68 oz.	3.5	3/4	1.47
81 D 536	F	5" x 7"	1.0 oz.	5.0	1	2.07
81 D 534	F	6" x 9"	1.47 oz.	8.0	1 1/4	2.54
82 D 250*	F	6" x 9"	1.47 oz.	8.0	1 1/4	2.79
81 D 507	D	8"	2.15 oz.	9.0	1 1/2	3.00
81 DX 508	D	12"	3.16 oz.	10.0	3 3/4	4.30

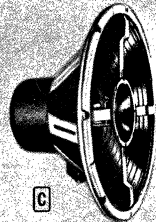

C

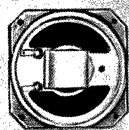

E

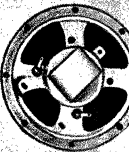

D

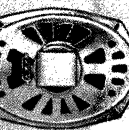

F



TALK-A-PHONE Chief

INTERCOMMUNICATIONS SYSTEMS

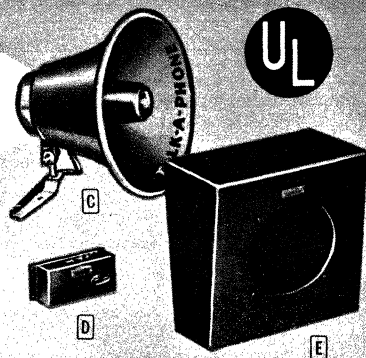
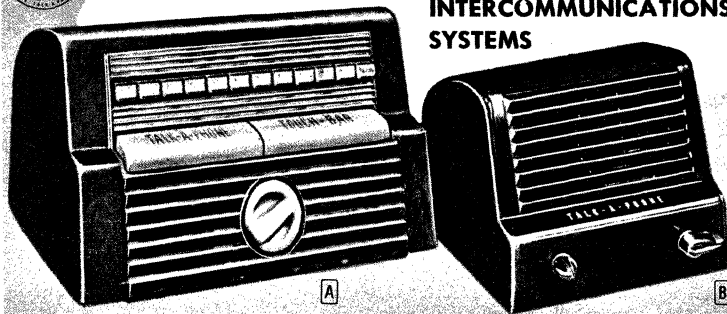

"CHIEF" UNIVERSAL MASTER STATIONS

A "Chief" Masters for communication systems with 6, 12, 20 or 30 station capacity. Highly versatile—use a Master for each station that must call and listen to every other station—may be installed in a system of all Masters, one Master and one or more Sub-stations, or in any system requiring several Masters intermixed with one or more Sub-stations. Permit private conferences or messages with particular stations merely by selecting desired push-buttons.

Feature push-button selector, convenient Push-to-Talk bar and illuminated volume control knob. Complete with junction box and instructions. Walnut-finish bakelite cabinets. 7x12x9 1/4". U.L. Approved. For operation from 110-120 volts DC or 50-60 cycles AC.

Stock No.	Mfr's Type	Capacity	Shpg. Wt.	List	NET EACH
95 RX 885	C-4906	6 stations	13 lbs.	\$99.00	58.20
95 RX 887	C-4912	12 stations	14 lbs.	119.00	69.95
95 RX 888	C-4920	20 stations	17 lbs.	140.00	82.30
95 RZ 889	C-4930	30 stations	20 lbs.	161.00	94.65

"CHIEF" EXTRA-POWER MASTER STATIONS

Use "Redi-Power" Masters in any "Chief" system where extra power is needed to overcome background noise. Built-in amplifier provides 20 watts which may be divided among stations, or concentrated on 1 station. Just press the handy Redi-Power button. For high-power paging use C-20 or HP-3 Sub-station (right). For AC only; other features same as Universal Masters, above.

12-STATION REDI-POWER MASTER. Type C-RP-5912. 18 lbs.
95 RX 882. List, \$179.00. NET PER STATION.....105.00

20-STATION REDI-POWER MASTER. Type C-RP-5920. 21 lbs.
95 RZ 883. List, \$200.00. NET PER STATION.....117.50

REDI-POWER MASTER WITH SINGLE-BUTTON PAGING. Type C-RP-5911. 11-station capacity. To page pre-selected stations, merely press "Page" button. Has all Redi-Power features. 18 lbs.
95 RX 892. List, \$199.00. NET PER STATION.....117.00

"CHIEF" SUB-STATIONS

B "Chief" Sub-stations are for use with any "Chief" Master, and work with models listed at left. Select from Subs that can originate calls to 1, 2 or 6 Masters. Subs can answer any Master but cannot talk to other Subs. Use Subs for locations that need to talk only to 1 to 6 central locations (Masters). All "Chief" Subs may be connected non-privately to permit persons at Subs to answer from a distance, without operating controls; or privately, to require operation of Talk-Listen switch. Subs are not connected to power line and consume no current. Bakelite cabinets (Fig. B) walnut color. Size, 6 1/4x8x7 1/2", except *push-button model C-46, 7x12x9 1/4". Subs in brown metal cabinets are 6 1/4x8x7 1/2". For High-Power Subs, see below. †No. of Masters Sub can call.

Stock No.	Type	Masters†	Cabinet	Wt.	List	NET
95 RX 886	C-41	one	bakelite	5 lbs.	\$22.95	13.50
95 R 863	C-41M	one	metal	3 lbs.	22.95	13.50
95 RX 890	C-42	two	bakelite	5 lbs.	29.95	17.50
95 R 864	C-42M	two	metal	3 lbs.	29.95	17.50
95 RX 891	C-46*	six	bakelite	9 lbs.	73.00	43.00

HIGH-POWER SUBS AND ORIGATION SWITCHES

HIGH-POWER SUB-STATIONS. Can answer Master. Originates calls when used with switches, below.

C C-20, TRUMPET TYPE. 9", weather-proof re-entrant horn for "Chief" and Master-Selective systems. 15 watts. 5 lbs.
95 RX 878. List, \$44.95. NET.....26.50

E HP-3, INDOOR TYPE. 8" speaker in brown, wrinkle-finish metal baffle. 5 watts. Size, 12x12x8". Shpg. wt., 8 lbs.
95 RX 849. List, \$28.00. NET.....16.50

D ORIGATION SWITCHES. Wall mounted type. Ideal for use with C-20 and HP-3 speakers, above. For Master-Selective system and "Chief" system. Shpg. wt., 2 lbs.
95 R 845. S-100. List, \$6.00. NET.....3.50
95 R 841. S-101*. Calls 1 Master. List, \$6.00. NET.....3.50
95 R 848. S-102*. Calls 2 Masters. List, \$11.00. NET.....6.50

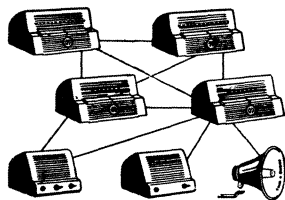

HOW TO SELECT YOUR "CHIEF" SYSTEM

It's easy—and economical—to select an intercom system when you follow suggestions by Allied's experienced intercom experts:

- 1.) Determine how many locations the system will serve. Select "Chief" master stations with capacity to handle all locations.
- 2.) Select a "Chief" Master for each location that must call every other station.
- 3.) Choose a Sub for each location that must answer or call Masters only. (Subs cannot talk to other Sub-stations.)
- 4.) There must be at least 1 Master in every system (only Masters have amplifiers and distribute audio power to the entire intercom system).
- 5.) Use a "Redi-Power" Master when you need extra power for noisy locations.



OPTIONAL FEATURES

PRIVACY EARPHONES. For all stations listed on this and opposite page. When lifted from rest, cuts out built-in speaker. In brown only. Add \$13.50 per station.

CRADLE PHONE. For Masters and bakelite-case Subs, except types CL-5, CL-10 and radio-intercom units listed on page 364. Add \$29.35 per station when ordering.

BUSY SIGNAL. For "Chief" Masters. Gives visual indication that another Master you call, similarly equipped, is "busy." Add \$7.00 per unit.

EXECUTIVE GRAY FINISH. All Talk-A-Phone Master and bakelite-cabinet Subs are available in executive gray. Add \$1.80 per sub; \$2.70 per master and indicate "Special" in place of Stock No. Allow 10 days for delivery.

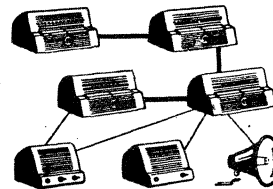

CABLE FOR "CHIEF" AND "SUPER CHIEF" SYSTEMS

For Master-to-Master, measure from 1st Master to 2nd Master only (heavy lines in diagram above), from 2nd to third Master only, etc. For 6-station Masters use Type 6212. Use Type 6224 for all other "Chief" Masters. Use single lengths of cable for 6 or 12-station Masters; double lengths for 20-station Masters; triple lengths for 30-station. For Master-to-Sub-stations (light lines), use Type 6204. Measure from Sub to each Master to which Sub originates calls. Type 6902 (1 pair) for connecting power supply to Master (see next page) and for connecting C-20 and HP-3 to Master.

Stock No.	Type	Lbs., 100'	Per Ft.
49W 606	6212	5	14c
49W 608	6224	9	28c
49W 607	6204	2 1/2	6c
49W 613	6902	2	2c

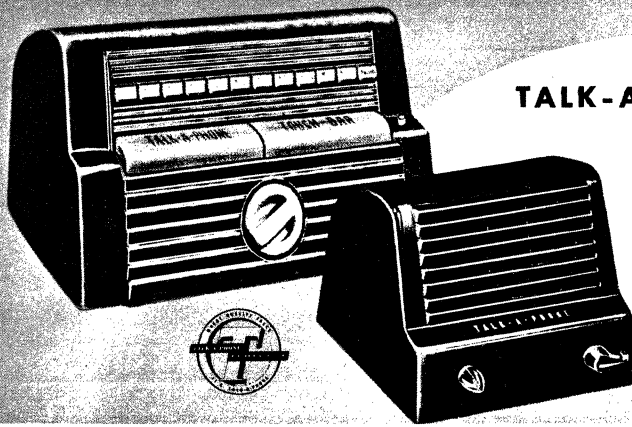

TALK-A-PHONE Super Chief

Featuring

**AUTOMATIC TRAFFIC CONTROL,
CHOICE OF VOICE
OR TOUCH CONTROL,
MULTI-MAGIC SELECTOR**



Introducing the all-new, top-performing Super Chief line of intercom units. Recommended for those desiring the ultimate in communication equipment. Masters have visual signals for automatically determining and controlling line traffic—a green light signals line is "clear"; red light informs you that line is "busy"; amber light tells you call has been established, ready for your reply. The multi-magic selector accommodates up to 20 stations with only 12 push-buttons; 30 stations controlled by 14 push-buttons. Masters feature automatic reply—directs your reply only to the station calling you; it is not necessary to know which station is calling you; and no other station can listen-in to your conversation.

Voice-controlled Masters (Series 7700, below) and touch-controlled Masters (Series 7600, below) can be intermixed for maximum flexibility within the same system. Can handle as many as 4 Masters for "closed-circuit" conferences. All Masters, Staffs and power supply units operate on 115-120 v., 60 cycles, AC only. Master stations measure 7x12x9"; come complete with junction box attached to Master with 6-ft. length of flexible cable. Staff station cabinets (see below) are 6¼x8¼x7½". Sturdy, impact-resistant bakelite cabinets are finished in rich walnut tone. All Super Chief Master stations and Staffs come complete with tubes and easy-to-follow instructions for quick installation.

AUTOMATION VOICE CONTROL MASTERS

SERIES 7700. The new Super Chief voice control Master features automation—simply depress a convenient button to automatically establish contact with the station calling you (you need not know who is calling—no other station can "listen-in" or interrupt). With the automatic reply button depressed, no further handling of the Master is necessary—unit is always "on"—ready for use.

Stock No.	Type	Capacity	Wt.	List	NET
93 RX 294	ACS-7704	4 stations	16 lbs.	\$211.00	124.00
93 RX 295	ACS-7710	10 stations	16 lbs.	238.00	140.00
93 RX 296	ACS-7720	20 stations	17 lbs.	278.00	163.50
93 RX 297	ACS-7730	30 stations	18 lbs.	318.00	187.00

TOUCH CONTROL MASTERS

SERIES 7600. A handy, manually-operated touch-bar permits automatic reply on the new Super Chief touch control Masters. Assures complete privacy—simply depress convenient touch bar to talk; release to listen—your reply will automatically be directed only to the station calling you. Touch bar can be locked in "talk" position for continuous dictation without further operation of controls.

Stock No.	Type	Capacity	Wt.	List	NET
93 RX 290	ACS-7604	4 stations	16 lbs.	160.00	94.00
93 RX 291	ACS-7610	10 stations	16 lbs.	177.00	104.00
93 RX 292	ACS-7620	20 stations	17 lbs.	199.00	117.00
93 RX 293	ACS-7630	30 stations	18 lbs.	221.00	130.00

STAFF STATIONS AND POWER SUPPLIES

Use the new Model ACS-7701 staff and ACS-7601 staff station for either Series 7700 automation voice control Masters; or for Series 7600 touch control Masters. Staffs can reply, but cannot originate calls. Systems using 10-station masters—use 1 ACS-77; systems with 20-station masters—use 1 ACS-77A; systems with 30-station masters—use 2 ACS-77A. Note: An additional power supply is required for each station more than 500 feet from a power supply.

Stock No.	Type	Description	Wt.	List	EACH
93 RX 286	ACS-7701	7700 series staff	8 lbs.	\$167.00	98.00
93 RX 287	ACS-7601	7600 series staff	8 lbs.	108.00	63.50
93 RX 288	ACS-77	Up to 10 sta. supply	11 lbs.	51.00	29.95
93 RX 289	ACS-77A	Up to 20 sta. supply	12 lbs.	66.00	39.00

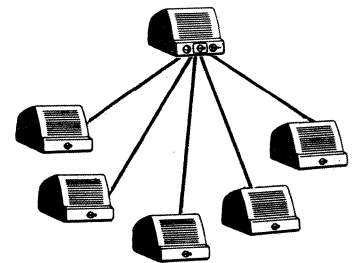
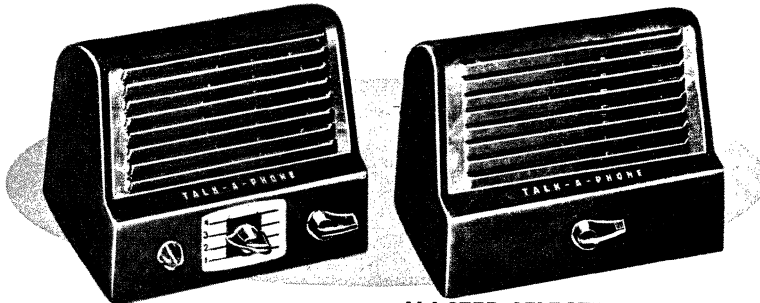

MASTER-SELECTIVE SYSTEMS

Ideal choice for a completely centralized intercom system—these Master-Selective systems provide efficient, low-cost intercommunication between a single Master and up to 10 Subs. *Only one Master station can be used in this system.* Master can select a single Sub at a time, for private conversation, or call all Subs simultaneously. Any Sub can call the Master, but cannot talk to other Subs. (See functional diagram.) System cuts out sounds from Subs when not in use, yet Subs can still call Master. Connection can be "non-private" to permit persons at Subs to answer from 50 ft. away, or "private" to require operation of Sub's Talk-Listen switch. Subs can be located as far as 2000 ft. from Master and are not connected to power line.

STANDARD SYSTEMS. For 110-120 v., AC or DC.

Stock No.	Type	Description	List	NET
95 RX 870	LM-5	Master for up to 5 Subs	\$49.95	29.35
95 RX 869	LM-10	Master for up to 10 Subs	65.00	38.20
95 RX 871	LR-3	Sub for LM-5, LM-10	16.95	9.95
95 R 846	LR-3M	Metal Sub for LM-5, LM-10	16.95	9.95

HIGH-OUTPUT SYSTEMS. For 110-120 volts, 50-60 cycle AC only.

95 RX 807	AC-5406	Master for up to 5 Subs	\$65.00	38.20
95 RX 808	AC-5411	Master for up to 10 Subs	79.95	47.00
95 RX 838	AR-3	Sub for AC-5406 or 5411	17.95	10.50
95 R 839	AR-3M	Metal Sub for AC-5406-11	17.95	10.50

CABLE REQUIREMENTS. Measure from Master Station to each Sub-Station, and total. Use 3-conductor, Type 5303 cable.

49 W 604, Type 5303 Cable, Wt., per 100', 3 lbs. Per Foot..... 3c

Standard Masters provide adequate volume for systems in average locations. For noisy locations, select High-Output Masters and Subs. All stations are supplied in attractive walnut-color bakelite cabinets; size, 8¼x6¼x7½", except LR-3M and AR-3M Subs in brown, rectangular metal cabinets, 7x5¼x3½". Metal cabinets may be wall-mounted. Shpg. wts.: Masters, 7 lbs.; all bakelite Subs, 5 lbs.; all metal Subs, 3 lbs.

Depend on Allied for All Your Intercom Needs



TALK-A-PHONE

HOME INTERCOM & RADIO SYSTEM

ALL-TRANSISTORIZED CIRCUITRY

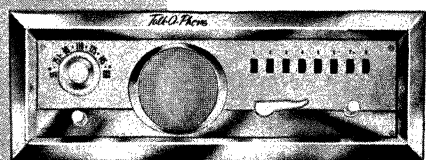

HI-9R



HI-9R
With HI-SM



HI-2

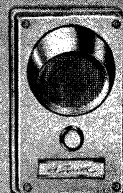

HI-1

MASTER AND STAFF STATIONS

New, all-transistorized home intercom. Up to 8 stations in a system. Each system requires one Central Master, and either one 4F6H 9-volt battery or one HI-PS AC power supply. Any Master or Staff can originate calls to any other station. Masters or Staffs also can monitor any Staff or Sub-Station which is switched to the "nursery" operation—a valuable feature for "listening in" on the nursery or sick room. All Master and Staff stations have 15¼x5¼" panel finished in gold and satin-silver—plus plating ring for in-wall mounting; may be placed on table-top or shelf, or hung from an overhead cabinet, if desired, by using HI-SM housing assembly.

MODEL HI-9R CENTRAL MASTER STATION. All-transistor circuit with 3 audio stages with push-pull output. Shpg. wt., 7 lbs.
93 RX 241. List, \$99.50. NET..... **58.00**

MODEL HI-9R CENTRAL MASTER STATION. Same as Model HI-9, but with built-in AM radio. Staffs or Indoor Subs can listen to radio whether or not Central Station is listening in. Wt., 8 lbs.
93 RX 242. List, \$154.00 NET..... **89.50**

MODEL HI-29R ADDITIONAL MASTER STATION. For rooms where "personal" radio facilities are desired. Identical to Central Master, but cannot listen-in on radio of HI-9R. May be used in addition to Central Master and in place of Staff or Sub-Stations. Has built-in radio. Shpg. wt., 8 lbs.
93 RX 243. List, \$154.00 NET..... **89.50**

MODEL HI-8 STAFF STATION. Has switch for "private" or "non-private" operation. Shpg. wt., 7 lbs.
93 RX 244. List, \$54.00. NET..... **31.50**

SUB-STATIONS AND SYSTEM ACCESSORIES

Indoor and Outdoor Sub-Stations can receive calls from and reply to any Master or Staff, but cannot originate calls. Indoor Subs can switch to "private" or "non-private." Outdoor Subs are "non-private" only; have push-button for connection to home chimes or buzzer, plus illuminated name-plate. Both types of Subs require 2" square x 2" deep opening for in-wall mounting. Polished gold and satin silver.

No.	Type	Description	Size	Wt.	List	NET
93 R 245	HI-1	Outdoor Sub	5¾x3¾"	1½ lbs.	\$27.50	15.95
93 R 246	HI-2	Indoor Sub	5¾x3¾"	1½ lbs.	27.50	15.95
93 R 247	HI-SM	Housing Assembly	6x15½x4"	2½ lbs.	19.00	11.00
93 R 248	HI-JB	Junction Box	1¾x8¾x8¾"	1 lb.	7.00	4.00
93 R 249	HI-PS	AC Power Supply	3x5x2"	5 lbs.	27.50	15.95
53 J 033	4F6H	9 v. Burgess Battery	8½x4x5½"	9 lbs.	6.45	4.30

CABLE REQUIREMENTS. Masters and Staffs can be interconnected with or without the HI-JB junction box, above. **Cable for Masters and Staffs (without using HI-JB):** Measure from first unit to second, second to third, third to fourth, etc., then add up to determine total length. **Cable for Masters and Staffs (when using HI-JB):** Measure from each station to the junction box, then add up to determine total length. **Cable for Sub-Stations:** Measure from each Sub to nearest Master or Staff. **Cable for Battery or Power Supply:** Measure from battery or power supply to Central Master. Use Type 6224 cable for Masters and Staffs; 6206 for Indoor Subs; 6202 for Outdoor Subs and Battery or Power Supply.

49 W 608. Type 6224 Cable. Wt., per 100', 12 lbs. PER FT..... **28c**
49 W 621. Type 6202 Cable. Wt., per 100', 4 lbs. PER FT..... **3½c**
49 W 622. Type 6206 Cable. Wt., per 100', 3 lbs. PER FT..... **8½c**

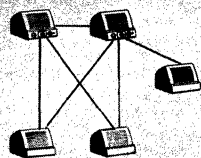

COMBINATION
PERFORMANCE
DIAGRAM



MASTER



SUB

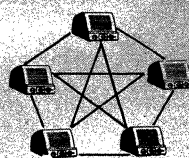

SUPER-SELECTIVE
PERFORMANCE
DIAGRAM

Low Cost-Intercommunication Systems

COMBINATION SYSTEM. Economical system that allows flexibility (see diagram above). Subs answer any Master, but do not originate calls. Both Masters and Subs can answer calls 40 feet from unit.

COMBINATION SYSTEM MASTERS. Choice of either 5-station or 10-station models. Masters have a rotary switch for selecting stations, volume control and Talk-Listen switch. Use a Master to originate calls to any Master or Sub in system. Walnut-color bakelite cabinets, 8¼x6¼x7½". U.L. Approved. For 110-120 volts, 50-60 cycles AC or DC. Type CL-5, 7 lbs; CL-10, 8½ lbs.

95 RX 842. 5-Station CL-5 Master. List, \$62.00. NET..... **36.40**
95 RX 843. 10-Station CL-10 Master. List, \$83.00. NET..... **48.80**

COMBINATION SYSTEM SUBS. Subs require no power and can be used anywhere. Use only with CL-5 and CL-10 Masters, above. Models LR-2 and LR-2M identical except, LR-2 cabinet of walnut bakelite, 8¼x6¼x7½"; LR-2M of brown metal, 7x5¾x3½".
95 RX 844. LR-2. 5 lbs. List \$15.95. NET..... **9.35**
95 R 847. LR-2M (Metal). 3 lbs. List, \$15.95. EACH..... **9.35**

CABLE REQUIREMENTS. For inter-connecting Masters, use Type 6212 cable for CL-5 Masters, 6224 cable for CL-10 Masters. Measure from first Master to 2nd Master only, 2nd to 3rd only, etc. For subs use Type 6902 cable, and measure from each Sub to nearest Master only.

49 W 606. Type 6212 Cable. Wt., per 100', 6 lbs. PER FT..... **14c**
49 W 608. Type 6224 Cable. Wt., per 100' 12 lbs. PER FT..... **28c**
49 W 613. Type 6902. Cable. Wt., per 100', ¾ lb. PER FT..... **2c**

SUPER-SELECTIVE SYSTEM. An unusually versatile, low-cost intercommunication system offering complete privacy and crisp, highly intelligible voice reproduction. Consists entirely of Master station units, allowing separate two-way conversations to be carried on simultaneously without cross-talk. (See performance diagram above.) Excellent choice to meet the growing intercom requirements of industry, offices, stores, homes, etc. System can be started with as few as 2 Masters and can easily be expanded up to 10 Masters. No Sub-Stations can be used in a Super-Selective system. System is designed for "private" operation only.

Any Master may talk to any other Master Station with absolute privacy. Masters may call one another whether or not station being called has power "on." Silencing feature eliminates all sound pickup when stations are not in use. Up to 2,000 ft. cable may be used between stations. Walnut color bakelite cabinet, 8¼x6¼x7½". For 110-120 volt, AC or DC. Shpg. wt., 7 lbs.

CHOICE OF MASTERS. For a maximum of 5 stations, use Type LS-5 Masters. For up to 10 stations, use Type LS-10 Masters.
95 RX 875. LS-5 MASTER. List, \$49.95. NET..... **29.35**
95 RX 874. LS-10 MASTER. List, \$65.00. NET..... **38.20**

CABLE REQUIREMENTS. For LS-5 Masters, use Type 5506 6-conductor cable. For LS-10 use Type 9911 11-conductor cable. Measure from 1st Master to 2nd only, 2nd to 3rd only, etc.

49 W 605. Type 5506 Cable. Wt., per 100', 4 lbs. PER FT..... **7½c**
49 W 603. Type 9911 Cable. Wt., per 100', 12 lbs. PER FT..... **14c**



R16

Bogen

INTERCOMMUNICATION AND MUSIC SYSTEMS

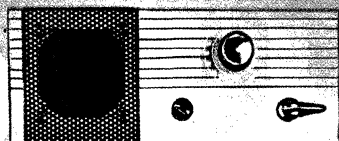

FC-2



F2



F3



FR-5

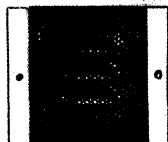

FR-4

"MUSIC MONITOR" INTERCOM

Excellent home radio-intercom system for built-in installation. Accommodates up to 6 rooms (1 Master and 5 Subs). Master offers choice of 4 functions: *Radio*, distributes program to all desired Subs; *Radio-Listen* allows monitoring any station by Master or Subs (while enjoying radio); *Listen*, for monitoring without radio on; *Talk*, to allow Master to talk to selected Subs. Indoor Subs can monitor or talk to each other, by arrangement with Master. Outdoor Subs, for entrance or patio, can be monitored by any indoor station and can reply when called. Only Master is connected to power line for distribution of audio power to Subs.

MODEL R16 MASTER STATION. Includes complete 6-tube superhet radio for AM reception. Controls: Tuning, Radio-Volume, Intercom-Volume, Function Selector. Has 6 station-selector switches. 4 3/4 x 15 1/2 x 3 3/4". For 110-120 v., 60 cycle AC. Wt., 8 1/2 lbs.
95 RX 955. List, \$79.95. NET..... **59.95**

MODEL F2 INDOOR SUB. With multi-purpose Function Selector (Monitor, Normal, Call) and Privacy Switch. Size, 4 3/4 x 9 1/2 x 2 1/2". Requires no power. Shpg. wt., 2 1/2 lbs.
95 R 956. List, \$11.95. NET..... **8.95**

MODEL F3 OUTDOOR SUB. No controls; needs no power. Size, 5 7/8 x 4 3/4 x 1 5/8". Shpg. wt., 2 lbs.
95 R 957. List, \$10.75. NET..... **8.05**

CABLE REQUIREMENTS. Measure from Master to each Sub. Use 4-conductor cable to indoor Subs, 2-conductor to outdoor Subs.

48 W 891. 4-conductor. Wt., per 100' 3 1/2 lbs. Per 100 ft.,..... **2.89**
48 W 890. 2-conductor. Wt., per 100' 3 lbs. Per 100 ft.,..... **1.76**

NEW "HOME COMMUNO-PHONE" SYSTEM

Versatile home intercom for in-wall mounting. For up to 10 stations (up to 6 Control Stations; up to 4 Remotes). Control Stations have 3 controls: Volume; lever for "talk", "listen" or "talk-listen"; 11-position switch that simultaneously selects stations and switches power supply from "standby" to "operate"—system uses practically no power when not in actual use. Remotes can reply, but not originate calls. FR-5 Remote has push-button for doorbell. Rear boxes keep out dust, dirt. Each system requires a PS-1LB Power Supply/Amplifier. For 110-120 v., 60 cycle AC. *Panel h. & w. of units.

No.	Type	Description	Size	Lbs.	NET
93R261	FC-2	Control Station	4 1/2 x 11 1/2"*	2 1/4	15.45
93R262	FR-4	Indoor Remote	4 1/2 x 5 1/2"*	1 1/2	7.20
93R263	FR-5	Outdoor Remote	4 1/2 x 5 1/2"*	1 1/2	8.10
93R264	PS1LB	Power Sup. & Amp.	10 x 10"*	6	30.90
93R266	RBPB	Rear Box for PS1LB	8 x 8 x 4"	5	4.50
93R267	RBFC2	Rear Box for FC-2	3 1/4 x 10 3/4 x 3 3/4"	1 1/2	2.91
93R268	RBR	Rear Box for FR-4, 5	3 3/4 x 4 3/4 x 2 1/8"	3/4	2.06

CABLE REQUIREMENTS. Measure from Control to Control and total (no need to wire last Control to first Control). *Lbs. per 100'.

No.	Pairs	Cable Application	Wt.*	Per Ft.	100-Ft.
48 W 898	11	Control-to-Control, 1 to 5 stations	8	13c	10.88
48 W 895	15	Control-to-Control, 6 to 10 stations	10	17c	14.21
48 W 890	1	Remote to nearest Control	1 3/4	2c	1.76
48 W 892	3	Power Supply to nearest Control	3 1/2	5c	3.82

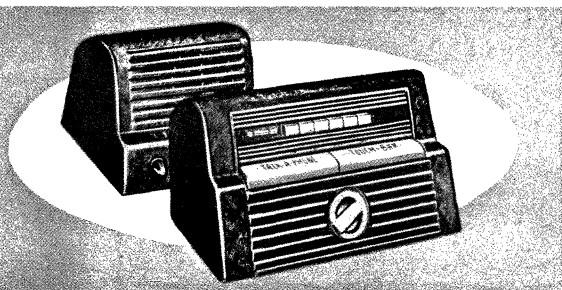

Talk-A-Phone Wireless Intercoms

Choice of deluxe selective and non-selective systems. Both feature "Uni-Trans" switch-lock to permit continuous transmission. In bakelite cabinets. U.L. Approved. Each station plugs into 110-120 volts AC or DC—no wiring needed between stations.
NON-SELECTIVE SYSTEMS. Every station hears all calls. Any number of stations can be used. Size, 7 1/2 x 8 1/4 x 6 1/4".

TWO STATION SYSTEMS. Walnut or executive gray. 14 lbs.
95 RX 821. LC-33. Walnut. List, \$120.00. NET PER PR..... **69.95**
95 RX 822. LC-33G. Gray. List, \$126.00. NET PER PR..... **73.55**

ADDITIONAL STATIONS. Walnut or executive gray. 7 lbs.
95 RX 823. LC-17. Walnut. List, \$60.00. NET..... **35.00**
95 RX 824. LC-17G. Gray. List, \$63.00. NET..... **36.80**

SELECTIVE SYSTEMS. Selective operation on up to 6 channels—or any number of stations can be used by sharing channels. Auxiliary stations operate on 1 fixed channel only (cannot originate calls to master; can call another Auxiliary on same channel.)

6-CHANNEL MASTERS. Type LCM-8806. 7x12x9". 12 1/2 lbs.
95 RX 826. Walnut. List, \$122.50. NET..... **72.00**
95 RX 827. Gray. List, \$127.50. NET..... **74.70**

SINGLE-CHANNEL AUXILIARIES. Walnut. 7 1/2 x 8 1/4 x 6 1/4". 7 lbs.
95 RX 828. LCS-801. Channel 1. **95 RX 832.** LCS-804. Channel 4.
95 RX 829. LCS-802. Channel 2. **95 RX 833.** LCS-805. Channel 5.
95 RX 831. LCS-803. Channel 3. **95 RX 834.** LCS-806. Channel 6.
 List, \$66.00. NET PER STATION..... **38.80**

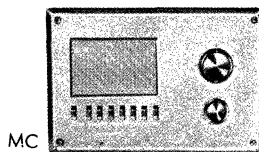

MC

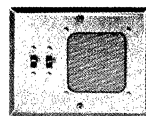

BC

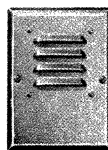

BD

FANON "MUSI-TALK" INTERCOM

New, moderately-priced home radio-intercom. Attractive, functional styling. For in-wall mounting. Economical to operate; easy to install. Masters and Remotes have a 3 1/2" speaker with an Alnico V magnet and 13 ohm voice coil. U.L. Approved. With instructions.

MODEL MC MASTER CONTROL. Has built-in 6-tube AM radio employing a printed circuit. Can accommodate up to 6 Remotes. Separate controls permit over-riding of music with conversation. A neon pilot light indicates when "On". In brushed copper with contrasting speaker grille. 10 3/4 x 7". Shpg. wt., 9 lbs.
93 R 251. List, \$89.95. NET..... **54.00**

MODEL BD DOOR REMOTE. Answers, but cannot originate calls. With weatherproof rubber gasket. 5x5". Wt., 1 1/2 lbs.
93 R 252. List, \$9.95. NET..... **5.97**

MODEL BC INDOOR REMOTE. Can originate a call to the Master or any other Remote. Receives any broadcast "piped-in" by Master. Finished in copper. 4 1/2 x 6". Shpg. wt., 1 1/2 lbs.
93 R 253. List, 11.25. NET..... **6.75**

MODEL BJ INDOOR REMOTE. Same as Model BC, above, but has jack and matching transformer. Permits hi-fi or FM to be "piped" to any or all indoor remotes—merely plug output of phono or tuner into provided jack. Shpg. wt., 1 1/2 lbs.
93 R 254. List, \$15.95. NET..... **9.60**

CABLE REQUIREMENTS. Measure from Master to Indoor Remote, from Remote to next Remote, etc., and total.

48 W 890. 2-Conductor. MC to BD. Wt., 1 3/4 lbs. Per 100'..... **1.76**
47 T 360. 3-Conductor. MC to BC or BJ. 2 lbs. Per 100'..... **2.43**

SOUND-POWERED TELEPHONES

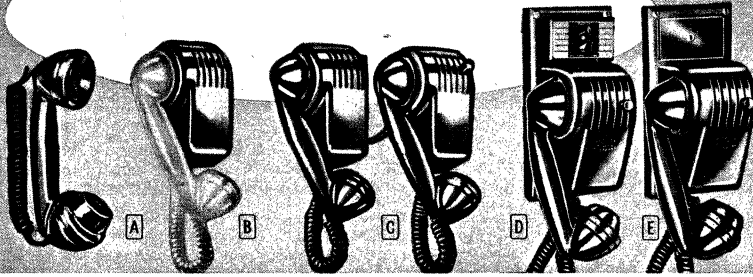

Wheeler Sound-Powered Telephones and Systems

An excellent selection of self-contained, sound-powered telephones and systems. All units provide communication over distances to 20 miles—without batteries or other outside power. Current for transmission is generated by the voice; bell-ringing current is generated by bell-ringing lever. Less cable. See cable listing in right hand column.

INDIVIDUAL HANDSETS AND HOLDERS

A MODEL SPT-102 HANDSET. Self-contained telephone handset. Voice generates needed power—requires no batteries or supply line voltage. Up to 12 units may be connected in parallel. Supplied with 3/2-ft. cable and clips, less wire. Uses 2-conductor, twisted-pair wire. Shpg. wt., 1 1/2 lbs.
59 R 350. List, \$13.75. NET EACH... 9.62

A MODEL SPT-123 HI-LEVEL HANDSET. Same as above, but extra sensitive. For use where background noise is high.
59 R 360. List, \$15.40. NET... 10.78

A MODEL SPT-150. Same as SPT-123 but with insulated clips.
59 R 361. List, \$16.00. NET... 11.20

B MODEL F-5308 HANDSET HOLDER. Wall mount handset holder with switch hook and terminal board for SPT-102, SPT-150 and SPT-123 handsets. For installations where separate ringing systems are to be used. 2 7/8x5 3/4x3 3/4. 1 1/2 lbs.
59 R 355. List, \$14.00. NET... 8.40

MODEL F-4182 HANDSET HOLDER WITH BELL. Same as F-5308, above, but includes bell. Has lever to ring bell at other end of line. Up to 3 may be used in a common ringing system. Shpg. wt., 1 1/2 lbs.
59 R 356. List, \$19.48. NET EACH... 11.69

MODEL B-5446 HANDSET HOOK. Not illus. Fastens to wall, side-of-desk, etc. 3 oz.
59 R 420. List, \$1.50. NET... 1.18

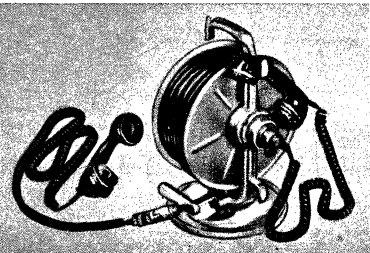

WHEELER PORTABLE PHONE UNIT

MODEL SPS-600 "COMMUNIPAK." Self-contained, sound-powered, portable reel-type communication package. Specially designed for use by Civilian Defense, emergency and radio-TV service crews. Requires no batteries or outside power supply. Provides clear speech reproduction; overcomes almost any background noise.

Withstands extremely rough handling—practically impervious to fumes and humidity. User can carry on conversation while cable is being strung out. Complete "Communipak" consists of 2 Wheeler sound-powered Hi-Level telephone handsets, each with 4-ft. neoprene retractable coil-cord and locking-type receptacles; 250 ft. of 2-conductor heavy-duty neoprene cable; special reel with knob handle for re-winding. Height, 21". Shpg. wt., 30 lbs.
59 RZ 363. List, \$166.00. NET... 99.60

TELEPHONES FOR MULTI-SERVICE SYSTEMS

All-Master System: Consists of up to 12 SPS-205-MI masters. Any can ring and communicate with any other master, or up to 6 may be used on a conference basis.
Master-Sub System: Consists of 1 SPS-205-MI and up to 11 SPS-205-SI subs. The master can ring and communicate with any sub; subs can ring and communicate with the master directly and can reach other subs by having the master ring the desired sub. Up to 6 stations may be used for conference. **Cable Requirements:** All-Master system, 2 common wires and 1 additional wire for each station; measure from 1st to 2nd, 2nd to 3rd, etc. Master-Sub System, 3 common wires, and 1 wire from each sub to the master. Wt., 5 lbs., each station.

Stock No.	Mfr's. Type	Fig.	List	NET
59 R 353	SPS-205-MI (Master)	D	61.60	36.96
59 R 354	SPS-205-SI (Sub)	E	52.25	31.35

2 & 3-PHONE SYSTEMS

C SERIES SPS. Each has lever for ringing bell at other end. Type 205-H similar to 205, but delivers higher voice level. Use 2-conductor wire for Types 205 and 205-3; 3-conductor for Type 205-H.

Stock No.	Mfr's. Type	Phones	Wt., Lbs.	List	Per System
59 R 351	205	2	7	73.15	43.89
59 RX 352	205-3	3	10	101.70	65.83
59 R 362	205-H	2	7	86.00	51.60

Bogen Telephones

New, deluxe phones for use in office, plant or home. Have push-button, selective ringing with a common-talk line (allows only one conversation at a time). Merely press button for desired station. Can be easily mounted on wall or desk. Handsomely styled in gray plastic. 9 1/2x3 1/4x3 1/4". Less cable and power supply. **Cable Requirements:** 3-conductors plus an additional conductor for each station used.

F MODEL TP-1 2-PHONE SYSTEM. Supplied with 4-ft. snarl-proof cord. Shpg. wt., 9 lbs.
93 R 256. List, \$49.95. NET PER PAIR 37.45

MODEL TP-6 PHONE. For up to 7-station systems. Shpg. wt., 5 lbs.
93 R 257. List, \$27.95. NET EACH 20.95

MODEL TP-12 PHONE. For up to 13-station systems. Shpg. wt., 5 lbs.
93 R 258. List, \$29.95. NET EACH 22.45

MODEL PRS-1. Power supply for Bogen phone systems (including TP-1); use one to a system. Plugs into any phone. For 110-120 v., 60 cycle AC. 4 lbs.
93 R 259. List, \$22.50. NET... 16.85

RECOMMENDED PHONE CABLES

Ideal cable for both indoor and outdoor use with Wheeler and Bogen telephones.

Stock No.	Cond.	Lbs., 100'	Per Ft.	Per 100'
48W 826	2	3	4¢	3.38
48W 825	3	4	5 1/2¢	5.08
48W 892	6	3 1/2	5¢	3.82
48W 893	12	6	7¢	5.44
48W 894	18	6 1/4	9¢	7.79

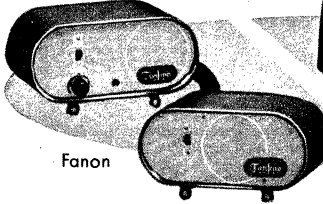

Fanon

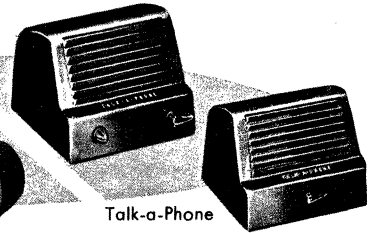

Talk-a-Phone

FANON 2-STATION INTERCOM

MODEL TWIN FX-2. Here's the height of convenience in a 2-station intercom. Combines outstanding performance and decorator styling—all at an unusually low price. Provides intercommunication between any 2 points—even serves as a baby sitter! Includes Master station, Sub-station and 50 ft. of cable (more can be added). Master connects to any AC or DC 110-volt outlet. Sub needs no power and can be placed anywhere. If desired, Sub can answer calls from a distance, without operating Talk-Listen switch. In steel cabinet with modern gray finish; contrasting front panel of white perforated metal. Underwriters' Laboratories Approved. Size, 8x4x4". Shpg. wt., 6 lbs.
95 RX 914. NET... 18.37

MODEL FS EXTRA SUB. Use 3-cond. cable to Master. Wt., 2 lbs.
94 R 923. NET... 7.35

TALK-A-PHONE 2-STATION INTERCOM

Provides voice communication between any two points in the home, farm, professional office, store, or other locations. Consists of one Master unit, a Substation, and fifty feet of cable. Up to 2000 feet of cable can be used. When connected "privately" the Master unit cannot listen in on the Substation. Either station may originate calls. When connected "non-privately" the Master station can listen in on the Substation. Master unit has a volume control. For operation from 110-120 volt AC-DC. U.L. Approved. Size, 8 1/4x6 1/4x7 1/2". Shpg. wt., 11 lbs.

LC-2. 2-STATION SYSTEM. Walnut.
95 RX 840. List, \$51.00. NET... 29.95

LC-2G. 2-STATION SYSTEM. Gray.
95 RX 857. List, \$57.00. NET... 33.55

TYPE 5303. Extra 3-conductor cable.
49 W 604. Wt., 100', 4 lbs. Per Ft... 3c

Allied is Headquarters for Intercom Equipment

PHOTOELECTRIC SYSTEMS FOR INDUSTRY

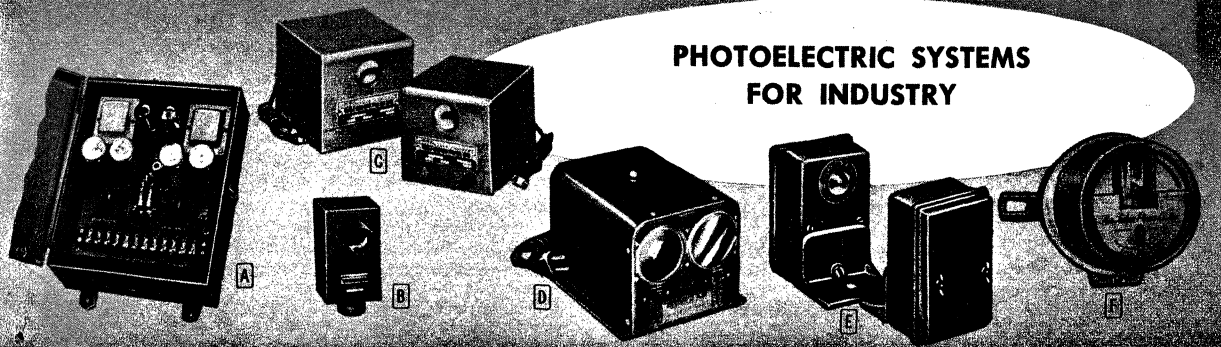

WORNER "FOTOELECTRIC" SYSTEM

The system consists of Model 63 Electronically Operated Relay, Model 33 Exciter Lamp and Model 23 Photo-cell Receiver. Model 33 has general-purpose (interchangeable) lens which provides a straight directional beam; may be placed up to 15 feet from Model 23 to detect objects of about 4" square or larger. Both exciter lamp and photo-cell units are housed in identical heavy-duty solid cast-metal case to withstand dampness. Lenses for specific applications are available on special order.

A MODEL 63 ELECTRONICALLY OPERATED DPDT RELAY. Responds to current from photocell. Contacts rated at 5 amps, non-inductive; 2 amps inductive at 110 v., 50-60 cycle AC. Operates up to 600 times per minute on complete or partial change of light intensity. Steel case, 9 1/4 x 11 1/2 x 5 1/2". For operation from 110-120 v., 50-60 cycle AC. Shpg. wt., 22 lbs.
77 PZ 085. NET..... 91.87

B MODEL 33 EXCITER LAMP. Light source. Projects beam 15 feet. Gray cast-iron case. Size, 4 1/4 x 2 3/4 x 2 3/4". For 6 v. operation. Takes power from Model 63 relay. Shpg. wt., 3 lbs.
77 P 087. NET..... 14.11

MODEL 23 PHOTO-CELL RECEIVER. Housed in same type of case as Model 33. Shpg. wt., 3 lbs.
77 P 090. NET..... 18.08

DETECT-O-RAY EQUIPMENT

D MODEL L-162C PHOTOELECTRIC SWITCH. Universal photoelectric system useful as an "unseen light" burglar alarm, counter, sorter, annunciator; for motor and safety control, etc. Housed in a single small case, only 5 x 6 1/4 x 7 1/2". Includes: Light which projects a conventional beam; a filter controlled by a lever which can be shifted to the front of the light if an "unseen" beam is desired; a photo-cell receiver; an amplifier, and a relay capable of actuating an alarm or similar device. Also built into the case is a switch to permit choice of intermittent or continuous operation of the actuated device. System is installed on one side of an area to be controlled, and an adjustable mirror (included) is installed on the opposite side. Range: 50 feet, white beam; 35 feet, "unseen" beam. Black wrinkle case. Terminals for any 5 or 6 volt AC device using up to 3/4 amp, or for the heavy-duty relay listed below. For 110-120 v., 50-60 cycle AC. Indoor use only. Shpg. wt., 7 lbs.
77 P 060. NET..... 38.86

MODEL L-205C POWER RELAY. (Not illustrated.) For use with above when operating heavy-duty equipment that draws up to 1,000 watts on 110 volts AC. SPDT, 110 v., 60 cycle AC switch with convenience outlets for normally on or normally off functions. Steel case. Black crackle finish. 1 1/4 x 2 1/2 x 2 1/2". Shpg. wt., 1 1/4 lbs.
77 P 061. NET..... 10.81

WORNER MODEL 4000 WATCHMAN

C An economical indoor alarm system. For the home, office, garage, warehouse, workshop, etc. An invisible light beam fully protects the area to be covered. Consists of matching exciter lamp unit and electronically operated relay. A built-in power supply provides 6 volts AC—any type of electrical alarm can be used with the relay unit. Toggle switch permits choice of continuous or intermittent alarm operation; also serves as reset switch if continuous alarm is used. Exciter lamp unit has 2 pre-focused f6 lenses for maximum light dispersion; infra-red filter to provide "unseen" beam. Range: 35 feet. Both units are in attractive hammerloid cases. Size, 5x5x 5 1/2". For 110-120 v., 50-60 cycle AC. Shpg. wt., 14 lbs.
77 PX 232. NET..... 47.04

AUTOTRON MODEL SIA-11A COUNTING EYE

E For industrial counting. Consists of light source and photoelectric control housed in rugged cast-aluminum cases. Light source is placed at one side of conveyor or passage and photoelectric control is mounted directly opposite (up to 6 feet apart). When used with electric counter (p. 196) will count anything intercepting beam. Provides dependable performance under continuous duty at high speeds. Built to heavy-duty industrial standards, these units feature splashproof and dustproof enclosures, rubber-based tube sockets, and fully adjustable mounting brackets. Has a smooth-functioning SPDT relay; contacts rated at 5 amps, 115 v. AC. Each case, 5x3 1/4 x 3". For operation from 115/230 volts, 50-60 cycle AC. Shpg. wt., 6 lbs.
77 P 079. NET..... 53.05

FISHER-PIERCE 63305-C BEACON LIGHT CONTROL

F High-quality light control unit. Expertly engineered to provide extremely dependable control of many different types of outdoor lighting systems, including aircraft obstruction lights. Turns lighting systems on or off when outdoor light intensity changes. Has delay of 7-10 seconds to prevent actuation by lightning, rotating beacons, or any short duration light source. SPST double-break contactor. Controls up to 3000 watts. Rating applies to incandescent, mercury or sodium vapor lights. Tested for an inrush current to steady state current ratio of 10 to 1. Turns on lights at 35 foot-candles and off at 55 foot-candles. Meets CAA requirements. Turn-on point is adjustable from 25-55 foot-candles. Turn-off is 20 foot-candles higher. Lights remain on in event of circuit failure. 8 1/4" mtg. ctrs.; 6 1/16" deep. For 105-130 v., 50-60 cycle AC. Shpg. wt., 9 1/2 lbs.
77 P 048. NET..... 53.90

FISHER-PIERCE MODEL 63300C STREET LIGHT CONTROL. Similar to above, but turns on light at 0.5 to 5.0 foot-candles and has SPDT double-break contactor. Rated 2000 watts normally open; 3000 watts, normally closed. Turn-off point 1.0 foot-candle above turn-on. Shpg. wt., 9 1/2 lbs.
77 P 054. NET..... 50.96

PHOTOELECTRIC EQUIPMENT—DESIGNED FOR THE HOME

FISHER-PIERCE NIGHTLIGHTER

Unusually economical, smooth-operating photo-electric switch. Turns electric lights on or off, depending on amount of daylight striking photocell. Simple installation—just plug into outlet and plug lights into control unit. Perfect for store windows, porch lights, outdoor signs, etc. Turns lights on as darkness approaches, turns them off at dawn. Excellent for burglary protection during vacation periods. Not a time switch—responds to light alone. Completely automatic—no need to set or reset. Nightlighter is housed in attractive sturdy brown bakelite case. Has convenient bracket for flat surface mounting if desired. Capacity, 300 watts. Complete with 8-ft. cord set with adapter plug. For interior use only. Size: 3 1/2 x 4 1/2 x 3 1/2". For operation from 110-120 v., 60 cycle AC. Shpg. wt., 3 lbs.
77 P 235. List. \$15.95. NET..... 10.94

WORNER "FOTOELECTRIC" ANNOUNCER

MODEL 61. Chime announces people or vehicles when light beam is intercepted. Consists of "Fotoelectric" unit, mirror and chime. Unit has exciter lamp and sensitive photo-cell. Projects beam across passage and receives reflected beam from mirror; may be placed 3 to 10 feet from mirror. Size, 10 3/4 x 7 1/2 x 2 3/4". For 110-120 volts, 50-60 cycle AC. Wt., 8 lbs.
77 P 028. NET..... 28.52

REPLACEMENT BULB. 32-candlepower, 2000-hour 6-volt bulb. For Models 33 (above left) and 61 (above). Shpg. wt., 5 oz.
77 P 023. NET..... 60c

REPLACEMENT CHIME. For Model 61. May also be used with any other 6-volt AC power supply. Excellent warning device for home or store. Shpg. wt., 2 lbs.
77 P 035. NET..... 2.58



Perma-Power

ELECTRONIC GARAGE DOOR OPENER

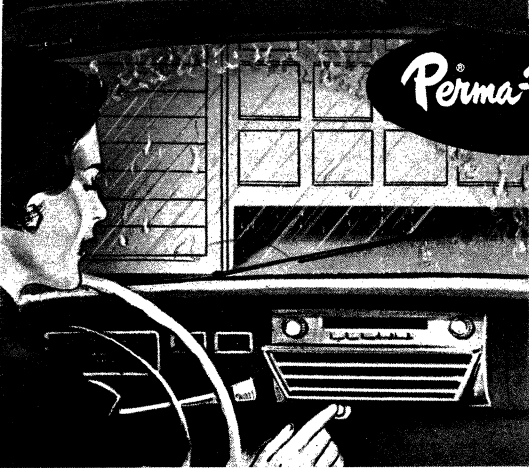

Automatically Opens and Closes Garage Doors from Interior of Any Car

\$154⁰⁰

- Automatic Shut-Off
- Large Overhead Light

Just touch a pushbutton on your car's dashboard—the garage door rolls up and the light goes on! Press pushbutton again to close and lock the door securely—or use the wall-mounted pushbutton at the garage exit. A tremendous convenience in bad weather—and it also offers protection for members of family coming home late at night. The transmitter sends out a signal when pushbutton on dash is pressed. Receiver in garage picks up signal, turns on the garage light and actuates the lifting mechanism. When pushbutton is pressed the second time, the motor reverses to close the door and lock it securely. Power shuts off automatically if obstruction blocks path of door travel. Door can be operated manually in event of power failure. Has thermal overload switch for complete electrical protection.

Transmitter operates from either 6 or 12-volt car battery. Crystal-controlled operation on FCC-authorized frequency of 27.255 mc. Receiver has only three tubes for low power drain and uses low-voltage (24-volt) control system. Handsome spun aluminum housing encloses motor mechanism. With 24-volt pushbutton and 22 ft. of wire to permit operation of door without radio control. Fits overhead, residential garage doors up to 18 ft. wide and 8 ft. high using a horizontal or curved roller track. Designed for use with either 1-piece or sectionalized doors. Clearance required between ceiling and high arc of door travel, only 2". All necessary parts and hardware are supplied—plus easy-to-follow instructions for quick, simplified installation. Mechanism and receiver operate from 110-120 volts, 50-60 cycle AC.

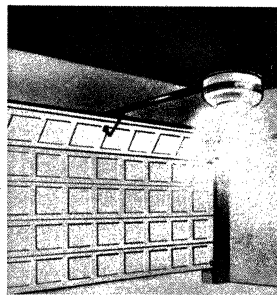
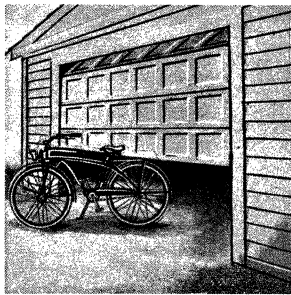

- Simple Push-Button Operation
- Easily Installed Without Special Tools
- Completely Automatic Safety Devices
- Supplied Complete—Nothing Else to Buy

System includes door mechanism, 1/2-hp motor, transmitter, receiver, antennas, manual pushbutton, overhead light, all hardware, tubes, wire, and instructions. Shpg. wt., 95 lbs.

77 SZ 290. List, \$220.00. NET..... 154.00

EXTRA TRANSMITTER. For 2-car families. Permits operation of system from either car. With antenna, mounting hardware, installation instructions, etc. Shpg. wt., 7 lbs.

77 SX 272. List, \$35.00. NET..... 24.50

COMPLETE ALTERNATE SYSTEM. Same as above system, but operates on another channel. For use where a neighbor already has a radio-controlled opener. Shpg. wt., 95 lbs.

77 SZ 295. List, \$220.00. NET..... 154.00

EXTRA TRANSMITTER FOR ABOVE. For a second car. 7 lbs.

77 SX 296. List, \$35.00. NET..... 24.50

KEY SWITCH. For either of above systems. Mount on garage wall or install on post in driveway. With 2 keys. Shpg. wt., 8 oz.

77 S 291. List, \$6.00. NET..... 4.20

DOOR OPENER MECHANISM ONLY

Door opener, less radio control. Has pushbutton, or may be operated with key switch above. Radio control may be added later (see below). For 110-120 v., 50-60 cycle AC. Shpg. wt., 85 lbs.

77 SZ 273. List, \$140.00. NET..... 98.00

RADIO CONTROL SYSTEM FOR INDUSTRIAL USE

- Efficient and Safe—Has Hundreds of Industrial Applications
- Transmitter Operates Over Distances in Excess of One Hundred Feet
- Perfect For Remote-Control Opening and Closing of Warehouse Doors, Etc.

Extremely versatile radio-control system only. Actually a radio-controlled switch, the unit consists of transmitter, receiver, antennas, cable and bracket, all hardware and instructions. It may be used to actuate any electrical device drawing up to 3 amps; or may be used with heavier-current devices by the addition of an auxiliary relay or relays. Uses for this system are limited only by the imagination!

Radio control provides greater safety, efficiency and operating economy. Eliminates use of cables where they may be difficult or expensive to install, or easily damaged. **Typical uses:** Operating any door or hatch in any type of plant; turning on areaway, parking store or porch lights; turning on landing lights and operating hangar doors from an incoming plane; turning on dock or harbor lights from a boat; operating warehouse doors from a forklift or runabout truck; opening and closing of furnace doors; etc. In addition, the radio-control system can be added to present electrically operated garage or plant doors.

Transmitter fully meets all FCC requirements. Employs an extremely stable, crystal-controlled, tone-modulated circuit. Operates from any 6 or 12-volt electrical system. Exceptionally compact, it is easily installed under the hood of a car or truck, or dashboard on panel of electric trucks, etc. Receiver operates from 100-120 volts, 50-60 cycle AC and includes a built-in relay rated at 3 amps at 115 volts. Built-in filter and delay network prevents accidental operation from other signals or electrical disturbances. Sturdy construction and of top-quality, conservatively rated components accounts for the exceptional reliability that users have achieved with this equipment. Size of transmitter and receiver, each: 4 1/2" high, 5 3/8" wide, 4 3/8" deep. Shpg. wt., 10 lbs.

77 SX 275. List, \$80.00. NET..... 56.00

Allied can also supply specialized, Perma-Power industrial radio-control equipment, including multi-channel transmitters to permit centralized radio-control of several operations. Write to Allied, giving full details of your requirements.

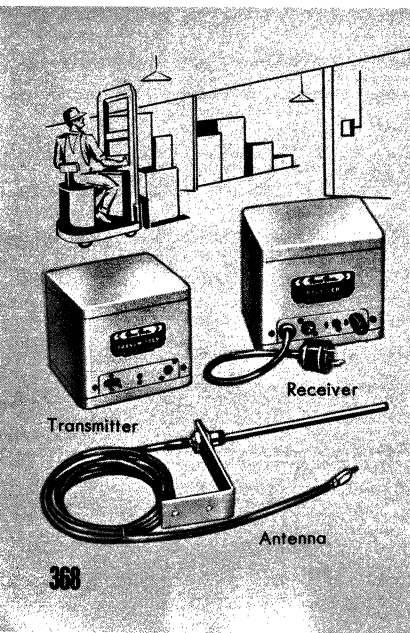

Select Your TV Antenna From Allied's Complete Top-Quality Lines

Allied carries the world's largest stocks of TV antennas and accessories. On this and the following pages (through page 390), you'll find a complete selection of antennas for every use—indoor or outdoor installation, VHF and UHF, metropolitan, suburban or remotest fringe area use—all providing equally fine reception for color and black-and-white television receivers. Complete selections from nationally-known manufacturers, at lowest prevailing market prices, assure you of full value.

WHEN SHOULD A TV ANTENNA BE REPLACED?

Often, poor picture quality is not the fault of the TV set, but of a weather-worn antenna. For this reason, antennas exposed to weather for an appreciable length of time should be considered for replacement. A new antenna, of latest design, often provides picture quality superior to the original. Depend on Allied for the best replacement antenna.

How to Select Your TV Antenna

Today, most VHF TV broadcasts (channels 2 through 13) can be received at distances up to 200 miles when the proper antenna is used. While antennas of many sizes and shapes are available, each can be classified in one of the 4 general groups listed below. To assist you in selecting an antenna for your particular location, the antennas on this page and the following pages have been identified with 1, 2, 3, or 4 stars to indicate their useful range as given below. When in doubt, select an antenna in the next higher group.

- ★ Metropolitan-Suburban (up to 35 miles).
- ★★ Semi-Fringe (up to 50 miles).
- ★★★ Fringe (up to 75 miles).
- ★★★★ Deep-Fringe (up to 200 miles).

Stacking two of the same type antennas will give up to 50% more signal strength. Stacking is recommended in installations located over 100 miles from the TV station. Obstructions such as tall buildings or hills near your location may necessitate stacking at distances less than 100 miles. *All of the TV antennas in this Catalog may be used for reception of black-and-white or color TV broadcasts.*

WORLD'S LARGEST SELECTION OF ANTENNAS & ACCESSORIES

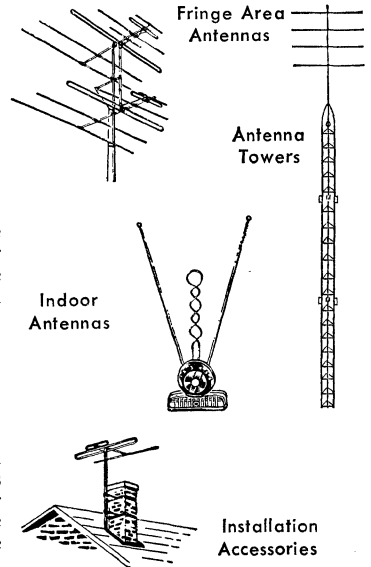

Easy-to-Install Fringe-Area TV Antenna Kits

★★★★ All-Channel's Super-Power "Riviera" UHF-VHF Antenna Kit

ONLY
\$35⁸⁸

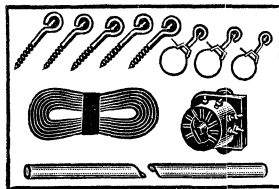

★★★★ Finney "Geomatic" B-8 Antenna Kit

ONLY
\$35⁸⁸

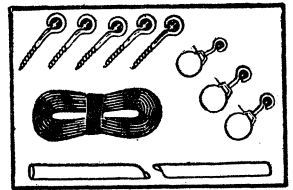

Everything You Need
Ready to Install

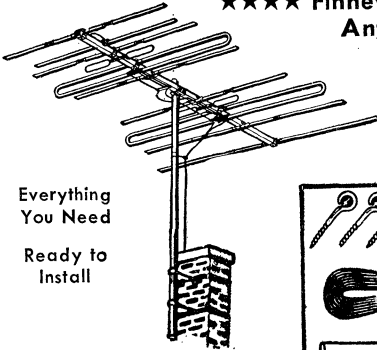
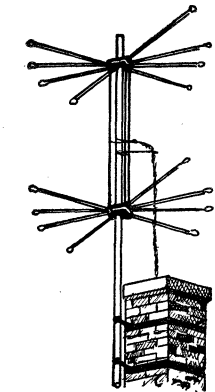

Famous "Riviera" all-directional antenna plus installation accessories. One of the finest for fringe areas where reception is possible from several different directions. Excellent signal-to-noise ratio. Construction utilizes 16 elements—each element of 1/2" aluminum tubing (with dowel inserts), 60" long. Solid aluminum stacking bars are 45" long. Triple-strength insulators. Features "electronic" rotation over 360° (without a motor-driven rotator) through use of a selector switch located at TV receiver. The 9-position switch allows selection of the proper set of elements that will feed the strongest signal into the TV set. Simply set switch on position that gives best reception on channel desired. Kit includes: Chimney mount; two 5-foot masts; 100 feet of 4-conductor lead-in cable; 8 standoff insulators. An outstanding value for VHF-UHF reception. Shpg. wt., 15 lbs. See page 377 for individual listing of All-Channel's "Riviera" antenna.
92 CZ 137. ONLY..... 35.88

Popular fringe-area TV antenna kit, complete with all installation accessories. Antenna is the famous Finney B-8 Geomatic, known for excellent reception in deep fringe areas. Features increased gain through the use of a combination of phased and parasitic elements. Directivity equals single channel yagis. Rugged box girder element brackets. Ideally suited for color reception. Kit also includes: Chimney mount; 5-ft. mast; 3 mast standoffs; 5 wall standoffs; and 100 feet of lead-in cable. Shpg. wt., 15 lbs. See page 376 for individual listing of the Finney B-8 antenna.
92 CZ 096. ONLY..... 35.88

MODEL A STACKING KIT. For stacking two B-8 antennas to give maximum high-band gain. Shpg. wt., 8 oz.
92 C 086. List, \$2.00. NET..... 1.18

MODEL C STACKING KIT. For stacking two B-8 antennas to give maximum low-band gain. Shpg. wt., 1 lb.
92 CX 087. List, \$3.00. NET..... 1.76

Allied's Fringe-Area Antenna Kits

Complete with Mast and All Installation Accessories
For Color and Black-and-White TV Reception
Completely Packaged—Ready for a Rugged, Efficient Installation

- Available with 20, 30 or 40-ft. Mast
- Rotator for Antenna Direction Control
- Complete with All Hardware
- Choice of 3 Famous-Make Antennas
- Detailed Installation Instructions
- Top Quality Throughout

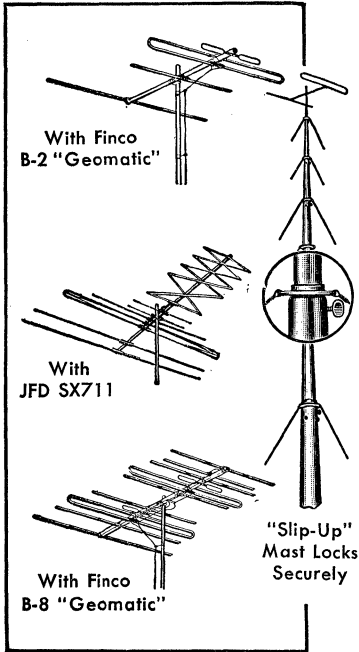

Complete with Installation Accessories

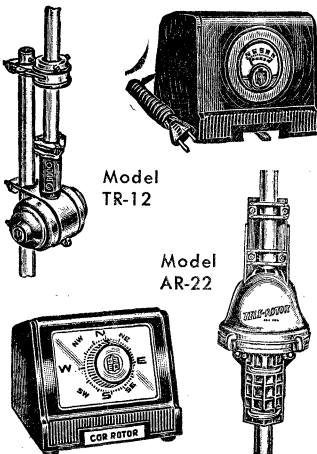
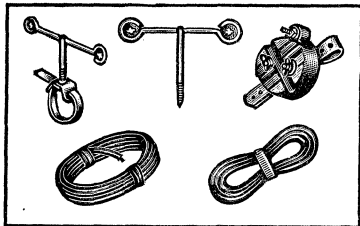

These deluxe, value-packed kits have been selected by Allied's antenna experts to meet practically any TV antenna requirement. Complete in every detail—there's nothing else to buy—and the package prices are actually less than the total cost of the components purchased individually. Provide outstanding fringe-area reception for color and black-and-white receivers.

CHOICE OF PACKAGES. Kits for "Semi-Fringe," "Fringe," and "Deep-Fringe" areas are listed with a choice of 20, 30 or 40-foot masts. The distance to TV stations determines which antenna to use, and local terrain (hills, trees, tall buildings, etc.) determines mast height. Rotator permits pointing antenna in any direction for excellent reception of any station. Meter on rotator control box indicates exact antenna direction.

All kits are complete with rugged, weather-resistant antenna; telescoping mast of heavy, galvanized steel; all-angle mast mount; guy wire; 100 ft. of twin line; 50 ft. of ground wire; ground rod; twin-line lightning arrester; guy wire hook-eyes; mast standoff insulators; woodscrew standoff insulators (plus 6 turnbuckles in 40-ft. antenna kits). Kits with rotator also include 10-ft. antenna mast; 100 ft. of rotator cable; and rotator cable lightning arrester. A complete set of instructions is supplied with each kit. Rotators are for 110-120 v., 60 cycle AC.

★★ SEMI-FRINGE ANTENNA KITS

KIT A-20. Includes two-section, 20-foot telescoping mast; Finco Model B-2 "Geomatic" TV antenna for clear, ghost-free reception on channels 2 to 13; exceptionally rugged, CDR Model TR-12 rotator; and accessories. Shpg. wt., 47 lbs.
92 CZ 175. NET..... 47.46

KIT A-20-L. As above, less rotator. Shpg. wt., 25 lbs.
92 CZ 153. NET..... 15.55

KIT A-30. Same as Kit A-20, but with 30-foot mast. Shpg. wt., 63 lbs.
92 CZ 176. NET..... 51.60

KIT A-30-L. As above, less rotator. Shpg. wt., 41 lbs.
92 CZ 154. NET..... 18.79

KIT A-40. Same as Kit A-20, but with 40-foot mast. Shpg. wt., 74 lbs.
92 CZ 177. NET..... 57.64

KIT A-40-L. As above, less rotator. Shpg. wt., 52 lbs.
92 CZ 157. NET..... 25.26

★★★ FRINGE ANTENNA KITS

KIT B-20. Includes two-section, 20-foot telescoping mast; extremely effective JFD Model SX711 TV antenna for channels 2 to 13; heavy-duty, fully automatic CDR Model AR-22 rotator; and all installation accessories. Shpg. wt., 50 lbs.
92 CZ 178. NET..... 62.84

KIT B-20-L. As above, less rotator. Shpg. wt., 26 lbs.
92 CZ 158. NET..... 26.22

KIT B-30. Same as Kit B-20, but with 30-foot mast. Shpg. wt., 66 lbs.
92 CZ 179. NET..... 66.98

KIT B-30-L. As above, less rotator. Shpg. wt., 42 lbs.
92 CZ 159. NET..... 29.94

KIT B-40. Same as Kit B-20, but with 40-foot mast. Shpg. wt., 77 lbs.
92 CZ 180. NET..... 73.02

KIT B-40-L. As above, less rotator. Shpg. wt., 53 lbs.
92 CZ 161. NET..... 35.98

★★★ DEEP-FRINGE ANTENNA KITS

KIT C-20. Includes two-section, 20-foot telescoping mast; deluxe, five-element Finco Model B-8 "Geomatic" TV antenna for excellent reception on channels 2 to 13; heavy-duty CDR Model AR-22 rotator (for mast, tower or platform mounting); and all installation accessories. Shpg. wt., 55 lbs.
92 CZ 181. NET..... 69.90

KIT C-20-L. Same as C-20 deep-fringe kit described above, but does not include Model AR-22 antenna rotator. Shpg. wt., 31 lbs.
92 CZ 162. NET..... 33.28

KIT C-30. Same as Kit C-20, but with 30-foot mast. Shpg. wt., 71 lbs.
92 CZ 182. NET..... 74.04

KIT C-30-L. As above, less rotator. Shpg. wt., 47 lbs.
92 CZ 163. NET..... 37.00

KIT C-40. Same as Kit C-20, but with 40-foot mast. Shpg. wt., 82 lbs.
92 CZ 183. NET..... 80.08

KIT C-40-L. As above, less rotator. Shpg. wt., 58 lbs.
92 CZ 164. NET..... 43.04

KNIGHT TV Antenna Kits and Accessories

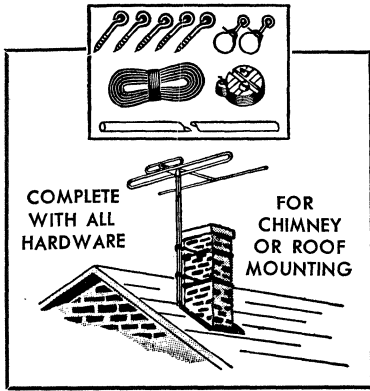

COMPLETE AND READY TO INSTALL—MOUNTING HARDWARE INCLUDED

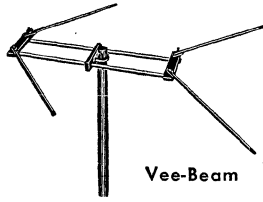

Vee-Beam

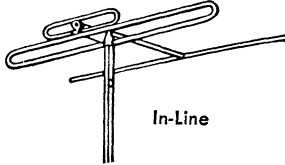

In-Line

Time-Saving
"Quick-Rig" Design
Swing Elements in
Place and Tighten!

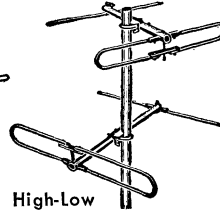

High-Low

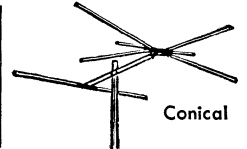

Conical

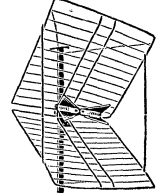

Corner Reflector

FAMOUS KNIGHT COMPLETE TV ANTENNA KITS

★IN-LINE ANTENNA KITS

NET \$7.96 WITH CHIMNEY MOUNT. A complete VHF antenna kit with chimney mount and accessories—at a money-saving price. Provides exceptional picture quality. Ready for quick and easy installation. Includes: An efficient, time-proven, in-line antenna; sturdy 5-ft. mast; 75-ft. of 300-ohm twin line; U.L. Approved lightning arrester; five 3½" woodscrew standoff insulators; and rugged chimney mount. Antenna elements are high-quality ½" seamless aluminum tubing. Shpg. wt., 10 lbs.
92 CZ 045. 6 or More, EACH...7.16 1-5, EACH.....7.96

WITH ROOF MOUNT. Includes same antenna and accessories as above, but has all-angle roof mount instead of chimney mount.
92 CZ 041. 6 or More, EACH...6.84 1-5, EACH.....7.60

IN-LINE ANTENNA ONLY. Less accessories. 5 lbs.
92 CZ 042. 6 or More, EACH...4.17 1-5, EACH.....4.63

★HIGH-LOW ANTENNA KITS

NET \$7.53 WITH CHIMNEY MOUNT. Exceptionally popular two-section antenna featuring individually adjustable sections for top performance on high and low VHF bands. Minimizes "ghosts" and "snow." Includes: Sturdy 5-ft. mast; 5 woodscrew standoff insulators; 2 mast standoff insulators; 75-ft. of 300-ohm twin line; U.L. Approved lightning arrester; and antenna. Antenna elements are ½" aluminum tubing. Shpg. wt., 10 lbs.
92 CZ 048. 6 or More, EACH...6.78 1-5, EACH.....7.53

WITH ROOF MOUNT. As above, but with roof mount.
92 CZ 047. 6 or More, EACH...6.16 1-5, EACH.....6.84

HIGH-LOW ANTENNA ONLY. Less accessories. 5 lbs.
92 CZ 016. 6 or More, EACH...3.91 1-5, EACH.....4.34

★NEW CORNER REFLECTOR UHF ANTENNA KITS

NET \$7.67 WITH CHIMNEY MOUNT. New Knight UHF corner reflector antenna kit for high-gain UHF reception. Includes: 5-ft. mast; 50-ft. of 300-ohm twin line; 2 mast standoff insulators; 4 wall standoff insulators; U.L. Approved lightning arrester; and chimney mount. 8 lbs.
92 CZ 290. 6 or More, EACH...6.90 1-5, EACH.....7.67

WITH ROOF MOUNT. Includes same antenna and accessories, but with roof mount.
92 CZ 291. 6 or More, EACH...6.20 1-5, EACH.....6.89

CORNER REFLECTOR UHF ANTENNA ONLY. Less accessories.
92 CZ 292. 6 or More, EACH...3.27 1-5, EACH.....3.63

CONICAL ANTENNA KITS

NET \$6.09 ★ SINGLE-BAY WITH CHIMNEY MOUNT. Value-packed antenna kit for excellent reception on all VHF TV channels. Kit includes: Conical antenna; sturdy 5-ft. mast; 50-ft. of twin line; 2 mast standoff insulators; 4 wall standoff insulators; lightning arrester; chimney mount. Everything needed to make a complete, first-class TV antenna installation is included at one low price. Shpg. wt., 7 lbs.
92 CZ 174. 6 or More, EACH...5.48 1-5, EACH.....6.09

★ SINGLE-BAY WITH ROOF MOUNT. Includes same antenna and accessories, but has all-angle roof mount instead of chimney mount.
92 CZ 135. 6 or More, EACH...5.14 1-5, EACH.....5.71

★★ 2-BAY WITH CHIMNEY MOUNT. As above, but with 2-bay conical antenna to give added gain and sensitivity required for excellent near-fringe VHF reception. With 10-ft. mast. Shpg. wt., 10 lbs.
92 CZ 173. 6 or More, EACH...8.75 1-5, EACH.....9.72

★★ 2-BAY WITH ROOF MOUNT. As above, but with roof mount. Shpg. wt., 10 lbs.
92 CZ 133. 6 or More, EACH...8.41 1-5, EACH.....9.34

★ SINGLE-BAY ANTENNA ONLY. Less accessories. 3 lbs.
92 CZ 136. 6 or More, EACH...2.67 1-5, EACH.....2.97

STACKING KIT. For stacking two single-bay conicals to make a two-bay array. Shpg. wt., 8 oz.
97 CX 389. NET64c

STACKING KIT. For stacking two 2-bay conicals to make a four-bay array. Shpg. wt., 1¼ lbs.
97 CX 387. NET.....1.55

★NEW KNIGHT VEE-BEAM ANTENNA KITS

NET \$5.98 WITH CHIMNEY MOUNT. New Knight Vee-Beam VHF antenna for high gain on all channels from 2 to 13. Complete with installation accessories. Includes: Vee-Beam antenna; 5-ft. mast; 50-ft. 300-ohm twin line; U.L. Approved lightning arrester; 4 wall standoff insulators; 2 mast standoff insulators; and chimney mount. A complete TV antenna system with all accessories at an amazingly low price. Shpg. wt., 8 lbs.
92 CZ 247. 6 or More, EACH...5.38 1-5, EACH.....5.98

WITH ROOF MOUNT. Includes same antenna and accessories, but with roof mount.
92 CZ 248. 6 or More, EACH...4.70 1-5, EACH.....5.22

VEE-BEAM ANTENNA ONLY. Less accessories. 4 lbs.
92 CZ 249. 6 or More, EACH...2.19 1-5, EACH.....2.43

Indoor TV Antennas

"ALL-CHANNEL" EMBASSY ANTENNAS

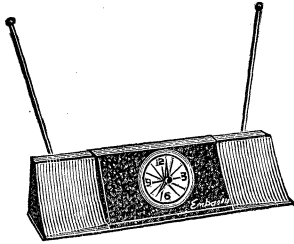

For VHF
Reception

Fits Into
Any Room
Decor

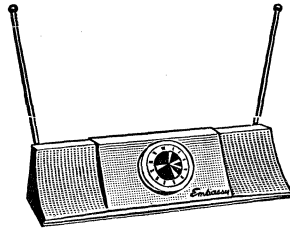

Antenna-Clock. New antenna-clock combination. Combines the famous "Embassy" indoor TV antenna and finest quality Sessions clock in one attractive unit. All-brass telescoping arms are easily adjusted—improve reception in unfavorable locations. Patented electronic circuit featuring exclusive 12-position dual control switch—eliminates or greatly reduces all ghosts and interference. Satin-gold trim. With 6 ft. of twin line and 12-ft. AC cord. Size, 14x4x3½". Clock operates from 110-120 v., 50-60 cycle AC. Shpg. wt., 3 lbs. 71 CX 538. Mahogany finish. 71 CX 542. Maple Walnut finish. 71 CX 571. Ebony finish. 71 CX 599. Ivory finish. List Each, \$24.95. NET EACH. 14.95

Antenna Only. Extremely popular indoor antenna. Same as unit at left but does not include clock feature. Provides excellent reception in metropolitan areas. Features a patented electronic circuit for increased gain. 12-position switch assures sharp, clear pictures on all channels from 2 to 13 with minimum ghosts and interference. Concealed 4-section brass telescoping arms provide the increased signal gain required for reception in unfavorable locations. With 6 ft. transmission line. Size, 14x4x3½". Shpg. wt., 2½ lbs. 92 CX 066. Mahogany finish. 92 CX 574. Maple Walnut finish. 92 CX 067. Ebony finish. 92 CX 068. Ivory finish. List Each, \$19.95. NET EACH. 11.95

"ALL-CHANNEL" REMBRANDT UHF-VHF ANTENNA

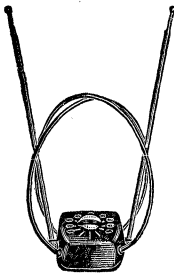

Deluxe indoor antenna featuring "radar loop" design plus all-angle telescoping dipoles. Delivers clear all channel reception. Convenient 9-position switch permits adjustment of antenna for maximum efficiency—highly effective in eliminating ghosts and interference. "Radar" loops are inductively coupled to the telescoping dipoles. Dipoles and loops can easily be adjusted to length and angle that provides best reception. Luminous numerals—easily visible in darkened room. Wide rectangular base prevents tipping. With twin lead. Shpg. wt., 3½ lbs. 92 CX 062. Model M-100. Mahogany finish. 92 CX 064. Model E-100. Ebony finish. 92 CX 065. Model I-100. Ivory finish. List Each, \$16.95. NET EACH. 9.95

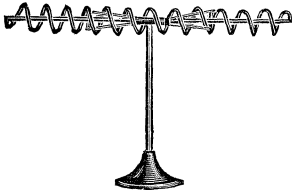

HI-LO "SPIRAL-TENNA"

Model 202 UHF-VHF. Popular, well-engineered indoor antenna. Gives excellent gain over the entire UHF-VHF bands (channels 2-83). Minimizes "ghosts" and interference. Requires no adjustment. Gold finish. Sturdy tip-proof base. Height 14"; width (span), 32". With 6 feet of 300 ohm twin lead. Shpg. wt., 2 lbs. 98 CX 449. 1-5, NET EACH. 5.85 6 or more, EACH. 5.26 Model 101 VHF. Similar to Model 202 but VHF only. 97 CX 391. 1-5, NET EACH. 5.58 6 or More, EACH. 5.02

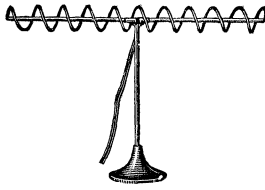

TRICRAFT VHF ANTENNA

Highly efficient VHF indoor antenna at an unusually low price. Brings in sharp, clear pictures in metropolitan areas. Carefully engineered helix coil, rigidly mounted on sturdy, black plastic base. For all channels from 2 to 13. Minimizes "snow," "ghosts," and interference. Requires no adjustment. Tip-proof base. Height, 14"; width (span), 32". Complete with 6-ft. length of 300-ohm twin-line, tipped with spade lugs, for quick installation. Shpg. wt., 2 lbs. 92 CX 126. 4.41

K-G DELTA-BEAM ANTENNAS

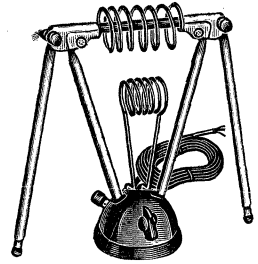

DELUXE UHF-VHF MODEL

An extremely efficient all-channel indoor antenna. Provides excellent reception on VHF channels 2-13 and UHF channels 14-83. Combines the engineering principles of the helix coil, folded dipole, straight dipole and deltamatch transformer. Features six-position switch—provides fingertip control for optimum reception on each channel. Switch matches line impedance and tunes antenna to match input of receiver. Also has additional switch which is highly effective in eliminating "ghosts". Double-rod telescoping dipoles. Can easily be adjusted to the length and angle which provides highest gain and best picture. Strikingly smart gold finish. Tip-proof, brown bakelite base, has protective rubber pad to prevent marring finish of TV cabinet. Size, 9" high; each arm extends to 15". Supplied complete with 6 feet of 300-ohm twin line. Shpg. wt., 2½ lbs. 92 C 013. 1-5, NET EACH. 5.85 6 or More, EACH. 5.26

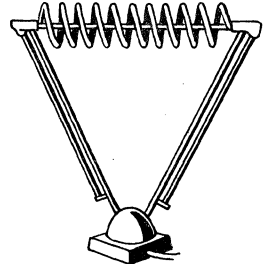

UHF-VHF ANTENNA KIT

For the do-it-yourself fan—here is an economical, high gain, Delta-Beam indoor antenna in kit form. Easily assembled without use of tools. Actually combines 4 antenna types—helix coil, folded dipole, straight dipole, and delta-match transformer. Helix coil is made of No. 10 aluminum wire. Elements are of ⅜" O.D. aluminum tubing. When assembled, arms can be swung out and locked in any position. All metal parts are finished in attractive anodized silver. Heavy ⅜" thick hard rubber base has felt flocked pad on bottom to prevent marring finish of TV set. Complete with 6 feet of 300-ohm twin-line. Shpg. wt., 2½ lbs. 92 C 011. NET. 3.63

Indoor and Window TV Antennas

QUALITY JFD ANTENNAS

NEW "MAGIC GENIE" UHF-VHF ANTENNA

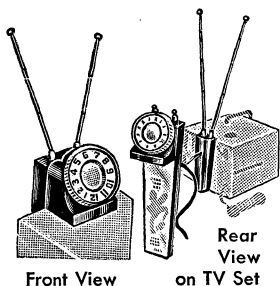

Advanced design indoor antenna. Handsome, inconspicuous and provides excellent reception. Has 5-section, 46" elements. Turret design allows 360° horizontal dipole adjustment for maximum signal strength. Uses printed circuit and 12-position switch for powerful, sharp tuning. Antenna mounts in back of TV set, leaving only the smartly-styled

dial and dipole tips exposed. Includes twin line tipped with spade lugs for easy installation. Shpg. wt., 1 lb.
 92 C 227. Model MG850. Mahogany finish.
 92 C 228. Model MG650. Blonde finish.
 92 C 229. Model MG750. Ebony finish.
 List, Each, \$17.95. NET EACH.....10.55

NEW "MERLIN" UHF-VHF ANTENNA

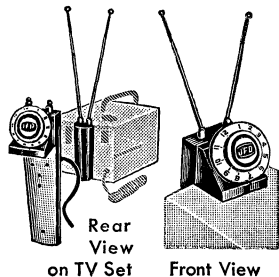

New, efficient, back-of-set antenna. Uses 4-section, 36" adjustable elements for optimum reception on all channels. Elements slide conveniently out of sight when not in use. Broad, easy-to-read dial has 12 positions to provide extra-sharp pictures and clear sound. Lustrous plastic construction blends well with any TV set. Attaches easily and securely

to the back of television receiver. Includes twin line tipped with spade lugs for easy installation. Supplied complete with instructions. Shpg. wt., 1 lb.
 92 C 572. Model L20. Mahogany finish.
 92 C 573. Model L10. Ivory finish.
 List Each, \$14.95. NET EACH.....5.95

NEW TA174 "PERISCOPE" UHF-VHF ANTENNA

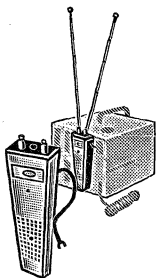

Newly developed, indoor antenna. Highly efficient design provides excellent, metropolitan-area reception. Telescoping dipole elements are mounted in a unique, ball-joint turret assembly. Complete freedom of movement allows 360° rotation of elements; excellent signal pickup from any desired direction. Elements are 4-section, 38" long; drop completely out of sight when not in use. Adjustable length permits optimum reception on all channels. Case is durable, lightweight plastic. Can be quickly

and securely mounted on back of any TV set. Includes twin line with spade lugs. Shpg. wt., 1 lb.
 92 C 571. List, \$12.95. NET.....4.08

MODEL TA-147 UHF-VHF ANTENNA

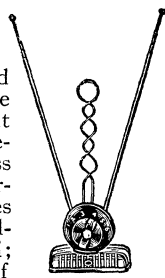

Famous indoor antenna featuring smart styling combined with outstanding performance. Has high signal gain; minimizes interference and ghosts. Employs 6-position impedance matching switch; permits adjustment for maximum efficiency on channel being received. Adjustable, 3-section brass dipoles are easily positioned for clearest picture. Distinctive design matches any decor. Base is weighted and balanced to prevent tipping. Has felt pad; will not mar finish. Includes 5 ft. of 300-ohm twin line and spade lug terminals for quick, simple attachment to TV set. Shpg. wt., 2 lbs.
 92 CX 124. List, \$9.95. NET.....3.24

MODEL C119 VHF WINDOW ANTENNA

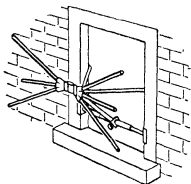

Low-cost, all-aluminum conical window antenna for strong signal reception on channels 2-13. Ideal for apartment buildings, hotels, etc., or wherever roof-top installations are not practical. Mounting bracket is adjustable from 32" to 42" in width. Easily fits on outer frames of most windows. Anchor

brackets of antenna fit snugly and slide smoothly along extension bar. Antenna can be adjusted to proper position for best reception. With mounting hardware—ready for quick, convenient installation. Less 300-ohm twin line. Shpg. wt., 7 lbs.
 97 CX 084. List, \$8.95. NET.....5.26

MODEL TA-187 UHF ANTENNA

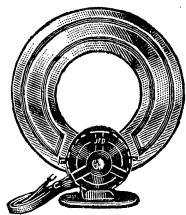

"Ultra-Loop" UHF indoor antenna for clear signal reception on channels 14-83. Circular, wide loop dipole provides flat, high-gain response across entire UHF band. Patterned after short-wave radio direction finding loop antenna, with adaptations for UHF. Adjustable for highest gain—dipole can be moved from vertical to horizontal angles for peaking at any point in the UHF spectrum. Rust-proof; red-gold, anodized aluminum dipole, with mahogany plastic base. Equipped with 4 ft. of 300-ohm twin line. Ht., 9 1/2"; dia., 9". Shpg. wt., 1 1/2 lbs.
 98 C 376, List, \$7.95. NET.....2.20

KNIGHT VHF ANTENNA



Popular indoor television antenna at unusually low cost. Features efficient, time-proven "rabbit ear" design. For use on VHF channels from 2 to 13—quickly and easily adjusted for clear picture with minimum ghosts and interference. Also excellent for FM reception. Uses sturdy, 3-section, brass-plated telescoping elements for convenient adjustment to desired length. Bakelite base is weighted to prevent tipping. With 3 ft. of 300-ohm twin

line. Shpg. wt., 2 lbs.
 92 CX 025. NET.....1.44

TELCO "HIDE-A-WAY" VHF ANTENNA

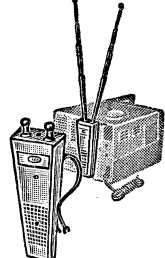

Compact, plastic-cased "Hide-A-Way" antennas. Provide excellent all-channel metropolitan-area reception. Telescoping elements are made of durable, nickel-plated brass tubing. Elements are mounted on ball-joint swivels; rotate 360° for excellent signal pickup from any direction. In models with 4- or 5-section elements. 4-section elements are 29 1/4"; 5-section elements are 37". With 300-ohm twin line. Shpg. wt., 1 lb.

92 C 029. 4-section. NET.....2.28
 92 C 581. 5-section. NET.....2.77

JFD TV Antennas

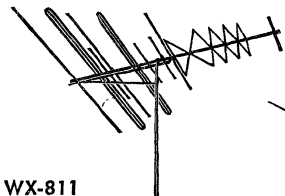

WX-811

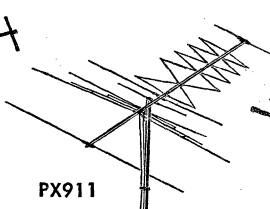

PX911

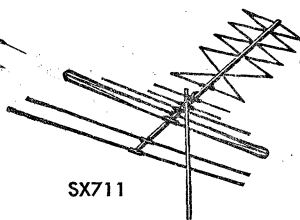

SX711

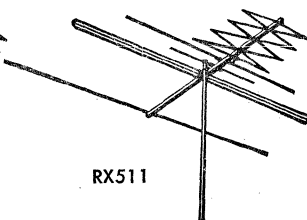

RX511

EASY-TO-INSTALL VHF-UHF ANTENNAS FOR OUTSTANDING TV RECEPTION

★★★★ MODEL WX811 "WONDER HELIX"

New, high-gain broadband antenna. Designed especially for deep-fringe areas. Also for use in strong UHF signal areas. "Wonder Helix" principle assures high gain and sharp directivity—provides clear, interference-free pictures. Made of strong, drawn aluminum for durability and corrosion resistance. Shipped preassembled—just flip elements in place and antenna is ready for operation. Engineered for close match to transmission line. Less mast and 300-ohm twin line. Shpg. wt., 8½ lbs.

92 CZ 195. List, \$39.50. NET.....23.23

★★★★ Model WX811S. Same as WX811 above, except two bays for higher gain. Shpg. wt., 17 lbs.

92 CZ 282. List, \$82.50. NET.....48.51

★★★★ MODEL PX911 "POWER HELIX"

This high-gain, single-bay VHF antenna provides extremely fine sensitivity on all VHF TV channels. Excellent for fringe areas, the unique "Power Helix" principle brings in clear, snow-free pictures. Also for use in strong-signal UHF areas. Engineered for an extremely close impedance match to transmission line of receiver. Made of durable, corrosion-resistant aluminum in the "in-line" style for pleasing appearance and low resistance to wind. Completely pre-assembled—practically installs itself. Elements flip into place. Less mast and 300-ohm twin line. Shpg. wt., 10 lbs.

92 CZ 141. List, \$35.00. NET.....20.58

★★★★ Model PX911S. As above, but 2 bays for higher gain. With stacking transformers. Requires 10' mast. 17 lbs.

92 CZ 140. List, \$72.50. NET.....42.63

★★★ MODEL SX711 "STAR HELIX"

Provides extremely high front-to-back ratio for highest rejection of co-channel and cross-channel interference. Delivers top performance on all VHF channels, with particularly good response on channel 13. Also for use in strong-signal UHF areas. Antenna is completely pre-assembled. Can be put together in seconds, without tools, without screws. Elements flip into place. Made of rugged, corrosion-resistant, solid-drawn aluminum. Less mast and 300-ohm twin line. Shpg. wt., 8 lbs.

92 CZ 113. List, \$25.50. NET.....14.99

★★★ Model SX711S. As above, but 2 bays for higher gain. With stacking transformers. Requires 10' mast. 16 lbs.

92 CZ 112. List, \$52.50. NET.....30.87

★★ MODEL RX511 "SUPER HELIX"

Here is the new, modified version of the "Star Helix" antenna. Designed specifically for near-fringe area installation, the Super Helix makes use of the helix principle—developed for microwave work—which greatly steps up the gain of the antenna. Also for use in strong-signal UHF areas. Entire antenna is pre-assembled of high-tension aluminum tubing. In-line design reduces wind resistance. Performs equally well on all VHF channels. Less mast and twin line. Shpg. wt., 6 lbs.

92 CZ 138. List, \$18.50. NET.....10.88

★★ Model RX511S. As above, but 2 bays for higher gain. With stacking transformers. Requires 10' mast. 12 lbs.

92 CZ 139. List, \$38.50. NET.....22.64

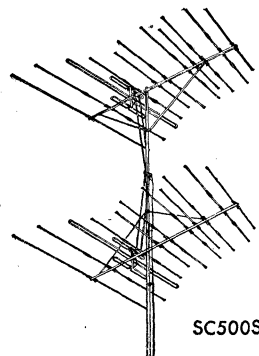

SC500S

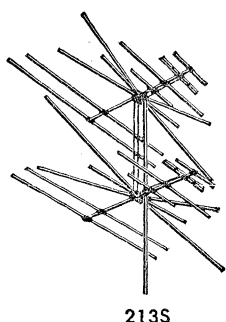

213S

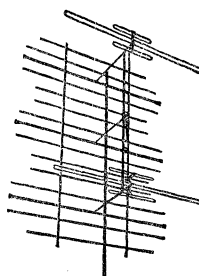

SC302S

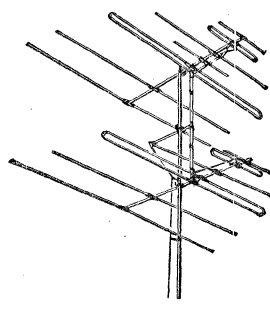

FB500S

★★★★ MODEL SC500S "SUPER CONSTELLATION"

2-bay, broadband antenna featuring extremely high gain. Ideal for deep-fringe VHF reception—double-bay stacking delivers highest signal to TV set. Also for strong-signal UHF areas. Performance is comparable to a 5-element Yagi on the low-band channels, and a 10-element Yagi on the high-band channels! Made of drawn aluminum for durability and corrosion resistance. Preassembled—simply flip elements into place and antenna is ready for use. Requires 10 ft. mast. Less 300-ohm twin line. Shpg. wt., 22 lbs.

92 CZ 142. List, \$75.70. NET.....44.51

★★★★ Model SC500. Same as Model SC500S above, but single-bay type. Shpg. wt., 11 lbs.

92 CZ 143. List, \$37.50. NET.....22.05

★★★★ MODEL 213S "SUPER POWER JET"

Stacked array for fringe-area VHF reception; also for local UHF reception. Provides exceptionally high gain on TV channels 2 to 13. Dual reflectors provide flat response on low channels. Driven elements are of conical shape for greatest bandwidth. Each high-band section consists of 2 driven elements and 2 directors—spaced and phased for peak performance. Supplied complete with quarter-wave stacking bars. Entirely pre-assembled of pure aluminum. Installed quickly. 1" square, rugged aluminum boom. Less mast and 300-ohm line. Shpg. wt., 14 lbs.

98 CZ 465. List, \$41.40. NET.....24.34

★★ Model 213. Similar to 213S antenna above, but single-bay type. Shpg. wt., 7 lbs.

98 CZ 464. List, \$19.85. NET.....11.67

★★★★ MODEL SC302S "SUPER DODO"

A high-gain, deep-fringe antenna. Bays are spaced ½ wavelength for maximum gain and exceptional reception even in remote VHF areas. Provides peaked gain on channels 2 to 6; excellent gain on all VHF channels. Also for local UHF reception. High front-to-back ratio. 6-dipole construction, with 15 reflectors. Shipped preassembled; elements pop into position. Takes masts up to 1½" diameter. Less mast and 300-ohm twin line. Shpg. wt., 17 lbs.

98 CZ 467. List, \$49.50. NET.....29.11

★★★ Model C302S. Same as SC302S above, but with standard spaced bays (¼ wave) and 10 reflectors. Less mast and 300-ohm twin line. Shpg. wt., 14 lbs.

98 CZ 466. List, \$38.70. NET.....22.76

★★★ FB500S "FIREBALL" UHF-VHF

The "Fireball" broadband array for deep-fringe VHF and local UHF coverage. Offers extremely high gain on both low and high VHF TV bands. Separate folded dipoles for low and high bands with individual reflectors and directors give high directivity and excellent front-to-back ratio. Lightweight construction simplifies installation on high towers. Constructed of corrosion-resistant, rust-proof aluminum—preassembled for quick installation. "Hi-Tension" brackets hold elements in position. Less twin line. Requires 10 ft. mast. Shpg. wt., 11 lbs.

92 CZ 123. List, \$36.65. NET.....21.55

★★ Model FB500. Same as FB500S above, but single-bay type. Shpg. wt., 5½ lbs.

92 CZ 122. List, \$17.35. NET.....10.20

JFD VHF-UHF TV Antennas

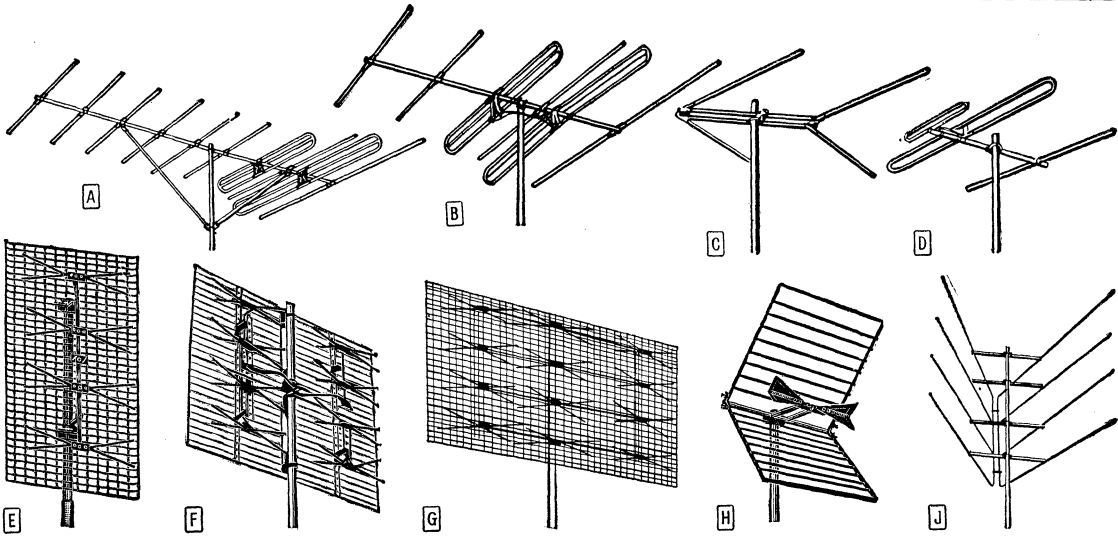

YAGI ANTENNAS

Yagi antennas are noted for their excellent fringe area gain characteristics and exceptionally sharp directivity. Completely pre-assembled for quick, simple installation.

A ★★★★★ SINGLE CHANNEL 10-ELEMENT TYPES. Provide 52% more signal gain than conventional 5-element type yagis. Very sharp directivity. Av. shpg. wt., 9 lbs.

No.	Type	Chan.	List	EACH
98 CZ 231	10B2	2	\$33.35	19.60
98 CZ 232	10B3	3	33.35	19.60
98 CZ 233	10B4	4	29.85	17.55
98 CZ 234	10B5	5	29.85	17.55
98 CZ 235	10B6	6	27.10	15.93
98 CZ 236	10B7	7		
98 CZ 237	10B8	8		
98 CZ 238	10B9	9		
98 CZ 239	10B10	10	13.85	8.14
98 CZ 240	10B11	11		
98 CZ 241	10B12	12		
98 CZ 242	10B13	13		

B ★★★★★ SINGLE CHANNEL 5-ELEMENT TYPES. Wide-spaced, single-driven-element yagi. Consists of 3 directors, 1 reflector and 1 folded dipole. Av. shpg. wt., 5 lbs.

No.	Model	Chan.	List	EACH
98 CZ 322	5B2	2	\$17.60	10.35
98 CZ 323	5B3	3	16.95	9.97
98 CZ 324	5B4	4	16.25	9.55
98 CZ 326	5B5	5	15.25	8.97
98 CZ 327	5B6	6	14.55	8.56
98 CZ 328	5B7	7		
98 CZ 329	5B8	8		
98 CZ 331	5B9	9		
98 CZ 332	5B10	10	7.65	4.50
98 CZ 333	5B11	11		
98 CZ 334	5B12	12		
98 CZ 335	5B13	13		

QUALITY VHF ANTENNAS

C ★ MODEL Q800. Vee-Beam antenna—covers channels from 2 to 13. Engineered for increased gain, especially on high band. "Quick-Rig" pre-assembled design for rapid, easy installation—entire array slides out of package ready for flip-assembly and tightening. Simply slip each section of the antenna in place; mechanical grooves and locks secure them permanently. Features corrosion-proof, aircraft aluminum construction throughout. Supplied with 1/2" boom. Less mast and 300-ohm twin line. Shpg. wt., 3 1/2 lbs.

98 CZ 166. List, \$6.25. NET..... 3.67

★★ MODEL Q801. Stacked Vee-Beam—2 bays for additional 3 db gain. Includes jumper harness. Less mast and twin line. Shpg. wt., 7 lbs.

98 CZ 167. List, \$13.50. NET..... 7.94

All antennas listed below have rust-proof, seamless, aluminum 1" O.D. crossarms. Low-band types have "Y" support for rigidity. Less mast and 300-ohm twin line.

CASCADE MULTI-CHANNEL TWIN-DRIVEN TYPES. Offer high-gain coverage of all low-band or all high-band channels with a single antenna. Uni-directional response.

A ★★★ MODEL 10B26. 10-element baline for channels 2-6. Wt., 9 lbs.

98 CZ 455. List, \$40.95. NET.... 24.08

A ★★★ MODEL 10B713. 10-element baline for channels 7-13. Wt., 9 lbs.

98 CZ 459. List, \$20.85. NET.... 12.25

B ★★ MODEL 5B26. 6-element wide-spaced baline for channels 2-6. Excellent performance in areas of medium signal strength. Shpg. wt., 7 lbs.

98 CZ 450. List, \$22.05. NET.... 12.97

STACKING HARNESES

Matching harnesses for stacking any of 5 and 10-element yagi antennas (above and left) for extra gain. *For Types 10B26 and 5B26; †for 10B713. Av. shpg. wt., 1/2 lb.

No.	Type	For Ch.	EACH
92 CX 253	BT2	2	
92 CX 254	BT3	3	
92 CX 255	BT4	4	1.03
92 CX 256	BT5	5	
92 CX 257	BT6	6	
92 C 258	BT7	7	
92 C 259	BT8	8	
92 C 260	BT9	9	.73
92 C 261	BT10	10	
92 C 262	BT11	11	
92 C 263	BT12	12	.73
92 C 264	BT13	13	.73
92 CX 265	*J175	2-6	1.76
92 C 266	†J178	7-13	.88

D ★ MODEL TPQ-150 VHF Tenna-Pak. In-line folded dipole design for powerful all-channel VHF reception. Has elements for both high and low bands and reflector. Unique design—high-band dipole boosts gain on low band; low-band dipole boosts gain on high band. Elements made of 1/2" corrosion-resistant, aircraft aluminum alloy. Unfolds and locks in exact alignment for easy installation. Complete with 5 ft. of 3/8" seamless fitted-joint mast tubing, all-angle base-mount, 60 feet of 300-ohm twin line, 4 screw-eye insulators, and 2 clip-on mast insulators. Wt., 9 lbs.

92 CZ 114. List, \$17.50. NET..... 10.29

★ MODEL Q150 IN-LINE ANTENNA. Hi-Lo folded dipole array as above, but less mast, twin line, and accessories. Wt., 5 lbs.

97 CZ 075. List, \$10.00. NET..... 5.88

UHF AND VHF-UHF ANTENNAS

E ★ MODEL UHF202. 4 bay, UHF bowtie antenna for suburban areas. Reflector for high gain on all channels and reduction of snow and troublesome reflections. Features "Custom-Channel" calibrator—permits peaking individual channels for optimum response. Precision spaced elements and phasing harness for maximum gain. Galvanized grid wire screen with 1/8" O.D. solid aluminum rods. Pre-assembled for fast installation. Less mast and twin line. Shpg. wt., 6 lbs.

92 CZ 151. List, \$9.95. NET..... 5.85

F ★★ MODEL UHF208. 8-bay, UHF bowtie antenna for semi-fringe area reception. Utilizes wire mesh reflector and matched elements to provide optimum gain on all channels. Rigidly constructed; solid aluminum rods and galvanized screen. Pre-assembled for simplified, rapid installation. Less mast and 300-ohm twin line. Shpg. wt., 8 lbs.

92 CZ 550. List, \$25.95. NET..... 15.26

G ★★★ MODEL UHF212. 12 bay, UHF bowtie antenna for fringe area reception. Designed to provide extremely high gain over all channels. Screen is engineered for efficient shielding of conical sections. Provides sharp directivity; greatly reduces interference. Pre-assembled for quick, easy installation. Less mast and 300-ohm twin line. Shpg. wt., 10 lbs.

92 CZ 551. List, \$33.50. NET..... 19.70

H ★ MODEL UHF410. UHF corner reflector—for suburban reception. High front-to-back and front-to-side ratio minimizes co-channel and adjacent channel interference and eliminates "ghosts." Bowtie dipole provides optimum beam width for maximum gain. Rigidly constructed of solid, lightweight, corrosion-proof aluminum. Flips open like a book for quick, easy installation. Less mast and 300-ohm twin line. Shpg. wt., 6 lbs.

92 CZ 152. List, \$9.95. NET..... 5.85

I ★★ UN105. UHF-VHF antenna for channels 2 to 83. 4-bay for extra gain and signal sensitivity for semi-fringe areas. Features Redwood crossarms. Pre-assembled. Simply swing sections open and tighten. Has anti-rust, anti-corrosion, all-aluminum construction. Less 300-ohm line and mast. Wt., 5 1/2 lbs.

92 CZ 107. List, \$10.95. NET..... 6.44

★ MODEL UN103. Same construction as antenna above, but 2-bay. Complete high gain coverage on all channels from 2 to 83. Less 300-ohm twin line and mast. Shpg. wt., 3 lbs.

92 CZ 108. List, \$5.95. NET..... 3.50

Finney TV Antennas

FRINGE AREA TV ANTENNAS

For "Deep Fringe"—Ideal For Color

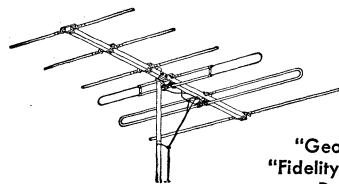

"Geomatic"
"Fidelity-Phasing"
Design

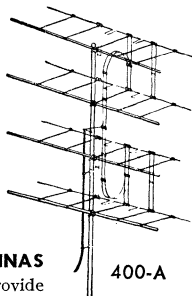
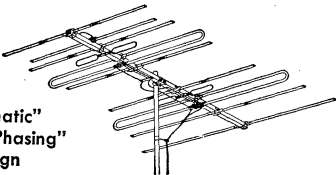

400-A

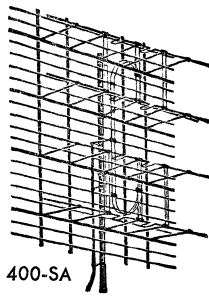

400-SA

"GEOMATIC" LOW-BAND ANTENNAS

★★★★ "Customized" series "Geomatic" television antennas. Specially engineered for outstanding "deep fringe" reception on the low-band channels. Model L-26 antenna covers the entire low band; all other models cover specific portions of the low band. These top performing antennas also provide high-band reception (on channels 7 through 13) in moderate and strong signal areas.

All incorporate Finney's exclusive "fidelity phasing" plus many other superior construction characteristics that provide very high gain, sharp directivity plus high front-to-back ratio. Pre-assembled design cuts installation time to a minimum.

May be stacked to achieve higher gain—see Model C Stacking Kit, listed at right below. Less mast and 300-ohm twin line. Av. shpg. wt., 8½ lbs.

- 92 CZ 283. Model L-26. Channels 2-6.
- 92 CZ 284. Model L-25. Channels 2-5.
- 92 CZ 285. Model L-24. Channels 2-4.
- 92 CZ 286. Model L-36. Channels 3-6.
- 92 CZ 287. Model L-35. Channels 3-5.
- 92 CZ 288. Model L-46. Channels 4-6.
- 92 CZ 289. Model L-45. Channels 4 and 5.

List, \$23.95. NET EACH.....14.08

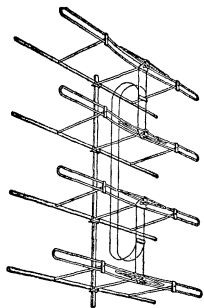

Model F-4
"Fidelity
Phasing"
Design

Highly
Sensitive

SUPER-FRINGE ANTENNA

★★★★ Model F4. A super-fringe VHF antenna with exclusive "Fidelity-Phasing." Produces "in-phase" colinear currents on both low band and high band for superior combined performance on all VHF channels from 2 through 13. Excellent reception even at locations extremely distant from TV stations. Highly suitable for color-TV reception—has very flat frequency response; less than 1 db variation in frequency response on any channel. 4 driven low-band, in-phase folded dipoles, plus 12 driven high-band, in-phase, folded dipoles form a highly effective colinear array.

Fidelity phasing accomplishes both low band dipole and high band colinear operation without complicated phasing harnesses; permits easier, more weatherproof installations. Extremely high sensitivity and directivity. VHF gain exceeds that of famous Models 400-A and 400-SA. Rugged, lightweight, aluminum construction to withstand heavy winds and ice loads. Antenna is pre-assembled for quick, simplified installation. Less mast and 300-ohm twin line. Shpg. wt. 13 lbs.

92 CZ 072. List, \$46.00. NET.....27.05

TWIN DRIVEN "GEOMATIC" ANTENNAS

Outstanding "Geomatic" antennas provide top-notch performance in super-fringe areas. Feature twin driven elements and "fidelity phasing." On channels 2-13, surpass the directivity of single-channel, Yagi-type antennas. Exclusive self-locking and self-aligning construction. Oversize, extra-heavy-gauge aluminum boom plus "lock-tite" saddle bracket assure fast installation and high strength. Less mast and twin line.

★★★★ Model B-8. Deluxe antenna featuring 3 directors and 2 reflectors for maximum front-to-back ratio, and extremely high directivity. Very effective in eliminating co-channel interference. Ideally suited for color TV reception—has extremely flat response; less than 1 db variation on any channel. Shpg. wt., 10 lbs.

92 CZ 085. List, \$37.50. NET.....22.05

★★★★ Model B-7. Same features as B-8, with 1 reflector. Shpg. wt., 6½ lbs.

92 CZ 093. List, \$24.90. NET.....14.64

★★★★ Model B-6. Same as B-7, but with 1 director. Shpg. wt., 5½ lbs.

92 CZ 094. List, \$18.90. NET.....11.11

SINGLE DRIVEN "GEOMATICS"

★★★★ Model B-5. Highly efficient super fringe antenna. Shpg. wt., 9½ lbs.

92 CZ 074. List, \$32.00. NET.....18.82

★★★★ Model B-4. Ideal for fringe areas. High gain; sharp directivity. 6 lbs.

92 CZ 076. List, \$17.50. NET.....10.29

★★★ Model B-3. For suburban-fringe areas. A top performer. Wt., 5 lbs.

92 CZ 078. List, \$13.50. NET.....7.94

★★ Model B-2. Metropolitan, suburban or semi-fringe areas. Shpg. wt., 3½ lbs.

92 CZ 082. List, \$7.35. NET.....4.32

★ Model B-1. Primarily metropolitan and suburban areas. Shpg. wt., 3¼ lbs.

92 CZ 083. List, \$6.10. NET.....3.59

STACKING KITS

Model A. Stacks two B-8, B-7, B-6, B-5, B-4, B-3, B-2 or B-1. For maximum high-band gain. Shpg. wt., 8 oz.

92 C 086. List, \$2.00. NET.....1.18

Model B. Stacks two B-5, B-4, B-3, B-2, or B-1. Boosts gain on low-band. ¾ lb.

92 CX 075. List, \$2.50. NET.....1.47

Model C. Stacks two B-8, B-7, or B-6. Also for low-band antennas listed at left, above. For maximum low-band gain. 1 lb.

92 CX 087. List, \$3.00. NET.....1.76

★★★★ "GEOMATIC" TWIN DRIVEN 2-BAY ANTENNAS

Model B-66-A. Deep fringe antenna featuring very great front-to-back ratio and high gain on all channels. Utilizes dual-tuned folded dipoles, which operate as one length on low-band signals and as electrically different lengths on high-band signals. Peak performance is achieved on both bands. Low-band reflector, high-band colinear reflector and combination director further increase gain and sharpness of directivity. Antenna is completely preassembled. Less mast and twin line. Shpg. wt., 10 lbs.

92 CZ 568. List, \$39.80. NET....23.40

Model B-66-C. For applications requiring maximum F/B ratio on channels 2 and 3, and maximum gain on 2-6. 10 lbs.

92 CZ 569. List, \$40.80. NET....23.99

CO-LATERAL UHF-VHF ANTENNAS

★★★★ Model 400-A. This highly efficient double-co-lateral antenna provides outstanding reception on all UHF and VHF channels. It features 32 driven elements which achieve remarkably high gain, extremely sharp directivity, and superior signal-to-noise ratio. Permits excellent reception on VHF channels at distances of 135 miles and more under average receiving conditions. Antenna's lightweight construction simplifies installation on high towers and masts—weighs only 8 lbs. Extremely rugged and weather resistant. All element brackets have aluminum "Box Girder" construction; self-locking and self-aligning to prevent bent, twisted, out-of-position elements. Also features oversize, extra heavy gauge aluminum boom. Pre-assembled for convenient installation. Requires 10-ft. (minimum) mast. Less mast and 300-ohm twin line. Shpg. wt., 14 lbs.

97 CZ 104. List, \$42.00. NET...24.70

Model 12 UHF Conversion Kit. For easy, convenient conversion of old Model 400 to the newer Model 400-A, described above. Shpg. wt., ¾ lb.

98 C 134. List, \$3.15. NET.....1.85

Model 14-S "Fro-Bac" Screen Reflector Kit. For use with Model 400 or Model 400-A antennas to provide increased gain and front to back ratio. Includes the "Fro-Bac" screen (see 400-SA, below) and stainless steel hardware for simple, convenient conversion. 80 sq. ft. of reflector surface. 5 lbs.

98 CZ 389. List, \$15.00. NET.....8.82

★★★★ Model 400-SA. Antenna similar to Model 400-A described above, but supplied with "Fro-Bac" full dimensional screen reflector. This special screen results in maximum signal gain plus extremely high front-to-back ratio. Eliminates unwanted rear signal interference and ghosting in fringe areas. Antenna and "Fro-Bac" dimensional screen are both preassembled as one unit ready for quick and easy installation. Reflector screen elements are full length—80 sq. ft. of highest efficiency reflector surface. Designed for minimum wind resistance and maximum strength. Requires 10 ft. mast. Less mast and 300-ohm twin line. Shpg. wt., 16½ lbs.

98 CZ 388. List, \$54.50. NET....32.05

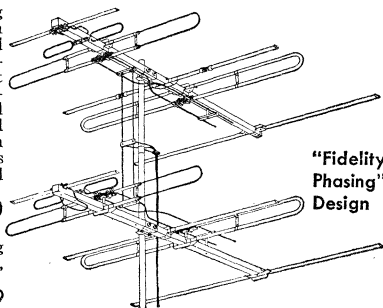

"Fidelity
Phasing"
Design

NEW FINNEY "GEOMATIC" HIGH-BAND VHF ANTENNAS

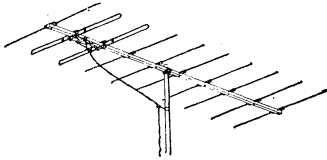

SERIES H-10 SINGLE-CHANNEL ANTENNAS

★★★★ New, customized 10-element "Geomatic" VHF TV antennas. Provide maximum gain, sharp directivity, and high front-to-back ratio in deep fringe areas. New, solid-rod construction for up to 300% greater wind and ice-load resistance. Pre-assembled; "box girder" brackets; heavy, square aluminum boom; solid aluminum elements, and saddle brackets. Less mast and 300-ohm line. Av. shpg. wt., 4 1/4 lbs.

Stock No.	Model	For
92 CZ 552	H-10-7	Channel 7
92 CZ 553	H-10-8	Channel 8
92 CZ 554	H-10-9	Channel 9
92 CZ 555	H-10-10	Channel 10
92 CZ 556	H-10-11	Channel 11
92 CZ 557	H-10-12	Channel 12
92 CZ 558	H-10-13	Channel 13

List, \$9.95. NET EACH..... 5.85

★★★★ Model H-10-713. New, twin-driven 10-element yagi. Similar to above, but covers channels 7-13. 4 3/8 lbs.

92 CZ 559. List, \$12.95. NET..... 7.61

SERIES H-5 SINGLE-CHANNEL ANTENNAS

★★★ New, 5-element "Geomatic" VHF antennas. Same superior construction as Series H-10; feature new solid-rod aluminum elements. Av. shpg. wt., 2 1/2 lbs.

Stock No.	Model	For
92 CZ 560	H-5-7	Channel 7
92 CZ 561	H-5-8	Channel 8
92 CZ 562	H-5-9	Channel 9
92 CZ 563	H-5-10	Channel 10
92 CZ 564	H-5-11	Channel 11
92 CZ 565	H-5-12	Channel 12
92 CZ 566	H-5-13	Channel 13

List, \$6.65. NET EACH..... 3.91

★★★★ Model H-6-713. New, twin-driven 6-element yagi. Similar to above, but covers channels 7-13. 2 3/4 lbs.

92 CZ 567. List, \$8.75. NET..... 5.14

Model A Stacking Kit. For all Finney Series H antennas above. Shpg. wt., 8 oz.

92 CZ 086. List, \$2.00..... 1.18

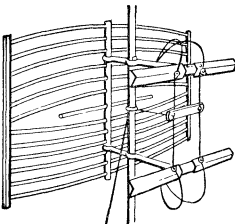

DAVIS UHF-VHF ANTENNA

★★★★ Model SV-ZR-1 "Zig-Rig." For superior fringe area VHF reception; excellent UHF reception in primary signal areas. Delivers 12 db or more average gain on high channels. Features electronic dipole separators. With 2 sets of matching harness—permits peaking antenna on weakest channel and still maintain excellent all-channel coverage. Less mast and 300-ohm line. Shpg. wt., 12 lbs.

92 CZ 210. List, \$29.95. NET..... 17.61

Model SK-1 Stacking Kit. For horizontal or vertical stacking of SV-ZR-1. 1 1/2 lbs.

51 CX 054. List, \$3.25. NET..... 1.91

ALL-CHANNEL'S FAMOUS UHF-VHF ANTENNAS

• Deep-Fringe & Semi-Fringe Models

"RIVIERA" ANTENNA

★★★★ The latest version of this highly popular, extremely powerful UHF-VHF antenna. Provides exceptionally clear signal reception in deep-fringe signal areas. It features a 9-position, ceramic switch at set for electronically "rotating" antenna without moving it. A turn of the switch conveniently selects the proper element combination for superior reception from any direction. Superb for high-fidelity FM reception; performance on color TV signals is equal to that of black and white. Provides unusually sharp directivity, very high gain and excellent signal-to-noise ratio. Extremely rugged, weather-resistant construction. Incorporates 16 elements—each element of 1/2" aluminum tubing (with dowel inserts), 60" long. Has 4 solid aluminum stacking bars, 45" long. Low loss, pre-assembled switch-to-set coupler. Insulators are of triple-strength design to assure dependable support of the antenna elements under conditions of high wind and icing. With 2, 7 1/2" stand-off insulators and instructions. Less mast and 4-conductor polymycalene transmission line (listed at right). Shpg. wt., 10 lbs.

98 CZ 495. List, \$36.75. NET..... 22.05



9-Position Switch for Electronic "Rotation"

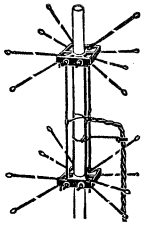

"SUBURBAN" ANTENNA

★★ Excellent semi-fringe antenna. Features special 8-element All-Channel design with air-spaced low-loss insulator; 9-position rotary ceramic switch for electronic "rotation" without moving antenna; all aluminum, dowel-reinforced elements 45" long and 3/8" in diameter; low-loss, pre-assembled switch-to-set coupler; 2—mast stand-offs; 2—screw-type insulators; 70 ft. of 4-conductor polyethylene transmission line; and easy-to-follow installation instructions. Less mast, Wt., 5 lbs.

92 CX 060. List, \$21.50. NET..... 12.90

4-Conductor Transmission Line. For use with Riviera antenna. 100 ft., 2 lbs.

47 TX 589. 100-ft. Coil. NET..... 8.90

47 W 599. Over 100', PER 100'..... 8.90

TACO BROAD-BAND VHF ANTENNAS

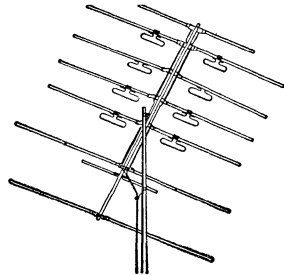

Outstanding in Deep Fringe Areas

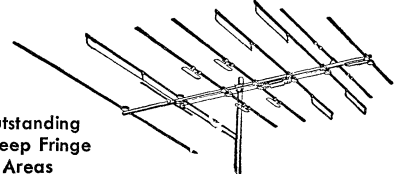

MODEL 2570 "TOPLINER"

★★★★ Exceptionally engineered, high-gain antenna for peak reception in deep-fringe areas. Features exclusive new phase delay line for improved impedance match to transmission line. 5 driven elements operate with equal efficiency on all VHF channels; give high gain and uniform response. Sharp directivity; minimizes ghosts and interference. Extremely high front-to-back ratio. Rugged, aluminum-alloy construction, pre-assembled for easy installation. Uses spring-loaded tension-booster locks—elements snap into place without tools. Less mast and 300-ohm twin line. Shpg. wt., 10 lbs.

92 CZ 296. List, \$36.75. NET..... 21.61

2502 Stacking Harness. For stacking two 2570 antennas for extra gain on channels 7-13. Shpg. wt., 1/2 lb.

92 CX 297. List, \$1.50. NET..... 88c

2503 Stacking Harness. For stacking two 2570 antennas for extra gain on channels 2-6. Shpg. wt., 1/2 lb.

92 CX 298. List, \$3.00. NET..... 1.76

MODEL 1890 "SUPER-TRAPPER"

★★★★ For outstanding performance in deep-fringe areas—high uniform gain on both high and low VHF bands. Features 5 driven elements; signal energy is always combined in phase regardless of channel being used. Extremely high front-to-back ratio. 1 1/4" dia. cross-arm; fiberglass insulators. Easy to install—elements snap into place without tools. Tough aluminum alloy construction. Less mast and 300-ohm twin line. Shpg. wt., 9 lbs.

92 CZ 030. List, \$34.50. NET..... 20.29

Model 1892 Stacking Kit. For stacking two 1890 antennas for extra high-band gain. Shpg. wt., 1/4 lb.

92 CX 031. List, \$1.50. NET..... 88c

Model 1893 Stacking Kit. For stacking two 1890 antennas for extra low-band gain. Shpg. wt., 7 oz.

92 CX 032. List, \$3.75. NET..... 2.20

WALSCO "IMPERIAL" VHF TV ANTENNAS

★★ Model 4062-F. Popular 2-bay conical antenna for channels 2-13. Provides excellent reception under all kinds of weather conditions—may be used in seacoast or industrial areas. Features barrier disc insulator with 2" air space between terminals—gain is unaffected by salt, moisture, corrosion, etc. Non-rusting contacts and terminals. Easily installed—partially pre-assembled. Less twin line and mast. Shpg. wt., 8 lbs.

98 CZ 404. List, \$19.85. NET..... 11.67

★ Model 4060-F. As above but single bay. 4 lbs.

98 CZ 405. List, \$9.25. NET..... 5.44

Stacking Kits. For stacking 4060-F single-bay antennas.

Stock No.	Model No.	Description	Wt. Lbs.	List	NET EACH
98 CZ 406	4060A-1	For 2-bay stacking	3/4	\$1.50	.88
98 CX 407	4005-5A	For 4-bay stacking	1 1/2	5.60	3.29

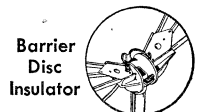
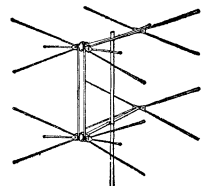

Barrier Disc Insulator

Amphenol TV Antennas & Accessories

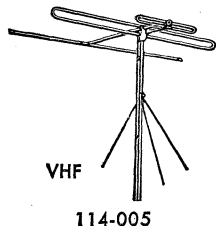

114-005

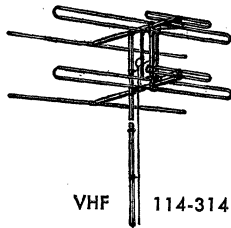

VHF 114-314

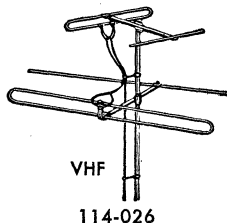

VHF 114-026

HIGHLY EFFICIENT VHF & UHF ANTENNAS

★INLINE VHF ANTENNA

Model 114-005. Covers all 12 VHF channels. Ideal for metropolitan and suburban use. Unusually broad frequency response. Uni-directional pattern and excellent impedance match on high and low-bands reduces stray reflections and "ghosts." Antenna elements constructed of sturdy aluminum tubing. Mast is heavy-gauge steel. Unique design permits large folded dipole (for 54-88 mc band) to operate as reflector for the smaller dipole (174-216 mc band). Includes one 5"x3/4" mast, guy ring, mounting bracket, hardware, stand-off insulators, 75 feet of high-quality 300-ohm twin line, and easy-to-follow installation instructions. Shpg. wt., 7 lbs.
97 CZ 438. List, \$19.50. NET..... 11.47

Model 114-009. Same antenna as 114-005 above but less 300-ohm twin line. With all hardware. Shpg. wt., 6 lbs.
97 CZ 439. List, \$17.00. NET..... 10.00

Model 114-040. Same as 114-005 above, but less mast, twin line and stand-off insulators. Shpg. wt., 5 lbs.
97 CZ 492. List, \$13.95. NET..... 8.20

★★INLINE STACKED ARRAY

Model 114-314. Properly phased for all 12 VHF channels. Each bay consists of 2 folded dipoles and low-band reflector element. Low-band folded dipole of each bay acts as reflector for high-band dipole. Matching section has correct impedance for 300-ohm twin line. Ready for quick and easy installation. With complete instructions; less 300-ohm twin line and masts. Shpg. wt., 12 lbs.
97 CZ 454. List, \$29.00. NET..... 17.05

ANTENNA COUPLERS

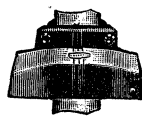

Antenna coupling networks. Eliminate antenna switching and separate lead-in lines. Permit using a single 300-ohm line to separate high and low-band VHF antennas and VHF and UHF antennas. Each coupler listed below consists of an efficient isolation filter for effectively isolating one antenna from the other; preserves the gain to assure good picture quality. Easily installed on antenna mast. With mounting hardware and installation instructions. Shpg. wt., 1 1/2 lbs.

Model 114-094 "Duonet." Couples separate high-band VHF antenna with a separate low-band VHF antenna on single 300-ohm twin line.
51 C 283. List, \$3.75. NET..... 2.20

Model 114-061 "Isonet." VHF-UHF coupling network. Permits using a single 300-ohm twin line to separate VHF and UHF antennas.
51 C 273. List, \$3.75. NET..... 2.20

Model 114-074 "Trisonet." Permits coupling three antennas (low-band VHF, high-band VHF and UHF) to a single 300-ohm transmission line.
51 C 277. List, \$4.75. NET..... 2.79

★★"PIGGY-BACK" VHF ANTENNA

Model 114-026. Amphenol's extremely popular "Piggy-Back" VHF antenna—a particularly fine choice for locations where high and low-band TV signals are received from different directions. Eliminates the need for compromising low-band reception in order to obtain good high-band reception, and vice-versa. Consists of individual, 2-element high-band and low-band antenna sections to permit separate directional adjustments for peak performance and minimum "ghosts" on channels 2-6 (low band) and 7-13 (high band).

Each antenna section employs its own folded dipole element plus a reflector element to assure excellent signal gain and a very favorable front-to-back ratio. Provides clear, sharp reception in metropolitan as well as suburban areas.

Antenna is supplied with the following installation accessories: 5-ft. steel mast, clamps, guy ring, isolating transmission harness, mounting support, stand-off insulators, 75 feet of 300-ohm twin line and instructions for quick, simplified installation. Sturdy, weather-resistant construction. Shpg. wt., 10 lbs.
97 CZ 360. List, \$19.50. NET..... 11.47

★UHF CORNER REFLECTOR

Model 114-058. Engineered for high gain over channels 14 to 83. UHF corner reflector design has proven most efficient antenna for both strong and weak signal areas. Excellent horizontal and vertical characteristics reduce "ghosts" as well as interference due to simultaneous telecasting on the same channel or adjacent channels. Spacing and dimensions of the elements and reflectors assure maximum broadband reception from the front with rejection of reflected signals from the sides and back. Ascending signal gain of 8 to 13 db across the entire UHF range. Impedance matches 300-ohm twin line. Electro-galvanized steel reflectors designed to resist corrosion. Fits masts up to 1 1/2" O.D. With complete mounting hardware. Less mast and 300-ohm twin line. Shpg. wt., 8 lbs.
97 CZ 263. List, \$12.50. NET..... 7.35

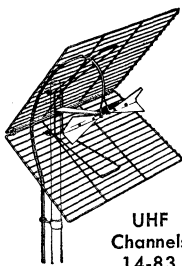

UHF Channels 14-83

MATCHING TRANSFORMER

Matching transformer for connecting 72 and 300-ohm impedances. Matches 72-ohm line to 300-ohm antenna or receiver inputs; matches 300-ohm line to 72-ohm antenna or receiver inputs. Spade lugs for convenient installation. Shpg. wt., 14 oz.
51 C 292. NET..... 71c

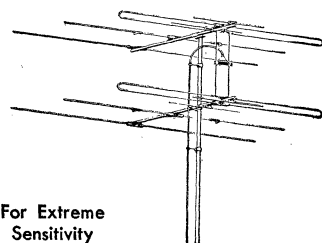
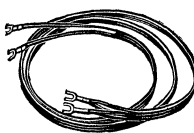

For Extreme Sensitivity

★★★"POWERAY" FRINGE-AREA VHF ANTENNA

Model 114-095. Designed for extreme sensitivity, the "Poweray" 2 bay fringe area VHF TV antenna produces outstanding signal reception even at distances to 75 miles from the transmitter. Features new "Sleeve Dipole" design for proper balance of gain and directivity, plus an extremely close impedance match between antenna, lead-in, and TV receiver. Exceptional gain due to high front to back ratio, sharp directivity, and very high efficiency assure outstanding picture quality on all channels from 2 to 13. Exceptionally high directivity eliminates adjacent channel and co-channel interference, and greatly reduces ground reflections causing "ghosts." Pre-assembled for quick and easy installation—elements swing out and lock with positive spring-lock design. Heavy-duty, all-aluminum construction withstands severe weather conditions—high winds, snow, icing, etc. Requires 10-ft. mast. Less mast and 300-ohm twin line. Shpg. wt., 14 lbs.
92 CZ 089. List, \$34.75. NET..... 20.43

Model 114-743 Stacking Harness. For stacking two 114-095 antennas. Wt., 1/2 lb.
92 CX 097. NET..... 1.18

ADJUSTABLE STACKED V UHF-VHF ANTENNA

★ Model 114-059. Extremely versatile, low-cost VHF-UHF antenna. Angle between elements can be adjusted to 3 positions to permit reception on UHF, VHF or a combination of both. Good vertical directivity serves to minimize ground reflections, or "ghosts," on UHF and also acts to reduce co-channel and adjacent channel interference. Non-corrosive seamless aluminum tubing and spacers. Other hardware is heavily coated for maximum protection against weather. Completely pre-assembled for quick installation on any 3/4" to 1 1/2" O.D. mast. Supplied with 2 U-bolts, with easy-to-follow instructions. Less mast and 300-ohm twin line. Shpg. wt., 2 1/2 lbs.
98 CZ 411. List, \$9.75. NET..... 5.73

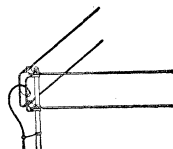

ANTENNA INSTALLATION KITS

2-Mast Kit. Provides needed installation accessories for use with any TV antenna. Every item supplied in kit is of top-quality construction. Mast sections are galvanized to resist corrosion. Includes everything needed for quick and easy installation of any antenna—perfect for service crews, etc. Contains: 2—31 1/2" mast sections; 60' of tubular twin-line; 1—lightning arrester; 2—mast stand-offs; 6—screw-type standoffs; and 4' ground wire. Shpg. wt., 4 lbs.
98 CX 372. List, \$11.55. NET..... 6.79

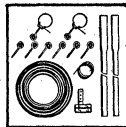

4-Mast Kit. Same as kit above, but with 4—31 1/2" mast sections instead of 2. Shpg. wt., 6 1/2 lbs.
98 CX 373. List, \$14.35. NET..... 8.44

TV and FM Antennas

TELREX UHF-VHF TV ANTENNA

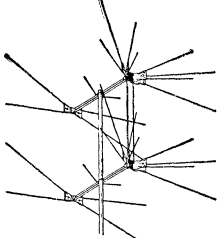

DUO-BAND UHF-VHF CONICAL V-BEAM ANTENNA

★★ **MODEL 440.** Universal 2-bay UHF-VHF antenna. Ideal for fringe and primary areas.

as. Unidirectional pattern. Special "V" type elements. Has excellent directivity and high signal-to-noise ratio on both UHF and VHF bands. Minimizes ghosts and co-channel interference. Both UHF and VHF signals are picked up at the same cone apex—no filters or isolation networks are required. Only one antenna and one transmission line for both bands. Higher frequency signals are further strengthened by the addition of 2 supplementary "V" splines. All aluminum construction. Easy to install. Less mast and 300-ohm line. Shpg. wt., 9 lbs.

92 CZ 204. List, \$26.40 NET. **15.52**

★ **MODEL 420.** Same antenna as above, but only 1 bay. Shpg. wt., 6 lbs.

92 CZ 205. List, \$13.03. NET. **7.66**

TACO FM ANTENNAS

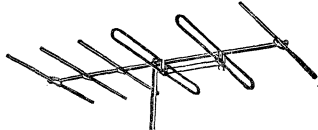

★★★★MODEL 644B 6-ELEMENT FM ANTENNA

Single-bay, 6-element yagi antenna for top FM performance in weak signal areas. Unidirectional design. High front-to-back ratio. 6 to 9 db gain. Completely assembled. Elements swing out—lock in place. Shpg. wt., 7 lbs.

92 CZ 546. List, \$20.20. NET. **11.88**

★★★★MODEL 610 10-ELEMENT FM ANTENNA

Single-bay, 10-element yagi antenna for outstanding long-distance FM reception. 8 to 10 db gain. Sharp directivity—extremely high front-to-back ratio. Completely assembled. Arms swing out—lock in place. Shpg. wt., 10½ lbs.

92 CZ 547. List, \$29.25. NET. **17.20**

Model 646 Stacking Kit. Phasing line, insulators, hardware. Permits stacking two 644B or 610 antennas. Wt., 1 lb.

92 CX 548. List, \$2.65. NET. **1.56**

MODEL 624STL FM ANTENNA

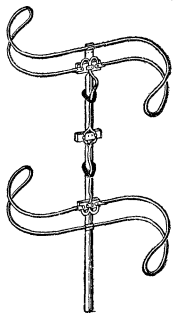

★★ An excellent value in a unique FM antenna—combines an all-directional pickup pattern with high gain. Consists of two S-type, stacked, folded dipoles connected with a phasing network for optimum efficiency. Reception characteristics are particularly suited for locations where stations must be received from several different directions. Stacked-element design provides

unusually good gain across the entire FM band. Sturdy, all-aluminum construction. Antenna is supplied with heavy-duty, 10-ft. aluminum mast. Less 300-ohm twin line. Shpg. wt., 7½ lbs.

92 CZ 039. List, \$14.95. NET. **8.79**

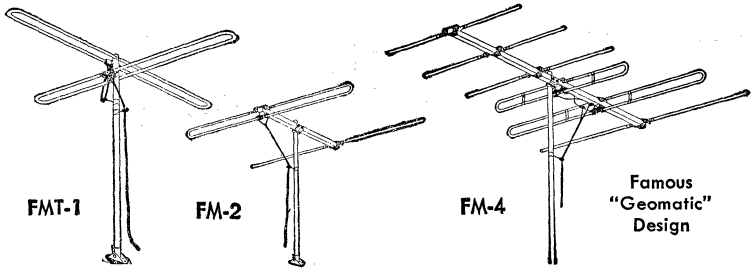

FMT-1

FM-2

FM-4

Famous "Geomatic" Design

FINNEY FM ANTENNAS

★MODEL FMT-1 ANTENNA KIT

All-direction FM antenna kit. Provides unusually fine reception over the entire FM band, 88 to 108 mc. Incorporates two sturdy, well designed folded dipoles mounted at right angles to each other for complete 360° coverage without rotation. Dipoles are matched with a special quarter wave phasing stub for optimum gain in all directions. Simplified installation. Each folded dipole attaches easily to pre-drilled mast. Stand-off insulators support line away from mast. Universal base will mount on any surface from horizontal flat roof to vertical side wall and allow mast to be adjusted to vertical position. Kit includes 50-ft. 300-ohm transmission line; heavy-duty 5-ft. antenna mast; universal mounting base; 2 mast stand-off insulators; and 3 screw-eye stand-off insulators. Shpg. wt., 6 lbs.

92 CX 278. List, \$13.95. NET. **8.20**

★★MODEL FM-2 ANTENNA KIT

Here's an excellent-performing antenna kit. A particularly fine choice for use where all signals are received from approximately the same direction. Employs an efficient FM dipole plus a reflector element to achieve high signal gain and good directivity. Gain is 3.5 db. Features rugged, weather-resistant construction throughout. All-aluminum boom and elements are completely pre-assembled with "snap-out," self-aligning aluminum brackets—designed for quick, simplified installation. Universal base will mount on any surface. Kit is supplied with 5-ft. antenna mast, heavy-duty mounting base, 50-ft. 300-ohm twin line, 2 mast-type stand-off insulators, and 3 screw-eye stand-off insulators. Shpg. wt., 6½ lbs.

92 CX 279. List, \$13.95. NET. **8.20**

★★★MODEL FM-3 ANTENNA

(Not illustrated.) An extremely effective broad band fringe-area FM antenna at a very moderate cost. Features a highly directive 4-element yagi design for outstanding gain on the FM band, 88 to 108 mc. All-aluminum construction with square boom. Special "Lock-Tite-No-Tilt" saddle bracket for permanent horizontal alignment. Uses folded dipole driven element for closer impedance matching and maximum energy transfer. Double wall reinforced elements have snap-out brackets. Elements lock in open position. Less mast and 300-ohm twin lead. Shpg. wt., 5 lbs.

92 CZ 281. List, \$12.50. NET. **7.35**

★★★★MODEL FM-4 ANTENNA

Deluxe, 6-element, high-gain antenna—provides superior fringe-area FM reception. Design is based on the famous "Geomatic" TV antenna principles. Features a specially engineered twin drive element with impedance matching by the well known "T-Match" system. Twin drive allows maximum gain to be realized over the full 88 to 108 mc band. 3 extra wide spaced parasitic director elements, plus the wide spaced parasitic reflector, also contribute substantially to the gain and broad-band features. All of the parasitic elements lock into open position by "snap lock" brackets. On the twin-drive dipoles it is only necessary to loosen nuts, swing into open position until brackets snap closed and retighten nuts. Equipped with rugged square aluminum boom; exclusive "Lock-Tite-No-Tilt" saddle mounting; "box-girder" snap out self-aligning brackets. Completely pre-assembled with double wall reinforced, lightweight, all-aluminum elements. Shpg. wt., 6½ lbs.

92 CZ 280. List, \$23.95. NET. **14.08**

AMPHENOL FM ANTENNAS



★MODEL 114-008 ANTENNA KIT

An efficient, sturdily constructed FM antenna. Easily installed unit employs folded dipole plus a reflector element. Use of folded dipole as driven element provides excellent impedance match with 300-ohm lead in line. Has unusually good gain and directional characteristics across the entire 88 to 108 mc FM band. A very dependable performer for use in areas where most FM stations are received from approximately the same direction. Made of lightweight, durable aluminum tubing—withstands adverse weather conditions. Universal mounting bracket allows mast to be installed vertically on any type of roof or side of house.

Supplied complete with a full set of high-quality accessories plus easy-to-follow assembly and installation instructions. Accessories consist of: 5 ft. x ¾" O.D. steel mast, 75 feet of 300-ohm twin line, low-loss stand-off insulators, universal mounting bracket and hardware. Shpg. wt., 7 lbs.

97 CX 433. List, \$16.25 NET. **9.55**

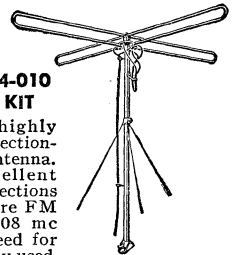

★MODEL 114-010 ANTENNA KIT

Amphenol's highly popular, all-directional FM dipole antenna. Provides excellent gain in all directions across the entire FM band, 88 to 108 mc without the need for rotation. Widely used in locations where FM stations are received from many different directions. Employs 2 folded dipole elements mounted at right angles to each other for a circular pickup pattern. A quarter-wave phasing stub precisely matches both dipoles to 300-ohm twin line to assure very efficient operation and equal gain from all directions.

Supplied complete with full set of accessories for easy, time-saving installation. Includes convenient, hinged base plate for simplified mounting of antenna on either a flat or sloping roof, 75 feet of quality 300-ohm twin line, all hardware, and sturdy 5-ft. x ¾" O.D. mast. Shpg. wt., 7 lbs.

97 CZ 434. List, \$16.25. NET. **9.55**

AM Antennas, Antenna Kits, TV Tuner

SUPERX HIGH-GAIN LOOPSTICK ANTENNAS

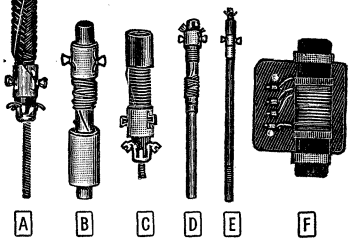

A VLT-240 Transistor Vari-Loopstick. Has impedance tap; convenient micrometer adjustment. Easily adjusted for peak efficiency. Simplified, one-hole snap-in mounting. For use with 365 mmf or 410 mmf variable tuning capacitor. Size: $7/16 \times 2"$. Shpg. wt., 4 oz. 51 C 029. NET73c

B Ferri-Loopstick. Excellent, low-cost, replacement antenna for AM broadcast receivers. Needs no orientation. Has "Q" of 240-275 for clear, powerful reception. Supplied with clamp for convenient single-hole snap-in mounting. Size: $7/16 \times 2"$ long. Shpg. wt., 4 oz. 51 C 036. NET44c

C Vari-Loopstick. For AM broadcast receivers, including the smallest portables. Has "Q" of 250. Adjustable ferrite core permits peaking for any portion of tuning range. Single-pole snap-in mounting. Size: $7/16 \times 2 1/4"$. Shpg. wt., 4 oz. 51 C 034. NET59c

C Vari-Tenna. Features high sensitivity and excellent signal-to-noise ratio. Boosts sensitivity and gain up to 25 times in older receivers. Single-hole mounting. Size: $1/2 \times 2 1/2"$. Shpg. wt., 4 oz. 51 C 032. NET73c

DELUXE BC-SW ANTENNA KIT

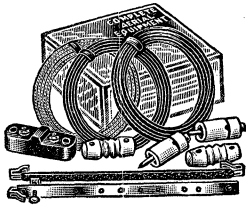

Handy antenna kit for broadcast and short wave reception. Increases "pulling power" of any set. Includes 100 ft., 7x26 bare copper antenna wire; 40 ft. rubber covered lead-in; 25 ft. rubber covered ground wire; 2 porcelain insulators; 1 window lead-in; 1 lightning arrester; 2 porcelain nut knobs; 1 ground clamp and full instructions Shpg. wt., $2 1/2$ lbs. 83 C 101. NET2.04

Standard BC-SW Antenna Kit. 50 ft., 7x26 bare copper wire; 25 ft. lead-in; 2 antenna insulators; 2 nail knob insulators; 1 window lead-in and ground clamp. Shpg. wt., $1 1/2$ lbs. 83 C 100. NET1.03

SERVICE INSTRUMENTS CO.

"UP-DOWN" VOLTAGE REGULATORS

Type LB2. An extremely handy, multi-purpose voltage regulator for the servicing bench. Designed to increase low line voltage or decrease high line voltage. Raises or lowers line voltage 10 volts by simple flick of a switch. Can be used with any television receiver or appliance which has a power consumption of 300 watts or less. Restores proper picture width and height, increases brightness, remedies oscillator drift and poor sync, and helps extend tube life. Size: $2 1/2 \times 3 3/4 \times 3 3/4"$. Rated, 300 watts. For operation from 115 volts, 60 cycles AC. Shpg. wt., 3 lbs. 63 G 985. NET5.85

Type LB2 (N). Same as Type LB2 described above, but has no indicator which operates when output voltage is too high, indicates when regulator should be turned off. Indicator light goes on when output voltage of regulator reaches 126 volts. 63 G 987. NET7.03

380

A complete selection of low-cost, high-efficiency ferrite-core antennas. Ideal for replacing old-fashioned loop antennas on the back of AM broadcast receivers. Feature extremely high gain and uniform response. Will greatly improve signal to noise ratio, and pull in many hard-to-get stations that can't be heard with ordinary loops. Troublesome orientation or moving of receivers is not required, since reception is equally sensitive from all directions. Extremely compact size and stable performance; antennas are unaffected by adjacent metallic or inductive elements. May easily be mounted in back of receiver. Tune 540 to 1600 kc with 365 mmf tuning capacitor, except transistor antennas, which use 365 mmf or 410 mmf capacitor.

D "Energized" Ferri-Loopstick. This 7" loopstick has a "Q" of up to 350. Extremely high gain brings in weak, distant stations. Adjustable coil with self-locking vinyl collar permits peaking for optimum result. Convenient single-hole mounting. Size: $7/8 \times 5"$. Shpg. wt., 6 oz. 51 C 038. NET88c

E 7" Loopstick. Same as "energized" loopstick described above, but 7" long for even greater sensitivity. Has "Q" of up to 425. Shpg. wt., 6 oz. 51 C 039. NET1.32

F High "Q" Transistor Loopsticks. Ideal universal replacement for most transistor sets. Feature extremely high "Q" core. Have movable turns and multiple impedance taps; provide complete adjustability for maximum gain. Flat design provides excellent pick-up. All tune 540 to 1600 kc with standard 365 or 410 mmf tuning capacitor. Complete with installation instructions.

Stock No.	Mfr's Type	μ H	Size	Shpg. Wt.	NET EACH
51 C 025	2FT-240	200-265	2 3/4"	4 oz.	1.62
51 C 026	3FT-240	200-265	3 3/4"	4 oz.	1.62
51 C 027	5FT-240	175-260	5 1/4"	4 oz.	1.62
51 C 028	7FT-240	170-265	7"	4 oz.	1.76

REPLACEMENT ANTENNA LOOP

Wound on rigid fiberboard form. Has lug terminals. Replaces antenna coil in battery and midget sets or portables. Turns may be removed to match loop being replaced. Overall size, $6 \times 8 1/4"$. Shpg. wt., 8 oz. 51 C 040. 1 to 9, NET EACH53c
10 or more, EACH48c

MINIATURE ANTENNA LOOP

For use where space is limited. Covers standard broadcast band with midget variable capacitors. 9x38 Litz wire for low loss. 214 microhenries; high "Q" of over 230. Two 4" leads. Overall size, $3 1/2 \times 5 1/4"$. Shpg. wt., 8 oz. 51 C 035. 1 to 9, NET EACH40c
10 or more, EACH36c

WINDOW LEAD-IN

Made of soft drawn flexible copper, covered with heavy black cotton braid. Thoroughly weatherproofed with multiple coats of Duco lacquer. For use with broadcast band and short wave antennas having single-wire lead-in. Fits under window. Has Fahnestock clip on each end. 12" long by $1/2"$ wide. 2 oz. 51 C 050. NET9c

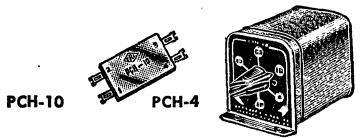

CENTRALAB TV H-PADS
For use in strong signal areas where TV signal requires attenuation to obtain optimum performance H-pad has 4 terminals. Installed in series with 300-ohm antenna lead-in. Size: $1 1/2 \times 1 1/2 \times 3 1/2"$. Shpg. wt., 3 oz.

No.	Type	Attenuation	EACH
11 L 190	PCH-10	10 db	88c
11 L 191	PCH-20	20 db	
11 L 192	PCH-30	30 db	
11 L 193	PCH-40	40 db	

PCH-100. Set of 4 H-pads, one each of above, in plastic box. 51 C 194. NET3.53

PCH-4. Switch with H-Pads above. With mounting bracket. 11 L 454. NET5.88

CONSOLIDATED ANTENNAS

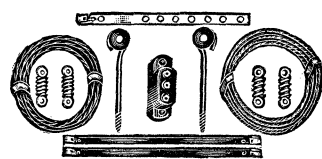

MODEL 615 LONG WAVE, SHORT WAVE & BC ANTENNA KIT

An excellent antenna kit for short-wave reception. Will also perform well on the long-wave and broadcast bands. Contains all wire and parts for any one of the following antennas: balanced doublet; double doublet; or inverted-L. Includes: 100 ft. of bare antenna wire, 50 ft. of insulated transmission line; 4 insulators; 2 bakelite screw eyes; doublet lightning arrester; lead-in strip; and ground clamp. With instructions. Shpg. wt., $3 3/4$ lbs. 51 C 263. NET4.26

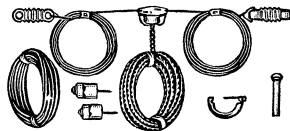

MODEL 635 DOUBLET ANTENNA

A highly efficient doublet antenna. Provides excellent short-wave, long-wave and broadcast band reception. Doublet sections are tuned to provide uniform response throughout the 16-49 meter short-wave band. Kit contains: 2-30 ft. coils of 7/24 bare copper wire; 50 ft. of twisted and braided transmission wire; 10 ft. of ground wire; 3-3" glass insulators; ground clamp; porcelain lead-in tube; 2 porcelain nail knobs; and easy-to-follow installation instructions. Shpg. wt., $3 3/4$ lbs. 51 C 264. NET3.72

COPPERWELD ANTENNA WIRE

High quality, copperweld antenna wire. Features copper outer conductor and steel core. May also be used for guying antenna tower.

Stock No.	Gauge	Feet	Wt., Lbs.	EACH
49 T 133	12	100	2	2.69
49 T 134	12	250	5	6.30
49 T 140	14	250	3 1/2	2.97
49 T 141	14	250	3	5.12
58 T 318	18	250	2	1.63
58 T 319	18	500	3	2.94
58 T 315	18	3000	18	14.48

NEW STANDARD COIL TUNER

Model NA-2100 Neutrode Replacement Tuner. Replaces TAA-050, 21-mc pentode and TCA-050, 21 mc cascode tuners. Features neutralized-triode circuit to provide substantial improvements in gain, signal-to-noise ratio and general performance. Delivers excellent pictures even in fringe areas. Uses 6BN4 RF amplifier and 6CQ8 converter. Printed circuit board. Has improved filter circuits and shielding; greatly reduced oscillator drift and radiation. IF frequency is pre-adjusted at factory to approx. 23.5 mc; can be adjusted over a wide range to suit specific installation requirements. Requires 125-150 v. D.C. plus heater voltage. With full instructions. Shpg. wt., 3 lbs. 60 G 228. NET19.35

TYPE 31M-213 TV TUNER STRIPS

Replace original Standard coil strips. Set includes antenna and oscillator strip for VHF (channels 2-13 only). Specify channel number required and tuner series letter stamped on original strips. 4 oz.

Stock No.	For Series	Stock No.	For Series
60 GG 322	F	60 GG 326	R
60 GG 323	H	60 GG 327	Q/R
60 GG 324	K	60 GG 328	U
60 GG 325	Q		

NET EACH2.19

TV Rotators & Distribution Amplifiers



B

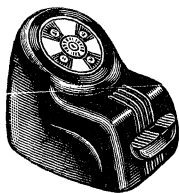

D

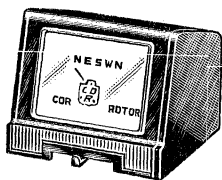

E

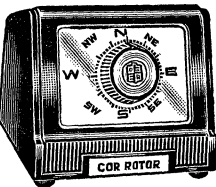

C

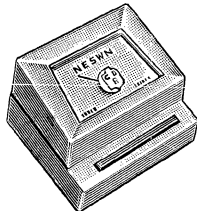

F

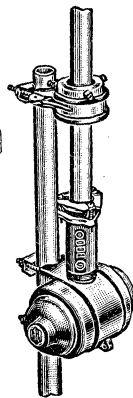

G

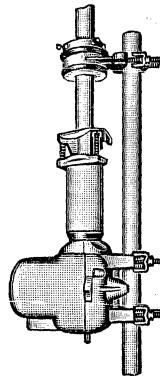

CORNELL-DUBILIER-RADIART TELEVISION ANTENNA ROTATORS

MODEL AR-22 ROTATOR WITH AUTOMATIC-TYPE CONTROL UNIT

A C Popular, fully automatic rotator for TV antennas up to 150 lbs. For mast, tower or platform mounting. Heavy-duty precision gears hold even large TV arrays steady in high winds. Rotor unit employs 12 large ball-bearings in two $6\frac{1}{2}$ " races. Motor reverses instantly—does not drag or coast. Overshoot of desired direction is prevented by magnetic brake. Streamlined bell-shaped housing is die-cast and heavily reinforced. Weather-sealed and factory lubricated for life. Reversible clamps on rotor unit take masts from $\frac{7}{8}$ " to 2" O.D. Rotor unit has 3 husky guy wire lugs built-in for convenience in installation.

Control unit dial is marked in compass points: N, S, E, W, NW, NE, SW, and SE. Operation is extremely simple: Set control unit pointer to desired direction, and antenna then automatically rotates to this position and stops. Eliminates necessity of watching control unit dial until antenna has rotated to desired direction. Control unit is housed in attractive brown plastic cabinet which is equipped with rubber feet to protect TV set finish. Complete with rotor, control unit, and full set of instructions. Requires 4-wire cable (see listing below). For operation from 110-120 volts, 50-60 cycle AC. Shpg. wt., 14 lbs.
92 TX 150, List, \$51.95. NET.....30.55

MODEL TR-4 ROTATOR WITH METER-TYPE CONTROL UNIT

A D Heavy-duty antenna rotor; same as above except with meter-type control unit. Dial calibrated N, E, S, W, and N. Lever at front of control box permits forward or reverse movement of antenna. Dial pointer begins to turn as soon as starter lever is actuated, and can be stopped at any desired direction. Sturdy plastic cabinet with attractive mahogany finish. For 110-120v, 50-60 cycle AC. Uses cable below. Shpg. wt., 16 lbs.
98 TX 393, List, \$49.95. NET.....29.37
4-CONDUCTOR CABLE. For use with the AR-22 or the TR-4 rotators. 100 ft., shpg. wt., 3 lbs.
97 T 365, 100-ft. coil. NET.....2.70
47 W 576, Over 100', PER 100'.....2.70

MODEL TR-2 ROTATOR WITH ILLUMINATED-COMPASS CONTROL UNIT

A B Heavy-duty rotator, same as the two above but uses illuminated control box with compass-type dial. As antenna rotates, letters N, E, S, W, light up—clearly indicating direction. Bar lever at front permits start, stop or reversing action. Less cable. Uses 8-wire cable listed below. For operation from 110-120, 50-60 cycle AC. With handsome plastic control cabinet. Shpg. wt., 16 lbs.
97 TX 463, List, \$45.95. NET.....27.02
8-CONDUCTOR CABLE. For TR-2 rotator above. Handles current for rotor and illumination circuits.
47 T 586, 100-ft. coil. NET.....4.73
47 W 593, Over 100', PER 100'.....4.73

WALDOM DISTRIBUTION AMPLIFIERS

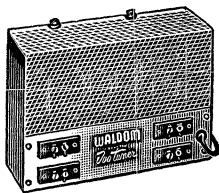

Model DA-2000—A two-set electronic TV distribution amplifier. Permits operation of two TV sets from one antenna. Broad bandwidth—ideal for reception of color TV. Signal delivered to each TV set is an average of 3 db better than the signal available directly from the antenna. 300-ohm inputs. Outputs: Two 300-ohm twin-lead connections to TV sets. Uses two 6BK7A tubes as separate and independent broad-band amplifiers. UHF input converts both sets to UHF reception with a single UHF converter. Size: $8\frac{1}{2} \times 4\frac{1}{2} \times 7\frac{1}{4}$ ". In sturdy gray metal cabinet. For operation from 110-120

volts, 60 cycle AC. Shpg. wt., 3 lbs.
98 T 473, List, \$45.45. NET.....26.72

Model DA-1010, Distribution Amplifier. Similar to Model DA-2000 above, but for use with up to ten TV sets. Uses 1—6BK7A and 3—6J6 tubes. Size: $12\frac{1}{2} \times 3\frac{1}{4} \times 7\frac{1}{4}$ ". In steel cabinet. For 110-120 volts, 60 cycle AC. Shpg. wt., 8 lbs.
98 T 494, List, \$102.95. NET.....60.53

MODEL AR-2 ROTATOR WITH AUTOMATIC-TYPE CONTROL UNIT

E C Completely automatic antenna rotator. To operate, place pointer on control unit dial to desired position. Antenna begins to rotate and dial lights up while rotation takes place. When antenna reaches desired position, the entire unit shuts off automatically. Will rotate in either direction. Mechanical brake, released magnetically, provides minimum overshoot and drifting in winds.

Quick-mounting antenna mast collet accepts masts up to $1\frac{1}{2}$ " O.D. — self-centering sawtooth clamp, grip mast securely. Rotor mechanism is streamlined for pleasing appearance and low wind resistance. Installation is speedy and simple, with no loose parts to assemble. Mounts on mast or pipe up to 2" O.D. 360° rotation; makes complete revolution in 45 seconds. With control unit and thrust bearing. Attractive plastic control unit uses 4-wire control cable (see below). For 110-120 volts, 50-60 cycle AC. Less control cable. Shpg. wt., 13½ lbs.
98 TX 414, List, \$49.95. NET.....29.37

MODEL TR-12 ROTATOR WITH METER-TYPE CONTROL UNIT

E D Antenna rotator using the same rotor unit as the Model AR-2 above, but with meter-type control unit as described at left with the Model TR-4 rotator. Has dial calibrated in directions N, E, S, W, and N. Rotor may be started, stopped, or reversed at any point by lever on front of control cabinet. Rugged plastic cabinet has attractive mahogany finish. For 110-120 v., 50-60 cycle AC. Uses 4-conductor cable listed below. Shpg. wt., 12 lbs.
98 TX 392, List, \$43.95. NET.....25.84

NEW MODEL TR-16 ROTATOR WITH METER-TYPE CONTROL UNIT

G F Newest model in the famous C-D line of rotators. Rotor unit is similar to the one in the Model TR-12, and AR-2 above, but in new modern style housing. Also has a newly designed meter-type control unit. Has same husky thrust bearing; instant locking—non-drift features. Mechanical brake—releases magnetically. Instantly reversible. Makes complete revolution in 45 seconds. Rugged, precision made gears. New, modern design control unit featuring meter-type dial and "piano key" control bar. Operates in the same manner as that described above and at left in the TR-4 and TR-12. Cabinet has been restyled for modern appearance. Slanted front panel allows dial to be more easily read. Rotor unit is easily installed—no loose parts to assemble. Quick mounting antenna mast collet. Completely weather sealed. Self centering sawtooth mast clamps grip antenna mast securely. Fits all standard towers. For use with mast diameter of 1½" O.D. For 110-120v, 50-60 cycle AC. Complete with thrust bearing and attractive, mahogany finish plastic control cabinet. Less cable. Uses 4-conductor cable listed below. Shpg. wt., 13 lbs.
92 TX 591, List, \$43.95. NET.....25.84

4-CONDUCTOR CABLE. For use with the AR-2, the TR-12 or the new TR-16 rotators. 100-ft., shpg. wt., 3 lbs.
97 T 365, 100-ft. coil. NET.....2.70
47 W 576, Over 100', PER 100'.....2.70

VEE-D-X VBM ANTENNA ROTATOR

Exceptionally rugged unit used to orient antenna in any direction for maximum signal strength. Features die-cast gears for long life and smooth operation. Sintered steel thrust bearing. Motor bearings are silicone-lubricated. Advanced in-line design for greater motor handling capacity (up to 200 lbs.) less wind resistance. Heavy-duty 3-jaw chuck-type clamps on top and bottom. Positive stop eliminates over-travel to permit pinpoint accuracy. Motor is reversible—has automatic built-in mechanical braking action. Mahogany-finish plastic control box with finger-tip control lever. Dial marked N, E, S, W, N; also numerical reference points. Uses control cable below. Rotation speed; 1½ rpm. For 110-120 volts, 60 cycle AC. Shpg. wt., 11 lbs.
98 TX 293, NET.....24.95

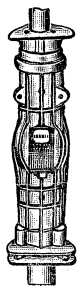

4-CONDUCTOR CABLE. For above. Shpg. wt., 100 ft., 3 lbs.
97 T 365, 100-ft. coil. NET.....2.70
47 W 576, Over 100 ft., PER 100 ft.....2.70

Blonder-Tongue TV Equipment

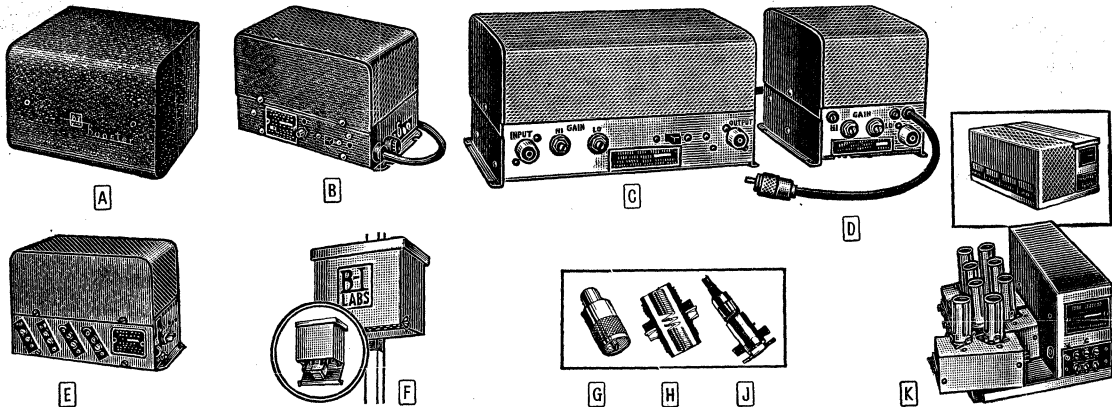

TV BOOSTERS AND DISTRIBUTION SYSTEMS

VHF ANTENSIFIERS

Two powerful TV boosters. Model HA-3 is for use with one TV receiver. Model CA-1B is for distribution systems and deluxe home installations. Both units are fully automatic.

A Model HA-3. Broadband booster featuring an advanced, 3-stage push-pull cascade circuit. Designed primarily for home operation of single receivers. Signal boost of greater than 16 db on all 12 VHF channels. No knobs, no tuning and no channel switching. Booster switches on and off with TV set. Employs three 6J6 low-noise, dual-triode tubes. Switch prevents overload on channels requiring no amplification. 5x5 $\frac{3}{4}$ x4". For 105-125 v., 60 cycles AC. Shpg. wt., 4 lbs.
98 T 221. List, \$44.50. NET.....27.70

B Model CA-1B. Powerful commercial TV VHF preamp—26 db gain on low band; 24 db on high band. May be used at any point of any distribution system. Ideal as line amplifier in master TV systems or community installations. Matching transformers for use with 75 and 300-ohm lines. Dual triodes used for best signal-to-noise ratio. Metal cabinet. 8x4 $\frac{1}{2}$ x5". With 2—6J6's and 2—6BQ7A's. For 105-125 v., 60 cycles AC. Shpg. wt., 7 lbs.
98 T 218. List, \$84.50. NET.....52.40

MLA VHF TV SIGNAL AMPLIFIER

C The "Masterline" VHF TV signal amplifier. Provides an effective signal boost of not less than 37 db. It is excellent where very long transmission lines weaken signal. May be installed in coax line going to single TV set, or used with antenna distribution system (described at far right), in installations feeding 2 or more TV sets from 1 antenna. Several "Masterlines" may be placed in cascade when extremely long transmission lines are used. May be used with MAGC unit (below), to virtually eliminate signal fluctuation. Offers maximum fidelity for color TV. Gain is adjustable on high and low bands. Response flat within ± 3 db over any 6 mc channel. Cascade amplifying circuits assure minimum noise level. Coax input and output connectors. 9x6x5" deep. In perforated gray metal cabinet. For operation from 110-120 v., 60 cycle AC. Wt., 9 lbs.
92 T 090. List, \$124.50. NET.....77.30

MAGC AUTOMATIC GAIN CONTROL

D For use with the Model MLA, above. Maintains a constant output level of the amplifier, even with 20 db variation in signal strength. Effective from 14,000 to 140,000 microvolts. Also compensates for AC line variations. Radiation-resistant coax connectors. Takes operating voltages from Model MLA. Has controls to independently adjust signal levels on high and low bands. Gray hammettone. 6x4x5". 6 lbs.
92 T 091. List, \$79.60. NET.....49.40

VHF DISTRIBUTION SYSTEM

E Model DA8-B. Combination booster and isolation-distribution system for use with up to 8 TV sets. Ideal for use in small apartment buildings, hotels, motels, etc. Permits operating up to 8 TV sets from a single antenna. 22 db minimum isolation between output circuits prevents interaction between TV receivers. Provides 10 db gain to each TV set to assure full-strength signals. Low-noise, all-triode circuit. Has inputs for 75- or 300-ohm line. Eight outputs accommodate 75- or 300-ohm line; one of these outputs may be used to feed another DA8-B to permit hook-up of additional TV sets. Screw terminals permit fast installation. 5 $\frac{3}{4}$ x9x5 $\frac{1}{2}$ ". For 105-125 v., 60 cycles AC. Shpg. wt., 7 lbs.
98 T 220. List, \$94.50. NET.....58.50

MODEL AB VHF BOOSTER

F Antenna mounted TV booster. Efficient broadband circuit provides more than 25 db gain on all VHF channels. Includes indoor control box which steps down the regular line voltage to 24 volts to operate booster. Voltage is delivered to booster by same line that carries TV signal. Built-in filter network isolates AC from TV signal. Operation is automatic—booster turns on and off with TV set. Unit has 300-ohm input and output. Amplifier unit is enclosed in weatherproof housing for installation at antenna. Supplied with mast mounting bracket. For 110-120 v., 50-60 cycle AC. Shpg. wt., 10 lbs.
92 T 092. List, \$99.50. NET.....62.00

CONNECTORS, COUPLER & TAPOFFS

G Model P-59S Male Connector. For use on "Masterline" Model MLA or MAGC signal amplifiers. Provides correct 75-ohm impedance match. P-59S is for RG-59/U coax cable. Wt., 3 oz.
51 C 113. List, \$1.55. NET EACH.....95

H Model P-11S Connector. As above, but for RG-11/U coax cable.
51 C 114. List, \$1.55. NET EACH.....95

J Model MTP-75 Terminating Plug. Terminates unused 75-ohm chassis receptacles. To terminate either RG-11/U or RG-59/U cable, use with Model MC-1 coupler and P-11S or P-59S coaxial cable connector. Shpg. wt., 5 oz.
51 C 115. List, \$2.50. NET EACH....1.60

H Model MC-1 Coax Coupler. For correct 75-ohm match in splicing, adapting or terminating RG-11/U and RG-59/U cable. Shpg. wt., 5 oz.
51 C 117. List, \$2.50. NET EACH....1.60

J Model MTO-11 Outdoor Cable Tapoff. Spliceless, weatherproof, RG-11/U cable tap. Uniform 17 db isolation, lowest shunt capacity and positive electrical protection through blocking capacitor. Less than $\frac{1}{2}$ db line loss. Wt., 6 oz.
51 C 118. List, \$6.75. NET EACH..4.30

MODEL MA4-1 MIXER-AMPLIFIER

K TV signal mixer, for up to five antennas. Amplifies and mixes up to five input signals into a common output. For either individual or master antenna systems. Permits the use of four separate high-gain Yagi antennas and one broadband antenna. Requires no rotators or boosters. Provides maximum ghost-free reception because each antenna can be individually oriented to the particular TV station desired when installed. Employs channel strips listed below. Any VHF and UHF antennas can be accommodated at any time with plug-in VHF strips and plug-in UHF converter strips. One input is broadband for signals requiring no preamplification. Remaining 4 single-channel inputs use separate plug-in strip assemblies with gain in excess of 17 db. Impedance: 75- and 300-ohms at all terminals. Gray case. Size of chassis with self-contained power supply, 4x6x8 $\frac{3}{4}$ ". For 105-125 volts, 60 cycle AC. Less plug-in strips (listed below). Wt., 7 lbs.
98 T 305. List, \$67.50. NET.....41.50

STRIPS & CONVERTERS FOR ABOVE

Model CS-1 VHF Channel Strips. Plug-in strips. For use with Model MA4-1 mixer-amplifier above. One strip used for each channel, for gain exceeding 17 db. Each plug-in channel strip has its own 75- and 300-ohm input terminals. Carefully designed and rigidly constructed in fully enclosed plated steel chassis. Polarized four-prong plug at one end for positive contact. Bakelite terminal strip at other end with binder-head screw terminals for antenna connections. Tubes fully shielded for reduction of noise pickup. Complete with tubes and two tinned spade lugs for low-resistance antenna connection. Tubes employed are 1—6AB4 and 1—6CB6, fixed-tuned for individual channels. Shpg. wt., 1 lb.

No.	Channel	No.	Channel
98 T 306	2	98 T 312	8
98 T 307	3	98 T 313	9
98 T 308	4	98 T 314	10
98 T 309	5	98 T 315	11
98 T 310	6	98 T 316	12
98 T 311	7	98 T 317	13

List, \$28.50. NET EACH.....17.80

Model UC-1 UHF Converter Units. Three-tube, high-gain, plug-in converter units with 17 db gain. Unusually stable and sensitive. For UHF reception on VHF receivers using MA4-1 mixer-amplifier, above. Converts UHF signals to VHF. Uses 2 input sockets to permit use of 3 additional antennas. 300-ohm input. Employs 6AF4, 6BK7A, 6CB6 tubes; 1N72 germanium crystal diode. Shpg. wt., 1 $\frac{1}{2}$ lbs.

NOTE: Available on special order; when ordering, specify UHF channel and unused VHF channel to be used as IF.
 List, \$90.00. NET EACH.....56.00

TV Boosters, Converters and Connectors

JERROLD TV ACCESSORIES

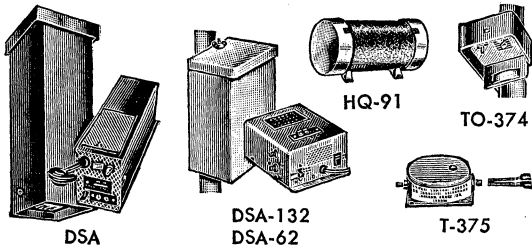

ANTENNA-MOUNTED TV BOOSTERS

Type DSA Single-Channel Boosters. High-gain, antenna-mounted VHF boosters, with power supply. Differ from conventional type boosters in that antenna mounting feature allows signal to be boosted without boosting noise picked up on transmission line. Provide gain of 30 db for individual channels from 2 through 13. Bandwidth is 6 mc at $\pm 1/2$ db. Excellent for color TV. Suitable for use with 72 or 300-ohm antennas and TV sets having either 72 or 300-ohm inputs. Require 72-ohm coax cable between booster and power unit; cable carries 24v AC from power unit to booster and TV signal from antenna to TV set simultaneously. Booster may be set to turn on and off automatically with TV set, or for continuous "on" operation. Size: Booster, $2\frac{1}{2} \times 3\frac{1}{2} \times 10\frac{1}{4}$ ". Power unit, $4\frac{1}{2} \times 5\frac{3}{4} \times 2\frac{3}{4}$ ". For 110-120v, 50-60 cycle AC. Shpg. wt., $8\frac{1}{4}$ lbs.

Stock No.	Type	Channel	Stock No.	Type	Channel
92 T 521	DSA-2	2	92 T 527	DSA-8	8
92 T 522	DSA-3	3	92 T 528	DSA-9	9
92 T 523	DSA-4	4	92 T 529	DSA-10	10
92 T 524	DSA-5	5	92 T 530	DSA-11	11
92 T 525	DSA-6	6	92 T 531	DSA-12	12
92 T 526	DSA-7	7	92 T 532	DSA-13	13

List Each, \$90.00. **NET EACH**..... 54.00

Type DSA-132 All-Channel Booster. Essentially the same as above but broadband rather than single channel. May be used with two antennas (one channel 2-6; one 7-13) or one antenna for Channels 2-13. Gain 25 db. Size: Booster, $5 \times 5 \times 10\frac{1}{4}$ ". Power unit, $2\frac{1}{2} \times 5\frac{1}{2} \times 7\frac{1}{4}$ ". For 110-120 v, 50-60 cycle AC. Shpg. wt., 12 $\frac{3}{4}$ lbs.

92 TX 095, List, \$109.50. **NET**..... 65.70
 92 TX 533, List, \$90.00. **NET**..... 54.00

MATCHING TRANSFORMERS

Model TO-374. Antenna matching transformer for outdoor installation. Matches 300 ohms to 72 ohms. Also isolates antenna from power line when used with AC-DC type TV sets. With mounting strap and cable connector. Size: $2\frac{1}{2} \times 2\frac{1}{4} \times 1$ ". Shpg. wt., 8 oz.
 71 C 831, List, \$10.00. **NET**..... 6.00

Model T-375. Matching transformer for indoor use. Matches 300 to 72 ohms. Also isolates antenna from power line when used with AC-DC TV sets. Shpg. wt., 4 oz.
 71 C 832, List, \$4.85. **NET**..... 2.91

"TRAP-EASE" ANTENNA TRAP

New "deep notch" type antenna trap for elimination of adjacent channel or FM interference. Up to 50 db attenuation of interfering signal. Tuning control for maximum interference reduction. Attaches simply to antenna and TV set with screw terminals. Does not affect reception of local channels. Choice of two models $7\frac{1}{2} \times 4\frac{1}{2} \times 4\frac{1}{2}$ " and $4\frac{1}{2} \times 4\frac{1}{2} \times 4\frac{1}{2}$ ".
 98 T 828, Model HQ-91, For Channels 2-6. | List Each, \$19.95.
 98 T 829, Model HQ-92, For Channels 7-13. | **NET EACH**..... 11.97

SOLDERLESS COAXIAL CABLE CONNECTORS

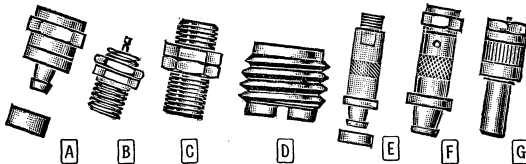

Carefully machined brass solderless connectors. Can be permanently bonded to all types of RG-11/U, RG-59/U and cables with simple crimping tools. All new "F" series connectors are accurately matched to 72 ohms. V.S.W.R. is less than 1.05 up to 200 mc. Can be wrench tightened. All exposed surfaces heavily silver-plated. Av. shpg. wt., 3 oz.

No.	Type	Fig.	Description	NET
71 C 833	F-59	A	Male. For RG-59/U cable. Mates with F-81, F-61 and A-61.	.48
71 C 834	F-61	B	Female chassis fitting. Mates with F-59, TR-72F. Mounts in $1/8$ " hole.	.55
71 C 835	F-81	C	Female feed-thru coupling. Mates with F-59's. Mounts in $3/8$ " hole.	.75
71 C 836	A-61	D	Adapter. Allows F-59 to mate with units using C-61 female connector.	1.25
71 C 837	F-101-59	E	Adapter. RG-11/U to F-59, TR-72F, etc.	1.46
71 C 838	AF-101	F	Male connector. For RG-11/U type, cables.	1.26
71 C 839	TR-72F	G	Terminating resistor. Mates with F-61.	.90

Type PL-802 Crimping Tool. For use on types F-59, F-101-59, and AF-101 above. No impedance mismatch or cable distortion. 1 lb.
 71 C 840, List, \$8.17. **NET**..... 4.90

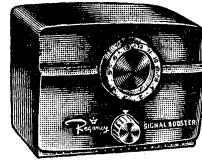

DB-550

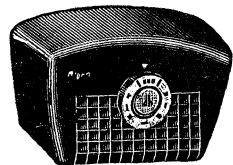

BB-1A

POPULAR TELEVISION BOOSTERS

REGENCY MODEL DB-550 VHF BOOSTER

Expertly designed booster which tremendously improves sensitivity and signal-to-noise ratio on all 12 VHF TV channels. Provides an average boost in gain of 17.5 db. Excellent for use in weak signal areas, the DB-550 provides greatly improved picture and sound. First stage uses 6J6 dual-triode in push-pull; second stage is 12AT7 grounded-grid, push-pull amplifier. Simple single-knob tuning. Advanced, triple-tuned circuit employs two stages in cascade, neutralized for maximum stability. Power supply has transformer for isolation of unit from power line. On-off switch controls both booster and television set. Input and output impedance: 300 ohms. Housed in attractive, mahogany finish plastic cabinet. Size, $4\frac{1}{2} \times 6 \times 4\frac{1}{2}$ ". U.L. Approved. For operation from 110-120 volts, 60 cycle AC. Shpg. wt., 5 lbs.
 98 T 363, List, \$37.50. **NET**..... 22.05

BOGEN MODEL BB-1A VHF BOOSTER

Advanced circuit, broadband, fringe-area booster. For improved TV picture and sound. Two 6J6 dual triodes with separate circuits for high and low bands. 18 db gain. High signal-to-noise ratio. Positive, no-backlash tuning. One control 6 mc bandwidth. Housed in brown plastic cabinet. Size, $8 \times 4\frac{1}{2} \times 4\frac{3}{4}$ ". For 110-120v, 60 cycle AC. U.L. Approved. With 4 feet of 300-ohm twin line. Shpg. wt., $4\frac{1}{2}$ lbs.
 98 T 360, List, \$32.50. **NET**..... 19.11

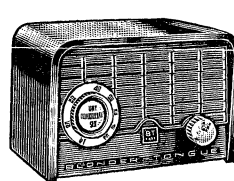

99

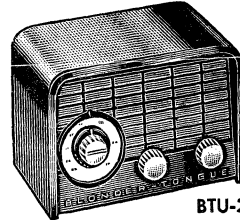

BTU-2

BLONDER-TONGUE UHF TV CONVERTERS

MODEL 99 CONVERTER

New, modernly styled, low-noise UHF converter designed for use in metropolitan signal areas. One-knob tuning. Choice of Channel 4, 5, or 6 as the IF output to TV set. Extremely sharp input and oscillator tuning for every UHF channel—eliminates multiple images and troublesome interference. Input circuit is tracked with oscillator to reject spurious signals and suppress oscillator radiation. Oscillator is thermally compensated to assure minimum drift. Precise input impedance match assures maximum signal conversion; no line ghosts or picture smear. In "Off" position, VHF signals are passed directly to TV set to permit regular VHF reception. Uses 6AF4A oscillator, crystal diode mixer and selenium rectifier. Exact 300 ohm input and output impedance match assures maximum signal power. Simple to install and operate. Housed in handsome mahogany-finished plastic cabinet. Size, $6\frac{1}{4} \times 4\frac{1}{4} \times 4\frac{3}{4}$ ". For operation from 110-120 volts, 60 cycle AC. Wt., 4 lbs.
 98 T 586, List, \$22.95. **NET**..... 15.95

MODEL BTU-2 CONVERTER

High-gain, low noise UHF converter. Adds all the new UHF stations to any TV set quickly and easily. Extra high signal-to-noise ratio guarantees clear, steady pictures, even in weak-signal locations. Fully shielded tune has 3-gangs. Continuous tuning type. Has dual-speed channel selector to precise, effortless tuning. Delivers VHF output on Channel 5 or 6. Antenna connects to converter; converter connects to TV set. Terminal for VHF or UHF transmission lines. Exact 300-ohm impedance match a both UHF input and VHF output plus highly efficient triode amplifier gives maximum usable signal power with no picture or sound distortion. Oscillator drift is minimized by thermal compensation. High selective, double-tuned RF pre-selector stage provides maximum gain and image rejection. Oscillator is completely shielded to minimize radiation. Completely automatic, turns on and off with TV set through thermal relay. Instant changover from UHF to VHF. Quickly and easily installed. With 6AF4A and 6AB4, crystal diode and selenium rectifier. Size: $6\frac{1}{4} \times 4\frac{1}{4} \times 4\frac{3}{4}$ ". For 110-120v, 60 cycle AC. Shpg. wt., 5 lbs.
 98 T 099, List, \$39.95. **NET**..... 27.50

JERROLD TV SET COUPLERS

Exceptionally low-loss couplers for use in fringe and metropolitan areas. Allow 2, 3, or 4 receivers to operate on one antenna. Feature AC isolation between AC-DC TV sets and antenna. Positive matching. High suppression of set interaction. Unbreakable case. Universal mounting. Connectors completely concealed and protected. Size: $4\frac{1}{2} \times 1\frac{1}{2} \times 1\frac{1}{4}$ " D.

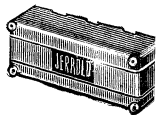

No.	Type	Description	Wt.	EA
71 C 841	M-2	2 Set Coupler for Strong Signal Areas. Blue-Gray.	6 oz.	2.1
71 C 842	MF-2	2 Set Coupler for Fringe Areas. Ivory.	6 oz.	2.7
71 C 843	MF-4	4 Set Coupler for Fringe Areas. Ivory.	6 oz.	3.4

TV Towers and Accessories

ALPROCO ALUMINUM ANTENNA TOWER

- Built-in Ladder Design
- Excellent for Fringe Areas

Lightweight, easy-to-install, 6-ft. triangular tower sections. Exceptionally well-constructed to provide long, reliable service. Ruggedly built of high-grade spring-tempered aircraft aluminum alloys and aluminum aircraft rivets. 6-foot sections can be quickly and easily bolted together permitting installation of TV antennas as high as 90 feet. Ideal for application in extreme fringe areas where reception is difficult due to high obstructions.

Light and strong—weighs slightly over 1 lb./ft. 90-foot maximum height tower will carry vertical static load of 300 lbs. and over 200 lbs. top loading in 100 mph wind. Tower has extremely low wind resistance of only 6 lbs./ft. in 100 mph wind. Designed to save the installer valuable time—utilizes built-in ladder bars (note magnified cut of illustration) for easy climbing. Tower requires guying every 30 feet. All 6-foot units come two-thirds factory preassembled, complete with special rivets for final, easy assembly.

6-FOOT TOWER SECTION

Model T-6W. Standard triangular 6-foot antenna tower section. Ideally designed—requires a minimum of space for stocking. Units are shipped two-thirds factory pre-assembled—ready for immediate, time-saving assembly at place of installation. Measures 11¼" wide on each side. Special impact rivets for final assembly. Has built-in ladder construction. Shpg. wt. 8 lbs.
97 CZ 072. NET.....10.50

STANDARD MAST KIT

Model MK-1W. 3 top trim pieces and 2 sets of brackets for attaching masts to tower. Ruggedly constructed to provide extra-firm support. Shpg. wt., 2½ lbs.
97 C 073. NET.....1.85

GUYING BRACKET

Model GB-1. Bracket for attaching guy wire to tower—three required per guying station. One guy station is required every 24 feet. Shpg. wt., 2 oz.
97 C 381. NET EACH.....14c

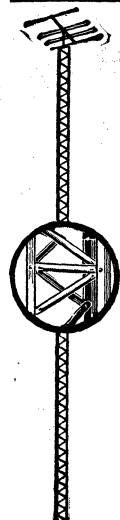

Rugged All-Aluminum Construction

Lightweight, easy-to-install, 6-ft. triangular tower sections. Exceptionally well-constructed to provide long, reliable service. Ruggedly built of high-grade spring-tempered aircraft aluminum alloys and aluminum aircraft rivets. 6-foot sections can be quickly and easily bolted together permitting installation of TV antennas as high as 90 feet. Ideal for application in extreme fringe areas where reception is difficult due to high obstructions.

SPAULDING TV TOWERS

- Self-Supporting
- No Guying needed

New, expertly engineered high-strength antenna towers featuring special base for quick, one-man installation without concrete. Self-supporting—requires no additional guying or support of any kind! Ideal tower for fringe-area reception locations or areas where added height of antenna is necessary for stronger signal.

Towers listed contain "most-wanted" features. All-riveted construction for rigid support of any television antenna; 100% galvanized steel; special design insures easy installation of any rotator in top section.

Every unit is specially constructed to minimize the effects of strong winds, yet light enough for easy handling and quick installation. Each tower package includes heavy-duty culvert-type base with adjustable hinge feet, eight feet of mast, listed quantity of 8-ft. tower sections, and easy-to-follow instructions. All sections are factory assembled.

Shipped F.O.B. Frankfort, Indiana. No C.O.D. shipments—please send full remittance to Allied with your order. Shipping charges will be collected on delivery.

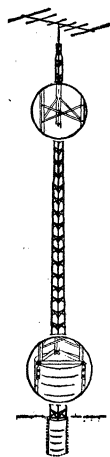

No Concrete Needed!

Stock No.	Mfr's. Type	Ant. Ht.	Secs.	Wt. lbs.	NET EACH
2 CZ 294	X28CB	23'	2	89	29.95
2 CZ 295	X36CB	31'	3	120	46.95
2 CZ 298	X44CB	39'	4	153	59.95
2 CZ 059	X52CB	47'	5	200	72.95

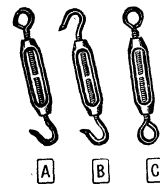

connected for mast lowering, etc. Weather-resistant for reliable service. Av. wt., 8 oz.

GUY WIRE TURNBUCKLES

Stock No.	Fig.	Closed	Open	NET EA.	10 or more, EACH
44 C 790	A	5½"	7½"	12c	11c
44 C 791	A	6½"	9½"	20c	18c
44 C 792	A	7½"	10½"	30c	27c
44 C 793	B	5½"	7½"	12c	11c
44 C 794	B	6½"	9½"	20c	18c
44 C 795	B	7½"	10½"	30c	27c
44 C 796	C	5½"	7½"	12c	11c
44 C 797	C	6½"	9½"	20c	18c
44 C 798	C	7½"	10½"	30c	27c

TELESCOPING TV MASTS

50-Ft. Mast. Heavy-duty, extremely compact, telescoping 50-ft. mast. Ideal for any television antenna array. Designed for exceptionally easy installation. Husky thumb screws lock sections at any height. 18 gauge tubing with .003" hot-dip zinc galvanizing inside and outside. Consists of five 10-ft. sections; O.D.: #1 (1¼"), #2 (1½"), #3 (1¾"), #4 (2"), #5 (2¼"). Supplied complete with guy rings, clamps and necessary hardware. Shpg. wt., 48 lbs.
92 CZ 103. NET.....13.98

40-Ft. Mast. Consists of 4 rugged sections (see sizes listed above): Nos. 1, 2, 3, and 4. Height, 40 feet. Shpg. wt., 37 lbs.
92 CZ 102. NET.....10.45

30-Ft. Mast. Consists of 3 sections: Nos. 1, 2, and 3. Maximum height, 30 feet. Shpg. wt., 26 lbs.
92 CZ 101. NET.....7.02

20-Ft. Mast. Consists of 2 sections: Nos. 1 and 2 described above. Height, 20 feet. Shpg. wt., 17 lbs.
92 CZ 100. NET.....4.24

Universal and Roof Mount. Heavy-duty swivel base mount for above telescoping masts. One type that meets the requirements for almost any mast installation: For any surface—flat, slanted, and peak roofs or walls. Ruggedly constructed of heavy-gauge steel to provide long, reliable service. Wt., 2½ lbs.
92 C 536. NET.....1.07

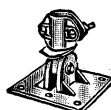
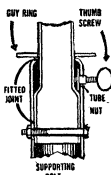

BMA-138



PRA-148

PENN TV MAST MOUNTS

TV mast mounts for flat and sloping roofs and side walls. Permit one-man installation of tall, fringe area antennas. Lock in any position. Made of "Pennalloy," an aluminum alloy.

BMA-138. Universal roof mount. Will swivel into any position. Locked securely by special bearing. Adjustable top supports masts from 1" to 2" O.D. Shpg. wt., 2 lbs.
97 C 176. NET.....2.76

BMA-136. Similar to above but for use with masts from 1" to 1½" O.D. Wt., 1 lb.
97 C 175. NET.....2.26

PRA-148. Universal peak roof mount with patented bearings for adjustment and locking at any angle. "Pennalloy" body. Adjustable top for masts from 1" to 2" O.D. Wt. 2 lbs.
97 C 177. NET.....3.35

PENN FLOATING GUY RINGS

GRA-140. Cast aluminum, floating guy ring and collar. Fastens to mast with hardened steel set screw. Permits rotating antenna after guy wires are installed. Excellent for antennas with rotators. Specially lubricated to assure smooth rotation. For 3-guy or 4-guy installations. For masts to 1½". Shpg. wt., 8 oz.
97 C 178. NET.....1.12



GRA-141. Same as GRA-140 but for masts up to 1¾" O.D. Shpg. wt., 9 oz.
97 C 179. NET.....1.17

GRA-142. Same as GRA-140 but for masts up to 2" O.D. Shpg. wt., 10 oz.
97 C 180. NET.....1.50



GROUND RODS

An excellent selection of new, low-cost ground rods. Constructed of moisture-resistant copper-plated steel. Special raised lip keeps ground lead connector permanently anchored on rod. With bolt for easy connection.

Size, 4"x¾". Shpg. wt., 1½ lbs.
92 CX 537. NET.....47c

Size, 6"x¾". Shpg. wt., 2¼ lbs.
92 CZ 538. NET.....59c

Size, 8"x¼". Shpg. wt., 5 lbs.
92 CZ 539. NET.....1.35

GROUND & GUY WIRE

Aluminum Ground Wire. No. 8 solid aluminum wire. For all grounding applications.

Stock No.	Coil Length	Wt., Lbs.	NET
49 T 653	50-ft.	1½	.70
49 T 650	100-ft.	2¼	1.26
49 TZ 652	1000-ft.	26	13.10

No. 20 Galvanized Guy Wire. Six-strand, No. 20 steel wire. Available in 100-ft. or 1000-ft. rolls. Shpg. wt., 100 ft. roll, 2 lbs.
58 T 312. 100-Ft. Roll. NET.....62c
71 TZ 513. 1000-Ft. Roll. NET.....5.74

No. 18 Galvanized Guy Wire. Same as above, but for heavier-duty applications. In 100-ft. or 1000-ft. rolls. Wt., 100 ft., 2½ lbs.
51 T 319. 100-Ft. Roll. NET.....94c
71 TZ 545. 1000-Ft. Roll. NET.....9.16



ANTENNA MAST SECTIONS

Ends are swaged for simplified installation. Made of heavy-wall steel with electro-galvanized finish. *Seamless type; others are seamed. All are 1¼" O.D.

Stock No.	Ht.	Wall	Shpg. Wt.	EACH NET
97 CX 137	5 ft.	.035"	3 lbs.	.71
98 CX 366*	5 ft.	.051"	4 lbs.	.97
97 CZ 136	5 ft.	.035"	5 lbs.	1.36
98 CZ 367*	10 ft.	.051"	7 lbs.	2.04

TV Mounts and Accessories



TV POWER CORDS AND CONNECTORS

A TV Power Cord and Connector. Identical to original equipment on most TV sets. No. 18 conductor; rubber-covered; 6 feet long. Soft rubber plug. U.L. Approved. Shpg. wt., 8 oz.
49 T 237. NET.....26c

9-Ft. Cord. As above, but 9' long.
49 T 234. NET.....33c

TV Power Cord and Connector. (Not illustrated.) Identical to original equipment on Zenith television sets. No. 18 conductor; rubber-covered cord, 6 feet long. Durable, molded-on rubber plug. U.L. Approved. Shpg. wt., 10 oz.
49 T 239. NET.....36c

B Male Connector. Flush mounting; used on most TV sets. Shpg. wt., 2 oz.
49 T 238. NET.....9c

SENCO TV JUMPER CORD



Model JC2. Universal jumper cord which exports power from back of TV set—provides serviceman with AC for soldering iron, instruments, etc. Eliminates furniture moving and bulky extensions to get AC for service equipment. Has switch for controlling TV set power from rear of chassis. Fits all TV interlock plugs and sockets. Small and lightweight. Shpg. wt., ½ lb.
49 T 247. NET.....1.91

ALL-PURPOSE SERVICE CORD



Female Type. One cord to service most TV sets. Plug one end in wall outlet; other end has AC outlets for service equipment, plus connectors (standard and Zenith male) for TV chassis. Shpg. wt., 1 lb.
52 T 665. NET.....1.03

Male Type. As above, but plugs into female connector on TV set back cover. 1 lb.
52 T 666. EACH.....1.53



TELCO LEAD-IN TUBES

Type 8641. Combination plastic lead-in tube and lightning arrester. Fits walls to 16" in thickness. Has lightning arrester on outside end; wall plug on inside. Simple installation—lead-in wire is fastened under teeth of lightning arrester and contact is made to inside. Requires ¾" mounting hole. Shpg. wt., 1 lb.
51 C 100. List, \$3.55. NET.....2.04

Type 8958. As above, less arrester and wall plug. Universal type lead-in tube for all types of UHF-VHF lead-in lines. Ideal for terminating open line outside and bringing standard line into house. Shpg. wt., ½ lb.
71 C 559. List, \$2.35. NET.....1.37

"NU-LIFE" CATHODE-RAY TUBE RESTORER

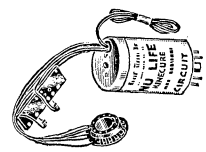

Remarkably versatile unit. Corrects many kinds of shorts and opens in magnetic-focus and electrostatic-focus picture tubes. Permanently eliminates

such defects as: Open cathode, shorted cathode to filament, shorted control grid to cathode, open control grid; or any combination of these. For use with either series or parallel-wired sets. Ingenious terminal board arrangement with plug-in leads allows undamaged elements to take the place of the damaged elements. Simple step-by-step instructions show how to connect terminal board to correct for any of the many possible defects. Also provides an easy and inexpensive method of restoring picture tube brightness. Built-in potentiometer allows adjustment to correct for low filament emission and slow heating. Shpg. wt., 12 oz.
80 G 145. NET.....4.95

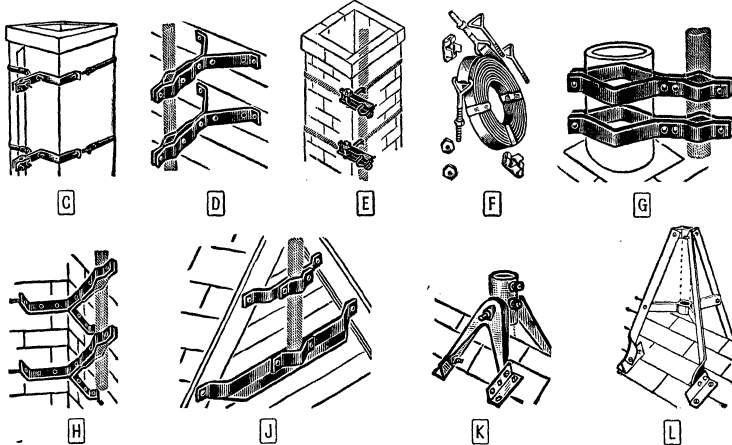

TELCO TV ANTENNA MOUNTS

LOW-COST CHIMNEY MOUNT

C Type 8005. Sturdy chimney bracket. An excellent choice for economy antenna systems. Can be installed in a few minutes. Only one piece to handle with a minimum of loose parts. Made of extra heavy gauge steel. Zinc-plated and dichromate-dipped for long life. Brackets securely support antenna mast—even under high wind conditions. Easily adjusted to provide snug, firm grip. Will support masts up to 1¼" diameter. Two 12" straps and hardware included. Shpg. wt., 4 lbs.
97 C 065. List, \$2.65. NET.....1.55

SNAP-IN WALL MOUNT

D Type 8306. Husky brackets for firmly mounting antenna mast to any flat vertical surface. Perfect for buildings with overhanging eaves. Mast snaps in place until nuts can be tightened. Permits one-man antenna installation. Constructed of heavy-gauge steel. Plated for resistance to moisture and harmful fumes. Holds mast 6" from wall. For masts up to 1¼" diameter. Supplied complete with plated mounting screws. Shpg. wt., 2½ lbs.
98 C 481. List, \$2.40. NET.....1.40

Type 8308. Same as above, but holds mast 8" from wall. Shpg. wt., 4 lbs.
98 C 482. List, \$3.90. NET.....2.28

DELUXE SNAP-IN MOUNT

D Type 8312. Heavy-duty wall brackets. Supports mast from side of building. Legs of bracket are spaced 16" apart to match studs of homes. Side sway prevented by sturdy mounting legs. Vertical support (not shown) eliminates sag. Provides 12" wall clearance. Shpg. wt., 5 lbs.
98 C 483. List, \$4.20. NET.....2.45

Type 8348. Same as above, but provides 18" wall clearance. Shpg. wt., 7 lbs.
98 CX 484. List, \$5.40. NET.....3.18

Type 8324. Same as Model 8312, but provides 24" wall clearance. Shpg. wt., 10 lbs.
98 CX 485. List, \$7.30. NET.....4.33

RATCHET CHIMNEY MOUNT

E Type 9219. With Stainless Steel Strapping. Ratchet-type mount. Both ends of strapping slip through slotted shaft. As ratchet is turned both ends of strapping are simultaneously tightened. Bracket made of heavy-gauge channel steel for extra strength; double plated with zinc and dichromate for utmost protection against weather, salt air, chemical and smoke fumes. Includes 2 brackets and two 12-ft. lengths of heavy-duty stainless steel strapping. Shpg. wt., 3½ lbs.
71 C 554. List \$6.35. NET.....3.75

Type 9218. Galvanized Steel. As above, but galvanized steel strapping.
71 C 555. List \$5.10. NET.....3.02

CHIMNEY MOUNT REPAIR KIT

F Type 8932. Stainless Steel. Stainless steel strapping, eye bolts, nuts and strap clamps. Replaces rusted or broken strapping on all types of chimney mounts. Heavy-gauge strapping for secure support. Stainless steel will resist weather, salt air and smoke fumes. Shpg. wt., 2 lbs.
71 C 558. List, \$3.55. NET.....2.04

Type 8931. Galvanized Steel. As above, but strapping, bolts, nuts and clamps are galvanized steel.
71 C 556. List, \$1.80. NET.....1.06

VENT PIPE MOUNT

G Type 8803. Handy vent pipe mount that will clamp on any pipe or vent from 4" to 6" in diameter. Perfect for antenna installations on roofs where chimney is inaccessible. Simple and easy to use. Made of extra heavy gauge steel. Handles all masts up to 1¼" in diameter. Securely supports antenna mast. Zinc-plated and dichromate-dipped. Shpg. wt., 3 lbs.
98 C 480. List, \$2.70. NET.....1.59

SNAP-IN CHIMNEY MOUNT

H Type 8930. With Stainless Steel Strapping. Excellent mount for quick, dependable installation. Extra-heavy construction. Simply snap mast into bracket and tighten bolts. Fits masts up to 1¼" diameter. Brackets of heavy-gauge steel. With two 12-ft. lengths of stainless steel strapping. Shpg. wt., 4 lbs.
97 C 027. List, \$4.70. NET.....2.75

Type 8610. With Galvanized Steel. As above but has galvanized steel strapping.
97 C 028. List, \$3.30. NET.....1.94

EAVE MOUNT

J Type 8933. For mounting antenna mast on eaves of buildings. Lower bracket is 48" long to straddle side of building; angle-iron construction provides high strength. Upper bracket mounts close to peak of roof. Weather-proof—zinc plated and dichromate dipped. With all hardware. For masts to 1¼" diameter. Shpg. wt., 7 lbs.
98 CX 486. List, \$7.15. NET.....4.16

"NO-GUY" ROOF MOUNT

K Type 9060. Steel and cast-iron base for mounting over ridge of peaked roof or on a flat roof. Adjustable legs. Will support average antenna on up to 10 ft. mast without guy wires. For masts up to 1¼" dia., 5 lbs.
98 C 490. List, \$4.75. NET.....2.77

ANTENNA BASE

L Type 9063. Sturdy antenna base. For masts of 10 feet or more and up to 1½" O.D. Eliminates guy wires in the average installation and provides extremely dependable mast support. Set screws anchor mast and permit orientation. Electro-galvanized; dichromate. 2-ft. high. Shpg. wt., 6½ lbs.
92 CX 040. List, \$7.15. NET.....4.16

Type 9144. As above, but 3 feet high and constructed from 1" electro-galvanized steel tubing. Shpg. wt., 8½ lbs.
92 CX 043. List, \$8.30. NET.....4.90

Type 9143. Same as Model 9144 but 5 feet high. Shpg. wt., 15 lbs.
92 CX 044. List, \$15.90. NET.....9.31

TACO SELECTIVE ATTENUATOR

Model 835. 300-ohm variable attenuator switch for TV and FM receivers. Cuts down strong incoming signals. Positions: 0 db for no attenuation (normal reception); 15 db for minimum attenuation; 30 db for maximum attenuation. 4½x2¼". Wt., 5 oz.
92 046. List, \$4.43. NET.....2.62

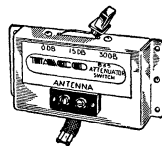

TV Mounts—Twin Line—Accessories

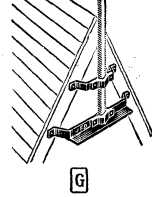
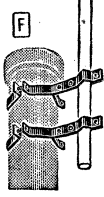
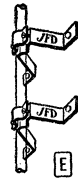
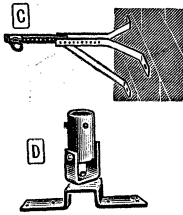
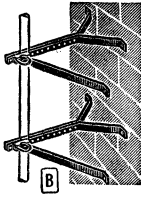
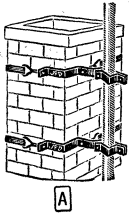

JFD ANTENNA MOUNTS

A BR2 Economy Chimney Mount. Dependable, high-quality chimney mount. Ruggedly constructed of corrosion-resistant steel. Securely holds masts up to 1 1/4" O.D. Supplied complete with two 12' galvanized steel straps and all hardware. Easily adjusted. Shpg. wt., 3 lbs.
71 C 600. NET PER SET.....1.91

B BR11X Adjustable Wall Brackets. Anchors 7/8" to 1 1/2" (O.D.) masts to walls and chimneys. Constructed of heavy steel. Set of 2 brackets; permit locating mast 10 to 15" from mounting surface. With U-bolts and hardware. Shpg. wt., 7 lbs.
97 CX 122. NET PER SET.....4.41

C BR11X Wall Bracket Extension Bars. Extends BR11 adjustable wall brackets, listed above, to provide up to 24" wall clearance. Same high-quality construction as BR11. Easily attached to wall brackets for a solid mounting. Shpg. wt., 1 1/2 lbs.
97 C 123. NET PER PAIR.....1.76

D JFD 2 1/4" Base Mount. Extremely versatile, heavy-duty universal swivel base and roof mount. Can be installed on any surface—flat, slanted and peak roofs, or walls. Ideal for all mast installations where speed and economy are important. Securely holds any size mast up to 2 1/4" (O.D.). Weather-proofed, heavy-gauge steel construction—resists rust and corrosion. Complete with hardware. Wt., 3 lbs.
97 C 120. NET EACH.....1.87

E BR46 Economy Wall Mount. Popular, ruggedly constructed wall mount. For vertical surface mounting. Sturdy clamp securely holds any size mast up to 1 1/2" (O.D.). U-bolt has serrated inside surface for non-slip grip. 14 gauge, 1/8" thick steel construction—galvanized finish prevents rusting. Includes 2 brackets with cadmium-plated hardware. Sizes below are distances brackets hold mast from wall. Av. shpg. wt., 1 1/2 lbs.
97 C 125. 4". NET PER SET.....1.17
97 C 126. 8". NET PER SET.....1.32

F BR9 Vent Pipe Mount. For sturdy mounting of 1/2" to 1 1/2" (O.D.) masts on most vent pipes. Easy-to-adjust clamps provide a solid grip on circular surfaces. Made of rust-resistant steel. Set of two brackets, with all necessary hardware. Shpg. wt., 3 lbs.
97 C 128. NET PER SET.....2.12

G BR-46-30 Eave Mount. Especially designed for difficult mounting of masts on eaves of buildings. Brackets provide 3" clearance of mast from eaves. Complete with all mounting hardware. Shpg. wt., 4 lbs.
71 CX 601. NET PER SET.....2.59

H BR13 All-Angle Mount. Dependable, low-cost mount. Easily adapted to a variety of locations. Sturdy, heavy-gauge steel construction. U-bolt holds 1/2" to 1 1/4" (O.D.) masts. Supplied complete with all mounting hardware. Shpg. wt., 1/2 lb.
97 C 129. EACH.....35c

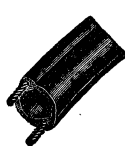

AMPHENOL, BELDEN, FEDERAL AND KNIGHT TWIN LINE

AMPHENOL TWIN LINE

J Type 214-056. Flat 300-ohm polyethylene twin line. 56-mil web thickness. 7-28 stranded conductors. Wt., per 100 ft., 2 lbs.
49 T 434. 25' Coil. NET.....80c
49 T 437. 50' Coil. NET.....1.26
49 T 439. 75' Coil. NET.....1.73
49 T 441. 100' Coil. NET.....2.11
49 W 436. Over 100', Per 100'.....2.12

L Type 214-100. Flat 300-ohm polyethylene twin line. 100-mil web thickness. 7-28 stranded copper conductors. Shpg. wt., per 100 ft., 2 1/2 lbs.
49 T 412. 50' Coil. NET.....1.45
49 T 418. 75' Coil. NET.....2.03
49 T 413. 100' Coil. NET.....2.65
49 W 419. Over 100', Per 100'.....2.65

J Type 214-185. Flat, heavy-duty, 300-ohm twin line. Thick jacket provides extra strength. 185-mil web thickness. Brown polyethylene. 7-26 stranded copper conductors. 100-ft. minimum. Wt., 100 ft., 5 lbs.
49 T 414. 100' Coil. NET.....4.88
49 W 426. Over 100', Per 100'.....4.88

J Type 214-318. Flat, 300-ohm twin line for indoor use only. 60-mil web clear polyethylene. Shpg. wt., 100 ft., 5 lbs.
49 T 481. 50-ft. Coil. NET.....1.35
49 T 482. 75-ft. Coil. NET.....1.85
49 T 484. 100-ft. Coil. NET.....2.32
49 W 484. Over 100', Per 100'.....2.32

J Type 214-559. "Steelcore" high strength twin line. 7-28 copperweld conductors, heavy 72-mil virgin polyethylene. Shpg. wt., per 100 ft., 2 lbs.
49 T 456. 50-ft. Coil. NET.....1.31
49 T 457. 75-ft. Coil. NET.....1.79
49 T 458. 100-ft. Coil. NET.....2.28
49 W 458. Over 100', Per 100'.....2.28

K Type 214-271. Tubular 300-ohm twin line. Air-core spacing for extremely high efficiency—ideal for UHF. 7-28 copper conductors. 100-ft. minimum. Wt., 100 ft., 3 lbs.
49 T 444. 100' Coil. NET.....3.41
49 W 447. Over 100', Per 100'.....3.41

Type 214-298. Four-Conductor Rotator Cable. Extruded brown polyethylene. 7-28 stranded conductors. Wt., 100 ft., 3 lbs.
49 T 423. 50' Coil. NET.....1.76
49 T 424. 75' Coil. NET.....2.44
49 T 415. 100' Coil. NET.....3.13
49 W 425. Over 100', Per 100'.....3.13

AMPHENOL TWIN LINE

K Type 214-076. Heavy-duty, extremely durable 300-ohm tubular twin line. Low-loss air-core spacing for high efficiency and extra durability. 7-26 bare copper conductors of high quality. 100-ft. minimum length. Shpg. wt., 100 ft., 3 1/2 lbs.
49 T 416. 100' Coil. NET.....6.23
49 W 409. Over 100', Per 100'.....6.23

BELDEN TWIN LINE

L Type 8225. Flat 300-ohm twin line. Finest quality 7-28 stranded copper conductors. High-quality polyethylene jacket has 58 mil web thickness. Shpg. wt., 100 ft., 1 1/4 lbs.
49 T 395. 50' Coil. NET.....1.06
49 T 396. 75' Coil. NET.....1.47
49 T 389. 100' Coil. NET.....1.84
49 W 384. Over 100', Per 100'.....1.84

L Type 8230. Weldohm 300-ohm twin-line. 70-mil jacket. Conductor of 7-28 stranded copper-coated steel wire. Copper coating provides high conductivity; steel core for high strength. Shpg. wt., 100 ft., 2 lbs.
49 T 387. 50' Coil. NET.....1.11
49 T 388. 75' Coil. NET.....1.55
49 T 394. 100' Coil. NET.....1.99
49 W 383. Over 100', Per 100'.....1.99

M Type 8275. 300-ohm UHF-VHF celluline. Has cellular plastic core, inert gas-filled. Brown polyethylene-plastic jacket. 7-28 copper-coated steel conductors. Shpg. wt., per 100 ft., 3 lbs.
49 T 396. 50' Coil. NET.....2.20
49 T 397. 75' Coil. NET.....3.09
49 T 395. 100' Coil. NET.....4.07
49 W 398. Over 100', Per 100'.....4.07

N Type 8235. 300-ohm, oval twin-line. Very low loss; for UHF-VHF use. Copper-coated, 7-28 steel wire conductors. Extremely tough 185-mil web thickness. Flexible and strong. 100-ft. minimum. Shpg. wt., per 100 ft., 3 lbs.
49 T 393. 100' Coil. NET.....4.12
49 W 399. Over 100', Per 100'.....4.12

Type 8222. 72-Ohm Twin Line. High-quality brown polyethylene jacket. .075x.128" diam. 100-ft. minimum. Shpg. wt., per 100 ft., 3 lbs.
49 T 392. 100' Coil. NET.....1.57
49 W 379. Over 100', Per 100'.....1.57

FEDERAL TWIN LINE

P Shielded 300-Ohm Line. For high-interference areas. Wt., 100 ft., 8 1/2 lbs.
49 W 498. Per Foot.....13c
100 ft. or more. Per 100 ft.....11.55

KNIGHT TWIN LINE

R UHF-VHF Open Line. 300-ohm. Loss 0.5 db per 100 ft. at 200 mc. In coil lengths below. Wt., 100 ft., 2 1/4 lbs.
49 T 429. 100' Coil. NET.....2.17
49 TX 579. 250' Coil. NET.....4.89

K UHF-VHF Tubular Twin-Line. 300-ohm cable. 100-ft. minimum length. Shpg. wt., 100 ft., 2 lbs.
49 T 429. 100' Coil. NET.....2.58
49 W 428. Over 100', Per 100'.....2.58

S 300-ohm VHF-TV Twin Line. High-quality twin line. 72-mil web thickness. Low-loss polyethylene jacket. No. 20 stranded conductors. 100-ft. minimum length. Shpg. wt., 100 ft., 2 lbs.
49 T 448. 100' Coil. NET.....1.74
49 W 435. Over 100', Per 100'.....1.74

AMPHENOL SILICONE COMPOUND

T Type 63-307. For water-proofing TV twin line. Maintains a constant impedance in line whether wet or dry. Covers hundreds of feet of standard 300 ohm twin line. 1 oz. tube. Shpg. wt., 4 oz.
43 N 135. List, \$2.00. NET.....1.18

EBY CRT EXTENSION HARNESS KIT

Model K302. Permits checking TV picture tubes when removed from set. Reduces danger of contact with high-voltage and tube breakage. Consists of 3-ft. anode extension harness for any glass cathode ray tubes; 4-ft. CRT socket harness for both electrostatic and magnetic tubes; 3-ft. yoke extension harness for sets using octal plug. Greatly simplifies work on sets where tube is mounted separately. Wt., 10 oz.
41 H 348. List, \$5.40 NET.....3.18



TV Antenna Accessories

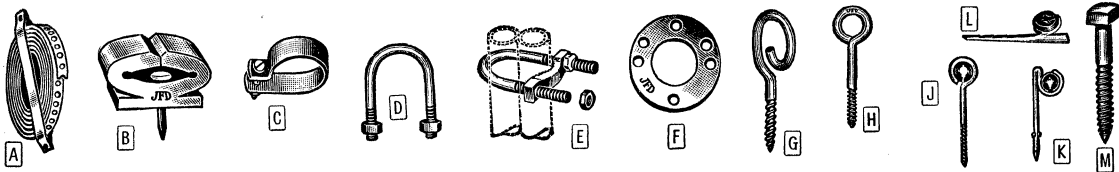

A Hanger Strap. For mounting masts to odd-shaped objects. Made of 3/4" galvanized steel strapping.
 71 C 400. 12' coil. Wt., 1 lb. NET.....43¢
 71 C 401. 100' coil. Wt., 5 lbs. NET...3.10

B Wall Stand-Off Insulator. For securing twin-lead to baseboards, etc. Tack-in type. Wt., per pkg., 10 oz. 10 per pkg.
 71 C 608. Per Pkg.....60¢

C Ring Clamp. Supports guy wire ring, etc. Corrosion-resistant steel. Fits mast diameters (O.D.) shown below. Shpg. wt., per pkg., 3 oz. 5 per pkg.
 71 C 609. 3/4"-1". Per Pkg.....37¢
 71 C 610. 1"-1 1/4". Per Pkg.....37¢

D U-Bolt. Galvanized steel. With nuts and washers. Fits up to 1 1/2" (O.D.) masts. Shpg. wt., per pkg., 4 oz. 2 per pkg.
 71 C 611. Per Pkg.....20¢

E Mast Clamp. Serrated yoke. For 2 masts with max. O.D. of 1 1/2" each. Galvanized steel. Shpg. wt., per pkg., 4 oz. 2 per pkg.
 71 C 612. Per Pkg.....35¢

F Universal Guy Rings. Rest unanchored on ring clamp. Fit mast. O.D. below. Shpg. wt., per pkg., 10 oz. 5 per pkg.
 71 C 613. 1". Per Pkg.....39¢
 71 C 615. 1 1/4". Per Pkg.....39¢
 71 C 616. 1 3/8". Per Pkg.....55¢
 71 C 617. 1 1/2". Per Pkg.....55¢
 71 C 618. 2". Per Pkg.....57¢

G Guy Wire Hook Eye. Anchors guy wires firmly. Screws into wood. Galvanized steel. Shpg. wt., per pkg., 10 oz. 5 per pkg.
 71 C 619. Per Pkg.....24¢

H Hook Eye. Provides an anchoring point for guy wires. Screws into wood. 3" long. Shpg. wt., per pkg., 8 oz. 5 per pkg.
 71 C 620. Per Pkg.....22¢

H Hook Eye. Anchors guy wires. 5" long. Shpg. wt., per pkg., 10 oz. 5 per pkg.
 71 C 621. Per Pkg.....25¢

K Drive-in Stand-Off Insulators. Universal. For flat, oval, tubular and coaxial TV lead-ins. Shpg. wt., per pkg., 5 oz. 5 per pkg.
 71 C 626. 3 1/2". Per Pkg.....20¢

J Universal Stand-Off Insulators. For use with flat, oval or tubular twin-lead, and coaxial TV lead-in. Polyethylene insulation. Fasten securely by screwing into wood. Av. shpg. wt., per pkg., 10 oz. 5 per pkg.
 71 C 622. 3 1/2". Per Pkg.....13¢
 71 C 623. 5 1/2". Per Pkg.....20¢
 71 C 624. 7 1/2". Per Pkg.....25¢

L Universal Hot Nail Stand-Off Insulators. For flat, oval, tubular, and coaxial TV lead-in line. Holds securely when driven into wood, mortar, or brick. Length, 3 1/2". Shpg. wt., per pkg., 4 oz. 5 per pkg.
 71 C 627. Per Pkg.....33¢

M Heavy-Duty Lag Bolts. For rigidly securing mast mounts, tower bases, etc., to wood, brick, masonry or other surfaces. Made of heavy cadmium-plated steel. Have 1/4" diameter shank. Tighten with wrench or pliers. Av. shpg. wt., per pkg. 5 oz. 10 per pkg.
 71 C 605. 1 1/2". Per Pkg.....45¢
 71 C 606. 2". Per Pkg.....49¢
 71 C 607. 3". Per Pkg.....59¢

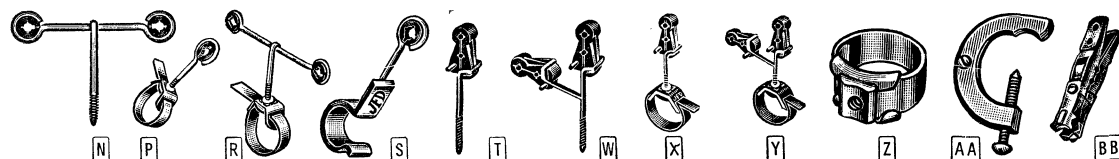

N Double Stand-Off Insulators. Wood screw type. For flat, oval, tubular and coaxial lines. Av. shpg. wt., per pkg., 10 oz. 5 per pkg.
 71 C 628. 3 1/2". Per Pkg.....48¢
 71 C 629. 5 1/2". Per Pkg.....49¢
 71 C 630. 7 1/2". Per Pkg.....50¢

P Strap-Type Single Stand-Offs. For flat, oval, tubular and coaxial lines. Mount on any mast. Shpg. wt., per pkg., 6 oz. 3 per pkg.
 71 C 654. 3 1/2". Per Pkg.....24¢
 71 C 655. 5 1/2". Per Pkg.....29¢
 71 C 656. 7 1/2". Per Pkg.....32¢

R Strap-Type Double Stand-Off Insulators. As above, but for two transmission lines. For flat, oval and round twin-lead or coaxial lines. Av. wt., per pkg., 8 oz. 3 per pkg.
 71 C 633. 3 1/2". Per Pkg.....40¢
 71 C 634. 7 1/2". Per Pkg.....42¢

S Snap-on Stand-Off Insulators. For flat, oval, tubular and coaxial lines. 3 1/2" long. Fit masts (O.D.) below. Av. shpg. wt., per pkg., 8 oz. 3 per pkg.
 71 C 636. 1". Per Pkg.....22¢
 71 C 637. 1 1/4". Per Pkg.....22¢
 71 C 638. 1 1/2". Per Pkg.....22¢

T Single Screw-Type Stand-Off Insulators. For any lead-in. Insulator swings out for insertion of lead-in. Snaps shut with finger pressure. Design assures isolation of lead-in from metal holder. Av. wt., per pkg., 9 oz. 5 per pkg.
 71 C 639. 3 1/2". Per Pkg.....22¢
 71 C 640. 5 1/2". Per Pkg.....25¢
 71 C 641. 7 1/2". Per Pkg.....35¢

W Double Screw-Type Stand-Off Insulators. As above, but with two insulators for securely supporting two transmission lines. Polyethylene insulation. Keeps lines well separated. Holds securely without crimping. Wt., per pkg., 11 oz. 5 per pkg.
 71 C 643. 7 1/2". Per Pkg.....65¢

X Single Strap-Type Stand-Off Insulators. For mounting stand-off insulators on masts. Easy installation; no loose parts. With polyethylene low-loss insulator design, electro-galvanized steel strap, and heavy gauge steel buckle. Bromzidite plating for maximum protection from corrosion. Installs quickly; no threading required. Av. shpg. wt., per pkg., 11 oz. 3 per pkg.
 71 C 649. 3 1/2". Per Pkg.....31¢
 71 C 650. 5 1/2". Per Pkg.....32¢
 71 C 651. 7 1/2". Per Pkg.....37¢

Y Dual Strap-Type Stand-Off Insulators. With two polyethylene pivot-action lock insulators. Electro-galvanized steel strap. Will hold two lead-in lines or lead-in plus rotor cable. Length, 7 1/2". Shpg. wt., per pkg., 13 oz. 3 per pkg.
 71 C 653. Per Pkg.....57¢

Z Mast Insulator Clamps. Consist of metal strap and nut block for 10-32 machine-screw type stand-off insulators. No need to drill hole in mast. Wt., per pkg., 5 oz. 3 per pkg.
 71 C 822. For 1" masts.
 71 C 823. For 1 1/4" masts.
 Per Pkg.....14¢
 10 or more pkgs., Per Pkg.....12¢

AA Ground Clamp. For secure ground connection to water pipes up to 1 1/4" diameter. Pointed screw tip for positive "bite"; screw terminal for ground wire. Shpg. wt., 4 oz.
 51 C 310. EACH.....15¢
 10 or more, EACH.....13¢

BB Antenna Clip. A very handy accessory for servicemen. Clips standard 300-ohm lead-in to antenna terminals of TV sets. Low-loss plastic clip with screw terminals for transmission line. 3 3/4" long. Shpg. wt., 2 oz.
 41 C 132. NET.....12¢

JFD SET & ANTENNA COUPLERS AND ANTENNA SWITCHES

JFD set couplers and antenna couplers provide convenience, efficiency and economy in many types of TV installations. The set couplers permit operating up to four TV sets from only one antenna. Antenna couplers make it possible to use only a single twin-line with up to three antennas. The antenna switches shown are ideal for multiple-antenna installations.

CC Model AC Set Couplers. Offered in choice of models to permit connecting 2, 3 or 4 TV sets to one antenna. With U-bolt to permit convenient mounting on antenna mast, if desired. 300 ohms. (See bottom view). Shpg. wt., 8 oz.

Stock No.	Type	Description	NET
71 C 661	AC40	2 TV sets to 1 antenna	2.06
71 C 662	AC60	3 TV sets to 1 antenna	2.35
71 C 663	AC70	4 TV sets to 1 antenna	2.85

DD Model AC Antenna Couplers. For connecting separate TV antennas to single twin-line. Eliminate need for running separate twin lines through the house. Supplied with hardware. Shpg. wt., 3/4 lbs.

Model AC10. Couples 2 antennas; high-band and low-band VHF.
 51 C 269. List, \$3.50. NET.....2.06

Model AC20. Couples 2 antennas. Permits connecting separate UHF and VHF antenna to a single length of twin line.
 51 C 266. List, \$3.75. NET.....2.20

Model AC30. Couples 3 antennas: Low-band and high-band VHF, and UHF.
 51 C 267. List, \$4.85. NET.....2.85

EE AS1 Antenna Switch. Smooth-operating "Bat-Handle" 3-way switch. Enclosed in sturdy, compact plastic housing. Permits instant selection of any one of 3 antennas. Shpg. wt., 2 lbs.
 71 C 539. List, \$3.75. NET.....2.20

FF AS3. Antenna Switch. Specially designed to permit instant switching to any antenna in a multiple Yagi installation. Used with up to 3 antennas. Employs smooth-working constant-impedance rotary switch with low-resistance silver-to-silver contacts. Housed in sturdy plastic case. Size, 1 3/4x2 1/2". Convenient screw terminals for quick, simplified hook-up. Shpg. wt., 2 lbs.
 71 C 540. List, \$4.95. NET.....2.91

AS4 Antenna Switch. Same as Type AS3 listed above but for use with up to 4 antennas.
 71 C 541. List, \$5.95. NET.....3.50

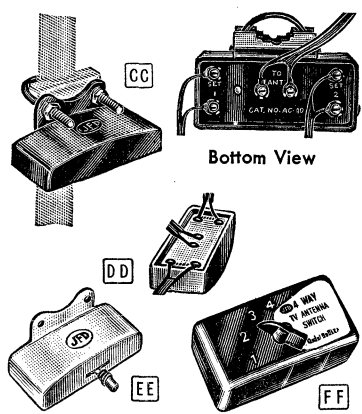

TV Antenna Accessories

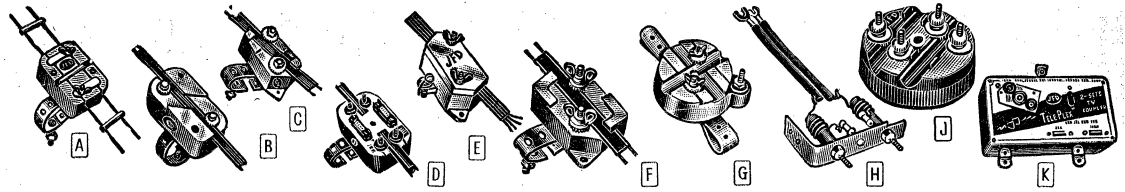

JFD LIGHTNING ARRESTERS, COUPLERS, WAVE TRAPS

A AT107 Lightning Arrester. For protection of all TV sets using open-wire transmission lines. Makes positive contact. Stainless steel strap. With 4-ft. ground wire. Size, 2x3x 1/2". U. L. Approved. Shpg. wt., 15 oz. 71 C 529. List, \$3.50. NET.....2.06

B AT102 Regular Flat-Line Lightning Arrester. Underwriters' Laboratories Approved. Complete with stainless steel hanger strap, 4-ft. aluminum ground wire and hardware. Shpg. wt., 15 oz. 71 C 479. List, \$2.25. NET.....1.32

C AT103 Lightning Arrester. Like Type AT102, described above, but for oval-jumbo and tubular twin lead-in line. U. L. Approved. Shpg. wt., 15 oz. 71 C 517. List, \$2.25. NET.....1.32

C AT105S Universal Arrester. Can be mounted on mast or pipe. Connections are made by saw-toothed screw terminals. For flat, tubular and open wire lead. Supplied with stainless steel hanger strap. U. L. Approved. Shpg. wt., 13 oz. 71 C 530. List, \$1.50. NET.....88c

C AT105. As above, less hanger strap. With ground lug and screws. Wt., 12 oz. 71 C 518. List, \$1.25. NET.....73c

D AT120 Lightning Arrester. Fused lightning arrester. For use with ribbon, tubular and open wire lead-ins. Features strain-relief retainers. With ground wire and strap. U. L. Approved. Shpg. wt., 6 oz. 71 C 536. List, \$4.75. NET.....2.79

E AT104 Lightning Arrester. For antenna rotator installations. Handles 4-wire lead-ins. 8 precision-spaced teeth make positive contact with conductors. U. L. Approved. With ground lug. Shpg. wt., 15 oz. 71 C 519. List, \$1.50. NET.....88c

F AT110 Lightning Arrester. For flat or open-type transmission lines. Strain-relief lip for protecting both types of lead-in. Mounts on outside wall or window sill. With ground-lug. U. L. Approved. Shpg. wt., 15 oz. 71 C 531. List, \$1.50. NET.....88c

F AT110S. Similar to the Type AT110 described above, but supplied with a stainless steel hanger strap. Shpg. wt., 15 oz. 71 C 532. List, \$1.75. NET.....1.03

G AT131 Lightning Arrester. For flat, tubular, oval, or open-wire transmission lines. Saw-tooth washers assure positive contact without cutting or stripping of wire. Constructed of low-loss material for full signal strength. With wood screw and strap. U. L. Approved. Shpg. wt., 10 oz. 71 C 537. List, 75c. NET.....44c

J Model RA-2 Two-Set TV Antenna Coupler. For operating two TV receivers from the same antenna. Delivers full signal strength to both receivers. Gives efficient operation on all VHF and UHF channels. Maintains constant 300-ohm impedance. Extremely compact. Quickly and easily attached with single mounting screw. Shpg. wt., 6 oz. 71 C 660. List, \$1.65. NET.....97c

K "Tele-Plex" TV Set Couplers. For operation of 2 to 4 TV receivers from a single antenna. Simply plug 300-ohm antenna lead-in into coupler input and plug in 300-ohm lead from each set. Bakelite case with built-in lightning arrester. *With arrester. Size, 6x3x3". With mounting screws and complete instructions. Shpg. wt., 1 lb.

Stock No.	Type	Used For	NET
98 C 140	TC2L*	2 sets	7.03
71 C 658	SC2	2 sets	6.44
98 C 141	TC4L*	up to 4 sets	7.61
71 C 659	SC4	up to 4 sets	7.03

Model TT2. Economy Coupler. 2-set TV coupler for low-cost jobs. As above, but has screw-type terminals for connecting twin lines. Less arrester. Shpg. wt., 1 lb. 98 C 143. List, \$3.75. NET.....2.20

H Model BR106-10-30 Wave Trap. Capacitive-inductive type wave trap for elimination of TV interference caused by signals originating on frequencies between 10 and 30 mc. Coils have adjustable, powdered-iron cores tunable to the interfering frequency. With adjusting bracket and 5' twin lead with timed lugs for connection to antenna input of TV receiver. Shpg. wt., 4 oz. 77 C 550. List, \$2.75. NET.....1.62

Model BR106-80-110. As above, but for elimination of TV interference caused by FM between 80 and 110 mc. 77 C 551. List, \$2.75. NET.....1.62

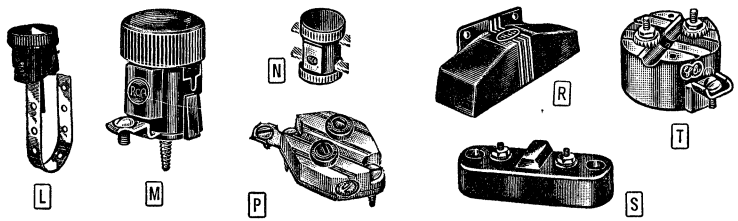

POPULAR LIGHTNING ARRESTERS AND COUPLERS

RCA ARRESTERS & COUPLER

L Type 235A1 Arrester. Low-loss UHF-VHF lightning arrester—no splicing, stripping, or soldering of antenna line necessary. Screw cap type—forces antenna line against staple contacts which pierce insulation and make contact with conductors. Underwriters' Laboratories Approved. Strap type for mounting on mast or water pipe. Shpg. wt., 8 oz. 51 C 229. NET.....73c

M Type 234A1 Arrester. As above, but screw-in type. For mounting on windowsills, eave line. Reduces oscillator interference below 300 mc. Resistance elements are made of a conductive rubber that is non-corrosive and impervious to moisture. Will accommodate almost all tubular, round, and oval UHF transmission lines without splicing. Shpg. wt., 8 oz. 51 C 228. NET.....81c

N Type 240A1 Coupler. Set Coupler. For operating two or more TV sets from one antenna having a 300-ohm transmission line. Save cost of additional antenna for that second set. Utilizes resistance elements only—does not affect impedance characteristics of transmission line. Reduces oscillator interference between sets. Easily installed. Wt., 6 oz. 51 C 246. NET.....90c

PORCELAIN ARRESTER

S General-purpose gap-type arrester. Designed for single-wire lead-in of radios. Made of high quality glazed porcelain. With barrier between terminals for maximum leakage path. Hex nut terminals and countersunk mounting holes. U. L. Approved. Shpg. wt., 6 oz. 51 C 280. NET.....25c

AMPHENOL ARRESTERS & COUPLERS

P Type 114-328 Arrester. UHF-VHF. Universal lightning arrester. For flat, tubular, or open line. No stripping, cutting, or splicing of line necessary. Knife-edge contacts, cut through insulation to make positive contact. Low loss, phenolic body. With screws for mounting. Underwriters' Laboratories Approved. Shpg. wt., 5 oz. 51 C 247. List, \$1.50. NET.....88c

Type 114-329. As above, with strap mount. 51 C 289. List, \$1.75. NET.....1.03

R Amphenol Tele-Couplers. Highly efficient couplers for operating up to 4 TV sets from one VHF or UHF antenna. Permits using a single transmission line to antenna. Bifilar wound network provides high degree of isolation to prevent interaction between sets. Also offers very low insertion loss to insure full strength signals to all sets. Weather-proof plastic case with protected screw-type terminals. May be installed indoors or outdoors. Shpg. wt., 1/2 lb.

Type 114-088. 2 set Telecoupler. 51 C 272. List, \$3.75. NET.....2.20

Type 114-090. Up to 4 set coupler. 51 C 274. List, \$5.75. NET.....3.36

TELCO LIGHTNING ARRESTER

T Type 8642. Versatile, low-cost lightning arrester. For use with round, oval, flat, or open lines, without stripping, cutting, or splicing insulation. Both circular contacts make firm contact. Underwriters' Laboratories Approved. Mounts on walls. Shpg. wt., 6 oz. 51 C 242. List, \$1.25. NET.....73c

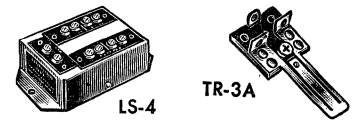

BLONDER-TONGUE LINE SPLITTER

Model LS-4. Provides low-cost means of dividing 300-ohm twin-line into four branches from one input. Enables signal to be distributed to four TV sets. Maintains 300-ohm impedance match. Excellent for multiple installations such as in apartments. Size, 2 3/4 x 4 1/4". Shpg. wt., 8 oz. 51 C 287. List, \$8.50. NET.....5.30

BLONDER-TONGUE THERMO RELAY

Model TR-3A. Replacement relay used in boosters and converters which automatically turn on and off with TV set. Silver contacts adjustable for time delay of .1 to 4 seconds; will handle up to 5 amp @ 117 v. or 1/4 amp @ 220 v., AC. Uniform operation over current range of .1-3 amps. 2 1/2 x 1 x 3/8". Wt. 2 oz. 51 C 210. List, \$2.00. NET.....1.30

MILLER ANTENNA TRANSFORMERS

Permits use of low-loss 52 or 72-ohm coaxial cable on 300-ohm receiver inputs. 2 required; one at antenna, and one at receiver. Excellent where long 300-ohm line gives poor picture. May be used outdoors. Size, 1 3/8 x 3/4 x 1 1/2". Tinned solder-lug terminals. Shpg. wt., 2 oz.

77 G 516. Type 6161. 52 ohms.
77 G 517. Type 6162. 72 ohms.
NET EACH.....1.62

COLOR TV DE-GAUSSING COIL

A valuable aid for every TV serviceman. Extremely effective de-gaussing coil designed especially for color TV alignment. Electro-magnetic field neutralizer eliminates stray magnetic fields to allow accurate purity adjustments. Coil is completely enclosed in molded plastic cover and conforms to standard color TV industry specifications. Supplied with 9 ft. cord. For operation from 110-120 volts, 50-60 cycles AC. Shpg. wt., 5 1/2 lbs. 71 CX 666. List, \$19.95. NET.....11.95

Television Accessories

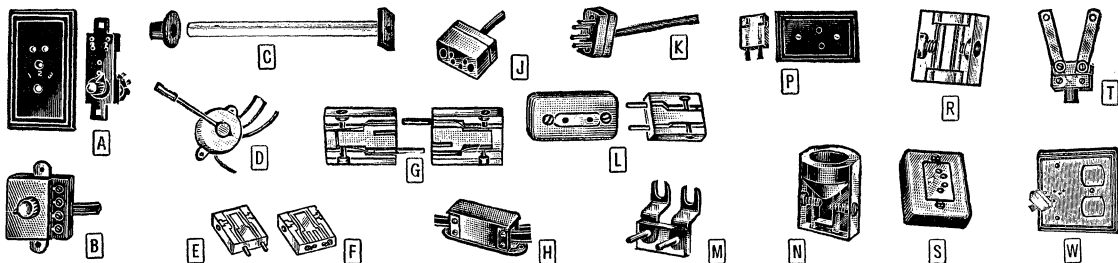

MOSLEY TWIN LINE ACCESSORIES

A Type F-10 3-Way Switch and Lead-in Socket. Switch and single twin-line socket in one flush-mounted unit. With face-plate. Shpg. wt., 12 oz.
40 C 336. With brown plate.
40 C 335. With ivory plate.
NET EACH.....2.31

B Type F-20 2-Way Antenna Switch. Same as Type F-20 below, but for 2 antennas.
40 C 425. Brown plastic case.
40 C 426. Ivory plastic case.
NET EACH.....1.21

C Type 625 Wall-Thru Insulator. For twin line or RG-59/U coax. Fits any wall up to 1 3/4" thick. Includes polystyrene tube 1/4" long, inside plate and outside cap. If desired, universal TV socket, 343-PK (listed below) may be installed directly on inside plate. Select matching color. Shpg. wt., 1 lb.
40 C 430. Brown plastic ends.
40 C 440. Ivory plastic ends.
NET EACH.....1.21

Type 625PK. Same as Type 625 above, but with universal TV lead-in socket for inside wall plate. Shpg. wt., 1 lb.
40 C 441. NET.....1.85

D Type F-20 3-Way Antenna Switch. Selects any of 3 antennas. Constant impedance in all positions. Mounts on back of TV set. Shpg. wt., 12 oz.
40 C 338. Brown plastic case. NET
40 C 423. Ivory plastic case. EACH.....2.31

G Type 321 Polarized Connector. Efficient twin-line connector consisting of 2 polystyrene plugs, each with one male and one female. Assures proper polarization. 1 3/8" long. Shpg. wt., 2 oz.
72 C 711. PER PAIR.....37c

L Type 343-PK Transmission Line Sockets with Plug. Can be mounted on inside plate of 625 Wall-Thru. With solderless twin line plug and mtg. screws. Shpg. wt., 2 oz.
40 C 413. Brown plastic case.
40 C 412. Ivory plastic case.
NET EACH.....66c

R Type 27-S Flat-Line Polystyrene Splicer. Strip wires, insert, and tighten set screws for positive electrical contact. Size, 3/2 x 3/4 x 1/4". Shpg. wt., 2 oz.
72 C 706. NET EACH.....1.1c
10 for.....99¢ 100 for.....89c

S Solderless Base Sockets. Precision molded polarized multi-wire connectors for 4 and 8 wire flat or round cable. Use with line plugs listed below. Shpg. wt., 2 oz.

Stock No.	Type	Description	NET
40 C 437	354	For 4-wire cable	.84
40 C 439	358	For 8-wire cable	1.08

K Line Plugs. Solderless; for 2, 4 and 8 wire; take flat or round cable. Shpg. wt., 2 oz.

Stock No.	Type	Description	NET
40 C 429	303	For 2-wire cable	19c
40 C 431	374	For 4-wire cable	46c
40 C 433	378	For 8-wire cable	62c

J Line Sockets. Take plugs, above. Polystyrene; for connecting or terminating multi-wire cable. Shpg. wt., 2 oz.

Stock No.	Type	Description	NET
40 C 434	364	For 4-wire cable	60c
40 C 436	368	For 8-wire cable	77c

E Type 301 Plug. Ideal for connecting TV antenna lead-in to set or booster. Made of polystyrene. 1/2" pin spacing (fits socket below). Shpg. wt., 2 oz.
72 C 705. NET.....19c

F Type 311 Socket. For use with twin-line plug above. Standard 1/2" spacing. Polystyrene insulation. Shpg. wt., 2 oz.
72 C 709. NET.....19c

M Type 304 Mosley Antenna Connector. For connection of lead-in to TV antenna terminal. Fits Type 311 socket, above. Shpg. wt., 2 oz.
40 C 339. NET.....19c

H Type 902 Dual-Match TV Coupler. Operates 2 TV sets from 1 antenna. For 300-ohm line. Shpg. wt., 3 oz.
40 C 424. NET.....1.82

Type 904. Four-Set Coupler As 902 above, but accommodates up to 4 sets.
40 C 445. NET.....3.86

T Type 263S. "Y-TV" for connecting all types of transmission lines to TV antenna elements. Solderless, screw connections 4" max. width. Wt., 6 oz.
40 C 443. NET.....40c

N Type 29-S Tubular To Flat-Line Splicer. For joining tubular or oval 300-ohm lines to standard flat lines. Clear polystyrene. Shpg. wt., 3 oz.
40 C 442. NET.....13c

P Type F-1PK Flush Socket and Wall Plate. For 300-ohm twin-line. Fits standard outlet box. Plastic plate. With plug and mtg. bracket. Shpg. wt., 6 oz.
40 C 419. Brown. NET
40 C 418. Ivory. EACH.....1.21

Type F-1PK Dual Flush Socket and Wall Plate. Similar to above, but for 2 twin-line connections, with plug. Shpg. wt., 6 oz.
40 C 417. Brown. NET
40 C 416. Ivory. EACH.....1.66

Type F-11PK Triple Flush Socket and Wall Plate. Similar to above, but for 3 twin-line connections. With plug. 6 oz.
40 C 427. Brown. NET
40 C 428. Ivory. EACH.....1.66

Type F-14PK Combination Flush Socket and Wall Plate. Similar to above, but for 300-ohm twin-line and 4-wire rotor cable. Plastic plate, with plugs. Shpg. wt., 6 oz.
40 C 415. Brown. NET
40 C 414. Ivory. EACH.....2.17

Type F-14PK Combination Flush Socket and Wall Plate. As above, but for 2 twin-lines and 4-wire rotor cable. With plug. 8 oz.
40 C 448. Brown plastic. NET
40 C 449. Ivory plastic. EACH.....2.17

AC-TV WALL PLATE SOCKETS. Shpg. wt., 6 oz.

AC-1PK. For 2 AC sockets and 300-ohm twin-line.
40 C 407. NET.....1.16

AC-14PK. As above, plus 4-wire rotor.
40 C 408. NET.....2.05

AC-18PK. Same as Type AC-1PK, plus 8-wire rotor.
40 C 409. NET.....2.28

CINCH-JONES WALL PLATE

For terminating TV lead-in and rotor cables in standard wall outlet. Wall plates are chrome-plated. S-302 for antenna lead-in. S-302-4 for lead-in plus 4 rotor wires; S-302-8, for lead-in and 8 rotor wires. Shpg. wt., 7 oz.

WPC Style TV Wall Plates

41 C 646. S-302. NET.....1.22
41 C 647. S-302-4. NET.....1.49
41 C 648. S-302-8. NET.....1.82

CCT Style Plugs for Above

40 H 802. P-302. Antenna plug. NET...43c
40 H 804. P-304 4-wire rotor plug. NET...51c
40 H 808. P-308 8-wire rotor plug. NET...62c

STANCOR TV TUBE BOOSTER

Model PB192. Self-contained unit adds life to aging picture tubes when dimness is due to low cathode emission. For all electro-magnetic pix tubes with parallel-connected filaments. Easily installed; mounts anywhere in set without soldering. Hi-Lo switch for two levels of tube brilliance. Simply remove tube connector. (no need to remove picture tube from set) attach to booster. Connector plug of booster attaches to picture tube. Complete with easy-to-follow instructions. 3 1/2 x 1 1/2". Shpg. wt., 8 oz.
80 G 182. List, \$5.44. NET.....3.20

PERMA-POWER TUBE BRITENERS AND ACCESSORIES



TV TUBE BRITENERS

X Model C-301 Isolation Type. Versatile brightener with 7.8 v. position, plus normal 6.3 v. position. Simple switch allows quick selection. For use in TV sets with either series or parallel-wired tube filaments. Shpg. wt., 10 oz.
80 G 184. List, \$4.45. NET.....2.49

Y Model C-201 Autoformer Type. Ideal for use in sets having series- or parallel-wired filaments. Can be installed on any black-and-white picture tube—8" or larger. 7.8 v. booster tap. Does not relieve cathode-filament shorts. Shpg. wt., 8 oz.
80 G 181. List, \$3.45. NET.....1.47

Model C-401 Autoformer Type. Exceptionally low-cost TV tube brightener. As above, but for sets having parallel-wired filaments only. Shpg. wt., 8 oz.
80 G 183. List, \$1.98. NET.....88c

Model C-402. Autoformer Type. Same as above, but for use in sets having series-wired filaments only.
80 G 188. List, \$1.98. NET.....88c

Z Model K-101 TV Tube Restorer. New, highly versatile picture tube restorer. Corrects open cathodes, heater-cathode shorts, open control grids, control grid-cathode shorts, low emission, etc. Shpg. wt., 1 lb.
80 G 189. List, \$5.50. NET.....3.08

LINE VOLTAGE REGULATOR

AA Model D101. Restores correct height and width to TV in locations where low line voltage causes picture shrinkage. Regulator plugs into AC outlet; TV set plugs into regulator. 3-position selector switch for boosting or lowering voltage. 300-watt rating. 4 3/4 x 4 3/4 x 2 1/4". Wt., 2 1/4 lbs.
80 G 186. List, \$6.75. NET.....3.97

HORIZONTAL BAR GENERATOR

BB Type B101. Provides series of horizontal lines for accurate checking of picture linearity. Also used for setting of deflection yoke and focus coil or magnet. Plugs into all duo-decal picture tube sockets. With instructions. Size 1 1/2 x 1 1/2". Wt., 5 oz.
51 C 212. NET.....1.72

TV Components and Accessories

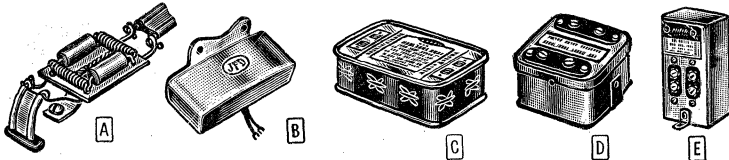

TV INTERFERENCE FILTERS

REGENCY HP-45 HIGH-PASS FILTER

A For attenuation of signals at frequencies below 55 mc. Provides effective aid in elimination of TVI. Has "K" type filter with cut-off frequency of 45 mc in a 300 ohm line. Approximately 20 db attenuation at 29 mc; 40 db or more at frequencies of 14 mc and below. Signals above 55 mc are passed through filter without loss. With mtg. bracket. 1 1/8 x 7/8". Shpg. wt., 2 oz.
77 C 569. List, \$1.65. NET.....97c

JFD INTERFERENCE FILTERS

B Model WT26. Reduces interference from diathermy, transmitters, TV oscillators, etc. Attaches to set. For channels 2-6. With screws and instructions. Shpg. wt., 8 oz.
77 C 680. List, \$4.50. NET.....2.65

Model WT713. As above, but for channels 7-13.
77 C 681. List \$4.50. NET.....2.65

AMPHENOL HIGH-PASS FILTER

C Model 114-330. Excellent high-pass filter for reducing TV interference caused by transmitters, diathermy, industrial devices, ignition, etc. Quick and easily installed between lead-in and antenna terminals of TV set. Provides almost 60 db attenuation of interference below 50 mc. Employs 3-individually shielded filters. Impedance, 300 ohms. Completely enclosed. 1 1/8 x 3/4 x 3 1/8". Shpg. wt., 6 oz.
51 C 279. List, \$6.95. NET.....4.09

R. L. DRAKE TVI FILTERS

D Model TV-300-HP. High-pass interference filters for any TV set with 300-ohm antenna input and 20 or 44-mc IF's. Attenuate interference from 0 to 52 mc more than 40 db. Fully shielded. Size, 2 1/2 x 2 1/2 x 1 1/2". Wt., 1/2 lb.
77 C 567. NET.....3.50

J. W. MILLER HIGH-PASS FILTER

E Model 6168. For use at TV set. Reduces interference from medical and industrial equipment, transmitters, etc. Cuts off below 40 mc. 300 ohms. Size, 1 7/8 x 1 1/2 x 3 1/2". Shpg. wt. 1/2 lb.
70 G 191. NET.....3.23

"CLEAR-PIX" TELEVISION INTERFERENCE FILTERS

Minimize or eliminate common TV interference. Effective against 21 mc Amateur transmitters, diathermy machines, strong FM stations, ignition, and other high frequency sources. 300 ohms. Screwdriver adjustment. Shpg. wt., 5 oz.



Stock No.	Mfr's Type	Interference Used For	NET EACH
51 C 043	CPH	21 mc Amateur	1.17
51 C 044	CPD	Diathermy machine	
51 C 046	CPF	Strong FM station	
51 C 045	CPI	Ignition or similar	

RCA TV COMPONENTS

231T1 Universal Flyback Transformer. Up to 15 kv. For replacement and conversion in sets using transformers with isolated secondaries for yokes. 7 secondary taps—matches any driver to yoke having inductances from 8-30 mh. For 50"-66" tubes. Primary matches any output tube and B supply. 2 lbs.
77 G 593. NET.....5.47



Model 201Y1 Convertit. An excellent kit for conversions using tubes up to 21". Includes 231T1 Universal transformer (above) and Type 211D2 "Anastigmat" deflecting yoke. Yoke has 66-70" deflection and separate horizontal coil neutralizing RC network for use with isolated-secondary horizontal transformers or autotformer types. Shpg. wt., 5 lbs.
77 G 592. NET.....10.61



RCA TV RECEIVER SERVICE PARTS

Exact duplicate replacement parts for RCA TV receivers with part numbers as given in RCA servicing and replacement manuals. Shpg. wt., 1 1/2 lbs., except *15 lbs., *6 oz., \$3 lbs.

Stock No.	Mfr's Type	Component	NET EACH
77 G 186	74586*	Power Transformer	17.64
77 G 146	74588	Horiz. Output & HV Transf.	9.70
77 G 188	74950	Vert. Deflection Output Transf.	3.23
77 G 263	74952*	Deflection Yoke	5.76
77 G 266	75221*	Selenium Rectifier	1.82
77 G 192	75508*	Power Transformers	14.11
77 G 193	75519	Horiz. Output & HV Transf.	4.41
77 G 268	76168	Focus Magnet	7.01
77 G 197	76531*	Horiz. Output & HV Transf.	3.70
77 G 255	76653*	Deflection Yoke	7.35
77 G 256	77697*	Deflection Yoke	7.06

TV MASKS, CONVERSION ASSEMBLIES, FILTERS

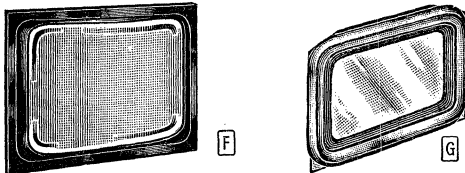

COLOR TINTED!

TV TUBE DELUXE PLASTIC MASKS

F Clear, 1/8"-thick plastic safety masks for rectangular picture tubes. Prevents tube breakage and guards against "implosion" and shattering. Gold metal-luster finish border. Easy to install. Shpg. wt., 1 1/4 lbs.

No.	For Tube	Size	NET
97 CX 923	17" Rect.	13 1/4 x 16 3/4"	5.35
97 CX 913	21" Rect.	15 3/4 x 21 1/2"	8.00

TELEVISION FILTERS

H For 16-17" Sets. Scientifically tinted (gray) to protect eyes. 13x17". Wt. 1 lb.
71 CX 814. NET.....2.19

For 19-21" Sets. 16x21". Wt., 1 1/4 lbs.
71 CX 820. NET.....2.79

WALDOM TV MASK ASSEMBLIES

G Ideal for use with cylindrical-face, rectangular tubes in custom TV installations. Also excellent for use when converting small screen TV receivers to a larger picture tube. Has metallic gold-finished escutcheon green-sprayed aluminum mask, and heavy protective glass. U.L. Approved. 21" assembly has 3/2" tilt to eliminate glare and light-reflections. Complete with mounting hardware and instructions. Av. shpg. wt., 7 lbs.

Stock No.	For Tube	Size	NET EACH
97 CX 917	17" Rect.	13 3/8 x 17 1/8"	12.70
97 CX 914	21" Rect.	17 1/2 x 21 1/2"	15.83

NEW WUERTH TUBE SAVER

Model 200. Designed to extend tube life in a wide variety of equipment—ideal for use with television receivers, radios, high-fidelity systems, public address amplifiers, electronic organs, juke boxes, medical equipment, laboratory instruments, etc. Provides thermal "cushioning" action to limit damaging surge of current when set or equipment is turned on—protects tubes from burnouts; minimizes damage to filaments and cathodes. Helps to keep equipment running at peak performance. Has built-in red jewel pilot light. Size, 5x2 1/2 x 3". For operation from 110-120 volts, AC or DC. Rated 100 to 300 watts. Wt., 1 1/2 lbs.
80 G 143. NET.....4.66

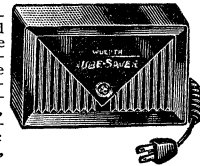

CRT HI-VOLTAGE CONNECTOR

Second-anode connector. Silver plated, snap-button plug; makes perfect contact with picture tube. Well insulated by 1/2" diameter rubber cap. Public address amplifiers, electronic organs, juke boxes, medical equipment, laboratory instruments, etc. Provides thermal "cushioning" action to limit damaging surge of current when set or equipment is turned on—protects tubes from burnouts; minimizes damage to filaments and cathodes. Helps to keep equipment running at peak performance. Has built-in red jewel pilot light. Size, 5x2 1/2 x 3". For operation from 110-120 volts, AC or DC. Rated 100 to 300 watts. Wt., 1 1/2 lbs.
80 G 143. NET.....4.66



RCA COLOR TV SERVICING AIDS

A "must" for service kits. Types 222X1 and 223X1 are for RCA color TV 1956 sets. Types 220X1 and 221X1 are for 1956 and 1957 sets. Types 224X1, 225X1 and 226X1 are for 1957 color television receivers.

Stock No.	Mfr's Type	Component	Wt., Oz.	NET EACH
77 G 310	220X1	CRT Socket Ext. Cable	9	7.25
77 G 311	221X1	Reflecting Yoke Ext. Cable	7	3.43
77 G 312	222X1	Converging-Magnet Assembly Ext. Cable	6	3.33
77 G 313	223X1	Hi-Volt Ext. Cable	2	1.32
77 G 314	206P1	Hi-Volt Interlock Plug	2	.41
77 G 315	224X1	Converging-Magnet Ext. Cable	2	2.62
77 G 316	225X1	Hi-Volt Ext. Cable	6	1.32
77 G 317	226X1	Grid Shunt	8	4.70

QUAM FOCALIZER UNIT

Type QF-4. For quick, accurate focusing and centering of raster. Fits all picture tubes regardless of size or anode voltage. Size, 1 3/4 x 3 1/4 x 5 1/2". Shpg. wt., 1 lb.
41 H 133. NET.....2.50



BARKHAUSEN ELIMINATOR

Very effective in eliminating Barkhausen oscillations. These oscillations appear as dark vertical lines. Fits around the horizontal output tube. For use on 6B06, 6AU6, 6AV5, etc. Shpg. wt., 3 oz.
41 H 129. NET.....73c



MILLER ADJUSTABLE ION TRAP

Model 6295. Universal single-magnet ion trap. Screw adjustment allows magnetic field to be varied between 32-55 gaussers. Replaces any single-magnet trap within this gauss range, greatly reduces your inventory. Extension spring permits easy installation. Shpg. wt., 6 oz.
60 H 796. List, \$1.25. NET.....73c

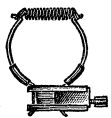

CLAROSTAT REGULATORS

Type TVA. Protects TV sets from line voltage surges. Reduces surge of 140 v., down to 110 v. Plug-in type. For sets using 200-300 watts. Shpg. wt., 5 oz.
31 E 085. NET.....1.76

Type TBV. For sets having a power consumption of 300 to 375 watts. Diameter, 1 1/4"; length, 3 3/4". Shpg. wt., 5 oz.
31 E 086. NET.....2.06



VIDAIRE TV ACCESSORIES

J "Kine Test." Checks electro-magnetic picture tubes by substitution method. No need to remove picture tube or chassis. Just plug tester into picture tube socket. Electron-ray tube dynamically checks filament, bias, and 1st anode voltages, video signal, etc. With instructions. 4 1/2 x 1 1/2". Shpg. wt., 6 oz.
84 C 017. List, \$4.90. NET.....2.88

K "Elim-A-Trace." Eliminates retrace lines in TV picture when brightness is advanced. Provides clearer picture on weak tubes. Plug-in installation. Shpg. wt., 8 oz.

Model TE-1. For grid-modulated CRT.
51 C 076. List, \$3.25. NET.....1.91

Model TE-2. For cathode-modulated CRT.
51 C 077. List, \$3.25. NET.....1.91

Selected Kit Values

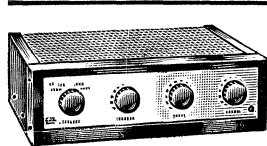

HF-12K

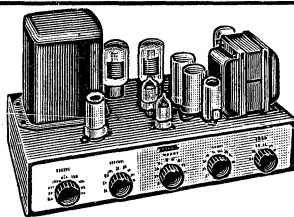

HF-20K
HF-52K



HF-61K

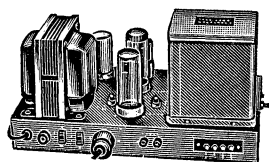

HF-60K

EICO HIGH-FIDELITY COMPONENTS

MODEL HF-12K 12-WATT AMPLIFIER KIT

New, beautifully-styled 12-watt Williamson-type amplifier kit. Built-in preamp-equalizer. Features NARTB equalized tape input for direct playback from tape heads; RIAA-equalized phono input for magnetic cartridge; 3-high level inputs for crystal cartridge, tuner, TV, etc. Has 5-position selector switch and separate bass and treble controls. **Rated Output:** 12 watts. **Response:** ± 0.5 db, 25-20,000 cps at 12 watts. **Distortion:** 1% harmonic, 1.3% IM at rated output. **Speaker Outputs:** 4, 8, and 16 ohms. Two EL84 tubes in output. $3\frac{1}{2} \times 12 \times 8\frac{1}{2}$ ". Brown enamel finish with brass panel. With all parts, tubes, wire, and instructions. For 110-120 v., 50-60 cycle AC. Shpg. wt., 13 lbs.

83 SX 954, NET..... 34.95
Model HF12. As above, but factory-wired.
87 SX 236, NET..... 57.95

MODEL HF-20K 20 WATT AMPLIFIER KIT

Popular 20-watt, ultra-linear Williamson-type amplifier kit. Combines versatility and superb performance. Can be easily constructed—even by a person having no previous technical experience. Has 4 high-level switched inputs for tuner, TV, tape, aux; 2 low-level inputs for magnetic cartridges. Low-impedance, tape recorder output. Includes 5-position record equalizer; separate bass and treble controls; loudness and level controls. **Rated Output:** 20 watts. **Response:** ± 0.5 db, 20-20,000 cps at rated output. **Distortion:** 0.3% harmonic, 1.3% IM at 20 watts. **Speaker Outputs:** 4, 8, and 16 ohms. Two 6L6GB tubes in output. $8\frac{1}{2} \times 15 \times 10$ ". Brown enamel finish with brass panel. Supplied complete with all parts, tubes and instructions. For operation from 110-120 v., 50-60 cycle AC. Shpg. wt., 24 lbs.

83 SZ 951, NET..... 49.95
Model HF20. As above, but factory-wired.
87 SZ 228, NET..... 79.95

MODEL HF-52K 50-WATT AMPLIFIER KIT

Similar in appearance and with same preamp controls as HF20K, above. **Rated Output:** 50 watts. **Response:** ± 0.5 db, 6-60,000 cps at rated output. **Distortion:** 0.5%. **Speaker Outputs:** 4, 8, 16 ohms. $8\frac{1}{2} \times 15 \times 10$ ". Brown case, brass panel. With all parts, tubes, wire, and instructions. For 110-120 v., 50-60 cycle AC. Wt., 30 lbs.

83 SZ 956, NET..... 69.95
Model HF52. As above, but factory-wired.
87 SZ 232, NET..... 109.95

Model E-1 Matching Cover. For HF-20 and HF-52 amplifiers above. $6\frac{1}{2} \times 15\frac{1}{2} \times 8\frac{1}{2}$ ". Shpg. wt., 4 lbs.
87 SX 234, NET..... 4.50

MODEL HF-60K 60-WATT BASIC AMPLIFIER KIT

An extremely high-quality basic amplifier kit. Delivers plenty of reserve power for clear, natural reproduction. Also, provides extra power needed for new electrostatic and other type low-efficiency speakers. Uses ultra-linear connected push-pull EL34 output tubes operated with fixed bias. **Rated Output:** 60 watts, 130 watts peak. **Frequency Response:** ± 0.1 db, 15-35,000 cps at rated output. **Harmonic Distortion:** Less than 0.5% at 60 watts, 20-20,000 cps. **Intermodulation:** Less than 0.5% at 50 watts; less than 1% at 60 watts. **Hum and Noise:** 90 db below rated output. **Damping Factor:** 17. **Sensitivity:** 0.55 volts for 60 watts output. Excellent stability and consistent response. **Speaker Outputs:** 4, 8, and 16 ohms. Fully-potted Acro TO-330 output transformer. Input level control. Designed for use with HF-61 (below) or any high-quality tuner or preamplifier with full set of controls. Standard octal socket provided for preamplifier power take-off. Spacious chassis and step-by-step instructions permit quick, easy assembly. $7 \times 14 \times 8\frac{1}{2}$ ". Brown enamel finish. With all parts, tubes, wire and instructions. For operation from 110-120 v., 50-60 cycle AC. Shpg. wt., 30 lbs.

83 SZ 957, NET..... 72.95
Model HF60. As above, but factory-wired.
87 SZ 233, NET..... 99.95

Model E-2 Matching Cover. For HF-60 amplifier above. $8 \times 14 \times 7\frac{1}{2}$ ". Shpg. wt., 4 lbs.
87 SX 235, NET..... 4.50

MODEL HF-61K PREAMPLIFIER

Hi-fi preamplifier kit for versatile control of music systems. Seven inputs (4 high-level and 3 low-level) accommodate all hi-fi equipment including magnetic, crystal or FM cartridges, tuner, tape, TV, etc. Features built-in high and low noise elimination filters; 5 positions of record equalization; loudness control; separate bass and treble controls. **Speaker Outputs:** tape output; cathode follower output; hum balance control; and 4 switched AC outlets. 3 tubes plus rectifier. Size, $4\frac{1}{2} \times 12\frac{1}{2} \times 4\frac{1}{2}$ ". Complete with all parts, tubes, cabinet, brass panel, and instructions. For 110-120 volts, 50-60 cycle AC. Shpg. wt., 8 lbs.

83 S 952, NET..... 29.95
Model HF-61 Preamplifier. As above, but factory-wired.
87 S 229, NET..... 44.95

Model 61AK Preamplifier Kit. Same as HF-61 kit, but less power supply. Requires 1 amp at 6.3 volts and 10 ma at 350 v. DC.
83 S 953, NET..... 24.95

Model 61A Preamplifier. As above, but factory-wired and tested.
87 S 230, NET..... 37.95

TECH-MASTER KITS AND WIRED HI-FI COMPONENTS

MODEL 21K 25-WATT AMPLIFIER KIT

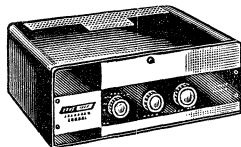

A new, neatly-styled amplifier with built-in preamplifier. Bass and treble tone controls are concentrically mounted; equalizer has fixed RIAA bass position, with exclusive Tech-Master calibrating feature on treble control for compensation of AES, NAB, LP, and 78 characteristics. Input selector switch for magnetic cartridge, crystal cartridge, tuner, TV, tape, etc. **Rated Output:** 25 watts. **Response:** ± 0.5 db, 10-50,000 cps. **Distortion:** 1% harmonic, 1% IM at 25 watts. **Speaker Outputs:** 4, 8, and 16 ohms. Two 6L6GB tubes in output. Size: $5\frac{1}{2} \times 14\frac{1}{4} \times 9\frac{1}{2}$ ". Gold and black enamel finish. Complete with all parts, tubes, and instructions. Less wire, solder, and cabinet. For 110-120 v., 50-60 cycle AC. Shpg. wt., 21 lbs.

83 SX 066, NET..... 58.75
Model 21. Same as 21K, but factory-wired and with 21C cabinet, below.
83 SX 067, NET..... 97.51

Model 21C Cabinet. For Model 21K amplifier kit. Burgundy enamel. $5\frac{1}{2} \times 14\frac{1}{4} \times 9\frac{1}{2}$ ". Shpg. wt., 1 lb.
83 SX 061, NET..... 7.35

MODEL 19K 60-WATT AMPLIFIER KIT

A high-powered amplifier-preamplifier kit, similar in appearance to 21K above. Selector switch has 10 positions; selects 5 inputs and provides 5 positions of record equalization. Separate bass and treble tone controls. **Rated Output:** 60 watts. **Response:** ± 0.5 db, 10 to 50,000 cps at rated output. **Distortion:** 1% harmonic, 1% IM at 60 watts. **Speaker Outputs:** 4, 8, and 16 ohms. Two 6550 tubes in output. $5\frac{1}{2} \times 14\frac{1}{4} \times 10\frac{1}{4}$ ". Black and gold enamel finish. Complete with all parts, tubes and instructions. For operation from 110-120 v., 50-60 cycle AC. Less wire, solder, and cabinet. Shpg. wt., 28 lbs.

83 SX 068, NET..... 78.35

Model 19. Same as 19K, but factory-wired and with 19C cabinet below.
83 SX 069, NET..... 127.35

Model 19C Cabinet. For Model 19K amplifier kit. Black enamel. $5\frac{1}{2} \times 14\frac{1}{4} \times 10\frac{1}{4}$ ". Shpg. wt., 1 lb.
83 SX 062, NET..... 7.35

MODEL FM-18 FM TUNER KIT

A high-fidelity FM tuner kit offering optimum performance at exceptionally low cost. Advanced, drift-free circuit combines high sensitivity and excellent selectivity. Provides clear, faithful reproduction of the entire audio spectrum. Features include: AFC and temperature compensation of oscillator for drift-free reception and ease of tuning; cathode follower and high-impedance outputs; balanced ratio detector; grounded-grid RF amplifier; and micro-vernier tuning drive. **Sensitivity:** 4 mv for 20 db quieting; **Bandwidth:** 200 kc; **Output:** Cathode follower, 0.8 v.; **High Impedance:** 3.2 v.; **Tubes:** 2—12AT 616, 6AU6 6AL5, 6C4 plus selenium rectifier. Complete with all parts and instructions. Less cabinet (below). Size: $4\frac{1}{2} \times 8 \times 6\frac{1}{4}$ ". For 110-120 v., 50-60 cycle AC. Shpg. wt., 6½ lbs.

83 S 078, NET..... 29.65
Model 18C Cabinet. Matching metal cabinet for above. Shpg. wt., 1½ lbs.
83 S 079, NET..... 7.35

MODEL TM-16SP PREAMPLIFIER KIT

Self-powered preamplifier equalizer kit. 5 positions of accurate record equalization. Loudness-compensated volume control provides faithful reproduction at low levels. Cathode follower output. All sockets and connectors are mounted—ready to wire. **Four Inputs:** Magnetic cartridges; crystal cartridges; FM-AM-TV tuners; auxiliary input for tape recorder, etc. **Five Positions of Record Equalization:** RIAA; FFR; AES; 78 rpm; old 78 rpm. **Controls:** Equalizer; Selector Switch; Off-On-Loudness; Treble; Bass. 3 tubes plus selenium rectifier. Size: $9\frac{1}{8} \times 3\frac{1}{2} \times 4\frac{1}{2}$ ". Supplied with all parts, tubes, cabinet, and escutcheon for custom mounting. Less wire and solder. For 110-120 volts, 50-60 cycle AC. Shpg. wt., 4 lbs.



83 S 098, NET..... 24.01

Selected Feature Values

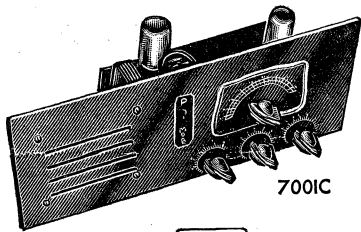

700C

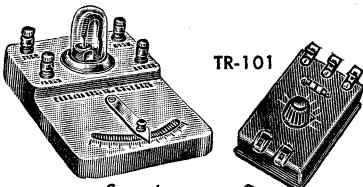

TR-101

Supertone

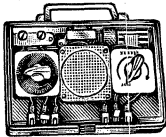

TR-22

PHILMORE BUILDER KITS & CRYSTAL SETS

Ideal for Learning Fundamentals of Radio

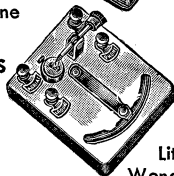

Little Wonder

Model TR-22 Transistor Radio Kit. Extremely popular loudspeaker model transistor radio kit—complete with two transistors and germanium diode. Provides excellent reception of broadcast band. Ideal unit for the builder or hobbyist. Uses a single, long-life battery. Supplied complete with attractive portable case, all necessary parts and detailed instructions. Less battery (see below). Shpg. wt., 1 lb. **83 S 563. NET.....12.94**

Type VS300 RCA Battery. 9-volt battery for above. Shpg. wt., 4 oz. **80 J 961. NET.....1.35**

Model TR-101 Transistor Radio Kit. Low-cost transistor radio kit designed to cover the broadcast band. Includes sensitive germanium diode crystal detector and transistor audio amplifier stage. Handsome polystyrene cabinet measures 3 1/2 x 2 1/2 x 1 1/2". Kit includes 1000-ohm headphone and headband. Less battery (see below). Shpg. wt., 8 oz. **83 S 562. NET.....6.31**

Type Z Battery. For above. Wt., 3 oz. **53 J 031. NET.....9¢**
83 C 100. Antenna Kit. 1 lb. **NET.....1.03**

Model 7000 "Little Wonder" Radio Re-made. One of the smallest crystal sets made. Complete with attractive bakelite case. Less headphones and antenna. Wt., 6 oz. **83 S 015. NET.....1.15**

Model 7001 "Supertone" Crystal Set. Gives splendid results on local stations (within 25-mile radius). Tuning is accomplished by smooth-action slider. Adjustable detector is enclosed in plastic for dust-free operation. Requires no batteries or tubes. Less headphones and antenna. Housed in handsome bakelite case, 4 1/2 x 5 3/4 x 2 3/4". Shpg. wt., 12 oz. **83 S 003. NET.....1.49**

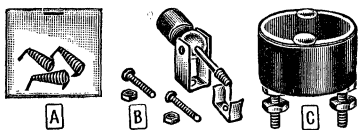

CRYSTAL SET ACCESSORIES

A Cat Whiskers. Tested spring steel. Tempered to give proper tension for best results. Shpg. wt., 2 oz. **52 S 011. PKG. of 3. NET.....12¢**

B Detector Mount Kit. Complete kit of all parts needed for mounting any crystal such as 52 S 005 or 52 S 006 (below) for use as crystal detector. Consists of standard crystal holder; cat-whisker; and swivel arm. Arm is mounted on universal swivel joint for quickly and easily adjusting cat-whisker to most sensitive point on crystal. Complete hardware for mounting parts is included. Less crystal (see below). Shpg. wt., 3 oz. **52 S 003. NET.....15¢**

Detector Mount Kit on Base. Same as detector mount kit above, but components are mounted on fiberboard base, ready for use. Includes Fahnestock clips for quick and easy connecting. Shpg. wt., 5 oz. **52 S 004. NET.....26¢**

C Fixed Detector. Permanently adjusted, fixed crystal detector mounted in a compact, durable bakelite case. Meter-tested to assure extreme sensitivity. Permanently adjusted at most sensitive setting. With mounting hardware. Shpg. wt., 3 oz. **52 S 001. NET.....71¢**

Economy Crystal. Highly sensitive; general-purpose crystal. Ideal for all types of crystal receivers. Genuine Galena crystal. Securely mounted in lead. Fits detector mount kit above. Shpg. wt., 2 oz. **52 S 005. NET.....6¢**

Meter-Tested Crystal. Highest-quality Galena crystal for dependable performance and sensitive reception in crystal receivers of all types. Tested under laboratory conditions using meter method. Selected to assure outstanding sensitivity. Has greater sensitivity than 52 S 005 above. Fits detector mount kit above. (Not illustrated). Shpg. wt., 3 oz. **52 S 006. NET.....16¢**

BUD WIRELESS PHONO-OSCILLATOR

Model WO-6. Compact, easy-to-operate, phono-oscillator for use with any record player.

"Broadcasts" from record player to any standard AM broadcast radio. Can be used at distances up to 50 feet between record player and radio. Any number of radios can be used within the 50-foot range. No interconnecting wires are needed between the record player and radios. Input of oscillator matches any crystal phono cartridge. Installation is simple, just connect the two leads from the cartridge to the phono oscillator. Any unused frequency between 1100 and 2150 kc can be used. Tone and volume can be individually regulated at each radio. Records that are played will be picked up by the radios just like a regular broadcast. Finished in dark gray hammertone. Size, 4 1/2 x 2 1/2 x 2 1/2"—small enough to mount in most record players. For operation from 110-120 volts, 50-60 cycles AC or DC. Shpg. wt., 3 lbs. **60 R 336. NET.....10.58**

SPEAKER GRILLE CLOTH

Beautiful new patterns in high quality, durable cloth. Perfect for modernizing old cabinets and for construction of new custom enclosures. Acoustically perfect for enclosure use. Supplied neatly folded in plastic bags.



MAHOGANY

43 N 605. 12x12". Wt., 2 oz. **NET.....47¢**
43 N 606. 13x24". Wt., 4 oz. **NET.....79¢**
43 N 607. 36x36". Wt., 6 oz. **NET.....3.70**

IVORY

43 N 608. 12x12". Wt., 2 oz. **NET.....47¢**
43 N 609. 13x24". Wt., 4 oz. **NET.....79¢**
43 N 610. 36x36". Wt., 6 oz. **NET.....3.70**

Walsco Fabric Cement. Ideal for cementing grille cloth to cabinets, felt to turntables, etc. Dries quickly; does not become brittle. Will not penetrate, shrink or disfigure material. 2 oz. bottle. Shpg. wt., 8 oz. **43 N 123. NET.....44¢**

FLOCK-COATED GRILLE SCREENING

Galvanized wire mesh, flocked on both sides. Soft, brown color. Durable and attractive. **86 N 060. 8x11".** Wt., 4 oz. **NET.....56¢**
86 NX 061. 18x24". Wt., 12 oz. **NET.....1.88**

DUTCH BRAND TAPE

A favorite with radom and electricians. Dutch Brand tape can always be depended upon for strength and excellent adhesive qualities.



3/4" Friction Tape. A very popular standard width tape. For radio, electrical, home and shop applications. Av. shpg. wt., 6 oz.

Stock No.	Size	Each, In Quantities of		
		1-29	30-99	100
52 N 610	3/4"x13'	14¢	13¢	12¢
52 N 611	3/4"x32'	22¢	21¢	20¢
52 N 612	3/4"x68'	42¢	40¢	38¢

3/8" Friction Tape. Handy, narrow width for radio work. 60 ft. long. Shpg. wt., 7 oz. **52 N 620. NET.....21¢**

Plastic Tape. Strong, black vinyl plastic electrical tape. Stretches and conforms to irregular surfaces, 3/4" type is only .007". Rated 7000 volts, 1/2" type is .010". Rated 10,000 volts. Av. shpg. wt., 6 oz.

52 N 614. 3/4"x44'. PER ROLL.....1.00
15-49. PER ROLL......90
50 or More. PER ROLL......80
52 N 623. 1/2"x108'. PER ROLL.....1.84
6-47. PER ROLL.....1.66
48 or More. PER ROLL.....1.50

SCOTCH NO. 33 PLASTIC BACKED TAPE

Plastic-backed electrical tape. .007" thick; 10,000 v. dielectric strength. Molds to irregular surfaces. Resistant to chemicals, abrasion, oil, salt water, weather. Av. wt., per roll, 6 oz.



Stock No.	Size	PER ROLL	12 or More Rolls	
			PER ROLL	PER ROLL
52 N 613	3/4"x20'	.54	.49	
52 N 616	3/4"x66'	1.47	1.32	



335

62T

LABELON "WRITE-ON-IT" TAPE

Plastic labeling tape with special carbon writing surface sandwiched between 2 layers of acetate. Writing stays legible; surface is protected by layer of plastic. Resists dirt, water, oil, etc. Sticks firmly to any surface without moistening—peels off cleanly. *Black. †Red. ‡Blue. Av. wt., per 400-in. roll, 5 oz.

Stock No.	Mfr's Type	Width	NET EACH		24 or More, EACH
			12-23	EACH	
52 N 751	335†	5/8"	1.37	1.24	1.18
52 N 753	415*	1/2"	1.57	1.42	1.35
52 N 754	425‡	1/2"	1.57	1.42	1.35
52 N 755	435†	1/4"	.57	.42	.35
52 N 757	515*	5/8"	1.76	1.59	1.51
52 N 761	615*	3/4"	1.91	1.72	1.63

TABLETS FOR TYPEWRITER USE

Each has 45, 3-inch strips. Write black; colors given are borders. Av. wt., 5 oz.

Stock No.	Type	Width	Color	NET EA.
52 N 775	62T	3/4"	Blue	98¢
52 N 776	62T	3/4"	Red	
52 N 777	64T	3/4"	Green	

WIRE CONNECTORS

Solderless. Simply strip two wire ends, push into connector and screw can down. No tools needed. Wires cannot be pulled out. Finest grade phenolic. U. L. Approved. Av. wts.: Pkg. of 25, 5.0¢; Pkg. of 100, 14.0¢.



Wire Size	Stock No.	Pkg. of 25	Stock No.	Pkg. of 100
16-18	52 N 874	.24	52 N 870	.83
14-18	52 N 875	.39	52 N 871	1.32
12-18	52 N 876	.49	52 N 872	1.67
10-18	52 N 877	.98	52 N 873	3.33

Selected Feature Values

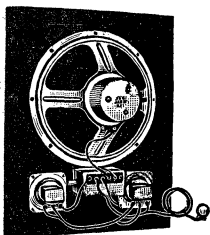

knight MODEL W 2-WAY SPEAKER SYSTEM

The new Knight two-way high-fidelity speaker system offers deluxe performance at very moderate cost. It consists of a heavy-duty 12" woofer with

1 1/4 lb. Alnico V magnet and two highly efficient, 3 1/2" metal-backed, cone-type tweeters with a 2000 cps L-C crossover network. A brilliance control with 24" cable, allows easy adjustment of tonal balance to suit room acoustics and personal tastes. The system is completely wired and all speakers are mounted on a 1/2" 5-ply, 16x20" baffleboard. Screw terminals make connection to your amplifier simple. This top-quality speaker system has a frequency response of 40 to 15,000 cps for brilliant high-fidelity reproduction of music throughout the audio spectrum. The 25-watt power handling capacity is more than adequate for even the largest living room with plenty of reserve for reproducing the loudest passages without distortion. Installation in a bass reflex or in a corner-type enclosure is recommended for full appreciation of this system's wide range of response. Requires 1418' cutout. Impedance, 8 ohms. Shpg. wt., 13 lbs.
93 DX 444, NET..... 39.95

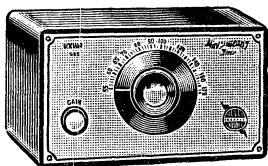

MILLER HIGH-FIDELITY AM TUBELESS TUNER

Model 565. Unique tubeless, high-fidelity AM tuner kit. Provides outstanding broadcast reception at an unusually low price. Tuned radio frequency (TRF) type circuit offers a response that is limited only by the audio system used and the quality of the transmitted signal. The circuit uses no tubes and no operating power is required. Designed for use with any high-fidelity amplifier, or TV audio section. Smooth-tuning dial covers frequencies from 550 to 1700 kc. The output cable of the tuner is equipped with a standard pin plug for direct connection to any standard, amplifier input jack.

The tuner is fundamentally a germanium diode detector employing two tuned circuits. Negative mutual coupling is employed between the antenna circuit and the RF circuit for exceptionally high efficiency. The audio output voltage of the tuner is directly proportional to the input signal. Output voltage ranges from .07 to .7 volts on stations within a 25-mile radius (depending upon the signal strength of the transmitting station). Output is equipped with a volume level control to permit adjusting the output voltage level to that required by the amplifier being used. With all parts, wire, hardware, cabinet, an easy-to-follow instructions. Cabinet is ebony bakelite with brass front panel. Size: 4x7x3 1/2". Wt., 2 lbs.
98 S 525, NET..... 14.70

Model 595. Same as above, but factory-wired and tested. Shpg. wt., 2 lbs.
98 S 529, NET..... 19.50

NEW FANON "BABY-COM" INTERCOM



Model RB-1. New, low-cost 1-station wireless radio-intercom for nursery or sickroom use. Provides 'round-the-clock' protection for children, and aged or handicapped persons. Highly sensitive, the "Baby-Com" picks up even the slightest noise, at distances up to 250 ft. and transmits it on its own frequency to your radio. Plugs into any AC outlet—works through any home, car or battery-operated portable radio. Frequency is adjustable; tunes to any unused portion of the radio dial. Employs super-sensitive, 4" PM speaker as a microphone. Metal cabinet is blue with white panel. With on-off switch and pilot light. Size, 4 1/2 x 6 1/2 x 4 3/4". U.L. Approved. For 110-120 v., 50-60 cycle A.C. Shpg. wt., 4 lbs.
94 R 970, List, \$19.95, NET..... 14.95

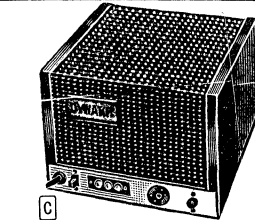

DYNAKIT BASIC AMPLIFIER KITS AND PREAMP KIT

C New Mark III 60-Watt Basic Amplifier Kit. Even a beginner can easily assemble this audio perfectionist's basic amplifier! The powerful Dynakit Mark III, rated at 60 watts output, is a new design by a leading American electronics engineer, incorporating new tubes and transformer that more than meets the most critical requirements. Some of its excellent features are: Choke filtering for absolute minimum noise; premium KT88 (or 6550) tubes supplied in matched pairs; printed circuit board with parts pre-mounted for trouble-free construction in less than 4 hours; "Biasist" feature for simple, accurate bias setting without using a meter; no balancing or critical adjustments. Output: Rated, 60 watts; peak, 120 watts. Response: ± 1/2 db, from 6 to 60,000 cps. Distortion: 1M, less than 1% at 60 watts—less than 1/2% at 50 watts—about .04% at average listening levels; Harmonic, less than 1% at 1 db, 20 to 20,000 cps at 60 watts. Noise: -90 db. Output Impedances: 4, 8 and 16 ohms. Tubes: 6AN8, 2—KT88 (or 6550); GZ34 and selenium rectifiers. Size, 6 1/2 x 9 x 9". Includes special Dynaco A-430 transformer, all parts, black metal cage-type cover and instructions. For 110-120 v. 50 cycle A.C. Shpg. wt., 28 lbs.
83 SZ 004, NET..... 79.95

C Mark II 60-Watt Basic Amplifier Kit. Similar to circuit of above, but 50-watt output; output impedances of 8 and 16 ohms; EL34/6CA7 output tubes and 5U4G rectifier. Size, 6 1/2 x 9 x 9". Shpg. wt., 27 lbs.
83 SZ 799, NET..... 69.75

D New Dynakit Preamp Kit. Low-noise, high-gain preamp kit; equalization for early LP, RIAA, and 78 rpm records. Employs feedback circuit and DC heater supply for low distortion and hum levels. Printed circuit board for easy wiring. 6 Inputs: High and low-level Mag Phono, Tuner, TV, Tape and option of Tape Head, Mike or extra Phono. 1M: Less than 0.1% at 1/2 v. output. Response: ± 1 db, 10 to 100,000 cps. Tubes: 2—12AX7 (or ECC83); selenium rectifier. Size, 2 3/4 x 12 x 6". Takes power from either of the Dynakit amplifiers above. Shpg. wt., 7 lbs.
83 SX 005, NET..... 34.95

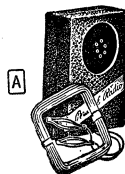

CRYSTAL RECEIVING SET

A An extremely small, completely self-contained "personal" set with built-in telephone. Carry it in your pocket wherever you go. Provides clear reception of local stations. Uses germanium diode crystal—an extremely sensitive detector which eliminates adjustment of catwhisker. Complete with antenna and ground leads; nothing else to buy. Size, 4 1/2 x 2 1/2 x 1 1/4". Shpg. wt., 1 lb.
83 S 006, NET..... 3.95



KNIGHT CRYSTAL MIKE

B Attractive crystal mike offering excellent performance at extremely low cost. Quality, shock-mounted crystal element provides response from 60-8500 cps. Balanced for hand-held use or secure table-top use without stand or bracket. Weighs only 3 1/2 ounces, including attached, 5-foot, fabric-covered cable. Ideal for tape recording or Amateur use. Output level: -45 db. Gray plastic case. Size: 2 1/4" high, 2 1/4" wide, 1" thick. Shpg. wt., 1 lb.
93 S 519, NET..... 2.95

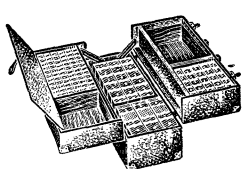

Carry Caddy

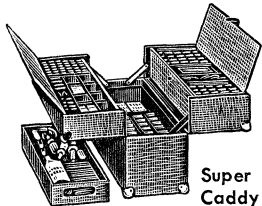

Super Caddy

TELEVISION TUBE CADDIES

Super Tube Caddy. New, ruggedly built, double-door type tube caddy for quick accessibility to tubes. Carries up to 325 tubes, one of the largest tube caddies available! Extra space accommodates meters, tools, probes, etc. Removable tool tray. "Egg crate" design for smaller tubes and parts. Styled in gray tweed leatherette. Size (HWD), 15 1/2 x 24 x 8 1/2". Shpg. wt., 16 1/2 lbs.
86 NX 153, NET..... 21.51

Carry Caddy. An exceptionally versatile tube caddy. Carries up to 262 tubes, also space for soldering gun, meter, etc. "Break away" design—opens outward from center. Handsome, gray-tweed leatherette. Size, 8 x 15 x 21". Shpg. wt., 13 lbs.
86 NX 129, NET..... 14.21

Jr. Tube Caddy. Smaller version of Super Tube Caddy (above). Easy-to-carry size for quick trips. Carries up to 143 tubes with room for meter, tools, etc. Size, 15 1/4 x 12 1/2 x 8". Shpg. wt., 13 lbs.
86 NX 155, NET..... 9.31

"COMFORT LINE" TV TABLES

All "Comfort Line" TV tables employ a tubular steel frame and offset legs for extra rigidity. Shipped unassembled—set up in a jiffy.

Model 81 TV Table With Shelf. New, beautifully styled swivel-top TV table. Fits any table-model TV set—arms extend from 17 1/2" to 32". Stands 18" high; 3" lucite casters. Satin black finish. Shpg. wt., 10 lbs.
99 CX 131, NET..... 5.96

Model 87. As above, but brass-plated.
99 CX 132, NET..... 7.96

Model 71 Phono-TV Table. Not illustrated. Table top is 1-piece sheet steel. Holds any size portable or table-model TV set, phonograph, etc. Arms extend from 17 1/2" to 32". Stands 23" high, 2" casters. Satin black. 12 lbs.
99 CX 149, NET..... 6.63

Model 77. As above, but brass-plated arms, legs, shelf and record holder; satin-black table top.
99 CX 159, NET..... 8.63

Model 531 Portable TV Table. For all portable TV sets. Includes storage shelf. Arms extend from 13" to 21". 24" high; 2" lucite casters. Satin black. Shpg. wt., 9 lbs.
99 CX 204, NET..... 5.30

Model 537. As above, but brass-plated.
99 CX 240, NET..... 7.30

Model 33 TV Table. Swivel-top table for 17" to 21" table-model TV sets. Arms extend from 17" to 30". Stands 19 1/2" high. Plastic glides on legs. Satin black. Shpg. wt., 10 lbs.
98 CX 966, NET..... 4.63



81
87



531
537

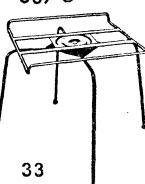

33

IT'S EASY TO ORDER FROM ALLIED



HOW TO ORDER

Orders may be sent on our order blanks or your own purchase order forms or stationery. To speed handling, please fill in all information requested on our order blank. If you use your own order forms or stationery, please give our stock number, quantity desired, name of item, manufacturer's type number and price. Remit to cover the full amount of the merchandise, plus postage and insurance for parcel post shipments. Don't worry about sending too much. **Every cent extra will be refunded.**

"Z" ITEMS SHIPPED BY EXPRESS

The letter "Z" in our stock numbers (as in 98 SZ 767) identifies items which are fragile or which exceed parcel post size or weight limits. To insure safe arrival, such items are shipped by express or the best lowest cost method. See Parcel Post and Express information at right.

HOW TO SEND MONEY

The best way to send money is by postoffice or express money order, bank draft or check. Avoid sending coin or currency, but if necessary, be sure to register your letter. Please do not remit in stamps except if necessary on very small orders. For rush handling, telegraph your order and money.

ABOUT C.O.D. ORDERS

You will save money by sending cash in full with your orders. On parcel post C.O.D. shipments, the Postoffice charges a C.O.D. collection fee and also a money order fee for forwarding the C.O.D. amount to us (This is in addition to regular postage; see C.O.D. fee and money order tables below.) Similar fees are collected on express and freight C.O.D. shipments. It will pay you to remit in full and save the C.O.D. charges. We will refund every penny not used. If a C.O.D. shipment is unavoidable, your order should be for a minimum of \$5.00, with a deposit of at least 20%. Please include full remittance with any orders for less than \$5.00.

PARCEL POST C.O.D. FEES

\$0.01 to \$5.00...30c | \$50.01 to \$100.00 80c
 5.01 to 10.00...40c | 100.01 to 150.00 90c
 10.01 to 25.00...60c | 150.01 to 200.00 1.00
 25.01 to 50.00...70c

MONEY ORDER FEES

From \$0.01 to \$ 5.00.....15c
 From 5.01 to 10.00.....20c
 From 10.01 to 100.00.....30c

SHIPPING INFORMATION AND HOW TO ESTIMATE CHARGES

PARCEL POST: Size and weight limits will vary depending on your postal zone from Chicago and the type of post office area in which you live. Items not mailable are identified by "Z" in our stock numbers (as in 98 SZ 767). See explanation in column at left.

Include Money for Postage and Insurance. Please send enough money to cover merchandise, postage and insurance on parcel post orders. Catalog gives approximate shipping weights. If you send too much, **we will refund every penny not used.** In case of insufficient remittance we ship C.O.D. for balance. To protect you we insure all parcel post. Allow for insurance:

Up to \$5.00.....5c | \$10.01 to \$25.00.....15c | \$50.01 to \$100.00.....30c
 \$5.01 to 10.00.....10c | 25.01 to 50.00.....20c | 100.01 to 200.00.....35c

HOW TO ESTIMATE PARCEL POST CHARGES

Up to 8 ounces, all zones, allow 2c for first ounce, 1c for each additional ounce

The post office charges a fraction of a pound as a full pound. For example, if the total weight is 3 pounds and 1 ounce to Zone 4, postage would be for 6 pounds (59¢).

WEIGHT IN POUNDS	Local	1st & 2nd Zone, up to 150 mi.	3rd Zone 150 to 300 mi.	4th Zone 300 to 600 mi.	5th Zone 600 to 1000 mi.	6th Zone 1000 to 1400 mi.	7th Zone 1400 to 1800 mi.	8th Zone Over 1800 mi.
1	.18	.23	.23	.24	.26	.28	.30	.32
2	.20	.27	.29	.31	.36	.40	.46	.51
3	.21	.31	.34	.38	.45	.52	.61	.69
4	.23	.35	.39	.45	.54	.64	.76	.87
5	.24	.39	.44	.52	.63	.76	.91	1.05
6	.26	.43	.49	.59	.73	.88	1.06	1.23
7	.27	.47	.54	.66	.82	1.00	1.22	1.41
8	.29	.51	.60	.73	.91	1.12	1.37	1.59
9	.30	.55	.65	.80	1.00	1.24	1.52	1.77
10	.32	.59	.70	.87	1.10	1.36	1.67	1.95
11	.33	.63	.75	.93	1.19	1.48	1.82	2.13
12	.34	.67	.80	1.00	1.28	1.60	1.98	2.31
13	.36	.71	.85	1.07	1.37	1.72	2.13	2.49
14	.37	.75	.90	1.14	1.47	1.84	2.28	2.67
15	.39	.79	.96	1.21	1.56	1.96	2.43	2.85
16	.40	.83	1.01	1.28	1.65	2.08	2.58	3.03
17	.42	.87	1.06	1.35	1.74	2.20	2.74	3.21
18	.43	.91	1.11	1.42	1.84	2.32	2.89	3.39
19	.45	.95	1.16	1.49	1.93	2.44	3.04	3.57
20	.46	.99	1.21	1.56	2.02	2.56	3.19	3.75
For Each Extra lb.	Add 1½c	Add 4c	Add 5c	Add 7c	Add 9¼c	Add 12c	Add 15¼c	Add 18c

EXPRESS: Please remit full amount for merchandise, but do not send any money for express charges with your order. All transportation charges are collected on delivery at no extra cost to you. All "Z" items (see column at left) are shipped by express. In addition, to assure safe arrival, we prefer to ship by express many hi-fi units, communications equipment, sound systems, transmitting and TV tubes, recorders, test units, and other fragile merchandise. If there is no express agent at your location, be sure to specify your nearest express office. Express rates include insurance.

HOW TO ESTIMATE EXPRESS CHARGES

(Rates are about 10% higher to eastern states. Add 3% Federal Tax for each shipment.)

Weight Pounds	Maximum Distance in Miles							
	50	150	300	500	750	1000	1500	2250
5	2.01	2.01	2.01	2.01	2.01	2.08	2.22	2.41
10	2.01	2.01	2.08	2.24	2.37	2.51	2.77	3.17
15	2.01	2.08	2.30	2.53	2.72	2.92	3.33	3.94
20	2.03	2.23	2.52	2.82	3.08	3.35	3.90	4.70
25	2.12	2.37	2.72	3.11	3.45	3.79	4.45	5.46
35	2.32	2.66	3.16	3.69	4.16	4.63	5.57	6.99
45	2.51	2.93	3.60	4.27	4.89	5.49	6.70	8.52
55	2.69	3.22	4.02	4.87	5.60	6.34	7.82	10.04
70	2.98	3.66	4.67	5.73	6.68	7.62	9.51	12.33
80	3.17	3.95	5.11	6.32	7.38	8.47	10.63	13.85
For each 100 lbs.	3.55	4.51	5.98	7.48	8.83	10.17	12.86	16.90

AIR SHIPMENTS: We will ship your order by Air Parcel Post, Air Express or Air Freight if you instruct us to do so. Air Parcel Post rates are given below. Consult your local express office for Air Express charges, and your nearest commercial airport office for Air Freight rates. Air Parcel Post size and weight limits are 70 pounds and 100 inches length and girth combined except on A.P.O. and F.P.O. shipments which are limited to 2 pounds, and 30 inches in length and girth combined.

AIR PARCEL POST RATES

ZONES	1, 2 & 3	4	5	6	7	8	U. S. Territories, Possessions and APO & FPO Addresses, 80c per lb.
1st lb.	60c	65c	70c	75c	75c	80c	
For each Extra lb.	Add 48c	Add 50c	Add 56c	Add 64c	Add 72c	Add 80c	

FREIGHT: If speed is not essential, freight is cheapest on heavy shipments. Minimum charge is for 100 pounds. For truck freight, you may specify the truck line you prefer.

Lowest Prices—Highest Quality—Best Service

IMPORTANT INFORMATION

OUR TERMS OF SALE

Cash Terms. Our general terms of sale are cash with order. You save payment of C.O.D. fees by including full remittance with your order. Every penny not used is refunded. If desired, we will ship C.O.D. See opposite page for C.O.D. orders.

Easy Payment Plan. Applies on everything in this catalog (except tubes and parts). Minimum order is for \$45.00; down payment only 10%. See Page 396 for full details. Your application form is on the back of our order blanks. Additional order blanks will be supplied on request.

Open Accounts. Open account terms are extended to well-rated firms, schools, institutions and government agencies. Firms without a published rating may apply for an open account by submitting three trade or bank references. Terms are net, 10 days, E.O.M.

ABOUT OUR PRICES

You Pay NET Catalog Prices. Catalog prices are net, f.o.b. Chicago, except where otherwise indicated. All trade and cash discounts have already been deducted from every price. Our NET catalog prices are the prices you pay.

Your Order is Shipped at the Current Price. Prices in this book replace prices in all previous Allied catalogs and are subject to change without notice. **Orders will be filled at prices in effect at time of shipment.**

You Benefit From Any Price Reduction. If prices are reduced during the life of this catalog, we always give you the advantage of the lower prices and refund the difference. We reserve the right to add any Federal, State or Local taxes now in effect or which may be levied after this book is printed.

Your Satisfaction Is Guaranteed

Every item you buy from us must satisfy in every way—or we want you to return it at once for exchange or refund. See Page 1 for full details of our guarantees which protect you on every purchase.

—ALLIED RADIO

IF YOU WRITE TO US

On cash orders, we return to you your original order and all related papers. Before writing us, please check explanations shown on your order and attached papers. If you do find it necessary to write, please include with your letter all order papers and correspondence that apply. If you do not have the order papers, be sure to give in detail the stock numbers and descriptions of the merchandise you ordered and the same name and address as on your original order. **On Easy Payment or Open Account orders,** only your invoice or account number is necessary.

HOW TO RETURN MERCHANDISE

Please include your instructions with your shipment, pack the merchandise carefully and insure.

On parcel post, place your instructions, all order papers and correspondence in an envelope **inside** your package. On the outside, mark "First Class Mail Enclosed" and affix additional first class postage for the enclosure.

On express shipments, place all papers in a **stamped** and sealed envelope inside the package. Date this envelope and draw several lines across postage stamp with a pen.

Your name and address should be plainly marked on your enclosure as well as on the outside of your package. **Note:** Merchandise not regularly stocked, but obtained especially for you, may not be returned for refund or exchange.

TELEPHONE ORDERS

We have a specially trained staff to handle your telephone orders. If you are in a hurry for any merchandise, telephone your order. It will be filled and shipped promptly. For extra-fast service, specify Air Shipment (see opposite page).



Phone: **HAYmarket 1-6800**

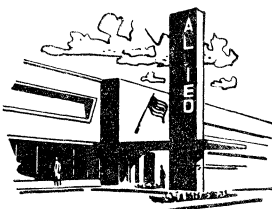

**100 N. WESTERN AVE.
CHICAGO 80, ILL.**

VISIT OUR CENTRAL SALESROOMS AND HI-FI STUDIOS

Salesrooms where you can obtain all merchandise listed in this catalog, as well as High Fidelity demonstration studios, are located in our main building at 100 N. Western Ave. You are invited to come in to see us. Enjoy a thrilling Hi-Fi demonstration, check the Knight Kits wired for your inspection, and examine tape recorders, tools, test instruments, sound equipment, and the great variety of other merchandise we have on display.

Our location at Western Avenue and Washington Blvd. is only a short distance from Chicago's Loop.

HOURS: Monday and Thursday, 9:00 A.M. to 9:30 P.M.
Other weekdays, and Saturday, 9:00 A.M. to 5:30 P.M.

ALLIED'S EASY PAYMENT PLAN

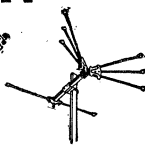
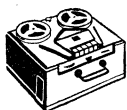

Kits Recorders Hi-Fi P.A. Ham Gear Test Equipment Books Tools TV Accessories

BUY OUR EASY-PAY WAY—ONLY 10% DOWN

Use Allied's Easy Pay Terms to get the equipment you want **now**, even if you don't have the ready cash. A small down payment is all you need on orders of \$45 or more.

Types of Merchandise Sold on Easy Payments. Included under the plan are High Fidelity Systems, separate Hi-Fi units and accessories; Recording, Public Address and Test Equipment; Cabinets, Phonographs and Record Changers; Amateur Gear; Build-Your-Own Kits, including Allied's Knight-Kit Electronic Kits; Radioactivity Detectors; TV Accessories; Chargers, Boosters and Converters; Power and Hand Tools; Manuals and Books; etc. Everything **except tubes and parts** may be purchased on Allied's Easy Terms.

Our Easy Payment Terms

Minimum Order—\$45.00 total cash value.

Down Payment—10%. A bigger down payment will reduce carrying charge and monthly payments.

Carrying Charge—See table. No carrying charges if paid in 60 days. See below.

Monthly Payments. See table. All monthly payments are for equal amounts, except for last payment which is for the odd amount remaining due. Minimum \$5.00 per month.

No Charges if Paid in 60 Days

You get a full refund of carrying charges if you complete payments within sixty days after shipment, or 50% of the carrying charges if you finish payments in half the required time. Take the full time to pay if you wish. But if you decide to pay in 60 days or even in half the contract time, you get a refund.

How to Buy on ALLIED'S Easy Pay Plan

Use your Allied order blank to enter the merchandise you want to buy on easy terms. Fill in the answers to the simple questions on the back of the order blank and sign it. Attach your remittance for the down payment (10% or more) and mail your order. It will be shipped as soon as your credit is approved. The first payment is not due until at least 30 days after shipment. Your invoice will have full details. No red tape—no finance companies to deal with—no hidden charges. Any responsible person of legal age, with a steady income, can get credit approved. Additional order blanks and our Easy Pay Bulletin explaining our Payment Plan in detail, will be sent on request.

Additional Purchases

Once your credit is established with Allied, you can "add on" to your Easy Payment Account with purchases of \$25 or more. Simply list the items you want (except tubes or parts) on one of our order blanks, write "add to my account" and give your account number. Please be sure to sign the Easy Payment agreement on the reverse side. After your new purchase and the usual carrying charge are added to the amount you owe, you pay on only one account. In most cases, you will continue to pay the same amount monthly. If your new unpaid balance is substantially different from the original amount, a new monthly payment will be set up. "Add on" carrying charges: \$25.00 to \$29.99, \$2.50; \$30.00 to \$34.99, \$3.40. See table for charges over \$35.00.

NOTE: Allied's Easy Payment Plan is offered to residents of the 48 states only. It does not cover shipments to U.S. Possessions or Territories, to A.P.O. and F.P.O. addresses, or to foreign countries.

EASY PAYMENT TABLE

If Unpaid Balance is	Carrying Charges	Monthly Payment
\$ 35.00 to \$ 40.99	\$ 3.70	
41.00 to 45.99	4.30	\$ 5.00
46.00 to 50.99	4.90	
51.00 to 54.99	5.30	6.00
55.00 to 60.99	5.70	
61.00 to 64.99	6.20	7.00
65.00 to 69.99	6.40	
70.00 to 74.99	6.80	8.00
75.00 to 79.99	7.50	
80.00 to 84.99	8.00	9.00
85.00 to 89.99	8.50	
90.00 to 95.99	9.00	10.00
96.00 to 101.99	9.50	
102.00 to 111.99	10.00	11.00
112.00 to 122.99	10.50	
123.00 to 133.99	11.00	12.00
134.00 to 140.99	12.00	
141.00 to 150.99	13.00	13.00
151.00 to 160.99	14.00	
161.00 to 170.99	15.00	14.00
171.00 to 180.99	16.00	
181.00 to 190.99	17.00	15.00
191.00 to 201.99	18.00	
202.00 to 209.99	19.00	16.00
210.00 to 218.99	20.00	
219.00 to 226.99	21.00	17.00
227.00 to 231.99	22.00	
232.00 to 236.99	23.00	18.00
237.00 to 241.99	24.00	
242.00 to 246.99	25.00	19.00
247.00 to 251.99	26.00	
252.00 to 256.99	27.00	20.00
257.00 to 261.99	28.00	
262.00 to 266.99	29.00	21.00
267.00 to 274.99	30.00	
275.00 to 282.99	31.00	22.00
283.00 to 290.99	32.00	
291.00 to 296.99	33.00	23.00
297.00 to 302.99	34.00	
303.00 to 311.99	35.00	24.00
312.00 to 321.99	36.00	
322.00 to 330.99	37.00	25.00
331.00 to 340.99	38.00	
341.00 to 349.99	39.00	26.00
350.00 to 359.99	40.00	
360.00 to 369.99	41.00	27.00
370.00 to 379.99	42.00	
380.00 to 390.99	43.00	28.00
391.00 to 400.00	44.00	29.00

On orders over \$400.00, send down payment of 10% or more. Payments and carrying charges will be in proportion to amounts shown on chart.

COMPLETE CATALOG INDEX

A

Adapters

Audio Connector. 174
Continental. 184
Crystal Socket. 277
Jack. 174, 179
Lamp Socket. 188
Mike Stand. 353
Plug. 174
Record. 64, 70
Trumpet. 356
Tube Socket. 165
AGC Analyzer. 294
Albums, Record. 77
Aligning Tools. 329, 336

Amateur Equipment

262-279
Antennas. 274-276
Accessories. 269, 274-276
Clock. 277
Code Practice. 269, 272, 278, 279
Kit. 229
Coils. 154, 158, 160, 161, 274, 276
Conelrad. 276
Converters. 272-274
Crystals. 277
Crystal Calibrators. 228, 262, 269, 277
Frequency Meters. 277
Grip Dip Meters. 255, 271
Headphones. 279, 281-283
Keys. 278, 279
Mobile. 263, 269, 270, 272, 273, 276
Monitors. 276
Noise Limiter. 272
Oscilloscope. 255, 270
Preselectors. 271
Receivers. 263, 267, 270-274
Kit. 228, 262
"S" Meter. 262, 265
SWR Bridge. 262, 278
Transceiver. 263, 272, 280
Transmitters. 263, 265, 268, 274
Kits. 229, 262, 268, 269
TVI Filters. 198, 269, 278, 363, 390
VFO's. 263, 269
Kit. 229, 262, 269
Ammeters. 244, 254, 256-258, 260, 261

Amplifiers

Hi-Fi. 26, 28-30, 32-43, 51, 391
Kits. 211, 212, 215, 216, 391, 393, Cov. 4
Miniature. 138
P.A. 338, 339, 345, 347
Phonograph. 84
Kit. 226
AM Tuners. 33, 39, 393

Antenna Equipment

Arresters. 388
Coaxial Cable. 181, 185
Connectors. 160, 362, 363, 387, 389
Couplers. 269, 274, 378, 383, 387-389
Distribution Units. 381, 382
Ground Clamps. 387
Rods. 384
Wire. 384
Guy Rings. 384, 387
Wire. 384
Hardware. 384, 387
Insulators. 160, 179, 387, 389
Masts. 384
Mounts. 384-386
Relays. 194, 196, 197, 388
Rotators. 275, 331

Antenna Equip. (cont'd)
Switches. 203, 387, 389
Towers. 275, 384
Transformers. 378, 383, 388
Twin Line. 277, 386
Wire. 181-183, 380

Antennas

AM. 152, 153, 380
Amateur. 275, 276, 380
Auto Radio. 163
Ferrite. 152, 153, 380
FM. 152, 375, 379
Indoor. 372, 373
Loop. 380
TV. 369-379
Argon Lamps. 188
Attenuators. 49, 55, 59, 75, 120, 121
FM. 385
TV. 117, 380, 385
Audio Generators. 237, 238, 252, 254, 274
Kits. 236, 252
Auto Radio
Antennas. 163
Capacitors. 164
Fuses. 190, 191
Speakers. 361
Switch. 202
Suppressors. 164
Vibrators. 164

B

Baffles, Ceiling & Wall. 357, 358
Boards. 74
Ballasts
Fluorescent. 291
Radio & TV. 110
Barkhausen Eliminator. 390
Batteries. 284-287, 290
Battery
Binding Posts. 175
Chargers. 287-289
Kit. 227
Clips. 178
Eliminators. 253, 287-289
Kit. 235, 253
Photoflash. 285
Plugs. 285
Sun. 106
Testers. 244, 253, 256
Kit. 253
Beacon Lamp Control. 367
Bench, Work. 332
BFO Coil. 154
Bias Cells. 287
Bias Supply. 238, 255, 287
Binaural Equipment (See Stereo)
Binding Posts. 157, 158, 175, 178
Blow Torches. 314
Books
Amateur. 279, 301, 305, 308, 309
Audio & Hi-Fi. 299, 300, 303-307
Recording. 299, 300, 306, 307
Service. 298-305, 307, 309
Transistor. 101, 299, 302-305, 309
Tube Manuals. 97, 105, 298, 301, 305
TV. 298-305, 307, 309
Boosters, TV. 352, 383
Bridges
Capacitance. 243
Capacitance-Resistance. 245, 252
Kit. 234
Standing Wave. 262, 269
Bulbs. 187-189

Burglar Alarms. 367
Kit. 223
Bushings, Insulated. 157, 158
Buzzer, High-Frequency. 279

C

Cabinets
Amplifier. 295
High-Fidelity. 50, 71-73
Metal. 292, 294-297, 330, 331
Phono. 77
Record. 73, 77
Repair Kit. 334, 335
Small Parts. 330, 331
Speaker. 45, 46, 52, 53, 57, 59-61, 71-73, 297, 358
Cable. 180-185
Clamps. 170, 172, 333
Connectors. 167-171, 173
Calculators. 115, 129, 308, 310
Capacitor
Decades. 245, 252
Substitution Boxes. 234, 245, 252, 255
Testers. 233, 234, 243-245, 255
Capacitors
Assortments. 129, 136
Bathtub. 125, 127, 130, 131
Ceramic. 124, 129, 130, 136, 137
Color Code Guides. 127
Door Knob. 129, 137
Electrolytic. 122-126, 128-131, 133-135
Hardware. 138
Mica. 125, 132
Motor-Starting. 126, 132, 135
Neutralizing. 159
Oil-Filled. 125, 127, 130
Padder & Trimmer. 136, 159, 160
Paper. 123-127, 131, 132, 135
Photoflash. 189
Plug-In. 123, 130
Suppressor. 126, 164
Tantalum. 123, 127, 134, 135
Vacuum. 156
Variable. 156-160
Carrying Cases
Phono & Record. 77
Speaker-Amplifier. 358
Tape. 94
Car-Top Platform. 343

Cartridges

Ceramic. 66, 82-84
Crystal. 81-84
Magnetic. 63, 65, 66
Microphone. 349
Cart, Serviceman's. 330
Casters. 292
Cathode Ray Tubes. 97, 103
Cement. 332, 335
Changers. 62, 64, 69, 70, 341, Cov. 3
Replacement Parts. 81
Chargers. 287-289
Kit. 227, 253
Chassis Bases. 293, 295, 296
Experimental. 297
Chassis Cradle. 326

Chokes

Audio. 143, 146
Filter. 140, 142, 143, 145, 146, 148, 151, 152, 155
RF. 152, 155

Circle Cutters. 317, 320, 325

Clamps

Cable. 170, 172, 333
Ground. 387
Tube. 101, 157
Clips. 176, 178, 328
Clocks. 208, 277
Coaxial
Cable. 180, 181, 185
Connectors. 160, 167, 169
Code Equipment. 229, 269, 272, 278, 279

Coils

Phono Oscillator. 154
Radio. 152-156, 158
Relay. 152
Transmitting. 160, 274, 276
TV. 139, 152-154, 156
Coil Forms. 156-158
Coil Stock. 160, 161
Coil Winder. 157
Color Bar Generators. 239, 240, 246
Color Code Kit. 334

Communications

Receivers. 263-267, 270-274, 280
Kit. 262
Condensers (See Capacitors)
Conelrad Equipment. 276
Cones, Speaker. 162

Connectors

AC. 168, 173, 388, 392
Cable. 167-171, 173, 179
Coaxial. 167, 169, 383
High Voltage. 390
Microphone. 179, 353-355
Military. 170, 171
Printed Circuit. 171
Twin Line. 157, 389
Constant Voltage Transformers. 149, 151
Contact
Cleaner. 334, 335
Fingers. 277
Protectors. 195
Controls (See Potentiometers and Speaker)
Converters
Amateur. 272-274
Power. 289
UHF. 382, 383
Cores, Memory. 110
Counters
Impulse. 196
Photoelectric. 367
Crossover Networks. 49, 55, 56, 59-61
Electronic. 41

Crystals

Cartridges. 81-84
Detectors. 392
Diodes. 106-109
Frequency. 277
Sets. 392, 393
Kit. 220
Sockets. 277

D

Decade Boxes. 245, 252
Decals. 310
Decibel Meters. 257, 259
Deflection Yokes. 139
Diagrams
Builders. 51, 227, 310
Service. 298-300, 303
Dials. 157, 158, 161, 162
Cord. 161, 333
Drive Mechanisms. 157, 158
Lamps. 183

Dials (cont'd)

Lock. 157
Plates. 161
Pointers. 161
Springs. 333
Diodes
Checker. 233, 255
Crystal. 106-109
Holder. 106
Handbook. 107, 108
Direction Finder. 266
Disc Recorders. 95
Accessories. 95
Discs. 95
Distortion Meter. 254
Dot-Bar Generators. 239, 240, 246
Dot Generator. 239, 240, 243, 246
Drafting Set. 329
Drawer Slides. 74
Drills. 315, 316, 327
Attachments. 315, 317, 320
Bits. 316, 320
Sharpener. 320
Drive, Right-Angle. 157, 158, 317
Dry Cells. 284-287, 290
Dynamotors. 288

E

Earphones. 279, 281-283
Electrical Accessories. 184, 392
Electric Eye Equipment. 106, 367
Kit. 223
Electroplater. 335
Electrostatic Speaker. 67
Eliminators, Battery. 253, 287-289
Kits. 235, 253
Equalizers, Phono. 65
Extension Cords. 184

F

Fan, Tube Cooling. 277
Feed-Through Insulators. 157
Ferrite Memory Cores. 110
Fiberglass Insulation. 74
Field Strength Meters. 241

Filters

Audio. 63, 145
Line. 145, 152, 198
TVI. 198, 269, 278, 383, 390
TV Picture. 390
Finger Stock. 277
Flashlights. 290
Batteries. 284-286, 290
Fluorescent Fixtures & Accessories. 290, 291
Flux, Soldering. 311
Flyback Testers. 244, 245, 249, 253
Kit. 234, 253

FM

Antennas. 75, 373, 379
Communications
Receivers. 280
Tuners. 32, 34, 36, 38-40, 43
Mobile. 272
Kit. 214, 391
FM-AM Tuners. 27, 28, 30, 32-41, 43, 51
Kit. 213, Cov. 4
Focus Coils. 390
Frequency Calibrators
Crystals. 277
Friction Tape. 392
Fuses. 184, 190, 191
Mountings. 164, 190, 191
Puller. 328
Resistors. 112, 115

continued
on next page

INDEX

continued from
previous page

G

Galvanometers 259, 260
Garage Door
Openers..... 368
Gauges
Drill..... 325
Needle Pressure... 77
Wire..... 325
Gear Trains..... 110
Generators, Signal
..... 237-240,
243, 246, 248-250,
252, 254, 389
Kit..... 235, 236
Germanium Diodes
..... 106, 107, 109
Power Rectifiers
..... 107-109
Grid Caps..... 156
Grid Dip Meters
..... 255, 271
Grille Cloth & Screen
..... 74, 392
Grinder, Bench..... 318
Grommets..... 333
Grounding Equipment
..... 184, 384, 387, 388
Guying Equipment
..... 384, 387

H

Hack Saws..... 327
Hammers..... 326, 329
Hardware..... 332, 333
Containers..... 330-332
Headphones..... 279,
281-283
Binaural..... 283
Hearing Aid
Batteries..... 284
Battery Testers..... 256
Headphone Sets
..... 281, 282

High-Fidelity

Amplifiers. 26, 28-30
32-43, 51, 391
Kits... 211, 212, 215,
216, 393, Cov. 4
Binaural Compon-
ents (See Stereo)
Cabinets... 50, 71-73
Cartridges..... 63,
65, 66, 83
Changers..... 62, 64,
69, 70, Cov. 3
Chassis, FM-AM... 29,
33, 34, 37, 38
Connecting Cables
Crossover Networks
..... 49, 55, 56, 59-61
Electronic..... 41
Enclosures..... 44-46,
50-53, 57,
59-61, 71-73
Kits..... 51, 53, 72
Headphones..... 89
Mixer..... 89
Needles..... 63,
65, 66, 83
Pickup Arms..... 63,
65-68, 83
Players..... 62,
67, 68, 70
Preamps..... 30, 31,
33, 38, 39, 41,
51, 63, 64, 391
Kits... 215, 391, 393
Record Compens-
ators..... 65
Records..... 80
Rumble Filter... 63
Speakers... 45, 46, 48,
49, 53-61, 67, 393
Systems..... 6-25
Stereophonic Compon-
ents... 9, 24, 25, 31,
32, 40, 42, 51, 88-91
Tape Recording
Equipment... 86-96

High-Fidelity (cont'd)
Tuner-Amplifiers... 29,
33, 34, 37, 38
Tuners..... 27, 28, 30,
32-41, 43, 51
Turntables..... 62,
65, 67-69
Tweeters..... 49, 55,
56, 59-61, 67
Woofers..... 48, 55,
56, 59-61
Hook-Up Wire... 182, 183
Humidity Sensor... 110

I

IF Transformers... 152-155
Indoor Antennas... 372, 373
Inspection Mirrors... 329
Lights..... 290, 329
Insulators
Antenna..... 160,
179, 387
Feed-Through... 157,
179, 389
Stand-Off..... 179, 387
Intercoms..... 345,
362-366, 393
Cable..... 181, 362-366
Kit..... 225
Speakers..... 360
Switches..... 202
Transformers..... 140
Interference Filters
..... 126, 164, 198, 269
Inverters..... 288
Ion Traps..... 390
Isolation Transformers
..... 141, 142

J

Jack Adapters... 174, 179
Jack Panels... 174, 175
Jacks
Banana..... 157,
175, 177, 179
Extension..... 174,
175, 179
Midget..... 174-176
Mike..... 176, 353-355
Phone..... 174-176
Pin..... 157, 168,
176, 177, 179
Tip..... 157, 177, 179
Jewels, Pilot... 186, 187
Jig Saws..... 317, 318

K

Keys..... 278, 279
Kits, Builders
Amateur..... 228, 229,
268, 269, 392
Amplifier... 211, 212,
215, 216, 226,
391, 393, Cov. 4
Battery Charger
..... 227, 253
Battery Eliminator
..... 235, 253
Battery Tester... 253
Capacitor Checker
..... 233
Code Practice
Oscillator... 229, 279
Crystal Calibrator
..... 228, 262
Crystal Set..... 220
Decade Box... 252
Intercom..... 225
Marker Generator
..... 250
Oscilloscope... 230,
231, 248, 250
Phono Oscillator... 226
Photoelectric... 223
Photoflash..... 225
Portable Radio
..... 219, 220
Power Supply... 248,
253, 273
Preamp-Equalizer
..... 215, 391, 393
RC Bridge..... 252
Receiver..... 218-220,
222, 223, 228,
262, 392
Signal Generator
..... 236, 248, 252

Kits, Builders (cont'd)
Signal Tracer... 253
Speaker System... 217
Substitution Box... 252
SWR Bridge... 229, 262
Ten-In-One..... 224
Test Equipment
..... 230-236,
248, 250-253, 255
Transmitter... 229,
262, 268, 269
Transistor & Diode
Checker... 233, 251
Transistor Experi-
ment... 101, 221
Transistor Radio
..... 218-220, 392
Tube Tester... 233,
248, 251, 253, 255
Tuner..... 213,
214, 393, Cov. 4
VFO..... 229, 262, 269
Voltage Calibrator
..... 231
VOM... 232, 251, 253
VTVM..... 232, 251
Wireless Broadcaster
..... 226
Z-Bridge... 229, 262
Knives..... 328
Knob Puller... 329
Knobs..... 158, 162
Set Screws... 333
Springs..... 333

L

Labeling Tape... 392
Labels, Recording... 94
Lacing Cord... 185
Lamp Cords... 183, 184
Lamp Sockets... 188, 291
Reducers..... 188
Lamps
Argon..... 188
Dash..... 187
Desk..... 291
Flashlight... 188
Fluorescent... 291
Neon..... 187, 188
Photoflash... 189
Pilot..... 187, 188
Lanterns..... 290
Levels..... 329
Turntable... 76
Lightning Arresters... 388
Line Cords... 183, 184
Resistance... 110
TV..... 385
Line Voltage Testers
..... 256
Litz Wire..... 182
Loop Antennas... 380
Loudness Controls
..... 117, 119
L-Pads..... 49, 59,
120, 121, 360
Lubricants..... 335
Oilers..... 329
Lugs... 176, 177, 321, 333
Luminous Paint... 334

M

Magnet Wire... 182, 183
Marine Radio Equip-
ment... 266, 270
Marker Generators
..... 238-240,
246, 249, 250
Kit..... 250
Marker Injectors... 238
Masks, TV..... 390
Masts..... 384
Megaphone..... 359
Mercury
Batteries..... 287
Relays..... 197
Meter
Cases... 256, 295, 296
Fuses..... 190
Rectifiers..... 256
Meters
Frequency... 256, 277
Grid Dip... 255, 271
Panel..... 256-261
RF..... 257, 260
Temperature
..... 245, 256
Microammeters
..... 239, 244,
257, 258, 260, 261

Micrometer..... 329
Microphones... 87, 278,
348-353, 393
Accessories... 90,
349-355
Cable..... 179,
180, 349, 353
Cartridges..... 89
Mixers..... 176, 347, 353
Stands... 350-352, 354
Switches... 353, 354
Microscope, Stylus... 76
Milliammeters... 256-258,
260, 261
Millivoltmeters... 259
Mixers... 89, 176, 347, 353
Modules..... 137
Motors, PM..... 110
Motors, Phono... 81

N

Needles
Playback..... 63,
65, 66, 85
Recording..... 95
Neon Lamps... 187, 188
Sockets..... 187, 188
Tester..... 185
Nibbling Tool... 324
Noise Filters... 273,
278, 388, 390
Noise Limiters... 164, 272
Nut Drivers... 322, 323

O

Ohmmeter..... 244
Ohms Law Calculators
..... 115, 310
Oscilloscopes... 239,
241, 243, 245, 246,
248-250, 255
Calibrators... 231, 252
Electronic Switch
..... 252
Kits..... 230,
231, 248, 250
Outlets
AC..... 173, 184
TV Antenna... 389

P

Pad Controls... 49,
55, 59, 75,
120, 121, 360
Paint..... 334, 335
Panel Bearings... 160
Panels... 292, 296, 297
Patch Cords... 86, 175
Phono Equipment
Amplifiers... 84
Kits..... 226
Cabinets..... 77
Cartridges... 63, 65,
66, 81-84
Changers... 62, 64,
69, 70, 341, Cov. 3
Changer Covers... 76
Changer Parts... 81
Compensators... 65
Drawer Slides... 74
Motors..... 81
Needles... 63, 65, 66, 85
Microscope... 76
Oscillator..... 392
Kit..... 226
Pickup Arms... 63,
65-68, 83, 84
Pin Plugs & Jacks
..... 176, 179
Preamps..... 38, 63
Spindle Spiders
..... 64, 70
Switches..... 83
Turntables... 81
Photographs... 78, 79
Photoelectric Equip.
..... 106, 367
Kit..... 223
Photofact Manuals... 300
Photoflash Components
..... 189
Batteries..... 252
Booklets..... 189
Pickup Arms
Hi-Fi..... 63, 65-68
Kit..... 66
Phono..... 83, 84

Picture Tubes... 97
Brighteners... 389
Restorer..... 385
Pilot Bulbs... 188
Coloring Kit... 334
Remover..... 187
Sockets, Jewels
..... 186-188
Plastic Sprays... 335
Plate Caps... 156
Pliers..... 324, 325

Plugs

Adapters... 174, 353
Banana..... 157,
175, 177, 179
Battery..... 285
Cable..... 167-171,
173, 174
Fused..... 184
Line Cord... 168, 184
Phone... 174-176, 279
Phone Tip... 177,
179, 281
Pin..... 168, 176
Twin Line... 157, 389
Polish..... 334, 335
Polystyrene... 332
Insulation..... 332
Cement..... 332, 335

Portable
PA Systems... 340, 344
Phonographs... 78, 79
Radio Batteries
..... 284-287
Radio Kit... 219, 220

Potentiometers... 115-121
Calibrated... 121
Power Supplies... 151,
248, 253, 273,
274, 287-289
Kits... 248, 253, 273

Preselectors... 271
Printed Circuit
Amplifiers... 138
Development Kits... 334
Repair Kits... 315
Replacement
Guide..... 138

Probes... 185, 238, 239,
241, 242, 250, 251
Prods, Test... 185
Projectors, Speaker
..... 355, 356

Public Address Sys-
tems... 340-344
Accessories... 343,
345-347, 357, 358
Pulleys, Idler... 81
Punches... 320, 324, 325

R

Racks, Steel... 292,
294, 296, 297
Radioactive Sample... 256
Radio Sets
(See Receivers)
Radiotelephones... 280
Reamers..... 327

Receivers
Communications
..... 263-267,
270-274, 280
Kits... 218-220, 222,
223, 228, 262, 392

Receiving Tubes

Record
Albums & Cases... 77
Blanks..... 95
Cabinet..... 73, 77
Care Accessories
..... 76, 77, 335
Changers... 62, 64,
69, 70, 341, Cov. 3
Code Course... 279
Compensators... 65
Players..... 62, 67,
68, 70, 341

Recorded Tape... 96
Recorders... 86-91, 95
Recording Tape... 86,
90, 92, 93
Recording Wire... 94
Records, Hi-Fi... 80
Test..... 80

Rectifiers
Crystal..... 106, 107
Dry-Disc... 108,
109, 287
Germanium Power
..... 109

Rectifiers (cont'd)
 Instrument 256
 Photoflash..... 189
 Selenium..... 108,
 109, 390
 Tube..... 98-101,
 103-105
 Tungar Bulb..... 188
 Reflectors, Photoflash
 189
 Relay Racks..... 292, 296
 Relays..... 192-197, 388
 Resistor-Capacitor
 Checkers..... 245,
 252, 255
 Kits..... 234, 252
 Resistor Substitution
 Boxes..... 255
 Kits..... 234, 252
Resistors..... 111-115
 Assortments..... 112-114
 Adjustable..... 114
 Color Code Guide
 113
 Color Code Kit..... 334
 Current Regulating
 110, 115
 Fuse..... 112, 115
 Line Cord..... 110
 Power..... 112-115
 Precision..... 112, 113
 RF Chokes..... 152, 155
 Retrace Eliminator..... 390
 Rheostats..... 116, 121
 Rotary Beam Equip.
 274, 275
 Rotators, Antenna
 Cable..... 275, 381, 386
 Rules..... 308,
 310, 325, 329
 Rumble Filter..... 63

S

"S" Meter Kit..... 262, 265
 Sales Aids, Tube..... 97
 Sanders..... 317, 319, 320
 Saws..... 317, 318, 320, 327
 Scissors & Shears
 324-326
 Scratch Removers
 334, 335
 Screwdrivers..... 321-323,
 328, 329, 336
 Scriber..... 325
 Selenium Rectifiers 108,
 109, 390
 Checkers..... 254
 Shaft Couplings
 157, 160
 Shelving..... 292, 296
 Shielding..... 180
 Strips..... 277
 Shields, Tube..... 156,
 157, 165, 166
 Short Wave Receivers
 263-267, 270-274
 Kits..... 228, 262, 392
 Signal Generators
 237-239, 241, 243,
 246, 248-250, 254, 389
 Kits..... 235, 248, 250
 Signal Tracers..... 249, 283
 Kits..... 236, 283
 Silicon Diodes..... 106-109
 Slide Rules..... 329
 Snaps and Studs..... 176
 Socket Adapters
 165, 277

Sockets

AC..... 173, 184, 385
 Argon Lamp..... 188
 Coil..... 157
 Crystal..... 277
 Fluorescent..... 291
 Neon Lamp..... 187
 Pilot Light..... 187, 188
 Transistor..... 165, 173
 Tube..... 138,
 165-167, 173
 Vector..... 165
 Socket Wrenches..... 199,
 321-323, 328
 Solar Cell..... 106
Solder..... 311
 Aid..... 311, 329
 Paste..... 311
 Pots..... 314
 Soldering Irons
 & Guns..... 311-315

Solenoids..... 195
Sound Systems
 337, 340-344,
 359, 366
 Sounder, Telegraph
 278
 Spaghetti..... 183
Speakers
 Auto..... 361
 Electro-Dynamic..... 360
 Electrostatic..... 67
 Hi-Fi..... 44, 46, 48,
 49, 53-61, 393
 Intercom..... 360
 Outdoor
 355-357, 360
 P.A..... 86, 347,
 355-357, 359
 Pillow..... 281
 Replacement
 360, 361
 Systems..... Cov. 2,
 44-47, 50, 52, 53,
 57, 59, 61, 67, 217,
 357, 358
 Trumpets..... 355, 356
 Tweeters..... 49, 55,
 56, 59-61, 67
 Woofers..... 48, 55,
 56, 59, 60

Speaker Accessories

Acoustic Padding..... 74
 Baffles..... 357, 358
 Baffle Boards..... 74
 Cable..... 75, 180
 Carrying Cases..... 358
 Car-Top Platform..... 343
 Controls..... 49, 55, 59,
 75, 120, 121, 360
 Crossover Networks
 49, 55, 56, 59-61
 Drivers..... 49, 55,
 56, 355, 356
 Grille Cloth..... 74,
 361, 392
 L-Pads..... 49, 59,
 120, 121, 360
 T-Pads..... 75, 121
 Reducing Rings..... 74
 Remote Control..... 75
 Switches..... 75
 Speaker Repair
 Service..... 162
 Speed Reducer..... 317
 Spiders..... 64, 70
 Spin Wrenches..... 199
 Sprayers..... 320, 334
 Spray, Plastic..... 335
 Springs..... 333
 Stand-Off Insulators
 179, 387
 Stands, Microphone
 350-352, 354
 Staple Gun..... 328
 Staples..... 184, 328
 Starters, Fluorescent
 291
 Stencil, Radio..... 308
 Stereophonic Equip-
 ment..... 9, 24, 25,
 31, 32, 40, 42,
 51, 88-91, 96
 Systems..... 24, 25
 Step-Down, Cord..... 110
 Transformers
 142, 315
 Storage Boxes..... 330-332
 Strippers, Wire..... 327
 Strips, TV..... 380
 Stroboscope Card..... 76
 Styli..... 63, 65,
 66, 83, 85
 Microscope..... 76
 Pressure Gauges..... 77
 Suppressors, Auto..... 164
 Sweep Generators
 238, 240
 Kit..... 235
 Switch Plates..... 161, 199,
 200, 202, 203

Switches

Antenna..... 203,
 387, 389
 Auto Radio Speaker
 202
 Coaxial..... 271
 Foot..... 204, 208
 Intercom..... 202
 Knife..... 204
 Lever..... 202-205
 Lock..... 199
 Microphone..... 353, 354
 Phono..... 75, 83

Switches (cont'd)
 Pushbutton..... 184,
 199-201, 203-205
 Rotary..... 199,
 201-203, 205
 Slide..... 199, 205
 Snap-Action..... 205
 Speaker..... 75
 Step-On..... 208
 Thermal..... 195, 388
 Time..... 206-208
 Toggle..... 199-201
 Volume Control
 116-118

T

Tables, TV..... 393
 Tape
 Electrical..... 392
 Eraser..... 94
 Labeling..... 94, 392
 Leader & Timing..... 93
 Recorded..... 96
 Recording..... 86,
 90, 92, 93
 Splicer..... 94
**Tape Recording
 Equipment**
 Accessories..... 86,
 87, 89, 90,
 93, 94, 335
 Decks..... 88-90
 Heads..... 94
 Preamps..... 31, 88, 89
 Recorders..... 86-91, 341
 Repeater..... 94
 Telephone Pickups..... 94
 VU Meters..... 94,
 257, 259-261
 Taps & Dies..... 326, 353
 Telephone
 Cable..... 183, 366
 Pickups..... 94
 Relays..... 192
 Telephones..... 362
Television
 Alignment Tools
 329, 336
 Antenna Couplers
 378, 383, 387-389
 Antenna Outlets..... 389
 Antennas..... 369-379
 Audio Tuner..... 110
 Ballasts..... 110
 Bias Supply..... 238, 255
 Boosters..... 382, 383
 Controls..... 139, 153
 De-gaussing Coil..... 388
 Distribution Units
 381, 382
 Field Strength Meters
 241
 Headphone Sets
 281, 282
 Interference Filters
 198, 269,
 278, 383, 388, 390
 Inverters..... 288
 Lightning Arresters
 388
 Line Cords..... 184, 385
 Modernization
 Components..... 390
 Picture Tubes..... 97
 Anode Connector
 390
 Brighteners
 385, 389
 Centers..... 390
 Extension Harness
 Kit..... 386
 Filters..... 390
 Masks..... 390
 Rejuvenator-Tester
 367
 Sockets..... 165, 166
 Testers..... 253,
 255, 390
 Rotators..... 381
 Signal Attenuators
 117, 380, 385
 Tables..... 393
 Towers..... 275, 384
 Tuners..... 27, 380
 Cleaners..... 335
 Strips..... 380
 Twin Line..... 386
 UHF Converters
 382, 383
 Voltage Regulators
 151, 380, 390

Temperature Meters
 245, 256
 Terminals..... 110, 157,
 158, 172, 176,
 321, 333
 Tools..... 321
 Test Clips..... 176, 178
 Leads..... 185
 Lights..... 185
 Probes..... 185, 388,
 242, 250, 251
 Prods..... 185, 185
Test Equipment
 230-256,
 261, 389, 390
 Kits..... 230-236,
 248, 250-253, 255
 Test Records..... 80
 Thermal Relays
 195, 388
 Thermometers..... 245, 256
 Tie Points..... 176
 Time Delay Relays
 195-197
 Time Meter..... 256
 Time Switches..... 206-208

Time Payment Plan

Tinning Block..... 396
 Toggle Switches
 199-201
 Tone Controls (See
 Potentiometers)
 Tool Chests..... 331, 332
 Tool Dip..... 335
 Tool Holders..... 330, 332
 Tool Kits, Hobby
 313, 319
 Tool Racks..... 332
 Tools..... 227,
 311-329, 336, 353
 Torches..... 314
 Toroids..... 145
 Towers..... 275, 384
 T-Pads..... 75, 121
 Transceivers..... 263,
 272, 280
 Transcription
 Players..... 62, 67-70, 359
 Pickup Arms..... 63,
 65-68, 83
 Turntables..... 62,
 65, 67-69

Transformers

Antenna..... 378,
 383, 388
 Audio..... 140-148, 151
 Constant Voltage
 Driver..... 140, 143-145,
 147, 148
 Filament..... 141-143,
 147, 148, 150, 151
 IF..... 152-155
 Intercom..... 140
 Isolation..... 141,
 142, 150, 239
 Line..... 140-148, 355
 Matching (See Line)
 Microphone..... 141, 143,
 144, 148, 349, 351
 Modulation..... 140, 148,
 145, 146, 148
 Oscilloscope..... 146
 Output..... 141-150
 Photoflash..... 189
 Plate..... 143, 146, 151
 Power..... 139, 140,
 142, 143, 146, 148,
 150, 151, 390
 Step-Down..... 142, 315
 Transceiver..... 140
 Transistor..... 142-144,
 147, 148, 150,
 153, 155
 Tube Checker..... 140
 TV..... 139, 146,
 152-154, 390
 Variable..... 142,
 144, 149, 151
 Vibrator..... 141
Transistors..... 102
 Amplifiers..... 138
 Batteries..... 284-287
 Experimenters' Kit
 101, 221
 Manuals..... 101
 Sockets..... 165, 173
Transmitters..... 263, 265,
 268-270, 272-274, 280
 Kits..... 229,
 262, 268, 269

Trouble Light..... 184, 329
 Trucks, Steel..... 330
 Trumpets..... 355, 356
 Tube
 Adapters..... 165
 Brighteners..... 385, 389
 Caddy..... 393
 Caps..... 156, 390
 Charts..... 309
 Clamps..... 101, 157
 Cooling Fan..... 277
 Hold-Downs..... 101
 Manuals..... 97,
 105, 301, 305
 Pin Straighteners..... 328
 Placement Guides
 301
 Pullers..... 328
 Sales Aids..... 97
 Shields..... 156,
 157, 165, 166
 Sockets..... 138, 162,
 165-167, 173
 Substitution Guide
 298
 Testers..... 237, 238,
 240, 243, 244, 246-
 249, 251, 254, 255

Tubes

Audio..... 101
 Ballast..... 110
 Cathode Ray..... 97, 103
 Geiger..... 103-105
 Hearing Aid..... 103-105
 Industrial..... 103-105
 Photoflash..... 189
 Picture..... 97
 Receiving..... 98-101
 Special Purpose
 103-105
 Transmitting..... 103-105
 Tubing
 Polystyrene..... 332
 Spaghetti..... 183
 Tool Insulating..... 335

Tuners

AM..... 33, 39, 393
 FM..... 32, 34,
 36, 38-40, 43, 272,
 391
 FM-AM..... 27, 28, 30,
 32-41, 43, 51
 TV Audio..... 27
 TV Front End..... 380
 Strips..... 380
 Tungar Bulbs..... 188
 Tuning Eye Mount..... 161
 Turnbuckles..... 384
 Turntables
 High-Fidelity..... 62,
 65, 67-69
 Phono..... 81
 Recording..... 95
 Turntable Accessories
 64, 74, 76, 77
 TVI Filters..... 198, 269,
 278, 383, 390
 Tweeters..... 49, 55,
 56, 59-61, 67

Twin Line

..... 277, 386
 Connectors..... 387, 389
 Feed-Through
 Insulators..... 385, 389
 Receptacles..... 389
 Transmitting..... 277
 Weather-Proofing
 Compound..... 334,
 335, 386
 Two-Way Radios..... 280

U

UHF Converters
 382, 383

V

Vacuum Tube
 Voltmeters..... 238,
 241, 242, 244,
 247-249, 251
 Variable Capacitors
 156-160
 Variable Voltage
 Transformers..... 142,
 144, 149, 151
 Varnish..... 335
 VFO's..... 263, 269

continued
 on next page

INDEX

continued from
previous page

Kits... 229, 262, 269
Vibrapacks... 287
Vibrators... 164, 189
Transformers... 141
Vises... 326
Voltage Calibrators
 231, 252
Voltage Dividers... 114

Voltage Regulators
Line... 149, 151,
 380, 389, 390
Tube... 103, 110
Volt-Ammeters... 254
Voltmeters... 244, 253,
 254, 256, 257, 259-261
Volt-Ohm
 Milliammeters
 238, 241,
 242, 244, 247-249,
 251, 253, 261
 Kits... 232, 251

Volume Controls
 ... 115-121
 Accessories... 121
 Assortment... 117

Volume Unit Meters
 ... 94, 257, 259-261

W

Wattmeters... 259
Wattmeter-Voltmeters
 ... 242, 244, 253
Wave Traps... 198,
 383, 388, 390
Window Antennas... 373

Wire & Cable
 Antenna 181-183, 380
 Coaxial 180, 181, 185
 Grid... 180
 Ground... 384
 Guy... 384

Wire & Cable (cont'd)
High-Voltage 180, 390
Hook-Up... 182, 183
Intercom... 181,
 362-366
Magnet... 181-183
Microphone... 179-181,
 349, 353
Phono... 180
POSJ & POT... 183
Recording... 94
Rotor... 275, 381, 386
Speaker 75, 180, 181
Telephone... 183, 366
Test Prod... 185
TV Camera... 181
Wire Cutters... 324,
 325, 327

Wire Gauge... 325
Wireless Broad-
 caster Kit... 226
Wireless Intercoms... 365
Wire Markers... 181
Wire Strippers... 327
Woofers... 48, 55,
 56, 59, 60
Wrenches... 199,
 315, 321, 323-325,
 328, 329, 333

Y

Yokes... 139, 390
Yoke Checkers... 244,
 245, 249, 253, 255

HANDY INDEX TO MANUFACTURERS

Acme... 149
Acoustic Research... 67
Acro... 205
Acrosound... 149
Advance... 196
Aerovox... 113,
 130-132, 137
Agastat... 197
All-Channel... 369,
 372, 377
Alliance... 81
Alprodco... 384
Altec-Lansing... 148
Ameco... 276, 278, 279
American Beauty... 314
American Bell... 279, 282
Anglo... 189
Amperex... 101,
 103-106, 156
Amperite... 110, 195, 353
Ampex... 91
Amphenol... 156, 161,
 166, 168-171, 185,
 201, 275, 277, 332,
 353, 355, 378, 379,
 386, 388, 390
Argos... 72, 358
A.R.R.L... 308
Arrow H. & H... 167, 199
Astatic... 82, 83, 95, 352
Atlas... 353, 354
ATR... 288
Audio Devices... 93-95
Audio Development
 ... 110, 175
Babco... 317, 320
Barber-Colman... 110, 197
Barker-Williamson... 160
 254, 271, 278
Belden... 180-182,
 184, 185, 386
Bell... 42, 88
Berlant-Concertone... 91
B & K... 237
Bliley... 277
Blonder-Tongue... 327,
 382, 383, 388
Bogen... 32-33, 70,
 346, 347, 359,
 365, 366, 383
Borg, G. W... 121
Bosak... 61
Bud... 156, 159,
 277-279, 292-295, 392
Burgess... 284, 285, 290
Buss... 191
Cabinart... 71
Cambridge Therm-
 ionic... 156
Cannon, C. F... 282
Cannon Electric... 167
Cardwell... 159
Carling... 201, 205
Carter... 288
Centralab... 119,
 136-138, 202
Chicago Industrial... 248

Chicago Transformer
 ... 150, 151
Cinch-Jones... 167,
 172, 173, 389
Clairex... 106
Clarostat... 110, 119, 390
Collaro... 69
Collins Radio Co... 263
Conant... 256
Consolidated Wire... 110,
 183, 380
Continental Carbon
 ... 113
Continental Electric
 ... 103-105
Cornell-Dubilier
 ... 122-125, 138, 164,
 189, 198, 245, 275,
 289, 381
Cousino... 94
Croname... 161, 162
Cutler-Hammer... 200
Davis... 377
Dialco... 186, 187
Diamond Calk... 324
Dormeyer... 315, 318
Dow-Key... 197
Drake Electric... 187,
 313, 314
Dremel... 318, 319
Dumont... 97, 297
Dynakit... 393
Ebnert... 197
Eby... 165, 386
Eico... 250-253, 391
Eimac... 103-105, 156, 277
Elco... 165, 167
Electrons, Inc... 103-105
Electro-Products... 288
Electro-Sonic... 66
Electro-Voice... Cov. 2,
 46-51, 66, 84, 350-355
Emico... 256
Emitron... 103-105
EQUIPTO... 330
Fairchild... 65, 76
Fanon... 365, 366, 393
Federal... 108, 189,
 195, 205, 386
Finney Co... 369,
 376, 377, 379
Fisher... 38, 39
Fisher-Pierce... 367
Garrard... 62, 66, 77
Geloso... 90
Genalex... 101, 103-105
General Cement... 115,
 161, 185, 227,
 326-329, 332, 334, 336
General Electric... 60,
 63, 102-106, 109,
 188, 189
General Industries
 ... 81, 95
Gernsback Pub... 303

Gonset... 272
Gramer-Halldorson... 148
Gray... 67
Grayhill... 106, 176, 205
Great Neck... 326, 328
Greenlee... 325
Gregg... 312
Grommes... 43
Guardian... 195
Hallcrafters... 264,
 265, 280
Hamilton... 331
Hammarlund... 159
Hanson... 160, 267, 274
Harman-Kardon... 36, 37
Harvey-Wells... 270
Hickok... 240-241
Hi-Lo... 372
Hoffman... 106
Hughes... 107
ICA... 155, 156, 161, 162,
 176, 178, 185, 205,
 279, 296, 297, 325
Industrial Timer... 206
Insl-x... 335
Inter-Matic... 207, 208
Int'l Rectifier... 106, 109
IRC... 109, 111,
 113, 117-119, 155
Jackson... 254, 279
James... 273
JansZen... 67
JBT... 201, 256
Jensen Industries... 66
Jensen Mfg. Co... 58,
 59, 355, 360
Jerrold... 241, 383
JFD... 110,
 156, 326, 373-375,
 386-388, 390
Johnson, E. F... 159-161,
 165, 179, 268,
 269, 275, 276, 278, 279
Kaar... 276, 280
Karson... 72
Kester... 227, 311
Knight... 26-31, 44, 45,
 84-87, 92, 142, 227,
 337-345, 353, 354,
 357, 358, 361, 371,
 373, 386, 393
Knight-Kit... 44, 45,
 209-236, 262,
 279, 310, Cov. 4
Knights, James... 277
Krauter... 227, 324
Lab-Tronics... 75, 179
Lakeshore Ind... 263, 274
Lansing, James... 56, 57
Lectromatic... 204, 208
Lexed... 195
Lenk... 314
Littelfuse... 190, 191
Livingston... 66
Lowell... 357
Luxo... 291
Lynn... 321
Magnecord... 90
Mallory... 75, 120, 121,
 133-135, 138, 164,
 175, 189, 198,
 203, 287
Marantz... 41
Master Mobile... 276
McGraw-Hill Pub... 304
McIntosh... 40

Meissner... 154, 155, 198
Merit... 148
Metzner... 67
Millen, James... 155-157,
 162, 165, 255, 277, 278
Miller, J. W... 152, 153,
 155, 198, 388,
 390, 393
Millers Falls... 320,
 326-329
Minn. Mining (Scott) ... 93
Mitchell... 290-291
Montgomery... 208
Montoradio... 280
Morrow... 273, 276
Mosley... 274, 277, 389
Mueller... 178
Mullard... 101, 103-105
Multi-Elmac... 273
Mytron... 283
National Co.... 155, 156,
 158, 165, 179, 266, 267
National Electronics
 ... 103-105
Ohmite... 114-117,
 155, 201
Oxy... 315
Perrless... 148
Pentron... 89, 353
Perma-Power... 254,
 259, 368, 389
PET... 317
Phaostroon... 261
Philmore... 392
Pickering... 65
Pilot... 34, 35
Potter & Brumfield... 392
 192-194, 276
Precise Development
 ... 101
Precision Apparatus
 ... 246, 247
Preso... 69
Production Instrument
 ... 196
Pyramid Instruments
 ... 254, 255
Quam... 61, 359-361, 390
Radio City Products
 ... 249
Raytheon... 97
RCA... 60, 75, 83,
 96-106, 109, 238,
 239, 286, 305, 360,
 388, 390
Recoton... 66
Reeves... 92, 95
Regency... 276, 383, 390
Rel-O-Kut... 66, 68, 95
Rider Pub... 298, 299
River Edge... 72
R.M.E... 61
RMB... 271
Robins... 94
Ronette... 81
Rotex... 317, 320
Sams Publications
 ... 300, 301
Sangamo... 132
Sarkes-Tarjian... 108
Schauer... 289
Scott, H. H... 40, 41
Seco... 247
Senocore... 255, 385
Sherwood... 43

Shopmate... 318
Shure... 66, 84,
 94, 348, 349
Simpson... 244, 245, 260
Smith, H. H... 156,
 176-178, 185
Sola... 151
Sonar Radio... 270
Sonotone... 66, 83
Speedex... 327
Sprague... 384
 115, 126-129,
 133, 189, 198, 205
Stackpole... 139-142,
 189, 389
Standard Coil... 380
Standard Electric... 151
Stevens-Walden
 ... 199, 321
Superex... 380
Superior... 149, 178
Switchcraft... 174,
 176, 204, 353
Sylvania... 102-106,
 189, 305
Taco... 377, 379, 385
Talk-A-Phone... 362-366
Tech-Master... 391
Tecraft... 274
Telco... 373, 385, 388
Telex... 176, 281
Telrex... 275, 379
Tenna... 163
Terado... 289
Texas Instrument
 ... 102, 107
Thor... 315, 316, 318, 319
Thordarson... 146-148
Thorens... 270
Tork... 207
Triad... 148
Trimm... 283
Triplett... 94, 242, 243,
 257-259, 277
Tungsol... 101, 103-105
Turner... 352
Ungar... 227, 313
Unimax... 205
University... 52-55,
 356, 357, 359
UTC... 143-145, 189
Utica... 325
Vaco... 323
Vibroplex... 278
Vidaire... 75, 390
Viking... 88
V.M... 70
Walco... 76
Waldom... 297, 381, 390
Walsco... 81, 161, 315,
 323, 324, 327,
 335, 336, 377
Ward... 163
Webcor... 64, 94, Cov. 3
Wellcor... 73, 358
Weller... 311
Wen... 227, 312,
 316, 318, 319
Westinghouse... 97,
 103-105
Wheeler... 366
Willard... 285
Wilton... 326
Wintronix... 254
Worner... 367
Wuerth... 110, 390
Xcelite... 227, 322

INDEX BEGINS ON... Page 397

TIME PAYMENT PLAN... Page 396

HOW TO ORDER... Page 394

OUR GUARANTEE... Page 1

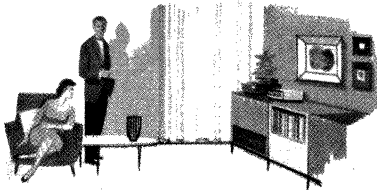

WEBCOR

verified high-fidelity diskchangers
with "MAGIC-MIND" feature ...
automagically selects 33 or 45 rpm speeds!



NEW "ECONOMY" BS1842 SERIES 4-SPEED DISKCHANGERS

AS LOW AS
\$3950

- Easy to Use—Simple to Install
- Exclusive "Magic Mind" Feature
- Stunning, New "Gold Tone" Styling
- Low in Cost—Tops in Hi-Fi Value!

Outstanding values, these new, low-cost record changers feature Webcor's unique "Magic Mind". Stack up any assortment of 33-1/3 and 45 rpm records in 7", 10" and 12" sizes, and in any sequence—then let the "Magic Mind" go to work. As each record drops for playing, this ingenious device *automagically* selects the proper speed, then sets the arm down precisely on the starting groove! Plays 78 rpm records separately, with positive intermix of 10" and 12" sizes.

Small in size, the BS1842 series of record changers fit in anywhere. Replace your present changer with one of these outstanding units. Attractive "gold tone" styling complements any furniture finish or decorating motif. Include AC cord and plug, phono cable and pin plug, and instructions. For operation from 110-120 v., 60 cycle AC. Shpg. wt., 15 lbs.

BS1842-1. On base, with high-quality ceramic cartridge and dual sapphire styli.

94 RX 963. List, \$53.75. NET **\$39.50**

BS1842-21. On base, with new G.E. 4G-050 magnetic cartridge and dual sapphire styli.

94 RX 964. List, \$58.00. NET **\$42.63**



LATEST "IMPERIAL" BR1831 DELUXE SERIES 4-SPEED DISKCHANGER

ONLY
\$5880

- Custom Features Plus "Magic Mind"
- Velvet-Smooth High-Fidelity Operation
- Precision Workmanship Throughout
- Distinctive "Gold Tone" Color Styling

Automagic record changing and a host of such custom features as: Manual or *automagic* play selector; featherweight pickup arm with readily accessible stylus pressure adjustment; dynamically balanced, 4-pole motor; replaceable cue light in arm rest; weighted turntable with record-protecting rubber mat; centralized control knob for instant speed selection, etc. Stack up any assortment of your favorite 33-1/3 and 45 rpm records—turn on the "Magic Mind"—and you're ready for some really pleasurable listening from records!

Motor automatically shuts off and pickup arm comes to rest after the last record has played. Idler wheel disengages in "off" position to prevent idler wheel "flats". Powerful, heavy-duty, 4-pole Rotodyne motor provides ultra-smooth, "wow-free" operation. Complete with AC line cord and plug, output cable and pin plug, template, and instructions for easy custom installation. For operation from 110-120 v., 60 cycle AC. Shpg. wt., 12 lbs.

BR1831-21. Less base; with new G.E. 4G-052 magnetic cartridge (.001" diamond, .003" sapphire styli).

94 RX 960. List, \$80.00. NET **\$58.80**

See Page 64 for Complete Listings of Webcor Diskchangers and Accessories



get the most for your hi-fi dollar
with easy-to-build ALLIED



knight-kits

**knight-kit 18-WATT
AMPLIFIER KIT**

**ONLY
\$3995**

- Newest RCA 6973 Tubes
- Only 0.5% Distortion
- Eight Inputs
- Printed Circuitry

A This splendid amplifier offers remarkable fidelity and the newest hi-fi features! An incomparable value at this low price, the Knight-Kit 18-watt amplifier includes these outstanding features: Full 18-watt output at only 0.5% distortion; RCA's newest, premium-type 6973 hi-fi output tubes; inputs for every possible signal source including NARTB-equalized tape head input; record equalization; bass and treble controls; output taps for 4, 8 or 16 ohm speakers; custom styling in French gray and ebony black to match other Knight-Kit hi-fi units; plus many other refinements.

Frequency response is a clean ± 1 db, from 20 to 30,000 cps; hum is better than 60 db below rated output. Employs Knight-Kit's exclusive printed circuit switch, and two printed circuit boards for extremely easy construction—most of the wiring is already done for you! Clearly written, step-by-step instruction manual won't let you go wrong! Shpg. wt., 15 lbs. (Other specifications on page 211.)

83 YX 786. \$4.00 Down. NET.....\$39.95

**knight-kit FM-AM
BASIC TUNER KIT**

**ONLY
\$4995**

- "Lock-In" FM Tuning
- Pre-Aligned Coils
- $2\frac{1}{2}$ μ v FM Sensitivity
- Flywheel Tuning

B An extraordinary performer, the new Knight-Kit FM-AM basic tuner is designed to be the perfect companion unit for either of the Knight-Kit amplifiers shown here. It offers first-rate FM-AM reception, deluxe, professional styling, and is remarkably easy to assemble.

Its advanced-design circuit features automatic frequency control for "lock-in" tuning of FM stations. Tuned RF stage on FM provides high sensitivity— $2\frac{1}{2}$ microvolts for 20 db quieting. AM sensitivity is 3 microvolts for 10 db signal-to-noise ratio. Pre-aligned RF and IF coils eliminate any further adjustment. A large printed circuit board with most of the wiring already done, makes this one of the easiest-to-build kits available! Other fine features include: Cathode follower output with 2 jacks for amplifier and tape recorder; weighted flywheel tuning; slide-rule dial with self-illuminated neon glow pointer, etc. Shpg. wt., 12 lbs. (Other specifications on page 213.)

83 YX 787. \$5.00 Down. NET.....\$49.95

**knight-kit 30-WATT
AMPLIFIER KIT**

**ONLY
\$7695**

- Eight Inputs
- Only .55% Distortion
- Precise Equalization
- Printed Circuitry

C An outstanding example of brilliant hi-fi engineering, the Knight-Kit 30-watt amplifier will be up-to-date for years to come. Incorporating every desirable feature and housed in a beautiful metal cabinet, it is unquestionably one of the finest high-fidelity values ever offered.

Here are some of its excellent features: Linear-deluxe, Williamson-type power amplifier circuit for superb response ($\pm \frac{1}{2}$ db, 15 to 100,000 cps at 30 watts); 2 printed circuit switches in the preamp section and 3 printed circuit boards for error-free assembly; equalization for all records within $\frac{1}{2}$ db of manufacturer's curves; DC on all filaments of preamp tubes for hum-free operation; A-AB-B speaker selection; continuously variable Level and Loudness controls; full set of controls and inputs for all accessory equipment. Harmonic distortion is only 0.55% at mid-frequencies, never exceeding 1% from 20-40,000 cps at 30 watts! Shpg. wt., 32 lbs. (Other specifications on page 212.)

83 YZ 762. \$7.70 Down. NET.....\$76.95

For Complete Selection of KNIGHT-KIT High-Fidelity Kits, See Pages 209-217

**THERE'S A MONEY-SAVING, KNIGHT-KIT FOR EVERY NEED
TEST INSTRUMENTS—AMATEUR GEAR—HOBBYIST KITS**

SEE PAGES 218-236