

DSP56000UM/AD  
REV 2

# DSP56000/DSP56001

## Digital Signal Processor

### User's Manual

# DSP



MOTOROLA



|   |           |
|---|-----------|
| Introduction                              | <b>1</b>  |
| Architectural Overview and Bus Structure  | <b>2</b>  |
| Memory Spaces                             | <b>3</b>  |
| Data Arithmetic Logic Unit                | <b>4</b>  |
| Address Generation Unit and Address Modes | <b>5</b>  |
| Program Controller                        | <b>6</b>  |
| Instruction Set Introduction              | <b>7</b>  |
| Processing States                         | <b>8</b>  |
| Port A                                    | <b>9</b>  |
| Port B                                    | <b>10</b> |
| Port C                                    | <b>11</b> |
| Instruction Set Details                   | <b>A</b>  |
| Benchmark Programs                        | <b>B</b>  |
| Additional Support                        | <b>C</b>  |
| Index                                     | <b>I</b>  |

**1** Introduction

**2** Architectural Overview and Bus Structure

**3** Memory Spaces

**4** Data Arithmetic Logic Unit

**5** Address Generation Unit and Address Modes

**6** Program Controller

**7** Instruction Set Introduction

**8** Processing States

**9** Port A

**10** Port B

**11** Port C

**A** Instruction Set Details

**B** Benchmark Programs

**C** Additional Support

**I** Index

# DSP56000/DSP56001

## DIGITAL SIGNAL PROCESSOR USER'S MANUAL

Motorola reserves the right to make changes without further notice to any products herein to improve reliability, function or design. Motorola does not assume any liability arising out of the application or use of any product or circuit described herein; neither does it convey any license under its patent rights nor the rights of others. Motorola products are not authorized for use as components in life support devices or systems intended for surgical implant into the body or intended to support or sustain life. Buyer agrees to notify Motorola of any such intended end use whereupon Motorola shall determine availability and suitability of its product or products for the use intended. Motorola and  are registered trademarks of Motorola, Inc. Motorola, Inc. is an Equal Employment Opportunity/Affirmative Action Employer.



# TABLE OF CONTENTS

| Paragraph<br>Number                             | Title   | Page<br>Number |
|---|---|----------------|
| <b>Section 1</b>                                |   |                |
| <b>Introduction</b>                             |   |                |
| 1.1   | Origin of the DSP56000 Architecture.....  | 1-1            |
| 1.2   | Summary of DSP56000 Family Features .....   | 1-7            |
| 1.3   | Manual Organization.....  | 1-9            |
| <b>Section 2</b>                                |   |                |
| <b>Architectural Overview and Bus Structure</b> |   |                |
| 2.1   | Data Buses.....   | 2-3            |
| 2.2   | Address Buses.....  | 2-3            |
| 2.2.1   | Internal Bus Switch .....   | 2-3            |
| 2.2.2   | Bit Manipulation Unit.....  | 2-3            |
| 2.3   | Data ALU.....   | 2-4            |
| 2.4   | Address Generation Unit.....  | 2-5            |
| 2.5   | X Data Memory .....   | 2-5            |
| 2.6   | Y Data Memory.....  | 2-5            |
| 2.7   | Program Memory.....   | 2-6            |
| 2.8   | Program Controller.....   | 2-6            |
| 2.9   | Input/Output.....   | 2-6            |
| 2.9.1   | Expansion Port (Port A).....  | 2-7            |
| 2.9.2   | General-Purpose I/O (Ports B and C).....  | 2-7            |
| 2.9.3   | Host Interface.....   | 2-7            |
| 2.9.4   | Serial Communication Interface .....  | 2-8            |
| 2.9.5   | Synchronous Serial Interface .....  | 2-8            |
| 2.10  | Signal Description .....  | 2-9            |
| 2.10.1  | Port A Address and Data Bus .....   | 2-9            |
| 2.10.1.1  | Address (A0–A15).....   | 2-9            |
| 2.10.1.2  | Data (D0–D23) .....   | 2-10           |
| 2.10.2  | Port A Bus Control .....  | 2-10           |
| 2.10.2.1  | Program Memory Select ( $\overline{PS}$ ).....  | 2-10           |
| 2.10.2.2  | Data Memory Select ( $\overline{DS}$ ).....   | 2-10           |
| 2.10.2.3  | X/Y Select ( $X/Y$ ) .....  | 2-10           |
| 2.10.2.4  | Read Enable ( $\overline{RD}$ ) .....   | 2-10           |
| 2.10.2.5  | Write Enable ( $\overline{WR}$ ).....   | 2-10           |
| 2.10.2.6  | Bus Request/Bus Strobe ( $\overline{BR/BS}$ ).....  | 2-10           |
| 2.10.2.7  | Bus Grant/Wait ( $\overline{BG/WT}$ ) .....   | 2-11           |
| 2.10.3  | Interrupt and Mode Control.....   | 2-11           |
| 2.10.3.1  | Mode Select A/External Interrupt Request A (MODA/IRQA) and<br>Mode Select B/External Interrupt Request B (MODB/IRQB) .. | 2-11           |

## TABLE OF CONTENTS (Continued)

| Paragraph<br>Number | Title                                     | Page<br>Number |
|---------------------|---|----------------|
| 2.10.3.2            | Reset ( <u>RESET</u> ).....               | 2-11           |
| 2.10.4              | Power and Clock.....                      | 2-11           |
| 2.10.4.1            | Power (VCC), Ground (GND).....            | 2-12           |
| 2.10.4.2            | External Clock/Crystal Input (EXTAL)..... | 2-12           |
| 2.10.4.3            | Crystal Output (XTAL).....                | 2-12           |
| 2.10.5              | Host Interface.....                       | 2-12           |
| 2.10.5.1            | Host Data Bus (H0–H7).....                | 2-12           |
| 2.10.5.2            | Host Address (HA0–HA2).....               | 2-12           |
| 2.10.5.3            | Host Read/Write (HR/W).....               | 2-12           |
| 2.10.5.4            | Host Enable (HEN).....                    | 2-12           |
| 2.10.5.5            | Host Request (HREQ).....                  | 2-12           |
| 2.10.5.6            | Host Acknowledge (HACK).....              | 2-13           |
| 2.10.6              | Serial Communications Interface.....      | 2-13           |
| 2.10.6.1            | Receive Data (RXD).....                   | 2-13           |
| 2.10.6.2            | Transmit Data (TXD).....                  | 2-13           |
| 2.10.6.3            | Serial Clock (SCLK).....                  | 2-13           |
| 2.10.7              | Synchronous Serial Interface.....         | 2-13           |
| 2.10.7.1            | Serial Control Zero (SC0).....            | 2-13           |
| 2.10.7.2            | Serial Control One (SC1).....             | 2-13           |
| 2.10.7.3            | Serial Control Two (SC2).....             | 2-14           |
| 2.10.7.4            | SSI Serial Clock (SCK).....               | 2-14           |
| 2.10.7.5            | SSI Receive Data (SRD).....               | 2-14           |
| 2.10.7.6            | SSI Transmit Data (STD).....              | 2-14           |

### Section 3 Memory Spaces

|         |                                      |     |
|---------|--------------------------------------|-----|
| 3.1     | Overview.....                        | 3-1 |
| 3.2     | DSP56000 Memory Introduction.....    | 3-1 |
| 3.2.1   | X Data Memory.....                   | 3-1 |
| 3.2.2   | Y Data Memory.....                   | 3-2 |
| 3.2.3   | Program Memory.....                  | 3-3 |
| 3.2.4   | Chip Operating Modes.....            | 3-3 |
| 3.2.4.1 | Single-Chip Mode (Mode 0).....       | 3-4 |
| 3.2.4.2 | Mode 1.....                          | 3-4 |
| 3.2.4.3 | Normal Expanded Mode (Mode 2).....   | 3-4 |
| 3.2.4.4 | Development Mode (Mode 3).....       | 3-5 |
| 3.2.5   | Security ROM Version (DSP56000)..... | 3-5 |
| 3.3     | DSP56001 Memory Introduction.....    | 3-6 |
| 3.3.1   | X Data Memory.....                   | 3-7 |
| 3.3.2   | Y Data Memory.....                   | 3-8 |
| 3.3.3   | Program Memory.....                  | 3-8 |
| 3.3.4   | Bootstrap ROM (DSP56001 Only).....   | 3-8 |



## TABLE OF CONTENTS (Continued)

| Paragraph<br>Number                                 | Title   | Page<br>Number |
|---|---|----------------|
| 3.3.5   | Chip Operating Modes .....                                    | 3-8            |
| 3.3.5.1   | Single-Chip Mode (Mode 0) .....                               | 3-9            |
| 3.3.5.2   | Special Bootstrap Mode (Mode 1) .....                         | 3-9            |
| 3.3.5.3   | Normal Expanded Mode (Mode 2) .....                           | 3-12           |
| 3.3.5.4   | Development Mode (Mode 3).....                                | 3-13           |
| <br><b>Section 4</b><br>                            |   |                |
| <b>Data Arithmetic Logic Unit</b>                   |   |                |
| 4.1   | Overview and Data ALU Architecture.....                       | 4-1            |
| 4.1.1   | Data ALU Input Registers (X1, X0, Y1, Y0) .....               | 4-3            |
| 4.1.2   | MAC and Logic Unit .....                                      | 4-3            |
| 4.1.3   | Data ALU Accumulator Registers (A2, A1, A0, B2, B1, B0) ..... | 4-5            |
| 4.1.4   | Accumulator Shifter .....                                     | 4-6            |
| 4.1.5   | Data Shifter/Limiter .....                                    | 4-6            |
| 4.1.5.1   | Limiting (Saturation Arithmetic).....                         | 4-6            |
| 4.1.5.2   | Scaling.....  | 4-8            |
| 4.2   | Data Representation and Rounding .....                        | 4-8            |
| 4.3   | Data ALU Programming Model.....                               | 4-11           |
| 4.4   | Data ALU Summary.....   | 4-11           |
| <br><b>Section 5</b><br>                            |   |                |
| <b>Address Generation Unit and Addressing Modes</b> |   |                |
| 5.1   | AGU Architecture .....  | 5-1            |
| 5.1.1   | Address Register Files (Rn) .....                             | 5-2            |
| 5.1.2   | Offset Register Files (Nn).....                               | 5-3            |
| 5.1.3   | Modifier Register Files (Mn) .....                            | 5-3            |
| 5.1.4   | Address ALU .....   | 5-3            |
| 5.1.5   | Address Output Multiplexers.....                              | 5-4            |
| 5.2   | Programming Model .....                                       | 5-4            |
| 5.2.1   | Address Register Files (R0–R3 and R4–R7) .....                | 5-5            |
| 5.2.2   | Offset Register Files (N0–N3 and N4–N7) .....                 | 5-5            |
| 5.2.3   | Modifier Register Files (M0–M3 and M4–M7) .....               | 5-5            |
| 5.3   | Addressing .....  | 5-5            |
| 5.3.1   | Address Register Indirect Modes .....                         | 5-6            |
| 5.3.1.1   | No Update.....  | 5-7            |
| 5.3.1.2   | Postincrement by 1 .....                                      | 5-8            |
| 5.3.1.3   | Postdecrement by 1 .....                                      | 5-8            |
| 5.3.1.4   | Postincrement by Offset Nn.....                               | 5-9            |
| 5.3.1.5   | Postdecrement by Offset Nn .....                              | 5-9            |
| 5.3.1.6   | Indexed by Offset Nn .....                                    | 5-10           |
| 5.3.1.7   | Predecrement by 1 .....                                       | 5-11           |

## TABLE OF CONTENTS (Continued)

| Paragraph Number          | Title  | Page Number |
|---------------------------|--|-------------|
| 5.3.2                     | Address Modifier Types .....                 | 5-11        |
| 5.3.2.1                   | Linear Modifier (Mn=\$FFFF).....             | 5-12        |
| 5.3.2.2                   | Modulo Modifier (Mn=MODULUS - 1).....        | 5-13        |
| 5.3.2.3                   | Reverse-Carry Modifier (Mn=\$0000).....      | 5-17        |
| 5.3.2.4                   | Address-Modifier-Type Encoding Summary ..... | 5-19        |
| <br>                      |  |             |
| <b>Section 6</b>          |  |             |
| <b>Program Controller</b> |  |             |
| 6.1                       | Overview .....                               | 6-1         |
| 6.2                       | Program Controller Architecture .....        | 6-2         |
| 6.2.1                     | Program Decode Controller .....              | 6-2         |
| 6.2.2                     | Program Address Generator.....               | 6-3         |
| 6.2.3                     | Program Interrupt Controller .....           | 6-3         |
| 6.2.4                     | Instruction Pipeline.....                    | 6-6         |
| 6.3                       | Clock Oscillator.....                        | 6-7         |
| 6.4                       | Programming Model.....                       | 6-7         |
| 6.4.1                     | Program Counter.....                         | 6-8         |
| 6.4.2                     | Status Register.....                         | 6-8         |
| 6.4.2.1                   | Carry (Bit 0).....                           | 6-9         |
| 6.4.2.2                   | Overflow (Bit 1).....                        | 6-9         |
| 6.4.2.3                   | Zero (Bit 2).....                            | 6-10        |
| 6.4.2.4                   | Negative (Bit 3).....                        | 6-10        |
| 6.4.2.5                   | Unnormalized (Bit 4).....                    | 6-10        |
| 6.4.2.6                   | Extension (Bit 5).....                       | 6-10        |
| 6.4.2.7                   | Limit (Bit 6).....                           | 6-10        |
| 6.4.2.8                   | Interrupt Masks (Bits 8 and 9) .....         | 6-10        |
| 6.4.2.9                   | Scaling Mode (Bits 10 and 11).....           | 6-11        |
| 6.4.2.10                  | Trace Mode (Bit 13) .....                    | 6-11        |
| 6.4.2.11                  | Reserved Status (Bits 7, 12, 14) .....       | 6-11        |
| 6.4.2.12                  | Loop Flag (Bit 15).....                      | 6-11        |
| 6.4.3                     | Operating Mode Register.....                 | 6-12        |
| 6.4.3.1                   | Chip Operating Mode (Bits 0 and 1).....      | 6-13        |
| 6.4.3.2                   | Data ROM Enable (Bit 2) .....                | 6-13        |
| 6.4.3.3                   | STOP Delay (Bit 6).....                      | 6-13        |
| 6.4.3.4                   | External Memory Access (Bit 7).....          | 6-14        |
| 6.4.3.5                   | Reserved OMR Bits (Bits 3-5 and 8-23).....   | 6-14        |
| 6.4.4                     | Loop Address Register.....                   | 6-14        |
| 6.4.5                     | Loop Counter Register .....                  | 6-15        |
| 6.4.6                     | System Stack.....                            | 6-15        |
| 6.4.7                     | Stack Pointer Register.....                  | 6-15        |
| 6.4.7.1                   | Stack Pointer (Bits 0-3).....                | 6-16        |
| 6.4.7.2                   | Stack Error Flag (Bit 4).....                | 6-16        |

## TABLE OF CONTENTS (Continued)

| Paragraph<br>Number   | Title   | Page<br>Number |
|---|---|----------------|
| 6.4.7.3   | Underflow Flag (Bit 5) .....                          | 6-17           |
| 6.4.7.4   | Reserved Stack Pointer Register Bits (Bits 6–23)..... | 6-17           |
| 6.4.8   | DSP56000/DSP56001 Programming Model Summary.....      | 6-17           |
| <br><b>Section 7</b><br><b>Instruction Set Introduction</b> |   |                |
| 7.1   | Syntax .....  | 7-1            |
| 7.2   | Instruction Formats.....                              | 7-3            |
| 7.2.1   | Operand Sizes.....                                    | 7-3            |
| 7.2.2   | Data Organization in Registers.....                   | 7-4            |
| 7.2.2.1   | Data ALU Registers.....                               | 7-4            |
| 7.2.2.2   | AGU Registers.....                                    | 7-4            |
| 7.2.2.3   | Program Control Registers .....                       | 7-5            |
| 7.2.3   | Data Organization in Memory.....                      | 7-7            |
| 7.2.4   | Operand References .....                              | 7-8            |
| 7.2.4.1   | Program References.....                               | 7-9            |
| 7.2.4.2   | Stack References.....                                 | 7-9            |
| 7.2.4.3   | Register References .....                             | 7-9            |
| 7.2.4.4   | Memory References.....                                | 7-9            |
| 7.2.4.4.1   | X Memory References.....                              | 7-9            |
| 7.2.4.4.2   | Y Memory References.....                              | 7-9            |
| 7.2.4.4.3   | L Memory References.....                              | 7-9            |
| 7.2.4.4.4   | YX Memory References.....                             | 7-9            |
| 7.2.5   | Addressing Modes.....                                 | 7-10           |
| 7.2.5.1   | Register Direct Modes .....                           | 7-10           |
| 7.2.5.1.1   | Data or Control Register Direct .....                 | 7-11           |
| 7.2.5.1.2   | Address Register Direct.....                          | 7-11           |
| 7.2.5.2   | Address Register Indirect Modes .....                 | 7-11           |
| 7.2.5.3   | Special Addressing Modes .....                        | 7-11           |
| 7.2.5.3.1   | Immediate Data.....                                   | 7-11           |
| 7.2.5.3.2   | Absolute Address.....                                 | 7-11           |
| 7.2.5.3.3   | Immediate Short.....                                  | 7-11           |
| 7.2.5.3.4   | Short Jump Address.....                               | 7-13           |
| 7.2.5.3.5   | Absolute Short.....                                   | 7-13           |
| 7.2.5.3.6   | I/O Short.....  | 7-13           |
| 7.2.5.3.7   | Implicit Reference .....                              | 7-13           |
| 7.2.5.4   | Addressing Modes Summary.....                         | 7-18           |
| 7.3   | Instruction Groups.....                               | 7-18           |
| 7.3.1   | Arithmetic Instructions.....                          | 7-19           |
| 7.3.2   | Logical Instructions .....                            | 7-19           |
| 7.3.3   | Bit Manipulation Instructions.....                    | 7-20           |
| 7.3.4   | Loop Instructions.....                                | 7-20           |
| 7.3.5   | Move Instructions.....                                | 7-22           |
| 7.3.6   | Program Control Instructions.....                     | 7-24           |

## TABLE OF CONTENTS (Continued)

| Paragraph<br>Number      | Title  | Page<br>Number |
|--------------------------|--|----------------|
| <b>Section 8</b>         |  |                |
| <b>Processing States</b> |  |                |
| 8.1                      | Normal Processing State.....   | 8-1            |
| 8.1.1                    | Instruction Pipeline.....  | 8-1            |
| 8.1.2                    | Summary of Pipeline-Related Restrictions .....   | 8-6            |
| 8.2                      | Exception Processing State (Interrupt Processing) .....  | 8-8            |
| 8.2.1                    | Interrupt Sources.....   | 8-9            |
| 8.2.1.1                  | Hardware Interrupt Sources.....  | 8-9            |
| 8.2.1.2                  | Software Interrupt Sources.....  | 8-11           |
| 8.2.1.3                  | Other Interrupt Sources .....  | 8-14           |
| 8.2.2                    | Interrupt Priority Structure .....   | 8-16           |
| 8.2.2.1                  | Interrupt Priority Levels .....  | 8-16           |
| 8.2.2.2                  | Exception Priorities within an IPL.....  | 8-17           |
| 8.2.3                    | Instructions Preceding the Interrupt Instruction Fetch.....  | 8-18           |
| 8.2.4                    | Interrupt Types.....   | 8-18           |
| 8.2.5                    | Interrupt Arbitration .....  | 8-19           |
| 8.2.6                    | Interrupt Instruction Fetch.....   | 8-20           |
| 8.2.7                    | Interrupt Instruction Execution.....   | 8-20           |
| 8.3                      | Reset Processing State .....   | 8-27           |
| 8.4                      | Wait Processing State.....   | 8-36           |
| 8.5                      | STOP Processing State .....  | 8-38           |
| <b>Section 9</b>         |  |                |
| <b>Port A</b>            |  |                |
| 9.1                      | Port A Interface.....  | 9-1            |
| 9.2                      | Port A Timing.....   | 9-8            |
| 9.2.1                    | Port A Wait States.....  | 9-10           |
| 9.2.2                    | Bus Control Register.....  | 9-12           |
| 9.2.3                    | Bus Strobe/Wait Pins .....   | 9-12           |
| 9.3                      | Bus Arbitration .....  | 9-15           |
| 9.3.1                    | Bus Request/Bus Grant .....  | 9-15           |
| 9.3.2                    | Shared Memory.....   | 9-16           |
| 9.3.2.1                  | Bus Arbitration Using Only $\overline{BR}/\overline{BG}$ with Internal Control.....                      | 9-16           |
| 9.3.2.2                  | Bus Arbitration Using Only $\overline{BR}/\overline{BG}$ with External Control.....                      | 9-16           |
| 9.3.2.3                  | Bus Arbitration Using $\overline{BR}/\overline{BG}$ and $\overline{BS}/\overline{WT}$ with No Overhead.. | 9-18           |
| 9.3.2.4                  | Signaling Using Semaphores.....  | 9-20           |
| <b>Section 10</b>        |  |                |
| <b>Port B</b>            |  |                |
| 10.1                     | General-Purpose I/O.....   | 10-2           |
| 10.1.1                   | Programming Parallel I/O.....  | 10-4           |
| 10.1.2                   | Port B Parallel I/O Timing .....   | 10-4           |

## TABLE OF CONTENTS (Continued)

| Paragraph<br>Number | Title  | Page<br>Number |
|---------------------|--|----------------|
| 10.2                | Host Interface (HI).....                               | 10-7           |
| 10.2.1              | Host Interface — DSP CPU Viewpoint.....                | 10-9           |
| 10.2.2              | Programming Model — DSP CPU Viewpoint.....             | 10-10          |
| 10.2.2.1            | Host Control Register (HCR).....                       | 10-11          |
| 10.2.2.1.1          | HCR Host Receive Interrupt Enable (HRIE) Bit 0 .....   | 10-12          |
| 10.2.2.1.2          | HCR Host Transmit Interrupt Enable (HTIE) Bit 1 .....  | 10-12          |
| 10.2.2.1.3          | HCR Host Command Interrupt Enable (HCIE) Bit 2.....    | 10-12          |
| 10.2.2.1.4          | HCR Host Flag 2 (HF2) Bit 3.....                       | 10-12          |
| 10.2.2.1.5          | HCR Host Flag 3 (HF3) Bit 4.....                       | 10-12          |
| 10.2.2.1.6          | HCR Reserved Bits (Bits 5, 6, and 7).....              | 10-13          |
| 10.2.2.2            | Host Status Register (HSR) .....                       | 10-13          |
| 10.2.2.2.1          | HSR Host Receive Data Full (HRDF) Bit 0.....           | 10-13          |
| 10.2.2.2.2          | HSR Host Transmit Data Empty (HTDE) Bit 1.....         | 10-13          |
| 10.2.2.2.3          | HSR Host Command Pending (HCP) Bit 2.....              | 10-14          |
| 10.2.2.2.4          | HSR Host Flag 0 (HF0) Bit 3.....                       | 10-14          |
| 10.2.2.2.5          | HSR Host Flag 1 (HF1) Bit 4.....                       | 10-14          |
| 10.2.2.2.6          | HSR Reserved Bits (Bits 5 and 6).....                  | 10-14          |
| 10.2.2.2.7          | HSR DMA Status (DMA) Bit 7 .....                       | 10-14          |
| 10.2.2.3            | Host Receive Data Register (HRX) .....                 | 10-14          |
| 10.2.2.4            | Host Transmit Data Register (HTX).....                 | 10-14          |
| 10.2.2.5            | Register Contents after Reset .....                    | 10-15          |
| 10.2.2.6            | Host Interface DSP CPU Interrupts .....                | 10-15          |
| 10.2.2.7            | Host Port Usage Considerations — DSP Side.....         | 10-15          |
| 10.2.3              | Host Interface — Host Processor Viewpoint .....        | 10-16          |
| 10.2.3.1            | Programming Model — Host Processor Viewpoint.....      | 10-17          |
| 10.2.3.2            | Interrupt Control Register (ICR).....                  | 10-18          |
| 10.2.3.2.1          | ICR Receive Request Enable (RREQ) Bit 0 .....          | 10-19          |
| 10.2.3.2.2          | ICR Transmit Request Enable (TREQ) Bit 1.....          | 10-19          |
| 10.2.3.2.3          | ICR Reserved Bit (Bit 2) .....                         | 10-19          |
| 10.2.3.2.4          | ICR Host Flag 0 (HF0) Bit 3.....                       | 10-20          |
| 10.2.3.2.5          | ICR Host Flag 1 (HF1) Bit 4.....                       | 10-20          |
| 10.2.3.2.6          | ICR Host Mode Control (HM1 and HM0) Bits 5 and 6 ..... | 10-20          |
| 10.2.3.2.7          | ICR Initialize Bit (INIT) Bit 7 .....                  | 10-21          |
| 10.2.3.3            | Command Vector Register (CVR) .....                    | 10-22          |
| 10.2.3.3.1          | CVR Host Vector (HV) Bits 0–4 .....                    | 10-22          |
| 10.2.3.3.2          | CVR Reserved Bits (Bit 5 and 6) .....                  | 10-22          |
| 10.2.3.3.3          | CVR Host Command Bit (HC) Bit 7 .....                  | 10-22          |
| 10.2.3.4            | Interrupt Status Register (ISR).....                   | 10-23          |
| 10.2.3.4.1          | ISR Receive Data Register Full (RXDF) Bit 0 .....      | 10-23          |
| 10.2.3.4.2          | ISR Transmit Data Register Empty (TXDE) Bit 1 .....    | 10-23          |
| 10.2.3.4.3          | ISR Transmitter Ready (TRDY) Bit 2 .....               | 10-23          |
| 10.2.3.4.4          | ISR Host Flag 2 (HF2) Bit 3.....                       | 10-24          |
| 10.2.3.4.5          | ISR Host Flag 3 (HF3) Bit 4.....                       | 10-24          |
| 10.2.3.4.6          | ISR Reserved Bit (Bit 5) .....                         | 10-24          |

## TABLE OF CONTENTS (Continued)

| Paragraph<br>Number | Title  | Page<br>Number |
|---------------------|--|----------------|
| 10.2.3.4.7          | ISR DMA Status (DMA) Bit 6 .....                   | 10-24          |
| 10.2.3.4.8          | ISR Host Request (HREQ) Bit 7 .....                | 10-24          |
| 10.2.3.5            | Interrupt Vector Register (IVR) .....              | 10-25          |
| 10.2.3.6            | Receive Byte Registers (RXH, RXM, RXL) .....       | 10-25          |
| 10.2.3.7            | Transmit Byte Registers (TXH, TXM, TXL) .....      | 10-25          |
| 10.2.3.8            | Registers after Reset .....                        | 10-25          |
| 10.2.4              | Host Interface Pins .....                          | 10-26          |
| 10.2.4.1            | Host Data Bus (H0–H7) .....                        | 10-26          |
| 10.2.4.2            | Host Address (HA0–HA2) .....                       | 10-26          |
| 10.2.4.3            | Host Read/Write (HR/W) .....                       | 10-27          |
| 10.2.4.4            | Host Enable (HEN) .....                            | 10-27          |
| 10.2.4.5            | Host Request (HREQ) .....                          | 10-27          |
| 10.2.4.6            | Host Acknowledge (HACK) .....                      | 10-27          |
| 10.2.5              | Servicing the Host Interface .....                 | 10-27          |
| 10.2.5.1            | HI Host Processor Data Transfer .....              | 10-28          |
| 10.2.5.2            | HI Interrupts Host Request (HREQ) .....            | 10-28          |
| 10.2.5.3            | Polling .....                                      | 10-30          |
| 10.2.5.4            | Servicing Non-DMA Interrupts .....                 | 10-30          |
| 10.2.5.5            | Servicing DMA Interrupts .....                     | 10-31          |
| 10.2.6              | HI Application Examples .....                      | 10-31          |
| 10.2.6.1            | HI Initialization .....                            | 10-31          |
| 10.2.6.2            | Polling/Interrupt Controller Data Transfer .....   | 10-31          |
| 10.2.6.2.1          | Host to DSP — Data Transfer .....                  | 10-35          |
| 10.2.6.2.2          | Host to DSP — Command Vector .....                 | 10-40          |
| 10.2.6.2.3          | Host to DSP — Bootstrap Loading Using the HI ..... | 10-43          |
| 10.2.6.2.4          | DSP-to-Host Data Transfer .....                    | 10-44          |
| 10.2.6.3            | DMA Data Transfer .....                            | 10-48          |
| 10.2.6.3.1          | Host-to-DSP Internal Processing .....              | 10-49          |
| 10.2.6.3.2          | Host-to-DSP DMA Procedure .....                    | 10-50          |
| 10.2.6.3.3          | DSP-to-Host Internal Processing .....              | 10-53          |
| 10.2.6.3.4          | DSP-to-Host DMA Procedure .....                    | 10-54          |
| 10.2.6.4            | Example Circuits .....                             | 10-54          |
| 10.2.6.5            | Host Port Usage Considerations — Host Side .....   | 10-56          |

### Section 11 Port C

|          |  |      |
|----------|--|------|
| 11.1     | General-Purpose I/O (Port C) .....         | 11-1 |
| 11.1.1   | Programming Parallel I/O .....             | 11-1 |
| 11.1.2   | Port C Parallel I/O Timing .....           | 11-6 |
| 11.2     | Serial Communication Interface (SCI) ..... | 11-8 |
| 11.2.1   | SCI I/O Pins .....                         | 11-9 |
| 11.2.1.1 | Receive Data (RXD) .....                   | 11-9 |
| 11.2.1.2 | Transmit Data (TXD) .....                  | 11-9 |

## TABLE OF CONTENTS (Continued)

| Paragraph<br>Number | Title   | Page<br>Number |
|---------------------|---|----------------|
| 11.2.1.3            | SCI Serial Clock (SCLK).....                              | 11-9           |
| 11.2.2              | Programming Model.....                                    | 11-9           |
| 11.2.2.1            | SCI Control Register (SCR) .....                          | 11-11          |
| 11.2.2.1.1          | SCR Word Select (WDS0, WDS1, WDS2) Bits 0, 1, and 2 ..... | 11-11          |
| 11.2.2.1.2          | SCR SCI Shift Direction (SSFTD) Bit 3.....                | 11-12          |
| 11.2.2.1.3          | SCR Send Break (SBK) Bit 4 .....                          | 11-12          |
| 11.2.2.1.4          | SCR Wakeup Mode Select (WAKE) Bit 5.....                  | 11-15          |
| 11.2.2.1.5          | SCR Receiver Wakeup Enable (RWU) Bit 6.....               | 11-15          |
| 11.2.2.1.6          | SCR Wired-OR Mode Select (WOMS) Bit 7 .....               | 11-16          |
| 11.2.2.1.7          | SCR Receiver Enable (RE) Bit 8 .....                      | 11-16          |
| 11.2.2.1.8          | SCR Transmitter Enable (TE) Bit 9 .....                   | 11-16          |
| 11.2.2.1.9          | SCR Idle Line Interrupt Enable (ILIE) Bit 10 .....        | 11-16          |
| 11.2.2.1.10         | SCR SCI Receive Interrupt Enable (RIE) Bit 11 .....       | 11-17          |
| 11.2.2.1.11         | SCR SCI Transmit Interrupt Enable (TIE) Bit 12 .....      | 11-17          |
| 11.2.2.1.12         | SCR Timer Interrupt Enable (TMIE) Bit 13.....             | 11-17          |
| 11.2.2.1.13         | SCR Reserved (Bit 14).....                                | 11-18          |
| 11.2.2.1.14         | SCR SCI Clock Polarity (SCKP) Bit 15.....                 | 11-18          |
| 11.2.2.2            | SCI Status Register (SSR).....                            | 11-18          |
| 11.2.2.2.1          | SSR Transmitter Empty (TRNE) Bit 0.....                   | 11-18          |
| 11.2.2.2.2          | SSR Transmit Data Register Empty (TDRE) Bit 1 .....       | 11-18          |
| 11.2.2.2.3          | SSR Receive Data Register Full (RDRF) Bit 2 .....         | 11-19          |
| 11.2.2.2.4          | SSR Idle Line Flag (IDLE) Bit 3 .....                     | 11-19          |
| 11.2.2.2.5          | SSR Overrun Error Flag (OR) Bit 4 .....                   | 11-19          |
| 11.2.2.2.6          | SSR Parity Error (PE) Bit 5 .....                         | 11-19          |
| 11.2.2.2.7          | SSR Framing Error Flag (FE) Bit 6.....                    | 11-20          |
| 11.2.2.2.8          | SSR Received Bit 8 (R8) Address Bit 7 .....               | 11-20          |
| 11.2.2.3            | SCI Clock Control Register (SCCR).....                    | 11-20          |
| 11.2.2.3.1          | SCCR Clock Divider (CD11-CD0) Bits 11-0.....              | 11-21          |
| 11.2.2.3.2          | SCCR Clock Out Divider (COD) Bit 12 .....                 | 11-21          |
| 11.2.2.3.3          | SCCR SCI Clock Prescaler (SCP) Bit 13.....                | 11-22          |
| 11.2.2.3.4          | SCCR Receive Clock Mode Source Bit (RCM) Bit 14 .....     | 11-22          |
| 11.2.2.3.5          | SCCR Transmit Clock Source Bit (TCM) Bit 15 .....         | 11-22          |
| 11.2.2.4            | SCI Data Registers.....                                   | 11-23          |
| 11.2.2.4.1          | SCI Receive Registers .....                               | 11-23          |
| 11.2.2.4.2          | SCI Transmit Registers.....                               | 11-24          |
| 11.2.2.5            | Preamble, Break, and Data Transmission Priority.....      | 11-25          |
| 11.2.3              | Register Contents After Reset.....                        | 11-25          |
| 11.2.4              | SCI Initialization.....                                   | 11-26          |
| 11.2.5              | SCI Exceptions .....                                      | 11-28          |
| 11.2.6              | Synchronous Data.....                                     | 11-32          |
| 11.2.7              | Asynchronous Data .....                                   | 11-39          |
| 11.2.7.1            | Asynchronous Data Reception.....                          | 11-39          |
| 11.2.7.2            | Asynchronous Data Transmission .....                      | 11-41          |
| 11.2.8              | Multidrop.....  | 11-47          |

## TABLE OF CONTENTS (Continued)

| Paragraph<br>Number | Title   | Page<br>Number |
|---------------------|---|----------------|
| 11.2.8.1            | Transmitting Data and Address Characters .....          | 11-49          |
| 11.2.8.2            | Wired-OR Mode .....                                     | 11-53          |
| 11.2.8.3            | Idle Line Wakeup.....                                   | 11-53          |
| 11.2.8.4            | Address Mode Wakeup.....                                | 11-53          |
| 11.2.8.5            | Multidrop Example .....                                 | 11-56          |
| 11.2.9              | SCI Timer.....  | 11-61          |
| 11.2.10             | Example Circuits.....                                   | 11-64          |
| 11.3                | Synchronous Serial Interface (SSI) .....                | 11-66          |
| 11.3.1              | SSI Data and Control Pins.....                          | 11-67          |
| 11.3.1.1            | Serial Transmit Data Pin (STD) .....                    | 11-68          |
| 11.3.1.2            | Serial Receive Data Pin (SRD) .....                     | 11-69          |
| 11.3.1.3            | Serial Clock (SCK).....                                 | 11-69          |
| 11.3.1.4            | Serial Control Pin (SC0) .....                          | 11-71          |
| 11.3.1.5            | Serial Control Pin (SC1) .....                          | 11-71          |
| 11.3.1.6            | Serial Control Pin (SC2) .....                          | 11-72          |
| 11.3.2              | SSI Interface Programming Model.....                    | 11-72          |
| 11.3.2.1            | SSI Control Register A (CRA) .....                      | 11-72          |
| 11.3.2.1.1          | CRA Prescale Modulus Select (PM7-PM0) Bits 0-7.....     | 11-72          |
| 11.3.2.1.2          | CRA Frame Rate Divider Control (DC4-DC0) Bits 8-12 .... | 11-76          |
| 11.3.2.1.3          | CRA Word Length Control (WL0, WL1) Bits 13 and 14.....  | 11-76          |
| 11.3.2.1.4          | CRA Prescaler Range (PSR) Bit 15.....                   | 11-76          |
| 11.3.2.2            | SSI Control Register B (CRB).....                       | 11-76          |
| 11.3.2.2.1          | CRB Serial Output Flag 0 (OF0) Bit 0 .....              | 11-77          |
| 11.3.2.2.2          | CRB Serial Output Flag 1 (OF1) Bit 1 .....              | 11-77          |
| 11.3.2.2.3          | CRB Serial Control 0 Direction (SCD0) Bit 2 .....       | 11-77          |
| 11.3.2.2.4          | CRB Serial Control 1 Direction (SCD1) Bit 3 .....       | 11-77          |
| 11.3.2.2.5          | CRB Serial Control 2 Direction (SCD2) Bit 4 .....       | 11-77          |
| 11.3.2.2.6          | CRB Clock Source Direction (SCKD) Bit 5 .....           | 11-79          |
| 11.3.2.2.7          | CRB Shift Direction (SHFD) Bit 6.....                   | 11-79          |
| 11.3.2.2.8          | CRB Frame Sync Length (FSL0 and FSL1) Bits 7 and 8....  | 11-79          |
| 11.3.2.2.9          | CRB Sync/Async (SYN) Bit 9.....                         | 11-79          |
| 11.3.2.2.10         | CRB Gated Clock Control (GCK) Bit 10 .....              | 11-79          |
| 11.3.2.2.11         | CRB SSI Mode Select (MOD) Bit 11.....                   | 11-80          |
| 11.3.2.2.12         | CRB SSI Transmit Enable (TE) Bit 12 .....               | 11-80          |
| 11.3.2.2.13         | CRB SSI Receive Enable (RE) Bit 13 .....                | 11-80          |
| 11.3.2.2.14         | CRB SSI Transmit Interrupt Enable (TIE) Bit 14 .....    | 11-81          |
| 11.3.2.2.15         | CRB SSI Receive Interrupt Enable (RIE) Bit 15 .....     | 11-81          |
| 11.3.2.3            | SSI Status Register (SSISR) .....                       | 11-81          |
| 11.3.2.3.1          | SSISR Serial Input Flag 0 (IF0) Bit 0 .....             | 11-81          |
| 11.3.2.3.2          | SSISR Serial Input Flag 1 (IF1) Bit 1 .....             | 11-82          |
| 11.3.2.3.3          | SSISR Transmit Frame Sync Flag (TFS) Bit 2.....         | 11-82          |
| 11.3.2.3.4          | SSISR Receive Frame Sync Flag (RFS) Bit 3.....          | 11-82          |
| 11.3.2.3.5          | SSISR Transmitter Underrun Error Flag (TUE) Bit 4 ..... | 11-82          |
| 11.3.2.3.6          | SSISR Receiver Overrun Error Flag (ROE) Bit 5.....      | 11-83          |



## TABLE OF CONTENTS (Concluded)

| Paragraph<br>Number | Title  | Page<br>Number |
|---------------------|--|----------------|
| 11.3.2.3.7          | SSISR SSI Transmit Data Register Empty (TDE) Bit 6 ..... | 11-83          |
| 11.3.2.3.8          | SSISR SSI Receive Date Register Full (RDF) Bit 7 .....   | 11-83          |
| 11.3.2.3.9          | SSI Receive Shift Register .....                         | 11-83          |
| 11.3.2.3.10         | SSI Receive Data Register (RX) .....                     | 11-84          |
| 11.3.2.3.11         | SSI Transmit Shift Register .....                        | 11-84          |
| 11.3.2.3.12         | SSI Transmit Data Register (TX) .....                    | 11-84          |
| 11.3.2.3.13         | Time Slot Register (TSR) .....                           | 11-84          |
| 11.3.3              | Operational Modes and Pin Definitions .....              | 11-87          |
| 11.3.4              | Registers After Reset .....                              | 11-88          |
| 11.3.5              | SSI Initialization .....                                 | 11-88          |
| 11.3.6              | SSI Exceptions .....                                     | 11-92          |
| 11.3.7              | Operating Modes — Normal, Network, and On-Demand .....   | 11-93          |
| 11.3.7.1            | Data/Operation Formats .....                             | 11-96          |
| 11.3.7.1.1          | Normal/Network Mode Selection .....                      | 11-96          |
| 11.3.7.1.2          | Continuous/Gated Clock Selection .....                   | 11-96          |
| 11.3.7.1.3          | Synchronous/Asynchronous Operating Modes .....           | 11-99          |
| 11.3.7.1.4          | Frame Sync Selection .....                               | 11-107         |
| 11.3.7.1.5          | Shift Direction Selection .....                          | 11-107         |
| 11.3.7.2            | Normal Mode Examples .....                               | 11-107         |
| 11.3.7.2.1          | Normal Mode Transmit .....                               | 11-113         |
| 11.3.7.2.2          | Normal Mode Receive .....                                | 11-114         |
| 11.3.7.3            | Network Mode Examples .....                              | 11-118         |
| 11.3.7.3.1          | Network Mode Transmit .....                              | 11-122         |
| 11.3.7.3.2          | Network Mode Receive .....                               | 11-124         |
| 11.3.7.4            | On-Demand Mode Examples .....                            | 11-127         |
| 11.3.7.4.1          | On-Demand Mode — Continuous Clock .....                  | 11-128         |
| 11.3.7.4.2          | On-Demand Mode — Gated Clock .....                       | 11-128         |
| 11.3.8              | Flags .....  | 11-133         |
| 11.3.9              | Example Circuits .....                                   | 11-138         |

### Appendix A Instruction Set Details

### Appendix B Benchmark Programs

### Appendix C Additional Support

### Index



## LIST OF ILLUSTRATIONS

| Figure<br>Number | Title  | Page<br>Number |
|------------------|--|----------------|
| 1-1              | Analog Signal Processing .....                               | 1-2            |
| 1-2              | Digital Signal Processing .....                              | 1-3            |
| 1-3              | DSP Hardware Origins .....                                   | 1-7            |
| 1-4              | DSP Block Diagram .....                                      | 1-7            |
| 1-5              | DSP56000 Block Diagram.....                                  | 1-8            |
|                  |  |                |
| 2-1              | DSP56000 Block Diagram.....                                  | 2-2            |
| 2-2              | DSP56001 Block Diagram.....                                  | 2-2            |
| 2-3              | DSP56000/DSP56001 Functional Signal Groups .....             | 2-9            |
|                  |  |                |
| 3-1              | DSP56000 Memory Map .....                                    | 3-2            |
| 3-2              | Memory Map for DSP56000 Mode 0: Single-Chip Mode .....       | 3-4            |
| 3-3              | Memory Map for DSP56000 Mode 2: Normal Expanded Mode .....   | 3-5            |
| 3-4              | Memory Map for DSP56000 Mode 3: Development Mode.....        | 3-6            |
| 3-5              | DSP56001 Memory Map .....                                    | 3-7            |
| 3-6              | Memory Map for DSP56001 Mode 0: Single-Chip .....            | 3-10           |
| 3-7              | Memory Map for DSP56001 Mode 2: Normal Expanded Mode .....   | 3-11           |
| 3-8              | Memory Map for DSP56001 Mode 3: Development Mode.....        | 3-13           |
|                  |  |                |
| 4-1              | DSP56001 Block Diagram.....                                  | 4-1            |
| 4-2              | Data ALU .....   | 4-2            |
| 4-3              | MAC Unit.....  | 4-4            |
| 4-4              | Saturation Arithmetic.....                                   | 4-7            |
| 4-5              | Bit Weighting and Alignment of Operands .....                | 4-9            |
| 4-6              | Integer-to-Fractional Data Conversion.....                   | 4-9            |
| 4-7              | Integer/Fractional Number Comparison.....                    | 4-10           |
| 4-8              | Integer/Fractional Multiplication Comparison .....           | 4-10           |
| 4-9              | Convergent Rounding .....                                    | 4-12           |
| 4-10             | DSP56000/DSP56001 Programming Model.....                     | 4-13           |
|                  |  |                |
| 5-1              | DSP56001 Block Diagram.....                                  | 5-1            |
| 5-2              | AGU Block Diagram .....                                      | 5-2            |
| 5-3              | AGU Programming Model .....                                  | 5-4            |
| 5-4              | Address Register Indirect — No Update .....                  | 5-7            |
| 5-5              | Address Register Indirect — Postincrement .....              | 5-8            |
| 5-6              | Address Register Indirect — Postdecrement.....               | 5-9            |
| 5-7              | Address Register Indirect — Postincrement by Offset Nn.....  | 5-10           |
| 5-8              | Address Register Indirect — Postdecrement by Offset Nn ..... | 5-11           |
| 5-9              | Address Register Indirect — Indexed by Offset Nn .....       | 5-12           |

## LIST OF ILLUSTRATIONS (Continued)

| Figure<br>Number | Title  | Page<br>Number |
|------------------|--|----------------|
| 5-10             | Address Register Indirect — Predecrement .....                   | 5-13           |
| 5-11             | Circular Buffer .....  | 5-14           |
| 5-12             | Linear Addressing with a Modulo Modifier .....                   | 5-15           |
| 5-13             | Modulo Modifier Example .....                                    | 5-16           |
| 5-14             | Bit-Reverse Address Calculation Example .....                    | 5-19           |
| 5-15             | Address Modifier Summary .....                                   | 5-21           |
| 6-1              | DSP56001 Block Diagram .....                                     | 6-1            |
| 6-2              | DSP56000/DSP56001 Program Controller .....                       | 6-2            |
| 6-3              | Fast and Long Interrupt Examples .....                           | 6-5            |
| 6-4              | Three-Stage Pipeline .....                                       | 6-7            |
| 6-5              | Program Controller Programming Model .....                       | 6-8            |
| 6-6              | Status Register Format .....                                     | 6-9            |
| 6-7              | OMR Format .....   | 6-12           |
| 6-8              | SP Register Format .....   | 6-15           |
| 6-9              | SP Register Values .....   | 6-16           |
| 6-10             | DSP56000/DSP56001 Central Processor Programming Model .....      | 6-18           |
| 7-1              | DSP56000/DSP56001 Central Processor Programming Model .....      | 7-2            |
| 7-2              | General Format of an Instruction Operation Word .....            | 7-3            |
| 7-3              | Operand Sizes .....  | 7-4            |
| 7-4              | Reading and Writing the ALU Extension Registers .....            | 7-5            |
| 7-5              | Reading and Writing the Address ALU Registers .....              | 7-5            |
| 7-6              | Reading and Writing Control Registers .....                      | 7-6            |
| 7-7              | Special Addressing — Immediate Data .....                        | 7-12           |
| 7-8              | Special Addressing — Absolute Addressing .....                   | 7-13           |
| 7-9              | Special Addressing — Immediate Short Data .....                  | 7-14           |
| 7-10             | Special Addressing — Short Jump Address .....                    | 7-15           |
| 7-11             | Special Addressing — Absolute Short Address .....                | 7-16           |
| 7-12             | Special Addressing — I/O Short Address .....                     | 7-17           |
| 7-13             | Hardware DO Loop .....   | 7-21           |
| 7-14             | Nested DO Loop .....   | 7-22           |
| 7-15             | Classifications of Parallel Data Moves .....                     | 7-23           |
| 7-16             | Parallel Move Examples .....                                     | 7-23           |
| 8-1              | Interrupting an SWI .....  | 8-11           |
| 8-2              | Illegal Instruction Interrupt Serviced by a Fast Interrupt ..... | 8-12           |
| 8-3              | Repeated Illegal Instruction .....                               | 8-13           |
| 8-4              | Trace Exception .....  | 8-15           |
| 8-5              | Interrupt Priority Register (Addr X:\$FFFF) .....                | 8-16           |
| 8-6              | Fast Interrupt Service Routine .....                             | 8-21           |
| 8-7              | Two Consecutive Fast Interrupts .....                            | 8-22           |
| 8-8              | Long Interrupt Service Routine .....                             | 8-23           |
| 8-9              | JSR First Instruction of a Fast Interrupt .....                  | 8-25           |

## LIST OF ILLUSTRATIONS (Continued)

| Figure<br>Number | Title  | Page<br>Number |
|------------------|--|----------------|
| 8-10             | JSR Second Instruction of a Fast Interrupt.....              | 8-26           |
| 8-11             | Interrupting an REP Instruction .....                        | 8-28           |
| 8-12             | Interrupting Sequential REP Instructions .....               | 8-29           |
| 8-13             | Reset Sequence.....  | 8-30           |
| 8-14             | Reset When OMR=0 .....                                       | 8-31           |
| 8-15             | Wait Instruction Timing.....                                 | 8-37           |
| 8-16             | Simultaneous Wait Instruction and Interrupt.....             | 8-37           |
| 8-17             | STOP Instruction Sequence.....                               | 8-39           |
| 8-18             | STOP Instruction Sequence Followed by IRQA.....              | 8-39           |
| 8-19             | STOP Instruction Sequence Recovering with RESET.....         | 8-42           |
|                  |  |                |
| 9-1              | Port A Signals.....  | 9-2            |
| 9-2              | External Program Space.....                                  | 9-3            |
| 9-3              | External X and Y Data Space.....                             | 9-4            |
| 9-4              | Memory Segmentation .....                                    | 9-5            |
| 9-5              | Port A Bootstrap Circuit.....                                | 9-6            |
| 9-6              | Port A Bootstrap ROM with X and Y RAM.....                   | 9-7            |
| 9-7              | Port A Bus Operation with No Wait States.....                | 9-8            |
| 9-8              | Port A Bus Operation with Two Wait States.....               | 9-9            |
| 9-9              | Mixed-Speed Expanded System.....                             | 9-11           |
| 9-10             | Bus Control Register.....                                    | 9-13           |
| 9-11             | Port A Access Control .....                                  | 9-13           |
| 9-12             | Bus Strobe/Wait Sequence.....                                | 9-14           |
| 9-13             | Bus Request/Bus Grant Sequence.....                          | 9-15           |
| 9-14             | Bus Arbitration Using Only BR/BG with Internal Control.....  | 9-17           |
| 9-15             | Two DSPs with External Bus Arbitration Timing .....          | 9-17           |
| 9-16             | Bus Arbitration Using Only BR/BG with External Control ..... | 9-18           |
| 9-17             | Bus Arbitration Using BR/BG and BS/WT with No Overhead.....  | 9-19           |
| 9-18             | Two DSPs with External Bus Arbitration Timing .....          | 9-19           |
| 9-19             | Signaling Using Semaphores .....                             | 9-20           |
|                  |  |                |
| 10-1             | Port B Interface .....                                       | 10-1           |
| 10-2             | Parallel Port B Registers .....                              | 10-2           |
| 10-3             | Parallel Port B Pinout.....                                  | 10-3           |
| 10-4             | Port B I/O Pin Control Logic.....                            | 10-3           |
| 10-5             | On-Chip Peripheral Memory Map .....                          | 10-5           |
| 10-6             | Write/Read Parallel Data with Port B .....                   | 10-6           |
| 10-7             | Port B Configuration Flowchart.....                          | 10-6           |
| 10-8             | I/O Port B Configuration .....                               | 10-7           |
| 10-9             | HI Block Diagram .....                                       | 10-10          |
| 10-10            | Host Interface Programming Model — DSP Viewpoint .....       | 10-11          |
| 10-11            | Host Flag Operation .....                                    | 10-13          |
| 10-12            | HSR-HCR Operation.....                                       | 10-16          |
| 10-13            | Host Processor Programming Model — Host Side.....            | 10-17          |

## LIST OF ILLUSTRATIONS (Continued)

| Figure<br>Number | Title   | Page<br>Number |
|------------------|---|----------------|
| 10-14            | HI Register Map.....                                      | 10-18          |
| 10-15            | Host Processor Transfer Timing.....                       | 10-28          |
| 10-16            | Host Registers After Reset — Host Side.....               | 10-29          |
| 10-17            | HI Interrupt Structure.....                               | 10-29          |
| 10-18            | DMA Transfer Logic and Timing.....                        | 10-32          |
| 10-19            | HI Initialization Flowchart.....                          | 10-32          |
| 10-20            | HI Initialization — DSP Side.....                         | 10-33          |
| 10-21(a)         | HI Configuration — Host side.....                         | 10-34          |
| 10-21(b)         | HI Initialization — Host Side, Polling Mode.....          | 10-34          |
| 10-21(c)         | HI Initialization — Host Side, Interrupt Mode.....        | 10-35          |
| 10-21(d)         | HI Initialization — Host Side, DMA Mode.....              | 10-36          |
| 10-22            | Host Mode and INIT Bits.....                              | 10-37          |
| 10-23            | Bits Used for Host-to-DSP Transfer.....                   | 10-38          |
| 10-24            | Data Transfer from Host to DSP.....                       | 10-39          |
| 10-25            | Receive Data from Host — Main Program.....                | 10-40          |
| 10-26            | Receive Data from Host Interrupt Routine.....             | 10-40          |
| 10-27            | Vector Table of Exception Sources.....                    | 10-41          |
| 10-28            | Host Command.....   | 10-42          |
| 10-29            | Bootstrap Using the HI.....                               | 10-44          |
| 10-30            | Transmit/Receive Byte Registers.....                      | 10-45          |
| 10-31            | Bootstrap Code Fragment.....                              | 10-45          |
| 10-32            | Bits Used for DSP-to-Host Transfer.....                   | 10-46          |
| 10-33            | Data Transfer from DSP to Host.....                       | 10-47          |
| 10-34            | Main Program — Transmit 24-Bit Data to Host.....          | 10-48          |
| 10-35            | Transmit to HI Routine.....                               | 10-49          |
| 10-36            | HI Hardware — DMA Mode.....                               | 10-50          |
| 10-37            | DMA Transfer and Host Interrupts.....                     | 10-51          |
| 10-38            | Host-to-DSP DMA Procedure.....                            | 10-52          |
| 10-39            | Host Bits with TREQ and RREQ.....                         | 10-53          |
| 10-40            | DSP-to-Host DMA Procedure.....                            | 10-55          |
| 10-41            | MC68HC11-to-DSP56000 Host Interface.....                  | 10-56          |
| 10-42            | MC68000-to-DSP56000 Host Interface.....                   | 10-57          |
| 10-43            | Multi-DSP Network Example.....                            | 10-58          |
|                  |   |                |
| 11-1             | Port C Interface.....                                     | 11-2           |
| 11-2             | Parallel Port C Pinout.....                               | 11-3           |
| 11-3             | Parallel Port C Registers.....                            | 11-3           |
| 11-4             | Port B I/O Pin Control Logic.....                         | 11-4           |
| 11-5             | On-Chip Peripheral Memory Map.....                        | 11-5           |
| 11-6             | Write/Read Parallel Data with Port C.....                 | 11-6           |
| 11-7             | Port C Configuration Flowchart.....                       | 11-6           |
| 11-8             | I/O Port C Configuration.....                             | 11-7           |
| 11-9             | SCI Programming Model — Control and Status Registers..... | 11-10          |
| 11-10            | SCI Programming Model.....                                | 11-11          |

## LIST OF ILLUSTRATIONS (Continued)

| Figure<br>Number | Title  | Page<br>Number |
|------------------|--|----------------|
| 11-11            | Serial Formats.....  | 11-13          |
| 11-12            | 16× Serial Clock.....  | 11-21          |
| 11-13            | SCI Baud Rate Generator.....   | 11-22          |
| 11-14            | Data Packing and Unpacking.....                                      | 11-24          |
| 11-15            | SCI Initialization Procedure.....                                    | 11-28          |
| 11-16            | SCI General Initialization Detail — Step 2.....                      | 11-29          |
| 11-17            | SCI Exception Vector Locations.....                                  | 11-33          |
| 11-18            | Synchronous Master.....  | 11-34          |
| 11-19            | Synchronous Slave.....   | 11-36          |
| 11-20            | Synchronous Timing.....  | 11-37          |
| 11-21            | SCI Synchronous Transmit.....  | 11-38          |
| 11-22            | SCI Synchronous Receive.....   | 11-39          |
| 11-23            | Asynchronous SCI Receiver Initialization.....                        | 11-40          |
| 11-24            | SCI Character Reception.....   | 11-42          |
| 11-25            | SCI Character Reception with Exception.....                          | 11-43          |
| 11-26            | Asynchronous SCI Transmitter Initialization.....                     | 11-44          |
| 11-27            | Asynchronous SCI Character Transmission.....                         | 11-45          |
| 11-28            | Transmitting Marks and Spaces.....                                   | 11-46          |
| 11-29            | SCI Asynchronous Transmit/Receive Example.....                       | 11-48          |
| 11-30            | 11-Bit Multidrop Mode.....   | 11-50          |
| 11-31            | Transmitting Data and Address Characters.....                        | 11-51          |
| 11-32            | Wired-OR Mode.....   | 11-52          |
| 11-33            | Idle Line Wakeup.....  | 11-54          |
| 11-34            | Address Mode Wakeup.....   | 11-55          |
| 11-35            | Multidrop Transmit/Receive Example.....                              | 11-57          |
| 11-36            | SCI Timer Operation.....   | 11-62          |
| 11-37            | SCI Timer Example.....   | 11-63          |
| 11-38            | Synchronous Mode Example.....  | 11-65          |
| 11-39            | Multimaster System Example.....                                      | 11-65          |
| 11-40            | Master-Slave System Example.....                                     | 11-66          |
| 11-41            | SSI Clock Generator Functional Block Diagram.....                    | 11-69          |
| 11-42            | SSI Frame Sync Generator Functional Block Diagram.....               | 11-70          |
| 11-43            | SSI Interface Programming Model — Control and Status Registers... .. | 11-73          |
| 11-44            | SSI Interface Programming Model.....                                 | 11-74          |
| 11-45            | Serial Control, Direction Bits.....                                  | 11-78          |
| 11-46            | Receive Data Path.....   | 11-85          |
| 11-47            | Transmit Data Path.....  | 11-86          |
| 11-48            | SSI Initialization Block Diagram.....                                | 11-89          |
| 11-49            | SSI CRA Initialization Procedure.....                                | 11-90          |
| 11-50            | SSI CRB Initialization Procedure.....                                | 11-91          |
| 11-51            | SSI Initialization Procedure.....                                    | 11-92          |
| 11-52            | SSI Exception Vector Locations.....                                  | 11-94          |
| 11-53            | SSI Exceptions.....  | 11-95          |
| 11-54            | CRB MOD Bit Operation.....   | 11-97          |

## LIST OF ILLUSTRATIONS (Concluded)

| Figure<br>Number | Title  | Page<br>Number |
|------------------|--|----------------|
| 11-55            | Normal Mode, External Frame Sync (8 Bit, 1 Word in Frame)..... | 11-98          |
| 11-56            | Network Mode (8 Bit, 2 Words in Frame).....                    | 11-98          |
| 11-57            | CRB GCK Bit Operation.....                                     | 11-100         |
| 11-58            | Continuous Clock Timing Diagram (8-Bit Example) .....          | 11-101         |
| 11-59            | Internally Generated Gated Clock Timing (8-Bit Example).....   | 11-102         |
| 11-60            | Externally Generated Gated Clock Timing (8-Bit Example) .....  | 11-103         |
| 11-61            | Synchronous Communication .....                                | 11-104         |
| 11-62            | CRB SYN Bit Operation.....                                     | 11-105         |
| 11-63            | Gated Clock — Synchronous Operation.....                       | 11-106         |
| 11-64            | Gated Clock — Asynchronous Operation .....                     | 11-106         |
| 11-65            | Continuous Clock — Synchronous Operation.....                  | 11-106         |
| 11-66            | Continuous Clock — Asynchronous Operation .....                | 11-106         |
| 11-67            | CRB FSL0 and FSL1 Bit Operation.....                           | 11-108         |
| 11-68            | Normal Mode Initialization for FSL1=0 and FSL0=0.....          | 11-109         |
| 11-69            | Normal Mode Initialization for FSL=1 and FSL0=0 .....          | 11-110         |
| 11-70            | CRB SHFD Bit Operation .....                                   | 11-111         |
| 11-71            | Normal Mode Example.....                                       | 11-113         |
| 11-72            | Normal Mode Transmit Example .....                             | 11-115         |
| 11-73            | Normal Mode Receive Example.....                               | 11-117         |
| 11-74            | Network Mode Example.....                                      | 11-118         |
| 11-75            | TDM Network Software Flowchart.....                            | 11-120         |
| 11-76            | Network Mode Initialization .....                              | 11-121         |
| 11-77            | Network Mode Transmit Example Program.....                     | 11-123         |
| 11-78            | Network Mode Receive Example Program .....                     | 11-125         |
| 11-79            | On-Demand Example .....  | 11-127         |
| 11-80            | On-Demand Data-Driven Network Mode.....                        | 11-129         |
| 11-81            | Clock Modes .....  | 11-130         |
| 11-82            | SPI Configuration .....  | 11-130         |
| 11-83            | On-Demand Mode Example — Hardware Configuration.....           | 11-131         |
| 11-84            | On-Demand Mode Transmit Example Program .....                  | 11-132         |
| 11-85            | On-Demand Mode Receive Example Program.....                    | 11-134         |
| 11-86            | Output Flag Timing.....  | 11-135         |
| 11-87            | Output Flag Example.....                                       | 11-136         |
| 11-88            | Output Flag Initialization .....                               | 11-137         |
| 11-89            | Input Flags.....   | 11-138         |
| 11-90            | SSI Cascaded Multi-DSP System.....                             | 11-138         |
| 11-91            | SSI TDM Parallel DSP Network.....                              | 11-140         |
| 11-92            | SSI TDM Connected Parallel Processing Array .....              | 11-141         |
| 11-93            | SSI TDM Serial/Parallel Processing Array.....                  | 11-142         |
| 11-94            | SSI Parallel Processing — Nearest Neighbor Array .....         | 11-143         |
| 11-95            | SSI TDM Bus DSP Network .....                                  | 11-144         |
| 11-96            | SSI TDM Master-Slave DSP Network .....                         | 11-145         |



## LIST OF TABLES

| Table<br>Number | Title   | Page<br>Number |
|-----------------|---|----------------|
| 1-1             | Benchmark Summary in Instruction Cycles.....                                    | 1-4            |
| 2-1             | Program and Data Memory Select Encoding.....                                    | 2-10           |
| 3-1             | Initial DSP56000 Operating Mode Summary .....                                   | 3-3            |
| 3-2             | Initial DSP56001 Operating Mode Summary .....                                   | 3-9            |
| 4-1             | Limited Data Values .....   | 4-8            |
| 5-1             | Address Register Indirect Summary .....   | 5-6            |
| 5-2             | Linear Address Modifiers.....   | 5-14           |
| 5-3             | Modulo Address Modifiers.....   | 5-17           |
| 5-4             | Reverse-Carry Address Modifiers.....  | 5-17           |
| 5-5             | Bit-Reverse Addressing Sequence Example .....                                   | 5-18           |
| 5-6             | Address-Modifier-Type Encoding Summary.....                                     | 5-20           |
| 6-1             | Interrupt Sources.....  | 6-4            |
| 6-2             | DSP56000/DSP56001 Operating Mode Summary.....                                   | 6-12           |
| 6-3             | DSP56000/DSP56001 DE Memory Control.....  | 6-13           |
| 7-1             | Addressing Modes Summary .....  | 7-18           |
| 8-1             | Instruction Pipelining .....  | 8-1            |
| 8-2             | Interrupt Sources.....  | 8-10           |
| 8-3             | Status Register Interrupt Mask Bits .....                                       | 8-16           |
| 8-4             | Interrupt Priority Level Bits .....   | 8-17           |
| 8-5             | External Interrupt Trigger Mode Bits .....                                      | 8-17           |
| 8-6             | Exception Priorities within an IPL .....  | 8-17           |
| 8-7             | HI Reset Effects — DSP56000/DSP56001 Programming Model.....                     | 8-32           |
| 8-8             | HI Reset Effects — Host Processor Programming Model.....                        | 8-33           |
| 8-9             | SSI Reset Effects.....  | 8-34           |
| 8-10            | SCI Reset Effects.....  | 8-35           |
| 8-11            | Ports A, B, and C Reset Effects.....  | 8-36           |
| 8-12            | $\overline{BR}/\overline{BG}$ During WAIT .....                                 | 8-38           |
| 9-1             | Program and Data Memory Select Encoding.....                                    | 9-5            |
| 9-2             | Power Requirements for Minimum and Maximum External Memory<br>Wait States ..... | 9-12           |
| 9-3             | Wait State Control.....   | 9-15           |

## LIST OF TABLES (Continued)

| Table<br>Number | Title   | Page<br>Number |
|-----------------|---|----------------|
| 10-1            | Host Registers after Reset — DSP CPU Side .....           | 10-15          |
| 10-2            | $\overline{\text{HREQ}}$ Pin Definition .....             | 10-19          |
| 10-3            | Host Mode Bit Definition .....                            | 10-20          |
| 10-4            | $\overline{\text{HREQ}}$ Pin Definition .....             | 10-21          |
| 10-5            | Host Registers after Reset (Host Side) .....              | 10-26          |
|                 |   |                |
| 11-1            | SCI Registers after Reset .....                           | 11-27          |
| 11-2(a)         | Asynchronous SCI Baud Rates for a 20.48-MHz Crystal ..... | 11-31          |
| 11-2(b)         | Frequencies for Exact Asynchronous SCI Baud Rates.....    | 11-31          |
| 11-3(a)         | Synchronous SCI Baud Rates for a 20.48-MHz Crystal .....  | 11-32          |
| 11-3(b)         | Frequencies for Exact Synchronous SCI Baud Rates .....    | 11-32          |
| 11-4            | Definition of SC0, SC1, SC2, and SCK.....                 | 11-68          |
| 11-5            | SSI Clock Sources, Inputs, and Outputs .....              | 11-70          |
| 11-6            | Mode and Pin Definition Table — Continuous Clock .....    | 11-87          |
| 11-7            | Mode and Pin Definition Table — Gated Clock .....         | 11-88          |
| 11-8            | SSI Registers after Reset .....                           | 11-89          |
| 11-9(a)         | SSI Baud Rates for a 20.48-MHz Crystal .....              | 11-93          |
| 11-9(b)         | SSI Baud Rates for a 26.624-MHz Crystal.....              | 11-93          |
| 11-10           | Crystal Frequencies Required for Codecs .....             | 11-93          |
| 11-11           | SSI Operating Modes.....                                  | 11-96          |

## SECTION 1 INTRODUCTION

The DSP56001 and DSP56000, user-programmable, CMOS digital signal processors (DSPs), are optimized to execute DSP algorithms in as few operations as possible while maintaining a high degree of accuracy. The architecture has been designed to maximize throughput in data-intensive DSP applications. This design has resulted in a dual-natured, expandable architecture with sophisticated on-chip peripherals and general-purpose I/O. The architecture, on-chip peripherals, and the low power consumption of the DSP56000/DSP56001 have minimized the complexity, cost, and design time needed to add the power of DSP to any design.

Being read-only memory (ROM) based, the DSP56000 is factory programmed with user software for minimum cost in high-volume applications. Being random-access memory (RAM) based, the DSP56001 is an off-the-shelf processor designed to load its program from an external source. The difference between the two processors is the on-chip memory resources. A secure version of the DSP56000, which prevents unauthorized access to the internal program memory, is also available.

This manual is written for both the DSP56000 and DSP56001. Normally, the reference will be to the DSP56000/DSP56001; however, when the two processors differ, they will be cited individually.

### 1.1 ORIGIN OF THE DSP56000 ARCHITECTURE

DSP is the arithmetic processing of real-time signals sampled at regular intervals and digitized. Examples of DSP processing are as follows:

- Filtering of Signals
- Convolution, Which Is the Mixing of Two Signals
- Correlation, Which Is a Comparison of Two Signals
- Rectification of a Signal
- Amplification of a Signal
- Transformation of a Signal

All of these functions have traditionally been performed using analog circuits. Only recently has technology provided the processing power necessary to digitally perform these and other functions using DSPs.

Figure 1-1 is a graphical description of analog signal processing. The circuit filters a signal from a sensor using an operational amplifier and controls an actuator with the result. Since the ideal filter is not possible to design, the engineer must design the filter for acceptable

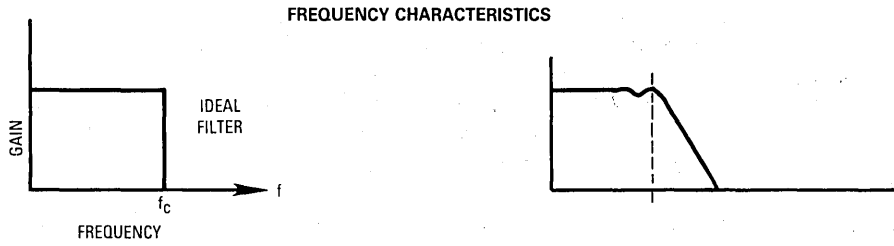
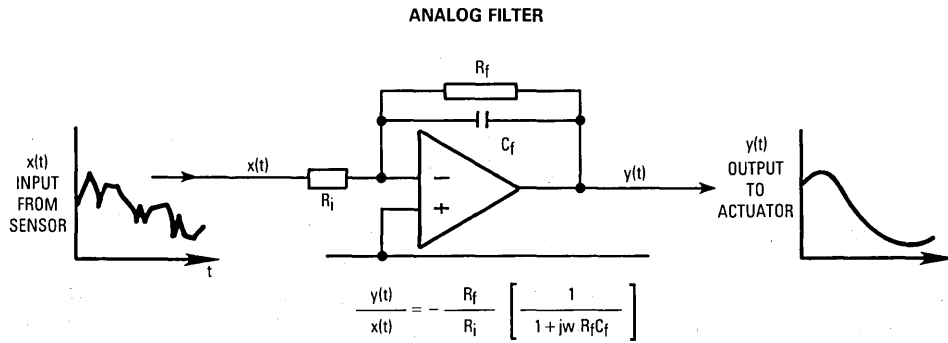

**Figure 1-1. Analog Signal Processing**

response, considering variations in temperature, component aging, power-supply variation, and component accuracy. The resulting circuit typically has low noise immunity, requires adjustments, and is difficult to modify.

The equivalent circuit using a DSP is shown in Figure 1-2. This application requires an analog-to-digital (A/D) converter and digital-to-analog (D/A) converter in addition to the DSP. Even with these additional parts, the component count can be lower using a DSP due to the high integration available with current components.

Processing in this circuit begins by band limiting the input with an antialias filter, eliminating out-of-band signals that can be aliased back into the pass band due to the sampling process. The signal is then sampled, digitized with an A/D converter, and then sent to the DSP.

The filter implemented by the DSP is strictly a matter of software. The DSP can directly implement any filter that can be implemented using analog techniques. Also, adaptive filters can be easily implemented using DSP; whereas, these filters are extremely difficult to implement using analog techniques.

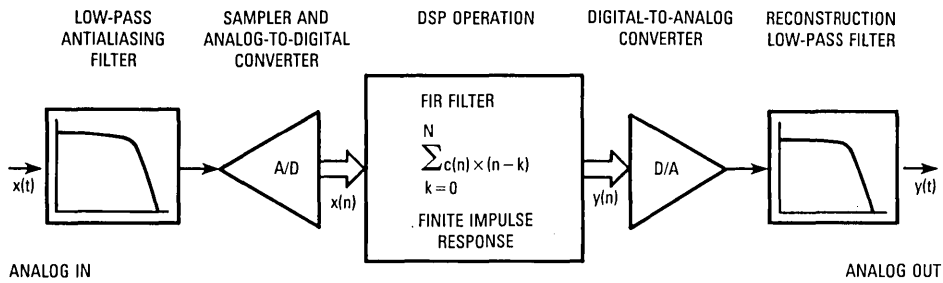

1

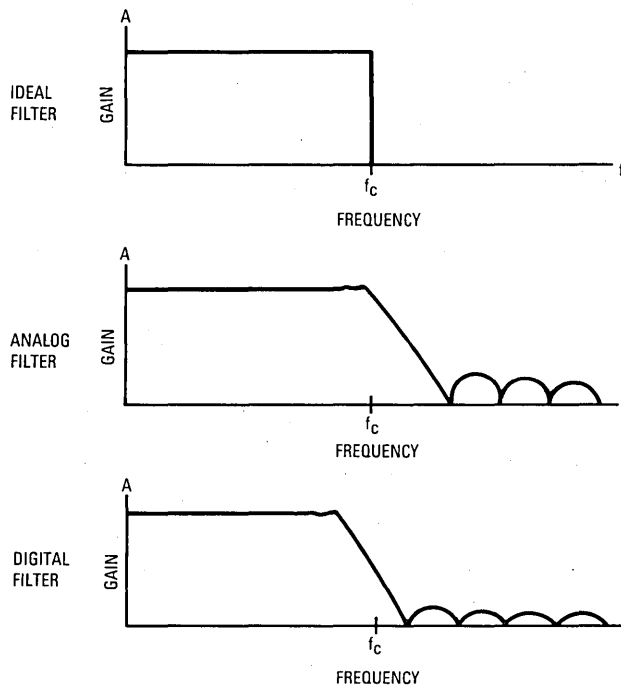

Figure 1-2. Digital Signal Processing

The DSP output is processed by a D/A converter and is low-pass filtered to remove the effects of digitizing. In summary, the advantages of using the DSP include the following:

- Fewer Components
- Stable, Deterministic Performance
- Wide Range of Application
- High Noise Immunity and Power-Supply Rejection
- Self-Test Can Be Built In

No Filter Adjustments  
 Filters with Much Closer Tolerances  
 Adaptive Filters Easily Implemented

1

The DSP56000/DSP5001 was not designed for a particular application but was designed to execute commonly used DSP benchmarks in a minimum time for a single-multiplier architecture. For example, a cascaded, 2<sup>nd</sup>-order, four-coefficient infinite impulse response (IIR) biquad section has four multiplies for each section. For that algorithm, the theoretical minimum number of operations for a single-multiplier architecture is four per section. Table 1-1 shows a list of benchmarks with the number of instruction cycles the DSP56000/DSP56001 uses compared to the number of multiplies in the algorithm.

**Table 1-1. Benchmark Summary in Instruction Cycles**

| Benchmark                                 | DSP56000/DSP56001<br>Number of Cycles | Number of Algorithm<br>Multiplies |
|---|---------------------------------------|-----------------------------------|
| Real Multiply                             | 3                                     | 1                                 |
| N Real Multiplies                         | 2N                                    | N                                 |
| Real Update                               | 4                                     | 1                                 |
| N Real Updates                            | 2N                                    | N                                 |
| N Term Real Convolution (FIR)             | N                                     | N                                 |
| N Term Real * Complex Convolution         | 2N                                    | N                                 |
| Complex Multiply                          | 6                                     | 4                                 |
| N Complex Multiplies                      | 4N                                    | N                                 |
| Complex Update                            | 7                                     | 4                                 |
| N Complex Updates                         | 4N                                    | 4N                                |
| N Term Complex Convolution (FIR)          | 4N                                    | 4N                                |
| N <sup>th</sup> -Order Power Series       | 2N                                    | 2N                                |
| 2 <sup>nd</sup> -Order Real Biquad Filter | 7                                     | 4                                 |
| N Cascaded 2 <sup>nd</sup> -Order Biquads | 4N                                    | 4N                                |
| N Radix Two FFT Butterflies               | 6N                                    | 4N                                |

These benchmarks and others are used independently or in combination to implement functions. The characteristics of these functions are controlled by the coefficients of the benchmarks being executed. Useful functions using these and other benchmarks include the following:

**Digital Filtering**

- Finite Impulse Response (FIR)
- Infinite Impulse Response (IIR)
- Matched Filters (Correlators)
- Hilbert Transforms
- Windowing
- Adaptive Filters/Equalizers

**Signal Processing**

- Compression (e.g., Linear Predictive Coding of Speech Signals)
- Expansion
- Averaging
- Energy Calculations
- Homomorphic Processing
- Mu-law/A-law to/from Linear Data Conversion

**Data Processing**

- Encryption/Scrambling
- Encoding (e.g., Trellis Coding)
- Decoding (e.g., Viterbi Decoding)

**Numeric Processing**

- Scaler, Vector, and Matrix Arithmetic
- Transcendental Function Computation (e.g., Sin(X), Exp(X))
- Other Nonlinear Functions
- Pseudo-Random-Number Generation

**Modulation**

- Amplitude
- Frequency
- Phase

**Spectral Analysis**

- Fast Fourier Transform (FFT)
- Discrete Fourier Transform (DFT)
- Sine/Cosine Transforms
- Moving Average (MA) Modeling
- Autoregressive (AR) Modeling
- ARMA Modeling

Useful applications are based on combining these and other functions. DSP applications affect almost every area in electronics because any application for analog electronic circuitry can be duplicated using DSP. The advantages in doing so are becoming more compelling as DSPs become faster and more cost effective. DSPs are also being used as high-speed math processors in many purely digital computer applications. Some typical applications for DSPs are presented in the following list:

**Telecommunication**

- Tone Generation
- Dual-Tone Multifrequency (DTMF)
- Subscriber Line Interface
- Full-Duplex Speakerphone
- Teleconferencing
- Voice Mail
- Adaptive Differential Pulse Code Modulation (ADPCM) Transcoder
- Medium-Rate Vocoders
- Noise Cancelation
- Repeaters
- Integrated Services Digital Network (ISDN) Transceivers
- Secure Telephones

- Personal Computers
- Graphics Accelerators

**Image Processing**

- Pattern Recognition
- Optical Character Recognition
- Image Restoration
- Image Compression
- Image Enhancement
- Robot Vision

**Graphics**

- 3-D Rendering
- Computer-Aided Engineering (CAE)
- Desktop Publishing
- Animation

**Data Communication**

- High-Speed Modems
- Multiple Bit-Rate Modems
- High-Speed Facsimile

**Instrumentation**

- Spectral Analysis
- Waveform Generation
- Transient Analysis
- Data Acquisition

**Radio Communication**

- Secure Communications
- Point-to-Point Communications
- Broadcast Communications
- Cellular Mobile Telephone

**Speech Processing**

- Speech Synthesizer
- Speech Recognizer
- Voice Mail
- Vocoder
- Speaker Authentication
- Speaker Verification

**Computer**

- Array Processors
- Work Stations

**Audio Signal Processing**

- Digital AM/FM Radio
- Digital Hi-Fi Preamplifier
- Noise Cancellation
- Music Synthesis
- Music Processing
- Acoustic Equalizer

**High-Speed Control**

- Laser-Printer Servo
- Hard-Disk Servo
- Robotics
- Motor Controller
- Position and Rate Controller

**Vibration Analysis**

- Electric Motors
- Jet Engines
- Turbines

**Medical Electronics**

- Cat Scanners
- Sonographs
- X-Ray Analysis
- Electrocardiogram
- Electroencephalogram
- Nuclear Magnetic Resonance Analysis

**Digital Video**

- Digital Television
- High-Resolution Monitors

**Radar and Sonar Processing**

- Navigation
- Oceanography
- Automatic Vehicle Location
- Search and Tracking

**Seismic Processing**

- Oil Exploration
- Geological Exploration

As evidenced in Figure 1-3, the keys to DSP are as follows:

- The Multiply/Accumulate (MAC) Operation
- Fetching Operands for the MAC
- Program Control To Provide Versatile Operation
- Input/Output To Move Data In and Out of the DSP

MAC is the basic operation used in DSP. Figure 1-3 shows how the architecture of the DSP56000/DSP56001 was designed to match the shape of the MAC operation. The two operands, C() and X(), are directed to a multiply operation, and the result is summed. This process is built into the DSP56000/DSP56001 by using two separate memories (X and Y) to feed a single-cycle MAC. The entire process must occur under program control to direct the correct operands to the multiplier and save the accumulator as needed. Since the two memories and the MAC are independent, it is possible to perform two moves, a multiply and an accumulate, in a single operation. As a result, many of the benchmarks shown in Table 1-1 can be executed at or near the theoretical maximum speed for a single-multiplier architecture.

Figure 1-4 shows how the MAC, memories, and program controller in Figure 1-3 are configured in the DSP56000/DSP56001. Three independent memories and memory buses are used to move two operands to the MAC while concurrently fetching a program instruction. The address generation unit (AGU) is divided into two arithmetic units used to independently control the X and Y memories and feed operands to the MAC. An additional block labeled I/O is shown in Figure 1-4. Many DSPs need additional parts to interface with their input and output circuits (such as A/D converters, D/A converters, or host processors). The DSP56000/DSP56001 provides on-chip serial and parallel interfaces to simplify this connection problem. Figure 1-5 is a block diagram of the DSP56000 showing all the major



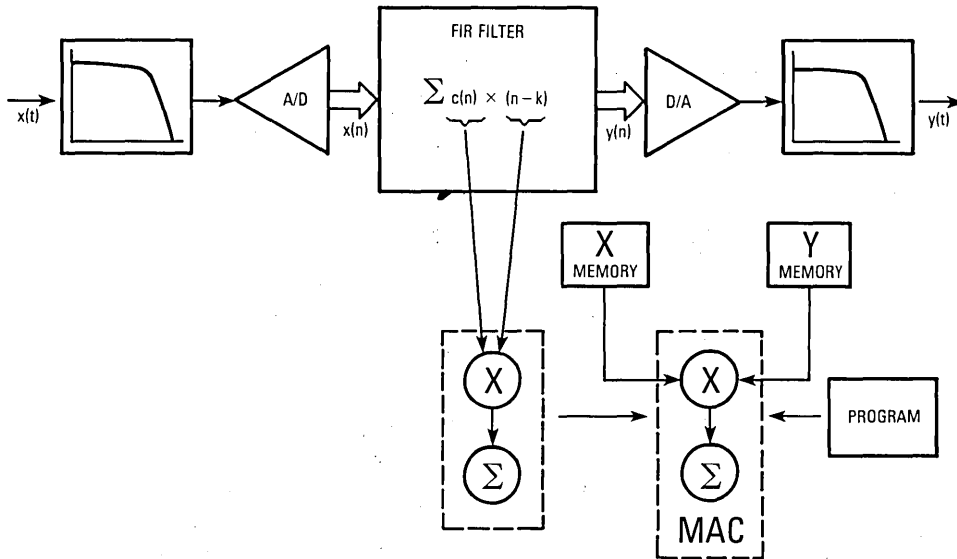

Figure 1-3. DSP Hardware Origins

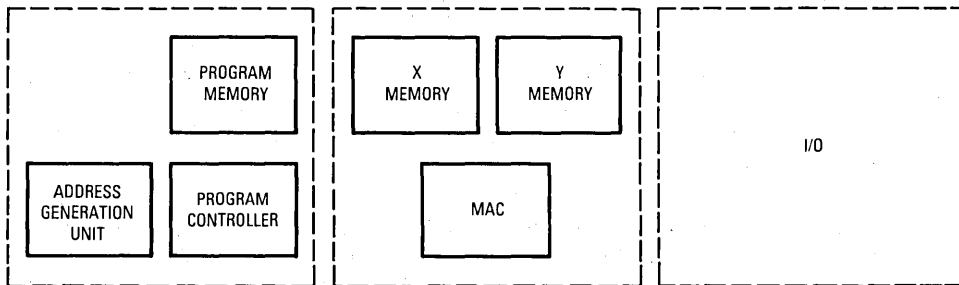

Figure 1-4. DSP Block Diagram

blocks with their interconnecting buses. The DSP56000 Family of processors has a dual Harvard architecture optimized for MAC operations.

## 1.2 SUMMARY OF DSP56000 FAMILY FEATURES

The DSP56000 and DSP56001 are the first two members of Motorola's Family of HCMOS, low-power, general-purpose DSPs. The DSP56001 features 512 words of full-speed, on-chip, program RAM, two preprogrammed data ROMs, and special on-chip bootstrap

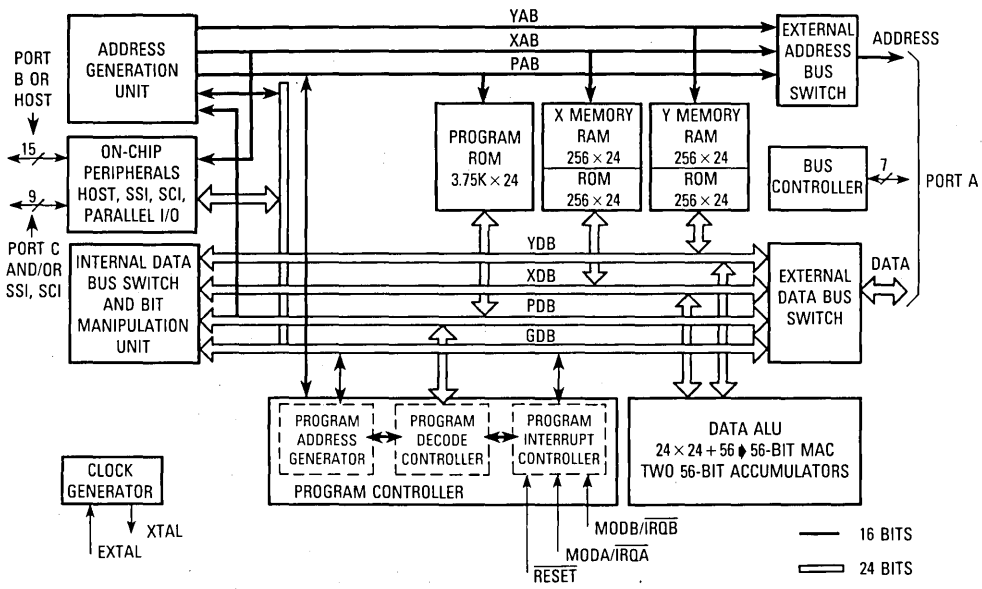

Figure 1-5. DSP56000 Block Diagram

hardware to permit convenient loading of user programs into the program RAM. The DSP56001 is an off-the-shelf part since there are no user-programmable, on-chip ROMs. The DSP56000 features 3.75K words of full-speed, on-chip, program ROM instead of 512 words of program RAM.

The heart of the processor consists of three execution units operating in parallel: the data arithmetic logic unit (ALU), the AGU, and the program controller. The DSP56000/DSP56001 has MCU-style on-chip peripherals, program memory, data memory, and a memory expansion port. The MPU-style programming model and instruction set allow straightforward generation of efficient, compact code.

The high throughput of the DSP56000/DSP56001 makes it well-suited for communication, high-speed control, numeric processing, computer applications, and audio applications. The main features facilitating this throughput are as follows:

- **Speed** — At 10.25 million instructions per second (MIPS), the DSP56000/DSP56001 can execute a 1024-point complex FFT in 3.23 ms.
- **Precision** — The data paths are 24 bits wide, providing 144 dB of dynamic range; intermediate results held in the 56-bit accumulators can range over 336 dB.
- **Parallelism** — Each on-chip execution unit (AGU, program controller, data ALU), memory, and peripheral operates independently and in parallel with the other units through

a sophisticated bus system. The data ALU, AGUs, and program controller operate in parallel so that an instruction prefetch, a 24-bit  $\times$  24-bit multiplication, a 56-bit addition, two data moves, and two address-pointer updates using one of three types of arithmetic (linear, modulo, or reverse-carry) can be executed in a single instruction cycle. This parallelism allows a four-coefficient IIR filter section to be executed in only four cycles, the theoretical minimum for single-multiplier architecture. At the same time, the two serial controllers can send and receive full-duplex data, and the host port can send/receive simplex data.

- **Integration** — In addition to the three independent execution units, the DSP56000/DSP56001 has six on-chip memories, three on-chip MCU-style peripherals (serial communication interface (SCI), synchronous serial interface (SSI), and host interface), a clock generator, and seven buses (three address and four data), making the overall system low cost, low power, and compact.
- **Invisible Pipeline** — The three-stage instruction pipeline is essentially invisible to the programmer, allowing straightforward program development in either assembly language or a high-level language such as a full Kernighan and Ritchie C.
- **Instruction Set** — The 62 instruction mnemonics are MCU-like, making the transition from programming microprocessors to programming the DSP56000/DSP56001 as easy as possible. The orthogonal syntax supports controlling the parallel execution units. The hardware DO loop instruction and the repeat (REP) instruction make writing straightline code obsolete.
- **DSP56000/DSP56001 Compatibility** — The DSP56001 is identical to the DSP56000 except for the following features:
  - 512-word  $\times$  24-bit, on-chip program RAM instead of 3.75K program ROM
  - 32-word  $\times$  24-bit bootstrap ROM for loading the program RAM from either a byte-wide, memory-mapped ROM or via the host interface
  - On-chip X and Y data ROMs preprogrammed as positive Mu-law and A-law to linear expansion tables and a full, four-quadrant sine-wave table, respectively
- **Low Power** — As a CMOS part, the DSP56000/DSP56001 is inherently very low power; however, three other features can reduce power consumption to exceptionally low levels.
  - The WAIT instruction shuts off the clock in the central processor portion of the DSP56000/DSP56001.
  - The STOP instruction halts the internal oscillator.
  - Power increases linearly (approximately) with frequency; thus, reducing the clock frequency reduces power consumption.

### 1.3 MANUAL ORGANIZATION

This manual is intended to provide practical information to help the user:

- Understand the Operation of the DSP56000 Family
- Interface the DSP56000 Family with Additional Memory
- Design Parallel Communication Links

Design Serial Communication Links  
Code DSP Algorithms  
Code Communication Routines  
Code Data-Manipulation Algorithms  
Locate Additional Support

1

The following list is a brief description of the contents of each section and each appendix:

#### Section 2. Architectural Overview and Bus Structure

A brief description of each subsystem of the DSP56000/DSP56001 is given. The buses interconnecting the major components in the DSP56000/DSP56001 are described in detail.

#### Section 3. Memory

This section describes and differentiates the memory for the DSP56000 and DSP56001. It describes the program memories, data memories, and the operating mode register (OMR) bits controlling the memory maps.

#### Section 4. Data Arithmetic Logic Unit

This section describes in detail the data ALU (one of the three execution units comprising the central processor) and its programming model.

#### Section 5. Address Generation Unit

This section specifically describes the AGU (one of the three execution units comprising the central processor), its programming model, address indirect modes, and address modifiers.

#### Section 6. Program Controller

This section describes in detail the program controller (one of the three execution units comprising the central processor) and its programming model.

#### Section 7. Instruction Set Introduction

A brief description of the syntax, instruction formats, operand/memory references, data organization, addressing modes, and instruction set is presented in this section. A detailed description of each instruction is given in **APPENDIX A INSTRUCTION SET DETAILS**.

#### Section 8. Processing States.

The five processing states (normal, exception, reset, wait, and stop) are described in this section.

#### Section 9. Port A

The port A section describes the external memory port, its control register, and control signals.

## Section 10. Port B

This section describes the port B parallel I/O, host interface, their registers, and the controls to enable/disable them.

## Section 11. Port C

This section describes the port C parallel I/O, SCI, SSI, their registers, and the controls to enable/disable them.

## Appendix A. Instruction Set Details

A detailed description of each DSP56000/DSP56001 instruction, its use, and its affect on the processor are presented.

## Appendix B. Benchmarks

DSP56000/DSP56001 benchmark results are listed in this appendix.

## Appendix C. Additional Support

This appendix presents a brief description of current support products and services and information on where to obtain them.



## SECTION 2

# ARCHITECTURAL OVERVIEW AND BUS STRUCTURE

The DSP56000/DSP56001 architecture has been designed to maximize throughput in data-intensive digital signal processor (DSP) applications. This objective has resulted in a dual-natured, expandable architecture with sophisticated on-chip peripherals and general-purpose I/O. The architecture is dual natured in that there are two independent, expandable data memory spaces, two address generation units (AGUs), and a data arithmetic logic unit (ALU) having two accumulators and two shifter/limiter circuits. The duality of the architecture facilitates writing software for DSP applications. For example, data is naturally partitioned into X and Y spaces for graphics and image-processing applications, into coefficient and data spaces for filtering applications, and into real and imaginary spaces for performing complex arithmetic.

The major components of the DSP56000/DSP56001 are as follows:

- Data Buses
- Address Buses
- Data ALU
- AGU
- X Data Memory
- Y Data Memory
- Program Controller
- Program Memory
- Input/Output:
  - Memory Expansion (Port A)
  - General-Purpose I/O (Ports B and C)
  - Host Interface
  - Serial Communication Interface (SCI)
  - Synchronous Serial Interface (SSI)

These components are depicted in Figure 2-1 for the DSP56000 and in Figure 2-2 for the DSP56001. A brief description is given for each component in the following paragraphs. The processors differ only in the on-chip memory resources.

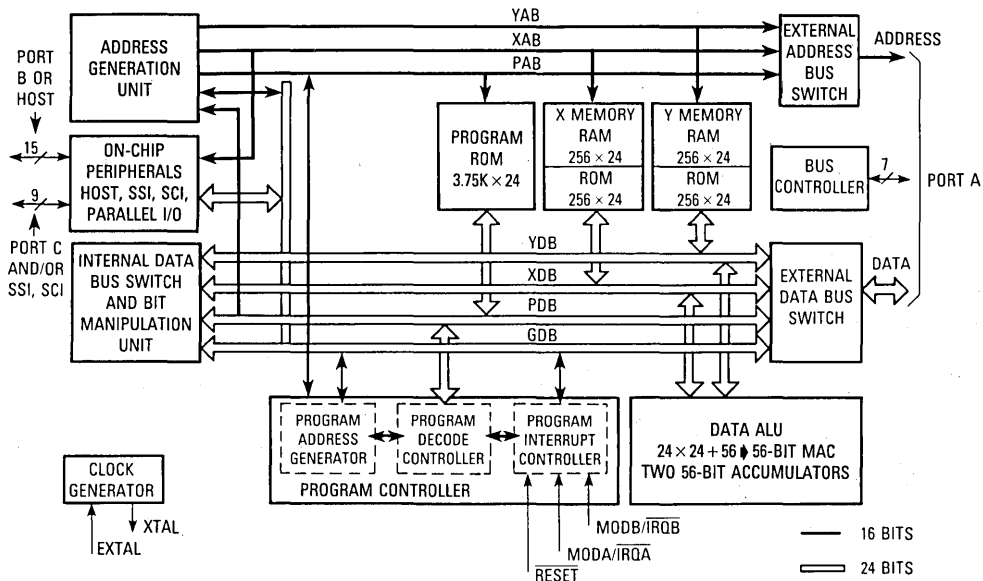

Figure 2-1. DSP56000 Block Diagram

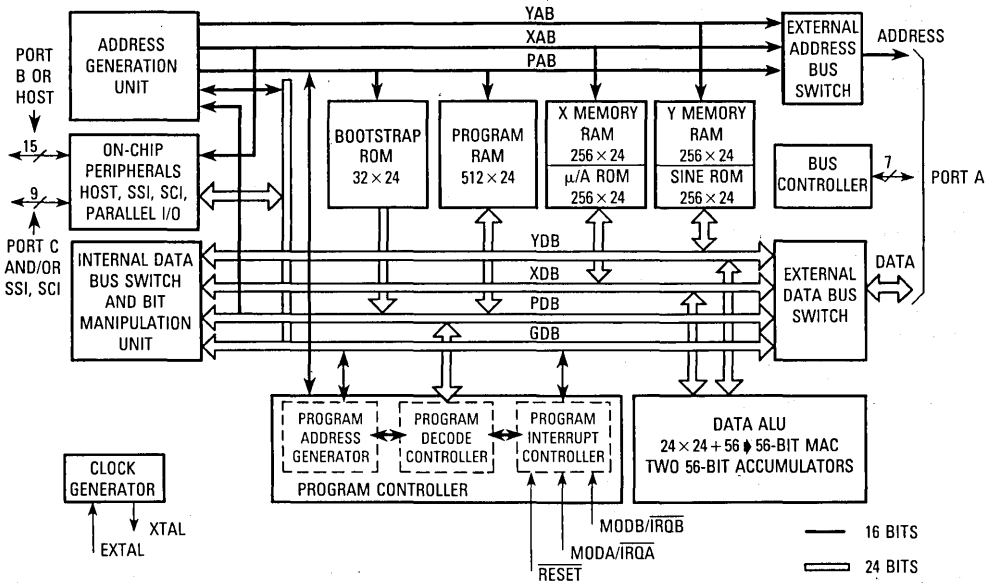

Figure 2-2. DSP56001 Block Diagram



## 2.1 DATA BUSES

The DSP56000/DSP56001 is organized around the registers of a central processor composed of three independent execution units. The buses move data and instructions while instructions are being executed inside the execution units. Data movement on the chip occurs over four, bidirectional, 24-bit buses: the X data bus (XDB), the Y data bus (YDB), the program data bus (PDB), and the global data bus (GDB). The X and Y data buses may also be treated by certain instructions as one 48-bit data bus by concatenation of XDB and YDB. Data transfers between the data ALU and the X data memory or Y data memory occur over XDB and YDB, respectively. XDB and YDB are kept local on the chip to maximize speed and minimize power dissipation. All other data transfers, such as I/O transfers with peripherals, occur over the GDB. Instruction word prefetches occur in parallel over the PDB. The bus structure supports general register-to-register, register-to-memory, and memory-to-register data movement and can transfer up to two 24-bit words and one 56-bit word in the same instruction cycle. Transfers between buses are accomplished in the internal bus switch.

## 2.2 ADDRESS BUSES

Addresses are specified for internal X data memory and Y data memory on two, unidirectional, 16-bit buses — X address bus (XAB) and Y address bus (YAB). Program memory addresses are specified on the bidirectional program address bus (PAB). External memory spaces are addressed via a single 16-bit, unidirectional address bus driven by a three-input multiplexer that can select the XAB, the YAB, or the PAB. Only one external memory access can be made in an instruction cycle. There is no speed penalty if only one external memory space is accessed in an instruction cycle. If two or three external memory spaces are accessed in a single instruction, there will be a one- or two-instruction-cycle execution delay, respectively. A bus arbitrator controls external access.

### 2.2.1 Internal Bus Switch

Transfers between buses are accomplished in the internal bus switch. The internal bus switch, which is similar to a switch matrix, can connect any two internal buses without adding any pipeline delays. This flexibility simplifies programming.

### 2.2.2 Bit Manipulation Unit

The bit manipulation unit is physically located in the internal bus switch block because the internal data bus switch can access each memory space. The bit manipulation unit performs bit manipulation operations on memory locations, address registers, control registers, and data registers via the XDB, YDB, and GDB.

## 2.3 DATA ALU

The data ALU has been designed to be fast and to provide the capability of processing signals having a wide dynamic range. Special circuitry has been provided to facilitate handling data overflows and roundoff errors.

2

The data ALU performs all of the arithmetic and logical operations on data operands. It consists of four 24-bit input registers, two 48-bit accumulator registers, two 8-bit accumulator extension registers, an accumulator shifter, two data bus shifter/limiter circuits, and a parallel, single-cycle, nonpipelined multiply-accumulator (MAC) unit. Data ALU operations use fractional twos-complement arithmetic. Data ALU registers may be read or written over XDB and YDB as 24- or 48-bit operands. The data ALU is capable of performing any of the following operations in a single instruction cycle — multiplication, multiply-accumulate with positive or negative accumulation, convergent rounding, multiply-accumulate with positive or negative accumulation and convergent rounding, addition, subtraction, a divide iteration, a normalization iteration, shifting, and logical operations. Data ALU source operands, which may be 24, 48, or, in some cases, 56 bits, always originate from data ALU registers. Arithmetic operations always have a 56-bit result stored in an accumulator; whereas, logical operations are performed on 24-bit operands, yielding 24-bit results in one of the two accumulators.

The 24-bit data word provides 144 dB of dynamic range, which is sufficient for most real-world applications since the majority of data converters are 16 bits or less, and certainly not greater than 24 bits. The 56-bit accumulation internal to the data ALU provides 336 dB of internal dynamic range so no loss of precision will occur due to intermediate processing.

The data shifter/limiter circuits provide special postprocessing on data read from the ALU accumulator registers A and B out to the XDB or YDB. The data shifters can shift data one bit to the left or one bit to the right as well as pass the data unshifted. Each data shifter has a 24-bit output with overflow indication. The data shifters are controlled by the scaling mode bits in the status register. These shifters permit dynamic scaling of fixed-point data without modifying the program code, which allows block floating-point algorithms to be implemented in a regular fashion. For example, fast Fourier transform (FFT) routines can use this feature to selectively scale each butterfly pass.

Saturation arithmetic is provided to minimize errors due to overflow. Overflow occurs when a source operand requires more bits for accurate representation than are available in the destination. To minimize error due to overflow, the DSP56000 writes the maximum (or "limited") signed value the destination can assume when an overflow condition is detected.

In the DSP56000/DSP56001, the data ALU accumulators A and B have extension registers that are used when more than 48-bit accuracy is needed. Therefore, when the extension registers are in use and either A or B is the source being read over XDB or YDB, limiting will occur. In the DSP56000/DSP56001, the limiters place a "limited" value on XDB or YDB. Limiting is performed on the contents of A or B after the contents have been shifted in the

shifter. There are two limiters allowing two-word operands to be limited independently in the same instruction cycle. The two data limiters can also be concatenated to form one 48-bit data limiter for long-word operands.

## 2.4 ADDRESS GENERATION UNIT

All of the address storage and effective address calculations necessary to indirectly address data operands in memory are performed in the AGU. This unit operates in parallel with other chip resources to minimize address-generation overhead. The AGU contains eight address registers (R0–R7), eight offset registers (N0–N7), and eight modifier registers (M0–M7). Rn are 16-bit registers that may contain an address or data. The contents of each Rn may be output to the XAB (65,536 locations), YAB (65,536 locations), or PAB (65,536 locations); thus, 196,608 24-bit data words can be directly addressed. Nn and Mn, which are 16-bit registers normally used in updating or modifying Rn registers, can also be used to store 16-bit data. The AGU registers may be read or written via the GDB as 16-bit operands.

The AGU has two identical address arithmetic units that can generate two 16-bit addresses every instruction cycle — one for any two of the XAB, YAB, or PAB buses. Each of the arithmetic units can implement three types of arithmetic: linear, modulo, and reverse-carry.

## 2.5 X DATA MEMORY

The on-chip X data random-access memory (RAM), a 24-bit-wide internal static memory, occupies the lowest 256 locations in X memory space. The on-chip X data read-only memory (ROM) occupies locations 256–511. On the DSP56001, the X data ROM has been programmed as positive Mu-law (128 locations) and A-law (128 locations) 24-bit companding tables useful in telecommunication applications. On the DSP56000, the X data ROM is user defined. The on-chip peripherals occupy the top 64 locations in X data memory space. Addresses are received from the XAB, and data transfers to the data ALU occur on the XDB. X memory may be expanded off-chip so that a total of 65,536 locations can be addressed.

## 2.6 Y DATA MEMORY

The on-chip Y data RAM, a 24-bit-wide internal static memory, occupies the lowest 256 locations in Y memory space. The on-chip Y data ROM occupies locations 256–511. On the DSP56001, the Y data ROM has been programmed as a full, four-quadrant, 24-bit sine table. On the DSP56000, the Y data ROM is user defined. The off-chip peripherals are optimally mapped into the top 64 locations in Y data memory space. Addresses are received from the YAB, and data transfers to the data ALU occur on the YDB. Y memory may be expanded off-chip so that a total of 65,536 locations can be addressed.

## 2.7 PROGRAM MEMORY

The on-chip program memory consists of a 3.75K-word by 24-bit ROM for the DSP56000 or a 512-word by 24-bit RAM for the DSP56001. Addresses are received from the program control logic (usually the program counter). The interrupt vector addresses for the on-chip resources are located in the bottom 64 locations of program memory. Program memory may be expanded off-chip so that a total of 65,536 locations can be addressed.

Bootstrap ROM is a 32-word by 24-bit factory-programmed ROM used only in the bootstrap mode (operating mode 1). The user can invoke bootstrap ROM only on the DSP56001; it is not available on the DSP56000. More detailed information on bootstrap ROM is discussed in the *DSP56001 Advance Information Data Sheet* (ADI1290).

## 2.8 PROGRAM CONTROLLER

The program controller performs instruction prefetch, instruction decoding, hardware DO loop control, and exception processing. The program controller contains a 15-level by 32-bit system stack memory and six directly addressable registers: the program counter (PC), loop address (LA), loop counter (LC), status register (SR), operating mode register (OMR), and stack pointer (SP). The 16-bit PC can address 65,536 locations in program memory space.

## 2.9 INPUT/OUTPUT

The I/O capability of the DSP56000/DSP56001 is extensive and advanced. This I/O structure facilitates interfacing into a variety of system configurations, including multiple DSP56000/DSP56001 systems with or without a host processor, global bus systems with bus arbitration, and many serial configurations, all with minimal additional "glue" logic. Each I/O interface, which has its own control, status, and data registers, is treated as memory-mapped I/O by the DSP56000/DSP56001. Each interface has several dedicated interrupt vector addresses and control bits to enable/disable interrupts, which minimizes the overhead associated with servicing the device since each interrupt source can have its own service routine. The interrupt sources can be programmed to one of three maskable priority levels.

The I/O structure consists of an extremely flexible, 47-pin expansion port (port A) and 24 additional I/O pins. These pins may be used as general-purpose I/O pins, called port B and port C, or allocated to on-chip peripherals under software control. Three on-chip peripherals are provided on the DSP56000/DSP56001: an 8-bit parallel host microprocessor unit/direct memory access (MPU/DMA) interface, an SCI, and an SSI. Port B is a 15-bit I/O interface that may be used as general-purpose I/O pins or as host MPU/DMA interface pins. Port C is a 9-bit I/O interface that may be used as general-purpose I/O pins or as SCI and SSI pins. These interfaces are described in the following paragraphs.

### 2.9.1 Expansion Port (Port A)

DSP56000/DSP56001 expansion port is designed to synchronously interface over a common 24-bit data bus having a wide variety of memory and peripheral devices. These devices include high-speed static RAMs, slower memory devices, and other DSPs and MPUs in master/slave configurations. This variety is possible because the expansion bus timing is programmable. Two pins can be defined with a control bit to operate either master processor controls (called bus strobe and wait in this configuration) or as slave processor controls (called bus request and bus grant). The expansion bus timing can also be controlled by a bus control register (BCR). The BCR controls the timing of the bus interface signals,  $\overline{RD}$  and  $\overline{WR}$ , and the data output lines. Each of the four memory spaces, X data, Y data, program data, and I/O, has its own 4-bit register in the BCR that can be programmed for inserting up to 15 wait states (one wait state is equal to a clock period or equivalently one-half of an instruction cycle). Thus, external bus timing can be tailored to match the speed requirements of the different memory spaces.

### 2.9.2 General-Purpose I/O (Ports B and C)

Each port B and port C pin may be programmed as a general-purpose I/O pin or as a dedicated, on-chip peripheral pin under software control. A 9-bit port C control register (PCC) allows each port C pin to be programmed for one of these two functions. The port control register associated with port B (PBC) contains only one bit, which programs all 15 pins. Also associated with each general-purpose port is a data direction register, which programs the direction of each pin, and a data register for data I/O. The fact that all these registers are memory mapped and read/write makes the use of bit manipulation instructions extremely effective.

### 2.9.3 Host Interface

The host interface is a byte-wide, full-duplex, parallel port that can be connected directly to the data bus of a host processor. The host processor may be any of a number of industry-standard microcomputers or MPUs, another DSP, or DMA hardware. The DSP56000/DSP56001 host interface has an 8-bit, bidirectional data bus, H0–H7 (PB0–PB7), and seven dedicated control lines, HA0, HA1, HA2, HR/W, HEN, HREQ, and HACK (PB8–PB14), to control data transfers. The host interface appears as a memory-mapped peripheral occupying eight bytes in the host-processor address space. Separate transmit and receive data registers are double buffered to allow the DSP56000/DSP56001 and host processor to efficiently transfer data at high speed. Host-processor communication with the host interface is accomplished using standard, host-processor data move instructions and addressing modes. Handshake flags are provided for polled or interrupt-driven data transfers with the host processor. DMA hardware may be used with the handshake flags to efficiently transfer data without using address lines HA0–HA2.

One of the most innovative features of the host interface is the host command feature. With this feature, the host processor can issue vectored exception requests to the DSP56000/DSP56001. The host may select any one of 32 DSP56000/DSP56001 exception routines to be executed by writing a vector address register in the host interface. This flexibility allows the host programmer to execute up to 32 preprogrammed functions inside the DSP56000/DSP56001. For example, host exceptions allow the host processor to read or write DSP56000/DSP56001 registers, X, Y, or program memory locations, force exception handlers (e.g., SSI, SCI,  $\overline{\text{IRQA}}$ ,  $\overline{\text{IRQB}}$  exception routines), and perform control and debugging operations if the exception routines are programmed in the DSP56000/DSP56001 to do these tasks.

#### 2.9.4 Serial Communication Interface

The SCI provides a full-duplex port for 8-bit data serial communication to other DSPs, MPUs, or peripherals such as modems. The communication can be either direct or via RS232C-type lines. This interface uses three dedicated pins — transmit data (TXD), receive data (RXD), and SCI serial clock (SCLK). It supports industry-standard asynchronous bit rates and protocols as well as high-speed (up to 2.5 Mbits/sec) synchronous data transmission. The asynchronous protocols include a multidrop mode for master/slave operation. The SCI consists of separate transmit and receive sections having operations that can be asynchronous with respect to each other by using the internal clock for one and an external clock for the other. A programmable baud-rate generator is included to generate the transmit and receive clocks. An enable and interrupt vector are included so that the baud-rate generator can function as a general-purpose timer when it is not being used by the SCI peripheral.

#### 2.9.5 Synchronous Serial Interface

The SSI is an extremely flexible, full-duplex serial interface that allows the DSP56000/DSP56001 to communicate with a variety of serial devices. These devices include one or more industry-standard codecs, other DSPs, MPUs, and peripherals. The following characteristics of the SSI can be independently defined by the user: the number of bits per word, the protocol, the clock, and the transmit/receive synchronization. There are three modes that can be selected: normal, on-demand, and network. The normal mode is typically used to interface with devices on a regular or periodic basis. The data-driven on-demand mode is intended to be used to communicate with devices on a nonperiodic basis. The network mode provides time slots in addition to a bit clock and frame synchronization pulse. The SSI functions with from two to 32 words of I/O per frame in the network mode. This mode is typically used in star or ring time division multiplex (TDM) networks with other DSP56000s and/or codecs. The clock can be programmed to be continuous or gated. Since the transmitter and receiver sections of the SSI are independent, they can be programmed to be synchronous (using a common clock) or asynchronous with respect to each other. The SSI supports a subset of the Motorola SPI. The SSI requires up to six pins, depending on the operating mode selected. The most common minimum configuration is three pins: transmit data (STD), receive data (SRD), and clock (SCK).

## 2.10 SIGNAL DESCRIPTION

The DSP56000/DSP56001 is available in an 88-pin pin-grid array package, surface mount, or 100-pin single-layer aluminium-metalization (SLAM) package. The input and output signals are organized into seven functional groups:

1. Port A Address and Data Buses
2. Port A Bus Control
3. Interrupt and Mode Control
4. Power and Clock
5. Host Interface or Port B I/O
6. SCI or Port C I/O
7. SSI or Port C I/O

Figure 2-3 also shows these seven functional groups of signals that are discussed in the following paragraphs.

### 2.10.1 Port A Address and Data Bus

The following signals relate to the port A address and data bus.

**2.10.1.1 ADDRESS (A0–A15):** These three-state output pins specify the address for external program and data memory accesses. To minimize power dissipation, A0–A15 do not change state when external memory spaces are not being accessed.

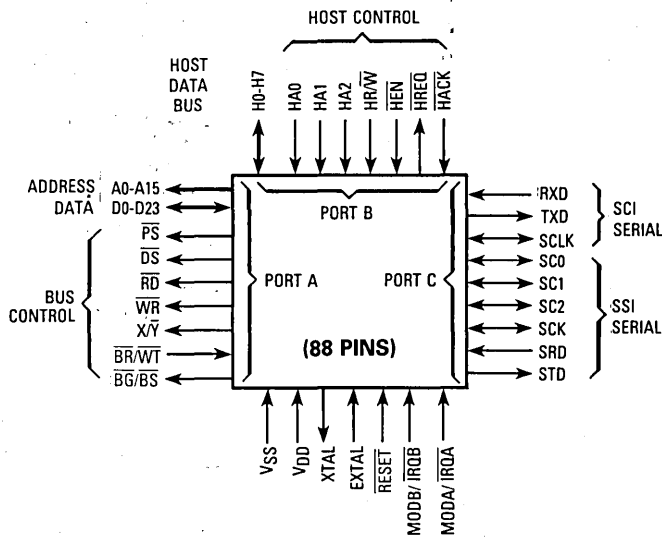

Figure 2-3. DSP56000/DSP56001 Functional Signal Groups

**2.10.1.2 DATA (D0–D23).** These pins provide the bidirectional data bus for external program and data memory accesses. D0–D23 are in the high-impedance state when the bus grant signal is asserted.

## 2.10.2 Port A Bus Control

The port A bus control signals are discussed in the following paragraphs.

**2.10.2.1 PROGRAM MEMORY SELECT ( $\overline{PS}$ ).** This three-state output is asserted only when external program memory is referenced (see Table 2-1).

**Table 2-1. Program and Data Memory Select Encoding**

| $\overline{PS}$ | $\overline{DS}$ | $X/\overline{Y}$ | External Memory Reference  |
|-----------------|-----------------|------------------|--|
| 1               | 1               | 1                | No Activity  |
| 1               | 0               | 1                | X Data Memory on Data Bus  |
| 1               | 0               | 0                | Y Data Memory on Data Bus  |
| 0               | 1               | 1                | Program Memory on Data Bus (Not Exception)                             |
| 0               | 1               | 0                | External Exception Fetch: Vector or Vector + 1 (Development Mode Only) |
| 0               | 0               | X                | Reserved   |
| 1               | 1               | 0                | Reserved   |

**2.10.2.2 DATA MEMORY SELECT ( $\overline{DS}$ ).** This three-state output is asserted only when external data memory is referenced (see Table 2-1).

**2.10.2.3 X/ $\overline{Y}$  SELECT ( $X/\overline{Y}$ ).** This three-state output selects which external data memory space (X or Y) is referenced by  $\overline{DS}$  (see Table 2-1).

**2.10.2.4 READ ENABLE ( $\overline{RD}$ ).** This three-state output is asserted to read external memory on the data bus (D0–D23).

**2.10.2.5 WRITE ENABLE ( $\overline{WR}$ ).** This three-state output is asserted to write external memory on the data bus (D0–D23).

**2.10.2.6 BUS REQUEST/WAIT ( $\overline{BR}/\overline{WT}$ ).** The bus request input (BR) allows another device such as a processor or DMA controller to become the master of the external data bus (D0–D23) and external address bus (A0–A15). When operating mode register (OMR) bit 7



is clear and  $\overline{BR}$  is asserted, the DSP56000/DSP56001 will always release D0–D23, A0–A15, and bus control pins,  $\overline{PS}$ ,  $\overline{DS}$ ,  $\overline{X/Y}$ ,  $\overline{RD}$ , and  $\overline{WR}$  (i.e., port A), by placing these pins in the high-impedance state after execution of the current instruction has been completed.

If OMR bit 7 is set, this pin is an input that allows an external device to force wait states during an external port A operation for as long as  $\overline{WT}$  is asserted.

**2.10.2.7 BUS GRANT/BUS STROBE ( $\overline{BG/BS}$ ).** If OMR bit 7 is clear, this output is asserted to acknowledge an external bus request after port A has been released. If OMR bit 7 is set, this pin is bus strobe and is asserted when the DSP accesses port A.

### 2.10.3 Interrupt and Mode Control

The following signals are the interrupt and mode control signals for the DSP56000/DSP56001.

**2.10.3.1 MODE SELECT A/EXTERNAL INTERRUPT REQUEST A ( $\overline{MODA/IRQA}$ ) AND MODE SELECT B/EXTERNAL INTERRUPT REQUEST B ( $\overline{MODB/IRQB}$ ).** These two inputs have dual functions: 1) to select the initial chip operating mode and 2) to receive an interrupt request from an external source.  $\overline{MODA}$  and  $\overline{MODB}$  are read and internally latched in the DSP when the processor exits the reset state. After leaving the reset state, the  $\overline{MODA}$  and  $\overline{MODB}$  pins automatically change to external interrupt requests,  $\overline{IRQA}$  and  $\overline{IRQB}$ . After leaving the reset state, the chip operating mode can be changed by software.  $\overline{IRQA}$  and  $\overline{IRQB}$  can be programmed to be level sensitive or negative edge triggered. When edge triggered, triggering occurs at a voltage level and is not directly related to the fall time of the interrupt signal; however, the probability of noise on  $\overline{IRQA}$  or  $\overline{IRQB}$  generating multiple interrupts increases with increasing fall time of the interrupt signal.

**2.10.3.2 RESET ( $\overline{RESET}$ ).** This Schmitt-trigger input pin is used to reset the DSP56000/DSP56001. When  $\overline{RESET}$  is asserted, the DSP56000/DSP56001 is initialized and placed in the reset state. When  $\overline{RESET}$  is deasserted, the initial chip operating mode is latched from the  $\overline{MODA}$  and  $\overline{MODB}$  pins. When coming out of  $\overline{RESET}$ , deassertion occurs at a voltage level and is not directly related to the rise time of the  $\overline{RESET}$  signal; however, the probability of noise on  $\overline{RESET}$  generating multiple resets increases with increasing rise time of the  $\overline{RESET}$  signal.

### 2.10.4 Power and Clock

The power and clock signals are presented in the following paragraphs.

**2.10.4.1 POWER (V<sub>CC</sub>), GROUND (GND).** There are five sets of power and ground pins: two pairs for internal logic, one power and two ground for port A address and control pins, one power and two ground for port A data pins, and one pair for peripherals.

**2.10.4.2 EXTERNAL CLOCK/CRYSTAL INPUT (EXTAL).** EXTAL may be used to interface the internal crystal oscillator input to an external crystal or an external clock.

**2.10.4.3 CRYSTAL OUTPUT (XTAL).** This output connects the internal crystal oscillator output to an external crystal. If an external clock is used, XTAL should not be connected.

## 2.10.5 Host Interface

The following paragraphs discuss the host interface signals.

**2.10.5.1 HOST DATA BUS (H0–H7).** This bidirectional data bus is used to transfer data between the host processor and the DSP56000/DSP56001. This bus is an input unless enabled by a host processor read and is high impedance when  $\overline{\text{HEN}}$  is deasserted. H0–H7 can be programmed as general-purpose parallel I/O pins (PB0–PB7) when the host interface is not being used.

**2.10.5.2 HOST ADDRESS (HA0–HA2).** These inputs provide the address selection for each host interface register. HA0–HA2 can be programmed as general-purpose parallel I/O pins (PB8–PB10) when the host interface is not being used.

**2.10.5.3 HOST READ/WRITE (HR/ $\overline{\text{W}}$ ).** This input selects the direction of data transfer for each host processor access. HR/ $\overline{\text{W}}$  can be programmed as a general-purpose I/O pin (PB11) when the host interface is not being used.

**2.10.5.4 HOST ENABLE ( $\overline{\text{HEN}}$ ).** This input enables a data transfer on the host data bus. When  $\overline{\text{HEN}}$  is asserted and HR/ $\overline{\text{W}}$  is high, H0–H7 become outputs and DSP56000/DSP56001 data may be read by the host processor. When  $\overline{\text{HEN}}$  is asserted and HR/ $\overline{\text{W}}$  is low, H0–H7 become inputs, and host data is latched inside the DSP. When  $\overline{\text{HEN}}$  is deasserted, the host data bus is three-stated. Normally, a chip select signal derived from host address decoding and an enable clock are used to generate  $\overline{\text{HEN}}$ .  $\overline{\text{HEN}}$  can be programmed as a general-purpose I/O pin (PB12) when the host interface is not being used.

**2.10.5.5 HOST REQUEST ( $\overline{\text{HREQ}}$ ).** This open-drain output signal is used by the DSP56000/DSP56001 host interface to request service from the host processor, DMA controller, or a simple external controller.  $\overline{\text{HREQ}}$  can be programmed as a general-purpose (not open-drain) I/O pin (PB13) when the host interface is not being used.

**2.10.5.6 HOST ACKNOWLEDGE ( $\overline{HACK}$ ).** This input has two functions: 1) to provide a host acknowledge handshake signal for DMA transfers and 2) to receive a host interrupt acknowledge compatible with M68000 Family processors.  $\overline{HACK}$  may be programmed as a general-purpose I/O pin (PB14) when the host interface is not being used.

## 2.10.6. Serial Communications Interface

The following signals relate to the SCI.

**2.10.6.1 RECEIVE DATA (RXD).** This input receives byte-oriented serial data and transfers the data to the SCI receive shift register. RXD can be programmed as a general-purpose I/O pin (PC0) when the SCI RXD function is not being used.

**2.10.6.2 TRANSMIT DATA (TXD).** This output transmits serial data from the SCI transmit shift register. TXD can be programmed as a general-purpose I/O pin (PC1) when the SCI TXD function is not being used.

**2.10.6.3 SCI SERIAL CLOCK (SCLK).** This bidirectional pin provides an input or output clock from which the transmit and/or receive baud rate is derived in the asynchronous mode and from which data is transferred in the synchronous mode. SCLK can be programmed as a general-purpose I/O pin (PC2) when the SCI SCLK function is not being used.

## 2.10.7 Synchronous Serial Interface

The SSI signals are presented in the following paragraphs.

**2.10.7.1 SERIAL CONTROL ZERO (SC0).** This bidirectional pin is used for control by the SSI as a flag or receiver clock. SC0 can be programmed as a general-purpose I/O pin (PC3) when the SSI SC0 function is not being used.

**2.10.7.2 SERIAL CONTROL ONE (SC1).** This bidirectional pin is used for control by the SSI as a flag or frame synchronization. SC1 can be programmed as a general-purpose I/O pin (PC4) when the SSI SC1 function is not being used.

**2.10.7.3 SERIAL CONTROL TWO (SC2).** This bidirectional pin is used for control by the SSI as a frame synchronization only. SC2 can be programmed as a general-purpose I/O pin (PC5) when the SSI SC2 function is not being used.

**2.10.7.4 SSI SERIAL CLOCK (SCK).** This bidirectional pin provides the serial bit rate clock for the SSI. SCK can be programmed as a general-purpose I/O pin (PC6) when SCK is not being used.

**2.10.7.5 SSI RECEIVE DATA (SRD).** This input pin receives serial data into the SSI receive shift register. SRD can be programmed as a general-purpose I/O pin (PC7) when SRD is not being used.

**2.10.7.6 SSI TRANSMIT DATA (STD).** This output pin transmits serial data from the SSI transmit shift register. STD can be programmed as a general-purpose I/O pin (PC8) when the SSI STD function is not being used.

## SECTION 3 MEMORY SPACES

This section is divided into two major subsections, the DSP56000 and DSP56001. Each subsection describes the memory spaces available and the operating modes that redefine these memory spaces.

3

### 3.1 OVERVIEW

The memory of the DSP56000/DSP56001 can be partitioned in several ways to provide high-speed parallel operation and additional off-chip memory expansion. Program and data memory are separate, and the data memory is, in turn, divided into two separate memory spaces, X and Y. Both the program and data memories can be expanded off-chip. There are also two on-chip data read-only memories (ROMs) that can overlay a portion of the X and Y data memories and a bootstrap ROM (DSP56001 only) that can overlay part of the program random-access memory (RAM). The data memories are divided into two independent spaces to work with the two address arithmetic logic units (ALUs) to feed two operands simultaneously to the data ALU.

### 3.2 DSP56000 MEMORY INTRODUCTION

The three independent memory spaces of the DSP56001, X data, Y data, and program, are shown in Figure 3-1. The memory spaces are configured by control bits in the operating mode register (OMR). The operating mode control bits (MA and MB) in the OMR control the program memory map and select the reset vector address. The data ROM enable (DE) bit in the OMR controls the X and Y data memory maps and enables/disables the internal X and Y data ROMs. The bootstrap memory on the DSP56000 is used only for factory testing and should not be invoked by the user.

#### 3.2.1 X Data Memory

The on-chip X data RAM is a 24-bit-wide, internal, static memory occupying the lowest 256 locations (0–255) in X memory space. The on-chip X data ROM (factory programmed to user specifications like the program ROM) occupies locations 256–511 in the X data memory space and is controlled by the DE bit in the OMR. The on-chip peripheral registers occupy the top 64 locations of the X data memory (\$FFC0–\$FFFF). The 16-bit addresses are received from the XAB, and 24-bit data transfers to the data ALU occur on the XDB. The X memory may be expanded to 64K off-chip.

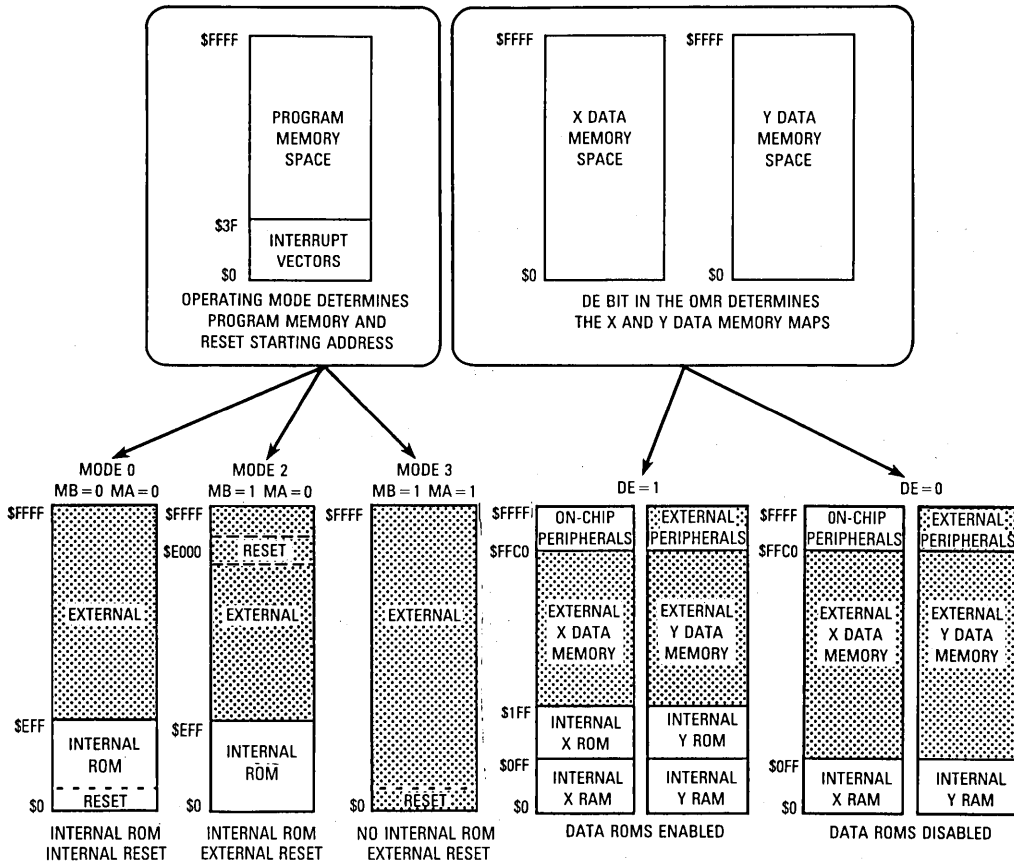

Figure 3-1. DSP56000 Memory Map

### 3.2.2 Y Data Memory

The on-chip Y data RAM is a 24-bit-wide, internal, static memory occupying the lowest 256 locations (0–255) in the Y memory space. The on-chip Y data ROM (factory programmed to user specifications like the program ROM) occupies locations 256–511 in Y data memory space and is controlled by the DE bit in the OMR. The off-chip peripheral registers should be mapped into the top 64 locations (\$FFC0–\$FFFF) to take advantage of the move peripheral data (MOVEP) instruction. The 16-bit addresses are received from the YAB, and 24-bit data transfers to the data ALU occur on the YDB. Y memory may be expanded to 64K off-chip.

### 3.2.3 Program Memory

On-chip program memory consists of a 3840-location by 24-bit, high-speed ROM (3.75K×24) that is enabled/disabled by the MA and MB bits in the OMR. When the on-chip program memory is disabled, either off-chip memory or a special mode 1 ROM is selected for program memory.

#### NOTE

The mode 1 ROM is used only for test purposes on the DSP56000 and should not be invoked by the user.

3

Addresses are received from the program control logic (usually the program counter) over the PAB. Off-chip program memory may be written using move program memory (MOVEM) instructions. The interrupt vectors for the on-chip resources are located in the bottom 64 locations (\$0000–\$003F) of program memory. Program memory may be expanded to 64K off-chip.

### 3.2.4 Chip Operating Modes

The DSP operating modes determine the memory maps for program and data memories and the startup procedure when the DSP leaves the reset state. The MODA and MODB pins are sampled as the DSP leaves the reset state, and the initial operating mode of the DSP is set accordingly. When the reset state is exited, the MODA and MODB pins become general-purpose interrupt pins,  $\overline{IRQA}$  and  $\overline{IRQB}$ . One of three initial operating modes is selected: single chip, normal expanded, or development. Chip operating modes can be changed by writing the operating mode bits (MB, MA) in the OMR. Changing operating modes does not reset the DSP. It is desirable to disable interrupts immediately before changing the OMR to prevent an interrupt from going to the wrong memory location. Also, one no-operation (NOP) instruction should be included after changing the OMR to allow for remapping to occur.

Some pins on the DSP are mode independent; whereas, the use of others depends on the particular operating mode. Specifically, external address bus, data bus, and bus control pins are affected by the particular operating mode. Table 3-1 shows the mode assignments.

**Table 3-1. Initial DSP56000 Operating Mode Summary**

| Operating Mode | MODB | MODA | Description          |
|----------------|------|------|----------------------|
| 0              | 0    | 0    | Single-Chip Mode     |
| 1              | 0    | 1    | Single-Chip Mode     |
| 2              | 1    | 0    | Normal Expanded Mode |
| 3              | 1    | 1    | Development Mode     |

**3.2.4.1 SINGLE-CHIP MODE (MODE 0).** In the single-chip mode, all internal program and data RAM memories are enabled. A hardware reset causes the DSP to jump to internal program memory location \$0000 (\$=hexidecimal notation) and resume execution. The memory map for this mode is shown in Figure 3-2. The memory maps for mode 0 and mode 2 (see Figure 3-3) are identical. The difference between the two modes is that reset vectors to program memory location \$0000 in mode 0 and vectors to location \$E000 in mode 2.

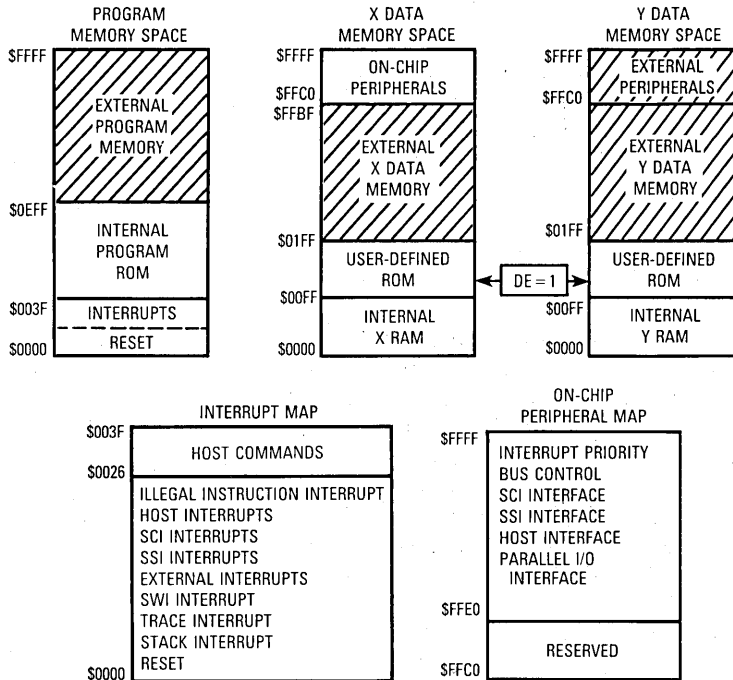

NOTE: Addresses \$FFC0-\$FFFF in X data memory are NOT available externally.

**Figure 3-2. Memory Map for DSP56000 Mode 0: Single-Chip Mode**

**3.2.4.2 MODE 1.** Mode 1 is the same as mode 0 on the DSP56000. It is recommended that this mode not be invoked by the user.

**3.2.4.3 NORMAL EXPANDED MODE (MODE 2).** Mode 2 is almost identical to mode 0 (see 3.2.4.1 SINGLE-CHIP MODE (MODE 0) for further information).



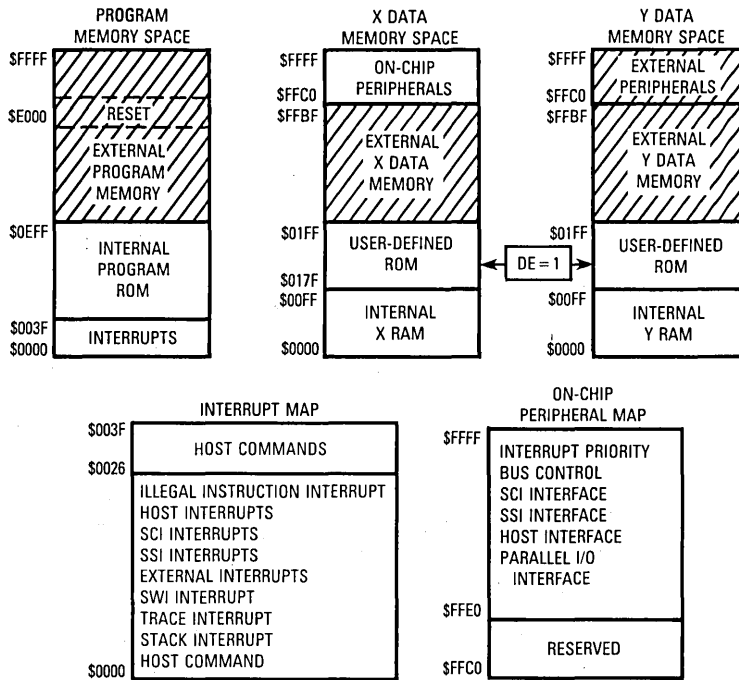

NOTE: Addresses \$FFC0-\$FFFF in X data memory are NOT available externally.

**Figure 3-3. Memory Map for DSP56000 Mode 2: Normal Expanded Mode**

**3.2.4.4 DEVELOPMENT MODE (MODE 3).** The development mode is similar to the normal expanded mode except that internal program memory is disabled. All references to program memory space are directed to external program memory, which is accessed on the external data bus. The memory map for this mode is shown in Figure 3-4. DSP56000 chips with bad or obsolete internal program ROM code can be used with external program memory in the development mode. The memory map in Figure 3-4 is shown with DE arbitrarily set to zero.

**3.2.5 Security ROM Version (DSP56000)\***

The security ROM version of the DSP56000 is a standard DSP56000 that has been modified to prevent unauthorized access to the program contained in the DSP program ROM. This protection is accomplished in two ways. First, the DSP is forced into the single-chip mode at reset. The chip powers up in single-chip mode, and it is not possible to enter any other

\*For additional information concerning this part, contact the Motorola field office.

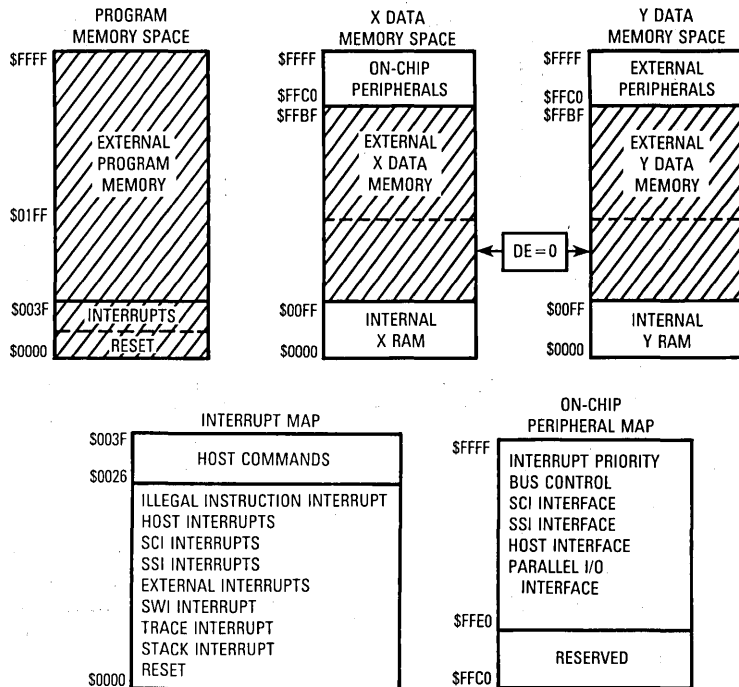

NOTE: Addresses \$FFC0–\$FFF in X data memory are NOT available externally.

**Figure 3-4. Memory Map for DSP56000 Mode 3: Development Mode**

mode on powerup. The  $\overline{\text{MODA}}/\overline{\text{IRQA}}$  and  $\overline{\text{MODB}}/\overline{\text{IRQB}}$  pins are configured only as  $\overline{\text{IRQA}}$  and  $\overline{\text{IRQB}}$  and cannot be used to change the mode. Second, the programmer must avoid fetches from external program memory — i.e., the user code must be placed only in internal program ROM. This placement prevents the execution of unauthorized code that might be used to dump the contents of the program ROM.

### 3.3 DSP56001 MEMORY INTRODUCTION

The three independent memory spaces of the DSP56001, X data, Y data, and program, are shown in Figure 3-5. The memory spaces are configured by control bits in the OMR. The MA and MB control bits in the OMR control the program memory map and select the reset vector address. The DE bit in the OMR controls the X and Y data memory maps and enables/disables the internal X and Y data ROMs. One additional memory available on the DSP56001 is the bootstrap memory that overlays the program memory in mode 1.

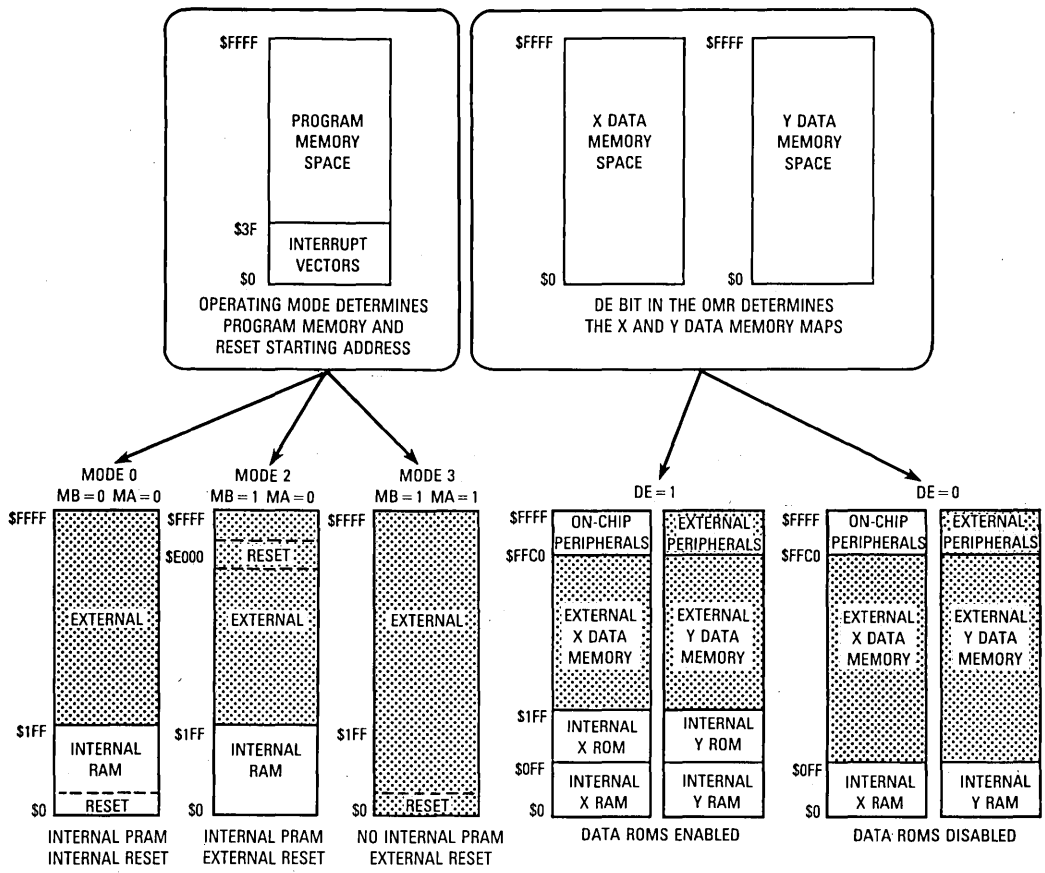

Figure 3-5. DSP56001 Memory Map

### 3.3.1 X Data Memory

The on-chip X data RAM is a 24-bit-wide, static, internal memory occupying the lowest 256 locations (0–255) in X memory space. The on-chip X data ROM occupies locations 256–511 in the X data memory space when enabled by setting DE to one in the OMR. The X data ROM is factory programmed with positive Mu-law and A-law expansion tables (see **APPENDIX D MU-LAW/A-LAW EXPANSION TABLES**), which are useful in telecommunication applications. The on-chip peripheral registers occupy the top 64 locations of the X data memory (locations \$FFC0–\$FFFF). The 16-bit addresses are received from the XAB, and 24-bit data transfers to the data ALU occur on the XDB. The X memory may be expanded to 64K off-chip.

### 3.3.2 Y Data Memory

The on-chip Y data RAM is a 24-bit-wide, static, internal memory occupying the lowest 256 locations (0–255) in the Y memory space. The on-chip Y data ROM occupies locations 256–511 in Y data memory space when enabled by setting DE to one in the OMR. The Y data ROM is factory programmed with a full, four-quadrant, sine-wave table (see *DSP56001 Advance Information Data Sheet (ADI1290)*), which is useful for fast Fourier transforms, discrete Fourier transforms, and waveform generation. The off-chip peripheral registers should be mapped into the top 64 locations (\$FFC0–\$FFFF) to take advantage of the MOVEP instruction. The 16-bit addresses are received from the YAB, and 24-bit data transfers to the data ALU occur on the YDB. Y memory may be expanded to 64K off-chip.

### 3.3.3 Program Memory

On-chip program memory consists of a 512-location by 24-bit, high-speed, static RAM that is enabled/disabled by the MA and MB bits in the OMR. When the on-chip program memory is disabled, either off-chip memory or a special bootstrap ROM is selected for program memory.

Addresses are received from the program control logic (usually the program counter) over the PAB. Program memory may be written using MOVEM instructions. The interrupt vectors for the on-chip resources are located in the bottom 64 locations (\$0000–\$003F) of program memory. Program memory may be expanded to 64K off-chip.

Program RAM provides a method of developing code efficiently, and programs can be changed dynamically, allowing efficient overlaying of DSP software algorithms. In this way, the on-chip program RAM operates as a fixed cache, thereby minimizing contention with accesses to external data memory spaces.

The bootstrap mode overlays the program memory in mode 1 and provides a convenient, low-cost method of loading the DSP56001 program RAM with a program after power-on reset. The bootstrap mode also allows loading the program RAM from a single, inexpensive EPROM through port A or via the host interface using a host processor.

### 3.3.4 Bootstrap ROM (DSP56001 Only)

Factory programmed to perform the bootstrap operation from the memory expansion port (port A) or from the host interface, the 32-word on-chip ROM is invoked while the processor is in operating mode 1. Users have no access to the bootstrap ROM other than through the bootstrap process.

### 3.3.5 Chip Operating Modes

The DSP operating modes determine the memory maps for program and data memories and the startup procedure when the DSP leaves the reset state. The MODA and MODB

pins are sampled as the DSP leaves the reset state, and the initial operating mode of the DSP is set accordingly. When the reset state is exited, the MODA and MODB pins become general-purpose interrupt pins,  $\overline{IRQA}$  and  $\overline{IRQB}$ . One of four initial operating modes is selected: single chip, special bootstrap, normal expanded, or development. Chip operating modes can be changed by writing the operating mode bits (MB, MA) in the OMR. Changing operating modes does not reset the DSP. It is desirable to disable interrupts immediately before changing the OMR to prevent an interrupt from going to the wrong memory location. For example, if the user changed to the bootstrap mode and an interrupt occurred, he would execute the bootstrap code out of order. Also, one NOP instruction must be included after changing the OMR to allow for remapping to occur.

Some pins on the DSP are mode independent; whereas, others depend on the particular operating mode. Specifically, external address bus, data bus, and bus control pins are affected by the particular operating mode. Table 3-2 depicts the mode assignments.

**Table 3-2. Initial DSP56001 Operating Mode Summary**

| Operating Mode | MODB | MODA | Description            |
|----------------|------|------|------------------------|
| 0              | 0    | 0    | Single-Chip Mode       |
| 1              | 0    | 1    | Special Bootstrap Mode |
| 2              | 1    | 0    | Normal Expanded Mode   |
| 3              | 1    | 1    | Development Mode       |

**3.3.5.1 SINGLE-CHIP MODE (MODE 0).** In the single-chip mode, all internal program and data RAM memories are enabled. A hardware reset causes the DSP to jump to internal program memory location \$0000 and resume execution. The memory map for this mode is shown in Figure 3-6. The memory maps for mode 0 and mode 2 (see Figure 3-7) are identical. The difference between the two modes is that reset vectors to program memory location \$0000 in mode 0 and vectors to location \$E000 in mode 2.

**3.3.5.2 SPECIAL BOOTSTRAP MODE (MODE 1).** The bootstrap mode is a special mode that loads internal program RAM either from a byte-wide external memory such as EPROM or from the host interface. After loading the internal memory, the DSP switches to the single-chip mode and begins program execution at on-chip program memory location \$0000.

One method of selecting mode 1 is to assert the reset pin on the DSP56001. When the DSP leaves the reset state ( $\overline{RESET}$  goes high), the MODB and MODA pins are sampled (they should be set to zero and one, respectively), and the initial operating mode of the DSP is

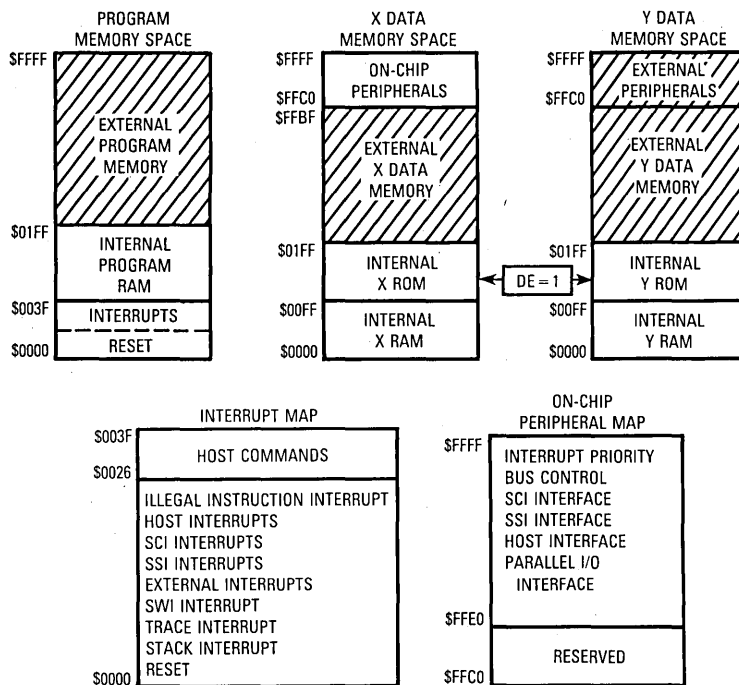

NOTE: Addresses \$FFC0-\$FFFF in X data memory are NOT available externally.

**Figure 3-6. Memory Map for DSP56001 Mode 0: Single-Chip**

set accordingly. The following actions occur once the processor comes out of the reset state.

1. The control logic maps the bootstrap ROM into the internal DSP program memory space starting at location \$0000.
2. The control logic causes program reads to come from the bootstrap ROM (only address bits 4-0 are significant) and all writes go to the program RAM (all address bits are significant). This condition allows the bootstrap program to load the user program from \$0000-\$01FF.
3. Program execution begins at location \$0000 in the bootstrap ROM. The bootstrap ROM program can load program RAM through either the memory expansion port or through the host interface. The choice is made by looking at bit 23 of P:\$C000. The processor loads from the host interface if bit 23 is a zero; if bit 23 is a one, it loads from a byte-wide memory starting at P:\$C000.
4. The bootstrap ROM program executes the following sequence to end the bootstrap operation and begin executing the user program. First, operating mode 2 is entered

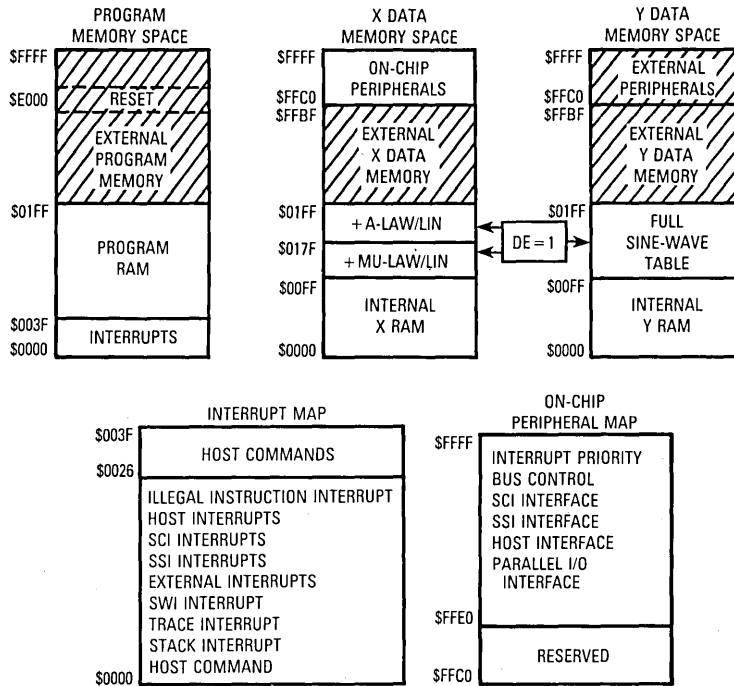

NOTE: Addresses \$FFC0-\$FFFF in X data memory are NOT available externally.

**Figure 3-7. Memory Map for DSP56001 Mode 2: Normal Expanded Mode**

by writing to the OMR. This action will be timed to remove the bootstrap ROM from the program memory map and re-enable read/write access to the program RAM. Second, the change to mode 2 is exactly timed to allow the bootstrap program to execute a single-cycle instruction (clear status register), then a JMP #<00, and begin execution of the user program at location \$0000.

The bootstrap mode may also be selected by writing zero to MB and one to MA in the OMR. This selection initiates a timed operation to map the bootstrap ROM into the program address space after a delay to allow execution of a single-cycle instruction and then a JMP #<00 to begin the bootstrap process previously described. This technique allows the DSP56001 user to reboot the system (with a different program, if desired). The code to enter the bootstrap mode is as follows:

```

MOVEP    #0,X:$FFFF    ; Disable interrupts.
MOVEC    #1,OMR        ; The bootstrap ROM is mapped
                       ; into the lowest 32 locations
                       ; in program memory.

```

```

NOP                                ; Allow one cycle delay for the
                                   ; remapping.
JMP    <$0                        ; Begin bootstrap.

```

The interrupts are disabled before executing the bootstrap code; otherwise, an interrupt could cause the DSP to execute the bootstrap code out of sequence because the bootstrap program overlays the interrupt vectors.

The bootstrap ROM contains the bootstrap firmware program that performs initial loading of the DSP56001 program RAM.

Written in DSP56001 assembly language, the program contains two separate methods of initializing the program RAM: loading from a byte-wide memory starting at location P:\$C000 or loading through the host interface. The particular method used is selected by the level of program memory location P:\$C000 bit 23.

If location P:\$C000 bit 23 is read as a one, the external bus version of the bootstrap program will be selected. Typically, a byte-wide EPROM will be connected to the DSP56001 address and data bus. The data contents of the EPROM must be organized as follows:

| Address of External<br>Byte-Wide Memory: | Contents Loaded to<br>Internal Program RAM at: |           |
|--|--|-----------|
| P:\$C000                                 | P:\$0000                                       | low byte  |
| P:\$C001                                 | P:\$0000                                       | mid byte  |
| P:\$C002                                 | P:\$0000                                       | high byte |
| .  | .  |           |
| .  | .  |           |
| .  | .  |           |
| P:\$C5FD                                 | P:\$01FF                                       | low byte  |
| P:\$C5FE                                 | P:\$01FF                                       | mid byte  |
| P:\$C5FF                                 | P:\$01FF                                       | high byte |

If location P:\$C000 bit 23 is read as a zero, the host interface version of the bootstrap program will be selected. Typically, a host microprocessor will be connected to the DSP56001 host interface. The host microprocessor must write the host interface byte-wide registers TXH, TXM, and then TXL with the desired contents of program RAM from location P:\$0000 up to P:\$01FF. If less than 512 words are to be loaded, the host programmer can exit the bootstrap program and force the DSP56001 to begin executing at location P:\$0000 by setting HF0 to one in the host interface control register. In most systems, the DSP56001 response is so fast that handshaking between the DSP56001 and the host is not necessary.

**3.3.5.3 NORMAL EXPANDED MODE (MODE 2).** Mode 2 is almost identical to mode 0 (see **3.3.5.1 SINGLE-CHIP MODE (MODE 0)** for details).



**3.3.5.4 DEVELOPMENT MODE (MODE 3).** The development mode is similar to the normal expanded mode except that internal program memory is disabled. All references to program memory space are directed to external program memory, which is accessed on the external data bus. The reset vector points to location \$0000. The memory map for this mode is shown in Figure 3-8. The memory map in Figure 3-8 is shown with DE arbitrarily set to zero.

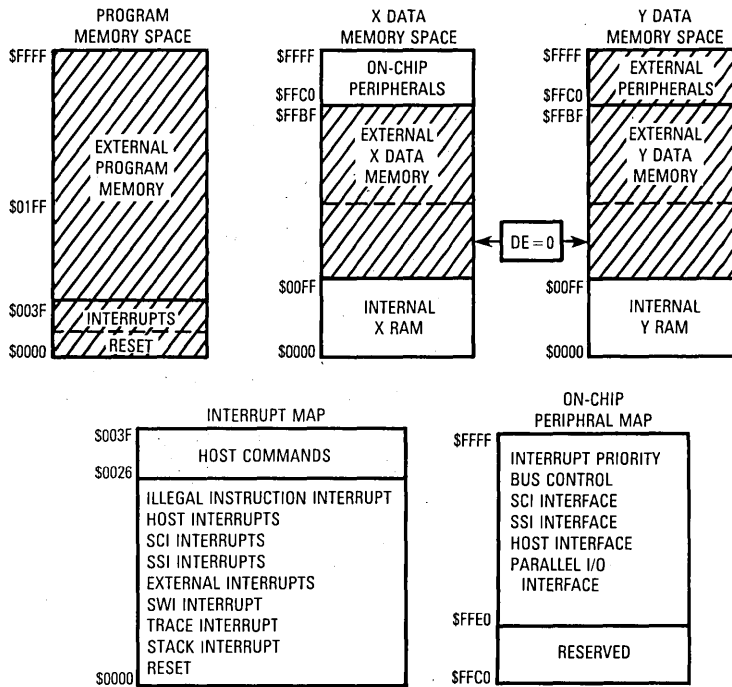

NOTE: Addresses \$FFC0–FFFF in X data memory are NOT available externally.

**Figure 3-8. Memory Map for DSP56001 Mode 3: Development Mode**



## SECTION 4 DATA ARITHMETIC LOGIC UNIT

This section describes the operation of the data arithmetic logic unit (ALU) registers and hardware. The data representation, rounding, and saturation arithmetic used within the data ALU are also presented. This section concludes with a discussion of the programming model.

### 4.1 OVERVIEW AND DATA ALU ARCHITECTURE

The DSP56000/DSP56001 central processor is composed of three execution units that operate in parallel. They are the data ALU, address generation unit (AGU), and the program controller (see Figure 4-1). These three units are register oriented rather than bus oriented and are designed to interface over the system buses with memory and memory-mapped I/O devices. The DSP56000/DSP56001 instruction set has been designed to allow flexible control of these parallel processing resources. Many instructions allow the programmer to keep each unit busy, thus enhancing performance. It was possible to make the programming model like that of conventional microprocessor units (MPUs), eliminating the

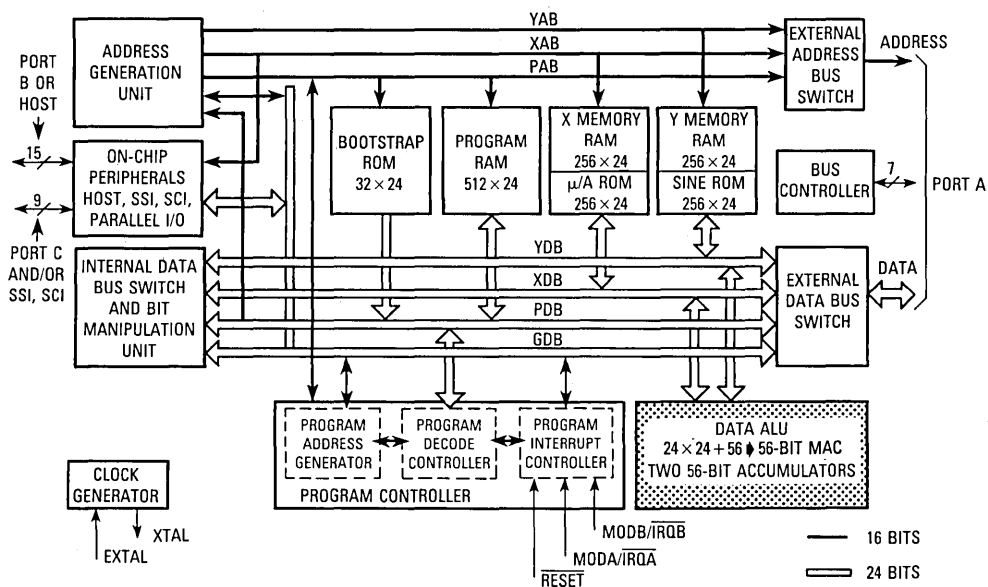

**Figure 4-1. DSP56001 Block Diagram**

need to refer to the detailed chip architecture when programming the DSP56000/DSP56001 because the parallel execution units appear to execute their operations in a nonpipelined manner.

The data ALU (see Figure 4-2) is the first of these execution units to be presented. The data ALU, which has been designed to be fast and yet provide the capability to process signals having a wide dynamic range, performs all the arithmetic and logical operations on data operands in the DSP56000/DSP56001.

The data ALU registers may be read or written over the XDB and the YDB as 24- or 48-bit operands. The source operands for the data ALU, which may be 24, 48, or 56 bits, always

**4**

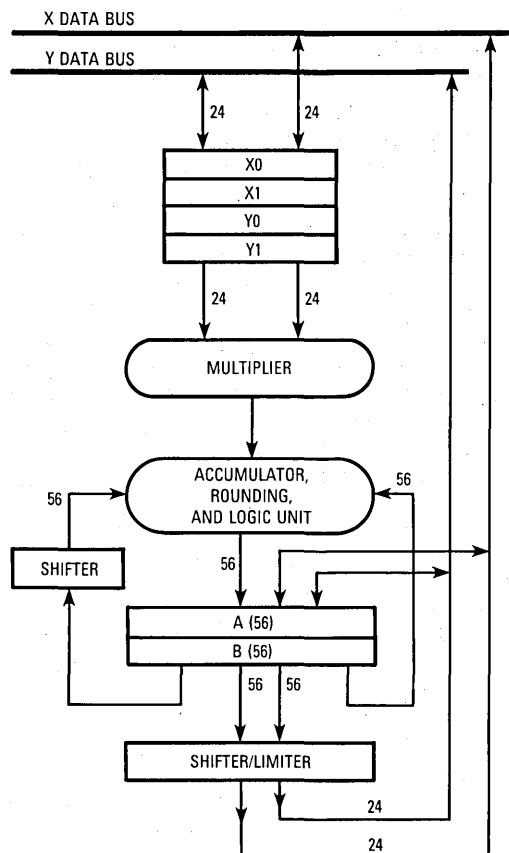

Figure 4-2. Data ALU

originate from data ALU registers. The results of all data ALU operations are stored in an accumulator.

The 24-bit data words provide 144 dB of dynamic range. This range is sufficient for most real-world applications since the majority of data converters are 16 bits or less, and certainly not greater than 24 bits. The 56-bit accumulator internal to the data ALU provides 336 dB of internal dynamic range so that no loss of precision will occur due to intermediate processing. Circuitry has been provided to facilitate handling data overflows and roundoff errors.

Any of the following operations can be performed by the data ALU in a single instruction cycle: multiplication, multiply-accumulate with positive or negative accumulation, convergent rounding, multiply-accumulate with positive or negative accumulation and convergent rounding, addition, subtraction, a divide iteration, a normalization iteration, shifting, and logical operations.

The components of the data ALU are as follows:

- Four 24-bit input registers
- A parallel, single-cycle, nonpipelined multiply-accumulator/logic unit (MAC)
- Two 48-bit accumulator registers
- Two 8-bit accumulator extension registers
- An accumulator shifter
- Two data bus shifter/limiter circuits

Each of these components is described in the following paragraphs as well as a description of data representation, rounding, and saturation arithmetic.

#### 4.1.1 Data ALU Input Registers (X1, X0, Y1, Y0)

X1, X0, Y1, and Y0 are four 24-bit, general-purpose data registers. They can be treated as four independent, 24-bit registers or as two 48-bit registers called X and Y, developed by the concatenation of X1:X0 and Y1:Y0, respectively. X1 is the most significant word in X and Y1 is the most significant word in Y. The registers serve as input buffer registers between the XDB or YDB and the MAC unit. They are used as data ALU source operands, allowing new operands to be loaded for the next instruction while the register contents are used by the current instruction. The registers may also be read back out to the appropriate data bus to implement memory-delay operations and save/restore operations for interrupt service routines.

#### 4.1.2 MAC and Logic Unit

The MAC and logic unit comprise the main arithmetic processing unit of the DSP and perform all of the calculations on data operands. In the case of arithmetic instructions, the unit accepts up to three input operands and outputs one 56-bit result of the following form,

extension: most significant product: least significant product (EXT:MSP:LSP). The operation of the MAC unit occurs independently and in parallel with XDB and YDB activity, and its registers facilitate buffering for both data ALU inputs and outputs. Latches are provided on the MAC unit input to permit writing an input register, which is the source for a data ALU operation in the same instruction.

The arithmetic unit contains a multiplier and two accumulators. The input to the multiplier can only come from the X or Y registers (X1, X0, Y1, Y0). The multiplier executes 24-bit  $\times$  24-bit, parallel, two's-complement fractional multiplies. The 48-bit product is right justified and added to the 56-bit contents of either the A or B accumulator. The 56-bit sum is stored back in the same accumulator (see Figure 4-3). An 8-bit adder, which is used as an extension

4

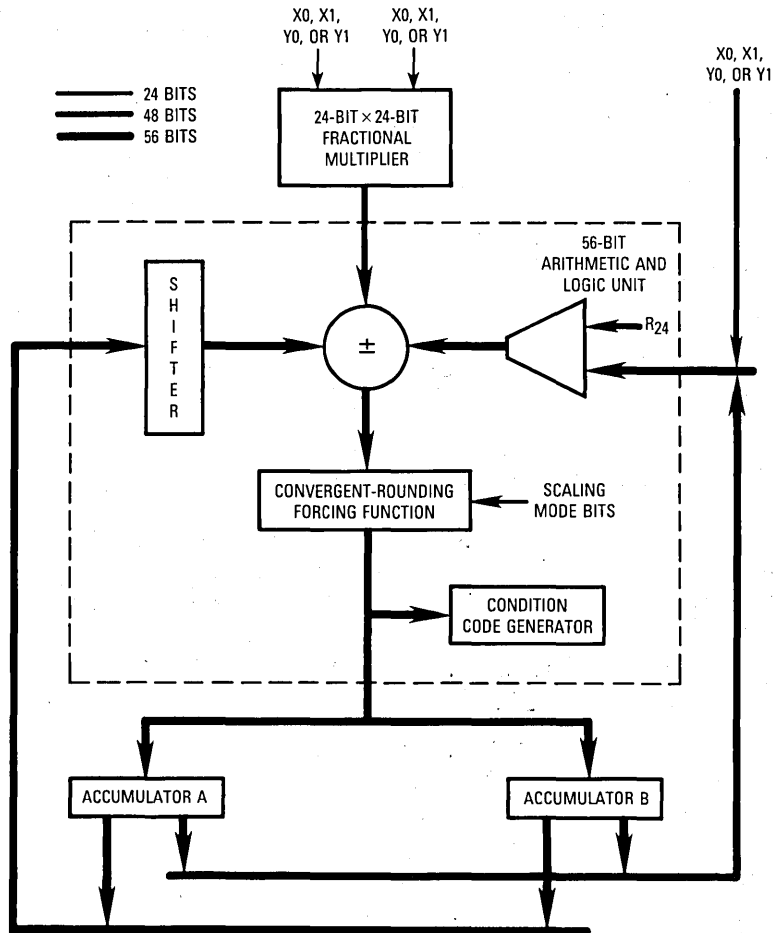

Figure 4-3. MAC Unit

accumulator for the MAC array, accommodates overflow of up to 256 and allows the two 56-bit accumulators to be added and subtracted from each other. The extension adder output is the EXT portion of the MAC unit output. This multiply/accumulate operation is not pipelined but rather is a single-cycle operation. If a multiply without accumulation (MPY) is specified in the instruction, the MAC clears the accumulator and then adds the contents to the product.

In summary, the results of all arithmetic instructions are valid (sign-extended and zero-filled) 56-bit operands in the form of EXT:MSP:LSP or A2:A1:A0 or B2:B1:B0. When a 56-bit result is to be stored as a 24-bit operand, the LSP can be simply truncated, or it can be rounded (using convergent rounding) into the MSP.

Convergent rounding (round-to-nearest) is performed when adding the multiplier's product to the contents of the accumulator if specified in the DSP instruction (e.g., the signed multiply-accumulate and round (MACR) instruction). The bit in the accumulator that is rounded is specified by the scaling mode bits in the status register.

The logic unit performs the logical operations, AND, OR, EOR, and NOT, on data ALU registers. This unit is 24 bits wide and operates on data in the MSP portion of the accumulator. The LSP and EXT portions of the accumulator are not affected.

#### **4.1.3 Data ALU Accumulator Registers (A2, A1, A0, B2, B1, B0)**

The six data ALU registers (A2, A1, A0, B2, B1, and B0) form two general-purpose, 56-bit accumulators, A and B. Each of these two registers consists of three concatenated registers (A2:A1:A0 and B2:B1:B0, respectively). The 24-bit MSP is stored in A1 or B1; the 24-bit LSP is stored in A0 or B0. The 8-bit EXT is stored in A2 or B2.

The 8-bit extension registers offer protection against overflow. On the DSP56000/DSP56001, the extreme values that a word operand can assume are  $-1$  and  $+0.9999998$ . If the sum of two numbers is less than  $-1$  or greater than  $+0.9999998$ , the result (which cannot be represented in a word operand — i.e., 24 bits) has underflowed or overflowed. The 8-bit extension registers can accurately represent the result of 255 overflows or 255 underflows. Whenever the accumulator extension registers are in use, the V bit in the status register is set.

Automatic sign extension is provided when writing to the 56-bit accumulators A or B with a 48- or 24-bit operand. When a 24-bit operand is written, the low-order portion will be automatically zero filled to form a valid 56-bit operand. The registers may also be written without sign extension or zero fill by specifying the individual register name. When accumulator registers A or B are read, they may be optionally scaled one bit left or one bit right for block floating-point arithmetic.

Reading the A or B accumulators over the XDB and YDB is protected against overflow by substituting a limiting constant for the data that is being transferred. The content of A or

B is not affected should limiting occur; only the value transferred over the XDB or YDB is limited. This overflow protection is performed after the contents of the accumulator have been shifted according to the scaling mode. Shifting and limiting will be performed only when the entire 56-bit A or B register is specified as the source for a parallel data move over the XDB or YDB. When A0, A1, A2, B0, B1, or B2 are specified as the source for a parallel data move, shifting and limiting are not performed. The accumulator registers serve as buffer registers between the MAC unit and the XDB and/or YDB. These registers are used as both data ALU source and destination operands.

Automatic sign extension of the 56-bit accumulators is provided when the A or B register is written with a smaller operand. Sign extension can occur when writing A or B from the XDB and/or YDB or with the results of certain data ALU operations (such as the transfer conditionally (Tcc) or transfer data ALU register (TFR) instructions). If a word operand is to be written to an accumulator register (A or B), the MSP (A1 or B1) portion of the accumulator is written with the word operand, the LSP (A0 or B0) portion is zero filled, and the EXT (A2 or B2) portion is sign extended from MSP. Long-word operands are written into the low-order portion, MSP:LSP, of the accumulator register, and the EXT portion is sign extended from MSP. No sign extension is performed if an individual 24-bit register is written (A1, A0, B1, or B0). Test logic is included in each accumulator register to support operation of the data shifter/limiter circuits. This test logic is used to detect overflows out of the data shifter so that the limiter can substitute one of several constants to minimize errors due to the overflow. This process is commonly referred to as saturation arithmetic.

4

#### 4.1.4 Accumulator Shifter

The accumulator shifter (see Figure 4-3) is an asynchronous parallel shifter with a 56-bit input and a 56-bit output that is implemented immediately before the MAC accumulator input. The source accumulator shifting operations are as follows:

No Shift (Unmodified)

1-Bit Left Shift (Arithmetic or Logical) ASL, LSL, ROL

1-Bit Right Shift (Arithmetic or Logical) ASR, LSR, ROR

Force to zero

#### 4.1.5 Data Shifter/Limiter

The data shifter/limiter circuits (see Figure 4-3) provide special postprocessing on data read from the ALU accumulator registers A and B out to the XDB or YDB. There are two independent shifter/limiter circuits (one for XDB and one for the YDB); each consists of a shifter followed by a limiting circuit.

**4.1.5.1 LIMITING (SATURATION ARITHMETIC).** In the DSP56000/DSP56001, the data ALU accumulators A and B have eight extension bits. Limiting will occur when the extension bits are in use and either A or B is the source being read over XDB or YDB. The limiters



in the DSP56000/DSP56001 place a shifted and limited value on XDB or YDB without changing the contents of the A or B registers. Having two limiters allows two-word operands to be limited independently in the same instruction cycle. The two data limiters can also be combined to form one 48-bit data limiter for long-word operands.

If the contents of the selected source accumulator can be represented without overflow in the destination operand size (i.e., accumulator extension register not in use), the data limiter is disabled, and the operand is not modified. If contents of the selected source accumulator cannot be represented without overflow in the destination operand size, the data limiter will substitute a limited data value having maximum magnitude (saturated) and having the same sign as the source accumulator contents: \$7FFFFFFF for 24-bit or \$7FFFFFFF FFFFFFFF for 48-bit positive numbers, \$800000 for 24-bit or \$800000 000000 for 48-bit negative numbers. This process is called saturation arithmetic. The value in the accumulator register is not shifted and can be reused within the data ALU. When limiting does occur, a flag is set and latched in the status register.

For example, if the source operand were 01.100 (+1.5 decimal) and the destination register were only four bits, the destination register would contain 1.100 (-1.5 decimal) after the transfer, assuming signed fractional arithmetic. This is clearly in error as overflow has occurred. To minimize the error due to overflow, it is preferable to write the maximum ("limited") value the destination can assume. In the example, the limited value would be 0.111 (+0.875 decimal), which is clearly closer to +1.5 than -1.5 and therefore introduces less error.

Figure 4-4 shows the effects of saturation arithmetic on a move from register A1 to register X0. The instruction "MOVE A1,X0" causes a move without limiting, and the instruction "MOVE A,X)" causes a move of the same 24 bits with limiting. The error without limiting is 2.0; whereas, it is 0.0000001 with limiting. Table 4-1 shows a more complete set of limiting situations.

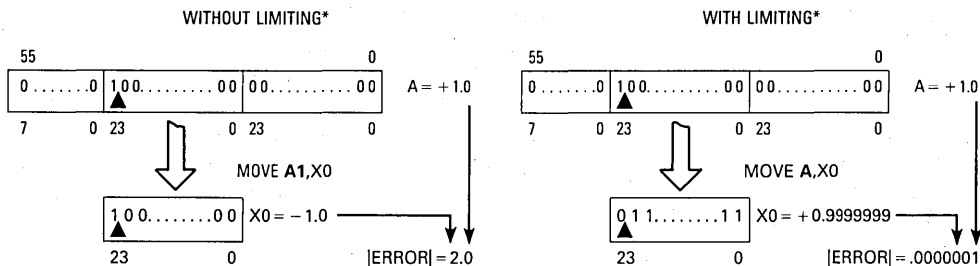

\*Limiting automatically occurs when the 56-bit operands A or B (not A2, A1, A0, B2, B1, or B0) are read. The contents of A or B are **NOT** changed.

Figure 4-4. Saturation Arithmetic

**Table 4-1. Limited Data Values**

| Destination Memory Reference | Source Operand | Accumulator Sign | Limited Value (Hexadecimal) |          | Type of Access |
|------------------------------|----------------|------------------|-----------------------------|----------|----------------|
|                              |                |                  | XDB                         | YDB      |                |
| X                            | X:A            | +                | 7FFFFFFF                    | —        | One 24 bit     |
|                              | X:B            | —                | 800000                      | —        |                |
| Y                            | Y:A            | +                | —                           | 7FFFFFFF | One 24 bit     |
|                              | Y:B            | —                | —                           | 800000   |                |
| X and Y                      | X:A Y:A        | +                | 7FFFFFFF                    | 7FFFFFFF | Two 24 bit     |
|                              | X:A Y:B        | —                | 800000                      | 800000   |                |
|                              | X:B Y:A        | +                | 7FFFFFFF                    | 7FFFFFFF |                |
|                              | X:B Y:B        | —                | 800000                      | 800000   |                |
|                              | L:AB           | +                | 7FFFFFFF                    | 7FFFFFFF |                |
|                              | L:BA           | —                | 800000                      | 800000   |                |
| L (X:Y)                      | L:A            | +                | 7FFFFFFF                    | FFFFFF   | One 48 bit     |
|                              | L:B            | —                | 800000                      | 000000   |                |

**4.1.5.2 SCALING.** The data shifters are capable of shifting data one bit to the left or one bit to the right as well as passing the data unshifted. Each data shifter has a 24-bit output with overflow indication and is controlled by the scaling mode bits in the status register. These shifters permit dynamic scaling of fixed-point data without modifying the program code. For example, this permits block floating-point algorithms such as fast Fourier transforms to be implemented in a regular fashion.

## 4.2 DATA REPRESENTATION AND ROUNDING

The DSP56000/DSP56001 uses a fractional data representation for all data ALU operations. Figure 4-5 shows the bit weighting of words, long words, and accumulator operands for this representation. The decimal points are all aligned and are left justified.

Data must be converted to a fractional number by scaling before being used by the DSP56000/DSP56001, or the user will have to be very careful in how the DSP manipulates the data. Moving \$3F to a 24-bit data ALU register does not result in the contents being \$00003F as might be expected. Assuming numbers are fractional, the DSP left justifies rather than right justifies. As a result, storing \$3F in a 24-bit register results in the contents being \$3F0000. The simplest example of scaling is to convert all integer numbers to fractional numbers by shifting the decimal 24 places to the left (see Figure 4-6). Thus, the data has not changed; only the position of the decimal has moved.

For words and long words, the most negative number that can be represented is  $-1$  whose internal representation is \$800000 and \$800000000000, respectively. The most positive word is \$7FFFFFFF or  $1 - 2^{-23}$  and the most positive long word is \$7FFFFFFFFF or  $1 - 2^{-47}$ . These limitations apply to all data stored in memory and to data stored in the data ALU input buffer registers. The extension registers associated with the accumulators allow word growth so that the most positive number that can be used is approximately 256 and the

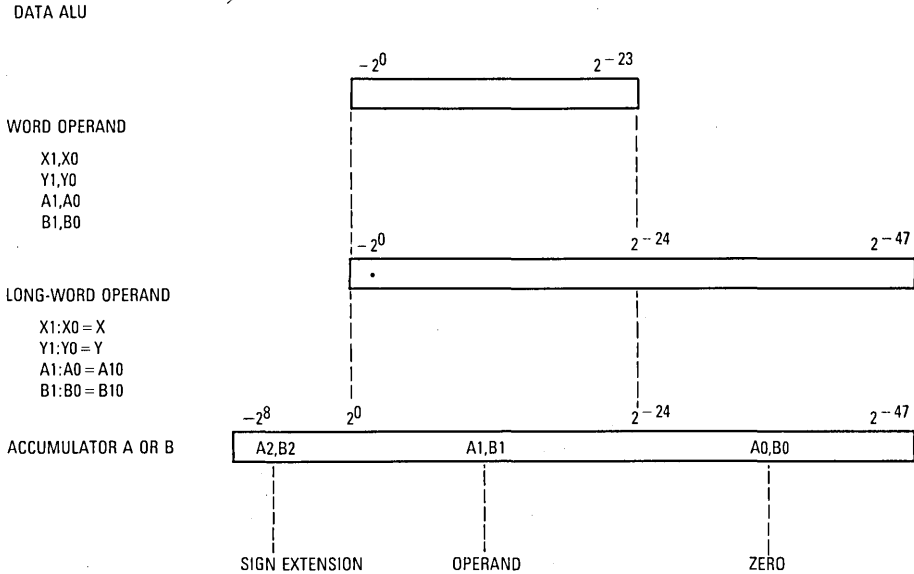

Figure 4-5. Bit Weighting and Alignment of Operands

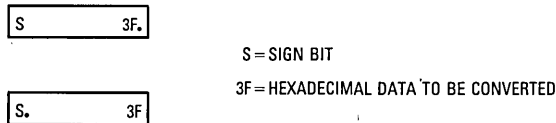

Figure 4-6. Integer-to-Fractional Data Conversion

most negative number is approximately  $-256$ . When the accumulator extension registers are in use, the data contained in the accumulators cannot be stored exactly in memory or other registers. In these cases, the data must be limited to the most positive or most negative number consistent with the size of the destination and the sign of the accumulator (the most significant bit (MSB) of the extension register).

To maintain alignment of the binary point when a word operand is written to accumulator A or B, the operand is written to the most significant accumulator register (A1 or B1), and

its MSB is automatically sign extended through the accumulator extension register. The least significant accumulator register is automatically cleared. When a long-word operand is written to an accumulator, the least significant word of the operand is written to the least significant accumulator register (see Figure 4-5).

A comparison between integer and fractional number representation is shown in Figure 4-7. The number representation for integers is between  $\pm 2^{(N-1)}$ ; whereas, the fractional representation is limited to numbers between  $\pm 1$ . To convert from an integer to a fractional number, the integer must be multiplied by a scaling factor so the result will always be between  $\pm 1$ . The representation of integer and fractional numbers is the same if the numbers are added or subtracted but is different if the numbers are multiplied or divided. An example of two numbers multiplied together is given in Figure 4-8. The key difference is that the extra bit in the integer multiplication is used as a duplicate sign bit and as the least significant bit (LSB) in the fractional multiplication. The advantages of fractional data representation are as follows:

The MSP (left half) has the same format as the input data.

The LSP (right half) can be rounded into the MSP without shifting or updating the exponent.

A significant bit is not lost through sign extension.

Conversion to floating-point representation is easier because the industry-standard floating-point formats use fractional mantissas.

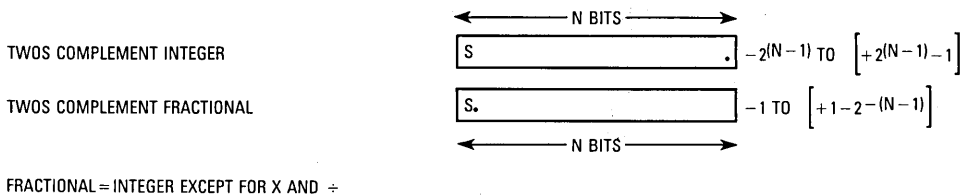

Figure 4-7. Integer/Fractional Number Comparison

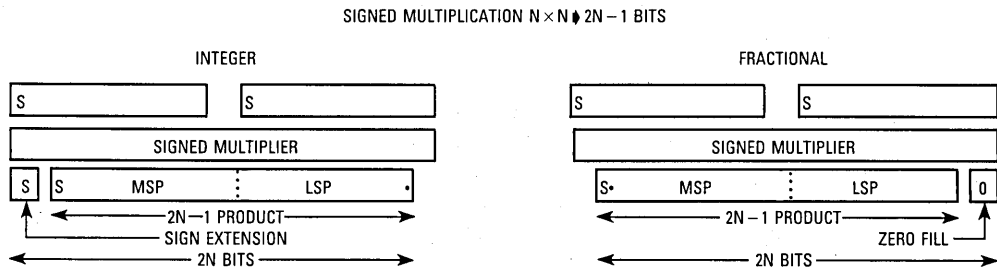

Figure 4-8. Integer/Fractional Multiplication Comparison

Coefficients for most digital filters are derived as fractions by the high-level language programs used in digital-filter design packages, which implies that the results can be used without the extensive data conversions that other formats require.

Should integer arithmetic be required in an application, shifting a one or zero, depending on the sign, into the MSB converts a fraction to an integer.

The data ALU MAC performs rounding of the accumulator register to single precision if requested in the instruction (the A1 or B1 register is rounded according to the contents of the A0 or B0 register). The rounding method used is called round-to-nearest (even) number, sometimes referred to as convergent rounding. The usual rounding method rounds up any value above one-half and rounds down any value below one-half. The question arises as to which way one-half should be rounded. If it is always rounded one way, the results will eventually be a bias in that direction. Convergent rounding solves the problem by rounding down if the number is odd (LSB = 0) and rounding up if the number is even (LSB = 1). Figure 4-9 shows the four cases for rounding a number in the A1 (or B1) register. If scaling is set in the status register, the resultant number will be rounded as it is put on the data bus. However, the contents of the register are not scaled.

### 4.3 DATA ALU PROGRAMMING MODEL

The data ALU features 24-bit input/output data registers that can be concatenated to accommodate 48-bit data and two 56-bit accumulators, which are segmented into three 24-bit pieces that can be transferred over the buses. Figure 4-10 illustrates how the registers in the programming model are grouped.

### 4.4 DATA ALU SUMMARY

The data ALU is optimized for arithmetic operations involving multiply and accumulate operations with two separate data spaces. The data ALU, which executes all instructions in one machine cycle, is not pipelined. The two 24-bit numbers being multiplied can come from the X registers (X0 or X1) or Y registers (Y0 or Y1). After multiplication, they are added (or subtracted) with one of the 56-bit accumulators and can be convergently rounded to 24 bits. The convergent-rounding forcing function detects the \$800000 condition in the LSP and makes the correction as necessary. The final result is then stored in one of the accumulators as a valid 56-bit number. The condition code bits are set based on the rounded output of the logic unit.

CASE I: IF  $A_0 < \$800000$  (1/2), THEN ROUND DOWN (ADD NOTHING)

BEFORE ROUNDING

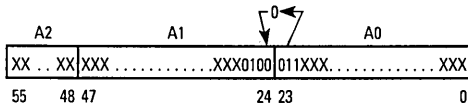

AFTER ROUNDING

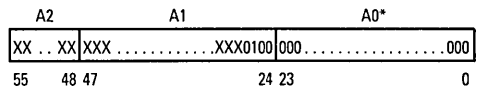

CASE II: IF  $A_0 > \$800000$  (1/2), THEN ROUND UP (ADD 1 TO A1)

BEFORE ROUNDING

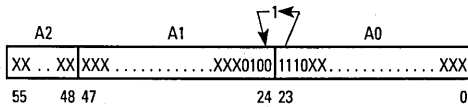

AFTER ROUNDING

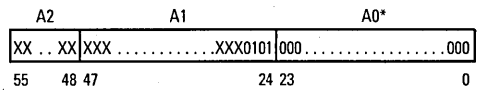

CASE III: IF  $A_0 = \$800000$  (1/2), AND THE LSB OF  $A_1 = 0$ , THEN ROUND DOWN (ADD NOTHING)

BEFORE ROUNDING

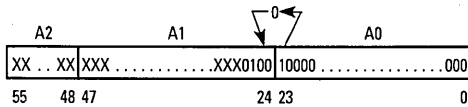

AFTER ROUNDING

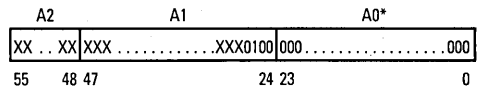

CASE IV: IF  $A_0 = \$800000$  (1/2), AND THE LSB = 1, THEN ROUND UP (ADD 1 TO A1)

BEFORE ROUNDING

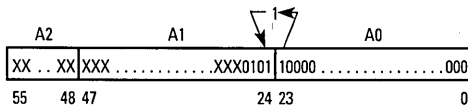

AFTER ROUNDING

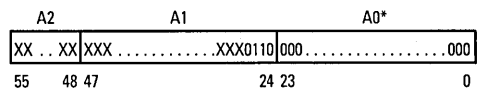

\*A0 is always clear; performed during RND, MPYR, MACR.

Figure 4-9. Convergent Rounding

DATA ALU  
INPUT REGISTERS

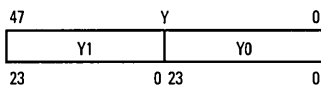
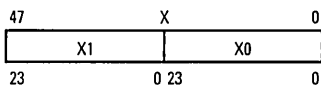

DATA ALU  
ACCUMULATOR REGISTERS

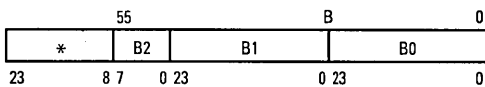
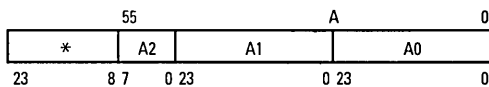

\*Read as zero, written as don't care.

Figure 4-10. DSP56000/DSP56001 Programming Model





## SECTION 5 ADDRESS GENERATION UNIT AND ADDRESSING MODES

This section contains three major subsections. The first subsection describes the hardware architecture of the address generation unit (AGU); the second subsection describes the programming model. The third subsection describes the addressing modes, illustrating how the Rn, Nn, and Mn registers work together to form a memory address.

### 5.1 AGU ARCHITECTURE

The AGU is one of the three execution units on the DSP56000/DSP56001 (see Figure 5-1). The AGU performs the effective address calculations (using integer arithmetic) necessary to address data operands in memory and contains the registers used to generate the addresses. It implements three types of arithmetic, linear, modulo, and reverse-carry, and operates in parallel with other chip resources to minimize address-generation overhead. The AGU is divided into two identical halves, each of which has an address arithmetic logic unit (ALU) and four sets of three registers (see Figure 5-2).

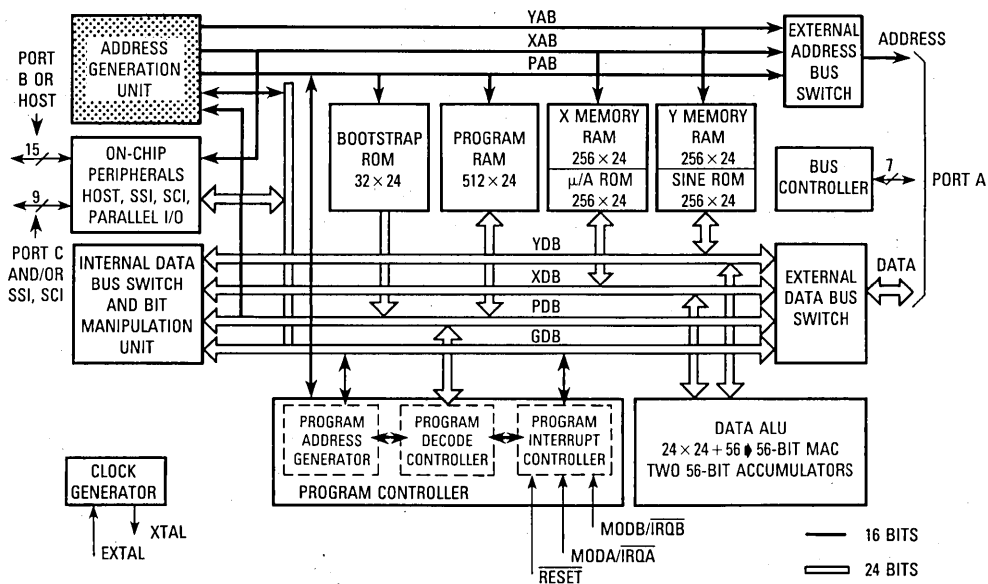

Figure 5-1. DSP56001 Block Diagram

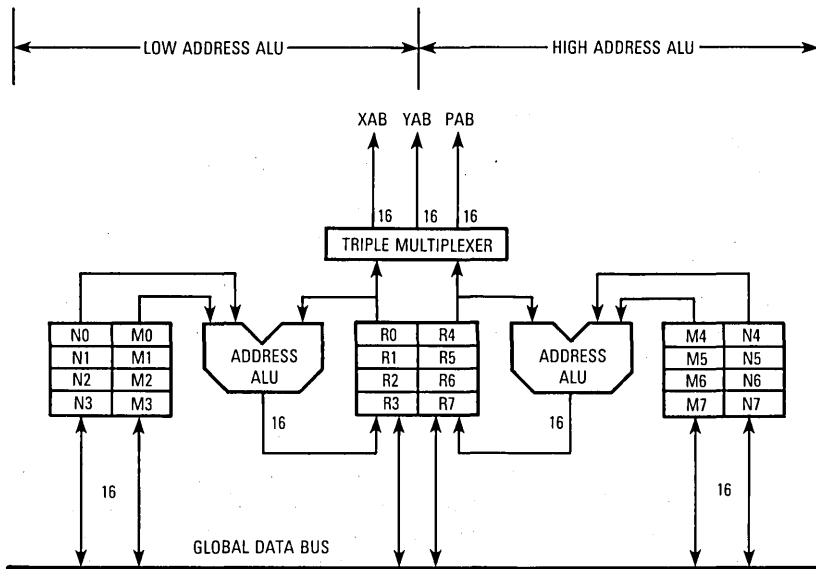

Figure 5-2. AGU Block Diagram

These registers are the address registers (R0–R3 and R4–R7), offset registers (N0–N3 and N4–N7), and the modifier registers (M0–M3 and M4–M7). The eight Rn, Nn, and Mn registers are treated as register triplets — e.g., only N2 and M2 can be used to update R2. The eight triplets are R0:N0:M0, R1:N1:M1, R2:N2:M2, R3:N3:M3, R4:N4:M4, R5:N5:M5, R6:N6:M6, and R7:N7:M7.

The two arithmetic units can generate two 16-bit addresses every instruction cycle — one for any two of the XAB, YAB, or PAB. The AGU can directly address 65,536 locations on the XAB, 65,536 locations on the YAB, and 65,536 locations on the PAB. The two independent address ALUs work with the two data memories to feed the data ALU two operands in a single cycle. Each operand may be addressed by an Rn, Nn, and Mn triplet.

### 5.1.1 Address Register Files (Rn)

Each of the two address register files (see Figure 5-2) consists of four 16-bit registers. The two files contain address registers R0–R3 and R4–R7, which usually contain addresses used as pointers to memory. Each register may be read or written by the global data bus (GDB). When read by the GDB, 16-bit registers are written into the two least significant bytes of the GDB, and the most significant byte is set to zero. When written from the GDB, only the two least significant bytes are written, and the most significant byte is truncated.

Each address register can be used as input to its associated address ALU for a register update calculation. Each register can also be written by the output of its respective address ALU. One Rn register from the low address ALU and one Rn register from the high address ALU can be accessed in a single instruction.

### 5.1.2 Offset Register Files (Nn)

Each of two offset register files, shown in Figure 5-2, consists of four 16-bit registers. The two files contain offset registers N0–N3 and N4–N7, which contain either offset values used to update address pointers or data. Each offset register can be read or written by the GDB. When read by the GDB, the contents of a register are placed in the two least significant bytes, and the most significant byte on the GDB is zero extended. When a register is written, only the least significant 16 bits of the GDB are used; the upper portion is truncated.

### 5.1.3 Modifier Register Files (Mn)

Each of two modifier register files, shown in Figure 5-2, consists of four 16-bit registers. The two files contain modifier registers M0–M3 and M4–M7, which specify the type of arithmetic used during address register update calculations or contain data. Each modifier register can be read or written by the GDB. When read by the GDB, the contents of a register are placed in the two least significant bytes, and the most significant byte on the GDB is zero extended. When a register is written, only the least significant 16 bits of the GDB are used; the upper portion is truncated. Each modifier register is preset to \$FFFF during a processor reset.

### 5.1.4 Address ALU

The two address ALUs are identical (see Figure 5-2) in that each contains a 16-bit full adder (called an offset adder), which can add 1) plus one, 2) minus one, 3) the contents of the respective offset register N, or 4) the two's complement of N to the contents of the selected address register. A second full adder (called a modulo adder) adds the summed result of the first full adder to a modulo value, M or minus M, where M is stored in the respective modifier register. A third full adder (called a reverse-carry adder) can add 1) plus one, 2) minus one, 3) the offset N (stored in the respective offset register), or 4) minus N to the selected address register with the carry propagating in the reverse direction — i.e., from the most significant bit (MSB) to the least significant bit (LSB). The offset adder and the reverse-carry adder are in parallel and share common inputs. The only difference between them is that the carry propagates in opposite directions. Test logic determines which of the three summed results of the full adders is output.

Each address ALU can update one address register, Rn, from its respective address register file during one instruction cycle and is capable of performing linear, reverse-carry, and

modulo arithmetic. The contents of the selected modifier register specify the type of arithmetic to be used in an address register update calculation. The modifier value is decoded in the address ALU.

The output of the offset adder gives the result of linear arithmetic (e.g.,  $R_n \pm 1$ ;  $R_n \pm N$ ) and is selected as the modulo arithmetic unit output for linear arithmetic addressing modifiers. The reverse-carry adder performs the required operation for reverse-carry arithmetic and its result is selected as the address ALU output for reverse-carry addressing modifiers. Reverse-carry arithmetic is useful for  $2^k$ -point fast Fourier transform (FFT) addressing. For modulo arithmetic, the modulo arithmetic unit will perform the function  $(R_n \pm N)$  modulo  $M$ , where  $N$  can be one, minus one, or the contents of the offset register  $N_n$ . If the modulo operation requires wraparound for modulo arithmetic, the summed output of the modulo adder gives the correct updated address register value; if wraparound is not necessary, the output of the offset adder gives the correct result.

**5**

**5.1.5 Address Output Multiplexers**

The address output multiplexers (see Figure 5-2) select the source for the XAB, YAB, and PAB. These multiplexers allow the XAB, YAB, or PAB outputs to originate from R0–R3 or R4–R7.

**5.2 PROGRAMMING MODEL**

The programmer’s view of the AGU is eight sets of three registers (see Figure 5-3). These registers can be used as temporary data registers and indirect memory pointers. Automatic updating is available when using address register indirect addressing. The  $R_n$  registers can be programmed for linear addressing, modulo addressing, and bit-reverse addressing.

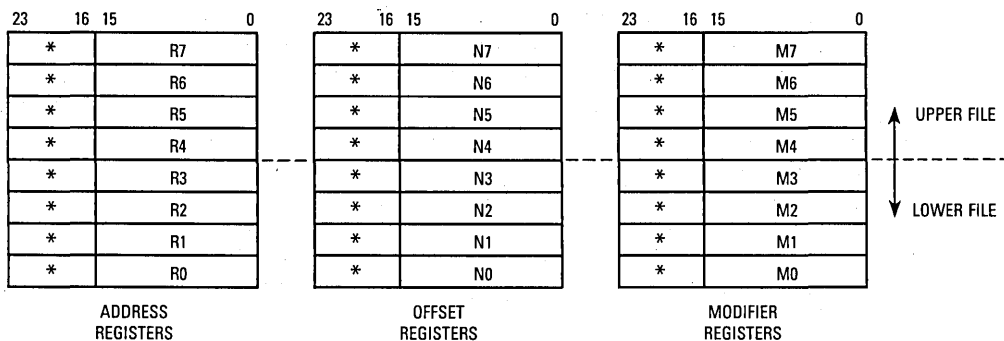

\*Written As Don't Care; Read As Zero

**Figure 5-3. AGU Programming Model**

### 5.2.1 Address Register Files (R0–R3 and R4–R7)

The eight 16-bit address registers, R0–R7, can contain addresses or general-purpose data. The 16-bit address in a selected address register is used in the calculation of the effective address of an operand. When supporting parallel X and Y data memory moves, the address registers must be thought of as two separate files, R0–R3 and R4–R7. The contents of an Rn may point directly to data or may be offset. In addition, Rn can be pre-updated or post-updated according to the addressing mode selected. If an Rn is updated, modifier registers, Mn, are always used to specify the type of update arithmetic. Offset registers, Nn, are used for the update-by-offset addressing modes. The address register modification is performed by one of the two modulo arithmetic units. Most addressing modes modify the selected address register in a read-modify-write fashion; the address register is read, its contents are modified by the associated modulo arithmetic unit, and the register is written with the appropriate output of the modulo arithmetic unit. The form of address register modification performed by the modulo arithmetic unit is controlled by the contents of the offset and modifier registers discussed in the following paragraphs. Each address register is preset to \$FFFF during a processor reset.

### 5.2.2 Offset Register Files (N0–N3 and N4–N7)

The eight 16-bit offset registers, N0–N7, can contain offset values used to increment/decrement address registers in address register update calculations or can be used for 16-bit general-purpose storage. For example, the contents of an offset register can be used to step through a table at some rate (e.g., five locations per step for waveform generation), or the contents can specify the offset into a table or the base of the table for indexed addressing. Each address register, Rn, has its own offset register, Nn, associated with it. Each offset register is preset to \$FFFF during a processor reset.

### 5.2.3 Modifier Register Files (M0–M3 and M4–M7)

The eight 16-bit modifier registers, M0–M7, define the type of address arithmetic to be performed for addressing mode calculations, or they can be used for general-purpose storage. The address ALU supports linear, modulo, and reverse-carry arithmetic types for all address register indirect addressing modes. For modulo arithmetic, the contents of Mn also specify the modulus. Each address register, Rn, has its own modifier register, Mn, associated with it. Each modifier register is set to \$FFFF on processor reset, which specifies linear arithmetic as the default type for address register update calculations. Each modifier register is preset to \$FFFF during a processor reset.

## 5.3 ADDRESSING

The DSP56000/DSP56001 provides three different addressing modes: register direct, address register indirect, and special (see Table 5-1). Since the register direct and special addressing modes do not necessarily use the AGU registers, they are described in **SECTION**

**7 INSTRUCTION SET SUMMARY.** The address register indirect addressing modes use the registers in the AGU and are described in the following paragraphs.

**Table 5-1. Address Register Indirect Summary**

| Address Register Indirect  | Uses Mn Modifier | Operand Reference |   |   |   |   |   |   |   | Assembler Syntax |           |
|----------------------------|------------------|-------------------|---|---|---|---|---|---|---|------------------|-----------|
|                            |                  | S                 | C | D | A | P | X | Y | L |                  | XY        |
| No Update                  | No               |                   |   |   |   | X | X | X | X | X                | (Rn)      |
| Postincrement by 1         | Yes              |                   |   |   |   | X | X | X | X | X                | (Rn) +    |
| Postdecrement by 1         | Yes              |                   |   |   |   | X | X | X | X | X                | (Rn) -    |
| Postincrement by Offset Nn | Yes              |                   |   |   |   | X | X | X | X | X                | (Rn) + Nn |
| Postdecrement by Offset Nn | Yes              |                   |   |   |   | X | X | X | X | X                | (Rn) - Nn |
| Indexed by Offset Nn       | Yes              |                   |   |   |   | X | X | X | X | X                | (Rn + Nn) |
| Predecrement by 1          | Yes              |                   |   |   |   | X | X | X | X | X                | -(Rn)     |

NOTE:

- S = System Stack Reference
- C = Program Controller Register Reference
- D = Data ALU Register Reference
- A = Address ALU Register Reference
- P = Program Memory Reference
- X = X Memory Reference
- Y = Y Memory Reference
- L = L Memory Reference
- XY = XY Memory Reference

### 5.3.1 Address Register Indirect Modes

When an address register is used to point to a memory location, the addressing mode is called address register indirect (see Table 5-1). The term indirect is used because the register contents are not the operand itself, but rather the address of the operand. These addressing modes specify that an operand is in memory and specify the effective address of that operand.

A portion of the data bus movement field in the instruction specifies the memory space to be referenced. The contents of specific AGU registers that determine the effective address are modified by arithmetic operations performed in the AGU. The type of address arithmetic used is specified by the address modifier register, Mn. The offset register, Nn, is only used when the update specifies an offset.

Not all possible combinations are available, e.g., +(Rn). The 24-bit instruction word size of the DSP56000/DSP56001 is not large enough to allow a completely orthogonal instruction set for all instructions used by the processor.

An example and description of each mode is given in the following paragraphs. **SECTION 7 INSTRUCTION SET SUMMARY** and **APPENDIX A INSTRUCTION SET DETAILS** give a complete description of the instruction syntax used in these examples. In particular, XY:

memory references refer to instructions in which an operand in X memory and an operand in Y memory are referenced in the same instruction.

**5.3.1.1 NO UPDATE.** The address of the operand is in the address register, Rn (see Table 5-1). The contents of the Rn register are unchanged by executing the instruction. Figure 5-4 shows a MOVE instruction using address register indirect addressing with no update. This mode can be used for making XY: memory references.

EXAMPLE: MOVE A1,X:(R0)

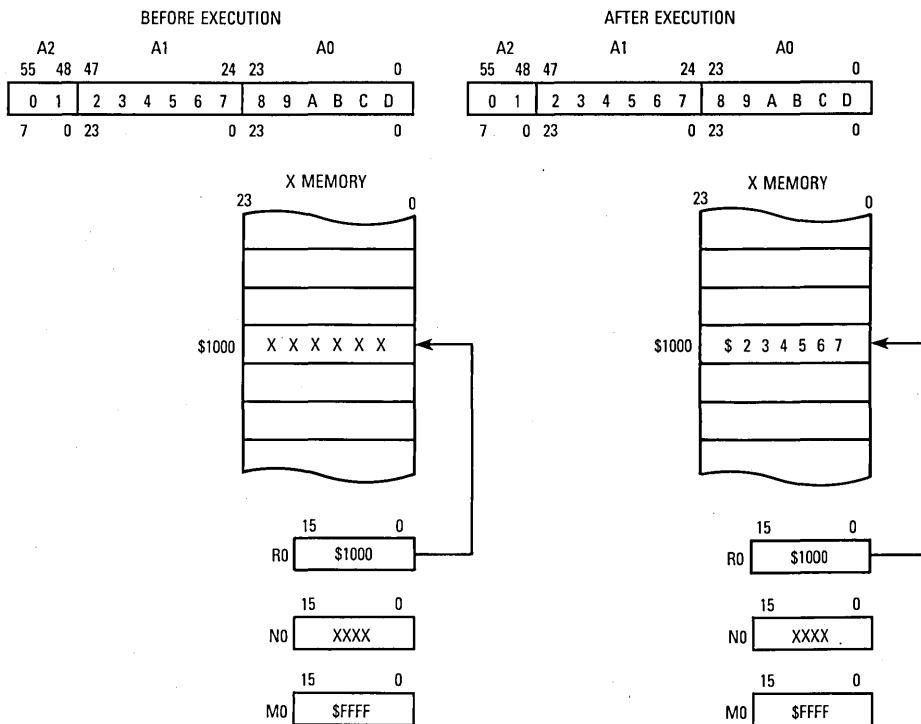

Assembler Syntax: (Rn)  
 Memory Spaces: P:, X:, Y:, XY:, L:  
 Additional Instruction Execution Time (Clocks): 0  
 Additional Effective Address Words: 0

Figure 5-4. Address Register Indirect — No Update

**5.3.1.2 POSTINCREMENT BY 1.** The address of the operand is in the address register, Rn (see Table 5-1 and Figure 5-5). After the operand address is used, it is incremented by 1 and stored in the same address register. This mode can be used for making XY: memory references and for modifying the contents of Rn without an associated data move.

**5.3.1.3 POSTDECREMENT BY 1.** The address of the operand is in the address register, Rn (see Table 5-1 and Figure 5-6). After the operand address is used, it is decremented by 1 and stored in the same address register. This mode can be used for making XY: memory references and for modifying the contents of Rn without an associated data move.

EXAMPLE: MOVE B0,Y:(R1)+

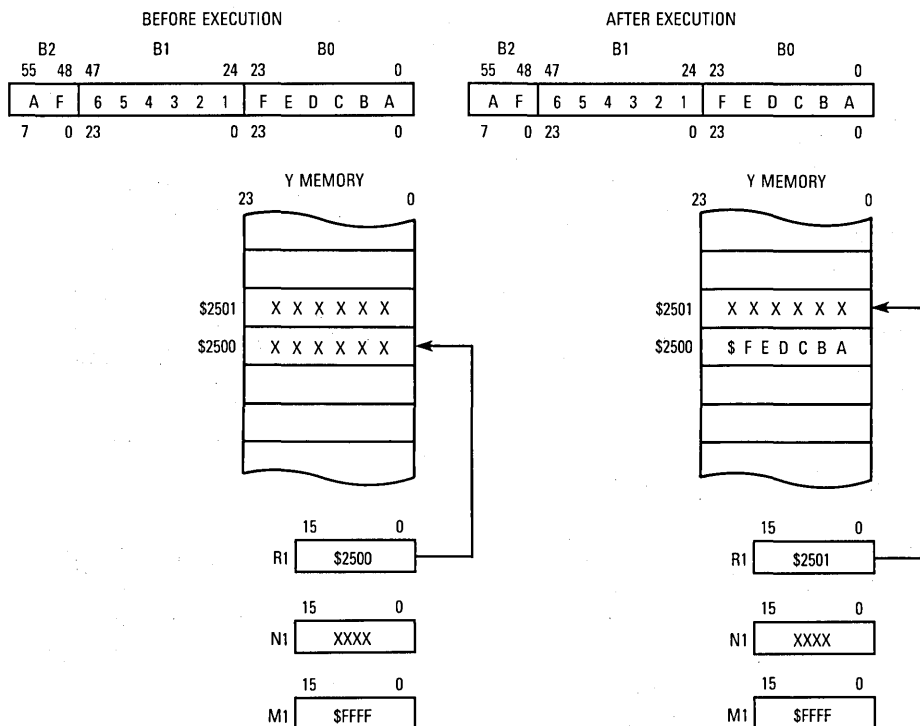

Assembler Syntax: (Rn)+  
 Memory Spaces: P:, X:, Y:, XY:, L:  
 Additional Instruction Execution Time (Clocks): 0  
 Additional Effective Address Words: 0

Figure 5-5. Address Register Indirect — Postincrement



EXAMPLE: MOVE Y0,Y:(R3) –

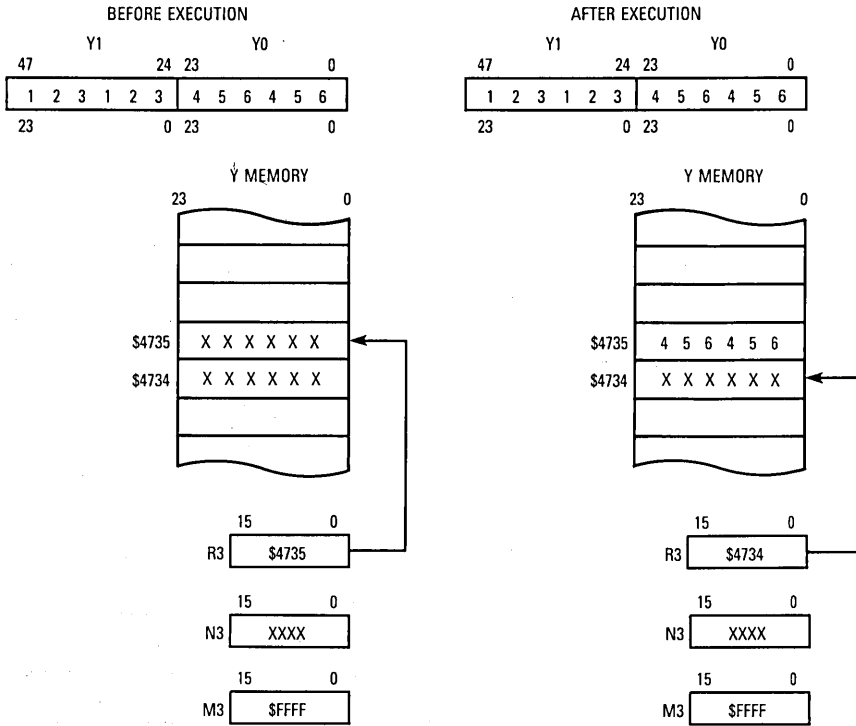

5

Assembler Syntax: (Rn) –  
 Memory Spaces: P:, X:, Y:, XY:, L:  
 Additional Instruction Execution Time (Clocks): 0  
 Additional Effective Address Words: 0

Figure 5-6. Address Register Indirect — Postdecrement

**5.3.1.4 POSTINCREMENT BY OFFSET Nn.** The address of the operand is in the address register, Rn (see Table 5-1 and Figure 5-7). After the operand address is used, it is incremented by the contents of the Nn register and stored in the same address register. The contents of the Nn register are unchanged. This mode can be used for making XY: memory references and for modifying the contents of Rn without an associated data move.

**5.3.1.5 POSTDECREMENT BY OFFSET Nn.** The address of the operand is in the address register, Rn (see Table 5-1 and Figure 5-8). After the operand address is used, it is decremented by the contents of the Nn register and stored in the same address register. The

EXAMPLE: MOVE X1,X:(R2)+N2

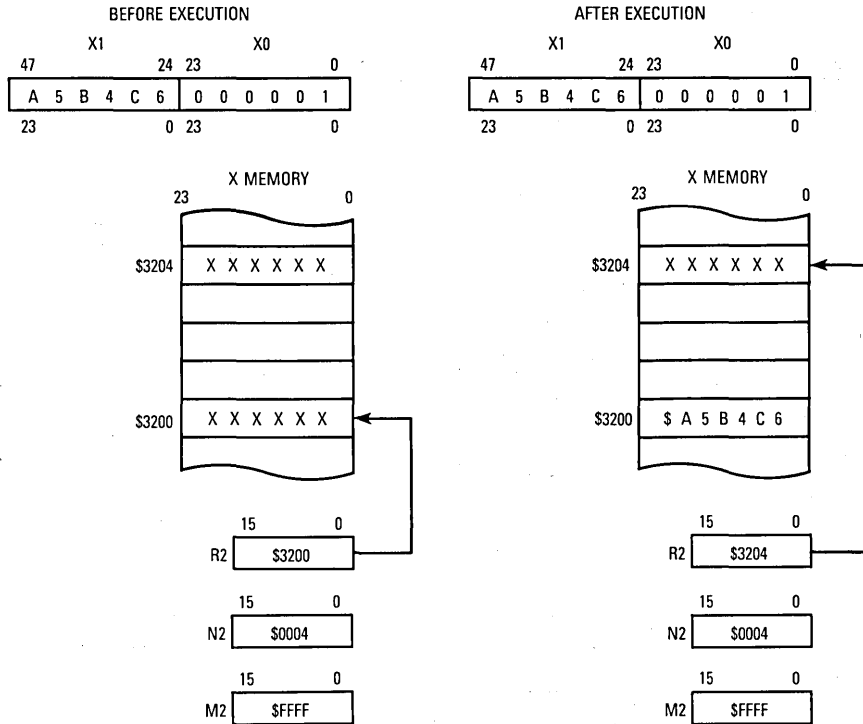

Assembler Syntax: (Rn)+Nn  
 Memory Spaces: P:, X:, Y:, XY:, L:  
 Additional Instruction Execution Time (Clocks): 0  
 Additional Effective Address Words: 0

Figure 5-7. Address Register Indirect — Postincrement by Offset Nn

contents of the Nn register are unchanged. This mode cannot be used for making XY: memory references, but it can be used to modify the contents of Rn without an associated data move.

**5.3.1.6 INDEXED BY OFFSET Nn.** The address of the operand is the sum of the contents of the address register, Rn, and the contents of the address offset register, Nn (see Table 5-1 and Figure 5-9). The contents of the Rn and Nn registers are unchanged. This addressing mode, which requires an extra instruction cycle, cannot be used for making XY: memory references.

EXAMPLE: MOVE X:(R4) – N4,A0

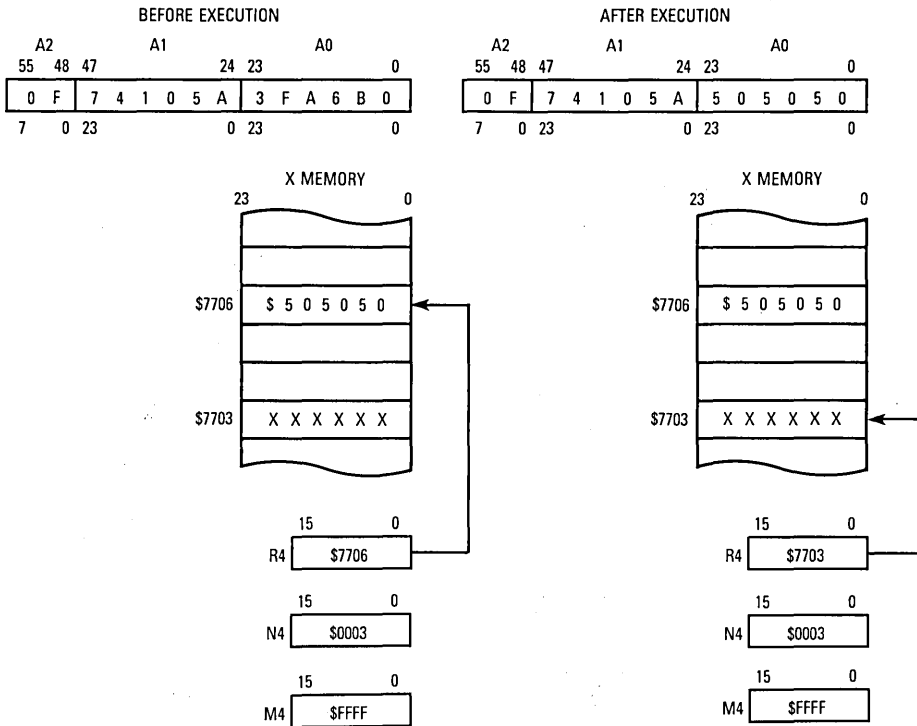

Assembler Syntax: (Rn) – Nn  
 Memory Spaces: P, X, Y, L:  
 Additional Instruction Execution Time (Clocks): 0  
 Additional Effective Address Words: 0

**Figure 5-8. Address Register Indirect — Postdecrement by Offset Nn**

**5.3.1.7 PREDECREMENT BY 1.** The address of the operand is the contents of the address register, Rn, decremented by 1 before the operand address is used (see Table 5-1 and Figure 5-10). The contents of Rn are decremented and stored in the same address register. This addressing mode requires an extra instruction cycle. This mode cannot be used for making XY: memory references, nor can it be used for modifying the contents of Rn without an associated data move.

### 5.3.2 Address Modifier Types

The DSP56000/DSP56001 address ALU supports linear, modulo, and reverse-carry arithmetic types for all address register indirect modes. These arithmetic types easily allow the

EXAMPLE: MOVE Y1,X:(R6 + N6)

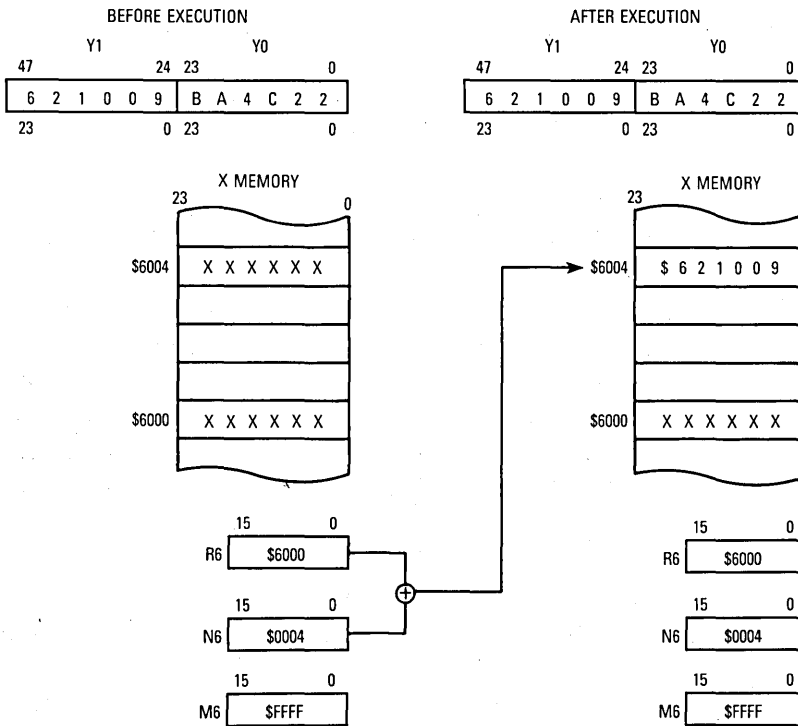

Assembler Syntax: (Rn + Nn)  
 Memory Spaces: P, X, Y, L:  
 Additional Instruction Execution Time (Clocks): 2  
 Additional Effective Address Words: 0

Figure 5-9. Address Register Indirect — Indexed by Offset Nn

creation of data structures in memory for FIFOs (queues), delay lines, circular buffers, stacks, and bit-reversed FFT buffers. Data is manipulated by updating address registers (pointers) rather than moving large blocks of data. The contents of the address modifier register, Mn, define the type of arithmetic to be performed for addressing mode calculations; for modulo arithmetic, the contents of Mn also specify the modulus. All address register indirect modes can be used with any address modifier. Each address register, Rn, has its own modifier register, Mn, associated with it.

**5.3.2.1 LINEAR MODIFIER (Mn = \$FFFF).** Address modification is performed using normal 16-bit linear (modulo 65,536) arithmetic (see Table 5-2). A 16-bit offset, Nn, and +1 or -1

EXAMPLE: MOVE X: -(R5),B1

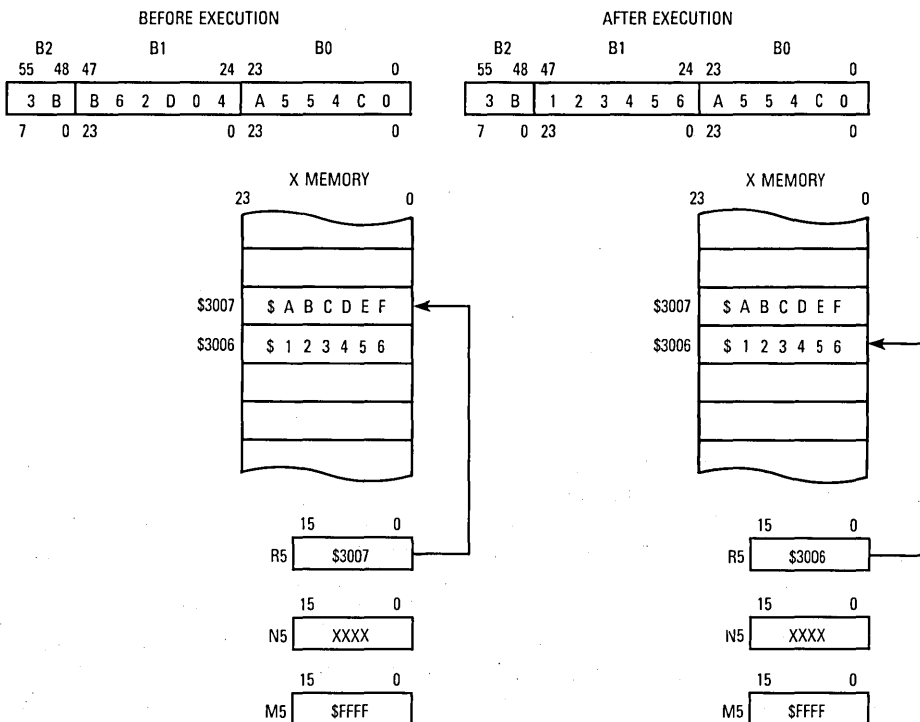

Assembler Syntax: `-(Rn)`  
 Memory Spaces: P, X, Y, L:  
 Additional Instruction Execution Time (Clocks): 2  
 Additional Effective Address Words: 0

Figure 5-10. Address Register Indirect — Predecrement

can be used in the address calculations. The range of values can be considered as signed (Nn from -32,768 to +32,767) or unsigned (Nn from 0 to +65,535) since there is no arithmetic difference between these two data representations. Addresses are normally considered unsigned, and data is normally considered signed.

**5.3.2.2 MODULO MODIFIER (Mn=MODULUS-1).** The address modification is performed modulo M, where M ranges from 2 to +32,768 (see Table 5-3). Modulo M arithmetic causes the address register value to remain within an address range of size M, defined by a lower and upper address boundary (see Figure 5-11). The value  $m = M - 1$  is stored in the modifier register, Mn. The lower boundary (base address) value must have zeros in the k LSBs, where  $2^k \geq M$ , and therefore must be a multiple of  $2^k$ . The upper boundary is

**Table 5-2. Linear Address Modifiers**

| Modifier Mn Value | Addressing Mode Arithmetic   |
|-------------------|------------------------------|
| 0                 | Reverse Carry (Bit Reverse)  |
| 1                 | Modulo 2                     |
| 2                 | Modulo 3                     |
| :                 | :                            |
| :                 | Modulo (Mn + 1)              |
| :                 | :                            |
| 32766             | Modulo 32767                 |
| 32767             | Modulo 32768                 |
| :                 | Reserved                     |
| <b>65535</b>      | <b>Linear (Modulo 65536)</b> |

the lower boundary plus the modulo size minus one (base address plus  $M - 1$ ). Since  $M \leq 2^k$ , once  $M$  is chosen, a sequential series of memory blocks (each of length  $2^k$ ) is created where these circular buffers can be located. If  $M < 2^k$ , there will be a space between sequential circular buffers of  $(2^k) - M$ . For example, to create a circular buffer of 21 stages,  $M$  is 21, and the lower address boundary must have its five LSBs equal to zero ( $2^k \geq 21$ , thus  $k \geq 5$ ). The  $Mn$  register is loaded with the value 20. The lower boundary may be chosen as 0, 32, 64, 96, 128, 160, etc. The upper boundary of the buffer is then the lower boundary plus 21. There will be an unused space of 11 memory locations between the upper address and next usable lower address. The address pointer is not required to start at the lower address boundary or to end on the upper address boundary; it can initially point anywhere within the defined modulo address range. Neither the lower nor the upper boundary of the modulo region is stored; only the size of the modulo region is stored in  $Mn$ . The boundaries are determined by the contents of  $Rn$ . Assuming the  $(Rn) +$  indirect addressing mode, if the address register pointer increments past the upper boundary of the buffer

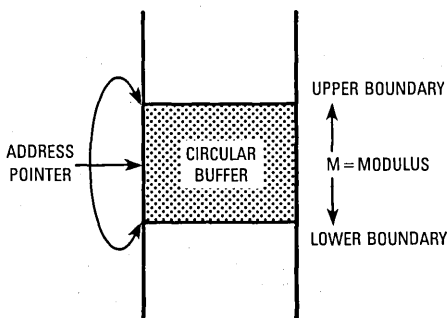

**Figure 5-11. Circular Buffer**

(base address plus  $M - 1$ ), it will wrap around through the base address (lower boundary). Alternatively, assuming the  $(Rn) -$  indirect addressing mode, if the address decrements past the lower boundary (base address), it will wrap around through the base address plus  $M - 1$  (upper boundary).

If an offset,  $Nn$ , is used in the address calculations, the 16-bit absolute value,  $|Nn|$ , must be less than or equal to  $M$  for proper modulo addressing. If  $Nn > M$ , the result is data dependent and unpredictable, except for the special case where  $Nn = P \times 2^k$ , a multiple of the block size where  $P$  is a positive integer. For this special case, when using the  $(Rn) + Nn$  addressing mode, the pointer,  $Rn$ , will jump linearly to the same relative address in a new buffer, which is  $P$  blocks forward in memory (see Figure 5-12). Similarly, for  $(Rn) - Nn$ , the pointer will jump  $P$  blocks backward in memory. This technique is useful in sequentially processing multiple tables or  $N$ -dimensional arrays. The range of values for  $Nn$  is  $-32,768$  to  $+32,767$ . The modulo arithmetic unit will automatically wrap around the address pointer by the required amount. This type address modification is useful for creating circular buffers for FIFOs (queues), delay lines, and sample buffers up to 32,768 words long as well as for decimation, interpolation, and waveform generation. The special case of  $(Rn) \pm Nn \text{ mod } M$  with  $Nn = P \times 2^k$  is useful for performing the same algorithm on multiple blocks of data in memory — e.g., parallel infinite impulse response (IIR) filtering.

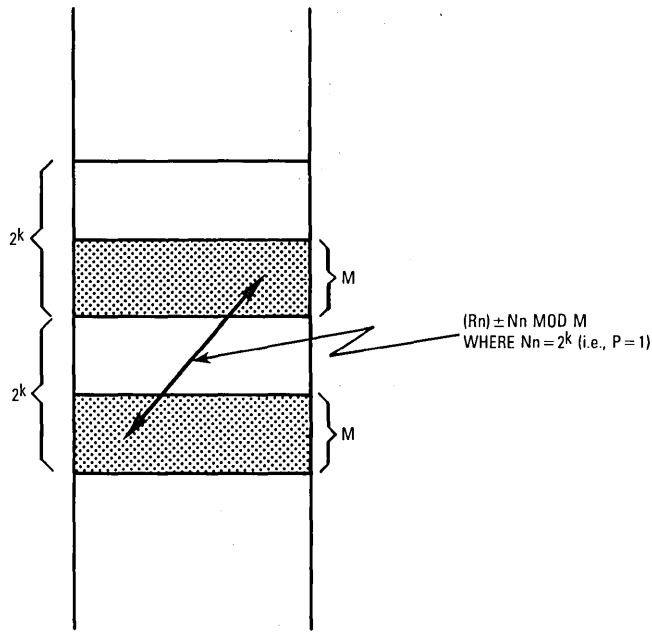

Figure 5-12. Linear Addressing with a Modulo Modifier

An example of address register indirect modulo addressing is shown in Figure 5-13. Starting at location 64, a circular buffer of 21 stages is created. The addresses generated are offset by 15 locations. The lower boundary =  $L \times (2^k)$  where  $2^k \geq 21$ ; therefore,  $k=5$  and the lower address boundary must be a multiple of 32. The lower boundary may be chosen as 0, 32, 64, 96, 128, 160, etc. For this example,  $L$  is arbitrarily chosen to be 2, making the lower boundary 64. The upper boundary of the buffer is then 84 (the lower boundary plus 20 ( $M - 1$ )). The  $M_n$  register is loaded with the value 20 ( $M - 1$ ). The offset register is arbitrarily chosen to be 15 ( $N_n \leq M$ ). The address pointer is not required to start at the lower address boundary and can begin anywhere within the defined modulo address range — i.e., within the lower boundary + ( $2^k$ ) address region. The address pointer,  $R_n$ , is arbitrarily chosen to be 75 in this example. When  $R_2$  is postincremented by the offset by the MOVE instruction, instead of pointing to 90 (as it would in the linear mode) it wraps around to 69. If the address register pointer increments past the upper boundary of the buffer (base address plus  $M - 1$ ), it will wrap around to the base address. If the address decrements past the lower boundary (base address), it will wrap around to the base address plus  $M - 1$ .

If  $R_n$  is outside the valid modulo buffer range and an operation occurs that causes  $R_n$  to be updated, the contents of  $R_n$  will be updated according to modulo arithmetic rules. For example, a MOVE  $B_0, X:(R_0) + N_0$  instruction (where  $R_0=6$ ,  $M_0=5$ , and  $N_0=0$ ) would apparently leave  $R_0$  unchanged since  $N_0=0$ . However, since  $R_0$  is above the upper boundary, the AGU calculates  $R_0 + N_0 - M_0 - 1$  for the new contents of  $R_0$  and sets  $R_0=0$ .

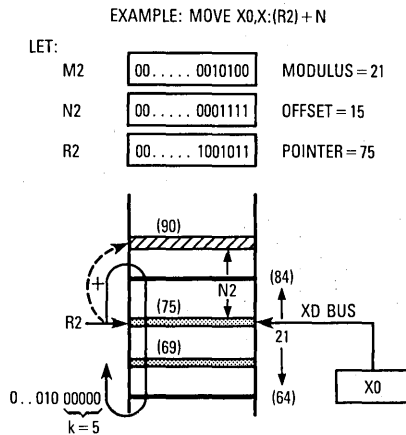

Figure 5-13. Modulo Modifier Example



Table 5-3. Modulo Address Modifiers

| Modifier Mn Value | Addressing Mode Arithmetic  |
|-------------------|-----------------------------|
| 0                 | Reverse Carry (Bit Reverse) |
| 1                 | <i>Modulo 2</i>             |
| 2                 | <i>Modulo 3</i>             |
| :                 | :                           |
| :                 | <i>Modulo (Mn + 1)</i>      |
| :                 | :                           |
| 32766             | <i>Modulo 32767</i>         |
| 32767             | <i>Modulo 32768</i>         |
| :                 | Reserved                    |
| 65535             | Linear (Modulo 65536)       |

The MOVE instruction in Figure 5-13 takes the contents of the X0 register and moves it to a location in the X memory pointed to by (R2), and then (R2) is updated modulo 21. The new value of R2 is not 90 (75 + 15), which would be the case if linear arithmetic had been used, but rather is 69 since modulo arithmetic was used.

**5.3.2.3 REVERSE-CARRY MODIFIER (Mn = \$0000).** Reverse carry is selected by setting the modifier register to zero (see Table 5-4). The address modification is performed in hardware by propagating the carry in the reverse direction — i.e., from the MSB to the LSB. Reverse carry is equivalent to bit reversing the contents of Rn (i.e., redefining the MSB as the LSB, the next MSB as bit 1, etc.) and the offset value, Nn, adding normally, and then bit reversing the result. If the +Nn addressing mode is used with this address modifier and Nn contains the value  $2^{(k-1)}$  (a power of two), this addressing modifier is equivalent to bit reversing the k LSBs of Rn, incrementing Rn by 1, and bit reversing the k LSBs of Rn again. This

Table 5-4. Reverse-Carry Address Modifiers

| Modifier Mn Value | Addressing Mode Arithmetic         |
|-------------------|------------------------------------|
| 0                 | <i>Reverse Carry (Bit Reverse)</i> |
| 1                 | Modulo 2                           |
| 2                 | Modulo 3                           |
| :                 | :                                  |
| :                 | Modulo (Mn + 1)                    |
| :                 | :                                  |
| 32766             | Modulo 32767                       |
| 32767             | Modulo 32768                       |
| :                 | Reserved                           |
| 65535             | Linear (Modulo 65536)              |

address modification is useful for addressing the twiddle factors in  $2^k$ -point FFT addressing and to unscramble  $2^k$ -point FFT data. The range of values for  $N_n$  is 0 to  $+32K$  (i.e.,  $N_n = 2^{15}$ ), which allows bit-reverse addressing for FFTs up to 65,536 points.

To make bit-reverse addressing work correctly for a  $2^k$  point FFT, the following procedures must be used:

1. Set  $M_n = 0$ ; this selects reverse-carry arithmetic.
2. Set  $N_n = 2(k - 1)$ .
3. Set  $R_n$  between the lower boundary and upper boundary in the buffer memory. The lower boundary is  $L \times (2^k)$ , where  $L$  is an arbitrary whole number. This boundary gives a 16-bit binary number "xx . . . xx00 . . . 00", where xx . . . xx =  $L$  and 00 . . . 00 equals  $k$  zeros. The upper boundary is  $L \times (2^k) + ((2^k) - 1)$ . This boundary gives a 16-bit binary number "xx . . . xx11 . . . 11", where xx . . . xx =  $L$  and 11 . . . 11 equals  $k$  ones.
4. Use the  $(R_n) + N_n$  addressing mode.

As an example, consider a 1024-point FFT with real data stored in the X memory and imaginary data stored in the Y memory. Since  $1,024 = 2^{10}$ ,  $k = 10$ . The modifier register ( $M_n$ ) is zero to select bit-reverse addressing. Offset register ( $N_n$ ) contains the value 512 ( $2(k - 1)$ ), and the pointer register ( $R_n$ ) contains 3,072 ( $L \times (2^k) = 3 \times (2^{10})$ ), which is the lower boundary of the memory buffer that holds the results of the FFT. The upper boundary is 4,095 (lower boundary +  $(2^k) - 1 = 3,072 + 1,023$ ).

Postincrementing by  $+N$  generates the address sequence (0, 512, 256, 768, 128, 640, . . . ), which is added to the lower boundary. This sequence (0, 512, etc.) is the scrambled FFT data order for sequential frequency points from 0 to  $2 \times \pi$ . Table 5-5 shows the successive contents of  $R_n$  when using  $(R_n) + N_n$  updates.

**Table 5-5. Bit-Reverse Addressing Sequence Example**

| Rn Contents | Offset from Lower Boundary |
|-------------|----------------------------|
| 3072        | 0                          |
| 3584        | 512                        |
| 3328        | 256                        |
| 3840        | 768                        |
| 3200        | 128                        |
| 3712        | 640                        |

The reverse-carry modifier only works when the base address of the FFT data buffer is a multiple of  $2^k$ , such as 1,024, 2,048, 3,072, etc. The use of addressing modes other than postincrement by  $+N_n$  is possible but may not provide a useful result.

The term bit reverse with respect to reverse-carry arithmetic is descriptive. The lower boundary that must be used for the bit-reverse scheme to work is  $L \times (2^k)$ . In the previous example shown in Table 5-5,  $L=3$  and  $k=10$ . The first address used is the lower boundary (3072); the calculation of the next address is shown in Figure 5-14. The  $k$  LSBs of the current contents of  $R_n$  (3,072) are swapped:

- Bits 0 and 9 are swapped.
- Bits 1 and 8 are swapped.
- Bits 2 and 7 are swapped.
- Bits 3 and 6 are swapped.
- Bits 4 and 5 are swapped.

The result is incremented (3,073), and then the  $k$  LSBs are swapped again:

- Bits 0 and 9 are swapped.
- Bits 1 and 8 are swapped.
- Bits 2 and 7 are swapped.
- Bits 3 and 6 are swapped.
- Bits 4 and 5 are swapped.

The result is  $R_n$  equals 3,584.

### 5.3.2.4 Address-Modifier-Type Encoding Summary

Table 5-6 is a summary of the address modifier types discussed in the previous paragraphs. There are three modifier types:

- Linear Addressing
- Reverse-Carry Addressing
- Modulo Addressing

EACH UPDATE,  $(R_n) + N_n$ , IS EQUIVALENT TO:

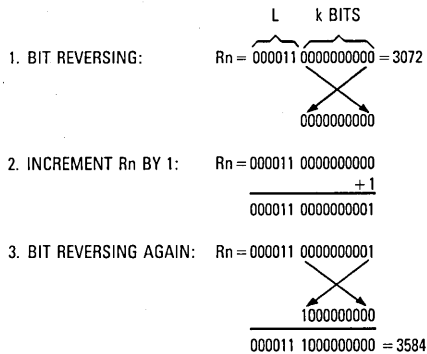

Figure 5-14. Bit-Reverse Address Calculation Example

**Table 5-6. Address-Modifier-Type Encoding Summary**

| Modifier Mn | Rn Update Arithmetic                   |
|-------------|--|
| 0           | Reverse-Carry (Bit-Reverse) Addressing |
| 1           | Modulo 2                               |
| 2           | Modulo 3                               |
| :           | :                                      |
| :           | Modulo (Mn + 1) Addressing             |
| :           | :                                      |
| 32767       | Modulo 32768                           |
| :           | Reserved                               |
| 65535       | Linear Addressing (Modulo 65536)       |

**5**

Bit-reverse addressing is useful for 2k-point FFT addressing. Modulo addressing is useful for creating circular buffers for FIFOs (queues), delay lines, and sample buffers up to 32,768 words long. The linear addressing is useful for general-purpose addressing. There is a reserved set of modifier values (from 32,768 to 65,534) that should not be used.

Figure 5-15 gives examples of the three addressing modifiers using 8-bit registers for simplification (all AGU registers in the DSP56000/DSP56001 are 16 bit). The addressing mode used in the example, postincrement by offset Nn, adds the contents of the offset register to the contents of the address register after the address register is accessed. The results of the three examples are as follows:

The linear address modifier addresses every fifth location since the offset register contains \$5.

Using the bit-reverse address modifier causes the postincrement by offset Nn addressing mode to use the address register, bit reverse the four LSBs, increment by 1, and bit reverse the four LSBs again.

The modulo address modifier has a lower boundary at a predetermined location, and the modulo number plus the lower boundary establishes the upper boundary. This boundary creates a circular buffer so that, if the address register is pointing within the boundaries, addressing past a boundary causes a circular wraparound to the other boundary.

**LINEAR ADDRESS MODIFIER**

MO = 255 = 1111 1111 FOR LINEAR ADDRESSING WITH R0

ORIGINAL REGISTERS: NO = 5, R0 = 75 = 0100 1011

POSTINCREMENT BY OFFSET NO:R0 = 80 = 0101 0000

POSTINCREMENT BY OFFSET NO:R0 = 85 = 0101 0101

POSTINCREMENT BY OFFSET NO:R0 = 90 = 0101 1010

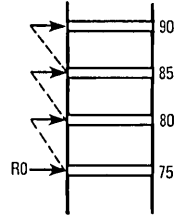

**MODULO ADDRESS MODIFIER**

MO = 19 = 0001 0011 FOR MODULO 20 ADDRESSING WITH R0

ORIGINAL REGISTERS: NO = 5, R0 = 75 = 0100 1011

POSTINCREMENT BY OFFSET NO:R0 = 80 = 0101 0000

POSTINCREMENT BY OFFSET NO:R0 = 65 = 0100 0001

POSTINCREMENT BY OFFSET NO:R0 = 70 = 0100 0110

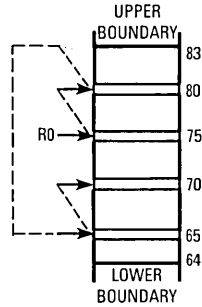

**REVERSE-CARRY ADDRESS MODIFIER**

MO = 0 = 0000 0000 FOR REVERSE-CARRY ADDRESSING WITH R0

ORIGINAL REGISTERS: NO = 8, R0 = 64 = 0100 0000

POSTINCREMENT BY OFFSET NO:R0 = 72 = 0100 1000

POSTINCREMENT BY OFFSET NO:R0 = 68 = 0100 0100

POSTINCREMENT BY OFFSET NO:R0 = 76 = 0100 1100

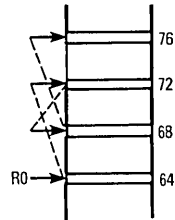

**Figure 5-15. Address Modifier Summary**



## SECTION 6 PROGRAM CONTROLLER

This section describes the hardware of the program controller and concludes with a description of the programming model. The instruction pipeline description is also included since understanding the pipeline is particularly important in understanding the DSP56000/DSP56001.

### 6.1 OVERVIEW

The program controller (one of the three concurrent execution units in the central processor) performs program address generation (instruction prefetch), instruction decoding, hardware DO loop control, and exception processing (see Figure 6-1). The programmer views the program controller as consisting of six registers and a hardware system stack (SS) as shown in Figure 6-2. In addition to the standard program flow-control resources, such as a program counter (PC), complete status register (SR), and SS, the program controller features registers (loop address (LA) and loop counter (LC)) dedicated to supporting the hardware DO loop instruction.

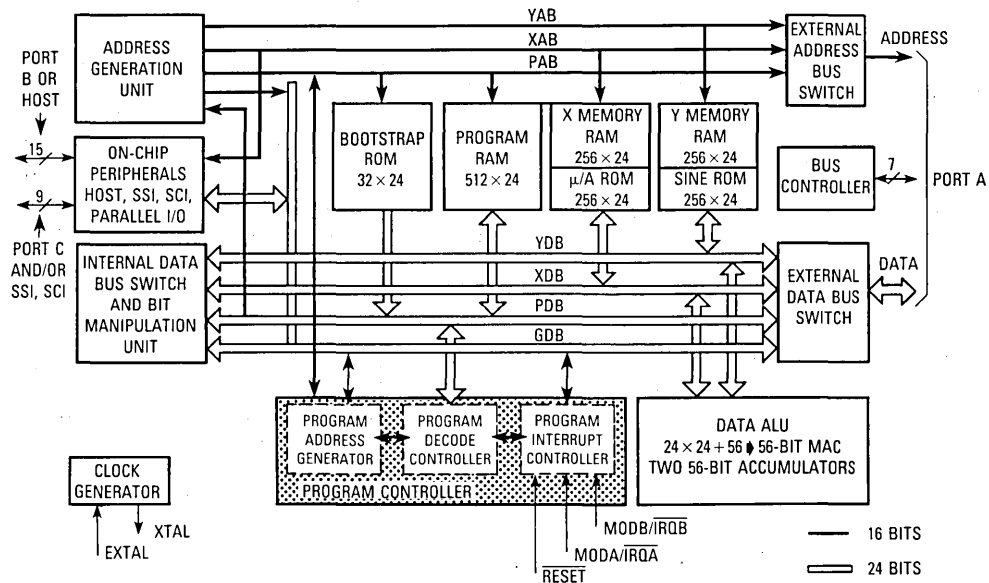
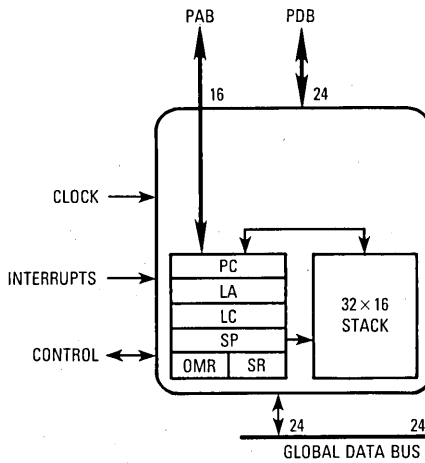

Figure 6-1. DSP56001 Block Diagram



**Figure 6-2. DSP56000/DSP56001 Program Controller**

**6**

The SS is a 15-level by 32-bit separate internal memory used to store the PC and SR during subroutine calls and long interrupts. The SS will also store the LC and LA registers in addition to the PC and SR registers for program looping. Each location in the SS is addressable as 16-bit registers, system stack high (SSH), and system stack low (SSL), which are pointed to by the stack pointer (SP). Thus, SS management is under software control.

All registers are read/write to facilitate system debugging. Although none of the program controller registers are 24 bits, they are read or written over 24-bit buses. When they are read, the least significant bits (LSBs) are significant, and the most significant bits (MSBs) are zeroed as appropriate. When they are written, only the appropriate LSBs are significant, and the MSBs are written as don't care. The program controller implements a three-stage (prefetch, decode, execute) pipeline and controls the five processing states of the DSP56000/DSP56001: normal, exception, reset, wait, and stop.

**6.2 PROGRAM CONTROLLER ARCHITECTURE**

The program controller consists of three hardware blocks: the program decode controller (PDC), the program address generator (PAG), and the program interrupt controller (PIC) (see Figure 6-1).

**6.2.1 Program Decode Controller**

The PDC contains the program logic array decoders, the register address bus generator, the loop state machine, the repeat state machine, the condition code generator, the interrupt



state machine, the instruction latch, and the backup instruction latch. The PDC decodes the 24-bit instruction loaded into the instruction latch and generates all signals necessary for pipeline control. The backup instruction latch stores a duplicate of the prefetched instruction to optimize execution of the repeat (REP) and jump (JMP) instructions.

### 6.2.2 Program Address Generator

The PAG contains the PC, the SP, the SS, the operating mode register (OMR), the SR, the LC register, and the LA register. Loops, which are frequent constructs in digital signal processing (DSP) algorithms, are supported by dedicated hardware on the DSP56000/DSP56001. Executing a DO instruction loads the LC register with the number of times the loop should be executed, loads the LA register with the address of the last instruction word in the loop (fetched during one loop pass), and asserts the loop flag in the SR. Executing the DO instruction also causes the contents of the LA, LC, and SR to be stacked prior to the execution of the DO instruction, thereby supporting nesting of DO loops. Under control of the loop state machine, the address of the first instruction in the loop is also stacked so the loop can be repeated with no overhead. While the loop flag in the SR is asserted, the loop state machine will compare the PC contents to the contents of the LA to determine if the last instruction word in the loop was fetched. If the last word was fetched, the LC contents are tested for one. If LC is not equal to one, then it is decremented, and the SS is read to update the PC with the address of the first instruction in the loop, effectively executing an automatic branch. If the LC is equal to one, then the LC, LA, and the loop flag in the SR are restored with the stack contents, while instruction fetches continue at the incremented PC value (LA + 1).

Block data moves can be accomplished using the repeat feature. The REP instruction loads the LC with the number of times the next instruction is to be repeated. Since the instruction to be repeated is only fetched once, throughput is increased by reducing external bus contention. However, REP instructions are not interruptable since they are fetched only once. A single-instruction DO loop can be used in place of an REP if interrupts must be allowed.

### 6.2.3 Program Interrupt Controller

The PIC receives all interrupt requests, arbitrates among all of them each cycle, and generates the interrupt vector address. There are four external and 16 internal interrupt sources that may generate interrupts.

The interrupts are organized in a flexible priority structure. Each interrupt has associated with it an interrupt priority level (IPL) that can be from zero to three. Levels 0 (lowest level), 1, and 2 are maskable. Level 3 is the highest IPL and is not maskable. Two interrupt mask bits in the SR reflect the current processor IPL and indicate the level needed for an interrupt source to interrupt the processor. Interrupts are inhibited for all IPLs less than the current processor priority. Level 3 interrupts can always interrupt the processor. All interrupt sources

and their IPLs are listed in Table 6-1. Each interrupt source is vectored (one of 32 vectors) to a separate, fixed, two-word service routine located in the lowest 64 words of program memory. If some of this space is not used, it may be used for program storage.

Upon entering the exception processing state, the current instruction in decode will execute normally, unless it is the first word of a two-word instruction, in which case it will be aborted and refetched at the completion of exception processing. The next two fetch addresses are supplied by the PIC. During these fetches, the PC is not updated. The PIC

**Table 6-1. Interrupt Sources**

| Interrupt Starting Address | IPL | Interrupt Source                                   |
|----------------------------|-----|--|
| P:\$0000 or P:\$E000       | 3   | Hardware RESET (External)                          |
| P:\$0002                   | 3   | Stack Error  |
| P:\$0004                   | 3   | Trace  |
| P:\$0006                   | 3   | SWI (Software Interrupt)                           |
| P:\$0008                   | 0-2 | IRQA (External)                                    |
| P:\$000A                   | 0-2 | IRQB (External)                                    |
| P:\$000C                   | 0-2 | SSI Receive Data                                   |
| P:\$000E                   | 0-2 | SSI Receive Data with Exception Status             |
| P:\$0010                   | 0-2 | SSI Transmit Data                                  |
| P:\$0012                   | 0-2 | SSI Transmit Data with Exception Status            |
| P:\$0014                   | 0-2 | SCI Receive Data                                   |
| P:\$0016                   | 0-2 | SCI Receive Data with Exception Status             |
| P:\$0018                   | 0-2 | SCI Transmit Data                                  |
| P:\$001A                   | 0-2 | SCI Idle Line                                      |
| P:\$001C                   | 0-2 | SCI Timer  |
| P:\$001E                   | 3   | NMI — Reserved for Hardware Development (External) |
| P:\$0020                   | 0-2 | Host Receive Data                                  |
| P:\$0022                   | 0-2 | Host Transmit Data                                 |
| P:\$0024                   | 0-2 | Host Command (Default)                             |
| P:\$0026                   | 0-2 | Available for Host Command                         |
| P:\$0028                   | 0-2 | Available for Host Command                         |
| P:\$002A                   | 0-2 | Available for Host Command                         |
| P:\$002C                   | 0-2 | Available for Host Command                         |
| P:\$002E                   | 0-2 | Available for Host Command                         |
| P:\$0030                   | 0-2 | Available for Host Command                         |
| P:\$0032                   | 0-2 | Available for Host Command                         |
| P:\$0034                   | 0-2 | Available for Host Command                         |
| P:\$0036                   | 0-2 | Available for Host Command                         |
| P:\$0038                   | 0-2 | Available for Host Command                         |
| P:\$003A                   | 0-2 | Available for Host Command                         |
| P:\$003C                   | 0-2 | Available for Host Command                         |
| P:\$003E                   | 0-2 | Illegal Instruction                                |

generates an interrupt instruction fetch address, which points to the first instruction word of a two-word fast-interrupt routine. All interrupts begin as fast interrupts (see Figure 6-3(a)). During fast interrupt servicing, the two instruction words at the interrupt vector addresses are jammed into the instruction stream without any overhead or stack usage. If one of the two words is a jump to subroutine (JSR), the fast interrupt routine becomes a long interrupt routine (see Figure 6-3(b)). The long interrupt service is the traditional context switch in which the stack is used for saving the status and return address. Sub-routines and interrupts can be nested using the 15-level stack. The stack can be extended in memory by using software to access the SSH and SSL registers. The exception processing state is described in more detail in **SECTION 8 PROCESSING STATES**.

Two external interrupt request inputs,  $\overline{IRQA}$  and  $\overline{IRQB}$ , can be defined as either level sensitive or negative edge triggered. One other external interrupt source is available. The nonmaskable interrupt (NMI) is edge sensitive and is generated on the first transition to

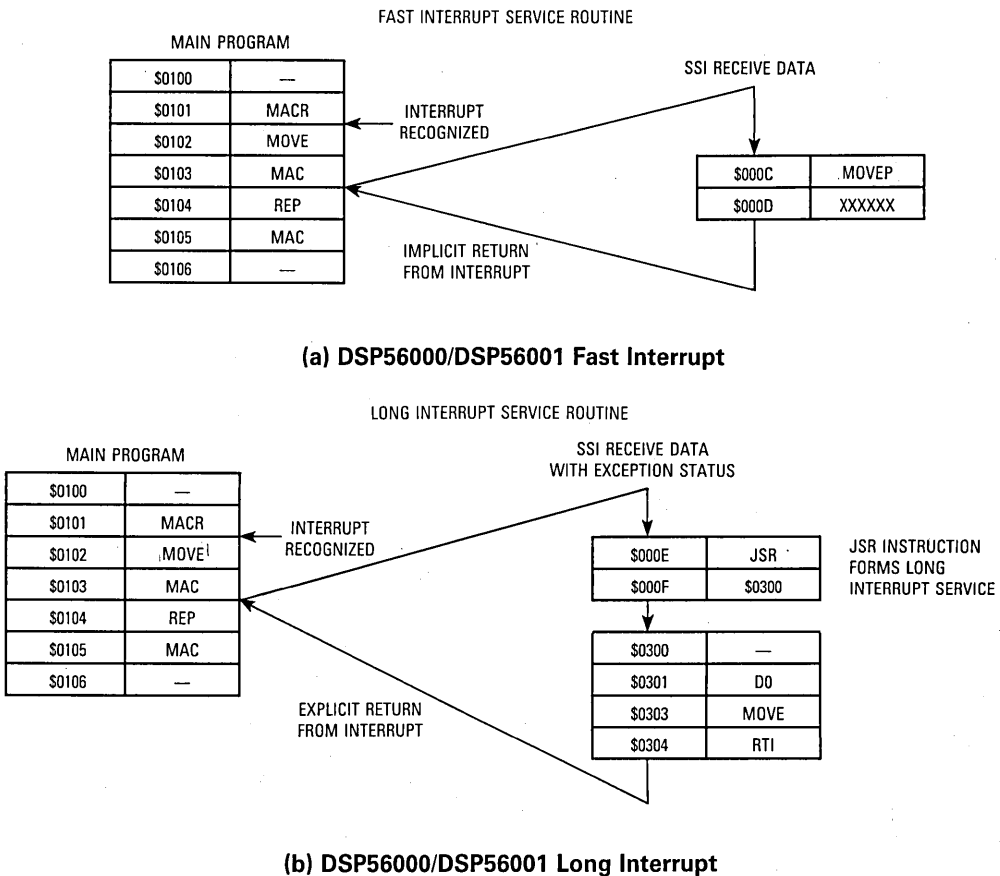

**Figure 6-3. Fast and Long Interrupt Examples**

10 V on the  $\overline{\text{IROB}}$  pin after the last time that the NMI interrupt was serviced or the chip was reset. The NMI is a priority level 3 interrupt and cannot be masked. Only RESET and illegal instruction have higher priority than NMI. NMI is reserved for hardware development and should not be used as a general-purpose interrupt pin. Continued use of this interrupt can cause damage to the chip (see the *DSP56001 Advance Information Data Sheet (ADI1290)*). NMI has been provided strictly as an aid to the developer. The hardware reset address vector may point to internal (P:\$0000) or external (P:\$E000) program memory, determined by the value of the MODA and MODB pins when the RESET pin is deasserted.

The NMI, trace, and software interrupt (SWI) instructions are used for debugging and development purposes. The SWI instruction is useful for implementing breakpoints. Tracing is entered after turning on the trace flag in the SR. During tracing, a trace interrupt will be generated after each instruction is executed, thereby creating a single-step feature.

Internally, the peripheral registers are accessed through the global data bus. All on-chip peripherals use the same interrupt request interface mechanism. Each peripheral provides a single interrupt request line to the PIC and receives two lines: vector read and interrupt acknowledge. Each peripheral possesses more than one interrupt source (see Table 6-1); therefore, interrupt arbitration between internal peripherals must be handled by the peripheral according to its own predefined IPL. The PIC arbitrates between the different I/O peripherals; when one of them is selected, the peripheral supplies the correct vector address to the PIC. The host command vector in the host interface (see **CHAPTER 10 PORT B**) can be programmed to point to any of the 32 starting addresses, including 13 routines designated specifically as host commands and located at locations P:\$0024–P:\$003C. The default value set in the host command vector register during a reset is \$0024.

## 6

### 6.2.4 Instruction Pipeline

The program controller implements a three-level pipelined architecture in which concurrent instruction fetch, decode, and execution occur. The fact that the pipelined operation remains essentially hidden from the user makes programming straightforward. The pipeline is illustrated in Figure 6-4. The first instruction, I1, should be interpreted as follows: multiply the contents of X0 by the contents of Y0, add the product to the contents already in accumulator A, round the result to the “nearest even,” store the result back in accumulator A, move the contents in X data memory (pointed to by R0) into X0; postincrement R0; move the contents in Y data memory (pointed to by R4) into Y1; postincrement R4. The second instruction, I2, should be interpreted as follows: clear accumulator A; move the contents in X0 into the location in X data memory pointed to by R0; postincrement R0; before the clear operation, move the contents in accumulator A into the location in Y data memory pointed to by R4; postdecrement R4. The third instruction, I3, is the same as I1, except a rounding operation is not performed. The operations of each of the execution units and all initial conditions necessary to follow the execution of the instruction sequence are depicted in Figure 6-4.

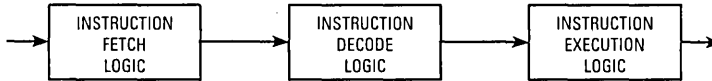

EXAMPLE: PROGRAM SEGMENT

```

11 MACR X0,Y1,A X:(R0)+,X0 Y:(R4)+,Y1
12 CLR A X0,X:(R0)+ A,Y:(R4)-
13 MAC X0,Y1,A X:(R0)+,X0 Y:(R4)+,Y1
  
```

| INSTRUCTION FETCH<br>INSTRUCTION DECODE<br>INSTRUCTION EXECUTION |   | 11 | 12 | 13  | 14  | 15  |
|--|---|----|----|---|---|---|
| PARALLEL OPERATIONS  | INITIAL CONDITIONS  |    |    |   |   |   |
| ADDRESS UPDATE (AGU)   | R0 = \$0005<br>R4 = \$0008  |    |    | R0 = 5 + 1<br>R4 = 8 + 1  | R0 = 6 + 1<br>R4 = 9 - 1  | R0 = 7 + 1<br>R4 = 8 + 1  |
| INSTRUCTION EXECUTION (DATA ALU)                                 | A:<br>A2 = \$00<br>A1 = \$000066<br>A0 = \$000000<br>X0 = \$400000<br>Y1 = \$000077 |    |    | A:<br>A2 = \$00<br>A1 = \$0000A2<br>A0 = \$000000<br>X0 = \$000005<br>Y1 = \$000008 | A:<br>A2 = \$00<br>A1 = \$000000<br>A0 = \$000000<br>X0 = \$000005<br>Y1 = \$000008 | A:<br>A2 = \$00<br>A1 = \$000000<br>A0 = \$000050<br>X0 = \$000007<br>Y1 = \$000008 |
| X MEMORY AT ADDRESS  | DATA<br>\$0005<br>\$0006<br>\$0007  |    |    | \$000005<br>\$000006<br>\$000007  | \$000005<br>\$000005<br>\$000007  | \$000005<br>\$000005<br>\$000007  |
| Y MEMORY AT ADDRESS  | DATA<br>\$0008<br>\$0009  |    |    | \$000008<br>\$000009  | \$000008<br>\$0000A2  | \$000008<br>\$0000A2  |

Figure 6-4. Three-Stage Pipeline

6.3 CLOCK OSCILLATOR

The DSP56000/DSP56001 uses a four-phase clock for instruction execution; therefore, the clock runs at twice the instruction execution rate. The clock can be provided by an internal oscillator (see Figure 6-1) by connecting an external crystal between XTAL and EXTAL or by an external oscillator connected to EXTAL.

6.4 PROGRAMMING MODEL

The program controller features LA and LC registers dedicated to supporting the hardware DO loop instruction in addition to the standard program flow-control resources, such as a PC, complete SR, and SS. With the exception of the PC, all registers are read/write to facilitate system debugging. Figure 6-5 shows the program controller programming model with the six registers and SS. The following paragraphs give a detailed description of each register.

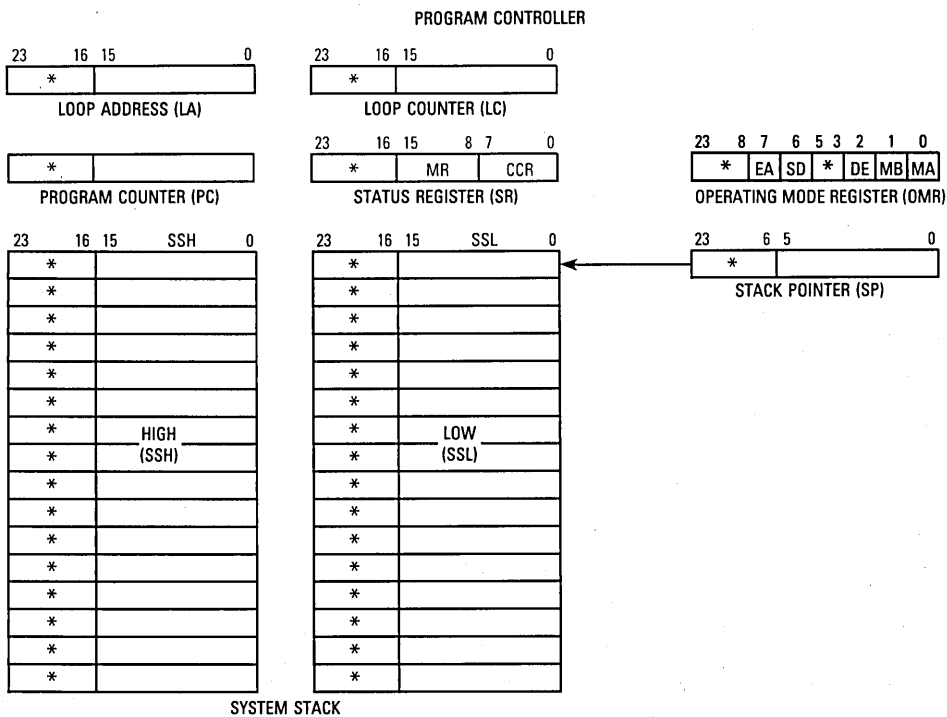

\* Written as don't care; read as zero

**Figure 6-5. Program Controller Programming Model**

### 6.4.1 Program Counter

This 16-bit register contains the address of the next location to be fetched from program memory space. The PC can point to instructions, data operands, or addresses of operands. References to this register are always inherent and are implied by most instructions. This special-purpose address register is stacked when program looping is initialized, when a JSR is performed, or when interrupts occur (except for no-overhead fast interrupts).

### 6.4.2 Status Register

The 16-bit SR consists of a mode register (MR) in the high-order eight bits and a condition code register (CCR) in the low-order eight bits. The SR is stacked when program looping is initialized, when a JSR is performed, or when interrupts occur (except for no-overhead fast interrupts). The SR format is shown in Figure 6-6.

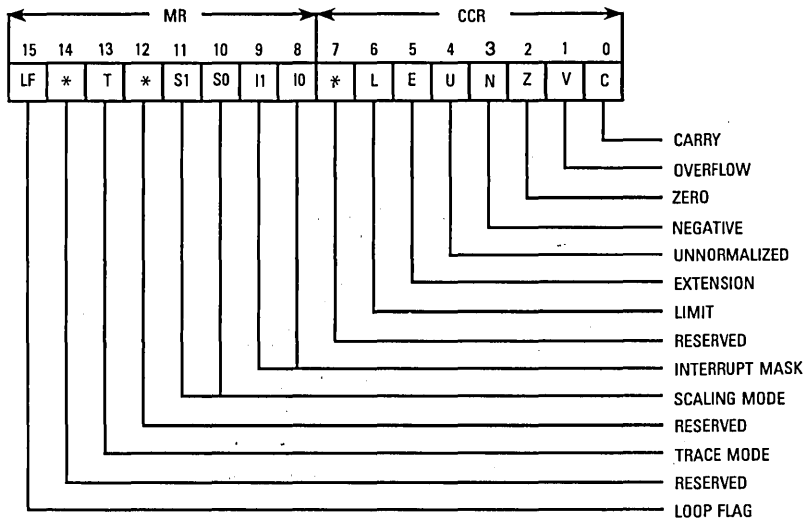

\*Written as don't care; read as zero

**Figure 6-6. Status Register Format**

The MR is a special-purpose control register defining the current system state of the processor. The MR bits are affected by processor reset, exception processing, the DO, end current DO loop (ENDDO), return from interrupt (RTI), and SWI instructions and by instructions that directly reference the MR register — OR immediate to control register (ORI) and AND immediate to control register (ANDI). During processor reset, the interrupt mask bits of the MR will be set; the scaling mode bits, loop flag, and trace bit will be cleared.

The CCR is a special-purpose control register that defines the current user state of the processor. The CCR bits are affected by data arithmetic logic unit (ALU) operations, parallel move operations, and by instructions that directly reference the CCR (ORI and ANDI). The CCR bits are not affected by parallel move operations unless data limiting occurs when reading the A or B accumulators. During processor reset, all CCR bits are cleared.

**6.4.2.1 CARRY (BIT 0).** The carry (C) bit is set if a carry is generated out of the MSB of the result in an addition. This bit is also set if a borrow is generated in a subtraction. The carry or borrow is generated from bit 55 of the result. The carry bit is also affected by bit manipulation, rotate, and shift instructions. Otherwise, this bit is cleared.

**6.4.2.2 OVERFLOW (BIT 1).** The overflow (V) bit is set if an arithmetic overflow occurs in the 56-bit result. This bit indicates that the result cannot be represented in the accumulator register; thus, the register has overflowed. Otherwise, this bit is cleared.

**6.4.2.3 ZERO (BIT 2).** The zero (Z) bit is set if the result equals zero; otherwise, this bit is cleared.

**6.4.2.4 NEGATIVE (BIT 3).** The negative (N) bit is set if the MSB (bit 55) of the result is set; otherwise, this bit is cleared.

**6.4.2.5 UNNORMALIZED (BIT 4).** The unnormalized (U) bit is set if the two MSBs of the most significant product (MSP) portion of the result are identical. Otherwise, this bit is cleared. The MSP portion of the A or B accumulators, which is defined by the scaling mode and the U bit, is computed as follows:

| S1 | S0 | Scaling Mode | U Bit Computation                            |
|----|----|--------------|--|
| 0  | 0  | No Scaling   | $U = (\text{Bit } 47 \oplus \text{Bit } 46)$ |
| 0  | 1  | Scale Down   | $U = (\text{Bit } 48 \oplus \text{Bit } 47)$ |
| 1  | 0  | Scale Up     | $U = (\text{Bit } 46 \oplus \text{Bit } 45)$ |

**6.4.2.6 EXTENSION (BIT 5).** The extension (E) bit is cleared if all the bits of the integer portion of the 56-bit result are all ones or all zeros; otherwise, this bit is set. The integer portion, defined by the scaling mode and the E bit, is computed as follows:

| S1 | S0 | Scaling Mode | Integer Portion             |
|----|----|--------------|-----------------------------|
| 0  | 0  | No Scaling   | Bits 55,54, . . . . . 48,47 |
| 0  | 1  | Scale Down   | Bits 55,54, . . . . . 49,48 |
| 1  | 0  | Scale Up     | Bits 55,54, . . . . . 47,46 |

If the E bit is cleared, then the low-order fraction portion contains all the significant bits; the high-order integer portion is just sign extension. In this case, the accumulator extension register can be ignored. If the E bit is set, it indicates that the accumulator extension register is in use.

**6.4.2.7 LIMIT (BIT 6).** The limit (L) bit is set if the overflow bit is set. The L bit is also set if the data shifter/limiter circuits perform a limiting operation; otherwise, it is not affected. The L bit is cleared only by a processor reset or by an instruction that specifically clears it, which allows the L bit to be used as a latching overflow bit (i.e., a "sticky" bit). L is affected by data movement operations that read the A or B accumulator registers.

**6.4.2.8 INTERRUPT MASKS (BITS 8 AND 9).** The interrupt mask bits, I1 and I0, reflect the current IPL of the processor and indicate the IPL needed for an interrupt source to interrupt the processor. The current IPL of the processor can be changed under software control. The interrupt mask bits are set during hardware reset but not during software reset.



| I1 | I0 | Exceptions Permitted | Exceptions Masked |
|----|----|----------------------|-------------------|
| 0  | 0  | IPL 0,1,2,3          | None              |
| 0  | 1  | IPL 1,2,3            | IPL 0             |
| 1  | 0  | IPL 2,3              | IPL 0,1           |
| 1  | 1  | IPL 3                | IPL 0,1,2         |

**6.4.2.9 SCALING MODE (BITS 10 AND 11).** The scaling mode bits, S1 and S0, specify the scaling to be performed in the data ALU shifter/limiter and the rounding position in the data ALU multiply-accumulator (MAC). The scaling modes are shown in the following table:

| S1 | S0 | Rounding Bit | Scaling Mode                              |
|----|----|--------------|---|
| 0  | 0  | 23           | No Scaling                                |
| 0  | 1  | 24           | Scale Down (1-Bit Arithmetic Right Shift) |
| 1  | 0  | 22           | Scale Up (1-Bit Arithmetic Left Shift)    |
| 1  | 1  | —            | Reserved for Future Expansion             |

The shifter/limiter scaling mode affects data read from the A or B accumulator registers out to the XDB and YDB. Different scaling modes can be used with the same program code to allow dynamic scaling. One application of dynamic scaling is to facilitate block floating-point arithmetic. The scaling mode also affects the MAC rounding position to maintain proper rounding when different portions of the accumulator registers are read out to the XDB and YDB. The scaling mode bits, which are cleared at the start of a long interrupt service routine, are also cleared during a processor reset.

**6.4.2.10 TRACE MODE (BIT 13).** The trace mode (T) bit specifies the tracing function of the DSP. If the T bit is set at the beginning of any instruction execution, a trace exception will be generated after the instruction execution is completed. If the T bit is cleared, tracing is disabled and instruction execution proceeds normally. If a long interrupt is executed during a trace exception, the SR having the trace bit set will be stacked, and the trace bit in the SR is cleared (see **CHAPTER 8 PROCESSING STATES** for a complete description of a long interrupt operation). The T bit is also cleared during processor reset.

**6.4.2.11 RESERVED STATUS (BITS 7, 12, 14).** These bits, which are reserved for future expansion, will read as zero during DSP read operations.

**6.4.2.12 LOOP FLAG (BIT 15).** The loop flag (LF) bit, set when a program loop is in progress, enables the detection of the end of a program loop. The LF is the only SR bit that is restored when terminating a program loop. Stacking and restoring the LF when initiating and exiting a program loop, respectively, allow the nesting of program loops. At the start of a long interrupt service routine, the SR (including the LF) is pushed on the SS and the

SR LF is cleared. When returning from the long interrupt with an RTI instruction, the SS is pulled and the LF is restored. During a processor reset, the LF is cleared.

### 6.4.3 Operating Mode Register

The OMR is a 24-bit register (only five bits are defined) that sets the current operating mode of the processor (i.e., the memory maps for program and data memories as well as the startup procedure). The OMR bits are only affected by processor reset and by instructions directly referencing the OMR: ANDI, ORI, and MOVEC. During processor reset, the chip operating mode bits, MB and MA, will be loaded from the external mode select pins B and A, respectively. The data ROM enable (DE) bit will be cleared, disabling the X and Y on-chip lookup-table ROMs. The OMR format is shown in Figure 6-7. Table 6-2 summarizes the DSP56000/DSP56001 operating modes and their effect on the memory map. Table 6-3 shows how the DE bit in the OMR affects the X and Y memory maps.

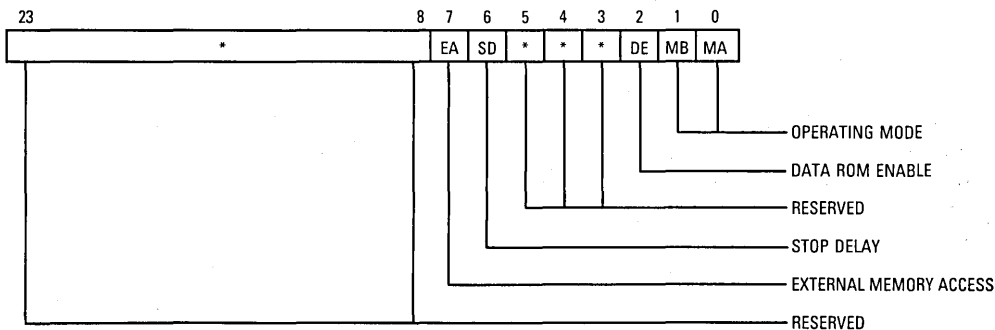

Figure 6-7. OMR Format

Table 6-2. DSP56000/DSP56001 Operating Mode Summary

| Operating Mode | MB | MA | DSP56000 Program Memory Map  |               |                   |
|----------------|----|----|--|---------------|-------------------|
|                |    |    | Internal RAM   | External      | Reset             |
| 0              | 0  | 0  | \$0000-\$01FF  | \$0200-\$FFFF | Internal — \$0000 |
| 1              | 0  | 1  | Mode 1 is not a valid mode for the DSP56000. Attempting to put the DSP56000 in mode 1 will put it into mode 0. |               |                   |
| 2              | 1  | 0  | \$0000-\$01FF  | \$0200-\$FFFF | External — \$E000 |
| 3              | 1  | 1  | —  | \$0000-\$FFFF | External — \$0000 |

**Table 6-2. DSP56000/DSP56001 Operating Mode Summary (Continued)**

| Operating Mode | MB | MA | DSP56001 Program Memory Map  |               |                   |
|----------------|----|----|--|---------------|-------------------|
|                |    |    | Internal RAM   | External      | Reset             |
| 0              | 0  | 0  | \$0000-\$01FF  | \$0200-\$FFFF | Internal — \$0000 |
| 1              | 0  | 1  | Special bootstrap mode; after program RAM loading, mode 2 is automatically selected but PC = \$0000. |               |                   |
| 2              | 1  | 0  | \$0000-\$01FF  | \$0200-\$FFFF | External — \$E000 |
| 3              | 1  | 1  | —  | \$0000-\$FFFF | External — \$0000 |

**Table 6-3. DSP56000/DSP56001 DE Memory Control**

| DE | Data Memory Map  |   |
|----|--|---|
|    | Y Memory   | X Memory  |
| 0  | Internal RAM: \$0000-\$00FF<br>External: \$0100-\$FFFF<br>—                                | Internal RAM: \$0000-\$00FF<br>External: \$0100-\$FFBF<br>On-Chip Peripherals: \$FFC0-\$FFFF                                |
| 1  | Internal RAM: \$0000-\$00FF<br>Internal ROM: \$0100-\$01FF<br>External: \$0200-\$FFFF<br>— | Internal RAM: \$0000-\$00FF<br>Internal ROM: \$0100-\$01FF<br>External: \$0200-\$FFBF<br>On-Chip Peripherals: \$FFC0-\$FFFF |

**6**

**6.4.3.1 CHIP OPERATING MODE (BITS 0 AND 1).** The chip operating mode bits, MB and MA, indicate the bus expansion mode of the DSP56000/DSP56001. On processor reset, these bits are loaded from the external mode select pins,  $\overline{\text{MODB}}$  and  $\overline{\text{MODA}}$ , respectively. After the DSP leaves the reset state, MB and MA can be changed under program control. The “secure DSP56000” is an exception. The external mode select pins,  $\overline{\text{MODB}}$  and  $\overline{\text{MODA}}$ , are disabled on the “secure DSP56000” and are only used for interrupts as  $\overline{\text{IRQA}}$  and  $\overline{\text{IRQB}}$ . The operating modes are shown in the following table:

| MB | MA | Chip Operating Mode               |
|----|----|-----------------------------------|
| 0  | 0  | Single-Chip Nonexpanded           |
| 0  | 1  | Special Bootstrap (DSP56001 Only) |
| 1  | 0  | Normal Expanded                   |
| 1  | 1  | Development Expanded              |

**6.4.3.2 DATA ROM ENABLE (BIT 2).** The DE bit enables the two, on-chip,  $256 \times 24$  data ROMs located at addresses \$0100-\$01FF in the X and Y memory spaces. When DE is cleared, the \$0100-\$01FF address space is part of the external X and Y data spaces, and the on-chip data ROMs are disabled.

**6.4.3.3 STOP DELAY (BIT 6).** The STOP instruction causes the DSP56000/DSP56001 to indefinitely suspend processing in the middle of the STOP instruction (see **SECTION 8**

**PROCESSING STATES).** When exiting the stop state, if the stop delay bit is zero, a 64K clock cycle delay (i.e., 131,072 T states) is selected before continuing the stop instruction cycle. However, if the stop delay bit is one, the delay before continuing the instruction cycle is 16 T states. The long delay allows a clock stabilization period for the internal clock to begin oscillating and to stabilize. When a stable external clock is used, the shorter delay allows faster startup of the DSP.

**6.4.3.4 EXTERNAL MEMORY ACCESS (BIT 7).** The external memory access mode bit selects the function of two of the port A control pins. The DSP56000/DSP56001 comes out of reset with these pins defined as bus request/bus grant ( $\overline{BR}/\overline{BG}$ ) — i.e., bit 7 is cleared. When bit 7 is clear, wait states are only introduced into the port A timing by using the bus control register (BCR). Additional information on the BCR can be found in **CHAPTER 10 PORT B**. When bit 7 is set under program control (using ANDI, ORI, or MOVEC), these pins are defined as bus strobe ( $\overline{BS}$ ) and wait ( $\overline{WT}$ ). In this mode, wait states are introduced into port A timing by using either the BCR or asserting  $\overline{WT}$ .  $\overline{BR}$  and  $\overline{BG}$  allow the DSP56000/DSP56001 to give the external bus to an external device, thus preventing bus conflicts.  $\overline{BS}$  and  $\overline{WT}$  allow the DSP56000/DSP56001 to work with asynchronous devices (bus arbitrators) on port A. The definition of the control pins is summarized in the following table:

| OMR Bit 7   | $\overline{BR}$ Pin (Input)     | $\overline{BG}$ Pin (Output)   |
|-------------|---------------------------------|--------------------------------|
| 0 (Default) | Bus Request ( $\overline{BR}$ ) | Bus Grant ( $\overline{BG}$ )  |
| 1           | Wait ( $\overline{WT}$ )        | Bus Strobe ( $\overline{BS}$ ) |

**6.4.3.5 RESERVED OMR BITS (BITS 3–5 AND 8–23).** These OMR bits, reserved for future expansion, will read as zero during DSP read operations.

#### 6.4.4 Loop Address Register

The contents of the LA register indicate the location of the last instruction word in a program loop. This register is stacked into the SSH by a DO instruction and is unstacked by end-of-loop processing or by execution of an ENDDO instruction. When the instruction at the address contained in this register is fetched, the contents of the LC register are checked. If the contents are not one, the LC is decremented, and the next instruction is taken from the address at the top of the SS; otherwise, the PC is incremented, the loop flag is restored (pulled from the SS), the SS is purged, the LA and LC registers are pulled from the SS and restored, and instruction execution continues normally. The LA register, a read/write register, is written by a DO instruction and read by the SS when stacking the register. Since the LC register can be accessed under program control, the number of times a loop has been executed can be determined.

### 6.4.5 Loop Counter Register

The LC register is a special 16-bit counter used to specify the number of times a hardware program loop is to be repeated. This register is stacked into the SSL by a DO instruction and unstacked by end-of-loop processing or by execution of an ENDDO instruction. When the end of a hardware program loop is reached, the contents of the LC register are tested for one. If the LC is one, the program loop is terminated, and the LC register is loaded with the previous LC contents stored on the SS. If LC is not one, it is decremented and the program loop is repeated. The LC can be read under program control, which allows the number of times a loop will be executed to be monitored/changed dynamically. The LC is also used in the REP instruction.

### 6.4.6 System Stack

The SS is a separate  $15 \times 32$ -bit internal memory divided into two banks: SSH and SSL, each 16 bits wide. The SSH stores the PC contents, and the SSL stores the SR contents for subroutine calls and long interrupts. The SS will also store the LA and LC registers in addition to the PC and SR registers for program looping. The SS is in stack memory space; its address is always inherent and implied by the current instruction.

The contents of the PC and SR register are pushed on the top location of the SS when a subroutine call or long interrupt occurs. When a return from subroutine (RTS) occurs, the contents of the top location in the SS are pulled and put in the PC; the SR is not affected. When an RTI occurs, the contents of the top location in the SS are pulled to both the PC and SR.

The SS is also used to implement no-overhead nested hardware DO loops. When the DO instruction is executed, the LA:LC are pushed on the SS, then the PC:SR are pushed on the SS. Since each SS location can be addressed as separate 16-bit registers (SSH and SSL), software stacks can be created for unlimited nesting.

Up to 15 long interrupts, seven DO loops, 15 JSRs, or combinations of these can be accommodated by the SS. When the SS limit is exceeded, a nonmaskable stack error interrupt occurs, and the PC is pushed to SS location zero, which is not implemented in hardware. The PC will be lost, and there will be no SP from the stack interrupt routine to the program that was executing when the error occurred.

### 6.4.7 Stack Pointer Register

The 6-bit SP register indicates the location of the top of the SS and the status of the SS (underflow, empty, full, and overflow). The SP register is referenced implicitly by some instructions (DO, REP, JSR, RTI, etc.) or directly by the MOVEC instruction. The SP register format, shown in Figure 6-8, is described in the following paragraphs. The SP register is implemented as a 6-bit counter that addresses (selects) a 15-location stack with its four LSBs. The possible SP values, shown in Figure 6-9, are described in the following paragraphs.

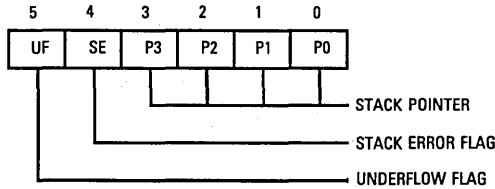

Figure 6-8. SP Register Format

| UF | SE | P3  | P2 | P1 | P0 |   |
|----|----|-----|----|----|----|---|
| 1  | 1  | 1   | 1  | 1  | 0  | ↓ STACK UNDERFLOW CONDITION AFTER DOUBLE PULL |
| 1  | 1  | 1   | 1  | 1  | 1  | ↓ STACK UNDERFLOW CONDITION                   |
| 0  | 0  | 0   | 0  | 0  | 0  | ↓ STACK EMPTY (RESET); PULL CAUSES UNDERFLOW  |
| 0  | 0  | 0   | 0  | 0  | 1  | ↓ STACK LOCATION 1                            |
|    |    | ... |    |    |    |   |
|    |    | ... |    |    |    |   |
| 0  | 0  | 1   | 1  | 1  | 0  | ↓ STACK LOCATION 14                           |
| 0  | 0  | 1   | 1  | 1  | 1  | ↓ STACK LOCATION 15; PUSH CAUSES OVERFLOW     |
| 0  | 1  | 0   | 0  | 0  | 0  | ↓ STACK OVERFLOW CONDITION                    |
| 0  | 1  | 0   | 0  | 0  | 1  | ↓ STACK OVERFLOW CONDITION AFTER DOUBLE PUSH  |

Figure 6-9. SP Register Values

**6.4.7.1 STACK POINTER (BITS 0–3).** The SP points to the last used location on the SS. Immediately after hardware reset, these bits are cleared (SP=0), indicating that the SS is empty.

Data is pushed onto the SS by incrementing the SP, then writing data to the location pointed to by the SP. An item is pulled off the stack by copying it from the location pointed to by the SP and then by decrementing SP.

**6.4.7.2 STACK ERROR FLAG (BIT 4).** The stack error flag indicates that a stack error has occurred, and the transition of the stack error flag from zero to one causes a priority level-3 stack error exception (see 6.4.7.1 STACK POINTER (BITS 0–3) for additional information).

When the stack is completely full, the SP reads 001111, and any operation that pushes data onto the stack will cause a stack error exception to occur. The SR will read 010000 (or 010001 if an implied double push occurs).

Any implied pull operation with SP equal to zero will cause a stack error exception, and the SP will read 111111 (or 111110 if an implied double pull occurs). The stack error bit is set as shown in Figure 6-9.

The stack error flag is a “sticky bit” which, once set, remains set until cleared by the user. There is a sequence of instructions which can cause a stack overflow which, without the sticky bit, would not be detected because the stack pointer is decremented before the stack error interrupt is taken. The sticky bit keeps the stack error bit set until cleared by the user by writing a zero to SP bit 4. It also latches the overflow/underflow bit so that it cannot be changed by stack pointer increments or decrements as long as the stack error is set. The overflow/underflow bit remains latched until the first move to SP is executed.

#### NOTE

When SP is zero (stack empty), instructions that read the stack without SP postdecrement and instructions that write to the stack without SP preincrement do not cause a stack error exception (i.e., 1) DO SSL,xxxx 2) REP SSL 3) MOVEC or move peripheral data (MOVEP) when SSL is specified as a source or destination).

**6.4.7.3 UNDERFLOW FLAG (BIT 5).** The underflow flag is set when a stack underflow occurs. The stack underflow flag is a “sticky bit” when the stack error flag is set i.e., when the stack error flag is set, the underflow flag will not change state. The combination of “underflow=1” and “stack error=0” is an illegal combination and will not occur unless it is forced by the user. If this condition is forced by the user, the hardware will correct itself based on the result of the next stack operation. Also see the description for the stack error flag (Section 6.4.7.2) for additional information.

**6.4.7.4 RESERVED STACK POINTER REGISTER BITS (BITS 6–23).** Any unimplemented SP register bits are reserved for future expansion and will read as zero during DSP56000/DSP56001 read operations.

### 6.4.8 DSP56000/DSP56001 Programming Model Summary

The complete programming model for the DSP56000/DSP56001 central processor is shown in Figure 6-10. **SECTION 9 PORT A**, **SECTION 10 PORT B**, and **SECTION 11 PORT C** describe in detail the programming model for the peripherals and external memory control (number of wait states).

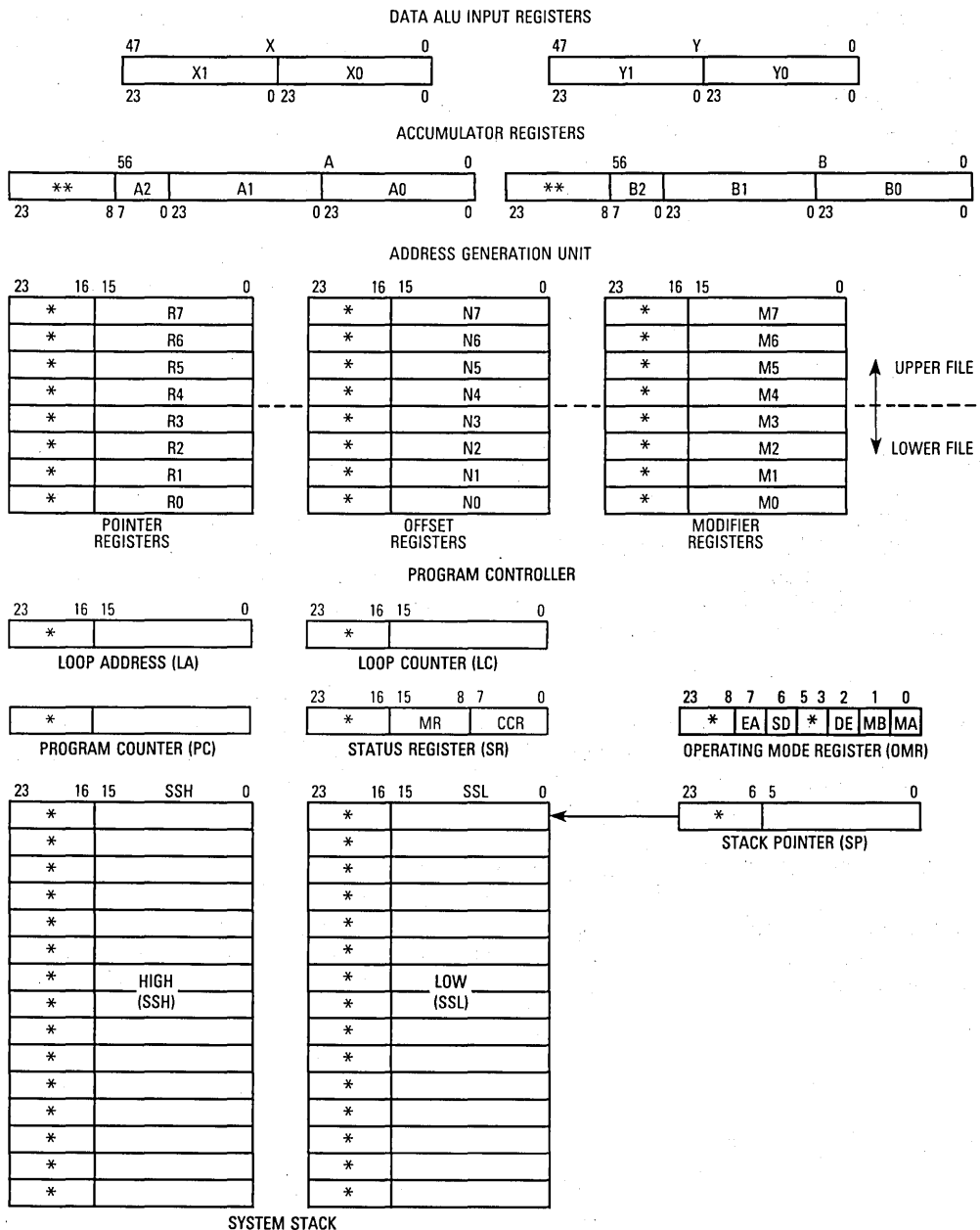

\* Written as don't care; read as zero  
 \*\* Read as sign extension bits; written as don't care

**Figure 6-10. DSP56000/DSP56001 Central Processor Programming Model**



## SECTION 7 INSTRUCTION SET INTRODUCTION

The programming model indicates that the DSP56000/DSP56001 central processor architecture can be viewed as three functional units operating in parallel: data arithmetic logic unit (ALU), address generation unit (AGU), and program controller (see Figure 7-1). The goal of the instruction set is to provide the capability to keep each of these units busy each instruction cycle, achieving maximum speed and minimum program size.

This section introduces the DSP56000/DSP56001 instruction set and instruction format. The complete range of instruction capabilities combined with the flexible addressing modes used in this processor provide a very powerful assembly language for implementing digital signal processing (DSP) algorithms. The instruction set has been designed to allow efficient coding for DSP high-level language compilers such as the C compiler. Execution time is minimized by the hardware looping capabilities, use of an instruction pipeline, and parallel moves.

7

### 7.1 SYNTAX

The instruction syntax is organized into four columns: opcode, operands, and two parallel-move fields. The assembly-language source code for a typical one-word instruction is shown in the following illustration. Because of the multiple bus structure and the parallelism of the DSP, up to three data transfers can be specified in the instruction word — one on the X data bus (XDB), one on the Y data bus (YDB), and one within the data ALU. These transfers are explicitly specified. A fourth data transfer is implied and occurs in the program controller (instruction word prefetch, program looping control, etc.). Each data transfer involves a source and a destination.

| Opcode | Operands | XDB        | YDB        |
|--------|----------|------------|------------|
| MAC    | X0,Y0,A  | X:(R0)+,X0 | Y:(R4)+,Y0 |

The opcode column indicates the data ALU, AGU, or program controller operation to be performed and must always be included in the source code. The operands column specifies the operands to be used by the opcode. The XDB and YDB columns specify optional data transfers over the XDB and/or YDB and the associated addressing modes. The address space qualifiers (X:, Y:, and L:) indicate which address space is being referenced. Parallel moves are allowed in 30 of the 62 instructions. Additional information is presented in **APPENDIX A INSTRUCTION SET DETAILS**.

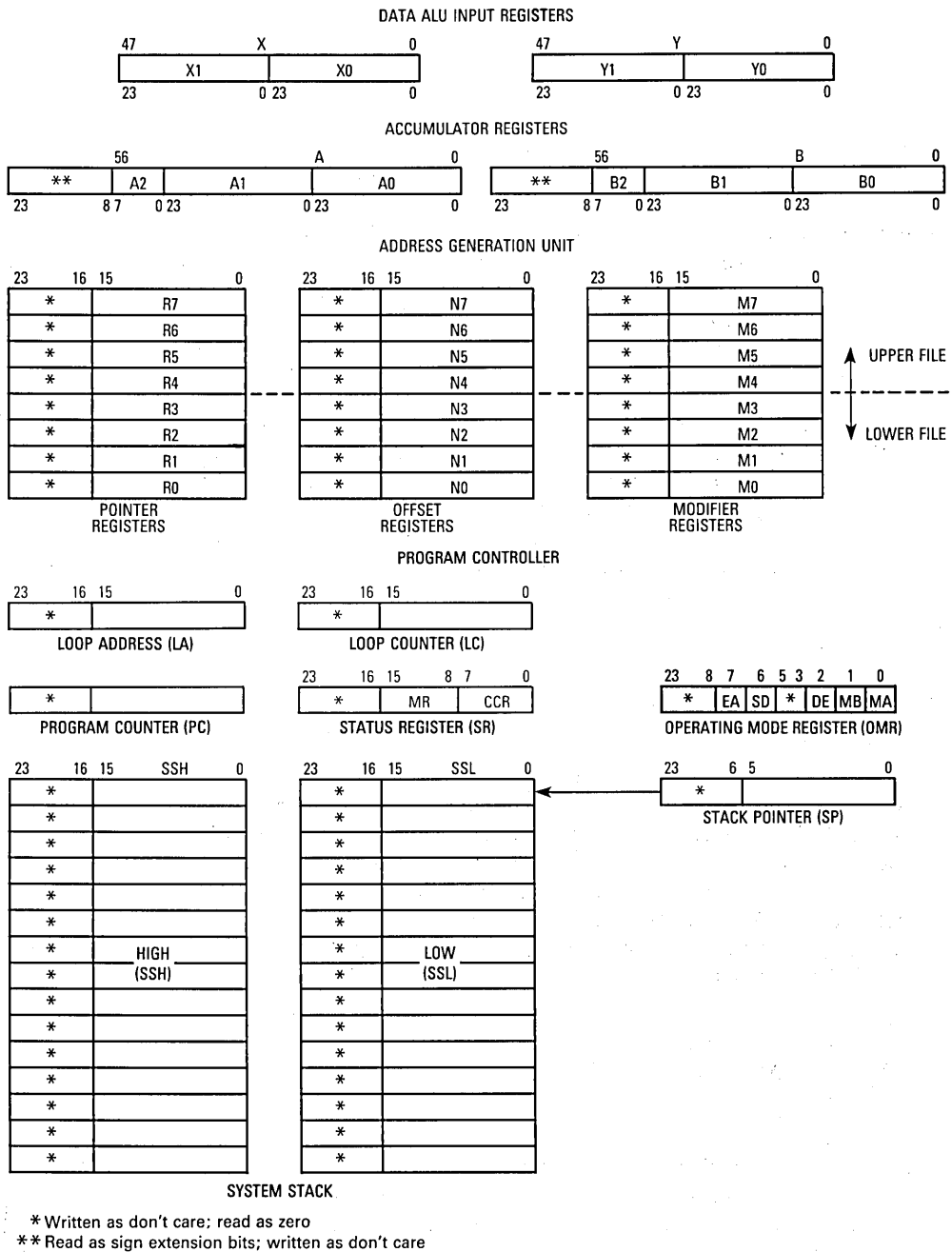

7

**Figure 7-1. DSP56000/DSP56001 Central Processor Programming Model**

## 7.2 INSTRUCTION FORMATS

The DSP56000/DSP56001 instructions consist of one or two 24-bit words — an operation word and an optional effective address extension word. The general format of the operation word is shown in Figure 7-2. Most instructions specify data movement on the XDB, YDB, and data ALU operations in the same operation word. The DSP is designed to perform each of these operations in parallel.

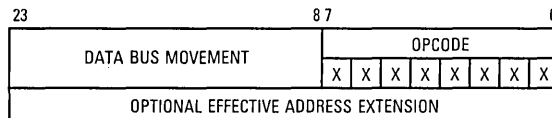

Figure 7-2. General Format of an Instruction Operation Word

The data bus movement field provides the operand reference type, which selects the type of memory or register reference to be made, the direction of transfer, and the effective address(es) for data movement on the XDB and YDB. This field may require additional information to fully specify the operand for certain addressing modes. An effective address extension word following the operation word is used to provide immediate data or an absolute address if required. Examples of operations that may include the extension word include the move operations X:, X:R, Y:, R:Y, and L:. Additional information is presented in **APPENDIX A INSTRUCTION SET DETAILS**.

The opcode field of the operation word specifies the data ALU operation or the program controller operation to be performed and any additional operands required by the instruction. Only those data ALU and program controller operations that can accompany data bus movement will be specified in the opcode field of the instruction. Other data ALU, program controller operations, and all address ALU operations will be specified in an instruction word with a different format. These formats include operation words containing short immediate data or short absolute addresses.

Encoding the 30 opcodes that allow up to two parallel data moves into 24 bits has used all of the available bits and precluded adding more instructions or instruction variations. The available operation codes form a very versatile microcontroller unit (MCU) style instruction set, providing highly parallel operations in most programming situations.

### 7.2.1 Operand Sizes

Operand sizes are defined as follows: a byte is 8 bits long, a short word is 16 bits long, a word is 24 bits long, a long word is 48 bits long, and an accumulator is 56 bits long (see Figure 7-3). The operand size for each instruction is either explicitly encoded in the instruction or implicitly defined by the instruction operation. Implicit instructions support some subset of these five sizes.

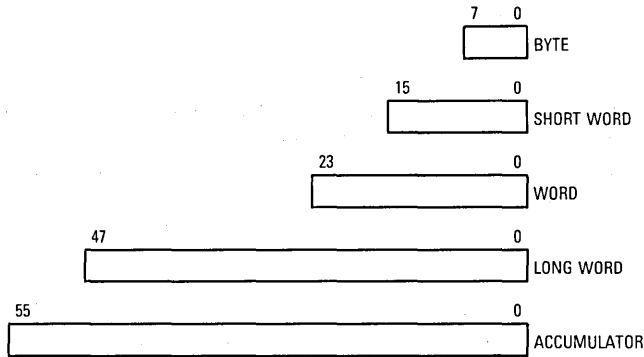

**Figure 7-3. Operand Sizes**

## 7.2.2 Data Organization in Registers

The ten data ALU registers support 8- or 24-bit data operands. Instructions also support 48- or 56-bit data operands by concatenating groups of specific data ALU registers. The eight address registers in the AGU support 16-bit address or data operands. The eight AGU offset registers support 16-bit offsets or may support 16-bit address or data operands. The eight AGU modifier registers support 16-bit modifiers or may support 16-bit address or data operands. The program counter (PC) supports 16-bit address operands. The status register (SR) and operating mode register (OMR) support 8- or 16-bit data operands. Both the loop counter (LC) and loop address (LA) registers support 16-bit address operands.

**7.2.2.1 DATA ALU REGISTERS.** The eight main data registers are 24 bits wide. Word operands occupy one register; long-word operands occupy two concatenated registers. The least significant bit (LSB) is the right-most bit (bit 0); whereas, the most significant bit (MSB) is the left-most bit (bit 23 for word operands and bit 47 for long-word operands). The two accumulator extension registers are eight bits wide. When an accumulator extension register is used as a source operand, it occupies the low-order portion (bits 0–7) of the word; the high-order portion (bits 8–23) is sign extended (see Figure 7-4). When used as a destination operand, this register receives the low-order portion of the word, and the high-order portion is not used. Accumulator operands occupy an entire group of three registers (i.e., A2:A1:A0 or B2:B1:B0). The LSB is the right-most bit (bit 0), and the MSB is the left-most bit (bit 55).

**7.2.2.2 AGU REGISTERS.** The 24 AGU registers, which are 16 bits wide, may be accessed as word operands for address, address modifier, and data storage. When used as a source operand, these registers occupy the low-order portion of the 24-bit word; the high-order portion is read as zeros (see Figure 7-5). When used as a destination operand, these registers receive the low-order portion of the word; the high-order portion is not used. The notation

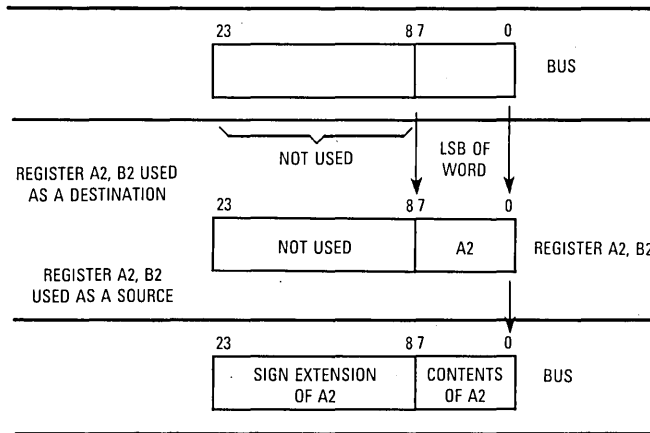

**Figure 7-4. Reading and Writing the ALU Extension Registers**

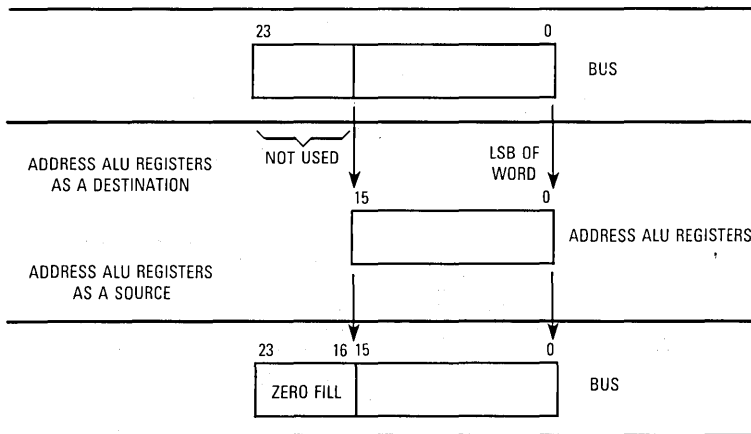
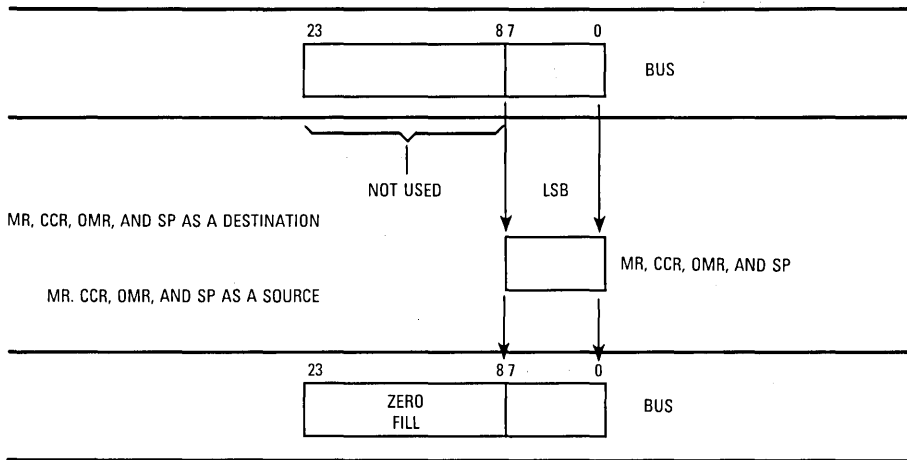

**Figure 7-5. Reading and Writing the Address ALU Registers**

Rn is used to designate one of the eight address registers, R0–R7; the notation Nn is used to designate one of the eight address offset registers, N0–N7; and the notation Mn is used to designate one of the eight address modifier registers, M0–M7.

**7.2.2.3 PROGRAM CONTROL REGISTERS.** The 8-bit OMR may be accessed as a word operand; however, not all eight bits are defined. In general, undefined bits are written as “don’t care” and read as zero. The 16-bit SR has the system mode register (MR) occupying

the high-order eight bits and the user condition code register (CCR) occupying the low-order eight bits. The SR may be accessed as a word operand. The MR and CCR may be accessed individually as word operands (see Figure 7-6(b)). The LC, LA, system stack high (SSH), and system stack low (SSL) registers are 16 bits wide and may be accessed as word



(a) 16 Bit

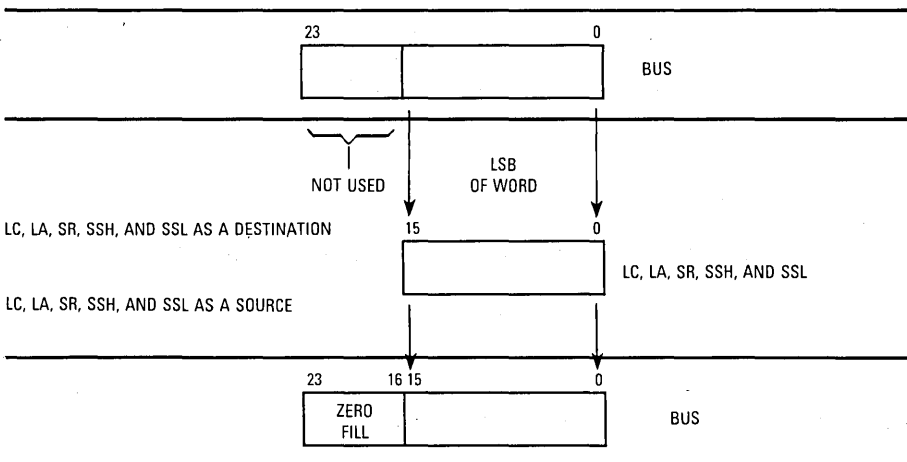

(b) 8 Bit

Figure 7-6. Reading and Writing Control Registers

operands (see Figure 7-6(a)). When used as a source operand, these registers occupy the low-order portion of the 24-bit word; the high-order portion is zero. When used as a destination operand, they receive the low-order portion of the 24-bit word; the high-order portion is not used. The system stack pointer (SP) is a 6-bit register that may be accessed as a word operand.

The PC, a special 16-bit-wide program control register, is always referenced implicitly as a short-word operand.

### 7.2.3 Data Organization in Memory

The 24-bit program memory can store both 24-bit instruction words and instruction extension words. The 32-bit system stack (SS) can store the concatenated PC and SR registers (PC:SR) for subroutine calls, interrupts, and program looping. The SS also supports the concatenated LA and LC registers (LA:LC) for program looping. The 24-bit-wide X and Y memories can store word, short-word, and byte operands. Short-word and byte operands, which usually occupy the low-order portion of the X or Y memory word, are either zero extended or sign extended on the XDB or YDB.

The symbols used to abbreviate the various operands and operations in each instruction and their respective meanings are shown in the following list:

#### Data ALU

|     |   |
|-----|---|
| Xn  | Input Registers X1, X0 (24 Bits)                    |
| Yn  | Input Registers Y1, Y0 (24 Bits)                    |
| An  | Accumulator Registers A2 (8 Bits), A1, A0 (24 Bits) |
| Bn  | Accumulator Registers B2 (8 Bits), B1, B0 (24 Bits) |
| X   | Input Register X (X1:X0, 48 Bits)                   |
| Y   | Input Register Y (Y1:Y0, 48 Bits)                   |
| A   | Accumulator A (A2:A1:A0, 56 Bits)*                  |
| B   | Accumulator B (B2:B1:B0, 56 Bits)*                  |
| AB  | Accumulators A and B (A1:B1, 48 Bits)*              |
| BA  | Accumulators B and A (B1:A1, 48 Bits)*              |
| A10 | Accumulator A (A1:A0, 48 Bits)                      |
| B10 | Accumulator B (B1:B0, 48 Bits)                      |

\*Data move operations: when specified as a source operand, shifting and limiting are performed. When specified as a destination operand, sign extension and zero filling are performed.

#### Address ALU

|    |  |
|----|--|
| Rn | Address Registers R0–R7 (16 Bits)          |
| Nn | Address Offset Registers N0–N7 (16 Bits)   |
| Mn | Address Modifier Registers M0–M7 (16 Bits) |

## Program Controller

|     |   |
|-----|---|
| PC  | Program Counter (16 Bits)                                 |
| MR  | Mode Register (8 Bits)                                    |
| CCR | Condition Code Register (8 Bits)                          |
| SR  | Status Register (MR:CCR, 16 Bits)                         |
| OMR | Operating Mode Register (8 Bits)                          |
| LA  | Hardware Loop Address Register (16 Bits)                  |
| LC  | Hardware Loop Counter (16 Bits)                           |
| SP  | System Stack Pointer (6 Bits)                             |
| SS  | System Stack RAM (15× 32 Bits)                            |
| SSH | Upper 16 Bits of the Contents of the Current Top of Stack |
| SSL | Lower 16 Bits of the Contents of the Current Top of Stack |

## Addresses

|       |   |
|-------|---|
| ea    | Effective Address                             |
| xxxx  | Absolute Address (16 Bits)                    |
| xxx   | Short Jump Address (12 Bits)                  |
| aa    | Absolute Short Address (6 Bits Zero Extended) |
| pp    | I/O Short Address (6 Bits Ones Extended)      |
| {...} | Contents of the Specified Address             |
| X:    | X Memory Reference                            |
| Y:    | Y Memory Reference                            |
| L:    | Long Memory Reference — X Concatenated with Y |
| P:    | Program Memory Reference                      |

## Miscellaneous

|         |                                |
|---------|--------------------------------|
| #xx     | Immediate Short Data (8 Bits)  |
| #xxx    | Immediate Short Data (12 Bits) |
| #xxxxxx | Immediate Data (24 Bits)       |
| #n      | Immediate Short Data (5 Bits)  |
| S,Sn    | Source Operand Register        |
| D,Dn    | Destination Operand Register   |
| D[n]    | Bit n of D Affected            |
| r       | Rounding Constant              |
| I1,I0   | Interrupt Priority Level in SR |
| LF      | Loop Flag in SR                |

### 7.2.4 Operand References

The DSP separates operand references into four classes: program, stack, register, and memory references. The type of operand reference(s) required for an instruction is specified by both the opcode field and the data bus movement field of the instruction; however, all operand reference types may not be used with all instructions. The operand size for each instruction is either explicitly encoded in the instruction or implicitly defined by the instruction operation. Implicit instructions support some subset of the five operand sizes.



**7.2.4.1 PROGRAM REFERENCES.** Program (P) references, which are references to 24-bit-wide program memory space, are usually instruction reads. Instructions or data operands may be read from or written to program memory space using the move program memory (MOVEM) and move peripheral data (MOVEP) instructions. Depending on the address and the chip operating mode, program references may be internal or external memory references.

**7.2.4.2 STACK REFERENCES.** Stack (S) references, which are references to a separate 32-bit-wide internal memory space (SS), are used implicitly to store the PC and SR for subroutine calls, interrupts, and returns. In addition to the PC and SR, the LA and LC registers are stored on the stack when a program loop is initiated. S references are always implied by the instruction. Data is written to the stack memory to save the processor state and is read from the stack memory to restore the processor state. In contrast to S references, references to SSL and SSH are always explicit.

**7.2.4.3 REGISTER REFERENCES.** Register (R) references are references to the data ALU, AGU, and program controller registers. Data can be read from one register and written into another register.

**7.2.4.4 MEMORY REFERENCES.** Memory references, which are references to the 24-bit-wide X or Y memory spaces, can be internal or external memory references, depending on the effective address of the operand in the data bus movement field of the instruction. Data can be read or written from any address in either memory space.

**7.2.4.4.1 X Memory References.** The operand, which is in X memory space, is a word reference. Data can be transferred from memory to a register or from a register to memory.

**7.2.4.4.2 Y Memory References.** The operand, a word reference, is in Y memory space. Data can be transferred from memory to a register or from a register to memory.

**7.2.4.4.3 L Memory References.** Long (L) memory space references both X and Y memory spaces with one operand address. The data operand is a long-word reference developed by concatenating the X and Y memory spaces (X:Y). The high-order word of the operand is in the X memory; the low-order word of the operand is in the Y memory. Data can be read from memory to concatenated registers X1:X0, A1:A0, etc. or from concatenated registers to memory.

**7.2.4.4.4 YX Memory References.** XY memory space references both X and Y memory spaces with two operand addresses. Two independent addresses are used to access two word operands — one word operand is in X memory space, and one word operand is in

Y memory space. Two effective addresses in the instruction are used to derive two independent operand addresses — one operand address may reference either X or Y memory space and the other operand address must reference the other memory space. One of these two effective addresses specified in the instruction must reference one of the address registers, R0–R3, and the other effective address must reference one of the address registers, R4–R7. Addressing modes are restricted to no-update and post-update by +1, –1, and +N addressing modes. Each effective address provides independent read/write control for its memory space. Data may be read from memory to a register or from a register to memory.

## 7.2.5 Addressing Modes

The DSP instruction set contains a full set of operand addressing modes. To minimize execution time and loop overhead, all address calculations are performed concurrently in the address ALU.

Addressing modes specify whether the operand(s) is in a register or in memory and provide the specific address of the operand(s). An effective address in an instruction will specify an addressing mode, and, for some addressing modes, the effective address will further specify an address register. In addition, address register indirect modes require additional address modifier information that is not encoded in the instruction. The address modifier information is specified in the selected address modifier register(s). All indirect memory references require one address modifier, and the XY memory reference requires two address modifiers. The definition of certain instructions implies the use of specific registers and addressing modes.

Some address register indirect modes require an offset and a modifier register for use in address calculations. These registers are implied by the address register specified in an effective address in the instruction word. Each offset register (Nn) and each modifier register (Mn) is assigned to an address register (Rn) having the same register number (n). Thus, the assigned register triplets are R0;N0;M0, R1;N1;M1, R2;N2;M2, R3;N3;M3, R4;N4;M4, R5;N5;M5, R6;N6;M6, and R7;N7;M7. Rn is used as the address register; Nn is used to specify an optional offset; and Mn is used to specify the type of arithmetic used to update the Rn.

The addressing modes are grouped into three categories: register direct, address register indirect, and special. These addressing modes are described in the following paragraphs. Refer to Table 7-1 for a summary of the addressing modes and allowed operand references.

**7.2.5.1 REGISTER DIRECT MODES.** These effective addressing modes specify that the operand source or destination is one of the data, control, or address registers in the programming model.

**7.2.5.1.1 Data or Control Register Direct.** The operand is in one, two, or three data ALU register(s) as specified in a portion of the data bus movement field in the instruction. Classified as a register reference, this addressing mode is also used to specify a control register operand for special instructions such as OR immediate to control registers (ORI) and AND immediate to control registers (ANDI).

**7.2.5.1.2 Address Register Direct.** Classified as a register reference, the operand is in one of the 24 address registers (Rn, Nn, or Mn) specified by an effective address in the instruction.

#### NOTE

Due to instruction pipelining, if an address register (Mn, Nn, or Rn) is changed with a MOVE instruction, the new contents will not be available for use as a pointer until the second following instruction.

**7.2.5.2 ADDRESS REGISTER INDIRECT MODES.** The address register indirect mode description is presented in **SECTION 5 ADDRESS GENERATION UNIT**.

**7.2.5.3 SPECIAL ADDRESSING MODES.** The special addressing modes do not use specific registers in specifying an effective address. These modes specify the operand or the operand address in a field of the instruction, or they implicitly reference an operand. Figure examples are given for each of the special addressing modes discussed in the following paragraphs.

**7.2.5.3.1 Immediate Data.** Classified as a program reference, this addressing mode requires one word of instruction extension containing the immediate data. Figure 7-7 shows three examples. Example A moves immediate data to register A0 without affecting A1 or A2. Examples B and C zero fill register A0 and sign extend register A2.

**7.2.5.3.2 Absolute Address.** This addressing mode requires one word of instruction extension containing the absolute address. Figure 7-8 shows that MOVE Y:\$5432,B0 copies the contents of address \$5432 into B0 without changing memory location \$5432, register B1, or register B2. This addressing mode is classified as both a memory reference and program reference. The 16-bit absolute address is stored in the 16 LSBs of the extension word; the eight MSBs are zero filled.

**7.2.5.3.3 Immediate Short.** The 8- or 12-bit operand, which is in the instruction operation word, is classified as a program reference. The immediate data is interpreted as an unsigned integer (low-order portion) or signed fraction (high-order portion), depending on the destination register. Figure 7-9 shows the use of immediate short addressing in four examples.

EXAMPLE A: IMMEDIATE INTO 24-BIT REGISTER  
(MOVE #123456,A0)



EXAMPLE B: POSITIVE IMMEDIATE INTO 56-BIT REGISTER  
(MOVE #123456,A)



EXAMPLE C: NEGATIVE IMMEDIATE INTO 56-BIT REGISTER  
(MOVE #801234,A)



Assembler Syntax: #XXXXXX  
Memory Spaces: P  
Additional Instruction Execution Time (Clocks): 2  
Additional Effective Address Words: 1

Figure 7-7. Special Addressing — Immediate Data

EXAMPLE: MOVE Y:\$5432,B0

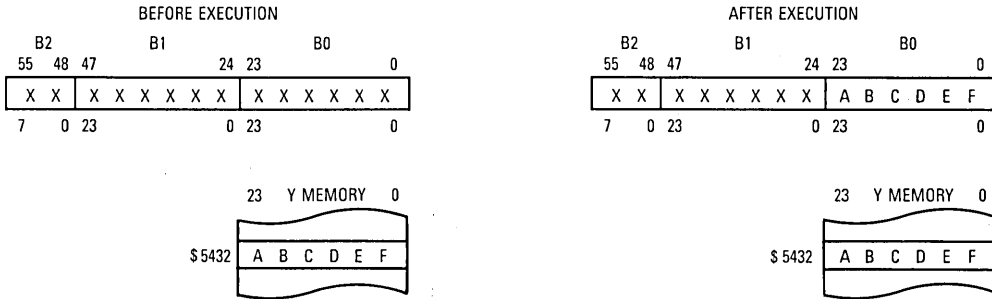

Assembler Syntax: XXXX  
 Memory Spaces: P:  
 Additional Instruction Execution Time (Clocks): 2  
 Additional Effective Address Words: 1

**Figure 7-8. Special Addressing — Absolute Addressing**

**7.2.5.3.4 Short Jump Address.** The operand occupies 12 bits in the instruction operation word, which allows addresses \$0000–\$0FFF to be accessed (see Figure 7-10). The address is zero extended to 16 bits when used to address program memory. This addressing mode is classified as a program reference.

**7.2.5.3.5 Absolute Short.** The address of the operand occupies six bits in the instruction operation word, allowing addresses \$0000–\$003F to be accessed (see Figure 7-11). Classified as both a memory reference and program reference, the address is zero extended to 16 bits when used to address an operand or program memory.

**7.2.5.3.6 I/O Short.** Classified as a memory reference, the I/O short addressing mode is similar to absolute short addressing. The address of the operand occupies six bits in the instruction operation word. I/O short is used with the bit manipulation and MOVEP instructions. The I/O short address is ones extended to 16 bits to address the I/O portion of X and Y memory (addresses \$FFC0–\$FFFF — see Figure 7-12).

**7.2.5.3.7 Implicit Reference.** Some instructions make implicit reference to PC, SS, LA, LC, or SR. For example, the jump instruction (JMP) implicitly references the PC; whereas, the repeat next instruction (REP) implicitly references LC. The registers implied and their uses are defined by the individual instruction descriptions (see **APPENDIX A INSTRUCTION SET DETAILS**).

EXAMPLE A: IMMEDIATE SHORT INTO A0, A1, A2, B0, B1, B2, Rn, Nn  
(MOVE #FF,A1)



NOTE: For these destinations, the immediate data is interpreted as an unsigned integer.

EXAMPLE B: POSITIVE IMMEDIATE SHORT INTO X0, X1, Y0, Y1, A, B  
(MOVE #1F,Y1)



NOTE: For these destination registers, the immediate data is interpreted as a signed fraction.

EXAMPLE C: POSITIVE IMMEDIATE SHORT INTO X, Y, A, B  
(MOVE #1F,A)

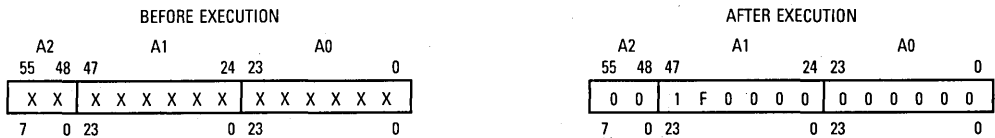

EXAMPLE D: NEGATIVE IMMEDIATE SHORT INTO X0, X1, X0, Y1, A, B  
(MOVE #83,B)



Assembler Syntax: #XX  
Memory Spaces: P  
Additional Instruction Execution Time (Clocks): 0  
Additional Effective Address Words: 0

Figure 7-9. Special Addressing — Immediate Short Data

EXAMPLE: JMP \$123

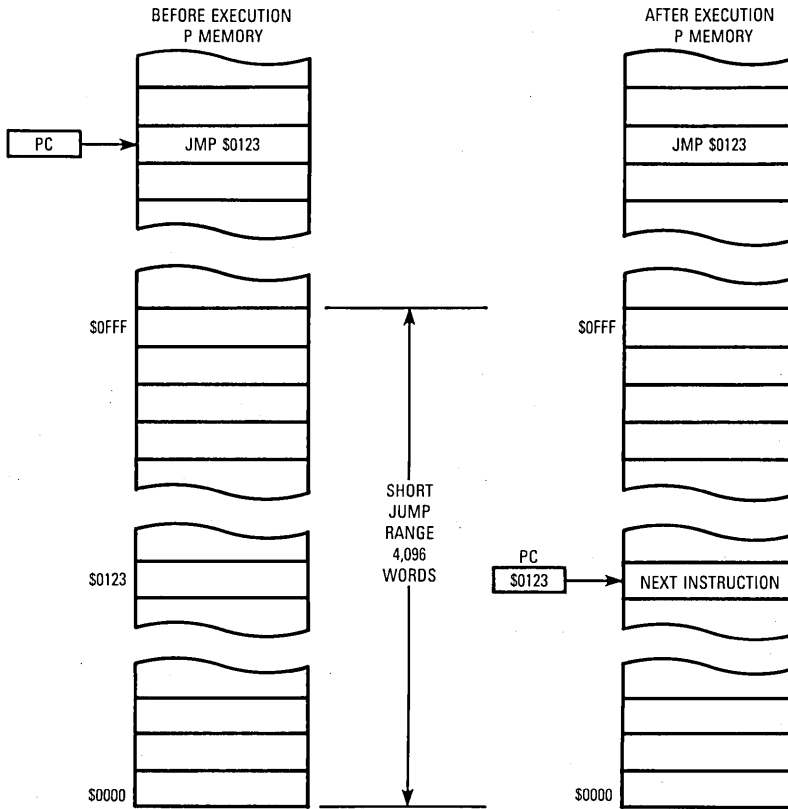

Assembler Syntax: XXX  
 Memory Spaces: P:  
 Additional Instruction Execution Time (Clocks): 0  
 Additional Effective Address Words: 0

Figure 7-10. Special Addressing — Short Jump Address

EXAMPLE A: MOVE P:\$3200,X0

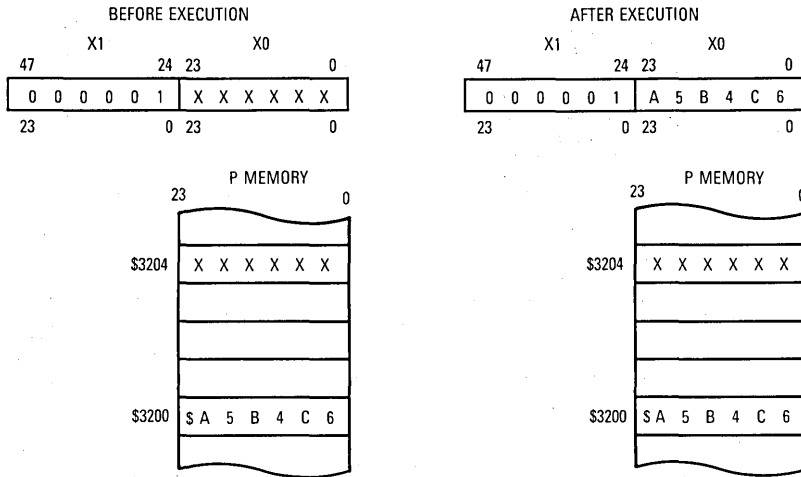

EXAMPLE B: MOVE A1,X:\$3

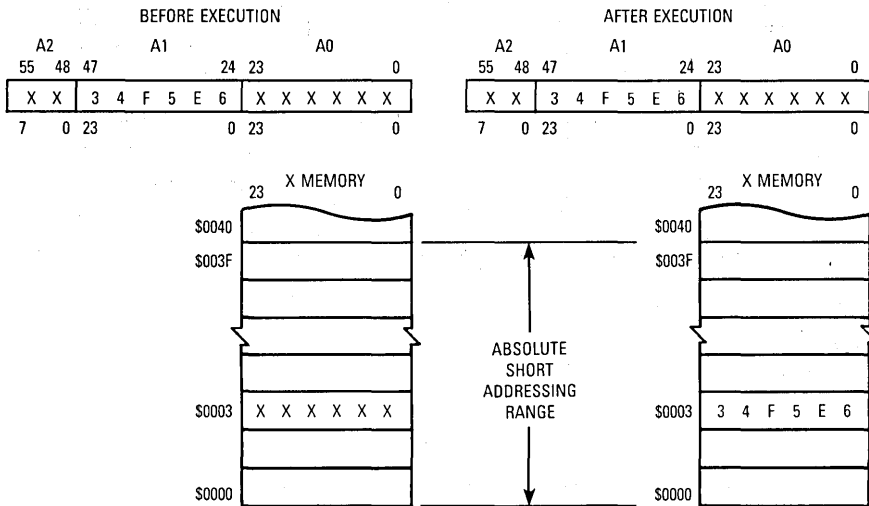

Assembler Syntax: aa  
 Memory Spaces: P, X, Y, L:  
 Additional Instruction Execution Time (Clocks): 0  
 Additional Effective Address Words: 0

Figure 7-11. Special Addressing — Absolute Short Address



EXAMPLE: MOVEP A1,X:<<\$FFFE

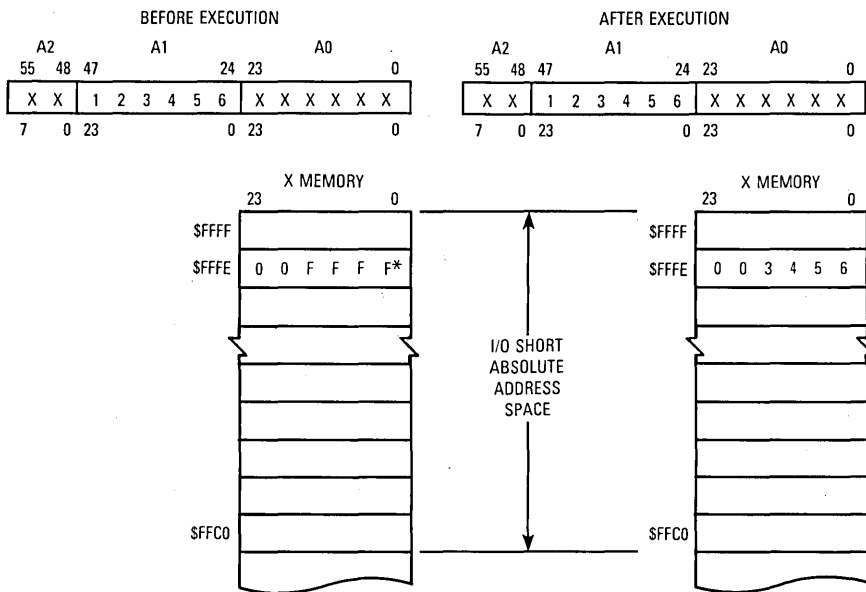

\*Contents of Bus Control Register (X:\$FFFE) After Reset

Assembler Syntax: pp  
 Operands Referenced: X, Y Memories  
 Additional Instruction Execution Time (Clocks): 0  
 Additional Effective Address Words: 0

Figure 7-12. Special Addressing — I/O Short Address

**7.2.5.4 ADDRESSING MODES SUMMARY.** Table 7-1 is a summary of the addressing modes discussed in the previous paragraphs.

**Table 7-1. Addressing Modes Summary**

| Addressing Mode                  | Modifier<br>MMMM | Operand Reference |   |   |   |   |   |   |   |    |
|----------------------------------|------------------|-------------------|---|---|---|---|---|---|---|----|
|                                  |                  | P                 | S | C | D | A | X | Y | L | XY |
| <b>Register Direct</b>           |                  |                   |   |   |   |   |   |   |   |    |
| Data or Control Register         | No               |                   |   | X | X |   |   |   |   |    |
| Address Register                 | No               |                   |   |   |   | X |   |   |   |    |
| Address Modifier Register        | No               |                   |   |   |   | X |   |   |   |    |
| Address Offset Register          | No               |                   |   |   |   | X |   |   |   |    |
| <b>Address Register Indirect</b> |                  |                   |   |   |   |   |   |   |   |    |
| No Update                        | Yes              | X                 |   |   |   |   | X | X | X | X  |
| Postincrement by 1               | Yes              | X                 |   |   |   |   | X | X | X | X  |
| Postdecrement by 1               | Yes              | X                 |   |   |   |   | X | X | X | X  |
| Postincrement by Offset Nn       | Yes              | X                 |   |   |   |   | X | X | X | X  |
| Postdecrement by Offset Nn       | Yes              | X                 |   |   |   |   | X | X | X | X  |
| Indexed by Offset Nn             | Yes              | X                 |   |   |   |   | X | X | X | X  |
| Predecrement by 1                | Yes              | X                 |   |   |   |   | X | X | X | X  |
| <b>Special</b>                   |                  |                   |   |   |   |   |   |   |   |    |
| Immediate Data                   | No               | X                 |   |   |   |   |   |   |   |    |
| Absolute Address                 | No               | X                 |   |   |   |   | X | X | X |    |
| Immediate Short Data             | No               | X                 |   |   |   |   |   |   |   |    |
| Short Jump Address               | No               | X                 |   |   |   |   |   |   |   |    |
| Absolute Short Address           | No               | X                 |   |   |   |   | X | X | X |    |
| I/O Short Address                | No               |                   |   |   |   |   | X | X |   |    |
| Implicit                         | No               | X                 | X | X |   |   |   |   |   |    |

Where: MMMM=Address Modifier  
P=Program Reference  
S=Stack Reference  
C=Program Controller Register Reference  
D=Data ALU Register Reference  
A=AGU Register Reference  
X=X Memory Reference  
Y=Y Memory Reference  
L=L Memory Reference  
XY=XY Memory Reference

### 7.3 INSTRUCTION GROUPS

The instruction set is divided into the following groups:

- Arithmetic
- Logical
- Bit Manipulation
- Loop
- Move
- Program Control

Each instruction group is described in the following paragraphs; detailed information on each instruction is given in **APPENDIX A INSTRUCTION SET DETAILS**.

### 7.3.1 Arithmetic Instructions

The arithmetic instructions, which perform all of the arithmetic operations within the data ALU, execute in one instruction cycle. These instructions may affect all of the CCR bits. Arithmetic instructions are register based (register direct addressing modes used for operands) so that the data ALU operation indicated by the instruction does not use the XDB, the YDB, or the global data bus (GDB). Optional data transfers may be specified with most arithmetic instructions, which allows for parallel data movement over the XDB and YDB or over the GDB during a data ALU operation. This parallel movement allows new data to be prefetched for use in subsequent instructions and allows results calculated in previous instructions to be stored. The following list contains the arithmetic instructions:

|       |                                      |
|-------|--------------------------------------|
| ABS   | Absolute Value                       |
| ADC   | Add Long with Carry                  |
| ADD   | Addition                             |
| ADDL  | Shift Left and Add                   |
| ADDR  | Shift Right and Add                  |
| ASL   | Arithmetic Shift Left                |
| ASR   | Arithmetic Shift Right               |
| CLR   | Clear an Operand                     |
| CMP   | Compare                              |
| CMPM  | Compare Magnitude                    |
| DIV*  | Divide Iteration                     |
| MAC   | Signed Multiply-Accumulate           |
| MACR  | Signed Multiply-Accumulate and Round |
| MPY   | Signed Multiply                      |
| MPYR  | Signed Multiply and Round            |
| NEG   | Negate Accumulator                   |
| NORM* | Normalize                            |
| RND   | Round                                |
| SBC   | Subtract Long with Carry             |
| SUB   | Subtract                             |
| SUBL  | Shift Left and Subtract              |
| SUBR  | Shift Right and Subtract             |
| Tcc*  | Transfer Conditionally               |
| TFR   | Transfer Data ALU Register           |
| TST   | Test an Operand                      |

\*These instructions do not allow parallel data moves.

### 7.3.2 Logical Instructions

The logical instructions, which execute in one instruction cycle, perform all of the logical operations within the data ALU (except ANDI and ORI). They may affect all of the CCR bits and, like the arithmetic instructions, are register based. Optional data transfers may be specified with most logical instructions, allowing parallel data movement over the XDB and YDB or over the GDB during a data ALU operation. This parallel movement allows

new data to be prefetched for use in subsequent instructions and allows results calculated in previous instructions to be stored. The following list includes the logical instructions:

|       |                                   |
|-------|-----------------------------------|
| AND   | Logical AND                       |
| ANDI* | AND Immediate to Control Register |
| EOR   | Logical Exclusive OR              |
| LSL   | Logical Shift Left                |
| LSR   | Logical Shift Right               |
| NOT   | Logical Complement                |
| OR    | Logical Inclusive OR              |
| ORI*  | OR Immediate to Control Register  |
| ROL   | Rotate Left                       |
| ROR   | Rotate Right                      |

\*These instructions do not allow parallel data moves.

### 7.3.3 Bit Manipulation Instructions

The bit manipulation instructions test the state of any single bit in a memory location and then optionally set, clear, or invert the bit. The carry bit of the CCR will contain the result of the bit test. The following list defines the bit manipulation instructions:

|      |                                  |
|------|----------------------------------|
| BCLR | Bit Test and Clear               |
| BSET | Bit Test and Set                 |
| BCHG | Bit Test and Change              |
| BTST | Bit Test on Memory and Registers |

### 7.3.4 Loop Instructions

The hardware DO loop executes with no overhead cycles — i.e., it runs as fast as straight-line code. Replacing straight-line code with DO loops can significantly reduce program memory. The loop instructions control hardware looping by 1) initiating a program loop and establishing looping parameters or by 2) restoring the registers by pulling the SS when terminating a loop. Initialization includes saving registers used by a program loop (LA and LC) on the SS so that program loops can be nested. The address of the first instruction in a program loop is also saved to allow no-overhead looping. The loop instructions are as follows:

|       |                         |
|-------|-------------------------|
| DO    | Start Hardware Loop     |
| ENDDO | Exit from Hardware Loop |

Both static and dynamic loop counts are supported in the following forms:

|    |           |             |
|----|-----------|-------------|
| DO | #xxx,Expr | ; (Static)  |
| DO | S,Expr    | ; (Dynamic) |

Expr is an assembler expression or absolute address, and S is a directly addressable register such as X0.

The operation of a DO loop is shown in Figure 7-13. When a program loop is initiated with the execution of a DO instruction, the following events occur:

1. The stack is pushed.
  - A. The SP is incremented.
  - B. The current 16-bit LA and 16-bit LC registers are pushed onto the SS to allow nested loops.
  - C. The LC register is initiated with the loop count value specified in the DO instruction.
2. The stack is pushed again.
  - A. The SP is incremented.
  - B. The address of the first instruction in the program loop (PC) and the current SR contents are pushed onto the SS.
  - C. The LA register is initialized with the value specified in the DO instruction decremented by one.
3. The LF bit in the SR is set. The LF bit is set when a program loop is in progress and enables the end-of-loop detection.

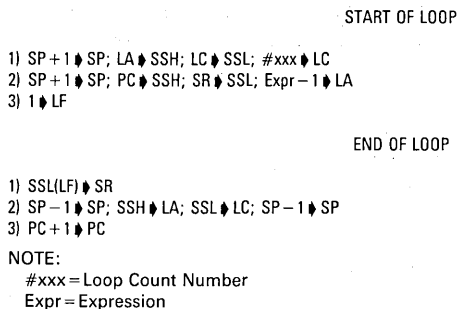
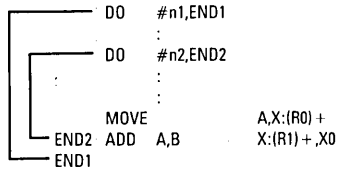

**Figure 7-13. Hardware DO Loop**

The program loop continues execution until the program address fetched equals the LA register contents (last address of program loop). The contents of the LC are then tested for one. If the LC is not one, it is decremented, and the top location in the stack RAM is read (but not pulled) into the PC to return to the start of the loop. If the LC is one, the program loop is terminated by the following sequence:

1. Reading the previous LF bit from the top location in the SS into the SR
2. Purging the SS (pulling the top location and discarding the contents), pulling the LA and LC registers off the SS, and restoring the respective registers
3. Incrementing the PC

The LF bit (pulled from the SS when a loop is terminated) indicates if the terminated loop was a nested loop. Figure 7-14 shows two DO loops, one nested inside the other. If the stack is managed to prevent a stack overflow, DO loops can be stacked indefinitely.



**Figure 7-14. Nested DO Loops**

The ENDDO instruction is not used for normal termination of a DO loop; it is only used to terminate a DO loop before the LC has been decremented to one.

### 7.3.5 Move Instructions

The move instructions perform data movement over the XDB and YDB or over the GDB. Move instructions do not affect the CCR except the limit bit L if limiting is performed when reading a data ALU accumulator register. An address ALU instruction (LUA) is also included in the following move instructions. The MOVE instruction is the parallel move with a data ALU no-operation (NOP).

|       |                       |
|-------|-----------------------|
| LUA   | Load Updated Address  |
| MOVE  | Move Data Register    |
| MOVEC | Move Control Register |
| MOVEM | Move Program Memory   |
| MOVEP | Move Peripheral Data  |

**NOTE:**

Due to instruction pipelining, if an address register (Mn, Nn, or Rn) is changed with a MOVE instruction, the new contents will not be available for use in an effective address calculation until the second following instruction.

There are nine classifications of parallel data moves between registers and memory. Figure 7-15 shows seven parallel moves. The source of the data to be moved and the destination are separated by a comma.

Examples of the other two classifications, XY and long (L) moves, are shown in Figure 7-16.

The first example (A) illustrates the following steps: 1) register X0 is added to register A and the result is placed in register A; 2) register X0 is moved to the X memory register location pointed to by R3, and R3 is incremented; and 3) the contents of the Y memory location pointed to by R7 is moved to the B register, and R7 is decremented.

The second example (B) depicts the following sequence: 1) register X0 is added to register A and the result is placed in register A; and 2) registers A and B are moved, respectively,

|                         | OPCODE/OPERANDS | PARALLEL MOVE EXAMPLES |
|-------------------------|-----------------|------------------------|
| IMMEDIATE SHORT DATA    | ADD X0,A        | #\$05,Y1               |
| ADDRESS REGISTER UPDATE | ADD X0,A        | (R0) + N0              |
| REGISTER TO REGISTER    | ADD X0,A        | A1,Y0                  |
| X MEMORY                | ADD X0,A        | X0,X:(R3) +            |
| X MEMORY PLUS REGISTER  | ADD X0,A        | X:(R4) - ,X1 A,Y0      |
| Y MEMORY                | ADD X0,A        | Y:(R6) + N6,X0         |
| Y MEMORY PLUS REGISTER  | ADD X0,A        | A,X0 B,Y:(R0)          |

NOTE: Parallel Move Syntax — Source(Src), Destination(Dst)

Figure 7-15. Classifications of Parallel Data Moves

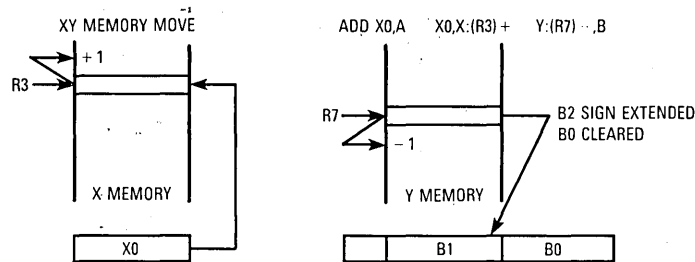

(a) Example A

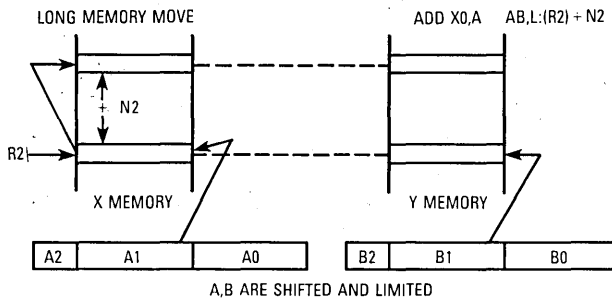

(b) Example B

Figure 7-16. Parallel Move Examples

to the locations in memories X and Y pointed to by R2, and then R2 is incremented by N2. The contents of the 56-bit registers A and B were rounded to 24 bits before moving to the 24-bit memory registers.

The DSP offers parallel processing of the data ALU, AGU, and program controller. For the instruction word above, the DSP will perform the designated operation (data ALU), the

data transfers specified with address register updates (AGU), and will decode the next instruction and fetch an instruction from program memory (program controller) all in one instruction cycle. When an instruction is more than one word in length, an additional instruction execution cycle is required. Most instructions involving the data ALU are register based (all operands are in data ALU registers), thereby allowing the programmer to keep each parallel processing unit busy. An instruction that is memory oriented (such as a bit manipulation instruction) or that causes a control-flow change (such as a JMP) prevents the use of parallel processing resources during its execution.

### 7.3.6 Program Control Instructions

The program control instructions include jumps, conditional jumps, and other instructions affecting the PC and SS. Program control instructions may affect the CCR bits as specified in the instruction. Optional data transfers over the XDB and YDB may be specified in some of the program control instructions. The following list contains the program control instructions:

|       |  |
|-------|--|
| II    | Illegal Instruction                    |
| Jcc   | Jump Conditionally                     |
| JMP   | Jump                                   |
| JCLR  | Jump if Bit Clear                      |
| JSET  | Jump if Bit Set                        |
| JScC  | Jump to Subroutine Conditionally       |
| JSR   | Jump to Subroutine                     |
| JSCLR | Jump to Subroutine if Bit Clear        |
| JSSET | Jump to Subroutine if Bit Set          |
| NOP   | No Operation                           |
| REP   | Repeat Next Instruction                |
| RESET | Reset On-Chip Peripheral Devices       |
| RTI   | Return from Interrupt                  |
| RTS   | Return from Subroutine                 |
| STOP  | Stop Processing (Low-Power Standby)    |
| SWI   | Software Interrupt                     |
| WAIT  | Wait for Interrupt (Low-Power Standby) |



## SECTION 8 PROCESSING STATES

The DSP is always in one of five processing states: normal, exception, reset, wait, and stop. These states are described in the following paragraphs.

### 8.1 NORMAL PROCESSING STATE

The normal processing state is associated with instruction execution. Details concerning normal processing of the individual instructions can be found in **APPENDIX A INSTRUCTION SET DETAILS**. Instructions are executed using a three-stage pipeline, which is described in the following paragraphs.

#### 8.1.1 Instruction Pipeline

DSP56000/DSP56001 instruction execution is performed in a three-stage pipeline, allowing most instructions to execute at a rate of one instruction every instruction cycle. However, certain instructions require additional time to execute: instructions longer than one word, instructions using an addressing mode that requires more than one cycle, and instructions causing a control-flow change. In the latter case, a cycle is needed to clear the pipeline.

Instruction pipelining allows overlapping of instruction execution so that the fetch-decode-execute operations of a given instruction occur concurrently with the fetch-decode-execute operations of other instructions. Specifically, while an instruction is executed, the next instruction to be executed is decoded, and the instruction to follow the instruction being decoded is fetched from program memory. Only one word is fetched per cycle so that, if an instruction is two words in length, the additional word will be fetched before the next instruction is fetched. Table 8-1 demonstrates pipelining; F1, D1, and E1 refer to the fetch, decode, and execute operations, respectively, of the first instruction. The third instruction, which contains an instruction extension word, takes two instruction cycles to execute. The

**Table 8-1. Instruction Pipelining**

| Operation | Instruction Cycle |    |    |     |     |     |    |   |   |   |
|-----------|-------------------|----|----|-----|-----|-----|----|---|---|---|
|           | 1                 | 2  | 3  | 4   | 5   | 6   | 7  | • | • | • |
| Fetch     | F1                | F2 | F3 | F3e | F4  | F5  | F6 | • | • | • |
| Decode    |                   | D1 | D2 | D3  | D3e | D4  | D5 | • | • | • |
| Execute   |                   |    | E1 | E2  | E3  | E3e | E4 | • | • | • |

extension word will be either an absolute address or immediate data. Although it takes three instruction cycles for the pipeline to fill and the first instruction to execute, an instruction usually executes on each instruction cycle thereafter.

Each instruction requires a minimum of three instruction cycles (12 clock phases) to be fetched, decoded, and executed. This means that there is a delay of three instruction cycles on powerup to fill the pipe. A new instruction may begin immediately following the previous instruction. Two-word instructions require a minimum of four instruction cycles to execute (three cycles for the first instruction word to move through the pipe and execute and one more cycle for the second word to execute). A new instruction may start after two instruction cycles.

The pipeline is normally transparent to the user. However, it will affect program execution in some situations. These situations, which are instruction-sequence dependent, are best described by case studies. Most of these restricted sequences occur because 1) all addresses are formed during instruction decode, or 2) they are the result of contention for an internal resource such as the status register (SR). If the execution of an instruction depends on the relative location of the instruction in a sequence of instructions, there is a pipeline effect. To test for a suspected pipeline effect, compare between the execution of the suspect instruction 1) when it directly follows the previous instruction and 2) when four NOPs are inserted between the two. If there is a difference, it is due to a pipeline effect. The DSP56000/DSP56001 assembler (ASM56000) is designed to flag instruction sequences with potential pipeline effects so that the user can decide if the operation will be as expected.

**Case 1:** The following two examples show similar code sequences.

1. No pipeline effect:

```
ORI #xx,CCR           ;Changes CCR at the end of execution time slot
Jcc xxxx             ;Reads condition codes in SR in its execution time slot
```

The Jcc will test the bits modified by the ORI without any pipeline effect in the code segment above.

2. Instruction that started execution during decode:

```
ORI #04,OMR          ;Sets DE bit at execution time slot
MOVE x:$100,a        ;Reads external RAM instead of internal ROM
```

A pipeline effect occurs in example 2 because the address of the MOVE is formed at its decode time before the ORI changes the DE bit (which changes the memory map) in the ORI's execution time slot. The following code produces the expected results of reading the internal ROM:

```
ORI #04,OMR          ;Sets DE bit at execution time slot
NOP                  ;Delays the MOVE so it will read the updated OMR
MOVE x:$100,a        ;Reads internal ROM
```

**Case 2:** One of the more common sequences where pipeline effects are apparent is as follows:

```

      .                               ;Move a number into register Rn (n=0-7).
      .
      MOVE #xx,Rn
      MOVE X:(Rn),A                ;Use the new contents of Rn to address memory.
      .
      .
  
```

In this case, before the first MOVE instruction has written Rn during its execution cycle, the second MOVE has accessed the old Rn, using the old contents of Rn. This is because the address for indirect moves is formed during the decode cycle. This overlapping instruction execution in the pipeline causes the pipeline effect. One instruction cycle should be allowed after a register has been written by a MOVE instruction before the new contents are available for use by another MOVE instruction. The proper instruction sequence is as follows:

```

      .                               ;Move a number into register Rn.
      .
      MOVE X0,Rn
      NOP                           ;Execute any instruction or instruction
      .                               ;sequence not using Rn.
      .
      MOVE X:(Rn),A                Use the new contents of Rn.
  
```

**Case 3:** A situation related to Case 2 can be seen in the boot ROM code shown in **APPENDIX A** of the *DSP56001 Advance Information Data Sheet (ADI1290)*. At the end of the bootstrap operation, the operation mode register (OMR) is changed to mode #2, and then the program that was loaded is executed. This process is accomplished in the last three instructions:

```

_BOOTEND   MOVEC   #2,OMR   ;Set the operating mode to 2
                                     ;(and trigger an exit from
                                     ;bootstrap mode).

          ANDI    #\$0,CCR   ;Clear SR as if RESET and
                                     ;introduce delay needed for
                                     ;Op. Mode change.

          JMP     <\$0       ;Start fetching from PRAM, P:\$0000
  
```

The JMP instruction generates its jump address during its decode cycle. If the JMP instruction followed the MOVEC, the MOVEC instruction would not have changed the OMR before the JMP instruction formed the fetch address. As a result, the jump would fetch the instruction at P:\\$0000 of the bootstrap ROM (MOVE #\\$FFE9,R2). The OMR would then change due to the MOVEC instruction, and the next instruction would be the second instruction of the downloaded code at P:\\$0001 of the internal RAM. However, the ANDI

instruction allows the OMR to be changed before the JMP instruction uses it, and the JMP fetches P:\$0000 of the internal RAM.

**Case 4:** An interrupt has two additional control cycles that are executed in the interrupt controller concurrently with the fetch, decode, and execute cycles (see **8.2 EXCEPTION PROCESSING STATE INTERRUPT PROCESSING** and Figure 8-2). During these two control cycles, the interrupt is arbitrated by comparing the interrupt mask level with the interrupt priority level (IPL) of the interrupt and allowing or disallowing the interrupt. Therefore, if the interrupt mask is changed after an interrupt is arbitrated and accepted as pending but before the interrupt is executed, the interrupt will be executed, regardless of what the mask was changed to. The following examples show that the old interrupt mask is in effect for up to four additional instruction cycles after the interrupt mask is changed. All instructions shown in the examples here are one-word instructions; however, one two-word instruction can replace two one-word instructions except where noted.

1. Program flow with no interrupts after interrupts are disabled:

```

.
.
ORI #03,MR           ;Disable interrupts
INST 1
INST 2
INST 3
INST 4
.
.

```

2. The four possible variations in program flow that may occur after interrupts are disabled:

|                 |            |            |                     |
|-----------------|------------|------------|---------------------|
| .               | .          | .          | .                   |
| .               | .          | .          | .                   |
| ORI #03,MR      | ORI #03,MR | ORI #03,MR | ORI #03,MR          |
| II (See Note 2) | INST 1     | INST 1     | INST 1              |
| II+1            | II         | INST 2     | INST 2              |
| INST 1          | II+1       | II         | INST 3 (See Note 1) |
| INST 2          | INST 2     | II+1       | II                  |
| INST 3          | INST 3     | INST 3     | II+1                |
| INST 4          | INST 4     | INST 4     | INST 4              |
| .               | .          | .          | .                   |
| .               | .          | .          | .                   |

**NOTES:**

1. INST 3 may be executed at that point only if the preceding instruction (INST 2) was a single-word instruction.
2. II=Interrupt instruction from maskable interrupt.

The following program flow **will not** occur because the ORI instruction becomes effective after a pipeline latency of four instruction cycles:

```

.
.
ORI #03,MR           ;Disable interrupts.
INST 1
INST 2
INST 3
INST 4
II                   ;Interrupts disabled.
II+1                 ;Interrupts disabled.
.
.

```

1. Program flow without interrupts after interrupts are re-enabled:

```

.
.
ANDI #00,MR          ;Enable interrupts
INST 1
INST 2
INST 3
INST 4
.
.

```

2. Program flow with interrupts after interrupts are re-enabled:

```

.
.
ANDI #00,MR          ;Enable interrupts
INST 1               ;Uninterruptable
INST 2               ;Uninterruptable
INST 3               ;II fetched
INST 4               ;II+1 fetched
II
II+1
.
.

```

The DO instruction is another instruction that begins execution during the decode cycle of the pipeline. As a result, there are a number of restrictions concerning access contention with the program controller registers accessed by the DO instruction. The ENDDO instruction has similar restrictions. **APPENDIX A INSTRUCTION SET DETAILS** contains additional information on the DO and ENDDO instruction restrictions.

**Case 5:** A resource contention problem can occur when one instruction is using a register during its decode while the instruction executing is accessing the same resource. One example of this is as follows:

```
MOVEC          X:$100,SSH
DO             #$10,END
```

The problem occurs because the MOVEC instruction loads the contents of X:\$100 into the system stack high (SSH) during T3 of its execution cycle. The DO instruction that follows pushes the stack (LA → SSH, LC → SSL) during T3 of its decode cycle. Therefore, the two instructions try writing to the SSH simultaneously and conflict.

### 8.1.2 Summary of Pipeline-Related Restrictions

A summary of the instruction sequences that cause pipeline effects is given in the following paragraphs. Additional information concerning the individual instructions can be found in **APPENDIX A INSTRUCTION SET DETAILS**.

DO instruction restrictions:

The DO instruction must not be immediately preceded by any of the following instructions:

```
BCHG/BCLR/BSET  LA, LC, SSH, SSL, or SP
MOVEC/MOVM to LA, LC, SSH, SSL, or SP
MOVEC/MOVM from SSH
```

8

Restrictions near the end of DO loops:

Proper DO loop operation is guaranteed if no instruction starting at address LA-2, LA-1, or LA specifies the program controller registers SR, SP, SSL, LA, LC, or (implicitly) PC as a destination register or specifies SSH as a source or a destination register. Also, SSH can not be specified as a source register in the DO instruction.

The restricted instructions at LA-2, LA-1, and LA are as follows:

```
DO
BCHG/BCLR/BSET  LA, LC, SR, SP, SSH, or SSL
BTST SSH
JCLR/JSET/JSCLR/JSSET SSH
MOVEC/MOVM/MOVM from SSH
MOVEC/MOVM/MOVM to LA, LC, SR, SP, SSH, or SSL
ANDI/ORI MR
```

The restricted instructions at LA include the following:

```
Any two-word instruction
Jcc, JMP, JSc, JSR,
REP, RESET, RTI, RTS, STOP, WAIT
```

Other restrictions are

DO SSH,xxxx

JSR/JScC/JScLR/JScSET to LA, if loop flag is set

ENDDO instruction restrictions:

The ENDDO instruction must not be immediately preceded by any of the following instructions:

BCHG/BCLR/BSET LA, LC, SR, SSH, SSL, or SP

MOVEC/MOVM to LA, LC, SR, SSH, SSL, or SP

MOVEC/MOVM from SSH

ANDI/ORI MR

RTI and RTS instruction restrictions:

The RTI instruction must not be immediately preceded by any of the following instructions:

BCHG/BCLR/BSET SR, SSH, SSL, or SP

MOVEC/MOVM to SR, SSH, SSL, or SP

MOVEC/MOVM from SSH

ANDI MR, ANDI CCR

ORI MR, ORI CCR

The RTS instruction must not be immediately preceded by any of the following instructions:

BCHG/BCLR/BSET SSH, SSL, or SP

MOVEC/MOVM to SSH, SSL, or SP

MOVEC/MOVM from SSH

8

SP and SSH/SSL register manipulation restrictions:

In addition to all the above restrictions concerning SP, SSH, and SSL, the following instruction sequences are illegal:

1. BCHG/BCLR/BSET SP

2. MOVEC/MOVM/MOVM from SSH or SSL

and

1. MOVEC/MOVM to SP

2. MOVEC/MOVM/MOVM from SSH or SSL

and

1. MOVEC/MOVM to SP

2. JCLR/JSET/JScLR/JScSET SSH or SSL

and

1. BCHG/BCLR/BSET SP

2. JCLR/JSET/JScLR/JScSET SSH or SSL

Also the instruction MOVEC SSH,SSH is illegal.

Rn, Nn, and Mn register restrictions:

If an address register (R0–R7, N0–N7, or M0–M7) is changed with a move-type instruction (LUA, Tcc, MOVE, MOVEM, MOVEC, or parallel move), the new contents will not be available for use as a pointer until the second following instruction. This restriction does not apply to registers updated as part of an indirect addressing mode.

Fast interrupt routines:

SWI, STOP, and WAIT may not be used in a fast interrupt routine.

## 8.2 EXCEPTION PROCESSING STATE (INTERRUPT PROCESSING)

The exception processing state is associated with interrupts that can be generated by conditions inside the DSP or from external sources. There are many sources for interrupts on the DSP56000/DSP56001; some of these sources can generate more than one interrupt. A prioritized interrupt vector scheme with 32 vectors is used to provide fast interrupt service. The following list outlines how interrupts are processed by the DSP56000/DSP56001:

1. A hardware interrupt is synchronized with the DSP clock, and the interrupt pending flag for that particular hardware interrupt is set. An interrupt source can have only one interrupt pending at any given time.
2. All pending interrupts (external and internal) are arbitrated to select which interrupt will be processed. The arbiter automatically ignores any interrupts with an IPL lower than the interrupt mask level in the SR and selects the remaining interrupt with the highest IPL.
3. The interrupt controller then freezes the program counter (PC) and fetches two instructions at the two interrupt vector addresses associated with the selected interrupt.
4. The interrupt controller jams the two instructions into the instruction stream and releases the PC, which is used for the next instruction fetch. The next interrupt arbitration is then begun.

If neither instruction is a change of program-flow instruction (i.e., a JSR), the state of the machine is not saved on the stack, and a fast interrupt is executed. A long interrupt is formed if one of the interrupt instructions fetched is a JSR instruction. The PC is immediately released, the SR and the PC are saved in the stack, and the jump instruction controls where the next instruction is fetched from. While either an unconditional jump or conditional jump can be used to form a long interrupt, they do not store the PC on the stack; therefore, there is no return path.

In digital signal processing, one of the main uses of interrupts is to transfer data between DSP memory or registers and a peripheral device. When such an interrupt occurs, a limited context switch with minimum overhead is often desirable. This limited context switch is



accomplished by a fast interrupt. The long interrupt is used when a more complex task must be accomplished to service the interrupt.

The second and third activities require two additional control cycles, which effectively make the interrupt pipeline five levels deep.

## 8.2.1 Interrupt Sources

Exceptions may originate from any of the 32 vector addresses listed in Table 8-2. The corresponding interrupt starting address for each interrupt source is shown. These addresses are located in the first 64 locations of program memory. When an interrupt is serviced, the instruction at the interrupt starting address is fetched first. Because the program flow is directed to a different starting address for each interrupt, the interrupt structure of the DSP56000/DSP56001 is said to be vectored. A vectored interrupt structure has low overhead execution. If it is known a priori that certain interrupts will not be used, those interrupt vector locations can be used for program or data storage.

The 32 interrupts are prioritized into four levels. Level 3, the highest priority level, is not maskable. Levels 0–2 are maskable. The interrupts within each level are prioritized according to a predefined priority. The level-3 interrupts (reset, illegal instruction, nonmaskable interrupt (NMI), stack error, trace, and software interrupt (SWI)) are discussed individually.

**8.2.1.1 HARDWARE INTERRUPT SOURCES.** There are two types of hardware interrupts in the DSP: internal and external. The internal interrupts include all of the on-chip peripheral devices (host interface (HI), synchronous serial interface (SSI), and serial communications interface (SCI)). Each internal interrupt source is latched and serviced if it is not masked. When it is serviced, the interrupt is cleared. Each internal hardware source has independent enable control.

The external hardware interrupts include  $\overline{\text{RESET}}$ , NMI,  $\overline{\text{IRQA}}$ , and  $\overline{\text{IRQB}}$ . The  $\overline{\text{RESET}}$  interrupt, which is level sensitive, is the highest level interrupt (IPL 3). The  $\overline{\text{IRQA}}$  and  $\overline{\text{IRQB}}$  interrupts can be programmed to be level sensitive or edge sensitive. Since the level-sensitive interrupts will not be cleared automatically when they are serviced, they must be cleared by other means to prevent multiple interrupts. The edge-sensitive interrupts are latched as pending on the high-to-low transition of the interrupt input and are automatically cleared when the interrupt is serviced.  $\overline{\text{IRQA}}$  and  $\overline{\text{IRQB}}$  can be programmed to one of three priority levels: 0, 1, or 2, all of which are maskable. Additionally, both of these interrupts have independent enable control.

When the  $\overline{\text{IRQA}}$  or  $\overline{\text{IRQB}}$  interrupts are disabled in the interrupt priority register, the pending request will be ignored, regardless of whether the interrupt input was defined as level sensitive or edge sensitive. Additionally, if the interrupt is defined as edge sensitive, its edge-detection latch will remain in the reset state as long as the interrupt is disabled; if

**Table 8-2. Interrupt Sources**

| Interrupt Starting Address | IPL | Interrupt Source                        |
|----------------------------|-----|---|
| \$0000                     | 3   | Hardware $\overline{\text{RESET}}$      |
| \$0002                     | 3   | Stack Error                             |
| \$0004                     | 3   | Trace                                   |
| \$0006                     | 3   | SWI                                     |
| \$0008                     | 0-2 | $\overline{\text{IRQA}}$                |
| \$000A                     | 0-2 | $\overline{\text{IRQB}}$                |
| \$000C                     | 0-2 | SSI Receive Data                        |
| \$000E                     | 0-2 | SSI Receive Data with Exception Status  |
| \$0010                     | 0-2 | SSI Transmit Data                       |
| \$0012                     | 0-2 | SSI Transmit Data with Exception Status |
| \$0014                     | 0-2 | SCI Receive Data                        |
| \$0016                     | 0-2 | SCI Receive Data with Exception Status  |
| \$0018                     | 0-2 | SCI Transmit Data                       |
| \$001A                     | 0-2 | SCI Idle Line                           |
| \$001C                     | 0-2 | SCI Timer                               |
| \$001E                     | 3   | NMI — Reserved for Hardware Development |
| \$0020                     | 0-2 | Host Receive Data                       |
| \$0022                     | 0-2 | Host Transmit Data                      |
| \$0024                     | 0-2 | Host Command (Default)                  |
| \$0026                     | 0-2 | Available for Host Command              |
| \$0028                     | 0-2 | Available for Host Command              |
| \$002A                     | 0-2 | Available for Host Command              |
| \$002C                     | 0-2 | Available for Host Command              |
| \$002E                     | 0-2 | Available for Host Command              |
| \$0030                     | 0-2 | Available for Host Command              |
| \$0032                     | 0-2 | Available for Host Command              |
| \$0034                     | 0-2 | Available for Host Command              |
| \$0036                     | 0-2 | Available for Host Command              |
| \$0038                     | 0-2 | Available for Host Command              |
| \$003A                     | 0-2 | Available for Host Command              |
| \$003C                     | 0-2 | Available for Host Command              |
| \$003E                     | 3   | Illegal Instruction                     |

the interrupt is defined as level sensitive, its edge-detection latch will remain in the reset state. If the level-sensitive interrupt is disabled while the interrupt is pending, the pending interrupt will be cancelled. However, if the interrupt has been fetched, it normally will not be cancelled.

Interrupt service, which begins by fetching the instruction word in the first vector location, is considered finished when the instruction word in the second vector location is fetched.

In the case of an edge-triggered interrupt, the internal latch is automatically cleared when the second vector location is fetched. The fetch of the first vector location **does not guarantee** that the second location will be fetched. Figure 8-1 illustrates the one case where the second vector location is not fetched. In Figure 8-1, the SWI instruction discards the fetch of the first interrupt vector to ensure that the SWI vectors will be fetched. Instruction n4 is decoded as an SWI while ii1 is being fetched. Execution of the SWI requires that ii1 be discarded and the two SWI vectors (ii3 and ii4) be fetched instead.

**CAUTION**

On all level-sensitive interrupts, the interrupt must be externally released before interrupts are internally re-enabled, or the processor will be interrupted repeatedly until the interrupt is released.

The edge-sensitive NMI is generated on the first transition to 10 V on the  $\overline{IRQB}$  pin after the last time the NMI interrupt was serviced or the DSP was reset. The NMI is a priority 3 interrupt and cannot be masked. Only  $\overline{RESET}$  and illegal instruction have higher priority than NMI. NMI is reserved for hardware development and should not be used in an application. Repeated use may damage the integrated circuit.

**8.2.1.2 SOFTWARE INTERRUPT SOURCE.** There are two software interrupt sources — illegal instruction interrupt (III) and SWI. The III is a nonmaskable interrupt (IPL 3), which is serviced immediately following the execution of the illegal instruction or the attempted execution of an illegal instruction (any undefined operation code). IIIs are fatal errors. Only a long interrupt routine should be used for the III routine; RTI or RTS should not be used at the end of the interrupt routine since return from the III to the main code should not be attempted. During the III service, the JSR located in the III vector will normally stack the address of the illegal instruction (this is the reason why return should not be attempted (see Figure 8-2)). The user may examine the stack (using MOVE SSH,dest) to locate the offending illegal instruction. The illegal instruction is useful for triggering the illegal interrupt service to see if the III routine is capable of recovery from illegal instructions.

|                           |    |    |     |     |     |     |     |     |     |     |     |  |
|---------------------------|----|----|-----|-----|-----|-----|-----|-----|-----|-----|-----|--|
| INTERRUPT CONTROL CYCLE 1 |    | i  |     |     | i*  |     |     |     |     |     |     |  |
| INTERRUPT CONTROL CYCLE 2 |    |    | ii  |     |     | i*  |     |     |     |     |     |  |
| FETCH                     | n3 | n4 | n5  | ii1 |     | ii3 | ii4 | sw1 | sw2 | sw3 | sw4 |  |
| DECODE                    | n2 | n3 | SWI | —   | —   | —   | JSR | —   | sw1 | sw2 | sw3 |  |
| EXECUTE                   | n1 | n2 | n3  | SWI | NOP | NOP | NOP | JSR | —   | sw1 | sw2 |  |
| INSTRUCTION BEING DECODED | 1  |    |     |     |     |     |     |     |     |     |     |  |

- i = INTERRUPT REQUEST
- i\* = INTERRUPT REQUEST GENERATED BY SWI
- ii1 = FIRST VECTOR OF INTERRUPT i
- ii3 = FIRST SWI VECTOR (ONE-WORD JSR)
- ii4 = SECOND SWI VECTOR
- n = NORMAL INSTRUCTION WORD
- n4 = SWI
- sw = INSTRUCTIONS PERTAINING TO THE SWI LONG INTERRUPT ROUTINE

**Figure 8-1. Interrupting an SWI**

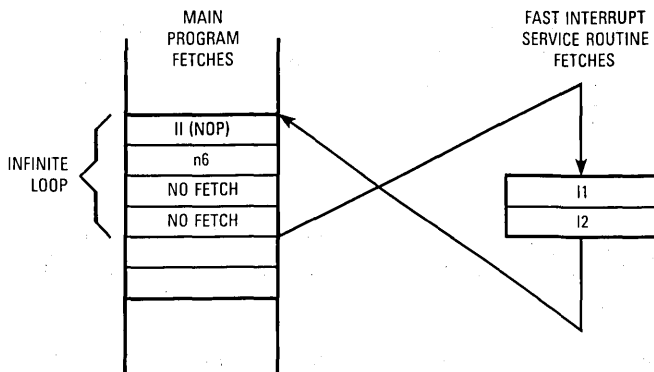

(a) Instruction Fetches from Memory

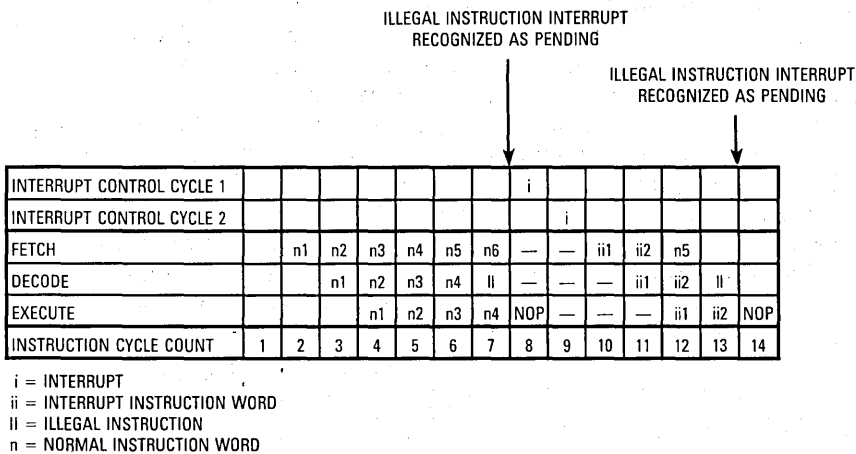

(b) Program Controller Pipeline

Figure 8-2. Illegal Instruction Interrupt Serviced by a Fast Interrupt

offending illegal instruction. The illegal instruction is useful for triggering the illegal interrupt service to see if the Ill routine is capable of recovery from illegal instructions.

There are two cases in which the stacked address will not point to the illegal instruction:

1. If the illegal instruction is one of the two instructions at an interrupt vector location and is fetched during a regular interrupt service, the processor will stack the address of the next sequential instruction in the normal instruction flow (the regular return address of the interrupt routine that had the illegal opcode in its vector).
2. If the illegal instruction follows an REP instruction (see Figure 8-3), the DSP will effectively execute the illegal instruction as a repeated NOP and the interrupt vector will then be inserted in the pipeline. The next instruction will be fetched but will not be decoded or executed. The processor will stack the address of the next sequential instruction, which is two instructions after the illegal instruction.

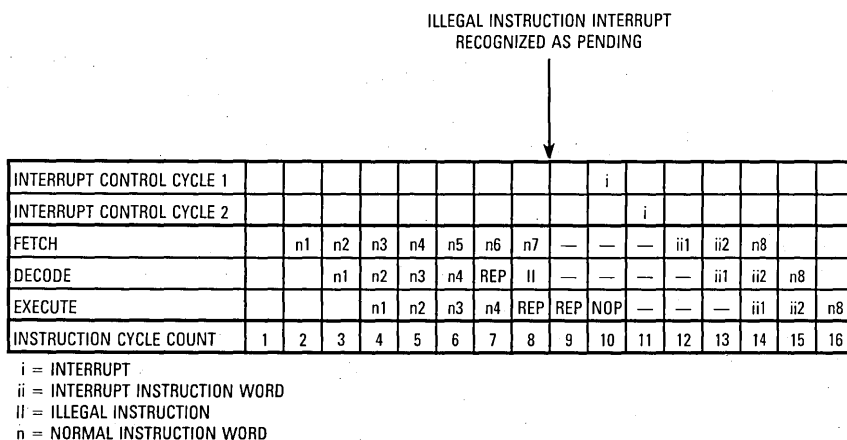

**Figure 8-3. Repeated Illegal Instruction**

In DO loops, if the illegal instruction is in the loop address (LA) location and the instruction preceding it (i.e., at LA-1) is being interrupted, the loop counter (LC) will be decremented as if the loop had reached the LA instruction. When the interrupt service ends and the instruction flow returns to the loop, the illegal instruction will be refetched (since it is the next sequential instruction in the flow). The loop state machine will again decrement LC because the LA instruction is being executed. At this point, the illegal instruction will trigger the Ill. The result is that the loop state machine decrements LC twice in one loop due to the presence of the illegal opcode at the LA location.

SWI is a nonmaskable interrupt (IPL 3), which is serviced immediately following the SWI instruction execution. A long interrupt service routine is usually used. The difference between an SWI and a JSR instruction is that the SWI sets the interrupt mask to prevent

interrupts below IPL 3 from being serviced. Masking out lower level interrupts makes the SWI very useful for setting breakpoints in monitor programs. The JSR instruction does not affect the interrupt mask.

**8.2.1.3 OTHER INTERRUPT SOURCES.** Other interrupt sources include the stack error interrupt and trace interrupt (IPL3 interrupts).

An overflow or underflow of the system stack (SS) causes a stack error interrupt (see **SECTION 6 PROGRAM CONTROLLER** for additional information on the stack error flag). The stack error interrupt is caused by a nonrecoverable error condition and is vectored to P:\$0002. Since the stack error is nonrecoverable, a long interrupt should be used to service the interrupt, and the service routine should not end in an RTI. Executing an RTI instruction "pops" the stack, which has been corrupted.

The DSP56000/DSP56001 includes a facility for instruction-by-instruction tracing as a program development aid. This trace mode (entered by setting the trace bit in the SR) generates a trace exception after each instruction executed (see Figure 8-4), which can be used by a debugger program to monitor the execution of a program.

The trace mode is entered by setting the trace bit in the SR. A trace exception is generated after executing each instruction executed while the trace bit is set. When servicing the trace exception, it is expected that a JSR will be encountered in the trace vector locations, thereby forming a long interrupt routine. The JSR causes the SR to be stacked and the trace bit in the SR to be cleared (clearing the trace bit in the SR prevents tracing while executing the trace exception service routine). This service routine should end with an RTI instruction, which restores the SR (with the trace bit set) from the SS, causing the next instruction to be traced. The pipeline must be flushed to allow each sequential instruction to be traced. Three instruction cycles are appended by the tracing facility to the end of each instruction traced (these are the three NOP instructions shown in Figure 8-4) flushing the pipeline and allowing the next trace interrupt to follow the next sequential interrupt.

During tracing, the REP instruction and the instruction being repeated are considered a single two-word instruction. That is, only after executing the REP instruction and all the repeats of the next instruction will the trace exception be generated.

Fast interrupts can not be traced because they are uninterruptable. Long interrupts will not be traced (unless the trace mode is entered in the subroutine) because the SR is pushed on the stack and the trace bit is cleared. Tracing is resumed upon returning from a long interrupt because the trace bit is restored when the SR is restored. Interrupts are not likely to occur during tracing because only an interrupt with a higher IPL can interrupt during a trace operation. While executing the program being traced, the trace interrupt will always be pending and will win the interrupt arbitration. During the trace interrupt, the interrupt mask is set to reject interrupts below IPL3.

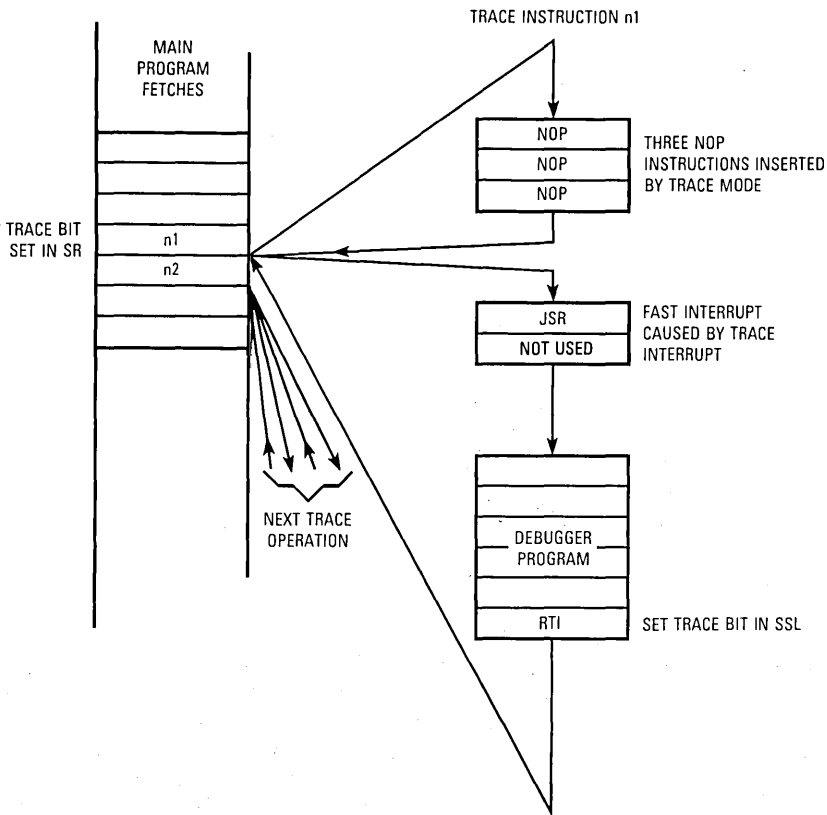

(a) Instruction Fetches from Memory

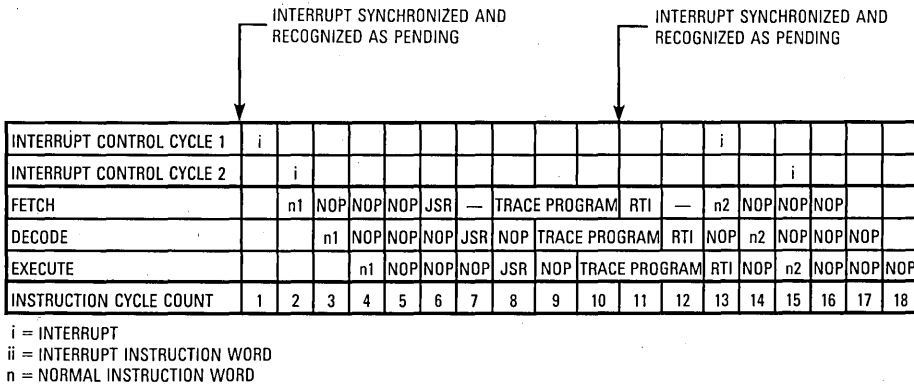

(b) Program Controller Pipeline

Figure 8-4. Trace Exception

## 8.2.2 Interrupt Priority Structure

Four levels of interrupt priority are provided. IPLs numbered 0, 1, and 2 are maskable (level 0 is the lowest level). Level 3 (highest level) is nonmaskable. The only IPL 3 interrupts are reset, ILL, NMI, stack error, trace, and SWI. The interrupt mask bits (I1, I0) in the SR reflect the current processor priority level and indicate the IPL needed for an interrupt source to interrupt the processor (see Table 8-3). Interrupts are inhibited for all priority levels less than the current processor priority level. However, level 3 interrupts are not maskable and therefore can always interrupt the processor.

**Table 8-3. Status Register Interrupt Mask Bits**

| I1 | I0 | Exceptions Permitted | Exceptions Masked |
|----|----|----------------------|-------------------|
| 0  | 0  | IPL 0, 1, 2, 3       | None              |
| 0  | 1  | IPL 1, 2, 3          | IPL 0             |
| 1  | 0  | IPL 2, 3             | IPL 0, 1          |
| 1  | 1  | IPL 3                | IPL 0, 1, 2       |

**8.2.2.1 INTERRUPT PRIORITY LEVELS.** The IPL for each on-chip peripheral device (HI, SSI, SCI) and for each external interrupt source ( $\overline{IRQA}$ ,  $\overline{IRQB}$ ) can be programmed under software control. Each on-chip or external peripheral device can be programmed to one of the three maskable priority levels (IPL 0, 1, or 2). IPLs are set by writing to the interrupt priority register shown in Figure 8-5. This read/write register specifies the IPL for each of the interrupting devices (HI, SSI, SCI,  $\overline{IRQA}$ ,  $\overline{IRQB}$ ). In addition, this register specifies the trigger mode of both external interrupt sources and is used to enable or disable the individual external interrupts. This register is cleared on  $\overline{RESET}$  or by the reset instruction. Table 8-4 defines the IPL bits. Table 8-5 defines the external interrupt trigger mode bits.

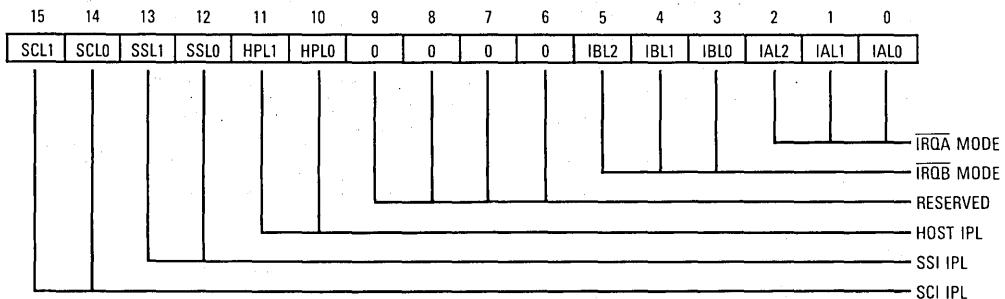

**Figure 8-5. Interrupt Priority Register (Addr X:\$FFFF)**



**Table 8-4. Interrupt Priority Level Bits**

| xxL1 | xxL0 | Enabled | IPL |
|------|------|---------|-----|
| 0    | 0    | No      | —   |
| 0    | 1    | Yes     | 0   |
| 1    | 0    | Yes     | 1   |
| 1    | 1    | Yes     | 2   |

**Table 8-5. External Interrupt Trigger Mode Bits**

| IxL2 | Trigger Mode  |
|------|---------------|
| 0    | Level         |
| 1    | Negative Edge |

**8.2.2.2 EXCEPTION PRIORITIES WITHIN AN IPL.** If more than one exception is pending when an instruction is executed, the interrupt with the highest priority level is serviced first. When multiple interrupt requests having the same IPL are pending, a second fixed-priority structure within that IPL determines which interrupt is serviced. The fixed priority of interrupts within an IPL and the interrupt enable bits for all interrupts are shown in Table 8-6. The interrupt enable bits for the HI, SSI, and SCI are located in the control registers associated with their respective on-chip peripherals.

**Table 8-6. Exception Priorities within an IPL**

| Priority                         | Exception                            | Enabled By     | Bit No. | X Data Memory Address |
|----------------------------------|--------------------------------------|----------------|---------|-----------------------|
| <b>Level 3 (Nonmaskable)</b>     |                                      |                |         |                       |
| Highest                          | Hardware RESET                       | —              | —       | —                     |
|                                  | III                                  | —              | —       | —                     |
|                                  | NMI                                  | —              | —       | —                     |
|                                  | Stack Error                          | —              | —       | —                     |
|                                  | Trace                                | —              | —       | —                     |
| Lowest                           | SWI                                  | —              | —       | —                     |
| <b>Levels 0, 1, 2 (Maskable)</b> |                                      |                |         |                       |
| Highest                          | IRQA (External Interrupt)            | IRQA Mode Bits | 0 and 1 | FFFF                  |
|                                  | IRQB (External Interrupt)            | IRQB Mode Bits | 3 and 4 | FFFF                  |
|                                  | Host Command Interrupt               | HCIE           | 2       | FFE8                  |
|                                  | Host Receive Data Interrupt          | HRIE           | 0       | FFE8                  |
|                                  | Host Transmit Data Interrupt         | HTIE           | 1       | FFE8                  |
|                                  | SSI RX Data with Exception Interrupt | RIE            | 15      | FFED                  |
|                                  | SSI RX Data Interrupt                | RIE            | 15      | FFED                  |
|                                  | SSI TX Data with Exception Interrupt | TIE            | 14      | FFED                  |
|                                  | SSI TX Data Interrupt                | TIE            | 14      | FFED                  |
|                                  | SCI RX Data with Exception Interrupt | RIE            | 11      | FFF0                  |
|                                  | SCI RX Data Interrupt                | RIE            | 11      | FFF0                  |
|                                  | SCI TX Data Interrupt                | TIE            | 12      | FFF0                  |
|                                  | SCI Idle Line Interrupt              | ILIE           | 10      | FFF0                  |
| Lowest                           | SCI Timer Interrupt                  | TMIE           | 13      | FFF0                  |

### 8.2.3 Instructions Preceding the Interrupt Instruction Fetch

The following one-word instructions are aborted when they are fetched in the cycle preceding the fetch of the first interrupt instruction word — REP, STOP, WAIT, RESET, RTI, RTS, Jcc, JMP, JScc, and JSR.

Two-word instructions are aborted when the first interrupt instruction word fetched will replace the fetch of the second word of the two-word instruction. Aborted instructions are refetched again when program control returns from the interrupt routine. The PC is adjusted appropriately before the end of the decode cycle of the aborted instruction.

If the first interrupt word fetch occurs in the cycle following the fetch of a one-word instruction not previously listed or the second word of a two-word instruction, that instruction will complete normally before the start of the interrupt routine.

The following cases have been identified where service of an interrupt might encounter an extra delay:

1. If a long interrupt routine is used to service an SWI, then the processor priority level is set to 3. Thus, all interrupts except other level-3 interrupts are disabled until the SWI service routine terminates with an RTI (unless the SWI service routine software lowers the processor priority level).
2. While servicing an interrupt, the next interrupt service will be delayed according to the following rule:  
After the first interrupt instruction word reaches the instruction decoder, at least three more instructions will be decoded before decoding the next first interrupt instruction word. If any one pair of instructions being counted is the REP instruction followed by an instruction to be repeated, then the combination is counted as two instructions independent of the number of repeats done. Sequential REP combinations will cause pending interrupts to be rejected and can not be interrupted until the sequence of REP combinations ends.
3. The following instructions are not interruptable: SWI, STOP, WAIT, and RESET.
4. The REP instruction and the instruction being repeated are not interruptable.
5. If the trace bit in the SR is set, the only interrupts that will be processed are the hardware RESET, ILL, NMI, stack error, and trace. Peripheral and external interrupt requests will be ignored. The interrupt generated by the SWI instruction will be ignored.

During an interrupt instruction fetch, two instruction words are fetched — the first from the interrupt starting address and the second from the interrupt starting address + 1 locations.

### 8.2.4 Interrupt Types

Two types of interrupt routines may be used: fast and long. The fast routine consists of the two automatically inserted interrupt instruction words. These words can contain any

unrestricted, single two-word instruction or any two one-word instructions (see **A.8 INSTRUCTION SEQUENCE RESTRICTIONS** for a list of restrictions). Fast interrupt routines are never interruptable.

### CAUTION

Status is not preserved during a fast interrupt routine; therefore, instructions that modify status should not be used at the interrupt starting address and interrupt starting address + 1.

If one of the instructions in the fast routine is a JSR, then a long interrupt routine is formed. The following actions occur during execution of the JSR instruction when it occurs in the interrupt starting address or in the interrupt starting address + 1:

1. The PC (containing the return address) and the SR are stacked.
2. The loop flag is reset.
3. The scaling mode bits are reset.
4. The IPL is raised to disallow further interrupts at the same or lower levels (except that hardware RESET, NMI, stack error, trace, and SWI can always interrupt).
5. The trace bit in the SR is cleared.

The long interrupt routine should be terminated by an RTI. Long interrupt routines are interruptable by higher priority interrupts.

### 8.2.5 Interrupt Arbitration

External interrupts are internally synchronized with the processor clock (takes up to three T cycles) before their interrupt-pending flags are set. Each external interrupt and internal interrupt has its own flag. After each instruction is executed, all interrupts are arbitrated — i.e., all hardware interrupts that have been latched into their respective interrupt-pending flags and all internal interrupts. During arbitration, each interrupt's IPL is compared with the interrupt mask in the SR, and the interrupt is either allowed or disallowed. The remaining interrupts are prioritized according to the priority shown in Table 8-6, and the highest priority interrupt is chosen. The interrupt vector is then calculated so that the program interrupt controller can fetch the first interrupt instruction. Interrupt arbitration and control, which occurs concurrently with the fetch-decode-execute cycle, takes two instruction cycles. Interrupts from a given source are not buffered. The interrupt-pending flag for the chosen interrupt is not cleared until the second interrupt vector of the chosen interrupt is being fetched. A new interrupt from the same source will not be accepted for the next interrupt arbitration until that time.

The internal interrupt acknowledge signal is used to clear the edge-triggered interrupt flags, the HC bit in the host port, the SCI timer interrupt, and the internal latches of the stack error, NMI, SWI, and trace interrupts. Peripheral interrupt requests that need a read/

write action to some register **do not** receive this signal, and those interrupts will remain pending until their registers are read/written. Also, level-triggered interrupts will not be cleared. The acknowledge signal will be generated after generation of the interrupt vectors, not before.

### 8.2.6 Interrupt Instruction Fetch

The interrupt controller generates an interrupt instruction fetch address, which points to the first instruction word of a two-word interrupt routine. This address is used for the next instruction fetch, instead of the contents of the PC, and the interrupt instruction fetch address + 1 is used for the subsequent instruction fetch. While the interrupt instructions are being fetched, the PC is inhibited from being updated. After the two interrupt words have been fetched, the PC is used for any subsequent instruction fetches.

After both interrupt vectors have been fetched, they are guaranteed to be executed. This is true even if the instruction that is currently being executed is a change-of-flow instruction (i.e., JMP, JSR, etc.) that would normally ignore the instructions in the pipe. After the interrupt instruction fetch, the PC will point to the instruction that would have been fetched if the interrupt instructions had not been inserted.

### 8.2.7 Interrupt Instruction Execution

8

Interrupt instruction execution is considered "fast" if neither of the instructions of the interrupt service routine cause a change of flow. A JSR within a fast interrupt routine forms a long interrupt, which is terminated with an RTI instruction to restore the PC and SR from the stack and return to normal program execution. Reset is a special exception, which will normally contain only a JMP instruction at the exception start address. At the programmer's option, almost any instruction can be used in the fast interrupt routine. The restricted instructions include SWI, STOP, and WAIT. Figures 8-6 and 8-8 show the fast and the long interrupt service routines. The fast interrupt executes only two instructions and then automatically resumes execution of the main program; whereas, the long interrupt must be told to return to the main program by executing an RTI instruction.

Figure 8-6 illustrates the effect of a fast interrupt routine in the stream of instruction fetches.

Figure 8-7 shows the sequence of instruction decodes between two fast interrupts. Four decodes occur between the two interrupt decodes (two after the first interrupt and two preceding the second interrupt). The requirement for these four decodes establishes the maximum rate at which the DSP56000/DSP56001 will respond to interrupts — namely, one interrupt every six instructions (six instruction cycles if all six instructions are one instruction cycle each). Since some instructions take more than one instruction cycle, the minimum number of instructions between two interrupts may be more than six instruction cycles.

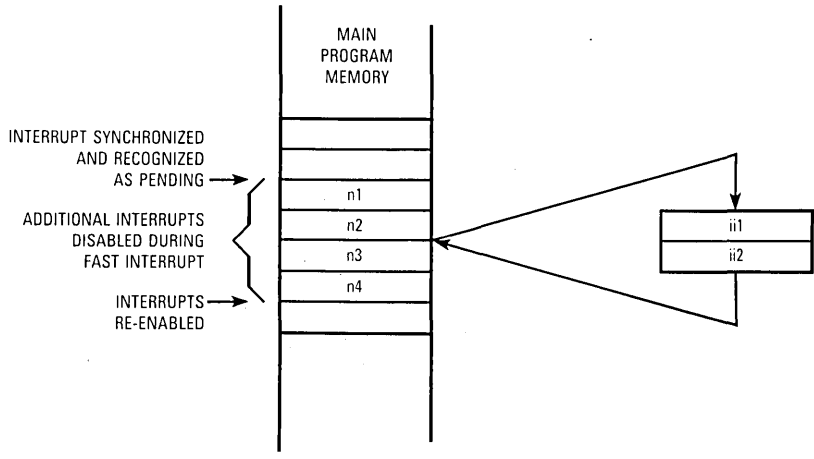

ii = INTERRUPT INSTRUCTION  
 n = NORMAL INSTRUCTION

(a) Instruction Fetches from Memory

INTERRUPT SYNCHRONIZED AND RECOGNIZED AS PENDING

INTERRUPTS RE-ENABLED

|                           |    |    |     |     |     |     |    |    |
|---------------------------|----|----|-----|-----|-----|-----|----|----|
| INTERRUPT CONTROL CYCLE 1 | i  |    |     |     |     |     |    |    |
| INTERRUPT CONTROL CYCLE 2 |    | i  |     |     |     |     |    |    |
| FETCH                     | n1 | n2 | ii1 | ii2 | n3  | n4  |    |    |
| DECODE                    |    | n1 | n2  | ii1 | ii2 | n3  | n4 |    |
| EXECUTE                   |    |    | n1  | n2  | ii1 | ii2 | n3 | n4 |
| INSTRUCTION CYCLE COUNT   | 1  | 2  | 3   | 4   | 5   | 6   | 7  | 8  |

i = INTERRUPT  
 ii = INTERRUPT INSTRUCTION WORD  
 n = NORMAL INSTRUCTION WORD

(b) Program Controller Pipeline

Figure 8-6. Fast Interrupt Service Routine

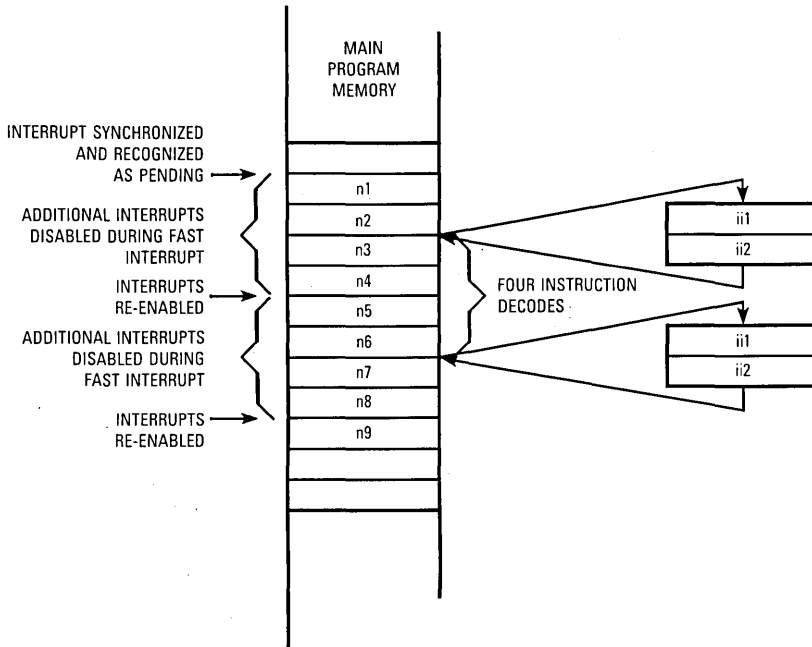

ii = INTERRUPT INSTRUCTION  
n = NORMAL INSTRUCTION

(a) Instruction Fetches from Memory

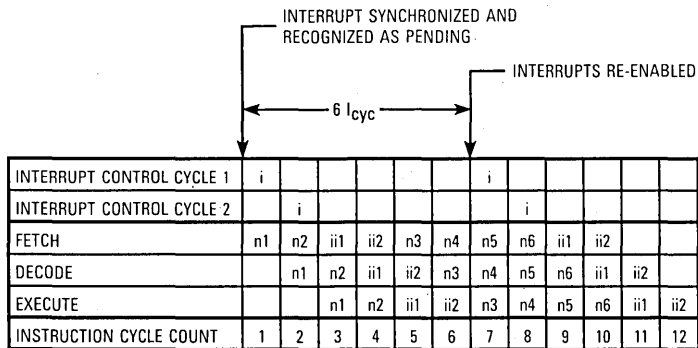

i = INTERRUPT  
ii = INTERRUPT INSTRUCTION WORD  
n = NORMAL INSTRUCTION WORD

(b) Program Controller Pipeline

Figure 8-7. Two Consecutive Fast Interrupts

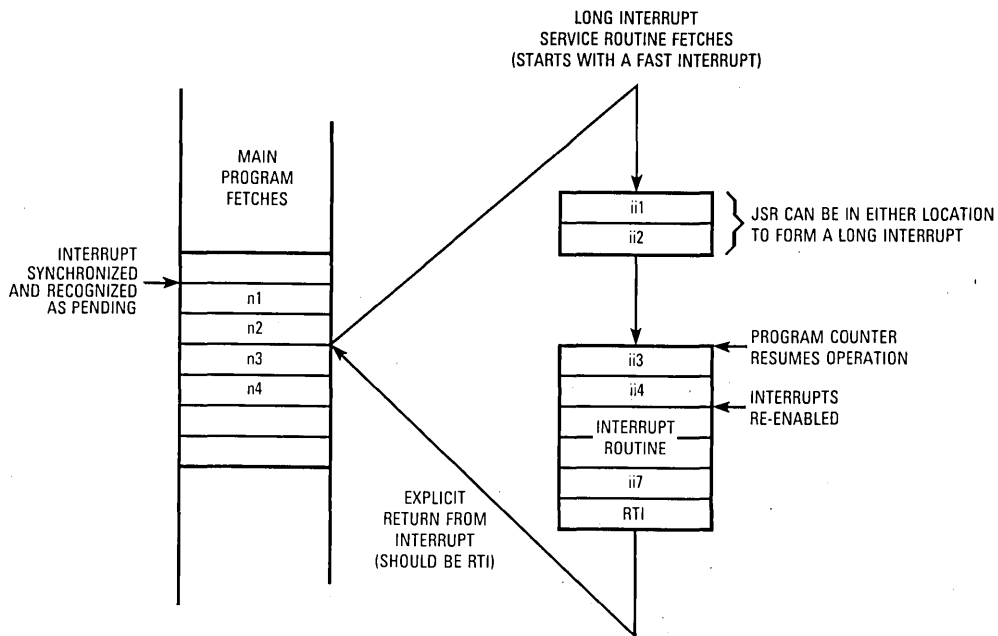

(a) Instruction Fetches from Memory

INTERRUPT SYNCHRONIZED AND RECOGNIZED AS PENDING

INTERRUPTS RE-ENABLED

|                           |    |    |     |     |     |     |     |     |     |     |     |     |     |    |    |  |  |  |
|---------------------------|----|----|-----|-----|-----|-----|-----|-----|-----|-----|-----|-----|-----|----|----|--|--|--|
| INTERRUPT CONTROL CYCLE 1 | i  |    |     |     |     |     |     |     |     |     |     |     |     |    |    |  |  |  |
| INTERRUPT CONTROL CYCLE 2 | i  |    |     |     |     |     |     |     |     |     |     |     |     |    |    |  |  |  |
| FETCH                     | n1 | n2 | ii1 | ii2 | ii3 | ii4 | ii5 | ii6 | ii7 | RTI | —   | n3  | n4  |    |    |  |  |  |
| DECODE                    |    | n1 | n2  | ii1 | ii2 | ii3 | ii4 | ii5 | ii6 | ii7 | RTI | NOP | n3  | n4 |    |  |  |  |
| EXECUTE                   |    |    | n1  | n2  | ii1 | ii2 | ii3 | ii4 | ii5 | ii6 | ii7 | RTI | NOP | n3 | n4 |  |  |  |
| INSTRUCTION CYCLE COUNT   | 1  | 2  | 3   | 4   | 5   | 6   | 7   | 8   | 9   | 10  | 11  | 12  | 13  | 14 | 15 |  |  |  |

i = INTERRUPT  
 ii = INTERRUPT INSTRUCTION WORD  
 n = NORMAL INSTRUCTION WORD

(b) Program Controller Pipeline

Figure 8-8. Long Interrupt Service Routine

Execution of a fast interrupt routine always conforms to the following rules:

1. A JSR to the starting address of the interrupt service routine is not located at one of the two interrupt vector addresses.
2. The processor status is not saved.
3. The fast interrupt routine may (but should not) modify the status of the normal instruction stream.
4. The fast interrupt routine may contain any single two-word instruction or any two one-word instructions except SWI, STOP, and WAIT.
5. The PC, which contains the address of the next instruction to be executed in normal processing, remains unchanged during a fast interrupt routine.
6. The fast interrupt returns without an RTI.
7. Normal instruction fetching resumes using the PC following the completion of the fast interrupt routine.
8. A fast interrupt is not interruptable.
9. A JSR instruction within the fast interrupt routine forms a long interrupt routine.
10. The primary application is to move data between memory and I/O devices.

Execution of a long interrupt routine always adheres to the following rules:

1. A JSR to the starting address of the interrupt service routine is located at one of the two interrupt vector addresses.
2. During execution of the JSR instruction, the PC and SR are stacked. The interrupt mask bits of the SR are updated to mask interrupts of the same or lower priority. The loop flag, trace bit, and scaling mode bits are reset.
3. The first instruction word of the next interrupt service (of higher IPL) will reach the decoder only after the decoding of at least four instructions following the decoding of the first instruction of the previous interrupt.
4. The interrupt service routine can be interrupted — i.e., nested interrupts are supported.
5. The long interrupt routine, which can be any length, should be terminated by an RTI, which restores the PC and SR from the stack.

Figure 8-8 illustrates the effect of a long interrupt routine on the instruction pipeline. A short JSR (a JSR with 12-bit absolute address) is used to form the long interrupt routine. For this example, word 6 of the long interrupt routine is an RTI. The point at which interrupts are re-enabled and subsequent interrupts are allowed is shown to illustrate the noninterruptable nature of the early instructions in the long interrupt service routine.

Either one of the two instructions of the fast interrupt can be the JSR instruction that forms the long interrupt. Figures 8-9 and 8-10 show the two possible cases. If the first fast interrupt vector instruction is the JSR, the second instruction is never used.



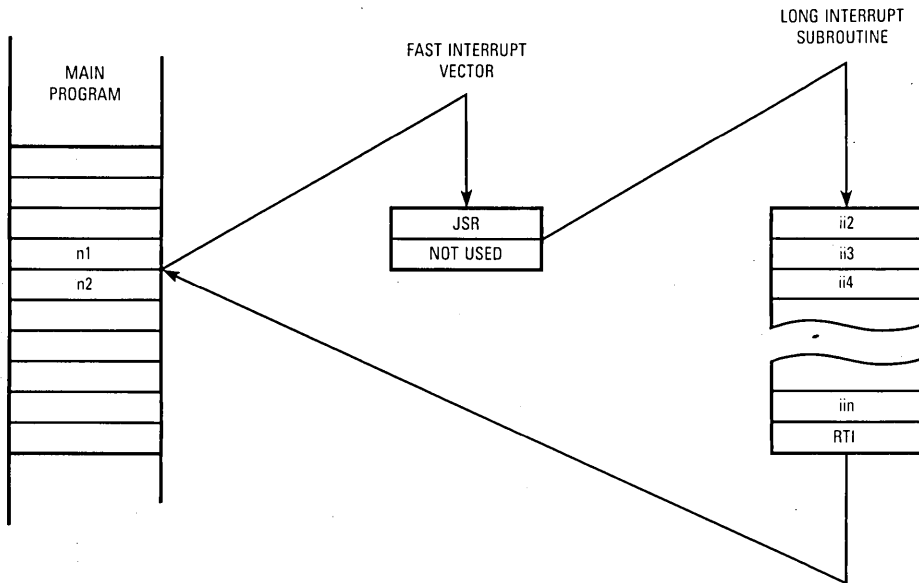

(a) Instruction Fetches from Memory

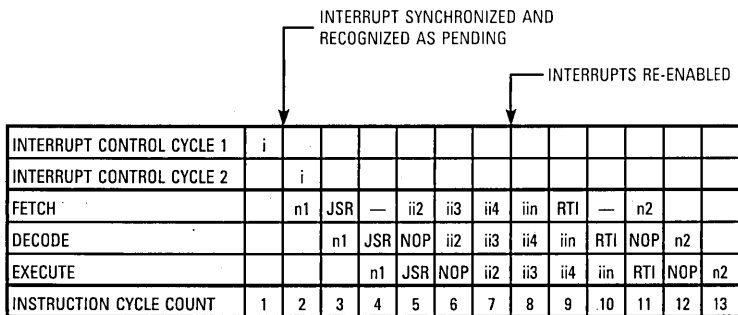

i = INTERRUPT  
ii = INTERRUPT INSTRUCTION WORD  
n = NORMAL INSTRUCTION WORD

(b) Program Controller Pipeline

Figure 8-9. JSR First Instruction of a Fast Interrupt

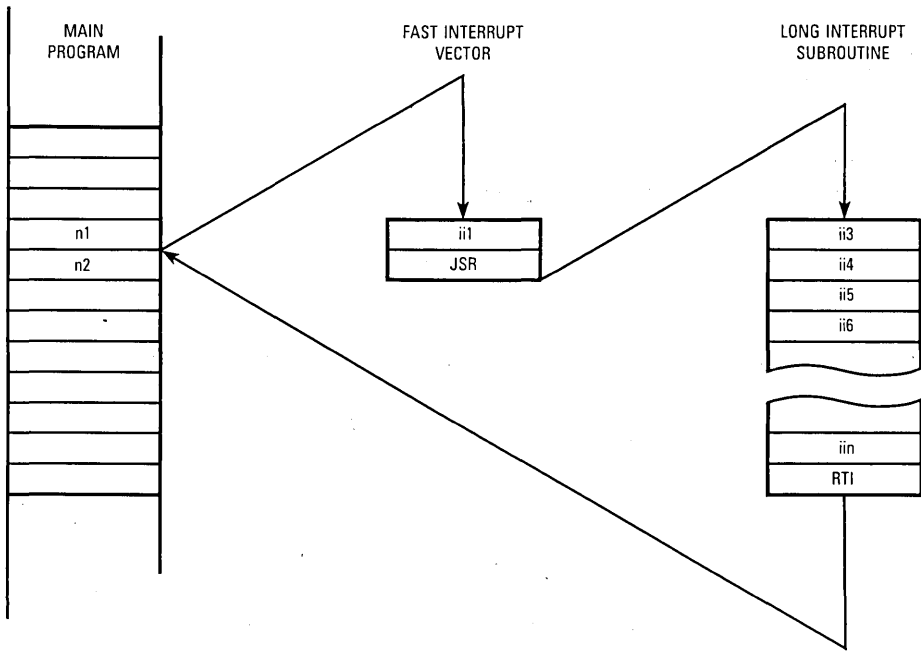

(a) Instruction Fetches from Memory

INTERRUPT SYNCHRONIZED AND RECOGNIZED AS PENDING

INTERRUPTS RE-ENABLED

|                           |   |    |     |     |     |     |     |     |     |     |     |     |     |     |    |  |  |
|---------------------------|---|----|-----|-----|-----|-----|-----|-----|-----|-----|-----|-----|-----|-----|----|--|--|
| INTERRUPT CONTROL CYCLE 1 | i |    |     |     |     |     |     |     |     |     |     |     |     |     |    |  |  |
| INTERRUPT CONTROL CYCLE 2 |   | i  |     |     |     |     |     |     |     |     |     |     |     |     |    |  |  |
| FETCH                     |   | n1 | ii1 | JSR | —   | ii3 | ii4 | ii5 | ii6 | iin | RTI | —   | n2  |     |    |  |  |
| DECODE                    |   |    | n1  | ii1 | JSR | NOP | ii3 | ii4 | ii5 | ii6 | iin | RTI | NOP | n2  |    |  |  |
| EXECUTE                   |   |    |     | n1  | ii1 | JSR | NOP | ii3 | ii4 | ii5 | ii6 | iin | RTI | NOP | n2 |  |  |
| INSTRUCTION CYCLE COUNT   | 1 | 2  | 3   | 4   | 5   | 6   | 7   | 8   | 9   | 10  | 11  | 12  | 13  | 14  | 15 |  |  |

i = INTERRUPT  
 ii = INTERRUPT INSTRUCTION WORD  
 n = NORMAL INSTRUCTION WORD

(b) Program Controller Pipeline

Figure 8-10. JSR Second Instruction of a Fast Interrupt

An REP instruction is treated as a single two-word instruction, regardless of how many times it repeats the second instruction of the pair. Instruction fetches are suspended and will be reactivated only after the LC is decremented to one (see Figure 8-11). During the execution of n2 in Figure 8-11, no interrupts will be serviced. When LC finally decrements to one, the fetches are reinitiated, and pending interrupts can be serviced.

Sequential REP packages will cause pending interrupts to be rejected until the sequence of REP packages ends. REP packages are not interruptable because the instruction being repeated is not refetched. While that instruction is repeating, no instructions are fetched or decoded, and an interrupt can not be inserted. For example, in Figure 8-12, if n1, n3, and n5 are all REP instructions, no interrupts will be serviced until the last REP instruction (n5 and its repeated instruction, n6) completes execution.

### 8.3 RESET PROCESSING STATE

The reset processing state is entered in response to the external RESET pin being asserted (a hardware reset). Upon entering the reset state (see Figure 8-13): 1) internal peripheral devices are reset, and their pins revert to general-purpose I/O pins; 2) the modifier registers are set to \$FFFF; 3) the interrupt priority register is cleared; 4) the BCR is set to \$FFFF, thereby inserting 15 wait states in all external memory accesses; 5) the stack pointer is cleared; 6) the scaling mode, trace mode, loop flag, and condition code bits of the SR are cleared, and the interrupt mask bits of the SR are set; 7) the data ROM enable bit, the stop delay bit, and the memory strobe bit are cleared; and 8) the DSP remains in the reset state until RESET is deasserted. Upon leaving the reset state 9), the chip operating mode bits of the OMR are loaded from the external mode select pins (MODA, MODB), and 10) program execution begins at program memory address \$E000 in normal expanded mode or at \$0000 in all other operation modes. The first instruction must be fetched and then decoded before executing. Therefore, the first instruction execution is two instruction cycles after the first instruction fetch.

Figure 8-14 is a copy of the output from the DSP56000/DSP56001 simulator showing all of the DSP56000/DSP56001 registers before the hardware reset and showing only the registers that were written by the hardware reset after the reset occurred. The instructions executed are as follows:

1. Reset s — Resets the simulator.
2. Change OMR 0 — Puts the DSP56000/DSP56001 in mode 0.
3. Display all — Displays all registers. Note that OMR=\$00.
4. Reset d — Is a hardware reset.
5. Display w — Causes the display command to only display the registers that were written in the last instruction.
6. Display — Displays the contents of the registers that were written by the hardware reset.

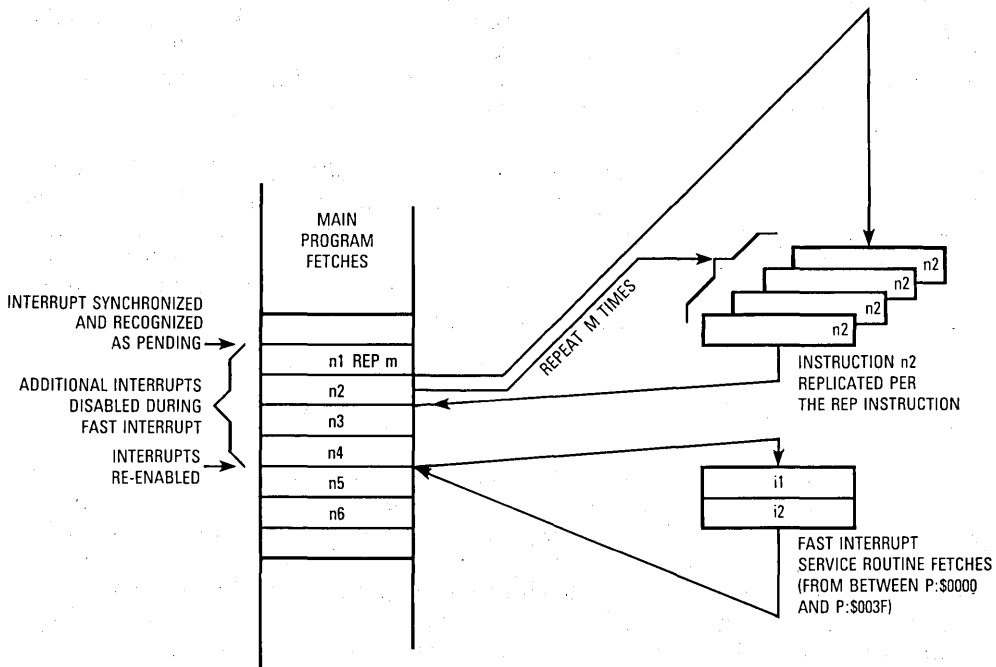

i = INTERRUPT INSTRUCTION  
n = NORMAL INSTRUCTION

(a) Instruction Fetches from Memory

INTERRUPT SYNCHRONIZED AND RECOGNIZED AS PENDING

INTERRUPTS RE-ENABLED

|                           |     |     |     |     |    |    |    |    |     |     |     |     |
|---------------------------|-----|-----|-----|-----|----|----|----|----|-----|-----|-----|-----|
| INTERRUPT CONTROL CYCLE 1 | i   |     |     |     |    |    |    | i  |     |     |     |     |
| INTERRUPT CONTROL CYCLE 2 |     | i%  |     |     |    |    |    | i  |     |     |     |     |
| FETCH                     | REP | n2  | n3  |     |    |    |    | n4 | ii1 | ii2 | n5  | n6  |
| DECODE                    |     | REP | NOP | n2  | n2 | n2 | n2 | n3 | n4  | ii1 | ii2 | n5  |
| EXECUTE                   |     |     | REP | NOP | n2 | n2 | n2 | n2 | n3  | n4  | ii1 | ii2 |
| INSTRUCTION CYCLE COUNT   | 1   | 2   | 3   | 4   | 5  | 6  | 7  | 8  | 9   | 10  | 11  | 12  |

i = INTERRUPT  
ii = INTERRUPT INSTRUCTION WORD  
n = NORMAL INSTRUCTION WORD  
i% = INTERRUPT REJECTED

(b) Program Controller Pipeline

Figure 8-11. Interrupting an REP Instruction

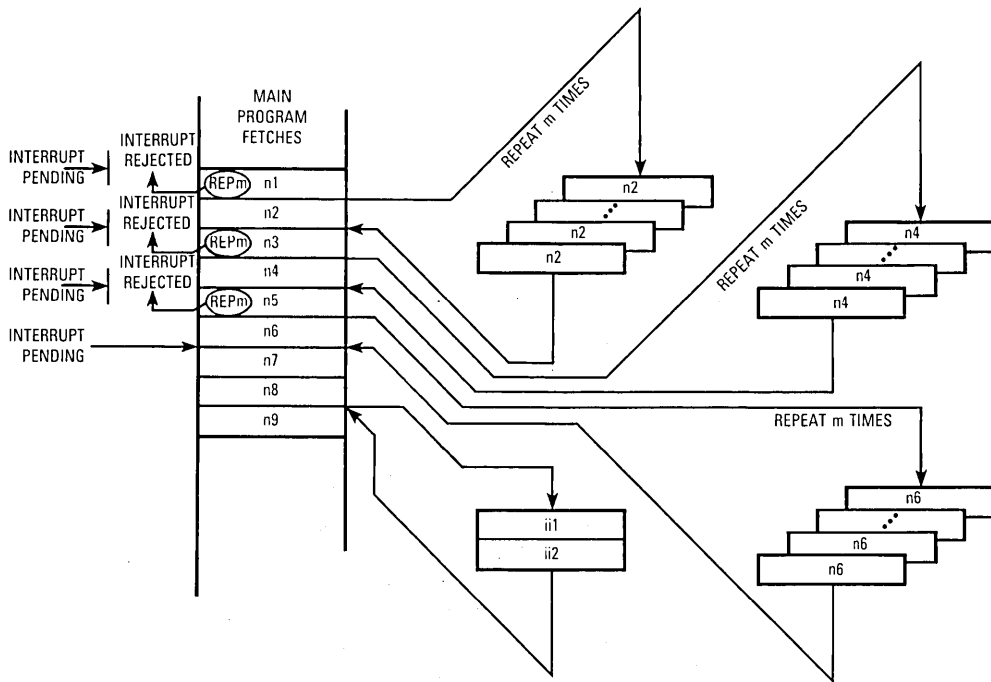

(a) Instruction Fetches from Memory

INTERRUPT SYNCHRONIZED AND RECOGNIZED AS PENDING

INTERRUPTS RE-ENABLED

|                           |     |     |     |     |    |    |     |     |     |    |    |     |     |     |    |    |     |     |     |     |     |    |  |  |  |  |
|---------------------------|-----|-----|-----|-----|----|----|-----|-----|-----|----|----|-----|-----|-----|----|----|-----|-----|-----|-----|-----|----|--|--|--|--|
| INTERRUPT CONTROL CYCLE 1 | i   |     |     |     |    |    |     |     |     |    |    |     |     |     |    | i  |     |     |     |     |     |    |  |  |  |  |
| INTERRUPT CONTROL CYCLE 2 | i%  |     |     |     |    |    |     |     |     |    |    |     |     |     |    | i  |     |     |     |     |     |    |  |  |  |  |
| FETCH                     | REP | n2  | REP |     |    |    | n4  | REP |     |    |    |     |     |     |    | n8 | ii1 | ii2 | n9  |     |     |    |  |  |  |  |
| DECODE                    |     | REP | NOP | n2  | n2 | n2 | REP | NOP | n4  | n4 | n4 | REP | NOP | n6  | n6 | n6 | n7  | n8  | ii1 | ii2 | n9  |    |  |  |  |  |
| EXECUTE                   |     |     | REP | NOP | n2 | n2 | n2  | REP | NOP | n4 | n4 | n4  | REP | NOP | n6 | n6 | n6  | n7  | n8  | ii1 | ii2 | n9 |  |  |  |  |
| INSTRUCTION CYCLE COUNT   | 1   | 2   | 3   | 4   | 5  | 6  | 7   | 8   | 9   | 10 | 11 | 12  | 13  | 14  | 15 | 16 | 17  | 18  | 19  | 20  | 21  | 22 |  |  |  |  |

i = INTERRUPT  
 ii = INTERRUPT INSTRUCTION WORD  
 n = NORMAL INSTRUCTION WORD  
 i% = INTERRUPT REJECTED

(b) Program Controller Pipeline

Figure 8-12. Interrupting Sequential REP Instructions

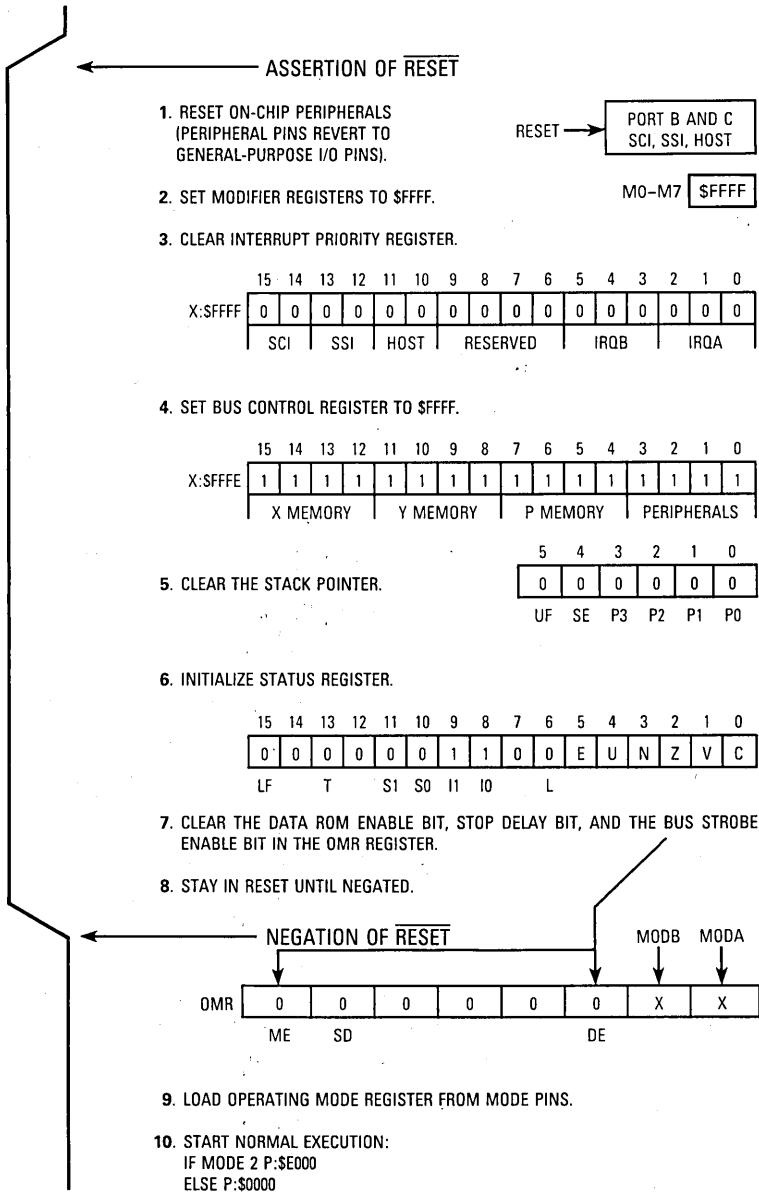

**Figure 8-13. Reset Sequence**

```

reset s
change omr 0
display all

```

```

x=          $000000000000 y=          $000000000000
a=          $00000000000000 b=          $00000000000000
          x1= $0000000 x0= $0000000 r7= $0000 n7= $0000 m7= $FFFF
          y1= $0000000 y0= $0000000 r6= $0000 n6= $0000 m6= $FFFF
a2= $00 a1= $0000000 a0= $0000000 r5= $0000 n5= $0000 m5= $FFFF
b2= $00 b1= $0000000 b0= $0000000 r4= $0000 n4= $0000 m4= $FFFF
          r3= $0000 n3= $0000 m3= $FFFF
pc= $E000 sr= $0300 omr= $00 r2= $0000 n2= $0000 m2= $FFFF
la= $0000 lc= $0000 r1= $0000 n1= $0000 m1= $FFFF
ssh= $0000 ssl= $0000 sp= $00 r0= $0000 n0= $0000 m0= $FFFF
pbc= $0 pbddr= $0000 pbd= $0000 pcd= $0000 pcddr= $0000 pcc= $0000
ipr= $0000 bcr= $FFFF htx= $0000000 hrx= $0000000 hsr= $02 hcr= $00
icr= $00 cvr= $12 isr= $06 ivr= $0F
rxh= $00 rxm= $00 rxl= $00 txh= $00 txm= $00 txl= $00
ssr= $03 scr= $0000 stx= $00 srx= $00 sccr= $0000 stxa= $00
tsr= $00 ssisr= $40 tx= $0000000 rx= $0000000 cra= $0000 crb= $0000
cyc=000000 ictr= 000000 cnt1= 000000 cnt2= 000000 cnt3=000000 cnt4=000000
P:$E000 000000 = NOP

```

```

reset d
display w
display

```

```

          m7= $FFFF
          m6= $FFFF
          m5= $FFFF
          m4= $FFFF
          m3= $FFFF
          m2= $FFFF
          m1= $FFFF
          m0= $FFFF
pc= $E000 sr= $0300 omr= $02
          sp= $00
pbc= $0 pbddr= $0000 pcddr= $0000 pcc= $0000
ipr= $0000 bcr= $FFFF hsr= $02 hcr= $00
icr= $00 cvr= $12 isr= $06 ivr= $0F sccr= $0000
ssr= $03 scr= $0000 ssisr= $40 cra= $0000 crb= $0000
X:$FFE3 $000000
X:$FFE8 $000000 $000002
X:$FFEC $000000 $000000 $000040
X:$FFFO $000000 $000003 $000000
X:$FFFF $000000
P:$E000 000000 = NOP

```

Figure 8-14. Reset When OMR=0

The OMR changed from \$00 to \$02, which is mode 2, because the MODA/IRQA and MODB/IRQB pins are set to a one and zero, respectively (binary 2) in the simulator. If the DSP had been in any other mode, the result would have been the same. The X: memory locations written to are the memory locations of the peripheral registers. The internal peripheral registers are memory mapped between X:\$FFC0 and X:\$FFFF.

The internal peripheral devices (HI, SSI, SCI, and ports A, B, and C) can be reset by several methods — hardware (HW) reset, software (SW) reset, individual (I) reset, and stop (ST) reset. Depending on the type of reset, the registers of these devices will be affected differently (see **SECTIONS 9 PORTA**, **SECTION 10 PORT B**, and **SECTION 11 PORT C** for

additional information on the internal peripherals). Tables 8-7–8-11 show how each bit in these registers is affected by the various resets. The HI is programmed for both the DSP56000/DSP56001 side of the interface and the host processor side of the interface.

The symbols used are as follows:

HW - Hardware reset is caused by asserting the external pin  $\overline{\text{RESET}}$ .

SW - Software reset is caused by executing the RESET instruction.

I - Individual reset is caused by all of the I/O pins for a given internal I/O device being configured for general-purpose I/O. These I/O devices are the HI, SSI, and SCI. The conditions for these resets are:

1. SSI individual reset occurs when port C control register bits 3–8 are set to zero.
2. SCI individual reset occurs when port C control register bits 0–2 are set to zero.
3. HI individual reset occurs when port B control register bit 0 is set to zero.

ST - Stop reset is caused by executing the STOP instruction.

1 - The bit is set during the xx reset.

0 - The bit is clear during the xx reset.

— - The bit is not changed during the xx reset.

**Table 8-7. HI Reset Effects — DSP56000/DSP56001  
Programming Model**

| Register Name   | Register Data Bits | HW Reset | SW Reset | I Reset | ST Reset |
|-----------------|--------------------|----------|----------|---------|----------|
| HCR<br>X:\$FFE8 | HF(3–2)            | 0        | 0        | —       | —        |
|                 | HCIE               | 0        | 0        | —       | —        |
|                 | HTIE               | 0        | 0        | —       | —        |
|                 | HRIE               | 0        | 0        | —       | —        |
| HSR<br>X:\$FFE9 | DMA                | 0        | 0        | 0       | 0        |
|                 | HF (1–0)           | 0        | 0        | 0       | 0        |
|                 | HCP                | 0        | 0        | 0       | 0        |
|                 | HTDE               | 1        | 1        | 1       | 1        |
|                 | HRDF               | 0        | 0        | 0       | 0        |
| HRX<br>X:\$FFEB | HRX(23–0)          | —        | —        | —       | —        |
| HTX<br>X:\$FFEB | HTX(23–0)          | —        | —        | —       | —        |



**Table 8-8. HI Reset Effects — Host Processor Programming Model**

| Register Name | Register Data Bits | HW Reset | SW Reset | I Reset | ST Reset |
|---------------|--------------------|----------|----------|---------|----------|
| ICR \$0       | INIT               | 0        | 0        | 0       | 0        |
|               | HM(1-0)            | 0        | 0        | 0       | 0        |
|               | TREQ               | 0        | 0        | 0       | 0        |
|               | RREQ               | 0        | 0        | 0       | 0        |
|               | HF(1-0)            | 0        | 0        | 0       | 0        |
| CVR \$1       | HC                 | 0        | 0        | 0       | 0        |
|               | HV(4-0)            | \$12     | \$12     | \$12    | \$12     |
| ISR \$2       | HREQ               | 0        | 0        | 0       | 0        |
|               | DMA                | 0        | 0        | 0       | 0        |
|               | HF(3-2)            | 0        | 0        | —       | —        |
|               | TRDY               | 1        | 1        | 1       | 1        |
|               | TXDE               | 1        | 1        | 1       | 1        |
|               | RXDF               | 0        | 0        | 0       | 0        |
| IVR \$3       | IV(7-0)            | \$0F     | \$0F     | —       | —        |
| RX \$5, 6, 7  | RXH(23-16)         | —        | —        | —       | —        |
|               | RXM(15-8)          | —        | —        | —       | —        |
|               | RXL(7-0)           | —        | —        | —       | —        |
| TX \$5, 6, 7  | TXH(23-16)         | —        | —        | —       | —        |
|               | TXM(15-8)          | —        | —        | —       | —        |
|               | TXL(7-0)           | —        | —        | —       | —        |

**Table 8-9. SSI Reset Effects**

| Register Name   | Register Data Bits | HW Reset | SW Reset | I Reset | ST Reset |
|-----------------|--------------------|----------|----------|---------|----------|
| CRA<br>X:\$FFEC | WL(2-0)            | 0        | 0        | —       | —        |
|                 | PSR                | 0        | 0        | —       | —        |
|                 | DC(4-0)            | 0        | 0        | —       | —        |
|                 | PM(7-0)            | 0        | 0        | —       | —        |
| CRB<br>X:\$FFED | RIE                | 0        | 0        | —       | —        |
|                 | TIE                | 0        | 0        | —       | —        |
|                 | RE                 | 0        | 0        | —       | —        |
|                 | TE                 | 0        | 0        | —       | —        |
|                 | MOD                | 0        | 0        | —       | —        |
|                 | GCK                | 0        | 0        | —       | —        |
|                 | SYN                | 0        | 0        | —       | —        |
|                 | FSL0               | 0        | 0        | —       | —        |
|                 | FSL1               | 0        | 0        | —       | —        |
|                 | SCKD               | 0        | 0        | —       | —        |
|                 | SCD(2-0)           | 0        | 0        | —       | —        |
| OF(1-0)         | 0                  | 0        | —        | —       |          |
| SR<br>X:\$FFEE  | RDF                | 0        | 0        | 0       | 0        |
|                 | TDE                | 1        | 1        | 1       | 1        |
|                 | ROE                | 0        | 0        | 0       | 0        |
|                 | TUE                | 0        | 0        | 0       | 0        |
|                 | RFS                | 0        | 0        | 0       | 0        |
|                 | TFS                | 0        | 0        | 0       | 0        |
|                 | IF(1-0)            | 0        | 0        | 0       | 0        |
| RX<br>X:\$FFEF  | RDR(23-0)          | —        | —        | —       | —        |
| TX<br>X:\$FFEF  | TDR(23-0)          | —        | —        | —       | —        |
| SRSR*           | RDR(23-0)          | —        | —        | —       | —        |
| STSR**          | RDR(23-0)          | —        | —        | —       | —        |

\*SRSR — SSI serial receive shift register  
 \*\*STSR — SSI serial transmit shift register

8

**Table 8-10. SCI Reset Effects**

| Register Name                                       | Register Data Bits                      | HW Reset | SW Reset | I Reset | ST Reset |
|---|---|----------|----------|---------|----------|
| SCR<br>X:\$FFF0                                     | SCKP                                    | 0        | 0        | —       | —        |
|   | TMIE                                    | 0        | 0        | —       | —        |
|   | TIE                                     | 0        | 0        | —       | —        |
|   | RIE                                     | 0        | 0        | —       | —        |
|   | ILIE                                    | 0        | 0        | —       | —        |
|   | TE                                      | 0        | 0        | —       | —        |
|   | RE                                      | 0        | 0        | —       | —        |
|   | WOMS                                    | 0        | 0        | —       | —        |
|   | RWU                                     | 0        | 0        | —       | —        |
|   | WAKE                                    | 0        | 0        | —       | —        |
|   | SBK                                     | 0        | 0        | —       | —        |
|   | SSFTD                                   | 0        | 0        | —       | —        |
|   | WDS(2-0)                                | 0        | 0        | —       | —        |
| SSR<br>X:\$FFF1                                     | R8                                      | 0        | 0        | 0       | 0        |
|   | FE                                      | 0        | 0        | 0       | 0        |
|   | PE                                      | 0        | 0        | 0       | 0        |
|   | OR                                      | 0        | 0        | 0       | 0        |
|   | IDLE                                    | 0        | 0        | 0       | 0        |
|   | RDRF                                    | 0        | 0        | 0       | 0        |
|   | TDRE                                    | 1        | 1        | 1       | 1        |
| TRNE  | 1                                       | 1        | 1        | 1       |          |
| SCCR<br>X:\$FFF2                                    | TCM                                     | 0        | 0        | —       | —        |
|   | RCM                                     | 0        | 0        | —       | —        |
|   | SCP                                     | 0        | 0        | —       | —        |
|   | COD                                     | 0        | 0        | —       | —        |
|   | CD(11-0)                                | 0        | 0        | —       | —        |
| SRX<br>X:\$FFF4<br>X:\$FFF5<br>X:\$FFF6             | SRX(23-0)<br>LOW<br>MID<br>HIGH         | —        | —        | —       | —        |
| STX<br>X:\$FFF4<br>X:\$FFF5<br>X:\$FFF6<br>X:\$FFF3 | STX(23-0)<br>LOW<br>MID<br>HIGH<br>STXA | —        | —        | —       | —        |
| SRS*  | SRS(23-0)                               | —        | —        | —       | —        |
| STSH**  | STSH(23-0)                              | —        | —        | —       | —        |

\*SRS — SCI receive shift register  
\*\*STSH — SCI transmit shift register

The definitions for individual reset for the ports A, B, and C register settings during individual reset are shown in Table 8-11.

**Table 8-11. Ports A, B, and C Reset Effects**

| Register Name     | Register Data Bits | HW Reset | SW Reset | I Reset | ST Reset | Comments         |
|-------------------|--------------------|----------|----------|---------|----------|------------------|
| BCR<br>X:\$FFFE   | BCR(15-0)          | \$FFFF   | —        | —       | —        | Port A Control   |
| PBC<br>X:\$FFE0   | PBC0               | 0        | 0        | N/A     | —        | Port B Control   |
| PBDDR<br>X:\$FFE2 | PBDDR(14-0)        | 0        | 0        | N/A     | —        | Port B Direction |
| PBD<br>X:\$FFE4   | PBD(14-0)          | —        | —        | N/A     | —        | Port B Data      |
| PCC<br>X:\$FFE1   | PCC(8-0)           | 0        | 0        | N/A     | —        | Port C Control   |
| PCDDR<br>X:\$FFE3 | PCDDR(8-0)         | 0        | 0        | N/A     | —        | Port C Direction |
| PCD<br>X:\$FFE5   | PCD(8-0)           | —        | —        | N/A     | —        | Port C Data      |

#### 8.4 WAIT PROCESSING STATE

8

The wait processing state is a low power-consumption state entered by execution of the WAIT instruction. In the wait state, the internal clock is disabled from all internal circuitry except the internal peripherals (e.g., the interrupt controller, the SCI, SSI, and HI). All internal processing is halted until an unmasked interrupt occurs or until the DSP is reset. The  $\overline{BR}/\overline{BG}$  circuits remain active during the wait state.

The wait state is one of two low power-consumption states. As a general rule, the normal operating current for the DSP56000/DSP56001 is typically less than 100 ma for a 20.5-MHz clock. The current is typically reduced to less than 10 ma (for a 20.5-MHz clock) in the wait state and to less than 1.0 ma (independent of the clock frequency) in the stop state. See the *DSP56001 Advance Information Data Sheet (ADI1290)* for exact figures. There are several other ways that power can be reduced. Power consumption varies linearly with both clock frequency and power-supply voltage. Changing clock frequency from 20 MHz to 4 MHz can reduce power consumption 75 percent (i.e., linearly with decreasing frequency). Changing the memory wait states from 0 to 15 can reduce power consumption by more than half during external memory accesses.

Figure 8-15 shows a WAIT instruction being fetched, decoded, and executed. It is fetched as n3 in this example and, during decode, is recognized as a WAIT instruction. The following instruction (n4) is aborted, and the internal clock is disabled from all internal circuitry except the internal peripherals. The processor stays in this state until an interrupt or reset is recognized. The response time is variable due to the timing of the interrupt with respect to the internal clock. Figure 8-15 shows the result of a fast interrupt bringing the processor

out of the wait state. The two appropriate interrupt vectors are fetched and put in the instruction pipe. The next instruction fetched is n4, which had been aborted earlier. Instruction execution proceeds normally from this point.

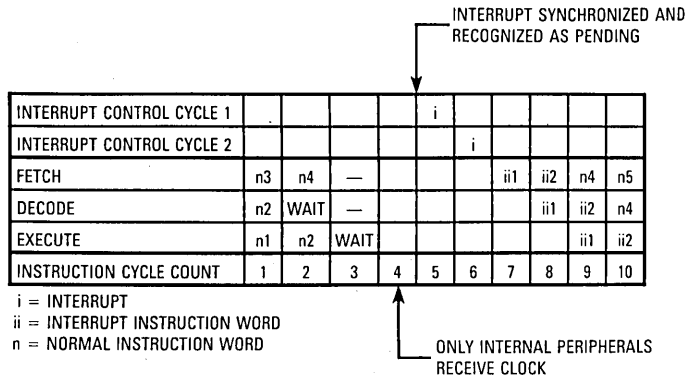

Figure 8-15. Wait Instruction Timing

Figure 8-16 shows an example of the WAIT instruction being executed at the same time that an interrupt is pending. Instruction n4 is aborted as before. There is a five-instruction-cycle delay caused by the WAIT instruction; then the interrupt is processed normally. The internal clocks are not turned off, and the net effect is that of executing eight NOP instructions between the execution of n2 and ii1.

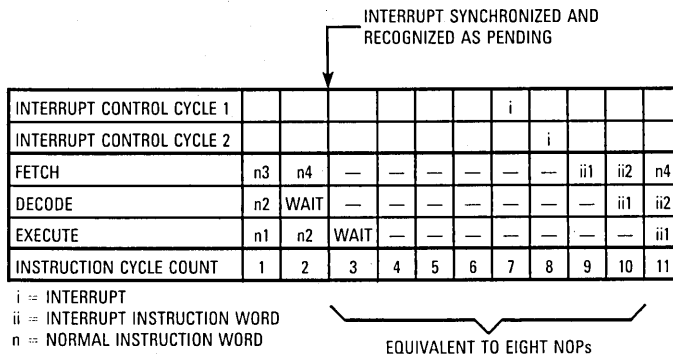

Figure 8-16 Simultaneous Wait Instruction and Interrupt

During the wait state, the  $\overline{\text{BR}}/\overline{\text{BG}}$  circuits remain active. Before  $\overline{\text{BR}}$  is asserted (see Table 8-12), all port A signals are driven. While the port is inactive, the control signals are deasserted, the data signals are inputs, and the address signals remain as the last address read or written. The signal timing during a read or write is given in the timing diagrams in the *DSP56001 Advance Information Data Sheet* (ADI1290). When  $\overline{\text{BG}}$  is asserted, all signals are three-stated (high impedance). Immediately after  $\overline{\text{BR}}$  is deasserted, the  $\overline{\text{RD}}$  and  $\overline{\text{WR}}$  signals are driven and are deasserted; all other signals remain in the high-impedance state. During the first T0 clock state following the exit from the wait state, control signals  $\overline{\text{PS}}$ ,  $\overline{\text{DS}}$ , and  $\overline{\text{X/Y}}$  are again driven; the data and address signals remain in the high-impedance state. During the first external access, all signals return to their normal operating mode.

Table 8-12.  $\overline{\text{BR}}/\overline{\text{BG}}$  During WAIT

| Signal                  | Before $\overline{\text{BR}}$ Asserted | While $\overline{\text{BG}}$ Asserted | After $\overline{\text{BR}}$ Deasserted | After Return to Normal State | After First External Access |
|-------------------------|--|---------------------------------------|---|------------------------------|-----------------------------|
| $\overline{\text{PS}}$  | Driven                                 | Three-state                           | Three-state                             | Driven                       | Driven                      |
| $\overline{\text{DS}}$  | Driven                                 | Three-state                           | Three-state                             | Driven                       | Driven                      |
| $\overline{\text{X/Y}}$ | Driven                                 | Three-state                           | Three-state                             | Driven                       | Driven                      |
| $\overline{\text{RD}}$  | Driven                                 | Three-state                           | Driven                                  | Driven                       | Driven                      |
| $\overline{\text{WR}}$  | Driven                                 | Three-state                           | Driven                                  | Driven                       | Driven                      |
| Data                    | Driven                                 | Three-state                           | Three-state                             | Three-state                  | Driven                      |
| Address                 | Driven                                 | Three-state                           | Three-state                             | Three-state                  | Driven                      |

## 8.5 STOP PROCESSING STATE

The stop processing state, which is the lowest power-consumption state, is entered by the execution of the STOP instruction. In the stop state, the clock oscillator is gated off; whereas, in the wait mode, the clock oscillator remains active. The chip clears all peripheral interrupts (HI, SSI, and SCI) and external interrupts ( $\overline{\text{IROA}}$ ,  $\overline{\text{IROB}}$ , and NMI) when entering the stop state. Trace or stack errors that were pending, remain pending. The priority levels of the peripherals remain as they were before the STOP instruction was executed. The SCI, SSI, and HI are held in their respective individual reset states while in the stop state.

All activity in the processor is halted until one of the following actions occurs:

1. A low level is applied to the  $\overline{\text{IROA}}$  pin.
2. A low level is applied to the RESET pin.

Either of these actions will gate on the oscillator, and, after a clock stabilization delay, clocks to the processor and peripherals will be re-enabled. The clock stabilization delay period is determined by the stop delay (SD) bit in the OMR.

The stop sequence is composed of eight instruction cycles called stop cycles. These are differentiated from normal instruction cycles because the fourth cycle is stretched an indeterminate period of time while the four-phase clock is turned off.

The STOP instruction is fetched in stop cycle 1 of Figure 8-17, decoded in stop cycle 2 (which is where it is first recognized as a stop command), and executed in stop cycle 3. The next instruction (n4) is fetched during stop cycle 2 but is not decoded in stop cycle 3 because, by that time, the STOP instruction prevents the decode. The processor stops the clock and enters the stop mode. The processor will stay in the stop mode until it is restarted.

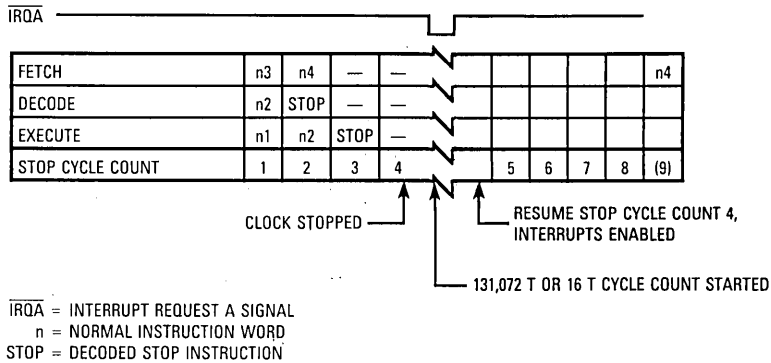

**Figure 8-17. STOP Instruction Sequence**

Figure 8-18 illustrates restarting the system by asserting the  $\overline{\text{IRQA}}$  signal. If the exit from stop state was caused by a low level on the  $\overline{\text{IRQA}}$  pin, then the processor will service the highest priority pending interrupt. If no interrupt is pending, then the processor resumes at the instruction following the STOP instruction that caused the entry into the stop state.

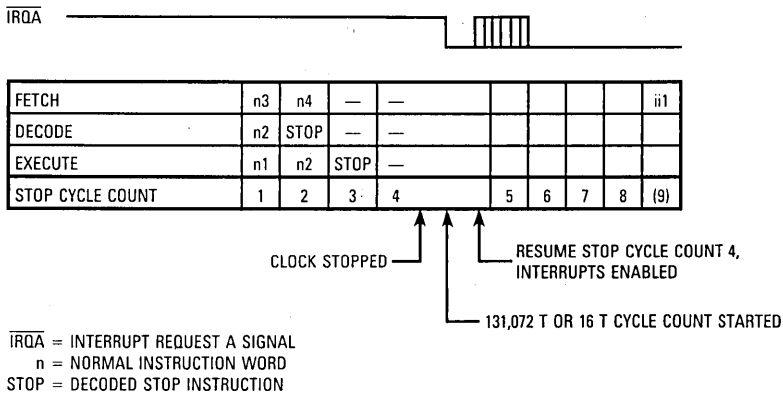

**Figure 8-18. STOP Instruction Sequence Followed by  $\overline{\text{IRQA}}$**

An  $\overline{\text{IRQA}}$  deasserted before the end of the stop cycle count will not be recognized as pending. If  $\overline{\text{IRQA}}$  is asserted when the stop cycle count completes, then an  $\overline{\text{IRQA}}$  interrupt will be recognized as pending and will be arbitrated with any other interrupts.

Specifically, when  $\overline{\text{IRQA}}$  is asserted, the internal clock generator is started and begins a delay determined by the SD bit of the OMR. If the internal clock oscillator is used, the SD bit should be set to zero, which enables a delay count of 128K T cycles (131,072 T cycles) to allow the clock oscillator to stabilize. If a stable external clock is used, the SD bit may be set to one, which enables a 16 T cycle delay.

The following description assumes that SD=0 (the 128K T counter is used). During the 128K T count, interrupts are ignored until the last few count cycles. At this time, the interrupts are synchronized. At the end of the 128K T cycle delay period, the chip restarts instruction processing, stop cycle 4 is completed (interrupt arbitration occurs at this time), and stop cycles 5, 6, 7, and 8 are executed (it takes 17T from the end of the 128K T delay to the first instruction fetch). If the  $\overline{\text{IRQA}}$  signal is released (pulled high) after a minimum of 4T but less than 128K T cycles, no  $\overline{\text{IRQA}}$  interrupt will occur, and the instruction fetched after stop cycle 8 will be the next sequential instruction (n4 in Figure 8-18). An  $\overline{\text{IRQA}}$  interrupt will be serviced (as shown in Figure 8-18) if 1) the  $\overline{\text{IRQA}}$  signal had previously been initialized as level sensitive, 2)  $\overline{\text{IRQA}}$  is held low from the end of the 128K T cycle delay counter to the end of stop cycle count 8, and 3) no interrupt with a higher interrupt level is pending. If  $\overline{\text{IRQA}}$  is not asserted during the last part of the STOP instruction sequence (6, 7, and 8) and if no interrupts are pending, the processor will refetch the next sequential instruction (n4). Since the  $\overline{\text{IRQA}}$  signal is asserted (see Figure 8-18), the processor will recognize the interrupt and fetch and execute the instructions at P:\$0008 and P:\$0009 (the  $\overline{\text{IRQA}}$  interrupt vector locations).

To ensure servicing  $\overline{\text{IRQA}}$  immediately after leaving the stop state, the following steps must be taken before the execution of the STOP instruction:

1. Define  $\overline{\text{IRQA}}$  as level sensitive.
2. Define  $\overline{\text{IRQA}}$  priority as higher than the other sources and higher than the program priority.
3. Ensure that no stack error or trace interrupts are pending.
4. Execute the STOP instruction and enter the stop state.
5. Recover from the stop state by asserting the  $\overline{\text{IRQA}}$  pin and holding it asserted for the whole clock recovery time. If it is low, the  $\overline{\text{IRQA}}$  vector will be fetched. Also, the user must ensure that NMI will not be asserted during these last three cycles; otherwise, NMI will be serviced before  $\overline{\text{IRQA}}$  because NMI priority is higher.
6. The exact elapsed time for clock recovery is unpredictable. The external device that asserts  $\overline{\text{IRQA}}$  must wait for some positive feedback, such as specific memory access or a change in some predetermined I/O pin, before deasserting  $\overline{\text{IRQA}}$ .



The STOP sequence totals 131,104 T cycles (if SD=0) or 16 T cycles (if SD=1) in addition to the period with no clocks from the stop fetch to the  $\overline{\text{IRQA}}$  vector fetch (or next instruction). However, there is an additional delay if the internal oscillator is used. An indeterminate period of time is needed for the oscillator to begin oscillating and then stabilize its amplitude. The processor will still count 131,104 T cycles (or 16 T cycles), but the period of the first oscillator cycles will be irregular; thus, an additional period of 19,000 T cycles should be allowed for oscillator irregularity (the specification recommends a total minimum period of 150,000 T cycles for oscillator stabilization). If an external oscillator is used that is already stabilized, no additional time is needed.

If the STOP instruction is executed when the  $\overline{\text{IRQA}}$  signal is asserted, the clock generator will not be stopped, but the four-phase clock will be disabled for the duration of the 128K T cycle (or 19 T cycle) delay count. In this case, the STOP looks like a 131,072K + 35 T cycle (or 51 T cycle) NOP, since the STOP instruction itself is eight instruction cycles long (32 T).

A trace or stack error interrupt pending before entering the stop state is not cleared and will remain pending. During the clock stabilization delay, all peripheral and external interrupts are cleared and ignored (includes all SCI, SSI, HI,  $\overline{\text{IRQA}}$ ,  $\overline{\text{IRQB}}$ , and NMI interrupts, but not trace or stack error). If the SCI, SSI, or HI have interrupts enabled in 1) their respective control registers and 2) in the interrupt priority register, then interrupts like SCI transmitter empty will be immediately pending after the clock recovery delay and will be serviced before continuing with the next instruction. If peripheral interrupts must be disabled, the user should disable them with either the control registers or the interrupt priority register before the STOP instruction is executed.

If  $\overline{\text{RESET}}$  is used to restart the processor (see Figure 8-19), the 128K T cycle delay counter would not be used, all pending interrupts would be discarded, and the processor would immediately enter the reset processing state as described in **8.3 RESET PROCESSING STATE**. The stabilization time required for the clock ( $\overline{\text{RESET}}$  should be asserted for this time) is only 50 T for a stabilized external clock but is the same 150,000 T for the internal oscillator. These stabilization times are recommended times but are not imposed by internal timers or time delays. The DSP fetches instructions immediately after exiting reset. If the user wishes to use the 128K T (or 16 T) delay counter, it can be started by asserting  $\overline{\text{IRQA}}$  for a short time (about two clock cycles).

During the stop mode, the port A bus is frozen. The state of each pin immediately before executing the STOP instruction will be held until the DSP leaves the stop state. Port A is not three-stated, and the  $\overline{\text{BR}}/\overline{\text{BG}}$  circuits are not operational. However, port A will remain three-stated if  $\overline{\text{BG}}$  was asserted before the STOP instruction was executed. One way to release the port A bus for use while the DSP is in the stop state is to use a port B or port C pin to initiate a bus request before executing the STOP instruction.

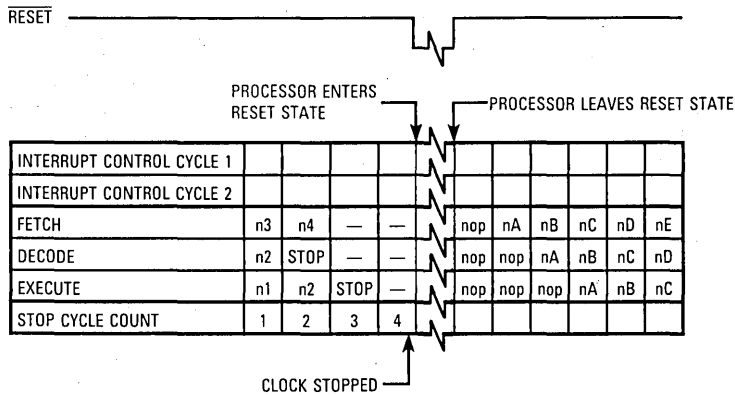

$\overline{\text{RESET}}$  = SIGNAL APPLIED TO  $\overline{\text{RESET}}$  PIN  
 n = NORMAL INSTRUCTION WORD  
 nA, nB, nC = INSTRUCTIONS IN RESET ROUTINE  
 STOP = DECODED STOP INSTRUCTION

**Figure 8-19. STOP Instruction Sequence Recovering with  $\overline{\text{RESET}}$**

## SECTION 9 PORT A

Port A is the memory expansion port that can be used for either memory expansion or for memory-mapped I/O (see **2.9.1 Expansion Port (Port A)**). A number of features make port A versatile and easy to use. These features provide a low-parts-count connection with fast memories, slow memories/devices, and multiple bus master systems.

The port A data bus is 24 bits wide with a separate 16-bit address bus capable of a sustained rate of one memory access per machine cycle (using no-wait-state memory). External memory is divided into three 64K-word  $\times$  24-bit spaces — X:, Y:, and P:. An internal wait-state generator can be programmed to insert up to 15 wait states if access to slower memory or I/O devices is required. A bus wait signal allows an external device to control the number of wait states inserted in a bus access operation. Bus arbitration signals allow an external device (e.g., a DMA controller or another processor) use of the bus while internal operations continue using the internal memories. Two power-reduction features are specific to port A. The first power-reduction feature is that accessing the internal memory spaces does not toggle the external memory signals, eliminating unneeded switching current. The second power-reduction feature is that, if lower memory speed is acceptable, wait states can be added to external memory accesses to significantly reduce power while accessing those memories.

### 9.1 PORT A INTERFACE

One or more of the digital signal processor (DSP) memory sources (X data memory, Y data memory, and program memory) can be accessed during the execution of an instruction. Each of these memory sources may be either internal or external to the DSP. Three address buses (XAB, YAB, and PAB) and four data buses (XDB, YDB, PDB, and GDB) are available for internal memory accesses during one instruction cycle, but only one address bus and one data bus (port A) are available for external memory accesses. If all memory sources are internal to the DSP, one or more of the three memory sources may be accessed in one instruction cycle (i.e., program memory access or program memory access plus an X, Y, XY, or L memory reference). However, when one or more of the memories are external to the DSP56000/DSP56001, memory references may require additional instruction cycles because only one external memory access can occur per instruction cycle.

If more than one external access is required in one instruction cycle, the accesses will be made in the following priority: X memory, Y memory, and program memory. It takes one instruction cycle for each external memory access — i.e., one access can be executed in one instruction cycle, two accesses take two instruction cycles, etc. Since the external bus is only 24 bits wide, one XY or long external access will take two instruction cycles.

Figure 9-1 shows the port A signals divided into their three functional groups. The bus control signals can be subdivided into three additional groups: read/write control, address space selection, and bus access control. The read/write controls are self-descriptive. They can be used as decoded read and write controls, or, as seen in Figures 9-2, 9-3, 9-4, and 9-6, the write signal can be used as the read/write control, and the read signal can be used

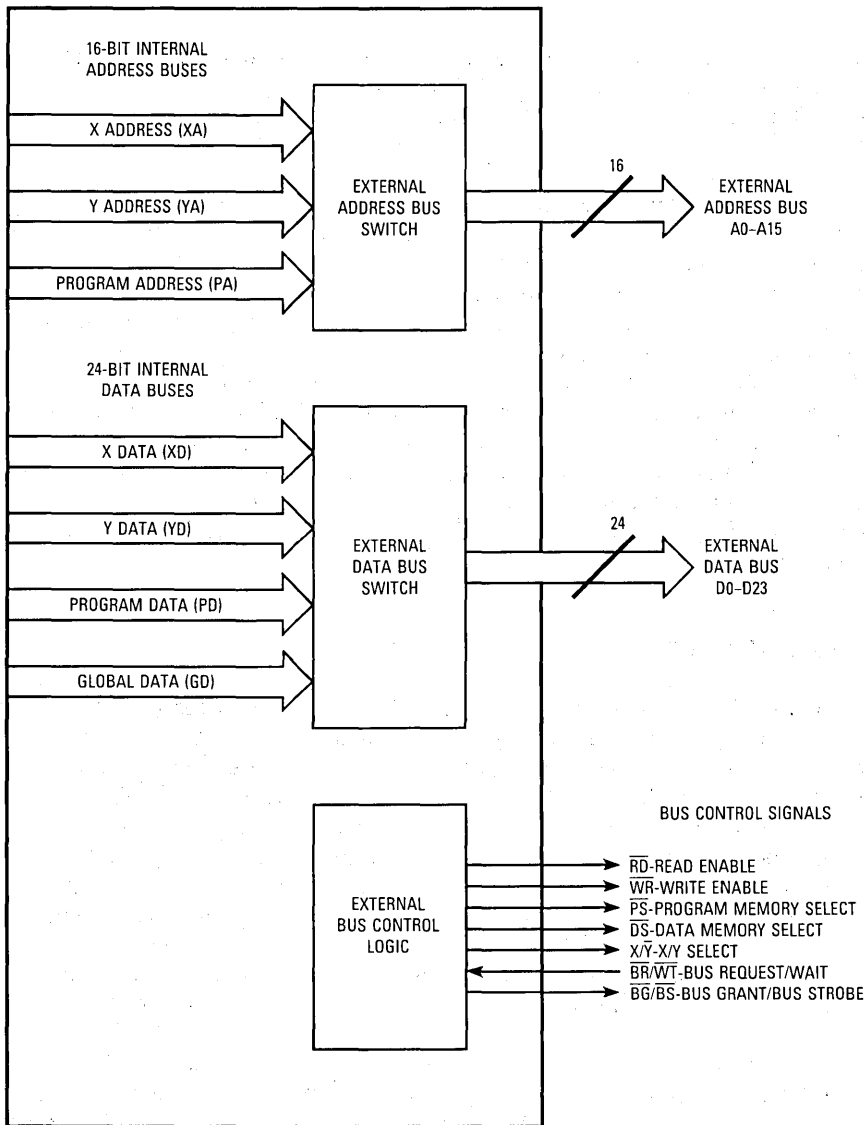

Figure 9-1. Port A Signals

as an output enable (or data enable) control for the memory. Decoding in this fashion simplifies connection to high-speed random-access memories (RAMs). The program memory select, data memory select, and X/Y select can be considered additional address signals, which extend the addressable memory from 64K words to 192K words.

Since external logic delay is large relative to RAM timing margins, timing becomes more difficult as faster DSPs are introduced. The separate read and write strobes used by the DSP56000/DSP56001 are mutually exclusive, with a guard time between them to avoid two data buffers being enabled simultaneously. Other methods using external logic gates to generate the RAM control inputs require either faster RAM chips or external data buffers to avoid data bus buffer conflicts.

Additional DSP56000/DSP56001 peripherals can be memory mapped. An easy way to interface with MC6800 and MC68000 peripherals and to have an early read/write indication is to use the X/Y output pin as an early R/W indication. The peripheral chip select should be derived from the address lines and the data strobe so the peripheral registers appear in both X and Y data memory spaces at the same addresses. For a read operation, perform an X memory read:

MOVE X:PERIPHERAL,X0      ;X/Y signal is high.

For a write operation, perform a Y memory write:

MOVE X0,Y:PERIPHERAL      ;X/Y signal is low.

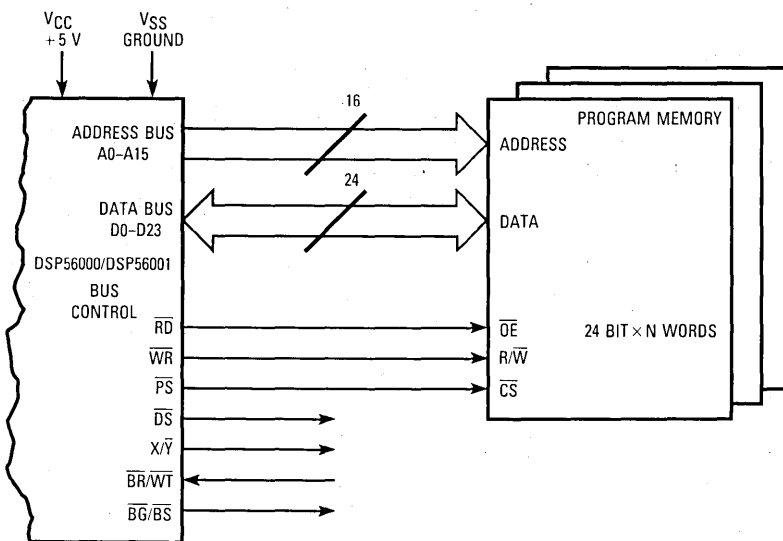

Figure 9-2. External Program Space

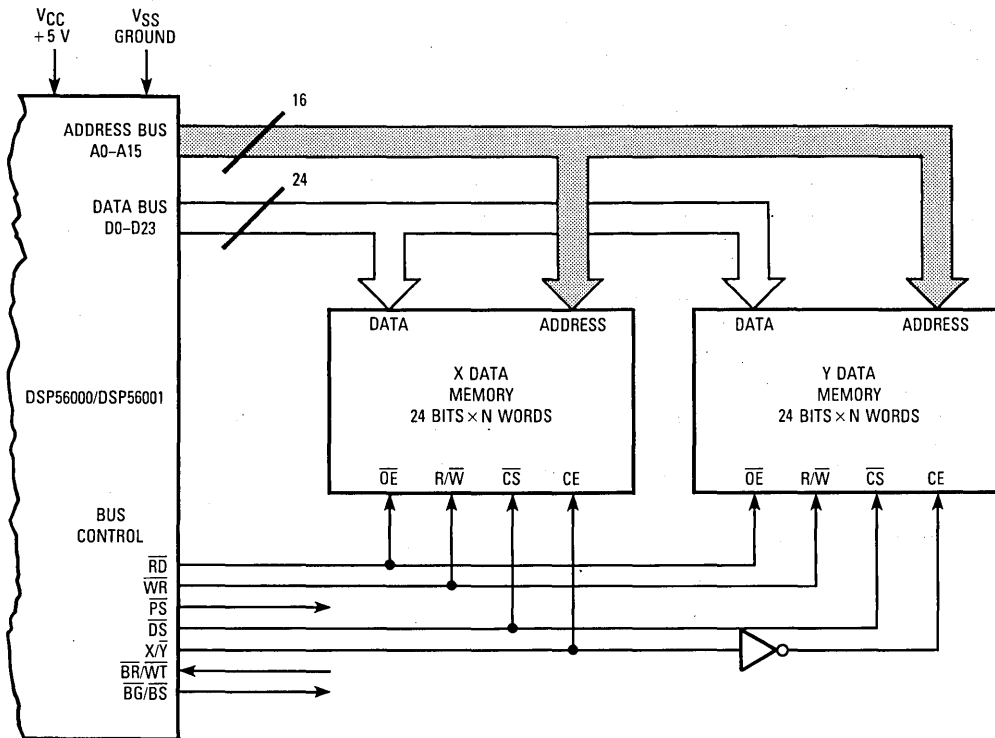

Figure 9-3. External X and Y Data Space

Since the  $X/\bar{Y}$  output signal has the same timing as the address lines, it provides an early direction indication. The  $\overline{RD}$  and  $\overline{WR}$  signals are ANDed together to form a "data strobe" signal. The only restriction is that X and Y memory space must be external at the same address. Thus, the I/O short addressing mode and the MOVEP instruction cannot be used for this application. Otherwise, the hardware and software are trivial.

Figure 9-2 shows an example of external program memory. A typical implementation of this circuit would use three-byte-wide static memories and would not require any additional logic. The  $\overline{PS}$  signal is used as the program-memory chip-select signal to enable the program memory at the appropriate time.

Figure 9-3 shows a similar circuit using the  $\overline{DS}$  signal to enable two data memories and using the  $X/\bar{Y}$  signal to select between them. The three external memory spaces (program, X data, and Y data) do not have to reside in separate physical memories; a single memory can be employed by using the  $\overline{PS}$ ,  $\overline{DS}$ , and  $X/\bar{Y}$  signals as additional address lines to segment the memory into three spaces (see Figure 9-4). Table 9-1 shows how the  $\overline{PS}$ ,  $\overline{DS}$ , and  $X/\bar{Y}$  signals are decoded. If the DSP is in the development mode, an exception fetch to any interrupt vector location will cause the  $X/\bar{Y}$  signal to go low when  $\overline{PS}$  is asserted.

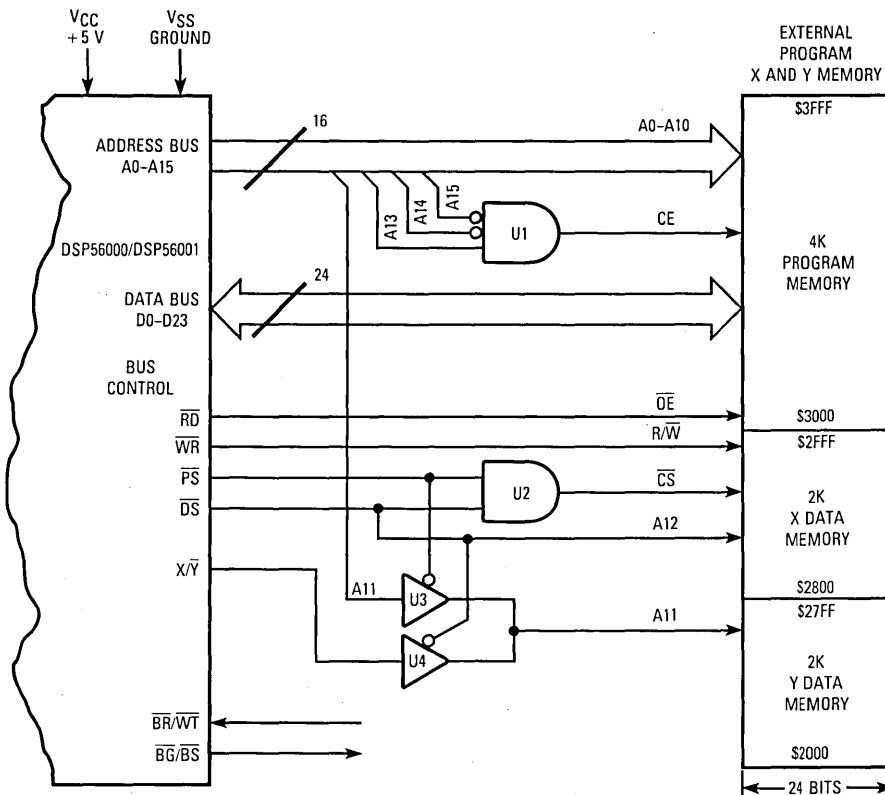

Figure 9-4. Memory Segmentation

This procedure is useful for debugging and for allowing external circuitry to track interrupt servicing.

Table 9-1. Program and Data Memory Select Encoding

| $\overline{PS}$ | $\overline{DS}$ | $X/\overline{Y}$ | External Memory Reference   |
|-----------------|-----------------|------------------|---|
| 1               | 1               | 1                | No Activity   |
| 1               | 0               | 1                | X Data Memory on Data Bus   |
| 1               | 0               | 0                | Y Data Memory on Data Bus   |
| 0               | 1               | 1                | Program Memory on Data Bus<br>(Not an Exception)                          |
| 0               | 1               | 0                | External Exception Fetch: Vector or<br>Vector + 1 (Development Mode Only) |
| 0               | 0               | X                | Reserved  |
| 1               | 1               | 0                | Reserved  |

Special provisions have been made to allow the DSP to load a program from an inexpensive byte-wide ROM (see Figure 9-5 and the *DSP56001 Advance Information Data Sheet (AD11290)*) into internal program memory during a poweron reset. On powerup, the wait-state generator adds 15 wait states to all external memory accesses so that slow memory can be used. If bit 23 of external memory is a logic one, the DSP will load the contents of an external ROM into internal program memory (if bit 23 is a logic zero, it will load from the host port). The bootstrap program uses the bytes in three consecutive memory locations in the external ROM to build a single word in internal program memory. Figure 9-6 shows a system that uses internal program memory loaded from an external ROM during powerup and that splits the data memory space of a single memory bank into X: and Y: memory spaces. Although external program memory must be 24 bits, external data memory does not. Of course, this is application specific. However, many systems use 16 or fewer bits for A/D and D/A conversion, since they only need to store 16, 12, or even eight bits of data.

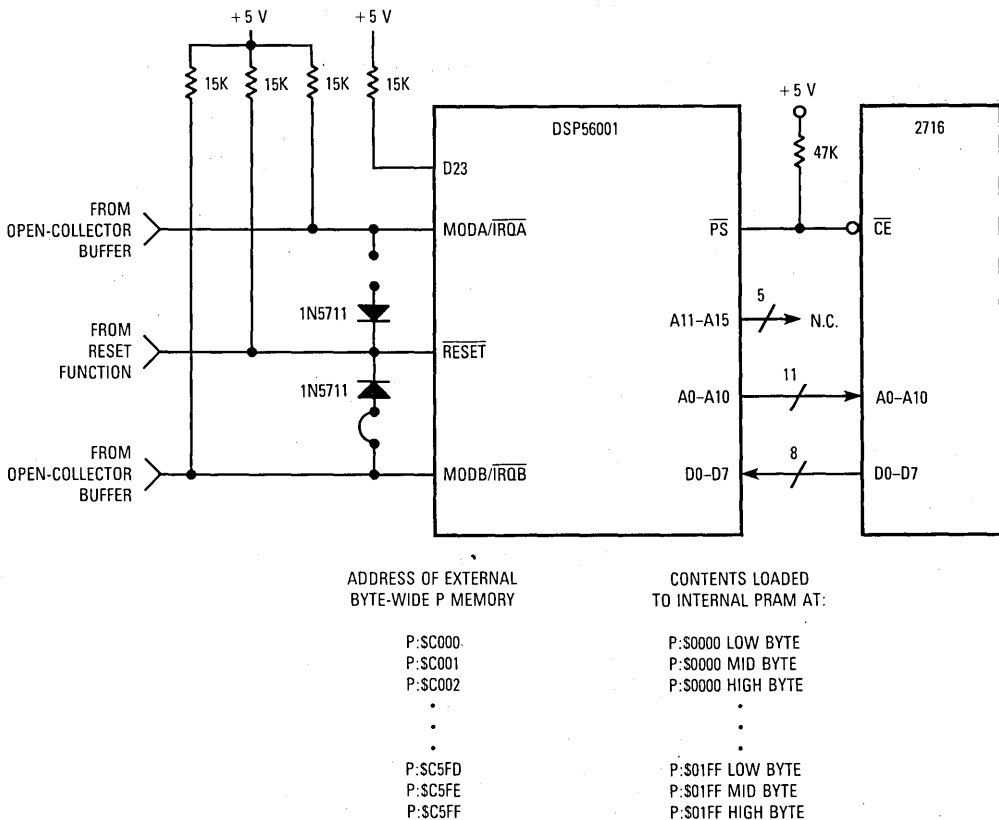

Figure 9-5. Port A Bootstrap Circuit



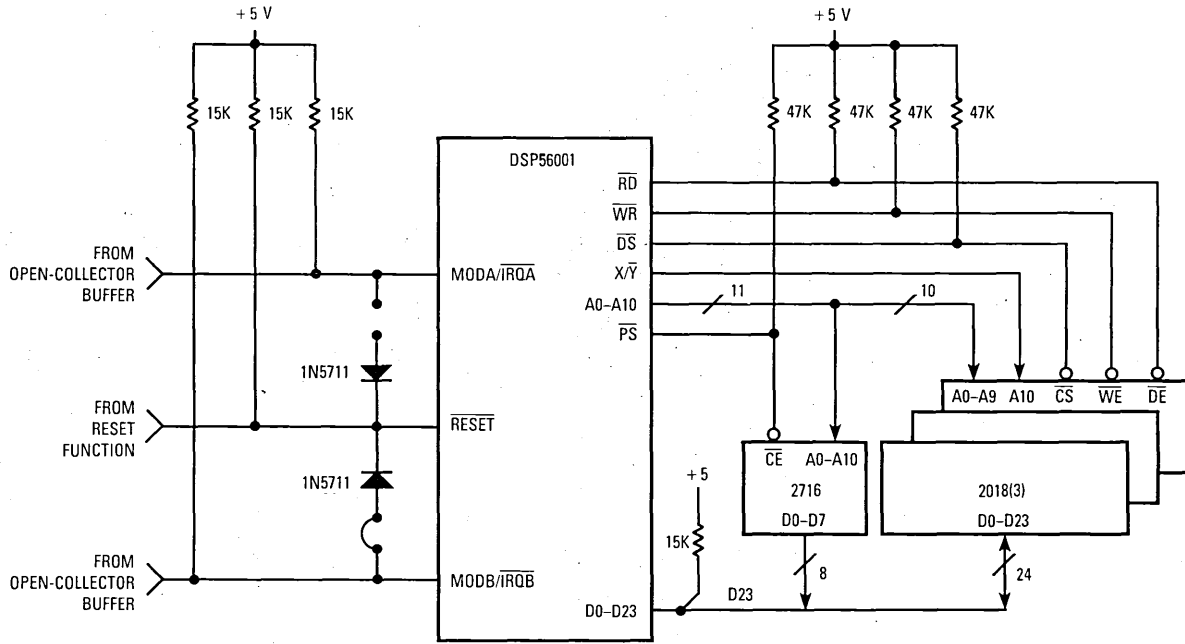

Figure 9-6. Port A Bootstrap ROM with X and Y RAM

The 24/56 bits of internal precision is usually sufficient for intermediate results. Recognizing this fact can save cost by reducing the number of external memory chips.

All unused inputs should have pullup resistors for two reasons: 1) floating inputs draw excessive power, and 2) a floating input can cause erroneous operation. For example, during RESET, all signals are three-stated. Without pullup resistors, the PS and  $\overline{DS}$  signals may become active, causing two or more memory chips to try to simultaneously drive the external data bus, which can damage the memory chips. A pullup resistor in the 50K-ohm range should be sufficient.

## 9.2 PORT A TIMING

The external bus timing is defined by the operation of the address bus, data bus, and bus control pins. The transfer of data over the external data bus is synchronous with the clock. The timing A, B, and C relative to the edges of an external clock (see Figures 9-7 and 9-8) are provided in the *DSP56001 Advance Information Data Sheet* (ADI1290). This timing is essential for designing synchronous multiprocessor systems. Figure 9-7 shows the port A timing with no wait states (wait-state control is discussed in **9.2.1 Port A Wait States**). One instruction cycle equals two clock cycles or four clock phases. The clock phases, which are numbered T0–T3, are used for timing on the DSP. Figure 9-8 shows the same timing with two wait states added to the external X: memory access. Four TW clock phases have been added because one wait state adds two T phases and is equivalent to repeating the T2 and  $\overline{T2}$  clock phases. The write signal is also delayed from the T1 to the T2 state when one

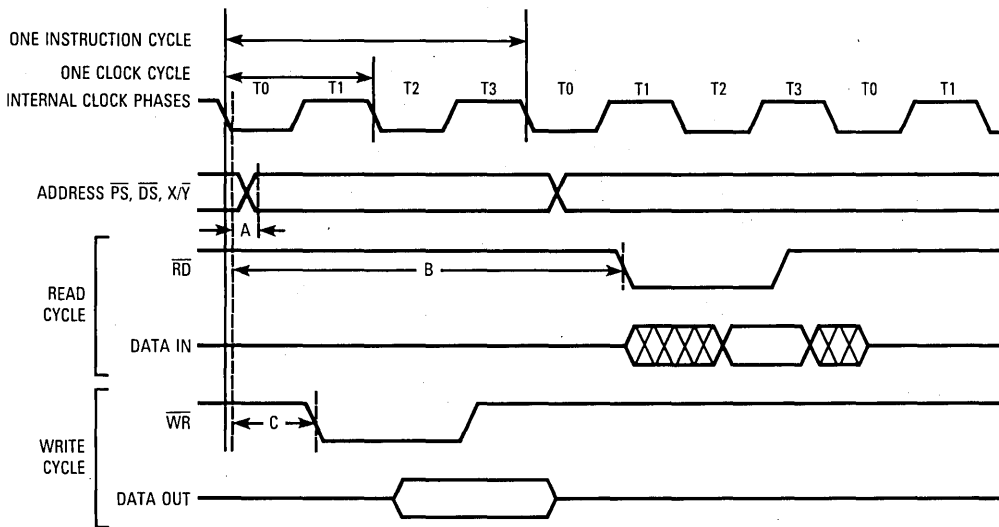

Figure 9-7. Port A Bus Operation with No Wait States

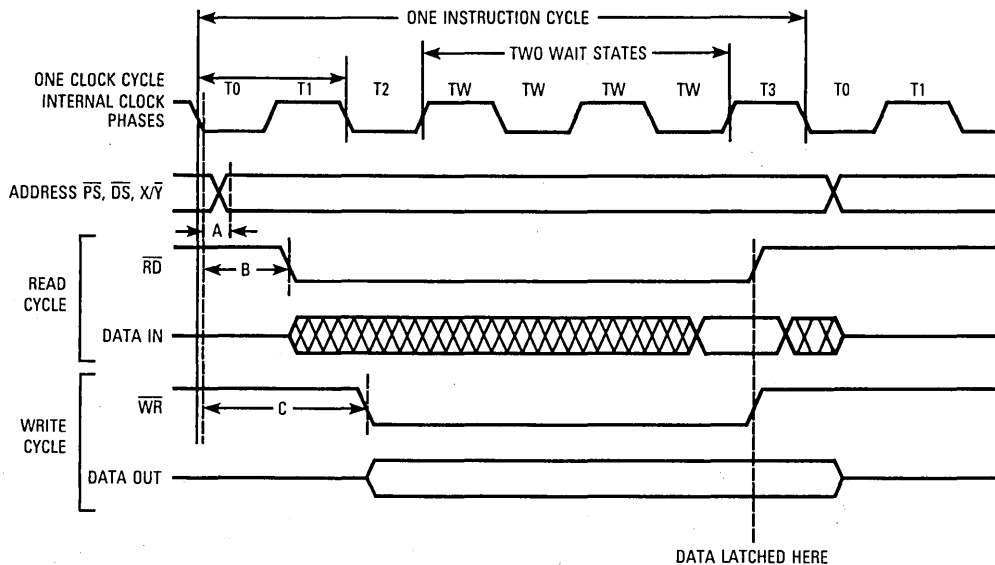

Figure 9-8. Port A Bus Operation with Two Wait States

or more wait states are added to ease interfacing to the port. Each external memory access requires the following procedure:

1. The external memory address is defined by the address bus (A0–A15) and the memory reference selects (PS, DS, and X/Y). These signals change in the first phase (T0) of the bus cycle. Since the memory reference select signals have the same timing as the address bus, they may be used as additional address lines. The address and memory reference signals are also used to generate chip-select signals for the appropriate memory chips. These chip-select signals change the memory chips from low-power standby mode to active mode and begin the read access time. This mode change allows slower memories to be used since the chip-select signals can be address based rather than read or write enable based. Read and write enable do not become active until after the address is valid. See the timing diagrams in the *DSP56001 Advance Information Data Sheet* (ADI1290) for detailed timing information.
2. When the address and memory reference signals are stable, the data transfer is enabled by read enable (RD) or write enable (WR). RD or WR is asserted to “qualify” the address and memory reference signals as stable and to perform the read or write data transfer. RD and WR are asserted in the second phase of the bus cycle (if there are no wait states). Read enable is typically connected to the output enable (OE) of the memory chips and simply controls the output buffers of the chip-selected memory. Write enable is connected to the write enable (WE) or write strobe (WS) of the memory chips and is the pulse that strobes data into the selected memory. For a read operation,

$\overline{RD}$  is asserted and  $\overline{WR}$  remains deasserted. Since write enable remains negated, a memory read operation is performed. The DSP data bus becomes an input, and the memory data bus becomes an output. For a write operation,  $\overline{WR}$  is asserted and  $\overline{RD}$  remains deasserted. Since read enable remains deasserted, the memory chip outputs remain in the high-impedance state even before write strobe is asserted. This state assures that the DSP and the chip-selected memory chips are not enabled onto the bus at the same time. The DSP data bus becomes an output, and the memory data bus becomes an input.

3. Wait states are inserted into the bus cycle by a wait-state counter or by asserting  $\overline{WT}$ . The wait-state counter is loaded from the bus control register. If the value loaded into the wait-state counter is zero, no wait states are inserted into the bus cycle, and  $\overline{RD}$  and  $\overline{WR}$  are asserted as shown in Figure 9-7. If a value  $W \neq 0$  is loaded into the wait state counter,  $W$  wait states are inserted into the bus cycle. When wait states are inserted into an external write cycle,  $\overline{WR}$  is delayed from T1 to T2. The timing for the case of two wait states ( $W=2$ ) is shown in Figure 9-8.
4. When  $\overline{RD}$  or  $\overline{WR}$  are deasserted at the start of T3 in a bus cycle, the data is latched in the destination device — i.e., when  $\overline{RD}$  is deasserted, the DSP latches the data internally; when  $\overline{WR}$  is deasserted, the external memory latches the data on the positive-going edge. The address signals remain stable until the first phase of the next external bus cycle to minimize power dissipation. The memory reference signals ( $\overline{PS}$ ,  $\overline{DS}$ , and  $X/\overline{Y}$ ) are deasserted (held high) during periods of no bus activity, and the data signals are three-stated. For read-modify-write instructions such as BSET, the address and memory reference signals remain active for the complete composite (i.e., two  $t_{CYC}$ ) instruction cycle.

## 9

Figure 9-9 shows an example of mixing different memory speeds and memory-mapped peripherals in different address spaces. The internal memory uses no wait states, X: memory uses two wait states, Y: memory uses four wait states, P: memory uses five wait states, and the analog converters use 14 wait states. Controlling five different devices at five different speeds requires only one additional logic package. Half the gates in that package are used to map the analog converters to the top 64 memory locations in Y: memory.

Adding wait states to external memory accesses can substantially reduce power requirements. Table 9-2 shows how the power was reduced during external memory and I/O operations by changing from zero to 15 wait states at four different clock speeds in a test circuit.

### 9.2.1 Port A Wait States

The DSP56000/DSP56001 features two methods to allow the user to accommodate slow memory by changing the port A bus timing. The first method uses the bus control register (BCR), which allows a fixed number of wait states to be inserted in a given memory access to all locations in each of the four memory spaces: X, Y, P, and I/O. The second method

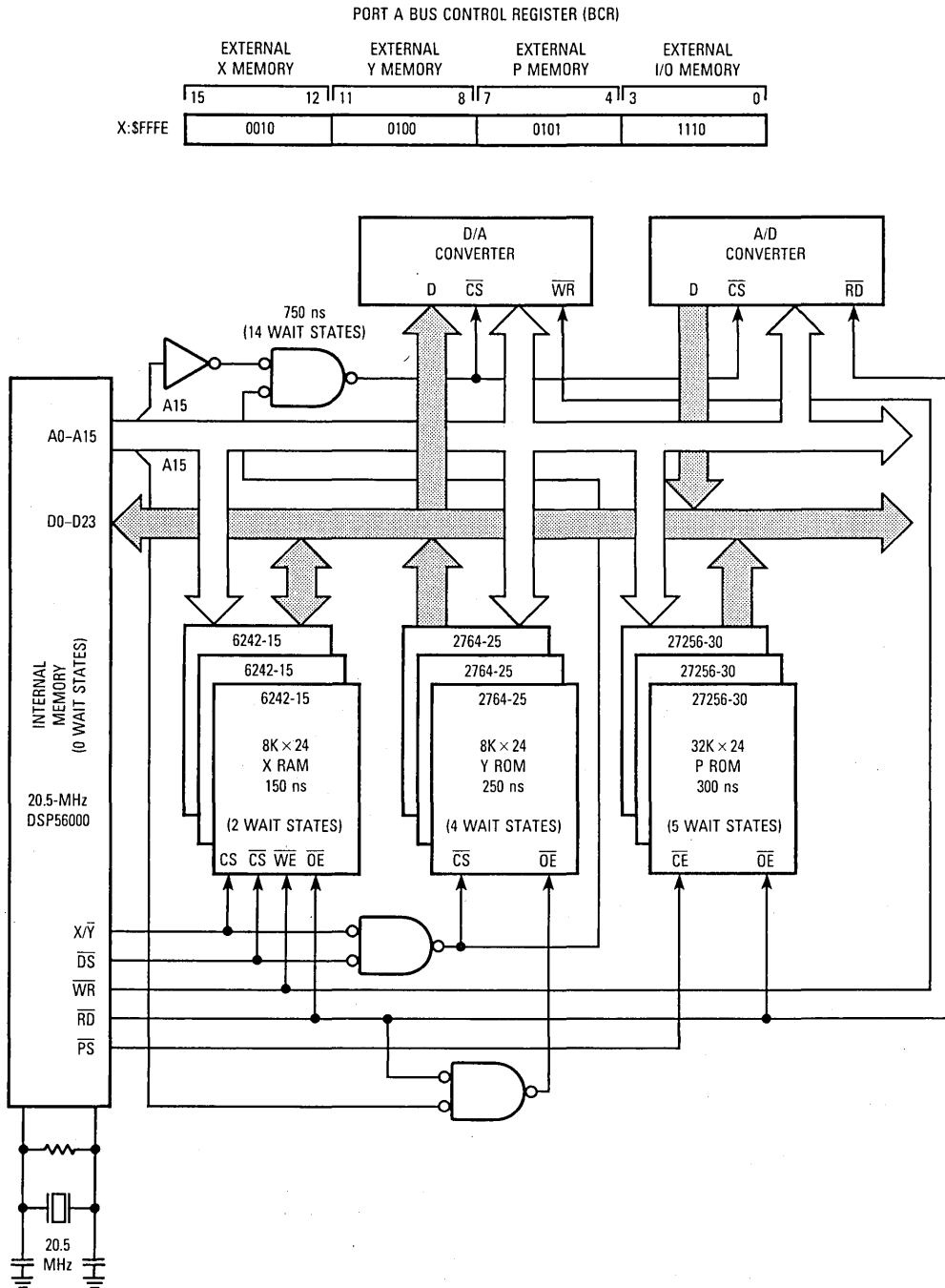

**Figure 9-9. Mixed-Speed Expanded System**

**Table 9-2. Power Requirements for Minimum and Maximum External Memory Wait States**

| Clock      | Current for 0 Wait States | Current for 15 Wait States |
|------------|---------------------------|----------------------------|
| 4.000 MHz  | 19.8 mA                   | 8.6 mA                     |
| 6.5536 MHz | 31.0 mA                   | 12.8 mA                    |
| 10.245 MHz | 46.8 mA                   | 18.8 mA                    |
| 20.000 MHz | 91.0 mA                   | 36.6 mA                    |

uses the bus strobe/wait ( $\overline{BS}/\overline{WT}$ ) facility, which allows an external device to insert an arbitrary number of wait states when accessing either a single location or multiple locations of external memory or I/O space. Wait states are executed until the external device releases the DSP to finish the external memory cycle.

### 9.2.2 Bus Control Register

The expansion bus timing is controlled by the BCR (see Figure 9-10) which controls the timing of the bus interface signals, RD and WR, and the data output lines. Each of the memory spaces, X data, Y data, program data, and I/O, has its own 4-bit BCR, which can be programmed for inserting up to 15 wait states (each wait state adds one-half instruction cycle to each memory access — i.e., 50 ns for a 20-Mhz clock). In this way, external bus timing can be tailored to match the speed requirements of the different memory spaces. On processor RESET, the BCR is preset to all ones (15 wait states).

Figure 9-10 illustrates which of the four BCR subregisters affect which external memory space. The BCR is a memory-mapped register located at X:\$FFFE. All the internal peripheral devices are memory mapped, and their control registers reside between X:\$FC00 and X:\$FFFF. Loading the BCR as shown in Figure 9-9 can be accomplished by executing a "MOVEP #\$245E, X:\$FFFE" instruction. Changing individual bits in one of the four subregisters can be accomplished by using the BSET and BCLR instructions.

### 9.2.3 Bus Strobe/Wait Pins

The DSP56000/DSP56001 has two reconfigurable pins that are used as either bus request/bus grant ( $\overline{BR}/\overline{BG}$ ) or as bus strobe/wait ( $\overline{BS}/\overline{WT}$ ). The ability to insert wait states using  $\overline{BS}/\overline{WT}$  provides a means to connect asynchronous devices to the DSP, allows devices with differing timing requirements to reside in the same memory space, allows a bus arbiter to provide a fast multiprocessor bus access, and provides another means of halting the DSP at a known program location with a fast restart. Bus strobe in the original in-house documentation was called "memory ready strobe" and wait was called "memory ready". The original names have been changed to be more descriptive.

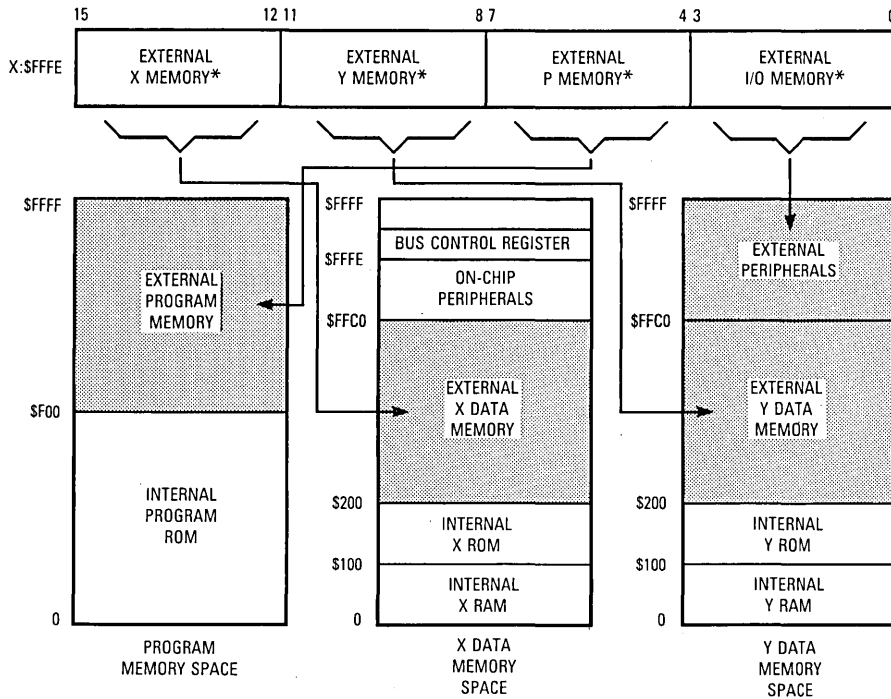

\*Zero to 15 wait states can be inserted into each external memory access.

Figure 9-10. Bus Control Register

RESET initializes the DSP in the  $\overline{BR}/\overline{BG}$  mode for compatibility. The  $\overline{BS}/\overline{WT}$  mode is selected if bit 7 in the OMR (see Figure 9-11) is set to one, which can be accomplished by executing an "ORI #80, OMR" instruction. Because the  $\overline{BR}/\overline{BG}$  and  $\overline{BS}/\overline{WT}$  modes are mutually exclusive, port A cannot be three-stated by an external device when in the  $\overline{BS}/\overline{WT}$  mode. The BCR is still operative in the  $\overline{BS}/\overline{WT}$  mode and defines the minimum number of wait states that are inserted.



EXTERNAL MEMORY ACCESS

0 BUS REQUEST/BUS GRANT ARBITRATION (RESET); USED BY A HOST TO THREE-STATE THE DSP56000 EXTERNAL BUS.

1 BUS STROBE/WAIT; USED BY A HOST TO DELAY OR STRETCH THE CURRENT DSP56000 BUS CYCLE

Figure 9-11. Port A Access Control

The timing of  $\overline{BS}$  and  $\overline{WT}$  pins is illustrated in Figure 9-12. Every external access,  $\overline{BS}$  is asserted concurrently with the address lines in  $T_0$ .  $\overline{BS}$  can be used by external wait-state logic to establish the start of an external access.  $\overline{BS}$  is deasserted in  $T_3$  of each external bus cycle, signaling that the current bus cycle will complete. Since the  $\overline{WT}$  signal is internally synchronized, it can be asserted asynchronously with respect to the system clock. The  $\overline{WT}$  signal should only be asserted while  $\overline{BS}$  is asserted. Asserting  $\overline{WT}$  while  $\overline{BS}$  is deasserted will give indeterminate results. However, for the number of inserted wait states to be deterministic,  $\overline{WT}$  timing must satisfy setup and hold timing with respect to the negative-going edge of  $\overline{EXTAL}$ . The setup and hold times are provided in the *DSP56001 Advance Information Data Sheet (ADI1290)*. The timing of  $\overline{WR}$  is controlled by the BCR and is independent of  $\overline{WT}$ . The minimum number of wait states that can be inserted using the  $\overline{WT}$  pin is two. Table 9-3 summarizes the effect of the BCR and  $\overline{WT}$  pin on the number of wait states generated.

OPERATING MODE REGISTER

|    |    |   |   |   |    |    |    |
|----|----|---|---|---|----|----|----|
| 7  | 6  | 5 | 4 | 3 | 2  | 1  | 0  |
| EM | SD | 0 | 0 | 0 | DE | MB | MA |

SET EM = 1

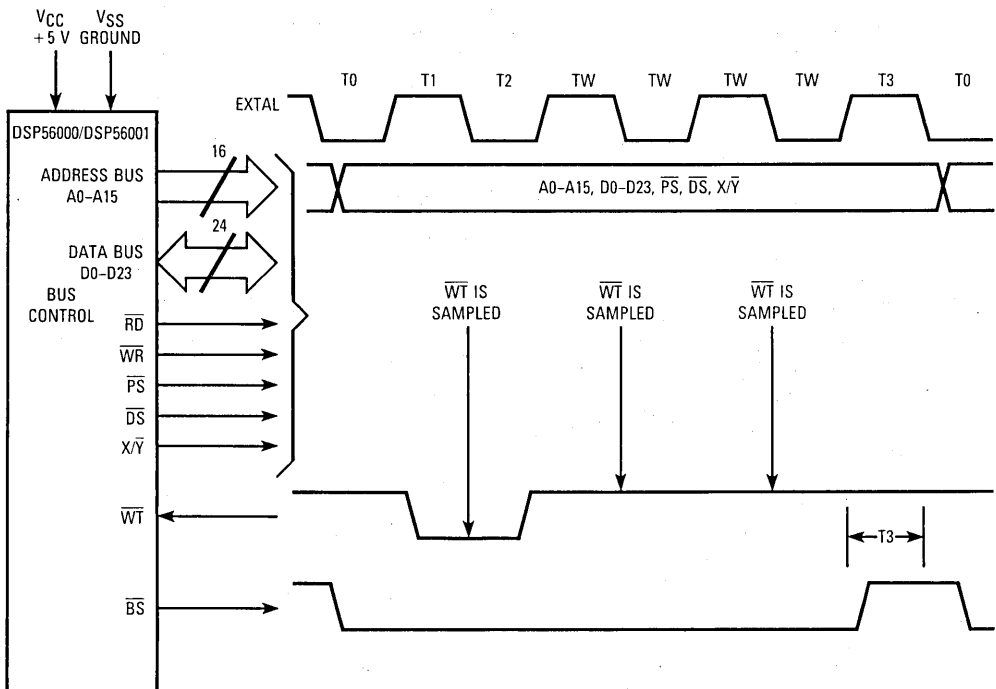

Figure 9-12. Bus Strobe/Wait Sequence



**Table 9-3. Wait State Control**

| BCR Contents | $\overline{WT}$ | Number of Wait States Generated  |
|--------------|-----------------|--|
| 0            | Deasserted      | 0  |
| 0            | Asserted        | 2 (minimum)  |
| >0           | Deasserted      | Equals value in BCR  |
| >0           | Asserted        | Minimum equals 2 or value in BCR. Maximum is determined by $\overline{WT}$ . |

### 9.3 BUS ARBITRATION

The  $\overline{BR}/\overline{BG}$  and  $\overline{BS}/\overline{WT}$  pins provide bus arbitration controls. The  $\overline{BR}/\overline{BG}$  mode allows an external device to request and be given control of the external memory bus (port A) while the DSP continues internal operations using internal memory spaces. This configuration allows a bus controller to arbitrate a multiple bus-master system. (A bus master can issue addresses on the bus; a bus slave can respond to addresses on the bus. A single device can be both a master and a slave, but can only be one or the other at any given time.) The  $\overline{BS}/\overline{BW}$  mode allows a bus arbitrator to extend the bus cycle of the DSP56000/DSP56001 to allow another bus master time to finish its bus access before allowing the DSP56000/DSP56001 access to the bus.

#### 9.3.1 Bus Request/Bus Grant

The  $\overline{BR}/\overline{BG}$  mode is selected if OMR bit 7 (see Figure 9-11) is set to zero (execute an “ANDI #7F,OMR” instruction). When  $\overline{BR}$  is asserted (see Figure 9-13), the DSP will assert  $\overline{BG}$  after the current external access cycle completes and will simultaneously three-state the port A signals (see the *DSP56001 Advance Information Data Sheet* (ADI1290) for exact timing of  $\overline{BR}/\overline{BG}$ ). The bus is then available to be used by the bus master requesting the bus. When  $\overline{BR}$  is deasserted,  $\overline{BG}$  is deasserted after the current external access, and the port A signals are no longer three-stated. Reset clears bit 7 of the OMR. Information on operation of the

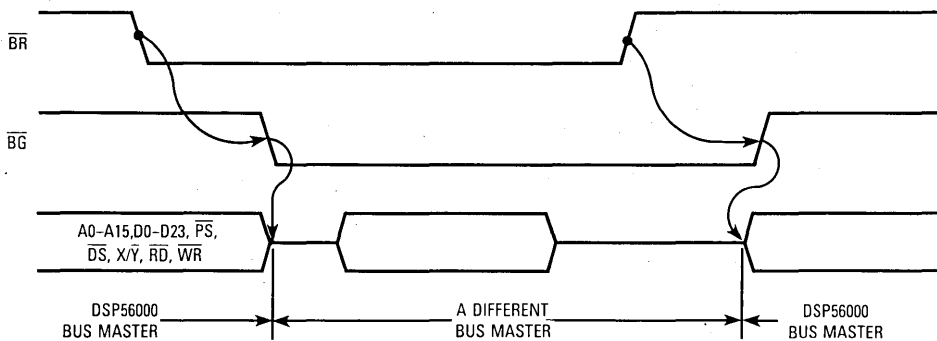

**Figure 9-13. Bus Request/Bus Grant Sequence**

$\overline{\text{BR}}/\overline{\text{BG}}$  pins after executing a WAIT or STOP instruction can be found in 8.4 WAIT PROCESSING STATE and 8.5 STOP PROCESSING STATE.

### 9.3.2 Shared Memory

The bus control signals described in the previous paragraphs provide the means to connect additional bus masters (which may be additional DSPs, microprocessors, direct memory access (DMA) controllers, etc.) to the port A bus. Four arbitration examples will be described in the following paragraphs: 1) bus arbitration using only  $\overline{\text{BR}}/\overline{\text{BG}}$  with internal control, 2) bus arbitration using only  $\overline{\text{BR}}/\overline{\text{BG}}$  with external control, 3) bus arbitration using  $\overline{\text{BR}}/\overline{\text{BG}}$  and  $\overline{\text{BS}}/\overline{\text{WT}}$  with no overhead, and 4) signaling using semaphores.

**9.3.2.1 BUS ARBITRATION USING ONLY  $\overline{\text{BR}}/\overline{\text{BG}}$  WITH INTERNAL CONTROL.** Perhaps the simplest example of a shared memory system using a DSP56000/DSP56001 is shown in Figure 9-14. The bus arbitration is performed internal to the DSP#2 by using software. DSP#2 controls all bus operations by using I/O pin OUT2 to three-state its own port A and by never accessing port A without first calling the subroutine that arbitrates the bus. When the DSP#2 needs to use external memory, it uses I/O pin OUT1 to request bus access and I/O pin IN1 to read bus grant. DSP#1 does not need any extra code for bus arbitration since the  $\overline{\text{BR}}/\overline{\text{BG}}$  hardware handles its bus arbitration automatically. The protocol for bus arbitration is as follows:

At RESET: DSP#2 sets  $\text{OUT2} = 0$  ( $\overline{\text{BR}}\#2 = 0$ ) and  $\text{OUT1} = 1$  ( $\overline{\text{BR}}\#1 = 1$ ), which gives DSP#1 access to the bus and suspends DSP#2 bus access.

When DSP#2 wants control of the memory, the following steps are performed (see Figure 9-15):

1. DSP# 2 sets  $\text{OUT1} = 0$  ( $\overline{\text{BR}}\#1 = 0$ ).
2. DSP# 2 waits for  $\text{IN1} = 0$  ( $\overline{\text{BG}}\#1 = 0$  and DSP#1 off the bus). This takes at most  $13T + 4T \cdot \text{WS} + 20$  ns (about 400 ns at 20 MHz) where T is  $t_{\text{cyc}}/4$  and WS is the number of wait states used by DSP# 1. If DSP#1 is not using any read/modify/write instructions in its external space, the maximum becomes only  $9T + 2T \cdot \text{WS} + 20$  ns (about 250 ns at 20 MHz).
3. DSP#2 sets  $\text{OUT2} = 1$  ( $\overline{\text{BR}}\#2 = 1$  to let DSP#2 on the bus).
4. DSP#2 accesses the bus for block transfers, etc. at full speed.
5. To release the bus, DSP#2 sets  $\text{OUT2} = 0$  ( $\overline{\text{BR}}\#2 = 0$ ) **after** the last external access.
6. DSP#2 then sets  $\text{OUT1} = 1$  ( $\overline{\text{BR}}\#1 = 1$ ) to return control of the bus to DSP#1.
7. DSP#1 then acknowledges mastership by deasserting  $\overline{\text{BG}}\#1$ .

**9.3.2.2 BUS ARBITRATION USING ONLY  $\overline{\text{BR}}/\overline{\text{BG}}$  WITH EXTERNAL CONTROL.** Figure 9-16 can be implemented with external bus arbitration logic, which will save processing

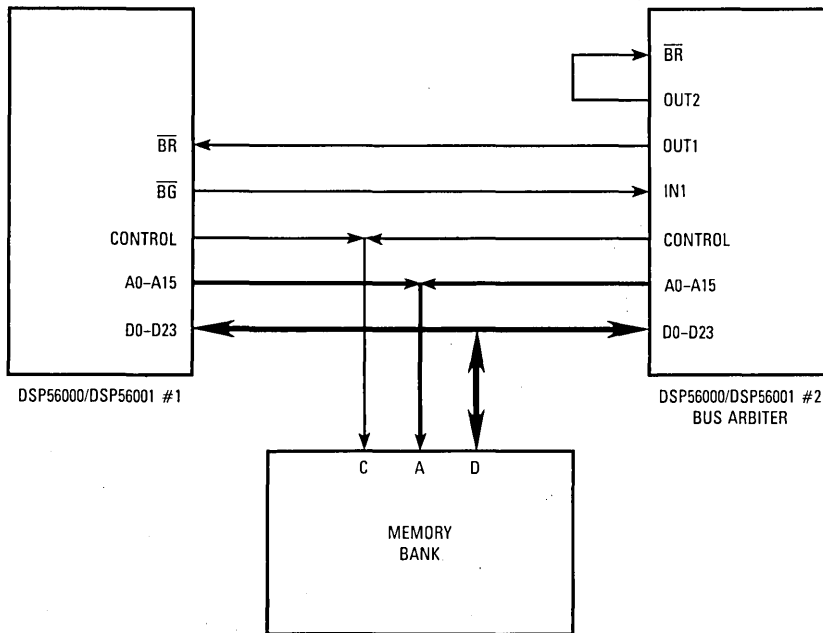

Figure 9-14. Bus Arbitration Using Only  $\overline{BR}/\overline{BG}$  with Internal Control

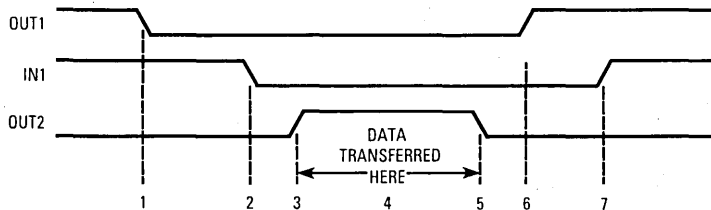

Figure 9-15. Two DSPs with External Bus Arbitration Timing

capacity on the DSPs and can make bus access much faster at a cost of additional hardware. Operation is similar to the system shown in Figure 9-14. The bus arbitration logic takes control of the external bus by deasserting an enable signal (E1, E2, and E3) to all DSPs, which will then acknowledge by granting the bus ( $\overline{BG} = 0$ ). When a DSP (DSP#1 in Figure 9-16) wants the bus, it will jump to a subroutine, which will set PC3 = 1. When the arbitration logic grants the bus to a DSP, it will issue a BG1 (BG2 for DSP#2; BG3 for DSP#3) to let the DSP know that it can have the bus. Arbitration logic will then enable the bus by asserting the appropriate enable (E1 = 1). When the DSP is ready to relinquish the bus, it deasserts PC3, and the arbiter deasserts E1 and BG1.

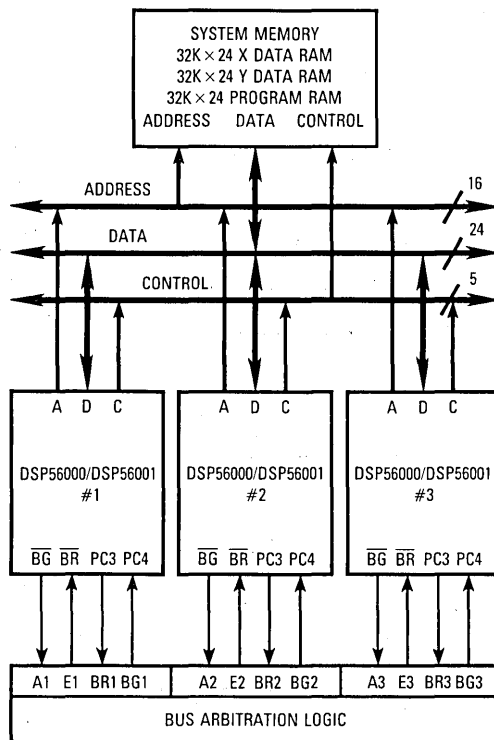

Figure 9-16. Bus Arbitration Using Only  $\overline{BR}/\overline{BG}$  with External Control

**9.3.2.3 BUS ARBITRATION USING  $\overline{BR}/\overline{BG}$  AND  $\overline{BS}/\overline{WT}$  WITH NO OVERHEAD.** By using the circuit shown in Figure 9-17, two DSPs can share memory with hardware arbitration that requires no software on the part of the DSPs. In Figure 9-17, DSP#1 has  $EM = 1$  in its OMR, and DSP#2 has  $EM = 0$  in its OMR. The protocol for bus arbitration in Figure 9-17 is as follows:

At RESET:  $\overline{BG}$  of DSP#2 is deasserted, which three-states the buffers, giving DSP#2 control of the memory. Reset causes DSP#1 to initially be in the  $\overline{BR}/\overline{BG}$  mode. DSP#1 OMR bit 7 must be set by software during initialization to change  $\overline{BR}/\overline{BG}$  to  $\overline{BS}/\overline{WT}$ .

When DSP#1 wants control of the memory the following steps are performed (see Figure 9-18):

1. DSP#1 makes an external access, thereby asserting  $\overline{BS}$ , which asserts  $\overline{WT}$  (causing DSP#1 to execute wait states in the current cycle) and asserts DSP#2  $\overline{BR}$  (requesting that DSP#2 release the bus).
2. When DSP#2 finishes its present bus cycle, it three-states its bus drivers and asserts  $\overline{BG}$ . Asserting  $\overline{BG}$  enables the three-state buffers, placing the DSP#1 signals on the

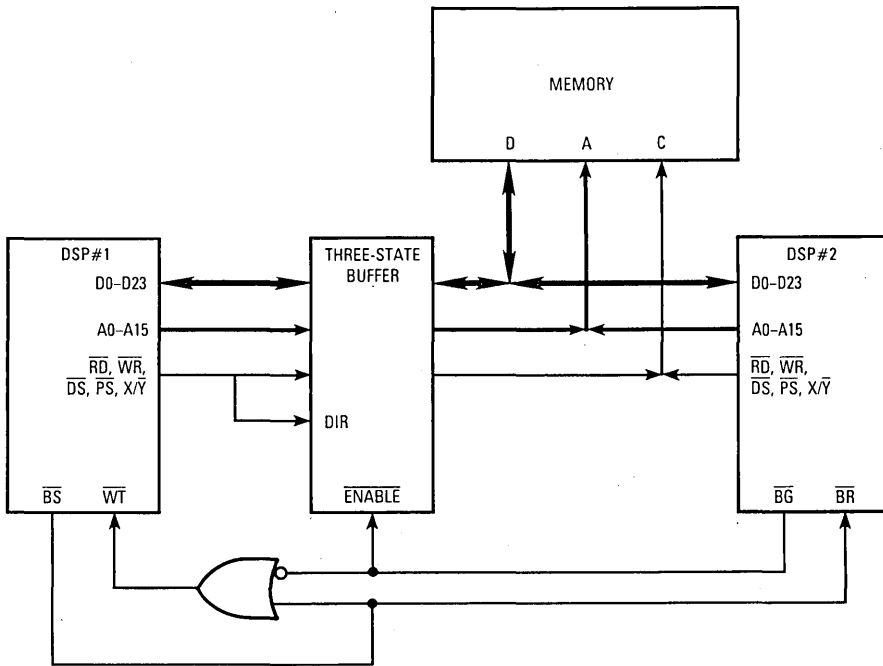

Figure 9-17. Bus Arbitration Using  $\overline{BR}/\overline{BG}$  and  $\overline{BS}/\overline{WT}$  with No Overhead

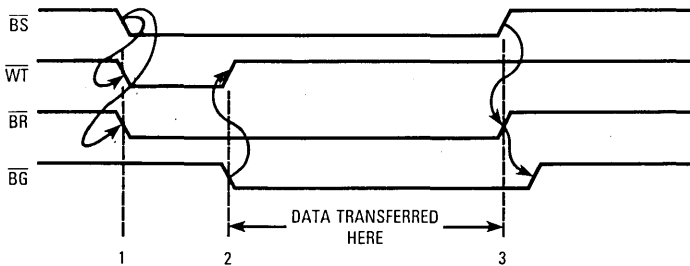
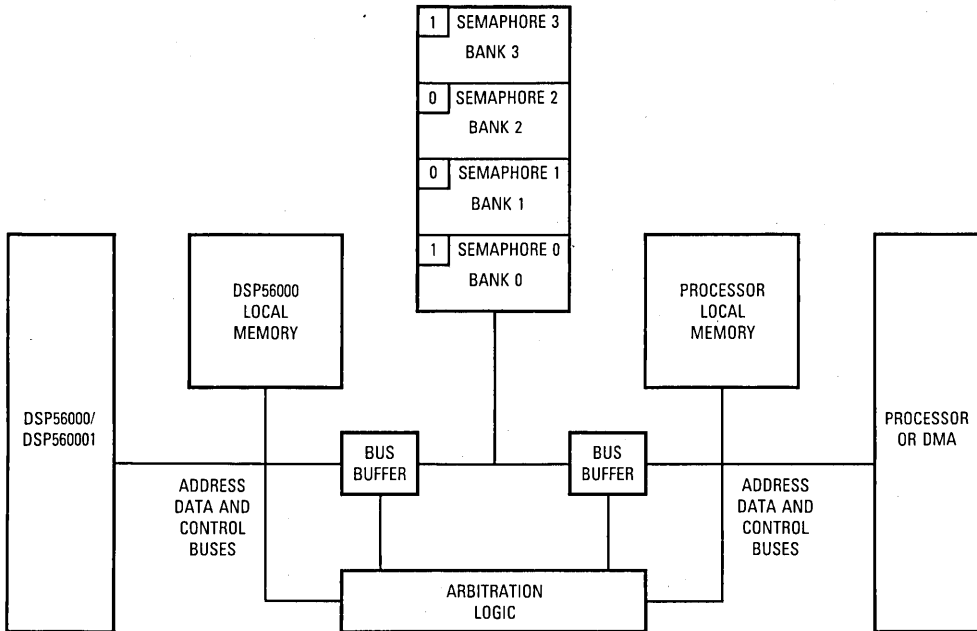

Figure 9-18. Two DSPs with External Bus Arbitration Timing

memory bus. Asserting  $\overline{BG}$  also deasserts  $\overline{WT}$ , which allows DSP#1 to finish its bus cycle.

- When DSP#1's memory cycle is complete, it releases  $\overline{BS}$ , which deasserts  $\overline{BR}$ . DSP#2 then deasserts  $\overline{BG}$ , three-stating the buffers and allowing DSP#2 to access the memory bus.

**9.3.2.4 SIGNALING USING SEMAPHORES.** Figure 9-19 shows a more sophisticated shared memory system that uses external arbitration with both local external memory and shared memory. The four semaphores are bits in one of the words in each shared memory bank used by software to arbitrate memory use. Semaphores are commonly used to indicate that the contents of the semaphore's memory blocks are being used by one processor and are not available for use by another processor. Typically, if the semaphore is cleared, the block is not allocated to a processor; if the semaphore is set, the block is allocated to a processor.



**Figure 9-19. Signaling Using Semaphores**

Without semaphores, one processor may try to use data while it is being changed by another processor, which may cause errors. This problem can occur in a shared memory system when separate test and set instructions are used to "lock" a data block for use by a single processor.

The correct procedure is to test the semaphore and then set the semaphore if it was clear to lock and gain exclusive use of the data block. The problem occurs when the second processor acquires the bus and tests the semaphore after the first processor tests the semaphore but before the first processor can lock the data block. The **incorrect** sequence

is 1) the first processor tests the semaphore and sees that the block is available; 2) the second processor then tests the bit and also sees that the block is available; 3) both processors then set the bit to lock the data; and 4) both proceed to use the data on the assumption that the data cannot be changed by another processor.

The DSP56000/DSP56001 has a group of instructions designed to prevent this problem. They perform an indivisible read-modify-write operation and do not release the bus between the read and write (specifically,  $A0-A15$ ,  $\overline{DS}$ ,  $\overline{PS}$ , and  $X/\overline{Y}$  do not change state). Not releasing the bus allows these instructions to test the semaphore and then to set, clear, or change the semaphore without the possibility of another processor testing the semaphore before it is changed. The instructions are bit test and change (BCHG), bit test and clear (BCLR), and bit test and set (BSET). The proper way to set the semaphore to gain exclusive access to a memory block is to use BSET to test the semaphore and to set it to one. After the bit is set, the result of the test operation will reveal if the semaphore was clear before it was set by BSET and if the memory block is available. If the bit was already set and the block is in use by another processor, the DSP will wait to access the memory block.





## SECTION 10 PORT B

Port B is a dual-purpose I/O port that can be used as 1) 15 general-purpose pins individually configurable as either inputs or outputs or as 2) an 8-bit bidirectional host interface (HI) (see Figure 10-1). When configured as general-purpose I/O, port B can be used for device control. When configured as the HI, port B provides a convenient connection to another processor. This section describes both port B configurations, including examples of how to configure and use the port.

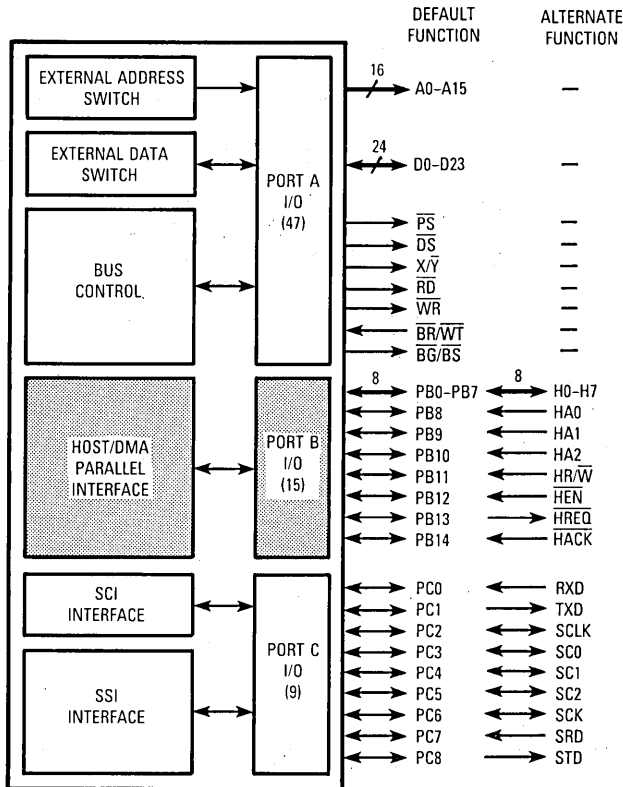

**Figure 10-1. Port B Interface**

## 10.1 GENERAL-PURPOSE I/O

When it is configured as general-purpose I/O, port B can be viewed as three memory-mapped registers (see Figure 10-2) that control 15 I/O pins (see Figure 10-3). The software and hardware reset configure port B as general-purpose I/O with all 15 pins as inputs by clearing all three registers (external circuitry connected to these pins may need pullups until the pins are configured for operation). These registers are the port B control register (PBC), port B data direction register (PBDDR), and port B data register (PBD). Selection between general-purpose I/O and HI is made by setting PBC bit 0 (memory location X:\$FFE0) to zero for general-purpose I/O or to one for HI. The PBDDR (memory location X:\$FFE2) selects each corresponding pin in the PBD (memory location X:\$FFE4), as an input pin if the PBDDR bit equals zero or as an output pin if the PBDDR bit equals one.

The port B I/O pin control logic is shown in Figure 10-4. Writing to PBD will write data to the pins designated as outputs by the PBDDR; reading the PBD will read the level on the pins designated as inputs by the PBDDR. When a pin is designated as an output and the

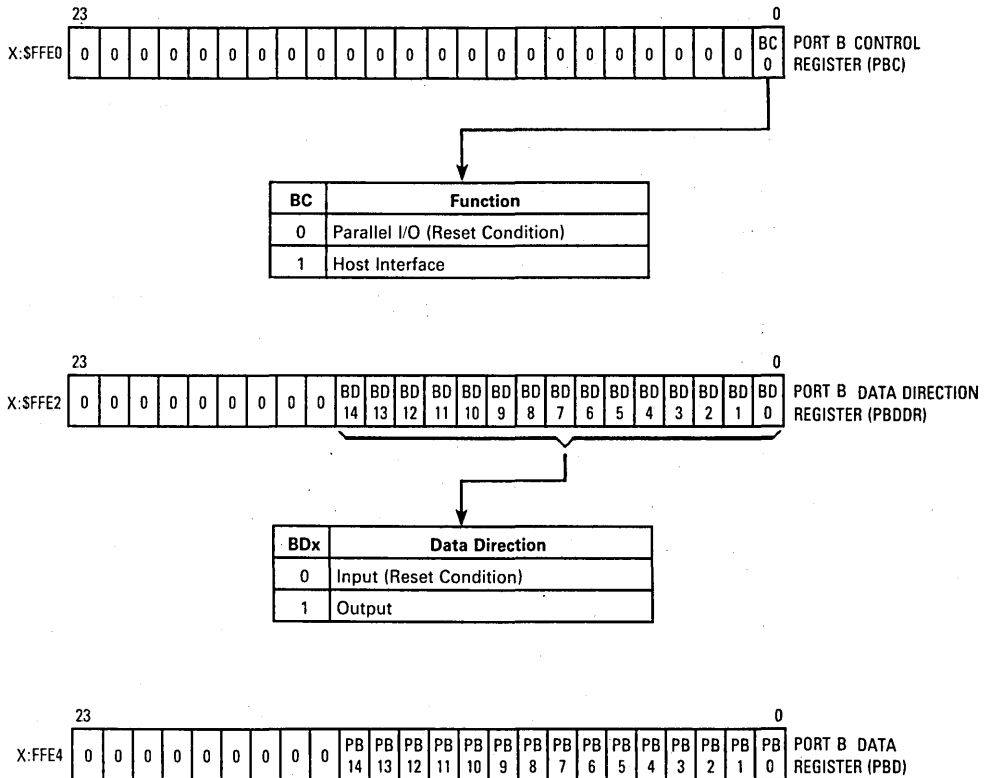

Figure 10-2. Parallel Port B Registers

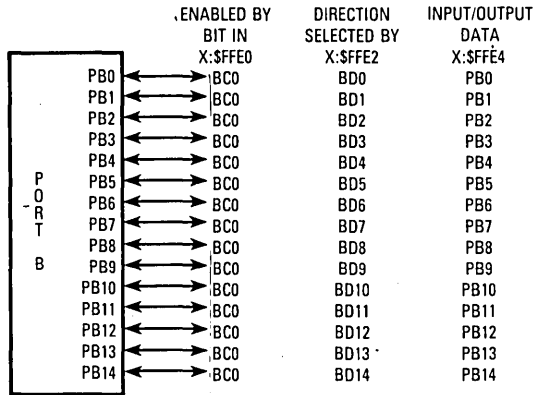

Figure 10-3. Parallel Port B Pinout

| Port Control Register Bit | Data Direction Register Bit | Pin Function       |
|---------------------------|-----------------------------|--------------------|
| 0                         | 0                           | Port Input Pin     |
| 0                         | 1                           | Port Output Pin    |
| 1                         | X                           | Alternate Function |

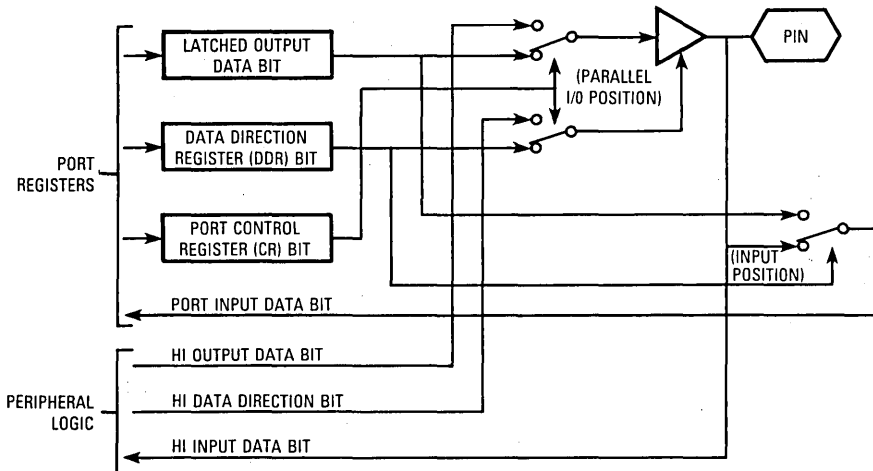

Figure 10-4. Port B I/O Pin Control Logic

PBD is read, the output of the output data bit latch is read, not the logic level on the pin itself. When the port is configured as the HI and the bit in the PBDDR is zero (input), then reading the PBD will show the logic level on the pin even though port B is configured as the HI. The HI function may be using the pin as an input or an output. This feature can be very useful when debugging the HI.

### 10.1.1 Programming Parallel I/O

Port B is a memory-mapped peripheral as are all of the DSP56000/DSP56001 peripherals (see Figure 10-5). The standard MOVE instruction transfers data between port B and a register; as a result, MOVE takes two instructions to perform a memory-to-memory data transfer and uses a temporary holding register. The MOVEP instruction is specifically designed for I/O data transfer as shown in Figure 10-6. Although the MOVEP instruction may take twice as long to execute as a MOVE instruction, only one MOVEP is required for a memory-to-memory data transfer, and MOVEP does not use a temporary register. Using the MOVEP instruction allows a fast interrupt to move data to/from a peripheral to memory and execute one other instruction or move the data to an absolute address. MOVEP is the only memory-to-memory move instruction; however, one of the operands must be in the top 64 locations of either X: or Y: memory.

The bit-oriented instructions that use I/O short addressing (BCHG, BCLR, BSET, BTST, JCLR, JSCLR, JSET, and JSSET) can also be used to address individual bits for faster I/O processing. The digital signal processor (DSP) does not have a hardware data strobe to strobe data out of the parallel I/O port. If a strobe is needed, it can be implemented using software to toggle one of the parallel I/O pins. The process of programming port B as general-purpose I/O is shown in Figure 10-7 and detailed in Figure 10-8. Normally, it is not good programming practice to activate a peripheral before programming it. However, reset activates the port B general-purpose I/O as all inputs; the alternative is to configure port B as an HI, which may not be desirable. In this case, it is probably better to insure that port B is initially configured for general-purpose I/O, and then configure the data direction and data registers. It may be better in some situations to program the data direction or the data registers first to prevent two devices from driving one signal. The order of steps 1, 2, and 3 in Figure 10-7 is optional and can be changed as needed.

### 10.1.2 Port B Parallel I/O Timing

Parallel data written to port B is synchronized to the central processing unit (CPU) but delayed by one instruction cycle — i.e., the instruction

```
MOVE DATA15,X:PORTB DATA24,Y:EXTERN
```

1) writes 15 bits of data to the port B register, but the output pins do not change until the following instruction cycle, and 2) writes 24 bits of data to the external Y memory, which appears on port A during T2 and T3 of the current instruction.

|                 | 23        | 16 | 15 | 8         | 7 | 0         |   |
|-----------------|-----------|----|----|-----------|---|-----------|---|
| X:\$FFFF        | [Pattern] |    |    | [Pattern] |   | [Pattern] | INTERRUPT PRIORITY REGISTER (IPR)               |
| X:\$FFFE        | [Pattern] |    |    | [Pattern] |   | [Pattern] | PORT A — BUS CONTROL REGISTER (BCR)             |
| X:\$FFFD        | [Pattern] |    |    | [Pattern] |   | [Pattern] | RESERVED  |
| X:\$FFFC        | [Pattern] |    |    | [Pattern] |   | [Pattern] | RESERVED  |
| X:\$FFFB        | [Pattern] |    |    | [Pattern] |   | [Pattern] | RESERVED  |
| X:\$FFFA        | [Pattern] |    |    | [Pattern] |   | [Pattern] | RESERVED  |
| X:\$FFF9        | [Pattern] |    |    | [Pattern] |   | [Pattern] | RESERVED  |
| X:\$FFF8        | [Pattern] |    |    | [Pattern] |   | [Pattern] | RESERVED  |
| X:\$FFF7        | [Pattern] |    |    | [Pattern] |   | [Pattern] | RESERVED  |
| X:\$FFF6        | [Pattern] |    |    | [Pattern] |   | [Pattern] | SCI HI-REC/XMIT DATA REGISTER (SRX/STX)         |
| X:\$FFF5        | [Pattern] |    |    | [Pattern] |   | [Pattern] | SCI MID-REC/XMIT DATA REGISTER (SRX/STX)        |
| X:\$FFF4        | [Pattern] |    |    | [Pattern] |   | [Pattern] | SCI LOW-REC/XMIT DATA REGISTER (SRX/STX)        |
| X:\$FFF3        | [Pattern] |    |    | [Pattern] |   | [Pattern] | SCI TRANSMIT DATA ADDRESS REGISTER (STXA)       |
| X:\$FFF2        | [Pattern] |    |    | [Pattern] |   | [Pattern] | SCI CONTROL REGISTER (SCCR)                     |
| X:\$FFF1        | [Pattern] |    |    | [Pattern] |   | [Pattern] | SCI INTERFACE STATUS REGISTER (SSR)             |
| X:\$FFF0        | [Pattern] |    |    | [Pattern] |   | [Pattern] | SCI INTERFACE CONTROL REGISTER (SCR)            |
| X:\$FFEF        | [Pattern] |    |    | [Pattern] |   | [Pattern] | SCI RECEIVE/TRANSMIT DATA REGISTER (RX/TX)      |
| X:\$FFEE        | [Pattern] |    |    | [Pattern] |   | [Pattern] | SSI STATUS/TIME SLOT REGISTER (SR/TSR)          |
| X:\$FFED        | [Pattern] |    |    | [Pattern] |   | [Pattern] | SSI CONTROL REGISTER B (CRB)                    |
| X:\$FFEC        | [Pattern] |    |    | [Pattern] |   | [Pattern] | SSI CONTROL REGISTER A (CRA)                    |
| X:\$FFEB        | [Pattern] |    |    | [Pattern] |   | [Pattern] | HOST RECEIVE/TRANSMIT REGISTER (HRX/HTX)        |
| X:\$FFEA        | [Pattern] |    |    | [Pattern] |   | [Pattern] | UNUSED  |
| X:\$FFE9        | [Pattern] |    |    | [Pattern] |   | [Pattern] | HOST STATUS REGISTER (HSR)                      |
| X:\$FFE8        | [Pattern] |    |    | [Pattern] |   | [Pattern] | HOST CONTROL REGISTER (HCR)                     |
| X:\$FFE7        | [Pattern] |    |    | [Pattern] |   | [Pattern] | RESERVED  |
| X:\$FFE6        | [Pattern] |    |    | [Pattern] |   | [Pattern] | RESERVED  |
| X:\$FFE5        | [Pattern] |    |    | [Pattern] |   | [Pattern] | PORT C — DATA REGISTER (PCD)                    |
| <b>X:\$FFE4</b> | [Pattern] |    |    | [Pattern] |   | [Pattern] | <b>PORT B — DATA REGISTER (PBD)</b>             |
| X:\$FFE3        | [Pattern] |    |    | [Pattern] |   | [Pattern] | PORT C — DATA DIRECTION REGISTER (PCDDR)        |
| <b>X:\$FFE2</b> | [Pattern] |    |    | [Pattern] |   | [Pattern] | <b>PORT B — DATA DIRECTION REGISTER (PBDDR)</b> |
| X:\$FFE1        | [Pattern] |    |    | [Pattern] |   | [Pattern] | PORT C — CONTROL REGISTER (PCC)                 |
| <b>X:\$FFE0</b> | [Pattern] |    |    | [Pattern] |   | [Pattern] | <b>PORT B — BUS CONTROL REGISTER (PBC)</b>      |
| X:\$FFDF        | [Pattern] |    |    | [Pattern] |   | [Pattern] | RESERVED  |
| X:\$FFC0        | [Pattern] |    |    | [Pattern] |   | [Pattern] | RESERVED  |

[Pattern] = Read as random number; write as don't care.

Figure 10-5. On-Chip Peripheral Memory Map

```

•
MOVE    #0,X:$FFE0      ;Select Port B to be general-purpose I/O

MOVE    #0,X:$FFE2      ;Select pins PB0–PB7 to be inputs
•
•
•
MOVEP   #data_out,X:$FFE4 ;Put bits 8-14 of "data_out" on pins
•
•
MOVEP   X:$FFE4,#data_in ;Put PB0–PB7 in bits 0–7 of "data_in"

```

**Figure 10-6. Write/Read Parallel Data with Port B**

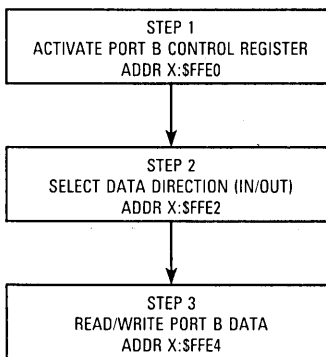

**Figure 10-7. Port B Configuration Flowchart**

10

As a result, if it is desirable to synchronize port A and port B outputs, two instructions must be used:

```

MOVE    DATA15,X:PORTB
NOP                                DATA24,Y:EXTERN

```

The NOP can be replaced by any instruction that allows parallel moves. Inserting one or more "MOVE DATA15,X:PORTB DATA24,Y:EXTERN" instructions between the first and second instruction effectively produces an external 39-bit write each instruction cycle with only one instruction cycle lost in setup time:

```

MOVE    DATA15,X:PORTB
MOVE    DATA15,X:PORTB DATA24,Y:EXTERN
MOVE    DATA15,X:PORTB DATA24,Y:EXTERN
:
:
MOVE    DATA15,X:PORTB DATA24,Y:EXTERN
NOP                                DATA24,Y:EXTERN

```

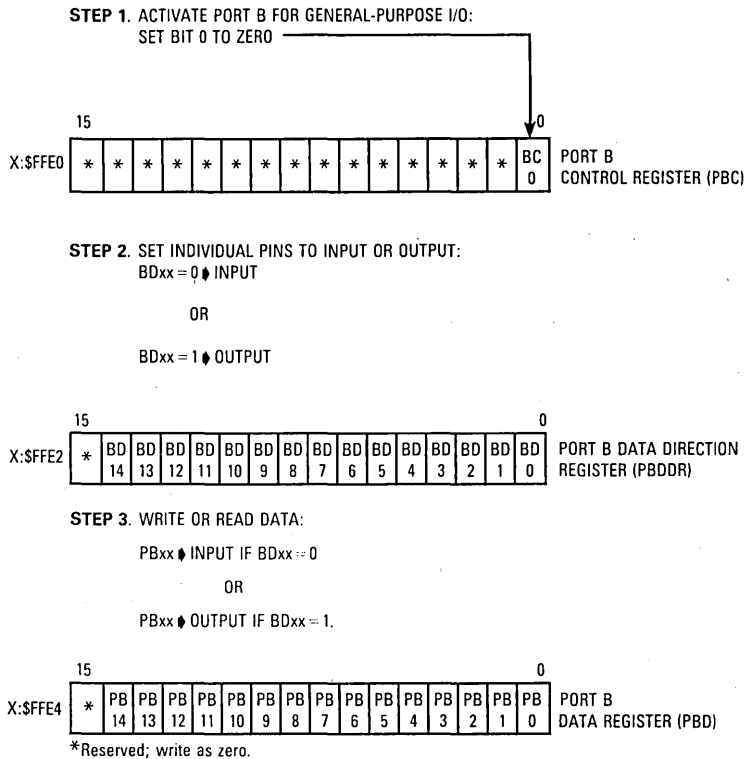

**Figure 10-8. I/O Port B Configuration**

One application of this technique is to create an extended address for port A by concatenating the port A address bits (instead of data bits) to the port B general-purpose output bits. The port B general-purpose I/O register would then work as a base address register, allowing the address space to be extended from 64K words (16 bits) to two billion words (16 bits + 15 bits = 31 bits).

Port B uses the DSP CPU four-phase clock for its operation. Therefore, if wait states are inserted in the DSP CPU timing, they also affect port B timing. The result is that ports A and B in the previous synchronization example will always stay synchronized, regardless of how many wait states are used.

**10.2 HOST INTERFACE (HI)**

The HI is a byte-wide, full-duplex, double-buffered, parallel port which may be connected directly to the data bus of a host processor. The host processor may be any of a number

of industry standard microcomputers or microprocessors, another DSP, or DMA hardware because this interface looks like static memory. The HI is asynchronous and consists of two banks of registers — one bank accessible to the host processor and a second bank accessible to the DSP CPU (see Figure 10-9). A brief description of the HI features is presented in the following listing:

### Speed

8 Mbyte/Sec Burst Data Transfer Rate

1.71 Million Word/Sec Interrupt Driven Data Transfer Rate (This is the maximum interrupt rate for the DSP56000/DSP56001 running at 20.5 MHz — i.e., one interrupt every six instruction cycles.)

### Signals (15 Pins)

|         |                         |
|---------|-------------------------|
| H0-H7   | Host Data Bus           |
| HA0-HA2 | Host Address Select     |
| HR/W    | Host Read/Write Control |
| HEN     | Host Transfer Enable    |
| HREQ    | Host Request            |
| HACK    | Host Acknowledge        |

### Interface — DSP CPU Side

Mapping: Three X: Memory Locations

Data Word: 24 Bits

Transfer Modes:

- DSP to Host
- Host to DSP
- Host Command

Handshaking Protocols:

- Software Polled
- Interrupt Driven (Fast or Long)
- Direct Memory Access

Instructions:

Memory-mapped registers allow the standard MOVE instruction to be used.

Special MOVEP instruction provides for I/O service capability using fast interrupts.

Bit addressing instructions (BCHG, BCLR, BSET, BTST, JCLR, JSCLR, JSET, JSSET) simplify I/O service routines.

I/O short addressing provides faster execution with fewer instruction words.



## Interface — Host Side

### Mapping:

- Eight Consecutive Memory Locations
- Memory-Mapped Peripheral for Microprocessors, DMA Controllers, etc.

Data Word: Eight Bits

### Transfer Modes:

- DSP to Host
- Host to DSP
- Host Command
- Mixed 8-, 16-, and 24-Bit Data Transfers

### Handshaking Protocols:

- Software Polled
- Interrupt Driven — Compatible with MC68000
- Cycle Stealing DMA with Initialization

### Dedicated Interrupts:

- Separate Interrupt Vectors for Each Interrupt Source

Special host commands force DSP CPU interrupts under host processor control, which are useful for

- Real-Time Production Diagnostics
- Debugging Window for Program Development
- Host Control Protocols and DMA Setup

Figure 10-9 is a block diagram showing the registers in the HI. These registers can be divided vertically down the middle into registers visible to the host processor on the left and registers visible to the DSP on the right. They can also be divided horizontally into control at the top, DSP-to-host data transfer in the middle (HTX, RXH, RXM, and RXL), and host-to-DSP data transfer at the bottom (THX, TXM, TXL, and HRX).

10

### 10.2.1 Host Interface — DSP CPU Viewpoint

The DSP CPU views the HI as a memory-mapped peripheral occupying three 24-bit words in data memory space. The DSP may use the HI as a normal memory-mapped peripheral, using either standard polled or interrupt programming techniques. Separate transmit and receive data registers are double buffered to allow the DSP and host processor to efficiently transfer data at high speed. Memory mapping allows DSP CPU communication with the HI registers to be accomplished using standard instructions and addressing modes. In addition, the MOVEP instruction allows HI-to-memory and memory-to-HI data transfers without going through an intermediate register. Both hardware and software reset disable the HI and change port B to general-purpose I/O with all pins designated as inputs.

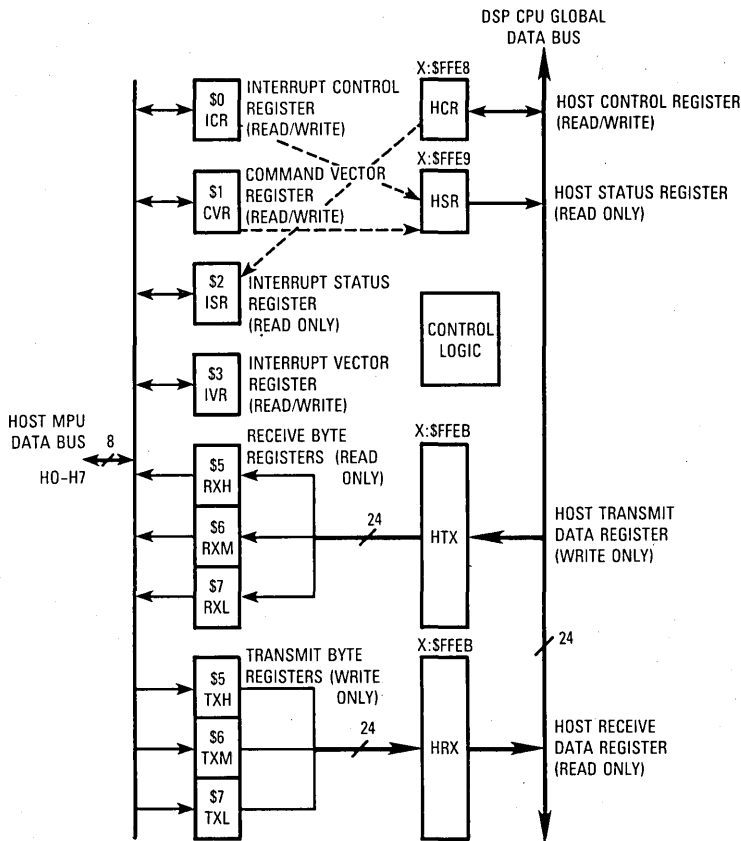
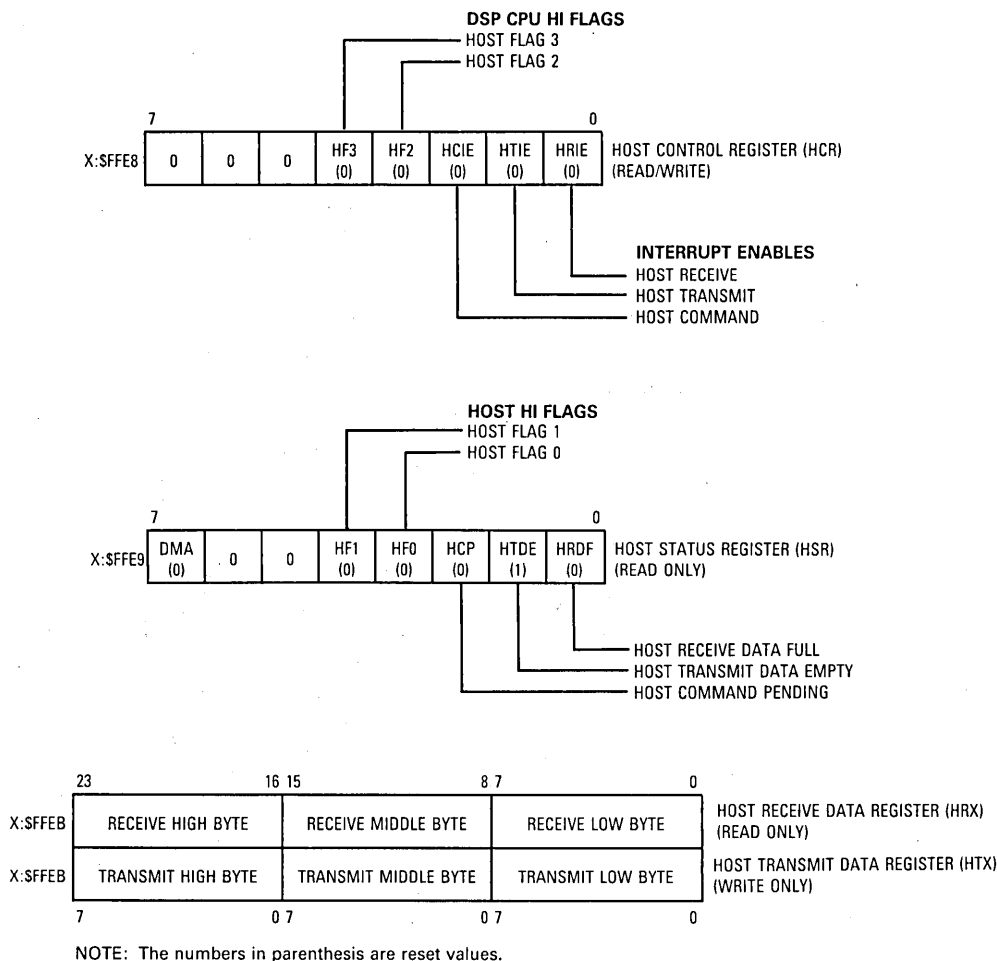

Figure 10-9. HI Block Diagram

### 10.2.2 Programming Model — DSP CPU Viewpoint

The HI has two programming models — one for the DSP programmer and one for the host processor programmer. In most cases, the notation used reflects the DSP perspective. The HI — DSP programming model is shown in Figure 10-10. There are three registers: 1) a control register (HCR), 2) a status register (HSR), and 3) a data transmit/receive register (HTX/HRX). These registers can only be accessed by the DSP56000/DSP56001; they can not be accessed by the host processor. The HI host processor programming model is shown in Figure 10-13.

The following paragraphs describe the purpose and operation of each bit in each register of the HI visible to the DSP CPU. The effects of the different types of reset on these registers are shown. A brief discussion of interrupts and operation of the DSP side of the HI complete



**Figure 10-10. Host Interface Programming Model — DSP Viewpoint**

the programming model from the DSP viewpoint. The programming model from the host viewpoint begins at **10.2.3.1 PROGRAMMING MODEL — HOST PROCESSOR VIEWPOINT.**

**10.2.2.1 HOST CONTROL REGISTER (HCR).** The HCR is an 8-bit read/write control register used by the DSP to control the HI interrupts and flags. The HCR cannot be accessed by the host processor. The HCR occupies the low-order byte of the internal data bus; the high-order portion is zero filled. HCR is a read/write register to allow individual control register bits to be set or cleared. Any reserved bits are read as zeros and should be programmed

as zeros for future compatibility. The bit manipulation instructions are useful for accessing the individual bits. The contents of HCR are cleared on hardware or software reset. The control bits are described in the following paragraphs.

**10.2.2.1.1 HCR Host Receive Interrupt Enable (HRIE) Bit 0.** The HRIE bit is used to enable a DSP interrupt when the host receive data full (HRDF) status bit in the host status register (HSR) is set. When HRIE is cleared, HRDF interrupts are disabled. When HRIE is set, a host receive data interrupt request will occur if HRDF is set. Hardware and software resets clear HRIE.

**10.2.2.1.2 HCR Host Transmit Interrupt Enable (HTIE) Bit 1.** The HTIE bit is used to enable a DSP interrupt when the host transmit data empty (HTDE) status bit in the HSR is set. When HTIE is cleared, HTDE interrupts are disabled. When HTIE is set, a host transmit data interrupt request will occur if HTDE is set. Hardware and software resets clear HTIE.

**10.2.2.1.3 HCR Host Command Interrupt Enable (HCIE) Bit 2.** The HCIE bit is used to enable a vectored DSP interrupt when the host command pending (HCP) status bit in the HSR is set. When HCIE is cleared, HCP interrupts are disabled. When HCIE is set, a host command interrupt request will occur if HCP is set. The starting address of this interrupt is determined by the host vector (HV). Hardware and software resets clear HCIE.

**10.2.2.1.4 HCR Host Flag 2 (HF2) Bit 3.** The HF2 bit is used as a general-purpose flag for DSP-to-host communication. HF2 may be set or cleared by the DSP. HF2 is visible in the interrupt status register (ISR) on the host processor side (see Figure 10-11). Hardware and software resets clear HF2.

#### NOTE

There are four host flags: two used by the host to signal the DSP (HF0 and HF1) and two used by the DSP to signal the host processor (HF2 and HF3). These flags are not designated for any specific purpose but are general-purpose flags. The host flags do not cause interrupts; they must be polled to see if they have changed. These flags can be used individually or as encoded pairs. See **10.2.2.7 HOST PORT USAGE CONSIDERATIONS** for additional information. An example of the usage of host flags is the bootstrap loader, which is listed in the *DSP56001 Advance Information Data Sheet* (ADI1290). Host flags are used to tell the bootstrap program whether or not to terminate early.

**10.2.2.1.5 HCR Host Flag 3 (HF3) Bit 4.** The HF3 bit is used as a general-purpose flag for DSP-to-host communication. HF3 may be set or cleared by the DSP. HF3 is visible in the ISR on the host processor side (see Figure 10-11). Hardware and software resets clear HF3.

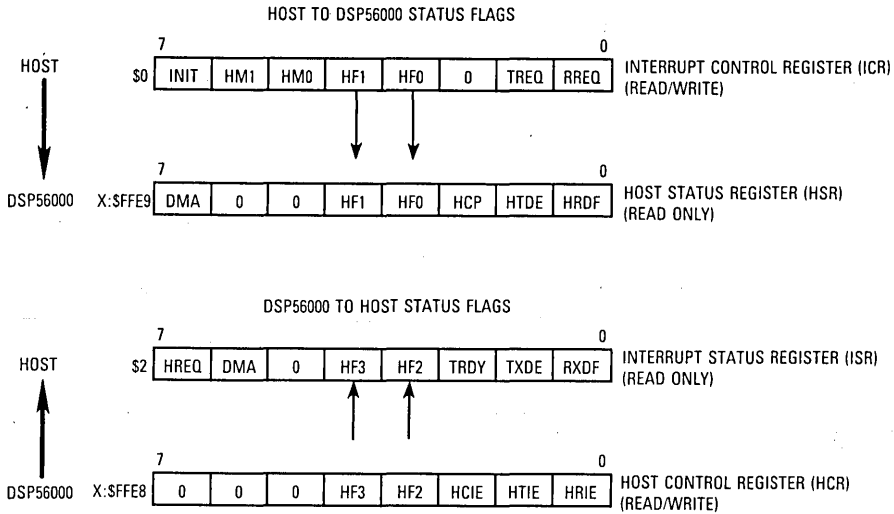

**Figure 10-11. Host Flag Operation**

**10.2.2.1.6 HCR Reserved Bits (Bits 5, 6, and 7).** These unused bits are reserved for future expansion and should be written with zeros for upward compatibility.

**10.2.2.2 HOST STATUS REGISTER (HSR).** The HSR is an 8-bit read-only status register used by the DSP to interrogate status and flags of the HI. It can not be directly accessed by the host processor. When the HSR is read to the internal data bus, the register contents occupy the low-order byte of the data bus; the high-order portion is zero filled. The status bits are described in the following paragraphs.

**10.2.2.2.1 HSR Host Receive Data Full (HRDF) Bit 0.** The HRDF bit indicates that the host receive data register (HRX) contains data from the host processor. HRDF is set when data is transferred from the TXH:TXM:TXL registers to the HRX register. HRDF is cleared when HRX is read by the DSP. HRDF can also be cleared by the host processor using the initialize function. Hardware, software, individual, and STOP resets clear HRDF.

**10.2.2.2.2 HSR Host Transmit Data Empty (HTDE) Bit 1.** The HTDE bit indicates that the host transmit data register (HTX) is empty and can be written by the DSP. HTDE is set when the HTX register is transferred to the RXH:RXM:RXL registers. HTDE is cleared when HTX is written by the DSP. HTDE can also be set by the host processor using the initialize function. Hardware, software, individual, and STOP resets set HTDE.

**10.2.2.2.3 HSR Host Command Pending (HCP) Bit 2.** The HCP bit indicates that the host has set the HC bit and that a host command interrupt is pending. The HCP bit reflects the status of the HC bit in the command vector register (CVR). HC and HCP are cleared by the DSP exception hardware when the exception is taken. The host can clear HC, which also clears HCP. Hardware, software, individual, and STOP resets clear HCP.

**10.2.2.2.4 HSR Host Flag 0 (HF0) Bit 3.** The HF0 bit in the HSR indicates the state of host flag 0 in the ICR on the host processor side. HF0 can only be changed by the host processor (see Figure 10-11). Hardware, software, individual, and STOP resets clear HF0.

**10.2.2.2.5 HSR Host Flag 1 (HF1) Bit 4.** The HF1 bit in the HSR indicates the state of host flag 1 in the ICR on the host processor side. HF1 can only be changed by the host processor (see Figure 10-11). Hardware, software, individual, and STOP resets clear HF1.

**10.2.2.2.6 HSR Reserved Bits (Bits 5 and 6).** These status bits are reserved for future expansion and read as zero during DSP read operations.

**10.2.2.2.7 HSR DMA Status (DMA) Bit 7.** The DMA bit indicates that the host processor has enabled the DMA mode of the HI by setting HM1 or HM0 to one. When DMA bit is zero, it indicates that the DMA mode is disabled by the HM0 and HM1 bits in the ICR and that no DMA operations are pending. When DMA bit is set, the DMA mode has been enabled by one or more of the host mode bits being set to one. The channel not in use can be used for polled or interrupt operation by the DSP. Hardware, software, individual, and STOP resets clear the DMA bit.

**10.2.2.3 HOST RECEIVE DATA REGISTER (HRX).** The HRX register is used for host-to-DSP data transfers. The HRX register is viewed as a 24-bit read-only register by the DSP CPU. The HRX register is loaded with 24-bit data from the transmit data registers (TXH:TXM:TXL) on the host processor side when both the transmit data register empty TXDE on the host processor side and DSP host receive data full (HRDF) bits are cleared. This transfer operation sets TXDE and HRDF. The HRX register contains valid data when the HRDF bit is set. Reading HRX clears HRDF. The DSP may program the HRIE bit to cause a host receive data interrupt when HRDF is set. Resets do not affect HRX.

**10.2.2.4 HOST TRANSMIT DATA REGISTER (HTX).** The HTX register is used for DSP-to-host data transfers. The HTX register is viewed as a 24-bit write-only register by the DSP CPU. Writing the HTX register clears HTDE. The DSP may program the HTIE bit to cause a host transmit data interrupt when HTDE is set. The HTX register is transferred as 24-bit data to the receive byte registers (RXH:RXM:RXL) if both the HTDE bit (DSP CPU side) and receive data full (RXDF) status bits (host processor side) are cleared. This transfer operation

sets RXDF and HTDE. Data should not be written to the HTX until HTDE is set to prevent the previous data from being overwritten. Resets do not affect HTX.

**10.2.2.5 REGISTER CONTENTS AFTER RESET.** Table 10-1 shows the results of four reset types on bits in each of the HI registers seen by the DSP CPU. The hardware reset (HW) is caused by the  $\overline{\text{RESET}}$  signal; the software reset (SW) is caused by executing the RESET instruction; the individual reset (IR) is caused by clearing the PBC register bit 0; and the stop reset (ST) is caused by executing the STOP instruction.

**Table 10-1. Host Registers after Reset — DSP CPU Side**

| Register Name | Register Data | Reset Type |          |          |          |
|---------------|---------------|------------|----------|----------|----------|
|               |               | HW Reset   | SW Reset | IR Reset | ST Reset |
| HCR           | HF(3-2)       | 0          | 0        | —        | —        |
|               | HCIE          | 0          | 0        | —        | —        |
|               | HTIE          | 0          | 0        | —        | —        |
|               | HRIE          | 0          | 0        | —        | —        |
| HSR           | DMA           | 0          | 0        | 0        | 0        |
|               | HF(1-0)       | 0          | 0        | 0        | 0        |
|               | HCP           | 0          | 0        | 0        | 0        |
|               | HTDE          | 1          | 1        | 1        | 1        |
|               | HRDF          | 0          | 0        | 0        | 0        |
| HRX           | HRX(23-0)     | —          | —        | —        | —        |
| HTX           | HTX(23-0)     | —          | —        | —        | —        |

**10.2.2.6 HOST INTERFACE DSP CPU INTERRUPTS.** The HI may request interrupt service from either the DSP or the host processor. The DSP CPU interrupts are internal and do not require the use of an external interrupt pin (see Figure 10-12). When the appropriate mask bit in the HCR is set, an interrupt condition caused by the host processor sets the appropriate bit in the HSR, which generates an interrupt request to the DSP CPU. The DSP acknowledges interrupts caused by the host processor by jumping to the appropriate interrupt service routine. The three possible interrupts are 1) receive data register full, 2) transmit data register empty, and 3) host command. The host command can access any interrupt vector in the interrupt vector table although it has a set of vectors reserved for host command use. The DSP interrupt service routine must read or write the appropriate HI register (i.e., clearing HRDF or HTDE, for example) to clear the interrupt. In the case of host command interrupts, the interrupt acknowledge from the program controller will clear the pending interrupt condition.

**10.2.2.7 HOST PORT USAGE CONSIDERATIONS — DSP SIDE.** Careful synchronization is required when reading multibit registers that are written by another asynchronous system.

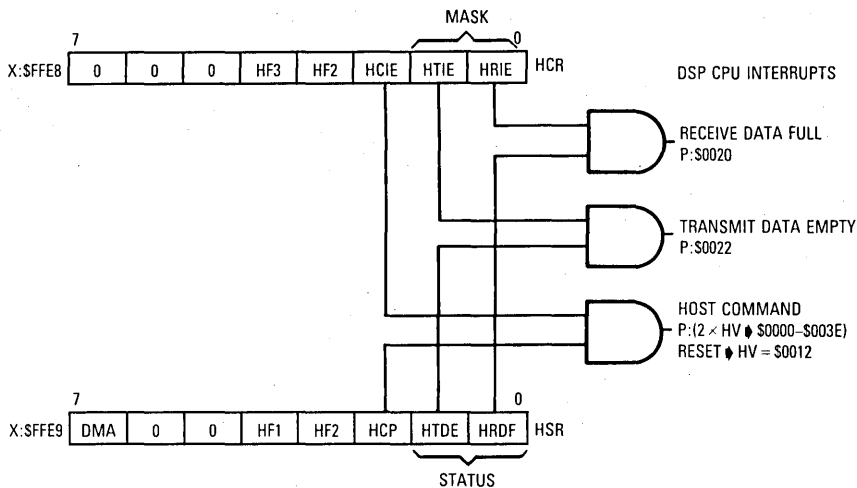

Figure 10-12. HSR-HCR Operation

This is a common problem when two asynchronous systems are connected. The situation exists in the HI. However, if the HI is used in the way it was designed, proper operation is guaranteed. The considerations for proper operation on the DSP CPU side are discussed in the following paragraphs, and considerations for the host processor side are discussed in **10.2.6.5 HOST PORT USAGE CONSIDERATIONS — HOST SIDE**.

DMA, HF1, HF0, HCP, HTDE, and HRDF status bits are set or cleared by the host processor side of the interface. These bits are individually synchronized to the DSP clock.

10

The only system problem with reading status occurs with HF1 and HF0 if they are encoded as a pair — e.g., the four combinations (00, 01, 10, and 11) each have significance. This problem occurs because there is a very small probability that the DSP will read the status bits during the transition. The solution to this potential problem is to read the bits twice for consensus (See **10.2.6.5 HOST PORT USAGE CONSIDERATIONS** for additional information).

10.2.3 Host Interface — Host Processor Viewpoint

The HI appears to the host processor as eight words of byte-wide static memory. The host may access the HI asynchronously by using polling techniques or interrupt-based techniques. Separate transmit and receive data registers are double buffered to allow the DSP CPU and host processor to transfer data efficiently at high speed. The HI contains a rudimentary DMA controller, which makes generating addresses (HA0-HA2) for the TX/RX registers in the HI unnecessary.



**10.2.3.1 PROGRAMMING MODEL — HOST PROCESSOR VIEWPOINT.** The HI appears to the host processor as a memory-mapped peripheral occupying eight bytes in the host processor address space (see Figures 10-13 and 10-14). These registers can be viewed as one control register (ICR), one status register (ISR), three data registers (RXH/TXH, RXM/TXM, and RXL/TXL), and two vector registers (IVR and CVR). The CVR is a special command register that is used by the host processor to issue commands to the DSP. These registers can be accessed only by the host processor; they can not be accessed by the DSP CPU. Host processors may use standard host processor instructions (e.g., byte move) and addressing modes to communicate with the HI registers. The HI registers are addressed so that 8-bit MC6801-type host processors can use 16-bit load (LDD) and store (STD) instructions for data transfers. The 16-bit MC68000/MC68010 host processor can address the HI

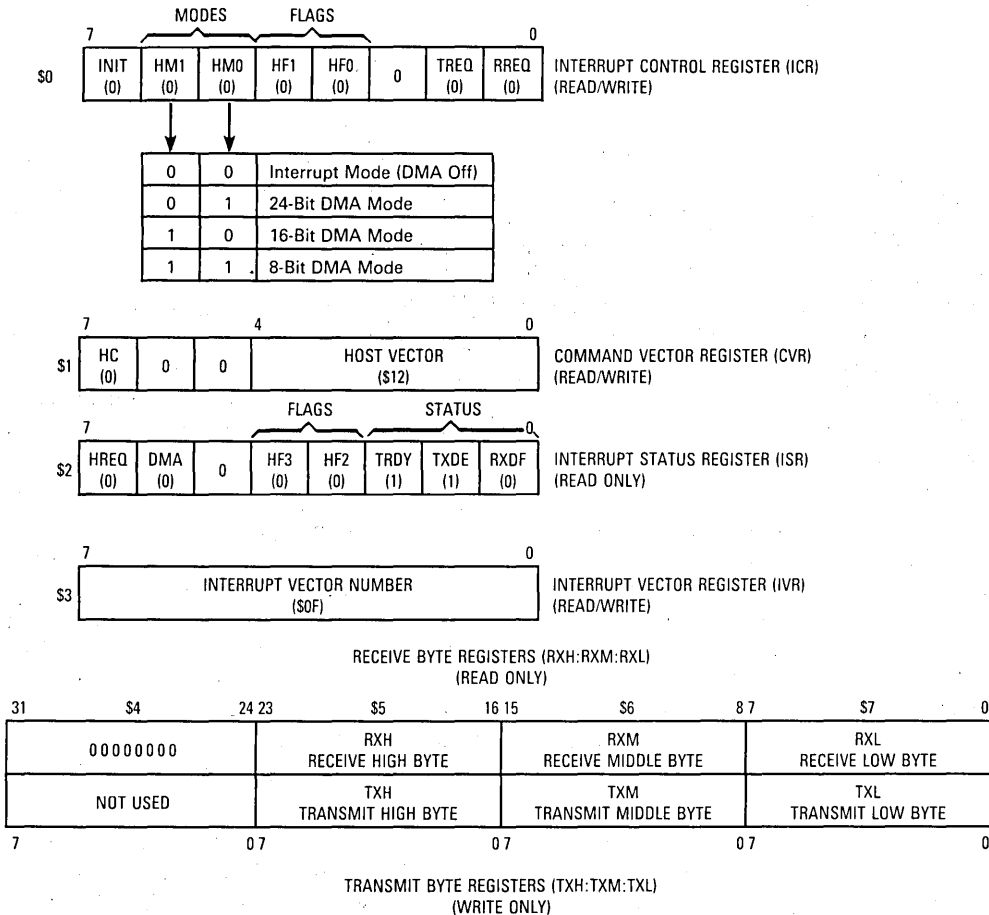

NOTE: The numbers in parenthesis are reset values.

**Figure 10-13. Host Processor Programming Model — Host Side**

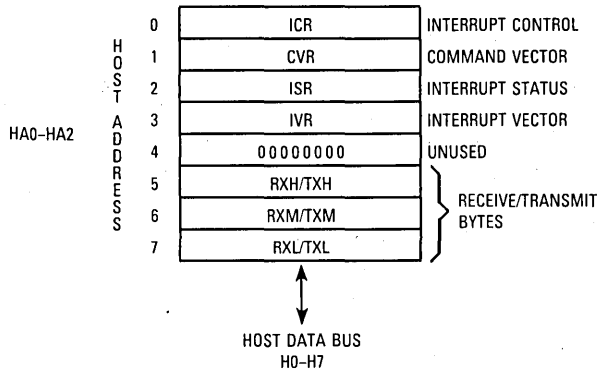

Figure 10-14. HI Register Map

using the special MOVEP instruction for word (16-bit) or long-word (32-bit) transfers. The 32-bit MC68020 host processor can use its dynamic bus sizing feature to address the HI using standard MOVE word (16-bit), long-word (32-bit) or quad-word (64-bit) instructions. The HREQ and HACK handshake flags are provided for polled or interrupt-driven data transfers with the host processor. Because the DSP interrupt response is sufficiently fast, most host microprocessors can load or store data at their maximum programmed I/O (non-DMA) instruction rate without testing the handshake flags for each transfer. If the full handshake is not needed, the host processor can treat the DSP as fast memory, and data can be transferred between the host processor and the DSP at the fastest host processor data rate. DMA hardware may be used with the handshake flags to transfer data without host processor intervention.

10

One of the most innovative features of the host interface is the host command feature. With this feature, the host processor can issue vectored exception requests to the DSP56000/DSP56001. The host may select any one of 32 DSP56000/DSP56001 exception routines to be executed by writing a vector address register in the HI. This flexibility allows the host programmer to execute up to 32 preprogrammed functions inside the DSP56000/DSP56001. For example, host exceptions can allow the host processor to read or write DSP56000/DSP56001 registers (X, Y, or program memory locations), force exception handlers (e.g., SSI, SCI,  $\overline{IRQA}$ ,  $\overline{IRQB}$  exception routines), and perform control and debugging operations if exception routines are implemented in the DSP56000/DSP56001 to perform these tasks.

**10.2.3.2 INTERRUPT CONTROL REGISTER (ICR).** The ICR is an 8-bit read/write control register used by the host processor to control the HI interrupts and flags. ICR cannot be accessed by the DSP CPU. ICR is a read/write register, which allows the use of bit manipulation instructions on control register bits. The control bits are described in the following paragraphs.

**10.2.3.2.1 ICR Receive Request Enable (RREQ) Bit 0.** The RREQ bit is used to control the  $\overline{\text{HREQ}}$  pin for host receive data transfers.

In interrupt mode (DMA off), RREQ is used to enable interrupt requests via the external host request ( $\overline{\text{HREQ}}$ ) pin when the receive data register full (RXDF) status bit in the ISR is set. When RREQ is cleared, RXDF interrupts are disabled. When RREQ is set, the external  $\overline{\text{HREQ}}$  pin will be asserted if RXDF is set.

In DMA modes, RREQ must be set or cleared by software to select the direction of DMA transfers. Setting RREQ sets the direction of DMA transfer to be DSP to host and enables the  $\overline{\text{HREQ}}$  pin to request data transfer. Hardware, software, individual, and STOP resets clear RREQ.

**10.2.3.2.2 ICR Transmit Request Enable (TREQ) Bit 1.** The TREQ bit is used to control the  $\overline{\text{HREQ}}$  pin for host transmit data transfers.

In interrupt mode (DMA off), TREQ is used to enable interrupt requests via the external  $\overline{\text{HREQ}}$  pin when the transmit data register empty (TXDE) status bit in the ISR is set. When TREQ is cleared, TXDE interrupts are disabled. When TREQ is set, the external  $\overline{\text{HREQ}}$  pin will be asserted if TXDE is set.

In DMA modes, TREQ must be set or cleared by software to select the direction of DMA transfers. Setting TREQ sets the direction of DMA transfer to be host to DSP and enables the  $\overline{\text{HREQ}}$  pin to request data transfer. Hardware, software, individual, and STOP resets clear TREQ.

Table 10-2 summarizes the effect of RREQ and TREQ on the  $\overline{\text{HREQ}}$  pin.

**Table 10-2.  $\overline{\text{HREQ}}$  Pin Definition**

| TREQ                  | RREQ | $\overline{\text{HREQ}}$ Pin       |
|-----------------------|------|------------------------------------|
| <b>Interrupt Mode</b> |      |                                    |
| 0                     | 0    | No Interrupts (Polling)            |
| 0                     | 1    | RXDF Request (Interrupt)           |
| 1                     | 0    | TXDE Request (Interrupt)           |
| 1                     | 1    | RXDF and TXDE Request (Interrupts) |
| <b>DMA Mode</b>       |      |                                    |
| 0                     | 0    | No DMA                             |
| 0                     | 1    | DSP to Host Request (RX)           |
| 1                     | 0    | Host to DSP Request (TX)           |
| 1                     | 1    | Undefined (Illegal)                |

**10.2.3.2.3 ICR Reserved Bit (Bit 2).** This bit, which is reserved and unused, reads as a logic zero.

**10.2.3.2.4 ICR Host Flag 0 (HF0) Bit 3.** The HF0 bit is used as a general-purpose flag for host-to-DSP communication. HF0 may be set or cleared by the host processor and cannot be changed by the DSP. HF0 is visible in the HSR on the DSP CPU side of the HI (see Figure 10-11). Hardware, software, individual, and STOP resets clear HF0.

**10.2.3.2.5 ICR Host Flag 1 (HF1) Bit 4.** The HF1 bit is used as a general-purpose flag for host-to-DSP communication. HF1 may be set or cleared by the host processor and cannot be changed by the DSP. Hardware, software, individual, and STOP resets clear HF1.

**10.2.3.2.6 ICR Host Mode Control (HM1 and HM0) Bits 5 and 6.** The HM0 and HM1 bits select the transfer mode of the HI (see Table 10-3). HM1 and HM0 enable the DMA mode of operation or interrupt (non-DMA) mode of operation.

**Table 10-3. Host Mode Bit Definition**

| HM1 | HM0 | Mode                     |
|-----|-----|--------------------------|
| 0   | 0   | Interrupt Mode (DMA Off) |
| 0   | 1   | DMA Mode (24 Bit)        |
| 1   | 0   | DMA Mode (16 Bit)        |
| 1   | 1   | DMA Mode (8 bit)         |

When both HM1 and HM0 are cleared, the DMA mode is disabled, and the TREQ and RREQ control bits are used for host processor interrupt control via the external  $\overline{\text{HREQ}}$  output pin. Also, in the non-DMA mode, the  $\overline{\text{HACK}}$  input pin is used for the MC68000 Family vectored interrupt acknowledge input.

When HM1 or HM0 are set, the DMA mode is enabled, and the  $\overline{\text{HREQ}}$  pin is used to request DMA transfers. When the DMA mode is enabled, the TREQ and RREQ bits select the direction of DMA transfers. The  $\overline{\text{HACK}}$  input pin is used as a DMA transfer acknowledge input. If the DMA direction is from DSP to host, the contents of the selected register are enabled onto the host data bus when  $\overline{\text{HACK}}$  is asserted. If the DMA direction is from host to DSP, the selected register is written from the host data bus when  $\overline{\text{HACK}}$  is asserted.

The size of the DMA word to be transferred is determined by the DMA control bits, HM0 and HM1. The HI register selected during a DMA transfer is determined by a 2-bit address counter, which is preloaded with the value in HM1 and HM0. The address counter substitutes for the HA1 and HA0 bits of the HI during a DMA transfer. The host address bit (HA2) is forced to one during each DMA transfer. The address counter can be initialized with the INIT bit feature. After each DMA transfer on the host data bus, the address counter is incremented to the next register. When the address counter reaches the highest register (RXL or TXL), the address counter is not incremented but is loaded with the value in HM1 and HM0. This allows 8-, 16- or 24-bit data to be transferred in a circular fashion and eliminates the need for the DMA controller to supply the HA2, HA1, and HA0 pins. For 16- or 24-bit data transfers, the DSP CPU interrupt rate is reduced by a factor of 2 or 3,

respectively, from the host request rate — i.e., for every two or three host processor data transfers of one byte each, there is only one 24-bit DSP CPU interrupt.

Hardware, software, individual, and STOP resets clear HM1 and HM0.

**10.2.3.2.7 ICR Initialize Bit (INIT) Bit 7.** The INIT bit is used by the host processor to force initialization of the HI hardware. Initialization consists of configuring the HI transmit and receive control bits and loading HM1 and HM0 into the internal DMA address counter. Loading HM1 and HM0 into the DMA address counter causes the HI to begin transferring data on a word boundary rather than transferring only part of the first data word. There are two methods of initialization: 1) allowing the DMA address counter to be automatically set after transferring a word and 2) setting the INIT bit, which sets the DMA address counter. Using the INIT bit to initialize the HI hardware may or may not be necessary, depending on the software design of the interface.

The type of initialization done when the INIT bit is set depends on the state of TREQ and RREQ in the HI. The INIT command, which is local to the HI, is designed to conveniently configure the HI into the desired data transfer mode. The commands are described in the following paragraphs and in Table 10-4. The host sets the INIT bit, which causes the HI hardware to execute the INIT command. The interface hardware clears the INIT bit when the command has been executed. Hardware, software, individual, and STOP resets clear INIT.

INIT execution always loads the DMA address counter and clears the channel according to TREQ and RREQ. INIT execution is not affected by HM1 and HM0.

**Table 10-4. HREQ Pin Definition**

| TREQ  | RREQ | After INIT Execution   | Transfer Direction Initialized |
|---|------|--|--------------------------------|
| <b>Interrupt Mode (HM1 = 0, HM0 = 0) INIT Execution</b> |      |  |                                |
| 0   | 0    | INIT = 0; address counter = 00   | None                           |
| 0   | 1    | INIT = 0; RXDF = 0; HTDE = 1; address counter = 00                     | DSP to Host                    |
| 1   | 0    | INIT = 0; TXDE = 1; HRDF = 0; Address Counter = 00                     | Host to DSP                    |
| 1   | 1    | INIT = 0; RXDF = 0; HTDE = 1; TXDE = 1; HRDF = 0; Address Counter = 00 | Host to/from DSP               |
| <b>DMA Mode (HM1 or HM0 = 1) INIT Execution</b>         |      |  |                                |
| 0   | 0    | INIT = 0; Address Counter = HM1, HM0                                   | None                           |
| 0   | 1    | INIT = 0; RXDF = 0; HTDE = 1; Address Counter = HM1, HM0               | DSP to Host                    |
| 1   | 0    | INIT = 0; TXDE = 1; HRDF = 0; Address Counter = HM1, HM0               | Host to DSP                    |
| 1   | 1    | Undefined (Illegal)  | Undefined                      |

The internal DMA counter is incremented with each DMA transfer (each  $\overline{\text{HACK}}$  pulse) until it reaches the last data register (RXL or TXL). When the DMA transfer is completed, the counter is loaded with the value of the HM1 and HM0 bits. When changing the size of the DMA word (changing HM0 and HM1 in the ICR), the DMA counter is not automatically updated, and, as a result, the DMA counter will point to the wrong data register immediately after HM1 and HM0 are changed. The INIT function must be used to preset the internal DMA counter correctly. Always set INIT after changing HM0 and HM1. However, the DMA counter can not be initialized in the middle of a DMA transfer. Even though the INIT bit is set, the internal DMA controller will wait until after completing the data transfer in progress before executing the initialization.

**10.2.3.3 COMMAND VECTOR REGISTER (CVR).** The CVR is used by the host processor to cause the DSP to execute a vectored interrupt. The host command feature is independent of any of the data transfer mechanisms in the HI. It can be used to cause any of the 32 possible interrupt routines in the DSP CPU to be executed.

**10.2.3.3.1 CVR Host Vector (HV) Bits 0–4.** The five HV bits select the host command exception address to be used by the host command exception logic. When the host command exception is recognized by the DSP interrupt control logic, the starting address of the exception taken is  $2 \times \text{HV}$ . The host can write HC and HV in the same write cycle, if desired.

The host processor can select any of the 32 possible exception routine starting addresses in the DSP by writing the exception routine starting address divided by 2 into HV. This means that the host processor can force any of the existing exception handlers (SSI, SCI, IRQA, IRQB, etc.) and can use any of the reserved or otherwise unused starting addresses provided they have been preprogrammed in the DSP. HV is set to \$12 (vector location \$0024) by hardware, software, individual, and STOP resets. Vector location \$0024 is the first of thirteen special host command vectors.

10

#### CAUTION

The HV should not be used with a value of zero because the reset location is normally programmed with a JMP instruction. Doing so will cause an improper fast interrupt.

**10.2.3.3.2 CVR Reserved Bits (Bits 5 and 6).** Reserved bits are unused and are read by the host processor as zeros.

**10.2.3.3.3 CVR Host Command Bit (HC) Bit 7.** The HC bit is used by the host processor to handshake the execution of host command exceptions. Normally, the host processor sets  $\text{HC} = 1$  to request the host command exception from the DSP. When the host command exception is acknowledged by the DSP, the HC bit is cleared by the HI hardware. The host

processor can read the state of HC to determine when the host command has been accepted. The host processor may elect to clear the HC bit, canceling the host command exception request at any time before it is accepted by the DSP CPU.

### CAUTION

The command exception might be recognized by the DSP and executed before it can be canceled by the host, even if the host clears the HC bit.

Setting HC causes host command pending (HCP) to be set in the HSR. The host can write HC and HV in the same write cycle if desired. Hardware, software, individual, and STOP resets clear HC.

**10.2.3.4 INTERRUPT STATUS REGISTER (ISR).** The ISR is an 8-bit read-only status register used by the host processor to interrogate the status and flags of the HI. The host processor can write this address without affecting the internal state of the HI, which is useful if the user desires to access all of the HI registers by stepping through the HI addresses. The ISR can not be accessed by the DSP. The status bits are described in the following paragraphs.

**10.2.3.4.1 ISR Receive Data Register Full (RXDF) Bit 0.** The RXDF bit indicates that the receive byte registers (RXH, RXM, RXL) contain data from the DSP CPU and may be read by the host processor. RXDF is set when the HTX is transferred to the receive byte registers. RXDF is cleared when the receive data low (RXL) register is read by the host processor. RXL is normally the last byte of the receive byte registers to be read by the host processor. RXDF can be cleared by the host processor using the initialize function. RXDF may be used to assert the external  $\overline{\text{HREQ}}$  pin if the RREQ bit is set. Regardless of whether the RXDF interrupt is enabled, RXDF provides valid status so that polling techniques may be used by the host processor. Hardware, software, individual, and STOP resets clear RXDF.

**10.2.3.4.2 ISR Transmit Data Register Empty (TXDE) Bit 1.** The TXDE bit indicates that the transmit byte registers (TXH, TXM, TXL) are empty and can be written by the host processor. TXDE is set when the transmit byte registers are transferred to the HRX register. TXDE is cleared when the transmit byte low (TXL) register is written by the host processor. TXL is normally the last byte of the transmit byte registers to be written by the host processor. TXDE can be set by the host processor using the initialize feature. TXDE may be used to assert the external  $\overline{\text{TREQ}}$  pin if the TREQ bit is set. Regardless of whether the TXDE interrupt is enabled, TXDE provides valid status so that polling techniques may be used by the host processor. Hardware, software, individual, and STOP resets set TXDE.

**10.2.3.4.3 ISR Transmitter Ready (TRDY) Bit 2.** The TRDY status bit indicates that both the TXH, TXM, TXL and the HRX registers are empty.

$$\text{TRDY} = \text{TXDE} \cdot \overline{\text{HRDF}}$$

When TRDY is set to one, the data that the host processor writes to TXH, TXM, and TXL will be immediately transferred to the DSP CPU side of the HI. This has many applications — e.g., if the host processor issues a host command which causes the DSP CPU to read the HRX, the host processor can be guaranteed that the data it just transferred to the HI is what is being received by the DSP CPU.

Hardware, software, individual, and STOP resets set TRDY.

**10.2.3.4.4 ISR Host Flag 2 (HF2) Bit 3.** The HF2 bit in the ISR indicates the state of host flag 2 in the HCR on the CPU side. HF2 can only be changed by the DSP (see Figure 10-11). HF2 is cleared by a hardware or software reset.

**10.2.3.4.5 ISR Host Flag 3 (HF3) Bit 4.** The HF3 bit in the ISR indicates the state of host flag 3 in the HCR on the CPU side. HF3 can only be changed by the DSP (see Figure 10-11). HF3 is cleared by a hardware or software reset.

**10.2.3.4.6 ISR Reserved Bit (Bit 5).** This status bit is reserved for future expansion and will read as zero during host processor read operations.

**10.2.3.4.7 ISR DMA Status (DMA) Bit 6.** The DMA status bit indicates that the host processor has enabled the DMA mode of the HI (HM1 or HM0 = 1). When the DMA status bit is clear, it indicates that the DMA mode is disabled (HM0 = HM1 = 0) and no DMA operations are pending. When DMA is set, it indicates that the DMA mode is enabled and the host processor should not use the active DMA channel (RXH, RXM, RXL or TXH, TXM, TXL depending on DMA direction) to avoid conflicts with the DMA data transfers. The channel not in use can be used for polled operation by the host and operates in the interrupt mode for internal DSP exceptions or polling. Hardware, software, individual, and STOP resets clear the DMA status bit.

**10.2.3.4.8 ISR Host Request (HREQ) Bit 7.** The HREQ bit indicates the status of the external host request output pin ( $\overline{\text{HREQ}}$ ). When the HREQ status bit is cleared, it indicates that the external  $\overline{\text{HREQ}}$  pin is deasserted and no host processor interrupts or DMA transfers are being requested. When the HREQ status bit is set, it indicates that the external  $\overline{\text{HREQ}}$  pin is asserted, indicating that the DSP is interrupting the host processor or that a DMA transfer request is occurring. The HREQ interrupt request may originate from either or both of two sources — the receive byte registers are full or the transmit byte registers are empty. These conditions are indicated by the ISR RXDF and TXDE status bits, respectively. If the interrupt source has been enabled by the associated request enable bit in the ICR, HREQ will be set if one or more of the two enabled interrupt sources is set. Hardware, software, individual, and STOP resets clear HREQ.



**10.2.3.5 INTERRUPT VECTOR REGISTER (IVR).** The IVR is an 8-bit read/write register which typically contains the exception vector number used with M68000 Family processor vectored interrupts. Only the host processor can read and write this register. The contents of IVR are placed on the host data bus (H0–H7) when both the  $\overline{\text{HREQ}}$  and  $\overline{\text{HACK}}$  pins are asserted and the DMA mode is disabled. The contents of this register are initialized to \$0F by a hardware or software reset, which corresponds to the uninitialized exception vector in the MC68000 Family.

**10.2.3.6 RECEIVE BYTE REGISTERS (RXH, RXM, RXL).** The receive byte registers are viewed as three 8-bit read-only registers by the host processor. These registers are called receive high (RXH), receive middle (RXM), and receive low (RXL). These three registers receive data from the high byte, middle byte, and low byte, respectively, of the HTX register and are selected by three external host address inputs (HA2, HA1, and HA0) during a host processor read operation or by an on-chip address counter in DMA operations. The receive byte registers (at least RXL) contain valid data when the receive data register full (RXDF) bit is set. The host processor may program the RREQ bit to assert the external  $\overline{\text{HREQ}}$  pin when RXDF is set. This informs the host processor or DMA controller that the receive byte registers are full. These registers may be read in any order to transfer 8-, 16-, or 24-bit data. However, reading RXL clears the receive data full RXDF bit. Because reading RXL clears the RXDF status bit, it is normally the last register read during a 16- or 24-bit data transfer. Reset does not affect RXH, RXM, or RXL.

**10.2.3.7 TRANSMIT BYTE REGISTERS (TXH, TXM, TXL).** The transmit byte registers are viewed as three 8-bit write-only registers by the host processor. These registers are called transmit high (TXH), transmit middle (TXM), and transmit low (TXL). These three registers send data to the high byte, middle byte and low byte, respectively, of the HRX register and are selected by three external host address inputs (HA2, HA1, and HA0) during a host processor write operation. Data may be written into the transmit byte registers when the transmit data register empty (TXDE) bit is set. The host processor may program the TREQ bit to assert the external  $\overline{\text{HREQ}}$  pin when TXDE is set. This informs the host processor or DMA controller that the transmit byte registers are empty. These registers may be written in any order to transfer 8-, 16-, or 24-bit data. However, writing TXL clears the TXDE bit. Because writing the TXL register clears the TXDE status bit, TXL is normally the last register written during a 16- or 24-bit data transfer. The transmit byte registers are transferred as 24-bit data to the HRX register when both TXDE and the HRDF bit are cleared. This transfer operation sets TXDE and HRDF. Reset does not affect TXH, TXM, or TXL.

**10.2.3.8 REGISTERS AFTER RESET.** Table 10-5 shows the result of four kinds of reset on bits in each of the HI registers seen by the host processor. The hardware reset is caused by asserting the  $\overline{\text{RESET}}$  pin; the software reset is caused by executing the RESET instruction; the individual reset is caused by clearing the PBC register bit 0; and the stop reset is caused by executing the STOP instruction.

**Table 10-5. Host Registers after Reset  
(Host Side)**

| Register Name | Register Data | Reset Type |          |          |          |
|---------------|---------------|------------|----------|----------|----------|
|               |               | HW Reset   | SW Reset | IR Reset | ST Reset |
| ICR           | INIT          | 0          | 0        | 0        | 0        |
|               | HM (1-0)      | 0          | 0        | 0        | 0        |
|               | TREQ          | 0          | 0        | 0        | 0        |
|               | RREQ          | 0          | 0        | 0        | 0        |
|               | HF (1-0)      | 0          | 0        | 0        | 0        |
| CVR           | HC            | 0          | 0        | 0        | 0        |
|               | HV (4-0)      | \$12       | \$12     | \$12     | \$12     |
| ISR           | HREQ          | 0          | 0        | 0        | 0        |
|               | DMA           | 0          | 0        | 0        | 0        |
|               | HF (3-2)      | 0          | 0        | —        | —        |
|               | TRDY          | 1          | 1        | 1        | 1        |
|               | TXDE          | 1          | 1        | 1        | 1        |
|               | RXDF          | 0          | 0        | 0        | 0        |
| IVR           | IV (7-0)      | \$0F       | \$0F     | —        | —        |
| RX            | RXH (23-16)   | —          | —        | —        | —        |
|               | RXM (15-8)    | —          | —        | —        | —        |
|               | RXL (7-0)     | —          | —        | —        | —        |
| TX            | TXH (23-21)   | —          | —        | —        | —        |
|               | TXM (15-8)    | —          | —        | —        | —        |
|               | TXL (7-0)     | —          | —        | —        | —        |

**10.2.4 Host Interface Pins**

The 15 HI pins are described here for convenience. Additional information, including timing, is given in the *DSP56001 Advance Information Data Sheet* (ADI1290).

**10.2.4.1 HOST DATA BUS (H0–H7).** This bidirectional data bus is used to transfer data between the host processor and the DSP56000/DSP56001. This bus is an input unless enabled by a host processor read. H0–H7 may be programmed as general-purpose parallel I/O pins called PB0–PB7 when the HI is not being used.

**10.2.4.2 HOST ADDRESS (HA0–HA2).** These inputs provide the address selection for each HI register. These inputs are stable when  $\overline{H\overline{EN}}$  is asserted. HA0–HA2 may be programmed as general-purpose parallel I/O pins called PB8–PB10 when the HI is not being used.

**10.2.4.3 HOST READ/WRITE ( $\overline{HR/\overline{W}}$ ).** This input selects the direction of data transfer for each host processor access. If  $\overline{HR/\overline{W}}$  is high and  $\overline{HEN}$  is asserted, H0–H7 are outputs, and DSP data is transferred to the host processor. If  $\overline{HR/\overline{W}}$  is low and  $\overline{HEN}$  is asserted, H0–H7 are inputs, and host data is transferred to the DSP.  $\overline{HR/\overline{W}}$  is stable when  $\overline{HEN}$  is asserted.  $\overline{HR/\overline{W}}$  may be programmed as a general-purpose I/O pin called PB11 when the HI is not being used.

**10.2.4.4 HOST ENABLE ( $\overline{HEN}$ ).** This input enables a data transfer on the host data bus. When  $\overline{HEN}$  is asserted and  $\overline{HR/\overline{W}}$  is high, H0–H7 become outputs, and DSP data may be latched by the host processor. When  $\overline{HEN}$  is asserted and  $\overline{HR/\overline{W}}$  is low, H0–H7 become inputs, and host data is latched inside the DSP when  $\overline{HEN}$  is deasserted. When  $\overline{HEN}$  is deasserted, H0–H7 are three-stated. Normally, a chip-select signal derived from host address decoding and an enable clock are used to generate  $\overline{HEN}$ .  $\overline{HEN}$  may be programmed as a general-purpose I/O pin called PB12 when the HI is not being used.

**10.2.4.5 HOST REQUEST ( $\overline{HREQ}$ ).** This open-drain output signal is used by the DSP56000/DSP56001 HI to request service from the host processor, DMA controller, or a simple external controller.  $\overline{HREQ}$  may be connected to an interrupt request pin of a host processor, a transfer request of a DMA controller, or a control input of external circuitry.  $\overline{HREQ}$  is asserted when an enabled request occurs in the host interface.  $\overline{HREQ}$  is deasserted when the enabled request is cleared or masked, DMA  $\overline{HACK}$  is asserted, or the DSP is reset.  $\overline{HREQ}$  may be programmed as a general-purpose I/O pin (not open-drain) called PB13 when the HI is not being used.

**10.2.4.6 HOST ACKNOWLEDGE ( $\overline{HACK}$ ).** This input has two functions: 1) to provide a host acknowledge handshake signal for DMA transfers and 2) to receive a host interrupt acknowledge compatible with M68000 Family processors. If programmed as a host acknowledge signal,  $\overline{HACK}$  may be used as a data strobe for HI DMA data transfers. If programmed as an MC68000 host interrupt acknowledge,  $\overline{HACK}$  is used to enable the HI interrupt vector register (IVR) onto the host data bus (H0–H7) if  $\overline{HREQ}$  is asserted. In this case, all other HI control pins are ignored, and the state of the HI is not affected.  $\overline{HACK}$  may be programmed as a general-purpose I/O pin called PB14 when the HI is not being used.

## 10.2.5 Servicing the Host Interface

The HI can be serviced by using one of the following protocols:

1. Polling or
2. Interrupts, which can be either
  - a. non-DMA or
  - b. DMA

From the host processor viewpoint, the service consists of making a data transfer since this is the only way of resetting the appropriate status bits.

**10.2.5.1 HI HOST PROCESSOR DATA TRANSFER.** The HI looks like static RAM to the host processor. Accordingly, to transfer data with the HI, the host processor

1. Asserts the HI address (HA0, HA1, HA2) to select the register to be read or written.
2. Asserts  $\overline{\text{HR}}/\overline{\text{W}}$  to select the direction of the data transfer.
3. Strobes the data transfer using  $\overline{\text{H}}\overline{\text{EN}}$ . When data is being written to the HI by the host processor, the positive-going edge of  $\overline{\text{H}}\overline{\text{EN}}$  latches the data in the HI register selected. When data is being read by the host processor, the negative-going edge of  $\overline{\text{H}}\overline{\text{EN}}$  strobes the data onto the data bus H0-H7.

This process is illustrated in Figure 10-15. The specified timing relationships are given in the *DSP56001 Advance Information Data Sheet* (ADI1290).

**10.2.5.2 HI INTERRUPTS HOST REQUEST ( $\overline{\text{H}}\overline{\text{REQ}}$ ).** The host processor interrupts are external and use the  $\overline{\text{H}}\overline{\text{REQ}}$  pin.  $\overline{\text{H}}\overline{\text{REQ}}$  is normally connected to the host processor maskable interrupt (IPL0, IPL1, or IPL2 in Figure 10-16) input. The host processor acknowledges host interrupts by executing an interrupt service routine. The most significant bit ( $\overline{\text{H}}\overline{\text{REQ}}$ ) of the ISR may be tested by the host processor to determine if the DSP is the interrupting device, and the two least significant bits (RXDF and TXDE) may be tested to determine the interrupt source (see Figure 10-17). The host processor interrupt service routine must read or write

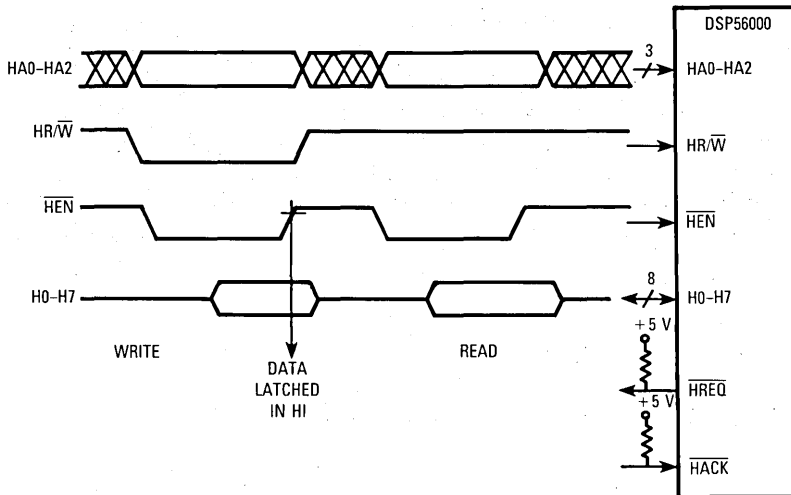

Figure 10-15. Host Processor Transfer Timing

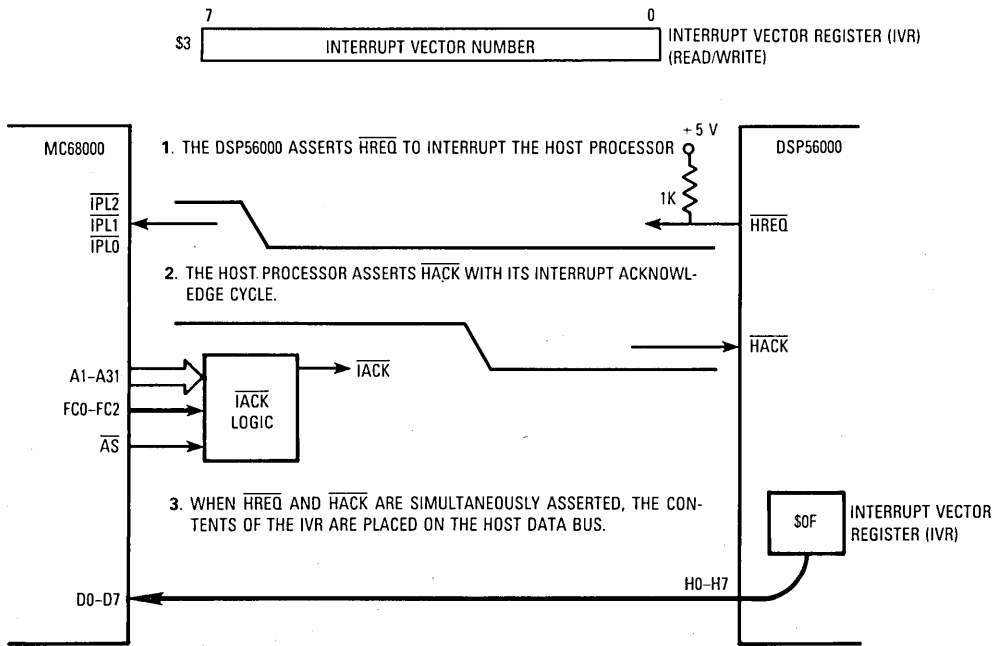

Figure 10-16. Host Registers After Reset — Host Side

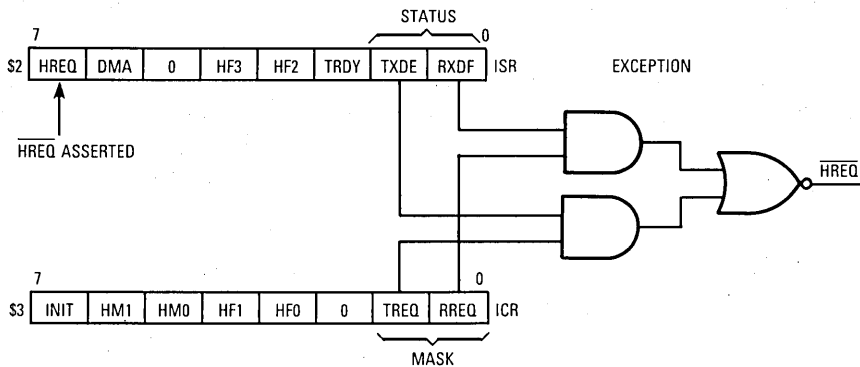

Figure 10-17. HI Interrupt Structure

the appropriate HI register to clear the interrupt.  $\overline{\text{HREQ}}$  is deasserted when 1) the enabled request is cleared or masked, 2) DMA  $\overline{\text{HACK}}$  is asserted, or 3) the DSP is reset.

**10.2.5.3 POLLING.** In the polling mode of operation, the  $\overline{\text{HREQ}}$  pin is not connected to the host processor, and  $\overline{\text{HACK}}$  must be deasserted to insure DMA data or IVR data is not being output on H0-H7 when other registers are being polled.

The host processor first performs a data read transfer to read the ISR (see Figure 10-17) to determine whether

1.  $\text{RXDF} = 1$ , signifying the receive data register is full so a data read should be performed.
2.  $\text{TXDE} = 1$ , signifying the transmit data register is empty so a data write can be performed.
3.  $\text{TRDY} = 1$ , signifying the transmit data register is empty and the receive data register on the DSP CPU side is empty so that the data written by the host processor will be transferred directly to the DSP side.
4.  $\text{HF2} \cdot \text{HF3} \neq 0$ , signifying an application-specific state within the DSP CPU has been reached, which requires action on the part of the host processor.
5.  $\text{DMA} = 1$ , signifying the HI is currently being used for DMA transfers. If DMA transfers are possible in the system, care must be exercised to deactivate  $\overline{\text{HACK}}$  prior to reading the ISR so both DMA data and the contents of ISR are not simultaneously output on H0-H7.
6. If  $\text{HREQ} = 1$ , the  $\overline{\text{HREQ}}$  pin has been asserted, and one of the previous five conditions exists.

Generally, after the appropriate data transfer has been made, the corresponding status bit will toggle.

10

If the host processor has issued a command to the DSP by writing the CVR and setting the HC bit, it can read the HC bit in the CVR to determine when the command has been accepted by the interrupt controller in the DSP CPU. When the command has been accepted for execution, the HC bit will be reset to zero by the interrupt controller in the DSP CPU.

**10.2.5.4 SERVICING NON-DMA INTERRUPTS.** When  $\text{HM0} = \text{HM1} = 0$  (i.e., non-DMA) and  $\overline{\text{HREQ}}$  is connected to the host processor interrupt input, the HI can request service from the host processor by asserting  $\overline{\text{HREQ}}$ . In the non-DMA mode,  $\overline{\text{HREQ}}$  will be asserted when  $\text{TXDE} = 1$  and/or  $\text{RXDF} = 1$  and the corresponding mask bit ( $\text{TREQ}$  or  $\text{RREQ}$ , respectively) is set. This process is depicted in Figure 10-17.

Generally, servicing the interrupt starts with reading the ISR, as described in the previous paragraphs, to determine which DSP has generated the interrupt and why. When multiple DSPs occur in a system, the HREQ bit in the ISR will normally be read first to determine

the interrupting device. The host processor interrupt service routine must read or write the appropriate HI register to clear the interrupt.  $\overline{\text{HREQ}}$  is deasserted when the enabled request is cleared or masked.

When the host processor is a member of the M680XX Family, servicing the interrupt will start by the DSP asserting  $\overline{\text{HREQ}}$  to interrupt the processor (see Figure 10-17). The host processor then acknowledges the interrupt by asserting  $\overline{\text{HACK}}$ . While  $\overline{\text{HREQ}}$  and  $\overline{\text{HACK}}$  are simultaneously asserted, the contents of the IVR are placed on the host data bus. This vector will tell the host processor which routine to use to service the  $\overline{\text{HREQ}}$  interrupt.

The  $\overline{\text{HREQ}}$  pin is an open-drain output pin so that it can be wire-ORed with the  $\overline{\text{HREQ}}$  pins from other DSP56000/DSP56001 processors in the system. When one of the DSP56000/DSP56001 processors generates an interrupt request, the host processor can poll the HREQ bit in each of the ISRs to determine which device generated the interrupt.

**10.2.5.5 SERVICING DMA INTERRUPTS.** When  $\text{HM0} \neq 0$  and/or  $\text{HM1} \neq 0$ ,  $\overline{\text{HREQ}}$  will be asserted to request a DMA transfer. Generally, the  $\overline{\text{HREQ}}$  pin will be connected to the  $\overline{\text{REQ}}$  input of a DMA controller. The HA0–HA2, HEN, and HR/W pins are not used during DMA transfers; DMA transfers only use the  $\overline{\text{HREQ}}$  and  $\overline{\text{HACK}}$  pins after the DMA channel has been initialized.  $\overline{\text{HACK}}$  is used to strobe the data transfer (see Figure 10-18) where an MC68440 is used as the DMA controller. DMA transfers to and from the HI are considered in more detail in **10.2.6 HI Application Examples**.

## 10.2.6 HI Application Examples

In the following paragraphs, examples of initializing the HI, transferring data with the HI, bootstrapping via the HI, and performing DMA transfers through the HI are described.

**10.2.6.1 HI INITIALIZATION.** Initializing the HI takes two steps (see Figure 10-19). The first step is to initialize the DSP side of the HI, which requires that the options for interrupts and flags be selected and then the HI be selected (see Figure 10-20). The second step is for the host processor to clear the HC bit by writing the CVR, select the data transfer method — polling, interrupts, or DMA (see Figures 10-21 and 10-23) — and write the IVR in the case of a M680XX Family host processor. Figures 10-19–10-22 provide a general description of how to initialize the HI. Later subsections provide more detailed descriptions for specific examples. These subsections include some code fragments illustrating how to initialize and transfer data using the HI.

**10.2.6.2 POLLING/INTERRUPT CONTROLLED DATA TRANSFER.** Handshake flags are provided for polled or interrupt-driven data transfers. Because the DSP interrupt response is sufficiently fast, most host microprocessors can load or store data at their maximum programmed I/O (non-DMA) instruction rate without testing the handshake flags for each

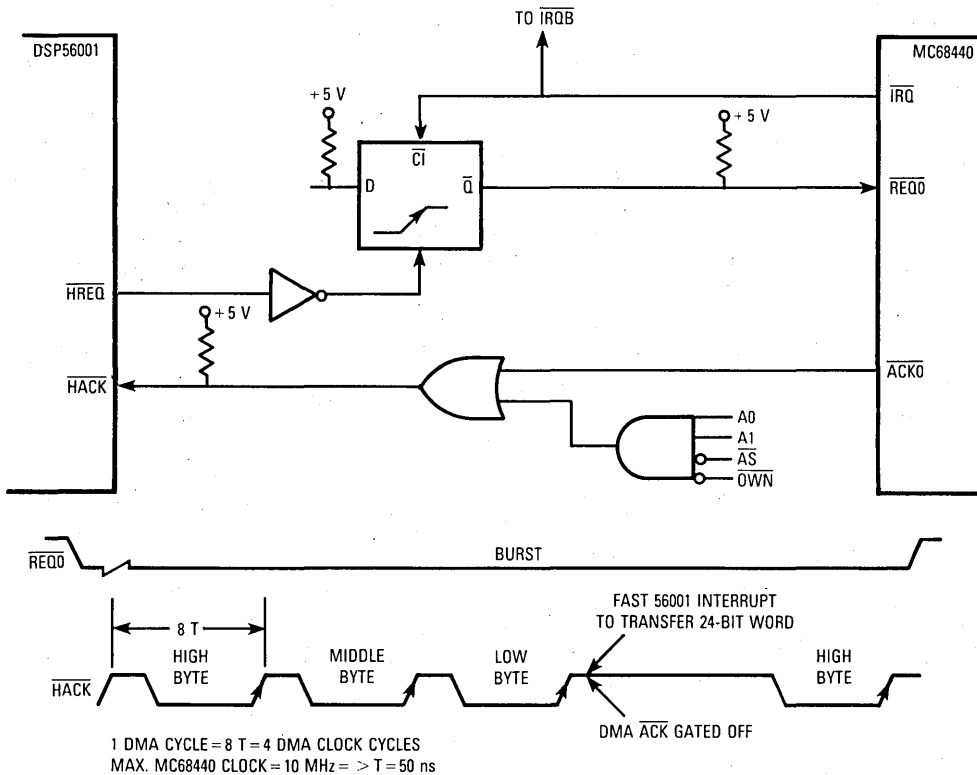

Figure 10-18. DMA Transfer Logic and Timing

10

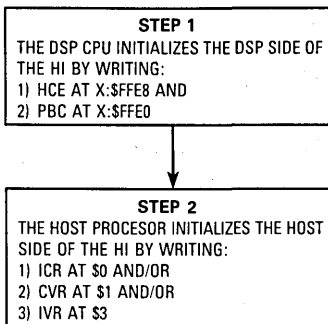
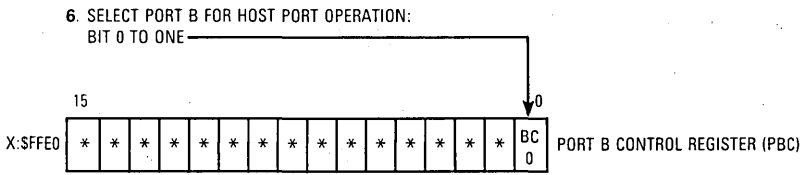
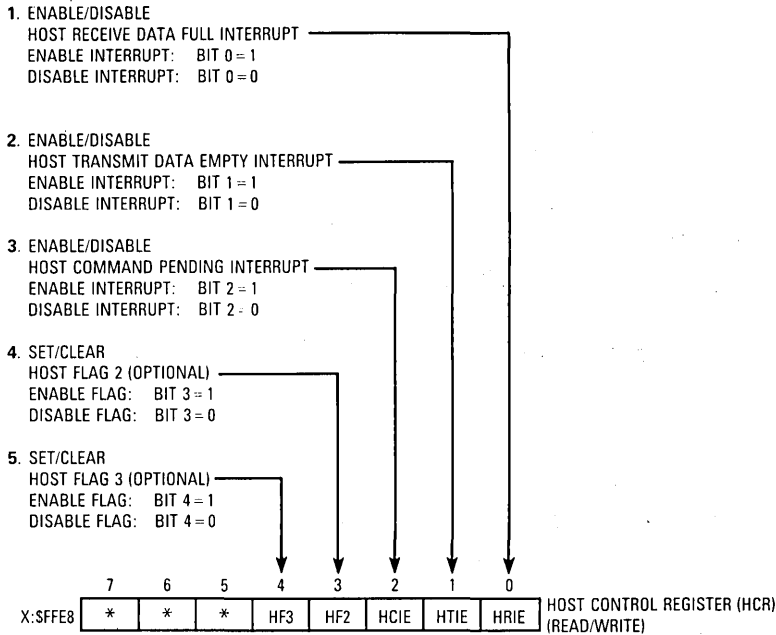

Figure 10-19. HI Initialization Flowchart



**STEP 1 OF HOST PORT CONFIGURATION**



\*Reserved; write as zero.

NOTE: The host flags are general-purpose semaphores. They are not required for host port operation but may be used in some applications.

**Figure 10-20. HI Initialization — DSP Side**

transfer. If the full handshake is not needed, the host processor can treat the DSP as fast memory, and data can be transferred between the host and DSP at the fastest host processor rate. DMA hardware may be used with the external host request and host acknowledge pins to transfer data at the maximum DSP interrupt rate.

The basic data transfer process from the host processor's view (see Figure 10-15) is for the host to

1. Assert  $\overline{\text{HREQ}}$  when the HI is ready to transfer data.
2. Assert  $\overline{\text{HACK}}$  if the interface is using  $\overline{\text{HACK}}$ .

**STEP 2 OF HOST PORT CONFIGURATION**

**1. CLEAR HOST COMMAND BIT (HC):**

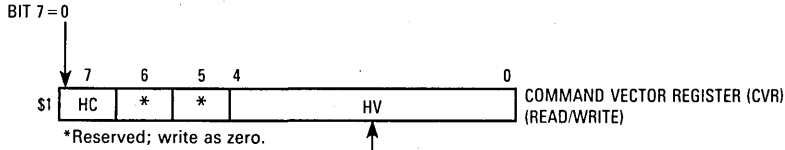

**2. OPTION 1: SELECT HOST VECTOR (HV)**

(OPTIONAL SINCE HV CAN BE SET ANY TIME BEFORE THE HOST COMMAND IS EXECUTED. DSP INTERRUPT VECTOR = THE HOST VECTOR MULTIPLIED BY 2. DEFAULT (UPON DSP RESET): HV = \$12 ↓ DSP INTERRUPT VECTOR \$0024

**Figure 10-21(a). HI Configuration — Host Side**

**STEP 2 OF HOST PORT CONFIGURATION**

**2. OPTION 2: SELECT POLLING MODE FOR HOST TO DSP COMMUNICATION**

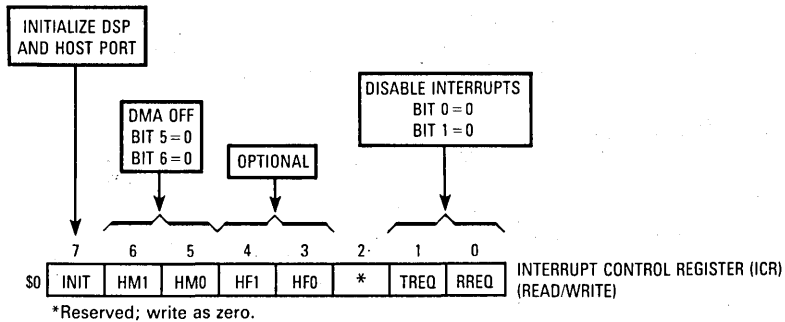
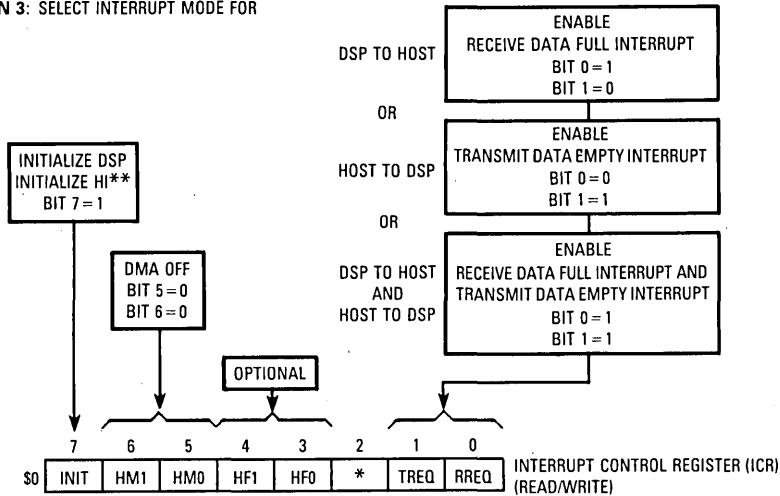

**Figure 10-21(b). HI Initialization — Host Side, Polling Mode**

3. Assert  $\overline{HR/\overline{W}}$  to select whether this operation will read or write a register.
4. Assert the HI address (HA2, HA1, and HA0) to select the register to be read or written.
5. Assert  $\overline{HEN}$  to enable the HI.
6. When  $\overline{HEN}$  is deasserted, the data can be latched or read, as appropriate, if the timing requirements have been observed.
7.  $\overline{HREQ}$  will be deasserted if the operation is complete.

**STEP 2 OF HOST PORT CONFIGURATION**

**2. OPTION 3: SELECT INTERRUPT MODE FOR**



**2. OPTION 4: LOAD HOST INTERRUPT VECTOR IF USING THE INTERRUPT MODE AND THE HOST PROCESSOR REQUIRES AN INTERRUPT VECTOR.**

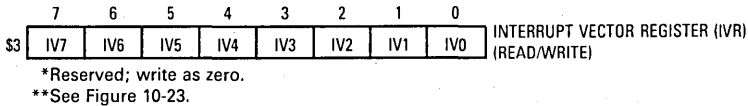

**Figure 10-21(c). HI Initialization — Host Side, Interrupt Mode**

The previous transfer description is an overview. Specific and exact information for the HI data transfers and their timing can be found in **10.2.6.3 DMA TRANSFER** and in the *DSP560001 Advance Information Data Sheet (ADI1290)*.

**10.2.6.2.1 Host to DSP — Data Transfer.** Figure 10-23 shows the bits in the ISR and ICR registers used by the host processor and the bits in the HSR and HCR registers used by the DSP to transfer data from the host processor to the DSP. The registers shown are the status register and control register seen by the host processor and status register and control register seen by the DSP. Only the registers used to transmit data from the host processor to the DSP are described. Figure 10-24 illustrates the process of that data transfer. The steps in Figure 10-24 can be summarized as follows:

1. When the TXDE bit in the ISR is set, it indicates that the HI is ready to receive a data byte from the host processor because the transmit byte registers (TXH, TXM, TXL) are empty.

STEP 2 OF HOST PORT CONFIGURATION

2. OPTION 5: SELECT DMA MODE FOR

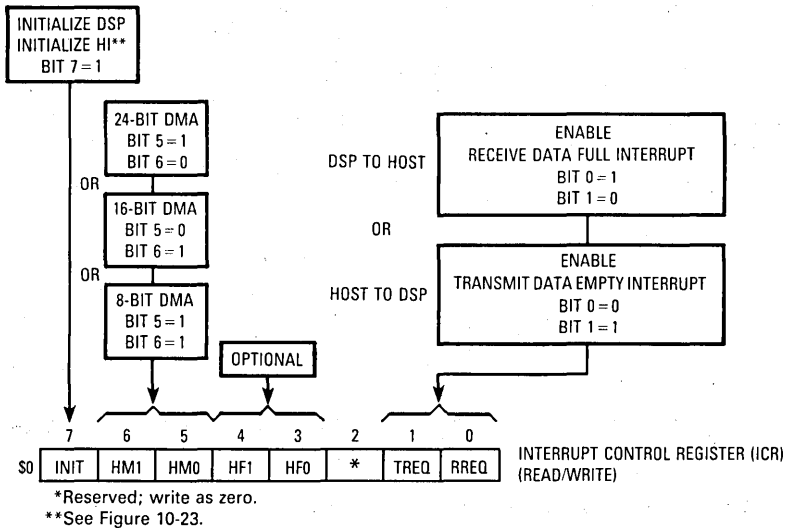

Figure 10-21(d). HI Initialization — Host Side, DMA Mode

10

2. The host processor can either poll or
3. Use interrupts to determine the status of this bit. Setting the TREQ bit in the ICR causes the  $\overline{\text{HREQ}}$  pin to interrupt the host processor when TXDE is set.
4. Once the TXDE bit is set, the host can write data to the HI by writing three bytes to TXH, TXM, and TXL, respectively, or two bytes to TXM and TXL, respectively, or one byte to TXL.
5. Writing data to TXL clears TXDE in the ISR.
6. From the DSP's viewpoint, the HRDF bit (when set) in the HSR indicates that data is waiting in the HI for the DSP.
7. When the DSP reads the HRX, the HRDF bit is automatically cleared, and TXDE in the ISR is set.
8. When TXDE = 0 and HRDF = 0, data is automatically transferred from TBR to HRX.
9. This transfer sets HRDF. The DSP can poll HRDF to see when data has arrived, or it can use interrupts.
10. If HRIE (in the HCR) and HRDF are set, exception processing is started using interrupt vector P:\$0020.



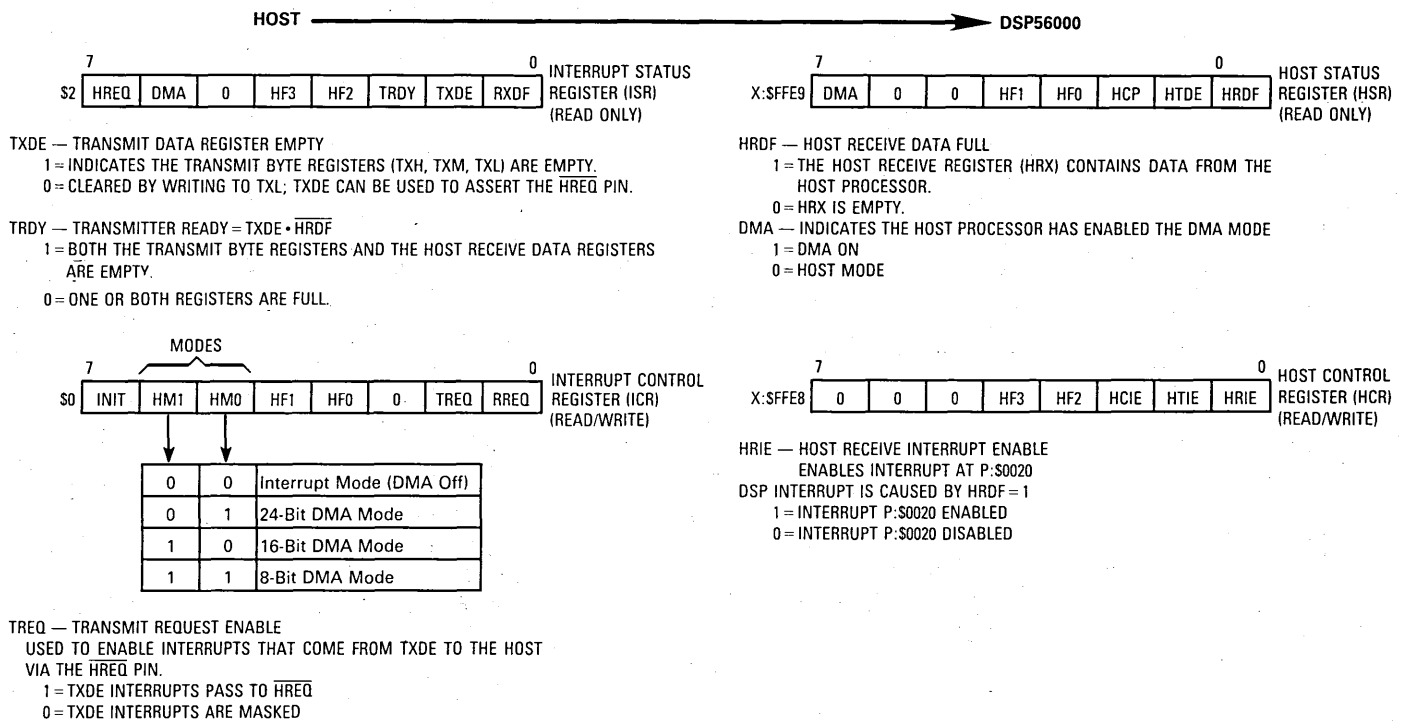

Figure 10-23. Bits Used for Host-to-DSP Transfer

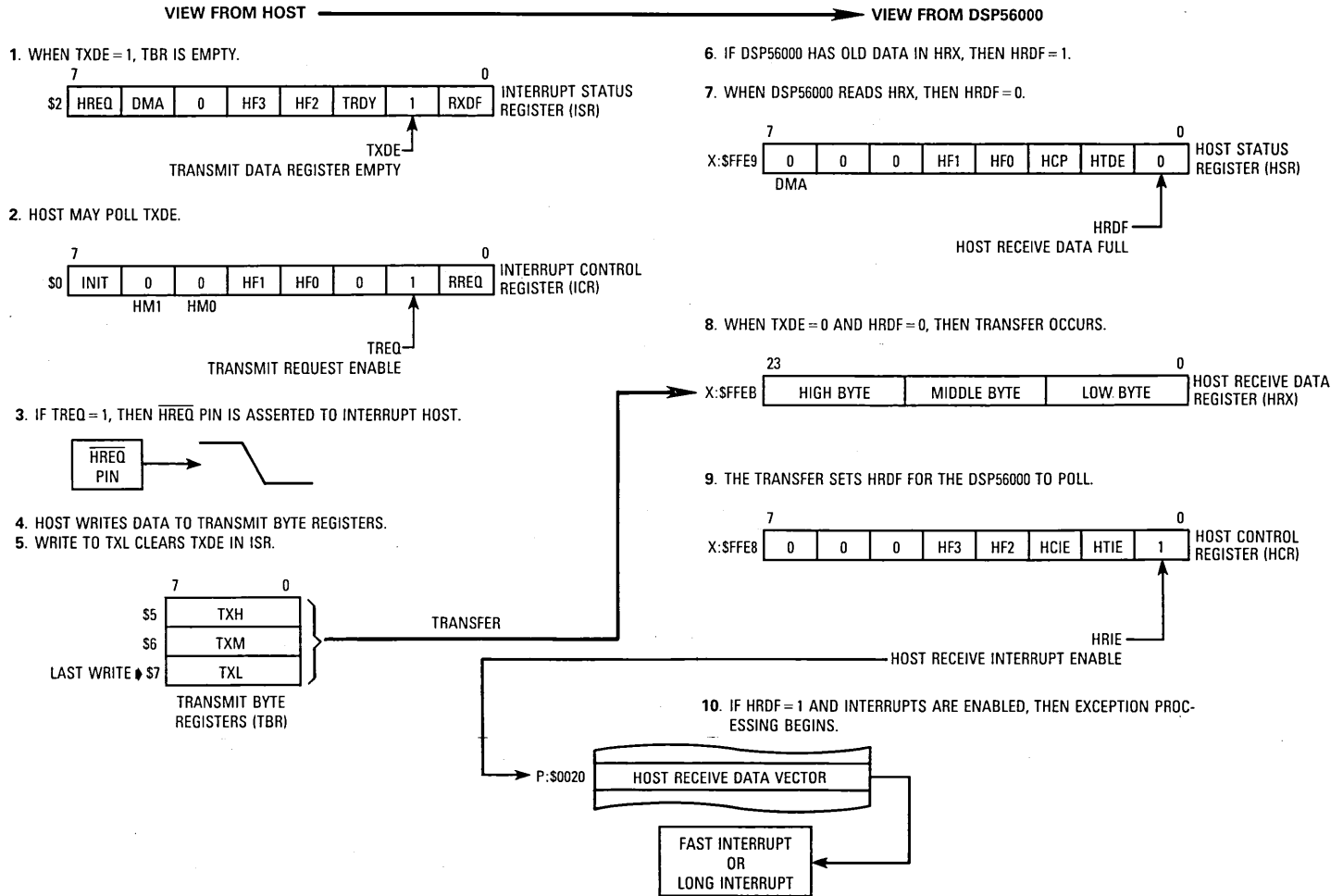

Figure 10-24. Data Transfer from Host to DSP

```

*****
; MAIN PROGRAM . . . receive data from host
*****
                ORG      P:$40
                MOVE    #0,R0
                MOVE    #3,M0

                MOVEP   #1,X:PBC          ;Turn on Host Port
                MOVEP   #0,X:HCR          ;Turn off XMT and RCV interrupts
                MOVEP   #$0C00,X:IPR       ;Turn on host interrupt

                MOVE    #0,SR             ;Unmask interrupts
                MOVE    #>$8,X0          ;Host flag mask for HF0

LOOP            MOVEP   X:HSR,A           ;Wait for HF0 (from host) set to 1
                AND     X0,A
                JEQ     LOOP

                MOVEP   #$1,X:HGR         ;Enable host receive interrupt

                JMP     *                  ;Now wait for interrupt

```

**Figure 10-25. Receive Data from Host — Main Program**

```

*****
; Receive from Host Interrupt Routine
*****
RVCV            MOVEP   X:HRX,X:(R0)+     ;Receive data.
                RTI

                END

```

**Figure 10-26. Receive Data from Host Interrupt Routine**

**10.2.6.2.2 Host to DSP — Command Vector.** The host processor can cause three types of interrupts in the DSP (see Figure 10-27). These are host receive data (P:\$0020), host transmit data (P:\$0022), and host command (P:\$0024–P:\$003C). The host command (HC) can be used to control the DSP by forcing it to execute any of thirteen subroutines that can be used to run tests, transfer data, process data, etc. In addition, the HC can cause any of the other 19 interrupt routines in the DSP to be executed. The process to execute an HC (see Figure 10-28) is as follows:



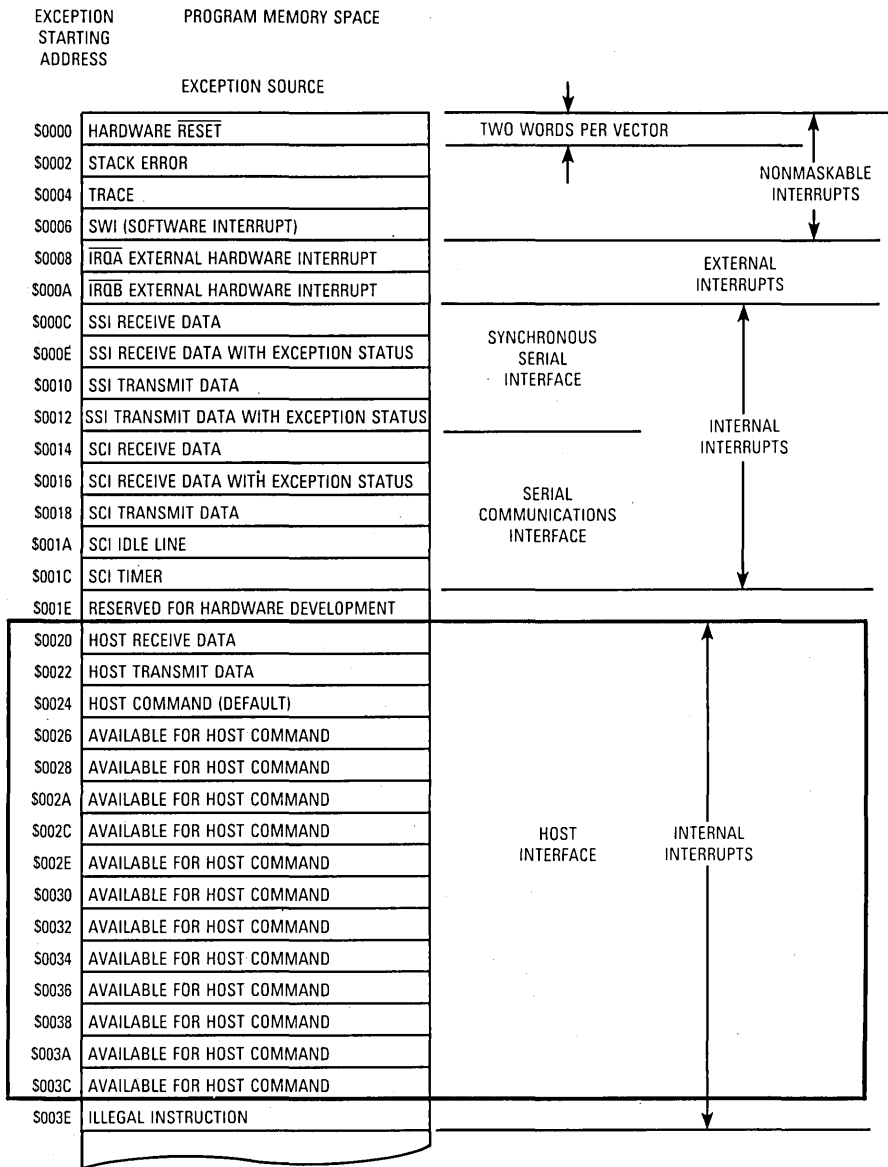
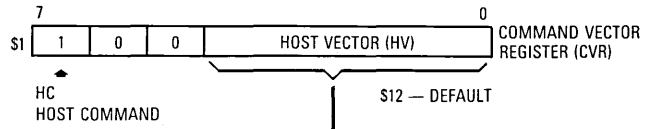

Figure 10-27. Vector Table of Exception Sources

VIEW FROM HOST

1. WRITE CVR WITH DESIRED HV.
2. SET HC = 1.



EXCEPTION VECTOR ADDRESS = HV × 2

5. WHEN THE HOST COMMAND EXCEPTION IS ACKNOWLEDGED, THE HC BIT IS CLEARED BY THE HOST COMMAND LOGIC. HC CAN BE READ AS A STATUS BIT.

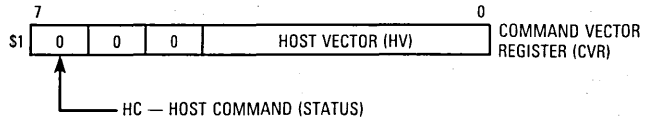

VIEW FROM DSP56000

3. HCP IS SET UNTIL EXCEPTION IS ACKNOWLEDGED.

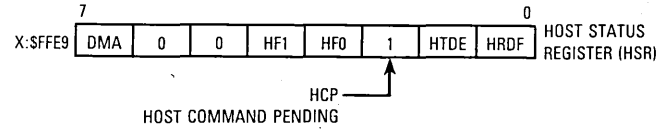

4. HOST COMMAND IS MASKED UNTIL HCIE = 1

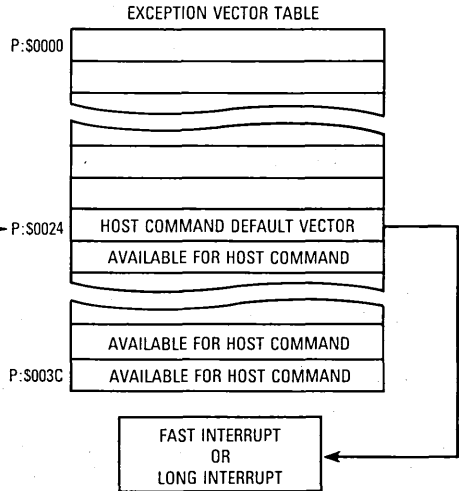
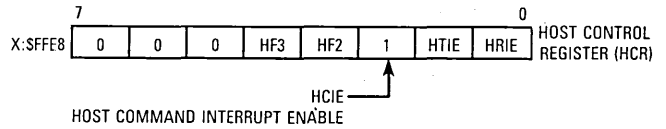

Figure 10-28. Host Command

1. The host processor writes the CVR with the desired HV (the HV is the DSP's interrupt vector (IV) location divided by 2 — i.e., if HV=\$12, IV=\$24).
2. The HC is then set.
3. The HCP bit in the HSR is set when HC is set.
4. If the HCIE bit in the HCR has been set by the DSP, the HC exception processing will start. The HV is multiplied by 2, and the result is used by the DSP as the interrupt vector.
5. When the HC exception is acknowledged, the HC bit (and therefore the HCP bit) is cleared by the HC logic. HC can be read by the host processor as a status bit to determine when the command is accepted. Similarly, the HCP bit can be read by the DSP CPU to determine if an HC is pending.

To guarantee a stable interrupt vector, write HV only when HC is clear. The HC bit and HV can be written simultaneously. The host processor can clear the HC bit to cancel a host command at any time before the DSP exception is accepted. Although the HV can be programmed to any exception vector, it is **not** recommended that HV=0 (RESET) be used because it does not reset the DSP hardware. DMA must be disabled to use the host exception.

**10.2.6.2.3 Host to DSP — Bootstrap Loading Using the HI.** The circuit shown in Figure 10-29 will cause the DSP to boot through the HI on powerup. During the bootstrap program, the DSP looks at P:\$C000 data bit 23. If D23 is high, it will boot from an external memory location; if it is low, as shown in Figure 10-29, it will load from the HI. Data is written by the host processor in a pattern of four bytes, with the high byte being a dummy and the low byte being the low byte of the DSP word (see Figures 10-29 and 10-30). Figure 10-30 shows how an 8-, 16-, 24-, or 32-bit word in the host processor maps into the HI registers. The HI register at address \$4 is not used and will read as zero. It is not necessary to use address \$4, but, since many host processors are 16- or 32-bit processors, address \$4 will often be used as part of the 16- or 32-bit word. The low-order byte (at \$7) should always be written last since writing to it causes the HI to initiate the transfer of the word to the HRX. Data is then transferred from the HRX to the DSP program memory. If the host processor needs to terminate the bootstrap loading before 512 words have been downloaded, it can set the HF0 bit in the ICR. The DSP will then terminate the download and start executing at location P:\$0000. Since the DSP56000/DSP56001 is typically faster than the host processor, handshaking during the data transfer is normally not required.

The actual code used in the bootstrap program is given in the *DSP56001 Advance Information Data Sheet* (ADI1290). The portion of the code that loads from the HI is shown in Figure 10-31. The BSET instruction configures port B as the HI and the first JCLR looks for a flag (HF0) to indicate an early termination of the download. The second JCLR instruction causes the DSP to wait for a complete word to be received, and then two MOVES are used to move the data from the HI to memory through an intermediate register, A1.

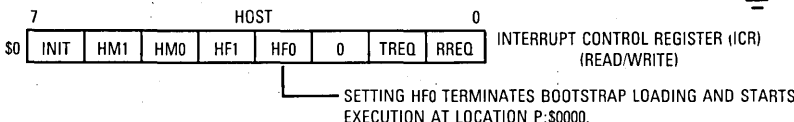
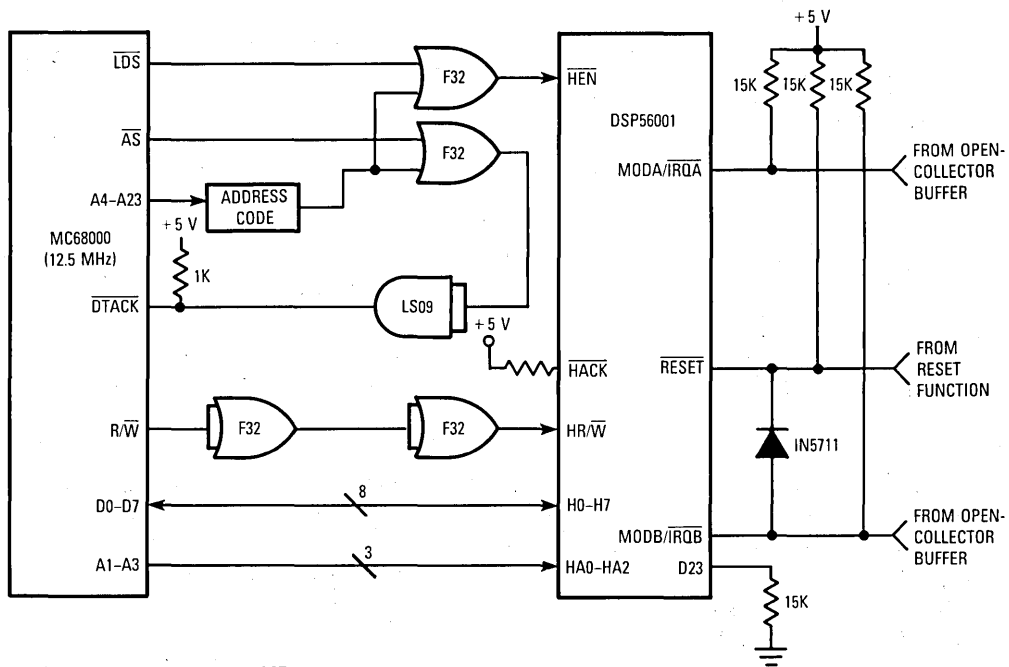

| HOST ADDRESS WRITTEN | CONTENTS LOADED TO INTERNAL PRAM AT: |
|----------------------|--------------------------------------|
| 4 (DUMMY)            |                                      |
| 5                    | P:\$0000 HIGH BYTE                   |
| 6                    | P:\$0000 MID BYTE                    |
| 7                    | P:\$0000 LOW BYTE                    |
| .                    | .                                    |
| .                    | .                                    |
| 4 (DUMMY)            |                                      |
| 5                    | P:\$01FF HIGH BYTE                   |
| 6                    | P:\$01FF MID BYTE                    |
| 7                    | P:\$01FF LOW BYTE                    |

\*Because the DSP56000 is so fast, host handshaking is generally not required.

Figure 10-29. Bootstrap Using the HI

**10.2.6.2.4 DSP-to-Host Data Transfer.** Data is transferred from the DSP to the host processor in a similar manner as from the host processor to the DSP. Figure 10-32 shows the bits in the status registers (ISR and HSR) and control registers (ICR and HCR) used by the host processor and DSP CPU, respectively. The DSP CPU (see Figure 10-33) can poll the HTDE bit in the HSR (1) to see when it can send data to the host, or it can use interrupts

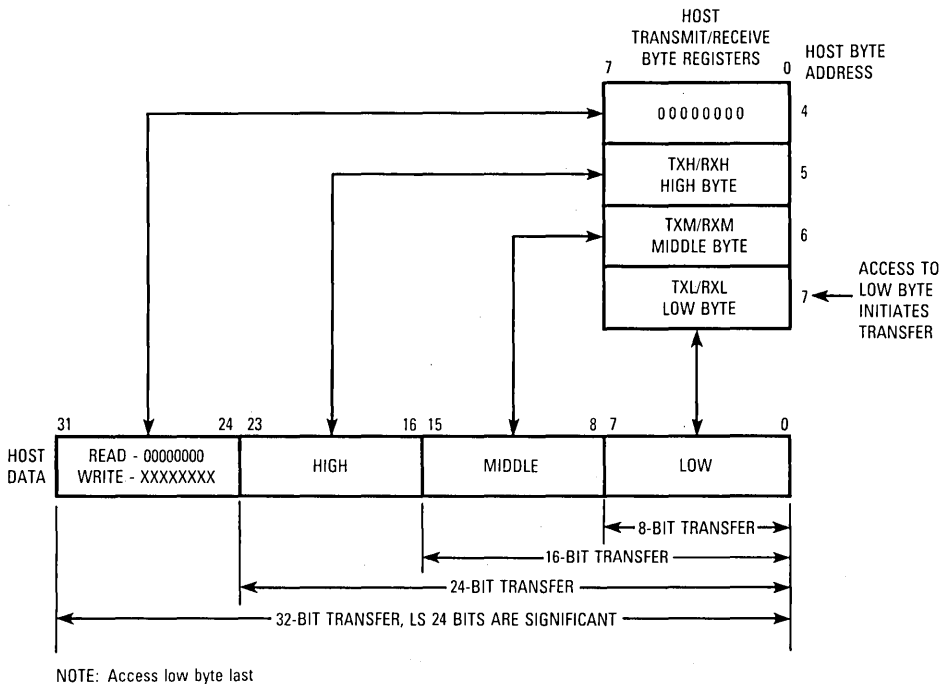

Figure 10-30. Transmit/Receive Byte Registers

```

INLOOP  D0      #512,_LOOP1      ;Load 512 instruction words.
        .
        .
        .
_HOSTLD  BSET    #0,X:$FFE0      ;Configure Port B as Host Interface
_LBLA   JCLR    #3,X:$FFE9,_LBLB ;If HF0= 1, stop loading data.
        ENDD0   ;Must terminate the D0 loop
_LBLB   JMP     <_BOOTEND        ;Boot complete, go to exit handler
        JCLR    #0,X:(R2),_LBLA  ;Wait for HRDF to go high
        ;(meaning 24-bit data is present)
_STORE  MOVE    X:$FEB,A1        ;Put 24-bit host data in A1
_LOOP1  MOVE    A1,P:(R0)+       ;Store 24-bit result in PRAM
        ;Return for another 24-bit word

```

Figure 10-31. Bootstrap Code Fragment

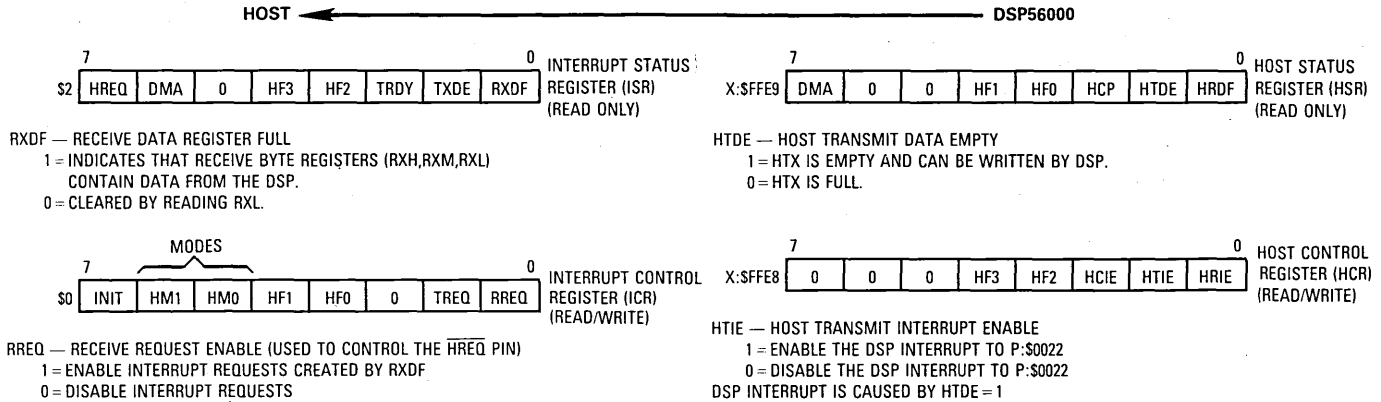

Figure 10-32. Bits Used for DSP to Host Transfer

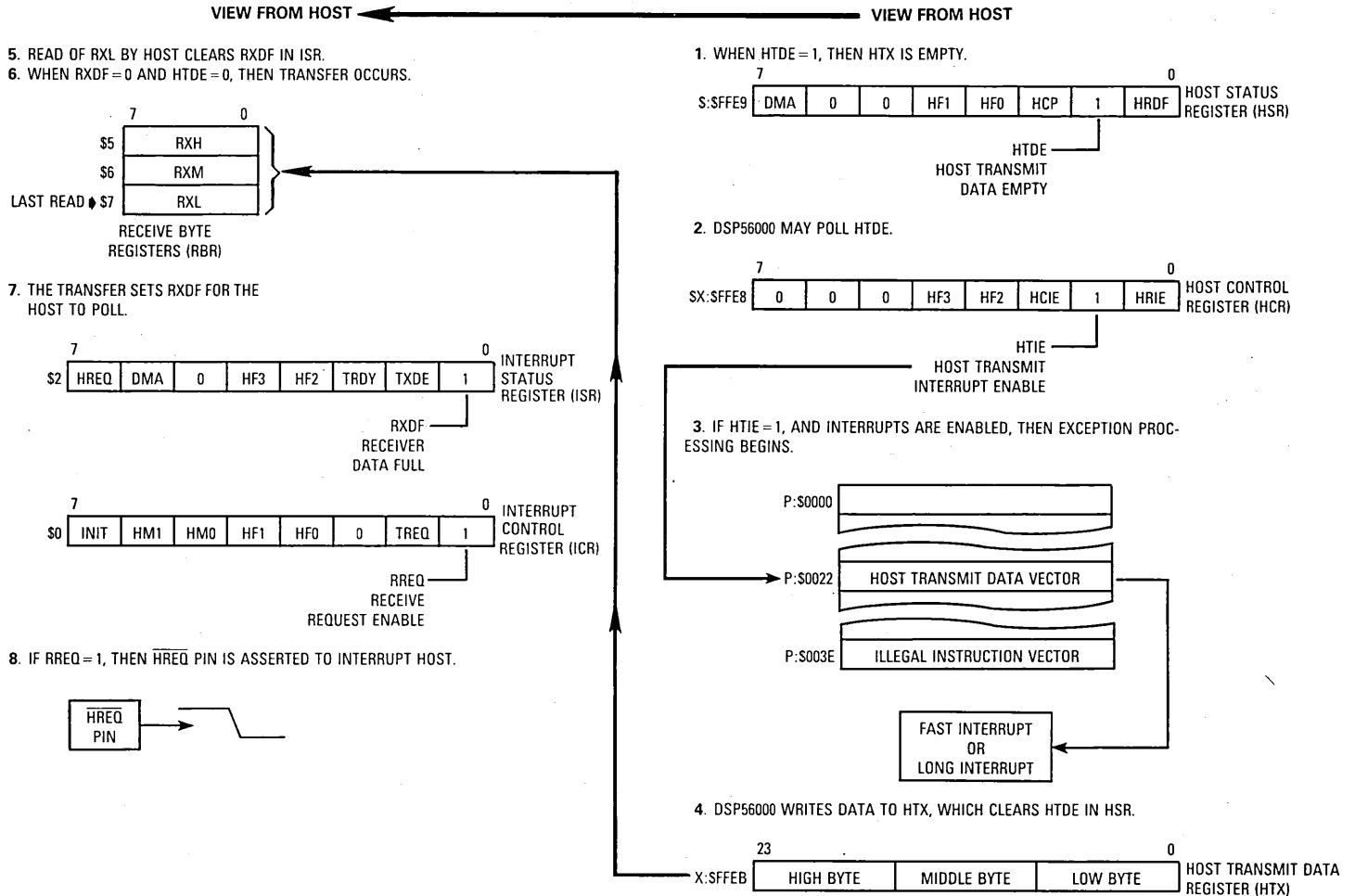

Figure 10-33. Data Transfer from DSP to Host

enabled by the HTIE bit in the HCR (2). If HTIE = 1 and interrupts are enabled, exception processing begins at interrupt vector P:\$0022 (3). The interrupt routine should write data to the HTX (4), which will clear HTDE in the HSR. From the host's viewpoint, (5) reading the RXL clears RXDF in the ISR. When RXDF = 0 and HTDE = 0 (6), the contents of the HTX will be transferred to the receive byte registers (RXH:RXM:RXL). This transfer sets RXDF in the ISR (7), which the host processor can poll to see if data is available, or, if the RREQ bit in the ICR is set, the HI will interrupt the host processor with  $\overline{\text{HREQ}}$  (8).

The code shown in Figure 10-34 is essentially the same as the MAIN PROGRAM in Figure 10-25 except that, since this code will transmit instead of receive data, the HTIE bit is set in the HCR instead of the HRIE bit.

The transmit routine used by the code in Figure 10-34 is shown in Figure 10-35. The interrupt vector contains a JSR, which makes it a long interrupt. The following code sends a fixed test pattern (\$123456) and then resets the HI for the next interrupt.

**10.2.6.3 DMA DATA TRANSFER.** The DMA mode allows the transfer of 8-, 16-, or 24-bit data through the DSP HI under the control of an external DMA controller. The HI provides the pipeline data registers and the synchronization logic between the two asynchronous processor systems. The DSP host exceptions provide cycle-stealing data transfers with the

```

;*****
; MAIN PROGRAM ... transmit 24-bit data to host
;*****

      ORG      P:$40

      MOVEP   #1,X:PBC           ;Turn on Host Port
      MOVEP   #0C00,X:IPR       ;Turn on host interrupt
      MOVEP   #0,X:HCR          ;Turn off XMT and RCV interrupts

      MOVE    #0,SR              ;Unmask interrupts
      MOVE    #>$8,X0           ;Host flag mask for HF0

      LOOP   MOVEP   X:HSR,A      ;Wait for HF0 (from host) set to 1
            AND     X0,A
            JEQ    LOOP

            MOVEP   #2,X:HCR      ;Enable host transmit interrupt

      JMP     *                  ;Now wait for interrupt

```

Figure 10-34. Main Program — Transmit 24-Bit Data to Host



```

;*****
; TRANSMIT to Host Interrupt Routine
;*****

XMT      MOVEP   #\$123456,X:HTX      ;Test value to transmit
         MOVEP   #0,X:HCR            ;Turn off XMT Interrupt
         RTI

        END

```

**Figure 10-35. Transmit to HI Routine**

DSP internal or external memory. This technique allows the DSP memory address to be generated using any of the DSP addressing modes and modifiers. Queues and circular sample buffers are easily created for DMA transfer regions. The host exceptions can be programmed as high-priority fast or long exception service routines. The external DMA controller provides the transfers between the DSP HI registers and the external DMA memory. The external DMA controller must provide the address to the external DMA memory; however, the address of the selected HI register is provided by a DMA address counter in the HI.

DMA transfers can only be in one direction at a time; however, the host processor can access any of the registers not in use during the DMA transfer by deasserting  $\overline{HACK}$  and using  $\overline{HEN}$  and HA0–HA2 to transfer data. The host can therefore transfer data in the other direction during the DMA operation using polling techniques.

**10.2.6.3.1 Host-To-DSP Internal Processing.** The following procedure outlines the steps that the HI hardware takes to transfer DMA data from the host data bus to DSP memory (see Figures 10-36 and 10-37):

1. HI asserts the  $\overline{HREQ}$  pin (see Figures 10-36 and 10-37) when TXDE = 1.
2. DMA controller enables data on H0–H7 and asserts  $\overline{HACK}$ .
3. When  $\overline{HACK}$  is asserted, the HI deasserts  $\overline{HREQ}$ .
4. When the DMA controller deasserts  $\overline{HACK}$ , the data on H0–H7 is latched into the TXH, TXM, TXL registers.
5. If the byte register written was not TXL (i.e., not \$7), the DMA address counter internal to the HI increments, and  $\overline{HREQ}$  is again asserted. Steps 2–5 are then repeated.
6. If TXL (\$7) was written, TXDE will be set to zero, and the address counter in the HI will be loaded with the contents of HM1 and HM0. When TXDE = 0, the contents of TXH:TXM:TXL are transferred to HRX if HRDF = 0. After the transfer to HRX, TXDE will be set to one, and  $\overline{HREQ}$  will be asserted to start the transfer of another word from external memory to the HI.

- When the transfer to HRX occurs within the HI, HRDF is set to one. Assuming HRIE = 1, a host receive exception will be generated. The exception routine must read the HRX to clear HRDF.

#### NOTE

The transfer of data from the TXH, TXM, TXL registers to the HRX register automatically loads the DMA address counter from the HM1 and HM0 bits in the DMA host to DSP mode. This DMA address is used within the HI to place the received byte in the correct register (TXH, TXM, or TXL).

Figure 10-37 shows the differences between 24-, 16-, and 8-bit DMA data transfers. The interrupt rate is three times faster for 8-bit data transfers than for 24-bit data transfers. TXL is always loaded last.

**10.2.6.3.2 Host-to-DSP DMA Procedure.** The following procedure outlines the typical steps that the host processor must take to set up and terminate a host-to-DSP DMA transfer (see Figure 10-38):

- Set up the external DMA controller (1) source address, byte count, direction, and other control registers. Enable the DMA controller channel.

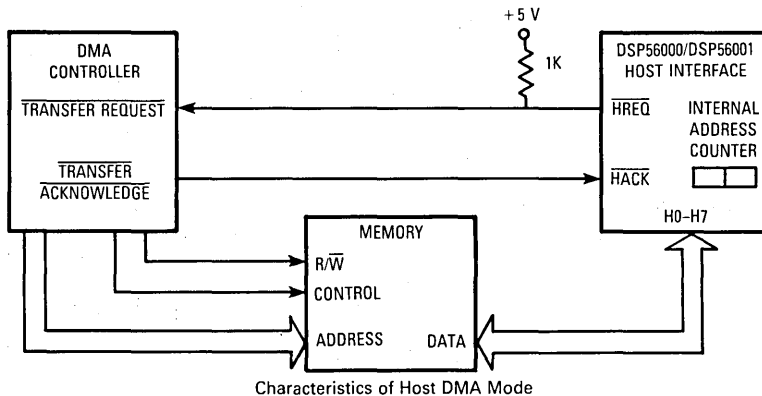

- The  $\overline{\text{HREQ}}$  pin is **NOT** available for host processor interrupts.
- TREQ and RREQ select the direction of DMA transfer.
  - DMA to DSP56000
  - DSP56000 to DMA
  - Simultaneous bidirectional DMA transfers are not permitted
- Host processor software polled transfers are permitted in the opposite direction of the DMA transfer.
- 8-, 16-, or 24-bit transfers are supported.
  - 16- or 24-bit transfers reduce the DSP interrupt rate by a factor of 2 or 3, respectively.

**Figure 10-36. HI Hardware — DMA Mode**

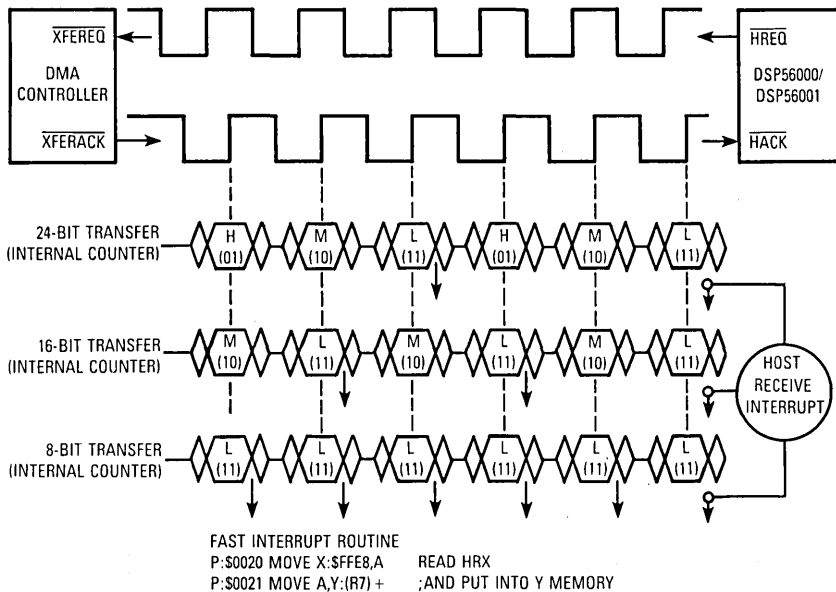

**Figure 10-37. DMA Transfer and Host Interrupts**

2. Initialize the HI (2) by writing the ICR to select the word size (HM0 and HM1), to select the direction (TREQ=1, RREQ=0), and to initialize the channel setting INIT=1 (see Figure 10-39).
3. The DSP's destination pointer (3) used in the DMA exception handler (e.g., address register) must be initialized, and HRIE must be set to enable the HRDF interrupt to the DSP CPU. This procedure can be done with a separate host command exception routine in the DSP.  $\overline{\text{HREQ}}$  will be asserted (4) immediately by the HI to begin the DMA transfer.
4. Perform other tasks (5) while the DMA controller transfers data (6) until interrupted by the DMA controller DMA transfer complete interrupt (7). The DSP interrupt control register (ICR), the interrupt status register (ISR), and RXH, RXM, and RXL registers may be accessed at any time by the host processor but the TXH, TXM, and TXL registers may not be accessed until the DMA mode is disabled.
5. Terminate the DMA controller channel (8) to disable DMA transfers.
6. Terminate the DSP HI DMA mode (9) in the ICR by clearing the HM1 and HM0 bits and clearing TREQ.

The  $\overline{\text{HREQ}}$  will be active immediately after initialization is completed (depending on hardware) because the data direction is host to DSP and TXH, TXM, and TXL registers are empty. When the host writes data to TXH, TXM, and TXL, this data will be immediately transferred to HRX. If the DSP is due to work in interrupt mode, HRIE must be enabled.

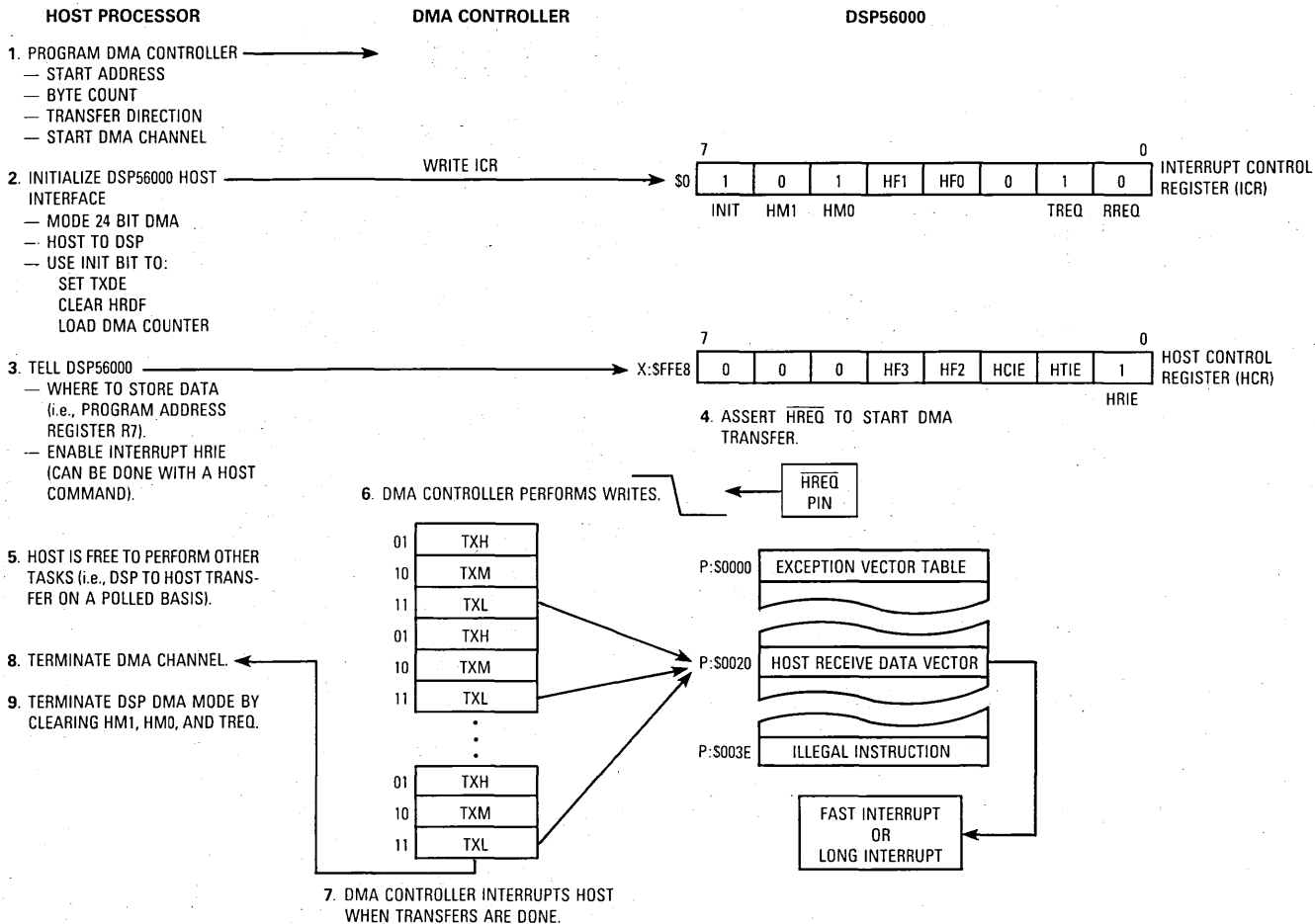

Figure 10-38. Host-to-DSP DMA Procedure

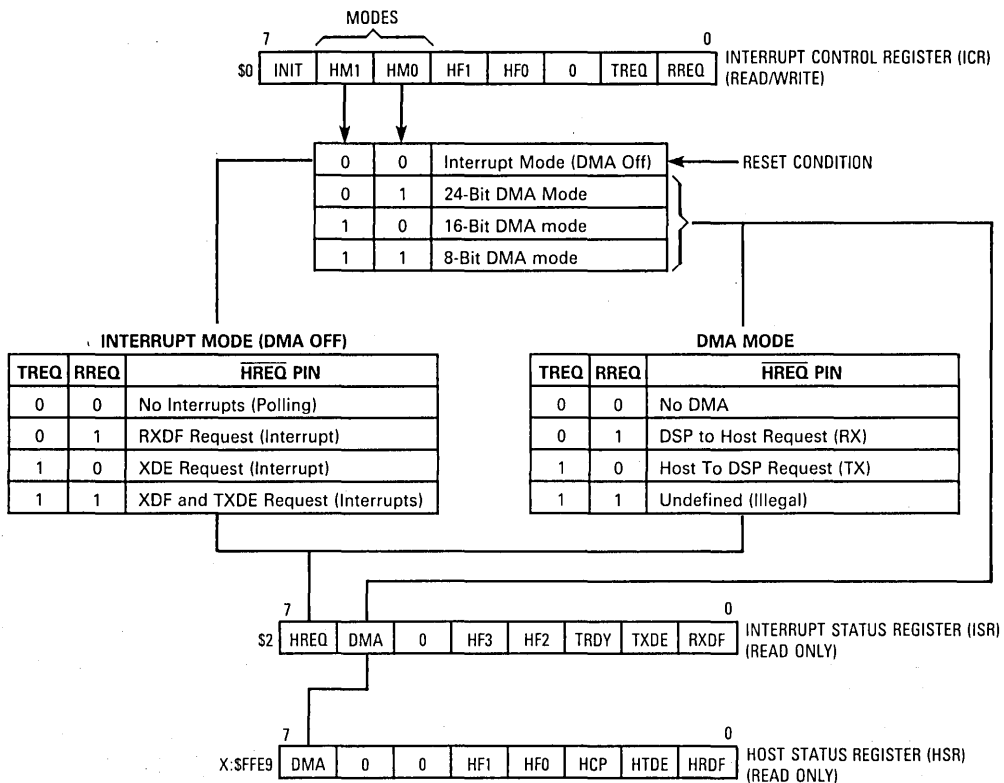

Figure 10-39. Host Bits with TREQ and RREQ

**10.2.6.3.3 DSP-to-Host Internal Processing.** The following procedure outlines the steps that the HI hardware takes to transfer DMA data from DSP memory to the host data bus:

1. On the DSP side of the HI, a host transmit exception will be generated when HTDE = 1 and HTIE = 1. The exception routine must write HTX, thereby setting HTDE = 0.
2. If RXDF = 0 and HTDE = 0, the contents of HTX will be automatically transferred to RXH:RXM:RXL, thereby setting RXDF = 1 and HTDE = 1. Since HTDE = 1 again on the initial transfer, a second host transmit exception will be generated immediately, and HTX will be written, which will clear HTDE again.
3. When RXDF is set to one, the HI's internal DMA address counter is loaded (from HM1 and HM0), and HREQ is asserted.
4. The DMA controller enables the data from the appropriate byte register onto H0-H7 by asserting H $\overline{\text{ACK}}$ . When H $\overline{\text{ACK}}$  is asserted, HREQ is deasserted by the HI.

5. The DMA controller latches the data presented on H0–H7 and deasserts  $\overline{\text{HACK}}$ . If the byte register read was not RXL (i.e., not \$7), the HI's internal DMA counter increments, and  $\overline{\text{HREQ}}$  is again asserted. Steps 3, 4, and 5 are repeated until RXL is read.
6. If RXL was read, RXDF will be set to zero, and, since  $\text{HTDE} = 0$ , the contents of HTX will be automatically transferred to RXH:RXM:RXL, and RXFD will be set to one. Steps 3, 4, and 5 are repeated until RXL is read again.

#### NOTE

The transfer of data from the HTX register to the RXH:RXM:RXL registers automatically loads the DMA address counter from the HM1 and HM0 bits when in the DMA DSP-to-host mode. This DMA address is used within the HI to place the appropriate byte on H0–H7.

**10.2.6.3.4 DSP-to-Host DMA Procedure.** The following procedure outlines the typical steps that the host processor must take to set up and terminate a DSP-to-host DMA transfer (see Figure 10-40).

1. Set up the DMA controller (1) destination address, byte count, direction, and other control registers. Enable the DMA controller channel.
2. Initialize the HI (2) by writing the ICR to select the word size (HM0 and HM1), to select the direction ( $\text{TREQ} = 0$ ,  $\text{RREQ} = 1$ ), and to set  $\text{INIT} = 1$  (see Figure 10-40 for additional information on these bits).
3. The DSP's source pointer (3) used in the DMA exception handler (e.g., an address register) must be initialized, and HTIE must be set to enable the DSP host transmit interrupt. This procedure can be done by the host processor with a host command exception routine.

The DSP host transmit exception will be activated immediately after HTIE is set. The DSP CPU will move data to HTX. The HI circuitry will transfer the contents of HTX to RXH:RXM:RXL, setting RXDF, which asserts  $\overline{\text{HREQ}}$ . Asserting  $\overline{\text{HREQ}}$  (4) starts the DMA transfer from RXH, RXM, and RXL to the host processor.

4. Perform other tasks (5) while the DMA controller transfers data (6) until interrupted by the DMA controller DMA complete interrupt (7): The DSP interrupt control register (ICR), the interrupt status register (ISR), and TXH, TXM, and TXL registers may be accessed at any time by the host processor but the RXH, RXM, and RXL registers may not be accessed until the DMA mode is disabled.
5. Terminate the DMA controller channel (8) to disable DMA transfers.
6. Terminate the DSP HI DMA mode (9) in the ICR by clearing the HM1 and HM0 bits and clearing RREQ.

**10.2.6.4 EXAMPLE CIRCUITS.** Figures 10-41, 10-42, and 10-43 illustrate the simplicity of the HI. The MC68HC11 in Figure 10-41 has a multiplexed address and data bus, which

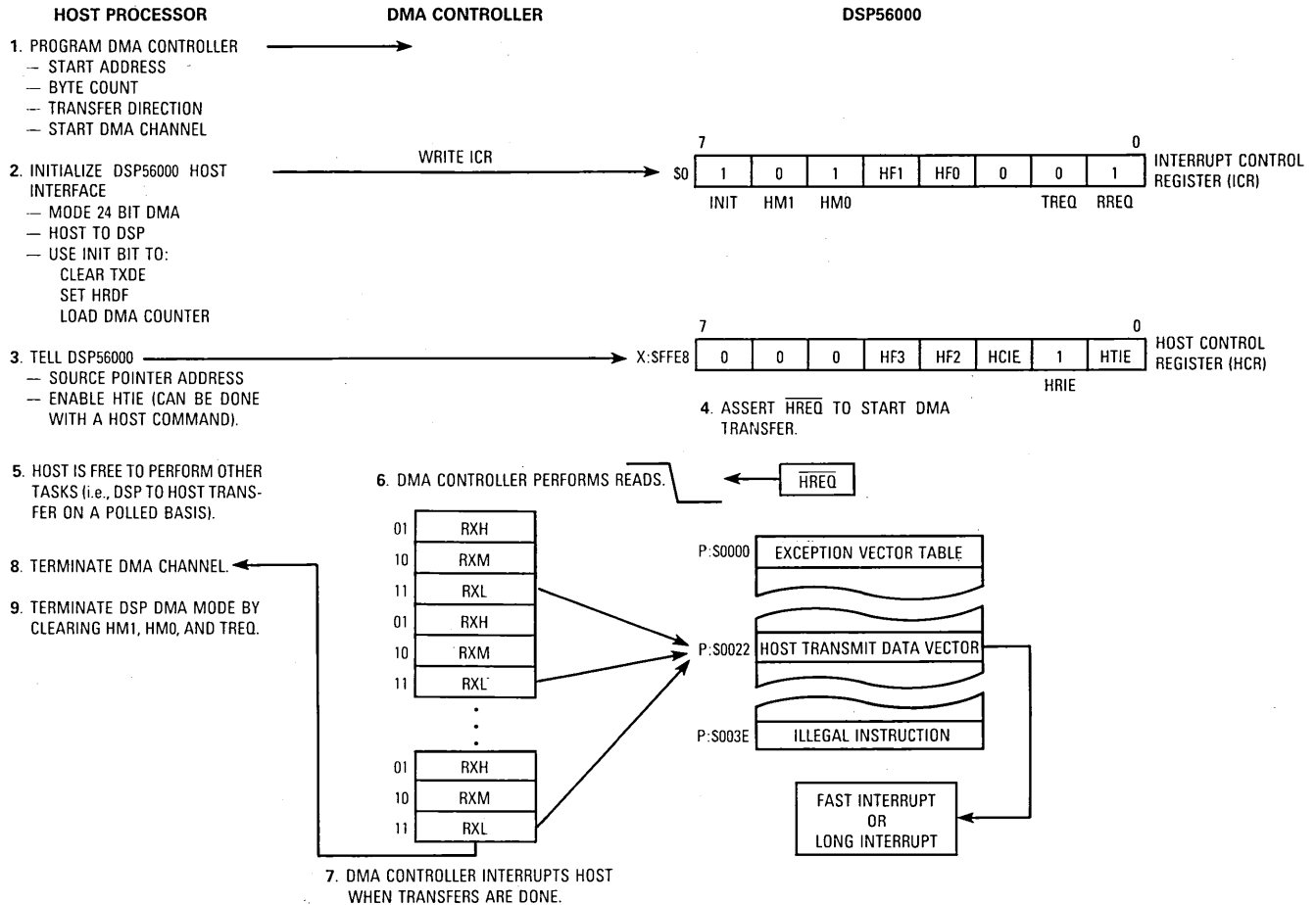
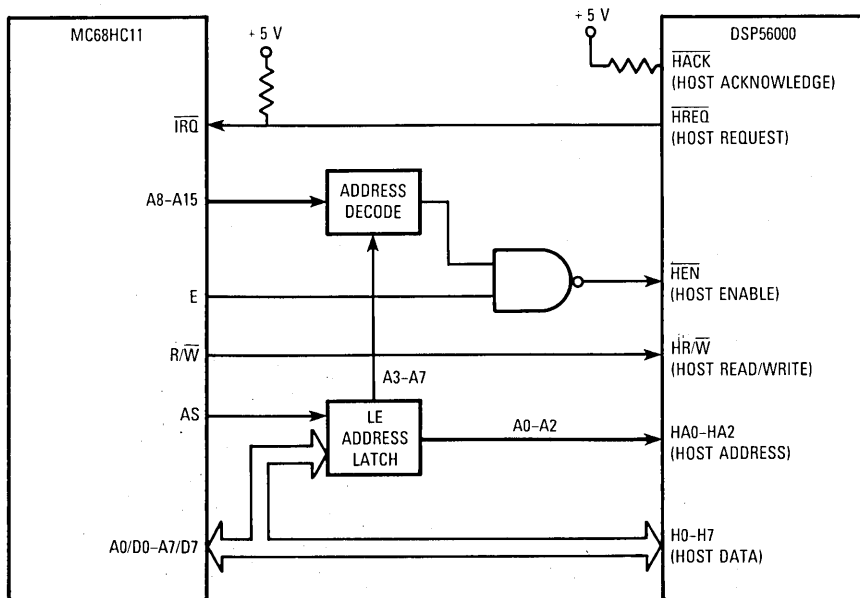

Figure 10-40. DSP-to-Host DMA Procedure



Use LDA and STA for 8-Bit Transfers.  
Use LDD and STD for 16-Bit Transfers.

**Figure 10-41. MC68HC11-to-DSP56000 Host Interface**

requires that the address be latched. Although the  $\overline{\text{HACK}}$  is not used in this circuit, it is pulled up. All unused input pins should be terminated to prevent erroneous signals. When determining whether a pin is an input, remember that a pin may change during reset or while changing port B between general-purpose I/O and HI functions.

The MC68000 (see Figure 10-42) can use a MOVEP instruction with word and long-word data size to transfer multiple bytes. If an MC68020 or MC68030 is used, dynamic bus sizing can be used to transfer multiple bytes with any instruction.

Figure 10-43 is a high-level block diagram of a system using a single host to control multiple DSPs. In addition, the DSPs use the SSI to network together the DSPs and multiple codecs. With four DSPs, this system can process 41 million instructions per second and can be easily expanded if more processing power is needed.

**10.2.6.5 HOST PORT USAGE CONSIDERATIONS — HOST SIDE.** Careful synchronization is required when reading multibit registers that are written by another asynchronous system. Synchronization is a common problem when two asynchronous systems are connected. The situation exists in the host port. However, if the port is used in the way it was



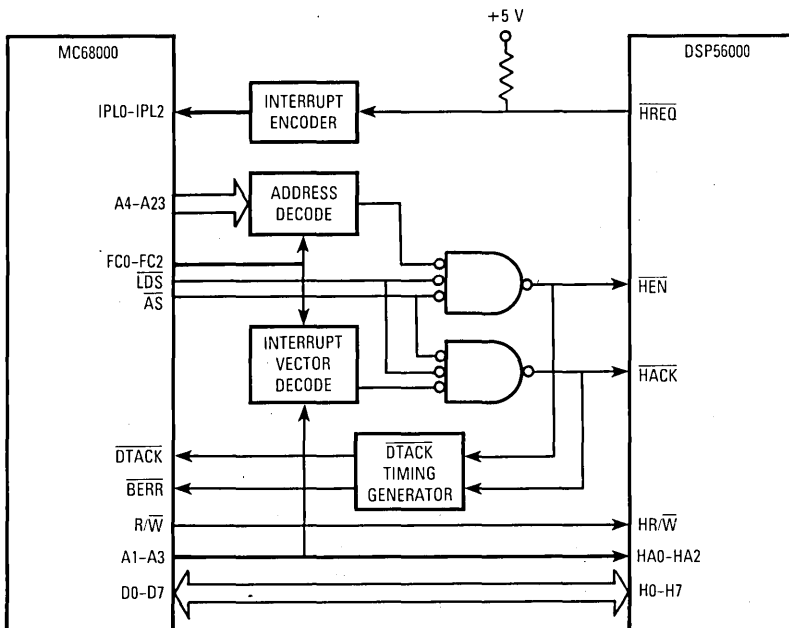

MC68000 — Use MOVEP for multiple byte transfers.  
 MC68020 or MC68030 — Any Memory references will work due to dynamic bus sizing.

**Figure 10-42. MC68000-to-DSP56000 Host Interface**

designed, proper operation is guaranteed. The considerations for proper operation are discussed in the following paragraphs:

**1. Unsynchronized Reading of Receive Byte Registers:**

When reading receive byte registers, RXH, RXM, or RXL, the host processor should use interrupts or poll the RXDF flag which indicates that data is available. This guarantees that the data in the receive byte registers will be stable.

**2. Overwriting Transmit Byte Registers:**

The host processor should not write to the transmit byte registers, TXH, TXM, or TXL, unless the TXDE bit is set, indicating that the transmit byte registers are empty. This guarantees that the DSP will read stable data when it reads the HRX register.

**3. Synchronization of Status Bits from DSP to Host:**

HC, HREQ, DMA, HF3, HF2, TRDY, TXDE, and RXDF status bits are set or cleared from inside the HI and read by the host processor. The host can read these status bits very quickly without regard to the clock rate used by the DSP, but there is a chance that the state of the bit could be changing during the read operation. This possible change

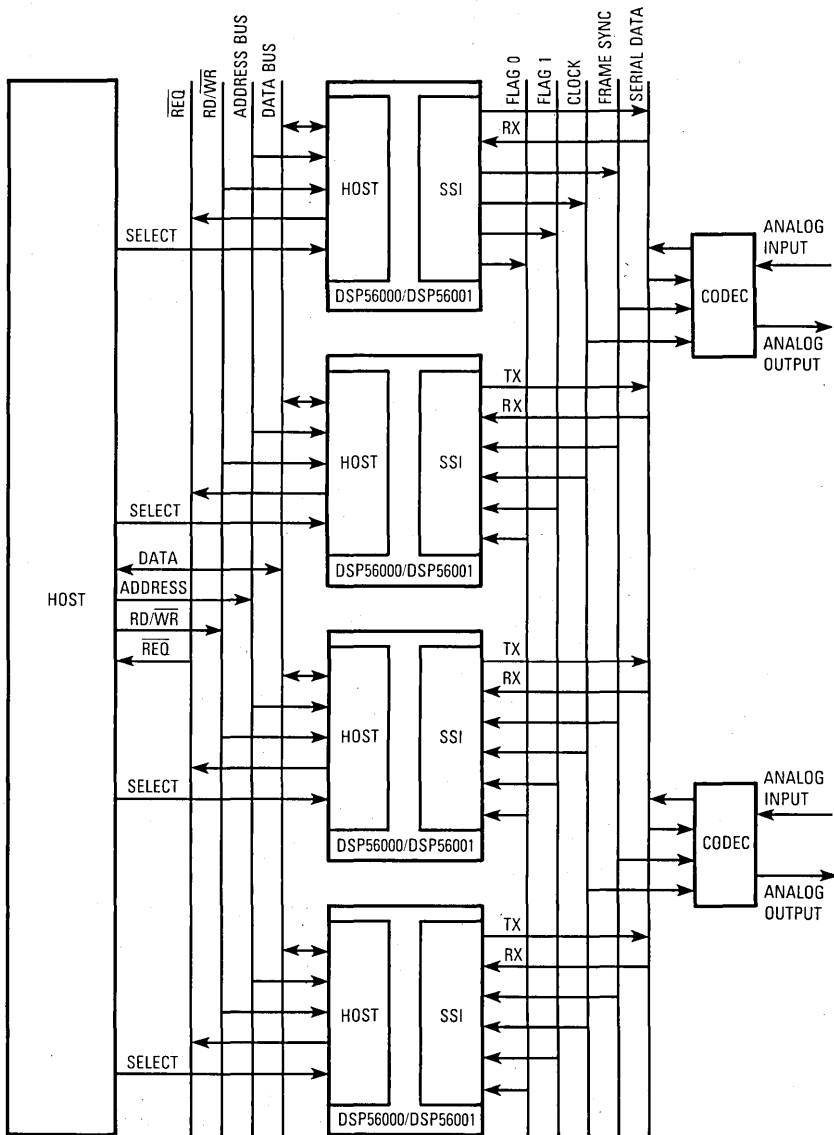

Figure 10-43. Multi-DSP Network Example

is generally not a system problem, since the bit will be read correctly in the next pass of any host polling routine.

However, if the host holds the  $\overline{\text{HEN}}$  for the minimum assert time plus 1.5 clock cycle, the status data is guaranteed to be stable. The 1.5 clock cycle is used to synchronize the HEN signal and to block internal updates of the status bits. There is no other minimum  $\overline{\text{HEN}}$  assert time relationship to DSP clocks.

There is a minimum  $\overline{\text{HEN}}$  deassert time of 1.5 clock cycle so that the blocking latch can be updated if host is in a tight polling loop. This minimum time only applies to reading status bits.

The only potential problem with the host processor reading status bits is reading HF3 and HF2 as an encoded pair. For example, if the DSP changes HF3 and HF2 from "00" to "11," there is a very small probability that the host could read the bits during the transition and receive "01" or "10" instead of "11". If the combination of HF3 and HF2 has significance, the host processor would potentially read the wrong combination. Two solutions would be to 1) read the bits twice and check for consensus and 2) hold HEN access for  $\overline{\text{HEN}} + 1.5$  clock cycle so that status bit transitions are stabilized.

#### 4. Overwriting the Host Vector:

The host programmer should change the host vector register only when the HC bit is clear. This will guarantee that the DSP interrupt control logic will receive a stable vector.

#### 5. Canceling a Pending Host Command Exception:

The host processor may elect to clear the HC bit to cancel the host command exception request at any time before it is recognized by the DSP. The DSP CPU may execute the host exception after the HC bit is cleared because the host processor does not know exactly when the exception will be recognized. This uncertainty in timing is due to differences in synchronization between the host processor and DSP CPU and the uncertainties of pipelined exception processing. For this reason, the HV should not be changed at the same time the HC bit is cleared. However, the HV can be changed when the HC bit is set.

#### 6. When using the $\overline{\text{HREQ}}$ pin for handshaking, wait until $\overline{\text{HREQ}}$ is asserted and then start writing/reading data using the $\overline{\text{HEN}}$ pin or the $\overline{\text{HACK}}$ pin.

When not using  $\overline{\text{HREQ}}$  for handshaking, poll the INIT bit in the ICR to make sure it is cleared by the hardware (which means the INIT execution is completed). Then, start writing/reading data.

If neither using  $\overline{\text{HREQ}}$  for handshaking nor polling the INIT bit, wait at least 6T after negation of  $\overline{\text{HEN}}$  that wrote ICR before writing/reading data. This wait ensures that INIT is completed, because the HI needs 3T for synchronization (worst case) plus 3T for executing the INIT.

7. All unused input pins should be terminated. Also, any pin that is temporarily not driven by an output 1) during RESET, 2) when reprogramming a port or pin, 3) when a bus is not driven, or 4) at any other time should be pulled up or down with a resistor, as appropriate. For example, the  $\overline{H\overline{EN}}$  is capable of reacting to 2-ns noise spikes when it is not terminated. Allowing  $\overline{HACK}$  to float may cause problems even though it is not needed in the circuit.

## SECTION 11

### PORT C

Port C is a triple-function I/O port with nine pins (see Figure 11-1). Three of the nine pins can be configured as general-purpose I/O or as the serial communications interface (SCI) pins, and the other six pins can be configured as general-purpose I/O or as the synchronous serial interface (SSI) pins. When configured as general-purpose I/O, port C can be used for device control. When the pins are configured as serial interfaces, port C provides a convenient connection to other DSPs, processors, codecs, digital-to-analog and analog-to-digital converters, and any of several transducers. This section describes all three port C functions as well as examples of how to configure and use each function.

#### 11.1 GENERAL-PURPOSE I/O (PORT C)

When configured as general-purpose I/O, port C can be viewed as nine I/O pins (see Figure 11-2), which are controlled by three memory-mapped registers (see Figure 11-3). RESET configures port C as general-purpose I/O with all nine pins as inputs by clearing all three registers (external circuitry connected to these pins may need pullups until the pins are configured for operation). These registers are the port C control register (PCC), port C data direction register (PCDDR), and port C data register (PCD). Each port C pin may be individually programmed as a general-purpose I/O pin or as a dedicated on-chip peripheral pin under software control. Pin selection between general-purpose I/O and SCI or SSI is made by setting the appropriate PCC bit (memory location X:\$FFE1) to zero for general-purpose I/O or to one for serial interface. The PCDDR (memory location X:\$FFE3) programs each pin corresponding to a bit in the PCD (memory location X:\$FFE5) as an input pin (if PCDDR=0) or as an output pin (if PCDDR=1). Writing to the PCD will write data to the pins designated as outputs by the PCDDR; reading the PCD will read the pins designated as inputs by the PCDDR.

The port C I/O pin control logic is shown in Figure 11-4. When a pin is designated as an output and the PCD is read, the output of the output data bit latch is read, not the logic level on the pin itself. When a port pin is configured as an SCI or SSI pin and the bit in the PCDDR is zero (input), then reading the PCD will show the logic level on the pin even though the pin is configured as a peripheral pin. The SCI or SSI function may be using the pin as an input or an output, which can be very useful when debugging the SCI or SSI.

##### 11.1.1 Programming Parallel I/O

Port C and all the DSP56000/DSP56001 peripherals are memory mapped (see Figure 11-5). The standard MOVE instruction transfers data between port C and a register; as a

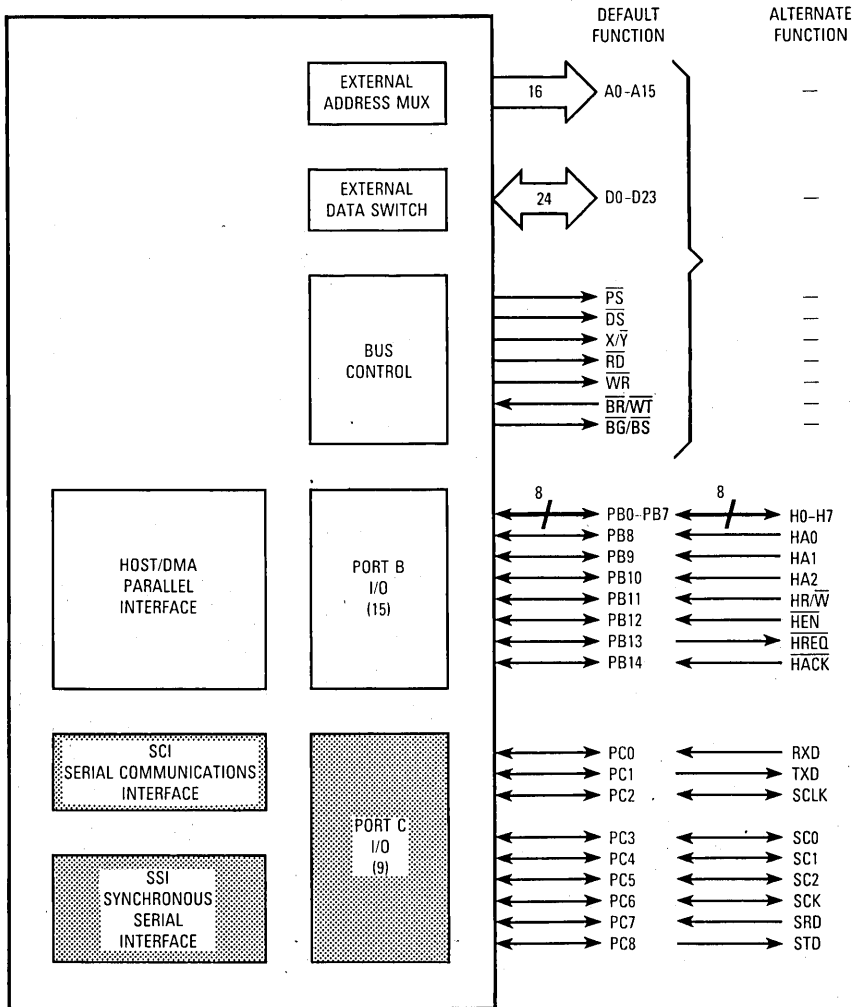

Figure 11-1. Port C Interface

result, performing a memory-to-memory data transfer takes two MOVE instructions and a register. The MOVEP instruction is specifically designed for I/O data transfer as shown in Figure 11-6. Although the MOVEP instruction may take twice as long to execute as a MOVE instruction, only one MOVEP is required for a memory-to-memory data transfer, and MOVEP does not use a temporary register. Using the MOVEP instruction allows a fast interrupt to move data to/from a peripheral to memory and execute one other instruction or to move the data to an absolute address. MOVEP is the only memory-to-memory move instruction;

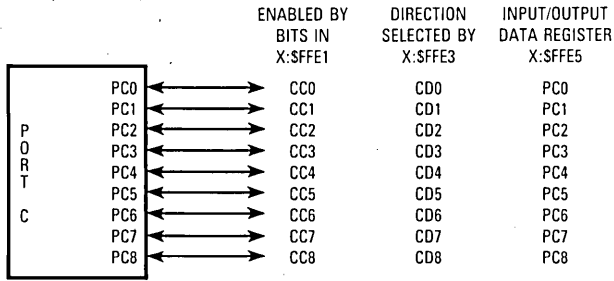
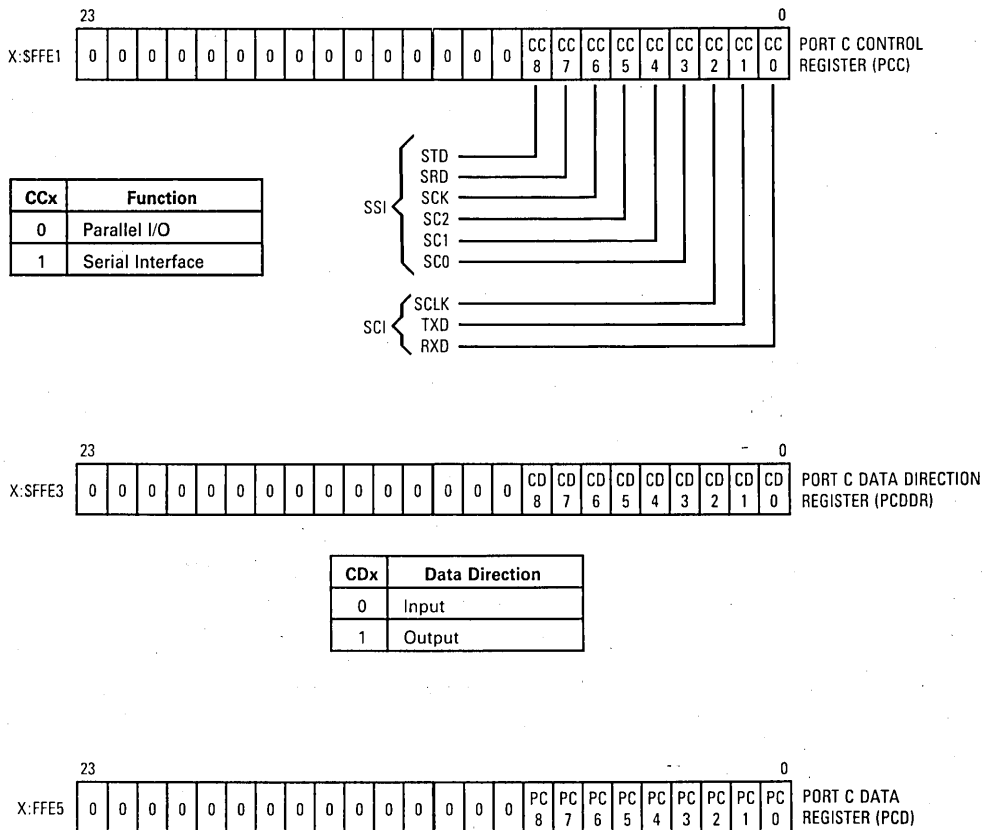

Figure 11-2. Parallel Port C Pinout



NOTE: Hardware and software reset clears PCC and PCDDR.

Figure 11-3. Parallel Port C Registers

| Port Control Register Bit | Data Direction Register Bit | Pin Function       |
|---------------------------|-----------------------------|--------------------|
| 0                         | 0                           | Port Input Pin     |
| 0                         | 1                           | Port Output Pin    |
| 1                         | X                           | Alternate Function |

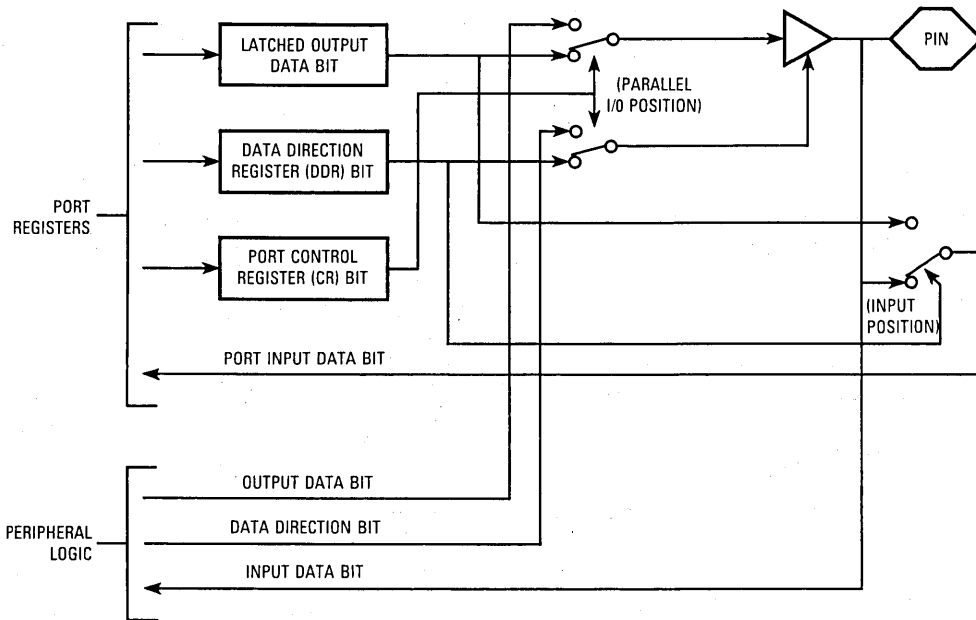

Figure 11-4. Port B I/O Pin Control Logic

however, one of the operands must be in the top 64 locations of either X: or Y: memory. The bit-oriented instructions using I/O short addressing (BCHG, BCLR, BSET, BTST, JCLR, JSCLR, JSET, and JSSET) can also be used to address individual bits for faster I/O processing. The DSP does not have a hardware data strobe to strobe data out of the parallel I/O port. If a data strobe is needed, it can be implemented using software to toggle one of the parallel I/O pins. The process of programming port C as general-purpose I/O is shown as a flowchart in Figure 11-7 and detailed in Figure 11-8. Normally, it is not good programming practice to activate a peripheral before programming it. However, reset activates the port C general-purpose I/O as all inputs, and the alternative is to configure the port as an SCI and/or SSI, which may not be desirable. In this case, it is probably better to insure that port C is initially configured for general-purpose I/O and then configure the data direction and data registers. It may be better in some situations to program the data direction or the data registers first to prevent two devices from driving one signal. The order of steps 1, 2, and 3 in Figure 11-7 is optional and can be changed as needed.



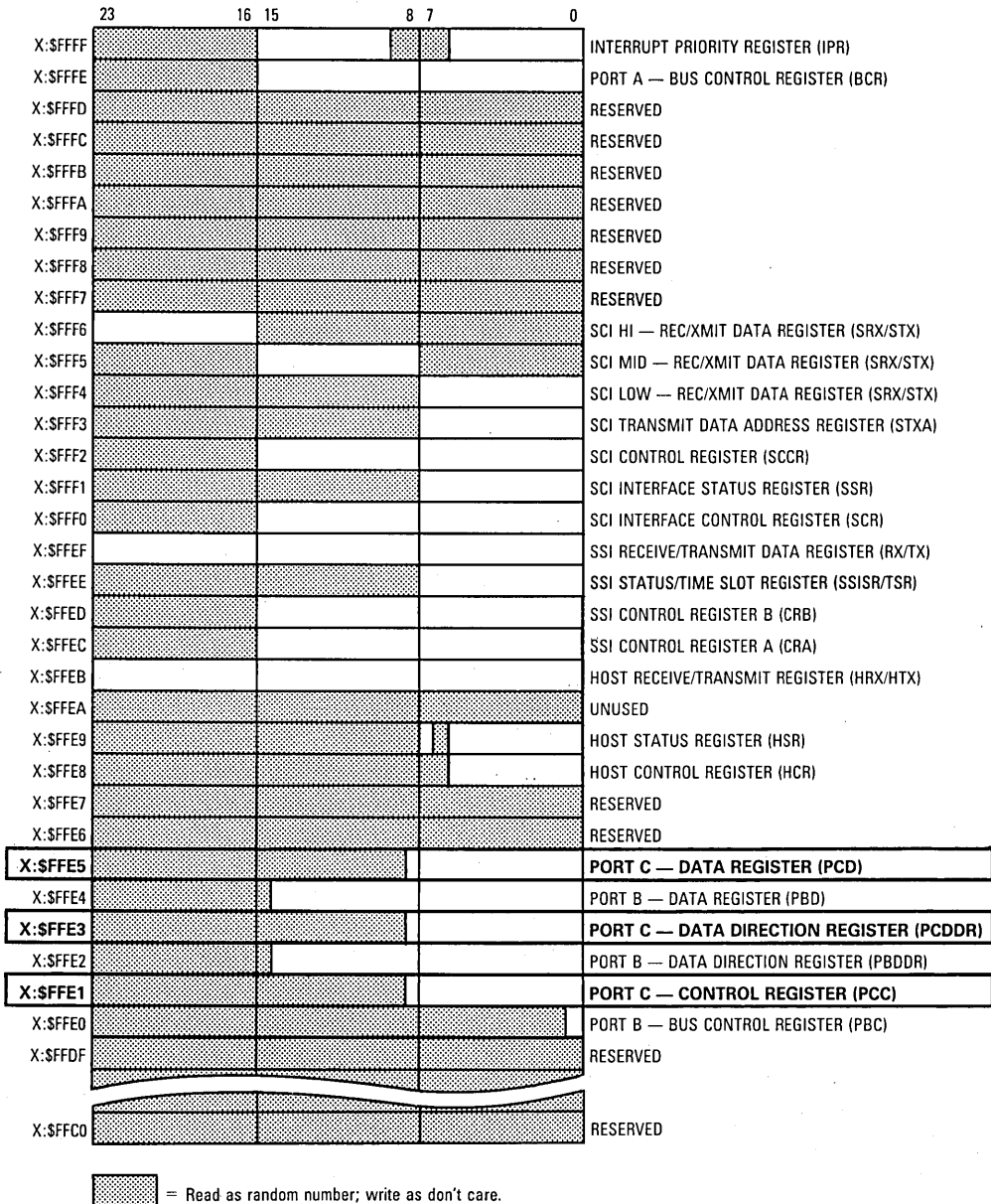

Figure 11-5. On-Chip Peripheral Memory Map

```

:
:
MOVEP #0,X:$FFE1      ;Select port C to be general-purpose I/O

MOVEP #01F0,X:$FFE3   ;Select pins PC0-PC3 to be inputs
:                       ;and pins PC4-PC8 to be outputs
:

MOVEP #data_out,X:$FFE5 ;Put bits 4-8 of "data_out" on pins
:                       ;PB4-PB8 bits 0-3 are ignored.

MOVEP X:$FFE0,#data_in ;Put PB0-PB3 in bits 0-3 of "data_in"

```

**Figure 11-6. Write/Read Parallel Data with Port C**

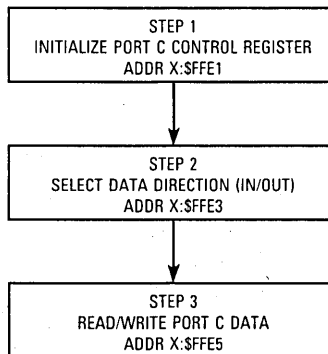

**Figure 11-7. Port C Configuration Flowchart**

### 11.1.2 Port C Parallel I/O Timing

Parallel data written to port C is delayed by one instruction cycle — i.e., the following instruction

```
MOVE    DATA9,X:PORTC    DATA24,Y:EXTERN
```

- 1) writes nine bits of data to the port C register, but the output pins do not change until the following instruction cycle, and
- 2) writes 24 bits of data to the external Y memory, which appears on port A during T2 and T3 of the current instruction.

**STEP 1. SELECT EACH PIN TO BE GENERAL-PURPOSE I/O OR AN ON-CHIP PERIPHERAL PIN:**  
 CCx = 0  $\blacktriangleright$  GENERAL-PURPOSE I/O  
 CCx = 1  $\blacktriangleright$  ON-CHIP PERIPHERAL

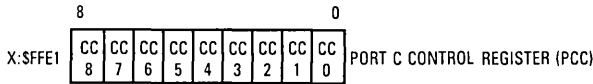

**STEP 2. SET EACH GENERAL-PURPOSE I/O PIN (SELECTED ABOVE) AS INPUT OR OUTPUT:**  
 CDxx = 0  $\blacktriangleright$  INPUT PIN  
 OR  
 CDx = 1  $\blacktriangleright$  OUTPUT PIN

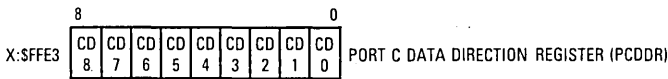

**STEP 3. READ/WRITE GENERAL-PURPOSE I/O PINS:**  
 PCx = OUTPUT DATA IF SELECTED FOR GENERAL-PURPOSE I/O AND OUTPUT IN STEPS 1 AND 2.  
 OR  
 PCx = INPUT DATA IF SELECTED FOR GENERAL-PURPOSE I/O AND INPUT IN STEPS 1 AND 2.

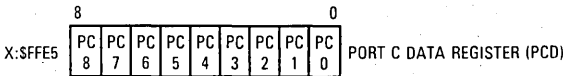

**Figure 11-8. I/O Port C Configuration**

As a result, if it is desirable to synchronize the port A and port C outputs, two instructions must be used:

```

MOVE      DATA9,X:PORTC
NOP                               DATA24,Y:EXTERN
  
```

The NOP can be replaced by any instruction that allows parallel moves. Inserting one or more "MOVE DATA15,X:PORTC DATA24,Y:EXTERN" instructions between the first and second instruction produces an external 33-bit write each instruction cycle with only one instruction cycle lost in setup time:

```

MOVE      DATA15,X:PORTC
MOVE      DATA15,X:PORTC          DATA24,Y:EXTERN
MOVE      DATA15,X:PORTC          DATA24,Y:EXTERN
:
:
MOVE      DATA15,X:PORTC          DATA24,Y:EXTERN
NOP                               DATA24,Y:EXTERN
  
```

One application of this technique is to create an extended address for port A by concatenating the port A address bits (instead of data bits) to the port C general-purpose output bits. The port C general-purpose I/O register would then work as a base address register, allowing the address space to be extended from 64K words (16 bits) to 33.5 million words (16 bits + 9 bits = 25 bits).

Port C uses the DSP central processing unit (CPU) four-phase clock for its operation. Therefore, if wait states are inserted in the DSP CPU timing, they also affect port C timing. The result is that port A and port C in the previous synchronization example will always stay synchronized, regardless of how many wait states are used.

## 11.2 SERIAL COMMUNICATION INTERFACE (SCI)

The SCI provides a full-duplex port for serial communication to other DSPs, microprocessors, or peripherals such as modems. The communication can be TTL-level signals or, with additional logic, RS232C, RS422, etc. This interface uses three dedicated pins: transmit data (TXD), receive data (RXD), and SCI serial clock (SCLK). It supports industry-standard asynchronous bit rates and protocols as well as high-speed (up to 3.375 Mbits/second for a 27-MHz clock) synchronous data transmission. The asynchronous protocols include a multidrop mode for master/slave operation with wakeup on idle line and wakeup on address bit capability. The SCI consists of separate transmit and receive sections whose operations can be asynchronous with respect to each other. A programmable baud-rate generator is included to generate the transmit and receive clocks. An enable vector and an interrupt vector have been included so that the baud-rate generator can function as a general-purpose timer when it is not being used by the SCI peripheral or when the interrupt timing is the same as that used by the SCI. The following is a short list of SCI features:

### Three-Pin Interface:

- TXD — Transmit Data
- RXD — Receive Data
- SCLK — Serial Clock

422 Kbit/Second NRZ Asynchronous Communications Interface (27-MHz System Clock)

3.375 Mbit/Second Synchronous Serial Mode (27-MHz System Clock)

### Multidrop Mode for Multiprocessor Systems:

#### Two Wakeup Modes:

- Idle Line
- Address Bit
- Wired-OR Mode

On-Chip or External Baud Rate Generation/Interrupt Timer

Four Interrupt Priority Levels

Fast or Long Interrupts

## 11.2.1 SCI I/O Pins

The SCI has three I/O pins, which can be configured as either general-purpose I/O or as a specific SCI pin. Each pin is independent of the other two, which means that if only TXD is needed, RXD and SCLK can be programmed for general-purpose I/O. At least one of the three pins must be selected as an SCI pin to release the SCI from reset.

However, the SCI interrupts may be enabled by programming the SCI control registers before any of the SCI pins are programmed as SCI functions. In this case, only one transmit interrupt can be generated because the transmit data register is empty. The timer and timer interrupt will operate as they do when one or more of the SCI pins is programmed as an SCI function.

**11.2.1.1 RECEIVE DATA (RXD).** This input receives byte-oriented serial data and transfers the data to the SCI receive shift register. Asynchronous input data is sampled on the positive edge of the receive clock ( $1 \times \text{SCLK}$ ) if SCKP equals zero. See the *DSP56001 Advance Information Data Sheet* (ADI1290) for detailed timing information. RXD may be programmed as a general-purpose I/O pin (PC0) when the SCI RXD function is not being used.

**11.2.1.2 TRANSMIT DATA (TXD).** This output transmits serial data from the SCI transmit shift register. Data changes on the negative edge of the asynchronous transmit clock (SCLK) if SCKP equals zero. This output is stable on the positive edge of the transmit clock. See the *DSP56001 Advance Information Data Sheet* (ADI1290) for detailed timing information. TXD may be programmed as a general-purpose I/O pin (PC1) when the SCI TXD function is not being used.

**11.2.1.3 SCI SERIAL CLOCK (SCLK).** This bidirectional pin provides an input or output clock from which the transmit and/or receive baud rate is derived in the asynchronous mode and from which data is transferred in the synchronous mode. SCLK may be programmed as a general-purpose I/O pin (PC2) when the SCI SCLK function is not being used. This pin may be programmed as PC2 when data is being transmitted on TXD since, in the asynchronous mode, the clock need not be transmitted. There is no connection between programming the PC2 pin as SCLK and data coming out the TXD pin because SCLK is independent of SCI data I/O.

## 11.2.2 Programming Model

The resources available in the SCI are described before discussing specific examples of how the SCI is used. The registers comprising the SCI are shown in Figures 11-9 and 11-10. These registers are the SCI control register (SCR), SCI status register (SSR), SCI clock control register (SCCR), SCI receive data registers (SRX), SCI transmit data registers (STX), and the SCI transmit data address register (STXA). The SCI programming model

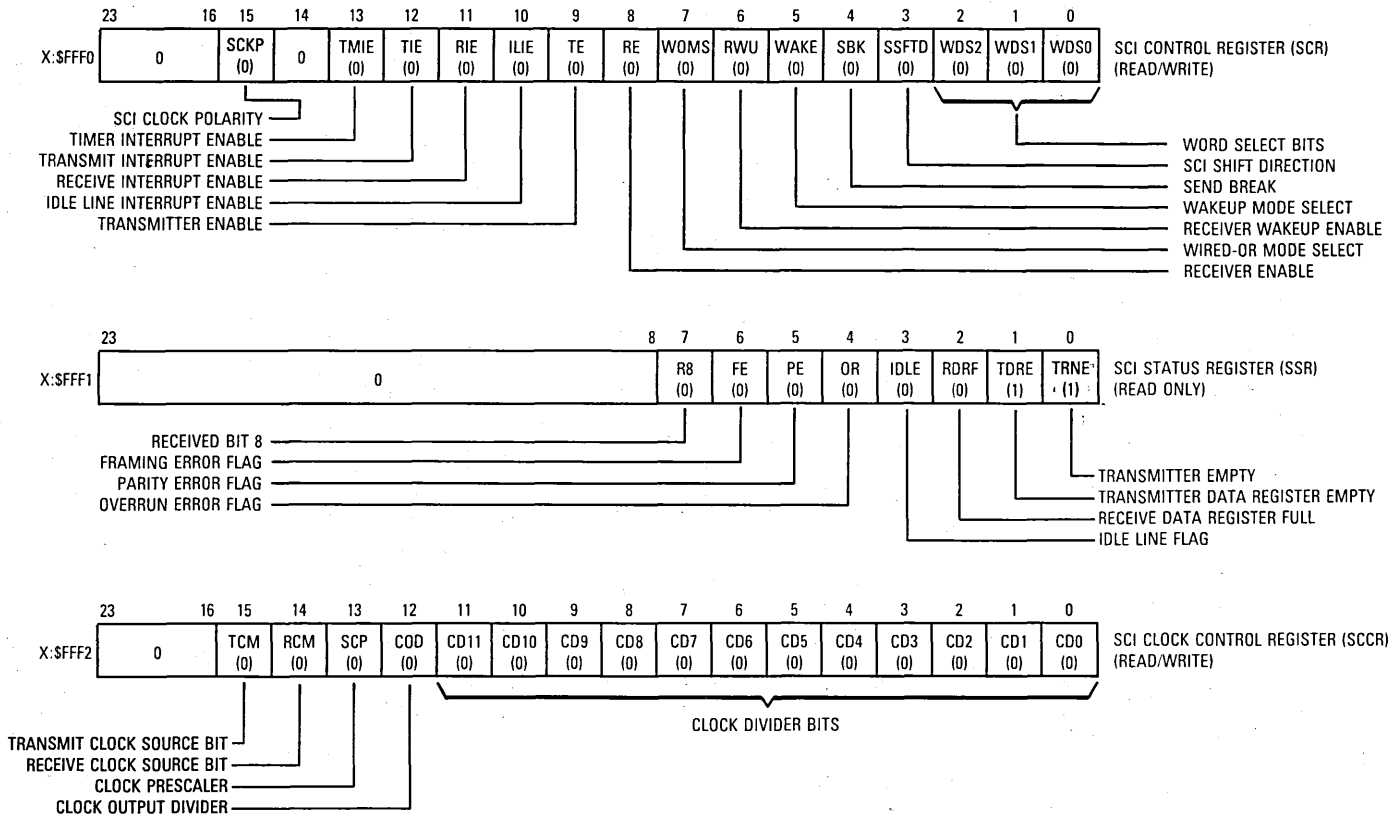

NOTE: The number in parenthesis is the condition of the bit after hardware reset.

Figure 11-9. SCI Programming Model — Control and Status Registers

can be viewed as three types of registers: 1) control — SCR and SCCR in Figure 11-9; 2) status — SSR in Figure 11-9; and 3) data transfer — SRX, STX, and STXA in Figure 11-10. The following paragraphs describe each bit in the programming model.

**11.2.2.1 SCI CONTROL REGISTER (SCR).** The SCR is a 16-bit read/write register that controls the serial interface operation. Fifteen of the 16 bits are currently defined. Each bit is described in the following paragraphs.

**11.2.2.1.1 SCR Word Select (WDS0, WDS1, WDS2) Bits 0, 1, and 2.** The three word-select bits (WDS0, WDS1, WDS2) select the format of the transmit and receive data. The formats include three asynchronous and one multidrop asynchronous mode as well as an 8-bit

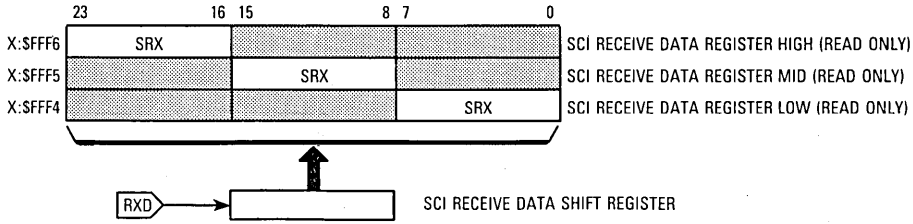

NOTE: SRX is the same register decoded at three different addresses.

**(a) Receive Data Register**

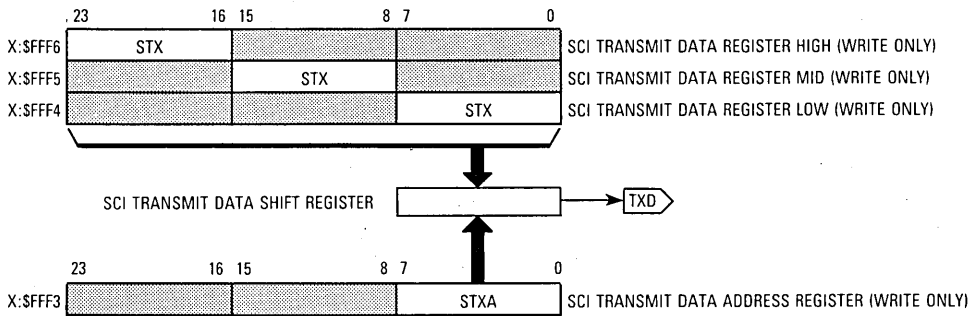

NOTES:

1. Bytes are masked on the fly.
2. STX is the same register decoded at three different addresses.

**(b) Transmit Data Register**

**Figure 11-10. SCI Programming Model**

synchronous (shift register) mode. The asynchronous modes are compatible with most UART-type serial devices. Standard RS232C communication links are supported by these modes.

The multidrop asynchronous modes are compatible with the MC68681 DUART, the M68HC11 SCI interface, and the Intel 8051 serial interface.

The synchronous data mode is essentially a high-speed shift register used for I/O expansion and stream-mode channel interfaces. Data synchronization is accomplished by the use of a gated transmit and receive clock that is compatible with the Intel 8051 serial interface mode 0. These formats are indicated below (also see Figure 11-11).

The word-select bits are cleared by hardware reset.

| WDS2 | WDS1 | WDS0 | Word Formats   |
|------|------|------|--|
| 0    | 0    | 0    | 8-Bit Synchronous Data (shift register mode)                 |
| 0    | 0    | 1    | Reserved   |
| 0    | 1    | 0    | 10-Bit Asynchronous (1 start, 8 data, 1 stop)                |
| 0    | 1    | 1    | Reserved   |
| 1    | 0    | 0    | 11-Bit Asynchronous (1 start, 8 data, 1 even parity, 1 stop) |
| 1    | 0    | 1    | 11-Bit Asynchronous (1 start, 8 data, 1 odd parity, 1 stop)  |
| 1    | 1    | 0    | 11-Bit Multidrop (1 start, 8 data, 1 data type, 1 stop)      |
| 1    | 1    | 1    | Reserved   |

When odd parity is selected, the transmitter will count the number of bits in the data word; if the total is not an odd number, the parity bit is made equal to one and thus produces an odd number. If the receiver counts an even number of ones, an error in transmission has occurred. When even parity is selected, an even number must result from the calculation performed at both ends of the line or an error in transmission has occurred. The three word-select bits are cleared by hardware and software reset.

**11.2.2.1.2 SCR SCI Shift Direction (SSFTD) Bit 3.** The SCI data shift registers can be programmed to shift data in/out either LSB first if SSFTD equals zero or MSB first if SSFTD equals one. The parity and data type bits do not change position and remain adjacent to the stop bit. SSFTD should be cleared for compatibility with early versions of the DSP56000/DSP56001. SSFTD is cleared by hardware and software reset.

**11.2.2.1.3 SCR Send Break (SBK) Bit 4.** A break is an all-zero word frame — a start bit zero, a character of all zeros (including any parity), and a stop bit zero: i.e., 10 or 11 zeros depending on the WDS mode selected. If SBK is set and then cleared, the transmitter completes transmission of any data, sends 10 or 11 zeros, and reverts to idle or sending data. If SBK remains set, the transmitter will continually send whole frames of zeros (10 or 11 bits with no stop bit). At the completion of the break code, the transmitter sends at



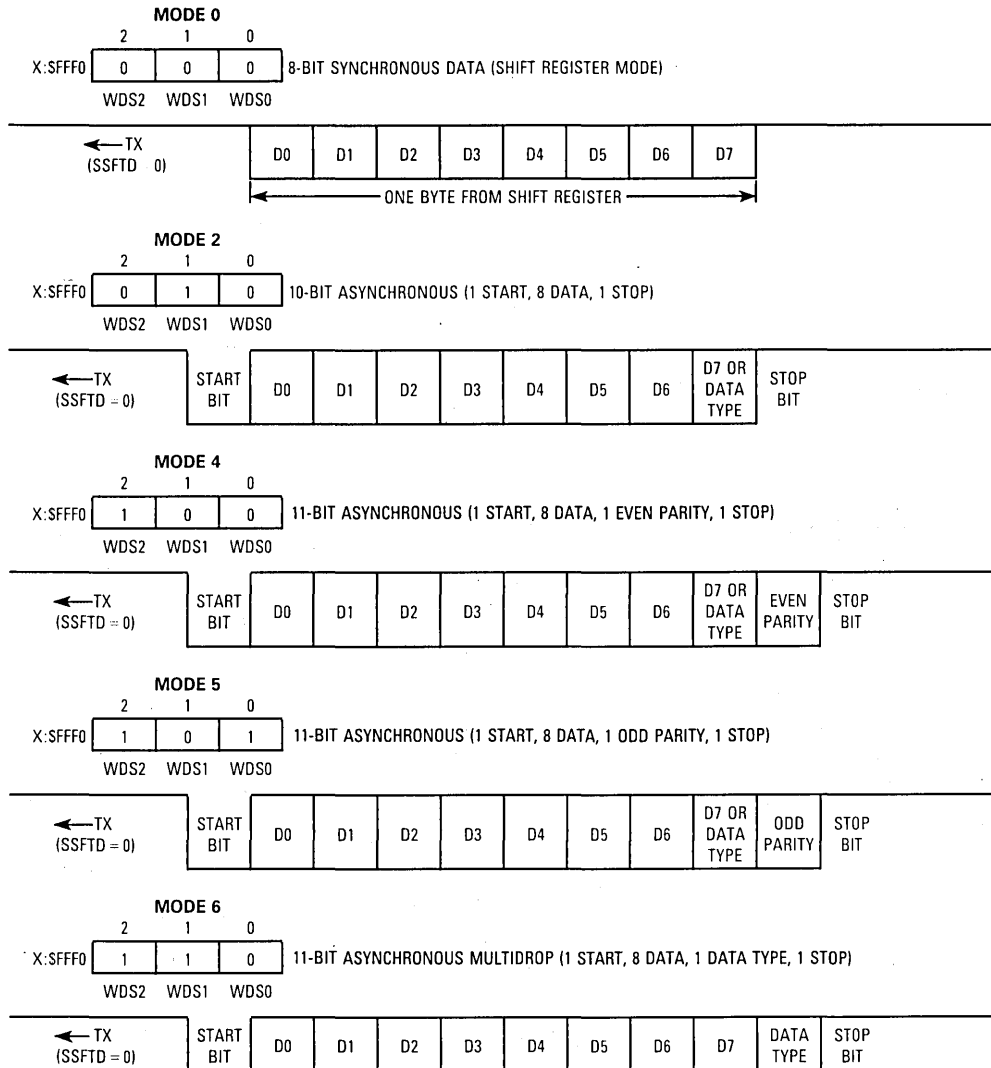

Data Type: 1 = Address Byte  
0 = Data Byte

**NOTES:**

1. Modes 1, 3, and 7 are reserved.
2. D0 = LDS; D7 = MSB
3. Data is transmitted and received LSB first if SSFTD=0 or MSB first if SSFTD=1.

**(a) SSFTD=0**

**Figure 11-11. Serial Formats (Sheet 1 of 2)**

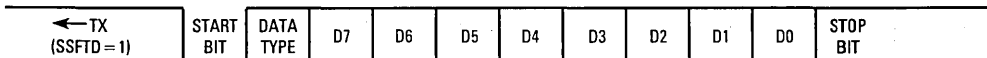
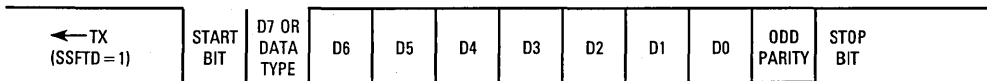
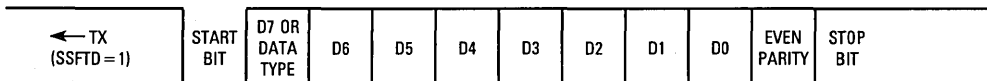
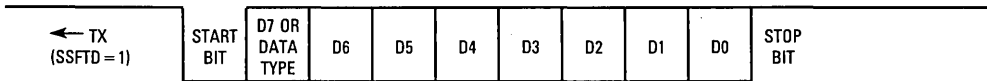
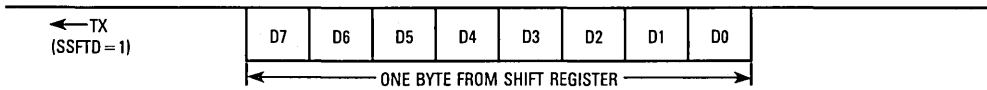
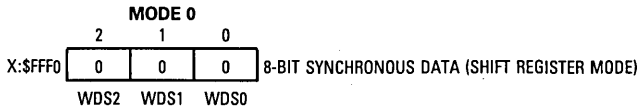

Data Type: 1 = Address Byte  
0 = Data Byte

NOTES:

1. Modes 1, 3, and 7 are reserved.
2. D0 = LSB; D7 = MSB.
3. Data is transmitted and received LSB first if SSFTD = 0 or MSB first if SSFTD = 1.

(b) SSFTD = 1

Figure 11-11. Serial Formats (Sheet 2 of 2)

least one high bit before transmitting any data to guarantee recognition of a valid start bit. Break can be used to signal an unusual condition, message, etc. by forcing a frame error, which is caused by a missing stop bit. Hardware and software reset clear SBK.

**11.2.2.1.4 SCR Wakeup Mode Select (WAKE) Bit 5.** When WAKE equals zero, an idle line wakeup is selected. In the idle line wakeup mode, the SCI receiver is re-enabled by an idle string of at least 10 or 11 (depending on WDS mode) consecutive ones. The transmitter's software must provide this idle string between consecutive messages. The idle string cannot occur within a valid message because each word frame contains a start bit that is a zero.

When WAKE equals one, an address bit wakeup is selected. In the address bit wakeup mode, the SCI receiver is re-enabled when the last (eighth or ninth) data bit received in a character (frame) is one. The ninth data bit is the address bit (R8) in the 11-bit multidrop mode; the eighth data bit is the address bit in the 10-bit asynchronous and 11-bit asynchronous with parity modes. Thus, the received character is an address that has to be processed by all sleeping processors — i.e., each processor has to compare the received character with its own address and decide whether to receive or ignore all following characters. WAKE is cleared by hardware and software reset.

**11.2.2.1.5 SCR Receiver Wakeup Enable (RWU) Bit 6.** When RWU equals one and the SCI is in an asynchronous mode, the wakeup function is enabled — i.e., the SCI is put to sleep waiting for a reason (defined by the WAKE bit) to wakeup. In the sleeping state, all receive flags, except IDLE, and interrupts are disabled. When the receiver wakes up, this bit is cleared by the wakeup hardware. The programmer may also clear the RWU bit to wake up the receiver.

RWU can be used by the programmer to ignore messages that are for other devices on a multidrop serial network. Wakeup on idle line (WAKE=0) or wakeup on address bit (WAKE=1) must be chosen.

1. When WAKE equals zero and RWU equals one, the receiver will not respond to data on the data line until an idle line is detected.
2. When WAKE equals one and RWU equals one, the receiver will not respond to data on the data line until a data byte with bit 9 equal to one is detected.

When the receiver wakes up, the RWU bit is cleared, and the first byte of data is received. If interrupts are enabled, the CPU will be interrupted, and the interrupt routine will read the message header to determine if the message is intended for this DSP.

1. If the message is for this DSP, the message will be received, and RWU will again be set to one to wait for the next message.
2. If the message is not for this DSP, the DSP will immediately set RWU to one. Setting RWU to one causes the DSP to ignore the remainder of the message and wait for the next message.

RWU is cleared by hardware and software reset. RWU is a don't care in the synchronous mode.

**11.2.2.1.6 SCR Wired-OR Mode Select (WOMS) Bit 7.** When the WOMS bit is set, the SCI TXD driver is programmed to function as an open-drain output and may be wired together with other TXD pins in an appropriate bus configuration such as a master-slave multidrop configuration. An external pullup resistor is required on the bus. When the WOMS is cleared, the TXD pin uses an active internal pullup. This bit is cleared by hardware and software reset.

**11.2.2.1.7 SCR Receiver Enable (RE) Bit 8.** When RE is set, the receiver is enabled. When RE is cleared, the receiver is disabled, and data transfer is inhibited to the receive data register (SRX) from the receive shift register. If RE is cleared while a character is being received, the reception of the character will be completed before the receiver is disabled. RE does not inhibit RDRF or receive interrupts. RE is cleared by a hardware and software reset.

**11.2.2.1.8 SCR Transmitter Enable (TE) Bit 9.** When TE is set, the transmitter is enabled. When TE is cleared, the transmitter will complete transmission of data in the SCI transmit data shift register; then the serial output is forced high (idle). Data present in the SCI transmit data register (STX) will not be transmitted. STX may be written and TDRE will be cleared, but the data will not be transferred into the shift register. TE does not inhibit TDRE or transmit interrupts. TE is cleared by a hardware and software reset.

Setting TE will cause the transmitter to send a preamble of 10 or 11 consecutive ones (depending on WDS). This procedure gives the programmer a convenient way to ensure that the line goes idle before starting a new message. To force this separation of messages by the minimum idle line time, the following sequence is recommended:

1. Write the last byte of the first message to STX.
2. Wait for TDRE to go high, indicating the last byte has been transferred to the transmit shift register.
3. Clear TE and set TE back to one. This queues an idle line preamble to immediately follow the transmission of the last character of the message (including the stop bit).
4. Write the first byte of the second message to STX.

In this sequence, if the first byte of the second message is not transferred to the STX prior to the finish of the preamble transmission, then the transmit data line will simply mark idle until STX is finally written.

**11.2.2.1.9 SCR Idle Line Interrupt Enable (ILIE) Bit 10.** When ILIE is set, the SCI interrupt occurs when IDLE is set. When ILIE is clear, the IDLE interrupt is disabled. ILIE is cleared by hardware and software reset.

An internal flag, the shift register idle interrupt (SRIINT) flag, is the interrupt request to the interrupt controller. SRIINT is not directly accessible to the user.

When a valid start bit has been received, an idle interrupt will be generated if both IDLE (SCI Status Register bit 3) and ILIE equals one. The idle interrupt acknowledge from the interrupt controller clears this interrupt request. The idle interrupt will not be asserted again until at least one character has been received. The result is as follows:

1. The IDLE bit shows the real status of the receive line at all times.
2. Idle interrupt is generated once for each idle state, no matter how long the idle state lasts.

#### **11.2.2.1.10 SCR SCI Receive Interrupt Enable (RIE) Bit 11.**

The RIE bit is used to enable the SCI receive data interrupt. If RIE is cleared, receive interrupts are disabled, and the RDRF bit in the SCI status register must be polled to determine if the receive data register is full. If both RIE and RDRF are set, the SCI will request an SCI receive data interrupt from the interrupt controller.

One of two possible receive data interrupts will be requested:

1. Receive without exception will be requested if PE, FE, and OR are all clear (i.e., a normal received character).
2. Receive with exception will be requested if PE, FE, and OR are **not** all clear (i.e., a received character with an error condition).

RIE is cleared by hardware and software reset.

**11.2.2.1.11 SCR SCI Transmit Interrupt Enable (TIE) Bit 12.** The TIE bit is used to enable the SCI transmit data interrupt. If TIE is cleared, transmit data interrupts are disabled, and the transmit data register empty (TDRE) bit in the SCI status register must be polled to determine if the transmit data register is empty. If both TIE and TDRE are set, the SCI will request an SCI transmit data interrupt from the interrupt controller. TIE is cleared by hardware and software reset.

**11.2.2.1.12 SCR Timer Interrupt Enable (TMIE) Bit 13.** The TMIE bit is used to enable the SCI timer interrupt. If TMIE is set (enabled), the timer interrupt requests will be made to the interrupt controller at the rate set by the SCI clock register. The timer interrupt is automatically cleared by the timer interrupt acknowledge from the interrupt controller. This feature allows DSP programmers to use the SCI baud clock generator as a simple periodic interrupt generator if the SCI is not in use, if external clocks are used for the SCI, or if periodic interrupts are needed at the SCI baud rate. The SCI internal clock is divided by 16 (to match the  $1 \times$  SCI baud rate) for timer interrupt generation. This timer does not require

that any SCI pins be configured for SCI use to operate. TMIE is cleared by hardware and software reset.

**11.2.2.1.13 SCR Reserved (Bit 14).** This unused bit is reserved and should be written with a zero for upward compatibility. It is read as a zero.

**11.2.2.1.14 SCR SCI Clock Polarity (SCKP) Bit 15.** The clock polarity, sourced or received on the clock pin (SCLK), can be inverted using this bit, eliminating the need for an external inverter. When bit 15 equals zero, the clock polarity is positive; when bit 15 equals one, the clock polarity is negative. In the synchronous mode, positive polarity means that the clock is normally positive and transitions negative during data valid; whereas, negative polarity means that the clock is normally negative and transitions positive during valid data. In the asynchronous mode, positive polarity means that the rising edge of the clock occurs in the center of the period that data is valid; negative polarity means that the falling edge of the clock occurs during the center of the period that data is valid. This bit should be cleared for compatibility with early versions of the DSP56000/DSP56001. SCKP is cleared on hardware and software reset.

**11.2.2.2 SCI STATUS REGISTER (SSR).** The SSR is an 8-bit read-only register used by the DSP CPU to determine the status of the SCI. When the SSR is read onto the internal data bus, the register contents occupy the low-order byte of the data bus and all high-order portions are zero filled. The status bits are described in the following paragraphs.

**11.2.2.2.1 SSR Transmitter Empty (TRNE) Bit 0.** The TRNE flag is set when both the transmit shift register and data register are empty to indicate that there is no data in the transmitter. When TRNE is set, data written to one of the three STX locations or to the STXA will be transferred to the transmit shift register and be the first data transmitted. TRNE is cleared when TDRE is cleared by writing data into the transmit data register (STX) or the transmit data address register (STXA), or when an idle, preamble, or break is transmitted. The purpose of this bit is to indicate that the transmitter is empty; therefore, the data written to STX or STXA will be transmitted next — i.e., there is not a word in the transmit shift register presently being transmitted. This procedure is useful when initiating the transfer of a message (i.e., a string of characters). TRNE is set by the hardware, software, SCI individual, and stop reset.

**11.2.2.2.2 SSR Transmit Data Register Empty (TDRE) Bit 1.** The TDRE bit is set when the SCI transmit data register is empty. When TDRE is set, new data may be written to one of the SCI transmit data registers (STX) or transmit data address register (STXA). TDRE is cleared when the SCI transmit data register is written. TDRE is set by the hardware, software, SCI individual, and stop reset.

In the SCI synchronous mode, when using the internal SCI clock, there is a delay of up to 5.5 serial clock cycles between the time that STX is written until TDRE is set, indicating the data has been transferred from the STX to the transmit shift register. There is a two to four serial clock cycle delay between writing STX and loading the transmit shift register; in addition, TDRE is set in the middle of transmitting the second bit. When using an external serial transmit clock, if the clock stops, the SCI transmitter stops. TDRE will not be set until the middle of the second bit transmitted after the external clock starts. Gating the external clock off after the first bit has been transmitted will delay TDRE indefinitely.

In the SCI asynchronous mode, the TDRE flag is not set immediately after a word is transferred from the STX or STXA to the transmit shift register nor when the word first begins to be shifted out. TDRE is set two cycles of the  $16\times$  clock after the start bit — i.e., two  $16\times$  clock cycles into to transmission time of the first data bit.

**11.2.2.2.3 SSR Receive Data Register Full (RDRF) Bit 2.** The RDRF bit is set when a valid character is transferred to the SCI receive data register from the SCI receive shift register. RDRF is cleared when the SCI receive data register is read or by the hardware, software, SCI individual, and stop reset.

**11.2.2.2.4 SSR Idle Line Flag (IDLE) Bit 3.** IDLE is set when 10 (or 11) consecutive ones are received. IDLE is cleared by a start-bit detection. The IDLE status bit represents the status of the receive line. The transition of IDLE from zero to one can cause an IDLE interrupt (ILIE). IDLE is cleared by the hardware, software, SCI individual, and stop reset.

**11.2.2.2.5 SSR Overrun Error Flag (OR) Bit 4.** The OR flag is set when a byte is ready to be transferred from the receive shift register to the receive data register (SRX) that is already full (RDRF = 1). The receive shift register data is not transferred to the SRX. The OR flag indicates that character(s) in the receive data stream may have been lost. The only valid data is located in the SRX. OR is cleared when the SCI status register is read, followed by a read of SRX. The OR bit clears the FE and PE bits — i.e., overrun error has higher priority than FE or PE. OR is cleared by the hardware, software, SCI individual, and stop reset.

**11.2.2.2.6 SSR Parity Error (PE) Bit 5.** In the 11-bit asynchronous modes, the PE bit is set when an incorrect parity bit has been detected in the received character. It is set simultaneously with RDRF for the byte which contains the parity error — i.e., when the received word is transferred to the SRX. If PE is set, it does not inhibit further data transfer into the SRX. PE is cleared when the SCI status register is read, followed by a read of SRX. PE is also cleared by the hardware, software, SCI individual, or stop reset. In the 10-bit asynchronous mode, the 11-bit multidrop mode, and the 8-bit synchronous mode, the PE bit is always cleared since there is no parity bit in these modes. If the byte received causes both parity and overrun errors, the SCI receiver will only recognize the overrun error.

**11.2.2.2.7 SSR Framing Error Flag (FE) Bit 6.** The FE bit is set in the asynchronous modes when no stop bit is detected in the data string received. FE and RDRE are set simultaneously — i.e., when the received word is transferred to the SRX. However, the FE flag inhibits further transfer of data into the SRX until it is cleared. FE is cleared when the SCI status register is read followed by reading the SRX. The hardware, software, SCI individual, and stop reset also clear FE. In the 8-bit synchronous mode, FE is always cleared. If the byte received causes both framing and overrun errors, the SCI receiver will only recognize the overrun error.

**11.2.2.2.8 SSR Received Bit 8 (R8) Address Bit 7.** In the 11-bit asynchronous multidrop mode, the R8 bit is used to indicate whether the received byte is an address or data. R8 is **not** affected by reading the SRX or status register. The hardware, software, SCI individual, and stop reset clear R8.

**11.2.2.3 SCI CLOCK CONTROL REGISTER (SCCR).** The SCCR is a 16-bit read/write register, which controls the selection of the clock modes and baud rates for the transmit and receive sections of the SCI interface. The control bits are described in the following paragraphs. The SCCR is cleared by hardware reset.

The basic points of the clock generator are as follows:

1. The SCI core always uses a  $16\times$  internal clock in the asynchronous modes and always uses a  $2\times$  internal clock in the synchronous mode. The maximum internal clock available to the SCI peripheral block is the oscillator frequency divided by 4. With a 20-MHz crystal, this gives a maximum data rate of 312.5 Kbits/sec for asynchronous data and 2.5 Mbits/second for synchronous data. These maximum rates are the same for internally or externally supplied clocks.
2. The  $16\times$  clock is necessary for the asynchronous modes to synchronize the SCI to the incoming data (see Figure 11-12).
3. For the asynchronous modes, the user **must** provide a  $16\times$  clock if he wishes to use an external baud rate generator (i.e., SCLK input).
4. For the asynchronous modes, the user may select either  $1\times$  or  $16\times$  for the output clock when using internal TX and RX clocks ( $TCM=0$  and  $RCM=0$ ).
5. The transmit data on the TXD pin changes on the negative edge of the  $1\times$  serial clock and is stable on the positive edge ( $SCKP=0$ ). For  $SCKP$  equals one, the data changes on the positive edge and is stable on the negative edge.
6. The receive data on the RXD pin is sampled on the positive edge (if  $SCKP=0$ ) or on the negative edge (if  $SCKP=1$ ) of the  $1\times$  serial clock.
7. For the asynchronous mode, the output clock is continuous.
8. For the synchronous mode, a  $1\times$  clock is used for the output or input baud rate. The maximum  $1\times$  clock is the crystal frequency divided by 8.



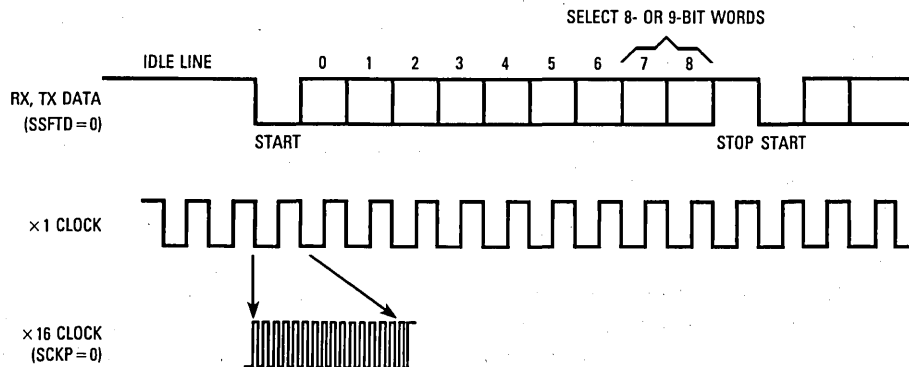

Figure 11-12. 16× Serial Clock

9. For the synchronous mode, the clock is gated.
10. For both the asynchronous and synchronous modes, the transmitter and receiver are synchronous with each other.

**11.2.2.3.1 SCCR Clock Divider (CD11–CD0) Bits 11–0.** The clock divider bits (CD11–CD0) are used to preset a 12-bit counter, which is decremented at the  $f_{cyc}$  rate (crystal frequency divided by 2). The counter is not accessible to the user. When the counter reaches zero, it is reloaded from the clock divider bits. Thus, a value of 0000 0000 0000 in CD11–CD0 produces the maximum rate of  $f_{cyc}$ , and a value of 0000 0000 0001 produces a rate of  $f_{cyc}/2$ . The lowest rate available is  $f_{cyc}/4096$ . Figures 11-13 and 11-36 show the clock dividers. Bits CD11–CD0 are cleared by hardware and software reset.

**11.2.2.3.2 SCCR Clock Out Divider (COD) Bit 12.** Figures 11-13 and 11-36 show the clock divider circuit. The output divider is controlled by COD and the SCI mode. If the SCI mode is synchronous, the output divider is fixed at divide by 2; if the SCI mode is asynchronous, and

1. If COD equals zero and SCLK is an output (i.e., TCM and RCM = 0), the SCI clock is divided by 16 before being output to the SCLK pin; thus, the SCLK output is a 1× clock.
2. If COD equals one and SCLK is an output, the SCI clock is fed directly out to the SCLK pin; thus, the SCLK output is a 16× baud clock.

The COD bit is cleared by hardware and software reset.

**11.2.2.3.3 SCCR SCI Clock Prescaler (SCP) Bit 13.** The SCI SCP bit selects a divide by 1 (SCP=0) or divide by 8 (SCP=1) prescaler for the clock divider. The output of the prescaler is further divided by 2 to form the SCI clock. Hardware and software reset clear SCP. Figures 11-13 and 11-36 show the clock divider diagram.

**11.2.2.3.4 SCCR Receive Clock Mode Source Bit (RCM) Bit 14.** RCM selects internal or external clock for the receiver (see Figure 11-36). RCM equals zero selects the internal clock; RCM equals one selects the external clock from the SCLK pin. Hardware and software reset clear RCM.

**11.2.2.3.5 SCCR Transmit Clock Source Bit (TCM) Bit 15.** The TCM bit selects internal or external clock for the transmitter (see Figure 11-36). TCM equals zero selects the internal clock; TCM equals one selects the external clock from the SCLK pin. Hardware and software reset clear TCM.

| TCM | RCM | TX Clock | RX Clock | SCLK Pin | Mode                     |
|-----|-----|----------|----------|----------|--------------------------|
| 0   | 0   | Internal | Internal | Output   | Synchronous/Asynchronous |
| 0   | 1   | Internal | External | Input    | Asynchronous Only        |
| 1   | 0   | External | Internal | Input    | Asynchronous Only        |
| 1   | 1   | External | External | Input    | Synchronous/Asynchronous |

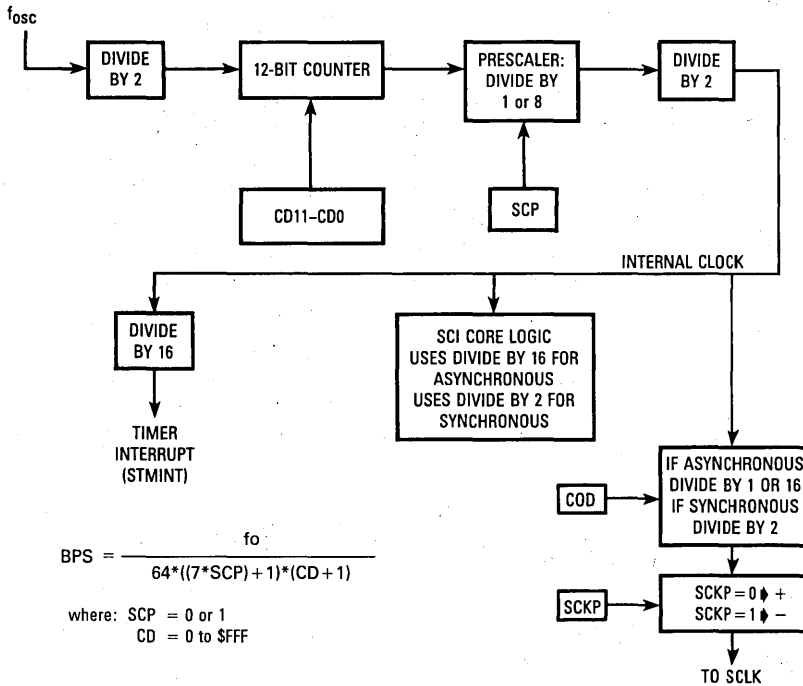

Figure 11-13. SCI Baud Rate Generator

**11.2.2.4 SCI DATA REGISTERS.** The SCI data registers are divided into two groups: receive and transmit. There are two receive registers — a receive data register (SRX) and a serial-to-parallel receive shift register. There are also two transmit registers — a transmit data register (called either STX or STXA) and a parallel-to-serial transmit shift register.

**11.2.2.4.1 SCI Receive Registers.** Data words received on the RXD pin are shifted into the SCI receive shift register. When the complete word has been received, the data portion of the word is transferred to the byte-wide SRX. This process converts the serial data to parallel data and provides double buffering. Double buffering provides flexibility to the programmer and increased throughput since the programmer can save the previous word while the current word is being received.

The SRX can be read at three locations: X:\$FFF4, X:\$FFF5, and X:\$FFF6 (see Figure 11-14). When location X:\$FFF4 is read, the contents of the SRX are placed in the lower byte of the data bus and the remaining bits on the data bus are written as zeros. Similarly, when X:\$FFF5 is read, the contents of SRX are placed in the middle byte of the bus, and when X:\$FFF6 is read, the contents of SRX are placed in the high byte with the remaining bits zeroed. Mapping SRX as described allows three bytes to be efficiently packed into one 24-bit word by ORing three data bytes read from the three addresses. The following code fragment requires that R0 initially points to X:\$FFF4, register A is initially cleared, and R3 points to a data buffer. The only programming trick is using BCLR to test bit 1 of the packing pointer to see if it is pointing to X:\$FFF6 and clearing bit 1 to point to X:\$FFF4 if it had been pointing to X:\$FFF6. This procedure resets the packing pointer after receiving three bytes.

```

                MOVE X:(R0),X0      ;Copy received data to temporary register
                BCLR # $1,R0        ;Test for last byte
                                ;reset pointer if it is the last byte
                OR   X0,A           ;Pack the data into register A
                MOVE (R0)+         ;and increment the packing pointer
                JCS  FLAG          ;Jump to clean up routine if last byte
                RTI                 ;Else return until next byte is received
FLAG:          MOVE A,(R3)+       ;Move the packed data to memory
                CLR  A             ;Prepare A for packing next three bytes
                RTI                 ;Return until the next byte is received

```

The length and format of the serial word is defined by the WDS0, WDS1, and WDS2 control bits in the SCI control register. In the synchronous modes, the start bit, the eight data bits with LSB first, the address/data indicator bit and/or the parity bit, and the stop bit are received in that order for SSFTD equals zero (see Figure 11-11(a)). For SSFTD equals one, the data bits are transmitted MSB first (see Figure 11-11(b)). The clock source is defined by the receive clock mode (RCM) select bit in the SCR. In the synchronous mode, the synchronization is provided by gating the clock. In either mode, when a complete word has been clocked in, the contents of the shift register can be transferred to the SRX and the flags; RDRF, FE, PE, and OR are changed appropriately. Because the operation of the

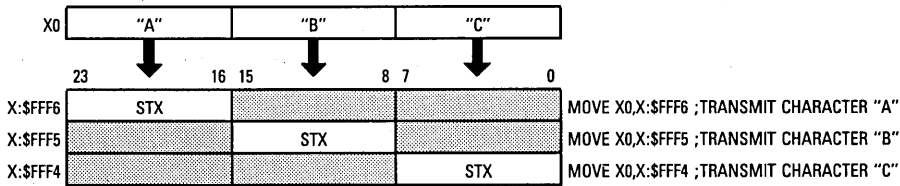

NOTE: STX is the same register decoded at three different addresses.

### (a) Unpacking

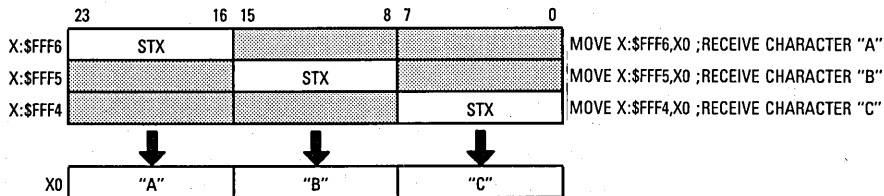

NOTE: SRX is the same register decoded at three different addresses.

### (b) Packing

Figure 11-14. Data Packing and Unpacking

SCI receive shift register is transparent to the DSP, the contents of this register are not directly accessible to the programmer.

**11.2.2.4.2 SCI Transmit Registers.** The transmit data register is one byte-wide register mapped into four addresses: X:\$FFF3, X:\$FFF4, X:\$FFF5, and X:\$FFF6. In the asynchronous mode, when data is to be transmitted, X:\$FFF4, X:\$FFF5, and X:\$FFF6 are used, and the register is called STX. When X:\$FFF4 is written, the low byte on the data bus is transferred to the STX; when X:\$FFF5 is written, the middle byte is transferred to the STX; and when X:\$FFF6 is written, the high byte is transferred to the STX. This structure (see Figure 11-10) makes it easy for the programmer to unpack the bytes in a 24-bit word for transmission. Location X:\$FFF3 should be written in the 11-bit asynchronous multidrop mode when the data is an address and it is desired that the ninth bit (the address bit) be set. When X:\$FFF3 is written, the transmit data register is called STXA, and data from the low byte on the data bus is stored in STXA. The address data bit will be cleared in the 11-bit asynchronous multidrop mode when any of X:\$FFF4, X:\$FFF5, or X:\$FFF6 is written. When either STX or STXA is written, TDRE is cleared.

The transfer from either STX or STXA to the transmit shift register occurs automatically, but not immediately, when the last bit from the previous word has been shifted out — i.e., the transmit shift register is empty. Like the receiver, the transmitter is double buffered. However, there will be a two to four serial clock cycle delay between when the data is transferred from either STX or STXA to the transmit shift register and when the first bit appears on the TXD pin. (A serial clock cycle is the time required to transmit one data bit). The transmit shift register is not directly addressable, and a dedicated flag for this register does not exist. Because of this fact and the two to four cycle delay, two bytes cannot be written consecutively to STX or STXA without polling. The second byte will overwrite the first byte. The TDRE flag should always be polled prior to writing STX or STXA to prevent overruns unless transmit interrupts have been enabled. Either STX or STXA is usually written as part of the interrupt service routine. Of course, the interrupt will only be generated if TDRE equals one. The transmit shift register is indirectly visible via the TRNE bit in the SSR.

In the synchronous modes, data is clocked synchronously with the transmit clock, which may have either an internal or external source as defined by the TCM bit in the SCCR. The length and format of the serial word is defined by the WDS0, WDS1, and WDS2 control bits in the SCR. In the asynchronous modes, the start bit, the eight data bits (with the LSB first if SSFTD=0 and the MSB first if SSFTD=1), the address/data indicator bit or parity bit, and the stop bit are transmitted in that order (see Figure 11-11).

In the synchronous mode, the data byte is transmitted LSB first if SCKP equals zero and MSB first if SCKP equals one. The data to be transmitted can be written to any one of the three STX addresses. If SCKP equals one and SSHTD equals one, the SCI synchronous mode is equivalent to the SSI operation in the 8-bit data on-demand mode.

**11.2.2.5 PREAMBLE, BREAK, AND DATA TRANSMISSION PRIORITY.** It is possible that two or three transmission commands are set simultaneously:

1. A preamble (TE was toggled).
2. A break (SBK was set or was toggled).
3. There is data for transmission (TDRE=0).

After the current character transmission, if two or more of these commands are set, the transmitter will execute them in the following priority:

1. Preamble
2. Break
3. Data

### 11.2.3 Register Contents After Reset

Four different methods of resetting the SCI exist. Hardware or software reset clears the port control register bits, which configure all I/O as general-purpose input. The SCI will remain in the reset state while all SCI pins are programmed as general-purpose I/O (CC2,

CC1, and CC0=0); the SCI will become active only when **at least one** of the SCI I/O pins is programmed as **not** general-purpose I/O.

During program execution, the CC2, CC1, and CC0 bits may be cleared (individual reset), which will cause the SCI to stop serial activity and enter the reset state. All SCI status bits will be set to their reset state; however, the contents of the interface control register are not affected, allowing the DSP program to reset the SCI separately from the other internal peripherals.

Executing the STOP instruction halts operation of the SCI until the DSP is restarted, causing the SSR to be reset. No other SCI registers are affected by the STOP instruction. Table 11-1 illustrates how each type of reset affects each register in the SCI.

#### 11.2.4 SCI Initialization

The correct way to initialize the SCI is as follows:

1. Hardware or software reset.
2. Program SCI control registers.
3. Configure SCI pins (at least one) as not general-purpose I/O.

Figures 11-15 and 11-16 show how to configure the bits in the SCI registers. Figure 11-15 is the basic initialization procedure showing which registers must be configured. (1) A hardware or software reset should be used to reset the SCI and prevent it from doing anything unexpected while it is being programmed. (2) Both the SCI interface control register and the clock control register must be configured for any operation using the SCI. (3) The pins to be used must then be selected to release the SCI from reset and (4) begin operation. If interrupts are to be used, the pins must be selected, and interrupts must be enabled and unmasked before the SCI will operate. The order does not matter; any one of these three requirements for interrupts can be used to finally enable the SCI. Figure 11-16 shows the meaning of the individual bits in the SCR and SCCR. The figures below do not assume that interrupts will be used; they recommend selecting the appropriate pins to enable the SCI. Programs shown in Figures 11-21, 11-22, 11-29, 11-35; and 11-37 use interrupts and control the SCI by enabling and disabling interrupts. Either method is acceptable.

Tables 11-2 and 11-3 provide the settings for common baud rates for the SCI. The asynchronous SCI baud rates show a baud rate error for the fixed oscillator frequency (see Table 11-2(a)). These small-percentage baud rate errors should allow most UARTs to synchronize. The synchronous applications usually require exact frequencies, which require that the crystal frequency be chosen carefully (see Table 11-3(a) and 11-3(b)). An alternative to selecting the system clock to accommodate the SCI requirements is to provide an external clock to the SCI.

**Table 11-1. SCI Registers after Reset**

| Register Bit | Bit Mnemonic | Bit Number | Reset Type |          |          |          |
|--------------|--------------|------------|------------|----------|----------|----------|
|              |              |            | HW Reset   | SW Reset | IR Reset | ST Reset |
| SCR          | SCKP         | 15         | 0          | 0        | —        | —        |
|              | TMIE         | 13         | 0          | 0        | —        | —        |
|              | TIE          | 12         | 0          | 0        | —        | —        |
|              | RIE          | 11         | 0          | 0        | —        | —        |
|              | ILIE         | 10         | 0          | 0        | —        | —        |
|              | TE           | 9          | 0          | 0        | —        | —        |
|              | RE           | 8          | 0          | 0        | —        | —        |
|              | WOMS         | 7          | 0          | 0        | —        | —        |
|              | RWU          | 6          | 0          | 0        | —        | —        |
|              | WAKE         | 5          | 0          | 0        | —        | —        |
| SSR          | SBK          | 4          | 0          | 0        | —        | —        |
|              | SSFTD        | 3          | 0          | 0        | —        | —        |
|              | WDS (2-0)    | 2-0        | 0          | 0        | —        | —        |
|              | R8           | 7          | 0          | 0        | 0        | 0        |
|              | FE           | 6          | 0          | 0        | 0        | 0        |
|              | PE           | 5          | 0          | 0        | 0        | 0        |
|              | OR           | 4          | 0          | 0        | 0        | 0        |
|              | IDLE         | 3          | 0          | 0        | 0        | 0        |
| SCCR         | RDRF         | 2          | 0          | 0        | 0        | 0        |
|              | TDRE         | 1          | 1          | 1        | 1        | 1        |
|              | TRNE         | 0          | 1          | 1        | 1        | 1        |
|              | TCM          | 15         | 0          | 0        | —        | —        |
|              | RCM          | 14         | 0          | 0        | —        | —        |
| SRX          | SCP          | 13         | 0          | 0        | —        | —        |
|              | COD          | 12         | 0          | 0        | —        | —        |
|              | CD (11-0)    | 11-0       | 0          | 0        | —        | —        |
| STX          | STX (23-0)   | 23-0       | —          | —        | —        | —        |
| SRSH         | SRS (8-0)    | 8-0        | —          | —        | —        | —        |
| STSH         | STS (8-0)    | 8-0        | —          | —        | —        | —        |

**NOTES:**

- SRSH — SCI receive shift register
- STSH — SCI transmit shift register
- HW — Hardware reset is caused by asserting the external RESET pin.
- SW — Software reset is caused by executing the RESET instruction.
- IR — Individual reset is caused by clearing PCC (bits 0-2) (configured for general-purpose I/O).
- ST — Stop reset is caused by executing the STOP instruction.
- 1 — The bit is set during the xx reset.
- 0 — The bit is cleared during the xx reset.
- — The bit is not changed during the xx reset.

1. PERFORM HARDWARE OR SOFTWARE RESET.
2. PROGRAM SCI CONTROL REGISTERS:
  - A) SCI INTERFACE CONTROL REGISTER — X:\$FFF0
  - B) SCI CLOCK CONTROL REGISTER — X:\$FFF2
3. CONFIGURE AT LEAST ONE PORT C CONTROL BIT AS SCI.

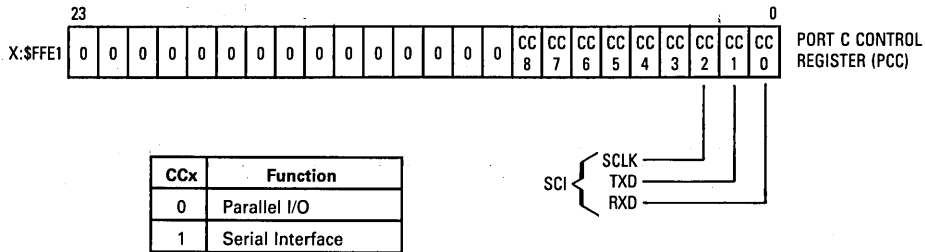

4. SCI IS NOW ACTIVE.

Figure 11-15. SCI Initialization Procedure

### 11.2.5 SCI Exceptions

The SCI can cause five different exceptions in the DSP (see Figure 11-17). These exceptions are as follows:

1. SCI Receive Data — caused by receive data register full with no receive error conditions existing. This error-free interrupt may use a fast interrupt service routine for minimum overhead. This interrupt is enabled by SCR bit 11 (RIE).
2. SCI Receive Data with Exception Status — caused by receive data register full with a receiver error (parity, framing, or overrun error). The SCI status register **must** be read to clear the receiver error flag. A long interrupt service routine should be used to handle the error condition. This interrupt is enabled by SCR bit 11 (RIE).
3. SCI Transmit Data — caused by transmit data register empty. This error-free interrupt may use a fast interrupt service routine for minimum overhead. This interrupt is enabled by SCR bit 12 (TIE).
4. SCI Idle Line — caused by the receive line entering the idle state (10 or 11 bits of ones). This interrupt is latched and then automatically reset when the interrupt is accepted. This interrupt is enabled by SCR bit 10 (ILIE).
5. SCI Timer — caused by the baud rate counter underflowing. This interrupt is automatically reset when the interrupt is accepted. This interrupt is enabled by SCR bit 13 (TMIE).



**STEP 2a. SELECT SCI OPERATION:**  
FOR A BASIC CONFIGURATION, SET:

- SCKP — BIT 14=0
- TMIE — BIT 13=0
- ILIE — BIT 10=0
- RWU — BIT 6=0
- WAKE — BIT 5=0
- SBK — BIT 4=0
- SSFTD — BIT 3=0

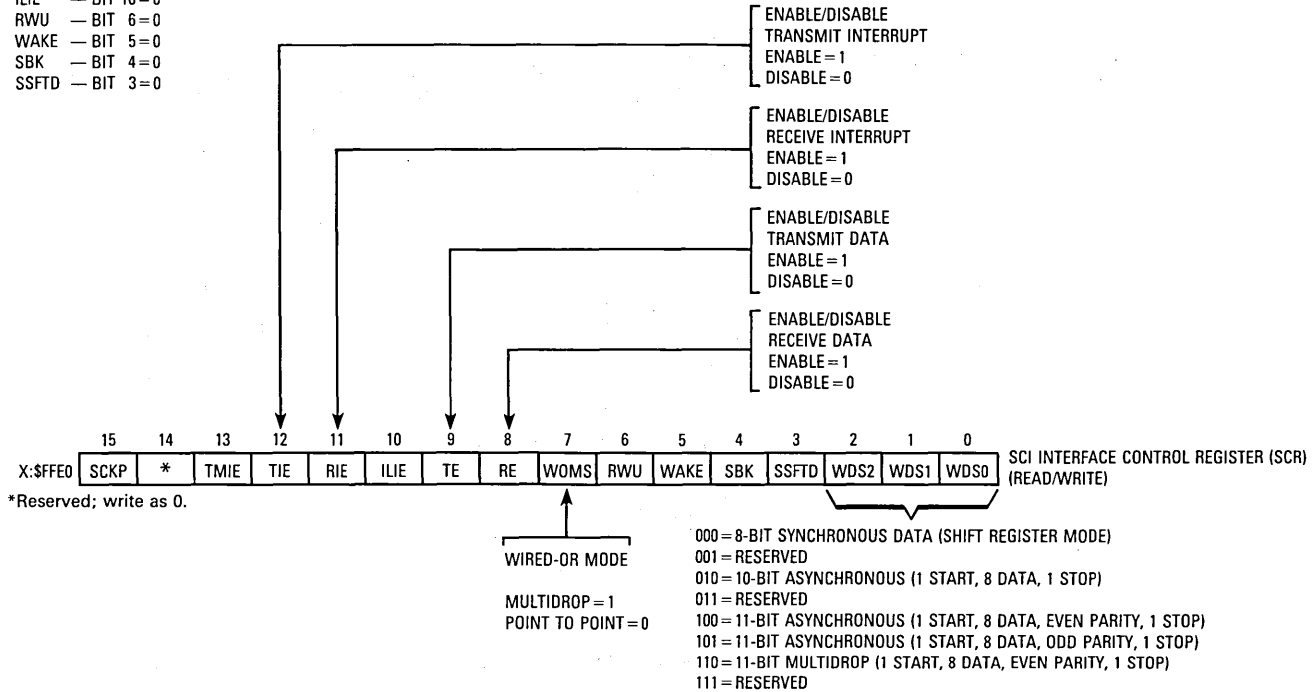

(a) Step 2a

Figure 11-16. SCI General Initialization Detail — Step 2 (Sheet 1 of 2)

**STEP 2b. SELECT CLOCK AND DATA RATE:**  
 SET THE CLOCK DIVIDER BITS (CD0-CD11) ACCORDING TO TABLES 11-2 OR 11-3.  
 SET THE SCI CLOCK PRESCALER BIT (SCP, BIT 13) ACCORDING TO TABLES 11-2 OR 11-3.

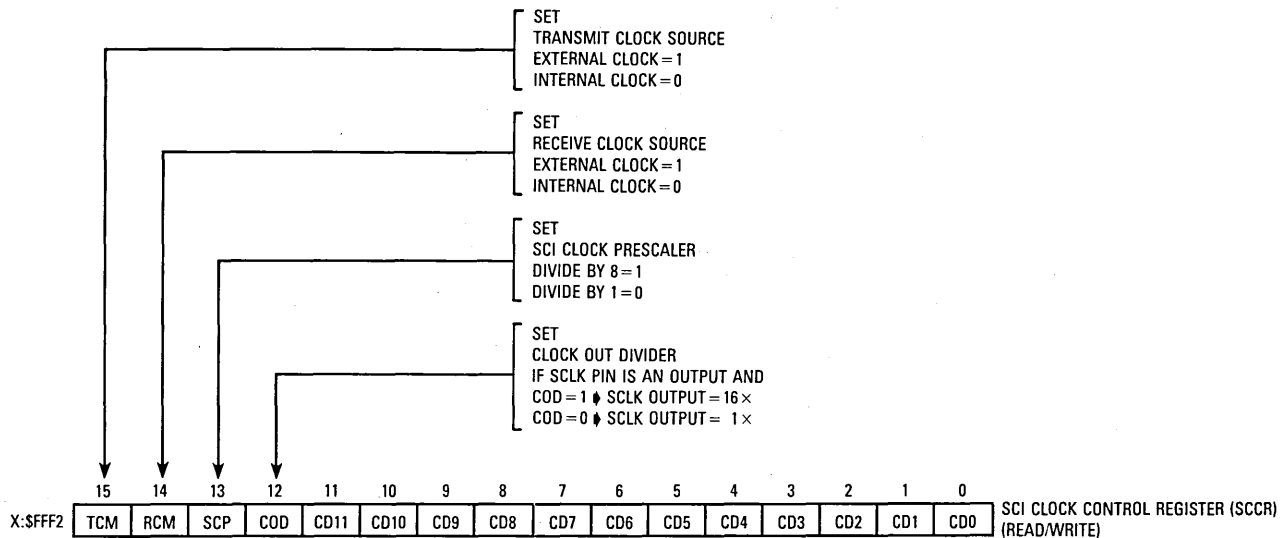

(b) Step 2b

Figure 11-16. SCI General Initialization Detail — Step 2 (Sheet 2 of 2)

**Table 11-2(a). Asynchronous SCI Baud Rates  
for a 20.48-MHz Crystal**

| Baud Rate (BPS) | SCP Bit | Divider Bits (CD0-CD11) | Baud Rate Error, Percent |
|-----------------|---------|-------------------------|--------------------------|
| 320.0K          | 0       | \$000                   | 0                        |
| 56.0K           | 0       | \$005                   | 4.762                    |
| 38.4K           | 0       | \$007                   | 4.167                    |
| 19.2K           | 0       | \$010                   | 1.961                    |
| 9600            | 0       | \$020                   | 1.010                    |
| 8000            | 0       | \$027                   | 0                        |
| 4800            | 0       | \$042                   | 0.498                    |
| 2400            | 0       | \$084                   | 0.251                    |
| 1200            | 1       | \$020                   | 1.010                    |
| 600             | 1       | \$042                   | 0.498                    |
| 300             | 1       | \$084                   | 0.251                    |

$BPS = f_0 \div (64 \times (7(SCP) + 1) \times (CD + 1))$ ;  $f_0 = 20.48$  MHz

SCP = 0 or 1

CD = 0 to \$FFF

**Table 11-2(b). Frequencies for Exact  
Asynchronous SCI Baud Rates**

| Baud Rate (BPS) | SCP Bit | Divider Bits (CD0-CD11) | Crystal Frequency |
|-----------------|---------|-------------------------|-------------------|
| 9600            | 0       | \$021                   | 20,500,000        |
| 4800            | 0       | \$042                   | 20,275,200        |
| 2400            | 0       | \$084                   | 20,275,200        |
| 1200            | 0       | \$108                   | 20,275,200        |
| 300             | 0       | \$420                   | 20,275,200        |
| 9600            | 1       | \$004                   | 19,660,800        |
| 4800            | 1       | \$008                   | 19,660,800        |
| 2400            | 1       | \$010                   | 19,660,800        |
| 1200            | 1       | \$020                   | 19,660,800        |
| 300             | 1       | \$080                   | 19,660,800        |

$f_0 = BPS \times 64 \times (7(SCP) + 1) \times (CD + 1)$

SCP = 0 or 1

CD = 0 to \$FFF

**Table 11-3(a). Synchronous SCI Baud Rates  
for a 20.48-MHz Crystal**

| Baud Rate (BPS) | SCP Bit | Divider Bits (CD0-CD11) | Baud Rate Error, Percent |
|-----------------|---------|-------------------------|--------------------------|
| 2.56M           | 0       | \$000                   | 0                        |
| 128K            | 0       | \$014                   | 0                        |
| 64K             | 0       | \$027                   | 0                        |
| 56K             | 0       | \$02E                   | 0.621                    |
| 32K             | 0       | \$04F                   | 0                        |
| 16K             | 0       | \$09F                   | 0                        |
| 8000            | 0       | \$140                   | 0                        |
| 4000            | 0       | \$27F                   | 0                        |
| 2000            | 0       | \$4FF                   | 0                        |
| 1000            | 0       | \$9FF                   | 0                        |

$BPS = f_0 \div (8 \times (7(SCP) + 1) \times (CD + 1))$ ;  $f_0 = 20.48$  MHz  
 SCP = 0 or 1  
 CD = 0 to \$FFF

**Table 11-3(b). Frequencies for Exact  
Synchronous SCI Baud Rates**

| Baud Rate (BPS) | SCP Bit | Divider Bits (CD0-CD11) | Baud Rate Error, MHz |
|-----------------|---------|-------------------------|----------------------|
| 2.048M          | 0       | \$000                   | 16.384               |
| 1.544M          | 0       | \$001                   | 24.576               |
| 1.536M          | 0       | \$001                   | 24.704               |

$f_0 = BPS \times 8 \times (7(SCP) + 1) \times (CD + 1)$   
 CP = 0 or 1  
 CD = 0 to \$FFF

**11.2.6 Synchronous Data**

The synchronous mode (WDS=0, shift register mode) is designed to implement serial-to-parallel and parallel-to-serial conversions. This mode will directly interface to 8051/8096 synchronous (mode 0) buses as both a controller (master) or a peripheral (slave) and is compatible with the SSI mode if SCKP equals one. In synchronous mode, the clock is always common to the transmit and receive shift registers.

As a controller (synchronous master) shown in Figure 11-18, the DSP outputs a clock on the SCLK pin when data is present in the transmit shift register (a gated clock mode). The master mode is selected by choosing internal transmit and receive clocks (setting TCM and RCM=0). The example shows a 74HC165 parallel-to-serial shift register and 74HC164 serial-to-parallel shift register being used to convert eight bits of serial I/O to eight bits of

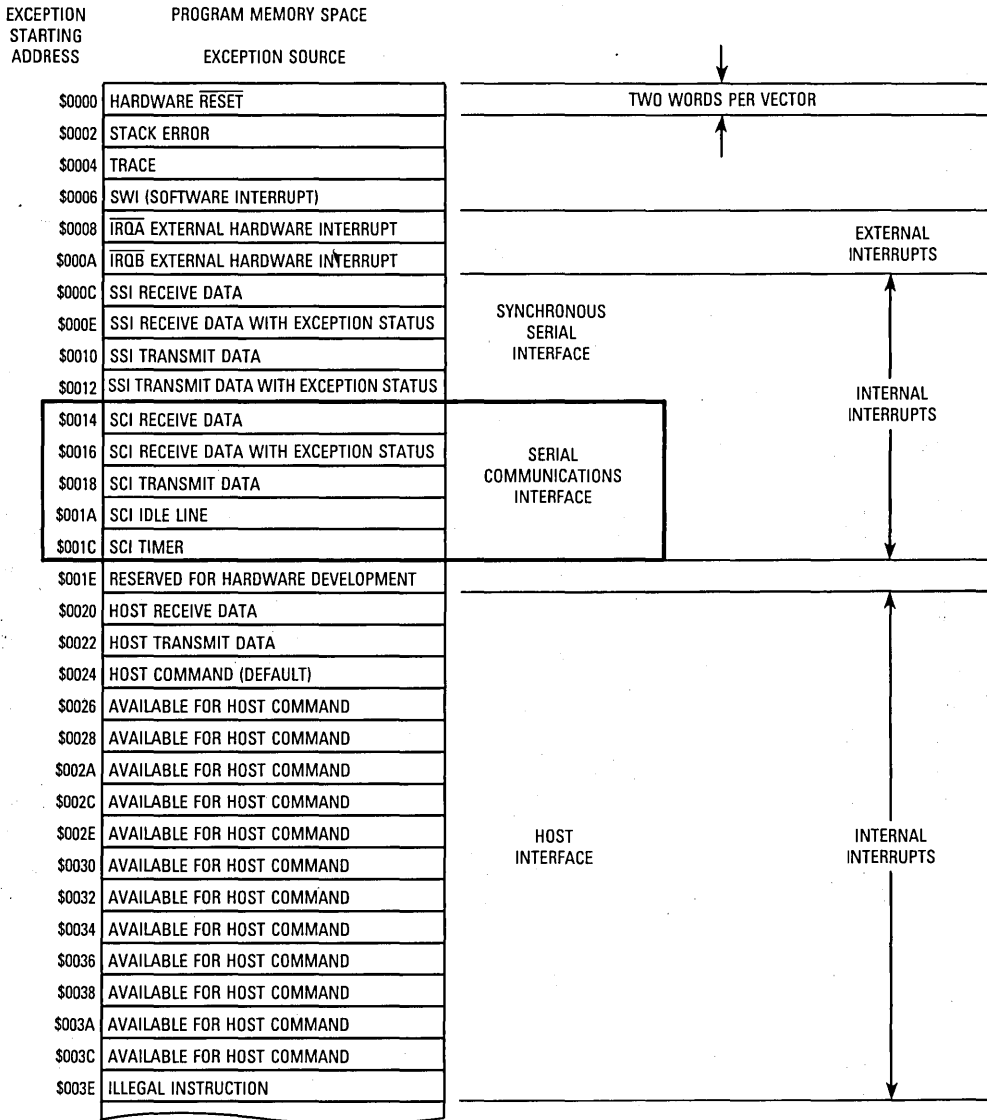
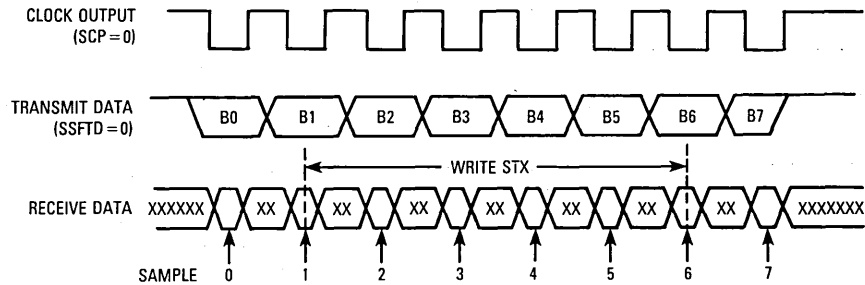
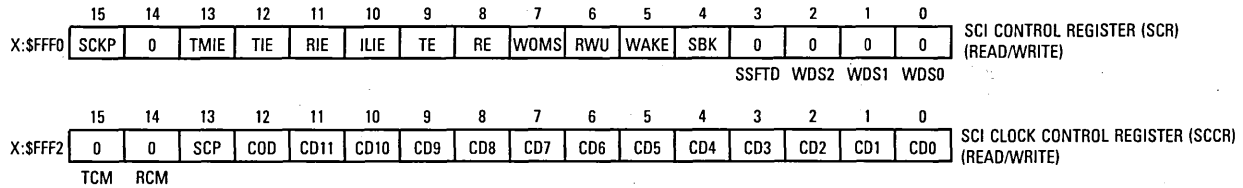

Figure 11-17. SCI Exception Vector Locations



Example: Shift Register I/O

EXAMPLE: SHIFT REGISTER I/O

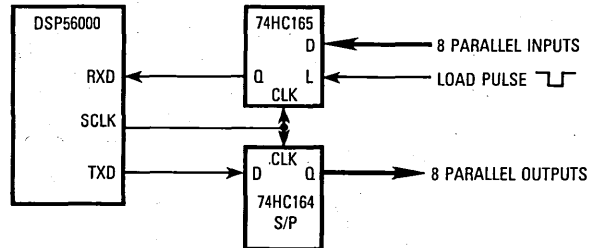

Figure 11-18. Synchronous Master

parallel I/O. The load pulse latches eight bits into the 74HC165 and then SCLK shifts the RXD data into the SCI (these data bits are sample bits 0-7 in the timing diagram). At the same time, TXD shifts data out (B0-B7) to the 74HC164. When using the internal clock, data is transmitted when the transmit shift register is full. Data is valid on both edges of the output clock, which is compatible with an 8051 microprocessor. Received data is sampled in the middle of the clock low time if SCKP equals zero or in the middle of the clock high time if SCKP equals one. There is a window during which STX must be written with the next byte to be transmitted to prevent a gap between words. This window is from the time TDRE goes high halfway into transmission of bit 1 until the middle of bit 6 (see Figure 11-20(a)).

As a peripheral (synchronous slave) shown in Figure 11-19, the DSP accepts an input clock from the SCLK pin. If SCKP equals zero, data is clocked in on the rising edge of SCLK, and data is clocked out on the falling edge of SCLK. If SCKP equals one, data is clocked in on the falling edge of SCLK, and data is clocked out on the rising edge of SCLK. The slave mode is selected by choosing external transmit and receive clocks (TCM and RCM=1). Since there is no frame signal, if a clock is missed due to noise or any other reason, the receiver will lose synchronization with the data without any error signal being generated. Detecting an error of this type can be done with an error detecting protocol or with external circuitry such as a watchdog timer. The simplest way to recover synchronization is to reset the SCI.

The timing diagram in Figure 11-19 shows transmit data in the normal driven mode. Bit B7 is essentially one-half SCI clock long ( $T_{SCI}/2 + 1.5 T_{EXTAL}$ ). The last data bit is truncated so that the pin is guaranteed to go to its reset state before the start of the next data word, thereby delimiting data words. The 1.5 crystal clock cycles provide sufficient hold time to satisfy most external logic requirements. The example diagram requires that the WOMS bit be set in the SCR to wired-OR RXD and TXD, which causes TXD to be three-stated when not transmitting. Collisions (two devices transmitting simultaneously) must be avoided with this circuit by using a protocol such as alternating transmit and receive periods. In the example, the 8051 is the master device because it controls the clock. There is a window during which STX must be written with the next byte to be transmitted to prevent the current word from being retransmitted. This window is from the time TDRE goes high, which is halfway into the transmission of bit 1 until the middle of bit 6 (see Figure 11-20(b)). Of course, this assumes the clock remains continuous — i.e., there is a second word. If the clock stops, the SCI stops.

The DSP is initially configured according to the protocol to either receive data or transmit data. If the protocol determines that the next data transfer will be a DSP transmit, the DSP will configure the SCI for transmit and load STX (or STXA). When the master starts SCLK, data will be ready and waiting. If the protocol determines that the next data transfer will be a DSP receive, the DSP will configure the SCI for receive and will either poll the SCI or enable interrupts. This methodology allows multiple slave processors to use the same data

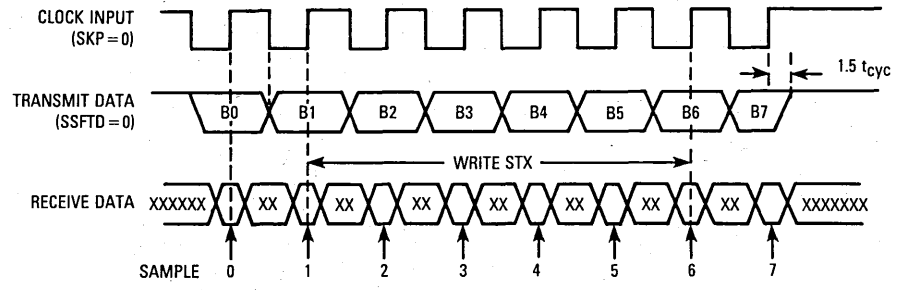
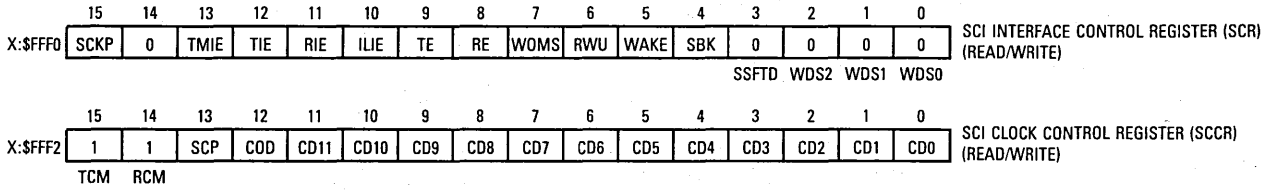

Example: Interface to synchronous microcomputer buses

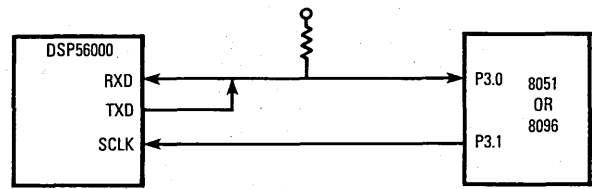
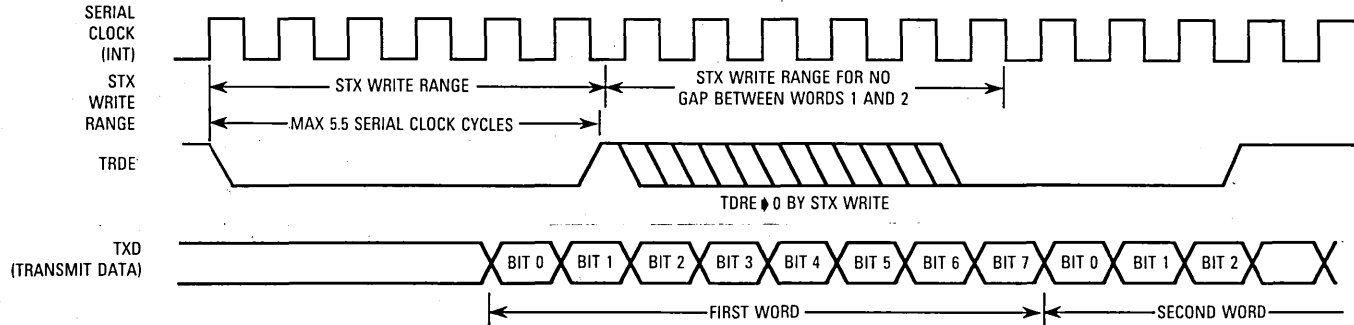

Figure 11-19. Synchronous Slave



SYNCHRONOUS MODE, INTERNAL CLOCK (MASTER)



NOTE: In internal clock mode, if data 2 is written after the middle of bit 6 of data 1, then a gap of at least two serial bits is inserted between word 1 and word 2. The gap is bigger as STX is written later.

(a) Master

SYNCHRONOUS MODE, EXTERNAL CLOCK (SLAVE)

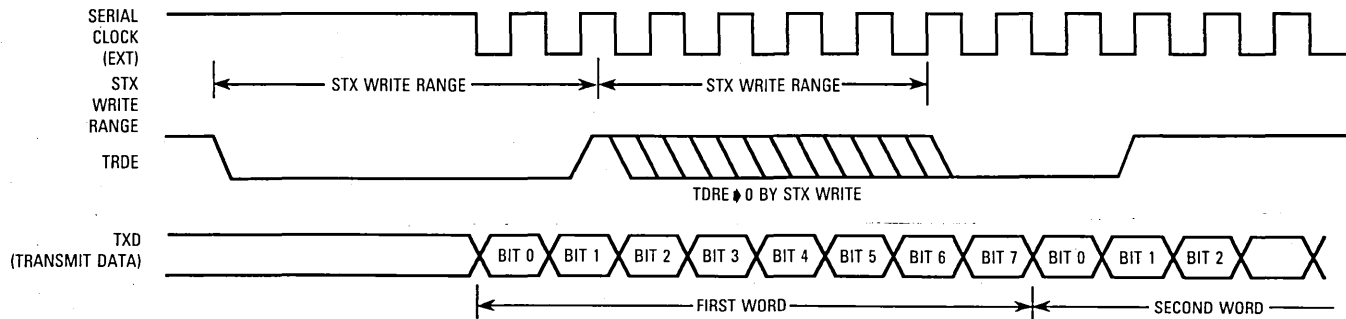

NOTE: In external clock mode, if data 2 is written after the middle of bit 6 of data 1, then the previous data is retransmitted and data 2 is transmitted after the retransmission of data 1.

(b) Slave

Figure 11-20. Synchronous Timing

line. Selection of individual slave processors can be under protocol control or by multiplexing SCLK.

#### NOTE

TCM=0,RCM=1 and TCM=1,RCM=0 are not allowed in the synchronous mode. The results are undefined.

The assembly program shown in Figure 11-21 uses the SCI synchronous mode to transmit only the low byte of the Y data ROM contents. The program sets the reset vector to run the program after a hardware reset, puts the MOVEP instruction at the SCI transmit interrupt vector location, sets the memory wait states to zero, and configures the memory pointers, operating mode register, and the IPR. The SCI is then configured and the interrupts are unmasked, which starts the data transfer. The jump-to-self instruction (LAB0 JMP LAB0) is used to wait while interrupts transfer the data.

```

ORG    P:0                ;Reset vector
JMP    $40                ;

ORG    P:$18              ;SCI transmit interrupt vector
MOVEP  Y:(R0)+,X:$FFF4    ;transmit low byte of data

ORG    P:$40
MOVEP  #0,X:$FFFE        ;Clear BCR
MOVE   #$100,R0          ;Data ROM start address
MOVE   #$FF,M0           ;Size of data ROM — Wraps around at $200
MOVEC  #6,OMR            ;Change operating mode to enable data ROM
MOVEP  #$C000,X:$FFFF    ;Interrupt priority register
MOVEP  #$1200,X:$FFF0    ;8-bit synchronous mode
MOVEP  #7,X:$FFE1        ;Port C control register — enable SCI
MOVEC  #0,SR             ;Unmask interrupts
LAB0   JMP    LAB0        ;Wait in loop for interrupts

```

**Figure 11-21. SCI Synchronous Transmit**

The program shown in Figure 11-22 is the program for receiving data from the program presented in Figure 11-21. The program sets the reset vector to run the program after hardware reset, puts the MOVEP instruction to store the data in a circular buffer starting at \$100 at the SCI receive interrupt vector location, puts another MOVEP instruction at the SCI receive interrupt vector location, sets the memory wait states to zero, and configures the memory pointers and IPR. The SCI is then configured and the interrupts are unmasked, which starts the data transfer. The jump-to-self instruction (LAB0 JMP LAB0) is used to wait while interrupts transfer the data.

```

ORG     P:0                ; Reset vector
JMP     $40                ;

ORG     P:$14              ; SCI receive data cector
MOVEP   X:$FFF4,Y:(R0) +   ; Receive low byte of data
NOP     ; Fast interrupt response

MOVEP   X:$FFF1,X0        ; Receive with exception. Read status register
MOVEP   X:$FFF4,Y:(R0) +   ; Receive low byte of data

ORG     P:$40
MOVEP   #0,X:$FFFE        ; Clear BCR
MOVE    #$100,R0          ; Data ROM start address
MOVE    #$FF,M0           ; Size of data ROM — wraps around at $200
MOVEP   #$C000,X:$FFFF    ; Interrupt priority register
MOVEP   #$900,X:$FFF0     ; 8-bit synchronous mode receive only
MOVEP   #$C000,X:$FFF2    ; Clock control register external clock
MOVEP   #7,X:$FFE1        ; Port C control register — enable SCI
MOVEC   #0,SR             ; Unmask interrupts
LAB0    JMP     LAB0        ; Wait in loop for interrupts

```

Figure 11-22. SCI Synchronous Receive

### 11.2.7 Asynchronous Data

Asynchronous data uses a data format with embedded word sync, which allows an unsynchronized data clock to be synchronized with the word if the clock rate and number of bits per word is known. Thus, the clock can be generated by the receiver rather than requiring a separate clock signal. The transmitter and receiver both use an internal clock that is  $16\times$  the data rate to allow the SCI to synchronize the data. The data format requires that each data byte have an additional start bit and stop bit. In addition, two of the word formats have a parity bit. The multidrop mode used when SCIs are on a common bus has an additional data type bit. The SCI can operate in full-duplex or half-duplex modes since the transmitter and receiver are independent. The SCI transmitter and receiver can use either the internal clock (TCM=0 and/or RCM=0) or an external clock (TCM=1 and/or RCM=1) or a combination. If a combination is used, the transmitter and receiver can run at different data rates.

**11.2.7.1 ASYNCHRONOUS DATA RECEPTION.** Figure 11-23 illustrates initializing the SCI data receiver for asynchronous data. The first step (1) resets the SCI to prevent the SCI from transmitting or receiving data. Step two (2) selects the desired operation by programming the SCR. As a minimum, the word format (WDS2, WDS1, and WDS0) must be selected, and (3) the receiver must be enabled (RE = 1). If (4) interrupts are to be used, set

1. HARDWARE OR SOFTWARE RESET
2. PROGRAM SCR WITH DESIRED MODE AND FEATURES.
3. TURN ON RECEIVER (RE = 1).
4. OPTIONALLY ENABLE RECEIVER INTERRUPTS (RIE = 1).

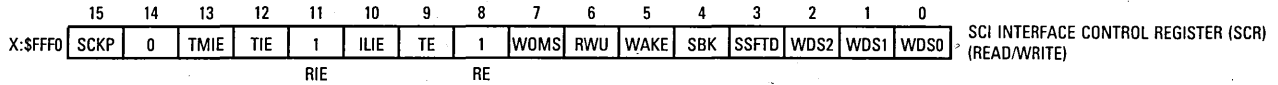

5. SET THE BAUD RATE BY PROGRAMMING THE SCCR.

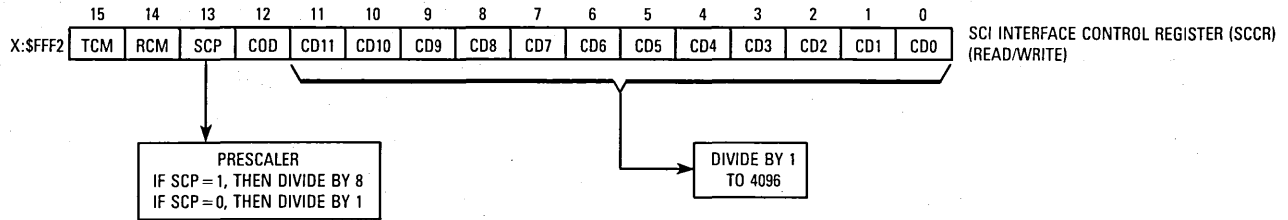

6. SET THE RXD BIT IN PCC TO ENABLE THE SCI RECEIVER SYSTEM.

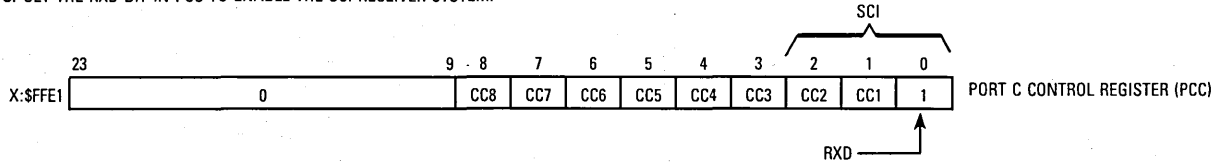

| CCx | Function         |
|-----|------------------|
| 0   | Parallel I/O     |
| 1   | Serial Interface |

NOTE: If RE is cleared while a valid character is being received, the reception of the character will be completed before the receiver is disabled.

Figure 11-23. Asynchronous SCI Receiver Initialization

RIE equals one. Use Tables 11-2 and 11-3 to set (5) the baud rate (SCP and CD0-CD11 in the SCCR). Once the SCI is completely configured, it is enabled by (6) setting the RXD bit in the PCC.

The receiver is continually sampling RDX at the  $16\times$  clock rate to find the idle-start-bit transition edge. When that edge is detected (1) the following eight or nine bits, depending on the mode, are clocked into the receive shift register (see Figure 11-24). Once a complete byte is received, (2) the character is latched into the SRX, and RDRF is set as well as the error flags, OR, PE, and FE. If (3) interrupts are enabled, an interrupt is generated. The interrupt service routine, which can be a fast interrupt or a long interrupt, (4) reads the received character. Reading the SRX (5) automatically clears RDRF in the SSR and makes the SRX ready to receive another byte.

If (1) an FE, PE, or OR occurs while receiving data (see Figure 11-25), (2) RDRF is set because a character has been received; FE, PE, or OR is set in the SSR to indicate that an error was detected. Either (3) the SSR can be polled by software to look for errors, or (4) interrupts can be used to execute an interrupt service routine. This interrupt is different from the normal receive interrupt and is caused only by receive errors. The long interrupt service routine should (5) read the SSR to determine what error was detected and then (6) read the SRX to clear RDRF and all three error flags.

**11.2.7.2 ASYNCHRONOUS DATA TRANSMISSION.** Figure 11-26 illustrates initializing the SCI data transmitter for asynchronous data. The first step (1) resets the SCI to prevent the SCI from transmitting or receiving data. Step two (2) selects the desired operation by programming the SCR. As a minimum, the word format (WDS2, WDS1, and WDS0) must be selected, and (3) the transmitter must be enabled ( $TE = 1$ ). If (4) interrupts are to be used, set TIE equals one. Use Tables 11-2 and 11-3 to set (5) the baud rate (SCP and CD0-CD11 in the SCCR). Once the SCI is completely configured, it can be enabled by (6) setting the TXD bit in the PCC. Transmission begins with (7) a preamble of ones.

If polling is used to transmit data (see Figure 11-27), the polling routine can look at either TDRE or TRNE to determine when to load another byte into STX. If TDRE is used (1), one byte may be loaded into STX. If TRNE is used (2), two bytes may be loaded into STX if enough time is allowed for the first byte to begin transmission (see **11.2.2.4.2 SCI Transmit Registers**). If interrupts are used (3), then an interrupt is generated when STX is empty. The interrupt routine, which can be a fast interrupt or a long interrupt, writes (4) one byte into STX. If multidrop mode is being used and this byte is an address, STXA should be used instead of STX. Writing STX or STXA (5) clears TDRE in the SSR. When the transmit data shift register is empty (6), the byte in STX (or STXA) is latched into the transmit data shift register, TRNE is cleared, and TDRE is set.

There is a provision to send a break or preamble. A break (space) consists of a period of zeros with no start or stop bits that is as long or longer than a character frame. A preamble (mark) is an inverted break. A preamble of 10 or 11 ones (depending on the word length selected by WDS2, WDS1, and WDS0) can be sent with the following procedure (see Figure 11-28). (1) Write the last byte to STX and (2) wait for TDRE equals one. This is the byte

1. THE RECEIVER IS IDLE UNTIL A CHARACTER IS RECEIVED IN THE DATA SHIFT REGISTER.

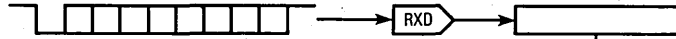

2. TRANSFERRING THE RECEIVED CHARACTER INTO SRX SETS RDRF IN THE SSR.

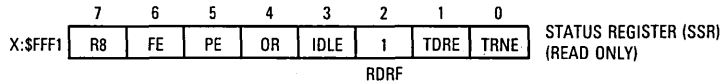

3. IF RIE = 1 IN SCR, THEN AN INTERRUPT IS GENERATED.

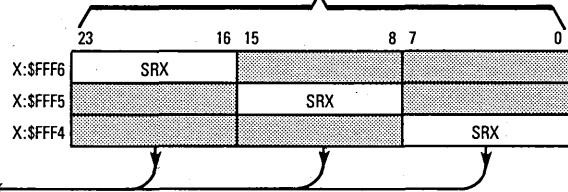

5. READING SRX CLEARS RDRF IN THE SSR.

4. THE RECEIVE INTERRUPT SERVICE ROUTINE READS THE RECEIVED CHARACTER.

Figure 11-24. SCI Character Reception

1. A CHARACTER IS RECEIVED WITH AT LEAST ONE OF THE FOLLOWING ERRORS:
  - FRAMING ERROR (FE = BIT 6 IN SSR)
  - PARITY ERROR (PE = BIT 5 IN SSR)
  - OVERRUN ERROR (OR = BIT 4 IN SSR)

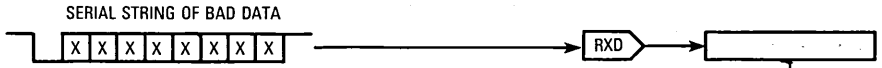

2. THIS SETS RDRF AND SET OR, PE, OR FE IN SSR.
3. SSR CAN BE POLLED BY SOFTWARE.

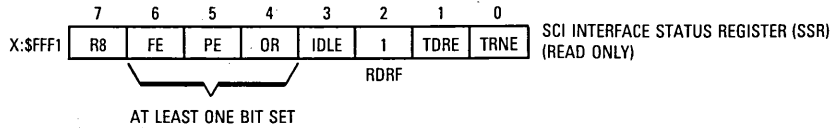

4. IF RIE = 1 IN SCR, THEN AN INTERRUPT WITH ERROR IS GENERATED.

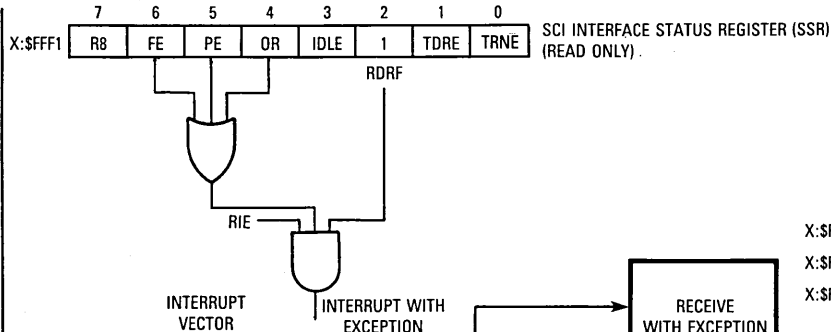

P:\$0016

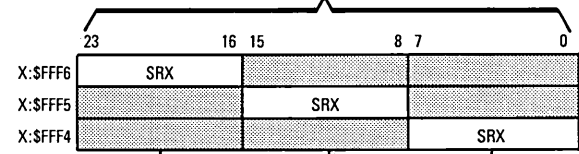
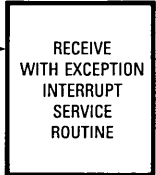
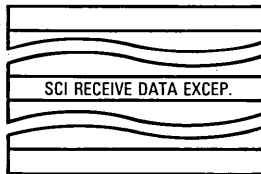

5. READ SSR, FOLLOWED BY
6. READING SRX. THIS CLEARS RDRF IN THE SSR AND CLEARS THE OR, PE, AND FE FLAGS.

Figure 11-25. SCI Character Reception with Exception

figure 11-26:

1. HARDWARE OR SOFTWARE RESET
2. PROGRAM SCR WITH DESIRED MODE AND FEATURES.
3. TURN ON TRANSMITTER (TE=1)
4. OPTIONALLY ENABLE TRANSMITTER INTERRUPTS (TIE=1).

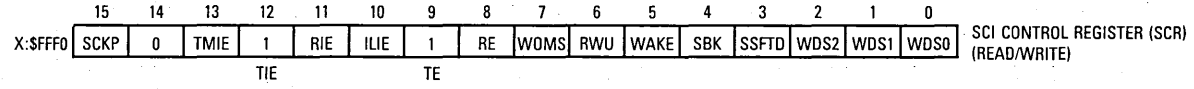

5. SET THE SCI CLOCK PRESCALER BIT AND THE CLOCK DIVIDER BITS IN THE SCCR.
6. SET THE TXD BIT IN PCC TO ENABLE THE SCI TRANSMITTER SYSTEM.

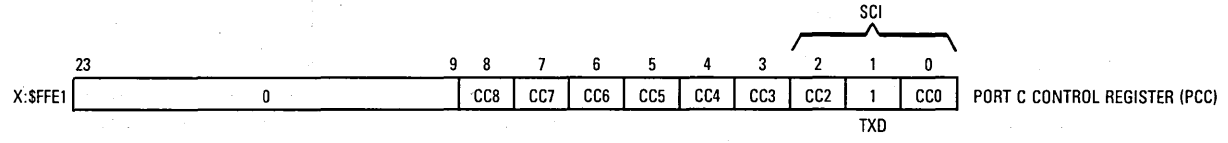

| CCx | Function         |
|-----|------------------|
| 0   | Parallel I/O     |
| 1   | Serial Interface |

7. THE TRANSMITTER WILL FIRST BROADCAST A PREAMBLE OF ONES BEFORE BEGINNING DATA TRANSMISSION:  
 10 ONES WILL BE TRANSMITTED FOR THE 10-BIT ASYNCHRONOUS MODE.  
 11 ONES WILL BE TRANSMITTED FOR THE 11-BIT ASYNCHRONOUS MODE.

NOTE: If TE is cleared while transmitting a character, the transmission of the character will be completed before the transmitter is disabled.

Figure 11-26. Asynchronous SCI Transmitter Initialization



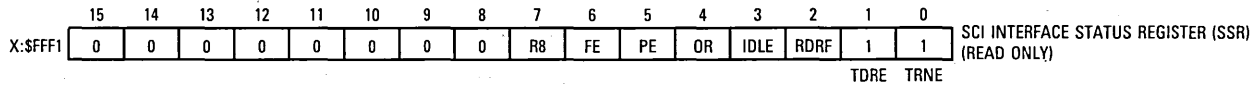

1. WHEN STX IS EMPTY, THEN TDRE=1.
2. WHEN STX IS EMPTY AND THE TRANSMIT DATA SHIFT REGISTER IS EMPTY THEN TRNE=1.
3. IF TIE=1 IN SCR AND TDRE=1 IN SSR, THEN AN INTERRUPT IS GENERATED.

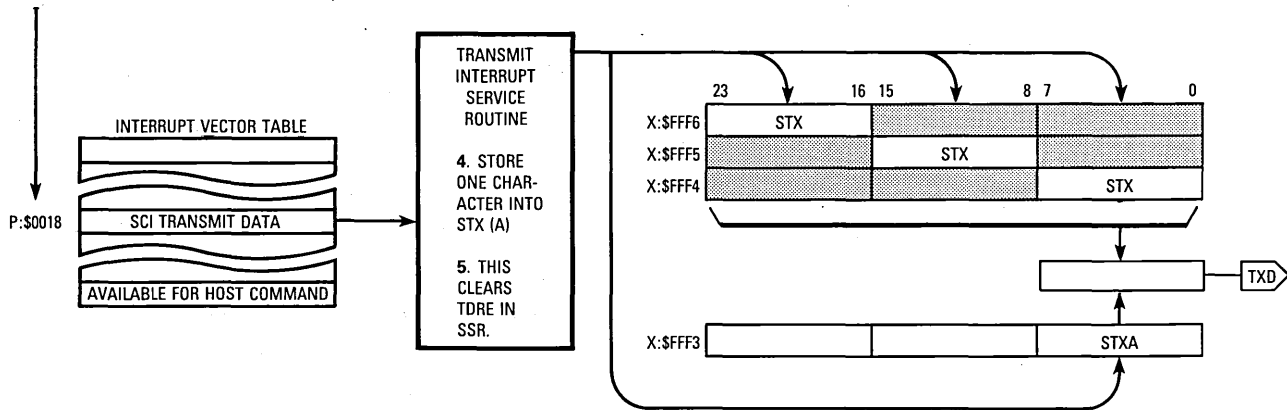

6. THE CHARACTER IN STX IS COPIED INTO TRANSMIT DATA SHIFT REGISTER. TRNE IS CLEARED. TDRE IS SET. GO TO STEP 2.

Figure 11-27. Asynchronous SCI Character Transmission

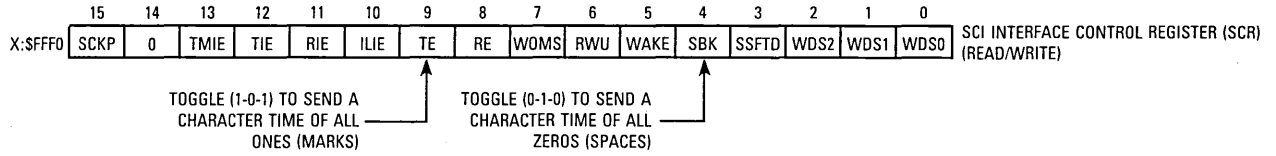

• 10 OR 11 ONES/ZEROS WILL BE SENT DEPENDING ON THE WORD LENGTH SPECIFIED BY WDS2, WDS1, WDS0.

**MARKS (ONES)**

1. WRITE THE LAST BYTE TO STX.
2. WAIT FOR TRDE = 1. THE LAST BYTE IS NOW IN THE TRANSMIT SHIFT REGISTER.
3. CLEAR TE AND SET BACK TO ONE. THIS QUEUES THE PREAMBLE TO FOLLOW THE LAST BYTE.
4. WRITE THE FIRST BYTE TO FOLLOW THE PREAMBLE INTO SRX.

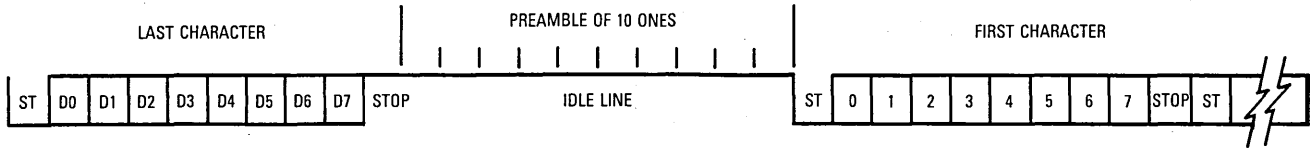

**SPACES (ZEROS)**

A STOP BIT AT THE END OF THE BREAK WILL BE INSERTED BEFORE THE NEXT CHARACTER STARTS.

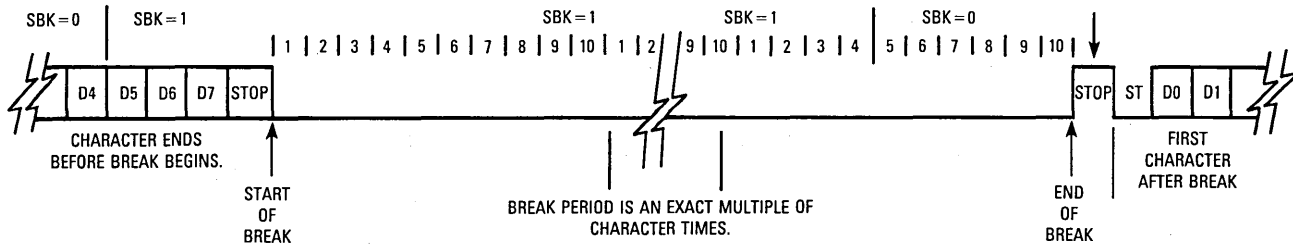

**Figure 11-28. Transmitting Marks and Spaces**

that will be transmitted immediately before the preamble. (3) Clear TE and then again set it to one. Momentarily clearing TE causes the output to go high for one character frame. If TE remains cleared for a longer period, the output will remain high for an even number of character frames until TE is set. (4) Write the first byte to follow the preamble into SRX before the preamble is complete and resume normal transmission. Sending a break follows the same procedure except that instead of clearing TE, SBK is set in the SCR to send breaks and then reset to resume normal data transmission.

The example presented in Figure 11-29 uses the SCI in the asynchronous mode to transfer data into buffers. Interrupts are used, allowing the DSP to perform other tasks while the data transfer is occurring. This program can be tested by connecting the SCI transmit and receive pins. Equates are used for convenience and readability.

The program sets the reset vector to run the program after reset, puts a MOVEP instruction at the SCI receive interrupt vector location, and puts a MOVEP and BCLR at the SCI transmit interrupt vector location so that, after transmitting a byte, the transmitter is disabled until another byte is ready for transmission. The SCI is initialized by setting the interrupt level, which configures the SCR and SCCR, and then is enabled by writing the PCC. The main program begins by enabling interrupts, which allows data to be received. Data is transmitted by moving a byte of data to the transmit register and by enabling interrupts. The jump-to-self instruction (SEND JMP SEND) is used to wait while interrupts transfer the data.

### 11.2.8 Multidrop

Multidrop is a special case of asynchronous data transfer. The key difference is that a protocol is used to allow networking transmitters and receivers on a single data-transmission line. Interprocessor messages in a multidrop network typically begin with a destination address. All receivers check for an address match at the start of each message. Receivers with no address match can ignore the remainder of the message and use a wakeup mode to enable the receiver at the start of the next message. Receivers with an address match can receive the message and optionally transmit an acknowledgment to the sender. The particular message format and protocol used are determined by the user's software. These message formats include point-to-point, bus, token-ring, and custom configurations. The SCI multidrop network is compatible with other leading microprocessors.

Figure 11-30 shows a multidrop system with one master and N slaves. The multidrop mode is selected by setting WDS2 equals one, WDS1 equals one, and WDS0 equals zero. One possible protocol is to have a preamble or idle line between messages, followed by an address and then a message. The idle line causes the slaves to wake up and compare the address with their own address. If the addresses match, the slave receives the message. If the addresses do not match, the slave ignores the message and goes back to sleep. It is also possible to generate an interrupt when an address is received, eliminating the need for idle time between consecutive messages and addresses. It is also possible for each slave to look for more than one address, which allows each slave to respond to individual messages as well as broadcast messages (e.g., a global reset).

```

; *****
; SCI ASYNC WITH INTERRUPTS AND SINGLE BYTE BUFFERS *
; *****
; *****
; SCI and other EQUATES *
; *****

START      EQU      $0040      ;Start of program
PCC        EQU      $FFE1      ;Port C control register
SCR        EQU      $FFF0      ;SCI interface control register
SCCR       EQU      $FFF2      ;SCI clock control register
SRX        EQU      $FFF4      ;SCI receive register
STX        EQU      $FFF4      ;SCI transmit register
BCR        EQU      $FFFE      ;Bus control register
IPR        EQU      $FFFF      ;Interrupt priority register
RXBUF     EQU      $100        ;Receive buffer
TXBUF     EQU      $200        ;Transmit buffer

; *****
; RESET VECTOR *
; *****

ORG        P:$0000
JMP        START

; *****
; SCI RECEIVE INTERRUPT VECTOR *
; *****

ORG        P:$0014      ;Load the SCI RX interrupt vectors
MOVEP     X:SRX,Y:(R0) + ;Put the received byte in the receive
NOP                                     ;buffer. This receive routine is
                                           ;implemented as a fast interrupt.

; *****
; SCI TRANSMIT INTERRUPT VECTOR *
; *****

ORG        P:$0018      ;Load the SCI TX interrupt vectors
MOVEP     X:(R3) + ,X:STX ;Transmit a byte and
                                           ;increment the pointer in the
                                           ;transmit buffer.
BCLR     #12,X:SCR      ;Disable transmit interrupts

```

Figure 11-29. SCI Asynchronous Transmit/Receive Example (Sheet 1 of 2)

```

; *****
;
;           INITIALIZE THE SCI PORT AND RX, TX BUFFER POINTERS           *
; *****
;
;           ORG           P:START           ;Start the program at location $40
;           ORI           # $03,MR         ;Mask interrupts temporarily
;           MOVEP        # $C000,X:IPR     ;Set interrupt priority to 2
;           MOVEP        # $0B02,X:SCR     ;Disable TX, enable RX interrupts
;                                           ;Enable transmitter, receiver
;                                           ;Point to point
;                                           ;10-bit asynchronous
;                                           ;(1 start, 8 data, 1 stop)
;           MOVEP        # $0022,X:SCCR    ;Use internal TX, RX clocks
;                                           ;9600 BPS
;           MOVEP        # >$03,X:PCC     ;Select pins TXD and RXD for SCI
;
;           MOVE         #RXBUF,R0        ;Initialize the receive buffer
;           MOVE         #TXBUF,R0        ;Initialize the transmit buffer
;
; *****
;
;           MAIN PROGRAM           *
; *****
;
;           ANDI         # $FC,MR         ;Re-enable interrupts
;           MOVE         # >$41,R0        ;Move a byte to the transmit buffer
;           MOVE         R0,X:(R3)
;           BSET         #12,X:SCR        ;and enable interrupts so it
;                                           ;will be transmitted
SEND      JMP           SEND             ;Normally something more useful
;                                           ;would be put here.
;
;           END           ;End of example.

```

Figure 11-29. SCI Asynchronous Transmit/Receive Example (Sheet 2 of 2)

**11.2.8.1 TRANSMITTING DATA AND ADDRESS CHARACTERS.** Transmitting data and address when the multidrop mode is selected is shown in Figure 11-31. The output sequence shown is idle line, data/address, and the next character. In both cases, an "A" is being transmitted. To send data, TE must be toggled to send the idle line, and then "A" must be sent to STX. Sending the "A" to the STX sets the ninth bit in the frame to zero, which indicates that this frame contains data. If the "A" is sent to STXA instead, the ninth bit in the frame is set to a one, which indicates that this frame contains an address.

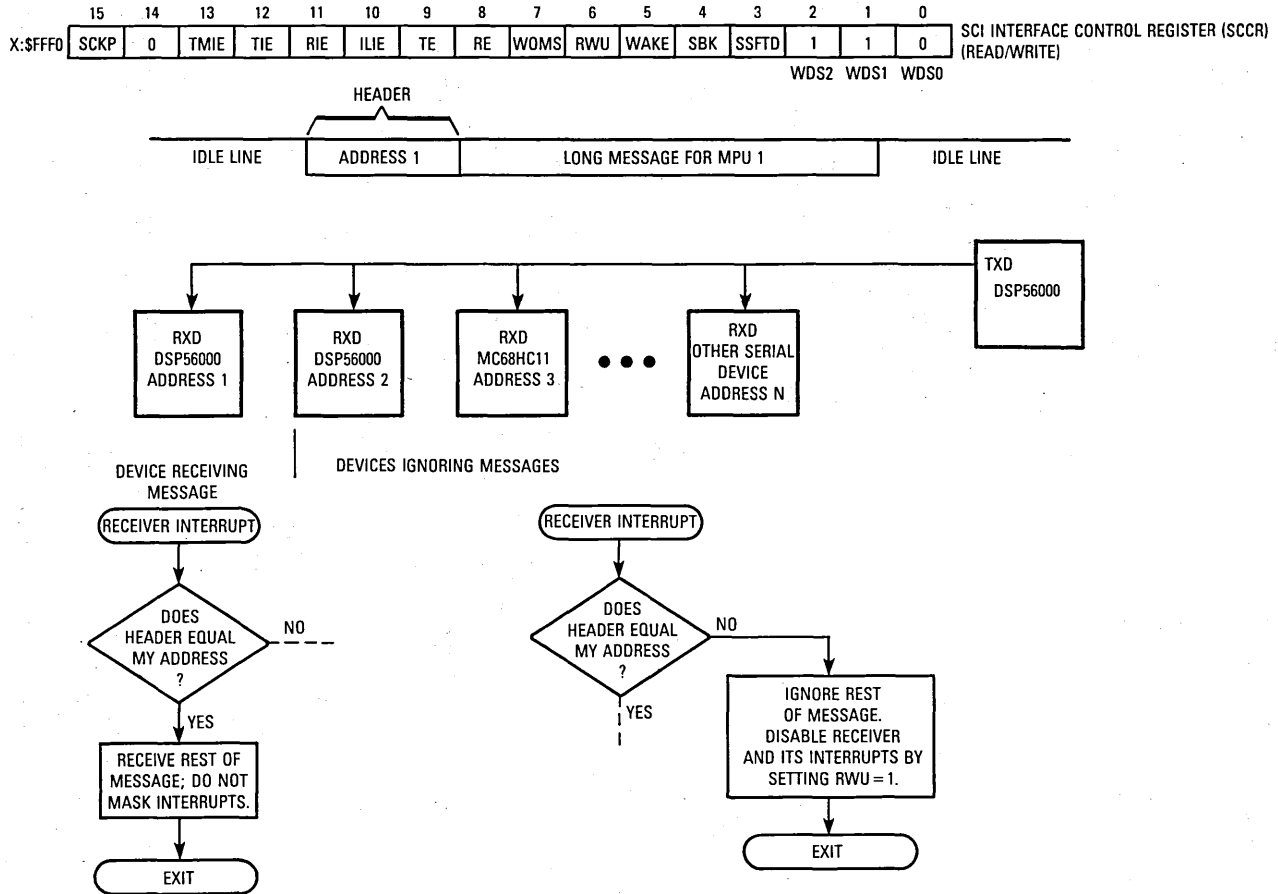

Figure 11-30. 11-Bit Multidrop Mode

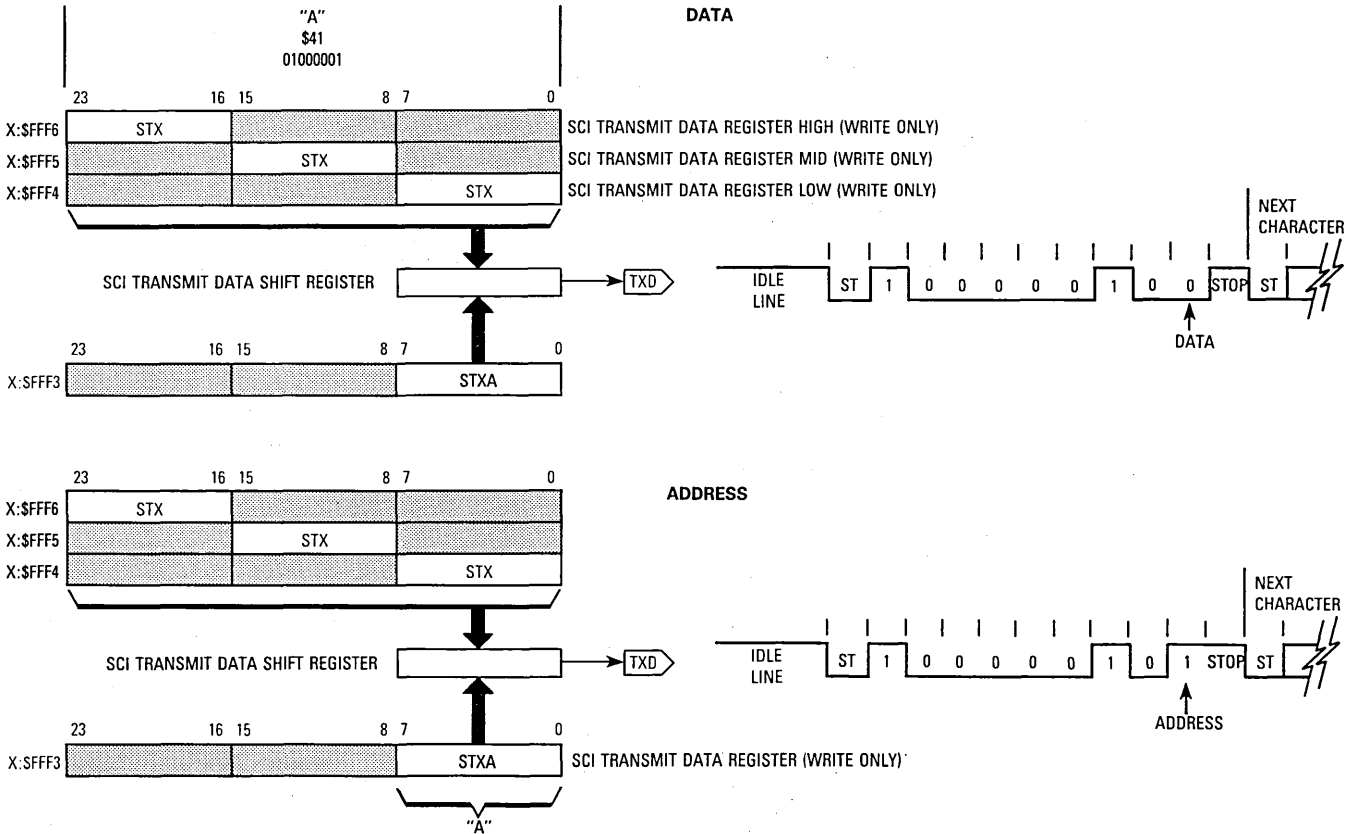

Figure 11-31. Transmitting Data and Address Characters

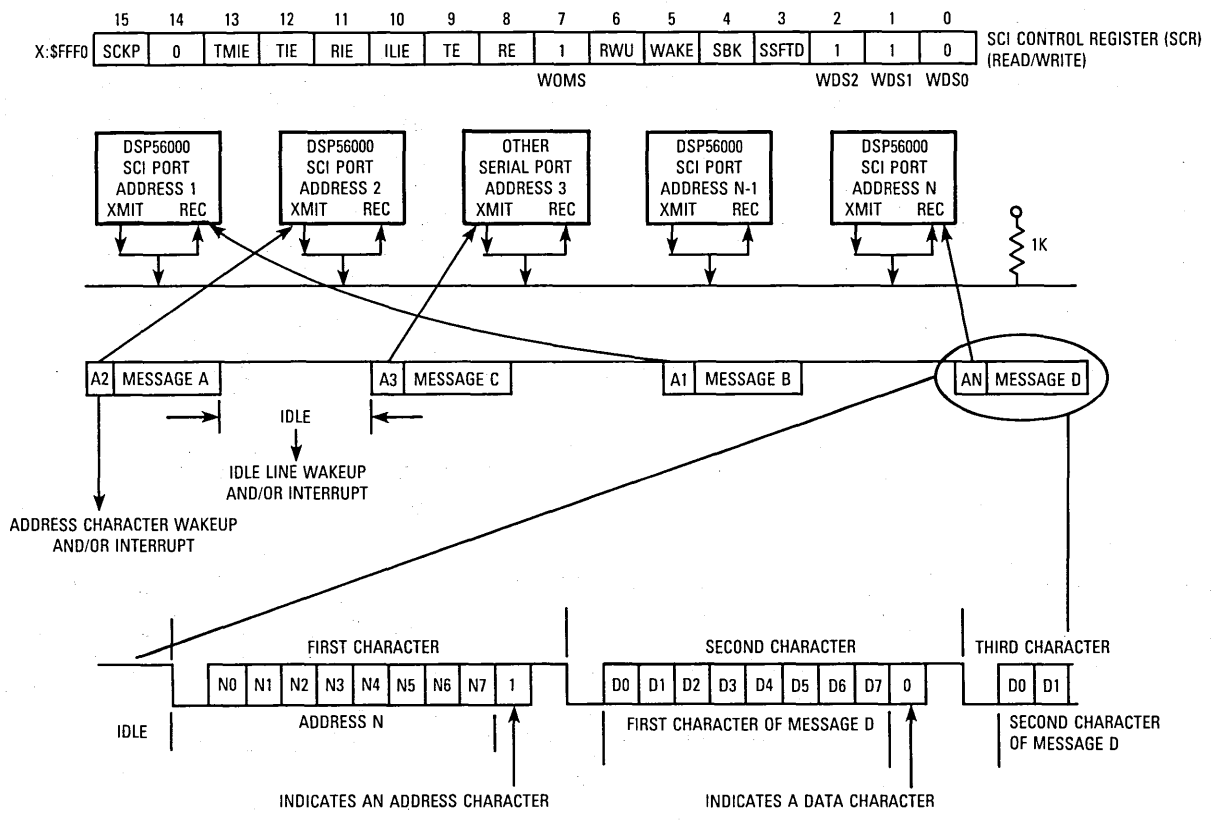

Figure 11-32. Wired-OR Mode



**11.2.8.2 WIRED-OR MODE.** Building a multidrop bus network requires connecting multiple transmitters to a common wire. The wired-OR mode allows this to be done without damaging the transmitters when the transmitters are not in use. A protocol is still needed to prevent two transmitters from simultaneously driving the bus. The SCI multidrop word format provides an address field to support this protocol. Figure 11-32 shows a multidrop configuration using wired-OR (set bit 7 of the SCR). The protocol shown consists of an idle line between messages; each message begins with an address character. The message can be any length, depending on the protocol. Each processor in this system has one address that it responds to although each processor can be programmed to respond to more than one address.

**11.2.8.3 IDLE LINE WAKEUP.** The purpose of a wakeup mode is to free a DSP from reading messages intended for other processors. The usual operational procedure is for each DSP to suspend SCI reception (the DSP can continue processing) until the beginning of a message. Each DSP compares the address in the message header with the DSP's address. If the addresses do not match, the SCI again suspends reception until the next address. If the address matches, the DSP will read and process the message and then suspend reception until the next address.

The idle line wakeup mode wakes up the SCI to read a message before the first character arrives. This mode allows the message to be in any format.

Figure 11-33 shows how to configure the SCI to detect and respond to an idle line. The word format chosen (WDS2, WDS1, and WDS0 in the SCR) must be asynchronous. The WAKE bit must be clear to select idle line wakeup, and RWU must be set to put the SCI to "sleep" and enable the wakeup function. RIE should be set if interrupts are to be used to receive data. If processing must occur when the idle line is first detected, ILIE should be set. The current message is followed by one or more data frames of ones (10 or 11 bits each, depending on which word format is used), which are detected as an idle line. If the word format is multidrop (an 11-bit code), after the 11 ones, the receiver determines the line is idle and (1) clears the RWU, enabling the receiver. The IDLE bit (2) and an internal flag SRIINT (3) are set, indicating the line is idle. The SCI is now ready to receive messages; however, nothing more will happen until the next start bit unless (4) ILIE is set. If ILIE is set, an SCI idle line interrupt will be recognized as pending. When the idle line interrupt is recognized (5), SRIINT is automatically cleared, and the SCI waits for the first start bit of the next character. Since RIE was set, when the first character is received, an SCI receive data interrupt (or SCI receive data with exception status interrupt if an error is detected) will be recognized as pending. When the receiver has processed the message and is ready to wait for another idle line, RWU must be set to one again.

**11.2.8.4 ADDRESS MODE WAKEUP.** The purpose and basic operational procedure for address mode wakeup is the same as idle line wakeup. The difference is that address mode wakeup re-enables the SCI when the ninth bit in a character is set to one (if cleared, this bit marks a character as data; if set, an address). As a result, an idle line is not needed,

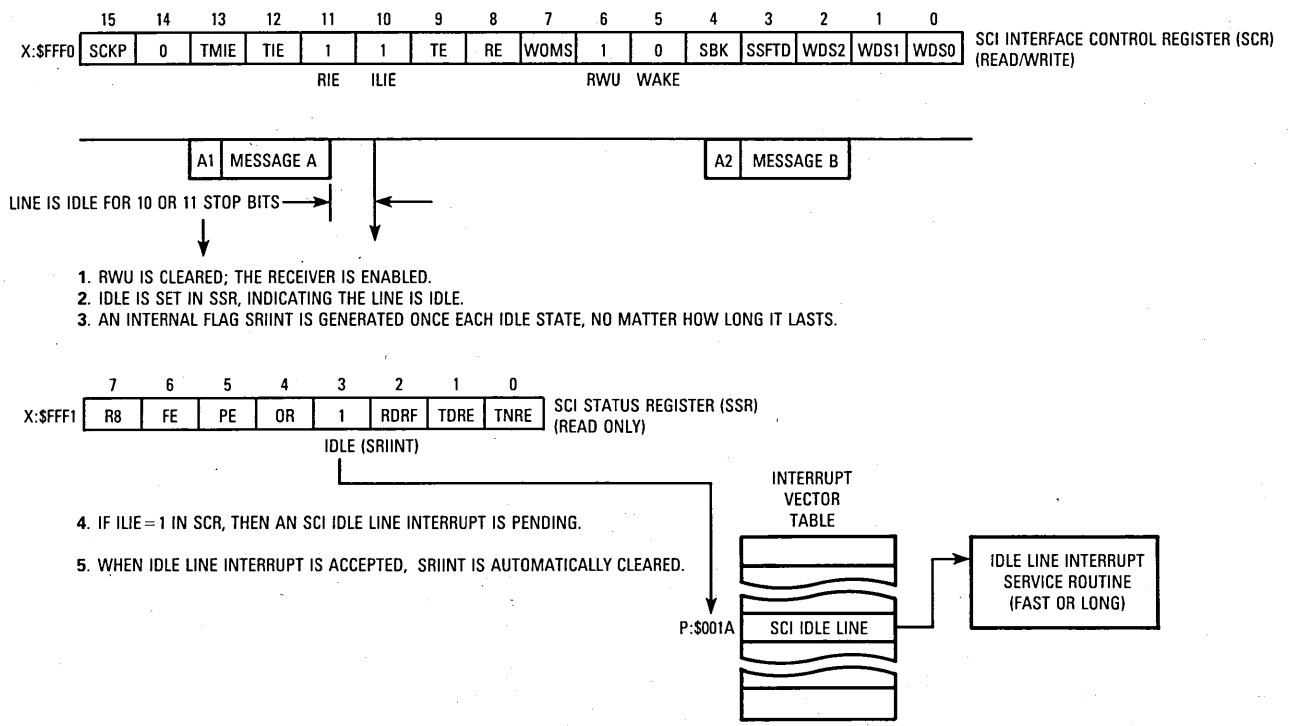

Figure 11-33. Idle Line Wakeup

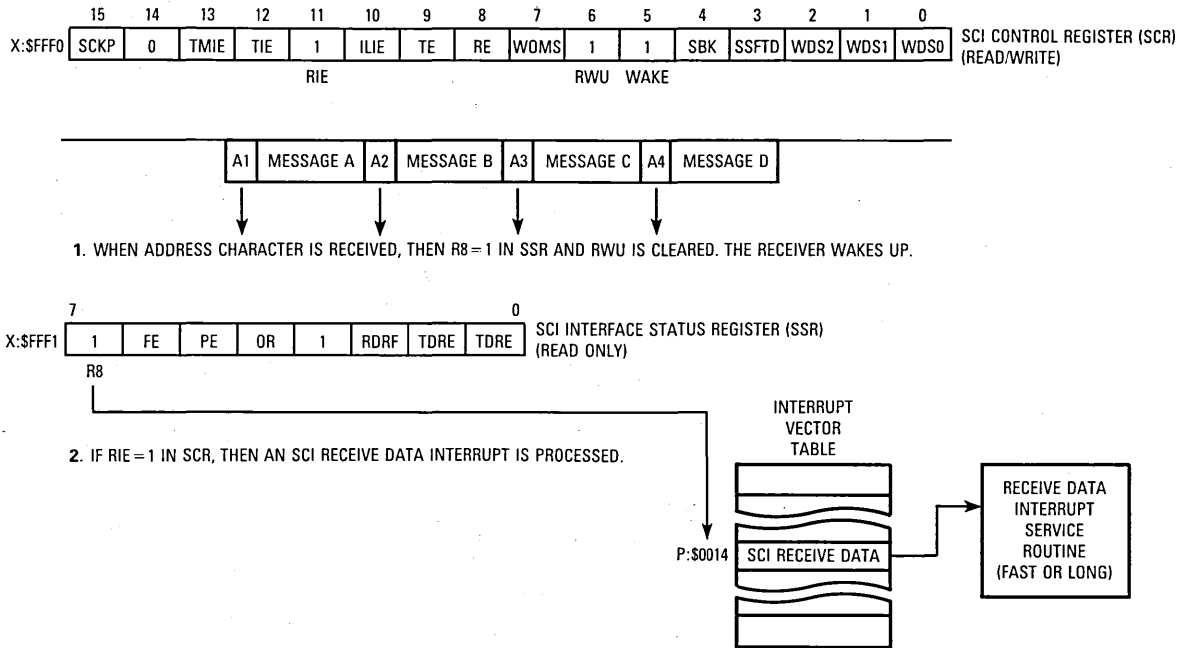

Figure 11-34. Address Mode Wakeup

which eliminates the dead time between messages. If the protocol is such that the address byte is not needed or is not wanted in the first byte of the message, a data byte can be written to STXA at the beginning of each message. It is not essential that the first byte of the message contain an address; it is essential that the start of a new message is indicated by setting the ninth bit to one using STXA.

Figure 11-34 shows how to configure the SCI to detect and respond to an address character. The word format chosen (WDS2, WDS1, and WDS0 in the SCR) must be an asynchronous word format. The WAKE bit must be set to select address mode wakeup and RWU must be set to put the SCI to "sleep" and enable the wakeup function. RIE should be set if interrupts are to be used to receive data. (1) When an address character (ninth bit = 1) is received, then R8 is set to one in the SSR, and RWU is cleared. Clearing RWU re-enables the SCI receiver. Since (2) RIE was set in this example, when the first character is received, an SCI receive data interrupt (or SCI receive data with exception status interrupt if an error is detected) will be recognized as pending. When the receiver is ready to wait for another address character, RWU must be set to one again.

**11.2.8.5 MULTIDROP EXAMPLE.** The program shown in Figure 11-35 configures the SCI as a multidrop master transmitter and slave receiver (using wakeup on address bit) that uses interrupts to transmit data from a circular buffer and to receive data into a different circular buffer. This program can be run with the I/O pins (RXD and TXD) connected and with a pullup resistor for test purposes.

The program starts by setting equates for convenience and clarity and then points the reset vector to the start of the program. The receive and transmit interrupt vector locations have JSRs forming long interrupts because the multidrop protocol and circular buffers require more than two instructions for maintenance. Byte packing and unpacking are not used in this example. The SRX and STX registers are equated to \$FFF4, causing only the LSB of the 24-bit DSP word to be used for SCI data. The SCI is then initialized as wired-OR, multidrop, and using interrupts. The SCI is enabled but the interrupts are masked, which prevents the SCI from transmitting or receiving data at this time.

The circular buffers used have two pointers. The first points to the first data byte; the second points to the last data byte. This configuration allows the transmit buffer to act as a first-in first-out (FIFO) memory. The FIFO can be loaded by a program and emptied by the SCI in real time. As long as the number of data bytes never exceeds the buffer size, there will be no overflow or underflow of the buffer. Registers M0-M3 must be loaded with the buffer size minus one to make pointer registers R0-R3 work as circular pointers. Register N2 is used as a constant to clear the receive buffer empty flag.

The main program starts by filling the transmit buffer with a data packet. When the transmit buffer is full, it calls the subroutine that transmits the slave's address and then jumps to self (SEND jmp SEND), allowing interrupts to transmit and receive the data.

The receive subroutine first checks each byte to see if it is address or data. If it is an address, it compares the address with its own. If the addresses do not match, the SCI is put back to sleep. If the addresses match, the SCI is left awake, and control is returned to the main program. If the byte is data, it is placed in the receive buffer, and the receive buffer empty flag is cleared. Although this flag is not used in this program, it can be used by another program as a simple test to see if data is available. Using N2 as the constant \$0 allows the flag to be cleared with a single-word instruction, which can be part of a fast interrupt.

The transmit subroutine transmits a byte and then checks to see if the transmit buffer is empty. If the buffer is not empty, control is returned to the main program, and interrupts are allowed to continue emptying the buffer. If the buffer is empty, the transmit buffer empty flag is set, the transmit interrupt is disabled, and control is returned to the main program.

The wakeup subroutine transmits the slave's address by writing the address to the STXA register and by enabling the transmit interrupt to allow interrupts to empty the transmit buffer. Control is then returned to the main program.

```

; *****
; MULTIDROP MASTER/SLAVE WITH INTERRUPTS AND CIRCULAR BUFFERS *
; *****

; *****
; SCI and other EQUATES *
; *****

START      EQU      $0040      ;Start of program
TX_BUFF    EQU      $0010      ;Transmit buffer location
RX_BUFF    EQU      $0020      ;Receive buffer location
B_SIZE     EQU      $000E      ;Transmit and receive buffer size
                                   ;(don't allow the TX buffer and RX
                                   ;buffers to overlap).
TX_MTY     EQU      $0000      ;Transmit buffer empty
RX_MTY     EQU      $0001      ;Receive buffer empty
PCC        EQU      $FFE1      ;Port C control register
SCR        EQU      $FFF0      ;SCI interface control register
SCCR       EQU      $FFF2      ;SCI clock control register
STXA       EQU      $FFF3      ;SCI transmit address register
SRX        EQU      $FFF4      ;SCI receive register
STX        EQU      $FFF4      ;SCI transmit register
BCR        EQU      $FFFE      ;Bus control register
IPR        EQU      $FFFF      ;Interrupt priority register

```

Figure 11-35. Multidrop Transmit Receive Example (Sheet 1 of 5)

```

; *****
;
;          RESET VECTOR          *
; *****
;
;          ORG          P:$0000
;          JMP          START
;
; *****
;
;          SCI RECEIVE INTERRUPT VECTOR      *
; *****
;
;          ORG          P:$0014          ;Load the SCI RX interrupt vectors
;          JSR          RX              ;Jump to the receive routine that
;                                     ;puts data packet in a circular
;                                     ;buffer if it is for this address.
;          NOP
;                                     ;Second word of fast interrupt not
;                                     ;needed
;          ORG          P:$0016          ;This interrupt occurs when data is
;                                     ;received with errors. This example
;          NOP
;                                     ;does not trap errors so this
;          NOP
;                                     ;interrupt is not used.
;
; *****
;
;          SCI TRANSMIT INTERRUPT VECTOR     *
; *****
;
;          ORG          P:$0018          ;Load the SCI TX interrupt vectors
;          JSR          TX              ;Transmit next byte in buffer
;          NOP
;
; *****
;
;          INITIALIZE THE SCI PORT          *
; *****
;
;          ORG          P:START          ;Start the program at location $40
;          ORI          #$03,MR         ;Mask interrupts temporarily
;          MOVEP        #$C000,X:IPR    ;Set interrupt priority to 2
;
;          MOVEP        #$0BE6,X:SCR    ;Disable TX, enable RX interrupts
;                                     ;Enable transmitter and receiver,
;                                     ;Wired-OR mode; Rec. wakeup mode,
;                                     ;11-bit multidrop (1 start,
;                                     ;8 data,1 data type, 1 stop)
;          MOVEP        #$0000,X:SCCR   ;Use internal TX, RX clocks
;                                     ;320K BPS
;          MOVEP        #>$03,X:PCC    ;Select pins TXD and RXD for SCI

```

Figure 11-35. Multidrop Transmit Receive Example (Sheet 2 of 5)

```

;*****
;  INITIALIZE INTERRUPTS, REGISTERS, ETC.  *
;*****
      MOVEP      #\$0,X:BCR          ;No wait states

      MOVE       #TX_BUFF,R0        ;Load start pointer of transmit
                                       ;buffer
      MOVE       #TX_BUFF,R1        ;Load end pointer of transmit
                                       ;buffer
      MOVE       #RX_BUFF,R2        ;Load start pointer of receive
                                       ;buffer
      MOVE       #RX_BUFF,R3        ;Load end pointer of receive
                                       ;buffer
      MOVE       #>\$41,R5           ;Init data register . . . R5 contains
                                       ;the data that will be sent in this
                                       ;example; it is initialized to an
                                       ;ASCII A.

      MOVE       #B_SIZE,M0         ;Load transmit buffer size
      MOVE       #B_SIZE,M1         ;Load transmit buffer size
      MOVE       #B_SIZE,M2         ;Load receive buffer size
      MOVE       #B_SIZE,M3         ;Load receive buffer size
      MOVE       #>\$1,N0            ;Load receive address
      MOVE       #>\$1,N1            ;Load first slave address
      MOVE       #0,N2               ;Load a constant (0) into N2
      MOVEP      X:SRX,X:(R0)       ;Clear receive register

;*****
;  MAIN PROGRAM  *
;*****
      ANDI       #\$FC,MR           ;Re-enable interrupts

      MOVE       (R1)+              ;Temporarily increment the tail
                                       ;pointer
                                       ;Build a packet
LOOP   MOVE       R1,A              ;Check to see if the TX buffer is
                                       ;full
      MOVE       (R1)-              ;(fix tail pointer now that we've
                                       ;used it)
      MOVE       R0,B               ;by comparing the head and tail
                                       ;pointers
      CMP        A,B                ;of the circular transmit buffer.
      JEQ        SND_BUF            ;if equal, transmit completed packet
      MOVE       R5,X:(R1)+         ;if not, put next character in
                                       ;transmit buffer and

```

Figure 11-35. Multidrop Transmit Receive Example (Sheet 3 of 5)

```

                MOVE      (R5)+          ;increment the pointers.
                MOVE      (R1)+          ;Temporarily increment the tail
                ;pointer to test buffer again
SND_BUF        JMP        LOOP
                JSR        WAKE_UP       ;Wake up proper slave and send
                ;packet
SEND           JMP        SEND          ;and allow interrupts to drain
                ;the transmit buffer.

```

```

; *****
;
; SUBROUTINE TO READ SCI AND STORE IN BUFFER USING A LONG INTERRUPT *
; *****

```

```

RX             JCLR       #7,X:$FFF1,RX-DATA ;Check if this is address or data.
                MOVEP     X:SRX,A        ;Compare the received address
                MOVE      N1,B          ;with the slave address.
                CMP       A,B
                JEQ       END_RX         ;If address OK, use interrupts to Rx
                ;packet
                BSET      #6,X:$FFF0     ;if not, go back to sleep
                JMP       END_RX         ;and return to previous program.
RX-DATA        MOVEP     X:SRX,X:(R3)+    ;Put data in buffer,
                MOVE      N2,X:RX-MTY    ;and clear the Rx buffer empty flag
END_RX         RTI                    ;Return to previous program

```

```

; *****
;
; SUBROUTINE TO WRITE BUFFER TO SCI USING A LONG INTERRUPT *
; *****

```

```

TX             MOVEP     X:(R0)+,X:STX    ;Transmit a byte and increment the
                ;pointer
                MOVE      R0,A          ;Check to see if the TX buffer is
                ;empty
                MOVE      R1,B
                CMP       A,B
                JNE      END_TX         ;If not, return to main
                MOVE      #$000001,X0   ;If it is, set the TX buffer empty
                ;flag
                MOVE      X0,X:TX-MTY
                BCLR      #12,X:SCR      ;disable transmit interrupts, and
END_TX         RTI                    ;return to main

```

Figure 11-35. Multidrop Transmit Receive Example (Sheet 4 of 5)



```

; *****
;                               SUBROUTINE TO WAKE UP THE ADDRESSED SLAVE                               *
; *****
WAKE_UP    MOVEP    N1,X:STXA      ;Transmit slave address using STXA
;                               ;not STX
           BSET    #12,X:SCR      ;Enable transmit interrupts to send
;                               ;packet
AWAKE      RTI
           END                    ;End of example.

```

**Figure 11-35. Multidrop Transmit Receive Example (Sheet 4 of 5)**

### 11.2.9 SCI Timer

The SCI clock used to determine the data transmission rate can also be used to cause a periodic interrupt. This interrupt can be used as an event timer or for any other timing function. Figure 11-36 illustrates how the SCI timer is programmed. Only bits CD11–CD0 and SCP in the SCCR are used to determine the time base. The crystal oscillator  $f_{OSC}$  is first divided by 2 and then divided by the number CD11–CD0 in the SCCR. The oscillator is then divided by 1 (if SCP=0) or eight (if SCP=1). Finally, it is divided by 2 and then by 16. If TMIE in the SCR is set (1) when the periodic timeout occurs, the SCI timer interrupt is recognized and pending. The SCI timer interrupt is automatically cleared when the interrupt is serviced. This interrupt will occur every time the periodic timer times out. If only the timer function is being used (i.e., PC0, PC1, and PC2 pins have been programmed as parallel I/O pins), the transmit interrupts should be turned off (TIE=0). Under individual reset, TDRE will remain set, continuously generating interrupts.

Figure 11-36 shows that an external clock can be used for SCI receive and/or transmit, which frees the SCI timer to be programmed for a different interrupt rate. In addition, both the SCI timer interrupt and the SCI can use the internal time base if the SCI receiver and/or transmitter require the same clock period as the SCI timer.

The following program (see Figure 11-37) configures the SCI to interrupt the DSP at fixed intervals. The program starts by setting equates for convenience and clarity and then points the reset vector to the start of the program. The SCI timer interrupt vector location contains “move (R0)+”, incrementing the contents of R0, which serves as an elapsed time counter.

The timer initialization consists of enabling the SCI timer interrupt, setting the SCI baud rate counters for the desired interrupt rate, setting the interrupt mask, enabling the interrupt, and then enabling the SCI state machine.

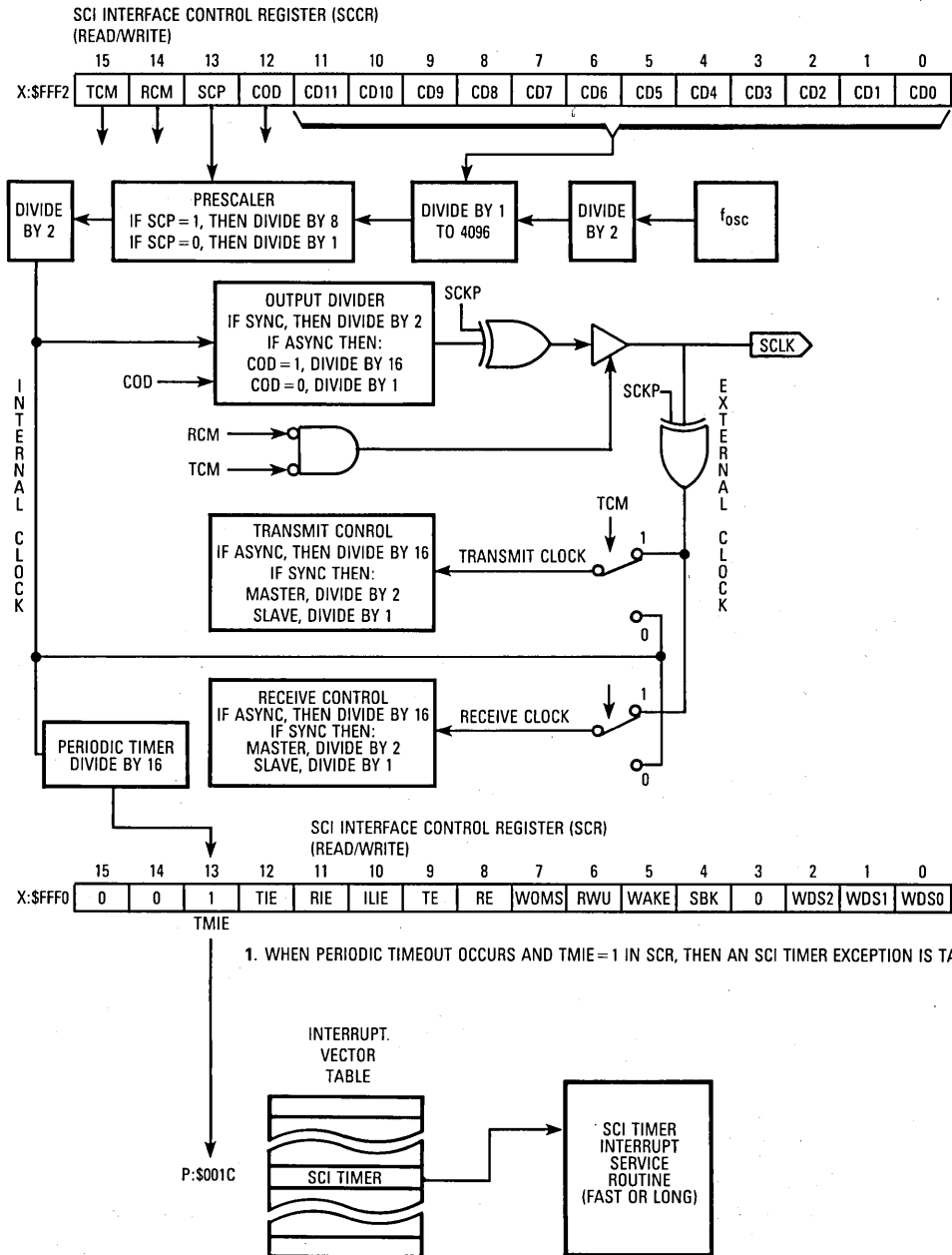

Figure 11-36. SCI Timer Operation

```

; *****
;                                     TIMER USING SCI TIMER INTERRUPT
; *****

```

```

; *****
;                                     SCI and other EQUATES
; *****

```

```

START      EQU      $0040      ;Start of program
SCR        EQU      $FFF0      ;SCI control register
SCCR       EQU      $FFF2      ;SCI clock control register
IPR        EQU      $FFFF      ;Interrupt priority register

```

```

; *****
;                                     RESET VECTOR
; *****

```

```

          ORG      P:$0000
          JMP      START

```

```

; *****
;                                     SCI TIMER INTERRUPT VECTOR
; *****

```

```

          ORG      P:$001C      ;Load the SCI timer interrupt vectors
          MOVE     (R0)+        ;Increment the timer interrupt counter
          NOP                    ;This timer routine is implemented
                                ;as a fast interrupt.

```

```

; *****
;                                     INITIALIZE THE SCI PORT
; *****

```

```

          ORG      P:START      ;Start the program at location $40
          MOVE     #0,R0        ;Initialize the timer interrupt counter

```

Figure 11-37. SCI Timer Example (Sheet 1 of 2)

```

MOVEP    #$2000,X:SCR      ;Select the timer interrupt
MOVEP    #$013F,X:SCCR    ;Set the interrupt rate at 1 ms.
                                     ;(arbitrarily chosen).
                                     ;Interrupts/second =
                                     ;fosc/(64 × (7(SCP) — + 1) × (CD + 1))
                                     ;Note that this is the same equation
                                     ;as for SCI async baud rate.
                                     ;For 1 ms, SCP=0,
                                     ;CD=0001 0011 1111.
MOVEP    #$C000,X:IPR     ;Set the interrupt priority level —
                                     ;application specific.
ANDI     #$FC,MR          ;Enable interrupts, set MR bits I1 and
                                     ;I0=0
END      JMP      END      ;Normally something more useful
                                     ;would be put here.

END      ;End of example.

```

**Figure 11-37. SCI Timer Example (Sheet 2 of 2)**

### 11.2.10 Example Circuits

The SCI can be used in a number of configurations to connect multiple processors. The synchronous mode shown in Figure 11-38 shows the DSP acting as a slave. The 8051 provides the clock that clocks data in and out of the SCI, which is possible because the SCI shift register mode timing is compatible with the timing for 8051/8096 processors. Transmit data is changed on the negative edge of the clock, and receive data is latched on the positive edge of the clock. A protocol must be used to prevent both processors from transmitting simultaneously. The DSP is also capable of being the master device.

A multimaster system can be configured (see Figure 11-39) using a single transmit/receive line, multidrop word format, and wired-OR. The use of wired-OR requires a pullup resistor as shown. A protocol must be used to prevent collisions. This scheme is physically the simplest multiple DSP interconnection because it uses only one wire and one resistor.

The master-slave system shown in Figure 11-40 is different in that it is full duplex. The clock pin is not required; thus, it is configured as a parallel I/O pin. Communication is asynchronous. The slave's transmitters must be wire-ORed because more than one transmitter is on one line. The master's transmitter does not need to be wire-ORed.

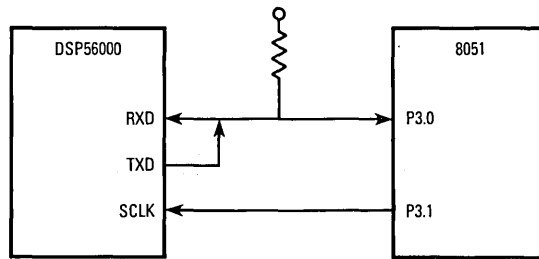
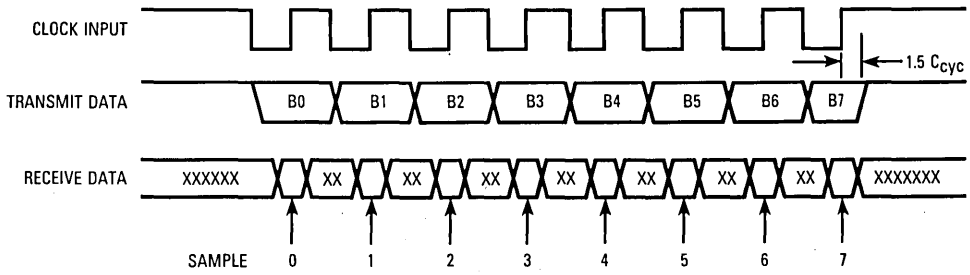

Figure 11-38. Synchronous Mode Example

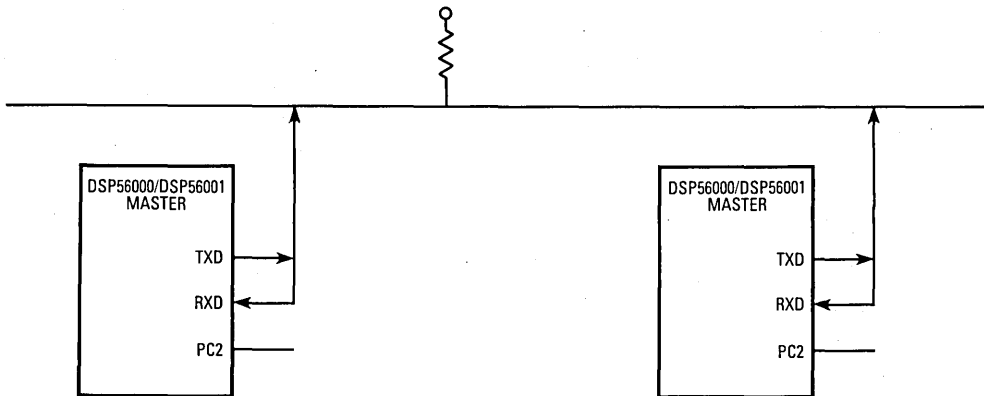

Figure 11-39. Multimaster System Example

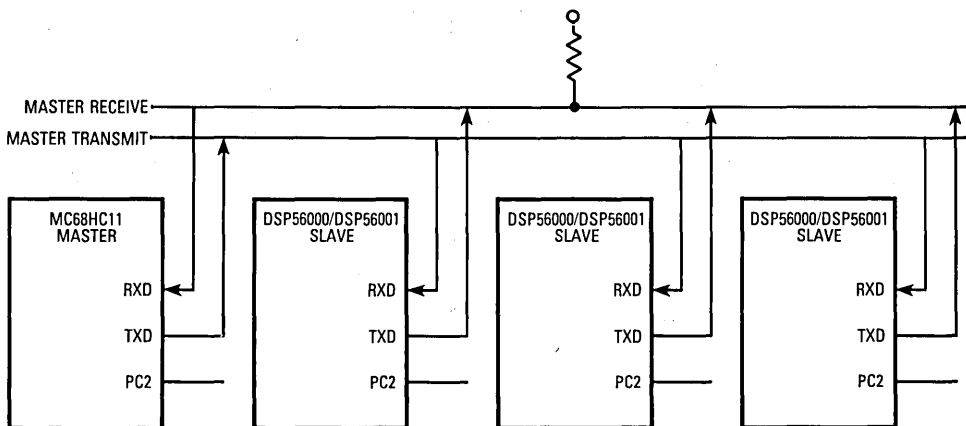

Figure 11-40. Master-Slave System Example

### 11.3 SYNCHRONOUS SERIAL INTERFACE (SSI)

The synchronous serial interface (SSI) provides a full-duplex serial port for serial communication with a variety of serial devices including one or more industry-standard codecs, other DSPs, microprocessors, and peripherals which implement the Motorola SPI. The SSI consists of independent transmitter and receiver sections and a common SSI clock generator. Three to six pins are required for operation, depending on the operating mode selected.

The following is a short list of SSI features:

- A 6.75 Million Bit/Second at 27 MHz ( $f_{OSC}/4$ ) serial interface

- Double Buffered

- User Programmable

- Separate Transmit and Receive Sections

- Control and Status Bits

- Interface to a Variety of Serial Devices, Including:

- Codecs (usually without additional logic)

- MC145500

- MC145501

- MC145502

- MC145503

- MC145505

- MC145402 (13-bit linear codec)

- MC145554 Family of Codecs

Serial Peripherals (A/D, D/A)  
Most Industry-Standard A/D, D/A  
DSP56ADC16 (16-bit linear A/D)  
DSP56000 to DSP56000 Networks  
Motorola SPI Peripherals and Processors  
Shift Registers

Interface to Time Division Multiplexed Networks without Additional Logic

Six Pins:

STD SSI Transmit Data  
SRD SSI Receive Data  
SCK SSI Serial Clock  
SC0 Serial Control 0 (defined by SSI mode)  
SC1 Serial Control 1 (defined by SSI mode)  
SC2 Serial Control 2 (defined by SSI mode)

On-chip Programmable Functions Include:

Clock — Continuous, Gated, Internal, External  
Synchronization Signals:  
— Bit Length  
— Word Length  
TX/RX Timing — Synchronous, Asynchronous  
Operating Modes — Normal, Network, On-Demand  
Word Length — 8, 12, 16, 24 Bits  
Serial Clock and Frame Sync Generator

Four Interrupt Vectors:

Receive  
Receive with Exception  
Transmit  
Transmit with Exception

This interface is named synchronous because all serial transfers are synchronized to a clock. Additional synchronization signals are used to delineate the word frames. The **normal mode** of operation is used to transfer data at a periodic rate, but only one word per period. The **network mode** is similar in that it is also intended for periodic transfers; however, it will support up to 32 words (time slots) per period. This mode can be used to build time division multiplexed (TDM) networks. In contrast, the **on-demand mode** is intended for nonperiodic transfers of data. This mode can be used to transfer data serially at high speed when the data becomes available. This mode offers a subset of the SPI protocol.

### 11.3.1 SSI Data and Control Pins

The SSI has three dedicated I/O pins (see Figure 11-1), which are used for transmit data (STD), receive data (SRD), and serial clock (SCK), where SCK may be used by both the transmitter and the receiver for synchronous data transfers or by the transmitter only for asynchronous data transfers. Three other pins may also be used, depending on the mode selected; they are serial control pins SC0, SC1, and SC2. These serial control pins may be

programmed as SSI control pins in the port C control register. Table 11-4 shows the definition of SC0, SC1, SC2, and SCK in the various configurations. The following paragraphs describe the uses of these pins for each of the SSI operating modes.

Figures 11-41 and 11-42 show the internal clock path connections in block diagram form. The receiver and transmitter clocks can be internal or external depending on the SYN, SCD0, and SCKD bits in CRB.

**Table 11-4. Definition of SC0, SC1, SC2, and SCK**

| SSI Pin Name<br>(Control Bit Name)  | Asynchronous<br>(SYN=0)      |                              | Synchronous<br>(SYN=1)       |                              |
|-------------------------------------|------------------------------|------------------------------|------------------------------|------------------------------|
|                                     | Continuous Clock<br>(GCK=0)  | Gated Clock<br>(GCK=1)       | Continuous Clock<br>(GCK=0)  | Gated Clock<br>(GCK=1)       |
| SC0=0 (in)<br>SC0=1 (out)<br>(SCD0) | RXC External<br>RXC Internal | RXC External<br>RXC Internal | Input F0<br>Output F0        | Input F0<br>Output F0        |
| SC1=0 (in)<br>SC1=1 (out)<br>(SCD1) | FSR External<br>FSR Internal | Not Used<br>FSR Internal     | Input F1<br>Output F1        | Input F1<br>Output F1        |
| SC2=0 (in)<br>SC2=1 (out)<br>(SCD2) | FST External<br>FST Internal | Not Used<br>FST Internal     | FS* External<br>FS* Internal | Not Used<br>FS* Internal     |
| SCK=0 (in)<br>SCK=1 (out)<br>(SCKD) | TXC External<br>TXC Internal | TXC External<br>TXC Internal | *XC External<br>*XC Internal | *XC External<br>*XC Internal |

TXC — Transmitter Clock  
 RXC — Receiver Clock  
 \*XC — Transmitter/Receiver Clock (synchronous operation)  
 FST — Transmitter Frame Sync  
 FSR — Receiver Frame Sync  
 FS\* — Transmitter/Receiver Frame Sync (synchronous operation)  
 PF0 — Flag 0  
 F1 — Flag 1

**11.3.1.1 SERIAL TRANSMIT DATA PIN (STD).** STD is used for transmitting data from the serial transmit shift register. STD is an output when data is being transmitted. Data changes on the positive edge of the bit clock. STD goes to high impedance on the negative edge of the bit clock of the last data bit of the word (i.e., during the second half of the last data bit period) with external gated clock, regardless of the mode. With an internally generated bit clock, the STD pin becomes high impedance after the last data bit has been transmitted for a full clock period, assuming another data word does not follow immediately. If a data word follows immediately, there will not be a high-impedance interval.

Codecs label the MSB as bit 0; whereas, the DSP labels the LSB as bit 0. Therefore, when using a standard codec, the DSP MSB (or codec bit 0) is shifted out first when SHFD=0, and the DSP LSB (or codec bit 7) is shifted out first when SHFD=1. STD may be programmed as a general-purpose pin called PC8 when the SSI STD function is not being used.



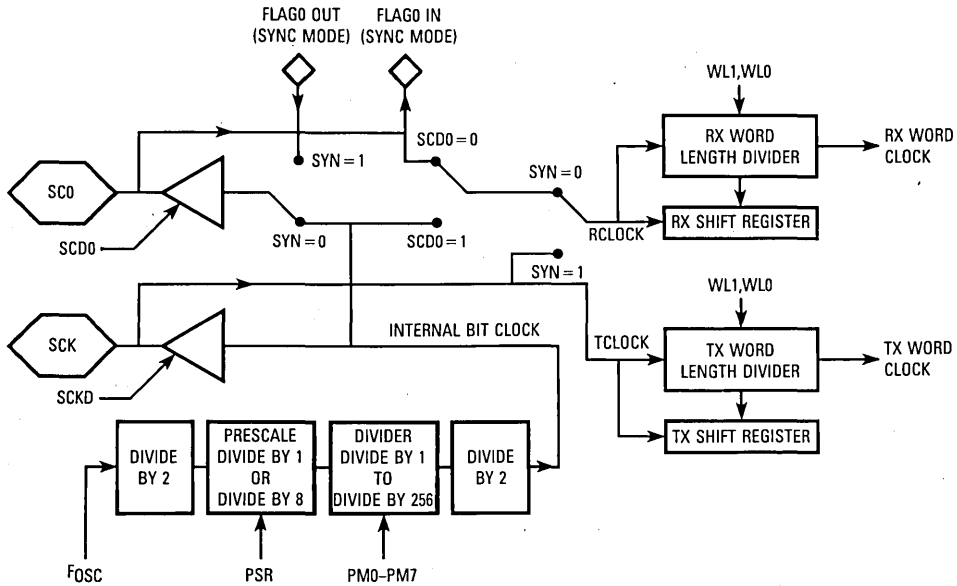

Figure 11-41. SSI Clock Generator Functional Block Diagram

**11.3.1.2. SERIAL RECEIVE DATA PIN (SRD).** SRD receives serial data and transfers the data to the SSI receive shift register. SRD may be programmed as a general-purpose I/O pin called PC7 when the SSI SRD function is not being used. Data is sampled on the negative edge of the bit clock.

**11.3.1.3 SERIAL CLOCK (SCK).** SCK is a bidirectional pin providing the serial bit rate clock for the SSI interface. The SCK is a clock input or output used by both the transmitter and receiver in synchronous modes or by the transmitter in asynchronous modes (see Table 11-5).

#### NOTE

Although an external serial clock can be independent of and asynchronous to the DSP system clock, it must exceed the minimum clock cycle time of  $8T$  (i.e., the system clock frequency must be at least four times the external SSI clock frequency). The SSI needs at least four DSP phases ( $\text{DSP phase} = T$ ) inside each half of the serial clock.

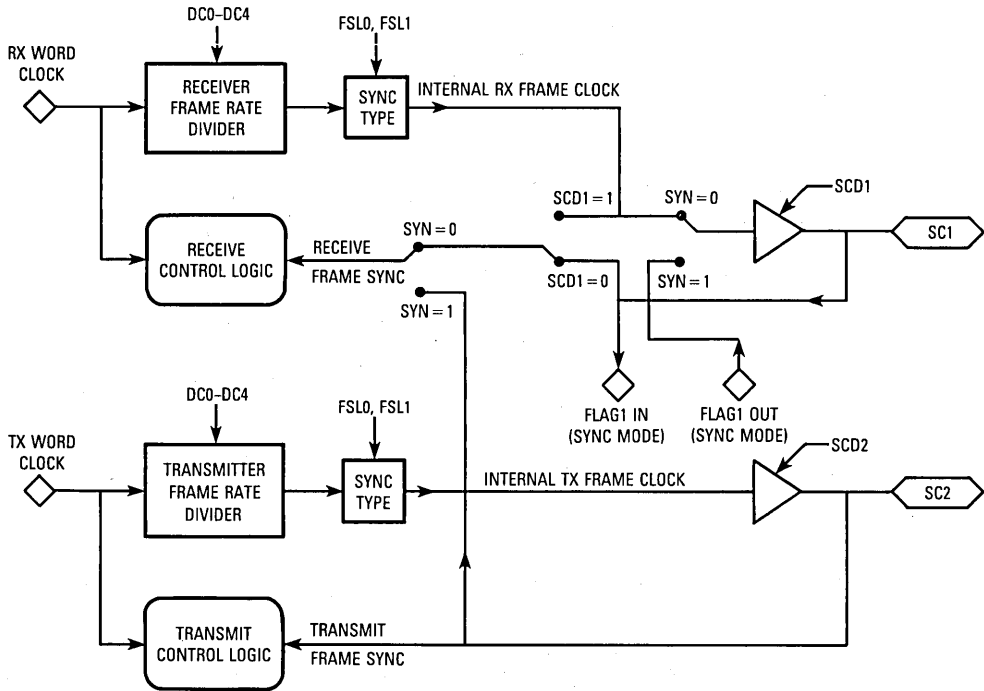

Figure 11-42. SSI Frame Sync Generator Functional Block Diagram

Table 11-5. SSI Clock Sources, Inputs, and Outputs

| SYN          | SCKD | SCD0 | R Clock Source | RX Clock Out | T Clock Source | TX Clock Out |
|--------------|------|------|----------------|--------------|----------------|--------------|
| Asynchronous |      |      |                |              |                |              |
| 0            | 0    | 0    | EXT, SCK       | —            | EXT, SCK       | —            |
| 0            | 0    | 1    | INT            | SC0          | EXT, SCK       | —            |
| 0            | 1    | 0    | EXT, SCK       | —            | INT            | SCK          |
| 0            | 1    | 1    | INT            | SC0          | INT            | SCK          |
| Synchronous  |      |      |                |              |                |              |
| 1            | 0    | 0    | EXT, SCK       | —            | EXT, SCK       | —            |
| 1            | 0    | 1    | EXT, SCK       | —            | EXT, SCK       | —            |
| 1            | 1    | 0    | INT            | SCK          | INT            | SCK          |
| 1            | 1    | 1    | INT            | SCK          | INT            | SCK          |

EXT — External Pin Name  
INT — Internal Bit Clock

**11.3.1.4 SERIAL CONTROL PIN (SC0).** The function of this pin is determined solely on the selection of either synchronous or asynchronous mode (see Tables 11-4 and 11-5). For asynchronous mode, this pin will be used for the receive clock I/O. For synchronous mode, this pin is used for serial flag I/O. A typical application of flag I/O would be multiple device selection for addressing in codec systems. The direction of this pin is determined by the SCD0 bit in the CRB as described in the following table. When configured as an output, this pin will be either serial output flag 0, based on control bit OF0 in CRB, or a receive shift register clock output. When configured as an input, this pin may be used either as serial input flag 0, which will control status bit IF0 in the SSISR, or as a receive shift register clock input.

| SYN          | GCK        | SCD0   | Operation           |
|--------------|------------|--------|---------------------|
| Synchronous  | Continuous | Input  | Flag 0 Input        |
| Synchronous  | Continuous | Output | Flag 0 Output       |
| Synchronous  | Gated      | Input  | Flag 0 Input        |
| Synchronous  | Gated      | Output | Flag 0 Output       |
| Asynchronous | Continuous | Input  | Rx Clock — External |
| Asynchronous | Continuous | Output | Rx Clock — Internal |
| Asynchronous | Gated      | Input  | Rx Clock — External |
| Asynchronous | Gated      | Output | Rx Clock — Internal |

**11.3.1.5 SERIAL CONTROL PIN (SC1).** The function of this pin is determined solely on the selection of either synchronous or asynchronous mode (see Table 11-4). In asynchronous mode (such as a single codec with asynchronous transmit and receive), this pin is the receiver frame sync I/O. For synchronous mode with continuous clock, this pin is serial flag SC1 and operates like the previously described SC0. SC0 and SC1 are independent serial I/O flags but may be used together for multiple serial device selection. SC0 and SC1 can be used unencoded to select up to two codecs or may be decoded externally to select up to four codecs. The direction of this pin is determined by the SCD1 bit in the CRB. When configured as an output, this pin will be either a serial output flag, based on control bit OF1, or it will make the receive frame sync signal available. When configured as an input, this pin may be used as a serial input flag, which will control status bit IF1 in the SSI status register, or as a receive frame sync from an external source for continuous clock mode. In the gated clock mode, external frame sync signals are not used.

| SYN          | GCK        | SCD1   | Operation                |
|--------------|------------|--------|--------------------------|
| Synchronous  | Continuous | Input  | Flag 1 Input             |
| Synchronous  | Continuous | Output | Flag 1 Output            |
| Synchronous  | Gated      | Input  | Flag 1 Input             |
| Synchronous  | Gated      | Output | Flag 1 Output            |
| Asynchronous | Continuous | Input  | RX Frame Sync — External |
| Asynchronous | Continuous | Output | RX Frame Sync — Internal |
| Asynchronous | Gated      | Input  | —                        |
| Asynchronous | Gated      | Output | RX Frame Sync — Internal |

**11.3.1.6 SERIAL CONTROL PIN (SC2).** This pin is used for frame sync I/O (see Table 11-4). SC2 is the frame sync for both the transmitter and receiver in synchronous mode and for the transmitter only in asynchronous mode. The direction of this pin is determined by the SCD2 bit in CRB. When configured as an output, this pin is the internally generated frame sync signal. When configured as an input, this pin receives an external frame sync signal for the transmitter (and the receiver in synchronous operation). In the gated clock mode, external frame sync signals are not used.

| SYN          | GCK        | SCD2   | Operation                |
|--------------|------------|--------|--------------------------|
| Synchronous  | Continuous | Input  | TX and RX Frame Sync     |
| Synchronous  | Continuous | Output | TX and RX Frame Sync     |
| Synchronous  | Gated      | Input  | —                        |
| Synchronous  | Gated      | Output | TX and RX Frame Sync     |
| Asynchronous | Continuous | Input  | TX Frame Sync — External |
| Asynchronous | Continuous | Output | TX Frame Sync — Internal |
| Asynchronous | Gated      | Input  | —                        |
| Asynchronous | Gated      | Output | TX Frame Sync — Internal |

### 11.3.2 SSI Interface Programming Model

The SSI can be viewed as two control registers, one status register, a transmit register, a receive register, and special-purpose time slot register. These registers are illustrated in Figures 11-43 and 11-44. The following paragraphs give detailed descriptions and operations of each of the bits in the SSI registers. The SSI registers are not prefaced with an "S" (for serial) as are the SCI registers.

**11.3.2.1 SSI CONTROL REGISTER A (CRA).** CRA is one of two 16-bit read/write control registers used to direct the operation of the SSI. The CRA controls the SSI clock generator bit and frame sync rates, word length, and number of words per frame for the serial data. The high-order bits of CRA are read as zeros by the DSP CPU. The CRA control bits are described in the following paragraphs.

**11.3.2.1.1 CRA Prescale Modulus Select (PM7–PM0) Bits 0–7.** The PM0–PM7 bits specify the divide ratio of the prescale divider in the SSI clock generator. A divide ratio from 1 to 256 (PM=0 to \$FF) may be selected. The bit clock output is available at the transmit clock (SCK) and/or the receive clock (SC0) pins of the DSP. The bit clock output is also available internally for use as the bit clock to shift the transmit and receive shift registers. Careful choice of the crystal oscillator frequency and the prescaler modulus will allow the industry-standard codec master clock frequencies of 2.048 MHz, 1.544 MHz, and 1.536 MHz to be generated. Hardware and software reset clear PM0–PM7.

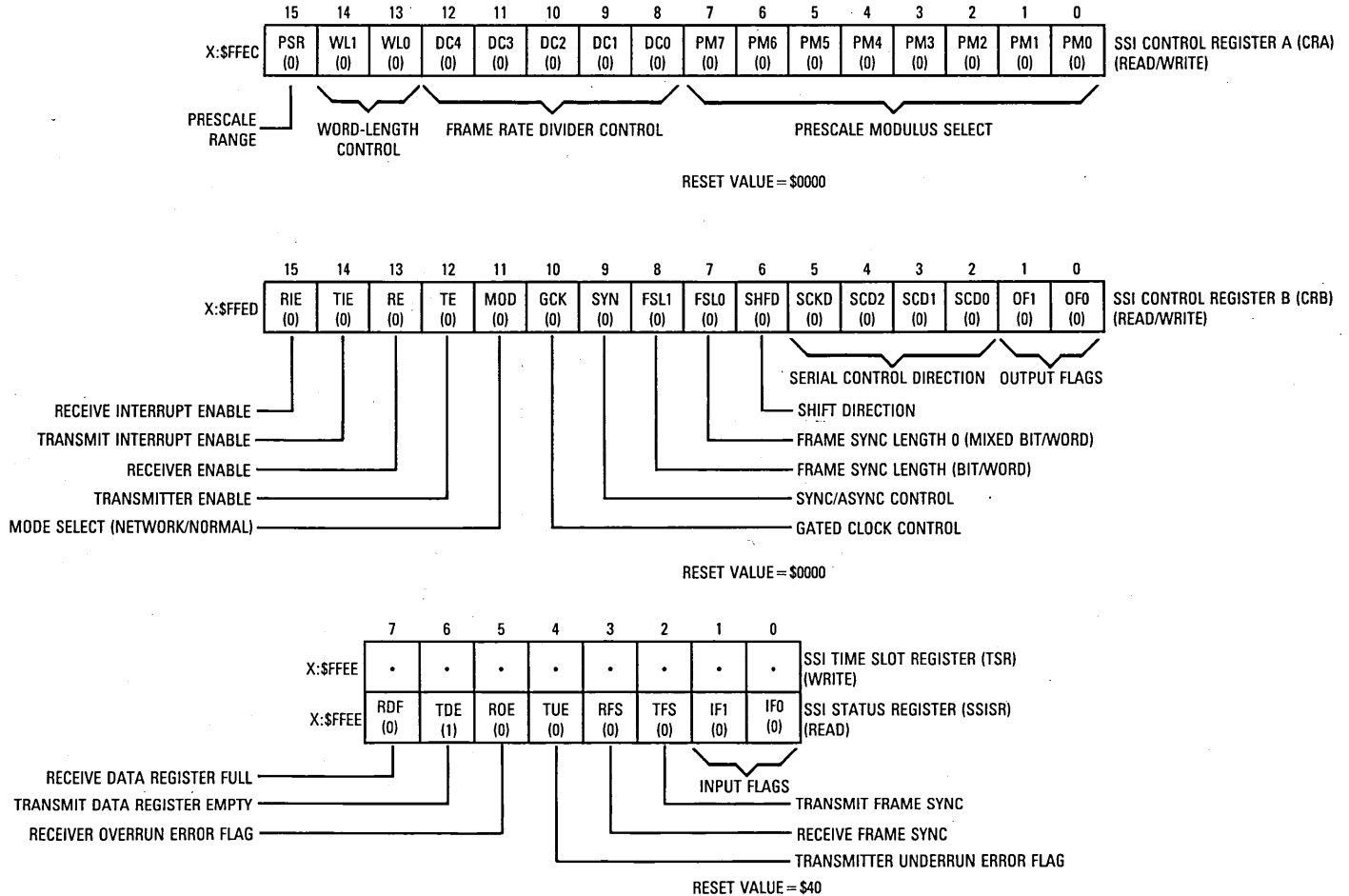
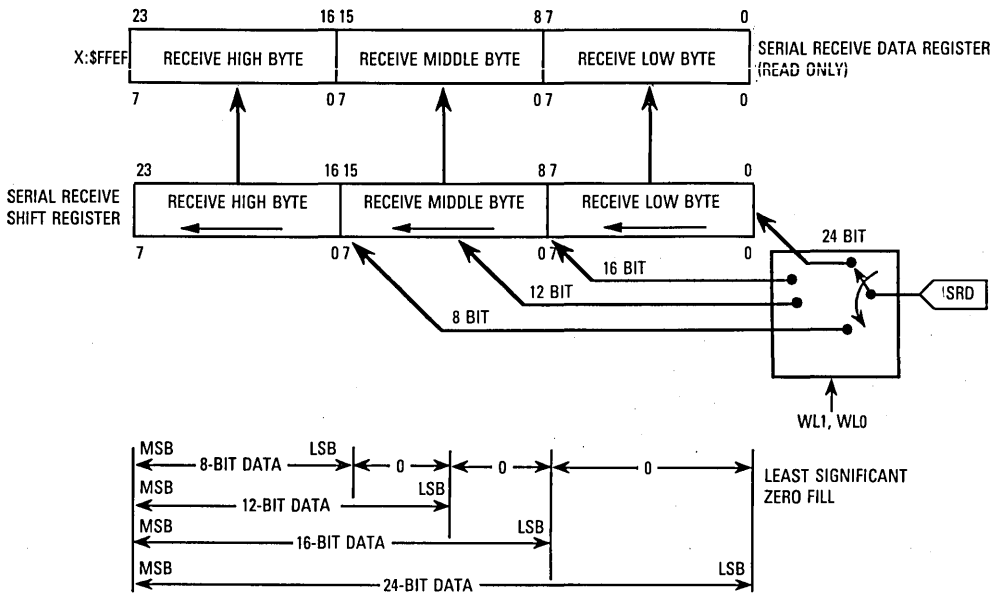
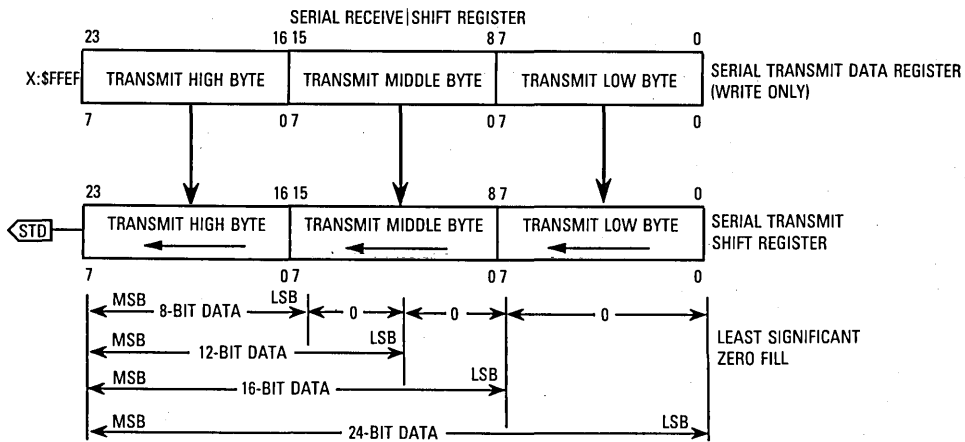

Figure 11-43. SSI Interface Programming Model — Control and Status Registers



- NOTES:
1. Data is received MSB first if SHFD = 0.
  2. Compatible with fractional format.

**(a) Receive Registers for SHFD = 0**



- NOTES:
1. Data is sent MSB first if SHFD = 0.
  2. Compatible with fractional format.

**(b) Transmit Registers for SHFD = 0**

**Figure 11-44. SSI Interface Programming Model (Sheet 1 of 2)**

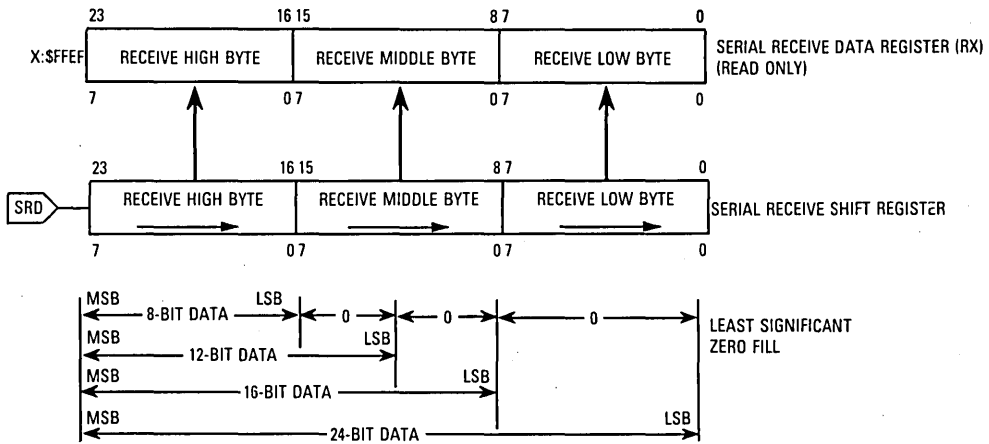

NOTES:

1. Data is received LSB first if SHFD=1.
2. Compatible with fractional format.

**(c) Receive Registers for SHFD = 1**

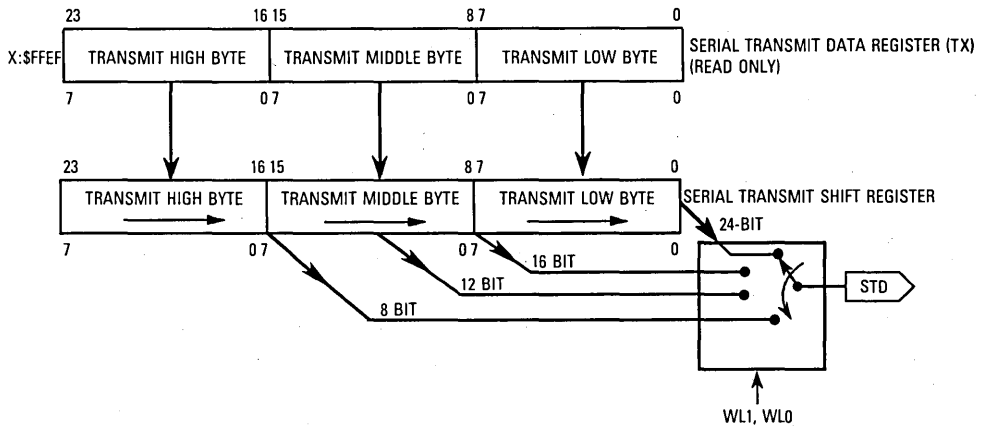

NOTES:

1. Data is sent LSB first if SHFD=1.
2. Compatible with fractional format.

**(d) Transmit Registers for SHFD = 1**

**Figure 11-44. SSI Interface Programming Model (Sheet 2 of 2)**

**11.3.2.1.2 CRA Frame Rate Divider Control (DC4–DC0) Bits 8–12.** The DC4–DC0 bits control the divide ratio for the programmable frame rate dividers used to generate the frame clocks (see Figure 11-42). In network mode, this ratio may be interpreted as the number of words per frame minus one. In normal mode, this ratio determines the word transfer rate. The divide ratio may range from 1 to 32 (DC=00000 to 11111) for normal mode and 2 to 32 (DC=00001 to 11111) for network mode.

A divide ratio of one (DC=00000) in network mode is a special case (see **11.3.7.4 ON-DEMAND MODE**). In normal mode, a divide ratio of one (DC=00000) provides continuous periodic data word transfers. A bit-length sync (FSL1=1, FSL0=0) must be used in this case. Hardware and software reset clear DC4–DC0.

**11.3.2.1.3 CRA Word Length Control (WL0, WL1) Bits 13 and 14.** The WL1 and WL0 bits are used to select the length of the data words being transferred via the SSI. Word lengths of 8, 12, 16, or 24 bits may be selected according to the following assignments:

| WL1 | WL0 | Number of Bits/Word |
|-----|-----|---------------------|
| 0   | 0   | 8                   |
| 0   | 1   | 12                  |
| 1   | 0   | 16                  |
| 1   | 1   | 24                  |

These bits control the number of active clock transitions in the gated clock modes and control the word length divider (see Figures 11-41 and 11-42), which is part of the frame rate signal generator for continuous clock modes. The WL control bits also control the frame sync pulse length when FSL0 and FSL1 select a WL bit clock (see Figure 11-41). Hardware and software reset clear WL0 and WL1.

**11.3.2.1.4 CRA Prescaler Range (PSR) Bit 15.** The PSR controls a fixed divide-by-eight prescaler in series with the variable prescaler. This bit is used to extend the range of the prescaler for those cases where a slower bit clock is desired (see Figure 11-41). When PSR is cleared, the fixed prescaler is bypassed. When PSR is set, the fixed divide-by-eight prescaler is operational. This allows a 128-kHz master clock to be generated for MC14550x series codecs.

The maximum internally generated bit clock frequency is  $f_{OSC}/4$ , the minimum internally generated bit clock frequency is  $f_{OSC}/4/8/256 = f_{OSC}/8192$ . Hardware and software reset clear PSR.

**11.3.2.2 SSI CONTROL REGISTER B (CRB).** The CRB is one of two 16-bit read/write control registers used to direct the operation of the SSI. CRB controls the SSI multifunction pins, SC2, SC1, and SC0, which can be used as clock inputs or outputs, frame synchronization pins, or serial I/O flag pins. The serial output flag control bits and the direction control bits



for the serial control pins are in the SSI CRB. Interrupt enable bits for each data register interrupt are provided in this control register. When read by the DSP, CRB appears on the two low-order bytes of the 24-bit word, and the high-order byte reads as zeros. Operating modes are also selected in this register. Hardware and software reset clear all the bits in the CRB. The relationships between the SSI pins (SC0, SC1, SC2, and SCK) and some of the CRB bits are summarized in Tables 11-4, 11-6, and 11-7. The SSI CRB bits are described in the following paragraphs.

**11.3.2.2.1 CRB Serial Output Flag 0 (OF0) Bit 0.** When the SSI is in the synchronous clock mode and the serial control direction zero bit (SCD0) is set, indicating that the SC0 pin is an output, then data present in OF0 will be written to SC0 at the beginning of the frame in normal mode or at the beginning of the next time slot in network mode. Hardware and software reset clear OF0.

**11.3.2.2.2 CRB Serial Output Flag 1 (OF1) Bit 1.** When the SSI is in the synchronous clock mode and the serial control direction one (SCD1) bit is set, indicating that the SC1 pin is an output, then data present in OF1 will be written to the SC1 pin at the beginning of the frame in normal mode or at the beginning of the next time slot in network mode (see **11.3.7 Operating Modes — Normal, Network, and On-Demand**).

The normal sequence for setting output flags when transmitting data is to set TDE (TX empty), to first write the flags, and then write the transmit data to the TX register. OF0 and OF1 are double buffered so that the flag states appear on the pins when the TX data is transferred to the transmit shift register (i.e., the flags are synchronous with the data). Hardware and software reset clear OF1.

#### NOTE

The optional serial output pins (SC0, SC1, and SC2) are controlled by the frame timing and are **not** affected by TE or RE.

**11.3.2.2.3 CRB Serial Control 0 Direction (SCD0) Bit 2.** SCD0 controls the direction of the SC0 I/O line. When SCD0 is cleared, SC0 is an input; when SCD0 is set, SC0 is an output (see Tables 11-4, 11-5, and Figure 11-45). Hardware and software reset clear SCD0.

**11.3.2.2.4 CRB Serial Control 1 Direction (SCD1) Bit 3.** SCD1 controls the direction of the SC1 I/O line. When SCD1 is cleared, SC1 is an input; when SCD1 is set, SC1 is an output (see Tables 11-4, 11-5 and Figure 11-45). Hardware and software reset clear SCD1.

**11.3.2.2.5 CRB Serial Control 2 Direction (SCD2) Bit 4.** SCD2 controls the direction of the SC2 I/O line. When SCD2 is cleared, SC2 is an input; when SCD2 is set, SC2 is an output (see Tables 11-4, 11-5, and Figure 11-45). Hardware and software reset clear SCD2.

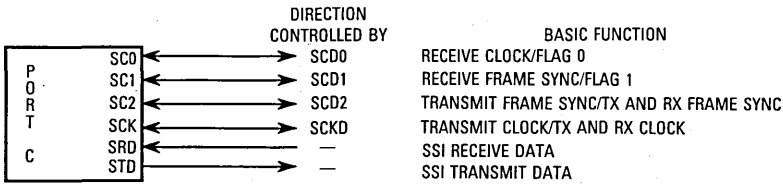
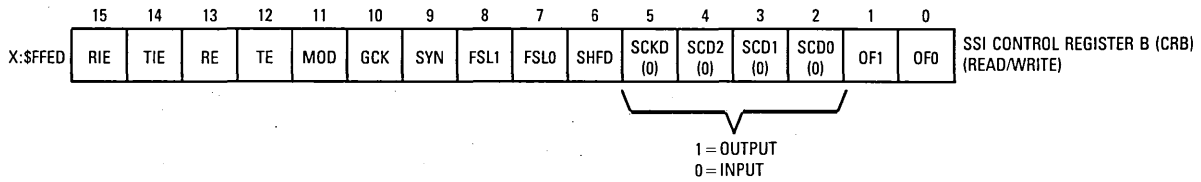

NOTE: Parentheses indicate RESET condition.

Figure 11-45. Serial Control, Direction Bits

**11.3.2.2.6 CRB Clock Source Direction (SCKD) Bit 5.** SCKD selects the source of the clock signal used to clock the transmit shift register in the asynchronous mode and both the transmit shift register and the receive shift register in the synchronous mode. When SCKD is set, the internal clock source becomes the bit clock for the transmit shift register and word length divider and is the output on the SCK pin. When SCKD is cleared, the clock source is external; the internal clock generator is disconnected from the SCK pin, and an external clock source may drive this pin. Hardware and software reset clear SCKD.

**11.3.2.2.7 CRB Shift Direction (SHFD) Bit 6.** This bit causes the transmit shift register to shift data out MSB first when SHFD equals zero or LSB first when SHFD equals one. Receive data is shifted in MSB first when SHFD equals zero or LSB first when SHFD equals one. Hardware reset and software reset clear SHFD.

**11.3.2.2.8 CRB Frame Sync Length (FSL0 and FSL1) Bits 7 and 8.** These bits select the type of frame sync to be generated or recognized. If FSL1 equals zero and FSL0 equals zero, a word-length frame sync is selected for both TX and RX that is the length of the data word defined by bits WL1 and WL0. If FSL1 equals one and FSL0 equals zero, a 1-bit clock period frame sync is selected for both TX and RX. When FSL0 equals one, the TX and RX frame syncs are different lengths. Hardware reset and software reset clear FSL0 and FSL1.

| FSL1 | FSL0 | Frame Sync Length                            |
|------|------|--|
| 0    | 0    | WL bit clock for both TX/RX                  |
| 0    | 1    | One-bit clock for TX and WL bit clock for RX |
| 1    | 0    | One-bit clock for both TX/RX                 |
| 1    | 1    | One-bit clock for RX and WL bit clock for TX |

**11.3.2.2.9 CRB Sync/Async (SYN) Bit 9.** SYN controls whether the receive and transmit functions of the SSI occur synchronously or asynchronously with respect to each other. When SYN is cleared, asynchronous mode is chosen and separate clock and frame sync signals are used for the transmit and receive sections. When SYN is set, synchronous mode is chosen and the transmit and receive sections use common clock and frame sync signals. Hardware reset and software reset clear SYN.

**11.3.2.2.10 CRB Gated Clock Control (GCK) Bit 10.** GCK is used to select between a continuously running data clock or a clock that runs only when there is data to be sent in the transmit shift register. When GCK is cleared, a continuous clock is selected; when GCK is set, the clock will be gated. Hardware reset and software reset clear GCK.

#### NOTE

For gated clock mode with externally generated bit clock, internally generated frame sync is **not** defined.

**11.3.2.2.11 CRB SSI Mode Select (MOD) Bit 11.** MOD selects the operational mode of the SSI. When MOD is cleared, the normal mode is selected; when MOD is set, the network mode is selected. In the normal mode, the frame rate divider determines the word transfer rate — one word is transferred per frame sync during the frame sync time slot. In network mode, a word is (possibly) transferred every time slot. For more details, see **11.3.3 OPERATIONAL MODES AND PIN DEFINITIONS**. Hardware and software reset clear MOD.

**11.3.2.2.12 CRB SSI Transmit Enable (TE) Bit 12.** TE enables the transfer of data from TX to the transmit shift register. When TE is set and a frame sync is detected, the transmit portion of the SSI is enabled for that frame. When TE is cleared, the transmitter will be disabled after completing transmission of data currently in the SSI transmit shift register. The serial output is three-stated, and any data present in TX will not be transmitted (i.e., data can be written to TX with TE cleared; TDE will be cleared, but data will not be transferred to the transmit shift register).

The normal mode transmit enable sequence is to write data to TX or TSR before setting TE. The normal transmit disable sequence is to clear TE and TIE after TDE equals one.

In the network mode, the operation of clearing TE and setting it again will disable the transmitter after completing transmission of the current data word until the beginning of the next frame. During that time period, the STD pin will remain in the high-impedance state. Hardware reset and software reset clear TE.

The on-demand mode transmit enable sequence can be the same as the normal mode, or TE can be left enabled.

#### NOTE

TE does not inhibit TDE or transmitter interrupts. TE does not affect the generation of frame sync or output flags.

11

**11.3.2.2.13 CRB SSI Receive Enable (RE) Bit 13.** When RE is set, the receive portion of the SSI is enabled. When this bit is cleared, the receiver will be disabled by inhibiting data transfer into RX. If data is being received while this bit is cleared, the remainder of the word will be shifted in and transferred to the SSI receive data register.

RE must be set in the normal mode and on-demand mode to receive data. In network mode, the operation of clearing RE and setting it again will disable the receiver after reception of the current data word until the beginning of the next data frame. Hardware and software reset clear RE.

#### NOTE

RE does not inhibit RDF or receiver interrupts. RE does not affect the generation of a frame sync.

**11.3.2.2.14 CRB SSI Transmit Interrupt Enable (TIE) Bit 14.** The DSP will be interrupted when TIE and the TDE flag in the SSI status register is set. When TIE is cleared, this interrupt is disabled. However, the TDE bit will always indicate the transmit data register empty condition even when the transmitter is disabled with the TE bit. Writing data to TX or TSR will clear TDE, thus clearing the interrupt. Hardware and software reset clear RE.

There are two transmit data interrupts that have separate interrupt vectors:

1. Transmit data with exceptions — This interrupt is generated on the following condition:  
TIE = 1, TDE = 1, and TUE = 1
2. Transmit data without exceptions — This interrupt is generated on the following condition:  
TIE = 1, TDE = 1, and TUE = 0

See **SECTION 8 PROCESSING STATES** for more information on exceptions.

**11.3.2.2.15 CRB SSI Receive Interrupt Enable (RIE) Bit 15.** When RIE is set, the DSP will be interrupted when RDF in the SSI status register is set. When RIE is cleared, this interrupt is disabled. However, the RDF bit still indicates the receive data register full condition. Reading the receive data register will clear RDF, thus clearing the pending interrupt. Hardware and software reset clear RIE.

There are two receive data interrupts that have separate interrupt vectors:

1. Receive data with exceptions — This interrupt is generated on the following condition:  
RIE = 1, RDF = 1, and ROE = 1
2. Receive data without exceptions — This interrupt is generated on the following condition:  
RIE = 1, RDF = 1, and ROE = 0

See **SECTION 8 PROCESSING STATES** for more information on exceptions.

**11.3.2.3 SSI STATUS REGISTER (SSISR).** The SSISR is an 8-bit read-only status register used by the DSP to interrogate the status and serial input flags of the SSI. When the SSISR is read to the internal data bus, the register contents occupy the low-order byte of the data bus, and the high-order portion is zero filled. The status bits are described in the following paragraphs.

**11.3.2.3.1 SSISR Serial Input Flag 0 (IF0) Bit 0.** The SSI latches data present on the SC0 pin during reception of the first received bit after frame sync is detected. IF0 is updated with this data when the receive shift register is transferred into the receive data register. The IF0 bit is enabled only when SCD0 is cleared and SYN is set, indicating that SC0 is an input and the synchronous mode is selected (see Table 11-4); otherwise, IF0 reads as a zero when it is not enabled. Hardware, software, SSI individual, and STOP reset clear IF0.

**11.3.2.3.2 SSISR Serial Input Flag 1 (IF1) Bit 1.** The SSI latches data present on the SC1 pin during reception of the first received bit after frame sync is detected. The IF1 flag is updated with the data when the receiver shift register is transferred into the receive data register. The IF1 bit is enabled only when SCD1 is cleared and SYN is set, indicating that SC1 is an input and the synchronous mode is selected (see Table 11- 4); otherwise, IF1 reads as a zero when it is not enabled. Hardware, software, SSI individual, and STOP reset clear IF1.

**11.3.2.3.3 SSISR TRANSMIT FRAME SYNC FLAG (TFS) Bit 2.** When set, TFS indicates that a transmit frame sync occurred in the current time slot. TFS is set at the start of the first time slot in the frame and cleared during all other time slots. Data written to the transmit data register during the time slot when TFS is set will be transmitted (in network mode) during the second time slot in the frame. TFS is useful in network mode to identify the start of a frame.

#### NOTE

In normal mode, TFS will always read as a one when transmitting data because there is only one time slot per frame — the “frame sync” time slot.

TFS, which is cleared by hardware, software, SSI individual, or STOP reset, is not affected by TE.

**11.3.2.3.4 SSISR Receive Frame Sync Flag (RFS) Bit 3.** When set, RFS indicates that a receive frame sync occurred during reception of the word in the serial receive data register. This indicates that the data word is from the first time slot in the frame. When RFS is clear and a word is received, it indicates (only in the network mode) that the frame sync did not occur during reception of that word.

#### NOTE

In normal mode, RFS will always read as a one when reading data because there is only one time slot per frame — the “frame sync” time slot.

RFS, which is cleared by hardware, software, SSI individual, or STOP reset, is not affected by RE.

**11.3.2.3.5 SSISR Transmitter Underrun Error Flag (TUE) Bit 4.** TUE is set when the serial transmit shift register is empty (no new data to be transmitted) and a transmit time slot occurs. When a transmit underrun error occurs, the previous data (which is still present in the TX) will be retransmitted.

In the normal mode, there is only one transmit time slot per frame. In the network mode, there can be up to 32 transmit time slots per frame.

TUE does not cause any interrupts; however, TUE does cause a change in the interrupt vector used for transmit interrupts so that a different interrupt handler may be used for a transmit underrun condition. If a transmit interrupt occurs with TUE set, the transmit data with exception status interrupt will be generated; if a transmit interrupt occurs with TUE clear, the transmit data without errors interrupt will be generated.

Hardware, software, SSI individual, and STOP reset clear TUE. TUE is also cleared by reading the SSISR with TUE set, followed by writing TX or TSR.

**11.3.2.3.6 SSISR Receiver Overrun Error Flag (ROE) Bit 5.** This flag is set when the serial receive shift register is filled and ready to transfer to the receiver data register (RX) and RX is already full (i.e., RDF=1). The receiver shift register is not transferred to RX. ROE does not cause any interrupts; however, ROE does cause a change in the interrupt vector used for receive interrupts so that a different interrupt handler may be used for a receive error condition. If a receive interrupt occurs with ROE set, the receive data with exception status interrupt will be generated; if a receive interrupt occurs with ROE clear, the receive data without errors interrupt will be generated.

Hardware, software, SSI individual, and STOP reset clear ROE. ROE is also cleared by reading the SSISR with ROE set, followed by reading the RX. Clearing RE does **not** affect ROE.

**11.3.2.3.7 SSISR SSI Transmit Data Register Empty (TDE) Bit 6.** This flag is set when the contents of the transmit data register are transferred to the transmit shift register; it is also set for a disabled time slot period in network mode (as if data were being transmitted after the TSR was written). Thirdly, it can be set by the hardware, software, SSI individual, or STOP reset. When set, TDE indicates that data should be written to the TX or to the time slot register (TSR). TDE is cleared when the DSP writes to the transmit data register or when the DSP writes to the TSR to disable transmission of the next time slot. If TIE is set, a DSP transmit data interrupt request will be issued when TDE is set. The vector of the interrupt will depend on the state of the transmitter underrun bit.

**11.3.2.3.8 SSISR SSI Receive Data Register Full (RDF) Bit 7.** RDF is set when the contents of the receive shift register are transferred to the receive data register. RDF is cleared when the DSP reads the receive data register or cleared by hardware, software, SSI individual, or STOP reset. If RIE is set, a DSP receive data interrupt request will be issued when RDF is set. The vector of the interrupt request will depend on the state of the receiver overrun bit.

**11.3.2.3.9 SSI Receive Shift Register.** This 24-bit shift register receives the incoming data from the serial receive data pin. Data is shifted in by the selected (internal/external) bit clock when the associated frame sync I/O (or gated clock) is asserted. Data is assumed to

be received MSB first if SHFD equals zero and LSB first if SHFD equals one. Data is transferred to the SSI receive data register after 8, 12, 16, or 24 bits have been shifted in, depending on the word-length control bits in the CRA (see Figure 11-46).

**11.3.2.3.10 SSI Receive Data Register (RX).** RX is a 24-bit read-only register that accepts data from the receive shift register as it becomes full. The data read will occupy the most significant portion of the receive data register (see Figure 11-46). The unused bits (least significant portion) will read as zeros. The DSP is interrupted whenever RX becomes full if the associated interrupt is enabled.

**11.3.2.3.11 SSI Transmit Shift Register.** This 24-bit shift register contains the data being transmitted. Data is shifted out to the serial transmit data pin by the selected (internal/external) bit clock when the associated frame sync I/O (or gated clock) is asserted. The number of bits shifted out before the shift register is considered empty and may be written to again can be 8, 12, 16, or 24 bits (determined by the word-length control bits in CRA). The data to be transmitted occupies the most significant portion of the shift register. The unused portion of the register is ignored. Data is shifted out of this register MSB first if SHFD equals zero and LSB first if SHFD equals one (see Figure 11-47).

**11.3.2.3.12 SSI Transmit Data Register (TX).** TX is a 24-bit write-only register. Data to be transmitted is written into this register and is automatically transferred to the transmit shift register. The data written (8, 12, 16, or 24 bits) should occupy the most significant portion of TX (see Figure 11-47). The unused bits (least significant portion) of TX are don't care bits. The DSP is interrupted whenever TX becomes empty if the transmit data register empty interrupt has been enabled.

**11.3.2.3.13 Time Slot Register (TSR).** TSR is effectively a null data register that is used when the data is **not** to be transmitted in the available transmit time slot. For the purposes of timing, TSR is a write-only register that behaves like an alternative transmit data register, except that, rather than transmitting data, the transmit data pin is in the high-impedance state for that time slot.



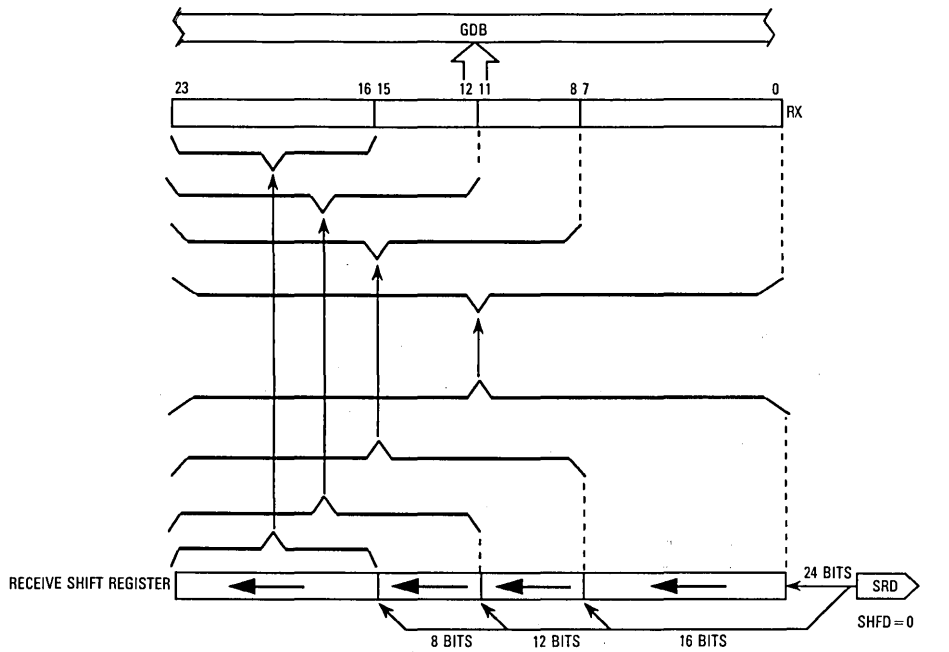

(a) SHFD=0

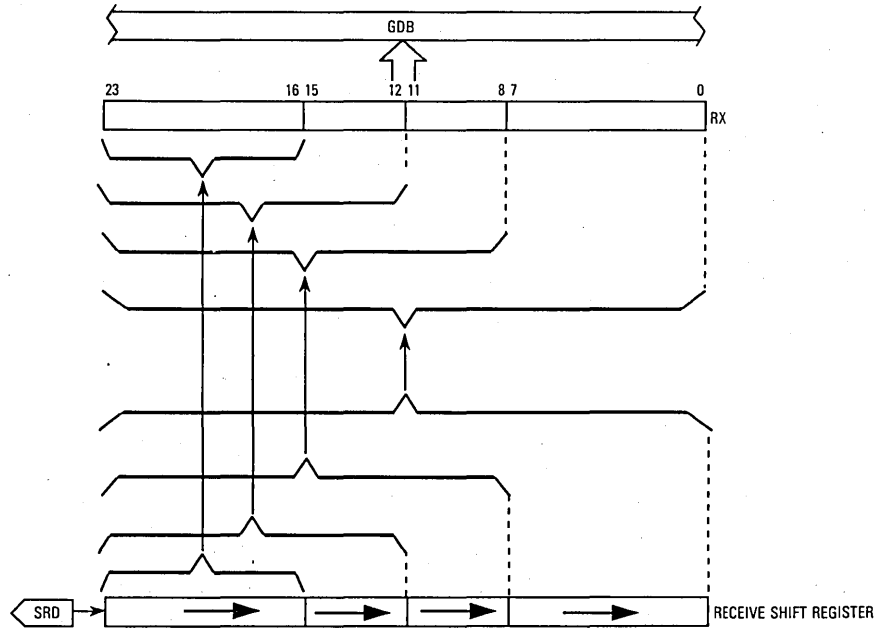

(b) SHFD=1

Figure 11-46. Receive Data Path

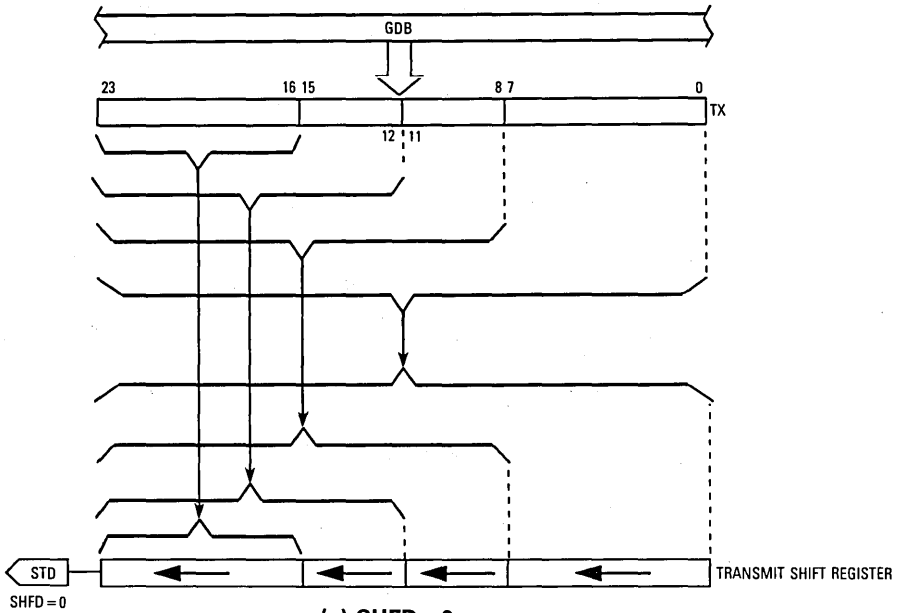

(a) SHFD = 0

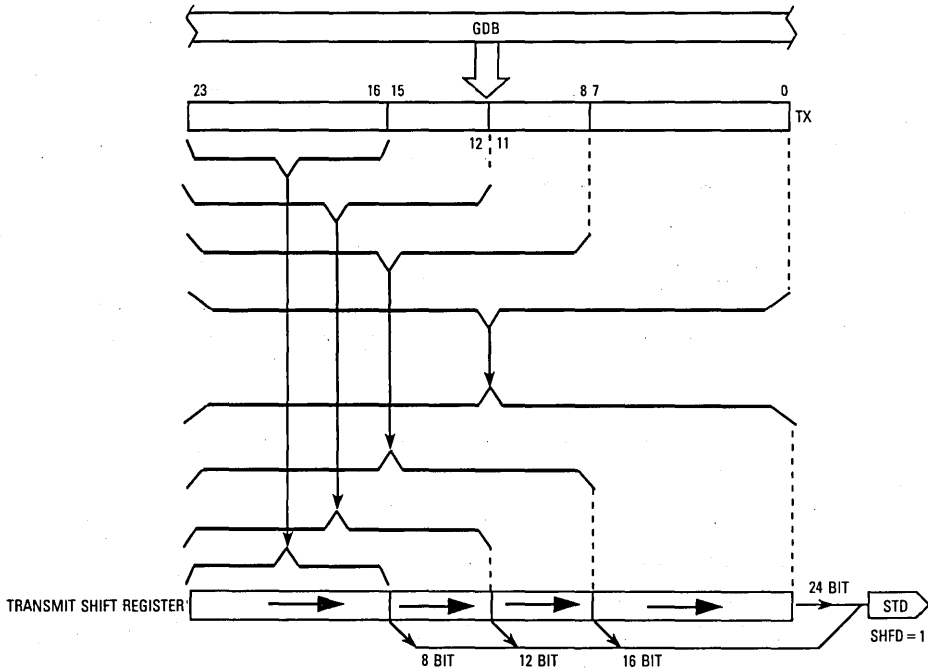

(b) SHFD = 1

Figure 11-47. Transmit Data Path

### 11.3.3 Operational Modes and Pin Definitions

Tables 11-6 and 11-7 completely describe the SSI operational modes and pin definitions (Table 11-4 is a simplified version of these tables). The operational modes are as follows:

1. Continuous Clock
  - Mode 1 — Normal with Internal Frame Sync
  - Mode 2 — Network with Internal Frame Sync
  - Mode 3 — Normal with External Frame Sync
  - Mode 4 — Network with External Frame Sync
2. Gated Clock
  - Mode 5 — External Gated Clock
  - Mode 6 — Normal with Internal Gated Clock
  - Mode 7 — Network with Internal Gated Clock
3. Special Case (Both Gated and Continuous Clock)
  - Mode 8 — On-Demand Mode (Transmitter Only)
  - Mode 9 — Receiver Follows Transmitter Clocking

**Table 11-6. Mode and Pin Definition Table — Continuous Clock**

| Control Bits |      |     |      |      |      |      |         | Mode |    | SC0 |     | SC1 |     | SC2 |     | SCK |     |
|--------------|------|-----|------|------|------|------|---------|------|----|-----|-----|-----|-----|-----|-----|-----|-----|
| MOD          | GCLK | SYN | SCD2 | SCD1 | SCD0 | SCKD | DC4-DC0 | TX   | RX | In  | Out | In  | Out | In  | Out | In  | Out |
| 0            | 0    | 0   | 1    | 1    | X    | X    | X       | 1    | 1  | RXC | RXC | —   | FSR | —   | FST | TXC | TXC |
| 0            | 0    | 1   | 1    | X    | X    | X    | X       | 1    | 1  | F0  | F0  | F1  | F1  | —   | FS* | *XC | *XC |
| 1            | 0    | 0   | 1    | 1    | X    | X    | 1       | 2    | 2  | RXC | RXC | —   | FSR | —   | FST | TXC | TXC |
| 1            | 0    | 1   | 1    | X    | X    | X    | 1       | 2    | 2  | F0  | F0  | F1  | F1  | —   | FS* | *XC | *XC |
| 0            | 0    | 0   | 0    | 1    | X    | X    | X       | 3    | 1  | RXC | RXC | —   | FSR | FST | —   | TXC | TXC |
| 0            | 0    | 0   | 1    | 0    | X    | X    | X       | 1    | 3  | RXC | RXC | FSR | —   | —   | FST | TXC | TXC |
| 0            | 0    | 0   | 0    | 0    | X    | X    | X       | 3    | 3  | RXC | RXC | FSR | —   | FST | —   | TXC | TXC |
| 0            | 0    | 1   | 0    | X    | X    | X    | X       | 3    | 3  | F0  | F0  | F1  | F1  | FS* | —   | *XC | *XC |
| 1            | 0    | 0   | 0    | 1    | X    | X    | X       | 4    | 2  | RXC | RXC | —   | FSR | FST | —   | TXC | TXC |
| 1            | 0    | 0   | 1    | 0    | X    | X    | 1       | 2    | 4  | RXC | RXC | FSR | —   | —   | FST | TXC | TXC |
| 1            | 0    | 0   | 0    | 0    | X    | X    | X       | 4    | 4  | RXC | RXC | FSR | —   | FST | —   | TXC | TXC |
| 1            | 0    | 1   | 0    | X    | X    | X    | X       | 4    | 4  | F0  | F0  | F1  | F1  | FS* | —   | *XC | *XC |
| 1            | 0    | 0   | 1    | 1    | X    | X    | 0       | 8    | 2  | RXC | RXC | —   | FSR | —   | FST | TXC | TXC |
| 1            | 0    | 1   | 1    | X    | X    | X    | 0       | 8    | 9  | F0  | F0  | F1  | F1  | —   | FS* | *XC | *XC |
| 1            | 0    | 0   | 1    | 0    | X    | X    | 0       | 8    | 4  | RXC | RXC | FSR | —   | —   | FST | TXC | TXC |

DC4-DC0=0 means that bits DC4=0, DC3=0, DC2=0, DC1=0, and DC0=0.

DC4-DC0=1 means that bits DC4-DC0≠0.

TXC — Transmitter Clock

RXC — Receiver Clock

\*XC — Transmitter/Receiver Clock (Synchronous Operation)

FST — Transmitter Frame Sync

FSR — Receiver Frame Sync

FS\* — Transmitter/Receiver Frame Sync (Synchronous Operation)

F0 — Flag 0

F1 — Flag 1

**Table 11-7. Mode and Pin Definition Table — Gated Clock**

| Control Bits |      |     |      |      |      |      |         | Mode |    | SC0 |     | SC1 |     | SC2 |     | SCK |     |
|--------------|------|-----|------|------|------|------|---------|------|----|-----|-----|-----|-----|-----|-----|-----|-----|
| MOD          | GCLK | SYN | SCD2 | SCD1 | SCD0 | SCKD | DC4-DC0 | TX   | RX | In  | Out | In  | Out | In  | Out | In  | Out |
| 0            | 1    | 0   | X    | X    | 1    | 1    | X       | 6    | 6  | —   | RXC | ?   | FSR | ?   | FST | —   | TXC |
| 0            | 1    | 1   | X    | X    | X    | 1    | X       | 6    | 6  | F0  | F0  | F0  | F1  | ?   | FS* | —   | *XC |
| 0            | 1    | 0   | X    | X    | 1    | 0    | X       | 5    | 6  | —   | RXC | ?   | FSR | ?   | ?   | TXC | —   |
| 0            | 1    | 0   | X    | X    | 0    | 0    | X       | 5    | 5  | RXC | —   | ?   | ?   | ?   | ?   | TXC | —   |
| 0            | 1    | 1   | X    | X    | X    | 0    | X       | 5    | 5  | F0  | F0  | F1  | F1  | ?   | ?   | *XC | —   |
| 1            | 1    | 0   | X    | X    | 1    | 1    | 0       | 8    | 7  | —   | RXC | ?   | FSR | ?   | FST | —   | TXC |
| 1            | 1    | 0   | X    | X    | 0    | 1    | 0       | 8    | 5  | RXC | —   | ?   | ?   | ?   | FST | —   | TXC |
| 1            | 1    | 1   | X    | X    | X    | 1    | 0       | 8    | 9  | F0  | F0  | F1  | F1  | ?   | FS* | —   | *XC |
| 0            | 1    | 0   | X    | X    | 0    | 1    | X       | 6    | 5  | RXC | —   | ?   | ?   | ?   | FST | —   | TXC |

DC4–DC0=0 means that bits DC4=0, DC3=0, DC2=0, DC1=0, and DC0=0.

TXC — Transmitter Clock

RXC — Receiver Clock

\*XC — Transmitter/Receiver Clock (Synchronous Operation)

FST — Transmitter Frame Sync

FSR — Receiver Frame Sync

FS\* — Transmitter/Receiver Frame Sync (Synchronous Operation)

F0 — Flag 0

F1 — Flag 1

? — Undefined

### 11.3.4 Registers After Reset

Hardware or software reset clears the port control register bits, which configure all I/O as general-purpose input. The SSI will remain in reset while all SSI pins are programmed as general-purpose I/O (CC8–CC3=0) and will become active only when at least one of the SSI I/O pins is programmed as **not** general-purpose I/O. Table 11-8 shows how each type of reset affects each SSI register bit.

### 11.3.5 SSI Initialization

The correct way to initialize the SSI is as follows:

1. Hardware, software, SSI individual, or STOP reset
2. Program SSI control registers
3. Configure SSI pins (at least one) as not general-purpose I/O

During program execution, CC8–CC3 may be cleared, causing the SSI to stop serial activity and enter the individual reset state. All status bits of the interface will be set to their reset state; however, the contents of CRA and CRB are not affected. This procedure allows the DSP program to reset each interface separately from the other internal peripherals.

The DSP program must use an SSI reset when changing the MOD, GCLK, SYN, SCKD, SCD2, SCD1, or SCD0 bits to ensure proper operation of the interface. Figure 11-48 is a flowchart illustrating the three initialization steps previously listed. Figures 11-49, 11-50, and 11-51 provide additional detail to the flowchart.

**Table 11-8. SSI Registers after Reset**

| Register Name | Register Data | Bit Number | Reset    |          |                  |          |
|---------------|---------------|------------|----------|----------|------------------|----------|
|               |               |            | HW Reset | SW Reset | Individual Reset | ST Reset |
| CRA           | PSR           | 15         | 0        | 0        | —                | —        |
|               | WL(2-0)       | 13, 14     | 0        | 0        | —                | —        |
|               | DC(4-0)       | 8-12       | 0        | 0        | —                | —        |
|               | PM(7-0)       | 0-7        | 0        | 0        | —                | —        |
| CRB           | RIE           | 15         | 0        | 0        | —                | —        |
|               | TIE           | 14         | 0        | 0        | —                | —        |
|               | RE            | 13         | 0        | 0        | —                | —        |
|               | TE            | 12         | 0        | 0        | —                | —        |
|               | MOD           | 11         | 0        | 0        | —                | —        |
|               | GCK           | 10         | 0        | 0        | —                | —        |
|               | SYN           | 9          | 0        | 0        | —                | —        |
|               | FSL1          | 8          | 0        | 0        | —                | —        |
|               | FSL0          | 7          | 0        | 0        | —                | —        |
|               | SHFD          | 6          | 0        | 0        | —                | —        |
|               | SCKD          | 5          | 0        | 0        | —                | —        |
| SCD(2-0)      | 2-4           | 0          | 0        | —        | —                |          |
| OF(1-0)       | 0, 1          | 0          | 0        | —        | —                |          |
| SSISR         | RDF           | 7          | 0        | 0        | 0                | 0        |
|               | TDE           | 6          | 1        | 1        | 1                | 1        |
|               | ROE           | 5          | 0        | 0        | 0                | 0        |
|               | TUE           | 4          | 0        | 0        | 0                | 0        |
|               | RFS           | 3          | 0        | 0        | 0                | 0        |
|               | TFS           | 2          | 0        | 0        | 0                | 0        |
|               | IF(1-0)       | 0, 1       | 0        | 0        | 0                | 0        |
| RDR           | RDR (23-0)    | 23-0       | —        | —        | —                | —        |
| TDR           | TDR (23-0)    | 23-0       | —        | —        | —                | —        |
| RSR           | RDR (23-0)    | 23-0       | —        | —        | —                | —        |
| TSR           | RDR (23-0)    | 23-0       | —        | —        | —                | —        |

**NOTES:**

1. RSR — SSI receive shift register
2. TSR — SSI transmit shift register
3. HW — Hardware reset is caused by asserting the external pin RESET.
4. SW — Software reset is caused by executing the RESET instruction.
5. IR — Individual reset is caused by SSI peripheral pins (i.e., PCC(3-8)) being configured as general-purpose I/O.
6. ST — Stop reset is caused by executing the STOP instruction.

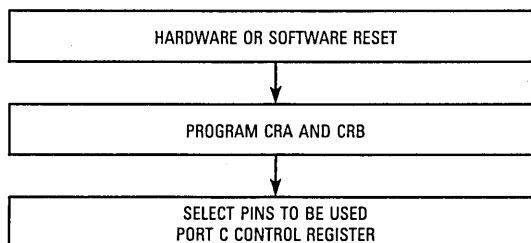

**Figure 11-48. SSI Initialization Block Diagram**

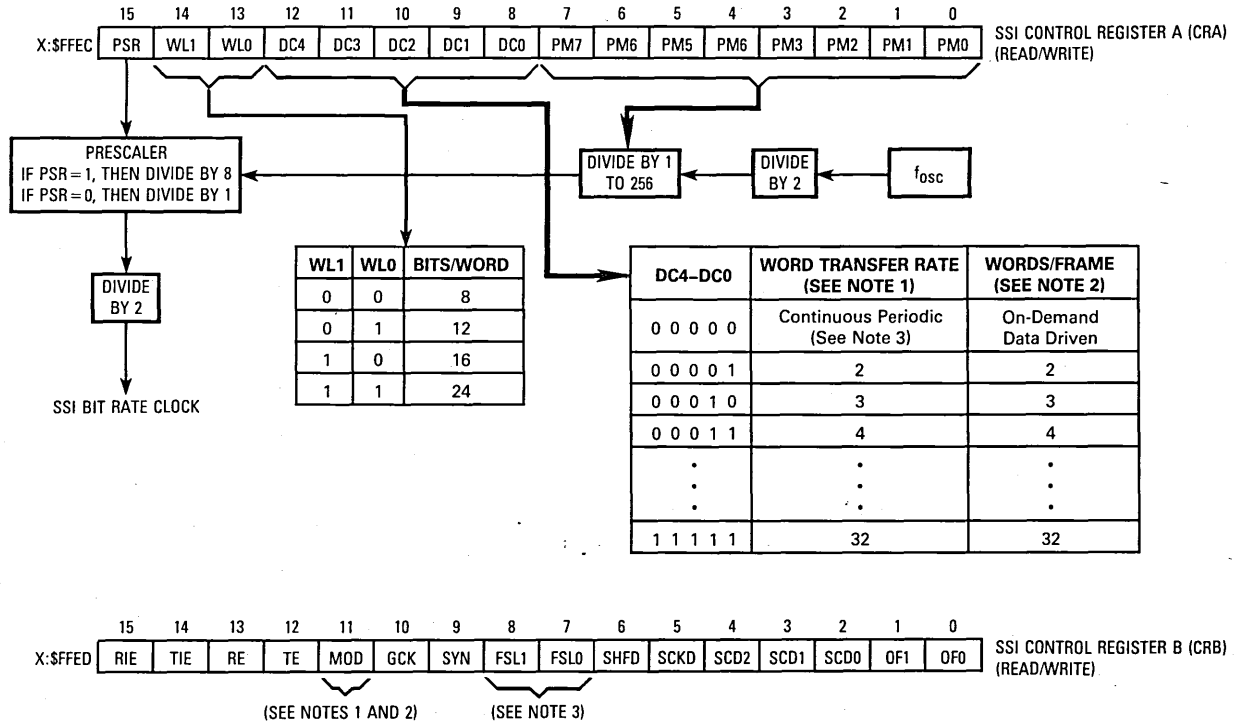

- NOTES:
1. Normal — MOD=0
  2. Network — MOD=1
  3. FSL1=1, FSL0=0

Figure 11-49. SSI CRA Initialization Procedure

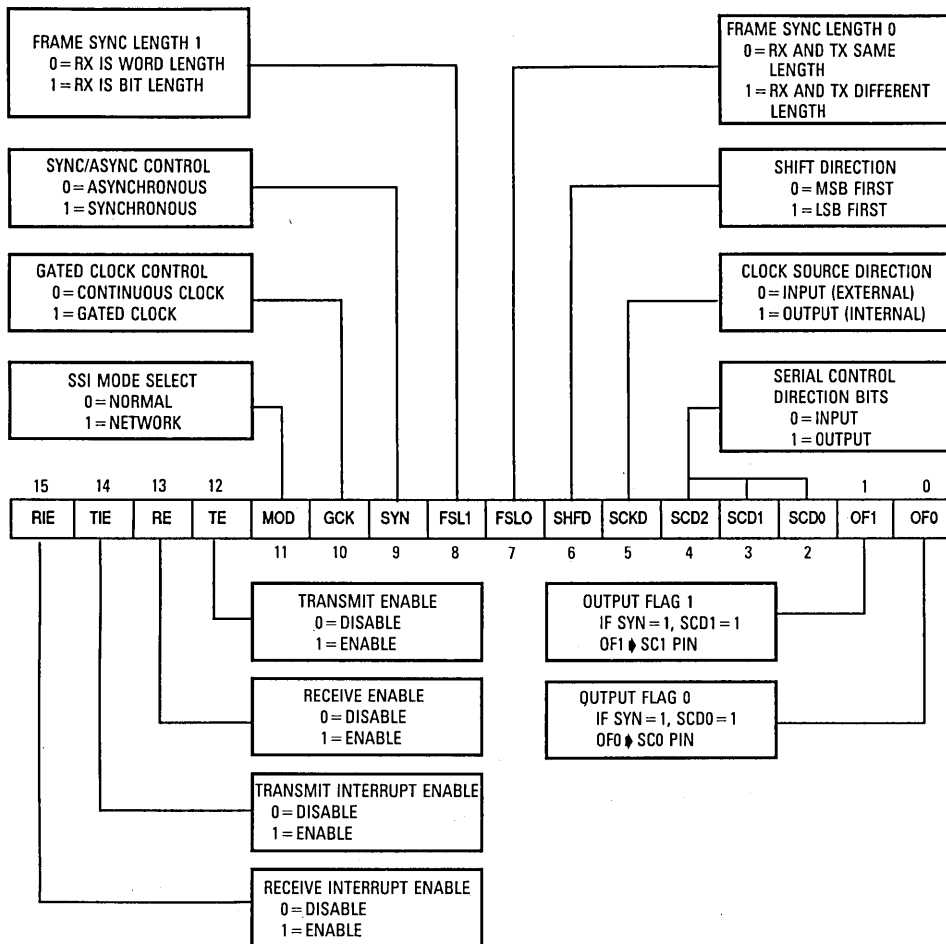
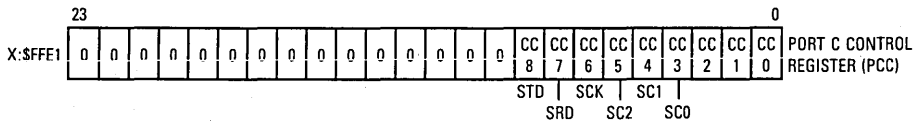
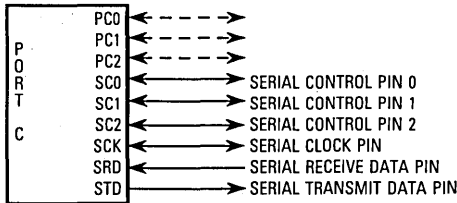

Figure 11-50. SSI CRB Initialization Procedure

Figure 11-51 shows the six control bits in the PCC, which select the six SSI pins as either general-purpose I/O or as SSI pins. The STD pin can only transmit data; the SRD pin can only receive data. The other four pins can be inputs or outputs, depending on how they are programmed. This programming is accomplished by setting bits in CRA and CRB as shown in Figure 11-45. The CRA (see Figure 11-49) sets the SSI bit rate clock with PSR and PM0-PM7, sets the word length with WL1 and WL0, and sets the number of words in a frame with DC0-DC4. There is a special case where DC4-DC0 equals zero (one word per frame). Depending on whether the normal or network mode is selected (MOD=0 or MOD=1, respectively), either the continuous periodic data mode is selected, or the on-demand data



| CCx | Function         |
|-----|------------------|
| 0   | Parallel I/O     |
| 1   | Serial Interface |



**Figure 11-51. SSI Initialization Procedure**

driven mode is selected. The continuous periodic mode requires that FSL1 equals one and FSL0 equals zero. Figure 11-50 shows the meaning of each individual bit in the CRB. These bits should be set according to the application requirements.

Table 11-9(a) and 11-9(b) provide a convenient listing of PSR and PM0–PM7 settings for the common data communication rates and the highest rate possible for the SSI for the chosen crystal frequencies. The crystal frequency selected for Table 11-9(a) is the one used by the DSP56000ADS board; the one selected for Table 11-9(b) is the closest one to 27 MHz that divides down to exactly 128 kHz. If an exact baud rate is required, the crystal frequency may have to be selected. Table 11-10 gives the PSR and PM0–PM7 settings in addition to the required crystal frequency for three common telecommunication frequencies.

### 11.3.6 SSI Exceptions

The SSI can generate four different exceptions (see Figures 11-52 and 11-53):

1. SSI Receive Data — occurs when the receive interrupt is enabled, the receive data register is full, and no receive error conditions exist. Reading RX clears the pending interrupt. This error-free interrupt can use a fast interrupt service routine for minimum overhead.
2. SSI Receive Data with Exception Status — occurs when the receive interrupt is enabled, the receive data register is full, and a receiver overrun error has occurred. ROE is cleared by first reading the SSISR and then reading RX.



**Table 11-9(a). SSI Baud Rates  
for a 20.48-MHz Crystal**

| Baud Rate (BPS) | PSR | PM    |
|-----------------|-----|-------|
| 1000            | 1   | \$27F |
| 2000            | 1   | \$13F |
| 4000            | 1   | \$9F  |
| 8000            | 1   | \$4F  |
| 16K             | 1   | \$27  |
| 32K             | 1   | \$13  |
| 64K             | 0   | \$4F  |
| 128K            | 0   | \$27  |
| 5.12M           | 0   | \$00  |

$BPS = f_{osc} \div (4 \times (7(PSR) + 1) \times (PM + 1))$  where  
 $f_{osc} = 20.48$  MHz  
 PSR = 0 or 1  
 PM = 0 to \$FFF

**Table 11-9(b). SSI Baud Rates  
for a 26.624-MHz Crystal**

| Baud Rate (BPS) | PSR | PM    |
|-----------------|-----|-------|
| 1000            | 1   | \$33F |
| 2000            | 1   | \$19F |
| 4000            | 1   | \$CF  |
| 8000            | 1   | \$67  |
| 16K             | 1   | \$33  |
| 32K             | 1   | \$19  |
| 64K             | 0   | \$67  |
| 128K            | 0   | \$33  |
| 6.656M          | 0   | \$00  |

$BPS = f_{osc} \div (4 \times (7(PSR) + 1) \times (PM + 1))$  where  
 $f_{osc} = 26.624$  MHz  
 PSR = 0 or 1  
 PM = 0 to \$FFF

**Table 11-10. Crystal Frequencies  
Required for Codecs**

| Baud Rate (BPS) | PSR | PM   | Crystal Frequency |
|-----------------|-----|------|-------------------|
| 1.536M          | 0   | \$03 | 24.576 MHz        |
| 1.544M          | 0   | \$03 | 24.707 MHz        |
| 2.048M          | 0   | \$02 | 24.576 MHz        |

$BPS = f_{osc} \div (4 \times (7(PSR) + 1) \times (PM + 1))$   
 PSR = 0 or 1  
 PM = 0 to \$FFF

3. SSI Transmit Data — occurs when the transmit interrupt is enabled, the transmit data register is empty, and no transmitter error conditions exist. Writing to TX or the TSR will clear this interrupt. This error-free interrupt may use a fast interrupt service routine for minimum overhead.
4. SSI Transmit Data with Exception Status — occurs when the transmit interrupt is enabled, the transmit data register is empty, and a transmitter underrun error has occurred. TUE is cleared by first reading the SSISR and then writing to TX or the TSR to clear the pending interrupt.

### 11.3.7 Operating Modes — Normal, Network, and On-Demand

The SSI has three basic operating modes and many data/operation formats. These modes can be programmed by several bits in the SSI control registers. Table 11-11 lists the SSI operating modes and some of the typical applications in which they may be used.

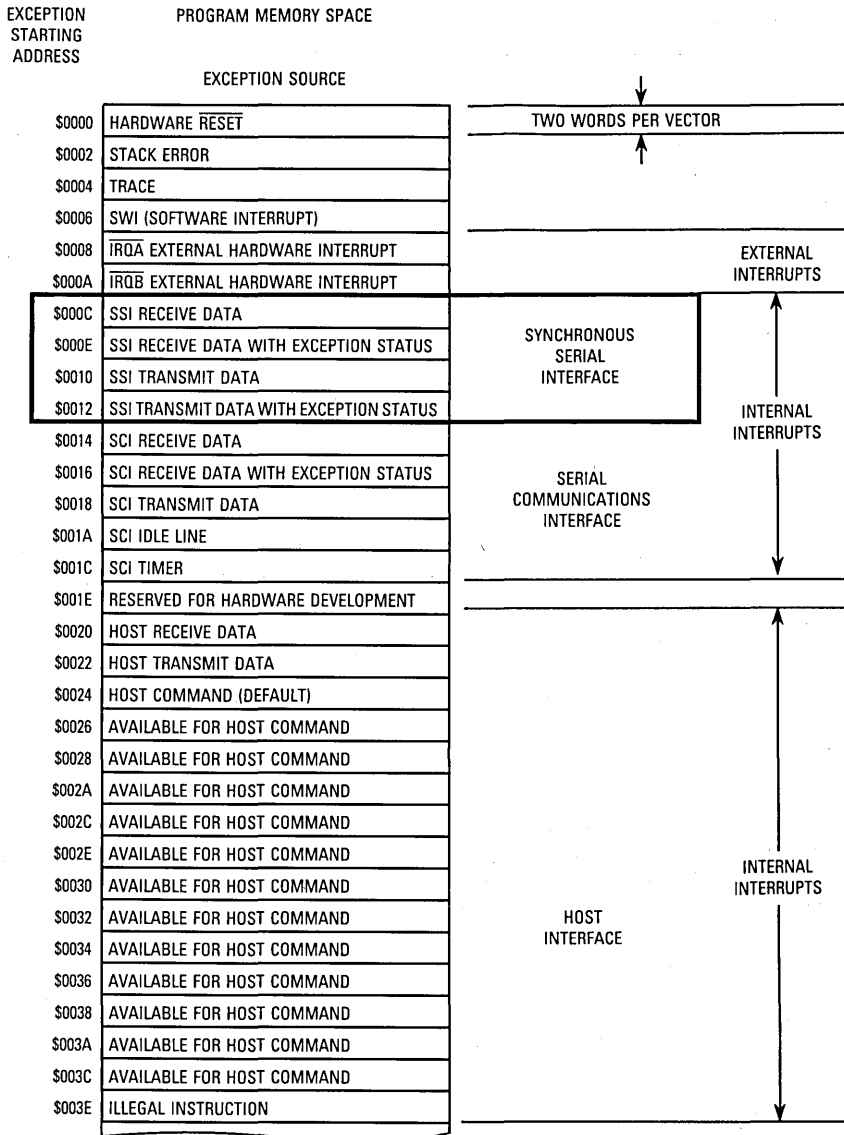

Figure 11-52. SSI Exception Vector Locations

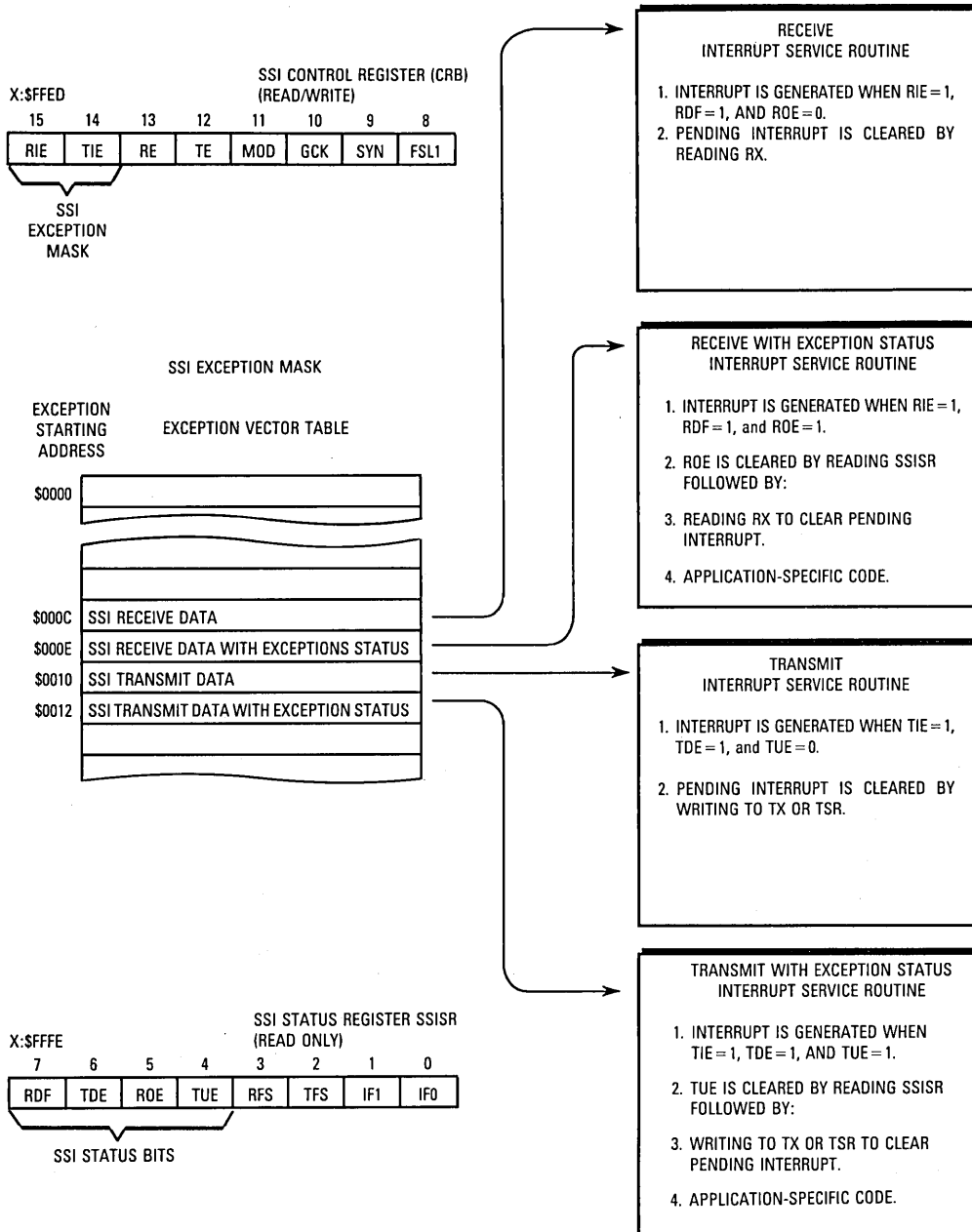

Figure 11-53. SSI Exceptions

**Table 11-11. SSI Operating Modes**

| Operating Format | Serial Clock | TX, RX Sections | Typical Applications                                     |
|------------------|--------------|-----------------|--|
| Normal           | Continuous   | Asynchronous    | Single Asynchronous Codec; Stream-Mode Channel Interface |
| Normal           | Continuous   | Synchronous     | Multiple Synchronous Codecs                              |
| Normal           | Gated        | Asynchronous    | DSP-to-DSP; Serial Peripherals (A/D,D/A)                 |
| Normal           | Gated        | Synchronous     | SPI-Type Devices; DSP to MCU                             |
| Network          | Continuous   | Asynchronous    | TDM Networks   |
| Network          | Continuous   | Synchronous     | TDM Codec Networks<br>TDM DSP Networks                   |
| On-Demand        | Gated        | Asynchronous    | Parallel-to-Serial and Serial-to-Parallel Conversion     |
| On-Demand        | Gated        | Synchronous     | DSP to SPI Peripherals                                   |

The data/operation formats are selected by choosing between gated and continuous clocks, synchronization of transmitter and receiver, selection of word or bit frame sync, and whether the LSB is transferred first or last. The following paragraphs describe how to select a particular data/operation format and describe examples of normal-mode and network-mode applications. The on-demand mode is selected as a special case of the network mode.

The SSI can function as an SPI master or SPI slave, using additional logic for arbitration, which is required because the SSI interface does not perform SPI master/slave arbitration. An SPI master device always uses an internally generated clock; whereas, an SPI slave device always uses an external clock.

**11.3.7.1 DATA/OPERATION FORMATS.** The data/operation formats available to the SSI are selected by setting or clearing control bits in the CRB. These control bits are MOD, GCK, SYN, FSL1, FSL0, and SHFD.

**11.3.7.1.1 Normal/Network Mode Selection.** Selecting between the normal mode and network mode is accomplished by clearing or setting the MOD bit in the CRB (see Figure 11-54). For normal mode, the SSI functions with one data word of I/O per frame (see Figure 11-55). For the network mode, 2 to 32 data words of I/O may be used per frame. In either case, the transfers are periodic. The normal mode is typically used to transfer data to/from a single device. Network mode is typically used in time division multiplexed (TDM) networks of codecs or DSPs with multiple words per frame (see Figure 11-56, which shows two words in a frame with either word-length or bit-length frame sync). The frame sync shown in Figure 11-54 is the word-length frame sync. A bit-length frame sync can be chosen by setting FSL1 and FSL0 for the configuration desired.

**11.3.7.1.2 Continuous/Gated Clock Selection.** The TX and RX clocks may be programmed as either continuous or gated clock signals by the GCK bit in the CRB. A continuous TX

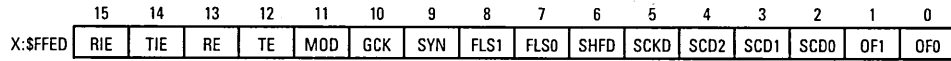

\*NORMAL MOD=0

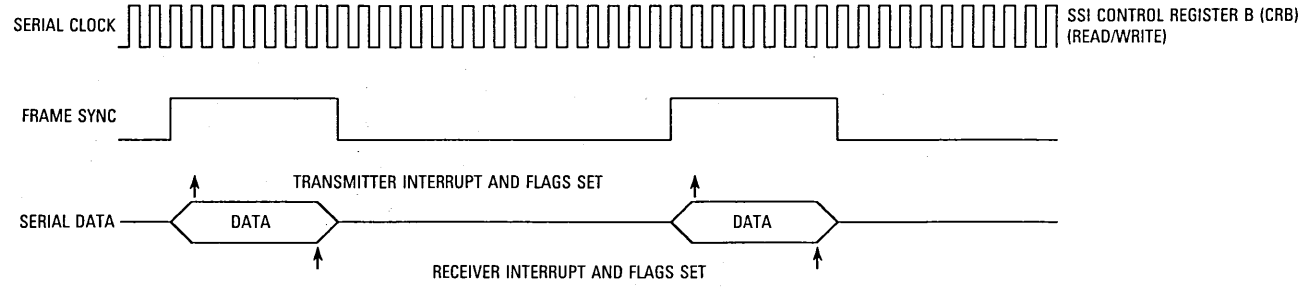

NOTE: Interrupts occur and data is transferred once per frame sync.

\*NETWORK MOD=1

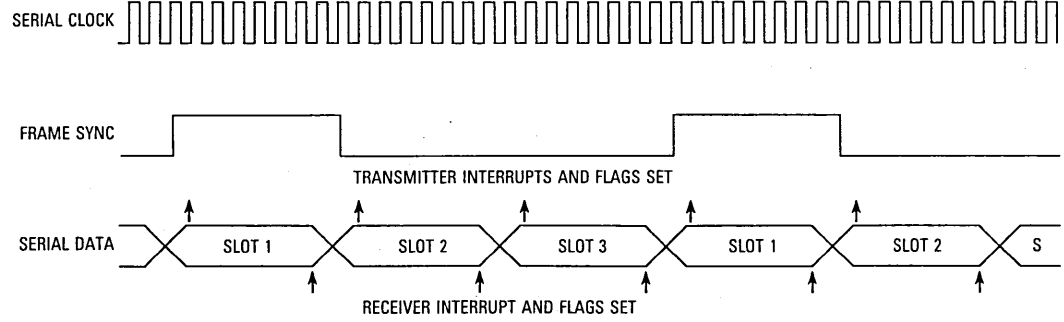

NOTE: Interrupts occur every time slot and a word may be transferred.

Figure 11-54. CRB MOD Bit Operation

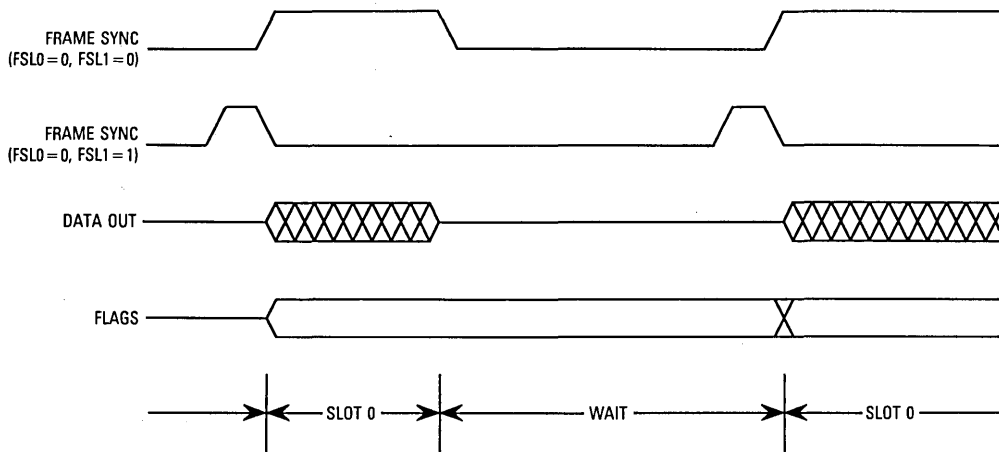

**Figure 11-55. Normal Mode, External Frame Sync (8 Bit, 1 Word in Frame)**

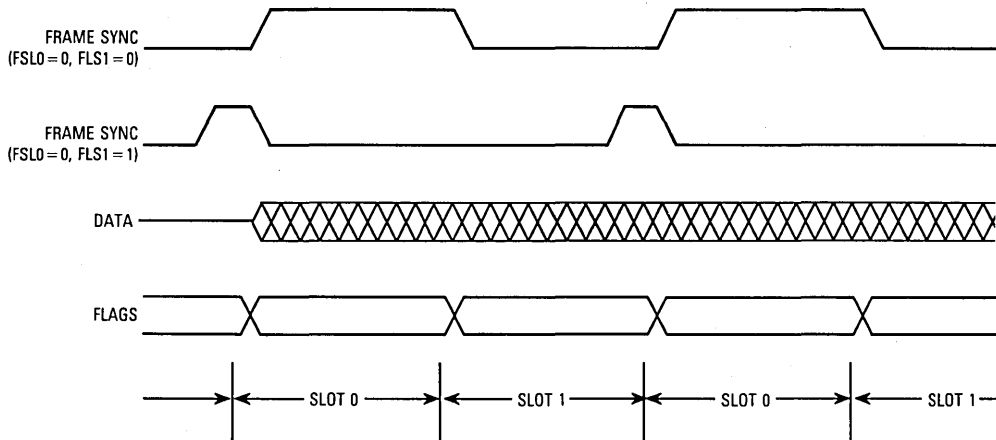

**Figure 11-56. Network Mode (8 Bit, 2 Words in Frame)**

and RX clock is required in applications such as communicating with some codecs where the clock is used for more than just data transfer. A gated clock, in which the clock only toggles while data is being transferred, is useful for many applications and is required for SPI compatibility. The frame sync outputs may be used as a start conversion signal by some A/D and D/A devices.

Figure 11-57 illustrates the difference between continuous clock and gated clock systems. A separate frame-sync signal is required in continuous clock systems to delimit the active clock transitions. Although the word-length frame sync is shown in Figure 11-57, a bit-length frame sync can be used (see Figure 11-58). In gated clock systems, frame synchronization is inherent in the clock signal; thus a separate sync signal is not required (see Figures 11-59 and 11-60). The SSI can be programmed to generate frame sync outputs in gated clock mode but does not use frame sync inputs.

Input flags (see Figures 11-59 and 11-60) are latched on the negative edge of the first data bit of a frame. Output flags are valid during the entire frame.

**11.3.7.1.3 Synchronous/Asynchronous Operating Modes.** The transmit and receive sections of this interface may be synchronous or asynchronous — i.e., the transmitter and receiver may use common clock and synchronization signals (synchronous operating mode, see Figure 11-61) or they may have their own separate clock and sync signals (asynchronous operating mode). The SYN bit in CRB selects synchronous or asynchronous operation. Since the SSI is designed to operate either synchronously or asynchronously, separate receive and transmit interrupts are provided.

Figure 11-62 illustrates the operation of the SYN bit in the CRB. When SYN equals zero, the SSI TX and RX clocks and frame sync sources are independent. If SYN equals one, the SSI TX and RX clocks and frame sync come from the same source (either external or internal).

Data clock and frame sync signals can be generated internally by the DSP or may be obtained from external sources. If internally generated, the SSI clock generator is used to derive bit clock and frame sync signals from the DSP internal system clock. The SSI clock generator consists of a selectable fixed prescaler and a programmable prescaler for bit rate clock generation and also a programmable frame-rate divider and a word-length divider for frame-rate sync-signal generation.

Figures 11-63, 11-64, 11-65, and 11-66 show the definitions of the SSI pins during each of the four main operating modes of the SSI I/O interface. Figure 11-63 uses a gated clock (from either an external source or the internal clock), which means that frame sync is inherent in the clock. Since both the transmitter and receiver use the same clock (synchronous configuration), both use the SCK pin. SC0 and SC1 are designated as flags or can be used as general purpose-parallel I/O. SC2 is not defined if it is an input; SC2 is the transmit and receive frame sync if it is an output.

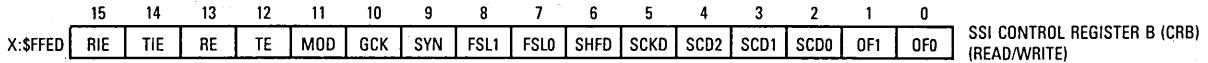

**\*CONTINUOUS CLOCK GCK=0**

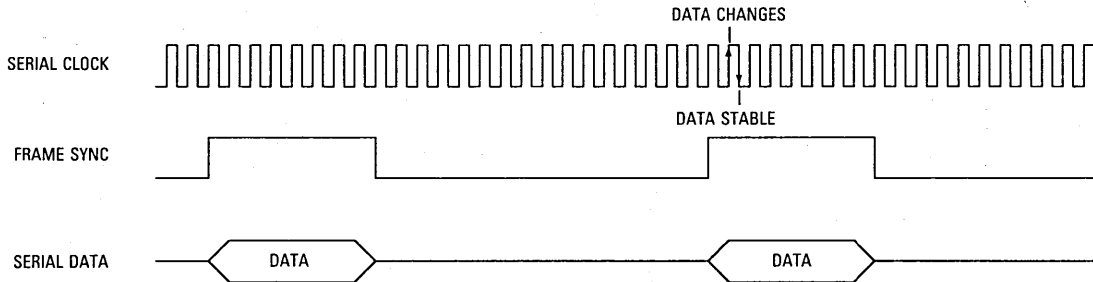

NOTE: Frame sync is required to tell when data is present.

**\*GATED CLOCK GCK=1**

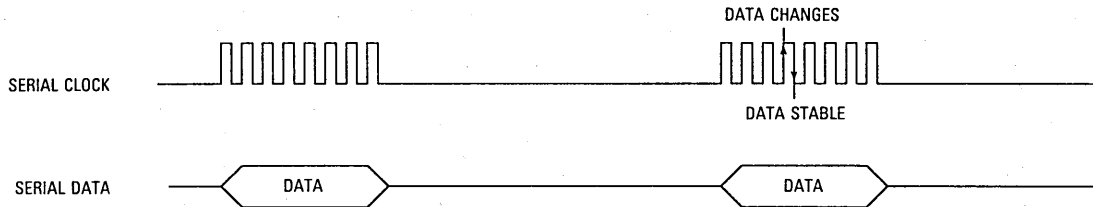

**NOTES:**

1. Word synchronization is inherent in the serial clock signal.
2. Frame Sync generation is optional.

Figure 11-57

**Figure 11-57. CRB GCK Bit Operation**



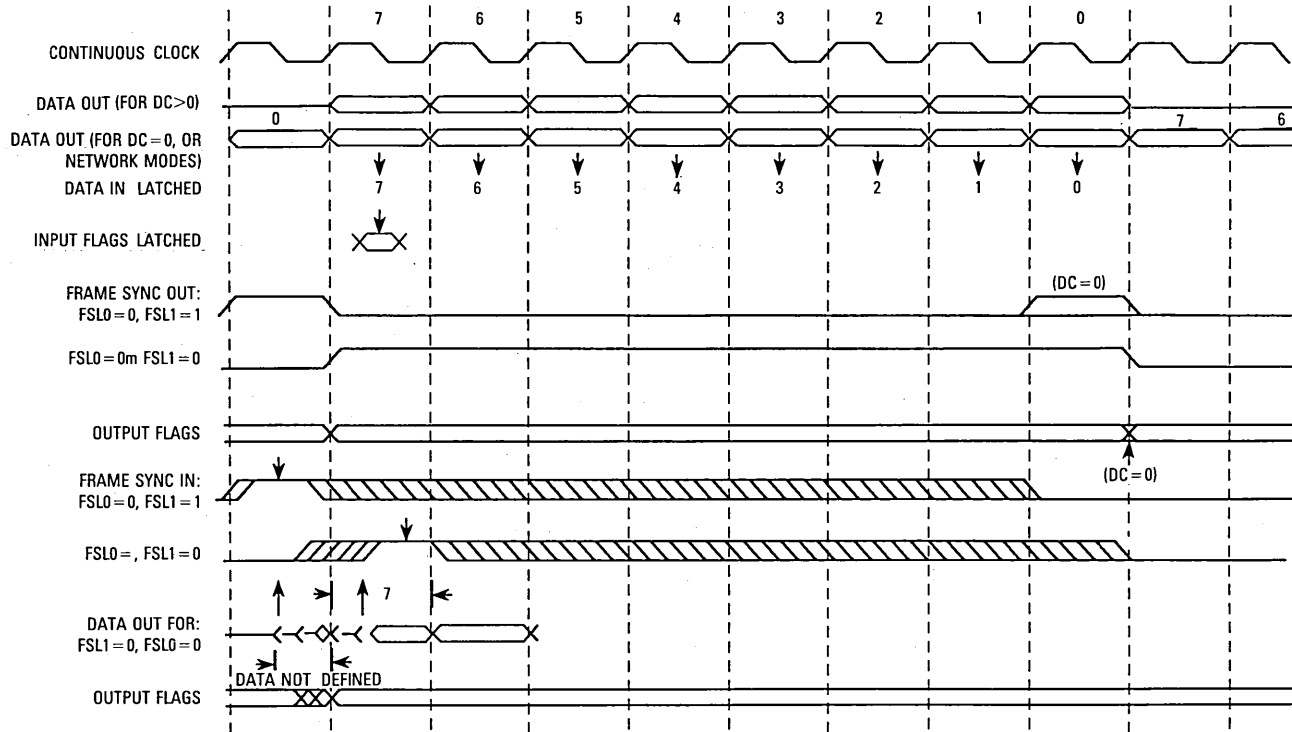

NOTES:

1. For FSL1=0 the frame sync is latched and enables the STD output buffer, but data may not be valid until rising edge of bit clock.
2. WL bit frame sync (FSL0=0, FLS1=0) is not defined for DC=0 in continuous clock mode.
3. Data and flags transition after external frame sync but not before rising edge of clock.

Figure 11-58. Continuous Clock Timing Diagram (8-Bit Example)

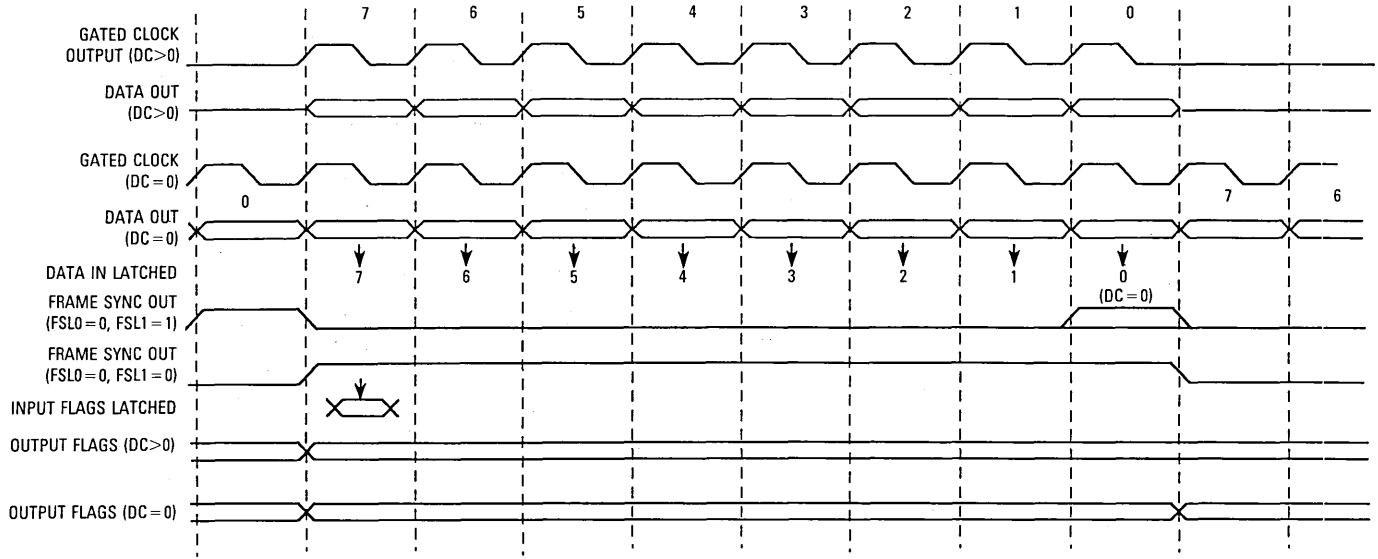
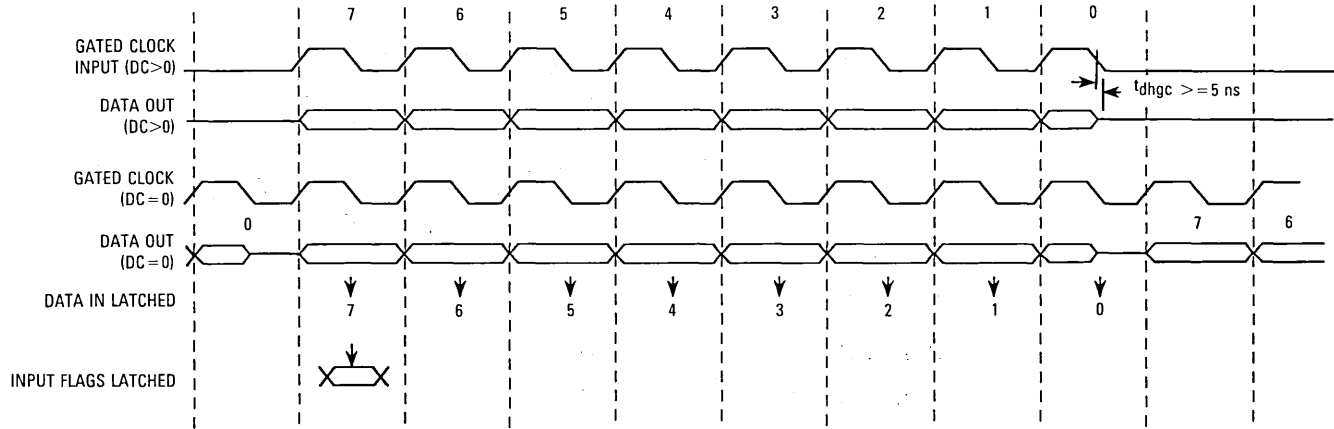

Figure 11-59. Internally Generated Gated Clock Timing (8-Bit Example)



## NOTES:

1. Output enabled on rising edge of first clock input.
2. Output disabled on falling edge of last clock pulse.
3.  $t_{dhgc}$  is guaranteed by circuit design.
4. Frame syncs (in or out) are not defined for external gated clock mode.

Figure 11-60. Externally Generated Gated Clock Timing (8-Bit Example)

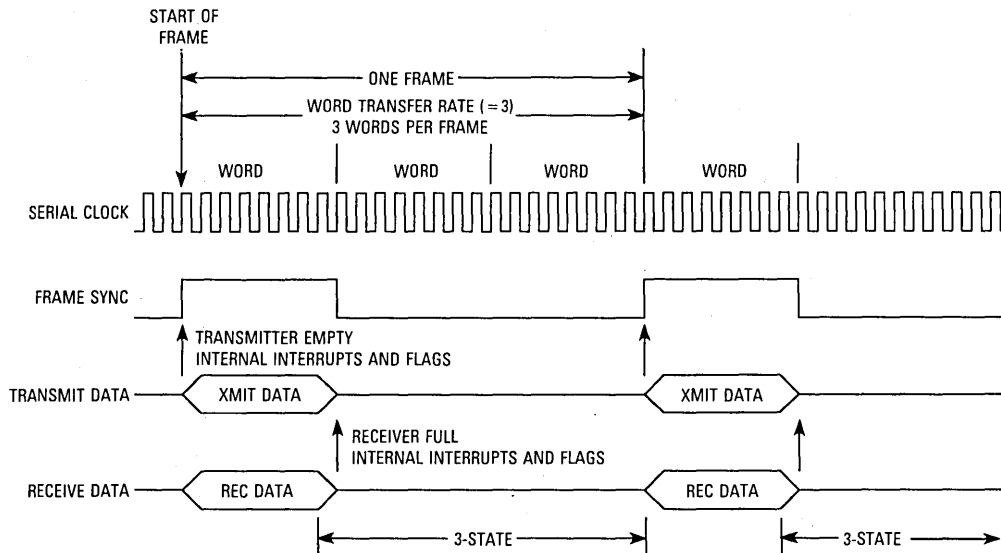
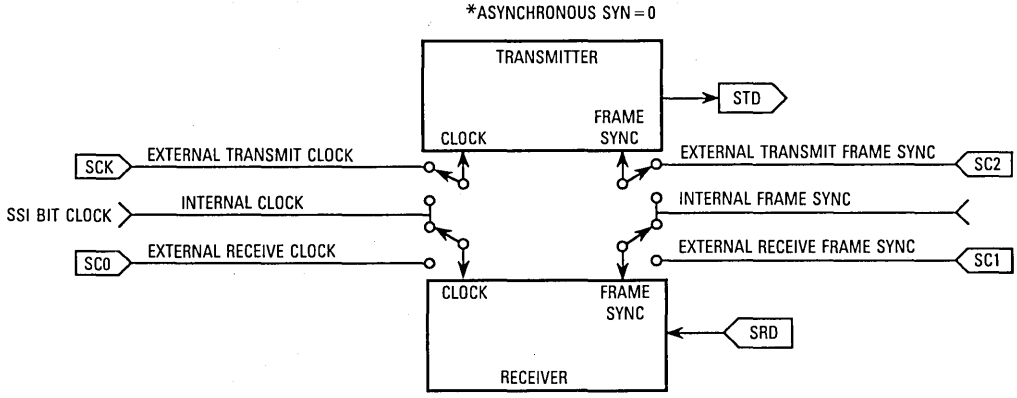
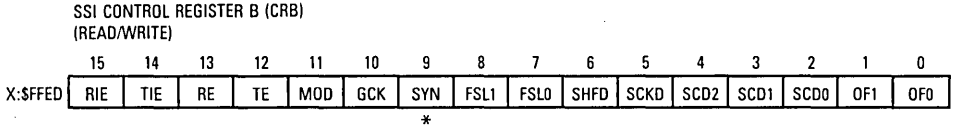

**Figure 11-61. Synchronous Communication**

Figure 11-64 shows a gated clock (from either an external source or the internal clock), which means that frame sync is inherent in the clock. Since this configuration is asynchronous, SCK is the transmitter clock pin (input or output) and SC0 is the receiver clock pin (input or output). SC1 and SC2 are designated as receive or transmit frame sync, respectively, if they are selected to be outputs; these bits are undefined if they are selected to be inputs. SC1 and SC2 can also be used as general-purpose parallel I/O.

Figure 11-65 shows a continuous clock (from either an external source or the internal clock), which means that frame sync must be a separate signal. SC2 is used for frame sync, which can come from an internal or external source. Since both the transmitter and receiver use the same clock (synchronous configuration), both use the SCK pin. SC0 and SC1 are designated as flags or can be used as general-purpose parallel I/O.

Figure 11-66 shows a continuous clock (from either an external source or the internal clock), which means that frame sync must be a separate signal. SC1 is used for the receive frame sync, and SC2 is used for the transmit frame sync. Either frame sync can come from an internal or external source. Since the transmitter and receiver use different clocks (asynchronous configuration), SCK is used for the transmit clock, and SC0 is used for the receive clock.



NOTE: Transmitter and receiver may have different clocks and frame syncs.

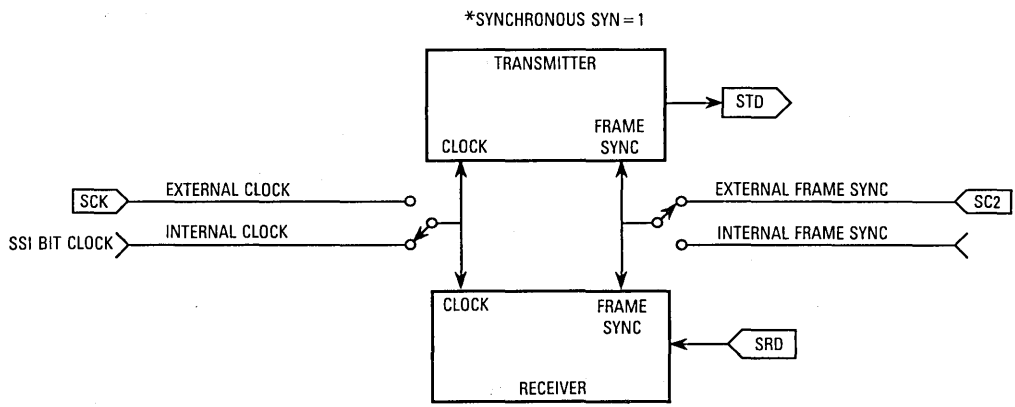

NOTE: Transmitter and receiver have the same clock frame syncs.

Figure 11-62. CRB SYN Bit Operation

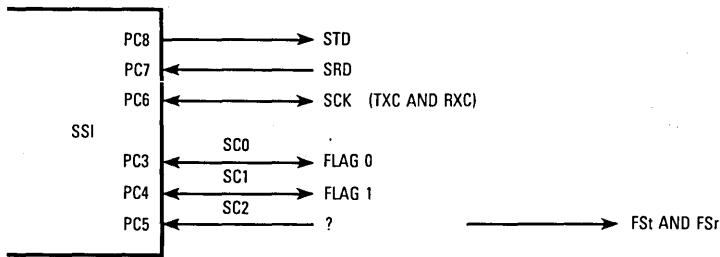

**Figure 11-63. Gated Clock — Synchronous Operation**

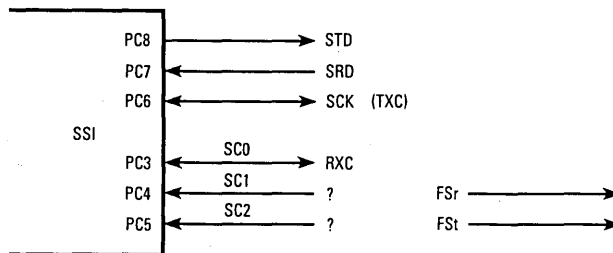

**Figure 11-64. Gated Clock — Asynchronous Operation**

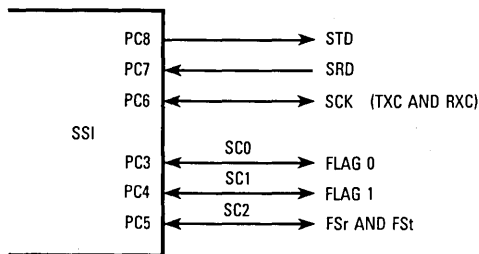

**Figure 11-65. Continuous Clock — Synchronous Operation**

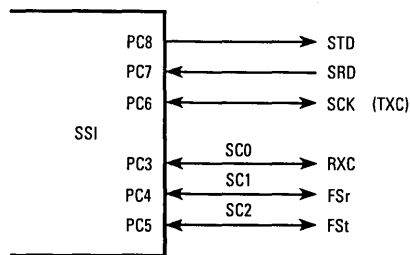

**Figure 11-66. Continuous Clock — Asynchronous Operation**

**11.3.7.1.4 Frame Sync Selection.** The transmitter and receiver can operate totally independent of each other. The transmitter can have either a bit-long or word-long frame-sync signal format, and the receiver can have the same or opposite format. The selection is made by programming FSL0 and FSL1 in the CRB as shown in Figure 11-67.

1. If FSL1 equals zero (see Figure 11-68), the RX frame sync is asserted during the entire data transfer period. This frame sync length is compatible with Motorola codecs, SPI serial peripherals, serial A/D and D/A converters, shift registers, and telecommunication PCM serial I/O.
2. If FSL1 equals one (see Figure 11-69), the RX frame sync pulses active for one bit clock immediately before the data transfer period. This frame sync length is compatible with Intel and National components, codecs, and telecommunication PCM serial I/O.

The ability to mix frame sync lengths is useful in configuring systems in which data is received from one type device (e.g., codec) and transmitted to a different type device.

FSL0 controls whether RX and TX have the same frame sync length (see Figure 11-67). If FSL0 equals zero, RX and TX have the same frame sync length, which is selected by FSL1. If FSL0 equals one, RX and TX have different frame sync lengths, which are selected by FSL1.

The SSI receiver looks for a receive frame sync leading edge only when the previous frame is completed. If the frame sync goes high before the frame is completed (or before the last bit of the frame is received in the case of a bit frame sync), the current frame sync will not be recognized, and the receiver will be internally disabled until the next frame sync. Frames do not have to be adjacent — i.e., a new frame sync does not have to immediately follow the previous frame. Gaps of arbitrary periods can occur between frames. The transmitter will be three-stated during these gaps.

**11.3.7.1.5 Shift Direction Selection.** Some data formats, such as those used by codecs, specify MSB first other data formats, such as the AES-EBU digital audio, specify LSB first. To interface with devices from both systems, the shift registers in the SSI are bidirectional. The MSB/LSB selection is made by programming SHFD in the CRB.

Figure 11-70 illustrates the operation of the SHFD bit in the CRB. If SHFD equals zero (see Figure 11-70(a)), data is shifted into the receive shift register MSB first and shifted out of the transmit shift register MSB first. If SHFD equals one (see Figure 11-70(b)), data is shifted into the receive shift register LSB first and shifted out of the transmit shift register LSB first.

**11.3.7.2 NORMAL MODE EXAMPLES.** The normal SSI operating mode characteristically has one time slot per serial frame, and data is transferred every frame sync. When the SSI is not in the normal mode, it is in the network mode. The MSB is transmitted first (SHFD=0), with overrun and underrun errors detected by the SSI hardware. Transmit flags are set

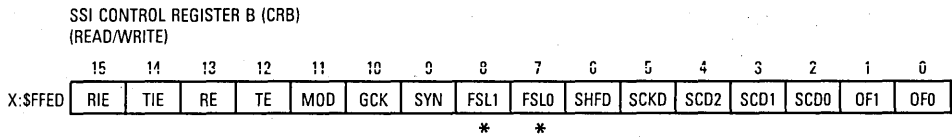

**\*WORD LENGTH: FSL1=0, FSL0=0**

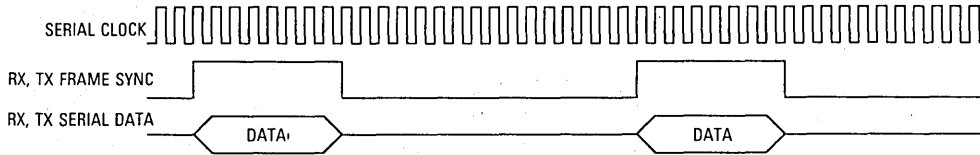

NOTE: Frame sync occurs while data is valid.

**\*ONE BIT: FSL1=1, FSL0=0**

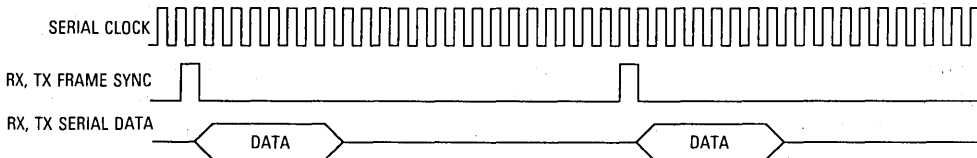

NOTE: Frame sync occurs for one bit time preceding the data.

**\*MIXED FRAME LENGTH: FSL1=0, FSL0=1**

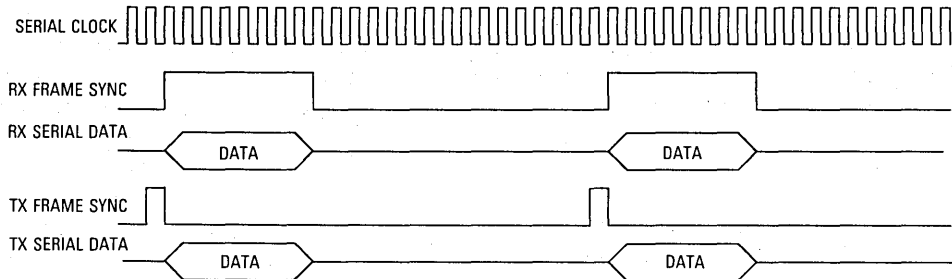

**\*MIXED FRAME LENGTH: FSL1=1, FSL0=1**

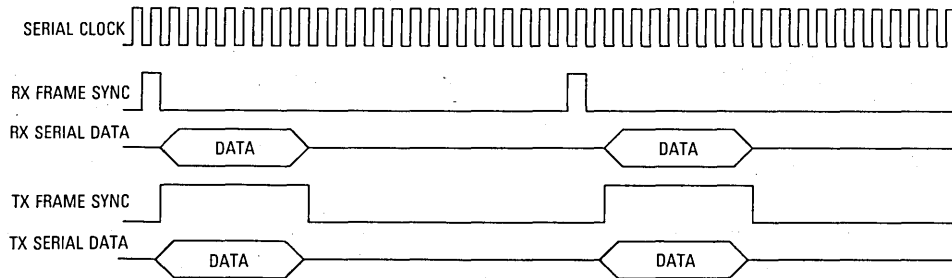

**Figure 11-67. CRB FSL0 and FSL1 Bit Operation**



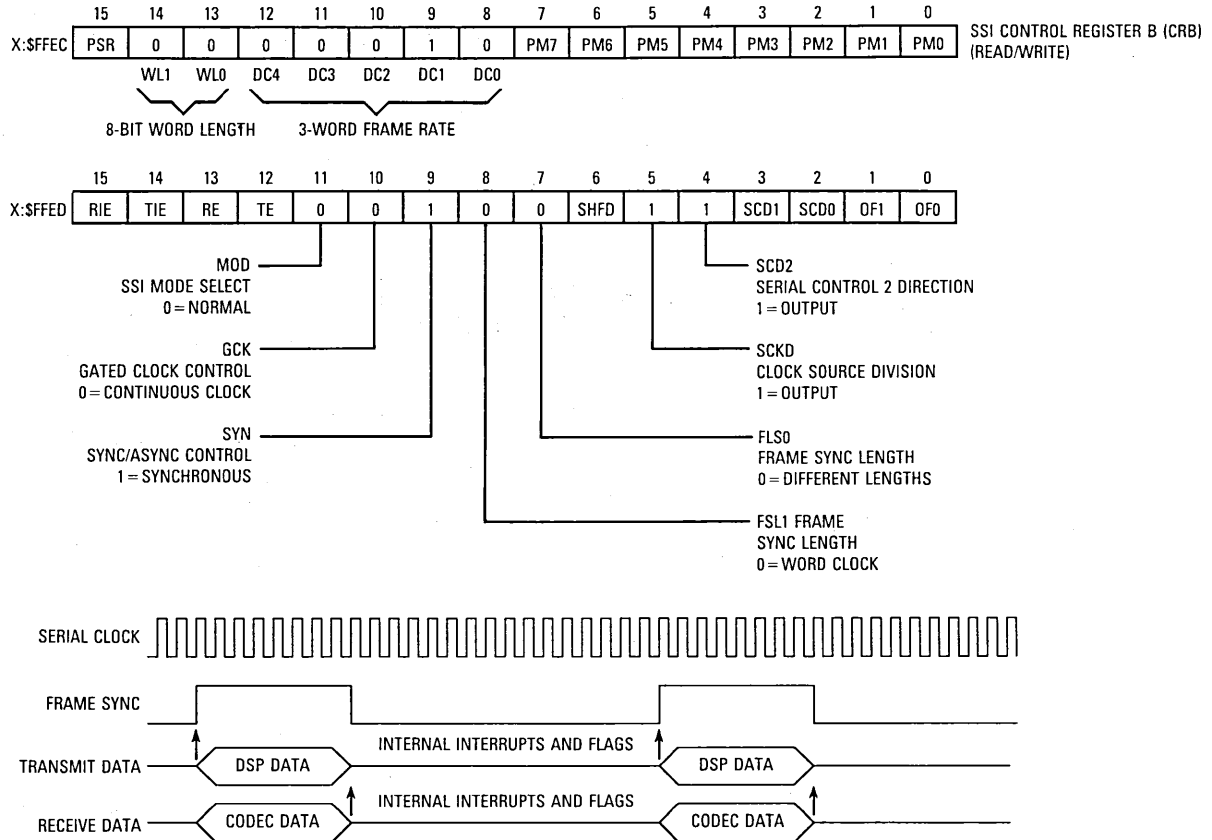

Figure 11-68. Normal Mode Initialization for FSL1=0 and FSL0=0

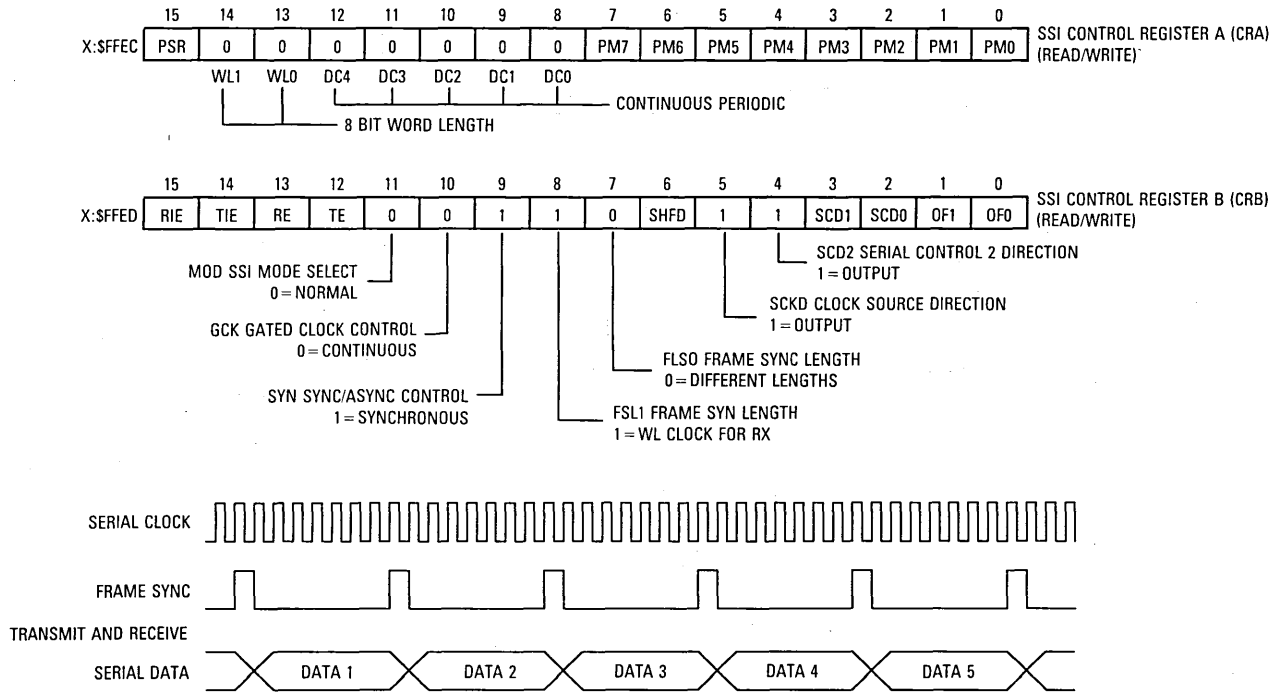
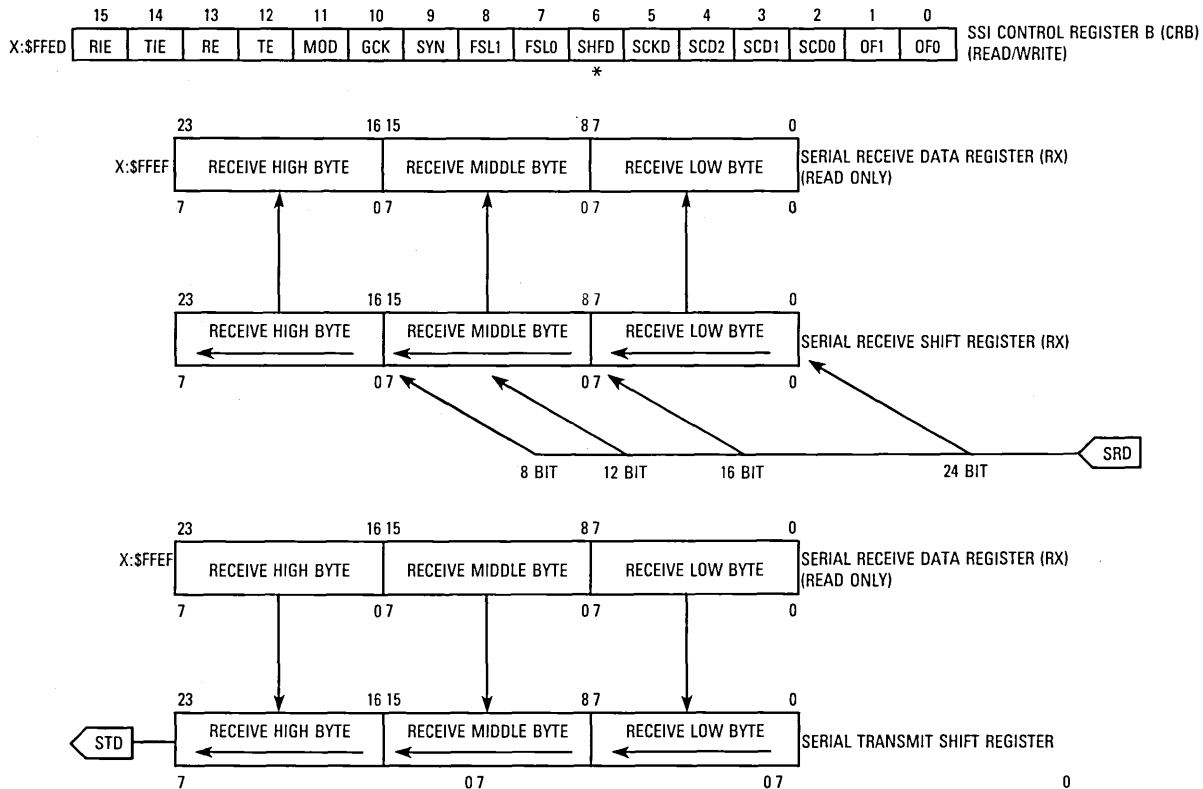
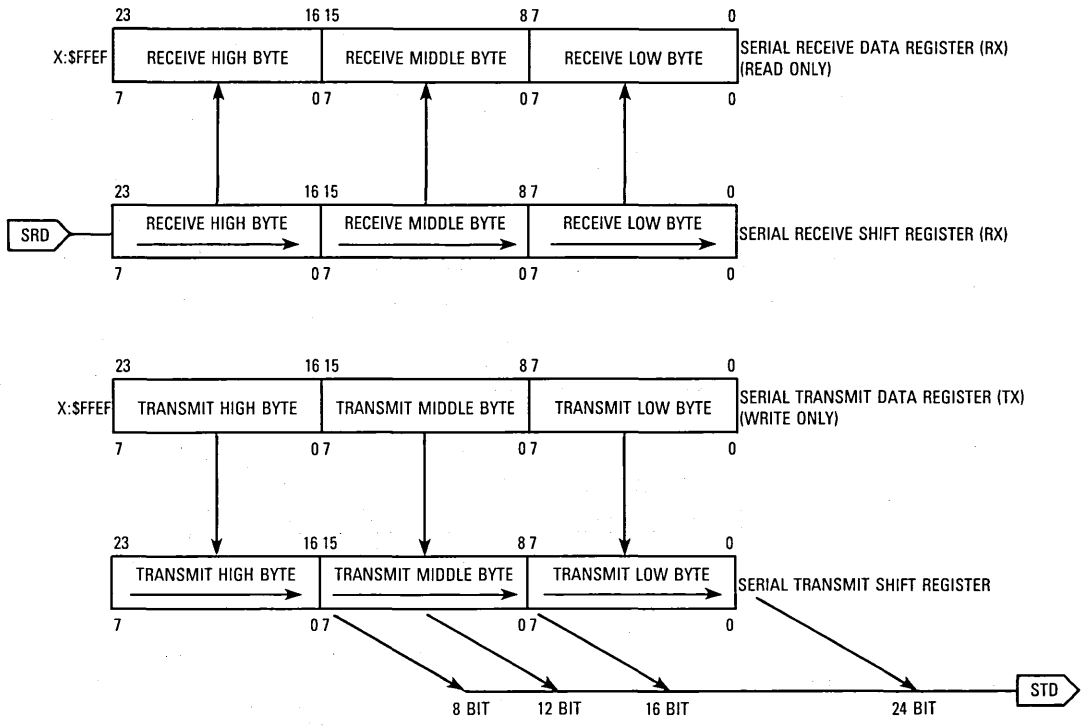

Figure 11-69. Normal Mode Initialization for FSL1 = 1 and FSL0 = 0



(a) SHFD = 0

Figure 11-70. CRB SHFD Bit Operation (Sheet 1 of 2)



(b) SHFD = 1

Figure 11-70. CRB SHFD Bit Operation (Sheet 2 of 2)

when data is transferred from the transmit data register to the transmit shift register. The receive flags are set when data is transferred from the receive shift register to the receive data register.

Figure 11-71 shows an example of using the SSI to connect an MC15500 codec with a DSP56000/DSP56001. No glue logic is needed. The serial clock, which is generated internally by the DSP, provides the transmit and receive clocks (synchronous operation) for the codec. SC2 provides all the necessary handshaking. Data transfer begins when the frame sync is asserted. Transmit data is clocked out and receive data is clocked in with the serial clock while the frame sync is asserted (word-length frame sync). At the end of the data transfer, DSP internal interrupts programmed to transfer data to/from will occur, and the SSISR will be updated.

**11.3.7.2.1 Normal Mode Transmit.** The conditions for data transmission from the SSI are as follows:

1. Transmitter is Enabled (TE = 1).
2. Frame sync (or clock in gated clock mode) is active.

When these conditions occur in normal mode, the next data word will be transferred from TX to the transmit shift register, the TDE flag will be set (transmitter empty), and the

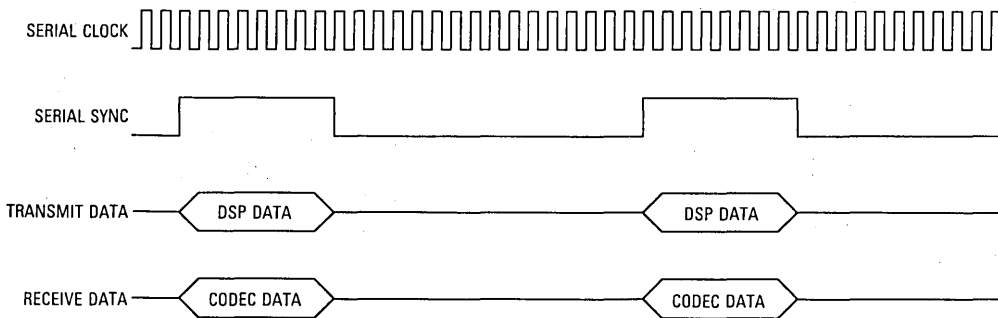
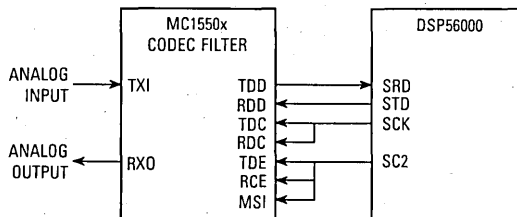

**Figure 11-71. Normal Mode Example**

transmit interrupt will occur if TIE equals one (transmit interrupt enabled.) The new data word will be transmitted immediately.

The transmit data output (STD) is three-stated, except during the data transmission period. The optional frame sync output, flag outputs, and clock outputs are not three-stated even if both receiver and transmitter are disabled.

The optional output flags are always updated at the beginning of the frame, regardless of TE. The state of the flag does not change for the entire frame.

Figure 11-72 is an example of transmitting data using the SSI in the normal mode with a continuous clock, a bit-length frame sync, and 16-bit data words. The purpose of the program is to interleave and transmit right and left channels in a compact disk player. Four SSI pins are used: SC0 is used as an output flag to indicate right-channel data (OF0 = 1) or left-channel data (OF0 = 0); SC2 is TX and RX frame sync out; STD is transmit data out; and SCK clocks the transmit data out. Equates are set for convenience and readability. Test data is then put in the low X: memory locations. The transmit interrupt vector contains a JSR instruction (which forms a long interrupt). The data pointer and channel flag are initialized before initializing CRA and CRB. It is assumed that the DSP CPU and SSI have been previously reset. At this point, the SSI is ready to transmit except that the interrupt is masked because the MR was cleared on reset and port C is still configured a general-purpose I/O. Unmasking the interrupt and enabling the SSI pins allows transmission to begin. A "jump to self" instruction causes the DSP to hang and wait for interrupts to transmit the data. When an interrupt occurs, a JSR instruction at the interrupt vector location causes the XMT routine to be executed. Data is then moved to the TX register, and the data pointer is incremented. The flag is tested by the JSET instruction and, if it is set, a jump to left occurs, and the code for the left channel is executed. If the flag is not set, the code for the right channel is executed. In either case, the channel flag in X0 and then the output flag are set to reflect the channel being transmitted. Control is then returned to the main program, which will wait for the next interrupt.

**11.3.7.2.2 Normal Mode Receive.** If the receiver is enabled, a data word will be clocked in each time the frame sync signal is generated (internal) or detected (external). After receiving the data word, it will be transferred from the SSI receive shift register to the receive data register (RX), RDF will be set (receiver full), and the receive interrupt will occur if it is enabled (RIE = 1).

The DSP program has to read the data from RX before a new data word is transferred from the receive shift register; otherwise, the receiver overrun error will be set (ROE = 1).

```

; *****
;                               *
;          SSI and other I/O EQUATES
; *****
IPR          EQU          $FFFF
CRA          EQU          $FFEC
CRB          EQU          $FFED
PCC          EQU          $FFE1
TX           EQU          $FFE1
FLG          EQU          $0010

                ORG          X:0
                DC           $AAAA00          ;Data to transmit.
                DC           $333300
                DC           $CCCC00
                DC           $F0F000

; *****
;                               *
;          INTERRUPT VECTOR
; *****

                ORG          P:$0010
                JSR          XMT

; *****
;                               *
;          MAIN PROGRAM
; *****

                ORG          P:$40
                MOVE         #0,R0          ;Pointer to data buffer.
                MOVE         #3,M0          ;Set modulus to 4.
                MOVE         #0,X0          ;Initialize channel flag for SSI flag.
                MOVE         X0,X:FLG      ;Start with right channel first.

; *****
;                               *
;          Initialize SSI Port
; *****

                MOVEP        #$3000,X:IPR   ;Set interrupt priority register for SSI.
                MOVEP        #$401F,X:CRA   ;Set continuous clock=5.12/32 MHz
                                                ;word length= 16.
                MOVEP        #$5334,X:CRB   ;Enable TIE and TE; make clock and
                                                ;frame sync outputs; frame
                                                ;sync= bit mode; synchronous mode;
                                                ;make SC0 an output.

```

Figure 11-72. Normal Mode Transmit Example (Sheet 1 of 2)

```

; *****
;
;           Init SSI Interrupt
; *****
;
;           ANDI      #$FC,MR           ;Unmask interrupts.
;           MOVEP    #$01F8,X:PCC      ;Turn on SSI port.
;
;           JMP      *                 ;Wait for interrupt.
;
; *****
;
;           MAIN INTERRUPT ROUTINE      *
; *****
;
XMT      MOVEP    X:(R0)+,X:TX         ;Move data to TX register.
;           JSET    #0,X:FLG,LEFT      ;Check channel flag.
;
RIGHT    BCLR     #0,X:CRB             ;Clear SC0 indicating right channel
;                                           ;data
;           MOVE    #>$01,X0          ;Set channel flag to 1 for next data.
;           MOVE    X0,X:FLG
;           RTI
;
LEFT     BSET     #0,X:CRB             ;Set SC0 indicating left channel data.
;           MOVE    #>$00,X0          ;Clear channel flag for next data.
;           MOVE    X0,X:FLG
;           RTI
;
;
;           END

```

**Figure 11-72. Normal Mode Transmit Example (Sheet 2 of 2)**

Figure 11-73 illustrates the program that receives the data transmitted by the program shown in Figure 11-72. Using the flag to identify the channel, the receive program receives the right- and left-channel data and separates the data into a right data buffer and a left data buffer. The program shown in Figure 11-73 begins by setting equates and then using a JSR instruction at the receive interrupt vector location to form a long interrupt. The main program starts by initializing pointers to the right and left data buffers. The IPR, CRA, and CRB are then initialized. The clock divider bits in the CRA do not have to be set since an external receive clock is specified (SCKD=0). Pin SC0 is specified as an input flag (SYN=1, SCD0=0); pin SC2 is specified as TX and RX frame sync (SYN=1, SCD2=0). The SSI port is then enabled and interrupts are unmasked, which allows the SSI port to begin data reception. A jump-to-self instruction is then used to hang the processor and allow interrupts to receive the data. Normally, the processor would execute useful instructions while waiting for the receive interrupts. When an interrupt occurs, the JSR instruction at the interrupt vector location transfers control to the RCV subroutine. The input flag is tested, and data is put in the left or right data buffer depending on the results of the test. The RTI instruction then returns control to the main program, which will wait for the next interrupt.



```

; *****
;           SSI and other I/O EQUATES           *
; *****
IPR          EQU          $FFFF
SSISR        EQU          $FFEE
CRA          EQU          $FFEC
CRB          EQU          $FFED
PCC          EQU          $FFE1
RX           EQU          $FFEF

; *****
;           INTERRUPT VECTOR                     *
; *****
                ORG          P:$000C
                JSR          RCV

; *****
;           MAIN PROGRAM                         *
; *****

                ORG          P:$40
                MOVE         #0,R0                ;Pointer to memory buffer for
                MOVE         #$08,R1             ;received data. Note data will be
                MOVE         #1,M0             ;split between two buffers which are
                MOVE         #1,M1             ;modulus 2.

; *****
;           Initialize SSI Port
; *****
                MOVEP        #$3000,X:IPR        ;Set interrupt priority register for SSI.
                MOVEP        #$4000,X:CRA        ;Set word length = 16 bits.
                MOVEP        #$A300,X:CRB        ;Enable RIE and RE; synchronous
                                                ;mode with bit frame sync;
                                                ;clock and frame sync are
                                                ;external; SC0 is an input.

; *****
;           Init SSI Interrupt
; *****
                ANDI         #$FC,MR            ;Unmask interrupts.
                MOVEP        #$01F8,X:PCC       ;Turn on SSI port.
                JMP          *                  ;Wait for interrupt.

```

Figure 11-73. Normal Mode Receive Example (Sheet 1 of 2)

```

; *****
;           MAIN INTERRUPT ROUTINE           *
; *****

RCV        JSET      #0,X:SSISR,RIGHT      ;Test SC0 flag.
LEFT       MOVEP     X:RX,X:(R0) +         ;If SC0 clear, receive data
          RTI        ;into left buffer (R0).
RIGHT      MOVEP     X:RX,X:(R1) +         ;If SC0 set, receive data
          RTI        ;into right buffer (R1).
          END

```

Figure 11-73. Normal Mode Receive Example (Sheet 2 of 2)

**11.3.7.3 NETWORK MODE EXAMPLES.** The network mode, the typical mode in which the DSP would interface to a TDM codec network or a network of DSPs, is compatible with Bell and CCITT PCM data/operation formats. The DSP may be a master device (see Figure 11-74) that controls its own private network or a slave device that is connected to an existing TDM network, occupying one or more time slots. The key characteristic of the network mode is that each time slot (data word time) is identified by an interrupt or by polling status bits, which allows the option of ignoring the time slot or transmitting data during the time slot. The receiver operates in the same manner except that data is always being shifted into the receive shift register and transferred to the RX. The DSP reads the receive data register and uses or discards the contents. Overrun and underrun errors are detected.

The frame sync signal indicates the beginning of a new data frame. Each data frame is divided into time slots; transmission or reception can occur in each time slot (rather than in just the frame sync time slot as in normal mode). The frame rate dividers (controlled by DC4, DC3, DC2, DC1, and DC0) control the number of time slots per frame from 2 to 32. Time-slot assignment is totally under software control. Devices can transmit on multiple time slots, receive multiple time slots, and the time-slot assignment can be changed dynamically.

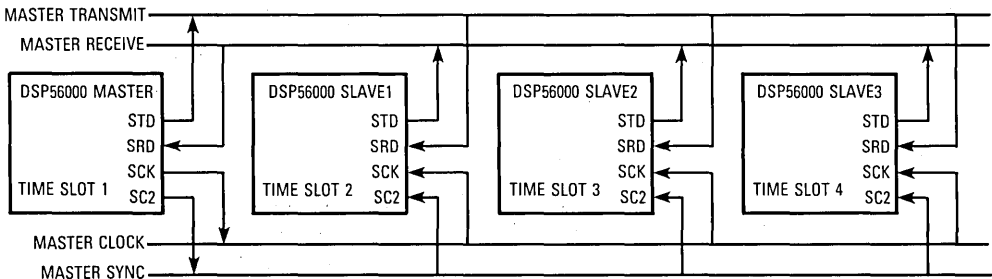

Figure 11-74. Network Mode Example

A simplified flowchart showing operation of the network mode is shown in Figure 11-75. Two counters are used to track the current transmit and receive time slots. Slot counter one (SLOTCT1) is used to track the transmit time slot; slot counter two (SLOTCT2) is used for receive. When the transmitter is empty, it generates an interrupt; a test is then made to see if it is the beginning of a frame. If it is the beginning of a frame, SLOTCT1 is cleared to start counting the time slots. If it is not the beginning of a frame, SLOTCT1 is incremented. The next test checks to see if the SSI should transmit during this time slot. If it is time to transmit, data is written to the TX; otherwise, dummy data is written to the TSR, which prevents a transmit underrun error from occurring and three-states the STD pin. The DSP can then return to what it was doing before the interrupt and wait for the next interrupt to occur. SLOTCT1 should reflect the data in the shift registers to coincide with TFS. Software must recognize that the data being written to TX will be transmitted in time slot SLOTCT1 plus one.

The receiver operates in a similar manner. When the receiver is full, an interrupt is generated, and a test is made to see if this is the beginning of a frame. If it is the beginning of a frame, SLOTCT2 is cleared to start counting the time slots. If it is not the beginning of a frame, SLOTCT2 is incremented. The next test checks to see if the data received is intended for this DSP. If the current time slot is the one assigned to the DSP receiver, the data is kept; otherwise, the data is discarded, and the DSP can then return to what it was doing before the interrupt. SLOTCT2 should reflect the data in the receive shift register to coincide with the RFS flag. Software must recognize that the data being read from RX is for time slot SLOTCT2 minus two.

Initializing the network mode is accomplished by setting the bits in CRA and CRB as follows (see Figure 11-76):

1. The word length must be selected by setting WL1 and WL0. In this example, an 8-bit word length was chosen (WL1=0 and WL0=0).
2. The number of time slots is selected by setting DC4–DC0. Four time slots were chosen for this example (DC4–DC0=\$03).
3. The serial clock rate must be selected by setting PSR and PM7–PM0 (see Tables 11-9 and 11-10).
4. RE and TE must be set to activate the transmitter and receiver. If interrupts are to be used, RIE and TIE should be set. RIE and TIE are usually set after everything else is configured and the DSP is ready to receive interrupts.
5. The network mode must be selected (MOD=1).
6. A continuous clock is selected in this example by setting GCK=0.
7. Although it is not required for the network mode, synchronous clock control was selected (SYN=1).
8. The frame sync length was chosen in this example as word length (FSL1=0) for both transmit and receive frame sync (FSL0=0). Any other combinations could have been selected, depending on the application.
9. Control bits SHFD, SCKD, SCD2, SCD1, SCD0, and the flag bits (OF1 and OF0) should be set as needed for the application.

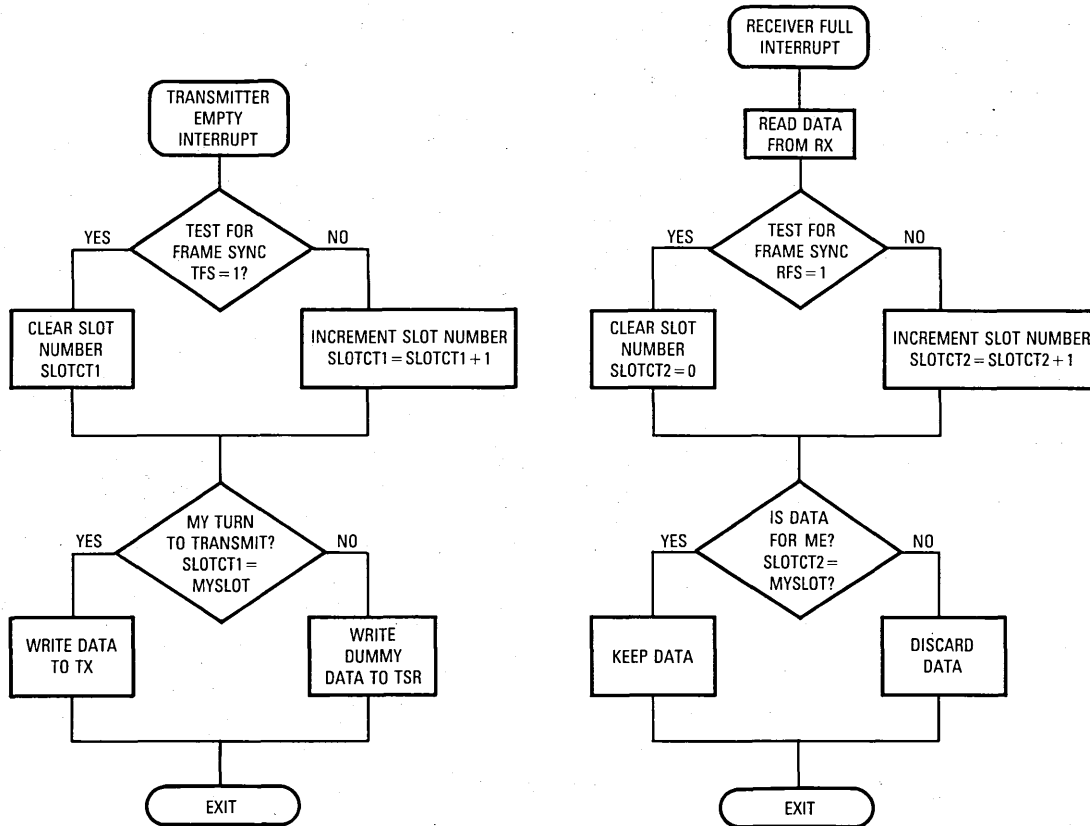

Figure 11-75. TDM Network Software Flowchart

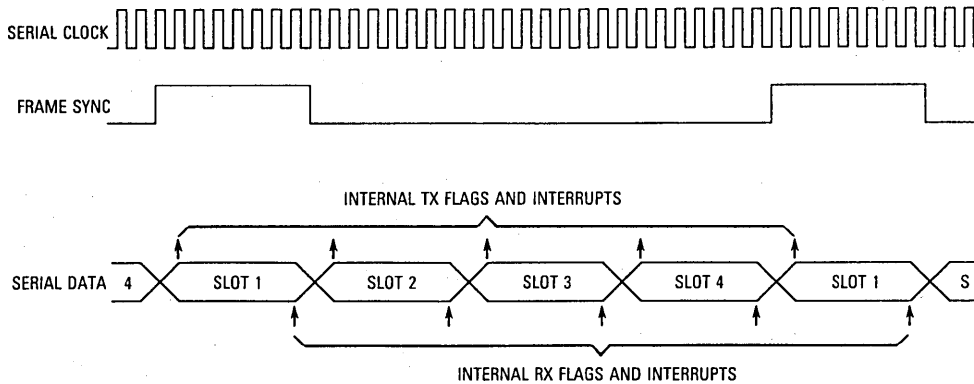
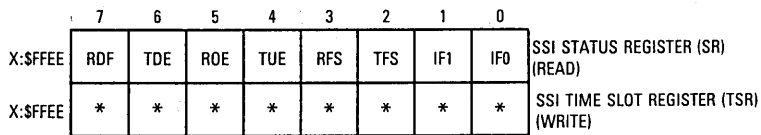
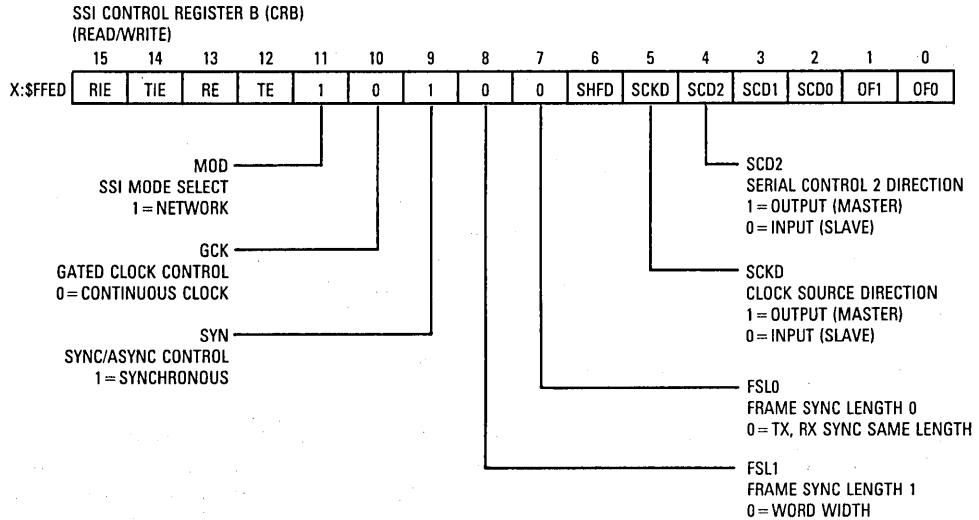
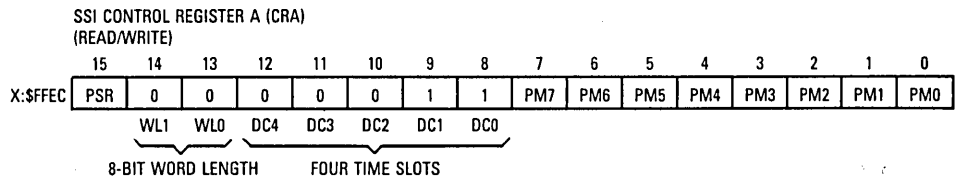

Figure 11-76. Network Mode Initialization

**11.3.7.3.1 Network Mode Transmit.** When TE is set, the transmitter will be enabled only after detection of a new data frame sync. This procedure allows the SSI to synchronize to the network timing.

Normal startup sequence for transmission in the first time slot is to write the data to be transmitted to TX, which clears the TDE flag. Then set TE and TIE to enable the transmitter on the next frame sync and to enable transmit interrupts.

Alternatively, the DSP programmer may decide **not** to transmit in the first time slot by writing any data to the time slot register (TSR). This will clear the TDE flag just as if data were going to be transmitted, but the STD pin will remain in the high-impedance state for the first time slot. The programmer then sets TE and TIE.

When the frame sync is detected (or generated), the first data word will be transferred from TX to the transmit shift register and will be shifted out (transmitted). TX being empty will cause TDE to be set, which will cause a transmitter interrupt. Software can poll TDE or use interrupts to reload the TX register with new data for the next time slot. Software can also write to TSR to prevent transmitting in the next time slot. Failing to reload TX (or writing to the TSR) before the transmit shift register is finished shifting (empty) will cause a transmitter underrun. The TUE error bit will be set, causing the previous data to be retransmitted.

The operation of clearing TE and setting it again will disable the transmitter after completion of transmission of the current data word until the beginning of the next frame sync period. During that time, the STD pin will be three-stated. When it is time to disable the transmitter, TE should be cleared after TDE is set to ensure that all pending data is transmitted.

The optional output flags are updated every time slot regardless of TE.

To summarize, the network mode transmitter generates interrupts every time slot and requires the DSP program to respond to each time slot. These responses can be

1. Write data register with data to enable transmission in the next time slot.
2. Write the time slot register to disable transmission in the next time slot.
3. Do nothing — transmit underrun will occur at the beginning of the next time slot, and the previous data will be transmitted.

Figure 11-77 is essentially the same program shown in Figure 11-72 except that this program uses the network mode to transmit only right-channel data. A time slot is assigned for the left-channel data, which could be inserted by another DSP using the network mode. In the "Initialize SSI Port" section of the program, two words per frame are selected using CRA, and the network mode is selected by setting MOD to one in the CRB. The main interrupt routine, which waits to move the data to TX, only transmits data if the current time slot is for the right channel. If the current time slot is for the left channel, the TSR is written, which three-states the output to allow another DSP to transmit the left channel during the time slot.

```

; *****
;           SSI and other I/O EQUATES           *
; *****
IPR          EQU          $FFFF
CRA          EQU          $FFEC
CRB          EQU          $FFED
PCC          EQU          $FFE1
TX           EQU          $FFE1
TSR          EQU          $FFEE
FLG          EQU          $0010

                ORG          X:0
                DC           $AAAA00          ;Data to transmit.
                DC           $333300
                DC           $CCCC00
                DC           $F0F000

; *****
;           INTERRUPT VECTOR                     *
; *****
                ORG          P:$0010
                JSR          XMT

; *****
;           MAIN PROGRAM                         *
; *****
                ORG          P:$40

                MOVE         #0,R0          ;Pointer to data buffer.
                MOVE         #3,M0          ;Set modulus to 4.
                MOVE         #0,X0          ;Initialize user flag for SSI flag.
                MOVE         X0,X:FLG       ;Start with the right channel.

; *****
;           Initialize SSI Port                   *
; *****
                MOVEP        #$3000,X:IPR   ;Set interrupt priority register for SSI.
                MOVEP        #$411F,X:CRA   ;Set continuous clock = 5.12/32 MHz,
                                                ;word length = 16.
                MOVEP        #$5B34,X:CRB   ;Enable TIE and TE; make clock and
                                                ;frame sync outputs; frame sync = bit
                                                ;mode; synchronous mode; make
                                                ;SC0 an output.

```

Figure 11-77. Network Mode Transmit Example Program (Sheet 1 of 2)

```

; *****
;                               *
;                               *
; *****
;                               *
;                               *
; *****
;                               *
;                               *
; *****

                                ANDI      #$FC,MR           ;Unmask interrupts.
                                MOVEP     #$01F8,X:PCC       ;Turn on SSI port.
                                JMP        *                 ;Wait for interrupt.

; *****
;                               *
;                               *
; *****
;                               *
;                               *
; *****
;                               *
;                               *
; *****

XMT

                                JSET      #0,X:FLG,LEFT      ;Check user flag.

RIGHT                            BCLR     #0,X:CRB           ;Clear SC0 indicating right channel
                                ;data.
                                MOVEP     X:(R0)+,X:TX       ;Move data to TX register.
                                MOVE      #>$01,X0          ;Set user flag to 1
                                MOVE      X0,X:FLG           ;for next data.
                                RTI

LEFT                              BSET     #0,X:CRB           ;Set SC0 indicating left channel data.
                                MOVEP     X0,X:TSR           ;Write to TSR register.
                                MOVE      #>$00,X0          ;Clear user flag
                                MOVE      X0,X:FLG           ;for next data.
                                RTI

                                END

```

Figure 11-77. Network Mode Transmit Example Program (Sheet 2 of 2)

**11.3.7.3.2 Network Mode Receive.** The receive enable will occur only after detection of a new data frame with RE set. The first data word is shifted into the receive shift register and is transferred to the RX, which sets RDF if a frame sync was received (i.e., this is the start of a new frame). Setting RDF will cause a receive interrupt to occur if the receiver interrupt is enabled (RIE = 1).

The second data word (second time slot in the frame) begins shifting in immediately after the transfer of the first data word to the RX. The DSP program has to read the data from RX (which clears RDF) before the second data word is completely received (ready to transfer to RX), or a receive overrun error will occur (ROE = 1), and the data in the receiver shift register will not be transferred and will be lost.



```

; *****
;           SSI and other I/O EQUATES           *
; *****

IPR          EQU          $FFFF
SSISR        EQU          $FFEE
CRA          EQU          $FFEC
CRB          EQU          $FFED
PCC          EQU          $FFE1
RX           EQU          $FFE1

; *****
;           INTERRUPT VECTOR                     *
; *****

                ORG          P:$000C
                JSR          RCV

; *****
;           MAIN PROGRAM                         *
; *****

                ORG          P:$40
                MOVE         #0,R0                ;Pointer to memory buffer for
                MOVE         #$08,R1             ;received data. Note data will be
                MOVE         #3,M0             ;split between two buffers using
                MOVE         #3,M1             ;modulus 4

; *****
;           Initialize SSI Port                   *
; *****

                MOVEP        #$3000,X:IPR        ;Set interrupt priority register for SSI.
                MOVEP        #$4100,X:CRA        ;Set word length = 16 bits.
                MOVEP        #$AB00,X:CRB        ;Enable RIE and RE; synchronous
                                                ;mode with bit frame sync; clock
                                                ;and frame sync are
                                                ;external; SC0 is an input.

```

Figure 11-78. Network Mode Receive Example Program (Sheet 1 of 2)

```

;*****
;
;           Init SSI Interrupt           *
;*****
;
;           ANDI           #$FC,MR           ;Unmask interrupts.
;           MOVEP        #$01F8,X:PCC       ;Turn on SSI port.
;           JMP          *                   ;Wait for interrupt.
;
;*****
;
;           MAIN INTERRUPT ROUTINE       *
;*****
;
RCV          JSET          #0,X:SSISR,RIGHT ;Test SC0 flag.
LEFT        MOVEP        X:RX,X:(R0) +     ;If SC0 clear, receive data
           RTI           ;into left buffer (R0).
RIGHT       MOVEP        X:RX,X:(R1) +     ;If SC0 set, receive data
           RTI           ;into right buffer (R1).
;
END

```

**Figure 11-78. Network Mode Receive Example Program (Sheet 2 of 2)**

If RE is cleared and set again by the DSP program, the receiver will be disabled after receiving the current time slot in progress until the next frame sync (first time slot). This mechanism allows the DSP programmer to ignore data in the last portion of a data frame.

#### NOTE

The optional frame sync output and clock output signals are not affected, even if the transmitter and/or receiver are disabled. TE and RE do not disable bit clock and frame sync generation.

To summarize, the network mode receiver receives every time slot data word unless the receiver is disabled. An interrupt can occur after the reception of each data word, or the programmer can poll RDF. The DSP program response can be

1. Read RX and use the data.
2. Read RX and ignore the data.
3. Do nothing — the receiver overrun exception will occur at the end of the current time slot.
4. Toggle RE to disable the receiver until the next frame, and read RX to clear RDF.

Figure 11-78 is essentially the same program shown in Figure 11-73 except that this program uses the network mode to receive only right-channel data. In the "Initialize SSI Port" section of the program, two words per frame are selected using the DC bits in the CRA, and the network mode is selected by setting MOD to one in the CRB. If the program in Figure 11-77 is used to transmit to the program in Figure 11-78, the correct data will appear in the data buffer for the right channel, but the buffer for the left channel will probably contain \$000000 or \$FFFFFF, depending on whether the transmitter output was high or low when TSR was written and whether the output was three-stated.

**11.3.7.4 ON-DEMAND MODE EXAMPLES.** A divide ratio of one (DC=00000) in the network mode is defined as the **on-demand** mode of the SSI because it is the only data-driven mode of the SSI — i.e., data is transferred whenever data is present (see Figures 11-79 and 11-80). STD and SCK from DSP1 are connected to DSP2 — SRD and SC0, respectively. SC0 is used as an input clock pin in this application. Receive data and receive data clock are separate from the transmit signals. On-demand data transfers are nonperiodic, and no time slots are defined. When there is a clock in the gated clock mode, data is transferred. Although they are not necessarily needed, frame sync and flags are generated when data is transferred. Transmitter underruns (TUE) are impossible in this mode and are therefore disabled. In the on-demand transmit mode, two additional SSI clock cycles are automatically inserted between each data word transmitted. This procedure guarantees that frame sync will be low between every transmitted data word or that the clock will not be continuous between two consecutive words in the gated clock mode. The on-demand mode is similar to the SCI shift register mode with SSFTD equals one and SCKP equals one. The receiver should be configured to receive the bit clock and, if continuous clock is used, to receive an external frame sync. Therefore, for all full-duplex communication in on-demand mode, the asynchronous mode should be used. The on-demand mode is SPI compatible.

Initializing the on-demand mode for the example illustrated in Figure 11-80 is accomplished by setting the bits in CRA and CRB as follows:

1. The word length must be selected by setting WL1 and WL0. In this example, a 24-bit word length was chosen (WL1 = 1 and WL0 = 1).
2. The on-demand mode is selected by clearing DC4–DC0.

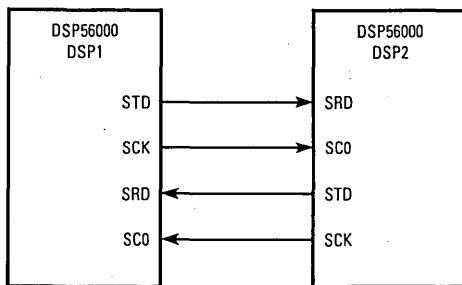

Figure 11-79. On-Demand Example

3. The serial clock rate must be selected by setting PSR and PM7–PM0 (see Tables 11-9 and 11-10).
4. RE and TE must be set to activate the transmitter and receiver. If interrupts are to be used, RIE and TIE should be set. RIE and TIE are usually set after everything else is configured and the DSP is ready to receive interrupts.
5. The network mode must be selected (MOD=1).
6. A gated clock (GCK=1) is selected in this example. A continuous clock example is shown in Figure 11-77.
7. Asynchronous clock control was selected (SYN=0) in this example.
8. Since gated clock is used, the frame sync is not necessary. FSL1 and FSL0 can be ignored.
9. SCKD must be an output (SCKD=1).
10. SCD0 must be an input (SCD0=0).
11. Control bit SHFD should be set as needed for the application. Pins SC1 and SC2 are undefined in this mode (see Table 11-7) and should be programmed as general-purpose I/O pins.

**11.3.7.4.1 On-Demand Mode — Continuous Clock.** This special case will not generate a periodic frame sync. A frame sync pulse will be generated only when data is available to transmit (see Figure 11-81(a)). The frame sync signal indicates the first time slot in the frame. The on-demand mode requires that the transmit frame sync be internal (output) and the receive frame sync be external (input). Therefore, for simplex operation, the synchronous mode could be used; however, for full-duplex operation, the asynchronous mode must be used. Data transmission that is data driven is enabled by writing data into TX. Although the SSI is double buffered, only one word can be written to TX, even if the transmit shift register is empty. The receive and transmit interrupts function as usual using TDE and RDF; however, transmit and receive underruns are impossible for on-demand transmission and are disabled. This mode is useful for interfacing to codecs requiring a continuous clock.

**11.3.7.4.2 On-Demand Mode — Gated Clock.** Gated clock mode (see Figure 11-81(b)) is defined for on-demand mode, but the gated clock mode is considered a frame sync source; therefore, in gated clock mode, the transmit clock must be internal (output) and the receive clock must be external (input). For on-demand mode, with internal (output) synchronous gated clock, output clock is enabled for the transmitter and receiver when TX data is transferred to the transmit data shift register. This SPI master operating mode is shown in Figure 11-82. Word sync is inherent in the clock signal, and the operation format must provide frame synchronization.

Figure 11-83 is the block diagram for the program presented in Figure 11-84. This program contains a transmit test program that was written as a scoping loop (providing a repetitive

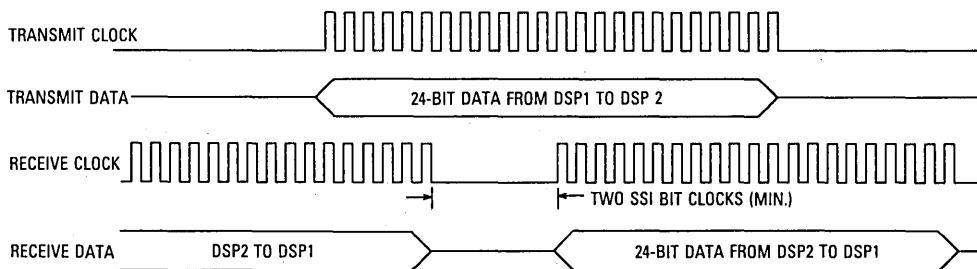
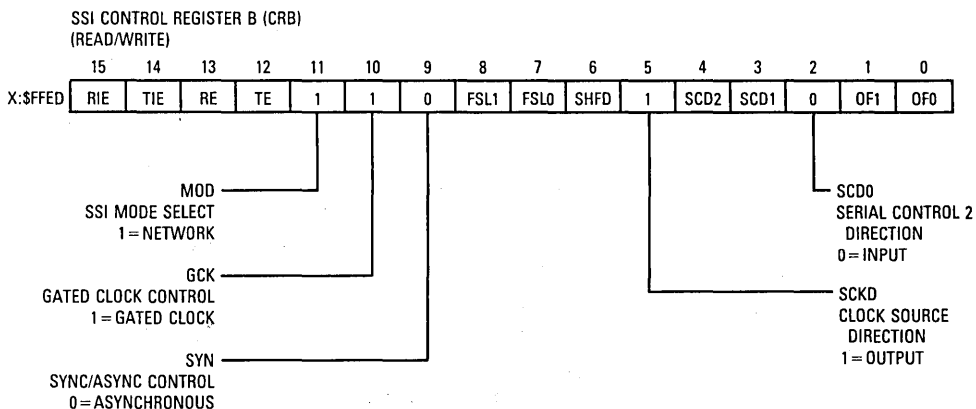
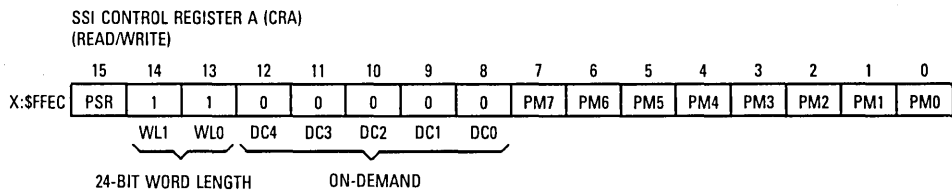

NOTE: Two SSI bit clock times are automatically inserted between each data word. This guarantees frame sync will be low between every data word transmitted and the clock will not be continuous for two consecutive data words.

Figure 11-80. On-Demand Data-Driven Network Mode

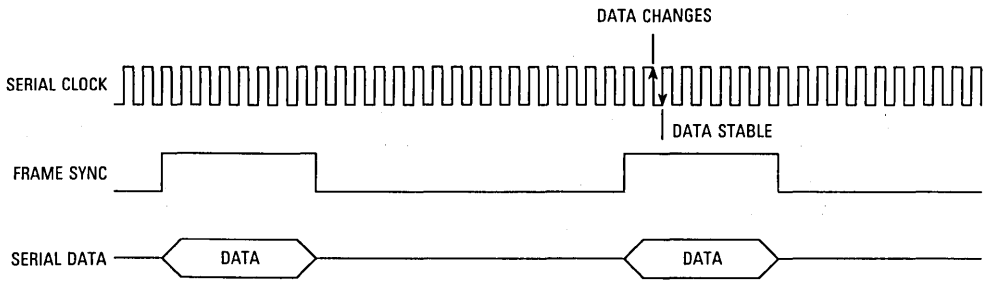

(a) Continuous

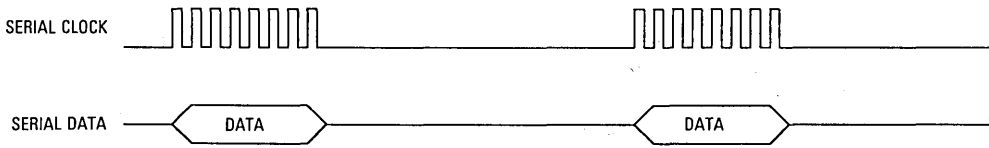

(b) Gated

Figure 11-81. Clock Modes

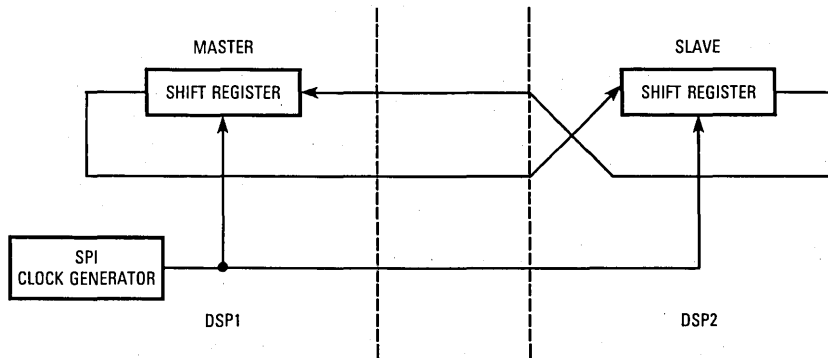
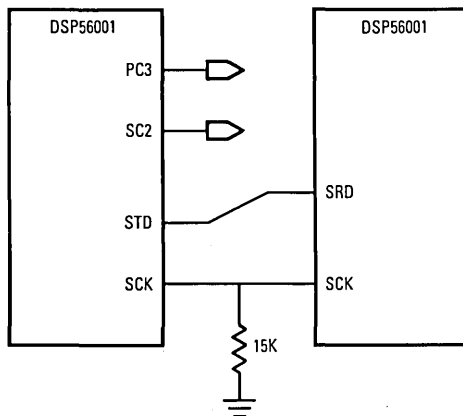

Figure 11-82. SPI Configuration



**Figure 11-83. On-Demand Mode Example — Hardware Configuration**

sync) using the on-demand, gated, synchronous mode with no interrupts (polling) to transmit data to the program shown in Figure 11-85. The program also demonstrates using parallel I/O pins as general-purpose control lines. PC3 is used as an external strobe or enable for hardware such as an A/D converter. The transmit program sets equates for convenience and readability. Test data is then written to X: memory, and the data pointer is initialized. Setting M0 to two makes the buffer circular (modulo 3), which saves the step of resetting the pointer each loop. PC3 is configured as a general-purpose output for use as a scope sync, and CRA and CRB are then initialized. Setting the PCC bits begins SSI operation; however, no data will be transmitted until data is written to TX. PC3 is set high at the beginning of data transmission; data is then moved to TX to begin transmission. A JCLR instruction is then used to form a wait loop until TDE equals one and the SSI is ready for another data word to be transmitted. Two more data words are transmitted in this fashion (this is an arbitrary number chosen for this test loop). An additional wait is included to make sure that the frame sync has gone low before PC3 is cleared, indicating on the scope that transmission is complete. A wait of 100 NOPs is implemented by using the REP instruction before starting the loop again.

Figure 11-85 is the receive program for the scoping loop program presented in Figure 11-84. The receive program also uses the on-demand, gated, synchronous mode with no interrupts (polling). Initialization for the receiver is slightly different than for the transmitter. In CRB, RE is set rather than TE, and SCKD and SCD2 are inputs rather than outputs. After initialization, a JCLR instruction is used to wait for a data word to be received (RDF=1). When a word is received, it is put into the circular buffer and loops to wait for another data word. The data in the circular buffer will be overwritten after three words are received (does not matter in this application).

```

; *****
; SSI and other I/O EQUATES *
; *****

```

```

CRA      EQU      $FFEC
CRB      EQU      $FFED
PCC      EQU      $FFE1
PCD      EQU      $FFE5
SSISR    EQU      $FFEE
TX       EQU      $FFEF
PCDDR    EQU      $FFE3

          ORG      X:0
          DC       $AA0000      ;Data to transmit
          DC       $330000
          DC       $F00000

```

```

; *****
; MAIN PROGRAM *
; *****

```

```

          ORG      P:$40

          MOVE     #0,R0      ;Pointer to data buffer
          MOVE     #2,M0      ;Length of buffer is 3

          MOVEP    #$08,X:PCDDR ;SC0 (PC3) as general
                               ;purpose output.

          MOVEP    #$001F,X:CRA ;Set Word Length=8, CLK=5.12/32
                               ;MHz.
          MOVEP    #$1E30,X:CRB ;Enable transmitter, Mode=On-
                               ;Demand,
                               ;Gated clock on, synchronous mode,
                               ;Word frame sync selected, frame
                               ;sync and clock are internal and
                               ;output to port pins.
          MOVEP    #$1F0,X:PCC  ;Set PCC for SSI and

LOOP0     BSET     #3,X:PCD     ;Set PC3 high (this is example enable
                               ;or strobe for an external device
                               ;such as an ADC).
          MOVEP    X:(R0)+,X:TX ;Move data to TX register

```

Figure 11-84. On-Demand Mode Transmit Example Program (Sheet 1 of 2)



```

TDE1      JCLR      #6,X:SSISR,TDE1      ;Wait for TDE (transmit data register
;empty) to go high.
          MOVEP    X:(R0)+,X:TX          ;Move next data to TX.
TDE2      JCLR      #6,X:SSISR,TDE2      ;Wait for TDE to go high.
          MOVEP    X:(R0)+,X:TX          ;Move data to TX.
TDE3      JCLR      #6,X:SSISR,TDE3      ;Wait for TDE = 1.

FSC       JSET     #5,X:PCD,FSC          ;Wait for frame sync to go low. NOTE:
;State of frame sync is directly
;determined by reading PC5.

          BCLR     #3,X:PCD              ;Set PC3 lo (example external
;enable).

;anything goes here (i.e., any processing)

          REP     #100
          NOP

          JMP     LOOP0                  ;Continue sequence forever.

          END

```

**Figure 11-84. On-Demand Mode Transmit Example Program (Sheet 2 of 2)**

### 11.3.8 Flags

Two SSI pins (SC1 and SC0) are available in the synchronous mode for use as serial I/O flags. The control bits (OF1 and OF0) and status bits (IF1 and IF0) are double buffered to/from SC1 and SC0. Double buffering the flags keeps them in sync with TX and RX. The direction of SC1 and SC0 is controlled by SCD1 and SCD0 in CRB.

Figure 11-86 shows the flag timing for a network mode example. Initially, neither TIE nor TE is set, and the flag outputs are the last flag output value. When TIE is set, a TDE interrupt occurs (the transmitter does not have to be enabled for this interrupt to occur). Data (D1) is written to TX, which clears TDE, and the transmitter is enabled by software. When the frame sync occurs, data (D1) is transferred to the transmit shift register, setting TDE. Data (D1) is shifted out during the first word time, and the output flags are updated. These flags will remain stable until the next frame sync. The TDE interrupt is then serviced by writing data (D2) to TX, clearing TDE. After the TSR completes transmission, the transmit pin is three-stated until the next frame sync.

```

;*****
;          SSI and other I/O EQUATES          *
;*****

```

```

CRA      EQU      $FFEC
CRB      EQU      $FFED
PCC      EQU      $FFE1
PCD      EQU      $FFE5
SSISR    EQU      $FFEE
RX       EQU      $FFF3
PCDDR    EQU      $FFE3

```

```

;*****
;          MAIN PROGRAM          *
;*****

```

```

ORG      P:$40

MOVE     #0,R0          ;Pointer to data buffer
MOVE     #2,M0          ;Length of buffer is 3

MOVEP    #$001F,X:CRA   ;Set Word Length=8, CLK=5.12/32
                        ;MHz.
MOVEP    #$2E00,X:CRB   ;Enable receiver, Mode=On-
                        ;Demand, gated clock on,
                        ;synchronous mode,
                        ;Word frame sync selected, frame
                        ;sync and clock are external.
MOVEP    #$1F0,X:PCC    ;Set PCC for SSI

LOOP

RDF1     JCLR          #7,X:SSISR,RDF1   ;Wait for RDF (receive data register
                        ;Full) to go high.
MOVEP    X:RX,X:(R0)+   ;Read data from RX into memory.

JMP      LOOP           ;Continue sequence forever.

END

```

Figure 11-85. On-Demand Mode Receive Example Program

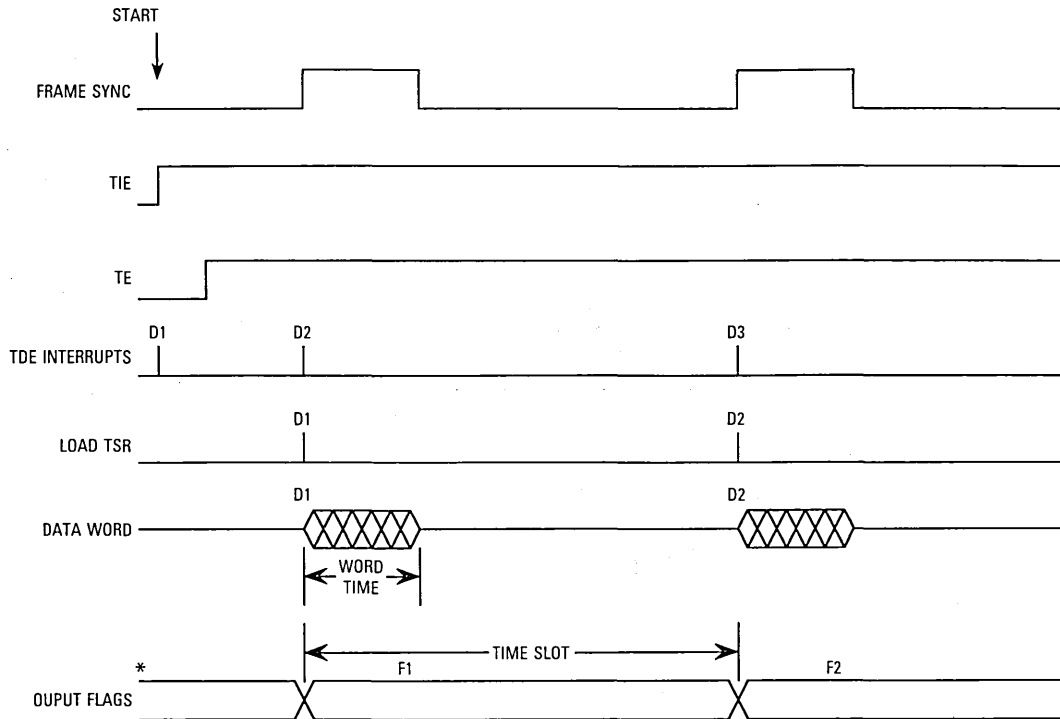

## NOTES:

1.  $F_n$  = flags associated with  $D_n$  data.
2. Output flags are double buffered with transmit data.
3. Output flags change when data is transferred from TX to the transmit data shift register.
4. Initial flag outputs (\*) = last flag output value.
5. Data and flags transition after external frame sync but not before rising edge of clock.

Figure 11-86. Output Flag Timing

Figure 11-87 shows a speaker phone example that uses a DSP56000 and two codecs. No additional logic is required to connect the codecs to the DSP. The two serial output flags in this example (OF1 and OF0) are used as chip selects to enable the appropriate codec for I/O. This procedure allows the transmit lines to be ORed together. The appropriate output flag pin changes at the same time as the first bit of the transmit word and remains stable until the next transmit word (see Figure 11-88). Applications include serial-device chip selects, implementing multidrop protocols, generating Bell PCM signaling frame syncs, and outputting status information.

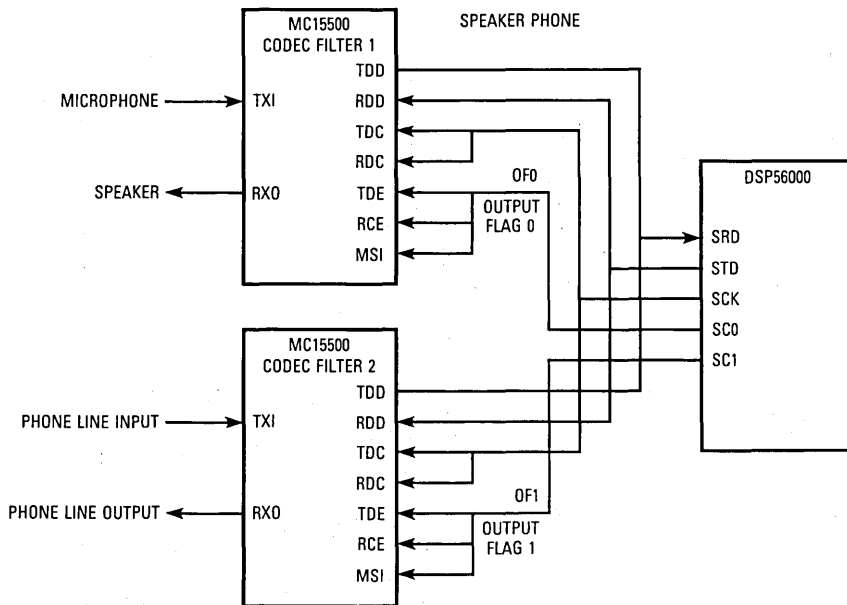

NOTE: SC0 and SC1 are output flag 0 and 1 used to software select either filter 1 or 2.

**Figure 11-87. Output Flag Example**

Initializing the flags (see Figure 11-88) is accomplished by setting SYN, SCD1, and SCD0. No other control bits affect the flags. The synchronous control bit must be set (SYN = 1) to select the SC1 and SC0 pins as flags. SCD1 and SCD0 select whether SC1 and SC0 are inputs or outputs (input = 0, output = 1). The other bits selected in Figure 11-88 are chosen for the speaker phone example in Figure 11-87. In this example, the codecs require that the SSI be set for normal mode (MOD = 0) with a gated clock (GCK = 1) out (SCKD = 1).

Serial input flags, IF1 and IF0, are latched at the same time as the first bit is sampled in the receive data word (see Figure 11-89). Since the input was latched, the signal on the

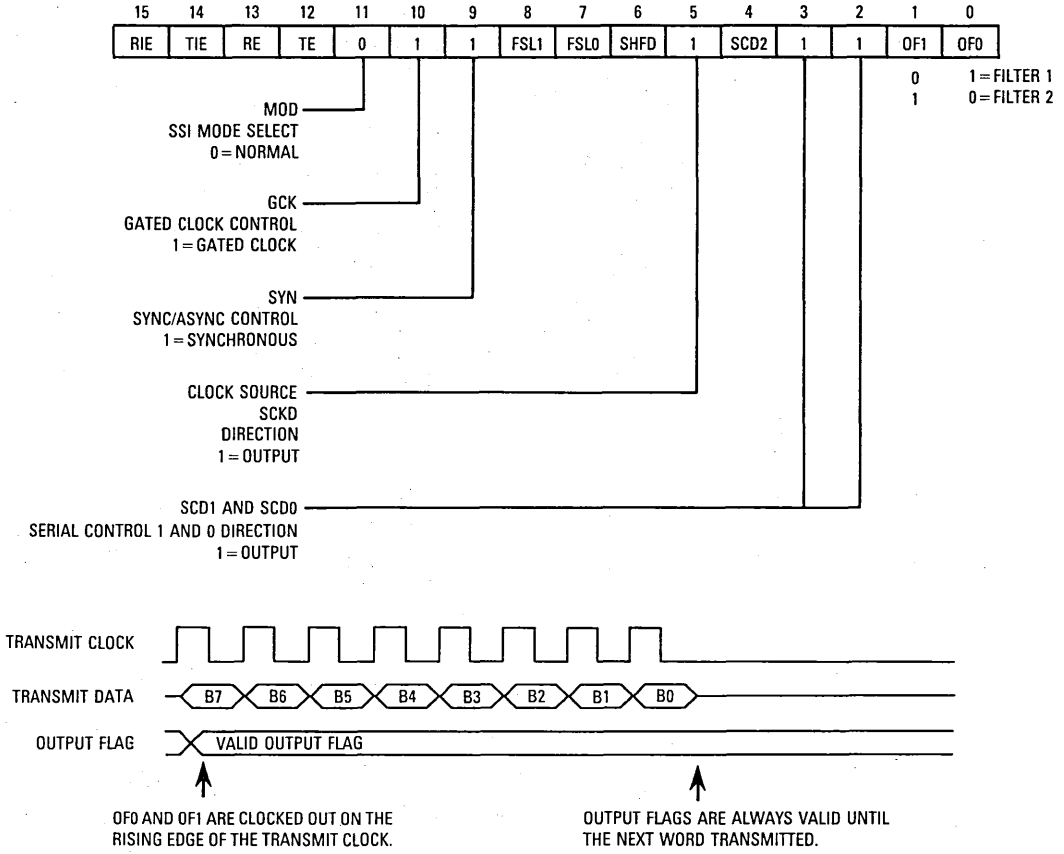
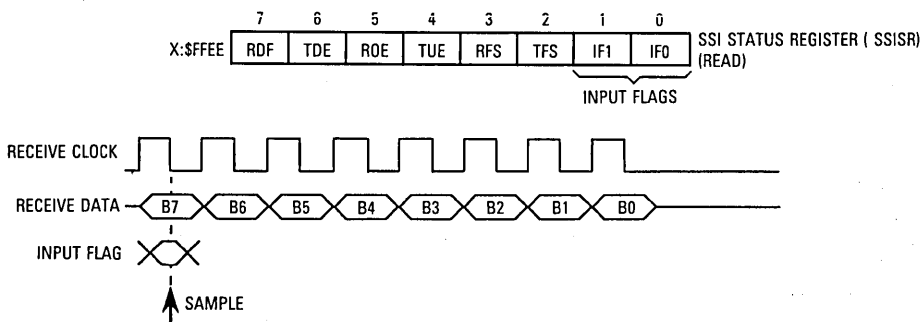

Figure 11-88. Output Flag Initialization

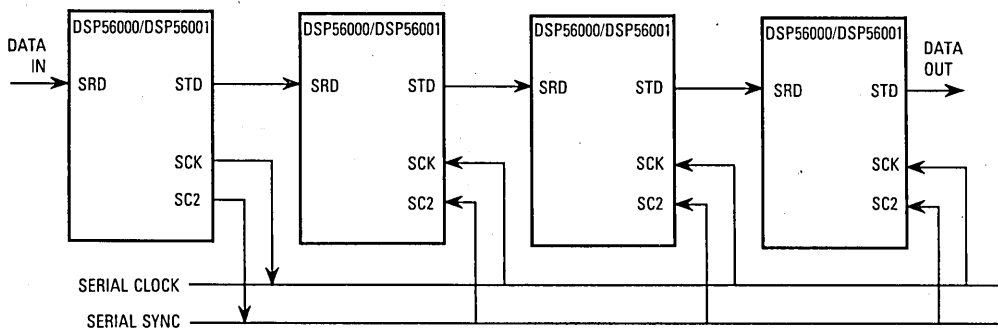

**Figure 11-89. Input Flags**

input flag pin can change without affecting the input flag until the first bit of the next receive data word. To initialize SC1 or SC0 as input flags, the synchronous control bit in CRB must be set to one ( $SYN = 1$ ) and SCD1 set to zero for pin SC1, and SCD0 must be set to zero for pin SC0. The input flags are bits 1 and 0 in the SSISR (at X:\$FFEE).

### 11.3.9 Example Circuits

The DSP-to-DSP serial network shown in Figure 11-90 uses no additional logic chips for the network connection. All serial data is synchronized to the data source (all serial clocks and serial syncs are common). This basic configuration is useful for decimation and data reduction when more processing power is needed than one DSP can provide. Cascading DSPs in this manner is useful in several network topologies including star and ring networks.



**Figure 11-90. SSI Cascaded Multi-DSP System**

TDM networks are useful to reduce the wiring needed for connecting multiple processors. A TDM parallel topology, such as the one shown in Figure 11-91, is useful for interpolating filters. Serial data can be received simultaneously by all DSPs, processing can occur in parallel, and the results are then multiplexed to a single serial data out line. This configuration can be cascaded and/or looped back on itself as needed to fit a particular application (see Figure 11-92). The serial and parallel configurations can be combined to form the array processor shown in Figure 11-93. A nearest neighbor array, which is applicable to matrix relaxation processing, is shown in Figure 11-94. To simplify the drawing, only the center DSP is connected in this illustration. In use, all DSPs would have four three-state buffers connected to their STD pin. The flags (SC0 and SC1) on the control master operate the three-state buffers, which control the direction that data is transferred in the matrix (north, south, east, or west).

The bus architecture shown in Figure 11-95 allows data to be transferred between any two DSPs. However, the bus must be arbitrated by hardware or a software protocol to prevent collisions. The master/slave configuration shown in Figure 11-96 also allows data to be transferred between any two DSPs but simplifies network control.

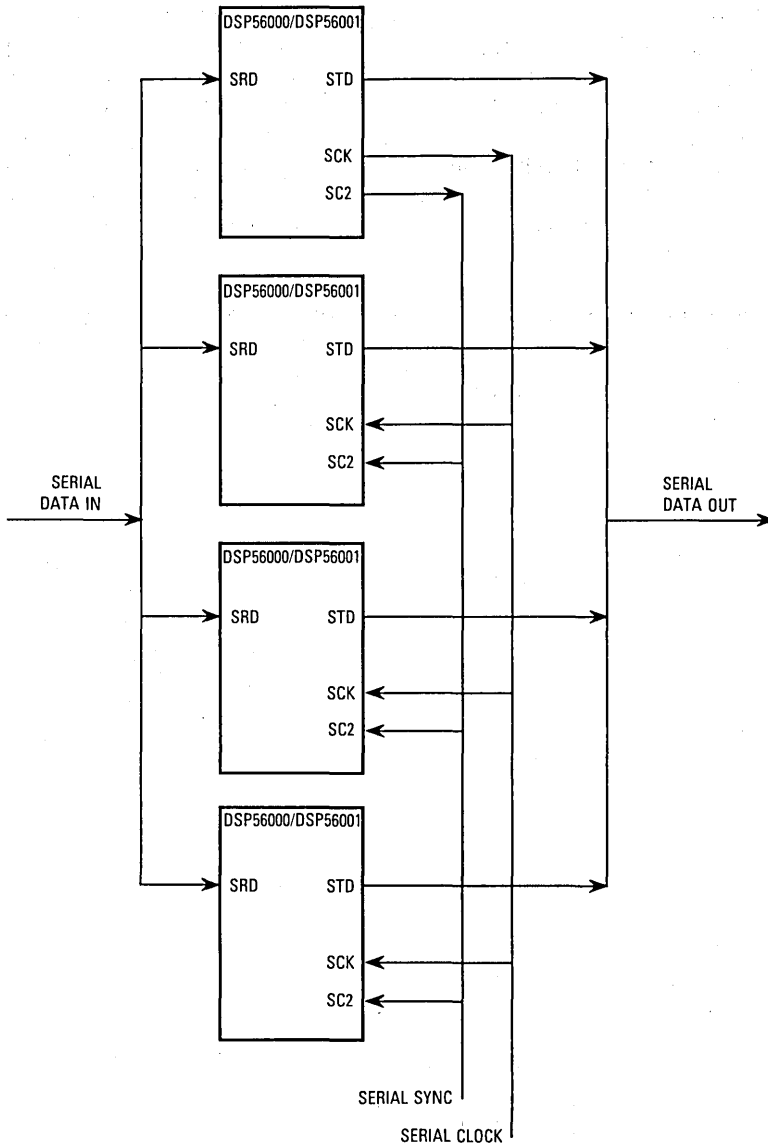

Figure 11-91. SSI TDM Parallel DSP Network



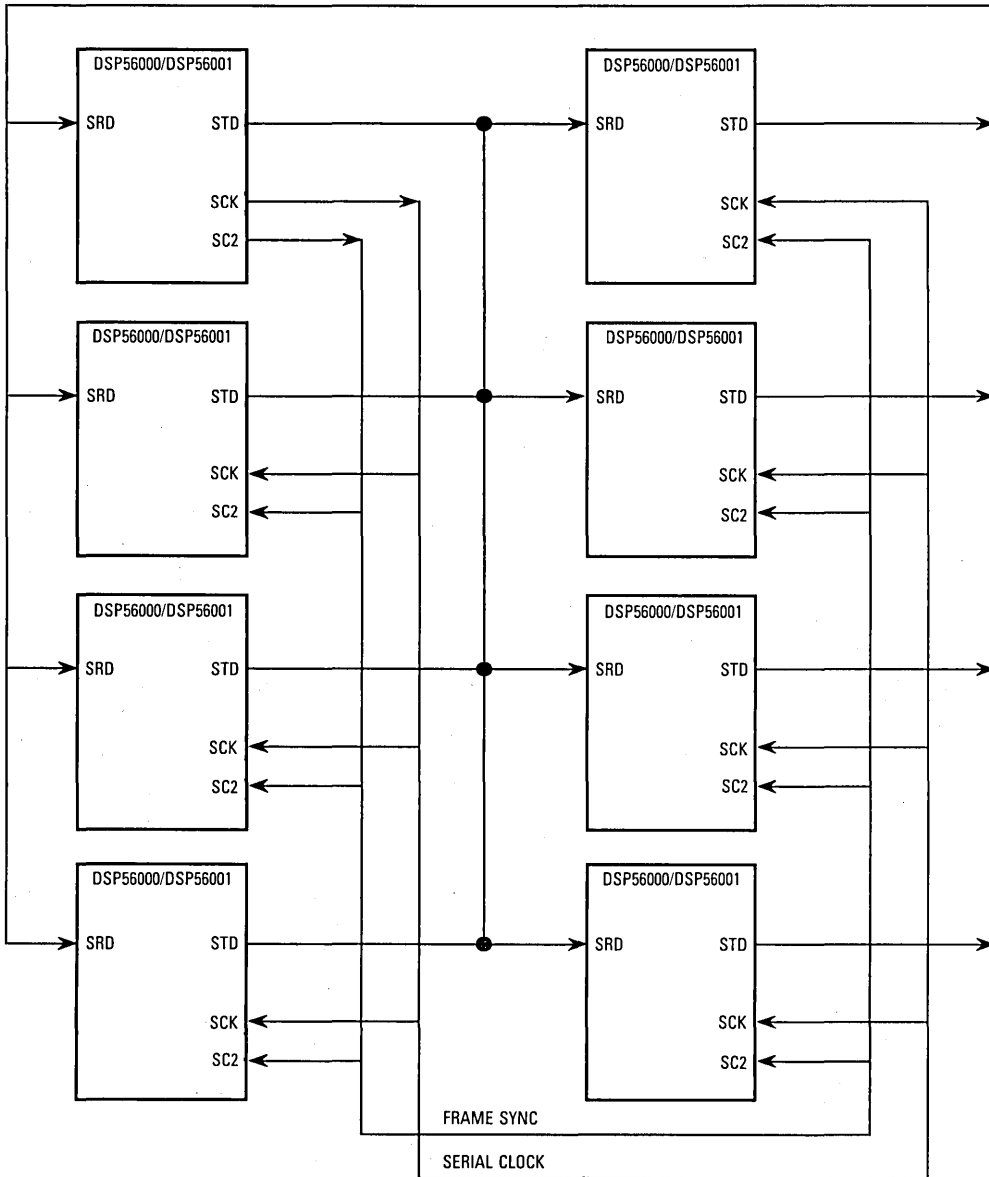
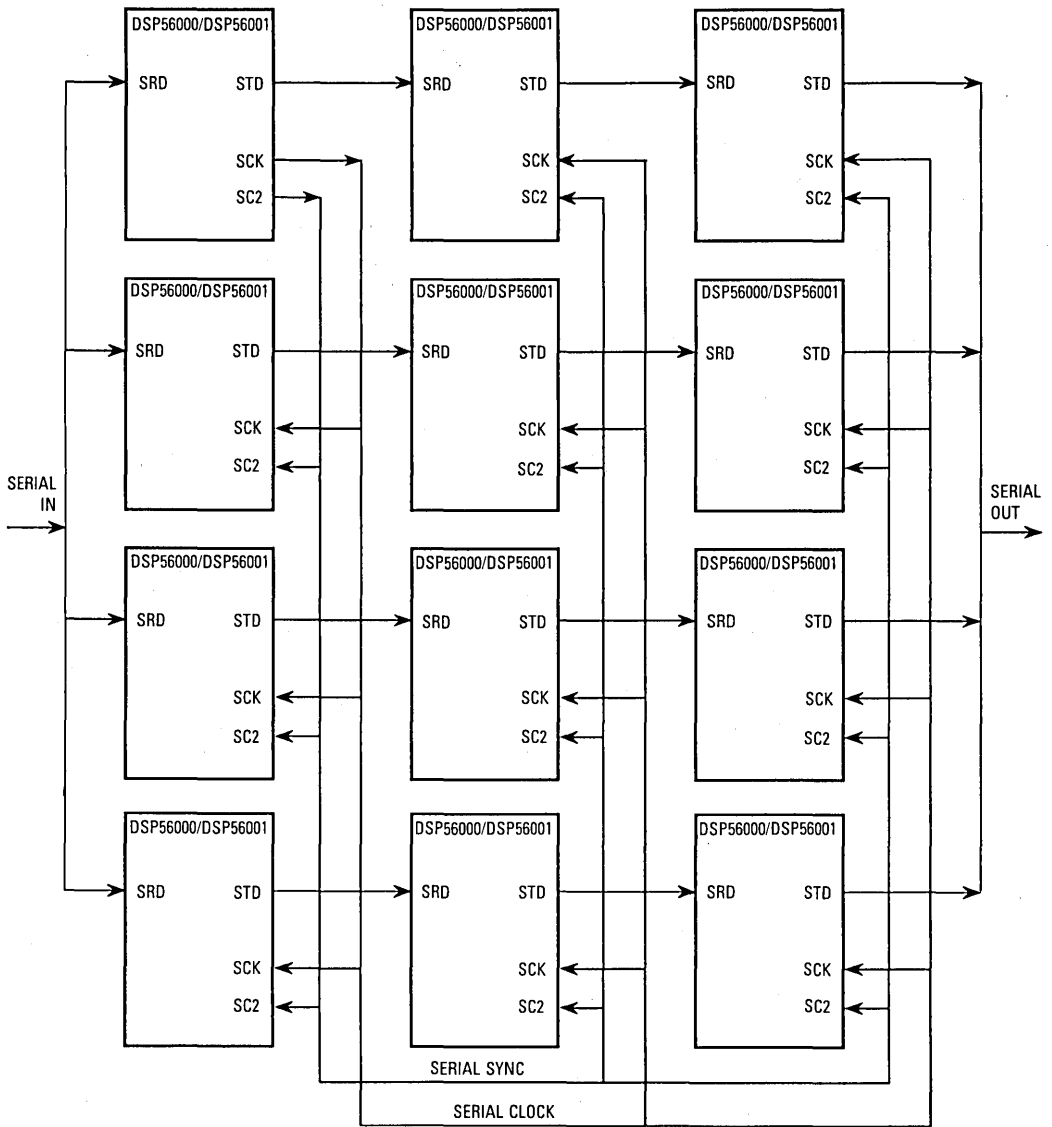

Figure 11-92. SSI TDM Connected Parallel Processing Array



11

Figure 11-93. SSI TDM Serial/Parallel Processing Array

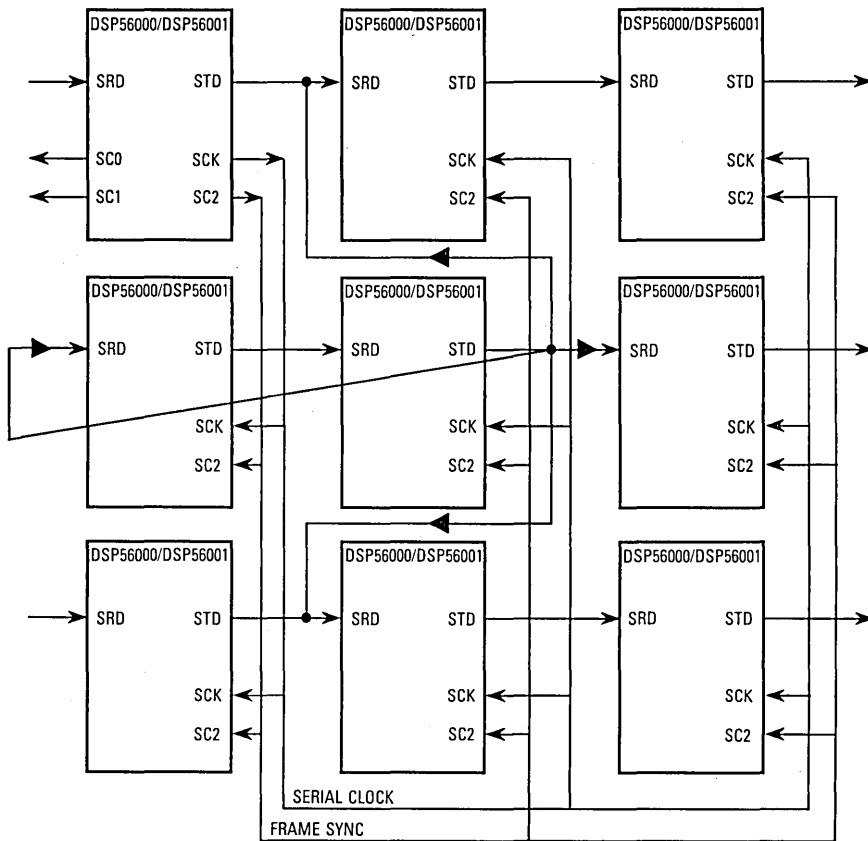
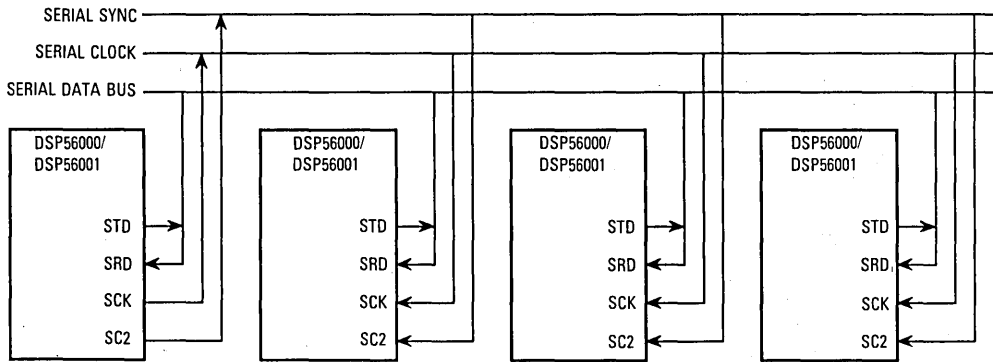
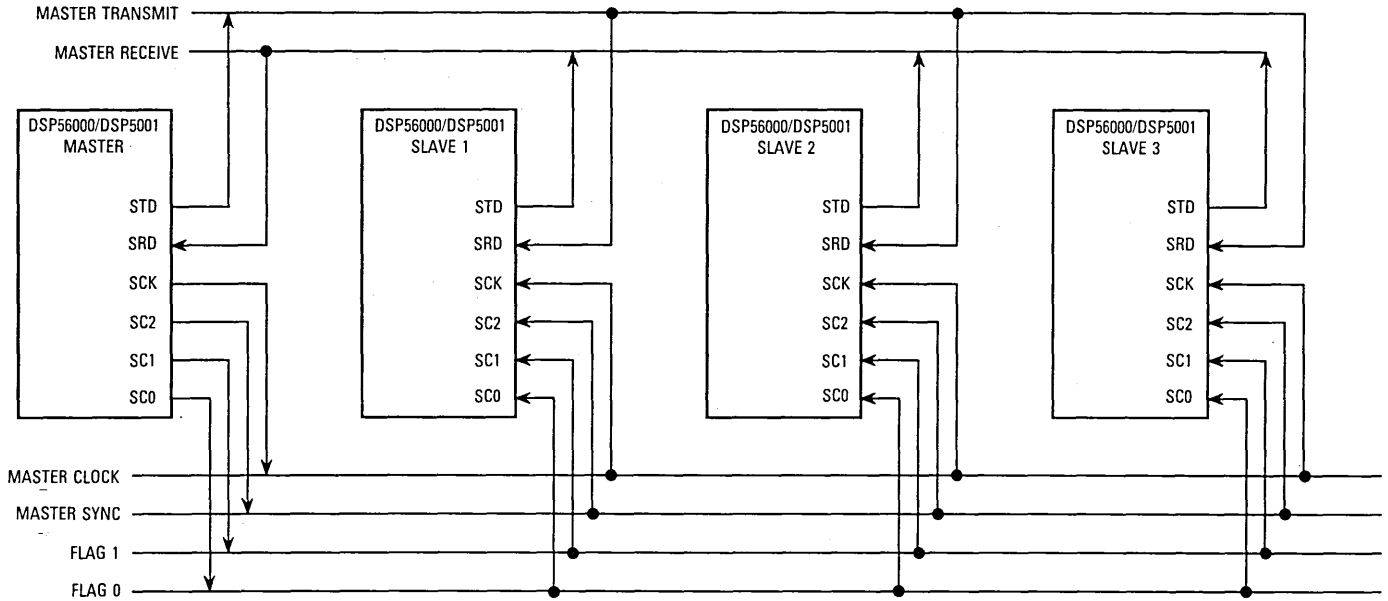

Figure 11-94. SSI Parallel Processing — Nearest Neighbor Array



**Figure 11-95. SSI TDM Bus DSP Network**



NOTE: Flags can specify data types: control, address, and data.

Figure 11-96. SSI TDM Master-Slave DSP Network



## APPENDIX A

### INSTRUCTION SET DETAILS

This appendix contains detailed information about each instruction in the DSP56000/DSP56001 instruction set. An instruction guide is presented first to help understand the individual instruction descriptions. This guide is followed by sections on notation and addressing modes. Since parallel moves are allowed with many of the instructions, they are discussed before the instructions. The instructions are then discussed in alphabetical order.

#### A.1 INSTRUCTION GUIDE

The following information is included in each instruction description with the goal of making each description self-contained:

1. **Name and Mnemonic:** The mnemonic is highlighted in **bold** type for easy reference.
2. **Assembler Syntax and Operation:** For each instruction syntax, the corresponding operation is symbolically described. If there are several operations indicated on a single line in the operation field, those operations do not necessarily occur in the order shown but are generally assumed to occur in parallel. If a parallel data move is allowed, it will be indicated in parenthesis in both the assembler syntax and operation fields. If a letter in the mnemonic is optional, it will be shown in parenthesis in the assembler syntax field.
3. **Description:** A complete text description of the instruction is given together with any special cases and/or condition code anomalies of which the user should be aware when using that instruction.
4. **Example:** An example of the use of the instruction is given. The example is shown in DSP56000/DSP56001 assembler source code format. Most arithmetic and logical instruction examples include one or two parallel data moves to illustrate the many types of parallel moves that are possible. The example includes a complete explanation, which discusses the contents of the registers referenced by the instruction (but not those referenced by the parallel moves) both before and after the execution of the instruction. Most examples are designed to be easily understood without the use of a calculator.
5. **Condition Codes:** The status register is depicted with the condition code bits which can be affected by the instruction highlighted in **bold** type. Not all bits in the status register are used. Those which are reserved are indicated with a double asterisk and are read as zeros.
6. **Instruction Format:** The instruction fields, the instruction opcode, and the instruction extension word are specified for each instruction syntax. When the extension word

A

is optional, it is so indicated. The values which can be assumed by each of the variables in the various instruction fields are shown under the instruction field's heading. Note that the symbols used in decoding the various opcode fields of an instruction are **completely arbitrary**. Furthermore, the opcode symbols used in one instruction are **completely independent** of the opcode symbols used in a different instruction.

7. **Timing:** The number of oscillator clock cycles required for each instruction syntax is given. This information provides the user a basis for comparison of the execution times of the various instructions in oscillator clock cycles. Refer to Table A-1 and **A.7 INSTRUCTION TIMING** for a complete explanation of instruction timing, including the meaning of the symbols "aio", "ap", "ax", "ay", "axy", "ea", "jx", "mv", "mvp", "mvc", "mvm", "mvp", "rx", "wio", "wp", "wx", and "wy".
8. **Memory:** The number of program memory words required for each instruction syntax is given. This information provides the user a basis for comparison of the number of program memory locations required for each of the various instructions in 24-bit program memory words. Refer to Table A-1 and **A.7 INSTRUCTION TIMING** for a complete explanation of instruction memory requirements, including the meaning of the symbols "ea" and "mv".

## A.2 NOTATION

Each instruction description contains symbols used to abbreviate certain operands and operations. Table A-1 lists the symbols used and their respective meanings. Depending on the context, registers refer to either the register itself or the contents of the register.

**Table A-1. Instruction Description Notation**

### Data ALU Registers Operands

|  |   |
|--|---|
| Xn   | Input Register X1 or X0 (24 Bits)                                   |
| Yn   | Input Register Y1 or Y0 (24 Bits)                                   |
| An   | Accumulator Registers A2, A1, A0 (A2 — 8 Bits, A1 and A0 — 24 Bits) |
| Bn   | Accumulator Registers B2, B1, B0 (B2 — 8 Bits, B1 and B0 — 24 Bits) |
| X  | Input Register X = X1:X0 (48 Bits)                                  |
| Y  | Input Register Y = Y1:Y0 (48 Bits)                                  |
| A  | Accumulator A = A2:A1:A0 (56 Bits)*                                 |
| B  | Accumulator B = B2:B1:B0 (56 Bits)*                                 |
| AB   | Accumulators A and B = A1:B1 (48 Bits)*                             |
| BA   | Accumulators B and A = B1:A1 (48 Bits)*                             |
| A10  | Accumulator A = A1:A0 (48 Bits)                                     |
| B10  | Accumulator B = B1:B0 (48 Bits)                                     |
| *NOTE: In data move operations, shifting and limiting are performed when this register is specified as a source operand. When specified as a destination operand, sign extension and possibly zeroing are performed. |   |

A



**Table A-1. Instruction Description Notation (Continued)**

**Address ALU Registers Operands**

|    |  |
|----|--|
| Rn | Address Registers R0–R7 (16 Bits)          |
| Nn | Address Offset Registers N0–N7 (16 Bits)   |
| Mn | Address Modifier Registers M0–M7 (16 Bits) |

**Program Controller Registers Operands**

|     |   |
|-----|---|
| PC  | Program Counter Register (16 Bits)                      |
| MR  | Mode Register (8 Bits)                                  |
| CCR | Condition Code Register (8 Bits)                        |
| SR  | Status Register = MR:CCR (16 Bits)                      |
| OMR | Operating Mode Register (8 Bits)                        |
| LA  | Hardware Loop Address Register (16 Bits)                |
| LC  | Hardware Loop Counter Register (16 Bits)                |
| SP  | System Stack Pointer Register (6 Bits)                  |
| SSH | Upper Portion of the Current Top of the Stack (16 Bits) |
| SSL | Lower Portion of the Current Top of the Stack (16 Bits) |
| SS  | System Stack RAM = SSH:SSL (15 Locations by 32 Bits)    |

**Address Operands**

|       |   |
|-------|---|
| ea    | Effective Address                               |
| eax   | Effective Address for X Bus                     |
| eay   | Effective Address for Y Bus                     |
| xxxx  | Absolute Address (16 Bits)                      |
| xxx   | Short Jump Address (12 Bits)                    |
| aa    | Absolute Short Address (6 Bits, Zero Extended)  |
| pp    | I/O Short Address (6 Bits, Ones Extended)       |
| <...> | Specifies the Contents of the Specified Address |
| X:    | X Memory Reference                              |
| Y:    | Y Memory Reference                              |
| L:    | Long Memory Reference = X:Y                     |
| P:    | Program Memory Reference                        |

**A**

**Table A-1. Instruction Description Notation (Continued)**

**Miscellaneous Operands**

|         |   |
|---------|---|
| S,Sn    | Source Operand Register                 |
| D,Dn    | Destination Operand Register            |
| D[n]    | Bit n of D Destination Operand Register |
| #n      | Immediate Short Data (5 Bits)           |
| #xx     | Immediate Short Data (8 Bits)           |
| #xxx    | Immediate Short Data (12 Bits)          |
| #xxxxxx | Immediate Data (24 Bits)                |

**Unary Operators**

|       |  |
|-------|--|
| -     | Negation Operator  |
| —     | Logical NOT Operator                                     |
| PUSH  | Push Specified Value onto the System Stack (SS) Operator |
| PULL  | Pull Specified Value from the System Stack (SS) Operator |
| READ  | Read the Top of the System Stack (SS) Operator           |
| PURGE | Delete the Top Value on the System Stack (SS) Operator   |
|       | Absolute Value Operator                                  |

**Binary Operators**

|     |                               |
|-----|-------------------------------|
| +   | Addition Operator             |
| -   | Subtraction Operator          |
| *   | Multiplication Operator       |
| ÷ / | Division Operator             |
| +   | Logical Inclusive OR Operator |
| •   | Logical AND Operator          |
| ⊕   | Logical Exclusive OR Operator |
| ↗   | "Is Transferred To" Operator  |
| :   | Concatenation Operator        |

**Addressing Mode Operators**

|    |  |
|----|--|
| << | I/O Short Addressing Mode Force Operator       |
| <  | Short Addressing Mode Force Operator           |
| >  | Long Addressing Mode Force Operator            |
| #  | Immediate Addressing Mode Operator             |
| #> | Immediate Long Addressing Mode Force Operator  |
| #< | Immediate Short Addressing Mode Force Operator |

**Table A-1. Instruction Description Notation (Continued)**

**Mode Register (MR) Symbols**

|       |   |
|-------|---|
| LF    | Loop Flag Bit Indicating When a DO Loop Is in Progress              |
| T     | Trace Mode Bit Indicating If the Tracing Function Has Been Enabled  |
| S1,S0 | Scaling Mode Bits Indicating the Current Scaling Mode               |
| I1,I0 | Interrupt Mask Bits Indicating the Current Interrupt Priority Level |

**Condition Code Register (CCR) Symbols**

Standard Definitions (Table A-3 Describes Exceptions)

|   |  |
|---|--|
| L | Limit Bit Indicating Arithmetic Overflow and/or Data Shifting/Limiting |
| E | Extension Bit Indicating If the Integer Portion of A or B Is in Use    |
| U | Unnormalized Bit Indicating if the A or B Result Is Unnormalized       |
| N | Negative Bit Indicating If Bit 55 of the A or B Result Is Set          |
| Z | Zero Bit Indicating If the A or B Result Equals Zero                   |
| V | Overflow Bit Indicating If Arithmetic Overflow Has Occurred in A or B  |
| C | Carry Bit Indicating If a Carry or Borrow Occurred in A or B Result    |

**Instruction Timing Symbols**

|     |   |
|-----|---|
| aio | Time Required to Access an I/O Operand                          |
| ap  | Time Required to Access a P Memory Operand                      |
| ax  | Time Required to Access an X Memory Operand                     |
| ay  | Time Required to Access a Y Memory Operand                      |
| axy | Time Required to Access XY Memory Operands                      |
| ea  | Time or Number of Words Required for an Effective Address       |
| jx  | Time Required to Execute Part of a Jump-Type Instruction        |
| mv  | Time or Number of Words Required for a Move-Type Operation      |
| mvb | Time Required to Execute Part of a Bit Manipulation Instruction |
| mvc | Time Required to Execute Part of a MOVEC Instruction            |
| mvm | Time Required to Execute Part of a MOVEM Instruction            |
| mvp | Time Required to Execute Part of a MOVEP Instruction            |
| rx  | Time Required to Execute Part of an RTI or RTS Instruction      |
| wio | Number of Wait States Used in Accessing External I/O            |
| wp  | Number of Wait States Used in Accessing External P Memory       |
| wx  | Number of Wait States Used in Accessing External X Memory       |
| wy  | Number of Wait States Used in Accessing External Y Memory       |

**A**

**Table A-1. Instruction Description Notation (Concluded)****Other Symbols**

|           |   |
|-----------|---|
| ( )       | Optional Letter, Operand, or Operation                            |
| (. . . .) | Any Arithmetic or Logical Instruction Which Allows Parallel Moves |
| EXT       | Extension Register Portion of an Accumulator (A2 or B2)           |
| LS        | Least Significant   |
| LSP       | Least Significant Portion of an Accumulator (A0 or B0)            |
| MS        | Most Significant  |
| MSP       | Most Significant Portion of an Accumulator (A1 or B1)             |
| r         | Rounding Constant   |
| S/L       | Shifting and/or Limiting on a Data ALU Register                   |
| Sign Ext  | Sign Extension of a Data ALU Register                             |
| Zero      | Zeroing of a Data ALU Register                                    |

**A.3 ADDRESSING MODES**

The addressing modes are grouped into three categories — register direct, address register indirect, and special. These addressing modes are summarized in Table A-2. All address calculations are performed in the address ALU to minimize execution time and loop overhead. Addressing modes, which specify whether the operands are in registers, in memory, or in the instruction itself (such as immediate data), provide the specific address of the operands.

The register direct addressing mode can be subclassified according to the specific register addressed. The data registers include X1, X0, Y1, Y0, X, Y, A2, A1, A0, B2, B1, B0, A, and B. The control registers include SR, OMR, SP, SSH, SSL, LA, LC, CCR, and MR.

Address register indirect modes use an address register  $R_n$  (R0–R7) to point to locations in X, Y, and P memory. The contents of the  $R_n$  address register ( $R_n$ ) is the effective address (ea) of the specified operand, except in the “indexed by offset” mode where the effective address (ea) is  $(R_n + N_n)$ . Address register indirect modes use an address modifier register  $M_n$  to specify the type of arithmetic to be used to update the address register  $R_n$ . If an addressing mode specifies an address offset register  $N_n$ , the given address offset register is used to update the corresponding address register  $R_n$ . The  $R_n$  address register may only use the corresponding address offset register  $N_n$  and the corresponding address modifier register  $M_n$ . For example, the address register R0 may only use the N0 address offset register and the M0 address modifier register during actual address computation and address register update operations. This unique implementation is extremely powerful and allows the user to easily address a wide variety of DSP-oriented data structures. All address register indirect modes use at least one set of address registers ( $R_n$ ,  $N_n$ , and  $M_n$ ), and the XY memory reference uses two sets of address registers, one for the X memory space and one for the Y memory space.

**A**

**Table A-2. DSP56000/DSP56001 Addressing Modes**

| Addressing Mode  | Uses Mn Modifier | Operand Reference |   |   |   |  |   |   |   |    |  |
|--|------------------|-------------------|---|---|---|--|---|---|---|----|--|
|  |                  | S                 | C | D | A | P  | X | Y | L | XY |  |
| <b>Register Direct</b>   |                  |                   |   |   |   |  |   |   |   |    |  |
| Data or Control Register   | No               | X                 | X | X |   |  |   |   |   |    |  |
| Address Register Rn  | No               |                   |   |   | X |  |   |   |   |    |  |
| Address Modifier Register Mn   | No               |                   |   |   | X |  |   |   |   |    |  |
| Address Offset Register Nn   | No               |                   |   |   | X |  |   |   |   |    |  |
| <b>Address Register Indirect</b>   |                  |                   |   |   |   |  |   |   |   |    |  |
| No Update  | Yes              |                   |   |   |   | X  | X | X | X | X  |  |
| Postincrement by 1   | Yes              |                   |   |   |   | X  | X | X | X | X  |  |
| Postdecrement by 1   | Yes              |                   |   |   |   | X  | X | X | X | X  |  |
| Postincrement by Offset Nn   | Yes              |                   |   |   |   | X  | X | X | X | X  |  |
| Postdecrement by Offset Nn   | Yes              |                   |   |   |   | X  | X | X | X |    |  |
| Indexed by Offset Nn   | Yes              |                   |   |   |   | X  | X | X | X |    |  |
| Predecrement by 1  | Yes              |                   |   |   |   | X  | X | X | X |    |  |
| <b>Special</b>   |                  |                   |   |   |   |  |   |   |   |    |  |
| Immediate Data   | No               |                   |   |   |   | X  |   |   |   |    |  |
| Absolute Address   | No               |                   |   |   |   | X  | X | X | X |    |  |
| Immediate Short Data   | No               |                   |   |   |   | X  |   |   |   |    |  |
| Short Jump Address   | No               |                   |   |   |   | X  |   |   |   |    |  |
| Absolute Short Address   | No               |                   |   |   |   | X  | X | X | X |    |  |
| I/O Short Address  | No               |                   |   |   |   |  | X | X |   |    |  |
| Implicit   | No               | X                 | X |   |   | X  |   |   |   |    |  |
| NOTE: S = System Stack Reference<br>C = Program Controller Register Reference<br>D = Data ALU Register Reference<br>A = Address ALU Register Reference<br>P = Program Memory Reference |                  |                   |   |   |   | X = X Memory Reference<br>Y = Y Memory Reference<br>L = L Memory Reference<br>XY = XY Memory Reference |   |   |   |    |  |

The special addressing modes include immediate and absolute addressing modes as well as implied references to the program counter (PC), the system stack (SSH or SSL), and program (P) memory.



Addressing modes may also be categorized by the ways in which they may be used. Table A-3 shows the various categories to which each addressing mode belongs. The following classifications will be used in the instruction descriptions.

These addressing mode categories may be combined so that additional, more restrictive classifications may be defined. For example, the instruction descriptions may use a **memory alterable** classification, which refers to addressing modes that are **both** memory addressing modes **and** alterable addressing modes. Thus, memory alterable addressing modes use address register indirect and absolute addressing modes.

**Table A-3. DSP56000/DSP56001 Addressing Mode Encoding**

| Addressing Mode                  | Mode<br>MMM | Reg<br>RRR | Addressing<br>Categories |   |   |   | Assembler<br>Syntax |
|----------------------------------|-------------|------------|--------------------------|---|---|---|---------------------|
|                                  |             |            | U                        | P | M | A |                     |
| <b>Register Direct</b>           |             |            |                          |   |   |   |                     |
| Data or Control Register         | —           | —          |                          |   |   | X | (See<br>Table A-1)  |
| Address Register                 | —           | —          |                          |   |   | X | Rn                  |
| Address Offset Register          | —           | —          |                          |   |   | X | Nn                  |
| Address Modifier Register        | —           | —          |                          |   |   | X | Mn                  |
| <b>Address Register Indirect</b> |             |            |                          |   |   |   |                     |
| No Update                        | 100         | Rn         |                          | X | X | X | (Rn)                |
| Postincrement by 1               | 011         | Rn         | X                        | X | X | X | (Rn) +              |
| Postdecrement by 1               | 010         | Rn         | X                        | X | X | X | (Rn) -              |
| Postincrement by Offset Nn       | 001         | Rn         | X                        | X | X | X | (Rn) + Nn           |
| Postdecrement by Offset Nn       | 000         | Rn         | X                        |   | X | X | (Rn) - Nn           |
| Indexed by Offset Nn             | 101         | Rn         |                          |   | X | X | (Rn + Nn)           |
| Predecrement by 1                | 111         | Rn         |                          |   | X | X | -(Rn)               |
| <b>Special</b>                   |             |            |                          |   |   |   |                     |
| Immediate Data                   | 110         | 100        |                          |   | X |   | #xxxxxx             |
| Absolute Address                 | 110         | 000        |                          |   | X | X | xxxx                |
| Immediate Short Data             | —           | —          |                          |   |   |   | #xx                 |
| Short Jump Address               | —           | —          |                          |   |   | X | xxx                 |
| Absolute Short Address           | —           | —          |                          |   |   | X | aa                  |
| I/O Short Address                | —           | —          |                          |   |   | X | pp                  |
| Implicit                         | —           | —          |                          |   |   | X |                     |

- Update Mode (U)** The update addressing mode is used to modify address registers without any associated data move.
- Parallel Mode (P)** The parallel addressing mode is used in instructions where two effective addresses are required.
- Memory Mode (M)** The memory addressing mode is used to refer to operands in memory using an effective addressing field.
- Alterable Mode (A)** The alterable addressing mode is used to refer to alterable or writable registers or memory.

The address register indirect addressing modes require that the offset register number be the same as the address register number. However, future family members may allow the offset register number to be different from the address register number. The assembler syntax "Nn" supports the future feature. The assembler syntax "N" may be used instead of "Nn" in the address register indirect memory addressing modes. If "N" is specified, the offset register number is the same as the address register number.

### A.3.1 Addressing Mode Modifiers

The addressing mode selected in the instruction word is further specified by the contents of the address modifier register Mn. The addressing mode update modifiers (M0–M7) are

shown in Table A-4. There are no restrictions on the use of modifier types with any **address register indirect** addressing mode.

**Table A-4. Addressing Mode Modifier Summary**

| 16-Bit Modifier Reg. (M0-M7)<br>MMMMMMMMMMMMMMMMMM* | Address Calculation Arithmetic |
|---|--------------------------------|
| 0000000000000000                                    | Reverse Carry (Bit Reversed)   |
| 0000000000000001                                    | Modulo 2                       |
| 0000000000000010                                    | Modulo 3                       |
| .   | .                              |
| .   | .                              |
| 0111111111111110                                    | Modulo 32767                   |
| 0111111111111111                                    | Modulo 32768                   |
| 1000000000000000                                    | Undefined                      |
| .   | .                              |
| 1111111111111110                                    | Undefined                      |
| 1111111111111111                                    | Linear (Modulo 65536)          |

\*MMMMMMMMMMMMMMMMMM = 16-Bit Modifier Reg. Contents

#### A.4 CONDITION CODE COMPUTATION

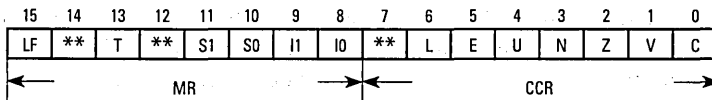

The condition code register (CCR) portion of the status register (SR) consists of seven defined bits:

- L — Limit Bit
- E — Extension Bit
- U — Unnormalized Bit
- N — Negative Bit
- Z — Zero Bit
- V — Overflow Bit
- C — Carry Bit

The E, U, N, Z, V, and C bits are **true** condition code bits that reflect the condition of the **result of a data ALU operation**. These condition code bits are **not latched** and are **not affected by address ALU calculations or by data transfers** over the X, Y, or global data buses. The L bit is a **latching overflow bit** which indicates that an overflow has occurred in the data ALU or that data limiting has occurred when moving the contents of the A and/or B accumulators.

The **standard definition of the condition code bits is as follows**. Exceptions to these standard definitions are given in Table A-5.



L (Limit Bit)

Set if the overflow bit V is set or if the data shifter/limiters perform a limiting operation. Not affected otherwise. This bit is **latched** and must be reset by the user.

E (Extension Bit)

Cleared if **all** the bits of the **signed integer portion** of the A or B result are the **same** — i.e., the bit patterns are either 00 . . . 00 or 11 . . . 11. Set otherwise. The signed integer portion is defined by the scaling mode as shown in the following table:

| S1 | S0 | Scaling Mode | Signed Integer Portion    |
|----|----|--------------|---------------------------|
| 0  | 0  | No Scaling   | Bits 55, 54, . . . 48, 47 |
| 0  | 1  | Scale Down   | Bits 55, 54, . . . 49, 48 |
| 1  | 0  | Scale Up     | Bits 55, 54, . . . 47, 46 |

Note that the **signed integer portion** of an accumulator **IS NOT** necessarily the same as the **extension register portion** of that accumulator. The signed integer portion of an accumulator consists of the MS 8, 9, or 10 bits of that accumulator, depending on the scaling mode being used. The extension register portion of an accumulator (A2 or B2) is **always** the MS 8 bits of that accumulator. **The E bit refers to the signed integer portion of an accumulator and NOT the extension register portion of that accumulator.** For example, if the current scaling mode is set for **no scaling** (i.e., S1 = S0 = 0), the signed integer portion of the A or B accumulator consists of **bits 47 through 55**. If the A accumulator contained the signed 56-bit value \$00:800000:000000 as a **result of a data ALU operation**, the E bit **would** be set (E = 1) since the **9 MS bits** of that accumulator were **not** all the same (i.e., neither 00 . . . 00 nor 11 . . . 11). This means that data limiting **will** occur if that 56-bit value is specified as a **source** operand in a move-type operation. This limiting operation will result in either a positive or negative, 24-bit or 48-bit saturation constant being stored in the specified destination. The **only** situation in which the signed integer portion of an accumulator and the extension register portion of an accumulator are the same is in the "Scale Down" scaling mode (i.e., S1 = 0 and S0 = 1).

U (Unnormalized Bit)

Set if the two MS bits of the MSP portion of the A or B result are the same. Cleared otherwise. The MSP portion is defined by the scaling mode. The U bit is computed as follows:

| S1 | S0 | Scaling Mode | U Bit Computation                            |
|----|----|--------------|--|
| 0  | 0  | No Scaling   | $U = (\text{Bit } 47 \oplus \text{Bit } 46)$ |
| 0  | 1  | Scale Down   | $U = (\text{Bit } 48 \oplus \text{Bit } 47)$ |
| 1  | 0  | Scale Up     | $U = (\text{Bit } 46 \oplus \text{Bit } 45)$ |

N (Negative Bit)

Set if the MS bit 55 of the A or B result is set. Cleared otherwise.

Z (Zero Bit)

Set if the A or B result equals zero. Cleared otherwise.





|                  |  |
|------------------|--|
| V (Overflow Bit) | Set if an arithmetic overflow occurs in the 56-bit A or B result. This indicates that the result cannot be represented in the 56-bit accumulator; thus, the accumulator has overflowed. Cleared otherwise.   |
| C (Carry Bit)    | Set if a carry is generated out of the MS bit of the A or B result of an addition or if a borrow is generated out of the MS bit of the A or B result of a subtraction. The carry or borrow is generated out of bit 55 of the A or B result. Cleared otherwise. |

Table A-5 details how each instruction affects the condition codes. The convention for the notation that is used is shown at the bottom of Table A-5.

## A.5 PARALLEL MOVE DESCRIPTIONS

Many of the instructions in the DSP56000/DSP56001 instruction set allow optional parallel data bus movement. **A.6 INSTRUCTION DESCRIPTIONS** indicates the parallel move option in the instruction syntax with the statement “(parallel move)”. The MOVE instruction is equivalent to a NOP with parallel moves. Therefore, a detailed description of each parallel move is given with the MOVE instruction details in **A.6 INSTRUCTION DESCRIPTIONS**.

## A.6 INSTRUCTION DESCRIPTIONS

The following section describes each instruction in the DSP56000/DSP56001 instruction set in complete detail. The format of each instruction description is given in **A.1 INSTRUCTION GUIDE**. Instructions which allow parallel moves include the notation “(parallel move)” in both the **Assembler Syntax** and the **Operation** fields. The example given with each instruction discusses the contents of all the registers and memory locations referenced by the opcode-operand portion of that instruction but not those referenced by the parallel move portion of that instruction. Refer to **A.5 PARALLEL MOVE DESCRIPTIONS** for a complete discussion of parallel moves, including examples which discuss the contents of all the registers and memory locations referenced by the parallel move portion of an instruction.

Whenever an instruction uses an accumulator as both a destination operand for a data ALU operation and as a source for a parallel move operation, the parallel move operation will use the value in the accumulator **prior** to execution of any data ALU operation.

Whenever a bit in the condition code register is defined according to the **standard** definition given in **A.4 CONDITION CODE COMPUTATION**, a brief definition will be given in **normal** text in the **Condition Code** section of that instruction description. Whenever a bit in the condition code register is defined according to a **special** definition for some particular instruction, the complete special definition of that bit will be given in the **Condition Code** section of that instruction in **bold** text to alert the user to any special conditions concerning its use.

**Table A-5. Condition Code Computations**

| Mnemonic | L | E | U | N | Z | V | C | Notes  | Mnemonic | L | E | U | N | Z | V | C | Notes  |
|----------|---|---|---|---|---|---|---|--------|----------|---|---|---|---|---|---|---|--------|
| ABS      | * | * | * | * | * | * | — |        | MAC      | * | * | * | * | * | * | — |        |
| ADC      | * | * | * | * | * | * | * |        | MACR     | * | * | * | * | * | * | — |        |
| ADD      | * | * | * | * | * | * | * |        | MOVE     | * | — | — | — | — | — | — |        |
| ADDL     | * | * | * | * | * | ? | * | 1      | MOVEC    | ? | ? | ? | ? | ? | ? | ? | 13     |
| ADDR     | * | * | * | * | * | * | * |        | MOVEM    | ? | ? | ? | ? | ? | ? | ? | 13     |
| AND      | * | — | — | ? | ? | 0 | — | 8,9    | MOVEP    | ? | ? | ? | ? | ? | ? | ? | 13     |
| ANDI     | ? | ? | ? | ? | ? | ? | ? | 2      | MPY      | * | * | * | * | * | * | — |        |
| ASL      | * | * | * | * | * | ? | ? | 1,3    | MPYR     | * | * | * | * | * | * | — |        |
| ASR      | * | * | * | * | * | 0 | ? | 4      | NEG      | * | * | * | * | * | * | — |        |
| BCHG     | — | — | — | — | — | — | ? | 5      | NOP      | — | — | — | — | — | — | — |        |
| BCLR     | — | — | — | — | — | — | ? | 5      | NORM     | * | * | * | * | * | ? | — | 1      |
| BSET     | — | — | — | — | — | — | ? | 5      | NOT      | * | — | — | ? | ? | 0 | — | 8,9    |
| BTST     | — | — | — | — | — | — | ? | 5      | OR       | * | — | — | ? | ? | 0 | — | 8,9    |
| CLR      | * | * | * | * | * | 0 | — |        | ORI      | ? | ? | ? | ? | ? | ? | ? | 6      |
| CMP      | * | * | * | * | * | * | * |        | REP      | * | — | — | — | — | — | — |        |
| CMPM     | * | * | * | * | * | * | * |        | RESET    | — | — | — | — | — | — | — |        |
| DIV      | * | — | — | — | — | ? | ? | 1,7    | RND      | * | * | * | * | * | * | — |        |
| DO       | * | — | — | — | — | — | — |        | ROL      | * | — | — | ? | ? | 0 | ? | 8,9,10 |
| ENDDO    | — | — | — | — | — | — | — |        | ROR      | * | — | — | ? | ? | 0 | ? | 8,9,11 |
| EQR      | * | — | — | ? | ? | 0 | — | 8,9    | RTI      | ? | ? | ? | ? | ? | ? | ? | 12     |
| Jcc      | — | — | — | — | — | — | — |        | RTS      | * | — | — | — | — | — | — |        |
| JCLR     | — | — | — | — | — | — | — |        | SBC      | * | * | * | * | * | * | * |        |
| JMP      | — | — | — | — | — | — | — |        | STOP     | — | — | — | — | — | — | — |        |
| JScC     | — | — | — | — | — | — | — |        | SUB      | * | * | * | * | * | * | * |        |
| JSCLR    | — | — | — | — | — | — | — |        | SUBL     | * | * | * | * | * | ? | * | 1      |
| JSET     | — | — | — | — | — | — | — |        | SUBR     | * | * | * | * | * | * | * |        |
| JSR      | — | — | — | — | — | — | — |        | SWI      | — | — | — | — | — | — | — |        |
| JSSET    | — | — | — | — | — | — | — |        | Tcc      | — | — | — | — | — | — | — |        |
| LSL      | * | — | — | ? | ? | 0 | ? | 8,9,10 | TFR      | * | — | — | — | — | — | — |        |
| LSR      | * | — | — | ? | ? | 0 | ? | 8,9,11 | TST      | * | * | * | * | * | 0 | — |        |
| LUA      | — | — | — | — | — | — | — |        | WAIT     | — | — | — | — | — | — | — |        |

where: \* Set according to the **standard** definition of the operation  
 — Not affected by the operation  
 ? Set according to a **special** definition and can be a 0 or 1  
 0 The V bit is cleared

**NOTES:**

- 1 V Set if an arithmetic overflow occurs in the 56-bit result. Also set if the MS bit of the destination operand is changed as a result of the left shift. Cleared otherwise.
- 2 ? Cleared if the corresponding bit in the immediate data is cleared when the operand is the CCR. Not affected otherwise.
- 3 C Set if bit 55 of the source operand is set. Cleared otherwise.
- 4 C Set if bit 0 of the source operand is set. Cleared otherwise.
- 5 C Set of bit #n of the source operand is set. Cleared otherwise.
- 6 ? Set if the corresponding bit in the immediate data is set when the operand is the CCR. Not affected otherwise.

**NOTES:**

- 7 C Set if bit 55 of the result is cleared. Cleared otherwise.
- 8 N Set if bit 47 of the result is set. Cleared otherwise.
- 9 Z Set if bits 47–24 of the result are zero. Cleared otherwise.
- 10 C Set if bit 47 of the source operand is set. Cleared otherwise.
- 11 C Set if bit 24 of the source operand is set. Cleared otherwise.
- 12 ? Set according to the value pulled from the stack.
- 13 ? If the status register (SR) is specified as a destination operand, set according to the corresponding bit of the source operand. If SR is not specified as a destination operand, the L bit is set if data limiting occurred. All ? bits are not affected otherwise.

The definition and thus the computation of both the E (extension) and U (unnormalized) bits of the condition code register (CCR) varies according to the scaling mode being used. Refer to **A.4 CONDITION CODE COMPUTATION** for complete details.

**NOTE**

The signed integer portion of an accumulator **IS NOT** necessarily the same as either the A2 or B2 extension register portion of that accumulator. The signed integer portion of an accumulator is defined according to the scaling mode being used and can consist of the MS 8, 9, or 10 bits of an accumulator. Refer to **A.4 CONDITION CODE COMPUTATION** for complete details.

# ABS

## Absolute Value

# ABS

### Operation:

| D | D (parallel move)

### Assembler Syntax:

ABS D (parallel move)

**Description:** Take the absolute value of the destination operand D and store the result in the destination accumulator.

### Example:

```

:
ABS A #123456,X0 A,Y0 ;take abs. value, set up X0, save value
:

```



**Explanation of Example:** Prior to execution, the 56-bit A accumulator contains the value \$FF:FFFFFF:FFFFFF2. Since this is a negative number, the execution of the ABS instruction takes the twos complement of that value and returns \$00:000000:00000E.

**NOTE:** For the case in which the D operand equals \$80:000000:000000 (-256.0), the ABS instruction will cause an overflow to occur since the result cannot be correctly expressed using the standard 56-bit, fixed-point, twos-complement data representation. Data limiting does not occur (i.e., A is not set to the limiting value of \$7F:FFFFFF:FFFFFF).

### Condition Codes:

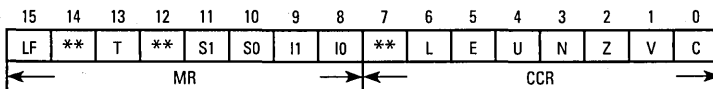

- L — Set if limiting (parallel move) or overflow has occurred in result
- E — Set if the signed integer portion of A or B result is in use
- U — Set if A or B result is unnormalized
- N — Set if bit 55 of A or B result is set
- Z — Set if A or B result equals zero
- V — Set if overflow has occurred in A or B result

**NOTE:** The definition of the E and U bits varies according to the scaling mode being used. Refer to **A.4 CONDITION CODE COMPUTATION** for complete details.



# ABS

Absolute Value

# ABS

**Instruction Format:**

ABS D

**Opcode:**

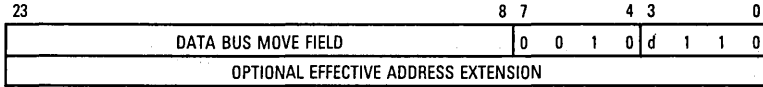

**Instruction Fields:**

D d

A 0

B 1

**Timing:** 2 + mv oscillator clock cycles

**Memory:** 1 + mv program words

# ADC

## Add Long with Carry

# ADC

**Operation:**

S+C+D → D (parallel move)

**Assembler Syntax:**

ADC S,D (parallel move)

**Description:** Add the source operand S and the carry bit C of the condition code register to the destination operand D and store the result in the destination accumulator. Long words (48 bits) may be added to the (56-bit) destination accumulator.

**NOTE:** The carry bit is set correctly for multiple precision arithmetic using long-word operands if the extension register of the destination accumulator (A2 or B2) is the sign extension of bit 47 of the destination accumulator (A or B).

**Example:**

```

:
MOVE L:<$0,X           ;get a 48-bit LS long-word operand in X
MOVE L:<$1,A           ;get other LS long word in A (sign ext.)
MOVE L:<$2,Y           ;get a 48-bit MS long-word operand in Y
ADD X,A L:<$3,B        ;add LS words; get other MS word in B
ADC Y,B A10,L:<$4      ;add MS words with carry, save LS sum.
MOVE B10,L:<$5         ;save MS sum
:

```

|   | Before Execution   |   | After Execution    |
|---|--------------------|---|--------------------|
| A | \$FF:800000:000000 | A | \$FF:000000:000000 |
| X | \$800000:000000    | X | \$800000:000000    |
| B | \$00:000000:000001 | B | \$00:000000:000003 |
| Y | \$000000:000001    | Y | \$000000:000001    |

**Explanation of Example:** This example illustrates long-word double-precision (96-bit) addition using the ADC instruction. Prior to execution of the ADD and ADC instructions, the double-precision 96-bit value \$000000:000001:800000:000000 is loaded into the Y and X registers (Y:X), respectively. The other double-precision 96-bit value \$000000:000001:800000:000000 is loaded into the B and A accumulators (B:A), respectively. Since the 48-bit value loaded into the A accumulator is automatically sign extended to 56 bits and the other 48-bit long-word operand is internally sign extended to 56 bits during instruction execution, the carry bit will be set correctly after the execution of the ADD X,A instruction. The ADC Y,B instruction then produces the correct MS 56-bit result. The actual 96-bit result is stored in memory using the A10 and B10 operands (instead of A and B) because shifting and limiting is not desired.

**A**

# ADC

## Add Long with Carry

# ADC

### Condition Codes:

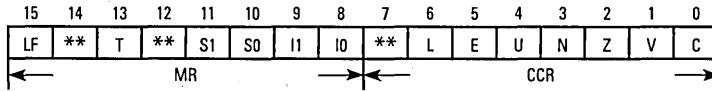

- L — Set if limiting (parallel move) or overflow has occurred in result
- E — Set if the signed integer portion of A or B result is in use
- U — Set if A or B result is unnormalized
- N — Set if bit 55 of A or B result is set
- Z — Set if A or B result equals zero
- V — Set if overflow has occurred in A or B result
- C — Set if a carry (or borrow) occurs from bit 55 of A or B result

**NOTE:** The definition of the E and U bits varies according to the scaling mode being used. Refer to **A.4 CONDITION CODE COMPUTATION** for complete details.

### Instruction Format:

ADC S,D

### Opcode:

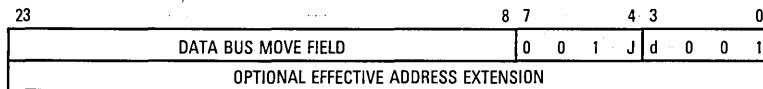

### Instruction Fields:

S,D J d

X,A 00

X,B 01

Y,A 10

Y,B 11

**Timing:** 2 + mv oscillator clock cycles

**Memory:** 1 + mv program words



# ADD

Add

# ADD

**Operation:**

S + D → D (parallel move)

**Assembler Syntax:**

ADD S,D (parallel move)

**Description:** Add the source operand S to the destination operand D and store the result in the destination accumulator. Words (24 bits), long words (48 bits), and accumulators (56 bits) may be added to the destination accumulator.

**NOTE:** The carry bit is set correctly using word or long-word source operands if the extension register of the destination accumulator (A2 or B2) is the sign extension of bit 47 of the destination accumulator (A or B). Thus, the carry bit is **always** set correctly using accumulator source operands, but can be set incorrectly if A1, B1, A10, or B10 are used as source operands and A2 and B2 are not replicas of bit 47.

**Example:**

ADD X0,A,A,X1 A,Y:(R1)+ ;24-bit add, set up X1, save prev. result

|    | Before Execution   | After Execution    |
|----|--------------------|--------------------|
| X0 | \$FFFFFF           | \$FFFFFF           |
| A  | \$00:000100:000000 | \$00:0000FF:000000 |

**Explanation of Example:** Prior to execution, the 24-bit X0 register contains the value \$FFFFFF and the 56-bit A accumulator contains the value \$00:000100:000000. The ADD instruction automatically appends the 24-bit value in the X0 register with 24 LS zeros, sign extends the resulting 48-bit long word to 56 bits, and adds the result to the 56-bit A accumulator. Thus, 24-bit operands are added to the MSP portion of A or B (A1 or B1) because all arithmetic instructions assume a fractional, twos complement data representation. Note that 24-bit operands can be added to the LSP portion of A or B (A0 or B0) by loading the 24-bit operand into X0 or Y0, forming a 48-bit word by loading X1 or Y1 with the sign extension of X0 or Y0 and executing an ADD X,A or ADD Y,A instruction.

A



# ADD

Add

# ADD

## Condition Codes:

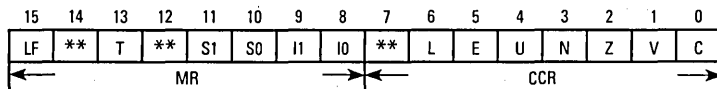

- L — Set if limiting (parallel move) or overflow has occurred in result
- E — Set if the signed integer portion of A or B result in use
- U — Set if A or B result is unnormalized
- N — Set if bit 55 of A or B result is set
- Z — Set if A or B result equals zero
- V — Set if overflow has occurred in A or B result
- C — Set if a carry (or borrow) occurs from bit 55 of A or B result

**NOTE:** The definition of the E and U bits varies according to the scaling mode being used. Refer to **A.4 CONDITION CODE COMPUTATION** for complete details.

## Instruction Format:

ADD S,D

## Opcode:

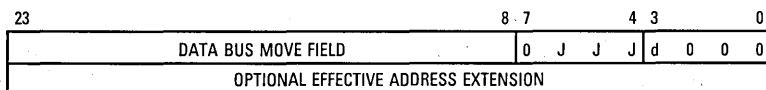

## Instruction Fields:

| S,D | J J J d | S,D  | J J J d | S,D  | J J J d |
|-----|---------|------|---------|------|---------|
| B,A | 0010    | X0,A | 1000    | Y1,A | 1110    |
| A,B | 0011    | X0,B | 1001    | Y1,B | 1111    |
| X,A | 0100    | Y0,A | 1010    |      |         |
| X,B | 0101    | Y0,B | 1011    |      |         |
| Y,A | 0110    | X1,A | 1100    |      |         |
| Y,B | 0111    | X1,B | 1101    |      |         |

**Timing:** 2+ mv oscillator clock cycles

**Memory:** 1+ mv program words



# ADDL

## Shift Left and Add Accumulators

# ADDL

### Operation:

$S + 2 * D \rightarrow D$  (parallel move)

### Assembler Syntax:

ADDL S,D (parallel move)

### Description:

Add the source operand S to two times the destination operand D and store the result in the destination accumulator. The destination operand D is arithmetically shifted one bit to the left, and a zero is shifted into the LS bit of D prior to the addition operation. The carry bit is set correctly if the source operand does not overflow as a result of the left shift operation. The overflow bit may be set as a result of either the shifting or addition operation (or both). This instruction is useful for efficient divide and decimation in time (DIT) FFT algorithms.

### Example:

```
:
ADDL A,B # $0,R0 ;A + 2*B → B, set up addr. reg. R0
:
```

|   | Before Execution   | After Execution    |
|---|--------------------|--------------------|
| A | \$00:000000:000123 | \$00:000000:000123 |
| B | \$00:005000:000000 | \$00:00A000:000123 |

### Explanation of Example:

Prior to execution, the 56-bit accumulator contains the value \$00:000000:000123, and the 56-bit B accumulator contains the value \$00:005000:000000. The ADDL A,B instruction adds two times the value in the B accumulator to the value in the A accumulator and stores the 56-bit result in the B accumulator.

### Condition Codes:

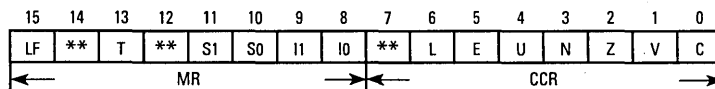

- L — Set if limiting (parallel move) or overflow has occurred in result
- E — Set if the signed integer portion of A or B result is in use
- U — Set if A or B result is unnormalized
- N — Set if bit 55 of A or B result is set
- Z — Set if A or B result equals zero
- V — **Set if overflow has occurred in A or B result or if the MS bit of the destination operand is changed as a result of the instruction's left shift**
- C — Set if a carry (or borrow) occurs from bit 55 of A or B result



# ADDL

## Shift Left and Add Accumulators

# ADDL

**NOTE:** The definition of the E and U bits varies according to the scaling mode being used. Refer to **A.4 CONDITION CODE COMPUTATION** for complete details.

### Instruction Format:

ADDL S,D

### Opcode:

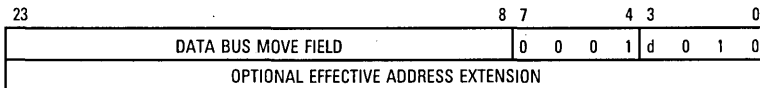

### Instruction Fields:

S,D d

B,A 0

A,B 1

**Timing:** 2 + mv oscillator clock cycles

**Memory:** 1 + mv program words

# ADDR

## Shift Right and Add Accumulators

# ADDR

### Operation:

S + D / 2  $\rightarrow$  D (parallel move)

### Assembler Syntax:

ADDR S,D (parallel move)

**Description:** Add the source operand S to one-half the destination operand D and store the result in the destination accumulator. The destination operand D is arithmetically shifted one bit to the right while the MS bit of D is held constant prior to the addition operation. In contrast to the ADDL instruction, the carry bit is always set correctly, and the overflow bit can only be set by the addition operation and not by an overflow due to the initial shifting operation. This instruction is useful for efficient divide and decimation in time (DIT) FFT algorithms.

### Example:

```

:
ADDR B,A X0,X:(R1)+N1 Y0,Y:(R4)- ;B + A / 2  $\rightarrow$  A, save X0 and Y0
:
```

|   | Before Execution   | After Execution    |
|---|--------------------|--------------------|
| A | \$80:000000:2468AC | \$C0:013570:123456 |
| B | \$00:013570:000000 | \$00:013570:000000 |

**Explanation of Example:** Prior to execution, the 56-bit A accumulator contains the value \$80:000000:2468AC, and the 56-bit B accumulator contains the value \$00:013570:000000. The ADDR B,A instruction adds one-half the value in the A accumulator to the value in the B accumulator and stores the 56-bit result in the A accumulator.

### Condition Codes:

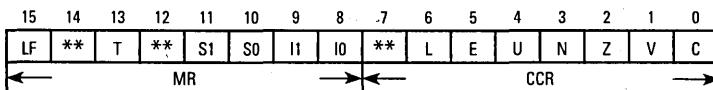

- L — Set if limiting (parallel move) or overflow has occurred in result
- E — Set if the signed integer portion of A or B result is in use
- U — Set if A or B result is unnormalized
- N — Set if bit 55 of A or B result is set
- Z — Set if A or B result equals zero
- V — Set if overflow has occurred in A or B result
- C — Set if a carry (or borrow) occurs from bit 55 of A or B result

# ADDR

## Shift Right and Add Accumulators

# ADDR

**NOTE:** The definition of the E and U bits varies according to the scaling mode being used. Refer to **A.4 CONDITION CODE COMPUTATION** for complete details.

### Instruction Format:

ADDR S,D

### Opcode:

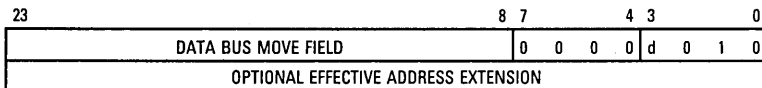

### Instruction Fields:

S,D d

B,A 0

A,B 1

**Timing:** 2 + mv oscillator clock cycles

**Memory:** 1 + mv program words

# AND

## Logical AND

# AND

### Operation:

$S \bullet D[47:24] \rightarrow D[47:24]$  (parallel move)  
 where  $\bullet$  denotes the logical AND operator

### Assembler Syntax:

AND S,D (parallel move)

**Description:** Logically AND the source operand S with bits 47–24 of the destination operand D and store the result in bits 47–24 of the destination accumulator. This instruction is a 24-bit operation. The remaining bits of the destination operand D are not affected.

### Example:

```

:
AND X0,A (R5)–N5 ;AND X0 with A1, update R5 using N5
:

```

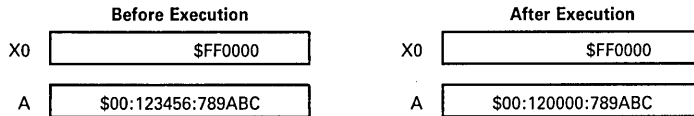

**Explanation of Example:** Prior to execution, the 24-bit X0 register contains the value \$FF0000, and the 56-bit A accumulator contains the value \$00:123456:789ABC. The AND X0,A instruction logically ANDs the 24-bit value in the X0 register with bits 47–24 of the A accumulator (A1) and stores the result in the A accumulator with bits 55–48 and 23–0 unchanged.

### Condition Codes:

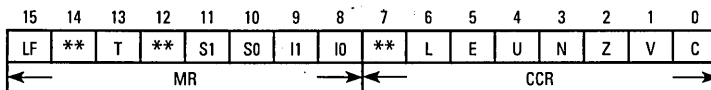

- L — Set if data limiting has occurred during parallel move
- N — Set if bit 47 of A or B result is set
- Z — Set if bits 47–24 of A or B result are zero
- V — Always cleared

### Instruction Format:

AND S,D

# AND

## Logical AND

# AND

Opcode:

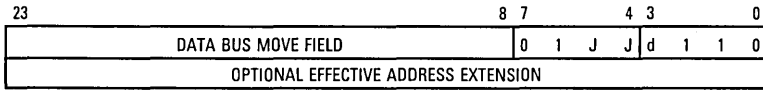

Instruction Fields:

|          |           |          |                        |
|----------|-----------|----------|------------------------|
| <b>S</b> | <b>JJ</b> | <b>D</b> | <b>d</b>               |
| X0       | 00        | A        | 0 (only A1 is changed) |
| X1       | 10        | B        | 1 (only B1 is changed) |
| Y0       | 01        |          |                        |
| Y1       | 11        |          |                        |

**Timing:** 2 + mv oscillator clock cycles

**Memory:** 1 + mv program words

A

# ANDI

## AND Immediate with Control Register

# ANDI

### Operation:

#xx • D ↗ D

where • denotes the logical AND operator

### Assembler Syntax:

AND(I) #xx,D

**Description:** Logically AND the 8-bit immediate operand (#xx) with the contents of the destination control register D and store the result in the destination control register. The condition codes are affected only when the condition code register (CCR) is specified as the destination operand.

**Restrictions:** The ANDI #xx,MR instruction cannot be used **immediately before** an ENDDO or RTI instruction and cannot be one of the **last three** instructions in a DO loop (at LA-2, LA-1, or LA).

The ANDI #xx,CCR instruction cannot be used **immediately before** an RTI instruction.

### Example:

```
:
AND #$FE,CCR           ;clear carry bit C in cond. code register
:
```

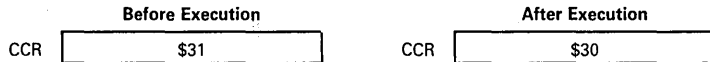

**Explanation of Example:** Prior to execution, the 8-bit condition code register (CCR) contains the value \$31. The AND #\$FE,CCR instruction logically ANDs the immediate 8-bit value \$FE with the contents of the condition code register and stores the result in the condition code register.

### Condition Codes:

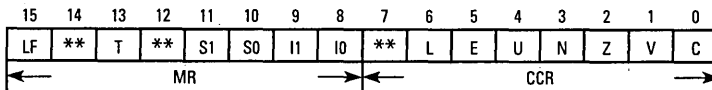

### For CCR Operand:

- L — Cleared if bit 6 of the immediate operand is cleared
- E — Cleared if bit 5 of the immediate operand is cleared
- U — Cleared if bit 4 of the immediate operand is cleared
- N — Cleared if bit 3 of the immediate operand is cleared
- Z — Cleared if bit 2 of the immediate operand is cleared



# ANDI

AND Immediate with Control Register

# ANDI

V — Cleared if bit 1 of the immediate operand is cleared

C — Cleared if bit 0 of the immediate operand is cleared

### For MR and OMR Operands:

The condition codes are not affected using these operands.

### Instruction Format:

AND(I) #xx,D

### Opcode:

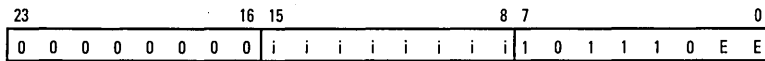

### Instruction Fields:

#xx = 8-bit Immediate Short Data — i i i i i i i i

D    E E

MR   0 0

CCR   0 1

OMR   1 0

**Timing:** 2 oscillator clock cycles

**Memory:** 1 program word

# ASL

## Arithmetic Shift Accumulator Left

# ASL

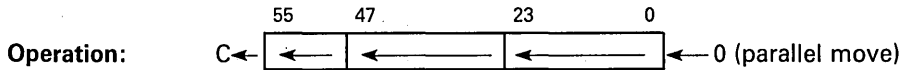

### Assembler

Syntax: ASL D (parallel move)

**Description:** Arithmetically shift the destination operand D one bit to the left and store the result in the destination accumulator. The MS bit of D prior to instruction execution is shifted into the carry bit C and a zero is shifted into the LS bit of the destination accumulator D. If a zero shift count is specified, the carry bit is cleared. The difference between ASL and LSL is that ASL operates on the entire 56 bits of the accumulator and therefore sets the V bit if the number overflowed.

### Example:

```

:
ASL A    (R3) -           ;multiply A by 2, update R3
:

```

|    | Before Execution   | After Execution    |
|----|--------------------|--------------------|
| A  | \$A5:012345:012345 | \$4A:02468A:02468A |
| SR | \$0300             | \$0373             |

**Explanation of Example:** Prior to execution, the 56-bit A accumulator contains the value \$A5:012345:012345. The execution of the ASL A instruction shifts the 56-bit value in the A accumulator one bit to the left and stores the result back in the A accumulator.

### Condition Codes:

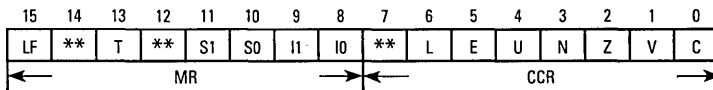

- L — Set if limiting (parallel move) or overflow has occurred in result
- E — Set if the signed integer portion of A or B result is in use
- U — Set if A or B result is unnormalized
- N — Set if bit 55 of A or B result is set
- Z — Set if A or B result equals zero
- V — Set if bit 55 of A or B result is changed due to left shift
- C — Set if bit 55 of A or B was set prior to instruction execution

# ASL

## Arithmetic Shift Accumulator Left

# ASL

**NOTE:** The definition of the E and U bits varies according to the scaling mode being used. Refer to **A.4 CONDITION CODE COMPUTATION** for complete details.

### Instruction Format:

ASL D

### Opcode:

|                                      |   |   |   |   |   |   |   |   |   |
|--------------------------------------|---|---|---|---|---|---|---|---|---|
| 23                                   | 8 | 7 | 4 | 3 | 0 |   |   |   |   |
| DATA BUS MOVE FIELD                  |   | 0 | 0 | 1 | 1 | d | 0 | 1 | 0 |
| OPTIONAL EFFECTIVE ADDRESS EXTENSION |   |   |   |   |   |   |   |   |   |

### Instruction Fields:

D d

A 0

B 1

**Timing:** 2+mv oscillator clock cycles

**Memory:** 1+mv program words

# ASR

## Arithmetic Shift Accumulator Right

# ASR

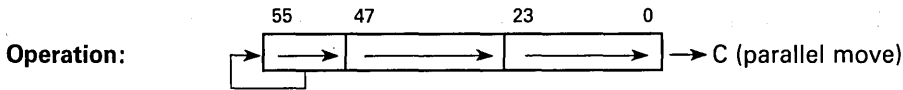

**Assembler**

**Syntax:** ASR D (parallel move)

**Description:** Arithmetically shift the destination operand D one bit to the right and store the result in the destination accumulator. The LS bit of D prior to instruction execution is shifted into the carry bit C, and the MS bit of D is held constant.

**Example:**

```

:
ASR B X: -(R3),R3 ;divide B by 2, update R3, load R3
:

```

|    | Before Execution   | After Execution    |
|----|--------------------|--------------------|
| B  | \$A8:A86420:A86421 | \$D4:543210:543210 |
| SR | \$0300             | \$0329             |

**Explanation of Example:** Prior to execution, the 56-bit B accumulator contains the value \$A8:A86420:A86421. The execution of the ASR B instruction shifts the 56-bit value in the B accumulator one bit to the right and stores the result back in the B accumulator.

**Condition Codes:**

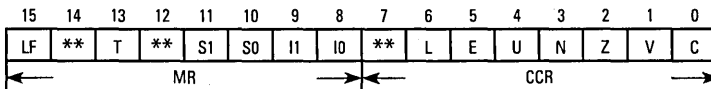

- L — Set if data limiting has occurred during parallel move
- E — Set if the signed integer portion of A or B result is in use
- U — Set if A or B result is unnormalized
- N — Set if bit 55 of A or B result is set
- Z — Set if A or B result equals zero
- V — Always cleared
- C — Set if bit 0 of A or B was set prior to instruction execution

**NOTE:** The definition of the E and U bits varies according to the scaling mode being used. Refer to **A.4 CONDITION CODE COMPUTATION** for complete details.



# ASR

## Arithmetic Shift Accumulator Right

# ASR

### Instruction Format:

ASR D

### Opcode:

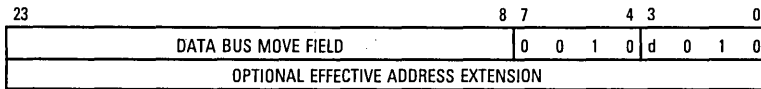

### Instruction Fields:

D d

A 0

B 1

**Timing:** 2 + mv oscillator clock cycles

**Memory:** 1 + mv program words

# BCHG

## Bit Test and Change

# BCHG

### Operation:

$D[n] \rightarrow C;$   
 $\overline{D[n]} \rightarrow D[n]$

$D[n] \rightarrow C;$   
 $\overline{D[n]} \rightarrow D[n]$

$D[n] \rightarrow C;$   
 $\overline{D[n]} \rightarrow D[n]$

$D[n] \rightarrow C;$   
 $\overline{D[n]} \rightarrow D[n]$

$D[n] \rightarrow C;$   
 $\overline{D[n]} \rightarrow D[n]$

$D[n] \rightarrow C;$   
 $\overline{D[n]} \rightarrow D[n]$

$D[n] \rightarrow C;$   
 $\overline{D[n]} \rightarrow D[n]$

### Assembler Syntax:

BCHG #n,X:ea

BCHG #n,X:aa

BCHG #n,X:pp

BCHG #n,Y:ea

BCHG #n,Y:aa

BCHG #n,Y:pp

BCHG #n,D

**Description:** Test the  $n^{\text{th}}$  bit of the destination operand D, complement it, and store the result in the destination location. The state of the  $n^{\text{th}}$  bit is stored in the carry bit C of the condition code register. After the test, the  $n^{\text{th}}$  bit of the destination location is complemented. The bit to be tested is selected by an immediate bit number from 0–23. This instruction performs a read-modify-write operation on the destination location using two destination accesses before releasing the bus. This instruction provides a test-and-change capability which is useful for synchronizing multiple processors using a shared memory. This instruction can use all memory alterable addressing modes.

### Example:

```

:
: BCHG #7,X:<<$FFE2 ;test and change bit 7 in I/O Port B DDR
:

```

|          | Before Execution |          | After Execution |
|----------|------------------|----------|-----------------|
| X:\$FFE2 | \$000000         | X:\$FFE2 | \$000080        |
| SR       | \$0300           | SR       | \$0300          |

**A**

# BCHG

## Bit Test and Change

# BCHG

**Explanation of Example:** Prior to execution, the 24-bit X memory location X:\$FFE2 (I/O port B data direction register) contains the value \$000000. The execution of the BCHG #7,X:<<\$FFE2 instruction tests the state of the 7<sup>th</sup> bit in X:\$FFE2, sets the carry bit C accordingly, and then complements the 7<sup>th</sup> bit in X:\$FFE2.

### Condition Codes:

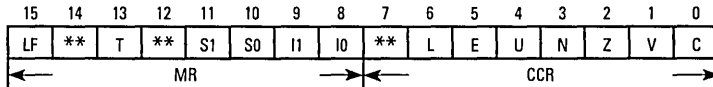

### CCR Condition Codes:

For destination operand SR:

- C — Changed if bit 0 is specified. Not affected otherwise.
- V — Changed if bit 1 is specified. Not affected otherwise.
- Z — Changed if bit 2 is specified. Not affected otherwise.
- N — Changed if bit 3 is specified. Not affected otherwise.
- U — Changed if bit 4 is specified. Not affected otherwise.
- E — Changed if bit 5 is specified. Not affected otherwise.
- L — Changed if bit 6 is specified. Not affected otherwise.

For other destination operands:

- C — Set if bit tested is set. Cleared otherwise.
- V — Not affected
- Z — Not affected
- N — Not affected
- U — Not affected
- E — Not affected
- L — Not affected

### MR Status Bits:

For destination operand SR:

- I0 — Changed if bit 8 is specified. Not affected otherwise.
- I1 — Changed if bit 9 is specified. Not affected otherwise.
- S0 — Changed if bit 10 is specified. Not affected otherwise.
- S1 — Changed if bit 11 is specified. Not affected otherwise.
- T — Changed if bit 13 is specified. Not affected otherwise.
- F — Changed if bit 15 is specified. Not affected otherwise.

# BCHG

## Bit Test and Change

# BCHG

For other destination operands:

- I0 — Not affected
- I1 — Not affected
- S0 — Not affected
- S1 — Not affected
- T — Not affected
- LF — Not affected

### Instruction Format:

BCHG #n,X:ea  
 BCHG #n,Y:ea

### Opcode:

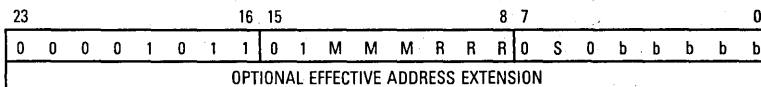

### Instruction Fields:

#n = bit number = bbbbb,  
 ea = 6-bit Effective Address = MMMRRR

| Effective Addressing Mode | MMMRRR      | Memory Space S | Bit Number bbbbb |
|---------------------------|-------------|----------------|------------------|
| (Rn) - Nn                 | 0 0 0 r r r | X Memory 0     | 00000            |
| (Rn) + Nn                 | 0 0 1 r r r | Y Memory 1     | .                |
| (Rn) -                    | 0 1 0 r r r |                | .                |
| (Rn) +                    | 0 1 1 r r r |                | .                |
| (Rn)                      | 1 0 0 r r r |                | 10111            |
| (Rn + Nn)                 | 1 0 1 r r r |                |                  |
| -(Rn)                     | 1 1 1 r r r |                |                  |
| Absolute address          | 1 1 0 0 0 0 |                |                  |

where "rrr" refers to an address register R0-R7

**Timing:** 4 + mvb oscillator clock cycles

**Memory:** 1 + ea program words

**A**



# BCHG

## Bit Test and Change

# BCHG

### Instruction Format:

BCHG #n,X:aa

BCHG #n,Y:aa

### Opcode:

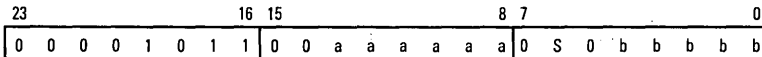

### Instruction Fields:

#n = bit number = bbbbb,

aa = 6-bit Absolute Short Address = aaaaaa

| Absolute Short Address aaaaaa | Memory Space S | Bit Number bbbbb |
|-------------------------------|----------------|------------------|
| 000000                        | X Memory 0     | 00000            |
| .                             | Y Memory 1     | .                |
| .                             |                | 10111            |
| 111111                        |                |                  |

**Timing:** 4 + mvb oscillator clock cycles

**Memory:** 1 + ea program words

### Instruction Format:

BCHG #n,X:pp

BCHG #n,Y:pp

### Opcode:

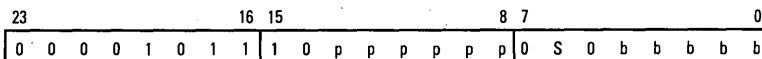

### Instruction Fields:

#n = bit number = bbbbb,

pp = 6-bit I/O Short Address = pppppp

| I/O Short Address pppppp | Memory Space S | Bit Number bbbbb |
|--------------------------|----------------|------------------|
| 000000                   | X Memory 0     | 00000            |
| .                        | Y Memory 1     | .                |
| .                        |                | 10111            |
| 111111                   |                |                  |

**Timing:** 4 + mvb oscillator clock cycles

**Memory:** 1 + ea program words



**Instruction Format:**

BCHG #n,D

**Opcode:**

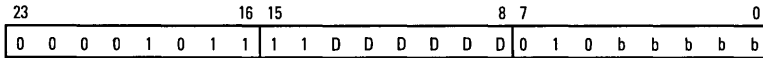

**Instruction Fields:**

#n = bit number = bbbbbb,

D = destination register = DDDDDD,

xxxx = 16-bit Absolute Address in extension word

| Destination Register                | D D D D D D | Bit Number bbbbbb |
|-------------------------------------|-------------|-------------------|
| 4 registers in Data ALU             | 0 0 0 1 D D | 00000             |
| 8 accumulators in Data ALU          | 0 0 1 D D D | .                 |
| 8 address registers in AGU          | 0 1 0 T T T | 10111             |
| 8 address offset registers in AGU   | 0 1 1 N N N |                   |
| 8 address modifier registers in AGU | 1 0 0 F F F |                   |
| 8 program controller registers      | 1 1 1 G G G |                   |

See **A.9 INSTRUCTION ENCODING** and Table A-18 for specific register encodings.

**Timing:** 4 + mvb oscillator clock cycles

**Memory:** 1 + ea program words

# BCLR

## Bit Test and Clear

# BCLR

### Operation:

D[n]  $\rightarrow$  C;  
0  $\rightarrow$  D[n]

D[n]  $\rightarrow$  C;  
0  $\rightarrow$  D[n]

D[n]  $\rightarrow$  C;  
0  $\rightarrow$  D[n]

D[n]  $\rightarrow$  C;  
0  $\rightarrow$  D[n]

D[n]  $\rightarrow$  C;  
0  $\rightarrow$  D[n]

D[n]  $\rightarrow$  C;  
0  $\rightarrow$  D[n]

D[n]  $\rightarrow$  C;  
0  $\rightarrow$  D[n]

### Assembler Syntax:

BCLR #n,X:ea

BCLR #n,X:aa

BCLR #n,X:pp

BCLR #n,Y:ea

BCLR #n,Y:aa

BCLR #n,Y:pp

BCLR #n,D

**Description:** Test the  $n^{\text{th}}$  bit of the destination operand D, clear it and store the result in the destination location. The state of the  $n^{\text{th}}$  bit is stored in the carry bit C of the condition code register. After the test, the  $n^{\text{th}}$  bit of the destination location is cleared. The bit to be tested is selected by an immediate bit number from 0–23. This instruction performs a read-modify-write operation on the destination location using two destination accesses before releasing the bus. This instruction provides a test-and-clear capability which is useful for synchronizing multiple processors using a shared memory. This instruction can use all memory alterable addressing modes.

### Example:

```

:
BCLR #14,X:<<$FFE4 ;test and clear bit 14 in I/O Port B Data Reg.
:

```

|          | Before Execution |          | After Execution |
|----------|------------------|----------|-----------------|
| X:\$FFE4 | \$FFFFFF         | X:\$FFE4 | \$FFBFFF        |
| SR       | \$0300           | SR       | \$0301          |

**A**

**Explanation of Example:** Prior to execution, the 24-bit X memory location X:\$FFE4 (I/O port B data register) contains the value \$FFFFFF. The execution of the BCLR #SE,X:<<\$FFE4 instruction tests the state of the 14<sup>th</sup> bit in X:\$FFE4, sets the carry bit C accordingly, and then clears the 14<sup>th</sup> bit in X:\$FFE4.

### Condition Codes:

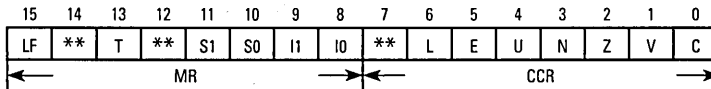

### CCR Condition Codes:

For destination operand SR:

- C — Changed if bit 0 is specified. Not affected otherwise.
- V — Changed if bit 1 is specified. Not affected otherwise.
- Z — Changed if bit 2 is specified. Not affected otherwise.
- N — Changed if bit 3 is specified. Not affected otherwise.
- U — Changed if bit 4 is specified. Not affected otherwise.
- E — Changed if bit 5 is specified. Not affected otherwise.
- L — Changed if bit 6 is specified. Not affected otherwise.

For other destination operands:

- C — Set if bit tested is set. Cleared otherwise.
- V — Not affected
- Z — Not affected
- N — Not affected
- U — Not affected
- E — Not affected
- L — Not affected

### MR Status Bits:

For destination operand SR:

- I0 — Changed if bit 8 is specified. Not affected otherwise.
- I1 — Changed if bit 9 is specified. Not affected otherwise.
- S0 — Changed if bit 10 is specified. Not affected otherwise.
- S1 — Changed if bit 11 is specified. Not affected otherwise.
- T — Changed if bit 13 is specified. Not affected otherwise.
- LF — Changed if bit 15 is specified. Not affected otherwise.

# BCLR

## Bit Test and Clear

# BCLR

For other destination operands:

- I0 — Not affected
- I1 — Not affected
- S0 — Not affected
- S1 — Not affected
- T — Not affected
- LF — Not affected

### Instruction Format:

BCLR #n,X:ea

BCLR #n,Y:ea

### Opcode:

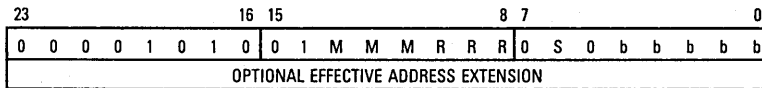

### Instruction Fields:

#n = bit number = bbbbb,

ea = 6-bit Effective Address = MMMRRR

| Effective Addressing Mode | MMMMRRR     | Memory Space | S | Bit Number bbbbb |
|---------------------------|-------------|--------------|---|------------------|
| (Rn) - Nn                 | 0 0 0 r r r | X Memory     | 0 | 00000            |
| (Rn) + Nn                 | 0 0 1 r r r | Y Memory     | 1 | .                |
| (Rn) -                    | 0 1 0 r r r |              |   | .                |
| (Rn) +                    | 0 1 1 r r r |              |   | .                |
| (Rn)                      | 1 0 0 r r r |              |   | 10111            |
| (Rn + Nn)                 | 1 0 1 r r r |              |   |                  |
| -(Rn)                     | 1 1 1 r r r |              |   |                  |
| Absolute address          | 1 1 0 0 0 0 |              |   |                  |

where "rrr" refers to an address register R0-R7

**Timing:** 4 + mvb oscillator clock cycles

**Memory:** 1 + ea program words



# BCLR

## Bit Test and Clear

# BCLR

### Instruction Format:

BCLR #n,X:aa  
 BCHR #n,Y:aa

### Opcode:

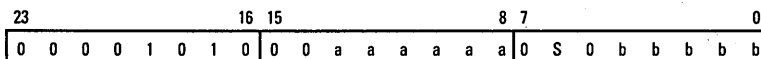

### Instruction Fields:

#n = bit number = bbbbb,  
 aa = 6-bit Absolute Short Address = aaaaaa

| Absolute Short Address aaaaaa | Memory Space S | Bit Number bbbbb |
|-------------------------------|----------------|------------------|
| 000000                        | X Memory 0     | 00000            |
| .                             | Y Memory 1     | .                |
| .                             |                | 10111            |
| 111111                        |                |                  |

**Timing:** 4 + mvb oscillator clock cycles

**Memory:** 1 + ea program words

### Instruction Format:

BCLR #n,X:pp  
 BCLR #n,Y:pp

### Opcode:

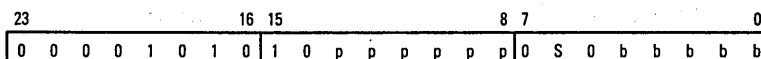

### Instruction Fields:

#n = bit number = bbbbb,  
 pp = 6-bit I/O Short Address = pppppp

| I/O Short Address pppppp | Memory Space S | Bit Number bbbbb |
|--------------------------|----------------|------------------|
| 000000                   | X Memory 0     | 00000            |
| .                        | Y Memory 1     | .                |
| .                        |                | 10111            |
| 111111                   |                |                  |

**Timing:** 4 + mvb oscillator clock cycles

**Memory:** 1 + ea program words



# BCLR

## Bit Test and Clear

# BCLR

### Instruction Format:

BCLR #n,D

### Opcode:

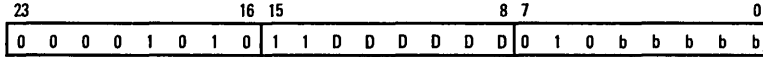

### Instruction Fields:

#n = bit number = bbbbb,

D = destination register = DDDDDD,

xxxx = 16-bit Absolute Address in extension word

| Destination Register                | D D D D D D | Bit Number bbbbb |
|-------------------------------------|-------------|------------------|
| 4 registers in Data ALU             | 0 0 0 1 D D | 00000            |
| 8 accumulators in Data ALU          | 0 0 1 D D D | .                |
| 8 address registers in AGU          | 0 1 0 T T T | 10111            |
| 8 address offset registers in AGU   | 0 1 1 N N N |                  |
| 8 address modifier registers in AGU | 1 0 0 F F F |                  |
| 8 program controller registers      | 1 1 1 G G G |                  |

See **A.9 INSTRUCTION ENCODING** and Table A-18 for specific register encodings.

**Timing:** 4 + mvb oscillator clock cycles

**Memory:** 1 + ea program words

# BSET

## Bit Test and Set

# BSET

### Operation:

D[n]  $\nabla$  C;  
1  $\nabla$  D[n]

D[n]  $\nabla$  C;  
1  $\nabla$  D[n]

D[n]  $\nabla$  C;  
1  $\nabla$  D[n]

D[n]  $\nabla$  C;  
1  $\nabla$  D[n]

D[n]  $\nabla$  C;  
1  $\nabla$  D[n]

D[n]  $\nabla$  C;  
1  $\nabla$  D[n]

D[n]  $\nabla$  C;  
1  $\nabla$  D[n]

### Assembler Syntax:

BSET #n,X:ea

BSET #n,X:aa

BSET #n,X:pp

BSET #n,Y:ea

BSET #n,Y:aa

BSET #n,Y:pp

BSET #n,D

**Description:** Test the  $n^{\text{th}}$  bit of the destination operand D, set it, and store the result in the destination location. The state of the  $n^{\text{th}}$  bit is stored in the carry bit C of the condition code register. After the test, the  $n^{\text{th}}$  bit of the destination location is cleared. The bit to be tested is selected by an immediate bit number from 0–23. This instruction performs a read-modify-write operation on the destination location using two destination accesses before releasing the bus. This instruction provides a test-and-set capability which is useful for synchronizing multiple processors using a shared memory. This instruction can use all memory alterable addressing modes.

### Example:

```

:
BSET #10,X:<<FFFE5 ;test and set bit 10 in I/O Port C Data Reg.
:

```

|          | Before Execution |          | After Execution |
|----------|------------------|----------|-----------------|
| X:\$FFE5 | \$000000         | X:\$FFE5 | \$000001        |
| SR       | \$0300           | SR       | \$0300          |



# BSET

## Bit Test and Set

# BSET

**Explanation of Example:** Prior to execution, the 24-bit X memory location X:\$FFE5 (I/O port C data register) contains the value \$000000. The execution of the BSET #0,X:<<\$FFE5 instruction tests the state of the 0<sup>th</sup> bit in X:\$FFE5, sets the carry bit C accordingly, and then sets the 0<sup>th</sup> bit in X:\$FFE5.

### Condition Codes:

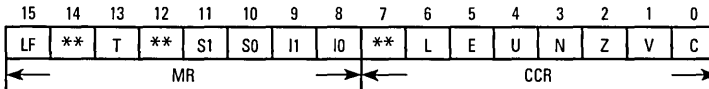

### CCR Condition Codes:

For destination operand SR:

- C — Changed if bit 0 is specified. Not affected otherwise.
- V — Changed if bit 1 is specified. Not affected otherwise.
- Z — Changed if bit 2 is specified. Not affected otherwise.
- N — Changed if bit 3 is specified. Not affected otherwise.
- U — Changed if bit 4 is specified. Not affected otherwise.
- E — Changed if bit 5 is specified. Not affected otherwise.
- L — Changed if bit 6 is specified. Not affected otherwise.

For other destination operands:

- C — **Set if bit tested is set. Cleared otherwise.**
- V — Not affected
- Z — Not affected
- N — Not affected
- U — Not affected
- E — Not affected
- L — Not affected

### MR Status Bits:

For destination operand SR:

- I0 — Changed if bit 8 is specified. Not affected otherwise.
- I1 — Changed if bit 9 is specified. Not affected otherwise.
- S0 — Changed if bit 10 is specified. Not affected otherwise.
- S1 — Changed if bit 11 is specified. Not affected otherwise.
- T — Changed if bit 13 is specified. Not affected otherwise.
- LF — Changed if bit 15 is specified. Not affected otherwise.

A

# BSET

## Bit Test and Set

# BSET

For other destination operands:

- IO — Not affected
- I1 — Not affected
- S0 — Not affected
- S1 — Not affected
- T — Not affected
- LF — Not affected

### Instruction Format:

BSET #n,X:ea  
 BSET #n,Y:ea

### Opcode:

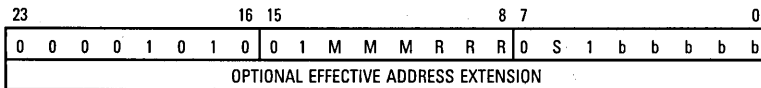

### Instruction Fields:

#n = bit number = bbbbb,  
 ea = 6-bit Effective Address = MMMRRR

| Effective Addressing Mode | MMMM R R R  | Memory Space S | Bit Number bbbbb |
|---------------------------|-------------|----------------|------------------|
| (Rn) - Nn                 | 0 0 0 r r r | X Memory 0     | 00000            |
| (Rn) + Nn                 | 0 0 1 r r r | Y Memory 1     | .                |
| (Rn) -                    | 0 1 0 r r r |                | .                |
| (Rn) +                    | 0 1 1 r r r |                | .                |
| (Rn)                      | 1 0 0 r r r |                | 10111            |
| (Rn + Nn)                 | 1 0 1 r r r |                |                  |
| -(Rn)                     | 1 1 1 r r r |                |                  |
| Absolute address          | 1 1 0 0 0 0 |                |                  |

where "rrr" refers to an address register R0-R7

**Timing:** 4 + mvb oscillator clock cycles

**Memory:** 1 + ea program words



# BSET

## Bit Test and Set

# BSET

### Instruction Format:

BSET #n,X:aa  
 BSET #n,Y:aa

### Opcode:

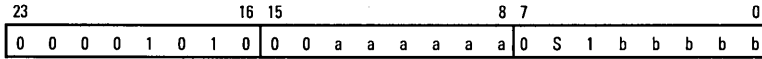

### Instruction Fields:

#n = bit number = bbbbb,  
 aa = 6-bit Absolute Short Address = aaaaaa

| Absolute Short Address aaaaaa | Memory Space S | Bit Number bbbbb |
|-------------------------------|----------------|------------------|
| 000000                        | X Memory 0     | 00000            |
| .                             | Y Memory 1     | .                |
| .                             |                | 10111            |
| 111111                        |                |                  |

**Timing:** 4 + mvb oscillator clock cycles

**Memory:** 1 + ea program words

### Instruction Format:

BSET #n,X:pp  
 BSET #n,Y:pp

### Opcode:

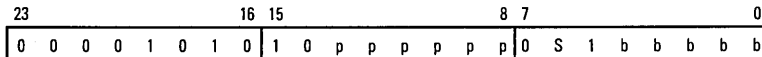

### Instruction Fields:

#n = bit number = bbbbb,  
 pp = 6-bit I/O Short Address = pppppp

| I/O Short Address pppppp | Memory Space S | Bit Number bbbbb |
|--------------------------|----------------|------------------|
| 000000                   | X Memory 0     | 00000            |
| .                        | Y Memory 1     | .                |
| .                        |                | 10111            |
| 111111                   |                |                  |

**Timing:** 4 + mvb oscillator clock cycles

**Memory:** 1 + ea program words



# BSET

## Bit Test and Set

# BSET

### Instruction Format:

BSET #n,D

### Opcode:

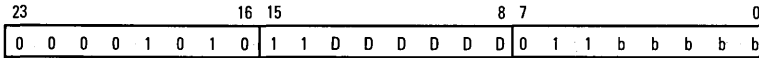

### Instruction Fields:

#n = bit number = bbbbb,

D = destination register = DDDDDD,

xxxx = 16-bit Absolute Address in extension word

| Destination Register                | D D D D D D | Bit Number bbbbb |
|-------------------------------------|-------------|------------------|
| 4 registers in Data ALU             | 0 0 0 1 D D | 00000            |
| 8 accumulators in Data ALU          | 0 0 1 D D D | .                |
| 8 address registers in AGU          | 0 1 0 T T T | 10111            |
| 8 address offset registers in AGU   | 0 1 1 N N N |                  |
| 8 address modifier registers in AGU | 1 0 0 F F F |                  |
| 8 program controller registers      | 1 1 1 G G G |                  |

See **A.9 INSTRUCTION ENCODING** and Table A-18 for specific register encodings.

**Timing:** 4 + mvb oscillator clock cycles

**Memory:** 1 + ea program words

# BTST

## Bit Test

# BTST

### Operation:

D[n] ↯ C

D[n] ↯ C

D[n] ↯ C

D[n] ↯ C

D[n] ↯ C

D[n] ↯ C

D[n] ↯ C

### Assembler Syntax:

BTST #n,X:ea

BTST #n,X:aa

BTST #n,X:pp

BTST #n,Y:ea

BTST #n,Y:aa

BTST #n,Y:pp

BTST #n,D

**Description:** Test the  $n^{\text{th}}$  bit of the destination operand D. The state of the  $n^{\text{th}}$  bit is stored in the carry bit C of the condition code register. The bit to be tested is selected by an immediate bit number from 0–23. This instruction is useful for performing serial to parallel conversion when used with the appropriate rotate instructions. This instruction can use all memory alterable addressing modes.

### Example:

```

:
BTST #1,X:<<$FFEE ;read SSI serial input flag IF1 into C bit
ROL A ;rotate carry bit C into LSB of A1
:

```

|          | Before Execution | After Execution |
|----------|------------------|-----------------|
| X:\$FFEE | \$000002         | \$000002        |
| SR       | \$0300           | \$0301          |

**Explanation of Example:** Prior to execution, the 24-bit X memory location X:\$FFEE (I/O SSI status register) contains the value \$000002. The execution of the BTST #1,X:<<\$FFEE instruction tests the state of the 1<sup>st</sup> bit (serial input flag IF1) in X:\$FFEE and sets the carry bit C accordingly. This instruction sequence illustrates serial to parallel conversion using the carry bit C and the 24-bit A1 register.

A

# BTST

## Bit Test

# BTST

### Condition Codes:

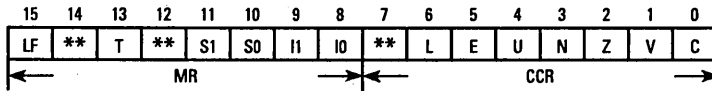

### CCR Condition Codes:

- C — Set if bit tested is set. Cleared otherwise.
- V — Not affected
- Z — Not affected
- N — Not affected
- U — Not affected
- E — Not affected
- L — Not affected

MR Status bits are not affected.

### SP — Stack Pointer:

- For destination operand SSH: SP — Decrement by 1.
- For other destination operands: SP — Not affected.

### Instruction Format:

- BTST #n,X:ea
- BTST #n,Y:ea

### Opcode:

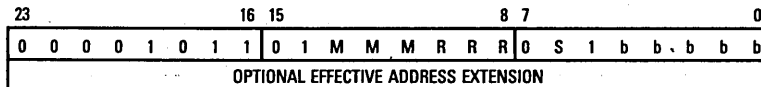

A

# BTST

## Bit Test

# BTST

### Instruction Fields:

#n = bit number = bbbbb,  
 ea = 6-bit Effective Address = MMMRRR

| Effective Addressing Mode | MMMR R R    | Memory Space S | Bit Number bbbbb |
|---------------------------|-------------|----------------|------------------|
| (Rn) - Nn                 | 0 0 0 r r r | X Memory 0     | 00000            |
| (Rn) + Nn                 | 0 0 1 r r r | Y Memory 1     | .                |
| (Rn) -                    | 0 1 0 r r r |                | .                |
| (Rn) +                    | 0 1 1 r r r |                | .                |
| (Rn)                      | 1 0 0 r r r |                | 10111            |
| (Rn + Nn)                 | 1 0 1 r r r |                |                  |
| -(Rn)                     | 1 1 1 r r r |                |                  |
| Absolute address          | 1 1 0 0 0 0 |                |                  |

where "rrr" refers to an address register R0-R7

**Timing:** 4 + mvb oscillator clock cycles

**Memory:** 1 + ea program words

### Instruction Format

BTST #n,X:aa  
 BTST #n,Y:aa

### Opcode:

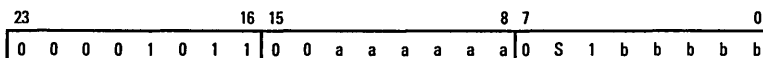

### Instruction Fields:

#n = bit number = bbbbb,  
 aa = 6-bit Absolute Short Address = aaaaaa

| Absolute Short Address aaaaaa | Memory Space S | Bit Number bbbbb |
|-------------------------------|----------------|------------------|
| 000000                        | X Memory 0     | 00000            |
| .                             | Y Memory 1     | .                |
| .                             |                | .                |
| 111111                        |                | 10111            |

**Timing:** 4 + mvb oscillator clock cycles

**Memory:** 1 + ea program words



# BTST

## Bit Test

# BTST

### Instruction Format:

BTST #n,X:pp

BTST #n,Y:pp

### Opcode:

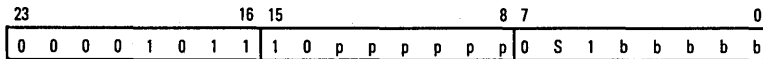

### Instruction Fields:

#n = bit number = bbbbb,

pp = 6-bit I/O Short Address = pppppp

| I/O Short Address pppppp | Memory Space S | Bit Number bbbbb |
|--------------------------|----------------|------------------|
| 000000                   | X Memory 0     | 00000            |
| .                        | Y Memory 1     | .                |
| .                        |                | 10111            |
| 111111                   |                |                  |

Timing: 4 + mvb oscillator clock cycles

Memory: 1 + ea program words

### Instruction Format:

BTST #n,D

### Opcode:

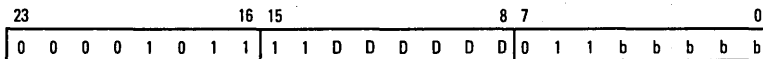

### Instruction Fields:

#n = bit number = bbbbb,

D = destination register = DDDDDD,

xxxx = 16-bit Absolute Address in extension word

A



# BTST

## Bit Test

# BTST

| Destination Register                | D D D D D   | Bit Number bbbbb |
|-------------------------------------|-------------|------------------|
| 4 registers in Data ALU             | 0 0 0 1 D D | 00000            |
| 8 accumulators in Data ALU          | 0 0 1 D D D | .                |
| 8 address registers in AGU          | 0 1 0 T T T | 10111            |
| 8 address offset registers in AGU   | 0 1 1 N N N |                  |
| 8 address modifier registers in AGU | 1 0 0 F F F |                  |
| 8 program controller registers      | 1 1 1 G G G |                  |

See **A.9 INSTRUCTION ENCODING** and Table A-18 for specific register encodings.

**Timing:** 4 + mvb oscillator clock cycles

**Memory:** 1 + ea program words

**A**

# CLR

## Clear Accumulator

# CLR

**Operation:**0  $\blacktriangleright$  D (parallel move)**Assembler Syntax:**

CLR D (parallel move)

**Description:** Clear the destination accumulator. This is a 56-bit clear instruction.**Example:**

```

:
CLR A # $7F,N0 ;clear A, set up N0 addr. reg.
:

```

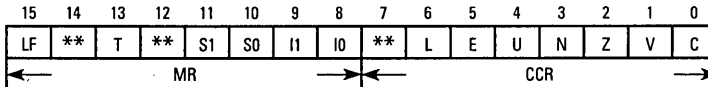

**Explanation of Example:** Prior to execution, the 56-bit A accumulator contains the value \$12:345678:9ABCDE. The execution of the CLR A instruction clears the 56-bit A accumulator to zero.

**Condition Codes:**

- L — Set if data limiting has occurred during parallel move
- E — Always cleared
- U — Always set
- N — Always cleared
- Z — Always set
- V — Always cleared

# CLR

Clear Accumulator

# CLR

**Instruction Format:**

CLR D

**Opcode:**

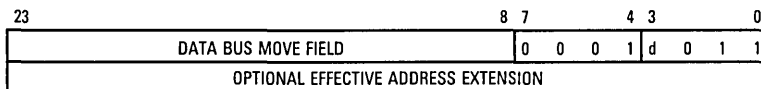

**Instruction Fields:**

D d

A 0

B 1

**Timing:** 2 + mv oscillator clock cycles

**Memory:** 1 + mv program words

**A**

# CMP

Compare

# CMP

**Operation:**

S2 - S1 (parallel move)

**Assembler Syntax:**

CMP S1,S2 (parallel move)

**Description:** Subtract the source one operand, S1, from the source two accumulator, S2, and update the condition code register. The result of the subtraction operation is not stored.

**NOTE:** This instruction subtracts 56-bit operands. When a word is specified as S1, it is sign extended and zero filled to form a valid 56-bit operand. For the carry to be set correctly as a result of the subtraction, S2 must be properly sign extended. S2 can be improperly sign extended by writing A1 or B1 explicitly prior to executing the compare so that A2 or B2, respectively, may not represent the correct sign extension. This note particularly applies to the case where it is extended to compare 24-bit operands such as X0 with A1.

**Example:**

```
:
:
CMP Y0,B X0,X:(R6)+N6 Y1,Y:(R0) - ;comp. Y0 and B, save X0, Y1
:
```

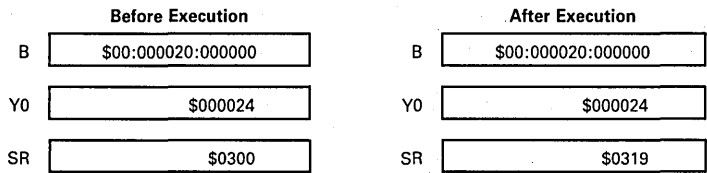

**Explanation of Example:** Prior to execution, the 56-bit B accumulator contains the value \$00:000020:000000 and the 24-bit Y0 register contains the value \$000024. The execution of the CMP Y0,B instruction automatically appends the 24-bit value in the Y0 register with 24 LS zeros, sign extends the resulting 48-bit long word to 56 bits, subtracts the result from the 56-bit B accumulator and updates the condition code register.



# CMP

## Compare

# CMP

### Condition Codes:

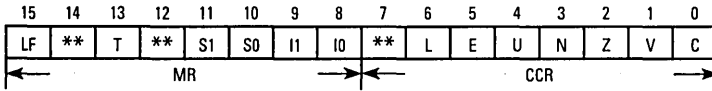

- L — Set if limiting (parallel move) or overflow has occurred in result
- E — Set if the signed integer portion of result is in use
- U — Set if result is unnormalized
- N — Set if bit 55 of result is set
- Z — Set if result equals zero
- V — Set if overflow has occurred in result
- C — Set if a carry (or borrow) occurs from bit 55 of result

**NOTE:** The definition of the E and U bits varies according to the scaling mode being used. Refer to **A.4 CONDITION CODE COMPUTATION** for complete details.

### Instruction Format:

CMP S1,S2

### Opcode:

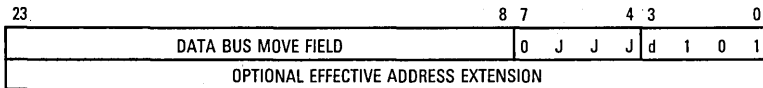

### Instruction Fields:

| S1,S2 | J J J d | S1,S2 | J J J d |
|-------|---------|-------|---------|
| B,A   | 0000    | Y0,B  | 1011    |
| A,B   | 0001    | X1,A  | 1100    |
| X0,A  | 1000    | X1,B  | 1101    |
| X0,B  | 1001    | Y1,A  | 1110    |
| Y0,A  | 1010    | Y1,B  | 1111    |

**Timing:** 2 + mv oscillator clock cycles

**Memory:** 1 + mv program words





# CMPM

## Compare Magnitude

# CMPM

### Condition Codes:

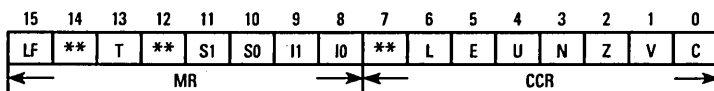

- L — Set if limiting (parallel move) or overflow has occurred in result
- E — Set if the signed integer portion of result is in use
- U — Set if result is unnormalized
- N — Set if bit 55 of result is set
- Z — Set if result equals zero
- V — Set if overflow has occurred in result
- C — Set if a carry (or borrow) occurs from bit 55 of result

**NOTE:** The definition of the E and U bits varies according to the scaling mode being used. Refer to **A.4 CONDITION CODE COMPUTATION** for complete details.

### Instruction Format:

CMPM S1,S2

### Opcode:

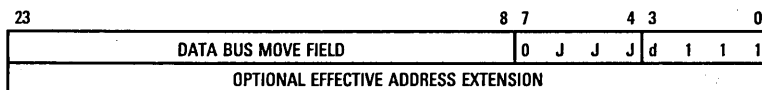

### Instruction Fields:

| S1,S2 | J J J d | S1,S2 | J J J d | S1,S2 | J J J d |
|-------|---------|-------|---------|-------|---------|
| B,A   | 0 0 0 0 | X0,B  | 1 0 0 1 | X1,A  | 1 1 0 0 |
| A,B   | 0 0 0 1 | Y0,A  | 1 0 1 0 | X1,B  | 1 1 0 1 |
| X0,A  | 1 0 0 0 | Y0,B  | 1 0 1 1 | Y1,A  | 1 1 1 0 |
|       |         |       |         | Y1,B  | 1 1 1 1 |

**Timing:** 2 + mv oscillator clock cycles

**Memory:** 1 + mv program words

A

# DIV

## Divide Iteration

# DIV

**Operation:** If  $D[55] \oplus S[23] = 1$ ,

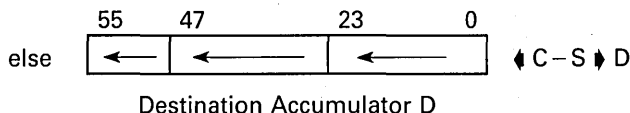
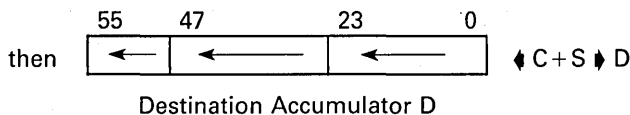

where  $\oplus$  denotes the logical exclusive OR operator

### Assembler

**Syntax:** DIV S,D

**Description:** Divide the destination operand D by the source operand S and store the result in the destination accumulator D. **The 48-bit dividend must be a positive fraction which has been sign extended to 56-bits and is stored in the full 56-bit destination accumulator D. The 24-bit divisor is a signed fraction and is stored in the source operand S.** Each DIV iteration calculates one quotient bit using a nonrestoring fractional division algorithm (see description on the next page). After the execution of the first DIV instruction, the destination operand holds both the partial remainder and the formed quotient. The partial remainder occupies the high-order portion of the destination accumulator D and is a signed fraction. The formed quotient occupies the low-order portion of the destination accumulator D (A0 or B0) and is a positive fraction. One bit of the formed quotient is shifted into the LS bit of the destination accumulator at the start of each DIV iteration. The formed quotient is the true quotient if the true quotient is positive. If the true quotient is negative, the formed quotient must be negated. **Valid results are obtained only when  $|D| < |S|$  and the operands are interpreted as fractions.** Note that this condition ensures that the magnitude of the quotient is less than one (i.e., is fractional) and precludes division by zero.

The DIV instruction calculates one quotient bit based on the divisor and the previous partial remainder. To produce an N-bit quotient, the DIV instruction is executed N times where N is the number of bits of precision desired in the quotient,  $1 \leq N \leq 24$ . Thus, for a full-precision (24 bit) quotient, 24 DIV iterations are required. In general, executing the DIV instruction N times produces an N-bit quotient and a 48-bit remainder which has  $(48 - N)$  bits of precision and whose N MS bits are zeros. The partial remainder is not a true remainder and must be corrected due to the nonrestoring nature of the division algorithm before it may be used. Therefore, once the divide is complete,

A



it is necessary to reverse the last DIV operation and restore the remainder to obtain the true remainder.

The DIV instruction uses a nonrestoring fractional division algorithm which consists of the following operations (see the previous **Operation** diagram):

1. **Compare the source and destination operand sign bits:** An exclusive OR operation is performed on bit 55 of the destination operand D and bit 23 of the source operand S;
2. **Shift the partial remainder and the quotient:** The 55-bit destination accumulator D is shifted one bit to the left. The carry bit C is moved into the LS bit (bit 0) of the accumulator;
3. **Calculate the next quotient bit and the new partial remainder:** The 24-bit source operand S (signed divisor) is either added to or subtracted from the MSP portion of the destination accumulator (A1 or B1), and the result is stored back into the MSP portion of that destination accumulator. If the result of the exclusive OR operation previously described was a "1" (i.e., the sign bits were different), the source operand S is added to the accumulator. If the result of the exclusive OR operation was a "0" (i.e., the sign bits were the same), the source operand S is subtracted from the accumulator. Due to the automatic sign extension of the 24-bit signed divisor, the addition or subtraction operation correctly sets the carry bit C of the condition code register with the next quotient bit.

**Example:**

**(4-Quadrant division, 24-bit signed quotient, 48-bit signed remainder)**

```

ABS A A,B           ;make dividend positive, copy A1 to B1
EOR X0,B B,X:$0     ;save rem. sign in X:$0, quo. sign in N
AND #$FE,CCR        ;clear carry bit C (quotient sign bit)
REP #$18            ;form a 24-bit quotient
DIV X0,A            ;form quotient in A0, remainder in A1
TFR A,B            ;save quotient and remainder in B1,B0
JPL SAVEQUO        ;go to SAVEQUO if quotient is positive
NEG B              ;complement quotient if N bit set
SAVEQUO TFR X0,B B0,X1 ;save quo. in X1, get signed divisor
ABS B              ;get absolute value of signed divisor
ADD A,B            ;restore remainder in B1
JCLR #23,X:$0,DONE ;go to DONE if remainder is positive
MOVE #B0,B         ;clear LS 24 bits of B
NEG B              ;complement remainder if negative
DONE              .....

```

|    | Before Execution   | After Execution     |
|----|--------------------|---------------------|
| A  | \$00:0E66D7:F2832C | \$\$F:EDCCAA:654321 |
| X0 | \$123456           | \$123456            |
| X1 | \$000000           | \$654321            |
| B  | \$00:000000:000000 | \$00:000100:654321  |

**Explanation of Example:** Prior to execution, the 56-bit A accumulator contains the 56-bit, sign-extended fractional dividend D ( $D = \$00.0E66D7:F2832C = 0.112513535894635$  approx.) and the 24-bit X0 register contains the 24-bit, signed fractional divisor S ( $S = \$123456 = 0.142222166061401$ ). Since  $|D| < |S|$ , the execution of the previous divide routine stores the correct 24-bit signed quotient in the 24-bit X1 register ( $A/X0 = 0.79111111164093 = \$654321 = X1$ ). The partial remainder is restored by reversing the last DIV operation and adding back the absolute value of the signed divisor in X0 to the partial remainder in A1. This produces the correct LS 24 bits of the 48-bit signed remainder in the 24-bit B1 register. Note that the remainder is really a 48-bit value which has 24 bits of precision. Thus, the correct 48-bit remainder is  $\$000000:000100$  which equals  $0.0000000000018190$  approximately.

Note that the divide routine used in the previous example assumes that the sign-extended 56-bit signed fractional dividend is stored in the A accumulator and that the 24-bit signed fractional divisor is stored in the X0 register. This routine produces a full 24-bit signed quotient and a 48-bit signed remainder.

This routine may be greatly simplified for the case in which only positive, fractional operands are used to produce a 24-bit positive quotient and a 48-bit positive remainder, as shown in the following example:

### 1-Quadrant division, 24-bit unsigned quotient, 48-bit unsigned remainder

```

AND #$FE,CCR           ;clear carry bit C (quotient sign bit)
REP #$18               ;form a 24-bit quotient and remainder
DIV X0,A               ;form quotient in A0, remainder in A1
ADD X0,A               ;restore remainder in A1
    
```

Note that this routine assumes that the 56-bit positive, fractional, sign-extended dividend is stored in the A accumulator and that the 24-bit positive, fractional divisor is stored in the X0 register. After execution, the 24-bit positive fractional quotient is stored in the A0 register; the LS 24 bits of the 48-bit positive fractional remainder are stored in the A1 register.

There are many variations possible when choosing a suitable division routine for a given application. The selection of a suitable division routine normally involves specification of the following items:

- 1) the number of bits of precision in the dividend;
- 2) the number of bits of precision N in the quotient;
- 3) whether the value of N is fixed or is variable;
- 4) whether the operands are unsigned or signed;
- 5) whether or not the remainder is to be calculated.

A complete discussion of the various division routines is beyond the scope of this manual. For a more complete discussion of these routines, refer to the application note entitled *Fractional and Integer Arithmetic Using the DSP56001*.

For extended precision division (i.e., for N-bit quotients where  $N > 24$ ), the DIV instruction is no longer applicable, and a user-defined N-bit division routine is required. For further information on division algorithms, refer to pages 524–530 of *Theory and Application of Digital Signal Processing* by Rabiner and Gold (Prentice-Hall, 1975), pages 190–199 of *Computer Architecture and Organization* by John Hayes (McGraw-Hill, 1978), pages 213–223 of *Computer Arithmetic: Principles, Architecture, and Design* by Kai Hwang (John Wiley and Sons, 1979), or other references as required.

### Condition Codes:

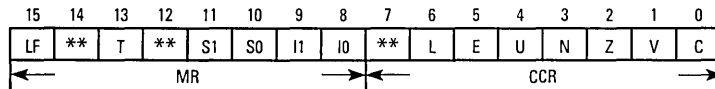

L — Set if overflow bit V is set

V — Set if the MS bit of the destination operand is changed as a result of the instruction's left shift operation

C — Set if bit 55 of the result is cleared



# DIV

## Divide Iteration

# DIV

### Instruction Format:

DIV S,D

### Opcode:

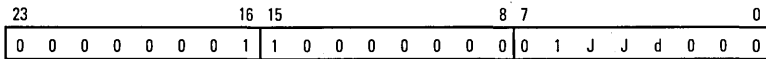

### Instruction Fields:

| S,D  | J J d | S,D  | J J d |
|------|-------|------|-------|
| X0,A | 0 0 0 | X1,A | 1 0 0 |
| X0,B | 0 0 1 | X1,B | 1 0 1 |
| Y0,A | 0 1 0 | Y1,A | 1 1 0 |
| Y0,B | 0 1 1 | Y1,B | 1 1 1 |

**Timing:** 2 oscillator clock cycles

**Memory:** 1 program word

A

# DO

## Start Hardware Loop

# DO

### Operation:

SP+1 ↗ SP;LA ↗ SSH;LC ↗ SSL;X:ea ↗ LC  
 SP+1 ↗ SP;PC ↗ SSH;SR ↗ SSL;expr-1 ↗ LA  
 1 ↗ LF

SP+1 ↗ SP;LA ↗ SSH;LC ↗ SSL;X:aa ↗ LC  
 SP+1 ↗ SP;PC ↗ SSH;SR ↗ SSL;expr-1 ↗ LA  
 1 ↗ LF

SP+1 ↗ SP;LA ↗ SSH;LC ↗ SSL;Y:ea ↗ LC  
 SP+1 ↗ SP;PC ↗ SSH;SR ↗ SSL;expr-1 ↗ LA  
 1 ↗ LF

SP+1 ↗ SP;LA ↗ SSH;LC ↗ SSL;Y:aa ↗ LC  
 SP+1 ↗ SP;PC ↗ SSH;SR ↗ SSL;expr-1 ↗ LA  
 1 ↗ LF

SP+1 ↗ SP;LA ↗ SSH;LC ↗ SSL;#xxx ↗ LC  
 SP+1 ↗ SP;PC ↗ SSH;SR ↗ SSL;expr-1 ↗ LA  
 1 ↗ LF

SP+1 ↗ SP;LA ↗ SSH;LC ↗ SSL;S ↗ LC  
 SP+1 ↗ SP;PC ↗ SSH;SR ↗ SSL;expr-1 ↗ LA  
 1 ↗ LF

### End of Loop:

SSL(LF) ↗ SR;SP-1 ↗ SP  
 SSH ↗ LA;SSL ↗ LC;SP-1 ↗ SP

### Assembler Syntax:

DO X:ea,expr

DO X:aa,expr

DO Y:ea,expr

DO Y:aa,expr

DO #xxx,expr

DO S,expr

**Description:** Begin a hardware DO loop that is to be repeated the number of times specified in the instruction's source operand and whose range of execution is terminated by the destination operand (previously shown as "expr"). No overhead other than the execution of this DO instruction is required to set up this loop. DO loops can be nested and the loop count can be passed as a parameter.

During the first instruction cycle, the current contents of the loop address (LA) and the loop counter (LC) registers are pushed onto the system stack. The DO instruction's source operand is then loaded into the loop counter (LC) register. The LC register contains the remaining number of times the DO loop will be executed and can be accessed from inside the DO loop subject to certain restrictions. If LC equals zero, the DO loop is executed 65,536 times. All address register indirect addressing modes may be used to generate the effective address of the source operand. If immediate short



data is specified, the 12 LS bits of LC are loaded with the 12-bit immediate value, and the four MS bits of LC are cleared.

During the second instruction cycle, the current contents of the program counter (PC) register and the status register (SR) are pushed onto the system stack. The stacking of the LA, LC, PC, and SR registers is the mechanism which permits the nesting of DO loops. The DO instruction's destination operand (shown as "expr") is then loaded into the loop address (LA) register. This 16-bit operand is located in the instruction's 24-bit absolute address extension word as shown in the opcode section. The value in the program counter (PC) register pushed onto the system stack is the address of the first instruction following the DO instruction (i.e., the first actual instruction in the DO loop). This value is read (i.e., copied but not pulled) from the top of the system stack to return to the top of the loop for another pass through the loop.

During the third instruction cycle, the loop flag (LF) is set. This results in the PC being repeatedly compared with LA to determine if the last instruction in the loop has been fetched. If LA equals PC, the last instruction in the loop has been fetched and the loop counter (LC) is tested. If LC is not equal to one, it is decremented by one and SSH is loaded into the PC to fetch the first instruction in the loop again. If LC equals one, the "end-of-loop" processing begins.

When executing a DO loop, the instructions are actually fetched each time through the loop. Therefore, a DO loop can be interrupted. DO loops can also be nested. When DO loops are nested, the end-of-loop addresses must also be nested and are not allowed to be equal. The assembler generates an error message when DO loops are improperly nested. Nested DO loops are illustrated in the example.

**NOTE:** The assembler calculates the end-of-loop address to be loaded into LA (the absolute address extension word) by evaluating the end-of-loop expression "expr" and subtracting one. This is done to accommodate the case where the last word in the DO loop is a two-word instruction. Thus, the end-of-loop expression "expr" in the source code must represent the address of the instruction AFTER the last instruction in the loop as shown in the example.

During the "end-of-loop" processing, the loop flag (LF) from the lower portion (SSL) of SP is written into the status register (SR), the contents of the loop address (LA) register are restored from the upper portion (SSH) of (SP - 1), the contents of the loop counter (LC) are restored from the lower portion (SSL) of (SP - 1) and the stack pointer (SP) is decremented by two. Instruction fetches now continue at the address of the instruction following the last instruction in the DO loop. Note that LF is the only bit in the status register (SR) that is restored after a hardware DO loop has been exited.

**NOTE:** The loop flag (LF) is cleared by a hardware reset.

A



# DO

## Start Hardware Loop

# DO

**Other Restrictions:** DO SSH,xxxx  
 JSR to (LA) whenever the loop flag (LF) is set  
 JScc to (LA) whenever the loop flag (LF) is set  
 JSCLR to (LA) whenever the loop flag (LF) is set  
 JSSET to (LA) whenever the loop flag (LF) is set

A DO instruction cannot be repeated using the REP instruction.

**NOTE:** Due to pipelining, if an address register (R0–R7, N0–N7, or M0–M7) is changed using a move-type instruction (LUA, Tcc, MOVE, MOVEC, MOVEM, MOVEP, or parallel move), the new contents of the destination address register will not be available for use during the **following** instruction (i.e., there is a single instruction cycle pipeline delay). This restriction also applies to the situation in which the **last** instruction in a **DO** loop changes an address register **and** the **first** instruction at the **top** of the **DO** loop uses that same address register. The **top** instruction becomes the **following** instruction because of the loop construct.

Similarly, since the DO instruction accesses the program controller registers, the DO instruction must not be immediately preceded by any of the following instructions:

**Immediately before DO** MOVEC to LA, LC, SSH, SSL, or SP  
 MOVEM to LA, LC, SSH, SSL, or SP  
 MOVEP to LA, LC, SSH, SSL, or SP  
 MOVEC from SSH  
 MOVEM from SSH  
 MOVEP from SSH

### Example:

```

:
DO #cnt1, END1           ;begin outer DO loop
:
DO #cnt2, END2           ;begin inner DO loop
:
:
MOVE A,X:(R0)+          ;last instruction in inner loop
:                        ;(in outer loop)
END2                     ;last instruction in outer loop
  ADD A,B X:(R1)+,X0     ;first instruction after outer loop
END1                     :
:

```

**A**



# DO

## Start Hardware Loop

# DO

**Explanation of Example:** This example illustrates a nested DO loop. The outer DO loop will be executed "cnt1" times while the inner DO loop will be executed ("cnt1" \* "cnt2") times. Note that the labels END1 and END2 are located at the first instruction past the end of the DO loop, as mentioned above, and are nested properly.

### Condition Codes:

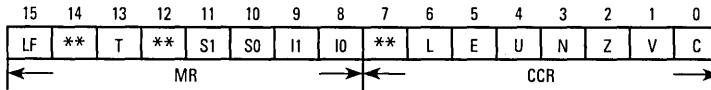

LF — Set when a DO loop is in progress

L — Set if data limiting occurred [see Note 2]

### Instruction Format:

DO X:ea, expr

DO Y:ea, expr

### Opcode:

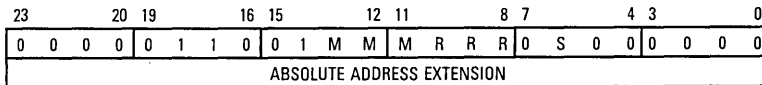

### Instruction Fields:

ea = 6-bit Effective Address = MMMRRR,

expr = 16-bit Absolute Address in 24-bit extension word

| Effective Addressing Mode | MMMRRR      | Memory Space | S |
|---------------------------|-------------|--------------|---|
| (Rn) - Nn                 | 0 0 0 r r r | X Memory     | 0 |
| (Rn) + Nn                 | 0 0 1 r r r | Y Memory     | 1 |
| (Rn) -                    | 0 1 0 r r r |              |   |
| (Rn) +                    | 0 1 1 r r r |              |   |
| (Rn)                      | 1 0 0 r r r |              |   |
| (Rn + Nn)                 | 1 0 1 r r r |              |   |
| -(Rn)                     | 1 1 1 r r r |              |   |

where "rrr" refers to an address register R0-R7

**Timing:** 6 + mv oscillator clock cycles

**Memory:** 2 program words

A

DO

Start Hardware Loop

DO

Instruction Format:

DO X:aa, expr  
DO Y:aa, expr

Opcode:

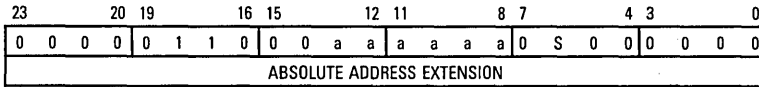

Instruction Fields:

aa = 6-bit Absolute Short Address = aaaaaa,  
expr = 16-bit Absolute Address in 24-bit extension word

| Absolute Short Address aaaaaa | Memory Space S |
|-------------------------------|----------------|
| 000000                        | X Memory 0     |
| .                             | Y Memory 1     |
| .                             |                |
| 111111                        |                |

Timing: 6 + mv oscillator clock cycles

Memory: 2 program words

Instruction Format:

DO #xxx, expr

Opcode:

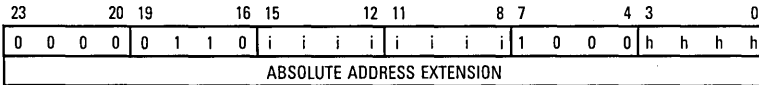

Instruction Fields:

#xxx = 12-bit Immediate Short Data = hhhh i i i i i i i i,  
expr = 16-bit Absolute Short Address in 24-bit extension word

| Immediate Short Data hhhh i i i i i i i i |
|---|
| 000000000000                              |
| .   |
| .   |
| 111111111111                              |

A

# DO

## Start Hardware Loop

# DO

**Timing:** 6+mv oscillator clock cycles

**Memory:** 2 program words

**Instruction Format:**

DO S, expr

**Opcode:**

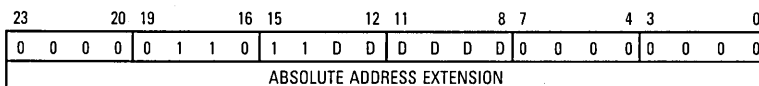

**Instruction Fields:**

S = 6-bit Source operand = DDDDDD,

expr = 16-bit Absolute Address in 24-bit extension word

|    | Source | DDDDDD | S | S/L | Source | DDDDDD |                  |       |   |   |   |   |   |                |
|----|--------|--------|---|-----|--------|--------|------------------|-------|---|---|---|---|---|----------------|
| X0 | 0      | 0      | 0 | 1   | 0      | 0      | no               | SR    | 1 | 1 | 1 | 0 | 0 | 1              |
| X1 | 0      | 0      | 0 | 1   | 0      | 1      | no               | OMR   | 1 | 1 | 1 | 0 | 1 | 0              |
| Y0 | 0      | 0      | 0 | 1   | 1      | 0      | no               | SP    | 1 | 1 | 1 | 0 | 1 | 1 [see Note 1] |
| Y1 | 0      | 0      | 0 | 1   | 1      | 1      | no               | SSL   | 1 | 1 | 1 | 1 | 0 | 1 [see Note 1] |
| A0 | 0      | 0      | 1 | 0   | 0      | 0      | no               | LA    | 1 | 1 | 1 | 1 | 1 | 0              |
| B0 | 0      | 0      | 1 | 0   | 0      | 1      | no               | LC    | 1 | 1 | 1 | 1 | 1 | 1              |
| A2 | 0      | 0      | 1 | 0   | 1      | 0      | no               | R0-R7 | 0 | 1 | 0 | r | r | r              |
| B2 | 0      | 0      | 1 | 0   | 1      | 1      | no               | N0-N7 | 0 | 1 | 1 | n | n | n              |
| A1 | 0      | 0      | 1 | 1   | 0      | 0      | no               | M0-M7 | 1 | 0 | 0 | m | m | m              |
| B1 | 0      | 0      | 1 | 1   | 0      | 1      | no               |       |   |   |   |   |   |                |
| A  | 0      | 0      | 1 | 1   | 1      | 0      | yes [see Note 2] |       |   |   |   |   |   |                |
| B  | 0      | 0      | 1 | 1   | 1      | 1      | yes [see Note 2] |       |   |   |   |   |   |                |

where rrr = Rn register  
 where nnn = Nn register  
 where mmm = Mn register

**NOTE 1: Implementation Notes:**

For DO SP, expr      The actual value that will be loaded into the loop counter (LC) is the value of the stack pointer (SP) before the execution of the DO instruction, incremented by 1.

Thus, if SP=3, the execution of the DO SP,expr instruction will load the loop counter (LC) with the value LC=4.



**DO****Start Hardware Loop****DO**

For **DO SSL, expr** The loop counter (LC) will be loaded with its previous value which was saved on the stack by the **DO** instruction itself.

**NOTE 2:** If A or B is specified as a source operand, the accumulator value is optionally shifted according to the scaling mode bits in the status register. If the data out of the shifter indicates that the accumulator extension is in use, the 24-bit data is limited to a maximum positive or negative saturation constant. The shifted and limited value is loaded into LC, although A or B remain unchanged.

**Timing:** 6 + mv oscillator clock cycles

**Memory:** 2 program words

**A**

# ENDDO

End Current DO Loop

# ENDDO

### Operation:

SSL(LF)  $\rightarrow$  SR; SP-1  $\rightarrow$  SP  
SSH  $\rightarrow$  LA; SSL  $\rightarrow$  LC; SP-1  $\rightarrow$  SP

### Assembler Syntax:

ENDDO

**Description:** Terminate the current hardware DO loop before the current loop counter (LC) equals one. If the value of the current DO loop counter (LC) is needed, it must be read before the execution of the ENDDO instruction. Initially, the loop flag (LF) is restored from the system stack and the remaining portion of the status register (SR) and the program counter (PC) are purged from the system stack. The loop address (LA) and the loop counter (LC) registers are then restored from the system stack.

**Restrictions:** Due to pipelining and the fact that the ENDDO instruction accesses the program controller registers, the ENDDO instruction must not be immediately preceded by any of the following instructions:

**Immediately before ENDDO** MOVEC to LA, LC, SR, SSH, SSL, or SP  
MOVEM to LA, LC, SR, SSH, SSL, or SP  
MOVEP to LA, LC, SR, SSH, SSL, or SP  
MOVEC from SSH  
MOVEM from SSH  
MOVEP from SSH  
ORI MR  
ANDI MR

Also, the ENDDO instruction cannot be the **next to last** (LA-1) or **last** (LA) instruction in a DO loop.

### Example:

```

:
DO Y0,NEXT           ;exec. loop ending at NEXT (Y0) times
:
MOVEC LC,A          ;get current value of loop counter (LC)
CMP Y1,A            ;compare loop counter with value in Y1
JNE ONWARD          ;go to ONWARD if LC not equal to Y1
ENDDO               ;LC equal to Y1, restore all DO registers
JMP NEXT            ;go to NEXT
ONWARD :            ;LC not equal to Y1, continue DO loop
:                  ;(last instruction in DO loop)
NEXT MOVE #$123456,X1 ;(first instruction AFTER DO loop)

```



# ENDDO

## End Current DO Loop

# ENDDO

**Explanation of Example:** This example illustrates the use of the ENDDO instruction to terminate the current DO loop. The value of the loop counter (LC) is compared with the value in the Y1 register to determine if execution of the DO loop should continue. Note that the ENDDO instruction updates certain program controller registers but does not automatically jump past the end of the DO loop. Thus, if this action is desired, a JMP instruction (i.e., JMP NEXT as previously shown) must be included after the ENDDO instruction to transfer program control to the first instruction past the end of the DO loop.

### Condition Codes:

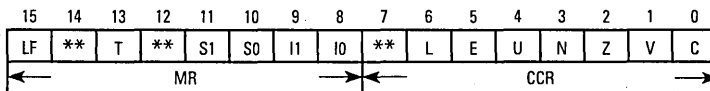

The condition codes are not affected by this instruction.

### Instruction Format:

ENDDO

### Opcode:

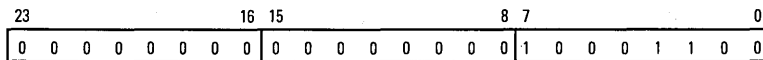

### Instruction Fields:

None

**Timing:** 2 oscillator clock cycles

**Memory:** 1 program word

# EOR

## Logical Exclusive OR

# EOR

**Operation:**

$S \oplus D[47:24] \rightarrow D[47:24]$  (parallel move)

**Assembler Syntax:**

EOR S,D (parallel move)

where  $\oplus$  denotes the logical Exclusive OR operator

**Description:** Logically exclusive OR the source operand S with bits 47–24 of the destination operand D and store the result in bits 47–24 of the destination accumulator. This instruction is a 24-bit operation. The remaining bits of the destination operand D are not affected.

**Example:**

```

:
EOR Y1,B (R2)+ ;Exclusive OR Y1 with B1, update R2
:

```

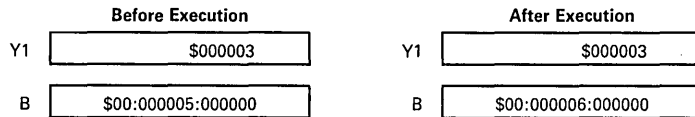

**Explanation of Example:** Prior to execution, the 24-bit Y1 register contains the value \$000003, and the 56-bit B accumulator contains the value \$00:000005:000000. The EOR Y1,B instruction logically exclusive ORs the 24-bit value in the Y1 register with bits 47–24 of the B accumulator (B1) and stores the result in the B accumulator with bits 55–48 and 23–0 unchanged.

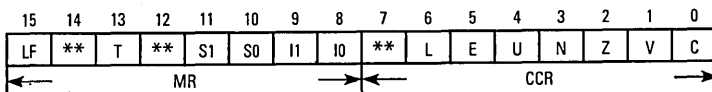
**Condition Codes:**

- I — Set if data limiting has occurred during parallel move
- N — Set if bit 47 of A or B result is set
- Z — Set if bits 47–24 of A or B result are zero
- V — Always cleared



# EOR

Logical Exclusive OR

# EOR

**Instruction Format:**

EOR S,D

**Opcode:**

|                                      |  |  |  |  |  |   |   |   |   |   |   |   |   |   |   |  |  |   |
|--------------------------------------|--|--|--|--|--|---|---|---|---|---|---|---|---|---|---|--|--|---|
| 23                                   |  |  |  |  |  | 8 | 7 |   |   |   |   | 4 | 3 |   |   |  |  | 0 |
| DATA BUS MOVE FIELD                  |  |  |  |  |  |   |   | 0 | 1 | J | J | d | 0 | 1 | 1 |  |  |   |
| OPTIONAL EFFECTIVE ADDRESS EXTENSION |  |  |  |  |  |   |   |   |   |   |   |   |   |   |   |  |  |   |

**Instruction Fields:**

|          |           |          |          |
|----------|-----------|----------|----------|
| <b>S</b> | <b>JJ</b> | <b>D</b> | <b>d</b> |
| X0       | 00        | A        | 0        |
| X1       | 10        | B        | 1        |
| Y0       | 01        |          |          |
| Y1       | 11        |          |          |

**Timing:** 2+ mv oscillator clock cycles

**Memory:** 1+ mv program words

**A**



# ILLEGAL

## Illegal Instruction Interrupt

# ILLEGAL

**Operation:**

Begin Illegal Instruction  
exception processing

**Assembler Syntax:**

ILLEGAL

**Description:** The ILLEGAL instruction is executed as if it were a NOP instruction. Normal instruction execution is suspended and illegal instruction exception processing is initiated. The interrupt vector address is located at address P:\$3E. The interrupt priority level (I1, I0) is set to 3 in the status register if a long interrupt service routine is used. The purpose of the ILLEGAL instruction is to force the DSP into an illegal instruction exception for test purposes. If a fast interrupt is used with the ILLEGAL instruction, an infinite loop will be formed (an illegal instruction interrupt normally returns to the illegal instruction) which can only be broken by a hardware reset. Therefore, only long interrupts should be used. Exiting an illegal instruction is a fatal error. The long exception routine should indicate this condition and cause the system to be restarted.

If the ILLEGAL instruction is in a DO loop at LA and the instruction at LA - 1 is being interrupted, then LC will be decremented twice due to the same mechanism that causes LC to be decremented twice if JSR, REP, etc. are located at LA. This is why JSR, REP, etc. at LA are restricted. Clearly restrictions cannot be imposed on illegal instructions.

Since REP is uninterruptable, repeating an ILLEGAL instruction results in the interrupt not being initiated until after completion of the REP. After servicing the interrupt, program control will return to the address of the second word following the ILLEGAL instruction. Of course, the ILLEGAL interrupt service routine should abort further processing, and the processor should be reinitialized.

**Example:**

```

:
ILLEGAL                ;begin ILLEGAL exception processing
:

```

**Explanation of Example:** The ILLEGAL instruction suspends normal instruction execution and initiates ILLEGAL exception processing.

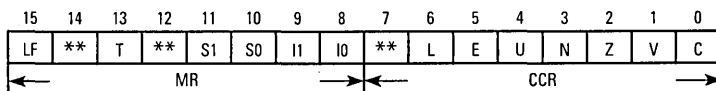
**Condition Codes:**

The condition codes are not affected by this instruction.



# ILLEGAL

Illegal Instruction Interrupt

# ILLEGAL

**Instruction Format:**  
ILLEGAL

**Opcode:**

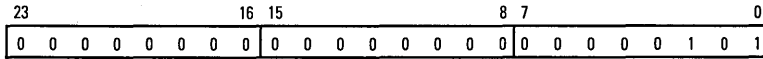

**Instruction Fields:**  
None

**Timing:** 8 oscillator clock cycles

**Memory:** 1 program word

**A**

# Jcc

## Jump Conditionally

# Jcc

### Operation:

If cc, then 0xxx  $\rightarrow$  PC  
 else PC+1  $\rightarrow$  PC  
 If cc, then ea  $\rightarrow$  PC  
 else PC+1  $\rightarrow$  PC

### Assembler Syntax:

Jcc xxx  
 Jcc ea

**Description:** Jump to the location in program memory given by the instruction's effective address if the specified condition is true. If the specified condition is false, the program counter (PC) is incremented and the effective address is ignored. However, the address register specified in the effective address field is always updated independently of the specified condition. All memory alterable addressing modes may be used for the effective address. A Fast Short Jump addressing mode may also be used. The 12-bit data is zero extended to form the effective address. See **A.8 INSTRUCTION SEQUENCE RESTRICTIONS** for restrictions. The term "cc" may specify the following conditions:

| "cc" Mnemonic                          | Condition                           |
|--|-------------------------------------|
| CC (HS) — carry clear (higher or same) | $C = 0$                             |
| CS (LO) — carry set (lower)            | $C = 1$                             |
| EC — extension clear                   | $E = 0$                             |
| EQ — equal                             | $Z = 1$                             |
| ES — extension set                     | $E = 1$                             |
| GE — greater than or equal             | $N \oplus V = 0$                    |
| GT — greater than                      | $Z + (N \oplus V) = 0$              |
| LC — limit clear                       | $L = 0$                             |
| LE — less than or equal                | $Z + (N \oplus V) = 1$              |
| LS — limit set                         | $L = 1$                             |
| LT — less than                         | $N \oplus V = 1$                    |
| MI — minus                             | $N = 1$                             |
| NE — not equal                         | $Z = 0$                             |
| NR — normalized                        | $Z + (\bar{U} \bullet \bar{E}) = 1$ |
| PL — plus                              | $N = 0$                             |
| NN — not normalized                    | $Z + (\bar{U} \bullet \bar{E}) = 0$ |

where

- $\bar{U}$  denotes the logical complement of U,
- + denotes the logical OR operator,
- $\bullet$  denotes the logical AND operator, and
- $\oplus$  denotes the logical Exclusive OR operator



# Jcc

## Jump Conditionally

# Jcc

**Restrictions:** A Jcc instruction used **within a DO loop** cannot begin at the address LA within that DO loop.

A Jcc instruction cannot be repeated using the REP instruction.

### Example:

```

:
JNN -(R4)           ;jump to P:(R4) - 1 if not normalized
:

```

**Explanation of Example:** In this example, program execution is transferred to the address P:(R4) - 1 if the result is not normalized. Note that the contents of address register R4 are decremented by 1, and the resulting address is then loaded into the program counter (PC) if the specified condition is true. If the specified condition is not true, no jump is taken, and the program counter is incremented by one.

### Condition Codes:

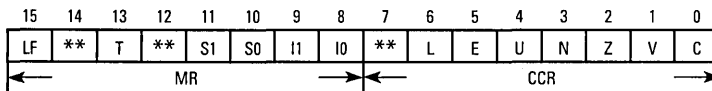

The condition codes are not affected by this instruction.

### Instruction Format:

Jcc xxx

### Opcode:

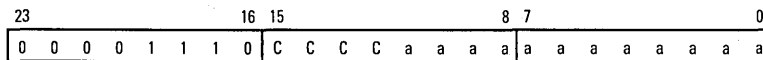

**A**

# Jcc

## Jump Conditionally

# Jcc

### Instruction Fields:

cc = 4-bit condition code = CCCC,  
 xxx = 12-bit Short Jump Address = aaaaaaaaaaaa

| Mnemonic | C C C C | Mnemonic | C C C C |
|----------|---------|----------|---------|
| CC (HS)  | 0 0 0 0 | CS (LO)  | 1 0 0 0 |
| GE       | 0 0 0 1 | LT       | 1 0 0 1 |
| NE       | 0 0 1 0 | EQ       | 1 0 1 0 |
| PL       | 0 0 1 1 | MI       | 1 0 1 1 |
| NN       | 0 1 0 0 | NR       | 1 1 0 0 |
| EC       | 0 1 0 1 | ES       | 1 1 0 1 |
| LC       | 0 1 1 0 | LS       | 1 1 1 0 |
| GT       | 0 1 1 1 | LE       | 1 1 1 1 |

**Timing:** 4 + jx oscillator clock cycles

**Memory:** 1 + ea program words

### Instruction Format:

Jcc ea

### Opcode:

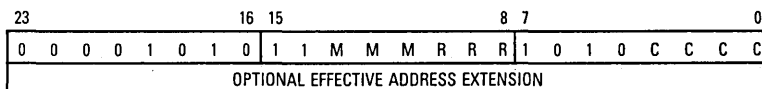

### Instruction Fields:

cc = 4-bit condition code = CCCC,  
 ea = 6-bit Effective Address = MMMRRR

| Effective Addressing Mode | MMM R R R   |
|---------------------------|-------------|
| (Rn) - Nn                 | 0 0 0 r r r |
| (Rn) + Nn                 | 0 0 1 r r r |
| (Rn) -                    | 0 1 0 r r r |
| (Rn) +                    | 0 1 1 r r r |
| (Rn)                      | 1 0 0 r r r |
| (Rn + Nn)                 | 1 0 1 r r r |
| -(Rn)                     | 1 1 1 r r r |
| Absolute address          | 1 1 0 0 0 0 |

where "rrr" refers to an address register R0-R7



# Jcc

## Jump Conditionally

# Jcc

| Mnemonic | C | C | C | C | Mnemonic | C | C | C | C |
|----------|---|---|---|---|----------|---|---|---|---|
| CC (HS)  | 0 | 0 | 0 | 0 | CS (LO)  | 1 | 0 | 0 | 0 |
| GE       | 0 | 0 | 0 | 1 | LT       | 1 | 0 | 0 | 1 |
| NE       | 0 | 0 | 1 | 0 | EQ       | 1 | 0 | 1 | 0 |
| PL       | 0 | 0 | 1 | 1 | MI       | 1 | 0 | 1 | 1 |
| NN       | 0 | 1 | 0 | 0 | NR       | 1 | 1 | 0 | 0 |
| EC       | 0 | 1 | 0 | 1 | ES       | 1 | 1 | 0 | 1 |
| LC       | 0 | 1 | 1 | 0 | LS       | 1 | 1 | 1 | 0 |
| GT       | 0 | 1 | 1 | 1 | LE       | 1 | 1 | 1 | 1 |

**Timing:** 4 + jx oscillator clock cycles

**Memory:** 1 + ea program words

**A**

# JCLR

## Jump if Bit Clear

# JCLR

### Operation:

If  $S[n]=0$ , then  $xxxx \rightarrow PC$   
else  $PC+1 \rightarrow PC$

If  $S[n]=0$ , then  $xxxx \rightarrow PC$   
else  $PC+1 \rightarrow PC$

If  $S[n]=0$ , then  $xxxx \rightarrow PC$   
else  $PC+1 \rightarrow PC$

If  $S[n]=0$ , then  $xxxx \rightarrow PC$   
else  $PC+1 \rightarrow PC$

If  $S[n]=0$ , then  $xxxx \rightarrow PC$   
else  $PC+1 \rightarrow PC$

If  $S[n]=0$ , then  $xxxx \rightarrow PC$   
else  $PC+1 \rightarrow PC$

If  $S[n]=0$ , then  $xxxx \rightarrow PC$   
else  $PC+1 \rightarrow PC$

### Assembler Syntax:

JCLR #n,X:ea,xxxx

JCLR #n,X:aa,xxxx

JCLR #n,X:pp,xxxx

JCLR #n,Y:ea,xxxx

JCLR #n,Y:aa,xxxx

JCLR #n,Y:pp,xxxx

JCLR #n,S,xxxx

**Description:** Jump to the 16-bit absolute address in program memory specified in the instruction's 24-bit extension word if the  $n^{\text{th}}$  bit of the source operand  $S$  is clear. The bit to be tested is selected by an immediate bit number from 0–23. If the specified memory bit is not clear, the program counter (PC) is incremented and the absolute address in the extension word is ignored. However, the address register specified in the effective address field is always updated independently of the state of the  $n^{\text{th}}$  bit. All address register indirect addressing modes may be used to reference the source operand  $S$ . Absolute Short and I/O Short addressing modes may also be used.

**Restrictions:** A JCLR instruction cannot be repeated using the REP instruction.

A JCLR located at  $LA$ ,  $LA-1$ , or  $LA-2$  of the DO loop cannot specify the program controller registers SR, SP, SSH, SSL, LA, or LC as its target.

JCLR SSH or JCLR SSL cannot **follow** an instruction that changes the SP.

**A**

# JCLR

Jump if Bit Clear

# JCLR

### Example:

```
JCLR #5,X:<<$FFF1,$1234 ;go to P:$1234 if bit 5 in SCI SSR is clear
```

**Explanation of Example:** In this example, program execution is transferred to the address P:\$1234 if bit 5 (PE) of the 8-bit read-only X memory location X:\$FFF1 (I/O SCI interface status register) is a zero. If the specified bit is not clear, no jump is taken, and the program counter (PC) is incremented by one.

### Condition Codes:

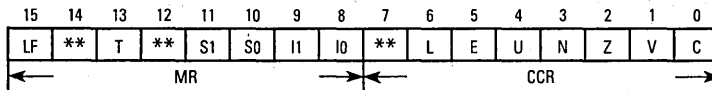

The condition codes are not affected by this instruction.

### Instruction Format:

JCLR #n,X:ea,xxxx

JCLR #n,Y:ea,xxxx

### Opcode:

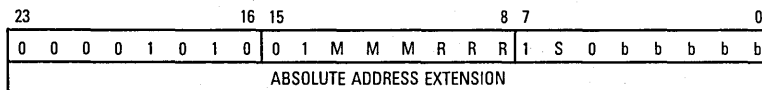

### Instruction Fields:

#n = bit number = bbbbb,

ea = 6-bit Effective Address = MMMRRR

xxxx = 16-bit Absolute Address in extension word

| Effective Addressing Mode | MMMR R R    | Memory Space | S | Bit Number bbbbb |
|---------------------------|-------------|--------------|---|------------------|
| (Rn) - Nn                 | 0 0 0 r r r | X Memory     | 0 | 00000            |
| (Rn) + Nn                 | 0 0 1 r r r | Y Memory     | 1 | .                |
| (Rn) -                    | 0 1 0 r r r |              |   | .                |
| (Rn) +                    | 0 1 1 r r r |              |   | .                |
| (Rn)                      | 1 0 0 r r r |              |   | 10111            |
| (Rn + Nn)                 | 1 0 1 r r r |              |   |                  |
| -(Rn)                     | 1 1 1 r r r |              |   |                  |

where: "rrr" refers to an address register R0-R7

**Timing:** 6 + jx oscillator clock cycles

**Memory:** 2 program words



# JCLR

Jump if Bit Clear

# JCLR

### Instruction Format:

JCLR #n,X:aa,xxxx

JCLR #n,Y:aa,xxxx

### Opcode:

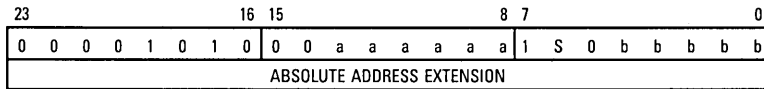

### Instruction Fields:

#n = bit number = bbbbb,

aa = 6-bit Absolute Short Address = aaaaaa,

xxxx = 16-bit Absolute Address in extension word

| Absolute Short Address aaaaaa | Memory SpaceS | Bit Number bbbbb |
|-------------------------------|---------------|------------------|
| 000000                        | X Memory 0    | 00000            |
| .                             | Y Memory 1    | .                |
| .                             |               | 10111            |
| 111111                        |               |                  |

**Timing:** 6 + jx oscillator clock cycles

**Memory:** 2 program words

### Instruction Format:

JCLR #n,X:pp,xxxx

JCLR #n,Y:pp,xxxx

### Opcode:

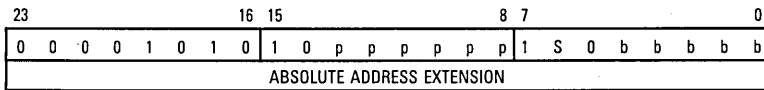

# JCLR

Jump if Bit Clear

# JCLR

### Instruction Fields:

#n = bit number = bbbbb,  
 pp = 6-bit I/O Short Address = pppppp,  
 xxxx = 16-bit Absolute Address in extension word

| I/O Short Address pppppp | Memory Space S | Bit Number bbbbb |
|--------------------------|----------------|------------------|
| 000000                   | X Memory 0     | 00000            |
| .                        | Y Memory 1     | .                |
| .                        |                | 10111            |
| 111111                   |                |                  |

**Timing:** 6 + jx oscillator clock cycles

**Memory:** 2 program words

### Instruction Format:

JCLR #n,S,xxxx

### Opcode:



### Instruction Fields:

#n = bit number = bbbbb,  
 S = source register = DDDDDD,  
 xxxx = 16-bit Absolute Address in extension word

| Destination Register                | DDDDDD      | Bit Number bbbbb |
|-------------------------------------|-------------|------------------|
| 4 registers in Data ALU             | 0 0 0 1 D D | 00000            |
| 8 accumulators in Data ALU          | 0 0 1 D D D | .                |
| 8 address registers in AGU          | 0 1 0 T T T | 10111            |
| 8 address offset registers in AGU   | 0 1 1 N N N |                  |
| 8 address modifier registers in AGU | 1 0 0 F F F |                  |
| 8 program controller registers      | 1 1 1 G G G |                  |

See **A.9 INSTRUCTION ENCODING** and Table A-18 for specific register encodings.

**Timing:** 6 + jx oscillator clock cycles

**Memory:** 2 program words



# JMP

## Jump

# JMP

**Operation:**     0xxx ↗ PC  
                   ea ↗ PC

**Assembler**    JMP xxx  
**Syntax:**       JMP ea

**Description:**   Jump to the location in program memory given by the instruction's effective address. All memory alterable addressing modes may be used for the effective address. A Fast Short Jump addressing mode may also be used. The 12-bit data is zero extended to form the effective address.

**Restrictions:**   A JMP instruction used **within a DO loop** cannot begin at the address LA within that DO loop.

A JMP instruction cannot be repeated using the REP instruction.

### Example:

```

:
JMP (R1 + N1)       ;jump to program address P:(R1 + N1)
:

```

**Explanation of Example:**   In this example, program execution is transferred to the program address P:(R1 + N1).

### Condition Codes:

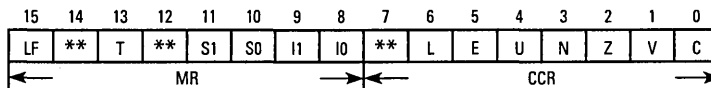

The condition codes are not affected by this instruction.



# JMP

Jump

# JMP

### Instruction Format:

JMP xxx

### Opcode:

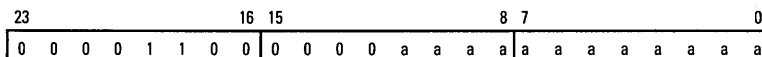

### Instruction Fields:

xxx = 12-bit Short Jump Address = aaaaaaaaaa

Timing: 4 + jx oscillator clock cycles

Memory: 1 + ea program words

### Instruction Format:

JMP ea

### Opcode:

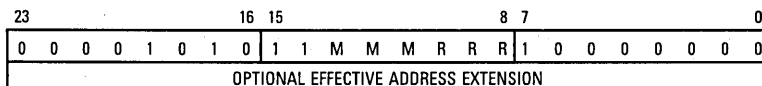

### Instruction Fields:

ea = 6-bit Effective Address = MMMRRR

| Effective Addressing Mode | MMM R R R   |
|---------------------------|-------------|
| (Rn) - Nn                 | 0 0 0 r r r |
| (Rn) + Nn                 | 0 0 1 r r r |
| (Rn) -                    | 0 1 0 r r r |
| (Rn) +                    | 0 1 1 r r r |
| (Rn)                      | 1 0 0 r r r |
| (Rn + Nn)                 | 1 0 1 r r r |
| -(Rn)                     | 1 1 1 r r r |
| Absolute address          | 1 1 0 0 0 0 |

where "rrr" refers to an address register R0-R7

Timing: 4 + jx oscillator clock cycles

Memory: 1 + ea program words



### Operation:

If cc, then SP+1  $\blacktriangleright$  SP; PC  $\blacktriangleright$  SSH; SR  $\blacktriangleright$  SSL; 0xxx  $\blacktriangleright$  PC  
 else PC+1  $\blacktriangleright$  PC

### Assembler Syntax:

JScC xxx

If cc, then SP+1  $\blacktriangleright$  SP; PC  $\blacktriangleright$  SSH; SR  $\blacktriangleright$  SSL; ea  $\blacktriangleright$  PC  
 else PC+1  $\blacktriangleright$  PC

JScC ea

**Description:** Jump to the subroutine whose location in program memory is given by the instruction's effective address if the specified condition is true. If the specified condition is true, the address of the instruction immediately following the JScC instruction (PC) and the system status register (SR) are pushed onto the system stack. Program execution then continues at the specified effective address in program memory. If the specified condition is false, the program counter (PC) is incremented, and any extension word is ignored. However, the address register specified in the effective address field is always updated independently of the specified condition. All memory alterable addressing modes may be used for the effective address. A fast short jump addressing mode may also be used. The 12-bit data is zero extended to form the effective address. The term "cc" may specify the following conditions:

| "cc" Mnemonic                          | Condition                       |
|--|---------------------------------|
| CC (HS) — carry clear (higher or same) | C=0                             |
| CS (LO) — carry set (lower)            | C=1                             |
| EC — extension clear                   | E=0                             |
| EQ — equal                             | Z=1                             |
| ES — extension set                     | E=1                             |
| GE — greater than or equal             | $N \oplus V=0$                  |
| GT — greater than                      | $Z+(N \oplus V)=0$              |
| LC — limit clear                       | L=0                             |
| LE — less than or equal                | $Z+(N \oplus V)=1$              |
| LS — limit set                         | L=1                             |
| LT — less than                         | $N \oplus V=1$                  |
| MI — minus                             | N=1                             |
| NE — not equal                         | Z=0                             |
| NR — normalized                        | $Z+(\bar{U} \bullet \bar{E})=1$ |
| PL — plus                              | N=0                             |
| NN — not normalized                    | $Z+(\bar{U} \bullet \bar{E})=0$ |

where

- $\bar{U}$  denotes the logical complement of U,
- + denotes the logical OR operator,
- $\bullet$  denotes the logical AND operator, and
- $\oplus$  denotes the logical Exclusive OR operator



**Restrictions:** A JScC instruction used **within a DO loop** cannot specify the **loop address (LA)** as its target.

A JScC instruction used **within in a DO loop** cannot begin at the address LA within that DO loop.

A JScC instruction cannot be repeated using the REP instruction.

**Example:**

```

:
JLS (R3+N3)          ;jump to subroutine at P:(R3+N3) if limit set (L=1)
:
    
```

**Explanation of Example:** In this example, program execution is transferred to the subroutine at address P:(R3+N3) in program memory if the limit bit is set (L=1). Both the return address (PC) and the status register (SR) are pushed onto the system stack prior to transferring program control to the subroutine if the specified condition is true. If the specified condition is not true, no jump is taken and the program counter is incremented by 1.

**Condition Codes:**

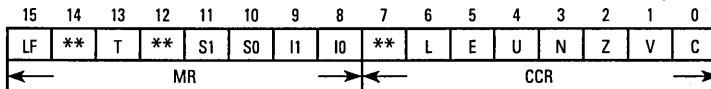

The condition codes are not affected by this instruction.

**Instruction Format:**

JScC xxx

**Opcode:**

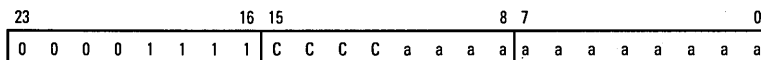

### Instruction Fields:

cc=4-bit condition code=CCCC,  
xxx=12-bit Short Jump Address=aaaaaaaaaa

| Mnemonic | C C C C | Mnemonic | C C C C |
|----------|---------|----------|---------|
| CC (HS)  | 0 0 0 0 | CS (LO)  | 1 0 0 0 |
| GE       | 0 0 0 1 | LT       | 1 0 0 1 |
| NE       | 0 0 1 0 | EQ       | 1 0 1 0 |
| PL       | 0 0 1 1 | MI       | 1 0 1 1 |
| NN       | 0 1 0 0 | NR       | 1 1 0 0 |
| EC       | 0 1 0 1 | ES       | 1 1 0 1 |
| LC       | 0 1 1 0 | LS       | 1 1 1 0 |
| GT       | 0 1 1 1 | LE       | 1 1 1 1 |

**Timing:** 4 + jx oscillator clock cycles

**Memory:** 1 + ea program words

### Instruction Format:

JScC ea

### Opcode:

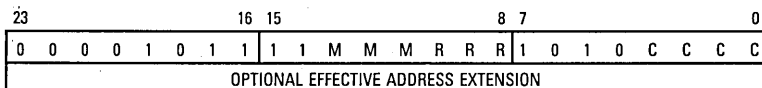

### Instruction Fields:

cc=4-bit condition code=CCCC,  
ea=6-bit Effective Address=MMMRRR

| Effective Address Mode | MMMR R R R  | Mnemonic | C C C C | Mnemonic | C C C C |
|------------------------|-------------|----------|---------|----------|---------|
| (Rn) - Nn              | 0 0 0 r r r | CC (HS)  | 0 0 0 0 | CS (LO)  | 1 0 0 0 |
| (Rn) + Nn              | 0 0 1 r r r | GE       | 0 0 0 1 | LT       | 1 0 0 1 |
| (Rn) -                 | 0 1 0 r r r | NE       | 0 0 1 0 | EQ       | 1 0 1 0 |
| (Rn) +                 | 0 1 1 r r r | PL       | 0 0 1 1 | MI       | 1 0 1 1 |
| (Rn)                   | 1 0 0 r r r | NN       | 0 1 0 0 | NR       | 1 1 0 0 |
| (Rn + Nn)              | 1 0 1 r r r | EC       | 0 1 0 1 | ES       | 1 1 0 1 |
| -(Rn)                  | 1 1 1 r r r | LC       | 0 1 1 0 | LS       | 1 1 1 0 |
| Absolute address       | 1 1 0 0 0 0 | GT       | 0 1 1 1 | LE       | 1 1 1 1 |

where "rrr" refers to an address register R0-R7

**Timing:** 4 + jx oscillator clock cycles

**Memory:** 1 + ea program words



# JSCLR

Jump to Subroutine  
if Bit Clear

# JSCLR

## Operation:

If  $S[n]=0$ ,  
then  $SP+1 \rightarrow SP$ ;  $PC \rightarrow SSH$ ;  $SR \rightarrow SSL$ ;  $xxxx \rightarrow PC$   
else  $PC+1 \rightarrow PC$

If  $S[n]=0$ ,  
then  $SP+1 \rightarrow SP$ ;  $PC \rightarrow SSH$ ;  $SR \rightarrow SSL$ ;  $xxxx \rightarrow PC$   
else  $PC+1 \rightarrow PC$

If  $S[n]=0$ ,  
then  $SP+1 \rightarrow SP$ ;  $PC \rightarrow SSH$ ;  $SR \rightarrow SSL$ ;  $xxxx \rightarrow PC$   
else  $PC+1 \rightarrow PC$

If  $S[n]=0$ ,  
then  $SP+1 \rightarrow SP$ ;  $PC \rightarrow SSH$ ;  $SR \rightarrow SSL$ ;  $xxxx \rightarrow PC$   
else  $PC+1 \rightarrow PC$

If  $S[n]=0$ ,  
then  $SP+1 \rightarrow SP$ ;  $PC \rightarrow SSH$ ;  $SR \rightarrow SSL$ ;  $xxxx \rightarrow PC$   
else  $PC+1 \rightarrow PC$

If  $S[n]=0$ ,  
then  $SP+1 \rightarrow SP$ ;  $PC \rightarrow SSH$ ;  $SR \rightarrow SSL$ ;  $xxxx \rightarrow PC$   
else  $PC+1 \rightarrow PC$

If  $S[n]=0$ ,  
then  $SP+1 \rightarrow SP$ ;  $PC \rightarrow SSH$ ;  $SR \rightarrow SSL$ ;  $xxxx \rightarrow PC$   
else  $PC+1 \rightarrow PC$

## Assembler Syntax:

JSCLR #n,X:ea,xxxx

JSCLR #n,X:aa,xxxx

JSCLR #n,X:pp,xxxx

JSCLR #n,Y:ea,xxxx

JSCLR #n,Y:aa,xxxx

JSCLR #n,Y:pp,xxxx

JSCLR #n,S,xxxx

**Description:** Jump to the subroutine at the 16-bit absolute address in program memory specified in the instruction's 24-bit extension word if the  $n^{\text{th}}$  bit of the source operand  $S$  is clear. The bit to be tested is selected by an immediate bit number from 0–23. If the  $n^{\text{th}}$  bit of the source operand  $S$  is clear, the address of the instruction immediately following the JSCLR instruction ( $PC$ ) and the system status register ( $SR$ ) are pushed onto the system stack. Program execution then continues at the specified absolute address in the instruction's 24-bit extension word. If the specified memory bit is not clear, the program counter ( $PC$ ) is incremented and the extension word is ignored. However, the address register specified in the effective address field is always updated independently of the state of the  $n^{\text{th}}$  bit. All address register indirect addressing modes

A



# JSCLR

## Jump to Subroutine if Bit Clear

# JSCLR

may be used to reference the source operand S. Absolute short and I/O short addressing modes may also be used.

**Restrictions:** A JSCLR instruction used **within a DO loop** cannot specify the **loop address (LA)** as its target.

A JSCLR located at LA, LA-1, or LA-2 of a DO loop, cannot specify the program controller registers SR, SP, SSH, SSL, LA, or LC as its target.

JSCLR SSH or JSCLR SSL cannot **follow** an instruction that changes the SP.

A JSCLR instruction cannot be repeated using the REP instruction.

### Example:

```
:  
JSCLR #S1,Y:<<$FFE3,$1357      ;go sub. at P:$1357 if bit 1 in Y:$FFE3 is clear  
:
```

**Explanation of Example:** In this example, program execution is transferred to the subroutine at absolute address P:\$1357 in program memory if bit 1 of the external I/O location Y:<<\$FFE3 is a zero. If the specified bit is not clear, no jump is taken and the program counter (PC) is incremented by 1.

### Condition Codes:

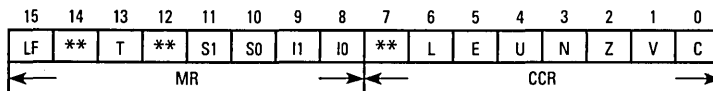

The condition codes are not affected by this instruction.

**A**

# JSCLR

Jump to Subroutine  
if Bit Clear

# JSCLR

### Instruction Format:

JSCLR #n,X:ea,xxxx

JSCLR #n,Y:ea,xxxx

### Opcode:

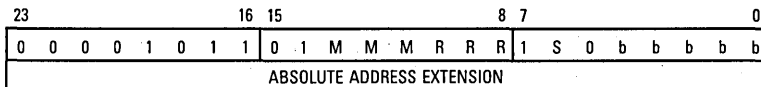

### Instruction Fields:

#n = bit number = bbbbb,

ea = 6-bit Effective Address = MMMRRR,

xxxx = 16-bit Absolute Address in extension word

| Effective<br>Addressing Mode | MMMRRR      | Memory Space S | Bit Number bbbbb |
|------------------------------|-------------|----------------|------------------|
| (Rn) - Nn                    | 0 0 0 r r r | X Memory 0     | 00000            |
| (Rn) + Nn                    | 0 0 1 r r r | Y Memory 1     | .                |
| (Rn) -                       | 0 1 0 r r r |                | .                |
| (Rn) +                       | 0 1 1 r r r |                | .                |
| (Rn)                         | 1 0 0 r r r |                | 10111            |
| (Rn + Nn)                    | 1 0 1 r r r |                |                  |
| -(Rn)                        | 1 1 1 r r r |                |                  |

where "rrr" refers to an address register R0-R7

**Timing:** 6 + jx oscillator clock cycles

**Memory:** 2 program words

### Instruction Format:

JSCLR #n,X:aa,xxxx

JSCLR #n,Y:aa,xxxx

### Opcode:

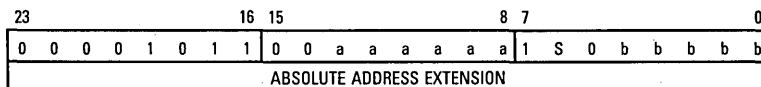

### Instruction Fields:

#n = bit number = bbbbb,

aa = 6-bit Absolute Short Address = aaaaaa,

xxxx = 16-bit Absolute Address in extension word

**A**

# JSCLR

## Jump to Subroutine if Bit Clear

# JSCLR

| Absolute Short Address aaaaaa | Memory SpaceS | Bit Number bbbbb |
|-------------------------------|---------------|------------------|
| 000000                        | X Memory 0    | 00000            |
| .                             | Y Memory 1    | .                |
| .                             |               | 10111            |
| 111111                        |               |                  |

**Timing:** 6 + jx oscillator clock cycles

**Memory:** 2 program words

### Instruction Format:

JSCLR #n,X:pp,xxxx

JSCLR #n,Y:pp,xxxx

### Opcode:

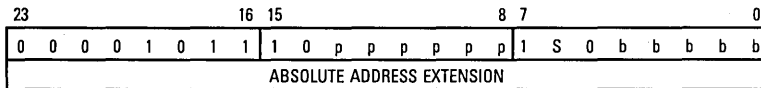

### Instruction Fields:

#n = bit number = bbbbb,

pp = 6-bit I/O Short Address = pppppp,

xxxx = 16-bit Absolute Address in extension word

| I/O Short Address pppppp | Memory SpaceS | Bit Number bbbbb |
|--------------------------|---------------|------------------|
| 000000                   | X Memory 0    | 00000            |
| .                        | Y Memory 1    | .                |
| .                        |               | 10111            |
| 111111                   |               |                  |

**Timing:** 6 + jx oscillator clock cycles

**Memory:** 2 program words



# JSCLR

Jump to Subroutine  
if Bit Clear

# JSCLR

### Instruction Format:

JSCLR #n,S,xxxx

### Opcode:

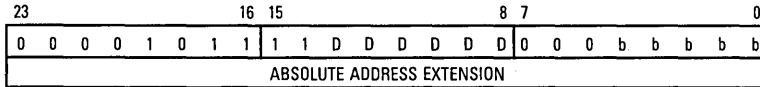

### Instruction Fields:

#n = bit number = bbbbb,

S = source register = DDDDD,

xxxx = 16-bit Absolute Address in extension word

| Destination Register                | D D D D D   | Bit Number bbbbb |
|-------------------------------------|-------------|------------------|
| 4 registers in Data ALU             | 0 0 0 1 D D | 00000            |
| 8 accumulators in Data ALU          | 0 0 1 D D D | .                |
| 8 address registers in AGU          | 0 1 0 T T T | 10111            |
| 8 address offset registers in AGU   | 0 1 1 N N N |                  |
| 8 address modifier registers in AGU | 1 0 0 F F F |                  |
| 8 program controller registers      | 1 1 1 G G G |                  |

See **A.9 Instruction Encoding** and Table A-18 for specific register encodings.

**Timing:** 6 + jx oscillator clock cycles

**Memory:** 2 program words

**A**

# JSET

## Jump if Bit Set

# JSET

### Operation:

If  $S[n] = 1$ , then  $xxxx \rightarrow PC$   
else  $PC + 1 \rightarrow PC$

If  $S[n] = 1$ , then  $xxxx \rightarrow PC$   
else  $PC + 1 \rightarrow PC$

If  $S[n] = 1$ , then  $xxxx \rightarrow PC$   
else  $PC + 1 \rightarrow PC$

If  $S[n] = 1$ , then  $xxxx \rightarrow PC$   
else  $PC + 1 \rightarrow PC$

If  $S[n] = 1$ , then  $xxxx \rightarrow PC$   
else  $PC + 1 \rightarrow PC$

If  $S[n] = 1$ , then  $xxxx \rightarrow PC$   
else  $PC + 1 \rightarrow PC$

If  $S[n] = 1$ , then  $xxxx \rightarrow PC$   
else  $PC + 1 \rightarrow PC$

### Assembler Syntax:

JSET #n,X:ea,xxxx

JSET #n,X:aa,xxxx

JSET #n,X:pp,xxxx

JSET #n,Y:ea,xxxx

JSET #n,Y:aa,xxxx

JSET #n,Y:pp,xxxx

JSET #n,S,xxxx

**Description:** Jump to the 16-bit absolute address in program memory specified in the instruction's 24-bit extension word if the  $n^{\text{th}}$  bit of the source operand  $S$  is set. The bit to be tested is selected by an immediate bit number from 0–23. If the specified memory bit is not set, the program counter (PC) is incremented, and the absolute address in the extension word is ignored. However, the address register specified in the effective address field is always updated independently of the state of the  $n^{\text{th}}$  bit. All address register indirect addressing modes may be used to reference the source operand  $S$ . Absolute short and I/O short addressing modes may also be used.

**Restrictions:** A JSET instruction used **within a DO loop** cannot specify the **loop address (LA)** as its target.

A JSET located at LA, LA–1, or LA–2 of a DO loop cannot specify the program controller registers SR, SP, SSH, SSL, LA, or LC as its target.

JSET SSH or JSET SSL cannot **follow** an instruction that changes the SP.

A JSET instruction cannot be repeated using the REP instruction.

A

# JSET

## Jump if Bit Set

# JSET

### Example:

```

:
JSET #12,X:<<$FFF2,$4321      ;$4321 ↯ (PC) if bit 12 (SCI COD) is set
:

```

**Explanation of Example:** In this example, program execution is transferred to the address P:\$4321 if bit 12 (SCI COD) of the 16-bit read/write I/O register X:\$FFF2 is a one. If the specified bit is not set, no jump is taken and the program counter (PC) is incremented by 1.

### Condition Codes:

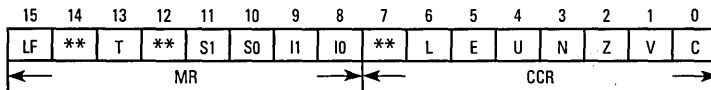

The condition codes are not affected by this instruction.

### Instruction Format:

```

JSET #n,X:ea,xxxx
JSET #n,Y:ea,xxxx

```

### Opcode:

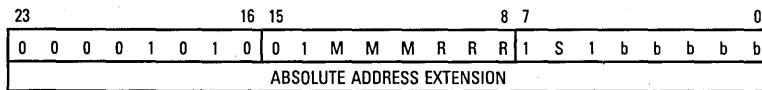

### Instruction Fields:

#n = bit number = bbbbb,  
 ea = 6-bit Effective Address = MMMRRR  
 xxxx = 16-bit Absolute Address in extension word

| Effective Addressing Mode | MMMRRR      | Memory Space | S | Bit Number bbbbb |
|---------------------------|-------------|--------------|---|------------------|
| (Rn) - Nn                 | 0 0 0 r r r | X Memory     | 0 | 00000            |
| (Rn) + Nn                 | 0 0 1 r r r | Y Memory     | 1 | .                |
| (Rn) -                    | 0 1 0 r r r |              |   | .                |
| (Rn) +                    | 0 1 1 r r r |              |   | .                |
| (Rn)                      | 1 0 0 r r r |              |   | 10111            |
| (Rn + Nn)                 | 1 0 1 r r r |              |   |                  |
| -(Rn)                     | 1 1 1 r r r |              |   |                  |

where "rrr" refers to an address register R0-R7

# JSET

Jump if Bit Set

# JSET

**Timing:** 6 + jx oscillator clock cycles

**Memory:** 2 program words

**Instruction Format:**

JSET #n,X:aa,xxxx

JSET #n,Y:aa,xxxx

**Opcode:**

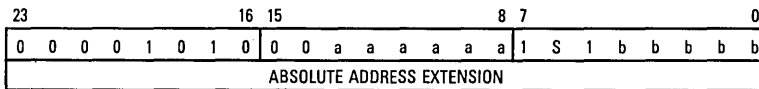

**Instruction Fields:**

#n = bit number = bbbbb,

aa = 6-bit Absolute Short Address = aaaaaa,

xxxx = 16-bit Absolute Address in extension word

| Absolute Short Address aaaaaa | Memory Space S | Bit Number bbbbb |
|-------------------------------|----------------|------------------|
| 000000                        | X Memory 0     | 00000            |
| .                             | Y Memory 1     | .                |
| .                             |                | 10111            |
| 111111                        |                |                  |

**Timing:** 6 + jx oscillator clock cycles

**Memory:** 2 program words

**Instruction Format:**

JSET #n,X:pp,xxxx

JSET #n,Y:pp,xxxx

**Opcode:**

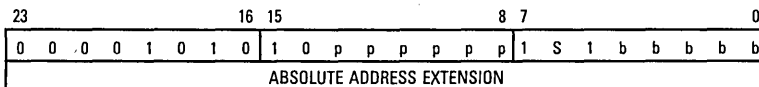

# JSET

## Jump if Bit Set

# JSET

### Instruction Fields:

#n = bit number = bbbbb,  
 pp = 6-bit I/O Short Address = pppppp,  
 xxxx = 16-bit Absolute Address in extension word

| I/O Short Address pppppp | Memory Space S | Bit Number bbbbb |
|--------------------------|----------------|------------------|
| 000000                   | X Memory 0     | 00000            |
| .                        | Y Memory 1     | .                |
| .                        |                | 10111            |
| 111111                   |                |                  |

**Timing:** 6 + jx oscillator clock cycles

**Memory:** 2 program words

### Instruction Format:

JSET #n,S,xxxx

### Opcode:

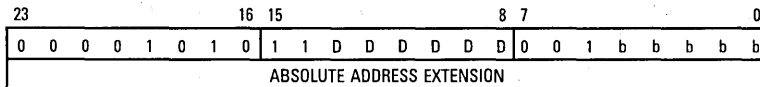

### Instruction Fields:

#n = bit number = bbbbb,  
 S = source register = DDDDDD,  
 xxxx = 16-bit Absolute Address in extension word

| Destination Register                | DDDDDD      | Bit Number bbbbb |
|-------------------------------------|-------------|------------------|
| 4 registers in Data ALU             | 0 0 0 1 D D | 00000            |
| 8 accumulators in Data ALU          | 0 0 1 D D D | .                |
| 8 address registers in AGU          | 0 1 0 T T T | 10111            |
| 8 address offset registers in AGU   | 0 1 1 N N N |                  |
| 8 address modifier registers in AGU | 1 0 0 F F F |                  |
| 8 program controller registers      | 1 1 1 G G G |                  |

See **A.9 Instruction Encoding** and Table A-18 for specific register encodings.

**Timing:** 6 + jx oscillator clock cycles

**Memory:** 2 program words

**A**



# JSR

## Jump to Subroutine

# JSR

### Operation:

SP+1 ↗ SP; PC ↗ SSH; SR ↗ SSL; 0xxx ↗ PC

SP+1 ↗ SP; PC ↗ SSH; SR ↗ SSL; ea ↗ PC

### Assembler Syntax:

JSR xxx

JSR ea

**Description:** Jump to the subroutine whose location in program memory is given by the instruction's effective address. The address of the instruction immediately following the JSR instruction (PC) and the system status register (SR) is pushed onto the system stack. Program execution then continues at the specified effective address in program memory. All memory alterable addressing modes may be used for the effective address. A fast short jump addressing mode may also be used. The 12-bit data is zero extended to form the effective address.

**Restrictions:** A JSR instruction used **within a DO loop** cannot specify the **loop address (LA)** as its target.

A JSR instruction used **within a DO loop** cannot begin at the address LA within that DO loop.

A JSR instruction cannot be repeated using the REP instruction.

### Example:

```
:  
JSR (R5)+           ;jump to subroutine at (R5), update R5  
:
```

**Explanation of Example:** In this example, program execution is transferred to the subroutine at address P:(R5) in program memory, and the contents of the R5 address register are then updated.

### Condition Codes:

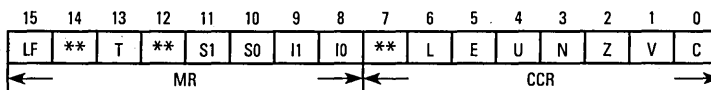

The condition codes are not affected by this instruction.



# JSR

## Jump to Subroutine

# JSR

### Instruction Format:

JSR xxx

### Opcode:

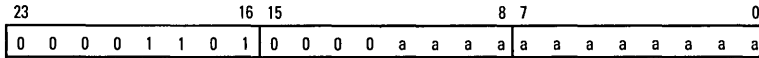

### Instruction Fields:

xxx = 12-bit Short Jump Address = aaaaaaaaaa

**Timing:** 4 + jx oscillator clock cycles

**Memory:** 1 + ea program words

### Instruction Format:

JSR ea

### Opcode:

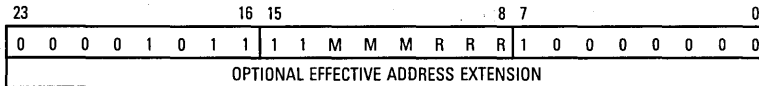

### Instruction Fields:

ea = 6-bit Effective Address = MMMRRR

| Effective Addressing Mode | MMMRRR      |
|---------------------------|-------------|
| (Rn) - Nn                 | 0 0 0 r r r |
| (Rn) + Nn                 | 0 0 1 r r r |
| (Rn) -                    | 0 1 0 r r r |
| (Rn) +                    | 0 1 1 r r r |
| (Rn)                      | 1 0 0 r r r |
| (Rn + Nn)                 | 1 0 1 r r r |
| -(Rn)                     | 1 1 1 r r r |
| Absolute address          | 1 1 0 0 0 0 |

where "rrr" refers to an address register R0-R7

**Timing:** 4 + jx oscillator clock cycles

**Memory:** 1 + ea program words

# JSSET

Jump to Subroutine  
if Bit Set

# JSSET

## Operation:

If  $S[n] = 1$ ,  
then  $SP + 1 \rightarrow SP$ ;  $PC \rightarrow SSH$ ;  $SR \rightarrow SSL$ ;  $xxxx \rightarrow PC$   
else  $PC + 1 \rightarrow PC$

If  $S[n] = 1$ ,  
then  $SP + 1 \rightarrow SP$ ;  $PC \rightarrow SSH$ ;  $SR \rightarrow SSL$ ;  $xxxx \rightarrow PC$   
else  $PC + 1 \rightarrow PC$

If  $S[n] = 1$ ,  
then  $SP + 1 \rightarrow SP$ ;  $PC \rightarrow SSH$ ;  $SR \rightarrow SSL$ ;  $xxxx \rightarrow PC$   
else  $PC + 1 \rightarrow PC$

If  $S[n] = 1$ ,  
then  $SP + 1 \rightarrow SP$ ;  $PC \rightarrow SSH$ ;  $SR \rightarrow SSL$ ;  $xxxx \rightarrow PC$   
else  $PC + 1 \rightarrow PC$

If  $S[n] = 1$ ,  
then  $SP + 1 \rightarrow SP$ ;  $PC \rightarrow SSH$ ;  $SR \rightarrow SSL$ ;  $xxxx \rightarrow PC$   
else  $PC + 1 \rightarrow PC$

If  $S[n] = 1$ ,  
then  $SP + 1 \rightarrow SP$ ;  $PC \rightarrow SSH$ ;  $SR \rightarrow SSL$ ;  $xxxx \rightarrow PC$   
else  $PC + 1 \rightarrow PC$

If  $S[n] = 1$ ,  
then  $SP + 1 \rightarrow SP$ ;  $PC \rightarrow SSH$ ;  $SR \rightarrow SSL$ ;  $xxxx \rightarrow PC$   
else  $PC + 1 \rightarrow PC$

## Assembler Syntax:

JSSET #n,X:ea,xxxx

JSSET #n,X:aa,xxxx

JSSET #n,X:pp,xxxx

JSSET #n,Y:ea,xxxx

JSSET #n,Y:aa,xxxx

JSSET #n,Y:pp,xxxx

JSSET #n,S,xxxx

**Description:** Jump to the subroutine at the 16-bit absolute address in program memory specified in the instruction's 24-bit extension word if the  $n^{\text{th}}$  bit of the source operand S is set. The bit to be tested is selected by an immediate bit number from 0–23. If the  $n^{\text{th}}$  bit of the source operand S is set, the address of the instruction immediately following the JSSET instruction (PC) and the system status register (SR) are pushed onto the system stack. Program execution then continues at the specified absolute address in the instruction's 24-bit extension word. If the specified memory bit is not set, the program counter (PC) is incremented, and the extension word is ignored. However, the address register specified in the effective address field is always updated independently of the state of the  $n^{\text{th}}$  bit. All address register indirect addressing modes may be used to reference the source operand S. Absolute short and I/O short addressing modes may also be used.

A

# JSSET

## Jump to Subroutine if Bit Set

# JSSET

**Restrictions:** A JSSET instruction used **within a DO loop** cannot specify the **loop address (LA)** as its target.

A JSSET located at LA, LA-1, or LA-2 of a DO loop, cannot specify the program controller registers SR, SP, SSH, SSL, LA, or LC as its target.

JSSET SSH or JSSET SSL cannot **follow** an instruction that changes the SP.

A JSSET instruction cannot be repeated using the REP instruction.

### Example:

```
:  
JSSET # $17, Y: < $3F, $100 ; go to sub. at P: $0100 if bit 23 in Y: $3F is set  
:
```

**Explanation of Example:** In this example, program execution is transferred to the subroutine at absolute address P: \$0100 in program memory if bit 23 of Y memory location Y: \$003F is a one. If the specified bit is not set, no jump is taken and the program counter (PC) is incremented by 1.

### Condition Codes:

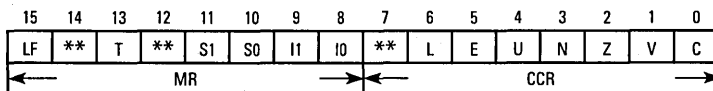

The condition codes are not affected by this instruction.

### Instruction Format:

```
JSSET #n, X:ea, xxxx  
JSSET #n, Y:ea, xxxx
```

### Opcode:



A

### Instruction Fields:

#n = bit number = bbbbb,  
 ea = 6-bit Effective Address = MMMRRR,  
 xxxx = 16-bit Absolute Address in extension word

| Effective Addressing Mode | MMMR R R    | Memory Space S | Bit Number bbbbb |
|---------------------------|-------------|----------------|------------------|
| (Rn) - Nn                 | 0 0 0 r r r | X Memory 0     | 00000            |
| (Rn) + Nn                 | 0 0 1 r r r | Y Memory 1     | .                |
| (Rn) -                    | 0 1 0 r r r |                | .                |
| (Rn) +                    | 0 1 1 r r r |                | .                |
| (Rn)                      | 1 0 0 r r r |                | 10111            |
| (Rn + Nn)                 | 1 0 1 r r r |                |                  |
| -(Rn)                     | 1 1 1 r r r |                |                  |

where "rrr" refers to an address register R0-R7

**Timing:** 6 + jx oscillator clock cycles

**Memory:** 2 program words

### Instruction Format:

JSSET #n,X:aa,xxxx  
 JSSET #n,Y:aa,xxxx

### Opcode:

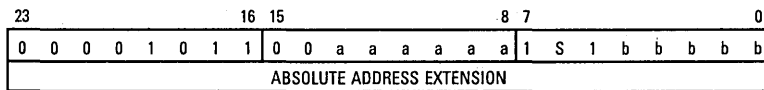

### Instruction Fields:

#n = bit number = bbbbb,  
 aa = 6-bit Absolute Short Address = aaaaaa,  
 xxxx = 16-bit Absolute Address in extension word

| Absolute Short Address aaaaaa | Memory Space S | Bit Number bbbbb |
|-------------------------------|----------------|------------------|
| 000000                        | X Memory 0     | 00000            |
| .                             | Y Memory 1     | .                |
| .                             |                | .                |
| 111111                        |                | 10111            |

**Timing:** 6 + jx oscillator clock cycles

**Memory:** 2 program words



# JSSET

Jump to Subroutine  
if Bit Set

# JSSET

### Instruction Format:

JSSET #n,X:pp,xxxx

JSSET #n,Y:pp,xxxx

### Opcode:

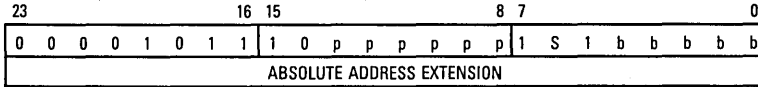

### Instruction Fields:

#n = bit number = bbbbb,

pp = 6-bit I/O Short Address = pppppp,

xxxx = 16-bit Absolute Address in extension word

| I/O Short Address pppppp | Memory Space S | Bit Number bbbbb |
|--------------------------|----------------|------------------|
| 000000                   | X Memory 0     | 00000            |
| .                        | Y Memory 1     | .                |
| .                        |                | 10111            |
| 111111                   |                |                  |

**Timing:** 6 + jx oscillator clock cycles

**Memory:** 2 program words

**A**

# JSSET

Jump to Subroutine  
if Bit Set

# JSSET

### Instruction Format:

JSSET #n,S,xxxx

### Opcode:

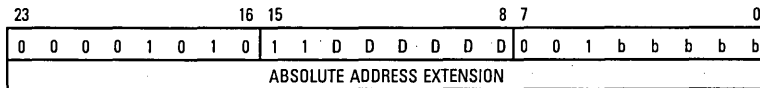

### Instruction Fields:

#n = bit number = bbbbbb,

S = source register = DDDDDD,

xxxx = 16-bit Absolute Address in extension word

| Destination Register                | D D D D D D | Bit Number bbbbbb |
|-------------------------------------|-------------|-------------------|
| 4 registers in Data ALU             | 0 0 0 1 D D | 00000             |
| 8 accumulators in Data ALU          | 0 0 1 D D D | .                 |
| 8 address registers in AGU          | 0 1 0 T T T | 10111             |
| 8 address offset registers in AGU   | 0 1 1 N N N |                   |
| 8 address modifier registers in AGU | 1 0 0 F F F |                   |
| 8 program controller registers      | 1 1 1 G G G |                   |

See **A.9 Instruction Encoding** and Table A-18 for specific register encodings.

**Timing:** 6 + jx oscillator clock cycles

**Memory:** 2 program words



# LSL

## Logical Shift Left

# LSL

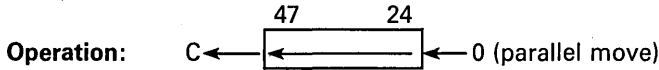

### Assembler

Syntax: LSL D (parallel move)

**Description:** Logically shift bits 47–24 of the destination operand D one bit to the left and store the result in the destination accumulator. Prior to instruction execution, bit 47 of D is shifted into the carry bit C, and a zero is shifted into bit 24 of the destination accumulator D. This instruction is a 24-bit operation. The remaining bits of the destination operand D are not affected. If a zero shift count is specified, the carry bit is cleared. The difference between LSL and ASL is that LSL operates on only A1 or B1 and always clears the V bit.

### Example:

```

:
LSL B # $7F,R0          ;shift B1 one bit to the left, set up R0
:

```

|    | Before Execution   | After Execution    |
|----|--------------------|--------------------|
| B  | \$00:F01234:13579B | \$00:E02468:13579B |
| SR | \$0300             | \$0309             |

**Explanation of Example:** Prior to execution, the 56-bit B accumulator contains the value \$00:F01234:13579B. The execution of the LSL B instruction shifts the 24-bit value in the B1 register one bit to the left and stores the result back in the B1 register.

### Condition Codes:

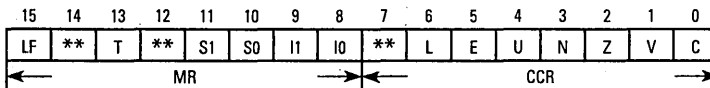

- L — Set if data limiting has occurred during parallel move
- N — Set if bit 47 of A or B result is set
- Z — Set if bits 47–24 of A or B result are zero
- V — Always cleared
- C — Set if bit 47 of A or B was set prior to instruction execution



# LSL

## Logical Shift Left

# LSL

### Instruction Format:

LSL D

### Opcode:

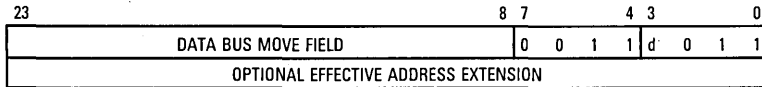

### Instruction Fields:

D d  
A 0  
B 1

**Timing:** 2 + mv oscillator clock cycles

**Memory:** 1 + mv program words

A

# LSR

## Logical Shift Right

# LSR

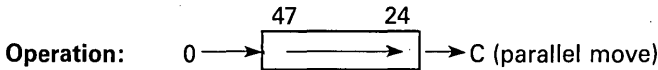

### Assembler

Syntax: LSR D (parallel move)

**Description:** Logically shift bits 47–24 of the destination operand D one bit to the right and store the result in the destination accumulator. Prior to instruction execution, bit 24 of D is shifted into the carry bit C, and a zero is shifted into bit 47 of the destination accumulator D. This instruction is a 24-bit operation. The remaining bits of the destination operand D are not affected.

### Example:

```

:
LSR A A1,N4           ;shift A1 one bit to the right, set up N4
:

```

|    | Before Execution   | After Execution    |
|----|--------------------|--------------------|
| A  | \$37:444445:828180 | \$37:222222:828180 |
| SR | \$0300             | \$0301             |

**Explanation of Example:** Prior to execution, the 56-bit A accumulator contains the value \$37:444445:828180. The execution of the LSR A instruction shifts the 24-bit value in the A1 register one bit to the right and stores the result back in the A1 register.

### Condition Codes:

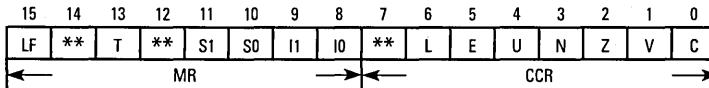

- L — Set if data limiting has occurred during parallel move
- N — Always cleared
- Z — Set if bits 47–24 of A or B result are zero
- V — Always cleared
- C — Set if bit 24 of A or B was set prior to instruction execution

**A**

# LSR

Logical Shift Right

# LSR

**Instruction Format:**

LSR D

**Opcode:**

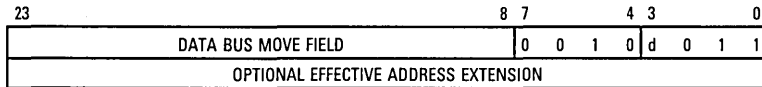

**Instruction Fields:**

D d

A 0

B 1

**Timing:** 2 + mv oscillator clock cycles

**Memory:** 1 + mv program words



**Operation:**  
ea ↗ d

**Assembler Syntax:**  
LUA ea,D

**Description:** Load the updated address into the destination address register D. The source address register and the update mode used to compute the updated address are specified by the effective address (ea). **Note that the source address register specified in the effective address is not updated.** All update addressing modes may be used.

**NOTE:** This instruction is considered to be a move-type instruction. Due to pipelining, the new contents of the destination address register (R0–R7 or N0–N7) will not be available for use during the following instruction (i.e., there is a single instruction cycle pipeline delay).

**Example:**

```

:
LUA (R0)+N0,R1      ;update R1 using (R0)+N0
:

```

|    | Before Execution | After Execution |
|----|------------------|-----------------|
| R0 | \$0003           | \$0003          |
| N0 | \$0005           | \$0005          |
| R1 | \$0004           | \$0008          |

**Explanation of Example:** Prior to execution, the 16-bit address register R0 contains the value \$0003, the 16-bit address register N0 contains the value \$0005, and the 16-bit address register R1 contains the value \$0004. The execution of the LUA (R0)+N0,R1 instruction adds the contents of the R0 register to the contents of the N0 register and stores the resulting updated address in the R1 address register. The contents of both the R0 and N0 address registers are not affected.

**Condition Codes:**

|      |    |    |    |    |    |    |    |         |   |   |   |   |   |   |   |
|------|----|----|----|----|----|----|----|---------|---|---|---|---|---|---|---|
| 15   | 14 | 13 | 12 | 11 | 10 | 9  | 8  | 7       | 6 | 5 | 4 | 3 | 2 | 1 | 0 |
| LF   | ** | T  | ** | S1 | S0 | I1 | I0 | **      | L | E | U | N | Z | V | C |
| ← MR |    |    |    |    |    |    |    | ← CCR → |   |   |   |   |   |   |   |

The condition codes are not affected by this instruction.



# MAC

## Signed Multiply-Accumulate

# MAC

### Operation:

$D \pm S1 * S2 \rightarrow D$  (parallel move)

$D \pm S1 * S2 \rightarrow D$  (parallel move)

### Assembler Syntax:

MAC ( $\pm$ )S1,S2,D (parallel move)

MAC ( $\pm$ )S2,S1,D (parallel move)

**Description:** Multiply the two signed 24-bit source operands S1 and S2 and add/subtract the product to/from the specified 56-bit destination accumulator D. The “-” sign option is used to negate the specified product prior to accumulation. The default sign option is “+”.

### Example:

MAC X0,X0,A X:(R2)+N2,Y1 ;square X0 and store in A, update Y1 and R2

|    | Before Execution   |    | After Execution    |
|----|--------------------|----|--------------------|
| X0 | \$123456           | X0 | \$123456           |
| A  | \$00:100000:000000 | A  | \$00:1296CD:9619C8 |

**Explanation of Example:** Prior to execution, the 24-bit X0 register contains the value of \$123456 (0.142222166), and the 56-bit A accumulator contains the value \$00:100000:000000 (0.125). The execution of the MAC X0,X0,A instruction squares the 24-bit signed value in the X0 register and adds the resulting 48-bit product to the 56-bit A accumulator ( $X0 * X0 + A = 0.145227144519197$  approximately = \$00:1296CD:9619C8 = A).

### Condition Codes:

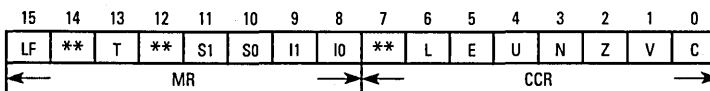

- L — Set if limiting (parallel move) or overflow has occurred in result
- E — Set if the signed integer portion of A or B result in use
- U — Set if A or B result is unnormalized
- N — Set if bit 55 of A or B result is set
- Z — Set if A or B result equals zero
- V — Set if overflow has occurred in A or B result

**NOTE:** The definition of the E and U bits varies according to the scaling mode being used. Refer to **A.4 CONDITION CODE COMPUTATION** for complete details.



# MAC

## Signed Multiply-Accumulate

# MAC

### Instruction Format:

MAC ( $\pm$ )S1,S2,D

MAC ( $\pm$ )S2,S1,D

### Opcode:

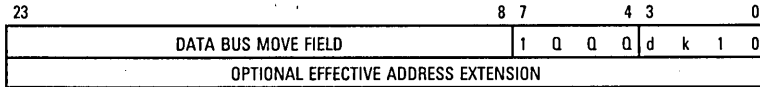

### Instruction Fields:

| S1*S2 | Q Q Q | Sign | k | D | d |
|-------|-------|------|---|---|---|
| X0 X0 | 0 0 0 | +    | 0 | A | 0 |
| Y0 Y0 | 0 0 1 | -    | 1 | B | 1 |
| X1 X0 | 0 1 0 |      |   |   |   |
| Y1 Y0 | 0 1 1 |      |   |   |   |
| X0 Y1 | 1 0 0 |      |   |   |   |
| Y0 X0 | 1 0 1 |      |   |   |   |
| X1 Y0 | 1 1 0 |      |   |   |   |
| Y1 X1 | 1 1 1 |      |   |   |   |

**NOTE:** Only the indicated S1\*S2 combinations are valid. X1\*X1 and Y1\*Y1 are not valid.

**Timing:** 2 + mv oscillator clock cycles

**Memory:** 1 + mv program words



# MACR

## Signed Multiply-Accumulate and Round

# MACR

### Operation:

$D \pm S1 * S2 + r \blacktriangleright D$  (parallel move)

$D \pm S1 * S2 + r \blacktriangleright D$  (parallel move)

### Assembler Syntax:

MACR ( $\pm$ )S1,S2,D (parallel move)

MACR ( $\pm$ )S2,S1,D (parallel move)

**Description:** Multiply the two signed 24-bit source operands S1 and S2, add/subtract the product to/from the specified 56-bit destination accumulator D, and then round the result using convergent rounding. The rounded result is stored in the destination accumulator D. The “-” sign option is used to negate the specified product prior to accumulation. The default sign option is “+”. The contribution of the LS bits of the result is rounded into the upper portion of the destination accumulator (A1 or B1) by adding a constant to the LS bits of the lower portion of the accumulator (A0 or B0). The value of the constant added is determined by the scaling mode bits S0 and S1 in the status register. Once rounding has been completed, the LS bits of the destination accumulator D (A0 or B0) are loaded with zeros to maintain an unbiased accumulator value which may be reused by the next instruction. The upper portion of the accumulator (A1 or B1) contains the rounded result which may be read out to the data buses. Refer to the RND instruction for more complete information on the convergent rounding process.

### Example:

```
MACR X0,Y0,B B,X0 Y:(R4)+N4,Y0 ;X0*Y0+B  $\blacktriangleright$  B, rnd B, update X0,Y0,R4
```

|    | Before Execution   |    | After Execution    |
|----|--------------------|----|--------------------|
| X0 | \$123456           | X0 | \$100000           |
| Y0 | \$123456           | Y0 | \$987654           |
| B  | \$00:100000:000000 | B  | \$00:1296CE:000000 |

**Explanation of Example:** Prior to execution, the 24-bit X0 register contains the value \$123456 (0.142222166), the 24-bit Y0 register contains the value \$123456 (0.142222166), and the 56-bit B accumulator contains the value \$00:100000:000000 (0.125). The execution of the MACR X0,Y0,B instruction multiplies the 24-bit signed value in the X0 register by the 24-bit signed value in the Y0 register, adds the resulting product to the 56-bit B accumulator, rounds the result into the B1 portion of the accumulator, and then zeros the B0 portion of the accumulator ( $X0 * Y0 + B = 0.145227144519197$  approximately = \$00:1296CD:9619C8, which is rounded to the value \$00:1296CE:000000 = 0.145227193832397 = B).

**A**



# MACR

## Signed Multiply-Accumulate and Round

# MACR

### Condition Codes:

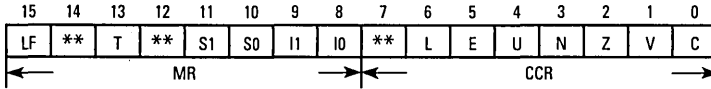

- L — Set if limiting (parallel move) or overflow has occurred in result
- E — Set if the signed integer portion of A or B result is in use
- U — Set if A or B result is unnormalized
- N — Set if bit 55 of A or B result is set
- Z — Set if A or B result equals zero
- V — Set if overflow has occurred in A or B result

**NOTE:** The definition of the E and U bits varies according to the scaling mode being used. Refer to **A.4 CONDITION CODE COMPUTATION** for complete details.

### Instruction Format:

MACR (±)S1,S2,D

MACR (±)S2,S1,D

### Opcode:

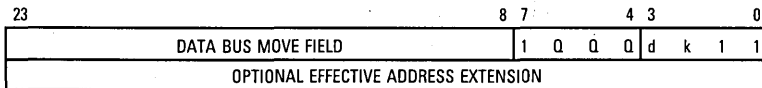

### Instruction Fields:

| S1*S2 | Q Q Q | Sign | k | D | d |
|-------|-------|------|---|---|---|
| X0 X0 | 0 0 0 | +    | 0 | A | 0 |
| Y0 Y0 | 0 0 1 | -    | 1 | B | 1 |
| X1 X0 | 0 1 0 |      |   |   |   |
| Y1 Y0 | 0 1 1 |      |   |   |   |
| X0 Y1 | 1 0 0 |      |   |   |   |
| Y0 X0 | 1 0 1 |      |   |   |   |
| X1 Y0 | 1 1 0 |      |   |   |   |
| Y1 X1 | 1 1 1 |      |   |   |   |

**NOTE:** Only the indicated S1\*S2 combinations are valid. X1\*X1 and Y1\*Y1 are not valid.

**Timing:** 2 + mv oscillator clock cycles

**Memory:** 1 + mv program words



# MOVE

## Move Data

# MOVE

**Operation:**  
S ↗ D

**Assembler Syntax:**  
MOVE S,D

**Description:** Move the contents of the specified data source S to the specified destination D. This instruction is equivalent to a data ALU NOP with a parallel data move.

When a 56-bit accumulator (A or B) is specified as a **source** operand S, the accumulator value is optionally shifted according to the scaling mode bits S0 and S1 in the system status register (SR). If the data out of the shifter indicates that the accumulator extension register is in use and the data is to be moved into a 24- or 48-bit destination, the value stored in the destination D is limited to a maximum positive or negative saturation constant to minimize truncation error. Limiting does not occur if an individual 24-bit accumulator register (A1, A0, B1, or B0) is specified as a source operand instead of the full 56-bit accumulator (A or B). This limiting feature allows block floating-point operations to be performed with error detection since the L bit in the condition code register is latched.

When a 56-bit accumulator (A or B) is specified as a **destination** operand D, any 24-bit source data to be moved into that accumulator is automatically extended to 56 bits by sign extending the MS bit of the source operand (bit 23) and appending the source operand with 24 LS zeros. Similarly, any 48-bit source data to be loaded into a 56-bit accumulator is automatically sign extended to 56 bits. Note that for 24-bit source operands both the automatic sign-extension and zeroing features may be disabled by specifying the destination register to be one of the individual 24-bit accumulator registers (A1 or B1). Similarly, for 48-bit source operands, the automatic sign-extension feature may be disabled by using the long memory move addressing mode and specifying A10 or B10 as the destination operand.

**Example:**

```

:
MOVE X0,A1          ;move X0 to A1 without sign ext. or zeroing
:
```

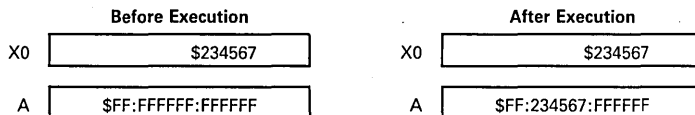

# MOVE

## Move Data

# MOVE

**Explanation of Example:** Prior to execution, the 56-bit A accumulator contains the value \$FF:FFFFFF:FFFFFF, and the 24-bit X0 register contains the value \$234567. The execution of the MOVE X0,A1 instruction moves the 24-bit value in the X0 register into the 24-bit A1 register without automatic sign extension and without automatic zeroing.

### Condition Codes:

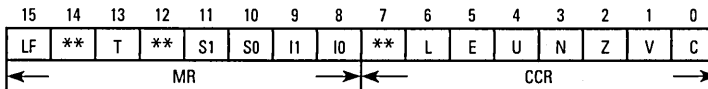

L — Set if data limiting has occurred during parallel move

### Instruction Format:

MOVE S,D

### Opcode:

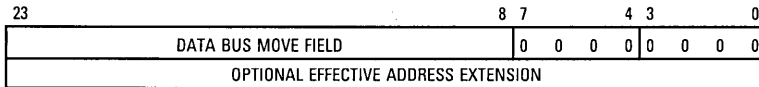

### Instruction Fields:

See **Parallel Move Descriptions** for data bus move field encoding.

**Timing:** 2 + mv oscillator clock cycles

**Memory:** 1 + mv program words

**Parallel Move Descriptions:** Thirty of the sixty-two instructions provide the capability to specify an optional parallel data bus movement over the X and/or Y data bus. This allows a data ALU operation to be executed in parallel with up to two data bus moves during the instruction cycle. Ten types of parallel moves are permitted, including register to register moves, register to memory moves, and memory to register moves. However, not all addressing modes are allowed for each type of memory reference. Addressing mode restrictions which apply to specific types of moves are noted in the individual move operation descriptions. The following section contains detailed descriptions about each type of parallel move operation.

When a 56-bit accumulator (A or B) is specified as a **source** operand S, the accumulator value is optionally shifted according to the scaling mode bits S0 and S1 in the system status register (SR). If the data out of the shifter indicates that the accumulator extension register is in use and the data is to be moved into a 24- or 48-bit destination, the value stored in the destination D is limited to a maximum positive or negative saturation constant to minimize truncation error. Limiting does not occur if an individual 24-bit accumulator register (A1, A0, B1, or B0) is specified as a source operand instead of the full 56-bit accumulator (A or B). This limiting feature allows block floating-point operations to be performed with error detection since the L bit in the condition code register is latched.

When a 56-bit accumulator (A or B) is specified as a **destination** operand D, any 24-bit source data to be moved into that accumulator is automatically extended to 56 bits by sign extending the MS bit of the source operand (bit 23) and appending the source operand with 24 LS zeros. Similarly, any 48-bit source data to be loaded into a 56-bit accumulator is automatically sign extended to 56 bits. Note that for 24-bit source operands both the automatic sign-extension and zeroing features may be disabled by specifying the destination register to be one of the individual 24-bit accumulator registers (A1 or B1). Similarly, for 48-bit source operands, the automatic sign-extension feature may be disabled by using the long memory move addressing mode and specifying A10 or B10 as the destination operand.

**A**

Note that the symbols used in decoding the various opcode fields of an instruction or parallel move are **completely arbitrary**. Furthermore, the opcode symbols used in one instruction or parallel move are **completely independent** of the opcode symbols used in a different instruction or parallel move.

## No Parallel Data Move

**Operation:**  
(.....)

**Assembler Syntax:**  
(.....)

where (.....) refers to any arithmetic or logical instruction which allows parallel moves.

**Description:** Many (30 of the total 62) instructions in the DSP56000/DSP56001 instruction set allow parallel moves. The parallel moves have been divided into 10 opcode categories. This category is a parallel move NOP and does not involve data bus move activity.

**Example:**

```

:
ADD X0,A           ;add X0 to A (no parallel move)
:

```

**Explanation of Example:** This is an example of an instruction which allows parallel moves but does not have one.

**Condition Codes:**

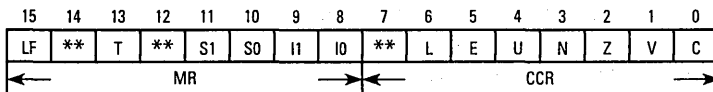

The condition codes are not affected by this type of parallel move.

**Instruction Format:**  
(.....)

**Opcode:**

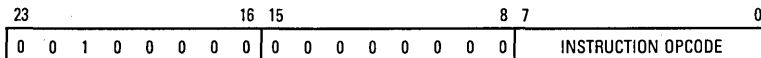

**Instruction Fields:**  
(defined by instruction)

**Timing:** mv oscillator clock cycles

**Memory:** mv program words



## Immediate Short Data Move

### Operation:

(.....), #xx ↯ D

### Assembler Syntax:

(.....) #xx,D

where (.....) refers to any arithmetic or logical instruction which allows parallel moves.

**Description:** Move the 8-bit immediate data value (#xx) into the destination operand D.

If the destination register D is A0, A1, A2, B0, B1, B2, R0–R7, or N0–N7, the 8-bit immediate short operand is interpreted as an **unsigned integer** and is stored in the specified destination register. That is, the 8-bit data is stored in the eight LS bits of the destination operand, and the remaining bits of the destination operand D are zeroed.

If the destination register D is X0, X1, Y0, Y1, A, or B, the 8-bit immediate short operand is interpreted as a **signed fraction** and is stored in the specified destination register. That is, the 8-bit data is stored in the eight MS bits of the destination operand, and the remaining bits of the destination operand D are zeroed.

If the arithmetic or logical opcode-operand portion of the instruction specifies a given destination accumulator, that same accumulator or portion of that accumulator may not be specified as a destination D in the parallel data bus move operation. Thus, if the opcode-operand portion of the instruction specifies the 56-bit A accumulator as its destination, the parallel data bus move portion of the instruction may not specify A0, A1, A2, or A as its destination D. Similarly, if the opcode-operand portion of the instruction specifies the 56-bit B accumulator as its destination, the parallel data bus move portion of the instruction may not specify B0, B1, B2, or B as its destination D. That is, **duplicate destinations are NOT allowed within the same instruction.**

**NOTE:** This parallel data move is considered to be a move-type instruction. Due to pipelining, if an address register (R or N) is changed using a move-type instruction, the new contents of the destination address register will not be available for use during the following instruction (i.e., there is a single instruction cycle pipeline delay).

### Example:

```
:  
ABS B  # $18,R1          ;take absolute value of B, # $18 ↯ R1  
:
```



## Immediate Short Data Move

**Explanation of Example:** Prior to execution, the 16-bit address register R1 contains the value \$0000. The execution of the parallel move portion of the instruction, # $\$18$ ,R1, moves the 8-bit immediate short operand into the eight LS bits of the R1 register and zeros the remaining eight MS bits of that register. The 8-bit value is interpreted as an unsigned integer since its destination is the R1 address register.

**Condition Codes:**

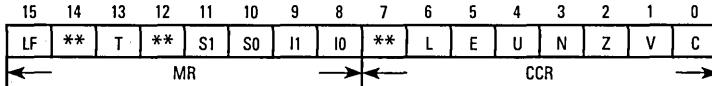

The condition codes are not affected by this type of parallel move.

**Instruction Format:**

(.....) #xx,D

**Opcode:**

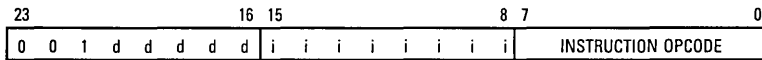

**Instruction Fields:**

#xx=8-bit Immediate Short Data = ijiiiiii

|       | D<br>d d d d d | D<br>Sign Ext | D<br>Zero |
|-------|----------------|---------------|-----------|
| X0    | 0 0 1 0 0      | no            | no        |
| X1    | 0 0 1 0 1      | no            | no        |
| Y0    | 0 0 1 1 0      | no            | no        |
| Y1    | 0 0 1 1 1      | no            | no        |
| A0    | 0 1 0 0 0      | no            | no        |
| B0    | 0 1 0 0 1      | no            | no        |
| A2    | 0 1 0 1 0      | no            | no        |
| B2    | 0 1 0 1 1      | no            | no        |
| A1    | 0 1 1 0 0      | no            | no        |
| B1    | 0 1 1 0 1      | no            | no        |
| A     | 0 1 1 1 0      | A2            | A0        |
| B     | 0 1 1 1 1      | B2            | B0        |
| R0-R7 | 1 0 r r r      |               |           |
| N0-N7 | 1 1 n n n      |               |           |

where "rrr" = Rn number  
 where "nnn" = Nn number

**Timing:** mv oscillator clock cycles

**Memory:** mv program words



**Operation:**

(.....); S  $\rightarrow$  D

**Assembler Syntax:**

(.....) S,D

where (.....) refers to any arithmetic or logical instruction which allows parallel moves.

**Description:** Move the source register S to the destination register D.

If the arithmetic or logical opcode-operand portion of the instruction specifies a given destination accumulator, that same accumulator or portion of that accumulator may not be specified as a destination D in the parallel data bus move operation. Thus, if the opcode-operand portion of the instruction specifies the 56-bit A accumulator as its destination, the parallel data bus move portion of the instruction may not specify A0, A1, A2, or A as its destination D. Similarly, if the opcode-operand portion of the instruction specifies the 56-bit B accumulator as its destination, the parallel data bus move portion of the instruction may not specify B0, B1, B2, or B as its destination D. That is, **duplicate destinations are NOT allowed within the same instruction.**

If the opcode-operand portion of the instruction specifies a given source or destination register, that same register or portion of that register may be used as a source S in the parallel data bus move operation. This allows data to be moved in the same instruction in which it is being used as a source operand by a data ALU operation. That is, **duplicate sources are allowed within the same instruction.**

When a 24-bit source operand is moved into a 16-bit destination register, the 16 LS bits of the 24-bit source operand are stored in the 16-bit destination register. When a 16-bit source operand is moved into a 24-bit destination register, the 16 LS bits of the destination register are loaded with the contents of the 16-bit source operand, and the eight MS bits of the 24-bit destination register are zeroed.

**NOTE:** The MOVE A,B operation will result in a 24-bit positive or negative saturation constant being stored in the B1 portion of the B accumulator if the signed integer portion of the A accumulator is in use.

**NOTE:** This parallel data move is considered to be a move-type instruction. Due to pipelining, if an address register (R or N) is changed using a move-type instruction, the new contents of the destination address register will not be available for use during the following instruction (i.e., there is a single instruction cycle pipeline delay).



**Example:**

```

:
MACR -X0,Y0,A Y1,N5 ; -X0*Y0+A ↯ A, move Y1 ↯ N5
:

```

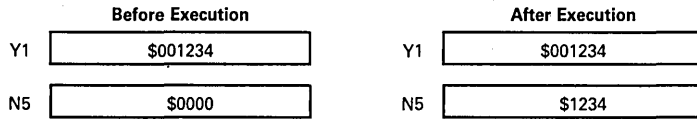

**Explanation of Example:** Prior to execution, the 24-bit Y1 register contains the value \$001234 and the 16-bit address offset register N5 contains the value \$0000. The execution of the parallel move portion of the instruction, Y1,N5, moves the 16 LS bits of the 24-bit value in the Y1 register into the 16-bit N5 register.

**Condition Codes:**

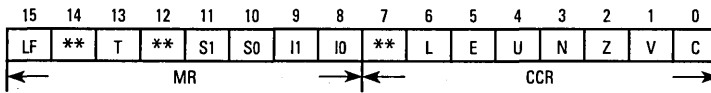

L — Set if data limiting has occurred during parallel move



**R****Register to Register Data Move****R****Instruction Format:**

(.....) S,D

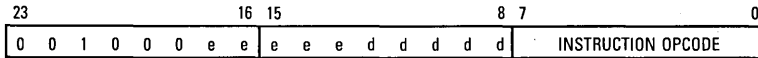
**Opcode:****Instruction Fields:**

|       | e e e e e<br>S or D d d d d d | S<br>S/L | D<br>Sign Ext | D<br>Zero |
|-------|-------------------------------|----------|---------------|-----------|
| X0    | 0 0 1 0 0                     | no       | no            | no        |
| X1    | 0 0 1 0 1                     | no       | no            | no        |
| Y0    | 0 0 1 1 0                     | no       | no            | no        |
| Y1    | 0 0 1 1 1                     | no       | no            | no        |
| A0    | 0 1 0 0 0                     | no       | no            | no        |
| B0    | 0 1 0 0 1                     | no       | no            | no        |
| A2    | 0 1 0 1 0                     | no       | no            | no        |
| B2    | 0 1 0 1 1                     | no       | no            | no        |
| A1    | 0 1 1 0 0                     | no       | no            | no        |
| B1    | 0 1 1 0 1                     | no       | no            | no        |
| A     | 0 1 1 1 0                     | yes      | A2            | A0        |
| B     | 0 1 1 1 1                     | yes      | B2            | B0        |
| R0-R7 | 1 0 r r r                     |          |               |           |
| N0-N7 | 1 1 n n n                     |          |               |           |

where "rrr" = Rn number  
 where "nnn" = Nn number

**Timing:** mv oscillator clock cycles**Memory:** mv program words**A**

**Operation:**  
 (.....); ea ↗ Rn

**Assembler Syntax:**  
 (.....) ea

where (.....) refers to any arithmetic or logical instruction which allows parallel moves.

**Description:** Update the specified address register according to the specified effective addressing mode. All update addressing modes may be used.

**Example:**

```

:
RND B (R3) + N3          ;round value in B into B1, R3 + N3 ↗ R3
:

```

|    | Before Execution |    | After Execution |
|----|------------------|----|-----------------|
| R3 | \$0007           | R3 | \$000B          |
| N3 | \$0004           | N3 | \$0004          |

**Explanation of Example:** Prior to execution, the 16-bit address register R3 contains the value \$0007, and the 16-bit address offset register N3 contains the value \$0004. The execution of the parallel move portion of the instruction, (R3) + N3, updates the R3 address register according to the specified effective addressing mode by adding the value in the R3 register to the value in the N3 register and storing the 16-bit result back in the R3 address register.

**Condition Codes:**

|      |    |    |    |    |    |    |    |       |   |   |   |   |   |   |   |
|------|----|----|----|----|----|----|----|-------|---|---|---|---|---|---|---|
| 15   | 14 | 13 | 12 | 11 | 10 | 9  | 8  | 7     | 6 | 5 | 4 | 3 | 2 | 1 | 0 |
| LF   | ** | T  | ** | S1 | S0 | I1 | I0 | **    | L | E | U | N | Z | V | C |
| ← MR |    |    |    |    |    |    |    | CCR → |   |   |   |   |   |   |   |

The condition codes are not affected by this type of parallel move.

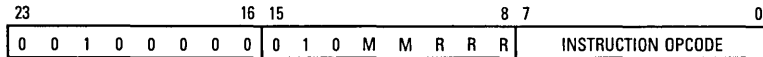
**U****Address Register Update****U****Instruction Format:****(.....) ea****Opcode:****Instruction Fields:**

ea = 5-bit Effective Address = MMRRR

| Effective<br>Addressing Mode | MMR R R   |
|------------------------------|-----------|
| (Rn) - Nn                    | 0 0 r r r |
| (Rn) + Nn                    | 0 1 r r r |
| (Rn) -                       | 1 0 r r r |
| (Rn) +                       | 1 1 r r r |

where "rrr" refers to an address register R0-R7

**Timing:** mv oscillator clock cycles**Memory:** mv program words**A**

**X:****X Memory Data Move****X:****Operation:**`( ..... ); X:ea ↗ D``( ..... ); X:aa ↗ D``( ..... ); S ↗ X:ea``( ..... ); S ↗ X:aa``( ..... ); #xxxxxx ↗ D`**Assembler Syntax:**`( ..... ) X:ea,D``( ..... ) X:aa,D``( ..... ) S,X:ea``( ..... ) S,X:aa``( ..... ) #xxxxxx,D`

where ( ..... ) refers to any arithmetic or logical instruction which allows parallel moves.

**Description:** Move the specified word operand from/to X memory. All memory addressing modes, including absolute addressing and 24-bit immediate data, may be used. Absolute short addressing may also be used.

If the arithmetic or logical opcode-operand portion of the instruction specifies a given destination accumulator, that same accumulator or portion of that accumulator may not be specified as a destination D in the parallel data bus move operation. Thus, if the opcode-operand portion of the instruction specifies the 56-bit A accumulator as its destination, the parallel data bus move portion of the instruction may not specify A0, A1, A2, or A as its destination D. Similarly, if the opcode-operand portion of the instruction specifies the 56-bit B accumulator as its destination, the parallel data bus move portion of the instruction may not specify B0, B1, B2, or B as its destination D. That is, **duplicate destinations are NOT allowed within the same instruction.**

If the opcode-operand portion of the instruction specifies a given source or destination register, that same register or portion of that register may be used as a source S in the parallel data bus move operation. This allows data to be moved in the same instruction in which it is being used as a source operand by a data ALU operation. That is, **duplicate sources are allowed within the same instruction.**

When a 24-bit source operand is moved into a 16-bit destination register, the 16 LS bits of the 24-bit source operand are stored in the 16-bit destination register. When a 16-bit source operand is moved into a 24-bit destination register, the 16 LS bits of the destination register are loaded with the contents of the 16-bit source operand, and the eight MS bits of the 24-bit destination register are zeroed.

**NOTE:** This parallel data move is considered to be a move-type instruction. Due to pipelining, if an address register (R or N) is changed using a move-type instruction,

**A**

**X:****X Memory Data Move****X:**

the new contents of the destination address register will not be available for use during the following instruction (i.e., there is a single instruction cycle pipeline delay).

**Example:**

```

:
ASL A  R2,X:-(R2)          ;A*2 ↯ A, save updated R2 in X:(R2)
:

```

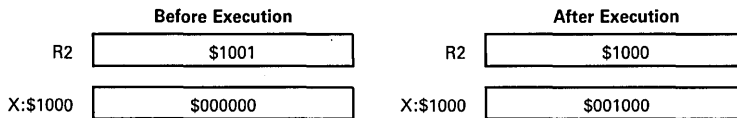

**Explanation of Example:** Prior to execution, the 16-bit R2 address register contains the value \$1001, and the 24-bit X memory location X:\$1000 contains the value \$000000. The execution of the parallel move portion of the instruction, R2,X:-(R2), predecrements the R2 address register and then uses the R2 address register to move the updated contents of the R2 address register into the 24-bit X memory location X:\$1000.

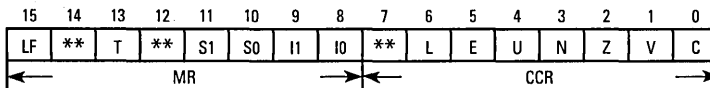
**Condition Codes:**

L — Set if data limiting has occurred during parallel move

**NOTE:** The MOVE A,X:ea operation will result in a 24-bit positive or negative saturation constant being stored in the specified 24-bit X memory location if the signed integer portion of the A accumulator is in use.

**A**

**X:****X Memory Data Move****X:****Instruction Format:**

(.....) X:ea,D  
 (.....) S,X:ea  
 (.....) #xxxxxx,D

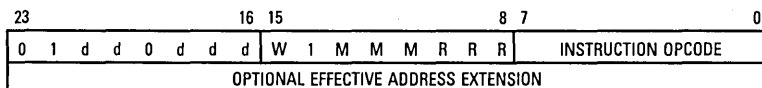
**Opcode:****Instruction Fields:**

ea=6-bit Effective Address=MMMMRRR

| Register W | Effective Addressing Mode | MMMMRRR     |
|------------|---------------------------|-------------|
| Read S 0   | (Rn)−Nn                   | 0 0 0 r r r |
| Write D 1  | (Rn)+Nn                   | 0 0 1 r r r |
|            | (Rn)−                     | 0 1 0 r r r |
|            | (Rn)+                     | 0 1 1 r r r |
|            | (Rn)                      | 1 0 0 r r r |
|            | (Rn+Nn)                   | 1 0 1 r r r |
|            | −(Rn)                     | 1 1 1 r r r |
|            | Absolute address          | 1 1 0 0 0 0 |
|            | Immediate data            | 1 1 0 1 0 0 |

| S,D | d d d d d | S/L | Sign | Ext | Zero | S,D   | d d d d d | S/L | Sign | Ext | Zero |
|-----|-----------|-----|------|-----|------|-------|-----------|-----|------|-----|------|
| X0  | 0 0 1 0 0 | no  | no   | no  |      | B2    | 0 1 0 1 1 | no  | no   | no  |      |
| X1  | 0 0 1 0 1 | no  | no   | no  |      | A1    | 0 1 1 0 0 | no  | no   | no  |      |
| Y0  | 0 0 1 1 0 | no  | no   | no  |      | B1    | 0 1 1 0 1 | no  | no   | no  |      |
| Y1  | 0 0 1 1 1 | no  | no   | no  |      | A     | 0 1 1 1 0 | yes | A2   | A0  |      |
| A0  | 0 1 0 0 0 | no  | no   | no  |      | B     | 0 1 1 1 1 | yes | B2   | B0  |      |
| B0  | 0 1 0 0 1 | no  | no   | no  |      | R0−R7 | 1 0 r r r |     |      |     |      |
| A2  | 0 1 0 1 0 |     |      |     |      | N0−N7 | 1 1 n n n |     |      |     |      |

where "rrr" = Rn number  
 where "nnn" = Nn number

**Timing:** mv oscillator clock cycles

**Memory:** mv program words







**Operation:****Class I**`(.....); X:ea ↗ D1; S2 ↗ D2``(.....); S1 ↗ X:ea; S2 ↗ D2``(.....); #xxxxxx ↗ D1; S2 ↗ D2`**Class II**`(.....); A ↗ X:ea; X0 ↗ A``(.....); B ↗ X:ea; X0 ↗ B`**Assembler Syntax:****Class I**`(.....) X:ea,D1 S2,D2``(.....) S1,X:ea S2,D2``(.....) #xxxxxx,D1 S2,D2`**Class II**`(.....) A,X:ea X0,A``(.....) B,X:ea X0,B`

where (.....) refers to any arithmetic or logical instruction which allows parallel moves.

**Description:** Class I: Move a one-word operand from/to X memory and move another word operand from an accumulator (S2) to an input register (D2). All memory addressing modes, including absolute addressing and 24-bit immediate data, may be used. The register to register move (S2,D2) allows a data ALU accumulator to be moved to a data ALU input register for use as a data ALU operand in the following instruction.

Class II: Move one-word operand from a data ALU accumulator to X memory and one-word operand from data ALU register X0 to a data ALU accumulator. One effective address is specified. All memory addressing modes, excluding long absolute addressing and long immediate data, may be used.

For both Class I and Class II X:R parallel data moves, if the arithmetic or logical opcode-operand portion of the instruction specifies a given destination accumulator, that same accumulator or portion of that accumulator may not be specified as a destination D1 in the parallel data bus move operation. Thus, if the opcode-operand portion of the instruction specifies the 56-bit A accumulator as its destination, the parallel data bus move portion of the instruction may not specify A0, A1, A2, or A as its destination D1. Similarly, if the opcode-operand portion of the instruction specifies the 56-bit B accumulator as its destination, the parallel data bus move portion of the instruction may not specify B0, B1, B2, or B as its destination D1. That is, **duplicate destinations are NOT allowed within the same instruction.**

If the opcode-operand portion of the instruction specifies a given source or destination register, that same register or portion of that register may be used as a source S1 and/or S2 in the parallel data bus move operation. This allows data to be moved in the same instruction in which it is being used as a source operand by a data ALU operation. That is, **duplicate sources are allowed within the same instruction**. Note that S1 and S2 may specify the same register.

### Class I Example:

```

:
CMPM Y0,A A,X:$1234 A,Y0 ;compare A,Y0 mag., save A, update Y0
:

```

|          | Before Execution   |          | After Execution    |
|----------|--------------------|----------|--------------------|
| A        | \$00:800000:000000 | A        | \$00:800000:000000 |
| X:\$1234 | \$000000           | X:\$1234 | \$7FFFFFF          |
| Y0       | \$000000           | Y0       | \$7FFFFFF          |

**Explanation of the Class I Example:** Prior to execution, the 56-bit A accumulator contains the value \$00:800000:000000, the 24-bit X memory location X:\$1234 contains the value \$000000, and the 24-bit Y0 register contains the value \$000000. The execution of the parallel move portion of the instruction, A,X:\$1234 A,Y0, moves the 24-bit limited positive saturation constant \$7FFFFFF into both the X:\$1234 memory location and the Y0 register since the signed portion of the A accumulator was in use.

### Class II Example:

```

:
MAC X0,Y0,A B,X:(R1)+ X0,B ;multiply X0 and Y0 and accumulate in A
;move B to X memory location pointed to
;by R1 and postincrement R1
;move X0 to B

```

|          | Before Execution     |          | After Execution    |
|----------|----------------------|----------|--------------------|
| X0       | \$400000             | X0       | \$400000           |
| Y0       | \$600000             | Y0       | \$600000           |
| A        | \$00:000000:000000   | A        | \$00:300000:000000 |
| B        | \$FF:7FFFFFFF:000000 | B        | \$00:400000:000000 |
| X:\$1234 | \$000000             | X:\$1234 | \$800000           |
| R1       | \$1234               | R1       | \$1235             |

**Explanation of the Class II Example:** Prior to execution, the 24-bit registers X0 and Y0 contain \$400000 and \$600000, respectively. The 56-bit accumulators A and B contain the values \$00:000000:000000 and \$FF:7FFFFFFF:000000, respectively. The 24-bit X memory location X:\$1234 contains the value \$000000, and the 16-bit R1 register contains the value \$1234. Execution of the parallel move portion of the instruction (B,X:(R1)+ X0,B) moves the 24-bit limited value of B (\$800000) into the X:\$1234 memory location and the X0 register (\$400000) into accumulator B1 (\$400000), sign extends B1 into B2 (\$00), and zero fills B0 (\$000000). It also increments R1 to \$1235.

### Condition Codes:

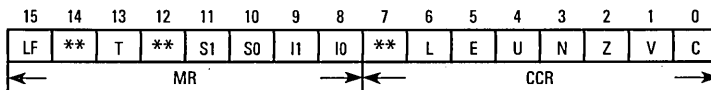

L — Set if data limiting has occurred during parallel move.



### Class I Instruction Format:

- (.....) X:ea,D1 S2,D2
- (.....) S1,X:ea S2,D2
- (.....) #xxxxxx, S2,D2

### Opcode:

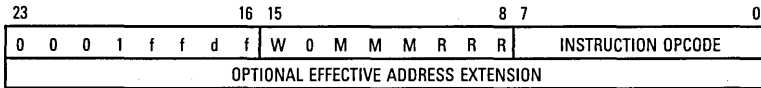

### Instruction Fields:

ea = 6-bit Effective Address = MMMRRR

| Register W | Effective Addressing Mode | MMM R R R   |
|------------|---------------------------|-------------|
| Read S1 0  | (Rn) - Nn                 | 0 0 0 r r r |
| Write D1 1 | (Rn) + Nn                 | 0 0 1 r r r |
|            | (Rn) -                    | 0 1 0 r r r |
|            | (Rn) +                    | 0 1 1 r r r |
|            | (Rn)                      | 1 0 0 r r r |
|            | (Rn + Nn)                 | 1 0 1 r r r |
|            | -(Rn)                     | 1 1 1 r r r |
|            | Absolute address          | 1 1 0 0 0 0 |
|            | Immediate data            | 1 1 0 1 0 0 |

where "rrr" refers to an address register R0-R7

| S1, D1 | S1  | D1   | D1       | S2    | D2 | D2            |
|--------|-----|------|----------|-------|----|---------------|
| f f    | S/L | Sign | Ext Zero | d S/L | f  | Sign Ext Zero |
| X0     | 0 0 | no   | no       | A     | 0  | yes no        |
| X1     | 0 1 | no   | no       | B     | 1  | yes no        |
| A      | 1 0 | yes  | A2 A0    |       |    |               |
| B      | 1 1 | yes  | B2 B0    |       |    |               |

**Timing:** mv oscillator clock cycles

**Memory:** mv program words

**A**

### Class II Instruction Format:

(.....) A  $\nabla$  X:ea X0  $\nabla$  A  
 (.....) B  $\nabla$  X:ea X0  $\nabla$  B

### Opcode:

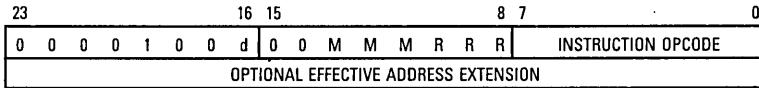

### Instruction Fields:

ea = 6-bit Effective Address = MMMRRR

| Effective Addressing Mode | MMMRRR      |
|---------------------------|-------------|
| (Rn) - Nn                 | 0 0 0 r r r |
| (Rn) + Nn                 | 0 0 1 r r r |
| (Rn) -                    | 0 1 0 r r r |
| (Rn) +                    | 0 1 1 r r r |
| (Rn)                      | 1 0 0 r r r |
| (Rn + Nn)                 | 1 0 1 r r r |
| -(Rn)                     | 1 1 1 r r r |
| Absolute address          | 1 1 0 0 0 0 |
| Immediate data            | 1 1 0 1 0 0 |

where "rrr" refers to an address register R0-R7

| S,D | S   | D        | D    | d | MOVE Opcode                   |
|-----|-----|----------|------|---|-------------------------------|
|     | S/L | Sign Ext | Zero |   |                               |
| X0  | no  | N/A      | N/A  | 0 | A $\nabla$ X:ea X0 $\nabla$ A |
| Y0  | no  | N/A      | N/A  | 1 | B $\nabla$ X:ea X0 $\nabla$ B |
| A   | yes | A2       | A0   |   |                               |
| B   | yes | B2       | B0   |   |                               |

**Timing:** mv oscillator clock cycles

**Memory:** mv program words

**Y:****Y Memory Data Move****Y:****Operation:**`(.....); Y:ea ↗ D``(.....); Y:aa ↗ D``(.....); S ↗ Y:ea``(.....); S ↗ Y:aa``(.....); #xxxxxx ↗ D`**Assembler Syntax:**`(.....) Y:ea,D``(.....) Y:aa,D``(.....) S,Y:ea``(.....) S,Y:aa``(.....) #xxxxxx,D`

where (.....) refers to any arithmetic or logical instruction which allows parallel moves.

**Description:** Move the specified word operand from/to Y memory. All memory addressing modes, including absolute addressing and 24-bit immediate data, may be used. Absolute short addressing may also be used.

If the arithmetic or logical opcode-operand portion of the instruction specifies a given destination accumulator, that same accumulator or portion of that accumulator may not be specified as a destination D in the parallel data bus move operation. Thus, if the opcode-operand portion of the instruction specifies the 56-bit A accumulator as its destination, the parallel data bus move portion of the instruction may not specify A0, A1, A2, or A as its destination D. Similarly, if the opcode-operand portion of the instruction specifies the 56-bit B accumulator as its destination, the parallel data bus move portion of the instruction may not specify B0, B1, B2, or B as its destination D. That is, **duplicate destinations are NOT allowed within the same instruction.**

If the opcode-operand portion of the instruction specifies a given source or destination register, that same register or portion of that register may be used as a source S in the parallel data bus move operation. This allows data to be moved in the same instruction in which it is being used as a source operand by a data ALU operation. That is, **duplicate sources are allowed within the same instruction.**

When a 24-bit source operand is moved into a 16-bit destination register, the 16 LS bits of the 24-bit source operand are stored in the 16-bit destination register. When a 16-bit source operand is moved into a 24-bit destination register, the 16 LS bits of the destination register are loaded with the contents of the 16-bit source operand, and the eight MS bits of the 24-bit destination register are zeroed.

**NOTE:** This parallel data move is considered to be a move-type instruction. Due to pipelining, if an address register (R or N) is changed using a move-type instruction,

**A**

**Y:****Y Memory Data Move****Y:**

the new contents of the destination address register will not be available for use during the following instruction (i.e., there is a single instruction cycle pipeline delay).

**Example:**

```

:
EOR X0,B #123456,A ;exclusive OR X0 and B, update A accumulator
:

```

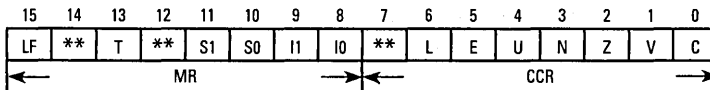

**Explanation of Example:** Prior to execution, the 56-bit A accumulator contains the value \$FF:FFFFFF:FFFFFF. The execution of the parallel move portion of the instruction, #123456,A, moves the 24-bit immediate value 123456 into the 24-bit A1 register, then sign extends that value into the A2 portion of the accumulator, and zeros the lower 24-bit A0 portion of the accumulator.

**Condition Codes:**

L — Set if data limiting has occurred during parallel move

**NOTE:** The MOVE A,Y:ea operation will result in a 24-bit positive or negative saturation constant being stored in the specified 24-bit Y memory location if the signed integer portion of the A accumulator is in use.

**A**

**Y:****Y Memory Data Move****Y:****Instruction Format:**

(.....) Y:ea,D  
 (.....) S,Y:ea  
 (.....) #xxxxxx,D

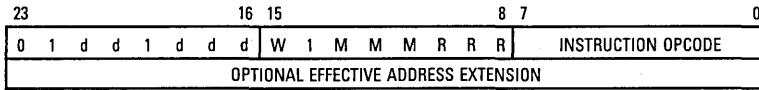
**Opcode:****Instruction Fields:**

ea = 6-bit Effective Address = MMMRRR

| Register W | Effective Addressing Mode | MMM R R R   |
|------------|---------------------------|-------------|
| Read S 0   | (Rn) - Nn                 | 0 0 0 r r r |
| Write D 1  | (Rn) + Nn                 | 0 0 1 r r r |
|            | (Rn) -                    | 0 1 0 r r r |
|            | (Rn) +                    | 0 1 1 r r r |
|            | (Rn)                      | 1 0 0 r r r |
|            | (Rn + Nn)                 | 1 0 1 r r r |
|            | -(Rn)                     | 1 1 1 r r r |
|            | Absolute address          | 1 1 0 0 0 0 |
|            | Immediate data            | 1 1 0 1 0 0 |

where "rrr" refers to an address register R0-R7

| S,D | d d d d d | S S/L | D Sign Ext | D Zero | S,D   | d d d d d | S S/L | D Sign Ext | D Zero |
|-----|-----------|-------|------------|--------|-------|-----------|-------|------------|--------|
| X0  | 0 0 1 0 0 | no    | no         | no     | B2    | 0 1 0 1 1 | no    | no         | no     |
| X1  | 0 0 1 0 1 | no    | no         | no     | A1    | 0 1 1 0 0 | no    | no         | no     |
| Y0  | 0 0 1 1 0 | no    | no         | no     | B1    | 0 1 1 0 1 | no    | no         | no     |
| Y1  | 0 0 1 1 1 | no    | no         | no     | A     | 0 1 1 1 0 | yes   | A2         | A0     |
| A0  | 0 1 0 0 0 | no    | no         | no     | B     | 0 1 1 1 1 | yes   | B2         | B0     |
| B0  | 0 1 0 0 1 | no    | no         | no     | R0-R7 | 1 0 r r r |       |            |        |
| A2  | 0 1 0 1 0 | no    | no         | no     | N0-N7 | 1 1 n n n |       |            |        |

where "rrr" = Rn number  
 where "nnn" = Nn number

**Timing:** mv oscillator clock cycles

**Memory:** mv program words



**Y:****Y Memory Data Move****Y:****Instruction Format:**

(. . . . .) Y:aa,D

(. . . . .) S,Y:aa

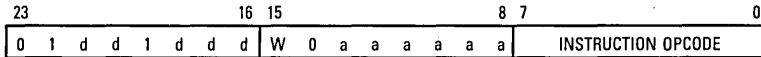
**Opcode:****Instruction Fields:**

aa = 6-bit Absolute Short Address = aaaaaa

| Register W | Absolute Short Address aaaaaa |
|------------|-------------------------------|
| Read S 0   | 000000                        |
| Write D 1  | 111111                        |

| S,D   | d d d d d | S<br>S/L | D<br>Sign Ext | D<br>Zero |
|-------|-----------|----------|---------------|-----------|
| X0    | 00100     | no       | no            | no        |
| X1    | 00101     | no       | no            | no        |
| Y0    | 00110     | no       | no            | no        |
| Y1    | 00111     | no       | no            | no        |
| A0    | 01000     | no       | no            | no        |
| B0    | 01001     | no       | no            | no        |
| A2    | 01010     | no       | no            | no        |
| B2    | 01011     | no       | no            | no        |
| A1    | 01100     | no       | no            | no        |
| B1    | 01101     | no       | no            | no        |
| A     | 01110     | yes      | A2            | A0        |
| B     | 01111     | yes      | B2            | B0        |
| R0-R7 | 10 r r r  |          |               |           |
| N0-N7 | 11 n n n  |          |               |           |

where "rrr" = Rn number  
 where "nnn" = Nn number

**Timing:** mv oscillator clock cycles**Memory:** mv program words

**Operation:****Class I**`(.....); S1 ↗ D1; Y:ea ↗ D2``(.....); S1 ↗ D1; S2 ↗ Y:ea``(.....); S1 ↗ D1; #xxxxxx ↗ D2`**Class II**`(.....); Y0 ↗ A; A ↗ Y:ea``(.....); Y0 ↗ B; B ↗ Y:ea`**Assembler Syntax:****Class I**`(.....) S1,D1 Y:ea,D2``(.....) S1,D1 S2,Y:ea``(.....) S1,D1 #xxxxxx,D2`**Class II**`(.....) Y0,A A,Y:ea``(.....) Y0,B B,Y:ea`

where (.....) refers to any arithmetic or logical instruction which allows parallel moves.

**Description:** Class I: Move a one-word operand from an accumulator (S1) to an input register (D1) and move another word operand from/to Y memory. All memory addressing modes, including absolute addressing and 24-bit immediate data, may be used. The register to register move (S1,D1) allows a data ALU accumulator to be moved to a data ALU input register for use as a data ALU operand in the following instruction.

Class II: Move one-word operand from a data ALU accumulator to Y memory and one-word operand from data ALU register Y0 to a data ALU accumulator. One effective address is specified. All memory addressing modes, excluding long absolute addressing and long immediate data, may be used. Class II move operations have been added to the R:Y parallel move (and a similar feature has been added to the X:R parallel move) as an added feature available in the first quarter of 1989.

For both Class I and Class II R:Y parallel data moves, if the arithmetic or logical opcode-operand portion of the instruction specifies a given destination accumulator, that same accumulator or portion of that accumulator may not be specified as a destination D2 in the parallel data bus move operation. Thus, if the opcode-operand portion of the instruction specifies the 56-bit A accumulator as its destination, the parallel data bus move portion of the instruction may not specify A0, A1, A2, or A as its destination D2. Similarly, if the opcode-operand portion of the instruction specifies the 56-bit B accumulator as its destination, the parallel data bus move portion of the instruction may not specify B0, B1, B2, or B as its destination D2. That is, **duplicate destinations are NOT allowed within the same instruction.**

If the opcode-operand portion of the instruction specifies a given source or destination register, that same register or portion of that register may be used as a source S1 and/or S2 in the parallel data bus move operation. This allows data to be moved in the same instruction in which it is being used as a source operand by a data ALU operation. That is, **duplicate sources are allowed within the same instruction**. Note that S1 and S2 may specify the same register.

### Class I Example:

```

:
ADDL B,A B,X1 Y:(R6) - N6,B ;2*A+B ↯ A, update X1,B and R6
:

```

|          | Before Execution   | After Execution    |
|----------|--------------------|--------------------|
| B        | \$80:123456:789ABC | \$00:654321:000000 |
| X1       | \$000000           | \$800000           |
| R6       | \$2020             | \$2000             |
| N6       | \$0020             | \$0020             |
| Y:\$2020 | \$654321           | \$654321           |

**Explanation of the Class I Example:** Prior to execution, the 56-bit B accumulator contains the value \$80:123456:789ABC, the 24-bit X1 register contains the value \$000000, the 16-bit R6 address register contains the value \$2020, the 16-bit N6 address offset register contains the value \$0020 and the 24-bit Y memory location Y:\$2020 contains the value \$654321. The execution of the parallel move portion of the instruction, B,X1 Y:(R6) - N6,B, moves the 24-bit limited negative saturation constant \$800000 into the X1 register since the signed integer portion of the B accumulator was in use, uses the value in the 16-bit R6 address register to move the 24-bit value in the Y memory location Y:\$2020 into the 56-bit B accumulator with automatic sign extension of the upper portion of the accumulator (B2) and automatic zeroing of the lower portion of the accumulator (B0), and finally uses the contents of the 16-bit N6 address offset register to update the value in the 16-bit R6 address register. The contents of the N6 address offset register are not affected.

Class II Example:

```

:
MAC X0,Y0,A  Y0,B  B,Y:(R1)+ ;multiply X0 and Y0 and accumulate in A
;move B to Y memory location pointed to
;by R1 and postincrement R1
;move Y0 to B
:
    
```

|          | Before Execution   |          | After Execution    |
|----------|--------------------|----------|--------------------|
| X0       | \$400000           | X0       | \$400000           |
| Y0       | \$600000           | Y0       | \$600000           |
| A        | \$00:000000:000000 | A        | \$00:300000:000000 |
| B        | \$00:800000:000000 | B        | \$00:600000:000000 |
| Y:\$1234 | \$000000           | Y:\$1234 | \$7FFFFFF          |
| R1       | \$1234             | R1       | \$1235             |

**Explanation of the Class II Example:** Prior to execution, the 24-bit registers, X0 and Y0, contain \$400000 and \$600000, respectively. The 56-bit accumulators A and B contain the values \$00:000000:000000 and \$00:800000:000000 (+1.0000), respectively. The 24-bit Y memory location Y:\$1234 contains the value \$000000, and the 16-bit R1 register contains the value \$1234. Execution of the parallel move portion of the instruction (Y0,B B,Y:(R1)+) moves the Y0 register (\$600000) into accumulator B1 (\$600000), sign extends B1 into B2 (\$00), and zero fills B0 (\$000000). It also moves the 24-bit limited value of B (\$7FFFFFF) into the Y:\$1234 memory location and increments R1 to \$1235.

Condition Codes:

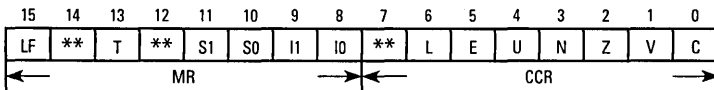

L — Set if data limiting has occurred during parallel move

### Class I Instruction Format:

- (.....) S1,D1 Y:ea,D2
- (.....) S1,D1 S2,Y:ea
- (.....) S1,D1 #xxxxxx,D2

### Opcode:

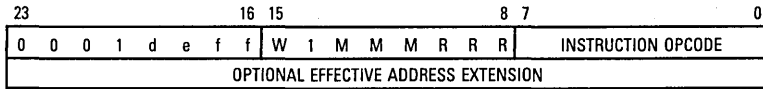

### Instruction Fields:

ea = 6-bit Effective Address = MMMRRR

| Register | W | Effective Address Mode | MMMRRR      |
|----------|---|------------------------|-------------|
| Read S2  | 0 | (Rn) - Nn              | 0 0 0 r r r |
| Write D2 | 1 | (Rn) + Nn              | 0 0 1 r r r |
|          |   | (Rn) -                 | 0 1 0 r r r |
|          |   | (Rn) +                 | 0 1 1 r r r |
|          |   | (Rn)                   | 1 0 0 r r r |
|          |   | (Rn) + Nn              | 1 0 1 r r r |
|          |   | -(Rn)                  | 1 1 1 r r r |
|          |   | Absolute address       | 1 1 0 0 0 0 |
|          |   | Immediate data         | 1 1 0 1 0 0 |

where "rrr" refers to an address register R0-R7

| S1       | D1            | D1   | S2            | D2       | D2   |
|----------|---------------|------|---------------|----------|------|
| S1 d S/L | D1 e Sign Ext | Zero | S2,D2 f f S/L | Sign Ext | Zero |
| A 0 yes  | X0 0 no       | no   | Y0 0 0 no     | no       | no   |
| B 1 yes  | X1 1 no       | no   | Y1 0 1 no     | no       | no   |
|          |               |      | A 1 0 yes     | A2       | A0   |
|          |               |      | B 1 1 yes     | B2       | B0   |

**Timing:** mv oscillator clock cycles

**Memory:** mv program words

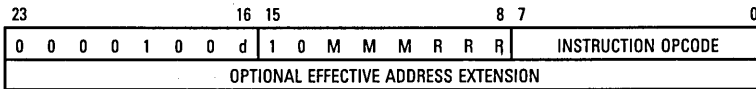

**Class II Instruction Format:**(.....) Y0  $\blacktriangleright$  A A  $\blacktriangleright$  Y:ea(.....) Y0  $\blacktriangleright$  B B  $\blacktriangleright$  Y:ea**Opcode:****Instruction Fields:**

ea = 6-bit Effective Address = MMMRRR

| Effective Addressing Mode | MMMRRR      |
|---------------------------|-------------|
| (Rn) - Nn                 | 0 0 0 r r r |
| (Rn) + Nn                 | 0 0 1 r r r |
| (Rn) -                    | 0 1 0 r r r |
| (Rn) +                    | 0 1 1 r r r |
| (Rn)                      | 1 0 0 r r r |
| (Rn + Nn)                 | 1 0 1 r r r |
| -(Rn)                     | 1 1 1 r r r |
| Absolute address          | 1 1 0 0 0 0 |
| Immediate data            | 1 1 0 1 0 0 |

where "rrr" refers to an address register R0-R7

| S,D | SRC S/L | DEST Sign Ext | DEST Zero | d | MOVE opcode   |
|-----|---------|---------------|-----------|---|---|
| X0  | no      | N/A           | N/A       | 0 | Y0 $\blacktriangleright$ A A $\blacktriangleright$ Y:ea |
| Y0  | no      | N/A           | N/A       | 1 | Y0 $\blacktriangleright$ B B $\blacktriangleright$ Y:ea |
| A   | yes     | A2            | A0        |   |   |
| B   | yes     | B2            | B0        |   |   |

**Timing:** mv oscillator clock cycles**Memory:** mv program words**A**

**L:****Long Memory Data Move****L:****Operation:**`(.....); X:ea ↗ D1; Y:ea ↗ D2``(.....); X:aa ↗ D1; Y:aa ↗ D2``(.....); S1 ↗ X:ea; S2 ↗ Y:ea``(.....); S1 ↗ X:aa; S2 ↗ Y:aa`**Assembler Syntax:**`(.....) L:ea,D``(.....) L:aa,D``(.....) S,L:ea``(.....) S,L:aa`

where (.....) refers to any arithmetic or logical instruction which allows parallel moves.

**Description:** Move one 48-bit long-word operand from/to X and Y memory. Two data ALU registers are concatenated to form the 48-bit long-word operand. This allows efficient moving of both double-precision (high:low) and complex (real:imaginary) data from/to one effective address in L (X:Y) memory. The same effective address is used for both the X and Y memory spaces; thus, only one effective address is required. Note that the A, B, A10, and B10 operands reference a single 48-bit signed (double-precision) quantity while the X, Y, AB, and BA operands reference two separate (i.e., real and imaginary) 24-bit signed quantities. All memory alterable addressing modes may be used. Absolute short addressing may also be used.

If the arithmetic or logical opcode-operand portion of the instruction specifies a given destination accumulator, that same accumulator or portion of that accumulator may not be specified as a destination D in the parallel data bus move operation. Thus, if the opcode-operand portion of the instruction specifies the 56-bit A accumulator as its destination, the parallel data bus move portion of the instruction may not specify A, A10, AB, or BA as destination D. Similarly, if the opcode-operand portion of the instruction specifies the 56-bit B accumulator as its destination, the parallel data bus move portion of the instruction may not specify B, B10, AB, or BA as its destination D. That is, **duplicate destinations are NOT allowed within the same instruction.**

If the opcode-operand portion of the instruction specifies a given source or destination register, that same register or portion of that register may be used as a source S in the parallel data bus move operation. This allows data to be moved in the same instruction in which it is being used as a source operand by a data ALU operation. That is, **duplicate sources are allowed within the same instruction.**

**NOTE:** The operands A10, B10, X, Y, AB, and BA may be used **only** for a 48-bit long memory move as previously described. These operands may not be used in any other type of instruction or parallel move.

**A**

L:

## Long Memory Data Move

L:

## Example:

```

:
CMP Y0,B  A,L:$1234      ;compare Y0 and B, save 48-bit A1:A0 value
:

```

|          | Before Execution   |          | After Execution    |
|----------|--------------------|----------|--------------------|
| A        | \$01:234567:89ABCD | A        | \$01:234567:89ABCD |
| X:\$1234 | \$000000           | X:\$1234 | \$7FFFFF           |
| Y:\$1234 | \$000000           | Y:\$1234 | \$FFFFFF           |

**Explanation of Example:** Prior to execution, the 56-bit A accumulator contains the value \$01:234567:89ABCD, the 24-bit X memory location X:\$1234 contains the value \$000000, and the 24-bit Y memory location Y:\$1234 contains the value \$000000. The execution of the parallel move portion of the instruction, A,L:\$1234, moves the 48-bit limited positive saturation constant \$7FFFFFF:FFFFFF into the specified long memory location by moving the MS 24 bits of the 48-bit limited positive saturation constant (\$7FFFFFF) into the 24-bit X memory location X:\$1234 and by moving the LS 24 bits of the 48-bit limited positive saturation constant (\$FFFFFF) into the 24-bit Y memory location Y:\$1234 since the signed integer portion of the A accumulator was in use.

## Condition Codes:

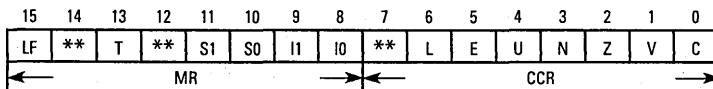

L — Set if data limiting has occurred during parallel move

**NOTE:** The MOVE A,L:ea operation will result in a 48-bit positive or negative saturation constant being stored in the specified 24-bit X and Y memory locations if the signed integer portion of the A accumulator is in use. The MOVE AB,L:ea operation will result in either one or two 24-bit positive and/or negative saturation constant(s) being stored in the specified 24-bit X and/or Y memory location(s) if the signed integer portion of the A and/or B accumulator(s) is in use.

A



L:

## Long Memory Data Move

L:

**Instruction Format:**

(.....) L:ea,D

(.....) S,L:ea

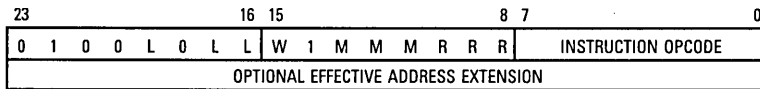
**Opcode:****Instruction Fields:**

ea = 6-bit Effective Address = MMMRRR

| Register W |   | Effective Addressing Mode | MMMRRR      |
|------------|---|---------------------------|-------------|
| Read S     | 0 | (Rn) - Nn                 | 0 0 0 r r r |
| Write D    | 1 | (Rn) + Nn                 | 0 0 1 r r r |
|            |   | (Rn) -                    | 0 1 0 r r r |
|            |   | (Rn) +                    | 0 1 1 r r r |
|            |   | (Rn)                      | 1 0 0 r r r |
|            |   | (Rn + Nn)                 | 1 0 1 r r r |
|            |   | -(Rn)                     | 1 1 0 r r r |
|            |   | Absolute address          | 1 1 0 0 0 0 |

where "rrr" refers to an address register R0-R7

| S   | S1 | S2 | S   | S/L | D   | D1 | D2 | D        | D     | L | L | L |
|-----|----|----|-----|-----|-----|----|----|----------|-------|---|---|---|
|     |    |    |     |     |     |    |    | Sign Ext | Zero  |   |   |   |
| A10 | A1 | A0 | no  |     | A10 | A1 | A0 | no       | no    | 0 | 0 | 0 |
| B10 | B1 | B0 | no  |     | B10 | B1 | B0 | no       | no    | 0 | 0 | 1 |
| X   | X1 | X0 | no  |     | X   | X1 | X0 | no       | no    | 0 | 1 | 0 |
| Y   | Y1 | Y0 | no  |     | Y   | Y1 | Y0 | no       | no    | 0 | 1 | 1 |
| A   | A1 | A0 | yes |     | A   | A1 | A0 | A2       | no    | 1 | 0 | 0 |
| B   | B1 | B0 | yes |     | B   | B1 | B0 | B2       | no    | 1 | 0 | 1 |
| AB  | A  | B  | yes |     | AB  | A  | B  | A2,B2    | A0,B0 | 1 | 1 | 0 |
| BA  | B  | A  | yes |     | BA  | B  | A  | B2,A2    | B0,A0 | 1 | 1 | 1 |

**Timing:** mv oscillator clock cycles**Memory:** mv program words

**L:****Long Memory Data Move****L:****Instruction Format:**

(.....) L:aa,D

(.....) S,L:aa

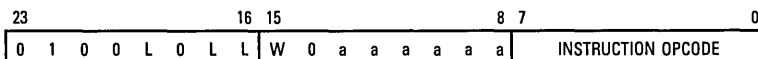
**Opcode:****Instruction Fields:**

aa=6-bit Absolute Short Address=aaaaaa

**Register W          Absolute Short Address aaaaaa**

Read S    0                            000000

Write D   1                            .

111111

|     |    |    | S   |     |    |    | D        | D     |   |   |   |
|-----|----|----|-----|-----|----|----|----------|-------|---|---|---|
| S   | S1 | S2 | S/L | D   | D1 | D2 | Sign Ext | Zero  | L | L | L |
| A10 | A1 | A0 | no  | A10 | A1 | A0 | no       | no    | 0 | 0 | 0 |
| B10 | B1 | B0 | no  | B10 | B1 | B0 | no       | no    | 0 | 0 | 1 |
| X   | X1 | X0 | no  | X   | X1 | X0 | no       | no    | 0 | 1 | 0 |
| Y   | Y1 | Y0 | no  | Y   | Y1 | Y0 | no       | no    | 0 | 1 | 1 |
| A   | A1 | A0 | yes | A   | A1 | A0 | A2       | no    | 1 | 0 | 0 |
| B   | B1 | B0 | yes | B   | B1 | B0 | B2       | no    | 1 | 0 | 1 |
| AB  | A  | B  | yes | AB  | A  | B  | A2,B2    | A0,B0 | 1 | 1 | 0 |
| BA  | B  | A  | yes | BA  | B  | A  | B2,A2    | B0,A0 | 1 | 1 | 1 |

**Timing:** mv oscillator clock cycles**Memory:** mv program words**A**

**X: Y:****XY Memory Data Move****X: Y:****Operation:**`(.....); X:<eax> ↯ D1; Y:<eay> ↯ D2``(.....); X:<eax> ↯ D1; S2 ↯ Y:<eay>``(.....); S1 ↯ X:<eax>; Y:<eay> ↯ D2``(.....); S1 ↯ X:<eax>; S2 ↯ Y:<eay>`**Assembler Syntax:**`(.....) X:<eax>,D1 Y:<eay>,D2``(.....) X:<eax>,D1 S2,Y:<eay>``(.....) S1,X:<eax> Y:<eay>,D2``(.....) S1,X:<eax> S2,Y:<eay>`

where (.....) refers to any arithmetic or logical instruction which allows parallel moves.

**Description:** Move a one-word operand from/to X memory and move another word operand from/to Y memory. Note that two independent effective addresses are specified (<eax> and <eay>) where one of the effective addresses uses the lower bank of address registers (R0–R3) while the other effective address uses the upper bank of address registers (R4–R7). All parallel addressing modes may be used.

If the arithmetic or logical opcode-operand portion of the instruction specifies a given destination accumulator, that same accumulator or portion of that accumulator may not be specified as a destination D1 or D2 in the parallel data bus move operation. Thus, if the opcode-operand portion of the instruction specifies the 56-bit A accumulator as its destination, the parallel data bus move portion of the instruction may not specify A as its destination D1 or D2. Similarly, if the opcode-operand portion of the instruction specifies the 56-bit B accumulator as its destination, the parallel data bus move portion of the instruction may not specify B as its destination D1 or D2. That is, **duplicate destinations are NOT allowed within the same instruction**. D1 and D2 may not specify the same register.

If the opcode-operand portion of the instruction specifies a given source or destination register, that same register or portion of that register may be used as a source S1 and/or S2 in the parallel data bus move operation. This allows data to be moved in the same instruction in which it is being used as a source operand by a data ALU operation. That is, **duplicate sources are allowed within the same instruction**. Note that S1 and S2 may specify the same register.

**A**

**X: Y:****XY Memory Data Move****X: Y:****Example:**

```

:
MPYR X1,Y0,A X1,X:(R0)+ Y0,Y:(R4)+N4 ;X1*Y0 A,save X1 and Y0
:

```

|          | Before Execution |          | After Execution |
|----------|------------------|----------|-----------------|
| X1       | \$123123         | X1       | \$123123        |
| Y0       | \$456456         | Y0       | \$456456        |
| R0       | \$1000           | R0       | \$1001          |
| R4       | \$0100           | R4       | \$0123          |
| N4       | \$0023           | N4       | \$0023          |
| X:\$1000 | \$000000         | X:\$1000 | \$123123        |
| Y:\$0100 | \$000000         | Y:\$0100 | \$456456        |

**Explanation of Example:** Prior to execution, the 24-bit X1 register contains the value \$123123, the 24-bit Y0 register contains the value \$456456, the 16-bit R0 address register contains the value \$1000, the 16-bit R4 address register contains the value \$0100, the 16-bit N4 address offset register contains the value \$0023, the 24-bit X memory location X:\$1000 contains the value \$000000, and the 24-bit Y memory location Y:\$0100 contains the value \$000000. The execution of the parallel move portion of the instruction, X1,X:(R0)+ Y0,Y:(R4)+N4, moves the 24-bit value in the X1 register into the 24-bit X memory location X:\$1000 using the 16-bit R0 address register, moves the 24-bit value in the Y0 register into the 24-bit Y memory location Y:\$0100 using the 16-bit R4 address register, updates the 16-bit value in the R0 address register, and updates the 16-bit R4 address register using the 16-bit N4 address offset register. The contents of the N4 address offset register are not affected.

**A****Condition Codes:**

|      |    |    |    |    |    |    |    |       |   |   |   |   |   |   |   |
|------|----|----|----|----|----|----|----|-------|---|---|---|---|---|---|---|
| 15   | 14 | 13 | 12 | 11 | 10 | 9  | 8  | 7     | 6 | 5 | 4 | 3 | 2 | 1 | 0 |
| LF   | ** | T  | ** | S1 | S0 | I1 | I0 | **    | L | E | U | N | Z | V | C |
| ← MR |    |    |    |    |    |    |    | CCR → |   |   |   |   |   |   |   |

L — Set if data limiting has occurred during parallel move

**NOTE:** The MOVE A,X:<eax> B,Y:<eay> operation will result in one or two 24-bit positive and/or negative saturation constant(s) being stored in the specified 24-bit X

# X: Y:

## XY Memory Data Move

# X: Y:

and/or Y memory location(s) if the signed integer portion of the A and/or B accumulator(s) is in use.

### Instruction Format:

- (.....) X:<eax>,D1 Y:<eay>,D2
- (.....) X:<eax>,D1 S2,Y:<eay>
- (.....) S1,X:<eax> Y:<eay>,D2
- (.....) S1,X:<eax> S2,Y:<eay>

### Opcode:

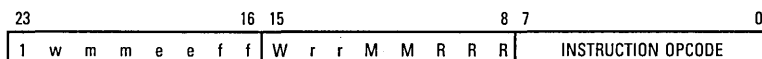

### Instruction Fields:

X:<eax> = 6-bit X Effective Address = WMMRRR (R0-R3 or R4-R7)

X:<eay> = 5-bit Y Effective Address = wmmrr (R4-R7 or R0-R3)

**X Effective**

| Addressing Mode | MMR R R   |
|-----------------|-----------|
| (Rn) + Nn       | 0 1 s s s |
| (Rn) -          | 1 0 s s s |
| (Rn) +          | 1 1 s s s |
| (Rn)            | 0 0 s s s |

where "sss" refers to an address register R0-R3 or R4-R7

| Register W | S1,D1 | e e | S1<br>S/L | D1<br>Sign Ext | D1<br>Zero | Y Effective<br>Addressing Mode | m m r r |
|------------|-------|-----|-----------|----------------|------------|--------------------------------|---------|
| Read S1 0  | X0    | 0 0 | no        | no             | no         | (Rn) + Nn                      | 0 1 t t |
| Write D1 1 | X1    | 0 1 | no        | no             | no         | (Rn) -                         | 1 0 t t |
|            | A     | 1 0 | yes       | A2             | A0         | (Rn) +                         | 1 1 t t |
|            | B     | 1 1 | yes       | B2             | B0         | (Rn)                           | 0 0 t t |

where "tt" refers to an address register R4-R7 or R0-R3 which is in the **opposite** address register bank from the one used in the X effective address, previously described

| Register W | S2,D2 | f f | S2<br>S/L | D2<br>Sign Ext | D2<br>Zero |
|------------|-------|-----|-----------|----------------|------------|
| Read S2 0  | Y0    | 0 0 | no        | no             | no         |
| Write D2 1 | Y1    | 0 1 | no        | no             | no         |
|            | A     | 1 0 | yes       | A2             | A0         |
|            | B     | 1 1 | yes       | B2             | B0         |

**Timing:** mv oscillator clock cycles

**Memory:** mv program words



# MOVEC

## Move Control Register

# MOVEC

### Operation:

X:ea ↗ D1

X:aa ↗ D1

S1 ↗ X:ea

S1 ↗ X:aa

Y:ea ↗ D1

Y:aa ↗ D1

S1 ↗ Y:ea

S1 ↗ Y:aa

S1 ↗ D2

S2 ↗ D1

#xxxx ↗ D1

#xx ↗ D1

### Assembler Syntax:

MOVE(C) X:ea,D1

MOVE(C) X:aa,D1

MOVE(C) S1,X:ea

MOVE(C) S1,X:aa

MOVE(C) Y:ea,D1

MOVE(C) Y:aa,D1

MOVE(C) S1,Y:ea

MOVE(C) S1,Y:aa

MOVE(C) S1,D2

MOVE(C) S2,D1

MOVE(C) #xxxx,D1

MOVE(C) #xx,D1

**Description:** Move the contents of the specified source **control register** S1 or S2 to the specified destination or move the specified source to the specified destination **control register** D1 or D2. The control registers S1 and D1 are a subset of the S2 and D2 register set and consist of the address ALU modifier registers and the program controller registers. These registers may be moved to or from any other register or memory space. All memory addressing modes, as well as an immediate short addressing mode, may be used.

If the system stack register SSH is specified as a source operand, the system stack pointer (SP) is postdecremented by 1 after SSH has been read. If the system stack register SSH is specified as a destination operand, the system stack pointer (SP) is preincremented by 1 before SSH is written. This allows the system stack to be efficiently extended using software stack pointer operations.

When a 56-bit accumulator (A or B) is specified as a **source** operand, the accumulator value is optionally shifted according to the scaling mode bits S0 and S1 in the system

A

status register (SR). If the data out of the shifter indicates that the accumulator extension register is in use and the data is to be moved into a 24-bit destination, the value stored in the destination is limited to a maximum positive or negative saturation constant to minimize truncation error. If the data is to be moved into a 16-bit destination and the accumulator extension register is in use, the value is limited to a maximum positive or negative saturation constant whose LS 16 bits are then stored in the 16-bit destination register. Limiting does not occur if an individual 24-bit accumulator register (A1, A0, B1, or B0) is specified as a source operand instead of the full 56-bit accumulator (A or B). This limiting feature allows block floating-point operations to be performed with error detection since the L bit in the condition code register is latched.

When a 56-bit accumulator (A or B) is specified as a **destination** operand, any 24-bit source data to be moved into that accumulator is automatically extended to 56 bits by sign extending the MS bit of the source operand (bit 23) and appending the source operand with 24 LS zeros. Whenever a 16-bit source operand is to be moved into a 24-bit destination, the 16-bit value is stored in the LS 16 bits of the 24-bit destination, and the MS 8 bits of that destination are zeroed. Similarly, whenever a 16-bit source operand is to be moved into a 56-bit accumulator, the 16-bit value is moved into the LS 16 bits of the MSP portion of the accumulator (A1 or B1), the MS 8 bits of the MSP portion of that accumulator are zeroed, and the resulting 24-bit value is extended to 56 bits by sign extending the MS bit and appending the result with 24 LS zeros. Note that for 24-bit source operands both the automatic sign-extension and zeroing features may be disabled by specifying the destination register to be one of the individual 24-bit accumulator registers (A1 or B1).

**NOTE:** Due to pipelining, if an address register (R, N, or M) is changed using a move-type instruction, the new contents of the destination address register will not be available for use during the following instruction (i.e., there is a single instruction cycle pipeline delay).

**Restrictions:** **NOTE:** The following restrictions represent very unusual operations, which probably would never be used but are listed only for completeness.

A MOVEC instruction used **within a DO loop** which specifies **SSH** as the **source** operand or **LA, LC, SR, SP, SSH, or SSL** as the **destination** operand cannot begin at the address LA-2, LA-1, or LA within that DO loop.

A MOVEC instruction which specifies **SSH** as the **source** operand or **LA, LC, SSH, SSL, or SP** as the **destination** operand cannot be used **immediately before** a DO instruction.

# MOVEC

## Move Control Register

# MOVEC

A MOVEC instruction which specifies **SSH** as the **source** operand or **LA, LC, SR, SSH, SSL, or SP** as the **destination** operand cannot be used **immediately before** an ENDDO instruction.

A MOVEC instruction which specifies **SSH** as the **source** operand or **SR, SSH, SSL, or SP** as the **destination** operand cannot be used **immediately before** an RTI instruction.

A MOVEC instruction which specifies **SSH** as the **source** operand or **SSH, SSL, or SP** as the **destination** operand cannot be used **immediately before** an RTS instruction.

A MOVEC instruction which specifies **SP** as the **destination** operand cannot be used **immediately before** a MOVEC, MOVEM, or MOVEP instruction which specifies **SSH** or **SSL** as the **source** operand.

A MOVEC SSH,SSH instruction is **illegal** and cannot be used.

### Example:

```

:
MOVEC LC,X0          ;move LC into X0
:

```

|    | Before Execution |    | After Execution |
|----|------------------|----|-----------------|
| LC | \$0100           | LC | \$0100          |
| X0 | \$123456         | X0 | \$000100        |

**Explanation of Example:** Prior to execution, the 16-bit loop counter (LC) register contains the value \$0100, and the 24-bit X0 register contains the value \$123456. The execution of the MOVEC LC,X0 instruction moves the contents of the 16-bit LC register into the 16 LS bits of the 24-bit X0 register and zeros the 8 MS bits of the X0 register.

### Condition Codes:

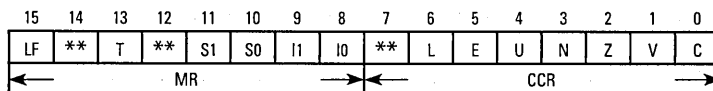

### For D1 or D2=SR operand:

- L — Set according to bit 6 of the source operand
- E — Set according to bit 5 of the source operand
- U — Set according to bit 4 of the source operand
- N — Set according to bit 3 of the source operand



# MOVEC

## Move Control Register

# MOVEC

Z — Set according to bit 2 of the source operand

V — Set according to bit 1 of the source operand

C — Set according to bit 0 of the source operand

For D1 and D2 ≠ SR operand:

L — Set if data limiting has occurred during move

### Instruction Format:

MOVE(C) X:ea,D1

MOVE(C) S1,X:ea

MOVE(C) Y:ea,D1

MOVE(C) S1,Y:ea

MOVE(C) #xxxx,D1

### Opcode:

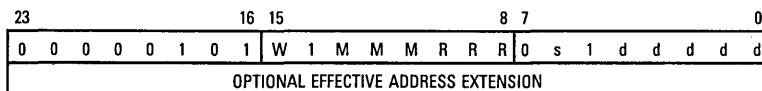

### Instruction Fields:

ea = 6-bit Effective Address = MMMRRR

| Register W     | Effective Addressing Mode | MMMRRR      |
|----------------|---------------------------|-------------|
| Read S1 0      | (Rn) - Nn                 | 0 0 0 r r r |
| Write D1 1     | (Rn) + Nn                 | 0 0 1 r r r |
|                | (Rn) -                    | 0 1 0 r r r |
|                | (Rn) +                    | 0 1 1 r r r |
|                | (Rn)                      | 1 0 0 r r r |
|                | (Rn + Nn)                 | 1 0 1 r r r |
|                | -(Rn)                     | 1 1 1 r r r |
|                | Absolute address          | 1 1 0 0 0 0 |
| Immediate data | 1 1 0 1 0 0               |             |

where "rrr" refers to an address register R0-R7



# MOVEC

## Move Control Register

# MOVEC

| Memory Space s | S1,D1 | d d d d d |
|----------------|-------|-----------|
| X Memory 0     | M0-M7 | 0 0 n n n |
| Y Memory 1     | SR    | 1 1 0 0 1 |
|                | OMR   | 1 1 0 1 0 |
|                | SP    | 1 1 0 1 1 |
|                | SSH   | 1 1 1 0 0 |
|                | SSL   | 1 1 1 0 1 |
|                | LA    | 1 1 1 1 0 |
|                | LC    | 1 1 1 1 1 |

where "nnn" = Mn number (M0-M7)

**Timing:** 2 + mvc oscillator clock cycles

**Memory:** 1 + ea program words

### Instruction Format:

MOVE(C) X:aa,D1  
 MOVE(C) S1,X:aa  
 MOVE(C) Y:aa,D1  
 MOVE(C) S1,Y:aa

### Opcode:

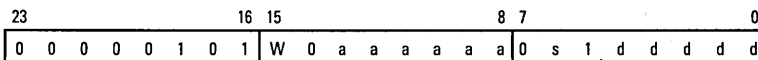

### Instruction Fields:

aa = 6-bit Absolute Short Address = aaaaaa

| Register W | Absolute Short Address aaaaaa |
|------------|-------------------------------|
| Read S 0   | 000000                        |
| Write D 1  | .                             |
|            | .                             |
|            | 111111                        |

| Memory Space s | S1,D1 | d d d d d |
|----------------|-------|-----------|
| X Memory 0     | M0-M7 | 0 0 n n n |
| Y Memory 1     | SR    | 1 1 0 0 1 |
|                | OMR   | 1 1 0 1 0 |
|                | SP    | 1 1 0 1 1 |
|                | SSH   | 1 1 1 0 0 |
|                | SSL   | 1 1 1 0 1 |
|                | LA    | 1 1 1 1 0 |
|                | LC    | 1 1 1 1 1 |

where "nnn" = Mn number (M0-M7)

# MOVEC

## Move Control Register

# MOVEC

**Timing:** 2+ mvc oscillator clock cycles

**Memory:** 1+ea program words

**Instruction Format:**

MOVE(C) S1,D2

MOVE(C) S2,D1

**Opcode:**

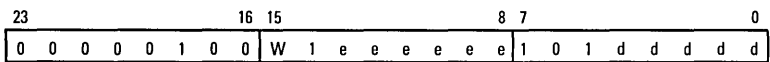

**Instruction Fields:**

| Register            | W        | S1,D1 | d d d d  |
|---------------------|----------|-------|----------|
| Read S1             | 0        | M0-M7 | 00 n n n |
| Write D1            | 1        | SR    | 11 00 1  |
|                     |          | OMR   | 11 01 0  |
|                     |          | SP    | 11 01 1  |
| <b>Memory Space</b> | <b>s</b> | SSH   | 11 10 0  |
| X Memory            | 0        | SSL   | 11 10 1  |
| Y Memory            | 1        | LA    | 11 11 0  |
|                     |          | LC    | 11 11 1  |

where "nnn" = Mn number (M0-M7)

| S2,D2 | e e e e e | S/L | Sign | Ext | Zero | S2,D2 | e e e e e |
|-------|-----------|-----|------|-----|------|-------|-----------|
| X0    | 00.0100   | no  | no   | no  | no   | R0-R7 | 010 n n n |
| X1    | 000101    | no  | no   | no  | no   | N0-N7 | 011 n n n |
| Y0    | 000110    | no  | no   | no  | no   | M0-M7 | 100 n n n |
| Y1    | 000111    | no  | no   | no  | no   | SR    | 111001    |
| A0    | 001000    | no  | no   | no  | no   | OMR   | 111010    |
| B0    | 001001    | no  | no   | no  | no   | SP    | 111011    |
| A2    | 001010    | no  | no   | no  | no   | SSH   | 111100    |
| B2    | 001011    | no  | no   | no  | no   | SSL   | 111101    |
| A1    | 001100    | no  | no   | no  | no   | LA    | 111110    |
| B1    | 001101    | no  | no   | no  | no   | LC    | 111111    |
| A     | 001110    | yes | A2   | A0  |      |       |           |
| B     | 001111    | yes | B2   | B0  |      |       |           |

where "nnn" = Rn number (R0-R7)  
 Nn number (N0-N7)  
 Mn number (M0-M7)



# MOVEC

## Move Control Register

# MOVEC

**Timing:** 2 + mvc oscillator clock cycles

**Memory:** 1 + ea program words

**Instruction Format:**

MOVE(C) #xx,D1

**Opcode:**

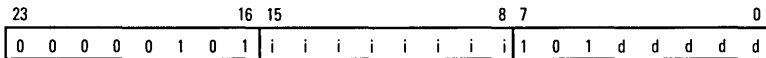

**Instruction Fields:**

#xx = 8-bit Immediate Short Data = i i i i i i i i

|       |             |
|-------|-------------|
| D1    | d d d d d   |
| M0-M7 | 0 0 n n n n |
| SR    | 1 1 0 0 1   |
| OMR   | 1 1 0 1 0   |
| SP    | 1 1 0 1 1   |
| SSH   | 1 1 1 0 0   |
| SSL   | 1 1 1 0 1   |
| LA    | 1 1 1 1 0   |
| LC    | 1 1 1 1 1   |

where "nnn" = Mn number (M0-M7)

**Timing:** 2 + mvc oscillator clock cycles

**Memory:** 1 + ea program words

A

# MOVEM

## Move Program Memory

# MOVEM

### Operation:

S ↯ P:ea

S ↯ P:aa

P:ea ↯ D

P:aa ↯ D

### Assembler Syntax:

MOVE(M) S,P:ea

MOVE(M) S,P:aa

MOVE(M) P:ea,D

MOVE(M) P:aa,D

**Description:** Move the specified operand from/to the specified **program (P) memory location**. This is a powerful move instruction in that the source and destination registers S and D may be **any** register. All memory alterable addressing modes may be used as well as the absolute short addressing mode.

If the system stack register SSH is specified as a source operand, the system stack pointer (SP) is postdecremented by 1 after SSH has been read. If the system stack register SSH is specified as a destination operand, the system stack pointer (SP) is preincremented by 1 before SSH is written. This allows the system stack to be efficiently extended using software stack pointer operations.

When a 56-bit accumulator (A or B) is specified as a **source** operand S, the accumulator value is optionally shifted according to the scaling mode bits S0 and S1 in the system status register (SR). If the data out of the shifter indicates that the accumulator extension register is in use and the data is to be moved into a 24-bit destination, the value stored in the destination is limited to a maximum positive or negative saturation constant to minimize truncation error. If a 24-bit source operand is to be moved into a 16-bit destination register D, the 8 MS bits of the 24-bit source operand are discarded, and the 16 LS bits are stored in the 16-bit destination register. Limiting does not occur if an individual 24-bit accumulator register (A1, A0, B1, or B0) is specified as a source operand instead of the full 56-bit accumulator (A or B). This limiting feature allows block floating-point operations to be performed with error detection since the L bit in the condition code register is latched.

When a 56-bit accumulator (A or B) is specified as a **destination** operand D, any 24-bit source data to be moved into that accumulator is automatically extended to 56 bits by sign extending the MS bit of the source operand (bit 23) and appending the source operand with 24 LS zeros. Whenever a 16-bit source operand S is to be moved into a 24-bit destination, the 16-bit source is loaded into the LS 16 bits of the destination operand, and the remaining 8 MS bits of the destination are zeroed. Note that for 24-bit source operands, both the automatic sign-extension and zeroing features may be disabled by specifying the destination register to be one of the individual 24-bit accumulator registers (A1 or B1).

A

# MOVEM

## Move Program Memory

# MOVEM

**NOTE:** Due to pipelining, if an address register (R, N, or M) is changed using a move-type instruction, the new contents of the destination address register will not be available for use during the following instruction (i.e., there is a single instruction cycle pipeline delay).

**Restrictions:** **NOTE:** The following restrictions represent very unusual operations, which probably would never be used but are listed only for completeness.

A MOVEM instruction used **within a DO loop** which specifies **SSH** as the **source** operand or **LA, LC, SR, SP, SSH, or SSL** as the **destination** operand cannot begin at the address LA-2, LA-1, or LA within that DO loop.

A MOVEM instruction which specifies **SSH** as the **source** operand or **LA, LC, SSH, SSL, or SP** as the **destination** operand cannot be used **immediately before** a DO instruction.

A MOVEM instruction which specifies **SSH** as the **source** operand or **LA, LC, SR, SSH, SSL, or SP** as the **destination** operand cannot be used **immediately before** an ENDDO instruction.

A MOVEM instruction which specifies **SSH** as the **source** operand or **SR, SSH, SSL, or SP** as the **destination** operand cannot be used **immediately before** an RTI instruction.

A MOVEM instruction which specifies **SSH** as the **source** operand or **SSH, SSL, or SP** as the **destination** operand cannot be used **immediately before** an RTS instruction.

A MOVEM instruction which specifies **SP** as the **destination** operand cannot be used **immediately before** a MOVEC, MOVEM, or MOVEP instruction which specifies **SSH** or **SSL** as the **source** operand.

### Example:

```
MOVEM P:(R5+N5),LC      ;move P:(R5+N5) into the loop counter (LC)
```

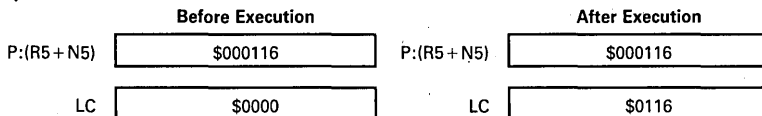

**Explanation of Example:** Prior to execution, the 16-bit loop counter (LC) register contains the value \$0000, and the 24-bit program (P) memory location P:(R5+N5) contains the value \$000116. The execution of the MOVEM P:(R5+N5),LC instruction moves the 16 LS bits of the 24-bit program (P) memory location P:(R5+N5) into the 16-bit LC register.

# MOVEM

## Move Program Memory

# MOVEM

### Condition Codes:

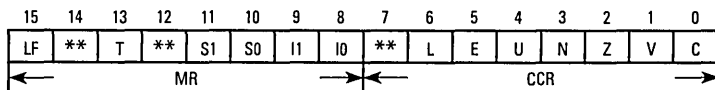

### For D=SR operand:

- L — Set according to bit 6 of the source operand
- E — Set according to bit 5 of the source operand
- U — Set according to bit 4 of the source operand
- N — Set according to bit 3 of the source operand
- Z — Set according to bit 2 of the source operand
- V — Set according to bit 1 of the source operand
- C — Set according to bit 0 of the source operand

### For D≠SR operand:

- L — Set if data limiting has occurred during move

### Instruction Format:

MOVE(M) S,P:ea

MOVE(M) P:ea,D

### Opcode:

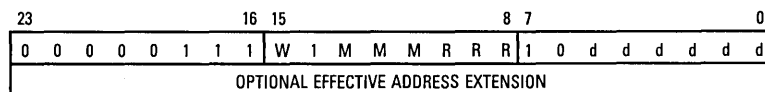

### Instruction Fields:

ea=6-bit Effective Address=MMMRRR

| Register W | Effective Addressing Mode | MMMR R R    |
|------------|---------------------------|-------------|
| Read S 0   | (Rn)−Nn                   | 0 0 0 r r r |
| Write D 1  | (Rn)+Nn                   | 0 0 1 r r r |
|            | (Rn)−                     | 0 1 0 r r r |
|            | (Rn)+                     | 0 1 1 r r r |
|            | (Rn)                      | 1 0 0 r r r |
|            | (Rn+Nn)                   | 1 0 1 r r r |
|            | −(Rn)                     | 1 1 1 r r r |
|            | Absolute address          | 1 1 0 0 0 0 |

where "rrr" refers to an address register R0–R7







# MOVEM

## Move Program Memory

# MOVEM

| S,D | dddddd | S   | D    | D        | S,D   | dddddd |
|-----|--------|-----|------|----------|-------|--------|
|     |        | S/L | Sign | Ext Zero |       |        |
| X0  | 000100 | no  | no   | no       | R0-R7 | 010nnn |
| X1  | 000101 | no  | no   | no       | N0-N7 | 011nnn |
| Y0  | 000110 | no  | no   | no       | M0-M7 | 100nnn |
| Y1  | 000111 | no  | no   | no       | SR    | 111001 |
| A0  | 001000 | no  | no   | no       | OMR   | 111010 |
| B0  | 001001 | no  | no   | no       | SP    | 111011 |
| A2  | 001010 | no  | no   | no       | SSH   | 111100 |
| B2  | 001011 | no  | no   | no       | SSL   | 111101 |
| A1  | 001100 | no  | no   | no       | LA    | 111110 |
| B1  | 001101 | no  | no   | no       | LC    | 111111 |
| A   | 001110 | yes | A2   | A0       |       |        |
| B   | 001111 | yes | B2   | B0       |       |        |

where "nnn" = Rn number (R0-R7)  
Nn number (N0-N7)  
Mn number (M0-M7)

**Timing:** 2 + mvm oscillator clock cycles

**Memory:** 1 + ea program words

# MOVEP

## Move Peripheral Data

# MOVEP

### Operation:

X:pp ↗ D  
X:pp ↗ X:ea  
X:pp ↗ Y:ea  
X:pp ↗ P:ea  
S ↗ X:pp  
#xxxxxx ↗ X:pp  
X:ea ↗ X:pp  
Y:ea ↗ X:pp  
P:ea ↗ X:pp  
Y:pp ↗ D  
Y:pp ↗ X:ea  
Y:pp ↗ Y:ea  
Y:pp ↗ P:ea  
S ↗ Y:pp  
#xxxxxx ↗ Y:pp  
X:ea ↗ Y:pp  
Y:ea ↗ Y:pp  
P:ea ↗ Y:pp

### Assembler Syntax:

MOVEP X:pp,D  
MOVEP X:pp,X:ea  
MOVEP X:pp,Y:ea  
MOVEP X:pp,P:ea  
MOVEP S,X:pp  
MOVEP #xxxxxx,X:pp  
MOVEP X:ea,X:pp  
MOVEP Y:ea,X:pp  
MOVEP P:ea,X:pp  
MOVEP Y:pp,D  
MOVEP Y:pp,X:ea  
MOVEP Y:pp,Y:ea  
MOVEP Y:pp,P:ea  
MOVEP S,Y:pp  
MOVEP #xxxxxx,Y:pp  
MOVEP X:ea,Y:pp  
MOVEP Y:ea,Y:pp  
MOVEP P:ea,Y:pp

**Description:** Move the specified operand from/to the specified **X or Y I/O peripheral**. The I/O short addressing mode is used for the I/O peripheral address. All memory addressing modes may be used for the X or Y memory effective address; all memory alterable addressing modes may be used for the P memory effective address.

A

If the system stack register SSH is specified as a source operand, the system stack pointer (SP) is postdecremented by 1 after SSH has been read. If the system stack register SSH is specified as a destination operand, the system stack pointer (SP) is preincremented by 1 before SSH is written. This allows the system stack to be efficiently extended using software stack pointer operations.

When a 56-bit accumulator (A or B) is specified as a **source** operand S, the accumulator value is optionally shifted according to the scaling mode bits S0 and S1 in the system status register (SR). If the data out of the shifter indicates that the accumulator extension register is in use and the data is to be moved into a 24-bit destination, the value stored in the destination is limited to a maximum positive or negative saturation constant to minimize truncation error. If a 24-bit source operand is to be moved into a 16-bit destination register D, the 8 MS bits of the 24-bit source operand are discarded, and the 16 LS bits are stored in the 16-bit destination register. Limiting does not occur if an individual 24-bit accumulator register (A1, A0, B1, or B0) is specified as a source operand instead of the full 56-bit accumulator (A or B). This limiting feature allows block floating-point operations to be performed with error detection since the L bit in the condition code register is latched.

When a 56-bit accumulator (A or B) is specified as a **destination** operand D, any 24-bit source data to be moved into that accumulator is automatically extended to 56 bits by sign extending the MS bit of the source operand (bit 23) and appending the source operand with 24 LS zeros. Whenever a 16-bit source operand S is to be moved into a 24-bit destination, the 16-bit source is loaded into the LS 16 bits of the destination operand, and the remaining 8 MS bits of the destination are zeroed. Note that for 24-bit source operands both the automatic sign-extension and zeroing features may be disabled by specifying the destination register to be one of the individual 24-bit accumulator registers (A1 or B1).

**NOTE:** Due to pipelining, if an address register (R, N, or M) is changed using a move-type instruction, the new contents of the destination address register will not be available for use during the following instruction (i.e, there is a single instruction cycle pipeline delay).

**Restrictions:** **NOTE:** The following restrictions represent very unusual operations, which probably would never be used but are listed only for completeness.

A MOVEP instruction used **within a DO loop** which specifies **SSH** as the **source** operand or **LA, LC, SR, SP, SSH, or SSL** as the **destination** operand cannot begin at the address LA - 2, LA - 1, or LA within that DO loop.

# MOVEP

## Move Peripheral Data

# MOVEP

A MOVEP instruction which specifies **SSH** as the **source** operand or **LA, LC, SSH, SSL, or SP** as the **destination** operand cannot be used **immediately before** a DO instruction.

A MOVEP instruction which specifies **SSH** as the **source** operand or **LA, LC, SR, SSH, SSL, or SP** as the **destination** operand cannot be used **immediately before** an ENDDO instruction.

A MOVEP instruction which specifies **SSH** as the **source** operand or **SR, SSH, SSL, or SP** as the **destination** operand cannot be used **immediately before** an RTI instruction.

A MOVEP instruction which specifies **SSH** as the **source** operand or **SSH, SSL, or SP** as the **destination** operand cannot be used **immediately before** an RTS instruction.

A MOVEP instruction which specifies **SP** as the **destination** operand cannot be used **immediately before** a MOVEC, MOVEM, or MOVEP instruction which specifies **SSH** or **SSL** as the **source** operand.

### Example:

```

:
MOVEP # $1113, X: << $FFFE      ; initialize Bus Control Register wait states
:
    
```

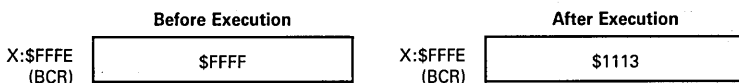

**Explanation of Example:** Prior to execution, the 16-bit, X memory-mapped, I/O bus control register (BCR) contains the value \$FFFF. The execution of the MOVEP # \$1113, X: << \$FFFE instruction moves the value \$1113 into the 16-bit bus control register X: \$FFFE, resulting in one wait state for all external X, external Y, and external program memory accesses and three wait states for all external I/O accesses.

### Condition Codes:

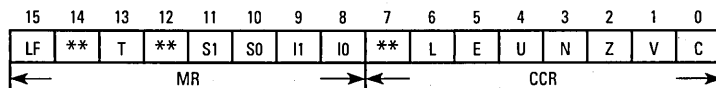

For D=SR operand:

- L — Set according to bit 6 of the source operand
- E — Set according to bit 5 of the source operand
- U — Set according to bit 4 of the source operand

# MOVEP

## Move Peripheral Data

# MOVEP

- N — Set according to bit 3 of the source operand
- Z — Set according to bit 2 of the source operand
- V — Set according to bit 1 of the source operand
- C — Set according to bit 0 of the source operand

For D ≠ SR operand:

- L — Set if data limiting has occurred during move

### Instruction Format (X: or Y: Reference):

```

MOVEP X:ea,X:pp
MOVEP Y:ea,X:pp
MOVEP #xxxxxx,X:pp
MOVEP X:pp,X:ea
MOVEP X:pp,Y:ea
MOVEP X:ea,Y:pp
MOVEP Y:ea,Y:pp
MOVEP #xxxxxx,Y:pp
MOVEP Y:pp,Y:ea
MOVEP Y:pp,Y:ea
    
```

### Opcode:

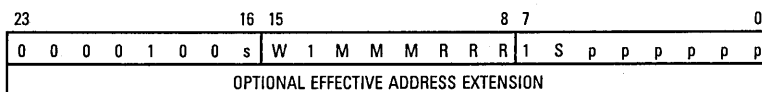

### Instruction Fields:

ea = 6-bit Effective Address = MMMRRR,  
 pp = 6-bit I/O Short Address = pppppp

| Memory Space            | S        | Effective Addressing Mode | MMMR R R    |
|-------------------------|----------|---------------------------|-------------|
| X Memory                | 0        | (Rn) - Nn                 | 0 0 0 r r r |
| Y Memory                | 1        | (Rn) + Nn                 | 0 0 1 r r r |
|                         |          | (Rn) -                    | 0 1 0 r r r |
| <b>Peripheral Space</b> | <b>s</b> | (Rn) +                    | 0 1 1 r r r |
| X Memory                | 0        | (Rn)                      | 1 0 0 r r r |
| Y Memory                | 1        | (Rn + Nn)                 | 1 0 1 r r r |
|                         |          | -(Rn)                     | 1 1 1 r r r |
| <b>Peripheral</b>       | <b>W</b> | Absolute address          | 1 1 0 0 0 0 |
| Read                    | 0        | Immediate data            | 1 1 0 1 0 0 |
| Write                   | 1        |                           |             |

where "rrr" refers to an address register R0-R7



# MOVEP

Move Peripheral Data

# MOVEP

**Timing:** 4 +.mvp oscillator clock cycles

**Memory:** 1 +ea program words

**Instruction Format (P: Reference):**

MOVEP P:ea,X:pp  
 MOVEP X:pp,P:ea  
 MOVEP P:ea,Y:pp  
 MOVEP Y:pp,P:ea

**Opcode:**

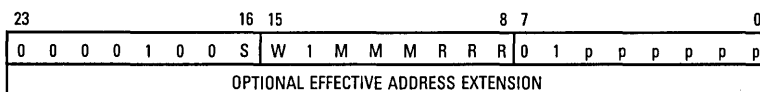

**Instruction Fields:**

ea = 6-bit Effective Address = MMMRRR,

pp = 6-bit I/O Short Address = pppppp

| Peripheral Space S | Effective Addressing Mode | MMMMRRR     |
|--------------------|---------------------------|-------------|
| X Memory 0         | (Rn) - Nn                 | 0 0 0 r r r |
| Y Memory 1         | (Rn) + Nn                 | 0 0 1 r r r |
|                    | (Rn) -                    | 0 1 0 r r r |
| Peripheral W       | (Rn) +                    | 0 1 1 r r r |
| Read 0             | (Rn)                      | 1 0 0 r r r |
| Write 1            | (Rn + Nn)                 | 1 0 1 r r r |
|                    | -(Rn)                     | 1 1 1 r r r |
|                    | Absolute address          | 1 1 0 0 0 0 |

where "rrr" refers to an address register R0-R7

**Timing:** 4 +.mvp oscillator clock cycles

**Memory:** 1 +ea program words

A

# MOVEP

## Move Peripheral Data

# MOVEP

### Instruction Format (Register Reference):

MOVEP S,X:pp  
 MOVEP X:pp,D  
 MOVEP S,Y:pp  
 MOVEP Y:pp,D

### Opcode:

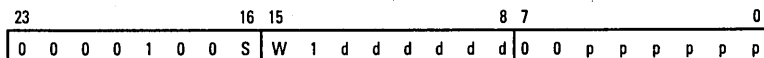

### Instruction Fields:

pp = 6-bit I/O Short Address = pppppp

|                           |                     |  |
|---------------------------|---------------------|--|
| <b>Peripheral Space S</b> | <b>Peripheral W</b> |  |
| X Memory      0           | Read          0     |  |
| Y Memory      1           | Write         1     |  |

|     | S           | D   | D    |     | S,D   | d d d d d d |
|-----|-------------|-----|------|-----|-------|-------------|
| S,D | d d d d d d | S/L | Sign | Ext | Zero  |             |
| X0  | 000100      | no  | no   | no  | R0-R7 | 010 nnn     |
| X1  | 000101      | no  | no   | no  | N0-N7 | 011 nnn     |
| Y0  | 000110      | no  | no   | no  | M0-M7 | 100 nnn     |
| Y1  | 000111      | no  | no   | no  | SR    | 111001      |
| A0  | 001000      | no  | no   | no  | OMR   | 111010      |
| B0  | 001001      | no  | no   | no  | SP    | 111011      |
| A2  | 001010      | no  | no   | no  | SSH   | 111100      |
| B2  | 001011      | no  | no   | no  | SSL   | 111101      |
| A1  | 001100      | no  | no   | no  | LA    | 111110      |
| B1  | 001101      | no  | no   | no  | LC    | 111111      |
| A   | 001110      | yes | A2   | A0  |       |             |
| B   | 001111      | yes | B2   | B0  |       |             |

where "nnn" = Rn number (R0-R7)  
 Nn number (N0-N7)  
 Mn number (M0-M7)

**Timing:** 4 + mvp oscillator clock cycles

**Memory:** 1 + ea program words



# MPY

## Signed Multiply

# MPY

### Operation:

$\pm S1 * S2 \blacktriangleright D$  (parallel move)

$\pm S1 * S2 \blacktriangleright D$  (parallel move)

### Assembler Syntax:

MPY ( $\pm$ )S1,S2,D (parallel move)

MPY ( $\pm$ )S2,S1,D (parallel move)

**Description:** Multiply the two signed 24-bit source operands S1 and S2 and store the resulting product in the specified 56-bit destination accumulator D. The “-” sign option is used to negate the specified product. The default sign option is “+”.

### Example:

MPY -X1,Y1,A #543210,Y0 ; -(X1\*Y1)  $\blacktriangleright$  A, update Y0

|    | Before Execution   | After Execution    |
|----|--------------------|--------------------|
| X1 | \$800000           | \$800000           |
| Y1 | \$C00000           | \$C00000           |
| A  | \$00:000000:000000 | \$FF:C00000:000000 |

**Explanation of Example:** Prior to execution, the 24-bit X1 register contains the value \$800000 (-1.0), the 24-bit Y1 register contains the value \$C00000, (-0.5), and the 56-bit A accumulator contains the value \$00:000000:000000 (0.0). The execution of the MPY -X1,Y1,A instruction multiplies the 24-bit signed value in the X1 register by the 24-bit signed value in the Y1 register, negates the 48-bit product, and stores the result in the 56-bit A accumulator ( $-X1 * Y1 = -0.5 = \$FF:C00000:000000 = A$ ).

### Condition Codes:

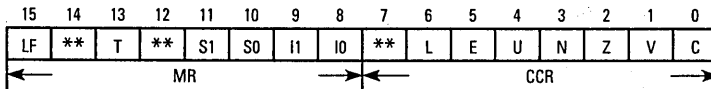

- L — Set if data limiting has occurred during parallel move
- E — Set if the signed integer portion of A or B result is in use
- U — Set if A or B result in unnormalized
- N — Set if bit 55 of A or B result is set
- Z — Set if A or B result equals zero
- V — Always cleared



# MPY

## Signed Multiply

# MPY

**NOTE:** The definition of the E and U bits varies according to the scaling mode being used. Refer to **A.4 CONDITION CODE COMPUTATION** for complete details.

### Instruction Format:

MPY ( $\pm$ )S1,S2,D

MPY ( $\pm$ )S2,S1,D

### Opcode:

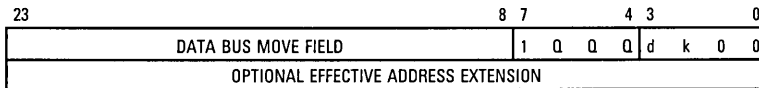

### Instruction Fields:

| S1*S2 Q Q Q | Sign k | D d |
|-------------|--------|-----|
| X0 X0 0 0 0 | + 0    | A 0 |
| Y0 Y0 0 0 1 | - 1    | B 1 |
| X1 X0 0 1 0 |        |     |
| Y1 Y0 0 1 1 |        |     |
| X0 Y1 1 0 0 |        |     |
| Y0 X0 1 0 1 |        |     |
| X1 Y0 1 1 0 |        |     |
| Y1 X1 1 1 1 |        |     |

**NOTE:** Only the indicated S1\*S2 combinations are valid. X1\*X1 and Y1\*Y1 are **not** valid.

**Timing:** 2 + mv oscillator clock cycles

**Memory:** 1 + mv program words



# MPYR

## Signed Multiply and Round

# MPYR

### Operation:

$\pm S1 * S2 + r \rightarrow D$  (parallel move)

$\pm S1 * S2 + r \rightarrow D$  (parallel move)

### Assembler Syntax:

MPYR ( $\pm$ )S1,S2,D (parallel move)

MPYR ( $\pm$ )S2,S1,D (parallel move)

**Description:** Multiply the two signed 24-bit source operands S1 and S2, round the result using convergent rounding, and store it in the specified 56-bit destination accumulator D. The “-” sign option is used to negate the product prior to rounding. The default sign option is “+”. The contribution of the LS bits of the result is rounded into the upper portion of the destination accumulator (A1 or B1) by adding a constant to the LS bits of the lower portion of the accumulator (A0 or B0). The value of the constant added is determined by the scaling mode bits S0 and S1 in the status register. Once the rounding has been completed, the LS bits of the destination accumulator D (A0 or B0) are loaded with zeros to maintain an unbiased accumulator value which may be reused by the next instruction. The upper portion of the accumulator (A1 or B1) contains the rounded result which may be read out to the data buses. Refer to the RND instruction for more complete information on the convergent rounding process.

### Example:

```

:
MPYR -Y0,Y0,B (R3)-N3 ;square and negate Y0, update R3
:

```

|    | Before Execution   | After Execution    |
|----|--------------------|--------------------|
| Y0 | \$654321           | \$654321           |
| B  | \$00:000000:000000 | \$FF:AFE3ED:000000 |

**Explanation of Example:** Prior to execution, the 24-bit Y0 register contains the value \$654321 (0.791111112), and the 56-bit B accumulator contains the value \$00:000000:000000 (0.0). The execution of the MPYR -Y0,Y0,B instruction squares the 24-bit signed value in the Y0 register, negates the resulting 48-bit product, rounds the result into B1, and zeros B0 ( $-Y0 * Y0 = -0.625856790961748$  approximately = \$FF:AFE3EC:B76B7E, which is rounded to the value \$FF:AFE3ED:000000 =  $-0.625856757164002 = B$ ).



### Condition Codes:

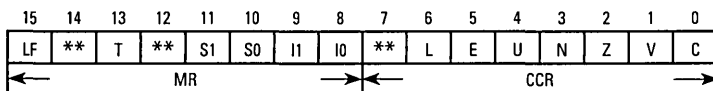

- L — Set if data limiting has occurred during parallel move
- E — Set if the signed integer portion of A or B result is in use
- U — Set if A or B result is unnormalized
- N — Set if bit 55 of A or B result is set
- Z — Set if A or B result equals zero
- V — Always cleared

**NOTE:** The definition of the E and U bits varies according to the scaling mode being used. Refer to **A.4 CONDITION CODE COMPUTATION** for complete details.

### Instruction Format:

MPYR (±)S1,S2,D  
 MPYR (±)S2,S1,D

### Opcode:

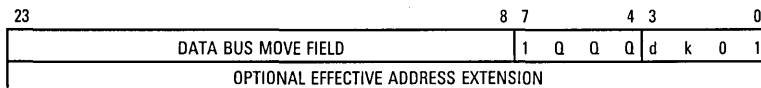

### Instruction Fields:

| S1*S2 | Q Q Q | Sign | k | D | d |
|-------|-------|------|---|---|---|
| X0    | X0    | 0    | 0 | + | 0 |
| Y0    | Y0    | 0    | 0 | - | 1 |
| X1    | X0    | 0    | 1 |   |   |
| Y1    | Y0    | 0    | 1 |   |   |
| X0    | Y1    | 1    | 0 |   |   |
| Y0    | X0    | 1    | 0 |   |   |
| X1    | Y0    | 1    | 1 |   |   |
| Y1    | X1    | 1    | 1 |   |   |

**NOTE:** Only the indicated S1\*S2 combinations are valid. X1\*X1 and Y1\*Y1 are **not** valid.

**Timing:** 2 + mv oscillator clock cycles

**Memory:** 1 + mv program words



# NEG

## Negate Accumulator

# NEG

**Operation:**

0-D ↯ D (parallel move)

**Assembler Syntax:**

NEG D (parallel move)

**Description:** Negate the destination operand D and store the result in the destination accumulator. This is a 56-bit, twos-complement operation.

**Example:**

```

:
NEG B X1,X:(R3)+ Y:(R6)-,A ;0-B ↯ B, update A,X1,R3,R6
:

```

|   | Before Execution   | After Execution    |
|---|--------------------|--------------------|
| B | \$00:123456:789ABC | \$FF:EDCBA9:876544 |

**Explanation of Example:** Prior to execution, the 56-bit B accumulator contains the value \$00:123456:789ABC. The NEG B instruction takes the twos complement of the value in the B accumulator and stores the 56-bit result back in the B accumulator.

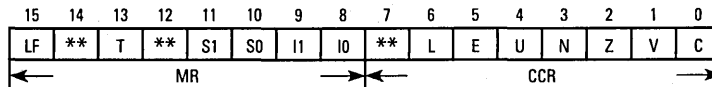
**Condition Codes:**

- L — Set if limiting (parallel move) or overflow has occurred in result
- E — Set if the signed integer portion of A or B is in use
- U — Set if A or B result is unnormalized
- N — Set if bit 55 of A or B result is set
- Z — Set if A or B result equals zero
- V — Set if overflow has occurred in A or B result

**NOTE:** The definition of the E and U bits varies according to the scaling mode being used. Refer to **A.4 CONDITION CODE COMPUTATION** for complete details.

**A**

# NEG

## Negate Accumulator

# NEG

### Instruction Format:

NEG D

### Opcode:

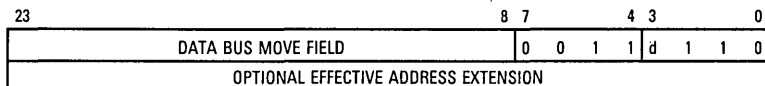

### Instruction Fields:

D    d  
A    0  
B    1

**Timing:** 2+ mv oscillator clock cycles

**Memory:** 1+ mv program words



# NOP

No Operation

# NOP

**Operation:**

PC + 1 → PC

**Assembler Syntax:**

NOP

**Description:** Increment the program counter (PC). Pending pipeline actions, if any, are completed. Execution continues with the instruction following the NOP.

**Example:**

```
NOP ;increment the program counter
```

**Explanation of Example:** The NOP instruction increments the program counter (PC) and completes any pending pipeline actions.

**Condition Codes:**

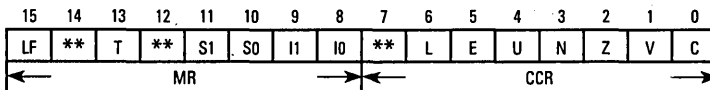

The condition codes are not affected by this instruction.

**Instruction Format:**

NOP

**Opcode:**

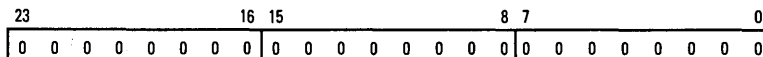

**Instruction Fields:**

None

**Timing:** 2 oscillator clock cycles

**Memory:** 1 program word

**A**

# NORM

## Normalize Accumulator Iteration

# NORM

### Operation:

If  $\bar{E} \bullet U \bullet \bar{Z} = 1$ , then ASL D and  $Rn - 1 \rightarrow Rn$   
 else if  $E = 1$ , then ASR D and  $Rn + 1 \rightarrow Rn$   
 else NOP

### Assembler Syntax:

NORM Rn,D

where  $\bar{E}$  denotes the logical complement of E, and  
 where  $\bullet$  denotes the logical AND operator

**Description:** Perform one normalization iteration on the specified destination operand D, update the specified address register Rn based upon the results of that iteration, and store the result back in the destination accumulator. This is a 56-bit operation. If the accumulator extension is not in use, the accumulator is unnormalized, and the accumulator is not zero, the destination operand is arithmetically shifted one bit to the left, and the specified address register is decremented by 1. If the accumulator extension register is in use, the destination operand is arithmetically shifted one bit to the right, and the specified address register is incremented by 1. If the accumulator is normalized or zero, a NOP is executed and the specified address register is not affected. Since the operation of the NORM instruction depends on the E, U, and Z condition code register bits, these bits must correctly reflect the current state of the destination accumulator prior to executing the NORM instruction. Note that the L and V bits in the condition code register will be cleared unless they have been improperly set up prior to executing the NORM instruction.

### Example:

```

:
REP #$2F                ;maximum number of iterations needed
NORM R3,A               ;perform 1 normalization iteration
:

```

|    | Before Execution   | After Execution    |
|----|--------------------|--------------------|
| A  | \$00:000000:000001 | \$00:400000:000000 |
| R3 | \$0000             | \$FFD2             |

**Explanation of Example:** Prior to execution, the 56-bit A accumulator contains the value \$00:000000:000001, and the 16-bit R3 address register contains the value \$0000. The repetition of the NORM R3,A instruction normalizes the value in the 56-bit accumulator and stores the resulting number of shifts performed during that normalization process in the R3 address register. A negative value reflects the number of left shifts performed; a positive value reflects the number of right shifts performed during the normalization process.

# NORM

## Normalize Accumulator Iteration

# NORM

### Condition Codes:

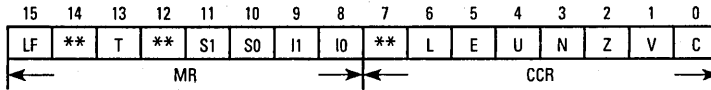

- L — Set if overflow has occurred in A or B result
- E — Set if the signed integer portion of A or B result is in use
- U — Set if A or B result is unnormalized
- N — Set if bit 55 of A or B result is set
- Z — Set if A or B result equals zero
- V — Set if bit 55 is changed as a result of a left shift

**NOTE:** The definition of the E and U bits varies according to the scaling mode being used. Refer to **A.4 CONDITION CODE COMPUTATION** for complete details.

### Instruction Format:

NORM Rn,D

### Opcode:

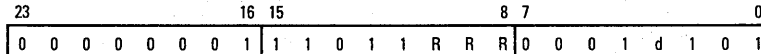

### Instruction Fields:

D d Rn RRR

A 0 Rn nnn

B 1

where "nnn" = Rn number

**Timing:** 2 oscillator clock cycles

**Memory:** 1 program word

**A**



# NOT

## Logical Complement

# NOT

### Operation:

$\overline{D[47:24]}$   $\rightarrow$  D[47:24] (parallel move)  
 where "—" denotes the logical NOT operator

### Assembler Syntax:

NOT D (parallel move)

**Description:** Take the ones complement of bits 47–24 of the destination operand D and store the result back in bits 47–24 of the destination accumulator. This is a 24-bit operation. The remaining bits of D are not affected.

### Example:

NOT A AB,L:(R2)+ ;save A1,B1, take the ones complement of A1



**Explanation of Example:** Prior to execution, the 56-bit A accumulator contains the value \$00:123456:789ABC. The NOT A instruction takes the ones complement of bits 47–24 of the A accumulator (A1) and stores the result back in the A1 register. The remaining bits of the A accumulator are not affected.

### Condition Codes:

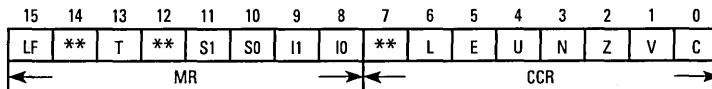

- L — Set if data limiting has occurred during parallel move
- N — Set if bit 47 of A or B result is set
- Z — Set if bits 47–24 of A or B result are zero
- V — Always cleared



# NOT

## Logical Complement

# NOT

**Instruction Format:**  
NOT D

**Opcode:**

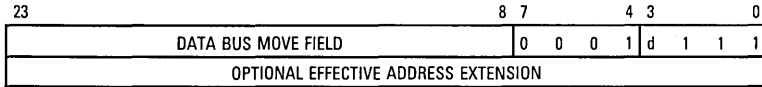

**Instruction Fields:**

D d

A 0

B 1

**Timing:** 2 + mv oscillator clock cycles

**Memory:** 1 + mv program words

**A**

# OR

## Logical Inclusive OR

# OR

### Operation:

S + D[47:24]  $\uparrow$  D[47:24] (parallel move)  
 where + denotes the logical inclusive OR operator

### Assembler Syntax:

OR S,D (parallel move)

**Description:** Logically inclusive OR the source operand S with bits 47–24 of the destination operand D and store the result in bits 47–24 of the destination accumulator. This instruction is a 24-bit operation. The remaining bits of the destination operand D are not affected.

### Example:

```

:
:
OR Y1,B    BA,L:$1234    ;save A1,B1, OR Y1 with B
:
:

```

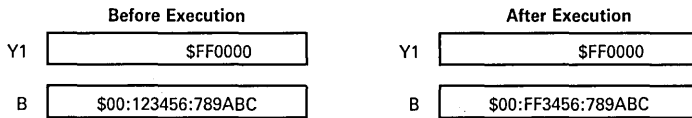

**Explanation of Example:** Prior to execution, the 24-bit Y1 register contains the value \$FF0000, and the 56-bit B accumulator contains the value \$00:123456:789ABC. The OR Y1,B instruction logically ORs the 24-bit value in the Y1 register with bits 47–24 of the B accumulator (B1) and stores the result in the B accumulator with bits 55–48 and 23–0 unchanged.

### Condition Codes:

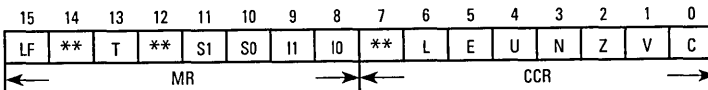

- L — Set if data limiting has occurred during parallel move
- N — Set if bit 47 of A or B result is set
- Z — Set if bits 47–24 of A or B result are zero
- V — Always cleared



# OR

## Logical Inclusive OR

# OR

### Instruction Format:

OR S,D

### Opcode:

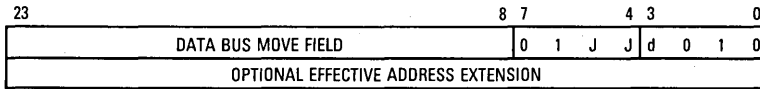

### Instruction Fields:

|          |            |          |          |
|----------|------------|----------|----------|
| <b>S</b> | <b>J J</b> | <b>D</b> | <b>d</b> |
| X0       | 0 0        | A        | 0        |
| X1       | 1 0        | B        | 1        |
| Y0       | 0 1        |          |          |
| Y1       | 1 1        |          |          |

**Timing:** 2 + mv oscillator clock cycles

**Memory:** 1 + mv program words

**A**

# ORI

## OR Immediate with Control Register

# ORI

### Operation:

#xx + D → D

where + denotes the logical inclusive OR operator

### Assembler Syntax:

OR(I) #xx,D

**Description:** Logically OR the 8-bit immediate operand (#xx) with the contents of the destination control register D and store the result in the destination control register. The condition codes are affected only when the condition code register is specified as the destination operand.

**Restrictions:** The ORI #xx,MR instruction cannot be used **immediately before** an ENDDO or RTI instruction and cannot be one of the **last three** instructions in a DO loop (at LA-2, LA-1, or LA).

### Example:

```

:
OR #8,MR ;set scaling mode bit S1 to scale up
:

```



**Explanation of Example:** Prior to execution, the 8-bit mode register (MR) contains the value \$03. The OR #8,MR instruction logically ORs the immediate 8-bit value \$8 with the contents of the mode register and stores the result in the mode register.

### Condition Codes:

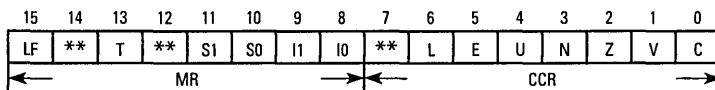

### For CCR operand:

- L — Set if bit 6 of the immediate operand is set
- E — Set if bit 5 of the immediate operand is set
- U — Set if bit 4 of the immediate operand is set
- N — Set if bit 3 of the immediate operand is set
- Z — Set if bit 2 of the immediate operand is set
- V — Set if bit 1 of the immediate operand is set
- C — Set if bit 0 of the immediate operand is set

**A**

# ORI

## OR Immediate with Control Register

# ORI

**For MR and OMR operands:**

The condition codes are not affected using these operands.

### Instruction Format:

OR(I) #xx,D

### Opcode:

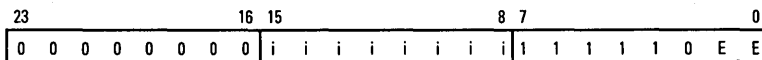

### Instruction Fields:

#xx = 8-bit Immediate Short Data = i i i i i i i i

D    E E

MR  0 0

CCR 0 1

OMR 1 0

**Timing:** 2 oscillator clock cycles

**Memory:** 1 program word

A

# REP

## Repeat Next Instruction

# REP

### Operation:

LC  $\blacktriangleright$  TEMP; X:ea  $\blacktriangleright$  LC  
Repeat next instruction until LC=1  
TEMP  $\blacktriangleright$  LC

LC  $\blacktriangleright$  TEMP; X:aa  $\blacktriangleright$  LC  
Repeat next instruction until LC=1  
TEMP  $\blacktriangleright$  LC

LC  $\blacktriangleright$  TEMP; Y:ea  $\blacktriangleright$  LC  
Repeat next instruction until LC=1  
TEMP  $\blacktriangleright$  LC

LC  $\blacktriangleright$  TEMP; Y:aa  $\blacktriangleright$  LC  
Repeat next instruction until LC=1  
TEMP  $\blacktriangleright$  LC

LC  $\blacktriangleright$  TEMP; S  $\blacktriangleright$  LC  
Repeat next instruction until LC=1  
TEMP  $\blacktriangleright$  LC

LC  $\blacktriangleright$  TEMP; #xxx  $\blacktriangleright$  LC  
Repeat next instruction until LC=1  
TEMP  $\blacktriangleright$  LC

### Assembler Syntax:

REP X:ea

REP X:aa

REP Y:ea

REP Y:aa

REP S

REP #xxx

**Description:** Repeat the **single-word instruction** immediately following the REP instruction the specified number of times. The value specifying the number of times the given instruction is to be repeated is loaded into the 16-bit loop counter (LC) register. The single-word instruction is then executed the specified number of times, decrementing the loop counter (LC) after each execution until LC=1. When the REP instruction is in effect, the repeated instruction is fetched only one time, and it remains in the instruction register for the duration of the loop count. Thus, **the REP instruction is not interruptible** (sequential repeats are also not interruptible). The current loop counter (LC) value is stored in an internal temporary register. If LC is set equal to zero, the instruction is repeated 65,536 times. The instruction's effective address specifies the address of the value which is to be loaded into the loop counter (LC). All address register indirect addressing modes may be used. The absolute short and the immediate short addressing modes may also be used. The four MS bits of the 12-bit immediate value are zeroed to form the 16-bit value that is to be loaded into the loop counter (LC).

A

# REP

## Repeat Next Instruction

# REP

If the A or B accumulator is specified as a **source** operand, the accumulator value is optionally shifted according to the scaling mode bits S0 and S1 in the system status register (SR). If the data out of the shifter indicates that the accumulator extension is in use, the value to be loaded into the loop counter (LC) register will be limited to a 24-bit maximum positive or negative saturation constant to minimize the error due to truncation. The LS 16 bits of the resulting 24-bit value are then stored in the 16-bit loop counter (LC) register.

If the system stack register SSH is specified as a source operand, the system stack pointer (SP) is postdecremented by 1 after SSH has been read.

**Restrictions:** The REP instruction can repeat any single-word instruction except the REP instruction itself and any instruction that changes program flow. The following instructions are not allowed to follow an REP instruction:

### Immediately after REP

|       |       |
|-------|-------|
| DO    | JSSET |
| Jcc   | REP   |
| JCLR  | RTI   |
| JMP   | RTS   |
| JSET  | STOP  |
| JScc  | SWI   |
| JSCLR | WAIT  |
| JSR   |       |

Also, a REP instruction cannot be the **last** instruction in a DO loop (at LA). The assembler will generate an error if any of the previous instructions are found immediately following an REP instruction.

### Example:

```

:
:
: REP X0 ;repeat (X0) times
: MAC X1,Y1,A X:(R1)+,X1 Y:(R4)+,Y1 ;X1*Y1+A ↗ A, update X1,Y1
:
:
```

|    | Before Execution |    | After Execution |
|----|------------------|----|-----------------|
| X0 | \$000100         | X0 | \$000100        |
| LC | \$0000           | LC | \$0000          |



# REP

## Repeat Next Instruction

# REP

**Explanation of Example:** Prior to execution, the 24-bit X0 register contains the value \$000100, and the 16-bit loop counter (LC) register contains the value \$0000. The execution of the REP X0 instruction takes the 24-bit value in the X0 register, truncates the MS 8 bits, and stores the 16 LS bits in the 16-bit loop counter (LC) register. Thus, the single-word MAC instruction immediately following the REP instruction is repeated \$100 times.

### Condition Codes:

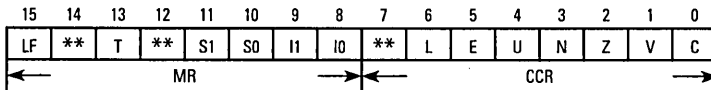

L — Set if data limiting occurred using A or B as source operands

### Instruction Format:

REP X:ea

REP Y:ea

### Opcode:

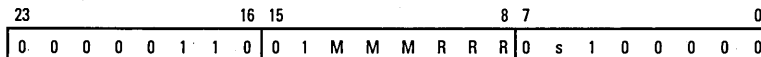

### Instruction Fields:

ea = 6-bit Effective Address = MMMRRR

| Effective Addressing Mode | MMM R R R   | Memory Space s |
|---------------------------|-------------|----------------|
| (Rn) - Nn                 | 0 0 0 r r r | X Memory 0     |
| (Rn) + Nn                 | 0 0 1 r r r | Y Memory 1     |
| (Rn) -                    | 0 1 0 r r r |                |
| (Rn) +                    | 0 1 1 r r r |                |
| (Rn)                      | 1 0 0 r r r |                |
| (Rn + Nn)                 | 1 0 1 r r r |                |
| -(Rn)                     | 1 1 1 r r r |                |

where "rrr" refers to an address register R0-R7

**Timing:** 4 + mv oscillator clock cycles

**Memory:** 1 program word



# REP

Repeat Next Instruction

# REP

### Instruction Format:

REP X:aa

REP Y:aa

### Opcode:

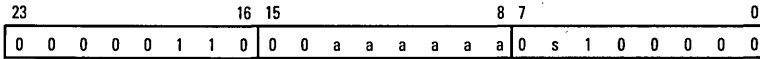

### Instruction Fields:

aa = 6-bit Absolute Short Address = aaaaaa

| Absolute Short Address aaaaaa | Memory Space s |
|-------------------------------|----------------|
| 000000                        | X Memory 0     |
| .                             | Y Memory 1     |
| .                             |                |
| 111111                        |                |

Timing: 4 + mv oscillator clock cycles

Memory: 1 program word

### Instruction Format:

REP #xxx

### Opcode:

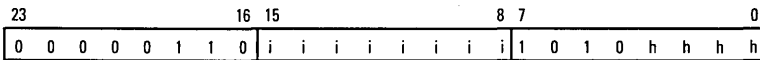

### Instruction Fields:

#xxx = 12-bit Immediate Short Data = hhhh i i i i i i i i

| Immediate Short Data hhhh i i i i i i i i |
|---|
| 000000000000                              |
| .   |
| .   |
| 111111111111                              |

Timing: 4 + mv oscillator clock cycles

Memory: 1 program word

**A**

# REP

## Repeat Next Instruction

# REP

### Instruction Format:

REP S

### Opcode:

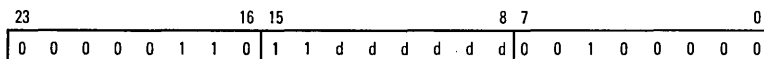

### Instruction Fields:

|    |        | S      |     |       |     |        |  |
|----|--------|--------|-----|-------|-----|--------|--|
|    | S      | dddddd | S/L |       | S   | dddddd |  |
| X0 | 000100 | no     |     | R0-R7 | 010 | nnn    |  |
| X1 | 000101 | no     |     | N0-N7 | 011 | nnn    |  |
| Y0 | 000110 | no     |     | M0-M7 | 100 | nnn    |  |
| Y1 | 000111 | no     |     | SR    | 111 | 001    |  |
| A0 | 001000 | no     |     | OMR   | 111 | 010    |  |
| B0 | 001001 | no     |     | SP    | 111 | 011    |  |
| A2 | 001010 | no     |     | SSH   | 111 | 100    |  |
| B2 | 001011 | no     |     | SSL   | 111 | 101    |  |
| A1 | 001100 | no     |     | LA    | 111 | 110    |  |
| B1 | 001101 | no     |     | LC    | 111 | 111    |  |
| A  | 001110 | yes    |     |       |     |        |  |
| B  | 001111 | yes    |     |       |     |        |  |

where "nnn" = Rn number (R0-R7)  
 Nn number (N0-N7)  
 Mn number (M0-M7)

**Timing:** 4 oscillator clock cycles

**Memory:** 1 program word



# RESET

## Reset On-Chip Peripheral Devices

# RESET

### Operation:

Reset the interrupt priority register  
and all on-chip peripherals

### Assembler Syntax:

RESET

**Description:** Reset the interrupt priority register and all on-chip peripherals. This is a **software reset** which is **NOT** equivalent to a hardware reset since only on-chip peripherals and the interrupt structure are affected. The processor state is not affected, and execution continues with the next instruction. All interrupt sources are disabled except for the trace, stack error, NMI, illegal instruction, and hardware reset interrupts.

**Restrictions:** A RESET instruction cannot be the **last** instruction in a DO loop (at LA).

### Example:

```
:  
RESET                ;reset all on-chip peripherals and IPR  
:
```

**Explanation of Example:** The execution of the RESET instruction resets all on-chip peripherals and the interrupt priority register (IPR).

### Condition Codes:

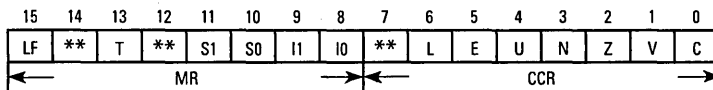

The condition codes are not affected by this instruction.

### Instruction Format:

RESET

### Opcode:

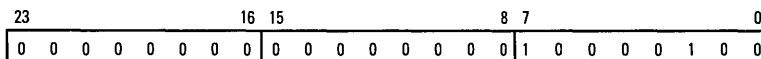

### Instruction Fields:

None

**Timing:** 4 oscillator clock cycles

**Memory:** 1 program word

A

**Operation:**

D+r ↗ D (parallel move)

**Assembler Syntax:**

RND D (parallel move)

**Description:** Round the 56-bit value in the specified destination operand D and store the result in the MSP portion of the destination accumulator (A1 or B1). This instruction uses a convergent rounding technique. The contribution of the LS bits of the result (A0 and B0) is rounded into the upper portion of the result (A1 or B1) by adding a rounding constant to the LS bits of the result. The MSP portion of the destination accumulator contains the rounded result which may be read out to the data buses.

The value of the rounding constant added is determined by the scaling mode bits S0 and S1 in the system status register (SR). A "1" is added in the rounding position as shown below:

| S1 | S0 | Scaling Mode | Rounding Position | Rounding Constant |    |    |    |       |
|----|----|--------------|-------------------|-------------------|----|----|----|-------|
|    |    |              |                   | 55-25             | 24 | 23 | 22 | 21-0  |
| 0  | 0  | No Scaling   | 23                | 0...0             | 0  | 1  | 0  | 0...0 |
| 0  | 1  | Scale Down   | 24                | 0...0             | 1  | 0  | 0  | 0...0 |
| 1  | 0  | Scale Up     | 22                | 0...0             | 0  | 0  | 1  | 0...0 |

**Normal or "standard" rounding** consists of adding a rounding constant to a given number of LS bits of a value to produce a rounded result. The rounding constant depends on the scaling mode being used as previously shown. Unfortunately, when using a twos-complement data representation, this process introduces a positive bias in the statistical distribution of the roundoff error.

**Convergent rounding** differs from "standard" rounding in that convergent rounding attempts to remove the aforementioned positive bias by equally distributing the roundoff error. The convergent rounding technique initially performs "standard" rounding as previously described. Again, the rounding constant depends on the scaling mode being used. Once "standard" rounding has been done, the convergent rounding method tests the result to determine if **all bits including and to the right** of the rounding position are **zero**. **If, and only if, this special condition is true**, the convergent rounding method will clear the bit immediately to the **left** of the rounding position. When this special condition is true, numbers which have a "1" in the bit immediately to the left of the rounding position are rounded **up**; numbers with a "0" in the bit immediately to the left of the rounding position are rounded **down**. Thus, these numbers are rounded **up half** the time and rounded **down** the rest of the time. Therefore, **the roundoff error averages out to zero**. The LS bits of the convergently rounded result are then cleared so that the rounded result may be immediately used by the next instruction.

**Example:**

```
RND A #123456,X1 B,Y1 ;round A accumulator into A1, zero A0
```

|           |   | Before Execution   |   | After Execution    |
|-----------|---|--------------------|---|--------------------|
| Case I:   | A | \$00:123456:789ABC | A | \$00:123456:000000 |
| Case II:  | A | \$00:123456:800000 | A | \$00:123456:000000 |
| Case III: | A | \$00:123455:800000 | A | \$00:123456:000000 |

**Explanation of Example:** Prior to execution, the 56-bit A accumulator contains the value \$00:123456:789ABC for Case I, the value \$00:123456:800000 for Case II, and the value \$00:123455:800000 for Case III. The execution of the RND A instruction rounds the value in the A accumulator into the MSP portion of the A accumulator (A1), using convergent rounding, and then zeros the LSP portion of the A accumulator (A0). Note that Case II is the special case that distinguishes convergent rounding from standard or biased rounding.

**Condition Codes:**

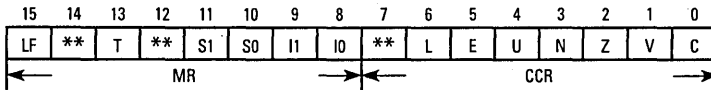

- L — Set if limiting (parallel move) or overflow has occurred in result
- E — Set if the signed integer portion of A or B result is in use
- U — Set if A or B result is unnormalized
- N — Set if bit 55 of A or B result is set
- Z — Set if A or B result equals zero
- V — Set if overflow has occurred in A or B result

**NOTE:** The definition of the E and U bits varies according to the scaling mode being used. Refer to **A.4 CONDITION CODE COMPUTATION** for complete details.



# RND

## Round Accumulator

# RND

**Instruction Format:**  
RND D

**Opcode:**

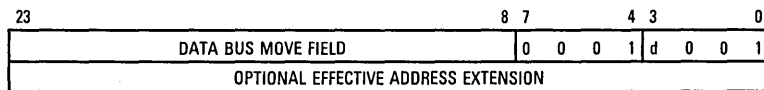

**Instruction Fields:**

|   |   |
|---|---|
| D | D |
| A | 0 |
| B | 1 |

**Timing:** 2+mv oscillator clock cycles

**Memory:** 1+mv program words

**A**

# ROL

Rotate Left

# ROL

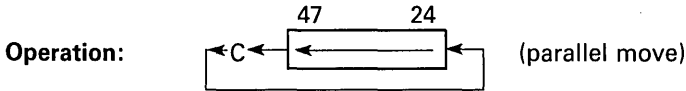

Assembler

Syntax: ROL D (parallel move)

**Description:** Rotate bits 47–24 of the destination operand D one bit to the left and store the result in the destination accumulator. Prior to instruction execution, bit 47 of D is shifted into the carry bit C, and, prior to instruction execution, the value in the carry bit C is shifted into bit 24 of the destination accumulator D. This instruction is a 24-bit operation. The remaining bits of the destination operand D are not affected.

**Example:**

```

:
:
: ROL A # $314,N2 ;rotate A1 left one bit, update N2
:
:

```

|    | Before Execution   | After Execution    |
|----|--------------------|--------------------|
| A  | \$00:000000:000000 | \$00:000001:000000 |
| SR | \$0301             | \$0300             |

**Explanation of Example:** Prior to execution, the 56-bit A accumulator contains the value \$00:000000:000000. The execution of the ROL A instruction shifts the 24-bit value in the A1 register one bit to the left, shifting bit 47 into the carry bit C, rotating the carry bit C into bit 24, and storing the result back in the A1 register.

**Condition Codes:**

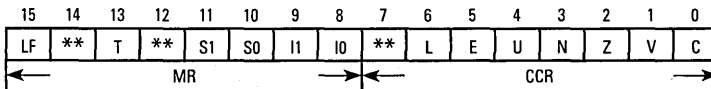

- L — Set if data limiting has occurred during parallel move
- N — Set if bit 47 of A or B result is set
- Z — Set if bits 47–24 of A or B result are zero
- V — Always cleared
- C — Set if bit 47 of A or B was set prior to instruction execution



# ROL

Rotate Left

# ROL

## Instruction Format:

ROL D

## Opcode:

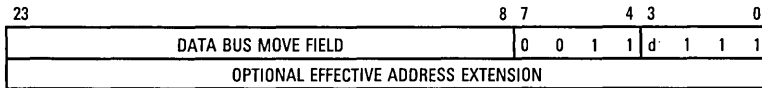

## Instruction Fields:

D    d  
A    0  
B    1

**Timing:** 2 + mv oscillator clock cycles

**Memory:** 1 + mv program words

# ROR

Rotate Right

# ROR

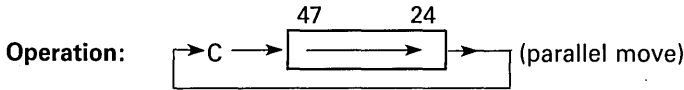

Assembler

Syntax: ROR D (parallel move)

**Description:** Rotate bits 47–24 of the destination operand D one bit to the right and store the result in the destination accumulator. Prior to instruction execution, bit 24 of D is shifted into the carry bit C, and, prior to instruction execution, the value in the carry bit C is shifted into bit 47 of the destination accumulator D. This instruction is a 24-bit operation. The remaining bits of the destination operand D are not affected.

**Example:**

```

:
ROR B #1234,R2          ;rotate B1 right one bit, update R2
:

```

|    | Before Execution   | After Execution    |
|----|--------------------|--------------------|
| B  | \$00:000001:222222 | \$00:000000:222222 |
| SR | \$0300             | \$0305             |

**Explanation of Example:** Prior to execution, the 56-bit B accumulator contains the value \$00:000001:222222. The execution of the ROR B instruction shifts the 24-bit value in the B1 register one bit to the right, shifting bit 24 into the carry bit C, rotating the carry bit C into bit 47, and storing the result back in the B1 register.

**Condition Codes:**

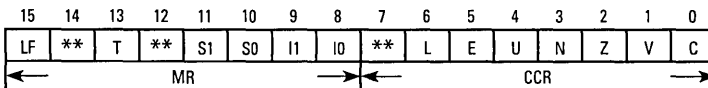

- L — Set if data limiting has occurred during parallel move
- N — Set if bit 47 of A or B result is set
- Z — Set if bits 47–24 of A or B result are zero
- V — Always cleared
- C — Set if bit 47 of A or B was set prior to instruction execution

# ROR

Rotate Right

# ROR

## Instruction Format:

ROR D

## Opcode:

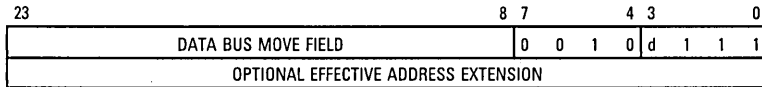

## Instruction Fields:

D    d  
A    0  
B    1

**Timing:** 2+mv oscillator clock cycles

**Memory:** 1+mv program words



# RTI

## Return from Interrupt

# RTI

### Operation:

SSH  $\blacktriangleright$  PC; SSL  $\blacktriangleright$  SR; SP - 1  $\blacktriangleright$  SP

### Assembler Syntax:

RTI

**Description:** Pull the program counter (PC) and the status register (SR) from the system stack. The previous program counter and status register are lost.

**Restrictions:** Due to pipelining in the program controller and the fact that the RTI instruction accesses certain program controller registers, the RTI instruction must not be immediately preceded by any of the following instructions:

|                               |                              |
|-------------------------------|------------------------------|
| <b>Immediately before RTI</b> | MOVEC to SR, SSH, SSL, or SP |
|                               | MOVEM to SR, SSH, SSL, or SP |
|                               | MOVEP to SR, SSH, SSL, or SP |
|                               | MOVEC from SSH               |
|                               | MOVEM from SSH               |
|                               | MOVEP from SSH               |
|                               | ANDI MR or ANDI CCR          |
|                               | ORI MR or ORI CCR            |

An RTI instruction cannot be the **last** instruction in a DO loop (at LA).

An RTI instruction cannot be repeated using the REP instruction.

### Example:

```
RTI ;pull PC and SR from system stack
```

**Explanation of Example:** The RTI instruction pulls the 16-bit program counter (PC) and the 16-bit status register (SR) from the system stack and updates the system stack pointer (SP).

A

# RTI

## Return from Interrupt

# RTI

### Condition Codes:

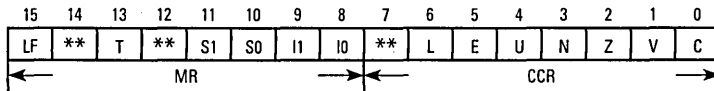

- L** — Set according to the value pulled from the stack
- E** — Set according to the value pulled from the stack
- U** — Set according to the value pulled from the stack
- N** — Set according to the value pulled from the stack
- Z** — Set according to the value pulled from the stack
- V** — Set according to the value pulled from the stack
- C** — Set according to the value pulled from the stack

### Instruction Format:

RTI

### Opcode:

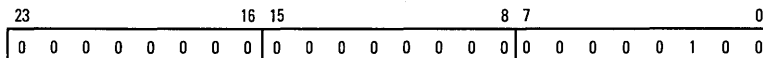

### Instruction Fields:

None

**Timing:** 4 + rx oscillator clock cycles

**Memory:** 1 program word

**A**

# RTS

## Return from Subroutine

# RTS

**Operation:**

SSH ↗ PC; SP - 1 ↗ SP

**Assembler Syntax:**

RTS

**Description:** Pull the program counter (PC) from the system stack. The previous program counter is lost. The status register (SR) is not affected.

**Restrictions:** Due to pipelining in the program controller and the fact that the RTS instruction accesses certain controller registers, the RTS instruction must not be immediately preceded by any of the following instructions:

|                               |                          |
|-------------------------------|--------------------------|
| <b>Immediately before RTS</b> | MOVEC to SSH, SSL, or SP |
|                               | MOVEM to SSH, SSL, or SP |
|                               | MOVEP to SSH, SSL, or SP |
|                               | MOVEC from SSH           |
|                               | MOVEM from SSH           |
|                               | MOVEP from SSH           |

An RTS instruction cannot be the **last** instruction in a DO loop (at LA).

An RTS instruction cannot be repeated using the REP instruction.

**Example:**

```

:
RTS                ;pull PC from system stack
:

```

**Explanation of Example:** The RTS instruction pulls the 16-bit program counter (PC) from the system stack and updates the system stack pointer (SP).

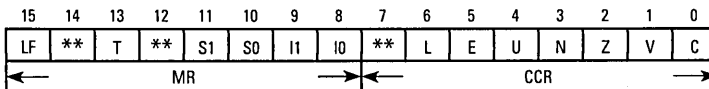
**Condition Codes:**

The condition codes are not affected by this instruction.



# RTS

Return from Subroutine

# RTS

**Instruction Format:**

RTS

**Opcode:**

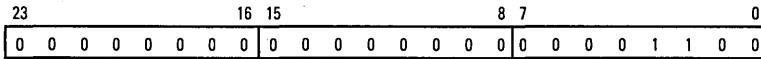

**Instruction Fields:**

None

**Timing:** 4 + rx oscillator clock cycles

**Memory:** 1 program word



**Operation:**

D-S-C ↗ D (parallel move)

**Assembler Syntax:**

SBC S,D (parallel move)

**Description:** Subtract the source operand S and the carry bit C of the condition code register from the destination operand D and store the result in the destination accumulator. Long words (48 bits) may be subtracted from the (56-bit) destination accumulator.

**NOTE:** The carry bit is set correctly for multiple-precision arithmetic using long-word operands if the extension register of the destination accumulator (A2 or B2) is the sign extension of bit 47 of the destination accumulator (A or B).

**Example:**

```

:
MOVE L:<$0,X           ;get a 48-bit LS long-word operand in X
MOVE L:<$1,A           ;get other LS long word in A (sign ext.)
MOVE L:<$2,Y           ;get a 48-bit MS long-word operand in Y
SUB X,A L:<$3,B        ;sub. LS words; get other MS word in B
SBC YB A10,L:<$4       ;sub. MS words with carry; save LS dif.
MOVE B10,L:<$5         ;save MS difference
:

```

|   | Before Execution   |   | After Execution    |
|---|--------------------|---|--------------------|
| A | \$00:000000:000000 | A | \$00:800000:000000 |
| X | \$800000:000000    | X | \$800000:000000    |
| B | \$00:000000:000003 | B | \$00:000000:000001 |
| Y | \$000000:000001    | Y | \$000000:000001    |

**Explanation of Example:** This example illustrates long-word double-precision (96-bit) subtraction using the SBC instruction. Prior to execution of the SUB and SBC instructions, the 96-bit value \$000000:000001:800000:000000 is loaded into the Y and X registers (X:Y), respectively. The other double-precision 96-bit value \$000000:000003:000000:000000 is loaded into the B and A accumulators (B:A), respectively. Since the 48-bit value loaded into the A accumulator is automatically sign extended to 56 bits and the other 48-bit long-word operand is internally sign extended to 56 bits during instruction execution, the carry bit will be set correctly after the



execution of the SUB X,A instruction. The SBC Y,B instruction then produces the correct MS 56-bit result. The actual 96-bit result is stored in memory using the A10 and B10 operands (instead of A and B) because shifting and limiting is not desired.

### Condition Codes:

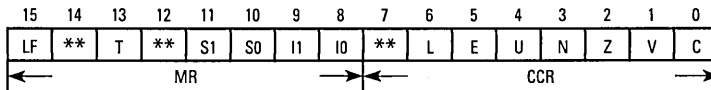

- L — Set if limiting (parallel move) or overflow has occurred in result
- E — Set if signed integer portion of A or B result is in use
- U — Set if A or B result is unnormalized
- N — Set if bit 55 of A or B result is set
- Z — Set if A or B result equals zero
- V — Set if overflow has occurred in A or B result
- C — Set if a carry (or borrow) occurs from bit 55 of A or B result

**NOTE:** The definition of the E and U bits varies according to the scaling mode being used. Refer to **A.4 CONDITION CODE COMPUTATION** for complete details.

### Instruction Format:

SBC S,D

### Opcode:

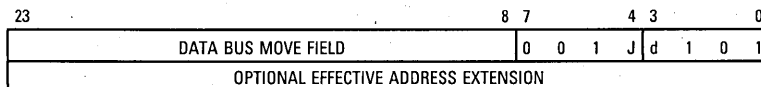

### Instruction Fields:

S,D J d  
 X,A 00  
 X,B 01  
 Y,A 10  
 Y,B 11

**Timing:** 2 + mv oscillator clock cycles

**Memory:** 1 + mv program words



# STOP

## Stop Instruction Processing

# STOP

**Operation:**

Enter the STOP processing state and stop the clock oscillator

**Assembler Syntax:**

STOP

**Description:** Enter the STOP processing state. All activity in the processor is suspended until the  $\overline{\text{RESET}}$  or  $\overline{\text{IRQA}}$  pin is asserted. The clock oscillator is gated off internally. The STOP processing state is a low-power standby state.

During the STOP state, port A is in an idle state with the control signals held inactive (i.e.,  $\overline{\text{RD}} = \overline{\text{WR}} = V_{\text{CC}}$  etc.), the data pins (D0–D23) are high impedance, and the address pins (A1–A15) are unchanged from the previous instruction. If the bus grant was asserted when the STOP instruction was executed, port A will remain three-stated until the DSP exits the STOP state.

If the exit from the STOP state was caused by a low level on the  $\overline{\text{RESET}}$  pin, then the processor will enter the reset processing state. The time to recover from the STOP state using  $\overline{\text{RESET}}$  will depend on the oscillator used. Consult the *DSP56001 Advance Information Data Sheet* (ADI1290) for details.

If the exit from the STOP state was caused by a low level on the  $\overline{\text{IRQA}}$  pin, then the processor will service the highest priority pending interrupt and will not service the  $\overline{\text{IRQA}}$  interrupt unless it is highest priority. The interrupt will be serviced after an internal delay counter counts 65,536 clock cycles (or a three clock cycle delay if the stop delay bit in the OMR is set to one) plus 17T (see the *DSP56001 Advance Information Data Sheet* (ADI1290) for details). During this clock stabilization count delay, all peripherals and external interrupts are cleared and re-enabled/arbitrated at the start of the 17T period following the count interval. The processor will resume program execution at the instruction following the STOP instruction that caused the entry into the STOP state after the interrupt has been serviced or, if no interrupt was pending, immediately after the delay count plus 17T. If the  $\overline{\text{IRQA}}$  pin is asserted when the STOP instruction is executed, the clock will not be gated off, and the internal delay counter will be started.

**Restrictions:** A STOP instruction cannot be used in a fast interrupt routine.

A STOP instruction cannot be the last instruction in a DO loop (i.e., at LA).

A STOP instruction cannot be repeated using the REP instruction.

# STOP

## Stop Instruction Processing

# STOP

### Example:

```

:
STOP                ;enter low-power standby mode
:

```

**Explanation of Example:** The STOP instruction suspends all processor activity until the processor is reset or interrupted as previously described. The STOP instruction puts the processor in a low-power standby state.

### Condition Codes:

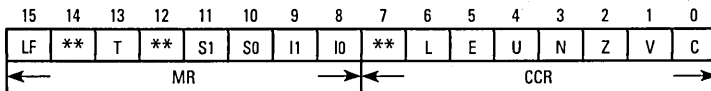

The condition codes are not affected by this instruction.

### Instruction Format:

STOP

### Opcode:

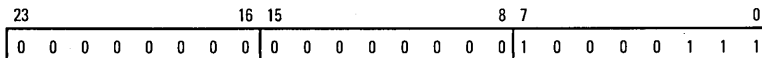

### Instruction Fields:

None

**Timing:** The STOP instruction disables the internal clock oscillator and internal distribution of the external clock.

**Memory:** 1 program word

A

# SUB

## Subtract

# SUB

**Operation:**

D - S → D (parallel move)

**Assembler Syntax:**

SUB S,D (parallel move)

**Description:** Subtract the source operand S from the destination operand D and store the result in the destination operand D. Words (24 bits), long words (48 bits), and accumulators (56 bits) may be subtracted from the destination accumulator.

**NOTE:** The carry bit is set correctly using word or long-word source operands if the extension register of the destination accumulator (A2 or B2) is the sign extension of bit 47 of the destination accumulator (A or B). The carry bit is **always** set correctly using accumulator source operands.

**Example:**

```

SUB X1,A X:(R2) + N2,R0 ;24-bit subtract, load R0, update R2

```

|    | Before Execution   |    | After Execution    |
|----|--------------------|----|--------------------|
| X1 | \$000003           | X1 | \$000003           |
| A  | \$00:000058:242424 | A  | \$00:000055:242424 |

**Explanation of Example:** Prior to execution, the 24-bit X1 register contains the value \$000003, and the 56-bit A accumulator contains the value \$00:000058:242424. The SUB instruction automatically appends the 24-bit value in the X1 register with 24 LS zeros, sign extends the resulting 48-bit long word to 56 bits, and subtracts the result from the 56-bit A accumulator. Thus, 24-bit operands are subtracted from the MSP portion of A or B (A1 or B1) because all arithmetic instructions assume a fractional, twos complement data representation. Note that 24-bit operands can be subtracted from the LSP portion of A or B (A0 or B0) by loading the 24-bit operand into X0 or Y0, forming a 48-bit word by loading X1 or Y1 with the sign extension of X0 or Y0, and executing a SUB X,A or SUB Y,A instruction.

**A**

# SUB

Subtract

# SUB

## Condition Codes:

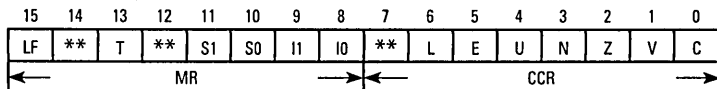

- L — Set if limiting (parallel move) or overflow has occurred in result
- E — Set if the signed integer portion of A or B result is in use
- U — Set if A or B result is unnormalized
- N — Set if bit 55 of A or B result is set
- Z — Set if A or B result equals zero
- V — Set if overflow has occurred in A or B result
- C — Set if a carry (or borrow) occurs from bit 55 of A or B result

**NOTE:** The definition of the E and U bits varies according to the scaling mode being used. Refer to **A.4 CONDITION CODE COMPUTATION** for complete details.

## Instruction Format:

SUB S,D

## Opcode:

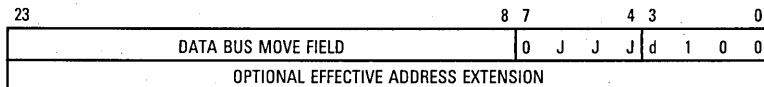

## Instruction Fields:

| S,D | J J J d | S,D  | J J J d | S,D  | J J J d |
|-----|---------|------|---------|------|---------|
| B,A | 0 0 1 0 | X0,A | 1 0 0 0 | Y1,A | 1 1 1 0 |
| A,B | 0 0 1 1 | X0,B | 1 0 0 1 | Y1,B | 1 1 1 1 |
| X,A | 0 1 0 0 | Y0,A | 1 0 1 0 |      |         |
| X,B | 0 1 0 1 | Y0,B | 1 0 1 1 |      |         |
| Y,A | 0 1 1 0 | X1,A | 1 1 0 0 |      |         |
| Y,B | 0 1 1 1 | X1,B | 1 1 0 1 |      |         |

**Timing:** 2 + mv oscillator clock cycles

**Memory:** 1 + mv program words



# SUBL

## Shift Left and Subtract Accumulators

# SUBL

### Operation:

$2 * D - S \rightarrow D$  (parallel move)

### Assembler Syntax:

SUBL S,D (parallel move)

**Description:** Subtract the source operand S from two times the destination operand D and store the result in the destination accumulator. The destination operand D is arithmetically shifted one bit to the left, and a zero is shifted into the LS bit of D prior to the subtraction operation. The carry bit is set correctly if the source operand does not overflow as a result of the left shift operation. The overflow bit may be set as a result of either the shifting or subtraction operation (or both). This instruction is useful for efficient divide and decimation in time (DIT) FFT algorithms.

### Example:

```
SUBL A,B Y:(R5+N5),R7 ;2*B-A → B, load R7, no R5 update
```

|   | Before Execution   | After Execution    |
|---|--------------------|--------------------|
| A | \$00:004000:000000 | \$00:004000:000000 |
| B | \$00:005000:000000 | \$00:006000:000000 |

**Explanation of Example:** Prior to execution, the 56-bit A accumulator contains the value \$00:004000:000000, and the 56-bit B accumulator contains the value \$00:005000:000000. The SUBL A,B instruction subtracts the value in the A accumulator from two times the value in the B accumulator and stores the 56-bit result in the B accumulator.

### Condition Codes:

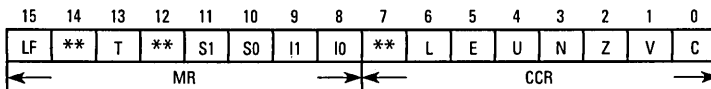

- L — Set if limiting (parallel move) or overflow has occurred in result
- E — Set if the signed integer portion of A or B result is in use
- U — Set if A or B result is unnormalized
- N — Set if bit 55 of A or B result is set
- Z — Set if A or B result equals zero
- V — Set if overflow has occurred in A or B result or if the MS bit of the destination operand is changed as a result of the instruction's left shift
- C — Set if a carry (or borrow) occurs from bit 55 of A or B result

# SUBL

Shift Left and Subtract Accumulators

# SUBL

**NOTE:** The definition of the E and U bits varies according to the scaling mode being used. Refer to **A.4 CONDITION CODE COMPUTATION** for complete details.

**Instruction Format:**

SUBL S,D

**Opcode:**

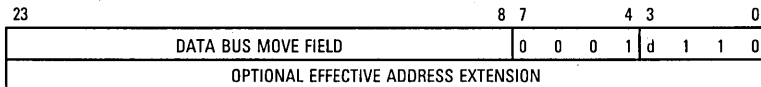

**Instruction Fields:**

|            |          |
|------------|----------|
| <b>S,D</b> | <b>d</b> |
| B,A        | 0        |
| A,B        | 1        |

**Timing:** 2 + mv oscillator clock cycles

**Memory:** 1 + mv program words



# SUBR

## Shift Right and Subtract Accumulators

# SUBR

### Operation:

D/2 - S → D (parallel move)

### Assembler Syntax:

SUBR S,D (parallel move)

**Description:** Subtract the source operand S from one-half the destination operand D and store the result in the destination accumulator. The destination operand D is arithmetically shifted one bit to the right while the MS bit of D is held constant prior to the subtraction operation. In contrast to the SUBL instruction, the carry bit is always set correctly, and the overflow bit can only be set by the subtraction operation, and not by an overflow due to the initial shifting operation. This instruction is useful for efficient divide and decimation in time (DIT) FFT algorithms.

### Example:

```

:
SUBR B,A N5,Y:-(R5) ;A/2 - B → A, update R5, save N5
:

```

|   | Before Execution   | After Execution    |
|---|--------------------|--------------------|
| A | \$80:000000:2468AC | \$C0:000000:000000 |
| B | \$00:000000:123456 | \$00:000000:123456 |

**Explanation of Example:** Prior to execution, the 56-bit A accumulator contains the value \$80:000000:2468AC, and the 56-bit B accumulator contains the value \$00:000000:123456. The SUBR B,A instruction subtracts the value in the B accumulator from one-half the value in the A accumulator and stores the 56-bit result in the A accumulator.

### Condition Codes:

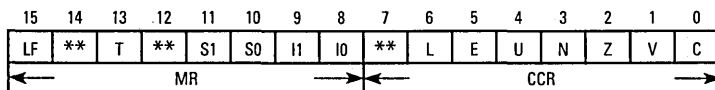

- L — Set if limiting (parallel move) or overflow has occurred in result
- E — Set if the signed integer portion of A or B result is in use
- U — Set if A or B result is unnormalized
- N — Set if bit 55 of A or B result is set
- Z — Set if A or B result equals zero
- V — Set if overflow has occurred in A or B result
- C — Set if a carry (or borrow) occurs from bit 55 of A or B result



# SUBR

## Shift Right and Subtract Accumulators

# SUBR

**NOTE:** The definition of the E and U bits varies according to the scaling mode being used. Refer to **A.4 CONDITION CODE COMPUTATION** for complete details.

### Instruction Format:

SUBR S,D

### Opcode:

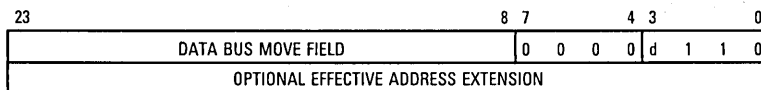

### Instruction Fields:

|     |   |
|-----|---|
| S,D | d |
| B,A | 0 |
| A,B | 1 |

**Timing:** 2 + mv oscillator clock cycles

**Memory:** 1 + mv program words

# SWI

## Software Interrupt

# SWI

**Operation:**

Begin SWI exception processing

**Assembler Syntax:**

SWI

**Description:** Suspend normal instruction execution and begin SWI exception processing. The interrupt priority level (I1,I0) is set to 3 in the status register (SR) if a long interrupt service routine is used.

**Restrictions:** An SWI instruction cannot be used in a fast interrupt routine.

An SWI instruction cannot be repeated using the REP instruction.

**Example:**

```
:  
SWI          ;begin SWI exception processing  
:
```

**Explanation of Example:** The SWI instruction suspends normal instruction execution and initiates SWI exception processing.

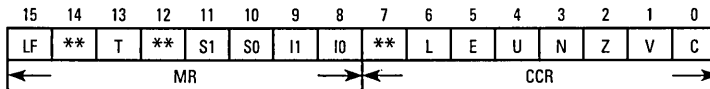
**Condition Codes:**

The condition codes are not affected by this instruction.

**Instruction Format:**

SWI

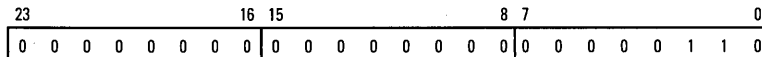
**Opcode:****Instruction Fields:**

None

**Timing:** 8 oscillator clock cycles

**Memory:** 1 program word

# Tcc

## Transfer Conditionally

# Tcc

### Operation:

If cc, then S1  $\rightarrow$  D1

If cc, then S1  $\rightarrow$  D1 and S2  $\rightarrow$  D2

### Assembler Syntax:

Tcc S1,D1

Tcc S1,D1 S2,D2

**Description:** Transfer data from the specified source register S1 to the specified destination accumulator D1 if the specified condition is true. If a second source register S2 and a second destination register D2 are also specified, transfer data from address register S2 to address register D2 if the specified condition is true. If the specified condition is false, a NOP is executed. The term "cc" may specify the following conditions:

|         | "cc" Mnemonic                  | Condition                       |
|---------|--------------------------------|---------------------------------|
| CC (HS) | — carry clear (higher or same) | $C=0$                           |
| CS (LO) | — carry set (lower)            | $C=1$                           |
| EC      | — extension clear              | $E=0$                           |
| EQ      | — equal                        | $Z=1$                           |
| ES      | — extension set                | $E=1$                           |
| GE      | — greater than or equal        | $N \oplus V=0$                  |
| GT      | — greater than                 | $Z+(N \oplus V)=0$              |
| LC      | — limit clear                  | $L=0$                           |
| LE      | — less than or equal           | $Z+(N \oplus V)=1$              |
| LS      | — limit set                    | $L=1$                           |
| LT      | — less than                    | $N \oplus V=1$                  |
| MI      | — minus                        | $N=1$                           |
| NE      | — not equal                    | $Z=0$                           |
| NR      | — normalized                   | $Z+(\bar{U} \bullet \bar{E})=1$ |
| PL      | — plus                         | $N=0$                           |
| NN      | — not normalized               | $Z+(\bar{U} \bullet \bar{E})=0$ |

where

- $\bar{U}$  denotes the logical complement of U
- + denotes the logical OR operator
- denotes the logical AND operator
- $\oplus$  denotes the logical Exclusive OR operator

When used after the CMP or CMPM instructions, the Tcc instruction can perform many useful functions such as a "maximum value," "minimum value," "maximum absolute value," or "minimum absolute value" function. The desired value is stored in the destination accumulator D1. If address register S2 is used as an address pointer into



an array of data, the address of the desired value is stored in the address register D2. The Tcc instruction may be used after any instruction and allows efficient searching and sorting algorithms.

The Tcc instruction uses the internal data ALU paths and internal address ALU paths. The Tcc instruction does not affect the condition code bits.

**NOTE:** This instruction is considered to be a move-type instruction. Due to pipelining, if an address register (R0–R7) is changed using a move-type instruction, the new contents of the destination address register will not be available for use during the following instruction (i.e., there is a single instruction cycle pipeline delay).

**Example:**

```

:
CMP X0,A                ;compare X0 and A (sort for minimum)
TGT X0,A  R0,R1        ;transfer X0 > A and R0 > R1 if X0<A
:

```

**Explanation of Example:** In this example, the contents of the 24-bit X0 register are transferred to the 56-bit A accumulator, and the contents of the 16-bit R0 address register are transferred to the 16-bit R1 address register if the specified condition is true. If the specified condition is not true, a NOP is executed.

**Condition Codes:**

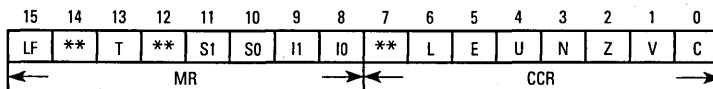

The condition codes are not affected by this instruction.

**Instruction Format:**

Tcc S1,D1

**Opcode:**

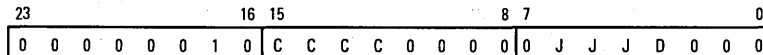

# Tcc

## Transfer Conditionally

# Tcc

### Instruction Fields:

cc=4-bit condition code=CCCC

| S1,D1 | J J J D | Mnemonic | C C C C | Mnemonic | C C C C |
|-------|---------|----------|---------|----------|---------|
| B,A   | 0 0 0 0 | CC (HS)  | 0 0 0 0 | CS (LO)  | 1 0 0 0 |
| A,B   | 0 0 0 1 | GE       | 0 0 0 1 | LT       | 1 0 0 1 |
| X0,A  | 1 0 0 0 | NE       | 0 0 1 0 | EQ       | 1 0 1 0 |
| X0,B  | 1 0 0 1 | PL       | 0 0 1 1 | MI       | 1 0 1 1 |
| X1,A  | 1 1 0 0 | NN       | 0 1 0 0 | NR       | 1 1 0 0 |
| X1,B  | 1 1 0 1 | EC       | 0 1 0 1 | ES       | 1 1 0 1 |
| Y0,A  | 1 0 1 0 | LC       | 0 1 1 0 | LS       | 1 1 1 0 |
| Y0,B  | 1 0 1 1 | GT       | 0 1 1 1 | LE       | 1 1 1 1 |
| Y1,A  | 1 1 1 0 |          |         |          |         |
| Y1,B  | 1 1 1 1 |          |         |          |         |

**Timing:** 2 oscillator clock cycles

**Memory:** 1 program word

### Instruction Format:

Tcc S1,D1 S2,D2

### Opcode:

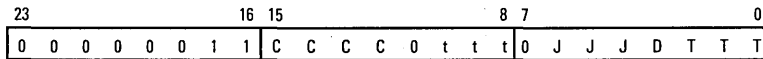

### Instruction Fields:

cc=4-bit condition code=CCCC

| S1,D1 | J J J D | S2 | t t t | Mnemonic | C C C C | Mnemonic | C C C C |
|-------|---------|----|-------|----------|---------|----------|---------|
| B,A   | 0 0 0 0 | Rn | n n n | CC (HS)  | 0 0 0 0 | CS (LO)  | 1 0 0 0 |
| A,B   | 0 0 0 1 |    |       | GE       | 0 0 0 1 | LT       | 1 0 0 1 |
| X0,A  | 1 0 0 0 |    |       | NE       | 0 0 1 0 | EQ       | 1 0 1 0 |
| X0,B  | 1 0 0 1 |    |       | PL       | 0 0 1 1 | MI       | 1 0 1 1 |
| X1,A  | 1 1 0 0 | D2 | T T T | NN       | 0 1 0 0 | NR       | 1 1 0 0 |
| X1,B  | 1 1 0 1 | Rn | n n n | EC       | 0 1 0 1 | ES       | 1 1 0 1 |
| Y0,A  | 1 0 1 0 |    |       | LC       | 0 1 1 0 | LS       | 1 1 1 0 |
| Y0,B  | 1 0 1 1 |    |       | GT       | 0 1 1 1 | LE       | 1 1 1 1 |
| Y1,A  | 1 1 1 0 |    |       |          |         |          |         |
| Y1,B  | 1 1 1 1 |    |       |          |         |          |         |

where "nnn" = Rn number (R0-R7)

**Timing:** 2 oscillator clock cycles

**Memory:** 1 program word



**Operation:**

S ↗ D (parallel move)

**Assembler Syntax:**

TFR S,D (parallel move)

**Description:** Transfer data from the specified source data ALU register S to the specified destination data ALU accumulator D. TFR uses the internal data ALU data paths; thus, data **does not** pass through the data shifter/limiters. This allows the full 56-bit contents of one of the accumulators to be transferred into the other accumulator **without** data shifting and/or limiting. Moreover, since TFR uses the internal data ALU data paths, parallel moves are possible. The TFR instruction only affects the L condition code bit, which can be set by data limiting associated with the instruction's **parallel move** operations.

**Example:**

```
TFR A,B A,X1 Y:(R4+N4),Y0 ;move A to B and X1, update Y0
```

|   | Before Execution   | After Execution    |
|---|--------------------|--------------------|
| A | \$01:234567:89ABCD | \$01:234567:89ABCD |
| B | \$FF:FFFFFF:FFFFFF | \$01:234567:89ABCD |

**Explanation of Example:** Prior to execution, the 56-bit A accumulator contains the value \$01:234567:89ABCD, and the 56-bit B accumulator contains the value \$FF:FFFFFF:FFFFFF. The execution of the TFR A,B instruction moves the 56-bit value in the A accumulator into the 56-bit B accumulator using the internal data ALU data paths without any data shifting and/or limiting. The value in the B accumulator **would** have been limited if a MOVE A,B instruction had been used. Note, however, that the **parallel move** portion of the TFR instruction **does** use the data shifter/limiters. Thus, the value stored in the 24-bit X1 register (not shown) **would** have been limited in this example. This example illustrates a **triple** move instruction.

**Condition Codes:**

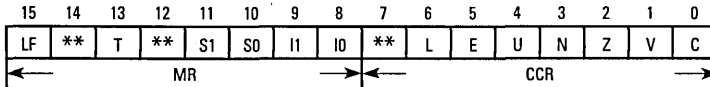

L — Set if data limiting has occurred during parallel move

# TFR

## Transfer Data ALU Register

# TFR

### Instruction Format:

TFR S,D

### Opcode:

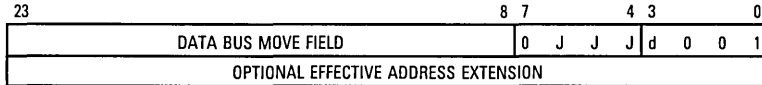

### Instruction Fields:

|            |                |
|------------|----------------|
| <b>S,D</b> | <b>J J J d</b> |
| B,A        | 0 0 0 0        |
| A,B        | 0 0 0 1        |
| X0,A       | 1 0 0 0        |
| X0,B       | 1 0 0 1        |
| X1,A       | 1 1 0 0        |
| X1,B       | 1 1 0 1        |
| Y0,A       | 1 0 1 0        |
| Y0,B       | 1 0 1 1        |
| Y1,A       | 1 1 1 0        |
| Y1,B       | 1 1 1 1        |

**Timing:** 2 + mv oscillator clock cycles

**Memory:** 1 + mv program words

A

# TST

## Test Accumulator

# TST

**Operation:**

S-0 (parallel move)

**Assembler Syntax:**

TST S (parallel move)

**Description:** Compare the specified source accumulator S with zero and set the condition codes accordingly. No result is stored although the condition codes are updated.

**Example:**

```

:
TST A  #345678,B          ;set CCR bits for value in A, update B
:

```

|     | Before Execution   | After Execution    |
|-----|--------------------|--------------------|
| A   | \$01:020304:000000 | \$01:020304:000000 |
| CCR | \$0300             | \$0330             |

**Explanation of Example:** Prior to execution, the 56-bit A accumulator contains the value \$01:020304:000000, and the 16-bit condition code register contains the value \$0300. The execution of the TST A instruction compares the value in the A register with zero and updates the condition code register accordingly. The contents of the A accumulator are not affected.

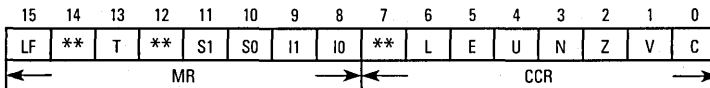
**Condition Codes:**

- L — Set if data limiting has occurred during parallel move
- E — Set if the signed integer portion of A or B result is in use
- U — Set if A or B result is unnormalized
- N — Set if bit 55 of A or B result is set
- Z — Set if A or B result equals zero
- V — Always cleared

**NOTE:** The definition of the E and U bits varies according to the scaling mode being used. Refer to **A.4 CONDITION CODE COMPUTATION** for complete details.

**A**



# TST

## Test Accumulator

# TST

### Instruction Format:

TST S

### Opcode:

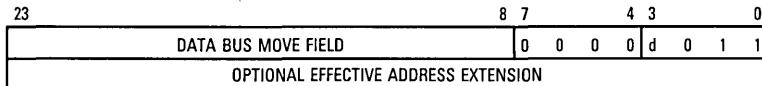

### Instruction Fields:

S d

A 0

B 1

**Timing:** 2 + mv oscillator clock cycles

**Memory:** 1 + mv program words

A

# WAIT

## Wait for Interrupt

# WAIT

**Operation:**

Disable clocks to the processor core and enter the WAIT processing state.

**Assembler Syntax:**

WAIT

**Description:**

Enter the WAIT processing state. The internal clocks to the processor core and memories are gated off, and all activity in the processor is suspended until an unmasked interrupt occurs. The clock oscillator and the internal I/O peripheral clocks remain active. If WAIT is executed when an interrupt is pending, the interrupt will be processed; the effect will be the same as if the processor never entered the WAIT state and three NOPs followed the WAIT instruction. When an unmasked interrupt or external (hardware) processor RESET occurs, the processor leaves the WAIT state and begins exception processing of the unmasked interrupt or RESET condition. The BR/BG circuits remain active during the WAIT state. The WAIT state is a low-power standby state. The processor always leaves the WAIT state in the T2 clock phase (see the *DSP56001 Advance Information Data Sheet (ADI1290)*). Therefore, multiple processors may be synchronized by having them all enter the WAIT state and then interrupting them with a common interrupt.

**Restrictions:**

A WAIT instruction cannot be used in a fast interrupt routine.

A WAIT instruction cannot be the **last** instruction in a DO loop (at LA).

A WAIT instruction cannot be repeated using the REP instruction.

**Example:**

```

:
WAIT                               ;enter low power mode, wait for interrupt
:

```

**Explanation of Example:**

The WAIT instruction suspends normal instruction execution and waits for an unmasked interrupt or external RESET to occur.

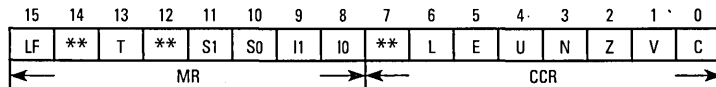
**Condition Codes:**

The condition codes are not affected by this instruction.

**A**

# WAIT

Wait for Interrupt

# WAIT

**Instruction Format:**

WAIT

**Opcode:**

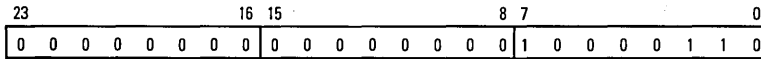

**Instruction Fields:**

None

**Timing:** The WAIT instruction takes a minimum of 16 cycles to execute when an internal interrupt is pending during the execution of the WAIT instruction.

**Memory:** 1 program word



## A.7 INSTRUCTION TIMING

This section describes how one can calculate DSP56000/DSP56001 instruction timing manually using the tables provided in this section. Three complete examples are presented to illustrate the "layered" nature of the tables. Alternatively, the user can obtain the number of instruction program words and the number of oscillator clock cycles required for a given instruction by using the DSP56000/DSP56001 simulator. This method of determining instruction timing information is much faster and much simpler than using the aforementioned tables. This powerful software package is available for the IBM<sup>™</sup> PC, VAX<sup>™</sup> (BSD 4.2 or VMS), and SUN-3<sup>™</sup> workstation.

Table A-6 gives the number of instruction program words and the number of oscillator clock cycles for each instruction mnemonic. Table A-7 gives the number of additional (if any) instruction words and additional (if any) clock cycles for each type of parallel move operation. Table A-8 gives the number of additional (if any) clock cycles for each type of MOVEC operation. Table A-9 gives the number of additional (if any) clock cycles for each type of MOVEP operation. Table A-10 gives the number of additional (if any) clock cycles for each type of bit manipulation (BCHG, BCLR, BSET, and BTST) operation. Table A-11 gives the number of additional (if any) clock cycles for each type of jump (Jcc, JCLR, JMP, JScC, JSCLR, JSET, JSR, and JSSET) operation. Table A-12 gives the number of additional (if any) clock cycles for the RTI and RTS instructions. Table A-13 gives the number of additional (if any) instruction words and additional (if any) clock cycles for each effective addressing mode. Table A-14 gives the number of additional (if any) clock cycles for external data, external program, and external I/O memory accesses.

The number of words per instruction is dependent on the addressing mode and the type of parallel data bus move operation specified. The symbols used reference subsequent tables to complete the instruction word count.

The number of oscillator clock cycles per instruction is dependent on many factors, including the number of words per instruction, the addressing mode, whether the instruction fetch pipe is full or not, the number of external bus accesses, and the number of wait states inserted in each external access. The symbols used reference subsequent tables to complete the execution clock cycle count.

All tables are based on the following assumptions.

### Assumptions:

1. All instruction cycles are counted in **oscillator clock cycles**.
2. The instruction fetch pipeline is **full**.

IBM is a trademark of International Business Machines  
VAX is a trademark of Digital Equipment Corporation  
SUN-3 is a trademark of Sun Microsystems, Inc.

3. There is no contention for **instruction** fetches. Thus, external program instruction fetches are assumed not to have to contend with external data memory accesses.
4. There are no wait states for **instruction** fetches done sequentially (as for non-change-of-flow instructions), but they are taken into account for change-of-flow instructions which flush the pipeline such as JMP, Jcc, RTI, etc.

To better understand and use the aforementioned tables, three examples are presented prior to the actual tables. These examples attempt to illustrate the "layered" nature of the tables.

### Example 1: Arithmetic Instruction with Two Parallel Moves

**Problem:** Calculate the number of 24-bit instruction program words and the number of oscillator clock cycles required for the instruction

$$\text{MACR} - X0, X0, A \quad X1, X:(R6) - \quad Y0, Y:(R0) +$$

where Operating Mode Register (OMR) = \$02 (normal expanded memory map),  
 Bus Control Register (BCR) = \$1135,  
 R6 Address Register = \$0052 (internal X memory), and  
 R0 Address Register = \$0523 (external Y memory).

**Solution:** To determine the number of instruction program words and the number of oscillator clock cycles required for the given instruction, the user should perform the following operations:

1. Look up the number of instruction program words and the number of oscillator clock cycles required for the opcode-operand portion of the instruction in Table A-6.

According to Table A-6, the MACR instruction will require (1 + mv) instruction program words and will execute in (2 + mv) oscillator clock cycles. The term "mv" represents the additional (if any) instruction program words and the additional (if any) oscillator clock cycles that may be required over and above those needed for the basic MACR instruction due to the parallel move portion of the instruction.

2. Evaluate the "mv" term using Table A-7.

The parallel move portion of the MACR instruction consists of an XY memory move. According to Table A-7, the parallel move portion of the instruction will require mv = 0 additional instruction program words and mv = (ea + axy) additional oscillator clock cycles. The term "ea" represents the number of additional (if any) oscillator clock cycles that are required for the effective addressing move specified in the parallel move portion of the instruction. The term "axy" represents the number of additional (if any) oscillator clock cycles that are required to access an XY memory operand.



3. Evaluate the "ea" term using Table A-13.

The parallel move portion of the MACR instruction consists of an XY memory move which uses both address register banks (R0-R3 and R4-R7) in generating the effective addresses of the XY memory operands. Thus, the two effective address operations occur in parallel, and the larger of the two "ea" terms should be used. The X memory move operation uses the "postdecrement by 1" effective addressing mode. According to Table A-13, this operation will require ea=0 additional oscillator clock cycles. The Y memory move operation uses the "postincrement by 1" effective addressing mode. According to Table A-13, this operation will also require ea=0 additional oscillator clock cycles. Thus, using the maximum value of "ea", the effective addressing modes used in the parallel move portion of the MACR instruction will require ea=0 additional oscillator clock cycles.

4. Evaluate the "axy" term using Table A-14.

The parallel move portion of the MACR instruction consists of an XY memory move. According to Table A-14, the term "axy" depends upon where the referenced X and Y memory locations are located in the DSP56000/DSP56001 memory space. **External** memory accesses require additional oscillator clock cycles according to the number of wait states programmed into the DSP56000/DSP56001 bus control register (BCR). Thus, assuming that the 16-bit bus control register contains the value \$1135, external X memory accesses require wx = 1 wait state of additional oscillator clock cycle while external Y memory accesses require wy = 1 wait state or additional oscillator clock cycle. For this example, the X memory reference is assumed to be an **internal** reference; the Y memory reference is assumed to be an **external** reference. Thus, according to Table A-14, the XY memory reference in the parallel move portion of the MACR instruction will require axy = wy = 1 additional oscillator clock cycle.

5. Compute final results.

Thus, based upon the assumptions given for Table A-6 and those listed in the problem statement for Example 1, the instruction

MACR -X0,X0,A X1,X:(R6)- Y0,Y:(R0) +

will require

$$\begin{aligned} & (1 + mv) \\ & = (1 + 0) \\ & = 1 \qquad \text{instruction program word} \end{aligned}$$

and will execute in

$$\begin{aligned} & (2 + mv) \\ & = (2 + ea + axy) \\ & = (2 + ea + wy) \\ & = (2 + 0 + 1) \qquad \text{oscillator clock cycles.} \\ & = 3 \end{aligned}$$

Note that if a similar calculation were to be made for a MOVEC, MOVEM, MOVEP, or one of the bit manipulation (BCHG, BCLR, BSET, or BTST) instructions, the use of Table A-7 would no longer be appropriate. For one of these cases, the user would refer to Table A-8, Table A-9, or Table A-10, respectively.

### Example 2: Jump Instruction

**Problem:** Calculate the number of 24-bit instruction program words and the number of oscillator clock cycles required for the instruction

JLC (R2 + N2)

where    Operating Mode Register (OMR) = \$02 (normal expanded memory map),  
          Bus Control Register (BCR)    = \$2246,  
          R2 Address Register            = \$1000 (external P memory), and  
          N2 Address Register            = \$0037.

**Solution:** To determine the number of instruction program words and the number of oscillator clock cycles required for the given instruction, the user should perform the following operations:

1. Look up the number of instruction program words and the number of oscillator clock cycles required for the opcode-operand portion of the instruction in Table A-6.

According to Table A-6, the Jcc instruction will require  $(1 + ea)$  instruction program words and will execute in  $(4 + jx)$  oscillator clock cycles. The term "ea" represents the number of additional (if any) instruction program words that are required for the effective address of the Jcc instruction. The term "jx" represents the number of additional (if any) oscillator clock cycles required for a jump-type instruction.

2. Evaluate the "jx" term using Table A-11.

According to Table A-11, the Jcc instruction will require  $jx = ea + (2 * ap)$  additional oscillator clock cycles. The term "ea" represents the number of additional (if any) oscillator clock cycles that are required for the effective addressing mode specified in the Jcc instruction. The term "ap" represents the number of additional (if any) oscillator clock cycles that are required to access a P memory operand. Note that the " $+(2 * ap)$ " term represents the two program memory instruction fetches executed at the end of a one-word jump instruction to refill the instruction pipeline.

3. Evaluate the "ea" term using Table A-13.

The JLC (R2 + N2) instruction uses the "indexed by offset Nn" effective addressing mode. According to Table A-13, this operation will require  $ea = 0$  additional instruction program words and  $ea = 2$  additional oscillator clock cycles.



4. Evaluate the "ap" term using Table A-14.

According to Table A-14, the term "ap" depends upon where the referenced P memory location is located in the DSP56000/DSP56001 memory space. **External** memory accesses require additional oscillator clock cycles according to the number of wait states programmed into the DSP56000/DSP56001 bus control register (BCR). Thus, assuming that the 16-bit bus control register contains the value \$2246, external P memory accesses require  $wp=4$  wait states or additional oscillator clock cycles. For this example, the P memory reference is assumed to be an **external** reference. Thus, according to Table A-14, the Jcc instruction will use the value  $ap=wp=4$  oscillator clock cycles.

5. Compute final results.

Thus, based upon the assumptions given for Table A-6 and those listed in the problem statement for Example 2, the instruction

JLC (R2+N2)

will require

$$\begin{aligned} & (1 + ea) \\ & = (1 + 0) \\ & = 1 \end{aligned} \qquad \text{instruction program word}$$

and will execute in

$$\begin{aligned} & (4 + jx) \\ & = (4 + ea + (2 * ap)) \\ & = (4 + ea + (2 * wp)) \\ & = (4 + 2 + (2 * 4)) \qquad \text{oscillator clock cycles.} \\ & = 14 \end{aligned}$$

**Example 3: RTI Instruction**

**Problem:** Calculate the number of 24-bit instruction program words and the number of oscillator clock cycles required for the instruction

RTI

where Operating Mode Register (OMR) = \$02 (normal expanded memory map),  
 Bus Control Register (BCR) = \$0012, and  
 Return Address (on the stack) = \$0100 (internal P memory).

**Solution:** To determine the number of instruction program words and the number of oscillator clock cycles required for the given instruction, the user should perform the following operations:

1. Look up the number of instruction program words and the number of oscillator clock cycles required for the opcode-operand portion of the instruction in Table A-6.



According to Table A-6, the RTI instruction will require one instruction program word and will execute in  $(4 + rx)$  oscillator clock cycles. The term "rx" represents the number of additional (if any) oscillator clock cycles required for an RTI or RTS instruction.

2. Evaluate the "rx" term using Table A-12.

According to Table A-12, the RTI instruction will require  $rx = (2 * ap)$  additional oscillator clock cycles. The term "ap" represents the number of additional (if any) oscillator clock cycles that are required to access a P memory operand. Note that the term " $(2 * ap)$ " represents the two program memory instruction fetches executed at the end of an RTI or RTS instruction to refill the instruction pipeline.

3. Evaluate the "ap" term using Table A-14.

According to Table A-14, the term "ap" depends upon where the referenced P memory location is located in the DSP56000/DSP56001 memory space. **External** memory accesses require additional oscillator clock cycles according to the number of wait states programmed into the DSP56000/DSP56001 bus control register (BCR). Thus, assuming that the 16-bit bus control register contains the value \$0012, external P memory accesses require  $wp = 1$  wait state or additional oscillator clock cycles. For this example, the P memory reference is assumed to be an **internal** reference. This means that the return address (\$0100) pulled from the system stack by the RTI instruction is in internal P memory. Thus, according to Table A-14, the RTI instruction will use the value  $ap = 0$  additional oscillator clock cycles.

4. Compute final results.

Thus, based upon the assumptions given for Table A-6 and those listed in the problem statement for Example 3, the instruction

RTI

will require

1

instruction program word

and will execute in

$$\begin{aligned}
 & (4 + rx) \\
 & = (4 + (2 * ap)) \\
 & = (4 + (2 * 0)) \\
 & = 4
 \end{aligned}$$

oscillator clock cycles.



**Table A-6. Instruction Timing Summary (see Note 3)**

| Mnemonic | Instruction Program Words | Osc. Clock Cycles | Notes | Mnemonic | Instruction Program Words | Osc. Clock Cycles | Notes |
|----------|---------------------------|-------------------|-------|----------|---------------------------|-------------------|-------|
| ABS      | 1+mv                      | 2+mv              |       | MAC      | 1+mv                      | 2+mv              |       |
| ADC      | 1+mv                      | 2+mv              |       | MACR     | 1+mv                      | 2+mv              |       |
| ADD      | 1+mv                      | 2+mv              |       | MOVE     | 1+mv                      | 2+mv              |       |
| ADDL     | 1+mv                      | 2+mv              |       | MOVEC    | 1+ea                      | 2+mv              |       |
| ADDR     | 1+mv                      | 2+mv              |       | MOVEM    | 1+ea                      | 6+ea+ap           |       |
| AND      | 1+mv                      | 2+mv              |       | MOVEP    | 1+ea                      | 4+mv              |       |
| ANDI     | 1                         | 2                 |       | MPY      | 1+mv                      | 2+mv              |       |
| ASL      | 1+mv                      | 2+mv              |       | MPYR     | 1+mv                      | 2+mv              |       |
| ASR      | 1+mv                      | 2+mv              |       | NEG      | 1+mv                      | 2+mv              |       |
| BCHG     | 1+ea                      | 4+mv              |       | NOP      | 1                         | 2                 |       |
| BCLR     | 1+ea                      | 4+mv              |       | NORM     | 1                         | 2                 |       |
| BSET     | 1+ea                      | 4+mv              |       | NOT      | 1+mv                      | 2+mv              |       |
| BTST     | 1+ea                      | 4+mv              |       | OR       | 1+mv                      | 2+mv              |       |
| CLR      | 1+mv                      | 2+mv              |       | ORI      | 1                         | 2                 |       |
| CMP      | 1+mv                      | 2+mv              |       | REP      | 1                         | 4+mv              |       |
| CMPM     | 1+mv                      | 2+mv              |       | RESET    | 1                         | 4                 |       |
| DIV      | 1                         | 2                 |       | RND      | 1+mv                      | 2+mv              |       |
| DO       | 2                         | 6+mv              |       | ROL      | 1+mv                      | 2+mv              |       |
| ENDDO    | 1                         | 2                 |       | ROR      | 1+mv                      | 2+mv              |       |
| EOR      | 1+mv                      | 2+mv              |       | RTI      | 1                         | 4+rx              |       |
| Jcc      | 1+ea                      | 4+jx              |       | RTS      | 1                         | 4+rx              |       |
| JCLR     | 2                         | 6+jx              |       | SBC      | 1+mv                      | 2+mv              |       |
| JMP      | 1+ea                      | 4+jx              |       | STOP     | 1                         | n/a               | 1     |
| JScC     | 1+ea                      | 4+jx              |       | SUB      | 1+mv                      | 2+mv              |       |
| JSCLR    | 2                         | 6+jx              |       | SUBL     | 1+mv                      | 2+mv              |       |
| JSET     | 2                         | 6+jx              |       | SUBR     | 1+mv                      | 2+mv              |       |
| JSR      | 1+ea                      | 4+jx              |       | SWI      | 1                         | 8                 |       |
| JSSET    | 2                         | 6+jx              |       | Tcc      | 1                         | 2                 |       |
| LSL      | 1+mv                      | 2+mv              |       | TFR      | 1+mv                      | 2+mv              |       |
| LSR      | 1+mv                      | 2+mv              |       | TST      | 1+mv                      | 2+mv              |       |
| LUA      | 1                         | 4                 |       | WAIT     | 1                         | n/a               | 2     |

Note 1: The STOP instruction disables the internal clock oscillator. After clock turnon, an internal counter counts 65,536 clock cycles (if bit 6 in the OMR is clear) before enabling the clock to the internal DSP circuits. If bit 6 in the OMR is set, only six clock cycles are counted before enabling the clock to the external DSP circuits.

Note 2: The WAIT instruction takes a minimum of 16 cycles to execute when an internal interrupt is pending during the execution of the WAIT instruction.

Note 3: If assumption 4 is not applicable, then to each one-word instruction timing, a " +ap" term should be added, and, to each two-word instruction, a " + (2\*ap)" term should be added to account for the program memory wait states spent to fetch an instruction word to fill the pipeline.

**Table A-7. Parallel Data Move Timing**

| Parallel Move Operation   | + mv Words | + mv Cycles | Comments       |
|---------------------------|------------|-------------|----------------|
| No Parallel Data Move     | 0          | 0           |                |
| I Immediate Short Data    | 0          | 0           |                |
| R Register to Register    | 0          | 0           |                |
| U Address Register Update | 0          | 0           |                |
| X: X Memory Move          | ea         | ea + ax     | See Note 1     |
| X:R X Memory and Register | ea         | ea + ax     | See Note 1     |
| Y: Y Memory Move          | ea         | ea + ay     | See Note 1     |
| R:Y Y Memory and Register | ea         | ea + ay     | See Note 1     |
| L: Long Memory Move       | ea         | ea + axy    |                |
| X:Y: XY Memory Move       | 0          | ea + axy    |                |
| LMS(X) LMS X Memory Moves | 0          | ea + ax     | See Notes 1, 2 |
| LMS(Y) LMS Y Memory Moves | 0          | ea + ay     | See Notes 1, 2 |

Note 1: The ax or ay term does not apply to MOVE IMMEDIATE DATA.

Note 2: The ea term does not apply to ABSOLUTE ADDRESS and IMMEDIATE DATA.

**Table A-8. MOVEC Timing Summary (see Note 2)**

| MOVEC Operation            | + mvc Cycles | Comments   |
|----------------------------|--------------|------------|
| Immediate Short → Register | 0            |            |
| Register ↔ Register        | 0            |            |
| X Memory ↔ Register        | ea + ax      | See Note 1 |
| Y Memory ↔ Register        | ea + ay      | See Note 1 |
| P Memory ↔ Register        | 4 + ea + ap  |            |

Note 1: The ax or ay term does not apply to MOVE IMMEDIATE DATA.

Note 2: If assumption 4 is not applicable, then to each one-word instruction timing, a "+ ap" term should be added, and to each two-word instruction, a "+ (2 \* ap)" term should be added to account for the program memory wait states spent to fetch an instruction word to fill the pipeline.



Note that the "ap" term present in Table A-8 for the P memory move entry represents the wait state spent when accessing the program memory during DATA read or write and does not refer to instruction fetches.

**Table A-9. MOVEP Timing Summary (see Note 2)**

| MOVEP Operation       | +mvp Cycles       | Comments   |
|-----------------------|-------------------|------------|
| Register ↔ Peripheral | aio               |            |
| X Memory ↔ Peripheral | ea + ax + aio     | See Note 1 |
| Y Memory ↔ Peripheral | ea + ay + aio     | See Note 1 |
| P Memory ↔ Peripheral | 2 + ea + ap + aio |            |

Note 1: The ax or ay term does not apply to MOVE IMMEDIATE DATA.

Note 2: If assumption 4 is not applicable, then to each one-word instruction timing, a "+ap" term should be added, and to each two-word instruction, a "(2 \* ap)" term should be added to account for the program memory wait states spent to fetch an instruction word to fill the pipeline.

Note that the "ap" term present in Table A-9 for the P memory move entry represents the wait states spent when accessing the program memory during DATA read or write operations and does not refer to instruction fetches.

**Table A-10. Bit Manipulation Timing Summary (see Note 2)**

| Bit Manipulation Operation | +mvp Cycles   | Comments   |
|----------------------------|---------------|------------|
| Bxxx Peripheral            | 2 * aio       | See Note 1 |
| Bxxx X Memory              | ea + (2 * ax) | See Note 1 |
| Bxxx Y Memory              | ea + (2 * ay) | See Note 1 |
| Bxxx Register Direct       | 0             | See Note 1 |
| BTST Peripheral            | aio           |            |
| BTST X Memory              | ea + ax       |            |
| BTST Y Memory              | ea + ay       |            |

Note 1: Bxxx=BCHG, BCLR, or BSET

Note 2: If assumption 4 is not applicable, then to each one-word instruction timing, a "+ap" term should be added, and to each two-word instruction, a "(2 \* ap)" term should be added to account for the program memory wait states spent to fetch an instruction word to fill the pipeline.

**Table A-11. Jump Instruction Timing Summary**

| Jump Instruction Operation | +jx Cycles         | Comments   |
|----------------------------|--------------------|------------|
| Jbit Register Direct       | 2 * ap             | See Note 1 |
| Jbit Peripheral            | aio + (2 * ap)     | See Note 1 |
| Jbit X Memory              | ea + ax + (2 * ap) | See Note 1 |
| Jbit Y Memory              | ea + ay + (2 * ap) | See Note 1 |
| Jxxx                       | ea + (2 * ap)      | See Note 2 |

Note 1: Jbit=JCLR, JSCLR, JSET, and JSSET

Note 2: Jxxx=Jcc, JMP, JSc, and JSR

All one-word jump instructions execute TWO program memory fetches to refill the pipeline, which is represented by the “+ (2 \* ap)” term.

All two-word jumps execute THREE program memory fetches to refill the pipeline, but one of those fetches is sequential (the instruction word located at the jump instruction 2nd word address+1), so it is not counted as per assumption 4. If the jump instruction was fetched from a program memory segment with wait states, another “ap” should be added to account for that third fetch.

**Table A-12. RTI/RTS Timing Summary**

| Operation | + rx Cycles |
|-----------|-------------|
| RTI       | 2 * ap      |
| RTS       | 2 * ap      |

The term “2 \* ap” come from the two instruction fetches done by the RTI/RTS instruction to refill the pipeline.

**Table A-13. Addressing Mode Timing Summary**

| Effective Addressing Mode        | + ea Words | + ea Cycles |
|----------------------------------|------------|-------------|
| <b>Address Register Indirect</b> |            |             |
| No Update                        | 0          | 0           |
| Postincrement by 1               | 0          | 0           |
| Postdecrement by 1               | 0          | 0           |
| Postincrement by Offset Nn       | 0          | 0           |
| Postdecrement by Offset Nn       | 0          | 0           |
| Indexed by Offset Nn             | 0          | 2           |
| Predecrement by 1                | 0          | 2           |
| <b>Special</b>                   |            |             |
| Immediate Data                   | 1          | 2           |
| Absolute Address                 | 1          | 2           |
| Immediate Short Data             | 0          | 0           |
| Short Jump Address               | 0          | 0           |
| Absolute Short Address           | 0          | 0           |
| I/O Short Address                | 0          | 0           |
| Implicit                         | 0          | 0           |



**Table A-14. Memory Access Timing Summary**

| Access Type | X Mem Access | Y Mem Access | P Mem Access | I/O Access | +ax Cycle | +ay Cycle | +ap Cycle | +aio Cycle | +axy Cycle  |
|-------------|--------------|--------------|--------------|------------|-----------|-----------|-----------|------------|-------------|
| X:          | Int          | —            | —            | —          | 0         | —         | —         | —          | —           |
| X:          | Ext          | —            | —            | —          | wx        | —         | —         | —          | —           |
| Y:          | —            | Int          | —            | —          | —         | 0         | —         | —          | —           |
| Y:          | —            | Ext          | —            | —          | —         | wy        | —         | —          | —           |
| P:          | —            | —            | Int          | —          | —         | —         | 0         | —          | —           |
| P:          | —            | —            | Ext          | —          | —         | —         | wp        | —          | —           |
| I/O:        | —            | —            | —            | Int        | —         | —         | —         | 0          | —           |
| I/O:        | —            | —            | —            | Ext        | —         | —         | —         | wio        | —           |
| L: XY:      | Int          | Int          | —            | —          | —         | —         | —         | —          | 0           |
| L: XY:      | Int          | Ext          | —            | —          | —         | —         | —         | —          | wy          |
| L: XY:      | Ext          | Int          | —            | —          | —         | —         | —         | —          | wx          |
| L: XY:      | Ext          | Ext          | —            | —          | —         | —         | —         | —          | 2 + wx + wy |

Note 1: wx = external X memory access wait states  
 wy = external Y memory access wait states  
 wp = external P memory access wait states  
 wio = external I/O memory access wait states

Note 2: wx, wy, wp, and wio are programmable from 0–15 wait states in the port A bus control register (BCR).

## A.8 INSTRUCTION SEQUENCE RESTRICTIONS

Due to the pipelined nature of the DSP core processor, there are certain instruction sequences that are forbidden and will cause undefined operation. Most of these restricted sequences would cause contention for an internal resource, such as the stack register. The DSP assembler will flag these as assembly errors.

Most of the following restrictions represent very unusual operations which probably would never be used but are listed only for completeness.

**NOTE:** The DSP56000/DSP56001 macro assembler is designed to recognize all restrictions and flag them as errors at the **source code** level. Since many of these are instruction **sequence** restrictions, they cannot be flagged as errors at the **object code** level such as when using the DSP56000/DSP56001 simulator's single-line assembler. Therefore, if any changes are made at the **object code** level using the simulator, the user should always re-assemble his program at the **source code** level using the DSP56000/DSP56001 macro assembler to verify that no restricted instruction sequences have been generated.

### A.8.1 Restrictions Near the End of DO Loops

Proper DO loop operation is not guaranteed if an instruction **starting** at address **LA–2**, **LA–1**, or **LA** specifies one of the **program controller registers** SR, SP, SSL, LA, LC, or

(implicitly) PC as a **destination** register. Similarly, the SSH register may not be specified as a **source or destination** register in an instruction starting at address **LA-2, LA-1, or LA**. Additionally, the SSH register cannot be specified as a **source** register in the **DO** instruction itself, and **LA** cannot be used as a **target for jumps to subroutine** (i.e., JSR, JScC, JSSET, or JSCLR to LA). The following instructions cannot **begin** at the indicated position(s) near the end of a DO loop:

**At LA-2, LA-1, and LA**

DO  
 BCHG LA, LC, SR, SP, SSH, or SSL  
 BCLR LA, LC, SR, SP, SSH, or SSL  
 BSET LA, LC, SR, SP, SSH, or SSL  
 BTST SSH  
 JCLR/JSET/JSCLR/JSSET SSH  
 MOVEC from SSH  
 MOVEM from SSH  
 MOVEP from SSH  
 MOVEC to LA, LC, SR, SP, SSH, or SSL  
 MOVEM to LA, LC, SR, SP, SSH, or SSL  
 MOVEP to LA, LC, SR, SP, SSH, or SSL  
 ANDI MR  
 ORI MR

**At LA**

any two-word instruction\*  
 Jcc  
 JMP  
 JScC  
 JSR  
 REP  
 RESET  
 RTI  
 RTS  
 STOP  
 WAIT

\*This restriction applies to the situation in which the DSP56000/DSP56001 simulator's single-line assembler is used to change the **last** instruction in a DO loop from a one-word instruction to a two-word instruction. All changes made using the simulator should be reassembled at the **source code** level using the DSP56000/DSP56001 macro assembler to verify that no restricted instruction sequences have been generated.



**Other Restrictions**

DO SSH,xxxx  
 JSR to (LA) whenever the loop flag (LF) is set  
 JScC to (LA) whenever the loop flag (LF) is set  
 JSCLR to (LA) whenever the loop flag (LF) is set  
 JSSET to (LA) whenever the loop flag (LF) is set

**NOTE:** Due to pipelining, if an address register (R0–R7, N0–N7, or M0–M7) is changed using a move-type instruction (LUA, Tcc, MOVE, MOVEC, MOVEM, MOVEP, or parallel move), the new contents of the destination address register will not be available for use during the **following** instruction (i.e., there is a single instruction cycle pipeline delay). This restriction also applies to the situation in which the **last** instruction in a **DO** loop changes an address register **and** the **first** instruction at the **top** of the **DO** loop uses that same address register. The **top** instruction becomes the **following** instruction because of the loop construct. The assembler will generate a warning if this condition is detected.

### A.8.2 Other DO Restrictions

Due to pipelining, the **DO** instruction must not be **immediately preceded** by any of the following instructions:

#### Immediately before **DO**

BCHG LA, LC, SSH, SSL, or SP  
BCLR LA, LC, SSH, SSL, or SP  
BSET LA, LC, SSH, SSL, or SP  
MOVEC to LA, LC, SSH, SSL, or SP  
MOVEM to LA, LC, SSH, SSL, or SP  
MOVEP to LA, LC, SSH, SSL, or SP  
MOVEC from SSH  
MOVEM from SSH  
MOVEP from SSH

### A.8.3 ENDDO Restrictions

Due to pipelining, the **ENDDO** instruction must not be **immediately preceded** by any of the following instructions:

#### Immediately before **ENDDO**

BCHG LA, LC, SR, SSH, SSL, or SP  
BCLR LA, LC, SR, SSH, SSL, or SP  
BSET LA, LC, SR, SSH, SSL, or SP  
MOVEC to LA, LC, SR, SSH, SSL, or SP  
MOVEM to LA, LC, SR, SSH, SSL, or SP  
MOVEP to LA, LC, SR, SSH, SSL, or SP  
MOVEC from SSH  
MOVEM from SSH  
MOVEP from SSH  
ANDI MR  
ORI MR

**A**



#### A.8.4 RTI and RTS Restrictions

Due to pipelining, the RTI and RTS instructions must not be **immediately preceded** by any of the following instructions:

|                               |  |
|-------------------------------|--|
| <b>Immediately before RTI</b> | BCHG SR, SSH, SSL, or SP<br>BCLR SR, SSH, SSL, or SP<br>BSET SR, SSH, SSL, or SP<br>MOVEC to SR, SSH, SSL, or SP<br>MOVEM to SR, SSH, SSL, or SP<br>MOVEP to SR, SSH, SSL, or SP<br>MOVEC from SSH<br>MOVEM from SSH<br>MOVEP from SSH<br>ANDI MR or ANDI CCR<br>ORI MR or ORI CCR |
|-------------------------------|--|

|                               |  |
|-------------------------------|--|
| <b>Immediately before RTS</b> | BCHG SSH, SSL, or SP<br>BCLR SSH, SSL, or SP<br>BSET SSH, SSL, or SP<br>MOVEC to SSH, SSL, or SP<br>MOVEM to SSH, SSL, or SP<br>MOVEP to SSH, SSL, or SP<br>MOVEC from SSH<br>MOVEM from SSH<br>MOVEP from SSH |
|-------------------------------|--|

#### A.8.5 SP and SSH/SSL Manipulation Restrictions

In addition to all the above restrictions concerning MOVEC, MOVEM, MOVEP, SP, SSH, and SSL, the following MOVEC, MOVEM, and MOVEP restrictions apply:

|   |  |
|---|--|
| <b>Immediately before MOVEC from SSH or SSL</b> | BCHG to SP<br>BCLR to SP<br>BSET to SP |
|---|--|

|   |  |
|---|--|
| <b>Immediately before MOVEM from SSH or SSL</b> | BCHG to SP<br>BCLR to SP<br>BSET to SP |
|---|--|

|   |  |
|---|--|
| <b>Immediately before MOVEP from SSH or SSL</b> | BCHG to SP<br>BCLR to SP<br>BSET to SP |
|---|--|



|  |   |
|--|---|
| <b>Immediately before MOVEC from SSH or SSL</b>      | MOVEC to SP<br>MOVEM to SP<br>MOVEP to SP |
| <b>Immediately before MOVEM from SSH or SSL</b>      | MOVEC to SP<br>MOVEM to SP<br>MOVEP to SP |
| <b>Immediately before MOVEP from SSH or SSL</b>      | MOVEC to SP<br>MOVEM to SP<br>MOVEP to SP |
| <b>Immediately before JCLR #n, SSH or SSL,xxxx</b>   | MOVEC to SP<br>MOVEM to SP<br>MOVEP to SP |
| <b>Immediately before JSET #n, SSH or SSL,xxxx</b>   | MOVEC to SP<br>MOVEM to SP<br>MOVEP to SP |
| <b>Immediately before JSCLR #n, SSH or SSL,xxxx</b>  | MOVEC to SP<br>MOVEM to SP<br>MOVEP to SP |
| <b>Immediately before JSSET #n, SSH or SSL,xxxx</b>  | MOVEC to SP<br>MOVEM to SP<br>MOVEP to SP |
| <b>Immediately before JCLR #n, SSH or SSL,xxxx</b>   | BCHG to SP<br>BCLR to SP<br>BSET to SP    |
| <b>Immediately before JSET #n, SSH or SSL,xxxx</b>   | BCHG to SP<br>BCLR to SP<br>BSET to SP    |
| <b>Immediately before JSCLR from SSH or SSL,xxxx</b> | BCHG to SP<br>BCLR to SP<br>BSET to SP    |
| <b>Immediately before JSSET from SSH or SSL,xxxx</b> | BCHG to SP<br>BCLR to SP<br>BSET to SP    |

Also, the instruction MOVEC SSH,SSH is illegal.

### A.8.6 R, N, and M Register Restrictions

If an address register (R0–R7, N0–N7, or M0–M7) is changed with a move-type instruction (LUA, Tcc, MOVE, MOVEC, MOVEM, MOVEP, or parallel move), the new contents of the destination address register will **not** be available for use as a pointer during the **following** instruction (i.e., there is a single instruction cycle pipeline delay). This does not apply to address registers that are updated as part of an addressing mode update.

**NOTE:** This restriction also applies to the situation in which the **last** instruction in a **DO** loop changes an address register using a move-type instruction **and** the **first** instruction at the **top** of the DO loop uses that same address register. The **top** instruction becomes the **following** instruction because of the loop construct. The DSP assembler will generate a warning if this condition is detected.

### A.8.7 Fast Interrupt Routines

The following instructions may not be used in a fast interrupt routine:

#### In a fast interrupt routine

- DO
- ENDDO
- RTI
- RTS
- MOVEC to LA, LC, SSH, SSL, SP, or SR
- MOVEM to LA, LC, SSH, SSL, SP, or SR
- MOVEP to LA, LC, SSH, SSL, SP, or SR
- MOVEC from SSH
- MOVEM from SSH
- MOVEP from SSH
- ORI MR or ORI CCR
- ANDI MR or ANDI CCR
- STOP
- SWI
- WAIT

### A.8.8 REP Restrictions

The REP instruction can repeat any single-word instruction except the REP instruction itself and any instruction that changes program flow. The following instructions are not allowed to follow an REP instruction:

|                              |       |
|------------------------------|-------|
| <b>Immediately after REP</b> | DO    |
|                              | Jcc   |
|                              | JCLR  |
|                              | JMP   |
|                              | JSET  |
|                              | JScC  |
|                              | JSCLR |
|                              | JSR   |
|                              | JSSET |
|                              | REP   |
|                              | RTI   |
|                              | RTS   |
|                              | STOP  |
|                              | SWI   |
|                              | WAIT  |

Also, an REP instruction cannot be the **last** instruction in a DO loop (at LA).

## A.9 INSTRUCTION ENCODING

This section summarizes instruction encoding for the DSP56000/DSP56001 instruction set. The instruction codes are listed in nominally descending order. The symbols used in decoding the various fields of an instruction are identical to those used in the **Opcode** section of the individual instruction descriptions. The user should always refer to the actual instruction description for complete information on the encoding of the various fields of that instruction.

**A**

**Section A.9.1** gives the encodings for (1) various groupings of registers used in the instruction encodings, (2) condition code combinations, (3) addressing, and (4) addressing modes.

**Section A.9.2** gives the encoding for the parallel move portion of an instruction. These 16-bit partial instruction codes may be combined with the 8-bit data ALU opcodes listed in **Section A.9.3** to form a complete 24-bit instruction word.

**Section A.9.3** gives the complete 24-bit instruction encoding for those instructions which do not allow parallel moves.

**Section A.9.4** gives the encoding for the data ALU portion of those instructions which allow parallel data moves. These 8-bit partial instruction codes may be combined with the 16-bit parallel move opcodes listed in **Section A.9.1** to form a complete 24-bit instruction word.

**Section A.9.5** contains instruction encodings for nonsensical instructions (called insane instructions) for which encodings exist but which cause problems such as writing two sources to one destination.

### A.9.1 Partial Encodings for Use in Instruction Encoding

**Table A-15. Single-Bit Register Encodings**

| Code | d* | e  | f  | Where:                       |
|------|----|----|----|------------------------------|
| 0    | A  | X0 | Y0 | d=2 Accumulators in Data ALU |
| 1    | B  | X1 | Y1 | e=2 Registers in Data ALU    |
|      |    |    |    | f=2 Registers in Data ALU    |

\*For class II encodings for R:Y and X:R, see Table A-16.

**Table A-16. Single-Bit Special Register Encodings**

| d | X:R Class II Opcode                 | R:Y Class II Opcode                 |
|---|-------------------------------------|-------------------------------------|
| 0 | A $\uparrow$ X:<ea> X0 $\uparrow$ A | Y0 $\uparrow$ A A $\uparrow$ Y:<ea> |
| 1 | B $\uparrow$ X:<ea> X0 $\uparrow$ B | Y0 $\uparrow$ B B $\uparrow$ Y:<ea> |

**Table A-17. Double-Bit Register Encodings**

| Code | DD | ee | ff |
|------|----|----|----|
| 00   | X0 | X0 | Y0 |
| 01   | X1 | X1 | Y1 |
| 10   | Y0 | A  | A  |
| 11   | Y1 | A  | B  |

Where: DD=4 registers in data ALU  
 ee=4 XDB registers in data ALU  
 ff=4 YDB registers in data ALU



**Table A-18. Triple-Bit Register Encodings**

| Code | DDD | LLL | FFF | NNN | TTT | GGG |
|------|-----|-----|-----|-----|-----|-----|
| 000  | A0  | A10 | M0  | N0  | R0  | *   |
| 001  | B0  | B10 | M1  | N1  | R1  | SR  |
| 010  | A2  | X   | M2  | N2  | R2  | OMR |
| 011  | B2  | Y   | M3  | N3  | R3  | SP  |
| 100  | A1  | A   | M4  | N4  | R4  | SSH |
| 101  | B1  | B   | M5  | N5  | R5  | SSL |
| 110  | A   | AB  | M6  | N6  | R6  | LA  |
| 111  | B   | BA  | M7  | N7  | R7  | LC  |

\*Reserved

Where: DDD: 8 accumulators in data ALU

LLL: 8 extended-precision registers in data ALU; LLL field is encoded as LOLL

FFF: 8 address modifier registers in address ALU

NNN: 8 address offset registers in address ALU

TTT: 8 address registers in address

GGG: 8 program controller registers

**Table A-19(a). Four-Bit Register Encodings for 12 Registers in Data ALU**

| D | D | D | D | Description       |
|---|---|---|---|-------------------|
| 0 | 0 | X | X | Reserved          |
| 0 | 1 | D | D | Data ALU Register |
| 1 | D | D | D | Data ALU Register |

**Table A-19(b). Four-Bit Register Encodings for 16 Condition Codes**

| Mnemonic | C | C | C | C | Mnemonic | C | C | C | C |
|----------|---|---|---|---|----------|---|---|---|---|
| CC (HS)  | 0 | 0 | 0 | 0 | CS (LO)  | 1 | 0 | 0 | 0 |
| GE       | 0 | 0 | 0 | 1 | LT       | 1 | 0 | 0 | 1 |
| NE       | 0 | 0 | 1 | 0 | EQ       | 1 | 0 | 1 | 0 |
| PL       | 0 | 0 | 1 | 1 | MI       | 1 | 0 | 1 | 1 |
| NN       | 0 | 1 | 0 | 0 | NR       | 1 | 1 | 0 | 0 |
| EC       | 0 | 1 | 0 | 1 | ES       | 1 | 1 | 0 | 1 |
| LC       | 0 | 1 | 1 | 0 | LS       | 1 | 1 | 1 | 0 |
| GT       | 0 | 1 | 1 | 1 | LE       | 1 | 1 | 1 | 1 |

A

**Table A-20. Five-Bit Register Encodings  
for 28 Registers in Data ALU and  
Address ALU**

| e<br>d | e<br>d | e<br>or<br>d | e<br>d | e<br>d | Description             |
|--------|--------|--------------|--------|--------|-------------------------|
| 0      | 0      | 0            | 0      | X      | Reserved                |
| 0      | 0      | 0            | 1      | X      | Reserved                |
| 0      | 0      | 1            | D      | D      | Data ALU Register       |
| 0      | 1      | D            | D      | D      | Data ALU Register       |
| 1      | 0      | T            | T      | T      | Address ALU Register    |
| 1      | 1      | N            | N      | N      | Address Offset Register |

Where: eeeee = source  
 ddddd = destination

**Table A-21. Six-Bit Register Encodings for  
43 Registers On-Chip**

| d | d | d | d | d | d | Description                 |
|---|---|---|---|---|---|-----------------------------|
| 0 | 0 | 0 | 0 | X | X | Reserved                    |
| 0 | 0 | 0 | 1 | D | D | Data ALU Register           |
| 0 | 0 | 1 | D | D | D | Data ALU Register           |
| 0 | 1 | 0 | T | T | T | Address ALU Register        |
| 0 | 1 | 1 | N | N | N | Address Offset Register     |
| 1 | 0 | 0 | F | F | F | Address Modifier Register   |
| 1 | 0 | 1 | X | X | X | Reserved                    |
| 1 | 1 | 0 | X | X | X | Reserved                    |
| 1 | 1 | 1 | G | G | G | Program Controller Register |

**Table A-22. Write Control  
Encoding**

| W | Operation                    |
|---|------------------------------|
| 0 | Read Register or Peripheral  |
| 1 | Write Register or Peripheral |

**Table A-23. Memory Space  
Bit Encoding**

| S | Operation |
|---|-----------|
| 0 | X Memory  |
| 1 | Y Memory  |



**Table A-24. Program Controller Register Encoding**

| E | E | Register                    |
|---|---|-----------------------------|
| 0 | 0 | MR Mode Register            |
| 0 | 1 | CCR Condition Code Register |
| 1 | 0 | OMR Operating Mode Register |
| 1 | 1 | — Reserved                  |

**Table A-25. Condition Code and Address Encoding**

| Code                            | Code Definition                          |
|---------------------------------|--|
| c c c c                         | 16 Condition Code Combinations           |
| b b b b                         | 5-Bit Immediate Data                     |
| i i i i i i i i                 | 8-Bit Immediate Data (int, frac, mask)   |
| i i i i i i i i x x x x h h h h | 12-Bit Immediate Data (iiii iiiii hhhh)  |
| a a a a a a                     | 6-Bit Absolute Short (Low) Address       |
| p p p p p p                     | 6-Bit Absolute I/O (High) Address        |
| a a a a a a a a                 | 12-Bit Fast Absolute Short (Low) Address |

**Table A-26. Effective Addressing Mode Encoding**

| M | M | M | R | R | R | Effective Addressing Mode |
|---|---|---|---|---|---|---------------------------|
| 0 | 0 | 0 | r | r | r | Post -N                   |
| 0 | 0 | 1 | r | r | r | Post +N                   |
| 0 | 1 | 0 | r | r | r | Post -1                   |
| 0 | 1 | 1 | r | r | r | Post +1                   |
| 1 | 0 | 0 | r | r | r | No Update                 |
| 1 | 0 | 1 | r | r | r | Indexed +N                |
| 1 | 1 | 1 | r | r | r | Pre -1                    |
| 1 | 1 | 0 | 0 | r | r | Absolute Address          |
| 1 | 1 | 0 | 1 | r | r | Immediate Data            |

RRR=three unencoded bits R0, R1, R2

MMM=three unencoded bits M0, M1, M2

NOTES:

- (1) R2 is 0 for low register bank and 1 for the high register bank.
- (2) M2 is 0 for all post update modes and 1 otherwise.
- (3) M1 is 0 for update by register offset and 1 for update by one.
- (4) M0 is 0 for minus and 1 for plus.
- (5) For X and Y moves, rr is a subfield or rrr with equations:  
r2 := R2.
- (6) For rr field, r1 is bit 14; r0 is bit 13.
- (7) For X and Y moves, mm is a subfield of mmm with equations: M2 := (M1 v M0) m2 := (m1 v m0).
- (8) For mm field, m1 is bit 21; m0 is bit 20. For MM field, M1 is bit 12; M0 is bit 11.





## A.9.2 Instruction Encoding for the Parallel Move Portion of an Instruction

### X: Y: Parallel Data Move

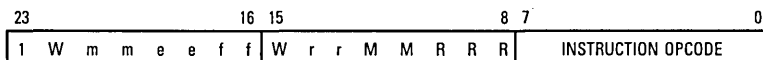

### X: Parallel Data Move

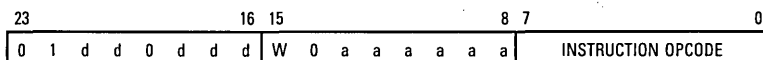
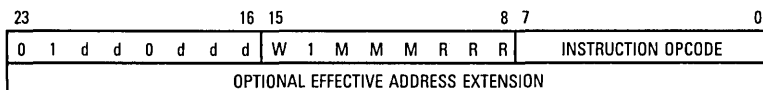

### Y: Parallel Data Move

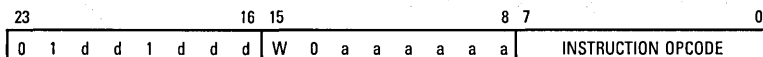
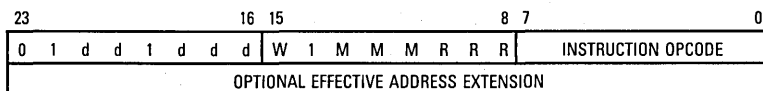

### L: Parallel Data Move

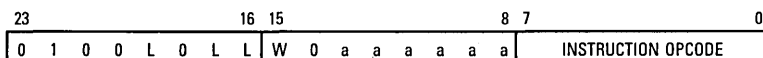
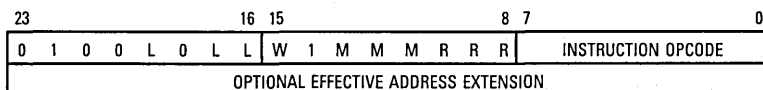

### I: Immediate Short Parallel Data Move

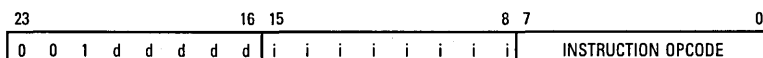

### R: Register to Register Parallel Data Move

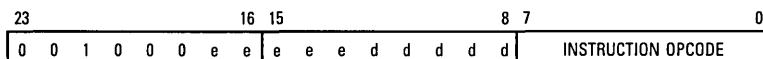

A

### U: Address Register Update Parallel Data Move

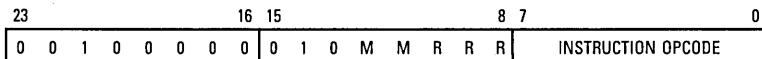

### Parallel Data Move NOP

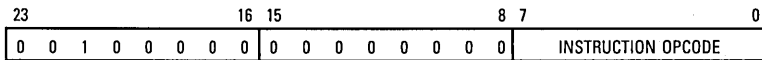

### R:Y Parallel Data Move

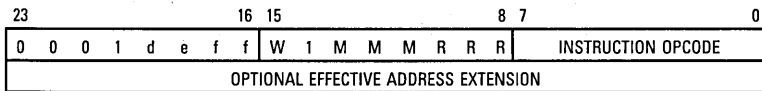

### X:R Parallel Data Move

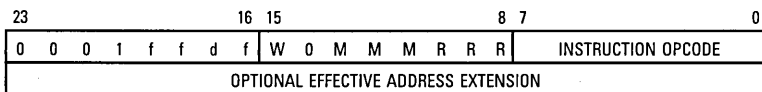

## A.9.3 Instruction Encoding for Instructions Which Do Not Allow Parallel Moves

NOTE: For following bit class instructions bbbbb = 11bbb is reserved:  
JSET, JSCLR, JSET, JCLR, BTST, BCHG, BSET, and BCLR.

### JScC xxx

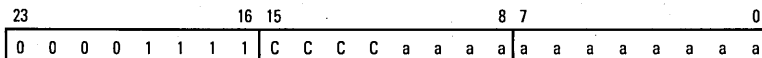

### Jcc xxx

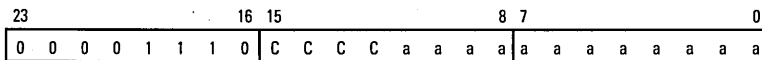

### JSR xxx

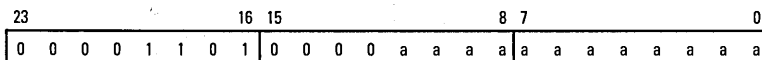

### JMP xxx

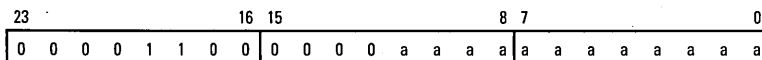

**JScC** ea

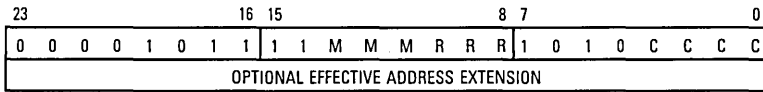

**JSR** ea

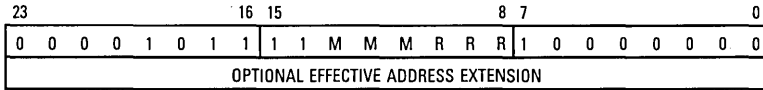

**JcC** ea

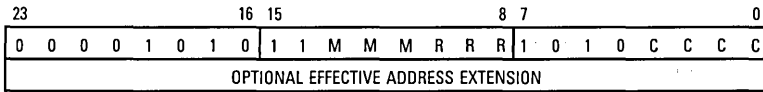

**JMP** ea

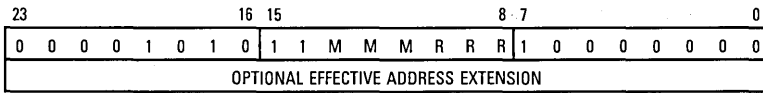

**JSSET** #n,X:pp,xxxx  
**JSSET** #n,Y:pp,xxxx

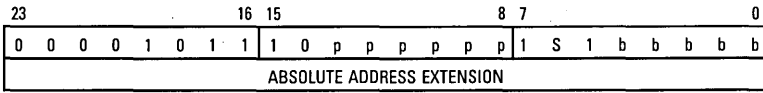

**JSCLR** #n,X:pp,xxxx  
**JSCLR** #n,Y:pp,xxxx

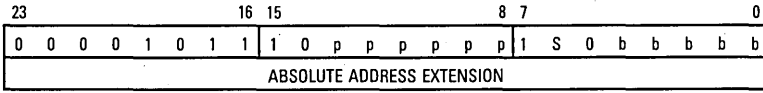

**JSET** #n,X:pp,xxxx  
**JSET** #n,Y:pp,xxxx

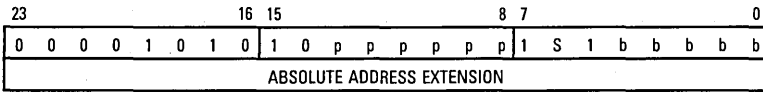

JCLR #n,X:pp,xxxx  
 JCLR #n,Y:pp,xxxx

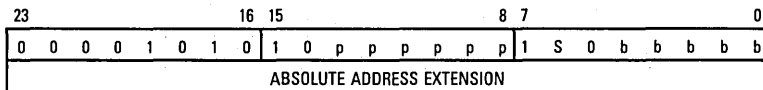

JSSET #n,X:ea,xxxx  
 JSSET #n,Y:ea,xxxx

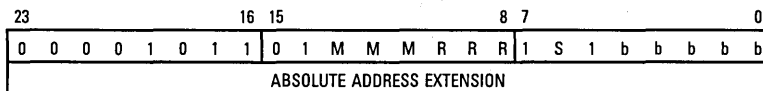

JSCLR #n,X:ea,xxxx  
 JSCLR #n,Y:ea,xxxx

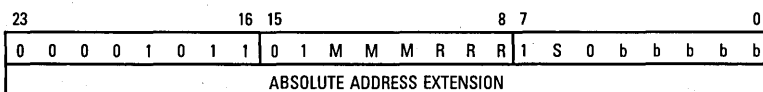

JSET #n,X:ea,xxxx  
 JSET #n,Y:ea,xxxx

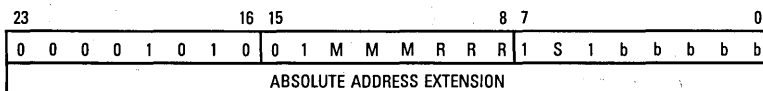

JCLR #n,X:ea,xxxx  
 JCLR #n,Y:ea,xxxx

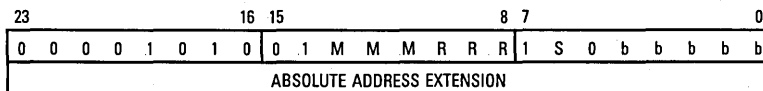

JSSET #n,X:aa,xxxx  
 JSSET #n,Y:aa,xxxx

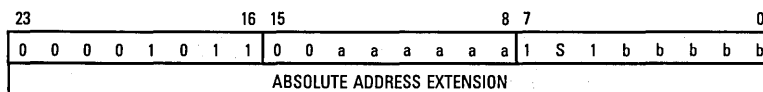

JSCLR #n,X:aa,xxxx  
 JSCLR #n,Y:aa,xxxx

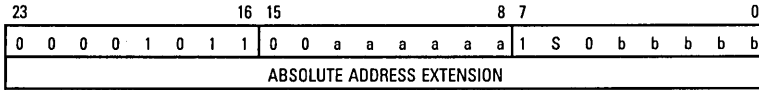

JSET #n,X:aa,xxxx  
 JSET #n,Y:aa,xxxx

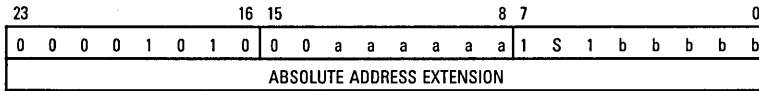

JCLR #n,X:aa,xxxx  
 JCLR #n,Y:aa,xxxx

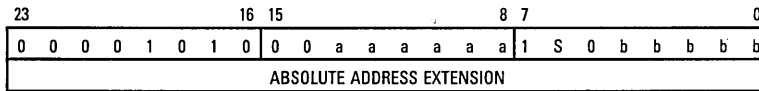

JSSET #n,S,xxxx

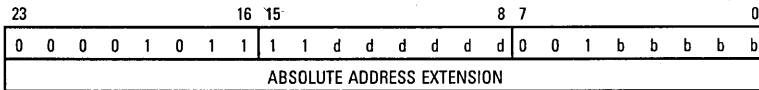

JSCLR #n,S,xxxx

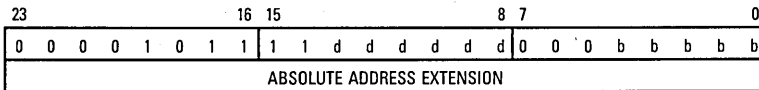

JSET #n,S,xxxx

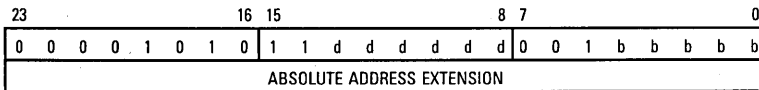

JCLR #n,S,xxxx

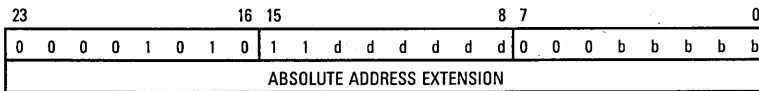

BTST #n,X:pp  
 BTST #n,Y:pp

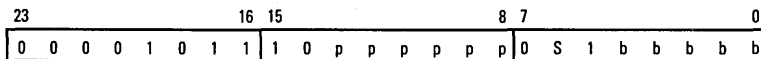

BCHG #n,X:pp  
 BCHG #n,Y:pp

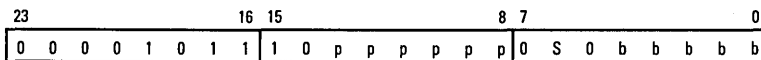

BSET #n,X:pp  
 BSET #n,Y:pp



BCLR #n,X:pp  
 BCLR #n,Y:pp

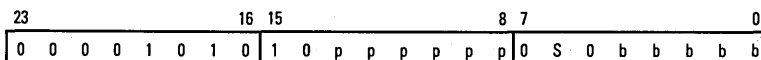

BTST #n,X:ea  
 BTST #n,Y:ea

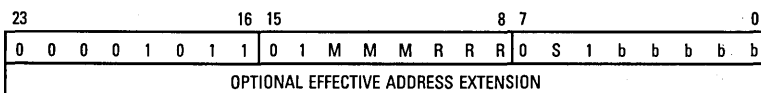

BCHG #n,X:ea  
 BCHG #n,Y:ea

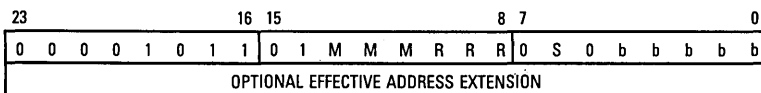

BSET #n,X:ea  
 BSET #n,Y:ea

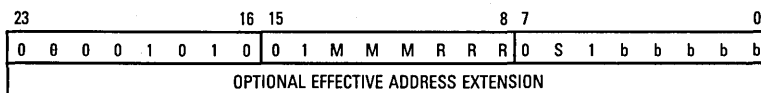

**A**

**BCLR** #n,X:ea  
**BCLR** #n,Y:ea

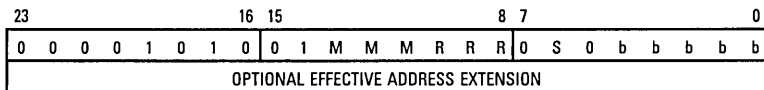

**BTST** #n,X:aa  
**BTST** #n,Y:aa

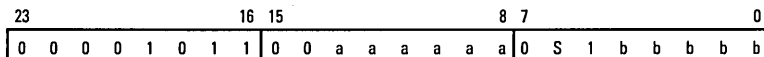

**BCHG** #n,X:aa  
**BCHG** #n,Y:aa

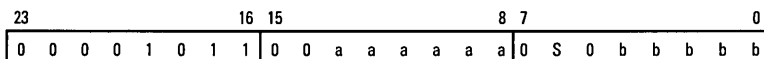

**BSET** #n,X:aa  
**BSET** #n,Y:aa

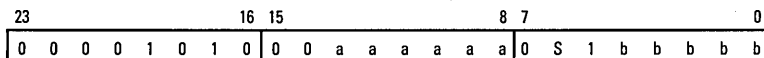

**BCLR** #n,X:aa  
**BCLR** #n,Y:aa

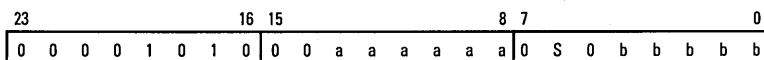

**BTST** #n,D

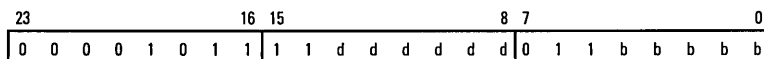

**BCHG** #n,D

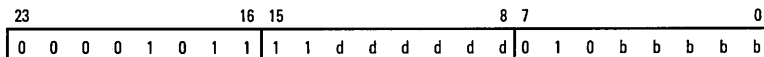

**BSET** #n,D

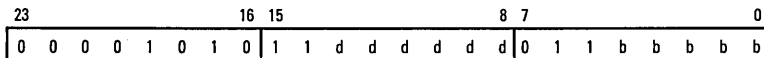

A

**BCLR #n,D**

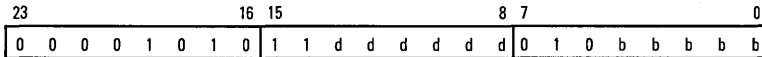

- MOVEP X:ea,X:pp
- MOVEP Y:ea,X:pp
- MOVEP #xxxxxx,X:pp
- MOVEP X:pp,X:ea
- MOVEP X:pp,Y:ea
- MOVEP X:ea,Y:pp
- MOVEP Y:ea,Y:pp
- MOVEP #xxxxxx,Y:pp
- MOVEP Y:pp,X:ea
- MOVEP Y:pp,Y:ea

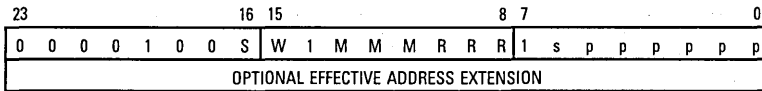

- MOVEP P:ea,X:pp
- MOVEP X:pp,P:ea
- MOVEP P:ea,Y:pp
- MOVEP Y:pp,P:ea

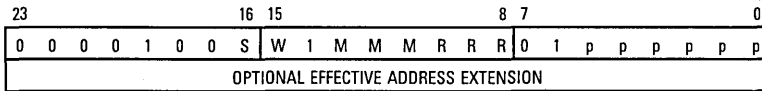

- MOVEP S,X:pp
- MOVEP X:pp,D
- MOVEP S,Y:pp
- MOVEP Y:pp,D

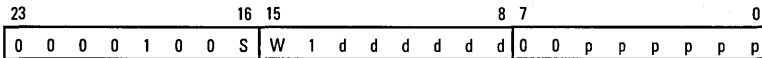

- MOVE(M) S,P:ea
- MOVE(M) P:ea,D

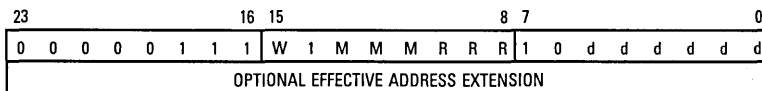

**A**



MOVE(M) S,P:aa  
 MOVE(M) P:aa,D

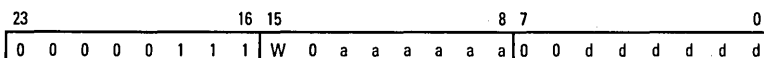

REP #xxx

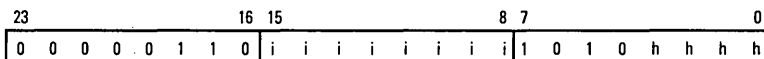

REP S

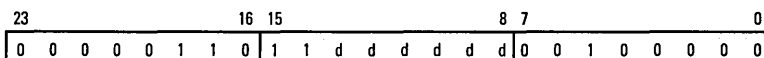

REP X:ea  
 REP Y:ea

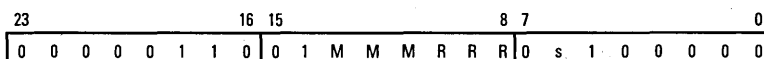

REP X:aa  
 REP Y:aa

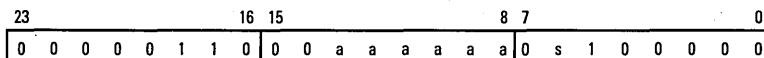

DO #xxx,expr

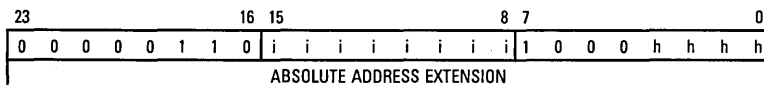

DO S,expr

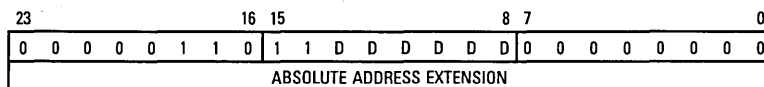

DO X:ea,expr  
 DO Y:ea,expr



A

DO X:aa,expr  
 DO Y:aa,expr

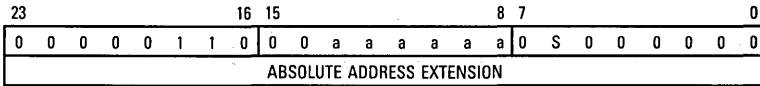

MOVE(C) #xx,D1

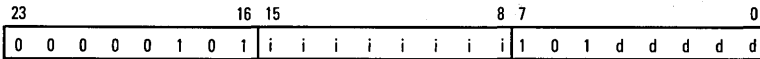

MOVE(C) X:ea,D1  
 MOVE(C) S1,X:ea  
 MOVE(C) Y:ea,D1  
 MOVE(C) S1,Y:ea  
 MOVE(C) #xxxx,D1

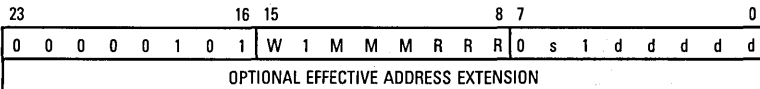

MOVE(C) X:aa,D1  
 MOVE(C) S1,X:aa  
 MOVE(C) Y:aa,D1  
 MOVE(C) S1,Y:aa

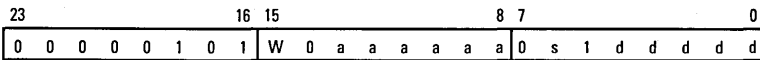

MOVE(C) S1,D2  
 MOVE(C) S2,D1

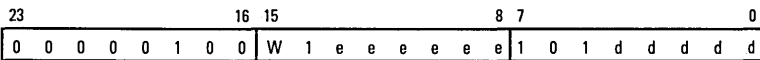

LUA ea,D

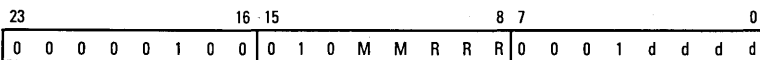

Tcc S1,D1 S2,D2

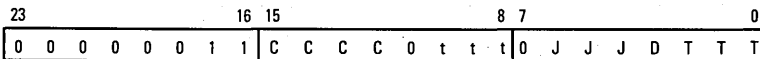

**A**



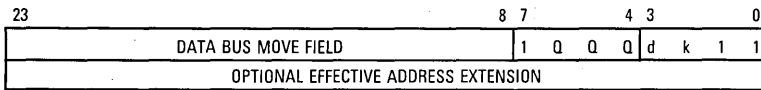

**Table A-28. Operation Code  
QQQ Decode**

| Q | Q | Q | S1 | S2 |
|---|---|---|----|----|
| 0 | 0 | 0 | X0 | X0 |
| 0 | 0 | 1 | Y0 | Y0 |
| 0 | 1 | 0 | X1 | X0 |
| 0 | 1 | 1 | Y1 | Y0 |
| 1 | 0 | 0 | X0 | Y1 |
| 1 | 0 | 1 | Y0 | X0 |
| 1 | 1 | 0 | X1 | Y0 |
| 1 | 1 | 1 | Y1 | X1 |

NOTE: S1 and S2 are the inputs to the multiplier

**MACR**     $(\pm)S1,S2,D$   
**MACR**     $(\pm)S2,S1,D$



**MAC**     $(\pm)S1,S2,D$   
**MAC**     $(\pm)S2,S1,D$

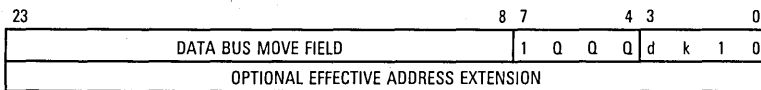

**MPYR**     $(\pm)S1,S2,D$   
**MPYR**     $(\pm)S2,S1,D$

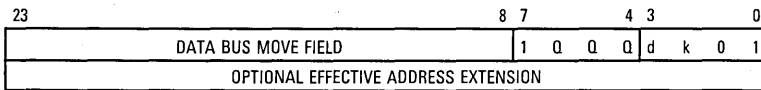

**MPY**     $(\pm)S1,S2,D$   
**MPY**     $(\pm)S2,S1,D$

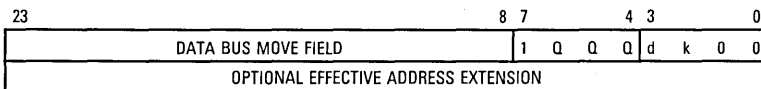

**A**

## Nonmultiply Instruction Encoding

The 8-bit operation code for instructions allowing parallel moves contains two 3-bit fields defining which instruction the operation code represents and one bit defining the destination accumulator register.

The 8-bit operation code = **0JJJ Dkkk** where JJJ = 1/2 instruction number  
 kkk = 1/2 instruction number  
 D = destination accumulator  
 D = 0 → A  
 D = 1 → B

**Table A-29. Nonmultiply Instruction Encoding**

| JJJ              | D=0<br>Src<br>Oper | D=1<br>Src<br>Oper | kkk               |     |      |     |     |     |      |      |
|------------------|--------------------|--------------------|-------------------|-----|------|-----|-----|-----|------|------|
|                  |                    |                    | 000               | 001 | 010  | 011 | 100 | 101 | 110  | 111  |
| 000              | B                  | A                  | MOVE <sup>1</sup> | TFR | ADDR | TST | *   | CMP | SUBR | CMPM |
| 001              | B                  | A                  | ADD               | RND | ADDL | CLR | SUB | *   | SUBL | NOT  |
| 010 <sup>2</sup> | B                  | A                  | —                 | —   | ASR  | LSR | —   | —   | ABS  | ROR  |
| 011 <sup>2</sup> | B                  | A                  | —                 | —   | ASL  | LSL | —   | —   | NEG  | ROL  |
| 010 <sup>2</sup> | X1X0               | X1X0               | ADD               | ADC | —    | —   | SUB | SBC |      |      |
| 011 <sup>2</sup> | Y1Y0               | Y1Y0               | ADD               | ADC | —    | —   | SUB | SBC |      |      |
| 100              | X0_0               | X0_0               | ADD               | TFR | OR   | EOR | SUB | CMP | AND  | CMPM |
| 101              | Y0_0               | Y0_0               | ADD               | TFR | OR   | EOR | SUB | CMP | AND  | CMPM |
| 110              | X1_0               | X1_0               | ADD               | TFR | OR   | EOR | SUB | CMP | AND  | CMPM |
| 111              | Y1_0               | Y1_0               | ADD               | TFR | OR   | EOR | SUB | CMP | AND  | CMPM |

**NOTES:**

\* = Reserved

1 = Special Case #1 (See Table A-30)

2 = Special Case #2 (See Table A-31)

**Table A-30. Special Case #1**

| O P E R C O D E | Operation |
|-----------------|-----------|
| 0 0 0 0 0 0 0 0 | MOVE      |
| 0 0 0 0 1 0 0 0 | Reserved  |

For JJJ = 010 and 011, k1 qualifies source register selection:

**Table A-31. Special Case #2**

| 0 J J J d k k k | Operation    |
|-----------------|--------------|
| 0 0 1 0 x x 0 x | Selects X1X0 |
| 0 0 1 1 x x 0 x | Selects Y1Y0 |
| 0 0 1 x x x 1 x | Selects A/B  |

**CMPM S1, S2**

|                                      |     |         |         |
|--------------------------------------|-----|---------|---------|
| 23                                   | 8 7 | 4 3     | 0       |
| DATA BUS MOVE FIELD                  |     | 0 J J J | d 1 1 1 |
| OPTIONAL EFFECTIVE ADDRESS EXTENSION |     |         |         |

**AND S,D**

|                                      |     |         |         |
|--------------------------------------|-----|---------|---------|
| 23                                   | 8 7 | 4 3     | 0       |
| DATA BUS MOVE FIELD                  |     | 0 1 J J | d 1 1 0 |
| OPTIONAL EFFECTIVE ADDRESS EXTENSION |     |         |         |

**CMP S1, S2**

|                                      |     |         |         |
|--------------------------------------|-----|---------|---------|
| 23                                   | 8 7 | 4 3     | 0       |
| DATA BUS MOVE FIELD                  |     | 0 J J J | d 1 0 1 |
| OPTIONAL EFFECTIVE ADDRESS EXTENSION |     |         |         |

**SUB S,D**

|                                      |     |         |         |
|--------------------------------------|-----|---------|---------|
| 23                                   | 8 7 | 4 3     | 0       |
| DATA BUS MOVE FIELD                  |     | 0 J J J | d 1 0 0 |
| OPTIONAL EFFECTIVE ADDRESS EXTENSION |     |         |         |

**EOR S,D**

|                                      |     |         |         |
|--------------------------------------|-----|---------|---------|
| 23                                   | 8 7 | 4 3     | 0       |
| DATA BUS MOVE FIELD                  |     | 0 1 J J | d 0 1 1 |
| OPTIONAL EFFECTIVE ADDRESS EXTENSION |     |         |         |

**OR S,D**

|                                      |     |         |         |
|--------------------------------------|-----|---------|---------|
| 23                                   | 8 7 | 4 3     | 0       |
| DATA BUS MOVE FIELD                  |     | 0 1 J J | d 0 1 0 |
| OPTIONAL EFFECTIVE ADDRESS EXTENSION |     |         |         |

**TFR S,D**

|                                      |     |         |         |
|--------------------------------------|-----|---------|---------|
| 23                                   | 8 7 | 4 3     | 0       |
| DATA BUS MOVE FIELD                  |     | 0 J J J | d 0 0 1 |
| OPTIONAL EFFECTIVE ADDRESS EXTENSION |     |         |         |

**ADD S,D**

|                                      |     |         |         |
|--------------------------------------|-----|---------|---------|
| 23                                   | 8 7 | 4 3     | 0       |
| DATA BUS MOVE FIELD                  |     | 0 J J J | d 0 0 0 |
| OPTIONAL EFFECTIVE ADDRESS EXTENSION |     |         |         |



**SBC S,D**

|                                      |     |         |         |
|--------------------------------------|-----|---------|---------|
| 23                                   | 8 7 | 4 3     | 0       |
| DATA BUS MOVE FIELD                  |     | 0 0 1 J | d 1 0 1 |
| OPTIONAL EFFECTIVE ADDRESS EXTENSION |     |         |         |

**ADC S,D**

|                                      |     |         |         |
|--------------------------------------|-----|---------|---------|
| 23                                   | 8 7 | 4 3     | 0       |
| DATA BUS MOVE FIELD                  |     | 0 0 1 J | d 0 0 1 |
| OPTIONAL EFFECTIVE ADDRESS EXTENSION |     |         |         |

**ROL D**

|                                      |     |         |         |
|--------------------------------------|-----|---------|---------|
| 23                                   | 8 7 | 4 3     | 0       |
| DATA BUS MOVE FIELD                  |     | 0 0 1 1 | d 1 1 1 |
| OPTIONAL EFFECTIVE ADDRESS EXTENSION |     |         |         |

**NEG D**

|                                      |     |         |         |
|--------------------------------------|-----|---------|---------|
| 23                                   | 8 7 | 4 3     | 0       |
| DATA BUS MOVE FIELD                  |     | 0 0 1 1 | d 1 1 0 |
| OPTIONAL EFFECTIVE ADDRESS EXTENSION |     |         |         |

**LSL D**

|                                      |     |         |         |
|--------------------------------------|-----|---------|---------|
| 23                                   | 8 7 | 4 3     | 0       |
| DATA BUS MOVE FIELD                  |     | 0 0 1 1 | d 0 1 1 |
| OPTIONAL EFFECTIVE ADDRESS EXTENSION |     |         |         |

**ASL D**

|                                      |     |         |         |
|--------------------------------------|-----|---------|---------|
| 23                                   | 8 7 | 4 3     | 0       |
| DATA BUS MOVE FIELD                  |     | 0 0 1 1 | d 0 1 0 |
| OPTIONAL EFFECTIVE ADDRESS EXTENSION |     |         |         |

**ROR D**

|                                      |     |         |         |
|--------------------------------------|-----|---------|---------|
| 23                                   | 8 7 | 4 3     | 0       |
| DATA BUS MOVE FIELD                  |     | 0 0 1 0 | d 1 1 1 |
| OPTIONAL EFFECTIVE ADDRESS EXTENSION |     |         |         |

**ABS D**

|                                      |     |         |         |
|--------------------------------------|-----|---------|---------|
| 23                                   | 8 7 | 4 3     | 0       |
| DATA BUS MOVE FIELD                  |     | 0 0 1 0 | d 1 1 0 |
| OPTIONAL EFFECTIVE ADDRESS EXTENSION |     |         |         |

**A**



**LSR D**

|                                      |     |         |         |
|--------------------------------------|-----|---------|---------|
| 23                                   | 8 7 | 4 3     | 0       |
| DATA BUS MOVE FIELD                  |     | 0 0 1 0 | d 0 1 1 |
| OPTIONAL EFFECTIVE ADDRESS EXTENSION |     |         |         |

**ASR D**

|                                      |     |         |         |
|--------------------------------------|-----|---------|---------|
| 23                                   | 8 7 | 4 3     | 0       |
| DATA BUS MOVE FIELD                  |     | 0 0 1 0 | d 0 1 0 |
| OPTIONAL EFFECTIVE ADDRESS EXTENSION |     |         |         |

**NOT D**

|                                      |     |         |         |
|--------------------------------------|-----|---------|---------|
| 23                                   | 8 7 | 4 3     | 0       |
| DATA BUS MOVE FIELD                  |     | 0 0 0 1 | d 1 1 1 |
| OPTIONAL EFFECTIVE ADDRESS EXTENSION |     |         |         |

**SUBL S,D**

|                                      |     |         |         |
|--------------------------------------|-----|---------|---------|
| 23                                   | 8 7 | 4 3     | 0       |
| DATA BUS MOVE FIELD                  |     | 0 0 0 1 | d 1 1 0 |
| OPTIONAL EFFECTIVE ADDRESS EXTENSION |     |         |         |

**CLR D**

|                                      |     |         |         |
|--------------------------------------|-----|---------|---------|
| 23                                   | 8 7 | 4 3     | 0       |
| DATA BUS MOVE FIELD                  |     | 0 0 0 1 | d 0 1 1 |
| OPTIONAL EFFECTIVE ADDRESS EXTENSION |     |         |         |

**ADDL S,D**

|                                      |     |         |         |
|--------------------------------------|-----|---------|---------|
| 23                                   | 8 7 | 4 3     | 0       |
| DATA BUS MOVE FIELD                  |     | 0 0 0 1 | d 0 1 0 |
| OPTIONAL EFFECTIVE ADDRESS EXTENSION |     |         |         |

**RND D**

|                                      |     |         |         |
|--------------------------------------|-----|---------|---------|
| 23                                   | 8 7 | 4 3     | 0       |
| DATA BUS MOVE FIELD                  |     | 0 0 0 1 | d 0 0 1 |
| OPTIONAL EFFECTIVE ADDRESS EXTENSION |     |         |         |

**SUBR S,D**

|                                      |     |         |         |
|--------------------------------------|-----|---------|---------|
| 23                                   | 8 7 | 4 3     | 0       |
| DATA BUS MOVE FIELD                  |     | 0 0 0 0 | d 1 1 0 |
| OPTIONAL EFFECTIVE ADDRESS EXTENSION |     |         |         |

**A**

## TST D

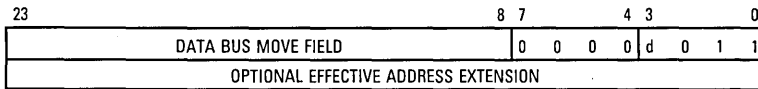

## ADDR S,D

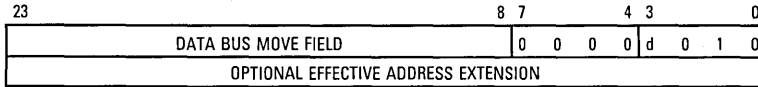

## ILLEGAL

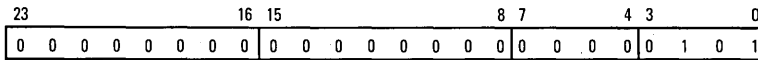

## MOVE S,D

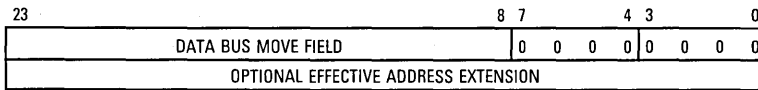

### A.9.5 Insane Instructions

Some instructions have legal operation codes but try to perform nonsensical operations. These instructions are called insane instructions. An example of an insane instruction is:

11xx 1111 1xxx xxxx yyyy xyyy X:ea ↗ B & Y:ea ↗ B

Both parallel moves write to the same register (register B) which puts an indeterminate result in B. These instructions are flagged as errors by the assembler. However, it is possible to produce illegal or insane instructions with the assembler using the DC command.

**A**

For the following insane instructions, let the operation code yyyy dyyy equal any combination of OPER CODE except:

1. 0000 0000 MOVE
2. 0000 1000 reserved
3. 0000 0100 RTI
4. 0000 1100 RTS

Also, no operation code is allowed that results in writing to a destination if there is a parallel move to that same destination. In each of the following tables, a duplicate destination is specified, which makes that specific case of the instruction an insane instruction.

**Table A-32. Insane X: and Y: Parallel Move**

| 23  | 16 15 | 8 7 | 0 | Parallel Instruction |
|---|-------|-----|---|----------------------|
| 1 w m m X X Y Y W r r M M R R R O P E R C O D E |       |     |   | X:ea,XX and Y:ea,YY  |
| 1 1 x x 1 1 1 1 1 x x x x x x y y y y x y y y   |       |     |   | X:ea ↗ B & Y:ea ↗ B  |
| 1 1 x x 1 0 1 0 1 x x x x x x y y y y x y y y   |       |     |   | X:ea ↗ A & Y:ea ↗ A  |
| 1 x x x 1 1 x x 1 x x x x x x y y y y 1 y y y   |       |     |   | X:ea ↗ B & ACC ↗ B   |
| 1 1 x x x x 1 1 x x x x x x y y y y 1 y y y     |       |     |   | Y:ea ↗ B & ACC ↗ B   |
| 1 x x x 1 0 x x 1 x x x x x x y y y y 0 y y y   |       |     |   | X:ea ↗ A & ACC ↗ A   |
| 1 1 x x x x 1 0 x x x x x x y y y y 0 y y y     |       |     |   | Y:ea ↗ A & ACC ↗ A   |

**Table A-33. Insane X: or Y: Parallel Move**

| 23  | 16 15 | 8 7 | 0 | Parallel Instruction           |
|---|-------|-----|---|--------------------------------|
| 0 1 0 1 S D D D W x x x x x x O P E R C O D E |       |     |   | X:xx,DDD or Y:xx,DDD           |
| 0 1 0 1 x x x 1 1 x x x x x x y y y y 1 y y y |       |     |   | X:xx ↗ B or Y:xx ↗ B & ACC ↗ B |
| 0 1 0 1 x x x 0 1 x x x x x x y y y y 0 y y y |       |     |   | X:xx ↗ A or Y:xx ↗ A & ACC ↗ A |

**Table A-34. Insane L: Parallel Move**

| 23  | 16 15 | 8 7 | 0 | Parallel Instruction      |
|---|-------|-----|---|---------------------------|
| 0 1 0 0 L 0 L L W x x x x x x O P E R C O D E |       |     |   | L:xx,LLL                  |
| 0 1 0 0 0 0 0 1 1 x x x x x x y y y y 1 y y y |       |     |   | L:xx ↗ B10 & ACC ↗ B      |
| 0 1 0 0 0 0 0 0 1 x x x x x x y y y y 0 y y y |       |     |   | L:xx ↗ A10 & ACC ↗ A      |
| 0 1 0 0 1 0 0 1 1 x x x x x x y y y y 1 y y y |       |     |   | L:xx ↗ B & ACC ↗ B        |
| 0 1 0 0 1 0 0 0 1 x x x x x x y y y y 0 y y y |       |     |   | L:xx ↗ A & ACC ↗ A        |
| 0 1 0 0 1 0 1 1 1 x x x x x x y y y y x y y y |       |     |   | L:xx ↗ B_A & ACC ↗ A or B |
| 0 1 0 0 1 0 1 0 1 x x x x x x y y y y x y y y |       |     |   | L:xx ↗ A_B & ACC ↗ A or B |



**Table A-35. Insane I: Parallel Move**

| 23  | 16 15 | 8 7 | 0 | Parallel Instruction |
|---|-------|-----|---|----------------------|
| 0 0 1 0 1 D D D i i i i i i i i O P E R C O D E |       |     |   | iiiiiii ↗ DDD        |
| 0 0 1 0 1 x x 1 x x x x x x y y y y 1 y y y     |       |     |   | Imm ↗ B & ACC ↗ B    |
| 0 0 1 0 1 x x 0 x x x x x x y y y y 0 y y y     |       |     |   | Imm ↗ A & ACC ↗ A    |

**Table A-36. Insane R: Parallel Move**

| 23          | 16 15   | 8 7     | 0                 | Parallel Instruction |
|-------------|---------|---------|-------------------|----------------------|
| 0 0 1 0 0 0 | d d d d | D D D D | O P E R C O D E   | d d d d ↗ D D D D    |
| 0 0 1 0 0 0 | x x x x | 0 1 x x | 1 y y y y 1 y y y | Reg ↗ B & ACC ↗ B    |
| 0 0 1 0 0 0 | x x x x | 0 1 x x | 0 y y y y 0 y y y | Reg ↗ A & ACC ↗ A    |

**Table A-37. Insane R:Y Parallel Move**

| 23      | 16 15       | 8 7             | 0               | Parallel Instruction |
|---------|-------------|-----------------|-----------------|----------------------|
| 0 0 0 1 | d X Y Y     | W 1 M M M R R R | O P E R C O D E | d ↗ X and Y:ea,YY    |
| 0 0 0 1 | x x 1 1 1 1 | x x x x x x     | y y y y 1 y y y | Y:ea ↗ B & ACC ↗ B   |
| 0 0 0 1 | x x 1 0 1 1 | x x x x x x     | y y y y 0 y y y | Y:ea ↗ A & ACC ↗ A   |

**Table A-38. Insane X:R Parallel Move**

| 23      | 16 15     | 8 7             | 0               | Parallel Instruction |
|---------|-----------|-----------------|-----------------|----------------------|
| 0 0 0 1 | X X d Y   | W 0 M M M R R R | O P E R C O D E | X:ea,XX and d ↗ Y    |
| 0 0 0 1 | 1 1 1 x x | 1 0 x x x x x x | y y y y 1 y y y | X:ea ↗ B & ACC ↗ B   |
| 0 0 0 1 | 1 1 0 x x | 1 0 x x x x x x | y y y y 0 y y y | X:ea ↗ A & ACC ↗ A   |

**Table A-39. Insane R:Y and X:R Parallel Move**

| 23      | 16 15       | 8 7             | 0               | Parallel Instruction        |
|---------|-------------|-----------------|-----------------|-----------------------------|
| 0 0 0 0 | 1 0 0 d s   | 0 M M M R R R R | O P E R C O D E | R:Y & X:R Class II MOVES    |
| 0 0 0 0 | 1 0 0 0 0 0 | 0 x x x x x x x | y y y y 0 y y y | A ↗ X:ea & X0 ↗ A & ACC ↗ A |
| 0 0 0 0 | 1 0 0 1 0 0 | 0 x x x x x x x | y y y y 1 y y y | B ↗ X:ea & X0 ↗ B & ACC ↗ B |
| 0 0 0 0 | 1 0 0 0 1 0 | 0 x x x x x x x | y y y y 0 y y y | Y0 ↗ A & A ↗ Y:ea & ACC ↗ A |
| 0 0 0 0 | 1 0 0 1 1 0 | 0 x x x x x x x | y y y y 1 y y y | Y0 ↗ B & B ↗ Y:ea & ACC ↗ B |

**A**

### A.9.6 Reserved Instruction Codes

The instruction codes shown in Table A-40 are reserved for future use and attempting to execute them will cause an illegal instruction interrupt.

**Table A-40. Reserved Operation Codes**

|             |        |           |                   |
|-------------|--------|-----------|-------------------|
| 00100000011 | MMRRR  | OPERCODE  |                   |
| 0010000000  | xxxxxx | OPERCODE  | (xxxxxx ≠ 000000) |
| 00000111x1  | xxxxxx | 0xxxxxx   |                   |
| 00000111x0  | xxxxxx | 1xxxxxx   |                   |
| 0000011010  | xxxxxx | 0x1xxxx   |                   |
| 0000011010  | xxxxxx | 0x0xxxx   |                   |
| 00000100    | xxxxxx | 0x1xxxx   |                   |
| 0000001     | xxxxxx | 1xxxxxx   |                   |
| 00000001    | xxxxxx | 1xxx Dxxx |                   |
| 000000010   | xxxxxx | 0xxx Dxxx |                   |
| 00000000    | xxxxxx | 0x1xxxx   |                   |

**A**

## APPENDIX B BENCHMARK PROGRAMS

Tables B-1 and B-2 provide benchmark numbers for 18 common DSP programs. The two tables are identical except that Table B-1 is for the 20.5-MHz DSP56001 and Table B-2 is for the 27-MHz DSP56001. The following four code examples (Figures B-1 to B-4) are representative of the benchmark programs shown in Tables B-1 and B-2. The code for these and other programs is free and available through the Dr. BuB electronic bulletin board. Figure B-1 is the code for the 20-tap FIR filter shown in Tables B-1 and B-2. Figure B-2 is the code for an FFT using a triple nested DO LOOP. Although this code is easier to understand and very compact, it is not as fast as the code used for the benchmarks shown in Tables B-1 and B-2, which are highly optimized using the symmetry of the FFT and the parallelism of the DSP. Figure B-3 is the code for the 8-pole cascaded canonic biquad IIR filter, which uses four coefficients (see Tables B-1 and B-2). Figure B-4 is the code for a 2N delayed least mean square (LMS) FIR adaptive filter, which is useful for echo cancellation and other adaptive filtering applications.

**Table B-1. 20.5-MHz Benchmark Results for the DSP56001R20**

| Benchmark Program                              | Sample Rate (Hz) or Execution Time | Memory Size (Words) | Number of Clock Cycles |
|--|------------------------------------|---------------------|------------------------|
| 20-Tap FIR Filter                              | 379.6 kHz                          | 50                  | 54                     |
| 64-Tap FIR Filter                              | 144.4 kHz                          | 138                 | 142                    |
| 67-Tap FIR Filter                              | 138.5 kHz                          | 144                 | 148                    |
| 8-Pole Cascaded Canonic Biquad IIR Filter (4×) | 410.0 kHz                          | 40                  | 50                     |
| 8-Pole Cascaded Canonic Biquad IIR Filter (5×) | 353.5 kHz                          | 45                  | 58                     |
| 8-Pole Cascaded Transpose Biquad IIR Filter    | 292.9 kHz                          | 48                  | 70                     |
| Dot Product                                    | 585.4 ns                           | 10                  | 12                     |
| Matrix Multiply 2×2 times 2×2                  | 2.049 μs                           | 33                  | 42                     |
| Matrix Multiply 3×3 times 3×1                  | 1.659 μs                           | 29                  | 34                     |
| M-to-M FFT 64 Point                            | 129.5 μs                           | 489                 | 2655                   |
| M-to-M FFT 256 Point                           | 645.1 μs                           | 1641                | 13255                  |
| M-to-M FFT 1024 Point                          | 3.231 ms                           | 6793                | 66240                  |
| P-to-M FFT 64 Point                            | 121.9 μs                           | 704                 | 2499                   |
| P-to-M FFT 256 Point                           | 458.2 μs                           | 2048                | 9394                   |
| P-to-M FFT 1024 Point                          | 1.958 ms                           | 7424                | 40144                  |

**B**



**Table B-2. 27-MHz Benchmark Results for the DSP56001R27**

| Benchmark Program                              | Sample Rate (Hz) or Execution Time | Memory Size (Words) | Number of Clock Cycles |
|--|------------------------------------|---------------------|------------------------|
| 20-Tap FIR Filter                              | 500.0 kHz                          | 50                  | 54                     |
| 64-Tap FIR Filter                              | 190.1 kHz                          | 138                 | 142                    |
| 67-Tap FIR Filter                              | 182.4 kHz                          | 144                 | 148                    |
| 8-Pole Cascaded Canonic Biquad IIR Filter (4×) | 540.0 kHz                          | 40                  | 50                     |
| 8-Pole Cascaded Canonic Biquad IIR Filter (5×) | 465.5 kHz                          | 45                  | 58                     |
| 8-Pole Cascaded Transpose Biquad IIR Filter    | 385.7 kHz                          | 48                  | 70                     |
| Dot Product                                    | 444.4 ns                           | 10                  | 12                     |
| Matrix Multiply 2×2 times 2×2                  | 1.556 μs                           | 33                  | 42                     |
| Matrix Multiply 3×3 times 3×1                  | 1.259 μs                           | 29                  | 34                     |
| M-to-M FFT 64 Point                            | 98.33 μs                           | 489                 | 2655                   |
| M-to-M FFT 256 Point                           | 489.8 μs                           | 1641                | 13255                  |
| M-to-M FFT 1024 Point                          | 2.453 ms                           | 6793                | 66240                  |
| P-to-M FFT 64 Point                            | 92.56 μs                           | 704                 | 2499                   |
| P-to-M FFT 256 Point                           | 347.9 μs                           | 2048                | 9394                   |
| P-to-M FFT 1024 Point                          | 1.489 ms                           | 7424                | 40144                  |

```

;*****
;Motorola Austin DSP Operation   June 30, 1988
;*****
;DSP56000/1
;20-tap FIR filter
;File name: 1-56.asm
;*****
; Maximum sample rate: 379.6 kHz at 20.5 MHz/500.0 kHz at 27.0 MHz
; Memory Size: Prog: 4+6 words; Data: 2x20 words
; Number of clock cycles: 54 (27 instruction cycles)
; Clock Frequency: 20.5 MHz/27.0 MHz
; Instruction cycle time: 97.6 ns/74.1 ns
;*****
; This FIR filter reads the input sample
; from the memory location Y:input
; and writes the filtered output sample
; to the memory location Y:output
;
; The samples are stored in the X memory
; The coefficients are stored in the Y memory
;*****

```

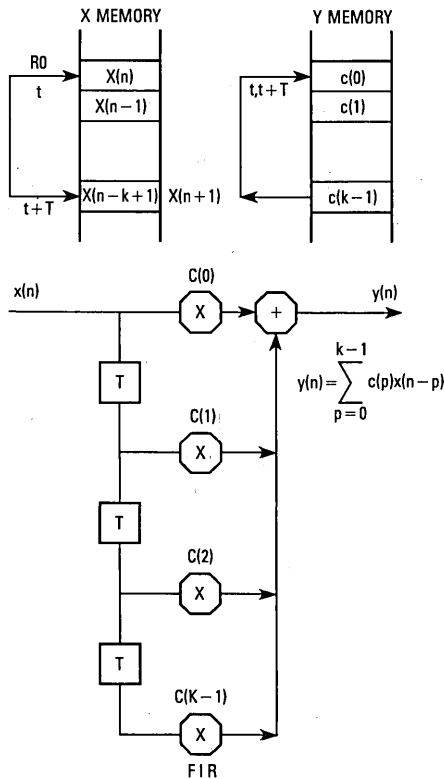

Figure B-1. 20-Tap FIR Filter Example (Sheet 1 of 2)

```

;
;
;
;*****
;
;
;          initialization
;*****
n          equ          20
start     equ          $40
wddr     equ          $0
cddr     equ          $0
input    equ          $ffe0
output   equ          $ffe1
;
;          org          p:start
;          move        #wddr,r0          ;r0 ← samples
;          move        #cddr,r4          ;r1 ← coefficients
;          move        #n-1,m0          ;set modulo arithmetic
;          move        m0,m4            ;for the 2 circular buffers
;
;          opt          cc
;          filter loop :8+(n-1) cycles
;*****
;          movep       y:input,x:(r0)    ;input sample in memory
;          clr         a                  x:(r0)+,x0    y:(r4)+,y0
;
;          rep         #n-1
;          mac         x0,y0,a           x:(r0)+,x0    y:(r4)+,y0
;          macr        x0,x0,a           (r0)-
;
;          movep       a,y:output        ;output filtered sample
;*****
end

```

Figure B-1. 20-Tap FIR Filter Example (Sheet 2 of 2)

```

;This program originally available on the Motorola DSP bulletin board.
;It is provided under a DISCLAIMER OF WARRANTY available from
;Motorola DSP Operation, 6501 William Cannon Drive, Austin, Tx., 78735.

```

```

;Radix-2, In-Place, Decimation-In-Time FFT (smallest code size).

```

```

;Last Update 30 Sep 86      Version 1.1

```

```

fftr2a      macro      points,data,coef
fftr2a      ident      1,1

```

```

;Radix-2 Decimation-In-Time In-Place FFT Routine

```

```

;      Complex input and output data
;      Real data in X memory
;      Imaginary data in Y memory
;      Normally ordered input data
;      Bit reversed output data
;      Coefficient lookup table
;      -Cosine values in X memory
;      -Sine vaues in Y memory

```

```

;Macro Call — fftr2a      points,data,coef

```

```

;      points      number of points (2-32768, power of 2)
;      data      start of data buffer
;      coef      start of sine/cosine table

```

```

;Alters Data ALU Registers

```

```

;      x1      x0      y1      y0
;      a2      a1      a0      a
;      b2      b1      b0      b

```

```

;Alters Address Registers

```

```

;      r0      n0      m0
;      r1      n1      m1
;      n2
;
;      r4      n4      m4
;      r5      n5      m5
;      r6      n6      m6

```

```

;Alters Program Control Registers

```

```

;      pc      sr

```

```

;Uses 6 locations on System Stack

```

**Figure B-2. Radix 2, In-Place, Decimation-In-Time FFT (Sheet 1 of 2)**

**B**

;Latest Revision — September 30, 1986

```

;
    move    #points/2,n0      ;initialize butterflies per group
    move    #1,n2            ;initialize groups per pass
    move    #points/4,n6     ;initialize C pointer offset
    move    #-1,m0          ;initialize A and B address modifiers
    move    m0,m1           ;for linear addressing
    move    m0,m4
    move    m0,m5
    move    #0,m6           ;initialize C address modifier for
                           ;reverse carry (bit-reversed) addressing
;
;Perform all FFT passes with triple nested DO loop
;
    do      #@cvi (@log(points)/@log(2)+0.5),_end_pass
    move    #data,r0        ;initialize A input pointer
    move    r0,r4           ;initialize A output pointer
    lua    (r0)+n0,r1      ;initialize B input pointer
    move    #coef,r6       ;initialize C input pointer
    lua    (r1)-,r5        ;initialize B output pointer
    move    n0,n1          ;initialize pointer offsets
    move    n0,n4
    move    n0,n5

    do      n2,_end_grp
    move    x:(r1),X1      y:(r6),y0      ;lookup -sine and
                           ; - cosine values
    move    x:(r5),a      y:(r0),b      ;preload data
    move    x:(r6)+n6,x0  ;update C pointer

    do      n0,_end_bfy
    mac     x1,y0,b      y:(r1)+,y1      ;Radx 2 DIT
                           ;butterfly kernel
    macr    -x0,y1,b    a,x:(r5)+      y:(r0),a
    subl   b,a          x:(r0),b      b,y:(r4)
    mac     -x1,x0,b    x:(r0)+,a     a,y:(r5)
    macr    -y1,y0,b    x:(r1),x1
    subl   b,a          b,x:(r4)+     y:(r0),b
_end_bfy
    move    a,x:(r5)+n5    y:(r1)+n1,y1  ;update A and B pointers
    move    x:(r0)+n0,x1  y:(r4)+n4,y1
_end_grp
    move    n0,b1          ;divide butterflies per group by two
    lsr    b    n2,a1      ;multiply groups per pass by two
    lsl    a    b1,n0
    move    a1,n2
_end_pass
    endm

```

**B**

Figure B-2. Radix 2, In-Place, Decimation-In-Time FFT (Sheet 2 of 2)

\*\*\*\*\*

;Motorola Austin DSP Operation June 30, 1988

\*\*\*\*\*

;DSP56000/1

;8-pole 4-multiply cascaded canonic IIR filter

;File name: 4-56.asm

\*\*\*\*\*

; Maximum sample rate: 410.0 kHz at 20.5 MHz/540.0 kHz at 27.0 MHz

; Memory Size: Prog: 6 + 10 words; Data: 4(2+4) words

; Number of clock cycles: 50 (25 instruction cycles)

; Clock Frequency: 20.5 MHz/27.0 MHz

; Cycle time: 97.5 ns/74.1 ns

\*\*\*\*\*

; This IIR filter reads the input sample  
 ; from the memory location Y:input  
 ; and writes the filtered output sample  
 ; to the memory location Y:output

; The samples are stored in the X memory  
 ; The coefficients are stored in the Y memory

; The equations of the filter are:

$$w(n) = x(n) - ai1*w(n-1) - ai2*w(n-2)$$

$$y(n) = w(n) + bi1*w(n-1) + bi2*w(n-2)$$

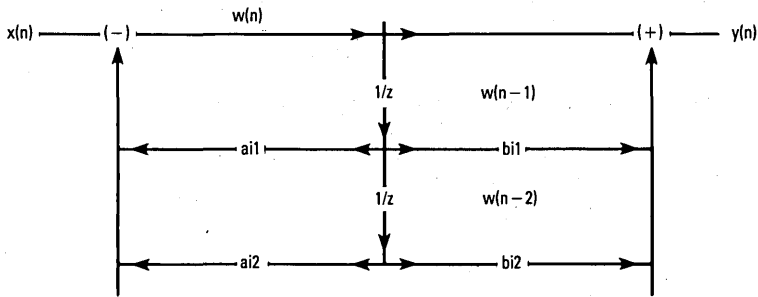

Figure B-3. 8-Pole 4-Multiply Cascaded Canonic IIR Filter (Sheet 1 of 2)



;newlms2n.asm

; New Implementation of the delayed LMS on the DSP56000 Revision C

;Memory map:

```

; Initial X
; x(n) x(n-1) x(n-2) x(n-3) x(n-4) H hx h0 h1 h2 h3
; ] ] ]
; r0 r5 r4

```

;hx is an unused value to make the calculations faster.

```

;
; opt      cc
; ntaps    equ      4
; input    equ      $FFC0
; output   equ      $FFC1

```

```

; org      x:$0
; state    ds      5
; org      y:$0
; coef     ds      5
;

```

```

; org      p:$40
; move     #state,r0      ;start of X
; move     #2,n0
; move     #ntaps,m0      ;mod 5
; move     #coef+1,r4     ;coefficients
; move     #ntaps,m4      ;mod 5
; move     #coef,r5       ;coefficients
; move     m4,m5          ;mod 5

```

```

;_smploop
; move     y:input,a      ;get input sample
; move     a,x:(r0)       ;save input sample
;                                     Prog   lcyc
;                                     word
;                                     1     1

```

;error signal is in y1

;FIR sum in a=a+h(k) old\*x(n-k)

;h(k)new in b=h(k)old+error\*x(n-k-1)

```

; clr      a      x:(r0)+,x0      ;x0=x(n)
; move     x:(r0)+,x1 y:(r4)+,y0 ;x1=x(n-1),y0=h(0)
; do       #taps/2,_lms
; mac     x0,y0,a  y0,b      b,y:(r5)+ ;a=h(0)*x(n),b=h(0)
; macr    x1,y1,b  x:(r0)+,x0 y:(r4)+,y0 ;b=h(0)+e*x(n-1)=h(0)new
;                                     ;x0=x(n-2) y0=h(1)
; mac     x1,y0,a  y0,b      b,y:(r5)+ ;a=a+h(1)*x(n-1) b=h(1)
; macr    x0,y1,b  x:(r0)+,x1 y:(r4)+,y0 ;b=h(1)+e*x(n-2)
;                                     ;x1=x(n-3) y0=H(2)
;

```

```

;_lms
; move     b,y:(r5)+      ;save last new c ( )
; move     (r0)-n0       ;pointer update
;                                     1     1
;                                     1     1

```

;(Get d(n), subtract fir output (reg a), multiply by "u", put the result in y1. This section is application dependent.)

```

; move     a,y:output      ;output fir if desired
; jmp     _smploop
; end
;

```

Totals: 11 2N+8

Figure B-4. LMS FIR Adaptive Filter



## APPENDIX C ADDITIONAL SUPPORT

User support from the conception of a design through completion is available from Motorola and third-party companies as shown in the following list:

|                     | <b>Motorola</b>  | <b>Third Party</b>   |
|---------------------|--|--|
| Design              | Data Sheets<br>Application Notes<br>Application Bulletins<br>Software Examples<br>Simulator                                    | Data Acquisition Packages<br>Filter Design Packages<br>Operating System Software   |
| Prototyping         | Assembler<br>Linker<br>C Compiler<br>Simulator<br>Application Development System (ADS)<br>In-Circuit Emulator<br>Cable for ADS | Logic Analyzer with<br>DSP56000/DSP56001 ROM Packages<br>In-Circuit Emulators<br>Data Acquisition Cards<br>DSP Development System<br>Cards<br>Operating System Software<br>Debug Software                      |
| Design Verification | Application Development System (ADS)<br>In-Circuit Emulator<br>Simulator   | Data Acquisition Packages<br>Logic Analyser with<br>DSP56000/DSP56001 ROM Packages<br>Data Acquisition Cards<br>DSP Development System<br>Cards<br>Application-Specific<br>Development Tools<br>Debug Software |

The following is a partial list of the support available for the DSP56000/DSP56001. Additional information can be obtained through Dr. BuB or the appropriate support telephone service.

### **Motorola DSP Product Support**

- DSP56000CLASx Design-In Software Package which includes:
  - Relocatable Macro Assembler
  - Linker
  - Simulator (simulates single or multiple DSP56000/DSP56001s)
  - Librarian
- DSP56KCCx Full Kernighan and Ritchie C Compiler
- DSP320to56001 Translator Software
- DSP56000/DSP56001 Applications Development System (ADS)
- Support Integrated Circuits
- DSP Bulletin Board (Dr. BuB)
- Motorola DSP Newsletter
- Motorola Field Application Engineers (FAEs)
  - See your local telephone directory for the Motorola Semiconductor Sector sales office telephone number.
- Design Hotline
- Applications Assistance
- Marketing Information
- Third-Party Support Information
- University Support Information

### **DSP56000CLASx Assembler/Simulator**

The macro cross assembler and simulator run on:

1. IBM<sup>®</sup> PC, XT, and AT under DOS 2.x and 3.x
2. Macintosh<sup>™</sup> II under MAC OS 4.1 or later
3. SUN-3<sup>™</sup> under UNIX<sup>™</sup> BSD 4.2
4. VAX<sup>™</sup> under VMS<sup>™</sup> 4.5 or later
5. NeXT<sup>™</sup> under Mach

IBM is a trademark of International Business Machines.  
Macintosh is a trademark of Apple Computer, Inc.  
SUN-3 is a trademark of Sun Microsystems, Inc.  
UNIX is a registered trademark of AT&T Bell Laboratories.  
VAX and VMS are trademarks of Digital Equipment Corp.  
NeXT is a trademark of NeXT, Inc.

### **Macro Cross Assembler Features:**

- Production of relocatable object modules compatible with linker program when in relocatable mode
- Production of absolute files compatible with simulator program when in absolute mode
- Supports full instruction set, memory spaces, and parallel data transfer fields of the DSP56000/DSP56001
- Modular programming features: local labels, sections, and external definition/reference directives
- Nested macro processing capability with support for macro libraries
- Complex expression evaluation including boolean operators
- Built-in functions for data conversion, string comparison, and common transcendental math functions
- Directives to define circular and bit-reversed buffers
- Extensive error checking and reporting

### **Simulator Features:**

- Simulation of DSP56001 (default) or DSP56000
- Simulation of multiple DSP56000/DSP56001s
- Linkable object code modules:
  - Nondisplay simulator library
  - Display simulator library
- C language source code for:
  - Screen management functions
  - Terminal I/O functions
  - Simulation examples
- Single stepping through object programs
- Up to 99 conditional or unconditional breakpoints
- Program patching using a single-line assembler/disassembler
- Instruction, clock cycle, and histogram counters
- Session and/or command logging for later reference
- ASCII input/output files for peripherals
- Help-file and help-line display of simulator commands
- Loading and saving of files to/from simulator memory
- Macro command definition and execution
- Display enable/disable of registers and memory
- Hexadecimal/decimal/binary calculator

## C Language Compiler

### DSP56KCCx C Language Compiler Features:

- Full Kernighan and Ritchie C
- Structures/Unions
- Floating Point
- In-line assembler language code compatibility
- Full function preprocessor for:
  - Macro definition/expansion
  - File inclusion
  - Conditional compilation
- Full error detection and reporting

## DSP320to56001 Translator

### DSP320to56001 Translator Features:

- Translates any TMS32010 linked object code to DSP56001 source assembler code
- Two modes of operation:
  - Translates to DSP56001 source assembler code for optimization and assembly using DSP56000CLASx
  - Translates and runs "as is" directly and immediately on the DSP56000ADSx
- C language DSP320to56001 source code is provided in addition to IBM PC/XT/AT object code to allow:
  - User modification for TMS32020 or TMS320C25 translation
  - User compilation to accommodate different host platforms

## DSP56000ADSx Application Development System

### DSP56000ADS Application Development System Hardware Features:

- Full-speed 20.48-MHz operation (upgradable to 27 MHz)
- Multiple application development module (ADM) support with programmable ADM addresses
- 8K/32Kx24 user-configurable RAM for DSP56000/DSP56001 code development
- 1Kx24 monitor ROM expandable to 4Kx24
- 96-pin Euro-card connector making all DSP56001 pins accessible
- In-circuit emulation capabilities when used with the DSP56KEMULTRCABL cable
- Separate berg pin connectors for alternate accessing of serial or host/DMA ports
- ADM can be used in standalone configuration
- No external power supply needed when connected to a host platform

### **DSP56000ADSx Application Development System Software Features:**

- Single/multiple stepping through DSP56000/DSP56001 object programs
- Up to 99 conditional or unconditional breakpoints
- Program patching using a single-line assembler/disassembler
- Session and/or command logging for later reference
- Loading and saving files to/from ADM memory
- Macro command definition and execution
- Display enable/disable of registers and memory
- Debug commands supporting multiple ADMs
- Hexadecimal/decimal/binary calculator
- Host operating system commands from within ADS user interface program
- Multiple OS I/O file access from DSP56000/DSP56001 object programs
- Fully compatible with the DSP56000CLASx design-in software package
- On-line help screens for each command and DSP56000/DSP56001 register

### **Support Integrated Circuits:**

- 8K × 24 Static RAM (available Q4, 1989)
- DSP56ADC16 16-bit, 100-kHz analog-to-digital Converter

### **Dr. BuB Electronic Bulletin Board**

Dr. BuB is an electronic bulletin board providing **free** source code for a large variety of topics that can be used to develop applications with Motorola DSP products. The software library includes approximately 100 files including FFTs, FIR filters, IIR filters, lattice filters, matrix algebra routines, companding routines, floating-point routines, a software debug monitor, and others. In addition, the latest product information and documentation (including information on new products and improvements on existing products) is posted. Questions concerning Motorola DSP products posted on Dr. BuB are answered promptly. Access to Dr. BuB is through the following phone numbers:

(212A — 300/1200 Baud) (512) 891-DSP1

(V.22 — 1200 Baud) (512) 891-DSP2

(V.22bis — 2400 Baud) (512) 891-DSP3

Format: 7 data bits, even parity, 1 stop bit

User ID=guest



The following is a partial list of the software available on Dr. BuB.

| Document ID                     | Version | Synopsis  | Size |
|---------------------------------|---------|---|------|
| <b>Codec Routines:</b>          |         |   |      |
| loglin.asm                      | 1.0     | Companded CODEC to linear PCM data conversion                           | 4572 |
| loglin.hlp                      |         | Help for loglin.asm   | 1479 |
| loglint.asm                     | 1.0     | Test program for loglin.asm   | 2184 |
| loglint.hlp                     |         | Help for loglint.asm  | 1993 |
| linlog.asm                      | 1.1     | Linear PCM to companded CODEC data conversion                           | 4847 |
| linlog.hlp                      |         | Help for linlog.asm   | 1714 |
| <b>Fast Fourier Transforms:</b> |         |   |      |
| sincos.asm                      | 1.2     | Sine-Cosine Table Generator for FFTs                                    | 1185 |
| sincos.hlp                      |         | Help for sincos.asm   | 887  |
| sinewave.asm                    | 1.1     | Full-Cycle Sinewave Table Generator Macro                               | 1029 |
| sinewave.hlp                    |         | Help for sinewave.asm   | 1395 |
| fftr2a.asm                      | 1.1     | Radix 2, In-Place, DIT FFT (smallest)                                   | 3386 |
| fftr2a.hlp                      |         | Help for fftr2a.asm   | 2693 |
| fftr2at.asm                     | 1.1     | Test Program for FFTs (fftr2a.asm)                                      | 999  |
| fftr2at.hlp                     |         | Help for fftr2at.asm  | 563  |
| fftr2b.asm                      | 1.1     | Radix 2, In-Place, DIT FFT (faster)                                     | 4290 |
| fftr2b.hlp                      |         | Help for fftr2b.asm   | 3680 |
| fftr2c.asm                      | 1.2     | Radix 2, In-Place, DIT FFT (even faster)                                | 5991 |
| fftr2c.hlp                      |         | Help for fftr2c.asm   | 3231 |
| fftr2d.asm                      | 1.0     | Radix 2, In-Place, DIT FFT 3727 (using DSP56001 sine-cosine ROM tables) | 3727 |
| fftr2d.hlp                      |         | Help for fftr2d.asm   | 3457 |
| fftr2dt.asm                     | 1.0     | Test program for fftr2d.asm   | 1287 |
| fftr2dt.hlp                     |         | Help for fftr2dt.asm  | 614  |

| Document ID     | Version | Synopsis   | Size |
|-----------------|---------|--|------|
| fftr2e.asm      | 1.0     | 1024 Point, Non-In-Place, FFT (3.39ms)   | 8976 |
| fftr2e.hlp      |         | Help for fftr2e.asm  | 5011 |
| fftr2et.asm     | 1.0     | Test program for fftr2e.asm  | 984  |
| fftr2et.hlp     |         | Help for fftr2et.asm   | 408  |
| dct1.asm        | 1.2     | Discrete Cosine Transform using FFT  | 5471 |
| dct1.hlp        | 1.1     | Help file for dct1.asm   | 970  |
| fftr2cc.asm     | 1.0     | Radix 2, In-place Decimation-in-time<br>complex FFT macro                              | 6524 |
| fftr2cc.hlp     | 1.0     | Help file for fftr2cc.asm  | 3533 |
| fftr2cn.asm     | 1.0     | Radix 2, Decimation-in-time Complex FFT<br>macro with normally ordered<br>input/output | 6584 |
| fftr2cn.hlp     | 1.0     | Help file for fftr2cn.asm  | 2468 |
| fftr2en.asm     | 1.0     | 1024 point, not-in-place, complex FFT<br>macro with normally ordered<br>input/output   | 9723 |
| fftr2en.hlp     | 1.0     | Help file for fftr2en.asm  | 4886 |
| dhit1.asm       | 1.0     | Routine to compute Hilbert transform in<br>the frequency domain                        | 1851 |
| <b>Filters:</b> |         |  |      |
| fir.asm         | 1.0     | Direct Form FIR Filter   | 545  |
| fir.hlp         |         | Help for fir.asm   | 2161 |
| firt.asm        | 1.0     | Test program for fir.asm   | 1164 |
| iir1.asm        | 1.0     | Direct Form Second-Order All-Pole<br>IIR Filter  | 656  |
| iir1.hlp        |         | Help for iir1.asm  | 1786 |
| iir1t.asm       | 1.0     | Test program for iir1.asm  | 1157 |
| iir2.asm        | 1.0     | Direct Form Second-Order All-Pole IIR<br>Filter with Scaling                           | 801  |
| iir2.hlp        |         | Help for iir2.asm  | 2286 |

| Document ID                     | Version | Synopsis  | Size        |
|---------------------------------|---------|---|-------------|
| iir2t.asm                       | 1.0     | Test program for iir2.asm   | 1311        |
| iir3.asm                        | 1.0     | Direct Form Arbitrary-Order All-Pole IIR Filter                         | 776         |
| iir3.hlp                        |         | Help for iir3.asm   | 2605        |
| iir3t.asm                       | 1.0     | Test program for iir3.asm   | 1309        |
| iir4.asm                        | 1.0     | Second-Order Direct Canonic IIR Filter (Biquad IIR Filter)              | 713         |
| iir4.hlp                        |         | Help for iir4.asm   | 2255        |
| iir4t.asm                       | 1.0     | Test program for iir4.asm   | 1202        |
| iir5.asm                        | 1.0     | Second-Order Direct Canonic IIR Filter with Scaling (Biquad IIR Filter) | 842         |
| iir5.hlp                        |         | Help for iir5.asm   | 2803        |
| iir5t.asm                       | 1.0     | Test program for iir5.asm   | 1289        |
| iir6.asm<br>iir6.hlp            | 1.0     | Arbitrary-Order Direct Canonic IIR Filter<br>Help for iir6.asm          | 923<br>3020 |
| iir6t.asm                       | 1.0     | Test program for iir6.asm   | 1377        |
| iir7.asm<br>iir7.hlp            | 1.0     | Cascaded Biquad IIR Filters<br>Help for iir7.asm                        | 900<br>3947 |
| iir7t.asm                       | 1.0     | Test program for iir7.asm   | 1432        |
| lms.hlp                         | 1.0     | LMS Adaptive-Filter Algorithm   | 5818        |
| transiir.asm                    | 1.0     | Implements the transposed IIR filter                                    | 1981        |
| transiir.hlp                    | 1.0     | Help file for transiir.asm  | 974         |
| <b>Floating-Point Routines:</b> |         |   |             |
| fpcalls.hlp                     | 2.0     | Storage format and arithmetic representation definition                 | 10600       |
| fplist.asm                      | 2.1     | Subroutine calling conventions  | 11876       |
| fprevs.hlp                      | 2.0     | Test file that lists all subroutines                                    | 1601        |
|                                 | 2.0     | Latest revisions of floating pt. lib                                    | 1799        |



| Document ID       | Version | Synopsis   | Size |
|-------------------|---------|--|------|
| fpinit.asm        | 2.0     | Library initialization subroutine                      | 2329 |
| fpadd.asm         | 2.0     | Floating-point add                                     | 3860 |
| fpsub.asm         | 2.1     | Floating-point subtract                                | 3072 |
| fpcmp.asm         | 2.1     | Floating-point compare                                 | 2605 |
| fpmpy.asm         | 2.0     | Floating-point multiply                                | 2250 |
| fpmac.asm         | 2.1     | Floating-point multiply-accumulate                     | 2712 |
| fpdiv.asm         | 2.0     | Floating-point divide                                  | 3835 |
| fpsqrt.asm        | 2.0     | Floating-point square root                             | 2873 |
| fpneg.asm         | 2.0     | Floating-point negate                                  | 2026 |
| fpabs.asm         | 2.0     | Floating-point absolute value                          | 1953 |
| fpscale.asm       | 2.0     | Floating-point scaling                                 | 2127 |
| fpfix.asm         | 2.0     | Floating to fixed-point conversion                     | 3953 |
| fpfloat.asm       | 2.0     | Fixed to floating-point conversion                     | 2053 |
| fpceil.asm        | 2.0     | Floating-point CEIL subroutine                         | 1771 |
| durbin.asm        | 1.0     | Solution for LPC coefficients                          | 5615 |
| durbin.hlp        | 1.0     | Help file for DURBIN.ASM                               | 2904 |
| fpfrac.asm        | 2.0     | Floating-point FRACTION subroutine                     | 1862 |
| <b>Functions:</b> |         |  |      |
| log2.asm          | 1.0     | Log base 2 by polynomial approximation                 | 1118 |
| log2.hlp          |         | Help for log2.asm                                      | 719  |
| log2t.asm         | 1.0     | Test program for log.asm                               | 1018 |
| log2nrm.asm       | 1.0     | Normalizing base 2 logarithm macro                     | 2262 |
| log2nrm.hlp       |         | Help for log2nrm.asm                                   | 676  |
| log2nrmt.asm      | 1.0     | Test program for log2nrm.asm                           | 1084 |
| exp2.asm          | 1.0     | Exponential base 2 by polynomial approximation         | 926  |
| exp2.hlp          |         | Help for exp2.asm                                      | 759  |
| exp2t.asm         | 1.0     | Test program for exp2.asm                              | 1019 |
| sqrt1.asm         | 1.0     | Square Root by polynomial approximation 7-bit accuracy | 991  |
| sqrt1.hlp         |         | Help for sqrt1.asm                                     | 779  |

| Document ID             | Version | Synopsis  | Size |
|-------------------------|---------|---|------|
| sqrt1t.asm              | 1.0     | Test program for sqrt1.asm  | 1065 |
| sqrt2.asm               | 1.0     | Square Root by polynomial approximation 10-bit accuracy           | 899  |
| sqrt2.hlp               |         | Help for sqrt2.asm  | 776  |
| sqrt2t.asm              | 1.0     | Test program for sqrt2.asm  | 1031 |
| sqrt3.asm               | 1.0     | Full precision Square Root Macro                                  | 1388 |
| sqrt3.hlp               |         | Help for sqrt3.asm  | 794  |
| sqrt3t.asm              | 1.0     | Test program for sqrt3.asm  | 1053 |
| t li.asm                | 1.1     | Linear table lookup/interpolation routine for function generation | 3253 |
| t li.hlp                | 1.1     | Help for tli.asm  | 1510 |
| bingray.asm             | 1.0     | Binary to Gray code conversion macro                              | 601  |
| bingrayt.asm            | 1.0     | Test program for bingray.asm                                      | 991  |
| rand1.asm               | 1.1     | Pseudo Random Sequence Generator                                  | 2446 |
| rand1.hlp               |         | Help for rand1.asm  | 704  |
| <b>Lattice Filters:</b> |         |   |      |
| latfir1.asm             | 1.0     | Lattice FIR Filter Macro  | 1156 |
| latfir1.hlp             |         | Help for latfir1.asm  | 6327 |
| latfir1t.asm            | 1.0     | Test program for latfir1.asm                                      | 1424 |
| latfir2.asm             | 1.0     | Lattice FIR Filter Macro (modified modulo count)                  | 1174 |
| latfir2.hlp             |         | Help for latfir2.asm  | 1295 |
| latfir2t.asm            | 1.0     | Test program for latfir2.asm                                      | 1423 |
| latiir.asm              | 1.0     | Lattice IIR Filter Macro  | 1257 |
| latiir.hlp              |         | Help for latiir.asm   | 6402 |
| latiirt.asm             | 1.0     | Test program for latiir.asm                                       | 1407 |

| Document ID                  | Version | Synopsis  | Size |
|------------------------------|---------|---|------|
| latgen.asm                   | 1.0     | Generalized Lattice FIR/IIR Filter Macro                        | 1334 |
| latgen.hlp                   |         | Help for latgen.asm   | 5485 |
| latgent.asm                  | 1.0     | Test program for latgen.asm                                     | 1269 |
| latnrm.asm                   | 1.0     | Normalized Lattice IIR Filter Macro                             | 1407 |
| latnrm.hlp                   |         | Help for latnrm.asm   | 7475 |
| latnrmt.asm                  | 1.0     | Test program for latnrm.asm                                     | 1595 |
| <b>Matrix Operations:</b>    |         |   |      |
| matmul1.asm                  | 1.0     | $[1 \times 3][3 \times 3] = [1 \times 3]$ Matrix Multiplication | 1817 |
| matmul1.hlp                  |         | Help for matmul1.asm  | 527  |
| matmul2.asm                  | 1.0     | General Matrix Multiplication, $C=AB$                           | 2650 |
| matmul2.hlp                  |         | Help for matmul2.asm  | 780  |
| matmul3.asm                  | 1.0     | General Matrix Multiply-Accumulate,<br>$C=AB+Q$                 | 2815 |
| matmul3.hlp                  | 1.0     | Help for matmul3.asm  | 865  |
| <b>Reed-Solomon Encoder:</b> |         |   |      |
| readme.rs                    | 1.0     | Instructions for Reed-Solomon coding                            | 5200 |
| rscd.asm                     | 1.0     | Reed-Solomon coder for DSP56000<br>simulator                    | 5822 |
| newc.c                       | 1.0     | Reed-Solomon coder coded in C                                   | 4075 |
| table1.asm                   | 1.0     | Include file for R-S coder                                      | 7971 |
| table2.asm                   | 1.0     | Include file for R-S coder                                      | 4011 |
| <b>Sorting Routines:</b>     |         |   |      |
| sort1.asm                    | 1.0     | Array Sort by Straight Selection                                | 1312 |
| sort1.hlp                    |         | Help for sort1.asm  | 1908 |
| sort1t.asm                   | 1.0     | Test program for sort1.asm                                      | 689  |
| sort2.asm                    | 1.1     | Array Sort by Heapsort Method                                   | 2183 |
| sort2.hlp                    |         | Help for sort2.asm  | 2004 |
| sort2t.asm                   | 1.0     | Test program for sort2.asm                                      | 700  |

| Document ID                  | Version | Synopsis  | Size |
|------------------------------|---------|---|------|
| <b>Speech:</b>               |         |   |      |
| lgsol1.asm                   | 2.0     | Leroux-Gueguen solution for PARCOR (LPC) coefficients | 4861 |
| lgsol1.hlp                   |         | Help for lgsol1.asm                                   | 3971 |
| durbin1.asm                  | 1.2     | Durbin Solution for PARCOR (LPC) coefficients         | 6360 |
| durbin1.hlp                  |         | Help for durbin1.asm                                  | 3616 |
| <b>Standard I/O Equates:</b> |         |   |      |
| ioequ.asm                    | 1.1     | Motorola Standard I/O Equate File                     | 8774 |
| ioequlc.asm                  | 1.1     | Lower Case Version of ioequ.asm                       | 8788 |
| intequ.asm                   | 1.0     | Standard Interrupt Equate File                        | 1082 |
| intequlc.asm                 | 1.0     | Lower Case Version of intequ.asm                      | 1082 |

### Motorola DSP News

The Motorola **DSP News** is a quarterly newsletter providing information on new products, application briefs, questions and answers, DSP product information, third-party product news, etc. This newsletter is free and is available upon request by calling the marketing information phone number listed below.

### Motorola Field Application Engineers

Information and assistance for DSP applications is available through the local Motorola field office. See your local telephone directory for telephone numbers or call (512) 891-2030.

### Design Hotline — 1-800-521-6274

This is the Motorola number for information pertaining to any Motorola product.

### **Applications Assistance — (512) 891-3230**

Design assistance for specific DSP applications is available by calling this number.

### **Marketing Information — (512) 891-2030**

Marketing information including brochures, application notes, manuals, price quotes, etc. for Motorola DSP-related products are available by calling this number.

### **Third-Party Support Information — (512) 891-3098**

Information concerning third-party manufacturers using and supporting Motorola DSP products is available by calling this number. Third-party support includes:

- Filter design software
- Logic analyzer support
- VME boards, IBM-PC/XT/AT boards, MACII boards
- Development systems
- Data conversion cards
- Operating system software
- Debug software

Additional information is available on Dr. Bub and in **DSP News**.

### **University Support — (512) 891-3098**

Information concerning university support programs and university discounts for all Motorola DSP products is available by calling this number.

### **Training Courses — (602) 897-8665**

There are two courses available for the DSP56000 Family:

1. Introduction to the DSP56000/DSP56001 (MTTA5) which is a 4.5-hour audio-tape course on the DSP56000/DSP56001 architecture and programming.
2. Introduction to the DSP56000/DSP56001 (MTT31) which is a four-day instructor-led course and laboratory covering the details of the DSP56000/DSP56001 architecture and programming.

Additional information is available by writing:

Motorola SPS Training and Technical Operations  
Mail Drop HW68  
P. O. Box 21007  
Phoenix, Arizona 85036

or by calling the number above. A technical training catalog is available which describes these courses and gives the current training schedule and prices.



## Text Books

A list of DSP-related books is included here as an aid for the engineer who is new to the field of DSP. This is a partial list of DSP references intended to help the new user find useful information in some of the many areas of DSP applications. Many books could be included in several categories but are not repeated.

### General DSP:

#### ADVANCED TOPICS IN SIGNAL PROCESSING

Jae S. Lim and Alan V. Oppenheim  
Englewood Cliffs, NJ: Prentice-Hall, Inc., 1988

#### APPLICATIONS OF DIGITAL SIGNAL PROCESSING

A. V. Oppenheim  
Englewood Cliffs, NJ: Prentice-Hall, Inc., 1978

#### DESCRETE-TIME SIGNAL PROCESSING

A. V. Oppenheim and R. W. Schafer  
Englewood Cliffs, NJ: Prentice-Hall, Inc., 1989

#### DIGITAL PROCESSING OF SIGNALS THEORY AND PRACTICE

Maurice Bellanger  
New York, NY: John Wiley and Sons, 1984

#### DIGITAL SIGNAL PROCESSING

Alan V. Oppenheim and Ronald W. Schafer  
Englewood Cliffs, NJ: Prentice-Hall, Inc., 1975

#### DIGITAL SIGNAL PROCESSING: A SYSTEM DESIGN APPROACH

David J. DeFatta, Joseph G. Lucas, and William S. Hodgkiss  
New York, NY: John Wiley and Sons, 1988

#### FOUNDATIONS OF DIGITAL SIGNAL PROCESSING AND DATA ANALYSIS

J. A. Cadzow  
New York, NY: MacMillan Publishing Company, 1987

#### HANDBOOK OF DIGITAL SIGNAL PROCESSING

D. F. Elliott  
San Diego, CA: Academic Press, Inc., 1987

#### INTRODUCTION TO DIGITAL SIGNAL PROCESSING

John G. Proakis and Dimitris G. Manolakis  
New York, NY: Macmillan Publishing Company, 1988

**MULTIRATE DIGITAL SIGNAL PROCESSING**

R. E. Crochiere and L. R. Rabiner  
Englewood Cliffs, NJ: Prentice-Hall, Inc., 1983

**SIGNAL PROCESSING ALGORITHMS**

S. Stearns and R. Davis  
Englewood Cliffs, NJ: Prentice-Hall, Inc., 1988

**SIGNAL PROCESSING HANDBOOK**

C.H. Chen  
New York, NY: Marcel Dekker, Inc., 1988

**SIGNAL PROCESSING — THE MODERN APPROACH**

James V. Candy  
New York, NY: McGraw-Hill Company, Inc., 1988

**THEORY AND APPLICATION OF DIGITAL SIGNAL PROCESSING**

Rabiner, Lawrence R., Gold and Bernard  
Englewood Cliffs, NJ: Prentice-Hall, Inc., 1975

**Digital Audio and Filters:**

**ADAPTIVE FILTER AND EQUALIZERS**

B. Mulgrew and C. Cowan  
Higham, MA: Kluwer Academic Publishers, 1988

**ADAPTIVE SIGNAL PROCESSING**

B. Widrow and S. D. Stearns  
Englewood Cliffs, NJ: Prentice-Hall, Inc., 1985

**ART OF DIGITAL AUDIO, THE**

John Watkinson  
Stoneham, MA: Focal Press, 1988

**DESIGNING DIGITAL FILTERS**

Charles S. Williams  
Englewood Cliffs, NJ: Prentice-Hall, Inc., 1986

**DIGITAL AUDIO SIGNAL PROCESSING AN ANTHOLOGY**

John Strawn  
William Kaufmann, Inc., 1985

**DIGITAL CODING OF WAVEFORMS**

N. S. Jayant and Peter Noll  
Englewood Cliffs, NJ: Prentice-Hall, Inc., 1984

**DIGITAL FILTERS: ANALYSIS AND DESIGN**

Andreas Antoniou  
New York, NY: McGraw-Hill Company, Inc., 1979

**DIGITAL FILTERS AND SIGNAL PROCESSING**

Leland B. Jackson  
Higham, MA: Kluwer Academic Publishers, 1986

**DIGITAL SIGNAL PROCESSING**

Richard A. Roberts and Clifford T. Mullis  
New York, NY: Addison-Welsey Publishing Company, Inc., 1987

**INTRODUCTION TO DIGITAL SIGNAL PROCESSING**

Roman Kuc  
New York, NY: McGraw-Hill Company, Inc., 1988

**INTRODUCTION TO ADAPTIVE FILTERS**

Simon Haykin  
New York, NY: MacMillan Publishing Company, 1984

**MUSICAL APPLICATIONS OF MICROPROCESSORS (Second Edition)**

H. Chamberlin  
Hasbrouck Heights, NJ: Hayden Book Co., 1985

**Controls:**

**ADAPTIVE CONTROL**

K. Astrom and B. Wittenmark  
New York, NY: Addison-Welsey Publishing Company, Inc., 1989

**ADAPTIVE FILTERING PREDICTION & CONTROL**

G. Goodwin and K. Sin  
Englewood Cliffs, NJ: Prentice-Hall, Inc., 1984

**AUTOMATIC CONTROL SYSTEMS**

B. C. Kuo  
Englewood Cliffs, NJ: Prentice-Hall, Inc., 1987

**COMPUTER CONTROLLED SYSTEMS: THEORY & DESIGN**

K. Astrom and B. Wittenmark  
Englewood Cliffs, NJ: Prentice-Hall, Inc., 1984

**DIGITAL CONTROL SYSTEMS**

B. C. Kuo  
New York, NY: Holt, Reinholt, and Winston, Inc., 1980





**DIGITAL CONTROL SYSTEM ANALYSIS & DESIGN**

C. Phillips and H. Nagle  
Englewood Cliffs, NJ: Prentice-Hall, Inc., 1984

**ISSUES IN THE IMPLEMENTATION OF DIGITAL FEEDBACK COMPENSATORS**

P. Moroney  
Cambridge, MA: The MIT Press, 1983

**Graphics:**

**CGM AND CGI**

D. B. Arnold and P. R. Bono  
New York, NY: Springer-Verlag, 1988

**COMPUTER GRAPHICS (Second Edition)**

D. Hearn and M. Pauline Baker  
Englewood Cliffs, NJ: Prentice-Hall, Inc., 1986

**FUNDAMENTALS OF INTERACTIVE COMPUTER GRAPHICS**

J. D. Foley and A. Van Dam  
Reading MA: Addison-Wesley Publishing Company Inc., 1984

**GEOMETRIC MODELING**

Michael E. Morteson  
New York, NY: John Wiley and Sons, Inc.

**GKS THEORY AND PRACTICE**

P. R. Bono and I. Herman (Eds.)  
New York, NY: Springer-Verlag, 1987

**ILLUMINATION AND COLOR IN COMPUTER GENERATED IMAGERY**

Roy Hall  
New York, NY: Springer-Verlag

**POSTSCRIPT LANGUAGE PROGRAM DESIGN**

Glenn C. Reid - Adobe Systems, Inc.  
Reading MA: Addison-Wesley Publishing Company, Inc., 1988

**MICROCOMPUTER DISPLAYS, GRAPHICS, AND ANIMATION**

Bruce A. Artwick  
Englewood Cliffs, NJ: Prentice-Hall, Inc., 1985

**PRINCIPLES OF INTERACTIVE COMPUTER GRAPHICS**

William M. Newman and Rogert F. Sproull  
New York, NY: McGraw-Hill Company, Inc., 1979

**PROCEDURAL ELEMENTS FOR COMPUTER GRAPHICS**

David F. Rogers

New York, NY: McGraw-Hill Company, Inc., 1985

**RENDERMAN INTERFACE, THE**

Pixar

San Rafael, CA. 94901

**Image Processing:**

**DIGITAL IMAGE PROCESSING**

William K. Pratt

New York, NY: John Wiley and Sons, 1978

**DIGITAL IMAGE PROCESSING (Second Edition)**

Rafael C. Gonzales and Paul Wintz

Reading, MA: Addison-Wesley Publishing Company, Inc., 1977

**DIGITAL IMAGE PROCESSING TECHNIQUES**

M. P. Ekstrom

New York, NY: Academic Press, Inc., 1984

**DIGITAL PICTURE PROCESSING**

Azriel Rosenfeld and Avinash C. Kak

New York, NY: Academic Press, Inc., 1982

**SCIENCE OF FRACTAL IMAGES, THE**

M. F. Barnsley, R. L. Devaney, B. B. Mandelbrot, H. O. Peitgen,

D. Saupe, and R. F. Voss

New York, NY: Springer-Verlag

**Numerical Methods:**

**ALGORITHMS (THE CONSTRUCTION, PROOF, AND ANALYSIS OF PROGRAMS)**

P. Berliout and P. Bizard

New York, NY: John Wiley and Sons, 1986

**MATRIX COMPUTATIONS**

G. H. Golub and C. F. Van Loan

John Hopkins Press, 1983

**NUMERICAL RECIPES IN C - THE ART OF SCIENTIFIC PROGRAMMING**

William H. Press, Brian P. Flannery,  
Saul A. Teukolsky, and William T. Vetterling  
Cambridge University Press, 1988

**NUMBER THEORY IN SCIENCE AND COMMUNICATION**

Manfred R. Schroeder  
New York, NY: Springer-Verlag, 1986

**Pattern Recognition:**

**PATTERN CLASSIFICATION AND SCENE ANALYSIS**

R. O. Duda and P. E. Hart  
New York, NY: John Wiley and Sons, 1973

**CLASSIFICATION ALGORITHMS**

Mike James  
New York, NY: Wiley-Interscience, 1985

**Spectral Analysis:**

**STATISTICAL SPECTRAL ANALYSIS, A NONPROBABILISTIC THEORY**

William A. Gardner  
Englewood Cliffs, NJ: Prentice-Hall, Inc., 1988

**THE FAST FOURIER TRANSFORM AND ITS APPLICATIONS**

E. Oran Brigham  
Englewood Cliffs, NJ: Prentice-Hall, Inc., 1988

**THE FAST FOURIER TRANSFORM AND ITS APPLICATIONS**

R. N. Bracewell  
New York, NY: McGraw-Hill Company, Inc., 1986

**Speech:**

**ADAPTIVE FILTERS — STRUCTURES, ALGORITHMS, AND APPLICATIONS**

Michael L. Honig and David G. Messerschmitt  
Higham, MA: Kluwer Academic Publishers, 1984

**DIGITAL CODING OF WAVEFORMS**

N. S. Jayant and P. Noll  
Englewood Cliffs, NJ: Prentice-Hall, Inc., 1984



DIGITAL PROCESSING OF SPEECH SIGNALS  
Lawrence R. Rabiner and R. W. Schafer  
Englewood Cliffs, NJ: Prentice-Hall, Inc., 1978

LINEAR PREDICTION OF SPEECH  
J. D. Markel and A. H. Gray, Jr.  
New York, NY: Springer-Verlag, 1976

SPEECH ANALYSIS, SYNTHESIS, AND PERCEPTION  
J. L. Flanagan  
New York, NY: Springer-Verlag, 1972

SPEECH COMMUNICATION — HUMAN AND MACHINE  
D. O'Shaughnessy  
Reading, MA: Addison-Wesley Publishing Company, Inc., 1987

**Telecommunications:**

DIGITAL COMMUNICATION  
Edward A. Lee and David G. Messerschmitt  
Higham, MA: Kluwer Academic Publishers, 1988

DIGITAL COMMUNICATIONS  
John G. Proakis  
New York, NY: McGraw-Hill Publishing Co., 1983

## INDEX

### — A —

- A-law, 2-5
- Aborted Instructions, 8-18
- ABS, A-14
- Absolute Address, 7-11
- Absolute Short, 7-13
- Accumulator Shifter, 4-6
- Adaptive Filter, B-1
- Adaptive Filters, 1-2
- ADC, A-16
- ADD, A-18
- Additional Support
  - Applications Assistance, C-13
  - C Language Compiler, C-4
  - Codec Routines, C-6
  - Design Hotline, C-12
  - Dr. BuB Electronic Bulletin Board, C-5
  - DSP320to56001 Translator, B-4
  - DSP56000ADSx Application Development System, B-4
  - DSP56000CLASx Assembler/Simulator, B-2
  - Fast Fourier Transforms, C-6
  - Filters, C-7
  - Floating Point Routines, C-8
  - Functions, C-9
  - Lattice Filters, C-10
  - Marketing Information, C-13
  - Matrix Operations, C-11
  - Motorola DSP News, C-12
  - Motorola DSP Product Support, B-2
  - Motorola Field Application Engineers, C-12
  - Reed-Solomon Encoder, C-11
  - Sorting Routines, C-11
  - Speech, C-12
  - Standard I/O Equates, C-12
  - Text Books, C-14
  - Third Party Support Information, C-13
  - Training Courses, C-13
  - University Support, C-13
- ADDL, A-20
- ADDR, A-22
- Address (A0-A15), 2-9
- Address ALU, 5-3
- Address ALU Registers, A-7
- Address Buses, 2-3
- Address Generation Unit, 2-5, 5-1
- Address Generation Unit Registers, 7-4
- Address Modifier
  - Linear Modifier, 5-12
  - Modulo Modifier, 5-13

- Address Modifier, Continued
  - Reverse-Carry Modifier, 5-17
  - Summary, 5-19
- Address Modifier Types, 5-11
- Address Operands, A-7
- Address Output Multiplexers, 5-4
- Address Register
  - Indexed by Offset Nn, 5-10
  - No Update, 5-7
  - Postdecrement by 1, 5-8
  - Postdecrement by Offset Nn, 5-9
  - Postincrement by 1, 5-8
  - Postincrement by Offset Nn, 5-9
  - Predecrement by 1, 5-11
  - Register Indirect, 5-6
- Address Register Direct, 7-11
- Address Register Indirect Mode, 5-6, 7-11
- Address Registers, 2-5, 5-2, 5-5
- Addressing Mode Encoding, A-8
- Addressing Mode Modifiers, A-8
- Addressing Mode Operators, A-8
- Addressing Modes, 5-5, 5-6, 7-10, A-6
- Addressing Modes Summary, 7-18
- Analog-to-Digital Converter, 1-2
- AND(I), A-26
- Antialias Filter, 1-2
- Applications, 1-5
- Arbitration, 9-16, 9-18
- Architecture, 1-1, 2-1
- Arithmetic Instructions, 7-19
- ASL, A-28
- Assembler, 8-2
- Assembler Syntax and Operation, A-1
- Assembly Language, 7-1

### — B —

- BCHG, 9-21, A-32
- BCLR, 9-21, A-37
- BCR, 2-7, 9-10
- Benchmarks, 1-4, B-1
- Binary Operators, A-4
- Bit Manipulation Instructions, 7-20
- Bit Manipulation Unit, 2-3
- Bit Reversed, 5-18
- Block Data Moves, 6-3
- Bootstrap Mode, 2-6
- Bootstrap ROM, 2-6
- BR/BG, 8-36, 8-38

BSET, 9-21, A-42  
BTST, A-47  
Bus Arbitrator, 2-3  
Bus Control Register, 9-10, 9-12  
Bus Grant/Wait (BG/WT), 2-11  
Bus Request/Bus Grant (BR/BG), 6-14, 9-15  
Bus Request/Bus Strobe (BR/BS), 2-10  
Bus Strobe/Wait, 9-12  
Bus Switch, 2-3

— C —

Carry Bit, 6-9, A-9  
Central Processor, 4-1  
Circular Buffer, 5-14, 11-56  
Clock Cycles, 9-8  
Clock Oscillator, 6-7, 8-38  
Clock Phases, 8-2, 9-8  
Clock Stabilization Delay, 8-38  
CLR, A-52  
CMP, A-54  
CMPM, A-56  
Coefficients, 4-11  
Condition Code Computation, A-9  
Condition Code Register, 6-8  
Condition Code Register (CCR) Symbols, A-5  
Condition Codes, A-1  
Convergent Rounding, 2-4, 4-5, 4-11  
Crystal Output (XTAL), 2-12

— D —

Data (D0-D23), 2-10  
Data ALU, 2-4, 4-3  
Data ALU Accumulator Registers, 4-5  
Data ALU Input Registers, 4-3, 4-5  
Data ALU Programming Model, 4-11  
Data ALU Registers, 4-5, 7-4, A-2  
Data ALU Summary, 4-11  
Data Buses, 2-3  
Data Memory Select (DS), 2-10  
Data or Control Register Direct, 7-11  
Data Organization in Memory, 7-7  
Data Organization in Registers, 7-4  
Data Representation, 4-8  
Data ROM Enable, 6-13  
Data Shifter/Limiter, 4-6  
Data Shifters, 4-8  
Digital Filters, 4-11  
Digital-to-Analog Converter, 1-3  
DIV, A-58  
DMA, 2-7  
DO, A-63  
DO Instruction Restrictions, 8-6  
DO Loop Control, 6-1

Dot Product, B-2  
Dr. BuB, B-1  
DSP Applications, 1-5  
DSP Functions, 1-4  
DSP56000 Memory Spaces, 3-1  
  Development Mode, 3-3, 3-5  
  Mode 0, 3-4  
  Mode 1, 3-4  
  Mode 2, 3-4  
  Mode 3, 3-5  
  Normal Expanded, 3-3, 3-4  
  Operating Mode Register, 3-1  
  Operating Modes, 3-3  
  Program Memory, 3-3  
  Security ROM DSP56000 Version, 3-5  
  Single Chip, 3-3, 3-4  
  X Data RAM, 3-1  
  X Data ROM, 3-1  
  Y Data RAM, 3-2  
  Y Data ROM, 3-2  
DSP56001 Memory Spaces, 3-1  
  A-law Expansion Tables, 3-7  
  Bootstrap Mode, 3-8, 3-9, 3-11  
  Bootstrap ROM, 3-8, 3-12  
  Chip Operating Modes, 3-8  
  Development Mode, 3-9, 3-12  
  Mode 0, 3-9  
  Mode 1, 3-9  
  Mode 2, 3-12  
  Mode 3, 3-13  
  Mu-law Expansion Tables, 3-7  
  Normal Expanded Mode, 3-9, 3-12  
  Operating Mode Register, 3-6  
  Program Memory, 3-8  
  Sine Wave Table, 3-8  
  Single-Chip Mode, 3-9  
  Special Bootstrap Mode, 3-9  
  X Data RAM, 3-7  
  X Data ROM, 3-7  
  Y Data RAM, 3-8  
  Y Data ROM, 3-8  
Dynamic Range, 2-4

— E —

Edge Sensitive, 6-5, 8-9  
Edge-Triggered, 6-5, 8-19  
Encodings  
  Condition Code and Address Encoding, A-242  
  Double-Bit Register, A-239  
  Effective Addressing Mode, A-242  
  Five-Bit Register, A-241  
  Four-Bit Register A-240  
  Insane Instructions, A-260  
  Memory Space Bit, A-241  
  Multiply Instruction, A-254  
  No Parallel Move, A-244

- Encodings, Continued
  - Nonmultiply Instruction, A-256
  - Operation Code, A-254
  - Parallel Move, A-243
  - Program Controller Register, A-242
  - Reserved Instruction Codes, A-263
  - Single-Bit Register, A-239
  - Single-Bit Special Register, A-239
  - Six-Bit Register, A-241
  - Triple-Bit Register, A-240
  - Write Control, A-241
- ENDDO, A-71
- ENDDO Instruction Restrictions, 8-7
- ENDDO Restrictions, A-234
- EOR, A-73
- Exception Priorities within an IPL, 8-17
- Exception Processing, 6-1, 8-8
- Exception Processing State, 8-8
- Exceptions, 11-92
- Execution Units, 1-8, 2-3, 4-1, 6-1
- Expansion Port, 2-7
- EXT:MSP:LSP, 4-4
- EXTAL, 6-7
- Extension Bit, 6-10, A-9
- External Clock/Crystal Input (EXTAL), 2-12
- External Interrupts, 8-9
- External Memory Access, 6-13
- Fast Interrupt, 6-5, 8-19, 8-24
- Fast Interrupt Restrictions, A-237
- Fetch, 8-20
- Fetch-Decode-Execute, 8-1
- FFT, 3-8, 4-8, 5-4, 5-18, B-2
- FIFO, 11-56
- FIR Filter, B-2, B-4
- Floating Point, 4-8
- Fractional, 4-8, 4-10
- Fractional Arithmetic, 4-7
- Functions, 1-1, 1-4

— G —

- General-Purpose I/O, 2-6, 2-7, 10-2
  - Port B, 10-1
  - Port C, 11-1
- Global Data Bus, 6-6
- Ground (GND), 2-12

— H —

- Hardware Interrupt Sources, 8-9
- Hardware RESET, 6-6
- Harvard Architecture, 1-7
- Host Interface, 10-7
  - Command Vector Register, 10-14
  - DMA Controller, 10-16, 10-20
  - DMA Counter, 10-22

- Host Interface, Continued
  - DMA Data Transfer, 10-48
  - DMA Interrupts, 10-31
  - DMA Status, 10-14, 10-24
  - DSP-to-Host Data Transfer, 10-44
  - DSP-to-Host DMA Procedure, 10-54
  - DSP-to-Host Internal Processing, 10-53
  - Example Circuits, 10-54
  - Host Address 0-2 (HA0,HA1,HA2), 10-26
  - Host Command, 10-15, 10-18, 10-22
  - Host Command Interrupt Enable, 10-12
  - Host Command Pending, 10-12, 10-14
  - Host Command Vector Register, 10-22
  - Host Control Register, 10-11
  - Host Data Bus (H0-H7), 10-26
  - Host Enable (HEN), 10-27
  - Host Flag 0, 10-14, 10-20
  - Host Flag 1, 10-14, 10-20
  - Host Flag 2, 10-12, 10-24
  - Host Flag 3, 10-12, 10-24
  - Host Interface Interrupts, 10-28
  - Host Mode Control, 10-20
  - Host Processor Data Transfers, 10-28
  - Host Read/Write (HR/W), 10-27
  - Host Receive Data Full, 10-13
  - Host Receive Data Register, 10-14
  - Host Receive Interrupt Enable, 10-12
  - Host Request, 10-24
  - Host Request (HREQ), 10-27
  - Host Status Register, 10-13
  - Host to DSP — Bootstrap Loading, 10-43
  - Host to DSP — Command Vector, 10-40
  - Host to DSP — Data Transfer, 10-35
  - Host-to-DSP DMA Procedure, 10-50
  - Host-to-DSP Internal Processing, 10-49
  - Host Transmit Data Empty, 10-12, 10-13
  - Host Transmit Data Register, 10-13
  - Host Transmit Interrupt Enable, 10-12
  - Host Transmit Register, 10-14
  - Host Vector, 10-22
  - INIT, 10-20, 10-21
  - Initialization, 10-31
  - Interrupt Control Register, 10-18
  - Interrupt Status Register, 10-23
  - Interrupt Vector Register, 10-25
  - Interrupt-Driven Data Transfers, 10-31
  - Interrupts, 10-15
  - MC68000, 10-20, 10-25, 10-56
  - MC68000/10, 10-17
  - MC68020, 10-18, 10-56
  - MC68030, 10-56
  - MC68HC11, 10-54
  - Non-DMA Interrupts, 10-30
  - Polling, 10-30, 10-31
  - Programming Model, 10-10, 10-17
  - Receive Byte Registers, 10-25
  - Receive Data from Host, 10-37
  - Receive Data Register Full, 10-23

## Host Interface, Continued

Receive Request Enable, 10-19  
Reset, 10-15, 10-25  
RXH:RXM:RXL, 10-13, 10-14, 10-23  
Termination, 10-60  
Transmit 12-Bit Data to Host, 10-48  
Transmit Byte Registers, 10-25  
Transmit Data Register Empty, 10-23  
Transmit Request Enable, 10-19  
Transmitter Ready, 10-23  
TXH:TXM:TXL, 10-13, 10-14  
Host Acknowledge (HACK), 2-13, 10-27  
Host Address 0-2 (HA0,HA1,HA2), 2-12  
Host Command, 2-8  
Host Data Bus (H0-H7), 2-12  
Host Enable (HEN), 2-12  
Host Interface, 2-6, 2-7, 10-2  
Host Read/Write (HR/W), 2-12  
Host Request (HREQ), 2-12

## — I —

I/O Short, 7-13  
IIR Filter, B-2, B-8  
ILLEGAL, A-75  
Illegal Instruction, 8-11  
Illegal Instruction Interrupt, 8-11  
Immediate Data, 7-11  
Immediate Short, 7-11  
Implicit Reference, 7-13  
Input/Output, 2-6  
Insane Instructions, A-260  
Instruction Decoding, 6-1  
Instruction Descriptions, A-11  
Instruction Encoding, A-238  
Instruction Format, 7-3, A-1  
Instruction Latch, 6-3  
Instruction Memory Requirements, A-2  
Instruction Pipeline, 6-6, 8-1  
Instruction Sequence Restrictions, A-232  
Instruction Timing, A-2, A-222  
Instruction Timing Symbols, A-5  
Integer, 4-10  
Internal Interrupts, 8-9  
Interrupt, 8-4  
Interrupt Arbitration, 8-19  
Interrupt Instruction Execution, 8-20  
Interrupt Mask, 6-10  
Interrupt Priority Level, 6-3, 6-10, 8-9, 8-16  
Interrupt Priority Register, 8-16  
Interrupt Processing, 8-8  
Interrupt Sources, 8-9  
Interrupt Types, 8-18  
Interrupts, 10-15  
IRQA, 6-5, 8-9  
IRQB, 6-5, 8-9

## — J —

Jcc, A-77  
JCLR, A-81  
JMP, A-85  
JScC, A-87  
JSCLR, A-90  
JSET, A-95  
JSR, A-100  
JSSET, A-101

## — L —

L Memory References, 7-9  
Least Mean Square (LMS), B-1, B-10  
Limit Bit, 6-10, A-9  
Limiting, 4-6, 4-7  
Linear Arithmetic, 5-4  
Logical Instructions, 7-19  
Long Interrupt, 6-5, 8-18, 8-24  
Loop Address, 2-6  
Loop Address Register, 6-14  
Loop Count, 2-6  
Loop Counter, 6-14  
Loop Flag (LF), 6-11  
Loop Instructions, 7-20  
LSL, A-107  
LSR, A-108  
LUA, A-110

## — M —

MA, 6-13  
MAC, 1-6, 4-3, A-112  
MACR, A-114  
Matrix Multiply, B-2  
MB, 6-13  
MC680XX, 10-31  
Memory Ready, 9-12  
Memory Ready Strobe, 9-12  
Memory References, 7-9  
MODA, 6-6, 6-13  
MODA/IRQA, 2-11  
MODB, 6-6, 6-13  
MODB/IRQB, 2-11  
Mode Register, 6-8  
Mode Register (MR) Symbols, A-5  
Modifier Registers, 2-5, 5-2, 5-3, 5-5  
Modulo Arithmetic, 5-4  
MOVE, A-116  
Move Instructions, 7-22  
MOVE(C), A-152  
MOVE(M), A-159  
MOVEP, A-167  
MPY, A-170



MPYR, A-172  
Mu-law, 2-5  
Multiplier/Accumulator, 1-6  
Multiply-Accumulator (MAC), 2-4, 4-3

— N —

NEG, A-174  
Negative Bit, 6-10, A-9  
NMI, 8-9  
Nonmaskable Interrupt, 6-5, 8-11  
NOP, A-176  
NORM, A-177  
Normal Processing State, 8-1  
NOT, A-179  
Notation, A-2

— O —

Offset Registers, 2-5, 5-2, 5-3, 5-5  
OMR Bit-7, 2-10, 2-11  
Opcode Field, 7-3  
Operand References, 7-8  
Operand Size, 7-3  
Operands, 7-1, A-2  
Operating Mode, 2-6, 6-13  
Operating Mode Register, 2-6, 3-6, 6-11  
Operation Code, A-254  
OR, A-181  
OR(I), A-183  
Overflow Bit, 4-7, 6-9, A-9

— P —

Parallel Data Moves, 7-22  
Parallel Move, 7-22  
    Address Register Update, A-125  
    Descriptions, A-118  
    Immediate Short Data Move, A-120  
    Instruction Coding, A-243  
    Long Memory Data Move, A-145  
    No Parallel Data Move, A-119  
    Register and Y Memory Data Move, A-140  
    Register to Register Data Move, A-122  
    X Memory and Register Data Move, A-131  
    X Memory Data Move, A-127  
    XY Memory Data Move, A-149  
    Y Memory Data Move, A-136  
Parallel Move Descriptions, A-11  
Parallel Processing, 7-24  
Pipeline, 6-2

Pipeline Effect, 8-2  
Pipelining, 7-22  
Port A, 2-6, 9-1  
    Access Priority, 9-1  
    Base Address Register, 10-7  
    Boot ROM, 9-6  
    Bus Arbitration, 9-15  
    DS, 9-4  
    Extended Address, 10-7, 11-8  
    External Memory Access, 9-9  
    Peripherals, 9-3  
    PS, 9-4  
    Pullup, 9-8  
    Read and Write Strokes, 9-3  
    Reduced Data Size, 9-6  
    Timing, 9-8  
    Wait States, 9-10  
    X/Y, 9-4  
Port B, 2-6, 10-1  
    Extended Address, 10-7  
    General-Purpose I/O, 10-2  
    HI Description, 10-8  
    HI Programming Model, 10-10  
    Parallel I/O Timing, 10-4  
    Port B Control Register, 10-2  
    Port B Data Direction Register, 10-2  
    Port B Data Register, 10-2  
    Programming Parallel I/O, 10-4  
Port C, 2-6, 11-1  
    Extended Address, 11-8  
    General-Purpose I/O, 11-1  
    Parallel I/O Timing, 11-6  
    Programming Parallel I/O, 11-1  
Power, 2-12, 9-1, 9-10  
Power Consumption, 8-36  
Power Dissipation, 2-9  
Priority Structure, 8-17  
Processing States, 6-2, 8-1  
Program Address Generation, 6-1  
Program Address Generator, 6-2, 6-3  
Program Control Instructions, 7-24  
Program Control Registers, 7-5, A-3  
Program Controller, 2-6, 6-1  
Program Counter, 2-6, 6-8  
Program Decode Controller, 6-2  
Program Interrupt Controller, 6-2, 6-3  
Program Memory, 2-6  
Program Memory Select (PS), 2-10  
Program References, 7-9  
Programming Model  
    Address Generation Unit, 5-4  
    Host Interface, 10-10, 10-17  
    Data Arithmetic Unit, 4-11  
    Program Controller, 6-7  
    SCI, 11-9  
    SSI, 11-72  
    Summary, 6-17  
    Pullup, 9-8, 11-16, 11-64

— R —

R, N, and M Register Restrictions, A-237  
Read Enable (RD), 2-10  
Read-Modify-Write, 5-5, 9-21  
Receive Data (RXD), 2-8, 2-13  
Register Direct Mode, 7-10  
Register Indirect, 5-6  
Register Indirect Mode, 7-10  
Register References, 7-9  
REP, 6-3, 8-27, A-185  
REP Restrictions, A-238  
Reserved Instruction Codes, A-263  
RESET, 2-11, 8-9, A-190  
  Host Interface, 10-15  
  SCI, 11-25  
  SSI, 11-88  
Reset Processing State, 8-27  
Restrictions Near the End of DO Loops, A-232  
Reverse Carry, 5-3  
Rn, Nn, and Mn Register Restrictions, 8-8  
RND, A-191  
ROL, A-195  
ROR, A-197  
Round to Nearest (Even), 4-11  
Rounding, 4-8, 4-11, 6-11  
RTI, A-198  
RTI and RTS Instruction Restrictions, 8-7, A-235  
RTS, A-200

— S —

Saturation Arithmetic, 2-4, 4-6  
SBC, A-202  
Scaling, 4-8  
Scaling Mode, 6-10, 6-11  
SCI  
  4X Internal Clock, 11-20  
  1X Clock, 11-20  
  2X Internal Clock, 11-20  
  8051, 11-12  
  Address Mode Wakeup, 11-15, 11-53  
  Asynchronous Data, 11-39  
  Asynchronous Data Reception, 11-39  
  Asynchronous Data Transmission, 11-41  
  Asynchronous Transmit/Receive Example, 11-47  
  Break, 11-25, 11-41  
  Circular Buffers, 11-56  
  Clock Divider, 11-21  
  Clock Out Divider, 11-21  
  Common Baud Rates, 11-26  
  Data Transmission Priority, 11-25  
  Example Circuits, 11-64  
  Exceptions, 11-28  
  Features, 11-8  
  FIFO, 11-56  
  Framing Error Flag, 11-20

SCI, Continued

  Idle Line Flag, 11-19  
  Idle Line Interrupt Enable, 11-16  
  Idle line Wakeup, 11-15, 11-53  
  Initialization, 11-26  
  Interrupts, 11-41  
  MC68681, 11-12  
  MC68HC11, 11-12  
  Multidrop, 11-47  
  Multidrop Example, 11-56  
  Multidrop Transmit/Receive Example, 11-61  
  Overrun Error Flag, 11-19  
  Parity Error, 11-19  
  Polling, 11-41  
  Preamble, 11-16, 11-25, 11-41  
  Programming Model, 11-9  
  Receive Clock Mode Source Bit, 11-22  
  Receive Data (RXD), 11-9  
  Receive Data Register Full, 11-19  
  Received bit 8 (address bit), 11-20  
  Receiver Enable, 11-16  
  Receiver Wakeup Enable, 11-15  
  Reset, 11-25  
  SCI Clock Control Register (SCCR), 11-9, 11-20  
  SCI Clock Polarity, 11-18  
  SCI Clock Prescaler, 11-22  
  SCI Control Register (SCR), 11-9, 11-11  
  SCI Data Registers, 11-23  
  SCI Receive Data Registers (SRX), 11-9  
  SCI Receive Interrupt Enable, 11-17  
  SCI Receive Registers, 11-23  
  SCI Serial Clock (SCLK), 11-9  
  SCI Shift Direction, 11-12  
  SCI Status Register (SSR), 11-9, 11-18  
  SCI Timer, 11-61  
  SCI Timer Example, 11-64  
  SCI Transmit Data Address Register (STXA), 11-9  
  SCI Transmit Data Registers (STX), 11-9  
  SCI Transmit Interrupt Enable, 11-17  
  SCI Transmit Registers, 11-24  
  Send Break, 11-12  
  SRIINT, 11-17  
  Synchronous Data, 11-32  
  Synchronous Master, 11-32  
  Synchronous Mode, 11-38  
  Synchronous Receive, 11-39  
  Synchronous Slave, 11-35  
  Synchronous Transmit, 11-38  
  Timer Interrupt Enable, 11-17  
  Transmit Clock Source Bit, 11-22  
  Transmit Data (TXD), 11-9  
  Transmit Data Register Empty, 11-18  
  Transmitter Empty, 11-18  
  Transmitter Enable, 11-16  
  Transmitting Data and Address Characters, 11-49  
  Wakeup Mode Select, 11-15  
  Wired-OR Mode, 11-53  
  Wired-OR Mode Select, 11-16  
  Word Select, 11-11

SCI Serial Clock (SCLK), 2-8, 2-13  
 Security ROM DSP56000 Version, 1-1, 3-1, 3-5, 6-13  
 Semaphores, 9-20  
 Serial Communication Interface, 2-6, 2-8, 2-13  
 Serial Control One (SC1), 2-13  
 Serial Control Two (SC2), 2-14  
 Serial Control Zero (SC0), 2-13  
 Shared Memory, 9-16  
 Shifter/Limiter, 2-4, 6-11  
 Short Jump Address, 7-13  
 Sign Extension, 4-5  
 Signal Description, 2-9  
 Signaling, 9-20  
 Simulator, 8-27  
 Software Interrupt, 8-11  
 SP and SSH/SSL Manipulation Restrictions, A-235  
 Special Addressing Mode, 7-11  
 SSI  
     Asynchronous, 11-104  
     Baud Rates, 11-92  
     CCITT, 11-118  
     Circular Buffer, 11-131  
     Clock Source Direction, 11-79  
     Codec, 11-113, 11-118, 11-136  
     Compact Disk Player, 11-114  
     Continuous Clock, 11-87, 11-104, 11-128  
     Continuous/Gated Clock Selection, 11-96  
     Data/Operation Formats, 11-96  
     Double Buffered, 11-128  
     Example Circuits, 11-138  
     Exceptions, 11-92  
     Features, 11-66  
     Flags, 11-133  
     Frame Rate Divider Control, 11-76  
     Frame Sync, 11-99, 11-107  
     Frame Sync Length, 11-79  
     Gated Clock, 11-87, 11-99, 11-104, 11-128  
     Gated Clock Control, 11-79  
     Initialization, 11-88  
     Input Flags, 11-99  
     MC15500, 11-113  
     Multidrop, 11-136  
     Network, 11-93  
     Network Mode, 11-67, 11-76, 11-119  
     Network Mode Examples, 11-118  
     Network Mode Receive, 11-124  
     Network Mode Transmit, 11-122  
     Normal, 11-93  
     Normal Mode, 11-67, 11-76  
     Normal Mode Examples, 11-107  
     Normal Mode Receive, 11-114  
     Normal Mode Transmit, 11-113  
     Normal/Network Mode Selection, 11-96  
     On-Demand Mode, 11-67, 11-76, 11-93, 11-128  
     On-Demand Mode Example, 11-127  
     Operational Modes, 11-87  
     Output Flags, 11-99, 11-114  
     Prescale Modulus Select, 11-72  
     SSI, Continued  
         Prescaler Range, 11-76  
         Programming Model, 11-72  
         Receive Data Register, 11-84  
         Receive Frame Sync Flag, 11-82  
         Receive Shift Register, 11-83  
         Receiver Overrun Error Flag, 11-83  
         Reset, 11-88  
         SC0, 11-71  
         SC1, 11-71  
         SC2, 11-72  
         SCK, 11-69  
         Serial Control 0 Direction, 11-77  
         Serial Control 1 Direction, 11-77  
         Serial Control 2 Direction, 11-77  
         Serial Input Flag 0, 11-81  
         Serial Input Flag 1, 11-82  
         Serial Output Flag 0, 11-77  
         Serial Output Flag 1, 11-77  
         Shift Direction, 11-79, 11-107  
         Speaker Phone, 11-136  
         SPI, 11-96  
         SRD, 11-69  
         SSI Control Register A (CRA), 11-72  
         SSI Control Register B (CRB), 11-76  
         SSI Mode Select, 11-80  
         SSI Receive Data Register Full, 11-83  
         SSI Receive Enable, 11-80  
         SSI Receive Interrupt Enable, 11-81  
         SSI Status Register (SSISR), 11-81  
         SSI Transmit Data Register Empty, 11-83  
         SSI Transmit Enable, 11-80  
         SSI Transmit Interrupt Enable, 11-81  
         Start Conversion Signal, 11-99  
         STD, 11-68  
         Sync/Async Control, 11-79  
         Synchronous, 11-67, 11-99, 11-104  
         Synchronous/Asynchronous Operating Modes,  
             11-99  
         Time Division Multiplex, 11-96  
         Time Slot Register, 11-84, 11-122  
         Transmit Data Register, 11-84  
         Transmit Frame Sync Flag, 11-82  
         Transmit Shift Register, 11-84  
         Transmitter Underrun Error Flag, 11-82  
         Word Length Control, 11-76  
     SSI Receive Data (SRD), 2-14  
     SSI Serial Clock (SCK), 2-14  
     SSI Transmit Data (STD), 2-14  
     Stack Error, 8-14  
     Stack Error Flag (SE), 6-16  
     Stack Pointer (SP), 2-6, 6-16  
     Stack Pointer Register, 6-15  
     Stack References, 7-9  
     Status Register, 2-6, 6-8  
     STOP, A-204  
     Stop Delay, 6-13  
     Stop Processing State, 8-38

Strobe/Wait, 9-10  
SUB, A-206  
SUBL, A-208  
SUBR, A-210  
Summary

Additional Support, C-1-C-20  
Address Modifier, 5-19  
Addressing Modes, 7-18  
Benchmark, 1-1, B-2, B-3  
Data ALU, 4-11  
DSP Advantages, 1-3  
DSP56000 Family Features, 1-7  
Host Interface, 10-8  
Programming Model, 6-17  
SCI, 11-8  
SSI, 11-66  
Pipeline-Related Restrictions, 8-6  
SWI, 6-6, A-212  
Synchronous Serial Interface (SSI), 2-6, 2-8, 2-13  
Syntax, 7-1  
System Stack, 6-2, 6-15  
System Stack High (SSH), 6-15  
System Stack Low (SSL), 6-15  
System Stack Memory, 2-6

— T —

Tcc, A-214  
Text Books  
Controls, C-14  
Digital Audio and Filters, C-14  
Division, A-453  
General DSP, C-14  
Graphics, C-17  
Image Processing, C-18  
Numerical Methods, C-18  
Pattern Recognition, C-19  
Spectral Analysis, C-19  
Speech, C-19  
Telecommunications, C-120  
TFR, A-216  
Three-state, 9-15  
Trace, 6-6, 8-14

Trace Mode Bit (T), 6-11  
Transmit Data (TXD), 2-8, 2-13  
TST, A-220

— U —

Unary Operators, A-4  
Underflow Flag (UF), 6-16  
Unnormalized Bit, 6-10, A-9

— V —

Vectored Interrupt, 8-9

— W —

WAIT, A-220  
Wait Processing State, 8-36  
Wait States, 8-36, 9-10  
Bus Strobe/Wait, 9-10  
Write Enable (WR), 2-10

— X —

X Data Memory, 2-5  
X Memory References, 7-9  
XOR — see EOR  
X/Y Select (X/Y), 2-10  
XY Memory References, 7-9

— Y —

Y Data Memory, 2-5  
Y Memory References, 7-9

— Z —

Zero Bit, 6-10, A-9

— NOTES —

— NOTES —

— NOTES —

— NOTES —



|  |           |
|--|-----------|
| <b>Introduction</b>                              | <b>1</b>  |
| <b>Architectural Overview and Bus Structure</b>  | <b>2</b>  |
| <b>Memory Spaces</b>                             | <b>3</b>  |
| <b>Data Arithmetic Logic Unit</b>                | <b>4</b>  |
| <b>Address Generation Unit and Address Modes</b> | <b>5</b>  |
| <b>Program Controller</b>                        | <b>6</b>  |
| <b>Instruction Set Introduction</b>              | <b>7</b>  |
| <b>Processing States</b>                         | <b>8</b>  |
| <b>Port A</b>                                    | <b>9</b>  |
| <b>Port B</b>                                    | <b>10</b> |
| <b>Port C</b>                                    | <b>11</b> |
| <b>Instruction Set Details</b>                   | <b>A</b>  |
| <b>Benchmark Programs</b>                        | <b>B</b>  |
| <b>Additional Support</b>                        | <b>C</b>  |
| <b>Index</b>                                     | <b>I</b>  |

- 1** Introduction
- 2** Architectural Overview and Bus Structure
- 3** Memory Spaces
- 4** Data Arithmetic Logic Unit
- 5** Address Generation Unit and Address Modes
- 6** Program Controller
- 7** Instruction Set Introduction
- 8** Processing States
- 9** Port A
- 10** Port B
- 11** Port C
- A** Instruction Set Details
- B** Benchmark Programs
- C** Additional Support
- I** Index



**Literature Distribution Centers:**

USA: Motorola Literature Distribution; P.O. Box 20912; Phoenix, Arizona 85036.

EUROPE: Motorola Ltd.; European Literature Center; 88 Tanners Drive, Blakelands, Milton Keynes, MK14 5BP, England.

JAPAN: Nippon Motorola Ltd.; 4-32-1, Nishi-Gotanda, Shinagawa-ku, Tokyo 141 Japan.

ASIA-PACIFIC: Motorola Semiconductors H.K. Ltd.; Silicon Harbour Center, No. 2 Dai King Street, Tai Po Industrial Estate,  
Tai Po, N.T., Hong Kong.



**MOTOROLA**