

Panasonic®

Optoelectronic Devices Data Book

L.E.D.

Lamps • Displays

Optoelectronic Devices

Panasonic®

Panasonic Optoelectronics

L.E.D. LAMPS

$\phi 5 (T-1\frac{3}{4})$			$\phi 4 (T-1\frac{1}{2})$			$\phi 3 (T-1)$			
LN21RPHL	LN21RCPHL	LN21CPHL	LN29RP	LN29RCP	LN29CP	LN28RP	LN28RCP	LN28CP	LN28WP
LN31GPHL	LN31GCPHL	LN31CPHL	LN39GP	LN39GCP	LN39CP	LN38GP	LN38GCP	LN38CP	LN38WP
LN41YPHL	LN41YCPHL	LN41CPHL	LN49YP	LN49YCP	LN49CP	LN48YP	LN48YCP	LN48CP	LN48WP

$\phi 3$	
LN23SRP(H)	LN23SCP(H)
LN33SGP(H)	LN33SCP(H)
LN43SYP	LN43SCP(H)

L.E.D. LAMPS

φ 5	φ 2.6	φ 2		φ 3.7	φ 2.6	φ 3	2 × 4
LN240CP	LN221RP	LN230RPP	LN222RP	LN253RP	LN231RP	LN238RP	LN251RCPP
LN340CP	LN321GP	LN330GPP	LN322GP	LN353GP	LN331GP	LN338GP	LN351GCPP
LN440CP	LN421YP	LN430YPP	LN422YP	LN453YP	LN431YP	LN438YP	LN451YCPP

※

1.8 × 5.3	2.5 × 5	7 × 3	1.75 × 7	2.5 × 5	2 × 5	1 × 4	1.8 × 3.5	4 × 4	2.5 × 5
LN217RP	LN219RP	LN216RP	LN220RP	LN210RP	LN248RP	LN236RP	LN211RP	LN252RP	LN213RP
LN317GP	LN319GP	LN316GP	LN320GP	LN310GP	LN348GP	LN336GP	LN311GP	LN352GP	LN313GP
LN417YP	LN419YP	LN416YP	LN420YP	LN410YP	LN448YP	LN436YP	LN411YP	LN452YP	LN413YP

※















※

1 × 5	1.5 × 5	1 × 4	2 × 5	4 × 7	5 × 5	2.7 × 5.7	5.5 × 5.5	4 × 4.5	3 × 5
LN224RP	LN229RP	LN233RP	LN242RP	LN246RP	LN250RP	LN249RP	LN255RP	LN212RP	LN228RP
LN324GP	LN329GP	LN333GP	LN342GP	LN346GP	LN350GP	LN349GP	LN355GP	LN312GP	LN328GP
LN424YP	LN429YP	LN433YP	LN442YP	LN446YP	LN450YP	LN449YP	LN455YP	LN412YP	LN428YP

2 × 2.5	3 × 5	2.5 × 5	φ 3.5	φ 2.4	1.9 × 1.9	1 × 2	Mini Bright	Submini	Glass Sealed
LN235RP	LN226RP	LN227RP	LN25RP	LN26RP	LN244RP	LN245RP	LN01201C	LN247RP	LN2G
LN335GP	LN326GP	LN327GP	LN35BP	LN36BP	LN344GP	LN345GP	LN01301C	LN347GP	LN3G
LN435YP	LN426YP	LN427YP	LN45YP	LN46YP	LN444YP	LN445YP	LN01401C	LN447YP	LN4G

※ CUSTOM

SEVEN SEGMENT NUMERICAL DISPLAYS









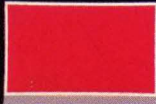

1 Digit (Mini)	1Digit(0.3inch)	1Digit(0.4inch)	1Digit(0.6inch)	2Digits(0.4inch)
				
LN513RAM/RKM	LN513RA/RK	LN514RA/RK	LN516RA/RK	LN524RA/RK
				
LN513GAM/GKM	LN513GA/GK	LN514GA/GK	LN516GA/GK	LN524GA/GK
				
LN513YAM/YKM	LN513YA/YK	LN514YA/YK	LN516YA/YK	LN524YA/YK

SEVEN SEGMENT NUMERICAL DISPLAYS



2 Digits (0.6inch)	4 Digits (0.3inch)	NEW PRODUCTS
LN526RA/RK	LN543RA/RK	LN503R
LN526GA/GK	LN543GA/GK	LN504R
LN526YA/YK	LN543YA/YK	LN506RA/RK

SURFACE DISPLAYS

5 × 15	7 × 9	12 × 15	12 × 20
			
LN 0202RP 2	LN0204RP2	LN0401RP 2	LN0603RP2
			
LN0202GP3	LN0204GP3	LN0401GP 3	LN0603GP3
			
LN0202YP4	LN0204YP4	LN0401YP4	LN0603YP4

HIGH INTENSITY LAMPS

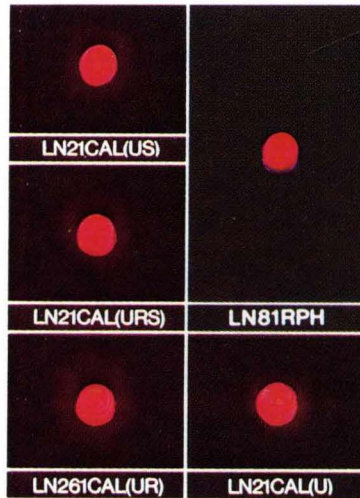

TWO COLOR LAMPS

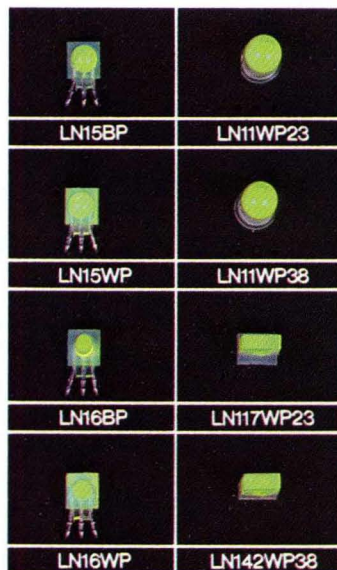

LEVEL METERS

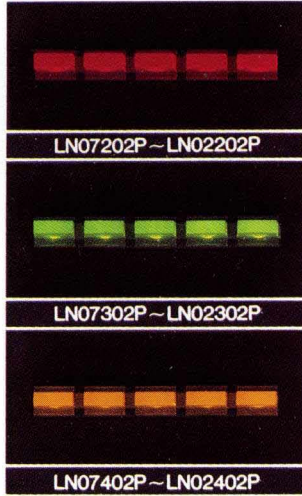

DEVICES FOR OPTO-ELECTRONICS (Visible Light Emitting Diodes)

TABLE OF CONTENTS

	PAGE
Industry Standard LED Lamps	
T-1 ¾ standard lead lamps.....	7
T-1 ¾ long lead lamps.....	10
T-1 ½ lamps.....	13
T-1 lamps.....	15
T-1 mini-lamps.....	17
Non Standard Shaped LED Lamps	
Round top view.....	19
Square top view.....	24
Triangular top view.....	34
Round side view.....	39
Round side view – two colors (red and green).....	42
Level Meter Arrays	
Five element.....	46
Seven element.....	49
Ten element.....	50
New Products	
Blue T-1 ¾ lamp.....	51
Hi-Brite T-1 ¾ red lamp.....	52
Subminiature lamps.....	53
Dual light emitting surface lamps.....	54
Glass sealed lamps.....	59
Light Bars	
5mm x 15mm series.....	56
12mm x 15mm series.....	57
12mm x 20mm series.....	58
Solid State Numerical 7-Segment LED Displays	
Single digit displays.....	60
Dual digit displays.....	64
Four digit displays.....	66
IC Led Drivers and Applications.....	68
Reliability Information.....	76
Usage Precautions.....	77
LED Cross Reference Guide.....	79

Optoelectronic Visible-Light-Emitting-Diode Materials

Panasonic visible-light-emitting-diodes (LEDs) consist of III-V family compound semiconductor GaP, GaAsP, and GaAlAs, providing the optoelectronic characteristics listed below.

Color	Materials	Wavelength	Half-Width	Forward Voltage	Junction
Red	GaP: Zn, O	700 (nm)	100 (nm)	2.2 (V)	Solution-Grown
Green	GaP: N	565	30	2.2	Solution-Grown
Red	GaAs _{0.6} P _{0.4}	660	20	1.75	Diffusion
Amber	GaAs _{0.15} P _{0.85} :N	590	30	2.2	Diffusion
Orange	GaAs _{0.35} P _{0.65} :N	630	40	2.1	Diffusion
Blue	GaN	490	80	7.5	Gaseous Phase
Red	GaAlAs	660	30	1.8	Solution-Grown

The GaAsP LED is a Zn diffused, gaseous-phased p-n junction layer of epitaxial-grown n-type GaAs_{1-x}P_x on the n-type GaAs or GaP substrate. A variety of colors, as shown above, can be obtained by changing the As and P concentration ratio.

The GaP LED is produced by forming an N and P type epitaxial layer using the solution-grown method on the n-type GaP substrate. Lighting color depends on doping impurities; red is obtained by a Zn-O dope, green is formed by an n-type dope. The light derived from a p-n junction layer can be obtained efficiently out of the device as GaP is a transparent material. The GaP (red) LED provides especially high luminance at low current, making it suitable for dc low current applications such as

battery-operated products; as shown in the relative spectral characteristics, the luminance is apt to saturate in the area of high current. The GaP (green) and GaAsP light-emitting diodes are suitable for pulse driver applications, as the luminance can be increased in proportion to current.

The GaN LED is formed by a gaseous-phased epitaxial-grown GaN layer on a sapphire substrate. The GaN layer is an n-type, where the N empty lattice point is donor, and is an MIS construction of Zn doping insulated layer I. The GaAlAs light-emitting diode is a single hetero construction consisting of epitaxial-grown n-type Ga_{1-y}Al_yAs formation in solution-grown p-type Ga_{1-x}Al_xAs, on the GaAs substrate.

Units of Radiation

Lighting characteristics of Panasonic LEDs are evaluated by photometric quantity based on their visibility as appearing to normal human eyesight.

1) Luminous Flux (lm, lumen)

The time rate of flow of light. Luminous flux is related to radiant flux by the eye-response curve.

2) Luminous Intensity (cd, candella)

Luminous intensity is measured in the perpendicular direction, of a surface of 1/6 square centimeter of a black body, at the temperature of melting point (2042°K).

3) Luminance B (fL, foot Lambert)

The luminous intensity of a surface in a given direction per unit of projected area of the surface as viewed from that direction.

Symbol

I_F : Forward Current (DC)	I_O : Luminous Intensity
I_{FM} : Peak Forward Current	$I_{O(d.p)}$: Luminous Intensity of Decimal Point
I_{FP} : Forward Current (Pulse) (Duty 1/10 Pulse width 1 msec.)	$I_{O(seg)}$: Luminous Intensity of Segment
I_R : Reverse Current	λ_p : Peak Emission Wavelength
V_F : Forward Voltage (DC)	T_a : Ambient Temperature
V_R : Reverse Voltage	T_{opr} : Operating Ambient Temperature
P_D : Power Dissipation	T_{stg} : Storage Temperature

Part Numbering Code

Point lighting Source

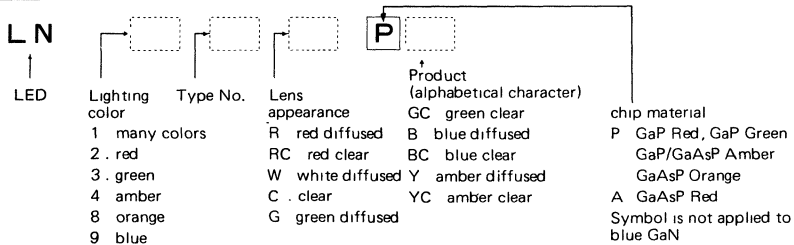

Surface lighting

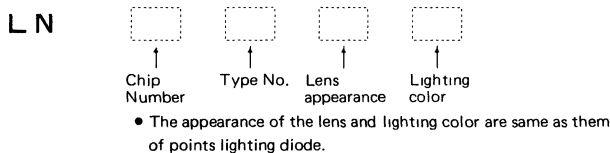

Level Meter

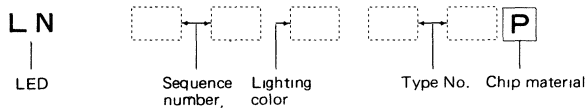

Numeric display

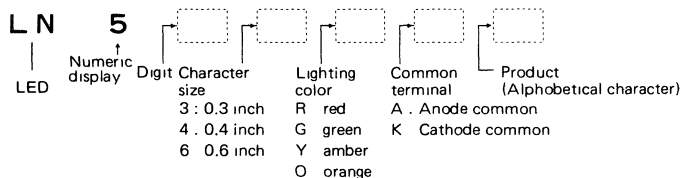

Alphanumeric Index

Part No.	Page
LN2G	59
LN3G	59
LN15BP	42
LN15WP	42
LN15WP(-F)	43
LN16BP	44
LN16WP	44
LN16WP(F)	45
LN21CAL	52
LN21CAL(-U)	52
LN21CPH	10
LN21RPH	10
LN21WPH	10
LN21CPHL	7
LN21RCPH	10
LN21RPHL	7
LN21WPHL	7
LN21RCPHL	7
LN23GRP(-H)	18
LN23SCP(-H)	17
LN25CP	39
LN25RP	39
LN25WP	39
LN25RCP	39
LN26RP	41
LN26WP	41
LN28RP	15
LN28RCP	15
LN28WP	15
LN28CP	15
LN29CP	13
LN29RP	13
LN29RCP	13
LN31GPH	11
LN31GCPH	11
LN31GPHL	8
LN31GCPH(G)	11
LN31GCPH(U)	11
LN31GCPHL	8
LN31GCPHL(-G)	8
LN31GCPHL(-U)	8
LN33SCP(H)	17
LN33SGP(H)	18
LN35BP	40
LN35GP	40
LN35GCP	40
LN36BP	41
LN38GP	16
LN38GCP	16
LN39GP	14
LN39GCP	14
LN41YPH	12
LN41YCPH	12
LN41YPHL	9
LN41YCPHL	9
LN43SYP	18
LN43SCP(H)	17
LN45YP	40
LN45-YCP	40
LN46YP	41
LN48YP	16
LN48YCP	16
LN49YP	14
LN49YCP	14
LN81CPH	12
LN81RPH	12
LN81CPHL	9

Part No.	Page
LN81RCPH	12
LN81RPHL	9
LN81RCPHL	9
LN91BC	51
LNO202GP3	56
LNO202RP2	56
LNO202YP4	56
LN210RP	31
LN210WP	31
LN211RP	24
LN211WP	24
LN212RP	35
LN213RP	30
LN217RP	32
LN219RP	29
LN220RP	33
LN221RP	21
LN222RP	19
LN224RP	26
LN226RP	37
LN227RP	36
LN228RP	38
LN229RP	27
LN230RP	20
LN233RP	25
LN235RPH	34
LN238RPH	23
LN242RP	28
LN242RPL	28
LN245RP	55
LN247CP	53
LN247RP	53
LN310GP	31
LN311GP	24
LN313GP	30
LN317GP	32
LN320GP	33
LN321GP	21
LN322GP	19
LN324GP	26
LN326GP	37
LN327GP	36
LN328GP	38
LN329GP	27
LN330GP	20
LN333GP	25
LN335GPH	34
LN338GPH	23
LN342GP	28
LN344GP	54
LN345GP	55
LN347GP	53
LN312GP	35
LN0401GP3	57
LN0401PR2	57
LN0401YP4	57
LN410YP	31
LN411YP	24
LN412YP	35
LN413YP	30
LN417YP	32
LN419YP	29
LN420YP	33
LN421YP	21
LN422YP	19
LN424YP	26

Part No.	Page
LN426YP	37
LN427YP	36
LN428YP	38
LN429YP	27
LN430YP	20
LN433YP	25
LN435YPH	34
LN438YPH	23
LN442YP	28
LN444YP	54
LN445YP	55
LN447YP	53
LN513GKS	60
LN513GKS	60
LN513RKS	60
LN513YKS	60
LN513GA/GK	61
LN513OA/OK	61
LN513RA/RK	61
LN513YA/GK	61
LN513YA/YK	61
LN514GA/GK	62
LN514OA/OK	62
LN514RA/RK	62
LN514YA/YK	62
LN516GA/GK	63
LN516OA/OK	63
LN516RA/RK	63
LN516YA/YK	63
LN524GA/GK	64
LN524OA/OK	64
LN524RA/RK	64
LN524YA/YK	64
LN526GA/GK	65
LN526OA/OK	65
LN526RA/RK	65
LN526YA/YK	65
LN543GA/GK	66
LN543RA/RK	66
LN543GA/GK	66
LN543GAH/GKH	67
LN543RAH/RKH	67
LN0603GP3	58
LN0603RP2	58
LN0603YP4	58
LN820WP	33
LN831RP	22
LN833WP	25
LN05201P	46
LN05203P	47
LN05263P	48
LN05301P	46
LN05303P	47
LN05363P	48
LN05401P	46
LN05403P	47
LN05463P	48
LN07202P	49
LN07302P	49
LN07402P	49
LN10204P	50
LN10304P	50
LN10404P	50

Round Type

(Standard Lead Type)

T-1 3/4 HL Series (Red)

- Characteristics:**
1. Lighting surface T-1 3/4 round type
 2. High radiation
 3. High reliability, long life

Absolute Maximum Ratings (Ta = 25°C)

Lighting Color	P _D (mW)	I _F (mA)	I _{FM} (mA)	V _a (V)	T _{opr} (°C)	T _{sig} (°C)
Red	70	25	30	4	-25~+85	-30~+100

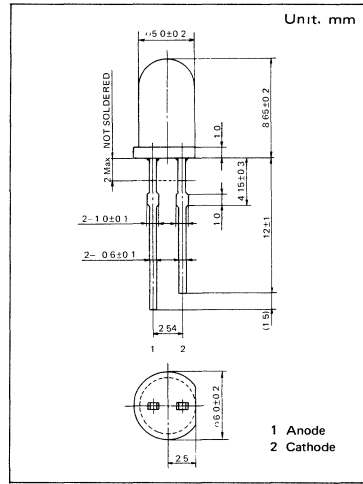

Electro-Optical Characteristics (Ta = 25°C)

Type No.	Lens Color	I ₀		I _F	V _F		λ _F	Δλ _F	I _F		
		Typ.	Min.		Typ.	Max.			Typ.	Max.	V _R
LN21RPHL	Red Diffused	3.0	1.0	15	2.2	2.8	700	100	20	5	4
LN21RCPHL	Red Clear	5.0*	2.5	15	2.2	2.8	700	100	20	5	4
LN21WPHL	White Diffused	3.0	1.0	15	2.2	2.8	700	100	20	5	4
LN21CPHL	Clear	5.0	2.0	15	2.2	2.8	700	100	20	5	4
Unit	—	mod	mcd	mA	V	V	nm	nm	mA	μA	V

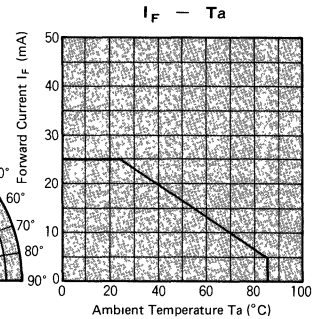
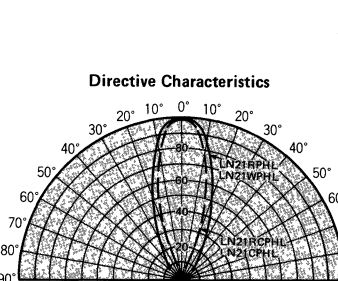
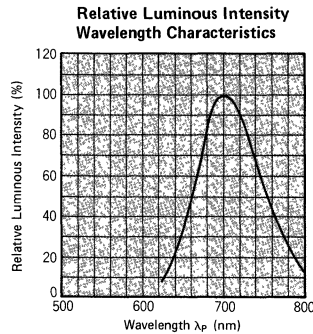
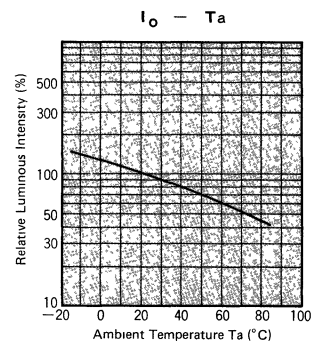
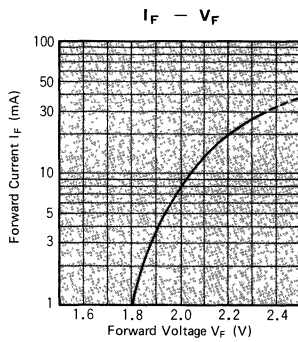
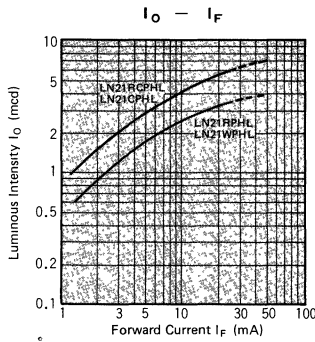

Round Type

(Standard Lead Type)

T-1^{3/4} HL Series (Green)

- Characteristics:**
1. Lighting surface T-1^{3/4} round type
 2. High radiation
 3. High reliability, long life

Absolute Maximum Ratings (Ta = 25°C)

Lighting Color	P _D (mW)	I _F (mA)	I _{FM} (mA)	V _R (V)	Topr(°C)	Tstg(°C)
Green	90	30	40	4	-25~+85	-30~+100

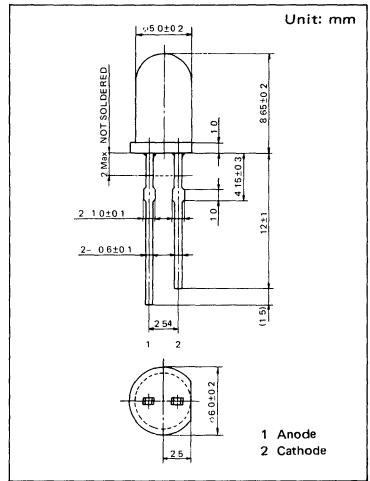

Electro-Optical Characteristics (Ta = 25°C)

Type No.	Lens Color	I ₀			V _F		λ _P	Δλ _P	I _F	I _R	
		Typ.	Min.	I _F	Typ.	Max.	Typ.	Typ.		Max.	V _R
LN31GPHL	Green Diffused	15	3.0	20	2.2	2.8	565	30	20	10	4
LN31GCPHL	Green Clear	20	7.5	20	2.2	2.8	565	30	20	10	4
LN31GCPHL(U)	Green Clear	50	23	20	2.2	2.8	565	30	20	10	4
LN31GCPHL(G)	Green Clear	7.5	3.0	20	2.2	2.8	555	20	20	10	4
Unit	—	mod	mod	mA	V	V	nm	nm	mA	μA	V

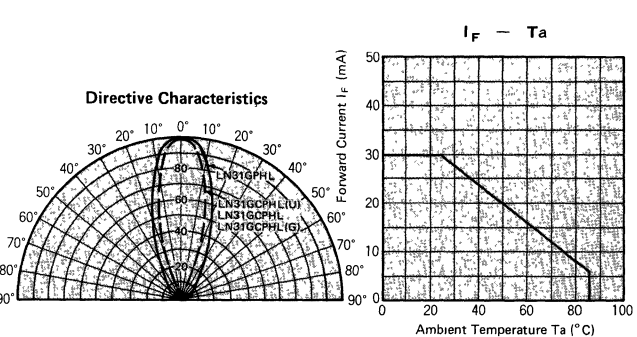
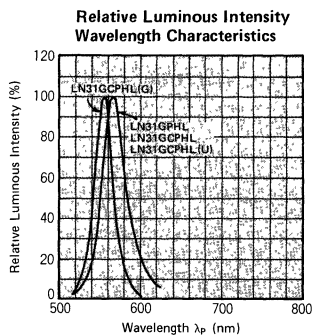
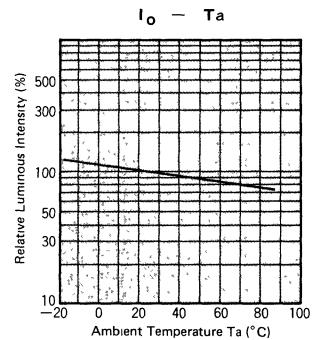
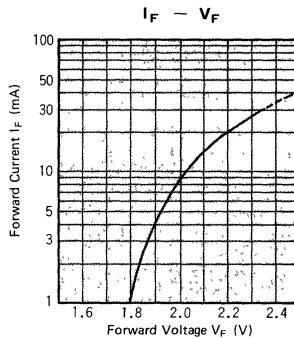
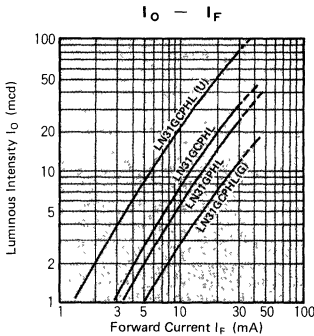

Directive Characteristics

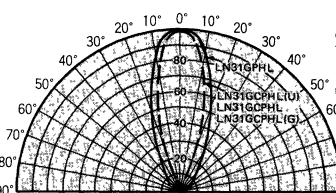

Round Type

(Standard Lead Type)

T-1^{3/4} HL Series (Amber Orange)

- Characteristics:**
1. Lighting surface T-1^{3/4} round type
 2. High radiation
 3. High reliability, long life

Absolute Maximum Ratings (Ta = 25°C)

Lighting Color	P _D (mW)	I _F (mA)	I _{FM} (mA)	V _P (V)	Topr(°C)	Tstg(°C)
Amber	90	30	40	4	-25~+85	-30~+100
Orange	90	30	40	3	-25~+85	-30~+100

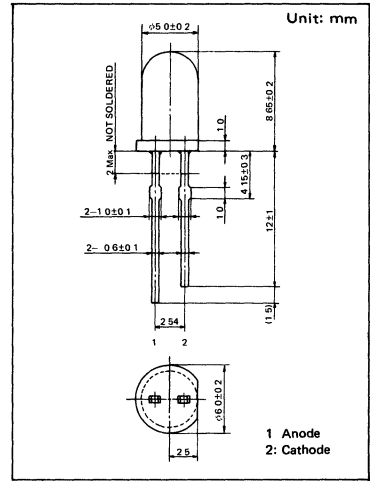

Electro-Optical Characteristics (Ta = 25°C)

Type No.	Lens Color	I ₀			V _F		λ _P	Δλ _P	I _F	I _R	
		Typ.	Min.	I _F	Typ.	Max.				Max.	V _R
LN41YPHL	Amber Diffused	8	3	20	2.2	2.8	590	30	20	10	4
LN41YCPHL	Amber Clear	20	10	20	2.2	2.8	590	30	20	10	4
LN81RPHL	Red Diffused	10	5	20	2.1	2.8	630	40	20	10	3
LN81RCPHL	Red Clear	20	8	20	2.1	2.8	630	40	20	10	3
LN81CPHL	Clear	25	10	20	2.1	2.8	630	40	20	10	3
Unit	—	mod	mod	mA	V	V	nm	nm	mA	μA	V

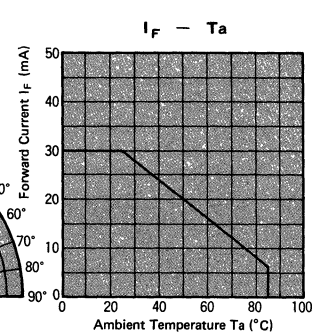
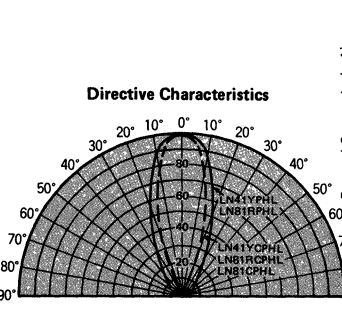
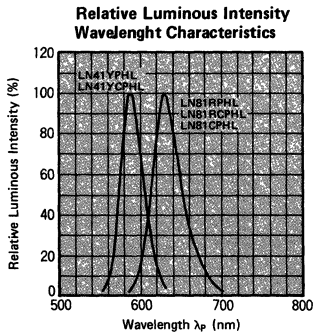
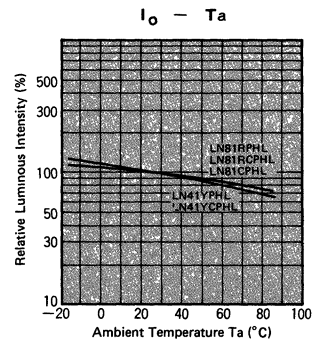
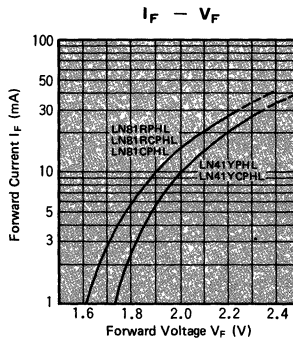
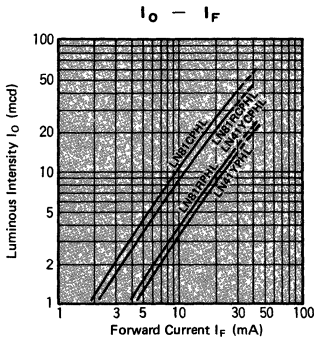

Round Type

(Long Lead Type)

T-1^{3/4} H Series (Red)

- Characteristics:**
1. Lighting surface T-^{3/4} round type
 2. Long lead wire, high radiation
 3. High reliability, long life

Absolute Maximum Ratings (Ta = 25°C)

Lighting Color	P _D (mW)	I _F (mA)	I _{FM} (mA)	V _R (V)	T _{opr} (°C)	T _{stg} (°C)
Red	70	25	30	4	-25~+85	-30~+100

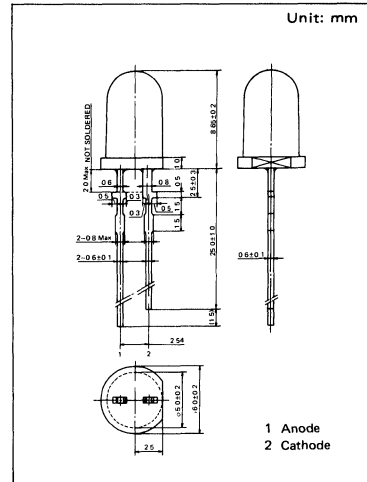

Electro-Optical Characteristics (Ta = 25°C)

Type No.	Lens Color	I _o			V _F		λ _p	Δλ _p	I _F	I _R	
		Typ.	Min.	I _F	Typ.	Max.				I _F	Max.
LN21RPH	Red Diffused	3.0	1.0	15	2.2	2.8	700	100	20	5	4
LN21RCPH	Red Clear	5.0	2.5	15	2.2	2.8	700	100	20	5	4
LN21WPH	White Diffused	3.0	1.0	15	2.2	2.8	700	100	20	5	4
LN21OPH	Clear	5.0	2.0	15	2.2	2.8	700	100	20	5	4
Unit	—	mod	mod	mA	V	V	nm	nm	mA	μA	V

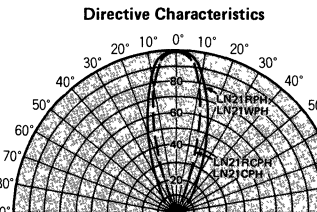
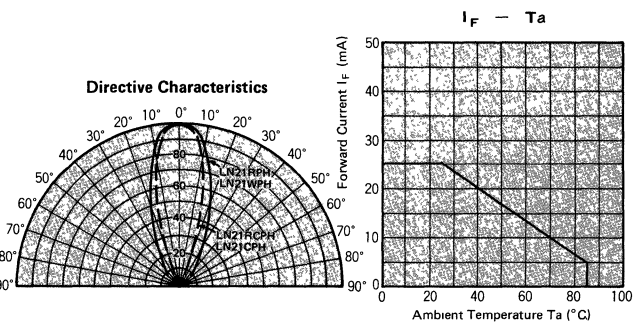
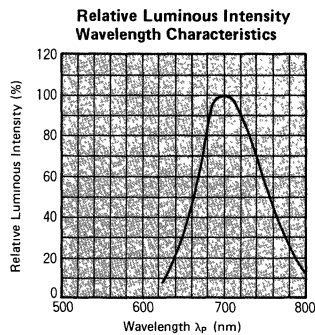
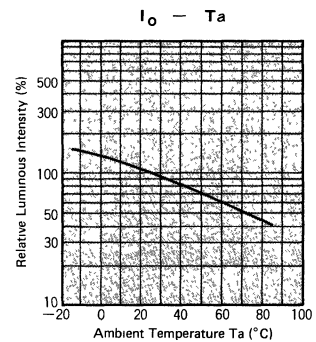
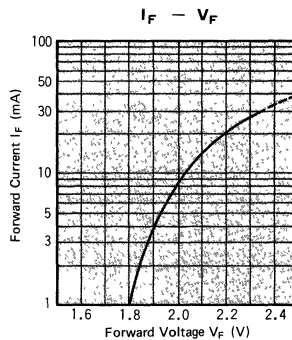
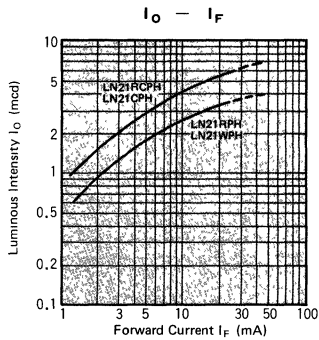

Round Type

(Long Lead Type)

T-1 3/4 H Series (Green)

- Characteristics:**
1. Lighting surface T-1 3/4 round type
 2. Long lead wire, high radiation
 3. High reliability, long life

Absolute Maximum Ratings (Ta = 25°C)

Lighting Color	P _D (mW)	I _F (mA)	I _{FM} (mA)	V _F (V)	T _{opr} (°C)	T _{stg} (°C)
Green	90	30	40	4	-25~+85	-30~+100

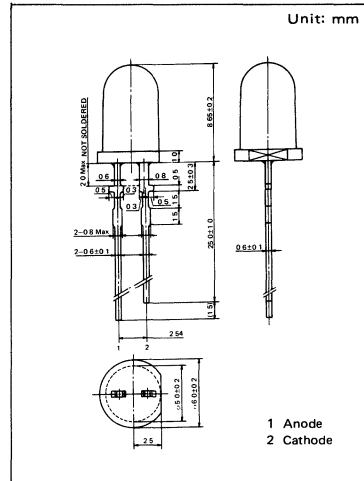

Electro-Optical Characteristics (Ta = 25°C)

Type No.	Lens Color	I _o			V _F		λ _p	Δλ _p	I _r	I _r	
		Typ.	Min.	I _F	Typ.	Max.				Max.	V _F
LN31GPH	Green Diffused	15	3.0	20	2.2	2.8	565	30	20	10	4
LN31GCPH	Green Clear	20	7.5	20	2.2	2.8	565	30	20	10	4
LN31GCPH(U)	Green Clear	50	23	20	2.2	2.8	565	30	20	10	4
LN31GCPH(G)	Green Clear	7.5	3.0	20	2.2	2.8	555	20	20	10	4
Unit	—	mod	mod	mA	V	V	nm	nm	mA	μA	V

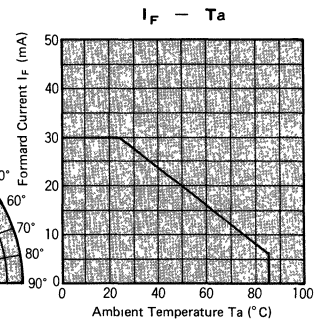
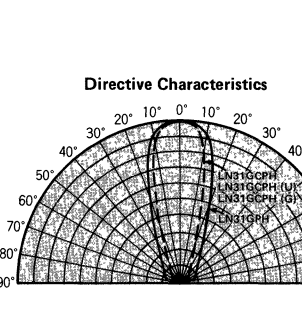
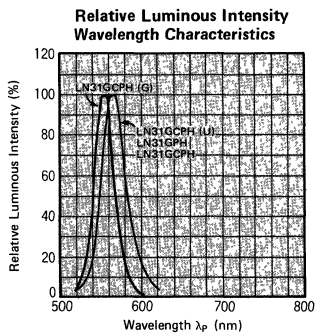
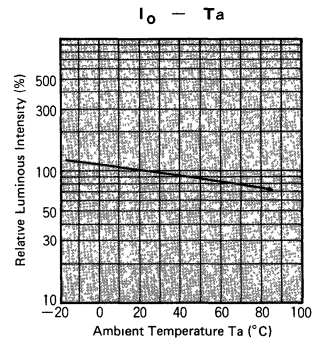
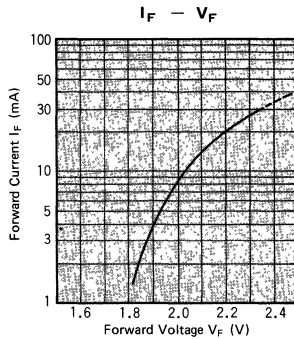
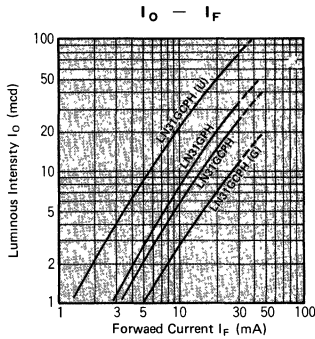

Round Type

(Long Lead Type)

T-1^{3/4} H Series (Amber/Orange)

- Characteristics:**
1. Lighting surface T-^{3/4} round type
 2. Long lead wire, high radiation
 3. High reliability, long life

Absolute Maximum Ratings (Ta = 25°C)

Lighting Color	P _D (mW)	I _F (mA)	I _{FM} (mA)	V _R (V)	To _{pr} (°C)	T _{stg} (°C)
Amber	90	30	40	4	-25~+85	-30~+100
Orange	90	30	40	3	-25~+85	-30~+100

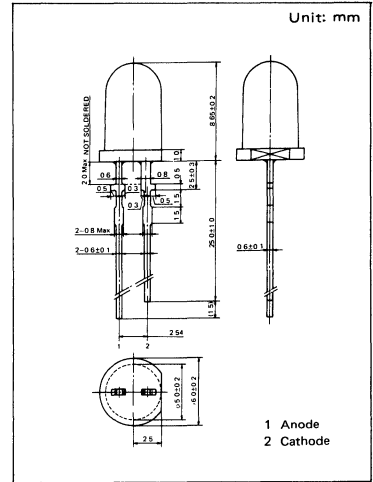

Electro-Optical Characteristics (Ta = 25°C)

Type No.	Lens Color	I _o			V _F		λ _p	Δλ _p	I _F	I _R	
		Typ.	Min.	I _F	Typ.	Max.				I _F	Max.
LN41YPH	Amber Diffused	8	3	20	2.2	2.8	590	30	20	10	4
LN41YCPH	Amber Clear	20	10	20	2.2	2.8	590	30	20	10	4
LN81RPH	Red Diffused	10	5	20	2.1	2.8	630	40	20	10	3
LN81RCPH	Red Clear	20	8	20	2.1	2.8	630	40	20	10	3
LN81GPH	Clear	25	10	20	2.1	2.8	630	40	20	10	3
Unit	—	mod	mod	mA	V	V	nm	nm	mA	μA	V

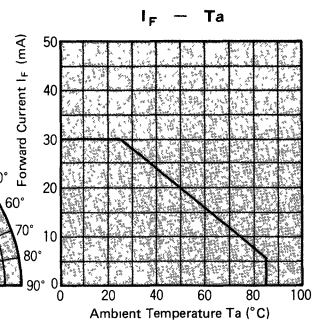
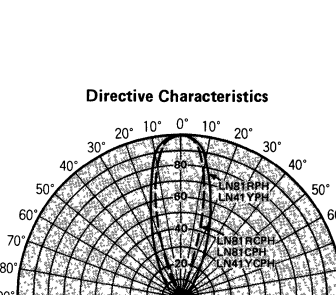
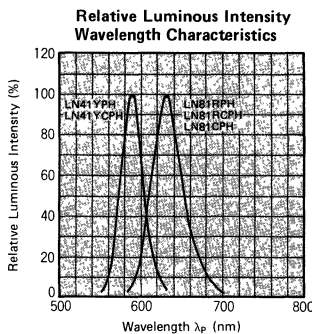
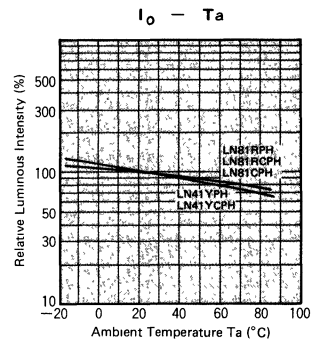
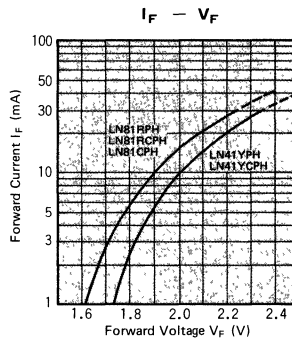
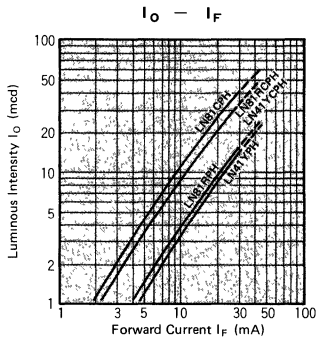

Round Type

(Standard Lead Type)

T-1½ Series (Red)

- Characteristics:**
1. Lighting surface T-1½ round type
 2. Many lens color variations
 3. High reliability, long life

Absolute Maximum Ratings (Ta = 25°C)

Lighting Color	P _D (mW)	I _F (mA)	I _{FM} (mA)	V _R (V)	Topt (°C)	Tstg (°C)
Red	70	25	30	4	-25~+85	-30~+100

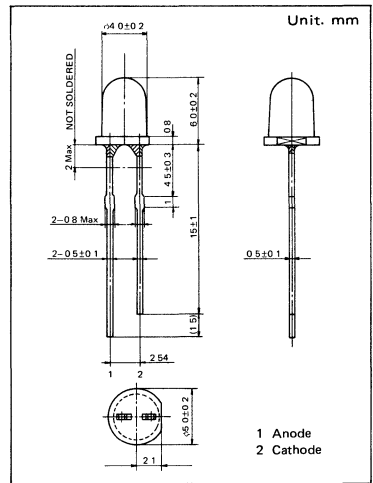

Electro-Optical Characteristics (Ta = 25°C)

Type No.	Lens Color	I ₀		I _F	V _F		λ _P	Δλ _C	I _F	I _F	
		Typ.	Min.		Typ.	Max.				μA	V
LN29RP	Red Diffused	1.0	0.3	15	2.2	2.8	700	100	20	5	4
LN29RCP	Red Clear	1.5	0.8	15	2.2	2.8	700	100	20	5	4
LN29WP	White Diffused	1.5	0.8	15	2.2	2.8	700	100	20	5	4
LN29CP	Clear	3.0	0.8	15	2.2	2.8	700	100	20	5	4
Unit	—	mcd	mcd	mA	V	V	nm	nm	mA	μA	V

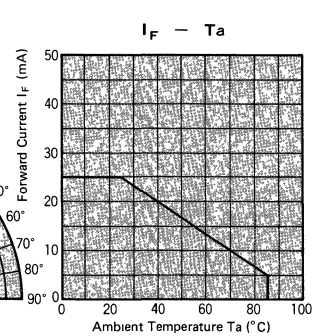
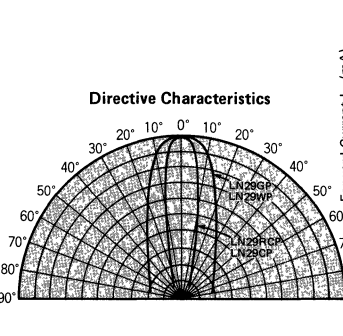
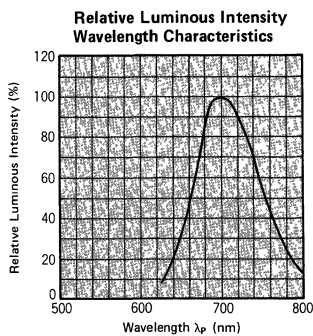
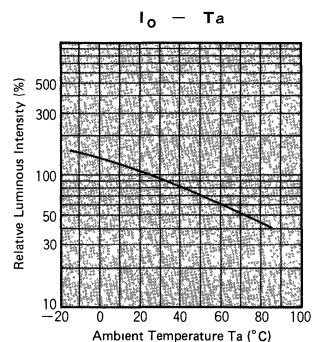
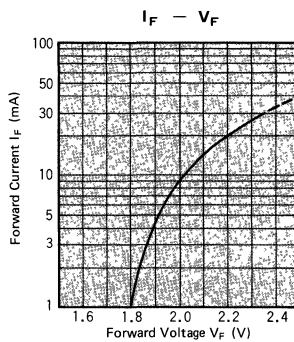
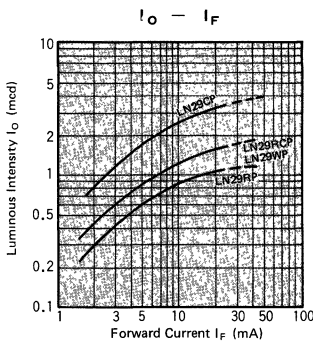

Round Type

(Standard Lead Type)

T-1½ Series (Green Amber)

- Characteristics:**
1. Lighting surface T-½ round type
 2. Many lens color variations
 3. High reliability, long life

Absolute Maximum Ratings (Ta = 25°C)

Lighting Color	P _D (mW)	I _F (mA)	I _{FM} (mA)	V _R (V)	T _{opr} (°C)	T _{stg} (°C)
Green	90	30	40	4	-25~+85	-30~+100
Amber	90	30	40	4	-25~+85	-30~+100

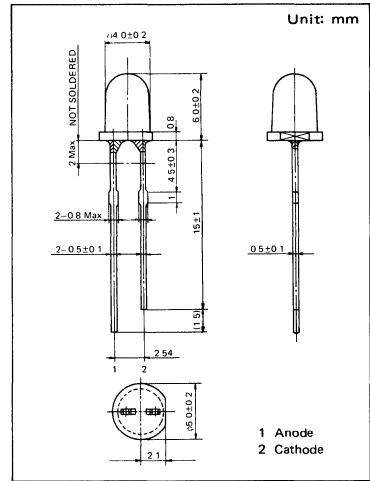

Electro-Optical Characteristics (Ta = 25°C)

Type No.	Lens Color	I _o			V _F		λ _p	Δλ _p	I _F	I _R	
		Typ.	Min.	I _F	Typ.	Max.				Max.	V _R
LN39GP	Green Diffused	2.0	0.8	20	2.2	2.8	565	30	20	10	4
LN39GCP	Green Clear	3.0	1.0	20	2.2	2.8	565	30	20	10	4
LN49YP	Amber Diffused	5.0	1.5	20	2.2	2.8	590	30	20	10	4
LN49YCP	Amber Clear	6.0	—	20	2.2	2.8	590	30	20	10	4
Unit	—	mod	mod	mA	V	V	nm	nm	mA	μA	V

△ Tentative specification

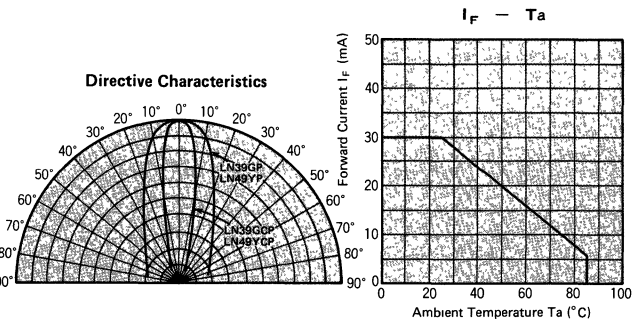
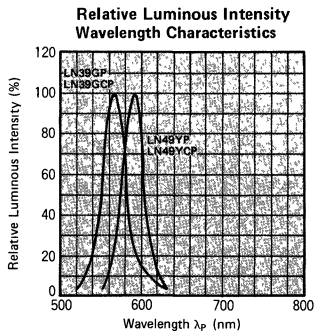
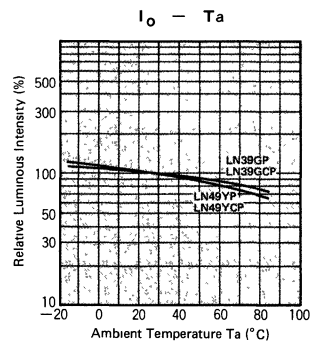
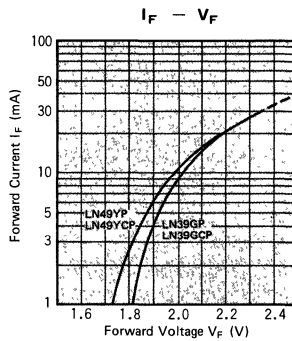
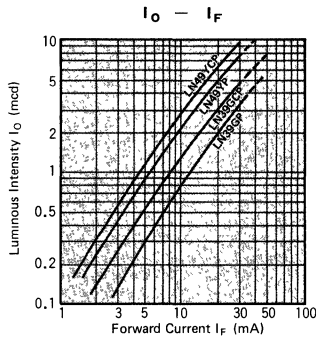

Round Type

(Standard Lead Type)

T-1 Series (Red)

- Characteristics:**
1. Lighting surface T-1 round type
 2. Many lens color variations
 3. High reliability, long life

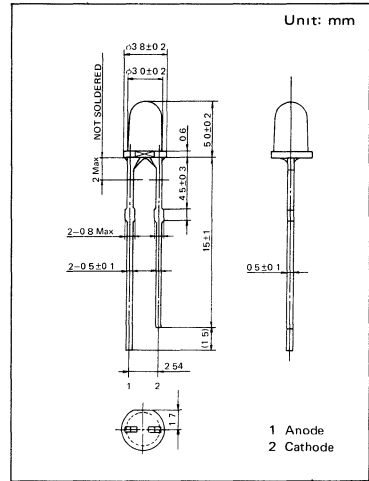

Absolute Maximum Ratings (Ta = 25°C)

Lighting Color	P _D (mW)	I _F (mA)	I _{FM} (mA)	V _R (V)	Topr(°C)	Tstg(°C)
Red	70	25	30	4	-25~+85	-30~+100

Electro-Optical Characteristics (Ta = 25°C)

Type No.	Lens Color	I ₀			V _F		λ _P	Δλ _P	I _F	I _R	
		Typ.	Min.	I _F	Typ.	Max.				Max	V _R
LN28RP	Red Diffused	0.8	0.3	15	2.2	2.8	700	100	20	5	4
LN28RCP	Red Clear	1.5	0.6	15	2.2	2.8	700	100	20	5	4
LN28WP	White Diffused	1.0	0.3	15	2.2	2.8	700	100	20	5	4
LN28CP	Clear	2.0	0.8	15	2.2	2.8	700	100	20	5	4
Unit	—	mcd	mcd	mA	V	V	nm	nm	mA	μA	V

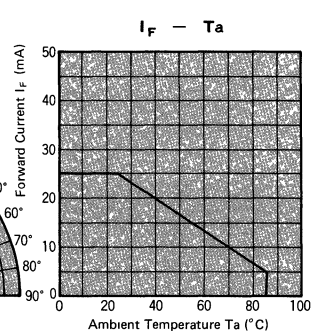
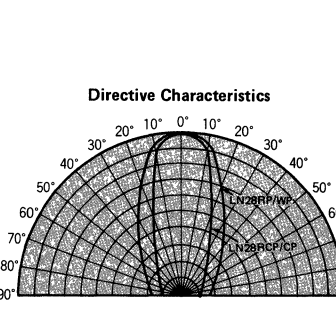
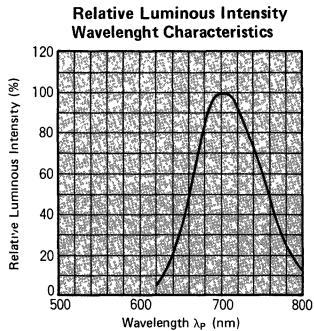
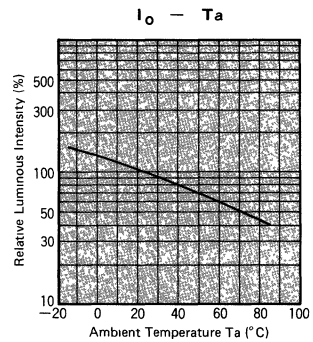
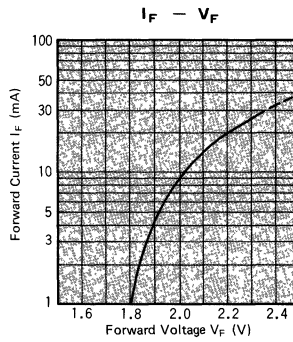
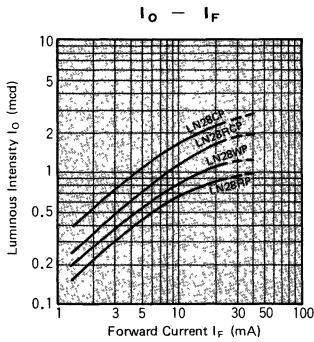

Round Type

(Standard Lead Type)

T-1 Series (Green Amber)

- Characteristics:**
1. Lighting surface T-1 round type
 2. Many lens color variations
 3. High reliability, long life

Absolute Maximum Ratings (Ta = 25°C)

Lighting Color	P _D (mW)	I _F (mA)	I _{FM} (mA)	V _R (V)	T _{opr} (°C)	T _{stg} (°C)
Green	90	30	40	4	-25~+85	-30~+100
Amber	90	30	40	4	-25~+85	-30~+100

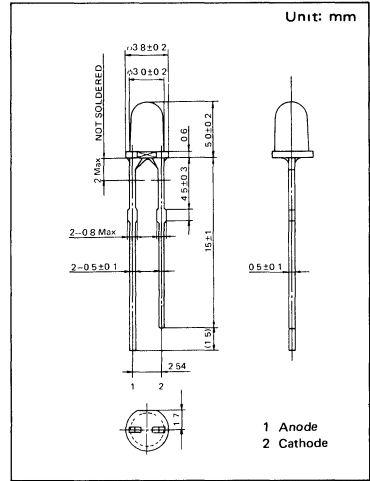

Electro-Optical Characteristics (Ta = 25°C)

Type No.	Lens Color	I _o			V _F		λ _p	Δλ _p	I _F	I _R	
		Typ.	Min.	I _F	Typ.	Max.				Max.	V _R
LN38GP	Green Diffused	2.0	0.7	20	2.2	2.8	565	30	20	10	4
LN38GCP	Green Clear	4.0	1.0	20	2.2	2.8	565	30	20	10	4
LN48YP	Amber Diffused	4.0	1.4	20	2.2	2.8	590	30	20	10	4
LN48YCP	Amber Clear	6.0	—	20	2.2	2.8	590	30	20	10	4
Unit	—	mod	mod	mA	V	V	nm	nm	mA	μA	V

△ Tentative specification

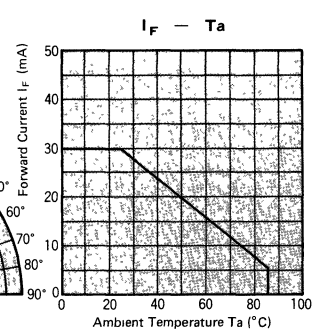
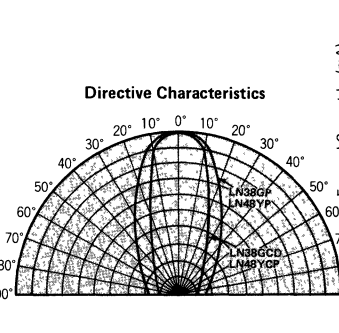
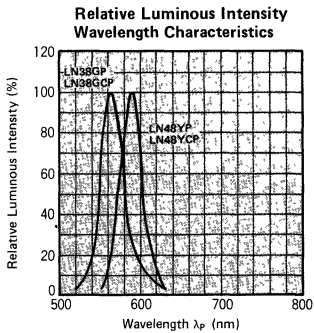
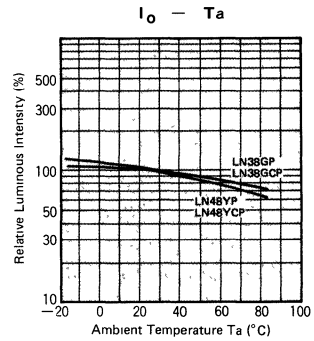
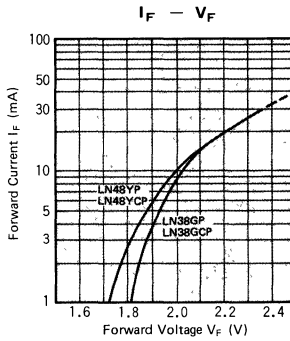
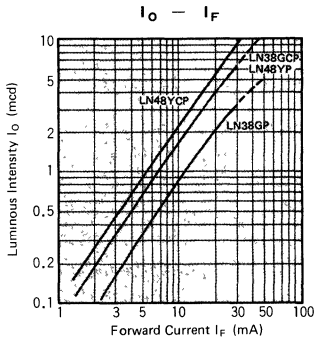

Round Type

Mini T-1 Series

- Characteristics:**
1. Lighting surface T-1 round type
 2. High radiation
 3. High reliability, long life

Absolute Maximum Ratings (Ta = 25°C)

Lighting Color	P _D (mW)	I _F (mA)	I _{FM} (mA)	V _F (V)	T _{opr} (°C)	T _{stg} (°C)
Red	55	20	25	4	-25~+85	-30~+100
Green	90	30	40	4	-25~+85	-30~+100
Amber	90	30	40	4	-25~+85	-30~+100

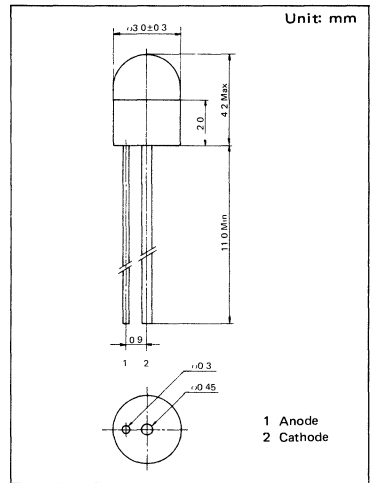

Electro-Optical Characteristics (Ta = 25°C)

Type No.	Lens Color	I ₀			V _F		λ _p	Δλ _{1/2}	I _F	I _R	V _R
		Typ.	Min.	I _F	Typ.	Max.	Typ.	Typ.			
LN23SCP(H)	Clear	1.3	0.8	15	2.2	2.8	700	100	20	5	4
LN33SCP(H)	Green Clear	3.0	2.0	20	2.2	2.8	565	30	20	10	4
LN43SCP(H)	Clear	3.0	2.0	20	2.2	2.8	590	30	20	10	4
Unit	—	mcd	mod	mA	V	V	nm	nm	mA	μA	V

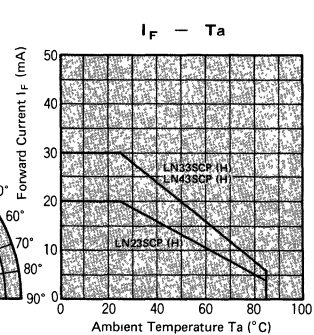
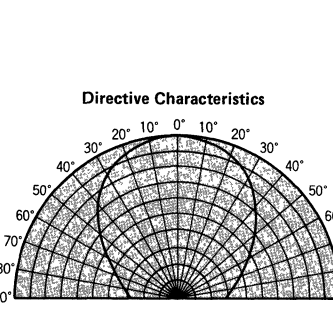
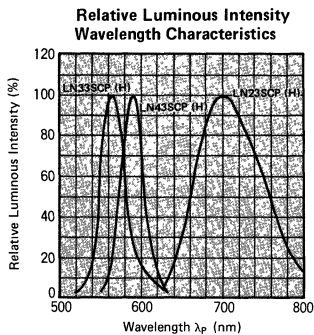
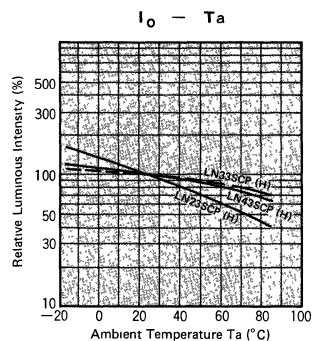
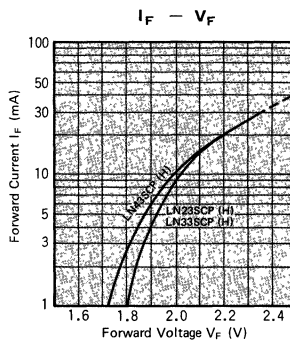
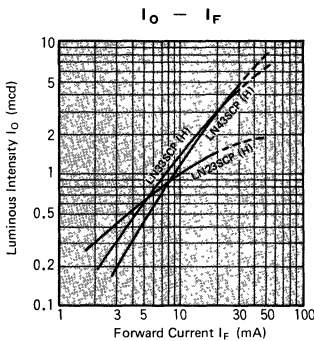

Round Type

Mini T-1 Series

- Characteristics:**
1. Lighting surface T-1 round type
 2. Wire directivity
 3. High reliability, long life

Absolute Maximum Ratings (Ta = 25°C)

Lighting Color	P _D (mW)	I _F (mA)	I _{FM} (mA)	V _R (V)	T _{opr} (°C)	T _{stg} (°C)
Red	70	25	30	4	-25~+85	-30~+100
Green	90	30	40	4	-25~+85	-30~+100
Amber	90	30	40	4	-25~+85	-30~+100

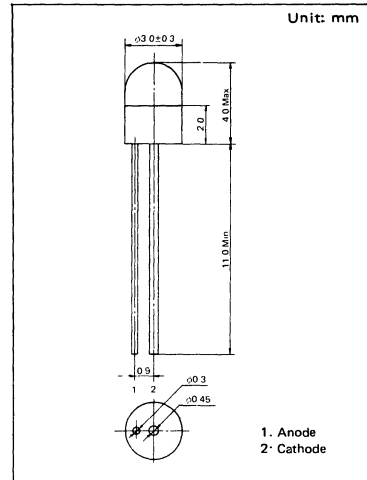

Electro-Optical Characteristics (Ta = 25°C)

Type No.	Lens Color	I _o			V _F		λ_p	$\Delta\lambda_p$	I _F	I _R	
		Typ.	Min.	I _F	Typ.	Max.				Max.	V _R
LN23SRP(H)	Red Diffused	0.6	0.3	15	2.2	2.8	700	100	20	5	4
LN33SGP(H)	Green Diffused	2.0	0.4	20	2.2	2.8	565	30	20	10	4
LN43SYP	Amber Diffused	1.5	0.2	20	2.2	2.8	590	30	20	10	4
Unit	—	mod	mod	mA	V	V	nm	nm	mA	μ A	V

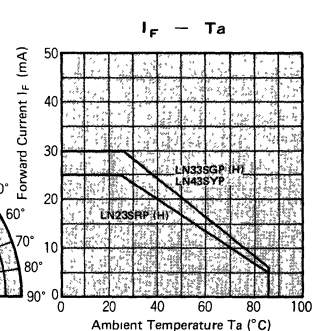
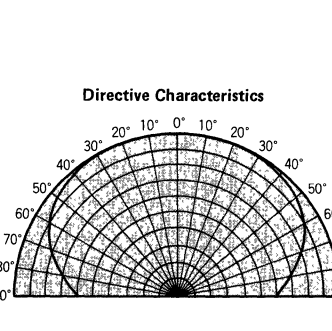
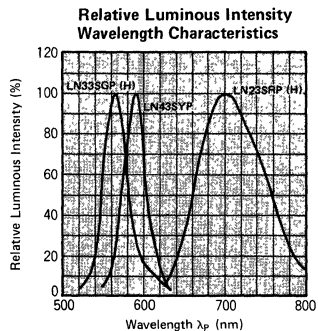
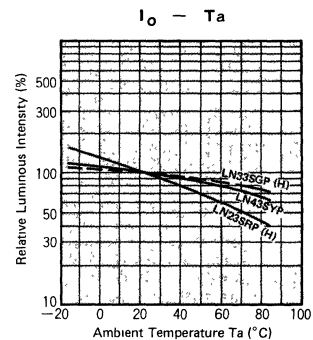
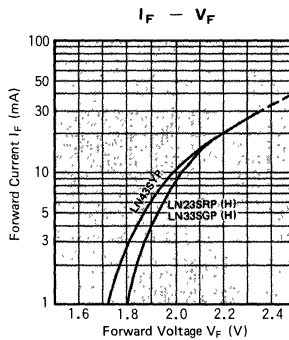
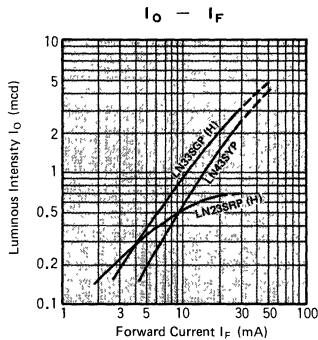

Round-Top View Type

Round-Top View 2mm Series

Characteristics: 1. Lighting surface 2.0mm round-top view type

2. Suitable for many LED use

3. High reliability, long life

Absolute Maximum Ratings (Ta = 25°C)

Lighting Color	P ₀ (mW)	I _F (mA)	I _{FM} (mA)	V _F (V)	To _{pr} (°C)	T _{stg} (°C)
Red	70	25	30	4	-25~+85	-30~+100
Green	90	30	40	4	-25~+85	-30~+100
Amber	90	30	40	4	-25~+85	-30~+100

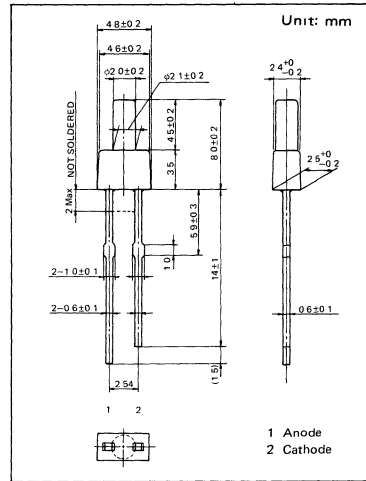

Electro-Optical Characteristics (Ta = 25°C)

Type No.	Lens Color	I ₀			V _F		λ _p	Δλ _p	I _F	I _R	
		Typ.	Min.	I _F	Typ.	Max.	Typ.	Typ.		Max.	V _R
LN222RP	Red Diffused	1.0	0.4	15	2.2	2.8	700	100	20	5	4
LN322GP	Green Diffused	1.0	0.4	20	2.2	2.8	565	30	20	10	4
LN422YP	Amber Diffused	2.5	1.2	20	2.2	2.8	590	30	20	10	4
Unit	—	mcd	mcd	mA	V	V	nm	nm	mA	μA	V

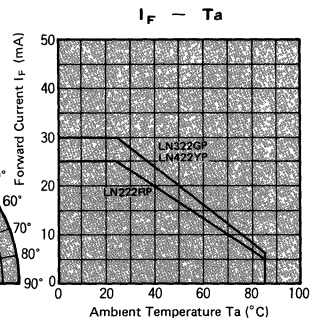
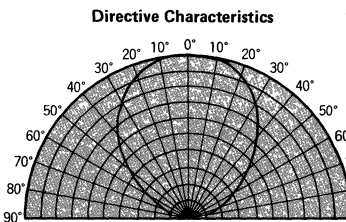
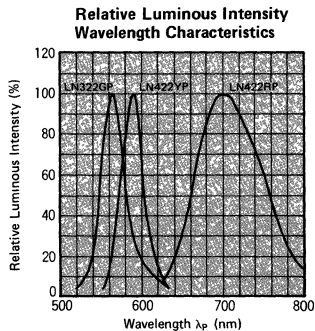
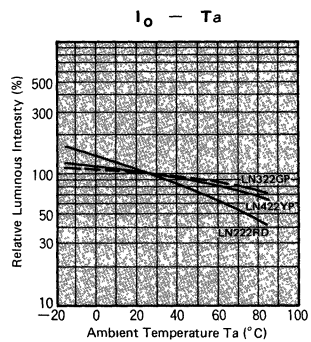
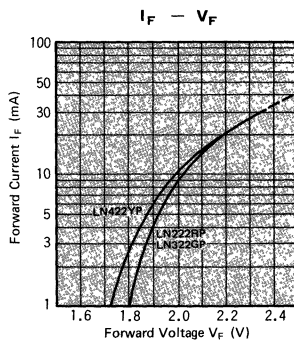
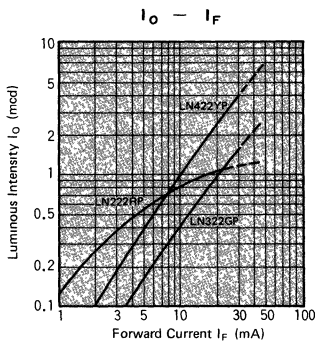

Round-Top View Type

Round-Top View 2mm Series

- Characteristics:**
1. Lighting surface 2.0mm round-top view type
 2. Suitable for many LED use
 3. High reliability, long life

Absolute Maximum Ratings (Ta = 25°C)

Lighting Color	P _D (mW)	I _F (mA)	I _{FM} (mA)	V _R (V)	To _{pr} (°C)	T _{stg} (°C)
Red	70	25	30	4	-25~+85	-30~+100
Green	90	30	40	4	-25~+85	-30~+100
Amber	90	30	40	4	-25~+85	-30~+100

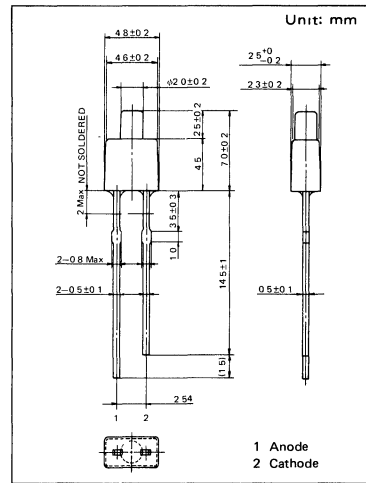

Electro-Optical Characteristics (Ta = 25°C)

Type No.	Lens Color	I ₀			V _F		λ _p	Δλ _p	I _F	I _R	V _R
		Typ.	Min.	I _F	Typ.	Max.					
LN230RPP	Red Diffused	0.5	0.2	15	2.2	2.8	700	100	20	5	4
LN330GPP	Green Diffused	1.5	0.6	20	2.2	2.8	565	30	20	10	4
LN430YPP	Amber Diffused	1.0	—	20	2.2	2.8	590	30	20	10	4
Unit	—	mod	mod	mA	V	V	nm	nm	mA	μA	V

△ Tentative specification

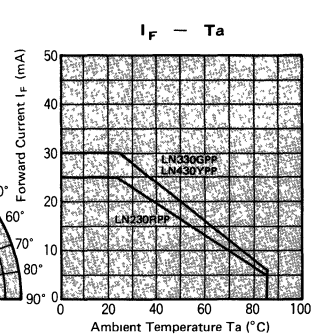
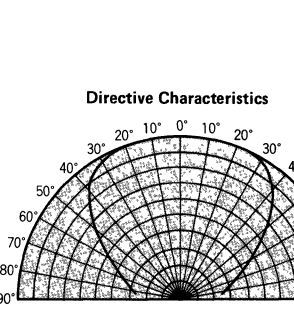
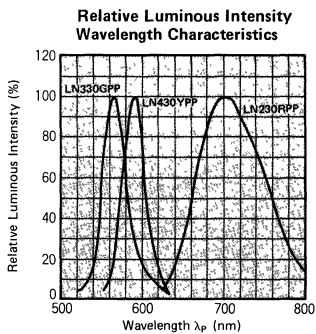
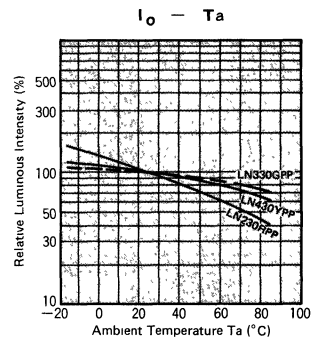
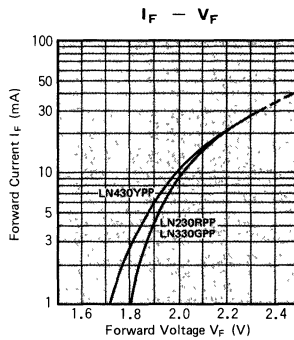
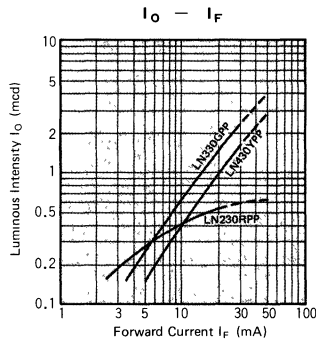

Round-Top View Type

Round-Top View 2.6mm Series

- Characteristics:**
1. Lighting surface 2.6mm round-top view type
 2. Suitable for many LED use
 3. High reliability, long life

Absolute Maximum Ratings (Ta = 25°C)

Lighting Color	P _D (mW)	I _F (mA)	I _{FM} (mA)	V _R (V)	Topt (°C)	Tstg (°C)
Red	70	25	30	4	-25~+85	-30~+100
Green	90	30	40	4	-25~+85	-30~+100
Amber	90	30	40	4	-25~+85	-30~+100

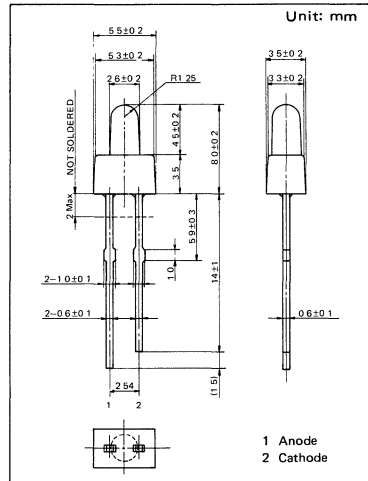

Electro-Optical Characteristics (Ta = 25°C)

Type No.	Lens Color	I ₀			V _F		λ _p	Δλ _p	I _F	I _F	
		Typ.	Min.	I _F	Typ.	Max.				Typ.	Max.
LN221RP	Red Diffused	1.0	0.5	15	2.2	2.8	700	100	20	5	4
LN321GP	Green Diffused	1.2	0.5	20	2.2	2.8	565	30	20	10	4
LN421YP	Amber Diffused	2.0	1.0	20	2.2	2.8	590	30	20	10	4
Unit	—	mcd	mcd	mA	V	V	nm	nm	mA	μA	V

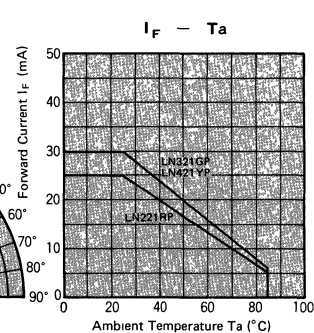
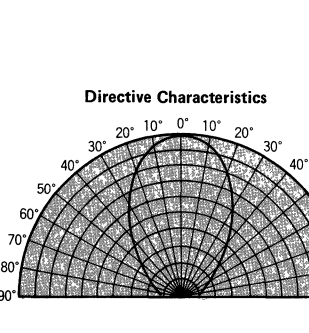
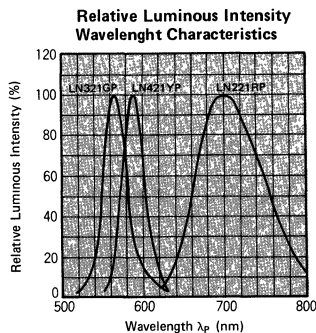
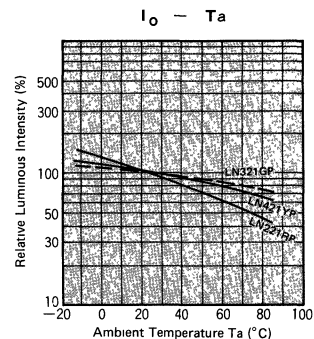
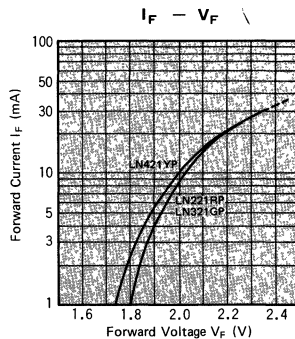
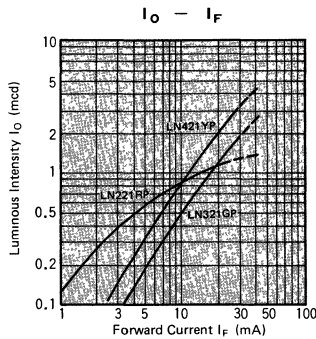

Round-Top View Type

Round-Top View 2.6mm Series

- Characteristics: 1. Lighting surface 2.6mm round-top view type
2. High radiation
3. High reliability, long life

Absolute Maximum Ratings (Ta = 25°C)

Lighting Color	P _D (mW)	I _F (mA)	I _{FM} (mA)	V _R (V)	Topr(°C)	Tstg(°C)
Orange	90	30	40	3	-25~+85	-30~+100

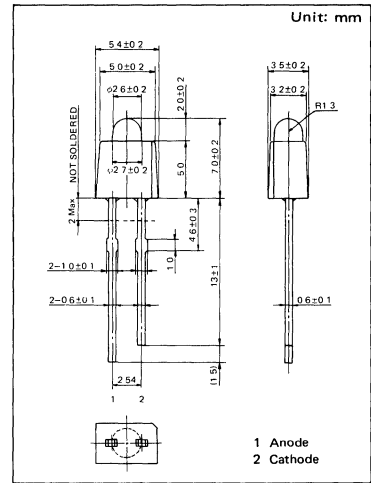

Electro-Optical Characteristics (Ta = 25°C)

Type No.	Lens Color	I ₀			V _F		λ _p	Δλ _p	I _F	I _R	
		Typ.	Min.	I _F	Typ.	Max.				Max.	V _R
LN831RP	Red Diffused	4.0	1.5	20	2.1	2.8	630	40	20	10	3
Unit	—	md	md	mA	V	V	nm	nm	mA	μA	V

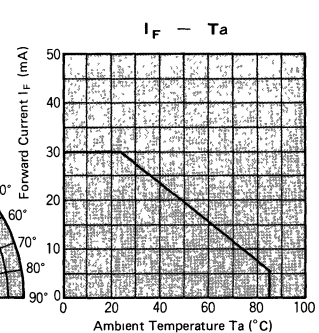
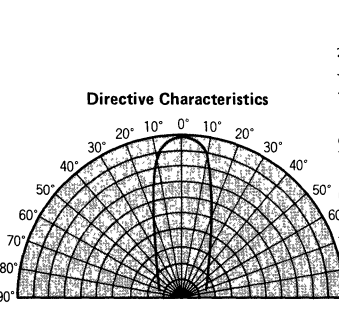
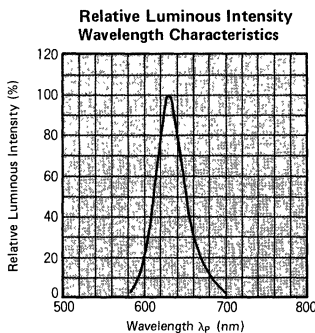
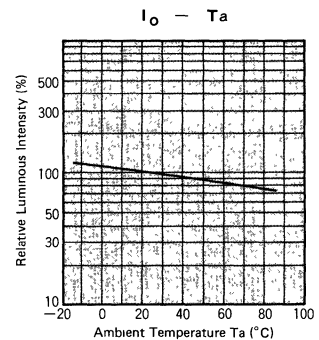
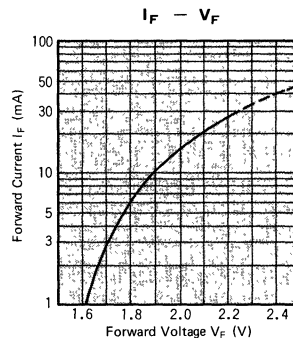
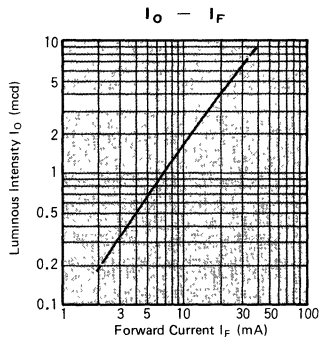

Round-Top View Type

Round-Top View 3mm Series

- Characteristics:**
1. Lighting surface 2.0mm round-top view type
 2. Long lead wire, high radiation
 3. High reliability, long life

Absolute Maximum Ratings (Ta = 25°C)

Lighting Color	P ₀ (mW)	I _F (mA)	I _{RM} (mA)	V _A (V)	T _{opr} (°C)	T _{stg} (°C)
Red	70	25	30	4	-25~+85	-30~+100
Green	90	30	40	4	-25~+85	-30~+100
Amber	90	30	40	4	-25~+85	-30~+100

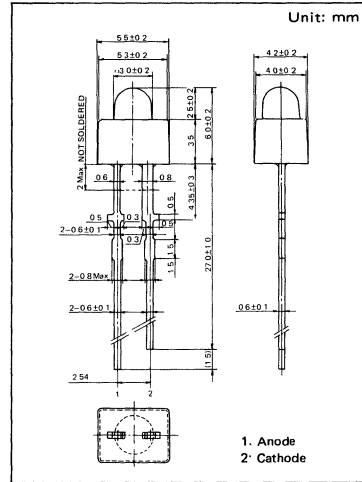

Electro-Optical Characteristics (Ta = 25°C)

Type No.	Lens Color	I ₀			V _F		λ _p	Δλ _p	I _F	I _R	
		Typ.	Min.	I _F	Typ.	Max.				Max.	V _R
LN238RPH	Red Diffused	2.0	1.0	15	2.2	2.8	700	100	20	5	4
LN338GPH	Green Diffused	4.0	1.5	20	2.2	2.8	565	30	20	10	4
LN438YPH	Amber Diffused	3.0	1.0	20	2.2	2.8	590	30	20	10	4
Unit	—	mcd	mcd	mA	V	V	nm	nm	mA	μA	V

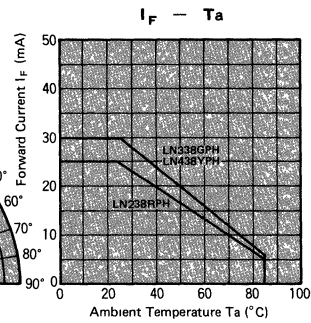
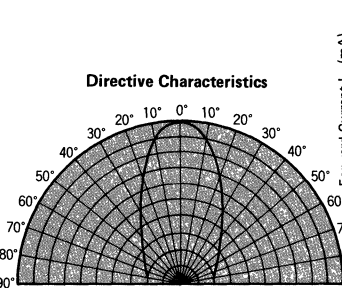
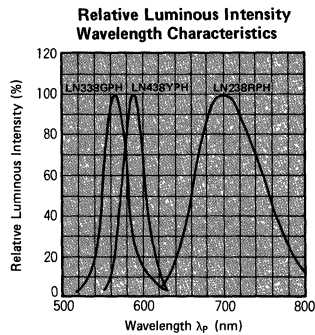
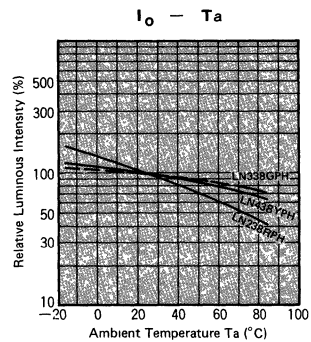
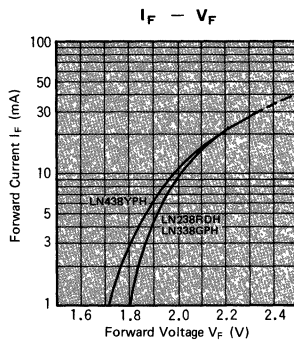
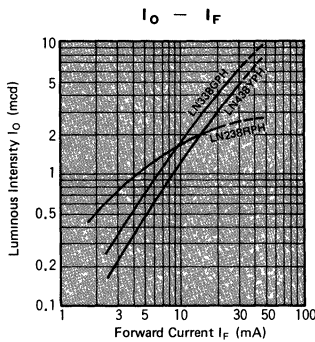

1.8mm X 3.5mm Series

- Characteristics:**
1. Lighting surface 1.8mm x 3.5mm rectangle
 2. Uniform lighting surface
 3. High reliability, long life

Absolute Maximum Ratings (Ta = 25°C)

Lighting Color	P _D (mW)	I _F (mA)	I _F M(mA)	V _R (V)	T _{opr} (°C)	T _{stg} (°C)
Red	70	25	30	4	-25~+85	-30~+100
Green	90	30	40	4	-25~+85	-30~+100
Amber	90	30	40	4	-25~+85	-30~+100

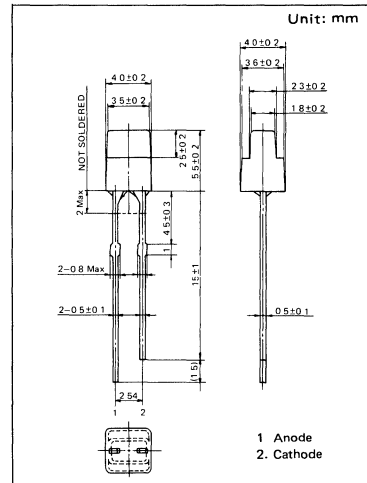

Electro-Optical Characteristics (Ta = 25°C)

Type No.	Lens Color	I ₀			V _F		λ _p	Δλ _p	I _F	I _R	
		Typ.	Min.	I _F	Typ.	Max.				Max.	V _R
LN211RP	Red Diffused	0.3	0.15	15	2.2	2.8	700	100	20	5	4
LN211WP	White Diffused	0.4	0.10	15	2.2	2.8	700	100	20	5	4
LN311GP	Green Diffused	1.0	0.45	20	2.2	2.8	565	30	20	10	4
LN411YP	Amber Diffused	1.0	0.40	20	2.2	2.8	590	30	20	10	4
Unit	—	mcd	mcd	mA	V	V	nm	nm	mA	μA	V

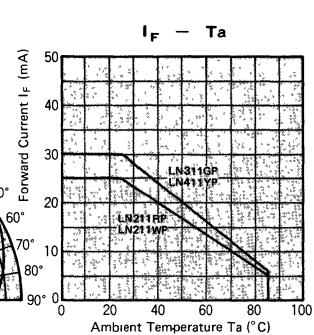
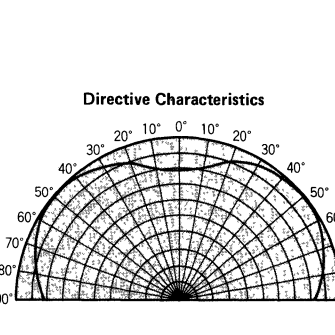
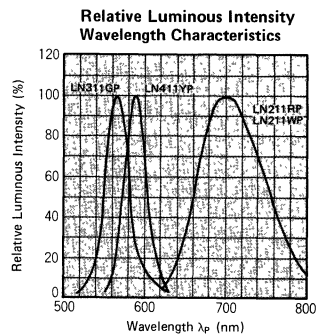
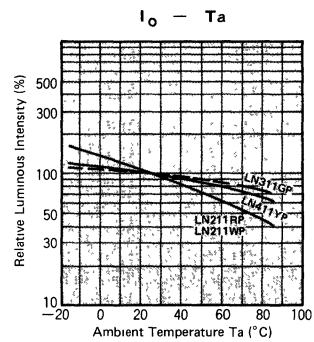
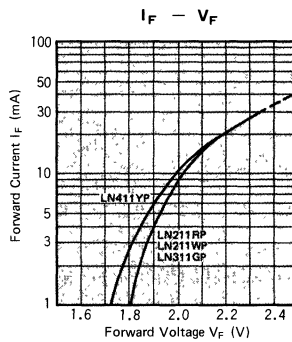
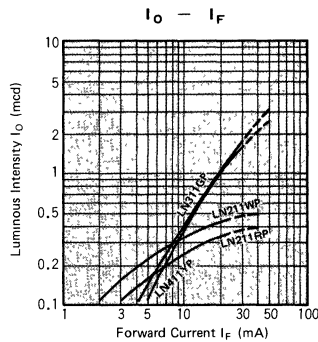

Square Type

1mm X 4mm Series

- Characteristics:**
1. Lighting surface 1 mm x 4mm rectangle
 2. Uniform lighting surface
 3. High reliability, long life

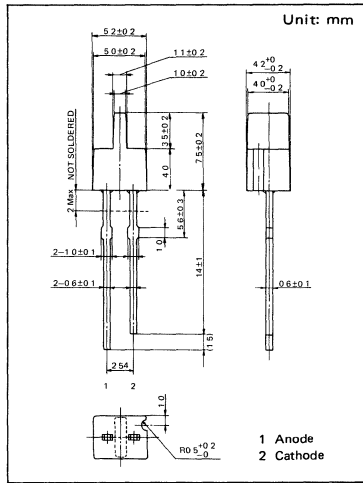

Absolute Maximum Ratings (Ta = 25°C)

Lighting Color	P ₀ (mW)	I _F (mA)	I _{F(av)} (mA)	V _F (V)	Topt(°C)	Tstg(°C)
Red	70	25	30	4	-25~+85	-30~+100
Green	90	30	40	4	-25~+85	-30~+100
Amber	90	30	40	4	-25~+85	-30~+100
Orange	90	30	40	3	-25~+85	-30~+100

Electro-Optical Characteristics (Ta = 25°C)

Type No.	Lens Color	I ₀			V _F		λ _p	Δλ _p	I _F	I ₀	
		Typ.	Min.	I _F	Typ.	Max.				I _F	Max.
LN233RP	Red Diffused	0.5	0.10	15	2.2	2.8	700	100	20	5	4
LN333GP	Green Diffused	2.0	0.75	20	2.2	2.8	565	30	20	10	4
LN433YP	Amber Diffused	1.5	0.50	20	2.2	2.8	590	30	20	10	4
LN833WP	White Diffused	2.0	0.75	20	2.1	2.8	630	40	20	10	4
Unit	—	mcd	mcd	mA	V	V	nm	nm	mA	μA	V

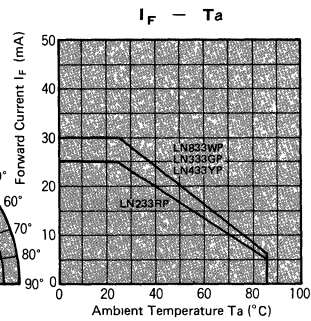
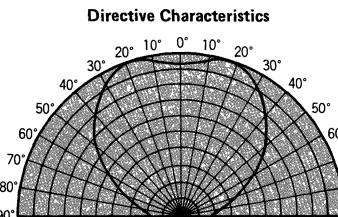
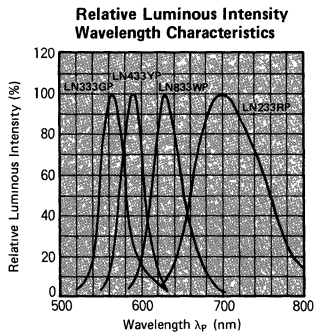
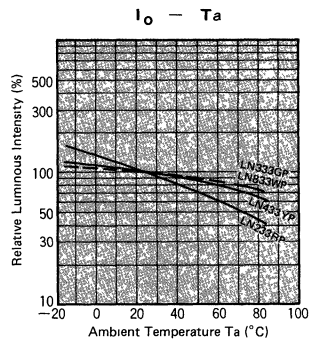
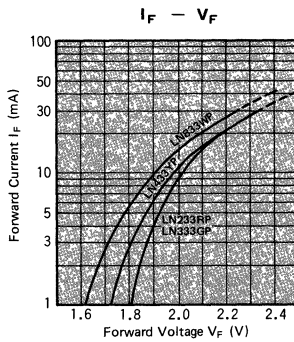
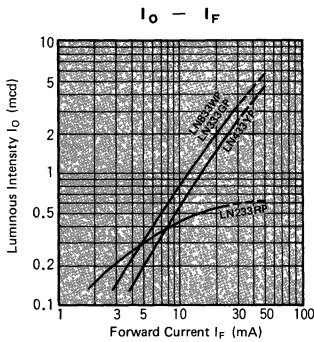

Square Type

1mm X 5mm Series

- Characteristics:**
1. Lighting surface 1.1mm x 5mm rectangle
 2. Uniform lighting surface
 3. High reliability, long life

Absolute Maximum Ratings (Ta = 25°C)

Lighting Color	P _D (mW)	I _F (mA)	I _{FM} (mA)	V _R (V)	T _{opr} (°C)	T _{stg} (°C)
Red	70	25	30	4	-25~+85	-30~+100
Green	90	30	40	4	-25~+85	-30~+100
Amber	90	30	40	4	-25~+85	-30~+100

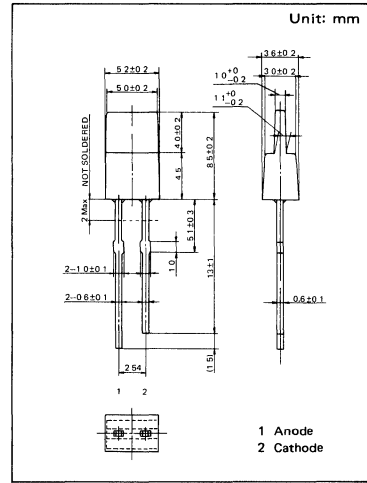

Electro-Optical Characteristics (Ta = 25°C)

Type No.	Lens Color	I ₀			V _F		λ _p	Δλ _p	I _F	I _R	
		Typ.	Min.	I _F	Typ.	Max.				Max.	V _R
LN224RP	Red Diffused	0.6	0.3	15	2.2	2.8	700	100	20	5	4
LN324GP	Green Diffused	2.5	1.0	20	2.2	2.8	565	30	20	10	4
LN424YP	Amber Diffused	2.0	0.7	20	2.2	2.8	590	30	20	10	4
Unit	—	mcd	mcd	mA	V	V	nm	nm	mA	μA	V

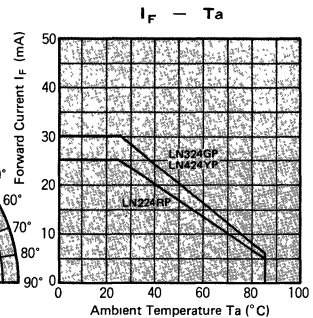
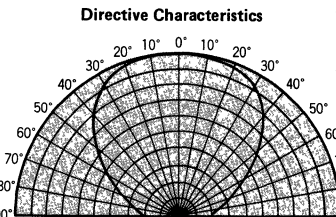
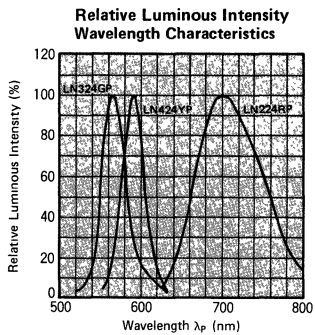
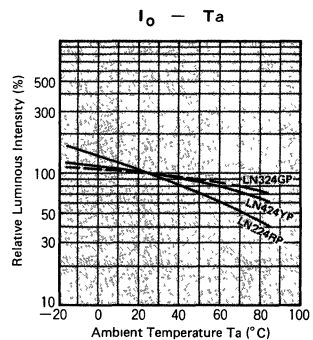
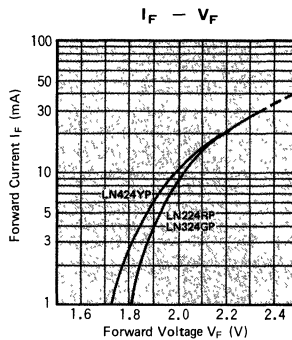
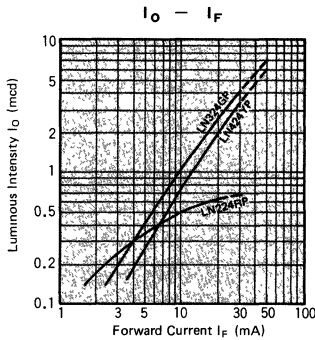

Square Type

1.5mm X 5mm Series

- Characteristics:**
1. Lighting surface 1.5mm x 5mm rectangle
 2. Uniform lighting surface
 3. High reliability, long life

Absolute Maximum Ratings (Ta = 25°C)

Lighting Color	P ₀ (mW)	I _F (mA)	I _{FM} (mA)	V _F (V)	T _{opr} (°C)	T _{stg} (°C)
Red	70	25	30	4	-25~+85	-30~+100
Green	90	30	40	4	-25~+85	-30~+100
Amber	90	30	40	4	-25~+85	-30~+100

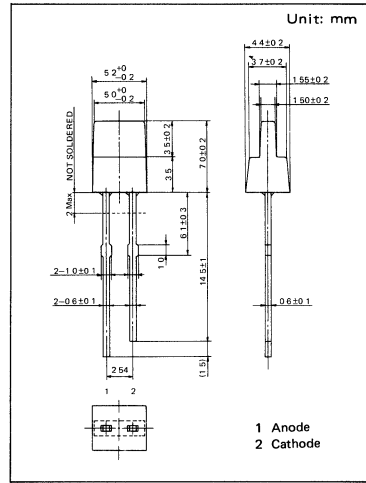

Electro-Optical Characteristics (Ta = 25°C)

Type No.	Lens Color	I ₀			V _F		λ _p	Δλ ₂	I _F	I _B	V _A
		Typ.	Min.	I _F	Typ.	Max.	Typ.	Typ.			
LN229RP	Red Diffused	0.5	0.2	15	2.2	2.8	700	100	20	5	4
LN329GP	Green Diffused	1.5	0.5	20	2.2	2.8	565	30	20	10	4
LN429YP	Amber Diffused	1.5	0.5	20	2.2	2.8	590	30	20	10	4
Unit	—	mcd	mcd	mA	V	V	nm	nm	mA	μA	V

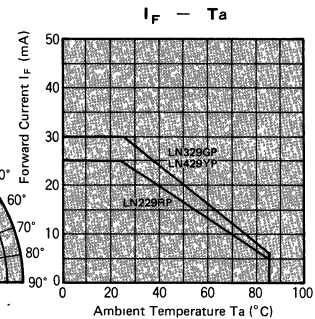
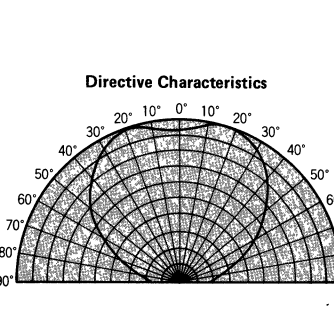
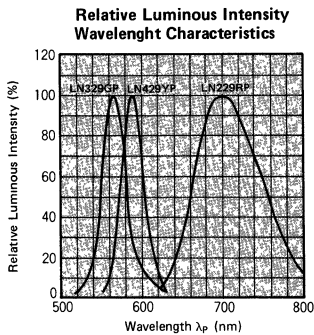
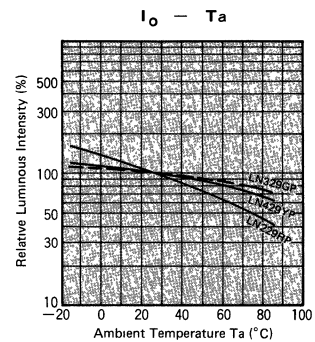
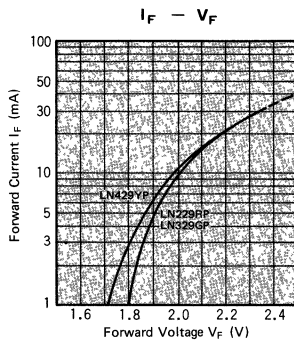
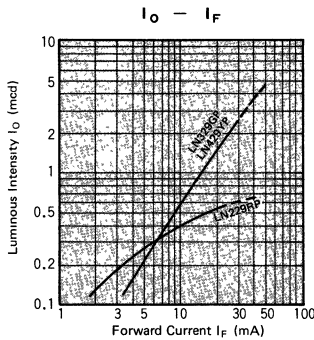

Square Type

2mm X 5mm Series

- Characteristics:**
1. Lighting surface 2mm x 5mm rectangle
 2. Shape for small space
 3. High reliability, long life

Absolute Maximum Ratings (Ta = 25°C)

Lighting Color	P _D (mW)	I _F (mA)	I _{F,Max} (mA)	V _R (V)	T _{opr} (°C)	T _{stg} (°C)
Red	70	25	30	4	-25~+85	-30~+100
Green	90	30	40	4	-25~+85	-30~+100
Amber	90	30	40	4	-25~+85	-30~+100

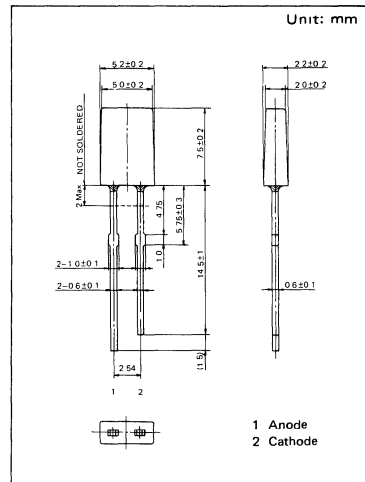

Electro-Optical Characteristics (Ta = 25°C)

Type No.	Lens Color	I _o			V _F		λ _p	Δλ _p	I _F	I _R	
		Typ.	Mn.	I _F	Typ.	Max.	Typ.	Typ.		Max.	V _R
LN242RP	Red Diffused	0.4	0.15	15	2.2	2.8	700	100	20	5	4
LN242RCP	Red Clear	1.0	0.40	15	2.2	2.8	700	100	20	5	4
LN342GP	Green Diffused	1.5	0.50	20	2.2	2.8	565	30	20	10	4
LN442YP	Amber Diffused	2.0	0.75	20	2.2	2.8	590	30	20	10	4
Unit:	—	mcd	mcd	mA	V	V	nm	nm	mA	μA	V

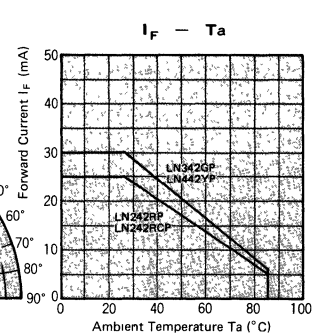
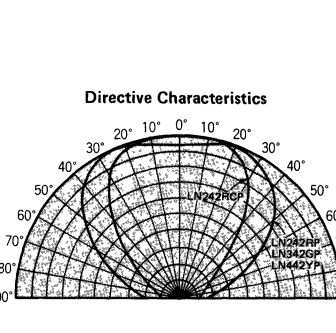
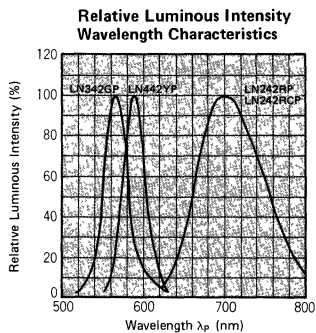
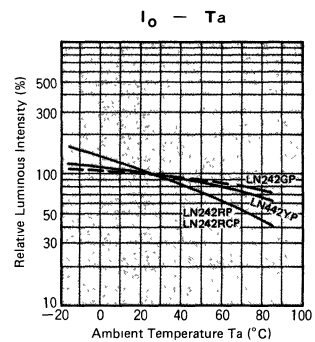
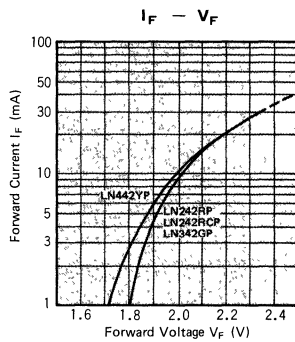
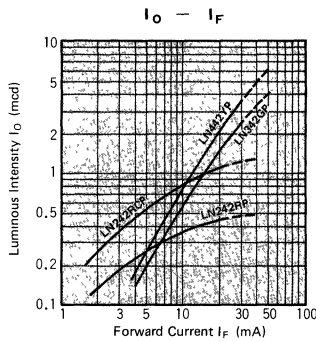

Square Type

Segment 2.5mm Series

- Characteristics:
1. Lighting surface 2.5mm x 5mm segment
 2. Uniform lighting surface
 3. High reliability, long life

Absolute Maximum Ratings (Ta = 25°C)

Lighting Color	P _o (mW)	I _F (mA)	I _{FM} (mA)	V _F (V)	To _{pr} (°C)	T _{stg} (°C)
Red	70	25	30	4	-25~+85	-30~+100
Green	90	30	40	4	-25~+85	-30~+100
Amber	90	30	40	4	-25~+85	-30~+100

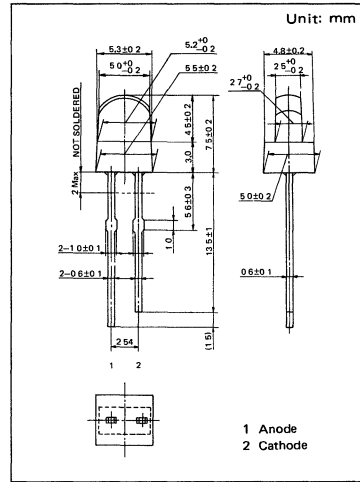

Electro-Optical Characteristics (Ta = 25°C)

Type No.	Lens Color	I _o			V _F		λ _p	Δλ _F	I _F	I _F	
		Typ.	Min.	I _F	Typ.	Max.				I _F	V _R
LN219RP	Red Diffused	1.2	0.6	15	2.2	2.8	700	100	20	5	4
LN319GP	Green Diffused	5.0	1.5	20	2.2	2.8	565	30	20	10	4
LN419YP	Amber Diffused	5.0	2.0	20	2.2	2.8	590	30	20	10	4
Unit	—	mod	mcd	mA	V	V	nm	nm	mA	μA	V

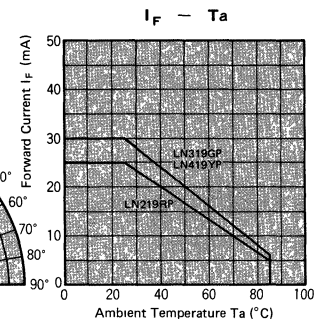
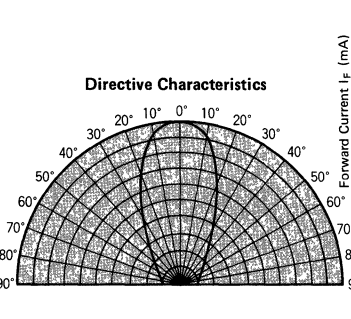
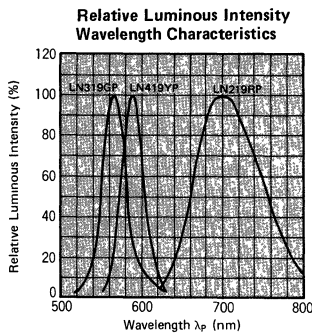
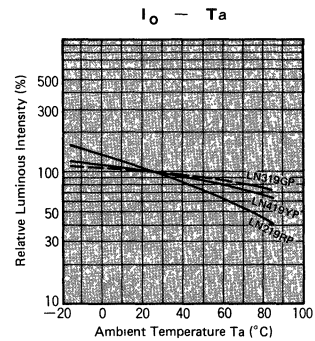
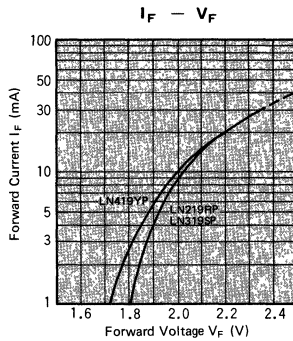
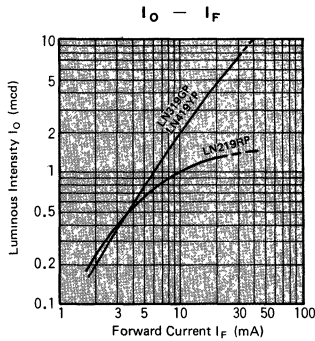

2.5mm X 5mm Series

- Characteristics:
1. Lighting surface 2.5mm x 5mm rectangle
 2. Uniform lighting surface
 3. High reliability, long life

Absolute Maximum Ratings (Ta = 25°C)

Lighting Color	P _D (mW)	I _F (mA)	I _{FM} (mA)	V _R (V)	T _{opr} (°C)	T _{stg} (°C)
Red	70	25	30	4	-25~+85	-30~+100
Green	90	30	40	4	-25~+85	-30~+100
Amber	90	30	40	4	-25~+85	-30~+100

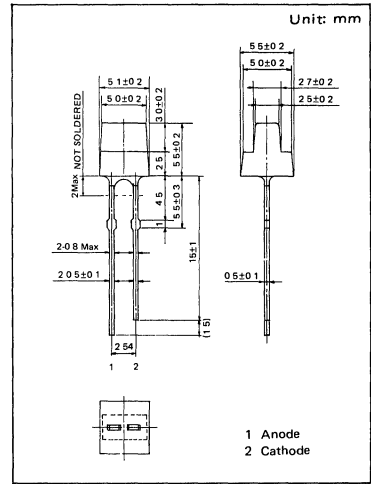

Electro-Optical Characteristics (Ta = 25°C)

Type No.	Lens Color	I ₀			V _F		λ _p	Δλ _p	I _F	I _R	
		Typ.	Min.	I _F	Typ.	Max.				I _F	Max.
LN213RP	Red Diffused	0.4	0.1	15	2.2	2.8	700	100	20	5	4
LN313GP	Green Diffused	1.0	0.4	20	2.2	2.8	565	30	20	10	4
LN413YP	Amber Diffused	1.0	0.4	20	2.2	2.8	590	30	20	10	4
Unit	—	mcd	mcd	mA	V	V	nm	nm	mA	μA	V

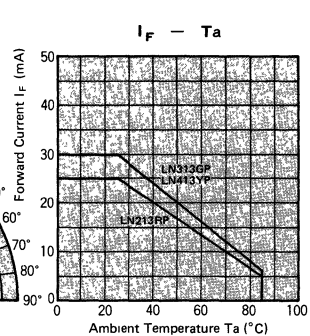
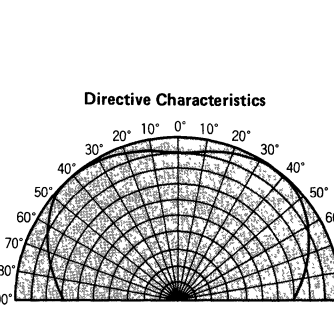
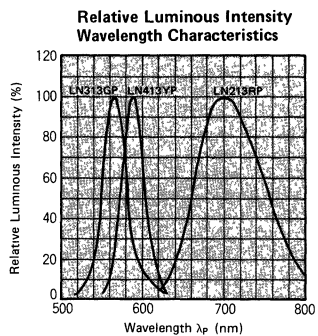
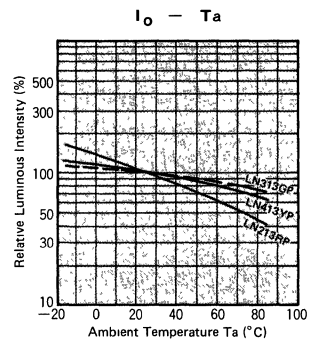
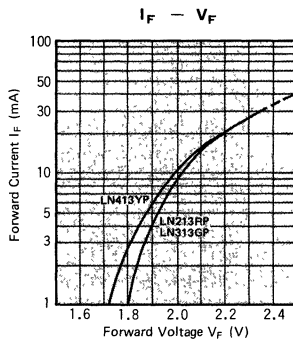
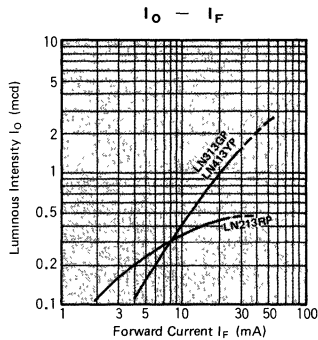

Square Type

2.5mm X 5mm Series

- Characteristics: 1. Lighting surface 2.5mm x 5mm rectangle
 2. Uniform lighting surface
 3. High reliability, long life

Absolute Maximum Ratings (Ta = 25°C)

Lighting Color	P _D (mW)	I _F (mA)	I _{FM} (mA)	V _F (V)	Topr (°C)	Tstg (°C)
Red	70	25	30	4	-25~+85	-30~+100
Green	90	30	40	4	-25~+85	-30~+100
Amber	90	30	40	4	-25~+85	-30~+100

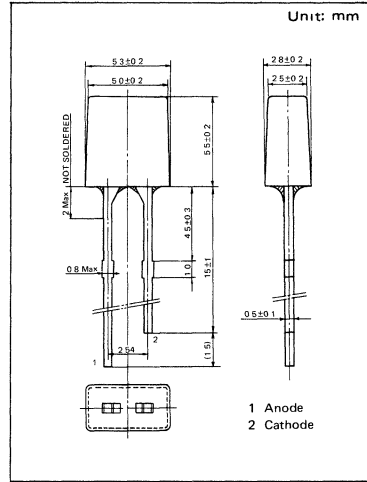

Electro-Optical Characteristics (Ta = 25°C)

Type No.	Lens Color	I ₀			V _F		λ _P		I _F	I _F	
		Typ.	Min.	I _F	Typ.	Max.	Typ.	Typ.		Max.	V _B
LN210RP	Red Diffused	0.4	0.10	15	2.2	2.8	700	100	20	5	4
LN210WP	White Diffused	0.4	0.10	15	2.2	2.8	700	100	20	5	4
LN310GP	Green Diffused	1.0	0.45	20	2.2	2.8	565	30	20	10	4
LN410YP	Amber Diffused	1.0	0.40	20	2.2	2.8	590	30	20	10	4
Unit	—	mcd	mcd	mA	V	V	nm	nm	mA	μA	V

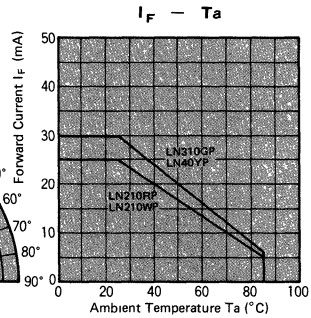
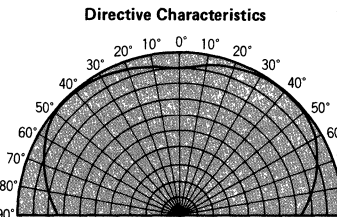
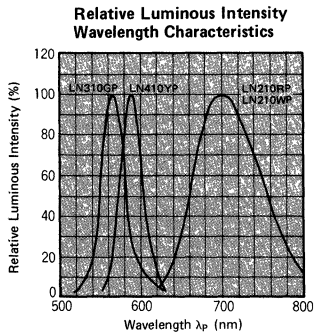
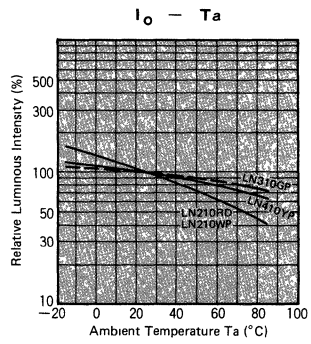
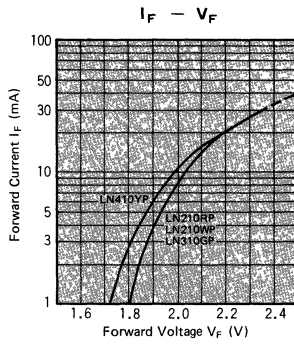
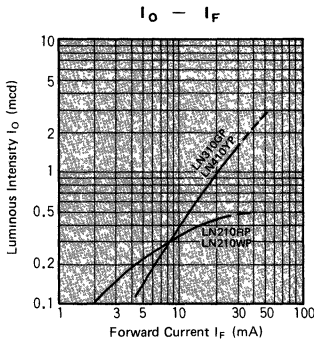

Square Type

1.8mm X 5.3mm Series

Characteristics: 1. Lighting surface 1.8mm x 5.3mm rectangle

2. Uniform lighting surface
3. High reliability, long life

Absolute Maximum Ratings (Ta = 25°C)

Lighting Color	P _D (mW)	I _F (mA)	I _{F(M)} (mA)	V _R (V)	Topr(°C)	Tstg(°C)
Red	70	25	30	4	-25~+85	-30~+100
Green	90	30	40	4	-25~+85	-30~+100
Amber	90	30	40	4	-25~+85	-30~+100

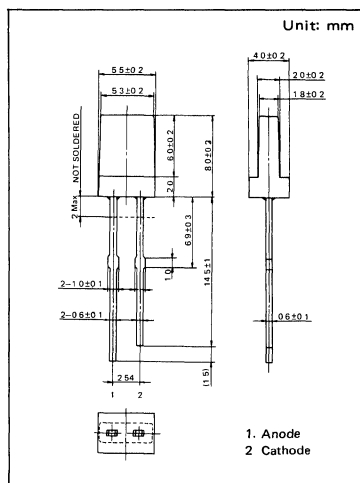

Electro-Optical Characteristics (Ta = 25°C)

Type No.	Lens Color	I _o			V _F		λ _p	Δλ _p	I _F	I _R	
		Typ.	Min.	I _F	Typ.	Max.	Typ.	Typ.		Max.	V _R
LN217RP	Red Diffused	0.6	0.3	15	2.2	2.8	700	100	20	5	4
LN317GP	Green Diffused	1.5	0.4	20	2.2	2.8	565	30	20	10	4
LN417YP	Amber Diffused	1.5	0.6	20	2.2	2.8	590	30	20	10	4
Unit	—	mcd	mcd	mA	V	V	nm	nm	mA	μA	V

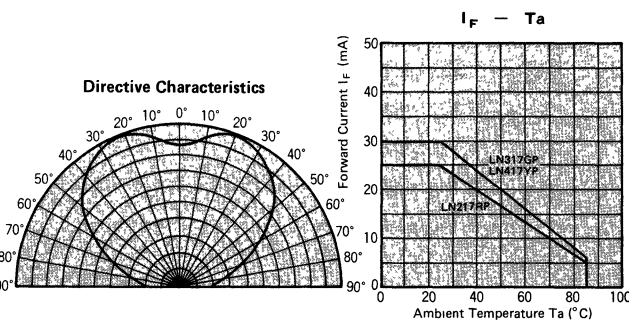
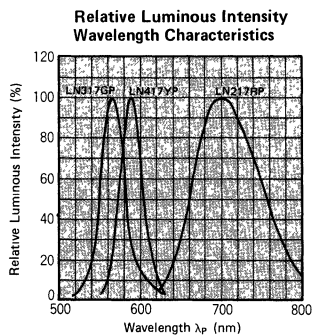
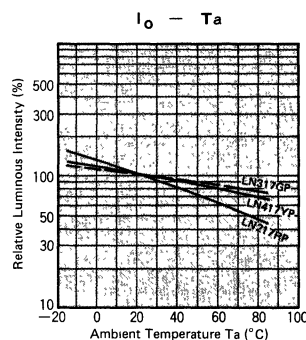
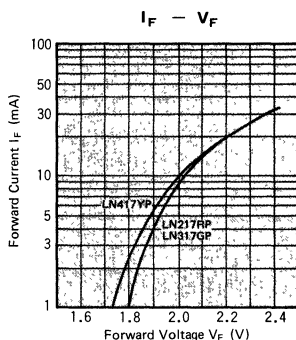
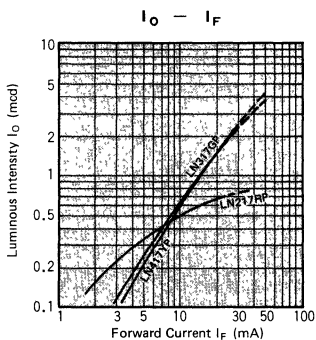

Square Type

1.75mm X 7mm Series

- Characteristics:**
1. Lighting surface 1.75mm x 7mm rectangle
 2. Lighting surface is formed at right angles with A.C. lead wire
 3. High reliability, long life

Absolute Maximum Ratings (Ta = 25°C)

Lighting Color	PO(mW)	IF(mA)	IFM(mA)	VF(V)	Topt(°C)	Tstg(°C)
Red	70	25	30	4	-25~+85	-30~+100
Green	90	30	40	4	-25~+85	-30~+100
Amber	90	30	40	4	-25~+85	-30~+100
Orange	90	30	40	3	-25~+85	-30~+100

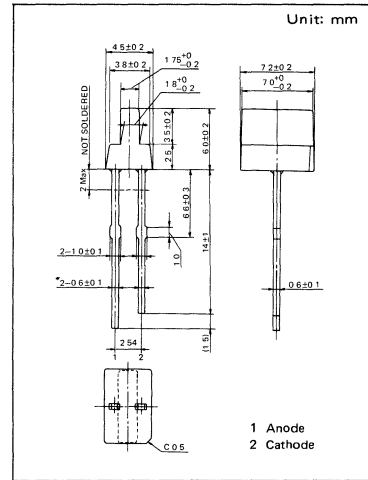

Electro-Optical Characteristics (Ta = 25°C)

Type No.	Lens Color	Io			VF		AP	ΔAP	IF	IR	
		Typ	Min	IF	Typ	Max				Max	VR
LN220RP	Red Diffused	0.4	0.15	15	2.2	2.8	700	100	20	5	4
LN320GP	Green Diffused	1.2	0.50	20	2.2	2.8	565	30	20	10	4
LN420YP	Amber Diffused	1.5	0.50	20	2.2	2.8	590	30	20	10	4
LN820WP	White Diffused	1.5	0.60	20	2.1	2.8	630	40	20	10	3
Unit	—	mcd	mcd	mA	V	V	nm	nm	mA	μA	V

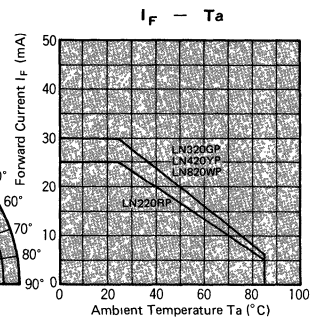
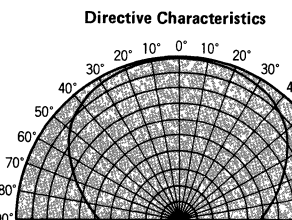
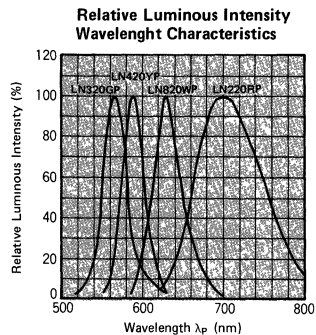
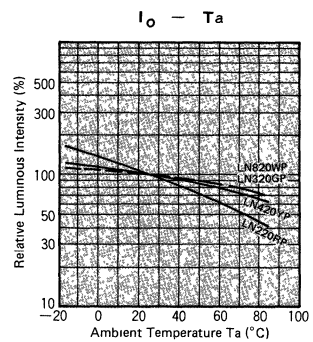
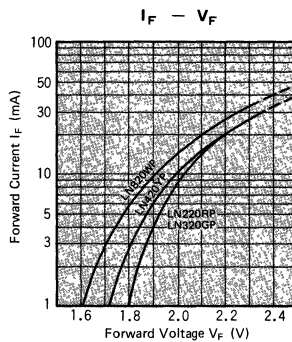
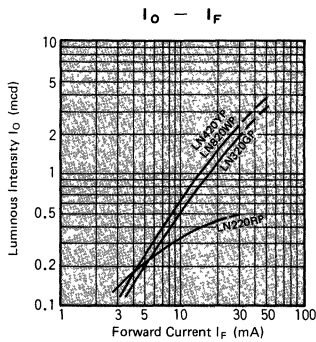

Triangle Type

Triangle 2mm X 2.5mm Series

- Characteristics:**
1. Lighting surface 2mm x 2.5mm triangle
 2. Long leadwire and suitable type for location indicator and line finder
 3. High reliability, long life

Absolute Maximum Ratings (Ta = 25°C)

Lighting Color	P _D (mW)	I _F (mA)	I _{FM} (mA)	V _R (V)	Topr(°C)	Tstg(°C)
Red	70	25	30	4	-25~+85	-30~+100
Green	90	30	40	4	-25~+85	-30~+100
Amber	90	30	40	4	-25~+85	-30~+100

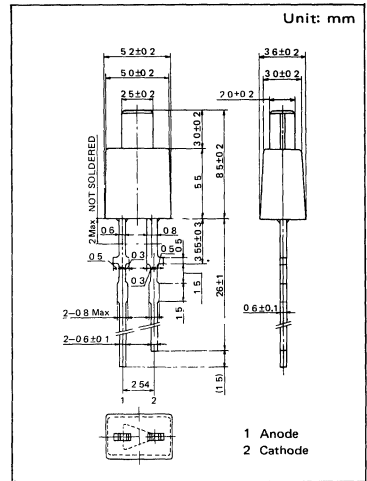

Electro-Optical Characteristics (Ta = 25°C)

Type No.	Lens Color	I ₀			I _F	V _F		λ _p	Δλ _p	I _F	I _R	
		Typ.	Min.			Typ.	Max.				Max.	V _R
LN235RPH	Red Diffused	0.5	0.25	15	2.2	2.8	700	100	20	5	4	
LN335GPH	Green Diffused	1.5	0.60	20	2.2	2.8	565	30	20	10	4	
LN435YPH	Amber Diffused	1.0	—	20	2.2	2.8	590	30	20	10	4	
Unit	—	mod	mod	mA	V	V	nm	nm	mA	μA	V	

△ Tentative specification

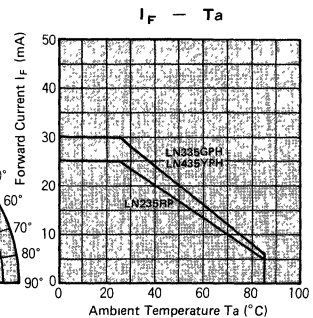
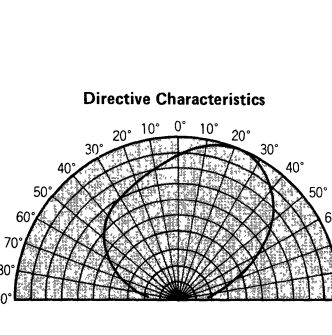
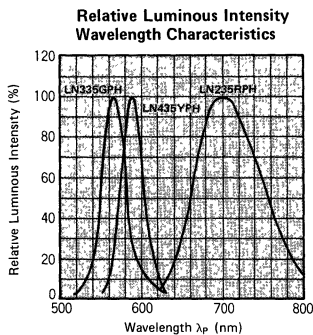
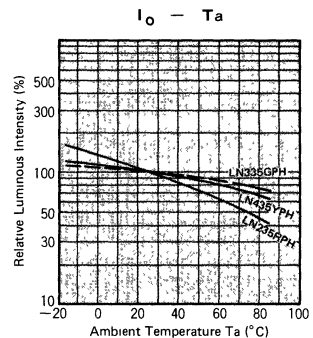
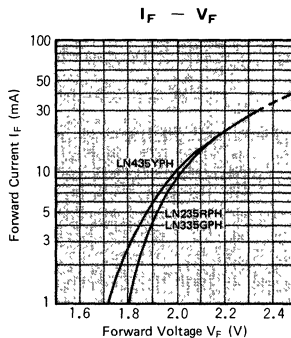
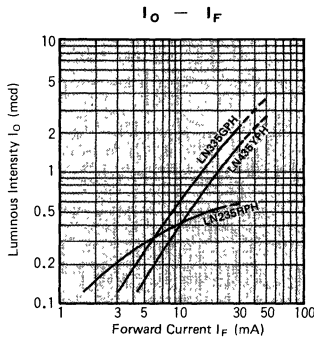

Triangle 4mm X 4.5mm Series

- Characteristics: 1. Lighting surface 4mm x 4.5mm triangle
 2. Suitable type for location indicator and line finder
 3. High reliability, long life

Absolute Maximum Ratings (Ta = 25°C)

Lighting Color	P _D (mW)	I _F (mA)	I _{FM} (mA)	V _R (V)	T _{opr} (°C)	T _{stg} (°C)
Red	70	25	30	4	-25~+85	-30~+100
Green	90	30	40	4	-25~+85	-30~+100
Amber	90	30	40	4	-25~+85	-30~+100

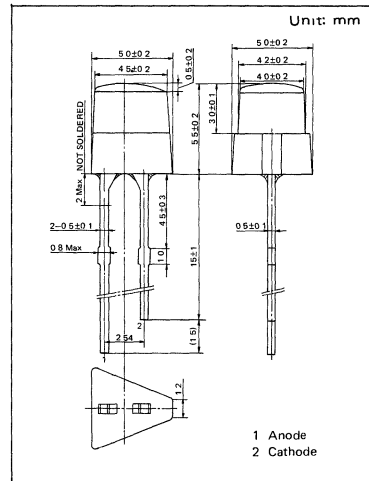

Electro-Optical Characteristics (Ta = 25°C)

Type No.	Lens Color	I ₀			V _F		λ _P	Δλ _F	I _c	I _R	
		Typ.	Min.	I _F	Typ.	Max.				Max.	V _R
LN212RP	Red Diffused	0.4	0.1	15	2.2	2.8	700	100	20	5	4
LN312GP	Green Diffused	1.0	0.3	20	2.2	2.8	565	30	20	10	4
LN412YP	Amber Diffused	1.0	0.4	20	2.2	2.8	590	30	20	10	4
Unit	—	mcd	mcd	mA	V	V	nm	nm	mA	μA	V

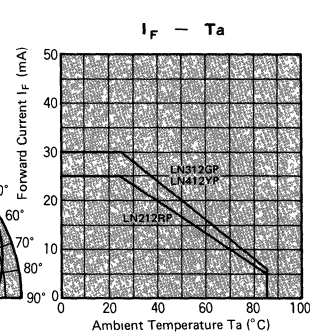
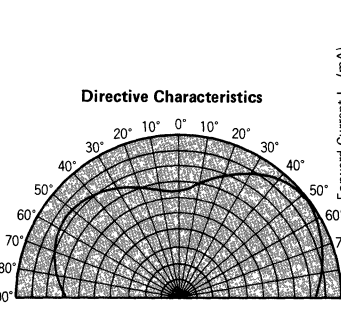
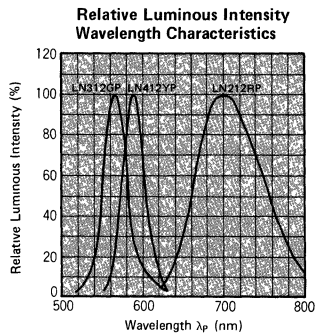
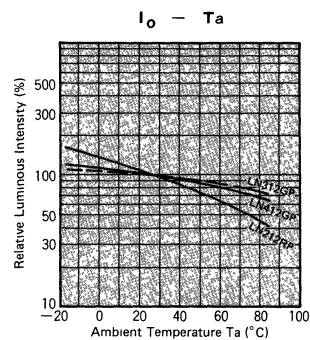
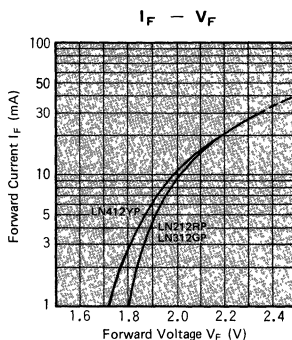
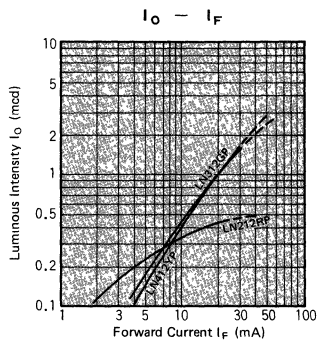

Triangle Type

Triangle 2.5mm X 5mm Series

- Characteristics:**
1. Lighting surface 2.5mm x 5mm triangle
 2. Suitable type for location indicator and line finder
 3. High reliability, long life

Absolute Maximum Ratings (Ta = 25°C)

Lighting Color	P _D (mW)	I _F (mA)	I _{FM} (mA)	V _R (V)	Topr(°C)	Tstg(°C)
Red	70	25	30	4	-25~+85	-30~+100
Green	90	30	40	4	-25~+85	-30~+100
Amber	90	30	40	4	-25~+85	-30~+100

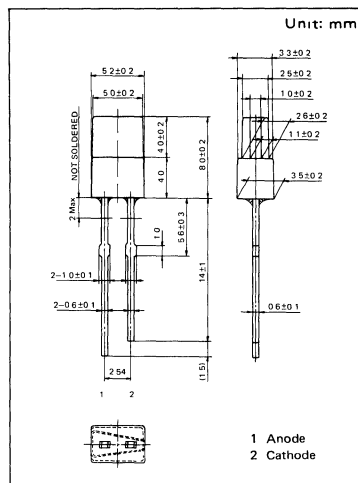

Electro-Optical Characteristics (Ta = 25°C)

Type No.	Lens Color	I ₀			V _F		λ _p	Δλ _p	I _F	I _R	V _R
		Typ.	Min.	I _F	Typ.	Max.	Typ.	Typ.			
LN227RP	Red Diffused	0.8	0.4	15	2.2	2.8	700	100	20	5	4
LN327GP	Green Diffused	2.0	0.7	20	2.2	2.8	565	30	20	10	4
LN427YP	Amber Diffused	1.0	0.3	20	2.2	2.8	590	30	20	10	4
Unit	—	mod	mod	mA	V	V	nm	nm	mA	μA	V

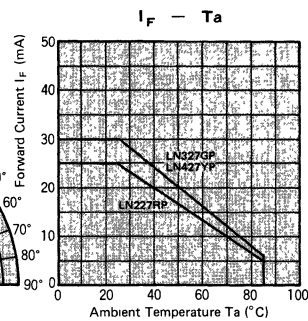
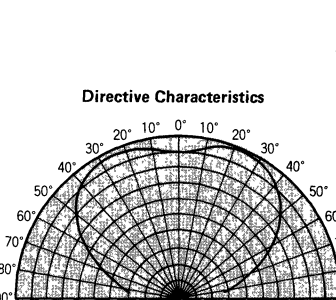
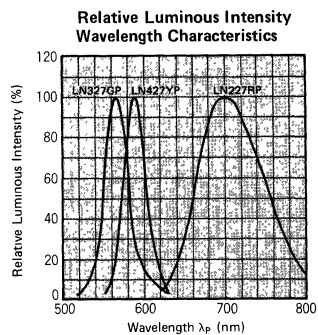
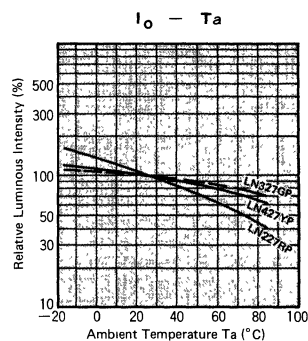
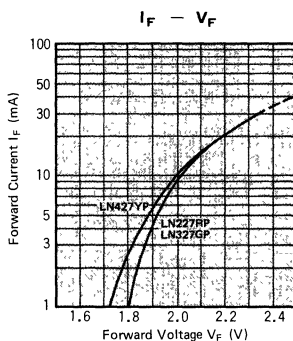
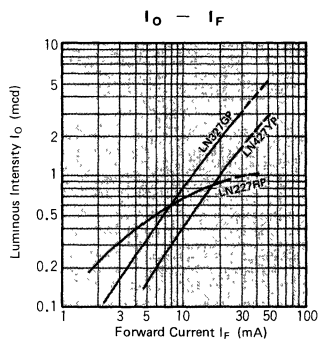

Triangle 3mm X 5mm Series

- Characteristics:**
1. Lighting surface 3mm x 5mm triangle
 2. Surtable type for location indicator and line finder
 3. High reliability, long life

Absolute Maximum Ratings (Ta = 25°C)

Lighting Color	P ₀ (mW)	I _F (mA)	I _{FM} (mA)	V _R (V)	T _{opr} (°C)	T _{stg} (°C)
Red	70	25	30	4	-25~+85	-30~+100
Green	90	30	40	4	-25~+85	-30~+100
Amber	90	30	40	4	-25~+85	-30~+100

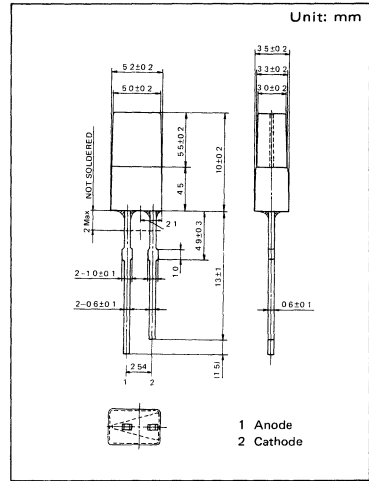

Electro-Optical Characteristics (Ta = 25°C)

Type No.	Lens Color	I ₀			V _F		λ _p	Δλ _p	I _F	I _n		V _R
		Typ	Min	I _F	Typ	Max				Max	V _R	
LN226RP	Red Diffused	0.8	0.4	15	2.2	2.8	700	100	20	5	4	
LN326GP	Green Diffused	2.0	0.7	20	2.2	2.8	565	30	20	10	4	
LN426YP	Amber Diffused	1.0	0.3	20	2.2	2.8	590	30	20	10	4	
Unit	—	mcd	mod	mA	V	V	nm	nm	mA	μA	V	

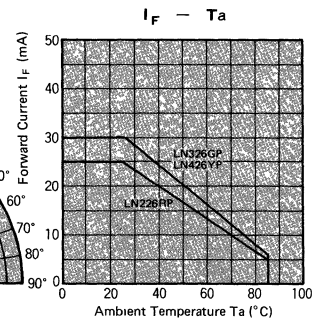
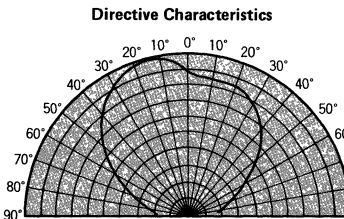
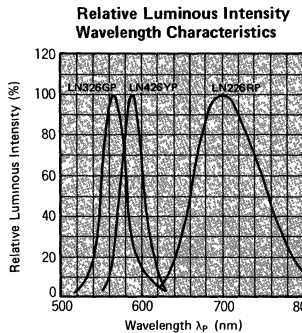
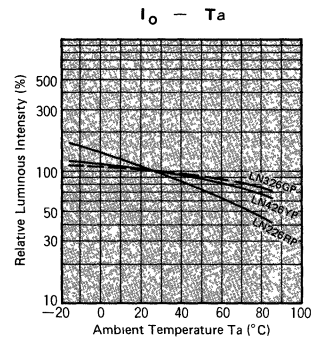
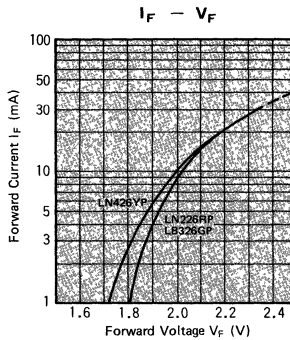
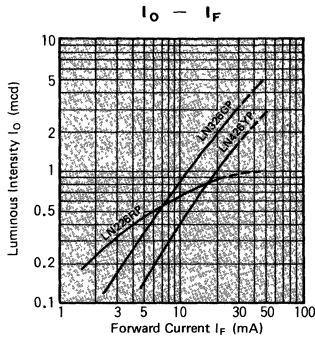

Triangle Type

Triangle 3mm X 5mm Series

- Characteristics:
1. Lighting surface 3mm x 5mm triangle
 2. Suitable type for location indicator and line finder
 3. High reliability, long life

Absolute Maximum Ratings (Ta = 25°C)

Lighting Color	P _D (mW)	I _F (mA)	I _{FM} (mA)	V _R (V)	Topr(°C)	Tstg(°C)
Red	70	25	30	4	-25~+85	-30~+100
Green	90	30	40	4	-25~+85	-30~+100
Amber	90	30	40	4	-25~+85	-30~+100

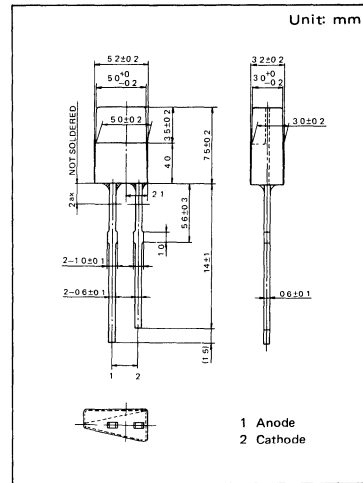

Electro-Optical Characteristics (Ta = 25°C)

Type No.	Lens Color	I ₀			V _F		λ _p	Δλ _p	I _F	I _R	V _R
		Typ.	Min.	I _F	Typ.	Max.	Typ.	Typ.			
LN228RP	Red Diffused	0.8	0.4	15	2.2	2.8	700	100	20	5	4
LN328GP	Green Diffused	2.0	0.7	20	2.2	2.8	565	30	20	10	4
LN428YP	Amber Diffused	1.0	0.3	20	2.2	2.8	590	30	20	10	4
Unit	—	mod	mod	mA	V	V	nm	nm	mA	μA	V

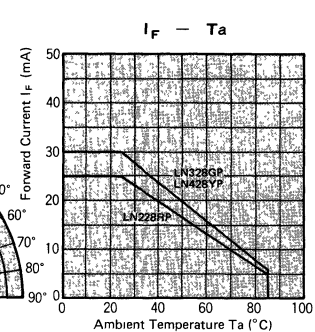
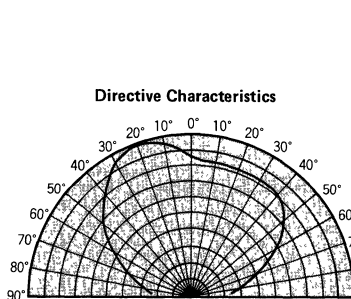
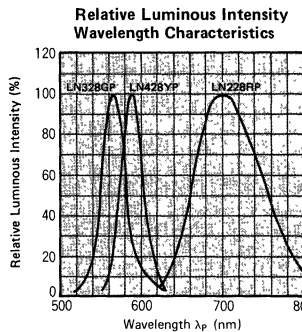
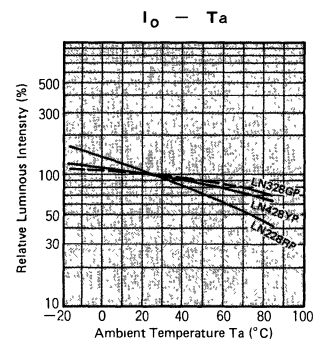
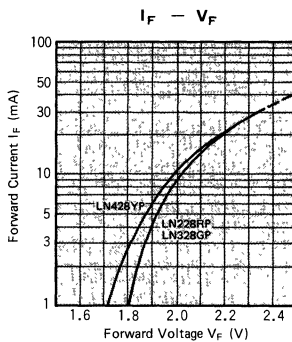
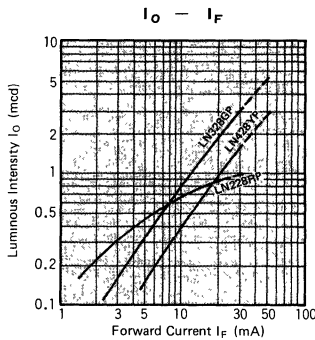

Round-Side View Type

Round-Side View 3.5mm Series

- Characteristics:**
1. Lighting surface side 3.5mm round side view
 2. High precise dimension
 3. High reliability, long life

Absolute Maximum Ratings (Ta = 25°C)

Lighting Color	P _D (mW)	I _F (mA)	I _{FM} (mA)	V _R (V)	T _{opr} (°C)	T _{stg} (°C)
Red	70	25	30	4	-25~+85	-30~+100

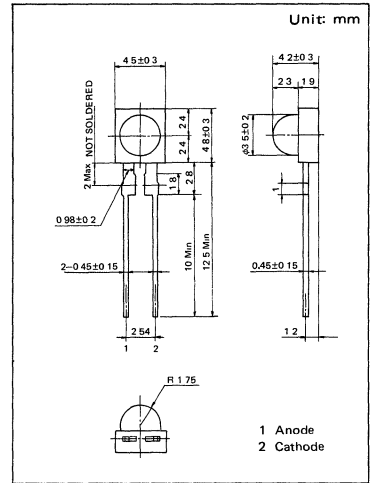

Electro-Optical Characteristics (Ta = 25°C)

Type No.	Lens Color	I _o			V _F		λ _p	Δλ _F	I _F		
		Typ.	Min.	I _F	Typ.	Max.			Typ.	Max.	V _R
LN25RP	Red Diffused	0.7	0.2	15	2.2	2.8	700	100	20	5	4
LN25RCP	Red Clear	1.5	0.5	15	2.2	2.8	700	100	20	5	4
LN25WP	White Diffused	0.7	0.2	15	2.2	2.8	700	100	20	5	4
LN25CP	Clear	2.5	0.7	15	2.2	2.8	700	100	20	5	4
Unit	—	mod	mod	mA	V	V	nm	nm	mA	μA	V

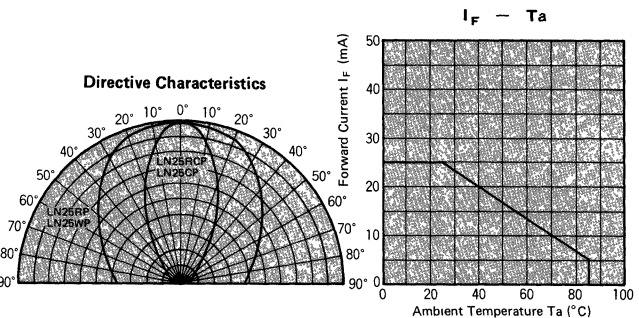
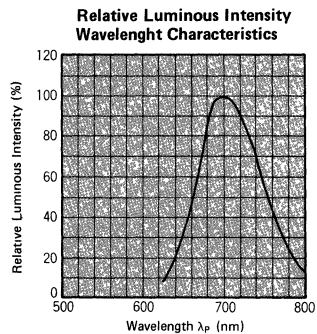
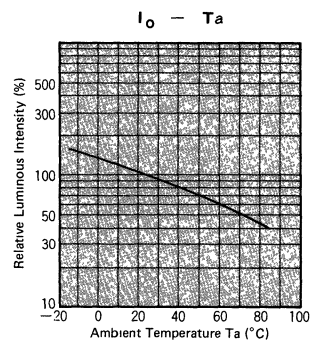
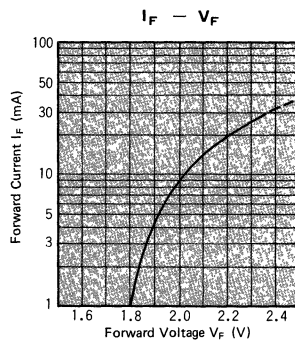
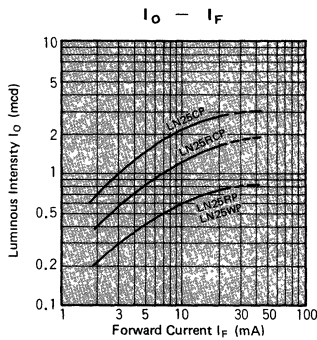

Directive Characteristics

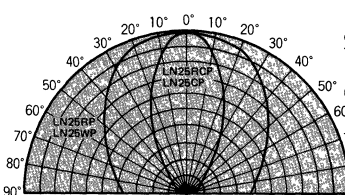

Round-Side View Type

Round-Side View 3.5mm Series

- Characteristics: 1. Lighting surface side 3.5mm round side view
2. High precision dimension
3. High reliability, long life

Absolute Maximum Ratings (Ta = 25°C)

Lighting Color	P _D (mW)	I _F (mA)	I _{FM} (mA)	V _R (V)	T _{opr} (°C)	T _{stg} (°C)
Green	90	30	40	4	-25~+85	-30~+100
Amber	90	30	40	4	-25~+85	-30~+100

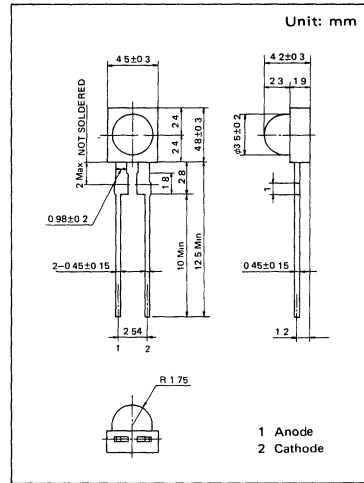

Electro-Optical Characteristics (Ta = 25°C)

Type No.	Lens Color	I _o			V _F		λ _p	Δλ _p	I _F	I _R	
		Typ.	Min.	I _F	Typ.	Max.				Max.	V _R
LN35BP	Blue Diffused	2.5	0.7	20	2.2	2.8	565	30	20	10	4
LN35GP	Green Diffused	1.2	0.3	20	2.2	2.8	565	30	20	10	4
LN35GCP	Green Clear	2.0	0.5	20	2.2	2.8	565	30	20	10	4
LN45YP	Amber Diffused	0.8	0.3	20	2.2	2.8	590	30	20	10	4
LN45YCP	Amber Clear	1.5	0.5	20	2.2	2.8	590	30	20	10	4
Unit	—	mod	mod	mA	V	V	nm	nm	mA	μA	V

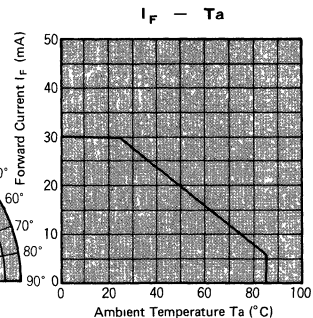
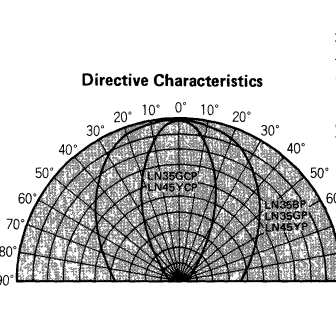
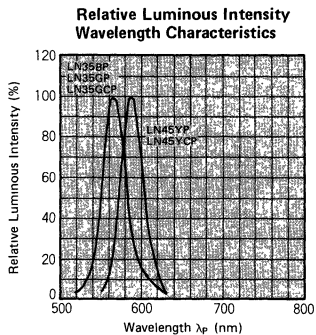
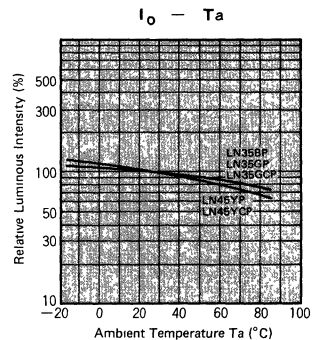
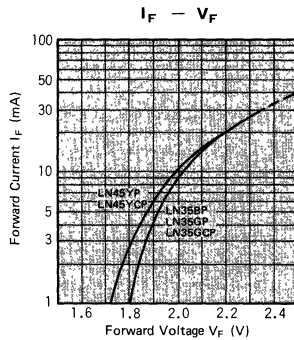
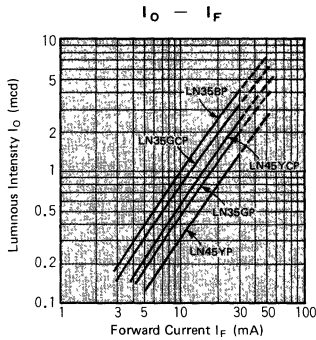

Round-Side View Type

Round-Side View 2.4mm Series

- Characteristics:**
1. Lighting surface side 2.4mm round side view
 2. High precise dimension
 3. High reliability, long life

Absolute Maximum Ratings (Ta = 25°C)

Lighting Color	P _D (mW)	I _F (mA)	I _{FM} (mA)	V _R (V)	T _{opr} (°C)	T _{stg} (°C)
Red	70	25	30	4	-25~+85	-30~+100
Green	90	30	40	4	-25~+85	-30~+100
Amber	90	30	40	4	-25~+85	-30~+100

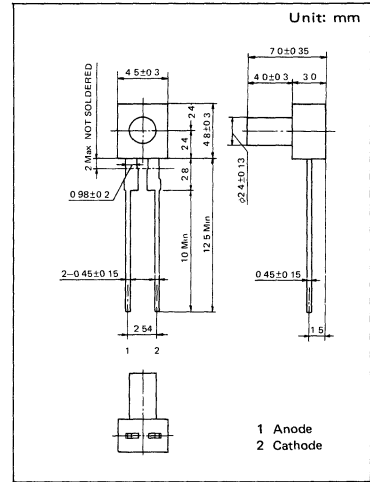

Electro-Optical Characteristics (Ta = 25°C)

Type No.	Lens Color	I _o			V _F		λ _F	Δλ _F	I _F	I _R	
		Typ.	Min.	I _F	Typ.	Max.				Max.	V _R
LN26RP	Red Diffused	0.3	0.1	15	2.2	2.8	700	100	20	5	4
LN26WP	White Diffused	0.5	0.1	15	2.2	2.8	700	100	20	5	4
LN36BP	Blue Diffused	0.8	0.2	20	2.2	2.8	565	30	20	10	4
LN46YP	Amber Diffused	1.0	0.2	20	2.2	2.8	590	30	20	10	4
Unit	—	mcd	mcd	mA	V	V	nm	nm	mA	μA	V

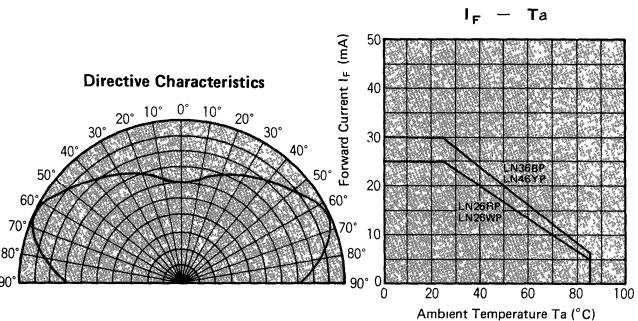
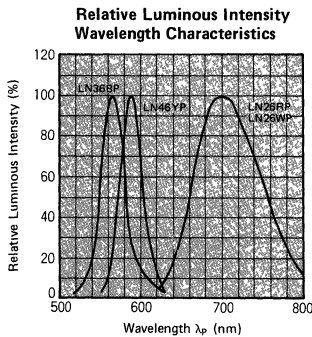
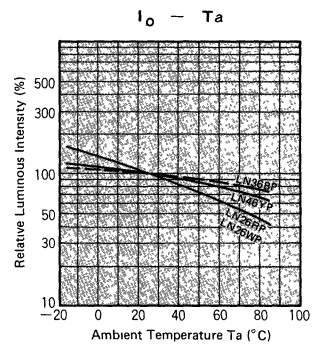
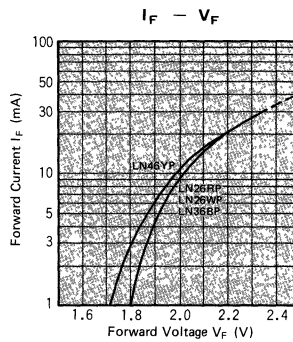
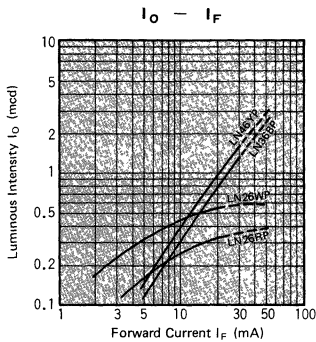

Two Colors Combination LED

Two Colors Combination LED Series

- Characteristics:**
1. Lighting surface Two color combination of 3.5mm round side view
 2. Cathode lead wire is used in common
 3. High reliability, long life

Absolute Maximum Ratings (Ta = 25°C)

Lighting Color	P _D (mW)	I _F (mA)	I _{FM} (mA)	V _R (V)	T _{opr} (°C)	T _{stg} (°C)
Red	60	30	40	4	-25~+85	-30~+100
Green	90	30	40	4	-25~+85	-30~+100

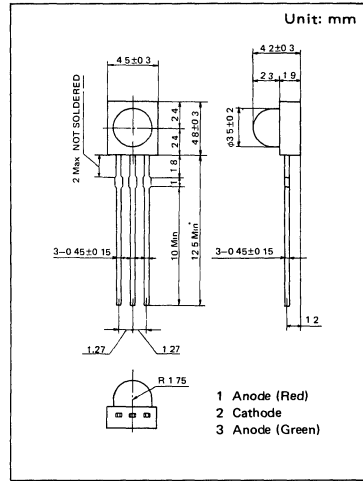

Electro-Optical Characteristics (Ta = 25°C)

Type No.	Lens Color	Lighting Color	I _o			V _F		λ _p	Δλ _p	I _F	I _R	
			Typ.	Min.	I _F	Typ.	Max.	Typ.	Typ.		Max.	V _R
LN15BP	Blue Diffused	Red	0.7	0.2	20	1.75	2.0	660	20	30	10	4
		Green	2.0	0.6	20	2.20	2.8	565	30	20	10	4
LN15WP	White Diffused	Red	0.6	0.2	20	1.75	2.0	660	20	30	10	4
		Green	2.0	0.6	20	2.20	2.8	565	30	20	10	4
Unit	—		mcd	mcd	mA	V	V	nm	nm	mA	μA	V

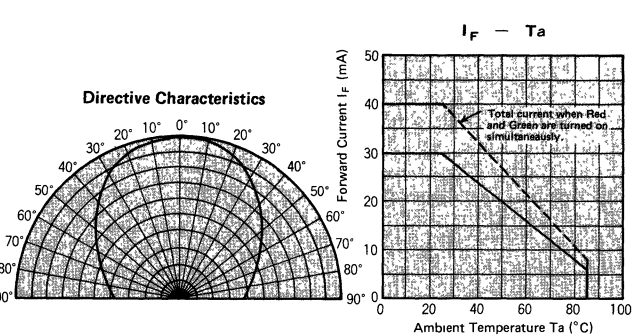
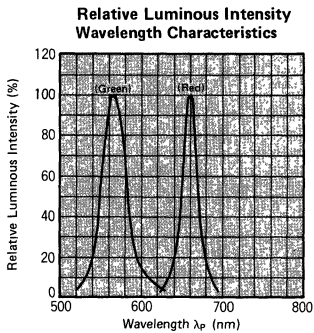
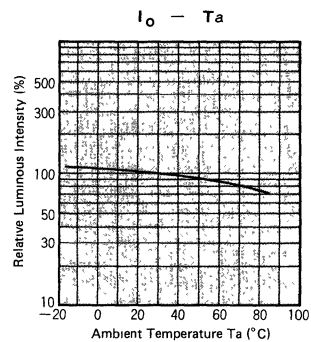
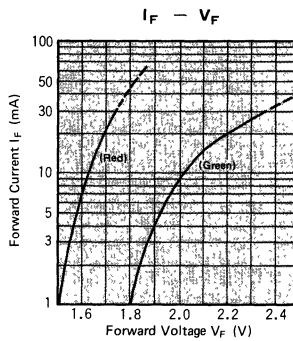
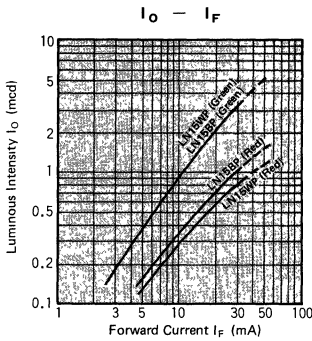

Two Colors Combination LED Series

- Characteristics:**
1. Lighting surface Two color combination of 3.5mm round side view
 2. Independent Anode. 4 lead wire Cathode
 3. High reliability, long life

Absolute Maximum Ratings (Ta = 25°C)

Lighting Color	P _D (mW)	I _F (mA)	I _{FM} (mA)	V _R (V)	T _{opr} (°C)	T _{stg} (°C)
Red	70	25	30	4	-25~+85	-30~+100
Green	90	30	40	4	-25~+85	-30~+100

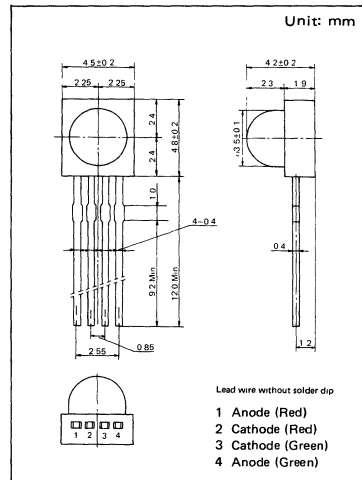

Electro-Optical Characteristics (Ta = 25°C)

Type No.	Lens Color	Lighting Color	I ₀			V _F		λ _F	Δλ _F	I _F	I ₀	
			Typ.	Min.	I _F	Typ.	Max.				I _F	Max.
LN15WP-(F)	White Diffused	Red	1.0	0.25	15	2.2	2.8	700	100	20	10	4
		Green	2.0	0.5	20	2.2	2.8	565	30	20	10	4
Unit			med	mod	mA	V	V	nm	nm	mA	μA	V

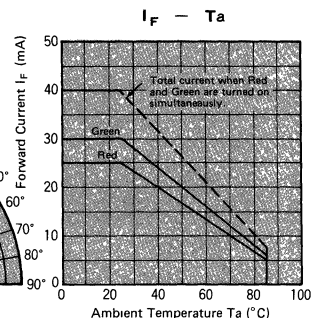
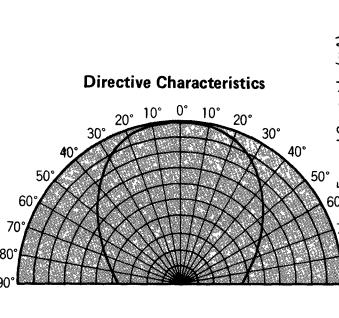
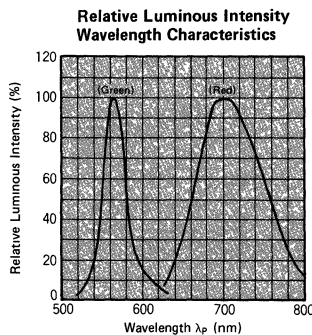
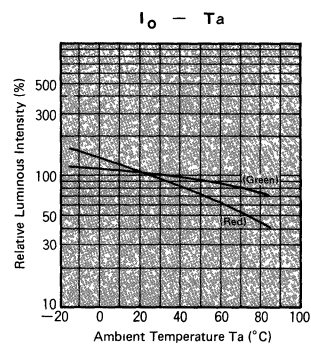
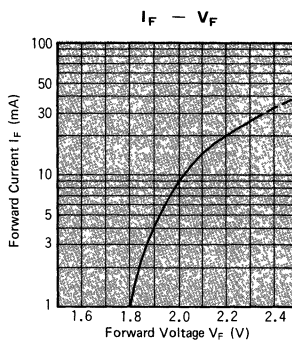
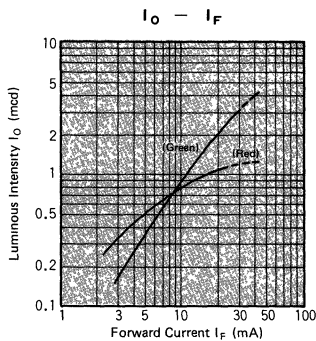

Two Colors Combination LED

Two Colors Combination LED Series

- Characteristics:**
1. Lighting surface Two color combination of 2.4mm round side view
 2. Cathode lead wire is used in common
 3. High reliability, long life

Absolute Maximum Ratings (Ta = 25°C)

Lighting Color	P _D (mW)	I _F (mA)	I _{FM} (mA)	V _R (V)	T _{opr} (°C)	T _{stg} (°C)
Red	60	30	40	4	-25~+85	-30~+100
Green	90	30	40	4	-25~+85	-30~+100

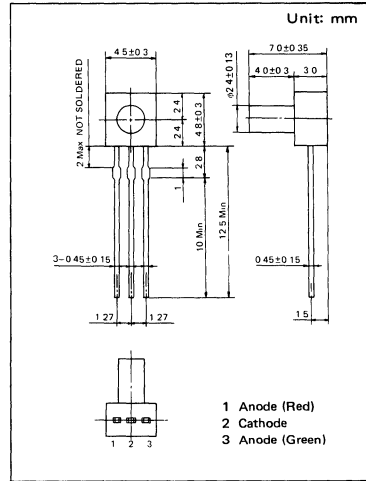

Electro-Optical Characteristics (Ta = 25°C)

Type No.	Lens Color	Lighting Color	I ₀			V _F		λ _p	Δλ _p	I _F	I _R	
			Typ.	Min.	I _F	Typ.	Max.	Typ.	Typ.		Max.	V _R
LN16BP	Blue Diffused	Red	0.2	0.06	20	1.75	2.0	660	20	30	10	4
		Green	1.2	0.10	20	2.20	2.8	565	30	20	10	4
LN16WP	White Diffused	Red	0.4	0.10	20	1.75	2.0	660	20	30	10	4
		Green	1.5	0.50	20	2.20	2.8	565	30	20	10	4
Unit			mod	mod	mA	V	V	nm	nm	mA	μA	V

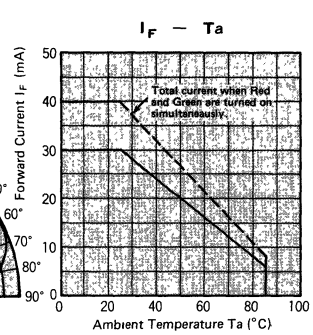
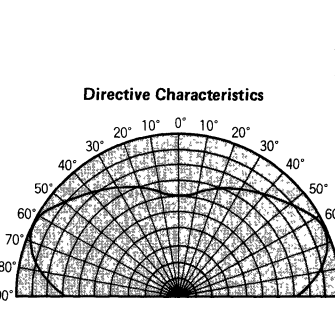
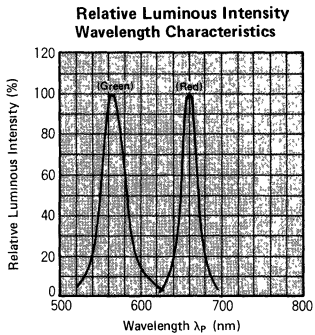
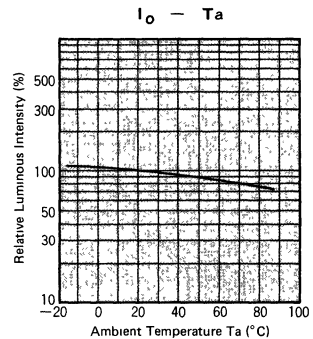
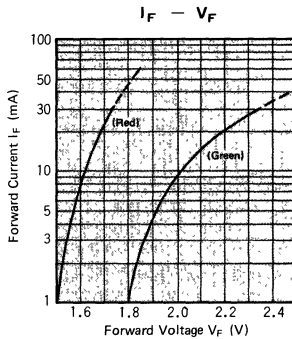
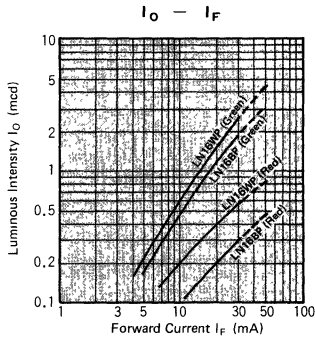

Two Colors Combination LED

Two Colors Combination LED Series

- Characteristics:**
1. Lighting surface Two color combination of 2.4mm round side view
 2. Independent Anode. 4 lead wire Cathode
 3. High reliability, long life

Absolute Maximum Ratings (Ta = 25°C)

Lighting Color	P _D (mW)	I _F (mA)	I _{F,Max} (mA)	V _F (V)	T _{opr} (°C)	T _{stg} (°C)
Red	70	25	30	4	-25~+85	-30~+100
Green	90	30	40	4	-25~+85	-30~+100

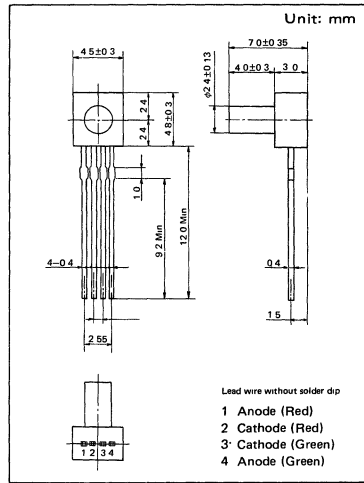

Electro-Optical Characteristics (Ta = 25°C)

Type No.	Lens Color	Lighting Color	I ₀			V _F		λ _p	Δλ _p	I _F	I _R	
			Typ.	Min.	I _F	Typ.	Max.				Max.	V _F
LN16WP-(F)	White Diffused	Red	0.5	0.25	15	2.2	2.8	700	100	20	10	4
		Green	1.5	0.75	20	2.2	2.8	565	30	20	10	4
Unit	—	—	mcd	mcd	mA	V	V	nm	nm	mA	μA	V

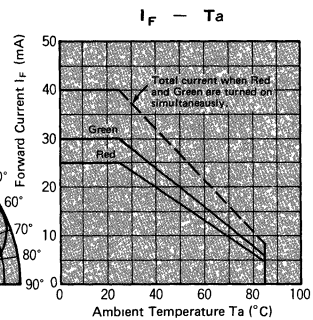
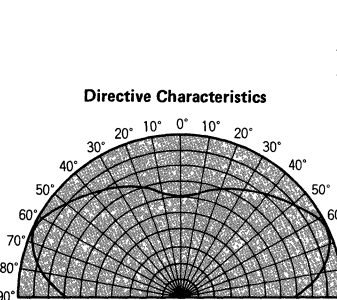
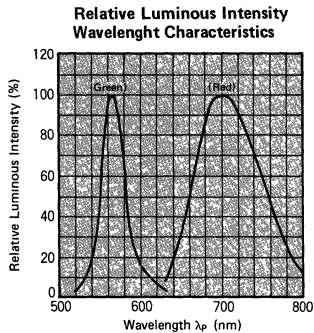
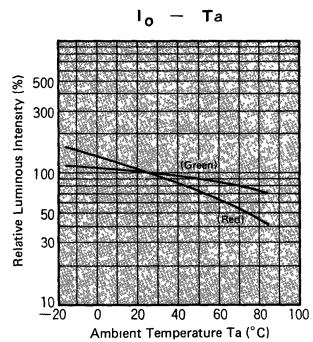
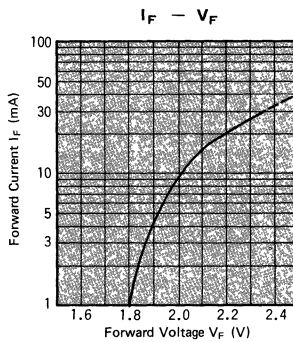
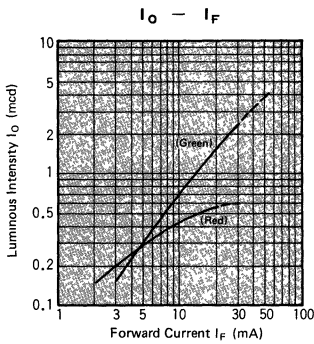

Level Meters

Level Meters 5-element Array Series

- Characteristics:**
1. Lighting surface 1.75mm x 7mm level meter
 2. Can combine colors by choice
 3. High reliability, long life

Absolute Maximum Ratings (Ta = 25°C)

Lighting Color	P _D (mW)	I _F (mA)	I _{FM} (mA)	V _R (V)	Topr(°C)	Tstg(°C)
Red	70	25	30	4	-25~+85	-30~+100
Green	90	30	40	4	-25~+85	-30~+100
Amber	90	30	40	4	-25~+85	-30~+100

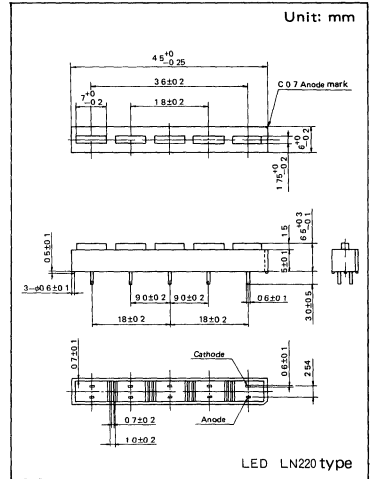

Electro-Optical Characteristics (Ta = 25°C)

Type No.	Lens Color	I ₀			V _F		λ _p	Δλ _p	I _F	I _R	
		Typ.	Min.	I _F	Typ.	Max.	Typ.	Typ.		Max.	V _R
LN05201P	Red Diffused	0.4	0.15	15	2.2	2.8	700	100	20	5	4
LN05301P	Green Diffused	1.2	0.50	20	2.2	2.8	565	30	20	10	4
LN05401P	Amber Diffused	1.5	0.50	20	2.2	2.8	590	30	20	10	4
Unit	—	mod	mod	mA	V	V	nm	nm	mA	μA	V

Note I₀ value shows the figure of LED

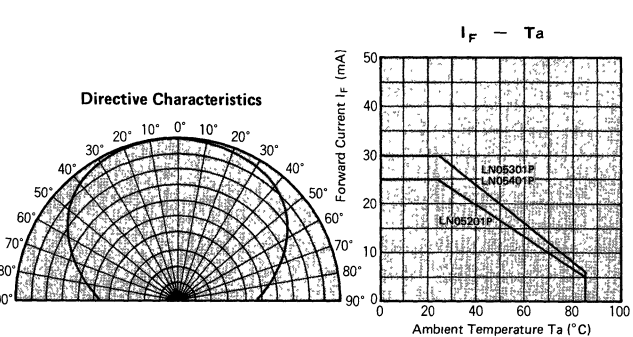
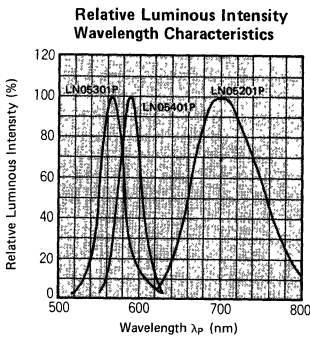
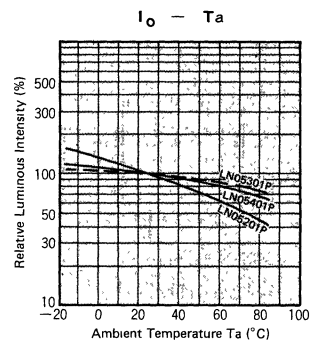
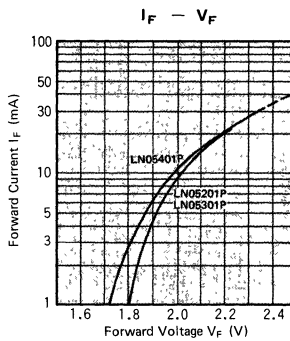
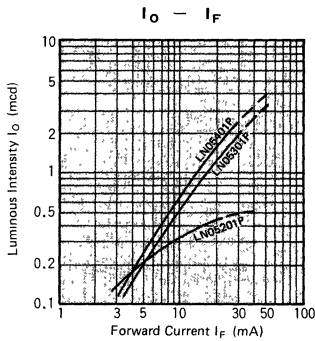

Level Meters 5-element Array Series

- Characteristics:**
1. Lighting surface 1.5mm x 5mm level meter
 2. Can combine colors by choice
 3. High reliability, long life

Absolute Maximum Ratings (Ta = 25°C)

Lighting Color	P _D (mW)	I _F (mA)	I _{FM} (mA)	V _R (V)	T _{opr} (°C)	T _{stg} (°C)
Red	70	25	30	4	-25~+70	-30~+75
Green	90	30	40	4	-25~+70	-30~+75
Amber	90	30	40	4	-25~+70	-30~+75

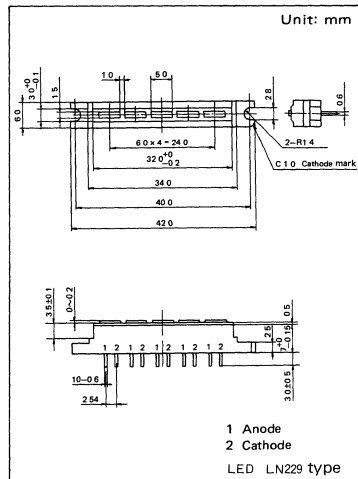

Electro-Optical Characteristics (Ta = 25°C)

Type No.	Lens Color	I ₀			V _F		λ _F	Δλ _F	I _F	I _m	V _R
		Typ.	Min.	I _F	Typ.	Max.					
LN05203P	Red Diffused	0.5	0.2	15	2.2	2.8	700	100	20	5	4
LN05303P	Green Diffused	1.5	0.5	20	2.2	2.8	565	30	20	10	4
LN05403P	Amber Diffused	1.5	0.5	20	2.2	2.8	590	30	20	10	4
Unit	—	mod	mod	mA	V	V	nm	nm	mA	μA	V

Note I₀ value shows the figure of LED

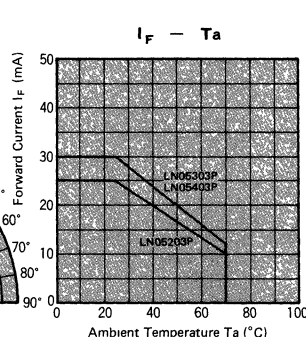
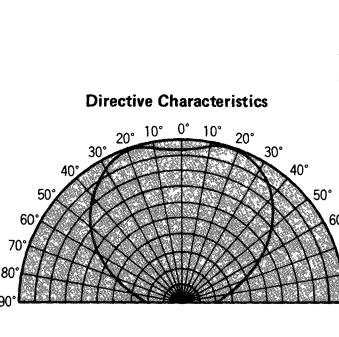
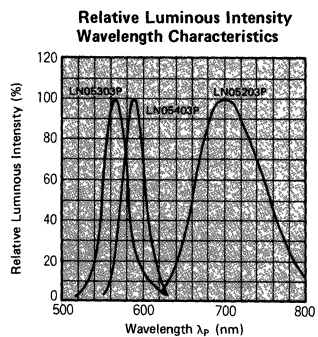
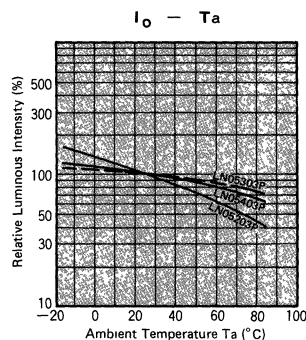
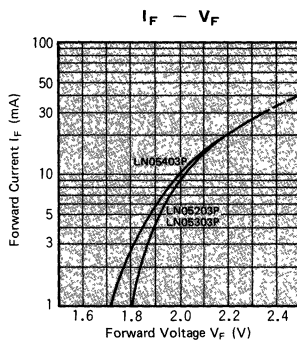
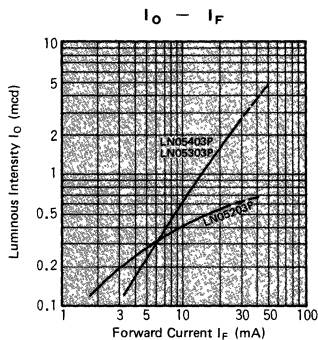

Level Meters

Level Meters Two Head 5-element Array Series

- Characteristics:**
1. Lighting surface 1.9mm x 1.9mm level meter
 2. On by 5 chips coner 10 surface
 3. High reliability, long life

Absolute Maximum Ratings (Ta = 25°C)

Lighting Color	P _D (mW)	I _F (mA)	I _{FM} (mA)	V _R (V)	T _{opr} (°C)	T _{stg} (°C)
Red	70	25	30	4	-25~+75	-30~+80
Green	90	30	40	4	-25~+75	-30~+80

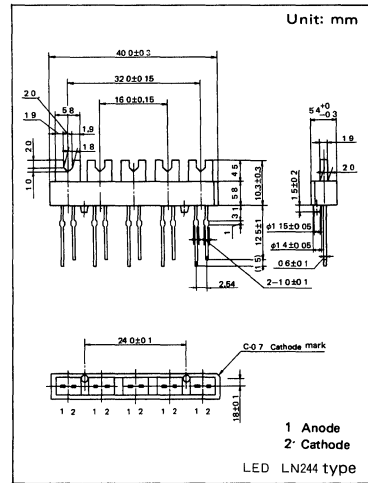

Electro-Optical Characteristics (Ta = 25°C)

Type No.	Lens Color	I ₀			V _F		λ _p	Δλ _p	I _F	I _R	
		Typ.	Min.	I _F	Typ.	Max.	Typ.	Typ.		Max.	V _R
LN05263P	Red Diffused	0.3	0.1	15	2.2	2.8	700	100	20	5	4
LN05363P	Green Diffused	1.5	—	20	2.2	2.8	565	30	20	10	4
LN05463P	Amber Diffused	1.2	—	20	2.2	2.8	590	30	20	10	4
Unit	—	mod	mcd	mA	V	V	nm	nm	mA	μA	V

△ Tentative specification Note I₀ value shows the figure of LED

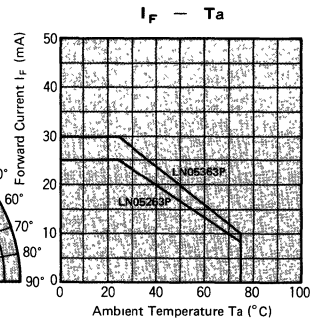
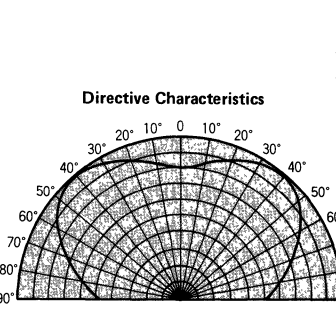
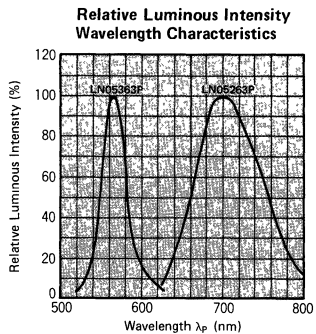
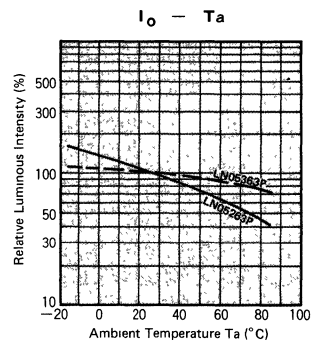
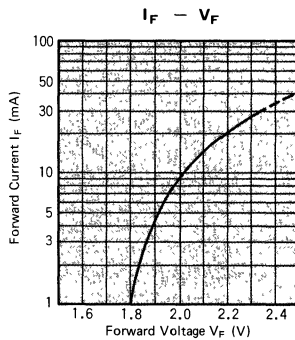
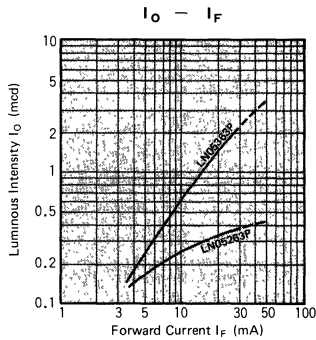

Level Meters

Level Meters 7-element Array Series

Characteristics: 1. Lighting surface 1.8mm x 5.3mm level meter

2. Can choose 3 colors
3. High reliability, long life

Absolute Maximum Ratings ($T_a = 25^\circ\text{C}$)

Lighting Color	P_D (mW)	I_F (mA)	I_{FM} (mA)	V_F (V)	T_{opr} ($^\circ\text{C}$)	T_{stg} ($^\circ\text{C}$)
Red	70	25	30	4	-25~+85	-30~+100
Green	90	30	40	4	-25~+85	-30~+100
Amber	90	30	40	4	-25~+85	-30~+100

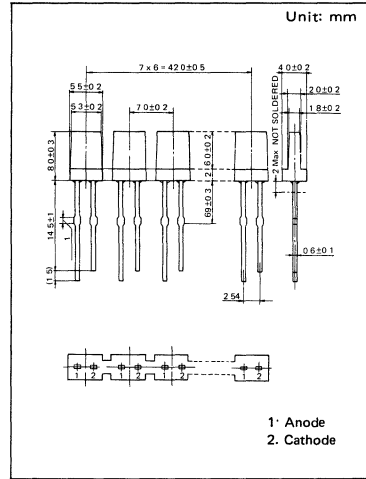

Electro-Optical Characteristics ($T_a = 25^\circ\text{C}$)

Type No.	Lens Color	I_o			V_F		λ_P	$\Delta\lambda_P$	I_F	I_R	
		Typ.	Min.	I_F	Typ.	Max.	Typ.	Typ.		Max.	V_R
LN07202P	Red Diffused	0.6	0.3	15	2.2	2.8	700	100	20	5	4
LN07302P	Green Diffused	1.5	0.4	20	2.2	2.8	565	30	20	10	4
LN07402P	Amber Diffused	1.5	0.6	20	2.2	2.8	590	30	20	10	4
Unit	—	mcd	mcd	mA	V	V	nm	nm	mA	μA	V

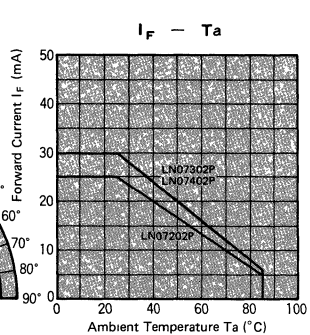
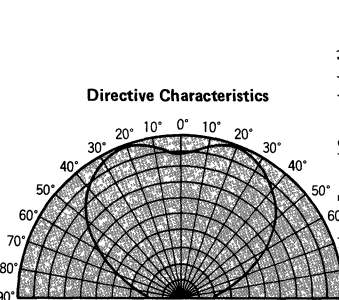
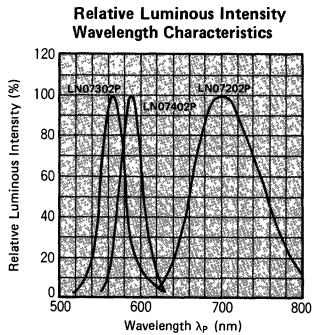
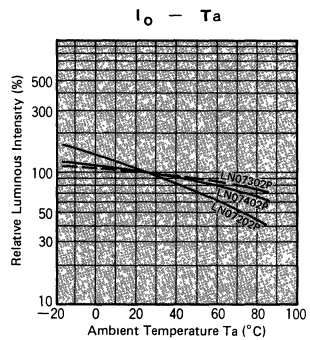
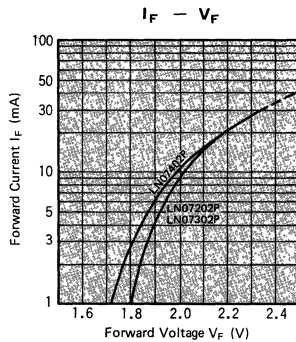
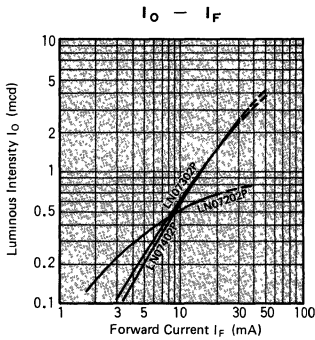

Level Meters

Level Meters 10-element Array Series

- Characteristics:**
1. Lighting surface 2mm cyliner type
 2. Lighting color combination
 3. High reliability, long life

Absolute Maximum Ratings (Ta = 25°C)

Lighting Color	P _D (mW)	I _F (mA)	I _F M(mA)	V _R (V)	T _{opr} (°C)	T _{stg} (°C)
Red	70	25	30	4	-25~+70	-30~+75
Green	90	30	40	4	-25~+70	-30~+75
Amber.	90	30	40	4	-25~+70	-30~+75

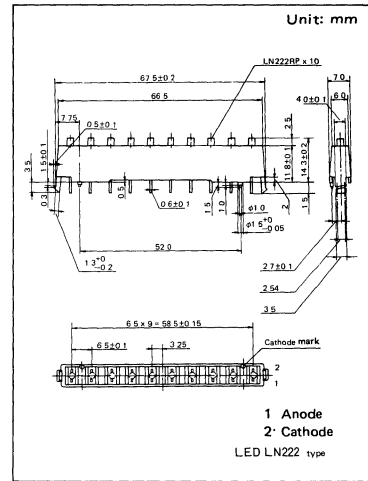

Electro-Optical Characteristics (Ta = 25°C)

Type No.	Lens Color	I ₀			V _F		λ _p	Δλ _p	I _F	I _R	
		Typ.	Min.	I _F	Typ.	Max.				Max.	V _R
LN10204P	Red Diffused	1.0	0.4	15	2.2	2.8	700	100	20	5	4
LN10304P	Green Diffused	1.0	0.4	20	2.2	2.8	565	30	20	10	4
LN10404P	Amber Diffused	2.5	1.2	20	2.2	2.8	590	30	20	10	4
Unit	—	mcd	mcd	mA	V	V	nm	nm	mA	μA	V

Note I₀ value is the figure of LED

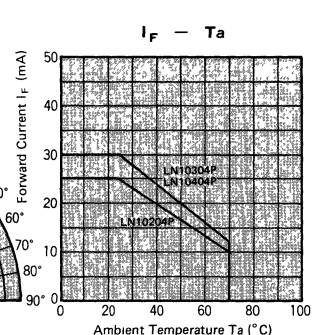
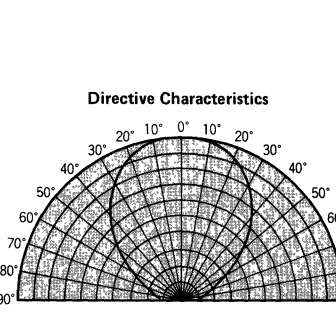
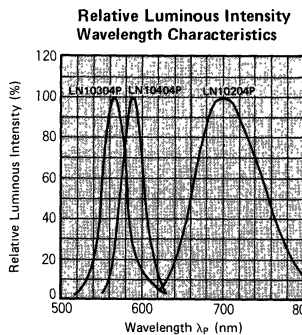
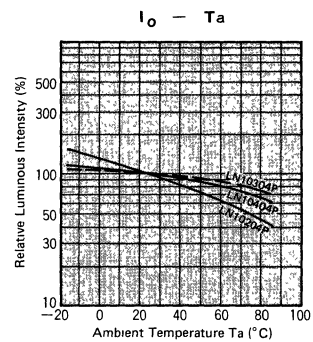
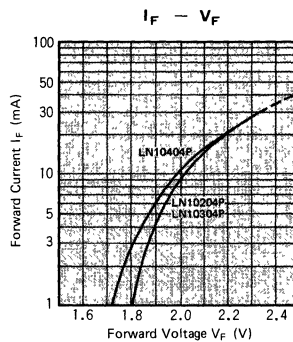
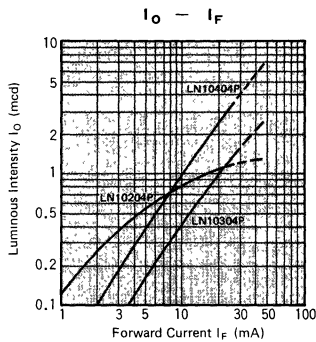

Blue T-1³/₄ Series

- Characteristics:
1. Blue color lighting by GaN
 2. High radiation
 3. High reliability, long life

Absolute Maximum Ratings (Ta = 25°C)

Lighting Color	P _D (mW)	I _F (mA)	I _{FM} (mA)	V _R (V)	Topr(°C)	Tstg(°C)
Blue	100	12	15	2	-25~+80	-30~+85

※ Reverse voltage more than 2V should not be applied

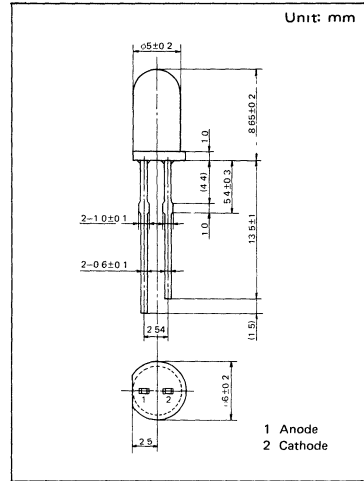

Electro-Optical Characteristics (Ta = 25°C)

Type No.	Lens Color	I _o			V _F		λ _p	Δλ _p	I _F	I _R	
		Typ.	Min.	I _F	Typ.	Max.				Max.	V _R
LN91BC	Blue Clear	10	2	10	7.5	10.0	490	80	10	1	2
Unit	—	md	md	mA	V	V	nm	nm	mA	mA	V

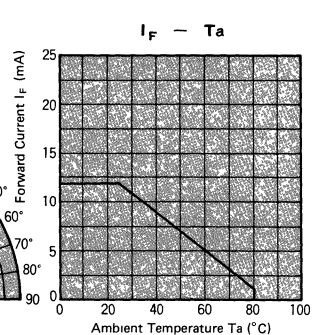
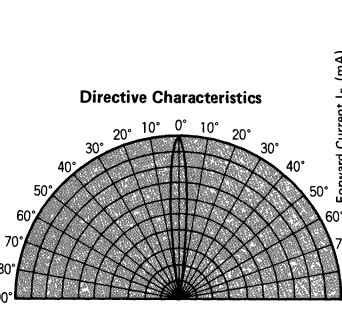
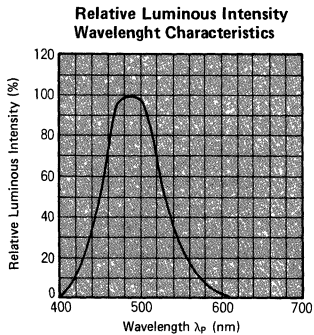
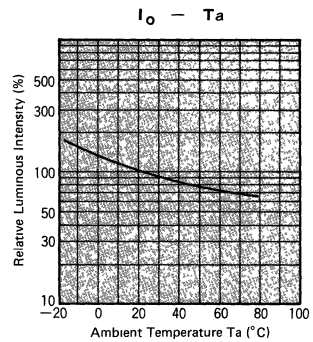
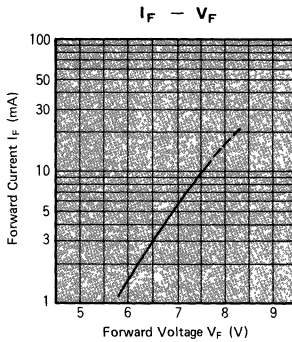
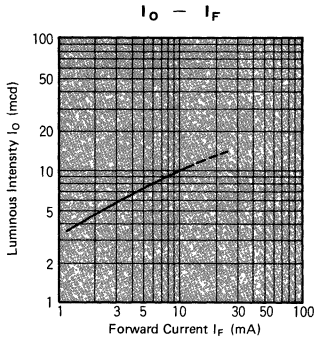

Hi-Brite T-1 3/4 Series

- Characteristics:**
1. Red color lighting by GaAlAs
 2. High radiation
 3. High reliability, long life

Absolute Maximum Ratings (Ta = 25°C)

Lighting Color	P _D (mW)	I _F (mA)	I _{FM} (mA)	V _R (V)	Topr(°C)	Tstg(°C)
Red	70	30	40	3	-25~+85	-30~+100

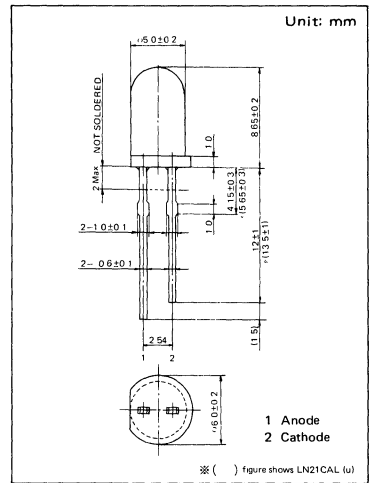

Electro-Optical Characteristics (Ta = 25°C)

Type No.	Lens Color	I _o			V _F		λ _P	Δλ _P	I _F	I _R	
		Typ.	Min.	I _F	Typ.	Max.	Typ.	Typ.		Max.	V _R
LN21CAL	Clear	20	5	20	1.8	2.4	660	30	20	10	3
△ LN21CAL(U)	Clear	200	20	20	1.8	2.4	660	30	20	10	3
Unit	—	mod	mcd	mA	V	V	nm	nm	mA	μA	V

△ Tentative specification

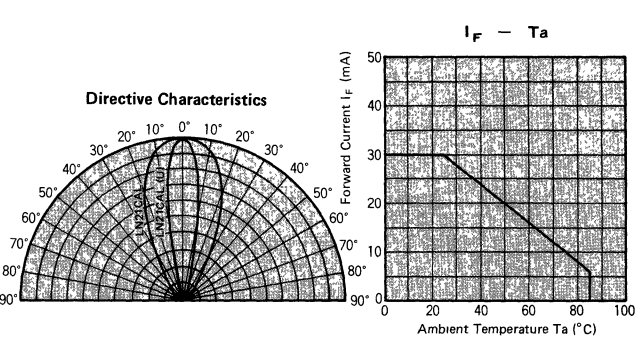
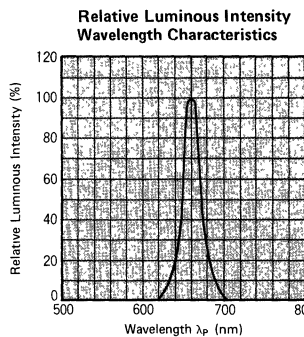
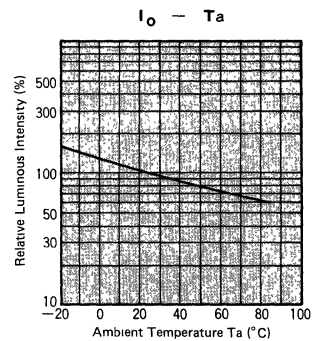
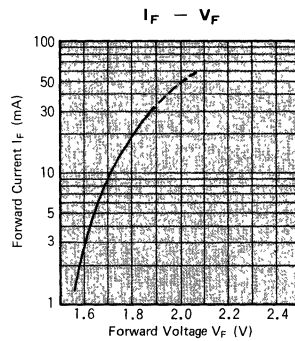
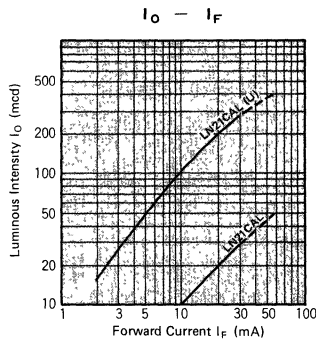

Subminiature Series

- Characteristics:**
- 1 Lighting surface 1.8mm round type
 - 2 High precise dimension
 - 3 High reliability, long life

Absolute Maximum Ratings (Ta = 25°C)

Lighting Color	P _d (mW)	I _F (mA)	I _{FM} (mA)	V _F (V)	T _{opr} (°C)	T _{stg} (°C)
Red	70	25	30	4	-25~+85	-30~+100
Green	90	30	40	4	-25~+85	-30~+100
Amber	90	30	40	4	-25~+85	-30~+100

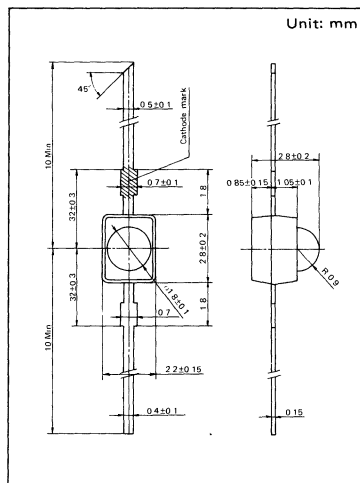

Electro-Optical Characteristics (Ta = 25°C)

Type No.	Lens Color	I ₀			V _F		λ _P	Δλ _{1/2}	I _F	Max	I _R	V _F
		Typ.	Min.	I _F	Typ.	Max.	Typ.	Typ.				
LN247RP	Red Diffused	0.7	0.25	15	2.2	2.8	700	100	20	10	4	4
LN247CP	Clear	2.5	0.9	15	2.2	2.8	700	100	20	10	4	4
LN347GP	Green Diffused	4.5	1.5	20	2.2	2.8	565	30	20	10	4	4
LN447YP	Amber Diffused	4.0	0.8	20	2.2	2.8	590	30	20	10	4	4
Unit	—	mcd	mcd	mA	V	V	nm	nm	mA	μA	V	

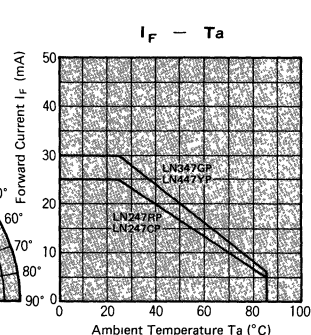
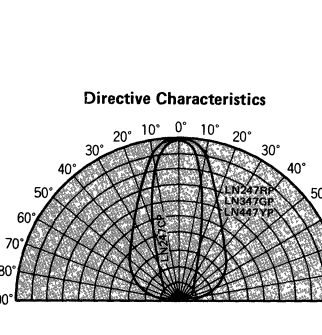
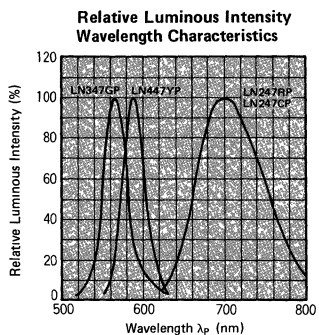
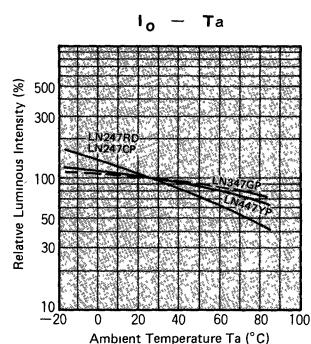
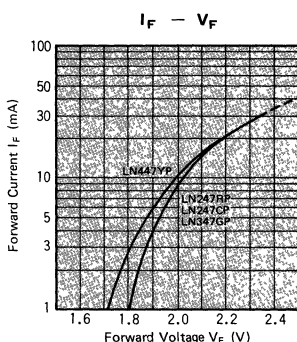
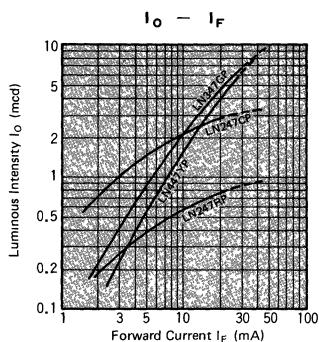

New Product

Dual Surface 1.9mm X 1.9mm X 2mm Series

- Characteristics: 1. Lighting surface 1.9mm x 1.9mm two head type
 2. 1 chip 2 surface lighting
 3. High reliability, long life

Absolute Maximum Ratings (Ta = 25°C)

Lighting Color	P ₀ (mW)	I _F (mA)	I _{Fm} (mA)	V _R (V)	To _{pr} (°C)	T _{stg} (°C)
Red	70	25	30	4	-25~+85	-30~+100
Green	90	30	40	4	-25~+85	-30~+100
Amber	90	30	40	4	-25~+85	-30~+100

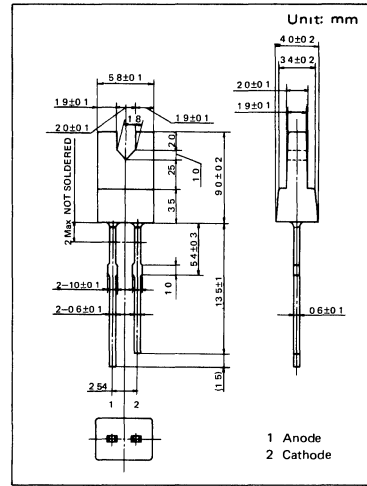

Electro-Optical Characteristics (Ta = 25°C)

Type No.	Lens Color	I ₀			V _F		λ _p	Δλ _p	I _F	I _R	
		Typ.	Min.	I _F	Typ.	Max.				I _F	Max.
LN244RP	Red Diffused	0.3	0.13	15	2.2	2.8	700	100	20	5	4
LN344GP	Green Diffused	1.5	—	20	2.2	2.8	565	30	20	10	4
LN444YP	Amber Diffused	1.2	—	20	2.2	2.8	590	30	20	10	4
Unit	—	mcd	mcd	mA	V	V	nm	nm	mA	μA	V

△ Tentative specification

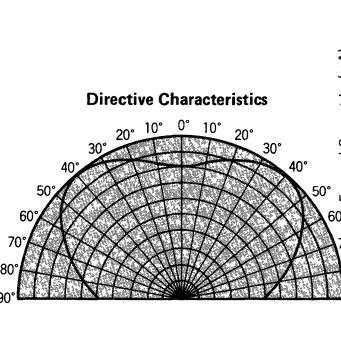
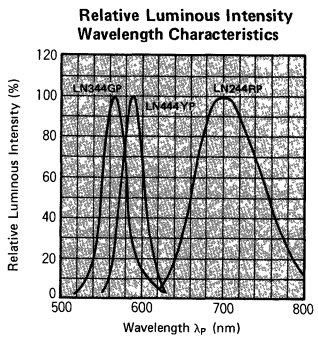
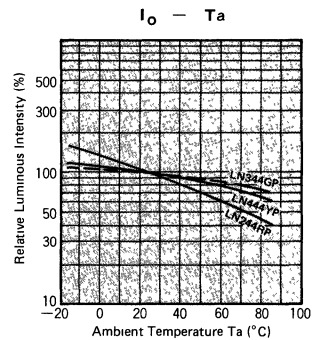
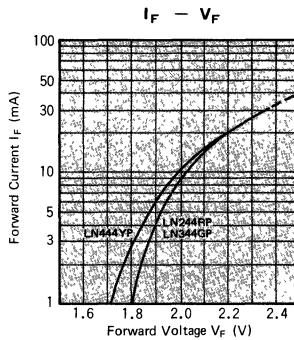
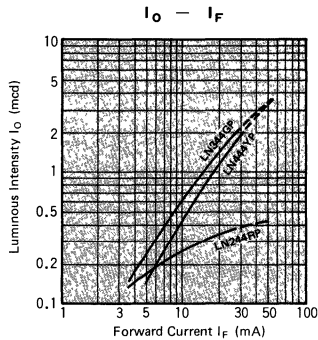

New Product

Dual Surface 1mm X 2mm X 2mm Series

- Characteristics:**
1. Lighting surface 1mm x 2mm two head type
 2. 1 chip 2 surface lighting
 3. High reliability, long life

Absolute Maximum Ratings (Ta = 25°C)

Lighting Color	P _D (mW)	I _F (mA)	I _{RM} (mA)	V _F (V)	T _{opr} (°C)	T _{stg} (°C)
Red	70	25	30	4	-25~+85	-30~+100
Green	90	30	40	4	-25~+85	-30~+100
Amber	90	30	40	4	-25~+85	-30~+100

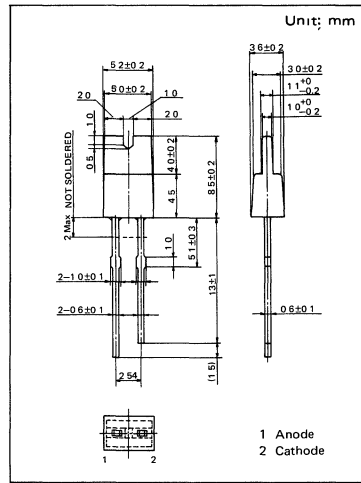

Electro-Optical Characteristics (Ta = 25°C)

Type No.	Lens Color	I ₀			V _F		λ _P		I _F	I _R	
		Typ	Min.	I _F	Typ	Max.	Typ	Typ		I _F	Max.
LN245RP	Red Diffused	0.5	0.2	15	2.2	2.8	700	100	20	5	4
LN345GP	Green Diffused	2.5	1.0	20	2.2	2.8	565	30	20	10	4
LN445YP	Amber Diffused	2.0	—	20	2.2	2.8	590	30	20	10	4
Unit	—	mcd	mcd	mA	V	V	nm	nm	mA	μA	V

△ Tentative specification

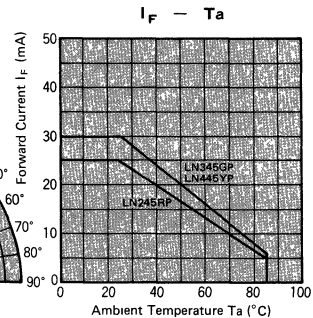
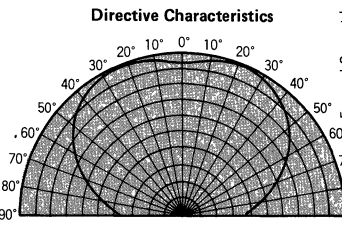
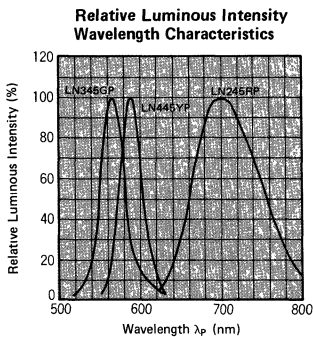
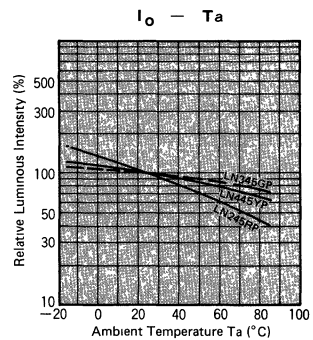
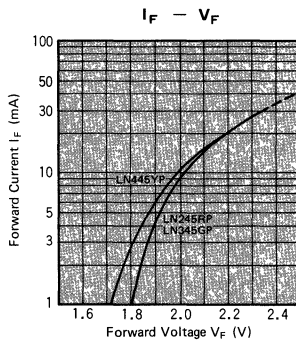
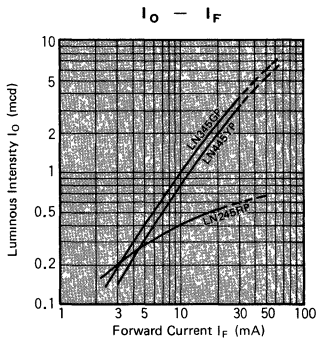

New Product

(Light Bar)

Surface 5mm X 15mm Series

- Characteristics:**
- 1.5mm x 15mm surface
 - High radiation, Uniform lighting surface
 - High reliability, long life

Absolute Maximum Ratings (Ta = 25°C)

Lighting Color	P _D (mW)	I _F (mA)	Note 1) I _{FP} (mA)	V _R (V)	T _{opr} (°C)	T _{stg} (°C)
Red	60	20	100	4	-25~+80	-30~+85
Green	60	20	100	4	-25~+80	-30~+85
Amber	60	20	100	4	-25~+80	-30~+85

Note 1) I_{FP} is duty 1/10 pulse with 1 msec

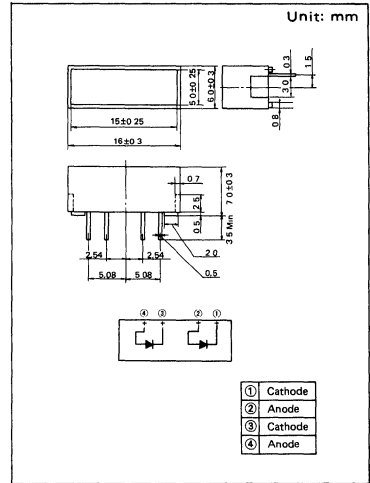

Electro-Optical Characteristics (Ta = 25°C)

Type No.	Lens Color	I ₀			I _F	V _F		λ _p	Δλ _p	I _F	I _h	V _R
		Typ.	Min.	Max.		Typ.	Max.					
LN0202RP2	Red Diffused	1.5	0.5	10	2.2	2.8	700	100	20	10	4	
LN0202GP3	Green Diffused	5.0	2.0	10	2.2	2.8	565	30	20	10	4	
LN0202YP4	Amber Diffused	3.0	1.0	10	2.2	2.8	590	30	20	10	4	
Unit	—	mod	mod	mA	V	V	nm	nm	mA	μA	V	

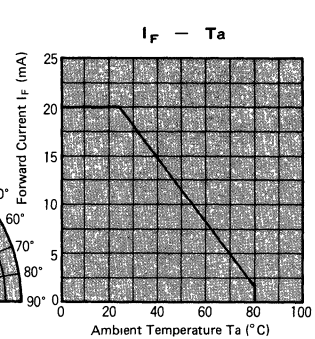
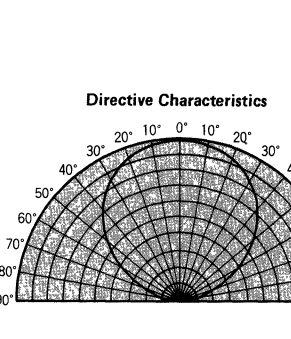
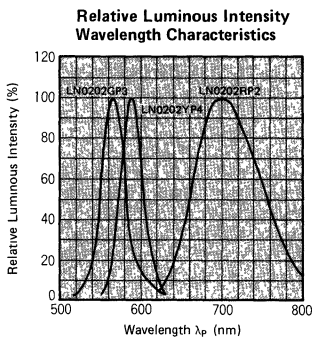
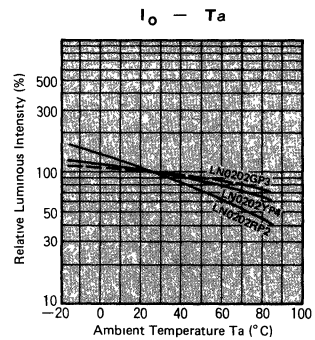
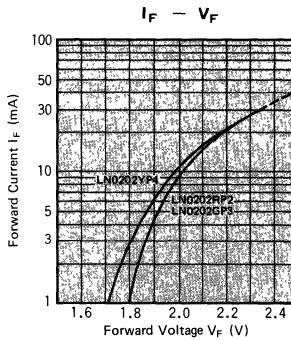
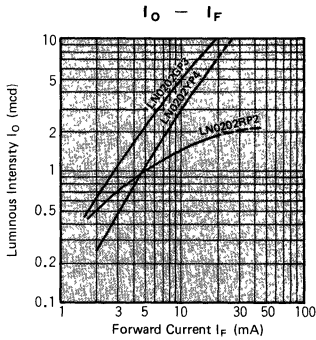

New Product

(Light Bar)

Surface 12mm X 15mm Series

Characteristics: 1. 12mm x 15mm surface

2. High radiation, Uniform lighting surface
3. High reliability, long life

Absolute Maximum Ratings (Ta = 25°C)

Lighting Color	P _D (mW)	I _F (mA)	Note 1) I _{FP} (mA)	V _{DF} (V)	T _{opr} (°C)	T _{stg} (°C)
Red	60	20	100	4	-25~+80	-30~+85
Green	60	20	100	4	-25~+80	-30~+85
Amber	60	20	100	4	-25~+80	-30~+85

Note 1) I_{FP} is duty 1/10 pulse with 1 msec

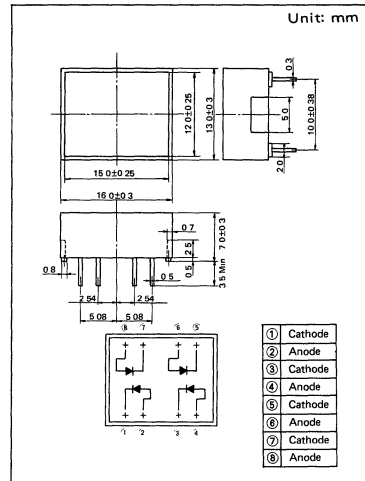

Electro-Optical Characteristics (Ta = 25°C)

Type No.	Lens Color	I ₀			V _F		λ _P	Δλ _F	I _F	I _R	
		Typ.	Min.	Max.	Typ.	Max.				Max.	V _R
LN0401RP2	Red Diffused	4.0	1.2	10	2.2	2.8	700	100	20	10	4
LN0401GP3	Green Diffused	8.0	2.5	10	2.2	2.8	565	30	20	10	4
LN0401YP4	Amber Diffused	6.0	2.0	10	2.2	2.8	590	30	20	10	4
Unit	—	mod	mod	mA	V	V	nm	nm	mA	μA	V

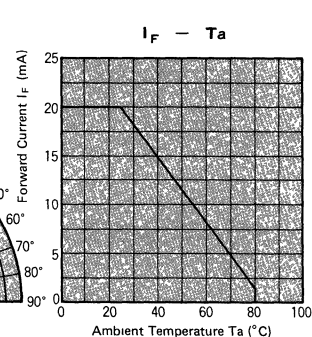
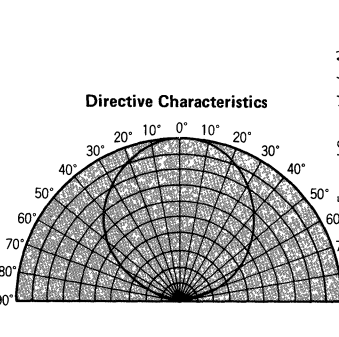
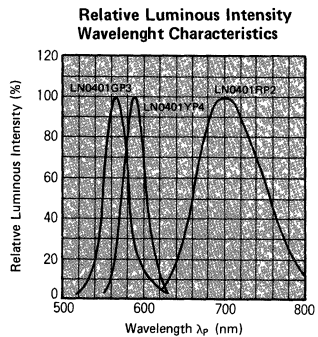
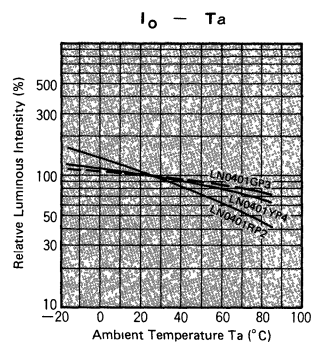
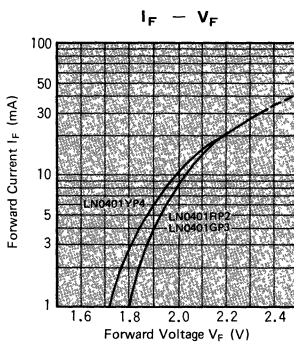
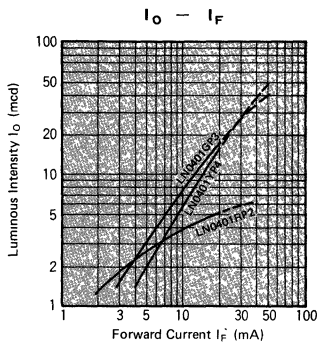

New Product

(Light Bar)

Surface 12mm X 20mm Series

- Characteristics:**
- 12mm x 20mm surface
 - High radiation, Uniform lighting surface
 - High reliability, long life

Absolute Maximum Ratings (Ta = 25°C)

Lighting Color	P _D (mW)	I _F (mA)	Note 1) I _{FF} (mA)	V _R (V)	Topr(°C)	Tstg(°C)
Red	60	20	100	4	-25~+80	-30~+85
Green	60	20	100	4	-25~+80	-30~+85
Amber	60	20	100	4	-25~+80	-30~+85

Note 1) I_{FF} is duty 1/10 pulse with 1 msec

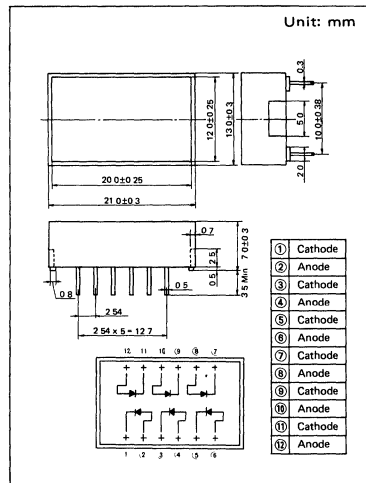

Electro-Optical Characteristics (Ta = 25°C)

Type No.	Lens Color	I ₀			V _F		λ _P	Δλ _P	I _F	I _R	
		Typ.	Min.	I _F	Typ.	Max.	Typ.	Typ.		Max.	V _R
LN0603RP2	Red Diffused	5.0	1.5	10	2.2	2.8	700	100	20	10	4
LN0603GP3	Green Diffused	15.0	5.0	10	2.2	2.8	565	30	20	10	4
LN0603YP4	Amber Diffused	15.0	5.0	10	2.2	2.8	590	30	20	10	4
Unit	—	mod	mod	mA	V	V	nm	nm	mA	μA	V

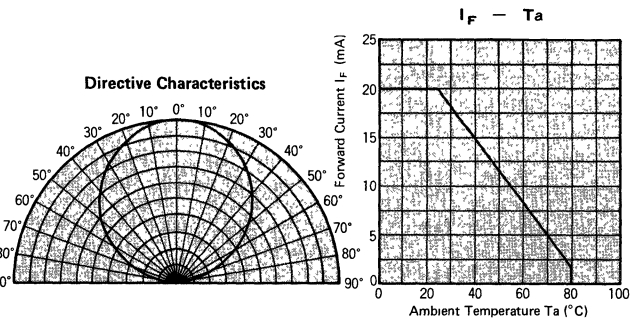
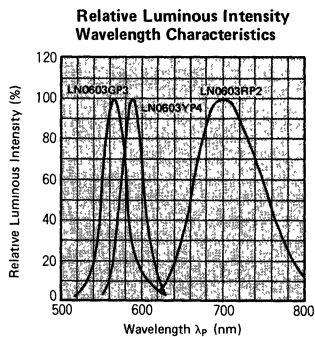
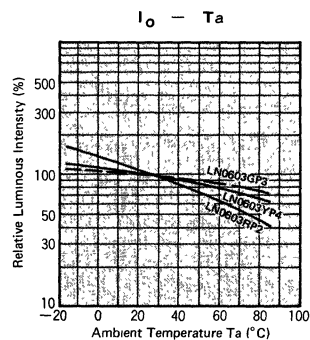
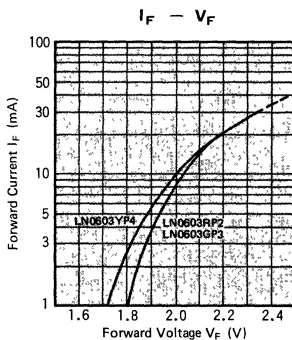
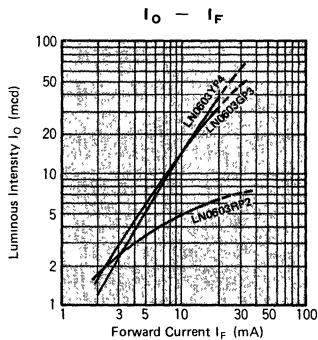

Glass Sealed 2mm Series

- Characteristics:**
1. Glass sealed 2mm cylinder type
 2. Wide directive characteristics
 3. High reliability, long life

Absolute Maximum Ratings (Ta = 25°C)

Lighting Color	P _D (mW)	I _F (mA)	I _{FM} (mA)	V _R (V)	T _{opr} (°C)	T _{stg} (°C)
Red	24	10	15	4	-25~+85	-30~+100
Green	24	10	15	4	-25~+85	-30~+100

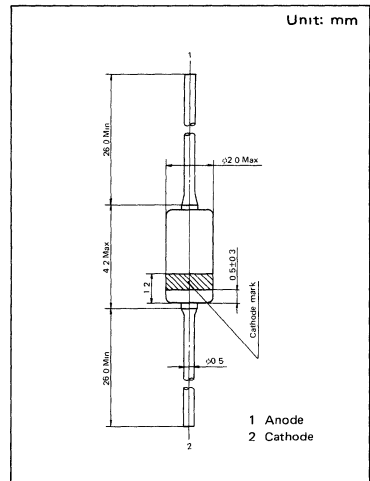

Electro-Optical Characteristics (Ta = 25°C)

Type No.	Lens Color	I ₀			V _F		λ _p	Δλ _p	I _F	I _R	
		Typ	Min	I _F	Typ	Max				Max	V _R
△ LN2G	Clear	100	30	5	2.0	2.4	700	100	10	10	4
△ LN3G	Clear	200	30	5	2.0	2.4	565	30	10	10	4
Unit	—	μcd	μcd	mA	V	V	nm	nm	mA	μA	V

△ Tentative specification

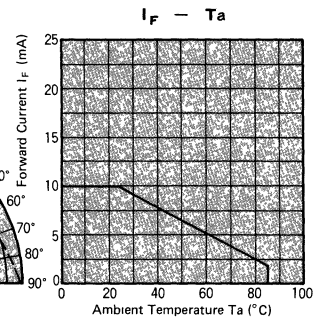
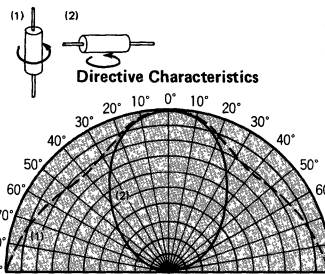
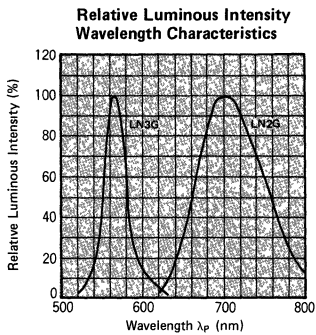
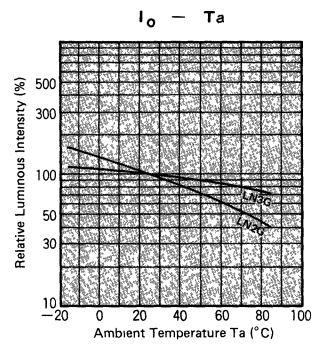
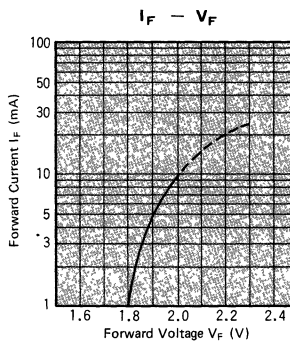
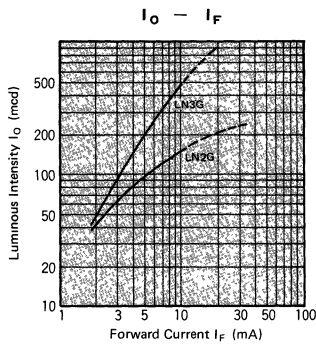

Numeric Display

1 Digit 0.3 inch Series

- Characteristics:**
1. Small and high brightness
 2. Black coated surface, colored seg
 3. High reliability, long life

Terminal Connection



Pin No	Assignment
1	Anode b
2	Anode a
3	Anode f
4	Anode e
5	Anode d
6	Anode c
7	Anode d p
8	Common Cathode
9	
10	
11	
12	Anode g

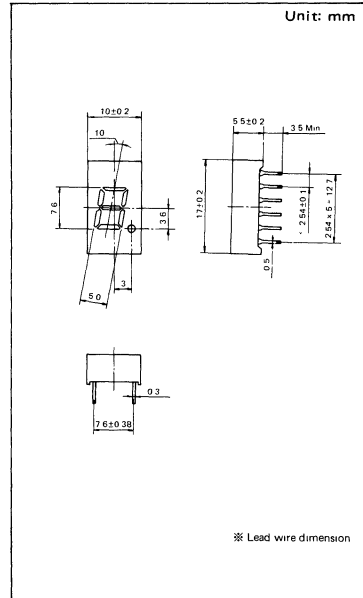

Absolute Maximum Ratings (Ta = 25°C)

Lighting Color	P _D (mW)	I _F (mA)	I _{FP} (mA) *	V _R (V)	Topr (°C)	Tstg (°C)
Red	60	20	100	5	-25~+80	-30~+85
Green	60	20	100	5	-25~+80	-30~+85
Amber	60	20	100	5	-25~+80	-30~+85
Orange	60	20	100	5	-25~+80	-30~+85

※ The condition of I_{FP} is duty 10%, Pulse width 1 msec

Electro-Optical Characteristics (Ta = 25°C)

Type No.	Lighting Color	I ₀ /seg		I ₀ /d.p	I _F	V _F		λ _p	Δλ _p	I _F	I _R	
		Typ.	Min.	Typ.		Typ.	Max.	Typ.	Typ.		Max.	V _R
LN513RKS	Red	400	150	150	5	2.2	2.8	700	100	20	10	5
LN513GKS	Green	1200	400	400	10	2.2	2.8	565	30	20	10	5
LN513YKS	Amber	600	200	200	10	2.2	2.8	590	30	20	10	5
LN513OKS	Orange	1000	300	400	10	2.1	2.8	630	40	20	10	5
Unit	—	μcd	μcb	μcd	mA	V	V	nm	nm	mA	μA	V

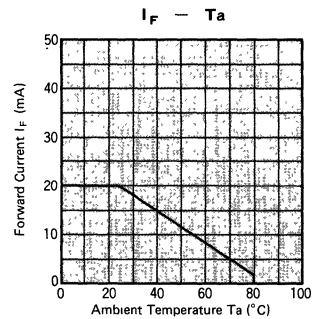
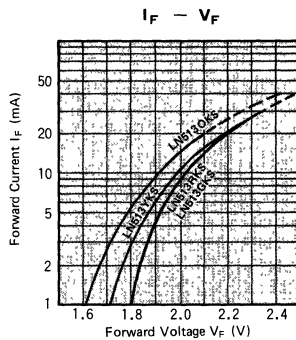
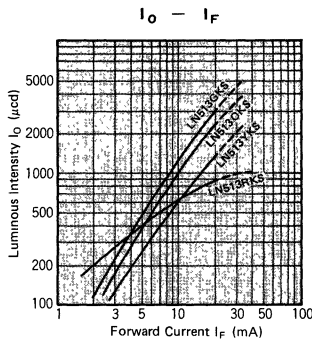

1 Digit 0.3 inch Series

- Characteristics:**
1. Uniform lighting surface and high radiation
 2. Black coated surface, colored seg.
 3. High reliability, long life

Terminal Connection



Pin No	Assignment	Assignment
1	Cathode a	Anode a
2	Cathode f	Anode f
3	Common Anode	Common Cathode
4	_____	_____
5	_____	_____
6	_____	_____
7	Cathode e	Anode e
8	Cathode d	Anode d
9	Cathode d p	Anode d p
10	Cathode c	Anode c
11	Cathode g	Anode g
12	_____	_____
13	Cathode b	Anode b
14	Common Anode	Common Cathode

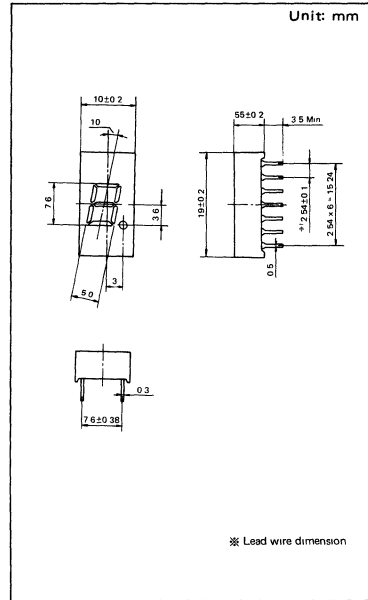

Absolute Maximum Ratings (Ta = 25°C)

Lighting Color	P _D (mW)	I _F (mA)	I _{FP} (mA) *	V _R (V)	T _{opr} (°C)	T _{stg} (°C)
Red	60	20	100	5	-25~+80	-30~+85
Green	60	20	100	5	-25~+80	-30~+85
Amber	60	20	100	5	-25~+80	-30~+85
Orange	60	20	100	5	-25~+80	-30~+85

* The condition of I_{FP} is duty 10%, Pulse width 1 msec

Electro-Optical Characteristics (Ta = 25°C)

Type No	Lighting Color	I ₀ /seg		I ₀ /d.p		V _F		λ _p	Δλ _p	I _F	I _F	
		Typ.	Min.	Typ.	I _F	Typ.	Max.				Max.	V _R
LN513RA/RK	Red	400	150	150	5	2.2	2.8	700	100	20	10	5
LN513GA/GK	Green	1200	400	400	10	2.2	2.8	565	30	20	10	5
LN513YA/YK	Amber	600	200	200	10	2.2	2.8	590	30	20	10	5
LN513OA/OK	Orange	1000	300	400	10	2.1	2.8	630	40	20	10	5
Unit	—	μcd	μcb	μcd	mA	V	V	nm	nm	mA	μA	V

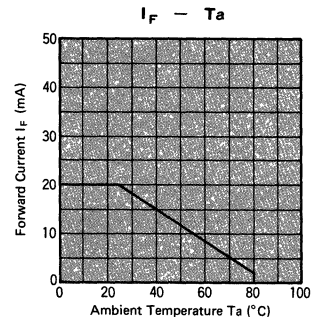
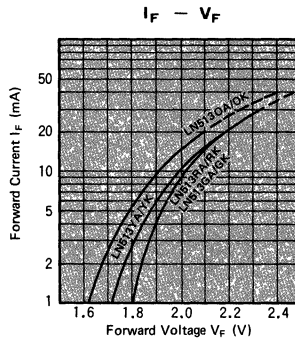
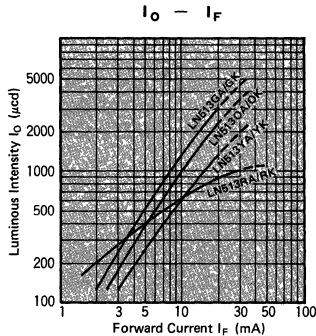

1 Digit 0.4 inch Series

- Characteristics:**
1. Uniform lighting surface and high radiation
 2. Black coated surface, colored seg
 3. High reliability, long life

Terminal Connection

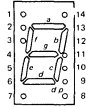

Pin No	Assignment	Assignment
1	Cathode a	Anode a
2	Cathode f	Anode f
3	Common Anode	Common Cathode
4	_____	_____
5	_____	_____
6	_____	_____
7	Cathode e	Anode e
8	Cathode d	Anode d
9	Cathode d p	Anode d p
10	Cathode c	Anode c
11	Cathode g	Anode g
12	_____	_____
13	Cathode b	Anode b
14	Common Anode	Common Cathode

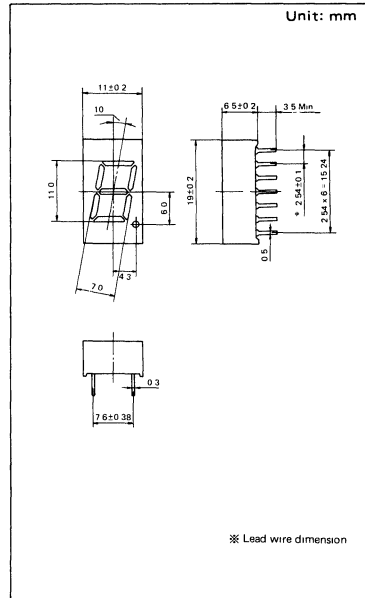

Absolute Maximum Ratings (Ta = 25°C)

Lighting Color	P _D (mW)	I _F (mA)	I _{FP} (mA) *	V _R (V)	Topr(°C)	Tstg(°C)
Red	60	20	100	5	-25~+80	-30~+85
Green	60	20	100	5	-25~+80	-30~+85
Amber	60	20	100	5	-25~+80	-30~+85
Orange	60	20	100	5	-25~+80	-30~+85

* The condition of I_{FP} is duty 10%, Pulse width 1 msec

Electro-Optical Characteristics (Ta = 25°C)

Type No.	Lighting Color	I ₀ /seg		I ₀ /d.p	I _F	V _F		λ _p	Δλ _p	I _F	I _R	
		Typ.	Min.	Typ.		Typ.	Max.	Typ.	Typ.		Max.	V _R
LN514RA/RK	Red	450	150	150	5	2.2	2.8	700	100	20	10	5
LN514GA/GK	Green	1500	500	500	10	2.2	2.8	565	30	20	10	5
LN514YA/YK	Amber	600	200	200	10	2.2	2.8	590	30	20	10	5
LN514OA/OK	Orange	1200	300	500	10	2.1	2.8	630	40	20	10	5
Unit	—	μcd	μcb	μcd	mA	V	V	nm	nm	mA	μA	V

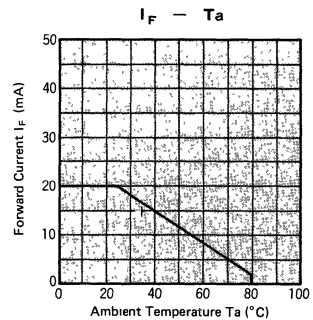
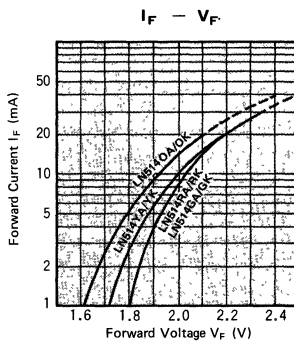
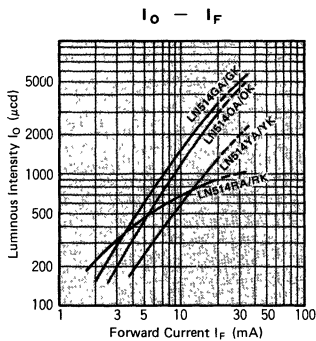

1 Digit 0.6 inch Series

- Characteristics:**
1. Good visible recognition, high radiation
 2. Black coated surface, colored seg.
 3. High reliability, long life

Terminal Connection

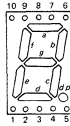

Pin No	Assignment	Assignment
1	Cathode e	Anode e
2	Cathode d	Anode d
3	Common Anode	Common Cathode
4	Cathode c	Anode c
5	Cathode d p	Anode d p
6	Cathode b	Anode b
7	Cathode a	Anode a
8	Common Anode	Common Cathode
9	Cathode f	Anode f
10	Cathode g	Anode g

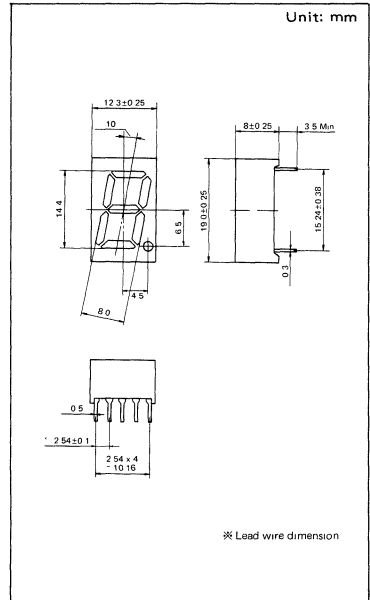

Absolute Maximum Ratings (Ta = 25°C)

Lighting Color	P _D (mW)	I _F (mA)	I _{FP} (mA)*	V _R (V)	T _{opr} (°C)	T _{stg} (°C)
Red	60	20	100	5	-25~+80	-30~+85
Green	60	20	100	5	-25~+80	-30~+85
Amber	60	20	100	5	-25~+80	-30~+85
Orange	60	20	100	5	-25~+80	-30~+85

* The condition of I_{FP} is duty 10%, Pulse width 1 msec

Electro-Optical Characteristics (Ta = 25°C)

Type No.	Lighting Color	I _o /seg		I _o /d.p	I _F	V _F		λ _p	Δλ _p	I _F	I _F	V _R
		Typ.	Min.			Typ.	Typ.					
LN516RA/RK	Red	600	250	600	5	2.2	2.8	700	100	20	10	5
LN516GA/GK	Green	1500	500	500	10	2.2	2.8	565	30	20	10	5
LN516YA/YK	Amber	800	300	300	10	2.2	2.8	590	30	20	10	5
LN516OA/OK	Orange	1200	300	500	10	2.1	2.8	630	40	20	10	5
Unit	—	μcd	μcb	μcd	mA	V	V	nm	nm	mA	μA	V

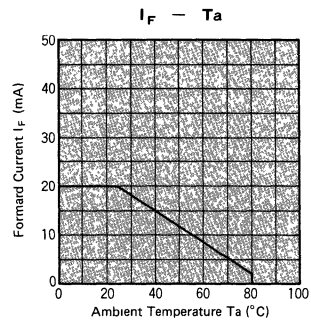
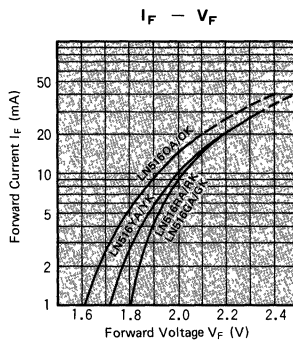
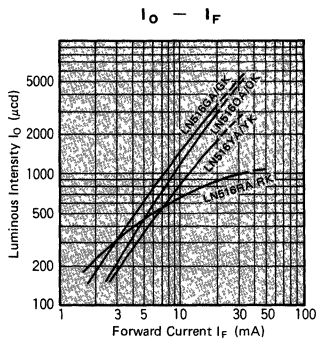

Numeric Display

2 Digit 0.4 inch Series

- Characteristics:**
1. Uniform lighting surface and high radiation
 2. Black coated surface, colored seg
 3. High reliability, long life

Terminal Connection

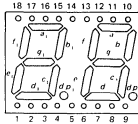

Pin No	Assignment	Assignment
1	Cathode e ₁	Anode e ₁
2	Cathode d ₁	Anode d ₁
3	Cathode c ₁	Anode c ₁
4	Cathode d ₀	Anode d ₀
5	Cathode e ₂	Anode e ₂
6	Cathode d ₂	Anode d ₂
7	Cathode g ₂	Anode g ₂
8	Cathode c ₂	Anode c ₂
9	Cathode d ₀	Anode d ₀
10	Cathode b ₂	Anode b ₂
11	Cathode a ₂	Anode a ₂
12	Cathode f ₂	Anode f ₂
13	Common Anode	Common Cathode
14	Common Anode	Common Cathode
15	Cathode b ₁	Anode b ₁
16	Cathode a ₁	Anode a ₁
17	Cathode g ₁	Anode g ₁
18	Cathode f ₁	Anode f ₁

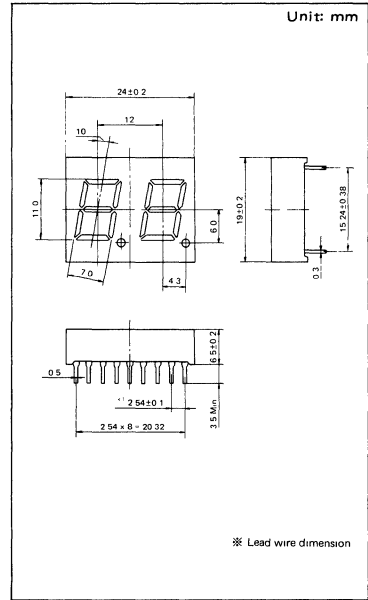

Absolute Maximum Ratings (Ta = 25°C)

Lighting Color	P _D (mW)	I _F (mA)	I _{FP} (mA)*	V _R (V)	T _{opr} (°C)	T _{stg} (°C)
Red	60	20	100	5	-25~+80	-30~+85
Green	60	20	100	5	-25~+80	-30~+85
Amber	60	20	100	5	-25~+80	-30~+85
Orange	60	20	100	5	-25~+80	-30~+85

※ The condition of I_{FP} is duty 10%, Pulse width 1 msec

Electro-Optical Characteristics (Ta = 25°C)

Type No.	Lighting Color	I ₀ /seg		I ₀ /d.p	I _F	V _F		λ _p		I _F	I _F	
		Typ.	Min.			Typ.	Typ.	Max.	Typ.		Typ.	Max.
LN524RA/RK	Red	450	150	150	5	2.2	2.8	700	100	20	10	5
LN524GA/GK	Green	1500	500	500	10	2.2	2.8	565	30	20	10	5
LN524YA/YK	Amber	600	200	200	10	2.2	2.8	590	30	20	10	5
LN524OA/OK	Orange	1200	300	500	10	2.1	2.8	630	40	20	10	5
Unit	—	μcd	μcb	μcd	mA	V	V	nm	nm	mA	μA	V

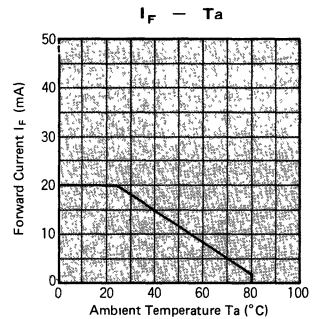
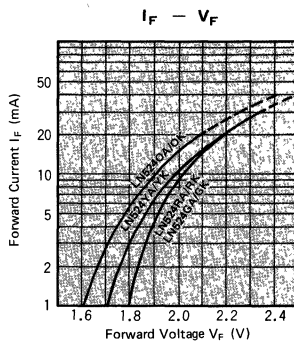
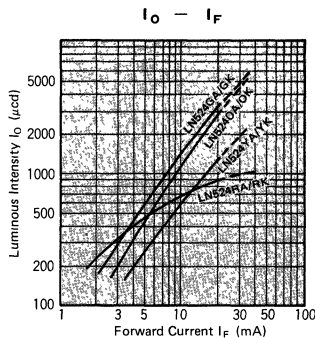

2 Digit 0.6 inch Series

- Characteristics:**
1. Good visible recognition, high radiation
 2. Black coated surface, colored seg.
 3. High reliability, long life

Terminal Connection

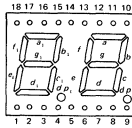

Pin No	Assignment	Assignment
1	Cathode e ₁	Anode e ₁
2	Cathode d ₁	Anode d ₁
3	Cathode c ₁	Anode c ₁
4	Cathode d p ₁	Anode d p ₁
5	Cathode e ₂	Anode e ₂
6	Cathode d ₂	Anode d ₂
7	Cathode g ₂	Anode g ₂
8	Cathode c ₂	Anode c ₂
9	Cathode d p ₂	Anode d p ₂
10	Cathode b ₂	Anode b ₂
11	Cathode a ₂	Anode a ₂
12	Cathode f ₂	Anode f ₂
13	Common Anode	Common Cathode
14	Common Anode	Common Cathode
15	Cathode b ₁	Anode b ₁
16	Cathode a ₁	Anode a ₁
17	Cathode g ₁	Anode g ₁
18	Cathode f ₁	Anode f ₁

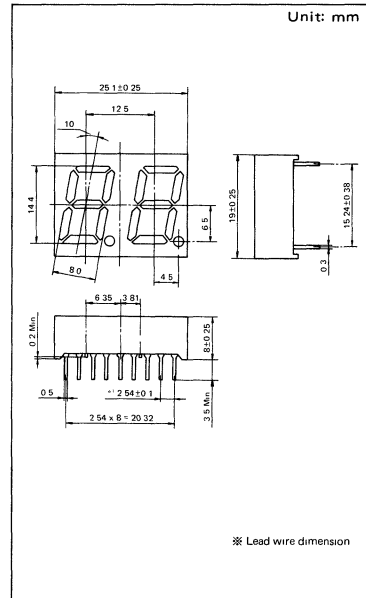

Absolute Maximum Ratings (Ta = 25°C)

Lighting Color	P _D (mW)	I _F (mA)	I _{FB} (mA) *	V _F (V)	Topr(°C)	Tstg(°C)
Red	60	20	100	5	-25~+80	-30~+85
Green	60	20	100	5	-25~+80	-30~+85
Amber	60	20	100	5	-25~+80	-30~+85
Orange	60	20	100	5	-25~+80	-30~+85

※ The condition of I_{FB} is duty 10%, Pulse width 1 msec

Electro-Optical Characteristics (Ta = 25°C)

Type No.	Lighting Color	I ₀ /seg		I ₀ /dp	I _F	V _F		Δp	Δλp	I _r	I _r	
		Typ.	Min.	Typ.		Typ.	Max.	Typ.	Max.		V _F	
LN526RA/RK	Red	600	250	600	5	2.2	2.8	700	100	20	10	5
LN526GA/GK	Green	1500	500	500	10	2.2	2.8	565	30	20	10	5
LN526YA/YK	Amber	800	300	300	10	2.2	2.8	590	30	20	10	5
LN526OA/OK	Orange	1200	300	500	10	2.1	2.8	630	40	20	10	5
Unit	—	μcd	μcb	μcd	mA	V	V	nm	nm	mA	μA	V

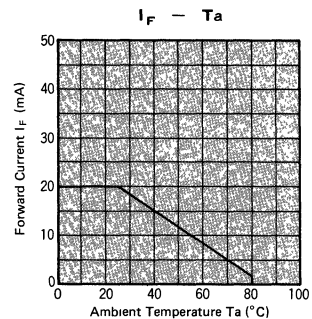
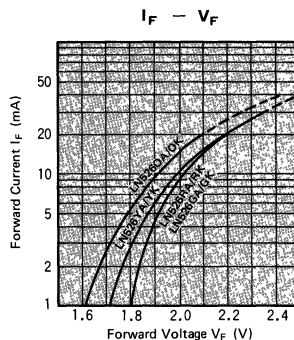
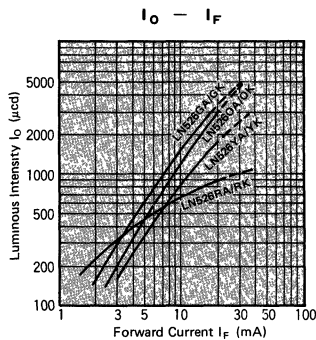

Numeric Display

4 Digit 0.3 inch Series

- Characteristics:**
1. Suitable for frequency and clock display
 2. Driver: dynamic lighting
 3. High reliability, long life

Terminal Connection

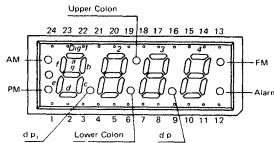

Pin No.	Assignment	Assignment
1	PM Anode	PM Cathode
2	Dig 1 Cathode	Dig 1 Anode
3	Seg d Anode	Seg d Cathode
4	d p 1 Anode	d p 1 Cathode
5	Dig 2 Cathode	Dig 2 Anode
6	Lower Colon Anode	Lower Colon Cathode
7	Upper Colon Anode	Upper Colon Cathode
8	Dig 3 Cathode	Dig 3 Anode
9	d p 2 Anode	d p 2 Cathode
10	Dig 4 Cathode	Dig 4 Anode
11	Seg e Anode	Seg e Cathode
12	Alarm Anode	Alarm Cathode
13	FM, Alarm Cathode	FM, Alarm Anode
14	FM Anode	FM Cathode
15	Seg a Anode	Seg a Cathode
16	d p 2 Cathode	d p 2 Anode
17	Upper Colon Lower Cathode	Upper Colon Lower Anode
18	Seg f Anode	Seg f Cathode
19	Seg b Anode	Seg b Cathode
20	Seg c Anode	Seg c Cathode
21	d p 1 Cathode	d p 1 Anode
22	Seg g Anode	Seg g Cathode
23	AW Anode	AW Cathode
24	AM, PM Cathode	AM, PM Anode

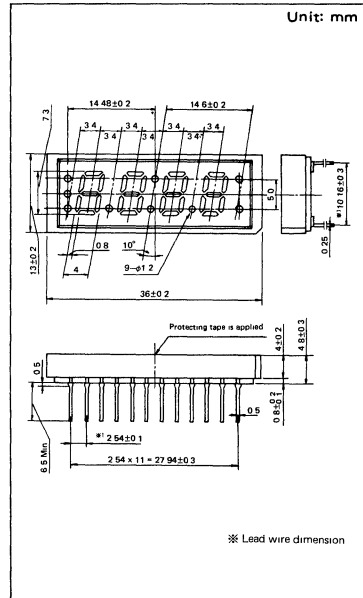

Absolute Maximum Ratings (Ta = 25°C)

Lighting Color	P _D (mW)	I _F (mA)	I _{FP} (mA)*	V _R (V)	T _{opr} (°C)	T _{stg} (°C)
Red	30	10	60	5	-25~+80	-30~+85
Green	30	10	60	5	-25~+80	-30~+85

* The condition of I_{FP} is duty 10%, Pulse width 1 msec

Electro-Optical Characteristics (Ta = 25°C)

Type No.	Lighting Color	I ₀ /seg		I ₀ /d.p	I _F	V _F		λ _p	Δλ _p	I _R	I _R	V _R
		Typ.	Min.			Typ.	Typ.					
LN543RA/RK	Red	200	100	100	5	2.03	2.8	700	100	10	10	5
LN543GA/GK	Green	200	80	80	10	2.03	2.8	565	30	10	10	5
Unit	—	μcd	μcd	μcd	mA	V	V	nm	nm	mA	μA	V

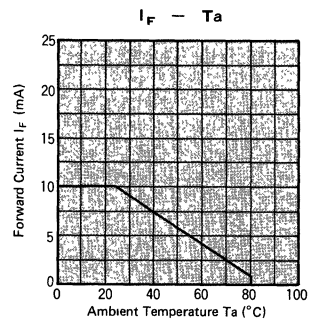
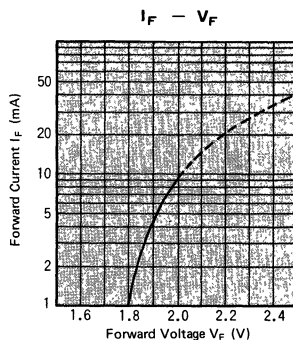
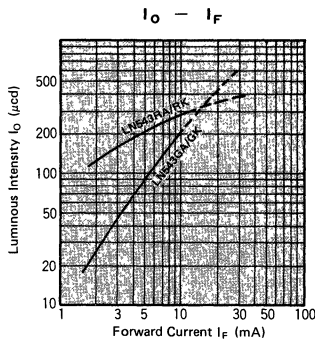

4 Digit 0.3 inch Series

- Characteristics:**
1. Suitable for frequency and clock display
 2. Driver: dynamic lighting
 3. High reliability, long life

Terminal Connection

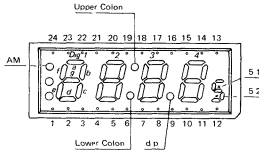

Pin No	Assignment	Assignment
1		
2	Dig 1 Cathode	Dig 1 Anode
3	Seg d Anode	Seg d Cathode
4		
5	Dig 2 Cathode	Dig 2 Anode
6	Lower Colon Anode	Lower Colon Cathode
7	Upper Colon Anode	Upper Colon Cathode
8	Dig 3 Cathode	Dig 3 Anode
9	d.p. 5.1 Anode	d.p. 5.1 Cathode
10	Dig 4 Cathode	Dig 4 Anode
11	Seg e Anode	Seg e Cathode
12	5.2 Anode	5.2 Cathode
13	5.1 5.2 Cathode	5.1 5.2 Anode
14		
15	Seg a Anode	Seg a Cathode
16	d.p. Cathode	d.p. Anode
17	Upper Lower Colon Cathode	Upper Lower Colon Anode
18	Seg f Anode	Seg f Cathode
19	Seg b Anode	Seg b Cathode
20	Seg c Anode	Seg c Cathode
21		
22	Seg g Anode	Seg g Cathode
23	AM Anode	AM Cathode
24	AM Cathode	AM Anode

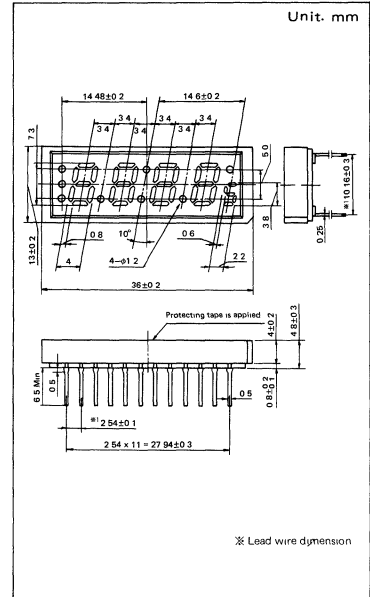

Absolute Maximum Ratings (Ta = 25°C)

Lighting Color	P _D (mW)	I _a (mA)	I _{FP} (mA) *	V _F (V)	T _{opr} (°C)	T _{stg} (°C)
Red	30	10	60	5	-25~+80	-30~+85
Green	30	10	60	5	-25~+80	-30~+85

※ The condition of I_{FP} is duty 10%, Pulse width 1 msec

Electro-Optical Characteristics (Ta = 25°C)

Type No.	Lighting Color	I _o /seg		I _o /d.p.		V _F		λ _p	Δλ _p	I _F	I _R	V _R
		Typ.	Min.	Typ.	I _F	Typ.	Max.	Typ.	Typ.			
LN543RAH/RKH	Red	200	100	100	5	2.03	2.8	700	100	10	10	5
LN543GAH/GKH	Green	200	80	80	10	2.03	2.8	565	30	10	10	5
Unit		μcd	μcb	μcd	mA	V	V	nm	nm	mA	μA	V

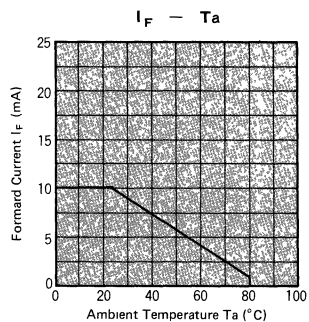
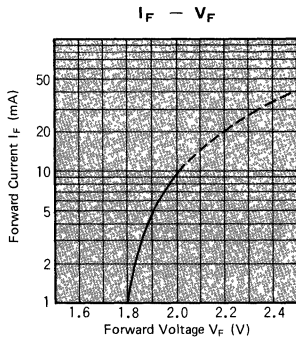
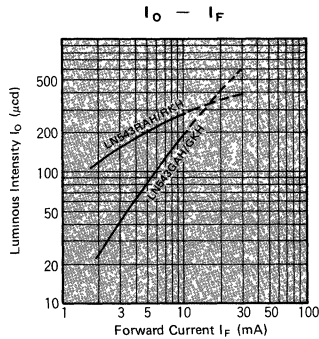

AN6875

5-Dot LED Driver (Logarithmic Response)

Description

The AN6875 is a circuit driving 5 LEDs and designed to turn them on logarithmically (dB). The brightness of the LED can be controlled since an output current adjusting terminal is available.

Features

- 5-dot LED display (point and bar model)
- Logarithmic response against input
- Output brightness adjustment for LED
- Large output current, green LED can be turned on
- Turning on/off voltage has hysteresis and no noise fluctuation.

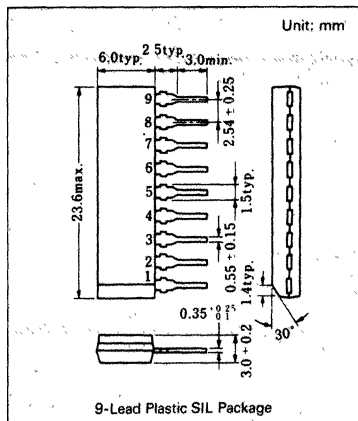

Absolute Maximum Ratings (Ta = 25°C)

Item		Symbol	Rating		Unit
Voltage	Supply Voltage	V _{CC}	-0.5	+18	V
	Circuit Voltage 8-5	V ₈₋₅	-0.5	+18	V
	Input Voltage for Setting Load Current	V ₇₋₅		+16	V
	Output Voltage	V _O	-0.5	+16	V
Current	Supply Current	I _{CC}	18		mA
	Input Current for Setting Load Current	I ₇	4.25		mA
	Output Current	I _O	20		mA
Power Dissipation		P _D	550		mW
Temperature	Operating Ambient Temperature	T _{opr}	-20 ~ +75		°C
	Storage Temperature	T _{stg}	-55 ~ +150		°C

Electrical Characteristics (Ta = 25°C)

Item	Symbol	Test Circuit	Condition	min.	typ.	max.	Unit
Input Voltage (LED ON)	LED1	V _{I(ON)1}	V _{CC} = 16V			1.12	V
	LED2	V _{I(ON)2}				1.86	V
	LED3	V _{I(ON)3}				3.10	V
	LED4	V _{I(ON)4}				5.18	V
	LED5	V _{I(ON)5}				8.66	V
Input Voltage (LED OFF)	LED1	V _{I(OFF)1}	V _{CC} = 16V		0.80		V
	LED2	V _{I(OFF)2}			1.49		V
	LED3	V _{I(OFF)3}			2.54		V
	LED4	V _{I(OFF)4}			4.28		V
	LED5	V _{I(OFF)5}			7.23		V
Load Current	Pin6	I ₆	V _{CC} = 16V, V _O = 1.2V, I ₇ = 4.25mA	13	16		mA
	Pin1 ~ 4	I _{1 ~ I4}	V _{CC} = 16V, V _O = 2.5V, I ₇ = 4.25mA	13	16		mA
	Pin1 ~ 4,6	I _{1 ~ I4, I6}	V _{CC} = 16V, V _O = 16V, I ₇ = 4.25mA		16	19	mA
Input Current	I _{I1}	1	V _{CC} = 16V, V ₈₋₅ = 8.7V			50	μA
	I _{I2}	1	V _{CC} = 16V, V ₈₋₅ = 16V			5	mA
Total Circuit Current	I _{tot}	1	V _{CC} = 16V, V ₈₋₅ = 16V			18	mA
Output Leak Current	I _{1 ~ I4, I6}	2	V _{CC} = 16V, V _O = 16V			15	μA

Operating voltage range V_{CC(oper)} = 12 ~ 16V

■ Block Diagram

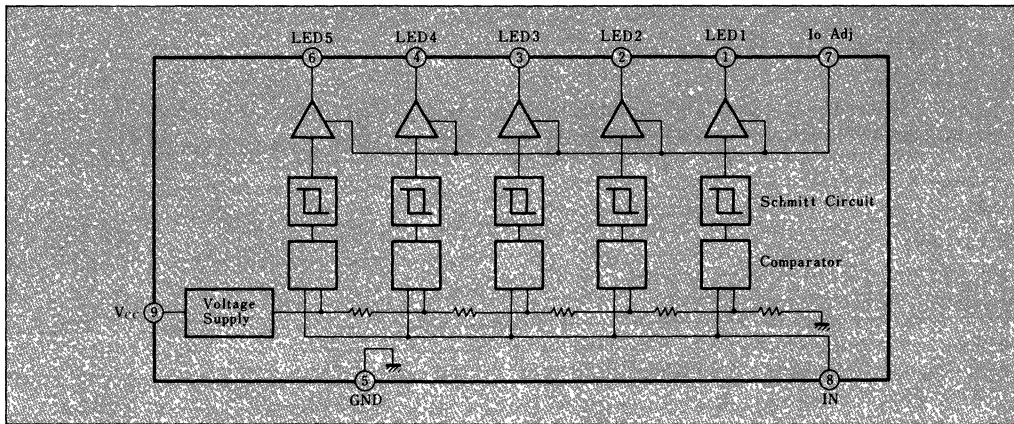

Test Circuit 1 (I_{11}, I_{12}, I_{10})

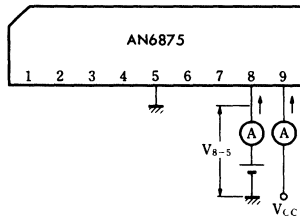

Test Circuit 2 ($V_{I(ON)1 \sim 5}, V_{I(OFF)1 \sim 5}, I_{1 \sim 4}, I_6$)

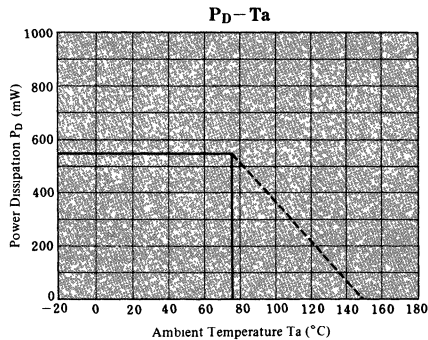
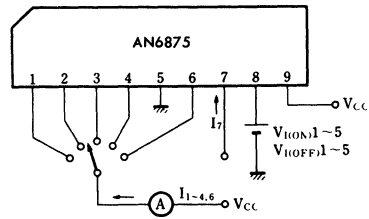

■ Application Circuit

1. Bar graph display

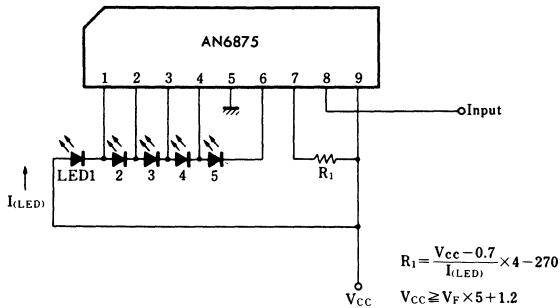

2. Dot display

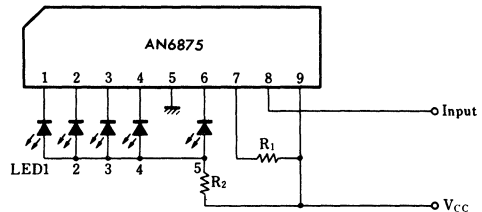

*) When the voltage of terminal 6 is high at 5-dot lighting, P_D should be decreased by inserting resistor into LED1 anode.

AN6876

5-Dot LED Driver (Linear Response)

■ Description

The AN6876 is a monolithic integrated circuit designed for 5 Dot LED driver applications responding linearly against an input signal. LED brightness can be controlled with a current adjusting terminal.

■ Features

- 5 dot LED display (bar and dot)
- Linear response against the input
- Outer brightness control for LED
- Large output current and green LED can be turned on.
- Turning on/off voltage has hysteresis and no fluctuation by noise.

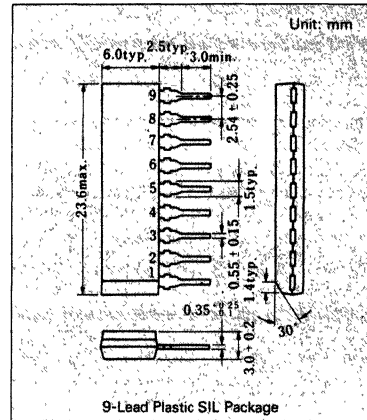

■ Absolute Maximum Ratings (Ta = 25°C)

Item		Symbol	Rating		Unit
Voltage	Supply Voltage	V _{CC}	-0.5	+18	V
	Terminal Voltage	V ₈₋₅	-0.5	+16	V
	Input Voltage for Setting Load Current	V ₇₋₅		+16	V
	Output Voltage*1	V _O	-0.5	+16	V
Current	Supply Current*1	I _{CC}	18		mA
	Input Current for Setting Load Current*2	I ₇	5		mA
	Output Current*1	I _O	20		mA
Power Dissipation (Ta = 75°C)		P _D	550		mW
Temperature	Operating Ambient Temperature	T _{opr}	-20 ~ +75		°C
	Storage Temperature	T _{stg}	-55 ~ +150		°C

Note: *1 Output terminal 1, 2, 3, 4, 6

*2 I₇ is maximum rating when it can set I_O = 20mA.

■ Electrical Characteristics (Ta = 25°C)

Item		Symbol	Test Circuit	Condition	min.	typ.	max.	Unit
Input Voltage (LED ON)	LED1	V _{I(ON)1}	2	V _{CC} = 16V	1.8	2.02		V
	LED2	V _{I(ON)2}			2.4	2.69		V
	LED3	V _{I(ON)3}			3.0	3.36		V
	LED4	V _{I(ON)4}			3.6	4.03		V
	LED5	V _{I(ON)5}			4.1	4.59		V
Input Voltage (LED OFF)	LED1	V _{I(OFF)1}	2	V _{CC} = 16V	1.58	1.8		V
	LED2	V _{I(OFF)2}			2.11	2.4		V
	LED3	V _{I(OFF)3}			2.64	3.0		V
	LED4	V _{I(OFF)4}			3.17	3.6		V
	LED5	V _{I(OFF)5}			3.61	4.1		V
Load Current	Pin6	I ₆	2	V _{CC} = 16V, V _O = 1.2V, I ₇ = 4.25mA	13	16		mA
	Pin1 ~ 4	I _{1 ~ I4}	2	V _{CC} = 16V, V _O = 2.5V, I ₇ = 4.25mA	13	16		mA
	Pin1 ~ 4,6	I _{1 ~ I4, I6}	2	V _{CC} = 16V, V _O = 16V, I ₇ = 4.25mA		16	19	mA
Input Current		I _{I1}	1	V _{CC} = 16V, V ₈₋₅ = 8.5V			50	μA
		I _{I2}	1	V _{CC} = 16V, V ₈₋₅ = 16V			5	mA
Total Circuit Current		I _{tot}	1	V _{CC} = 16V, V ₈₋₅ = 16V			18	mA
Output Leak Current		I _{1 ~ I4, I6}	2	V _{CC} = 16V, V _O = 16V			15	μA

Note: Operating supply voltage V_{CC(opr)} = 12 ~ 16V

■ Block Diagram

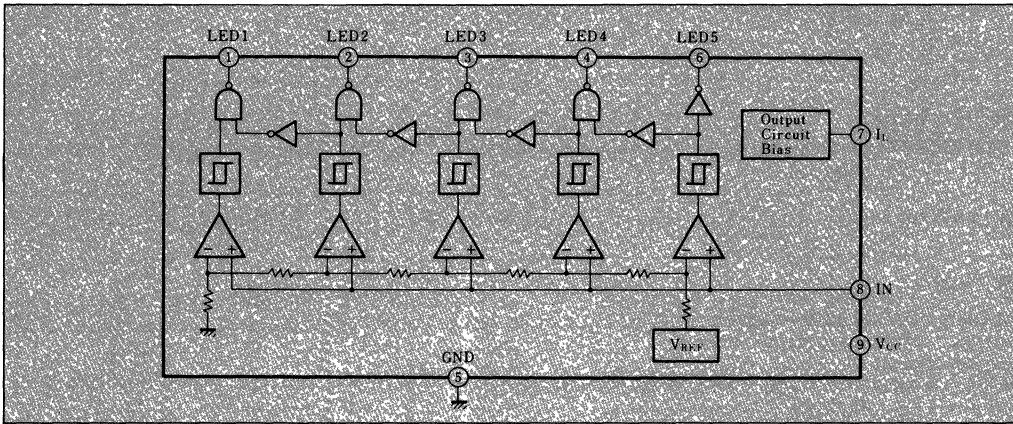

Test Circuit 1 (I_{I1} , I_{I2} , I_{tot})

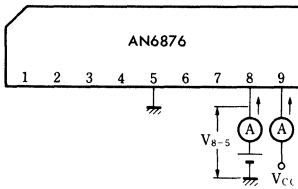

Test Circuit 2 ($V_{I(ON)1 \sim 5}$, $V_{I(OFF)1 \sim 5}$, $I_1 \sim I_4$)

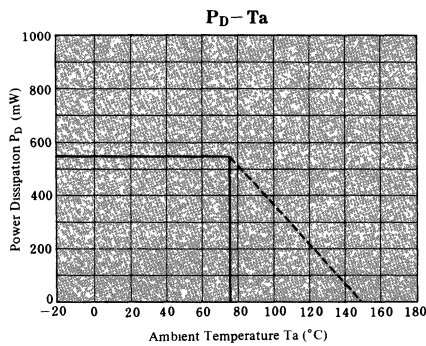
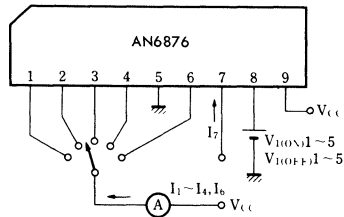

■ Application Circuit

1. Bar graph display

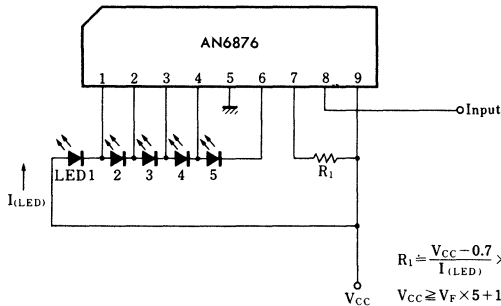

2. Dot display

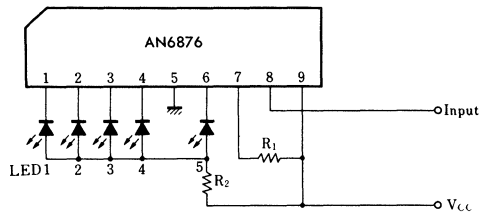

*) When the voltage of terminal 6 is high, P_D should be decreased by inserting resistor LED1 anode.

AN6877, AN6878

7-Dot LED Driver (Linear Response/Logarithm Response)

■ Description

AN6877 and AN6878 are the monolithic integrated circuit designed for 7 LED driver. AN6877 response linearly against the input signal and AN6878 response logarithmically. LED brightness can be adjusted owing to the output current adjusting terminal.

■ Features

- 7-dot LED display (bar and dot)
- Linear (AN6877) and Logarithmic (AN6878) response against the input signal.
- Outer brightness control of LED.
- Large output current: 25mA max.
- More than 7 point bar display can be enabled in serial connection.
- Built-in reference supply voltage circuit.
- LED current stable against supply voltage.

■ Absolute Maximum Ratings (Ta = 25°C)

Item	Symbol	Rating	Unit	
Voltage	Supply Voltage	V _{CC}	18	V
	Terminal Voltage	V _I	7.5	V
	Input Voltage	V _{IN}	16	V
	Output Voltage	V _O	16	V
Current	Supply Current	I _{CC}	25	mA
	Output Current	I _O	25	mA
Power Dissipation (Ta = 25°C)		P _D	1,800	mW
Temperature	Operating Ambient Temperature	T _{opr}	-30 ~ +75	°C
	Storage Temperature	T _{stg}	-55 ~ +150	°C

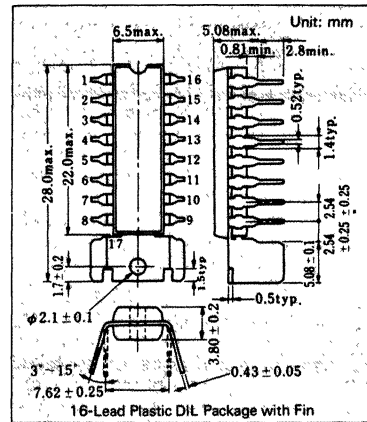

■ Electrical Characteristics (Ta = 25°C)

Item	Symbol	Test Circuit	Condition	min.	typ.	max.	Unit
Total Circuit Current	I _{tot}	1	V ₂ = V ₃ = 0V	4		18	mA
Output Current	I ₉₋₁₅	2	V ₁ = 3.55V, V ₇ = 3.5V	13		25	mA
Reference Voltage	V _{REF}	3		3.55	3.75	3.95	V
Output Offset Voltage (Amp)	V _{offset}	4	V _{CC} = 16V, G _v = 20dB	-150		150	mV
Voltage Gain (Amp)	G _v	4	V ₂ = 50mV	18	20	22	dB
Output Leak Current	I _{Leak}	5	V _{CC} = 18V	0		20	μA
Input Bias Current (Amp)	I _{Bias1}	6	V _{CC} = 18V	-2		0	μA
	I _{Bias2}	6	V ₂ = V ₃ = 0V	-2		0	μA
Input Bias Current (Comparator)	I _{Bias3}	7	V _{CC} = 18V, V ₂ = 10V, V ₃ = 0V V ₇ = V ₈ = 0V	-10		0	μA
	I _{Bias4}	7	V _{CC} = 18V, V ₃ = 10V, V ₁ = V ₂ = 0V V ₆ = V ₇ = V ₈	-10		0	μA
Comparator Level (AN6877)	GD ₁	8	V ₇ = 3.65V V ₈ = 0V	0.44	0.5	0.56	V
	GD ₂			0.88	1	1.12	V
	GD ₃			1.32	1.5	1.68	V
	GD ₄			1.76	2	2.24	V
	GD ₅			2.2	2.5	2.8	V
	GD ₆			2.64	3	3.36	V
	GD ₇			3.1	3.5	3.9	V
Comparator Level (AN6878)	GD ₁ *	8	V ₇ = 3.5V V ₈ = 0V	-17	-15	-13	dB
	GD ₂			-9	-7	-5	dB
	GD ₃			-4	-3	-2	dB
	GD ₄			-1	0	1	dB
	GD ₅			1.5	2	2.5	dB
	GD ₆			3.5	4	4.5	dB
	GD ₇			4.5	5	5.5	dB

* The reference voltage of comparator should be 3.5V and 2.0V

Note: Operating supply voltage V_{CC(opr)} = 5 ~ 16V

■ Block Diagram

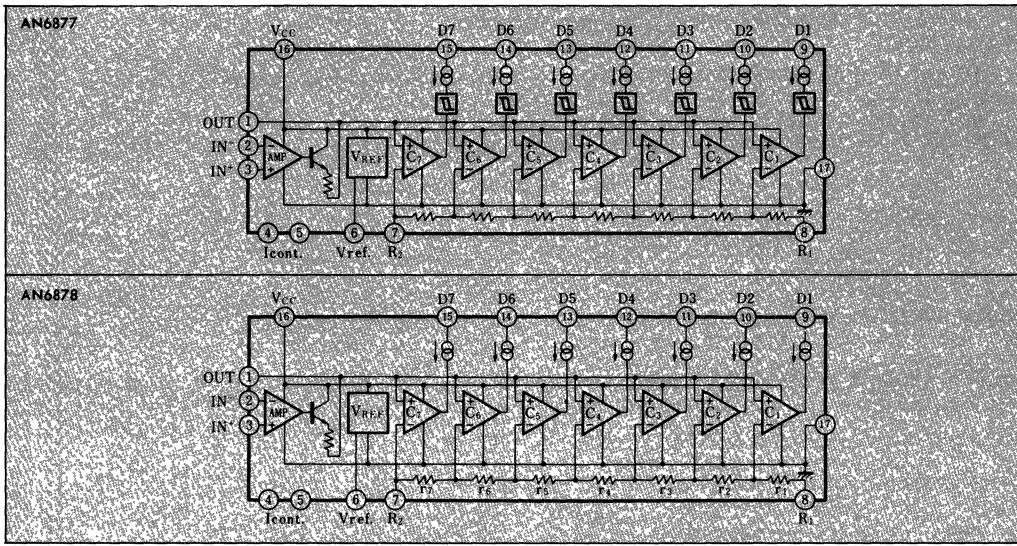

Test Circuit 1 (I_{tot})

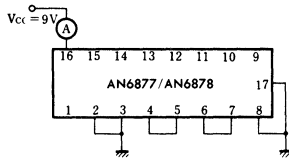

Test Circuit 2 (I_{9-15})

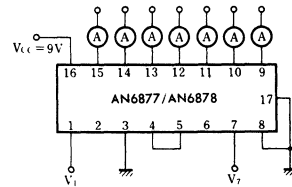

Test Circuit 3 (V_{REF})

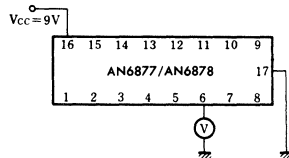

Test Circuit 4 ($V_{offset, Gv}$)

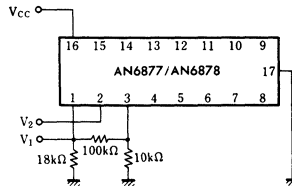

Test Circuit 5 (I_{Leak})

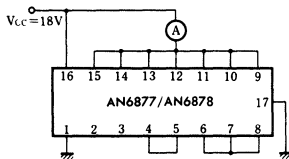

Test Circuit 6 (I_{Bias1}, I_{Bias2})

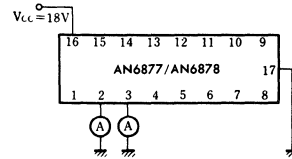

Test Circuit 7 (I_{Bias3}, I_{Bias4})

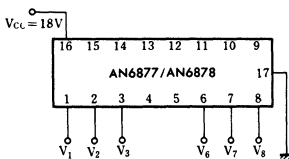

Test Circuit 8 (GD_{1-7})

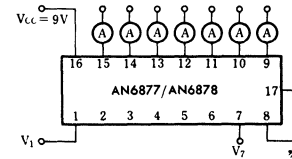

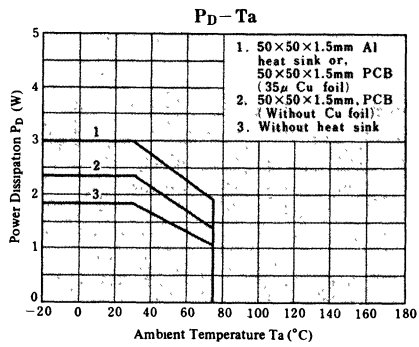
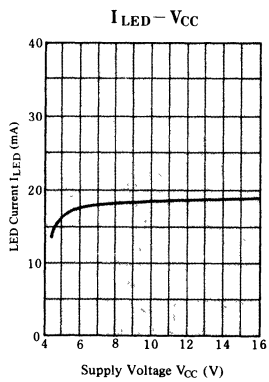
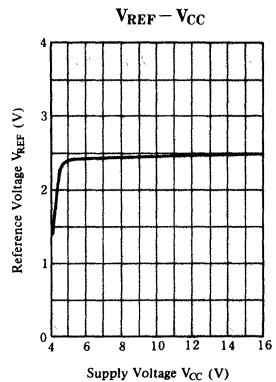
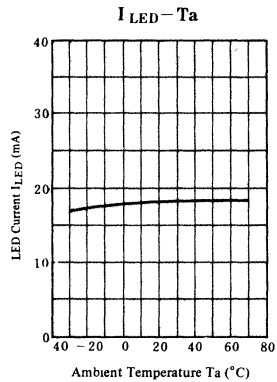
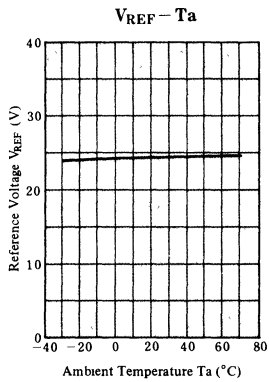

■ **Application Circuit**

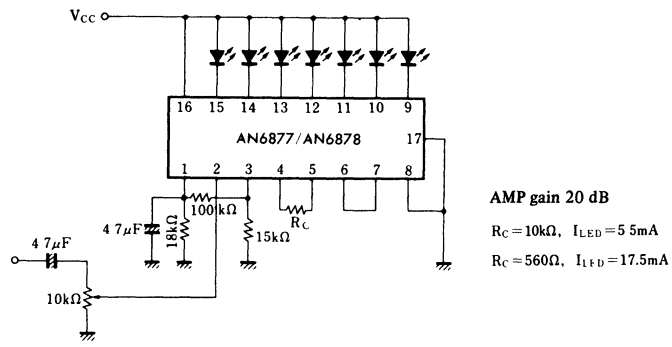

AN6882 (Tentative)

Low Power Consumption 7 Dot LED Driver (Logarithmic Response)

■ Description

The AN6882 is a monolithic integrated circuit designed for 7-dot LED driver.

■ Features

- Capable green LED drive, low power consumption
- Low current: $I_{tot} = 9 \text{ mA}$ (typ.)
($V_{CC} = 12\text{V}$, $R_L = 4.7 \text{ k}\Omega$)
- Wide operating supply voltage: $V_{CC} = 6\text{V} \sim 16\text{V}$
- Capable bar response or Dot response

■ Main Characteristics

- Input offset voltage..... $< 10 \text{ mV}$
- Reference voltage..... 2.7V (typ.)
- Output current: $I_{O1} = 4 \text{ mA} \sim 10 \text{ mA}$
($V_{CC} = 12\text{V}$, $R_A = 10 \text{ k}\Omega$)
 $I_{O2} = 6.3 \text{ mA} \sim 15 \text{ mA}$
($V_{CC} = 12\text{V}$, $R_A = 10 \text{ k}\Omega$, $R_B = 22 \text{ k}\Omega$)

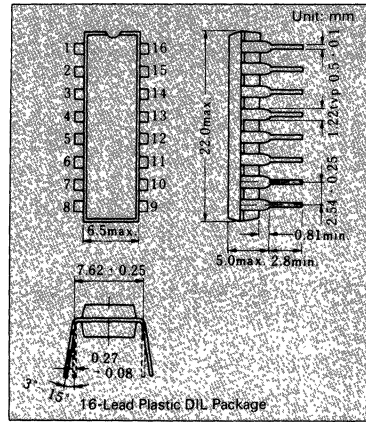

■ Application Circuit

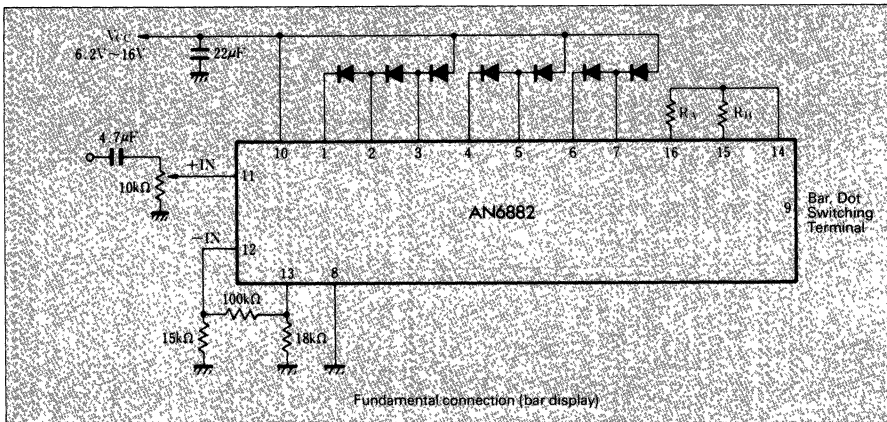

Reliability

Although reliability testing methods differ depending on individual products and customer requirements, the general test conditions performed by the manufacturer are listed below. These test conditions are based on EIAJ specifications (SD-121), and take into consideration actual field situations of visible light emitting diodes.

Group	Test	Conditions	Description
Operation Endurance	Operating Life Test	$I_F = \text{maximum rating current.}$ $T_a = 25 \pm 3^\circ\text{C}$ 1000 ⁺⁷² ₋₂₄ Hours	Determines resistance to failure in electrical and thermal stresses.
	High Temperature Storage Test	$T_a = T_{\text{stg max.}}$ 1000 ⁺⁷² ₋₂₄ Hours	Determines resistance to failure under high temperature conditions over a specified number of hours.
	Low Temperature Storage Test	$T_a = T_{\text{stg min.}}$ 1000 ⁺⁷² ₋₂₄ Hours	Determines resistance to failure under low temperature conditions over a specified number of hours.
	T.H.B. Test	$T_a = 65 \pm 3^\circ\text{C}$ RH = 90 ^{+5%} ₋₁₀ 1000 ⁺⁷² ₋₂₄ Hours	Determines resistance to failure under tropical conditions over a specified number of hours.
Environmental Test	Temperature Cycle Test	[$T_{\text{stg min.}} \sim 25^\circ\text{C} \sim T_{\text{stg max.}} \sim 25^\circ\text{C}$] [(30 min.) (5 min.) (30 min.) (5 min.)] x 5 cycle	Determines resistance to failure under sudden extreme changes in high and low temperature.
	Thermal Shock Test*1	[$T_{\text{stg max.}} \sim 0^\circ\text{C}$] [(15 sec.) (5 sec.)] x 5 cycle	
	Solder Dip Test	($T_a = 260 \pm 5^\circ\text{C}$ T = 10 seconds) x 1 cycle More than 2mm away from resin	Determines thermal characteristic resistance to failure under sudden extreme changes in high and low temperature when soldering lead wires.
	Solderability Test	($T_a = 230 \pm 5^\circ\text{C}$ t = 5 ± 1 seconds flux) x 1 cycle	Determines how well soldering can be performed on leads.
	Salt Atmosphere Test	$T_a = 35 \pm 2^\circ\text{C}$ Salt water concentration = 5% 24 Hours	Tests for metal corrosion on lead wire and determines insulation quality on the electrode surface.
Mechanical Treatment	*2 Mechanical Shock Test	(h = 75 cm) x 3 cycle	Determines resistance to failure when subjected to moderately severe shocks as a result of suddenly applied forces or abrupt changes in motion produced by rough handling, transportation or field operation.
	Lead Tension Test	W = 1 kg t = 30 second	Determines strength of lead wire when subjected to severe shocks as a result of suddenly applied forces, such as tension and bending produced during handling and soldering.
	Lead Bend Test	(W = 0.5 kg 90°) x 3 cycle	

* 1 4 digit numerical displays don't be tested.

* 2 7-element array level meter is excluded.

Usage Precautions

The visible light emitting diode can be handled the same as other general-use semiconductors; however, the following notes concerning optoelectronic characteristics should be carefully considered.

1) Chemical Resistance

Organic solvents such as acetone should not be used as they may cause damage to the device. Cleaning should be performed for 30 seconds under 45°C, using the chemicals listed below:

- Point light source: alcohol, chloroform, freon TF, hexan
 - Numerical display/level meter – freon TF, hexan
- (Case should not come in contact with chemicals.)

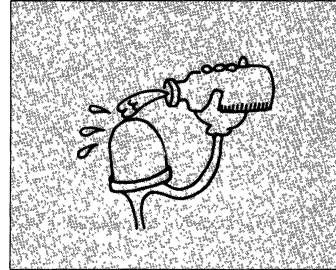

2) Abrasion Resistance

Some of the devices are made of resin with low-hardness characteristics, and therefore could be easily damaged when scratched by metal, fingernails, sand-blast, etc.

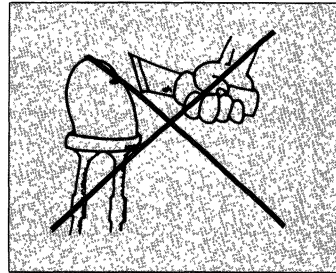

3) Lead Wire Stress

- Lead forming should be performed prior to soldering, so as not to add stresses into the resin with cutting pliers.
- When the device is mounted into a PC board, pitch spacing should be carefully aligned to avoid stresses to the lead wires. Any stress will cause trouble in the device under high temperature operation. Three minutes must elapse for the device to return to normal temperature after the soldering operation.

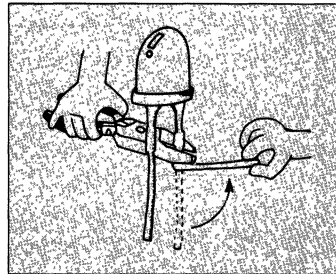

4) Lead Wire Cutting

Lead cutting should be performed at normal room temperature; **DO NOT CUT LEADS IMMEDIATELY AFTER SOLDERING.** Wait at least three minutes after soldering for device to return to room temperature before cutting.

Usage Precautions

5) Soldering Resistance

Lead soldering should be performed below the tiebar cutting point, in accordance with the following conditions.

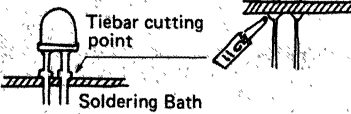
Item	Condition	Temperature	Time
Soldering iron	Soldering iron: Under 25W Top point of the iron: Under $\phi 45$ x more than 30 		Less than 30 seconds
Soldering Bath		240°C	Less than 5 seconds
		260°C	Less than 3 seconds

When soldering the lead wire, pincette should be recommendedly used.

6) Overcurrent Protection

A protection resistor should be incorporated to guard against excess current. The design should be such that instantaneous excess current is not applied to the device during the ON/OFF cycles.

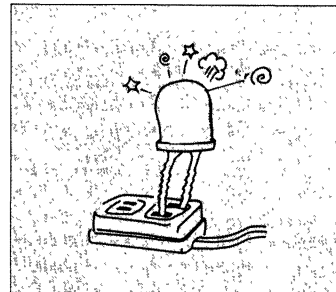

Panasonic Optoelectronics Cross Reference Guide LED Lamps

GENERAL INSTRUMENT

COMPETITOR	PANASONIC	CODE
MV5020	LN21CPHL	A
MV5021	LN21RCPHL	A
MV5022	LN21RCPHL	A
MV5023	LN21RPHL	A
MV5024	LN21RCPHL	A
MV5025	LN21RPHL	A
MV5026	LN21RPHL	A
MV5050	LN21CPH	A
MV5052	LN21RPH	A
MV5053	LN21RCPH	A
MV5054-1	LN21RPH	A
MV5054-2	LN21RPH	A
MV5054-3	LN21RPH	A
MV5055	LN21RPH	A
MV5056	LN21RPH	A
MV5074B	LN28RP	A
MV5074C	LN28RP	A
MV5075B	LN28RP	A
MV5075C	LN28RP	A
MV5094	LN21RAHL	A
MV5152	LN81CPH	B
MV5153	LN81RPH	A
MV5154	LN81RCPH	A
MV5152	LN31GCPH	A
MV5253	LN31GPH	A
MV5254	LN31GCPH	A
MV5274B	LN38GP	A
MV5274C	LN38GP	A
MV5352	LN41YCPH	B
MV5353	LN41YPH	A
MV5354	LN41YCPH	A
MV5374B	LN48YP	A
MV5374C	LN48YP	A
MV5752	LN21CAL/LN81CPH	B
MV5753	LN81RPH	A
MV5754	LN81RCPH	A
MV5774B	LN28RP	A
MV5774C	LN28RP	A

LITRONIX

COMPETITOR	PANASONIC	CODE
CQX13-1	LN31GPHL	B
CQX13-2	LN31GPHL	B
CQX23-1	LN21RPHL	B
CQX23-2	LN21RPHL	B
CQX33-1	LN41YPHL	B
CQX33-2	LN41YPHL	B
GL211	LN38GP	A
GL4484	LN38GP	A
GL4850	LN31GPH	A
GL4950	LN31GPH	A
LD30A	LN28RP	A
LD30-1	LN28RP	A
LD30-2	LN28RP	B
LD30-3	LN28RP	B
LD30-C	LN28CP	A
LD32C	LN28RCP	A
LD32-1	LN28RP	B
LD32-2	LN28RP	B
LD36A	LN48YP	A
LD36C	LN48YCP	A
LD36-1	LN48YP	A
LD36-2	LN48YP	A
LD37A	LN38GP	A

LITRONIX

COMPETITOR	PANASONIC	CODE
LD37C	LN38GCP	B
LD37-1	LN38GP	A
LD37-2	LN38GP	B
LD41A	LN21RPHL	A
LD41-1	LN21RPHL	A
LD41-2	LN21RPHL	A
LD50A	LN21RPHL	A
LD50-1	LN21RPHL	A
LD50-2	LN21RPHL	B
LD52C	LN21RCPHL	B
LD52CA	LN21RCPHL	B
LD52-1	LN21RPHL	A
LD52-2	LN21RPHL	B
LD56A	LN41YPHL	A
LD56C	LN41YCPHL	A
LD56CA	LN41YCPHL	A
LD56-1	LN41YPHL	A
LD56-2	LN41YPHL	A
LD57A	LN31GPHL	A
LD57C	LN31GCPHL	A
LD57CA	LN31GCPHL	A
LD57-1	LN31GPHL	B
LN57-2	LN31GPHL	B

HEWLETT PACKARD

COMPETITOR	PANASONIC	CODE
HLMP-1300	LN28RA or LN28RP	B
HLMP-1301	LN28RA or LN28RP	B
HLMP-1302	LN28RA or LN28RP	B
HLMP-1400	LN48YP	B
HLMP-1401	LN48YP	B
HLMP-1402	LN48YP	B
HLMP-1500	LN38GP	B
HLMP-1501	LN38GP	B
HLMP-1502	LN38GP	B
5082-4480	LN28RA or LN28RP	B
5082-4483	LN28WVP	B
5082-4484	LN28RA or LN28RP	B
5082-4486	LN28RCP	B
5082-4487	LN28RCP	B
5082-4488	LN28RCP	B
5082-4494	LN28RA or LN28RP	A
5082-4550	LN41YPH	A
5082-4555	LN41YPH	A
5082-4557	LN41YCPH	A
5082-4558	LN41YCPH	A
5082-4650	LN81RPH	A
5082-4655	LN81RPH	A
5082-4657	LN81RCPH	A
5082-4658	LN81RCPH	B
5082-4690	LN81RPH	B
5082-4693	LN81RPH	B
5082-4694	LN81RCPH	B
5082-4695	LN81RCPH	A
5082-4850	LN21RPH	A
5082-4855	LN21RPH	B
5082-4880	LN21RPHL	B
5082-4881	LN21RPHL	B
5082-4882	LN21RPHL	B
5082-4883	LN21CPHL	B
5082-4884	LN21CPHL	B
5082-4885	LN21CPHL	A
5082-4950	LN31GPH	A
5082-4955	LN31GPH	A
5082-4957	LN31GCPH	A
5082-4958	LN41YCPH	A

Code Definition:

A = Direct Equivalent

B = Minor Electrical or Mechanical Difference

Panasonic Optoelectronics Cross Reference Guide LED Lamps

LITRONIX			LITRONIX		
COMPETITOR	PANASONIC	CODE	COMPETITOR	PANASONIC	CODE
LD80A	LN219RP	B	RL209-1	LN28RP	B
LD80-1	LN219RP	B	RL209-2	LN28RP	B
LD80-2	LN219RP	B	RL200	LN21RPH	A
LD82A	LN219RP	B	RL4403	LN21RPH	A
LD82-1	LN219RP	B	RL4480	LN28RP	B
LD82-2	LN219RP	B	RL4480-1	LN28RP	B
LD86A	LN419YP	B	RL4480-2	LN28RP	B
LD86-1	LN419YP	B	RL4480-5	LN28RP	B
LD86-2	LN419YP	B	RL-4484	LN28RP	B
LD87A	LN319GP	B	RL-4850	LN21RPH	A
LD87-1	LN319GP	B	RL-5054-1	LN21RPH	A
LD87-2	LN319GP	B	RL-5054-2	LN21RPH	A
OL30-3	LN81RPHL	A	RL-5054-5	LN21RPH	A
OL30-6	LN81RPHL	A	RLT-1	LN23SRP (H)B	B
OD30-30-3	LN81RPH	A	YL212	LN48YP	B
OL30-30-6	LN81RPH	A	YL4484	LN48YP	B
RL-2	LN29RP	A	YL4550	LN41YPH	A
RL-209A	LN28RP	B	YL4850	LN41YPH	A

Panasonic Optoelectronics Cross Reference Guide LED 7 – Segment Displays

GENERAL INSTRUMENT			HEWLETT PACKARD		
COMPETITOR	PANASONIC	CODE	COMPETITOR	PANASONIC	CODE
MAN51A	LN513GA	A	HDSP-7631	LN513GA	A
MAN43A	LN513GK	B	HDSP-7633	LN513GK	B
MAN71A	LN513RA	A	HDSP-7651	LN514RA	A
MAN74A	LN513RK	B	HDSP-7653	LN514RK	A
MAN81A	LN513YA	A	HDSP-7661	LN514YA	A
MAN84A	LN513YK	B	HDSP-7663	LN514YK	A
MAN3610A	LN513OA	A	HDSP-7671	LN514GA	A
MAN3640A	LN513OK	B	HDSP-7673	LN514GK	A
MAN4510	LN514GA	A	HDSP-7731	LN513RA	A
MAN4540	LN514GK	B	HDSP-7740	LN513RK	B
MAN4610	LN514OA	A	HDSP-7751	LN514RA	A
MAN4640	LN514OK	B	HDSP-7760	LN514RK	A
MAN4710	LN514RA	A			
MAN4740	LN514RK	B			
MAN4810	LN514YA	A			
MAN4840	LN514YK	B			
MAN6610	LN526OA	A			
MAN6640	LN526OK	A			
MAN6660	LN516OA	A			
MAN6680	LN516OK	A			
MAN6710	LN526RA	A			
MAN6740	LN526RK	A			
MAN6760	LN516RA	A			
MAN6780	LN516RK	A			

HEWLETT PACKARD			LITRONIX		
COMPETITOR	PANASONIC	CODE	COMPETITOR	PANASONIC	CODE
HDSP-3531	LN513RA	A	DL-500	LN516RK	A
HDSP-3533	LN513RK	B	DL-507	LN516RA	A
HDSP-3731	LN514RA	A	DL-527	LN526RA	A
HDSP-3733	LN514RK	A	DL-528	LN526RK	A
HDSP-4031	LN513YA	A	DL-704	LN513RK	B
HDSP-4033	LN513YK	B	DL-707R	LN513RA	B
HDSP-4131	LN514YA	A	DL-727	LN526RA	A
HDSP-4133	LN514YK	A	DL-728	LN526RK	A
HDSP-7611	LN513RA	A	DL-4770	LN543RA/RK	B
HDSP-7613	LN513RK	B	DL-7731	LN513RA	A
HDSP-7621	LN513YA	A	DL-7734	LN513RK	B
HDSP-7623	LN513YK	B	DL-7740	LN513RK	B
			DL-7751	LN514RA	A
			DL-7760	LN514RK	A
			DLG-7671	LN514RA	A
			DLG-7673	LN514RK	A
			DLO-500	LN516RK	A
			DLO-507	LN516RA	A
			DLO-527	LN526RA	A
			DLO-528	LN526RK	A
			DLO-4770	LN543RA/RK	A
			DLO-7611	LN513RA	B
			DLO-7613	LN513RK	B
			DLO-7614	LN513RK	B
			DLO-7651	LN514RA	A
			DLO-7653	LN514RK	A
			DLY-7661	LN514RA	A
			DLY-7663	LN514RK	A

Code Definition:
A = Direct Equivalent
B = Minor Electrical or Mechanical Difference

Panasonic Industrial Company

SALES OFFICES

HEADQUARTERS

Panasonic Industrial Company
Electronic Components Division
Division of Matsushita Electric
Corporation of America
One Panasonic Way
Secaucus, NJ 07094
(201) 392-4496

NORTHEASTERN REGION

Panasonic Industrial Company
Electronic Components Division
Division of Matsushita Electric
Corporation of America
333 Meadowlands Parkway
Secaucus, NJ 07094
(201) 348-5233

MIDWESTERN REGION

Panasonic Industrial Company
Electronic Components Division
Division of Matsushita Electric
Corporation of America
425 East Algonquin Road
Arlington Heights, IL 60005
(312) 981-4837

SOUTHERN REGION

Panasonic Industrial Company
Electronic Components Division
Division of Matsushita Electric
Corporation of America
4405 C International Boulevard
Suite 102
Norcross, GA 30093
(404) 923-9700

WESTERN REGION

Panasonic Industrial Company
Electronic Components Division
Division of Matsushita Electric
Corporation of America
6550 Katella Avenue
Cypress, CA 90630
(714) 895-7200