

SPECIFICATION NOTES ON BOBBIN CORES FOR COMPUTER APPLICATION

by

JAMES SPOOL

Marketing Manager

Toroidal cores using ultra-thin 4-79 Molybdenum Permalloy tapes, wound on ceramic or stainless steel bobbins are employed in non-linear transformer applications in computers, such as shift registers, switching or gate transformers, pulse transformers, and other elements of logic circuits. The theory and application of these ultra-thin tape cores have been under development for a number of years, and the technical literature of the past decade is replete with numerous contributions to the advancement of the technology. (See Bibliography in Appendix.)

It is here sought to approach this technology with a summary oriented to review the specific parameters important to the practical specification of bobbin cores for use in computer logic circuits.

The bobbin core using ultra-thin tape should be distinguished from the familiar tape-wound toroid commonly used in magnetic amplifiers, saturable reactors, and other special transformers. As a practical matter, the two types can be distinguished on the basis of both physical construction and operating conditions. It should be emphasized that these distinctions are useful for discussion purposes and are not to be thought of as mutually exclusive.

The features of construction which generally distinguish bobbin cores from tape-wound magnetic amplifier cores are:

Tape Thickness -- Bobbin cores generally use ultra-thin 4-79 Molybdenum Permalloy tapes, nominally 1/8 mil, 1/4 mil or 1/2 mil thick; magnetic amplifier cores customarily use tape thicknesses of 1 mil, 2 mil, 4 mil, 6 mil or even 12 mils nominal. Magnetic amplifier tapes may be 4-79 Molybdenum Permalloy,

50%-50% grain-oriented Nickel Iron, or 3% grain-oriented Silicon Iron. (Some bobbin cores are manufactured with 50%-50% grain-oriented Nickel Iron).

Core Size -- Bobbin cores generally have a mean length of magnetic path of less than 1.5 inches (core I.D. of less than .5) while magnetic amplifier core mean magnetic path lengths are generally greater. The size division is certainly not rigid, but bobbin cores are commonly thought of as being smaller than most tape-wound magnetic amplifier cores.

Physical Core Support -- Bobbin cores derive their name from the fact that they are wound on ceramic or stainless steel bobbins which provide support for the tape toroid from the very beginning of the manufacturing process because of the extreme strain sensitivity of the ultra-thin (1/8 mil, 1/4 mil, and 1/2 mil) tape materials. A protective jacket of a polyester, nylon, polyethylene, or other material is often placed over the open edge of the bobbins to protect the magnetic tape during handling and the winding of the wire on the cores. Magnetic amplifier cores are generally self-supporting, and are placed in aluminum, phenolic, or plastic cases only to protect the core from the strains resulting from handling and the ultimate winding of the wire on the core.

The features of the operating conditions which generally distinguish bobbin cores from tape-wound magnetic amplifier cores are:

Frequency -- Bobbin cores are generally used in computer circuits where the frequencies or pulse repetition rates may be as high as several hundred kilocycles per second; magnetic amplifier cores generally operate at 60 or 400 cycles per second, although some of the latest applications go as high as 1600, 2400 and 6000 cycles per second.

Shape of Applied Currents -- Bobbin cores are generally used with rectangular or other sharp rise time pulses. Magnetic amplifier cores generally operate under sinusoidal voltage conditions.

Core Testing -- Bobbin cores are generally tested under pulse conditions using rectangular pulses with rise times in the range of .1 to .5 microseconds; magnetic amplifier cores are generally tested under sinusoidal conditions, both full wave and half wave, at 60 cycles, 400 cycles, or higher, and in combination with direct current continuously applied.

The discussion which follows assumes that the reader understands the basic physics of what happens when a current pulse is applied to the winding on a toroidal core of magnetic material with a rectangular d-c hysteresis loop such as shown in Figure 1. The discussion is limited to the core parameters described below, tested under pulse conditions such as those commonly found in computer logic circuits.

The parameters of major interest to bobbin core users are as follows (refer to Figure 1):

The total flux change ($\phi_1 \text{ max}$) which occurs when the core is "switched" from negative remnance

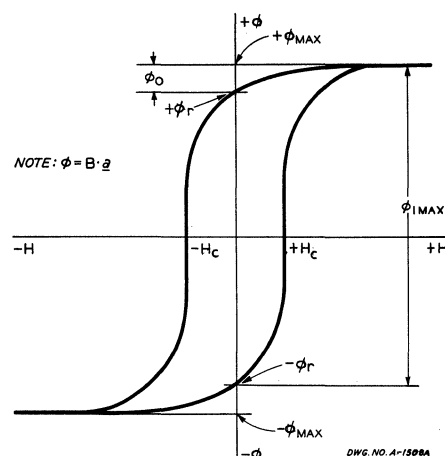

FIGURE 1

- (- ϕ_R) to positive saturation (+ ϕ_M);
- The drive input (H) required to achieve this flux change;
- The switching time (T_{SW}) taken by the core to undergo the flux change ϕ_1 at the stated drive;
- The open circuit voltage per turn (V_1) developed by this change in flux. (Voltage is directly proportional to the time rate of change of flux);
- The minor flux change (ϕ_0) which occurs in going from + ϕ_R to + ϕ_M , or vice versa.
- The minor open circuit voltage per turn (V_0) developed by the minor flux change ϕ_0 .
- The minor drive which represents the threshold of drive between switching and non-switching of the core.
- The mean length of magnetic path for the core, the actual cross-sectional area of core metal, and the area enclosed by the bobbin cross-section.

a. Total Flux Change ϕ_1 max.

This parameter is controlled primarily by the amount of magnetic material in the core. It is essentially independent of drive when the drive is sufficient to saturate the core, and is proportional to the area a of magnetic material measured at the cross-section of the core as shown in Figure 2. It is common to find specifications which fix this cross-sectional area, (and thereby fix the total flux change in the core) by calling out a particular number of wraps of tape of fixed thickness and width. Other specifications commonly call for a core to sustain a certain ϕ_1 and leave the number of wraps required to the core manufacturer.

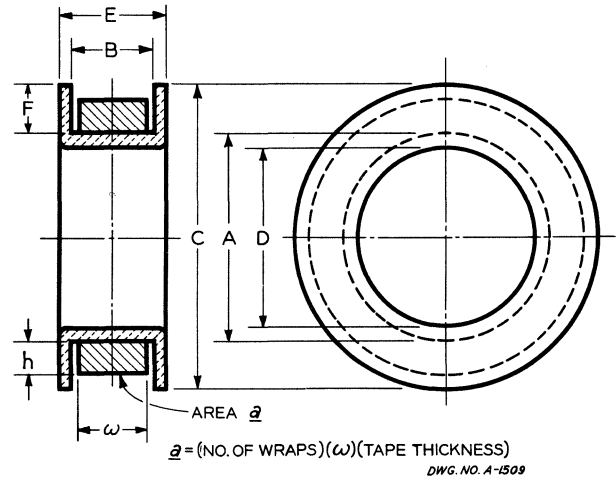

FIGURE 2

The practice at Dynacor, Inc. is to use ϕ_1 max. as a basic classification parameter for bobbin cores, because it is a parameter of principal significance in virtually all circuit designs.

For normal production, it is common to hold ϕ_1 to $\pm 10\%$. A tolerance of $\pm 5\%$ may be achieved economically where tolerances on the other parameters, discussed subsequently, are widened.

ϕ_1 may be expressed in Maxwells (EMU system) or Webers (MKS system). Refer to Table I for conversion factors. Note that flux in any core is related to the flux density B by the expression:

$$B = \frac{\phi}{a} \quad (1)$$

TABLE I
Basic Units and Conversion Factors

Dimension	Conversion		
	MKS Units	Multiplier	EMU (CGS) Units
Length	meter	$= 10^{-2}$	x Centimeter
Mass	kilogram	$= 10^{-3}$	x gram
Time	second	$= 1$	x second
Magnetic Field Strength or Intensity (H)	$\frac{\text{Ampere-turns}}{\text{meter}}$	$= \frac{10^{-3}}{4\pi}$	x Oersted
Magnetomotive Force (F)	Ampere-turns	$= 10/4\pi$	x Gilberts
Flux density or Induction (B)	$\frac{\text{Weber}}{(\text{meter})^2}$	$= 10^{-4}$	x Gauss
Total Flux (ϕ)	Weber	$= 10^{-8}$	x Maxwells
Permeability (μ)	$\frac{\text{Henry}}{\text{meter}}$	$= 4\pi \times 10^{-7}$	x Gauss/Oersted

where a is the area of magnetic material shown in Figure 2. B may be expressed in Gauss (a in square centimeters) for the EMU system, or in Webers per square meter for the MKS system.

b. Drive Input (H)

The drive input under which the core develops the flux change ϕ_1 should be completely defined in any bobbin core specification. The significant parts of this definition are: pulse amplitude, rise time, pulse width, and polarity sequence (generally called pulse logic). Figure 3 describes these parameters as well as the necessary reset pulse parameters.

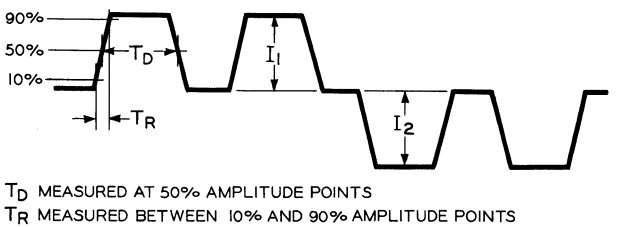

FIGURE 3

T_D MEASURED AT 50% AMPLITUDE POINTS
 T_R MEASURED BETWEEN 10% AND 90% AMPLITUDE POINTS
 DWG. NO. A-1510

The drive input is generally expressed in terms of field strength (H) or magnetomotive force (\mathcal{F}).

$$H = \frac{\mathcal{F}}{\ell} = \frac{.4 NI}{\ell} \quad (2)$$

where ℓ is the mean length of magnetic path of the core in centimeters and NI

is in ampere-turns. The units for H are either ampere-turns per meter (MKS system) or Oersteds (EMU system). The units for \mathcal{F} are either ampere-turns, in the MKS system, or Gilberts, in the EMU system (See Table I.)

c. Switching Time (T_{SW})

The switching time of a bobbin core is the time it takes for the core to change its flux from $-\phi_R$ to $+\phi_M$ at some specific drive input. In contrast to the total flux change parameter $\phi_1 \text{ max.}$ which is dependent primarily upon the cross-sectional area of the core, T_{SW} is a parameter dependent upon many things, including the metallurgical structure of the tape.

T_{SW} is affected by (1) drive pulse amplitude H , (2) drive pulse rise time T_R , (3) heat treatment or anneal experienced by the core, (4) tape thickness, and (5) the magnetic viscosity of the tape. Under pulse conditions, T_{SW} and H are related by the curve shown in Figure 4. The magnetic viscosity coefficient is proportional to the slope of the linear portion of the curve, and is, more or less, a constant for a particular lot of material.

Core characteristics may also be described by the family of curves which show the relationship between flux change, drive current and pulse width, (Figure 5.) In these curves the switching time T_{SW} is equal to or less than the pulse width T_D for values of $\frac{\phi_1}{\phi_1 \text{ max.}}$

of .95 or greater. The values of $\frac{NI_1}{\pi A}$

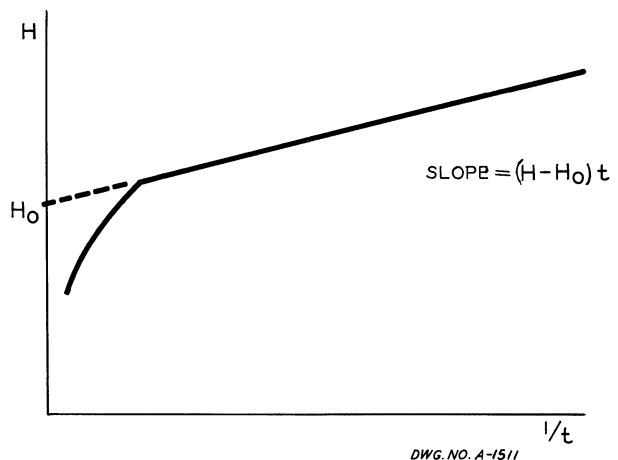

FIGURE 4

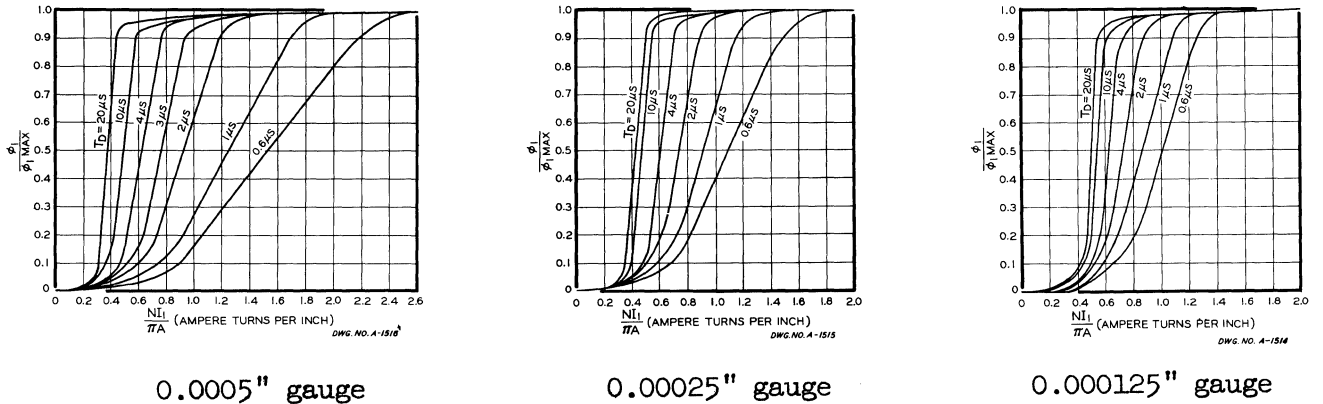

FIGURE 5

are proportional to H in Oersteds. NI_1 is expressed in ampere-turns, and A is the diameter at the bottom of the bobbin groove in inches.

Switching time may be defined as the time interval from the onset of the drive pulse to the point where the core is fully switched. If the output winding on the core is connected directly to an oscilloscope, the voltage pattern shown in Figure 6a is developed when the core switches. If this same winding is connected through an r-c network or electronic integrating circuit to the scope, the volt-time integral of the output pulse, which is equivalent to the flux change ϕ_1 appears in the form of the pattern shown in Figure 6b.

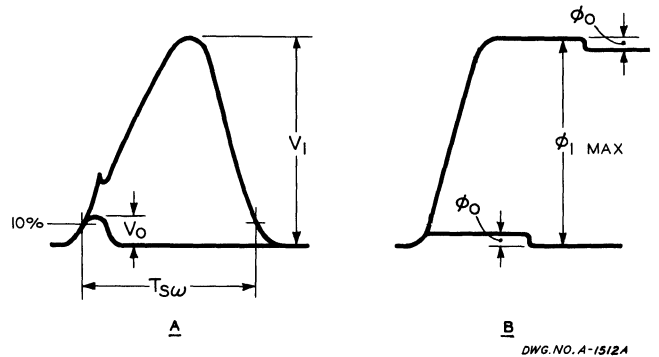

FIGURE 6a

FIGURE 6b

The drive pulse onset point and fully switched point are difficult to determine in both of these patterns because they occur where lines are tangent. Accordingly, it is generally understood in the industry that T_{SW} may be measured at the 10% amplitude level of the output voltage pattern, or between the 10% and 90% amplitude points on the integrated flux pattern. The numerical values of T_{SW} will be different, depending on which pattern is used, because the 10% voltage level does not occur at the same time as a 10% change in flux, or after a 90% change in flux.

The measurement of T_{SW} from 10% to 90% of the integrated flux pattern is generally not recommended in production because differences in integrator constants and integrator loading characteristics make correlation of test equipment difficult. The conditions under which T_{SW} is measured should be specifically called out in any specification.

T_{SW} is generally measured in microseconds, and tolerances of $\pm 10\%$ are normal for production runs. A tolerance of $\pm 5\%$ can be achieved where tolerances on other parameters are relaxed.

d. Open Circuit Voltage Per Turn (V_1)

V_1 is the maximum open circuit voltage per turn developed in the core

by the changing flux ϕ_1 and is given by the expression $V = d\phi/dt$ where $\phi = f(t)$. (By "turns" we mean the number of turns of wire wound on the core, not the number of wraps of tape in the core). When the input drive is sinusoidal, as is generally the case in magnetic amplifiers, these expressions reduce to:

$$V = 4.44 \phi_M f \times 10^{-8} \quad (3)$$

Since bobbin cores are generally used under pulse conditions, measurements are usually made under such conditions, and these expressions reduce to:

$$V_1 = K \phi_1 / T_{SW} \quad (4)$$

A typical open circuit voltage wave form is shown in Figure 6a. The area under the curve is proportional to ϕ_1 . Since ϕ_1 is constant for any given core, this area must be constant. Therefore, equation (4) and the Figure 6a show that V_1 is inversely proportional to T_{SW} . Since T_{SW} depends upon the drive amplitude, V_1 will also be dependent upon this amplitude.

For normal production, it is common to hold V_1 to $\pm 10\%$. Tighter tolerances can be achieved by relaxing tolerances on ϕ_1 and T_{SW} and vice versa. In view of the relationship of V_1 , and ϕ_1 and T_{SW} shown in equation (4) preceding, specifications should not fix all three parameters independently without full knowledge of constant "K" for the particular "heat" of core material.

e. Noise Flux Change (ϕ_0)

The minor flux change, or noise flux, is developed whenever a core, which has just been switched, is pulsed a second time in the same direction as the switching pulse. When the pulse comes on, the core goes from $+\phi_R$ to $+\phi_M$ Figure 1, and when it shuts off, the core retraces the path from $+\phi_M$ back down to $+\phi_R$. ϕ_0 is shown in Figure 6b.

Like the flux change ϕ_1 max. the noise flux ϕ_0 has a magnitude proportional to the cross-sectional area of the core. In addition, ϕ_0 is also affected by the amplitude of the drive pulse, the tape thickness, and the heat treatment or anneal experienced by the core.

ϕ_0 may be expressed in Webers or Maxwells, and should be specified for a particular drive amplitude. Bobbin cores with ϕ_0 in the range of 3% to 10% of ϕ_1 max. are available in normal production, depending upon the drive amplitude and switch time specifications, and the tape thickness used in the core.

"Squareness ratio" is a term which is sometimes used to define the quality of a magnetic core with rectangular hysteresis loop characteristics. There are numerous definitions of "squareness ratio", but the most common is the ratio B_R/B_M . The use of this ratio in the application of bobbin cores to digital pulse circuit technology is derived from its use in the magnetic amplifier field, but it is inconvenient because neither B_R nor B_M is directly measured under pulse conditions.

Dynacor, Inc. considers that a more appropriate way to express core quality is the ratio $\frac{\phi_0}{\phi_1 \text{ max.}}$, both parts of which are actually measured with

production test equipment. This ratio, called the "noise ratio", is related to the B_R/B_M squareness ratio by the following:

$$\frac{B_R}{B_M} = \frac{1 - \frac{\phi_0}{\phi_{1 \text{ max.}}}}{1 + \frac{\phi_0}{\phi_{1 \text{ max.}}}} \quad (5)$$

It should be noted that as the noise ratio approaches zero, the B_R/B_M squareness ratio approaches one from less than one.

Specifications which include a squareness ratio or noise ratio factor should include a drive amplitude at which the ratio is to be measured, as well as a clear definition of the term. A Miller Integrator circuit for measuring ϕ_1 and ϕ_0 is shown on page 9.

f. Open Circuit Noise Voltage Per Turn (V_0)

The noise voltage is the maximum volts per turn developed when the core experiences the flux change ϕ_0 . Its magnitude is dependent primarily upon the rise time T_R of the drive pulse and the magnitude of ϕ_0 , which in turn, is affected by the drive amplitude, the tape thickness, and the anneal or heat treatment experienced by the core. Specifications which call out a specific V_0 should also fix the pulse rise time T_R . Figure 6a shows V_0 .

g. Minor Drive

The threshold region of \mathcal{F} , below which no switching occurs and above which the core is fully switched, is the region of the minor drive. Where the applied drive is cyclic at a rate approaching d-c, the point on the H axis, where ϕ is zero numerically, is called the coercive force H_C .

The limits of the threshold region are important because they fix the minimum drive required to achieve the flux change ϕ_1 , as well as the maximum drive which may be permitted in the core circuit where no switching or flux change is desired. While it is generally important to the bobbin core user that the limits of the threshold region be kept constant within a core lot, and from lot to lot, absolute values in Oersteds or ampere-turns are not important except when the core specification is originally generated from the circuit requirements. Accordingly, production tests may not measure these threshold limits but often will merely seek to assure that they are within specified regions.

The shape of the dynamic B-H (hysteresis) loop of a core depends upon the wave form and frequency of the applied drive. A family of these loops is shown in Figure 7. Under pulse conditions, the rise time T_R is usually so short that the pulse amplitude H is reached before more than a small flux change takes place. Under these conditions, with an unloaded core, the loop described approximates a parallelogram, the width of which is dependent upon the amplitude of the drive pulse. The limits of the threshold region under pulse conditions are further out on the H axis of the B-H loop than for the 400 cycle loop shown in Figure 7 because the pulse widths normally used in computer applications are extremely short - on the order of 20 microseconds or less. This implies that

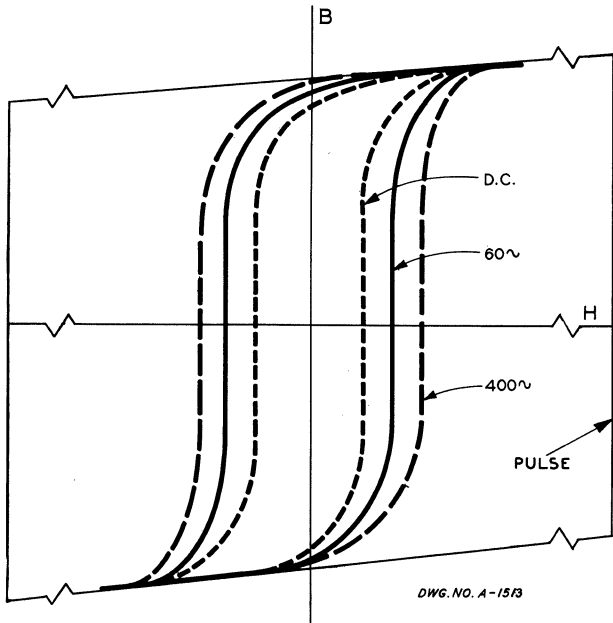

FIGURE 7

permeability, the ratio B/H , has little meaning in the specification of a bobbin core tested under pulse conditions.

The d-c H_C for 1/8 mil 4-79 molypermalloy is generally in the region of 0.07 Oersted. but the upper limit of the threshold region associated with bobbin cores operating under pulse conditions may be several times this value.

h. Physical Sizes

At the present time, physical standardization in the bobbin core industry is limited to bobbin dimensions, and is the result of new users copying the bobbins of others in the field.

Bobbins are commonly classified by the

width of tape they will accept and by their groove diameter.

It can be assumed that little error is introduced into circuit calculations if the mean length of magnetic path \underline{l} is assumed to be the circumference at the bottom of the bobbin groove. However, when comparing the performance of cores of different groove diameter or different $\phi_1 \text{ max.}$ levels, the error of this assumption may be significant. Equation 6 below may be used in such circumstances to provide a closer approximation of the true mean length of magnetic path for each of the cores under consideration:

$$\underline{l} = \pi A + C_l \phi_1 \text{ max.} \quad (6)$$

where C_l is the mean length correction factor in inches per Maxwell and is proportional to the ratio of effective bobbin groove depth to the $\phi_1 \text{ max.}$ of the largest core which could be placed on the bobbin under consideration.

In selecting the proper bobbin for a specific core, consideration is given to the buildup resulting from the insulation which must be applied to the surfaces of the tape in order to prevent welding during the heat treatment, and reduce eddy current losses in operation. Since insulation thickness is constant and independent of tape thickness, it can be shown that for a fixed bobbin slot depth, the cross-section area of actual core material, and therefore the $\phi_1 \text{ max.}$ sustainable in the core increases as the tape thickness is increased from 1/8 mil through 1 mil.

The area enclosed by the bobbin cross-section and the protective jacket determines the cross-section area of the toroidal winding. The ratio of this actual core material cross-section to the total cross-section is an important factor in the figure of merit of the toroidal winding and is critical in high speed pulse applications. This ratio may be increased to better the figure of merit by reducing the thicknesses of the bobbin wall and the protective jacket. Ceramic bobbin walls are normally on the order of .030" thick, but some stainless steel bobbin walls measure as thin as .005".

SPECIFICATION CHECK LIST

To summarize, the following data should be included to make up a complete specification for a bobbin core:

Physical Characteristics

1. Bobbin material and dimensions.
2. Tape material and dimensions.
3. Protective jacket.

Electrical Test Conditions (Figure 3)

1. Drive and reset pulse amplitudes and shapes (I_1 and I_2 for single turn drive windings; NI_1 and NI_2 for N turn drive winding).
2. Drive and reset pulse rise times T_R .
3. Drive and reset pulse widths (T_D).
4. Pulse logic pattern.

Core Performance Characteristics (Figure 5)

1. ϕ_1 with tolerance and T_{SW} with tolerance, and how measured, or V_1 with tolerance and T_{SW} with tolerance and how measured.
2. ϕ_0 with tolerance or
3. V_0 with tolerance, at specific T_R if different from above.

MILLER INTEGRATOR CIRCUIT

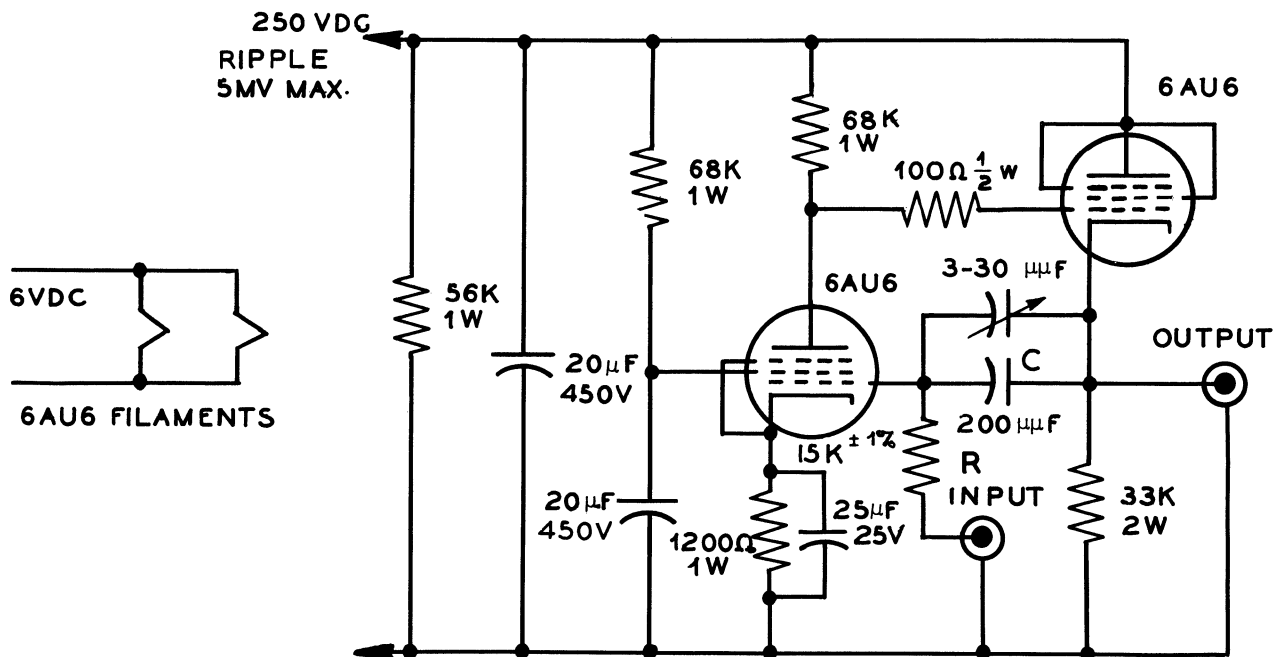

TABLE II - SUMMARY OF SYMBOLS

ϕ_M, B_M	Maximum flux, maximum flux density
ϕ_R, B_R	Residual flux, residual flux density
ϕ_1	Flux change under any pulse condition
$\phi_1 \text{ max.}$	Flux change from $-\phi_R$ to $+\phi_M$
ϕ_0	Flux change from $+\phi_R$ to $+\phi_M$
H	Drive field strength
\mathcal{F}	Drive magnetomotive force
I_1, I_2	Drive set and reset current pulse amplitudes
T_R, T_D	Drive pulse rise time, pulse width
T_{SW}	Switching time
V_1	Maximum open circuit volts per turn developed by flux change ϕ_1 .
V_0	Maximum open circuit volts per turn developed by flux change ϕ_0 .
\underline{a}	Core material cross sectional area
\underline{l}	Core magnetic path length
N	Number of turns in winding through the core
f	Frequency of drive input
\mathcal{C}_l	Mean length correction factor

APPENDIX

Bibliography

1. Wyien, Joseph, "Pulse Characteristics of Rectangular-Hysteresis Loop Ferromagnetic Materials," AIEE, pg. 649-658, November, 1953.
2. Sands, Eugene, A., "The Behavior of Rectangular Hysteresis Loop Magnetic Materials Under Current Pulse Conditions," Proceedings IRE, pg. 1246-1250, October, 1952.
3. Papoulis, A., "Penetration of an Electromagnetic Wave Into a Ferromagnetic Material," Journal Applied Physics, Vol. 25, No. 2, February, 1954.
4. Menyuk, N., and Goodenough, J. R., "Magnetic Materials For Digital-Computer I Components," Journal Applied Physics, Vol. 26, No. 1, January, 1955.
5. Menyuk, Norman, "Magnetic Materials For Digital Computers II," Journal Applied Physics, Vol. 26, No. 6, June, 1955.
6. Van Sant, Oscar, J., "Magnetic Viscosity 4-79 Molybdenum Permalloy," Journal Applied Physics, Vol. 28, No. 4, pg. 486-494, April, 1957.
7. Papiian, W. N., "A Coincident-Current Magnetic Memory Cell For The Storage of Digital Information," Proceedings IRE, Vol. 40, pg. 475-78, 1952.
8. Shannon, Claude, E., "A Symbolic Analysis of Relay And Switching Circuits," AIEE, Vol. 57, pg. 713, 1938.
9. McConnel, H. M., "Eddy-Current Phenomena In Ferromagnetic Materials," AIEE, Vol. 73, part I, pg. 226-235, 1954.
10. Van Sant, O. J., "Considerations For The Selection Of Magnetic Core Materials For Digital Computer Elements," Convention Record IRE, part 4, pg. 109-113, 1954.
11. Silva, L. F., "Magnetic Materials Used In Digital Computer Magnetic Circuits", Library of Congress, 49 pages, (Photostat \$7.80), PB 113505, April, 1955.
12. Littmann, M. F., "Ultrathin Tapes Of Magnetic Alloys With Rectangular Hysteresis Loops," Communication and Electronics AIEE, Transactions Part 1, Vol. 71, pg. 220-223, July, 1952.
13. Gyorgy, E. M., "Rotational Model Of Flux Reversal In Square Loop Ferrites," Journal Applied Physics, Pg. 28, 1011, 1957.
14. Freeman, J. R., "Pulse Response Of Ferrite Memory Cores," Proceedings Wescon Computer Sessions, pg. 60-61, at Los Angeles, August, 1954.
15. Arnold Engineering Company, "Production Testing Of Tape Core Materials For Magnetic Amplifiers," August 25, 1954.
16. Roberts, R. W., "Magnetic Characteristics Pertinent To The Operation Of Cores In Self Saturating Magnetic Amplifiers," AIEE, pg. 682-690, January, 1956.

17. Friedlaender, F. J., "Flux Reversal In Magnetic Amplifier Cores," AIEE, July, 1956.
18. Wang, A. N., "Magnetic Delay Line Storage," Proceedings IRE, Vol. 39, pg. 401-407, April, 1951.
19. Sands, E. A., "Analysis Of Magnetic Shift Register Operation," Proceedings of the IRE, Vol. 41, No. 8, August, 1953.
20. Minnick, Robert, C., "Magnetic Switching Circuits," Journal Applied Physics, Vol. 25, No. 4, pg. 479-485, April, 1954.
21. Kodis, R. D., Ruhman, S., and Woo, W. D., "Magnetic Shift Register Using One Core Per Bit," Convention Record, IRE National Convention, Part 7, pg. 38-42, March, 1953.
22. Widrow, Bernard, "A Radio-Frequency Non-Destructive Readout For Magnetic-Core Memories," Proceeding IRE Professional Group on Electronic Computers, Vol. EC-3, No. 4, December, 1954.
23. Papoulis, Athanasios, "The Non-Destructive Readout Of Magnetic Cores," Proceedings IRE, pg. 1283-1288, August, 1954.
24. Newhouse, V. L., and Prywes, N. S., "High-Speed Shift Register Using One Core Per Bit," Proceedings IRE, pg. 114-120, September 1955.
25. Wang, A. N., Woo, Way, Dong, "Static Magnetic Storage And Delay Line," Journal Applied Physics, Vol. 21, pg. 49-54, 1950.
26. Forrestel, J. W., "Digital Information Storage In Three Dimensions Using Magnetic Cores," Journal Applied Physics, Vol. 22, pg. 44-48, 1951.
27. Auerbach, I., "A Static Magnetic Memory System For The Eniac," Proceedings For Computing Machinery, pg. 213-222, May 2-3, 1952.
28. Rajchman, J. A., "Static Magnetic Matrix Memory And Switching Circuits," RCA Review, Vol. 13, pg. 183-201, 1952.
29. Gordon, B. M., and Nicola, R. N., "A High Speed Magnetic-Core Output Printer," Proceedings, Association for Computing Machinery, pg. 6-12, Sept. 2-10, 1952.
30. Ramey, R. A., "The Single Core Magnetic Amplifier As A Computer Element," AIEE Transactions, Vol. 71, Part 1, pg. 442-446, January, 1953.
31. Auerbach, I. L., and Disson, S. B., "Magnetic Elements In Arithmetic And Control Circuits," AIEE, September, 1955.
32. U. S. Naval Ordnance Laboratory, "Zero Signal Reliability In Magnetic Shift Register," Report 4164, Navord.
33. Wang, A., "Magnetic Triggers," Proceedings IRE, Vol. 38, pg. 626-629, June, 1950.
34. Kincaid, M., Alden, J. M., and Hanna, R. B., "Static Magnetic Memory For Low cost Computers," Electronics, Vol. 24, pg. 108-111, January, 1951.

35. Haynes, M. K., "Magnetic Cores As Elements Of Digital Computing Systems," Doctor's Thesis, University of Illinois, August, 1950.
36. Saunders, N. B., "Magnetic Binaries In The Logical Design Of Information Handling Machines," Proceedings Computing Machinery, pg. 223-339, May 2-3 1952.
37. Guterman, S., Kodis, R. D., and Ruhman, S., "Circuits To Perform Logical And Control Functions With Magnetic Cores," Convention Record IRE, Part 4, pg. 124-132, March 22-25, 1954.
38. Minnick, R. C., "The Use Of Magnetic Cores As Switching Devices," Doctor's Thesis, Harvard University, April, 1953.
39. Goodell, J. D., "Testing Magnetic Decision Elements," Electronics, Vol. 27, pg. 200-203, January, 1954.
40. Papian, W. N., "A Coincident-Current Magnetic Memory Cell For The Storage Of Digital Information," Proceedings IRE, Vol. 40, pg. 475-478, April, 1952.
41. Wang, A., "Static Magnetic Memory - Its Application to Computers And Controlling Systems," Proceedings Association of Computing Machinery, Pittsburgh Meeting, pg. 207-212, May 23, 1952.
42. Haynes, M. K., "Multidimensional Magnetic Memory Selection System", Transactions IRE Professional Group on Electronic Computers, pg. 25-29, December, 1952.
43. Rajchman, J. A., "A Myrabit Magnetic Core Matrix Memory," Proceedings IRE, Vol. 41, pg. 1407-1421, October, 1953.
44. Buck, D. A., and Frank, W. I., "Non-Destructive Sensing Of Magnetic Cores", Communication and Electronics, pg. 822-830, January, 1954.
45. Guterman, S., and Kodis, R. D., "Magnetic Core Selection Systems," Convention Records IRE 1954 National Convention, Part 4, pg. 116-123, March 22-25 1954.
46. Karnaug, M., "Pulse-Switching Circuits Using Magnetic Cores," Proceedings IRE, Vol. 43, pg. 570-583, May, 1955.
47. Scarrott, G. G., Harwood, W. J., and Johnson, K. C., "The Design And Use Of Logical Devises Using Saturable Magnetic Cores," Proceedings Institute of Electrical Engineers, Vol. 103, Part B, Supplement No. 2, Convention on Digital-Computer Techniques, pg. 302-312, April, 1953.
48. Miehle, W., Paivinen, J., Wylen, J., and Loev, D., "Bimag Circuits For Digital Data-Processing Systems," Proceedings IRE, Vol. 44, pg. 154-162, Feb. 1956.
49. Guterman, S., Kodis, R. D., and Ruhman, S., "Logical And Control Functions Performed With Magnetic Core," Proceedings IRE, Vol. 43, pg. 291-298, March, 1956.
50. Kodis, R.D., "Using Magnetic Cores In Computers," Electronic Design, Pg. 23-25, April, 1956.

51. Kodis, R. D., "Application And Performance Of Magnetic Core Circuits In Computing Systems," Proceedings Eastern Joint Computer Conference, Philadelphia, pg. 30-34, December, 1954.
52. Guterman, S. S., and Carey, W. M., "A Transistor-Magnetic Core Circuit; A New Device Applied To Digital Computing Techniques," Convention Record of IRE, Part 4, pg. 84-94, 1955.
53. Rajchman, J. A., and Lo, A. W., "The Transfluxor-A Magnetic Gate With Stored Variable Setting," RCA Review, Vol. 16, pg. 303-311, June, 1955. Proceedings IRE, Vol. 44, pg. 321-332, March, 1956.
54. Meyerhoff, A. J., "Magnetic Core Components For Digital Control Applications," Automatic Control, pg. 15-19, April, 1956; pg. 13-15 May, 1958, pg. 34-40 July, 1956.
55. Lincoln, A. J., "Ferromagnetic Core Logical Circuitry And Its Application To Digital Computers," Office of Technical Services, U. S. Department of Commerce, Washington, D. C., Price \$1.50, PB 111954, August, 1955.







**MAGNETIC MATERIALS, MAGNETIC COMPONENTS,
MAGNETIC CIRCUITRY**



DYNACOR, INC.
A Subsidiary of the Sprague Electric Company
Kensington, Maryland