

DATA**70**MATION®

September 15

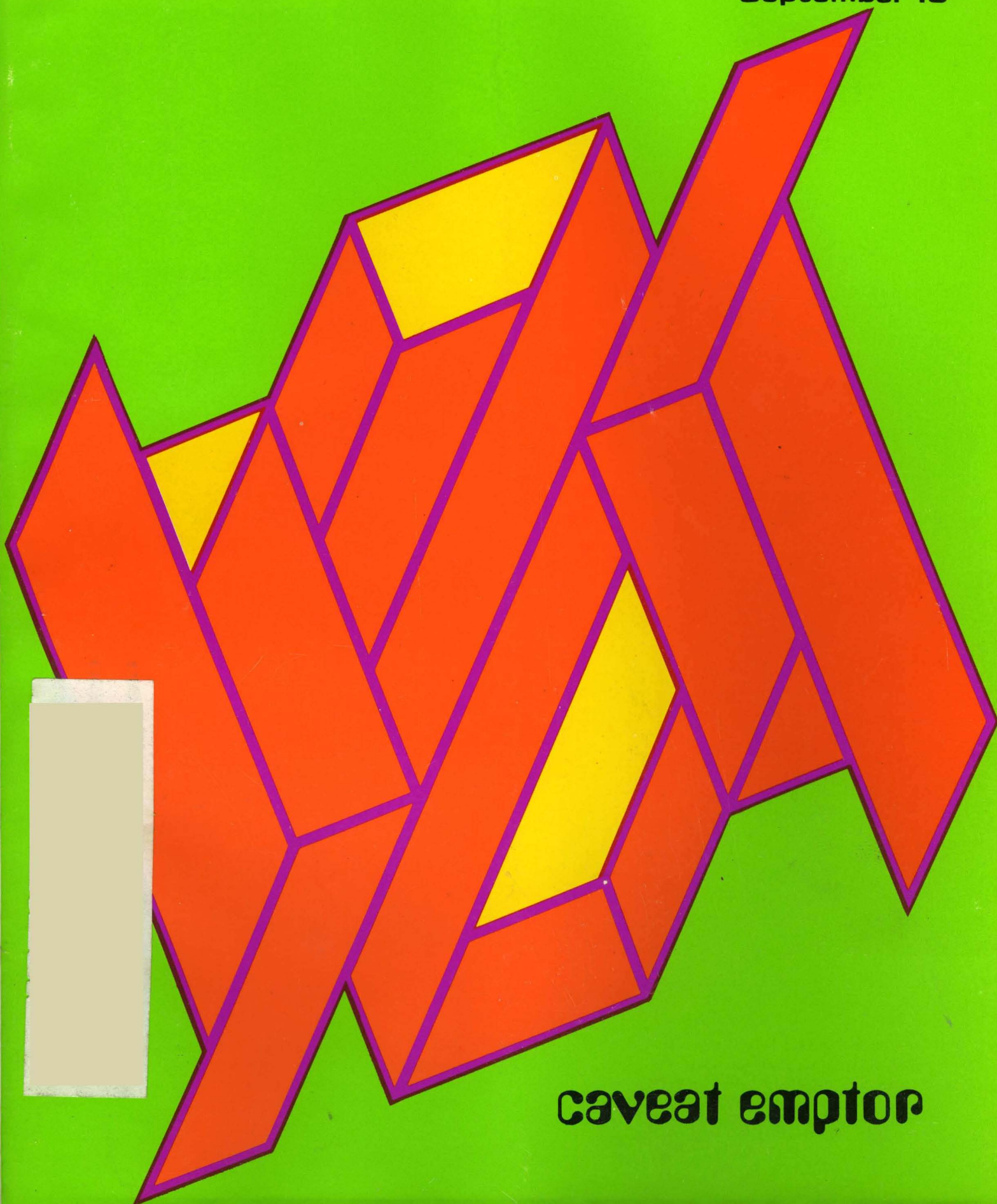

caveat emptor

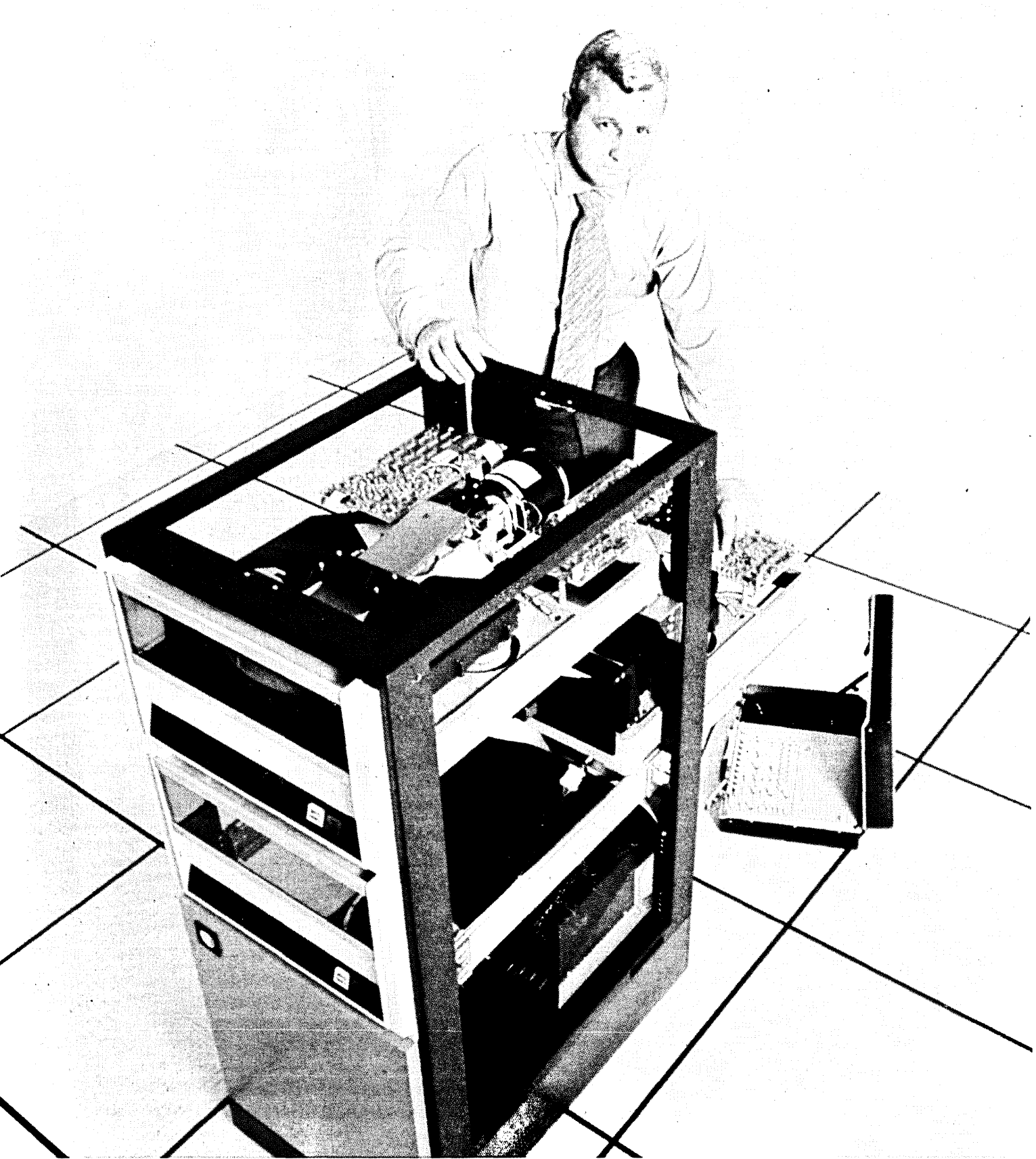

Anatomy of the Caelus® Disk Cartridge Drive

The facts are these: this high density disk drive provides the lowest bit cost in the country. Available in single or dual configuration with 22 or

44 megabit capacity. Random access heads. Both disks are removable. Rack mountable in your cabinet or ours, with ease of access for maintenance.

Single power supply. The disk cartridges, drives and test units are made by Caelus, which says it all for quality and performance.



CAELUS® MEMORIES, INC. P. O. Box 6297, San Jose, California 95133. Telephone (408) 298-7080

CIRCLE 1 ON READER CARD

No One Ever Heard of Colorado Instruments

...except for some of the world's outstanding manufacturers* who save time, money and man-hours with CII source data collection systems.

We're the great unknown. Except for a number of installations within some of the best known firms in the country.

They're taking advantage of Colorado Instruments' brand of source data collection systems: Peripheral components that collect data from its source . . . the man on the job . . . and transmit it on or off-line to the computer. Fast. Reliably. Economically.

Source data collection eliminates keypunching. Eliminates record keeping. Reduces cost. Increases accuracy. Increases speed of transmission.

And because of the flexible modularity of CII components, applications are open to the boundaries of imaginative systems design. We've applied our very special logic to solving problems in time and attendance recording,

production reporting, inventory and materials control and ordering, purchasing and receiving, machine loading, and a variety of others. In offices. In libraries. In hospitals. In educational institutions and manufacturing environments.

In fact, wherever there's a gap between people and computers.

So we're taking this time and space—at no small expense—to tell you how good we really are. And that we intend, within a short time, to be widely known

as the hottest source for source data collection systems in the world.

You can help by getting to know Colorado Instruments. Write for literature, or call toll free 800/525-1625.

*Names available upon request

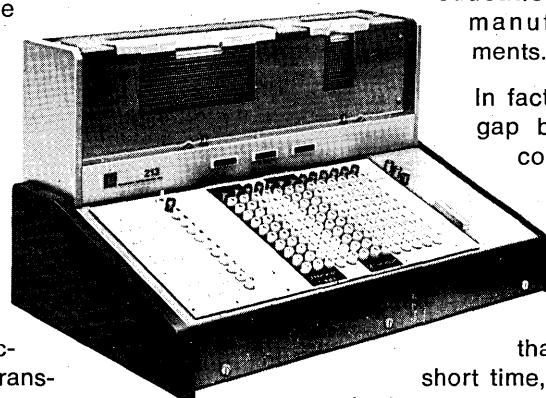

3213 TERMINAL

Filling the gap between people and computers.

COLORADO



INSTRUMENTS

ONE PARK STREET • BROOMFIELD, COLORADO 80020 • (303) 466-1881

If our new alphanumeric digital printer didn't work, neither would thousands of Friden calculators.

But of course Friden* calculators do work. Including the thousands of electronic printing models we've sold for the past 4 years.

With this ad, we're introducing 30-character and 40-character alphanumeric printers, both of which work exactly the same as the standard Friden 20-character model. A little wheel zips across the tape, printing up to 28 columns at 46 characters per second, inking itself on a roller made of solid ink.

Popping in a new ink roller when required is the only service that's needed. And there are no adjustments to make.

It's a printer you can count on. Ask anybody who owns one of our calculators.

And if you'd like complete information on all three Friden digital printers, ask Mr. Gary Dotzler, Sales Manager, OEM Products, Friden Division, The Singer Company, San Leandro, California 94577.

SINGER
FRIDEN DIVISION

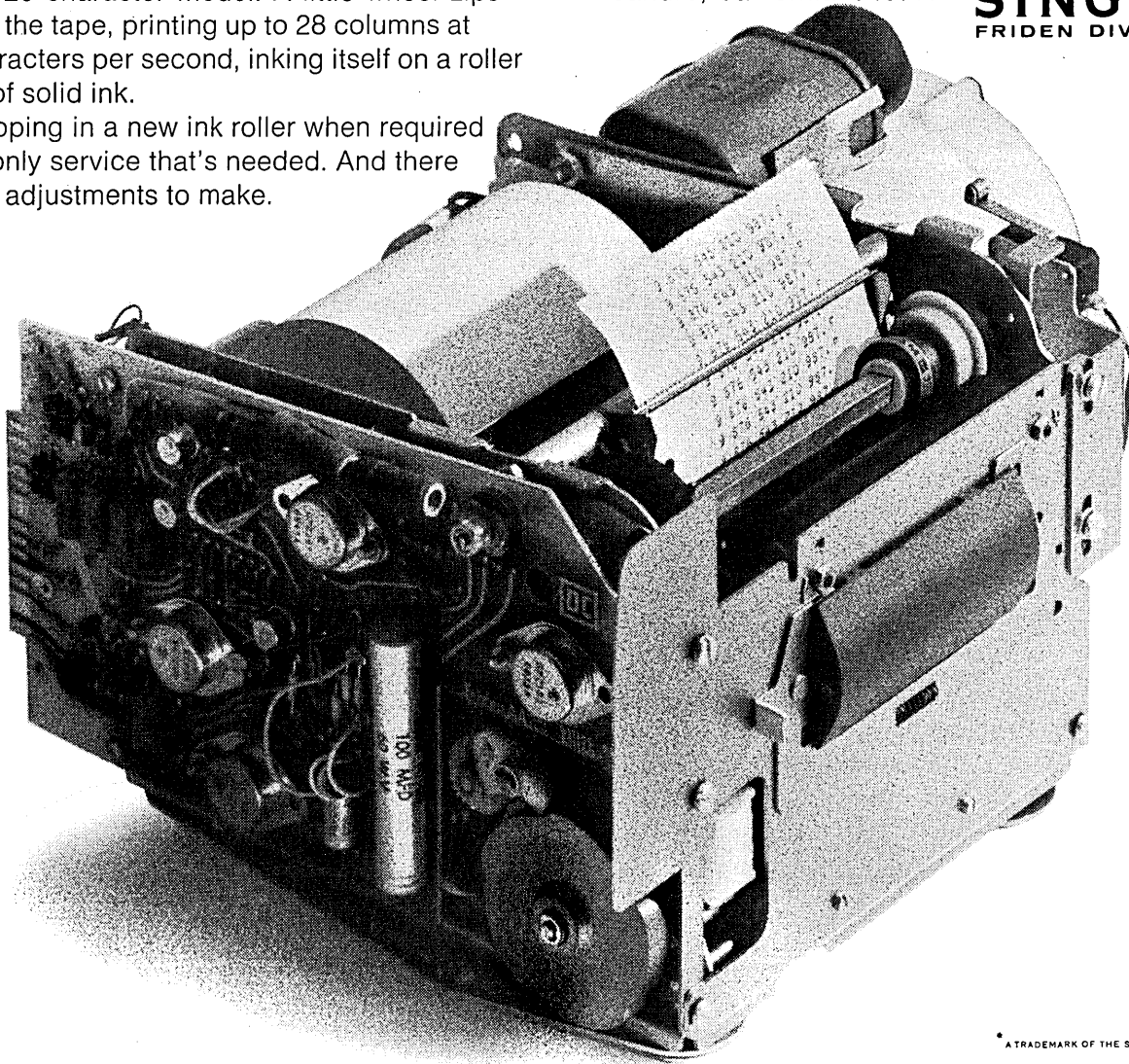

* A TRADEMARK OF THE SINGER COMPANY

CIRCLE 38 ON READER CARD

DATA MATI O N[®]

SEPT. 15, 1970

volume 16 number 11

departments	
<i>Calendar</i>	9
<i>Letters to the Editor</i>	11
<i>Look Ahead</i>	17
<i>Editor's Readout</i>	23
<i>Perspective</i>	49
<i>Poem</i>	57
<i>News Scene</i>	71
<i>System Spotlight</i>	94
<i>Hardware</i>	103
<i>Software</i>	113
<i>Literature</i>	119
<i>People</i>	129
<i>World Roundup</i>	135
<i>Index to Advertisers</i>	137
<i>The Forum</i>	139

M ANAGEMENT

24 Project Management Games

When the stakes are in the millions, supplier and user management play for keeps. A consultant who has watched both sides in action offers a guide to users who want to win.

35 Software Buying

Data processing managers need to develop techniques for dealing with the new breed of software package salesmen. Planning and caution are the watchwords.

41 Contract Caveats

The user has more muscle than he may think when it comes to contracts and warranties. But to avoid being the 98-pound weakling, he'd better get his lawyer in early.

59 Decision Models—Part 2

Because the real world is far too complex and ill-defined to be contained in any precise model, the human decision maker must pursue the art of capturing the essence of the problem at hand. Here are some techniques.

T ECHNICAL

53 Whither APL?

The APL fanatics have a convincing story. But chances of the language gaining wide acceptance depend on how the extensions are handled.

G ENERAL

94 System Spotlight

The Chicago Transit Authority is trying out a computer-based system, using a GE/PAC 4020, to control the city buses.

C OMMENTARY

49 Perspective

Changes in federal hardware/software procurement policies are in the making and it looks as if GSA will get more control.

As electric power utilities reach their capacity limits, fluctuating voltage makes trouble for dp users and uninterruptible power supplies find a growing market.

The Phillips cassette has been the subject of an industry debate. A potential market of \$5 or \$6 million for tape drives and systems has attracted a variety of approaches to cassettes produced for digital recording.

About the Cover

Crafty buyers keep the shape of their needs clearly in mind and never fall prey to those illusionary games sellers sometimes play. Or do they? Better look again. Our design is by Barbara Benson.

Save time...money...trouble...

Lease your teletype equipment
from RCA...

Model 33ASR (with tape perforator
and reader) just **\$50 per month.**
available in quantity
for immediate delivery.

Includes nationwide maintenance
service by RCA's own technicians

Call or write nearest office: RCA Service Company
A Division of RCA, Technical Products Service

Bldg. 204-2
Camden, N. J. 08101
Phone: (609) 963-8000
Ext. PY-4129

3310 South 20th Street
Philadelphia, Pa. 19145
Phone: (215) HO 7-3300 (Pa.)
(609) WO 3-2043 (N.J.)

1778 Marietta Blvd., N.W.
Atlanta, Ga. 30318
Phone: (404) 355-6110

5121 W. 161st Street
Cleveland, Ohio 44142
Phone: (216) 267-2725

43 Edward J. Hart Rd.
Liberty Industrial Park
Jersey City, N. J. 07305
Phone: (201) 434-2318 (N.J.)
(212) 732-9494 (N.Y.)

7620 Gross Point Road
Skokie, Ill. 60076
Phone: (312) 965-7550

2711 Irving Blvd.
Dallas, Texas 75207
Phone: (214) ME 1-8770

1501 Beach Street
Montebello, Calif. 90640
Phone: (213) 685-3092

RCA

CIRCLE 13 ON READER CARD

"OPEN SESAME!"

Imagine being dowered with fabled Ali Baba's magic power to gain entrance — not to the thieves' cave of loot — but to the great money-hives of the human race!

That's emphatically what a young giant enterprise, now creating a sensation in business circles, makes possible for its affiliates. Shows the road to wealth even beyond the dreams of avarice. For the possibilities and actualities stagger the imagination.

The "product"? Potent, scientific aids — success-generating "tools" that free others from the oppressive fetters of a dull existence and low incomes, sparking an era of progress and prosperity for them. The world can't get enough of it. It is the backbone of all progress; the spinal column of all certainty. Not alone for "the forgotten man" but also for the wealth-conscious who fill stations of marked responsibility.

Forced expansion is generating extremely high-bracket opportunities for more qualified associates. For those who want a blue-chip business that moves without stress or strain. Not affected by conditions that often demoralize other businesses. Also for the man who prefers to represent a branch of the organization, not content with earnings of only a few thousand a month.

Identification with this "young giant" could be the best thing that ever happened to you. The most challenging and rewarding opportunity on the American scene today. Nominal investment required puts lazy dollars — idle dollars — to work in fertile soil spawning prolific profits. Illuminating "prospectus"-booklet mailed on request. Strips the proposition clear of any deceptive allurements and reveals the raw facts.

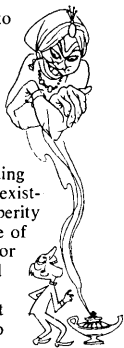

SAI INTERNATIONAL, INC.
Box 22458 Denver, Colo. Phone: 303-757-5500

CIRCLE 62 ON READER CARD

DATAMATION®

SEPTEMBER 15, 1970

volume 16 number 11

This issue 105,579 copies

EDITOR

ROBERT B. FOREST

EDITORIAL STAFF

Managing Editor

Senior Associate Editors
Associate Editors

Copy Editor

Assistant Editors
Special Features Editor

Eastern Editors

New England Editor

Washington Editor

Midwestern Editor

European Editor

Australian Editor

Contributing Editors

EDWARD K. YASAKI

WILLIAM J. ROLPH, TOM McCUSKER

AUBREY DAHL, RICHARD A. McLAUGHLIN,

EDITH D. MYERS, JOHN T. WATERHOUSE

JANET EYLER

ANNE WILKS, MICHAEL WILLIAM CASHMAN

ANGELINE PANTAGES

JOHN WESSLER, F. BARRY NELSON

W. DAVID GARDNER

PHIL HIRSCH

LAWRENCE RAGAN

PEARCE WRIGHT

FREDERICK A. BLAND

HOWARD BROMBERG, ROBERT V. HEAD,

PHILIP H. DORN, LOUIS B. MARIENTHAL,

DANIEL D. McCRACKEN, F. G. WITHINGTON,

PAUL ARMER, ROBERT P. BIGELOW

ROBERT L. PATRICK

LOWELL AMDAHL

Editorial Adviser

Technical Consultant

EDITORIAL OFFICES

HEADQUARTERS: 94 S. Los Robles Ave., Pasadena, Calif. 91101, Phone: (213) 681-8486; EASTERN: 35 Mason St., Greenwich, Conn. 06830, (203) 661-5400; 19 Marlborough St., Boston, Mass. 02116, (617) 267-9414; 9805 Singleton Dr., Bethesda, Md. 20034, (301) 365-8671; MIDWESTERN: 407 S. Dearborn St., Chicago, Ill. 60605, (312) 922-8245. FOREIGN: 65, Hill Road, Chelmsford, Essex, England; 322, Park Regis, Park St., Sydney, NSW 2000, Australia.

GRAPHIC DESIGN AND PRODUCTION

Art & Production Director

Production Manager

Production Assistants

CLEVE MARIE BOUTELL

MARILEE PITMAN

GLORIA CASTAGNA, LOUISE T. O'CONNOR

CIRCULATION

35 Mason Street
Greenwich, Conn. 06830

Director of Circulation

Circulation Manager

Marketing Research Director

FRANK DeCARLO

MAE VAN RENNES

DOUGLAS DeCARLO

PUBLISHER

GARDNER F. LONDON

ASSISTANT PUBLISHER

JAMES M. MORRIS

Circulation audited by
Business Publications Audit



Member, American
Business Press, Inc.

DATAMATION is published twice monthly on or about the first and fifteenth day of every month by Thompson Division, Technical Publishing Company, 1301 South Grove Ave., Barrington, Illinois 60010; Arthur L. Rice Jr., President; Gardner F. Landon, Executive Vice President. Executive, Circulation and Advertising offices, 35 Mason Street, Greenwich, Conn. 06830 (203) 661-5400. Editorial offices, 94 So. Los Robles Avenue, Pasadena, California 91101. Published at Chicago, Ill.

DATAMATION is circulated without charge by name and title to certain qualified individuals who are employed by companies involved with automatic information handling equipment. Available to others by subscription at the rate of \$25 annually in the U.S. and Canada. Reduced rate for qualified students. Foreign subscriptions are on a paid basis only at a rate of \$38 annually. No subscription agency is authorized by us to solicit or take orders for subscriptions. Controlled circulation paid at Columbus, O. and Form 3579 to be sent to Technical Publishing Company, P.O. Box 2000, Greenwich, Conn. 06830. Copyright 1970, Technical Publishing Company. Microfilm copies of DATAMATION may be obtained from University Microfilms, Inc., 313 No. First St., Ann Arbor, Michigan. Printed by Beslow Associates, Inc.

While your computer is remembering Louie's name, our 410 is placing his face.



We think computers are great. But let's face it; they can't make a face. Our 410 can. And when it's interfaced with your computer, you see a picture with the data. That's pretty important when you need to identify someone.

While your computer is coming up with a suspect's name, our 410 is coming up with a face, fingerprints and history of arrests and convictions.

A computer can tell you a lot but it can't show you anything graphic quickly or economically. Our 410 can show you anything in its files in a matter of seconds. And

if you want a copy of what you're looking at, you can have it in a few more seconds. It all happens at your desk, via a TV screen.

We don't claim that a picture is worth a thousand words. We do claim, however, that the 410 can save you time, eliminate errors, minimize your active filing space, and free your computer to do things it does best. For

information, write to Mosler, Dept.D-9, Information Systems Div., Hamilton, Ohio 45012.



Mosler
An American-Standard Company

Improving systems for security and communications

OUR MINI COMPUTER TIME SHARING SYSTEM IS BETTER THAN THEIRS

You already know a lot about mini computer time sharing systems.

You know they provide the cheapest way yet to use a computer.

That they cost less per terminal than the same number of sophisticated desk calculators.

That they're less expensive than leasing the same number of terminals from a commercial time sharing utility.

That having your computer in the same building is much more convenient than having it on the other end of a busy phone line.

Finally, you know that BASIC is the most-used time sharing language, that it can be learned in a day, and that it operates in two modes: one that lets you use a terminal just like a sophisticated calculator, and one that lets you write your own computer programs.

The fact is, you know a lot about mini computer time sharing systems in general.

We want you to know a lot about them in particular.

On the opposite page, we've compared two of the many configurations offered by us and by our competition. Other configurations offer similar comparisons.

Study them.

We think you'll come to the conclusion that we offer better mini computers (after all, they're our only business), a more extensive BASIC language (we can also supply ALGOL 60 and FORTRAN IV for stand-alone use), and that our experience alone (we'd installed hundreds of mini computers before our competitor, shipped his first) gives us the competitive edge.

Finally, if you'd like additional information on our system, write us.

Because when it comes down to the final decision of which system is for you, the more you know, the better off we'll be.

Data General Corporation,
Southboro, Mass. 01772

WANG 3300

1. 4-user system
2. \$5,362.50 per terminal
\$21,450.00 total
3. 1500 8-bit bytes of core storage per terminal
4. 8-bit word length, single-accumulator computer

5. 16-user system
6. \$3,340.62 per terminal
\$53,450.00 total
7. 1125 8-bit bytes of core storage per terminal
8. 8-bit word length, single-accumulator computer

9. BASIC Time Sharing language

10. For stand-alone use, software includes: assembler, editor, debug package.

11. For stand-alone use, peripherals include: none available as yet.

12. General purpose computer experience: none previous.

NOVA

1. 4-user system
2. \$5,585.00 per terminal
\$22,340.00 total
3. 2728 8-bit bytes of core storage per terminal (81% more)
4. 16-bit word length, multi-accumulator Nova computer

5. 16-user system
6. \$3,142.69 per terminal
\$50,283.00 total
7. 1496 8-bit bytes of core storage per terminal (33% more)
8. 16-bit word length, multi-accumulator super-fast Supernova. (With its 800 nanosecond cycle time, Supernova is the world's fastest mini computer. In larger time sharing configurations, this speed yields superior performance, yet our cost is still below the Wang system.)

9. BASIC Time Sharing language with full extensions: string and matrix manipulation capabilities.

10. For stand-alone use, software includes: FORTRAN IV, ALGOL 60, disc operating system, relocatable assembler, editor, symbolic debug package.

11. For stand-alone use, peripherals include: disc systems, industry-compatible mag tape units, paper tape reader/punch, card reader, line printer, real-time clocks, A/D, D/A, communications equipment.

12. General purpose computer experience: more than 600 Nova's and Supernova's installed.

SUPERNOVA

DATA GENERAL

Southboro, Mass. (617) 485-9100 / Hamden, Conn. (203) 248-9660 / Commack, L.I., New York (516) 368-3304 / Rochester, New York (716) 235-5959 / Clark, New Jersey (201) 381-3500 / Bowie, Maryland (301) 262-1198 / Bryn Mawr, Pa. (215) 527-1630 / Orlando, Florida (305) 425-5505 / Chicago, Illinois (312) 539-4838 / Richardson, Texas (214) 231-4846 / Englewood, Colo. (303) 771-0140 / Manhattan Beach, Cal. (213) 376-7917 / Palo Alto, Cal. (415) 321-9397 / Reading, Berkshire, England Reading 25370 / Munich, West Germany 0811-295513 / Zurich, Switzerland (051) 34 07 77. DATAGEN OF CANADA LTD.: Hull, Quebec (819) 770-2030 / Montreal, Quebec (514) 341-4571 / Toronto, Ontario (416) 447-8000 / Vancouver, British Columbia (604) 731-2711.

Wright Line Accessories Complete the Picture

In any data processing installation the computer is only part of the picture. Wright Line completes the picture by adding the essential storage and handling accessories that speed throughput and protect vital EDP media.

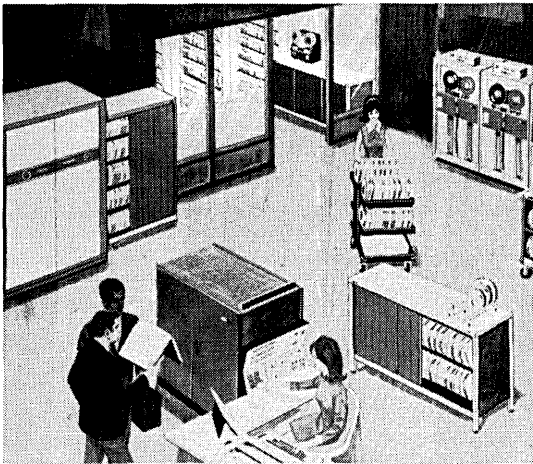

in tape systems...

1. Data-Bank Safe for the protection of Magnetic Media
2. Tape-Seal Belts in 8 colors
3. Tape Cabinets
4. Library Storage units
5. Tape Trucks
6. Racks
7. Binders and Carrying Cases

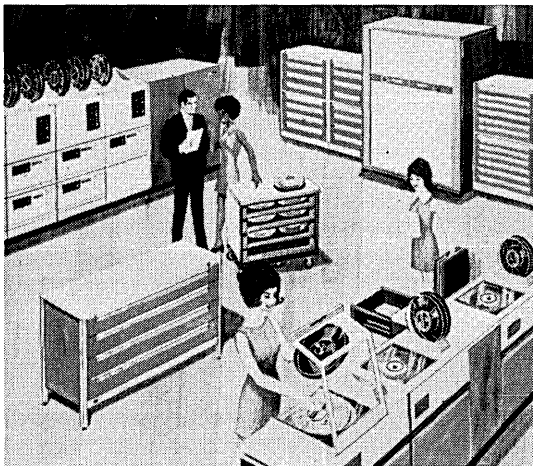
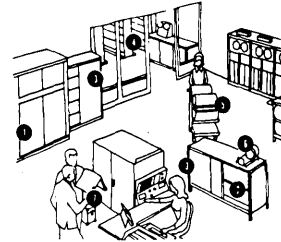

in disk systems...

1. Wright Line Disk Packs
2. Data-Bank Safe for protection of Magnetic Media
3. Library Storage Units
4. Computer Room Storage Cabinets
5. Disk Trucks
6. Cover Holders
7. Carrying Cases

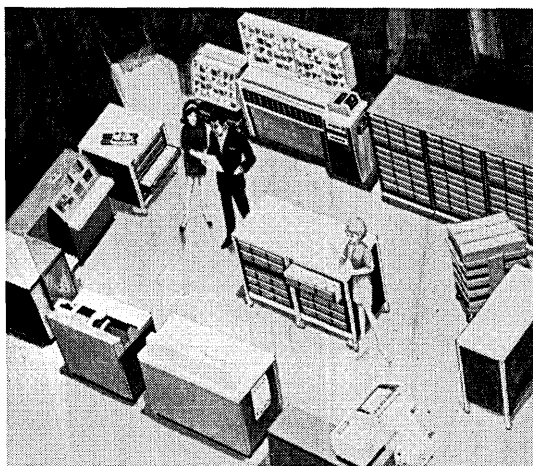
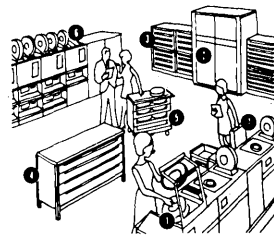

in card systems...

1. Card Files and Indexes
2. Cross Access Files
3. Card Tray Trucks
4. Card Handling Equipment
5. Card Punches
6. Card Box, Form and Binder Storage
7. Carriage Tape Holders

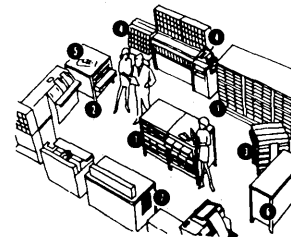

For complete information on Wright Line accessories, including a completely new line of coordinated equipment for use with IBM System/3, circle readers' service number or contact any of Wright Line's more than 80 offices throughout the U.S. and Canada.

160 GOLD STAR BOULEVARD, WORCESTER, MASSACHUSETTS 01606
A DIVISION OF BARRY WRIGHT CORPORATION



DATA PROCESSING ACCESSORIES

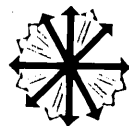

C A L E N D A R

Sept. 28- Oct. 2	Amer. Library Assn. & Information Networks Conference	Warrenton, Va.	Joseph Becker, Rm. 409 6400 Goldsboro Rd. Bethesda, Md. 20034	Invitational, by application
Oct. 5-8	CBEMA DP Conference	Toronto, Canada	Canada Presentation, Ltd. 74 Victoria St. Toronto 210, Canada	No fee
Oct. 5-9	BETA Computer 70 Int'l. Exhibition	London, England	BETA 109 Kingsway London, W.C.2, England	Seminars, \$16.80 each
Oct. 8-9	Cybernetics Society 4th International Symposium	Washington, D.C.	Dr. Roy Herrmann George Washington Univ. Washington, D.C. 20006	Unknown
Oct. 11-15	ASIS 33rd Annual Meeting	Philadelphia	Amer. Soc. Info. Sci. 1140 Conn. Ave., N.W. Washington, D.C. 20036	\$45, members \$60, others
Oct. 12-13	IEEE, ACM Annual Microprogramming Workshop	Buffalo, N.Y.	W. Y. Stevens, IBM Box 390 Poughkeepsie, N.Y. 12602	Unknown
Oct. 12-17	Dept. of Commerce Computers and Peripheral Exhibit	Tokyo	U.S. Dept. of Commerce BIC-936 Washington, D.C. 20230	Exhibitor's fee: \$975
Oct. 14-16	AFIP Int'l. Conf., Management Information Systems	Copenhagen, Denmark	Danish EDP Council 1 Vesterbrogade DK1620 Copenhagen V, Denmark	Unknown
Oct. 14-16	EDUCOM Fall Council Meeting	Atlanta	EDUCOM Box 364 Princeton, N.J. 08540	\$30, members \$40, others
Oct. 14-16	ADAPSO 30th Management Conference	Nassau, Bahamas	ADAPSO 551 Fifth Ave. New York, N.Y. 10017	\$100, members \$150, others
Oct. 26-28	DP Supplies Assn. Input/Output Systems Seminar 70	New York City	DPSA 116 Summer St. Stamford, Conn. 06905	\$150, non-members
Oct. 26-29	ISA Silver Jubilee Conference & Exhib.	Philadelphia	ISA 400 Stanwix St. Pittsburgh, Pa. 15222	\$12, members \$18, others Exhibits free
Oct. 26-30	BEMA 12th Annual Expo and Conference	New York City	BEMA 1828 L. St. Washington, D.C. 20036	Conference sessions, \$30 each
Nov. 12-13	AIEE Nat'l. Conf. Computer Applications & Systems Technology	Miami Beach	CAST '70 P.O. Box 1081 Miami, Fla. 33148	\$65, members \$75, others
Nov. 17-19	Fall Joint Computer Conference	Houston	AFIPS 210 Summit Ave. Montvale, N.J. 07645	\$20, members \$40, others
Nov. 20-26	Biennial Int'l. Instr. & Automation Exhibition	Milan, Italy	U.S. Commerce Dept. BIC-932 Washington, D.C. 20230	Unknown
Nov. 30- Dec. 2	IBFI 3rd Int'l. Forum on Data Communications	Hollywood Beach, Fla.	IBFI/PIA Center 1730 N. Lynn St. Arlington, Va. 22209	Unknown

ATTENTION OEM USERS... THE MONEY SAVERS ARE HERE

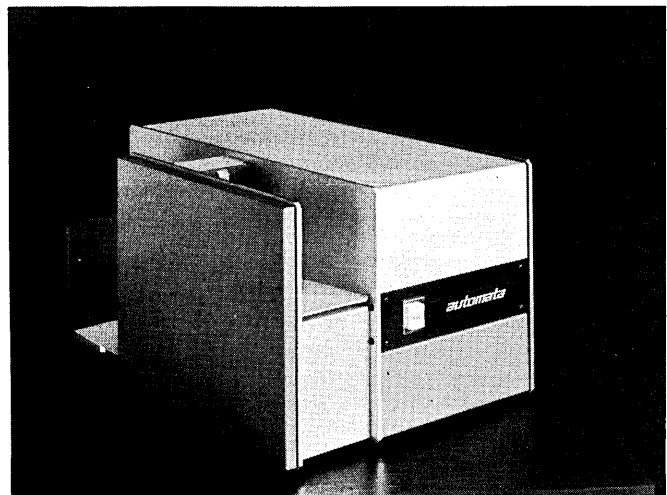
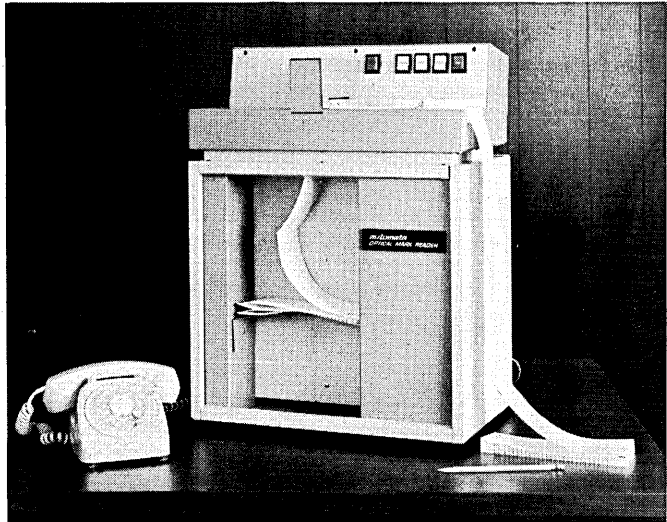
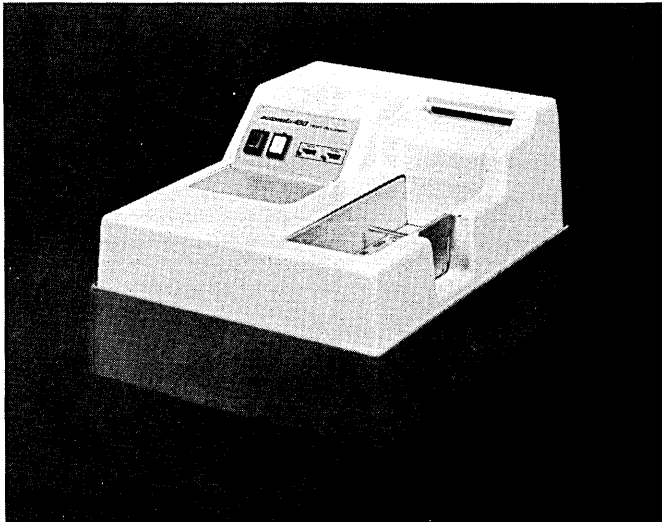

Automata has created a full line of optical mark readers that cost a fraction of what you are paying today for OMR equipment. For instance, the Automata optical mark readers can read from 300 cards per hour to 300 cards per minute. They feature bifurcated fiber optics and optical compensation electronics to provide superior data optical reading integrity. Add to that the solid state, integrated construction and only three moving parts and you have outstanding reliability. This is available to you at the unbelievably low price of \$1000 in OEM quantities, depending on the options. Contact Bob Sprehe at Automata to see how simply the Automata Optical Mark Readers can be adapted to your OEM requirements. Think what you will save (and time is money).

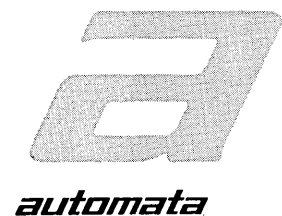

AUTOMATA CORPORATION, ■ 1305 MANSFIELD AVENUE, ■ RICHLAND, WASHINGTON 99352



LETTERS

Functional junk

Sir:

In the July 15th issue (p. 29), Mr. Donald W. Kearney complains that he received no results when he complained about someone selling his name to a "junk mail" house.

He is wrong, there was indeed a result. This action would put his name on a "crank" or "grouch" name list, and he should begin receiving junk mail for burglar alarms, muscle building courses, books on judo, etc. etc.

Incidentally, I recently came across a couple of 360/30s, each with four high-speed printers spending all of its time grinding out junk mail. It made me feel good to see a machine doing a function producing junk rather than totally useless junk like hexadecimal dumps.

JOHN MATLOCK
Salt Lake City, Utah

Reform school

Sir:

As a longtime reader of your magazine, I am now writing to you with a plea for help. I am presently a student in the data processing course here at the Indiana Reformatory. This program is a very good one and we have (the state) turned a lot of men to the computer field for a possible career. The men here are very willing and able to learn, but there is a slight snag in the program.

The full program is set up in two main parts: 1) introduction to the basic data processing machine (key-punch, interpreters, sorter, tabulator, etc.), and 2) introduction to IBM computers (which is held at the Youth Camp in Plainfield). The last phase of the course is very well up to date, but the first part is quite a mess. The only machines we have are very old Remington Rands and have seen better days. These all have been given to the class by different companies. We would appreciate help from people to obtain machines from companies that have any to donate to a good cause. If the class doesn't acquire newer machines, the future classes may lose interest and the class will fold, causing the course to be dropped.

Now, sir, that would be a very bad thing to have happen. A lot of very good men have gone through this course and are now enjoying their new careers. (Upon my release, I am going to apply myself wholly to this career.) Many men (good men who wish to learn this field) may not be able to do so. Could you please ask your readers if they could possibly help with this matter? Even if it is just a few books (manuals) for the machines, it would be of great help.

I may be breaking the rules by writing this letter and asking you, but I, for one, would like to see this course grow and turn out many more good men. I feel that the men in the reformatory have done a very fine job. They have started from scratch and now have a wonderful opportunity going for others to better themselves. Since it is not possible for us to have an instructor, we inmates have to teach the course (once we complete it) to new trainees. All of the previous trainees have done wonderfully. I am sure that the future ones will prove just as good, if not better!

JACK D. MYERS
51643-Box 28
Pendleton, Indiana 46064

Broad indictment

Sir:

We, as professional women in the data processing field, were deeply offended by the ad you ran on pages 196-197 of your June issue, and have written to the company in question to tell them so.

We wonder that DATAMATION should find such copy acceptable, especially a phrase like ". . . It's so easy to use, a girl can be trained to operate it in a couple of hours. . . ." We suggest you try replacing the female identifier with another word, such as "black," "Mexican," "Pole," etc., and see how it reads.

If this company has indeed developed a system so simple it can be operated by a person of minimal skills and training, why don't they say so?

We hope that in future you will exercise some editorial judgment over the advertising copy, so as to avoid antagonizing a significant and

influential minority in the field.

MRS. ALISON GARRETT
VALERIE COOKE
B. L. THOMAS
CYNTHIA C. HALL
MRS. R. BRUCE EMERSON III
LILY LO
KALPANA MAKANI
MRS. B. A. PANZL
San Francisco, California

Dialectics tone

Sir:

I ordinarily would not respond to such shallow criticism as that of Jean Pierre Grankenhuis in the July 15th issue, in which he blasts my article, "Data Processing in Brazil," which appeared in May. However, since he is so unperceptive that he found it necessary to distort statements of fact, I feel compelled to reply.

He is unhappy at my observing the absence of a strong middle class, and says that I must never have crossed a street and been threatened by hordes of onrushing middle class vw drivers. Well, I did, and I was, but what matters the number of vw's in Rio and Sao Paulo? It's like making the assumption that there are a great many very wealthy people in the U.S. because of the rents that are paid in the upper east side of Manhattan. Even though there is a bigger middle class in Brazil now than there was 20 years ago, that does not put it into the category of the U.S. or West German middle class.

A better measure than the number of Volkswagens of the strength of the emerging middle class is the potential for upward mobility of someone born into a poor family. As yet, this is virtually nonexistent. More than one third of the population is illiterate. Almost two thirds live in what we would consider poverty. So is it really significantly wrong to say there is no strong (read *large*) middle class? At the very least, the expression "middle class" is relative, not to mention "strong middle class." Apparently Mr. G. is unwilling to accept that language is at best approximate, and means different things to different people.

Here's another example of the height (or depth) of inanity he reaches. I mention in my article that there is not much in the way of scientific applications in Brazil. Mr. G. devotes a lengthy paragraph to the argument (as nearly as I can tell)

(Continued on page 13)

THE 30-DAY SHAKEDOWN.

The new DPF-2427 tape drive is not to be believed.

It's to be seen.

Which is why we're willing to consider lending you one. Free. For a full month. To test under the most demanding conditions there are: on-line in your system.

A month should be enough time to make sure it's completely compatible with the IBM 2420. Models 5 and 7. Plug to plug.

A month should be enough time to check out its 100 to 200 ips speed, its 320 kc transfer rate and its 1600 bpi recording density.

It should be enough time to test its completely automatic loading operation. Using either IBM tape cartridges or any other standard tape reel from the 10½-inch to the mini.

It should be enough time to evaluate its tape handling characteristics. From the air bearings at all turnaround points to the servo control that protects the tape during rewinding. From the one-point contact head to the fail-safe brake system.



It should be enough time to make sure it will never need more than 60 seconds to rewind a full 2400-foot reel.

And it should be enough time to notice all the refinements that make the DPF-2427 more reliable than all the others. The solid-state, integrated-circuit controls. The new single capstan motor. Even the UL listing.

If, at the end of a month, you aren't convinced that it offers you the best price/performance you can get—from any tape drive—we'll pull it out and take it back.

No hard feelings. No problems.
No charge.

We think you'll not only want to keep it, but you'll want more like it. Because we've tried it ourselves. We've tested everything there is to test. We've not only used it, but we've abused it. And we've established our own nation-wide maintenance operation to service it.

So we know what the new DPF-2427 offers.

And we don't take chances.

Call Don Raby, V.P., (914) 428-5000



Data Processing Financial & General Corporation, 141 Central Park Avenue South, Hartsdale, N.Y. 10530

Letters . . .

that I shouldn't have said that, and he concludes with this gem, "In the country which essentially invented the coffee break by inventing coffee, and the easygoing life for the heck of it, what is the sense of an automatic and computerized reorder system?" My serious answer to this unserious question would be that the greatest opportunity for planned growth is offered by a backward country in which modern techniques are employed.

I could go on and on, for example by mentioning that the manuscript was reviewed for accuracy by ten Brazilian data processing executives, including one of the founders, and the current president, of SUCESU, a rival of Mr. G.'s organization [ABRACE]. Aha! A light dawns. Mr. G., quite obviously, felt very personally affronted by something in my article. Until now, I thought it to be some unknown reason, lodged deep within his psyche. But could the reason be that I gave a bigger mention in the article to SUCESU?

RICHARD IANNUZZO
New York, New York

Pro census info

Sir:

The affiliation listed below is for identification purposes. However, it should show that I have had both some interest and experience in the problems of civil liberties.

In his letter in the July 15th issue, Mr. James Doody brings up once again the question of legitimacy of Census information. There has been more heat and less light on this issue than on almost any other that I have had contact with. First of all, Census information is private. Census information that could conceivably be related to any specific respondent is not released in any way to anybody. As I happen to know personally several people in the Census Bureau, I am aware that they are very concerned indeed, from their own personal beliefs, about this question. The facts are that there has not been a conviction on misuse of Census information and there have been almost no accusations.

To give an example of the heat without light, consider Mr. Doody's statement about race. The question of race is asked on the Census for the benefit primarily of the development of government programs to aid minority groups. Contrary to the beliefs

of many amateur civil libertarians, the Constitution is not color blind but rather does not permit the use of color to limit the rights of any group. This is the considered opinion of every Board of the American Civil Liberties Union that has considered the question. For example, the Civil Liberties Union itself continuously uses Census data on race for the specific purpose of demonstrating failure in the society to give adequate equal opportunity to all of the population of the United States. Without the use and availability of the Census, this problem would be considerably exacerbated and much of the progress in desegregating endangered.

MICHAEL A. RAPPEPORT
*New Jersey Chapter
American Civil Liberties Union*

Aim hire

Sir:

"Caposis": A disease of resumes, often caused by programmers who failed to spend their whole working lives behind a desk or coding sheet. Your Resume Reader (July 15) well stated the signs of the "loser," as defined throughout the curiously homogeneous world of big business personnel.

Among the widely shared ideas of what constitutes good personnel administration is pigeonholing and blacklisting of certain classes of persons who never are permitted to be considered on their merits. Perhaps these policies make selection easier by automatically cutting down the number of applicants to choose from. But where is the evidence that better selection or more effective business results, than if personnel did the harder job and did it well?

Resulting social problems are well known. Rehabilitation efforts are frustrated because ex-convicts, reformed alcoholics, etc., are not permitted to prove themselves and return to society. Physical impairments which do not lessen job performance can exclude persons from almost all large organizations, except through special hire-the-handicapped programs.

Four-year college degree requirements jam our schools, though educators say that 85% of the population, including some of the most competent and intelligent, have no special aptitude for books and blackboards and could best develop and employ their talents elsewhere.

Among employees of large organizations there is widespread unhappiness about this irrational injustice, this formalism and misuse of talent which, historically, seem to characterize dying societies. Yet these misgivings seldom move beyond private conversations, because employees have no channels for reaching the policy makers. Is there no way for the mighty colossus of interlocking organizations to listen and consider recharting its direction?

JOHN S. JAMES
Tulsa, Oklahoma

To resume

Sir:

Congratulations to DATAMATION on your new look. I like it!

I was amused by Sylmar Van Nuys' article on Resume Reading (July 15, p. 60), although I'm not sure that reading a resume is a vital skill. Isn't the skill to hire the right man more important? About all that reading a resume should do is to save the interviewer some time by helping to eliminate obvious knockouts. If it is decided to talk with an applicant, a resume may also provide useful clues for interviewing. And I doubt that a perceptive interviewer would be snowed by a boss-decrier, chronic bad actor or any other such loser. Likewise, I doubt that learning to read a resume between the lines would help the chronic bad hirer.

In my judgment there are basically three attributes of the successful hirer: (1) the ability to ask perceptive questions, then shut up and listen, rather than incessantly talking about glorious plans and pipe dreams; (2) the patience to thoroughly check out a candidate through reference checking, testing, and using technical people to participate in the interviewing; and (3) the ability to avoid rose-colored glasses. It has been my experience that an interviewer will frequently view an applicant as the interviewer would like the applicant to be—not as he really is.

In any event, to use a few of Mr. Van Nuys' words, I found the article a harmless diversion that served to remind me that there is another world beyond that inhabited by those dull, competent people everyone would rather rely on.

NEWELL E. USHER
Chicago Heights, Illinois

(Continued on page 123)

**THE FIRST TOTAL, FULL PERFORMANCE,
ON-LINE COM SYSTEM FOR AN HONEST \$49K.**

We call it "MOM." She pays her own way.

MOM, our new Micromation On-Line Microfilmer, pays her own way. Just two small printout applications per month make MOM self-supporting. Your savings in postage and paper alone can absorb her monthly rental rate. The rest is pure gravy.

How full is "full performance"? For openers, MOM is a giant step ahead in resolution and micro-imagery. DatagraphiX' CHARACTRON® Shaped Beam recording sees to this. MOM is a total package. That means everything is standard. Like: our Universal Camera for recording images on 16mm, 35mm, 105mm both comic and cine mode sequencing both roll film and microfiche a built-in controller and forms projector 25X and 42X reductions fully software-supported direct data conversion from any IBM 360 model 25 and up. And so on.

All for an honest \$49,000. Or low leasing if you prefer. A great bargain for a great MOM, or the DatagraphiX 4200, MOM's official title.

It's easy to afford the brightest picture of COM. For more information about COM's MOM, please write or call us.

DatagraphiX

Stromberg DatagraphiX, Inc., a General Dynamics subsidiary
P. O. Box 2449, San Diego, California 92112
(714) 283-1038 TWX (910) 335-2058

Datagraphix 42000

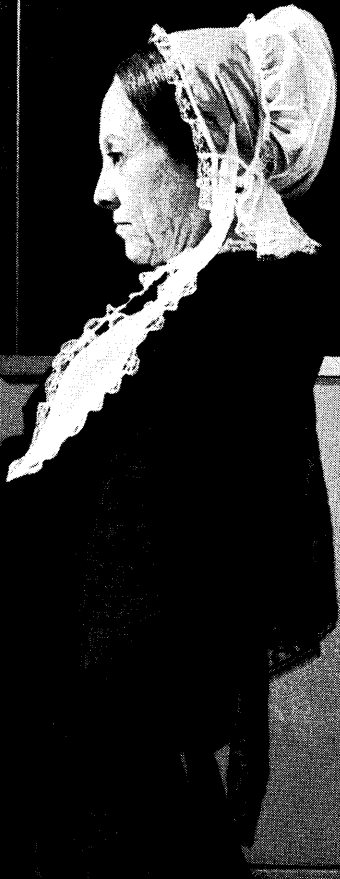

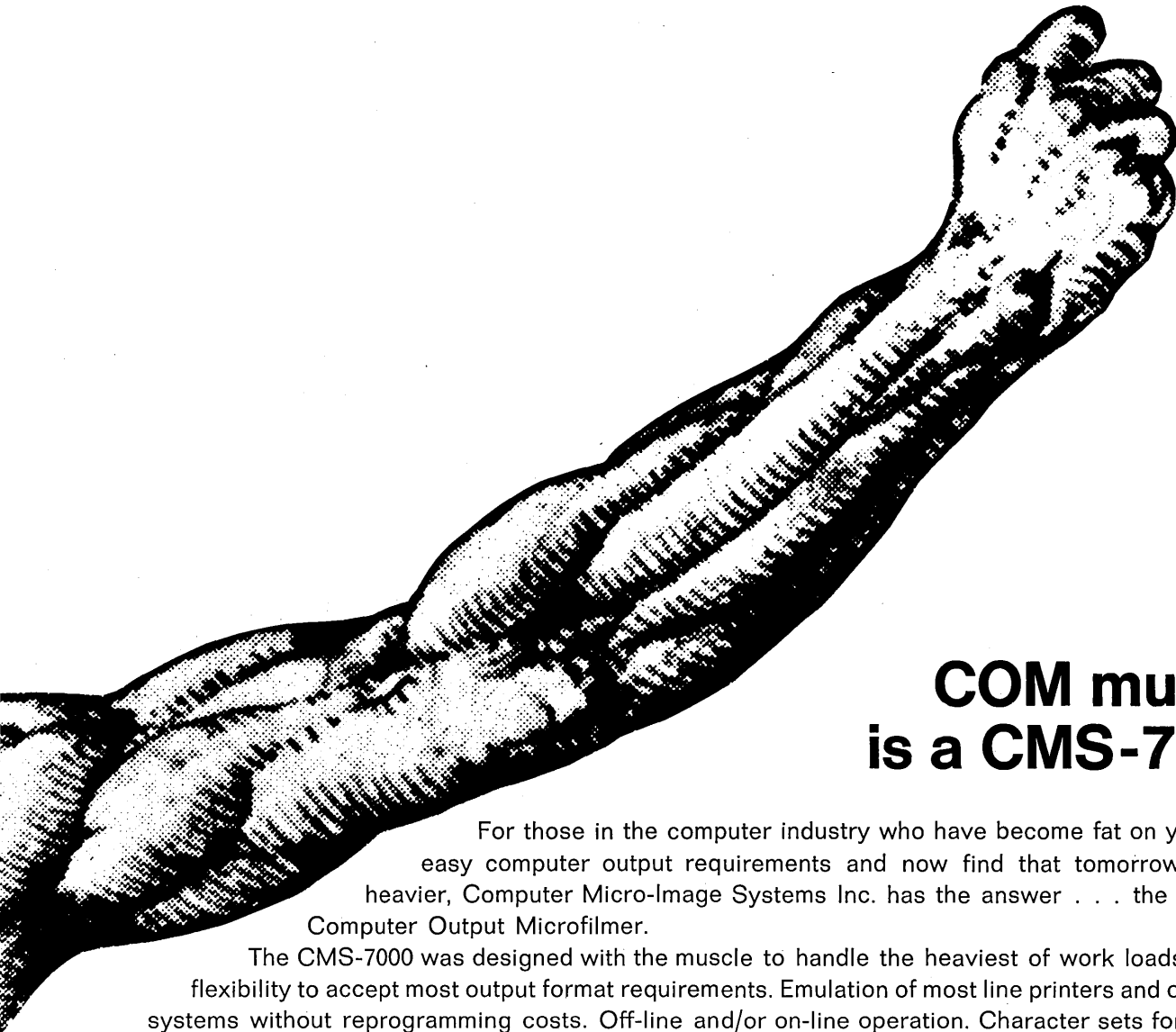

COM muscle is a CMS-7000

For those in the computer industry who have become fat on yesterday's easy computer output requirements and now find that tomorrow's load is heavier, Computer Micro-Image Systems Inc. has the answer . . . the CMS-7000

Computer Output Microfilmer.

The CMS-7000 was designed with the muscle to handle the heaviest of work loads—like the flexibility to accept most output format requirements. Emulation of most line printers and other COM systems without reprogramming costs. Off-line and/or on-line operation. Character sets for Japanese *Katakana* and most other alphabets available. Up to three character sizes in one line. Page format controlled by job set-up card. Automatic retrieval coding of all popular codes. Up to 500 pages per fiche with reduction ratios from 12X to 55X. Hair-splitting forms alignment. Plus all the regular CMS features such as 128 printed lines per page, up to 256 characters per line, any input character code, and speed to reduce your cost per frame. Whether your application is printing on roll film and/or microfiche, phototypesetting, 2-up, 4-up, the CMS-7000 has the capability to meet any challenge.

To solve today's problems and to make tomorrow's plans, call Computer Micro-Image Systems Inc., we have all the muscle you need.



Computer Micro-Image Systems Inc.

9600 DeSoto Avenue, Chatsworth, California 91311 (213) 882-8900

LOOK AHEAD

IBM USERS SEEKING PERIPHERALS ELSEWHERE

IBM is obviously worried about the growing number of customers going elsewhere for peripherals. One, the State of Ohio, has gone Telex in a big way: 45 disc drives and 48 tape drives are in, 10 printers on the way. Ohio says the drives cost \$300K/year less than their IBM counterparts and provide a throughput increase of 15-25%.

Elsewhere, we hear that IBM is definitely not pushing front-end communications processors and usually isn't bidding systems that require them. (Unless, say, you'll take a 155 in front of a 165.) The mod 2969 (360/50-based) that we said earlier might be IBM's answer to this problem for the 370s was actually a special system developed for American Airlines and isn't now offered to others who ask. Also, IBM isn't letting on to users whether an integrated communications system will be announced. Confusion continues.

WHERE ADR NO LONGER TRENDS...

Deserted by ADR which dropped all legal action against IBM last month, software houses now have a new antitrust champion. On-Line Software Inc., NYC, is suing, not IBM but Univac for alleged tie-in selling and premature announcements plus other Sherman Act violations. Treble damages of \$11.5 million are asked by the eight-man firm which specializes in Univac software.

Maybe Univac will settle quickly by marketing On-Line's software as IBM is doing with ADR's Autoflow (under the settlement), and maybe we'll have a new trend.

TREND OF THE MINIS: SHORTER, CHEAPER

Just as all the major entries in the minicomputer sweepstakes appear to have jockeyed into place, there are rumors that Data General will debut two 16-bit machines. One model, some say, will sell in the \$5500 range without tty, about the price of most 8- and 12-biters and cheaper than any 16-bitter.

Data General is a spinoff of DEC, and if the rumors are true, competition between the two should heat up. DEC is planning April delivery of its PDP-8E, low-cost 12-bitter, and DG is said to be racing to ready its production lines for its model at the same time. Current guess is that the Nova, DG's flagship, will be obsoleted by the new models, but the Supernova will remain.

NEW TWIST TO THE INTERCONNECTION DEBATE

The FCC's Common Carrier Bureau is being asked to simplify the entry of independents into the telephone terminal market. In a dramatic new twist to the debate over interconnection, Dittberner Associates, a Bethesda consulting firm which specializes in telecommunications, says the commission should presume that independently made terminals, interfaces, and communication systems pose no threat to the performance of the telephone network and these should be certified unless the carriers can prove otherwise.

Dittberner was hired by the commission to suggest

ways to implement recommendations made this summer by a panel of the National Academy of Sciences. The panel recommended that a terminal standardization certification program controlled by the FCC could provide adequate technical protection — but almost in the same breath said the present setup was feasible. Under this setup, terminal interfaces are supplied exclusively by the carriers. If the FCC agrees with Dittberner, the telephone terminal market, now largely the preserve of Western Electric, Automatic Electric, and other carrier affiliates, would be opened to independent suppliers.

UCC TRIMS AT THE TOP

Bud Schuster has resigned as computer group vp of University Computing Co. Following in his wake are two other ex-RCA marketeers — the president and marketing vp of the Graphics Systems Div.

The winner and still champion at UCC is exec vp E. W. "Mac" McCain, ex-Univac, who thus strengthens his hold on the company's sprawling range of enterprises. He's installed Harry Crumpacher as acting manager of the Graphics Systems Div., Datel, and the Data Communications & Systems Div. Credited with getting Datel production flying, Crumpacher is reportedly supposed to see if he can salvage the languishing GSD (the updated Benson-Lehner plotter line plus COM).

But it's no secret that UCC chairman Sam Wyly has a fierce distaste for red-ink operations, and GSD may be on the block. Schuster, meanwhile, has formed Venture Management, Inc., a D.C. firm that will specialize in bailing out sick companies. His first client could be the new owner of the Graphics Systems Div.

IRATE USERS STRIKE BACK

Rumors persist that IBM unbundling is not yet a smashing success. A source insists that SE and other services aren't bringing in enough to make up for the 3% reduction in rentals that came with the new policy. Too, IBM is losing out on some bids partly because of the cost of SE services. One such loss was a system for the State of Virginia, the first major contract IBM hasn't captured there. A few reports on program products trickling in say that IBM support is not as wholehearted as it is on expensive hardware. "If they call us back when we have a problem, they call collect," complains one user.

Ornery users are coming up with imaginative ways to price their own services to IBM, such as debugging IBM software, submitting invoices to IBM, subtracting their charges from IBM's and paying the difference, and withholding payment. Even rental strikes are faintly mentioned if all doesn't go well.

RUMORS AND RAW RANDOM DATA

CDC has rebounded somewhat. Second quarter orders are said to be over \$100 million and the company may be ready to announce the Star supercomputer—sometime next month? . . . IBM has changed its pricing policy for on-site education services. Any courses longer than two days will no longer be charged by SE time, but rather on a fee-per-student basis . . . We hear SHARE members at the recent Montreal meeting did their voting by raising their installation ID cards — 90-column round-holed Univac style.

SAC introduces

graf/pen™

our way of getting
man and machine on better terms

The GRAF/PEN/hand/computer interface is a digitizing graphical input device for computers, CRTs, and transmission circuits. It provides a simple and accurate means of interaction between man and computer, offering high resolution, stability, precision, flexibility, and reproducibility at an incredibly low price.

Anything drawn, marked or written through the GRAF/PEN yields a permanent copy and is simultaneously digitized for immediate or delayed computer analysis, real-time display on a storage CRT, or transmission by radio or voice-grade phone circuit. Coordinate pairs are generated 200 per second with a resolution of 1000 x 1000 line pairs and overall accuracy of 0.03 inch.

One outstanding feature of the GRAF/PEN is its unique capability of direct interaction with the blank areas on a CRT (storage-type included).

You can solve just about any graphical problem with the GRAF/PEN — quickly, accurately, economically.

Science Accessories Corporation is ready to discuss samples and production quantities on an OEM basis; user inquiries are also welcomed.

The GRAF/PEN will enhance the scope — and appeal — of the most sophisticated EDP equipment.

We think it's a sound investment.

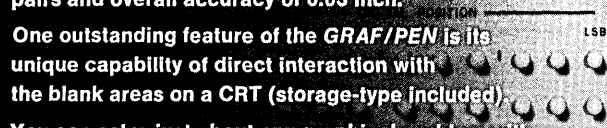
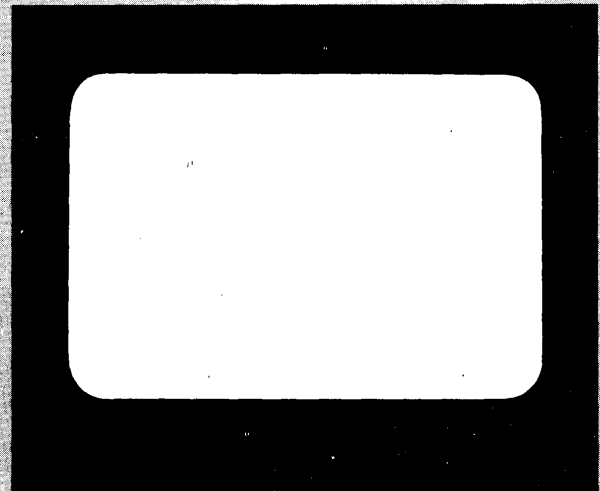

SCIENCE ACCESSORIES CORP. SOUTHPORT, CONN. U.S.A.

SAC SCIENCE ACCESSORIES CORPORATION

65 STATION STREET, SOUTHPORT, CONN 06490, U.S.A. 203-255-1525

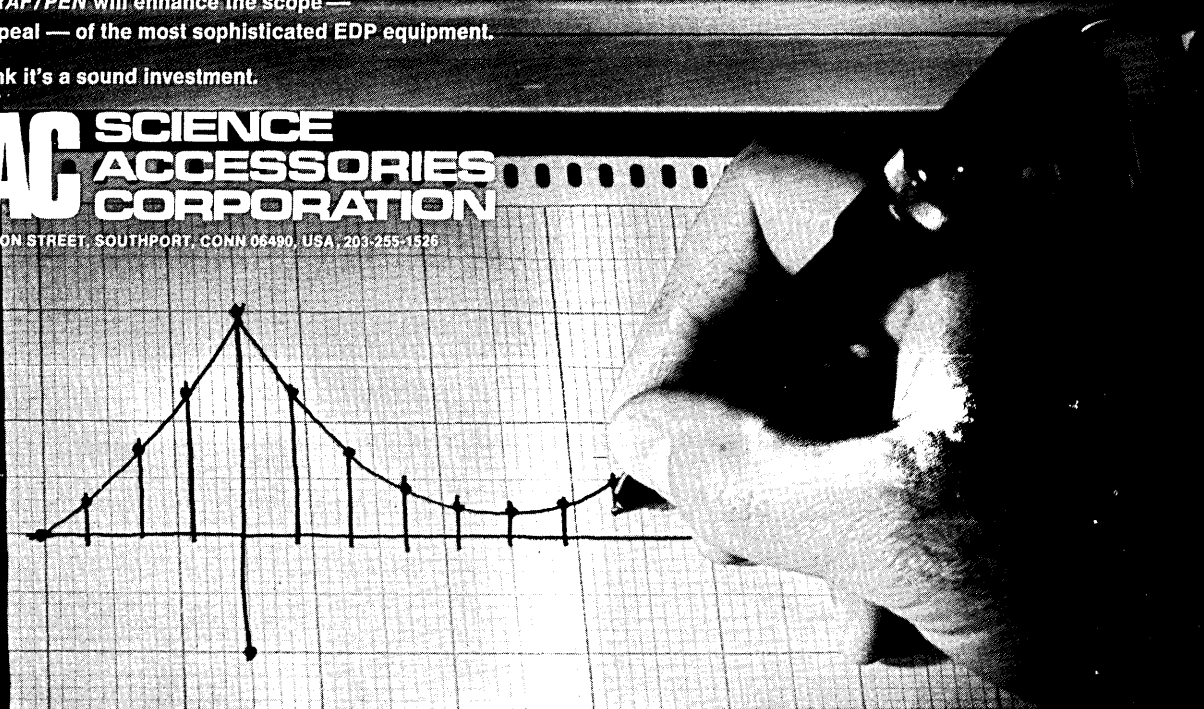

\$25,000 disc storage drive sells for \$15,000.

We mean it, and we can prove it.

Our new Bryant 1100 Disc Storage Drive (which sells for about \$15,000 and leases for \$460) is equal in every way to IBM's 2311 (which sells for about \$25,000 and leases for \$570).

The 1100 has the same 7.25 million byte capacity. Same access

time. Same function, style and interface. In other words, the Bryant 1100 is instantly compatible with IBM 360 computers using the 1316 written disc pack.

And we didn't forget about service. We regularly schedule maintenance on a three-month cycle. Or as quick as you need it. On a nationwide

basis.

In our estimation, this makes the 1100 just a little bit better than the 2311. So, why pay \$10,000 more for a set of initials? If you can think of a reason—even a little one—drop us a line. Bryant Computer products, 850 Ladd Rd., Walled Lake, Mich. 48088.



**BRYANT
COMPUTER PRODUCTS**

A UNIT OF



EX-CELL-O CORPORATION



Bryant offers OEM pricing discounts on proven end-user disc drives.

Now you can save a bundle on our new Bryant 1100 Disc Storage Drive that is *equal* in every way to IBM's 2311.

No kidding. Our 1100 has the same 7.25 million byte capacity. Same access time. Same function, style and interface. In other words, the Bryant 1100 is *instantly* compatible with IBM 360 computers using the 1316 written disc pack.

And we don't stop here. Take service. We can regularly schedule maintenance on a three-month cycle. Or as quick as you need it. On a nation-wide basis. You can also take advantage of our formal service training program. Either at our place or yours.

So about the only difference between IBM's 2311 and our 1100 is the price tag.

The 1100 costs a lot less. But why not find out for yourself. Contact a Bryant salesman and discover just how much you can save on an 1100 with our quantity discounts. Or else drop us a line. Bryant Computer Products, 850 Ladd Rd., Walled Lake, Michigan 48088.



Watch for next month's Bryant Bulletin announcing another new product.

BRYANT COMPUTER PRODUCTS

A UNIT OF



EX-CELL-O CORPORATION

**If you're a sophisticated,
analytical, demanding cheapskate,
have we got a computer for you.**



It would be nice to sell a Sigma 5 sometime without having to undergo a rigorous analysis by a hard-nosed customer who knows exactly what he wants and what he wants to pay for it.

No such luck. When we install a Sigma 5 it's invariably because all the elements of the system — hardware, software, service — combine to give superior price/performance in a difficult, sophisticated application.

Most of these applications involve routine batch processing concurrently with critical foreground tasks. Like interactive time-sharing. Or real-time process control. Or store-forward message switching. Or remote data collection and concentration. Or nuclear reactor monitoring and experiment analysis. Or on-line telemetry data conversion, compression and display. Or multiphasic health screening and

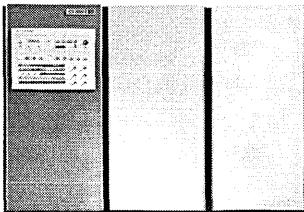

Sigma 5

hospital patient monitoring.

It's not just Sigma 5's foreground/background architecture, its flexible I/O system, and its tremendous throughput capacity that make it so cost efficient in areas like these. It's also the wide range of powerful, proven software that comes with the machine.

Bit for bit, Sigma 5 hardware isn't the cheapest around. But in the environments it was designed for, Sigma 5 almost always delivers far more performance per dollar than anybody else can.

No sophisticated, analytical, demanding cheapskate should be without one.

XDS
Xerox Data Systems
El Segundo, California

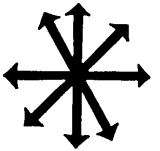

TECHNOLOGY GAPOSIS

No one doubts that the world is divided into first- and second-class nation states. In general this is taken to mean the difference between the industrially developed countries and poorer emerging sovereignties of Asia, Africa, and Latin America. But about 10 years ago, the same sort of connotation seemed to develop between the United States and Europe in the phrase "technology gap," which was to gain currency in the sixties. Maybe European industrialists are sensitive creatures, but whatever the reason they undoubtedly took it as something of a slur.

Certainly if you scratch one of those delicate creatures you can still find the spark of righteous indignation not far beneath the surface. Whether this is justified or not, the awareness of a technical divergence between the two continents has led to a series of invaluable studies by the Organization for Economic Co-operation and Development (OECD). They ranged wide, taking in differences in policies in research and development, education, technological innovation, as well as more specific industry comparisons such as electronics and computers.

It happens that OECD has recently published in this series a report* containing a rather interesting section entitled "Member Countries Performance in Originating Innovation." One of the exhibits in this section is a table setting out chronologically over 30 years from 1936 the main inventions and innovations in the computer industry.

It appears that in the first 15 years of this period the Europeans were level with the United States in readiness to move into the era in which we now find ourselves. In terms of the important computer industry inven-

tions made at that time, France, Germany, and the U.K. contributed a total of 10, the same number as is listed for the U.S. In the second half of the period the Americans scored 15, and the total successes of the other countries numbered 5.

Just how relevant this all is may be a moot point. On the other hand, it may provide an interesting basis for looking at the re-opening of negotiations between France and Britain for a merger of their computer interests.

About three years ago there was virtually no French computer industry, and the U.K. industry had struggled to its feet after coming within a hairbreadth of being k.o.d. In both countries the spectre of IBM seemed only too close to attending the wake. French businessmen suffered perhaps the greatest humiliation in seeing what had once been one of their leading industrial stocks, Bull Machines, fall to the hands of GE. Under a series of Government-financed shot-gun marriages, the U.K. merged its available resources into a single fighting unit. Talks between France and Britain opened for the first time. But with the best will in the world, it is difficult to see how these two ailing parties could have offered one another much hope for resuscitation. They had in fact lost any of the initiative which would seem to have been reflected in the table of invention. Would the story have been different if some clairvoyant could have persuaded them to pool their resources much earlier?

It could well be argued from the analysis of the distribution of talent for innovation, showing the inventive capacity to be evenly spread between France, Germany, and the U.K., that collaboration was 1) technically necessary to match the States and 2) economically desirable from the standpoint of respective market

sizes. If this is still a potentially successful proposition, then the sooner the parties involved get on with it the better.

But if we may be allowed, we would like to inject a cautionary note. For there are precedents to this sort of negotiation: one of them concerns the European space effort. It involves the three countries mentioned, plus Italy, the Netherlands, and Benelux. These countries were persuaded by the British to set up a joint rocket group in the European Development Launcher Organization. It was motivated (or rather Britain was) because the U.K. had a spare rocket research and development program based on a vehicle called Blue Streak. It became available when the British and Americans extended their post-war agreements on nuclear weapons in such a way that the U.K. would confine its nuclear delivery vehicles to the American-supplied Polaris system and its successors.

For 10 years the European Launcher Development Organization has struggled against overwhelming odds to perfect Blue Streak—extended by French, German, and Italian upper stages—as a satellite launcher. It was doomed from the outset in much the same way as would be paralleled by an organization struggling with an entire range of incompatible computers. But this ill-conceived political expediency has cost almost \$600 million over the past six years alone of money contributed to the international pool. The nations involved have also spent large sums on national programs that are of equally dubious value. In fact they have frittered close to \$1.5 billion with nothing to show for it. Perhaps there is some explanation here of the reason for the technology gap.

And a lesson about the basis chosen for a computer merger.

—Pearce Wright

*Gaps in Technology, Analytical Report, \$8. U.S. sales office, OECD Publications Center, Suite 1305, 1750 Pennsylvania Ave., N.W., Washington, D.C. 20006.

**It's user versus supplier,
and may the best negotiator win**

Project Management

M The common assumption that technical and managerial competence coupled with both honesty and integrity are necessary and sufficient to manage large projects is justified in many cases. However, there are exceptions. The inherent conflict of interest between supplier and user, augmented by competitive pressures, may lead to situations where honesty and integrity are replaced behind the scene by political games based on deception and trickery. At stake are the careers of managerial people connected with a project. Virtue will not necessarily be victorious. It is to this kind of situation that the following discussion applies.

The large and complex real-time systems for inventory management and control (seat reservation, production planning, etc.) or for command and control (both military and civilian) are based on computer networks requiring extensive programming for each specific system. Such projects are notorious for cost overruns and completion delays. The games are played to fix responsibility for these overruns and delays. Since millions of dollars and years of time are usually at stake, there are many considerations and approaches which do not appear at all, or only in rudimentary form, in other projects. Therefore, the discussion is cast in the framework of a complex real-time system.

I have personal knowledge of the occurrence of all incidents and considerations described below, in at least one of many such projects (both in the U.S.A and in Europe) I am familiar with. Both the supplier and the user discussed below exhibit features observed in many different supplier and user organizations, collected over many projects. For this reason the discussion may appear to be somewhat unrealistic and exaggerated.

The proposal

The purpose of a proposal is to permit the user to select a supplier, and to permit the supplier to eliminate competition. Occasionally, the user has made up his mind in advance as to who will or will not get the business. In this case he uses competitive proposals strictly as a (necessary) formality to demonstrate his impartiality. There may be sound reasons for such a policy (past performance, a desire of having at least two suppliers, etc.); there may be political reasons (a former employee of a supplier does in fact make the decision, in case of a flop no one gets really blamed if the largest and best known supplier is selected, etc.); and, very rarely, there may be shady or criminal reasons. Thus, the supplier must qualify the user before he invests more than a low key surveillance type marketing effort.

While, in general, everybody connected with a project will tell the truth, and outright liars are few and far between (and do not last very long), it is equally true that in general practically everybody is biased and will not necessarily tell the whole truth, nor use clearly defined terms in his statements. It is many times difficult to tell where biased honesty ends and outright deception starts. By the time facts concerning a project have filtered up through management, and have been suitably reemphasized and diluted, the man who does make the formal decisions very rarely is deluding himself into thinking that he does anything else than formalize, after a suitable ritual of deliberations, decisions made by other people at a much lower level in the organization.

For the supplier it is therefore imperative to discover these de facto decision makers as soon as possible, and to estimate their future behavior before he decides to submit a proposal. I know of at least one supplier who keeps a file on de facto decision-making user personnel connected with every actual or potential large (\$20 million and up) project. One file I am aware of includes not only information available publicly, but also such matters as personal financial status, personal character weaknesses and objectionable habits, etc., together with an evaluation of intelligence, technical competence, power to influence supplier selection (and user project management) and, last but not least, bias in favor of or against different suppliers. Normally this kind of information (whether or not it is organized formally in a file) is used by the supplier to determine whom to pay special attention to on the user side, to select congenial salesmen (in one case this entailed searching for a homosexual salesman to deal with just one user manager; since none was available internally, the supplier finally found and hired one), and to give specific instructions to salesmen regarding entertainment (who prefers the red light district to a classical concert). Quite obviously, derogatory information may also be used (should the need arise) to intimidate user personnel or, if this should not succeed, to attempt to have hostile user personnel removed from a project (by leaking information to higher user management).

Getting inside

In order to receive meaningful proposals, a user must tell potential suppliers what he wants or needs. It is of considerable advantage to a potential supplier if he can participate directly or indirectly in the preparation of system specifications, or what is even better, in the preparation of the whole request for bids. The specifications may thus be slanted in favor of a particular supplier. Even if the request for bids cannot be influenced, a potential supplier will try to

Games

by Werner W. Leutert

generate faith in the supplier's organization and capability by having his top people spend time with user personnel (you are important), by parading supplier research people before them (you will get an advanced system), and by visiting other users (well chaperoned by the supplier) for unsolicited testimonials (we had faith and were justified, why don't you do likewise). These activities will also give the supplier an opportunity to size up the user in more ways than one. His salesmen may offer free transportation (from continent to continent if necessary), free room and board, and lavish entertainment. A naive user who believes he may accept all proffered favors from all supplier salesmen may run into unforeseen complications when some unsuccessful and disgruntled salesman (he may be reassigned or discharged for failing to get the contract) eventually leaks compromising information to the user's top management. I know two executives whose careers were ruined this way.

The preparation of a formal proposal is a somewhat tricky business since a proposal should contain as few legally binding commitments as possible, and still eliminate competition. It is obviously quite safe—and very desirable—to dwell at great length on off-the-shelf hardware of demonstrated performance. Since the user buys system performance and not just hardware, the former may be mentioned in connection with a puffed-up simulation model, which is frequently quite unrealistic. Instead of defining system performance and stating simply (and legally binding) that this system performance will be reached or exceeded and demonstrated with the following acceptance tests performed under realistic conditions, many proposals concentrate on the design of a simulation model, and on how this model shows that the system as simulated by the model will greatly outperform the specifications.

A careful reading of the text of such a proposal will show that the supplier makes no commitment whatsoever about the performance of the system he is trying to sell. Coupled with a little breastpounding about the eminence of the supplier in the field, and a list of happy customers which may be contacted for references, this simulation gambit succeeds far more often than one would expect (otherwise, it would not be attempted so frequently).

On the other hand, if some performance commitments have to be made, they mean very little unless they are demonstrated under realistic conditions. Therefore, a proposal tries to avoid being specific in the definition of performance as well as of the acceptance tests necessary to demonstrate it. For example, it is perfectly safe to state that the MTBF (mean time between failure) of certain computer components is 200 years, while forgetting to mention that the MTBF

of the computer itself is some 200 hours (still a reasonably safe statement since accurate records need not be kept before formal acceptance tests, and even then the computer is supposedly being "burned in"), or that the MTBF of the whole system (when suitably defined) is more like two hours (which could be proved or disproved statistically with a high level of confidence), and thus would have a significant effect on operating performance and maintenance costs after acceptance.

Details later

If the user insists on the proposal containing both detailed performance specifications and realistic acceptance test specifications a little hidden sentence may state somewhere that a better performance estimate will be worked out during the detailed planning necessary to prepare detailed functional specifications after the contract is signed (and competition eliminated). It fails to mention that these refined performance estimates will be no worse than the proposal estimates (which now are no longer legally binding). Or the supplier may propose "cooperation" in programming for the system, leaving open the question of who will bear responsibility for inferior performance of system functions executed in part by programs on which user personnel have "cooperated." In this case, almost any performance which is theoretically possible, and almost any not absolutely impossible time schedule, may be promised in the proposal at very little risk to the supplier.

The matter of money needs to be handled with considerable care in a proposal so that the financial exposure of the supplier is minimal when the system will not perform as promised, or when it will not be delivered on time. It is very unlikely today that a user will buy a system on a time and materials basis (carrying no financial risk whatsoever for the supplier). Rather, it is fashionable now to buy a turnkey installation for a "fixed price." Consequently, the supplier is faced with the problem of proposing a fixed-price contract with a sufficient number of loopholes so that in reality it is no fixed-price contract at all.

In most cases, this is not too difficult. Obviously, all later changes in scope of work will reopen the contractual price and time schedule. Therefore, a few contradictions may be slipped into the proposal without any procedure on how to resolve them (what takes precedence).

For example, the time schedule may show two months for formal acceptance tests, while the statement of work defines the scope of the acceptance tests. If a conflict arises the supplier will usually claim that he based his price on the time schedule. A more

Project Management Games . . .

subtle scheme is to avoid stating any precedence relation between the functional specifications (which will be prepared later and approved by the user) and system performance specifications in the contract. Again, the supplier is likely to claim later that he sold a design and not performance.

Sometimes, some contradictions not affecting contractual performance are built into the design itself such that operation of the system would be very uneconomical unless the contradiction is resolved according to the user interpretation of the contract. The supplier objects and frequently collects some money and an extension of the time schedule. A fruitful field for this little bit of trickery is handover of system functions between computers, and degraded operation in general.

Another scheme is to leave out, or to treat in a cursory manner, important nonoperational aspects of the project, such as user personnel training, or spare parts and maintenance, so that a later financial recovery in these areas is possible. I know of one case where a subcontractor to a supplier was willing to sell certain spare parts directly to a user at 25% of the cost charged by the supplier. The supplier pointed out that any such purchase would invalidate the warranty for the whole system. The user was intimidated and continued to pay through the nose.

A second class of loopholes is based on shared responsibility for the system, or "cooperation." Here,

the financial exposure of the supplier is indeed minimal. For example, the user may be talked into agreeing to his portion of the time schedule (site preparation, time to review drafts of functional specifications or acceptance test specifications before concurrent meetings, etc.) on a basis just as fictional as that used by the supplier. It is always surprising to discover the immense effects which a little user delay causes to a project, and how ingeniously these effects are justified with spurious arguments by a supplier. Since it is extremely unlikely that a user will refuse to wait a few months for completion of a project (even if it should cost the user a considerable amount of money to do so) the most optimistic time schedule with no contingency reserve at all carries very little financial risk for a supplier.

A warranty clause is important to both the supplier and the user. For the supplier it facilitates acceptance of the system. Except in rare and rather serious cases, a warranty is of very limited usefulness to a user since the burden of proof is on him, and the warranty procedure is usually so cumbersome and laced with time delays (to establish the validity of a warranty claim) that the user will fix all minor problems himself despite the existence of a formal warranty.

The contract

As a project progresses, the bargaining position of the user deteriorates steadily with time. While he has many options at proposal time (he may change suppliers or even cancel the whole project at little inconvenience) the situation is radically different at time of acceptance. The loss of calendar time cannot be recovered. The user has invested in personnel time but, most important, he has put some of his prestige on the line (if the supplier is no good, why was he awarded the contract?). In addition, a vested interest in the project has been building up in the user organization. Thus the supplier may expect some help from certain user personnel in covering up his mistakes and shortcomings. Therefore, it is a rare user indeed who is willing to cancel a large project because of inferior performance or delayed completion. It is far more common to adjust performance specifications to the actual system at hand, or to accept a useless system and then give the supplier a follow-on contract to make it work (euphemistically called "modifications based on operating experience").

The award of a contract terminates competitive pressures on the supplier and reduces drastically the bargaining position of the user. Therefore, a user who first announces to the public the award of a contract and then proceeds to negotiate the terms of this contract with a gleeful supplier is making a serious mistake for which he is likely to pay dearly. The outcome is predictable (the user will be at the supplier's mercy) and will not be considered further. Rather, the discussion from here on is based on a fixed-price option contract for a turnkey installation. Such an option contract might say simply that the supplier is willing to sign the attached contract within a specified time period, and that the option is at no cost to the user.

As far as I know, the first option contracts of this type (fixed-price turnkey installation) for a large (in the \$50 million range) real-time system (a European



© DATAMATION ®

command and control system for air defense) were signed some six years ago (by U.S. and British suppliers). The potential suppliers were paid a nominal amount each (about 0.1% of the money spent on the project) for the additional effort (contract negotiations despite a substantial risk of not being awarded the contract) required of them. Any user who follows the option contract route assumes the additional burden of negotiating several contracts with several suppliers for the same system. This is effort and time well spent. If internal user security is reasonably effective (no details leak out), the user may be able to play off potential suppliers against each other and incorporate terms into the option contracts which could not be obtained by any other legitimate approach.

The user usually gets tested by the supplier for the first time in earnest when the detailed wording of the (option) contract is worked out. It begins mostly with the rather mild device of the supplier failing to incorporate some of the user specifications or contract terms of the user request for bids into the draft of the contract, even though they were discussed and agreed upon in a formal contract meeting. If and when the user points out this deficiency, the supplier response may range all the way from an apology for a sloppy typist to a statement that the supplier has thought those particular terms over and was about to ask for reconsideration or is sorry that he forgot to do so.

A rather extreme example along those lines happened not too long ago when three major competitors for a large real-time system each "forgot" three times in a row on three consecutive drafts of option contracts to incorporate certain agreed-on programming norms and conventions. Each supplier remembered the agreement each time it was brought up (nobody can afford to admit to a potential customer that he does not have or does not use programming norms and conventions). By the time the third round of option contract negotiations came around the standard supplier apology became so funny that the supplier negotiating teams did not seem to understand what could be so hilarious about an apology.

The switch

Depending on user reaction to minor irritations (if the user does not react, the pecking order is established), or in any case, the supplier may try a somewhat bolder maneuver. A lawyer will state simply at the beginning of negotiations that he has been given some leeway by top management but must check back if any decision comes up that would exceed it. The next step is to take a rather innocuous paragraph on which a great deal of time and money might depend (like performing acceptance tests under realistic conditions). The lawyer gives a speech about the sun rising in the east, and finally announces that it is against company policy to clutter up a contract with such obvious and self-evident drivel. If the user reacts sharply, he will never see the supplier lawyer again; the supplier project manager takes over, gives a speech about the apparent reasonableness of the user request, and finally offers to check back with top management through technical channels. After a suitable time delay, the "misunderstanding" is resolved in favor of the user.

On his part, the user may employ the "Chinese torture" type of negotiations designed to physically wear out the opposition. To be successful in this game the user must prepare his own draft of an option contract and augment it by some unreasonable paragraphs (like a 20-year requirement for spare parts) which can be justified only by a lively stretch of the imagination, and which serve as bargaining objects. What is most effective, however, is to take some salesmen's statements literally, and to give speeches about good faith at the appropriate moment (with allusions to the good faith of the supplier's competitors). If a paragraph cannot be agreed upon, it is postponed until later. In this way the contract draft is discussed over and over until one of the negotiating teams folds up. I am aware of perhaps an extreme example when it took three long days before a "compromise" (at the supplier's expense) was made.

Quite obviously, the fall-back position and negotiating strategy of the opposition is of considerable value during contract negotiations. This explains the rush of dinner invitations during such a time of conflict. The ostensible purpose is to maintain good personal relationships despite disagreements at the conference table. The real reason is to obtain useful information. Here the personal files on user negotiators may come in handy.

I am aware, for example, of a bar conversation



between two men when the talk drifted eventually to business in South America, the need for payoffs, and how they were made. After a few more drinks the conversation turned closer to home, to working conditions and job satisfaction. Finally, one man asked the other whether he felt he was being paid properly by his employer. When he replied that he would not be working there if he was not, the conversation left the subject.

A more serious approach was made in a group of people at a bar in my presence. After discussing the dope culture at some length, a supplier representative looked at a user negotiator and said, "I just read the other day that many otherwise respectable business people smoke pot. I wonder how many of these birds we would find in our organization if we knew the truth, or in yours or anybody else's for that matter." The user negotiator became ill the next day and had to be replaced. A few months later he changed employers. I doubt that this was a coincidence.

Watch your language

The contract language is quite important for several reasons. It is not possible in practice to define a large system and all associated procedures in complete detail by the time an option contract is signed. In my view, this is not even desirable. The user is much better off with clear general statements free of technical or legal jargon so that they are easily understood (and cannot be misconstrued) by any person of average intelligence. For example, "All known deficiencies shall be corrected, and the absence of these deficiencies shall be demonstrated prior to system acceptance" is such a statement. Quite obviously, it is to the supplier's advantage not to take on clearly spelled out commitments of a general nature. Furthermore, an obscure and highly technical contract is far less dangerous in a contract dispute in front of top management. This explains the usual and considerable opposition of suppliers to putting this kind of statement into a contract.

Since it is extremely unlikely that the system will be both accepted on time and perform as specified for the price agreed upon, the user should take some special precautions to guard his financial exposure. For example, any progress payments should be contingent on clearly defined project events and not on calendar dates. At any given time the incremental costs of the supplier to complete the project (regardless of the time schedule) should be quite smaller than the amount of money still payable to him.

A mutual penalty clause for time delays is usually desirable, but it should be realistic and not symbolic like \$100/day. I am familiar with several contracts involving penalty clauses of 1% or 1½% per month of the total contract price (between \$10 million and \$50 million) with an upper limit of about 10% of the total contract price. For example, rumors have it that a European airline financed an office building from the penalties it collected on a contract for a seat reservation system. Such a penalty clause will usually absolve both parties from being liable for consequential damages, and should be considered in that light.

Furthermore, the supplier should assume the clear obligation to increase, or at least to maintain, the level of his efforts from the time the system is scheduled to

perform according to specifications until it does so in reality. Thus it is not unusual to demand and to get a performance bond of considerable magnitude (since court action is required before a user can touch it, a performance bond has limited practical value).

Finally, an astute user will take advantage of the invariable puffery practiced by practically every supplier (This is wonderful. Let's put it in the contract), his bragging about preeminence and experience in the field (If you have indeed delivered three working systems just like this one, what risks are you taking by contracting for the fourth one at a fixed price?), and the convention that the buyer is supposed to be right in minor matters (Look, you say this paragraph is obvious and trivial to you. Therefore, you should not care whether or not it is in the contract. We are buying this system. We care to have it in. So let's put it in). Since no supplier can afford to admit in public that he is not acting in good faith, questioning his good faith is a powerful argument. Therefore, it should be used sparingly on matters of some importance only. I am aware of one situation where a supplier agreed to throw in about one million dollar's worth of extra programming (after trying to keep it out of an option contract and thus negating a little puffery in the proposal) just to save the fiction of his acting in good faith.

Thus, if a supplier is somewhat tricky and deceptive, a user may realistically choose only between not doing business with him or, by trying to beat him at his own game, to gain the upper hand. Thus, at the time the award is made and the contract signed formally, the user aims to have the supplier project manager respect him, be somewhat apprehensive about him, and worry about the project, rather than think that user personnel are a bunch of real nice guys.

Reduced expectations

After the project is formally initiated with the contract award and signature, the work at the supplier's organization is elevated to a formal project outside of the regular line organization and acting like an internal prime contractor. The supplier project manager soon realizes that he is competing for scarce internal resources (top-flight technical people), and that the time schedule will be met only if a minor miracle should happen. While he may exaggerate his predicament for internal consumption in the fight for more resources, he will present a picture of supreme confidence to the user. The time schedule will not only be met but is likely to be too conservative. This buildup is even more pronounced when there is reason to believe that the user may not be able to live up to his part of the bargain (site preparation, etc.) on time either. Whoever has to admit a delay first is at a definite disadvantage.

The first major project task is to prepare a draft of the detailed functional specifications. Every essential detail of the system must be specified from the point of view of the user. Upon closer examination it usually turns out that those parts of other systems, which were supposed to be taken over unchanged, do in fact require extensive modifications. Some general statements in areas such as degraded operation (graceful degradation) turn out to have unforeseen conse-

quences when they are translated into detailed specifications. Thus, the project manager realizes he has a bear by the tail and embarks on a rescue operation. Internally, this takes the form of a request for more programmers to work on the project, and since the personnel department wants to save money (after all, it is a fixed-price contract) the supplier advertises for mediocre programmers ("two years' experience desirable").

Externally, the user is flooded with proposals to modify the contractual specifications. They range all the way from changes to streamline system operation by simplifying it (so that less programming will be required), to take into account operating experience elsewhere (so that parts of other systems can indeed be used without modification), or to use new hardware developed since the proposal was made because it is faster, more reliable, has more capacity, etc. I have yet to see an example where the new hardware costs less than that it replaces.

Specify or suffer

Some suppliers have actually developed something of a reputation for this "bait and switch" tactic practiced on unsuspecting users. Especially if the user was foolish enough not to specify system functions and system performance in legally binding form in the contract, he will now discover that he either has to scale down greatly his expectations, or ante up substantial amounts of money, or both. The supplier has the upper hand. The user has lost the contest and is doomed. There will be one or more shakeups in the user project organization as the project progresses and the outlook turns progressively bleak (and more expensive). Occasionally, a supplier will play a little politics inside the user organization to force the first shakeup (so he is more or less free to wheel and deal while the new user project manager is learning the ropes). This alternative presents no special surprises, and will not be discussed further.

Since in practice almost any large and complex system can be improved at almost any time, the prudent course to take for the user is to do his homework before the contract award is made, and to announce at this stage that he will be pleased to consider system improvement proposals after system acceptance. The possible exceptions (to remove real contradictions) should become part of a package deal made at the conclusion of the concurrence meetings for the functional specifications.

Nevertheless, the user is likely to have a few problems of his own. The acquisition of any reasonably large system will force some reorganization, which will increase the importance of some people and decrease that of others. Special-interest groups form inside the user organization to force either acceptance or rejection of the system, more or less regardless of its condition. If the user has used the people affected directly by the system to participate in the preparation of the contract specifications, he will usually enter the concurrence meetings with considerable leeway between what is essential and what is desirable in enlarging the system (euphemistically called "making it work").

The draft of the functional specifications is usually one order of magnitude larger than the contractual

specifications (some 1000 pages compared to some 100 pages). Even though there is a substantial conflict of interest, reason prevails at the protracted concurrence meetings. There are no threats of walk-outs.

Whichever side has the upper hand tries not to show it too much. If the supplier has the advantage, he goes through a disguised sales effort, supplying the user with the necessary arguments disguised as technical necessities to be employed by the user personnel to extract money from user management. If the user has the upper hand, he too will talk of operational necessities to make the system usable (to enlarge it, really). He might try the Chinese torture technique and play for time (of which he has plenty) while the supplier is boxed in by a schedule.

In any case (since this is a technical meeting) the user must be able to answer the real and spurious arguments the supplier puts on the table to demolish the user proposals. This requires considerable technical competence. A simpler and less demanding ploy is for the user to state at the beginning that all "concessions" are contingent on a final agreement. The next step is to set up as many real and imaginary concessions as possible, and to keep a list of them which can be quoted from time to time to the other party to show how unequally the concessions up to the present have been distributed, and that it is about time the supplier made a concession on the point under discussion. Graceful degradation, system adaptation to overload, etc., are some areas where it is relatively easy to set up substantial concessions based on a few general specifications in the contract. Usually, a supplier does not know too much about these matters either, since he has included them in the original proposal simply for competitive reasons.

Unless the supplier has the user in his pocket, the concurrence meetings for the functional specifications will result normally in a draw. The user has to lower his liberal expectations somewhat and spend some money to realize his more recent wishes. The supplier recognizes that his effort will be smaller than it could be, but still substantially larger than he assumed when he signed the contract. He may or may not receive some money. He is tied down more than ever (by the increased detail of specifications). He has lost time.

Thus detailed functional specifications are not very desirable from the supplier's point of view. Therefore, a sure sign that the supplier has the advantage is the fact that detailed functional specifications are either not prepared at all, or in piecemeal fashion as the project progresses. The latter approach is ideal for the supplier since it permits him to reduce system functions and performance as well as to extract money from the user in properly timed increments so that this bitter medicine is as painless as possible. A smooth operator will, of course, keep up appearances by supplying copious technical justifications but knowing full well that the user is completely at his mercy. This approach is known as the "salami tactic."

It is very important to the user to have detailed acceptance test specifications prepared and concurred in as soon as possible after the functional specifications are available. The user's bargaining position deteriorates with time and will never be better in the future. The supplier still claims that he can

meet the performance detailed in the functional specifications and in the contract. He knows that acceptance test specifications will box him in further. Therefore, it usually requires some prodding from a determined user—with a contractual schedule to back him up—to get this effort going.

Avoiding real tests

Because the effort necessary to get the system accepted might be reduced substantially, the supplier, regardless of what the contract might say, will make a last effort to specify design verification tests instead of performance tests. He is fortunate indeed when he reaches this goal. Based on experience, it is safe to claim that any performance not formally verified will not be met and any system function not formally demonstrated will not work at time of acceptance. The supplier is quite familiar with this empirical law. He will claim (correctly) that it is not possible to test within a reasonable time every detail of every system function under all possible operating conditions. Furthermore, he points to the warranty which is supposed to take care of all (minor) problems discovered after acceptance. Thus there is another conflict of interest, which has to be resolved by negotiations.

If the user is not very careful he will agree to acceptance test specifications which permit the supplier to pass all tests and force acceptance, even though the system is laced with deficiencies, does not meet performance specifications, and is not operational. This is the ideal situation for a follow-on contract.

Of several examples of this type I am familiar with, the most extreme concerns a \$40 million system which passed its acceptance tests with flying colors. After the user spent another \$80 million on follow-on contracts, it finally became operationally useful. In another case, a single acceptance test was conducted in bits and pieces over a period of nine months while several hundred programming errors were being corrected, and some of the hardware affected by the test was modified extensively (the supplier protested vigorously but in vain when he was asked to repeat the test). Thus, unless the user pays particular attention to specifying obvious and self-evident matters, he is likely to find himself in never-never land during the acceptance tests.

If the user has succeeded in establishing detailed functional and acceptance test specifications early during the life of the contract, he will usually end up with somewhat reduced but more realistic expectations. The supplier, on the other hand, is now severely handicapped in his efforts to palm off eventually a system which is not quite operational, which cannot meet contractual performance, and which costs more money. Therefore, the conflict continues, and some special efforts (not taught in Sunday school) will now be necessary. This is a good time for the supplier project manager to realize that the project is likely to destroy him, and to begin casting around for an opportunity to leave the project while, on the surface, it is still doing well. His chances of leaving the project with his reputation intact will now decrease quite rapidly with time.

Usually by the time the acceptance test specifica-

tions have become a contractual document (superseding the more general specifications of the original contract), the supplier realizes that he is in serious trouble. He cannot possibly meet the agreed-on time schedule, and it is quite unlikely that certain performance specifications will be met. However, the general idea is to postpone the day of reckoning for as long as possible. The bargaining position of the user deteriorates with time, and some measures of the supplier are likely to be at least partially successful.

Quite obviously, the user must be kept in the dark about the real status of the project. Except for occasional guided tours he is barred from the supplier premises (which can easily be justified on fixed-price contracts). The supplier progress reports are carefully edited, full of ambiguous generalities ("The internal time schedule is being met." The user has never heard of it), and designed to maintain the user's confidence. The periodic (quarterly) progress meetings are "frank" in the sense that the supplier does not misrepresent significantly the status of the project but justifies it with his supposed practice of very thorough planning to catch design errors early, and thus reduce the time required for construction and testing. The user is pleased with this heavy emphasis on zero defects. Thus very little special effort is needed to keep the user in line.

In the meantime, the supplier project manager continues to battle his own organization for more resources. He may discover that his project is being overcharged (use of joint facilities, via inflated overhead, for unrelated work done by internal subcontractors), or that some of the brightest subcontractor people have been pulled out of the project because of some "emergency" elsewhere. Rather than fighting the organization head on (not likely to succeed) he tries to exploit its weaknesses by manipulating internal charges (to company-sponsored research, etc.), and by putting pressure on his internal subcontractors (Why should these newly hired green programmers be trained by and work for my project? etc.). Since the other supplier project managers were not born yesterday either, the supplier project manager has to invest a considerable amount of his time in internal scheming and bickering just to keep from losing ground.

If a new round of supplier proposals (to modify the functional specifications) coupled with pleas to be "reasonable" meets with an unfavorable user response, some stronger measures are necessary. For example, the supplier might pick some auxiliary function, like adaptation of the system to overload, and propose to reduce it simply to the rejection of inputs with the justification that overload will occur at best once every few years (by neglecting to take into account that 25% of computer time is needed for internal housekeeping), and that no other operational system (designed some five years ago) has it.

A few weeks after this proposal has been rejected by the user, the supplier informs him orally (through a liaison man) that through an "administrative error" the rejection was not passed on to the affected programmers, and that any "change" now will delay the project for several months. He asks for reconsideration, and after a little wavering the user rejects again. Depending on how he estimates his chances of success, the supplier may either push this problem up the

organizational ladder in the user organization, or he may simply announce orally (to be confirmed in writing later after the user has reacted) that the design will not be changed. In either case, a commotion results.

If the user appears to get tough, the supplier retreats, the promised supplier letter arrives and states that he correction will not be made now but later so as not to impede the orderly progress of the project. With most users this ploy has a fair chance of success and will, of course, give the supplier the upper hand again. In any case, more "administrative errors" occur, and more and more discrepancies between functional specifications and implementation are to be resolved "later." When the next progress meeting arrives, the serious project problems can be hidden no longer. The user has become apprehensive and brings along not only the project manager but also the big boss (who has no more than a hazy notion of what the project is all about). The supplier will try to turn this progress meeting to his advantage.

The titans meet

The standard procedure is for the big boss of the supplier to invite the big boss of the user to have dinner with him before the first day of the progress meeting. He explains that there has been a rotten apple in his own organization causing all sorts of administrative problems. This man has been "removed" (he was quietly transferred or promoted to another project a few days ago as a sort of peace offering to the gods). However, he must point out that there seem to be some unreasonable nitpickers in the user project organization who, perhaps, have impeded the progress of the project also (if pressed he will name names).

In any case, mutual cooperation is required to bring the project to a timely and successful conclusion. His own (supplier) project manager in whom he has full confidence (he has not removed him yet because he may need a scapegoat later) would like to extend the time schedule by about one month but he, the supplier big boss, has come up with another plan. To keep the organization on its toes he proposes an all out effort to meet the current schedule.

This entails doing some tasks in parallel (instead of in series) so that he can assign more people (two to be exact) to the project. This would mean also that some (up to now unsuccessful) factory tests would be completed after installation at the user sites. Another possibility now being investigated is to start some formal acceptance tests while some unrelated subprograms are being checked out. In any event, he would appreciate it if the user's personnel would sit through the presentations tomorrow, and not ask questions which would tend to destroy the morale of his people.

If nothing else, this scheme will keep the user personnel quiet during the progress meeting. If more persuasion appears necessary, a somewhat more desperate approach is to wait until after the guided tour, call the user big boss out of a meeting, and have the supplier big boss tell him that he has just heard that during the tour a member of the user group has made a snide remark to a supplier project worker, and thus given the final push in destroying his morale.

If the user big boss should not cave in and apologize for the (unknown) sinner but demand to know names and circumstances, an employee who has in fact just discussed with the supplier project manager his intention to quit is brought before the two big bosses and questioned. He will admit that he is quitting because of low morale but deny that any user personnel have insulted him lately. Since nobody wants to upset him, he soon leaves and the project manager enters, explaining that somebody overheard the conversation and told him in confidence, and that he is sorry the whole matter came up, since with a little extra effort on his (the supplier project manager's) part, the employee might still be retained. He refuses to divulge names (he does not have any), saying he has to respect confidential sources and, anyway, it would serve no useful purpose.

I have seen this game played twice. Both times the user big boss apologized and later gave strict orders to his people to be more cooperative and refrain from negative comments and wisecracks. Thus a ruthless and resourceful supplier is likely to carry the day in this minor showdown. The time schedule is still in effect (and the penalty clause inactive) even though nobody believes in it any more. The hardware will be shipped (partially tested) on time (and the corresponding progress payment collected by the supplier). Finally, the user big boss has been intimidated. The user project people may see through the whole maneuver but they are too late and can only "cooperate" with the supplier in the new spirit, hoping that the day of retribution is not too far off.

Showdown

The user has lost a battle and, if he is not very careful, he will lose the war. The latter alternative holds few surprises, and will not be discussed any further. It is far more likely, however, that the user project manager will attempt to salvage as much as possible and prepare for the now inevitable final

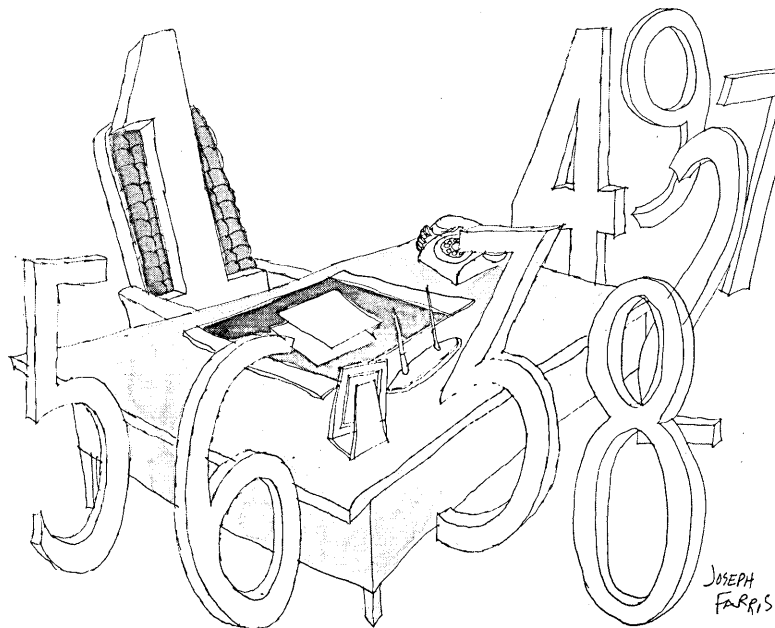

© DATAMATION ®

showdown.

Together with the hardware, the whole project moves in essence to the user's premises and the true project status can now no longer be concealed by the supplier. It turns out, for example, that the supplier internal integration tests have been performed only in the most offhand and cursory manner (so that nobody can be called a liar). Rather, the supplier apparently plans to use the formal acceptance tests (which are supposed to demonstrate operational performance) to test integration as well.

There are significant discrepancies (administrative and other errors) between functional specifications and system implementation. The workmanship on all but mass-produced standard hardware is sloppy, and there are many deficiencies compared to the contractual norms. This is most pronounced in the programming area where most supplier programmers act as if they never had heard of contractual norms. Nevertheless, the supplier continues to claim that the project is on time, that the formal acceptance tests will begin perhaps a month late but will be completed in time for formal acceptance to take place on the date specified in the contract. It is quite obvious that the supplier intends to have the system accepted regardless of its condition. He also launches trial balloons about a follow-on contract (basically on a time and materials basis for the people already working on the project).

The chief executive officers of both the supplier and user organizations (to whom the big bosses report) do not know anything about the project, except that apparently it is doing well. For different reasons, the true project status has been withheld from them.

On the supplier side, the project expenditures have stayed roughly within the cash flow forecast, and the user has always paid promptly on the dates shown in the forecast. The chief executive officer may be dimly aware of the possibility that sometimes under "competitive pressure" a few things might be done which are not exactly a credit to the public image he has labored so hard to create for his organization. He does not want to hear of any little shenanigans, and if it ever turned out that the big boss were guilty of a significant departure from the supplier organization's "high ethical standards," he would have no choice but to replace him.

On the other hand, the user big boss now realizes that he made a mistake when he authorized early shipment. He still does not know how he could have avoided it (by demanding adherence to the contract), and he certainly is less than anxious to discuss this point with his chief executive officer. After all, he too is working for a bonus and a promotion.

The critical date for the supplier is the contractual acceptance date. If the system can be turned over to the user on that date, the storm clouds have passed and there will be clear sailing. Even if there should be a delay of a few weeks or a couple of months (because, for example, not all formal acceptance tests have been attempted), irreparable damage to the supplier project manager and big boss can be averted by firing the technical man on the project manager's staff responsible for the functional specification concurrent agreement. He is accused (even if he has seen the light and quit before) of having capitulated when faced with the user's demands.

This will appease the supplier big boss (who has been toying with the idea of replacing the project manager), and give him some arguments when he has to inform the supplier chief executive officer (that the money from the user will not be forthcoming on time). He will also tell him that he is disappointed in his project manager but cannot replace him at this critical time (he knows more about the project than anybody else).

However, he has assigned a vice president from his staff to the project full time (as the de facto project manager with the regular project manager as his mouthpiece). The supplier big boss will tell the vice president (either in front of the chief executive officer or in writing) that he has his full confidence and therefore a "free hand" (to save his own skin later if things should go wrong). The vice president (really the supplier trouble shooter) is somewhat more resourceful and ruthless than others in the organization, and he is willing to sacrifice anything and anybody to get the system accepted. He might pick the employee most expendable to the project and fire him (with or without good reason) while granting some instantaneous merit increases to the least expendable workers. Thus, the sense of urgency increases and the pace accelerates.

Heat on the user

The user too comes under mounting internal pressure to accept the system. There are hints and suggestions (encouraged by the supplier) that maybe the system is indeed more complex than necessary, that after all there is a warranty clause to fix deficiencies after acceptance, and maybe giving the supplier a follow-on contract would speed up acceptance and restore confidence of the people slated to operate it afterwards (they are afraid because they know the system is not operational).

Meanwhile, the vice president launches trial balloons about partial acceptance (of those parts which supposedly work). The user big boss has several alternatives, none of them very pleasant. He may choose to fight a showdown (of somewhat uncertain outcome). He may cave in and attempt to cover up (if the attempt is unsuccessful, his career is finished). The user chief executive officer (who now must be briefed) is likely to go along with either choice (he does not know much about the project anyway). In addition, the user big boss may resign (his enemies will spread the news that it was under fire), he may become sick (his career suffers anyway), or very rarely, he may commit suicide (I know of one case). Thus only the first two alternatives (showdown or coverup) are realistic choices. If the project is in halfway decent shape, the user big boss is likely to choose coverup. The outcome is predictable and need not be discussed further beyond saying that the vice president will make sure he gets full credit before moving on to the next project in trouble. The supplier project manager, having some seniority, is assigned a staff position where he will wither away gradually and sink into oblivion.

The most likely time for the showdown is when the acceptance tests are completed, and the supplier wants to go into a routine cleanup just prior to acceptance. The user claims that these formal tests

have been unsuccessful, or not representative, or both, and must be repeated under realistic conditions. This is the issue to be resolved by the showdown. The two chief executive officers will be the judges of the conflict (court action is very rare) and make the final determination or deal. To follow the preparations of both sides, the clock has to be turned back to when the vice president first appeared on the scene.

Quite likely, the vice president gives orders to put top priority on formal testing. This includes temporary fixes to "pass" the next formal test, postponement of deficiency correction until after acceptance, con-

cealment of newly discovered deficiencies from user personnel whenever possible, etc. The supplier project manager, knowing there may be dismissal or a staff position in his future, is anxious to please the vice president (with whom he confers daily in person or by telephone) and may even invent a few schemes of his own to shorten the acceptance test period.

The user representatives intensify their efforts to collect incontrovertible evidence while playing a waiting game. They make sure that the supplier test conductor's report contains the required configuration statement (to show that each test was run with a different configuration), a list of temporary program patches (which may short out entire system functions and support a charge of trickery), a list of open discrepancies before the test, and a list of new discrepancies discovered during the test (to show that the tests are not representative). The supplier-prepared test analysis report shows which (of several) test criteria were not satisfied and may contain more new discrepancies (from an analysis of recorded test data). If necessary, the user refuses test support (including power) unless and until this contractually required information is available in final form from the supplier.

Getting the chief

However, to really upset the supplier chief executive officer some more emotional facts are needed (to attack the supplier's corporate image, a very sensitive spot of any chief executive officer). Three well-documented and airtight examples are usually sufficient to convince anybody that a general charge (of trickery or deception) has merit. If a study of temporary program patches and other quick fixes does not yield sufficient evidence, a somewhat ruthless user may engage in a few little schemes himself to procure it.

For example, a user representative may make it a habit to invite supplier programmers for a cup of coffee (and some lengthy discussions) immediately after they have made a temporary program patch, dumped the program, signed and dated the dump, and given the user representative an unofficial copy. Later checks of the official configuration control documents might show that some of these temporary patches may not have found their way into the official record (supporting a charge of deception). Or the user may get hold of some supplier-documented deficiencies which the latter has failed (following the vice president's orders) to make known to the user. Some of the supplier project personnel may object to the vice president's methods on moral grounds and take revenge by supplying the user with incriminating evidence (I know several such examples).

The presentation of the evidence, and the tactics to be followed at the meeting, must be worked out carefully. There should be no intricate or involved technical or legal arguments which the two chief executive officers are unable to follow, but rather general concepts supported by examples.

The general statements of the contract and of the functional and acceptance test specifications now come in handy. Since the user has the floor first, it is to his advantage to present his case that the acceptance tests are not representative and that most were unsuccessful anyway (thanks to a general statement



"... and now, a word to the wise."

© DATAMATION

which specifies that a test must satisfy all criteria to be successful), but to mention only one example of trickery or deception (to provoke the supplier into trying to explain it away, so that there will be a drawn-out discussion of the supplier's honesty).

For the benefit of the chief executive officers and the big bosses a concise summary of the relevant facts should be prepared and handed out at the meeting. In all of several showdown preparations I have participated in on the user side, a detailed list of possible supplier arguments (followed by user counterarguments) was prepared also and given to the user chief executive officer and big boss (in practice, about 75% of all supplier arguments can be anticipated and answered in advance this way). It is of the utmost importance that the supplier not learn of these elaborate preparations.

Meanwhile, the supplier vice president may catch on that something is brewing. He expects an attack on contractual and legal grounds (which the user includes as a formality in the small print of his presentation). He has a study of the contract made and arguments developed about "being reasonable." Not realizing the extent of the user's preparations, the vice president banks on some sweeping arguments ("We passed all acceptance tests, except for a few minor deficiencies which will be corrected and demonstrated to your complete satisfaction"), some bragging ("This is the most complex real-time system in the whole world. All other systems I know of, including those produced by us, were accepted when they were in a condition far inferior to that of yours"), and some lecturing ("Some people just do not fully understand the purpose and function of a warranty clause").

He intends to hold back discussion of legal matters (he knows he has violated both the letter and the spirit of the contract) but prepares quite thoroughly for it. He cannot afford to present his arguments in writing but expects that quick thinking on his feet will help him carry the day.

Thus the request from the user for a meeting between the two chief executive officers does not arrive unexpectedly. After a few unsuccessful attempts to postpone or cancel the meeting (the user refuses to pay and to furnish test support, the vice president threatens to withdraw all project personnel), the meeting date is agreed upon. The supplier will now launch a major effort to find out what the user is up to. If user security is reasonably tight he will only learn that the user wants the acceptance tests repeated because they have not been performed according to contractual specifications.

All final showdowns I am familiar with were won by the user because he had done his homework well. The consequences are predictable. The formal acceptance tests will be repeated. The supplier chief executive officer will loosen the purse strings, and cooperation in the generally accepted sense is the order of the day. The user does not gloat over his victory (supplier respect for him will skyrocket anyway). For reasons of decorum (and to not admit guilt indirectly) the vice president will not be fired immediately but suddenly discover that he needs a long vacation. He is likely to have lost the power to fire the project manager (he blames him for not discovering the user's intensive showdown preparations) but the

big boss may fire the project manager instead (to save his own skin), or the big boss may be replaced also by the chief executive officer (for the damaged corporate image).

Hindsight

No outsider listening to the acceptance speeches for the system (with somewhat reduced performance) would believe that the user and the supplier showering each other with praise were at each other's throats not too long ago, or that the project has (perhaps rightly so) ruined the careers of several executives. Even the delayed acceptance is excused with the argument that such delays are really customary and have to be expected.

A closer look shows that the composite system discussed here (and many systems in real life) could have been completed at least one year in advance of the actual completion date. The two major causes of the delay are the early shipment of partially tested hardware to user sites, and the unsuccessful attempt to dispense with internal integration tests and conduct formal acceptance tests on a system not yet ready for them. The lack of any contingency reserve whatsoever in the original time schedule is a third and more formal cause.

In my view, project management games are played so often simply because they are so often successful. The composite user winning the final showdown, as described above, is not a typical user (how many users sign fixed-price option contracts for turnkey installations before the contract award?) but a very astute one. In general, the chances of financial recovery through changes in scope, equipment substitutions, and follow-on contracts (including spare parts sales) are quite substantial. Thus unscrupulous suppliers are tempted to bid low on purpose and then to play games to recover. A supplier making honest and realistic estimates is put at a competitive disadvantage unless the potential users recognize the true state of affairs. Therefore, the most effective countermeasure against project management games is, in my opinion, a user who does not accept blindly the lowest bid (it may turn out to be the most expensive in the long run) but who looks before he leaps to sign on the dotted line. ■

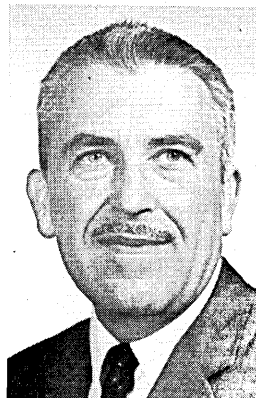

Dr. Leutert has been an independent consultant for the past eight years. Previously he taught at the University of Maryland and held positions in industry and government, including that of chief of the computing lab at the Aberdeen Proving Grounds' Ballistics Research Laboratory while the ENIAC was still in operation there. He holds a D.Sc. degree from the Swiss Federal Institute of Technology.

How to buy a software package with style

Software Buying

by Howard Bromberg

M Watch out for that guy sitting in your front office. You will recognize him almost at once. He's a conservative dresser—white shirt, Ivy League suit, and a pair of wing tip, thick-soled cordovan shoes. Along with this he carries the thinnest of all possible attaché cases. Who is he? The newest breed of computer creatures—the software salesman.

This new breed has evolved from computer systems sales, from computer time sales, and from professional services sales. The difference, however, between him and any one of his predecessors is that to a large extent he is significantly more skilled in the art of technical salesmanship. He cut his teeth selling computer systems and refined his techniques on professional services. Now that he's pushing packages, he is more than a match for the average data processing manager.

Within his little case he has a software package for any need and a payment plan to fit any budget. These plans include long-term payouts, leasing, monthly rental, lease purchase, outright purchase—everything short of accepting trade-ins and payment in kind. In addition to the variety of payment plans, he may further entice and snare you with an equal variety of “try it yourself” plans. They range from, “Try it out with no obligation for as long as you would like,” to the other extreme of “Sign the contract now, pay the money, and if you don't like it. . . .”

In today's computer environment, software purchasing has become a necessary pursuit. Manufactur-

ers' unbundling and the ease of entry into the software business have created a plethora of software products. As a result, the consideration between buying and building most often favors the former choice. The time span before a custom package is completed, the high costs of technical labor and computer time, and the ever present danger of overruns and failure point to steadily increasing activity in software purchasing.

For the most part, the marketing success of a given software product appears to be dependent upon the adroitness of the salesman rather than upon the elegance of the product. Far too many packages are “sold” rather than “purchased” and spend the rest of their existence installed in the owner's bookshelf rather than on his computer. While frivolous and spontaneous purchases are often very pleasant activities and provide great therapy for both buyer and seller, it is not unreasonable to suggest that these types of purchases be avoided when contemplating a software acquisition. This is not to say that a \$50 package offered through the mail should not be acquired on the spur of the moment—it may be useful. What I am saying is that purchases requiring significant outlays of dollars, perhaps \$1,000 or more, deserve some reflection.

The intelligent purchase of software requires following a rather rigorous multiphase purchase plan. Of course, time and effort can be saved by avoiding such a purchase plan and applying the savings directly to the cost of the software package. But this requires a

Software Buying . . .

great amount of faith in the software package contemplated for purchase—a faith that is not warranted by the history of software merchandizing. This article describes a procedure for software acquisition that substitutes planning for faith and, hopefully, satisfaction for disillusionment.

Recognition of need

The first step in software planning involves recognition of the need for the software package. There are two ways such recognition can occur.

One way is to be convinced by the software developer. In this case the salesman brings to your attention the availability of a particular package and describes how it would be useful within your environment. Probably the recognition of the need for the majority of software packages sold comes about in this manner.

The second way of recognizing the need for a software package is through an independently determined effort. This is probably a more satisfactory method for both buyer and seller as it eliminates the necessity for the buyer to be "sold" on the conceptual merits of the particular kind of package being considered. It permits the salesman to concentrate on the specifics of his package and allows the technical group to make a precise evaluation.

To facilitate recognition planning, I think it would be reasonable for an installation manager to ask his technical people twice a year to make a list of those kinds of software packages that would make their lives easier were they available. This will allow the people with the problem to have a direct input into the solution and, at the same time, allow management to investigate the savings that could be realized from the specific suggestions.

Once the need for a particular type of software package has been recognized, the next step involves a survey of the available products. This step is relatively easy due to the numerous directories of software packages that have recently been published. The purpose of this step is to determine the existence of various packages—not to question the veracity of their advertising or usefulness of function. I say this because to my knowledge it is relatively simple for any software manufacturer to procure a listing in any of the available directories without having to prove the accuracy of his statements. So this step merely identifies the various choices. Another means of accomplishing the same goal, without any work on your part, is to take a small advertisement in any one of a number of publications. I can assure you that a one inch ad stating that your company is interested in acquiring a particular type of software product would not go unnoticed.

Evaluation

The third step in the purchase plan is the technical evaluation. This evaluation can be done by your own technical group, by outside consultants, or by the software manufacturer. In each case certain precautions must be exercised and certain controls established. For example, I know of a case where an internal evaluation of a software product was con-

ducted in such a fashion that the amount of time and money expended would have been sufficient to have created the package in the first place. This is not what I mean by technical evaluation. What I *do* mean is the establishment of a mechanism that will allow you to determine whether this package works on your data. It's really as simple as that. The other more esoteric considerations need not be a job for the technical organization. At this stage in the purchase plan, the objective is to eliminate the outrageous cases—those packages that clearly do not function at all or do not function effectively within your particular environment.

Certain trade-offs in the interest of saving time and money must be expected. As an example, if there are more than 20 prospective candidates for acquisition, the actual computer test runs should not be done internally. Rather, benchmarks should be established for execution by the software vendor, with the results evaluated by your technical group. Similarly, consideration should be given to the use of an outside consultant when the software package under consideration is exceptionally complex. In such cases, it is reasonable to pay to have the service performed rather than to pay doubly by having your technical staff develop a technique for the package and then apply it. In any event the result of this survey phase will provide a list of potentially acceptable packages for further consideration.

The fourth stage in the software purchase planning activity is the administrative evaluation in which those packages that survived the technical evaluation are evaluated on the basis of several nontechnical considerations. I have listed these considerations in the order that I consider to be the most important. Your order may not only be different, but your list may include additional items. In any case, do not be afraid to establish priorities. There are very few things in life that should be considered with equal weight.

Cost: Of paramount importance is the cost of the software package. Cost is a combination of many factors, but let us consider just two: purchase price and return on investment. There is, of course, no reason to pay \$100,000 for a payroll package, nor would you consider buying one for \$100. The point is that the purchase price must represent some reasonable value. The reasonableness of the price can easily be determined by requesting approximate bids from software houses or your own technical group. Not all software packages permit an easy determination of the investment return. Utility packages are much easier to evaluate in this respect than application packages. Nonetheless, some determination must be made of investment return before an effective evaluation of cost can be determined. In this case, even gross approximations are allowed.

Ease of Use: The next most important consideration is the ease of use of the package. In all cases, the package must have no detrimental effect on the morale of the organization. That is, it must be complementary rather than detracting. This is particularly important if the package has its own language that may impose a severe handicap on the technical personnel. If the package is too difficult to use, your money will have been wasted regardless of the cost. If the package requires use of a notation completely

charge. In other words, you must ascertain if you are purchasing a static package for a one-time charge or many static packages for multiple charges. In some instances, you may be fortunate enough to receive a dynamic package for a single charge.

Training: Describe on paper the kind of training program you consider to be most effective for your situation. Submit this to the software vendor and see how close he can come. Be sure to include items such as training your instructors (let's not be dependent on the manufacturer to supply training for new people), programmed instruction material, video aids, and complete case study examples. And do not forget to ask for the credentials of the instructors supplied by the manufacturer. For years I have restrained a tremendous urge to ask one of these instructors to sit down and write a complete program for me using the very technique that he is teaching.

Installation: I assume that any software vendor who does not offer to make an on-site installation of his package on your equipment and to demonstrate its functioning to your satisfaction is quite mad. Consequently no more discussion on this point is required.

Documentation of the Package: This is different from documentation of the use of the package. Most often this point is terribly confused. The documentation of use must be covered under consideration of training. The documentation of the package should be a relatively straightforward item and should be tied directly into the maintenance policy. As I see it, the function of documentation is to provide materials that facilitate communicating errors and questions concerning the operation of the package directly to the software manufacturer.

Other Users: The final consideration involves other users of the same package. You notice that I place this last in my list of weighted considerations. The reason for this is because I have very little means at my disposal for evaluating any report received from another user. For example, the man at the other organization whom I call may give an absolutely superb report on the effectiveness of the package. In truth, the case may have been that the package did not work as anticipated, but that the individual on the telephone was responsible for its purchase. On the other hand, he may give an unsatisfactory report. The background may be that he has had a falling out with his management and has already given notice, or he has decided to form his own software company to compete directly with the package under consideration. So my feeling is that it is nice to know that other users have taken the same step that you are contemplating, but beyond that all information is highly suspect. In addition, I have found salesmen to be loathe to offer names of dissatisfied users of their products.

To digress for just a moment, there is a fifth step that represents another alternative that should be mentioned. If the survey, the technical evaluation or the evaluation of these other considerations produces no acceptable candidate, there are other possibilities available. These include a joint venture with other users having similar problems, a joint venture with a software manufacturer who will participate in the activity for the subsequent marketing rights and, for the foolhardy, the establishment of their own software company. The joint venture is in reality just another

means of spreading the risk. It is, of course, only effective in those cases where the particular software item under consideration is of such a nature that other organizations can profit by its use. Utility type programs most obviously fit into this category. Many applications can be designed this way although there is a danger that the generality required may make the program inefficient or that the additional time required to gain agreement by the joint venturers may significantly increase the time and cost of implementation.

Buying the package

Step 6 is the final stage in the software purchase plan and involves buying the package. As mentioned previously there are a variety of terms under which a software package can be acquired. It is not imperative that you choose any one of these existing plans although you most likely will find one that will be consistent with your goals. Be prepared to offer alternatives. Always act as if it is a buyer's market. You will very quickly and clearly be told if you are mistaken. This does not mean that you should bargain and attempt to cut prices. No reputable organization should be placed in this position any more than your own company should be placed in a bargaining position for its own products. The computer industry has gained considerable notoriety for its activities involving price cutting and discounting and this is not exclusively attributable to small software houses operating out of garages at night. I maintain that there should be one software package price for all users. Your responsibility is to determine whether that price is a fair price for the value received.

Terms Available: Basically, the terms available for acquisition of a software package include outright purchase, lease purchase and rental. In all cases it is imperative to determine whether items such as installation, training, maintenance, and the like are included within your particular purchase plan. The outright purchase plan normally involves the payment of a single sum for acquisition of the package. In some cases, depending upon the type of free trial arrangement, a front-end deposit may be required. This deposit is then deducted from the full purchase price.

The lease purchase arrangement involves a monthly payment for a fixed number of months after which time the package is then owned. The cost to you of a lease purchase arrangement should be related to the cost of the package plus the cost of money for each year that the manufacturer is required to maintain the lease. A rental agreement differs in the sense that there may be a minimum number of months that a rental must be in force and usually no expiration of the agreement. Termination of rental agreements is usually accomplished by 30 days' notice after the minimum number of rental months has passed. A point that must be very explicit in lease purchase and rental type agreements is the mechanism involved in converting from one form of purchase plan to another. Often it may be advantageous to you to be able to convert from a straight rental to an outright purchase, or from a lease purchase to an outright purchase. Some agreement must be reached so that you do not suffer an extraordinary loss through such a

INPUT UNDERGROUND ATTACKED AS ADVERTISING GIMMICK.

Dear Underground:

Okay. I'm on to you. The Input Underground is nothing but an advertising gimmick to call attention to Recognition Equipment's new product line.

Why can't you guys run straight ads like everybody else?

*J.C.B.
Des Moines, Iowa*

Dear J.C.B.:

The Input Underground contacted Recognition Equipment in regard to your letter.

They sent us the following straight ad:

INPUT 80: THE EXPANDABLE READING SYSTEM

Somebody finally developed a comprehensive page reading system that can be customized to the job and expanded to handle a growing workload.

Somebody finally developed INPUT 80.

The new OCR system, designed and developed by Recognition Equipment Incorporated, is three to twelve times faster than the company's previous page

reader. It's also more flexible and more versatile.

INPUT 80 can process a wide variety of forms and read a large number of type fonts as well as handprinting, carbon copy and mark sense data.

The system can be used for many applications in many different industries.

In the banking field, INPUT 80 can save considerable time by replacing keypunch and tedious data conversion techniques now used to process installment loans, demand deposits, and savings account transactions.

Insurance companies can cut data processing costs critically by using INPUT 80 to process daily reports, claims and premium billing. Service bureaus serving independent insurance agencies can put INPUT 80 to work on a whole range of insurance records management jobs.

There are also applications for INPUT 80 in state government. The Department of Motor Vehicles can use the system to process drivers license applications. The Human Resources Development Agency can use INPUT 80 to

process wage and salary reports, applications for disability and unemployment insurance, and other field-prepared forms. The State Controllers office has two major needs for INPUT 80, payroll and claims.

And, the Board of Education in any major city will find life a lot easier if they process student records with INPUT 80.

For complete information on INPUT 80 or other Recognition Equipment Systems, write to us care of the Input Underground, P.O. Box 5274, Dallas, Texas 75222.

How's that J.C.B.?

It's not too late to join the Input Underground. Just send us your name and address and we'll send you a membership card and button.

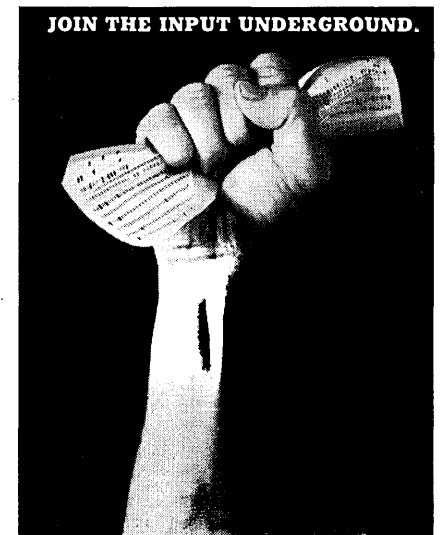

PUBLISHED AS A PUBLIC SERVICE BY RECOGNITION EQUIPMENT INCORPORATED.

conversion.

Another consideration when discussing purchase terms involves payment in kind. This approach presupposes that you have some goods or services that are of value to the software manufacturer. This being the case, you can offer to trade your goods for his. A practical example of this type of agreement is in computer time where the manufacturer would buy computer time from you at retail price and pay for it with his software package. (There are certain limitations to this approach, however. Recently I received an offer to trade a software package for computer time in Saskatoon, Saskatchewan, Canada.)

After deciding upon the appropriate payment plan, it is important to evaluate the stability of the software manufacturer from whom you are acquiring the package. This must be done in order to assure yourself of the manufacturer's financial stability as well as his general business reputation. Obviously I am not advocating doing business only with high-seven-figure firms. If I did it would significantly reduce the number of software packages available for acquisition. What I am saying is that certain precautions should be taken, particularly when dealing with undercapitalized or temporarily unstable organizations. In such a case, provision must be made to guarantee that you have free and clear ownership of the package if the manufacturer for any reason goes out of business. This should also include the delivery of the source deck, as maintenance would certainly cease once the manufacturer is no longer in business.

Staking Out the Arena: Once all the evaluations have been accomplished and all the considerations discussed, it is time to describe your conclusions in a formal purchase agreement called a contract. Most often, in an effort to save both parties' time, the software manufacturer will provide a contract. This is usually a standard contract that covers all available purchase plans for the particular software package. Feel free to modify this contract to your needs. Consider the software manufacturer's standard contract nothing more than a suggestion which you must modify in order to indicate the requirements and conditions that you have established.

In any case, it is imperative to read the contract. Scanning is just not acceptable. Close scrutiny of the contract at this time is like desk checking a computer program. It can save a lot of heartache and subsequent expenditures of time and money. There are a lot of platitudes associated with contracts, ranging from, "They are only as good as the integrity of the people signing them" to "Contracts are unnecessary when you know the people you're dealing with." This is really just a lot of foolish talk. Contracts are important not just for the current activity associated with purchase, but also for the subsequent problems that may arise as a result of the purchase. These problems are usually based on a misunderstanding between buyer and seller as well as on items that were omitted from the original contract.

It is always pleasant to assume that people are basically reasonable. I think, however, that one can assume this and still have everything clearly described in a contract. Thus if any difficulty should arise you can depend upon both the reasonableness and the contract to clarify the situation. A friend of mine profoundly states that the purpose of a contract

is to define the arena in which you are going to do battle in case a disagreement arises.

Apology

These then are the various considerations that should be investigated when contemplating purchase of a software package. What I have attempted to do is to separate these considerations into purely technical, technical management and administrative categories. Further, I have avoided any mention of the more subjective elements of evaluation. Decisions based upon emotion or cosmetics should play no part in the plan for software purchase that has been described.

There are two other aspects of software purchase that I have not mentioned. This is not solely because they should be disregarded, but because they either did not easily fit into the evaluation plan or they involved too high a degree of subjective analysis or faith. One of these aspects is investigation of the background of the package creation. This includes determining by whom the package was constructed, why, how and for what reasons it is offered for sale. Another is the consideration of "free" software that usually comes from government and university sources. In the former case, it seems that this kind of information is interesting after the fact, i.e., the technical evaluation, and falls into the category of, "What if it is discovered that Shakespeare did not write Hamlet?" The latter case involves decisions concerning the effect on the organization of absence of items such as maintenance, documentation and extensions.

Many of you are aware that I am associated with a company that sells software. As a result, you may think it peculiar that I should write an article describing how one should buy software. Most of the points discussed in this article were derived from actual situations with customers, prospects, lawyers, controllers, vice presidents, service bureau representatives, salesmen and marketing reps. Like most attempts at definition, the list is not exhaustive. I hope, however, that you will find it a practical guide to software package acquisition. Our salesmen each carry a copy of this around with them. If any of them violates any one of these suggestions, please throw him out on his package. ■



Mr. Bromberg is president of Information Management Inc. and a contributing editor of *Datamation*. He is chairman of the ANSI COBOL standardization activity and chief of the U.S. delegation to the International Standards Organization's Technical Committee on Programming Languages Standardization.

**Call in your lawyer early
if you want
the protection those contracts
and warranties seem to promise**

Contract Caveats

by Robert P. Bigelow

M “Caveat Emptor” is a frequently heard expression. Properly translated it means, “Let the purchaser take care.” The history of the computer industry indicates that buyers haven’t been very careful so far. The number of complaints about poor systems design, ineffective computers, messed-up operating systems, late installations, poor programming and every other conceivable difficulty has been legion, but the number of law suits has been miniscule. Why? Among possible reasons are a computer “mystique” engendered by the manufacturer and embellished by the user’s edp department; the manufacturer’s bundled and “we’ll solve it all” approach; and, to a large degree, the fact that the user has, without argument, signed the supplier’s contract with all its built-in defenses.

Since unbundling some of the rules have changed—even for the big boys. When IBM first presented its new systems engineering contract to the users, the screams reached the cloistered halls of Armonk, and, wonder of wonders, changes were made! CDC’s patent infringement clause (if the user is sued because of CDC’s patent infringement, CDC will help the user—at the user’s expense) was castigated from a public platform with some CDC people present—the form was soon changed. The ACM Special Interest Group on University Computing Centers held a two-day session in Atlanta last February, and a couple of major manufacturers made a point of stating that their contracts were being revised to meet user objections.

So the user has some muscle in the contract field and doesn’t have to take whatever the manufacturer dishes out. But how does he use this muscle? How does he take care? One of the cheapest ways—in the long run—is to bring in his lawyer early. In any major systems study there is often a task force set up, and the lawyer should be at least an adviser to, and preferably a member of, the task force.

Records. If the new system is going to affect how business records are kept (very few systems don’t), the lawyer who is brought in at the very beginning may pay his way before the user ever talks to potential suppliers. Getting corporate records which are in machine-readable form admitted by a court as evidence can be very difficult, especially if the program documentation is not in good shape. The lawyers can advise how to set up the records properly.

There may be government regulatory requirements that limit how much a corporation can computerize its records. For example, the Securities and Exchange Commission requires that brokerage houses keep voluminous records for six years, including almost every transaction for every customer, and all interoffice correspondence and memos. Until June 15, 1970, these brokers had to keep hard copy records for the immediately preceding two years. Only during the last three months has the SEC permitted immediate microfilm [Regulation X15a-4 (f)]. The Internal Revenue Service still requires an audit trail of hard copy (Revenue Procedure 64-12). (I once heard a government tax man chuckle as he told of the difficulties a major company ran into when it designed a computerized system that didn’t meet the IRS requirements.)

As more and more permanent corporate records are computerized and new systems come along, systems designers must also ensure that the records can be converted from the obsolete format into a format usable by the new system. For example, if records were kept on 90 column punch cards and have to be produced in court, where does the dp manager find the Remington Rand equipment to read those cards?

Proposals. A lawyer can also be very helpful in writing up the performance standards in any RFP. The specifications should state who provides the test data and the standards of performance this data has

Contract Caveats . . .

to meet. It may be difficult to quantify these standards, but even consultants' contracts can have performance criteria which can entitle the user to restitution when these are not met [see *Sanitary Linen Service Co. v. Alexander Proudfoot Co.*, 304 F. Supp. 339 (1969)].

Are ad claims included?

The lawyer can also be useful in evaluating the contract forms supplied by the bidders, and particularly in comparing the forms with the brochures and other advertising material that the bidders supply. The advertisements stress service and "how wonderful it will be," but does the contract repeat this? Probably not. In fact the contract probably says that there are no warranties or representations of any nature whatsoever except as stated by the wording of the contract itself. While it is sometimes possible after lengthy and expensive litigation to prove that oral or written representations were made by the supplier and relied on by the user, and that these representations were really part of the contract, it's much cheaper to have a lawyer make sure that the representations are in the contract to start with.

Warranties. The question of warranties is particularly tricky. Most contracts for hardware and, to some degree, software exclude warranties, but state governments have been demanding them for years. If the user has enough muscle he can usually get warranties even if he has to pay extra (see *DATAMATION*, April, 1970, p. 220). The Uniform Commercial Code, which has generally been enacted throughout the country, sets forth certain implied warranties in sales agreements for tangible (touchable) products. There are several cases indicating that these warranties will apply to equipment that is leased, and there is a good argument for saying that software is a tangible product and as such does not differ from hardware so far as the uniform code is concerned. However, the code does not apply to services, and any warranties or guarantees of performance in this kind of contract should be clearly spelled out.

Even where the code may apply, the supplier usually specifically sets forth his warranties, and includes a clause that says (to quote the IBM software contract), "The foregoing warranty is in lieu of all other warranties express or implied, including, but not limited to, the implied warranties of merchantability and fitness for a particular purpose." Such contracts also usually include a limitation of liability to the amount that the user has paid under the contract, or some other easily ascertainable standard. (Univac is reported to have refused a contract rather than give up its limited liability, *Computerworld*, March 25, 1970.)

But some companies are using warranties as a part of their marketing strategy. For example, Redcor states that it will provide a lifetime warranty on its conversion products such as the 990 Integrated Circuit Tester (*Computer Daily*, March 24, 1970, p. 3). And one purveyor of a computerized data bank warrants to the purchaser of the information that "the Data has been compiled by and is the original product of International Data Corporation, and that it has the exclusive and unrestricted right to sell the same . . . [and] will indemnify and hold harmless the Pur-

chaser for any obligation or liability to a third party based upon any adverse proprietary claim to such Data" (*Interface*, April 1970, p. 2).

The user should be particularly careful about warranties in second-hand equipment. Often this is sold as is, without warranties, and since IBM has not unbundled its support or done away with the second-user doctrine insofar as maintenance is concerned, the buyer should take great care in contracting for previously owned hardware.

Proprietary rights. The problem of infringement of proprietary rights pervades the entire computer field. Most manufacturers will accept the obligation to defend their customers against claims that the products the customers have bought infringe someone's patent or copyright. (As noted above, Control Data tried the other tack last year, perhaps as a result of its experience in a suit now pending in Baltimore.) If the contract doesn't include an agreement that the supplier will accept responsibility for infringement, the user might have to give up using the product for which it paid good money and possibly have to pay additional damages to the owner of the patent or copyright. If the broad warranty exclusion that is customary in many contracts is also included, the user may find himself prevented from claiming damages against his supplier, too.

Hardware and software can be acquired either by purchase, lease or rental. Purchase provides a full cash payout for the seller, but if he is claiming proprietary rights in the product (particularly in software), these rights may be seriously diminished by a sale; the buyer, of course, assumes the danger of obsolescence. In a lease or rental situation the seller's payout is much slower, but he can control the use of the product more easily and enforce more effectively his claimed trade secret, copyright, or patent rights. By leasing, the user need not come up with all the cash to buy the product, and, if the lease or rental agreement permits him to terminate before the end of the lease period, he can avoid the risk of obsolescence.

Hell or high water

Lease caveats. The user should be very careful to examine the terms of the lease agreement. He may be signing what has been sometimes called a "hell or high water" clause; this says that he must pay under any and all circumstances. Or, alternatively, the lessee may sign an installment note equal to the total amount of the lease cost plus interest; the supplier can then discount this note with a financial institution. If the user stops payment on the note because of deficiencies in the product and the finance company sues on the note, the user's claim that the product doesn't work is no defense.

If the lease agreement has renewal or purchase options, and the price of these options is very low, the Internal Revenue Service may claim that there was a sale in the beginning of the lease with an installment payoff. This could have adverse tax effects for both the user and supplier which should be considered by the user's lawyer before the contract is signed.

Tax problems. Computers and computer systems are of growing interest to taxing authorities on the national, state and local levels. Last fall the Internal

Revenue Service issued guidelines on the tax treatment of software (Revenue Procedure 69-21). These have been covered elsewhere (Antonio & Enke, "New IRS Hard Line on Software," *DATAMATION*, March 1970, p. 71; Smith, "Guidelines Concerning the Federal Income Tax Treatment of Software Costs," *Data Management*, December, 1969, p. 22). Systems designers should never forget the IRS requirements for auditing business records, including the retention of most information in hard copy form (Revenue Procedure 64-12).

The standard computer lease or rental contract passes on all taxes to the user, so the user must look at these costs as part of the procurement procedure. State sales and use taxes are a particularly fertile field for imaginative tax administrators. Recent decisions in Ohio have indicated that time-shared computer systems are particularly vulnerable to this type of taxation (General Data Corp. v. Porterfield, 21 Ohio St. 2d. 223, 257 N.E. 2d. 359, Bunker-Ramo Corp. v. Porterfield, 21 Ohio St. 2d. 231, 257 N.E. 2d. 365; see *DATAMATION*, September, 1967, p. 17). Stating maintenance costs separately from hardware costs may avoid sales taxes on the maintenance costs in some states.

Personal property taxes on the equipment can be a particularly unpleasant surprise for management (Ultronic Systems Corp. v. Assessors of Boston, 244 N.E. 2d. 318). States like Hawaii and New Mexico have gross receipts taxes which apply to personnel services (even fees charged by lawyers); knowledgeable tax planning may avoid liability for this type of tax also.

Personal services. In contracting for personal services, the user should carefully review the contract forms offered by suppliers. For example, the IBM systems engineering contract is very specific about what IBM will regard as confidential. The current (summer, 1970) version provides that IBM will instruct its personnel to keep confidential, "by using the same care and discretion that they use with similar data which IBM designates as confidential," such financial, statistical and personal data relating to the customer's business as the customer designates as confidential. However, technical data such as trade secrets, which IBM needs to know to accomplish its job, will receive such confidential treatment only when listed on a "confidentiality supplement." Under this supplement, IBM designates an individual person to receive the trade secrets; if the customer discloses this data to anyone else in the IBM organization, IBM is off the hook. Furthermore, "the maximum period for treatment of Customer technical data as confidential under this Supplement is 30 months after commencement of the Schedule of Services as shown on the Service Estimate." (IBM personnel have stated that this 30 month period is negotiable upwards.)

The IBM SE contract (and similar contracts in other companies) has created a considerable amount of static among users. One user signs a new SE contract for each project; the contract spells out in considerable detail the job to be done and the dates of performance. Another customer takes the position that an SE who is not satisfactory will be shown the door as he walks on the premises, and this will continue until IBM sends the SE that the customer wants.

Particularly with personal services, the user should make sure that the contract has not only reasonable rates for straight time and overtime, but also that the supplier's personnel who are traveling to the user at the user's expense are limited in the amount they may spend for living expenses; some users have found that traveling experts can have exceedingly expensive tastes.

Dangerous associations

Antitrust. The advent of unbundling has strengthened the movement toward "users' groups" and has also strengthened the desire of peripheral manufacturers, communications equipment manufacturers, software companies, service bureaus and others to form associations for mutual advantage. The formation of any trade association is a dangerous procedure because of the historic perversion of such groups into "protective" associations. This has led to investigation and prosecution by the Federal Trade Commission and the Department of Justice and also lays the members of such a group open to treble damage actions by persons who may have been injured by their activities. Any company—or individual—who is considering joining such a group should have his lawyer review not only the documents establishing the group, but also how the group is actually functioning.

(Continued on page 44)

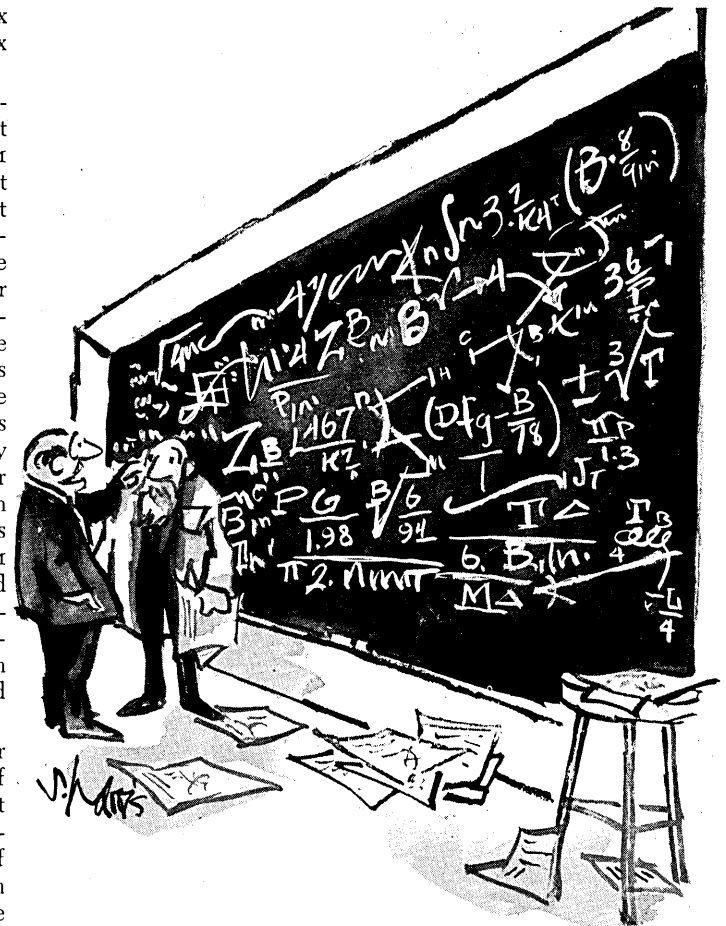

"That's the finest vacuum cleaner you've ever designed."

© DATAMATION ®

Contract Caveats . . .

The Robinson-Patman Act applies primarily to sellers of goods and prevents the sale of like goods to like buyers at different prices (unless the discrimination is specifically permitted by the statute). But it also applies to the buyer who knowingly "receives a discrimination in price which is prohibited." And the buyer who induces allowances or services which do not fall within the quoted prohibition, but are illegal for sellers under other parts of the Robinson-Patman Act, may have violated the Federal Trade Commission Act. Associations which have been formed for the sole purpose of obtaining cumulative volume discounts offered by suppliers have been found in violation of the antitrust laws (The Automotive Parts Cases, 55 FTC 1279 & 1430).

Hardware reminders. In considering a hardware contract there are some particular items that the buyer should watch for. One is the supplier's requirements as to the preparation of the site for the equipment and associated problems such as power, supplies, air conditioning, and so on. If this is not done on time, the user may find himself with equipment in house, unusable, and rent being charged. The state of Indiana is reported to have had a scanner and recording devices costing \$1800 per month in rent just sitting in the cellar for at least that long because the necessary air conditioning had not yet been installed in the computer room (*EDP Daily*, June 30, 1970 p. 465). If the site is not prepared within the specifications laid down by the manufacturer, the user may find that not only does his equipment not work properly, but the manufacturer's warranty won't apply either. This can be particularly important where communications equipment is involved because of the reluctance of the telephone companies to cooperate in the installation and connection of equipment which they do not supply.

Contract specifications

The user should also be careful about the language of the contract defining satisfactory installation. In one case, the contract provided that the supplier's invoices were payable "when the system has been delivered, installed and certified by National as being ready for use," and the 90-day warranty commenced on the date of certification. Part of the system was not delivered until well after date of certification, but the user made no complaint within the 90 days. Later the user tried to get out of the contract on the ground that the system had not been completely installed. The court held that certification by the supplier and no complaints by the user for considerably more than the warranty period indicated an unequivocal acceptance of the supplier's interpretation of the agreement (*National Cash Register Co. v. Marshall Savings and Loan Assoc.*, 415 F2d. 1131).

Software. Contracts for software are now the rage, and much has been written and spoken on the subject. In contracting for software the user should be sure to review everything that is in the contract proposed by the supplier. For example, the warranty on IBM program products provides that the programs in Classification A or B "will conform to its published Program Product Specifications." The user should be sure that the specifications are reviewed, and preferably attached to the contract. The user's lawyer might

also ask to review the internal program specifications that the supplier issues to its sales force. These often state what the supplier feels are the customer's responsibilities before installation.

One area which should be very carefully reviewed by the user's lawyer is the limitations on the use and reproduction of a program. These vary from company to company and may require the establishment of procedures which the user does not currently have. (The security procedures required by the supplier may also help the user establish the authenticity of his business records at some later date.) Some contracts limit the number of central processors on which the program can be run or the number of copies of the program that can be made. Some contracts have strict requirements about the disclosure of the supplier's trade secret and confidential information contained in the program; the user should be sure that if the package does not do the job, the user can then do his own programming or acquire a package from another supplier without running into a claim from the original supplier that the user violated the trade secret clause.

Ownership of programmed software packages, data bases and anything else in machine-readable form, should be clearly set forth in the contract. There is at least one case now pending in California involving this question (*DATAMATION*, July, 1969, p. 115). Ownership can become particularly sticky when the user improves the program, and wants to claim some rights in the improved version. But if problems arise with the improved program, the supplier may claim the warranty was violated. The user should also be sure that he will be able to obtain the supplier's improvements to the program. Those which "debug" it should be available free or at a very reasonable cost; those which improve its capability substantially should be automatically available at a reasonable cost.

Conclusion. The possible variations in computer contracts are many. Problems that can arise in the acquisition and installation of hardware and software are legion. Getting legal advice early in the game is like putting bomb-proof windows on the computer room. The initial cost may seem high, but if a lawyer does his job well, problems which would cost ten times as much to solve later will never arise. ■



Mr. Bigelow practices law in Boston. He is a member of the American Bar Association's Standing Committee on Law and Technology, the American Management Association, ACM, DPMA, and is a *Datamation* contributing editor. He is editor of *Computers and the Law* and author of several manuals on the legal aspects of the computer industry.

Now! A 60 page report in 1 minute.

Make room for Statos® 21 — the new line of electrostatic printer/plotters featuring the quickest output in the EDP business. Statos 21. Zings out 8½x11 hardcopies at a page-a-second rate. Or 5,000 very readable lines a minute. On Z-fold or roll paper.

And *plots* at the same time, if you wish.

At that rate, Statos'll do the work of 2, 3, even 4 contemporary printers or plotters. Or eliminate a mag tape unit as a middle-man. All in a space of 4 square feet.

It'll give you plug-to-plug compatibility with computers ranging from the IBM/360 to the Varian 620/f. And something no other non-impact printer offers: forms control.

Designed from the floor up as a full-fledged computer peripheral, Statos 21 will handle full lines of alphanumeric data, allowing efficient I/O programming at the data source.

With its 80-character line buffer the Statos 21 can handle card-image records, teletype-compatible listings plus a wide gamut of other business data formats. Statos 21.

You can't beat it. For the whole persuasive story, with a surprise cost ending, contact us at 611 Hansen Way, Palo Alto, Calif. 94303. Call 415-326-4000.



varian
graphics & data
systems division



Statos 21

A short Guide to the 'new' mnemonics

1

for the systems architect who desires main memory extension capability at I/O storage prices. The SSU Semiconductor Storage Unit—an auxiliary storage device that transfers data at the speed of core with 40-times faster access than existing I/O storage.

With 1, 2, 4, or 8-megabyte capacities, the SSU is the largest semiconductor memory in the world.

The unit is designed for high-usage storage requirements which normally would be in main memory, but which, because of high core prices, are relegated to much slower drums and discs. Examples include OS data sets — JOBQUE, SVCLIB; time sharing — TSO, CP-67, TSS; swap areas or pages; data base modules—IMS, GIS; and many others. These I/O bottlenecks can be significantly reduced by the SSU, resulting in substantial improvements in total system throughput. For the first time, nearly 100% CPU utilization can be achieved! By a unique combination of semiconductor production technology and computer design capability, AMS has bridged the gap between main-frame core and electromechanical I/O storage.

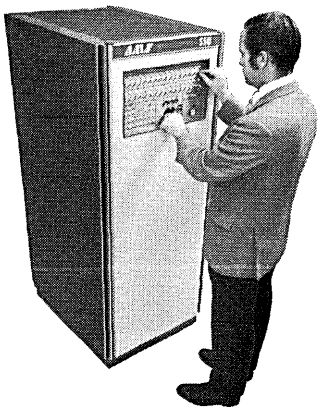

2

for the small digital system that needs more memory at a mini price.

The SSU/m, Semiconductor Storage Unit Module provides high-speed auxiliary storage with data transfer rates of up to 64 megabits per second — at prices well below core memory.

Available in 1/4, 1/2, 1 or 2-megabit modules, the SSU/m is ideal for main memory extension, computer peripheral buffering or real-time buffering applications such as process control, video, data communications, and lab automation systems.

Because of its modular, all solid-state construction, the SSU/m offers speed, dependability, small size and low cost. The SSU/m — a new concept in computer peripherals.

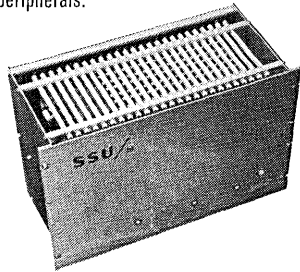

3

for the system designer who wants access time in nanoseconds. With 15-nanosecond access, AMS modular memory cards are the world's fastest. These fully functional, all semiconductor read/write memory cards are organized 32 x 8 or 9; 128 x 8 or 9; and 4K x 1.

Also available are the advanced memory devices which are the heart of these high-speed cards—the AMS 0161 and the 0641. Organized 16 x 1 and 64 x 1 respectively, these bipolar components operate with access time of less than 10 nanoseconds. For register replacement, scratch pad, control and buffer memory, high-speed A/D conversion or other signal processing applications, AMS modular cards and devices are the fastest memories available.

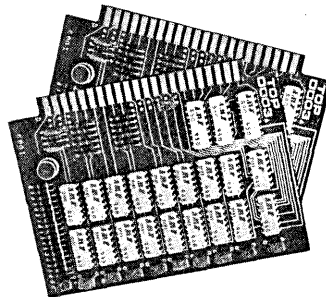

4

for the designer who realizes that core memory is obsolete. AMS was the first to introduce a dynamic MOS/LSI 1024-word by 1-bit random access read/write memory. With an access time of 400 nanoseconds and a cycle time of 800 nanoseconds, these monolithic, fully decoded devices are already less expensive than core.

Packed in 24-lead DIP's and dissipating less than 50 microwatts per bit, the 1024 encompasses all the economy and reliability associated with batch fabrication.

Soon to be announced are a series of TTL-compatible, low-cost, modular memory cards, the first being organized 4K x 8 or 9 bits per card. These cards, which utilize the 1024 x 1 device, provide modularly expandable random access read/write memory in an economical, small-sized assembly. Why pay more for core?

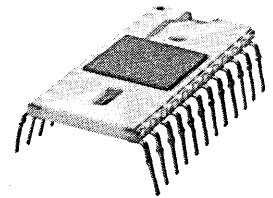

Semiconductor memory devices modular cards, or complete memory systems—MOS or bipolar— from the fastest main-frame application to the lowest cost peripheral . . . AMS delivers it. In bits or megabytes.

AMS

ADVANCED MEMORY SYSTEMS
1276 Hammerwood Avenue
Sunnyvale, California 94086
Telephone (408) 734-4330

CIRCLE 51 ON READER CARD

If your PDP-10 could stand expansion, but your budget can't, here's your answer.

Plug-compatible with PDP-10, our CEK-100 core memory has 1-microsecond cycle time, capacity of 64K words by 37-bits, and is

available with either 4- or 16-port interface.

Those may not be Lockheed exclusives, but this grabber is: the CEK-100 costs just about 1/3 less than the comparable system offered for PDP-10. And that amounts to a walloping savings.

Circle our number and get the full specs on CEK-100, the thrifty PDP-10 expander. From the people who've shipped more bits of high-speed core memory systems than all other independent manufacturers combined.

The CEK-100 memory fits two things. PDP-10 and a tight budget.

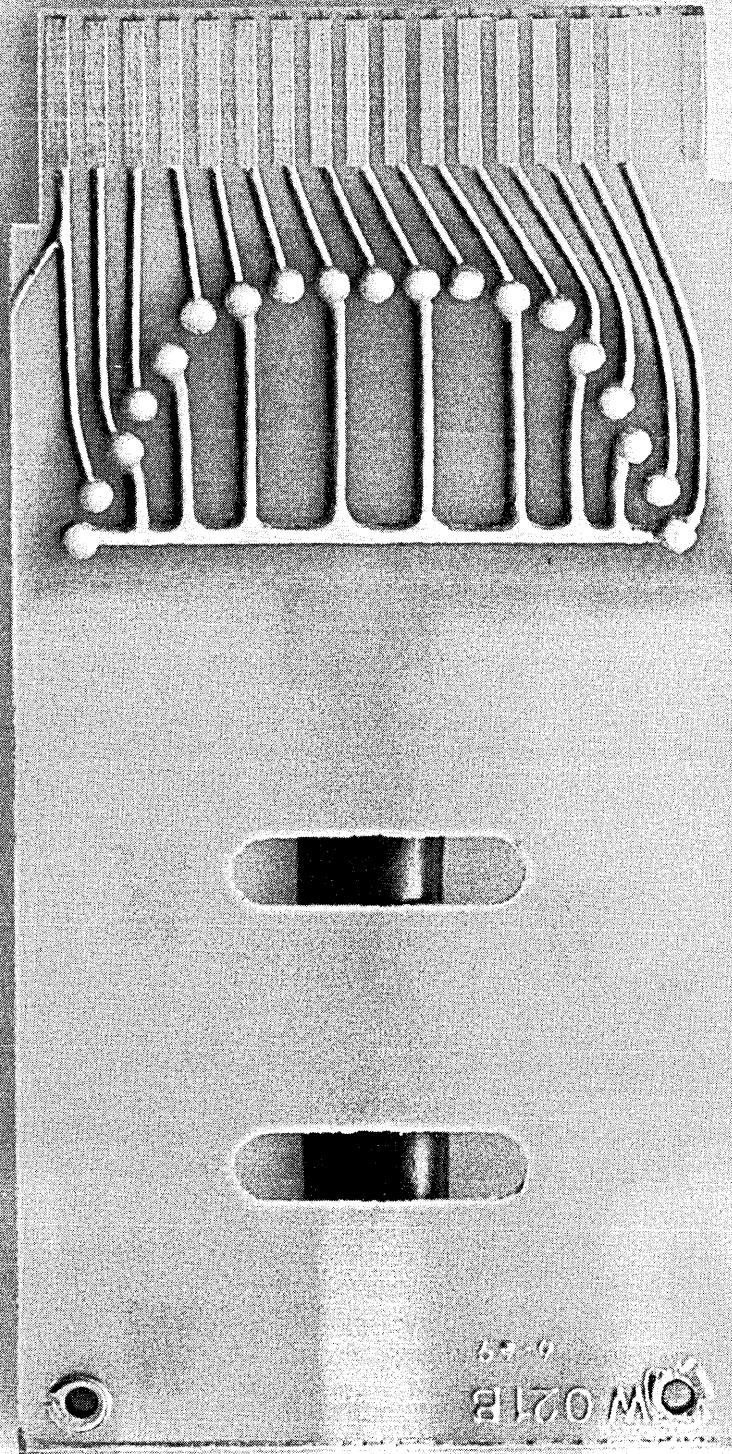

CIRCLE 15 ON READER CARD

Lockheed Electronics

Data Products Division, A Division of Lockheed Aircraft Corporation

PERSPECTIVE

an interpretive review of significant developments

Pressure Grows to Give GSA More Control Over DP Buys

Big changes are brewing in federal hardware/software procurement policies. Implementation will require "at least two years," says one expert, who adds that "the key battles will be fought long before then, of course."

One likely battleground is an upcoming hearing of Jack Brooks' GovOps subcommittee, tentatively scheduled for this month or next. Recently, in a speech to a federal adp users' group, Brooks suggested procuring more hardware and software on a volume basis, developing cpu and peripheral performance standards, and inventorying federal software. He thought peripheral makers could largely resolve the standard I/O interface problem themselves and stressed the need for a data description language and for data tape formats that can be interpreted without reference to the related programs. A subcommittee source reports that all of these matters will be discussed at the hearing.

Another shaper of things to come is a recent meeting in Myrtle Beach, S. C., sponsored by the Office of Management and Budget (former Budget Bureau), and attended by all major dp policymakers and users within the federal government. Reportedly, there was "a fairly strong consensus" that: peripheral makers should develop a standard I/O interface; "residual values" (i.e., a system's prospects for being reutilized within the federal establishment) should be considered when making system purchase vs. lease decisions; software purchases by federal agencies should be "coordinated" to reduce duplication and promote standardization; and a catalog of terminal and storage devices would be a good first step toward implementation of a comprehensive, computerized hardware/software product data base.

GAO's sharp pencil

The General Accounting Office, meanwhile, has completed — but not yet officially released — two reports which recommend giving GSA far

more procurement authority and for less to federal agencies. GAO also wants more lessors and other non-manufacturers (like system integration firms) to bid on RFPs, and more use made of multiyear leases. It says residual factors should be considered by system bid evaluators, and recommends various ways of reducing the amount of rented equipment — notably by replacing it with excess government-owned units and by exercising purchase options on systems where the government has earned a lot of purchase credit.

GAO says the adp revolving fund set up by the Brooks Bill must be enhanced to finance these recommendations. Recently, GSA — which administers the fund — asked Congress for a \$30 million supplemental appropriation, but agency officials don't have much hope of getting the money, and a knowledgeable source says much more than this is needed.

Stretching leases

One way of obtaining the needed cash quickly, according to an influential source, would be for federal agencies to let GSA act as their adpe rental agent.

General Services could negotiate multiyear leases with the suppliers at lower rates, collect rentals from the users (these would be somewhat lower than what the users are charged now), and pay the suppliers from this revenue. Because of the spread between annual and multiyear lease charges, the source says, GSA would still end up collecting from the users more than it had to pay the suppliers. The agency could re-invest this "profit" by buying and leasing back dpe which federal users are now leasing directly from equipment suppliers. Since GSA could amortize the equipment over a longer period than the suppliers (because of the opportunity for re-utilization within the government), the purchase and lease-back scheme offers even greater profit potential than multiyear leasing.

By becoming the middleman between federal agencies wanting to lease adpe and equipment suppliers, GSA would be in a position to increase the adp revolving fund at a geometric rate.

The major obstacle is a set of federal laws, the "Anti-deficiency Statutes," which say, in effect, that no federal agency can sign a leasing agreement unless it has money in the till to cover all the related financial obligations. Since the revolving fund has only about \$10 million, GSA officials say multiyear leasing isn't practical; there are better investment opportunities available.

But GAO, in one of the recently completed reports, says that RCA, Burroughs, CDC, GE, and NCR have offered multiyear leasing discounts which don't conflict with the anti-deficiency statutes. These companies will lease systems for a year at a time, and if the equipment is kept for three years, they give the user a discount.

\$16 million saving

GAO estimated, on the basis of 1969 adp inventory figures, that the feds could save up to \$16 million by exploiting the Burroughs, CDC, GE, and NCR offers. Many peripherals makers are willing to grant similar terms, added GAO. It criticized GSA for not taking "any specific action" to promote use of these plans.

The GAO report admits that potential savings would be much greater if legislation were passed excluding the adp revolving fund from the anti-deficiency statutes. Obtaining this legislation, the agency suggested, isn't as difficult as some federal adp managers think it is. Congress has already granted some exceptions. According to the report, one agency has negotiated 21 multiyear leases covered by one-year funds. "Although it is achieving economies," says GAO, "(this agency) is violating . . . the anti-deficiency statutes."

(Continued on page 50)

The recently released "Fitzhugh Report" also seems likely to generate changes in federal adpe procurement and management practices. The report is based on a top-to-bottom study of DOD made by a blue-ribbon panel of civilians under the chairmanship of Metropolitan Life's board chairman, Gilbert W. Fitzhugh. Regarding adpe, the panel recommended that Pentagon system spec writers define their needs in terms of equipment capabilities rather than application requirements. Also, adpe management responsibilities should be shifted upward on the DOD organization chart, and the Pentagon should establish an

in-house system design staff.

One knowledgeable source expects the second recommendation to be implemented "within six months." Specifically, the dp-related responsibilities of DOD Comptroller Bob Moot would be transferred to the recently created office of Assistant Secretary of Defense (Telecommunications). The likely result of this shift, says our source, is that "DOD's front office will have more visibility and more clout concerning the design, selection, procurement, and operation of general-purpose computers used by the Services."

— Phil Hirsch

Power Crises Generate EDP Trouble And UPS Makers Find More Takers

It's still summer and we're fortunate that it hasn't been an unusually hot one, since many of the nation's electric power utilities are stretched to their limits of capacity. And computers must have reliable, consistent power.

Headlines in the general press have noted the danger of power blackouts of the nature of the Northeast blackout of 1965 (though hopefully on a smaller scale), but this is not the real problem facing computer users; rather, it is the possibility of fluctuating voltage, or "transients," which occur when switching is performed in a power network. A transient can cause processing errors and — apparently — even hardware damage, without the user being at all aware that anything has gone awry — unless he has some expensive monitoring equipment to keep track of his electric power.

Another widely publicized power deficiency has been the planned "brownouts," whereby voltage is reduced during periods of excessive use, typically very hot days. Such reductions are commonly 2-5%, and should not effect computing equipment, except that systems are more vulnerable to harm by transients when the power has already been reduced. According to an intercepted IBM missile, IBM equipment should be able to withstand up to 10% variations in normal voltage without degradation of performance, with larger fluctuations causing errors and even shutdowns,

depending on magnitude and duration.

Expanding markets

There is little the user can do about the power supplied by his local public utility, but he can at least partially protect himself by the use of uninterruptible power supplies (UPS). Such equipment has been traditionally used only in "critical" applications, such as airlines, rather than typical commercial edp installations. But this could change abruptly as power crises worsen and users become more aware. At present, very little is known about the actual effects of power deficiencies on edp operations, because those affected rarely know why.

Noncritical commercial users are considering UPS today, however, and at least one major firm has completed an in-house study with startling conclusions. Though the local utility claimed that transients with voltage drop down to 90 from the normal 120V occurred only a little more than two dozen times a year, monitoring equipment showed they occurred about *30 times a day* between May and September! And while it is difficult to prove a transient is to blame for damage to equipment, incidents concurrent with transients included crashed heads on a 2314 and a drum wipe-out.

Uninterruptible power supplies are

nothing new, and some are quite simple. For example, a motor generator system uses the utility-supplied electric power to run an electric motor which, in turn, drives a generator with a very large flywheel. The generator powers the computing equipment, and the flywheel provides steady power over utility voltage fluctuations of short duration — perhaps .5 to 1.5 seconds. But such rotating power supplies are prone to breakdown — as are the utilities' generator — and are expensive to maintain. The advantage is relatively low initial cost; about \$30K per 100 KVA. But the motor generator itself disrupts the power supply when switching on or off, so everything had better be powered by the generator.

A similar system uses a motor connected to a generator via an eddy current coupling. The motor spins faster than the generator and the coupling decreases the slippage if the motor speed drops. It provides protection for less than 30 second lapses, but is expensive to maintain, and costs about \$60-80K for 100 KVA.

The most reliable variety of UPS is a "static" system; no moving parts and all solid-state components. The system draws regular AC from the utility, then passes it through a rectifier into batteries, and then through an inverter for AC output. It is very flexible in that a variety of voltages may be output; an automatic bypass may be used to cut in the system when needed; and it is easily made redundant. The batteries will last only about two hours, however. But maintenance is low and output quality is high. It's expensive, of course; a 100 KVA system with 15-minute battery is about \$120K.

Vendors and users

Vendors of UPS equipment include GE, Westinghouse, Borg-Warner, Inet, Exide, Avtel, Solid State Controls, Garret, and Lear-Jet. Users of UPS include: IBM, White Plains; American Airlines, Sabre Center; the TWA System Center in New Jersey; FAA, Jacksonville; Jet Propulsion Laboratory; Eastern Airlines; First National City Bank; and Merrill Lynch.

And, in Fun City, the Consolidated Edison Computer Center is investigating UPS. (See Sept. 1, p. 18.)

— Barry Nelson

The Case for Cassettes, Standards, and Nonstandards

It's about 4 inches by 2½ inches and filled with 300 feet of .5-mil ¼-inch magnetic tape. Those are the basic specifications of the Phillips cassette, the subject of a computer industry debate somewhat disproportionate to its size. But possibly not out of proportion to its potential market.

One guesstimate of this market puts it currently at \$5 or \$6 million in tape, drives, and systems. Another is \$20 million, including devices that contain cassette systems.

Drive manufacturers project an annual market of 100,000 units in two years and around 250,000 by 1975, but this year of tight money could slow growth. One claims the potential is huge, supporting this with "it must be pretty big, since IBM is protesting so much."

IBM isn't so much protesting; rather it's protecting itself by introducing its own cassette system. But others are. The first criticism is that the equipment hasn't the reliability or use life for the digital environment. This arises from its evolving out of audio recording technology.

It is two years since the cassette and cassette drives for digital recording made their debut. Since then manufacturers have produced second- and even third-generation units, each having less in common with the audio equipment. Just about every manufacturer has completely redesigned its product for digital recording, often keeping the cassette dimensions as the only common link.

Varying philosophies

Exactly what they've done, though, depends on whether they are after the low end of the market or the top. The former seeks the broad business providing data capture devices for business machines. The latter is interested in the higher priced business with manufacturers of on-line terminals and minicomputer peripherals. The price spread is between \$500 and \$1500 for single units and \$250 and \$500 for 1000-unit quantities.

International Computer Products, Dallas, manufactures a \$285 (in quantities of 1000) spindle drive with variable speed and two-channel selection.

R.N. Miller, vp, engineering, says the company's philosophy is tape handling over ruggedness. Heavying up the drive, he feels, is going counter to the market direction, which is toward lower prices and less critical use. Precise tape guidance, good motion control, and maintenance of tape tension, he said, matter more than weight or price.

Sycor and Ampex both have rugged units and both stress "dimensional stability." To Sam Irwin of Sycor, this is the prime physical factor affecting interchangeability of cassettes, and it is maintained by the strength of the deck — not, as he feels many people wrongly believe, by the cassette.

Company philosophy differs. Irwin has opted for the spindle drive and smaller deck dimensions — only a 3½ x 7-inch surface. He wants to produce "an economic medium-priced unit with the highest possible performance," to use in his company's programmable terminals and for OEM's to use with adding machines and similar office equipment. The current Sycor product has the \$500 quantity price.

Ampex, which announced its TMC cassette drive and companion cassette this spring, is aiming directly at computer peripheral use. Ed Kinney, Ampex's cassette man, feels the TMC matches regular ½-inch tape units in performance and reliability except for its 9600 bps transfer speed. Ball bearings in both the twin-capstan drive and the cassettes provide tighter tolerance, but the cassettes sometimes won't work on less exact drives.

Phillips has developed a drive similar to the Ampex unit, and a cassette, both scheduled for announcement in the U.S. this fall. Digitronics Corp., a North American Phillips subsidiary, will market the drive.

The standards effort

All the manufacturers emphasize interchangeability and the fact that reliability is also influenced by the tape and coding format. These points have been discussed by an ECMA standards group for the past year and will be topics for a similar BEMA group

which starts work this month.

The standards committees are expected to specify the magnetic properties of the tape, the cassette dimensions, and data encoding formats. The ECMA group has been working off a Phillips proposal. The initial U.S. proposal will be quite similar. Among those interested in the standards there is close agreement on the first two points, while there are three and possibly four competing encoding techniques: the Manchester and Harvard phase encoding techniques and two-track complimentary recording. The possible fourth is Bit Mark Sequence (BMS), a development of ICP. It is a two-channel technique that shares the self-generating clocking feature of phase encoding and also allows interchangeability of tape without regard to recording density or differences in recording and playback speeds.

The standards group will also have to consider alternate cassette standards because of a proposal IBM made in July. It described a twin reel, ¼-inch, 4-track, 340-foot tape pack with a packing density of 1600 bpi, twice the present maximum for Phillips cassettes, and transport speed of 50 ips. Maximum cassette transport speed is 120 ips. The IBM pack is written and read a single track at a time and is not flipped.

Though there is some talk of a paper machine and a deterrent to keep potential buyers from committing to one tape pack, manufacturers claim IBM has been working on the system a couple of years and has it running. They are taking it calmly. It won't touch their market because it is a higher priced device, said one. Another said it only means that everyone outside of IBM will need another piece of equipment if they want compatibility with its pack. He added that the standards group has made no statements against alternate cassettes. BASF in Germany also has a ¼-inch pack, and Teletype has a ½-inch pack.

The people who have opted for the Phillips dimensions feel that market acceptance and present and potential manufacturing economy give them the edge. Bit for bit at current prices it is not cheaper than punched cards or regular tape, but it is much easier for the novice or anyone else to handle.

— John Wessler

Some history, advantages and disadvantages of the new language to help judge where it will go from here

Whither APL?

by Daniel D. McCracken

T It's definitely here to stay, but will APL really make the big time?

Implementations exist for machines of at least half a dozen manufacturers. APL is an IBM program product, and the indications are that Burroughs and XDS will announce program products by the end of the year. Something like 10 books will be in print by the end of the year, explaining the language from various viewpoints. Maybe half a dozen time-sharing companies around the country offer APL services. There is a full-scale APL Project in SHARE, something akin to a user's organization in process of formation; and people are starting to worry seriously about standardization.

Experts can be found to tell you that APL is the greatest language ever devised, for doing everything from sentence parsing to sort-merges. Other experts will tell you that there is no principle of good language design that APL does not violate. Everything normal, in other words.

Where things go from here depends heavily on actions that must be taken in the next year or so, especially on the matter of extensions to the language.

It might be helpful, in trying to get a perspective on the events of the months to come, to sketch a bit of history. And although this article is not a tutorial, it might be useful to try to compile a tentative list of advantages and disadvantages.

The name "APL" comes from *A Programming Language*, the title of a 1962 Wiley book by Kenneth E.

Iverson, who had devised the language while teaching at Harvard. Iverson says that he was motivated initially by the need for a clear and concise way to describe algorithms, whether or not computer execution was a factor. In fact, one of the landmarks in APL history was an article in 1964 in the *IBM Systems Journal* in which the operation of the System/360 central computer was described in APL. No implementation existed at the time; that wasn't the point.

Iverson went to IBM in 1960, where he was joined by Adin D. Falkoff. The two have worked together closely since then. In 1966 an experimental time-sharing system was implemented at IBM Research by a group in which Larry Breed, now with Scientific Time Sharing Corp., played a prominent role. The system was widely demonstrated. A set of videotapes produced during this period by Allen Rose, also now of Scientific Time Sharing, is still in wide use. Early outside encouragement came from NASA-Goddard, in the person of Cyrus J. Creveling, who has consistently pushed IBM to make APL more widely available.

The first system outside IBM was at the University of Alberta, followed by a commercial time-sharing service from Marquardt and a major program at Syracuse University. The sparkplug for APL at Syracuse was Prof. Garth Foster, who isn't even in the computer department but is strongly interested in computers and in APL especially. Foster became involved in the SHARE APL activity, which has by now become a Project, with Foster as chairman. As one

Whither APL? . . .

indication of the level of interest, an APL demonstration by Ken Iverson at the SHARE meeting in Denver in March of this year reportedly drew 500 attendees.

About a year ago Foster issued an APL Newsletter, initially as a SHARE activity. The word got around that there was an "APL User's Group," which wasn't quite true but which led to a lot of inquiries. It also led to several meetings of interested parties, most recently a June meeting at Goddard Space Flight Center hosted by Cy Creveling. Some 150 people got together to discuss extensions, argue about standardization, and lay plans for a formal organization.

One important outcome of the meeting was a "founders committee" that is chartered to draw up bylaws, etc., for a new organization. The five members include Garth Foster, William Berquist of IBM's APL marketing group, Ted Edwards of the University of Alberta, Alan McEwan of Lakehead University, Ontario, and John Rose of Agoronomic Teleprocessing Systems, a Miami-based APL time-sharing firm. At the time of writing (July) it was not definite when the next meeting of the group would be held, but the target was early fall. It was also not definite whether the founders committee would recommend moving in the direction of requesting formation of an ACM Special Interest Committee or going independent.

(The situation is a bit unusual: there has apparently never before been a "user's group" for a language.)

The users

Don't get the idea that the users are only going to meetings. They are also busy using computers, especially, for the moment, in education.

Syracuse has a 360 Model 50 with 72 terminals, running APL in the foreground for student use 12 hours a day, five days a week. The University of Massachusetts has a CDC 3600 with about 50 terminals including Teletypes; Prof. Conrad Wogrin reports an "alarming" increase in computer utilization when the introduction of APL made computer work so much easier. Prof. Patrick Haggarty has been in charge of putting APL on the Univac 1108 at the University of Maryland. This implementation will be available through the Univac user's group, perhaps by the end of the year. (Haggarty says: "Anybody who actually uses APL becomes a fanatic for it. The detractors generally are people who have not used it themselves.") Implementations have been done for the Burroughs B5500 at the University of Washington, and for the xds Sigma 7 at Montana State University and at the Canadian Defense Research Establishment. IBM implementations are available for the System/360, Model 40 and up, and for the 1130 and 1050.

One of the Model 50s is in the Atlanta public school system, which runs APL through the school day with various financial and student accounting in the background. Thomas McConnell, Atlanta director of information processing systems, reports that they have 14 terminals scattered around the junior and senior high schools. High-school students are introduced to computing with a five-hour APL course, after which the ones with special interests are given guidance in doing their thing. One eighth-grader wrote a tutorial program for teaching German, and another rewrote the IBM King of Sumer economics

game. (It is reliably reported that McConnell has a Teletype Model 37 with an APL character matrix, which proves that *that* can be done.)

The manufacturers

APL started out in IBM, of course, since that's where Iverson and Falkoff are. IBM had the first, and for years the only, implementation. Yet, in the opinion of many observers, they have been puzzlingly slow to get behind it in a big way. Prior to unbundling (June, 1969), APL was released but certainly was not pushed hard. In September, 1969, it was made available as a "controlled release," which is still its status, which means that it is provided on an as-is basis, without guarantee since no claim of full testing is made. The impression is unavoidable that IBM was pushed into this action by the beating of customers on the door.

No one seems to know exactly why IBM should have had to be dragged kicking and screaming into a money-making deal. The most plausible guess seems to be that supporting a new language is a pretty expensive commitment, and they wanted to be sure that the demand was for real.

At any rate, the message seems to have been received. It was announced June 30 that, beginning the end of this year, IBM would support APL on the same basis as any other major program product. ("Class A Maintenance," for those who follow the IBM terminology.) A number of valuable language extensions were announced at the same time. (For APLers: encode and decode will apply to arrays; catenation of arrays will be allowed; a single operator for matrix inversion will be provided.) IBM will provide machine-readable source code so users can modify the implementation if they wish, and a complete program logic manual will be available. Just like FORTRAN, so to speak.

One is always tempted to make the automatic identification of APL with IBM, but it isn't so. No other manufacturer has made a formal announcement as yet, but Burroughs publicly admits the existence of an APL implementation group under James Ryan at Paoli, and one doesn't have to be a logical genius to suspect that an announcement might follow. All the indications are that xds will announce something, maybe this fall. CDC has not announced anything, but the widely nonannounced STAR computer (STRING ARRAY processor), which exists although it has not been announced, is said to implement something like 70% of the central features of APL.

A number of the APL time-sharing concerns are to be included among the implementers, since most of them offer various extensions and special-purpose packages. This was particularly evident at the Goddard meeting. Larry Breed and Al Rose of Scientific Time Sharing described and demonstrated their APL file system, which permits several users to share files and which has most of the capabilities of a bulk input and output system. (Eric Iverson, Ken Iverson's son, participated in the file system through his work with I. P. Sharp, the Canadian affiliate of Scientific Time Sharing.) John Rose of Agoronomic Teleprocessing Systems and Jerry Enfield of The Computer Company both made presentations on APL file systems and provided user's manuals.

So what is all the shouting about? The following list may not be complete, and I can't claim that it is

"totally objective," whatever that might mean, since I freely admit that I think APL is pretty exciting. But maybe it will give some indication of what is going on.

Advantages of APL

1. It is easy to get started. A beginner can learn a little bit of the language and immediately start using it, thus reinforcing his learning and, perhaps, even getting useful work done. What he doesn't know won't hurt him, which is a statement that can't be made for every language.

2. The error messages are meaningful, for the most part. There is none of this business of being told "ABEND-CZC0111-DCB ALREADY OPENED FOR ANOTHER MEMBER" (that's a quote from another system), when the problem has to do with the name chosen for a subroutine.

3. Response time is excellent, at least on the implementations that I've used (one at Scientific Time Sharing and two at IBM). Users who become accustomed to the quick reaction of APL tend to become unstable when subjected to the excruciating delays in doing simple things that one experiences with something like, say, tss.

4. The handling of vectors, matrices, and other arrays is especially simple and powerful. All ordinary operations on scalars (single numbers), such as arithmetic, taking a maximum, computing a factorial, etc., extend to arrays with no change in notation. You write $A+B$; if A and B are scalars, you get a scalar result, but if A and B are 3 by 41 matrices, you get the element-by-element sum of the two. Subscript expressions can contain subscripted variables, of course, as well as any of the APL operations. Sorting the elements of a vector into ascending sequence, for instance, is a matter of writing the "grade up" operator within a subscript expression. This can be done as an incidental part of a statement having some other primary purpose.

5. There are operators of remarkable power and flexibility, the likes of which are not to be found in other languages. Number-base conversion, with mixed bases if needed, is a single operation. The rows or columns of a matrix can be rotated by varying amounts in one operation. A vector containing the element numbers of all the blanks in an arbitrary length string can be produced in an easy-to-understand way in a part of one statement, using a combination of four simple operators. The first or last N characters of a string can be obtained in one operation, where N is a run-time variable. There are several fairly obvious ways to generate the identity matrix of order N in one statement. A one-statement program can be written to remove all the commas from an arbitrary length string, closing up the space where the commas were.

It can be argued, and is, whether the ability to write vastly condensed programs in APL is all to the good. And in fact sometimes it isn't. I'm thinking of a classic four-line matrix inversion program. It is a beautiful illustration of the action of quite a number of advanced APL operators, and for all I know it makes efficient use of the machine—but it took me *four hours* to figure out how it worked. This kind of thing can be very damaging when demonstrating APL

to skeptical programmers who know other languages.

But programs don't have to be written that way, especially when intended for teaching. Perhaps it would be fair to suggest that the very power of APL does make it uncommonly easy to make "mistakes" in the sense of overly clever programs, but that this is not inherently a fault of APL.

6. There are no precedence rules for operators. In the absence of parentheses everything is interpreted from right to left, and that is that. So $2 \times 3 + 4$ means 2 times the sum of 3 and 4. Naturally, some people would move this item to the "disadvantages" section. This is partly a matter of taste, for which there is no accounting. Probably most people's reaction, on first exposure to something like $2 \times 3 + 4$, is that it is "unnatural." But then, when you look at the operator precedence list for, say, PL/I, where there are nine different levels to keep straight, you begin to wonder just how "natural" the whole thing is. At any event, it's something you have to get used to if you are going to use APL. I can testify that one does become accustomed to it fairly readily; I now have trouble with FORTRAN!

7. There are no data declarations, with the one exception of the designation of variables to be local to a function. There are only two data types, numeric and character, and things like array sizes and shapes are dynamically changeable at execution time anyway. In a language that was designed for interactive use, it is a distinct advantage not to have to paw through 18 feet of paper on the floor in back of the terminal to find out how you described a variable about which you are now getting an error message.

8. APL hangs together well. It was invented in the first place by one Ken Iverson and for years was under the exclusive control of Ken and a band of devoted disciples. The original design was remarkably "tight," that is, self-consistent and economical, and later extensions were subjected to rigorous examination before being included. APL exhibits all the advantages of *not* having been designed by a committee, like some others I could mention. Whether this advantage can be maintained is another question, of course, and is considered below.

Disadvantages of APL

Nothing can be all good. What are the problems with APL?

1. Present implementations are all interpreters, and to a degree perhaps that is inevitable. This can mean, especially in certain kinds of number-crunching, a large penalty in cpu time. (This depends very strongly on the implementation. There is a serious danger of misjudging "APL" when what you are really looking at is the particular implementation.)

This objection is pretty fuzzy when you try to pin it down. Any language that permits dynamic array structures, run-time formats, or recursive functions has to delay some operations to run time. By that test, virtually all FORTRAN "compilers" are to some extent interpreters.

Anyway, to paraphrase the Winston commercial, what do you want? Fast programming or fast execution? What matters, usually, is some combination of the two. In certain circumstances one or the other may completely dominate. If you have a complicated

Whither APL? . . .

expression-parsing algorithm to check out and the choice is between COBOL and APL, you better use APL. If you have a linear programming problem with 400 inequalities and 800 constraints, you probably better not use APL, or at least not any implementation currently available. It may very well be that some day there will be many computers around where the machine language is essentially APL, but it isn't so today.

2. APL programs can be terribly hard to read. An APL nut, if you will pardon the expression, can readily put together a statement containing literally dozens of operators, most of which have run-time arguments, and very possibly with both input and output combined with everything else in the one statement. The result can be an interlocking Chinese puzzle that is for all practical purposes "opaque," being intelligible only after a long terminal session with sample data. Although possibly sometimes defensible, this kind of programming is ordinarily a mistake in any language. As noted above, APL is at fault only to the degree that its great power and flexibility permits this kind of thing. APL doesn't *force* this kind of fiendishly clever programming; it just makes it easier to do.

3. There is no static block structure. A program cannot be defined to *be* a part of another program—although one program can *call* another program. APL defenders will say that in an interactive language this is an advantage, and that APL was deliberately designed that way. In other contexts it certainly appears to be a disadvantage, since the nesting of program blocks is a standard way to minimize the size of programs and to make them easier to understand. As a corollary of this limitation, it is not possible to transfer from within one procedure to an arbitrary location in another procedure; the only thing that can be done is to execute the normal return to the spot where the procedure was called. This can be decidedly awkward in some cases.

4. In the language as presently defined, there is no generalized way to operate on a program as data, as for instance by using an edit program to create and modify programs. (There is a very powerful mechanism for editing one statement at a time, *in the interactive mode*. What I am talking about here is operation on a program *by another program*.)

5. Some one or more new string operators are clearly needed. As the language now stands, for instance, a vector cannot consist of other vectors—with the one very restrictive exception that a matrix can sometimes be used in this way. *Some* kinds of operations on character text *are* very powerful and convenient. I have used APL, for example, to create camera copy of the index for the second edition of my COBOL book, written with Umberto Garbassi of Esso Standard Libya, where an edit package was used to produce input to a little program of mine that turned out a three-column index with lines at most 27 characters long and the "turnovers" indented three spaces, etc. But generalized string operations, a la SNOBOL or LISP, are not directly available and are somewhat awkward to simulate.

6. Bulk input and output is not available in the basic language as promulgated by IBM at this time. (It is available in the extended versions from several of the time-sharing houses, however, and reportedly will be available from Burroughs.) APL implementa-

tions started out as *terminal* systems, and largely still are.

7. A special character set with 88 characters is used, and some of the characters are like nothing else in the world. Most of the symbols are more or less familiar, but something like a dozen of them have meanings that are essentially unique to APL. Several have shapes that are remarkably similar to letters or digits, when written by hand. On the APL typeball they are perfectly distinguishable and, indeed, many kind things can be said about the design of the APL type font. But for work at a blackboard it is a bit rough.

Implementations with terminals not based on the IBM Selectric typewriter obviously have some problems with APL. For the Teletype Model 33, for instance, this means two-character transliterations since there are too few characters available and since physical backspacing is not possible. (Quite a number of APL operators are formed by overstriking two characters.) The Teletype Model 37 does permit backspacing, but so far the APL character matrix for it has not been made widely available.

Extensions?

When the plus items and the minus items are added up, it is clear that enough people think APL is a good thing to guarantee its acceptance at some level. There may well be those who think it's a disaster and some who are bored by it. But there are enough enthusiasts to keep the pot boiling for a good while yet. So what might we look for next?

Probably the biggest question mark at the moment is the matter of extensions to the language. Just about everyone agrees that if APL is to move out of the interesting sidelight category it will have to be extended to include things like bulk I/O, program editing, file storage, string operators, and interchangeability of programs. I haven't heard of anyone who is opposed in principle to the idea of such extensions, and IBM, for instance, has established a language design and extension control section in Philadelphia specifically to deal with such matters.

The problem is that there are dangers in the process. They are not unique with APL; the same things come up with any language at some point in its history. There are twin dangers:

If the extension process is too tightly controlled, potential users will drift away because what they wanted to do was only possible if the language were extended. Such people were present en masse at the Goddard meeting in June. But the danger on the other extreme is that of uncontrolled growth, which could lead to a cancerous mass of incompatible special packages, each with its adherents, none of whom could communicate with any other.

An instructive historical parallel is provided by ALGOL in about 1963. At that time there were enough ALGOL enthusiasts around to guarantee a lively time and, indeed, ALGOL is still with us. There were also at that time users eager to use the language for everyday sorts of computing, but who needed extensions, and needed them to be standardized; this was especially true of input and output. Unfortunately for ALGOL, no effective mechanism was worked out for controlled extensions, and the language atrophied, in terms of its

degree of acceptance for what might be called "practical" work.

Will the same thing happen to APL? It is hard to tell, but it is clear that the battle lines are being drawn up. Those who might be called the "conservatives" place highest priority on preserving the advantages the language already has; those who might be designated the "liberals" concentrate on adding features to compensate for what they regard as the weaknesses in an otherwise good system.

Just as in politics, the liberals and the conservatives are both right, in the sense that taken in isolation their basic assumptions are both defensible. It is true that there are good features in APL that could be lost by uncontrolled extensions. It is true that there are omissions and perhaps flaws that need to be corrected. The question is, just as in politics, where is the best balance between the two, considering that to some extent they are in conflict?

In all fairness to both sides, it should be said that *anybody* who enthusiastically supports something as different as APL probably ought to be called a "radical." When I say "liberal" and "conservative," I am thinking solely of the question of how to manage extensions.

And I think both sides of the debate would probably agree, in broad outline at least, to this description. Iverson and Falkoff would not object to being called conservatives in this context, I think, since they are deeply concerned with controlling the extension process in such a way that the existing strengths are not lost. Yet they are heavily involved in the IBM extension work. Jim Ryan of Burroughs would have to

be designated a liberal, since he is working night and day on things like features for conditional execution of statements, static block structure, and what he describes as the unification of the three APL modes of command language, function definition, and statement execution into one single mode. Yet he goes out of his way to say that he has no quarrel with the great bulk of APL, and only wants to make a good system even better. He readily agrees that poorly-controlled or poorly-thought-out extensions could damage APL.

Time will tell. The issue will have to be one of the most pressing problems for the new organization that should be on the verge of formation by the time this appears in print. It should be an interesting year. ■



Mr. McCracken is a consultant on programmer education and the author of 10 books introducing programming to beginners. In 1966 he entered Union Theological Seminary, intending to become a minister. He received his bachelor of divinity degree in May but has decided to return to computing. He is a Data-mation contributing editor.

A New Constrained Art Form THE HEXADECIMAL CORE DUMP



Even in our current uninhibited era, the constrained art form continues to engender a certain perverse fascination. The computer field is not immune to this mania, as witness the numerous computer printouts fashioned in the form of the Mona Lisa, JFK, or the Playmate of the Month. Here we present a similar but heretofore unobserved form: the Hexadecimal Core Dump.

This form is based on the fact that a base-16 core dump includes the letters A, B, C, D, E, and F, and thus has some probability of forming words.

At least two subclasses exist. The strict form employs only the letters themselves, as in the example below (with punctuation added):

ABE, ABED, FACED DEEDEE, BEADED BABE.
—BAD FEED—BEEFED ABE.
—A BAD CAFE, DAD—CEDED DEEDEE.
—BEEF A DECADE DEAD—ADDED ABE.
—A BAD DEED, ACE—ACCEDED DEEDEE.
—BE FAB, BABE—BADE ABE.

ABE FADED, EBBED.
DEEDEE DABBED FACE.
ABE DECEDED . . .
A FACADE EFFACED.

Several practitioners prefer the free form, which allows a broader range of expression by sacrificing the purity of the strict form. In the free form, 0 and 1 are allowed to act as O and I, and other numbers are allowed to be sounded out, as in the following example:

ABIDE, 1 BID
0 ACID-AIDED 1D
A FIEF OF F8
1 DICE B4 DEB8

Results of a recent survey indicate that enthusiasm for creating this sort of art form reaches its maximum in programmers who have stared at a hexadecimal core dump for about an hour, without its providing a clue to the program bug they are looking for.

—Herman Hollywreath

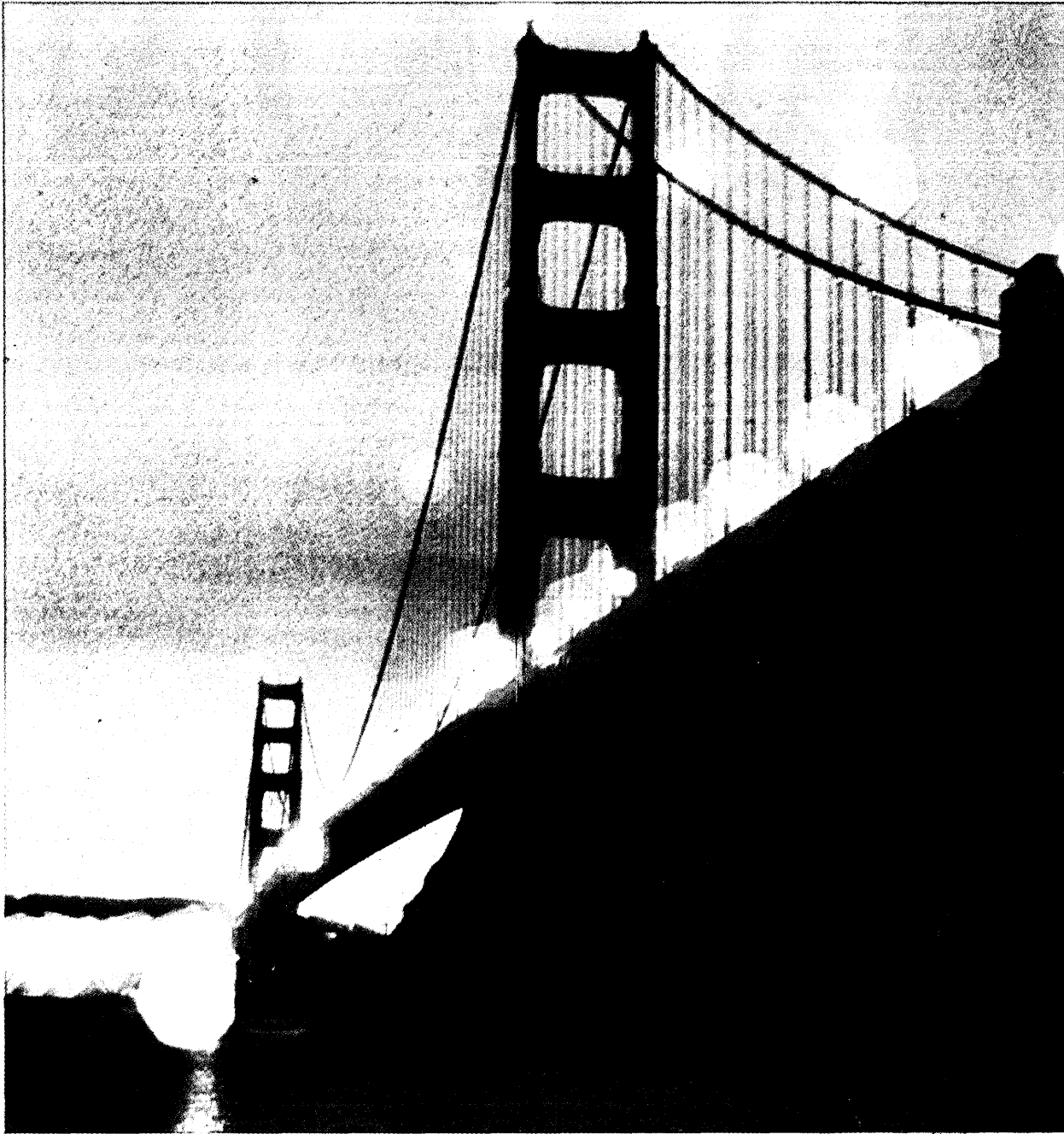

Strong, Unique and Outstanding

AMI is strong, unique and outstanding in MOS — Metal Oxide Semiconductor technology — the “new” technology that is producing startling results for our customers in profitable new products such as calculators, computers, peripherals and other electronic items. Our strength and unique MOS

expertise can also be put to work for you — to strengthen your company’s product line. If your company manufactures anything with electronic parts, hop a jet and visit our Santa Clara headquarters to see for yourself what we are doing with microscopic chips of silicon. Afterwards, you could visit the

Golden Gate Bridge in nearby San Francisco.

American Micro-systems, Inc.
3800 Homestead Road, Santa Clara,
Calif. 95051 Phone: (408) 246-0330



THE LEADING
MOS COMPANY,
WITH FACILITIES IN
CALIFORNIA, MEXICO,
IDAHO & KOREA

Models can be helpful in MIS optimization decisions - but not all problems allow their use

Part 2

Decision Models

by James C. Emery

M ANALYTICAL DECISION MODELS and the general requirements for optimization were discussed in Part 1 of this two-part article. Part 2 deals with the necessary compromises between reality and feasibility, sensitivity studies, simulation models, sources of data, and the role of the human decision maker.

The model as a compromise

The requirements for an optimizing model are obviously very stringent. In fact, they can never be met completely. The real world is far too complex to be described faithfully with a series of equations; our objectives are far too ill-defined and diffuse to be captured precisely in the form of an explicit objective function; and the resulting model, even if it could be constructed, would present insuperable computational difficulty. It is therefore necessary to develop models that only approximate the real world in order to make them mathematically and computationally feasible. The real art in model making lies in the analyst's ability to find the simplest model that nevertheless captures the essence of the problem at hand.

There are numerous ways in which a model can be simplified. One way is to ignore the uncertainty that surrounds the estimate of a parameter by simply using a single fixed value. Another way is to use a relatively simple mathematical relationship in place of the much more complex relationship that may actually exist. Linear relationships are particularly popular because of the great computational efficiency of linear programming procedures. The world is not really linear, but frequently it is nearly enough linear within a restricted range of the decision variables that one is willing to give up some accuracy in order to gain substantial computational efficiency.

The scope and detail of a model govern the number of variables included in the mathematical representation. This in turn affects the complexity and computational requirements of the model. In order to make the model manageable one must normally deal (more or less independently) with small fragments of the total problem. It is also usually necessary to compress

detail by dealing largely with aggregate variables.

Consider, for example, the case of scheduling the production within a multiplant firm. If significant interactions exist among the plants—if they supply one another with material, say, or if they share common resources or markets—then there may be substantial benefits from some degree of centralized scheduling. A detailed corporate model, in which each product at each plant is scheduled individually, would normally not be practical; instead, one would have to break the problem down and develop separate plant—or, more likely subplant—models that are suboptimized independently.

In order to partially *integrate* the separate models, it may be possible to develop an aggregate corporate model that sets constraints or adjusts the objective functions of the lower-level models. The process can even be repeated (or *iterated*) as a means of converging toward the corporate-wide optimum schedule. Hierarchies of linked models of this sort are not very common, but there is considerable current interests in extending their use. Their attractiveness lies in their ability to converge toward a global optimum through a series of independent (and hence simplified) sub-optimized models.

Use of heuristics

It is often possible to introduce nonoptimal simplifying procedures to reduce complexity and computational time. For example, in a multiwarehouse inventory model it may be very difficult to optimize the total distribution of items among all warehouses. A complete optimization would have to take account of such detailed matters as the relative cost of shipment by full versus less-than-truckload quantities.

Rather than considering this issue during the optimization calculation, it may be legitimate to use the LTL rates in a distribution model, and then to round up to a full truckload if a shipment approaches that quantity. One might, for instance, use the rule "When W (the fraction of a full truckload represented by a given shipment) exceeds .7, adjust all individual quantities of the items comprising the shipment by the factor $1/W$." Such a rule will certainly not result

in an optimum distribution, but it may be good enough to justify the very great simplification that this brings about.

Many large models find it convenient to use "common sense" rules, or heuristics, of this type. (A model builder may be a heuristic programmer without knowing it—much like the man who discovered at age 60 that he had been speaking prose all his life.) Indeed, for certain models for which a computationally feasible optimizing procedure is not available, the entire computational process may be based on such heuristics. This has been done, for example, in warehouse location and truck scheduling problems. The test of a heuristic procedure is not whether it yields optimal solutions—it does not—but whether it provides decisions that are superior to the best alternative approach.

Man-machine decision systems

There exists a wide class of problems that cannot be formalized to the extent required to develop optimizing models or even explicit heuristic procedures. The preparation of annual operating budgets, for example, entails so many subjective judgments that its complete formalization is out of the question. On the other hand, budgeting deals with large masses of quantitative data that can easily swamp a human decision maker. The objective in the design of a *man-machine* decision system is to draw upon the best capabilities of both man and computer in dealing with problems too ill-defined and complex to be handled well by either partner alone.

Man in such a system normally has the task of conceiving of alternatives (for which he employs his own informal heuristics). The computer then predicts the consequences of each proposed alternative. It does this on the basis of a model.¹ For example, a planner may propose a budget that calls for an increase in marketing expenditures that he expects will result in, say, a 10% increase in sales. A model can be developed that considers such things as existing machine and labor capacity, current inventories, and various relationships among production volume and cost. On the basis of this model the consequences of the proposed budget can then be calculated in terms of cash flow requirements, additional labor requirements, changes in production costs, a projected income statement, and similar measures.

With such a system, the decision maker can exercise his judgment in assessing the relative merits of different alternatives. The models may not relieve him from the difficult task of making (implicit) trade-offs among goals (risk versus expected payoff, for example), but it at least provides him with predicted consequences that would otherwise be extremely difficult for him to estimate.

If the predicted consequences are unsuitable in some way (e.g., cash requirements exceed safe borrowing limits), he can revise the plan (e.g., lower mar-

keting expenditure) in a way that he hopes will result in improved predicted consequences. The search for an improved plan can continue until the decision maker believes that further search will not yield sufficient benefits to justify its cost. To the extent that the decision maker is correct in this judgment, the plan obtained by the man-machine process can be viewed as the optimum that recognizes the cost of the decision process itself.

The effectiveness of a man-machine process is usually enhanced if it is implemented in a quick-response on-line system. The most obvious advantage is that it permits many more alternatives to be explored; it may also permit the man to retain a better grasp of the problem between evaluations. However, in the case of a complex model that requires extensive computing or protracted assessment by the man, an on-line system may offer relatively little advantage.

Sensitivity studies

Very often a decision maker is less interested in the "optimum" solution from a model (which of course is only an approximation to the true optimum) than he is in gaining some insight into the effect on the objective function of changes in the model. A *sensitivity study* is aimed at providing a measure of the incremental effect (i.e., the *sensitivity*) of changes in the model.

The simplest type of change is to modify the value of a parameter. For example, one may wish to study the effects of a change in sales forecasts in an inventory model, the probability distribution of arrival times in a queueing model, or the capacity constraints in a scheduling model. In certain types of models sensitivity data of this sort can be obtained as a by-product of the optimization procedure. For example, the calculations used in solving linear programs yield directly the so-called *shadow prices* of the resources allocated by the model. The shadow price of a resource gives the incremental effect of a (small) change in the total amount of the resource available.² If sensitivity data cannot be obtained as a by-product of the optimization calculation, it may be feasible (but clearly more expensive) to introduce a changed parameter value into the model, recalculate the optimum solution, and then compare the two solutions.

More basic, structural changes to a model can also be studied, but with considerably more effort. For example, one may wish to explore the effect on the accuracy of a model of introducing simplifications of the sort discussed earlier. If it turns out, say, that the use of deterministic estimates for processing times in a scheduling model gives essentially the same result as probabilistic estimates, then there is little advantage in using the more elaborate version.

Sensitivity studies are employed in several different ways. For one thing, the construction of the model itself can often be aided by such studies. The model builder may first develop a very simple model, and then proceed to test which of the variables and parameters appear to be most sensitive. He can then

¹ Probably most man-machine models are analytical, but they can also be simulation models (discussed below). Often an analytical model may employ a Monte Carlo technique to draw random samples from a probability distribution of a parameter (e.g., sales, cost of material, etc.) in order to generate a distribution of possible outcomes (e.g., net profit from a new product). This technique should be viewed as a computational method for dealing with compound probability distributions, rather than an example of simulation.

² In the linear programming example in Part 1 it was shown that the incremental profit for additional weavers' time is \$2 per hour; this is therefore the shadow price of weaving. However, a maximum of 3000 hours of weaving can be used because of the limit on spinning; therefore, weaving has a shadow price of zero beyond 3000 hours.

expand and elaborate the more crucial parts of the model. This process can continue in hierarchical fashion until the total model is suitable enough for the purpose at hand.

Sensitivity studies are also very useful in interpreting the results of a model. The model is always imperfect to some degree, and therefore for important decisions it is imperative to impose human judgment on the model's solution.³ Judgment is needed to assess such things as the effect of uncertainty in the parameter estimates and the effect of ignoring in the model certain intangible issues. Sensitivity studies provide valuable aid in such assessments. They can, for example, indicate the risk (i.e., the potential penalty) if sales turn out to be 50% less than planned, or the quantifiable cost of reducing inventory stockout probability from .10 to .05.

Finally, sensitivity data sometimes help in making higher-level decisions that impose constraints on lower-level decisions. For example, the shadow prices from a linear programming model for scheduling a refinery are useful in estimating the payoff from expanding plant capacity or shifting some production to an alternate facility. If the higher-level decision is formalized (in the form of a capital budgeting model or a corporate scheduling model, for example), sensitivity data provide the primary means of linking, or integrating, the hierarchy of models.

Simulation models

The models discussed so far have all been of analytical form in which the objective function and constraints are expressed in a series of equations. With such a model, the consequences of a given alternative can be determined by evaluating the equations using the specified values of the decision variables. In some cases the evaluation is trivial, while in others it may be exceedingly difficult. (The determination of the *optimum* set of decision variables is still another matter, and may or may not be possible.)

In contrast to this, a simulation model does not allow the direct evaluation of the consequences of an alternative. A simulation model duplicates, more or less faithfully, the actual events that occur over time in the real world for a given set of parameters and decision variables. Certain consequences stem from the events that take place during the course of the simulation. The consequences are then presented to a decision maker, usually in highly aggregated form,⁴ to aid him in predicting the consequences of implementing the specified alternative in the real world. Thus, a simulation model is run and the nonsequences are then *measured*, not *evaluated*.

Each event included in a simulator may entail the generation of a "random" variable drawn from a probability distribution provided as part of the parameters of the problem. Examples of random variables include daily demands or replenishment lead times in an inventory model, processing times in a scheduling

model, and time intervals between arrivals in a queuing model.

Simulation models have been used widely. Inventory simulators, for example, are often used to test inventory policies. One might wish to test the consequences of a given order point and order quantity for an item. The events simulated include the arrival of withdrawal demands, the ordering of replenishment stock, and the receipt of stock. [See Fig. 1. The simulator duplicates the events in an inventory sys-

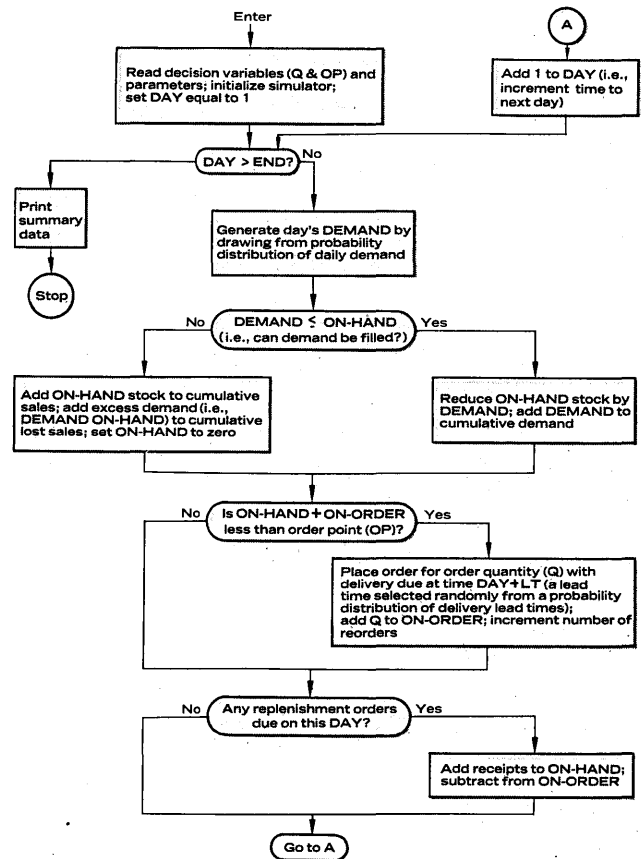
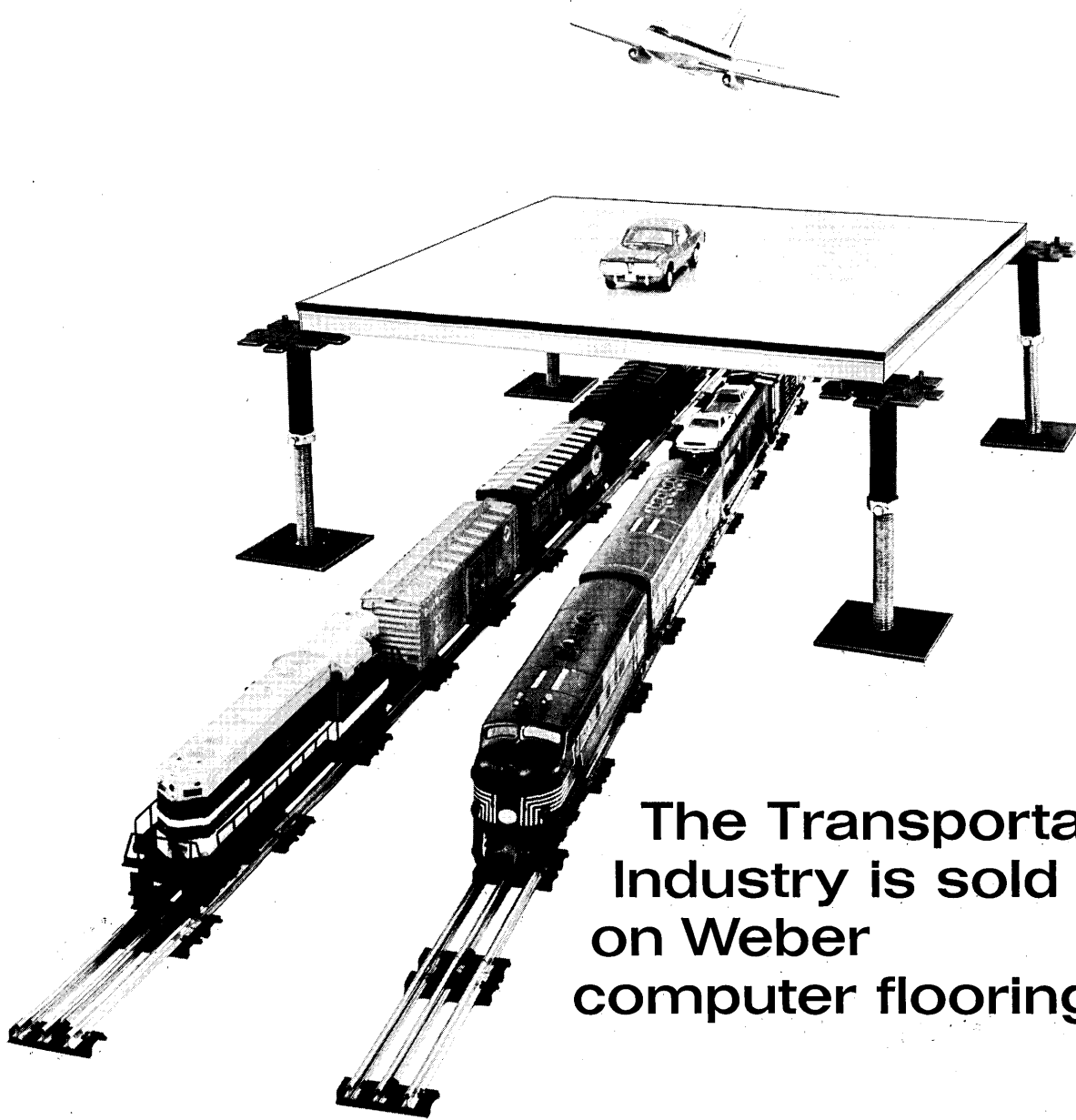

Fig. 1 Logic of an inventory simulator.

tem. At the beginning of the simulation, decision variables Q (order quantity) and OP (order point) are read, along with cost parameters, demand and lead time parameters, and parameters that specify the number of days to be simulated (END). Some of the variables included in the model to keep track of current status (e.g., $ON-HAND$) are shown in capital letters. The model assumes that stock is issued until it is exhausted; after that further demand during a stockout condition is lost forever (i.e., no backorders are allowed). In this simulation time moves in equal increments from one day to the next. Each day's demand is handled in the aggregate, rather than treating separately individual orders that arrive during a day. Results at the end of the simulation are printed; they would include such measures as total cost (per year, say), ordering cost, carrying cost, and number of lost sales due to stockouts.] The consequences measured may include the cost of carrying inventory, cost of replenishing stock, and the number of stockouts. More detailed data, such as the average

³ When the model is used for detailed, relatively unimportant decisions, such as the control of low-valued inventory items, one cannot afford to scrutinize individual decisions; only decisions in the aggregate can normally be given close attention once the model has been implemented.

⁴ As in the real world, one must choose which summary data are worth retaining as the best compressed description of results.



The Transportation Industry is sold on Weber computer flooring.

Figuratively speaking, we've practically floored the transportation field. Weber Computer Flooring is used by all of the Big Four auto makers. And by the world's largest railroad. Of the top seven airlines, United, Pam Am, Eastern, Delta, and Braniff all have it in their computer rooms. And so do Lockheed, North American, Boeing, and Douglas among the aircraft builders. □ Why Weber flooring? Their reasons vary, but they'll interest you if you're installing a new computer facility or expanding an old one. Some liked our product: we build one of the best access flooring systems in the business. Others liked our prices: we aren't always low bidder, but we're usually competitive (when you compare oranges with oranges). And we have the ability to take total job responsibility and deliver on time. But a big reason why these and other companies picked us is our long-term stability as part of Walter Kidde & Company. They know we'll be around when they need add-on's and service in years to come. □ Write for our new Bulletin 205. Weber Technical Products, Division of Walter Kidde & Company, Inc., 1340 Monroe Avenue, NW, Grand Rapids, Mich. 49502.

WEBER TECHNICAL PRODUCTS

DIVISION OF WALTER KIDDE & COMPANY, INC.



Decision Models, Part 2 . . .

customer delay due to stockouts, may also be obtained.

Simulation models have also been widely applied to queueing problems. In choosing the number of checkout counters to provide in a supermarket, for example, one can simulate such events as the arrival of customers at the counter and the servicing of customers by the checkout clerk. Consequences might be measured by the cost of clerks, average wait time, maximum wait time, and the like.

The principal advantage of simulation is that it can cope with problems far too complicated to handle analytically. Analytical models are quite limited in dealing with complex relationships (particularly when probability distributions are involved), while simulation models are not. A simulation model can be developed for virtually any quantifiable problem; the cost of developing and running the model is the only serious limitation.

Simulator versatility

Consider, for example, the versatility of an inventory simulator. It can deal with a variety of inventory schemes, such as an order point-order quantity, min-max, or periodic reorder policy. Demands and delivery lead times can be represented by any type of probability distribution. Complex backordering and expediting rules can be included. In short, any variety that exists in a real-world inventory system can be duplicated (at a cost) in a simulator.

Simulation models, with rare exception, depend utterly on the computational capacity of a computer. They typically involve a large number of variables and deal with a large number—perhaps many thousands—of simulated events in order to gain greater statistical validity in measuring consequences. Dealing with each event may entail considerable complexity, such as the handling of an inventory demand or the determination of job priority in a job shop scheduling model. Clearly, models of this sort are only feasible when implemented on a computer.

The task of developing a simulator involves the identification of the significant events to be simulated and the specification of the logic required to handle each event. The logic is then expressed in some computer language. This is often facilitated by the use of a language specifically designed for simulation problems, such as GPSS or SIMSCRIPT. These languages make it especially easy to program (often, unfortunately, at a considerable penalty in computer efficiency) such tasks as the generation of random variables, keeping track of arrivals and departures from queues, and handling the *clocking* mechanism that controls the advancing of simulated time (either from event to event or in equal time increments).

A simulation model is typically used in the same way as a nonoptimizing analytical model—namely, as a predictor of the consequences of a proposed alternative. The search for the best alternative normally draws on a human decision maker to propose alternatives and evaluate consequences. In some cases, however, it may be possible to develop heuristics for doing this without direct human intervention.

The question often arises in model building whether one should develop an analytical or simula-

tion model. An analytical model is generally to be preferred if a satisfactory one can be found. For one thing, it is often much cheaper to develop and operate than a simulation model. Furthermore, it provides useful insights about relationships among variables, and the computational procedure used to find the optimum (if one exists) often yields valuable sensitivity data. A simulation model, on the other hand, is often *too* life-like: underlying relationships are difficult to perceive in the jumble of simulated events, and random variation introduced to duplicate reality often makes it difficult to distinguish significant effects from mere random noise. And finally, an optimizing analytical model provides a specific decision, while a simulation model normally does not.

Simulation can thus be viewed as a brute force technique that one may resort to in the absence of a feasible analytical approach. The fact is, however, that very often appropriate analytical techniques are *not* available. The development of an analytical model may in many circumstances call for too many compromises with reality. The resulting “optimum” obtained from such a model is only optimum with respect to the alternatives permitted by the model; it

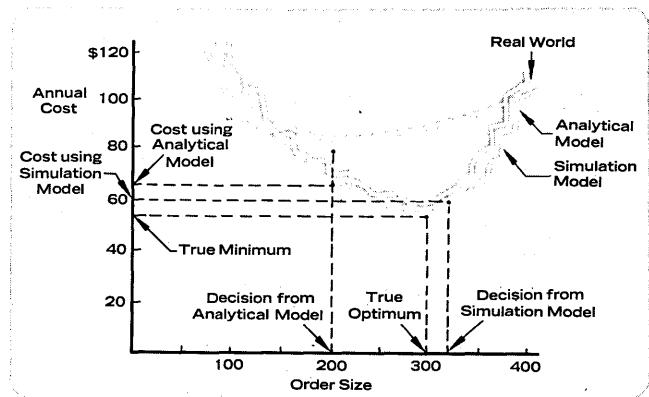

Fig. 2. Results achieved with optimizing versus simulation models for inventory.

may be a long way from the true optimum. A simulation model can be made as realistic as one is willing to pay for. In general it will not be possible to find the optimum solution from such a model, but it may yield a decision that is superior to the one obtained from an unrealistic analytical models. (See Fig. 2.)

Data for decision models

The implementor of a decision model must always face the critical task of obtaining such input parameters as forecasts, processing times, and costs. These data can come from *ad hoc* sources, or they can come from a direct link of the model with an on-going data base that is updated through routine transaction processing.

Ad hoc sources offer the great advantage of simplicity. No formal link need be developed to provide inputs in the precise form required by the model. Instead, the link is made informally by an analyst. The data may be collected specifically to support the model, or they may come originally from the existing data processing system. In any case, the analyst (or

Decision Models, Part 2 . . .

decision maker) performs any manipulation necessary to transform input data into the coding, format, sequence, and content demanded by the model.

Ad hoc data sources are certainly appropriate for one-shot or infrequent decision making. Plant location studies, major new investments, the launching of a new major product, and similar decisions may be adequately served by such sources. But in the case of repetitive decisions, particularly at the tactical level where decisions tend to be made often and demand high volumes of input data, *ad hoc* collection is quite unsatisfactory. The sheer cost of obtaining the data may be overwhelming, and—what is often worse—the possibility of obtaining accurate data may be slight indeed. Many a four-hour linear programming run has had to be repeated, for example, because of incorrect input data.

The real payoff from decision models has often come from embedding the model into the routine processing system. Inputs for such a model mostly come directly from the data base, with automatic transformation of transaction data into the form required by the model. For example, sales data may be transformed into forecasts that are in turn fed to an inventory model. (Parameters that are quite stable, such as standard costs, should normally be obtained from *ad hoc* sources and be updated periodically.) Outputs may be printed directly by the system in the form of such working documents as production schedules or purchase orders (monitored, to be sure, by a human, at least in aggregate form).

Linking decision models to the routine processing system is obviously very difficult. Integration through a common data base, accessed through a data management system, offers some real hope of better coping with the problem of obtaining transaction data to support the model. Perhaps more serious is the problem of automatically transforming the transaction data into the form required by the model. Unadjusted transaction data, such as past sales and actual production times, do not necessarily provide the best predictions for use in a model; they reflect nonstandard random events, abnormal conditions, and an environment that subsequently may have shifted. In order to be used in a model, transaction data should typically be smoothed, normalized, or adjusted to reflect expected future conditions. Achieving this automatically within the information system is not a trivial task.

The human decision maker

An organization faces a whole spectrum of decisions that range all the way from extremely ill-structured ones to those that are susceptible to complete formalization. Although this article has focused on formal models, it should be obvious that for many of the most important decisions these models offer little aid. A problem may be too ill-defined to permit any significant formalization, or it may be handled well enough by informal means that the potential payoff from a complex model may not justify the large cost typically required for its development, implementation, and operation.

In an informal decision process the decision maker chooses an alternative unaided by a formal model. If

the process is at all rational, however, he has an informal "model" that allows him to estimate the consequences of his acts. The model may be highly subjective, biased, and imprecise, but it may also incorporate some exceedingly powerful and effective heuristics for dealing with ill-structured problems. The information system may in this informal case only provide relatively undigested data in such form as sales or financial reports, production reports, and the like.

In the case of man-machine processes, the human receives much more direct aid from the formal information system. The decision process nevertheless relies heavily on human creative ability to discover attractive alternatives for evaluation, to perceive subtle patterns among decision variables and their consequences, and to exercise judgment in assessing the relative merits of alternatives.

As more and more of the decision process is shifted to the model—and especially in the extreme case of an optimizing model that provides decisions that are executed with little direct human intervention—the locus of decision making changes. The decisions more and more come to be made by the model builder. Value judgments, insights about functional relationships, estimates of risk, the generation and assessment of alternatives—all become incorporated in the model.

If these decisions can best be made by technical experts, so be it (but the surrender of these responsibilities by management should at least be made explicit). It is much more likely, however, that the essential policy decisions made in the course of model development can best be made by managers that in the past have been successful in creating their own informal "models." The formal models merely make explicit human insights and experience.

The role of model formulator makes a manager no less a decision maker; in fact, by incorporating his decision *process* in a model he makes a much more fundamental contribution. But to play this role successfully the manager must view the model and the associated information system as a primary means of effecting decisions—which is to say that he must learn to manage through the system. This calls for sophisticated skills and a basic understanding of the systems on which he relies. ■

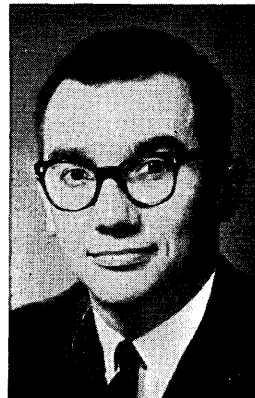

Dr. Emery is presently professor of industry at the Wharton School of Finance and Commerce, University of Pennsylvania. His previous work included systems design at Westinghouse; staff analyst, Office of Secretary of Defense (Comptroller); and consultant in logistics systems and MIS. He has a BS in chemistry from the University of Arkansas, and a SM and PhD in industrial management from MIT.

Think before you speak

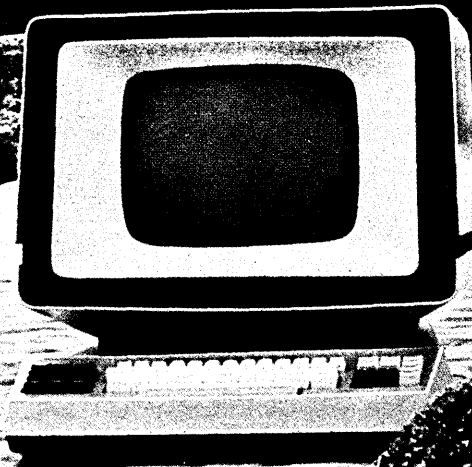

Validate, verify and qualify data . . . before transmission.

Catch errors at their source. Increase the performance and economy of your overall system.

The SPD™ 10/20 contains a small, powerful, parallel byte computer built right into the display. SPD means Stored Program Display – up to 2048 words at 1.6 microseconds cycle time, plus a repertoire of 58 instructions. Just tell it what to do.

Or, for that matter, tell it what to look like. Because of the computer, the SPD 10/20 changes

terminal characteristics as needed. So it stays compatible with central-site changes – even if you haven't thought them up yet.

In effect, the operator can design each terminal in the optimum configuration for its *next* intended use – no matter what business you're in.

And think again before you lease or buy – we can tell you a thing or two there as well.

Check with us for our scheduled demonstrations in your city. Contact M.R. Clement, Jr., *Vice President of Marketing*.

INCOTERM™
CORPORATION

... the international computer terminals people

Hayes Memorial Drive / Marlborough, Massachusetts 01752

Tel: (617) 481-2000

Atlanta, Georgia / (404) 451-2307

New York, N.Y. / (212) 868-7557

How can you determine the software package for your

Look no further!

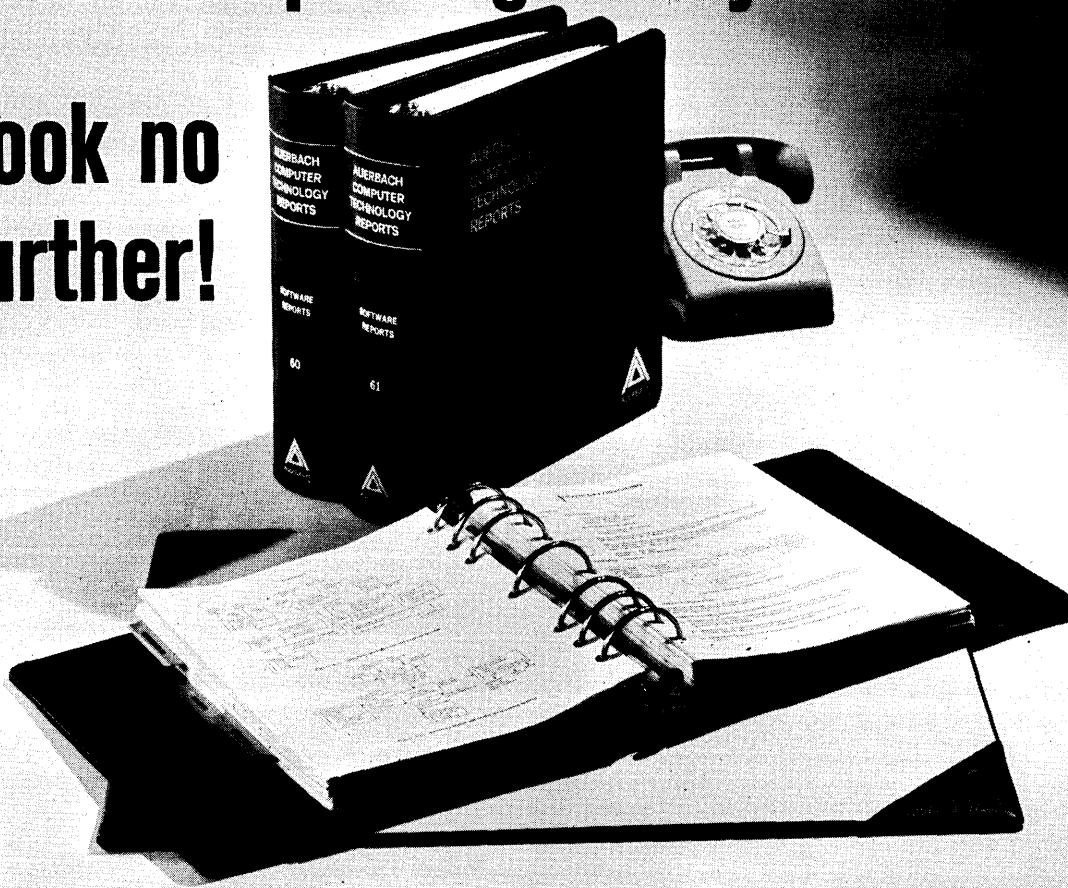

AUERBACH SOFTWARE REPORTS give you the facts you need to decide whether to develop a software system in-house or buy an existing one.

You'll save weeks of frustrating research. And you'll be able to justify your decision in much less time than it takes to make a wrong one.

It enables you to select the right package for your applications from the more than 3,000 proprietary software programs now being offered.

Business . . . Scientific and Engineering . . . Systems Software. Here are the facts you've been looking for, covering more than 20 application areas, such as:

**Inventory Control
Payroll
Accounts Receivable
Accounts Payable
General Ledger**

**Information Retrieval
Flow Charting
File Maintenance
Production Planning
and Control**

Definitional Reports and Comparison Charts show you hardware requirements, operational characteristics, programming languages, sources and availabilities—and the cost for each package!

AUERBACH Software Reports is a brand new loose-leaf reference service. It is up-dated bi-monthly, so you will always have the latest, most accurate information at your fingertips. For further details and sample pages, mail the coupon below.

AUERBACH Info, Inc.
121 N. Broad Street,
Philadelphia, Pennsylvania 19107

Please send me detailed information and sample pages from the new AUERBACH Software Reports.

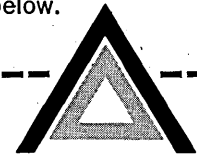

AUERBACH

*First with the last
word on computers*

Name _____ Title _____
(Please Print)

Company _____

Address _____

City _____ State _____ Zip _____

Phone _____

Signature _____

Information and Management consulting services available through AUERBACH Associates, Inc.

CartriFile is a one-in-a-billion kind of tape system

For EDP applications with highest data-reliability requirements, you need a minicomputer magnetic tape system that equals the performance of the big, "IBM-compatible" equipment. Depending on housekeeping and other variables, that means bit error rates between one part in 10^7 and one part in 10^9 .

In our CartriFile, data reliability toward the high end of this range —1 in 10^9 —is built in. It stems from such features as full-thickness, quarter-inch, computer-grade tape, integral electronic error correction, redundant data recording — and a quick-change, file-protected tape cartridge specifically developed for digital data-processing applications.

CartriFiles are made for minicomputer users who need high data retention and want the flexibility of four separate, independently controlled tape transports in one unit, along with 4, 6, 8, and 12-bit words, variable record length, and interfaces for all widely used minicomputers.

If you can use those qualities in your magnetic tape system, get in touch with Tri-Data. On your command, we'll send full details on CartriFile, the high-performance magnetic tape unit for minicomputers.



TRI-DATA

800 Maude Avenue, Mountain View, Ca 94040 (415) 969-3700

CIRCLE 10 ON READER CARD

OUR NETWORK ALLOWS AN UNDERMANNED POLICE FORCE TO PROTECT LARGE POPULATION AREAS. IN SECONDS, ALERT, A NEW COMPUTERIZED TELEPROCESSING SYSTEM, ANSWERS QUERIES ABOUT

SEVERAL FILES, INCLUDING: NAME, VEHICLE LICENSE, WARRANT WANT, VEHICLE IDENTITY NUMBER AND CROSS REFERENCE INDEX FILE. SYSTEM

CAN ALSO INTERFACE WITH FBI'S, WASHINGTON, D.C. NATIONAL CRIME INFORMATION CENTER.

OUR NETWORK LETS POLICE CHECK OUT SUSPICIOUS CARS BY RADIO. OUT-OF-STATE LICENSES ARE CALLED TO HEADQUARTERS AND CHECKED THROUGH THE STATE POLICE COMPUTER SYSTEM. IF NECESSARY, THEY ARE ALSO RUN THROUGH WASHINGTON, D.C.'S SYSTEM. IF A CAR IS STOLEN, COMPUTER TRANSMITS PERTINENT FACTS, VIA TELETYPEWRITER, BACK TO HEADQUARTERS AND THEN TO WAITING PATROL CAR. ALL WITHIN 15 SECONDS!

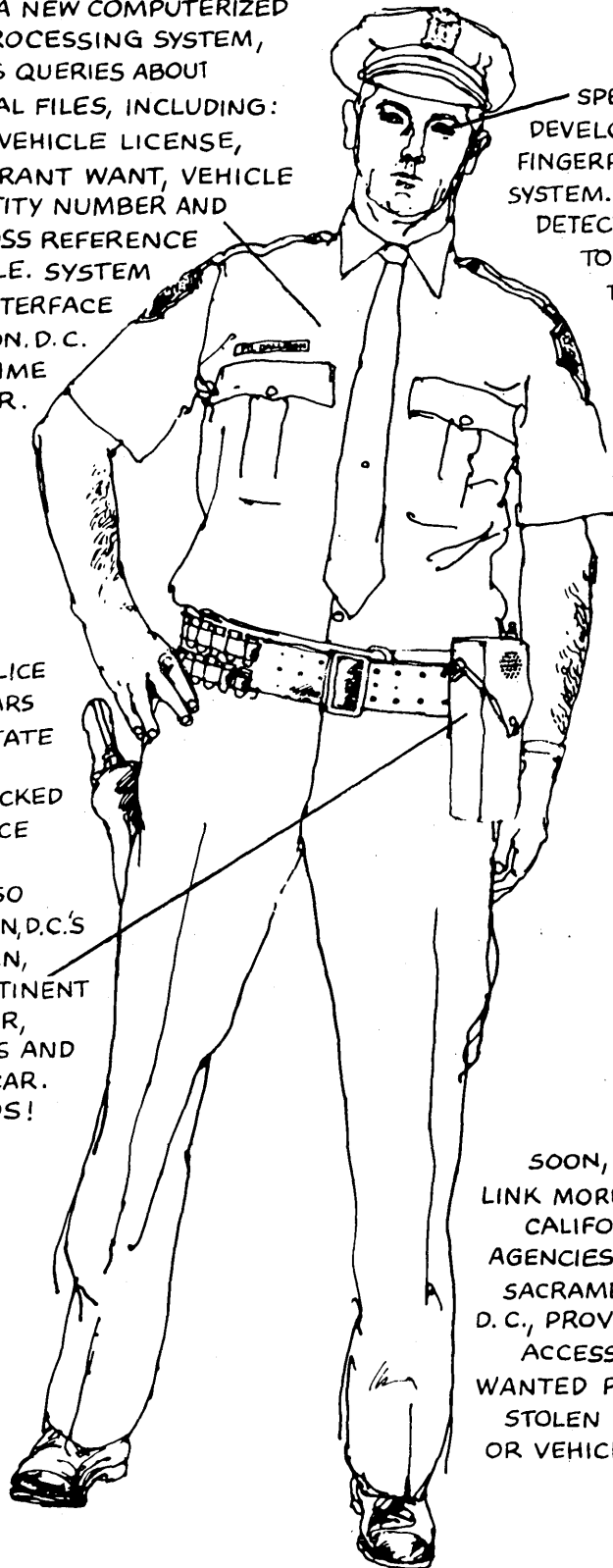

SPECIALISTS ARE DEVELOPING A COMPUTERIZED FINGERPRINT CLASSIFICATION SYSTEM. USING OUR NETWORK, DETECTIVES WILL BE ABLE TO IDENTIFY "SCENE OF THE CRIME" FINGERPRINTS WITHIN SECONDS.

SOON, OUR NETWORK WILL LINK MORE THAN 450 CALIFORNIA LAW ENFORCEMENT AGENCIES TO CRIME FILES IN SACRAMENTO AND WASHINGTON D.C., PROVIDING INSTANT ACCESS TO INFORMATION ON WANTED PERSONS, LOST OR STOLEN PROPERTY, FIREARMS OR VEHICLES.

Data communications helps enforce the law and protects the public.

Next time you're moving information, remember—no one knows more about moving it than the people who run the world's largest communications network.



The new PDP-8/e: Its own mother wouldn't know it.



The PDP-8/e is a radical departure in computer design. There's no back panel wiring — everything plugs into the OMNIBUS,[™] even the CPU. In any order. It's completely flexible; you buy only what you need. And if you need more later, just buy it and plug it in. And the PDP-8/e is easier to interface and easier to maintain than old-style computers.

We've made a few other changes. Easier programming. 1.2 μ sec memory cycle time. 15 added instructions. 256 words of read-only memory. 256 words of read/write memory.

Yet there's no generation gap between the PDP-8/e and the rest of the PDP-8 family computers in 7500 world-wide installations. They all use the same peripherals (over 60 of them). They're all program and interface compatible, they all have extensive applications and documentation. PDP-8/e was born with a silver software package in its mouth.

The basic 4K machine sells for less than \$5000. With teletype, less than \$6500. Quantity discounts available.

digital
COMPUTERS • MODULES

Digital Equipment Corporation
Maynard, Mass. 01754 (617) 897-5111

NEWS SCENE

Computing in Europe — "Clubs" Challenge IBM

When IBM World Trade Corp. president Jacques G. Maisonrouge announced IBM's new 370 series in Europe, he said: "Perhaps for the first time in a major product decision, Europe carried as much weight as the United States."

His remark underscored the increasing importance of the European computer market, which is growing at twice the rate of the U. S. market. It raised the question of how IBM's European competitors are reacting.

The most obvious effect has been the trend towards merger among the remaining firms, with the Bull-GE-Honeywell merger being the prime example. Furthermore, everyone seems to be talking with everyone else in Europe with the result that there will certainly be more mergers, more licensing agreements, and more mutual agreements among many of IBM's competitors. The trend is clear.

The European market is somewhat fragmented, providing more and better possibilities for mergers than in the U. S. For instance, the shareout in France is estimated at 60% IBM, 25% Bull-GE, 6% France's CII, and 4% Britain's ICL. The IBM computer colossus is credited, in comparison, with 70% of the U. S. market.

When the French government gave its approval to the Bull-GE-Honeywell merger, the measure acted as a spur to the formation of a "club" composed of CII, ICL, and Control Data of the U. S. At this point no one can say precisely where the loose arrangement among the three firms will lead, but the feeling is that each of the three firms can't effectively fight the IBM giant throughout Europe without reinforcements.

Observers see the arrangement this way: CDC and the French company have agreed to an exchange of research and technology in a wide range of activities covering processors and peripherals. The French negotiations with Britain's ICL cover proposals for collaborative efforts in production, marketing, and development. Planning groups from the French and British companies are

working out a long-term plan.

On the face of it, the triumvirate would appear to be an ideal one. CII — heavily funded and heavily favored by the French government — would be a fine marketing Trojan Horse in France for CDC and ICL equipment. This is an important factor since the French are sensitive about foreign companies — particularly American companies — selling in France. One illustration was the recent installation of Honeywell 316 computers in the Paris Metro system. The computers were bought before Honeywell obtained a major French manufacturing base through the Bull-GE merger, but the French bought through Holland's Phillips, which purchased the 316s from Honeywell.

With CDC in the picture, ICL's thoughts about making a supercomputer are superfluous, particularly since the new Conservative administration in Britain is not likely to look upon supporting ICL in the development of a large computer with as much favor as the previous Labor government. Thus there is more incentive to bring the companies together.

Some problems: CII is unprofitable. The U.S. government has blocked sales of CDC's 6600 machines for use in developing French nuclear weapons. So the French government is not likely to bless any formal computer combine that could embargo computers on order of the U.S. Government.

But these problems are dwarfed by the problem of IBM competition. Thus, the three companies can be expected to do more than just talk.

Univac has not been sleeping in Europe. The company is reliably reported to be disinterested — for the time being at least — in making any major hardware mergers or deals, preferring instead the software market in Europe which it is building up on a country-by-country basis, rather than in one fell swoop.

One Univac executive, R. R. Castiglione, reports that Univac's policy of remaining bundled has been a plus factor in Europe. "The Europeans aren't quite as sophisticated about computers and they tend to be more cautious than U. S. customers," he says. "Thus, many European custom-

(Continued on page 76)

Programs to Determine If Submarine's Yellow

A little of the slack for ex-aerospace programmers has been taken up with the opening of Univac's Defense System Div.'s Valencia, Calif., facility for work on the software for the firm's 1832 multiprocessor computer, which will operate aboard the Navy's S-3A antisubmarine warfare aircraft.

Under a \$40 million contract with Lockheed-California Co. to design and manufacture nine 1832s over the next three years, some 200 programmers will work on software that will enable the computer to determine not only that there is a submarine under the surface of the sea, but which submarine.

"Start up 10 Chevys in the parking lot and they all have different sounds," a Lockheed participant said. "So do submarines."

About 175 of the 200 programmers have been hired (around 10% are ladies), and there is housing just over

the hill from the facility, which is located about 30 miles northwest of Los Angeles. People will make moves for a three-year contract.

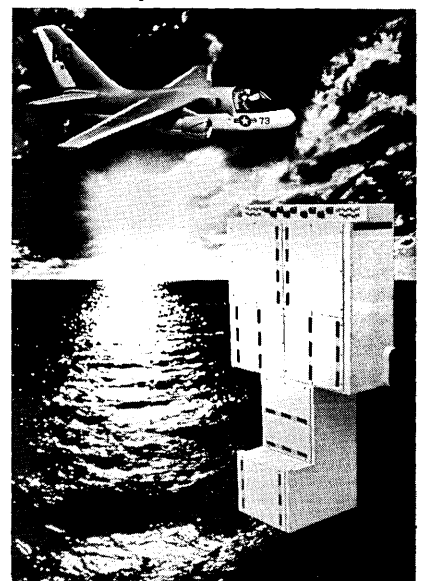

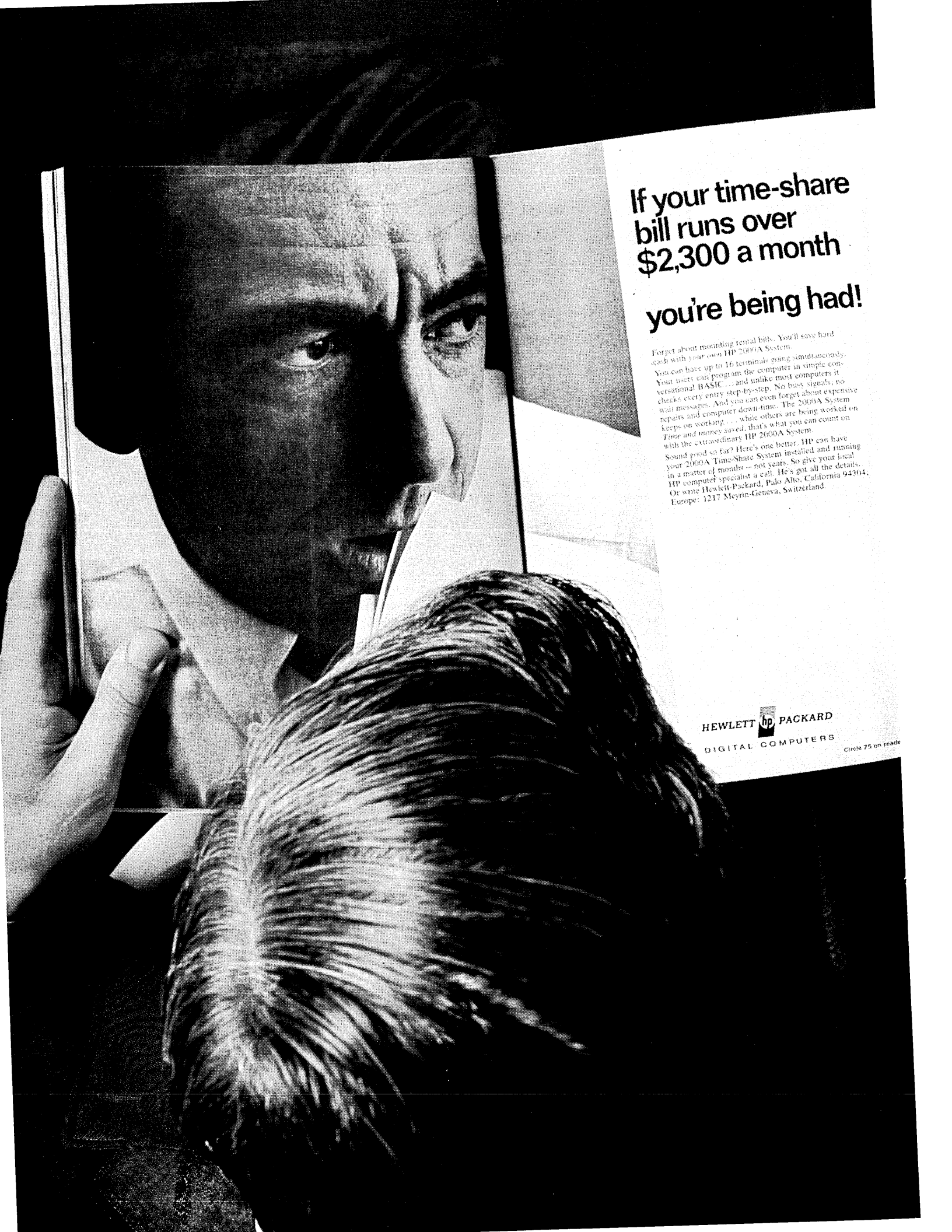

**If your time-share
bill runs over
\$2,300 a month
you're being had!**

Forget about mounting rental bills. You'll save hard cash with your own HP 2000A System.

You can have up to 16 terminals going simultaneously. Your users can program the computer in simple conversational BASIC... and unlike most computers, it checks every entry step-by-step. No busy signals, no wait messages. And you can even forget about expensive repairs and computer down-time. The 2000A System keeps on working... while others are being worked on. *Time and money saved, that's what you can count on with the extraordinary HP 2000A System.*

Sound good so far? Here's one better. HP can have your 2000A Time-Share System installed and running in a matter of months — not years. So give your local HP computer specialist a call. He's got all the details. Or write Hewlett-Packard, Palo Alto, California 94304; Europe: 1217 Meyrin-Geneva, Switzerland.

HEWLETT  PACKARD
DIGITAL COMPUTERS

Circle 75 on reader



**Last year this ad offered you
the best time-share buy
on the market.**

**Now we've got an even
better deal. Our new system
handles twice the users
for just \$3117 a month.**

Last year, we had one Time-Share system that made a lot of sense to a lot of people. Now, we've got two! Our new HP 2000B System does an even better job of holding the line on rising time-share costs. It handles 32 users simultaneously. Twice as many as its "little brother" (HP 2000A) —for only a third more cost.

Of course, if you already have a 2000A (or only need a 16-terminal system right now), you can upgrade to 32 terminals any time you're ready. Either way, you'll still have the best time-share buy on the market.

Both systems provide the advantages of HP BASIC, easiest programming language around. More scientists, engineers, educators and businessmen are using it every day. To make the 2000B even more useful, some new language features have been added. Like chaining (where one program calls in another automatically). Common storage for simplified programming. And doubled data file capability, for access to 16 files simultaneously.

Sound good so far? Here's more. Our 2000B, complete with custom software, control teleprinter and all 32 terminal interfaces, costs just \$119,900. Or \$3117 a month on our four-year lease plan. And if you want to start with a minimum investment, our HP 2000A is still only \$92,000. And don't forget what we said about upgrading!

For all the details, contact your nearest HP computer specialist. Or write to Hewlett-Packard, Palo Alto, California 94304; Europe: 1217 Meyrin-Geneva, Switzerland.

HEWLETT  PACKARD

DIGITAL COMPUTERS

**Who says the
Key Processing System
is a better way
to prepare data?**

American Express
Union Carbide
Blue Cross of Southern California
Continental Airlines
City of Los Angeles
First National City Bank
Universal City Studios
Pacific Gas and Electric Co.
Security Title Insurance Co.
Pacific Coast Stock Exchange
Federal National Mortgage Assn.

That's who.

They ought to know.

They punched a lot of little holes in a lot of little cards before they installed our system.

Why did they install our system?

Their reasons were different because their needs were different. But they all had one basic need. A more efficient way to get information into their computers.

And the KeyProcessing System, a totally new method of data preparation, is about as efficient as you can get.

It eliminates slow, mechanical hole

punching. And all the card shuffling that goes with it.

And every operation, from up to 32 keyboards, is controlled by one small central computer built right into the system.

Actually, there's only one thing we don't have yet. A big name.

Unless you count American Express, Union Carbide, Blue Cross of Southern California, Continental Airlines, City of Los Angeles...



Computer Machinery Corporation

2231 Barrington Avenue, Los Angeles, California 90064
New York • Washington • Chicago • Detroit • Dallas • San Francisco • Boston • Philadelphia • London • Paris

RFL builds Data Sets to meet every need

NEWS SCENE

ers like bundling. Even some of our most sophisticated customers like being bundled."

Univac's Western European operations did about \$125 million last year — about 30% in sales and 70% in leasing. Marketing strategy is mixed. In France it pushes smaller scale machines. In Germany there's a heavy thrust on selling the larger 1108 model. So long as its European operations continue to be profitable, there will be less pressure to merge or team up in some way with other firms.

The Diebold Group's European Software operations, headed by Gemini Computer Systems, Inc., is adding to its capabilities. It recently signed an agreement to market System Development Corp. software packages in Europe. Says M. A. Chargueraud, head of Diebold's European operation, "IBM's unbundling in Europe would appear to be a plus sign, but we're certainly not planning our future on IBM complacency."

RCA's greatest strength in Europe continues to be its agreement with West Germany's Siemens, which markets the Spectra computers. Siemens is looked upon by many as a merger candidate if it could find a way to spin off its computer operations.

But it is IBM's awesome dominance of the European computer market that should act as the prime impetus in bringing the splintered competition together. Its far-flung facilities have become major and valuable industrial resources within the Western European countries. A host of IBM European facilities are playing key roles in the development and manufacture of the 370 Series. Its research laboratories in Boeblingen (W. Germany), La Gaude (France), Lindingoe (Sweden), and Hursley (Great Britain) participated heavily in developing the new line's programming. The Model 155 is being produced at Montpellier, France, the Model 165 in Havant, Great Britain. The 3330 disc storage unit will be made at IBM's Mainz plant in West Germany, while the high-speed printer will be manufactured in Vallingby, Sweden. Monolithic circuits are to be made at Sindelfingen, West Germany, and at Essonnes, France.

Maisonrouge calls it "multination-alism," another word for IBM's coming on as tougher competition than ever in Europe.

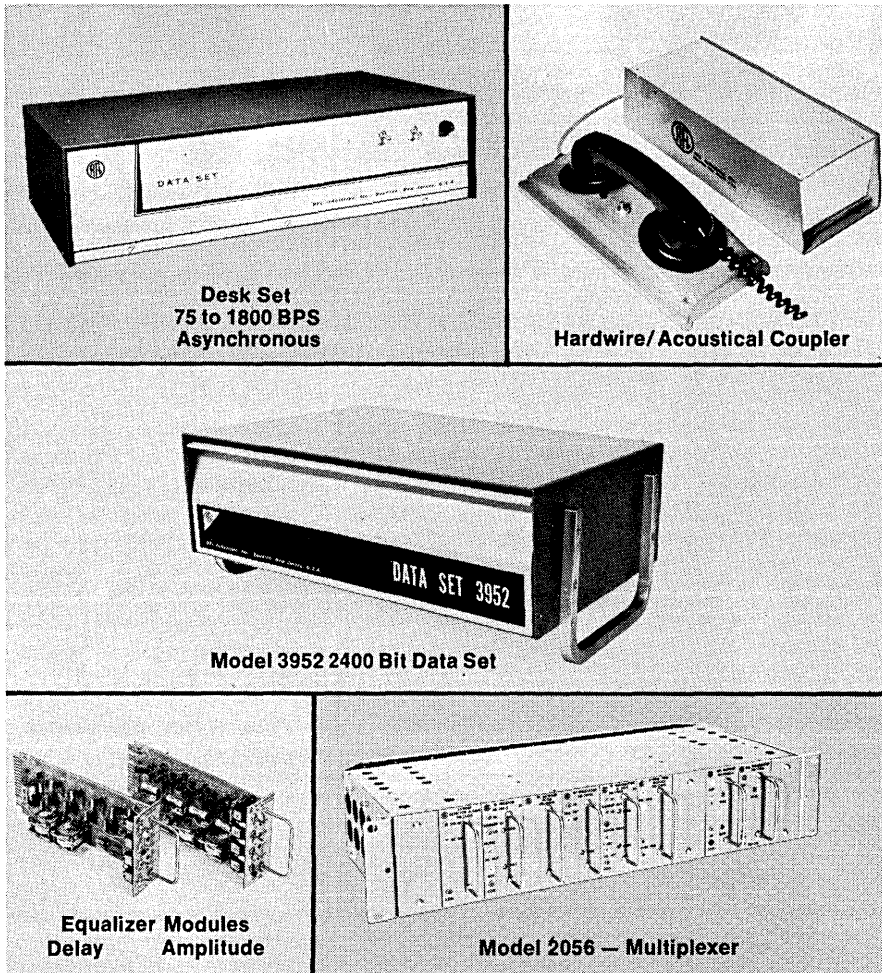

No matter what your data communication needs, look to RFL. RFL Data Sets handle computer, telegraph and terminal data, individually or in combination . . . with data speeds up to 2400 bps. Rack or desk models are available, both Bell compatible. The Model 2056 series — latest in transistorized multiplexers — permits use of up to 23 channels over a single circuit. New delay and amplitude equalizers provide improved line conditions for higher speed data over poor transmission facilities.

RFL offers outright purchase or rental plans, with prompt delivery. We've been building quality data sets for over 12 years. Write or phone today for full details.

 **RFL Industries, Inc.**
Communications Division, Boonton, N.J. 07005

TEL. 201-334-3100/TWX: 710-987-8352/CABLE RADAIRCO, N. J.

French Tax Deal A Coup for Honeywell

Honeywell has quietly pulled off something of a coup in France by landing a contract to supply a multi-computer system for the Direction Generale des Impots, the French government's equivalent of the U.S. Internal Revenue Service. The contract involves 19 machines in all — eight 200s, eight 1200s, and three 3200s. The multimillion dollar contract hasn't been announced and probably never will be, because of the sensitivity of doing computer business with the French government.

The fact that Honeywell nailed down the contract is even more interesting because the American company firmed up the deal before it established a major computer manufacturing base in France with the Bull-GE merger. The French tax agency will have eight computer centers in the Honeywell system — each with one Model 200 and one Model 1200. The 200s and the 1200s have been delivered, and the 3200s are scheduled to be delivered before the end of the year.

It is particularly difficult to sell against CII to the French government . . . difficult enough to prompt at least one member of the French parliament to complain recently about CII's "de facto monopoly" as a computer supplier to the French government, which subsidizes the company.

Ironically, Honeywell's edp operation in France, the Division Informatique of Honeywell, S.A., will probably see some of its sales thrust blunted by the merger with Bull-GE. Honeywell has been picking up about 40% of its sales from Bull-GE customers. Now, with the merger virtually consummated, Honeywell, S.A., would be stealing business from its parent company if it takes the sales away from Bull-GE.

Actually, Honeywell had been doing quite well in France before the Bull-GE merger. Starting from virtually ground zero in 1965, "the other computer company" made a firm decision to compete vigorously in France in 1966. Now, reliable sources report, Honeywell has some 100 computer contracts in France. The largest of these is the one with the Direction Generale des Impots. Fifty per cent of

Honeywell's market in France is said to be composed of its small machines, the 120 and the 125. Also reported to be selling particularly well is Honeywell's newest computer, the 115.

When the merger is completed, Honeywell can be expected to be doing more head-to-head selling against IBM. In the past about 40% of Honeywell's edp sales in France have come from IBM customers.

The Grass Isn't Always Greener . . .

Jill Farnden, a programmer with GEC-Elliott, left England for the U.S. last May convinced of two things: that the British computer industry ought to give a better deal to women and that U.S. women are more on a par with men in the industrial world.

She returned to England last month after having visited some 50 U.S. computer manufacturers, computer users, and software companies still convinced of the first but not so convinced of the second. She said she found the position of women in the U.S. computer industry to be pretty much the same as that of women in the industry in England.

Miss Farnden's three-month tour of the U.S. was sponsored by the Winston Churchill Memorial Trust ostensibly to study "employment of women in engineering and technology," but she limited it to the computer industry because that's what she's in. She was particularly interested in the idea of part-time employment for women programmers who have left the field to get married and raise families. She feels programming is a job which lends itself to being performed on a part-time basis as solutions to programming problems often "come to you when you're doing something else."

She had believed that in the U.S. many of the difficulties which face women who wish to be part-time programmers — awkward hours and career development — are removed, and she wanted to find out how this was done. What she found out was there is less part-time employment of women programmers here than there is in the U.K. She said she found U.S. companies rarely do this at all unless it's a previously employed person or

someone recommended by a friend, and "of course there's the added problem here of full-time people being laid off."

She found U.S. salaries to be "much better," even as compared to buying power, but fringe benefits, she said, are better in England. "Everybody gets at least three weeks' holiday and the medical thing is taken care of by the government."

Miss Farnden developed her own itinerary working from Computer Yearbook, technical magazines, yellow pages, and directories. It was hard, she said, "as even though you know the companies by name you don't know where they are or where they're doing what." Considering climate, she routed herself first through the South to the West Coast, then back through the North, departing from Boston on Aug. 16.

She taped her impressions as she went and will be pulling these together this fall into a report she hopes to have completed by Christmas. She also plans a series of lectures to interested industry and educational groups, all of which will have to be sandwiched in with her regular programming job with GEC-Elliott which she resumed Sept. 1.

And she will continue to collect any information she can get her hands on regarding employment of women in the computer industry, as she is determined to help improve the lot of the British female programmer.

She should have a busy fall.

Canadian Firm Looks To Turn \$ Tide

Reversing the normal trade situation, Consolidated Computer, Ltd., Toronto, envisions most of its revenues coming from the Canadian government in the form of guaranteed repayment of 90% of loans for equipment financing obtained by the company from financial organizations.

The maximum amount guaranteed under the agreement, obtained under terms of the General Adjustment Assistance Program, is \$12 million. Such a guarantee should be especially useful under present conditions of tight money and economic uncertainty, the latter having particularly affected

(Continued on page 78)

Do your programmers know basic systems concepts and applications?



Systemation, the on-the-job training that will do just that, without detracting from his programmer duties

One hour per day for 25 weeks, your registrant will cover such topics as

- Systems Writing
- Data & Forms
- Survey & Analysis
- Systems Concepts
- Management Process

Upon completion, he will have an excellent working knowledge of systems concepts, which he will be able to put into practice immediately! Also, The Basic Systems Course for Programmers will help close that ever widening gap between programmer and systems departments.

Put us to the test.
Cost \$345, group rates available.

Systemation, Inc., serving over 5,000 companies coast to coast in systems training and consulting.

SEND FOR INFORMATION TODAY!

NAME _____
 TITLE _____
 COMPANY _____
 ADDRESS _____
 CITY _____ STATE _____



computer stocks. The firm has also received government grants to cover research, amounting to about 25% last year, and expected to be "considerably more" this year

The firm's wholly owned U.S. subsidiary, Consolidated Computer International, Inc., Waltham, Mass., is aggressively marketing the parent firm's keyboard entry systems (Aug. '69, p. 159) and Hewlett-Packard-based time-sharing systems (June '69, p. 231) in the U.S. The Canadian government is said to have smiled upon Consolidated Computer because of its success in the U.S. market. More than 50 key-edit systems have been sold in the U.S., and t-s systems are also selling well, including one order of 35 systems for extended delivery.

So far, Consolidated Computer claims it is the only company in the computer industry to have obtained Canadian government aid. It also claims to be the only Canadian manufacturer of "computing systems." The key-edit system uses a DEC PDP-8 cpu, while the t-s system uses a Hewlett-Packard 2116B, but both are otherwise of Canadian manufacture.

Ultimately, the firm sees the "great majority" of its sales in the U.S.

CSC Promising New Money, New Business

New financing and new business last month sent Computer Sciences Corp. on the way to recovery from a series of reversals that left the industry's biggest software company in a cash bind, cut down its earnings, and led to disillusion in the investment community. Its stock dropped from a high of \$34 earlier this year to below \$6 last month.

The stock plunge came after Computicket was scrapped in April and the company this summer said its earnings in the 13 weeks ended June 26 dropped by 13¢ a share from a year ago. In dropping Computicket, the computerized entertainment and recreation ticket-selling subsidiary, CSC wrote off \$12.7 million for the fiscal year ended March 27, bringing earnings down to 41¢ from 53¢ a year ago. Its later 13-week loss was attributed to reductions in sales of proprietary packages and services, reduced investment tax credits, and the high

cost of money.

But at the company's annual meeting last month in Los Angeles, CSC's chairman Fletcher Jones was optimistic. He announced CSC was negotiating refinancing plan with a group of banks that would give the company some \$8-10 million in new funds and convert a short-term debt of \$17.5 million to a long-term debt.

He also announced the company has been awarded the contract to design and develop New York City's off-track horse race betting system. It's a five-year job estimated at \$22 million.

During the 90-minute meeting, Jones adeptly fielded questions about the demise of Computicket and the advisability of launching the Information Network division (Infonet) at a time when time-sharing companies are faring badly.

Jones says the size of CSC's investment (\$100 million) and its wealth of software tools will insure Infonet's survival. The company invested \$16 million in Infonet last year and plans to spend \$20 million in the 1971 fiscal year. But he admitted that Infonet could be abandoned with the same swiftness as Computicket was dropped last April.

The decision to abandon Computicket was reached after a two-week study, and Jones praised it as "the kind of decisiveness I like to see in this company."

"Would you act with the same decisiveness and abandon Infonet if it were found to be necessary," a stockholder asked. "I would say the answer to that question is yes," Jones said.

He said, however, Infonet is expected to be profitable by February of 1972 and by 1975 account for nearly half of CSC's revenues.

CSC nosed out five other finalists out of 14 bidders to win the New York City Off-Track Betting Corp. job. It will provide terminals, computers and software and manage the computer facilities. In its announcement, the company said off-track betting systems represent a potential national market of more than \$200 million.

CAI Banking On Moneyed Merger

Computer Applications Inc. has decided merger is the only way to end

the money outflow that threatens to take the decade-old software firm down the drain. It has a letter of intent to merge with Volt Information Sciences Inc. The resulting company would continue the CAI name, but the board of directors would be controlled by Volt.

Volt is noted for writing and producing technical manuals. In 20 years of existence it has branched out into supplying engineering talent in bulk, VIP office temporary service, education and training, sales promotion, some edp activity, and, lately, site and land development. Revenue for 1969 was around \$45 million, and 1970 first-quarter net income is \$417,000 on almost \$10 million revenues. An executive said net worth of the company was \$20 million. It has \$10 million in liquid assets.

Liquidity is what CAI is after. Its first-half 1970 report, after some raised eyebrows from the SEC, indicated a \$9.8 million loss. SPEEData, CAI's effort for a people-independent product, was responsible for \$6.3 million of this. The market reporting service for grocery stores became a \$17 million write-off and a big dam on money flow. There is still \$4.5 million of the development cost to be charged against revenue.

The report also showed \$1.2 million written off for New Era Lithograph Co. and \$2.3 million in operational losses. The last would've been more but for the extraordinary gain of \$3.3 million from the sale of E.B.S. Data Processing stock. The report wasn't improved by a \$1 million decline in revenue, something that hadn't happened in the past despite a shaky profit curve.

The Volt deal is complex. Initial approval must come from holders of some \$18.7 million worth of CAI debentures. They've already been asked to accept an exchange of equity securities.

Volt and CAI would then draw up a definitive agreement and ask for stockholder approval. Part of the agreement calls for a 2 for 13 reduction of outstanding CAI shares (1.7 million down to 261,500). The Volt shareholders would get one new CAI share for three shares, giving them a total of almost 2 million shares.

Mitchell Goldstone, Volt vice president, said the two companies comple-

ment each other. And well they might, since much of his company's business, particularly site development and training, is with alphabetic government agencies. In the last months CAI has increased its government orientation. Since the departure of John DeVries in June, new president Joseph Delario has sold off William Penn Publishing and the New York commercial programming business. The latter went to Programming Methods Inc., one of the profitable second-generation software houses. It was created by ex-CAI people. PMI has yet to say what exactly it is getting and how much it is paying for it. The Volt spokesman said it is only some six accounts and PMI president George Langnas said it is nowhere near the \$6 million in business there was some years back.

CAI executive Howard Morrison said the company was cutting back to "hard core" and would concentrate on government business. With the government, he added, CAI has longevity and profit, pointing out the current economic situation makes it "a helluva time to be fighting uphill." CAI strength, he said, is currently about 600 people. This includes the Urban System Group, systems engineering and "substantial software operation" — 190 people in Washington and a West Coast contingent, among others. The company also has what it once touted as its entry into facilities management seven years early, an operation contract for NASA's Space Flight Center; and subsidiaries E.B.S. Data Processing, Inc., with offices in New York, Denver and Chicago; Home Testing Institute/TvQ, Inc.; Mercedes Book Distribution Corp.; and New Era Letter, Inc.

DOD Contractors May Face Tighter Controls

A House-Senate conference committee last month okayed a bill requiring many DOD contractors to use uniform cost accounting standards developed by the government. The legislation seemed likely to be enacted as part of the pending Defense Production Act.

Cost accounting standards would be applied to winners of "negotiated prime contract and subcontract na-

(Continued on page 82)

New Directions in Computer Programming from Wiley-Interscience

A GUIDE TO COBOL PROGRAMMING, Second Edition
by DANIEL D. McCracken, McCracken Associates, and UMBERTO GARBASSI, Esso Mathematics and Systems, Inc.

"For the uninitiated, COBOL is the name of a computer language which uses terminology consistent with business use... This book has extreme merit in that the reader does not need to know a particular machine, but he can understand the purpose and construction of COBOL and its general application to the area of business problems."—from a review of the first edition in *The Accounting Review*

"The revisions made in the second edition bring in the experience of heavy use of COBOL in the years since it was introduced. Emphasis is laid on the options that people really use, and special warnings are given about errors that experience shows are commonly made. Suggestions from many instructors are incorporated, clarifying troublesome points and adding explanations where classroom experience has shown it is needed. The changes in COBOL itself are fully reflected in the second edition. Material on discs has been added, in particular, and there is a discussion of operating systems."—from the Preface to the Second Edition

1970 220 pages (approx.) paper, \$6.95 tent.

SYSTEM/360 JOB CONTROL LANGUAGE

By GARY DeWARD BROWN, The Rand Corporation
This manual presumes no knowledge of System/360 JCL and is appropriate for those familiar with any computer language whether they code in COBOL, FORTRAN, PL/I, assembly language, RPG, or some other language. The manual serves as a learning text for the programmer who wants to understand and use System/360 Job Control Language, and as a reference for the experienced JCL programmer.

"Each Job Control Language feature is described in complete detail, examples are given for its use, and possible applications are discussed. Many System/360 facilities are also described in detail, with abundant examples given to show how they can be used through Job Control Language. These facilities include the linkage editor, indexed-sequential data sets, and several IBM-supplied utility programs."—from the Preface

1970 292 pages paper, \$7.95

AUTOMATIC DATA PROCESSING

System/360 Edition

By FREDERICK P. BROOKS, JR., University of North Carolina at Chapel Hill, and KENNETH E. IVERSON, Thomas J. Watson Research Center, IBM

Of direct interest to data processing specialists and to workers in all fields, this outstanding volume covers the fundamental aspects of data processing common to all fields of application. It illustrates and applies theoretical material solely in terms of IBM's System/360 computers. Since Professor Brooks managed the design of the System/360, this is an especially authoritative introduction to machine principles and functions. The book is suitable for self-study, due to its emphasis on references, exercises, and self-contained development although it is expected that the reader will have some experience with a programming language and college algebra.

1969 466 pages \$14.50

wiley

WILEY-INTERSCIENCE
a division of JOHN WILEY & SONS, Inc.
605 Third Avenue, New York, N.Y. 10016
In Canada: 22 Worcester Road, Rexdale, Ont.

Pssst...don't tell

the big guys but PEC is bigger than they are in tape transports.

And now they're second sourcing us.

Who would have believed it? PEC's now NUMBER 1 in digital tape transports. Some of the reasons: Our digital transports cost less and work better. Less than \$3,000 buys a PEC 10½ inch reel, NRZI synchronous transport. And since PEC makes more than 200 different models in 3 reel sizes, there's a wider choice of tape speeds (6.25 to 45 ips) and densities (200

to 1600 cpi). What's more, PEC's huge new plant means on-time, come what may, delivery. With features like these it's not surprising PEC's become the new standard in the industry. For all the facts and figures on the transports that have made us Number 1, write Peripheral

Equipment Corp., 9600 Irondale Avenue, Chatsworth, Calif. 91311, (213) 822-0030.

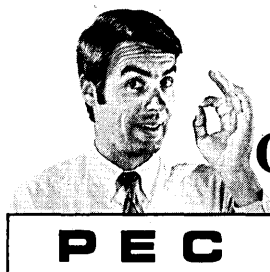
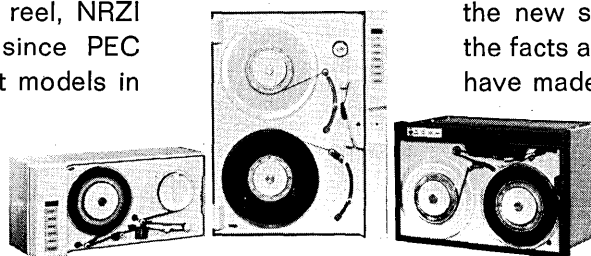

Okay, now you can tell 'em.

DEBUG

ON-LINE SYSTEMS FASTER AND EASIER!



The Spectron Universal Monitor insures fast, accurate diagnosis of on-line system problems.

Get on-line and stay on-line, with minimum system downtime. We offer a simple, economical way to do this. Our Universal Monitor helps you pinpoint problems in *all* system hardware and software by showing you—in the form of hard copy—exactly what was sent and received over the data link. So errors caused by software bugs, equipment malfunctions or line problems are immediately visible. Less time is spent tracing problems because system operation is shown in full detail.

The Universal Monitor is simple to install and is as easy for programmers to use as it is for engineers. It connects to the business machine interface of any standard modem, and automatically synchronizes with the data stream to provide a record of every character on the line—not only the usual printable characters, but all control characters as well. The system monitors any code and speed up to 7200 bps, accommodates all line coordination systems, and works with synchronous or start-stop transmissions.

There are two basic components of the Universal Monitor system. These are a Monitor Control Unit which provides synchronization and control, and decodes the monitored data for printing; and the Monitor Printing Unit which is a high-speed non-impact printer. Other components are available which allow switch-selection of lines to be monitored in a multi-line system. For more information or a demonstration, fill in and return the coupon below. Or call (609) 667-5700.



1060 Kings Highway North
Cherry Hill, New Jersey 08034

Please send technical bulletin on Universal Monitor System.

Please arrange Universal Monitor System demonstration at my convenience.

Name _____ Title _____

Company _____

Address _____

City _____ State _____ Zip _____

Telephone _____

NEWS SCENE

tional defense procurements . . . in excess of \$100K." The only major exception would be contracts involving "established catalog or market prices of commercial items sold in substantial quantities." The legislation establishes a "Cost Accounting Standards Board" to promulgate the rules, and grant exemptions. The board consists of five members — the controller general, two accountants, one industry and one other federal government representative.

Before they could do business with the government, contractors subject to the board's regulations would have to agree to disclose their cost-accounting principles in writing. Also, if the government was overcharged because a contractor failed to abide by the new board's regulations, he would have to repay the extra amount, with interest.

Although exemptions are permitted, a concurrent congressional resolution could kill any of them.

The legislation requires the board to publish its regulations in the Federal Register and give affected parties 30 days to respond. To insure compliance with its directives, the board is given the right to examine relevant contractor and subcontractor records.

The inspiration for uniform cost-accounting standards came from Sen. William Proxmire of Wisconsin, who claimed they could cut federal procurement costs by a billion dollars. The Electronics Industry Association said the alleged savings were a myth.

Elsewhere on Capitol Hill:

The Senate Armed Services Committee proposed an amendment to the military procurement authorization bill which would limit, to \$625 million, DOD payments in FY '71 to contractors for independent research and development (IR&D), bid and proposal (B&P), and other technical effort (OTE). The limitation applies to about 50 firms which, collectively, account for 95% of DOD's expenditure of IR&D, B&P, and OTE; the three items, together, are known as "contractor independent technical effort" (CITE). Each of these firms received more than \$2 million in CITE money during its last fiscal year.

Among the companies that will be affected by the legislation if it passes are: Honeywell, XDS, CAI, CSC,

Sperry Rand, RCA, IBM, GE, TRW, Philco-Ford, Computing and Software, Ampex, and Sanders Associates.

The proposed \$625 million payment ceiling would generate a total FY '71 expenditure of about \$656 million for CITE, since the limitation applies to 95% of the expenditure. In FY '69, by comparison, a total of \$759 million was spent, and in FY '70, \$656 million. The original projection for FY '71 was \$645 million. Thus, if the amendment is enacted, as seems likely, DOD will be able to spend somewhat more for CITE than originally planned.

The Pentagon, backed by the contractor community, wanted to tighten CITE controls through administrative action rather than congressional order. While DOD officials seemed to have lost that battle, they probably avoided an even worse defeat when the Senate Armed Services Committee decided not to approve S-3003, a bill introduced by Senator Proxmire which would have imposed far more stringent controls over CITE expenditures.

The House version of the military procurement authorization bill doesn't contain any new restrictions on the CITE program. Assuming the Senate language is approved by the full chamber, the final version will be worked out by a conference committee.

NAR to Consolidate EDP Operations: 2 for 10

The computer population of North American Rockwell's Aerospace & Systems Group is expected to go the way of its employee population within a year — down.

The group, that portion of NAR which formerly was North American Aviation, went from a peak employment of more than 100,000 in the mid-'60s to a current 50,000. Its edp operations currently are handled by some 10 cpu's. This is expected to drop to two.

A committee of five NAR edp men (each of the group's four divisions is represented) last month was formulating a plan for edp consolidation "in the interests of economy and efficiency" and was expected to have the

plan completed by Sept. 1. It was pretty much decided by mid-August that the consolidation would involve use of two cpu's, probably an IBM 360/195 and a 65, but where they would be located was still up in the air. In the past, policy would have dictated such a consolidated effort be located in the division which had the major contract . . . in present circumstances, that would mean the Los Angeles Div. in El Segundo, working on the Air Force B-1; but past is past, and speculators were guessing the larger contract would be outweighed by the factor of company ownership of facilities, and an NAR-owned facility in Seal Beach was looked upon as a likely candidate.

An NAR spokesman said the plan would be implemented within a year. And, of course, layoffs will be involved, but the extent will remain unknown until final implementation. Only the group's Southern California operations (it has small activities in Tulsa and Columbus, O.) would be affected. The two consolidation cpu's would replace two 65s in the Autonetics Div., Anaheim; an 85 in the Space & Informations Systems Div., Downey; two 65s in the Los Angeles Div.; and a 65 in the Power Systems Div. (formerly the Rocketdyne Div.), Canoga Park. The group also has "a few" 50s and 60s "here and there." The consolidated operation would put high-speed terminals in all divisions and would utilize common software being developed by the consolidation com-



Henry Sherwood, an admiral in the Texas Navy and vice president of Diebold Europe, is well known for his ability to be photographed with luminaries (including the Pope). Here he's shown with West German Chancellor Willy Brandt at a recent Diebold Research Program conference.

mittee.

The Space & Information Systems Div., one of the hardest hit in terms of personnel cuts (from 35,000 during the mid-'60s to 12,000 now with only 10,500 of these in Downey and with more cuts anticipated before year-end) will be experiencing its second edp consolidation when the corporate plan goes into effect. The division just recently consolidated its own dp operations replacing two 65s with the 85 it now uses.

Computer Machinery Adds New Software Cog

An agreement in principle has been reached for Computer Machinery Corp., L.A.-based manufacturer of the KeyProcessing data input system, to acquire Programmatic, Inc., an L.A. software firm, from Applied Data Research, which itself acquired Programmatic in May of '69.

The status of the antitrust suit Programmatic has pending against IBM is still quo, according to Programmatic's president Dave Ferguson, and Jim Sweeney, president of CMC, and it will be pursued "certainly through the next steps."

Sweeney said the acquisition is in line with the firm's aim to become the complete computer company, manufacturing and marketing only those products directly related to edp (no typewriters, no television sets, no thermostats). He considers Programmatic to be a product-oriented software firm "making very fine products," with a software capability in small machine programming "we'll be needing soon."

Sweeney said that Programmatic, operating as an entity, would provide healthy competition for his own in-house software group in developing proprietary packages. "That way, everyone grows."

NEW COMPANIES

The Mendoza group may not be a familiar name in North America, but in South America it is an industry in itself with 60 diversified companies and annual sales of \$300 million. It will team with University Computing Co. of Dallas, and the Venezuelan people, to

(Continued on page 84)

This announcement is neither an offer to sell nor a solicitation of an offer to buy these securities.
The offer is made only by the Prospectus.

182,000 Shares

Inforex, Inc.

Common Stock
(\$25 Par Value)

Price \$17.50 per Share

Copies of the Prospectus are obtainable in any State from only such of the undersigned and such other dealers as may lawfully offer these securities in such State.

DREXEL HARRIMAN RIPLEY
INCORPORATED

GOLDMAN, SACHS & CO.

WHITE, WELD & CO.

ALEX. BROWN & SONS

DOMINICK & DOMINICK,
INCORPORATED

EQUITABLE SECURITIES, MORTON & CO.
INCORPORATED

W. E. HUTTON & CO.

F. S. MOSELEY & CO. REYNOLDS & CO. TUCKER, ANTHONY & R. L. DAY

July 22, 1970

CIRCLE 25 ON READER CARD

NEWS SCENE

launch a computer utility in that country, operated in the same way as UCC's centers in the U.S. and Europe. The Mendoza mantle will also cover marketing services for UCC remote terminals and other equipment. . . . A better known group, Diebold, has gone officially worldwide with the formation of **The Diebold Group International, Inc.**, a conglomerate financed by the Industrial Bank of Japan; The Crown Agents of London, Australia and New Zealand Banking Group; and at home, Manufacturers Hanover Trust Co. Until now, Diebold had been operating in overseas projects mainly through a European subsidiary, Griffenhagen-Kroeger; management and government consulting already have been under way in Brazil, Venezuela, Argentina, Algeria, the Philippines, Indonesia, Jordan, Japan — and Nepal (a five-year plan for improved public administration). . . . Companies that have performed installed their own dp overseas are trying to take advantage of their facilities' free time by offering services to the natives, the latest being in Puerto Rico, where Commonwealth Oil Refining has formed **Corco Data Services** as an offshoot not only to help meet the expenses of its 360/40, but to furnish time-sharing and remote teleprocessing for the profit of all. . . . A company financed by the FMC Corp., **Information Instruments, Inc.**, established in Bala Cynwyd, Pa., is undertaking an "extremely ambitious" program to provide instrumentation for maintenance, calibration and monitoring data lines and terminals, as well as data communications devices. President and board chairman Harold Gruen believes that 50% of business telephones will carry data by 1972, and already overloaded communications require new intermediary products — his. . . . **Signal Galaxies, Inc.**, Van Nuys, Calif., will produce and market a "flux ring" memory to replace core and plated wire, no less, in control, storage, and mass memory applications, claiming lower cost, higher packing densities and 100 nsec cycle times, with less vulnerability. . . . Shawnee Mission, Kan., is the hq of **United Business Communications, Inc.**, which is starting out with Rixon Electronics, Inc., as a subsidiary inherited from the parent of both, United

Everything for data processing... ...except the computer

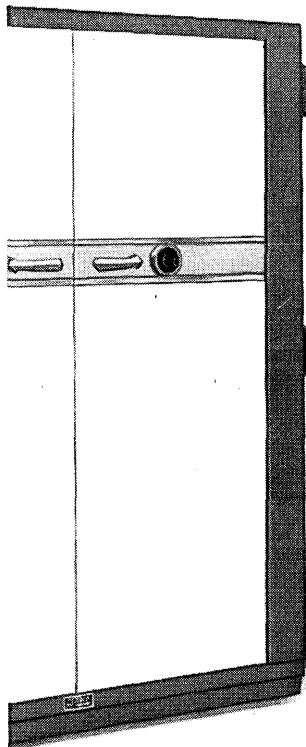

DATA BANK SAFES

A double wall safe for the protection of vital records stored on tape or disks. The only safes to carry the U. L. 150°-4 hour label for the **safest** storage of magnetic media. Four models available. Circle readers service no. 101



DISK & DISK PACK STORAGE

Wright Line is the only company that provides high quality Disk Packs with the super smooth and durable Data-Coat Surface plus all of the storage and handling equipment to complete the picture in your Disk Pack System. Circle readers service no. 102

GOLD STAR FILES

The widest selection and most beautiful computer-coordinated files available. Line includes exclusive three wide files, countertop models with plastic-laminate surface, trucks and transfer file. Gold Star is a complete filing system. Circle readers service no. 103

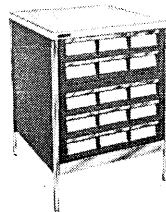

160 GOLD STAR BOULEVARD, WORCESTER, MASSACHUSETTS 01606
A DIVISION OF BARRY WRIGHT CORPORATION

CIRCLE 101 ON READER CARD

Utilities, Inc. UBC will promote and market Rixon's data communications equipment. . . . **Software Enterprises Corp.** is the name of a San Fernando Valley firm (Woodland Hills) currently developing configuration management procedures for a large military system.

MERGERS, ACQUISITIONS

National Data Communications, Inc., Dallas, has secured operating funds — by giving up half of its common stock shares, with an option to acquire more — from **Technicon Corp.**, Tarrytown, N.Y., manufacturer of continuous flow analytical systems. Technicon is interested in NDCI's subsidiary, Reach Corp., which specializes in computerized hospital information systems, and figures to add the capability to its extensive medical market. . . . **Computer Learning and Systems Corp.**, Chevy Chase, Md., last month sold **Clasco, Inc.**, Sunnysvale, Calif., maker of a disc drive system plug-interchangeable with IBM's 2314, to **Ampex Corp.** for an undisclosed amount. . . . In New England, **Halstead & Associates**, Boston, went through with its deal to merge with **Computer Assistance, Inc.**, Hartford. The two of them will jointly do service Massachusetts, Connecticut, and NYC, and market program packages and educational services. . . . **National Information Services, Inc.**, Cambridge, Mass., has sold **Becker Research Corp.** to plain **Information Services, Inc.**, of Babson Park. Becker is a leading marketing survey and research firm, and will go on with its projects and clients, accessing ISI's computer resources. . . . Codon Corp. has sold its t-s subsidiary, **Codon Computer Utilities, Inc.**, to **First Data Corp.** in Waltham. No interruption of client services. Codon (parent) will continue in software and systems design. . . . Boothe Computer has acquired another software firm, **Systems Resources, Inc.**, for its L.A. affiliate, **Boothe Resources International, Inc.** . . . **Computing and Software, Inc.**, L.A., has acquired **CIU Computer Credit Corp.**, Chicago.

September 15, 1970

NEWS BRIEFS

ANCOM Comes On

ANCOM Systems, Los Angeles, a division of General Analytic Corp., is readying a data base management system built around a minicomputer for Mt. St. Mary's College in L.A. to be delivered in November. The system, which will handle registration, payroll, grades, course status, etc., comprises a Micro Systems 810, Iomec disc equipment, a Peripheral Equipment Corp. tape unit, and up to 10 terminals, and it's all expandable. As the college grows, so can the system (Mt. St. Mary's has about 2000 students). The basic system will sell for around \$150K, and the company claims it's comparable to other systems selling for \$1 million.

The firm is also in the final stages of a contract with XDS to make its RIS (Reactive Information System) data bank management system compatible with the Sigma 5 and 7. RIS is English-language oriented.

Minis on Campus

The National Science Foundation would like to know if small colleges can effectively use minicomputers the way big schools with big research grants use big computers. It wants yearly reports on the advantages and disadvantages of the mini (price: \$12K to \$75K) as a low-cost approach to instructional computing service. It has awarded grants totaling \$398,400 to 10 colleges and universities and to the Southern Regional Education Board in Atlanta, Ga., to study the question, with the Atlanta group administering the study and preparing the reports.

Spring Is Here

While everyone is concentrating on the Fall Joint Computer Conference, plans for the SJCC are going apace, with more than 30,000 expected to attend at Atlantic City, May 18-20. The theme will be RESPONSIBILITY (caps from AFIPS), and a call for papers already has been issued with an early deadline — Oct. 9. The range of topics is broad: credit and the consumer, elections, media, data files, education and training, historical perspectives, law enforcement and the

(Continued on page 87)

Now, the fastest strip printer is the lightest, too.

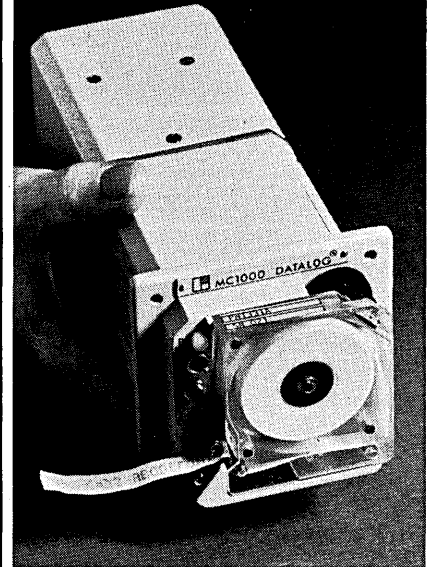

Litton DATALOG's amazing new MC 1000 Military Strip Printer weighs less than 5 pounds — with the power supply! At speeds up to 100 alphanumeric characters per second, with measurements of only 3 x 3 x 8½" and a disposable paper cassette, the MC 1000 is the lightest and fastest Military Strip Printer available.

The printer is qualified to MIL-E-5400 and is ideal for hard copy readout in applications such as airborne integrated data systems, field and command communication and mobile communication systems.

The MC 1000 contains only one moving part, thus making it incredibly reliable. It consumes an average of 45 Watts and is available with or without the power supply.

This printer far surpasses any other Military Strip Printer on the market for speed, reliability, lightness and quick loading. Call or write DATALOG for further information:

DATALOG Division, Litton Industries, 7801 E. Belleview Avenue, Englewood, Colorado 80110; A. C. 303-771-2010.

 **DATALOG DIVISION
LITTON INDUSTRIES**

CIRCLE 43 ON READER CARD

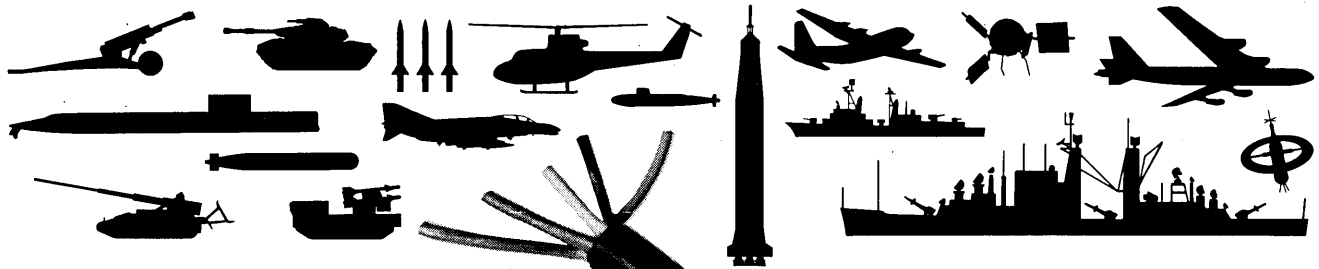

**plug in...
turn on!**



Regardless of your computer application, the BR-1018 is certain to be a strong contender.

The BR-1018 is an advanced state-of-the-art computer utilizing Large Scale Integrated Circuits (LSI) throughout. It features small size (67 cubic inches), light weight (4.5 lbs) high MTBF (20,000 hours), and outstanding overall speed and performance. These features are a direct result of a proprietary micropackaging technology perfected by Bunker-Ramo. This micropackaging technique, which is referred to as Planar Coax, interconnects the entire computer with small constant impedance coaxial lines and eliminates plug in friction type interconnections completely.

The BR-1018 is an 18-bit computer with a 1 MHz clock, 43 basic instructions, short instruction time of 5 microseconds and average multiply and divide times of 33 and 43 microseconds. The basic machine has 2,048 words of plated wire or semiconductor memory expandable to 131,072 words. The I/O is modular and can be easily tailored to any requirement.

If you would like more information on the BR-1018, contact Mr. William G. Garner, Director — Products Marketing. (213) 889-2211.

 **THE BUNKER-RAMO CORPORATION**
DEFENSE SYSTEMS DIVISION
31717 LA TIENDA DRIVE, WESTLAKE VILLAGE, CALIFORNIA 91360

judiciary, manpower, technology forecasting, teleprocessing, national policies, informing the laity, transportation, and the "techniques and practices of embezzlement." Abstracts (150 words) and papers (six copies, double spaced, not exceeding 5,000 words) should be submitted to Dr. N. Macon, P. O. Box 30130, Bethesda, Md. 20014.

New Lease on Life

Xynetics, Inc., Canoga Park, Calif., manufacturer of a large plotter based on a patented two-axis linear motor (June 1969, p. 123), has been pulled out of the financial doldrums by a \$1½ million refinancing from, among others, Transamerica and its new board chairman, Arthur Rock, who chaired Scientific Data Systems before its sale to Xerox.

One-Legged Race

Intranet Industries, 1½-year-old Los Angeles time-sharing firm, was down from 100 employees to some 70 last month and was, as one of its financial backers put it, "on one leg but still hopping." The firm was hard hit by the January fold-up of Scientific Control Corp., which forced the layoff of about 20 people working on software for the SciControl 6700 computer which wasn't picked up when the Texas firm reopened. But optimism in the company was buoyed by the mid-August receipt of a \$680K contract from JPL for removable discs to be integrated into Univac equipment and indications of imminent fruition for "three or four other long-term projects."

COM-ing Together

A group for the benefit of both users and manufacturers in the computer-output-microfilm (COM) industry has been set up under the name of COMTEC (Computer Micrographics Technology). It hopes to include the major COM manufacturers and eliminate the need for promoting separate user organizations by individual companies (i.e., Datagraphix UAIDE). But snags already reportedly have developed over the precise definition of "vendor" and "user," which might cause difficulty, since the user is admitted to the group at no charge, while the vendor must agree to a certain financial share of the sponsorship. Also, the

organization is basically an outgrowth of the original FR-80 user's unit of Information International, Inc.

As things now stand, COMTEC will be firmly under the control of the users under bylaws which specify that role for the chairman and vice president, but the treasurer must be a manufacturer, and directors are evenly divided between users and manufacturers. The group has no official connection with the National Mi-

crofilm Association, but NMA's president, George Harmon, is an executive of Information International. Officers of COMTEC are sufficiently impressive: Virgil DeVine, XDS, chairman; Walter Clark, Western Electric, vice-chairman; Leon Goodman, Computer Micro-Image Systems, treasurer; Alan Smith, Idaho Nuclear, secretary; and directors Bob Wylie, Kodak; Marvin Fishman, Information International; Gene Steiger, Lockheed. ■

CASE

CASE takes the guesswork out of making sound computer system decisions—accurate decisions which may involve even the most complex aspects of multiprogramming, real-time or time-sharing systems.

CASE (Computer Aided System Evaluation) is a proven simulation system which will predict for any application the interaction of virtually any combination of computer hardware, software, data base and user programs.

Use CASE for—

- Overall System Design
- Configuration Management
- Equipment Selection
- Installation Audits

The use of CASE is the least costly way to make system decisions; it is available under lease, license or service plans. We can train you to use it or we will provide highly skilled and experienced analysts to assist you in your simulation efforts. CASE will also interface with our X-RAY™ Computer Performance Measurement System.

For complete details, contact:

APPLIED SYSTEMS
Division of Computer Learning and Systems Corporation
5530 Wisconsin Avenue, Chevy Chase, Maryland 20015
(301) 652-9220

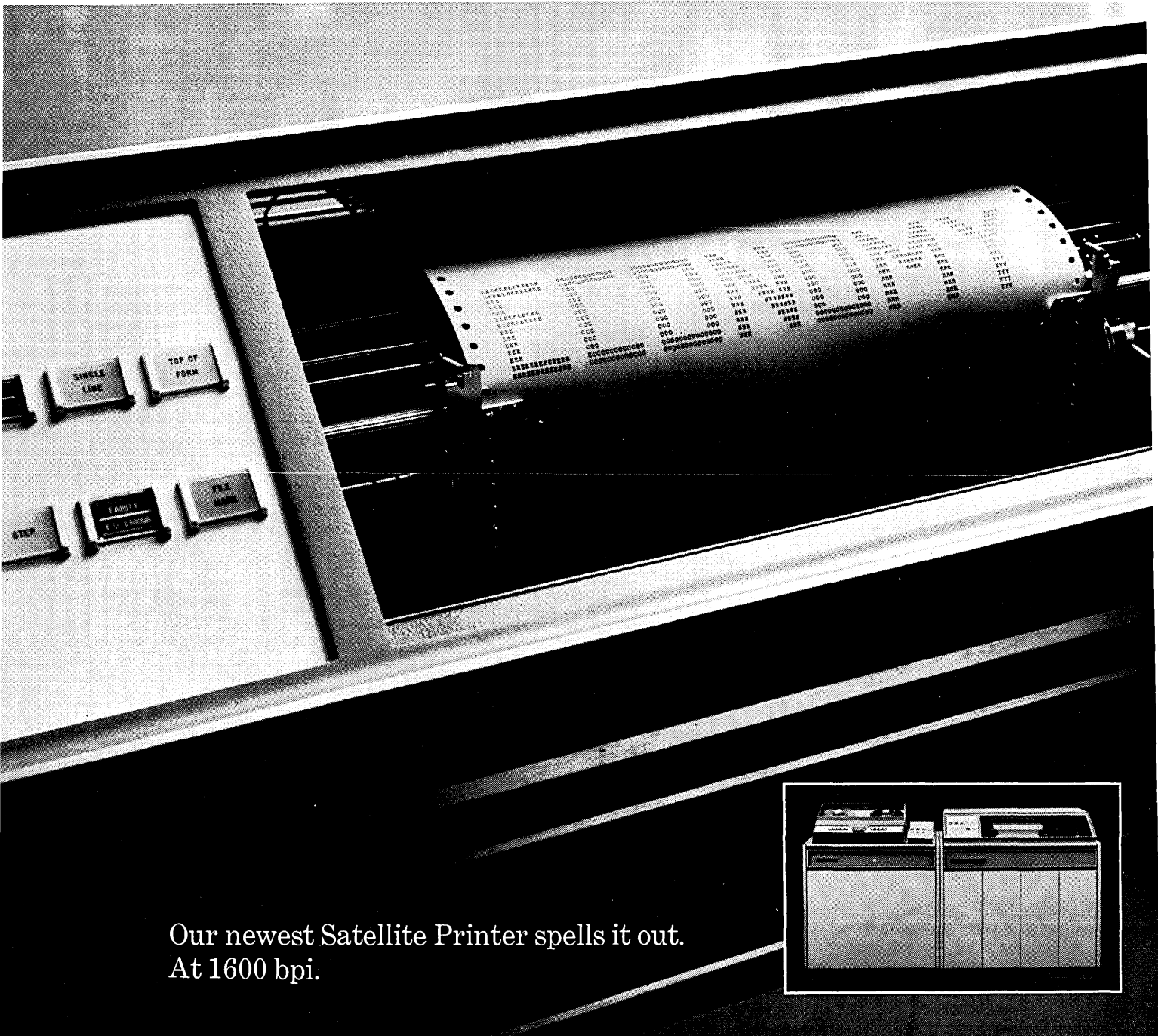

Our newest Satellite Printer spells it out.
At 1600 bpi.

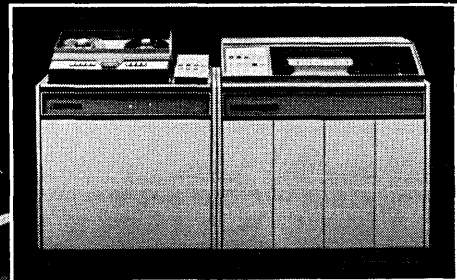

Computer time is money. Your computer is wasting both when it has to do its own printing. The fact is, your computer generates tapes many times faster than it prints. And our newest Satellite Printer can take those tapes and print without reprogramming. You'll get arrow-straight, clean printouts. And more problem-solving time from your computer. Our Automatic Code Translator (ACT) makes the Satellite compatible with your computer. What's more, it's the only off-line printer being delivered with 200-to-1600 bpi capacity. Economy. That's the word on the Satellite Printer.

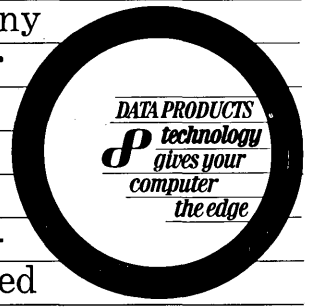

DATA PRODUCTS
systems division

6219 De Soto Avenue/Woodland Hills, California 91364

U.S. Sales Offices: Allentown 215/395-6233; Atlanta 404/633-6367; Baltimore 301/323-6900; Boston 617/237-1950; Chicago 312/325-6630; Cleveland 216/464-1848; Dallas 214/231-8265; Detroit 313/354-5880; Houston 713/626-0081; Los Angeles 213/483-7054; Minneapolis 612/927-8747; New York 212/532-9504; Philadelphia 215/884-1885; Pittsburgh 412/687-1700; Rochester 716/436-7410; St. Louis 314/644-3450; San Francisco 415/421-9375; Seattle 206/228-2440; Washington 301/652-8120. Europe: London 01/579-2917.

CIRCLE 87 ON READER CARD

Full tape protection in a one-piece container for the price of seals.

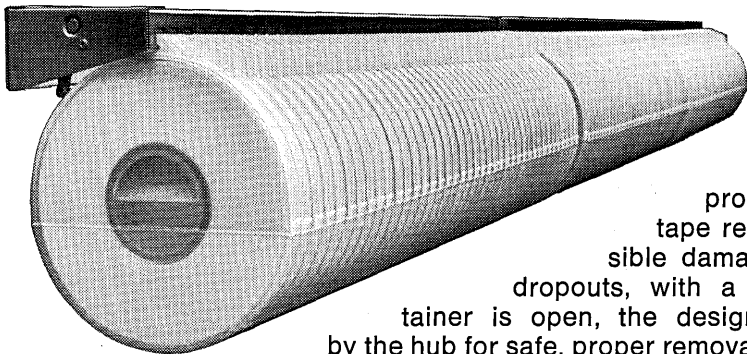

That's New Tab Reelgard! Exclusive Reelgard one-piece construction assures the ultimate in safe magnetic tape storage, even if you are using open aperture reels. The hinges, hanging hook and positive Reelgard locking system are molded into a thin $\frac{3}{32}$ " , high-impact, shatter-proof polypropylene case. Reelgard keeps magnetic tape reels from resting on their edges, to prevent possible damage to the tape and to eliminate the danger of dropouts, with a molded-in support. When the Reelgard container is open, the design of the container permits grasping the reel by the hub for safe, proper removal of tape. A very tight, positive tongue and groove closure gives added protection against contamination damage. The Reelgard snap-latch opens easily with a snap of the fingers. There's no more fighting fit and suction as in old fashioned two-piece tape cases. When

it comes to saving you precious magnetic tape storage space, Reelgard benefits

you even further. Compared to conventional two-piece canisters, Tab Reelgard containers can accommodate 60% more magnetic tape in the same space, for half the cost! Whether you are hanging magnetic tape or storing it on shelves, Reelgard combines with proven Tab magnetic tape storage systems to help you store more, safer, in less space. With Tab

Snap!

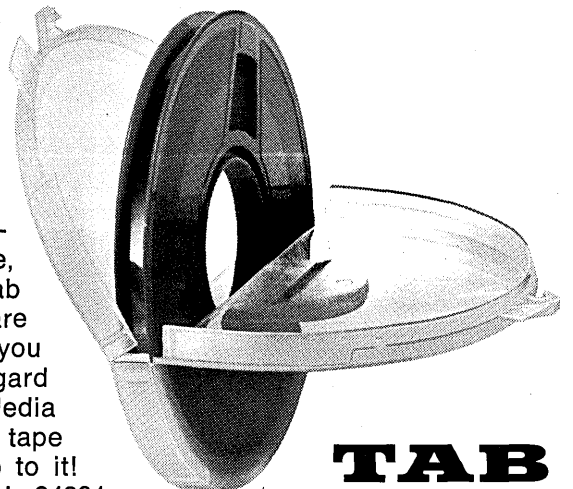
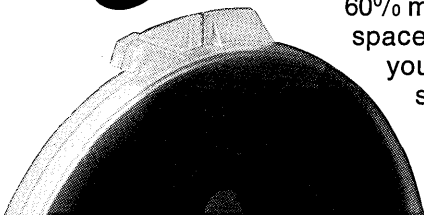

Unit Spacefinder tape storage systems, new hanging racks are available for Reelgard in either 30" or 42" wide assemblies. If you want closed cabinet storage for your tape, new hanging Reelgard racks or conventional wire racks can be used in Tab Data Media Cabinets. For complete information about new Tab Reelgard tape containers, call your local Tab Products representative. Snap to it! Tab Products Company, 2690 Hanover Street, Palo Alto, California 94304

TAB
PRODUCTS CO.

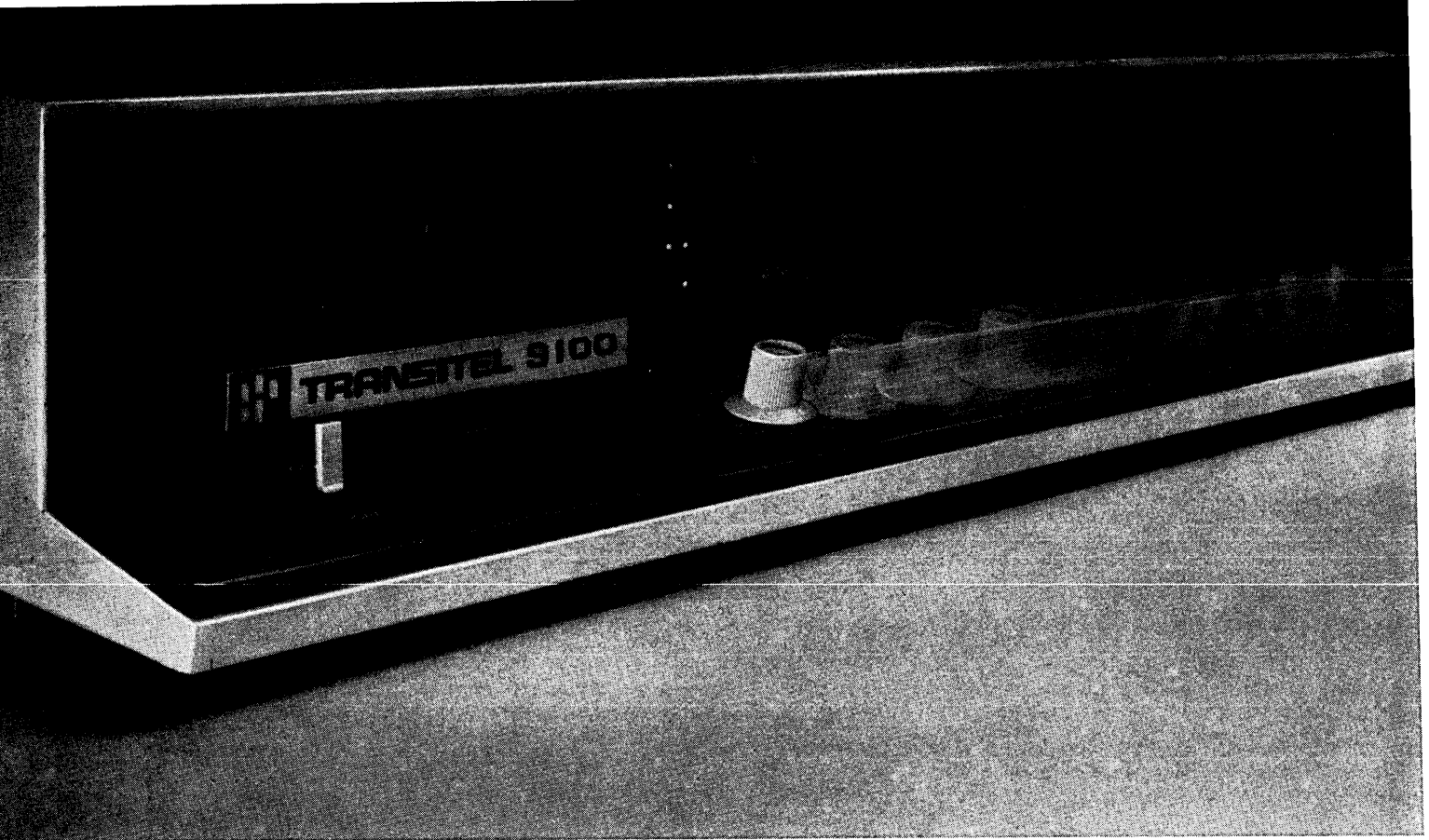

Fact:

**Transitel
Key-to-tape
Data Stations
are faster to learn...
faster in action than
Honeywell or Mohawk.**

Sorry about that, Honeywell and Mohawk.

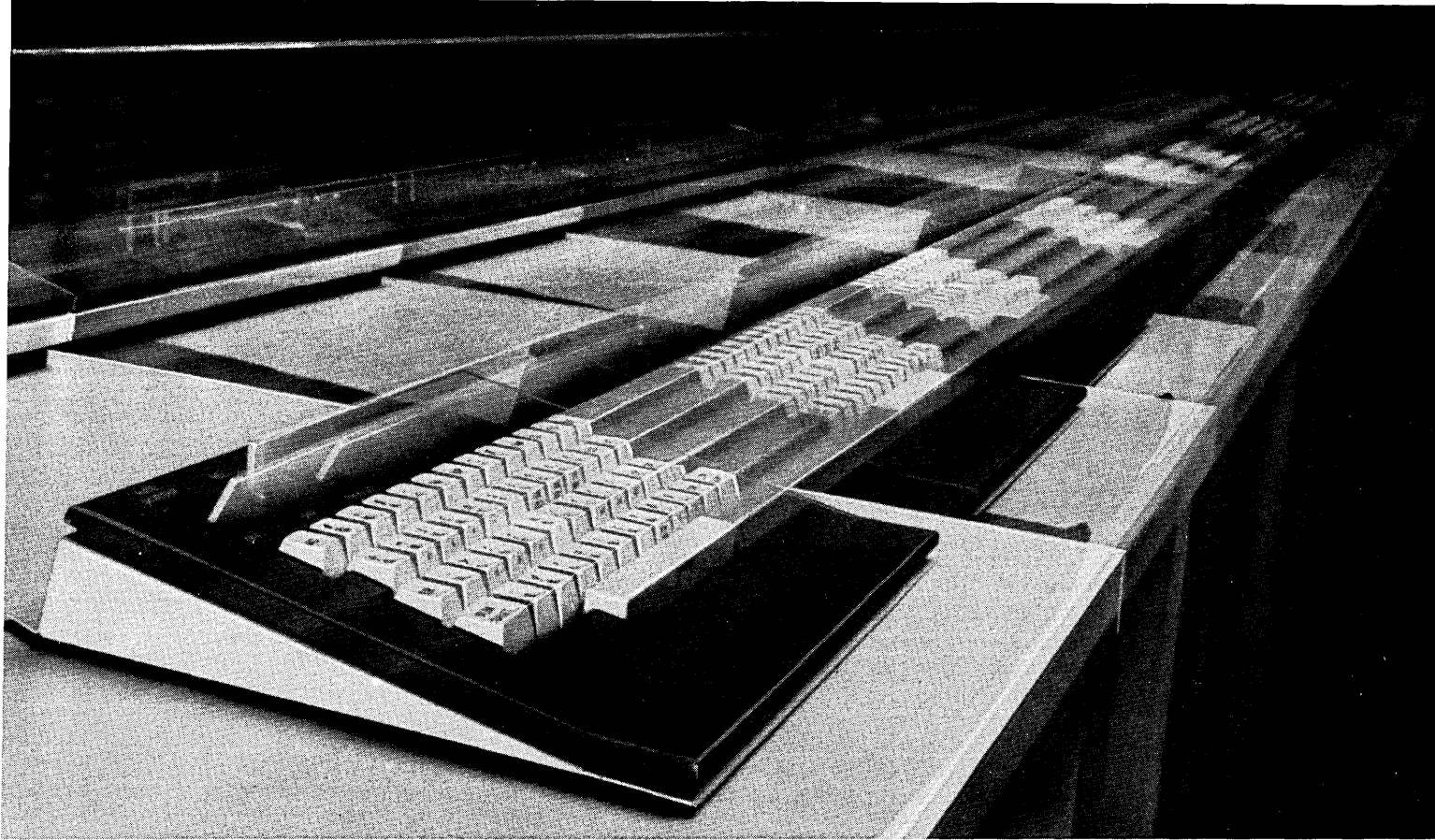

Comfort design increases productivity. Operators appreciate the large work area (over five square feet of desktop), the convenient personal effects drawer, and the added leg room to reduce strain and fatigue.

Plus total tape control. Tape transport sits in upper desk drawer for easy access. Reel-to-reel handling, with automatic tape loading and unloading features, cuts set-up time.

And easy error correction. Operator-sensed errors are quickly corrected by backspacing, then entering the right character.

And flexible programming. Selectable record size (20-240 characters) permits a wide range of data formats.

And computer compatibility. Your choice of 7 or 9 channel 1/2" tape models, 200, 556, or 800 bpi density.

Transitel Key-to-tape Data Stations. Faster than others. Far easier to learn and use. Complete details in the new Transitel line brochure. Yours for the asking.

**equipment
that's nice
to people**

These high-performance units demonstrate Transitel philosophy. First, to engineer in more production potential. Then to people-design the equipment so workers can realize this potential... and enjoy doing it.

Consider these Transitel Data Station features:

English display uncomplicates learning. With true character representation, trainees don't have to memorize codes. They can read characters instantly. English display also helps them toward more accurate verification and easier error recovery.

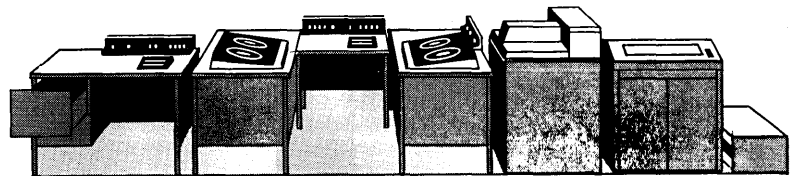

TRANSITEL
COMPUTER SUPPORT SYSTEMS

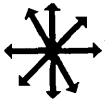

**Information for this series is invited
Applications submitted must be
installed and operational**

Transit Control System

Chicago uses 3300 buses as part of its transportation system, and has experienced all the attendant problems of scheduling them, communicating with their drivers, and sometimes just locating them. The city now has a pilot transit control system called Monitor-CTA which was started with the approval of the Department of Housing and Urban Development under a \$1.5 million-plus grant from the Department of Transportation. The first such system to be used in the nation, Monitor-CTA (CTA for Chicago Transit Authority) has been implemented on a trial basis on the 500 buses used on "owl" runs between 12:00 midnight and 5:00 am.

In addition to performing its automatic fleet monitoring function, Monitor provides an emergency alarm system for each bus, to be used in case of robbery or passenger illness, for instance, and two-way voice communications between the driver and dispatcher. The system was designed and installed by Motorola Communications and Electronics, Inc.

Situated on traffic light controller boxes and on traffic light poles at strategic locations along Chicago's streets there are 120 very small "electronic signposts," small radio trans-

mitters that work something like landlocked signal buoys. Their sole purpose in life is to continually transmit a weak identifying radio signal. Located an average of two miles apart, each is assigned a 10-bit binary identifier code which it translates to tones from digital pulses and modulates onto a radio signal.

In addition to these stationary beacons, Monitor hardware includes both data and audio receiver/transmitters on the buses, the GE/PAC 4020 computer with its telemetry equipment and interface equipment, and satellite receiving stations located throughout the city to relay the relatively weak signals from the buses.

As each bus leaves the garage to go to work, its driver reaches over and sets a run number in the digital thumbwheels next to his handset. The Chicago Transit Authority maintains 12 garages, and the run numbers within a garage are all unique. Hard-wired into the bus radio gear is the garage number, which further identifies each vehicle.

When the bus comes within 200 feet or so of its first signpost transmitter and receives its location information, the incoming code is demodulated back to tones, the tones are

converted to pulses, and fed into an error detector. When it is determined to have been read correctly, the location information is stored in a register, erasing whatever data was there previously.

As the bus leaves the 200-foot radius around the transmitter, an elapsed time generator starts incrementing a counter every 12 seconds. Given the bus's scheduled speed, the counter and location register provide

COMPUTER AND PERIPHERALS

GE/PAC 4020
with 12K (24-bit) words of core.
1.6 usec cycle time.
Dual crt Datamet 760 display.
One million word disc.
ASR 35 Teletype, card reader,
paper tape reader and paper
tape punch.
Data link to CTA's GE 415
computer.

enough information to determine well enough where the bus is located every moment. The time pulse generator is turned off when the bus is within the 200-foot sending distance of the signposts, so that a standing bus does not automatically look like a moving one.

As the bus moves through its route it is polled by the central site computer. At 66 $\frac{2}{3}$ msec intervals the cpu puts out a bus identification number, which goes through the same kind of digital-to-radio conversion used by the signposts and is transmitted to all buses at the same time. All buses receive the signal, reconvert it, check it for errors, and compare it with their individual ID numbers. On all but one bus, nothing else occurs. On the bus where the numbers compare, a transmission is initiated. That bus sends out its location register and

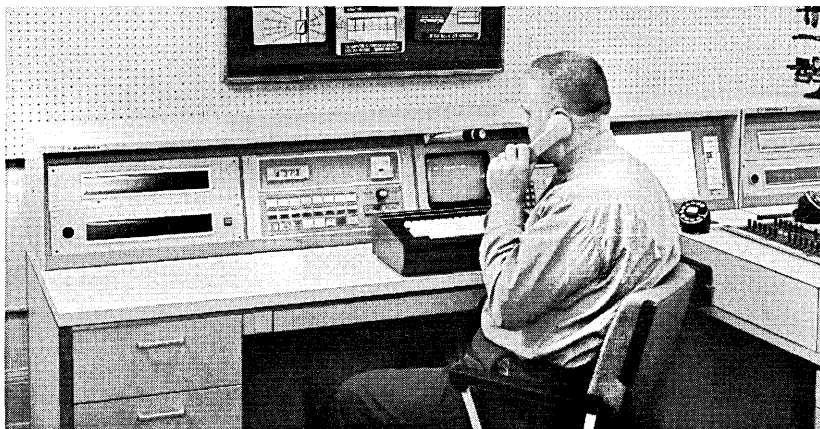

In the Monitor-CTA program, 500 of Chicago's 3300 buses have been equipped with the Motorola voice/data/alarm communications gear.

time counter information, which is picked up by satellite receivers through the city and sent to the dispatchers' office. At the control center the signals are fed through "voting" equipment, and the strongest forwarded to the cpu where it is checked against a stored run schedule.

The signals sent to the buses can be requests for the operator to pick up his handset and call in; such "requests" turn on a light at the driver's seat. Similarly, when the driver responds he need not give his identifying numbers; his transmitter automatically does that.

The location data from the bus is compared against a run schedule. If the deviation from the schedule is outside wide limits tolerance, a crt message appears to alert the dispatcher and a permanent record is made. The dispatcher then has the option of dialing the bus's id number, a procedure which puts him right through the automatic conversion process. (In fact, the dispatcher's call and the normal interrogation message look alike to the bus's telemetry system except for the address code.) When the bus driver's handset is lifted, the on-board radio equipment switches automatically from the data frequency to the audio channel. The driver's voice, like data transmissions but at a different frequency, is picked up on one or more of three satellite receivers and passed through "voting" equipment before the strongest version of his reply is passed to the dispatcher. While the driver uses the communications band, his bus cannot automatically respond to a location inquiry since it has only one transmitter, and the bus is listed as "lost" for that interrogation.

The hardware that identifies the bus and its location comes into play automatically in the alarm sending mode, also. The driver has a foot pedal which turns on the alarm. The alarm is sent out continuously for two minutes on the voice channel and, for reasons of driver and passenger safety, no indication of the alarm is given on board the vehicle.

Software

Five control programs are contained in the software. They are: Location-Status, Bus Interrogation, crt

Output, Alarm Detector, and Alarm Decoder. They operate under rtmos, General Electric's Real Time Multi-programming Operating System for the 4020. Location-Status is the most important of the group. It operates on "route blocks," 1000-word blocks containing schedule information on one or more bus runs. Location Status controls the transfer of these blocks into and out of core, testing them to see if they have runs to be processed, and forming an interrogation message if required. The program also takes the input messages, the location data responses to the interrogations, and compares them with the run schedule. In the case of an off-schedule bus, this program also sets up the crt message.

Bus Interrogation moves data from lists set up by Location-Status to the

communications equipment, causing the 66 msec interrogation signals to be issued. The crt Output program is similarly self-explanatory.

Alarm Detector senses alarms and turns to the Alarm Decoder program for determining the route on which a bus is in trouble, the direction of travel, and distance from last signpost. This program turns on crt Output, which produces, in this case, a flashing message.

The control programs are loaded by paper tape into the system; programs being compiled come through the card reader. Both readers are slow speed devices, as the primary i/o channel for the 4020 goes directly to the Transit Authority's GE 415, where schedule data is input and output and permanent records can be compiled on tape or printed. ■



The dispatcher can respond to a crt-displayed "late run" message by dialing the bus and talking with its operator. The dispatcher already knows the bus's garage, run, and vehicle numbers and its location.

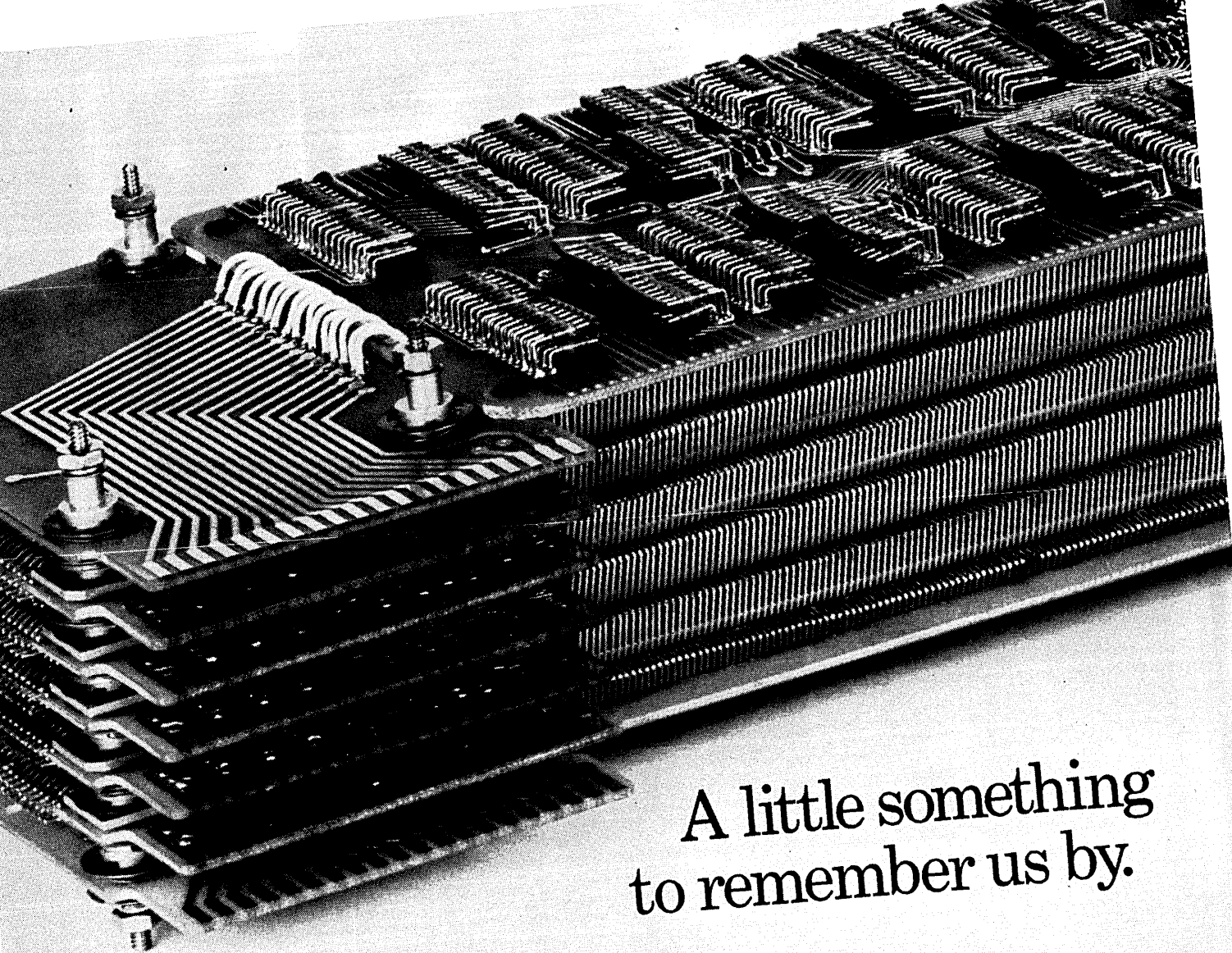

*A little something
to remember us by.*

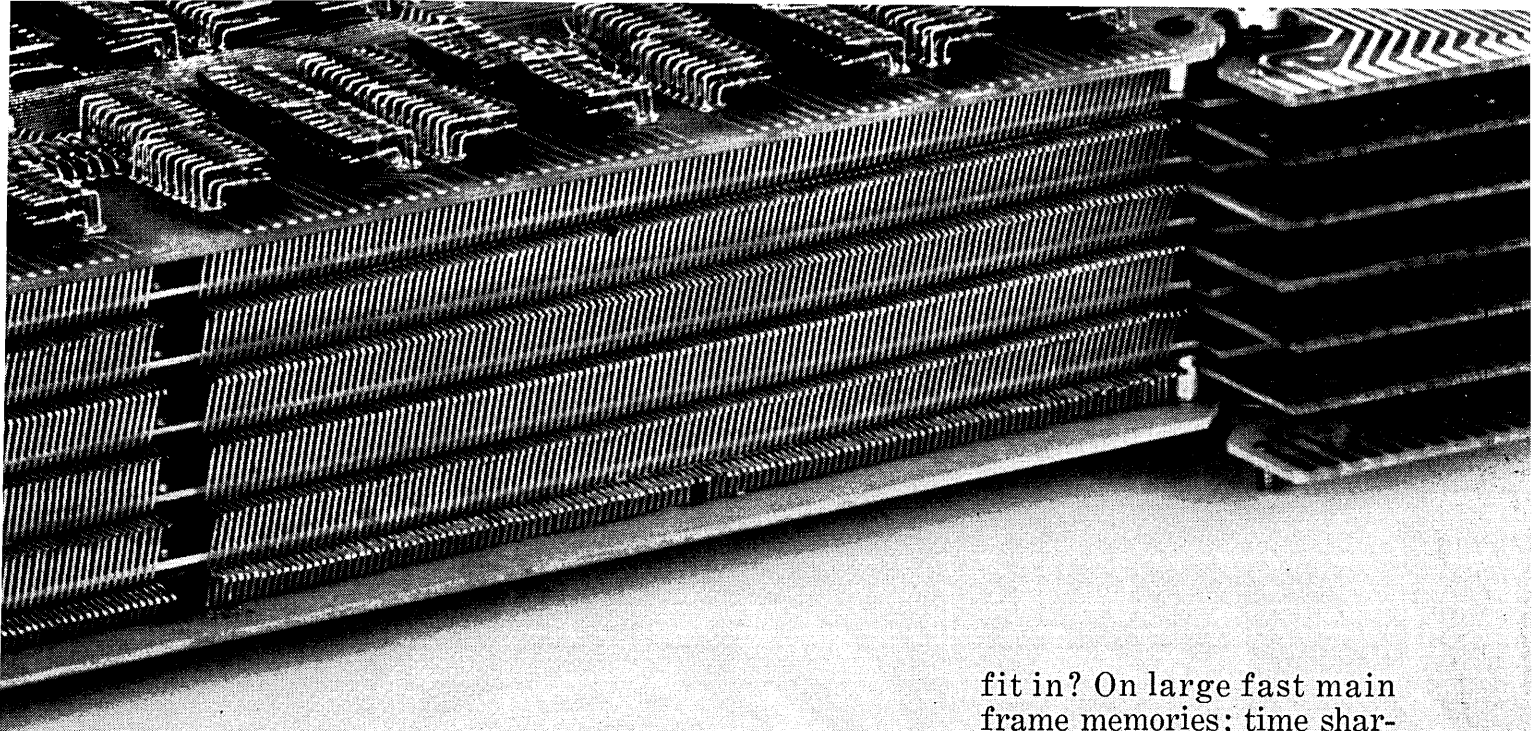

You're looking at an actual size photograph of the new Nanostak[®] NS-3020 commercial memory stack. Proof that big things come in small packages. This stack is so compact its volume is only 25% of competing planar designs.

But we didn't cut corners on performance.

Nanostak is a modular

2½D stack with full cycle times as fast as 700 nanoseconds. Its maximum capacities are 32,768 words by 20 bits, 16,384 words by 40 bits and 8,192 words by 40 bits.

And everything happens so easily.

We've designed Nanostak with printed circuit board edge connectors and mounting jack screws. Which gives you a simple plug-in unit for all NS-3020 configurations.

Just where does Nanostak

fit in? On large fast main frame memories; time sharing systems; electronic telephone exchanges and radar signal processors. We've built enough reliability into this stack for process control applications in the most severe industrial environments. Wide temperature range cores are even available as an option.

Nanostak. A little something you might want to talk over with us. Soon.



Electronic Memories. Worth remembering.

Face the facts.

Fact: Accodata is the *only* square ring EDP binder on the market. Fact: square rings permit sheets to lie absolutely flat. Fact: flat sheets are easier to read. Fact: square rings hold more sheets. Fact: sheets go in and out of square rings much faster. Fact: Accodata Square Ring Binders come in waterproof, scuffproof, tearproof Accohide.* Fact: you'll get more details writing for our 4/color catalog or asking your Acco dealer. All the details, in fact.

* A chemical resin.

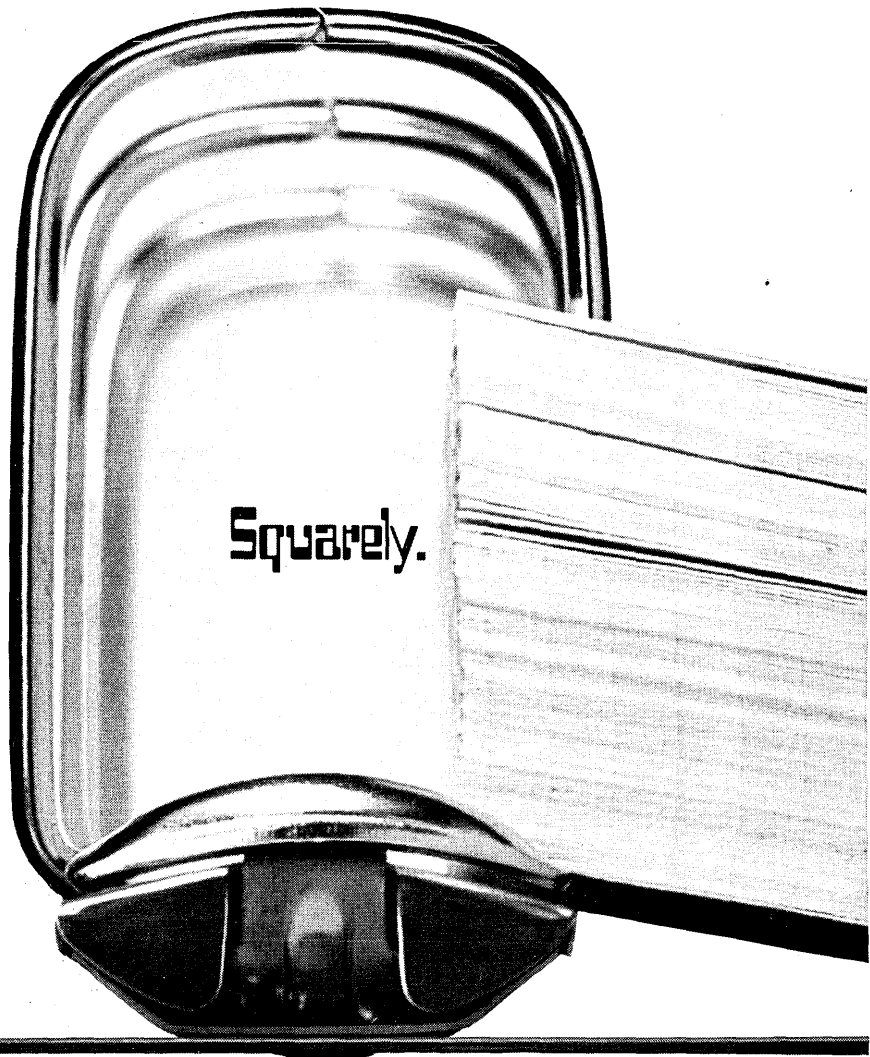

ACCO



5150 N. Northwest Highway,
Chicago, Illinois 60630;
New York, Los Angeles, Boston;
Gary International, Chicago, U.S.
Canada/England/Holland/Mexico
Venezuela/El Salvador/Jamaica
Japan/ Divisions of Gary Industries, Inc.

Now, Strength and Precision in Steel or Aluminum Floating Floors Panels

New Steel Floating Floors® Panels have a top plate of 13 gauge hot-rolled steel continuous bonded to a uniform support grid.

These panels will support a concentrated load of 1,000 lb. on one square inch with a maximum deflection of only .080" or a uniform live load of 250 lb. per square foot without damage. They are factory finished with a rust inhibiting paint.

Die Cast Aluminum Floating Floors Panels provide more strength than steel at approximately ½ the weight. The inherent corrosion resistance of aluminum prevents environmental contamination from iron oxide. The system is approved for seismic conditions.

All Floating Floors systems are laterally stable, allow infinite access to underfloor wiring and are square and completely interchangeable. Vinyl, vinyl asbestos, plastic laminate or carpeted surfaces are available.

Site Environment Systems - SES

SES® Units manufactured by Floating Floors, Inc. reliably hold room air temperatures within $\pm 2^\circ$ F., and relative humidity levels within $\pm 5\%$, 24 hours a day, 365 days a year.

Write for our new color brochure on the full Floating Floors/SES line.



FLOATING FLOORS, INC.

Floating Floors, Inc.
Subsidiary of National Lead Company
5400 N. Detroit Avenue/Toledo, Ohio 43612
Telephone (419) 479-0721/TWX 442-1709

CIRCLE 58 ON READER CARD

Now we give you
dry, flat COM printout...

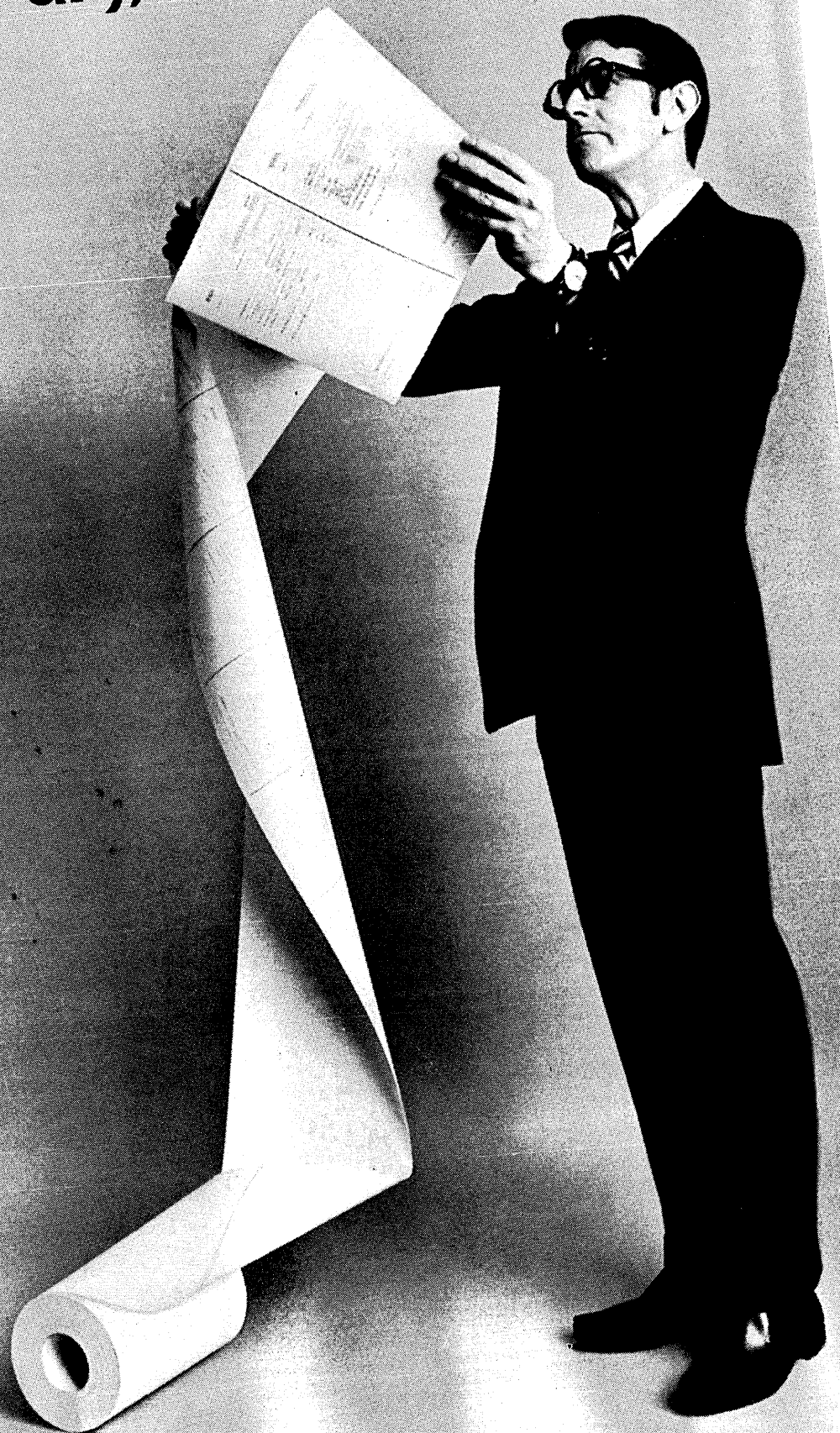

any way you look at it.

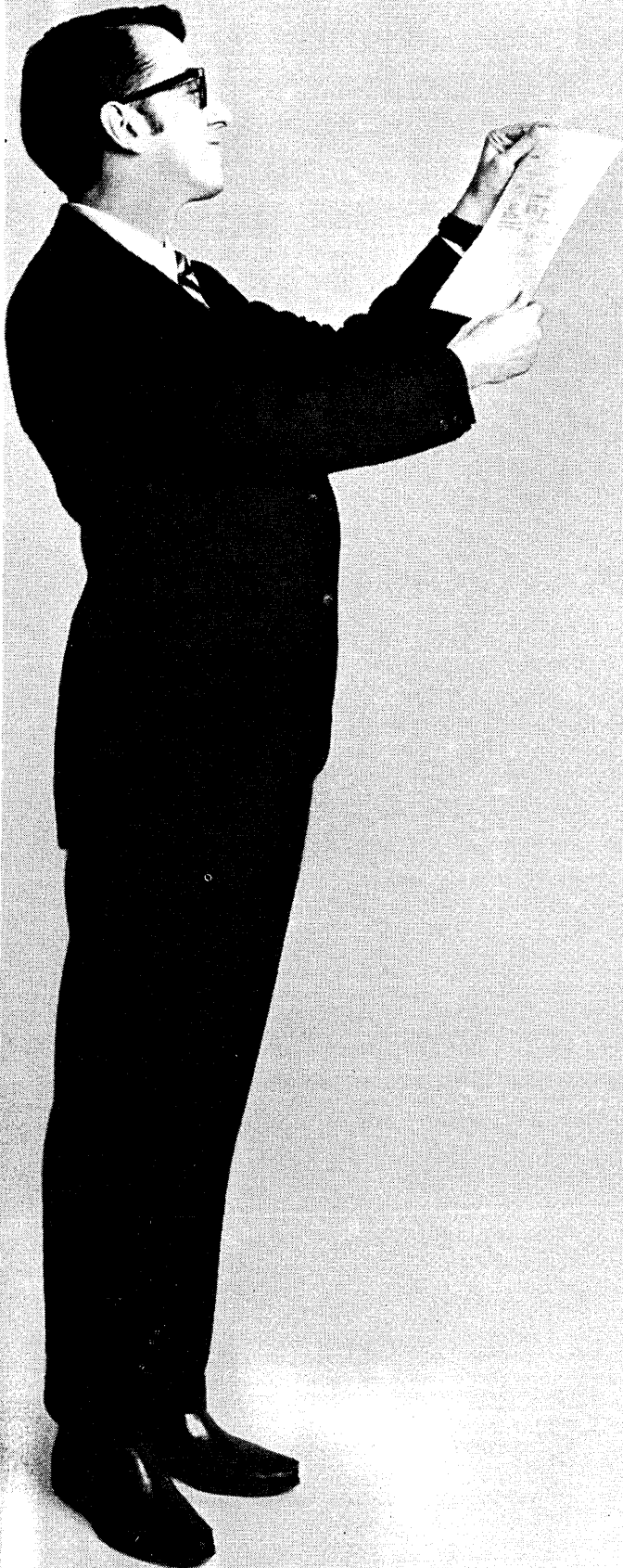

Sometimes you want COM printout by the page, at point of need.

Other times you want it in quantity, foot after foot.

Either way there's a Xerox machine that can take your electronically-generated microfilm and give you printout the way it's most useful. Dry and flat. And fast.

For selective printout there's the Xerox microprinter. In 10 seconds it gives you enlargements on plain, untreated paper that you can use and mark up the instant they're made.

You simply select the frame, push a button, and out come your blowups. From any size or kind of microfilm. In magnification ratios of 12x, 16x, 20x or 24x.

The other way we give you printout is the Copyflo II Continuous Printer. It makes sharp, dry positive enlargements at 50 to 60 pages per minute. On ordinary, unsensitized paper, translucent intermediates, or offset master material.

The microprinter and the Copyflo II. Any way you look at it, they're worth looking into.

For more information, write Xerox, Dept. MP, Xerox Square, Rochester, New York 14603.

And we'll have one of our product specialists call on you.

XEROX

CIRCLE 34 ON READER CARD

THE EVANS & SUTHERLAND LDS-1 SIMULATES A PERFECT LANDING!

A New "Perspective" in Hardware

Perspective is Essential to Simulation—

The Evans & Sutherland LDS-1 quickly and accurately computes and displays *true perspective*. As the pilot of a simulated airplane approaches touch down on a carrier, the picture of the ship and landing deck becomes larger as shown in the actual display photographs at right. Fast and accurate perspective is possible whatever the application such as the simulated docking of space craft. The nearing sister ship will loom larger and larger until it fills the entire screen. The highway in front of a simulated moving automobile will narrow as it trails into the distance. The LDS-1 is uniquely well suited to provide *true perspective* giving the closest representation possible of the picture you would see if you were the pilot, the astronaut or the driver.

Perspective Three-Dimensional Displays

Require Division—Unlike analog systems with their inherent problems in performing division, the fully digital LDS-1 processor divides coordinates needed for perspective display with ease and speed. The LDS-1 is fast with 10 microseconds typical for processing each line. A long line requiring considerable processing may take up to 50 microseconds. Accurate too, no analog system can approach our 18, 20 or 24 bit per coordinate accuracy. Using 24 bits, the LDS-1 system will accurately represent one inch in 264 miles. The LDS-1 processes only the visible portions of the pictures. Segments of lines behind the observer or out of his field of vision are automatically clipped before the perspective computation.

Fast and Accurate Hardware Rotation—

Simplified Coding—The LDS-1 Matrix Multiplier does three-dimensional rotation and translation in half the time of other

systems and with greater digital accuracy. Objects moving with respect to each other such as aircraft in combat or other airport traffic in front of a landing airplane are each positioned by a single four-by-four matrix and the LDS-1 automatically draws them into a composite picture. Compound rotations such as folding landing gear or convertible top linkages are automatically combined by the LDS-1 into the proper single matrix multiplication greatly simplifying required coding.

Easily Displays 2,500 Lines in Real-time—

The complexity of possible pictures depends on how the graphic elements are grouped together. Objects with 2,500 lines are simple for the LDS-1 to display in real-time. If any of the lines of the objects are out of view, there can be more lines in the objects because only the lines in the field of view are processed. The right part of a line shows in the right place even when only part of that line is visible.

A New Attitude About Three-Dimensional Display—

The LDS-1 represents a new concept of creating perspective with ease in simulations. The user thinks in three dimensions; the LDS-1 computes the correct two-dimensional perspective. It can compute displays for its scope or for your existing or proposed computer graphic equipment. LDS-1 data formats are the most flexible in the industry. The LDS-1 is exactly what you expect from Evans & Sutherland Computer Corporation . . . The Most Sophisticated Name in Computer Graphics.

Evans & Sutherland Computer Corporation, 3 Research Road, Salt Lake City, Utah 84112. Phone:(801) 322-5847.

Printed from actual display photographs.

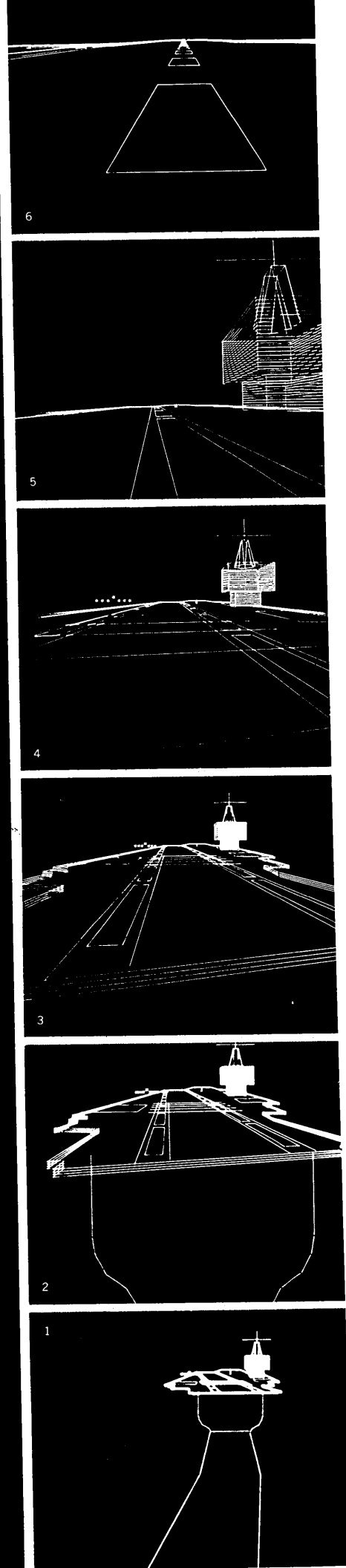

EVANS & SUTHERLAND COMPUTER CORPORATION



CIRCLE 125 ON READER CARD

Product Spotlight

Input Editor

The Model 1500 data editor supports an edp installation by providing comprehensive data editing and validation functions and formatting the information onto tape for computer processing. By increasing the accuracy of coding the computer processes and reducing the number of operations necessary for program preparation, the data editor will probably increase operational efficiency.

Consisting of a small processor with 8K of 16-bit core memory (expandable to 65K), an operator's console with a crt unit, and up to four magnetic tape units for production of computer-ready tape, the 1500 reads tape cartridges prepared on such devices as IBM's model 050 magnetic data inscriber. (A model to process standard-size tape is in the works.)

The data is then displayed on the crt for the operator to duplicate, sequence, and expand record sizes, as well as obtain batch totals. More specialized procedures, such as table look-ups, field comparisons, field content checks, multiple and conditional verification, as well as insertion of information that remains the same from record to record, are performed by



the operator using a non-technical control language called ESCAPE.

Output (input for the computer) tape records are IBM-compatible 9-channel 800 and 1600 bpi, or 7-channel 556 and 800 bpi EBCDIC, or Honeywell-compatible 7-channel 556 and 800 bpi. Records can be blocked up to 2K characters.

Options include additional tape cartridge units (up to 14 allowed), a low-speed printer, tty, and provision

for up to five communication lines to be attached for data transmission from terminals at 300 to 9600 baud.

Monthly rental for a basic 8K system is \$1,450 plus maintenance. With a printer and output tape unit, the rental is \$2K per month, including maintenance. The basic model can be purchased for \$62,250. DATA ACTION, Minneapolis, Minn. For information:

CIRCLE 360 ON READER CARD

Century 200 Discs

A new disc unit for the NCR Century 200 Series will feature capacities of 29.8 or 59.6 million bytes compared with a maximum 4.2 million bytes per spindle or 8.4 million bytes per unit for previous Century disc units. Two models will be available: the 657-101, a single-spindle model, and the 657-102 with dual spindles.

Single-spindle units have an "add-on drawer" feature that doubles the storage capacity by the addition of a second disc spindle. Conversion to a dual spindle can be made at the user location.

Average access time, including latency, is 72.5 msec, and maximum transfer rate is 315,000 bytes/sec.

The new units will require a 625-201 controller which can supervise

up to eight spindles; rental is \$875 per month, or \$40,250 sale. Rental for the 657-101 and -102 discs is \$575 and \$900 per month, or \$26,450 and \$41,400, respectively, on purchase. First deliveries are scheduled for the fourth quarter of next year. NCR, Dayton, Ohio. For information:

CIRCLE 365 ON READER CARD

Time Sharing Computer

The significance of the 2+2 computer is that it was designed specifically to make large scale time-sharing profitable. Narrowing the application to t-s only allows tailoring the I/O architecture for this purpose and has in the case of the 2+2 resulted in a unique I/O layout.

Basically the memory/processor unit has been divided into four parts (whence 2+2 designation—two general-purpose processors and two specialized processors) and each processor optimized for its respective function. There is a control processor (CP), applications processor (AP), a peripheral processor (PP), and a drum processor (DP). Where 90 nsec

ROM could be used (in all processors except the DP), 3 or 4K 16-bit words are employed, the remainder of the memory being 900 nsec core in chunks of 8-32K for the CP and 32-65K for the AP. The user will be dealing only with the four-way interleaved memory in the applications processor and will be using 20 accumulators and eight I/O registers.

Where other t-s systems tended to become I/O bound very quickly, the 2+2 utilizes a 2 megabyte/second transfer rate drum to keep 512-word memory pages on time. Computer simulations of the 2+2 show that the drum-based system can support 128 terminals with a user having to wait no longer than two seconds for system response under the worst condi-

tions. The remainder of the hardware is the standard assortment of tapes, printers, disc units, etc.

Excluding variations and privileged instructions, there are 180 microcoded instructions available to the user, as are MAP, BASIC, and a system editor. FORTRAN will shortly be added to the list. Data base manipulation, interactive debugging, and utilities are all included.

Available next March, a complete 2+2 system leases for \$20K per month on a 36-month contract, or can be purchased for \$600K from the bundled vendor. LOGICON, INC., Los Angeles, Calif. For information:

CIRCLE 361 ON READER CARD

(Continued on page 105)

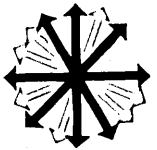

HARDWARE

Singer's System Ten. The computer that goes where the work is.

A computer on every desk. In shipping and receiving. In the stockroom. In billing. In payroll. In the Office of the President. And in the budget.



It's the Singer System Ten. The computer that goes wherever your people need data processing, or you need data input. And it's designed to be understood and used effectively

by nearly everyone.

System Ten goes so much further and does so much more because we've designed it with seven important advantages especially for business applications:

1. The workstations can be located virtually anywhere in your office or plant.
2. The system can process up to 20 jobs simultaneously. Including batch processing. 20 jobs, no waiting.
3. The system has mass storage. 10K built into the CPU, expandable to 110K, and an additional 100 million characters is available with disc drives. Room for all.
4. Time-sharing control is built in with hardware. So no expensive executive software is needed.
5. System Ten uses simple assembler-

language programming. Anyone can do it.

6. Data communications capability to interface System Ten with other on-site or remote computers.

7. Total modularity, leading to remarkable cost economies. Total flexibility of size and configuration now, expandability for the future. For a new application, just add a new workstation.

In addition to these functional advantages, System Ten hardware needs only minimal environmental control. And the simple two-wire connections eliminate the need for expensive false-flooring to conceal heavy cable.

Find out more about the computer system of the decade. Call where the System



Ten people are, your nearest Friden office. Or write: Friden Division, The Singer Company, San Leandro, California 94577.

SINGER
FRIDEN DIVISION

CRT Terminal

Split screen displays, three separate keyboard styles, regular or double size characters, and two different screen sizes (9- and 12-inch diagonal), are some of the choices that allow 27 assorted configurations of the ADS-760 crt terminal. The models range from a simple display screen to a full stand-alone terminal with editing and storage capabilities.

Using their patented 9 by 14 filled stroke method, the vendor claims that characters displayed (from four lines of 32 double-size characters to 30 lines of 80 standard-size charac-

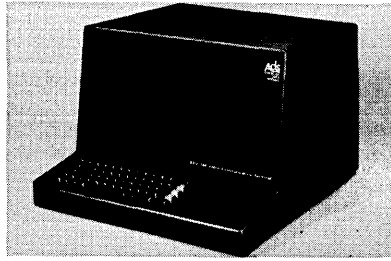

ters) are better looking than cursive stroke displays—which might mean easier to read. The screen is refreshed at 60 Hz, and a tape cassette unit is used to store the ASCII characters either for later display or output. An

accessory printer provides hard copy printout.

Half- and full-duplex data provisions are available. Operating in asynchronous or synchronous serial mode, input and output rates can range from 75 to 9600 baud. In parallel mode, rates range up to 15,000 characters/second.

A basic configuration, including keyboard, is priced at \$1900. A fully equipped terminal is \$3900. AMERICAN DATA SYSTEMS, Canoga Park, Calif. For information:

CIRCLE 364 ON READER CARD

OEM PDP-11

The third in the PDP-11 series of minicomputers is the 11/15, which nestles between the 11/10 and 11/20 (Jan., p. 201), sharing the same cpu capabilities as the latter, but differing from both in being intended solely for the OEM market. Equipped with a Teletype, the /15 is a general-purpose computer, completely capable of assembling its own programs.

The basic PDP-11/15 includes the cpu, programmer's console, 4K 16-bit words of 1.2 usec core (expandable to 32K), the Unibus data path for communications between memory and peripherals without going through the cpu, and multi-device direct memory access. Included, too, is a warranty under which the firm

will deliver and install the machine at the purchaser's site or that of any of his customers. Prices start at \$6200 and drop to \$4960 in lots of 100. First deliveries are scheduled for next spring.

The 11/15 is also available without the programmer's console, for \$200 less. Instead, it is equipped with a remotely controllable, tamperproof front panel. It seems that in many instances where the computer is part of a larger system, the programmer's console and Teletype are only used at maintenance time or when programs are being written. In the case of the 11/15 with this panel, programs can be written on an 11/20. An optional 32K read-only memory can be programmed to read such programs into the 11/15. For maintenance, the service personnel

will be equipped with a field maintenance pack including a programmer's console and paper tape reader for entering diagnostic programs into the 11/15.

Options available with the 11/15 include read only memory in 1K-word increments, read/write memory in 1K- and 2K-word increments, automatic restart in case of power failure, extended arithmetic element, magnetic tape and disc storage, and a line printer. Software includes that developed for the 11/20. A special BASIC package permits programs written in that language for other computers to be run on the PDP-11/15 without modification. DIGITAL EQUIPMENT CORP., Maynard, Mass. For information:

CIRCLE 369 ON READER CARD

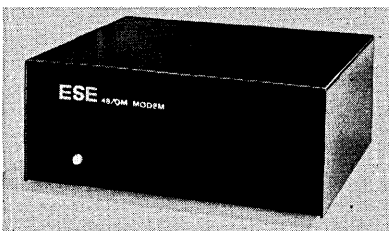

Modem

Our north-of-the-border friends build modems too, and this is the first one from a company that has been developing telephone transmission equipment in the past. Called the 48/QM modem, it operates at 4800 baud over voice-grade lines. Available in

the U.S. near the end of the year, the modem sells for \$4250 in single units; the price drops to \$3200 in quantities of 100 or more. ESE LIMITED, Toronto, Canada. For information:

CIRCLE 367 ON READER CARD

Mag Card Processor

Magnetic cards can be competitive with cassette storage, according to this vendor who is marketing a card processor as a minicomputer peripheral that uses 80-column-sized cards with a 768 (8-bit) byte capacity.

The data storage side of the card is completely coated with oxide; data is recorded on 12 tracks at a density of 100 bpi. The other side of the card may be written or typed on.

Each read or write pass over the

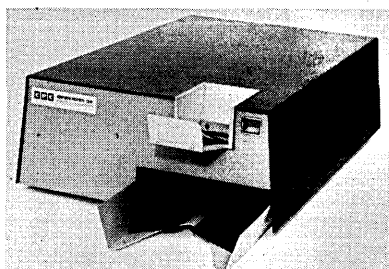

card takes about one second, but only one third of the card—four tracks or 2K bits—can be read or recorded in

one pass. Output cards can be selectively stacked into either of two hoppers.

The card unit is available four months ARO for use with Data General Nova's; interfacing is being prepared for DEC processors.

The card processor is unit priced at \$5000. The cards start at 25¢ each in quantities of 1000. COMPUTER PROPERTY CORP., New York, N.Y. For information:

CIRCLE 371 ON READER CARD

(Continued on page 107)

We designed the T113ATS Sangamodem

for originate mode
teletype applications
at up to 300 bits/sec.

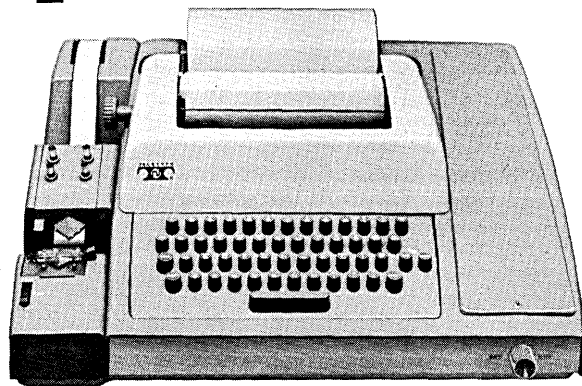

That's why it's so reasonably priced.

Sangamo's T113ATS is a completely solid state data modem designed for two-wire full duplex operation. Total price is under \$200. End to end compatibility with thousands of Western Electric 103A2 or 103E data sets permits immediate assimilation into existing systems without any terminal modifications. Since the T113ATS is electrically connected to the telephone network, 60 db channel separation is guaranteed. And performance is not degraded by second harmonic distortion prevalent in other coupling methods. By designing the T113ATS for a specific application, the cost was minimized. Data set lease

charges for only 7 months will more than equal the total purchase price. It's easy to install, with only a medium sized screwdriver.

For more data on Sangamo's new T113ATS or any other Sangamodem contact:

Communication Systems

SANGAMO
ELECTRIC COMPANY

P.O. Box 3347, Springfield, Illinois 62708,
(217) 544-6411

T777

Data Set

Designed for manual, full-duplex, originate-only operation, the model 113A transmits and receives serial data at up to 300 baud over telephone lines to phone company or customer-provided terminal equipment. The unit can communicate with 101C, 103A and 103E data sets and is EIA RS-232B compatible.

An interesting feature of the 113A is that it obtains the necessary operating current solely from the telephone line. The lease rate ranges from \$10 to \$12 per month from your local Bell System company. A receive-only model (113B) will debut in the last quarter of the year. AT&T, New York, N.Y. For information:

CIRCLE 374 ON READER CARD

Coupler

Utilizing IC technology and a simplified housing design, the RT-332A Acoustic/Magnetic data coupler sells for only \$210 in single units, with discounts available for quantity orders. The unit operates at a maximum of 300 baud for both transmit and receive modes, full or half duplex, and is intended to interface with Bell 103 series modems.

It comes with a cable for the ASR33 Teletype, reducing initial connection time to a matter of minutes. Performance of the RT-332A is guaranteed for one year, with service provided on a factory exchange basis. ITI ELECTRONICS, INC., Clifton, N.J. For information:

CIRCLE 372 ON READER CARD

Drum Memory

Boasting an average access time of 4.4 msec, the SA 8000 series drum packs up to 1800 bpi on 256, 512, or 1,024 tracks. Thus the 5- to 20-million-bit-capacity units, rotating at 7200 rpm, attain transfer rates of four megabits per track.

The vendor will supply the necessary controller to your specifications, and the unit is also available to OEMs. In single units, the five megabit model sells for approximately \$17,000 plus controller, and the 20 megabit model is \$25,000 plus controller. SYSTEMATICS DIV., GENERAL INSTRUMENT, Hawthorne, Calif. For information:

CIRCLE 368 ON READER CARD

Key Security

Locks for terminals in multi-user systems have been discussed at every session on systems security, and usually everyone disagrees on how they can best be implemented. Here is one company that has taken the lock literally and developed a key.

It is a coded plastic key that is inserted into a reader assembly. The assembly can be incorporated into any terminal. It scans in serial or parallel. The key must be coded with 28 bits of data in any code although BCD is most common thus far. It can also be color coded, since both it and the assembly are available in yellow, red, or blue.

The price for this security is \$56 for a single assembly. There are re-

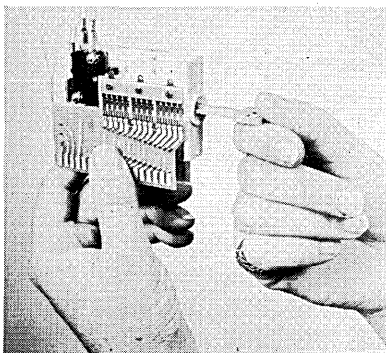

ductions for quantity purchases. The assembly and key were developed by Comperipherals Inc. and are being marketed by ADDO-X, INC., New York, N.Y. For information:

CIRCLE 363 ON READER CARD

Tape for Minis

The TC8009 can control up to four 7- or 9-track tape units, either 12.5, 18.75, 25 or 37.5 ips models. Reel size can be either 8½ or 10½ inches. It is a synchronous read system that can be interfaced to the negative or positive logic bus of the PDP-8, PDP-8/L or PDP-8/I. (Many of the older computers make use of a negative bus.)

A basic TC8009 with an 800 bpi, 25 ips recorder, 10½ inch reel, all interconnecting cables, positive bus interfacing, software diagnostics, and one-year warranty will cost \$9000. Delivery is 60 days ARO. DATA-COME, INC., Fort Walton Beach, Fla. For information:

CIRCLE 362 ON READER CARD

Multiplexor/Concentrator

The Timeline 220 multiplexor operates as a character- or bit-interleaved multiplexor or both. It also permits speed mixing and channel adding and collecting. The last two features enable it to function as a concentrator by tying in low-speed channels at intermediate points in point-to-point configurations and by collecting high-speed channels (carrying already multiplexed low-speed traffic) at remote points or at the computer.

The basic channel for the 220 is 4800 bpi. This can be partitioned into 56 110-baud, 43 135-baud, 38 150-baud or 19 300-baud channels or any combination thereof. Bandwidth partition, reports the manufacturer,

is exact. The diagnostic panel permits isolation and definition of problems in the multiplexor, lines or data sets.

A basic Timeline 220 with four channels is priced at \$4860. This includes the base unit at \$4500 and the channels at \$360, plus two years of free service. The channels are full duplex 1/0; hence the \$90 per channel-end price. Delivery for the multiplexor is 30 days ARO. INFOTRON SYSTEMS, Pennsauken, N.J. For information:

CIRCLE 373 ON READER CARD

Magnetic Card Reader

For the system that needs input from magnetic strip encoded credit cards, here is the MCR 100 series reader. A component-level unit, it can read up to 90 characters of information. It meets the IATA's 120 VAC input standard and outputs data and strobe signals at logic voltage level. Single unit price for the MCR 100 reader is \$450, but it is directed at the OEM market. For quantities of 100 the price is less than \$200 each. There is a 60 day wait ARO. ID SYSTEMS CORP., Lexington, Mass. For information:

CIRCLE 370 ON READER CARD

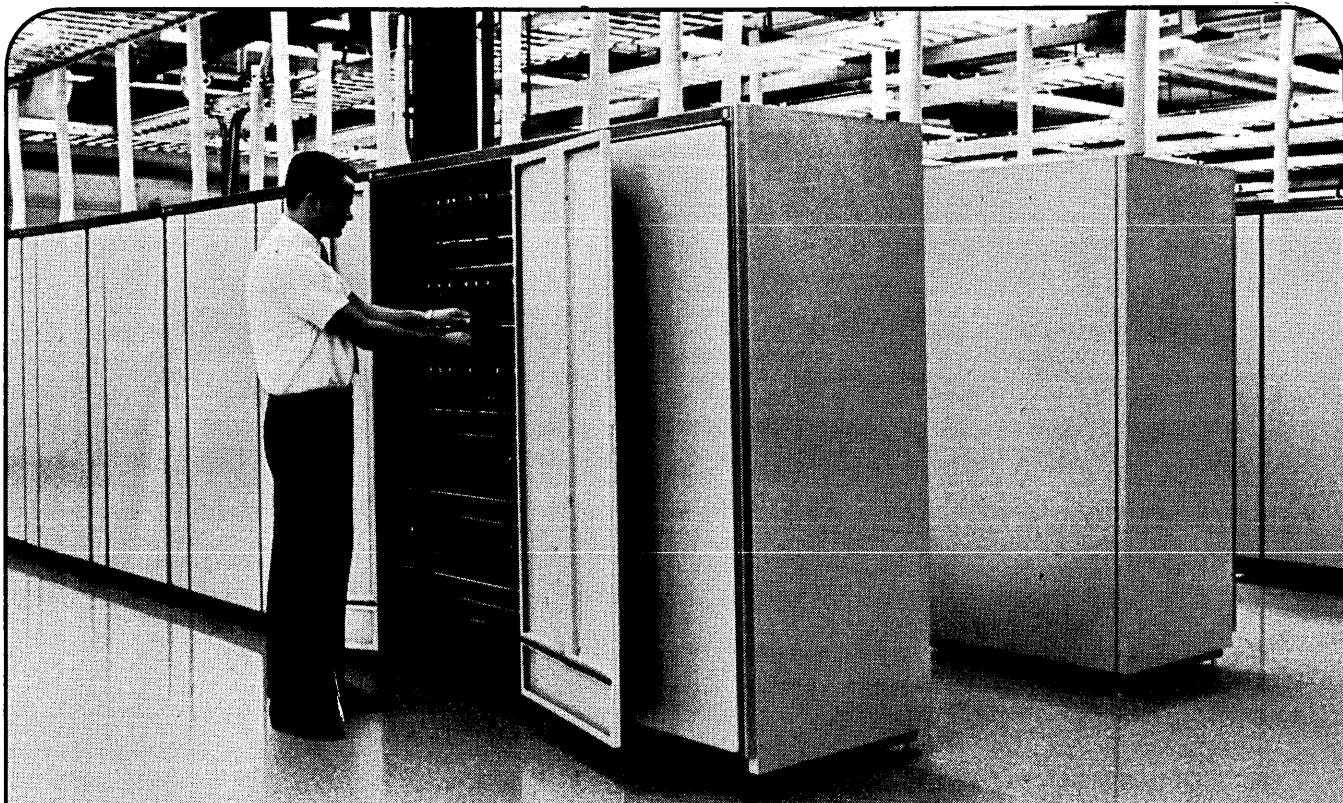

Collins C-System **...the kind of system** **you've been saying** **computer companies** **should offer.**

Processing, communications, control. All integrated in a single, total, simple, easily understood system. Reliability? One of its greatest strengths. Ask customers who depend on Collins processors for 24-hour-a-day, 7-day-a-week, 365-day-a-year operation. Applications? Name it. Process business data, solve scientific problems, collect data, control an entire factory, switch messages. Do it all or any part of it—at one site or at widely separated locations. Expandability? No need to

purchase more capability than current or expected operations require. As needs change, simply add standard configuration units—don't start over with a new system. A common file for the entire network gives you unequalled efficiency. Also: the C-System can work with your existing computer equipment. Contact Collins Radio Company, Dept. 300, Dallas, Texas 75207. Phone: (214) 235-9511.



ANOTHER REASON TO THINK COLLINS WHEN YOU THINK COMPUTER SYSTEMS

CIRCLE 57 ON READER CARD

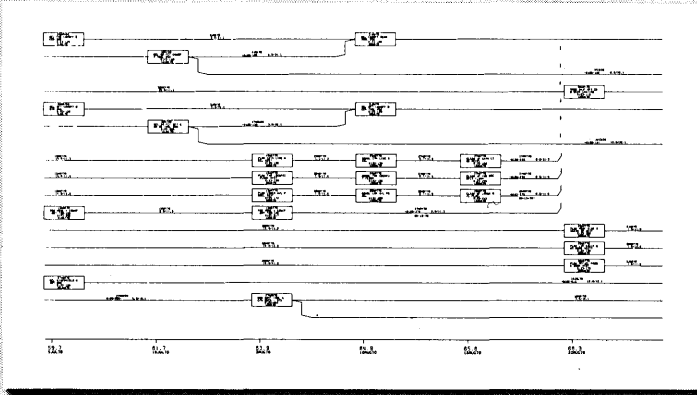

AUTONET PROGRAM

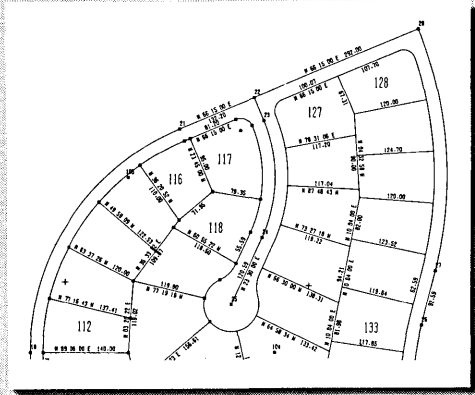

SAMPS PROGRAM

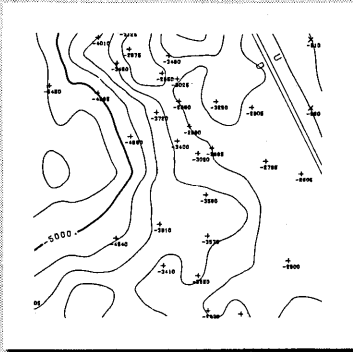

GPCP PROGRAM

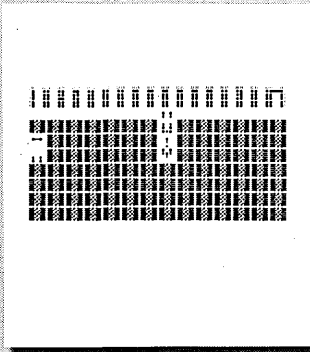

MASKGEN PROGRAM

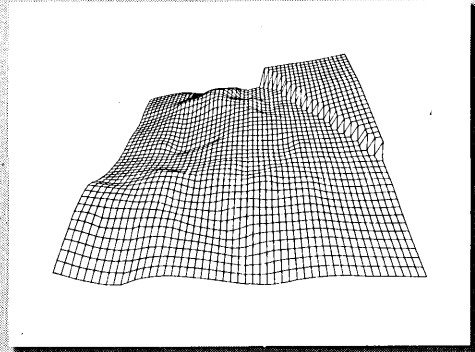

THREE-D PROGRAM

CalComp has software you can draw on.

No waiting.

The day we deliver your CalComp plotter, your plotter can deliver drawings like these.

Because CalComp also offers a wide range of *software* packages to let your plotter go right to work.

Our AUTONET program automatically produces CPM/PMS network charts. Easier to read. Faster to draw. Less expensive. And more consistently accurate than hand-drawn charts.

Our SAMPS program can handle drafting for subdivision planning and mapping. To aid in design. Eliminate errors. Provide accurate working plots. Produce annotated final maps. And more.

Our GPCP program is the most

complete, accurate and versatile package available for automated contour mapping. Including maps and diagrams of seismic, demographic, geological, thermal and pressure data.

Our MASKGEN program for integrated circuit design lets designers lay out and verify computer-stored patterns. And actually *cut* circuit masks on a CalComp plotter.

And our THREE-D program offers a way to visualize any structure described by XYZ coordinates, from an area of terrain to a mathematical formula. In any perspective. And even in stereo.

No matter what your graphics problem, call your local CalComp man for fast

relief today. He'll be happy to help you.

He has the hardware.
And he's a softy.

CALCOMP

TEACH YOUR COMPUTER TO DRAW.

California Computer Products, Inc.
2411 West La Palma Avenue, Dept. D-9
Anaheim, California 92801

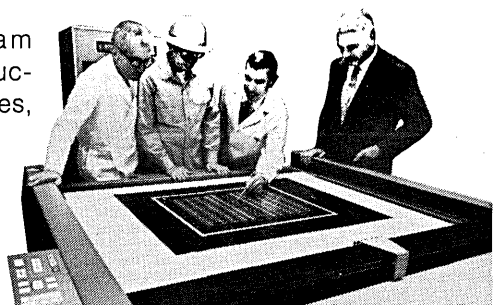

ACCOUNT NAME	NRA CODE	DISTRIBUTOR LOCATION	SLS DIS	DIST CODE	PROCESS CATEGORY	TOTAL	EQUIPMT	MISC SUPP	MASTERS	QTY OF MASTERS	231	421	422	451	1124	2817	3121	3337	4784	4487	683	1886	4484	4221	
IRS	011-02	PARKERSBURG W VA	02	4687	OFFSET	181	5,700	21	88	182															
IRS	011-02	DENVER COLO	03	582	AZOGRAPH IMPR PPR	52	9,988	52	79	561															
BU WEAPONS	011-02	HOUSTON TEXAS	03	4131	ELECTRO	1,565	1,272	47	249	278															
BU WEAPONS	011-02	AUSTIN TEXAS	03	4133	OFFSET ELECTRO	215	228	89	118	53															
BUSHIPS	011-02	PHOENIX ARIZ	04	231	AZOGRAPH	14	7,362	14																	
BUSHIPS	011-02	SAN FRANCISCO CAL	04	421	AZOGRAPH SPIRIT	728	718	18	96	221															
BUSANDA	011-02	SALT LAKE CTY UTAH	04	4221	MIMED OFFSET IMPR PPR	8	12	8																	
BUSANDA	011-02	SEATTLE WASH	04	4511	IMPR PPR	7	10		7	36															
AF ACC/FIN	011-02	SPRINGFIELD	05	1124	AZOGRAPH	69			69	206															
AF ACC/FIN	011-02	DETROIT MICH	05	2817	MIMED OFFSET	35			35	189															
US NAV ACADEMY	011-02	MINNEAPOLIS MINN	05	2121	AZOGRAPH IMPR PPR	84		17	47	187															
DEP DEFENSE	011-02	CINCINNATI OHIO	05	3337	OFFSET ELECTRO	11	7,634	17	84	256															
DEP DEFENSE	011-02	MILWAUKEE WIS	05	4784	ELECTRO	222			222	123															
POST OFFICE	011-02	ARLINGTON VIRGINIA	07	4487	OFFSET AZOGRAPH	382		382		5976															
SAV. BOND DIV.	011-03	PITTSFIELD MASS	01	683	MIMED	6	21	2	4	12															
SAV. BOND DIV.	011-03	BALTIMORE MD	02	1886	MIMED	7	11	7																	
SAV. BOND DIV.	011-03	RICHMOND VA	02	4484	MIMED OFFSET	488	488																		
SAV. BOND DIV.	011-03	SALT LAKE CTY UTAH	04	4221	ELECTRO	3,457	1,362	185	1,998	212															
TOTAL PARENT CO. -						23,543	4,165	4,617	14,761																

Observe one minute of silence

The whisper-quiet ink jet printer.

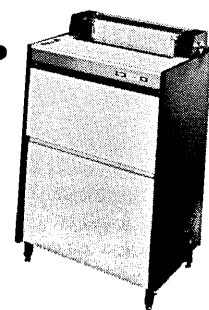

CIRCLE 74 ON READER CARD

Actual photograph of one minute of Videojet printout.

ACCOUNT NAME	NBA CODE	DISTRIBUTOR LOCATION	SL5 DIS	DIST CODE	PROCESS CATEGORY	TOTAL	EQUIPMT	MISC SUPP	MASTERS	MTY OF MASTERS
IRS	011-02	PARKERSBURG H VA	02	4607	OFFSET	181	5,788	21	88	182
IRS	011-02	DENVER COLO	03	582	AZOGRAPH IMPR PPR	52	9,988	52	79	581
BU WEAPONS	011-02	HOUSTON TEXAS	03	4131	ELECTRO	1,568	1,272	47	249	278
BU WEAPONS	011-02	AUSTIN TEXAS	03	4133	OFFSET ELECTRO	215	228	99	116	65
BUSHIPS	011-02	PHOENIX ARIZ	04	231	AZOGRAPH	14	7,382	14		
BUSHIPS	011-02	SAN FRANCISCO CAL	04	421	AZOGRAPH SPIRIT	728	718	18	96	221
BUSANDA	011-02	SALT LAKE CTY UTAH	04	4221	MIMED OFFSET SPIRIT IMPR PPR	8	12	8		
BUSANDA	011-02	SEATTLE WASH	04	4511	IMPR PPR	7	18		7	36
AF ACC/FIN	011-02	SPRINGFIELD	05	1124	AZOGRAPH	69			69	286
AF ACC/FIN	011-02	DETROIT MICH	05	2817	MIMED OFFSET	35			35	189
US NAV ACADEMY	011-02	MINNEAPOLIS MINN	05	2121	AZOGRAPH IMPR PPR	64		17	47	187
DEP DEFENSE	011-02	CINCINNATI OHIO	05	3337	OFFSET ELECTRO	11	2,788	11	3,962	4167
DEP DEFENSE	011-02	MILWAUKEE WIS	05	4784	ELECTRO	222			222	123
POST OFFICE	011-02	ARLINGTON VIRGINIA	07	4487	OFFSET AZOGRAPH	382		382		5978
SAV. BOND DIV.	011-03	PITTSFIELD MASS	01	683	MIMED	8	21	2	4	12
SAV. BOND DIV.	011-03	BALTIMORE MD	02	1886	MIMED	7	11	7		
SAV. BOND DIV.	011-03	RICHMOND VA	02	4484	MIMED OFFSET	488	488			
SAV. BOND DIV.	011-03	SALT LAKE CTY UTAH	04	4221	ELECTRO	3,457	1,362	185	1,958	212
TOTAL PARENT CO. -						23,543	4,165	4,617	14,761	

from A. B. Dick Videojet®

One minute of silence from Videojet is worth 15 minutes of mechanical clatter from ordinary communications printers.

That's because Videojet prints a completely new way—with an ink jet. So at 250 characters a second, the sound of printing is no louder than the sound of ink hitting paper. There's another advantage to the ink jet—its simplicity. This makes for very little servicing.

And because Videojet prints as fast as your telephone lines can deliver, you can use it in remote applications with your computer. It's also plug to plug interchangeable with IBM 2848/2260 terminals.

Videojet prints full computer length lines on standard, fan-fold business forms. And unlike most impact printers, character sizes and number of characters per line (up to 200 characters) can be adjusted to fit your needs. So if you're looking for a flexible inexpensive printer, this is it.

Now that you've observed one minute of silence from Videojet, wouldn't you like to see a lot more? Videojet. Another information handling product from A. B. Dick Company, 5700 Touhy Avenue, Chicago, Illinois 60648.

A. B. DICK®

THINK

Think Twice.

Compare the IBM 360/20 with the NCR Century 100.

Compare language ability.

The NCR Century 100 computer offers three languages: COBOL, FORTRAN and NCR's own NEAT/3. The NCR Century has an RPG Translator that easily converts RPG source programs to NEAT/3.

Compare cost performance ratios. The NCR Century 100 computer proves itself to be 23 per cent to 43 per cent more productive than the 360/20 Model 2 or 4, according to an independently conducted benchmark study.

Think about the NCR Century 100.

And to make you even more thoughtful, we'll send you a brochure that details the advantages of the NCR Century 100 computer. Write to NCR, Dayton, Ohio 45409

Think. Think twice. Think NCR.

NCR
Computers[®]

NCR is proud to be the sponsor of the Space Exploration Exhibit in the United States Pavillon at Expo '70, Osaka, Japan.

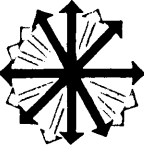

IBM Printout Speeded

The printout speed of System/360 and 370 systems under DOS or TOS is increased 10-50% by Compuspeed, a software package that maximizes I/O processing overlap when using IBM 1403, 1443, or 3211 printers. The greatest speed increases are realized when the system is utilizing programs with larger processing loads. Compuspeed operates in environments in which ASA spacing control is

used, as in COBOL, which employs the ASA or write-after-advancing printing logic. Because it must be simulated, this form of high-speed printing is not normally efficient on IBM printers, which are not designed to operate with these controls.

Existing logical IOCS provides virtually no processing overlap on the IBM printers in ASA mode. This condition and the printing technique is compensated for by Compuspeed, according to the vendor. The im-

proved speed is achieved with no source program changes; Compuspeed is simply included in the user's program at link-edit time, when it is substituted for standard IOCS routines. The price is \$2000 for all compatible systems at a single installation, with discounts for multiple installations. COMPUTING EFFICIENCY, INC., Bohemia, N.Y. For information:

CIRCLE 375 ON READER CARD

All Sorts of Sort

Sort, for IBM 1130s, rearranges whole records into a specified order, using the two-way merge method and an in-core directory to keep track of the physical location of data strings. It works on files in FORTRAN, RPG sequential, or the company's own Disc Control System. The files can be in user areas, fixed areas, or working storage, and the sort can be either in place or onto a separate output file. New data can be merged with previously sorted data.

Sort can handle up to 430,000 records, single drive, or 509,440, multi-drive, at one time. An unlim-

ited number of sort keys can be selected from the following formats—single or double integer; part-word binary; standard or extended precision floating point; A1, A2, A4, and A6 of any length; A3 (**IDEAL**), D1, and D4 (for a commercial subroutine package) of any length; and any length RPG A2 and RPG packed. The keys can be specified as either signed or unsigned and either ascending or descending.

The package permits sorting of a 12,000-record random data file of 16-word records in place on 16 integer keys in 10 minutes on a 3.6 usec 8K 1130 with a disc drive and console. If the file is partially ordered, sort time

decreases by nearly 50%.

The package, written in 1130 assembler language, takes 2K and needs 6K for a sort buffer. The program can be input via cards or optionally stored on disc. Another option is a rollout feature that clears the core, placing this data on a disc, and returns the calling program after the sort is finished.

Sort is available as a basic package—a stand-alone control-card sort, with manual and one year free maintenance—for \$495. The optional features are \$45 each. DNA SYSTEMS, INC., Flint, Mich. For information:

CIRCLE 377 ON READER CARD

T-S Monitor

For PDP-10 users, the new **TOPS-10** (Time-sharing Operating System-10) monitor reduces the time a t-s user needs to do his jobs by enhancing the performance of the system's rotating memory. **TOPS-10** also enables an installation to handle more users without expanding existing systems or lengthening response time.

The monitor's new file service increases system throughput by 400-800% by performing seeking operations on movable head discs and transfers on data channels in parallel whenever possible. **TOPS-10** also reduces interference from other users.

Time-sharing installations may customize their PDP-10-based systems by varying a group of parameters that define how the monitor allocates

disc space. The monitor also offers improved protection codes, monitor commands, error codes, and system programs; user storage quota limits; and the ability to handle additional rotating memories without modification. It is presently available at no charge to PDP-10 users. **DIGITAL EQUIPMENT CORP.**, Maynard, Mass. For information:

CIRCLE 378 ON READER CARD

Library Maintenance

A library maintenance and multifunction program, **GAMMA** is intended to simplify operations and reduce costs. For example, in going from card to tape or in modifying an existing deck, it will replace, update, add, or delete any existing cards or decks.

GAMMA will also sequence or resequence any specified length, field, increment from any starting point; and it will insert any constant to a specified field, making it applicable to any source language, COBOL, FORTRAN, BAL, PL/I, etc. Additionally, it has the ability to execute cards from the library if JCL is present.

An accessible index keeps track of modification dates, making it possible

to trace a program through many alterations. A parameter card initiates each of seven distinct functions. The program is written in BAL, and operates on 360/30s and up. The price is \$700. **ASSOCIATED BEHAVIORAL CONSULTANTS**, New York, N.Y. For information:

CIRCLE 381 ON READER CARD

Payroll

Yup—another payroll package. This one is from a small group specializing in commercial applications, and the price of \$2850 includes normal installation and a full year of system support and maintenance.

Basically tailored for a 360 Model

30 or 40, it can get by with as little as 32K bytes utilizing overlays, but is more at ease with 64K bytes and four tape drives in a DOS environment (five for TOS usage).

With simple input data preparation, the multi-department, multi-firm, multi-state, multi-tax capable package can process an unlimited number of employees at the rate of one employee per second.

Another version of the same payroll package, geared more for banks and service bureaus, is \$10K. **LINGBLOOM ENTERPRISES**, Mill Valley, Calif. For information:

CIRCLE 384 ON READER CARD

(Continued on page 115)

The incredible reducing machine is here!

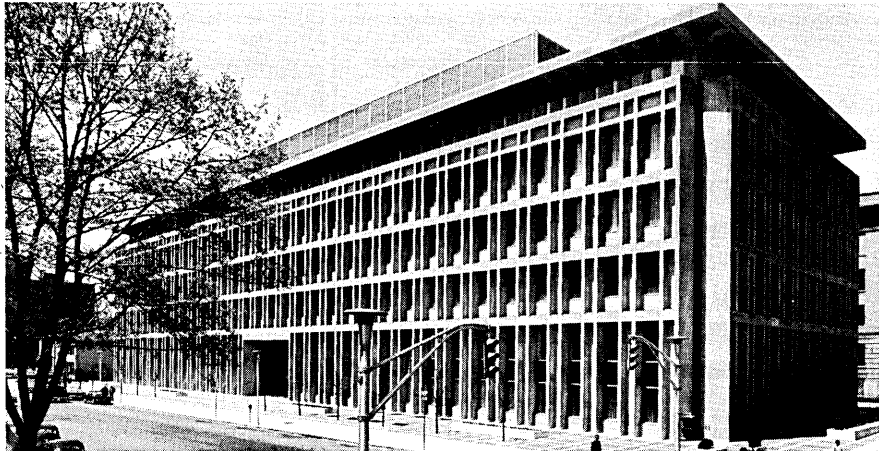

London Life Insurance Company data preparation problems reduced by KEY-EDIT —the incredible reducing machine.

ASK them at London Life, one of Canada's leading insurance companies, how they like KEY-EDIT. They'll tell you that before they gave the Incredible Reducing Machine a trial, their operation was using roughly 23 million key punch cards a year. Next year, KEY-EDIT could reduce that number substantially. This remarkable data preparation system was installed in early April of this year. Ordinary transactions, Automatic Bank Check changes, health claims checks, and other checks that were previously coded on punched cards are now transcribed directly onto tape by KEY-EDIT, and then fed into the big computer in Computer Operations. The reaction to this sixteen keyboard installation has been most favorable for a number of reasons:

Bill Thomson, Information Systems Executive, has this to say about the KEY-EDIT system: "A mistake, either made by the key-stroker or even on the original card, will be found and corrected the same day. With this time-saving factor, ultimately this will speed up our service to policy owners."



Mrs. Linda Brown says: "I think I'll enjoy working on the system. There's less work involved for everyone and it doesn't take long to catch onto it. The keyboards are pretty much the same as the keypunch machines. But these are so much faster —they're right on the spot. And they're noiseless. I think it would be a good idea to have all the work done like this."

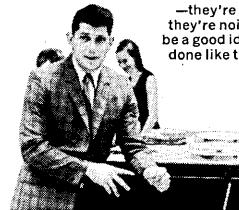

Larry Fazakas, Data Input & Control says: "Every year, we've had a tremendous increase in our workload resulting in more overtime for our keypunchers. We've also had a continual rapid growth in the keypunch area. We hope that with KEY-EDIT we'll slow down this growth rate and reduce the overtime work."

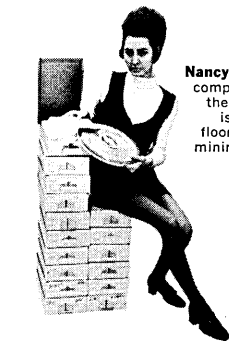
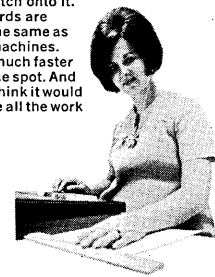

Nancy Foster shows the reel of computer tape that will replace the 32,000 punched cards she is sitting on. KEY-EDIT reduces floor space and costs to a minimum.



Expect more from
CONSOLIDATED COMPUTER

BOSTON
 235 Wyman Street
 Waltham, Massachusetts, 02154
 617-891-0210

TORONTO, CANADA
 48 Yonge Street
 Toronto, Ontario
 416-366-7643

LONDON, ENGLAND
 Northdale House
 North Circular Road
 London N.W. 10, England

Chicago Cleveland Detroit Los Angeles New York Philadelphia San Francisco Washington, D.C. Ottawa Montreal

Simulation System

CSSL III (Continuous System Simulation Language) is equally at home simulating the Viking '75 Mars soft-landing mission or a projected power plant. Applications other than aerospace/engineering and industrial dynamics could be in the petroleum and chemical processing industries, and the bio-engineering and bio-chemistry fields.

Providing hybrid and real-time capabilities on 360s, Univac 1108s, and CDC 6000 series computers typi-

cally requires 180K bytes for the FORTRAN IV-based system to accommodate such features as interactive debugging, diagnostics, and a highly flexible macro processor for generating conditional arguments, or generating macros to simulate certain specialized pieces of hardware. Control is via FORTRAN statements to obtain results in either listing or graphic form (sc 4020 now, others possible). Implicit structure used in CSSL III allows standard functions to take place with a minimum of effort by experienced programmers, while the ven-

dor claims that programmers not familiar with simulations require one-tenth as much time to learn how CSSL III works compared to other similar systems.

CSSL III has the blessing of the Simulation Software Committee of Simulation Council and is priced at \$15,000 under a 3-year licensing plan, or a monthly lease plan is available. PROGRAMMING SCIENCES CORP., New York, N.Y. For information:

CIRCLE 382 ON READER CARD

Computer Load Scheduling

Optimization of processor production is the objective of this job scheduling system. It works on System 360 Model 50 and above, single or multi-processor installations, with OS/MFT or MVT. It is written in PL/I version V and requires storage only for processing, since it is not a resident program. The storage needs are based on the number of processors and job streams that are being scheduled. Scheduling three cpu and three job streams requires 130K. One disc pack is said to

be sufficient for file storage.

The files required are job characteristics and accounting history. Jobs are scheduled to be run before deadlines with the system reconciling all conflicts; i.e., deadline duplication is resolved by the most flexible job being given an earlier start time. The system identifies and allows for such bottlenecks as printer or card reader overload.

In addition to scheduling, the system produces projected usage reports and analyses of job variability. It can also be used as an installation model

to study the effects of hardware and application changes.

Support for the scheduling system includes instruction in file preparation and system operation and some tailoring of the package to installation requirements. Program updates will be made available. The system is available either on a \$30,000 full payout lease at \$1,500 monthly or for \$25,000 through the exercising of a 60-day purchase option. TIME SHARING RESOURCES, INC., New York, N.Y. For information:

CIRCLE 379 ON READER CARD

Name Identification

ENID (Ethnic Name Identification System) is a PL/I and COBOL program for searching a user's name file to locate people of a particular ethnic group. Greater efficiency than similar programs written in FORTRAN is claimed through improved character and character string manipulation, more extensive use of tables, and faster processing speed. An isolated name is compared by an algorithm to a table of suffixes, prefixes, or infixes of names. If a match is made, the

record is written onto the output file.

ENID is available in two versions: version 16 is for users who maintain a name list in a single format, and is provided in object deck form with the specific I/O routines and file format required by the user; and version 17, for users whose file is in several formats. Version 17 is provided both in source and object deck form. When compiled, the source deck provides a description of the I/O file and the location of the last name record. The identification algorithm itself is provided in object deck form

which can be combined with the source deck after compilation.

ENID requires 32K bytes, and is available now for System 360. It can be readied for other computers, depending on customer's need. Purchase of ENID 16 requires \$2800, and version 17 is priced at \$3600; a lease plan is available. RESEARCH AND INFORMATION SYSTEMS ENTERPRISES, INC., Los Angeles, Calif. For information:

CIRCLE 380 ON READER CARD

Cobol Test Data

DATAGEN automatically generates test data by reading the source program. File definitions, device specification, logical unit specification, key locations, record formats, and field definitions are extracted and used to generate test records.

All sequential and indexed access methods and all formats are supported, as are the COBOL copy statement and all devices supported by COBOL. DATAGEN runs on System/360 under either DOS or OS with 24K of program core required. Generation

time is usually less than a compile of the same program. The price is \$2500, including installation and one-year warranty. PROGRAMMING SCIENCES CORP., New York, N.Y. For information:

CIRCLE 383 ON READER CARD

Data Base Management

The TOTAL integrated data base management system is for use on Spectra 70 TROS and Honeywell Series 200 and 1200 systems. Minimum design level is normally 32K. TOTAL

allows entry and association of information from a virtually unlimited number of data bases, featuring multi-file and multilinkage capabilities. It includes a Data Base Definition Language, and a Data Manipulation Language which functions at the call level with any "host language," such as COBOL or PL/I. The facilities of the DBDL and DML transform the host language into a data base language. Basic rental is \$750 per month. CINCOM SYSTEMS, INC., Cincinnati, Ohio. For information:

CIRCLE 376 ON READER CARD

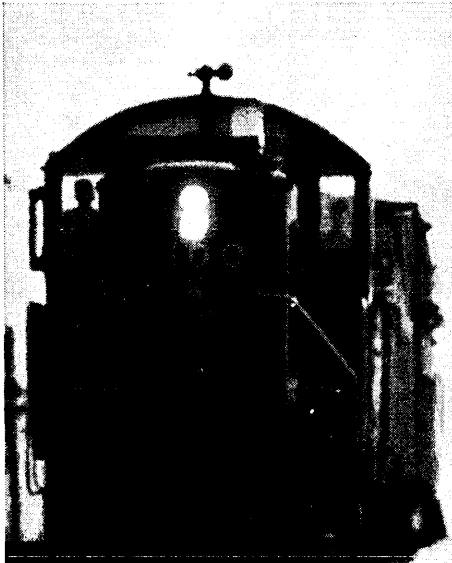

data bits from Teletype

8 million pounds of food moved daily!

When you handle 14,000 food-filled freight cars annually, deal with more than 160 truck carriers to service the daily needs of over 500 retail chain and independent outlets, the need to know takes on staggering proportions.

The warehouse that copes with this logistical problem has linked its customers with a computer using Teletype® terminals. Shipping data from processors and food packers is fed into the computer on a daily basis. Retail buyers use Teletype equipment to obtain up-to-the-minute inventory status reports, to place orders and receive concise shipping data. This enables the warehouse to keep track of, and move some 8 million pounds of food every day. Fast, accurate data communications has also helped cut processor billing time down from over a week to twenty-four hours.

time-sharing money saver

There are probably more Teletype 33 sets being used in time-sharing applications than any other data terminal. Because, on a price/performance basis, it is one of the most reliable and economical terminals available.

The model 33 has everything required for preparing programs, getting them into the computer and retrieving information. It communicates in ASCII and operates at 100 words per minute. Its design simplicity makes computer dialog easier for the operator. But, what's really nice, is the price: It's amazingly low for all of its capabilities.

The model 33 line includes options and accessories needed for a variety of time-sharing needs. If you would like to know more about this low-priced terminal line, write for the model 33 brochure.

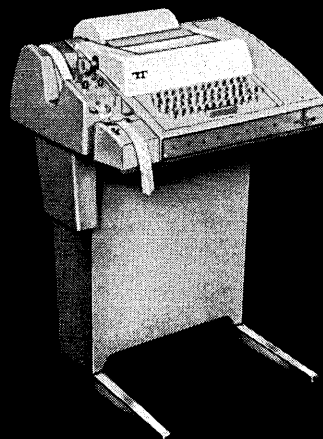

nine year old
squeezes
a year
into
38
days

A young boy became so fascinated with a Teletype 33 terminal that he completed a whole year's arithmetic program in 38 days. His school is involved in a computer assisted educational program using a remote university computer. The simplicity of the terminal enables the youngest of students to master its operation in a short period of time.

Some subjects included in the program are reading, science and arithmetic. Students receive individual drill and instruction geared to their own level of comprehension. The slower student gets much needed practice at a level which he can achieve. The average student reinforces his grasp of the subject with drill and practice at the terminal. The bright are offered programs that challenge and are limited only by their own abilities. Computer assisted education also enables teachers to find more time for individual student needs.

erasing errors on-line

Teletype has an interesting solid-state device called the Stuntronic™ parity error detector which helps locate and eliminate parity errors. It can be used with Teletype 33, 35, 37, Telespeed™ and Inktronic® terminals.

This accessory will accept a signal with up to 45% distortion and regenerate the signal with less than 5% distortion before passing it on to the terminal. Minimizing erroneous print-outs due to distorted signals.

It will also locate individual vertical parity errors and alert the station operator so that corrective action can be taken.

HERE IS AN EASY WAY TO SPOT AND 432*
CORREC* ERRORS RECEIVED IN TEXT 5678
OR NUMBER TRANSMI*SION. 90*2

With the Stuntronic detector, a preprogrammed substitute character can be used to graphically indicate exactly where an error is on the terminal print-out.

Stuntronic accessories can also count errors, light a signal lamp and generate a line break, notifying the sender of any errors.



recommended reading

Teletype has a number of bulletins on equipment, applications, and case history data. A short description of what is available is contained in: "How to get answers to your questions about Teletype equipment." Write for your copy.

Teletype data communication equipment is available in send-receive capabilities of up to 2400 words per minute. Included are hard-copy, magnetic-tape and paper-tape terminals, error control devices, options and accessory equipment to fit most data communication system requirements. For information, write:



TELETYPE CORPORATION
Dept. 81-12, 5555 Touhy Ave., Skokie, Ill. 60076
machines that make data move
Teletype is a trademark registered in the U.S. Pat. Office

The IBM 2314 is a slower, more expensive replacement for a CDS 114/1014 disk storage system.

The CDS 114/1014 and the IBM 2314 direct-access storage systems do the same work. They're plug-for-plug replacements for each other, they use the same recording format, and you can intermix libraries between the two and never know the difference.

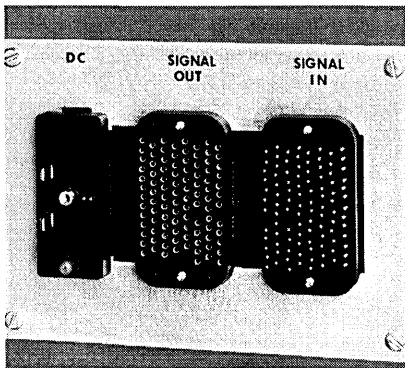

The CDS 114/1014 and the IBM 2314 are plug-for-plug replacements for each other.

But there is a difference.

The CDS 114 gives you data transfer rates of 312,000 bytes per second, track-to-track access of 12 msec, and average access time of 35 msec. The 2314 (according to latest published manufacturer's specs) gives you 25 msec. track-to-track, and 60 msec. average access.



Our electromagnetic positioning system is the most reliable and accurate system there is because you can't wear out an air gap.

And, of course, the CDS 114 has our electromagnetic positioning system which uses no mechanical pawls, detents, gears, or optical devices. Head position is sensed by a fixed variable-reluctance transducer mounted near the rack face. It's the most reliable and accurate system there is because you can't wear out an air gap.

The CDS 114 plugs into a 2314 controller, or you can get it with the Century Data 1014 controller. The CDS 1014 controls eight on-line drives and one off-line spare, and is completely interchangeable with the 2314 controller for any system 360/30 or larger.

Send for our complete specifications and description. You'll find that there's only one characteristic of the 2314 which we don't match: The high price.

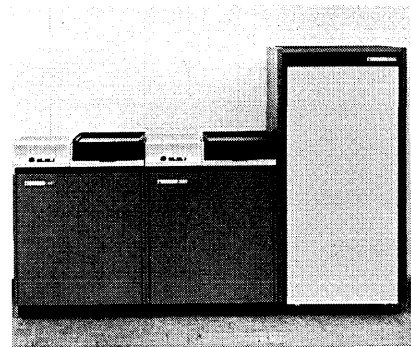

The CDS 114 gives you data transfer rates of 312,000 bytes per second, track-to-track access of 12 msec, and average access time of 35 msec.



Century Data
SYSTEMS

1630 South State College Blvd.
Anaheim, California 92806
(714) 639-5900

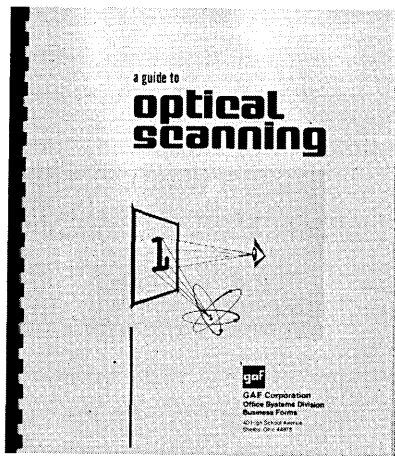

About OCR

This plastic-bound guide contains more than 30 pages of information helpful in the understanding of optical scanning and the forms required. The brochure includes information on scanning terms, examples of bar coding, mark and character reading systems, plus readable ocr fonts. A brief explanation and diagrams of an optical scanning system and examples of scannable forms are also included. GAF CORP., Shelby, Ohio. For copy:

CIRCLE 350 ON READER CARD

Getting the Most

A 20-page illustrated report on "How To Get the Most Out of Your Computer Staff" shows how to design a first-rate employee development plan and outlines steps to train operators, programmers, analysts, and managers. Maybe should also be read by those who are going to get the most gotten out of. ADVANCED MANAGEMENT SCIENCES, Lynnfield, Mass. For copy:

CIRCLE 351 ON READER CARD

MIS Proceedings

The proceedings of last fall's smis Founders Conference are now available for \$25 (\$10 for libraries). Sessions covered include "Fundamental Building Block for Management Information Systems," "Decision Systems for Planning and Control," "Manpower Resources for Management Information Systems," "Distributed Computer Communication Networks," "The Role Top Management Must Play in MIS Planning and Implementation," and "Trends in MIS Technology." Also included are Congressman Jack Brooks' keynote

speech; the dinner address by Terrence Hanold, president of Pillsbury; and the president's address, "Why smis?" THE SOCIETY FOR MANAGEMENT INFORMATION SYSTEMS, One First National Plaza, Chicago, Ill. 60670.

Individual Privacy

A 77-page study recently released by The RAND Corp. reports that the agglomeration of data on individuals, via the computer, presents a serious threat to the individual's right to privacy and if allowed to proliferate, the deleterious effects on the indi-

vidual, and therefore society, are likely to be irreparable. The researcher concludes that information systems must incorporate certain properties in their initial design in order to safeguard individuality while still providing a complex and interdependent society the information it needs to function effectively. He suggests ways of using available techniques to safeguard society. Order AD-706 963. Cost: \$3; microfiche, \$.65. CLEARINGHOUSE, U.S. DEPT. OF COMMERCE, Springfield, Va. 22151.

PERT Profits

A 14-page report on the cost benefits of automated PERT (CPM) networks vs. manual drafting consists of an economic analysis of manual network preparation compared with automation through computer software and digital plotters. After a brief review of PERT and PERT graphics, the report presents a cost benefit analysis of the company's EZPERT, EZNET, and EZCPM systems relative to a user's

PERT network volume per month. From the computed curves a user can derive the expected savings that apply in his specific situation. SYSTONETICS, Anaheim, Calif. For copy:

CIRCLE 352 ON READER CARD

Students for Data Ed

A folder outlines the new Students for Data Education (SDE) program of The Society of Data Educators.

The SDE is said to be the only national student group seeking to inform students about the social consequences of automation, as well as the career possibilities and future user benefits of computers and data processing. The group is urging the formation of student chapters on secondary school and college campuses. THE SOCIETY OF DATA EDUCATORS, Northfield, Vt. For copy:

CIRCLE 354 ON READER CARD

System Design Problems

This 147-page book is the third in a series of surveys and analyses based on selective review of the literature, r&d efforts, and needs in the computer and information sciences. It deals with those system design problems that involve more than one of the component processes, such as problems concerning programming languages and remote terminals used for both input and output. Cost: \$1.25. (The first two volumes are concerned with *generalized* informa-

tion sciences. (Vol. 1, \$1.50, is titled Information Acquisition, Sensing, and Input; Vol. 2, Processing, Storage, and Output Requirements in Information Processing Systems, is available for \$1.25.) Specify sd Catalog No. C13.44:113/Vol. 1, 2, or 3. SUPERINTENDENT OF DOCUMENTS, U.S. Government Printing Office, Washington, D.C. 20402.

Engineer to Manager

A six-page pamphlet describes a home study course designed to train electronics and engineering personnel to manage a company by teaching fundamental financial methods through simulated on-the-job experience. For what it's worth, more than 5,000 executives have completed the course. MANAGEMENT GAMES INSTITUTE, Larchmont, N.Y. For copy:

CIRCLE 353 ON READER CARD
(Continued on page 121)



Bound-up in EDP problems?

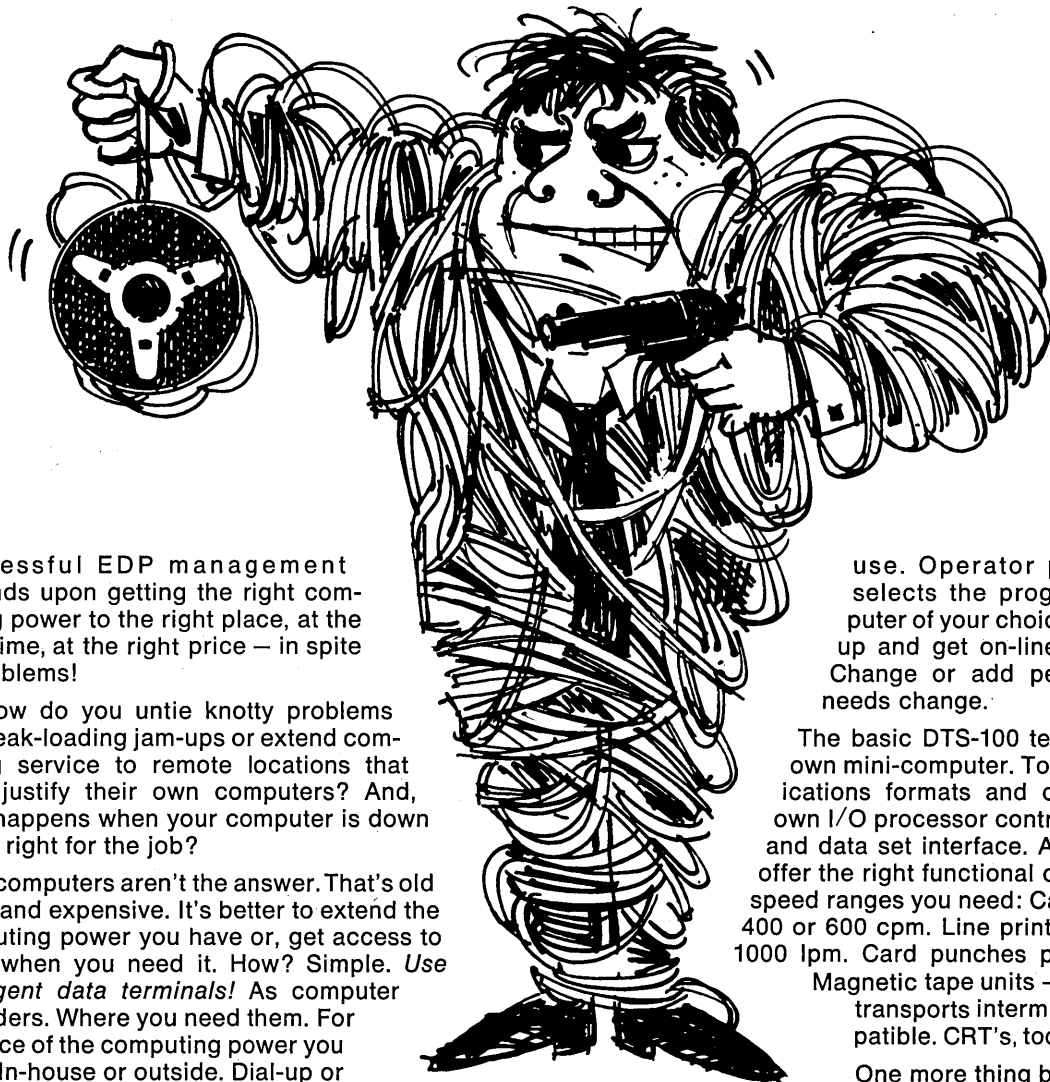

Successful EDP management depends upon getting the right computing power to the right place, at the right time, at the right price — in spite of problems!

So, how do you untie knotty problems like peak-loading jam-ups or extend computing service to remote locations that can't justify their own computers? And, what happens when your computer is down or not right for the job?

More computers aren't the answer. That's old hat — and expensive. It's better to extend the computing power you have or, get access to more when you need it. How? Simple. Use *intelligent data terminals!* As computer extenders. Where you need them. For a choice of the computing power you want. In-house or outside. Dial-up or dedicated.

And, that's where DTS-100 comes in. It's *the* "intelligent" remote batch data processing terminal. It's programmable for ready access to the computer you need — when you need it. That's the job it does. It talks with other terminals, too. It also works stand-alone for off-line data pre-processing and formatting. It's a complete data processing package. Consider this, too. DTS-100 is simple to

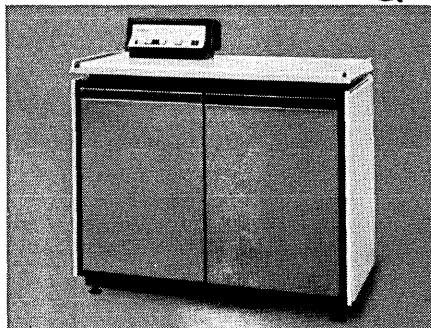

use. Operator program loading selects the program for the computer of your choice. You merely dial-up and get on-line. It's flexible, too. Change or add peripherals as your needs change.

The basic DTS-100 terminal includes its own mini-computer. To program communications formats and compress data. Its own I/O processor controls the peripherals and data set interface. And, its peripherals offer the right functional combination for the speed ranges you need: Card readers read at 400 or 600 cpm. Line printers print at 300 or 1000 lpm. Card punches punch at 100 cpm. Magnetic tape units — 25 ips 7 or 9 track transports intermixed — are IBM compatible. CRT's, too.

One more thing before you go.

We'd like to tell you more about DTS-100. Write for our Bulletin 1035. Or call us. Remember you can use DTS-100 even if you don't have your own computer but need computing power. It talks to them all. Besides, it costs a lot less to use. You'll like that.

NOLLER
a division of Badger Meter Manufacturing Company

the computer extenders!

MANUFACTURING FACILITY AND MAIN SALES OFFICE: 150 EAST STANDARD AVE. • RICHMOND, CALIF. 94804 • TELEPHONE (415) 233-8220 • CENTRAL SALES OFFICE: 4545 W. BROWN DEER RD. • MILWAUKEE, WIS. 53223 • TELEPHONE (414) 355-0400

Microfilm Systems

Not only the components of microfilm systems, but guidelines for system selection are furnished in 24-page full-color brochure, *Engineering Documentation Microfilm Systems Plus*. Ten evaluation questions are first posed, then answered throughout the remaining information on everything from camera input through reader/printer. A summary contains six more operational considerations that have been incorporated into design of the components. ITEK BUSINESS PRODUCTS, Rochester, N.Y. For copy:

CIRCLE 357 ON READER CARD

Handbooks

Individual digests, guides and state-of-the-art appraisals of the computer industry are described in a brochure giving the specific titles and prices. Subjects range from computer characteristics and data communications to terminals and minicomputers. The first state-of-the-art volume is on time-sharing. Although the information has been compiled from that furnished in a detailed regular service, the idea was to condense it for quick reference to essential facts. AUERBACH INFO, INC., Philadelphia, Pa. For copy:

CIRCLE 358 ON READER CARD

S/3 Card Peripherals

Data sheet describes the CS 8000 sorter and CR 8000 reader for the 96-column card. The CS 8000 sorts at 1500 cards/minute to six 600-card-capacity output stacks. The reader option turns the off-line sorter into an on-line reader with 1000 and 1500 cpm synchronous read rates. The reader can read IBM System/3 punched code (all 96 characters in one pass) or Potter Magnetic Bar Code. POTTER INSTRUMENT CO., Plainview, N.Y. For copy:

CIRCLE 356 ON READER CARD

WEMA Directory

The 100-page 1970 WEMA Directory reports information on 600 electronic manufacturers and information technology firms in the West, including general office and plant locations, ownership, products, employment level, and top management. More than 80% of the member companies are small businesses with fewer than 500 employees. Cost: \$15. WEMA, 2600 El Camino Real, Palo Alto, Calif. 94306.

Off-the-shelf delivery: Another Remex advantage.

First we gave you fiber optics, a Remex exclusive. Then a self-cleaning, vibration-proof quartz iodine lamp with unvarying illumination for 15,000 hours (another Remex exclusive). Now it's quick delivery: in most cases only 2 weeks from receipt of your P.O. That goes for our standard Readers and the Remex Series 3000 and 4001 tape reader/spoolers. Each offers sensitive, perceptive, reliable reading. And, in a very short time, a Remex Reader/Spooler can be a part of your system. Call us at 213-772-5321, regarding our off-the-shelf delivery. Or write for free literature to Remex Electronics, 5250 W. El Segundo Blvd., Hawthorne, California 90250.



REMEX ELECTRONICS

In Europe and the U.K., contact S.p.A. Microtecnica, Torino, Italy



A UNIT OF



EX-CELL-O CORPORATION

CIRCLE 29 ON READER CARD

A dirty tape can give a computer the DT's.

Dirty tape causes data dropouts. And dropouts can make a computer see things that aren't there. That costs you money. And that's enough to make anyone see red.

RCA Computer Tape helps computers read and write right.

It's a special formulation that starts cleaner. Every inch of every reel is tested and certified in the cleanest of white-room conditions. (We think statistical testing leaves too many blind spots.) And it stays cleaner, longer.

So? Fewer dropouts, more

efficient computing.

Help your computer see things as they really are. Write RCA Magnetic Products, 201 E. 50th St., New York 10022.

Our tape keeps the DT's away.

RCA Computer Tape

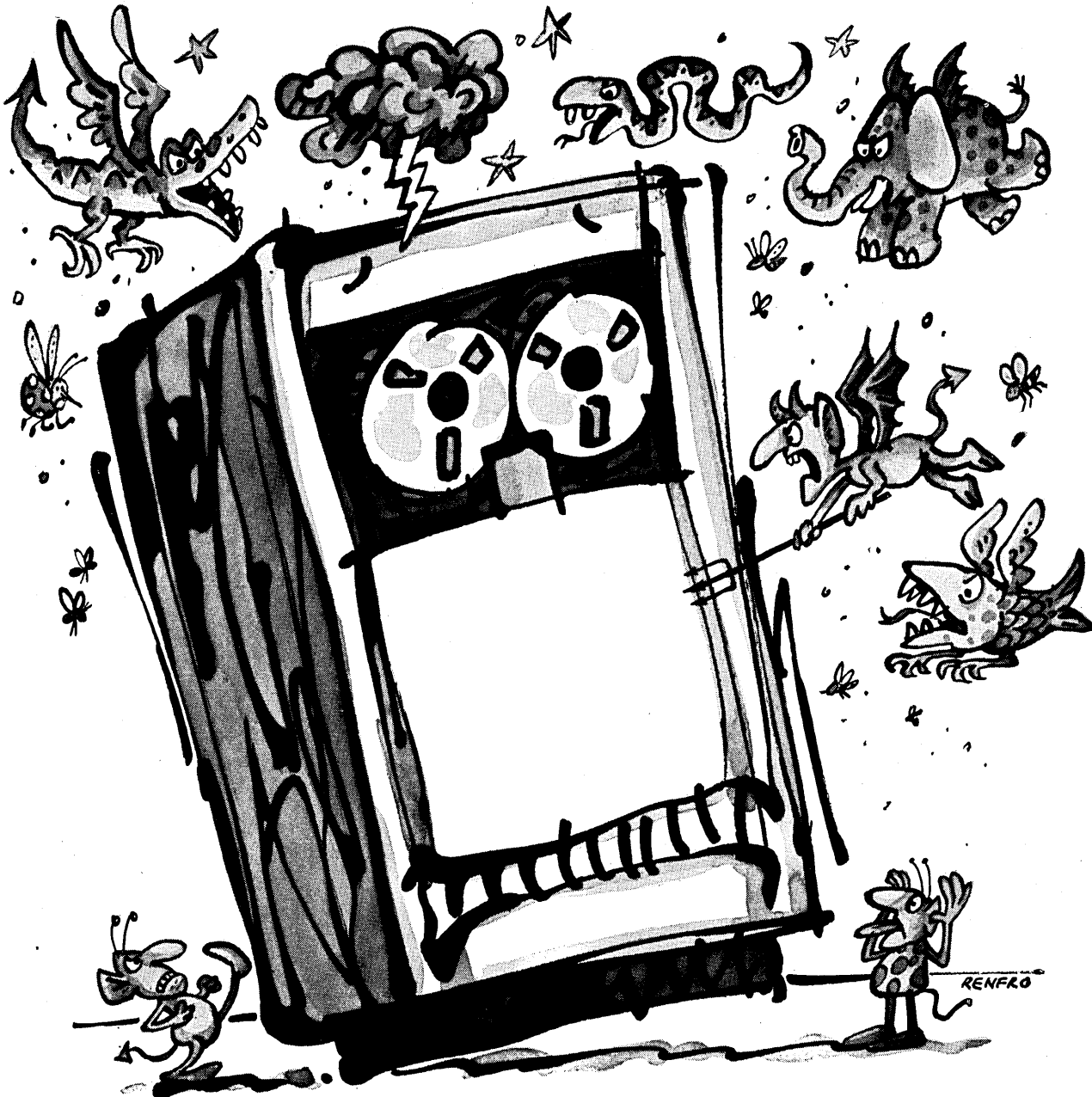

Letters . . .

TICCET reservations

Sir:

The TICCET system, developed by MITRE Corporation (Aug. 1, p. 60), offers a promising new option for CAI professionals concerned with the decline of public and private investment in computer-assisted instruction. As was noted in the story, people are more likely to invest in a \$155,000 system than in a \$10 million system, especially in these times of declining research and development funds. The restriction to short cable length requiring a self-contained terminal classroom is not a bad one for mass implementation since curricula can be developed around specific purposes to keep such small systems busy. The off-line preparation of the curriculum also provides some measure of the protection that is necessary to provide an incentive market for the development of high-quality curriculum material.

An advantage not mentioned in the story is that a small system can be justified by means of a relatively modest curriculum development effort. Engineering high-quality computer-assisted instruction materials is a formidable task, requiring much time and money. Developing enough material to keep a 100-terminal system busy for 2000 hours per year is far less formidable than developing enough material to keep a 4000-terminal system such as the one proposed at the Univ. of Illinois busy for one year. There is no denying the statistical advantages which can accrue in the costs of central equipment and operations staff when a divisor of 4000 terminals is applied. However, with the present state of the art and the market, there are many factors which favor the smaller system concept represented by TICCET.

One concern which must be expressed regarding the development of TICCET is that the "algorithmic frame" capability be made as extensive as possible. While it is possible to justify a frame-oriented system for computer-managed instruction, many of the more promising applications of computers in higher education, including computer-assisted instruction, require more extensive logical and processing capability. MITRE would be well to leave flexibility in their systems design for trading off terminals against processing capability.

(Continued on page 126)

BUILT-IN RELIABILITY

with only
these 3 Moving Parts

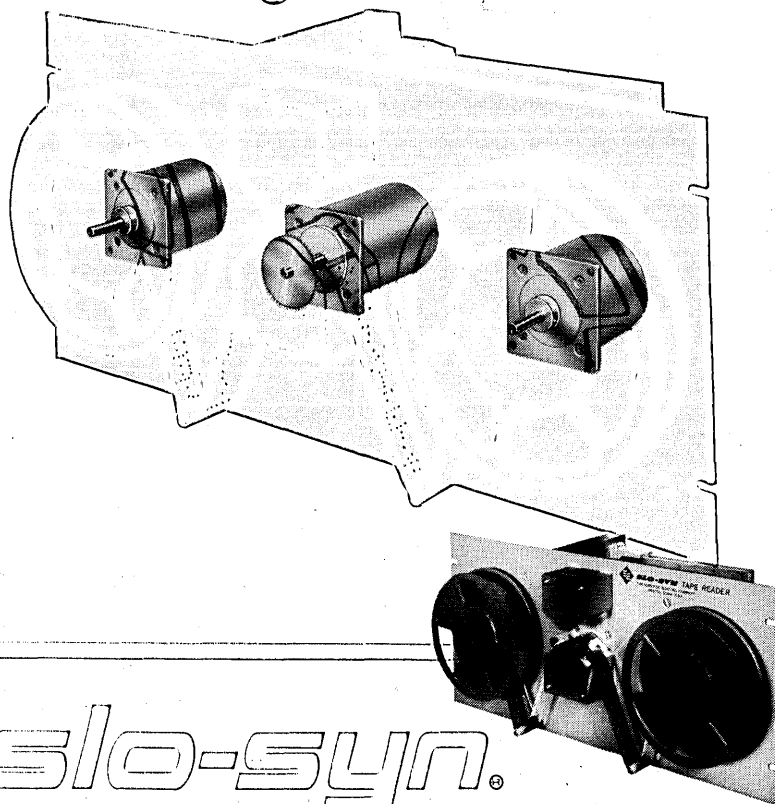

slo-syn.

Photoelectric Tape Reader

Maintenance? Hardly ever — not enough to even mention. The secret lies in simplicity: NO detents, ratchets, belts or gears; NO clutches or mechanical drives; NO on-off switching servos. Just three reliable SLO-SYN motors — one stepping motor advances the sprocket and two torque motors drive the reels and tension the tape.

There are models with 15-volt signal levels for discrete components and 5-volt signal levels for integrated circuits. Reading rates are up to 125 characters a second asynchronous. All field offices have demonstrators for your personal evaluation. For full information, contact them or write, wire or phone:

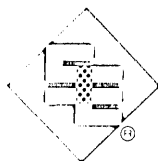

**THE
SUPERIOR ELECTRIC
COMPANY**

383 Middle St., Bristol, Conn. 06010, 203/582-9561

Sales/service centers: Atlanta • Boston • Chicago • Cleveland • Dallas • Detroit • Los Angeles • New York • Philadelphia • Rochester • St. Louis • San Francisco • Washington

CIRCLE 31 ON READER CARD

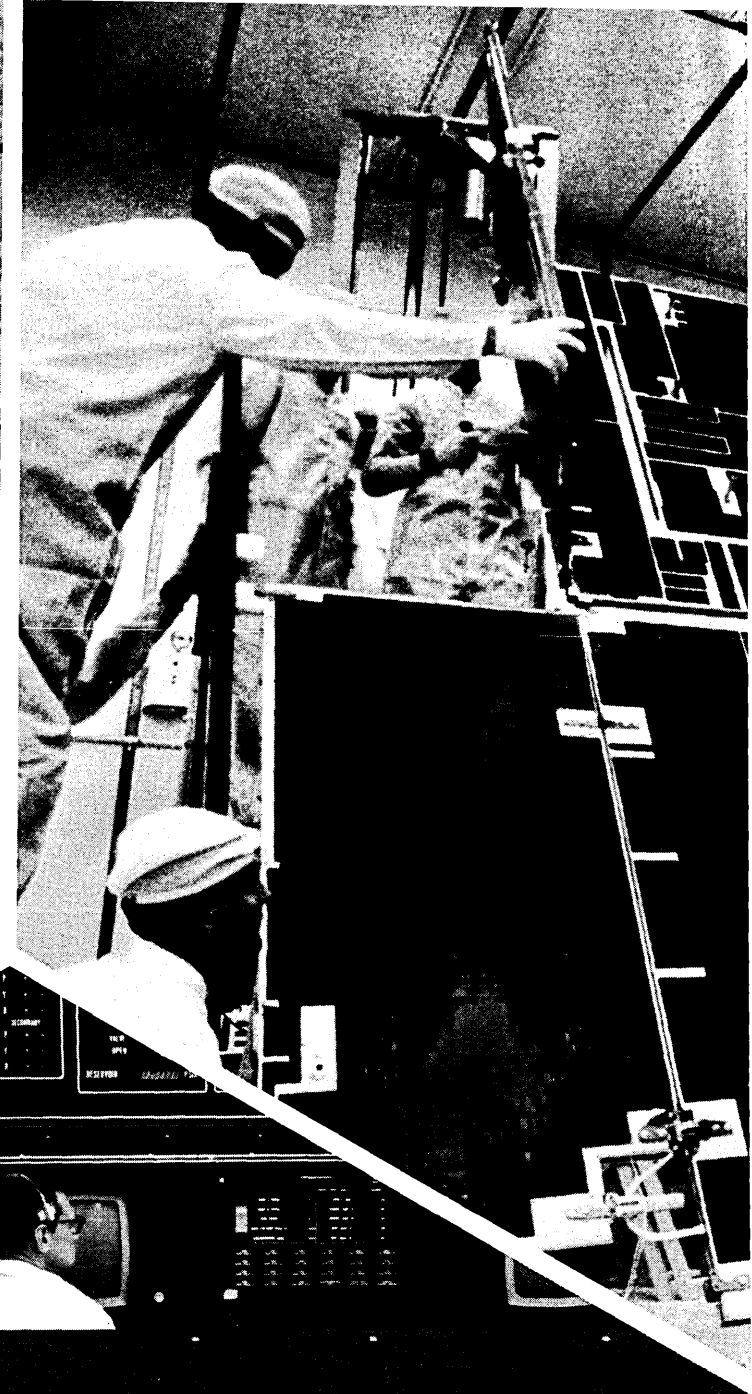
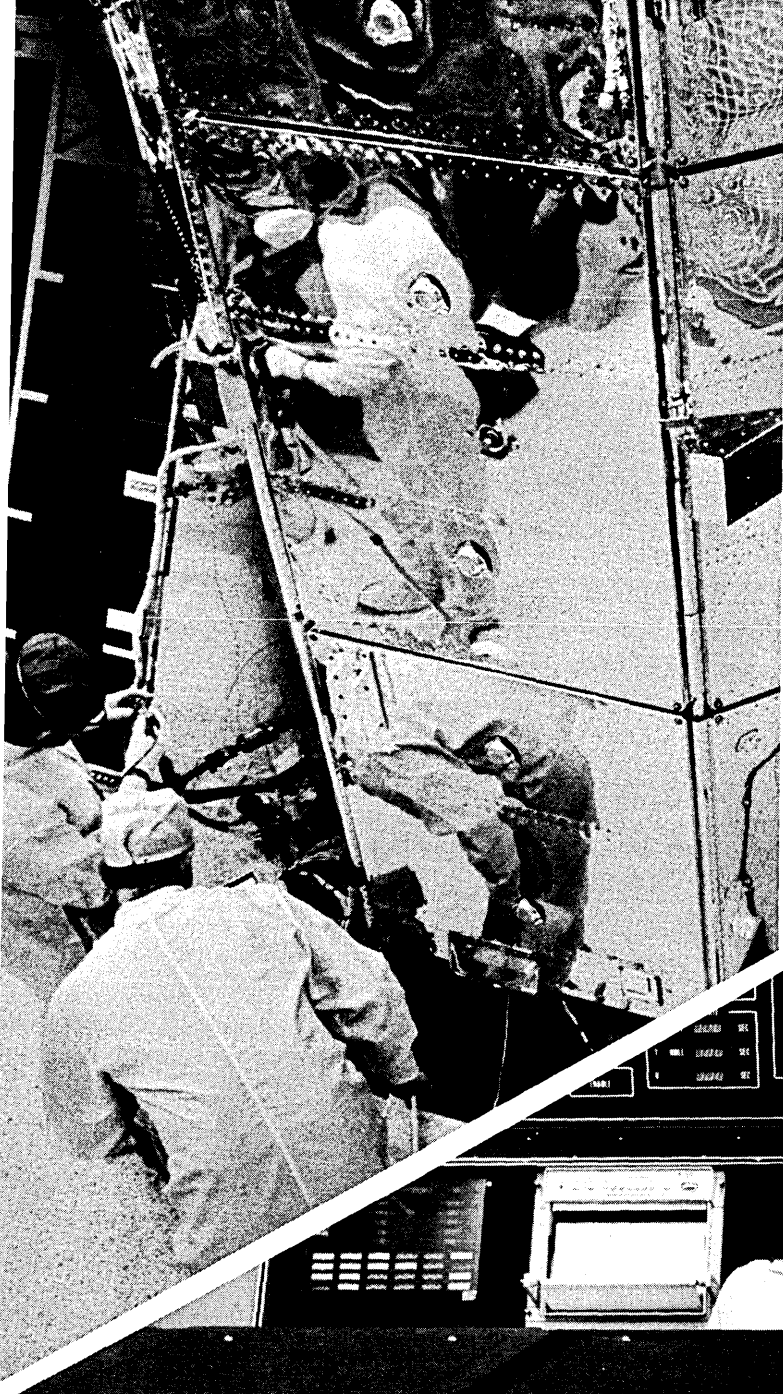

When the Goddard Space Flight Center wrote their specs for a hardcopy printer, they wound up with a choice of one.

They didn't mean to. It just turned out that way.

Because of all the printers around, the Gould 4800 was the only printer which could give the Goddard people all they asked for.

Speed Goddard asked for 1000 lines per minute. The 4800 will whip out 4800.

Silence Goddard planned to put their printer right in their on-line control room. And weren't about to put up with a noisy impact printer. With the Gould 4800, they don't have to. It's electrostatic. And very quiet.

Printout Width Goddard wanted a full 80 columns wide. The Gould 4800 provides it.

On convenient 8½" wide paper.

The Goddard people also were impressed by several other important factors:

alphanumeric and graphics — the Gould 4800 delivers words and pictures,

simultaneously, direct from computer

output; *permanent paper* — special,

high-contrast, won't curl, get yellow or brittle . . . you can write on

it with anything; *reliability* — smooth, quiet, impact-free operation means less wear and tear on parts, less maintenance, little downtime; *versatility* — Gould 4800 generates wide variety of fonts, from smallest matrix on up, in many weights, sizes and faces. It can be integrated into a console set-up (see Goddard installation photo on opposite page) or used independently as shown below. One more thing: The Gould 4800 is priced at or below printers that can't come close to the performance. So the Goddard people not only got quite a lot more than they bargained for. They also got quite a bargain.

Talk to your computer people about the Gould 4800. Then talk to us about a demonstration.

We're ready whenever you are.

Gould Inc., Graphics Division, 3631 Perkins Avenue, Cleveland, Ohio 44114.

 **GOULD**

Gould 4800. The next generation of high-speed printers.



Dynamic 1970 careers. And the salaries they command.

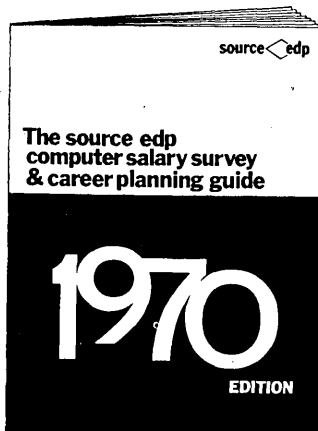

Here is an up-to-the minute report on opportunities for computer professionals including new fields for career advancement on a national and international basis. Plus the techniques and strategy of how and when to change positions. And for how much. (As high as \$75,000.)

It's in the all-new 10,000-word 1970 Source EDP Computer Salary Survey and Career Planning Guide. Compiled and edited by the Source EDP Computer experts. To speed delivery of your free copy write or call your nearest Source EDP office. Or circle the reader inquiry card.

source  edp

Atlanta—William G. Barnett, 11 Corporate Square 30329, (404) 634-5127
Chicago—Thomas D. Walsh, 100 S. Wacker Drive 60606, (312) 782-0857 and 903 Commerce Drive, Oak Brook, Ill. 60521 (312) 323-8980
Cleveland—Jack B. Sellers, Suite 715, Investment Plaza, 1801 E. 9th St. 44114, (216) 861-0808
Dallas—Paul E. Dittmer, 7701 Stemmons Freeway 75247, (214) 638-4080
Detroit—Robert T. Stevens, 24500 Northwestern Highway Southfield, Mich. 48075, (313) 352-6520
Greenwich, Conn.—Edward J. Golden, 9 Benedict Place 06830, (203) 661-3344
Houston—Robert V. Kinney, 2300 W. Loop S. 77027, (713) 621-6070
Los Angeles—Wayne B. Emigh 3550 Wilshire Blvd. 90005, (213) 386-5500
Minneapolis—Fred N. Anderson, 801 Nicollet Mall 55402, (612) 332-8735
New York—Charles I. Stern, 1414 Avenue of the Americas 10019, (212) 752-8260
Palo Alto—Gordon F. Best, 525 University Ave. 94301, (415) 328-7155
Philadelphia—George P. Ramming, 1700 Market Street 19103, (215) 665-1717
St. Louis—Robert H. Trumbull, Suite 207, 130 S. Bemiston, Clayton, Mo. 63105, (314) 862-3800
San Francisco—Richard M. Clark, 111 Pine Street 94111, (415) 434-2410
Union, New Jersey—Daniel A. Mickel, 2204 Morris 07083, (201) 687-8700

Affiliates in the United Kingdom.
Client companies assume our charges

CIRCLE 506 ON READER CARD

Letters . . .

ity. Applications in high school, junior college, and college may be more promising than the applications in elementary school which MITRE has so far explored. Yet, system requirements for these applications favor far greater algorithmic capability than is indicated in the presently conceived TICCET system.

C. VICTOR BUNDERSON
CAI Laboratory
University of Texas,
Austin, Texas

Use the dump

Sir:

I would like to share with other current and potential users of commercial time-sharing services a concern involving the ease with which one can ignore appropriate safeguards in their use, in the sense of not providing for system dumps or file dumps to tape from time to time. This is something we would not fail to do in our own computer centers, but somehow seem to be very willing to fail to do when using facilities which we control to a far lesser extent. The most apparent hazard is, of course, fire or other physical damage to the contractor's computer center. One far less commonly thought of, but which is a very real danger at the present time, is the possibility that such a contractor may experience, if his business is failing, certain kinds of legal actions which might operate to tie up the contents of his disc or tape libraries for undetermined periods of time. This kind of hazard is particularly important when the time-sharing users are not professional edp people, but, rather, casual users who may not have much idea of risks to which their data or programs are exposed.

ROBERT HARRIS

International Monetary Fund
Washington, D.C.

No ladies room

Sir:

Your July 15th issue contained two extremely interesting articles on the people problem in the computer business. I thought you might be interested in my own experience.

Almost four years ago, at a private edp school, the teaching level was good, but screening of applicants was

so shoddy that although they profess to limit entrants by virtue of a two-hour aptitude test score, in reality many are accepted who actually fail this test. This leads to a student population containing a wide spectrum of ability. The curriculum must be covered in the time allotted; the bright students absorb quickly, but others get further and further behind. The slower students graduate, but when applying for jobs at working installations, they fail aptitude tests!

Others, like myself, found no jobs in IBM installations for which we were ostensibly trained, but found positions as console operators, sorter operators, or jobs with other manufacturers. I went with a major manufacturer and had to learn all their accounting machines from scratch (which I could have done without spending time and money in the school). Although I rose in three years to the level of programmed electronic accounting machines, there was no chance to go up to third generation.

All government regulations and private protestations notwithstanding, many employers will not hire women programmers because of their insistence on late hours and/or weekend work resulting from constantly prevailing crisis situations in third generation work.

With a B.A. in English and previous editorial and programming experience, I was able to change jobs at a great increase in salary to a private firm as a technical writer, with the responsibility of developing system and user operation manuals, marketing proposals, corporate brochures, etc. This may sound exciting to some, but for me it is not the same, since I think programming is the most fun a person can have, working!

And here I sit, a woman with almost four years' involvement and exposure in the computer business . . . locked by personal responsibilities to the Long Island area and at least the salary I am now receiving, and knowing I have the capability, and I can't move into third generation programming without taking a big salary cut and being a trainee again! Although I have done system analysis and design in conjunction with the electronic accounting machine programming effort, the lack of a universal language keeps me from moving ahead.

Name withheld by request

PEC's just filled the vacuum with a 45ips no vacuum transport. It does everything any other transport can do. For \$3150.

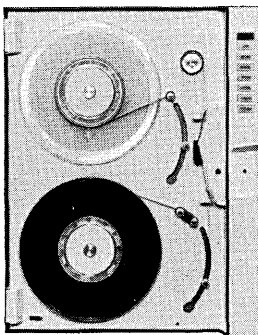

Here's the Transport.

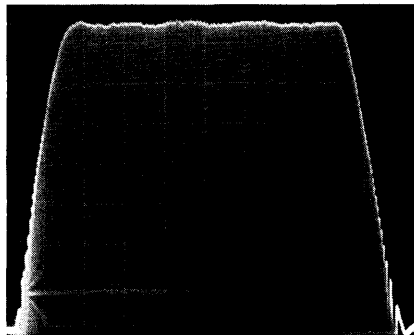

Here's the Proof.

Here's a complete new line of low cost, 45ips transports that get up to speed with no velocity transients, no overshoot, and no ringing. And a price tag of \$3150 in quantities of 100 for read-after-write. Available in read/write at \$2930 in the same quantities, and at similar low prices in 72 new models of read only for off-line applications such as COM. With exclusive PEC data recovery features, this new 45ips, 10½" reel 6000 series comes in 7- and 9-track, 800cpi NRZI. Also available in the new 9-track, 1600cpi phase-encoded USASII and IBM compatible formats. Get the full story on this 45ips breakthrough. Write Peripheral Equipment Corporation, 9600 Irondale Avenue, Chatsworth, California 91311. (213) 882-0030.

PEC

SALES OFFICES: Los Angeles (213) 882-0030 • Orange County (714) 546-4836 • Chicago (312) 696-2460 • Boston (617) 899-6230 • New York (203) 966-3453 • London Reading 582115

IMS Users. This is the coupon you'd expect IBM to offer:

Since IBM gave you IMS, you probably think they'd offer you a query and reporting language for it.

They don't.

We do.

We call our language QL/1.

If you'd like to find out how QL/1 takes care of communications and reporting while it eliminates 90% of the programming time, we'll send you the technical information manual.

Just send us the coupon.

You can't get a better offer than that.

Name _____

Title _____

Company _____

Street _____

City _____

State _____ Zip _____

Mail the coupon to:
General Analytics Corporation
100 Main Street
Reading, Massachusetts 01867



GENERAL ANALYTICS CORPORATION
New York, Boston, Washington D.C., Los Angeles

PEOPLE

WEMA's annual Medal of Achievement was awarded to Dr. **Simon Ramo**, vice chairman of the board of TRW, during the WESCON show last month. . . . **James B. Moran**, former vp, has been elected president of BASF Systems Inc., Bedford, Mass. He succeeds Dr. **Dieter H. Ambros**, who has been promoted to president of BASF Corp., Parsippany, N.J. . . . **Jack Roseman** is now exec vp and a director of On-Line Systems, Pittsburgh time-sharing firm. He had been vp of the Heliodyne Corp., where he founded its Washington Information Processing Div. in 1966. . . . **Charl J. Beyleveld** has been appointed president of Computer Sciences South Africa, Ltd., an affiliate of csc, which will provide Infonet t-s and other services throughout Southern Africa. . . . **Frank McBee, Jr.**, who has been with Tracor since its founding in 1955, is the company's new president and chief executive officer, succeeding **Richard N. Lane**, who remains on as chairman. . . . **Milton E. Mohr**, former president, chief executive officer, and a director of Bunker-Ramo, now fills the same three posts at Scantlin Electronics. He succeeds **J. Vance Holdam, Jr.**, who resigned for personal reasons. . . . Also resigning for personal reasons is **Thomas T. Fleming**, who was president and chief executive officer at Scientific Resources. He is replaced by **Jack L. Wolgin** who had resigned just last March as chairman and a director of the company, which he joined at its inception in 1953. . . . **Adrian C. Bos**, president of csc's Computer Sciences Leasing Co., is now also president of the corporation's Information Systems Div., Los Angeles. Prior to joining csc, Bos was vp, commercial marketing, for Univac. . . . **Michael E. McMahon** has been appointed manager of data communications for The American Bankers Assn. with primary responsibility for the development of standards in bank data communications. He had been communications manager for Reuters. . . . At presstime Management Assistance Inc. had not named a successor to president **L. A. Schwalm**, who will continue with the company as a director and consultant. . . . **Robert L. Peshel**, former president of Data-mode Inc., Palo Alto consultants in

mag tape recording and data communications, has joined Tri-Data Corp., Mountain View, as a member of the technical staff responsible for new product development. . . . **John D. Barbour**, president of Xavier Corp., a Houston-based investment/development firm, has been elected chairman and chief executive officer of Communications Logic, a Computer Complex subsidiary. . . . **Arno F. Glimm**, manager of Raytheon's Missile Systems Div. software dept. for the past three years, has moved West and gone into business for himself in Northridge, Calif., doing engineering consulting and contract programming. But he plans to open a Boston office next year. . . . Elected to the board of Xenex Corp. (formerly Management Methods, Inc.), Waltham, Mass., are: **Robert C. Fisher**, exec vp of Fisher Corp., Troy, Mich.; **James D. LeVan**, one of the founders of Sanders Assoc.; **Donald R. Twyman**, president of Industrial Data Processing and vp of Industrial Components, both of Detroit; and **Theodore O. Yntema**, a director of Bell & Howell, chairman of the National Bureau of Economic Research, and much more. . . . **James A. Yunker** has resigned as president of troubled Astrodata and is succeeded by **Robert B. Baker**, treasurer and former vp of the company. . . . **Robert A. Elmore** will retain responsibility for finance and accounting functions at Transamerica Computer Co. and will take on the additional duty of computer lease administration. . . . **Harry Shaw**, former exec vp, is now president and chief executive officer of Maxson Electronics Corp., a Riker-Maxson subsidiary. Former president **Dr. Harold Goldberg**, exec vp of the parent company, moves up to chairman of the board. . . . **William B. McWhirter**, former president of IBM's Data Systems Div., has been elected a director of ITEL Corp., San Francisco. . . . **Herman L. Philipson, Jr.**, president of Recognition Equipment, has filled the vacant-since-November posts of chairman, chief executive officer, president, chief operating officer, and director of REI subsidiary Corporation S. Philipson himself takes over the first two jobs, and **Don W. Hartson**, a Corporation S vp, the last three. ■

computer careers

Why base your career on just one interview? Make your choice from among several career positions!

EUROPEAN and NATIONWIDE CHOICE

N.Y., N.J., NEW ENGLAND, WASHINGTON, D.C., PHILA., MINNESOTA, TEXAS, HUNTSVILLE, FLORIDA, ARIZONA, CALIFORNIA AND OTHERS

Contact us if you have some experience or interest in any of the following:

- Computer Hardware & Terminal Dev. & Design
- Software Development — Languages, Compilers, Assemblers, Monitors or OS Design
- Digital/Logic or Circuit Design
- Real Time/Communications & Process Control Systems
- Software Applications Techniques for OS/DOS 360 or Minis
- Systems Engineering or Programming Systems Support To Marketing
- Management Sciences/Consulting

Unique opportunities exist in the \$9000-30,000 class for Managers, Seniors & Professionals who can accept management responsibility and rapid growth

DIRECT SALES MARKETING

HARDWARE & SYSTEMS TO \$35,000

All expenses are assumed by our client companies.

Write in confidence, including present salary, acceptable locations or call (Collect) Mr. Nellissen (Area Code 212) Plaza 9-1720

a&n
ALBERT NELLISSEN, INC.

Leading Consultants to Management
in the Data Processing Field

510 MADISON AVENUE, N.Y., N.Y. 10022

CIRCLE 500 ON READER CARD

Our memory disc blanks give you new freedom from metallurgical flaws.

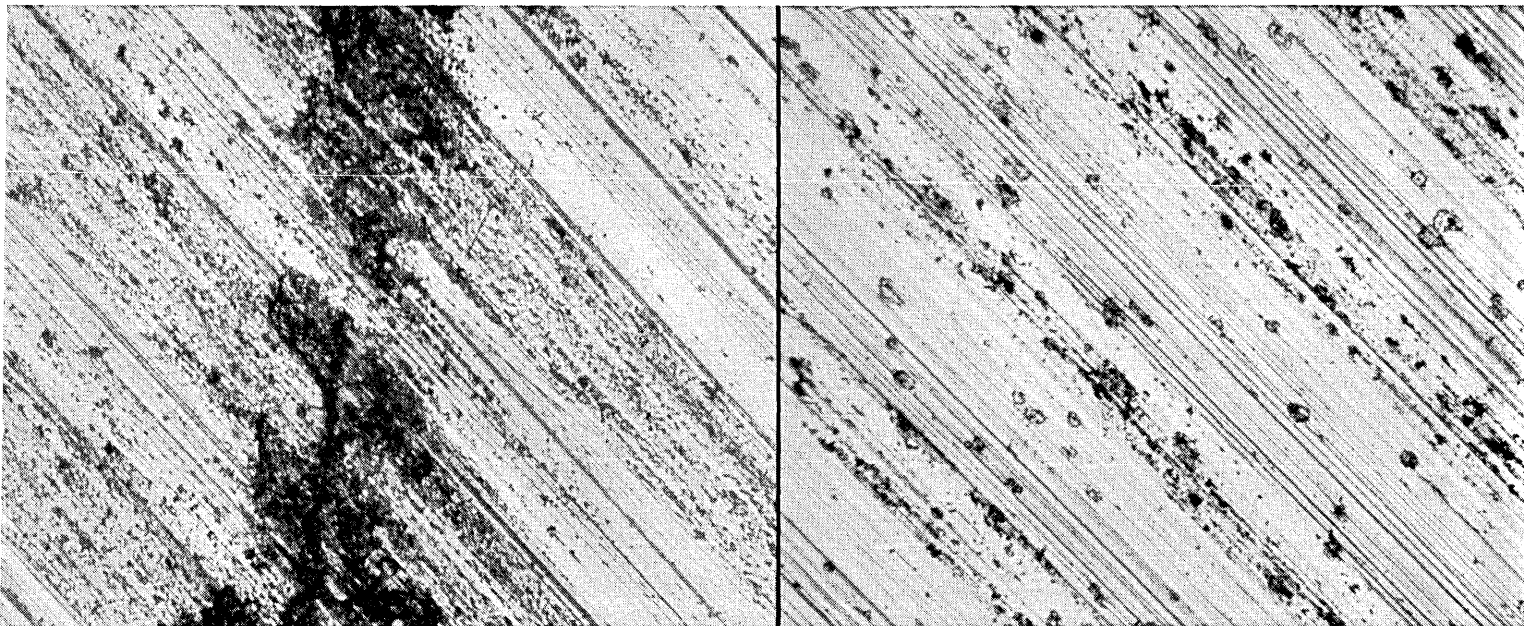

Others. Ordinary memory disc substrate (100x) after machining. Rough valleys show where stringers were "torn" out. Disc could be rejected—or corrected by excessive lapping or polishing. Otherwise, finished disc would be subject to high data dropouts.

Ours. New Kaiser Aluminum *ultiMemory* O-temper substrate (100x) after machining. Unique filtering minimizes stringers. Result: Lowest rejection rate in the industry for subsurface discontinuities. Finished disc can be expected to deliver minimum dropouts.

Our new *ultiMemory*TM substrate has the least metallurgical flaws of any memory disc substrate in the industry. We've effectively reduced stringers and oxides with a unique filtering process. And eliminated all surface protrusions to minimize your pre-sanding operations.

In O-temper, *ultiMemory* also is the flattest substrate available. Our special thermal flattening technique is the reason. This means you cut production time and costs. We deliver *ultiMemory* substrate in air-tight, heat-shrunk plastic packaging to keep blanks clean, scratch-free. And each "pack" weighs only 24 pounds which may be easily handled by women.

If you want to start cleaner for a smoother finish, use the reader inquiry card. Or write *the knowledgeable source*—Kaiser Aluminum, Room 2129, Kaiser Center, Oakland, California 94604.

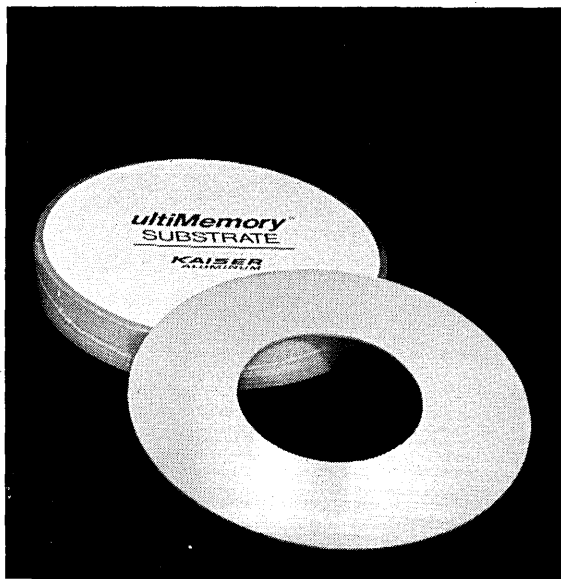

KAISER
ALUMINUM

CIRCLE 59 ON READER CARD

WORLD ROUNDUP

**"DOCTOR, I'VE
GOT A PAIN..."**

For some time, patients entering the Southern General Hospital in Glasgow, Scotland, have been meeting a computer instead of a doctor. Preliminary results of this experiment were explained last month at a London conference on Man-Computer Interaction at the National Physical Laboratory. Dr. Christopher Evans, senior research psychologist at NPL and one of the organisers, believes the man on the street finally is beginning to feel the impact of computers. The "new math," he says, is only an indirect impact...just as most of the work with time-sharing has been conducted within large organisations and confined mainly to specialists.

But the type of application under investigation at the Scottish hospital really does take the machine into ordinary people's lives. This involves a terminal which has been installed in the admitting room of an outpatient clinic at Southern General.

**... BUT WHERE
ARE YOU DOCTOR???**

It is used by patients with suspected gastric or duodenal ulcers visiting the gastroenterology specialist. On arrival they are asked to use a simplified typewriter terminal which has a special panel covering the normal keyboard so that there are only three large buttons to be pushed. There are "yes," "no," and "don't know" buttons. A short dialog between machine and patient gets the answers to a series of repetitive questions that the physician puts to all his patients. They range from "do you get an acid or bitter taste in your mouth after eating food?" to "can you indicate where you feel pain?" Some subtle questioning compensates for the last type of inquiry where traditionally the patient has used gestures, such as placing the flat of his hand or a finger over the position of pain. The patient just pushes the appropriate button; but periodically the machine prints out soothing statements such as "you are being a great help" and "take your time, we're in no hurry." After the list of questions is completed, the printout is torn off by a nurse and attached to the notes that go with the patient to the doctor. An attitude survey of patients indicates that many are quite content to strike up a relationship with the impersonal machine. Some even prefer it.

**... NOW THERE,
EVERYTHING IS ALL RIGHT."**

The project has been devised by Prof. W. Card, in the department of medicine relating to computing and mathematics, Glasgow Univ. The psychology of the software and terminal development, in terms of patient reaction, has been designed by a group from NPL. A second stage of the study is being considered, using a recorded voice response operated from the computer. However, this is causing some debate among the experimenters because they are uncertain about whether patients would like a warm chatty approach or the imperious attitude of many consultants. The cost of the scheme on a regular basis would probably be about \$8 to \$10 a patient, but the consultant should be able to give more time to each subject and also see more people an hour. For the trial, the terminal was linked to a GEIS t-s bureau.

**YOU DON'T HAVE
TO TAP A TELE-
PHONE WIRE TO FIND
OUT HOW YOU COMPARE
WITH YOUR CONTEMPORARIES**

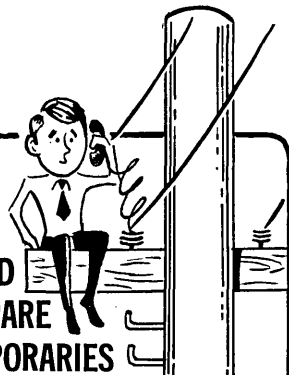

The Callahan Center, with offices in Philadelphia and California, has accumulated many facts over the past four years in placing computer professionals all over the country and overseas. We would like to share them with you.

Now you can determine exactly how you compare with your contemporaries. This FREE 1970 edition lists typical backgrounds of professionals in the EDP field. This includes their year of graduation, a description of their experience, (including Machines, Languages, and Applications), their present salary and bona fide offers.

Find out
where you stand.
Write for this
free booklet now.

FREE



All of our services are employer paid.

Callahan

CENTER FOR COMPUTER PROFESSIONALS

Suite 1515, Broad-Locust Bldg., Philadelphia, Pa. 19102 • 215-985-1700
Western Office: Del Almo Financial Center
Torrance, Calif. • 213-371-4659

CIRCLE 503 ON READER CARD

Senior Systems Analysts

Large Florida corporation seeks senior systems analysts with computer oriented business systems background. Must have minimum of 1 year computer programming experience and two years' experience in developing business, engineering, factory and job shop systems. Bachelor degree in business administration or allied area required.

Send resume to T. E. Armer

FLORIDA RESEARCH AND DEVELOPMENT CENTER
WEST PALM BEACH, FLORIDA 33402

**Pratt &
Whitney
Aircraft**

DIVISION OF UNITED AIRCRAFT CORPORATION

**U
A**

An Equal Opportunity Employer

CIRCLE 507 ON READER CARD

Si vous êtes un "SYSTEMS ANALYST" de premier plan ayant quelques années d'expérience . . .
Si vous voulez connaître les problèmes et les méthodes des entreprises européennes . . .

POURQUOI NE PAS SAISIR CETTE OCCASION DE TRAVAILLER EN

FRANCE ?

SERTI

(Membre du Groupement Français d'Informatique, 300 spécialistes, chiffre d'affaires 1969 : \$6 millions) est un Bureau d'Etudes et de Conseil en Informatique de Gestion, qui vous offre la possibilité de participer à la conception et à la réalisation de projets importants faisant intervenir des techniques avancées :

- Temps réel;
- Grands fichiers;
- Nombreux terminaux "on-line".

LA PRATIQUE DU FRANÇAIS COURANT EST NECESSAIRE

Si vous êtes intéressé par cette proposition, écrivez-nous: Pourquoi vous intéresse-t-elle? Qui êtes vous? Que pouvez-vous nous apporter?

Pour assurer le succès de notre collaboration, parlez-nous de vos expériences et de vos projets. Précisez le salaire souhaité.

Nous vous demandons de nous envoyer une lettre manuscrite.

Nos correspondants aux USA recevront si nécessaire les candidats sélectionnés.

SERTI

17 Rue Monsigny,
PARIS-2e, France.

CIRCLE 511 ON READER CARD

ADVERTISERS' INDEX

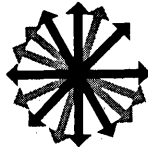

ACCO	98
Advanced Memory Systems, Inc.	46, 47
Albert, Nellissen, Inc.	129
American Micro-Systems, Inc.	58
American Technological Institute	134
American Telephone and Telegraph Company	68, 69
Applied Systems Division of Computer Learning and Systems Corporation	87
Auerbach Info, Inc.	66
Automata Corporation	10
The Bendix Corporation, Communication Division	Cover 3
Bryant Computer Products, A Division of Ex-Cell-O Corporation	20, 21
Bryant EDP-Systems, A Division of Bryant Associates	138
The Bunker-Ramo Corporation	86
Cadillac Associates, Inc.	138
Caelus Memories, Inc.	Cover 2
California Computer Products, Inc.	109
Callahan Center for Computer Professionals	136
Century Data Systems	118
Collins Radio Company	108
Colorado Instruments	1
Computer Machinery Corporation	74, 75
Computer Micro-Image Systems Inc.	16
Consolidated Computer	114
Control Data Corporation	88, 89
Data General	6, 7
Data Processing Financial & General Corporation	12
Data Products	90
Datalog Division Litton Industries	85
DATAMATION Magazine	131
A. B. Dick Company	110, 111
Digital Equipment Corporation	70
Drexel Harriman Ripley Incorporated	84
Electronic Memories	96, 97
Evans & Sutherland Computer Corporation	102
Floating Floors, Inc. A Subsidiary of National Lead Company	99
General Analytics Corporation	128
Gould Inc., Graphics Division	124, 125
Hewlett Packard	72, 73
Incoterm Corporation	65
Kaiser Aluminum	130
Lockheed Electronics Data Products Division, A Division of Lockheed Aircraft Corporation	48
Micro Switch, A Division of Honeywell	52
Mosler, An American Standard Company	5
The National Cash Register Company	112
Noller a Division of Badger Meter Manufacturing Company	120
Peripheral Equipment Corporation	80, 81, 127

Pratt & Whitney Aircraft, Division of United Aircraft Corp.	136, 142
RCA Computer Systems Division	141
RCA Magnetic Products	122
RCA Service Company a Division of RCA	4
Recognition Equipment Incorporated	39
Redcor Corporation	Cover 4
Remex Electronics, A Division of Ex-Cell-O Corporation	121
RFL Industries, Inc.	76
Sangamo Electric Company	106
Science Accessories Corporation	19
Serti	136
The Singer Company, Friden Division	2, 104
Source EDP	126
Spectron Corporation	82
Stromberg Datagraphix, Inc.	14, 15
Success Associates International, Inc.	4
The Superior Electric Company	123
Systemation	78
Tab Products Company	91
Teletype Corporation	116, 117
Transitel Division of Sangamo Electric Company	92, 93
Tri Data	67
Varian Graphics and Data Systems Division	45
Weber Technical Products, Division of Walter Kidde & Company, Inc.	62
Wells Recruiting Systems, Inc.	138
Wiley-Interscience a Division of John Wiley & Sons, Inc.	79
Wright Line, A Division of Barry Wright Corporation	8, 84
Xerox	100, 101
Xerox Data Systems	22

TECHNICAL PUBLISHING COMPANY

Arthur L. Rice, Jr., President
 Gardner F. Landon, Exec. Vice President, and President, Thompson Division
 James B. Tafel, Exec. Vice President, and President, Technical Division
 Calverd F. Jacobson, Financial Vice President
 Edwin C. Prouty, Jr., Secretary and Director of Data Processing

ADVERTISING OFFICES

Sales Manager & Vice President	JOHN BRENNAN 205 West Wacker Drive, Chicago, Ill. 60606 (312) Financial 6-1026
Eastern District Managers	JAMES M. MORRIS WARREN A. TIBBETTS IRWIN L. WERFEL 35 Mason Street, Greenwich, Conn. 06830 (203) 661-5400
New England District Manager & Vice President	WARREN A. TIBBETTS 112 West Haven Rd. Manchester, N.H., 03104 (603) National 5-9498
Midwest District Manager	JOHN M. GLEASON 205 West Wacker Drive, Chicago, Ill. 60606 (312) Financial 6-1026
Western Manager & Senior Vice President	HAMILTON S. STYRON 94 So. Los Robles Ave., Pasadena, Cal. 91101 (213) 681-8486—from Los Angeles
Western District Manager	JAMES E. FILIATRAULT 260 Sheridan Ave. Palo Alto, Calif. (415) 321-1440

WHAT IS YOUR TRUE WORTH?

FREE JOB OPPORTUNITIES BULLETIN

Cadillac Associates represents the nation's largest and most respected professional placement service. Our close relationship with the nation's finest firms generates continuous career opportunity information and allows us to confidentially present your qualifications to those at "decision-making" levels.

Our bulletin, published monthly, listing available opportunities in the Systems & Data Processing field is available free of charge and will be mailed to your home monthly upon your request.

For your free bulletin, without any obligation, circle reader service card #509. Please USE HOME ADDRESS ONLY!

FREE CONFIDENTIAL PLACEMENT SERVICE

If you desire immediate assistance in locating an opportunity consistent with your objectives (professional/financial/geographic), CALL OR WRITE TODAY. A member of our staff of SYSTEMS & EDP SPECIALISTS will reach you by telephone to discuss your objectives and how we might help you to satisfy them. A resume, or some details of background, will be appreciated.

Remember: Our client firms are located from coast to coast and assume all expenses (agency fee, interviewing & relocation).



LON D. BARTON, President
CADILLAC ASSOCIATES, INC.*
 32 West Randolph St. Chicago, Ill. 60601
 Financial 6-9400

West coast residents—contact:
 Lon D. Barton Associates, 3325 Wilshire Blvd.
 Los Angeles, California 90005
 (213) 385-9111

*"Where More Executives Find Their Positions Than Anywhere Else in The World."

CIRCLE 509 ON READER CARD

\$12,000 to \$48,000

move into upper brackets
 with OUR FREE
CAREER ANALYSIS

- PROGRAMMERS-ANALYSTS
- SYSTEMS MANAGERS
- EDP SALES/MARKETING
- OPERATIONS RESEARCHERS
- MIS DIRECTORS
- Software-Timesharing-Conversion
 Communication Specialists



If you're bigger than your present position, change it. Evaluate your career, with the help of our EDP-CAREER SPECIALISTS, and move up to a better position. One telephone call can solve your problems for the 1970's.

Our staff is recognized by industry and individuals alike for bringing together the right person and the right job. BRYANT EDP-SYSTEMS serves the best-qualified Data Processors in the computer industry and in strictest confidence. Call collect 9 A.M. to 5 P.M. Every weekday or Saturday until Noon.

Richard Ondre, Mike Dorn, and Dick McCarty
 (312) 726-5860 or 726-6232

or send your resume to:

Rick Adonis, President

BRYANT EDP-SYSTEMS

A Division Of Bryant Associates

67 E. Madison, Suite 1608 Chicago, Ill. 60603
 Agency Licensed

CIRCLE 501 ON READER CARD

program us to find you a better job in programming

Tell us about yourself and we'll be able to tell you where the better opportunities lie in programming. Here's what we'd like to hear in a resume or letter: Jobs you've had in programming. Machine languages you can write. Hardware and software you're familiar with. Your education.



Tell us too, what field you want to be in—investment and brokerage, manufacturing, retailing, insurance, accounting, engineering. If you're bored with the programs you're writing now, if you want more sophisticated techniques to handle, and if you want more room to move, we'd like to know about it.



Program us to help you! Send us your resume or letter including salary desired. When we have this input, we'll call and tell you about the various companies that have asked us to find you! We'll arrange for a client company to bring you in for a personal interview at no cost to you.



**Tell us ...
 so we can
 start
 telling you ...**

Wells Recruiting Systems, Inc.

875 North Michigan Avenue, Chicago, Illinois 60611 (312) 664-8166
 170 Broadway, New York, New York 10038 (212) 964-5566
 3435 Wilshire Blvd., Los Angeles, California 90005 (213) 380-0212

AN IMPORTANT ANNOUNCEMENT FROM WELLS

W.R.S. franchises are now available to qualified applicants. Minimum capital requirement about \$20,000. Partnerships can be arranged. Write or call collect Toby S. Brimberg, Wells Management Franchising Corp., 170 Broadway, New York, New York 10038, (212) 964-0211.

CIRCLE 505 ON READER CARD

Maybe LSI Can Work

C The subject of large scale integration has seen considerable discussion. It has run the gamut from wild enthusiasm to dour head-shaking.

On the enthusiastic side, we have seen the normal headlong rushes to build . . . to build anything, so long as it was LSI. We have seen curves that promise large profits, that show astounding "yield" rates, and that show how close to the ideal in data processors we can get with LSI.

Anyone who wants recognition nudges management with LSI-peppered talks and curves (there's a world of sincerity in a curve) showing how an LSI-oriented computer can save his company N millions of dollars in computing payrolls alone. No manager worth his salt can afford to ignore this double potent pitch.

LSI is a recent development. The ballyhoo around it is not; it was merely passed on from the previous "recent development." For such a development to have enduring substance, it has to be examined via absolute terms. If there are no pertinent absolute terms it would be advisable to dismiss the subject out of hand.

What is absolute about LSI? A few invariant facts can be listed, and then some pertinent comments can be made. We can claim these things to be known about LSI:

1. Its nature is monolithic; i.e., all the parts are formed into one nondivisible unit. This is the significance of the "integration" in LSI.
2. Fabrication can occur with relatively as few operations to make a complex LSI circuit as to make a single gate.
3. It can be complex. An involved gating tree, or shift register, or other logic element grouping can be formed monolithically. Hence the "large scale" identity.

These three items can be demonstrated, repeatedly and predictably.

They form an absolute reference. We will now consider their significance from a popular viewpoint.

Point 1 might make the reader think that "compactness" is easily reached by LSI. This may be true. On the other hand, compactness is questionable if a hundred connectors have to be attached to an area about the size of the period at the end of this sentence. A large amount of "uncompacting" has to be done to get resolvable terminals.

It is not known for a fact that LSI is inexpensive. Point 2 says "few operations" may be involved in making a complex digital circuit. Anybody who equates this with "inexpensive" is jumping to conclusions. It might be necessary to make 10,000 digital circuits before a "good" one comes along, even though few operations are involved for each.

There seems to be no limit to what adventurous engineers can conceive in complexity, all the way to complete computer systems. This is point 3 above. There is a minor point of controversy, however. When the number of gates falls below a certain level, the circuitry loses the dignity of its LSI standing. It becomes medium scale integration.

The MSI terminology is not to be discarded lightly. The letters MSI somehow carry the assurance of safety and conservatism of design. MSI components are commercially available. Everybody uses them.

There is a dark suspicion that MSI is used sometimes to convince management that the associated venture will be profitable and safe. LSI, on the other hand, is used to convey the impression of fearless leadership and adventure.

Since the MSI/LSI boundary is the least definable element in this article, it will be discarded entirely. Thus the spectre of SSI (small scale integration) is obliterated immediately.

A three-point basis for the definition/evaluation of LSI has been made. We will say that if all three points

apply to a project in digital circuitry, that endeavor is in the field of LSI.

Shortly after it was shown that complex digital elements could be fabricated with integrated circuitry, there was a natural wave of application. The early efforts were little more than a conversion of standard techniques into the new elements. One would not expect a cross-disciplinary impact to burst out with the first discovery.

Insight into problem areas came shortly thereafter. It was mentioned above that the simple matter of making connections into the microworld of LSI is awkward. But the connections have to be made, if only to test the new elements.

There is the new breed of problems. How are we going to apply the test probes? How are we even going to find the terminals? How are we going to hold the elements in registration, so we know exactly where they are? What constitutes an efficient and comprehensive test pattern? How can we keep from destroying the elements in the act of testing them?

Clearly, such problems are beyond the fast man with an ohmmeter. Micromanipulators are painfully slow, and can still make mistakes.

Enter design automation. Perhaps a man cannot handle probes with dexterity, and know correct signal responses from hundreds of stimulating combinations, but a machine can cope with the task.

It is probably not new to the reader, but the design automation staff in the "average" company has had a curious history. To a certain degree, such a staff existed in the first place because it was unseemly not to have one. To the extent that certain kinds of signal sortings and listings were undertaken, the staff was highly lauded. On the other hand, undertaking original work in such subjects as fault isolation, network synthesis, package placement,

and conductor routing was likely to evoke a cold nonresponse, or possibly some billing as tinkerers with undesired esthetics.

LSI has changed all that. Without automated assistance, for example, merely identifying good chips from bad chips can be expensive.

The ice has been broken, and it is now in vogue to associate many other facets of LSI design and construction with design automation. A major impact of LSI, then, is the recognition of design automation as a mandatory adjunct.

No sooner are the construction problems of LSI within conceptual range than other basic considerations arise. For example, might not our whole understanding of the design process be affected by the properties of LSI?

Consider the three basic points above. Complex devices, fabricated with few operations in a monolithic configuration, can hardly be equated to a room full of relays. Yet the design philosophy being impressed on LSI is probably closer to the design philosophy one would associate with relays than with a completely new medium.

Let us ask a basic question: What did we stress with logic which was implemented with relays, diodes, or any array of parts realizing logic nodes which cost money on an individual basis?

Save the logic nodes! Find redundant elements and eliminate them. Pay for the economy with time, if need be. Multiplex where possible, but save the hardware!

It is painfully obvious now that there is another conservation law which should replace the conservation-of-logic-nodes law. Gates we can duplicate, says LSI (point 2). We can build logic nodes in astronomical quantities, says LSI (point 3). Then why try to conserve where the need for conservation is secondary at best?

Let us reconsider the LSI dot whose connectors make it look like it is growing hair. What should we be saving? We should be saving connectors!

An interesting inversion has taken place: it is not the logic elements which cost the most, but the conductors leading to those elements.

The first reaction to this new kind of conservation is studies of optimal packaging. The idea is to arrange the logic internally so that conductors are minimized. This in itself does not lead to a change in design philosophy.

Now it is well known that, in any subject, the greatest gains are made in philosophical orientation before commitment. The simple decision *not* to undertake a project can be the most profitable in a company's history. The gains that are made by technical adjustments after the fact of application are trivial by comparison. Rearranging logic to save connectors is in this latter category.

One would expect intuitively that a major development like LSI would have an impact on the way designers think. When we further combine LSI with the strides which have been made in design automation, the change in thinking should be quite measurable.

No such change really seems to have come about.

Now let us look at what at least a part of the change in thinking should have been. We can do this by retracing events and drawing conclusions.

It was mentioned that current design in digital logic is still based on a conservation-of-nodes philosophy. "Relay logic" is a good description of this. It has been good practice to save hardware by identifying repeating logic patterns, and simply have one element operate repeatedly in time. Multiplication is an example of this, where some form of repeating additions is an economical method of obtaining a product.

One trouble with saving logic nodes at the expense of time is the time expense itself. For this reason a high priority has been assigned to the physical problem of "fast" logic. The controversy between MOS and bipolar logic implementation is based partly on relative speeds.

Suppose that the logical elements came without cost. Would there still be the need for this saving in time? Clearly not. The elements could be used in parallel to a much larger extent.

This is currently the case. Certain kinds of digital logic can employ

parallel gating networks. This reduces multiplexing, interim storages, and all the connections needed for design which uses time-distributed logic.

When we consider that parallel logic can be more easily tested than logic which contains storage elements and feedback lines, we wonder why it is not used more often. When we consider that parallel logic is by its nature faster than time-distributed logic, hence will permit slower elements to be used, we wonder why it is not used more often.

The conclusion is that major impact of LSI should have been the increased use of parallel logic as a standard design technique.

As it appears at this writing, parallel logic is not in common use, nor is its use imminent. A clear recognition of the need for it exists in parallelism at a higher level, such as with parallel processing schemes, overlapping operations, and the like. But these devices beg the issue of basic design philosophy. If there is some kind of a barrier to thinking in terms of parallel logic, it behooves us to investigate it.

Consider that the design of digital logic has always been a manual task. Books have been written on the subject. Courses are taught at the colleges.

Classically, the steps in designing a system are:

1. Select or devise an algorithm through which an operation can be implemented.
2. Draw time-steps of charts to illustrate the algorithms.
3. Convert the charts to detailed schematic diagrams or logic equations.
4. Construct the circuits.

The gross steps are perfectly acceptable, and have produced noteworthy results. Note that only step 1 is of a truly "creative" nature. What colors things heavily is that all the steps have been carried out generally under a conservation-of-nodes philosophy.

There is another factor. It is based on a human property. This is the limited number of variables that a man can process reasonably at one time. There is little question that a man's
(Continued on page 142)

**At RCA
it's 18 months from now.**

That's how far RCA is ahead of the field in the fastest growing segment of the computer market.

We're talking about large time-sharing, multi-function, multi-user operating systems.

We're looking for EDP professionals whose minds run to broad-gauge thinking. In total systems planning for hardware and software. Professionals

with a deft mind in hardware/software trade-offs.

We're thinking of people with an eye for advanced thinking. People who might find our lead of eighteen months isn't big enough.

One thing for sure. The opportunity is big enough.

It's a year and a half from now at RCA. You could be there.

Your experience should be in any of the following: programming; language processing; control systems;

operating systems; utility systems; communication systems; micro-programming; field sales and system support; education or product planning.

*Write to: Mr. Thomas Beckett, Dept. 18,
RCA Computer Systems Division,
Bldg. 202-1, Cherry Hill, New Jersey 08101.
We are an equal opportunity employer.*

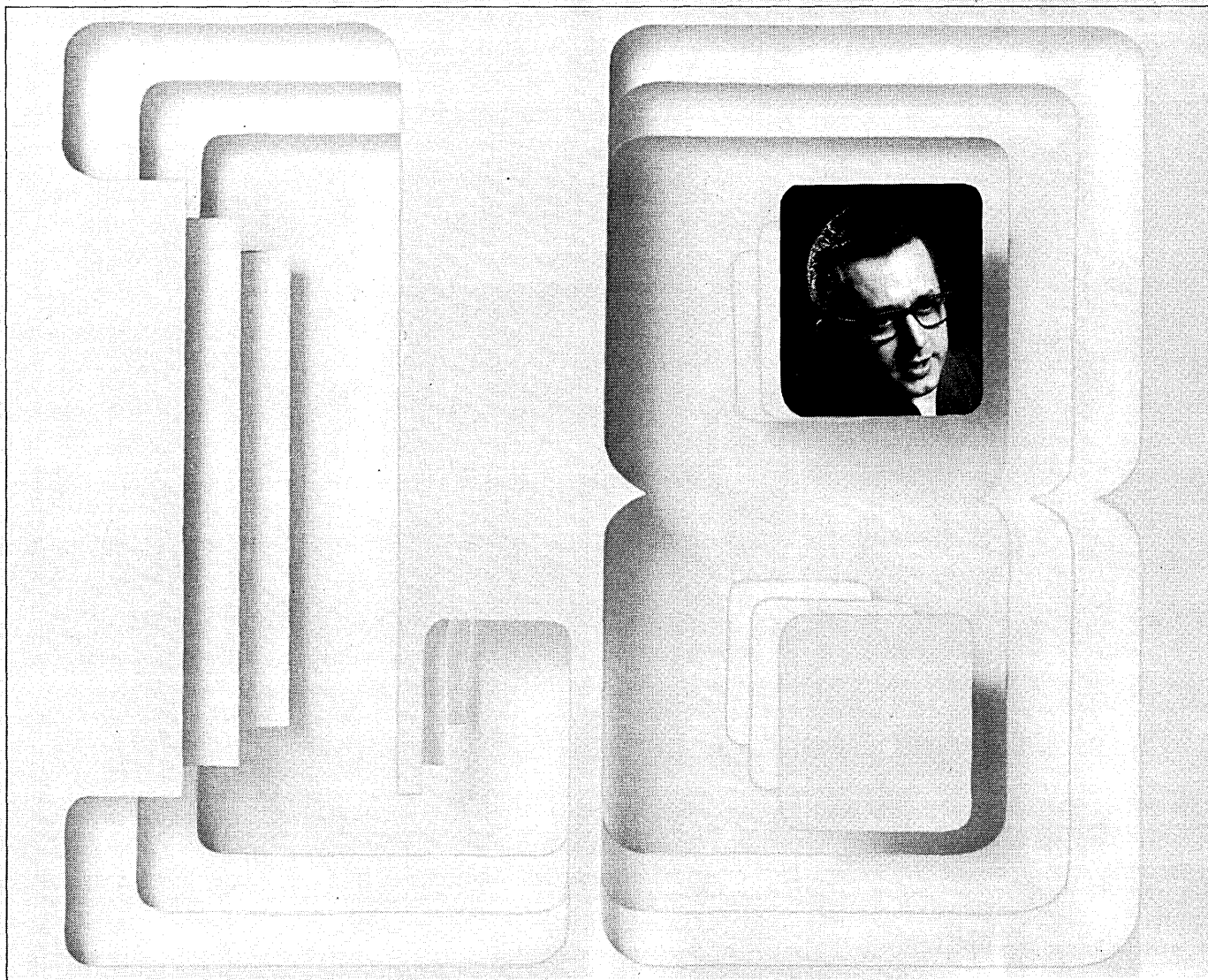

RCA
COMPUTERS

Programmers / Systems Analysts:

IMS

is alive and well at

P&WA

While others talk about it, ours is operational. Just one of the feature attractions in Information Systems at Pratt & Whitney Aircraft, world's leading producer of jet engines.

Another is a full bag of tools, including 360 models 20, 30, 50 and 65; tapes, random devices, 2314's; data collection equipment; on-line facilities; DOS and OS.

Applications? The gamut! Manufacturing, Product Support, Engineering, Finance, Purchasing, Advanced Planning, Management Sciences . . . name it!

Best of all, P&WA offers an outstanding program for professional development in a planned environment. Our Systems-Programming Analysts are exposed to virtually every phase of this dynamic business. They get to move around, and they get to move up . . . just as fast as their talents will take them. Isn't it time *you* talked to P&WA?

For openers, why not send your resume and salary requirements to Mr. H. M. Heldmann, Professional Placement, Office A-44, Pratt & Whitney Aircraft, East Hartford, Connecticut 06108. An equal opportunity employer.



The Forum . . .

processing ability in this dimension can be augmented by a computer.

Why doing so is not general practice is not known for certain. Some designers claim that there is no need for parallel switching logics of much over six variables . . . but it has to be noted that this is also the limit of what a man can contain easily. There can be coincidence, of course, but there does seem to be some correlation.

Now we have something of a paradox. Any stigma which may have been attached to parallel circuitry because of complexity and hardware count has been greatly suppressed via LSI. The advantages of parallel circuitry, such as inherent speed, become more attractive by association.

The paradox is the lack of drive in making use of these obvious facts. There is a need for faster circuitry which is not encumbered by internal storage elements and feedback loops. The need can probably be filled to a large extent by parallel circuitry. The design of such circuitry is readily generated by computer, operating from Boolean functions. All signals seem to be "go." Why, then, are we not going?

There is a secondary impact. If systems can be built in this manner, what of intercomponent logic? Once again the number of variables can get beyond easy manipulation, and so a computer has to be used.

Once the design of systems using parallel logic becomes standard operating procedure, it is clear that a new philosophy of system design will have been implemented.

In this new philosophy, the use of the computer as a network synthesizing device will be routine. So also will be the general acceptance of LSI parallel circuitry. This means that the discipline of design per se will deal almost exclusively with basic algorithms and concepts . . . or the first "creative" step in the design procedure listed above. The rest will be largely automatic.

The practical impact: designers of systems will be spending a greater percentage of their time in creative thinking, rather than the routine of implementing standard concepts via long lists of signals.

—J. Robert Logan

Add interactive graphic display capability to your IBM 1130 for \$5500!

That's right. We wanted this capability for our own in-house IBM 1130. But it was not available at our price. So we built our own system. And it's working so well we've decided to offer it to other IBM 1130 users.

We call our versatile display the Bendix ICD-1100. Its basic features include:

- Hardware/software interface
- FORTRAN callable routines
- Compatibility with digital plotter software
- High resolution (10 bit)
- Two-speed joystick for program interaction
- Alphanumeric display

We have more good things to tell you about the ICD-1100, as a peripheral to the IBM 1130.

Call (301) 825-7604. Or write: The Bendix Corporation, Communications Division, East Joppa Road, Baltimore, Maryland 21204.

Bendix



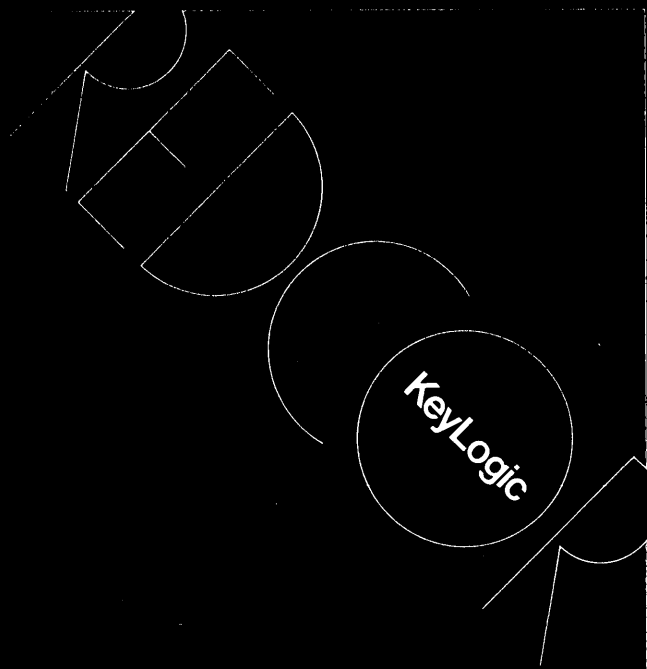

KeyLogic:

**The most expensive
key to disc system**

**at the lowest cost and
highest throughput
per source document.**

Redcor's "bundled" system includes:

- batch balance
- value range check
- check digit
- operator statistics
- reformatting
- on-site S.E. and C.E. support.

R REDCOR CORPORATION
C Telephone: (213) 348-5892