

DATA MATION 80[®]

JUNE/4.00 U.S.A.



**DATA
COMMUNICATIONS:
THE TOP 50
MANUFACTURERS**
ALSO:
**SYMMETRICAL
MULTIPROCESSING
REDUNDANT SYSTEMS
FOCUS ON MAINFRAMERS**



A Marriage of Convenience— for PDP and LSI users!

It's a marriage made in heaven—for DEC PDP-11 and LSI-11 owners who would like a low-cost, quick-to-install, high-density data storage system. The union consists of Kennedy's Series 5300 fixed media, Winchester technology disk drives and Kennedy emulation controllers. The controllers, which use standard DEC PDP-11 operating systems and diagnostic software, are embedded inside the computer, allowing the Series 5300 to be easily attached to both PDP-11 and LSI-11 mini in one sweet, short

ceremony. Series 5300, with its one, two or three platter versions and unformatted data capacity of 70M bytes and

track density of 300 TPI can be joined with the KSC111 unibus disk controller for the PDP-11, and the KSC011, for use with the LSI-11. And no software changes or other alterations are required. Kennedy Series 5300, controllers and your PDP-11 or LSI-11—put them together, plug them in and you have a winning system.

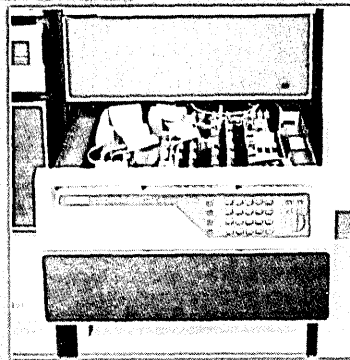

KENNEDY

Schickel, Magnetics & Electronics Inc.

11300 Shamrock Ave. Monrovia, CA 91016
(214) 357-1851 FAX 910/585-3249

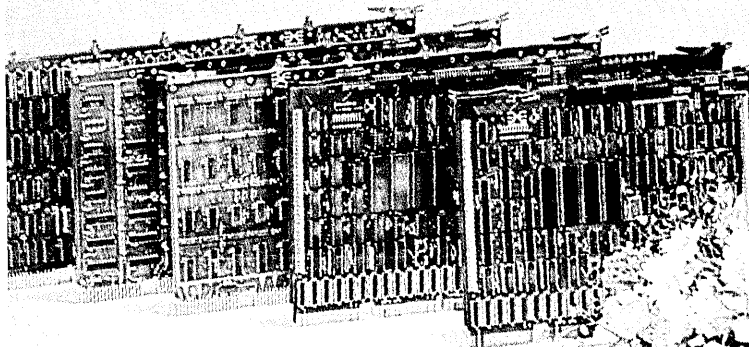

JUST MARRIED

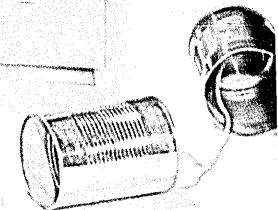
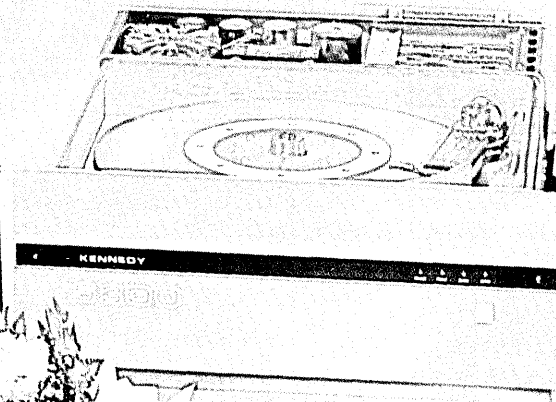

BONANZA!

For PDP-11* users, the most cost effective, "no-compromise," SMD disc controller

Maximize your system's cost performance factor with the full capability DC-233 Disc Drive Controller. Its unique master-slave bit slice micro-processor architecture provides total DEC software transparency with up to eight drives. Use it with the CDC 9762 80mb drive to emulate DEC's RM02/03 (67mb of formatted capacity per drive). Or—use it with the Memorex 677 Series 100/200mb drives to emulate DEC's RP05/06 (up to 176mb of formatted capacity per drive). Or—use it with eight 300mb drives for up to 2.1 billion bytes of formatted data in non-software compatible mode.

AND THERE'S MORE

- Embedded design fits all PDP-11's*
- Dual drive porting
- Optional dual unibus porting
- Automatic NPR throttling
- ECC fully implemented
- Media compatible

SEND FOR COMPLETE INFORMATION

Division of WESPERCORP

(714) 730-6250 — TWX 910-595-1775
Cable WESPER
14321 Myford Rd., Tustin, Calif. 92680

*Trade name of Digital Equipment Corporation

CIRCLE 4 ON READER CARD





Here's the state of the art in low-cost hard-disk computers

11 MEGABYTES OF

FAST HARD-DISK STORAGE

Yes, the Cromemco Model Z-2H is in a class by itself in the computer field.

These Z-2H features tell you why:

- 11 megabytes of hard-disk storage
- 64 kilobytes of fast RAM
- Two dual-sided floppy disk drives
- Z-80A type processor
- Fast 4 MHz operation—150 nanosecond access time
- Fast hard-disk transfer rate of 5.6 megabits/second
- Low cost

And that's not all you get. Not nearly.

BROAD SOFTWARE SUPPORT

You also get Cromemco software support—the broadest software sup-

port in the microcomputer field. Software that Cromemco is known for. Like this:

- Structured BASIC
- FORTRAN IV
- RATFOR (RATional FORtran)
- COBOL
- Z-80 Macro Assembler
- Word Processing System
- Data Base Management

And more all the time.

FIELD PROVEN

The Z-2H is clearly in a class by itself. We introduced it last summer. It's field proven. It's reliable.

And it's rugged. Housed in a sturdy, all-metal cabinet.

EASILY EXPANDABLE

As always with Cromemco, you get expandability. The fast 64K RAM in this Model Z-2H can be expanded to 512 kilobytes. That amount of RAM combined with 11 megabytes of hard-disk storage gives you enormous

computer power—the equal or even beyond what much larger computers sometimes offer.

What's more, this computer gives you a 12-slot card cage. That's to plug in your special circuits as well as additional RAM and interface cards.

This expandability is supported by still more Cromemco value—the Z-2H's heavy-duty power supply that gives you 30A at 8V and 15A at $\pm 18V$ to support plug-ins.

LOW COST — SEE IT NOW

The Z-2H is real. It's been in the field for many months. It's proven itself.

You should see the Z-2H now. Contact a Cromemco representative and arrange for a demo. Learn that Cromemco is a survey-winner for reliability.

And learn that the Z-2H is under \$10K.

In the long run it always pays to get the best.



Cromemco
i n c o r p o r a t e d

280 BERNARDO AVE., MOUNTAIN VIEW, CA 94040 • (415) 964-7400

Tomorrow's computers today

CIRCLE 5 ON READER CARD

DATAMATION⁸⁰®

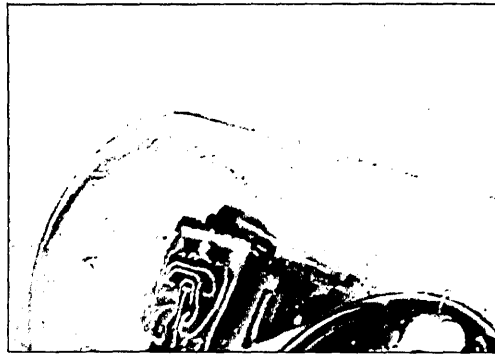

112



202

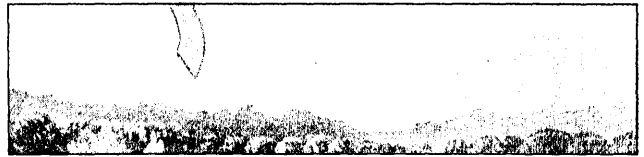

188

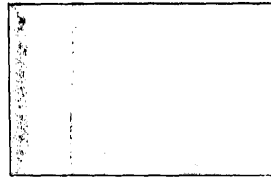

180



216

FEATURES

45 FOCUS

Willie Schatz
A survey of the mainframe industry finds the outlook basically positive.

112 THE TOP 50

For the second year, DATAMATION surveyed data communications manufacturers. In "Alive and Well" Ron Frank provides an overview of the industry. A chart showing the Top 50 will be found on pp. 120-121, and a list of the companies, their addresses, and their products begins on p. 125.

146 COMPUTING IN THE NEW INDIA

Hesh Wiener
India's computer users are reaching toward the future.

156 A HOSPITAL'S CARES

Robert Spaziano
An on-line, real-time medical system provides greater hospital efficiency.

169 REPLACING THE PAD AND PENCIL

Amy D. Wohl
An update on the word processing scene.

180 THE FIRST MAN TO COMPUTE THE WEATHER

Molly Gleiser
Lewis Fry Richardson dreamed of making a numerical prediction of the weather from atmospheric models.

188 REAL-TIME ESTIMATING

Edward L. Griffin
Avoiding the 50% to 100% error traditionally associated with software development cost estimates.

202 HEDGING YOUR BETS

Samuel Feldman
Redundant systems help achieve increased reliability.

216 MORE POWER TO YOU

Allan E. Wilson
Symmetrical multiprocessing gives large-scale computer power at a lower cost.

265 READERS' FORUM

James L. Rogers examines a report by the Association for Computing Machinery on guidelines for college career programs, and Robert L. Glass gives the subject of turnaround a whirl.

Cover photograph by James Joern. ©1980.

NEWS IN PERSPECTIVE

- 64 **STRATEGIES**
Forging a new alliance.
- 66 **EDUCATION**
Problems with dp schools.
- 77 **LEASING**
Fear and loathing in leasing.
- 81 **COMMUNICATIONS**
Ready to compete with Bell. Finding the ideal product.
- 88 **PERSONAL COMPUTERS**
Kids love the dp scene.
- 99 **INTERNATIONAL**
Dp: an easy target.
- 101 **SOFTWARE**
Compiler company grows.
- 102 **MEETINGS**
One day at a time.
- 106 **BENCHMARKS**
AT&T plans satellites; Simulating magnetic bubbles; West coming East? IBM 4331 Group 2; Informatics into mini software.

DEPARTMENTS

- 8 **LOOKING BACK**
- 17 **LOOK AHEAD**
- 24 **CALENDAR**
- 31 **LETTERS**
- 37 **EDITOR'S READOUT**
- 228 **PEOPLE**
- 231 **HARDWARE**
- 240 **SOFTWARE & SERVICES**
- 247 **SOURCE DATA**
- 255 **MARKETPLACE**
- 259 **ADVERTISERS' INDEX**

The Associative File Processor. AFP.

A Special Purpose Hardware System for Retrieving Textual Information.

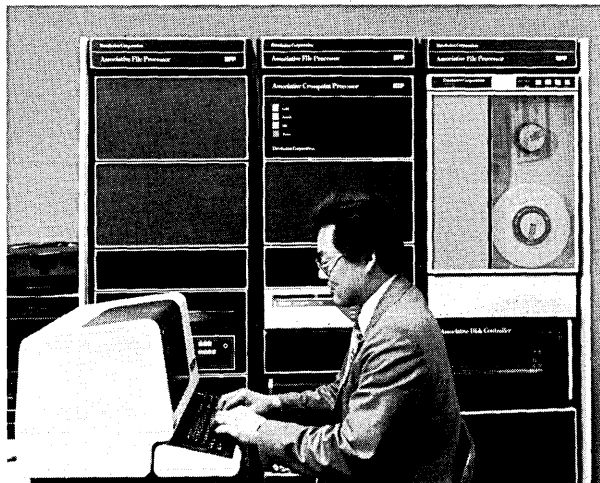

Full Text Retrieval. Finds relevant information in large free text files (typically 300 million characters or more) that match queries.

Unrestricted Queries. Unrestricted query vocabulary with boolean AND, OR, NOT and proximity key word logic.

Simple Configuration. AFP® runs on a PDP11 host mini-computer and includes all necessary user software.

Real Time Data Input. New data may be input and searched as it is received, if necessary.

Special Associative Hardware. The processing power is made possible by the special AXP® hardware effectively having the capability of 1200 cpu's.

Affordable. Now you can afford full text retrieval costing only a few pennies per search.

Available in Three Configurations. The AXP100 attaches to an existing PDP11 computer; the AXP200 is self contained with a communication interface to a network or another host computer; the AXP300 is a turn key system including CRT terminals and a line printer.

Application Areas Include:

Military and Intelligence
Law Enforcement
Library Search
Word Processing Support
Abstract Search
Title and Property Search
Trial Transcripts
Patent Search
Litigation Support

Technical Report Retrieval
Generic Record Keeping
Current Awareness Bulletin
Laboratory Testing and Retrieval
Journal Abstracting and Control
Pharmaceutical Literature Retrieval
Product Bibliographies
Chemical Compound Retrieval
Historical Records and Archives



Call (213) 887-9523 or write for a detailed brochure.

Datafusion Corporation

21031 Ventura Boulevard, Woodland Hills, California 91364

CIRCLE 6 ON READER CARD

DATAMATION.

Editor John L. Kirkley
Senior Editor Tom McCusker
Articles Editor Wendy Reid Crisp
News Editor Becky Barna
International Editor Linda Runyan
European Editor Ralph Emmett
Products Editor Bill Musgrave
Copy Editor Florence Lazar
Surveys Editor Louise C. Shaw
Assistant Editor Sarah Rolph
Editorial Assistants Deborah Sojka,
Don Rosenthal

Special Issue Editor Nancy Knottek

Bureau Managers

San Francisco Edward K. Yasaki
Los Angeles Edith D. Myers
Boston Vin McLellan

Correspondents

Washington Willie Schatz
London Fred Lamond, Malcolm Peltu
Paris Andrew Lloyd

Sydney, Australia Norman Kemp

Telecommunications Editor Ronald Frank

Editorial Advisor Robert L. Patrick

Technical Advisor Lowell Amdahl

Contributing Editors Ralph G. Berglund,
Howard Bromberg, Philip H. Dorn, John M.
Eger, David Hebditch, Angeline Pantages,
Russell Pipe, Carl Reynolds, F. G.
Withington.

EDITORIAL OFFICES

Headquarters: 666 Fifth Ave., New York, NY 10103.
Phone (212) 489-2588. **New England:** 161 High St., Boston, MA 02110, (617) 482-4606. **Eastern:** 1531 Inlet Ct., Reston, VA 22090, (703) 435-3206. **Southwestern:** 11500 Stemmons North, Suite 152, Dallas, TX 75299, (214) 247-5221. **Western:** 1801 S. La Cienega Blvd., Los Angeles, CA 90035, (213) 559-5111; 2680 Bayshore Frontage Rd., Suite 401, Mountain View, CA 94043, (415) 965-8222. **International:** 6605 Burlington Pl., Springfield, VA 22152, (703) 569-3383. **Foreign:** 20 Leamington Road, Southend-on-Sea, Essex, SS1 2SN, England; phone: Southend (0702) 611648. **New York, N.Y. TELEX 640-229.**

Art Director Kenneth Surabian

Production Manager Robert Gaydos

Art/Production Coordinator Susan M. Rasco

CIRCULATION

666 Fifth Avenue, New York, NY 10103

Circulation Manager Suzanne A. Ryan

Director of Marketing Deborah Dwelley

Publisher James M. Morris

Technical Publishing

DB a company of
The Dun & Bradstreet Corporation

VBPA Circulation audited
by Business Publications Audit

★ABP Member American Business Press, Inc.

DATAMATION (USPS 508-290) Magazine is issued monthly on or about the first day of every month, with the exception of Nov., which is semimonthly. Published by Technical Publishing, a company of the Dun and Bradstreet Corporation, 1301 South Grove Ave., Barrington, Illinois 60010. James B. Tafel, Chairman, John K. Abely, President. Executive, advertising, and editorial offices, 666 Fifth Ave., New York, NY 10103. Published at East Greenville, Penn. DATAMATION is circulated without charge by name and title to certain qualified individuals in the United States and Canada who are employed by companies involved with automatic information handling equipment. Available to others by subscription at the rate of \$36 (U.S. and Possessions), \$45 (Canadian). Reduced rate for qualified U.S. students: \$18. Foreign subscriptions: £38. Additional charge for airmail: £32. Japan, Australia and New Zealand: £42 (air-shipped). Sole agent for all subscriptions outside the U.S.A. and Canada is J. B. Tratsart, Ltd. 154 A Greenford Road, Harrow, Middlesex HA13QT, England, (01)422-8293 or 422-2456. No subscription agency is authorized by us to solicit or take orders for subscriptions. Controlled circulation postage paid at Bethlehem, PA 18016. Copyright 1980 by Technical Publishing Company, a Division of Dun-Donnelley Publishing Corporation. All rights reserved. * "Datamation" registered trademark of Technical Publishing Company. Microfilm copies of DATAMATION may be obtained from University Microfilms, A Xerox Company, 300 No. Zeeb Road, Ann Arbor, Michigan 48106. Printed by Brown Printing Co., Inc. POSTMASTER: Form 3579 to be sent to Technical Publishing Company Circulation Office, 666 Fifth Avenue, New York, NY 10103. ISSN: 0011-6963. Single copy: \$4.00 in U.S.A.

A Lasting Relationship.

Intel and Information Resource Management, your family of solutions.

A lasting relationship is exactly what you'll find in Intel's new family of Information Resource Management products. Combining the very best of proven products with Intel's newest innovations in both hardware and software, it's a family which brings an integrated data dictionary, powerful data base management, coordinated data communications, distributed data base facilities, and incredibly efficient data base hardware.

Integrated Data Dictionary: IDD.

Heading up the family is Intel's Integrated Data Dictionary, IDD. An indispensable tool for effective data administration, IDD helps you streamline and control your environment. IDD is an applications design aid, a documentation vehicle, a way to enforce standards and procedures, a master reference for determining the impact of changes to your data.

Data Base Management: SYSTEM 2000®/80.

Blending the finest enhancements from previous releases with a multitude of advanced facilities, SYSTEM 2000®/80 DBMS is a family member which you, your designers, programmers, data administrators, and end users will all appreciate. Each feature is designed to increase productivity and make your environment as flexible as possible.

Multiple languages. For designers and programmers, there's PLEX, Intel's Programming Language Extension to COBOL, PL/1, FORTRAN and Assembler. And for end users, Intel provides QUEST, an easy-to-use (but powerful) English-like language.

Multiple data structures. SYSTEM 2000/80 DBMS indexing and direct access keys provide fast access to relational, hierarchical, and network data structures.

Multiple operating systems and mainframes. SYSTEM 2000/80 DBMS runs on IBM, CDC,

are Intel's communications extensions to the leading TP monitors, including CICS.

Distributed Data Base: DDB.

Intel's newest addition is Multiple Systems Coupling, MSC. Providing communications between two or more IBM processors, including the new 4300 series, our MSC software lets you execute applications and transactions in one CPU while accessing data managed by SYSTEM 2000/80 DBMS in another.

Data Base Hardware: DBH.

Bringing synergism to hardware and software technologies is the FAST-3805 Data Base Assist Processor. With this option, transaction throughput capacity can be improved by as much as 100 percent and with a 50 percent or better reduction in response time.

The Family and You.

Start your lasting relationship with our new family by calling the Market Information Office at 512/258-5171, Intel Commercial Systems Division, P.O. Box 9968, Austin, Texas 78766.

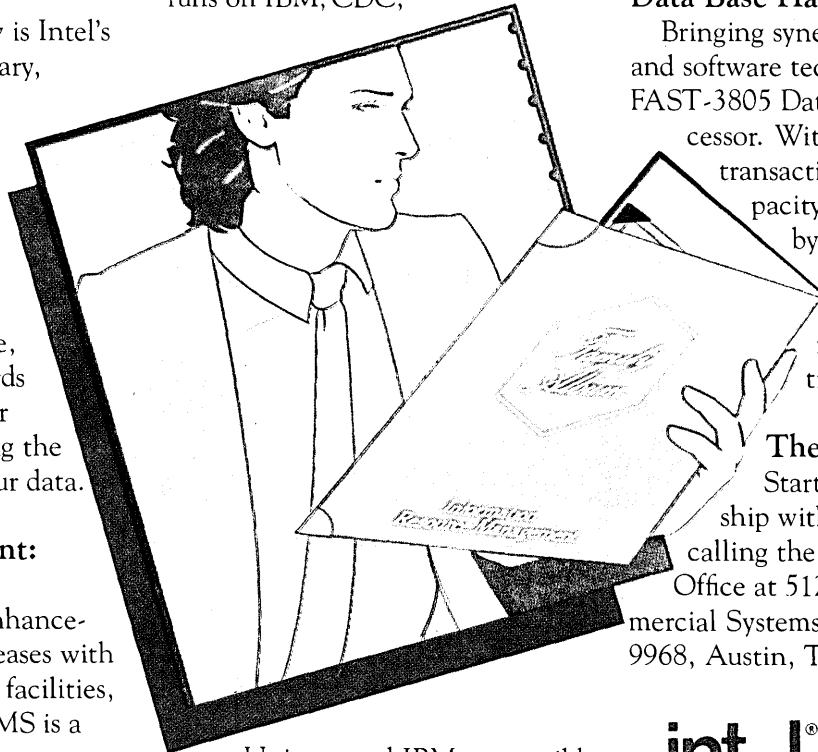

Univac, and IBM-compatible mainframes. And Intel was first with a DBMS for IBM's new 4300 series.

Data Communications: DC.

Supporting your need for high volume, on-line production processing

**intel® delivers
solutions.**

Europe: Intel Semiconductor (Nederland) B.V., Commercial Systems Division, Oranjestraat 1, 3441 Ax Woerden, The Netherlands, 31/3480-11264, Telex 47970 CSD NL.

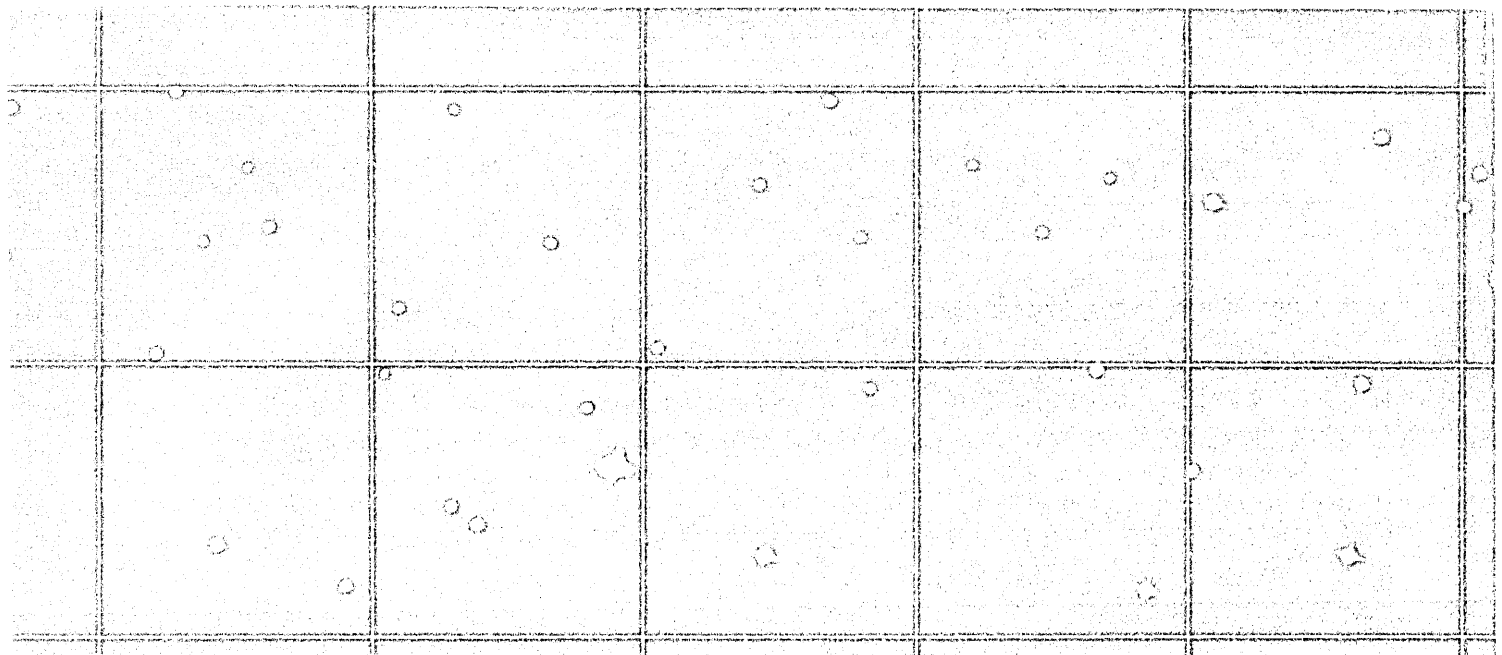

Small rectangular stamp or label with illegible text.

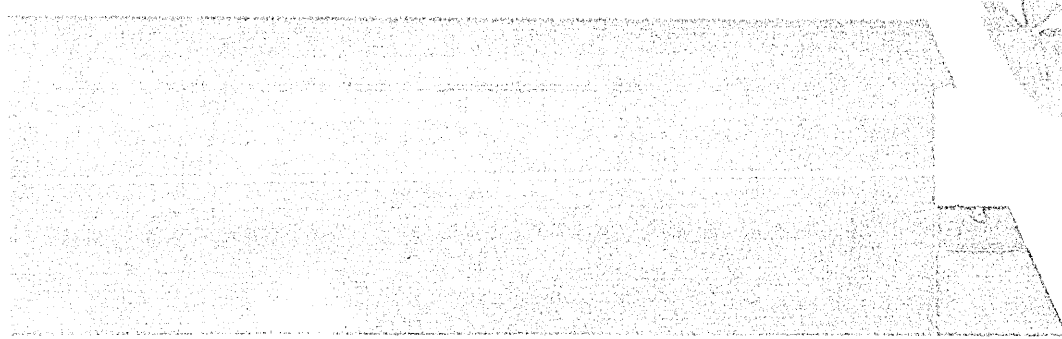
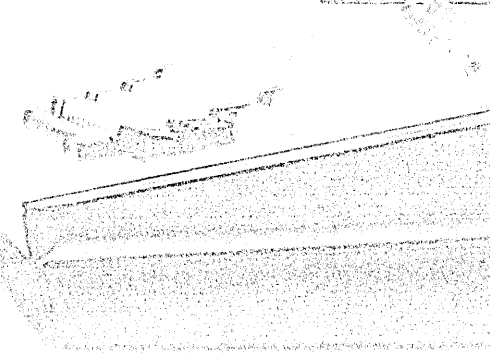
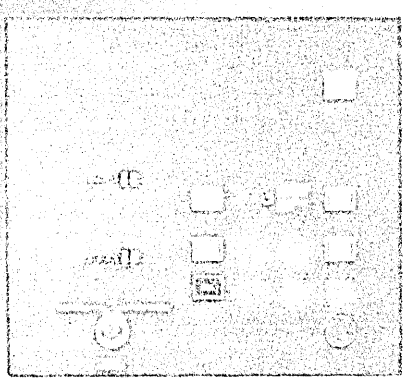
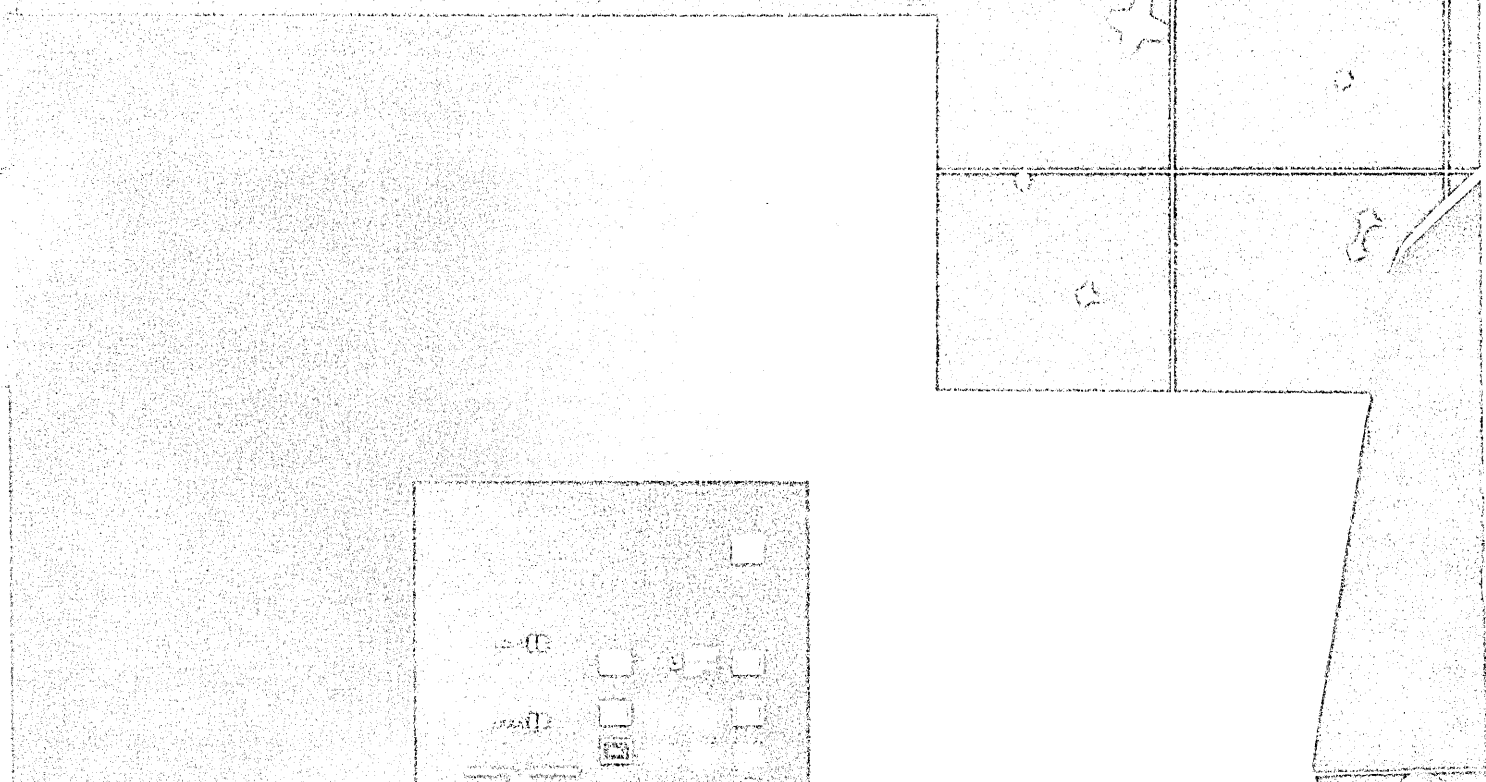

The AS/5000. Not even IBM can offer this much for this little.

It has been a popular misconception in the computer industry that no one is able to offer the kind of price, performance, and support that IBM can.

We'd like to clarify matters.

Our AS/5000 computer is a medium-scale, IBM-compatible system that offers 15% better performance than an IBM 3031, at a substantially lower cost. It forms the middle of our Advanced Systems (AS) product line, the broadest range of IBM-compatible computers available today.

The AS/5000 is a two-megabyte, six-channel system, optionally expandable to eight megabytes. Through the use of advanced integrated circuit technology, the number of components, pins, and connections is substantially less than used by IBM — resulting in unsurpassed reliability. The AS/5000 is lighter, takes up less floor space, requires 50% less power, and generates about half as much heat as comparable IBM systems.

A truly flexible system, with tailored support.

The AS/5000 supports all IBM System/370 and 303X operating systems, including their extensions. The AS/5000 runs complete VM-ECPS, including EVMA, more than is offered on the IBM 3031.

In addition, we offer new, more flexible software support services. Choose between Central Program Support Services or Local Program Support Services, and get software support tailored to your specific needs.

Another important feature of the AS/5000 is its advanced microcode architecture. Through microcoding, language functions become a part of the machine itself, rather than an element of the software. This feature allows performance enhancements such as MVS/SE and VM-ECPS to be implemented, and allows the AS/5000 to remain compatible with any additional enhancements to existing IBM systems. We provide what you really need — on-going compatibility to protect your sizeable investments in systems, software and training.

That's one reason why we're called the Compatible Computer Company.

More computer for your money. Now.

The AS/5000 is manufactured at our Southern California facility and is available now. You can receive shipment of your computer when you want it — and need it.

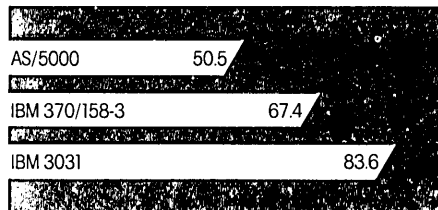

FLOOR SPACE IN SQUARE FEET

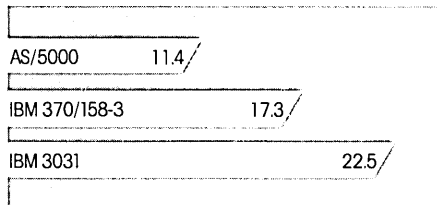

POWER CONSUMPTION IN KVA

Our commitment to deliver superior performance and reliability at a lower cost extends beyond the design and development of our equipment. We back the AS/5000 with the finest support in the industry, including a world-wide network of expert Field Engineers and Software System Support Representatives. We offer total support capabilities to help protect your computer investment. Now and in the future.

We also offer versatile financing alternatives, including several highly competitive long-term or short-term leasing programs.

If the AS/5000 sounds like what you've been looking for, contact your local National Advanced Systems sales office, or write to Marketing Dept. A2, 3145 Porter Drive, Palo Alto, CA 94304, 415/856-5000. We'll be happy to send you all the information you need.

The AS/5000 from National Advanced Systems.

If IBM built theirs like ours, we'd have some serious competition.

 **National
Advanced Systems**
The Compatible Computer Company
A Subsidiary of National Semiconductor.

Human Designed Systems



Loved.

For its
multiple
pages
of memory

Open up a new world of applications capability, not available in any other video terminal, with four full pages of memory — 96 80-character lines, and full windowing (multiple pages per window, multiple windows per page) — that'll enable you to store lengthy forms, programs, or text, and easily access them by scrolling forward or backward, a line or page at a time. Or "window" to any portion of the screen. It's yours through our *concept* terminals — ASCII, APL/ASCII, and VT-52 compatible models — for as low as \$1440 in OEM quantities, and they're available in 30 days.

HDS

Human
designed
systems, Inc.

3700 Market Street Philadelphia, PA 19104
215-382-5000

Now, a new sales office in California.

Boston — (617) 329-3510; **San Francisco** — (415) 692-4184; **New York City Area** — Infocon (201) 624-1372; **New York State** — Naco Electronics: Syracuse (315) 699-2651, Rochester (716) 223-4490;
Delaware — Infocon: (302) 239-2942;
Washington, DC — International Systems Marketing: (301) 986-0773; **Canada** — CAIL Systems: Toronto (416) 782-1151, Allcom Data Ltd.: Ottawa (613) 226-2340, Montreal (514) 288-8784;
Switzerland — Mitek AG: 01 66 22 52.
DISTRIBUTORSHIP INQUIRIES INVITED.

CIRCLE 9 ON READER CARD

Twenty Years Ago/Ten Years Ago

LOOKING BACK

MAY/JUNE 1960

A major feature in this issue was a discussion of the uses and the advantages of tunnel, or Esaki, diodes. Frank J. Hierholzer Jr., Sperry Rand, stated, "Perhaps the two most important assets of the tunnel diode are the potential extremely fast switching speed and the power gain capability of the device." He also had positive comments on the tunnel diodes' low cost, reliability, and resistance to water and other impurities.

A.K. Rapp, Pacific Semiconductors, Inc.; Jan A. Rajchman, RCA Labs; R.L. Petritz, TI; J.F. Kalbach, Burroughs Corp; and F. J. Van Poppelin, Jr., Motorola, Inc., all had positive comments on the future of tunnel diodes in the digital computer industry. An example from Petritz: "The effect that diodes will have in the next five years can be discussed with relation to two broad areas. The first area concerns the general purpose digital computer that operates at clock rates slower than one millimicrosecond; the second area is the extremely high speed computer that operates at clock rates faster than one millimicrosecond. High speed transistors can serve the first area and have a number of desirable features. Tunnel diodes, on the other hand can be a serious competitor to the transistor for this market if it proves to be a more economical and more reliable device." Van Poppelin discussed Motorola's interest in diodes, and stated in his closing, "We believe there will be a large market for both tunnel diodes and transistors 10 years from today . . ."

Leo Esaki, inventor of the tunnel diodes, was in Japan when he invented the new diode in the early '60s, and later worked for IBM Research Labs in Yorktown Heights. Esaki's diode is still manufactured today by a few companies, and is used in highly specialized microwave applications.

The major reason for the diodes' diminished popularity was that transistors and integrated circuits were easier to manufacture and control. Tunnel diodes also had a comparatively short life span during high

power usage, and were not feasible as high speed computer switches.

JUNE 1970

The FBI's NCIC (National Crime Information Center) network began pilot operations in January 1967, with 16 law enforcement agencies all over the country on-line to an FBI computer in Washington, D.C. NCIC programs were run on one of the FBI's two 360/50s, with another identical machine available for backup. Originally, NCIC was to act as a record index on wanted persons, stolen property, and criminal events.

With the exception of Alaska, the U.S. and Canada were both entirely on-line with the NCIC network. As of January 1970, 93 control terminals were directly connected to Washington, and 24 of these remote terminals were computers. They consisted of IBM, RCA, Univac, and Burroughs machines. During the first half of 1970, over 2,000 law enforcement agencies had direct access to the NCIC via local or state computer terminals. By the end of 1970, a minimum of 15 additional computer terminals were planned to be added to the system. NCIC also interfaced with the U.S. Secret Service, the U.S. Army, Navy, and Air Force, and the Royal Canadian Mounted Police in Ottawa, Canada. This extensive coverage supplied on-line agencies with accurate, vital information in a few seconds. Average response time to an inquiry from a remote terminal was five to 10 seconds. Over 470 "hits" a day were made by participating law enforcement agencies. A "hit" is a positive match made by the computer between the participating agency's inquiry and an identical record on file in the NCIC data bank.

The NCIC has expanded quite a bit since 1970, and now has tie-ins to Alaska, Puerto Rico, and the Virgin Islands. It operates on one 360/65, with an undedicated 65 available for backup. Plans for upgrading are in the works.

—Deborah Sojka

The NEC Disk Drive. A Head of its time.

High-performance Winchester. Available right now.

When you need Winchester-type disk drives in 20-, 40- or 80-megabyte capacities, take a hard look at the NEC D-1200 Series disks.

You'll find packaging, features, reliability and technology that are the results of 15 years of building high-performance disk systems.

Take the read/write head of the D-1200. It is loaded with technical enhancements. Like contact fixed read/write capability that reduces ambient errors. Like LSI preamplification in every head, which further reduces errors by improving signal-to-noise ratios. Like address mark detection for faster seek-and-search. Like high-speed data transfer rates of 1.2 megabytes per second. And with two fixed-head-per-track options to improve seek time and speed up overall performance even more.

Every NEC D-1200 disk has an industry-standard storage module (SMD) interface, so it is immediately connectable to

any mainframe or mini that uses storage module disks. But with higher speeds (8.3 millisecond latency time) and greater configurability (its dual-port option lets two CPUs share a single disk) than many other SMD disk drives.

And every NEC D-1200 disk drive has reliability-plus. Its MTBF exceeds 10,000 hours. Because all of its components are NEC-designed and NEC-built—the unique rotary actuator, the circuitry, the sealed disk module, and the read/write heads.

Join the growing number of systems builders who rely on NEC D-1200 disk drives to make their total system more attractive. For more information, contact our nearest sales office.



NEC Information Systems, Inc.

Head Office: 5 Militia Drive, Lexington, MA 02173, (617) 862-3120
Eastern Office: 36 Washington Street, Wellesley, MA 02181, (617) 431-1140
Central Office: 3400 South Dixie Drive, Dayton, OH 45439, (513) 294-6254
West Coast Office: 8939 S. Sepulveda Blvd., Los Angeles, CA 90045 (213) 670-7346
Southern Office: 2945 Flowers Road South, Atlanta, GA 30341, (404) 458-7014

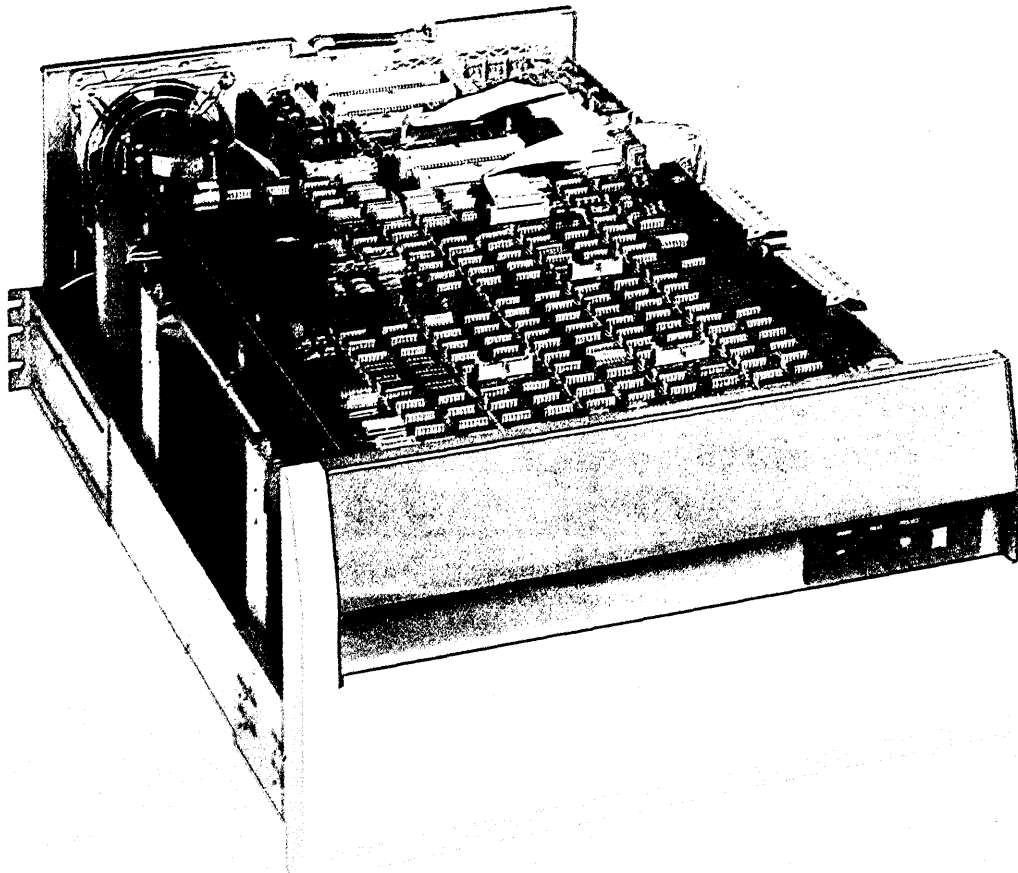

CIRCLE 10 ON READER CARD

Datapoint introduces Four systems,

Word Processing

This is the only system which offers you full physical and functional integration of WP, DP, EMS, and Voice and Data Communications Management. Why settle for any system offering less?

If you thought multifunction systems just mixed words and data, we've got news for you. Now organizations of any size can significantly increase the efficiency with which they handle *all* the basic business media—data, words, messages and telephone communications. This is Datapoint's Integrated Electronic Office. It offers a unified approach to office automation that lets you grow step by step from where you are today to where you want to be tomorrow.

The multifunction system you can't outgrow.

Most multifunction systems work fine... up to a point. But no one can predict just when they'll run out of gas

Data Processing

trying to support increasing terminal and application loads. Not with Datapoint. Here's why.

With our ARC™ system architecture, you can add on work stations, increase processing power, expand peripherals, and broaden the common database virtually without limit. And no matter how large the system, the same responsive performance is provided at every Datapoint work station without the degradation common in shared logic systems.

Put a hundred work stations at headquarters. Ten in each region. And one in every branch—each with local files and peripherals. Datapoint lets you tie it all together, uniting your organization with a two-way path for information flow.



Word processing with new search power.







Datapoint's Word Processing System speeds and simplifies the generation, revision, and distribution of general

Electronic Message Service

correspondence and other business documents. Complementing a full range of text-editing features is AIM (Associative Index Method), a content-oriented information retrieval system that lets you find any document quickly based on phrases, words, or even partial words. If you can't find it with AIM, it isn't there.

Pick the size you need.

   1 MB + *Single User* \$284/month

       
20 MB + *Multi-User* \$1790/month

3-year lease prices shown do not include printers (many types available) or maintenance/installation charges. WP & EMS software licensed at \$750 and \$1500 respectively including training.

Cut long distance telephone costs up to 40 percent.

One of the largest expenses in most offices is voice communications, often rivaling data processing costs. You

true office integration: one keyboard.

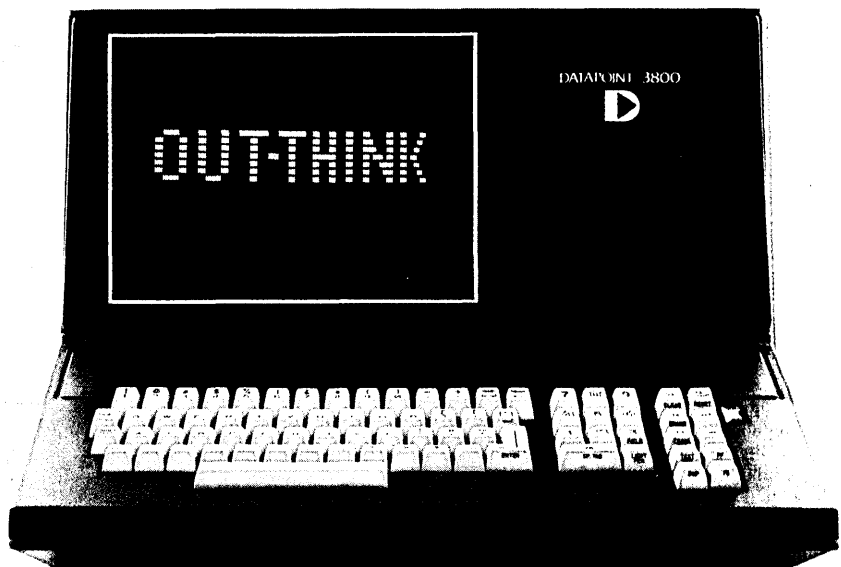

Data and Voice Communications Management

can control these costs with our Long Distance Control System, a key component of the Integrated Electronic Office. Operating with existing PBX or CENTREX exchanges, the LDSC reduces long distance costs by a combination of least-cost routing, queuing, and call buffering. You can add LDSC capability to your system at any time. Or begin building your automated office here.

Send messages across the hall or across the nation—free.

Datapoint's Electronic Message System enables documents entered through the Word Processing System to be stored, retrieved, and transmitted to other Datapoint work stations automatically.

By interleaving message traffic with voice communications and utilizing excess line capacity during off-peak hours, EMS gives your interoffice correspondence a free ride. You can also use EMS for auto-

Datapoint has combined all four capabilities into one integrated system using a common database. And every function is available at each 3800 work station.

matic encryption/decryption, priority transmission, and downline loading of system software and application programs to remote Datapoint processors.

Process transactions and batches concurrently.

What about data processing? That's where we began. And it's all still here for source data entry, local processing, and printing with COBOL, BASIC, RPG, and our easy-to-use DATASHARE®. A choice of compatible processors and a broad range of peripherals lets you match system capacity exactly to the job.

Apply the power of integrated function.

New applications come up fast with Datapoint. The key — simple programming, a common database, and ARC.

ARC communicates easily with your central mainframe, in both batch and interactive 3270 modes.

Enter data...compute and store...retrieve and incorporate in text...transmit messages interleaved with voice...receive confirmations automatically. With Datapoint, anything goes.

We're ready to help you apply the power of the Integrated Electronic Office to your organization *now*. Our team of marketing representatives, systems specialists, and customer service engineers will support you with experience gained in over 30,000 user locations worldwide.

For further information, call (512) 699-7151 for the number of your nearest Datapoint office. Or write Datapoint Corporation, Marketing Communications MS-KO5, 9725 Datapoint Drive, San Antonio, TX 78284.



DATAPOINT



GTC. The right button to push for all your display

The key to GTC is versatility. We're the only terminal manufacturer with production and service facilities on both U.S. coasts. And GTC is one of the largest suppliers of data display terminals to Europe and the Orient. So we can deliver whatever you need, wherever you need it.

GTC offers models that are teletype-compatible as well as terminals that are interface-compatible with DEC, Burroughs and NCR computers. And GTC offers

models that emulate other major terminals, too.

Both our GT-100 and GT-400 Series also offer the versatility of user-programmable function keys, multiple keyboard configurations (including foreign character sets), full video attributes, plus editing and line drawing capability.

GTC is versatile in its thinking, too. We're willing to spend a little more, to experiment and innovate a little more, to bring

terminal needs.

you a lot more, for the money.

*And if that's what you want
in a display terminal source, then
you've got your finger on the right
button.*

For more information on GTC products and services, call toll-free today. In California: 800-432-7006. Anywhere else in the United States: 800-854-6781. Ask for Gloria Page. Or write Gloria Page at General Terminal Corporation, 14831 Franklin Avenue, Tustin, CA 92680. Telex: 910-595-2428. We have offices throughout the world. In Canada, contact Lanpar Ltd., 85 Torbay Road, Markham, Ontario L3R. Phone: 416-495-9123.

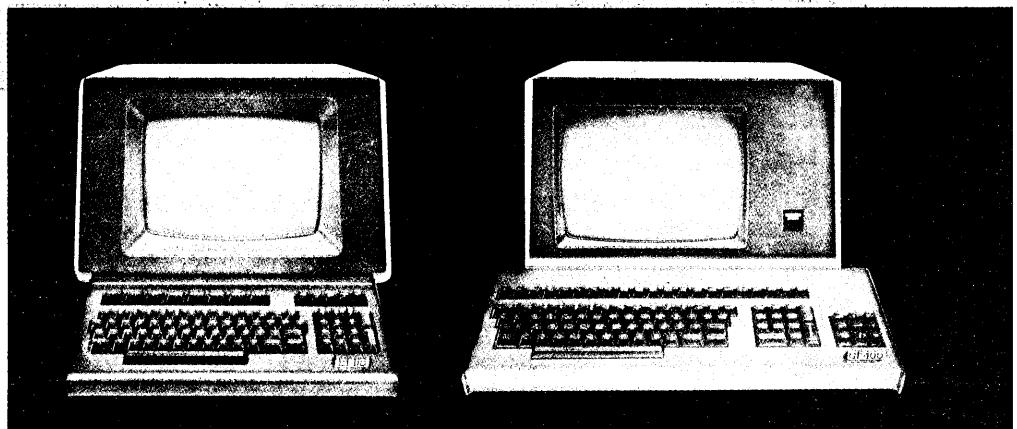

The right button to push.™
General Terminal Corporation

CIRCLE 12 ON READER CARD

Our new display terminal has a great supporting cast.



The AJ 510 display terminal with AJ 460 Micro Diskette System, AJ 832/RO receive-only printer, and AJ 1234 acoustic data coupler/modem.

The AJ 510, the most versatile CRT terminal in its class, excels at interactive timesharing and a lot of other jobs. And with the addition of these supporting AJ products, you can greatly expand your application flexibility.

Start with the AJ 510

As a stand-alone device, the AJ 510 is ideal for jobs such as data entry, text editing, order entry, and graphics. It includes such features as ASCII, Graphics, and optional APL character sets; a bright 15-inch screen; 16 video enhancements; editing capability; a format mode with protected fields; and communications rates up to 9600 bps.

Now add data storage

For convenient, low-cost data storage and retrieval, the AJ 460 Micro Diskette System offers you local data manipulation and high-speed on-line communications. Combined with the AJ 510, the AJ 460 helps you reduce telephone charges and computer connect time, while further increasing application flexibility.

And top quality printing

Connect an AJ 832/RO receive-only printer and you get letter-quality hard copy output. Features include selectable data rates up to 45 cps, dual pitch selection,

vertical forms control, and more—even interchangeable "daisy" wheel printing elements so you can customize the type face to the application. Now you have a system that's ideal for form letters, contracts, and camera-ready art of all kinds.

And communications

Finally, from the wide range of AJ couplers and modems, select the one that best fits your application. The AJ 1234 coupler/modem, for example, lets you take advantage of full duplex 1200 bps communications over dial-up or two-wire leased lines.

The final act

We not only build all this equipment, we also lease, sell, and service it. We'll take care of it throughout its lifetime. Which makes life easier for you.

So whether you need a stand-alone terminal or one with a strong supporting cast, AJ has the answer. Get in touch with the AJ regional office nearest you: San Jose (408) 946-2900; Chicago (312) 671-7155; Hackensack (201) 488-2525. Or write Anderson Jacobson, Inc., 521 Charcot Avenue, San Jose, California 95131.

Also available through AJ subsidiaries in Ottawa, Ontario; Paris, France; Shepperton, Middlesex, U.K.; and distributors throughout Europe.

 **ANDERSON
JACOBSON**

CIRCLE 13 ON READER CARD

PRECISION PLOTTING

...at the speeds for which
your plotter was designed.

Ask about the Koh-I-Noor "RAPIDDRAW" System for Liquid-Ink Plotting, a total integration of the most effective plotting point, plotting ink and plotting surface to provide a system customized for your requirements. This total-system approach assures superior quality and faultless operation for even the most demanding plotting requirements.

At a single point of contact — where the plotting point touches the plotting surface — you see the final results of your investment and time. It is here that Koh-I-Noor should be your point of contact, because we provide plotter points in 3 different materials, pen bodies, complete plotter pens and adaptors for numerous plotters and a broad

range of applications. In addition, we custom engineer pens, adaptors and bushings for specialized applications, eliminating expensive plotter modifications.

The total systems approach integrates the proper pen flow rate, point material, ink viscosity, surface tension, and drafting surface chemistry with the plotting speed, and up and down acceleration of your machine to achieve optimum efficiency with liquid ink plotting.

If you want more from your plotting point of contact, call or write Koh-I-Noor Rapidograph, Inc., 100 North St., Bloomsbury, N.J.; toll free 800-631-7646, or collect 201-479-4124. In Canada: 1815 Meyer-side Dr., Mississauga, Ont. L5T 1B4; toll free 800-268-4961, or collect 416-671-0696.

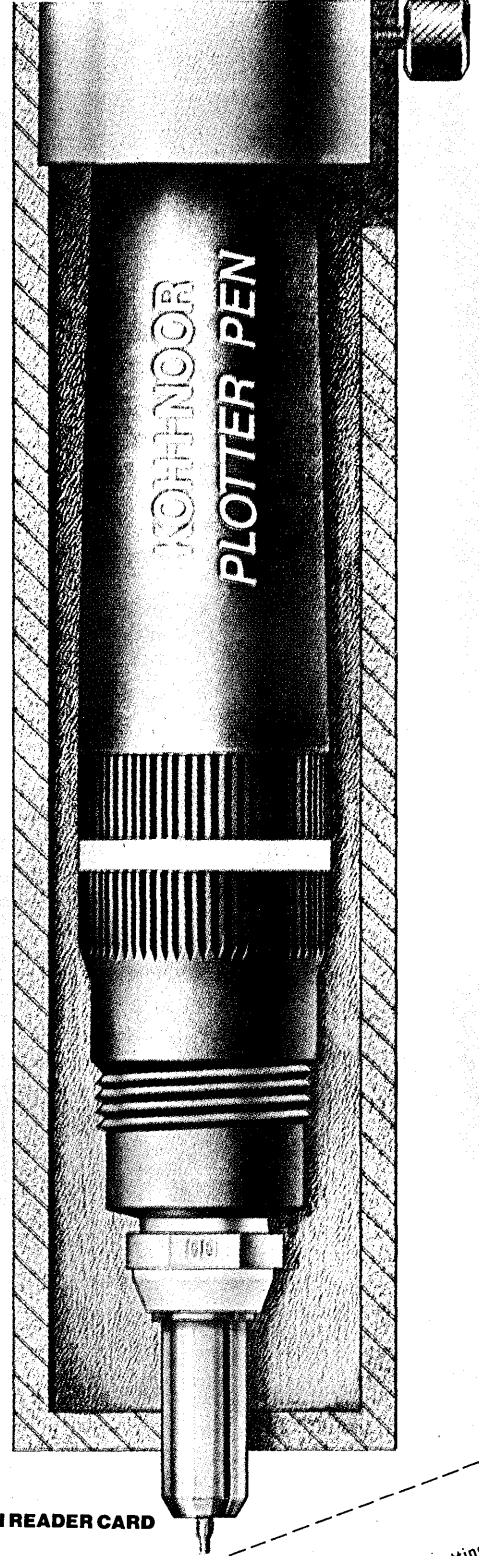

CIRCLE 14 ON READER CARD

TELL ME MORE, KOH-I-NOOR!

- Please send me your free brochure on the "RAPIDDRAW" System for Liquid-Ink Precision Plotting.
 Please have a representative call me about a particular plotting materials question.

NAME (PLEASE PRINT OR TYPE)

COMPANY

ADDRESS

CITY

TITLE

STATE

ZIP

D-6-80

Op Art from "Rapiddraw" Liquid-Ink
Precision Plotting, by Calcomp.

Introducing. The entire BTI family of 32-bit multiprocessor systems.

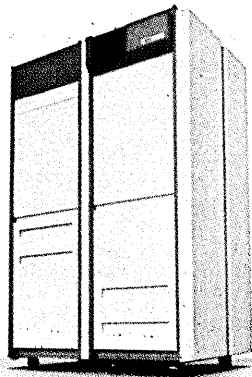

Finally, there's a computer system that lets you grow by plugging in resources, instead of by changing models – the BTI 8000.

Our family secret is Variable Resource Architecture (VRA): a flexible mix of hardware resources controlled by a single, self-regulating operating system. The result is mainframe level performance at substantially lower costs, plus unequalled flexibility.

You can tailor the BTI 8000 to serve over 200 on-line, interactive users. Or to handle large batch loads. Or to do some of each. And, you can

vary processing capability **over a tenfold range** by merely adding or deleting hardware modules.

Additionally, built-in growth potential allows you to respond to changing requirements easily and quickly – without modifying either the operating system or your applications software.

As for reliability and support, they're established family traditions, proven by over 2,500 other BTI computers operating in the U.S., Canada and Europe. For full details about the BTI 8000, contact the BTI office nearest you.



Corporate Offices: 870 West Maude Avenue, Sunnyvale, CA (408) 733-1122 Regional Offices: Piscataway, NJ (201) 457-0600; Palatine, IL (312) 397-9190; Dallas, TX (214) 630-2431; Sunnyvale, CA (408) 733-1122 Sales Offices in major U.S. cities.

CIRCLE 15 ON READER CARD

LOOK AHEAD

BELL DREAMS OF LOCAL DATA NETS

When an unregulated subsidiary of the Bell System finally makes an appearance in the big, cruel, competitive world, it may well have some unexpected products to help build customers fast. In addition to modems, terminals, and probably diagnostic gear, Bell Competition Inc. might become a provider of local data networks. These nets, which interconnect a myriad of otherwise noncompatible devices, would be a natural for a telco spin-off. The phone company has endless experience wiring up office buildings, campus environments, and other localized areas where these data nets will be required in the coming years. And BCI would be allowed to provide customers with the processors required to operate the local data net. Some sources see the new Bell company becoming a turnkey business house to solve users' local networking problems. Asked to comment, a key AT&T official admitted that the local network area was being studied, adding with a smile, "You're getting a little bit ahead of us."

B-OF-A SET TO BUILD IMS NET

Having just qualified 120 different contract programming firms for future work, running help wanted ads across the country, and hiring IBM's guru, Peter Hill, as a new vp, the Bank of America has set out to develop the world's largest IMS network.

BEING SHARPER THAN SHARP

Sharp Corp. of Japan has a pocket computer that speaks BASIC. While the New Jersey headquarters of the company denies the machine's existence, we have seen a prototype. The \$175 model has 1K of user memory; the \$125 model has a lot less. Actual marketing is being held up until the plug-in printer is ready, we hear. The machine features full alphanumeric displayed via a 20-character LCD window into memory.

WANG SPEAKS IN MANY TONGUES

Wang will introduce an ideographic word processing system -- for Chinese and Japanese script -- this month. Wang now offers keyboards and printers for 15 different languages.

NEW INFONET SERVICE COMING

Infonet, the network services of Computer Sciences Corp., this month will introduce a distributed network service for its large customers who operate remote computing sites. DEC hardware, and software provided by INFONET, will link these remote sites to the five Infonet centers in North America as well as to others in 50 nations

LOOK AHEAD

overseas. Infonet's service will allow remote centers to perform data entry and data editing, develop local applications packages, and do data base management using a subset of CDC's dbms. DEC's PDP-11/14 or 11/23 will be bundled with the service at prices as low as \$5,000 for 128K of main memory, a megabyte of disk storage, a 180 cps printer, and a video terminal. The largest of six configurations to be offered has 512K of main memory, 286 megabytes of disk storage, a 600 lpm printer, and six terminals.

EDUCATORS WON OVER BY APPLE

There may be some eye-opening price/performance comparisons when commercial users see the Apple Computer-based network now going on-line among the college dp consortium, EDUCOM, of Princeton, N.J. Using software developed by the North Carolina Educational Computing Service, EDUCOM colleges can use 48K Apple II units to access any of the 19 large systems already linked in the consortium's EDUNET -- with automatic log-on from five systems and file transfers from two. EDUCOM gets a discount, but list price for this intelligent terminal configuration -- the Apple, 48K, Apple PASCAL language card, communications interface card, floppy diskette drive, and controller -- is still a bargain at \$2,810.

NEW FROM LEXITRON

Raytheon's Lexitron will introduce its eighth communications protocol this month, reportedly making its VP word processing terminal the first wp system with 327X emulation for tie-in to IBM-compatible mainframes.

NEW FROM LEXICON

Lexicon, the little Miami corporation which developed the first handheld language translator (now the LK 3000 sold by Nixdorf), has come up with a little battery-powered modem -- the LEX-11, which can turn the LK 3000 into a minuscule terminal -- pulling, say, stock quotes over a pay phone.

ICL'S WOES WITH U.S. SIBLING

It looks like British mainframer ICL is having trouble with its U.S. sibling. The first wind of that trouble came when ICL's U.S. chief Dick Bright bolted for greener pastures. Sources close to the company speculate that Bright's defection was due in large part to ICL's unwillingness to fund the U.S. plunge. During his brief stint as ICL's man in America, Bright reportedly received no marketing budget and only paltry funds for an ad campaign. To add to its U.S. woes, ICL is also rumored to be considering transferring its Utica, N.Y., manufacturing oper-

(Continued on page 63)

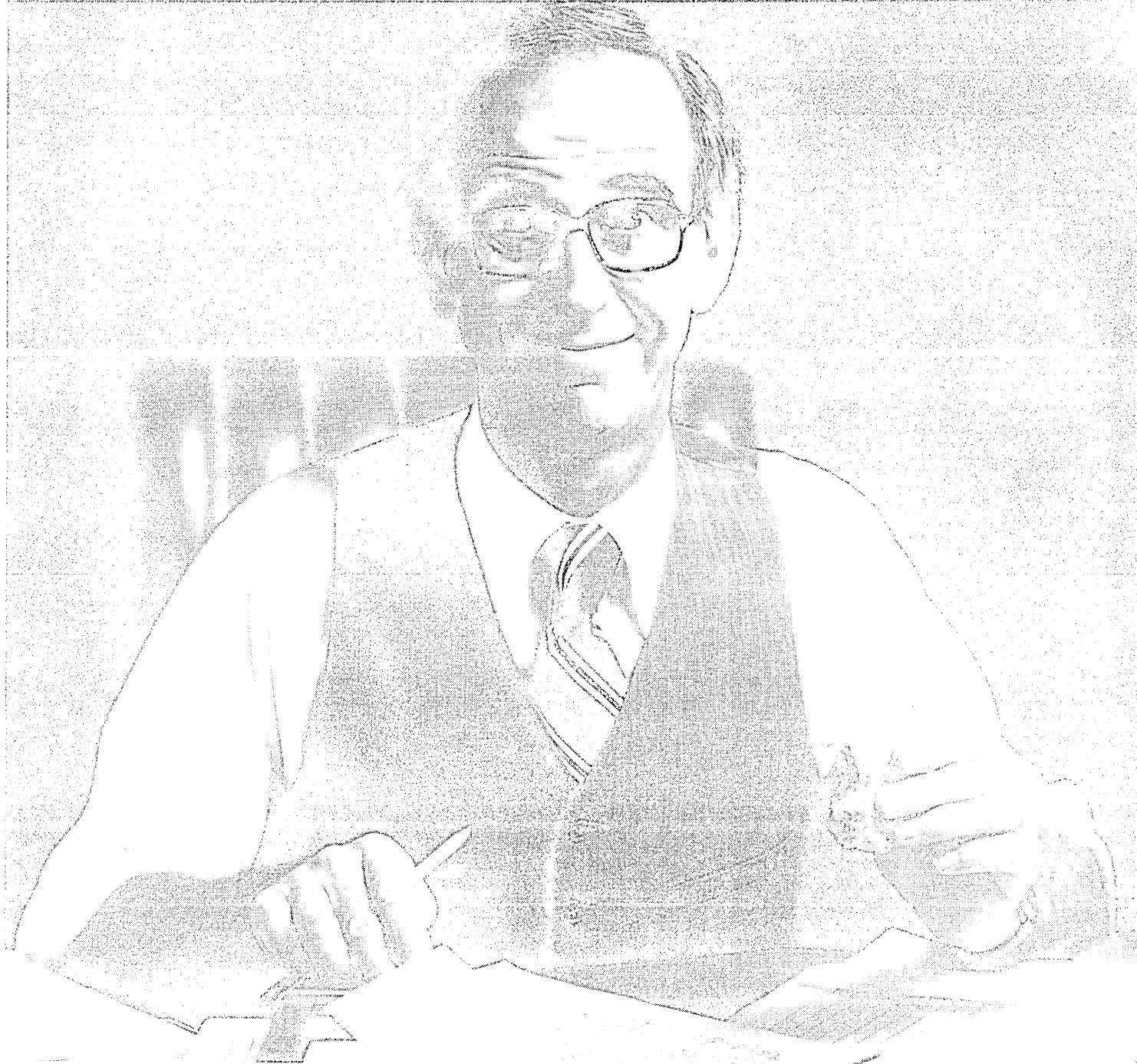

Our users save over \$1,000,000 a month.

The SHRINK 2 file compression systems reduce the volume of data on disks and tapes by as much as 80% for users of OS/360/370 and compatible systems.

A software solution to a hardware problem. File sizes can be enlarged without adding more spindles.

Existing spindles are freed up for new applications.

That can mean enormous savings in capital outlays for hardware.

Not to mention the savings on enlarged computer rooms, cooling requirements and other related costs.

And compressed files are made secure through encryption at no extra cost.

We also offer another version, SHRINK/IMS, designed for IMS/VS data bases. It's totally transparent to IMS application programs; the programmer never even knows it's there. And its compression is selective for maximum performance.

Why not help yourself to more file capacity from your present hardware and to big savings. Call, send the reply form below, write on your letterhead, or just attach your business card to the coupon.

21050 Vanowen Street, Canoga Park, California 91304 S-D-680

Tim Corey, Product Manager (213) 887-9131

Telex 09-8715 Cable INFORMATIC

informatics inc

Send me information about SHRINK 2

Send me information about SHRINK/IMS

Send me a salesman with an order form

Name _____

Title _____

Company _____

Tel. () _____

Ext. _____

Address _____

City _____

State _____

Zip _____

CPU _____

Op. System _____

Disk Model _____

Quan. _____

SHRINK® Software by Imformatics.

CIRCLE 16 ON READER CARD

The Information Management Company.

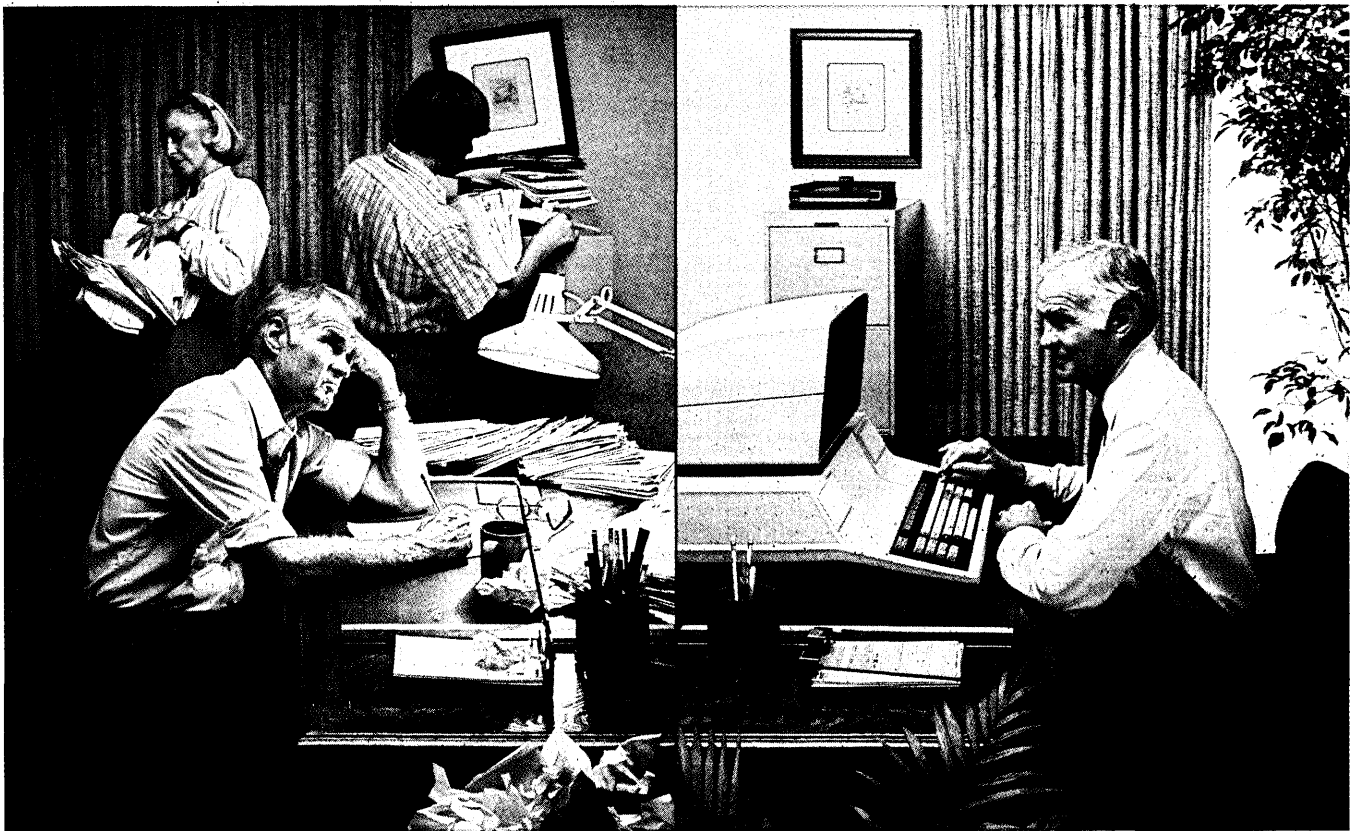

Problem Solved.

TI's small business computers. Solutions for OEMs and their customers alike.

Solve problems for your customers and solve a few of your own at the same time—and at prices starting at under \$10,000*!

Your applications programs combined with TI's highly-reliable small business computer systems give your customers the power they need to tackle today's demanding business problems—like payroll, accounting and inventory control.

Both the Model 771 and DS990 Model 1 are powerful, complete, desktop systems. Since they are compatible with our larger business computer systems, helping your

customers upgrade as their needs grow is a snap.

Implementing your applications on both these systems is no trouble either. For maximum versatility the DS990 Model 1 operates on a variety of software and programming languages, including BASIC, FORTRAN, COBOL, Pascal and TPL, TI's unique program for simplified forms generation.

The Model 771 desktop computer, with its single-sided, single-density diskette, stores up to a total of 500,000 characters of instantly available on-line data.

The DS990 Model 1 stores up to 4,600,000 characters using double-sided, double-density diskette storage. This outstanding capacity makes it among the most powerful small business computers available anywhere.

Texas Instruments products are backed by trained specialists world-wide. Service is available wherever TI products are sold or TI will train your service personnel.

Solve your problems reliably and efficiently using small business computers from Texas Instruments, the company appointed the official computer and calculator company of the 1980 Olympic Winter Games.

Contact the TI sales office nearest you, or write Texas Instruments Incorporated, P. O. Box 1444, M/S 7784, Houston, Texas 77001. In Europe write, Texas Instruments, European Digital Systems Division, Boîte Postale 5, 06270 Villeneuve-Loubet, France.



*Quantity one, U.S. domestic price. Quantity discounts available. Copyright ©1980, Texas Instruments Incorporated

TEXAS INSTRUMENTS

We put computing within everyone's reach.

CIRCLE 17 ON READER CARD

A video bandwidth of 30 MHz and a 1200-line resolution make this new CRT monitor the brightest and sharpest you can get.

C. Itoh's new model 1201BE in our QDMI series is capable of receiving separate horizontal drive pulse, vertical drive pulse and video input at the TTL level. This separate signal mode eliminates composite sync and video signal processing. The CRT is equipped with its own power supply unit. P4 phosphor is standard, but optional P31 or P39 phosphors can be provided. Available options: Dynamic Focus, Skip Scan, a non-glare etched face and a 19.5 KHz horizontal frequency.

The high performance and low price offered with this new CRT monitor give you all you need to really outshine your system's competition. For complete information contact your nearest C. Itoh representative or C. Itoh Electronics, Inc., 5301 Beethoven Street, Los Angeles, CA 90066; Tel. (213) 390-7778;

Telex: (WU) 65-2451; or 666 Third Avenue, New York, NY 10017; Tel (212) 682-0420; Telex: (WU) 12-5059.

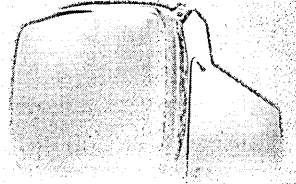

C. ITOH ELECTRONICS, INC.

Introducing the 12" CRT monitor
for the systems designer with bright ideas.



CIRCLE 18 ON READER CARD

OLIVETTI ANSWERS SOME OFFICE AUTOMATION.

A famous tough guy puts Olivetti through its paces.

Q. How come you're talking about automation? I thought all you made was typewriters.

A. No sir. We make a full line of office products. We've got electric and electronic typewriters. Word processors. Electronic calculators. Copiers. Terminals. Mini-computers. Supplies. Software. The whole works. In fact, nobody else has a broader line for the office.

Q. A little company like Olivetti does all that?

A. We're not exactly little. Had \$2.3 billion in sales worldwide last year. We have 28 factories. Employ 57,000 people. Do business in over 100 countries. Worldwide, we're one of the top companies in office automation.

Q. Okay. So you're a giant. But there are hundreds of suppliers out there. Why do I need Olivetti?

A. One reason is that we're pretty hard to match when it comes to return on investment. In some cases, downright impossible. Our ET221 is the only electronic typewriter for \$2,000 with text display. And our TES401—also with display—has the most text editing power of any desktop unit for \$6,000. Our Copia 2000 is the only copier under \$16,000 that reduces, collates, and prints on two sides. Should I continue?

Q. Never mind. I get the picture. But nothing's perfect. What about service?

A. If you mean technical support people, we've got them. In

36 major cities. As a matter of fact, we have one of the biggest service organizations in the business. We're ahead of Lanier, Wang, and Qyx. And all of our technical people use state-of-the-art equipment to test and train with.

On the other hand, if you mean software and sales support, we've got that, too. In just as many places. In fact...

Q. Yeah, okay. Suppose I'm not in one of those 36 cities.

A. We can handle it. We've got 2,000 dealers, and we're in every state. If we can't service a product, we won't sell it.

Q. All this electronic typing sounds good. But isn't it faster to phone?

A. You can do both. Let's say you have our ET221 with the communications option. All you do is make a phone call, type the document in one city, and it types out in another city at the same time. Simple.

Q. What about the human factor? Don't these machines threaten people?

A. It depends. Sure, if you come in like a bull in a china shop, people are going to get upset. But we've had 70 years' experience in providing offices with writing machines. So we know better.

We like to move gradually, a step at a time. Evolution, instead of revolution. And we like to start at the secretary's desk. Not in the computer room. That way, the secretary

Ed Asner

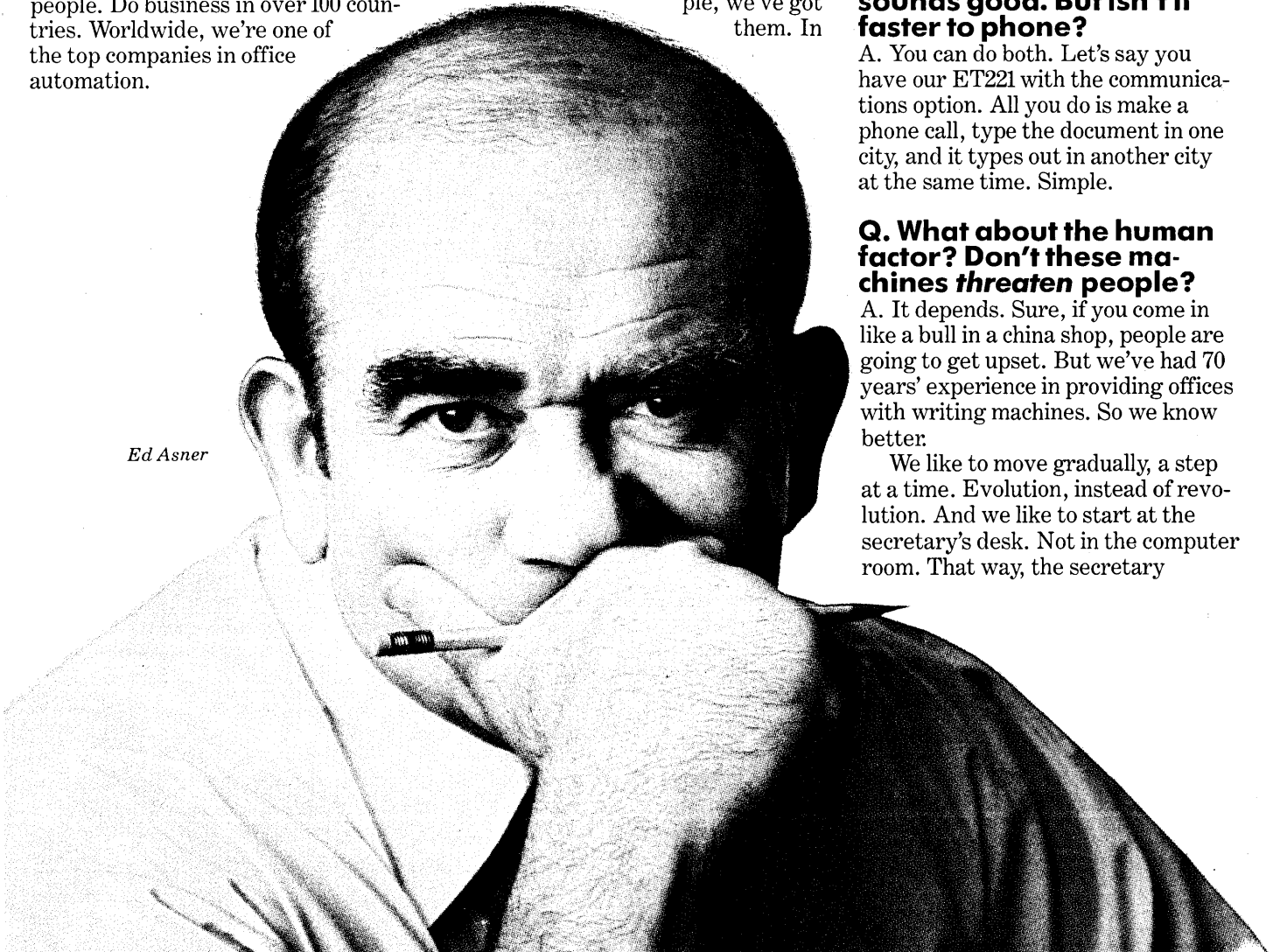

TOUGH QUESTIONS ABOUT

doesn't get tossed into a typing pool. And the boss doesn't lose the secretary.

ET221: the only electronic typewriter for \$2,000 with text display. "Thin window" text display. It's the coming thing. But we've got it now

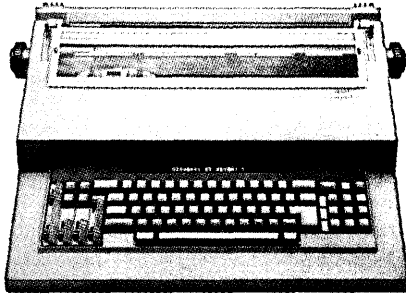

because we pioneered it. Lets you correct mistakes before they go on paper. Other ET221 features: Interchangeable print wheels. Automatic decimal tab. Non-volatile memory that can't be erased by accidental unplugging.

TES401: the most text editing power of any desk-top unit for \$6,000.

Brings word processing to the secretary's desk. Approaches text

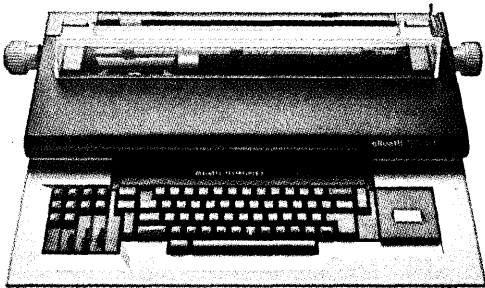

editing power of much more costly machines, yet easy to master. Removable, dual-source memory with automatic merge (so you can "mass produce" personalized letters).

Many advantages over "mag card" machines—at same or lower cost. Thin window text display. Interchangeable print wheels.

TES501: the only word processor under \$10,000 with information retrieval.

You can access the external memory (100-page discs) at the touch of a key. Thin window text display. Handles words or numbers equally well. Sort by up to 40 different qualifiers. Perfect for operations like selective mailings, calling for high-speed search and retrieval, plus automatic personalization and typing. (Not Shown)

TES701: the CRT text editor to beat.

All the power of the TES501, plus page text display. Ideal for statistical

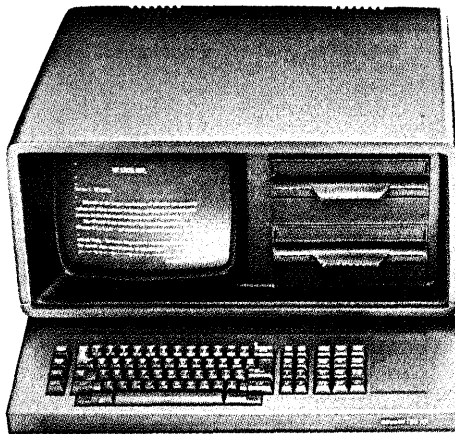

typing and documents requiring a lot of formatting and revision. Stores on single or dual diskettes. Interchangeable print wheels. High-speed printer. Easy to learn because it instructs operator.

Copia 2000: the only copier under \$16,000 that reduces, collates and prints on 2 sides automatically.

Prints 30 copies per minute, any size. A unique "batching" system easily

separates varied sets of copies. Self-diagnostic reliability: checks your supply levels and minimizes downtime. Blessedly simple to operate. The first *complete* system at anywhere near the price. (Not Shown)

BCS2030: the only mini-computer in its price range that produces a full-size hard copy.

Fits easily into any working environment. Reflects what we've learned from installing over 300,000 account-

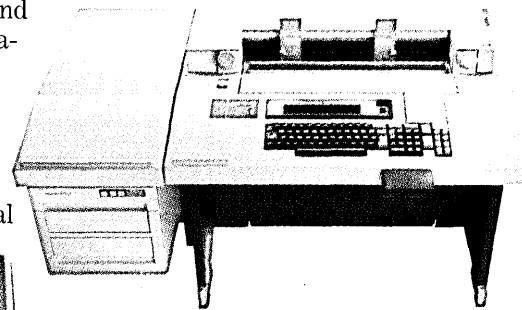

ing, administrative, and data management systems worldwide. Simple to operate: no need for computer specialists. Flexible: uses mag cards or floppy discs as storage media.

TC800: ultimate reliability for thrift institutions and insurance companies.

On-line financial terminal. Works on distributed intelligence. Operations continue even if central processor or communications line fails. Modular design. Comes in 3 versions for maximum flexibility and user growth. Over 40,000 sold. Available in selected markets.

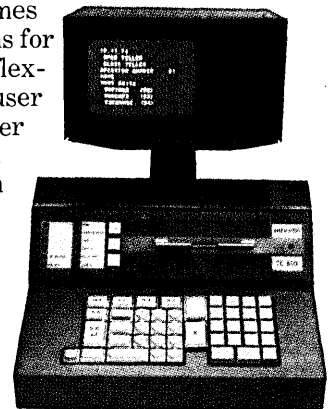

olivetti

Ask us your own tough questions: 800-431-1866.

Olivetti Corporation, 155 White Plains Road, Tarrytown, New York 10591
In Canada: Olivetti Canada Limited, 1390 Don Mills Road, Don Mills, Ontario M3B 2X3/416-447-3351

In New York: 800-942-1917.

CIRCLE 19 ON READER CARD

CALENDAR

JUNE

DATA COMM, June 17-19, Geneva, Switzerland.

DATA COMM is an international forum where developments in microprocessors, mini/microcomputers and associated services can be seen, together with new equipment for data communications and distributed processing. Contact Industrial and Scientific Conference Management, Inc., 222 West Adams St., Chicago, IL 60606, (312) 263-4866.

Computerfest '80, June 20-22, Columbus, Ohio.

Fifth annual gathering of the Midwest Affiliation of Computer Clubs (MACC), focusing on small business and personal requirements and uses. Contact James Crowley, 4008 Rickenbacker Ave., Columbus, OH 43213.

World Computing Services Industry Congress II, June 23-25, San Francisco.

Geared toward the serious discussion of responsibilities as custodians of the international information resources. Contact ADAPSO, 1925 Lynn St., Arlington, VA 22209, (703) 522-5055.

Syntopican VIII, June 23-26, Minneapolis.

The International Word Processing Association conference will feature four days of conference and three days of exhibits. Contact IWP, Maryland Rd., Willow Grove, PA 19090. (215) 657-3220.

JULY

Harvard Computer Graphics Week 1980, July 28-August 1, Cambridge, Mass.

Five-day conference features business graphics and computer mapping in commercial, educational, and governmental areas. Contact Kathy Devaney, Center for Management Research, 850 Boylston St., Chestnut Hill, MA 02167, (617) 738-5020.

SEPTEMBER

Workshop for International Marketing Decision-Makers, September 8-9, Washington, D.C.

Exporting products in the '80s is the theme. Cosponsored by DATAMATION and the U.S. Department of Commerce. Contact Graydon Associates, P.O. Box 566, Red Bank, NJ 07701 (201) 741-2690.

MIMI '80, September 9-10, Montreal, Quebec, Canada

13th International symposium and exhibition on mini and micro-computer applications. Contact Prof. M.H. Hamza, Department of Electrical Engineering, the University of Calgary, Calgary, Alberta, Canada T2N 1N4.

Integrated Systems Expo '80, September 9-11, Washington, D.C.

The National Micrographics Association will feature the develop-

ment and promotion of the effective uses of micrographics, including interfaces with other information-processing technologies. Contact John Bidwell, NMA, 8719 Colesville Rd., Silver Spring, MD 20910, (301) 587-8202.

Internepon/Semiconductor International Expo, September 11-13, Singapore.

Keyed to the specific needs of engineering, manufacturing, and support personnel of Southeast Asia. Contact Industrial and Scientific Conference Management, Inc., 222 W. Adams St., Chicago, IL 60606, (312) 263-4866.

DPMA Symposium on Office Automation, September 15-17, Chicago.

The Education Foundation of the DPMA announces a one-day series of workshops, followed by two days of general conference. Contact DPMA, 12611 Davan Dr., Silver Spring, MD 20904.

Wescon '80, September 16-18, Anaheim, Calif.

This convention is the largest high technology assembly in the U.S. Contact Robert Myers, Communications Counsel, Wescon, 999 N. Sepulveda Blvd., El Segundo, CA 90245, (213) 772-2965.

SICOB '80, September 17-26, and Convention Informatique, September 15-19, Paris, France.

These back-to-back exhibitions and conferences cover personal computing to office equipment, and constitute the largest French international show. Contact Pierre Wagner, International Trade Shows in France, 1350 Sixth Ave., New York, NY 10019, (212) 582-4960.

IPAD National Symposium, September 17-19, Denver.

NASA and an Industry Technical Advisory Board (ITAB) to report on progress of the joint industry/government computer-aided design project called IPAD (Integrated Programs for Aerospace-Vehicle Design). Contact IPAD Project Office, Mail Stop 246, NASA Langley Research Center, Hampton, VA 23665, (804) 827-2888.

Federal Computer Conference, September 22-24, Washington.

Cosponsored by DATAMATION. Will address the management of change in the 1980s for federal dp users. Contact Ms. Lynn Green, P.O. Box 368, Wayland, MA 01778, (617) 358-5181.

12th Annual Conference of the Society for Management Information Systems, September 22-25, Philadelphia.

The conference theme will be "MIS Management in the Emerging Information Age" and will examine the challenges facing the MIS Executive. Emphasis will be on the impact of converging technologies on the role of the MIS executive in the 1980s. Contact M. Rippey, the Society for Management Systems Information, 111 East Wacker Dr., Chicago, IL 60601, (312) 644-6610. *

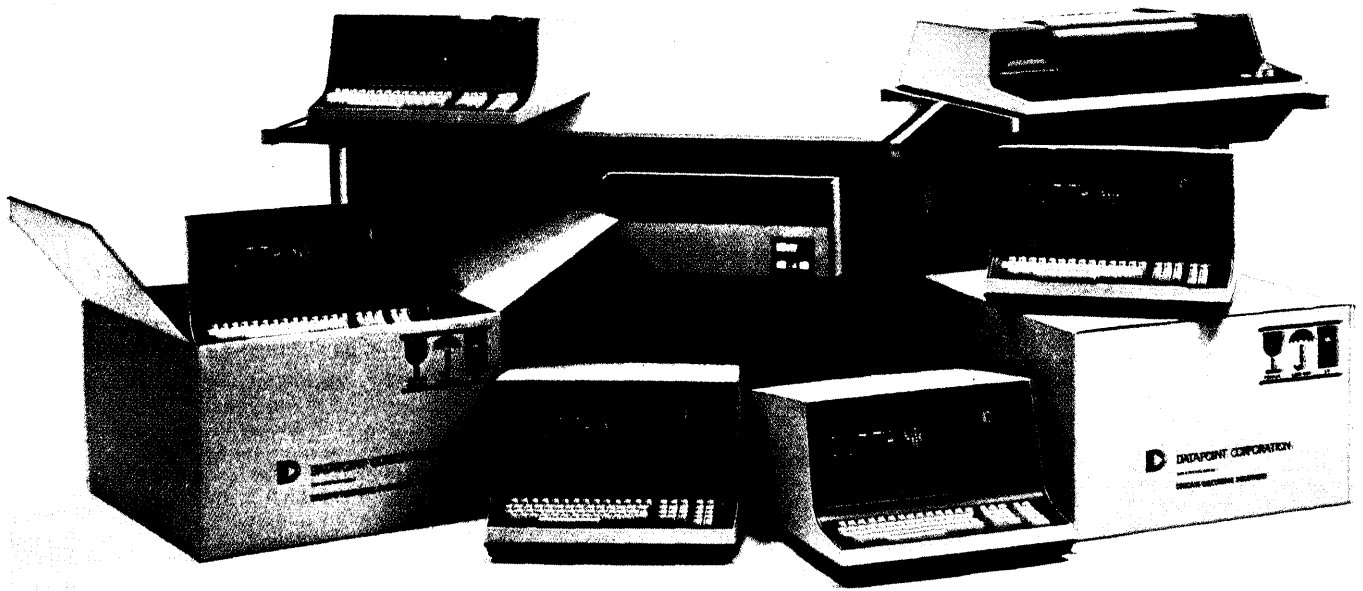

Out of the box, up and running fast.

That's reason #1 to buy Datashare, the multi-user system built for business.

Bring up interactive applications in weeks, not months, with Datashare. Here are 10 more reasons you'll benefit from choosing the transaction processing system users depend on in 15,000 installations worldwide.

2. Simple Programming. An easy-to-use language helps you put custom applications on-line quickly. Datashare's comprehensive utilities, efficient file structure, and complete documentation all combine to produce rapid results.

3. Ready-to-Run Applications. If you don't want to write your own, select from a wide variety written by Datashare users and software houses, all listed in our Applications Software Catalog — yours free for the asking.

4. Transaction Processing Power. Datashare handles big jobs easily because it was designed from the ground up specifically for interactive business applications. A choice of compatible processors lets you match system capacity exactly to the job. The compiler is fast. The language is fast. And operators are fast in getting the job done.

5. Proven Performance. Datashare's reputation for reliable performance is known worldwide. It's been helping organi-

zations do business since 1972 and has grown in capability every year.

6. Pick Your Disk, Pick Your Printer. Choose from a small diskette-based system up to a large 180 MB system. Select from 7 printers — 80 CPS to 900 LPM. Share one on the system, and add others at individual displays.

7. Batch and Inquiry Communications. Datashare communicates with other Datapoint systems and with your central mainframe. You can transmit batches concurrently with operator activity during the day. Or in unattended mode at night. And since Datashare also supports 3270 inquiry to your mainframe, you can access both local files and the central database from any display.

8. Grow and Expand. As you grow, so will Datashare. With our ARC™ system architecture, you can add on displays, increase processing power, expand peripherals, and extend your database virtually without limit. And whenever you're ready, you can add word processing, electronic message service, and data and voice communications management to the same system. With Datapoint, anything goes.

9. Low-Cost Lease or Purchase. You can put Datashare to work for only \$54,550 complete or \$261 per station per month on

a 3-year lease, including maintenance. That buys a 6600 processor with 20 MB of disk storage, 8 workstations, and one 240/340 LPM printer.

10. Prompt Delivery. Lead times are now averaging 4 to 6 weeks.

11. Nationwide Service and Systems Support. Our systems engineers and service professionals grew up with this system. If there's a problem, they know how to fix it quickly. And we back them up round the clock.

Need more facts? We'll get them to you fast. Let us itemize more of Datashare's advantages to you in person. Call (512) 699-7151 for the name and number of your nearest Datapoint representative. Or write to Datapoint Corporation, Marketing Communications DM-KO5, 9725 Datapoint Drive, San Antonio, TX 78284.

DATAPPOINT



At the Forefront of E.D.P.

A Technique for Software and System Design

by **R. J. LANO**, *TRW Systems and Energy, Inc., California, U.S.A.*

1979 124 pages US \$29.25/Dfl. 60.00

One of the increasingly significant problems facing the system designers and master planners of today is the timely and accurate definition of system element interfaces and task or activity interrelationships.

This book presents the N-squared (N^2) chart, which is a new technique for the definition, analysis, tabulation, and description of functional and physical interactions and interfaces. The technique presented is not limited to any particular field, discipline, market area, or system type. The N^2 chart technique is simple and easy to understand, structured and methodical, top-down in nature, communicative of the design, and forces a uniform level of design consistency. The N^2 chart is an effective tool for the integration of all of the people, products, procedures, and paper that make up any given system.

Volume 1 in the Monograph Series of the International Council of Computer Communications:

The Office of the Future

Communication and Computers

by **RONALD P. UHLIG**, *Bell Northern Research Limited, Canada*, **DAVID J. FARBBER**, *University of Delaware, U.S.A.*, and **JAMES H. BAIR**, *SRI International, U.S.A.*

1979 420 pages US \$35.00/Dfl. 85.00

This is the first book containing a comprehensive discussion of the many different uses of computers and communications which may come about in future offices, the technology which is making this possible, and some of the impacts on individuals, groups and organizations. The material is based on the considerable practical experience and research of the authors in using computer/communication tools which are the forerunners of tools which will be commonplace in future offices, and on their observations of the impact of these tools on themselves, colleagues and co-workers in government, industry and academia.

Part I of the work develops an analysis relating activities of knowledge workers to the processes which go on in offices. Based on this analysis, future computer/communication tools that support knowledge workers in the activities of communicating, gathering, analyzing, organizing, and maintaining information are described.

Part II discusses the technological factors which are making it technically and economically feasible to place the

tools discussed in Part I into the hands of office workers. It examines trends in Large Scale Integration, economics of volume production of electronic components, storage systems, and input/output systems.

Part III examines the impact of the technology and these new uses of communications and computers on individual knowledge workers, groups, and organizations. There follows a description of strategies and principles for implementing these new tools in the offices of business and government. A methodology for measuring the impact of this new technology is proposed to overcome the confounding factors present in organizations. Finally, Part III speculates about potential productivity improvements in terms of potential benefits and projected payoffs from improved interpersonal communications in the "Office of the Future".

Issues in Data Base Management

edited by **HERBERT WEBER** and **ANTHONY I. WASSERMAN**.

1979 272 pages US \$34.25/Dfl. 70.00

This work contains the material from the survey sessions held at the Fourth International Conference on Very Large Data Bases in Berlin, 13-15 September, 1978. Important issues in contemporary data base system research and data base management practice were elaborately discussed. Five subject areas were selected for presentation and discussion during the sessions: (1) data base design, (2) data base software engineers, (3) distributed data base systems, (4) impact of new technologies and (5) data base security and privacy. Emphasis was placed on a description of the work motivation, on the problems and achievements in the area, and an opinion of future trends and needs for research and development.

Data Base Architecture

Proceedings of the IFIP Working Conference on Data Base Architecture, Venice, Italy, 26-29 June, 1979

edited by **G. BRACCHI**, *Politecnico di Milano, Italy*, and **G. M. NIJSSEN**, *Control Data Europe, Brussels, Belgium*.

1979 352 pages US \$46.25/Dfl. 95.00

These proceedings address the research and development problems related with the organization of data base systems and their interfaces. Some 70 top-ranking data base professionals from various countries were specially invited participants at the Conference; presentations were given by well-known experts affiliated with the main computer manufacturers, large organizations, and various universities in Europe, America and Japan.

The Human Side of Information Processing

Proceedings of the Copenhagen Conference on Computer Impact - 78, 25-27 October, 1978

edited by **NIELS BJØRN-ANDERSEN**, *Information Systems Research Group, Copenhagen Business School, Denmark*.

1980 240 pages US \$31.75/Dfl. 65.00

With the growing awareness of user problems and the increasing interest of trade unions in systems development, the area of "human aspects of information systems" is rapidly expanding. The set of papers published in this work provides the most up-to-date knowledge of the key issues involved. Never before has such a large group of well-qualified researchers given such a comprehensive picture of this tremendously complex area.

Thirteen articles are divided into two groups covering administrative systems and decision support systems. There is an almost equal balance between descriptive analyses and normative recommendations on how to design for the human aspects. Each article is followed by brief extracts of statements by discussants. Although the articles are written by some of the most outstanding and knowledgeable researchers in the field, they are all written in such a way that they can easily be supplementary reading to any textbook in administrative data-processing.

Integrated Office Systems: Burotics

edited by **NAJAH NAFFAH**, *Institut de Recherche d'Informatique et d'Automatique, Rocquencourt, France*.

1980 283 pages US \$41.50/Dfl. 85.00

This work represents the proceedings of the first international workshop (Versailles, France, November 1979) on the new field of Office Automation: Burotics. The papers included, written by international experts and research engineers cover various important topics:

- Modeling of the Office: trying to understand the office, its internal procedures, the way we can represent these procedures with formal models, and DB;
- Architecture of the Office Systems;
- Local Networks;
- Networks: linking the office workstations;
- Research Tools and Taxonomies.

The book also includes the result of the discussions which took place the last day and a half of the workshop. The reports of the four working groups show the new problems of the office systems implementation and indicate where consensus has been reached.

North-Holland Publishing Company :

P.O. Box 211, Amsterdam, The Netherlands
52 Vanderbilt Ave, New York, N.Y. 10017, U.S.A.

Dialogue

AN ADVERTISING COMPANY THAT HAS BEEN A PART OF THE BUSINESS FOR OVER 20 YEARS

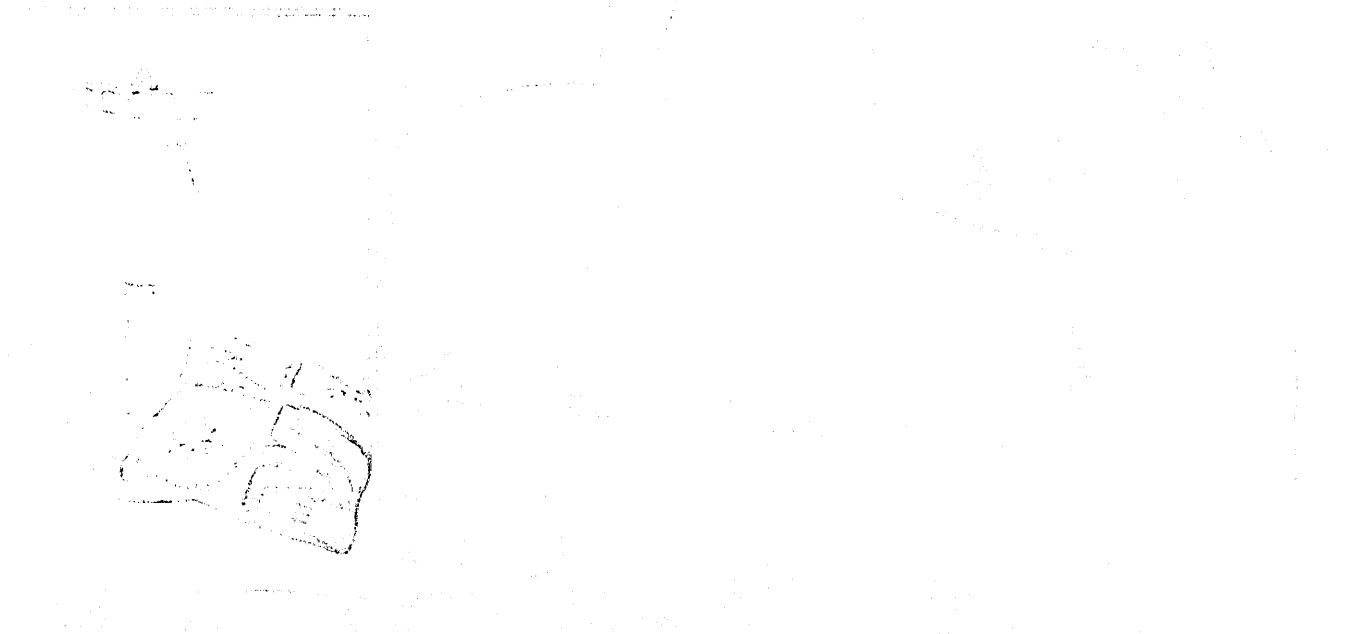

Stained glass and needlework are among the craft projects available from Artercraft Concepts. The C. H. Stuart division uses distributed data processing to cut both the time and the cost of customer order processing.

Quicker Shipment: Distributed Processing Shortens Customer Order Cycle

Through the use of distributed processing, Artercraft Concepts, a division of C. H. Stuart Inc., has shortened the customer order cycle from three days to two, resulting in a corresponding reduction in receivables outstanding.

Artercraft designs, manufactures and markets craft projects including crewel, in-the-home needlepoint, weaving, stained glass, and rug hooking. According to Robert G. Boss, vice president of management services, Artercraft has been the Stuart pilot division for distributed data processing. Today, the processing of customer orders for Artercraft is performed on an IBM S100 Information System at the division's headquarters in Ballston Spa, New York. Formerly, all order entry for Stuart, a world leader in direct-to-consumer marketing, was handled in a computer center in the Stuart corporate headquarters in Newark, New York.

Customer orders for Artercraft are written by field representatives called counselors and mailed to Ballston Spa. There, operators key the data into terminals online to the S100.

"The people who process the orders are intimately familiar with the product line, so they can answer most questions immediately," Boss points out.

Previously, he explains, couriers brought the order forms 200 miles to Newark for processing, and brought the shipping documents back to Artercraft. This remains the standard procedure for other Stuart subsidiaries which make and market jewelry.

"The division now has complete control over its own data entry, its own priorities," Boss notes. "But control of data processing implementation is retained at corporate — there are no programmers at the division location. By keeping the ex-

pertise here, we can bring the techniques developed for one division to the others, and act as a catalyst for DP development throughout the company."

Today, the corporate computer queries Artercraft's S100 to pick up the order data, which it needs for inventory control and sales analysis. And it batch transmits shipping and payment data back to the S100, which prints the shipping documents and commission checks for the counselors.

"We avoid the delays, the costs of the courier, the extra handling, and the vulnerability to snow," he says. "And we protect the integrity of our operations: the original written order never leaves Ballston Spa.

"We installed the S100 ourselves," Boss adds. "We had it running — operating system and application programs — in two eight-hour days."

With Data Encryption, Scents are Safe at IFF



Ingredients are mixed for a perfume fragrance at International Flavors & Fragrances. To protect valuable formulas during transmission, IFF uses IBM 3845 and 3846 Data Encryption Devices.

Some of the world's most fragrant data traffic flows between New York City and Hazlet, New Jersey. As International Flavors & Fragrances Inc. (IFF) transmits valuable formulas for synthetic scents between its Hazlet headquarters and its New York office through the public telephone system, an IBM data encryption device protects them from unauthorized access.

Referring to the IBM 3845/6 Data Encryption Devices, Lewis G. Augustine, director of systems and data processing, says: "We plugged them in and they worked; that was the entire installation procedure. And data encryption has never been the cause of any operating problem."

Few compounds are more complex than the fragrances used in toiletries, detergents, cosmetics and many other consumer items. The bill of materials for one scent typically includes thousands of line items, and its summarized "explosion" can require 50 pages of printout from the firm's IBM System/370 Model 138 at Hazlet. Augustine points out that fragrances are formulated by combining "subcompounds" — recognized varieties such as lilac and geranium — which are themselves mixtures of subcompounds and primary ingredients. A completed formula may include subcompounds at 33 levels.

"Our creative group in New York develops a thousand new fragrances a month to submit to our customers," Augustine continues, "so there is a continuous heavy flow of formulas between that office and our technical people here. This traffic is multiplied because a single fragrance often must be formulated many times: a scent for, say, a line of related toiletries works differently in the cologne, soap, deodorant, and so forth.

"The ability of our creative group to develop a fragrance that meets a customer's need — and to synthesize that fragrance suitably for his product — is our major business asset. The security of that data traffic is vital to us. With the IBM data encryption devices, we have the absolute security of communication we need."

The 3845 and 3846 use the U.S. National Bureau of Standards Data Encryption Standard, a process for encrypting data under control of a key-variable supplied by the user.

"Without these devices, our alternatives would not have been attractive: to develop our own software encryption method and install a decrypting computer in New York. Or to hire couriers to hand-carry formulas. Obviously, the IBM devices have been far more simple, economical, and effective."



Interior of a Cities Service production platform in the Gulf of Mexico. Cities Service uses the IBM DB/DC Data Dictionary to help assure the integrity and validity of data in its corporate information system.

Dictionary Insures Data Integrity at Cities Service

"We concentrate on making data meaningful," Larry Myerley of Cities Service Company says. "Vital strategic data must be current, accurate and secure. The dictionary plays a vital role in achieving that."

Myerley, manager, data base development, is discussing the role of the IBM DB/DC Data Dictionary. Cities Service, he explains, has made data management for its corporate information system a separate professional function, to define and standardize data elements used in common by many applications.

Myerley's staff has identified 28 attributes of a data element, he continues, such as the coding structure, the input source, persons authorized to access or change it, and other data with which it is interdependent. The dictionary stores these attributes of each element, the identity of all programs that use or affect it, and a record of the frequency with which it is used. Naming standards created at Cities Service are used to assign both computer-oriented and business (i.e., end-user oriented) designations, with the dictionary providing the cross-references between them.

The Cities Service corporate computer center in Tulsa, which includes an IBM System/370 Models 168AP and 158AP, uses the Information Management System/Virtual Storage (IMS/VS). "When we began putting data in IMS instead of imbedding it in individual programs," Myerley notes, "we immediately found that we needed a tool to keep track of it, even on a small-scale pilot project. We couldn't keep the information in our heads."

It is important, he points out, to respond to changing needs. As an example, he cites the introduction of a new employees stock ownership plan that required 11 or 12 new programs.

"With the aid of the dictionary," he adds, "we had no difficulty adding the required elements to the IMS data base without impacting existing programs."

"Or consider a set of 12 master files for financial processing. They support about 300 programs serving different interests, but the dictionary enables us to identify every application program using any data element, and to measure and plan the work of preparing these applications to migrate to IMS.

"Eventually, the data system, though independent, will be available to the information systems, and will be dedicated to producing valid, current data. It will be stable, changing slowly. But the information systems — processing data to produce useful information — will be dynamic, changing as needs change. The stability of the data environment, achieved with the help of the data dictionary, will let us respond fast to these demands."

DP Dialogue is designed to provide you with useful information about data processing applications, concepts and techniques. For more information about IBM products or services, contact your local IBM branch office, or write Editor, DP Dialogue, IBM Data Processing Division, White Plains, N.Y. 10604.

IBM[®]

Data Processing Division



Introducing the office of tomorrow with everything you need today.

Prime's Office Automation System has word processing, data processing, electronic mail, correspondence management, scheduling, automatic proofreading, language translation, networking capabilities—virtually everything you need—all integrated into a single incredibly efficient system with three major functions.

Word Processing includes a screen editor that displays text as it's entered. Menus that lead the user through the system. Labelled function keys that eliminate the need for heavy user memorization. And storage that will easily handle about a million pages of information.

It also has management and administrative workstations. Powerful text creation and editing facilities. A user-created boilerplate library. Comprehensive filing and retrieval capabilities. List processing. And a printer that provides letter-quality output.

Management Communications/Support has electronic mail that can forward documents and notes to offices down the hall, across the city, or around the world.

Correspondence Management cuts paperwork and simplifies filing. An Electronic In-tray receives and stores notes, documents, and appointment requests. A Tickler File reminds you when certain tasks have to be done. Calendar Management allows you to maintain a confidential two-month personal calendar.

And scheduling lets you request a meeting, get confirmation of a specific date and time, then actually schedule the meeting.

Advanced Text Management employs a 60,000 word electronic dictionary. The contents are user-defined, so medical, legal, or industry terminology can easily be added. Spelling is electronically compared with the dictionary for accuracy, and hyphenation is done automatically.

It will also support multi-lingual dictionaries for creating foreign language documents or translating one language to another.

Hardworking workstations.

Prime's Office Automation System is supported by two workstations; one administrative and one management. They both can access all capabilities of the system, but each is tailored to the specific needs of its users.

The System operates on a multifunctional Prime 50 Series computer system. All Prime computers share the same operating system, file system, and communications products. So no matter what size computer you start with, you can easily upgrade to over sixty users.

In short, Prime's Office Automation System can deliver what you need. So if you're ready for this kind of office, we're ready to deliver the System. Write Prime Computer, Advertising Department, 3 Newton Executive Park, Newton, Massachusetts 02162.

PRIME Computer

LETTERS

ONIONS

Re: "Hanging In" (Nov. 25, 1979, p. 104), I am writing to let you know how much I disliked your inclusion of the ridiculous, uninformed, uncalled-for article by Marvin Grosswirth. I was talking with a fellow DATAMATION reader the other day, and he and I ended up agreeing that the overall quality of your magazine has noticeably declined in the past couple of years. Pointless contributions such as Grosswirth's do nothing to reverse this perceived trend.

SID HUFF

Professor, School of Business Admin.
The University of Western Ontario
London, Canada

Marvin Grosswirth replies: What can one say beyond, "*Chacun a son goût?*" I feel obliged to add, however, that satire is never "pointless," and if Prof. Huff and—presumably—his fellow reader failed to perceive the point(s) in "Hanging In," then clearly there exists a communications problem. Whether the malfunction is in the transmission or in the reception I will leave for others to decide.

STANDARDS DEVELOPMENT

Re: "Networks At Last?" (March, p. 122), mention is made of "open systems architectures" without further specific identification. Since the same nomenclature has been employed from time to time in the U.S. and internationally in the course of development of the "Reference Model of Open Systems Interconnection" (OSI), some clarification would be helpful to the readers. (In the U.S. the primary public standards development body is the American National Standards Committee (ANSC) X3 for Computers and Information Processing, organized under the American National Standards Institute. Internationally, similar work is carried out by ISO, the International Organization for Standardization; the U.S. is a member of ISO.)

The scope of the Reference Model (which has a total of seven layers) is to provide "a common basis for the coordination of standards developments for the purpose

of systems interconnection," and clearly is a generative step removed from the standards themselves and several steps removed from any implemented devices.

Standards themselves are adopted voluntarily in the U.S. as each implementing organization deems appropriate. The concept of forcing is totally absent from the voluntary standards process. The Reference Model has been adopted for use in ANSC X3 as one planning and management tool for systematizing the standards development work of over 65 technical committees and working groups in ANSC X3. In itself it is not intended for and not suitable for implementation as the standards are.

J.S. FOLEY

Manager, Systems Standards Engineering
Burroughs Corp.
Detroit, Michigan

IN MEMORIAM

Re: "In the Beginning there was Mauchly" (March, p. 55), Dr. Mauchly claimed to have proved that the moon influences the earth's weather. While I have not seen his proof, I suspect it is similar to one I investigated and disproved some years ago.

Back in the middle '60s I worked as a computer programmer at the Bureau of Meteorology in Melbourne, Australia, and the director of adp mentioned to me one day that someone in the U.S. weather service had claimed to have proved that the moon influenced the earth's weather. In particular, the claim was made that rainfall varies with the phase of the moon. Out of curiosity I did some research into the matter, and discovered that there was a fundamental flaw in the methodology of the proof which accounted for the apparent variation in rainfall.

To show that rainfall varied according to the phase of the moon, a given day's rainfall was allocated to the particular phase of the moon on that day. The problem is that the phases of the moon do not correspond to equal intervals of time, owing to perturbations in the moon's orbit. In particular there is one perturbation, discovered by Ptolemy, whose period is exactly one-half

the fundamental period of 28 days, so that averaging over a number of periods, the various phases of the moon will not be of equal duration.

We did not publish our result, as it did not seem all that important at the time, especially as the view that the moon affects the earth's weather has never received any significant support from the scientific community.

ALAN J. ROBINSON
Flossmoor, Illinois

MISINFORMATION

Re: "1980 Salary Survey" (April, pp. 110-118), the survey has again misinformed the data processing community of what the real world is like. DATAMATION has taken a survey of only 400 to predict what thousands of data processors are making. The survey has left many gaps, and many more disillusionments which are being used by personnel departments to set salary requirements. Conclusions are being drawn on a relatively small amount of information.

Marketing research personnel could argue that a survey of 400 would be adequate if distribution of the inquiries were made in a scientific and orderly manner. DATAMATION has failed to illustrate on p. 116 the number of respondents by industry. From p. 118 of the survey, I conclude that data base administrators are nonexistent in Atlanta, and systems analysis and programming is not being used in San Francisco. From p. 114 of the survey, I suggest that position number 521-7 staff consultant make a career change since the \$2,397 that the person is earning does not fall in the range of \$18,000 to \$21,128.

In conclusion, and furthermore, DATAMATION will continue making salary surveys in the same manner, personnel departments will continue to look at these surveys, data processors will continue to be misinformed and misunderstood, and I will continue to be amazed at the lack of concern.

RENDER SWYGERT
Systems Manager
Lakeland, Florida

10-DAY FREE TRIAL

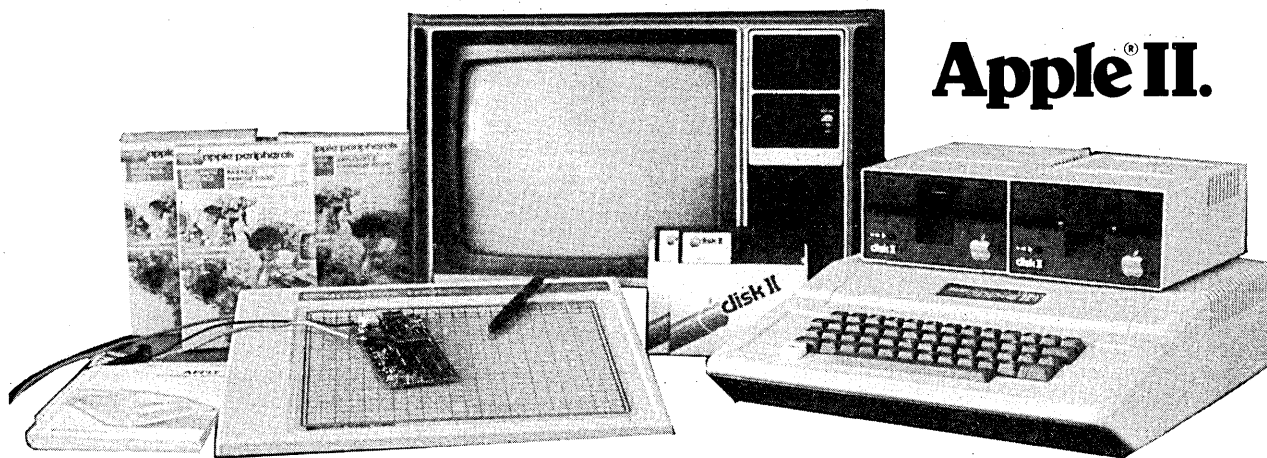

Apple II.

Here's a way to buy the great Apple Computer and receive FREE either a Centronics P1 Printer or a Zenith Color Monitor.

A Compumart Exclusive: Order any combination of Apple Computers and accessories from Compumart totalling \$3,500 and we will send you your choice of the following with your order:

1. A Zenith Color Monitor

The perfect color monitor to complement the color capability of your Apple Computer. (Value \$499.00)

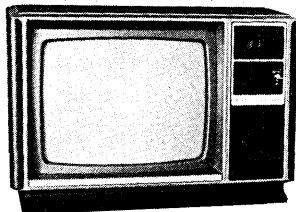

2. A Centronics P1 Printer

Imagine a Free printer for your Apple. (Value \$470.00)

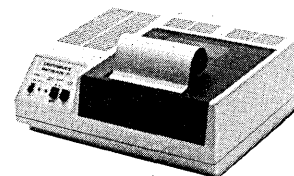

Apple II Computer

16K Apple II	\$1,195.00
32K Apple II	\$1,295.00
48K Apple II	\$1,395.00
16K Apple II Plus	\$1,195.00
32K Apple II Plus	\$1,295.00
48K Apple II Plus	\$1,395.00

Apple Accessories

PASCAL	\$495	Disk and Controller	\$595
Micromodem	\$379	Parallel Printer Card	\$180
Visicalc	\$150	Communications Card	\$225
The Controller		Hi-Speed Serial Card	\$195
(Business Package)	\$625	Firmware Card	\$200
The Cashier (POS System)	\$250	NEW! AppleWriter Text Editor ...	\$ 75
Integer BASIC ROM Card	\$200	NEW! Apple Graphics Tablet	\$795
Centronics Printer Interface	\$225		



COMPUMART

To Order: 1(800) 343-5504
In Mass: 1(617) 491-2700
Call Toll-free for complete product descriptions and details.

1250 N. Main St.
Ann Arbor, MI 48104
270 Third St.
Cambridge, MA 02142

We've had a reputation for dependability since 1971.

Member Computer Dealers Assoc.

CIRCLE 23 ON READER CARD

SUPERSTAR

Intrusion's New Data PBX

Top performance in any data network is the key to making your computer do its job better and do it faster. To do this you must get the most out of your existing network infrastructure. That's why you need the benefits of Data PBX.

Data PBX always provides a secure, private, and easy-to-use network system. It's the only system that offers the safety of a private line, the speed of a dedicated line, and the flexibility of a public line. The result is a network that's secure, reliable, and easy to use — by anyone.

The network manager still has the freedom to choose the best way to handle data traffic. It's the only system that offers the flexibility of a public line, the speed of a dedicated line, and the safety of a private line. The result is a network that's secure, reliable, and easy to use — by anyone.

The network manager still has the freedom to choose the best way to handle data traffic. It's the only system that offers the flexibility of a public line, the speed of a dedicated line, and the safety of a private line. The result is a network that's secure, reliable, and easy to use — by anyone.

The network manager still has the freedom to choose the best way to handle data traffic. It's the only system that offers the flexibility of a public line, the speed of a dedicated line, and the safety of a private line. The result is a network that's secure, reliable, and easy to use — by anyone.

INTRUSION SYSTEMS CORPORATION
10000 WILSON AVENUE
DALLAS, TEXAS 75243
TEL: (214) 343-1111
FAX: (214) 343-1112
CIRCLE 460 ON READER SERVICE CARD

Intrusion Systems

460

INTRUSION SYSTEMS CORPORATION
10000 WILSON AVENUE
DALLAS, TEXAS 75243
TEL: (214) 343-1111
FAX: (214) 343-1112
CIRCLE 460 ON READER SERVICE CARD

*"Smart is beautiful."
Don Adams*

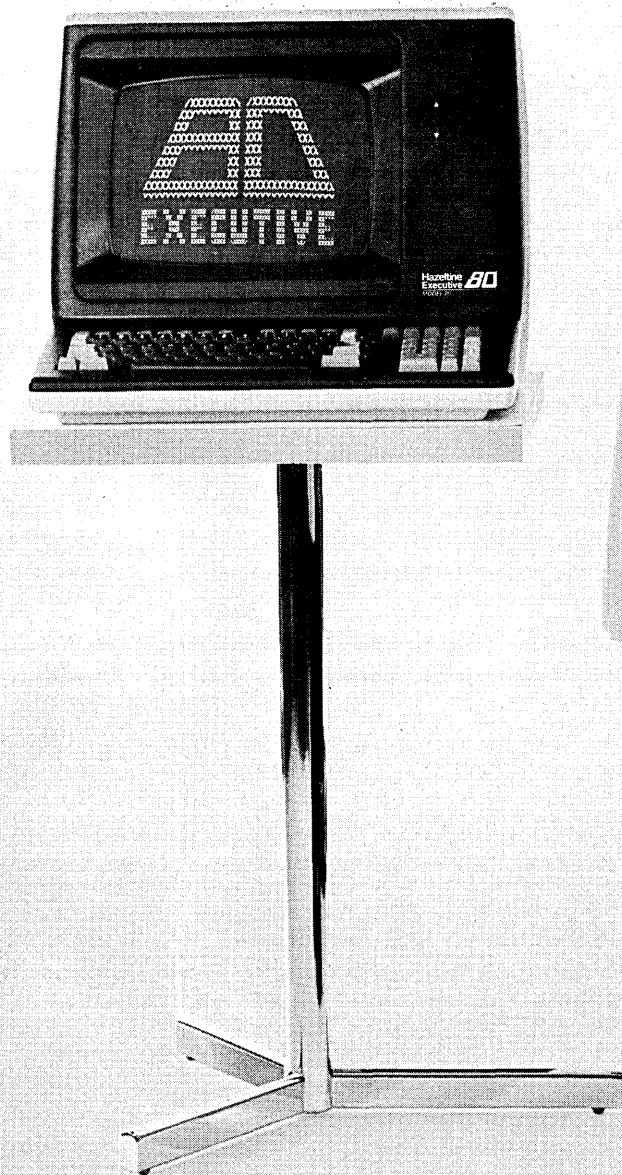

Hazeltine announces the smart terminal for the eighties.

Executive 80™ is a beautiful new concept in smart terminals, designed to meet the needs of the new decade.

It's beautifully featured. Video highlighting, line drawing, smooth scrolling, programmable function keys, split screen display and variable character size are just the beginning of a long feature list, organized for such applications as data entry, form fill, data inquiry and software design.

It's beautifully flexible. There are two basic models. Executive 80, Model 20 is optimized for top price/performance in buffered or conversational environments. Model 30 is designed for high performance editing. Each can be ordered with detachable keyboard, and a 15 inch smooth scrolling monitor — the standard is 12 inch — which selectively displays either 80 or 132 column formats in normal size or double height and width.

It's beautifully reliable. The terminal has Hazeltine's traditional quality, to be sure. Executive 80 adds powerful self diagnosis, enabling the terminal to isolate its own failures. That means faster, less expensive maintenance.

It's beautiful to work with. High resolution characters are easy on the eyes. So is the non-glare screen, the full use of non-reflective surfaces and the user selectable double size characters. There's even a tilt display which when combined with the detachable keyboard lets users select the most comfortable work positions. A sculptured keyboard design takes the drudgery out of data entry.

With Executive 80, you can configure and feature your terminals for the maximum price/performance in your application. You can build in all the smarts your work demands. In the seventies, it was cute to be dumb. But in the eighties, smart is beautiful. That's why Executive 80 is such a beautiful buy.

Hazeltine Corporation, Computer Terminal Equipment,
Greenlawn, NY 11740 (516) 549-8800 Telex: 96-1435

Hazeltine and the Pursuit of Excellence

New York (212) 586-1970 • New Jersey (201) 584-4661 • Chicago (312) 986-1414
San Francisco (415) 342-6070 • Atlanta (404) 952-8444 • Arlington (703) 979-5500
Orlando (305) 628-0132 • Dallas (214) 980-9825 • Los Angeles (213) 553-1811
Columbus (614) 889-6510 • England 01-568-1851 Telex: (851) 928572

*Don't be dumb.
Get smart!*



**Hazeltine
Executive** 

Answers for the Eighties

CIRCLE 25 ON READER CARD

SCIENCE/SCOPE

New three-dimensional polymer fiber networks show promise for a variety of industrial and commercial applications. The unique materials, comprised of high-strength fibers, are produced by vibrating an object in a supercooled polymer solution. The fibers can be grown directly on electronic devices prior to encapsulation with plastic, thereby providing internal fiber reinforcement. Hughes, with U.S. Air Force sponsorship, will apply its proprietary in situ fiber technology to a number of high-voltage electronic devices to validate a production process. Other potential uses include filters, high-strength composites, and medical implants.

Novel digital logic circuits employing charge-coupled devices (CCDs) may soon be used in a wide range of military systems, including communications, radar, voice processing, sonar, and guidance. Experimental chips developed by Hughes are five times more compact than similar circuits made with I²L (integrated injection logic) or CMOS (complementary metal oxide semiconductor) processes. They also can provide up to 10 times the throughput per unit power when structured to perform many different logic operations at the same time.

An infrared sensor that would detect and track ballistic missiles -- and perhaps even distinguish "live" missiles from decoys -- has proven extremely successful in initial tests. The device, a part of the Designating Optical Tracker (DOT) program, is designed to be carried by a rocket to an altitude of 100 nautical miles. There, at the outer edge of the atmosphere, it scans a wide area of space and then relays the data it gathers to the ground. The infrared sensor is much more sensitive than conventional infrared devices because it's supercooled. The device was developed by Hughes for the U.S. Army Ballistic Missile Defense Advanced Technology Center under subcontract to Boeing Aerospace Company.

Hughes Missile Systems Group, located in Canoga Park, California, is seeking engineers and scientists to work on a growing list of development and production programs. The list includes AMRAAM, Wasp, multimode guidance, TOW, Phoenix, Maverick, and U.S. Roland. Typical openings are in areas of LSI, radars, IR systems, signal processing, pattern recognition, computer software, electronic components, guidance and controls, gyro-stabilized platforms, and digital systems. Please send resume to Hughes Engineering Employment, Dept. SE, Fallbrook at Roscoe, Canoga Park, CA 91304. Equal opportunity M/F/HC.

A traveling-wave tube newly introduced for use in satellite earth terminal transmitters is capable of more than 250 watts of CW power in the 14.0 to 14.5 GHz frequency range. The device is a metal-ceramic tube with PPM focusing and forced-air cooling. A modulating anode allows beam current to be turned on and off quickly during normal operating sequencing and under fault conditions. Internal programming assures a proper TWT/power supply interface and simplifies field maintenance. The TWT is designated Hughes Model 881H.

Creating a new world with electronics

HUGHES

HUGHES AIRCRAFT COMPANY
CULVER CITY, CALIFORNIA 90230

EDITOR'S READOUT

WHO HAS THE LAST WORD?

**Second verse,
same as the first**

About five years ago we were speculating that word processing and data processing were more than just casual friends and actually might enjoy connubial bliss sometime in the future.

We were also concerned about who was going to implement and manage this new partnership—the data processing manager or the administrative manager. Showing a not unexpected bias toward our readers, we opted for the data processing professional, arguing that he knew more about the emerging technology and that he had to integrate word processing into the overall corporate information structure. We felt this was particularly true if his company's needs called for word processing gear which used the capabilities of the central computer site.

We must admit that these thoughts didn't come in a blinding flash of insight over coffee one morning. At the time we were receiving much advice and counsel from Amy Wohl and Phil Dorn. Dorn was, and still is, an advisor for DATAMATION and a highly respected industry consultant; Wohl was working for Datapro at the time and beginning to carve out a reputation as the most knowledgeable person around in this new field of word processing. She is now also a highly respected consultant and a DATAMATION advisor.

Time has proved the accuracy of their contention that wp and dp would merge. But they were not the only ones examining this phenomenon.

Five years ago, in Technical Publishing Co.'s East Coast headquarters, Debbie Dwelley and the members of the DATAMATION marketing research group wrote their questionnaires, addressed their envelopes, licked their 10¢ first class stamps and launched their first study of the



interaction of these two technologies.

Being tenacious types, they reasoned that their data would be all the better if they came back and asked the same questions at some point in the future. They did so this year. And happily for our two advisors and for us, their research confirms the speculations we made so long ago.

Both surveys confirm the dp department's frequent involvement in recommending and selecting wp gear for use in its own or other end-user departments. Five years ago, of the dp managers who were planning to acquire wp equipment for their own department, 16% were first time users, 11% were adding to existing wp equipment. Today the picture has changed. The 1980 survey shows a reduction of first time users to 8% and a jump to 24% in those who plan to expand their use of wp.

The research group also discovered that the highest acceptance of wp today is among computer and data processing service bureaus. Other big users are in manufacturing, government, and the finance sectors. Education, usually an also-ran when it comes to adopting new technology, is surprisingly one of the sectors where wp is finding strong acceptance.

Until recently, one of the articles of faith in the wp/dp world was that one system could not be used efficiently to do the

other's work. But the 1980 survey shows that fully 36% of the respondents are doing word and data processing on the same system. And, with the rash of new announcements of office automation equipment having both capabilities, the figure is sure to rise rapidly.

With the introduction of the new digital PABXs and a flood of multifunction devices such as the IBM 6670 "Information Distributor," with the lowering of communications costs and the implications of AT&T's entry as an unregulated competitor into information processing, the outlines of the office of the future are beginning to emerge.

But despite the accelerated pace, our message to the dp professional hasn't changed much in five years. You are the individual who should be putting together the pieces of this complex information system for your corporation. You must learn all you can about wp, electronic mail, and all the rest. And you must understand data communications, the glue that ties all these systems together. And further, once it is all in place, you must provide the leadership to manage and constantly improve this information resource.

It's a big challenge, but one that we know today's data processing professional will meet and overcome. *

Customize for high performance. . .

**If you need a high performance display terminal,
go to the top.**



Talk to us.

Our DELTA 7000 Series 16-bit microprocessor display terminals are the most advanced available. What makes them different from all the others, is that we can make them so *different* for you. Simply by *customizing* their standard features to precisely meet your special application. We've done it differently for many organizations around the world, and we're ready to do it for you now.

All DELTA 7000 Series display terminals include these special features:

- Independent split screens
- Programmable function keys
- Large scrolling text memory
- Multiple character sets

The Associated Press did.

We've also built special DELTA 7000 Series terminals for the National Institutes of Health, Hughes Aircraft, Commodity News Service, Black Dot and many other organizations.

Talk to us about your high performance terminal requirements today.



The Associated Press Mighty Mouse System is the most advanced wire service copy processing network in the world. Over 300 Delta display terminals are used in this system.

Courtesy Associated Press

CIRCLE 27 ON READER CARD



DELTA DATA SYSTEMS CORPORATION
Woodhaven Industrial Park
Cornwells Heights, PA 19020
(215) 639-9400

U.K. Subsidiary:
DELTA DATA SYSTEMS LTD.
Welwyn Garden (07073) 33833
Service in over 150 locations in the U.S.,
and 10 European Countries and Canada.

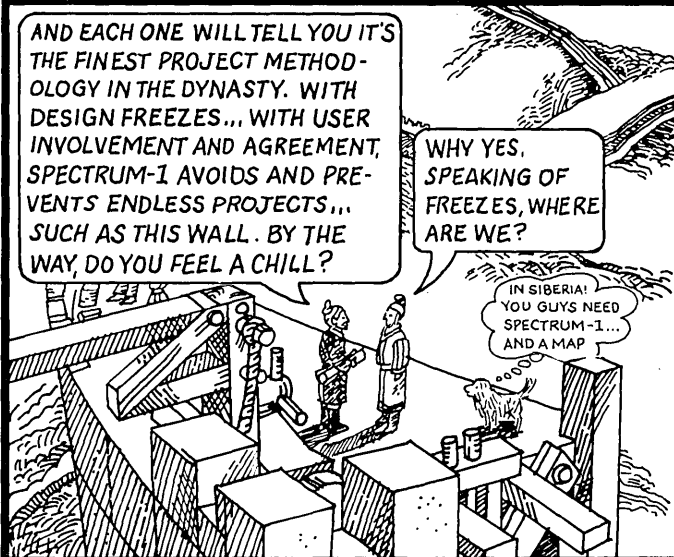
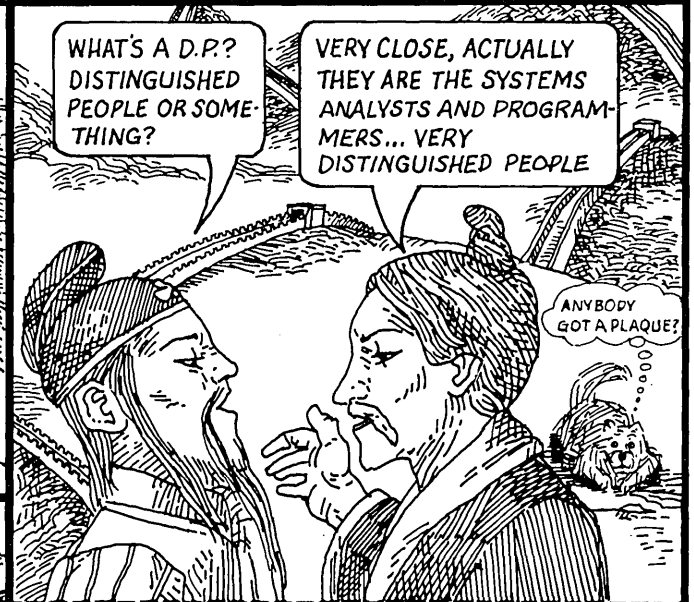
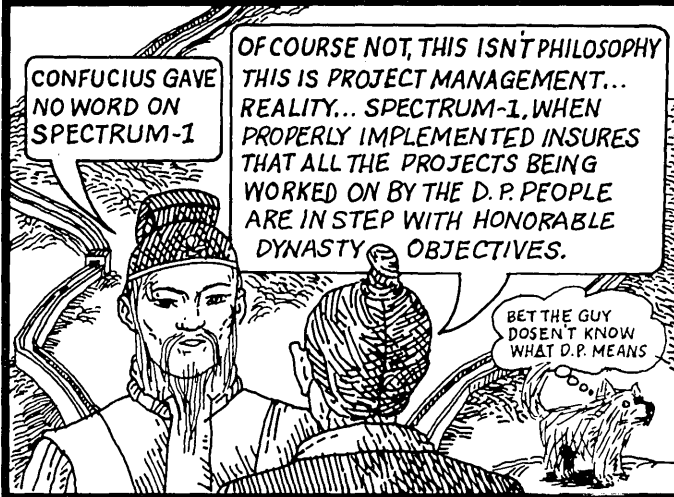
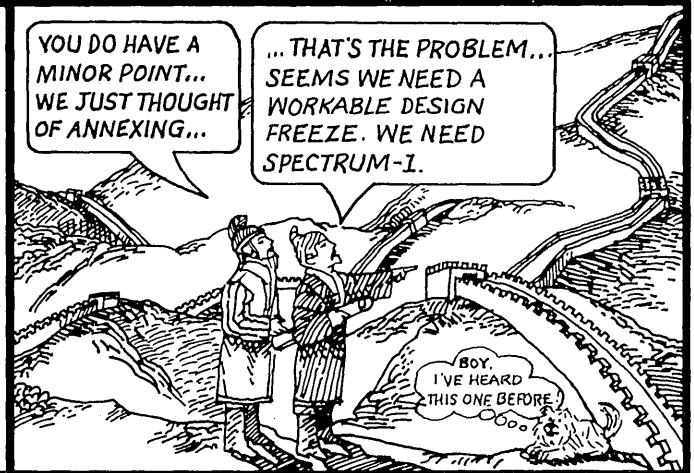
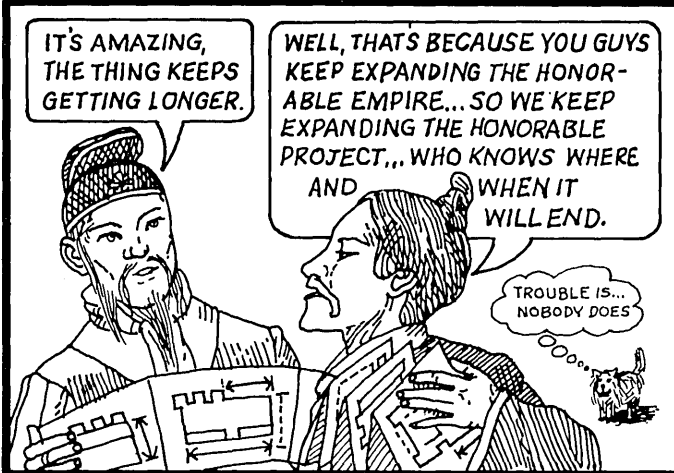
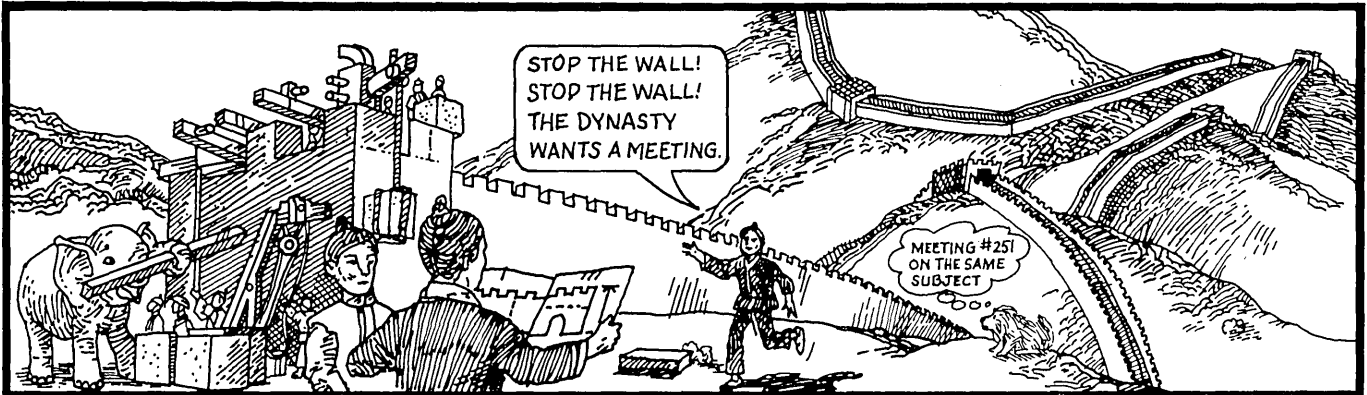

SPECTRUM INTERNATIONAL INCORPORATED
 4311 WILSHIRE BLVD. STE. 312
 LOS ANGELES, CA 90010 • (213) 931-1127

GENTLEMEN: PLEASE SEND ME FURTHER INFORMATION ON SPECTRUM-I ALONG WITH A FREE POSTER REPRODUCTION OF THIS EPISODE

NAME _____
 TITLE _____
 COMPANY _____
 STREET _____
 CITY _____ STATE _____ ZIP _____

DA CH

IF FAST CHANGING ARE SLOWING YOUR YOU REALLY NEED



FACTS PRODUCTIVITY, RESULTS.

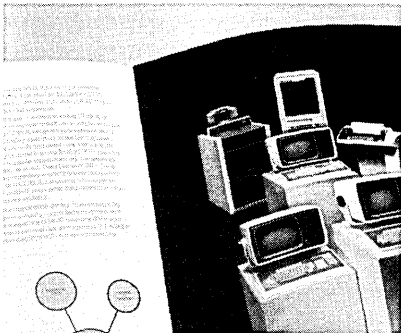

**THE NEXT STEP IN DATA BASE
MANAGEMENT IS HERE.**

And to help you get them, Data General announces DG/DBMS, a brand new, results-oriented database management system for ECLIPSE® distributed data processing systems.

DG/DBMS is a sophisticated CODASYL-based DBMS. And it's described in detail in a booklet every productivity-minded data processing manager ought to read. The title? Appropriately enough, it's called "Results."

We designed DG/DBMS to let you change as fast as the facts change. Company expansion and diversification

plans, plus frequent changes in accounting regulations, EEO rules, EPA laws, privacy laws, all dictate the need to respond fast when changes occur.

Our DBMS begins saving you time and money right in the computer room. DG/DBMS is designed for ease-of-use so programmers can be more productive. One user, in fact, reported productivity gains of twenty-five percent. Beyond the computer room, our DG/DBMS interactive query facility provides fast data inquiry and report generation in user departments. That's why our DBMS is more cost-effective, reliable, and more manageable than any other. Put it together with our new XODIAC™ Network Management System, our new AZ-TEXT™ word processing, our RCX70 emulation software, and all our other fully compatible AOS-based ECLIPSE software tools and processors, and sophisticated languages. You'll have all the data processing power and growth you'll need to take care of business through the 1980's and beyond.

Find out about our new DG/DBMS and ECLIPSE Data Systems. Send for our brochure: RESULTS.

Data General Corporation, Westboro,
MA 01580 (617) 366-8911
ECLIPSE is a registered trademark
and XODIAC and AZ-TEXT are
trademarks of Data General.
©Data General
Corporation, 1980

CIRCLE 29 ON READER CARD

Data General

Mail to: Data General Corporation, Westboro, MA 01580
 I want Results. Get that booklet in the mail now!
 I demand Results. Get a sales rep in here ASAP!

Name _____
 Title _____
 Company _____
 Address _____
 City _____ State _____ Zip _____

Tel. _____

The Computer
of the
U.S. Olympic Sports
Medicine Committee

D680

IDS's reliable family of Limited Distance Modems...they'll cut your data communications network costs.

Why spend the money for a standard modem, when IDS's Limited Distance Modems can access terminals within a 23 mile radius — for just a fraction of the cost. Check the specifications listed below. You'll find our features and engineering more than outshine competition. Write or call for complete information. The closer you look at our Limited Distance Modems, the more you'll realize that they can lower your local data distribution costs.

Models 6000-L & 6000-H. Access terminals up to 23 miles at a fraction of the cost of standard modems.

Synchronous multi-speed switch selectable for 2400, 4800 and 9600 bps. (Model 6000-H operates at 4800, 9600 and 19,200 bps.) Operates in point-to-point, multidrop, 4-wire full-duplex or 2 wire half-duplex networks. Built-in power supply. Built-in analog loopback feature for local testing. Built-in test pattern for self or remote test. Transmitter and receiver lines are transformer coupled — no D.C. line continuity required. Transmitted signal conforms to AT&T 43401 specs.

Model 6200. Up to 19,200 bps, asynchronous. Up to 20 miles on 19 gauge wire. 2 or 4 wire twisted pair networks. Point-to-point or multidrop. Analog loopback switch for easy testing. Interface: EIA RS-232, CCITT V.24 standard. TTY Current Loop optional.

Model 6210. Up to 9600 bps asynchronous over TELCO or private lines. Up to 18 miles on 19 gauge wire. 2 or 4 wire twisted pair networks. Point-to-point or multidrop. Meets AT&T 43401 specs. Analog loopback switch for easy testing. Interface: EIA RS-232, CCITT V.24 standard. TTY Current Loop optional.

 **INTERNATIONAL DATA SCIENCES, INC.**
7 Wellington Rd., Lincoln, RI 02865
Tel. 401-333-6200 TWX 710-384-1911
Export: EMEC, Box 1285, Hallandale, FLA. 33009
Telex 51-43-32



CIRCLE 30 ON READER CARD

FLOPPY MULTIPLE CHOICE.

OUR FLOPPY COPYTM CAN:

- TEST FLOPPY DRIVES
- COPY FLOPPIES
- INITIALIZE FLOPPIES
- FORMAT
- DO INCOMING INSPECTIONS
- ADAPT TO SPECIAL INTERFACES
- SUPPORT FIELD SERVICES

If you selected any of the above (you could have chosen them all), you're probably one of the hundreds of users who've already discovered our systems. Let us show you all the ways our systems can manage your floppies.

We handle full size or minis—drives or diskettes. Single or double sided. Standard or non-standard. Hard or soft sectoring. Even an automatic stacker loader.

Use either our 400 or 450 system for drive, media, or service testing; for initializing and copying diskettes; for distributing software updates; or for production testing and engineering development.



However you use our systems, you can count on reliability. Applied Data Communications has been supplying the computer industry for nearly a decade, and that translates into service you can trust—every time.

Sales and service nationwide.

Applied Data Communications,
14272 Chambers Road, Tustin, CA 92680.

(714) 731-9000.

Eastern Regional Office:

Applied Data Communications,
50 Mall Road, Suite 209, Burlington,
MA 01803. (617) 273-4844.

ADC APPLIED DATA
COMMUNICATIONS

It's As Simple As ADC.

CIRCLE 31 ON READER CARD

PROFIT PICTURES

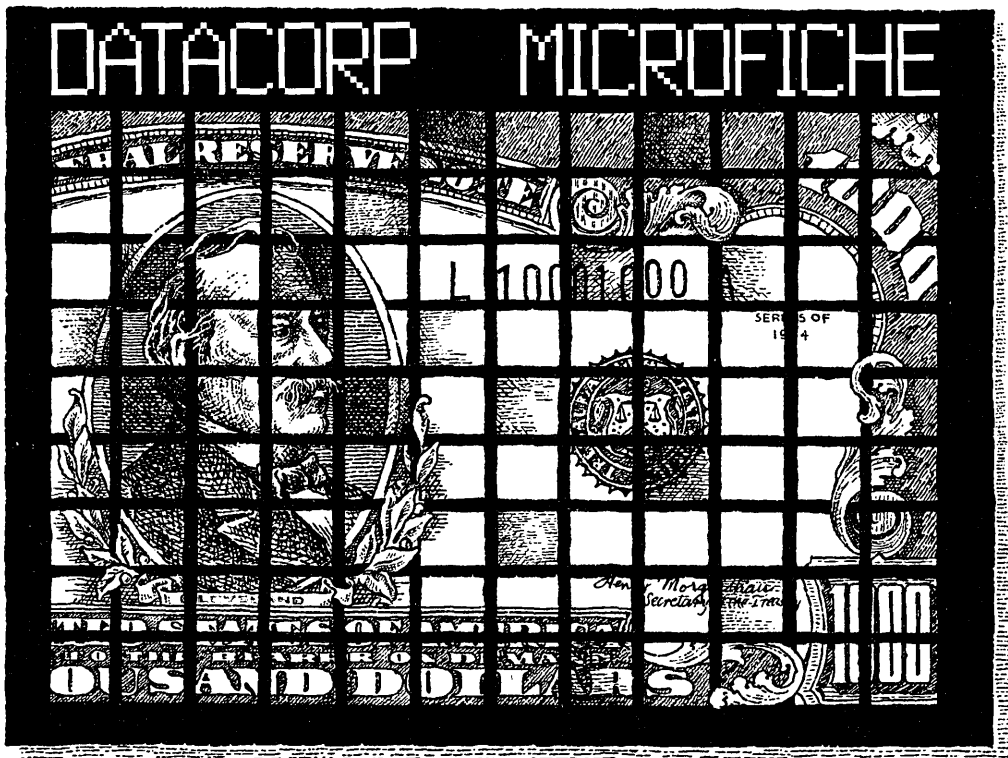

Ericsson

Datacorp's total COM service saves you paper money

The dollars you're spending for paper printout reports are eating away at your profit margins and your productivity. In today's business climate, you need timely information at the lowest possible cost.

The solution? COM, Computer Output Microfilm, from Datacorp. We're the nation's leading COM service organization, last year producing 12 billion pages of computer data on microfilm in 41 service centers across the country. Over 2,000 customers depend on us for reliable, high quality service, fast turnaround and competitive prices.

In addition to COM service, Datacorp is a major supplier of in-house COM systems. We offer complete solutions—from site analysis through installation and ongoing system support.

Whether you use Datacorp service, or produce your own COM, you can take advantage of our volume purchasing power to save on COM equipment and

supplies as well. Readers, duplicators, film, chemistry and more, all at highly competitive prices.

Consider the facts in dollars and you'll see COM makes sense for you. Compared to paper printout, COM offers savings of 50-80%. Paper costs are eliminated. Decollating and binding costs disappear. You can duplicate, mail and store data less expensively. With COM, information retrieval is easy and fast. Using the 72x format developed by Datacorp, you can store 690 pages of printout on a single 4x6-inch microfiche.

So let Datacorp help your company realize the cost and productivity advantages of COM. Give us a call—together we'll find the COM solution that will save you lots of paper money.

DATACORP

5075 S.W. Griffith Drive • Beaverton, Oregon 97075
(503) 641-7400

MAINFRAME INDUSTRY SURVEY

Despite economic and product cycle uncertainty, the outlook for the mainframe industry appears basically positive, although less so than a year ago.

Neither price increases nor energy crises nor inflation nor recession apparently can stay the yearning for increased systems capacity.

Despite economic and product cycle uncertainties, the outlook for the mainframe industry appears positive, according to the 1980 Mainframe Industry Survey conducted by DATAMATION and G. S. Grumman/Cowen & Co., the Boston-based investment research firm.

Based on responses from 5,773 mainframe users in the U.S., the recently completed survey indicates that software and a melding of dp and office systems functions will be where it's happening in the next few years.

The past year proved to be one of industry cross-currents. This was most apparent in the year-end spate of price increases, which reversed the steady down trend that had been in progress since the last bout with hyperinflation in 1974/75. On balance, last year's pricing actions will result in a net increase in 1980 for the mainframers, and dp budgets will be stepped higher accordingly for hardware, and even more so for software.

Sharply rising deliveries of systems announced in '79, coupled with a strong peripherals add-on business for already installed cpus, should buttress 1980 shipment and net yield prospects. Moreover, the absence of visible excess installed capacity—and, indeed, the perceived future need for additional capacity, especially at the high end—as well as a substantial new applications backlog should help mitigate the potential impact of a recession.

The key question once again will be the sales/lease mix and, for IBM at least, the cost/availability of third party financing could be crucial. The outlook appears favorable for rental and services revenues, on the other hand, helped in part by the price increases. And, a sizable pool is being built for possible future lease-to-purchase conversions.

For the longer term, the market still appears to be price elastic. If inflation persists, however, the trend in prices could well be up rather than down for the foreseeable future. Nevertheless, a favorable progression in system price/performance is expected to continue and could be even more compelling in an inflationary environment.

The shift continues in systems pricing

FIG. 1
YEAR-AHEAD DEMAND OUTLOOK

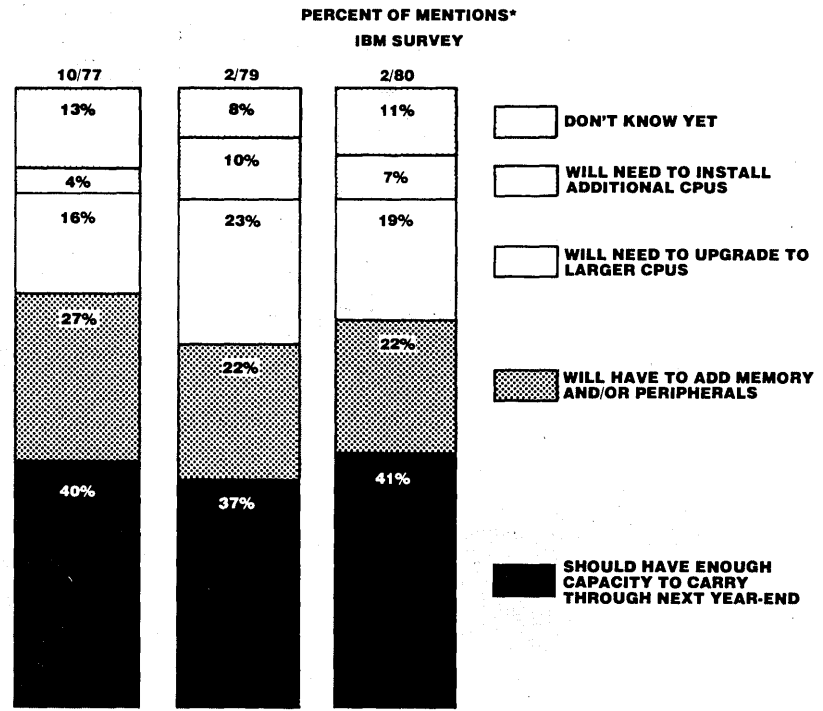

ing mix from hardware to unbundled software and services, with a discernably higher rate of growth shaping up on the non-hardware side of computing. Still, the principal reliance for development of new user applications is expected to stay with short-supply in-house resources, a factor which could constrain industry growth.

Looking at the competitive picture, the survey found that the PCM market incursion has seemingly stabilized in the cpu area, much as it did a few years earlier where peripherals were concerned. This situation allows IBM greater leeway in raising prices and it eases the pressures on the non-PCM suppliers in the process.

Looking at the survey of IBM users, respondents indicated plans to install IBM systems worth roughly \$1.7 billion on an if-sold basis during the next 24 months. This represents a sharp drop-off in planned installation activity, in dollar terms, largely due to a substantial reduction in 303X systems that respondents project will be in-

stalled, versus a year ago.

In terms of units, however, planned installation activity is up somewhat over last year's projections, perhaps due to the lower priced 4300. With the 303X apparently heading for a shipment decline and the 4300 on a steep up-ramp, the survey suggests relatively flat gross system shipments for IBM in 1980. Nonetheless, IBM is expected to experience a good aggregate net installation increase, with a lift coming largely from peripherals.

Respondents indicated plans to add significantly to already installed IBM systems during 1980/81. Users anticipate needing 11,300 disk drives, a 28% increase on an average-per-site basis over 1979, with IBM enjoying a modestly improved share; 2,500 tape drives, down somewhat from the previous year; more than 67,000 terminals, a 29% jump over last year's expected needs, with IBM receiving an expanded share in that market activity; and nearly 650 MB of memory, a 23% jump over last year's

FOCUS

projections, of which IBM will recoup its majority share position due to its aggressive 1979 pricing actions and shorter delivery lead times.

Considering that IBM has both raised and lowered hardware and software prices during the past year, users were asked what the aggregate pricing effect would be in 1980. Of those surveyed, 43% expect to experience a price increase, 11% expect a decrease, and 46% expect no aggregate effect at all. Of those expecting a price increase, 12% anticipate adding to their installed systems sooner than previously planned; of those expecting a decrease, 23% plan to add now rather than later, as will 6% of those expecting no change in their overall budget. Compared to respondents' previous 1980 budget expectations, 39% expect to spend more, 12% expect to spend less, and 49% expect to stay at the same level.

Asked how they expected to be set for systems capacity at year-end 1980, 11% of IBM users replied they did not yet know,

Respondents indicated plans to add significantly to already installed IBM systems during 1980/81.

7% said they would need to install additional cpus, 19% will upgrade to larger cpus, 22% will add memory and/or peripherals, and 41% said they can hang on with what they've got until next year. Looking at the General Systems Div. users only, 15% said they were unsure, 3% expect to need additional cpus, 16% expect to upgrade, 24% will need to add memory and/or peripherals, and 42% expect no change.

Consistent with last year's survey was the relatively small downward migration evidenced in plan-to-install responses, with few 4341s scheduled to replace installed 3031s. Also in line with 1979's survey, 4341s account for nearly 60% of the expected 4300 unit shipments and more than 70% of the dollar value. The migration patterns additionally indicate generally favorable net yield trends for IBM.

With the 303X apparently headed for a shipment decline, even the expected rise in 4300 installation activity will not be enough to prevent the industry leader from an overall activity drop compared to 1979. Strong net yields from peripherals will be one revenue boost. Since 4300s as well as 8100s and System/38s will be much more heavily leased than purchased, and with 4300 shipments exceeding 303X shipments in dollar terms, this should lead to a strong improvement in rental revenue growth.

The overall sales/lease mix, however, seems likely to move lower unless high-end system introductions, such as the H Series, are soon forthcoming. With a majority of indicated 303X purchases actually third-party leases from a user stand-

FIG. 2
PERCENTAGE RATING VENDOR'S PRODUCTS/SERVICES SUPERIOR TO IBM'S

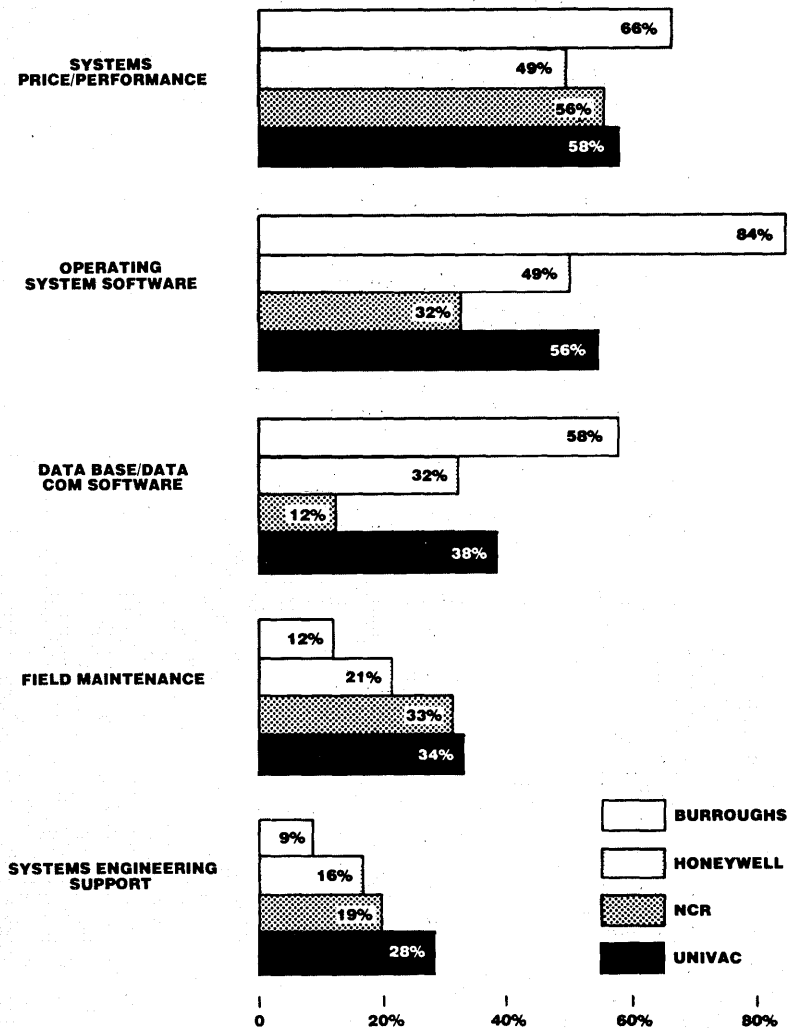

point, the willingness and ability of third-party lessors to continue business in the dire straits of an adverse money market is among IBM's key questions for 1980.

The same dilemma may affect Burroughs. Its users showed a modest downshift in total purchase business from a year ago. At the same time, Burroughs experienced a 5% increase in leases from the manufacturer itself and a corresponding 5% decline in leases from third parties. Burroughs' large lease pool remains a stabilizing force for its business, but as users upgrade from a leased cpu to a new leased cpu, the rising incidence of sideways of adverse netting provides a source of long-term concern. The recent upturn in pricing may offset these pressures. In addition, some of the slack in rental growth is being alleviated by expanding revenues from separately priced software.

The survey showed continued

strong demand for Burroughs products, with planned installation activity ahead of a robust 1979. In part, this reflects the attraction of aggressively priced machines, particularly at the high end.

Respondents' planned installation activity over the next 24 months will be up both in unit and in dollar terms. The B68-6900s to be installed in that time period will equal half of the B67-6800s currently in place at respondent sites. And B7800s to be installed will equal 78% of B77-7800s in place. Such plans indicate a spurt in large systems shipments, augmented by a migration of the remaining 700 series base. Users indicated plans to upgrade 26% of their B6700s and 24% of their B6800s and replace 26% of their B7700s with B7800s.

Burroughs' major problem appears to be its poor image on maintenance and system engineering. So far, however, this potential Achilles' heel is not being evi-

DOUBLE OR DOUBLE DOU

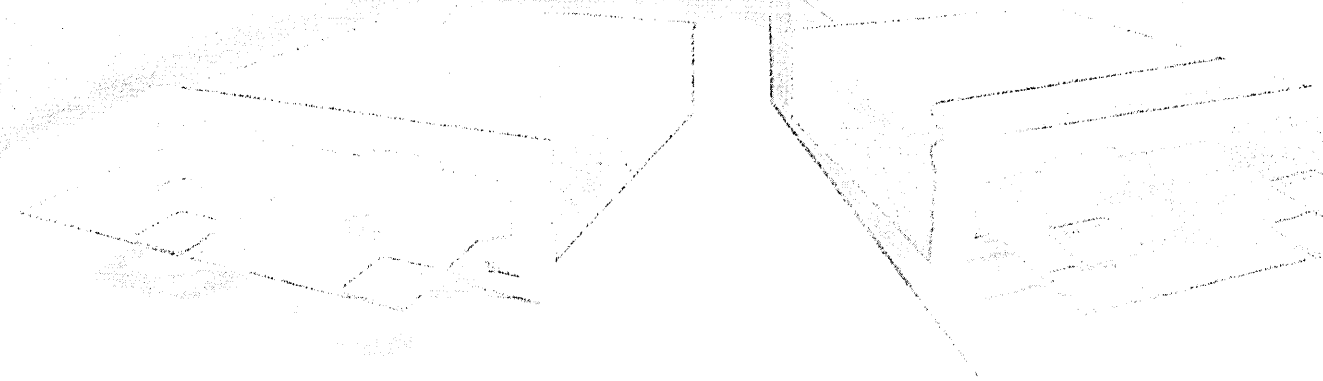

DOUBLE	DOUBLE DOU
<ul style="list-style-type: none"> • SINGLE-SIDE DISK SYSTEMS • LARGE CAPACITY DISK SYSTEMS • HIGH-RELIABILITY, ON-LINE DISK SYSTEMS 	<ul style="list-style-type: none"> • DOUBLE-SIDE, HIGH-DENSITY • LARGE CAPACITY DISK SYSTEMS • HIGH-RELIABILITY, ON-LINE SYSTEMS • COMPLETELY AUTOMATIC DISK REPAIRS • COMPLETELY AUTOMATIC REPAIRS • COMPLETELY AUTOMATIC REPAIRS
<ul style="list-style-type: none"> • High performance • Full maintenance • Excellent reliability 	<ul style="list-style-type: none"> • High performance • High performance • Superior service

ASK US ABOUT OTHER DSD SOLUTIONS FOR YOUR DISK STORAGE NEEDS.

Advanced technology and innovative engineering deliver DEC-compatible flexible disk systems with added capabilities and superior performance. When you need increased storage capacity and proven reliability for your DEC computer, look to the leader, look to THE INDUSTRY STANDARD — DATA SYSTEMS DESIGN.

Please call me Please send me more information.
 My system is: PDP-8 LSI-11 PDP-11-03, LSI-11/23 PDP-11

Name _____ Title _____ Dept. _____
 Address _____ City _____ State _____ Zip _____
 Telephone _____

DATA SYSTEMS DESIGN, Inc.
 3130 Coronado Drive
 Santa Clara, CA 95051
 (408) 727-9353
 FAX 910-338-0240

Eastern Regional Sales
 51 Morgan Drive
 Norwood, MA 02062
 (617) 769-7420
 FAX 710-338-0410

FOCUS

denced by customer defection. When asked about the primary course for future system expansion, most existing Burroughs users indicated plans to grow within the current family of systems. While there was relatively little evidence of customers planning to switch vendors within any Burroughs product family, the highest committed customer defection was seen at B1700 (9% of surveyed sites), B25-4700 (10%), and B4800 (7%) user sites. Not one B67-7800 user expressed plans to switch vendors, nor was there a single instance of vendor switching among those planning to install 900 series gear. While respondents' plans to install the 900 series is reminiscent of the cautious initial reaction to the 800 series, 13% of respondents said they intend to have 900 series gear on site by the end of 1981.

The survey showed that users do seem satisfied that Burroughs is keeping pace on the key parameters of systems price/performance, operating system software, ad data base/data communications software. And the survey left no doubt that Burroughs customers consider themselves in the forefront with respect to the use of advanced functionality.

The survey showed continued strong demand for Burroughs products, with planned installation activity ahead of a robust 1979.

As for NCR, the V-8500M, introduced in response to IBM's 4300, appears to be progressing well and could be a major factor for the improved, healthier outlook for the company than was recorded last year. However, the absence of any user plans to install 8600-class systems raises some question about the prospective success of NCR's high-end thrust, at least in the U.S. (It is important to note that NCR's computer systems business is much larger outside the U.S. than domestically.)

NCR's outlook would be considerably brighter were it not for the problems with systems engineering support, which 42% of the respondents rated inferior to IBM, and sales personnel, which 36% rated inferior. Those low marks held NCR to a 2% jump in overall product/service rating over last year, which was interpreted as a positive indicator.

Another positive indicator was the average price of systems to be installed, which at \$8,300 was more than 20% higher than the \$6,800 average of 1979 and 15% greater than the average for systems already installed. Respondents' planned installation activity was up three percentage points in dollars and down one percentage point in units, reflecting a shift in the mix of to-be-installed systems to the higher average priced 8500M series machines.

There was also a sharp shift in the

FIG. 3

GROWTH OF UNBUNDLED SOFTWARE REVENUES

PERCENTAGE OF ANNUAL DP BUDGET CURRENTLY SPENT ON UNBUNDLED SOFTWARE FROM IBM AND OTHER OUTSIDE SOFTWARE PACKAGES

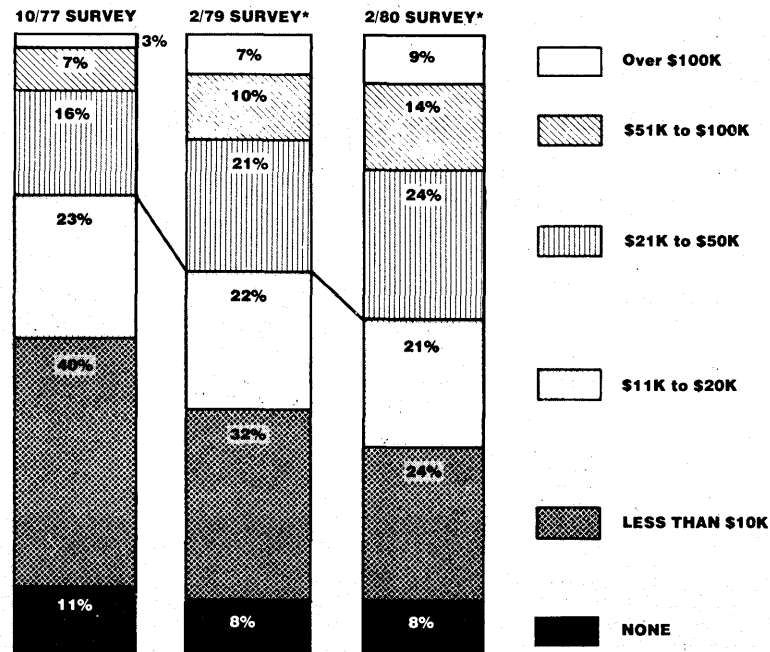

*EXCLUDES SYSTEMS 3, 32 AND 34, WHICH HAD NOT BEEN INCLUDED IN 77/78 SURVEY SAMPLE

FIG. 4

NEW APPLICATIONS BACKLOG IBM USER SURVEY

MONTHS REQUIRED TO IMPLEMENT ALL CURRENTLY PLANNED APPLICATIONS

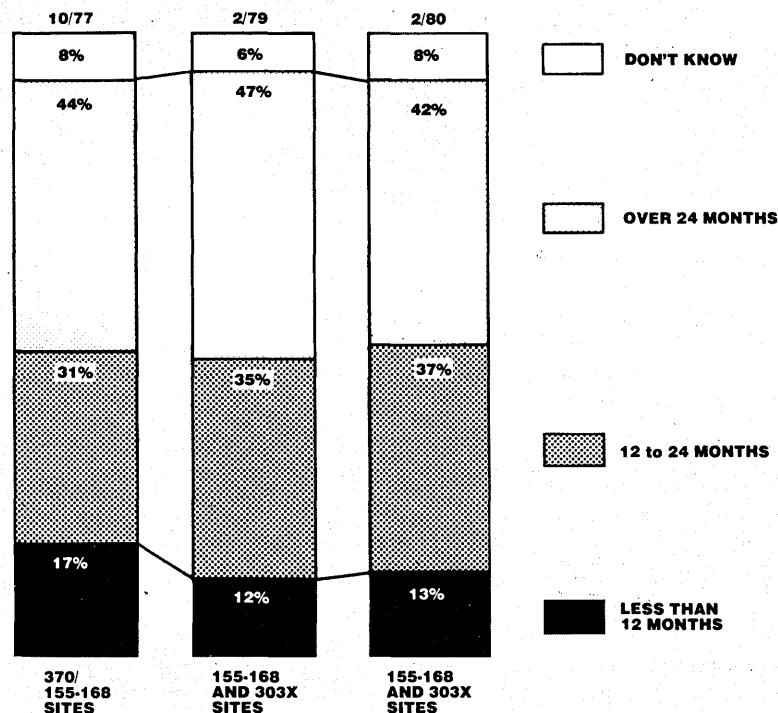

370/
155-168
SITES

155-168
AND 303X
SITES

155-168
AND 303X
SITES

A Timeplex Report on Statistical Multiplexing

TRUTH NO.

1

FLEXIBLE PROGRAMMING MEANS FLEXIBLE NETWORKS

What Is Flexible Programming?

TIMEPLEX' Flexible Programming System permits each SERIES II MICROPLEXER™* data channel to be individually configured to interface with virtually any type of terminal for maximum network efficiency. Up to 14 parameters may be individually programmed for each asynchronous data channel, including speed, code, parity, buffer priority, fixed/adaptive speed, traffic control, and many others.

Is It Important, And Why?

Yes! Data Networks are evolutionary, and like it or not, no matter how well you plan, requirements change. Flexible Programming allows your network to support an unrestricted variety and intermix of terminals — including those that haven't been invented yet.

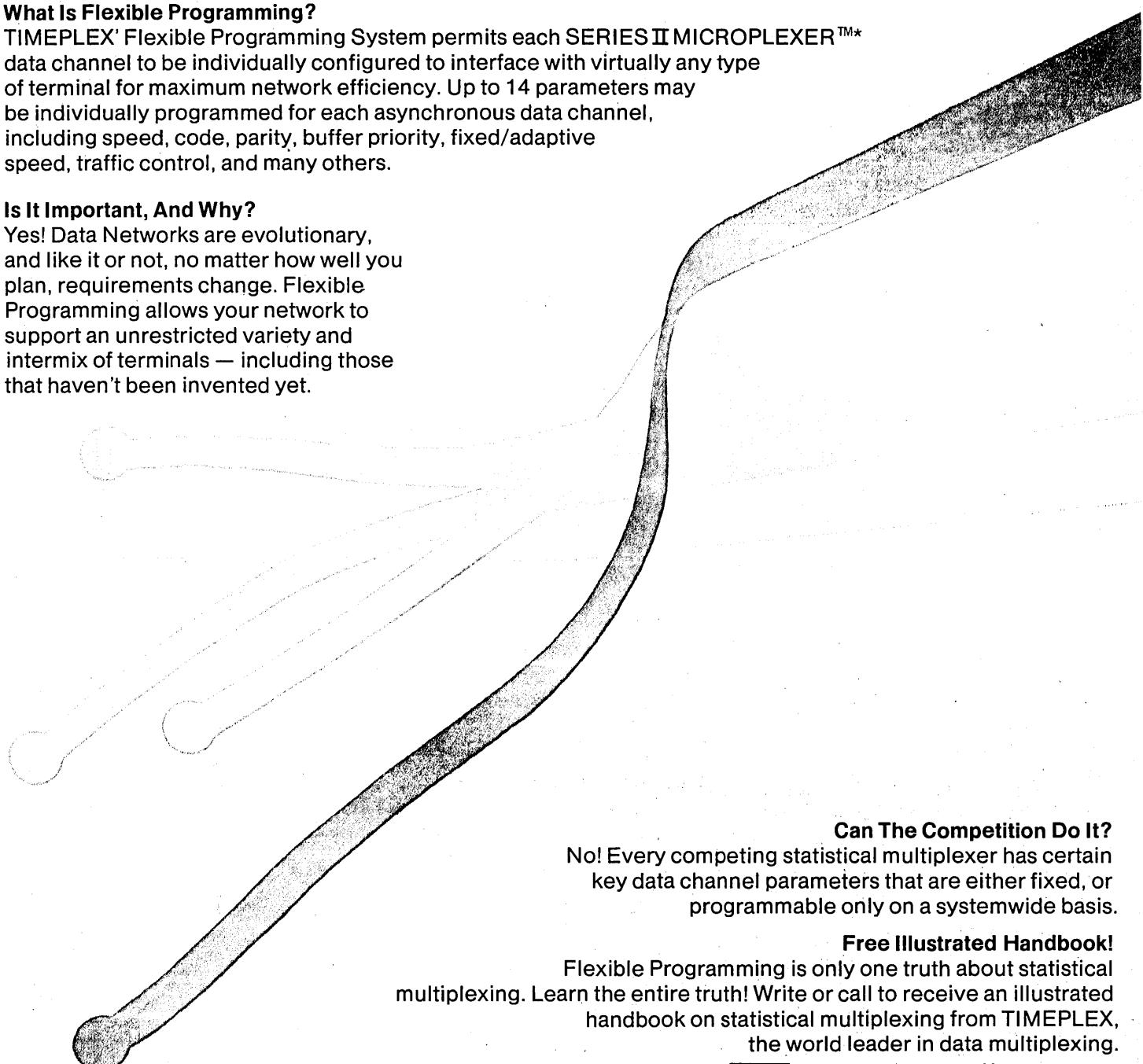

Can The Competition Do It?

No! Every competing statistical multiplexer has certain key data channel parameters that are either fixed, or programmable only on a systemwide basis.

Free Illustrated Handbook!

Flexible Programming is only one truth about statistical multiplexing. Learn the entire truth! Write or call to receive an illustrated handbook on statistical multiplexing from TIMEPLEX, the world leader in data multiplexing.

Timeplex®

Timeplex, Inc./One Communications Plaza/Rochelle Park, N J 07662
(201) 368-1113 TWX: 710-990-5483

CIRCLE 34 ON READER CARD

*PAT. PEND.

Introducing the Identification Network.



Data Collection, pure and simple.

From the moment your employees entered the front gate until they left for home, they've always been on their own.

And no matter how dependable they were it's been almost impossible to hold them accountable for their actions and their whereabouts.

Accounting for the heretofore unaccountable.

The Identification Network from Rusco Electronics gives you accountability for people and facilities that you never thought possible. It monitors and reports employee whereabouts and actions. And gives you an accurate, immediate record of who, what, where, and when.

Now basic data entry is available anywhere. For instance, you can control the locking and unlocking of doors on a pre-programmed time schedule.

Parking lot entrances and exits can be tied into the Identification Network. So you can always find out if an employee is on the premises.

You can account for the use of the copying machine and know how

many copies each employee makes.

You can create an electronic time and attendance log of your employees ins-and-outs for automatic payroll processing.

You can even restrict after hours elevator use. For certain key people and certain floors.

Those are just a few examples.

How the Identification Network works.

Each of your employees gets an Identification Network EntryCard™ with a personalized code. Each room or piece of equipment that requires accountability has a single, compact CARDENTRY™ reader.

You simply tell the Identification Network which employees are allowed into each room and which employees are authorized to use each piece of equipment.

If someone attempts to enter a room or use a piece of equipment that's off limits to them, the door will not open

or the machinery will not work.

And a central printer immediately tells your security people that an attempted unauthorized entry has occurred, where it occurred, and when.

It's that easy to account for (and control) unauthorized access and activities. And that easy to save money.

The most important control of all.

That, of course, is the ability to control losses.

The simple fact is, if you can account for detailed activities in areas where you lose money due to theft and misuse of materials, machinery and information, you can cut those losses dramatically.

That's exactly what the Identification Network does. It saves a lot of money. In a lot of places.

Call or Write: Rusco Electronics Systems, 1840 Victory Blvd., Glendale, CA 91201, 1-800-528-6050, ext. 691. In Arizona, 1-602-955-9714, ext. 691.

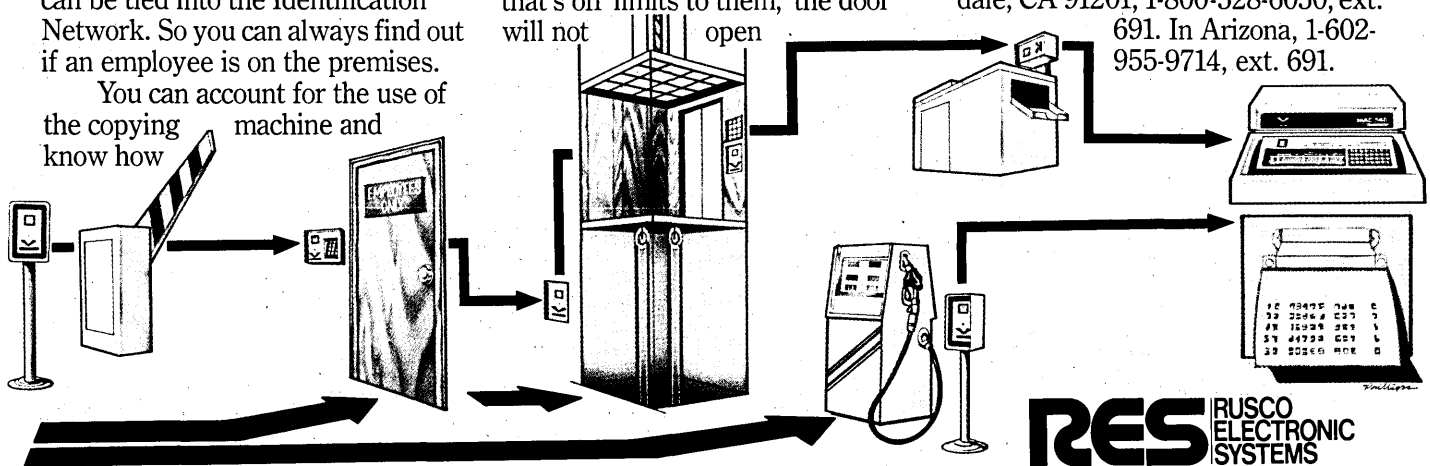

RES RUSCO
ELECTRONIC
SYSTEMS
A DIVISION OF ATO

We give you controlling interest.

CIRCLE 35 ON READER CARD

FIG. 5
**PERCENTAGE OF SOFTWARE
 STAFF RESOURCES ALLOCATED TO
 NEW APPLICATIONS DEVELOPMENT**

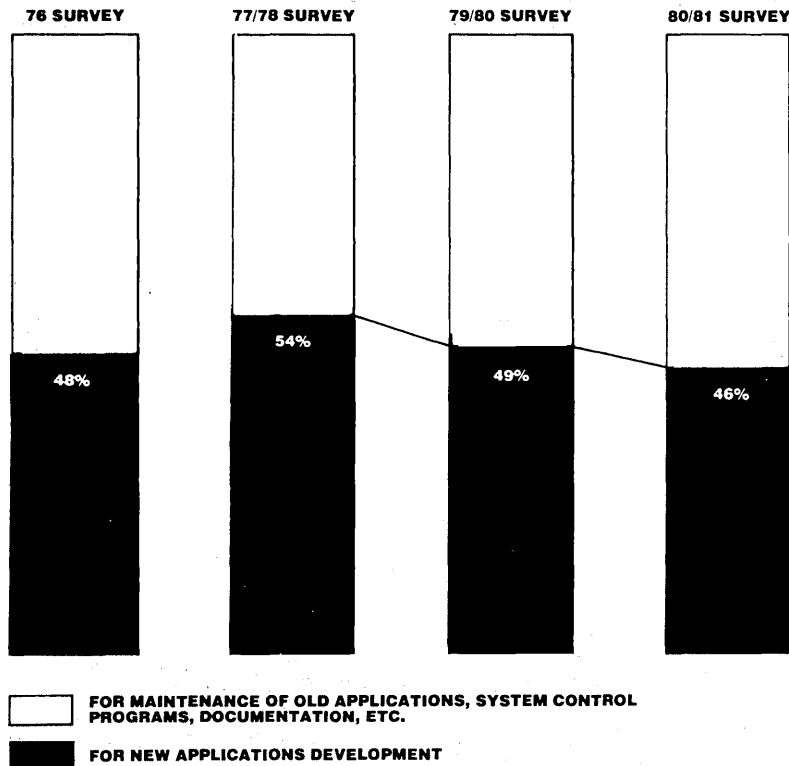
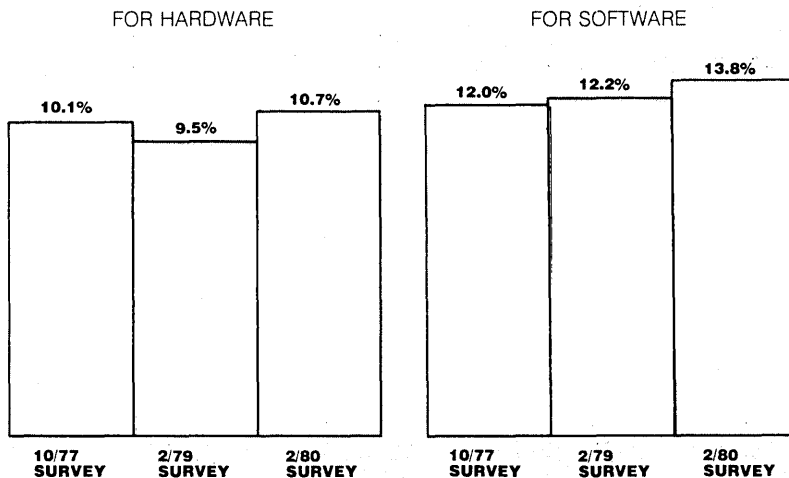

FIG. 6
LONGER-TERM GROWTH IN USER SPENDING

AVERAGE ANNUAL RATE PROJECTED BY RESPONDENTS FOR NEXT THREE TO FIVE YEARS



to-be-installed mix toward long-term lease, based primarily on respondents; fears that product technology was changing so fast that they wanted to maintain the flexibility to change with it. Despite NCR's aggressive pricing actions, which are expected to result in an overall increase in budget spending for 52% of surveyed users, the net yield looks strong on replacement of those systems already on lease. Those users who have already purchased a Century 101-201 machine, however, are less inclined to follow the general migration trend toward the Criterion/8000 series than those who are leasing or renting. Of those not planning to install Criterion, 26% cited dissatisfaction with NCR as their supplier, a four percentage point increase in that category over 1979.

Honeywell's hopes for the future are largely pinned on prospects for the DPS 8. Bolstered by a good initial takeoff for DPS 8 high-end products, respondents installation plans are tangibly ahead of those indicated one year ago. As a percentage of the installed base, mainframe installation activity over the next 24 months (excluding Level 6)

Honeywell's hopes for the future are largely pinned on prospects for the DPS 8, and HIS is under the gun to deliver as promised.

should be up four percentage points in dollars, while installation activity in units should be down one percentage point from a year ago.

But HIS is under the gun to deliver as promised. Users indicated a willingness to shuffle expansion plans to get an early crack at DPS hardware. Thus Honeywell's ability to ramp up production of these new systems is the major key to 1980 shipment trends. Assuming DPS 8 deliveries materialize as expected, HIS shipment and revenue picture, on balance, should be in pretty good shape for 1980, despite the distinct shift from third-party leasing.

Among those users who have set their long-range expansion plans, Honeywell must confront customer defection ranging from 11% of those replacing the L64 to 31% of those replacing the small H200/2000. This potential loss may be softened, however, by very extensive minicomputer add-on activity, particularly among high end systems users. Honeywell had a far higher percentage in this area than any other vendor.

Long-range prospective demand is equally encouraging in the add-on market for memory and peripherals, as 30% of Honeywell users surveyed said they would have to boost those requirements by year-end. Users' expressed cpu capacity requirements for the post 1981 period bode well for DPS 8 demand in 1981 as well.

Longer term returns in the computer

FOCUS

business remain sub-par, although the picture is much better than a couple years ago. Until returns improve, HIS has limited tools with which to cushion adverse developments and/or truly stimulate growth.

The forecast for Univac is that the add-on business will boom and the cpu business will just hang on. Univac's add-on business is second only to IBM's, with substantial installation increases indicated in disks, terminals, and add-on memory.

As for cpus, however, the survey indicated that there was not much user enthusiasm among Series 90 users for converting to Univac's mainstay 1100 series. Only 11% of 90/30 users and 6% of 90/60 users indicated a desire to switch to the 1100 for their future systems growth. More significantly, not one 90/80 user indicated definite plans to convert. However, with 39% of

The forecast for Univac is that add-on business will boom and cpu business will just hang on.

90/30 users and 28% of 90/60 users still undecided about expansion plans, those now uncommitted customers could prove to be a source of new 1100 series users. The survey suggested that most 90/80 users apparently feel trapped, and 18% of those responding indicated a long-term plan to install non-Univac equipment.

Thus, planned installation activity was down markedly over the 1979 survey—20 percentage points in dollars and one percentage point in units. The decline was partially due to shorter lead times, with 78% of 1100s to be installed scheduled for delivery in 1980, whereas in the 1979 survey 44% of expected installations spilled over beyond the ensuing 12 months. But Univac's very large foreign business is probably in a position to take up much of the slack in shipments if it occurs in the next 12 to 18 months.

With cpu shipments down from a year ago, the respondents' sharply increased add-on peripherals plans should provide a good buffer. Finance leases and cash sales continue to account for almost all of Univac's mainframe-related revenues. Ultimately, however, the accelerating industry product cycle, particularly at the high end, precludes major benefits from finance lease residuals and casts doubt on the profitability of the company's finance lease strategy. Another long-term problem is the melding of product lines, made extremely difficult by Series 90 users' lack of enthusiasm for the 1100.

The greatest detriment appears to be Univac's sub-par profitability ratios. With purchase content already very high, it is difficult to visualize the avenues for much improvement in margins and return on assets.

Some additional survey findings are shown in the accompanying graphs.

—Willie Schatz

FIG. 7
IBM LEAD AMONG RESPONDENTS AS WORD PROCESSING SYSTEMS SUPPLIER

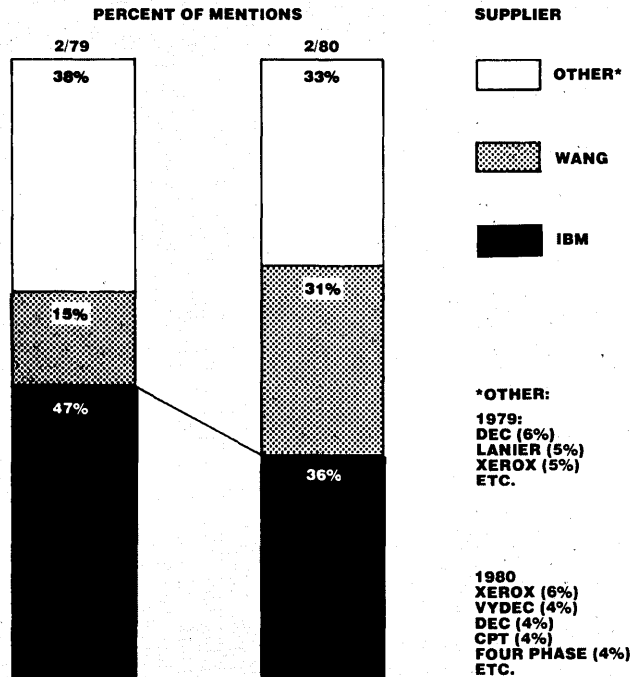
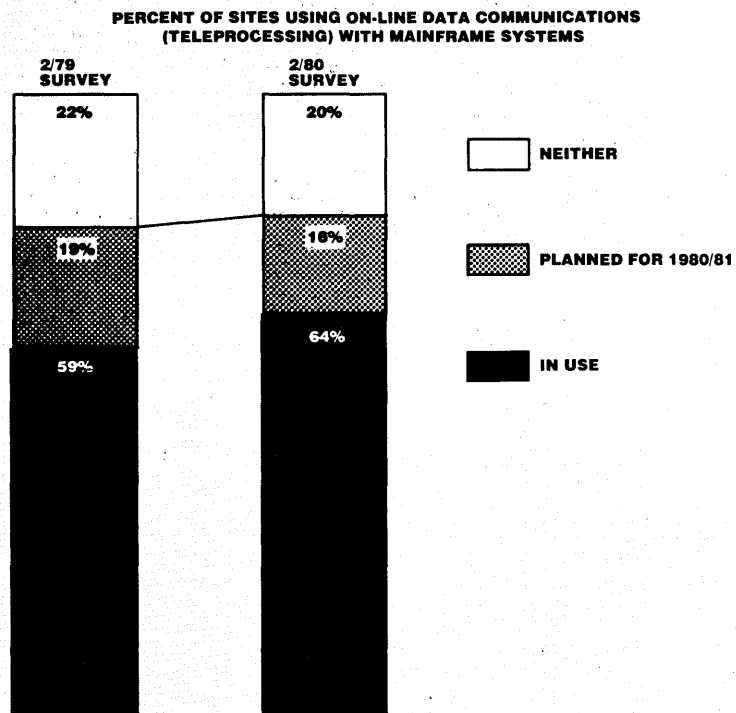
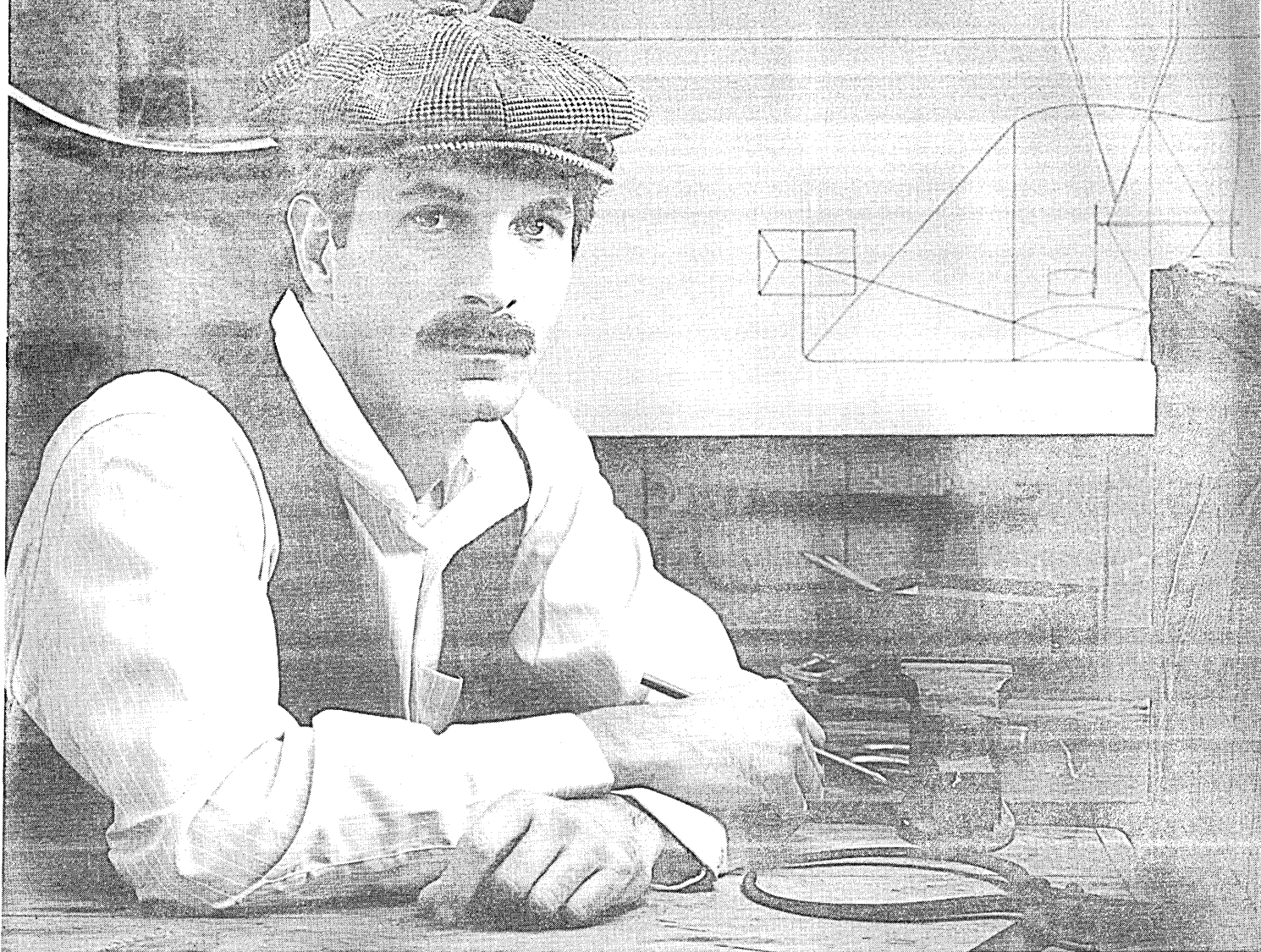

FIG. 8
GROWTH IN DATA COMMUNICATIONS USAGE



If you were Wilbur Wright, we'd be your brother Orville.



They were more than just brothers. They were a team.

On the ground or in the air, Wilbur knew Orville would always be there when he needed him.

Which is just how a lot of people feel about us.

They count on Avanti to always come up with newer and better solutions to their local data distribution problems. To keep expanding our family of telephone line modems to meet their changing needs.

Avanti's new 9600 is a prime example. It's the kind of high speed medium distance modem you need today. With room for a lot of the options you'll want tomorrow. And a list of features no modem's ever had before. Like:

- Microprocessor-based and all digital filter-

- ing for flawless operation in any environment
- Compatibility with CCITT/V.29 long haul modems
- An Intelligent Equalizer™ that entirely eliminates manual line adjustments
- Hinged front panel for easy access to option switches, board replacement and maintenance
- Optional voice or data communication

Surprisingly, you can own any of Avanti's phone line modems for about half the cost of a conventional modem. For complete details on the Avanti 9600, or the equally remarkable 4800 model, write or call Avanti Communications Corp.



Avanti Communications Corp., Aquidneck Industrial Park
Newport, RI 02840, Tel: (401) 849-4660, TWX: (710) 387-6543

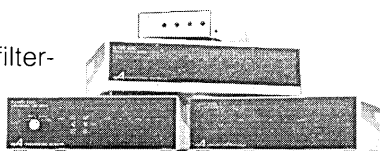

We're always here when you need us.

CIRCLE 36 ON READER CARD

NEW!

Another TEC First

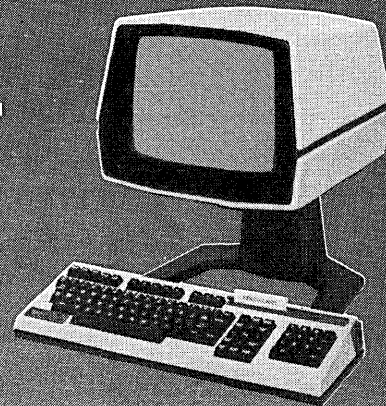

Model 70C Microprocessor Based CRT

Card Reader CRT Terminal

- Magnetic stripe card reader keyboard.
- Reads cards encoded to the international air transport association (IATA) standard.
- Up to 76 alpha/numeric characters may be recorded on one card.
- ASCII data is read from the card and sent to the CPU, and is stored in the terminal's memory but not displayed to provide security.
- Offers ability to control access to computer and data files by requiring each operator to have a card, possibly containing a user identification number and security level code.
- Read error light signals operator to reread card in the event of a card misread.
- Applications include credit card sales transactions, airline ticketing, security.

CREDIT CARD

← SLIDE IN

CREDIT CARD

MAGNETIC STRIP

**Distributor
Inquiries
Welcomed**



TEC, Incorporated

2727 N. FAIRVIEW AVE., TUCSON, ARIZONA USA 85705 (602) 792-2230 TWX 910-952-1377 TELEX 16-5540

• BOSTON (617) 879-6886
• CHICAGO (312) 655-1060

• DALLAS (214) 436-3416
• LOS ANGELES (714) 541-4137
• MINNEAPOLIS (612) 941-1120

• SAN FRANCISCO (408) 374-2660
• WEST PALM BEACH (305) 684-1604

TEC International, Inc.

EUROPEAN SALES OFFICE: AVENUE LOUISE 148 - BOX 6, BRUSSELS, BELGIUM (02) 649-8154 TLX 846-63553

CIRCLE 37 ON READER CARD



If you're going to copy it, at least do it right.

You see them every day.

Copycat terminals, with flashy features, all claiming to be as good as the renowned Dumb Terminal® video display terminal. Some even claim the same reliability that made the Dumb Terminal a household word.

But none can claim the ADM-3A's field-proven average of 15 months between service calls. Which means you spend less time and money on repairs. That's why the Dumb Terminal has become the industry standard — and why we've sold over 100,000 of them. It makes us feel that our extensive burn-ins and grueling quality control have been worth it.

We didn't load the Dumb Terminal with fancy frills — just dependable features that get the job done. Like a 12" diagonal

screen, full or half duplex at 11 selectable data rates (75-19.2K baud), 1920 characters in 24 rows of 80 letters, RS232C extension port, and direct cursor addressing. Plus a host of sensible options. All for just \$895.

So don't be fooled by Dumb Terminal imitations. Because there's simply no substitute for Dumbness.

Lear Siegler, Inc./Data Products Division, 714 N. Brookhurst Street, Anaheim, CA 92803, 800/854-3805. In California 714/774-1010. TWX: 910-591-1157. Telex: 65-5444. Regional Sales Offices: San Francisco 408/263-0506, Los Angeles 213/454-9941, Chicago 312/279-5250, Houston 713/780-2585, Philadelphia 215/245-1520, New York 212/594-6762, Boston 617/423-1510, Washington, D.C. 301/459-1826, England (04867) 80666.

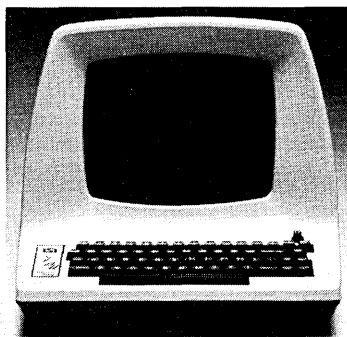

**DUMB TERMINAL.
SMART BUY.**



LEAR SIEGLER, INC.
DATA PRODUCTS DIVISION

CIRCLE 38 ON READER CARD

Another Able card trick which can make your PDP-11 run three times faster.

SCAT/45™ (ADD-IN FASTBUS MEMORY)

Applicable Computers – PDP-11/45, PDP-11/50, and PDP-11/55.

Run and Response Time – Run time reductions up to 67% make possible the same amount of computing functions in 33% of the time required without SCAT/45.

Switch Selectable – Can be used across the 124K word range. Beginning address on any 4096 word boundary gives user up to 124K words of 330 nsec cycle time memory instead of the 32K word limitation of MOS or bipolar memory option if purchased from computer manufacturer.

Expandability – Expands in 32K word increments with each increment requiring one circuit board. Only half the available FASTBUS space required to accommodate a FULL 124K word memory complement.

FASTBUS and PDP are registered trademarks of Digital Equipment Corporation.

1751 LANGLEY AVENUE
IRVINE, CALIFORNIA 92714
(714) 979-7030, TWX 910-595-1729

Teach your computer our latest card trick. You'll get performance you never thought possible at a price which makes SCAT/45 the biggest bargain in the industry, using 1/4 the power and 1/4 the space at 1/4 the cost of the DEC "equivalent" bipolar. That's a pretty good trick! Write for details, and find out why our customers call us the leader among manufacturers of DEC enhancements. Able Computer, 1751 Langley Avenue, Irvine, California 92714. (714) 979-7030. TWX 910-595-1729.

Able, the computer experts

DEC, FASTBUS and PDP are registered trademarks of Digital Equipment Corporation.

CIRCLE 40 ON READER CARD



Abqaiq, Saudi Arabia

No baseball, no morning paper,
no pizza, no autumn leaves.

But here's the great life that makes
Aramco people stay on and on.

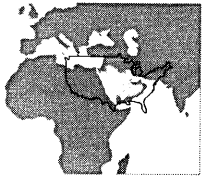

If you never considered working in Saudi Arabia because you think it's all sand and hardships, consider this.

3,900 Americans like you work for Aramco in Saudi Arabia now. Ask them why they stay and they'll tell you that, besides money, it's the casual lifestyle, American-style hometowns, top-notch schools, and vacation travel they used to only daydream about.

Where on earth is Abqaiq?

Located close to the world's largest oil field (Ghawar), Abqaiq is the center of a giant oil-gathering and processing system that handles 60% of all the oil produced by Aramco, the world's largest producer.

Does Aramco's paycheck justify living in a desert kingdom?

Yes! You get a base salary competitive with top U.S. oil firms. We compensate you for overseas cost-of-living differences.

On top of that, Aramco pays an **incentive of up to 40%** for overseas employment, and you are reimbursed for any foreign or U.S. Federal income tax on the premium. So your premium is tax-protected.

Another benefit: employees overseas participate in Aramco's Retirement Income Plan on an **accelerated** basis.

With this financial package, no wonder 3,900 Americans like you work for Aramco in Saudi Arabia today.

What can you do with all that money stuck out in the desert?

Aramco people use 40-day paid vacations



Aramcos vacation in Asia, Africa, the Middle East and Europe

(every 12½ months) and 12 paid holidays (average) to visit fabulous places like the Pyramids, Greek Islands, Mt. Everest, the Serengeti Plain, Hong Kong.

Doesn't a child's education suffer so far away?

No! Aramco has a modern American school system. Teachers are primarily American and more than 75% of them have master's degrees. The teacher-student ratio is 1 to 15 in grades 1 to 6; 1 to 20 in grades 7 to 9.

Where do you go if you get seriously ill, or need dental surgery?

Aramco's Dhahran Health Center is one of three hospital systems outside the

U.S. accredited by the Joint Commission on Accreditation of Hospitals. The Dental Clinic is as fine as any in the States. Better than most.

Aramco recruiting ads mention "comfortable housing." Is that on the level?

At first, you'll live approximately 18 months in adequate but not terribly attractive off-camp temporary housing. Next, it's on to comfortable on-camp temporary housing. Then, based on a housing priority-point system using job level and length of service, you'll get your permanent residence. Many of these are like homes you'd want to live in, in the States.

What jobs are open today? Can a person advance?

Aramco's operations are so big that our job opportunities are probably unduplicated anywhere. Challenging jobs are open in administration, refineries, gas plants, support facilities, everywhere.

We need accountants, medical personnel, technicians, teachers, vocational trainers, communications specialists and materials forecasting specialists. And scores of engineers: in construction, project management, operations and maintenance—for operations in oil, gas, petrochemicals, EDP, computers, transportation, utilities, name it.

You'll have challenges, responsibilities, and management advancement opportunities.

Interested? Send your resume in confidence to: Aramco Services Company, Department DM040080GENA, 1100 Milam Building, Houston, Texas 77002.

CHALLENGE BY CHOICE

ARAMCO
SERVICES COMPANY

CIRCLE 41 ON READER CARD

WHEN YOUR COMPUTER'S DOWN, ARE YOU OUT OF BUSINESS?

You need the Tandem NonStop™ System. It will keep on running right through a failure which would shut down any other system on the market today.

And never lose or duplicate any transaction in process at the time of a failure.

Providing absolutely unsurpassed protection for the data base.

Expanding with all its original software. Even the operating system. Growth with supplements, not replacements. Unusual.

Expandable without penalty from the basic two processor system to a four thousand processor system which blankets the globe.

Transaction oriented, with an extremely low cost-per-transaction. Cost efficient. High throughput. Wherever computer downtime equals irreversable or non-supportable loss. Dollar for dollar, it's the soundest investment you can make for high volume transaction processing.

TANDEM

Tandem Computers, Inc.

Toll Free 800-538-3107 or in California (408) 725-6000

Branch Offices throughout the U.S.A., Canada, U.K. and Europe. Service throughout the world.

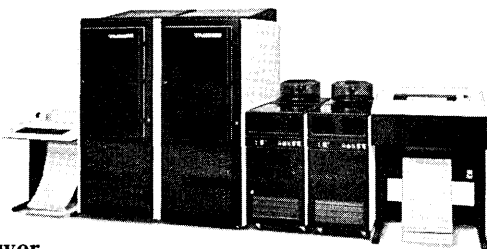

Here's
the answer.

A Tandem NonStop System. From \$150 thousand to \$3 million. Expandable without cost or performance penalties to sixteen processors per system and up to 255 systems per network. Local or global, no system of comparable cost can even approach the performance.

CIRCLE 42 ON READER CARD

Tandem Computers, Inc.
19333 Vallco Parkway, Cupertino, California 95014
Attn: Marketing Communications, Department D-6

- Please send me your introductory brochure on the benefits and applications of NonStop computing.
- Please arrange a demonstration of your unique NonStop capabilities.

My potential application is in _____

Name _____ Title _____

Company _____ Street _____

City/State/Zip _____ Phone _____

INTERACTIVE USER REPORTS

"Cost savings of 70%."

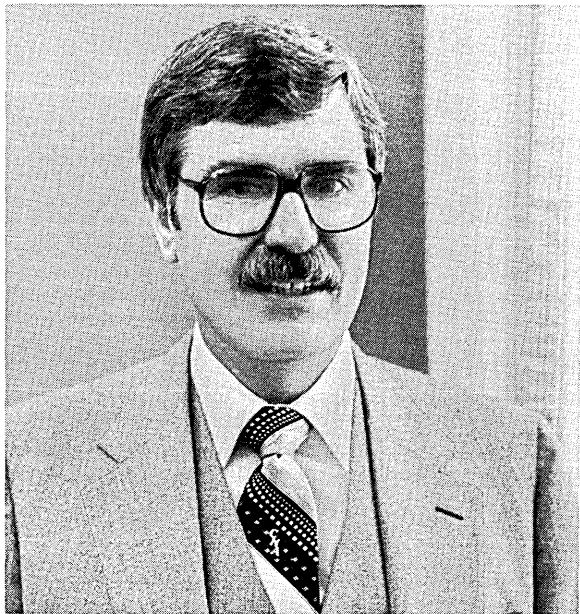

Chuck Anastasi, Manager, Timesharing Services, 3M, St. Paul, Minnesota.

Price/Performance.

"3M is a worldwide company with 47 U.S. operating divisions and subsidiaries.

"We were buying computer time from 15 different service bureaus and spending between \$1.5 million and \$2 million a year. Because of this cost we decided to develop an in-house system and establish our own timesharing service.

"Within 18 months we had installed two DECSYSTEM-2060s and were providing 75% of our U.S. timesharing requirements. Eventually, we'll have over 90% of our work done on the in-house computers.

"Our price/performance ratio is outstanding. The in-house service on the DECSYSTEM-2060s costs 30% of what it would cost to do outside. That's a cost savings of 70%, which is even more than we expected."

Versatility.

"The University of D.C. was created in 1976 as a consolidation of three colleges in the area.

"Initially U.D.C. had a batch system, but since it was already overloaded with administrative work, neither the faculty nor the students could get any computer time. We decided to get another system to share the workload and to improve services to the students and the faculty.

"We wanted a distributed system that could be used on all three campuses, and that meant an interactive DECSYSTEM-2060.

"Now we can use our DECSYSTEM-2060 any time day or night because our uptime is over 98%. Our applications range from word processing for producing proposals to sophisticated graphics, which we use extensively in our Physics, Chemistry, and Engineering departments. And response time is six times faster than with our batch system."

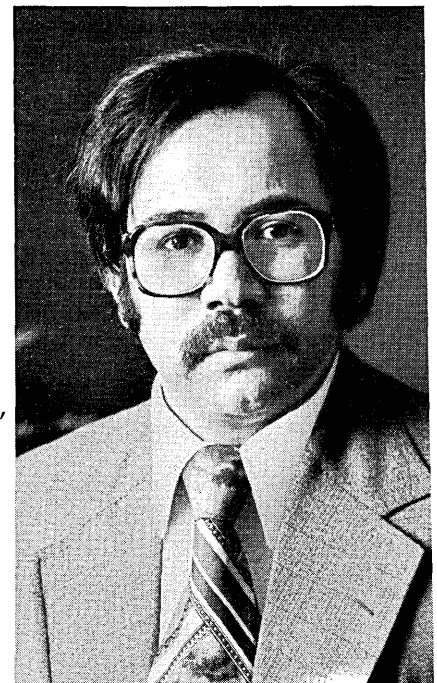

Dr. Daryao S. Khatri, Associate Professor, Physics Dept., University of the District of Columbia, Washington, D.C.

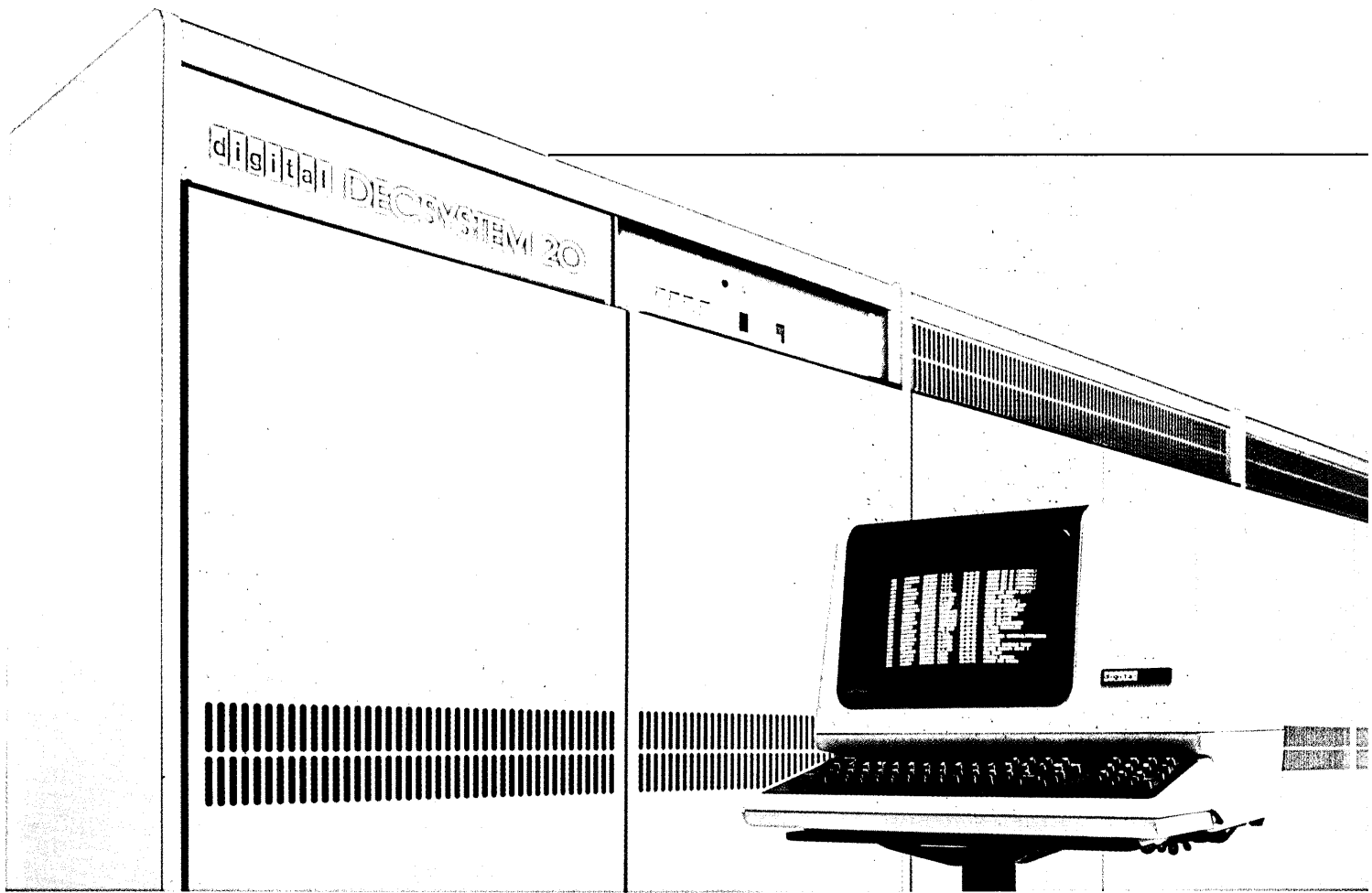

Ease of Use.

"At the Paulsboro Lab of Mobil Research, we do research and development for petroleum refining processes and products.

"Our laboratory was computerized with a network of PDP-8s and PDP-11 s. But to handle the enormous amount of data generated, we decided to add a computer as a database and for data analysis. APL was the language we needed, and

we also wanted a system that was easy enough for everybody to use—scientists, engineers, technicians, and management people.

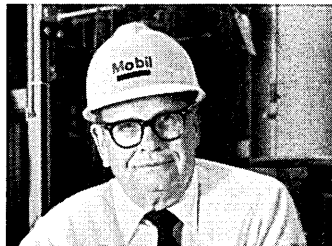

*Dr. Dwight Prater, Sr.
Scientist and Research
Advisor, Mobil Research and
Development Corporation,
Paulsboro, New Jersey.*

"Since most APL -systems on the market had been tested extensively, we knew the best system was APLSF on the DECSYSTEM-2060.

"Now we have up to 45 interactive users at any one time and virtually everybody here can run this system. Even some of the secretaries are trained in APL.

"With the DECSYSTEM-2060 and APLSF, data can be analyzed and processes are developed three to five times faster than before."

DECSYSTEM-2060 The interactive computers for the big system jobs.

- Please send your Interactive User Reports Brochure.
- Please have a sales representative contact me.

Name _____

Title _____

Company _____

Address _____

City _____ State _____

Zip _____ Telephone _____

Send to: *Digital Equipment Corporation,
MR1-1/M55, 200 Forest St., Marlborough,
MA 01752. Tel. 617-481-9511, Ext. 6885.*

A-6-0

digital

A NEW SERIAL PRINTER FROM THE LEADER IN MATRIX TECHNOLOGY

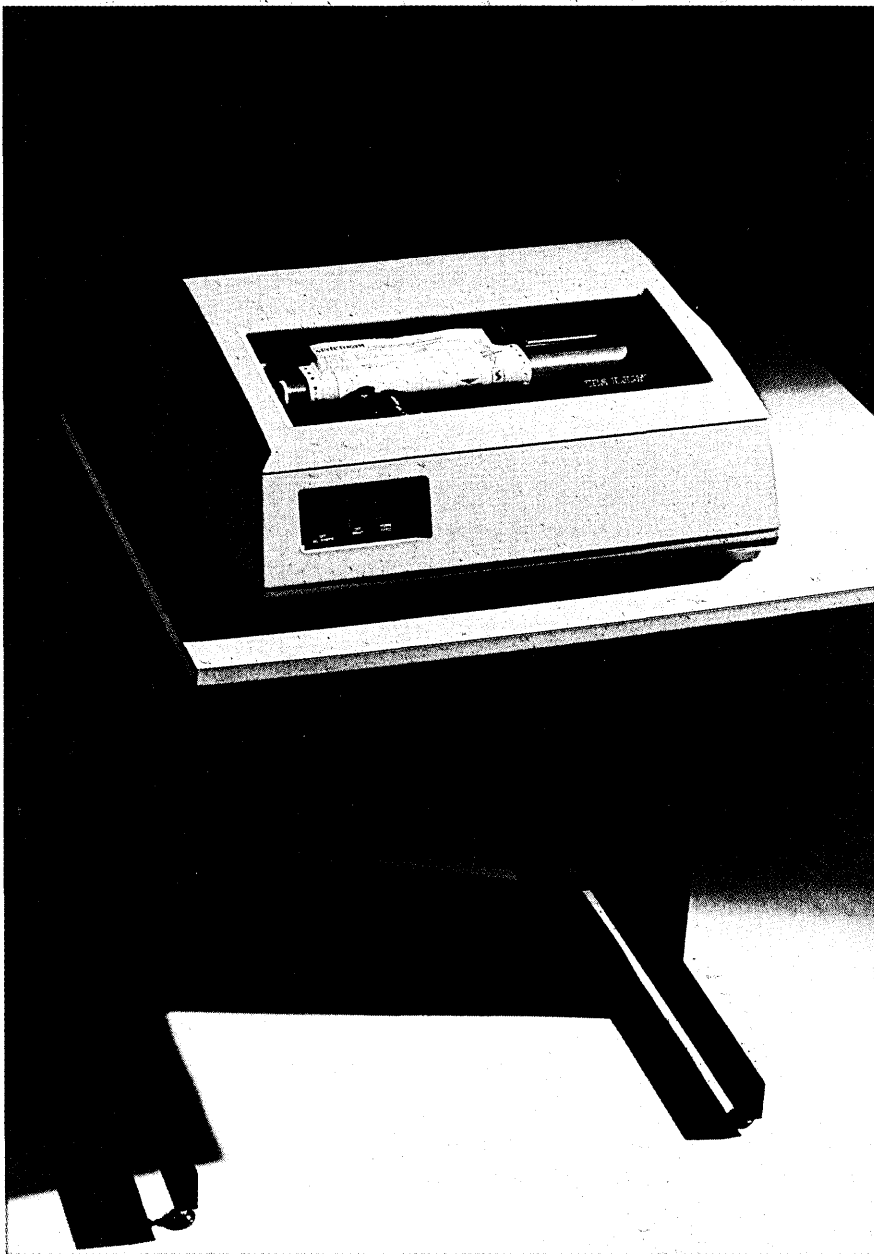

Mannesmann Tally sets the pace in price with the T1705.

From the Tally tradition of quality and reliability comes another dramatic advancement in lowered cost of ownership. A combination of low purchase price, low maintenance costs and low parts usage. A "no options" fully loaded printer that combines the latest in LSI electronics with precision mechanics. You get standard features that are extra cost options on other printers.

OEM's will select it because users will prefer it!

The T1705 is the quietest impact printer on the market. It has 160 cps optimized bi-directional printing with high speed 48 ips head slew for throughput speeds up to 200 lines per minute. Rugged reliability. No preventive maintenance requirements.

Standard features include a new operator changeable precision print head for long life and superb print quality. Dual tractors for positive paper positioning and control. Operator selectable 6 or 8 lpi spacing. Self test. Forms control. A convenient snap-in ribbon cartridge for clean, fast and easy ribbon changing. Double wide character printing. And a buffered serial interface.

A new serial printer. Competitively priced. 30 day delivery. Call your nearest Tally sales representative today.

See us at NCC Anaheim,
Booth #1527



**MANNESMANN
TALLY**

Mannesmann Tally
8301 South 180th Street
Kent, WA 98031. (206) 251-5524.
Telex - 320-200

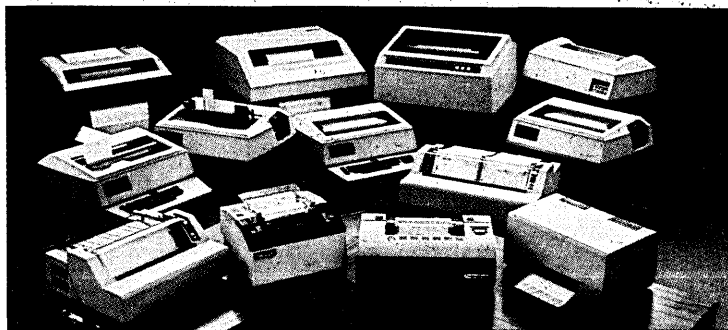

CIRCLE 44 ON READER CARD

LOOK AHEAD

(continued from page 18)

AFIPS HIRES HEADHUNTERS

ation back to British shores. The move, which would severely undermine ICL's U.S. image, would appease U.K. unions and gain the company more preferential funding from the British government.

AFIPS is dead serious about finding a new executive director. The group has hired honcho headhunters Russel Reynolds Associates Inc., the prestigious and high-priced firm that earns its fee (rumored to be at least 30% of salary) for producing what it feels is a qualified body, whether or not its recommended recruit is accepted for the post. RRA men were combing the crowds at NCC last month in search of a likely candidate.

EURONET'S DAYS NUMBERED?

How long will Euronet survive? Not very long, claims one senior British Post Office official who sees the European PTT's packet switching fading away. Its demise stems from the fact that the data base traffic on the once highly touted net has remained national rather than international. To make matters worse, one of the overriding rationales for Euronet now no longer exists -- the PTTs hoped to use the net to interconnect separate national packet nets as they went into operation.

RACE IS ON IN ECON MODELING

Merrill Lynch Econometrics has apparently dumped NCSS service to its huge econometrics model -- one highly regarded on Capitol Hill -- and has brought the gargantuan processing job in-house. Merrill Lynch salesmen are already canvassing the econometric crystal ball market, and the Wall Street firm is set to challenge DRI and Chase Econometrics in the thriving soothsayer business.

IBM HAS MIDEAST VENTURE

The oil-rich Middle East is the site of one of IBM's newest international ventures. This time IBM is setting up an applications research center in Kuwait. Due to start operating by year-end, the center will be run by IBM in conjunction with the Kuwait Institute for Scientific Research.

RUMORS AND RAW RANDOM DATA

Brazil is wooing U.S. semiconductor firms in hopes they'll set up a manufacturing facility on Brazilian soil. But one company, National Semiconductor, has initially nixed these overtures, feeling the market there is still too small... Following recent leaks of confidential information, ICL has created a new and "elite" core of execs. Known internally as the General Salary Survey, the GSS club includes 500 of ICL's key worldwide employees who will be plugged into an "insiders" information grapevine.

NEWS

IN PERSPECTIVE

STRATEGIES

FORGING A NEW ALLIANCE

Interesting alliances are shaping up in the world dp market.

A complex series of institutional investments in France, Italy, and here in the U.S. have recently created a new European consortium of advanced data processing firms. Loosely linked are Italy's Olivetti Corp.; Cii-HB, the French computer firm in which Honeywell has a strong minority position; and St Gobain Point-à-Mousson, France's largest private company.

St Gobain, a cash-rich multinational construction conglomerate, recently purchased a 22% share in the holding company which has the 53% controlling share in Cii-HB. And St Gobain is rumored to be seeking the French government's 20% share in the holding company.

In April, St Gobain also moved into Italy, purchasing one-third of Olivetti—forging a promising link between Olivetti, Europe's leading automated office equipment supplier, and Cii-HB, whose prime interests are in large mainframe computers.

Olivetti meanwhile purchased one-third of IPL Systems Inc., an American company recently chosen by Olivetti to offer the bottom line of PCM systems Olivetti planned to market in Europe. Based in Waltham, Mass., IPL is the plug-compatible mainframe vendor that supplies CDC's Omega.

The announcements of the various agreements, purchases, and investments seemed to come quickly, one upon the other, over the last few months. But there is at the moment little sense of exactly how these firms will interrelate or cooperate, although Olivetti issued an ebullient statement celebrating its new relationship with St Gobain and Cii-HB.

Bruno Bisentini, Olivetti chairman, said the French investment "will enable Olivetti to form an industrial and financial alliance" with St Gobain, which, through its Cii-HB holdings, is "already active in sectors very similar to those in which we operate."

"The operation opens the way for cooperation between Olivetti, Europe's leading company in office equipment and distributed data processing, and Honeywell Bull, Europe's leading company for mainframe data processing," declared Prof. Bisentini. "The object of this cooperation, which would be based on a common strate-

gic viewpoint, will be the specification of joint initiatives in the fields of research, production, and marketing."

As is often the case in European corporate alliances, a shared institutional investor can redefine company relationships and forge the first links of a working partnership. Such, obviously, is Olivetti's understanding of St Gobain's role and plans. (St Gobain executives had previously said that they had an agreement with Cii-HB not to make any outside equity purchases without Cii-HB's approval.)

It is not yet clear what, if any, impact Olivetti's new liaison with Cii-HB would have upon the Italian firm's announced plans to market Hitachi and IPL IBM-compatible mainframe systems in Europe, but Olivetti finalized its purchase of one-third of IPL Systems only days after the St Gobain/Olivetti announcement.

IPL Systems Inc. is the smallest pawn on this corporate chessboard, with 1979 sales of a little over \$12 million. IPL has introduced three models of its 480 processor, in successive upgrades, all competing in the IBM 4341 market. IPL was only recently able to buy back the 40% of its stock previously held by Cambridge Memories Inc. The plug-compatible peripherals firm had taken \$4.125 million and a license to manufacture the IPL 480, models 1 and 2, for its holding. Olivetti stepped in and financed the Cambridge deal with its own purchase of one-third of IPL's stock. (Olivetti put Vittorio Levi, the Olivetti market-

A shared institutional investor can redefine company relationships and forge the first link of a working partnership.

ing director, and Mario Gabrielli, the company's chief financial officer, on the IPL board.)

IPL has a nonexclusive agreement with Control Data Corp. to market Omega, but IPL president Stephen Ippolito said he expected no difficulties in continuing the agreement. It was his understanding, said Ippolito, that Olivetti had "no near-term plans to market the 480 in the U.S. or Canada," but that the Italian firm might move into South America. (Cii-HB has a sizable South American operation, which may or may not be involved in Olivetti's expanded marketing.)

In both Europe and America, the St Gobain buy into Compagnie des Machines Bull, the French holding company for 53% of Cii-HB, sparked rumors of unhappiness at Honeywell Corp., which holds the other 47% of Cii-HB. Informed Honeywell sources report, however, that the U.S. firm seems considerably more sanguine about the St Gobain moves than indicated by its restrained public comment on recent devel-



Vincent van Dumb.

The Dumb Terminal® video display terminal has done it again.

For around \$2000, you can have all the alphanumeric capabilities of the renowned ADM-3A Dumb Terminal, plus the full vector drawing and point plotting capabilities of a sophisticated graphics terminal. All in one neat package. That's less than half the cost of other comparably equipped graphics terminals.

The ADM-3A with Retro-Graphics™ gives you complete flexibility to develop bar charts, pie diagrams, histograms, even function plots. What's more, it's completely Tektronix® Plot 10™ software-compatible.

The package consists of an ADM-3A Dumb Terminal plus a single plug-in card engineered to fit neatly inside the ADM-3A without soldering, special tools, or a service call.

Retro-Graphics is a product of Digital Engineering, Inc., and is sold separately

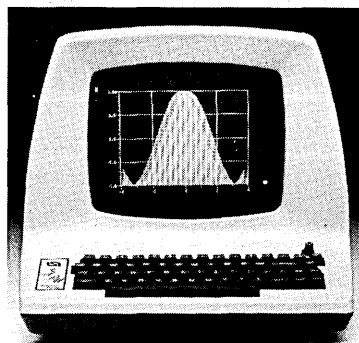

**DUMB TERMINAL.
SMART BUY.**



CIRCLE 45 ON READER CARD

or installed in the ADM-3A by local Lear Siegler distributors. Contact the distributors listed below, any Lear Siegler sales office or Digital Engineering, Inc., 1775-C Tribute Road, Sacramento, CA 95815, 916/920-5600.

The Retro-Graphics-equipped Dumb Terminal. What does it mean to you?

Draw your own conclusions.

Lear Siegler, Inc./Data Products Division, 714 N. Brookhurst Street, Anaheim, CA 92803 800/854-3805. In California 714/774-1010. TWX: 910-591-1157. Telex: 65-5444. Regional Sales Offices: • San Francisco 408/263-0506 • Los Angeles 213/454-9941 • Chicago 312/279-5250 • Houston 713/780-2585 • Philadelphia 215/245-1520 • New York 212/594-6762 • Boston 617/423-1510 • Washington, D.C. 301/459-1826 • England (04867) 80666.

DISTRIBUTORS: • Oakland, CA, Advanced Technology (415) 452-1401 • Oakland, CA, Consolidated Data Terminals (415) 638-1222 • San Diego, CA, Data Systems Marketing (714) 560-9222 • Los Angeles, CA, David Jamison Carlyle Corp. (213) 277-4562 • Richardson, TX, Data Applications (214) 931-1100 • Hazelwood, MO, Dytec/South (314) 731-5400 • Arlington Heights, IL, Dytec/Central (312) 394-3380 • St. Paul, MN, Dytec/North (612) 645-5816 • Orlando, FL, Gentry Associates (305) 859-7450 • Cleveland, OH, W.C. Koepf Associates (216) 247-5129 • Falls Church, VA, Marva Data Services (703) 893-1544 • Gaithersburg, MD, Leasametric (301) 948-9700 • Cherry Hill, NJ, Data Store (609) 779-0200 • Stamford, CT, National Computer Communications (203) 325-3831 • Bedford, MA, Continental Resources (617) 275-0850.

Dumb Terminal® is a registered trademark of Lear Siegler, Inc. Retro-Graphics™ is a trademark of Digital Engineering, Inc. Tektronix® and Plot 10™ are trademarks of Tektronix, Inc.

NEWS IN PERSPECTIVE

opments. St Gobain and Honeywell executives are familiar with each other and the French firm is held in high regard in Minneapolis. St Gobain, for its part, is even now installing HIS process control systems in its cement and fiberglass factories. There is, say these sources, virtually no overlap between Olivetti and Honeywell Italia, the U.S. firm's wholly owned Italian subsidiary: "The only duplication is in small impact printers."

"In fact," said a Wall Street source, "Olivetti and HIS Italia are really very compatible, but that doesn't mean Honeywell wants to take on that company with all its problems." Olivetti, which is expected to earn only \$40 million on international sales of over \$2 billion this year, will undoubtedly gain from St Gobain's solid financial management, note Honeywell sources.

Honeywell, according to several reports from HIS' Minneapolis headquarters, feels no sense of threat from St Gobain and has been kept fully informed of the European developments.

The tie with St Gobain would permit Olivetti to bid on French government contracts that are restricted to French firms.

HIS president Stephen Jerritts is perhaps one of the best informed American ceos when it comes to the French style of blended business and politics. After 18 years with IBM, Jerritts went to France in 1967 as a consultant for Bull-GE, a Cii-HB predecessor. He stayed with the company first as a consultant and then as a top executive, for 5½ years, during and after the merger of Honeywell and General Electric. Jerritts, in fact, came to Honeywell via Cii-HB. His recommendations for the reorganization of Bull-GE resulted in the formation of the French company's peripherals division, which Jerritts was asked to manage. In that position, he was a member of the Cii-HB management committee. Jerritts became president of Honeywell Information Systems last January.

Honeywell, according to financial analysts, understands that St Gobain has a strong nationalistic and European interest in developing high technology on the Continent. "It's that crazy French way of mixing business and politics," explained a Midwest analyst, "but Honeywell has learned to live with that." In France, it is commonly reported that the French government would be pleased to see St Gobain—a \$10 billion multinational conglomerate with U.S. revenues of close to \$1 billion—take over the government's paternalistic role in French dp. Honeywell seems adaptable.

It's evident that both the French and Italian governments heartily approve the St Gobain moves. If the Olivetti public statement is any measure of the Italian attitude,

the French money was certainly welcome. Olivetti executives have blamed capital shortages for their company's poor financial performance. And there is, apparently, a natural synergy between Cii-HB and Olivetti. Even Honeywell, noticeably weak in automated office systems, could benefit from some of the products that might develop from joint ventures.

St Gobain, according to Olivetti, had agreed before the sale to reconfirm Olivetti's top executives—Bisentini as chairman, Carlo de Benedetti as ceo and vice chairman, and Franco de Benedetti as managing director—when they stand again for election in 1982. Olivetti executives seemed particularly excited that St Gobain's participation would permit Olivetti to bid on French government contracts restricted to French firms.

The script, style, and pace of the St Gobain reorganization of European dp reflects the very different structure of European capitalism, where weak public money markets throw the task of capital formation to institutions. It often seems mysterious and vaguely conspiratorial to businessmen accustomed to American business—and perhaps, by American terms, it is. St Gobain is not the first to attempt to weld together such a European consortium, but if St Gobain lives up to its reputation, it may offer its U.S. allies and competitors an interesting blend of style and savvy: French commerce that's frankly commercial.

St Gobain, by the way, was founded by Louis XIV and his chief economic consultant, Colbert. And that, in France or elsewhere, indicates some measure of corporate adaptability. St Gobain has stepped into new markets before.

—Vin McLellan

EDUCATION

PROBLEMS WITH DP SCHOOLS

By all indications, computer trade schools are still missing the mark in training tomorrow's computer professionals.

Members of the Massachusetts Chamber of Commerce could have gagged when the state's High Technology Council recently reported that at least 53,000 new jobs in high technology fields would be created in the Bay State in the next three years. You see, the council also warned that many of

the jobs might not be filled for lack of trained personnel. "The education system," it reported, "will not be able to supply a sufficient number of personnel . . . to meet the demand."

The situation in Massachusetts, one of the nation's leading technology centers, is indicative of the education crisis plaguing the computer industry. While demand for trained workers is high, the supply is very low; qualified personnel can practically name their price.

Logically, computer trade schools should fill the gap, providing a stream of trainees, computer operators, programmers, and systems analysts. Numerically, they do. But when employers look for skills, these schools and their graduates often get poor marks. Computer professionals say graduates lack proper training; even educators say the training doesn't emphasize needed skills.

When asked what is the most pressing need in computer education, educators and industry leaders point to the absence of any set, national standards for training qualified personnel. Computer techniques and systems go by several different names, as do courses of study. Although educational associations have recommended degree standards, these are nonbinding, allowing schools to offer programs that vary widely in quality.

One industry source summed up computer vocational education thus: "They offer what's hot this year."

The computer education field has grown so quickly—some sectors by over 100% a year—that there is no reliable national survey of the quantity, much less the quality, of the courses offered. "This has gotten so big, you can't put your arms around it," said one computer education vendor. "This is an easy business to get into and it encourages people to get in. It's the biggest single market for continuing education. What other field obsolesces itself every three or four years?"

The more things change, the more they remain the same. In the computer industry, where equipment seems to become outdated even as it is being installed, the appeals made by computer schools have remained remarkably constant. By direct statement and innuendo, they promise would-be students wealth, happiness, glamour, and excitement in the computer field. Yet, while making such blatant appeals, many computer schools fail to provide students with basic skills to get the high-paying jobs in the field.

Who are these students? A recent survey showed that students taking courses at computer trade schools are young (80% under 30), a majority (58%) are women, and a high proportion are nonwhite (28.5%). They often come from lower income groups, viewing computer education as a key to a better standard of living.

You Ought To Be In Pictures

Computer Graphics Beats Searching Stacks of Printouts.

ISSCO graphics software speeds decision making. Instantly, obscure data comes into sharp focus. Complex relationships are suddenly simple. You get the total picture, not just a bunch of numbers. DISSPLA® graphics software is easy to use. The typical plot requires less than 10 instructions. Programs never terminate because of error. Instead, you get correction messages in plain English. DISSPLA works on most large scale computers and a selected number of superminis. It drives any plotting device that can draw a straight line and takes advan-

tage of the advanced features of today's graphics devices. Built-in flexibility lets you experiment with graphic formats from simple to complex. You get quality graphs and charts for presentations, management reports, internal documents... even slides. Quickly. Accurately. Easily. DISSPLA features include: automatic scaling and legend, various axes systems, extensive business features, shading patterns, fifty-seven alphabets, plus many more graphic enhancements.

Now for non-programmers there's TELL-A-GRAF® for virtual IBM and DEC systems. The secret? Plain English commands to easily generate bar, column, line, surface and pie charts without the frustration of explaining your needs to a programmer or art department.



Integrated Software Systems Corporation
 4186 Sorrento Valley Blvd.
 San Diego, CA 92121 (714) 452-0170
ISSCO Deutschland, GmbH
 Dietzstrasse 16
 D-5400 Koblenz, West Germany
 49 261 407989 Telex: 862891

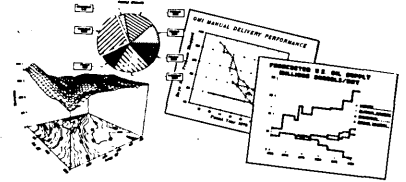

LEADING THE WORLD
 IN MACHINE AND
 DEVICE INDEPENDENT
 GRAPHICS SOFTWARE
 FOR OVER A DECADE. 1970-1980

10

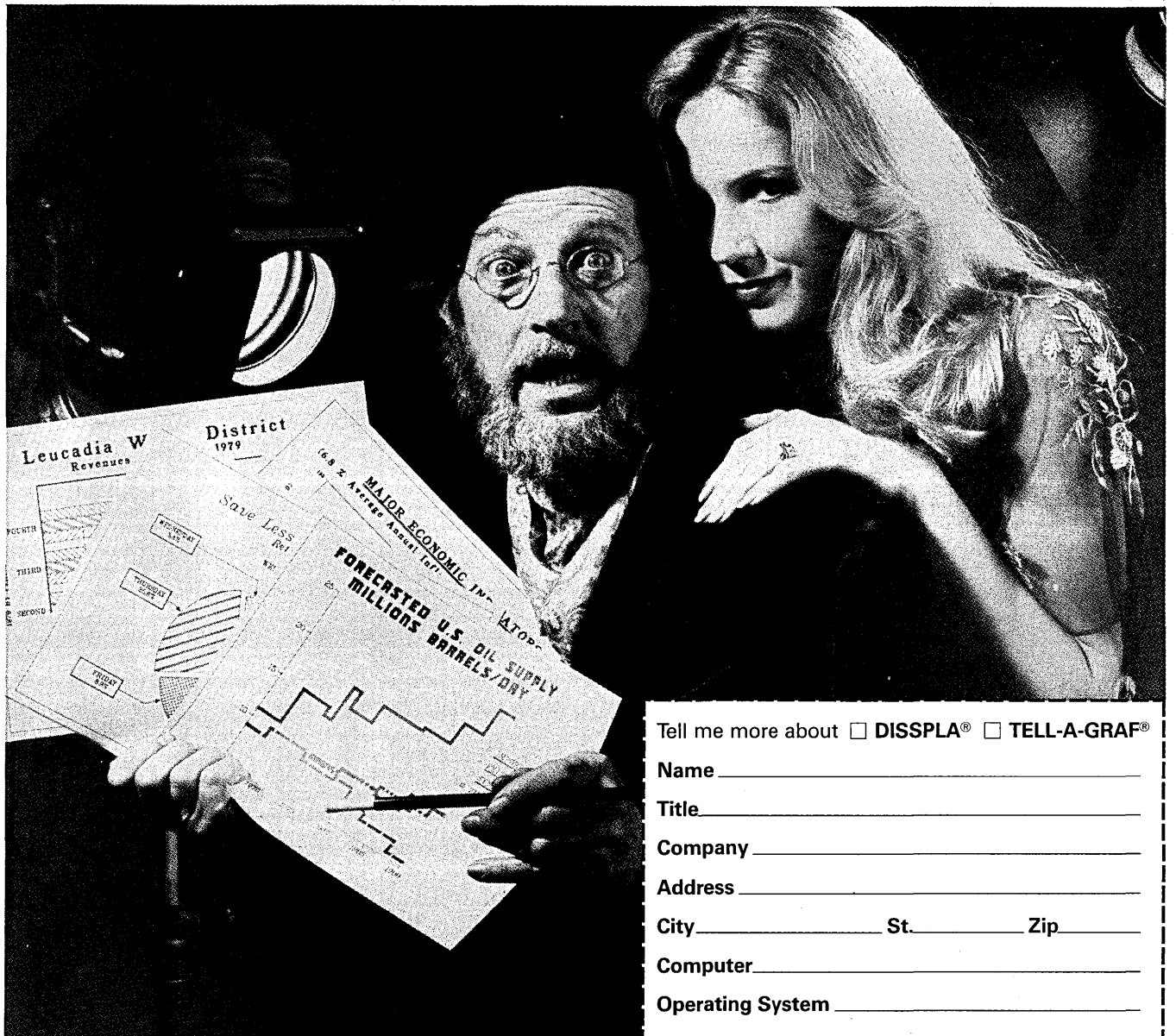

Tell me more about DISSPLA® TELL-A-GRAF®

Name _____

Title _____

Company _____

Address _____

City _____ St. _____ Zip _____

Computer _____

Operating System _____

CIRCLE 46 ON READER CARD

NEWS IN PERSPECTIVE

The quality and cost of the computer education they receive can vary widely.

According to figures compiled by the U.S. Department of Education, the average private computer education program provides 536 hours of instruction and costs \$1,755; the average public computer education program provides 612 hours of instruction and costs \$205. There is a course to meet any student's ability to attend and to pay. But student evaluation of these courses prior to attendance is extremely difficult. An education official in California said that just keeping track of the number of schools was a formidable task: "Private schools come and go every month."

In most states, prospective computer school students have a hard time getting any evaluation of vocational education programs. Roy McDermott, manager of the Illinois State Board of Education's division of Non-Public School Approval, points out that "all the data is present, but we're not required to report it." Interviews with education officials in other states show that the necessary data often isn't even collected, provided minimal criteria are met by school operators. A California Department of Education official reported that at present "we only get information from degree-granting institutions."

McDermott said that Illinois set "stringent requirements" for proprietary

EMPLOYMENT, 1978 and 1990 (projected)

Occupation	Employment 1978 (est.)	1990 (est.)	Percent change	Annual openings
Office Machine Operators	160,000	202,000	26.2	9,700
Computer Operators	666,000	665,000	(.2)	12,500
Programmers	247,000	320,000	29.6	9,200
Systems Analysts	182,000	250,000	37.4	7,900
TOTAL:	1,255,000	1,437,000	23.2 (avg.)	39,300

Source: U.S. Department of Labor

STUDENTS

Program	Total No.	Public	Private
Computer Operator	1,534	97	1,437
Key punch Operator	18,106	2,710	15,396
Computer Programmer	17,084	2,540	14,544
Systems Analyst	100	—	100
Bus. Data Programmer	10,025	3,689	6,336
TOTAL:	46,849	9,036	37,813

Source: U.S. Department of Education

For IBM mainframe and major mini-computer users, Adage 4000 Series systems now offer the same superior performance that has made us, for years, the recognized leader in interactive graphics. All systems feature host channel speed interfaces, host computer off-loading, image buffer, local hard copy output, and high-speed interactive displays.

For IBM System Users

The 4250 — our higher-performance, plug-compatible replacement for the IBM 3250. With 12 displays, the 4250 offers the most economical price/display ratio available today.

The 4370 — our full 3D graphics terminal designed to interface directly to an IBM/370 compatible channel.

THE ADAGE ADVANTAGE

Interactive Graphics for IBM and Mini-Computer Users

The 4380 — our innovative combination of all 4250 and 4370 functions in one terminal.

For Mini-Computer Users

The 4100 Series — includes 2D (4115 and 4125) and 3D (4135 and 4145) models with state-of-the-art graphics capabilities

and direct interfaces to popular mini-computers.

The Adage Advantage

For over a decade Adage systems have been

helping customers in industries including aerospace, automotive, heavy machinery and petroleum, solve their most complex graphics problems. These include applications such as CAD/CAM, command and control, simulation, and data analysis.

To learn how Adage can help you, call (617) 783-1100.



U.S.: 1079 Commonwealth Ave. • Boston, MA 02215
(617) 783-1100 • TWX 710-330-0141

Europe: Markstrasse 9, 3308 Koenigsutter
am Elm, West Germany
Phone: 05353/1089, Telex 095528

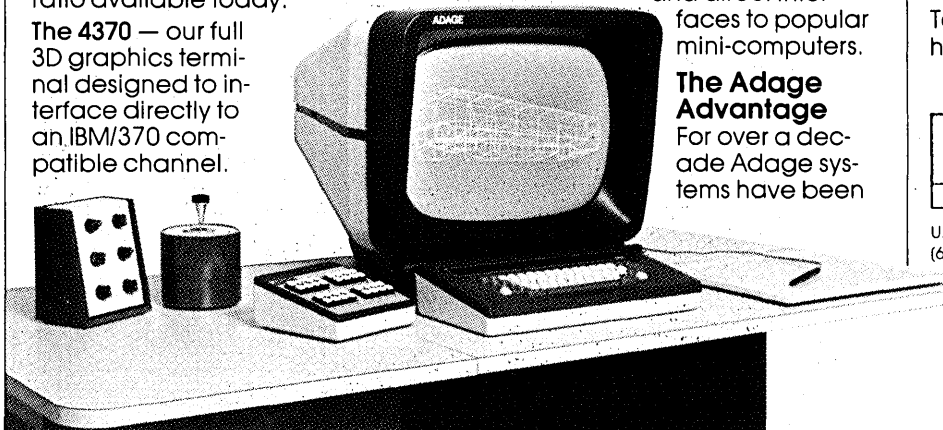



INTRODUCING VIDEOPRINT: The picture perfect peripheral.

Videoprint is the convenient economical means of obtaining distortion-free line or continuous tone hardcopy from raster line computer graphics displays in full, brilliant color. The entire system is self contained in the convenient desk-top unit shown above.

Videoprints eliminate such off-the-screen photography problems as barrel distortion, color de-saturation and loss of color fidelity. Videoprints also minimize the effects of raster lines and video noise.

Videoprints are instantly produced with Polaroid® SX-70 or Polacolor 4" x 5" films, as well as with conventional color negative or 35 mm slide transparency films, offering you a range of handy sizes. The pictures can be made by untrained personnel at the push of a button.

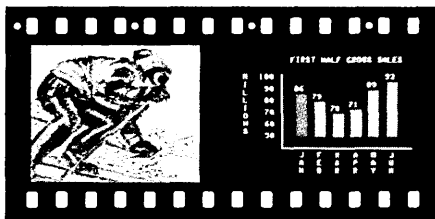
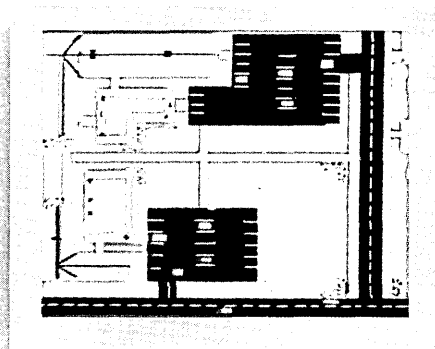

If you've ever wanted to distribute copies of computer graphics or TV video stills or file them in your permanent records, or send them through the mail or project them as slides, you need Videoprint.

If you've ever wanted to document alternatives in an interactive graphics process, or monitor periodic events without 24-hour observation, you need Videoprint.

In fact, if you use computer graphics in any form, you really need Videoprint. Find out all about this exciting new tool. Write or call us today.



IMAGE RESOURCE

The Videoprint People.

Image Resource Corporation
2260 Townsgate Road, Westlake Village, CA 91361
(805) 496-3317

CIRCLE 48 ON READER CARD

"Polaroid", "Polacolor" and "SX-70" are registered trademarks of the Polaroid Corporation.

NEWS IN PERSPECTIVE

schools, to foster "a quality education." However, in an interview he added that such requirements generally regulate the "process of education," not the content: "Regulations governing the content are the weakest," he said. The private computer schools are left alone, providing they don't "mislead" the public. Also, there is no "stringent requirement" covering the equipment used in computer training courses.

"Equipment standards are difficult to set," McDermott said. "Some fields lend themselves to common, set standards, but this is not one of them. The state does not have the staff resources to establish specific skill standards in all fields."

There is one big exception. In December 1979, the New York State Consumer Protection Board issued a report entitled "Check It Out: A Comparative Guide to New York State's Computer Schools," providing the first in-depth examination of computer training schools (often only after suing other state agencies for data, under Freedom of Information statutes).

The report, designed for use by students, concluded that only 25 of the 230 programs offered by computer schools in New York State were providing "modern instruction" for entry level students or those seeking instruction in computer programming. It found that many schools

COSTS

Program	Mean Charges		Mean Length(Hours)	
	Public	Private	Public	Private
Computer Operator	\$255	\$1,409	547	364
Keypunch Operator	127	666	377	266
Computer Programmer	356	2,242	1,132	593
Systems Analyst	—	2,298	—	586
Bus. Data Programmer	290	2,164	1,006	872
AVERAGE:	\$205	\$1,755	612	536

Source: U.S. Department of Education

SALARIES (average weekly)

City	Systems Analyst	Programmer	Operator	Key Entry
New York	\$424.50	\$318.50	\$235.50	\$181.00
Los Angeles	407.50	292.50	239.00	197.50
Philadelphia	401.50	319.00	229.00	171.50
Chicago	387.50	305.50	236.50	187.50
Boston	366.00	279.00	213.50	174.00
AVERAGE:	\$397.40	\$302.90	\$230.70	\$182.30

Source: Bureau of Labor Statistics

INTERTEST saves you time for the finer things in life.

INTERTEST cuts CICS application development time by as much as 75%.

It keeps your production system running smoothly and interactive tools make testing and debugging a breeze.

INTERTEST's SYMBOLIC option allows COBOL and ASSEMBLER programmers to debug at the source level, further simplifying the debugging process.

If you're running CICS without INTERTEST, you're not only missing the finer things in life, you're missing the finest software tool available.

Call for more information on INTERTEST,
 recipient,  1979 Datapro Software Award of Merit.
 (201) 488-7770 or TOLL FREE (800) 526-0272
 65 ROUTE 4 EAST RIVER EDGE, NEW JERSEY 07661

**ON
 LINE SOFTWARE
 INTERNATIONAL**

CIRCLE 49 ON READER CARD

Building a computer facility is not a do-it-yourself project.

It's too important. And you have too much to do to coordinate the efforts of:



architects and
design engineers installation
teams

project managers
and space planners

contractors and
subcontractors

HVAC
suppliers

security specialists power supply
vendors

purchasing agents
and decorators

But we do it all the time. And in the last 12 years, we've planned or built facilities for more than 400 customers. Facilities for all sorts of computers.

We know computers. We know construction. We know how to create an environment for the efficient operation of a computer center. And we offer a full range of services, from consultation to the entire job.

We're international, too. With 12 offices in the United States and 14 in other

countries, we're ready to serve customers around the world.

We'd like to show you what we can do for you. For more information on our full range of services, contact your nearest Control Data office or write to:

Darryl E. Olson
Marketing Manager
Facility Planning and Construction,
Control Data Corporation,
HQN111, P.O. Box 0,
Minneapolis, MN, 55440.



Addressing society's major needs

CIRCLE 50 ON READER CARD

NEWS IN PERSPECTIVE

exaggerated or distorted course offerings, used obsolete equipment and/or techniques, and distorted placement records; 10 schools refused to provide any information despite the urgings of state officials.

"It is a startling indictment of the [computer school] industry," said Rosemary S. Pooler, executive director of the Consumer Protection Board. "Few programs were recommendable."

"Check It Out" found that many of the state's schools use "very small" IBM 360 mainframes, limited-capacity mini-computers, and a variety of "obsolete" electronic accounting machines (EAM) to teach dp techniques. For example, while many of the schools teach modern data entry methods in the classroom, their hands-on training often requires keypunch cards for input.

The report also found that many schools taught obsolete techniques (such as EAM instruction) and "entirely outdated" languages (RPG I, FORTRAN II, COBOL D, COBOL F). Donald E. Price, president of the Data Processing Management Association (DPMA) Education Foundation, notes that a recent survey of 1,200 companies showed that 47% use COBOL; only 17% use RPG and 10% use FORTRAN. "If a community college or technical school is training programmers or programmer analysts, it's got to teach the business languages," he said.

COURSES

Program	Total No.	Public	Private
Computer Operator	60	5	55
Keypunch Operator	247	45	202
Computer Programmer	184	28	156
Systems Analyst	7	—	7
Bus. Data Programmer	185	78	107
TOTAL:	683	156	527

Source: U.S. Department of Education

"Check It Out" revealed that many of the schools, regardless of their job placement record, had extremely high dropout rates. On average, in a breakdown of 93 programs, 33% of the students dropped out, 14% got no jobs, 34% got jobs, and 19% were listed as "other" (generally indicating students who went on to further study or who got jobs in other fields). Looking at the entire list of 93 programs, a 0.0% showing could be found in each of the categories. The highest showings in each category were 86% dropout, 78% no jobs, 90% got jobs, and 78% "other."

The cost of the courses ranged from

nothing up to \$7,000. While many of the less expensive courses were found useless, some had job placement percentages among the very highest; conversely, some of the most expensive schools (including a few two-year degree programs) were so inadequate that most graduates had to find work in other fields.

"The figures we came up with showed 24,000 students and only 3,000 jobs," said Lawrence Kramer, a consultant with the Consumer Protection Board. "Even in a high growth field, that's a problem. A lot of people are going to be losers."

"Check It Out" caused a sensation

FOCUS meets the demand for on-line data access.

FOCUS is a high level, user-oriented software system. By linking today's powerful hardware with management's need for immediate data access, FOCUS stimulates rapid and informed decision-making.

FOCUS operates in an interactive environment (CMS/TSO) on IBM 370, 4300, or equivalent mainframes. Users have complete access to all needed information through FOCUS' ability to cross-reference individual data fields in separate files.

FOCUS' English-language commands let non-programmers perform their own data analysis from basic queries to complex "what if" problem solutions. Complex applications can be developed by systems designers in up to one-tenth the time required by procedural languages. Either way, FOCUS eliminates data production bottlenecks.

Over 400 major companies, institutions, and government facilities are using FOCUS in a variety of applications to speed up their data analysis. Among them are: J.C. Penney, ITT-Continental Baking, Merrill Lynch, RCA, Yale University, and the U.S. Army Corps of Engineers.

Typical applications are in: personnel,

finance, general administration, marketing, sales, research, results tracking, manufacturing, and customer service.

FOCUS is fully supported with experienced consultants, applications assistance, and complete training. Simple queries can be learned within hours and more comprehensive reports within a day; systems designers can develop major applications after two days.

FOCUS can save you time, effort, and money. For more information, call or write for our brochure.

 **FOCUS**

Information Builders, Inc.
254 West 31st Street
N.Y., N.Y. 10001
(212) 736-4433

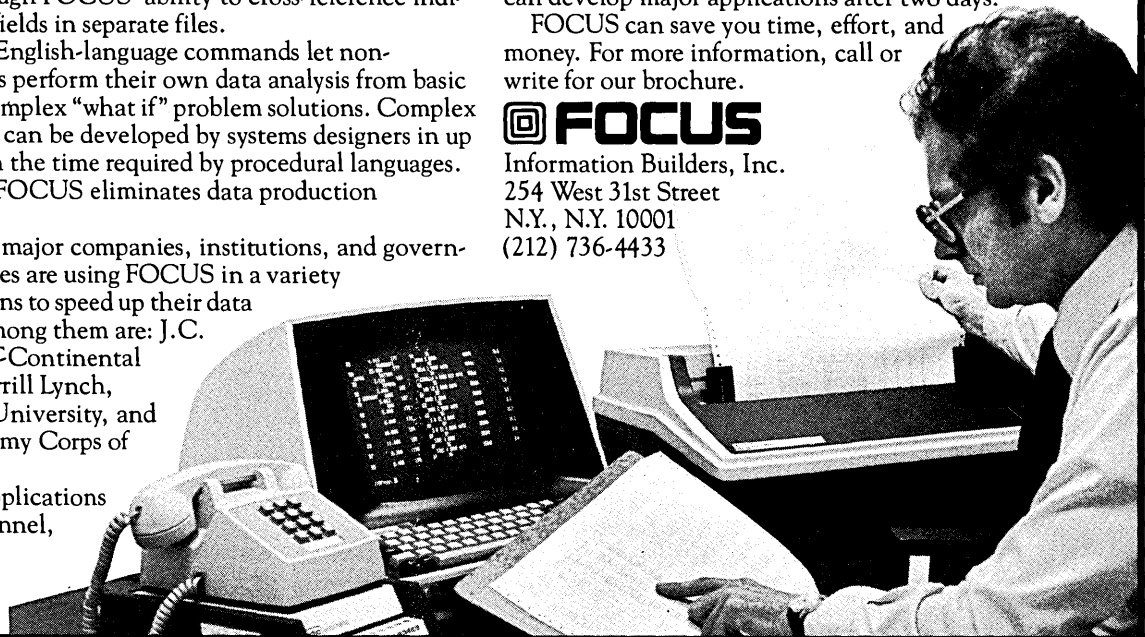

CIRCLE 51 ON READER CARD

Economy Sized Computers™ don't carry inflated price tags.

Think of this page as our competitor's price.
And think of our ad as our price.

Ours is about ¼ the size of theirs. Pretty clever
analogy, huh?

With Economy Sized Computers, you get data
and word processing capabilities you only
expect from much larger computers. All
for the price of a new copying machine—
just \$10,463 suggested retail price.

So see the Vector Economy Sized
Computer dealer near you.

And start improving the state of your
economy.

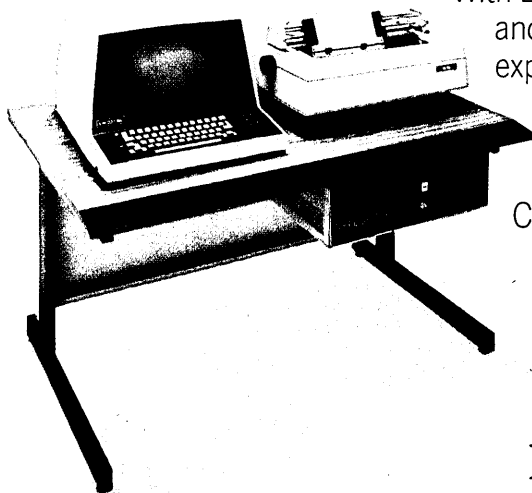

VECTOR
VECTOR GRAPHIC INC.

Economy Sized Computers

31364 Via Colinas, Westlake Village, CA 91361, 213/991-2302

CIRCLE 52 ON READER CARD

NEWS IN PERSPECTIVE

on its release, prompting several state and local governments to launch similar projects. In Washington, D.C., the Vocational Education Information Project issued a guide in January 1980, called "Where to Get Job Training in the D.C. Area," which included a special section on Data Entry Training. A second guide, to be released in the fall, will add a guide to computer programming courses.

As was the case in New York State, Washington, D.C. computer school operators were reluctant to provide course information. The authors of "Where to Get Job Training" refused to rate 70% of their programs due to the poor quality of information provided.

However, as the number of students in vocation schools grows, consumer groups will put greater pressure on computer schools to provide prospective students with full information. Officials in California, Illinois, and other states have indicated a strong interest in putting together reports evaluating computer schools, and New York's Consumer Protection Board has prepared a booklet, "Checking Them Out," showing them "how to prepare a shoppers' guide to vocational training programs."

Criticism of computer schools dates back to the early '60s, and in 1965 the industry created its own accrediting group, the National Association of Trade and

Technical Schools, NATTS. It requires computer schools seeking accreditation to provide:

- Qualified and sufficient instructors
- Up-to-date courses
- Proper facilities ("If the school doesn't have its own computer, it must lease time")
- Standards for admission ("It must admit only those students who are at a level to benefit from training")
- Success in placing graduates in the industry

"Some fields lend themselves to common, set standards, but this is not one of them."

However, a NATTS spokesperson pointed out that the association does not collect information on vocational education as a sector: "We stay away from ratings."

The New York State Consumer Protection Board takes a dim view of NATTS and other private accreditation groups. "The agencies involved rarely take strong action against any school," it reported, "and they devote much of their efforts to protecting the schools from public scrutiny and criticism."

Public scrutiny, along with effective quality control and ratings, is precisely what many industry observers say is

needed. Computer education programs "are not meeting the needs of industry," says DPMA's Price. "People hired out of [them] aren't prepared to be programmers, application programmers, or programmer analysts."

J. Daniel Couger, professor of computer and management science at the University of Colorado, says failure to set education standards is creating a "national deficiency" of trained computer personnel.

A recent survey of information systems programs in American colleges, conducted by the Association of Computing Machinery (ACM), of which Couger is a leading member, revealed that 25% of the undergraduate and 33% of the master's degree programs do not meet ACM "minimum requirements" for information systems programs (which include five semester courses in technical areas and four in organization and administrative functions).

Price said there were several areas where computer education could be improved, but the most important was development of an "applied program" which would be "much less theory-oriented" than most present programs.

The DPMA is working on a new approach to computer education. "We are proposing a core of 10 courses, with probably four at the community college level," says Price. The objective is to improve

Wherever static is more than just a nuisance.

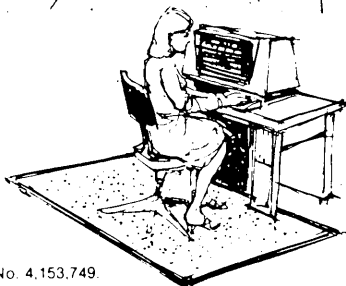
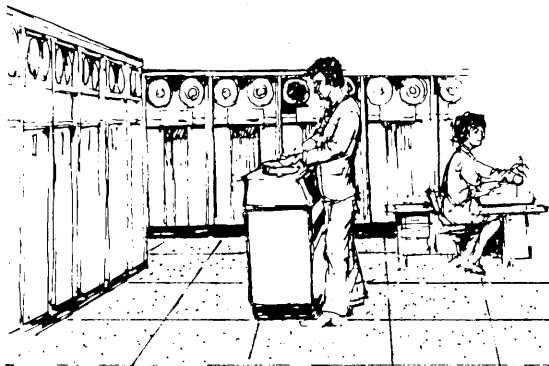

U.S. Pat. No. 4,153,749

Eliminate static problems ... permanently

COMPU-CARPET™ is a unique, high performance anti-static carpeting developed specifically for use in computer rooms, terminal areas and other static-sensitive environments. Attractive and durable, Compu-Carpet has superior electrostatic properties even when compared with tile.

COMPU-MAT™ is produced from the same proprietary anti-static materials as Compu-Carpet. It is best suited for solving localized static problems at terminals and isolated mini and micro processors. Send for complete information.

Mfd. by

**UTP UNITED
TECHNICAL
PRODUCTS, INC.**

THE STATIC CONTROL PEOPLE

Dept. E/D

32 Southwest Industrial Park, Westwood, MA 02090. (617) 326-7611

CIRCLE 53 ON READER CARD

COMPARE SMARTS.

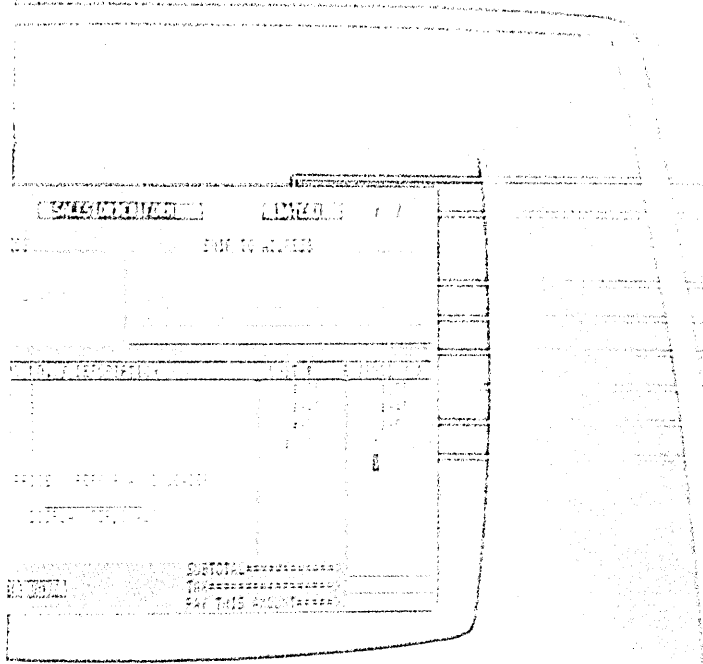

Introducing the new SMARTS (Small Business Accounting and Reporting System) that lets you compare smart. SMARTS lets you compare prices, profitability, and more.

SMARTS lets you compare prices, profitability, and more. It's the only system that lets you compare prices, profitability, and more. It's the only system that lets you compare prices, profitability, and more.

SMARTS lets you compare prices, profitability, and more. It's the only system that lets you compare prices, profitability, and more. It's the only system that lets you compare prices, profitability, and more.

SMARTS lets you compare prices, profitability, and more. It's the only system that lets you compare prices, profitability, and more. It's the only system that lets you compare prices, profitability, and more.

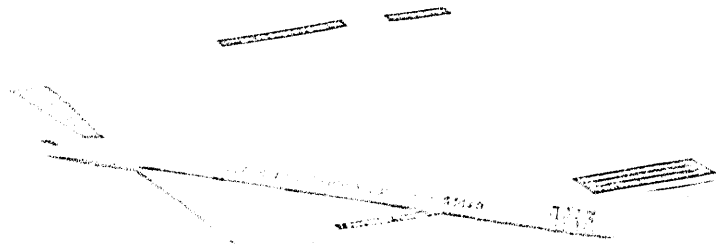
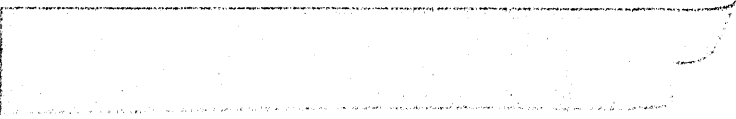
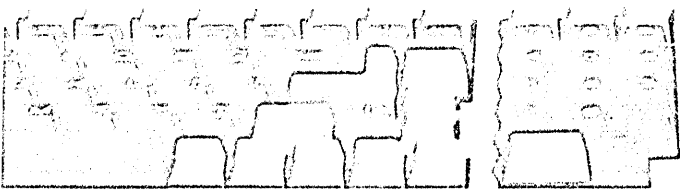

How to Improve Your Image

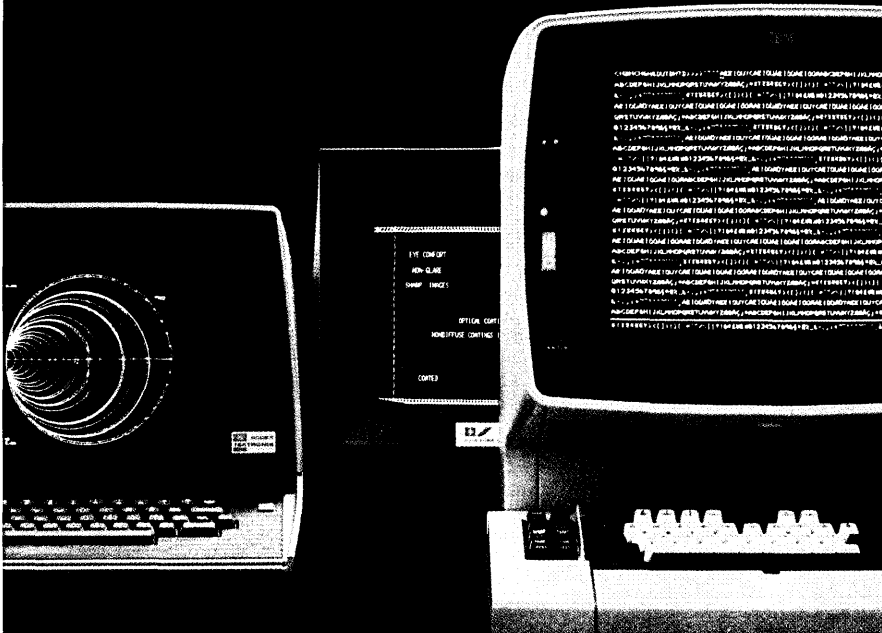

The Problem: Glare. And poor image-to-background contrast. They wash out displayed information, cutting operator efficiency and lowering productivity.

The Solution: OCLI Contrast Enhancement. It reduces glare by 17 to 1 over untreated glass. It's working now for some of the biggest names in display technology, including IBM, Four-Phase and Tektronix. Write us. We'll explain how it can work for you.

I'd like to improve my image.

Tell me more about OCLI Contrast Enhancement for CRTs.

Name: _____

Title: _____

Company: _____

Address: _____

City: _____ State: _____ Zip: _____

OCLI

DEPT. 109-1, 2789 Giffen Ave.,
P.O. Box 1599, Santa Rosa, CA 95402
TWX (510) 744-2083 Telephone (707) 545-6440

D-80

VISIT OUR BOOTH NO 922/924 AT SYNTOPICAN VIII, JUNE 24-26, MINNEAPOLIS
CIRCLE 55 ON READER CARD

NEWS IN PERSPECTIVE

education standards by treating programming and other computer skills "as professions rather than applied vocations."

Price believes that professional status could alter education standards, by mandating some degree of individual certification. "Rating [schools] would be an excellent thing, but very difficult," he said. "Until we can certify individuals, it will be impossible to rate trade schools." Illustrating his point, Price adds that the CDP (Certificate of Data Processing) exam, offered by the Institute for Certification of Computer Professionals, has a current success rate of only 35%.

National figures, though not as complete as those gathered in New York State, indicate a similar oversupply of computer school graduates. But, if reports like that of the Massachusetts High Technology Council are correct, the shortage of graduates with the necessary qualifications is acute.

The U.S. Department of Education reports there are now 683 noncollegiate computer education programs with over 46,000 enrolled students. These students are competing for the 39,300 annual job openings for computer operators, programmers, and system analysts.

A research report by the Conference Board showed only 14,400 annual openings for computer and peripheral equipment operators, and 12,300 openings for programmers, with none projected for key-punch operators save through attrition. However, the number of jobs overall is expected to increase by 25% in the next decade—one of the highest growth rates in any job category.

Regardless of whose figures are used, the shortage of trained, qualified personnel is evident from a glance at any newspaper employment listing. The key word is "qualified."

Earnings of qualified computer school graduates vary from region to region, state to state. Donald Price estimates an average programmer trainee/graduate should be earning around \$12,000 a year in nonurban areas, and \$14,000 to \$16,000 in urban areas along the West Coast. According to "Check It Out," New York State figures are somewhat lower, ranging from \$8,000 to \$14,000. Washington, D.C., salary ranges fall between \$7,500 and \$9,500 for trainees, with exceptions as high as \$14,000. Additional experience and/or academic training yields substantial pay increases (a computer science major can command \$20,000 and up at the entry level).

But for many computer school graduates, their only substantial pay has gone out instead of come in—for a high-priced diploma and skills of questionable value. Computer trade schools, to judge from placement figures, have never been well accepted by the industry they ostensibly serve.

—Josh Martin

LEASING

FEAR AND LOATHING IN LEASING

The third-party leasing business is a "market gone wild."

The sound track from *Jaws*—manic, incessant, a rhythm of mannered hysteria—is almost a theme song for the independent computer leasing industry. And, with the bizarre economics of April and May, *Jaws* is perhaps a suitable script for an early summer audience as well.

Over the last several years, users have been luring the third-party lessors into ever-deeper waters, demanding shorter and shorter lease terms. Finally, even Lloyds of London recognized the fey chill and refused to guarantee the sand beneath their feet. When the "creature" struck last year and drew Itel beneath the waves, there was the predictable panic on shore and a lot of thrashing out to sea, but the critics had warned us about a sequel.

Sanity does not come cheaply to anyone who has had recent contact with Wall Street, bankers, the computer industry, or any nexus of the three like the computer leasing business. Blessed be the Federal Reserve, but pity the corporate budget people.

Watching the long-term interest rates—purportedly the banking establishment's estimate of the *average* interest rate over the next five years—skyrocket five to seven points in a month, then plunge as far in a week is almost enough to send grown men grasping for the kids' Monopoly money. The bankers seem honestly embarrassed, the businessmen are permanently pale, the IBM comptroller is probably under sedation, and even a quiet fellow like Hesh Wiener, publisher of *Computer and Communications Buyer*, the pricing newsletter, shrieks of "madness" and a "market gone wild" as he tries to describe the yoyo prices of the secondary markets for lease and sale of used equipment. The product markets are already wrenched topsy-turvy by the palpable force of user anticipation of IBM's new products; for the credit market to go bonkers in a sympathetic implosion is perhaps only fitting.

By the beginning of May the leasing industry had a lot in common with the Dead Sea. It was there—but there was nary a sign of life. Interest rates had peaked above 20% in April and, as Paul Raynault, vice president of Computer Financial Inc., a Hacken-

sack, N.J., computer leasing firm, put it to institutional investors who sought his advice: "Anyone who goes to a third-party lessor for IBM computer equipment with these interest rates is just crazy!"

Raynault has earned a reputation for his dismal oracle on residual computer values and the leasing industry; he's widely respected among his peers and the financial community for unpopular but accurate forecasts. A veteran of six years with IBM as a long-range planner, he helped launch Computer Financial (CFI) in the early 1970s. For CFI, Raynault developed a computer model of IBM technology and residual product values—and the interplay of lease and purchase prices—using statistics he brought from Armonk.

"Anyone who goes to a third-party lessor for IBM computer equipment with these interest rates is just crazy."

The accuracy of his pricing forecasts over the past decade—compared to IDC, ADL, Input, and American Computer Appraisal—has been, he explained, a major factor in giving CFI a place among the cash-rich behemoths who dominated the leasing industry. CFI was hired to assist some of the largest U.S. banks place over \$250 million

in computer leases, and the company today is one of the few third-party computer lessors that can convincingly claim to have made money in its ventures.

CFI made money, said Raynault, because it was small enough to slow down, controllable enough to turn cautious, and wise enough to simply stop buying equipment before almost anyone else. For all that, CFI specialized in the risk or operating lease—where the lessor accepts the risk of product obsolescence, betting on residual value after the term of the lease.

"We made money in the operating lease business because we were very selective," said Raynault. "But we've been unsuccessfully lecturing people for 10 years about not making the same mistake the 360 leasing companies made.

"The 360 was announced in 1964. But 1968 was the biggest purchase year for the 360 leasing companies. Then the 370 was announced in 1970. You don't wait four years before you buy heavily on short-term operating leases. Yet that is exactly what the 360 leasing companies did, and that's exactly what the dumb 370 leasing companies did—including some of the biggest. . . ."

"Anyone who bought IBM equipment in 1976 or later—lessors buying for risk leasing—is in deep trouble," declared Raynault, condemning virtually the entire

YOUR COMPUTER PRINTER IS NOW OBSOLETE.

Now there's the Xerox 9700 Electronic Printing System. The 9700 is the only electronic printer that prints forms, reports and printouts using unlimited type styles, logos and graphics.

It can also print circles around your computer printer. For more information, call or write:

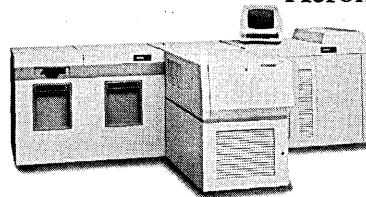
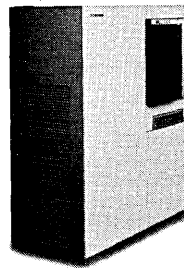

XEROX

XEROX® and 9700 are trademarks of XEROX CORPORATION.

Xerox Printing Systems
Division, 880
Apollo Drive,
P-1, El Segundo,
CA 90245.
(213) 615-6329.

CIRCLE 56 ON READER CARD

Tomorrow's Database Software, Today.

When your long-range plan for database software systems includes Cullinane's comprehensive and fully integrated family of advanced database software products, you don't have to wait five years to make it happen.

Because IDMS is truly a data dictionary-driven system, any component you require—regardless of when you acquire it—is fully integrated with the DBMS via the data

dictionary with great attendant benefits.

For example, a dictionary-driven teleprocessing system can be reconfigured dynamically without ever bringing the system down and disrupting operations.

Also, it is now possible to have a fully automated applications development system which will greatly improve programmer productivity in years to come.

Database Management

IDMS is the state-of-the-art database management system for use in the IBM environment (including the new 4300 series). The only DBMS named to the Datapro Honor Roll for four consecutive years.

Data Communications

IDMS-DC is the only data communications system designed specifically for use in the database environment. Fully integrated with IDMS, IDMS-DC therefore gives faster response time, more economical use of memory and greater simplicity of use than any other TP monitor can in a sophisticated multi-terminal configuration. IDMS-DC provides a powerful recovery facility, mapping support, storage protection and many more superior programmer productivity and data integrity features.

Integrated Data Dictionary

IDD is the only "active" data dictionary because it is fully integrated with a database system. It is a powerful design and control tool for use with IDMS and with the other Cullinane software components, yet it can be used as a stand-alone system to define and standardize all data resources whether manual or automated, database or conventional file systems. IDD supports FORTRAN, COBOL, PL/1 and Assembler.

Report Generator

CULPRIT can be used to produce even the most complex reports quickly, easily and with a bare minimum of coding. It can access virtually any file structure including conventional files or databases. CULPRIT is economical. It can produce up to 100 reports with a single pass. CULPRIT can be used as a powerful stand-alone or as part of a fully-integrated database management system from Cullinane. EDP AUDITOR combines the capabilities of CULPRIT with a special Library of Audit Routines to make it the premiere audit package available.

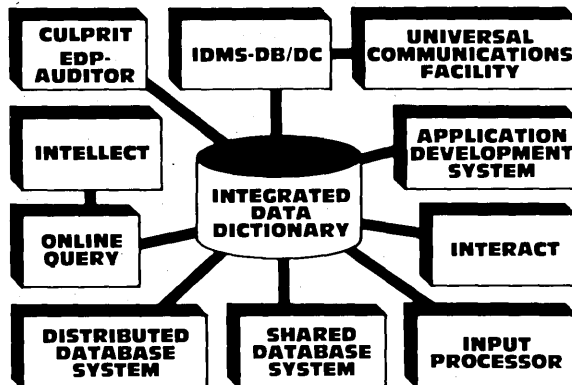

INTELLECT

This sophisticated English language inquiry system is designed for use by those in top management who have no background in computers, but have a need for timely information. Operating with a large, flexible dictionary, this new system has an outstanding ability to respond to conversational questions.

OnLine Program Development

INTERACT is an online system for program development, remote job processing, text editing and word processing. INTERACT is the programmer productivity system. It offers a powerful command repertoire, fast terminal response time, and economical CPU requirements.

Input Processor

IDMS-Input allows programmers, as well as non-technical end users, to develop application programs in an IDMS batch environment. This new product comes with its own simple language, making it easier and faster to program with IDMS-Input than with traditional programming languages.

Universal Communications Facility

Applications developed with IDMS/UCF will run under any TP monitor without modification—a truly major technical accomplishment. With IDMS/UCF, programmers don't even have to know the characteristics of the TP monitor they are using or may use. Applications will execute equally well through terminals connected to CICS, SHADOW II, Intercomm, Westi, Task/Master and others.

OnLine Query

OnLine Query, Release 2.0, is a major new advance in interactive information retrieval systems. Fully integrated with IDMS, it requires no programming in order to be immediately useful upon installation. OnLine Query provides managers and user departments with a powerful, easy-to-use set of English commands that allow instant access to selected information stored in the database.

ESCAPE

ESCAPE is an interface that lets a DL/I application program access an IDMS database. Now, users with an investment in DL/I applications can take advantage of the benefits of IDMS without having to re-write their DL/I programs. And, IDMS users can take advantage of the many useful DL/I programs available from independent vendors.

Distributed Database

Cullinane's Distributed Database System allows multiple IBM computers to share a common IDMS database. Distributed database is a unique Cullinane capability. For the first time you can support applications programs at remote sites and allow them to access a central database with complete user transparency and full data integrity. Cullinane Distributed Database is the system of the future—available today.

Attend a free seminar in your area.

Start planning for the future today. Send for information on these products, plus a schedule of our free management seminars.

Cullinane Corporation
20 William Street,
Wellesley, MA 02181
Phone (617) 237-6600



Database: Cullinane

CIRCLE 57 ON READER CARD

NEWS IN PERSPECTIVE



PAUL RAYNAULT: "The only purchaser today is the customer with the exceptional situation."

industry. "And the few who bought in 1975 may also be in trouble. Anyone who bought in 1976—IBM's biggest year for third-party lease purchasers—is up the creek." He checks off some of the biggest names in the business: Atlantus, DPF, Ford, Decimus, GE Credit, Finalco, Greyhound. "Most of these guys got damaged; many got damaged very badly," he said, "and some haven't even realized it yet." Among the large leasing firms, "I can't think of any who didn't buy late. They all got caught up in the enthusiasm of buying."

But in this industry, he said, bad management can keep people in jobs. "If you're the employee of some firm and you only get paid a commission on the business you sell, it's very hard to say, 'We should stop doing business for the next two years until a new generation comes out'—exactly what these companies should have done. But a certain momentum built up.

"What happened was, the salesmen all managed to buy such a large volume of equipment, on which they have such large exposure and on which they have to do so much remarketing, they've guaranteed themselves that while their companies are going to lose their shirts, the companies are going to need their services!" The salesmen, the managers, the managers of managers, little companies, and divisions of giant corporations—they all walked the same path, he claimed.

By April 1979, the high interest rates had dealt the coup de grace to third-party risk leasing, which had already become a borderline proposition as user anticipation of new IBM cpus forced shorter-term leases, he explained. What opportunities then existed for third-party leases—opportunities which will again emerge with lower interest rates—came out of IBM's juggling of lease and purchase prices as the Grey Mother attempts to push users toward purchase to sustain current income. In April of this year, stratospheric interest rates

effectively, if temporarily, wiped out third-party leasing altogether.

Computer users see five options for obtaining a computer, Raynault said, while IBM sees only three. Users choose between IBM's monthly rentals, IBM's two- to four-year lease plans, third-party two- to four-year leases, third-party five- to eight-year leases, and end-user purchase. For IBM, the first two are lease income options, but the latter three all register on its books as purchases.

From 95% to 99% of users don't even consider the IBM monthly rental anymore, said Raynault. "It's just too high." In the mid-1970s users did a lot of direct purchases, and a "fair amount" of five- to eight-year third-party leases. As the rumors spread last year about the possibility of IBM obsoleting the 370 line—particularly after the introduction of the 4300—users cut back drastically on the length of time they were willing to commit themselves to 370 and 303X cpus. They walked away from direct purchases, he said, and on third-party leases, they wanted three- or four-year terms—at most five-year terms—rejecting the previously common seven-year lease.

For IBM the situation became awkward too. Before 1973, until the announcement of the 158/168 machines, IBM actually sold less than 20% of its machines (except for a slight spurt in 1968,

when the 360 lessors bought heavily).

In 1974 through 1976, IBM's purchase income grew to 60% of revenues. In 1978, when the new 303X was shipped, CFI tracked most of the new units and identified only 7% IBM leases. A purchase income from perhaps over 90% of revenues was a "dramatic change for IBM," a peak which only highlighted the drop the following year, 1979, when purchase suddenly plunged to about 50% of revenues as users backed off long-term commitments. In the latter half of 1979, said Raynault, IBM barely managed to dampen the rush towards lease—with its immediate impact of lessening cash flow—only with three successive price changes: two hikes in IBM's rental prices, and one purchase price cut.

"Our feeling right now is that IBM is lucky to get 20% purchase income. It's shifted over completely," said Raynault. "The only purchaser today is the customer with the exceptional situation, as in the late '60s and early '70s"—insurance companies and utilities, users with a low cost of funds or guaranteed profit over costs.

Yet with IBM's finagling to control the lease/purchase balance of its income, with IBM's late fall cut of purchase prices and the hike in IBM rental, the company again opened a window for third-party lessors. Independents like CFI could use a combination of tax benefits to structure a four-

ONLY ONE PRINTING SYSTEM HAS A GRAPHIC DIFFERENCE.

The Xerox 9700.

It's the only printing system in the world that prints reports, forms and printouts using unlimited type styles, company logos and graphics. It can even print your signature.

If you still think all printing systems are pretty much the same, call or write Xerox. We'll demonstrate the difference.

Graphically.

Xerox Printing Systems Division,
880 Apollo Drive, P-1, El Segundo, CA
90245. (213) 615-6329.

XEROX

XEROX* and 9700 are trademarks of XEROX CORPORATION.

The powerful and versatile, high-speed Xerox 9700 lets you integrate your computer information directly from the computer into your steps. Little modification to your current system.

Administra

CIRCLE 58 ON READER CARD

NEWS IN PERSPECTIVE

year full payout finance lease that just undercut the newly hiked IBM four-year lease plan. January and February saw a modest but brisk market for finance leases, said Raynault.

Then the unprecedented credit crunch hit. The business was already very tightly figured, and the relatively minor cost additions of the new interest rates tipped the scale. (With the users' monthly payment so principal-weighted, explained Raynault, a 50% hike in interest could add maybe 5% to the monthly payment.)

Long-term interest rates vary considerably from bank to bank to various private capital sources, and particularly so with the confusion in capital markets. (A moderate-sized bank in the Northeast charted its five-year interest rate from 15¾% on Feb. 20, 16½% on the 25th, 18½% by March 15, 20% by April 1, and then the drop: 18½% by May 1.) CFI's capital source offered lower rates to begin with, but they climbed steeper and plunged quicker. One can imagine how IBM strategists, struggling to tilt the user trend toward purchase, saw the soaring interest rate.

Raynault said he had just finished financing a large lease with money from the Midwest at 13½% in March, when he connected on another deal to finance \$1.2 million worth of peripherals for a large bank in the Northeast. "I priced this new deal at

13½% and went out to finance it, and people said, 'Hah! you're lucky if you get 17%.' And I said, 'You're kidding!' I called some more people, and they said, 'Hah! you're lucky if you get 18%!'

"In three weeks the interest rates went from 13% to 20%," he recalled. "Nobody was quoting, they just said, 'I don't know what it's going to be but . . . ' and then they'd guess higher.

"I had this lease committed at 18% and I had gotten the customer to sign it. People had been willing to lend money and commit themselves at 13% for five years,

"In three weeks, interest rates went from 13% to 20%."

and I couldn't believe that the world had changed so much that 18% wasn't a go deal. Well, I finally got the financing committed at 18¼% with almost everybody telling me 'twenty, twenty, twenty.' For two weeks, I'm living with the fact that I had a lease signed at 18% and the best I could get on the money was a commitment at 18¼%. So I was going to lose money on it. And everybody is telling me I was lucky to get 18¼%.

"Then, a week and a half ago, when Chase brought its prime down a quarter of a point, all the banks say, 'Hah! look at that! The direction is down!'

"And day after day, I was calling. One bank, on Thursday, said 20%; on Friday, no problem at 19%. Called them on Monday and the guy said he could commit at 18½%. On Tuesday, another bank calls me and says, 'Hey, we're back at 17½%. And on Wednesday, two people called with 17%. And now I'm negotiating with someone at 16½%. I see where it's going, but I'm going to close it at 16½%. I don't trust any of it.

"But I'll tell you, this has never happened before. In my years in this business, when long-range interest moved a half-point, it was a big deal; it really hit people. The prime can jump around, but this is the bank's estimate of average interest over five years! For a bank to say, money on an average of 13% over the next five years and two weeks later say, no, on the average of 19%! The guy was a fool at either one or the other rate.

"That's almost a 50% difference in a one-month period. It's just shocking. It totally destroys my confidence in the banking community. And you know, I give this same spiel to all these bankers, and they say, 'You're absolutely right. We don't know what we're doing.' "

Maybe in the banks, at the Treasury, or in the Fed, they're whistling the soundtrack from *The Fog*.

—Vin McLellan



It's no trick!

GUARDIAN stands up to any other on-line security system available.

Call today to find out about GUARDIAN's expansive set of air-tight security features.

800 526-0272 or in N.J. (201) 488-7770
65 Route 4 East, River Edge New Jersey 07661

ON LINE SOFTWARE INTERNATIONAL

CIRCLE 59 ON READER CARD

COMMUNICATIONS

READY TO COMPETE WITH BELL

Modem makers assess their positions as competition with an unregulated AT&T subsidiary draws nearer.

The specter of an unleashed Bell System entering the competitive arena free from the umbrella of regulation has haunted the data communications industry for some time. But is the specter real? Opinion seems to be divided.

One of the directly affected industry segments would be the modem makers. Having competed head-on with the telephone company for many years, these vendors have flourished in the existing environment against a regulated Bell monopoly. And now that AT&T competition appears to be coming closer, the modem vendors are carefully assessing their positions.

One industry spokesman who believes Bell has been benefiting from regulation is Matt Kenny, vice president for sales and marketing at Racal-Milgo Inc. "If AT&T is spun out there in the cold cruel world along with the rest of us, they'll have to be a lot more accurate about what they are doing," he says.

"It costs an incredible amount of money to develop a new product in today's technically sophisticated environment, and those firms in the unregulated sector have to make each product stand on its own. If it's not a profitable product, we can't continue with it. A regulated monopoly is not under that particular constraint." Thus, Kenny adds, the net result of an unregulated Bell subsidiary would be higher prices to the customer since actual costs would have to be recovered in the price of the product. He believes that AT&T prices are often unrealistically low under the present regulatory framework because Bell is able to subsidize equipment costs with revenues from other areas.

So, can an adequate structure be developed by the Federal Communications Commission to safeguard against one service subsidizing another? "It depends on whether the spin-off requires that the regulated subsidiaries operate as a profit and loss center on their own," Kenny explains. "If set up correctly, a competitive subsidiary would have to subcontract its research and development work to Bell Laboratories and they would have to pay for the results at rea-

sonable engineering rates that are standard in the industry. And manufacturing costs for the subsidiary would have to be accurately stated as compared to the rest of the industry. Then the volume of their sales would give an indication of what the manufacturing costs of the subsidiary were. And these types of data, taken together, would provide a reasonably good picture of whether accurate costs were being reported."

A less positive evaluation was given by Sidney C. Haw, vice president of marketing and sales at Penril Corp. "If we get a competitive subsidiary from AT&T in the marketplace, it is going to be a very prominent factor." The biggest selling point of the independent suppliers, Haw says, has always been that Bell was restricted to monthly rentals of its equipment while users had both longer term lease and purchase options from the independents. If the phone company is able to sell its equipment in the same way as other competitors, "it will do nothing but expand on its present customer base," he predicts.

Haw also expressed doubts that a structure could be devised that would eliminate the cross-subsidy problem, and if allowed to go through, the results would "be like an octopus—an extension of the present Bell System with more options."

At Intertel, Ralph Lowry, vice president of product and international mar-

keting, commented that even with a fully competitive subsidiary, AT&T would face many of the same limitations that it copes with today. Among them, he questions how quickly Bell can introduce new products, how well it determines its pricing strategies, and how quickly it can adapt to the needs of the marketplace.

"Presumably they would take some business away from us, but our firm and the other competitors would not be in business unless we could do some things better with products than they can, and we will still be strongly competitive," Lowry says. "While I am not anxious for them to come in on a nonregulated basis, it certainly would not cast a big dark shadow over the entire industry. The independent vendors will not just shrivel up and die; the Bell subsidiary will have to prove itself just like any new company would."

The new AT&T subsidiary would "be like an octopus—an extension of the present Bell System with more options."

Assuming that outright financial subsidy from the parent telephone company could be avoided by strict rules, Lowry sees some benefits coming to a competitive entity from such things as manufacturing tech-

ONLY ONE PRINTING SYSTEM MAKES OBSOLETE FORMS OBSOLETE.

The next time one small change makes you throw out a ton of forms, think of this: The Xerox 9700 creates and stores forms electronically. And it's the only electronic printer that does.

And it prints reports and printouts of such high quality you'll have to admire their form.

For more information, call or write: Xerox Printing Systems Division, 880 Apollo Drive, P-1, El Segundo, CA 90245. (213) 615-6329.

XEROX

XEROX® and 9700 are trademarks of XEROX CORPORATION.

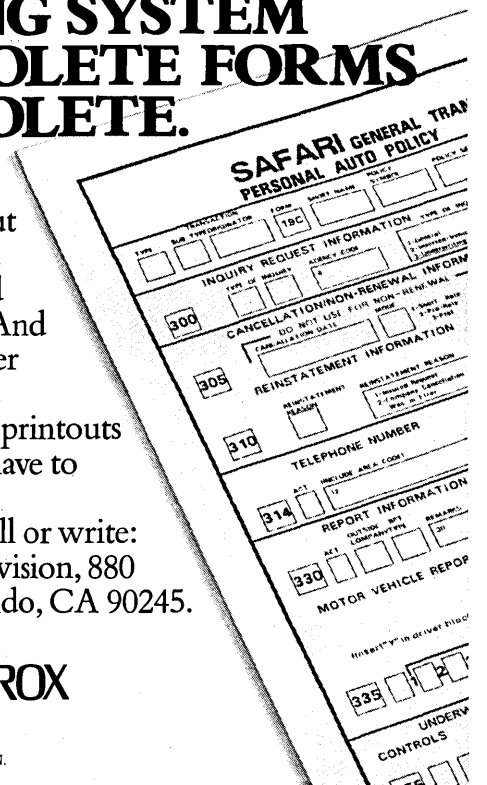

CIRCLE 60 ON READER CARD

In a world full of uncertainty, we certify every flexible disk we make. Not every other one.

While other companies have been putting a lot of money into sophisticated advertising, we've been putting a lot of money into sophisticated test equipment.

And putting the test equipment to work on every disk we make.

That way, the only *Ectype*™ Flexible Disks you can buy are disks that have been 100% certified error-free. At higher than standard industry specs.

Our disks live longer, too. Because we add all the correct ingredients to our initial formula. Instead of adding some later as an afterthought.

The result is wear life that exceeds 10 million passes!

Ectype disks are hard to lose and easy to use, too. Because they come in an E-Z Vue box that protects them and doubles as a file system.

So in addition to 100% certification, you get 100% convenience.

For full details, call us toll-free at 1-800-843-9862.

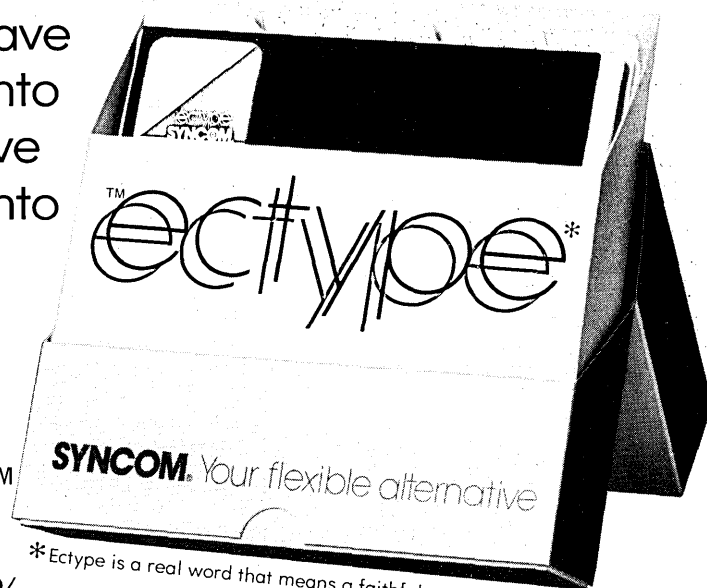

SYNCOM® Your flexible alternative.

P.O. Box 130, Mitchell, SD 57301

NEWS IN PERSPECTIVE

niques at Western Electric, "but that is a very limited type of subsidization compared to skimming money from every phone call." And the independents could compete against such technical benefits as long as no financial subsidy entered into the picture, he adds.

If a telephone company competitive arm is "done right" with the proper safeguards, the larger independents that have adequate financial resources will be able to handle the added competition, says John W. Pugh, vice president of marketing at Codex, which is now a subsidiary of Motorola. But some of the smaller suppliers would be adversely affected. For these companies with more limited finances, the entry of a competitive telephone subsidiary would mean that they have to become "niche players," Pugh claims. While not predicting that a new Bell entry would force a shakeout among the smaller independents, Pugh made it clear that these vendors would have a much harder time and thus would have to carefully select how and where they were able to compete.

Data communications is becoming a big business and only the largest companies can afford to be total systems suppliers, Pugh points out. As the market expands, the smaller independents will find pressure from other areas regardless of what AT&T does.

Actually, IBM is already in data communications, and probably the real threat will come from "Japan Inc.," Pugh contends, "But I don't see our strategy changing one bit as a result of an AT&T subsidiary entering the market."

A much harder line was taken by Walter Manning, president of ComData Corp. A regulated monopoly should stay out of competitive markets, he believes, pointing out that the industry has developed as a result of the free enterprise efforts of the independents. The independents "have completely swamped Bell with technology," he says, and while the competitors can certainly hold their own against the phone company, they should not be allowed to compete.

Comparing the situation with the early days of electric and gas utilities, Manning notes that these utilities initially provided appliances as well as electricity and gas. Now the appliances are supplied by competitive vendors and the utilities provide only the basic service. That is the way it should be done with the Bell System too, he suggests.

But conceding that AT&T might well enter the competitive arena, Manning expressed confidence that the independents would be able to handle the situation as they have managed to live with the phone company in the past.

Unless the accounting systems are clear, there will always be that gray area about where the money is coming from to

finance any competitive subsidiary, according to David L. Peters, product marketing manager at Racal-Vadic Inc.

But past history shows that even with its vast resources, Bell has not been terribly innovative, Peters says. So even if a subsidiary appears on the scene and some dependence on the parent company is evident, he thinks the independents will handle it. He points out that in 1980, Vadic expects for the first time to ship more modems than the Bell System. All in all, the company is thriving and it will be able to react to any competitive threat launched by Bell in the future, he says.

In three to four years, a large percentage of the modems will be built into terminal devices. And in this area a Bell subsidiary will be at a disadvantage compared to the independents, Peters predicts.

Most of those surveyed felt it would take several years before an AT&T subsidiary could actually begin operations. Many full regulatory and legal challenges will have to be cleared away before the FCC mandate to compete is allowed to stand. And Bell will need to gear up to a new role as an entrant in the competitive market, while the challenges are being adjudicated.

Thus, nobody in the modem industry expects any instant changes as a result of the FCC's decision in Computer Inquiry II.

—Ronald A. Frank

FINDING THE IDEAL PRODUCT

TeleProcessing Products started with a staff, and then went in search of an ideal product to produce.

It's a rare company that staffs up first and decides on a product second, but TeleProcessing Products Inc., Simi Valley, Calif., did just that.

In 1978 the then four-year-old company was little more than a garage shop operation, "merely a refined version of junior achievement," said president David Kirby. "I decided it was time to either get out of the garage or quietly die."

So, "I hired a bunch of people, a manufacturing guy, an engineering guy, and a resident wizard (executive vice president John B. Scott), and we spent the next six to eight months deciding on a product."

In a sense, TeleProcessing Products dates back to the early '70s, when Kirby, then a manufacturers' representative in the

ONLY ONE ELECTRONIC PRINTER CUTS PAPER COSTS IN HALF.

Xerox has an answer to the rising cost of paper: The Xerox 9700. It's the only electronic printer that prints on both sides of a piece of paper. And cuts paper costs in half.

If you'd like more information on the Xerox 9700, you could write us. But if you call, you'll save time. And paper.

Xerox Printing Systems Division, 880 Apollo Drive, P-1, El Segundo, CA 90245. (213) 615-6329.

XEROX

XEROX® and 9700 are trademarks of XEROX CORPORATION.

CIRCLE 62 ON READER CARD

JUNE 1980 83

"WHAT WOULD YOU SAY TO BIG COMPUTER PERFORMANCE FROM YOUR MICROCOMPUTER?"

"YOU'RE TALKING OUR LANGUAGE: PL/I-80.TM"

New PL/I-80 from Digital Research Brings Big Computer Programming Power to Microcomputer Systems.

PL/I-80 is the biggest news for small system users and OEMs since we introduced CP/M[®] and MP/M. PL/I-80 is ANSI's General Purpose Subset of full PL/I, tailored into a language for 8080, 8085 and Z80 users who expect the software revolution they've seen in hardware — better results at lower cost. PL/I-80 works harder than any other general-purpose language for business, science, research and education.

The PL/I-80 software package includes a native code compiler, comprehensive subroutine library, linkage editor and relocating macro assembler. And it's backed by our CP/M and MP/M operating systems.

Best of all, the complete PL/I-80 system diskette and documentation costs just \$300.

PL/I-80: There's no better way to get big-machine results from your 8-bit processor.

Single- and Multi-User Operating Systems That Set Industry Standards.

CP/M is the industry standard operating system for small machines. With thousands of users throughout the world, it's the most popular and widely used. It's the original, hardware-independent 'bus' for users working with a broad array of languages, word-processing and applications software available from scores of suppliers at affordable prices.

Now we've made a great CP/M even better. CP/M 2.2 is the latest release of the efficient, reliable system that's truly universal, able to manage virtually any 8080, 8085 or Z80 micro and its floppy or hard-disk subsystems. Named to the 1979 Datapro Software Honor Roll, CP/M comes on a diskette with its own operating manual, for just \$150 in unit quantity.



MP/M provides big-computer power at small-computer cost. It provides multi-terminal access with multi-programming at each terminal. And it's CP/M compatible, so you can run many programming languages, applications packages and development software on your system.

Check these advanced capabilities. Run editors, translators, word processors and background print spoolers simultaneously. Use MP/M's real-time facilities to monitor an assembly line and schedule programs automatically, or control a network of micros. Even write your own system processes for operation under MP/M. The possibilities are endless, yet MP/M costs just \$300 (unit price for diskette and manual).

Utilities That Work For You.

Use our utilities. Thousands do. They're designed to make your small system work a cinch, yet they cost surprisingly little.

- MAC[™] (Macro Assembler) — \$90
- SIB[™] (Symbolic Instruction Debugger) — \$75
- ZSIB[™] (Z80 Symbolic Instruction Debugger) — \$100
- IFX (Text Formatter) — \$75
- DESPOOL[™] (Background Print Utility) — \$50

All are supplied on a diskette, with operating manual.

CIRCLE 63 ON READER CARD

Digital Research
P.O. Box 579
801 Lighthouse Avenue
Pacific Grove, CA 93950
408 649 3896
1WX 910 360 5001

 DIGITAL RESEARCH

NEWS IN PERSPECTIVE

data communications field, and a friend got an idea for a battery operated, transportable line tester that would tell a data communications user first if he had a line and second if it would support data communications.

Nothing was done for a couple of years until Kirby got together with another friend, this one in the field service business, and built a model. This they shipped with a check to another company and got two prototypes. "To refine to something shippable took another three or four months," Kirby recalled. "We were shipping by early 1975 and had also cooked up several other equally simpleminded products." In the next two and a half to three years we added other little products."

In early 1977, Kirby's partner learned of an opportunity to distribute a printer interface for the Teletype 40, produced by an East Coast company. "He liked the idea and I didn't," Kirby recalled. "We agreed to get a divorce." At that time the company was a partnership with three employees.

It was then that Kirby made his get-out-of-the-garage or die decision.

"We filled two pages with criteria for our ideal product," he remembered. "We wanted to be in data communications because we had a track record there and a customer base. Also, I felt that was the fastest growing segment of American industry."

"We also wanted a product that wouldn't require field maintenance. We wanted something in the price range of \$2,000 to \$3,000, and we looked at the other half—what people needed."

Kirby came out of the metalworking industry in New England. "There, people know exactly what they're buying, what they can expect, when it will wear out. There are no surprises."

In the computer industry, he said, "the average user doesn't know what he's spending his money on. It's gotten a lot better in the last 10 years but there's still a long way to go."

TeleProcessing Products decided on a product "that would give the data communications user a device to find out whether or not he's getting what he's paying for, one that would help him contemplate major expenditures and know where to throw his money."

"What we wanted," said Kirby, "was something to evaluate data communications, to provide fault isolation. There was a need to analyze performance."

What they came up with was their TP-270 network analyzer, "and we're still pleased almost two years later." The product has been in production a little more than a year.

The first version was for users of 3270 remote bisynchronous protocol. A more recent one is for users of SDLC SNA. "But," said Scott, "the units can be made

sensitive to any protocol. The two units are the beginning of a family of devices."

"We underwrote software development for the IBM environment because the market is there. If we see other markets developing . . . it's just a matter of changing the firmware to the microprocessors," Kirby said. The bisync version uses one Intel 8085 microprocessor and the SDLC SNA version, two.

The TP-270 was designed to permit a

What they came up with was their TP-270 network analyzer.

user to determine the effects of both hardware and software changes to an on-line system.

"There's a lot of equipment around for troubleshooting, diagnostics," Kirby said. "We chose a different approach, performance measurement. Comparing our unit to diagnostic equipment, stuff which can cause you to go bananas when you're setting it up, we're straightforward."

He described the unit as easy to use and "friendly to the user." Ease of use, he said, was one of the design criteria.

One user, Charles R. Autry, teleprocessing analyst with the First National Bank of Denver, found this trait a good selling tool for his management.

Autry's bank has a network supporting 56 affiliate banks, most in Colorado and two in Wyoming. When the bank's Sales and Service Dept. began getting response time complaints, "they came down on the head of data processing," Autry said. "Correspondents [banks] were threatening to shop elsewhere."

Autry was assigned the responsibility for finding out what was wrong. "I looked up everything I could about response time. I had a Spectron Data Scope. We did have I/O counts, done with a stopwatch by sales and service. I had no software tools to tell me what was going on out there. I felt it would take me six months to find out what was happening."

The Data Scope gave only symptomatic data. Autry contacted local suppliers to see what network analysis equipment was available. Late in the second quarter of 1979, he acquired a TP-270.

"It impressed management," he said, "because even they could understand it."

For the three months following acquisition of the TP-270, each line on First of Denver's teleprocessing system was monitored. Autry said he discovered, based on the records generated, that the average response time rarely exceeded three seconds.

"This was excellent system respon-

ONLY ONE ELECTRONIC PRINTER MAKES YOU LOOK THIS GOOD ON PAPER.

Nothing improves your appearance like a Xerox 9700.

It can make your entire business look a lot more businesslike.

The 9700 can improve the impact of your communication with company logos, graphics, or even your signature. And it's the only electronic printer that can.

Improve your image. Call or write:
Xerox Printing Systems Division, 880
Apollo Drive, P-1, El Segundo, CA 90245.
(213) 615-6329.

XEROX

XEROX® and 9700 are trademarks of XEROX CORPORATION.

CIRCLE 64 ON READER CARD

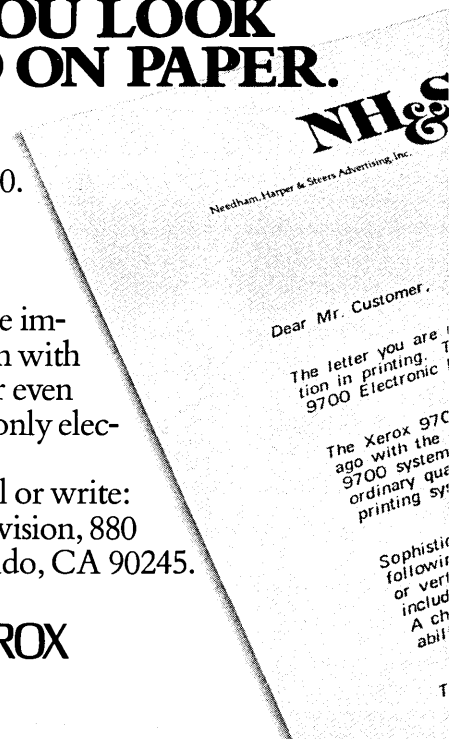

If you've encountered a
CULPRIT who has no
ANSWER/2 EASYTRIEVE[®]
you need

The Data Analyzer

Provides complete Data Retrieval and Presentation Capabilities PLUS:

- New, more Powerful and Flexible Macro Processor
- New On-Line CICS Data Retrieval Capability
- New On-Line IMS/DB/DC Retrieval Capability
- Free Form Language
- Extensive Graphic Capability
- Major Data Base Interfaces
- Regression Analysis Capability
- New Extended Table Look-Up Capability

Please send more detailed information on The Data Analyzer

Name _____

Company _____ Position _____

Address _____ City _____ State _____ Zip _____

OR, call Ray Novak
(201) 391-9800



Program Products Incorporated
95 Chestnut Ridge Road
Montvale, New Jersey 07645
201/391-9800
TWX - 710-990-0203

Market Analysis by Difference
 (CONTRAST METHOD)

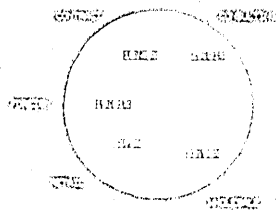

HEROES: GLEN ENTERTAINMENT
 (SAS PROC GCHART)



SAS Installation by State
 (SAS PROC GCHART)

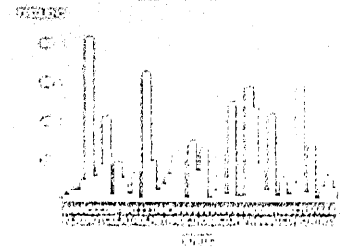

Insurance Benefits Paid

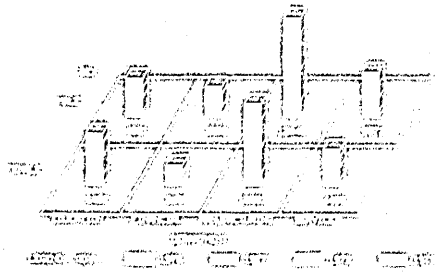

SALES BY QUARTER

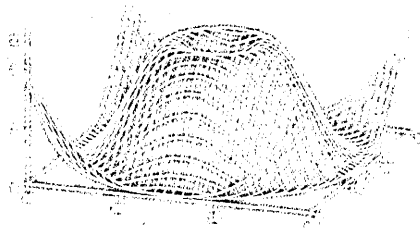

SALES BY QUARTER

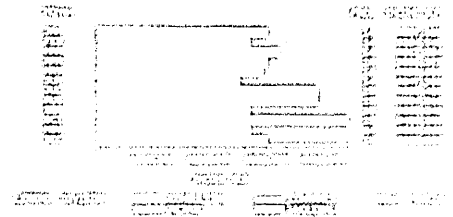

INDUSTRY OIL PRODUCTION
 (SAS PROC GCHART)

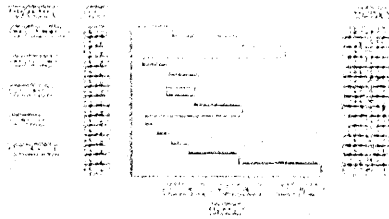

INDUSTRY OIL PRODUCTION FORECAST

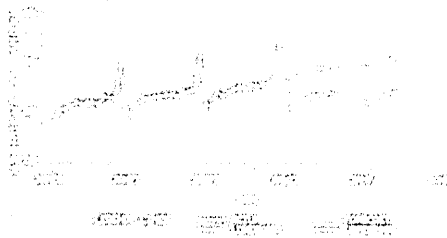

TRUCKS BY DIVISION
 (SAS PROC GCHART)

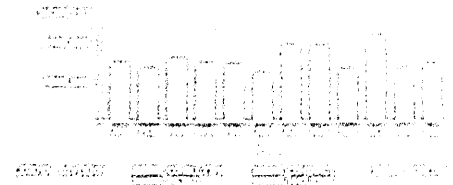

This new software is the result of our research and development. And we've packed our years of experience into a new product: SAS GRAPH.

SAS GRAPH pioneers a new direction for graphics software.

Old software systems were tied to a particular hardware and a particular way of thinking about graphics. And because the software had to do most of the work it was designed to be device-independent.

But SAS GRAPH is device-intelligent. It's designed to use the time-saving features built into most modern hardware.

For example, look at the illustration of a company's sales figures. The first chart is a standard 2D plot.

to color it, a device-independent system would require hundreds of lines of code. And it would take a long time to draw it.

And you'll save user time. Because SAS GRAPH produces most displays with two or three simple statements.

SAS so you'll get the benefits of the entire SAS system — a system now saving time in report writing, statistical analysis, data management and non-higher-level programming language at more time.

And you'll save user time. Because SAS GRAPH produces most displays with two or three simple statements.

Call or write today. We'll send you a more complete information very quickly.

SAS Institute Inc., 1900 South Lakeside Blvd., Cary, NC 27513.



siveness but it was the maximum response times that were causing complaints."

The maximum response times were observed and broken down to the factors involved. This, Autry said, showed poll to poll times which were consistently responsible for the greater percentage of overall response time. It showed the most severe problem was line loading. "As the number of active messages increased, the amount of time given to polling decreased, resulting in the maximum response times." In addition, he said, ailing terminals and cpu tie-ups also were pinpointed as contributors to the problem.

Based on data obtained from his monitoring, Autry determined that reconfiguration of teleprocessing line loading would alleviate the maximum response time problems during peak periods.

And, in anticipation of network expansion, Autry said he now requires his technicians to monitor each of the teleprocessing lines daily. These data are compiled and are used on an ongoing basis for network modifications.

Routine problems, he said, are now discovered before they become complaints. "We can go to the users before they come to us."

At present all sales are to end users but the company foresees an oem business with development of systems using its units.

Kirby said 60% of all sales of the TP-270 have been to banks and other financial institutions. At present all sales are to end users but the company foresees an oem business.

"We see development of systems using our units which would incorporate a mini to poll them and to develop and message the data. We did add a remote control option but we stopped there."

If the TP-270 does become a systems component, TeleProcessing Products will be content to be a supplier. "We're talking possible systems now with three major modem manufacturers," said Scott.

TeleProcessing Products continues to sell its earlier "more simpleminded" products including the one that got the company started, now sold as the TP-260 line tester.

And the company is getting help from IBM. In one of a number of regional tests linking IBM's Office Products Div.'s Office System 6 with the firm's 3800 laser printer, a mix of TPI's products was used to link the two.

"Now their salesmen are quietly recommending us," said Scott. "We even were asked to display the equipment at the most recent meeting of their 100% club."

—Edith Myers

PERSONAL COMPUTERS

KIDS LOVE THE DP SCENE

Children flock to Menlo Park's public library to do more than read books.

In a public library in Menlo Park, Calif., are four personal computers that can be used at no charge. They are part of a program to acquaint people with computers in this affluent city of about 30,000 adjacent to Palo Alto and Stanford Univ. Fifteen minutes of instructions suffice to teach people how to turn the machines on and off, insert a cassette tape, load a program, and respond when the processor asks whether the user is ready. That instruction, too, is free and is a prerequisite to hands-on use, in addition to a card from any recognized library.

"Last week I taught someone from Australia," says teaching assistant Jim McClenahan matter-of-factly, "and I also taught six people from Argentina." The TA, one of two hired by the library, is 12 years old. He was an early convert to the cult when the first personal computer was brought to the library early last year, re-

ceived the same instructions, and showed sufficient interest and proficiency to subsequently be offered the newly funded job. This summer he and the other TA are scheduled to begin writing their own programs under supervision, most likely more games to be added to the extensive inventory of games on cassettes at the library.

The computers, three Pets from Commodore Business Machines and a TRS-80 from Radio Shack, are located in the children's library, although they are available also to adults. The goal has been to introduce them to students from grades 3 through 8. Because the local high schools have a number of personal computers, those students tend to use the machines at their schools.

During school days, computers are in constant use from 2 p.m. to about 6 p.m., according to Suzanne Rocca-Butler, head of the children's library. There's sporadic use during the day and after 6 p.m. But during the summer months and on weekends, the computers are in constant use during library hours. And on weekends, kids are lined up before the librarian opens the doors at 10 a.m., which produces a mad rush to the sign-up book. Users are guaranteed a half-hour without interruption, but then must surrender the machine to anyone signed up for the following 30 minutes. There have been as many as 15 people waiting for a turn on one of the computers.

"It's caught on like wildfire," says Rocca-Butler. "It brings out the most amazing reactions in the kids." There nor-



FAMILY COMPUTING: A father and son, enrolled in Bob Albrecht's junior college evening course called "Computers for Kids and Parents," spend Tuesday nights at the Menlo Park Library playing one of more than 30 computer games available to the public. The course requires that a parent and a child aged 7 to 13 enroll together to learn how to use and program personal computers. The Pet is said to have a good cassette operating system, making it ideal for this Computertown USA program. But elsewhere in this room, another father and son were writing their own program on the lone TRS-80 at the library.

Multidrop communications for minicomputer users. Save lines, save modems, save money.

If you're supporting asynchronous dumb terminals remotely on your minicomputer system, you're probably registering a line for each of those point-to-point leased phone lines. It's the price you pay for using low-cost terminals, right?

Wrong! With MICOM's new Micro90 Multidrop Controller, you can multidrop those dumb terminals at different remote locations, singly or in clusters, and share a single multidrop telephone line. You can slash your phone bill immediately *without special software*. What's more, the Micro90 provides automatic retransmission control to ensure *error-free* communications on the multidropped

telephone line. It's ideally suited for use with DEC, Data General, or any other minicomputer system.

The Micro90 supports two protocols: V.22, an older point-to-point Micro90 Data Communications single remote site cluster controller for dumb terminals. What's more, the Micro90's are already in service, installed by the user as painlessly as plugging in a terminal.

So if you use dumb terminals, but you want to enjoy state-of-the-art communications efficiency, sign them to the last drop, save for complete details on the Micro90 today. With prices starting at only \$1950 (a 2-year-old unit, *we know*, you'll love it).

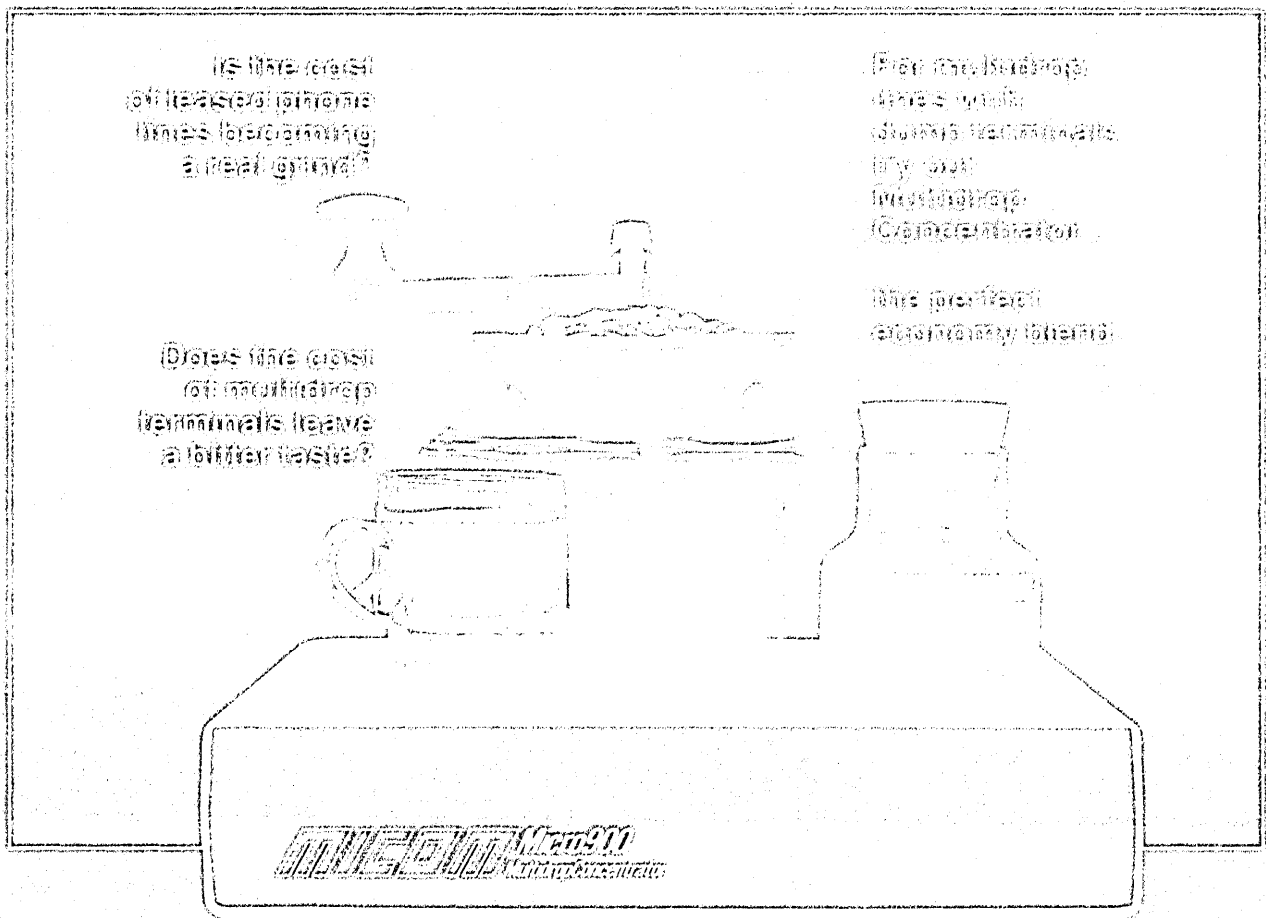

MICROM Communications for Remote Terminals

MICROM SYSTEMS, INC. • 9561 Inverdale Avenue • Chatsworth, California 91311 • Telephone (818) 892-8888 • FAX 818-892-8076
Regional Offices • Atlanta (404) 452-1800 • Boston (617) 255-8970 • Chicago (815) 825-8898
Philadelphia (610) 267-8888 • Washington (301) 770-291-2908

Available now from these international distributors:

Australia (01) 925-8187 • Belgium (03) 225-2070 • Canada (416) 291-2908
Denmark (45) 365-5211 • Finland (09) 74077 • France (01) 49 20 11 11
Germany (030) 2751-2752 • Germany (0524) 2411-2412 • Italy (02) 49 20 11 11
Israel (03) 462-7516 • Italy (02) 49 20 11 11 • Japan (03) 214-2142
Luxembourg (46) 672 • Netherlands (074) 213-213 • New Zealand (04) 492-2142
Singapore (04) 250-2500 • South Africa (011) 729-1000 • Spain (01) 492-2142
Sweden (08) 2600-10 • Switzerland (022) 365-5211 • United Kingdom (01) 492-2142

CIRCLE 67 ON READER CARD

NEWS IN PERSPECTIVE

mally is no discipline problem in the library with kids, she explains, but they do experience some problems over the use of computers. "It brings out a competitiveness, a lot of emotion. It's just amazing to watch."

The community project, promoted as "Computertown USA," is the work of the Peoples Computer Co., the folks who opened the world's first storefront computer center in this town for use by neighborhood kids and adults alike. PCC now publishes *Recreational Computing* magazine, and two of its editors, Bob Albrecht and Ramon Zamora, have donated to the library the proceeds from introductory courses they've taught so that TAS might be hired to monitor the equipment use. They also wrote introductory and instructional books for the vendors in return for the computers.

Albrecht, in trying to promote this project, was rebuffed early on by the local supervisor of schools and by the chamber of commerce. From the latter he wanted a donation of a color tv set so they would be able to use Atari and Apple computers. The request was turned down. Undaunted, Albrecht has completed more writing assignments and is awaiting five or six more Pets for use in the library, in addition to an Atari.

He looks forward now to permitting the youngsters to take a computer home. No fee has been set as yet, but Albrecht thinks an 8K Pet might rent for \$5 a day.

But it is not at all clear that a library is the ideal site for a collection of personal computers. Some will have you believe that youngsters who go to a library to use a computer will, while awaiting their turn, read books. Not necessarily true, says Rocca-Butler.

The computer games improve a child's skills in quick response, quick thinking, mathematical abilities, and strategies.

"If anybody can figure out a transition from using a computer to reading, I would be very interested," she says. When the machines are all taken, she observes, the kids lean over the shoulders of others playing games and kibitz, rather than curl up in a corner with a good book. "It does not work," she sighs. "They do not read."

The computer games played, of which the library has more than 30 cassettes, have such names as *Swordquest*, a fantasy of exploration and problem solving. It is said to develop in a child such things as intuitive probability (in some circles, it's called oddsmaking), resource conservation (whether to expend one type of firepower, of which there is a plentiful supply, or a more powerful missile, a resource quickly exhausted), and contingency planning (he who fights and runs away lives to fight another day). And there's also *Taipan*, a

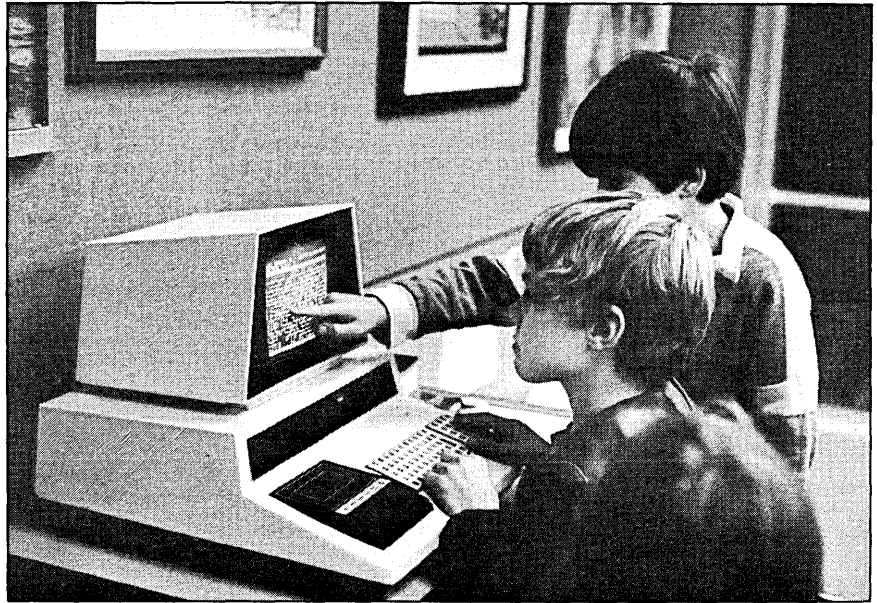

GAMES PEOPLE PLAY: These kids are playing *Swordquest*, which visually looks like a maze on the screen. In it, the player must work his way from the left of the grid to the far right while being pursued by a devilish enemy armed with an assortment of weapons. The player is given time to evaluate his position on the grid, look over the encroaching enemy, and make his move, all the while being called upon to fire from a limited supply of ammunition. The object: make it to the opposite end before exhausting his supply. In the photo below, Bob Albrecht can be seen among a gaggle of kids. Albrecht is explaining the several alternatives open to the player if he is to escape from the approaching bad guys. Here, too, it's a boy's world; there's only one girl.



simulation of seagoing trade in China in the 1800s. For the younger set, there's a game that teaches the names of the states.

"What this does, I'm sure, is improve the skills in quick response, quick thinking, mathematical abilities, strategy," Rocca-Butler says. "I'm sure the computer games have this impact." And while more youngsters come to the library because of

the computers, their coming is not at all related to the presence there of books. "But it's related to learning, very definitely."

Accordingly, the librarian thinks the ideal setup would be to have a separate audiovisual wing of a library equipped with such things as computers, phonographs with headsets, and slide projectors.

—Edward K. Yasaki

Hardware

COMPUTER ADVANCES

Vol 5 No. 9 June 1980

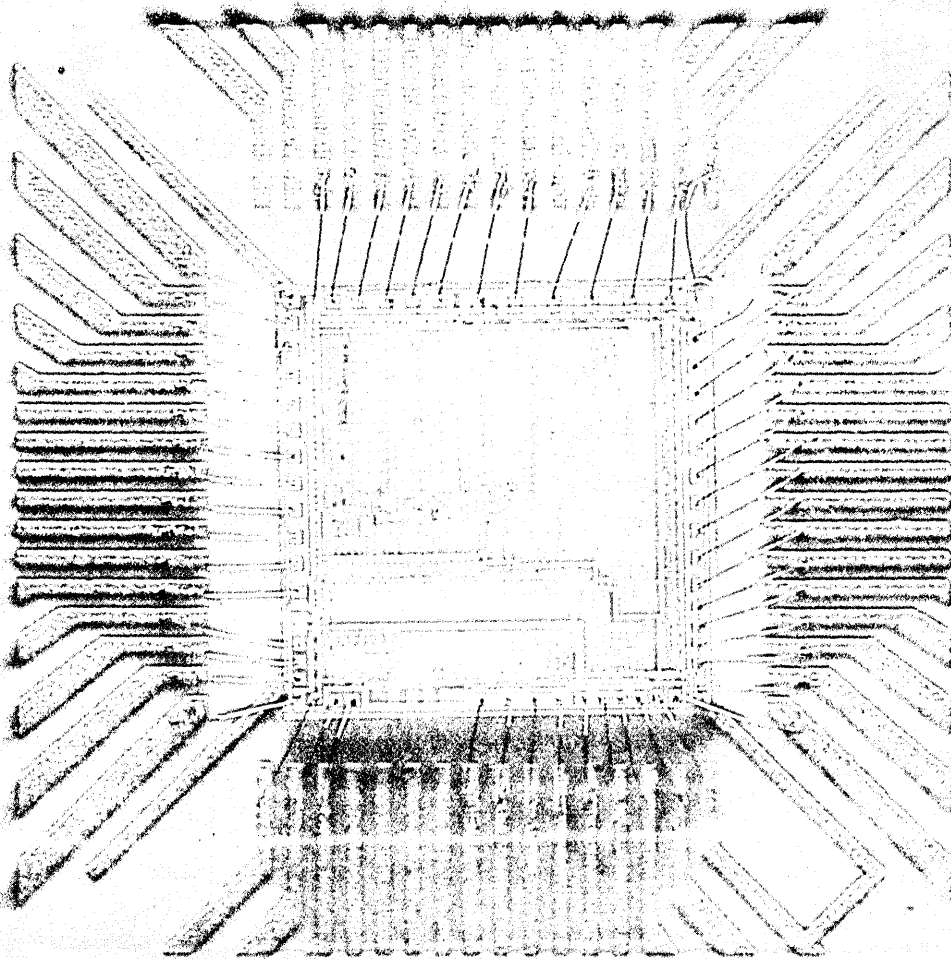

Two SOS processors
in one low-cost computer

SOS lowers cost, speeds I/O in new HP 1000 L-Series

Many low-cost computer applications are so I/O-intensive that the sheer volume of input/output transactions can degrade overall computer performance despite a high CPU instruction rate.

We designed the HP 1000 L-Series computer, newest and least expensive of the HP 1000 family, so that CPU and I/O instructions are processed separately. This "distributed intelligence" architecture provides high performance in both dimensions. And because this performance is achieved with silicon-on-sapphire LSI technology, it comes at a low cost. The L-Series CPU and 64K byte memory "board set" can be bought for \$2,250*.

Two SOS microprocessors are the brains of the L-Series. One is the central processing unit for the computer; the other is an input/output processor (IOP).

The CPU chip implements the base instruction set common to all HP 1000 computers, making the L-Series compatible with the more powerful M-, E- and F-Series HP 1000s. Also implemented on the CPU chip are a real time clock and the memory protection facilities necessary to support real-time multi-programming applications. The IOP, one of which runs each interface board in the L-Series,

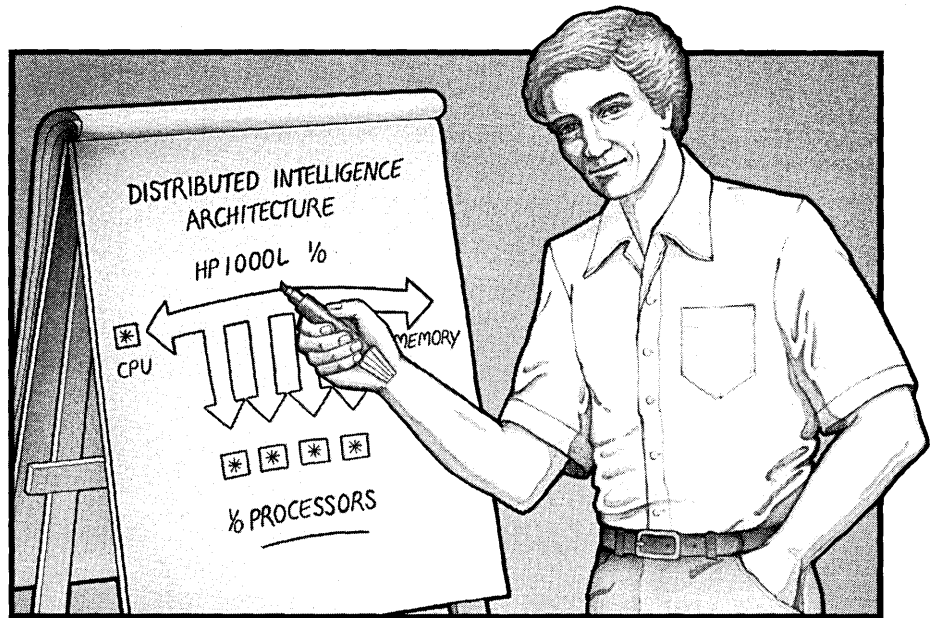

Multiple I/O processors, each with direct access to memory, speed I/O and free the CPU to perform computation.

accesses memory directly, and performs other "housekeeping" functions so that the CPU is free to compute.

This architecture was made possible with the SOS technology that only HP, among major chip and computer makers, has delivered in commercial products. The crystalline structure of SOS allows devices to be packed very densely on the chip and to be operated at high speeds. SOS has shrunk the parts count in the HP 1000 from 337 in previous family members to 67 in the L-Series. The result is higher reliability as well as lower costs.

I/O power on a card

The HP-IB interface card makes the fullest use of the L-Series exceptional I/O power. The board

has two SOS chips—an IOP and a special processor to control the interface protocols of both the 1975 (low speed) and 1978 (high speed) IEEE 488 standards. The benefit is that a single HP-IB card can interface with up to 14 instruments, or the same card can be used for connecting a wide variety of peripherals, including fixed and removable media hard discs, flexible discs, and printers. This interface saves I/O slots and power.

For users who wish to implement special I/O cards, a breadboard card supplies the IOP and space for custom logic or microprocessors. Other cards interface with asynchronous serial (RS-232C and 449) devices, and make high-speed parallel transfers. A storage module provides up to 64K bytes of UV-erasable PROM storage of user

◀ Cover

The HP 1000 L-Series central processor provides many system level functions integrated into a single silicon-on-sapphire (SOS) chip.

programs and data; this card can eliminate the need for peripheral memory devices, allowing the L-Series to be operated in harsh environments.

Real-time operating software

The L-Series operating system, RTE-L, is a comprehensive subset of the RTE-IVB real time multi-programming system introduced for the HP 1000 family last year. RTE-L will support program development in FORTRAN, BASIC, and assembly language, and will execute programs written in PASCAL. It can manage on-line and background batch processing simultaneously. Systems can also be developed on an RTE-IVB machine and loaded into the L-Series.

Configurations

The simplest L-Series system, the 2103LK, consists of a set containing the CPU board and a 64KB memory board. It sells for \$2,250*. The OEM user can add a power supply, a 5- or 10-slot card cage, and interface boards.

The L-Series also comes as a rack-mounted computer, the 2103L, with processor, memory board, and 8 I/O slots, for \$4,450*. A complete system, the HP 1000 model 10, includes the L-Series computer with 64KB of memory, RTE-L, a 1.2 Mbyte flexible disc, 12 Mbyte fixed disc console and cabinet. It costs \$22,500*.

Please check A on reply card for L-Series literature.

*USA domestic price only

DMA saves CPU cycles

Since each interrupt by an I/O device can cost the CPU up to a millisecond of computing time, the key to I/O performance is to minimize the number of interrupts. Direct memory access (DMA) requires only one interrupt for an entire block of characters and thus offers significant advantages over the normal method in which the CPU is interrupted for every character transferred. The I/O processor on every L-Series interface card provides DMA at a very low cost.

Setting up an I/O transfer under DMA is fast and simple. Only three pieces of information are usually needed: a buffer address that tells where the data will be transferred to or from in memory; a word count that tells how much data is to be transferred, and a configuration word that specifies how the information is to be transmitted to the interface card.

Three instructions will enter control words into three registers on the IOP chip, and a fourth instruction starts the transfer. The IOP takes care of all handshaking protocols with the peripheral device. Information is transferred to memory on a cycle-stealing basis, and the IOP

interrupts the CPU only when the transfer is complete.

Chained DMA transfers

Another way to set up the interface card for a data transfer is to use the IOP's "self-configuring mode" for multiple transfers. In this process, the program tells the IOP where in memory the three control words are located, and the IOP can configure itself for the transfer by loading the words into its own internal registers.

With this approach, the IOP can check at the end of each transfer to see if another transfer is required, and then configure itself to perform the next operation.

DMA itself eliminates about 95 percent of CPU interrupts; chained DMA saves two-thirds of the remaining interrupts.

Since it has an IOP on every interface board, the L-Series computer has DMA capability on every I/O channel. Because of this feature, the I/O programs in RTE-L use DMA for all low-speed as well as high-speed transfers, resulting in a significant increase in overall processing efficiency. Total DMA bandwidth is 2.7 Mbytes/second.

High-level implementation of 1974 ANSICOBOL

COBOL II/3000 is one of the most complete implementations of the 1974 ANSICOBOL Standard for any system in the price range of the HP 3000. It executes under the MPE operating system on the HP 3000 Series III, 30, and 33, offering a wide range of standard and extended features to improve both programmer efficiency and run-time performance.

HP's COBOL II implements 9 out of 12 modules at level 2 of the ANSICOBOL Standard—that is, with all the instructions and options defined for them. The 9 modules are: Nucleus, Table Handling, Sequential Access, Relative I/O, Indexed I/O, Sort-Merge, Segmentation, Library, and Inter-Program Communication. This level of implementation provides a wide range of industry-standard features to maximize programmer effectiveness within the COBOL environment.

LEVEL 2

LEVEL 1

In place of the Debug and Data Communication Modules defined by the ANSICOBOL Standard, COBOL II offers interactive

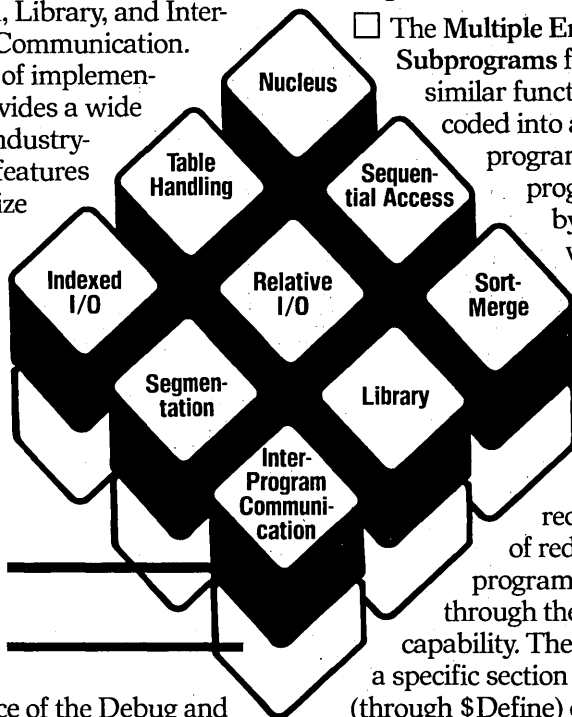

debugging through MPE Debug and data communications through DS 3000. These facilities are simpler to use in an HP 3000 environment than those defined within the ANSICOBOL Standard.

Extended features improve productivity

HP's COBOL II/3000 offers extended features which reduce the coding effort by eliminating redundant code. Programmers using typical structured programming techniques will find COBOL II extremely efficient since code may be written once and accessed thereafter by a single identifier.

□ The Multiple Entry Points to Subprograms feature allows similar functions to be coded into a single subprogram. This subprogram is accessed by entering at various sections of the code and executing only the portion appropriate to the function.

□ Preprocessor Functions help reduce the amount of redundant code a programmer must write, through the use of a macro capability. The user can equate

a specific section of code (through \$Define) or a file (through \$Include) to a single identifier. When this identifier is referenced in a program, the

compiler will automatically replace it with the referenced code.

Easy access to system capabilities

COBOL II/3000 is designed to allow users to access powerful MPE operating system features through CALL procedures without having to write system-level interface routines. The result is simplified access to a broad range of HP 3000 operating system features, with a reduction in coding effort and system overhead.

Tools for simplified programming

COBOL II/3000 provides full access to standard data management and data communication software of the HP 3000. Standard tools which can be directly accessed include the MPE Sequential File System and KSAM/3000 (HP's Indexed File System). These are accessed directly as defined

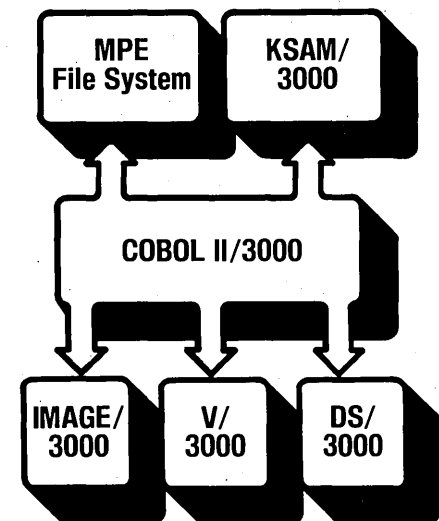

within the ANSI Standard to simplify the programming effort.

In addition, COBOL II interfaces to the other HP 3000 data management and data communication tools through library procedures, thus increasing the overall capabilities of the programmer. These tools include IMAGE/3000, HP's data base management package, V/3000, which is used to generate and access complex screens for data entry, and DS 3000, which is used for data transfer between systems.

Data management extensions to ANSI Standard

In addition to providing access to the data management tools of the HP 3000, COBOL II implements special extended features which simplify the complex programming effort normally required for elementary data manipulation. An example is the ACCEPT-FREE statement, which allows users to invoke terminal input of single fields. The user merely inputs the data, and COBOL II does the editing and formatting.

Ease of conversion

COBOL II—with its high-level implementation of the ANSI Standard and widely used, packed decimal data format—provides most of the programming features available in the industry, thus simplifying conversion to the HP 3000.

In addition, HP has provided a simplified conversion path for existing customers by means of an upward compatibility of features. All features available

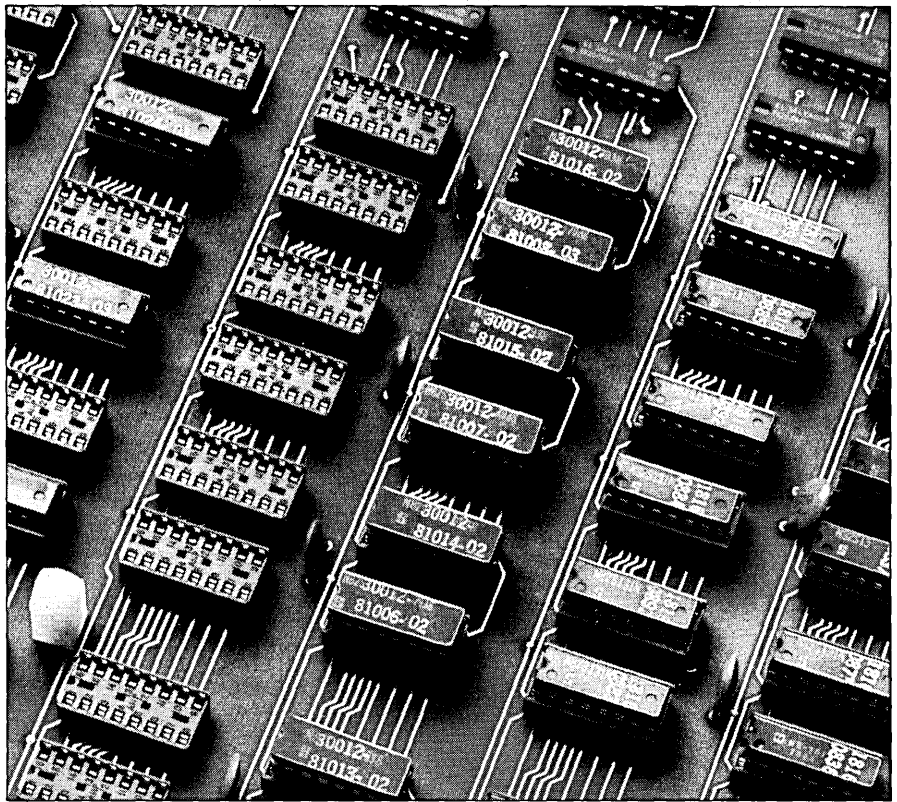

Microcoded instruction set improves run-time efficiency.

under COBOL/3000 are supported by COBOL II/3000 through the 74 ANSI Standard implementation or through language extensions. The only changes a user must make are when new reserved words, defined for the 1974 Standard but not for the 1968 Standard, have been used as identifiers in a COBOL/3000 program.

To simplify making these changes, a conversion guide and program are provided. The guide lists all the new reserved words as well as all the new features of COBOL II/3000 which were not available under COBOL/3000. The conversion program, described in the guide, automatically flags any of the new reserved words being used as identifiers in the COBOL/3000 program. The programmer can then simply change the flagged statements and recompile under COBOL II.

Increased performance through firmware

COBOL II offers improved run-time performance through the

implementation of a microcoded instruction set. This instruction set optimizes run-time performance of frequently utilized code for subroutine access, data manipulation, and editing.

In tests run in a batch environment, improvements in the range of 10 to 20 percent for execution time were observed. Tests run in an on-line environment yielded execution times equal to or slightly better than those written in COBOL/3000. Performance comparisons with COBOL/3000 may vary depending on the exact application.

The microcoded instruction set, along with the high-level implementation of the ANSI Standard and COBOL II's many extended features, reaffirms HP's commitment to high-technology software products designed to increase programmer productivity and improve run-time performance.

For more information check B on reply card.

Data base management— on a desk top

The first data base management system (DBMS) implemented on a desktop computer—the HP System 45—will reduce programming costs and improve data integrity, access and security for a wide range of scientific, technical and industrial users.

At the heart of System 45 DBMS is IMAGE/45, a subset of HP's user tested and approved IMAGE/3000, one of the most widely installed DBMS packages in the world. IMAGE/45 provides 26 new BASIC statements and routines in ROM for managing the data base. It enables you to build, maintain, access, re-structure and back-up a data base without writing special application programs.

IMAGE/45 provides great flexibility in data base size: up to 32 data sets per base and 32,767 records per set. Within each 1,022 byte (max.) record, you can have up to 127 fields.

System 45 DBMS uses a chained approach to data retrieval in which pointers logically connect records having common attributes. This allows cross-referenced access to collections of data and ensures fast access to related data by key values.

Included in System 45 DBMS is QUERY/45, a highly interactive and powerful data access and manipulation software package—written using IMAGE/45 tools—that enables you to access your data base without writing BASIC programs. QUERY/45 facilitates “ad hoc” or unanticipated data base inquiries through the use of user soft keys, “help” files and a system information file. QUERY/45 is

divided into six software modules that contain the primary data access routines:

- DEFINE, allows you to create or modify a data base while being prompted from the CRT screen.
- SHOW, provides a graphic “picture” of the data base structure.
- SEARCH, allows multi-criteria data selection (including computed or partial value searches). Searches are done using “threads” that link sets with common key values.
- UPDATE, allows you to add, delete or modify data with or without a pre-defined form.
- FORMS, allows you to create new forms to be used with UPDATE, or modify old ones.
- FRAMEWORK, allows QUERY/45 to function as a front-end to user written programs. Your program can use QUERY/45 to select and sort data from the data base.

Reduced costs

System 45 DBMS lets users modify a data base with a minimum of programming effort because the data is defined independently of the application programs. Moreover, QUERY/45 can serve as a direct replacement for many applications programs.

Improved data integrity and security

System 45 DBMS allows independent files to be consolidated into a centrally located set of files. This ensures that the most current information is maintained. It eliminates the problems associated with multiple users updating

multiple versions of the same file.

Powerful error detection and recovery routines are also provided. If a data transfer is interrupted for any reason, the data base is flagged “corrupt,” since the pointer updates may not have been completed.

A system of passwords, maintenance words and named values provides excellent data security for System 45 data bases.

Link to HP software

To simplify statistical processing, QUERY/45 provides a program that lets you reformat data from the data base and then automatically pass that data to programs from the HP Statistical Software Library.

System 45 DBMS is powerful and easy to use. It doesn't just put your data on file... it puts it to work.

The System 45 DBMS includes firmware, software, manuals, a practice data base and a data base design kit and costs \$5,000.

For further information, check C on the reply card.

Computer Advances is written to inform professionals of the latest technical contributions from Hewlett-Packard. You are invited to receive issues at your place of business or residence. Write
Bob Ingols, Editor
Computer Advances
19320 Pruneridge Ave.
Cupertino, CA 95014



**HEWLETT
PACKARD**

NEWS IN PERSPECTIVE

INTERNATIONAL

DP: AN EASY TARGET

While terrorist attacks usually endanger people, Europeans fear computers are being threatened as well.

Firms with dp operations in Europe are faced with a new threat to computer security—terrorist attack. In the last 18 months, more than a dozen installations have been victims of sabotage in a number of countries, including Italy, the German Federal Republic, France, and the United Kingdom.

Despite this disturbing new phenomenon, observers say most users remain careless over security gaps in their own installations. Vendors, however, have become distinctly jumpy because full-scale security systems might give computers a "1984" image. They are also concerned that publicity for the terrorist actions might attract even more anticomputer attacks, a view shared by the national police.

The most recent wave of attacks came in France, where extremists damaged installations at Air France, Philips Data Systems, and Cii-Honeywell Bull—all in the space of a few days. A further unsuccessful bazooka attack was made on a French Transport Ministry computer center. There, terrorist rockets missed the sixth floor computer suite, hitting instead the fifth floor library.

While Italian and German dp sites have also suffered, the United Kingdom has so far been exempt, apart from incidents in the already embattled province of Northern Ireland. Here, a dp center was incidentally damaged in an attack on the Belfast Cooperative Society, and a more specific attack was made on the Queen's University computer, also in Belfast, which was suspected of holding police information.

"I don't think people are very aware of this sort of threat. We're doing our best to make them aware," says Michael Wood, privacy and security manager at the United Kingdom's National Computing Center (NCC) in Manchester. "Most installations continue to be very, very vulnerable, just like normal offices," he declares. Concern at the NCC mirrors anxiety in other European countries, but this is often at official or governmental levels rather than at the user level. Wood circulates security information to about 120 firms, and some of these companies are beginning to take action.

According to Wood, the European scene is different from that in the U.S. where, he says, "they seem more concerned about monetary fraud than terrorist attacks." In Europe, banks have already begun to take some initiatives towards increased physical security. They are moving their dp centers away from big cities, and adopting a perimeter fence approach instead of having entrances straight off the street. Another dp banking expert comments: "They are moving away from one central computer to several regional centers" to guard against all aspects of vulnerability.

But the European security campaign is only gathering momentum slowly, boosted a bit by the events in France, where the incidents at Philips and Cii-HB made front page news in the national dailies. According to unconfirmed information from an industry source, one U.S. chemical company is considering pulling most of its dp operations out of France. The reason is that it feels the dangers of terrorist attack in France are too great. What the firm plans in order to reduce reliance on its French dp center is to move it to a site close to the Swiss border and set up back-to-back system with another mainframe just over the border on the Swiss side. Also nervous about France's Arab oil connections, the firm believes the Swiss may have the terrorist problem under better control, says the source. In the event of any problems in France, the firm can switch to the Swiss center, it reasons.

One new French computer security outfit, Sogesi, launched with impeccable timing just a couple of days before the Philips and Cii-HB attacks, reports that as a result of the incidents, company heads are now asking their dp managers if they have taken measures to guard against terrorist action. Says Sogesi president Pierre Leroy: "Most firms are very badly protected in terms of general computer security. There are now very few risks at the level of hardware alone. But there is a real risk in how and why dp is used." Leroy says it is increasingly important for dp users to be very conscious of the risks—for the people as well as to the hardware and software.

Nonetheless, no site can be totally secure. At Air France, the first of the French attack victims, the attackers blew up telecommunications lines outside the airline's already heavily fortified center on the French Riviera. Though a spokesman said the airline had stepped up its security measures, it is almost impossible to protect telecommunications lines outside its premises. The incident, which went unclaimed by any terrorist organization, managed to put the airline's reservation system out of action for five hours.

The Philips and Cii-HB incidents both took place in Toulouse, and both were in customer demonstration centers. While this minimized the damage done to the ven-

A New Bar Code Printer. Under \$5,000.

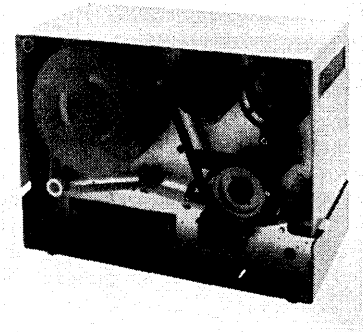

Intermec introduces the 8220 printer, the first dedicated bar code printer priced at under \$5,000 capable of producing high quality, high density CODE 39® labels and tags.

The 8220 features RS 232C computer input or conversational operator prompting on a user-supplied terminal.

Label print quality is what you expect from an Intermec printer... high resolution CODE 39 at 9.4 characters/inch.

EPOXY-A QA SAMP
038970 LOT32-5



(LABEL SHOWN IS ACTUAL SIZE.)

Bar code scanning provides rapid, accurate data entry with minimum training of your workers and without impacting their regular job.

A bar code system, using an 8220 printer, has many applications... production tracking, QA specimen ID, product configuration control, time and attendance reporting, inventory control, file folder/document tracking.

For more information contact:
Interface Mechanisms, Inc.
P.O. Box N, Lynnwood, WA 98036
Phone (206) 743-7036
TWX (910) 449-0870

INTERMEC®
The Bar Code Experts

CIRCLE 68 ON READER CARD

JUNE 1980 99

NEWS IN PERSPECTIVE

dors' major operations, in the Philips case the attack came while customers were waiting for application programs being developed by the vendor. Both companies admit they had only normal office security precautions in force. The intruders broke into the offices, setting fire to data storage media (tape cassettes, floppy disks and punched cards) at Philips, and destroying a Level 61 DPS system at Cii-HB with a fire bomb plus incendiary chemicals.

The companies will give no official estimate of the damage done, although unofficial reports say it is unlikely to have exceeded \$700,000. This is a small amount compared with what could have happened if either of the two companies' internal dp systems had been destroyed. Besides considerable costs to replace mainframe hardware and software, consequential losses of stored data and ongoing operations could cripple a company if it had no adequate backup systems available.

It is not clear whether there is any common political thread connecting the sabotage attempts in different European countries. Commentators have for some time suggested links between Italian, German, and French terrorists. But the computer incidents seem to have been provoked by different bodies. In the recent French attacks, the Air France incident, not far from the Italian border, was not claimed by any

organization. But two organizations claimed to have sabotaged the Philips installation.

The first, Action Directe, a little-known leftist body, also claimed responsibility for the attack on the Cii-HB center and the Transport Ministry (where the attackers also damaged two other ministry buildings in different parts of Paris). But police have discounted the Action Directe claim for the Philips job. Another organization, CLODO, seems to have come up with convincing proof that it entered the Philips premises. It reported afterwards that there was a Rolls Royce brochure in the Philips manager's desk—a claim substantiated by the company. ("It was there because we advertised in it," said a Philips spokesman, anxious to

CLODO, translated as the Computer Liquidation and Hijack Committee, boasts of its attack on Philips Data Systems.

dispel any impression that its branch managers were in the Rolls Royce league.)

CLODO stands for Comité Liquidant ou Détournant les Ordinateurs, which translates to Computer Liquidation and Hijack Committee. Police in Toulouse believe that this group has been responsible for other anticomputer actions in the last few months.

In one instance, CLODO publicly exposed a local department store that was maintaining a file on petty thieves caught in the store, including data on their psychology and morals—a file which is illegal under French data protection laws.

CLODO made its views on dp quite clear in a statement to the French press: "We are workers in the field of dp, and consequently well placed to know the current and future dangers of dp and telematics. The computer is the favorite tool of the dominant. It is used to exploit, to put on file, to control, and to repress."

But the message that the French press seems to have picked up is that terrorists are well aware of the vital role played by computer systems in the day-to-day management of powerful organizations. As the leading pro-government French daily, *Le Figaro*, observed in its page-one leading article: "... a modern nation is infinitely vulnerable. It is much more effective for those who aim to harm or even paralyze it to put computers out of action than to shoot up ministries or murder policemen."

In France at least, security forces have increased their surveillance activities at all Toulouse offices of computer suppliers, and an Interior Ministry spokesman said police were also intensifying security efforts in Paris.

—Andrew Lloyd

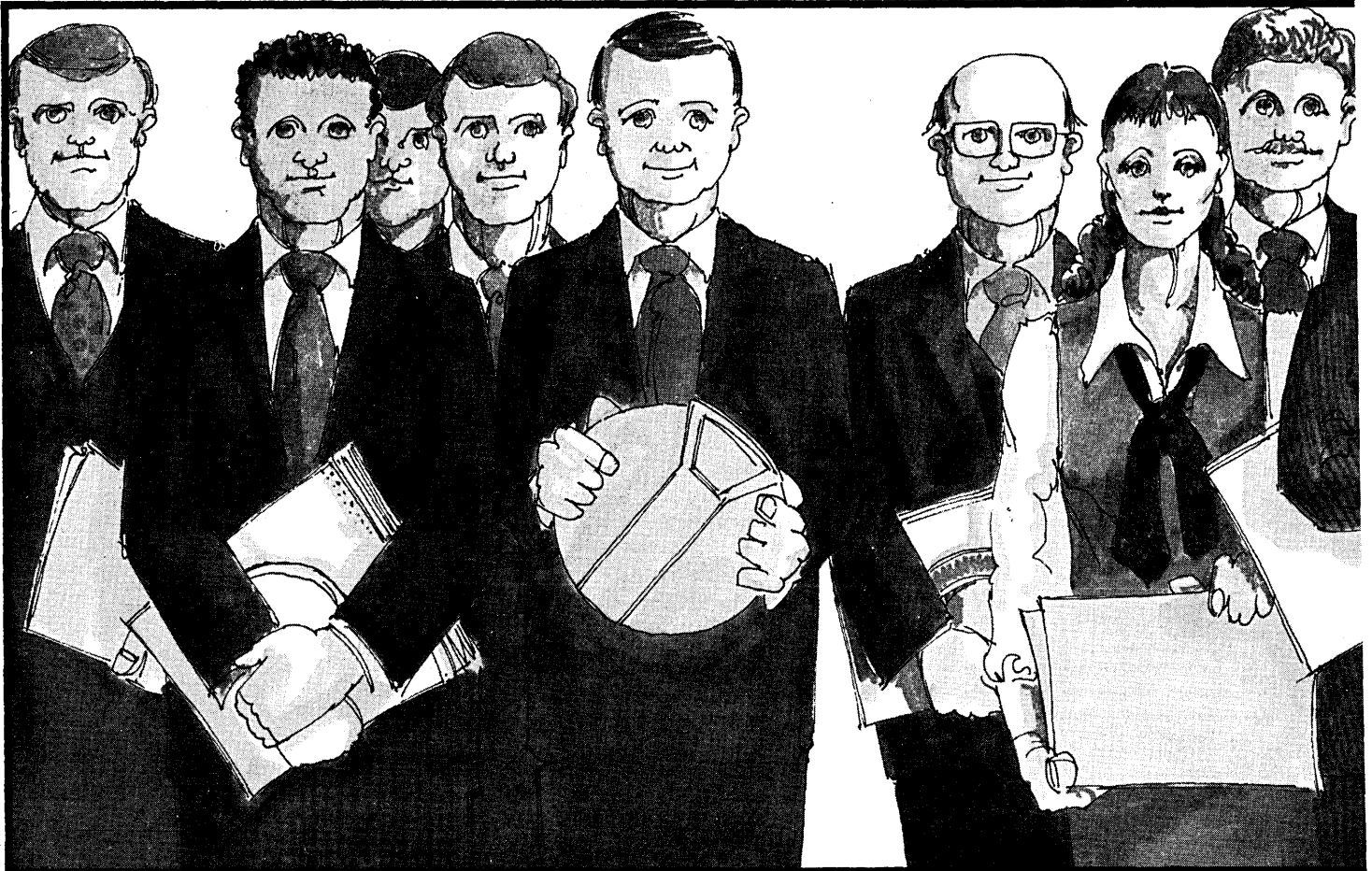

SOFTWARE

COMPILER COMPANY GROWS

Many companies are built on breakthroughs.

Donald R. Ryan and David E. McFarland have been building a company at a 50% compounded growth rate since 1970 on a lack of breakthroughs.

"Software development isn't any better now than it was in 1963," said Ryan, president of Ryan-McFarland Corp., Palos Verdes, Calif.-headquartered developers of custom and proprietary compilers. McFarland is vice president.

"The hardware is beautiful," said Ryan. "Hardware problems are a thing of the past. We don't even account for time lost because of computer down time."

But he doesn't look for any breakthroughs in software development in the foreseeable future. "I've been hearing about automatic software generators ever since I've been in the business."

And that has been since 1961 when,



STRICTLY COMPILERS: Donald R. Ryan (left) and David E. McFarland formed the company to develop custom and proprietary compilers.

with James Dunlap, he founded Digitek Corp. Digitek was formed to build a computer, but turned to designing compilers and

compiler kits as its initial operation. It never did build a computer, but continued with compiler development and got into time-sharing. McFarland was a vice president of Digitek.

Digitek came into bad times in 1970 and on July 5 of that year, Ryan and McFarland left and formed their present company. At the end of July it acquired the Systems Programming Div. of Digitek for "a percentage of participation" over a two-year period. With the acquisition of the Systems Programming Div., Ryan-McFarland got all contracts, warranties, and maintenance rights for existing customers, many of whom they still have today.

As a fledgling firm, Ryan-McFarland wanted to develop commercial software packages in addition to developing compilers. It developed and began selling a billing package for orthodontists. This activity didn't last long. "Orthodontists are too hard to deal with," said Ryan. "They needed too much hand-holding and we weren't equipped for that." So they decided to stick to compilers.

The company, with 50 employees worldwide, has developed more than 100 compilers, encompassing most generally accepted programming languages.

Early this year it established a Software Products Group in Aptos, Calif., to specialize in packaged compilers for

System 1022™

The odds are 9 to 1 you'll pick it over any other large DEC Data Base System.

The Datapro Leader. Again.

In the latest Datapro survey, System 1022 was again rated highest among data base management systems for DECsystem-10 and 20 computers. It's hardly a surprise. In the marketplace, the acid test, System 1022 has won in 9 out of 10 competitive evaluations involving these computers.

Something for Everyone.

System 1022's strongest appeal is its simplicity. It's incredibly easy to use, so your users do a lot of their work themselves. At the same time, there are several advanced features such as extensive transaction capabilities, host language interfaces, audit trails, tight security and comprehensive reporting.

In short, System 1022 was designed for everyone, from the sophisticated computer guru to the clerk in accounting. And the message has spread. Today, System 1022 can be found in just about any area you can name, including business, education, government, manufacturing, medicine and health, communications, energy and transportation.

It's Also Fun. Yes, Fun. Try It For 60 Days Free.

Users report exceptional results with System 1022: application development up to 10 times faster; significant dollar and manpower savings; far better and more timely information. One response common to all, however, is that System 1022 is actually fun. So get in on it. We'll be happy to give you a free 60-day trial. Just write or call Eugene Shklar, Software House, 1105 Mass. Ave., Cambridge, MA 02138. (617) 661-9440.

Software House

The Data Base

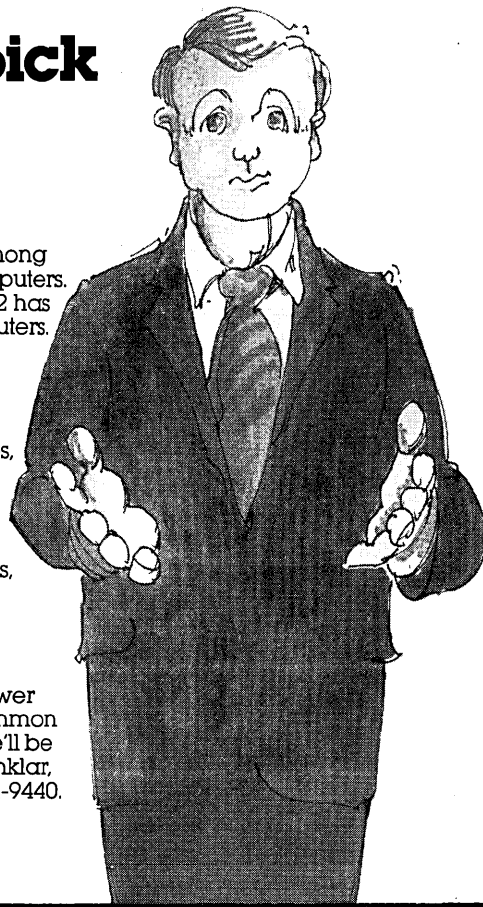
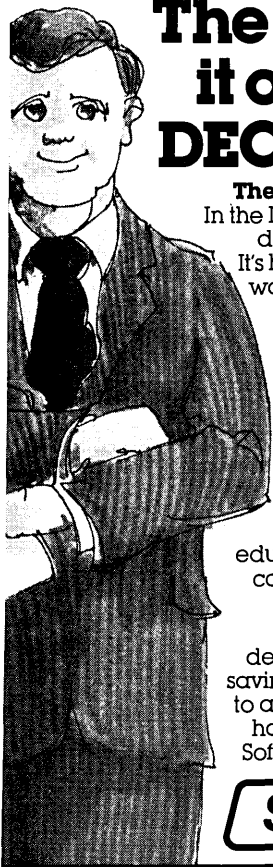

NEWS IN PERSPECTIVE

microcomputer-based systems. That division supplies RM/COBOL to Onyx Systems for its Z-80 based C 8000 microcomputer.

Michael Saccomano, general manager of the group, believes there "is a tremendous growth potential in adapting large-machine languages on microcomputers." He explained that RM/COBOL is a high-level ANSI/COBOL, providing many extended features including full Level-2 I/O. "The combination of multikeyed ISAM and Texas Instruments' 990/10 language compatibility provides immediate availability of large-machine application packages to the microcomputer."

Ryan-McFarland Corp. has a spin-off company, Ryan-McFarland Inc., in Austin, Texas, dedicated to providing custom software for Texas Instruments and proprietary packages for TI oems.

The parent company's products include the first FORTRAN for a 4K minicomputer, the first time-sharing COBOL for 16-bit minicomputers, the first COBOL system for microcomputers, and Micro BASIC I and D systems for 8080/Z80 and 6800-based microcomputers.

Ryan said microcomputers are "a different industry. The computer business it isn't. They're now running into the same problems everybody else did in 1963." He'll go with the microcomputer business "as required" but he doesn't want to "com-

pete in the toy business. They're like the orthodontists."

He prefers to "deal professional to professional."

Ryan considers in-house development to be his firm's biggest competition, and says, "We can do it in one-third or one-fourth the time. The way we build these things, 40% is old code, well tested. We don't have to do everything from scratch."

Ryan-McFarland's customers have included Texas Instruments, IIT in Europe, Data 100, Perlec Computer Corp., NCR, Univac, Data Saab in Sweden, RCA, Redcor, IBM, System Development Corp., Airborne Instruments Lab., Control Data Corp., Electronics Associates Inc., General Electric, Computer Automation, Ford Motor Co., Hughes Aircraft, Sun Oil, and Leeds and Northrup.

Computers for which they have developed compilers include Motorola 6800, Intel 8080, TI 990, IBM 360 and 370, Data 100 Model 85, Z80, NCR 8200, Century 200 and 315, IIT 3200, General Automation SPC 16, Univac 90/30 and 90/70, Data Saab 5/30, RCA 1600, SDS Sigma 5, CDC 3200, EAI 8400, Computer Automation LSI 3, LSI 4, and Alpha/LSI, DEC PDP-6, Honeywell 20, and General Electric 635.

Currently they are working with Tandy Corp. on language preparation on Radio Shack computers and with Sycor

Inc., among others. Many of their customers, they say, shy away from precompletion announcements, even though work is being done.

At present they have 14 computers on-site at their Palos Verdes headquarters, although they own only one of these, a TI 990. "Customers ship us a computer to use in development and when the development is done, we ship it back." They had the TI 990 "so long it seemed like a fixture. We got it at a good rate," said Ryan.

McFarland said they often keep computers on-site long after their development work has been completed. "They [the customers] sometimes forget where they are."

In addition to the TI 990 at headquarters, the company owns two more 990s at Austin and a Zilog MCZ and an Onyx at Aptos.

And they're even having computers shipped to them from Europe. In the old days, they recalled, we'd have to send a man over for a number of weeks to develop software for a European customer. "Now it's cheaper to ship the computer."

—Edith Myers

MEETINGS

ONE DAY AT A TIME

Thousands flocked to Washington's Federal DP Expo to hear that creating a successful information system doesn't happen overnight.

Due to "technical, logistic, and business planning considerations," the anxiously awaited IBM series won't debut until sometime in 1981. Such was the latest pronouncement on IBM's next generation of computers from Charles P. Lecht, president of Advanced Computer Techniques Corp., who until recently was one of the last holdouts for a late June announcement of the H series.

In the keynote speech at the recent Federal DP Expo in Washington, Lecht offered his listeners a number of predictions on the computer giant's future offerings. Foremost among them was his statement that a "stretched" 303X series will be introduced by IBM this summer as "end-of-life kickers" to boost its mainframe dominance until the H series can be introduced.

"Although H series design and preproduction models have successfully passed their reviews," Lecht said, "the

OBS WYLBUR® = INCREASED PRODUCTIVITY

FOUR PACKAGES IN ONE TO DECREASE DEVELOPMENT AND TEST TURNAROUND TIME:

- On-line program development
- On-line production job scheduling
- Document formatting
- Interactive word processing

PRICED 30-50% BELOW COMPETITIVE SYSTEMS, WYLBUR® HELPS YOU ATTRACT AND KEEP THE BEST PROGRAMMING TALENT. CONSIDER THESE FEATURES:

- Fast and flexible full screen cursor editing
- Job submit, control and output retrieval
- Dataset maintenance
- Interactive command language
- One- to three-second response time
- A forgiving syntax
- VTAM support
- Low resource consumption

FOR MORE INFORMATION OR A FREE TRIAL CALL
(415) 391-9555

*WYLBUR is a trademark of Stanford University

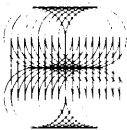

ON-LINE BUSINESS SYSTEMS, INC.

115 Sansome Street, San Francisco, California 94104

CIRCLE 70 ON READER CARD

Minicomputer TOTAL[®]

It's the only DBMS that works with
 our PDP-11, our PDP-11/23,
 our System/80, our System/80/2,
 and our Pathes in all cases.

Flexibility and compatibility are key factors in your choice of a data base management system (DBMS) for your computer. Because we considered applications people all forms of PDP's, System/80 and Pathes, we've designed an open architecture operating system.

Our DBMS software has the flexibility to work with any minicomputer system.

Our DBMS software works with PDP-11, System/80 and Pathes, and is available for PDP-11, System/80 and Pathes.

Our DBMS software works with PDP-11, System/80 and Pathes, and is available for PDP-11, System/80 and Pathes.

Our DBMS software works with PDP-11, System/80 and Pathes, and is available for PDP-11, System/80 and Pathes.

Our DBMS software works with PDP-11, System/80 and Pathes, and is available for PDP-11, System/80 and Pathes.

Our DBMS software works with PDP-11, System/80 and Pathes, and is available for PDP-11, System/80 and Pathes.

and flexibility in DBMS available today. Its powerful design provides the maximum performance and cost savings. The flexibility of our products is the first advantage you'll experience. Our DBMS software works with PDP-11, System/80 and Pathes, and is available for PDP-11, System/80 and Pathes.

Our DBMS software works with PDP-11, System/80 and Pathes, and is available for PDP-11, System/80 and Pathes.

Our DBMS software works with PDP-11, System/80 and Pathes, and is available for PDP-11, System/80 and Pathes.

Our DBMS software works with PDP-11, System/80 and Pathes, and is available for PDP-11, System/80 and Pathes.

Our DBMS software works with PDP-11, System/80 and Pathes, and is available for PDP-11, System/80 and Pathes.

Our DBMS software works with PDP-11, System/80 and Pathes, and is available for PDP-11, System/80 and Pathes.

Our DBMS software works with PDP-11, System/80 and Pathes, and is available for PDP-11, System/80 and Pathes.

Our DBMS software works with PDP-11, System/80 and Pathes, and is available for PDP-11, System/80 and Pathes.

Our DBMS software works with PDP-11, System/80 and Pathes, and is available for PDP-11, System/80 and Pathes.

Our DBMS software works with PDP-11, System/80 and Pathes, and is available for PDP-11, System/80 and Pathes.

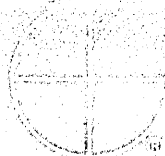
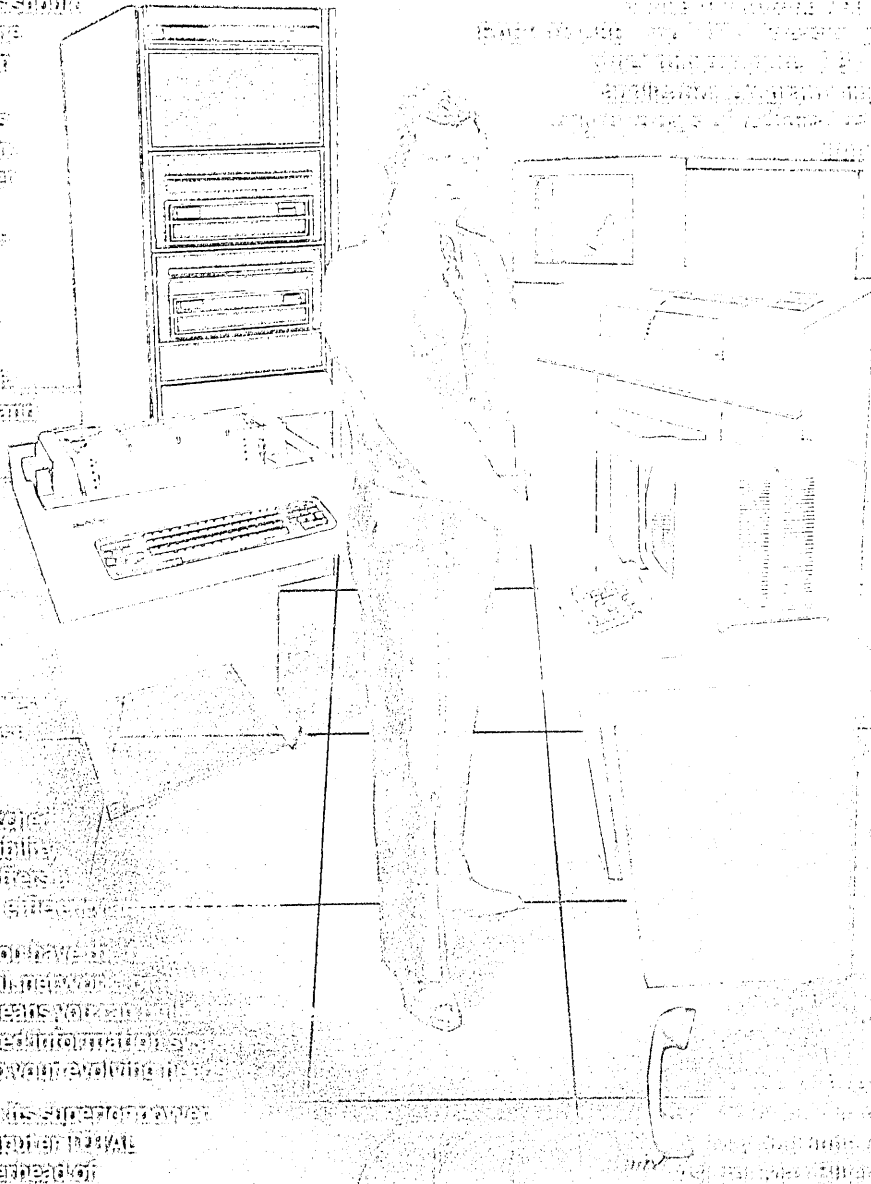

Chrom Systems, Inc.
 Microcomputers, Minicomputers, Computers
 2300 Montrose Avenue, Cincinnati, Ohio 45216
 (616) 521-1000

This announcement is neither an offer to sell nor a solicitation of an offer to buy these securities. The offer is made only by the Prospectus.

400,000 Shares



Tymshare, Inc.

Common Stock

(without par value)

Price \$42.75 a Share

Copies of the Prospectus are obtainable in any State from only such of the undersigned and such other dealers as may lawfully offer these securities in such State.

Drexel Burnham Lambert
INCORPORATED

Hambrecht & Quist

Bache Halsey Stuart Shields
INCORPORATED

The First Boston Corporation

Bear, Stearns & Co. **Blyth Eastman Paine Webber** **Dillon, Read & Co. Inc.**
INCORPORATED

Donaldson, Lufkin & Jenrette
SECURITIES CORPORATION

Goldman, Sachs & Co.

E. F. Hutton & Company Inc.

Kidder, Peabody & Co.
INCORPORATED

Lazard Frères & Co.

Lehman Brothers Kuhn Loeb
INCORPORATED

L. F. Rothschild, Unterberg, Towbin

Salomon Brothers

Shearson Loeb Rhoades Inc.

Smith Barney, Harris Upham & Co.
INCORPORATED

Warburg Paribas Becker
A. G. BECKER

Wertheim & Co., Inc.

Dean Witter Reynolds Inc.

EuroPartners Securities Corporation

April 18, 1980

NEWS IN PERSPECTIVE

product line could not be certified for manufacturing mass production in time for the original 1980 introduction.

"To recoup from these slippages," he continued, "we believe IBM has implemented a 303X 'stretch' tactical plan. Stretch is a fallback plan which, if successful, would enable IBM to maintain its competitive position and earnings growth during the difficult 1980/81 period, and at the same time buy time to ensure the successful launching of the H, G and Sierra series models."

Delaying the H series introduction should improve 1980 earnings at the expense of 1981's, Lecht postulated, as the expected stretch processors—3031E, 3033N, and 3034—will carry higher price tags than their predecessor models. But Lecht added that he and his associates at ACT weren't in agreement with IBM about the validity of that strategy.

"In our view," Lecht said, "it would be far better for IBM management to introduce the new technology and new function product line now, and take its earnings lump in 1980, rather than again extending an aging technology." While he conceded that there are mitigating factors such as the weakness of the U.S. economy and competition from Amdahl/Storage Technology and the Japanese forcing preemptive action, he still contended that the right time for H is now.

Most of the three-day conference focused on the here-and-now of federal data processing.

So much for the future. Most of the three-day conference focused on the here-and-now of federal data processing, as in the session on microcomputers' impact on dp. A panel comprised of two software company presidents and a government naval engineer agreed that micros and desktop computers are developing capabilities previously expected only from mainframes or large minicomputers.

"I see the same historical cycle as in the early days of mainframes," said Larry Putnam of Quantitative Software Management in McLean, Va. "Efficiencies started to come into software programs as the language became more sophisticated. When we learn that these computers have a terrible time sensitivity, we'll be able to build software for microprocessors."

"People want to buy machines that can deliver to the user right away," explained Paul Willis of Polytechnic Associates in Arlington, Va. "There's no difference in buying a microcomputer or a larger computer if you have people who can program the software. Bringing the problem to the computer has been replaced by bringing the computer to the problem. It

132 COLUMNS	underline	8 function keys	row & col enter	half & full dplx
132 COLUMNS		8 FUNCTION KEYS		HALF & FULL DPLX
132 COLUMNS	BLINK	8 function keys	CURRENT LOOP	half & full dplx
132 COLUMNS	BLINK	8 FUNCTION KEYS	CURRENT LOOP	HALF & FULL DPLX

24 LINES				AUTO REPEAT
24 LINES				auto repeat
24 LINES				AUTO REPEAT
24 LINES	dual intensity	numeric pad	menu set-up	auto repeat
24 LINES	DUAL INTENSITY	NUMERIC PAD	MENU SET-UP	AUTO REPEAT

STATUS LINE	dual intensity	CURSOR CTRL	menu set-up	VT-100 OPTION
STATUS LINE	DUAL INTENSITY	CURSOR CTRL	MENU SET-UP	vt-100 option
STATUS LINE	dual intensity	CURSOR CTRL	menu set-up	VT-100 OPTION
STATUS LINE	DUAL INTENSITY	CURSOR CTRL	MENU SET-UP	vt-100 option
STATUS LINE	underline	CURSOR CTRL	row & col enter	vt-100 option
STATUS LINE	UNDERLINE	CURSOR CTRL	ROW & COL ENTER	VT-100 OPTION

132 COLUMNS	underline	8 FUNCTION KEYS	ROW & COL ENTER	HALF & FULL DPLX
132 COLUMNS	underline	8 function keys	row & col enter	half & full dplx
132 COLUMNS		8 FUNCTION KEYS		HALF & FULL DPLX
132 COLUMNS	BLINK	8 function keys	CURRENT LOOP	half & full dplx
132 COLUMNS	BLINK	8 FUNCTION KEYS	CURRENT LOOP	HALF & FULL DPLX
24 LINES	BLINK	NUMERIC PAD	CURRENT LOOP	AUTO REPEAT

MODEL 132-1

The Difference is Clear!

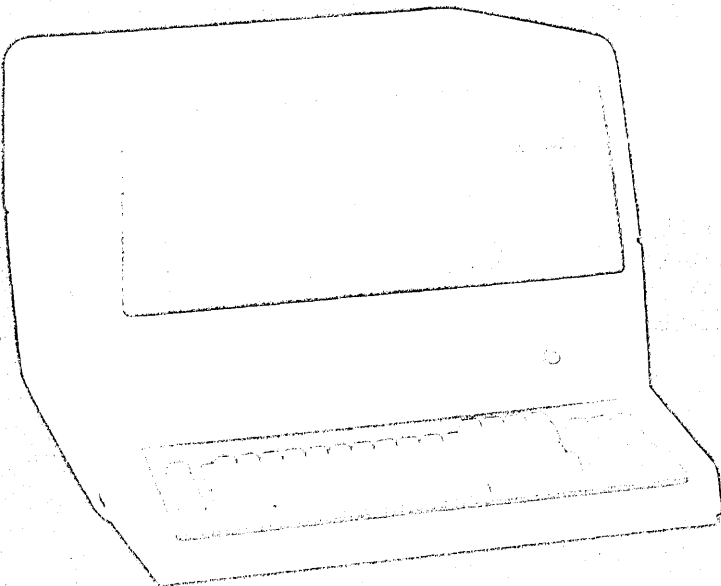

The model 132-1 introduces a new high in 132 column display quality with functional versatility at an economy price. The partial list of features are shown as actually displayed on a 132-1 with the Datagraphix patented Characteron® cathode ray tube.

An exceptional new terminal.

Compare, THE DIFFERENCE WILL BE CLEAR.

Write or call for complete information today.

P.O. Box 82449 San Diego, California 92138 (714) 291-9960

Datagraphix

a General Dynamics subsidiary

NEWS IN PERSPECTIVE

may not be the best solution in terms of cost/benefit analyses, but it's here."

The productivity predicament was another topic probed in a conference session. The fault for lack of productivity improvements, according to a panel of experts, lies not with the machines but with their masters. The panelists—Zalman Shavell, director of an EFT study in the congressional Office of Technology Assessment; Ann Work, senior education consultant with Deltak in Washington; and David Skeen, director, MIS Division of the Naval Civilian Personnel Command—agreed that lack of planning, understanding, and communication among managers, workers, and users has resulted in a disturbing shortage of professionalism and productivity in dp.

"In terms of professionalism, dp managers are better than they're given credit for," Work said. "But their weakness is spending too much time communicating with their subordinates. They need to use both data processing and new educational techniques to improve performance. The tremendous shortage of dp professionals can be solved if you change the emphasis and analysis of the situation. Let people know where they stand and what's expected of them, but keep the organization in mind at all times."

But keeping an eye on the big picture is not always easy, said Walter Haase, a consultant to the Office of Management and Budget. In a session he chaired, Haase said the recommendations of the President's task force on federal adp are being implemented slowly but not necessarily surely.

"We have to recognize that a successful information system must be developed in an evolutionary manner," Haase said. "You have to state the unknowns as often as the needs, and stress a system that can adapt and grow incrementally. Build on the existing system, strengthen its operation, and think about software development."

Now in its fourth straight year in the nation's capital, Federal DP Expo '80 attracted a crowd of about 10,000, hosted 37 technical and management sessions, and packed 175 exhibitors into the Sheraton Washington Hotel. The breadth of exhibitors stretched from the likes of the Bell System and Burroughs, both of which described business at the show as "fantastic," to the Brookings Institution, more renowned for its lofty intellectual analyses of the world's ills than for the time-sharing program it was promoting.

"You go to this for the exposure," commented Carl Rushling of Computer Sciences Corp., one of the 175 companies displaying their dp wares. "I wouldn't expect to sell anything here. I never bring any order blanks with me. But we've had a lot of interested people come by. It's much better than last year. Nothing happened then."

—Willie Schatz

BENCHMARKS

AT&T PLANS SATELLITES: AT&T has a \$230 million plan to launch and operate three of its own satellites. The company has been leasing three Comstar satellites from a unit of Communications Satellite Corp., and wants to end its dependency on leasing. An application for clearance has been filed with the FCC, and AT&T hopes to launch the first of its satellites in 1983. Another is planned for launching in 1984, and the third in 1985. The AT&T/Comstar lease for two satellites continues through 1983, but the third satellite lease runs until 1985. AT&T plans to use a fourth Comstar satellite until its own system establishes full operation, to "ensure continued capacity." Comstar had stated earlier that it did not expect AT&T to renew the leases, which cost almost \$47 million per year. AT&T said its satellites will have a longer life span (approximately 10 years compared to Comstar's seven years), and each satellite could handle as many as 21,600 simultaneous conversations (Comstar's allow approximately 18,000). AT&T has not yet selected suppliers for the satellites or launch vehicles.

SIMULATING MAGNETIC BUBBLES: IBM engineers have developed a computer controlled simulator for designing magnetic bubble chips. This is a process that allows research scientists to test new designs before building the actual hardware. Magnetic bubbles, small regions of magnetism that exist in certain types of magnetic materials, are used for information storage and can be relocated within the material by applying magnetic fields. This technology permits greater storage capacity potential than conventional magnetic recording methods. The design system consists of three parts: a large host processor, a display terminal, and a designer. These parts are then linked together by several computer programs. Dr. R. Wade Cole and Dr. Thomas W. Collins, both of IBM, developed this simulation process. Use of these magnetic bubble chips helps produce a theoretical base for design, predicts specifications, aids in selecting design directions, and thus reduces the number of hardware iterations.

WEST COMING EAST?: Maryland business, government, and education representatives recently traveled to Santa Clara, Calif., to woo Silicon Valley companies over to the East Coast. The semiconductor industry has long been based in Silicon Valley, and Maryland state officials are trying to alter the geographics. Gov. Harry Hughes and James Roberson, secretary for economic and community development, related the marvels of Maryland to some 70 valley-based company representatives. "We're deadly serious about being the most

pro-business state in the nation," said Roberson. Maryland offers "an ample supply of talent that lessens competition, respected schools of engineering, and reasonably priced land." Expansion plans in the semiconductor industry continue, while land costs rise, and competent workers become scarce. Maryland's promises were tempting and well directed. State officials are planning a follow-up visit to talk over the details with interested companies. This opening of the Maryland campaign cost an estimated \$70,000 to \$80,000, paid for half by the state and half by the Economic Development Council of the Greater Baltimore Committee. The program, according to attendants, was well done and well received—the highlight being the Maryland crab luncheon, of course.

IBM 4331 MODEL GROUP 2: IBM's expected 4300 announcement came last month—the 4331 Group 2 processors, developed at IBM labs in Boeblingen, Germany. They will be manufactured at IBM's Endicott, N.Y., facilities. The new 4331 Group 2 processor offers almost twice the internal performance and up to four times the storage capacity of the 4331 Group 1 machines. The Group 2 also offers mid-sized system users significant growth potential, and the Group 1 processors can be upgraded on location to Group 2 level.

In addition to increased speed and storage capacity, the Group 2 processor increases versatility in configuring systems. An optional high-speed channel is available which allows data to be transferred from IBM 3330, 3340, 3344, 3350, and 3370 disk storage devices at speeds of up to 1.86 million characters per second. Customer shipments of the new processor are scheduled to begin in the fourth quarter of this year, and upgrades from Group 1 to Group 2 are scheduled for the third quarter. Purchase price for a Group 2 with 1 million characters of main storage is \$150,000. The processor can be rented monthly for \$5,035, and can be leased for two years at a monthly rate of \$4,285. The Group 2 equipped with 4 million characters of main storage can be purchased for \$197,100, rented for \$6,445 a month, or leased for \$5,485 a month.

INFORMATICS INTO MINI SOFTWARE: Informatics has entered the small computer packaged software market, with products for use on IBM System/34s and Hewlett-Packard HP 3000s. A new division has been set up, called the Minicomputer Applications Products Div., which is headed by Donald K. Lane, vice president and general manager. The first new product offered, a general ledger system, will have capabilities for forecasting, cost allocation, profit planning, budgeting, and variance reporting. Planned in the near future is an accounts payable system. *

Will American productivity be crushed by the paper weight?

There's still a chance you can escape the paperwork pile-up that threatens productivity all over the country.

At NBI, we're helping cut the problem down to size.

We build the NBI System 3000, an office system designed to manage all the paperwork, information processing and communication problems your company can generate.

Unlike most systems, we try to make every task as automatic as possible. Functions like outlining, indexing, sorting, footnoting and equation typing can be done easily, with minimal operator effort. And the NBI System 3000 is document oriented so any time you make a change, the copy

adjusts — page by page — without operator assistance.

Of course, the NBI System 3000 does all the things you'd expect of a leading word processor — text editing, communications, arithmetic, mailing list control and repetitive typing. The NBI System 3000 just makes it all easier and more efficient.

People become more productive, automatically and electronically.

So if paperwork is starting to pile up around you, remember, you've still got a chance.

Call NBI, 1695 38th St., Boulder,
CO 80301, 800/525-0844.

In Colorado, call
303/825-8403.

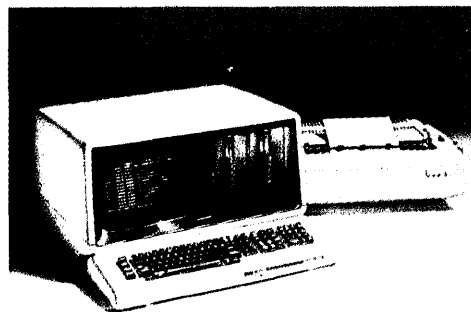

Lifting America from under the paper weight.

CIRCLE 74 ON READER CARD



Our Automated Funds Transfer Systems can do your bank a world of good.

As a commercial bank, worldwide funds transfer is a vital part of your operation. Streamline this vital function, and you'll go a long way toward maximizing profits. Improving your competitive position. Attracting and holding new accounts, too. And that's precisely what the new Rockwell-Collins Automated Funds Transfer Systems are all about.

As the first fully integrated, upward-compatible family of advanced, computer-based systems, our AFTS interfaces all of the available funds transfer networks. Automates much of the internal handling. Cuts costs. Reduces delays. Gives you up-to-the-minute visibility.

AFTS works by integrating transaction processing with communications processing and message handling. Say good-bye to error-prone file reference. Interdepartmental hand carry. Manual record keeping. Say hello to automatic storage for incoming transactions. Automatic processing for fixed-format transactions. Automatic recording of processing events. Local data base of account information. Balance checking. Current position. Reformat to match wire type. And finally, automatic recording and reporting on work load distribution by priority.

Can one of the new Rockwell-Collins AFTS systems make your operation run more efficiently? You can bank on it. For details, contact your nearest representative listed below. Collins Communication Switching Systems Division, Dept. 420-200, Electronics Operations, Rockwell International, Dallas, Texas 75207. Phone: 214/996-2336.



Rockwell International

...where science gets down to business

Dallas, Tex. (214) 996-2336 • New York, N.Y. (212) 661-6530 • Newport Beach, Calif. (714) 833-4645 • Chicago, Ill. (312) 298-5177.
Atlanta, Ga. (404) 996-7112 • Washington, D.C. (703) 685-2679

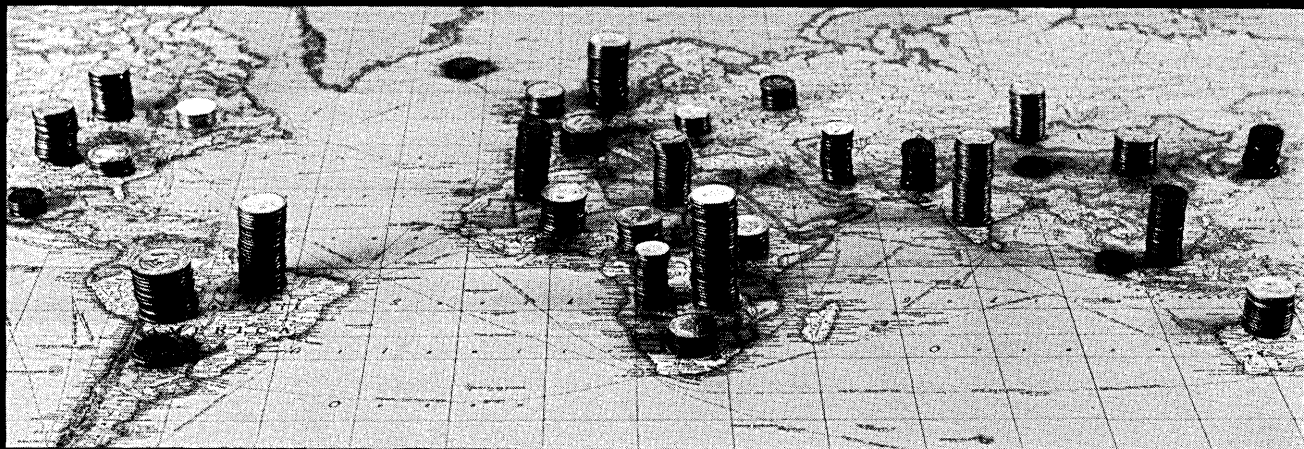

The latest words in communications: Rockwell-Collins.

Brussels 242-4048 • Cairo 894531 • Frankfurt (0) 6106-4093 • Hong Kong 5-274-321 • Kuala Lumpur 27283 • London 01-759-9911 • Manila 892-742 • Mexico City (905) 533-1846
Melbourne (Lilydale) (03) 726-0766 • Paris (Rungis Cedex) 687-31-02 • Rio de Janeiro 286-8296 • Riyadh 69060 • Rome (0) 6-862-415 • Seoul 74-9276
Tokyo 478-1278 or 478-1279 • Toronto (416) 757-1101 • Jeddah 54600

CIRCLE 75 ON READER CARD

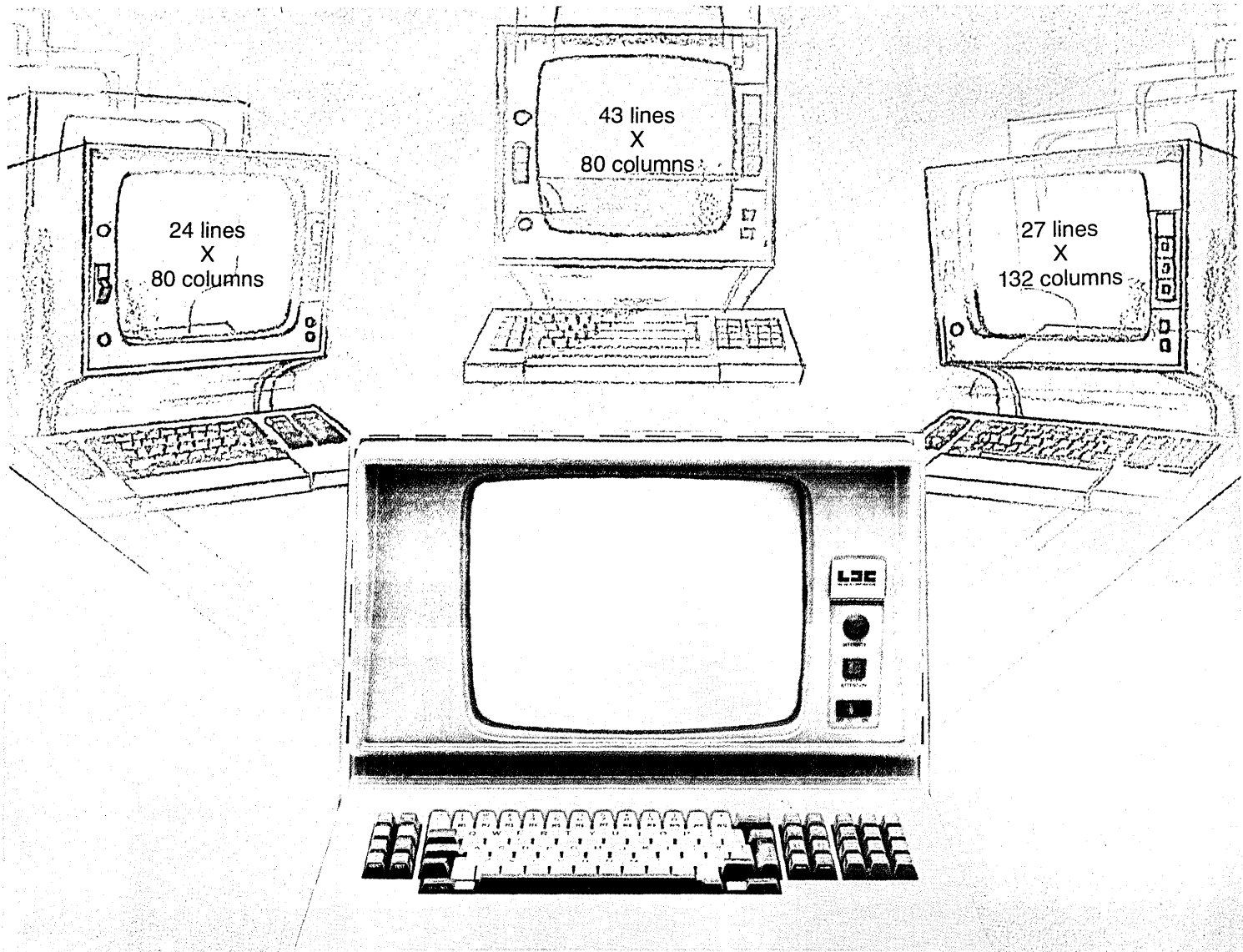

IT ONLY TAKES ONE TO DO IT ALL

**The only one that does it all
is LDC's new All-in-One
SOFTPRINT™ Display System.**

For the first time ever, here's the display that incorporates the features of three IBM 3278 Models — 2, 4 and 5. It's the LDC All-In-One SOFTPRINT Display, the new one that's the obvious way to go in distributed data processing.

What you get is dynamic selection of either the 27-line by 132-column or 43-line by 80-column screen format as an alternate to the 24-line by 80-column format. On top of that is the availability of operation with both LDC Local and LDC Remote 3274 compatible controllers. LDC Series 300 Display Systems offer many other pluses, including price and delivery advantages.

**First to deliver 132-column IBM compatible
displays. Now first and only to
deliver the All-In-One Display.**

**All-In-One
SOFTPRINT**

LDC

LEE DATA CORPORATION

10206 Crosstown Circle, Eden Prairie, MN 55344
(612) 932-0300

CALL OUR SYSTEM SPECIALISTS TOLL FREE

800-526-3938

CIRCLE 76 ON READER CARD



The only limitations are

Computer Sciences Corporation believes that any problem humans can conceive of, they can eventually solve. The only limitation is the sophistication of their science. That belief has involved us in many of the world's most difficult problems and in some of its most astonishing accomplishments.

It has also made CSC the world's largest

information services company. That may surprise you. Almost everyone knows what we've done, but hardly anyone knows that CSC has done it.

As NASA's computing partner, CSC has developed programs and systems and handled data processing for the missions that have orbited the earth and explored the solar system.

the ones you bring with you.

By integrating the technologies of software, communications and hardware, we are continuously advancing the techniques of problem solving.

CSC is developing the capacity of history's most profound tool, the computer, to change man's relationship with everything he has ever known.

It's the ultimate challenge. Maybe you'd

like to help us. If you think you're good, and you're not afraid to find out how good you really are, you should be in touch with Computer Sciences Corporation. We're looking for people who are not afraid to try anything.

CSC

COMPUTER SCIENCES CORPORATION

Corporate Offices: 650 N. Sepulveda Blvd., El Segundo, CA 90245 • An Equal Opportunity Employer

Healthy sales gains and respectable profits mark data com companies, according to the second annual survey of the industry.

ALIVE AND WELL

by Ronald A. Frank

The data communications industry continues to move along at a healthy clip—this, the second annual industry survey, shows most of the 50 suppliers etched out sales gains and achieved respectable profit levels, even though there was gloom in other sectors of the economy.

While the major upheaval of a shift from analog to digital facilities remains a favorite speculation at industry conferences, data communications *networks* continue to rely on analog technology. The real changes are taking place in the data communications *equipment* area.

As users have become more familiar with the powers and pitfalls of their networks, suppliers have increased the sophistication of product lines. This trend is evident in management and control as users want more detailed operational data about systems.

Not so long ago the modem was considered necessary—it was the black box that *had* to be installed wherever a business machine was to operate compatibly with a data communications line. Now, however, modems have taken on a new identity as the catalyst and the focal point of more complex systems. The first indication of this change came several years ago, when modem suppliers began to incorporate test features in individual data sets.

More recently, modems have become key elements in the so-called technical control centers installed in large private line networks. These control centers were pioneered and developed by independent modem vendors, providing a level of user control previously reserved for the telephone companies.

Many of the control centers have now grown beyond the original network tasks and have taken on such diverse functions as accounting, statistical management, encryption, and protocol conversion. Users have been able to progress into advanced capabilities as their network needs become more complex. The advanced control centers now available are a far cry from the simple modulation and demodulation functions originally found in modems.

It should be added that the independent (noncarrier) vendors such as Racal-Milgo, Intertel, Paradyne, and a host of pioneers have become so successful they have spurred both IBM and AT&T into responding with similar capabilities. It is generally recognized within the industry that IBM's introduction of its 386X series of diagnostic modems was a move to start users of Systems Network Architecture (SNA) down the road to network management. Despite the IBM modem announcements, many private line networks at sites that have IBM mainframes rely on data communications modems and other specialized devices from independent suppliers, if for no other reason than deliveries of the IBM modems weren't scheduled to begin until this March.

So there is little doubt that modems are the center of the action in data communications. A recent study by Creative Strategies International estimates that the independent modem business will be worth about \$550 million in 1980, which is a jump of \$100 million over 1979 shipments.

Modems are generally classified into three groups based on speed. The low speed area covers up to 1,200 bps, with medium speed ranging up to 2,400 bps, and high speed units reaching into the Kbps area. Although dividing lines between the groups may overlap, as speed goes up so does price.

As more devices within companies are connected to communications facilities, another type of modem is taking on increased importance. With word processing, electronic mail, and similar operations expanding, short haul modems must be used for local data networks. These local nets usually operate within the same building or several buildings located near each other, and they provide a method of interfacing terminals that operate in local mode, meaning they transmit data over short distances without going over conventional telephone company lines. Gandalf, Prentice, and other suppliers provide short haul modems. Generally speaking, when local links exceed several thousand feet in length, short haul modems must be used. Extensive research is being done in the area of local networks, and the technology is chang-

ing rapidly so that the need for short haul modems often depends on the specific characteristics of a network.

SMALL COMPUTER IS KEY

Data communications is one field where small computers have taken on a high degree of specialization. From the early days of the IBM 270X series (which was designated as a communications line controller) to today's more sophisticated front-ends and intelligent network processors, these cpus have become key elements in communications networks.

Since a mainframe computer is designed for data processing and not data communications functions, the communications processor acts as a buffer or interface between the mainframe on the one side and the network on the other.

Among the functions typically performed by these specialized processors are line control, character and message handling, conversion of data and protocols, error control, message editing, flow control, message queuing, and a variety of similar network-related tasks. The IBM 3705 is the most common front-end and it shares network software with the host and also handles increasingly complex network control functions as IBM continues to expand its SNA capabilities. The 370X series has been a major IBM product for many years and industry observers expect major upgrades during 1980.

Most mainframe vendors have their own front-ends and in many cases this is the major communications revenue source for computer suppliers. The number of independent front-end vendors has always been small; it includes Memorex and Computer Communications Inc. Comten was on the list until it was recently acquired by NCR; its future role as a front-end supplier is being watched by the industry.

There is another class of communications processor which operates in distributed dp networks. These processors perform functions similar to front-ends but their communications operations are not dependent on associated mainframes. There appears to be trend developing in the network area to have

PHOTOGRAPH BY JAMES JOERN



Anagram

A GOOD FAMILY SHOULD
BE FATHER BEING A FORTUNE
ESTABLISHED AT FIRST AT HULL, B.

SCOTT

Small computers have taken on a high degree of specialization in data communications.

freestanding computers dedicated to management network and control, as exemplified by the GTE Telenet TP 4000 and the Tymnet Engine. IBM has hinted that its 8100 and 4300s may assume this role in the future, but detailed software has yet to be announced.

As dp functions become decentralized, it seems logical to move communications out into the network also. One advantage of a centralized front-end/mainframe approach, however, is that network traffic can be funneled through one site. It is not clear how this could be accomplished in distributed nets, and it is likely that each processor will need to have some communications capability with perhaps the dedicated communications machine handling network management functions.

Many users prefer independent communications processors for the same reason that they use independent modems. They theorize that vendors specializing in communications will provide more expertise than a mainframer that supplies data communications machines as an adjunct to its main business. Despite this theory there are many more communications networks where the same vendor supplies the host cpu and front-end.

Because of the variety of functions provided by communications processors, accurate estimates of the market are relatively scarce. It is probable that shipments of these machines total about \$600 million dollars, which puts them close to revenues derived from modems. But modems are low-cost items ranging in the hundreds of dollars, while processors are priced in the hundreds of thousands with far fewer shipments.

It is estimated that 70% of communications processors are used as front-ends, about 20% as terminal controllers, with a small percentage used as message switching devices and remote concentrators.

Multiplexors are natural extensions of modems and many suppliers handle both types of devices. Multiplexors become important as networks grow in size because they allow data streams to be combined over common carrier facilities, thus lowering communication line costs. The early muxes used frequency division multiplexing (FDM) and were primarily analogs operating at lower data speeds. More recently all-digital time division multiplexors (TDM) have gained in popularity as networks handle data at higher speeds.

As users have demanded more sophisticated network features, the statistical TDM has evolved. These are intelligent muxes that can monitor lines for transmission errors, buffer data, and retransmit information—all under microprocessor control. By providing network management diagnostics and control, the statistical multiplexors are taking on many of the functions previously handled by front-ends and network control centers.

The multiplexor vendors include Infotron Systems, Timeplex, Codex and General DataComm.

TEST EQUIPMENT

As networks become more complex and user sophistication increases, communications testers are gaining in popularity. Most of these units provide users with a crt display of vital data and line characteristics. Where down time cannot be tolerated, as in on-line bank teller nets, test equipment at network control centers provides continual hardcopy readouts of important parameters. In many cases line or equipment outages can be prevented if malfunctions are preceded by warning signs monitored and recorded by test devices. It is not unusual for a corporate network control center to call a local phone company data

communications group to warn that rapidly degraded line quality may require a switch to backup facilities. Most users who install this level of test capability report that carriers and vendors readily accept trouble reports once they understand the capabilities the customer has in-house.

While some of the testers are portable so they can be moved from site to site, others are built into network centers and operate under computer control. Among the vendors supplying test equipment are Racal-Milgo, Universal Data Systems, Spectron, Tran Telecommunications, and a host of others. Most vendors will provide training in the proper use of this equipment as well as accurate interpretation of the test indications.

Some categories of data communications capabilities did not fit in the major groups. These included voice response systems that provide computer-controlled synthesized "voice" answers to terminal inquiries. Although these systems usually are installed in front-end processors, they differ from the usual communications features. Switching also stands apart in that these units allow network operators to shift from primary to alternate facilities when network problems occur or during test periods. Most switches must be activated manually, but a few systems are available that will automatically switch to backup equipment or lines when malfunctions occur.

NOTES ON THE SURVEY

The only manufacturer from last year's list not back this year is Plessey (number 36 in 1979). Not that it doesn't deserve to be, but when the final deadline had come and gone with no word from Plessey, there was no choice but to leave it out.

The top 50 chart is heavy in financial information. The survey directory of the individual companies is slanted toward product categories. The profile of a particular company is placed under the category heading where most of its data com revenues are made. If there is a 60%-20%-20% breakdown of products, the company's name only will appear in the 20% categories. This year's questionnaire asked for percent of data com revenues attributable to six main product categories: network/node controllers, computer front-ends, modems/multiplexors, test equipment, switching, and finally "other." Each category is followed by a definition.

Looking over the list, a few numbers stand out. Of 50 companies, the majority, 24, fall into the modem/multiplexor category as the major product producing data communications revenues. There are 11 front-end manufacturers, with the heavyweights—IBM and Control Data—appearing here. Down in the "other" column, the most frequently



CARTOON BY SIDNEY HARRIS

Where reliability counts,
the world chooses Racal-Milgo.



When you're counting on a data communications network to stay up and running, you need system hardware you can rely on. That's why so many of the world's largest data communications users, like International Harvester, continue to choose Racal-Milgo equipment. In hundreds of smaller systems, too, where uptime is just as vital, Racal-Milgo is the first choice.

We can provide the reliability you demand, whatever your network size, with technically-advanced modems, network management systems, terminals, data security devices—and unmatched service support. We've become the industry leader by taking a total systems approach to each of our customer's needs.

For the full story on reliable data communications, send for a package of our latest product literature. Or contact your nearby Racal-Milgo communications consultant today.

Racal-Milgo Information Systems, Inc.
8600 N.W. 41st Street Miami, Fl. 33166 Telephone (305) 592-8600

Photo courtesy of International Harvester.

CIRCLE 78 ON READER CARD

Racal-Milgo™
RACAL
The Electronics Group

Tape cleaners and testers... Why you should buy from Kybe:

Kybe cleaners and testers are first with the highest throughput speeds. First with the most effective cleaning and testing techniques. First in precision retensioning and restacking. And first in ease of operation. That's why all major mainframe manufacturers use Kybe equipment. It's also why more tape manufacturers and more tape libraries install Kybe equipment than all others combined.

Find out for yourself. The best equipment, competitively priced... from Kybe.



KYBE
Dennison KYBE Corporation
132 Calvary Street, Waltham, Mass. 02154
Tel. (617) 899-0012; Telex 94-0179

Sales Offices

Boston — (617) 899-0012 Los Angeles — (213) 960-8365
Chicago — (312) 644-5650 New York — (212) 594-9272
Houston — (713) 524-3111 Wash., D.C. — (703) 527-2292

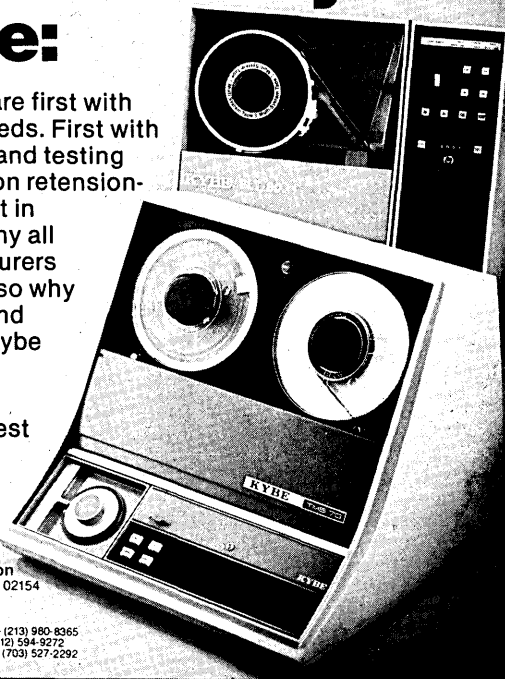

CIRCLE 79 ON READER CARD



A New Standard

The fast and cost-efficient way to X.25 compatibility.

The new addition to the world's family of standard weights and measures doesn't measure mass or size. It measures compatibility.

Just as a standard weight does on a scale, XPRT™ strikes a balance between Data Terminal Equipment and Data Communications Equipment — pretending to be either one for testing the other.

Built for use by terminal manufacturers, network operators,

common carriers and others, XPRT™ provides:

- a means for learning X.25 inexpensively
- a logic specification for X.25 hardware and software
- a mechanism for interactively testing X.25 products

XPRT™ is from TRAN, the company with more international experience in digital networks than any other company in the world.



Corporate headquarters: 2500 Walnut Avenue, Marina del Rey, Calif. 90291 (213) 822-3202
Tran Communications Ltd.: 1320 Shawson Drive, Mississauga, Toronto, Ontario, Canada L4W 1C3 (716) 847-1126
Tran Telecommunications Ltd.: 112-118 Cricklade Road, Swindon, Wiltshire, England SN2 6AG (44) 793-45476
Digital Network Engineering S.p.A.: 33 Corso Porta Vigentina, 20122 Milan, Italy (39) 2 546-1551
Tran Systems (Pty.) Ltd.: 12th Floor, Braamfontein Centre, Braamfontein 2017, Republic of South Africa (27) 11 39-6575

CIRCLE 80 ON READER CARD

mentioned product was audio response; in future surveys it may warrant a heading of its own.

Had we gone down to 51 companies, that spot would have gone to ADC Products in Minneapolis, whose sale of test equipment totaled \$1.5 million for fiscal year '79.

As for the financial figures, every reasonable precaution has been applied to collection and assemblage. Those coming from publicly held companies carry a greater weight of accuracy, especially when they are doing business in one nicely defined category. Private companies, always reluctant to part with figures, were asked to give guidelines and direction. Of greatest concern was that as much help as possible be directed our way in order to ensure an accurate and fair survey.

It must be emphasized that many companies don't separate figures by industry segment or product category. Northern Telecom is one example. For many companies, public or private, the name of the game was estimating. Some even undertook to break out the figures for us for the first time. The final result is that the numbers are correct in proportion if not absolute dimension; they represent the bulk of what is out there between the terminal controller at one site and the cpu at another.

Our first questions were what are the boundaries? What will be included? What will be left out? Are terminals to be counted? How many new product categories have appeared? What do we do with companies with data com products that aren't sold as separate entities but as parts of larger products?

The final decision? Last year's definition remains the guide—"All the hardware and all the services that operate on our coded message as it travels between a terminal or terminal controller and the computer to which it is addressed." We still excluded "Anything that smacks of telephony, anything that wouldn't have a role to play if all data died tomorrow morning." PABXS were again excluded but maybe for the last time, as they are blending more and more with network/node controllers and multiplexors.

And finally a note about acquisitions and mergers. At first glance it seemed they played havoc with last year's list. The number 17 company last year, NCR, bought the number four company, Comten. The end result was NCR Corp. residing in third place. 3M bought Interactive Systems, Inc., which last year was number 42. This year 3M is the number six data com company, with its Interactive/3M division producing data com revenues of almost \$49 million—not quite 1% of its parent company's total earnings. The largest corporation in the U.S., Exxon, purchased last year's 21st largest data communications company by revenues, Periphonics. This year Periphonics, as a wholly owned Exxon subsidiary, is ranked as the 26th largest data com revenue producer. *

The data com survey was prepared by Louise C. Shaw with the assistance of Marva Levine and Roseanna Gulisano.

Datacorder:



intelligent terminal, smart price.

If you're looking at intelligent terminals for remote data entry, you're probably looking at CRTs, floppy disks, and high prices.

Take another look.

This desktop terminal with the single-line display, cassette output, and reasonable price tag is a Datacorder remote data entry terminal.

Datacorder remote terminals will format the input data for your computer, handle communications protocol, and give you a choice of programming in Extended Basic or in our own Quick programming language. They offer prompting and data checking features and are especially friendly to novice users. And they're not susceptible to headcrash problems that can render disk-stored data inaccessible.

We can tell you a lot more about Datacorder terminals, including some prices that will make you wonder about *our* intelligence. Just fill out the coupon or circle our number on the reader service card.

International Entry Systems, Inc., 408 NE 72nd St., Seattle, WA 98115. Phone 206-525-6800 or call toll-free 1-800-426-7740.

Tell me more!

- Please send me more information about Datacorder I and Datacorder II remote data entry terminals.
- I would like a demonstration. Call me for an appointment at this number _____.

Name _____

Title _____

Company _____

Address _____

City, State, Zip _____

Mail to: International Entry Systems, Inc., 408 NE 72nd Street, Seattle, WA 98115

The data entry people. **IESI**

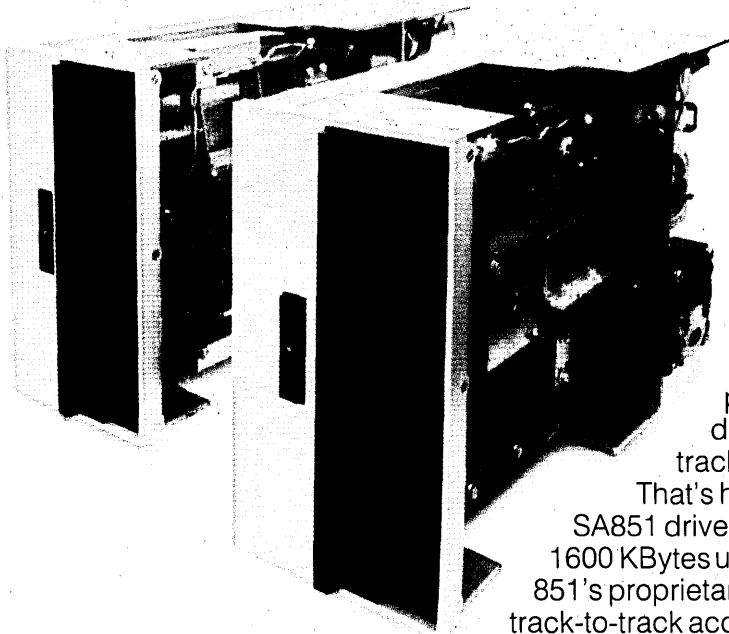

Want 800-1600 KBytes? Choose our SA801/851 series. With the SA801 8-inch floppy, you have a choice of 400 or 800 KBytes in single or double density, on the same drive for the same price. Well over half a million of these standard-setting drives have been specified by OEM's around the world. They know that they can count on Shugart's proprietary read/write head technology to deliver media life of over 3.5 million passes per track, and head life of more than 15,000 hours.

That's headstrong performance. And the double-sided SA851 drive gives you even more capacity. It stores 800 to 1600 KBytes using single or double density recording. The 851's proprietary Fasflex™ band actuator improves track-to-track access time to a fast 3 ms. There's also a programmable door lock and write protect. The headstrong SA801/851. Solid performers from the leader in floppy technology.

The head Choose your

Moving up to 5-29 MBytes? Check Shugart's SA1000 and SA4000 fixed disk drives with the lowest cost per MByte in their capacity range. The new 8-inch

SA1000 breaks the \$1,000 price barrier and is available in 5 and 10 MByte versions. Its dimensions and mounting holes are exactly the same as our floppy drives, and it's more compatible electrically than competitive drives.

The SA4000 offers 14.5 and 29 MByte capacity with an optional 144 KBytes of head-per-track storage. Compact and lightweight, it uses only 5¼

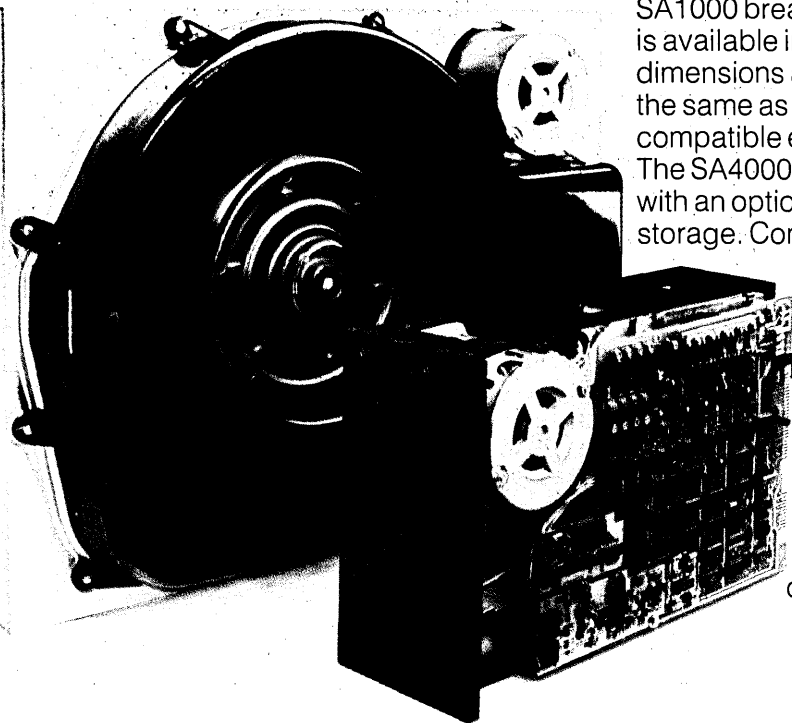

inches of panel space and weighs only 35 pounds. All Shugart fixed disk drives use proven Winchester head and media technology to ensure better data integrity and longer life. And system integration is easy because both the SA1000 and SA4000 can share a power supply with your floppy drives. Shugart fixed disk drives. The head of the family in capacity and cost/performance.

Need 220-440 KBytes? The famous Minifloppy™ is the right choice. Choose the original SA400 Minifloppy or the double-sided SA450. You can store up to 218.8 KBytes single-sided and up to 437.5 KBytes double-sided (unformatted, double density). Both are the same compact size and weigh only three pounds. Both are I/O compatible, and use Shugart's own glass bonded ferrite/ceramic read/write heads. The double-sided SA450 uses our new

Bi-Compliant™ head assembly for superior compliance and data reliability. Both drives allow you to read and write data on any single or double-sided minidiskette, so you can continue to use your existing disk library.

Low heat dissipation, DC drive motor, write protect, positive media insertion and activity light are all standard. Since we invented the Minifloppy, over half a million have been installed in systems like yours—proof that this is the 5¼-inch floppy with the right capacity and the right price/performance.

Choose the original. Minifloppy.

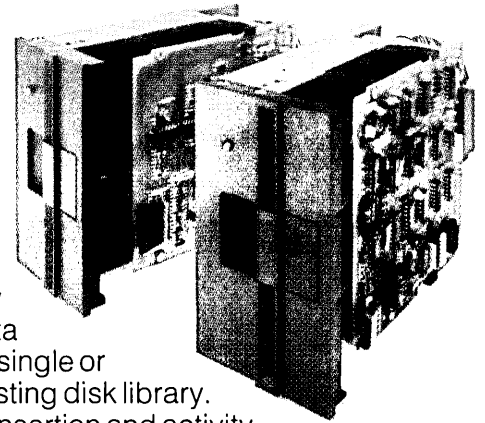

strong family. capacity.

Choose the Headstrong Shugart disk drives. No matter which disk drive you select from our family, you get the competitive edge when you go with Shugart. We are Headstrong about helping to keep you competitive too, with high volume deliveries of drives that offer superior reliability, quality, and value. This

Shugart commitment is also backed by all the support you need including helpful technical services, in-depth documentation, and design assistance. And when your product line grows, we'll be there with a complete family of floppy, Minifloppy, and fixed disk drives in a full range of capacities. Reliable products, volume delivery, superior quality, and value. That's what we're Headstrong about at Shugart. □

Shugart Associates: 435 Oakmead

Parkway, Sunnyvale, CA (408) 733-0100

Sales & Service: Sunnyvale, CA; Costa Mesa, CA; Minneapolis, MN; Richardson, TX; Waltham, MA; Landing, NJ; Atlanta, GA; Toronto, Ontario; Paris, France; Munich, Germany. □ Shugart products are also available off the shelf from local Hamilton/Avnet outlets.

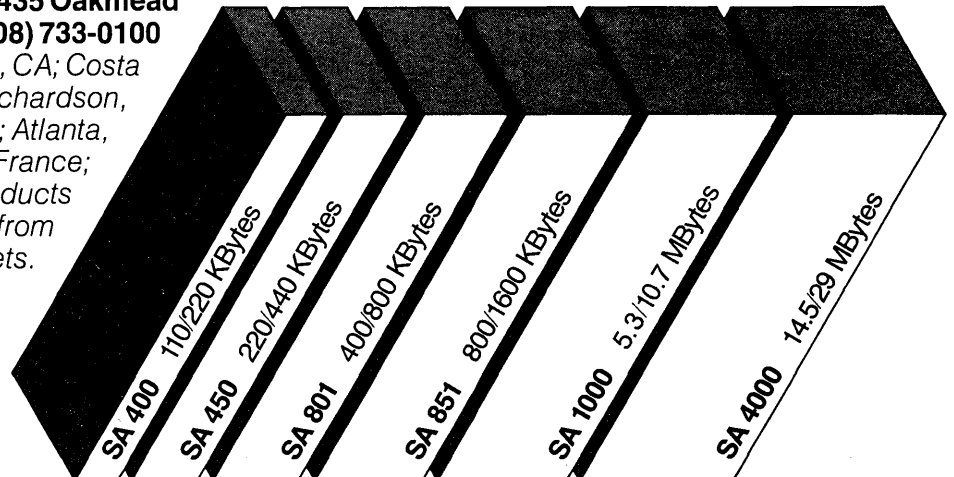

Shugart
The Headstrong Family

CIRCLE 82 ON READER CARD

THE TOP 50 DATA COMMUNICATION INDUSTRY MANUFACTURERS

Rank	Company	Total Data Com Revenues \$K	Data Com Product Revenues % of Total	Controllers	Computer Front-Ends	Modems Multiplexors
1	IBM*	157,753	<1	0	100	0
2	Racal-Milgo, Inc. (A)	121,000	100	0	0	80
3	NCR Corp.*	81,588	2.7	20	80	0
4	Motorola*	81,319	3	0	0	90
5	Memorex	53,944	7.3	0	100	0
6	3M*	48,960	<1	0	20	80
7	General Data Comm	41,724	100	0	0	85
8	Paradyne Corp.	41,411	100	0	0	70
9	Control Data	40,000	>1.2	40	60	0
10	Rixon, Inc.	36,156	100	0	0	100
11	Northern Telecom/Spectron	30,000	<2	0	0	0
12	Hewlett-Packard*	29,500	<1	0	67	0
13	Burroughs*	28,309	1	12	88	0
14	Racal-Vadic, Inc.	24,500	100	0	0	100
15	Data Access Systems, Inc.	24,000	90	0	0	5
16	Sperry-Univac	23,700	<1	0	100	0
17	Tran Telecommunications Corp.	19,700	100	40	0	50
18	Infotron	18,785	100	0	0	100
19	Computer Communications	18,200	100	18	60	2
20	Micom Systems	15,400	100	10	0	90
21	Intertel, Inc.	15,000	100	0	0	70
22	Honeywell*	14,530	1	0	100	0
23	Timeplex Inc. (A)	13,659	100	0	0	100
24	Bolt, Beranek & Newman	12,441	33	70	30	0
25	Digital Communications Corp.	11,900	>35	40	20	30
26	Periphonics	11,000	100	0	80	0
27	Atlantic Research Corp.	9,778	18	0	0	0
28	Anderson Jacobson	9,715	28	0	0	100
29	Dynatech Corp.	9,275	33.7	0	0	5
30	T-Bar Inc.	9,250	50	0	0	0
31	Tektronix Inc.*	7,869	1	0	0	0
32	Gandalf Data	5,577	100	0	0	60
33	Prentice Corp.	5,200	100	0	0	100
34	International Data Sciences, Inc.	5,024	100	0	0	0
35	Rockwell International Corp.*	5,000	>>1	80	20	0
36	Digitech Data Industries, Inc.	4,600	100	0	0	0
37	Penril	4,415	19.5	0	0	100
38	Halcyon*	4,000	33.3	0	0	0
39	Novation Inc.	3,500	100	0	0	100
40	Livermore Data Systems, Inc.	3,400	100	0	0	90
41	Cognitronics	3,000	35	0	0	0
42	Comdata	3,000	100	0	0	80
43	Digital Communications Assoc.	2,700	100	35	20	45
44	Harvey Hubbell*	2,537	>1	0	0	100
45	Tek-Com, Inc.	2,500	100	0	0	100
46	Votrax*	2,407	4	0	0	0
47	Wavetek*	2,360	8	0	0	0
48	Astrocom	2,300	60	0	0	70
49	Datastream Communication*	2,200	100	30	45	20
50	Nytronics, Inc.	1,679	100	0	0	100

Source: * DATAMATION Estimate A: Fiscal figures adjusted for calendar '79 R: Restated figures

Test Equipment	Switching	Other	1978 Data Com Revenues \$K	1979 Total Revenues \$K	1979 Net Income (loss) \$K	Fiscal Year Ends
0	0	0	144,000	22,862,776	3,011,259	Dec. 31
0	0	20	—	121,000	—	(March 31)
0	0	0	—	3,002,640	234,602	Dec. 31
0	0	10	66,200	2,713,795	154,296	Dec. 31
0	0	0	8,750	737,761	31,544	Dec. 31
0	0	0	—	5,440,000	655,000	Dec. 31
0	0	15	31,169	41,724	3,236	Sep. 30
0	0	30	25,899	41,411	4,117	Dec. 31
0	0	0	15,800	3,250,000	124,200	Dec. 31
0	0	0	22,000	36,156	3,152	Dec. 31
100	0	0	—	1,900,522	113,500	Oct. 31
33	0	0	14,800	2,361,000	203,000	Dec. 31
0	0	0	18,800	2,830,976	305,536	Dec. 31
0	0	>85	2,415	28,153	3,415	Aug. 31
0	0	0	12,000	24,500	—	March 31
0	0	0	15,600	2,050,000	199,000	March 31
10	0	0	11,293	19,700	218	June 30
0	0	0	14,387	18,785	3,157	Dec. 31
0	12	8	17,129	18,200	900	June 30
0	10	0	5,400	15,400	1,850	March 31
0	0	30	12,500	15,000	2,400	Oct. 31
0	0	0	16,500	1,453,000	152,000	Dec. 31
0	0	0	11,517	13,659	1,086	(June 30)
0	0	0	10,550	37,708	2,700	June 30
0	25	10	7,160	30,291	—	Sep. 30
0	0	20	11,000	11,000	—	Dec. 31
70	10	20	4,970	54,556	1,632	Dec. 31
0	0	0	7,615	34,697	1,760	Dec. 31
25	70	0	6,600	27,527	2,328	March 31
0	100	0	6,350	18,500	1,553	Dec. 31
60	0	40	8,607	786,936	77,151	May 31
0	40	0	3,300	5,577	—	July 31
0	0	0	3,500	5,200	—	April 30
75	20	5	3,700	5,024	387	July 31
0	0	0	4,500	6,180,000	261,100	Sep. 30
100	0	0	—	4,600	—	Dec. 31
0	0	0	R4,471	22,692	1,453	(July 31)
100	0	0	—	12,000	—	March 31
0	0	0	2,000	3,500	360	June 31
0	0	10	—	3,400	—	Dec. 31
0	0	100	—	8,000	526	Dec. 31
0	0	20	3,014	3,000	—	June 30
0	0	0	1,427	2,700	—	June 30
0	0	0	1,967	362,438	26,757	Dec. 31
0	0	0	—	2,500	—	May 31
0	0	100	1,970	60,180	3,828	July 1
0	0	100	2,567	29,500	1,958	Sep. 30
30	0	0	—	3,400	<90	Dec. 31
0	0	5	1,800	2,200	—	June 30
0	0	0	1,600	114,871	3,264	July 31



"Series 80 TOTAL and Environ/1 gives us the power and versatility to handle a complex database involving wide-ranging manufacturing applications and service a 400-terminal network with up to 85,000 transactions daily."

George B. Ream
Division Manager
Systems & Information Services
Mack Truck, Inc.



Mack is one of the leading manufacturers of heavy-duty trucks in North America.

SERIES 80 TOTAL® THE DBMS YOU'LL BE IMPRESSED WITH AFTER YOU'VE BOUGHT IT.

Almost every data base management system is impressive on paper. But Series 80 TOTAL is every bit as impressive in the real world of data processing operations.

Because in addition to giving you what you expect from a DBMS as a data processing specialist, it also gives you what you need as a manager.

That's not just us saying so. It's what DBMS users told International Data Corporation (IDC)—the independent research group—in the most comprehensive study of this type ever.

SAVES MAN-HOURS AND TIME

For example, IDC reported Series 80 TOTAL saves man hours two ways. First, it only requires an average of one person spending half his time to support the system. That's one fourth the people required by another leading package which needed four people on average and sometimes as many as 12. Unlike another leading package, Series 80 TOTAL was reported up and running right on schedule, not behind it. And unlike two other major packages, Series 80 TOTAL users were completely satisfied with its fast response time in actual operation.

EASILY ADAPTS TO CHANGE

It stands to reason that the more useful a DBMS is to management, the more they'll use it. According to the IDC survey, users integrated Series 80 TOTAL into an average of 41% of all applications. That's more than any other DBMS and almost twice as much as the next leading system.

That's because with Series 80 TOTAL's powerful data structuring capabilities almost any data relationship can be rapidly and easily defined.

And, as your business needs change, Series 80 TOTAL's modular step-by-step development capabilities are flexible enough to be adapted to change, quickly and economically.

You can add new data, new functions, even new applications without having to scrap, update, maintain or rewrite a dozen existing programs for every new one.

KEEPS ALL ITS PROMISES

Many DBMS packages promise to do everything we have just told you Series 80 TOTAL does. But when IDC asked DBMS users how they'd change their present package, Series 80 TOTAL was the only one of the three leading systems to emerge with a clean bill of health.

None of this is the least bit surprising. Because many of the new features and facilities that have made Series 80 TOTAL so successful come from more than 3,000 users who have used Series 80 TOTAL in almost half their operations over the last decade.

The end result is a DBMS that easily accommodates distributed processing, data base machines, even migration to the new IBM 4300 (because it supports VSAM) and TIS, Cincom's revolutionary new Total Information System. So, if you don't want to take our word, take the word of the users IDC surveyed.

Fill in the coupon below, or call Dennis Yablonsky, our National Sales Manager at (513) 662-2300 and we will review all the pertinent details of the IDC study. You will learn how Series 80 TOTAL has been designed and engineered for the 80's.

Contact us now, because the best time to find out how well a DBMS will do after it's installed, is before you buy it.

Please bring me proof of why Series 80 TOTAL outperforms the competition.

Name _____ Title _____

Company _____

Address _____

City State _____ Zip _____

Mail to: U.S.A.: Department D.C.
Cincom Systems, Inc., 2300 Montana Ave.,
Cincinnati, Ohio 45211, (513) 662-2300
International: Cincom Systems International,
17-19 Rue Montoyer, 1040 Brussels, Belgium,
(02) 511-6548

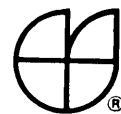

Cincom Systems
Systems Software Division



Multisavings on multitasking.

The new Model 3500 intelligent terminal from Perkin-Elmer. Only \$5,883*.

The Perkin-Elmer 3500 gives you an intelligent terminal with multitasking capabilities and sophisticated software at a price you can afford. 60 day delivery.

*Quantity prices start at \$5,883 each for five units, the minimum factory order, with 16KB of main memory (32 and 48KB available) and two microfloppy disc drives. Each drive has its own controller and DMA channel.

Speeds throughput.

The Perkin-Elmer 3500 handles multiple functions at the same time, maximizing operator productivity. The operator can enter data as the terminal verifies it, accesses the discs, communicates with your host computer, and drives your serial printer.

The Model 3500's 320KB of

disc has room for numerous screen formats, application programs, reports, and a day's worth of data for the host computer.

Speeds programming.

The Perkin-Elmer ROM-resident operating system uses only 3KB of main memory. It saves you programming time with its device independent I/O, repertoire of 18 commands for controlling devices and files, command substitution system, and ROM-resident debugger. Complete disc utilities, too.

You can develop your applications right on the 3500, using our extended BASIC Interpreter and Macro Assembly language. The BASIC can call assembly language subroutines. The Editor speeds source coding, the As-

sembler produces object code, and the Task Generator converts it into executable program or library files.

Speeds screen generation.

The Model 3500's Screen Generator software makes developing transaction processing applications especially easy, from screen formatting right through to establishing, maintaining, and accessing the associated disc files and interfacing with the application tasks.

Only 19" high, 19" wide and 22¼" deep, fits anywhere.

Call or write us for details: The Perkin-Elmer Corporation, Terminals Division, 360 Route 206 South, Flanders, NJ 07836; 201-584-1400.

PERKIN-ELMER

MANUFACTURERS AND PRODUCTS

In DATAMATION's 1980 survey to determine the top data communications manufacturers, companies were asked to indicate how their products were divided among six major categories: network/node controllers, computer front-ends, modems/multiplexors, test equipment, switching, and other.

A definition of each of the six categories precedes the list of companies that offer those products. The companies are listed under each category in which they manufacture products, and a company profile is provided under the category from which the majority of its data com revenue is derived. Thus Digital Communications Associates, Inc.'s name will be found under the controller, front-end, and modem/multiplexor headings and its profile under modems/multiplexors. Except for 100% product companies such as IBM and Memorex (front-ends) and Rixon (modems/multiplexors), most manufacturers appear in several categories.

What name should appear on the list has always been something of a debate. This year the following rule of thumb that was followed as closely as possible (sometimes without success): subsidiaries of companies appear under their own name (such as Peripherals, a subsidiary of Exxon), while divisions appear as the parent company on the list (e.g., 3M), but the division's name is given prominence in the list of manufacturers (e.g., Interactive 3M).

Finally, the reporting was done on a fiscal year basis, where a company's reporting cycle is different than the calendar year. In an up market like this one, such reporting can work to the disadvantage of some firms' rankings, since they are reporting revenues from an earlier, less productive period. Business done in a fiscal year which ends on March 31, for example, is for sales through March 31, 1979—a year ago.

There is at least one company which reported a negative income; we urge caution about classing anyone as a loser in any way. Spending money on development and staking out new market territories is a common characteristic of these companies, which comes across in the profiles.

NETWORK/NODE CONTROLLERS: Specialized processors which perform communications control functions within data communications networks. Typically used in distributed processing network configurations, these processors act as controllers to maintain communications.

BOLT BERANEK AND NEWMAN, INC.
33 Moulton St.
Cambridge, MA 02238
(617) 491-1850

Bolt Beranek and Newman, Inc. is the data communications subsidiary of BBN Computer Corp. BBN, Inc. developed ARPANET, one of the pioneers of packet-switching networks, which it now operates for The Department of Defense. It is also the founder of Telenet, a network of 91 switching centers in 182 U.S. cities. In June 1979, Telenet merged with GTE, the culmination of a major effort on BBN's part to transform its developed packet-switching technology into a nationwide public data communications network. While its business is split into acoustics and computer technology, BBN has now transferred expertise in packet switching to its new manufacturing company—BBN Computer Corp. This year BBN unveiled its new C/30 packet-switch processor—a very fast, powerful, microprogrammed cpu. We estimate BBN's data communication revenues to be at \$12.4 million, or about 33% of its total revenues. This number reflects a gain of about \$2 million over the previous year.

(Rockwell International Corp.)
COLLINS COMMUNICATION SWITCHING SYSTEMS DIV.
P.O. Box 10462
Dallas, TX 75207
(214) 996-2336

Collins Communication Switching Systems Div. is the data communications arm of Rockwell. It is here the design, development, and manufacture of data communication and digital voice switching systems takes place. Its products fall into the categories of controllers, computer front-ends, and switching. The C-System for computer front-ending is

its baby and is used by commercial banks to interface specialized financial wire services and to automate internal processing for such transactions. The Rockwell financial network controller is a standalone front-end switching system designed to integrate dissimilar networks such as SNA and Telex. Collins specializes in supplying large scale, multicenter, high reliability communication networks on a turnkey basis. Although Collins' financial reporting is hidden beneath the layers of Rockwell's, we estimate it contributed much less than 1%, or \$5 million, to Rockwell's \$6.8 billion total revenues last year.

COMPUTER COMMUNICATIONS, INC.

CONTROL DATA

DATASTREAM COMMUNICATIONS, INC.

DIGITAL COMMUNICATIONS ASSOCIATES, INC.

DIGITAL COMMUNICATIONS CORP.
117 Exploration Lane
Germantown, MD 20767
(301) 428-5500

Digital Communications Corp., a subsidiary of M/A Com, did \$11.9 million worth of data communications business last year under its Data Communication Div. DCD manufactures a wide variety of equipment, including controllers, front-ends, modems and multiplexors, and switching devices. This year it introduced the CM9100, a low-cost concentrator multiplexor fashioned after its CM9000, a multiple microprocessor. DCC also offers the Bus Interface Unit (BIU), which is a wall mounted device that allows economical interconnectivity among hundreds of terminals and computers in a local data distribution system using a single high-speed cable bus, such as used by CATV systems. Last year DCC's total revenue was \$30 million of which slightly more than one-third was brought in by the data communications end of the business. Two new major network customers last year resulted in a spectacular jump in revenues—to \$11.9 million, from \$1.4 million the year before.

The Top 50...

MICOM SYSTEMS, INC.

NGR CORP.

TRAN TELECOMMUNICATIONS

COMPUTER FRONT-ENDS: specialized processors attached to mainframe cpus which handle communications control between computer and network. The front-end performs network control and access method functions so that data transmitted over the network can be assimilated by the computer.

BOLT BERANEK & NEWMAN, INC.

BURROUGHS CORP.

**Burroughs Place
Detroit, MI 48232
(313) 972-7267**

Burroughs is second to IBM in the dp equipment business and is a principal supplier of node controllers to the SWIFT network. The company remains well poised, through its Redactron word processing systems, its office equipment, and its Dexnet facsimile network, to capture its share of the developing office communications market. It labels its new B6900, in the medium- to large-scale family, as a step toward the "coming era of worldwide computer networks."

(Rockwell International) COLLINS COMMUNICATION SWITCHING SYSTEMS DIV.

COMPUTER COMMUNICATIONS, INC.

**2610 Columbia St.
Torrance, CA 90503
(213) 320-9101**

Computer Communications Inc. is an independent supplier of data communications systems. It manufactures a bit of everything in this field: network controllers, computer front-ends, multiplexors, switching equipment, and software products. CCI produced the IBM 270X/370X emulation/front-end processor, sophisticated networking including remote concentration, and airlines reservations systems. CCI was formed in 1966. This year it introduced the CC-85 Advanced Communications Processor and the C-8R Remote Concentrator. CCI recently made an agreement to supply communications processors to Codex. Having reported healthy growth in both sales revenue and net income, CCI's 1979 revenue is at the \$18.2 million mark.

CONTROL DATA CORP.

**Box 0
Minneapolis, MN 55440
(612) 853-4656**

Control Data Corp. had an excellent year, with data communications revenue up to the \$40 million mark, according to CDC estimates. An upward trend started last year, when CDC clocked \$15 million, as contrasted with 1977, when the revenue in the data communications field was about \$12 million. Its

business is three-quarters in the controller field with the remaining income coming from computer front-ends. CDC's Cyber 1000 product line is marketed as either a protected message exchange or distribution network. CDC's 252X series network system provides communication capabilities for CDC Cyber 170, 70, 6,000, and 3,000 product lines. CDC recently moved its Communications Div. from Santa Ana to Anaheim.

DATASTREAM COMMUNICATIONS, INC.

**555B Ellis St.
Mountain View, CA 94043
(415) 965-9911**

Datastream is the producer of small front-end processors which can attach to minis or to large computers to handle protocol conversion, message routing, message translation between dissimilar terminals, or cpus—many of the functions which Bell's ACS intended to provide. In addition, Datastream manufactures controllers and modems and multiplexors. Started in 1973, this is a closely held private company. We estimate its 1979 revenues to be at the \$2.2 million level, a half-million increase over the previous year. The company recently moved from Brisbane to Mountain View, Calif.

DIGITAL COMMUNICATIONS ASSOCIATES, INC.

DIGITAL COMMUNICATIONS CORP.

HEWLETT-PACKARD CO.

**1501 Page Mill Rd.
Palo Alto, CA 94304
(415) 857-1501**

Hewlett-Packard makes two general categories of data communications equipment: specialized test equipment and data facilities to link data acquisition equipment to computers and other peripherals. Examples of HP specialized data communications test equipment include pattern-generator/error-detectors and automatic data network surveillance systems. The data specific test and measurement products are thought to be about 5% of the total test and measurement business done by HP. Data links to interconnect HP computers and their peripherals constitute a small fraction of equipment sales. HP estimates sales for fiscal year 1979 of test equipment was \$10 million, and sales in front-ends was \$19.5 million. While some unknown number of HP small computers are in use as communication controllers, none have been included in the \$29.5 million total estimate.

HONEYWELL, INC.

**Honeywell Plaza
Minneapolis, MN 55408
(612) 870-5200**

Honeywell's communications front-ends claim ancestry going back at least to the joint project between General Electric and Dart-

mouth which led to BASIC language and time-sharing. Although Honeywell's smaller computers have integrated communications, its large-scale machines have had separate communication boxes at least through the beginning of the third generation, when those large scale machines wore GE labels (and beat IBM into the third-generation marketplace). Honeywell takes a slightly different tack on its front-end processors too, allowing the direct attachment of disks, for instance, to log communications traffic independently. The main part of Honeywell's current front-end business is in attaching such devices to Level 66 DPS, DPS 8 and Level 68. The firm also owns Spectronics (which is developing fiber-optic data communications gear but is not yet a significant data com revenue generator), and a Florida branch that builds such things as modems, primarily for the military. Although Honeywell does not break out its data com revenues, we estimate this to be about 1% of its annual revenues for FY 79 of \$1.4 billion, or \$14.5 million.

IBM

**Armonk, NY 10504
(914) 765-1900**

IBM's 370X series front-end processors still qualify it as the unequivocal leader in the data communications industry. It has also recently gotten into the modem production end of the industry, but as yet has not marketed any test equipment. Although IBM does not break out its data communications figures specifically, we estimate its annual revenue to be 1% of IBM's total business, or about \$158 million for fiscal 1979.

(3M)

INTERACTIVE/3M

MEMOREX CORP.

**San Tomas at Central Expressway
Santa Clara, CA 95052
(408) 987-1000**

Memorex is one of the few companies manufacturing data communications products for both ends of the transmission line. Memorex's 1270 hard-wired communications controller supports a wide variety of synchronous and asynchronous terminals, line types, modems operating systems, and software. Intelligence has now been added to the 1270 with ILA (Intelligent Line Adapter), a microprocessor-based component that provides system flexibility. The Memorex 1380 communications processor is a programmable communications controller that uses intelligence in emulation mode, performing control and monitoring functions without demanding host cpu time and storage. We estimate Memorex's data communications revenue to be 7.3% of total revenue, or about \$53.9 million. Last year Memorex's data com revenues were listed at just over \$8 mil-

The 9103 *S-MUX

A smart data concentrator
that sets a new standard
of performance for
datacomm hardware.

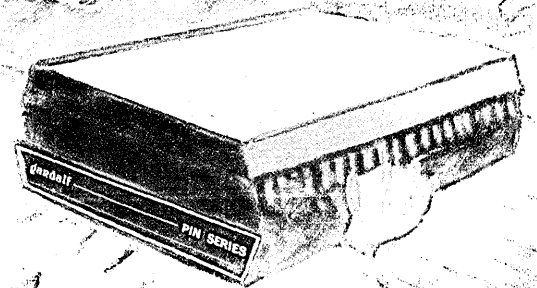

For complete product information, call or write for nearest Candell representative.

Call Data Line: 1010 South Wood Street, Wheeling, Illinois 60090 (312) 541-6060.

In Canada: Candell Data Communications Ltd., Candell Plaza, 9 Slack Road, Ottawa, Ontario K2C 0B7 (613) 223-0565

In U.K.S.: Candell Optical Communications Ltd., 4 Cranford Court, Harwood Grange, Warrington, Cheshire, England Warrate 0925-617-755

is a PIN series product.

CIRCLE 5 ON READER CARD

The Top 50...

lion, or a little over 1% of its total revenues. Those figures were too low, a result of first year information gathering.

NCR CORP.
1700 S. Patterson Blvd.
Dayton, OH 45479
(513) 449-2000

NCR has always been one of the leading data com manufacturers, appearing on last year's list as the 17th biggest company. Last June NCR acquired Comtem, last year's fourth largest company. The financial figures presented represent the combined NCR-Comtem operations in the data communication field. NCR Corp. now has the luxury of offering potential users products from two areas. Computer front-ends remain the dominant product offering, with Comtem the largest independent manufacturer of such devices and NCR bringing two of its own models into the merger.

PERIPHONICS CORP.
75 Orville Dr.
Bohemia, NY 11716
(516) 567-1000

Periphonics is now a wholly owned subsidiary of Exxon. Its main business is the manufacture of communication front-ends used by the banking industry, among other concerns. Periphonics also produces audio response systems. This company is best known for its T-Com 7, a commercial front-end processor, and the audio response system Voice Pac 2000. Revenue for fiscal 1979 reached the \$11 million mark.

SPERRY UNIVAC
P.O. Box 500
Blue Bell, PA 19424
(215) 542-4736

Sperry Univac computer operations had a strong year. Revenue and income increased substantially, and at year-end the installed

base exceeded \$10 billion, an increase of 13% over the previous year. In the data communications field, it manufactures computer front-ends. The big product here is the Distributed Communications Processor (DCP) which connects to anything in Univac's line from 9060 up. Univac has introduced the Distributor Communications Processor/40, and it will be worth watching closely as to its effects on the industry. The data communications revenue, which is slightly more than 1% of Univac's \$2 billion business, brought in about \$23.7 million to the coffers last year. This is a substantial increase from the \$15.6 million of the year before.

MODEM: since a business machine generates a digital signal and conventional phone lines accept only an analog signal, it is necessary to modulate the signal on the transmit end and demodulate the signal on the receive end. A modem is the device that performs these modulation/demodulation functions.

MULTIPLEXOR: a device that makes it possible to transmit two or more messages simultaneously over a single channel or other transmission facility.

ANDERSON JACOBSON, INC.
521 Charcot Ave.
San Jose, CA 95131
(408) 263-8520

Anderson Jacobson has just completed its 12th year as a manufacturer of proprietary computer terminals and data communications equipment. In its data communications line are found acoustic couplers and modems. We estimate that the coupler and modems are now bringing in about 25% of the firm's revenue, or about \$29.7 million for fiscal 1979. New product development expenditures of \$1.6 million for fiscal year 1979 represented an 11% increase over the previous year. The continued emphasis on new product research and development resulted in the introduction

during the past year of the AJ1234, a 1200 baud acoustic coupler, and its modem equivalent, the AJ1255.

ASTROCOM
120 West Plato Blvd.
St. Paul, MN 55107
(612) 227-8651

Astrocom, appearing for the first time in this survey, is the maker of synchronous and asynchronous short haul modems (to 300bps), acoustic couplers, and asynchronous long haul modems, as well as a modem emulator. In the test equipment area two devices hold sway: the Mini-Check, a bit error test set, and the Maxi-Check. The company's net income loss was due to the starting up of a small business computer division. Astrocom's other major line of production is printed circuit cards. The company, formed in 1968, reports data communication revenue of \$2.3 million, or 60% of its total revenue.

COMDATA CORP.
8115 Monticello
Skokie, IL 60076
(312) 677-3900

ComData is a manufacturer of multiplexors, acoustic couplers, and modems of all speeds. Modems and multiplexors contribute 80% of the total revenue, with 20% going to the couplers. A privately held corporation, it was established late in 1968 after the Carterfone decision. Since that time it has developed its operations to the \$3 million point.

**COMPUTER COMMUNICATIONS
DATA ACCESS**

DATASTREAM COMMUNICATIONS

**DIGITAL COMMUNICATIONS
ASSOCIATES, INC.**
135 Technology Park/Atlanta
Norcross, GA 30092
(404) 448-1400

DCA made its appearance on the data communications scene in 1972 and since then has done well. Last year its name appeared in the number 50 slot on the list of top manufacturers; this year it's climbed up quite a bit. Fiscal year earnings totaled \$2.7 million (\$3.8 million on a calendar basis) as it continued to make strides in the production of statistical multiplexors and network processors. Currently DCA has three series of statistical multiplexors: the 100 transparent line of stat mux; the Series 200, which consists of data com front-ends for DEC computers; and the Series 300, which is the newest line of transparent high performance network processors. DCA prides itself that all networking systems are compatible and are easily expandable.

DIGITAL COMMUNICATIONS CORP.
DYNATECH CORP.

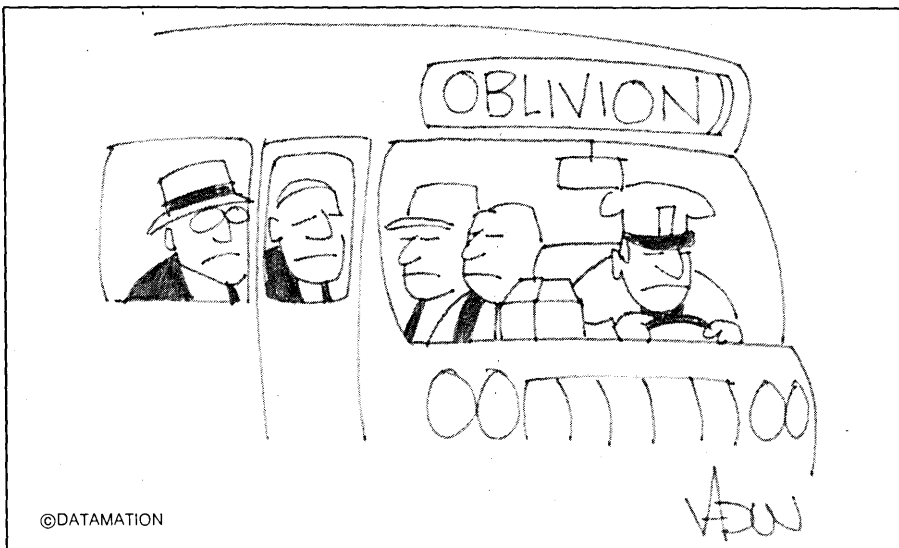

©DATAMATION

CARTOON BY CHUCK VADUN

Send for this fiche to see
 the high quality of DuPont
**RECRON® High Definition
 COM silver film.**

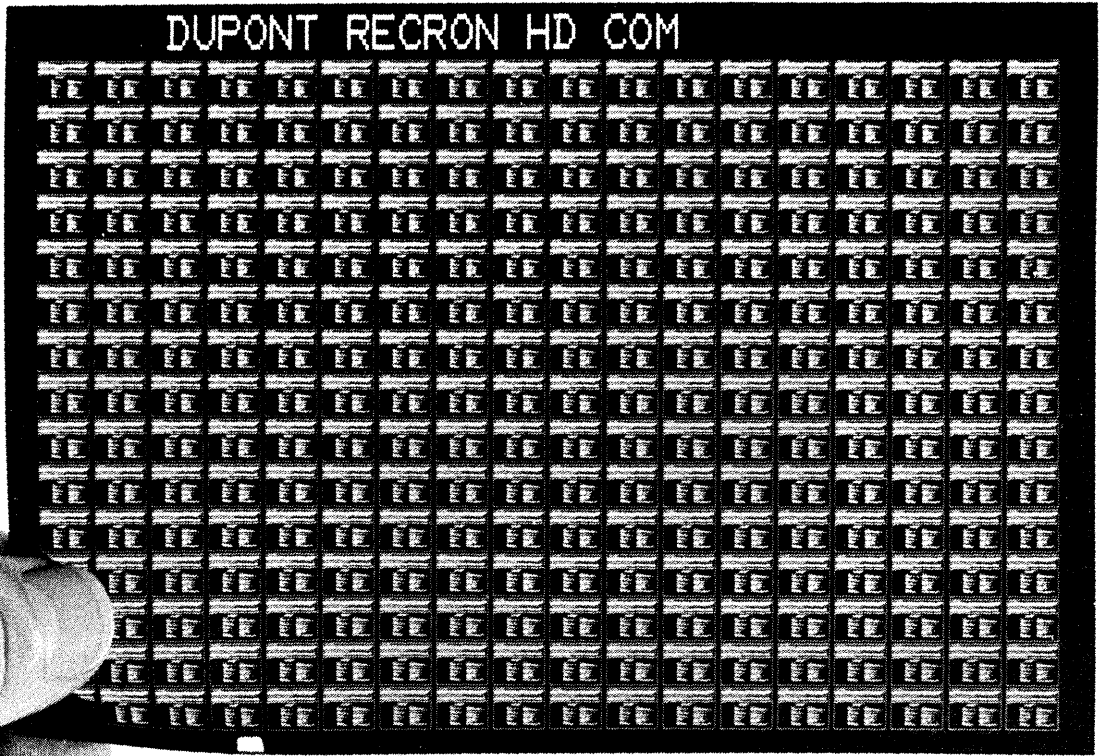

It has brightness, clarity and sharpness that you can actually see. DuPont RECRON High Definition COM silver film has a new emulsion that produces easy-to-duplicate images in reductions of 42x, 48x and higher. That means more information in less space. Wide processing latitude assures you of excellent results under a variety of conditions.

The film comes on a CRONAR® base protected with a new anti-static treatment. The base is only .004 inch thick, up to 25% thinner than conventional acetate COM films, so you can get more film on a spool and reduce reloading time. This base is really durable and withstands repeated duplication without damage. RECRON High Definition COM silver film comes backed up with chemicals, processor and a nationwide network of DuPont Technical Representatives to make it all work most economically for you.

Send for your film sample and in-depth information about it. Mail the coupon today.

*RECRON is a DuPont registered trademark for its microfilm, microfilm processors and chemicals.

CIRCLE 86 ON READER CARD

Mail this coupon today.

DuPont Company, Room 36794
 Wilmington, DE 19898

Please send me the fiche of RECRON High Definition COM silver film. I'm interested in high quality.

Name _____

Title _____

Company _____

Address _____

City _____

State _____ Zip _____

Phone () _____

**Industrial
 Photo Systems**



REG. U.S. PAT. & TM. OFF.

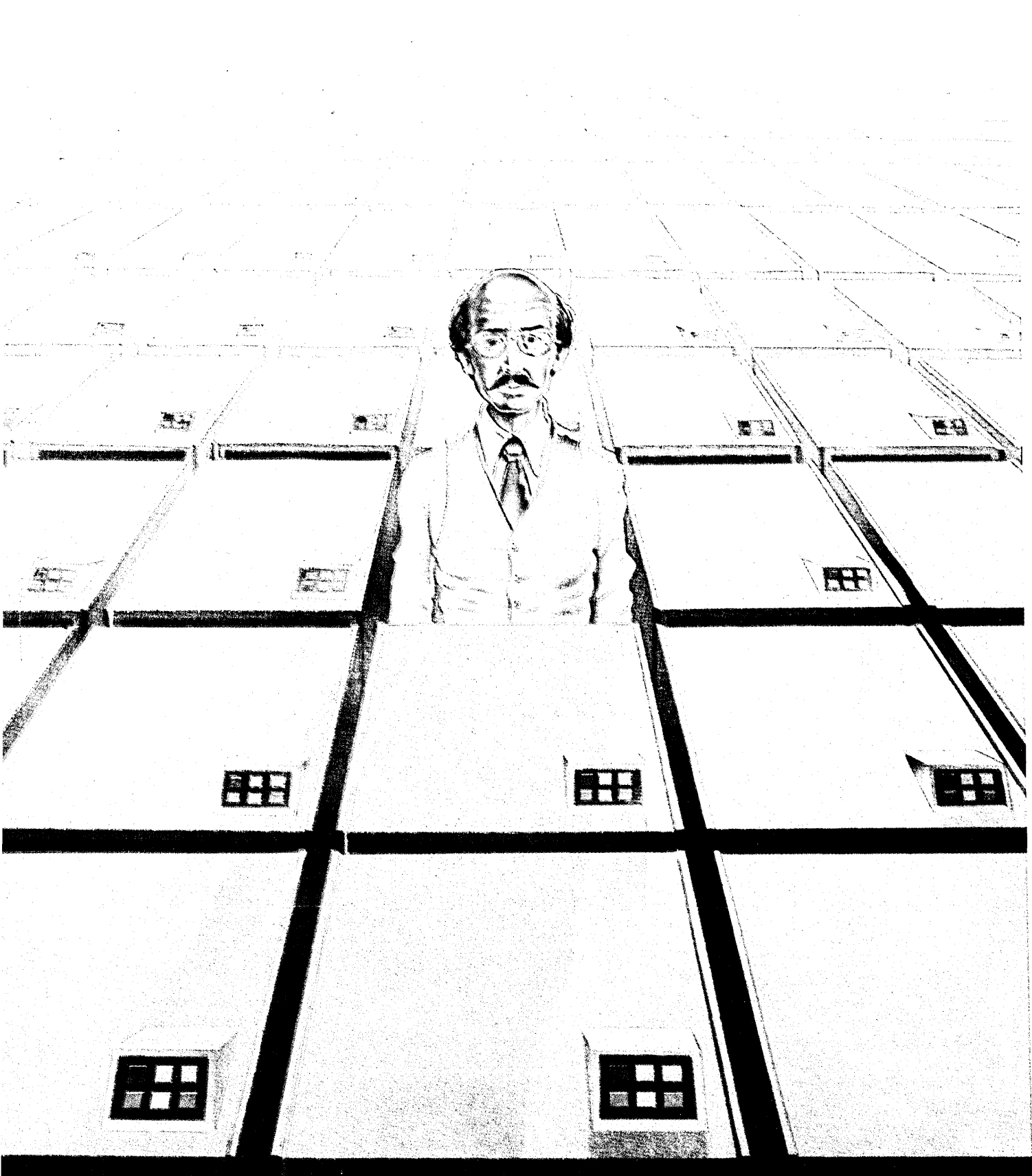

Some day you'll have to stop relying on new hardware to solve your disk space problems.

Especially since a single software package can solve it for you ... at a fraction of the cost.

The UCC-3/ADAM Disk Management System can vastly increase the availability of usable disk space ... without spending a cent for expensive new disk drives. Because, chances are, your shop already has all the disk space it needs ... it's just not being used efficiently.

UCC-3 eliminates disk fragmentation and maximizes DASD space usage efficiency. It produces complete reports that allow you to analyze your disk space problems. Then, based on your criteria, it will solve the

problem by automatically migrating selected data sets and scratching unneeded and invalid data sets. And UCC-3 keeps the problem from recurring by controlling data set allocation.

Don't buy another disk drive until you call us toll-free at 1-800-527-5012 (in Texas, call 214-353-7312) or circle 87

And, why not ask us about:
A Tape Management System that protects data from loss or destruction (UCC-1). Circle 88
A DOS Under OS System that lets you execute DOS programs without conversion (UCC-2). Circle 89
A PDS Space Management System that eliminates PDS com-

pression (UCC-6). Circle 90
A Production Control System that makes scheduling systems obsolete (UCC-7). Circle 91
A Data Dictionary/Management that really gets IMS under control (UCC-10). Circle 92
An Automated Re-run and Tracking System that solves your re-run problems (UCC-11). Circle 93
A Hardware Vendor Accountability package that gives you the facts on reliability (UCC Reliability Plus). Circle 94
General Accounting software packages. Circle 95
Application software for the Banking and Thrift industries. Circle 96

UCC

SOFTWARE AND COMPUTING SERVICES

UNIVERSITY COMPUTING COMPANY • DALLAS • LONDON • TORONTO • ZURICH

UCC is a subsidiary of Wyly Corporation (NYSE)
For information and an Annual Report, write 1000 UCC Tower, Exchange Park, Dallas, Texas 75235

The Top 50...

GANDALF DATA INC.
1019 S. Noel Ave.
Wheeling, IL 60090
(312) 541-6060

Gandalf, founded in 1974, manufactures a broad base of modems, multiplexors and data switches. The U.S. branch does the manufacturing and selling for the U.S. market while the designs come out of the Canadian parent company. The parent also manufactures for the international market. Its products include modem eliminators and short-haul modems which can have multichannel interfaces. Among Gandalf's new products are the SM9600, which is a long-haul 9600bps modem, a statistical mux, and a new line of asynchronous short-haul modems. Gandalf has now begun to shift emphasis to forming a broadened data communication base of products. Last year its efforts pulled in \$5.5 million, a healthy 40% increase over the year before. Combined sales of Gandalf and its Canadian parent were over \$12 million for 1979.

GENERAL DATACOMM INDUSTRIES, INC.
One Kennedy Avenue
Danbury, CT 06810
(203) 797-0711

General DataComm believes it is now the largest independent supplier of equipment to the data communications market, claiming it represents 10% of the total market and has captured 25% of the low speed data transmission business. The equipment made by GDC includes time division and frequency division multiplexors, a wide range of data sets, and network diagnostic equipment to monitor and maintain data communications systems. In 1979, GDC introduced its 1240 and 1241

statistical multiplexors, which can achieve multiplexing efficiencies far exceeding those offered by hard-wire logic multiplexors through the application of advanced micro-processing techniques. It also launched the GDC 4801 Fast Poll Modem, which incorporates state-of-the-art techniques featuring microprocessor elements for internal signal processing. Sales grew 34% over last year with the most significant gains coming in the international market. The overall company revenue is marked at \$41.7 million.

(Harvey Hubbell Inc.)
PULSECOM
5714 Columbia Pike
Falls Church, VA 22041
(703) 998-4300

Hubbell's Pulse Communications Div. represents its participation in the data communications market. Pulsecom supplies advanced equipment to more than 2,000 customers worldwide for voice and data transmission over telephone lines. Although Pulsecom represents a small part of Hubbell's total sales, we estimate its contribution to be around the \$2.5 million mark.

INFOTRON SYSTEMS CORP.
Cherry Hill Industrial Center
Cherry Hill, NJ 08003
(609) 424-9400

Infotron, a privately held company formed in 1968, features a line of statistical multiplexors, modems, and data switches as its primary products. The multiplexors operate in intelligent time division and conventional time modes. Also offered are computer port selectors and processor interfaces. Last year three new products, including two modems and a

data switch, were introduced. On the financial side, revenues increased by \$4 million to \$18.7 million for FY'79. Infotron had also opened direct sales offices in nine cities and relocated its engineering department to its own 15,000 square foot building.

(3M)
INTERACTIVE SYSTEMS/3M
3980 Varsity Dr.
Ann Arbor, MI 48104
(313) 973-1500

3M's listing represents its purchase of last year's 42nd largest company Interactive Systems located in Ann Arbor, Mich. IS/3M is now a part of 3M's Telecom Division. IS/3M is in the business of manufacturing coax cable networks for carrying voice, data, and video in-plant. The pieces of the networks include modems, multiplexors and intelligent multiplexors which front-end the cpu. In an attempt to expand its product line into the broadband total communications systems components for oems and end-users, it introduced the model 920 Universal Broadband Communication modem and the model 460 multichannel frequency switch.

INTERTEL, INC.
6 Vine Brook Park
Burlington, MA 01803
(617) 273-0950

Intertel closed out its first decade with company revenues reaching the \$15 million mark. Its revenues come from the sale of high-speed modems and a related network of monitoring and diagnostic equipment. The latter is its microprocessor based EMS 1 series, which provides for automatic or manual monitoring of data communications lines. Among the new product offerings last year was the M1200, the RAP1000 and the ACH410. Intertel plans to relocate to a new 83,000 square foot facility in Andover, Mass., this July.

LIVERMORE DATA SYSTEMS, INC.
2050 Research Dr.
Livermore, CA 94550
(415) 447-2252

Livermore Data Systems is in the business of manufacturing modems. The company manufactures a 300 baud acoustic coupler called the Star, which was introduced last year. The Star is an answer and originate, half and full duplex system with full diagnostic capabilities. This 11-year-old company reports 1979 revenues at the \$3.4 million mark.

MICOM SYSTEMS, INC.
9551 Irondale Ave.
Chatsworth, CA 91311
(213) 882-6890

Micom, a privately held corporation founded in 1973, recorded a revenue and net income increase last year of 300%. The company's products address the three fundamental prob-



©DATAMATION

CARTOON BY HARLEY L. SCHWADRON

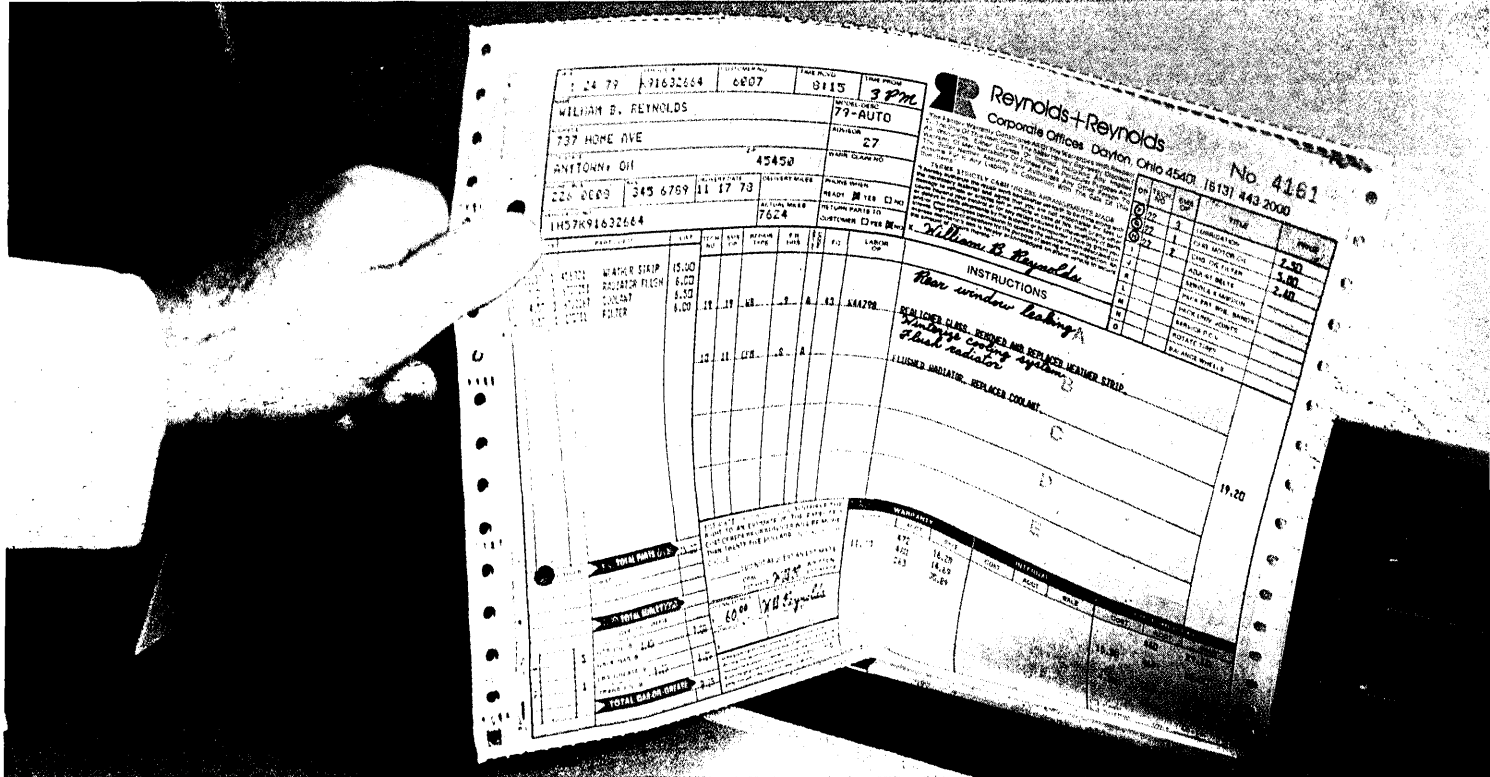

Push-n-pull tractors, adjustable tear bar and 1-to-9 part forms handling: all in one printer.

Finally, real-time forms access plus continuous forms output in one printer. Perfect for such applications as airline ticketing, invoicing, order preparation and more. And another example of the expanding TermiNet 200 printer family's application versatility.

No-waste, flexible forms control

One reason: an adjustable tear bar that lets you use standard forms with different header lengths. For precise alignment, no paper waste and clean paper tear. Every time.

More reasons: servo-driven tractors that allow infinite manual adjustment in both forward and reverse. A non-volatile electronic VFU that makes forms set-up easy and permits storage of up to 8 vertical formats. A down-line loading option enabling you to load formats directly from your data source. Plus straight-through paper path and push-n-pull tractors that give you perfect first-to-last-copy registration. As well as smoother paper handling for all types of forms, including single-part paper.

More features add up to more application versatility

With TermiNet 200 printers, you can also get a 9 x 9 printhead for exceptionally legible underlining and lower-case descenders. Two complete 96-character switchable print fonts for ASCII/APL use or your own special needs. A choice of Magnetic Tape or Edit Buffer Accessory. Plus a 100% duty cycle capability, excellent print quality at speeds up to 200 cps and low cost of ownership. All of which help make TermiNet 200 teleprinters and line printers the industry workhorses.

Immediate delivery instead of piecemeal allocation

Why wait months for other printers when TermiNet 200 printers are available now? When you need them. Mail the coupon today and find out how the expanding TermiNet 200 printer family can meet your range of application needs and generate real cost savings.

**Great rip-offs:
Just one way
TermiNet[®] 200
printers give
you no-waste
forms access**

Quality that will make a lasting impression



CIRCLE 100 ON READER CARD

Mail today to:
J. Walsh,
General Electric
Company,
TermiNet 794-49
Waynesboro, VA 22980.
Telephone: (703) 949-1474.

Send me more information about the expanding TermiNet 200 printer family.

Have a sales representative contact me.

I'm also interested in a TermiNet 200 printer demonstration.

Name _____

Title _____

Company _____

City _____ State _____ Zip _____

Telephone _____

TO EVERYONE WHO'S SAID, "DATA TRANSMISSION ERRORS ARE INEVITABLE,"



CIRCLE 101 ON READER CARD

FIDDLESTICKS.

DCA statistical multiplexors/network processors have been providing error-free data transmission in terminal-to-computer networks since 1974. And DCA equipment is completely protocol compatible — our newest stat muxes communicate error-free with our six-year old models. So if you can't afford mistakes, contact DCA — the company that made errors obsolete. Digital Communications Associates, Inc., 135 Technology Park/Atlanta, Norcross, GA 30092 404/448-1400.



ENGINEERED
TO EXPAND

DCA announces new high-performance network processors that lower data communications costs

A new concept in datacomm networks was introduced at Interface '80. The DCA Series 300 statistical multiplexor/network processor line is the foundation for a range of products that can be upgraded with future technology. A unique "building block" approach based on DCA's proven Integrated Network Architecture (INA) allows networks to grow either in size or performance — or both. Thus, small networks can be configured without paying for performance that would never be used. And by the same token, any network — large or small — can have "big network" features.

Modular Network Expansion. For networks that are bound to grow, Series 300 continues a DCA tradition: highly cost-effective modular expansion. The series supports from 1 to 62 trunk links so networks that begin small can grow into the future. The new series is also completely compatible with all existing INA network processors — the current Series 100 line can even be upgraded in the field to the Series 300 level!

Modular Performance. Common hardware is used extensively, and Series 300 actually achieves greater results (10 to 20 times the throughput of presently-available technology) with less hardware than ever before. This unique growth-oriented architecture allows system performance to be improved at very low cost and without obsoleting investments made in DCA components.

DCA's microprocessor-based processing modules (PMs), for example, can be interchanged to achieve just the level of performance that's needed for a particular net-

work. Because system programs are software loaded, the same PMs can be used throughout the entire series. They can be programmed and updated to perform any networking function, yet since they are identical until programmed, a single PM acts as a spare for the entire series.

Advanced Features. Series 300 supports any asynchronous and certain synchronous terminals, plus a multitude of network protocols — including X.25. Series 300 offers a private network as a superior performing, low-cost alternative to packet-switched networks. DCA's exclusive protocol conversion modules will give terminal users access to virtually any host computer. Extensive self-diagnostic capabilities surpass anything currently on the market.

Like other INA systems, Series 300 offers multipoint multiplexing, error-free data transmission, port contention, host selection, and a multitude of other features that reduce data communications costs.

Before you buy a network to meet today's needs, check out the network that's de-

signed to meet tomorrow's needs as well. For complete details on the Series 300 network processors, write or call DCA today. Digital Communications Associates, Inc., 135 Technology Park/Atlanta, Norcross, GA 30092. 404/448-1400.



ENGINEERED
TO EXPAND

CIRCLE 102 ON READER CARD

lem areas of line costs, transmission errors, and computer port utilization, especially where microcomputers are involved. It is best known for its Micro800 Data Concentrator, a low cost statistical multiplexor. Since its introduction in January 1978, more than 10,000 of these units have been installed. The Micro800 is now complemented by the Micro900 Multidrop Concentrator, which allows dumb terminals, for the first time, to be multidropped without special software. Also at bat for the first time is the Micro500 Error Controller, which guarantees error-free data communication for dumb terminals, and the Micro600 Port Selector, which allows dumb terminals to select host computers in a multiple computer environment. These additions to its line helped bring in \$15.4 million worth of revenues last year.

(Motorola)
CODEX
20 Cabot Blvd.
Mansfield, MA 02048
(617) 364-2000

UDS
4900 Bradford Dr.
Huntsville, AL 35805
(205) 837-8100

Motorola's data com operations are provided by two major U.S. subsidiaries: Codex in Mansfield, Mass., and Universal Data Systems (UDS) in Alabama. The parent company does not break out the revenue and data com figures for either subsidiary. Among new data com product announcements last year were the 6520 communications front-end processor, the CDX-68 family of intelligent terminals, and the LSI 48 v/.27 data modem.

NOVATION, INC.
18664 Oxnard St.
Tarzana, CA 91356
(213) 996-5060

Novation's business is acoustic couplers, low and medium speed direct modems, and automatic dialers. The couplers range up to 300baud and the modems to 1200baud. A privately held company, it made its appearance on the data communications scene in 1967. Novation reported an annual revenue of \$3.5 million for last year.

(Nytronics, Inc.)
OMNITEC
2405 S. 20th St.
Phoenix, AZ 85034
(602) 258-8244

Nytronics' niche in the data communications chart is provided by its Omnitec Data Products Div., which manufactures components for computer time-sharing and message communications equipment. In fiscal 1979, this division accounted for 2% of the company's sales and 1% of its operating profit. Omnitec's product line consists of two major items

—acoustic telephone couplers and modems. When the division was organized in 1965, the acoustic coupler was its principal product, and in 1979 the coupler continued to account for over half of its sales. Recently Omnitec began to increase its production of modems and at present is developing nine modems, five of which will be in production during fiscal year '80. Last year it also obtained a license from Western Electric to manufacture and market a variable speed modem. Omnitec's products are sold to the oem market through distributors, manufacturers' reps, and directly to certain factory users.

PARADYNE CORP.
8550 Ulmerton Rd.
Largo, FL 33542
(813) 536-4771

Paradyne celebrated its 10th anniversary in the data communications industry last year. Among its presents was an increase in company revenues of about 65%, bringing the figure to just over \$41 million. The company develops, manufactures, markets, and services high speed data communications equipment. Its products are offered in system configurations to handle the transmission of data among computers and peripheral devices via public and private communications media, principally telephone lines. Primary products are medium and high speed modems and the PIX/PIXNET systems. PIX/PIXNET is designed to provide more efficient communications between remote peripheral devices and IBM computers. In 1979 Paradyne announced a new product called RESPONSE, which provides users with a distributed data processing capability placing application hardware and software in remote locations utilizing PIXNET for its communications function.

PENRIL CORP.
5520 Randolph Rd.
Rockville, MD 20852
(301) 881-8151

Penril's Data Communications Div. manufactures a broad range of low, medium, and high speed modems which have put Penril on the map of data com equipment makers. It also offers styles that are compatible with European common carrier specifications and short-haul modems. All of the modems in Penril's line contain basic built-in diagnostic capabilities, but several models go significantly further, offering extensive centralized diagnostic testing, monitoring, and control of the complete data com network. A large year-end sale in '78 pushed revenues up to \$4.9 million, compared to \$4.1 million last year. The company is already projecting record revenues for FY '80, saying the first half of this fiscal year saw sales totaling \$4.4 million. As a result of two product line acquisitions the division now offers Bell compatibility, including a 300/1200 modem

introduced in February of last year. The second product acquisition in the summer of '79 brought to the company a line of Bell-compatible modems from the Tele-Dynamics Div. of AMBAC Industries Inc.

PRENTICE CORP.
266 Caspian Dr.
Sunnyvale, CA 94086
(408) 734-9810

Prentice is a full-line supplier of low-speed Bell compatible modems, short-haul modems, and statistical multiplexors. The product emphasis is on diagnostics, packaging, and other user conveniences. The 10-year-old company saw revenues of \$5.2 million last year. Several new products were added to its offerings, including a statistical multiplexor and full duplex line of modems, which includes a Bell-type 212A. Two other major changes during the past year were the official change of the company's name from Prentice Electronic Corp. and location change to Sunnyvale from its old home in Palo Alto.

RACAL-MILGO, INC.
8600 N.W. 41st. St.
Miami, FL 33166
(305) 591-5225

Racal-Milgo is a subsidiary of Racal Electronics Ltd. of Bracknell, England, and is among the leading manufacturers of data communications products, including modems and a network of management and control systems as well as terminals. The modems are of the medium-speed, high-speed, wide-band and short-haul variety. These account for 80% of the data communications revenue. Last year new loop modems, clustered terminals, and data security products were launched. This Miami-based firm also conducts business in California, England, Japan, Germany, and Argentina. The data com revenue figure of \$121 million is adjusted to the 12-month 1979 calendar year. For its FY 78/79 which ended Mar. 31, 1979, the revenue figure was \$83 million. Revenues for this company and its sister company, Racal-Vadic, are listed separately.

RACAL-VADIC, INC.
222 Caspian Dr.
Sunnyvale, CA 94086
(408) 744-0810

Racal-Vadic, sister company of Racal-Milgo, manufactures low- and medium-speed modems with speeds of 300, 1200 and 2400 bps, acoustic couplers and automatic dialers. Its dial-up modems are FCC registered and directly connect to telephone lines, and are available in rack-mounted and standalone form. Racal-Vadic has introduced several new products, including a triple modem and a modem compliant with CCITT recommendation V.22 alternative C for use outside the

The Top 50...

U.S. and Canada. Its products are marketed in the U.S. via stocking reps and distributors. In export market areas the products are sold and serviced through the same distribution network as Racal-Milgo of Miami, Fla.

RIXON, INC.
2120 Industrial Parkway
Silver Spring, MD 20904
(301) 622-2121

Rixon saw its 1979 revenues increase by 63%, bringing its annual revenue to \$36.1 million. This company is a subsidiary of Sangmo, which is held by Weston, itself a subsidiary of Schlumberger. Products marketed include a complete range of modems from 300 to 9600 bps, line drivers and statistical multiplexors from 4 to 240 channels, and private line diagnostic and termination equipment round out the choices. Product distribution is mainly to commercial concerns, with about 5% of its sales going to the United States government. This year Rixon started to put a greater emphasis on expansion from a telephone company supplier to the end-user supply line. New product introductions included a Bell-type 209 modem with 9600 bps, a statistical mux, and LDM.

TEK-COM INC.
2142 Paragon Dr.
San Jose, CA 95131
(408) 263-7400

Founded in January 1977, Tek-Com has in a short time become an important supplier of acoustic couplers and modems. The basic product is the low-medium speed modem (0-2400 bps). Tek-Com offers the series 3000 data modems, which are designed for acous-

tic and hard-wire operations via the switched telephone network or private line installation. Of this line, Tek-Com produces the TC 3006 acoustic coupler, and the TC 3001 and TC 3002, which are acoustic coupler/modem devices. The company is 100% data communications-oriented and 100% in the modem field. Tek-Com estimates an annual revenue of \$2.5 million for 1979.

TIMEPLEX, INC.
One Communications Plaza
Rochelle Park, NJ 07662
(201) 368-1113

Timeplex moved from Hackensack this year, transferring 65% of its staff to new corporate headquarters and engineering center. The 10-year-old public company's product offerings consist principally of data multiplexors. The newly released Series II Microplexer series of statistical multiplexors/data concentrators augments Timeplex's leading share in TDMS. Its newly formed modem division provides total data communication systems capabilities. Future plans call for expanding end-user and distribution sales, and keeping a close watch over direct sales and service subsidiaries in the United Kingdom. Last year Timeplex posted \$13.6 million company revenue, all from sales in the data communications area.

TRAN TELECOMMUNICATIONS CORP.
2500 Walnut Ave.
Marina del Rey, CA 90291
(213) 822-3202

Tran Telecommunications develops public and private digital telecommunications networks, and manufactures computer-based

network switching and management systems. Its products include test sets, modems—both high and low-speed—multiplexors, network access concentrators, and data switches. Tran lists among its "firsts" since beginning operation in 1969 the first optical transceiver (infrared) for short-haul high-speed wireless data communications, the first wide-band time division multiplexor for use within the Bell System, and the first nationwide digital data network (Canada's Dataroute). Among its new product introductions during the past fiscal year was XPRT, an X.25 protocol tester. Tran's revenues increased by 50% last year.

TEST EQUIPMENT: devices used to monitor the characteristics of communications lines. These devices usually provide detailed analyses of physical line parameters as well as monitoring the contents and formats of data being transmitted over these facilities.

ASTROCOM

ATLANTIC RESEARCH CORP.
5390 Cherokee Ave.
Alexandria, VA 22314
(703) 642-4416

In 1979 Atlantic Research strengthened its position in the data communications field by further establishing itself as a prime developer and supplier of test equipment. The Inter-shake Test System continued to be accepted in the marketplace as a powerful and versatile diagnostic test instrument, with sales remaining at a level of about \$2 million. Also, a new product, the Interview 3000 series, was introduced at the end of 1979. The unit is primarily a data analyzer and is designed specifically with a less technical operation in mind. Another high point in FY '79 was a doubling of network control systems sales.

DIGITECH DATA INDUSTRIES, INC.
66 Grove St.
Ridgefield, CT 06877
(203) 438-3731

Digitech has the major distinction of being affiliated with one of the major data com carrier companies. A subsidiary of Central Telephone and Utilities, Digitech is a first timer on this list. It manufactures and markets digital diagnostic equipment for data communications products. Digitech, which was acquired in 1979, introduced its Encore data communications test unit, which has shown extremely strong sales results. During 1980 the company plans to introduce several new products, including a data line monitor called Data Monitor 200, which is a field diagnostic test system expected to perform more functions and cost less than competitive models. Digitech reports a \$4.6 million 1979 fiscal year.

DYNATECH CORP.



"By heavens, Higgins, you're right. It is magic marker."

©DATAMATION

CARTOON BY JOSEPH A. DAWES

**Get a complete
data processing center
without costly hardware.**

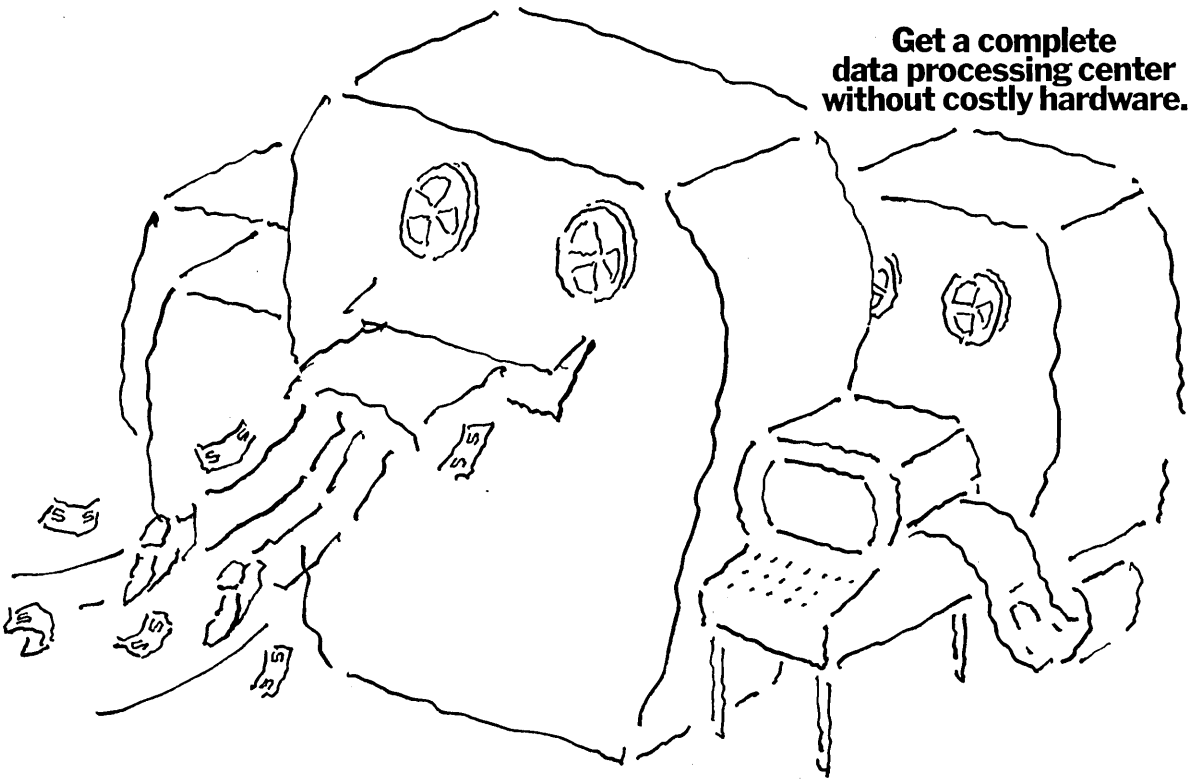

Now there's a software package that can turn a minicomputer into a small-scale data processing center with from 5 to 40 terminals. The UNIX™ System.

UNIX Systems are time-sharing operating systems that are easy to program and maintain. So easy, in fact, that more than 800 systems are already in use outside the Bell System.

UNIX Systems give fast and efficient data processing. They feature more than 100 user utilities.

UNIX System, Seventh Edition, and UNIX/32V System. The new UNIX System, Seventh Edition, offers greatly enhanced capabilities, including a larger file system and inter-machine communications. The Seventh Edition is designed for PDP-11 minicomputers. For those needing its capabilities on a larger machine, the UNIX/32V System is available for the VAX-11/780. The Seventh Edition's improved portability features allow users to adapt it more easily to other computers.

Both the UNIX System, Seventh Edition, and the UNIX/32V System can support up to 40 users with FORTRAN 77 and high-level "C" languages.

Programmer's Workbench. For large software design projects, the PWB/UNIX System (Programmer's Workbench) allows up to 48 programmers to simultaneously create and maintain software for many computer applications. The PWB/UNIX System features a unique, flexible set of tools, including a Source Code Control System and a remote job entry capability for the System/370.

Developed for our own use, UNIX Systems are available under license from Western Electric and come "as is". With no maintenance agreements, no technical support.

For more information about UNIX Systems or

other Bell System software, complete the coupon and mail to Bell System Software, P.O. Box 25000, Greensboro, N.C. 27420. Or call 919-697-6530. Telex 5109251176.

UNIX is a Trademark of Bell Laboratories.

To: Bell System Software,
P.O. Box 25000, Greensboro, N.C. 27420

DAT-11

Please send me more information about Bell System software packages.

UNIX Systems. Other Bell System software packages.

Name _____

Title _____ Company _____

Address _____

City _____ State _____ Zip _____

Telephone _____ Hardware _____



CIRCLE 103 ON READER CARD

The Top 50 . . .

HALCYON

1 Halcyon Plaza
2121 Zanker Rd.
San Jose, CA 95131
(408) 293-9970

A subsidiary of Tortel Inc., Halcyon posted \$12 million in revenues for fiscal 1979. Of that figure, data communications revenue totaled about \$4 million. Test equipment is the main product category, which features analog and digital equipment. Halcyon is moving into the multiplexor business with its new 4200 series statistical multiplexor. The new 802 Data Monitor is described by the company as the world's first automatic monitor.

HEWLETT-PACKARD

INTERNATIONAL DATA SCIENCES, INC.

7 Wellington Rd.
Lincoln, RI 02865
(401) 333-6200

International Data Sciences makes patching and monitoring systems, switching devices, and modems. The company's most successful product remains the Rangerider line diagnostic series. Two years ago it added the Mini Tech control and protocol monitoring device. Combined, these products brought in \$5.02

million for fiscal 1979, a healthy increase over the \$3.7 million for the previous year. Calling itself a growth-oriented company, IDS has listed extensive plans for the next five years, including an ambitious product development program. Product development under this program will enable IDS to explore new markets. The program officially got underway with the introduction of limited distance modems.

(Northern Telecom Inc.)

SPECTRON
344 New Albany Rd.
P.O. Box 620
Moorestown, NJ 08057
(609) 234-5700

Northern Telecom Inc.'s Spectron Div. is its best-known data communications manufacturing area. NTI is owned by Northern Telecom Ltd. of Canada. Spectron is a manufacturer of data transmission test equipment and line drivers. It also produces switching devices and transmission equipment. Northern Telecom Ltd.'s total revenues for 1979 were \$1.9 billion, \$30 million of which were from sales by Spectron.





TRAN TELECOMMUNICATIONS

TEKTRONIX, INC.

P.O. Box 500
Beaverton, OR 97077
(503) 644-0161

Tektronix's business falls into two categories: display products and test/measurement products. The latter constitutes 79% of its sales but only a tiny portion of that is in data-specific test and measurement equipment. Of new equipment, the 833 Data Tester heads the list. It is a high performance, first-line service tool that provides the means to locate problems in a data com network. Also available is the 851 Digital Tester, an easy-to-operate first-line tool used to troubleshoot and maintain a wide range of digital equipment. We estimate the data communications revenue figure to be about 15% of its entire revenue, giving Tektronix data communications revenues of \$7.9 million for fiscal 1979.

SWITCHING: equipment which allows users to select specific communication circuits on demand. Such switching equipment may operate either manually or in automatic mode and is designed to provide alternate facilities in case of line malfunctions, circuit overloads, or other operational conditions.

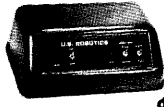
U.S. ROBOTICS, INC. 1035 W. LAKE ST. CHICAGO, ILL. 60607		Terminals Modems Couplers at Low Prices
<p>Call now for a quotation (312) 733-0497</p> <p>The 550 BANTAM from Perkin-Elmer</p>  <p style="text-align: right;">\$799</p> <p>All the features of the Hazeltine 1400 & LSI ADM-3A plus</p> <ul style="list-style-type: none"> • Upper/Lower Case • 7x10 Character Matrix • White or Black Characters • Transparent Mode • Addressable Cursor • Tab Function • Backspace Key • Shiftlock Key • Print Key • Integrated Numeric Pad • Editing Functions • Extremely Compact: 15" W x 19" D x 14" H • Silent fan-free operation <p>All products in stock!</p>	<p>LA34 DECwriter IV</p>  <p style="text-align: right;">\$1199</p> <ul style="list-style-type: none"> • Tabs • 132 columns • 10, 12, 13.2, 16.5 characters/inch • 2, 3, 4, 5, 8 or 12 lines/inch • Optional tractor feed • 110 or 300 baud • RS232C/ASCII • Friction feed/up to 15" wide paper • 9x7 dot matrix, impact printing • Upper/lower case 	<p>PENRIL 300/1200 MODEM Originate/Auto-Answer</p>  <p style="text-align: right;">\$799</p> <ul style="list-style-type: none"> • 0-300 or 1200 baud • Bell 212A & 103/113 compatible • 1 year warranty • Stand alone • RS232 • Full duplex over voice grade phone lines • FCC certified for direct connection to phone lines via RJ11C voice jack (standard extension phone jack)
	<p>Teletype Model 43 KSR \$1049</p>  <ul style="list-style-type: none"> • 110 or 300 baud • RS232C/ASCII • Pin feed/8½" H x 11" W paper is perfect for filing and copying. 	<p>USR-310 Originate Acoustic Coupler</p>  <p style="text-align: right;">\$159</p> <ul style="list-style-type: none"> • 0-300 Baud • Bell 103/113 compatible • Stand Alone • RS232 • 1 Year Warranty • Crystal Controlled • State of the Art LSI circuitry • 5 stage active filters <p>USR-330 Originate/Auto-Answer Modem</p>  <p style="text-align: right;">\$339</p> <p>FCC certified for direct connection to phone lines via standard extension phone jack</p>

CIRCLE 104 ON READER CARD

What do you do when your large-scale IBM is all batched up?

Call the second center facility you probably didn't know you had. The Sungard Center.

There are a number of different ways your large-scale IBM can be non-plussed by overload.

Which could result in the delay or deferment of a number of pressing projects. From new program development to critical application back-up. And cause costly overtime in batch or interactive processing, software conversions or systems development.

The Sungard Center can remedy this rapidly.

Sungard was established as a highly advanced disaster/recovery center. Utilizing IBM's largest computers.

We're glad to report that the response to this service has been over-

whelming. We're also glad to report that no one has yet had a disaster.

So now we find our 3033 has a lot of spare time on its hands. As will our shortly-to-be-installed 3031.

As a result, you have a second center capability at your disposal.

Able to take a big load off your mind. Or act as an interim facility until IBM introduces its new package.

We offer this spare time at extremely attractive rates. Because it's pre-emptible. In case the center is ever needed for disaster recovery.

Whatever the need, remember, you now have another large-scale computer to count on.

Sun Information Services Company
Sungard Headquarters
656 E. Swedesford Road
Wayne, PA 19087 (215) 972-4776.

I feel a batch-up coming on. Tell me more about:

- Systems development and testing.
 Software conversions.
 Remote batch or interactive processing.
 Timesharing. Other _____
 Please send me more information. Please call.

Name _____ Title _____

Company _____ Phone _____

Address _____

City _____ State _____ Zip _____

A Sun Company Subsidiary

Sun INFORMATION
SERVICES
COMPANY

DM - 680

The Top 50...

ATLANTIC RESEARCH CORP. COMPUTER COMMUNICATIONS

DYNATECH DATA SYSTEMS
7644 Dynatech Ct.
Springfield, VA 22153
(703) 569-9000

Dynatech Data Systems, a subsidiary of Dynatech Corp. in Burlington, Mass., manufactures test equipment for high-speed data communications systems. Its test instruments interact with the network, simulating a terminal, modem, or computer to locate sources of system errors. Using backup and patching, the flow of traffic can be redirected to isolate faulty equipment for further analysis. The microprocessor-based Dyna-Test 2000 features a preprogrammed menu of analysis routines plus the ability to construct custom programs for complex monitoring functions. This year the parent corporation acquired Telecommunications Techniques Corp., which deals in satellite test systems, and U-Z Manufacturing Inc., producers of high frequency switches. Last year Dynatech Data Systems reported a 40% sales growth, bringing data com revenues to \$9.2 million, about one-third the company's total revenues.

DIGITAL COMMUNICATIONS CORP. GANDALF DATA, INC.

**INTERNATIONAL DATA SCIENCES
T-BAR INC.**
141 Danbury Rd.
Wilton, CT 06897
(203) 762-8351

T-Bar manufactures switches used in switching peripherals from one processor to another and in switching communications lines. T-Bar has also developed equipment that would allow an operator to reconfigure data flow so one computer or its peripherals (such as printers, displays, or banks) could move from task to task as desired. This eliminates the necessity of having duplicate equipment assigned to each specific task, increases utilization, and reduces capital output. The company also pioneered three distinct applications of supervisory control, one for data communications and data processing systems; another for restoring service through reliable switching; and the third for facilitating monitoring, testing, and reconfiguring systems upon command. In 1979, T-Bar realized a sales increase of 46% and an increase in earnings of 41%. Last year T-Bar introduced two new

products to its data communications line, the MASS+ and the Explorer instrument line.

OTHER: Equipment not included in other categories, such as voice response equipment.

ATLANTIC RESEARCH CORP.

(Motorola)
CODEX, UDS

COGNITRONICS CORP.

25 Crescent St.
Stamford, CT 06906
(203) 327-5307

Cognitronics is in the audio response league. Its 680 series Speechmaker is a microprocessor controlled voice response unit used in a wide range of applications from account status and credit checking to instrumentation readout, as well as a variety of telephone industry uses. Data communications revenue, which accounts for about 35% of the total company revenue, is pegged at \$3 million for fiscal 1979. Cognitronics, another Top 50 debutante, was formed in 1960.

COMDATA CORP.

COMPUTER COMMUNICATIONS

Eliminate the Hidden Costs of Systems Development

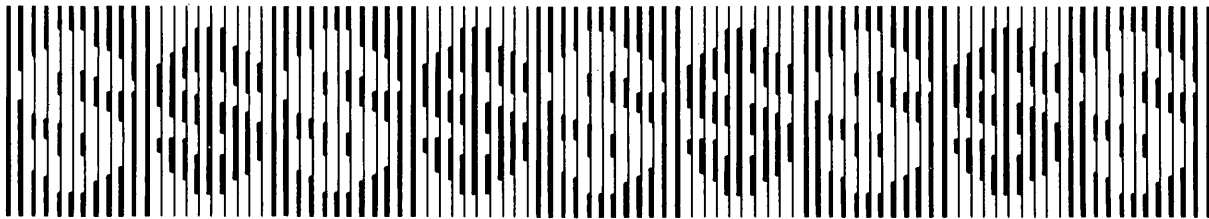

With Central Software from PRC International

Central Software, a systems development tool for IBM 370 users, puts a handle on the obvious and not-so-obvious costs of developing on-line and batch applications software.

How? Central Software eliminates the need for many routine and time-consuming functions in the systems development process. These routine and inefficient functions are often the root of delays and cost overruns. Central Software promotes effi-

ciency, security, and reliability... and puts you in control.

Here's what Central Software can do for you:

- save up to 40% on human resources
- reduces development time & costs up to 50%
- enhances programmer productivity
- eliminates hours of debugging time
- reduces training time



prc

Planning Research Corporation

Program Products Group
1764 Old Meadow Lane
McLean, Virginia 22102
Telephone: (703) 893-8909
Telex: 899 105 PRC INT MCLN

CIRCLE 106 ON READER CARD



Amnon Ben-Yehuda
General Manager
Micrographic Systems Division

“NCR Micrographic Systems enhance the value of your computer.”

Information management can be a cost-effective resource for your company

There's a more efficient way to access computer generated information, and enhance the value of the computer to your operation at the same time.

How?

With an NCR Micrographic System, and the technology that converts data into its most useful format. A format that gives you complete control over information.

NCR Micrographic Systems are fast, accessible and very easy to use. Systems that maximize the value of the investment in your computer by

making data conveniently available to every facility in your organization, regardless of how small or remote.

NCR is a total systems company, the only computer manufacturer to provide complete systems capabilities. Our systems span the entire business computer range. In addition, NCR offers data terminals, communications networks, 25 Data Processing Service Centers and Field Engineers. We provide support when and where you need it. With this total systems approach to information management, it's no wonder NCR is a leader in Micrographics data processing.

Executives in major industries around the world are finding new ways to hold down operating costs. And, NCR Micrographics are making it happen.

NCR can make it happen for you, too. To learn about the Micrographic System that's just right for your business, write Micrographic Systems Division, NCR Corporation, Box 606, Dayton, Ohio 45401.

NCR
Complete Computer Systems

CIRCLE 107 ON READER CARD

SWINGLINE'S DECOLLATOR SEPARATES FORMS FAST, EASY, CLEAN.

Why mess with taking apart forms?
Our table-top Decollator separates carbon and carbonless continuous forms quickly and easily. Stacks 'em up nice and neat with no carbon mess. It's easy to load, no special set up or operating skills needed. There's even a variable speed control. Made in U.S.A.



THE Swingline
COMPANY

Swingline 6300
Table-Top Decollator

The Swingline Company
A Division of Swingline Inc., Dept. D-6
32-00 Skillman Avenue, L.I.C., N.Y. 11101

CIRCLE 108 ON READER CARD

The Branch you can call home...

Just 15 minutes from downtown Dallas and D/FW Airport, Farmers Branch, Texas, is an excellent location for your home or branch office. Farmers Branch offers an established industrial and commercial base, quality city services and a favorable tax environment. And educational and people resources can support your plans for business growth.

Beautiful residential areas, combined with the finest schools and cultural and recreational facilities, make Farmers Branch a vital and prosperous home and business community.

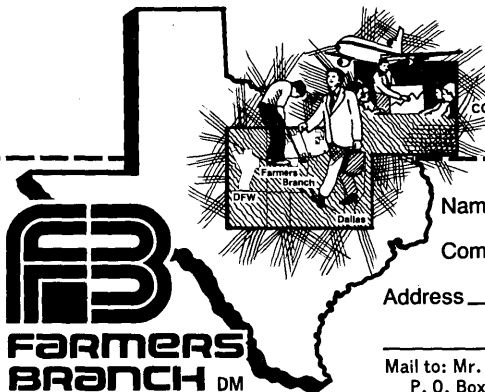

To learn more about Farmers Branch
and its relocation advantages,
contact Charlie McIlvain (214) 247-3131,
or return this coupon.

(Inquiry strictly confidential)

Name _____

Company _____

Address _____

Mail to: Mr. Charlie McIlvain, City of Farmers Branch
P. O. Box 340435, Farmers Branch, Texas 75234

CIRCLE 109 ON READER CARD

DATA ACCESS SYSTEMS, INC.
Route 42 & Coles Rd.
P.O. Box 1230
Blackwood, NJ 08012
(201) 335-3322

Data Access Systems, Inc.'s 1979 data communications revenue of \$25.3 million is 10 times the 1978 figure of \$2.4 million. This represents roughly 90% of total business. Modems and portable data terminals are the proprietary products manufactured by DASI. The company provides service for all equipment which it markets, including products from the leading U.S. manufacturers of computer peripherals. DASI's "One Source Responsibility" provides servicing for its data communication equipment through its 21 nationwide marketing centers, which is double the number the year before. The company credits its large jump in revenues to an expanded sales force.

DATASTREAM COMMUNICATIONS, INC.

GENERAL DATA COMM INDUSTRIES, INC.

INTERNATIONAL DATA SCIENCES, INC.

INTERTEL, INC.

LIVERMORE DATA SYSTEMS, INC.

PARADYNE CORP.

PERIPHONICS CORP.

RACAL-MILGO, INC.

TEKTRONIX, INC.

(Federal Screw Works)

VOTRAX

500 Stephenson Highway

Troy, MI 48084

(313) 588-2050

Federal Screw Works data communications division is Votrax (Vocal Interface Div.). It is engaged in the manufacturing and selling of electronic voice products, including phonetic voice synthesizers and digital voice systems, both of which are solid-state devices for simulating human speech. This end of the business accounts for about 4% of its total revenue, or about \$2.4 million. The rest of business is, as the name implies, in nuts, bolts, and screws, with a large portion of that being used in the automotive industry. This year FSW introduced the LVM-80 Business Communicator and VSB Voice Synthesizer, both expected to contribute to next year's data communications' picture.

WAVETEK DATA COMMUNICATIONS

9045 Balboa

San Diego, CA 92123

(800) 854-2846

Wavetek manufactures and markets products in two principal industry segments: general-purpose electronic test and measurement instruments and special-purpose data com systems. Data communications products account for 8% of overall Wavetek sales. The audio response line includes terminals, network controllers, voice and ARU units, from direct channel devices to complete standalone systems. A communication network processor was introduced last year.

*

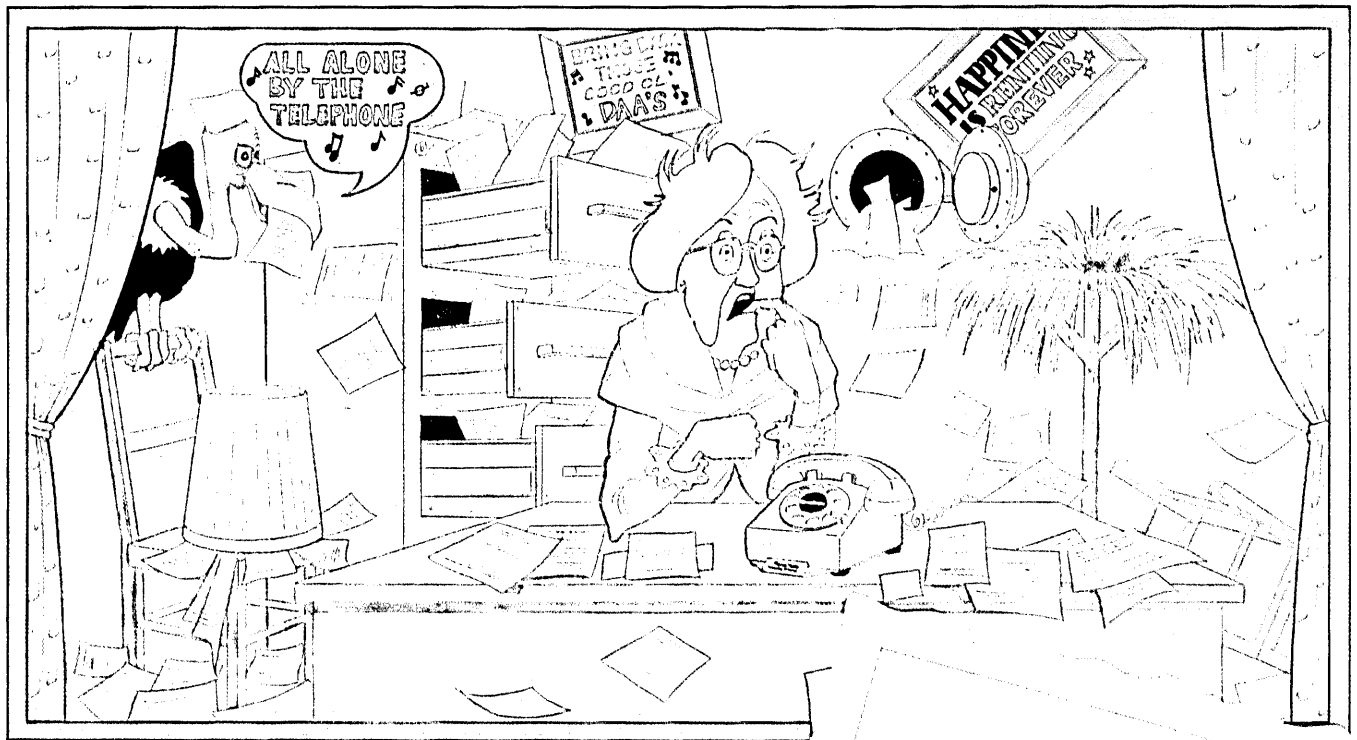

Dear Ma:
Stop looking for Racal-Vadic's
new modem.
It's inside the telephone!

Better sit down for this, Ma. Racal-Vadic has an invisible modem! Called a Modemphone, it's a standard rotary or tone telephone with a built-in 103/113 compatible 0 to 300 bps full duplex modem. It's even direct connect and full originate/answer, too.

It's amazingly simple to install and operate. Just plug the terminal cable into the Modemphone's RS232C connector, plug the 8-foot switched network cable into the voice-data jack, and start communicating.

Imagine, Ma. For just \$250 a telephone that handles both voice and data, completely eliminating the need for a separate modem and associated wiring. It even has optional automatic originate/answer.

Phone or write for the whole story today.

Your independent thinking son,

PS: Racal-Vadic has shipped over 250,000 modems to date.

Alexander Graham Jr.

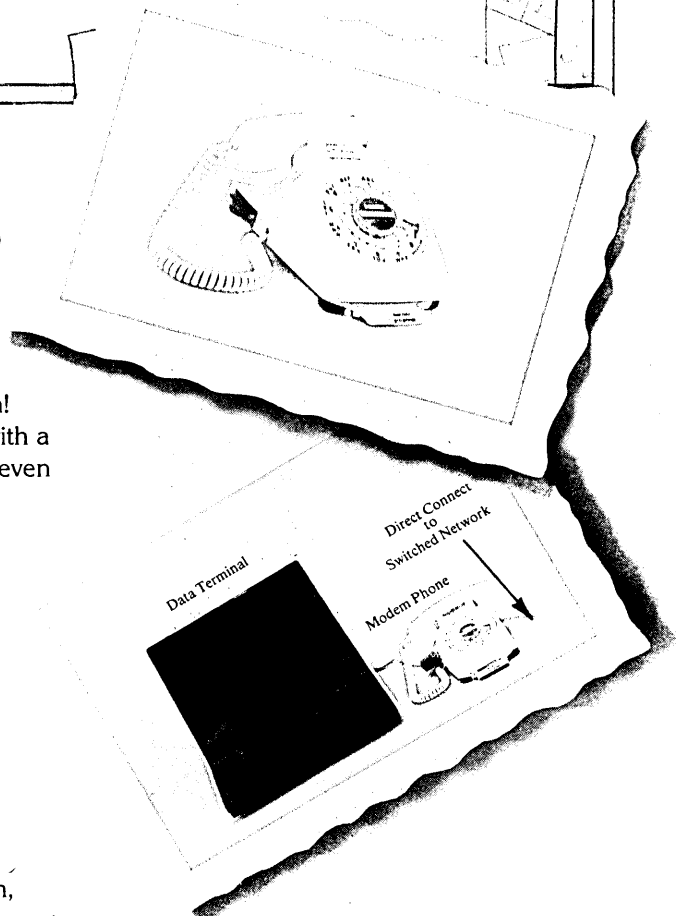

Racal-Vadic Member IDCMA

RACAL
 The Electronics Group

222 Caspian Drive,
 Sunnyvale, CA 94086
 Tel: (408) 744-0810 • TWX: 910-339-9297

Racal-Vadic Regional Offices: West: (408) 744-1727 • East: (301) 459-7430 • Central: (312) 932-9268 • Northeast: (617) 245-8790 • Southwest: (817) 277-2246

Available from these stocking reps...

Alabama: (800) 327-6600 • Alaska: (907) 344-1141 • Arizona: (602) 947-7841 • California: S.F. (408) 249-2491, L.A. (714) 635-7600, S.D. (714) 578-5760 • Canada: Calgary (403) 243-2202, Montreal (514) 849-9491, Toronto (416) 675-7500, Vancouver (604) 681-8136 • Colorado: (303) 779-3600 • Conn.: (203) 265-0215 • Dist. of Columbia: (301) 622-3535 • Florida: Ft. Lauderdale (800) 432-4480, Orlando (305) 423-7615, St. Petersburg (800) 432-4480 • Georgia: (800) 327-6600 • Illinois: (312) 255-4820 • Indiana: (317) 846-2591 • Kansas: (913) 362-2366 • Maryland: (301) 622-3535 • Mass.: (617) 245-8900 • Michigan: (313) 973-1133 • Minnesota: (612) 944-3515 • Missouri: (314) 821-3742 • New Jersey: North (201) 445-5210, South (609) 779-0200 • New York: Binghamton (607) 785-9947, N.Y.C. (212) 695-4269, Rochester (716) 473-5720, Syracuse (315) 437-6666 • N. Carolina: (800) 327-6600 • Ohio: Cleveland (216) 333-8375, Dayton (513) 859-3040 • Oregon: (503) 224-3145 • Penn.: East (609) 779-0200, West (412) 681-8609 • S. Carolina: (800) 327-6600 • Texas: Austin (512) 451-0217, Dallas (214) 231-2573, Houston (713) 688-9971 • Utah: (801) 484-4496 • Virginia: (301) 622-3535 • Wash.: (206) 763-2755 • Wisconsin: (414) 547-6637

CIRCLE 110 ON READER CARD



Jacquard Systems

For the second year in a row, actual users ranked us first in the Datapro Survey for shared logic word processing systems. This means a lot to us, but more importantly, it can mean a lot to you.

Our AMI Jacquard i100 won because of

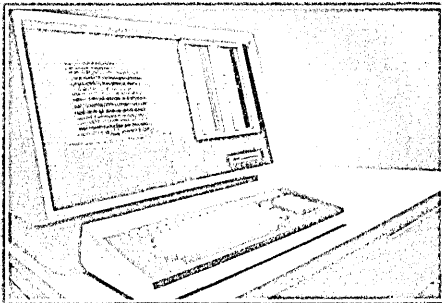

qualities such as ease of operation, functions, features, applications, service and customer support.

all vitally important in the selection of word processing equipment. No wonder hands down, users rated us number one, hands down.

Although the award was for our shared logic system, the same winning qualities are built into AMI Jacquard's full line of word processing equipment—including our 425 stand-alone word processor, our 225 power typing station, our 324 mag card reader and our 325 laser-based OCR device.

Another AMI Jacquard benefit is stability. We're a division of AMI International, a multinational, Fortune 500 corporation. So you can have confidence that whether your busy or not, we'll be around if you need us.

Join the winners. Call or write us for details. AMI Jacquard Systems—the Informationists. P.O. Box 17, 3340 Oregon Park Blvd., Santa Monica, CA 90405. (213) 450-1242

LET'S TALK ABOUT WINNERS.

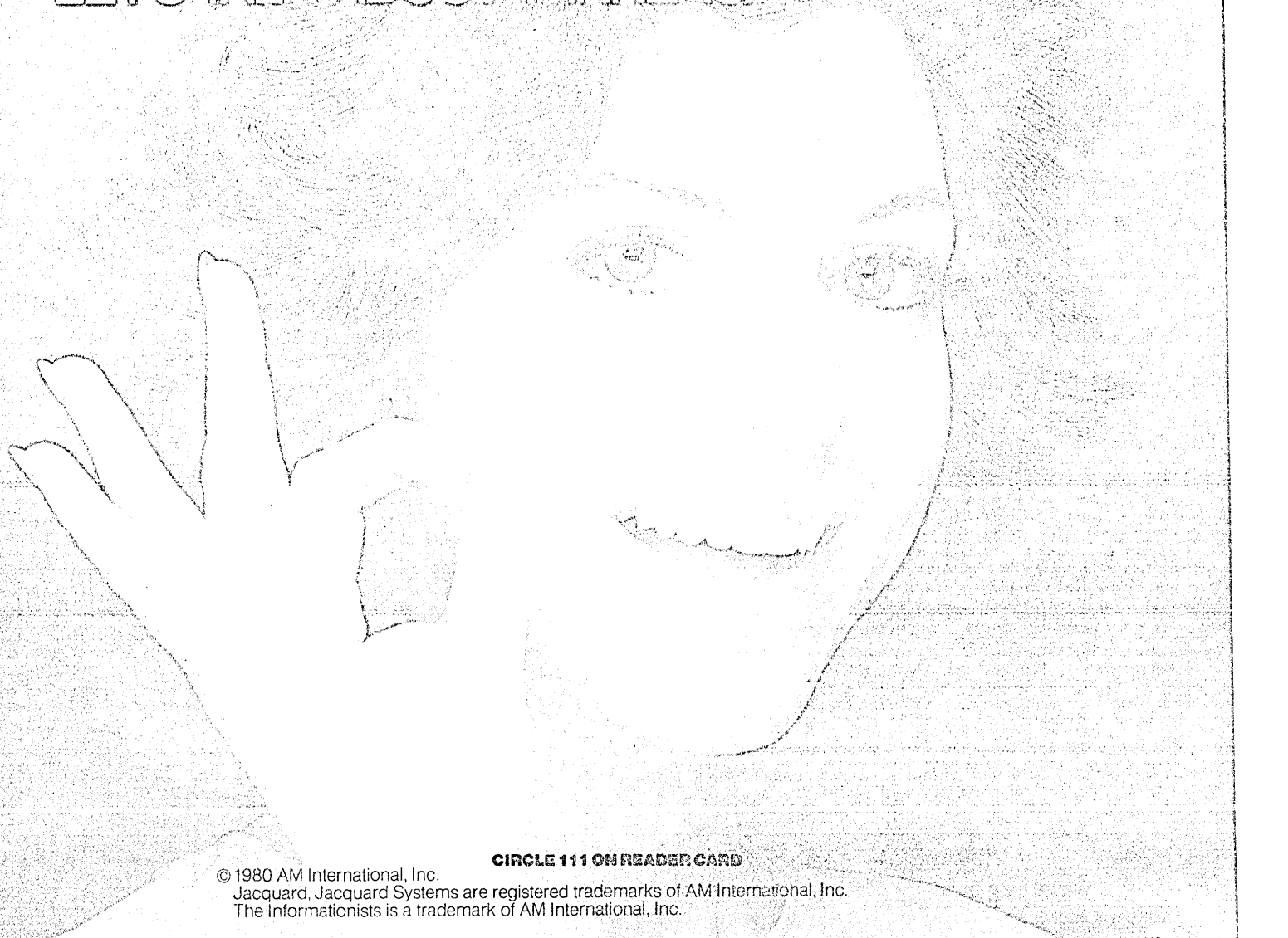

CIRCLE 111 ON READER CARD

© 1980 AM International, Inc.
Jacquard, Jacquard Systems are registered trademarks of AM International, Inc.
The Informationists is a trademark of AM International, Inc.

The Kodak IMT microimage terminal. It's the brains behind Electronic Filing from Kodak.

Your office already has electronic typing.

You probably have electronic data processing, too.

Then isn't it about time you looked into Electronic Filing from Kodak?

The Kodak IMT microimage terminal, for example, is so intelligent it practically thinks for itself. Thanks to its own built-in microcomputer, an IMT terminal can perform on-line information lookups in seconds. At the touch of a button. Without tying up your mainframe.

An IMT terminal pinpoints images so precisely, in fact, that it practically eliminates lookup errors, which increases office productivity. In the meantime, your computer is left free to process data — not search for it.

Find out how many other intelligent things an IMT microimage terminal can do. Send in the coupon for more information. Or contact your Kodak representative for a demonstration of the Kodak IMT microimage terminal.

Either way, the move you make will be a smart one.



1880  1980

©Eastman Kodak Company, 1980

EASTMAN KODAK COMPANY • Business Systems Markets Division
Dept. DP0602, Rochester, NY 14650

Please send me more information about the Kodak IMT microimage terminal.

Please have a Kodak representative contact me.

NAME _____ TITLE _____

COMPANY _____

ADDRESS _____ CITY _____

STATE _____ ZIP _____ PHONE _____

A country beset by social and political problems embarks on the rocky road to renaissance, counting on computers to pave the way.

COMPUTING IN THE NEW INDIA

by Hesh Wiener

Mr. Wiener recently returned from a trip to India organized by the U.S. Department of Commerce. His article is based on extensive discussions with users and vendors in that country.

You hear about it in the gleaming capital of New Delhi. You hear about it in the business center of Bombay, and even in Communist Calcutta. Everywhere you go, you hear about the New India. And when you hear about the New India, you hear about computers.

Computers will help India bridge the gap between its older ways of doing business and the more modern methods used by nations it has targeted for exports. The country also needs computers to be competitive with the increasingly automated producers in Asia and the rest of the Third World. This need for enhanced management capability through automation is recognized by India's business community. But until recently the government has set equivocal policies on the importation and local manufacture of dp equipment. In the New India, the government will have to work closely with business to insure easier access to computer resources.

Computers are currently scarce in India, and the demand for data processing is high. This is despite government policies and social problems that make it easier for many organizations to avoid computing entirely. In recent months, for a variety of reasons, the restrictions on computer imports have been relaxed. Prospective buyers have become more optimistic, and Indian agencies, overseeing machine acquisitions, have been deluged with import license requests.

It will take time for this new wave of systems to come onstream, but the country's automation intentions are clear. A New India

is in the making, and computers will have to play an important role in that renaissance.

India's culture has been shaped in part by persons and ideas from other lands. In the centuries before Christ, Hinduism gave way to Buddhism which was again replaced by Hindu philosophy. Along the way, the country's science, architecture, medicine, and social organization grew richer and more diverse. During the past two millennia, the Muslim influence was strongly felt. In recent centuries, this influence has been diluted by the European incursion.

In this century, India has been strongly affected by the United States and the Soviet Union. Both these nations have reshaped the Indian way of life. One area where the influence of the 20th century superpowers is quite visible is in technology.

The first computer in India was of British origin, but the most populous range of machines, 1401s, came from IBM. These computers are considered obsolete in the U.S. but are still of current value in India. Today, one out of four computers in India is a 1401.

Such vintage wares as the 1401s are all that's left of IBM's equipment base in India. That's because the company, responding to the government's Foreign Exchange Regulatory Act, decided in November 1977 to close or sell off its local facilities. (The act requires foreign companies to sell 60% of their equity to Indian investors.) Preliminary discussions between IBM and the Indian government were held in the hopes of striking a compromise, but no accord was reached. Presently, IBM would like to set up what it calls a "liaison office" to assist customers in buying IBM machines imported from other countries. If and when such an office is opened, IBM will try to provide new and larger systems to Indian users.

Computers from the Eastern Bloc are also very important in India, but they will soon be joined by more advanced mainframes of various capacities supplied by Burroughs, Univac, Cii-Honeywell Bull, and ICL. There is also interest in large, fast machines from Control Data Corp., at least among scientific researchers, but this interest may be frustrated by U.S. export restrictions.

The lively part of the market is not at the top, however. Indian users are more interested in small mainframes and large minicomputers. Increasingly, the versatile small business machines made from microcomputer chips are attracting the attention of users, and a domestic small computer manufacturing industry is developing. Imports of micro-based systems are being blocked by the Indian government to enable local production to get off to a safe start, but peripherals for local as well as imported machines must, in general, be purchased abroad. This situation could well change in the coming years.

Foreign companies seeking a piece of the Indian market must join forces with Indian companies. They can do that either by using the Indian companies as sales agents or by forming partnerships where the majority ownership is vested in Indian hands.

When an Indian buyer wants a computer, things can get very complicated. To get an imported machine, such as any medium- or large-scale system, a license must be obtained. Basically, this is a declaration of need, a procedure to give the Indian authorities control over the export of wealth. Once an import license is granted, the buyer must also meet other demands aimed at fostering the export of an Indian intellectual product (as well as the physical products of data processing).

Indian organizations that bring in computers are expected to export goods or

ILLUSTRATION BY CHRIS SPOLLEN



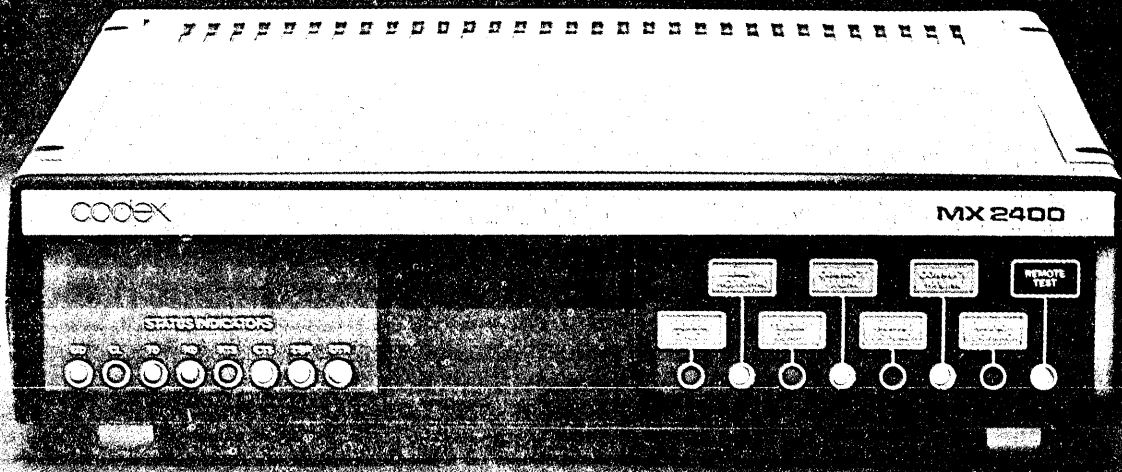

The MX 2400 Series of Data Modems
 Codex quality, performance, and reliability
 at 2400 bps.

The Power.

The ultimate in operating performance through automatic adaptive equalization... flexibility to meet all network requirements through built-in options, including advanced network control, line quality monitoring, two channel multiplexer, automatic dial restore, and FCC registered interface... these are just a few of the benefits you get with the MX 2400 modem series, the most powerful medium speed modems ever, from Codex the leader in modem

quality, performance, and reliability. Five models incorporate the latest in Codex technology to provide you with all the capabilities and options needed for dial, multipoint, and point-to-point applications. 201 compatibility, V.26/V.26bis compatibility... all that's necessary for both domestic and international requirements. Codex, a world leader in data communications technology, is dedicated to providing a wide range of

advanced products to meet the demanding requirements of on-line data communications networks. Call or write today for more information. Codex - The Power in data communications!

codex
 We'll get you through

member of
IDGMA

Codex Corporation, 20 Cabot Boulevard, Mansfield, Mass. 02048 • Tel: (617) 364-2000 • Telex: 922439
 Codex Corp., 2-3-11 Chitose, Yotsuya, Shinjuku-ku, Tokyo 160, Japan • (03) 355-0492 • Telex: 2324978
 Codex Europe S.A., Avd. de l'Europe 58, B-1150 Brussels, Belgium • Tel: (02) 762-2351 • Telex: 26542

CIRCLE 112 ON READER CARD

The Indian organizations most eager for new computers are service bureaus, many of which have IBM 1401s.

Table I

SUPPLIERS OF INDIAN COMPUTERS

(Data complete through May 1978.)

Vendor	Number
Burroughs	6
CII	4
Comp. Auto	19
DEC	59
ECIL (India)	99
Honeywell	12
HP	17
IBM	154
ICL	42
Interdata	4
Ryad	8
Varian	6
Others*	18
Total	448

*Others include: Elliot (U.K.), Metrimpox (Hungary), Minsk, CDC, BESM, Data General, Fujitsu, Ju (India), TIFR (India), Ural, HIL (U.K.) Telescience.

services equal in value to the systems they import. Alternatively, duties exceeding the cost of the system must be paid to the government. In the end, a person who does not reexport and buys a computer with funds earned within India may pay twice the value of the computer in taxes. Thus a computer in India can be two or three times as expensive as the same machine in the exporting country.

Other means are available to Indian nationals who wish to import a computer, however. These approaches to import problems are helping users acquire systems on a more affordable basis.

SERVICE BUREAUS EAGER

The Indian organizations most eager for new computers are service bureaus. Many of them now depend on IBM 1401s, which are run three shifts a day and usually boast a large complement of peripherals. Nearly all the 1401 users are in the process of adding to and diversifying their facilities. The favored method of expansion is via U.S. minicomputers.

The service bureaus' mainstay machines include: DEC 11/34s and larger 16-bit systems; the full range of Prime computers;

all of Wang's dp gear; and various Burroughs computers.

These computers will be configured for bread-and-butter data processing, mainly in batch mode. They control printers, disks, tapes, and unit record equipment. Increasingly, Indian service bureaus are adding terminals, but data base applications lag behind other on-line uses of the machines.

Because computers are so scarce in India, service bureaus can charge high prices and still get heavy loadings on their systems. This can offset the high prices and difficult terms under which Indians acquire their systems. In addition, Indian computing operations must run at high levels of efficiency to turn a decent profit. Many of their customers are only interested in results, so the service bureaus provide in-depth support including software, analysis, and planning services.

Quite a few of the service bureaus will mature into facilities management companies. This change is already under way, with some of the service companies being asked by their customers to replicate bureau facilities as in-house computing installations. They will also manage these operations once they are up and running.

As the service bureaus move into facilities management, they seem to be taking on the style and philosophy of IBM. Several former IBM executives, in fact, run full-service companies in India. These companies import only carefully selected machinery and tested software packages such as language processors. They do everything else.

As these service bureaus/facilities management companies grow, and as their customers' needs become more complex, a market for IBM plug-compatible systems may emerge. There have been talks between software-compatible machine makers and Indian organizations, but none of these discussions has resulted in any installations so far. This leaves the Soviet Union as the only supplier of systems compatible with IBM mainframes.

Some computers are sold directly to users by representatives or affiliates of the major manufacturers from other nations. This direct selling is the basis of all installations of large systems, and will increasingly result in installations of small systems. In the academic world, users are very well prepared to run their own operations, but in many businesses, the problems associated with getting a computer for the first time can lead to short-term disillusionment.

USERS CRY FOR HELP

It can also lead to sales agents getting caught between the buyer and the foreign vendor, with users asking both vendor and agent for help. This help may have been promised to the user or

Table II

WHERE COMPUTERS ARE USED IN INDIA

Year Installed	R&D Education	Public Sector	Private Sector	Total
1960	1			1
1961		1		1
1962		1		1
1963	3			3
1964	6	4		10
1965	4	3	5	12
1966	2	5	7	14
1967	6	8	9	23
1968	2	13	8	23
1969	4	7	8	19
1970	2	7	5	14
1971	8	10	16	34
1972	1	12	18	31
1973	5	7	5	17
1974	5	15	7	27
1975	14	33	4	51
1976	12	17	2	31
1977	11	25	6	42
1978*	7	15	8	30
Unknown ^o	16	34	14	64
	109	217	122	448

* 1978 data through May only

^o Records unclear or prior to 1960

Only two mainframers seem to have outstanding reputations in India, Burroughs and Fujitsu.

otherwise represented as part of a sale. The Indian buyer may also be expecting more free support than is realistic, and if the agent does not clarify things, acrimony can follow an installation. With time this kind of friction will decrease, but for now it is affecting potential sales to India's largest and most important business organizations. Only two mainframe suppliers seem to have outstanding reputations in India, and they have good images for different reasons.

Burroughs sells its systems in India through the Tata Group, one of the two most powerful private conglomerates in the country. Tata is a tightly run organization and prides itself on good customer relations. Because of its highly diversified nature, many Tata clients deal with the giant company on several fronts. Thus the partnership appears to be giving Burroughs a significant advantage with customers.

Fujitsu also is enjoying good relations in India, even though the company has not really sold much machinery yet. Fujitsu seems to be trying to enter the IBM-compatible market (or at least promote systems similar to those made by IBM). Fujitsu owes its good image to its realistic approach—the company tells prospective buyers the bad news as well as the good news about computers. This realistic attitude and a certain inflexibility in negotiations is followed, various sources say, by a determination to make everything work once a sale is completed. In the long run, this will prove to be an advantage.

Because there are so many highly educated people in the Indian academic world, computers in university or research settings are diverse in size, origin, and configuration. In addition to direct uses, such as handling school recordkeeping, computation centers operated in conjunction with academic institutions also provide data processing to outside organizations. Often these outside clients are government agencies. Private firms, however, also take advantage of this computer power. Regional computing centers controlled by the public sector are also springing up to serve the full spectrum of Indian computing needs.

Research laboratories, with their need for large scientific systems, do not have an easy time in India. While the Indian government seems to be interested in boosting its scientific computing capability, political considerations in the U.S. and other vendor nations have made it difficult if not impossible for India to get the kinds of computers it wants. The rationale for American export restrictions is complex, and stems from the U.S. desire to discourage, or at least not encourage, research into the military uses of atomic energy. India has already demonstrated its ability to detonate nuclear charges, but little is known outside government circles

about the practicality or sophistication of Indian nuclear devices.

There is also fear in Washington that technology entering India could find its way to the U.S.S.R. The Soviets enjoy good relations with India. Ironically, the systems American vendors might supply to India have long since been sold to the Russians.

INDIA'S PIVOTAL POSITION

One result of Indian's pivotal position in Asian (and world) politics has been the installation of several large Eastern Bloc computers. These machines are sold through the Indian company Computronics. The company has supplied Russian Ryad systems as well as products from Warsaw pact nations to various Indian users. The Ryads run IBM software. Depending on their vintage, they are compatible with IBM 360 or 370 systems.

European vendors are interested in the Indian market, too, but have not really gotten much penetration. Cii-HB is relatively active these days, and ICL had installed a number of systems but has not made much headway recently. ICL however, is expected to make another push in the subcontinent, and may be waiting for the right political climate.

The Indian government that served in the latter years of the last decade was reluctant to deal with the issues raised by automation. The Indian economy was in a state of stagnation while population increased, leaving a troubled legacy for the present Gandhi government.

India is beset by social and political conflicts. The nation may be viewed as two distinct countries, one essentially agrarian and based on a populous peasantry, the other an advanced industrial state. The two nations coexist in a democratic federation of states more loosely bound than those of the U.S. and more tightly connected than the nations of the European Economic Community.

Hindi is the official language of India, but it is not spoken by the majority of the people. There are something like 14 major languages and hundreds of dialects. Not only are the words in India different in different regions, but the alphabets are also completely independent of each other. English, where it is spoken, is the one language that connects India's different regions. It's also the language of the industrial state; the agrarian nation is largely ignorant of English and illiterate in any language.

In addition, India's caste system resists change, notwithstanding the election of a pariah, or untouchable, as the last prime minister. The combination of caste distinctions with poverty—the gross domestic product in India is less than \$200 per capita per year—makes any threat to workers severe.

Sometimes it seems that it is impossi-

ble to govern India, let alone to bring in technology with the risk of social disruption. But India cannot sacrifice its businesses to stability; it must compete in world markets. So India is trying to use computers in ways that provide maximum benefits at minimum social cost.

Word processing, for example, is pretty much out of the question, while process control is a fertile field. Accounting, a traditionally difficult area, may be accepted in some settings but not in others. Banks in India desperately need to use computers, but clerical unions have been adamant in their opposition to automation.

India is aware that the electronics business can be a source of income. Other Asian and Pacific sites, such as Singapore and Taiwan, have worked well for both host and source nations in the electronics industry. India has abundant inexpensive labor and a social tradition that will readily accept the new skills of high technology manufacturing.

The first concrete result of New Indian attitudes may be found outside Bombay at the Santa Cruz Electronics Export Processing Zone (SEEPZ). This free trade area has no barriers to imports and exports, although sales from SEEPZ into India are treated much the way sales from other areas of the world are handled.

The computer industry's showcase at SEEPZ is a matrix printer plant built by the Burroughs-Tata partnership. There, 20,000 printers a year will roll off the assembly lines, more matrix printers than are made at any other single factory in the world. Today, everything but print heads is made at SEEPZ, and the print head fabrication facility will come onstream soon. Intersil, which also makes products in Singapore, has come to SEEPZ, too. A number of other companies have also set up plants in the free trade zone, and it is generally expected that many of the SEEPZ residents during the 1980s will be American and European.

SEEPZ not only provides India with wealth, it provides the country with a base of trained technicians. SEEPZ will also benefit India without incurring social costs, because the products of the zone will be reexported.

In the long run, the success of SEEPZ will make the Indian people aware of the benefits of electronics and computing. This will alter the population's receptivity to the changes that must come through the import and application of computers in India—the New India, just on the verge of developing its own computer industry that is now very small. *

Hesh Wiener, publisher of the monthly "Computer and Communications Buyer" and "Technology News of America," has been an industry analyst for eight years.

The small computer breakthrough.

Burroughs new B 90s combine the most advanced computer hardware, operating software and application programs in a powerful, easy-to-use package. All at a minicomputer price.

Introducing Burroughs B 90 Series. The system that brings together the best of what a small computer can offer your business today:

High-speed processing power. B 90 processors operate at two to five times the speed of Burroughs previous small computers.

Expanded main memory. Up to 512,000 bytes of main memory, four times previous memory capacity.

Extensive data storage capacity. The B 90s utilize Burroughs new Super Mini-Disk II, a breakthrough in magnetics engineering. This dual flexible disk system stores up to six million bytes. Three times the maximum industry capacity per disk. Other disk options provide total storage up to 46.8 million bytes.

And there's more. Expanded data communications.

Multiple work station capability.

Advanced automatic operating and control system software. And true multiprogramming capability.

Adding up to powerful workflow, in stand-alone applications or in a distributed processing network.

Most important, the B 90s are easy

to use. Operating software manages the systems' resources and, via display screen, guides the operator every step of the way.

More good news: B 90 prices start at less than \$18,000. Add Burroughs proven application programs — available for all major lines of business — and your B 90 is ready to go to work, instantly.

And remember, every Burroughs system fulfills the need that counts most in your business: increased productivity. Burroughs has understood this for over 90 years.

That's why we provide total capability in information management. Computers, word processing systems, facsimile communications, system software, application programs, customer training, maintenance, plus business forms and supplies. We call it Total System Support.

And it's there to help you improve your productivity.

For additional information, call your local Burroughs office or write Burroughs Corporation, Department DM-22, Burroughs Place, Detroit, Michigan 48232.

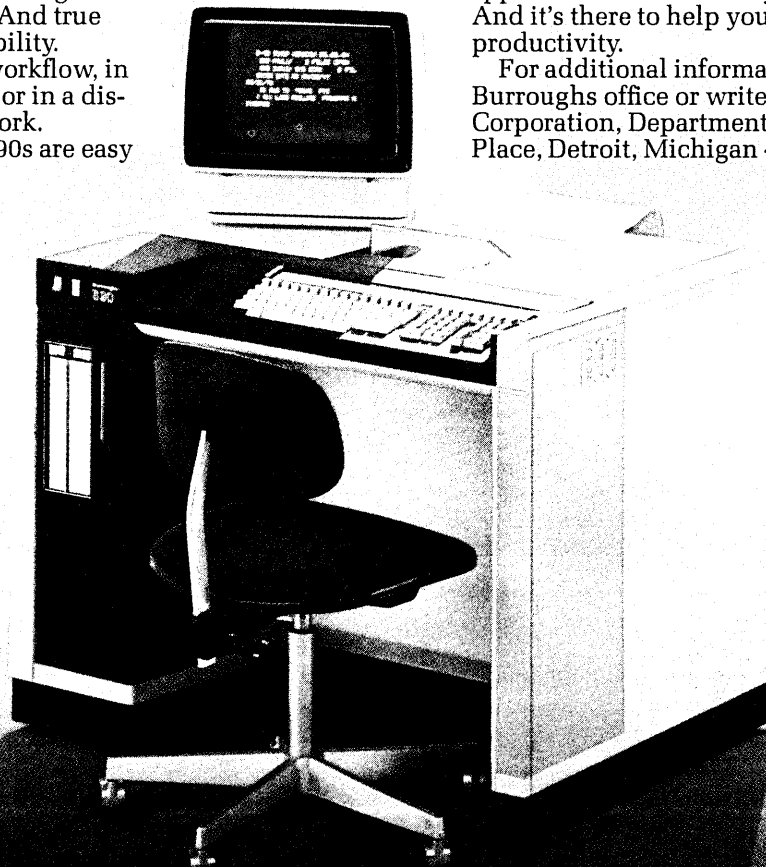

Burroughs



R.W. Bare, Assistant Corporate Controller, J I Case, A Tenneco Company, Racine, Wisconsin

The IBM Series/1 is a family of small, powerful, general-purpose computers for both distributed processing and standalone use. At over 50 company-owned stores nationwide of J I Case, a leading manufacturer of construction equipment and farm machinery, Series/1 systems are resulting in greater customer satisfaction through faster service on crucial parts orders.

"Through a visual display at the parts counter, a store clerk can gain

full information on the availability of a part in that store," says R. W. Bare, assistant corporate controller. "If the part is ordered, the Series/1 prints a picking ticket and produces an invoice to accompany the order.

"By speeding order handling and accounting procedures, the system has cut related workloads in half in some stores, helping to support a 10% to 20% growth in parts sales in the stores in which it is used. This productivity benefit alone justifies

the system for us. Most important, by transmitting consolidated data daily to Case headquarters, it gives management greater control over financial and production planning."

The IBM Series/1 is small enough to fit almost anywhere, flexible enough to manage a variety of data processing tasks and powerful enough to handle both remote terminal and central information processing. It features online capability so that information is available to

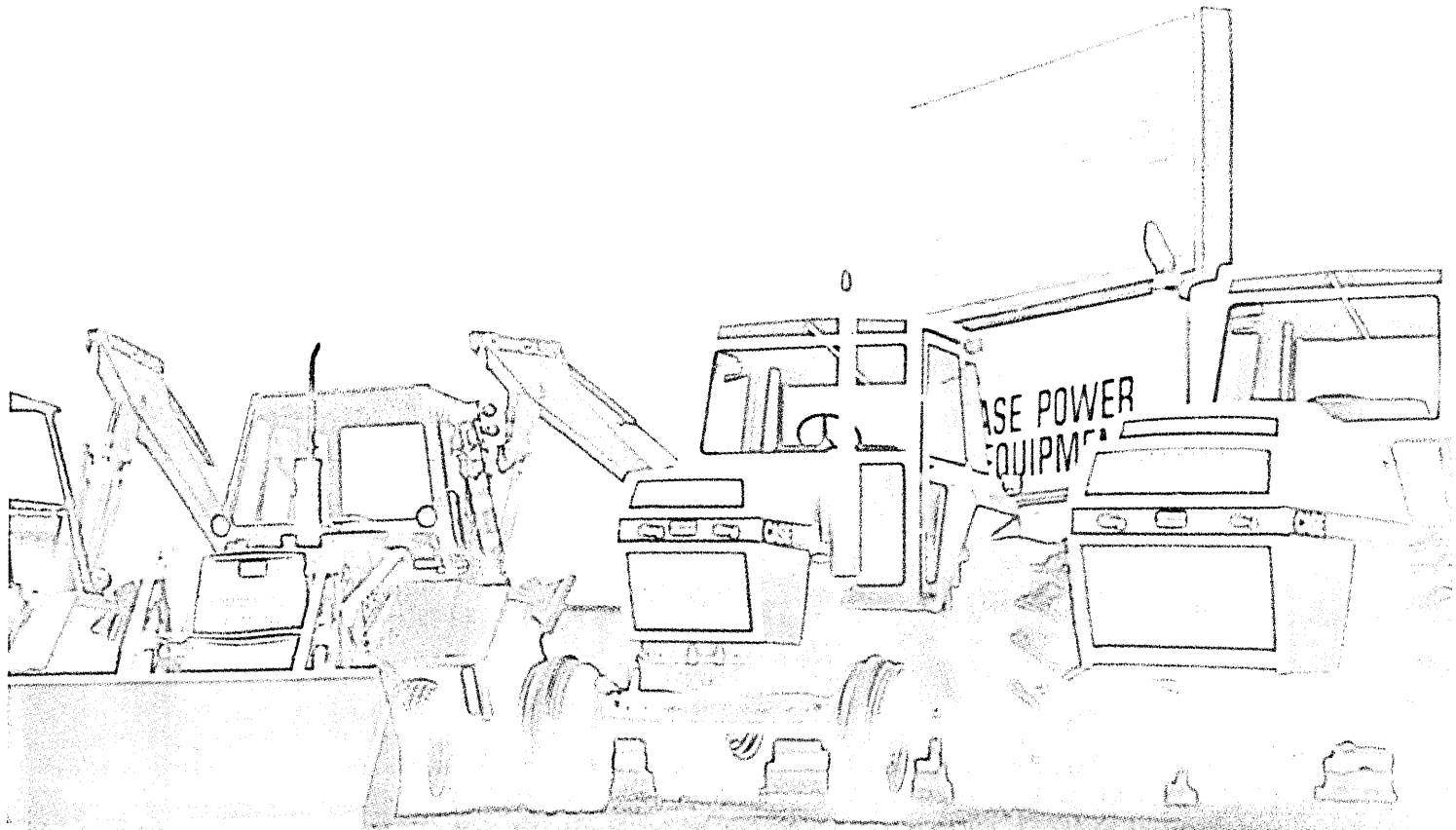

The IBM Series/1 data processing network helps
 meet the unique needs of your business
 for parts and service while
 increasing productivity up to 30%.*

you at any terminal just as quickly
 as it's processed. And because it's
 modular, Series/1 is ready to grow
 when you are. What's more, Series/1
 is supported by an extensive service
 organization that enables IBM to
 respond promptly to your service
 needs, even in remote areas.

To learn more about the Series/1,
 get in touch with your nearby IBM
 General Systems Division office.
 Or write IBM, P.O. Box 2068,
 Atlanta, GA 30301.

*The remarkably flexible IBM Series/1
 offers a range of modular features
 that allows you to build the
 data processing system
 you need at a low cost.*

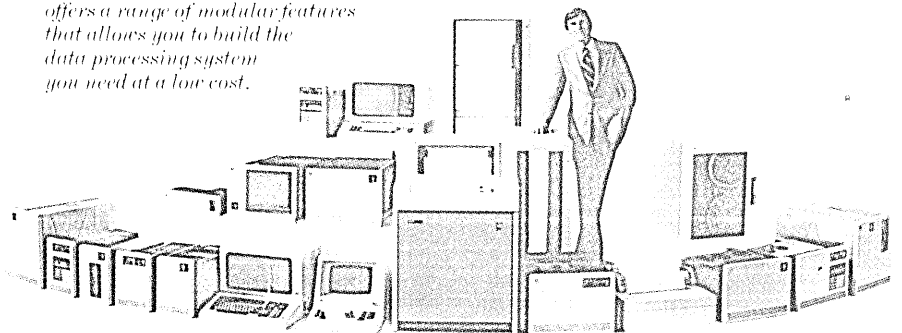

A small computer can make a big difference.

CIRCLE 115 ON READER CARD

Now: A Disk Subsystem that will help

If you suspect your CPU isn't delivering all the throughput it promises, here's the solution: STC's 8000 Series Disk Subsystem. It's a family of disk drives and controllers that goes beyond mere compatibility to provide innovative hardware features and architectural enhancements. Coupled with STC's uncompromising support, the 8000 Series will enable your IBM or compatible system to process more information, faster. And, at significantly lower cost of ownership.

More paths for your data. More ways to store it.

The 8000 Series is absolutely software compatible with IBM's 3350, but that's where the similarities end. You have a choice of string switch, dual port, or both — on the same subsystem. You get contiguous addressing, 64-volume support and 8-string addressing for configuration flexibility and increased availability. And you get a choice of the proven STC 8350 with 317.5 Mbytes per spindle and the double-density STC 8650 with 635 Mbytes per spindle. In short, it's the most powerful disk subsystem ever offered for mainframe computers.

Fitting the solution to your problem.

Hardware that extends well beyond mere compatibility is the foundation that permits skilled STC Systems Engineers to craft a solution tailored to your particular operation. Using powerful performance analysis and tuning software, they can virtually split open every pack in your shop to seek out performance bottlenecks and show how to eliminate them. They'll even simulate your new subsystem configuration to document both the performance benefits and the cost — before you spend a nickel.

Dual port option improves accessibility and provides path redundancy.

Powerful diagnostics cut service time and cost.

Use double-density 8650 for high-performance, high capacity storage. Unique mapping speeds access.

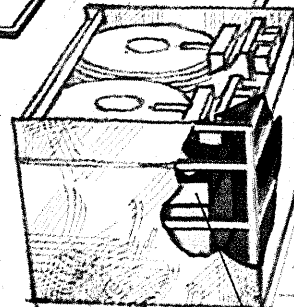
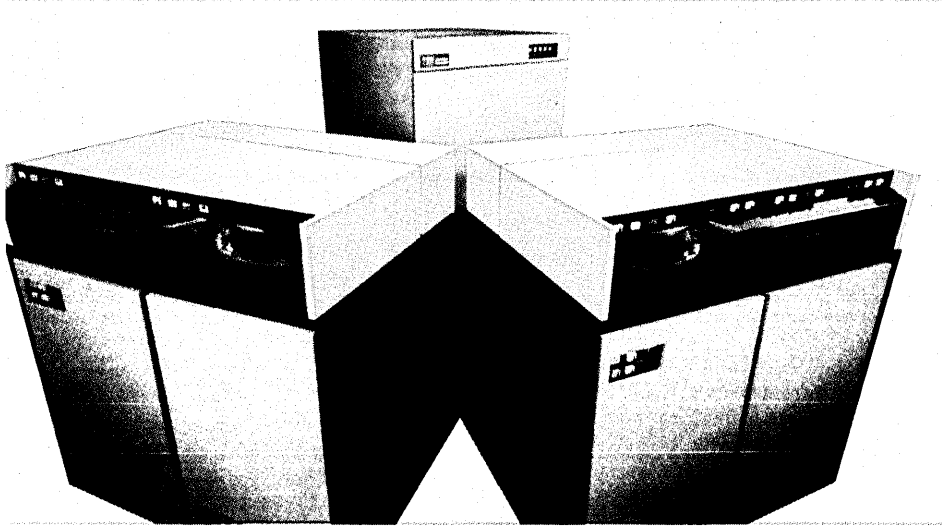
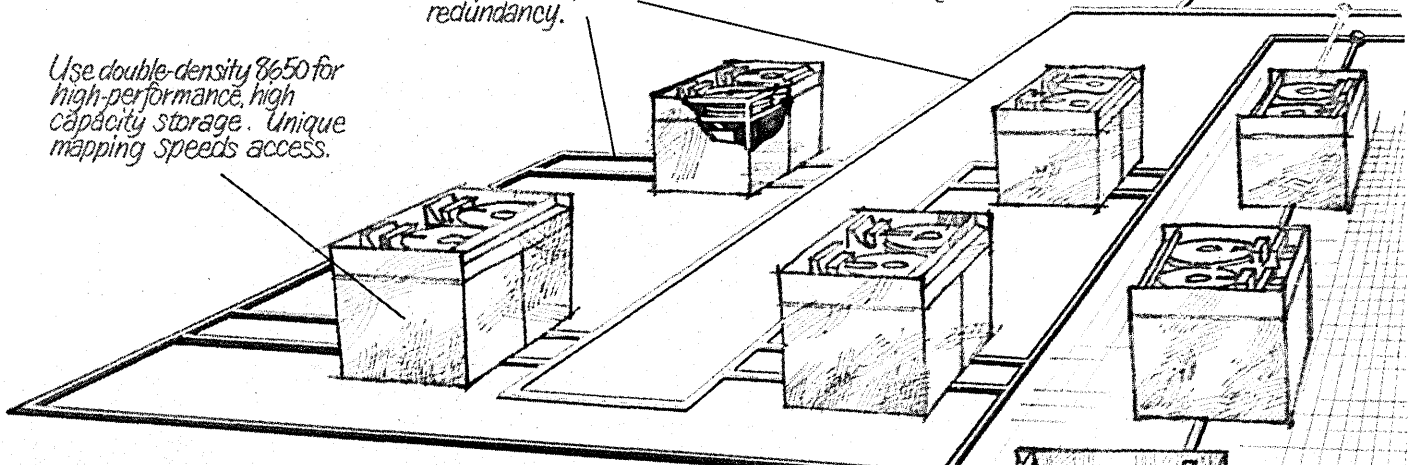
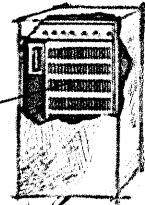

Fully redundant electronics for enhanced reliability.

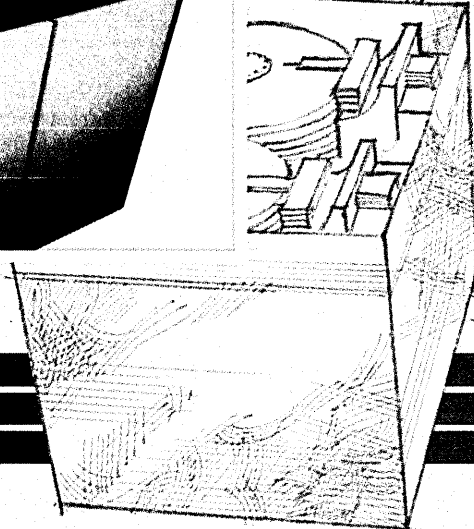

your computer fulfill its potential.

Superior support for peak availability.

Once your 8000 Series Subsystem is up and running, our top-rated Field Engineers will keep it that way. Among their maintenance tools are powerful software programs that highlight performance trends, enabling our FE's to solve problems before they happen. Other programs pinpoint malfunctions quickly to facilitate speedy on-site service. Our uncompromising field support is your assurance that your 8000 Series Subsystem will deliver all the performance we've promised, every day of its service life.

Get more from your processor. Now.

For more details on STC 8000 Series Disk Subsystems, call your local STC sales office. To receive your copy of our new 8000 Series brochure, write to: Storage Technology Corporation, Mail Drop 3-M, 2270 South 88th Street, Louisville, Colorado 80027. Phone (303) 673-5151.

8-string addressing reduces string contention.

8350's on short strings for catalogs, TSO, sorts - all high activity data sets.

Performance tuning software places data across volumes, strings and channels for maximum performance. Can simulate performance before you install.

STC provides utility programs to help manage data efficiently.

STC Systems Engineers analyze performance to reveal inefficiencies and bottlenecks.

**STORAGE
TECHNOLOGY
CORPORATION**

Fulfilling the promise of technology.

CIRCLE 116 ON READER CARD

Huntington Memorial was bogged down by increasing data management problems until a dedicated in-house system was installed.

by Robert Spaziano

Huntington Memorial Hospital was founded in 1892 as the 16-bed Pasadena Hospital Association. It took its current name in 1936 after receiving substantial bequests from the estate of Henry E. Huntington. Today, HMM operates 565 general acute beds and 32 newborn bassinets and has an occupancy rate of 76%. As the major regional health care provider for Pasadena and the greater San Gabriel Valley east of Los Angeles, it is a teaching hospital for interns, residents, nurses, and technicians. The staff includes more than 2,000 full- and part-time employees, over half of whom are in nursing. In 1979, there were 147,000 patient days, 85,000 outpatient

A HOSPITAL'S CARES

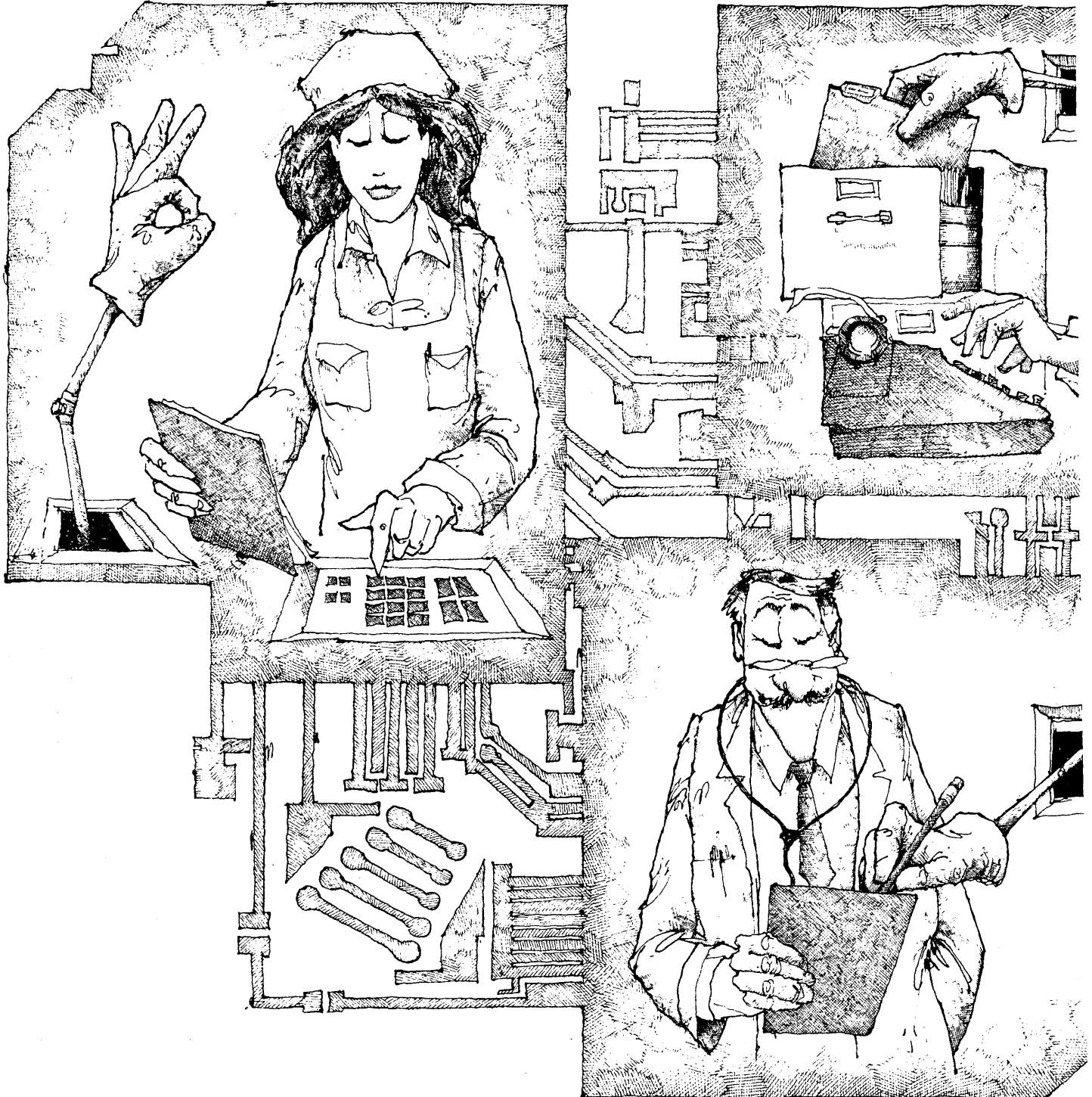

visits, and 37,000 emergency cases.

In the late '60s, HMH was facing increasingly sizable data management problems, and an effort was made in 1969 to install a time-sharing computer system to provide current hospital bed census and to process accounts payable and outpatient billing.

Conversion from the manual system to the time-shared service bureau was slow. Census took six months to come on-line, and progress stopped at outpatient billing. From 1970 through 1973, there were continuing difficulties from debugging software. Costs and system down-time were excessive. Data entry and report delivery were slow. There were many problems communicating with the remote mainframe computer. Finally it was

determined that the shared services system simply could not handle the volume and growth factors of a 565-bed hospital.

In September 1972, the board approved a study recommending the investigation of the time-shared system with a dedicated in-house system, and an RFP (request for proposal) was prepared.

An ad hoc management committee heavily involved in specifying system criteria for the RFP met many times to help the dp staff review vendors and proposed systems. Membership included the chief of staff; the directors of nursing, ancillary services, materials management, and plant maintenance; plus the vice presidents and administrators in charge of finance, administration, health care, and

general services. The committee still meets at least quarterly to review progress, discuss new applications, and analyze costs.

In establishing its objectives, the committee's overriding goal was to attack sources of data throughout the hospital, rather than follow the then traditional technique of working backwards through historical data coming into the business office. In essence, if HMH were going to be automated, it would be done in patient care areas where everything originates, and have business data fall through as a direct by-product of patient care.

That approach was based on belief that a hospital-wide system would be justified if its only accomplishment was to centralize and expedite interdepartmental commu-

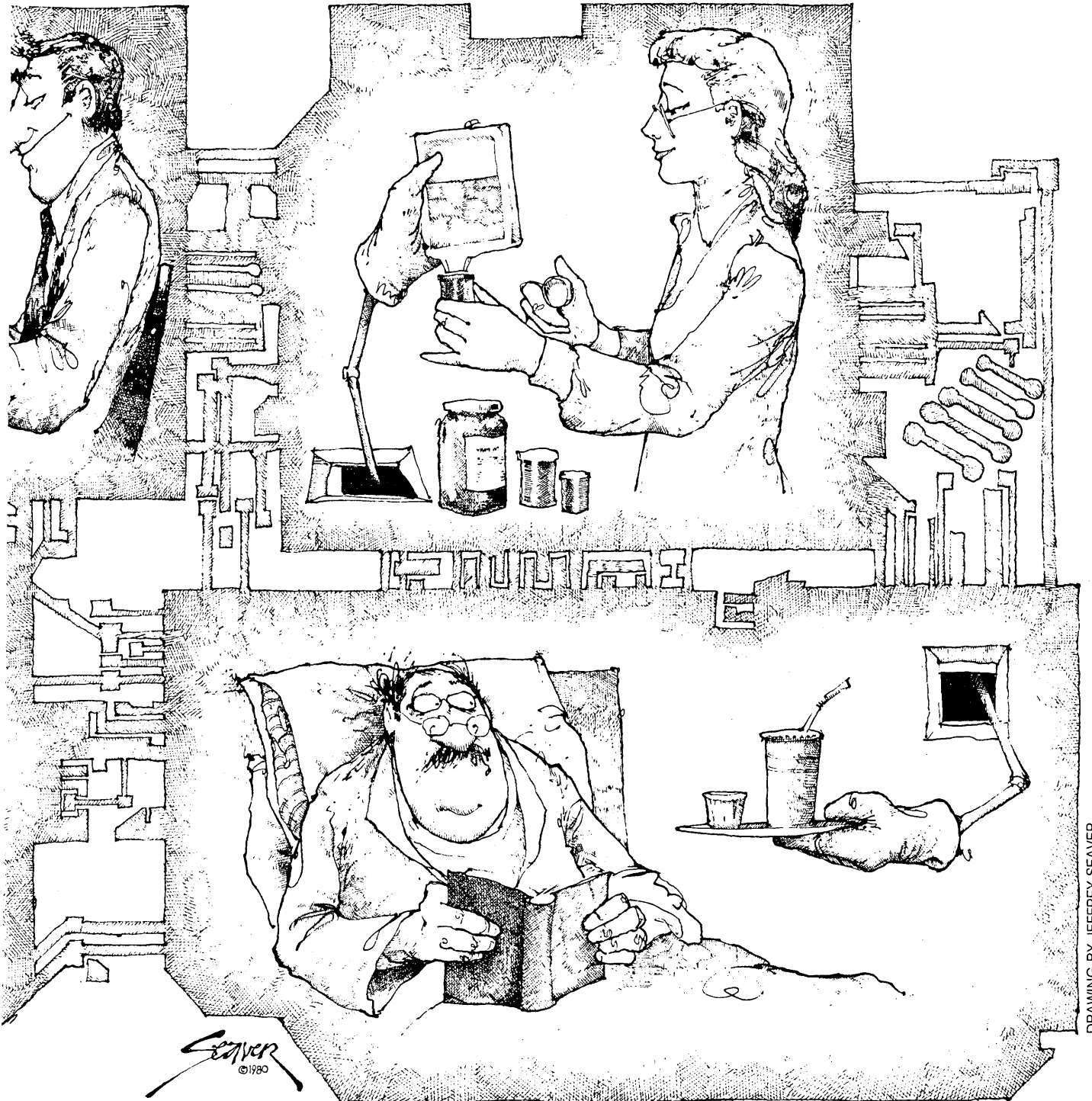

DRAWING BY JEFFREY SEAVER

The goal was to establish credibility and success, not just to make waves.

tions, particularly in support of nursing. As in many hospitals, HMM's communications were hampered by nonstandard messages, memos, and requisitions; the variety of professional and foreign languages and technical jargon being used; and an unsatisfactory pneumatic tube system.

The financial department and auditors were also aware that in any large hospital, with the tremendous number of ancillary services being provided to patients, all paperwork doesn't always find its way to the business office. There are problems transcribing data where they are generated: in writing down correct dollar amounts, in re-writing data, in lost pieces of paper.

The "known" solution was a computerized system to pick up standardized data once and lock it into the system. Then, there would be no worries about language interpretations, pricing errors, nonrecording of services, or the loss or misrouting of data. What was unknown was the tremendous magnitude of the problem.

ABOUT THE RFP

The RFP encompassed five major objectives, all to be attained within the initial five-year period 1974-79.

- Capture all patient data (whether medical or business) at their source, and store them in a single record for each patient.
- Accept and record all orders and other patient data from the professional and administrative staffs, and communicate them as needed to other authorized personnel and to medical records.
- Facilitate record-keeping and communication of data to enable scheduling of patients, hospital personnel, and medical care services.
- Improve the quality and decrease the cost of medical services.
- Have sufficient capacity and growth potential to serve increasing numbers of patients, doctors, and health services, such as automated clinical lab tests and results reporting.

To do all this, the system would have to capture all data at the source and put it into a single, variable-format, variable-length record for each patient. The patient's record would have to include all doctors' orders; diagnoses and diagnostic interpretations from ancillary departments; drugs administered or dispensed; clinical laboratory results; services, operations, deliveries, etc.; and admissions/discharges/transfers information, including patients' selective histories, insurance pro-rating, and other financial data.

Additionally, the system would have to provide physicians and nurses, other staff personnel, and the business office with all or any part of that data, automatically or on-call, in the form of visual displays or printed reports, as required by each department.

Above all, the system would have to be usable by regular hospital personnel. HMM did not want to hire typing pools or specialized data transcribers who would add complexity to system usage, as well as add personnel costs.

The RFP also stated clearly that vendor selection would depend on demonstration of a fully operational, field-tested installation of any system that was proposed. HMM did not intend to design and develop its own. Neither was it going to pioneer anything new for a vendor that wanted a test-bed to enter the field. The committee was interested only in something whose efficacy could be proved, something that would be seen, studied, and evaluated in light of its specifications.

Formal criteria for ultimate vendor selection also called for an evaluation of the vendor's financial stability, management competence, personnel turnover, and its user satisfaction. Conversion, training support, and costs were considered, along with documentation capabilities, hardware/software growth potential, data security, and disaster recovery.

The RFP was issued in October 1972, and it was sent primarily to vendors of small business systems. Of the 26 vendors who submitted proposals, most told us that we would not find what we wanted—particularly when it came to nursing station automation—but that we would do well to help the vendor develop its system, which *might* do the job someday.

The 26 proposals were reviewed with the help of the ad hoc management committee, our auditors, Price Waterhouse & Co., and a consultant. Eighteen were eliminated quickly as being totally unresponsive to the RFP. The remaining eight were invited in for personal discussions of their proposals, which narrowed the field to four: McDonnell Douglas Automation Co., National Data Communications, Inc. (Nadacom), System Development Corp., and Technicon Corp.

Each of the four prospective vendors made detailed presentations. Then committee and consultants scheduled visits to user installations to evaluate actual field operations. In two cases, it was found that working user installations did not really exist; the proposed systems were still under internal vendor development. With the two other vendors—after many discussions with nurses, ancillary departments, and business offices at the hospitals that were using the systems—the committee and consultants finally determined that Nadacom came closest to doing the kind of job called for by the RFP.

NADACOM DESIGNS CARES

CARES (Communications, Analysis, and Reports for Effective Services) was designed by National Data

Communications, Inc. (Nadacom). Throughout HMM 145 Nadacom remote keyboard/display terminals are distributed in departments for data entry and retrieval by authorized staff and administrative personnel; 90 remote terminal printers provide hardcopy where required, and the system's software runs on a triplexed minicomputer installation in the main computer room.

The Phase I plan was to have CARES process the on-line real-time inpatient admitting applications 10 hours a day to cover the peak period. Then the system would be cycled down overnight to do 12 hours of key entry and batch processing of ancillary department charges, accounts payable, patient billing, and other business office tasks. The two hours remaining were for overruns and preventive maintenance.

With equipment scheduled for installation in May 1974, HMM had six months to build a computer room and department, begin training programs, develop the visual display screen formats needed to admit patients, design the paper forms for the remote printers, and assemble the "catalogs" of services and their individual costs.

Hands-on user training to enter patient charges into the system was conducted in the department for dp and pharmacy personnel. Admitting personnel trained in their own areas. (Business office personnel were not trained initially because dp was providing data entry for them.)

Throughout the training program and installation of keyboard/display terminals outside of dp, care was exercised to keep a low profile and allow the system to "seep" into the organization. The goal was to establish credibility and success, not just to make waves and appear to be precipitating major changes for the sake of change.

The result was an extremely smooth conversion. After the hardware was in and the software was tested, the dp staff came in on a Saturday night, changed out the old forms and imprinters, and had everything in place, working and ready for the first shift Monday morning. After a one-month test period, CARES went live on June 1, 1974.

Despite all the advance planning and smooth conversion, the system was severely overloaded within a week. Batch processing for the business office, required 14 to 16 hours, rather than the usual 12. When eight to 10 on-line, real-time (OL/RT) hours were added, which were committed firmly to admissions, there was no margin left for problems, especially a problem as basic as the one that appeared.

No one—not HMM nor Nadacom—had expected CARES would have to process as much data as turned up; the historical records and preliminary surveys had been wrong.

First, twice as many patient accounts

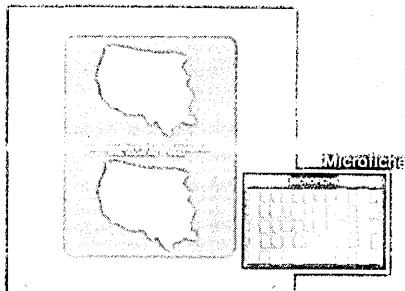
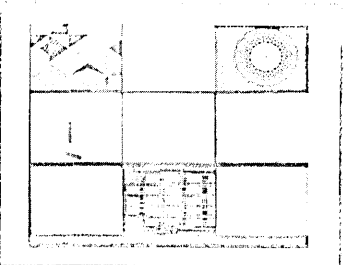
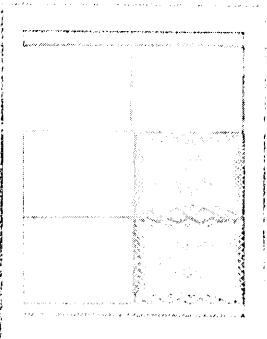
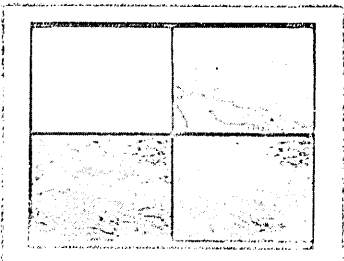
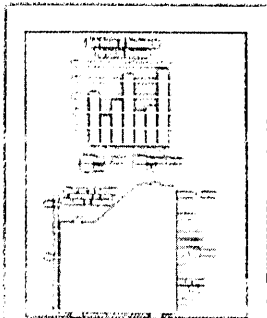
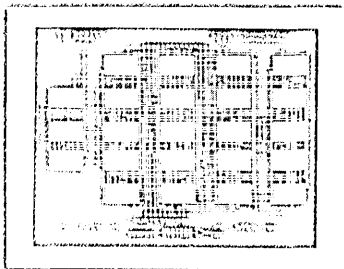

Overhead projection transparency



Slide

Hard copy shown reduced from original 8" x 10" slide and microfilm films

Multiple images recorded on a single sheet of film

"Matrix" is a registered trademark of the Polaroid Corporation

Color Graphics Hard Copy... Made Easy

The Matrix Color Graphics Camera System converts the output of any raster scan computer color terminal into brilliant, high resolution photographic hard copy. Both line and continuous tone images can be made with accurate, bright, saturated colors.

Our system does what no other instrument can do — it produces instant, on-the-spot results with Polaroid® 8 x 10 film, 8 x 10 color transparencies for backlit displays and overhead projection, 35mm color slides, 60 image color microfilms, and 16mm/35mm color animation films. All with one camera system. It also allows recording of multiple image formats. Related and sequential images can be recorded in orderly arrays, on a single sheet of 8 x 10 instant print film. The resultant ease of comparison and analysis is unmatched. The system is also fully modular and field upgradeable... you purchase only the capability that you need now.

Microprocessor based electronics provide many automation, self-calibration, self-diagnosis and remote control functions. Color graphics hard copy made easy by Matrix Instruments, the leading manufacturer of precision electro-optical imaging cameras for diagnostic medical applications.

For more information,
film samples, or a demonstration,
contact Matrix Instruments,
280 Pegasus Avenue,
Northvale, New Jersey
07647.
Telephone (313) 439-8832.
Or call toll-free:
(800) 521-1596.

MATRIX
INSTRUMENTS

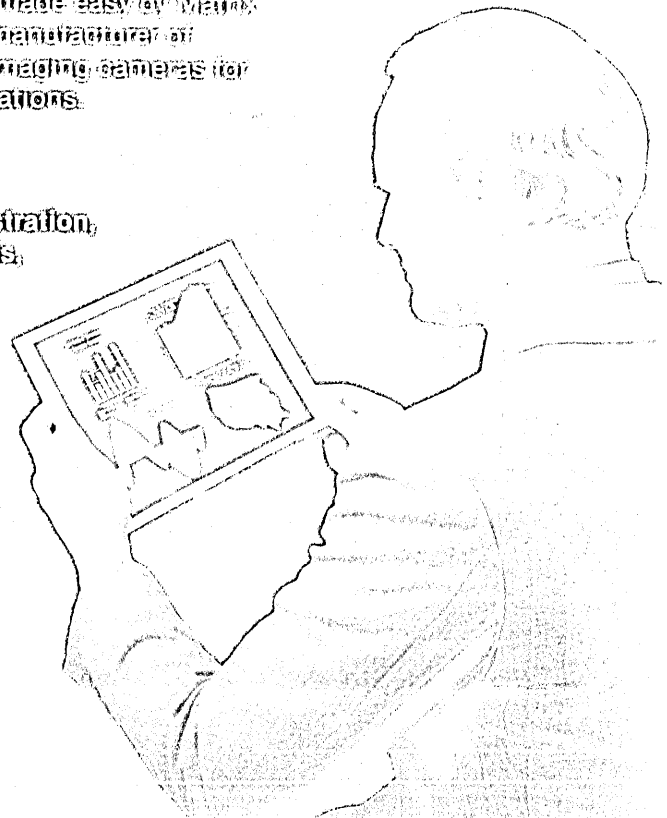

**Remote Job Entry
from Northern Telecom.**

**We also make
plain vanilla.**

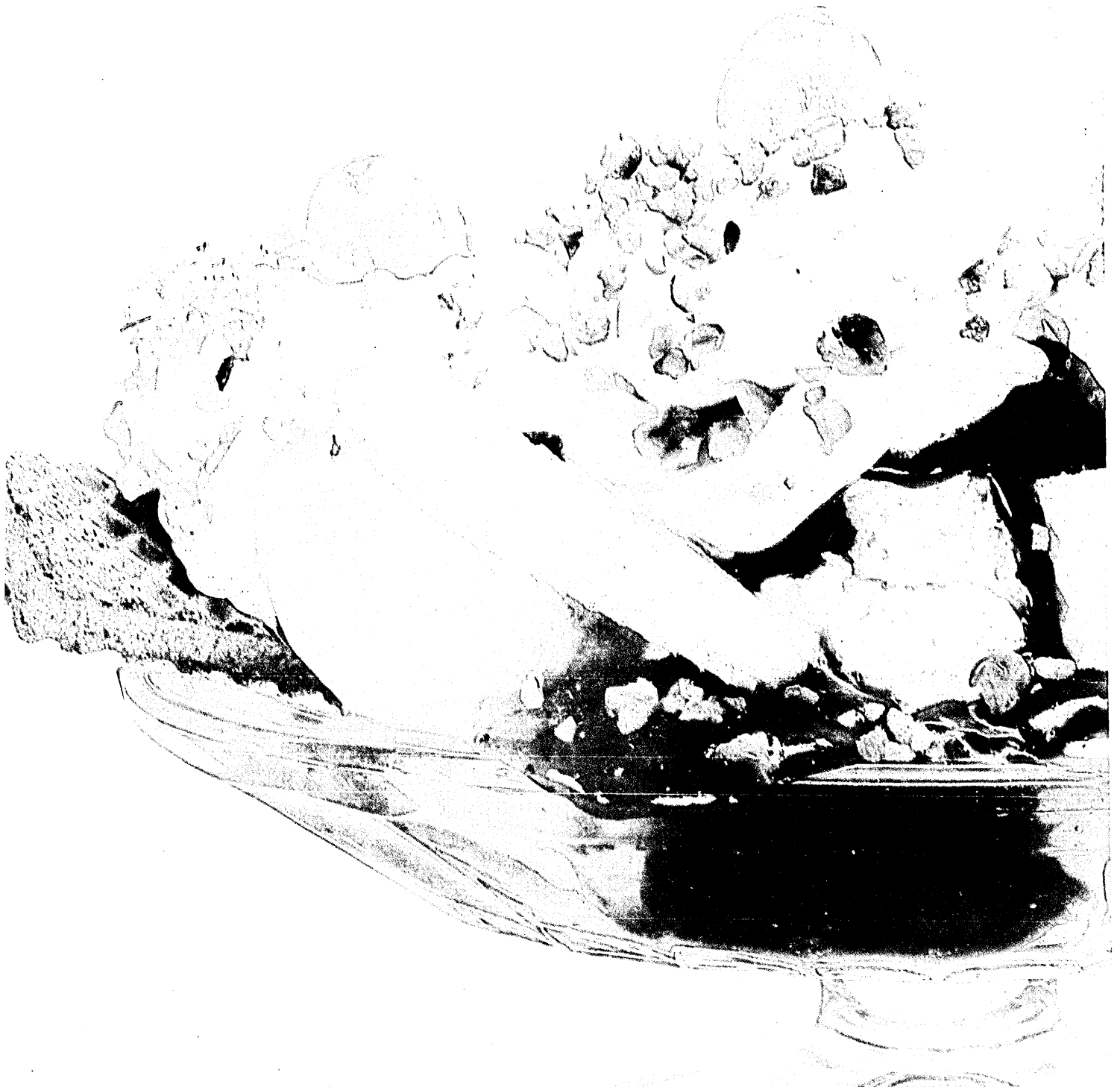

We build a low-priced, basic Remote Job Entry system—all the essentials without all the trimmings. Because it is extraordinarily cost-effective, it is one of the best-known, best-selling RJE systems in the country. But it's not the only kind of RJE you can get from Northern Telecom Systems Corporation.

For hearty appetites.

If you need a lot of throughput, our large-scale RJE system can deliver up to 56,000 bits per second. And push as many as 14 peripherals at the same time—to copy, convert and print out data at 1,250 lines per minute.

For sophisticated tastes.

Our large-scale RJE system accepts input and dispenses output in all the most popular flavors: cards, tape, disk and diskette. It drives exotic peripherals, like plotters, punches and paper tape readers. It can feed your output to remote printers—and save mailing time by printing invoices, checks or bulky reports right where they're needed.

Add a KEYBATCH® package, and our large-scale RJE system can do volume Data Entry jobs in its spare time. In fact, if you have both systems, each can be a back-up for the other.

Three delicious extras.

Plain or fancy, RJE systems from Northern Telecom can handle RPG. It's a handy way to generate reports your management would like to see.

Each RJE system is compatible with Burroughs, Honeywell, Univac and CDC—as well as IBM.

And since RJE compatibility is useless without communications flexibility, we offer synchronous or bi-synchronous.

We can meet all your remote processing needs. So we can often meet them for less.

Northern Telecom can deliver systems for Data Entry, DDP and On-Line, as well as RJE. Buying from a single source could save you money. And when you work with us, one service team can take responsibility for every part of your remote processing system. Twelve hundred field engineers across the country are ready to go to work for you right now.

But the best reason to talk to Northern Telecom today—is tomorrow.

We're combining data processing expertise with telecommunications expertise—in a mix no other company can match. Today, it means better access to all the processing power you pay for. Tomorrow, it means a smoother transition to the single system that will meet all your processing and telecommunications needs. Talk to Northern Telecom Systems Corporation. Where computers and communications meet.

For the office nearest you, call our Marketing Services Department at 1-800-328-6760. In Minnesota call (612) 932-8202. Or write Northern Telecom Systems Corporation, Box 1222, Minneapolis, MN 55440.



**Northern Telecom
Systems Corporation**

CIRCLE 118 ON READER CARD

Essential to the expansion was top management support and the complete participation of the user departments.

as anticipated had to be converted, doubling processing time for that one major element. Secondly, far more data than anyone knew existed was being generated by the ancillary departments. Patient tests and services already in catalogs were being performed in unprecedented high numbers; tests and services no one knew about were coming out of the woodwork.

Much of the unexpected data overload simply came from CARES' greater efficiency and complete accuracy. The system was getting all the information that was being generated, and it was correct information.

We also learned that under the previous system tests and services requiring prices that had not been listed in the catalogs often had not been priced and charged to the patients, and some data had been discarded when people had not completed their day's work.

The net result of all the additional data turned up by CARES was that HMH's catalogs got bigger and bigger, and the amount of information that had to be processed grew and grew. This situation continued for almost a year until all patient tests and services were identified properly and entered into the catalogs.

In the meantime, within its first month of operation, CARES was behind on everything. The harder and more successfully it worked, and the better it kept track of the data being generated throughout the hospital, the further it fell behind.

The solution to the data overload was the installation of a second central processor in August 1974. With another 516, CARES came out of the woods rapidly. The 10-hour window for OL/RT admitting applications could be expanded to 24 hours on one system, while the second system was available another 24 hours for all business office processing.

The two central processors eliminated the backlog within a few weeks; then keyboard/display terminals were installed in the business office for direct OL/RT input of cash accounts. This made it unnecessary for the business office to send its paperwork to dp for key entry. As the cash applications came on-line, others followed, and soon the entire business office had OL/RT access to the system.

By late 1974, CARES was running smoothly enough to consider Phase I of its implementation a success. Attention then turned to expanding the system throughout the hospital, with the nursing stations and ancillary departments being first in line for installation of keyboard/display and printer terminals.

Essential to the expansion was top management support, the complete participation of the user departments, thorough preparation for the orderly conversion of each department, and adequate orientation and

training of all users and data processing, personnel sufficiently experienced in planning and control.

FINDING A HALF-MILLION

Progress during Phase I was being watched very closely by the board of directors, which asked for a full report on whether the original objectives were being met. Rather than conduct an in-house study that later might be interpreted as self-serving, the dp department asked the finance committee to conduct the study with its independent auditors.

Price Waterhouse's consulting team investigated everything: system implementation in admitting and the business office, the overload during the first six months, the situation after catching up. Included were initial and incremental costs for equipment, maintenance, software, facilities management, data processing personnel, and forms.

Results of the study were presented to the board in February 1975, nine months after the system began working. They were very favorable. Price Waterhouse found the system was not only cost-justified and doing the job it was designed to do, but it was far exceeding original cost-containment expectations. Pricing and charging for services were far more complete and accurate with the system, all data was being captured, and no data was being lost or misplaced—which had been responsible, for example, for ancillary services losing from 2% to 5% of the revenues that should have been received. It all added up to an estimated additional \$600,000 annual cash revenue for HMH.

With those early results, the board unanimously approved condensing the original five-year, multiphase plan to two years. Rather than wait until late 1979, the decision was made to bring up the nursing stations and ancillary departments by the end of 1976 (about 18 months after approval).

It wasn't that CARES needed that much time; technically, the nursing and ancillary departments could have been brought on-line almost immediately. The time delay was intended mainly as a period to train nurses, laboratory technicians, and others in using the system. It also afforded them an opportunity to suggest any changes they thought would help them do their jobs better. This helped dp and Nadacom further define the system according to the individual needs of each user department, rather than tailor user procedures to the initial system.

The training and evaluation period lasted about nine months. During that period, all systems changes were accomplished, and complete documentation was produced, including user manuals for 21 departments.

During Phase III, many orientation meetings were held for hospital personnel, in-

cluding physicians, to increase their awareness of computers and computer usage in a hospital environment. Overcoming fear of the unknown and the kind of skepticism normally associated with major change was a critical mission for dp.

Formal training programs for more than 1,000 employees provided eight hours of hands-on experience during an eight-week period before the system was brought on-line in nursing and ancillary departments.

Each trainee received an initial three hours of training on operating the keyboard/display and printer terminals. This was followed by another three hours of studying departmental procedures, and classes concluded with two hours on terminal operations and procedures.

By the time training classes were over, not only were all new users throughout HMH thoroughly familiar with the system, but their comments and suggestions had led to useful changes and additions to display and printed formats, input techniques, and more. As a result, before the system went live in nursing and ancillary services, it had the full support of its users. They knew the system was designed to make their jobs easier, and they wanted to begin using it. Now, if the system goes down, nurses would rather wait for it to come back up to enter an order (unless it's "stat") because it's much easier and there is no chance of an order getting lost.

A particularly strong effort was made to train nurses to use the system. As the central link in patient care (half of all hospital personnel were nurses), their proper usage and complete acceptance of CARES was essential to its success.

All head nurses went through the program first. This ensured at an early date that each nursing floor would have at least one person on duty during each shift who would be expert enough to help others learn to use the system and had the authority to get things done, with the flexibility to adjust their schedules for training others. In some cases, head nurses who were particularly effective in running the system and training others were relieved of their regular duties temporarily to concentrate on the conversion.

When nursing went on the system during Phase III, everyone in the department, including RNs and secretaries, knew what to do and how to do it.

CARES' nursing and ancillary services applications were turned on in March 1976—three years ahead of the first schedule and a half-year ahead of the second. After two to three weeks of the type of system debugging that is always needed, CARES again had settled into a dependable routine and was performing as planned.

By keeping track of all orders and charges, plus automatic communications

A B C D E F G H I

J K L M N O P Q R

S T U V W X Y Z

IS OUR BUSINESS.

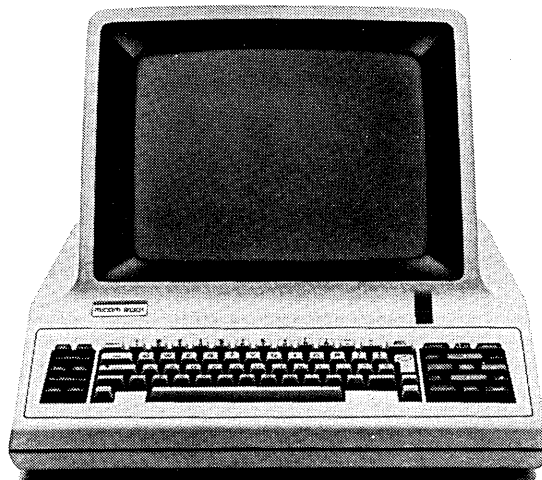

We are Micom and Word Processing is our business. We didn't start out as a computer company. Or as a copier company. Or even as a general office equipment company. We started out and built our name solely on our ability to arrange the printed word quickly and efficiently. We are Word Processing.

And Word Processing is so many things in the office today. Word Processing is writing, editing, revising, storing, filing and sorting your written documents in a fraction of the time they're taking now.

It's printed communication of uncompromising quality without

spending valuable time and money doing it. It's a principle that creates a productive environment freeing you and your staff from tedious tasks. So that they can get on with their work, leaving you to get on with yours.

Word Processing is so many things. But its true value and what it can do for you is best seen in a live demonstration. We'd like to arrange that demonstration for you, free and without obligation. Just mail the coupon alongside or call us toll-free.

It makes no difference how big or how small your company is, Word Processing can make you a more productive company. From A to Z.

Mail to: Micom, Box 1122, Radio City Station, N.Y., N.Y. 10019. Tel.: 800-223-2100. In N.Y. call 212-765-4300.

- Please send me more information on Micom Word Processing Equipment.
 We'd like to see a live demonstration of Micom Word Processing Equipment.

NAME _____
TITLE _____
COMPANY _____
ADDRESS _____
CITY _____ STATE _____
ZIP CODE _____ TEL. NO. _____

DATA 680

MICOM

We are Word Processing.

PHILIPS



Micom is backed worldwide by Philips N.V.

The system would have to capture all data at the source and put it into a single, variable-format, variable-length record for each patient.

among departments and a single record for every patient, it completely solved the major problems inherent in traditional paperwork communications. Now, all data had to be entered into the system before anything could get done; all data were edited for accuracy by the user as they were entered; all data in the system were communicated correctly; and no data were lost, misrouted, or otherwise delayed.

Price Waterhouse & Co. was brought in again (as it has been every year since) to audit the system planning, training, and so forth. Once more, the system received high marks for meeting or exceeding every operating and cost goal.

The outcome was the further telescoping of the original five-year plan. By the end of 1976, everything planned for accomplishment by the end of 1979 was in and operating according to objectives. Payroll, budget, general accounting, time-clock entry, and other new applications were added; new objectives were being set.

A major accomplishment in 1978 was interfacing CARES with automated test equipment in the clinical laboratories, which perform some 300,000 tests annually for HMH and private laboratories.

Before CARES, a pneumatic tube system connected the laboratories and nursing stations; carriers were constantly being sent to the wrong places, or they were not being put into the tubes at all. When doctors couldn't find their results, they would reissue "stat" orders and start the process all over again. This led to slower turnaround on test results and much duplication in work by nursing and laboratory personnel, and it frayed tempers seriously.

Many of these problems disappeared (after data overload problems were solved) when CARES began communicating orders and reports between nursing stations and laboratories. Yet it continued to be a slower process than it might have been, because laboratory results still had to be typed into the keyboard/display terminals manually, even though much of it was produced by automated test equipment.

Solving the latter problem is a two-way automated laboratory interface developed jointly by Nadacom and Berkeley Scientific Laboratories, Inc. (BSL). Installed in April 1978, it connects CARES directly with the standalone BSL minicomputer used for clinical laboratory applications.

RESULTS WITH CARES

When a patient enters the hospital, all admitting information is transferred immediately and automatically from CARES to the BSL system via the interface. This ensures that as soon as the patient is admitted, the laboratory has correct

information on the patient's name, medical record number, hospital location, date of birth, and anything else pertinent.

Orders for laboratory tests flow automatically through CARES into the BSL system; results—whether from automated or nonautomated test equipment—automatically flow back into the CARES system. During this process, the combined system automatically prepares worksheets and load lists, prepares reminders, prints labels and specimen collection lists, and so forth.

All clinical laboratory data, results, and reports that have been completed are viewable immediately on CARES' keyboard/display terminals throughout the hospital. Printouts can be directed selectively to all intensive care units.

Again, with the system handling all transactions for the automated laboratory interface and other new applications, no data related to those applications were overlooked or lost; and, by finding that more data existed than anyone had ever recognized, CARES again began moving into an overload situation. One 516 was devoted solely to 24-hour-a-day OL/RT work, while the other was being used 20 hours a day for batch processing.

The obvious growth path was into Honeywell 716s, but they were no longer being manufactured. After a late 1977 study of available minicomputer hardware and software, HMH and Nadacom decided to get a Prime 400 as the third computer in the CARES system.

The Prime 400 was brought on-line over the weekend of June 10-11, 1978, creating a triplex computer system in which all three computers work together, sharing resources as required. Its installation was no more difficult than that of the second 516, because the Prime 400 hardware is compatible with the Honeywell mainframes and Nadacom's software is hardware independent.

The Prime 400 now supports all OL/RT applications 24 hours a day without any capacity problems, and the current configuration can be expanded considerably whenever required. The two 516s make available 48 hours a day of batch processing time.

Addition of the new hardware—including 10 much larger disk drives in two five-disk mirror-image strings—not only solved previous capacity problems, but also enabled additional key applications to be brought on-line in 1979, including processing pharmacy orders and inventory, patient billing, and so forth.

(By this time, the original 90 keyboard/display terminals have grown to 145, and the two remote printers have become 90. In the span of five years, CARES is running at 145% of original capacity, and there are more new services to bring on-line.)

Many benefits can be attributed to CARES' steady growth and success: services and charges are more clearly identified, operations are much more businesslike; and myriad internal and external reports are produced quickly and easily.

Previously, when a body such as the Joint Commission on Accreditation of Hospitals (JCAH) asked to see the hospital's catalogs, about all that was readily available on laboratory, for example, might be a two-page list of frequent tests. Now, with a completely detailed, completely priced catalog of every test and procedure, JCAH has everything it needs.

HMH is much more efficient in many other ways. All personnel now have clearly defined data recordings and communications processes to follow in their jobs. The general ledger has considerably more detail than before. Budget reports are available with a depth of detail and at a speed that were unknown before.

Eliminating the sometimes interminable delays in receiving all patient charges from the departments enables patient bills to be produced in a much more timely manner. With the exception of data such as additional charges that may be incurred for on-going laboratory tests, for instance, all charges are in the system by the time a patient has been discharged. To provide some leeway, the cutoff for completion or cancellation of all orders in the system is 40 hours after discharge.

This makes it possible to mail bills to patients four or five days after they leave the hospital. Previously, 15 working days was normal, and the delay would often be as long as 20 to 30 days.

A valuable by-product of more timely patient billing has been more timely patient payments. Generally, this has reduced the level of receivables and improved cash flow considerably.

CARES has also made it possible to reduce the rate of increase in personnel costs throughout the hospital—a rate that had seen the number of employees per patient double from less than two to slightly over four in the past 10 years. The business office, for example, has been able to handle a tremendously increased work load with about the same staff; dp requires only 20 people for all jobs on all shifts, compared with previous staffing, where 22 people were needed around the clock just to keypunch data for the business office and admissions.

The system's rapid, fail-safe communications also has eliminated the need for nurses, orderlies, and others to spend considerable time preparing written orders and reports and, many times, having to personally hand-carry those pieces of paper to their destination to be certain of their delivery and

Overcoming fear of the unknown and the kind of skepticism normally associated with major change was a critical mission for the dp department.

follow-up action. This growing freedom from paperwork enables hospital personnel to spend far more of their time providing patient care and performing administrative services.

Although new positions have to be added continuously to keep pace with HMH's growth, personnel costs as a percentage of total costs have been dropped to about 50%, versus 60% in 1976 (some of which may stem from sharply higher costs in expenses such as insurance, equipment, and depreciation). The unknown factor is how many more employees of all types HMH would have needed if CARES did not exist. It is certain, however, that the effect on the bottom line has been significant compared with what costs would have grown to without the system.

PATIENT DAY COSTS

Net cost for the total CARES system in 1979—based on equivalent patient days (comprising inpatient days plus one-third of outpatient visits)—was approximately \$4.50 per patient day. The finance committee considers this level more than acceptable.

Assumptions underlying the calculation of that amount include a split of expenses (based on file structure) that allocates 39% to the business office and 61% to interdepartmental communications. Subtracted from gross system costs in both areas are confirmed dollar savings the auditors established from installation and operation of the system.

By the middle of 1980, HMH anticipates having a completely OL/RT patient data base. This will store and have available for immediate recall all hospital/medical records and complete demographic data on each of the more than 125,000 outpatients and inpa-

tients who will be in the system initially, with a growth capacity to store 600,000 names.

A major benefit from a complete patient data base is the ability it gives many departments to provide each patient with faster, more personal services. And it saves much time. Admitting clerks, nurses, and technicians, for example, do not have to ask repeatedly for the same information. Data for each returning patient are available immediately, whenever he or she enters the hospital. All patients know the hospital remembers them as individuals.

In development for implementation in 1980 is a total nursing program that will support all of the nurse's data needs. Added to CARES' current capabilities will be nurse care planning, charting according to plan, staffing according to acuity factors, and automatic auditing of the quality of nursing care.

Generally, after a nurse enters a patient's diagnosis into the system, the system will respond with information on potential problems associated with that diagnosis and a checklist of what might need to be done. The nurse then will select the areas that need to be followed through routinely. As long as the patient is in the hospital, CARES will update the plan regularly from more recent orders and reports, and it will produce a complete care plan for each shift or as needed.

Additionally, with a complete nursing care plan and all orders in the system for each patient, the system will not accept charting unless a report is made for each item in the plan. This will mean that the nurse, automatically and provably, will meet all standards of JCAH Title 22, which requires charting according to care plan.

In acuity planning, a requirement of

various regulatory bodies, each procedure will be assigned a relative unit of value. The value might encompass, for instance, how many minutes of RN and/or LVN time the procedure requires. Aggregating the values for similar procedures and personnel required in all the nursing care plans for each unit will provide a reasonably good estimate of the types and numbers of staff personnel needed for each shift.

In auditing, actual nursing care will be evaluated after a patient is discharged to determine if everything was done that was called for in the plan. Exception reporting will indicate what should have been done that wasn't, and vice versa. JCAH Title 22 requirements also will be met with auditing. It will obviate the need for nurses to spend hours poring through their records to prepare the paperwork required.

The future is also expected to bring more work from the medical staff. Some doctors, particularly obstetricians, are already using CARES to issue standing orders automatically when their patients are admitted and to check on their patients' progress during their stays.

Being considered, too, is installation of keyboard/display terminals in off-site doctors' offices. Data communications technology will enable these doctors to use their remote terminals to enter admitting information and orders directly into CARES and to access laboratory, X-ray, and other reports without actually having to visit the hospital.

The ultimate goal, attainable within the next five years, is to interface CARES with any function in HMH that generates, receives, or otherwise uses data—which means virtually everything in the hospital. *

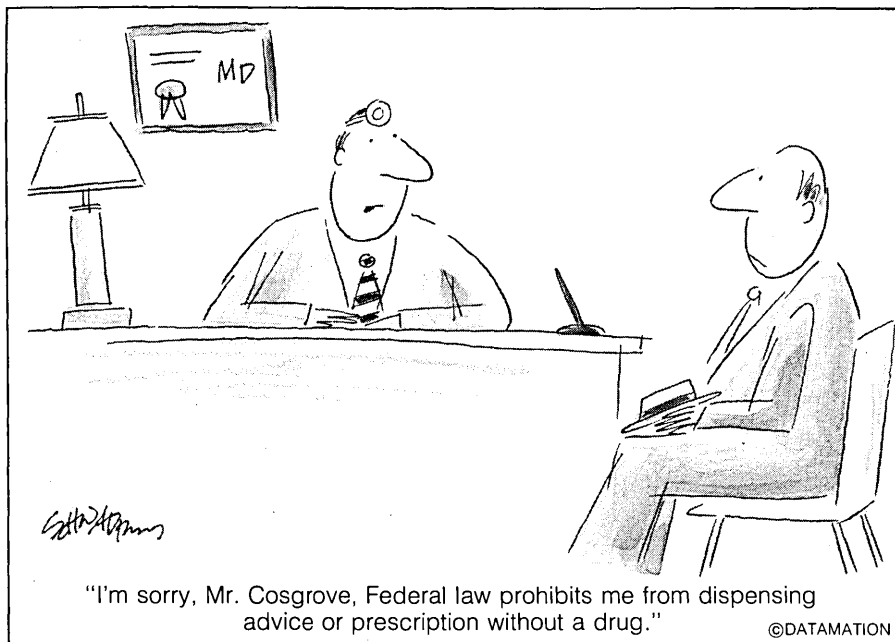

ROBERT SPAZIANO



Mr. Spaziano is the director of systems and communications at Huntington Memorial Hospital, Pasadena, Calif. His responsibilities include the

ongoing development and implementation of the hospital-wide information processing system. Mr. Spaziano also teaches systems implementation at Cal State—L.A., and is affiliated with the Hospital Management Systems Society, Hospital Information Systems Sharing Group, DPMA, and Association of Systems Management.

From the graphics leader

Push a button... put virtually any video display on paper in seconds.

Copyright © 1979 Tektronix Inc. All rights reserved.



dry process means no liquid toner mess, no wasted copies. Operation is quiet and thoroughly dependable.

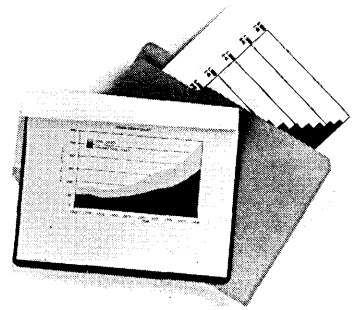

For years, Tektronix has been a leader in the fiber optic technology that provides fast, finely detailed raster scan reproductions. Find out what the 4632 can do for your system. Call your local Tektronix representative or our toll-free, automatic answering service at 1-800-547-1512. In Oregon, call 644-9051 collect.

OEM terms and conditions available.

Tektronix, Inc.
Information Display Division
P.O. Box 500
Beaverton, OR 97077
Tektronix International, Inc.
European Marketing Centre
Post Box 827
1180 AV Amstelveen
The Netherlands

Special symbols.
Graphics.
Multi-font
alphanumerics. Gray
scale. They're all easy
to copy with the
**Tektronix 4632 Video
Hard Copy Unit.**

The 4632 provides high resolution copies of raster scan and other video displays. Their quality is excellent — perfect for formal reports. Yet their cost is low enough to use them for first drafts, and the image long-lasting enough for the file.

RS170 interface makes the 4632 a natural companion to most video systems. Users of video terminals and systems like the DEC MINC system shown here, are taking advantage of the 4632's high resolution hard copies, available at the push of a button. Our

CIRCLE 121 ON READER CARD

Tektronix®
COMMITTED TO EXCELLENCE

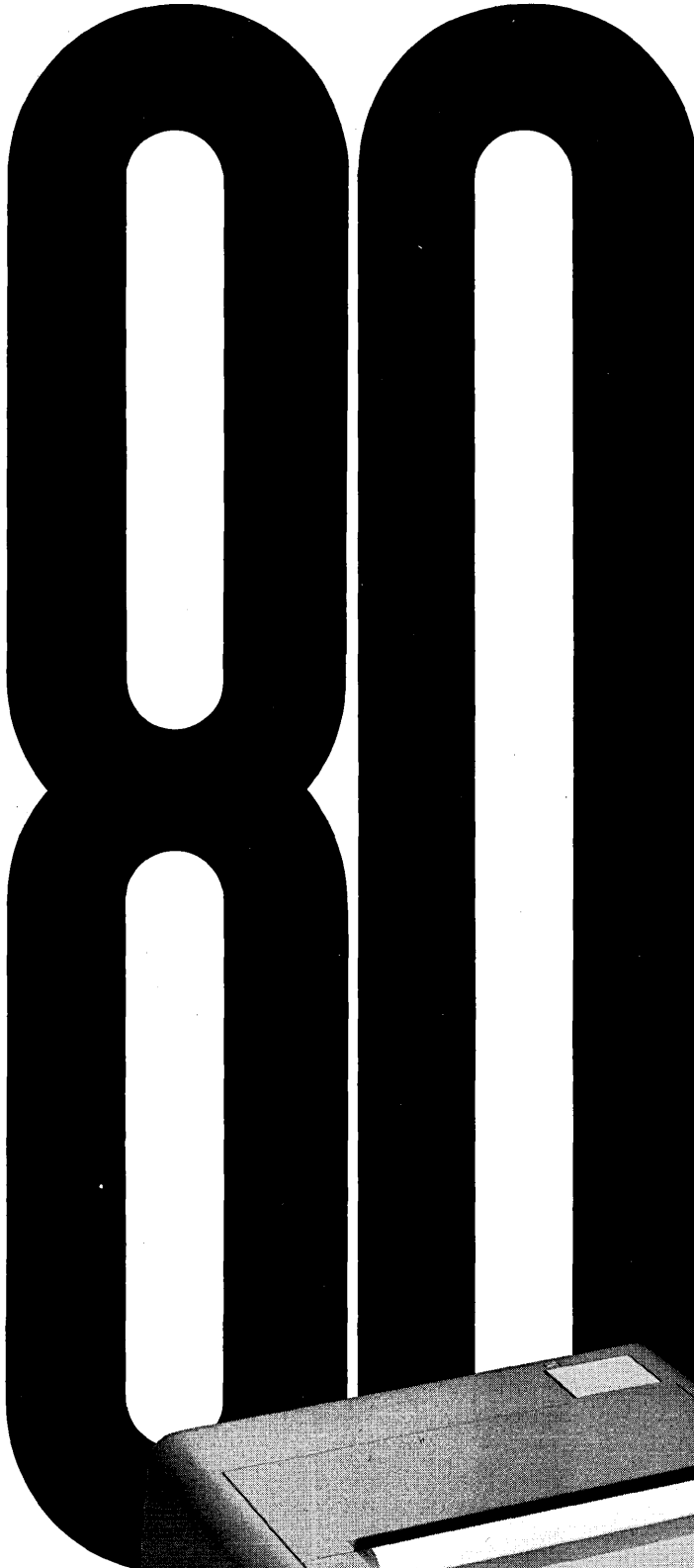

80%

That's how much one Fortune 500 company slashed the man-hours required for their field transactions. 80%.

The reason? Productivity through Portable Processing. With the Miniterm® 1206, a lightweight, briefcase-size portable computer, people take data processing power directly to the work being performed. Wherever it is.

That way, essential decision-making information that can determine success or failure in the field is available on the spot, at the point of transaction. Important sales orders can be processed immediately with greater accuracy, and confirmed without delay. Transactions that took weeks by mail now take only minutes. And, human resources are used far more productively.

Just as important, this same information is available immediately to management via telephone when it's most timely and valuable, so that business trends can be spotted . . . and planned for.

Today, more and more companies in such diverse industries as pharmaceuticals, apparel, finance, agriculture, manufacturing, insurance, and others are integrating portable Miniterms into their field operations to extend the economy and efficiency of computers right to the source of the work.



I'd like to know more about Portable Processing and the Miniterm's potential in my company.

Please send me your brochure.

Please have your representative call me.

COMPUTER DEVICES INC.
25 North Avenue
Burlington, MA 01803

Name _____

Title _____

Company _____

Street _____

City _____ State _____ Zip _____

Type of Business _____

D

Available under GSA

The potential applications of portable computer systems are just beginning to be realized. If you'd like to explore Miniterm's potential for your company, fill in the coupon. Or call Computer Devices, Inc. toll-free: 800-225-1230. In Massachusetts call (617) 273-1550.

Europe: Computer Devices, Inc. 108 Place Des Miroirs. 91000 Evry, France. (6) 079 0077. Telex 692 671.

We travel in the best companies.

CIRCLE 122 ON READER CARD

Computer-based work stations would do away with the antiquated tools professionals and managers have been using for a hundred years.

REPLACING THE PAD AND PENCIL

by Amy D. Wohl

For about 15 years, most office automation activity has focused on the mechanization of a single task—typing—through the creation, refinement, and spread of word processing technology. While many worthwhile gains in secretarial productivity have come about by this technique, it is clear that plowed ground will be less fertile as time goes on and that it is now time to seek new fields. Secretaries are only a fraction of the total office work force. And typing is perhaps 20% of the total function of the "average" secretary.

Most office workers spend a major portion of their time collecting, analyzing, and assembling information and then communicating that information to their employees, peers, or superiors. Word processing assists all levels of workers in this process by offering better quality documents more quickly, but large portions of the data collection and distribution process remain virtually untouched by computer-based products.

The management work station (currently the subject of much discussion in the office automation field—and the main item in two major studies by the consulting firms of Quantum Sciences and Booz Allen, Hamilton) offers fertile new ground for improvement of productivity. Most managerial and professional workers face each day with tools that have been available for nearly a hundred years—pencils, yellow pads, and a telephone. In a few cases (perhaps 10 percent), they have become converted to the use of dictation equipment to speed document input, but many resist this technology or feel that it is too difficult to dictate anything but routine correspondence. A very few professionals and managers work with computer-connected display terminals. These professionals are generally concentrated in the data processing area itself—some programmers now write programs or program documentation directly on computer systems—or in financially focused areas such as banking, the stock market, and insurance.

The focus on the definition and development of a computer-based work station for managers is intended to offer new tools to enhance and support traditional management skills. Some of the tasks that these workers perform which lend themselves to computer assistance include:

Data Access. Most managers and professionals spend a large part of their day collecting data and rearranging this data into meaningful presentations. The assembly and arrangement of data is a prerequisite to the decision-making process that is a main function of management. Today, much of the office's data is still retained on paper, in metal filing cabinets, or it exists on computer printouts, inaccessible to the office worker except as it appears on the printed page.

A terminal in the manager's office or at the professional's desk could provide access to data stored in the firm's computer facilities, provided that proper access arrangements are available. Please note that this function is equivalent to the MIS type of function long touted as the wave of the future, but slow in coming due to the cost of providing large numbers of terminals, the cost of making mainframe access available (in both hardware and programming resources), and the difficulty in providing an appropriate level of interface for noncomputer users. Management work station designers and theorists hope to avoid the problems faced by the MIS group in several ways:

- Bring down the cost or amortize it more successfully by offering a variety of meaningful functions. If the terminal is used intensively enough, it will be easier to cost justify.
- Lessen the strain on the data processing department by offering some processing at the management work station and most of the programming (if not all) on a packaged basis.
- Provide a human engineered interface which essentially allows the manager or professional to use the computer-based work station with minimal training and no need to learn a new language. An English language interface is considered a requirement here.

Self-Authored Text. Today, managers get text typed in one of several ways. They write material in longhand and have it typed on the word processor or (frequently) by typewriter. They dictate material for keyboarding (usually employing machine dictation equipment, although a few traditionalists continue to use a stenographer). A very few professionals, generally ex-journalists who work in areas like advertising and public relations, or technical writers, work with a typewriter.

Obviously, there is not much incentive for the high level manager whose text is dictated to a shorthand-taking executive secretary (or written for him by professional staff) to learn to do word processing for himself. However, many professional workers find it difficult to get text typed on a timely basis. If we could offer a very-easy-to-use word processing function on a multifunction work station it is likely that some professional and managerial workers would choose to keyboard at least some of their own text. Even if this facility is not used by all workers, or only on occasion (such as evenings and weekends), it would still be a useful enhancement to the manager who does not mind typing and wants to see immediate results. Again, the problem is providing an English language interface that requires the minimum of memorization and provides reasonable function.

AN ADDED USEFUL FUNCTION

For those who will be quick to point out that managerial typists would prove unreasonably expensive, it should be mentioned that it is *not* intended that every manager become a typist. It is intended that this useful facility be offered as an additional function those managers who find it useful. There is nothing that says the professional could not choose to use part of the function. For instance, a professional with a multifunction work station could choose to:

- Self-author drafts, but leave cleanup and formatting to his secretary.
- Continue to get text into the system via his

With the proper access arrangements, a terminal in the manager's office could provide access to data stored in the firm's computer facilities.

normal route (longhand, shorthand, machine dictation, staff writer), but use the word processing functions of the work station to permit review and revision.

- Use the system only to review documents, giving revision instructions to the secretary through notes or machine dictation.

Electronic Mail. Many of the pioneering firms that have already started to offer some office automation to nonsecretarial workers begin with electronic mail. In the jargon of the office automation expert, this is a high leverage application. That is, small sums of money can potentially have large results in terms of cost savings or positive feedback on the viability of office automation projects in general.

First, it might be well to define what we mean by electronic mail. Some word processing users think of electronic mail as document distribution, the electronic transmission and receipt of formatted documents with a "letterlike" appearance. Most of the electronic mail pilot projects are not like that at all. In fact, they are electronic message systems that permit managers or professionals (and, in some cases, their secretaries) to send informal notes at high speed. They tend to fulfill several needs:

- They permit managers to exchange information in a timely way. It is no more trouble or effort to inform all of your peers of an idea or activity than to inform one, thanks to the "carbon copy" function on these systems.
- They permit workers to send memos at convenient times, without regard to normal working hours. This permits the writer to create his electronic message at any time (regardless of whether secretarial help is available at that time) and permits the document to be sent immediately or at least-cost time in

the future. The recipient need not be in the office and can "read his mail" when he next returns or from a compatible terminal nearly anywhere in the world. Sophisticated systems permit messages to be automatically rerouted to the correct location to allow for transferred managers or managers in transit.

AVOID TIME ZONES

An interesting aspect of electronic message systems is that they get around the problem of workers who function in widely separated time zones. For instance, a firm with offices in New York and California may actually have only two hours per day when both offices are fully staffed. A firm with offices in the U.S. and Far East may have no overlapping hours at all. An electronic mail system permits questions to be asked and answered without the constant game of telephone tag that is normally played in such situations.

Users of electronic message systems generally check their electronic mailboxes three or four times a day (for regular users), typically first thing in the morning, around lunch time, early afternoon, and just before leaving for the day. A few hardy users take a terminal home with them (or have installed a home terminal on a permanent basis) and can continue to send and receive electronic mail at all hours.

Also, messages on an electronic mail system tend to be brief and to the point, frequently achieving real savings in managerial time (on both the authoring and the reading ends), plus savings in telephone charges spent exchanging meaningless pleasantries.

While it is sometimes difficult to justify the use of a terminal only for electronic mail, depending upon the frequency of usage,

the cost of the terminal selected, and the value of the electronic mail itself (a single timely message in the change of a commodity price could, for instance, pay for the annual costs of an entire system all by itself), in multifunction environments the incremental value of electronic mail is usually easy to sell. Also, electronic mail is a good beginner's application. It doesn't require much training (even on current commercial systems, which offer precious little human engineering) and the user can remember how to get onto the system and send and receive mail even if he or she an infrequent user. It frequently causes satisfied users to ask for additional functions in areas like storage and text editing, leading the user into natural extensions of office automation functions.

Administrative Functions. This tag is used to include a market basket of activities including an electronic calendar, scheduling functions (cross-checking with other's calendars to plan meetings), and tickler files (reminding the user of deadlines to be met and activities to be performed). Essentially, any data processing system which can offer selecting and sorting functions can provide, via software, these types of facilities. The catch is that they must be provided, once again, in a form the user is willing to work with. This probably means very easy, English language access, with a minimum of procedure for entering and retrieving information.

Also, scheduling systems turn out to have a moral overtone in that many employees do not want their peers (much less management) to have full details on their individual schedules. What would happen to long lunches, afternoon golf games, leaving early? Therefore, several creative solutions have been offered. The system could inspect each individual calendar when, for instance, it tries to schedule a meeting between four managers, but would not be told *what* they are doing—only *if* they are available.

Again, employees do not want to give up control over their schedules, so the system would be likely to request that they schedule a meeting for a time known to be suitable, rather than simply adding the meeting to their schedule, without permission. Given the number of phone calls secretaries must normally make to set up a meeting between several managers, any kind of assistance in scheduling meetings should be helpful.

It is also possible to schedule the meeting space as well. Simply by making the meeting rooms participants in the scheduling system, the secretary can find out if a particular room (of the correct size, location, equipment, etc.) is available when the participants are free. The room can, of course, be scheduled without its permission (although the system may make room scheduling the function of a particular administrative employee and

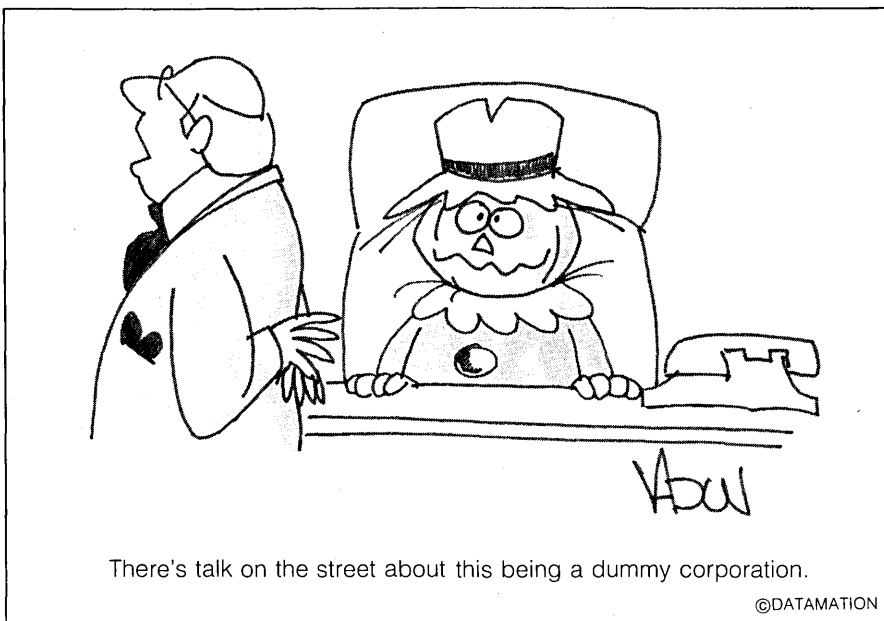

“What I like about Qyx is that we can *add in* features without buying a new typewriter every time.”

“What I like about Qyx is that it makes typing so much easier.”



Hard to say which is the more appealing quality of Qyx®, The Intelligent Typewriter®. Certainly, secretaries who are pleased with their typewriters are apt to be more productive and turn out better work.

Qyx is Cost Efficient

The cost efficiency story of Qyx is a remarkable one, too. You never have to invest in more typewriter capability than you need. And that capability can be increased at any time, without changing typewriters. The features you want are simply *added into* the Qyx you already have.

Adding in is Easy

For example, if you want to increase Qyx memory from 4 pages to 30 pages, your Qyx can be modified in minutes at your secre-

tary's desk at moderate cost. You won't have to spend money on new typewriters or upset your office routine. Your Qyx will be upgraded without any change in size.

Mini-diskettes can be added in to give your Qyx unlimited memory. You can also add in a 24-character display to further simplify typing.

Sends Documents Miles

A communications option can also be added in. This enables you to send original documents to a Qyx in the next office or thousands of miles away, in seconds.

Cost efficiency and ease of typing are only two of the impressive benefits of Qyx. Arrange today for a private demonstration to see how much this extraordinary typewriter can do for your business.

For a private demonstration write to Qyx, Box 400, Lionville, PA 19353, or call toll free:

800-345-8123

In Pennsylvania call 800-662-7171.

Name _____ Title _____

Company _____ Phone _____

Address _____

City _____ State _____ Zip _____

18

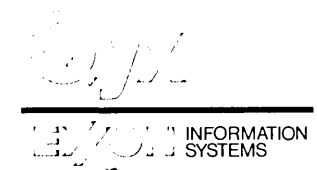

“Qyx” and “The Intelligent Typewriter” are trademarks of Exxon Corporation.

CIRCLE 123 ON READER CARD

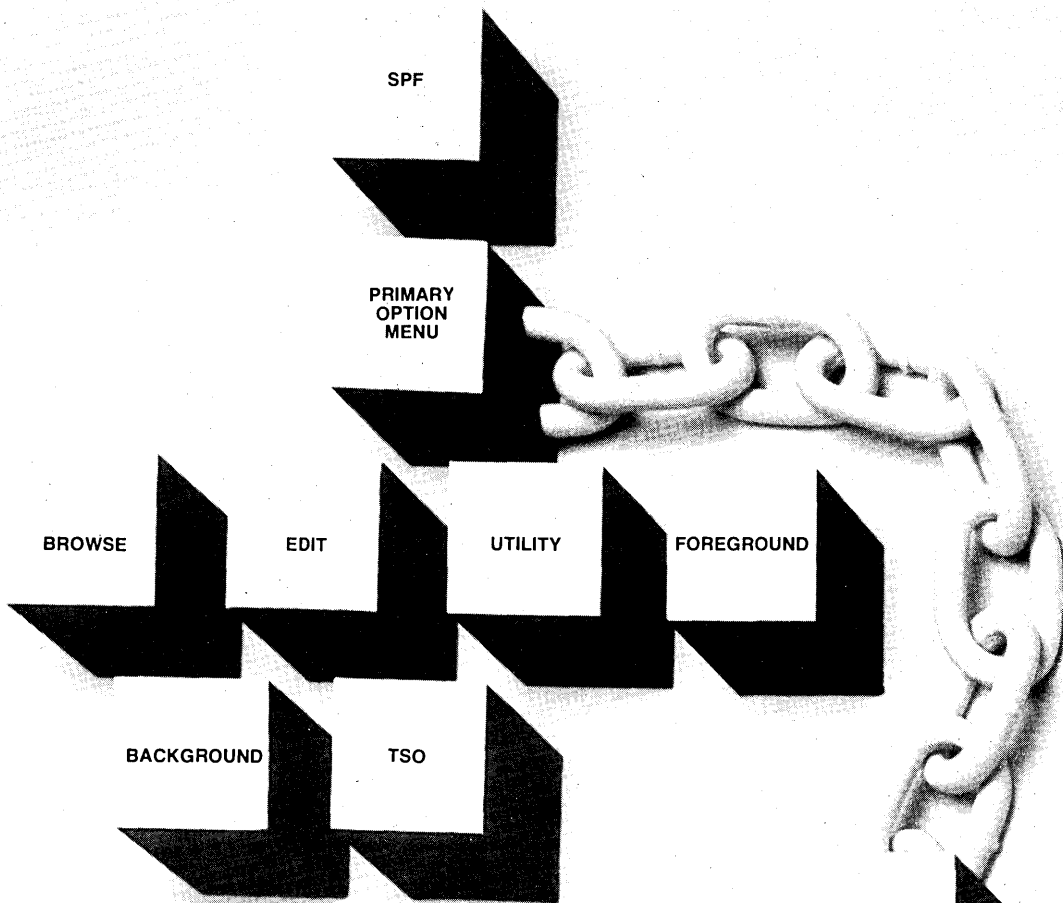

A link between the best of two worlds.

The PANVALET SPF Option combines programmer productivity with source library management and control and helps you get more out of your IBM software investment. Its release adds yet another Pansophic interface to on-line programming systems, which already include CICS, CMS and TSO.

The PANVALET SPF Option provides DIRECT communication between SPF and a PANVALET library. There are no longer time- and overhead-consuming intermediate steps.

Standard SPF EDIT and BROWSE facilities are intact, as are all of the efficiencies, library management and control facilities of PANVALET. Automatic maintenance and display of PANVALET statement level stamps gives you an audit trail for changes made through SPF. And by utilizing SPF menus, you enter fewer key strokes; reducing the chance for error and incurring less overhead.

You get the best of two worlds: SPF as a programmer tool; PANVALET as the library management and control system.

PANVALET SPF Option. Another important interface to on-line programming systems. From the people who bring you quality systems software.

Pansophic Systems, Inc.
709 Enterprise Drive
Oak Brook, IL 60521

PANVALET/SPF
for programmer efficiency and library control
800-323-7335

PANSOPHIC

CIRCLE 124 ON READER CARD

Georgia's USCN Network ...

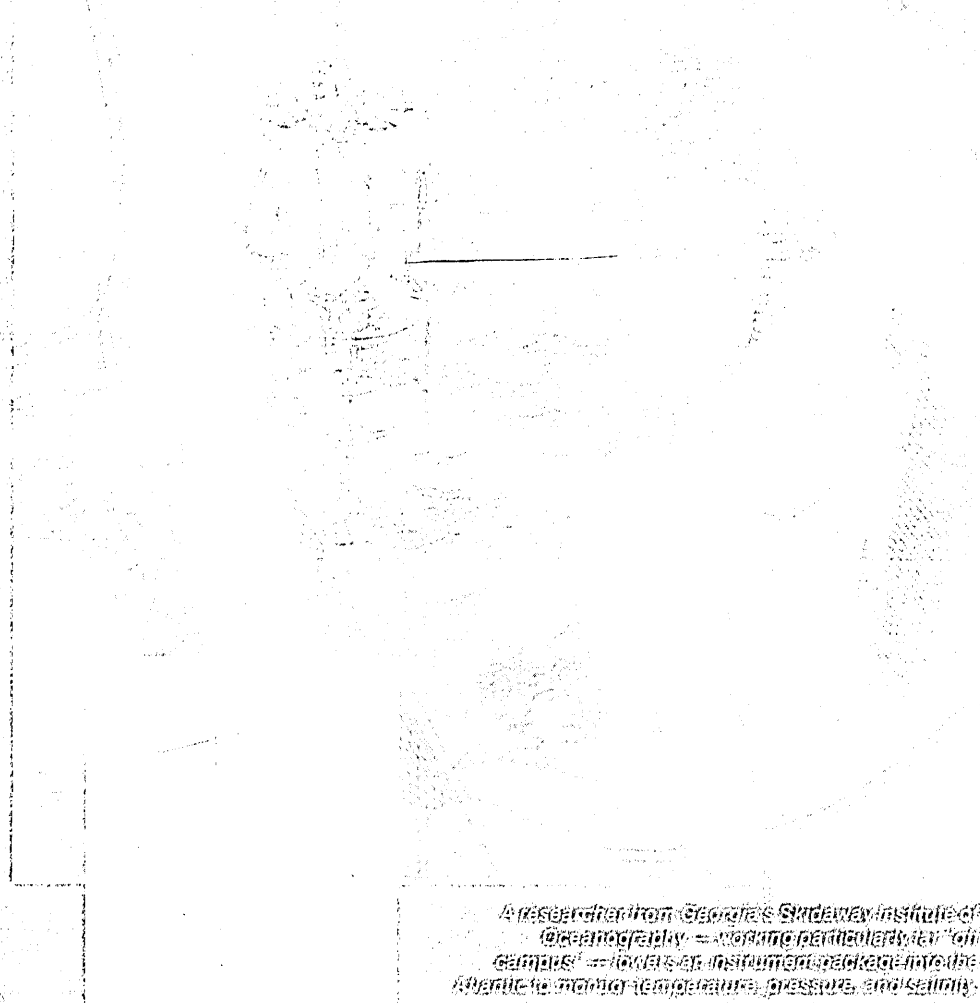

A researcher from Georgia's Stateway Institute of Oceanography - working periodically on campus - inserts an instrument packed into the Atlantic to monitor temperature, pressure, and salinity.

... is also a Tran Network.

Georgia's University System Computer Network was officially established in May, 1974 to provide access to major computer resources for all units of the university system. The problem then, as now, was in providing a cost effective communications path from any terminal to any computer.

Today USCN encompasses hundreds of miles of communications equipment and over 2500 miles of private and public exchange telephone lines, 1000's of local offices, 30 campuses, experiment stations, the Stateway Institute of Oceanography, and several other user sites throughout the state and distant facilities further extending reach.

The all-digital computer connectivity supports switched synchro-

nous and asynchronous traffic at up to 2500 bits per second statewide, plus simultaneous packet and time division switched traffic at 50000 bits per second between its main nodes in Atlanta and Athens.

Over thirty computers are used to tie the network at present, the largest of which are Control Data Cyber 70/74s, IBM 370/155s, and Univac 6080s, which serve as network hosts. Remote job entry stations plus many hundreds of remote analytical terminals keep the processors busy.

No census of the rapidly growing and changing mix of computers from and communications processors and terminals stays current long. Anticipating this, USCN designers pro-

duced a network which is easily reconfigured and which can quickly grow to accommodate new users and applications. In these respects too, USCN continues to be a happy success, confirming the original design philosophy.

Tran has installed several such networks for university systems, and many more for sophisticated users in private industry, financial institutions, government agencies, telephone operating companies, and others from the United States and in other nations. Accordingly, Tran now has more international experience in the construction of digital data networks than any other communications company in the world.



Professionals would probably choose to keyboard at least some of their own text with a very-easy-to-use wp function on a multifunction work station.

request that this employee schedule the room—again, the issue of control).

Storage and Retrieval of Files. Eventually, all data and text are likely to be stored electronically (although additional paper or other files may be maintained for convenience or for legal reasons). When that day comes, it is likely that office workers will want to access and review stored data and text electronically, on a display work station, rather than having it transferred to paper. Already there are systems on the market (and many waiting in the wings) that permit some limited retrieval of electronically stored data with a minimum of user knowledge of data base or file structures. While it is clear that we will want to have electronic access to files (and some of us want it right now), a few things will have to happen first:

- Storing files electronically, particularly text files, will have to become cheaper. This requires cheaper, very high capacity storage.
- Access to the files will have to be available using English-type commands. No one is going to ask for File #123654.987. We will want to say, "I want the letter I sent to Mr. Jones last year about the lost tractor shipment." Or, "May I have any correspondence from Mr. Client to Mr. Hostile or Mr. Unfriendly."
- We will have to get into the filing system all the documents that were created and stored on paper before the creation of electronic files. While most of us will probably choose to go with a mixed paper-electronic system for some time, omnifont optical character recognition scanners show some promise for converting previously typed material to digital codes, storable in an electronic filing system. The Kurzweil scanner, acquired by Xerox recently, already offers most of the capabilities that would be required for such functions.
- Entering into the system all the paper that comes into our office after the electronic filing system is implemented. Again, the omnifont OCR scanner seems to have interesting possibilities. Also, this need would presumably go down as more and more businesses converted to electronic document distribution systems during the mid-'80s to early '90s.
- We will have to figure out a legal way of filing things on magnetic media (not subject to invisible, undetectable change). Or we will have to discover a low-cost alternative to magnetic media. Optical media, such as the materials being discussed in video and optical disk, seem to have applicability here.

FILLING WORKERS' NEEDS

In addition to the functions mentioned here, management work stations could include other functions, with the capabilities offered tied to the needs of the individual worker. For instance, some workers would want graphics capabilities.

Others would want personal (or local) computing, with programmability via a flexible, higher level language. Others will want special software that will permit specialized functions such as money market analysis or sales reporting, and so forth. It is likely that hardware and/or software vendors will offer special multifunction packages designed for specific vertical markets with well-defined special needs. These packages are likely to include both general-purpose functions (like electronic mail and electronic filing) plus special functions. For instance, a system for law firms might offer tax law information (customized by state), client billing, interface to the electronic legal data bases, and special tickler files for filings. Other systems might include general ledger packages, personnel subsystems, and the ability to build custom data bases.

Before we get managers to use multifunction work stations designed and marketed for their special requirements, there are some issues to be addressed:

- Should such systems be centralized in nature (dumb terminals connected to the mainframe computer), or should they consist of their own microprocessor, multistation system nodes, with each node connected to the mainframe for such functions as access to high capacity storage?
- Will data bases have to be redesigned to permit the efficient storage of text? And can we build more human engineered interfaces in front of data base management systems, so that office users will be able to use them meaningfully?
- Does the firm require a large critical mass to start an office automation project such as electronic mail? Or can small projects (with minimum investments), properly chosen, give useful information and positive feedback?
- What does a management work station look like? Answers here vary from a traditional display work station to specialized display work stations where all functions are accessed via labeled keys to such special arrangements as a large display on the wall plus a keyboard that can be moved around the room (e.g., from desktop to sofa table). It is clear that the electronic office environment will have to replicate a number of managerial processes if it is to gain wide acceptance. This will probably require large displays (so that they can be broken up into multiple simultaneous functions, much as today's managers work with multiple piles of paper).

It may also require exotic interfaces, designed for nonkeyboarding managers. Areas that seem fruitful include voice, touch screens, and light pens—with voice likely to be the most important. Already, it is possible to use relatively primitive single-word voice recognition systems to provide an interface to

office automation systems, permitting the user to get things out, but not to put things in (unless he cares to spell!) More sophisticated multiword, large vocabulary voice recognition systems are likely to become available (at commercial prices) in the mid- to late '80s.

There are already some management-directed office automation products in the commercial market. They include Data-point's offering, which provides such functions as electronic mail, data processing, data entry, word processing, and information retrieval (but most of these functions at lower levels than will be required for meaningful, widespread use of such systems), and the new Axxa offering, born of the Citibank management work station project.

Most users of managerial office automation today are pioneers. Convinced that even small productivity gains among classes of employees that are valuable, scarce, and highly paid will translate into large dollar savings on the bottom line, a number of firms—particularly those in the paper-heavy industries like insurance and banking—have begun to explore office automation for managers and professionals. Most firms are starting small, with pilot projects designed for specific, high-leverage groups. A few firms are planning to study their entire corporation looking at all the possibilities before making long range, big dollar commitments, and picking individual projects.

This is an area that has the potential to be even more important than word processing in changing the way that people work in offices—and allowing them to perform their business functions more effectively. Also, by doing the repetitive and mechanical parts of employees' jobs, the employee is left with the most meaningful, most interesting part of the job.

Of course, not every employee wants to be challenged, and there is sure to be resistance to any kind of change, much less changes with such broad implications. Because when the automated office really comes (and it is sure to do just that) it has the potential to change our entire way of doing business.

People will be able to choose to work at home or in remote locations with all the support normally afforded to them only in their offices. And professionals and managers, freed of semimemorial tasks, will be free to set their minds roving in search of ever more creative (and profitable) ways to further the business goals of their firms. *

Amy D. Wohl, a contributing editor of DATAMATION, is president of Advanced Office Concepts Corp., Bala Cynwyd, Pa., and the publisher of a monthly newsletter on word processing.

**"Our 33502, with 635 megabyte capacity,
is the better business decision."**

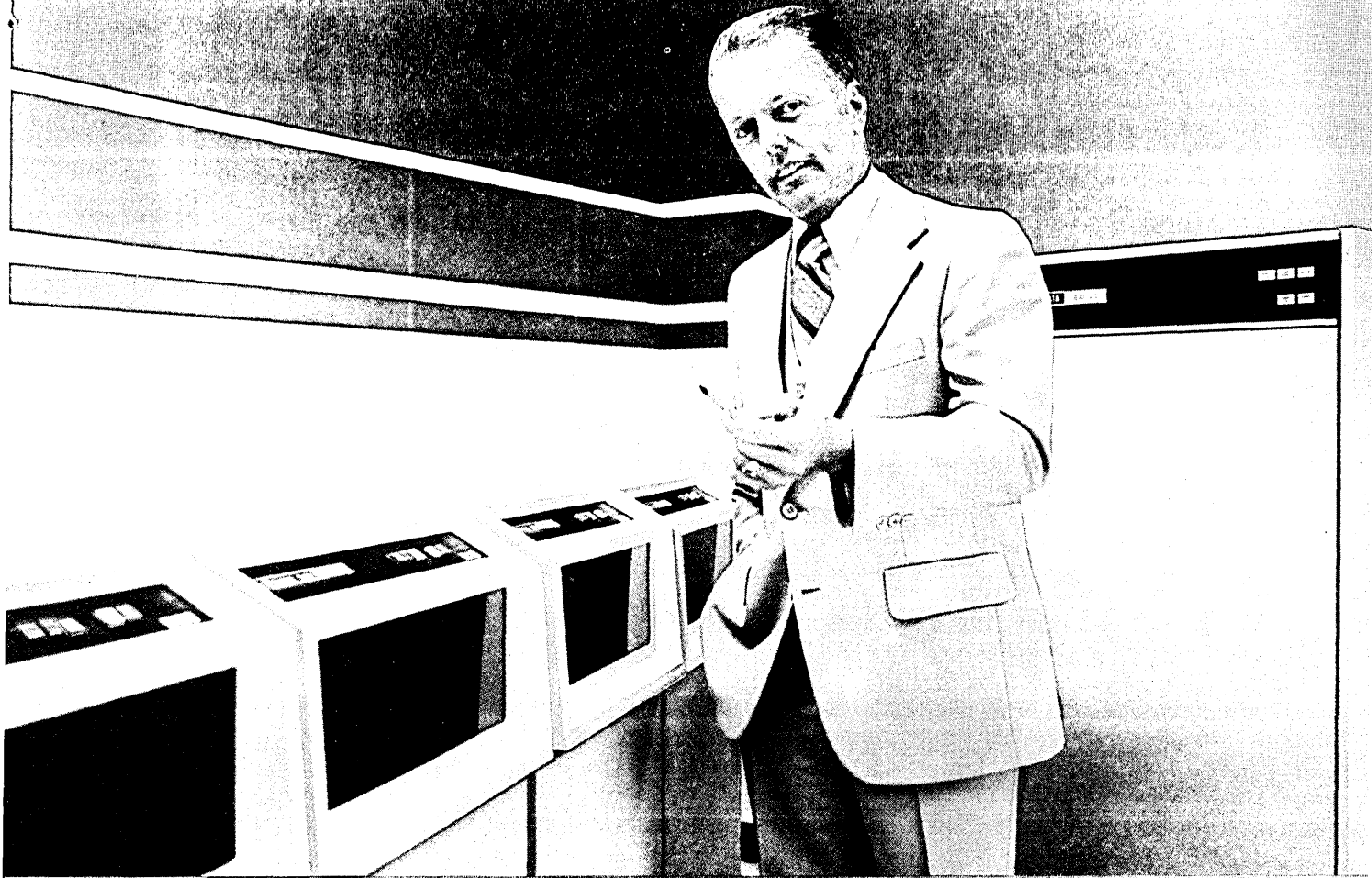

Jim Cron, General Sales Manager, Peripheral Systems/Marketing

"Our 33502 has twice the capacity of an IBM 3350. So you can save dollars and floor space. And the improved technology behind our new 33502 data module offers other advantages.

"Better performance, for example. Track-to-track access time is faster than the 3330/3350 technology can offer. Average access time is faster too—19 milliseconds per 317.5 Mbyte logical volume. And you get more optional fixed head storage—1.72 Mbytes instead of only 1.14 Mbytes.

"Another technological innovation is our dynamic dual access. It gives you up to 25% greater throughput over a comparable switch configuration. And if you have a multiple CPU installation, we can offer you both string switch and dual access to provide four data paths to each spindle.

"And when you choose Control Data's 33502, you needn't worry about conversion or com-

patibility problems. It is totally compatible with all IBM 3330/3350 disks and controllers. Our Storage Controller lets you intermix 100MB, 200MB, 317.5MB, 400MB, 635MB— even Mass Storage all on the same unit.

"Besides technical considerations, there are many other reasons that make the 33502 a better business decision. Control Data's reputation is for reliability, service support and broad product experience. And there are more reasons. For the full story contact your local representative, or call 612/553-4153."

**CD CONTROL DATA
CORPORATION**

Addressing society's major needs

CIRCLE 126 ON READER CARD

DISTRIBUTED POWER.

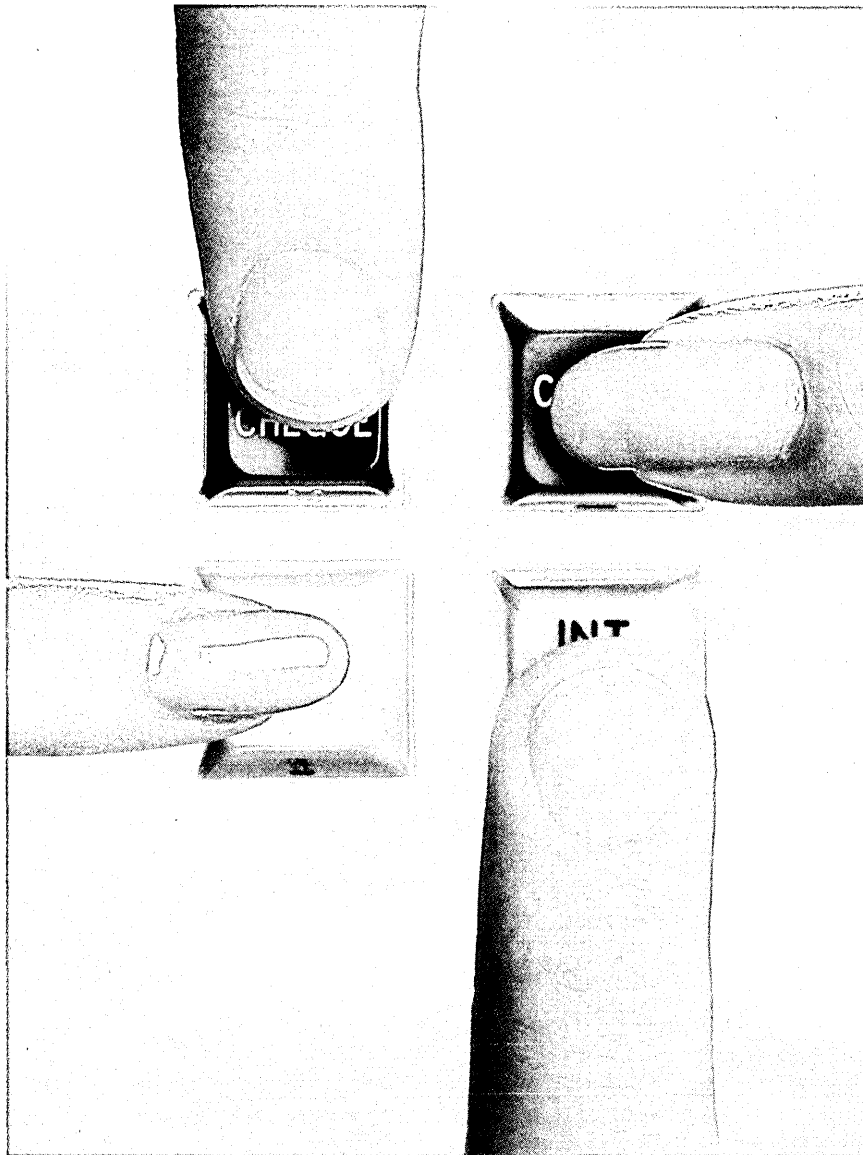

Honeywell's new DPS 8/20 puts more remote processing power at users' fingertips.

The whole point of a distributed processing system is to have the right data in the right place at the right time. Right?

Well, that's what the Honeywell DPS 8/20 is all about. The smallest of the DPS 8 family of large-scale distributed processing systems, it's a cost-effective way to bring big processing power to more and more locations. It's another option between the large central computer and the minicomputer in a network. And it's another plus for Honeywell.

With its powerful GCOS operating system, it's a free-standing processor that can be used as a remote host to a series of Level 6 systems. You can use it to provide peak-load back up to a larger DPS 8 or Level 66 mainframe computer. Or use it to develop programs for the host computer and satellites.

It's compact, energy efficient, versatile, compatible, and available now.

You'll give it extra points for software flexibility. You can take advantage of the new GCOS 8 operating system, Data Management-IV (DM-IV) Transaction Processor, COBOL-74, and Integrated Data Store/II (I-D-S/II) Data Manager.

That's the DPS 8/20. It's small enough for specialized tasks, powerful enough for large-scale jobs, and a natural for distributed networks.

Your Honeywell representative can give you all the details. Or write: Honeywell, 200 Smith Street (MS 487), Waltham, Massachusetts 02154.

Honeywell

FORECAST

WIND

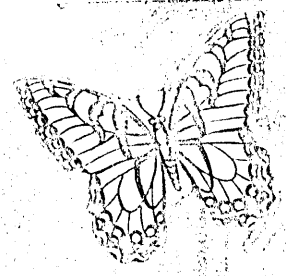

TEMPERATURE



STORMS



RAIN

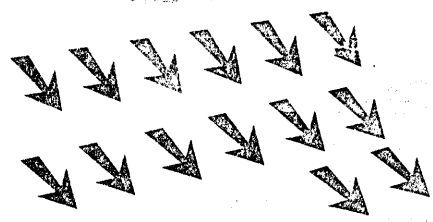

Lewis Fry Richardson dreamed of saving man from the destruction caused by tornadoes and hurricanes.

THE FIRST MAN TO COMPUTE THE WEATHER

by Molly Gleiser

Once a man had a dream: perhaps it would be possible to make a numerical prediction of the weather from atmospheric models. Such a prediction would save man from the destruction wreaked by tornadoes and hurricanes, and might even avert famine through forecasts of droughts and wet spells. When his numerical weather model failed to work, he turned to a greater dream: a mathematical theory of war. That man was Lewis Fry Richardson.

Richardson was born in 1881, the youngest of seven children of a Quaker family in Newcastle-on-Tyne, England, well known for owning a profitable leather works for about 300 years. At age 13 Lewis was sent to a Quaker boarding school, Bootham, in York. This school did not allow use of the cane, and functioned rather like an extended family. To encourage autonomy and breadth, it awarded all prizes for work done outside the classroom, and placed great emphasis on extracurricular activities such as archeology, debate, drama, music, and natural history. Here, Richardson first discovered meteorology, and became convinced through one of the masters, A. Neave Brayshaw, that "science ought to be subordinate to morals."

As a family, the Richardsons were talented both scientifically and artistically. Lewis later drew comical little sketches of colleagues, and one of his nephews became the world-renowned actor, Sir Ralph Richardson. A brother, Lawrence, discovered a new star, and another brother, Gilbert, who could read Sanskrit and Greek fluently, started a new international language, Edo. The family, though, considered it a sacred duty for all the children to enter the leather works. Luckily for Richardson, with four older brothers already in the tannery there was no place for him, and he was left free to pursue his scientific interests.

He studied under the famous physicist J. J. Thomson at Cambridge, where he took the natural science tripos, a smorgasbord of several sciences. For nearly a decade he held a couple of minor teaching posts and short-term scientific jobs: one at the National Physical Laboratory's meteorology department, three years at a tungsten lamp factory

(the Sunbeam Lamp Company in Gateshead), and another at the National Peat Industries. There he became interested in the flow of water through peat, a problem that involved the solution of differential equations not formally soluble. The work terminated abruptly when the managing director absconded with a large sum of money. Richardson, however, without formal mathematical training, had already discovered how to solve the differential equations by an approximate method of finite differences. When in 1913 he landed the job of director of Eskdalemuir Observatory high up in a remote part of Dumfriesshire, Scotland, he decided to apply these methods to a numerical calculation of the weather. At that time, weather could only be roughly forecast from an extrapolation of human observation.

Richardson's idea was not new. In 1904, a Norwegian physicist, Vilhelm Bjerknes, had already suggested that accurate forecasting was a problem in mechanics and physics that could be solved by mathematical analysis. Essentially, the problem was to predict temperatures, rainfall, and so on from the change in atmospheric flow, but the differential equations involved presented difficulties. Richardson had the answer to these equations, and by the time he reached Eskdalemuir he had conceived a detailed plan.

His idea was to divide the atmosphere into layers and the layers into squares, and to tabulate values of the pressures, temperatures, and humidity of various upper air data at given longitudes, latitudes, and heights on "computing forms," the equivalent of today's computer program, to describe the state of the atmosphere. Then, by using classical laws of physics such as the conservation of energy, and by solving the resultant equations, he could obtain subsequent states of the weather after a series of short time intervals. He had even visualized the offices in which these calculations were to take place.

WEATHER COMPUTER THEATER

The ceiling represents the north polar regions, England is in the gallery, the tropics in

"Imagine a large hall like a theater . . . The walls of this chamber are painted to form a map of the globe.

ILLUSTRATION BY JANE STERRETT



“The man in charge is like the conductor of an orchestra in which the instruments are slide rules and calculating machines.”

the upper circle . . . A myriad of computers are at work upon the weather of the part of the map where each sits . . . Numerous ‘night signs’ display the instantaneous values so that neighboring computers can read them. Each number is thus displayed in three adjacent zones so as to maintain communication to the North and South on the map. From the floor of the pit a tall pillar rises . . . In it sits a man in charge of the whole theater . . . One of his duties is to maintain a uniform speed of progress in all parts of the globe. In this respect he is like the conductor of an orchestra in which the instruments are slide rules and calculating machines. But instead of waving a baton he turns a beam of rosy light upon those who are behind hand.”

He concluded rather whimsically: “Outside are playing fields, houses, mountains, and lakes, for it was thought that those who compute the weather should breathe it freely!”

A happy fantasy. But in 1914, war broke out, and as a Quaker and conscientious objector his mind was not at rest.

“I was torn,” he wrote, “between intense curiosity to see war at close quarters, and intense objection to killing people, both mixed with ideas of public duty, and doubt as to whether I could endure danger.”

Finally in August 1916, with British casualties mounting—in the battle of the Somme alone they were to reach half a million men—he extricated himself from Eskdalemuir, where the authorities were reluctant to release him, and volunteered for the Friends’ Ambulance Unit.

By September, Richardson found himself in France, confronting a battlefield strewn with helmets, badges, ripped uniforms, and human rubble. Men were scraped from tanks, bones protruded through skin, and limbless soldiers screamed with pain as they were eased ever so gently onto stretchers into the motorized ambulance convoy and conveyed to makeshift hospitals in the rear.

To keep his sanity, Richardson carried his weather manuscript with him, continuing to revise it between intervals of transporting the wounded.

“My office,” he wrote, “was a heap of hay in a cold rest billet.”

The calculations involved complex thermodynamic and hydrologic considerations and were massively detailed descriptions of the atmosphere in terms of the role of radiation, eddy diffusion, and other factors. He faced enormous difficulties. High altitude winds were explored; observatories were not arranged in the chessboard fashion required in his model; and worst of all, fast computers had not yet been invented. He was not discouraged.

“Perhaps someday in the dim future,” he wrote, “it will be possible to

advance the computations faster than the weather advances and at a cost less than the saving to mankind due to the information gained. But that is a dream.”

In fact, the drawbacks had the paradoxical effect of encouraging him. In Chapter 9 of his manuscript, he forecast a change of pressure at the ground of 145 millibar in six hours at a point in central Europe. The actual change was more than 100 times smaller. But Richardson was confident the error arose not from a flaw in his model but from the inadequacies of upper wind data.

Twice the manuscript got lost, once during the battle of Champagne in April 1917, only to be recovered months later under a pile of coal. But still Richardson pressed on, escaping at least for a time the realities of war.

Richardson had married Dorothy Garnet in 1909; she was a sister of a fellow science student at Cambridge. They were Rh-incompatible and, after several miscarriages and deaths, they decided to adopt children, first Olaf, age two, then Stephen, one, and finally Elaine. After the war, sharp noises from the children startled him, and at night he sleepwalked screaming through the hall while his wife explained that father had been shell-shocked during the war.

Instead of returning to Eskdalemuir, he took a job at Benson Observatory in Oxfordshire. His work there provided much needed relief from war trauma. He was developing an accurate method to measure upper wind data by shooting steel balls ranging in size from a pea to a cherry hundreds of feet above ground and noting the return of these missiles to earth to measure wind shift.

Then, like a bombshell, the Meteorological Office was transferred to the Air Ministry. Its work conflicted with Richardson’s Quaker values: private and public duty and the condemnation of war. His work was in no way warlike, but his wife described the inevitable outcome:

“There came a time of heartbreak when those most interested in his ‘upper air’ researches proved to be the ‘poison gas’ experts. Lewis stopped his meteorological researches, destroying such as had not been published. What this cost him, none will ever know.”

FIRST WEATHER TEXTBOOK

Richardson left Benson Observatory in 1920 and took a job as head of the physics department at Westminster Training College in London and in 1922 his book on *Weather Prediction* appeared. With slide rule and mechanical calculator, the only tools then available, it would have taken 64,000 computers to “race the weather round the globe,” but this was the first textbook of dynamic meteorology to ap-

pear. London University honored him with a DSc, and he was made a Fellow of the Royal Society.

But Richardson had a secret passion: to apply science to human situations. He had, as early as 1906, sold his physics books in order to raise money to visit Professor Karl Pearson in London and learn about statistical proof. And he had already, while with the ambulance convoy in World War I, written a paper entitled *The Mathematical Psychology of War*. So far ahead of its day was it that no suitable outlet for publication existed, so he had 300 copies printed himself and gave most of them away.

“It was little noticed,” he commented. “Some of my friends thought it funny.”

After publication of his weather book, he began an intensive study of psychology, and finally, at 47, he took a BSc in that field at London University. That same year he became principal of Paisley Technical College and School of Arts in Scotland, and began to devote all his spare time to developing a theory of the causes of war.

One of the first problems was to choose an index of the magnitude of war. He chose as that index the number of war dead, and combed through some 70 history books to categorize the numbers of wars according to their magnitude. He continued to update his figures through World War II including the millions of murders taken from the statistics of 17 countries.

As another part of the work, he focused his attention on the etiology of war and examined the effect of eight “pacifiers” such as sports, collective security, intermarriage, and armed strength. Then, just as he had made a mathematical model of the weather, he formulated the dynamics of war in equations like one connecting the rate of arms buildup with the perceived menace minus the restraining pacifiers.

This work must have been given great impetus by the rise of the Nazis to power. His children, with whom he played tennis and cricket and joined on camping trips, were now growing up. Olaf later became a motor engineer. Stephen, who attended Harvard, became a professor in the department of Pediatrics and Community Medicine at Albert Einstein College of Medicine in New York. Elaine studied drama before marrying M. F. Traylen, a meteorological officer. Richardson’s house filled with an ominous stream of refugees who became part of the family until they could be independent.

Richardson focused more and more on the problems of the arms race. But though some of his work was published in reputable journals like *Nature*, Fellows of the Royal Society would still smile when his name was mentioned: oh, yes, a sweet man and not impractical, but a bit visionary, you know. His



OUR AUTOMATIC SAVINGS PLAN.

Plugging in our line of interface-compatible terminals can automatically reduce your terminal budget — by as much as 50%. And nowadays, that's like money in the bank.

General Terminal Corporation offers models that are teletype-compatible as well as terminals that are interface-compatible with DEC, Burroughs and NCR computers. And GTC offers models that emulate other major terminals, too. All for less.

And because GTC is the only major terminal manufacturer with production facilities on both U.S. coasts, we can

deliver what you want, where you want, when you want.

More for less, automatically. That's what happens when you push the right button.

For more information on GTC products and services, call toll-free today. In California: 800-432-7006. Anywhere else in the United States: 800-854-6781. Ask for Georgia Sand. Or write Georgia Sand at General Terminal Corporation, 14831 Franklin Avenue, Tustin, CA 92680. Telex: 910-595-2428. We have offices throughout the world. In Canada, contact Lanpar Ltd., 85 Torbay Road, Markham, Ontario L3R. Phone: 416-495-9123.

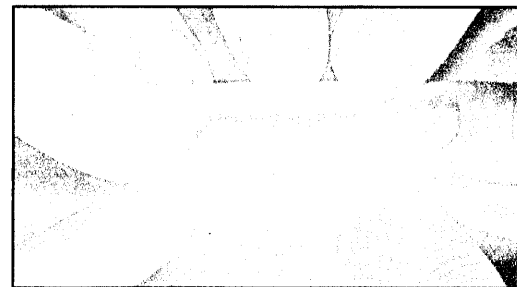

The right button to push.™
General Terminal Corporation

CIRCLE 128 ON READER CARD

“There came a time of heartbreak when those most interested in his ‘upper air’ researches proved to be the ‘poison gas’ experts.”

Generalized Foreign Politics, published in 1939, still only groped for results. But the extent to which his work combined the philosophical, technical, and psychological-ethical aspects of such large scale events made it extraordinary.

Richardson’s stand as a conscientious objector in World War I had barred him in the eyes of the establishment from university teaching. But by 1940, when a university finally did offer him the professorship for

which he had longed, he turned it down to devote himself to his war studies, retiring to Kilmun, a tiny fishing village on Holy Loch, a three-mile long inlet of the Firth of Clyde. It overlooked a submarine base, a dreadful reminder of the importance of his war studies.

There the ruddy white-haired English gentleman was known to walk to the end of the pier and drop parsnips off the end to measure wind turbulence. But only rarely, for relaxation, did he indulge his passion for

meteorology. Mainly he focused on his study of what, erasing the difference between riots, rebellions and wars, he called “deadly quarrels.” Early retirement coupled with wartime inflation had left him quite impoverished. But that didn’t matter. For him “the value of life consisted in the amount of self-denial you paid for it.”

The end of hostilities in 1945 coupled with the dropping of the atom bombs and the 1948 arms race can only have served to intensify his efforts. He could now include data from 1936-39 as well as from that present period in his work on arms buildup. It looked as if international trade might be a factor in preventing war, and arms buildup one of the leading causes. But even as he worked the position changed. In 1952 the hydrogen bomb appeared. It was cheaper than its equivalent of conventional explosives, and it altered the factor of intimidation that entered into his calculations. Richardson did not even dare predict what might happen.

In 1946 John von Neumann, the famous mathematician at Princeton, formed a group for the purpose of using the modern computer for forecasting the weather. Jule G. Charney, who joined him in 1948, devised some simplified models of the atmosphere, closer actually to Bjerknes’ model than to Richardson’s, and in 1950 the group used a modern electronic computer, the ENIAC at Aberdeen Proving Ground, to obtain the first computerized weather forecast. A few years later the U.S. National Meteorological Center for increased accuracy adopted a mathematical model fundamentally no different from Richardson’s.

In 1953, three years after the Charney breakthrough, Richardson, age 72, died in his sleep of a heart attack. He has labored alone for 30 years on his mathematical model of war. None of his publications on the topic, even his last book, *Arms and Insecurity*, reach firm conclusions. But he had seen one of his dreams come true. *

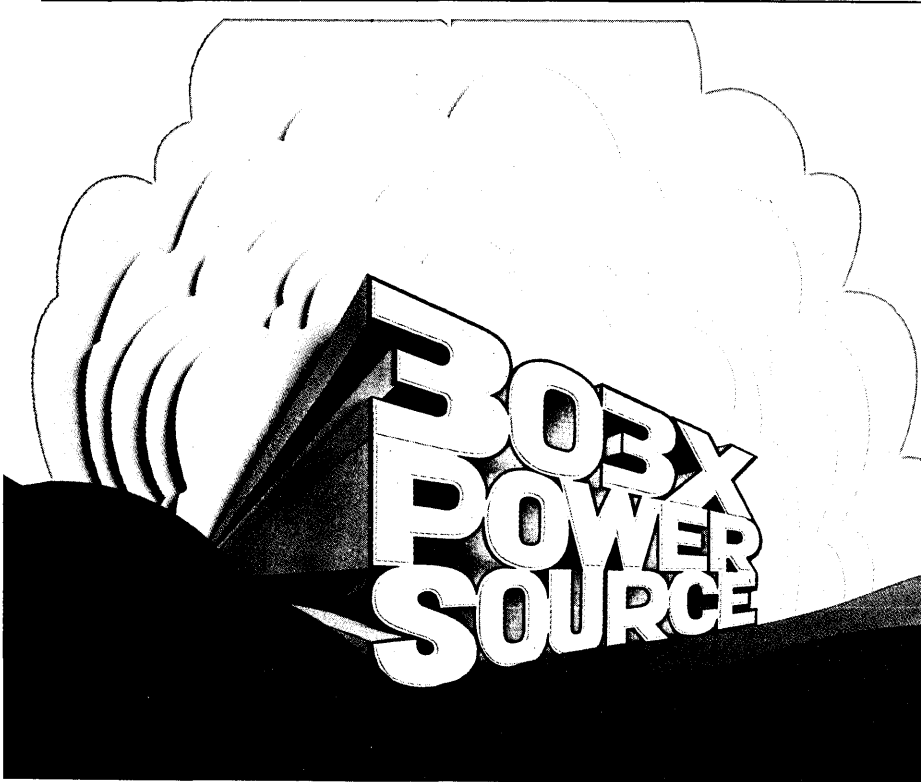

For the new generation of computers—IBM 303X series and 370/168; Amdahl 470V/5, 6, 7, 8; Control Data; and, Univac—a reliable, separate 415 Hz power source is required. More and more users of these newer, large-scale computers are selecting solid-state uninterruptible power supply systems from Emerson. Emerson UPS systems are more reliable, less costly to operate, and more efficient than other types of power sources.

Added Power Protection

You get an added benefit when you select Emerson UPS. In the event of a power failure or power outage, Emerson gives you reserve backup power or, if necessary, provides a means for an orderly shutdown of your computer operations.

Free 303X Power Source Guide

For more information on the power behind every great computer, ask for our free 303X Power Source guide. Call or write Emerson today at:

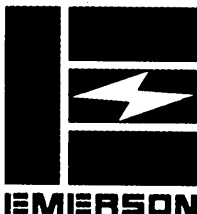

Industrial Controls Division
3300 S. Standard Street, Santa Ana, CA 92702
714/545-5581, Telex 67-8460

Electric Industrial Controls, Ltd.
Elgin Drive, Swindon, SN2 6DX
Wilts, England
793-24121, Telex 449101

Sales Offices:
Charlotte, NC (704) 568-5525;
Dallas, TX (214) 783-1831;
Palisades Park, NJ (201) 224-6306;
Raleigh, NC (919) 872-6525;
Richmond, VA (804) 264-2528;
St. Louis, MO (314) 291-4535;
Canada: Toronto, Ontario (416) 278-5501;

MOLLY GLEISER



Dr. Gleiser was born in England and came to the U.S. as part of the fabled brain drain in 1952, to work at places such as Ohio State Univ. and MIT. Later she

worked on solar energy at the National Physical Laboratory of Israel. After doing more on thermodynamics at the Lawrence Berkeley Laboratory until 1970, she turned to freelance writing and editing.

CIRCLE 129 ON READER CARD

Moore decollators, detachers, and imprinters speed information flow while slashing your forms handling costs.

If the forms coming off your computer printer are handled manually or with outmoded equipment, you only have half a system. And you're paying for the excessive time and costs.

Moore forms handling equipment solves your problems. Carbons are removed and forms separated as they come off the computer. Individual sheets are detached and stacked ready to distribute. Documents are signed or imprinted automatically when necessary.

Choose from the full line of Moore forms handling equipment. You save money because you buy only the

capacity you need, from single function portable models to large automated multi-function models. Most units pay for themselves in less than a year by saving tedious work. Moore equipment is simple and easy to use. Anyone can take over when the regular operator is out of the office. All units are rugged, dependable. Moore's preventive maintenance program and nationwide emergency service make sure your forms keep moving. Start saving time and money by automating forms handling now. Most units can be delivered, ready to operate, in less than 30 days. Call or write for our color brochures.

Unless your forms handling is as fast as your computer, you're wasting time and money.

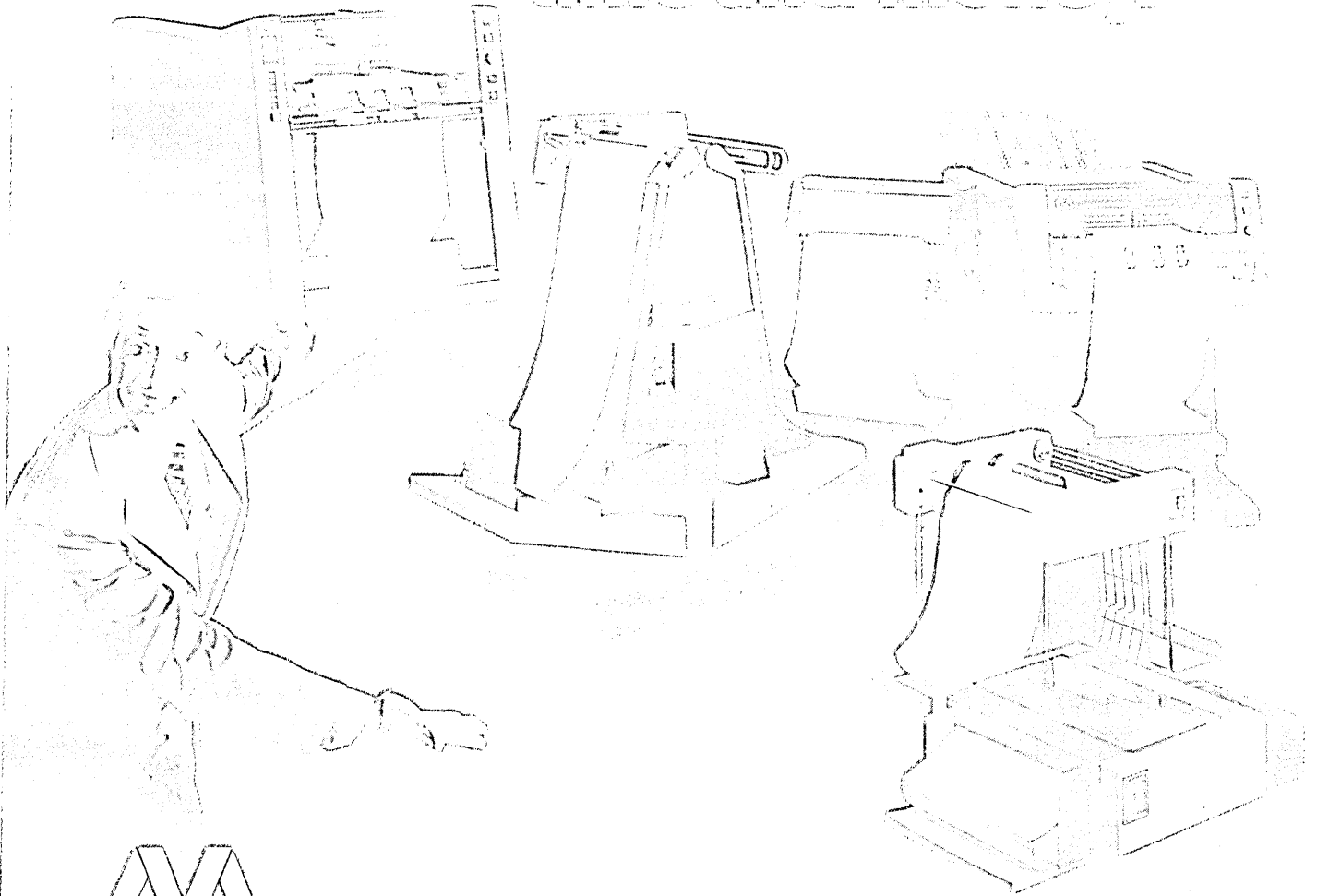

MOORE BUSINESS FORMS, INC.

©1988 MOORE BUSINESS FORMS, INC.

10000 W. 111th Street, Overland Park, MO 66204
816-491-2222



This computer expert saved his management Big Bucks.

He did it by specifying Computer Communications' CC-8 Enhanced Emulation Processor. A most versatile high performance communications processing system which operates as a front-end to one or more IBM mainframe computers.

In addition to cutting data communications costs up to 30%, he upgraded performance way beyond the conventional IBM 270X or 370X configuration. His CC-8 system delivered

concurrent multiple host support that allows for a company's growth, along with automatic baud rate detection, diagnostics, code conversion, polling, terminal emulation, and terminal-initiated host application selection.

He also got a new level of personal system control. The CC-8 intelligent front-end is equipped with a unique color CRT console that functions selectively in system supervisor or system monitor mode. In the former, he can

dynamically reconfigure his system through real-time assignment of lines, terminals and other components. In the latter, he gets instant system status reports. The result, of course, is a lot more up time and throughput with a lot less waiting for users.

So don't wait to tell your management about the big bucks they can save with CCI. For full information or to arrange an executive seminar, contact us now.

 **Computer Communications, Inc.**
2610 Columbia Street; Torrance, California 90503; Telephone: (213) 320-9101

CIRCLE 131 ON READER CARD

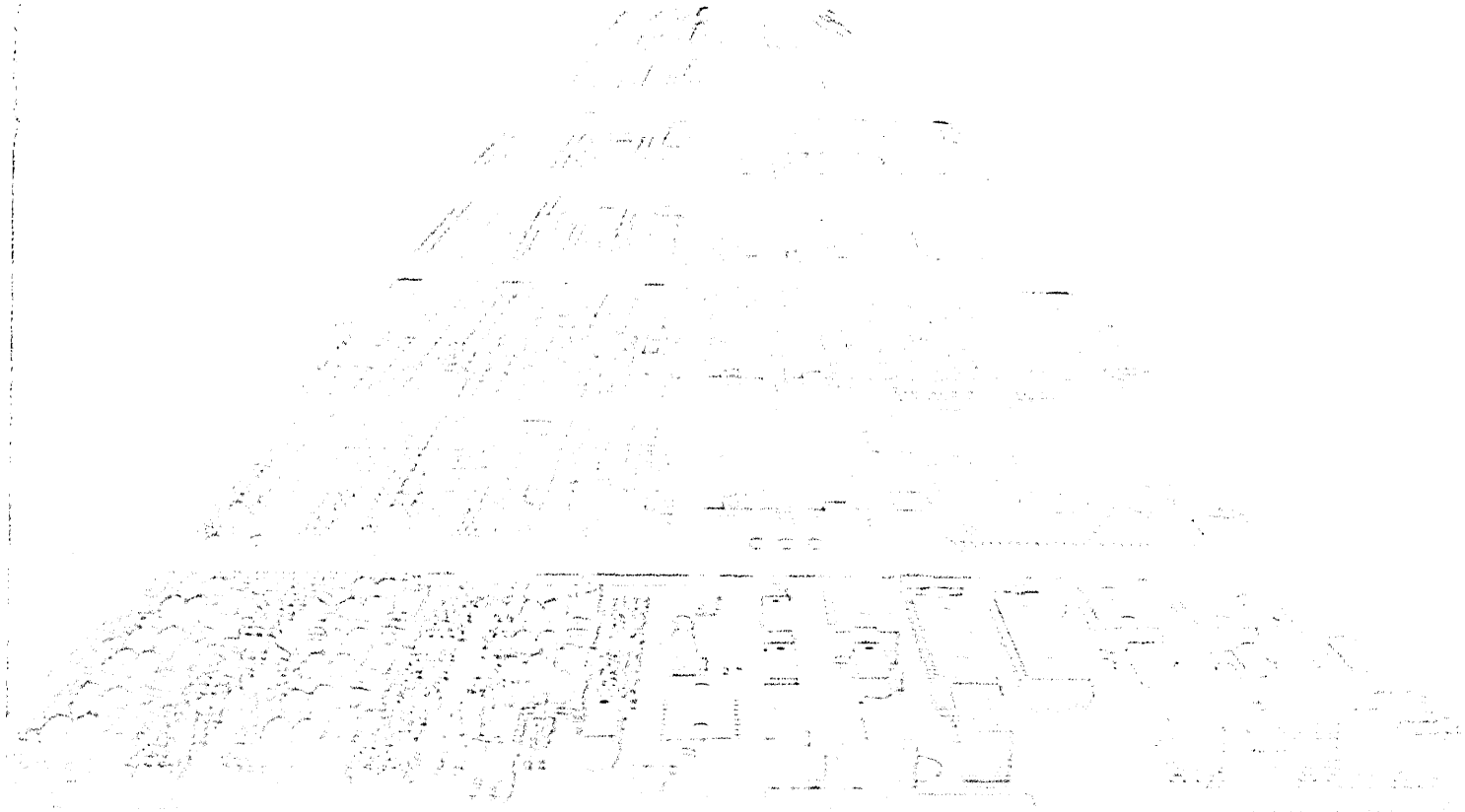

Voice Recognition Modules

DOV

INTERSTATE
ELECTRONICS
CORPORATION
SUBSIDIARY OF 

The 50% to 100% error traditionally associated with software development cost estimates is unacceptable in today's contract environment.

REAL-TIME ESTIMATING

by Edward L. Griffin

A real-time software development cost estimate is one that is generated with minimal information in quick response to a rough order of magnitude pricing request or to a quick turnaround proposal. The quality of the estimate is impacted by the response time duration; the level of detail in the backup varies widely. These durations may be categorized into one to two hours, one to two days, or one to two weeks, any of which is possible in today's competitive aerospace or commercial world.

Despite the temptation to label this estimate a scientific wildly assumed guesstimate (SWAG), it must contain sufficient information to withstand the scrutiny of upper management and customers.

The more familiar and rigorous estimating techniques (Wolverton,¹ Metzger,² RADC 74-300 Vol XI,³ Myers,⁴ and Putnam⁵) are only partially applicable because of the real-time constraint. The basic steps of performance requirement definition, requirement allocation to functions, size and time estimation, difficulty factor evaluation, and conversion of these steps to manpower, materiel, and other direct charge cost numbers must still be accomplished. The error traditionally associated with these estimates, 50%-100% or more, is unacceptable in today's fixed-price or cost-plus-fixed-fee contract environment.

The cost factors that impact the development estimate include (1) level of detail of system requirement definition, (2) level of required documentation, (3) systems engineering support availability, (4) training requirements, (5) developmental facility accessibility, (6) rigor of software test, and (7) interoperability of software and systems tests.

Factors not directly involved in development but in ongoing and subsequent support are complexity of hardware/software integration, level of systems test support, and level of software postdelivery support. These cost factors impact all developmental phases. Detailed knowledge of the expected impact of an item in a phase will lead to more realistic and competitive estimates.

The major developmental impact factors are tabulated with respect to the program phase they influence. The level of system definition influences the design phase first. The span of detail inherent in this definition and the availability and experience of systems engineering requirements and integration, systems design, and system tests personnel makes this the major impact to development planning and estimation. Small items that are overlooked in estimation of system performance inevitably grow to large costs during implementation. If the system requirements are not fully defined, a major risk compensation factor must be applied to both developmental planning and cost estimation.

The level of required documentation influences all phases of developmental and cost estimation planning. This documentation includes the software performance requirements, as-built software description (product specification or unit folders), developmental (unit and integration) test scripts, and qualification test plans and procedures. Levels of documentation range from handwritten data in programmer notebooks with commented listings to full military standard specifications containing detailed equations and implementations at the performance level. The detail in performance specifications influences the test program directly, since that documentation must satisfy verification and qualification of all performance requirements.

Besides being a factor in system definition, the requirements and integration, systems design, and systems test support functions can supply help in interface definition, algorithm development, and test definition that would otherwise be required of software development personnel.

Programming staff training requirements primarily affect the coding and integration test portions of the program development effort. This training may range from assembly language, through macro or operating

system programming, to higher-order language programming. The impact is felt in the cost of the classes (generally lasting one week), travel, and per diem while in attendance, and in schedule, as work power is lost during the training period.

The results of this training are more efficient programs and more efficient programming, followed by actual schedule compression and cost decrease owing to the increased productivity.

The developmental facility affects the code and integration test portions of the programming effort also. The ideal facility offers unlimited access with instant turnaround to every programmer. The more realistic approach offers each programmer access of at least three hours a day, and each test team four hours a day. The facility must also support library and configuration control functions. The least desirable is a batch facility which typically offers two runs a day on a 12- to 24-hour turnaround.

Software testing may be categorized into three levels: integration/operation tests, qualification tests, and certification tests. The first level is an extension of multimodule integration testing to total program tests, accomplished by supervisor approved test scripts. The second level is accomplished by or under leadership of an independent test group to verify that all performance requirements are met. This verification includes detailed examination of the as-built code to find acceptable responses to simulation and documentation of the test set that will show the performance requirement has been met. The certification test involves exercise of the program under dynamic conditions, actual or simulated, to verify that performance is acceptable to both software and system requirements. The latter two test categories require increasingly sophisticated levels of documentation to support the tests.

The final major program impact is evaluation of the system test plan and coordination of the software test effort with that plan. This can affect the formal software test phase by allowing software operability tests to be performed at the software test level, then qualification and certification testing to be performed at the system test level in a comprehensive and cooperative software systems effort with the other systems tests (i.e., acceptance) on system hardware. The software-

1. Ray W. Wolverton, "The Cost of Developing Large-Scale Software," TRW-SS-7201, March 1972.

2. Philip W. Metzger, "Managing a Programming Project," Prentice-Hall, Inc., Englewood Cliffs, N.J., 1973.

3. Ronald L. Smith, "Estimating Software Project Resource Requirements," Structural Programming Series (Volume XI), U.S. Department of Commerce, National Technical Information Service AD-AO16 416, 1975.

4. Ware Myers, "A Statistical Approach to Scheduling Software Development," *Computer*, December 1978, pp. 23-25.

5. Lawrence Putnam and Ann Fitzsimmons, "Estimating Software Costs," *DATAMATION*, September 1979, pp. 189-198; October 1979, pp. 171-178; November 1979, pp. 137-140.

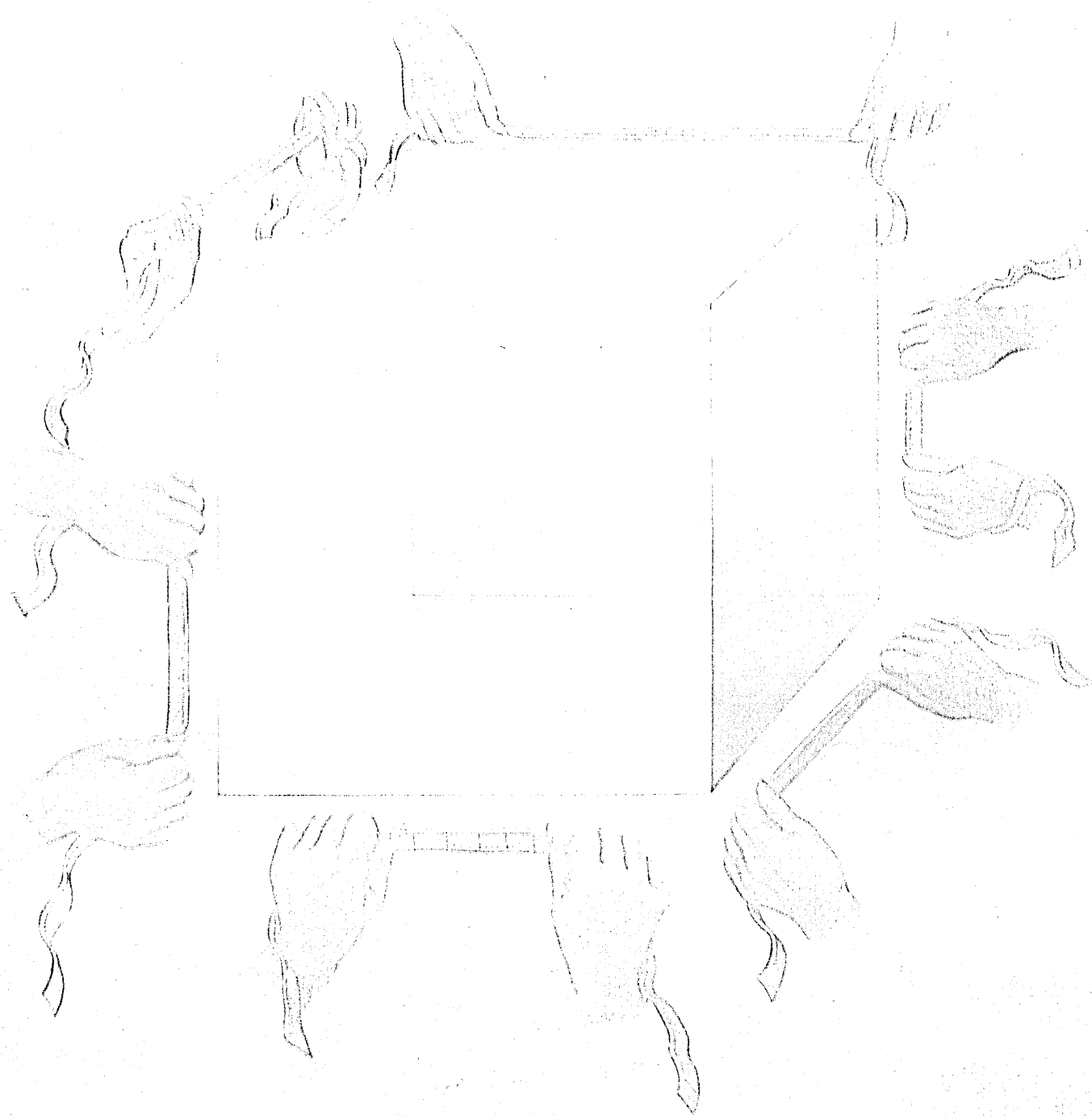

oriented documentation would still be necessary, but the task of procedure/code debug and trouble determination could be spread among a base of both software and test personnel that overall could reduce schedule time and test complexity.

DEVELOP THE ESTIMATE

The three major jobs involved in developing the software cost estimate are defining the size of the software development task, defining the developmental program, and generating the costs on a negotiable, line item basis.

The definition of the size of the software development starts with allocation of software performance requirements from the system performance requirements. The system performance source can vary—a concept definition conversation, a feasibility study report, a technical requirement document, or a detailed system performance specification. This diversity of sources makes allocation of the applicable portions of the system requirement to the computer program hazardous. Ideally, a set of trade studies that evaluate alternative configurations of hardware, software, and manually oriented procedural functions will result in an efficient allocation of requirements to these three major subsystems. Trial approaches at implementation with tentative cost estimates will then be cross-examined to produce a cost-effective system. This process can be repeated several times. In the worst case, an engineering estimate based on an equivalent program may be all that can be accomplished. Regardless of the allowed estimation time response, the performance allocation must be defined and documented, even if only through reference to another program. The level of systems engineering support available is extremely critical in this phase.

The performance requirements allocated to the software must next be suballocated to computer program functions. This is generally documented in a design requirement sheet or a software performance requirement. This document defines the processing performed by each program function and the hardware and software interfaces (input and output) for that function. Sizing and timing estimates are generated from rough code or analytic equation operation counts, and the software test program is outlined to complete the definition. Under time-constrained criteria, an equivalent program may be all that is available to fulfill definition of software performance, sizing, and timing estimation. Experience has shown that a well-defined estimate will usually grow only by a factor of 1.5:1, while a poorly defined program can grow by a factor of 2.0 to 4.0:1. The validity of the sizing estimate and the potential growth factor must be documented for

FIG. 1

THE SOFTWARE DEVELOPMENT CYCLE

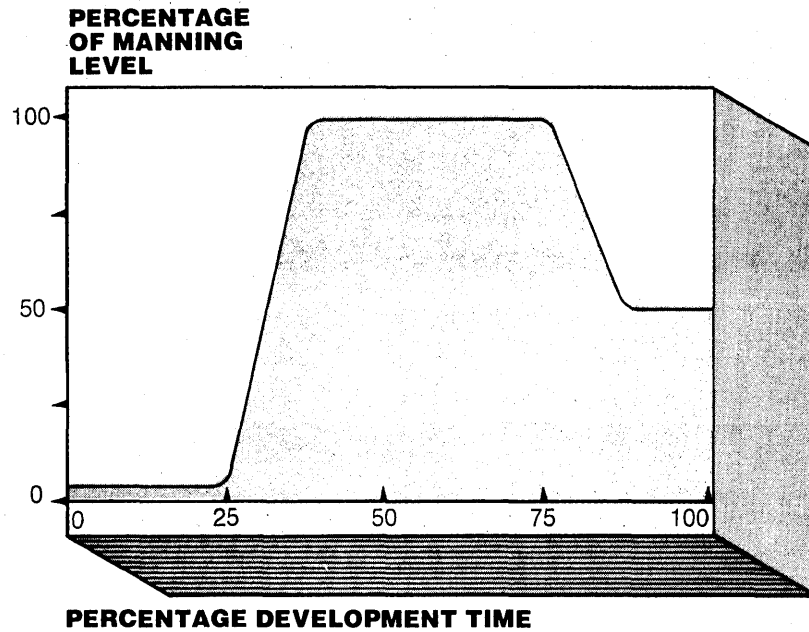

PROGRAM PHASE	PROGRAM PHASE TIME LENGTH	PERCENTAGE TOTAL EFFORT
DESIGN	_____	3.49
DETAILED DESIGN	_____	11.05
CODE AND UNIT TEST	_____	23.17
INTEGRATION TEST	_____	27.82
QUALIFICATION TEST	_____	34.47

PROGRAMMING LIFE CYCLE

The developmental programming cycle is illustrated in Fig. 1. It is not the Raleigh distributed total life cycle curve usually quoted, but more representative of actual program generation. Its phases include design, detailed design, code and unit test, unit and integration test, and qualification test. The design phase includes interpretation of the system performance requirements and allocation into software performance functions and subfunctions.

These functions are defined as processes, with input, output, size, and time descriptors, and the results documented in a performance specification. Detailed design is first completed in skeletal form for presentation in a preliminary design review. The final draft of the detailed requirements, including data base design, signal and control flow, and processing definition in flowcharts and text are documented in a product specification for presentation in a critical design review.

The implementation portion of the task begins with coding and unit testing. Coding forms are completed, desk checks are made, documentation is updated and walkthroughs are accomplished. Compilation runs are completed, test drivers and scripts are written, and module or unit tests are completed. After successful passage,

documentation is updated and configuration control invoked. The unit and integration test phase completes retest of the modules and begins integration and test of groups of modules. Test scripts and drivers are written for these groups to ensure proper flow of data and control between the modules.

The qualification test portion of the developmental cycle is accomplished to more formal test plans and procedures. A performance/conformance matrix is generated that must be satisfied by the as-built code. Detailed procedural steps based on the code are generated and debugged, and tests are run to these procedures to prove program performance. Tests may always go beyond a performance specification, but must, at a minimum, satisfy all of the performance requirements. Hardware/software integration with the target computer is accomplished, if possible, during integration and qualification testing.

Integration of the work-power curve over time gives the following nominal percentages of developmental effort per program phase:

Design	3.49%
Detailed Design	11.05%
Code and Unit Test	23.17%
Unit and Integration Test	27.82%
Qualification Test	34.47%

Right On Track.

IMMEDIATE
DELIVERY

IMC conducts business with TI's 745.

International Minerals & Chemical Corporation's Fertilizer Group uses TI's *Silent 700** Model 745 Portable Data Terminal to conduct their daily shipping and customer service coordination while reducing communications costs.

Railroad station agents rely on the 13-pound portable data terminal to gather shipping information from IMC's host computer. With a push of a button, the Model 745's speedy 30 characters-per-second thermal printer supplies agents with up-to-date printouts of railcar status and freight destinations. And the reliable 745 proves its versatility during the fall and spring when planting and harvesting require efficient, up-to-the-minute scheduling.

IMC's sales force finds the portable 745 to be the ideal traveling companion. Using the data terminal's built-in acoustic



coupler connected to a standard telephone, sales agents assemble data the night before a sales call. Or, in some cases, right in the customer's office. The responsive 745 provides IMC sales representatives with instant order status, customer credit history and accounts receivable information. And, with the 745's easy-to-use typewriter-like keyboard, they can access data seven days a week. By adding the virtually silent 745 to their sales force, IMC has cut down on communications costs by approximately 60 percent.

TI is dedicated to producing quality, innovative products like the Model 745 Portable Data Terminal. And TI's hundreds of thousands of data terminals shipped worldwide are backed by the technology and reliability

that comes from over 30 years of experience in the electronics industry.

Supporting TI's data terminals is the technical expertise of our worldwide organization of factory-trained sales and service representatives, and TI-CARE†, our nationwide automated service dispatching and field service management information system.

That's why TI was appointed the official computer and calculator company of the 1980 Olympic Winter Games.

If you would like more information on the Model 745 Portable Data Terminal, contact the TI sales office nearest you, or write Texas Instruments Incorporated, P.O. Box 1444, M/S 7784, Houston, Texas 77001, or phone (713) 937-2016.



Model 745

*Trademark of Texas Instruments †Service Mark of Texas Instruments Copyright © 1980, Texas Instruments Incorporated

TEXAS INSTRUMENTS

We put computing within everyone's reach.

CIRCLE 133 ON READER CARD

The level of required documentation influences all phases of developmental and cost estimation planning.

TABLE I

SOFTWARE ESTIMATION IMPACT FACTORS

	X Instruc. Y Data Base	×	1.5:1 Good 2.0:1 Eq. Program 4.0:1 Weak Defin.	×	0.2:1 Data Base 1.0:1 Average Code 1.5:1 Complex Code
Defined Software Functions and Size Estimate			Validity of Estimate Multiplier		Difficulty Factor Multiplier
	X Eq. Inst.	÷	÷ 168 LOC/MM Listings ÷ 100 LOC/MM Spec, Folders ÷ 75 LOC/MM Mil Eq. Doc. ÷ 50-25 LOC/MM Mil App. Doc.	=	Schedule and Manloading per Function
Equivalent LOC			Work-month Documentation Divisor		Equivalent Work-months
	1.0:1 Ded. Facil. 1.23:1 2 hr. Cent. Fac. 1.46:1 4 hr. Cent. Fac.	+	3 weeks/task leader 2 weeks/lead programmer 1 week/programmer	+	.0 Oper. Test .32 Qual. Test .64 Cert. Test
Developmental System Impact Multiplier			Training Impact Addition		Test Impact Multiplier
	.25 Simple Hardware .37 Complex Hardware .5 Hardware and Software	=	Equivalent Work-months		One man level of effort per 12K LOC
Hardware/Software Integration Multiplier			Estimate Result		Support After Delivery

subsequent risk evaluation.

The second step, developmental plan generation, combines the computer program definition, company developmental standards, and developmental resources and transforms them into a schedule, developmental facility definition, and organization. Each computer program function that was defined previously must have a difficulty factor assigned. This assignment will generate equivalent program instructions. A tested set of difficulty factor assignments are (1) data base equates to instructions by dividing the data words by 5, (2) average code (equation transformation or simple logic) is acceptable as given in the program definition, and (3) complex code (executive or heavily time-constrained routines) is multiplied by a factor of 1.5. These equivalent instruction counts may now be used to determine schedule time spans for each function.

Four categories of developmental coding time spans have been defined through experience related to levels of required documentation. Where design flowcharts and commented listings are the only documentation, program generation over the development phase can be estimated at 168 lines of code (LOC) per work-month. Where development plans, performance design requirements, product specification equivalent unit folders, and integration/test procedures are

generated, 100 LOC per work-month is reasonable. Where these specifications, plans, and procedures must be placed in military equivalent format, but are not subject to customer approval, 75 LOC per work-month is used. Where a fully interactive customer/developer program with all reviews and approvals of documentation is considered, 50 to 25 LOC per work-month is not unreasonable. Using these dividers, the equivalent size estimates may be transformed into nominal developmental time spans for each function. These incremental time spans are analyzed to detect the interdependency and adaptability to the total program schedule. The final product is the nominal developmental schedule and personnel requirements, with an audit trail to the program functions.

The schedule and work-loading are now ready to be impacted by developmental system constraints, if nominal, three-hour-per-day programmer access to the developmental system is available, and work-loading is unchanged. If a central facility with two-hour turnaround is used, the programmer will have less than half the access of the interactive system, so the coding portion of software development (23%) will generate a multiplier of 1.23 to the total program work-loading for planning and alteration of work habits to accommodate the decreased accessibility. If less accessibility is foreseen, the multiplier

could go to 1.46 to give revised equivalent work-loading.

TRAINING AND TEST

A further impact to work-power is training. At this point in work-power estimation, the number of people on the project and the organization of task leaders and managers can be defined. At least three weeks of study or training courses should be scheduled for task leaders, two weeks for lead programmers, and one week for programmers. This time impact can increase the overall work-power requirement if the schedule time length must remain fixed.

The final impact to development is test. Test has been categorized as operational, qualification, and certification. Operational testing assures that the program modules work together and do not impact work-loading estimates. Qualification testing, with its planning, scripting, and procedural debug, doubles the 34% of qualification test phase effort over operational testing, generating a .34 multiplier for developmental work-power. Certification testing involves program checkout in a dynamic environment, with twice the complexity of qualification testing, leading to a .68 multiplier on the developmental work-power. These factors are then added.

Not directly attributable to develop-

Both sides now

North Star Announces — Double Density x 2 Sides = Quad Capacity!

The North Star Horizon now delivers quad capacity by using two-sided recording on our new mini drives! That's 360,000 bytes per diskette! A four drive North Star system accesses over 1.4 megabytes of information on-line! Think of the application flexibility that so much information storage can give you!

North Star has quadrupled the disk capacity of the Horizon computer but prices have increased a modest 15 percent. On a dollar per byte basis, that's a bargain that is hard to beat!

The proven North Star disk controller was originally designed to accommodate the two-sided drives. North Star DOS and BASIC are upgraded to handle the new capacity, yet still run existing programs with little or no change. Of course, single sided diskettes are compatible with the new disk system.

North Star Horizon OEM Prices
(Includes 32K RAM, one parallel and two serial I/O ports),*
assembled, burned-in and tested:

Horizon-1-32K-Q	\$1890
Horizon-2-32K-Q	\$2265
Horizon-1-32K-D	\$1890
Horizon-2-32K-D	\$2265

*In quantities of 100 or more

Get both sides now! Call Bernard Silverman for more information.

NorthStar 

North Star Computers, Inc.
1440 Fourth Street
Berkeley, CA 94710
(415) 527-6950 TWX/Telex 910-366-7001

CIRCLE 134 ON READER CARD

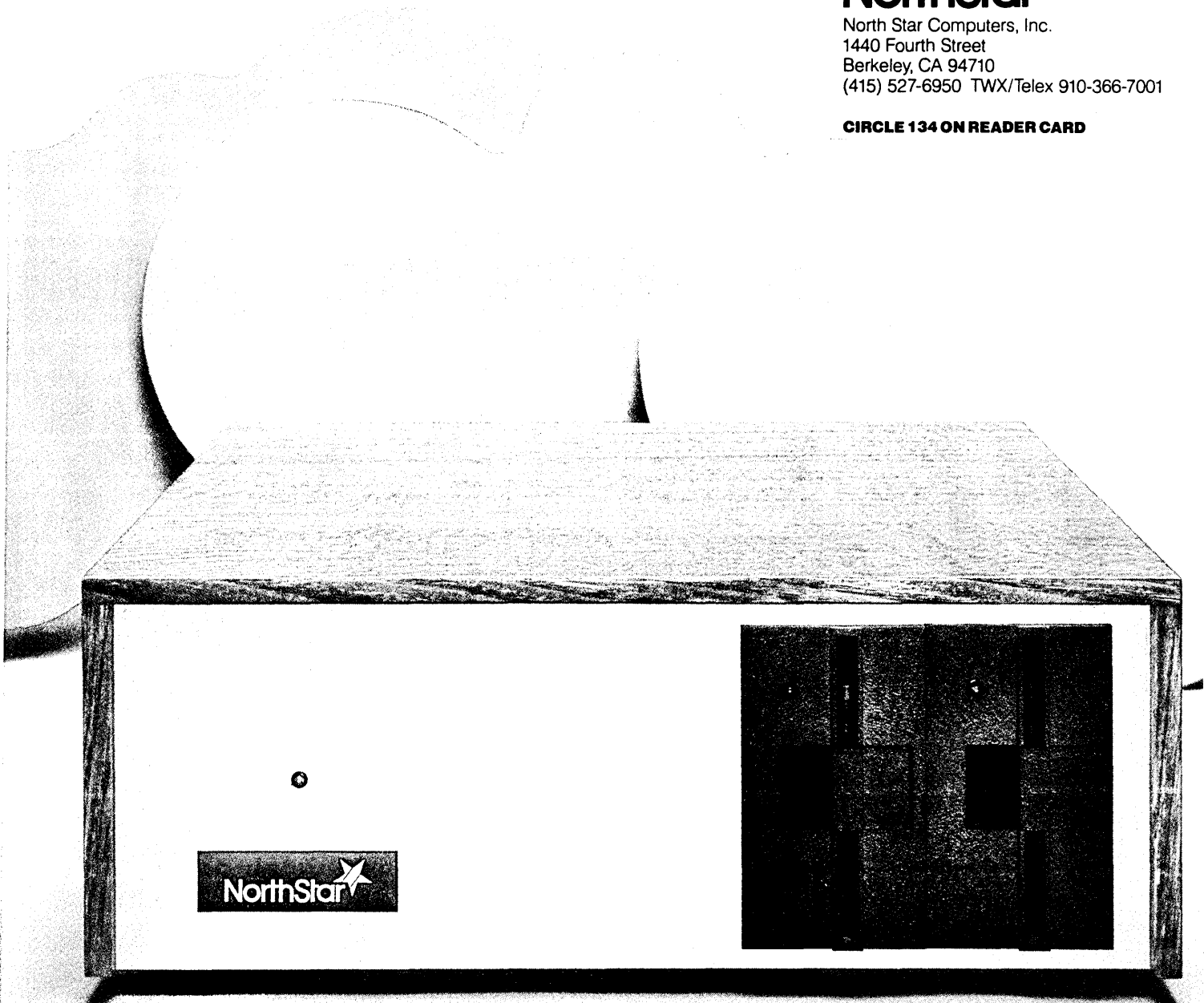

DIGITAL INTRODUCES THE MOST AWESOME ARRAY

At Digital, network technology has just taken another giant step.

Announcing Phase III networking: a host of new capabilities that will make your computer power easier to allocate, easier to control, and easier than ever to justify to your management.

With Phase III, your options have never been greater. Or more cost-effective. As always, you can match the right Digital system to the right local job. But now, you can network those systems virtually wherever, whenever, and however you want. Even when your mix includes another manufacturer's mainframe.

And no matter how you network, you'll be doing it in the most economical way possible. Just consider these new capabilities.

SNA Protocol Emulator.

Now Digital systems can talk to and support IBM mainframes using the SNA protocol. Thus, you can protect an investment in hierarchical networks, even as you commit to more flexible distributed systems.

Adaptive Routing. Now Digital networks can automatically find the least expensive path between two nodes. Not only that, they automatically re-route information around problem areas. Your line costs are held down.

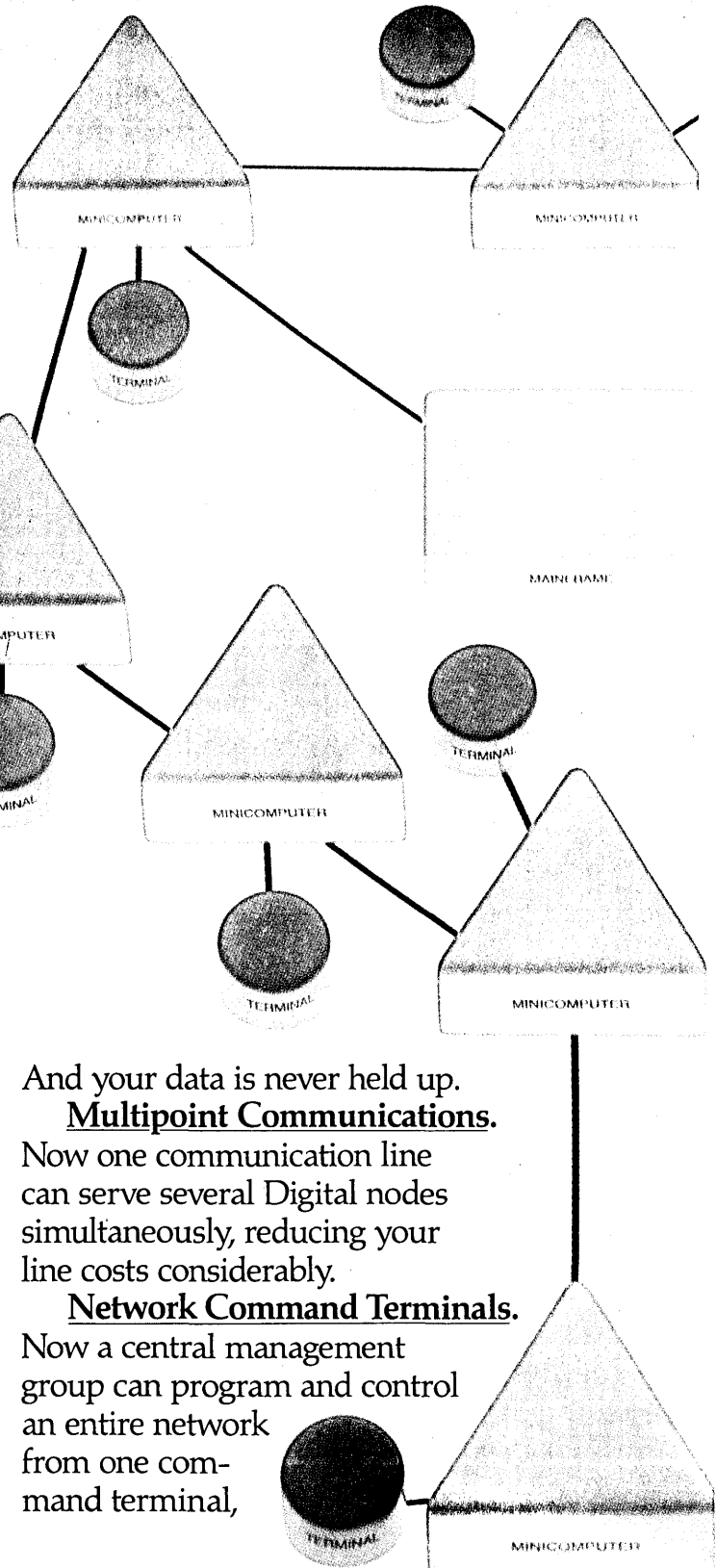

And your data is never held up.

Multipoint Communications.

Now one communication line can serve several Digital nodes simultaneously, reducing your line costs considerably.

Network Command Terminals.

Now a central management group can program and control an entire network from one command terminal,

PHASE III. OF NETWORK OPTIONS EVER.

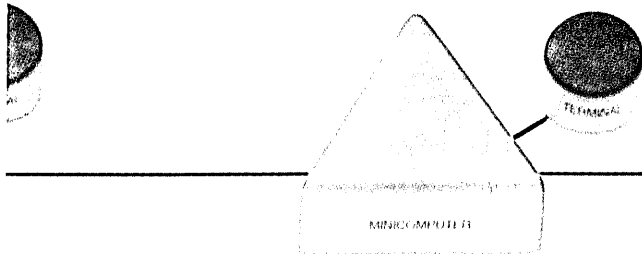

public packet switching networks using the X.25 protocol. Digital Packetnets are currently being tested

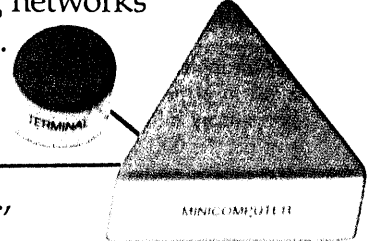

and certified in the U.S., Canada, and France.

More flexibility. More control. And the most cost-effective ways to achieve them. Add these new Phase III capabilities to the already formidable array of Digital

networking options, and you have the elements of an awesome network.

But then, that's just what you'd expect from Digital. Innovative technology. And the leadership to put it to work.

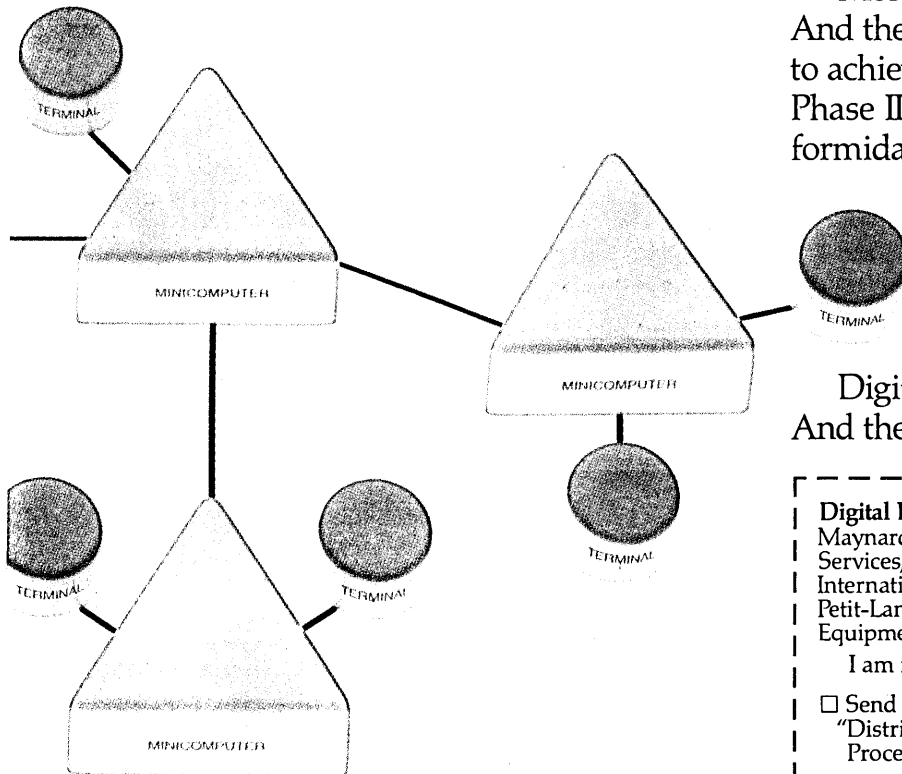

thus cutting the cost of programming individual nodes in widely dispersed locations.

Enhanced Network Management.

Now you can add on systems, change communication links, gather operating statistics, and detect problems, all without shutting down the network. Imagine the savings on downtime and expansion costs.

X.25 Packetnets. Digital is firmly committed to supporting

Digital Equipment Corporation, 146 Main Street, Maynard, Massachusetts 01754. Attn: Communication Services, NR-2/2 or Digital Equipment Corporation International, 12 av. des Morgines, 1213 Petit-Lancy, Geneva, Switzerland. In Canada, Digital Equipment of Canada, Ltd.

I am interested in Digital's Phase III. Tell me more.

- Send me the brochure, "Distributed Data Processing and Networks." Send me the handbook, "Introduction to DECnet."

Name _____

Company _____

Street _____

City _____ State _____ Zip _____

DX146

digital

There are three major jobs in cost estimating: defining the size of the task, defining the development program, and generating the costs.

ment but still a cost factor is hardware/software integration. If the software crew must accomplish this, the multiplier is .25 for simple (digital) interfacing, .37 for complex (analog and digital), and .5 for interface with another computer in which hardware and software must interact. All of these estimating multipliers are illustrated in Table I in order of application. Included in the table is a level of effort for subsequent program support during initial fielding or test of one person per 12,000 LOC.

The software development estimator is always faced with internal and customer audits of his cost figures. The estimator must be prepared to deal with percentage cuts and suggest scope changes if management of the customer must take out reserves or is unable to afford the estimated cost. A further level of detailed justification, show in Table II, coupled with the major impacts documented through the estimation process, should give sufficient insight into the "how" of selected scope cuts. The table shows the subtasks required for each function and the approximate percentage of effort associated with each. Where percentages vary because of impacts such as the increased documentation, or rigor of test, etc., these are noted. The availability of this level of data allows the estimator to vary the scope of the program judiciously, rather than penalizing the whole effort with insufficient application of resources in the wrong phase.

A path trace through Table I shows that 432 alternative program costs can be de-

rived. As an example, costly, moderately expensive, and inexpensive development efforts are illustrated in Table III, in which the task is to develop an autopilot for a missile. The program schedule allocated to this development is 12 months from initiation until delivery to systems test for testing.

The first step in the example impacts

the defined program with the validity of estimate factors. These are shown on the example as good, equivalent, and weak, which, except in explicit cases, will correlate to the defined time spans of one to two weeks, one to two days, and one to two hours, respectively. The same difficulty factor is applied to the validity estimates giving 1,905, 2,390, and

**TABLE II
SOFTWARE DEVELOPMENT SUBTASKS**

Performance Definition and Specification	
Functional Definition 1%	Interface Definition .5%
Functional Allocation .5%	Sizing and Timing 1.49%
Detailed Design	
Detailed Requirements 8.0%	Flowcharts and Writeups 3.05%
Code and Unit Test	
Code Form 8%	Test Script 3%
Desk Check 2%	Test Driver 2%
Documentation Update 1%	Test Conduct 3.17%
Recode 2%	Update and Redocument 1%
Recheck and Redocument 1%	
Integration Test	
Plan 3%	Test Drivers 5%
Procedure 5%	Integration and Debug 14.82%
Qualification Test Plan and Procedure	
Test Plan 3%	Procedural Steps 10%
Performance/Conformance Matrix 2%	Documentation 2%
Qualification Test Debug/Conduct	
Test Driver 5%	Conduct .47%
Code/Procedure Debug 10%	Report 1%
Dry Run 1%	

**TABLE III
SOFTWARE ESTIMATE EXAMPLE**

Required Program	Validity of Estimate	Difficulty Factor	Level of Document.	Development. System	Training	Rigor of Test	Complexity of Integration
Autopilot Application 700 LOC 300 Data B. Exec. 300 LOC 300 Data B.	Good	1050	Mil. App.	4 hr. Cent.	5 people	Cert.	HW and SW
	1050	90	38.1 MM	55.62 MM	57.37 MM	81.75 MM	100.8 MM
	450	675	Listing	Dedicated	1 person	Operatnl.	Simple HW
	450	90	11.33 MM	11.33 MM	11.58 MM	11.58 MM	14.41 MM
	1905						
	Equiv.	1400	1400				
	600	120	Spec., Fld.	2 hr. Cent.	3 people	Qual.	Complex HW
	600	750	23.9 MM	29.39 MM	30.64 MM	38.28 MM	47.12 MM
	600	120					
	2390						
Weak	2800	2800	Listing	Dedicated	3 people	Operatnl.	Simple HW
	1200	240	30.23 MM	30.23 MM	31.48 MM	31.48 MM	39.04 MM
	1200	1800	Mil. App.	4 hr. Cent.	12 people	Cert.	HW and SW
	1200	240	101.6 MM	146.34 MM	152.34 MM	217.36 MM	268.16 MM
	5080						

Meet Computer Task Group



the all pro team

We're looking for more than a few good players.

At Computer Task Group, we put people on our team who thrive on competition and challenge.

Our professional staff is tops in performance and technical excellence.

We train our team—Initial Systems Engineering Development Programs, Technical Enhancement Programs, and continuing education to keep our team at the State of the Art.

A CTG Professional grows both personally and technically. In an industry with a great need for experienced personnel, we've taken the lead with the best development program for Professional Services Systems Engineers.

Join our 600 professionals. They're on a winning streak with CTG.

CTG is an Equal Opportunity Employer M/F.



Computer Task Group inc.

CORPORATE OFFICES / 800 DELAWARE AVENUE / BUFFALO, NEW YORK 14209 / 716-882-8000

CHICAGO
312-648-1084

PHILADELPHIA
215-964-0430

BALTIMORE
301-796-7010

BUFFALO
716-882-8000

ROCHESTER
716-325-4220

SYRACUSE
315-463-6276

PITTSBURGH
412-323-8600

NEW YORK
212-398-1600

CIRCLE 139 ON READER CARD

The software development estimator is always faced with internal and customer audits of his cost figures.

5,080 LOC equivalents as the estimates to be priced. The variation between the smallest and the largest number is 2.6:1.

Two sets of documentation criteria were applied to the good and weak estimates, while a medium set was applied to the equivalent estimate. As expected, the 2.6:1 ratio holds for equal documentation criteria among the good to weak estimates, but if documentation standards are ignored, the ratio diverges to 9:1. Progressing through the development system, training, and rigor of test columns on the figure, the ratio of 2.6:1 remains constant for equal impact criteria. If impact criteria are ignored, the ratio diverges further to a ratio of 18.7:1. The integration factor causes even more divergence if the complexity factor is ignored.

The normal yardstick used by most managers, cost per line of code, is worth investigation. Assuming an average burdened programmer cost of \$6,000 per work-month, the following results are apparent from the figure:

Good Definition,	\$45/LOC
Best Case Multipliers	
Good Definition,	\$317/LOC
Worse Case Multipliers	

Equivalent Definition,	118/LOC
Normal Multipliers	
Poor Definition,	\$46/LOC
Best Case Multipliers	
Poor Definition,	\$316/LOC
Worse Case Multipliers	

The results are as expected for application of equal criteria, but the differences of \$45, \$118, and \$316 per line of code show that the managerial estimating technique of "6,000 lines of code at \$25 per line" leaves much to be desired. If the variation in estimates were to become actual numbers through a program development, the best to worst case cost in \$86,460 to \$1,608,960. If the difference had only nominal impact on a company because of its diversity, it should have a major impact on the estimator that allowed the contract to be signed at the lower, erroneous figure.

It is evident that there is no substitute for a good program definition to begin the software estimation cycle. The major time portion of any allocated time period for estimation should be spent in defining the tasks to be accomplished or bounding the work to be accomplished. This effort will minimize the effects of the 2.6:1 error that is possible in this phase. It is also evident that ignorance of cus-

tomers delivery requirements, development impacts, and integration complexity can add a further 8:1 error in the development estimate. The use of this or an equivalent methodology for a "real-time" estimate can supplement engineering judgment and provide the facts and measure the risks inherent in a software estimate. *

EDWARD L. GRIFFIN

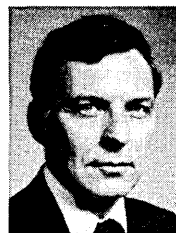

Mr. Griffin is a senior group engineer with Martin Marietta Corp., Orlando, Fla. He has worked in and managed software development and test for the past five years, with previous experience in systems engineering and computer hardware applications. He serves as an Air Force Reservist, working computer hardware and software development with Wright-Patterson AFB.

Managing the DP Professional—the challenge of the '80s

Turnover Productivity Career Momentum

DP Professionals are your most costly, yet most valuable resource. Managing these high talent people—systems analysts, application programmers, and data communications specialists—is different from managing workers in manufacturing or sales or administration. It requires special understanding and skill . . . skill that until now could only come from seat-of-the-pants experimentation.

MANAGING THE DATA PROCESSING PROFESSIONAL is

- A solutions-oriented workshop for the data processing manager.
- Developed by DP professionals for DP professionals.
- Focusing on today's concerns in running a productive data processing operation.

Increased productivity through management effectiveness—the thrust of this highly-participative workshop. Topics include:

- What makes the DP professional tick?** Understand high talent motivation as it relates to productivity.

- Your best management style, what is it?** Identify your style and how to adapt your role to complement your individuality.
- The team concept.** Learn how to achieve the synergism required for effective teamwork.
- Managing turnover.** Discover what you can do to control attrition—actually make it work with you, not against you.
- Career management.** Address the need for career planning to encourage technical growth, job satisfaction, and loyalty.

ATTEND 1, 2 OR 3 DAYS:

This workshop has been structured in three separate segments to enable managers with limited time to select one or a combination of days that best fits their needs and schedule. Write or call for the course outline of the three days.

Workshop leader: SAMUEL R. CONNOR, Director of Roberts Associates, formerly Manager of Management Development, Data Processing Division, IBM.

REGISTER for one of the 1980 Workshops:

- ▶ June 30-July 2, Tarrytown, NY
- ▶ Aug. 19-21, San Francisco
- ▶ Sept. 16-18, Los Angeles
- ▶ Oct. 7-9, Houston
- ▶ Nov. 5-7, Boston

CALL Carol Nardi

(203) 629-2906

OR CLIP & RETURN

THE COUPON.



ENTERPRISES

Providing quality education for the information-processing industry.

COURSE FEE: Single registration is \$200/day, \$550/3 days.	REGISTRATION: <input type="checkbox"/> 1 day \$200, <input type="checkbox"/> 2 days \$400, <input type="checkbox"/> 3 days \$550
DISCOUNTS: Team attendance recommended for additional benefits—assures uniform understanding of concepts throughout company. 10% discount available for 3 or more.	PAYMENT: <input type="checkbox"/> Check enclosed. <input type="checkbox"/> Bill my firm: P.O. # _____
REGISTRATION DEADLINES: 2 weeks prior to seminar date. Mail form or telephone (203) 629-2906.	SEMINAR CHOICE: _____
CANCELLATIONS: Course fee fully refundable up to 3 business days prior to seminar date. 50% refund afterward.	INFORMATION: <input type="checkbox"/> Send more information. <input type="checkbox"/> Please send information about in-house training.
	NAME: _____
	TITLE: _____
	ORGANIZATION: _____
	ADDRESS & ZIP: _____
	TELEPHONE: _____
	Mail to Ubi ENTERPRISES, 30 Milbank Avenue, Greenwich, CT. 06830

CIRCLE 137 ON READER CARD

"NCR's VRX is more transparent than any operating system I have ever seen."

Peter P. Blozis, H.J. Wilson Co., Inc.

PETE BLOZIS:

"I've been in EDP for 19 years and have gone through many conversions. So I anticipated problems in installing our new NCR V-8585M. It turned out to be the smoothest conversion I ever experienced."

LEA EDMUNDS:

"We had good reason to be apprehensive. We were putting in the first V-8585M to be installed anywhere. And, at the same time, we were switching to new operating software, NCR's VRX. We ran parallel for three weeks and never developed a conflict. As it turned out, we could have switched over in a single day."

PETE BLOZIS:

"We resisted conversion as long as we could, and then discovered it was completely painless. The V-8585M hardware ran just as NCR predicted. VRX is more



Peter P. Blozis (right) is Wilson's Vice President, Information Services Division. Lea Edmunds is Technical Services Manager.

transparent than any operating software I have ever seen."

* * *

WILSON'S is a chain of jewelry/ catalog showrooms that is spreading across the Sunbelt. And growing at the impressive rate of 37 percent per year. This growth has caused Wilson's to step through five NCR Century systems up to the V-8585M. Supporting an NCR system is easy. As Pete Blozis says "We can support our NCR V-8585M with fewer systems programmers than we'd need for other systems of comparable size."

Find out what NCR VRX can do for you. Phone your representative at your local NCR office. Or write to EDP Systems, NCR Corporation, Box 606, Dayton, Ohio 45401. Learn how NCR brings a new level of convenience to data processing operations.

NCR
Complete Computer Systems

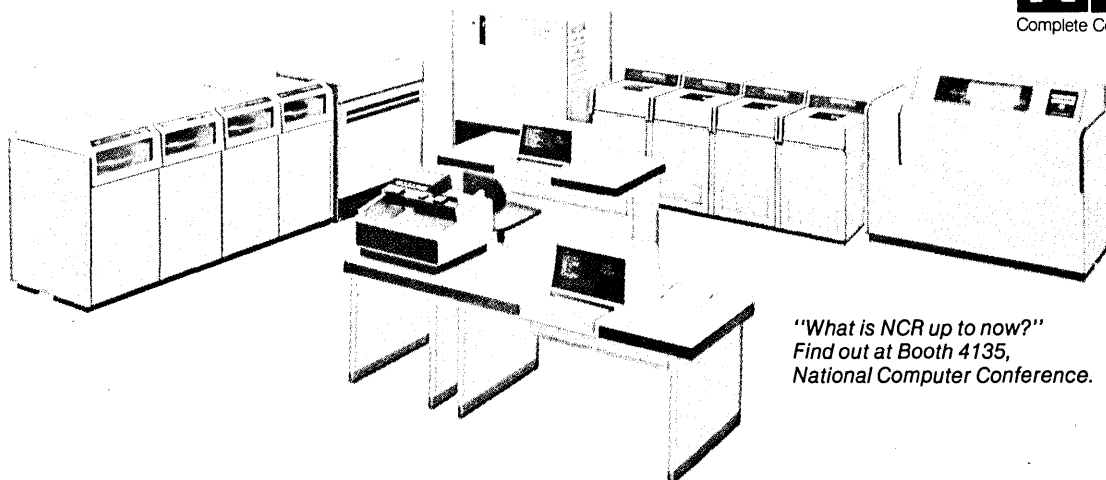

"What is NCR up to now?"
Find out at Booth 4135,
National Computer Conference.

An NCR computer can make it happen for you, too.

CIRCLE 138 ON READER CARD

THE LARGEST COMPUTER SHOW EVER TO BE HELD IN THE PROVINCE OF QUÉBEC



Salon International de l'Ordinateur et Conférences, a major computer industry event will take place at Montréal's Place Bonaventure, from June 4-6, 1980.

In terms of attendance and the number of exhibitors, it will be the largest and most authoritative computer show and conference ever held in the Province of Québec.

More than 100 of the computer industry's leading suppliers of systems and related equipment will exhibit in the show, — an eloquent testimony of the growing importance of the computer market in Québec.

Over 10,000 visitors representing key decision areas in every level of the Quebec business community, government and educational institutions will attend the show.

Organization of the conference, which is to run concurrently with the show, is well advanced with an impressive array of speakers already engaged. The theme of the conference is "Productivity of the Computer".

The show and conference is managed by Industrial Trade Shows of Canada Ltd. and sponsored by the Canadian Information Processing Society.

**ATTEND THE SHOW AND HAVE A CHANCE TO WIN A
SUNFLIGHT HOLIDAY FOR TWO TO ANYWHERE OF
YOUR CHOICE, UP TO A VALUE OF \$2,500.00.**

Sunflight Holidays 

Canada's Number One Holidaymaker.

It's that short hop in style

RIXON Limited Distance Modems... Look great—save you money... and are easy to install!

- LDM 710-Asynchronous up to 9600 bps
- LDM 720-Synchronous 1800 to 19,200 bps
- 2 wire or 4 wire point-to-point or multipoint
- Complete Diagnostics — self test, analog loopback, digital loopback & LED's for the key interface leads
- Easy, Quick Installation — no test equipment needed
- Intermix LDM cards in our RM70 Rack
- Interface EIA RS-232-C/CCITT V.24 or 20 ma current
- Meets Bell Transmission Requirements Pub. 43401

If you're transmitting under 24.5 miles, use our LDM's. If over, use our full line of long haul data modems. Write for complete details.

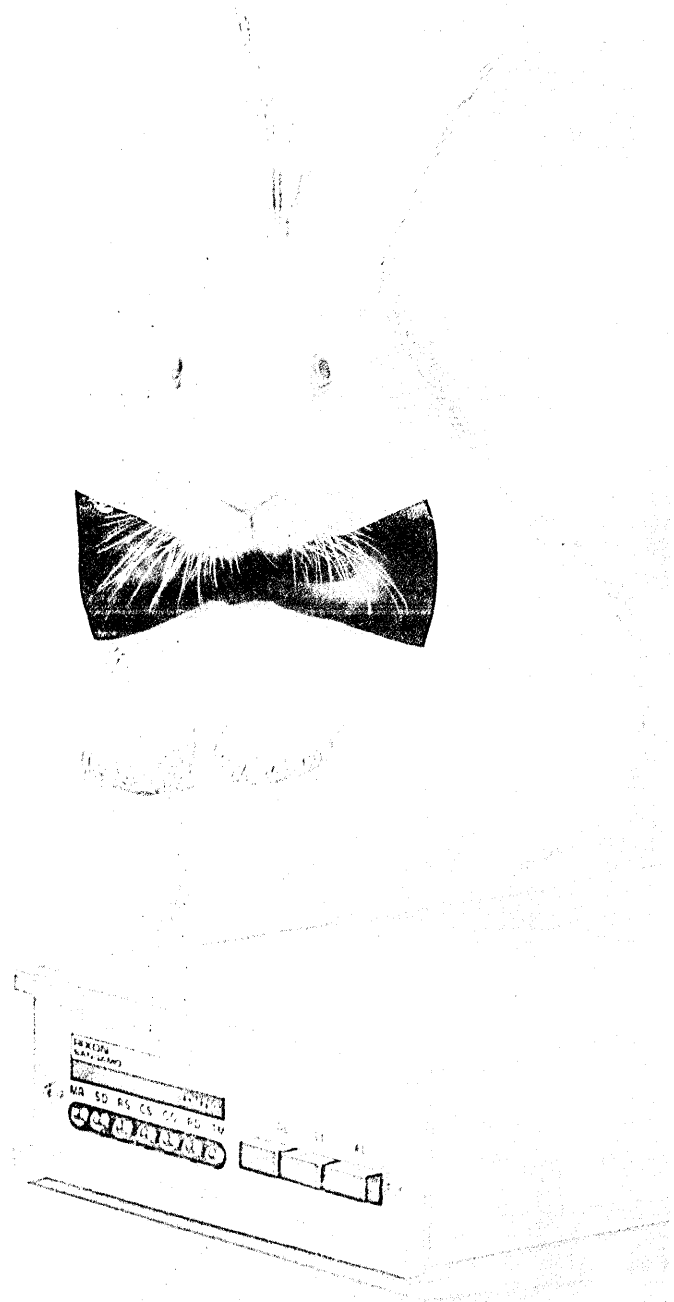
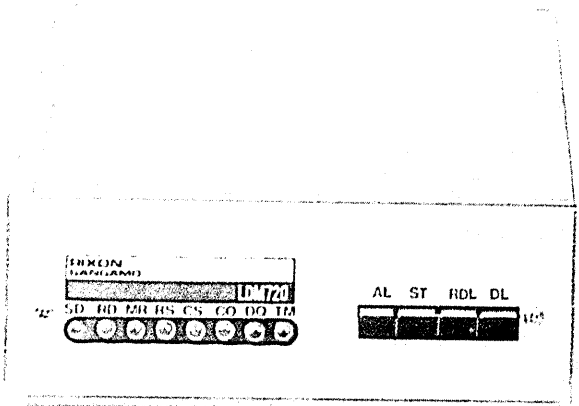

RIXON INC., A SUBSIDIARY OF
SANGAMO WESTON

2120 Industrial Parkway, Silver Spring, Maryland 20904
(301) 622-2121 • TWX: 710 825-0071 • TLX: 89-8347

CIRCLE 140 ON READER CARD © Rixon Inc., 1980

3025

Duplicating processors does not guarantee reliability, but one can often achieve increased reliability by duplicating critical components.

HEDGING YOUR BETS

by Samuel Feldman

It is 9 a.m. in the control room of a large oil refinery, and already there is serious trouble. Pressure is rising rapidly on isomerization unit number two. An emergency shut down may be required. The decisive information is the unit trend data collected by the on-line computer during the night. This same computer is now undergoing preventive maintenance. The refinery operators are not concerned. All the necessary trend data was automatically copied to a redundant standby machine. As a result, a costly and possibly unnecessary reactor shutdown may be averted.

Later that afternoon, a line of thunderstorms sweeps across the rush hour congested expressway, causing numerous accidents. The highway traffic control center receives a direct lightning strike knocking out main surveillance computer A. The highway supervisor is dismayed. But his frown becomes a smile when the green computer B on-line indicator flashes on as the automatic switchover logic completes its operation.

Duplicating processors does not guarantee reliability. In fact there are many factors which if not suitably considered can cause all of one's processors to fail concurrently. The reader can perhaps provide more, but a few of these factors are: a clean environment free of electrical interference, fire and flood protection, reliable power sources, adequate hardware and software maintenance, trained and competent personnel, and good plant security.

Assuming these factors have been provided for, one can often achieve increased reliability by duplicating critical compo-

nents. Table 1 shows the relative failure rates for different classes of computer components. Although processors are nonmechanical and thus not likely to fail, the associated peripherals may be failure prone; having separate processors, each with its own peripherals, provides an effective means of isolating problems. For example, two disk controllers on a single processor will protect against single disk failures, but it will be impossible to replace a failed disk controller without stalling the processor and shutting down the entire system.

There are many ways of configuring multiprocessor systems; most of them, however, can be classified as either parallel processing systems or on-line/standby systems.

In parallel processing systems all the processors are essentially on-line concurrently. Input data is processed by all the processors but only one controls the output. This type of system requires special hardware and is often complex and expensive. However, the switch from one controlling processor to another can be accomplished with perfect continuity. The Space Shuttle system, which consists of four identical IBM AP-101 general purpose computers, is a good example of a parallel processing system. In the Space Shuttle system outputs are determined by plebiscite (four processors are required so that if one fails, two voting against one still constitutes a majority).¹

Not all applications are as critical as the Space Shuttle. For applications where some loss of continuity can be tolerated, the

on-line/standby variety of redundant processor system can provide satisfactory reliability for less money. The systems described in this article are of the on-line/standby type; the essential features are shown in Fig. 1. Only one processor, in this case system A, is on-line and connected to sensor and operator control interfaces. The other processor is in standby mode and is ready to assume on-line functions when a switchover is executed. One or more switches are used to switch devices to either processor. Switching can be manual or automatic. System status and historical data are periodically transferred from the on-line to the standby system to assure an acceptable level of data continuity at the time of a switch. Either communication links and/or shared shortage may be used for transferring this information.

In addition to simpler hardware and generally low cost, the on-line/standby system has the following advantages over systems where all processors run on-line software continuously:

- The approach is machine independent. Virtually any vendor's equipment can be used. This is particularly advantageous for those who wish to upgrade single processor systems to multiprocessor configurations.
- The systems are loosely coupled, and it is possible to upgrade the hardware on one without affecting the other.
- Symmetrical systems are not required; witness the traffic control system in Fig. 3.
- The standby systems can be used for development while remaining ready to assume control. This of course involves some risk. Most systems, however, are upgraded or changed from time to time, and few users are

1. Sheridan, C.T., "Space Shuttle Software," DATAMATION, July 1978, pp. 128-140.

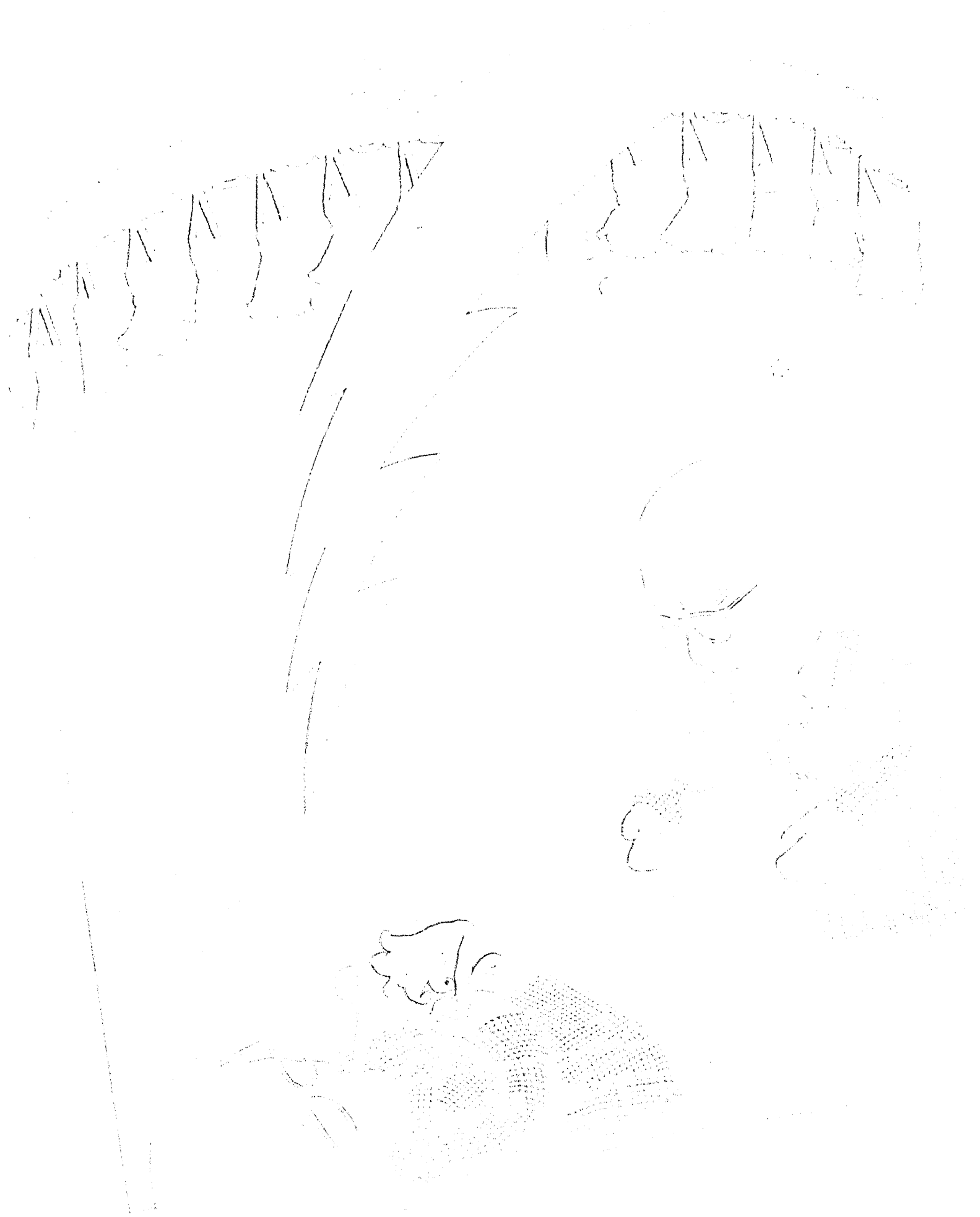

Designing high availability systems is challenging, since it is impossible to predict every failure mode.

fortunate enough to have a complete stand-alone computer for development.

SYSTEM DESIGN

Designing high availability systems is challenging. It is impossible to predict every failure mode—Murphy's Law clearly states that all possible failures will occur sooner or later. Multiple failures cannot be ruled out since the detection of a failed component may depend on the failure of other components; for example, a failed switch may go unnoticed until the software attempts to switch a failed sensor interface.

How then is the designer to provide maximum useful service under such uncertain conditions? Two concepts can provide guidance: fallbacks, or degraded mode of operation, and deadlocks.

Operating with any failure is a fallback, so there are conceivably as many fallbacks as there are hardware and software components that can fail. However, only a limited number of these fallback modes are self-consistent and can provide useful service.

It is a good idea to write various fallback modes into the system's functional specifications. These modes should also be demonstrated during acceptance and should be rehearsed periodically during regular operations. The ultimate fallback is no computer operation at all, and if the application is really critical this mode must be planned for.

Deadlocks are unavoidable in complex systems. Once aware of deadlocks the designer will be able to work around them and avoid the more obvious traps. There will always be some deadlocks that are unavoidable.

Some deadlocks can be avoided by careful hardware selection. For example, where possible, all the switched components should be on a single switch. In this manner, even if the switch fails, at least one processor will have access to all the on-line peripherals. If only some peripherals are switched, then the resulting configuration may preclude any of the processors from performing useful on-line functions. Also, in automatically switched systems, it is essential that a processor failure be corroborated by two independent indicators. Otherwise, a component failure could be misinterpreted as a processor failure, in which case both processors will vie for control and neither will be able to perform on-line functions. For example, in the on-line refinery system shown in Fig. 2, a watchdog timer is used to corroborate system failure if the communication link should fail.

The oil refinery system was conceived from the start as a multiprocessor system, whereas the traffic control system (Fig. 3) was upgraded from a single processor system. A comparison of these two systems

TABLE 1

COMPONENT RELIABILITY (BASED ON PART-COUNT RELIABILITY)

TYPE	EXAMPLE	FAILURE RATES & FAILURES PER 10 ⁶ HOURS
Solid State	Logic Boards	1-100
	Interfaces	
	Sensor	
	Interfaces	
Moving Magnetic	Memories	100-600
	Magnetic Disks,	
	Magnetic Tape	
Electromechanical	Printers, Switches	200-1,000
	Devices	
	Keyboards,	
	Function Keys	

FIG. 1

ON-LINE/STANDBY REDUNDANT PROCESSOR SYSTEM

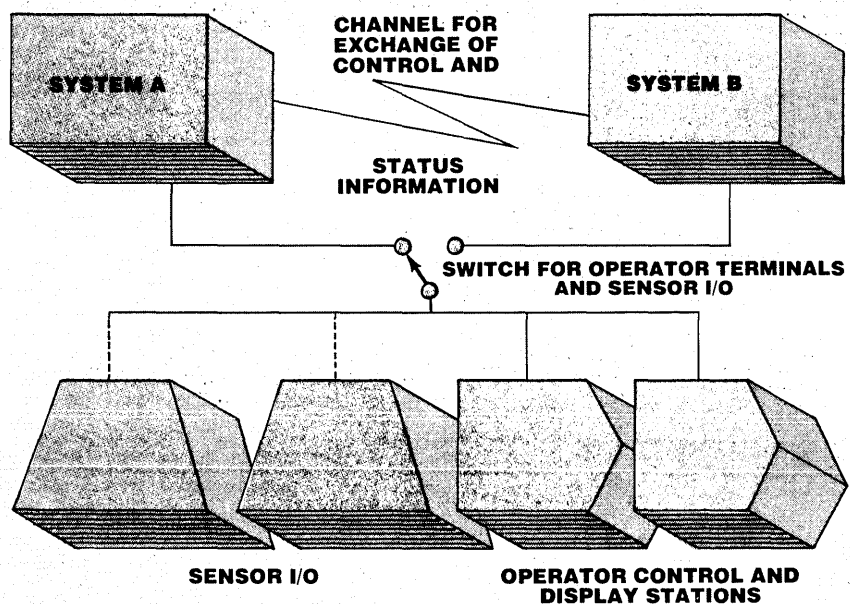

CHARTS BY CYNTHIA STODDARD



These spheres are a primary component in the Agastat®, pneumatic indicators, produced by Amerace Corporation—a company that relies on MDS SERIES 21 Systems.

The Information Controller



MDS SERIES 21 Distributed Data Processing System

Controlling The Flow Of Vital Data—a key ingredient in an effective information management program. MDS SERIES 21 Distributed Data Processing Systems—with their exceptional communications capabilities—provide the means of controlling this vital flow.

With SERIES 21 Systems—branch, production facilities, warehouses and field sites can have today's information today—as a matter of fact, they can have it in minutes... and process it where it's received.

Efficient communication is only one of the advantages offered by MDS SERIES 21 Systems. But, to companies like the CONTROL PRODUCTS DIVISION of AMERACE CORPORATION, it's a very important one.

Utilizing these systems, they have reduced order processing time at the

central office from days to hours. Production efficiency has improved by allowing plant managers to analyze machine operations on a daily basis, and tighten controls on raw material ordering and product shipping.

In short, MDS SERIES 21 Distributed Data Processing Systems have substantially helped improve this company's overall information management—as they have in many industries—worldwide.

Communications capabilities, the flexibility to do multiple jobs concurrently, local programming capability and expandable modular design are just some of the advantages MDS SERIES 21 Systems offer... there are many more. Let MDS show you.

- Please send additional information Please have an MDS representative call for an appointment. Please call our M.I.S. Manager.

Name _____ Title _____

Company _____

No. & Street _____ Phone _____

City/State/Zip _____

CIRCLE 141 ON READER CARD

® Agastat is a registered trademark of the Amerace Corporation.

SERIES 21 Reg. U.S. Pat. & Tm. Off.

DM680

MDS MOHAWK DATA SCIENCES

1599 Littleton Road, Parsippany, N J 07054
(201) 540-9080

Measure our new 9200 family of microprocessor-based, information processing systems and you'll find a perfect fit, whether your requirements are for data entry and information retrieval or concurrent communications with multiple hosts. We've designed and engineered the 9200 family so that *flexibility* match *requirements* and capabilities can be added as required by growth. System operation is easy and efficient and maintainability and expandability are convenient and economical. Size up the Harris 9200 for yourself.

Communications Capabilities
Initially designed for compatibility with IBM's 3270 Information Display System, the 9200 offers both local host attachment and remote communication speeds up to 9600 bps. Local attachment is via byte, block or selector channel in 3272 or System Network Architecture (SNA) modes. Remote attachment to IBM host systems is accomplished utilizing either BSC or SNA/VSOLC protocols. For networks with multiple hosts, the

9200 system provides multiple communication interfaces operating concurrently.

System Tailoring

Tailoring the system to meet individual requirements is easily accomplished by inserting diskettes into the processor, allowing you to define parameters such as printer authorization, screen configuration and number of devices. When you want to reconfigure the system, simply enter new parameters.

Displays and Printers

The basic 9200 supports up to 32 devices per system with local attachment at channel speed, and remote host communications up to 9600 bps.

Displays have been carefully designed to complement the 9200 system. The Harris 9278 CRT display is a non-glare, low-profile device featuring large, readable green phosphor characters and screen sizes from 960 to 3440 characters. A status line on each screen provides system data and diagnostic capabilities. IBM 3277 display stations can also be supported.

Harris provides a variety of printers to match user applications. Whether you need only low-speed screen copy or high volume print output for long reports, there's a Harris printer to choose from. They range from 80, 130 and 180 cps dot matrix bidirectional impact models to 300 lpm (band models).

The 9200... The System for Today That Expands for Tomorrow

The Harris name on every 9200 assures you of reliable, efficient and economical performance for years to come. Thanks to the 9200's innovative design, you can select a system that meets your needs today and provides a growth path for the networking requirements of tomorrow. Designed-in reliability and complete diagnostic capabilities are inherent in every system.

Will your system measure up to the demands of today and tomorrow? It will... if it's a Harris 9200. Write or call today for Harris Data Communications Division, 1161011 Dallas Parkway, P. O. Box 4000110, Dallas, Texas 75240, phone 214/386-2000.



THE NEW 9200 FAMILY

OF INFORMATION PROCESSING SYSTEMS FROM HARRIS

FOR TODAY AND TOMORROW.

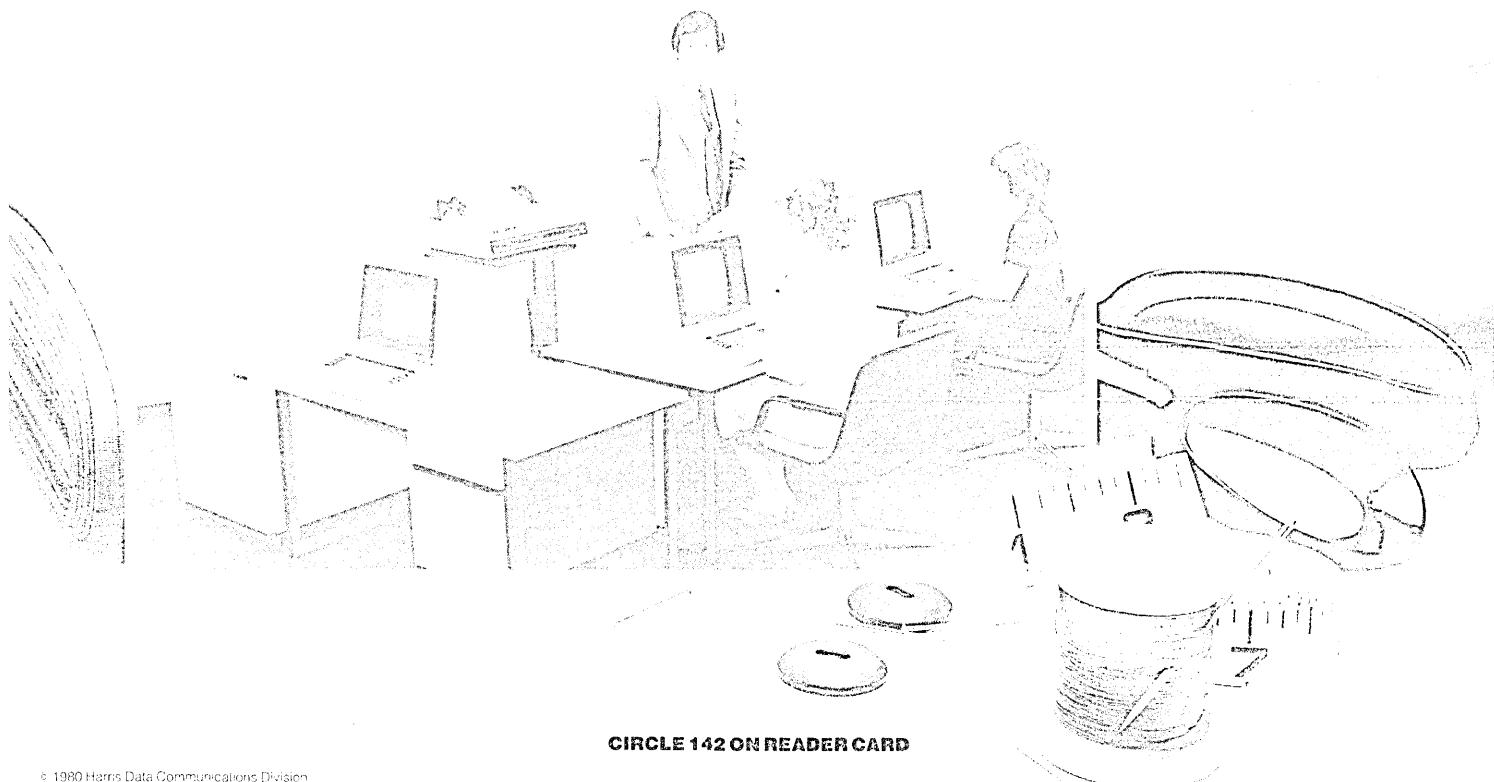

CIRCLE 142 ON READER CARD

System status and process trend information is shared via a high-speed serial line.

FIG. 2

REDUNDANT OIL REFINERY PROCESS CONTROL SYSTEM

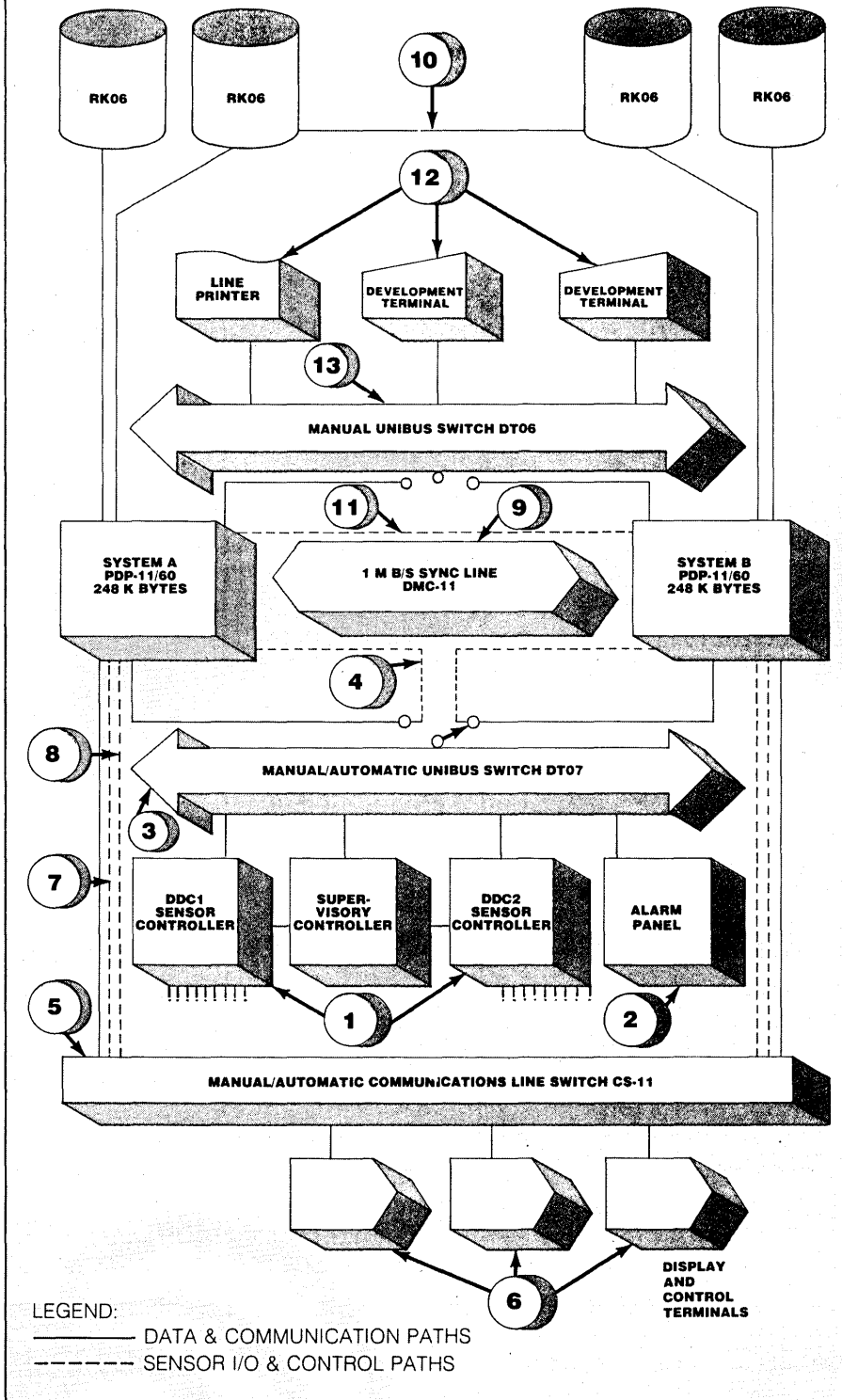

should provide useful insights for those contemplating similar ventures, so I will detail the design features of each.

In the oil refinery system (Fig. 2), all sensor I/O interface to the main computers via sensor controllers (1), which are connected to a manual/automatic unibus switch. An alarm panel (2), which notifies the operator of any system failures is connected to this same bus. Either processor has access to the switch (3). Normally the standby processor would operate the switch as part of an automatic switchover (4). However, if the switchover failed, the on-line processor could regain control. An automatic/manual line switch (5) provides access to the display and control terminals (6). Either processor can control the switch (7) or interrogate the switch to determine its position (8). The fact that two items must be switched (i.e., the bus and the line switch) is a necessary but less than desirable feature, since a deadlock is possible if only one of these items switches correctly.

System status and process trend information is shared via a high speed serial line (9). If the line fails, shareable disk drivers (10) provide an auxiliary means of sharing data.

An on-line system stall must be confirmed by at least two independent indicators, otherwise an alternating control deadlock is possible whereby each machine assumes the other has failed and both attempt to seize control. A serial line failure (9) would be one indication: the "watchdog" timer status line (11) provides a second failure indicator. Development terminals and printers (12) are interfaced to a manually switched bus (13).

HIGHWAY CONTROL SYSTEM

In the highway control system (Fig. 3), all critical surveillance and control data interface to the main computers via serial communication lines connected to gauged manual/automatic line switches (1). Since all the lines switch together, we avoid a deadlock situation where some of the lines are connected to one computer and some to the other. Traffic surveillance is via buried road sensors interfaced to two front-end computers (2). Traffic control is via rotating road signs which can route or divert traffic to alternate roadways (3). Operators monitor and control traffic operations via block mode crts (4).

In the automatic mode either processor can control line switching (5). Processors can also monitor switch positions (6). If the automatic control should fail, the processors can still interrogate the switch and determine the switch position. Whichever processor has access to the switched line then becomes the "on-line" system. Lines can also be switched individually as a final fallback procedure.

Essential traffic and sign position

Once aware of deadlocks, the designer will be able to work around them and avoid the more obvious traps.

status information as well as system status is transferred from the on-line system disk to the standby system via a high speed serial line (7). Shared access drives (8) provide an alternate means of transferring data, should the communication line fail.

Nonessential surveillance and control data interface to a core-only third processor, System C (9) via a digital I/O controller (10). This includes a roadmap display (11), an operator control panel (12), and an alarm panel (13). A master "time of day" clock (14) is used to synchronize time for all three computers. System C communicates with systems A and B via serial lines (15). Control and display data as well as status information are transferred over these lines. System C monitors both systems A and B and directs systems switchover, either in response to an error condition or by commands by the operator control panel.

Having one processor direct switching eliminates deadlocks caused by alternating control. However, if system C should fail, the on-line system will be determined by the position of the line switch.

CHOOSING SWITCH TYPE

The designer may wonder whether manual or automatic switching is better for a given application.

Actually the choice is more involved than a choice between manual or automatic switching; there are at least four identifiable levels of switching control: manual switching, manual switching with prompting, operator initiated switching, and automatic switching. Each succeeding level requires less operator involvement. Lower levels should be considered fallbacks when higher levels fail. Each level has advantages and disadvantages.

Level 1—Manual Switching. The operator must operate all the switches and must initiate all software processes. A highly trained operator is required. Even so, there are many opportunities for mistakes, especially given the stress induced by a system failure. The only advantage of purely manual switching is low cost.

Level 2—Manual Switching with Prompting. The operator must still operate the switches, but the computer guides the operator through the switchover process, telling him or her what to do and in what order. The computer also confirms switch operation. In some systems the processor may detect certain failure conditions and inform the operator that a switchover to the standby system is required. Finally, the computer sequences all software operations. This level of switching requires a trained staff, but the likelihood of failures and deadlocks is much less than with a purely manual system. A reasonable interval of time is required for switchover with this approach, and on-line

FIG. 3

REDUNDANT HIGHWAY CONTROL SYSTEMS

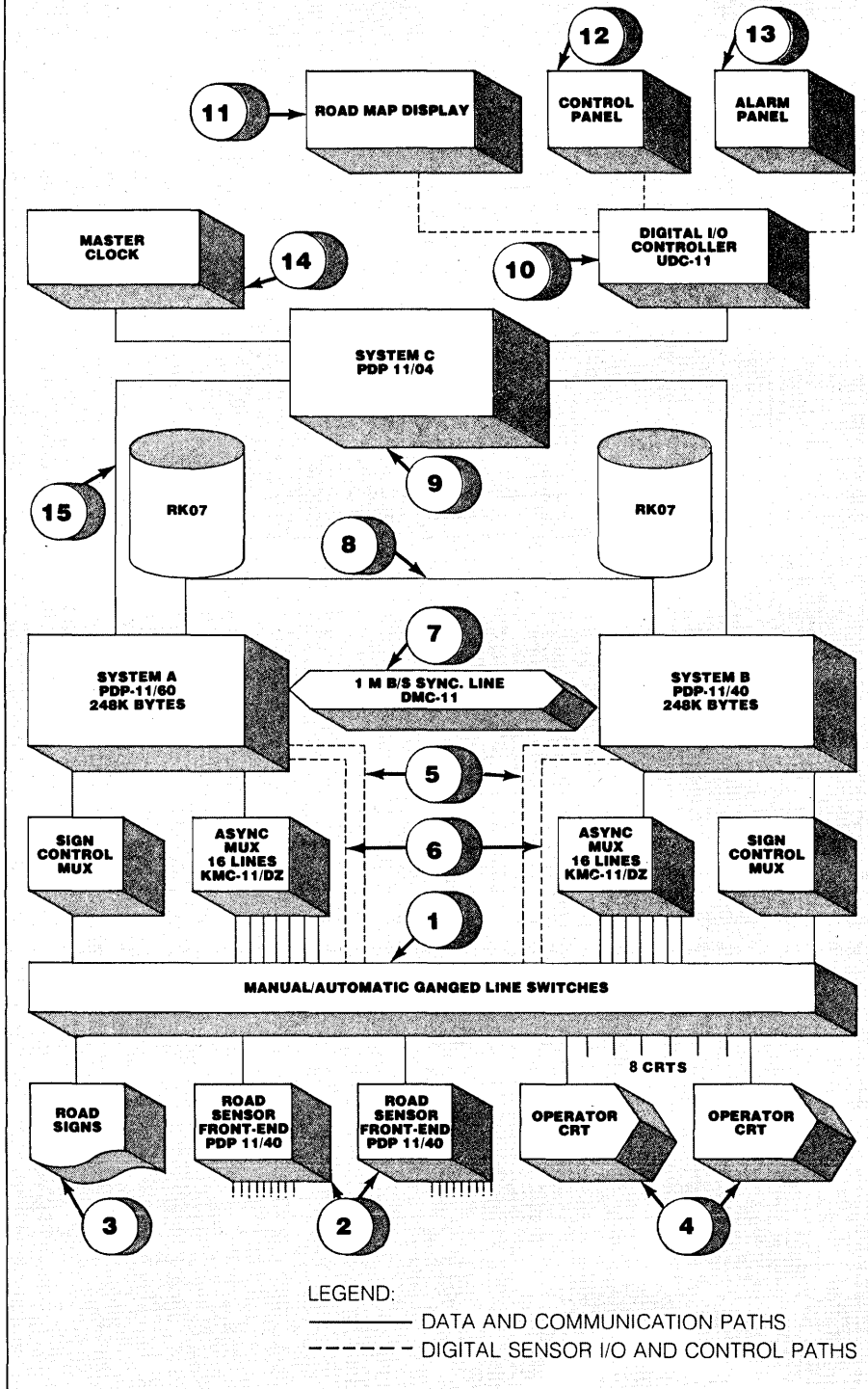

Imagine...



...the dynamics of vector graphics now in full raster color.

Imagine the dynamic performance of a workstation that can create the most demanding graphics.

Now you are not. Now there's performance only raster graphics can provide.

Imagine the dynamic performance of a workstation that can create the most demanding graphics. Now you are not. Now there's performance only raster graphics can provide.

Choose from over a dozen colors of raster displayed at any scan rate.

Choose from over a dozen colors of raster displayed at any scan rate.

Choose from over a dozen colors of raster displayed at any scan rate.

Choose from over a dozen colors of raster displayed at any scan rate.

Choose from over a dozen colors of raster displayed at any scan rate.

Imagine the dynamic performance of a workstation that can create the most demanding graphics. Now you are not. Now there's performance only raster graphics can provide.

Imagine the dynamic performance of a workstation that can create the most demanding graphics. Now you are not. Now there's performance only raster graphics can provide.

Imagine the dynamic performance of a workstation that can create the most demanding graphics. Now you are not. Now there's performance only raster graphics can provide.

Imagine the dynamic performance of a workstation that can create the most demanding graphics. Now you are not. Now there's performance only raster graphics can provide.

Imagine the dynamic performance of a workstation that can create the most demanding graphics. Now you are not. Now there's performance only raster graphics can provide.

Imagine the dynamic performance of a workstation that can create the most demanding graphics. Now you are not. Now there's performance only raster graphics can provide.

Imagine the dynamic performance of a workstation that can create the most demanding graphics. Now you are not. Now there's performance only raster graphics can provide.

Imagine the dynamic performance of a workstation that can create the most demanding graphics. Now you are not. Now there's performance only raster graphics can provide.

Imagine the dynamic performance of a workstation that can create the most demanding graphics. Now you are not. Now there's performance only raster graphics can provide.

Imagine the dynamic performance of a workstation that can create the most demanding graphics. Now you are not. Now there's performance only raster graphics can provide.

Imagine the dynamic performance of a workstation that can create the most demanding graphics. Now you are not. Now there's performance only raster graphics can provide.

Imagine the dynamic performance of a workstation that can create the most demanding graphics. Now you are not. Now there's performance only raster graphics can provide.

Imagine the dynamic performance of a workstation that can create the most demanding graphics. Now you are not. Now there's performance only raster graphics can provide.

Imagine the dynamic performance of a workstation that can create the most demanding graphics. Now you are not. Now there's performance only raster graphics can provide.

Imagine the dynamic performance of a workstation that can create the most demanding graphics. Now you are not. Now there's performance only raster graphics can provide.

Imagine the dynamic performance of a workstation that can create the most demanding graphics. Now you are not. Now there's performance only raster graphics can provide.

Imagine the dynamic performance of a workstation that can create the most demanding graphics. Now you are not. Now there's performance only raster graphics can provide.

NEC SYSTEMS

COMPUTER GRAPHICS SYSTEMS

10000 W. BRIDGEWAY, CHICAGO, IL 60642



Unpredictability...no security...and little opportunity for growth. Serious power problems until now?

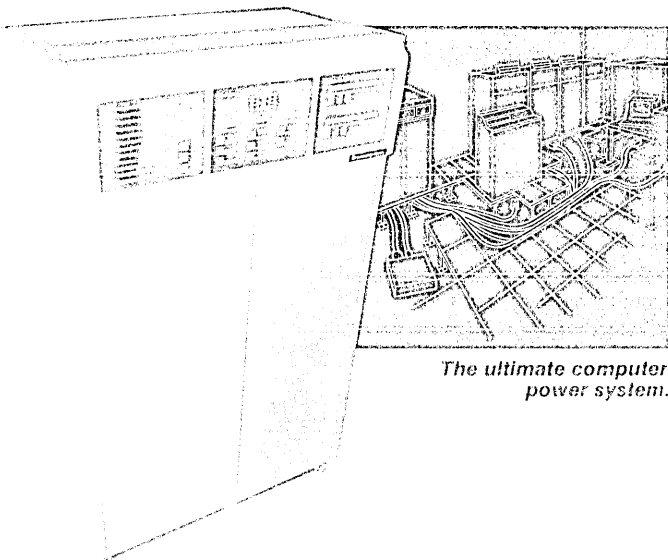
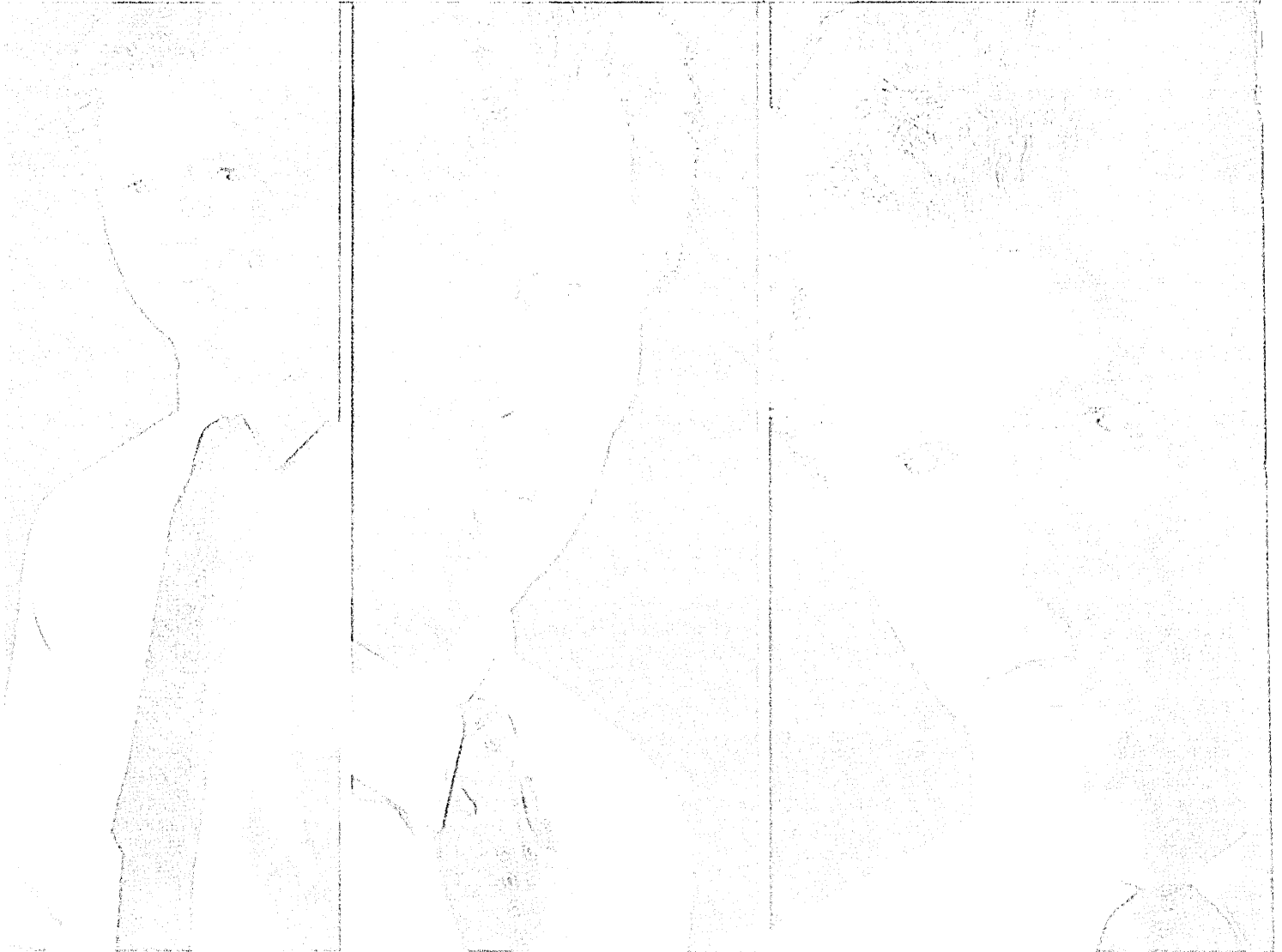

The ultimate computer power system.

Now — Total computer power all in one package!

For years, DP administrators have been concerned with: The need for clean, conditioned power! Costly, inflexible power distribution! And, problems with make-shift, space-wasting solutions! Conditioned Power has the answer!

The Power Management Center!

Engineered to the Liebert standard of excellence, this is the *only* self-contained power system that eliminates *all* power fluctuations... Conditions raw power (varying as much as $\pm 30\%$) to deliver a source within *all* manufacturers' specs... And, monitors the total electrical activity!

For full details on this cost-effective assurance of uptime, call or write Conditioned Power, 1950 Dardiana Drive, P.O. Box 29136, Columbus, Ohio 43229-0136 (614) 291-0946

CIRCLE 144 ON READER CARD

 **Conditioned Power**
subsidiary of Liebert

Having one processor direct switching eliminates deadlocks caused by alternating control.

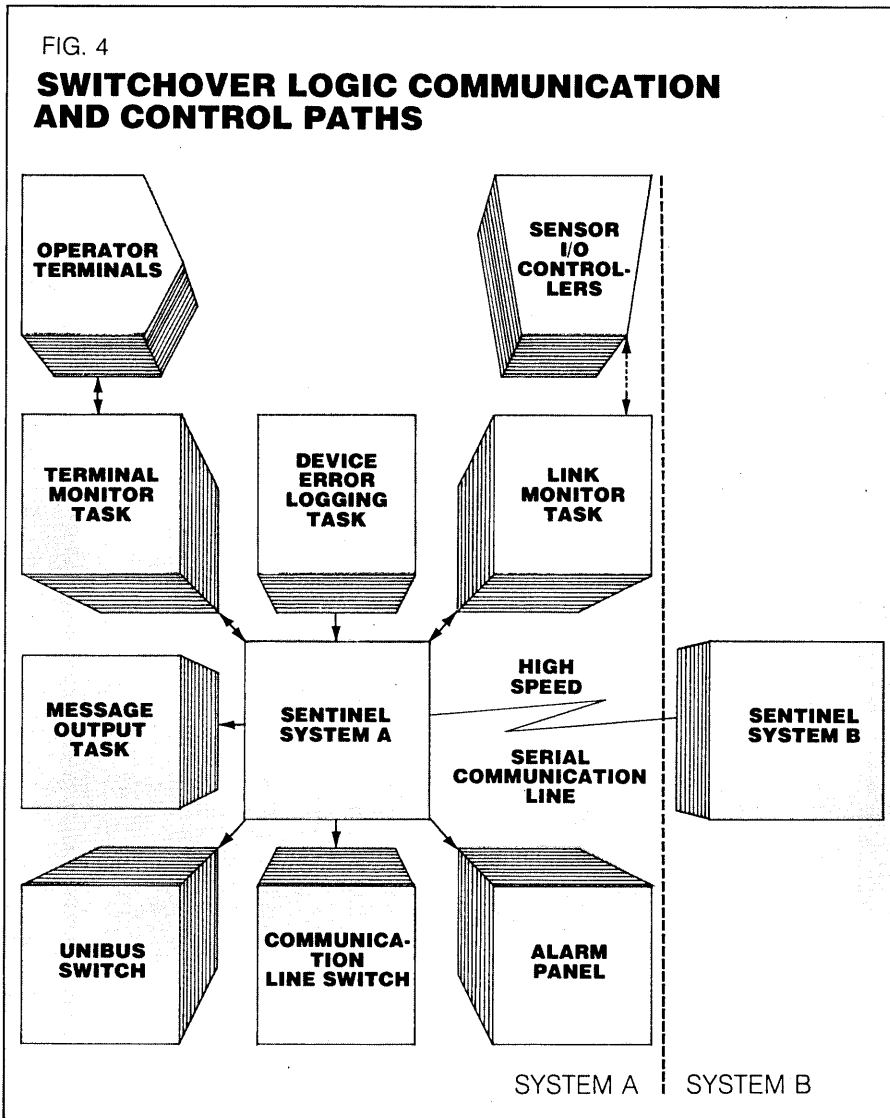

continuity will be lost during this interval. However, expensive processor controlled switches are not required.

Level 3—Operator Initiated Switching. Between this level and the previous level, the only difference is that the processor controls the switches and is thus able to sequence all the required hardware and software operations without operator intervention. The operator must still initiate a switchover, either via a typed command or a function key; however, the processor may advise the operator when a switchover is prudent. Once the switchover is initiated it can proceed rapidly and there are no opportunities for operator induced deadlocks. This level of switching may be acceptable in systems that are unattended for extended periods.

Level 4—Automatic Switchover. This level is similar to the previous level except that the processor might detect failures and determine whether these failures warrant a

switchover. There are many applications where operator involvement in the decision process is mandatory so that the automatic switching would not be appropriate. Moreover, operator initiated switching must always be provided as a fallback. However, for the very little cost above that of operator initiated switching, automatic switching provides a very convenient "hands off" redundancy.

SWITCH-OVER SEQUENCE

There are three stages to the switchover process. The first stage is failure detection. This phase is common to all four levels of control described above. The second stage involves decisions on whether or not a given failure warrants switching processors. In all but level 4, automatic switching, this decision is made by an operator. The third stage involves the orderly process of switching control from the on-line

to the standby processor. The oil refinery system shown in Fig. 1 is a convenient example for detailing these three stages.

Stage 1, failure detection, is accomplished as shown in Fig. 4. All process I/O, communication, and operator interfaces are controlled by specific monitor tasks. These tasks in turn communicate with a supervisory task called the Sentinel. In this way all component status information is routed to a single task, the Sentinel, which in turn writes status messages on a typewriter and codes status information into a status word. In addition, failures and status indications are displayed on an alarm panel located in a prominent place in the control center.

The status information together with the time of day information is transmitted from the on-line Sentinel to its counterpart on the standby machine every 15 seconds.

All of the stage 2 switchover decision logic resides in the standby machine. This is necessary to avert deadlocks, since only the standby machine knows whether or not it is healthy enough to assume on-line control. When the standby machine receives the on-line processor's status message, it combines this information with its own status in the single status word. This status word is then processed by simple decision tree logic, the output of which is a decision to initiate a switch or not to.

Stage 3, the actual switchover sequence, is best illustrated with a stage diagram (Fig. 5). On-line states are shown on the right, standby states on the left.

Starting with a "reboot," a processor always switches to the standby state unless the reboot was part of the switchover sequence, in which case the "switch initiated" state is entered immediately. From the standby state the operator can request a change to the "on-line switch initiated" state. If a switchover decision is made when the system is in a development state, then a fresh reboot will be required before proceeding. This is necessary to avert deadlocks, since the viability of any development system is always suspect.

In either case, when the standby enters the switchover state, a control message is transmitted to the on-line system. The on-line system enters a "switchover in the process" state, stalls all on-line jobs, and starts a five-minute switchover timer. If the standby computer is unable to complete a switchover in this allotted time, then it is assumed that the switchover has failed, and the on-line system will attempt to regain control.

While in the "on-line switch initiated" state, the standby system attempts to operate all switches and to initiate all on-line software. If it fails, a "switchover failed" message is transmitted to the on-line system, which will attempt to regain control. If it suc-



DO YOU INTEND TO SOLVE YOUR APPLICATIONS BY A MINICOMPUTER? IF SO, WE GIVE YOU THE IDEAL SOLUTION: MAKE USE OF OUR INDEPENDENT—100 CORAL 1001/4011 AND M-18 MINICOMPUTERS!

Due to their diversified applications software and peripheral equipments, these new low-cost minicomputers having core and RAM memory (I-100) as well as RAM, PROM and REPRAM memory (M-18), can be successfully used in various application fields such as: process control, scientific research, engineering and scientific computation, business data processing, data communication, data teleprocessing on-line or off-line connected to FELIX C-256/512 systems, communication line concentrators, computer-assisted education, etc.

For further information and detailed documentation do not hesitate to contact the exporting company



ELECTRONUM
Export-Import
Specialized Foreign Trade Company
70317 Bucharest - ROMANIA
11-15 Olari Street
P.O.B. 34-36
Telex: 11547, 11584

CIRCLE 145 ON READER CARD

FIG. 5

SWITCHOVER STATE

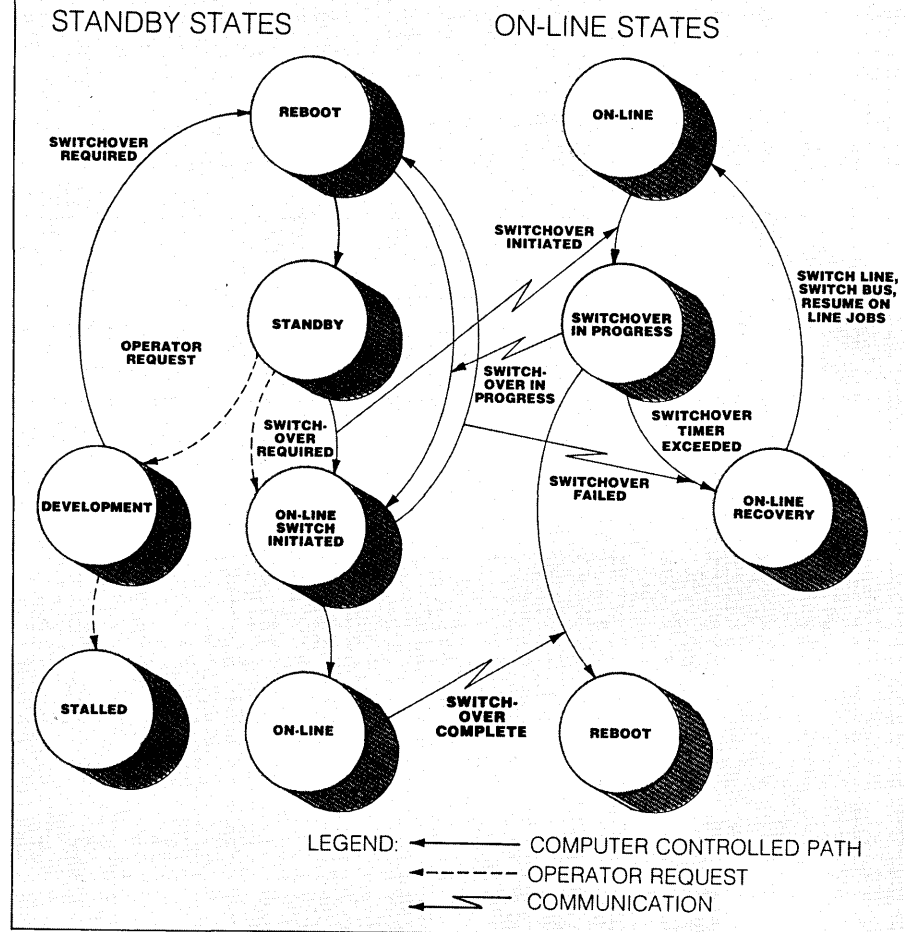

ceeds, it becomes the new on-line system. The former on-line system then reboots and becomes the new standby system. The operators should notice the alarm lights that indicate the circumstances of the failure and notify maintenance so that repairs can be made before another switchover is required.

Notice that the system can only be intentionally stalled from the development state. The development state is protected with password access and this arrangement prevents unauthorized users from accidentally stalling the standby system or, worse yet, stalling the on-line system.

BEST DONE IN PHASES

Implementation of redundant systems is best done in phases, where each phase represents a complete self-consistent intermediate system. If there are problems with the more recent system, the former tested system can be quickly restored with minimum loss of on-line continuity.

This approach reduces a complex design to a number of simpler designs and makes testing easier. For example, an automatic system will always have at least two fallback modes, manual and operator initiated switching.

The first phase would be the manual

switchover. This would serve to verify the operation of hardware components and would give the operators some redundant capability while the switchover software was being developed.

Next, the operator initiated switching could be implemented and tested, and finally the fully automatic mode.

When the redundant system is fully operational, the user's confidence in the computer system will increase and he will wonder how he was able to get along for so long with only one computer. *

SAMUEL FELDMAN

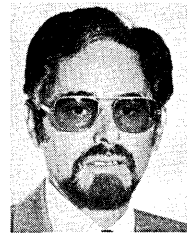

Dr. Feldman is a software consultant and technical coordinator for Digital Equipment Corp.'s New Jersey district. He is also the district training coordinator. Feldman is the inventor of a patented digital phase lock loop, which is used in most earth station demodulators.

"The data from this experiment could affect national defense. That's why we use Scotch® Brand Disk Cartridges."



Ken Bish, Engineer,
Systems Research Laboratories,
Inc., Dayton, Ohio

Every Scotch Disk Cartridge is tested and certified error-free before it leaves the factory. Because, for the defense of your data, nothing less than perfection is acceptable.

The disks in Scotch Disk Cartridges are defended by 3M's exclusive CRASHGUARD® protective disk coating. It greatly minimizes the possibility of a head crash, and minimizes the damage, should one occur.

Scotch front-loading Disk Cartridges also feature our exclusive Living Hinge air door, which reduces the possibility of damage to the disk from contact with the air door stop during shipping and handling.

You can get Scotch Disk Cartridges in front or top-loading models. To find out where you can find Scotch Disk Cartridges or virtually any other data recording medium, call toll-free: 800-328-1300. (In Minnesota, call collect: 612-736-9625.) Ask for the Data Recording Products Division.

**If it's worth remembering,
it's worth Scotch
Data Recording Products.**

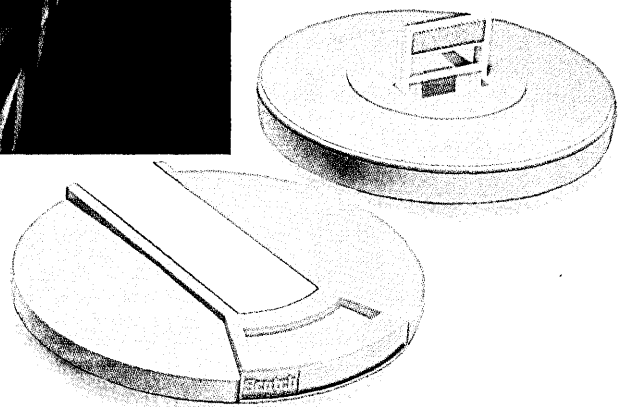

3M

CIRCLE 146 ON READER CARD

**31st SICOB[®]
PARIS - FRANCE
YOU'LL BE
WELCOME**

SICOB: International Exhibition for Data Processing, Telematics, Communication and Office Organization.

SEPTEMBER 17-26, 1980

CONVENTION INFORMATIQUE

International Conference on Data Processing.

SEPTEMBER 15-19, 1980

AT THE SICOB

339,934 visitors from 111 countries registered in 1979.

2,226 makes from 29 countries shown.

AT THE CONVENTION INFORMATIQUE

2,752 delegates from 41 countries registered in 1979.

150 conferences and panel discussions organized.

**PARIS
ON THE SPOT
FOR DATA
PROCESSING**

FOR INFORMATION APPLY:

INTERNATIONAL TRADE SHOWS IN FRANCE
French Chamber of Commerce in the United States Inc.
1350 Avenue of The Americas
NEW YORK N.Y. 10019 - Tel.: (212) 582.4960

PUBLICIS T 7814

GRAHAM

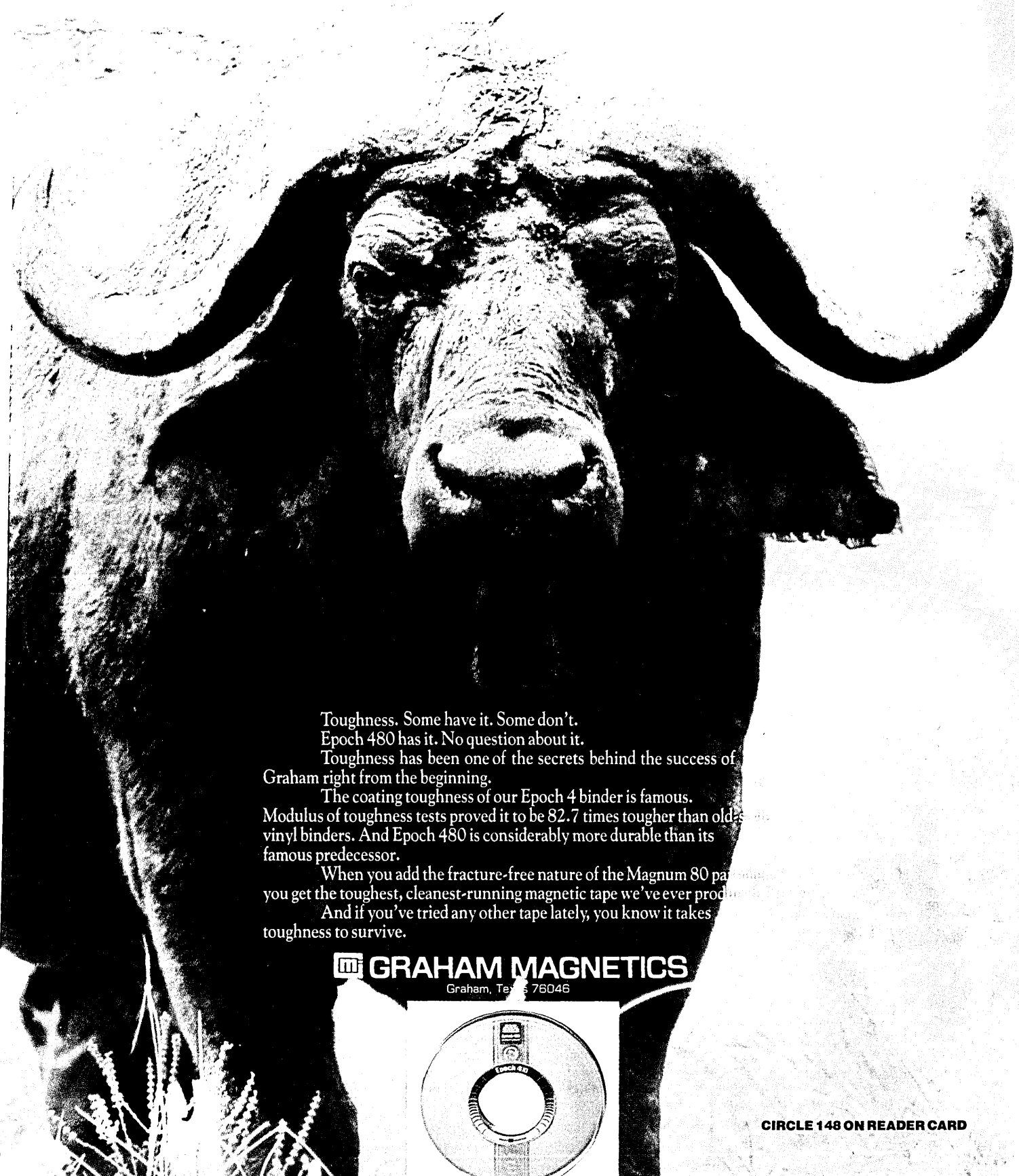

Toughness. Some have it. Some don't.
Epoch 480 has it. No question about it.

Toughness has been one of the secrets behind the success of
Graham right from the beginning.

The coating toughness of our Epoch 4 binder is famous.
Modulus of toughness tests proved it to be 82.7 times tougher than old-style
vinyl binders. And Epoch 480 is considerably more durable than its
famous predecessor.

When you add the fracture-free nature of the Magnum 80 particulate
you get the toughest, cleanest-running magnetic tape we've ever produced.

And if you've tried any other tape lately, you know it takes
toughness to survive.

 **GRAHAM MAGNETICS**

Graham, Texas 76046

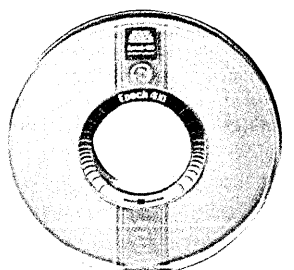

CIRCLE 148 ON READER CARD

Symmetrical multiprocessing gives large-scale computer power at a lower cost and with higher availability.

MORE POWER TO YOU

by Allan B. Wilson

Multiprocessing is a computer organization in which multiple cpus are interconnected. A multiprocessing solution can be used to satisfy different system design goals. Multiple cpus are used on spacecraft to provide high availability. If one or more cpus fail, system hardware and software assure continued system operation. Other multiprocessing design projects under way seek to provide large-computer power by using many interconnect micro or minicomputer cpus.

The basic idea is that one can obtain a minicomputer relatively inexpensively. Ten of these minis with suitable hardware and software will give large-scale computer power, but at a lower cost and with higher availability (if one of the 10 minis goes down, the remaining nine continue working while the 10th is being repaired; thus the system suffers only small degradation in service).

Another reason for multiprocessing is that it offers uniprocessor sites a means of obtaining more cpu power with little hardware or software investment. The additional cpus will be of the same type as the existing cpu, assuring hardware and software compatibility. Also, hardware maintenance is not compromised: site engineers need no additional training to deal with the new cpu, and system spares are the same.

Certainly one option a site with a uniprocessor system has is to acquire another independent system, that is, one with its own cpu, memory, and peripherals. Again, maintenance engineers need no additional training and spares are the same; however, there are economic inefficiencies resulting from multiple copies of the operating system, supporting software, system disks, etc. The system is also more difficult to administer. The user community must be partitioned between the two systems, so manual load balancing is necessary, and both systems must be kept current with software updates (did bug X get fixed on both systems?). Additional operators may be required.

There are two generic multiprocessing organizations: loosely coupled and tightly coupled. Loosely coupled multiprocessing connects two or more individual systems by

means of a communication link (Fig. 1). Each system is capable of independent processing, but supports the link to allow at least file-system access, and perhaps task interchange for a form of load balancing. File-system access provides not only a file transfer mechanism among systems, but more generally allows a task on one system to open a file on another system. File I/O is transparent to the task so that records going to or from a file on another system are passed across the link instead of requiring direct file I/O on the task's cpu and peripherals. System software should support links of various types and speeds so the one most appropriate for a particular operating environment can be selected.

A tightly coupled multiprocessor organization (Fig. 2) has a single shared memory and a single copy of the operating system and supporting software.

MASTER/SLAVE SETUP

In the master/slave organization (Fig. 3) the master is the general-purpose cpu: it does both computation and all system I/O. The slave has no I/O devices except a console terminal and therefore is present only for computation.

In Digital's TOPS-10 master/slave organization, the slave does not take orders from the master. Both cpus execute the TOPS-10 scheduling routines looking for jobs to run; there is code to prevent both cpus from selecting the same job. The slave differs from the master when its job makes a monitor call for some system service, typically I/O. Except for some non-I/O monitor calls, the slave cannot proceed. It simply marks the job as needing the master's attention, enters the scheduler, and selects another job to run. The master, in the meantime, is working on other jobs, and when it schedules again it will find and run jobs marked as "run-on-master" by the slave. Thus the slave is a slave by virtue of the fact that it simply cannot perform all system duties and relies on the master for many services.

In terms of performance, the master/slave organization can be successful, especially if there are plenty of compute-bound jobs it can work on: as long as jobs do no master-only monitor calls, the slave can con-

tinue to run them. Availability of peripheral switches contributes to the utility of master/slave. If the slave fails, only some cpu power is lost; if the master fails, devices can be switched and the former slave reloaded as master.

As the speed of I/O devices (essentially mechanically limited) have remained constant relative to increases in cpu speed, the newer computer systems tend to be more I/O bound. For example, if a program does I/O every 10,000 instructions, a faster cpu will execute the 10,000 instructions more quickly and reach the I/O requests sooner than a slower cpu. Thus, the faster cpu spends a larger percentage of its time waiting for I/O. This phenomenon means that job mixes well-suited to master/slave multiprocessing on older cpus are not necessarily well balanced on later cpu models. Thus, the definitions of compute-bound and I/O-bound change with introduction of faster cpus, and since master/slave efficiency depends on having adequate compute-bound jobs in the mix to work on, master/slave may or may not be satisfactory when existing customers upgrade to newer cpus, or when vendor or user software characteristics tend to make software I/O-bound.

Therefore, the underlying basis for master/slave deficiencies is system architectural asymmetry, i.e., cpus are not functionally equivalent—only the master can do both computation and I/O.

Eliminating master/slave restrictions by extending full functional capabilities to all cpus has been the goal of TOPS-10's new Symmetrical Multiprocessing (SMP) organization. Notice (Figs. 3, 4) that SMP hardware configurations are quite similar to master/slave configurations except that with SMP, I/O devices can be connected to both cpus. Memory is still shared between processors and there is still a single copy of the operating system. With SMP, however, the entire monitor is reentrant and all monitor calls can be executed on all cpus. (While the SMP release officially supports only two processors, the SMP software has been designed and written to support up to six.)

Because monitor calls can be executed by any cpu, a cpu can continue to run a

ILLUSTRATION BY KATHY JEFFERS/PHOTO BY MARTY UMANS

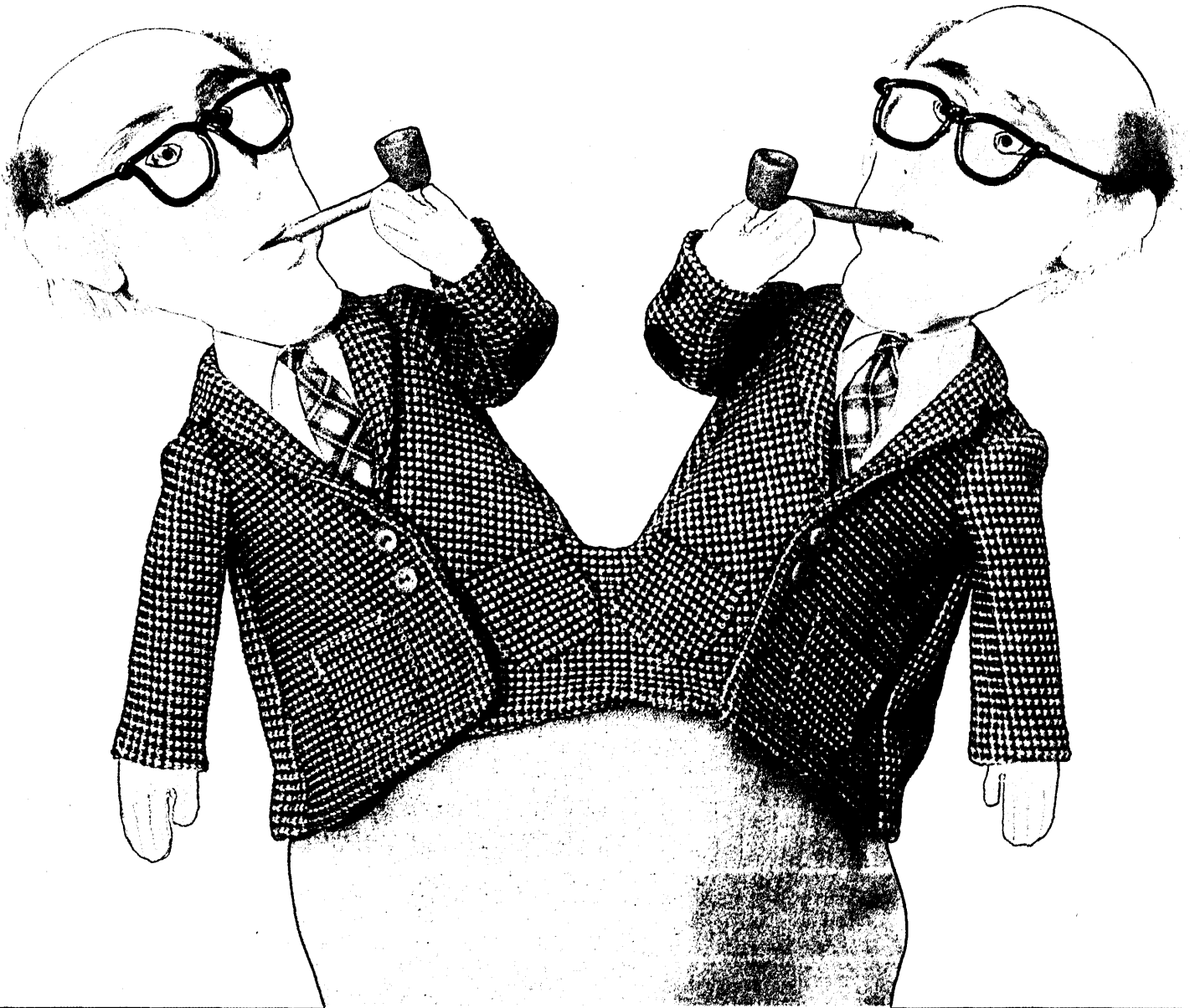
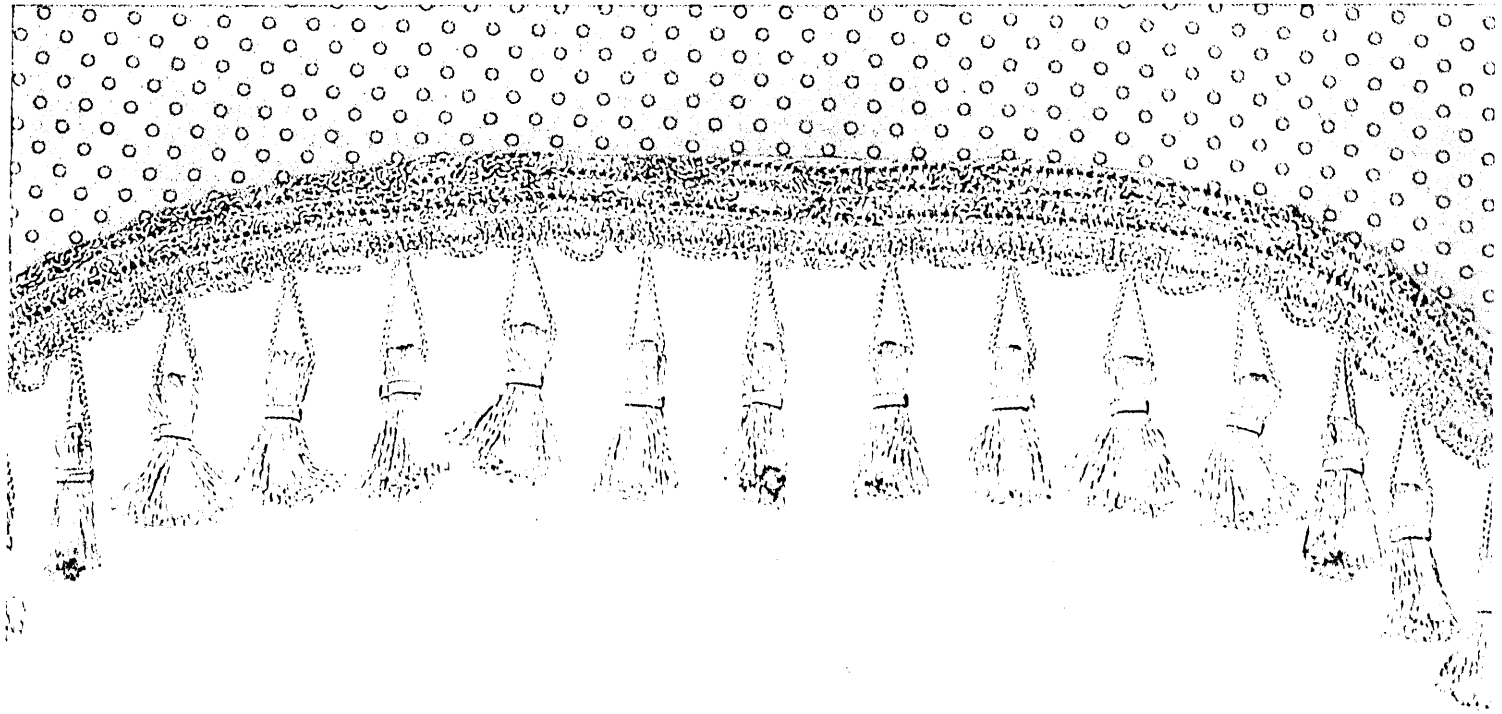

job even if the job requests I/O on devices that are connected to a different cpu in the system. A queued I/O protocol has been developed to implement this capability.

In SMP, the cpu running a job is called the executing cpu; the cpu connected to devices used by the job is called the owning cpu. If a job requests I/O to devices on the executing cpu, the request is processed by putting it in that cpu's I/O queues. If a job requires devices on a different cpu, then a request is made by the executing cpu that will cause the owning cpu to queue the request for action. Once the request is made, the executing cpu can complete the monitor call and resume the job, relying on the owning cpu to deal with the I/O transfers. Context-switching overhead is much reduced in this organization; in master/slave each I/O request on the slave requires a context-switch to the master. (Context-switching is the action of stopping execution of the currently executing job, appropriately saving its status—"context"—for later execution, scheduling to select another job to run, and setting up and starting the new job. Context-switching can take from several microseconds to several milliseconds, depending on hardware characteristics, scheduler design and implementation, and amount of context to save/restore.)

Note that SMP scheduling, both cpus executing the scheduling routines to find jobs to run, will typically result in the same job being run at different times by different cpus throughout the course of its processing. The queued I/O protocol ensures that I/O requests are handled properly regardless of which cpu executes a job or where in the system the job's files and devices are physically located.

This scheduling technique of multiple cpus working on a single queue of jobs is efficient. Queuing theory shows that multiple servers working from a single queue give better response than multiple servers and multiple queues, which would be the case in a loosely coupled multiprocessing organization or with multiple independent systems, where each cpu has its own operating system and thus its own scheduler and scheduler queue. Therefore, SMP offers automatic and dynamic load balancing, which neither of the other multi-cpu approaches provides.

Another feature of SMP permits I/O load balancing. As shown in Fig. 5, in SMP, multiported disks can have dual port access by a single cpu (also supported by the master/slave system) or by two different cpus. Load balancing is thus dynamic and automatic on dual-ported disks and yields higher availability and throughput.

IMPLEMENTATION OF SMP

Scheduling in a multiprocessor system provides additional flexibility over a single-cpu system. While

FIG. 1

LOOSELY COUPLED MULTIPROCESSING

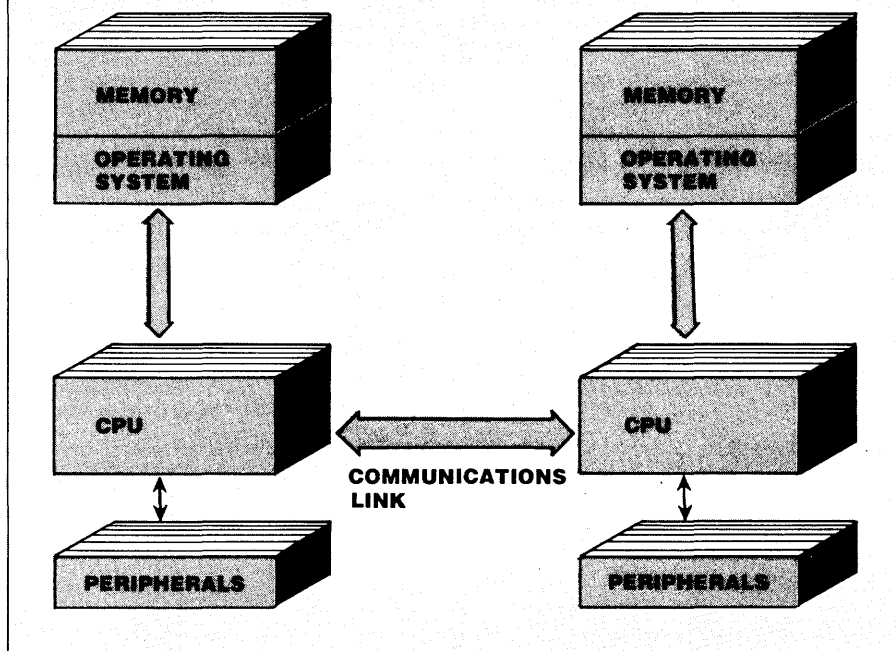
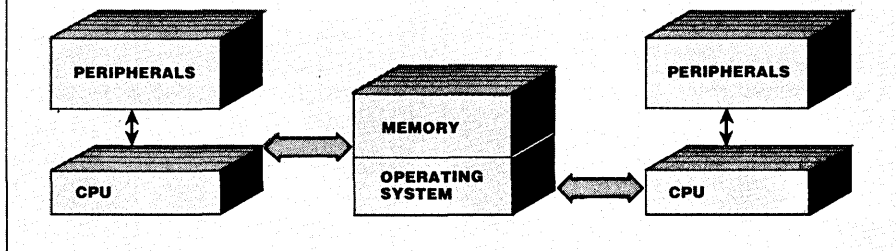

FIG. 2

TIGHTLY COUPLED MULTIPROCESSING



knowing details of the TOPS-10 scheduler is not necessary to understand the scheduling implications in SMP, a simplified description is useful. Basically, the TOPS-10 scheduler runs both periodically, driven by a clock, and when the currently executing job is finished or temporarily unable to continue (waiting for I/O completion, for example). In selecting the next job, TOPS-10 gives designated jobs and interactive work higher priority to use the cpu than "normal priority" and compute-bound work. TOPS-10 attempts to run high priority and interactive jobs when they request the cpu; other jobs are run in the background. Optionally, the system administrator can partition background jobs into classes, and allocate percentages of cpu time to individual classes.

Currently in SMP, one cpu processes work using these priorities. The other cpu, however, looks for background work first, and will process such jobs as long as they are available; designated high priority jobs and interactive jobs are serviced by this cpu only if there is no background work to do. This

"asymmetric scheduling" has the basic effect that one cpu works on interactive jobs, while the other runs compute-bound jobs. If there are sufficient compute-bound jobs in the mix, the second cpu processes them with little context-switching overhead, even if there is also a heavy interactive load. The disadvantage is that if the mix is predominantly interactive, the second cpu wastes time looking for compute-bound work before it gets to the interactive jobs.

It is possible in SMP that the system administrator will be given the option of dynamically specifying symmetric or asymmetric scheduling to reflect current operating demands. Alternatively, it has been considered to have the system alter scheduling itself, based on mix characteristics.

An important aspect of scheduling in a multiprocessor environment is inter-cpu interference. For example, if both cpus enter the scheduling routines simultaneously they can compete for accesses to instructions and data, and, even more significantly, cause each other to wait for various interlocks (such

TOREN/GAYNOR



Wir sprechen viele Sprachen.

(We speak many languages)

Over 15,000 Ontel intelligent systems are used worldwide with many languages—English, Italian, German, French, Spanish and Hebrew. Our software languages include—PASCAL, BASIC, FORTRAN and OP/L. Ontel provides everything for successful OEM installations... data processing... word processing... communications... delivery... customer support... operating systems. And certainly not least—highly attractive pricing. Contact me today. You'll find we speak your language.

Edward J. Heinze
Vice President Marketing
Ontel Corporation
250 Crossways Park Drive
Woodbury, NY 11797
(516) 364-2121

CIRCLE 149 ON READER CARD

Ontel

The master/slave organization can be successful if there are plenty of compute-bound jobs it can work on.

as the one to prevent cpus from selecting the same job to run). While studies show that most scheduling is done as a result of jobs blocking for I/O or other events, and not because of periodic timer interrupts, SMP skews the clocks on all cpus to ensure that their clock interrupts occur at different times. Each cpu gets the same frequency of timer interrupts, but none occurs at the same time as interrupts on other cpus. Thus cpu clocks in SMP are intentionally skewed to prevent periodic simultaneous scheduling and attendant overhead.

While it has nothing to do with scheduling, the periodic timer interrupts which cause a cpu to run the scheduler are also the occasions on which the cpu scans a global queued-I/O request queue to see if there is I/O the cpu needs to perform for jobs run on other cpus. The requests are removed from the global queue and placed on a cpu-local queue for processing. Any jobs waiting for the requested I/O to finish are marked as runnable when a transfer completes. Thereafter, the job can be run by any available cpu in the system.

CACHE USED AS BUFFER

The memory controller portion of the KL-10 cpu (Fig. 6) coordinates memory access requests from the cpu and from peripheral devices such as disks and magnetic tapes connected via internal channels/controllers (RH20s). The cache is a 2048-word semiconductor memory that serves as a buffer for primary memory. Read references to primary memory by the cpu result in the memory controller checking to see if the referenced words are in the cache. If so, the memory controller supplies the cpu with the data directly from the cache; this results in rapid memory access times, because the five or six times slower primary memory need not be accessed.

If the requested data are not in the cache, the memory controller gets the data from primary memory, supplies them to the cpu, and places them in the cache, where they will be found on subsequent references. (Actually, accesses to primary memory and cache-fills are done in "quad-words," so that the referenced word and three adjacent words are fetched; thus speed of sequential accesses to instructions and data is improved by pre-loading cache locations.)

Memory write operations are done only in the cache (not in both cache and primary memory as in a write-through cache organization). The cpu has instructions to explicitly validate memory with updated cache contents ("sweep the cache"); memory validation is automatic if the memory controller needs in-use cache locations for new data. The memory controller also deals with memory accesses by the internal channel/

controllers and will supply updated data from the cache on "write-from-memory" (output) transfers.

Typical program characteristics and system operation result in using data in the cache 90%-95% of the time, thus improving primary memory access times and thereby increasing cpu speed. Thus 90%-95% of cpu primary memory references are avoided, reducing contention for primary memory and eliminating many memory interference problems.

While the KL-10 cache organization is efficient with respect to primary memory accesses and improved cpu speeds, it does cause two problems. The first and most significant is that when a cpu runs a job or does anything which causes job data to be modified in its cache, the cpu must sweep its cache to validate primary memory before another cpu can run the same job. Otherwise, the new cpu could use "stale" data in primary memory because updated values would be in the other cpu's cache. The new cpu cannot recognize the data as stale, and thus would not be working with the job's proper context. Such operation is incorrect and can result in subtle bugs that are difficult to track down.

The second problem is important in terms of availability. It may be the case that a cpu has modified data in its cache for several different jobs before a sweep completes. If the cpu suffers a failure before the sweep completes, other system cpus cannot select any of these jobs since they cannot be run with respect to cache. Therefore, these jobs are effectively lost. The jobs must be manual-

FIG. 3

MASTER/SLAVE MULTIPROCESSING

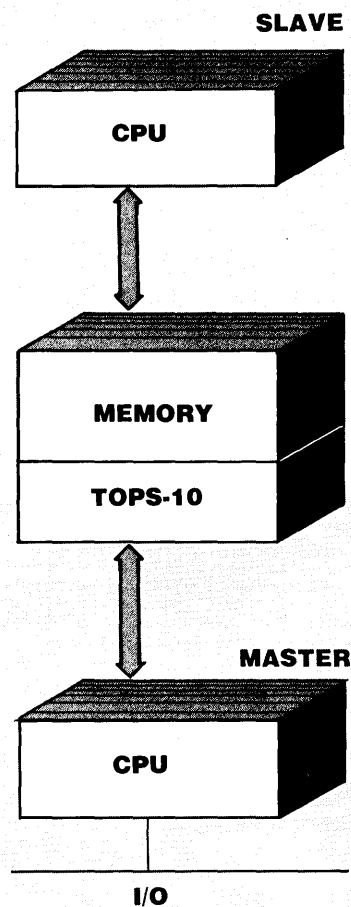
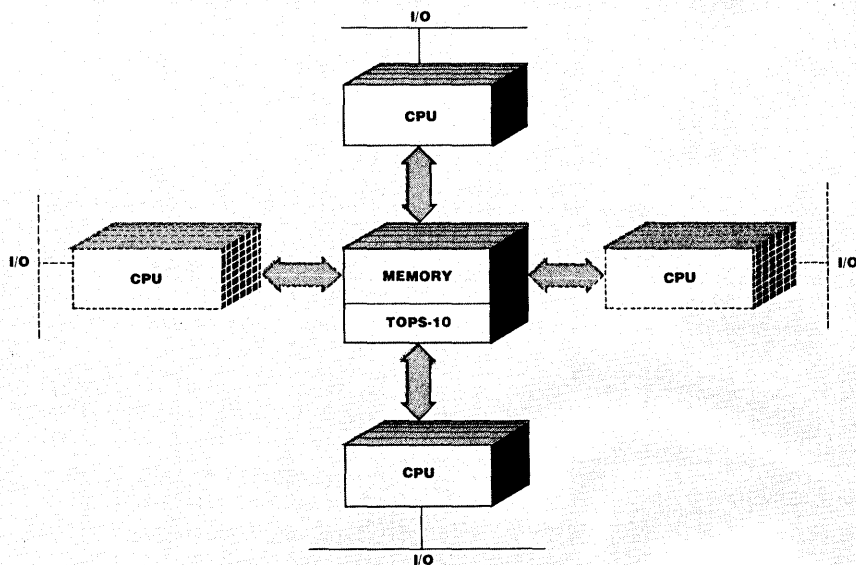

FIG. 4

SYMMETRICAL MULTIPROCESSING



FINALLY, A SMART TERMINAL THAT DOESN'T SACRIFICE FORM FOR FUNCTION.

Bright, crisp, non-glare CRT is easy on the eyes.

Standard 25th status line lets you know what's happening as it's happening.

You have 16 function keys right at your fingertips, operable in shifted and non-shifted modes.

Sculptured, typewriter-style keys are smooth, responsive to the touch.

Displayed data can be enhanced with a wide choice of video attributes.

Reliable operation up to 19,200 baud.

Cursor control keypad is compact, easy to use, with centrally located home key.

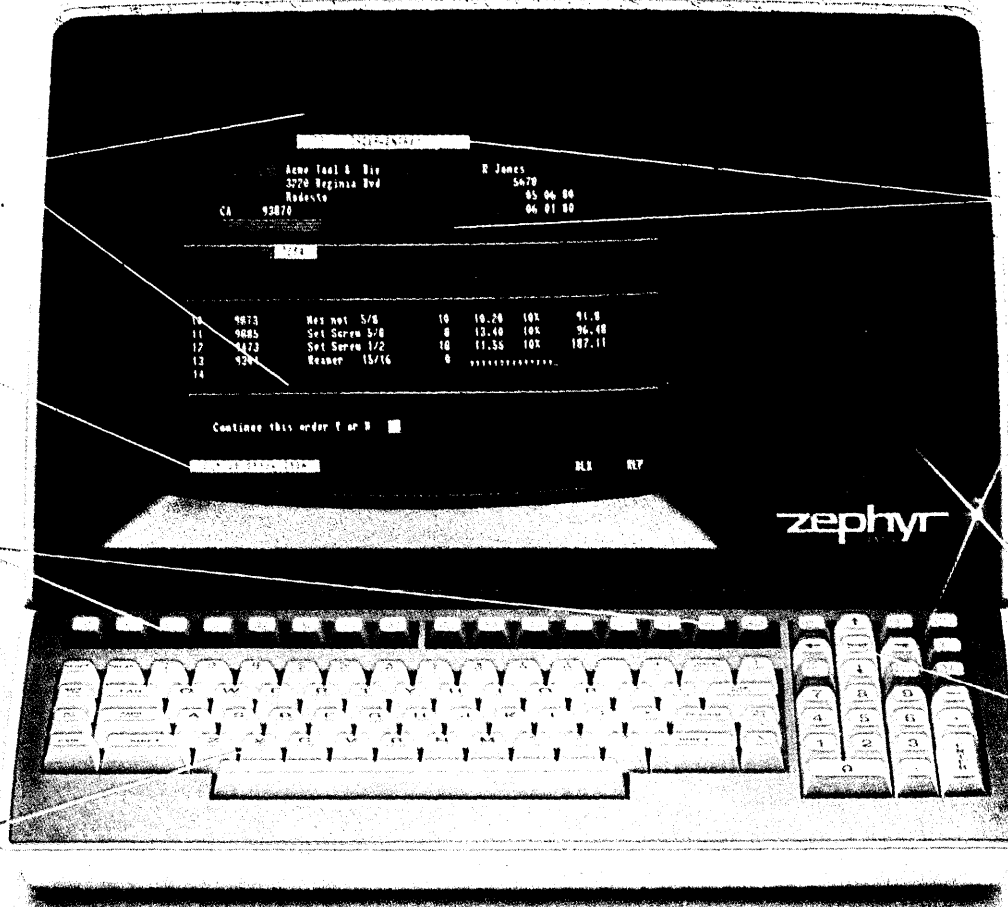

THE ZEPHYR™ BY ZENTEC.

There's really only one way to appreciate our new Zephyr. On the seat of your pants.

Go ahead. Sit down and touch test the Zephyr's typewriter-style keyboard. It's positive, yet responsive to the touch. And it's laid out for operator convenience. Above the standard 96 ASCII keys you'll find 16 function keys that operate in both shifted and unshifted modes. To the right, there's a compact numeric keypad and a cursor control pad with centrally positioned home control, both functionally designed to help you process more data, more efficiently.

The keyboard's not our only stroke of genius, though.

Zephyr's CRT is a sight for sore eyes, too. The large 12" non-glare video display incorporates a high resolution P-4 phosphor that makes it easier for you to work with words. You can quickly address two full 1,920 character pages of video display and enhance displayed data with a choice of video attributes including dim, blink, blank, reverse video and underscore.

Zephyr functions in both conversational and block modes, too, so you can transmit data with each keystroke, or transmit only unprotected data within a protected form, greatly improving your system throughput. And because

Zephyr is a product of Zentec experience, you are assured of reliable performance, day in and day out. Year after year. You have our word on it.

Isn't it time you found out how much more our Zephyr can do for you and your CPU? Just call your nearest Zephyr distributor and ask for a demonstration. He's listed below. Or call us at (408) 727-7662 and ask for Ted Atlee. It could be one of the smartest moves you've ever made. Zentec Corporation, 2400 Walsh Ave., Santa Clara, CA 95050.

ZENTEC

... the last word in intelligent terminals

Authorized distributors: David Jamison Carlyle Corporation, Los Angeles, CA, (213) 277-4562; Comspec, Inc., Houston, TX, (713) 461-4487; ADL Corp., Wharton, N.J., (201) 328-1300; Leasametric, Inc., Foster City, CA, (415) 574-4441; R. C. Data, Santa Clara, CA, (408) 988-7510.

CIRCLE 150 ON READER CARD

A feature of SMP is that it permits I/O load balancing.

ly restarted from the beginning or the last checkpoint.

Thus, because of the KL-10 cache implementation, a cpu failure may cause from zero to several jobs to be lost. Nevertheless, losing a few jobs is still preferable to losing 80 to 100 jobs, as would be the case if a loosely coupled or completely independent system cpu failed.

A cache sweep serial number scheme is used to keep track of primary memory currency with respect to cache. Every time a cpu completes a sweep of its cache, it increments its cache sweep serial number. When a job is stopped or requests I/O, the current cpu and cache sweep serial numbers are saved. The operating system can tell if a cache sweep has completed a job by comparing the current cache sweep serial number for the cpu with the saved value. If the current cache sweep serial number for the cpu is greater than the saved value, at least one sweep (and a single one is sufficient) has completed. Thus the system can safely manipulate the job, knowing that primary memory is up-to-date.

If during a cpu's scheduling cycle, jobs are available to run but cannot be run because cache has not been swept for them yet, the scheduling cpu keeps track of this "cache lost time" as a cpu operational statistic. High cache lost time is bad, because it means that a cpu is available to run jobs but has to remain idle since jobs cannot be run with respect to cache. To minimize cache lost time, a cpu can request that another cpu sweep its cache, thereby updating primary memory with cache data from jobs the other cpu has processed. Every major scheduling cycle, each cpu honors any sweep requests from other cpus (one sweep suffices for all requests). To further reduce cache lost time, if a cpu selects a job to run and is context-switching from another job, it starts a cache sweep so that the "old" job will become runnable with respect to cache on other cpus when the sweep completes (in about 250 microseconds).

The cache implementation does permit cache to be enabled or disabled for each page in memory. This facility allows the monitor to "uncache," i.e., selectively disable cache for pages containing certain monitor data for which sweeps would be impractical. Terminal I/O buffers and cpu cache sweep serial numbers are examples of data stored in uncached pages. Accesses to such data are relatively infrequent, so no large cpu speed or primary memory access penalties are incurred.

RINGING A CPU'S DOORBELL

Cpus in SMP communicate continually since a single copy of the operating system is shared among all cpus. Accessing and modifying global values such as job status information is a common

form of communication. Reading another cpu's cache sweep serial number is a typical example of one cpu needing specific information about another cpu. However, there is no cpu hardware such as a "doorbell" for one cpu to interrupt another cpu or get its attention. The design and implementation of SMP revealed that for scheduling or cache management no such doorbell is necessary. In fact, a hardware doorbell would only be useful during emergencies ("I'm dying" or "get out of my way").

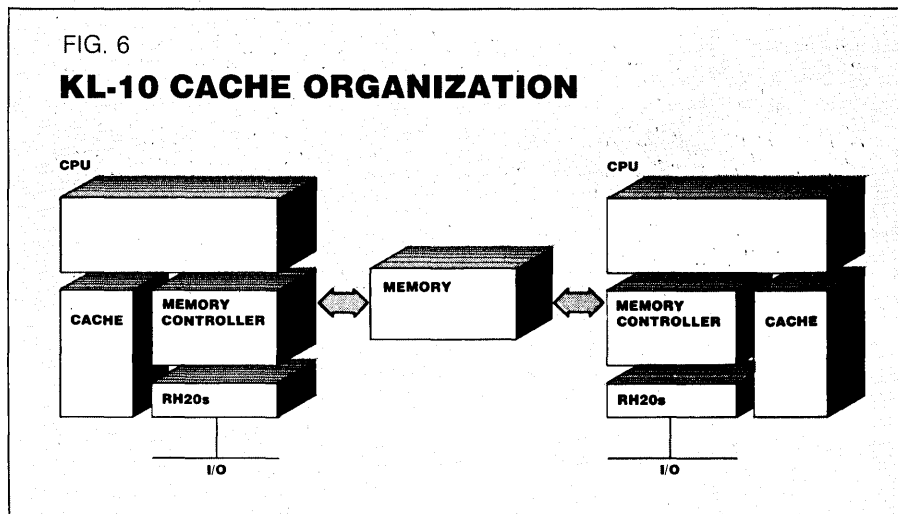
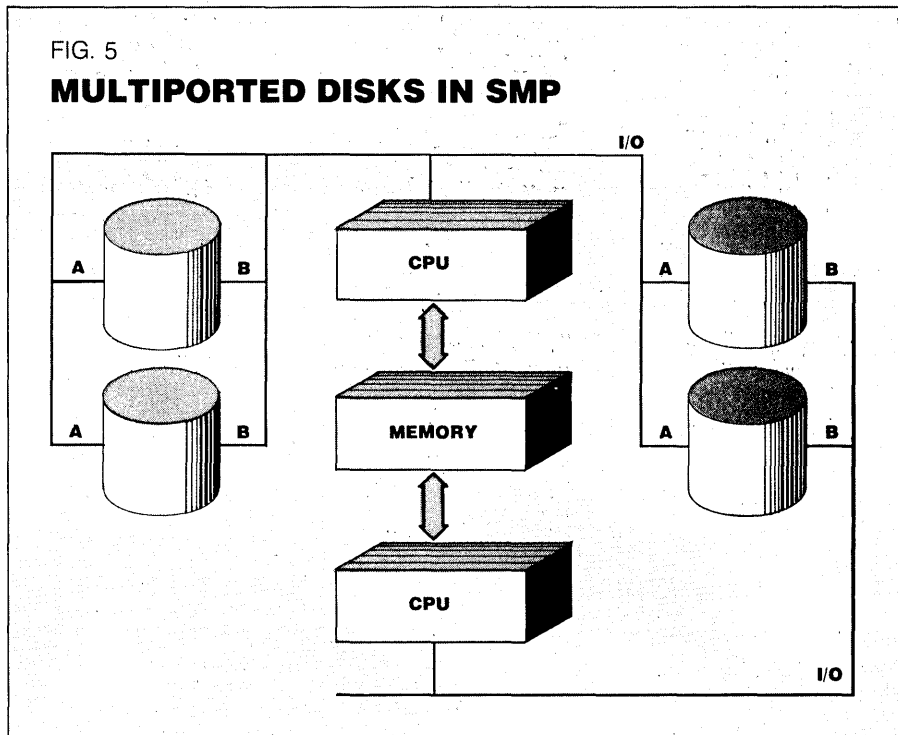

form of communication. Reading another cpu's cache sweep serial number is a typical example of one cpu needing specific information about another cpu. However, there is no cpu hardware such as a "doorbell" for one cpu to interrupt another cpu or get its attention. The design and implementation of SMP revealed that for scheduling or cache management no such doorbell is necessary. In fact, a hardware doorbell would only be useful during emergencies ("I'm dying" or "get out of my way").

Rather than implement a hardware doorbell, a software doorbell was chosen for SMP. The basic mechanism allows a cpu to ring another cpu's doorbell, or the doorbells

of all other cpus, on a "significant event," such as cache sweep done (jobs can be run with respect to cache), I/O done (job can be run because I/O request has been satisfied), and queued-I/O request made (I/O to do for job run on another cpu).

A cpu has to "listen" for a doorbell; a doorbell will not interrupt or otherwise disturb a cpu. Currently, the only time a cpu pays attention to doorbells is when it is idle, that is, when it has scheduled, found nothing to do, and runs the "null job" until something happens to make work available.

This software doorbell implementation is good in that a cpu is not taken away from useful work with interruptions. A nega-

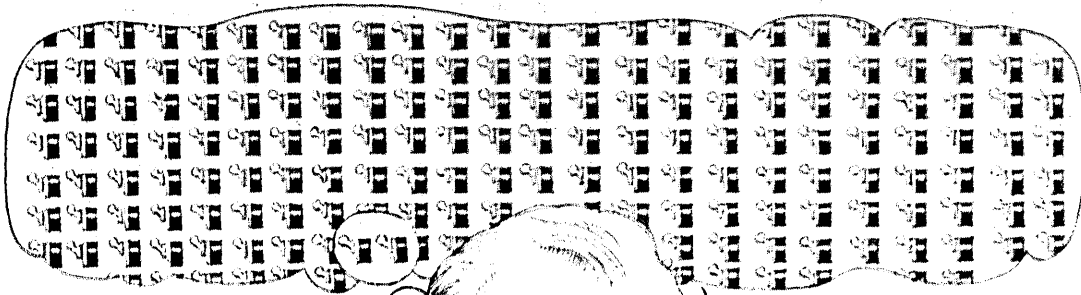

Problem:

You've *got* to get 25,000 electronic switches to New York, Boston, Chicago, Pittsburgh and Miami—*tomorrow!*

And...you've *got* to have 'em picked up at your door and delivered to each factory.

And...you're going crazy with worry.

Solution:

Make *one* call.

- over 1,400 flights a day to your most important markets—and every plane carries cargo
- we carry large and small shipments
- one-carrier responsibility—we do it all
- door-to-door service
- competitive rates

We're in the Yellow Pages under Air Cargo.



UNITED AIRLINES CARGO

One call does it all.



See things our way.

We have something for you to see!

SIGGRAPH '80, the Seventh Annual Conference on Computer Graphics and Interactive Techniques, is offering a full week of intensive exposure to the capabilities of computer graphics systems.

You'll see presentations on the latest in computer graphics applications in business, industry, and education.

You can attend basic and advanced tutorials on state of the art topics like color, interactive displays, low cost graphics, and management systems.

More than 80 vendors will participate in the world's largest exhibition of the latest graphics hardware, software and services. You can discuss your needs in detail with knowledgeable vendor representatives, and be able to compare and evaluate a wide variety of computer graphics systems.

You'll meet other users of graphics software and hardware, who can show you how they have met their management needs with computer graphics.

So plan to join us in Seattle, July 14-18.

For more information call or write:
SIGGRAPH '80
P.O. Box 88203
Seattle, Washington 98118
(206) 453-0599

SIGGRAPH '80

Sponsored by **acm**, The Association for Computing Machinery

SMP is administratively simpler and more economical than multiple independent systems or loosely coupled microprocessors.

tive aspect is that a cpu may look for work to do as the result of a doorbell yet find nothing to do. While looking for work to do, it holds interlocks and increases memory contention, and thereby possibly interferes with other cpus that do have work to do.

Route-through and multipathing extend the utility and availability of SMP systems. Route-through means that intermediate nodes pass along data destined for other nodes in the network; multipathing allows alternate paths to destination nodes such that a failure in one path does not prevent the arrival of messages through an alternate path (transparent to users).

Redundancy, or duplication of critical components, increases availability by providing additional units to handle a particular function should one unit fail; the failing unit can be repaired while the backup units assume the workload. The master/slave system provides cpu redundancy but requires additional operator action for switching and re-loading after certain failures.

SMP has better inherent availability than master/slave. In SMP, all devices can be duplicated and placed on all cpus. Thus any device in an SMP system can fail (*single

point failure'') and the system can still provide all critical functions and services. With dual-ported disks, failure of a cpu, channel, controller, or disk port will not prevent the system from accessing the data base through the other path. Such operation is automatic and the operator is notified of the failure so corrective maintenance can be scheduled.

Memory parity errors are rare, but will be automatically retried up to three times per word. A hard error, that is, an access unsuccessful on all retries, causes the associated job to be stopped and an error message issued to the user if the access is to a private page. A hard error in a shared page causes the system to get a new copy from the disk area used for shared pages and continue automatically. Parity errors within the monitor itself are also handled. If the situation warrants it, the operating system moves itself into better memory.

The operating system logs all system errors and failures so that the system administrator and maintenance personnel have a history of system operation and can detect trends. Components configured into and out of the system are also logged.

Finally, SMP is administratively sim-

pler and more economic than multiple independent systems or loosely coupled multiprocessors. No resources are wasted in multiple copies of the operating system, supporting software, system disk areas, etc. Keeping software versions current on multiple systems, partitioning the user community among systems, and manual load balancing are all avoided. *

ALLAN B. WILSON



Mr. Wilson is currently international marketing manager for the Laboratory Data Products Group of Digital Equipment Corp.,

Marlborough, MA. He has held positions in software development and technical support, and his primary technical interests are operating systems, communications, and computer architecture.



Get a handle on the future.

Telcon's Ambassador Portable Terminal

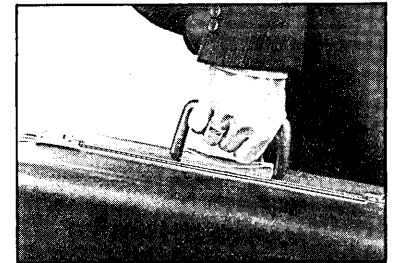

If you've been waiting for the future to bring the most sophisticated terminal in portable form, wait no more. It's here, the Telcon Ambassador. Look at these features; Full Screen Display combined with 40 Column Printing, Instantaneous Cassette Memory, Auto Word Wrap, every desired Text Editing Feature. Communicate anywhere in the world using Standard ANPA

bureau protocol, conventional or time sharing. And it's so rugged, you can treat it like an ordinary piece of luggage.

The Telcon Ambassador, for those who carry their office in a case. Call or write for a brochure on the extraordinary Ambassador I, don't wait for the future, it's here today at Telcon.

CIRCLE 153 ON READER CARD

TELECOMMUNICATION SYSTEMS AND EQUIPMENT



INDUSTRIES, INC.

1401 N.W. 69th St. • Ft. Lauderdale, FL 33309 • (305) 971-2250 • TWX 510-956-9412

Philadelphia: P.O. Box 253 • Morrisville, PA 19067 • (215) 547-1092

London: 76 Shoe Lane • Suite 307 • London, England EC4A3JB • 01-353-6621

Caracas: Esquina De Madrices-Centro • Edificio Lilue #82 • Caracas, Venezuela • Telephone (58-2) 81-95-74

Distributed by:

Amfax Communications, Inc. • Suite 203 • 49 Pleasant St. S. Weymouth, MA 02190 • (617) 337-3415

Canfax Communications, Inc. • Suite 6 • 8180 Devonshire Mt. Royal, Que. H4P 2K3 • (514) 737-8696

Mark your calendar now for the Federal ADP community's major annual event!



Come September, thousands of your colleagues will be on hand for this year's Federal Computer Conference at the Sheraton Washington Hotel in Washington, D.C.

It's the Federal ADP community's major annual event... an outstanding opportunity to catch up on the latest developments in automatic data processing and their impact on Federal Government operations.

Three days crammed with stimulating sessions!

The program, planned with the help of a Federal ADP Advisory Group, meets informational needs at every level. You'll find topics targeted right to your areas of interest and responsibility — plus speakers you won't want to miss.

Washington's most acclaimed computer exposition!

The only major Washington conference last year to attract blue-chip exhibitors like IBM, AT&T, Data General and Digital Equipment Corporation!

Over 100 leading companies exhibited the latest in computer hardware, software and services. This year's Exposition will be even bigger!

Record-breaking attendance!

The Federal Computer Conference — the first full-scale conference and exposition for Federal data processing interests — continues to attract a record-breaking number of attendees each year. Don't miss out on this unusual learning experience. Plan now to join your colleagues at the major annual event of the Federal ADP community!

The dates: September 22, 23 & 24, 1980.
The place: Sheraton Washington Hotel, Washington, D.C.

CIRCLE 154 ON READER CARD

For more information, send the coupon. Or call 617-358-5181 collect.



Scenes from the 1979 Conference

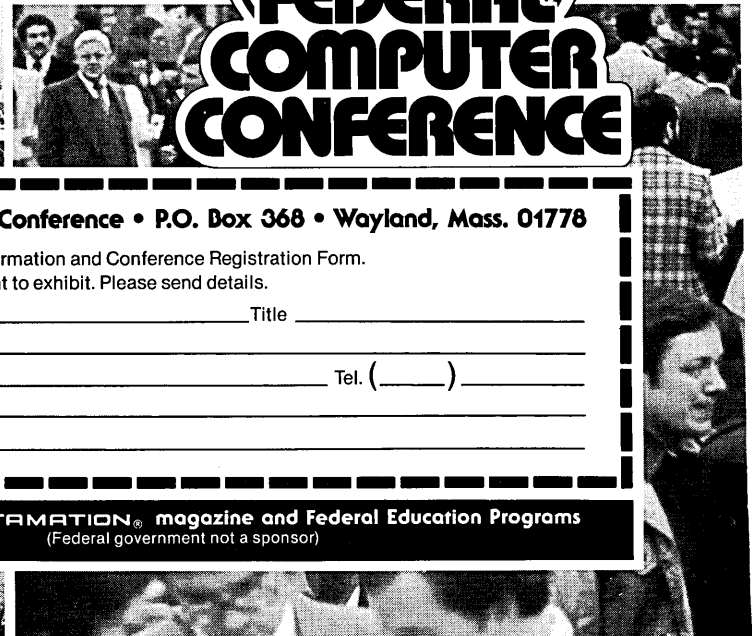

Federal Computer Conference • P.O. Box 368 • Wayland, Mass. 01778

- Please send more information and Conference Registration Form.
- My company may want to exhibit. Please send details.

Name _____ Title _____

Organization _____

Address _____ Tel. (____) _____

City, State, Zip _____

Co-sponsored by **DATAMATION**® magazine and Federal Education Programs
 (Federal government not a sponsor)



FEDERAL COMPUTER CONFERENCE

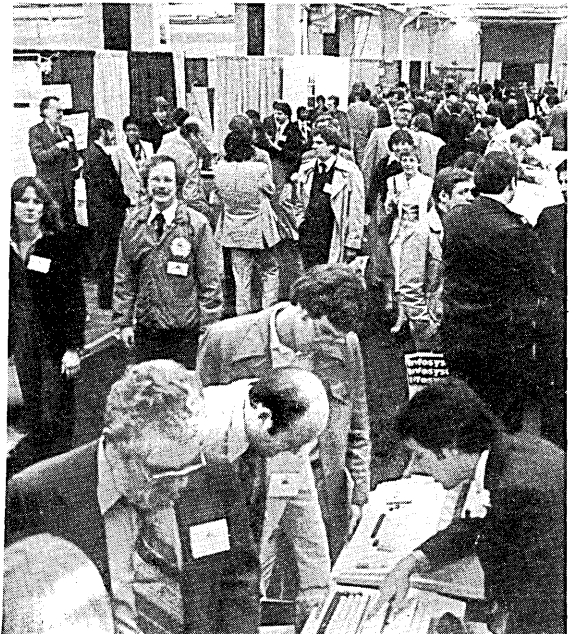

PEOPLE

SAND IN HIS SHOES

A nationwide network of field support, including parts and repair vans, is what's keeping Sorbus, Inc., the domestic service subsidiary of Management Assistance Inc., at record revenues.

"I believe the wave is coming . . . there will be alternative ways of service other than personal appearance of the service representative. Sorbus, for example, has a van fleet that provides mobile service to 12 U.S. cities," says Stephen J. Keane, president of Sorbus. "The idea is to get the customer up and running—and get out."

Sorbus's field support consists of over 80,000 pieces of information processing equipment, ranging from simple printers and video display terminals to large scale IBM systems and including MAI's Basic Four business computers, Wordstream word processing systems, and G Series terminals and printers. Operating from 160 locations nationwide with major support facilities in King of Prussia, Pa., and Orange County, Calif., the field organization provides remedial and preventive maintenance, systems reconfiguration, modification and reconditioning services, and memory and printed circuit repairs.

Keane's background covers more than 25 years of experience in diversified engineering, manufacturing, and marketing assignments in the aerospace and dp industries. Keane earned his BS in mechanical engineering from the Polytechnic Institute of New York in 1954 and an MS in management from Columbia University in 1960. His first assignment in the commercial dp business was at Potter Instrument Co., where he started in 1962. Keane remembers when he was approached by Max Palevsky, who wanted Potter to sell his fledgling Scientific Data Systems a printer on credit. Keane turned him down. A year later, Keane was banging on his door, begging for SDS's business. In 1969, he was one of the founders and president of Bucode, a compa-



STEPHEN J. KEANE—The idea is to get the customer up and running.

ny engaged in the design and manufacture of magnetic tape systems for the oem market. "You get the sand in your shoes for running your own company and Sorbus is absolutely like that—MAI gives its subsidiaries a great deal of autonomy."

In 1973 Bucode was acquired by Mohawk Data Sciences, at which time Keane became vice president at Mohawk responsible for oem, distributor, and supply business activities until June 1977. In July of that year Keane was appointed president of Sorbus and in August 1979 he was elected a vice president of Management Assistance Inc.

Keane believes that personnel management in the service business is critical. "Incentive programs, such as Sorbus's Magna program, result in only a 5% to 8% turnover in the field force; since the Magna program has been in effect, 50% of the participants have been promoted."

Sorbus supports IBM System/3, 3270 terminals, 370s, MAI's products (Basic/Four) and "other manufacturers," in which there are 50 contracts. The company has 10,000 end-user customers, and, as far as IBM equipment goes, "Our only customers are people who own the equipment—either directly or through third-party leasing. About 20% of IBM users fall into this category. Our company's real strength is

not only in servicing major metropolitan areas, but also in servicing the secondary cities—Harrisburg, Albany, Sacramento, Austin . . . a total of 160 areas nationwide."

Tying together all the areas is a Technical Information Center (TIC), which is staffed with specialists who are ready to assist service representatives who are encountering unusual problems in diagnosing system malfunction. The TIC provides the field organization with engineering change information, reference manuals listing potential service problems, planning data for design and configuration of equipment, parts catalogs, technical information bulletins, and information for specification of equipment and service tools.

In addition to supplying parts and pickup, Sorbus initiated a Field Inventory System (FIS), which became fully operational during fiscal 1979. When a part is required, service personnel have an inventory of over 90,000 types of data processing hardware to pull from. With its seven Basic/Four system 700s at King of Prussia connected to interactive video display terminals in the field, a service representative is in communication with 2,900 parts locations nationwide and can learn in seconds where parts are available.

How do new machines affect a service company? "People prefer products with some field history; they're better off in avoiding the early engineering problems. We're still servicing 7090s and 1401s. People didn't realize how long they would last. When you purchase a machine you tend to hold on to it.

"Today's economic environment will not affect basic business. We're getting our market share and our business is countercyclical. Third-party leasing is cheaper, users tend to be multivendor, have site responsibility, systems experience, and some capability to define the problems."

Since 1972, when Sorbus became a subsidiary of MAI, it has had a 15% to 18% annual growth. With revenues up 29% from 1978 and with Sorbus representing 26% of MAI's total revenues, Stephen J. Keane proves that house calls are still popular and growing. *

Wang's 2200 Series Small Business Computers deliver custom solutions to specific business problems.

Too often, buying a small business computer means settling for a general-purpose answer.

But not with Wang. Because in addition to high performance, low cost and ease of use, our 2200 Series interactive computers offer something

very rare: customizing.

From our entry-level PSC II to our multi-job, multi-user 2200MVP, our 2200 computers are designed to be specially tailored—in both hardware and software—to do exactly what you need done. Payroll. Accounts receivable. Inventory. And plenty more.

Also, they let you expand into new applications easily—without giv-

ing up the investment you've already made. And our direct hardware and software support means you'll get all the help you need in planning and developing your system.

So instead of buying a computer that's just right for everybody, call Wang. And get a computer that's just right for you.

Wang Laboratories, Lowell, MA 01851, (617) 851-4111.

I'm interested in a fitting. Tell me more.

Name _____

Title _____

Organization _____

Address _____

City _____

State _____ Zip _____

Tel. # _____

Send to:
Wang Laboratories
Lowell, MA 01851
(617) 851-4111



Wang computers: Firm-fitting.



WANG

Making the world more productive.

©1979 Wang Laboratories, Inc., Lowell, MA 01851

CIRCLE 155 ON READER CARD



VISION^{Reg. S.M.} puts project management at your fingertips.

For effective project management and control you need up-to-the-minute information at your fingertips. You need reports presented fast and accurately in a variety of formats. You need **one** easy-to-use system that does it all. You need VISION.

VISION DOES IT ALL.

With VISION you can: ■ Develop project plans and schedules. ■ Monitor, control and update information (interactive or batch). ■ Do cost analysis and resource allocation. ■ Perform "what if" simulations. ■ Produce EZPERT graphics (networks, barcharts, X-Y graphs). ■ And much more.

WITH VISION IT'S EASY.

Utilizing VISION's CRT terminal—guided by preformatted displays—you work in plain English. There are no complicated program languages to learn. VISION asks the questions, you fill in the blanks, then VISION gives you output three ways: Printed Reports, Screen Displays, Plotted Graphics. (A Report Writer & Query module is also available for free format reports and displays.)

THERE'S SYSTEM VERSATILITY TOO.

With our family of hardware and software we can tailor VISION to big company, small company or distributed processing needs. A



PRINTED REPORTS

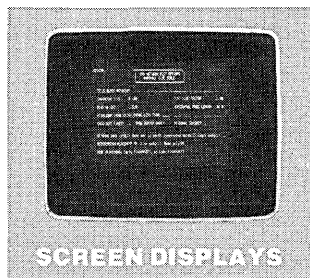

SCREEN DISPLAYS

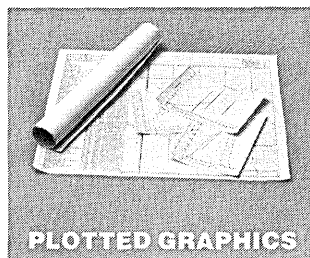

PLOTTED GRAPHICS

single operating system and plug-in upgrades of CPU's, peripherals and controllers means we can grow with your needs to support from 1 to 63 simultaneous users. In addition, VISION can be easily integrated into your existing data processing system. VISION provides RJE communications to IBM, CDC, UNIVAC and Honeywell; and can also emulate and support IBM 3271/3277 Display Systems.

BACKED BY EXPERIENCE.

The company behind VISION is Systonetics, Inc., the pioneer in automated project management systems. We have hundreds of satisfied customers—around the world—in a wide variety of industries.

Find out about the cost and time saving benefits of putting VISION at your fingertips ...call or write today.



Putting project management into perspective.

SYSTONETICS, INC.

600 N. Euclid St., Anaheim, CA 92801
Phone (714) 778-1600 • Telex 692-327

VISION gives you visibility three ways.

CIRCLE 156 ON READER CARD

HARDWARE

OFF-LINE

Gambling chips aren't the only chips to be found in casinos these days. Semiconductor chips have come to mean money to the firms supplying the gambling industry.

Nevada's Gaming Commission has approved a microprocessor-based conversion package for slot machines. Summit Systems, Inc., developer of the system, believes that modified slot machines will need less maintenance and will prove to be harder to cheat (we've heard that most of a slot machine's innards are comprised of security and antichecking functions). Additionally, converted slots are compatible with a cost accounting and security system developed by Summit.

Also drawing a bead on the slot machine upgrade market, Advanced Patent Technology, Inc., and Microbar Systems Inc. have announced an agreement in principle giving APT exclusive marketing rights to Microbar's Electronic Gaming Control System. The agreement covers all countries except England and Australia. Built to APT's specifications, the system includes Individual Controller Units located in each slot machine, handheld Record Collection Units, and a Record Conversion Computer. The system will be tested at the Colorado Belle Casino, opening the first of July, in Laughlin, Nev.

Cii Honeywell Bull, the French computer maker, has entered into a multiyear oem contract with Floating Point Systems, the Beaverton, Ore., array processor company. This is Floating Point's largest international contract to date, with revenues projected to fall between \$15 million and \$20 million.

PORTABLE TERMINAL

The Execuport 4000G wide carriage portable terminal adds business graphics capabilities to this vendor's 136 column upper/lower case ASCII terminals. In graphics mode, the thermal printer can produce plots, bar charts, histograms, pie charts and other images useful for business presentations; output can be made directly onto

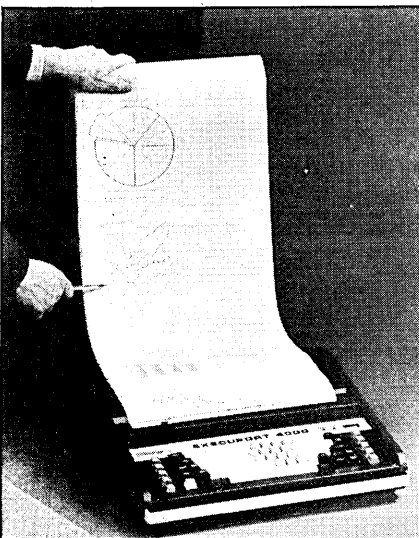

transparent film for immediate use with an overhead projector. Lines can be drawn in any direction, with a graphics resolution of 1,920 points per square inch (40 by 48). Alphanumeric output uses the 128 character ASCII set, while graphics are generated with a modified ASCII code with graphics characters. The 4000G operates at 30cps and includes an acoustic coupler. In singles, it sells for \$3,795. COMPUTER TRANSCIVER SYSTEMS, INC., Paramus, N.J.

FOR DATA CIRCLE 310 ON READER CARD

TERMINALS

A Teletype-compatible terminal and a 3278-compatible unit, both targeted against IBM offerings, are the latest offerings in this vendor's terminal line. The vendor's model 310, destined to compete with IBM's 3101, is an ASCII terminal capable of displaying 24 lines of 80 characters on its 15 inch diagonal screen; a 25th line is provided for status

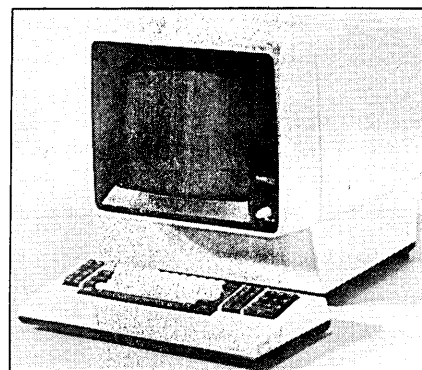

information. The terminal has a detached keyboard with numeric keypad and programmable function keys. Interfacing can be RS232 or current loop, with full- or half-duplex communications at speeds ranging from 110bps to 9600bps; an auxiliary RS232 port is optional. A single 310 sells for \$1,250, with quantity discounting dropping the price to \$900 per unit in lots of 100 or more.

Complementing the vendor's 3278-compatible model 278, the model 278E is a compact 9 inch diagonal terminal designed for use in cramped quarters—it needs only 21 inches of depth at the workplace. It has a 1,920-character screen (24 lines of 80 characters) with a 25th status line. It has most 3278 features, except for a light pen. It can work with its vendor's TC 276 controller, or IBM's 3276 or 3274. Printer support is provided. Field formatting capabilities include protected and unprotected, alphanumeric, normal intensity, intensified fields, nondisplay, and numeric lock. In unit quantities, the 278E sells for \$2,200. Leases are offered. TELEX COMPUTER PRODUCTS, INC., Tulsa, Okla.

FOR DATA CIRCLE 311 ON READER CARD

PORTABLE DATA ENTRY TERMINAL

This vendor of portable terminals has extended its handheld data entry line to include a new entry-level terminal, the model 66. Compatible with the vendor's 77 and 88 series terminals, the model 66 is aimed at electronic ordering and inventory management applications. Operating from four AA

HARDWARE

batteries, the model 66 allows data entry from its calculator-style keyboard or optional optical wand scanner. The 1 lb. 6 oz. terminal has a 12-digit display, and is offered with either 4KB or 8KB of memory. It can communicate with a host computer via a number of the vendor's communications modules, including an acoustic coupler. Communications can use either eight-bit ASCII codes or five-bit codes; data rates range from 300bps to 1200bps. A single model 66 with 4KB of memory sells for \$460, while an 8KB model 66 is \$560. Quantity discounts are offered on the terminal and its related communications and wand scanner options. MSI DATA CORP., Costa Mesa, Calif.

FOR DATA CIRCLE 301 ON READER CARD

PLUG-COMPATIBLE MAINFRAMES

Replacing the vendor's previously announced VMX 200 and VMX 400 plug-compatible mainframes, this vendor's QMX 6300 series consists of three processors, the largest of which is said to provide 170% the performance of IBM's 4300 series. The microcoded systems are said to support all 360 and 370 operating and applications software, while retaining the flexibility for future performance enhancements. Main memory sizes range from 1/2MB to 4MB.

The first model scheduled for shipment, the QMX 6336, reportedly offers 130% the performance of a 370/148, placing it in the middle of IBM's 4300 series. It supports from 1MB to 4MB of main memory cycling at 495nsec per 8 bytes; the processor cycle time is said to be 175nsec to 350nsec, with simultaneous multiple instruction processing. The basic QMX 6336 comes with one-byte multiplexor channel (50KBps) and two block multiplexors (2MBps per channel in burst mode). Two block multiplexors can be added as options. The aggregate data rate is in excess of 8MBps. QMX 6336 pricing ranges from \$163,000 to \$212,000.

The smaller 6333 provides 1.7 times the processing power of an IBM 4331 and supports from 1/2MB to 2MB of memory, 1-byte multiplexor and two block multiplexors. Pricing ranges from \$98,000 to \$123,000. The 6343, said to be 10% more powerful than a 4341, has yet to be priced. NANODATA COMPUTER CORP., Buffalo, N.Y.

FOR DATA CIRCLE 302 ON READER CARD

DAISYWHEEL PRINTER

Intended for oems building systems for word processing, data processing, and communications applications, the Model 630 impact printer can use either plastic or metallized daisywheels. Printing speeds range from 32cps (standard English font and text) to 40cps, depending on the print wheel and output text. Users can select print wheels from the more than 100 metal and

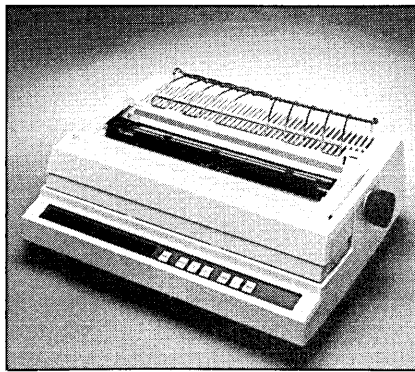

plastic daisywheels offered from the vendor, including 10-pitch, 12-pitch, and true proportional spacing. The 630 accepts ASCII characters via serial interfaces at speeds ranging from 110bps to 4800bps (20mA or 60mA current loop) and to 9600bps (RS232); an oem printer interface provides eight bidirectional data lines and six unidirectional control lines. In 10 pitch, the 630 can print up to 132 characters per line; column spacing is variable in 1/120th-inch increments and line spacing is variable in 1/48th-inch increments. The basic mechanism, with control electronics and microprocessor interface (for oems) sells for \$860 in quantities of 500; a packaged 630, with communications interface, control panel, power supply, and packaging, sells for \$1,705 in quantities of 500. DIABLO SYSTEMS INC., A Xerox Co., Hayward, Calif.

FOR DATA CIRCLE 303 ON READER CARD

HANDPRINT DATA ENTRY

A few years back, this British company introduced a handprint data entry system consisting of a number of work stations connected to a minicomputer that actually handled character recognition. Now, the firm has done away with the minicomputer, and incorporated all recognition logic into the microprocessor-based Micropad handprint data entry terminal. As the user writes (most likely on a preprinted form), his pen strokes are digitized and recognized by the Micropad. The unit recognizes ordinary handprinted characters, numerals, and special characters. The Micropad has a 40-character display, allowing the user to verify that the terminal has correctly recognized his input. Both RS232 and 20mA current loop interfaces are provided for connection to a host computer. The vendor is in the process of setting up a U.S. subsidiary to market the Micropad, and it is looking for interested oems. The end-user price in the U.S. is targeted at \$3,500. QUEST AUTOMATION LTD., Wimborne, Dorset, England.

FOR DATA CIRCLE 304 ON READER CARD

MODEM

This modem maker has made yet one more move guaranteed to keep it off of Ma Bell's Christmas list: it has introduced its ModemPhone, a telephone with integral low speed modem. Available in either touchtone or rotary dial versions, the ModemPhone can function as a regular telephone or as a 103A/

HARDWARE SPOTLIGHT

SMALL SYSTEMS

Reinforcing its position in the small business computer market, this vendor has come up with two new small computers, a recasting of its first-time-user PCS system, a disk multiplexor, and an applications program generator. The single-user 2200 SVP and multi-user 2200 LVP both support the vendor's BASIC-II programming language. The SVP starts off with a 32KB processor, crt terminal (including business graphics capabilities), and a single-sided, double-density diskette drive capable of storing 500KB on a diskette. The system can be expanded to 64KB of memory; other options include an additional diskette drive, 2MB or 4MB (formatted) of Winchester disk storage, and a 120cps printer. System pricing ranges from \$12,000 to \$20,000.

Up to four concurrent users can be accommodated by the 2200 LVP. User memory sizes range from 32KB to 128KB; the operating system uses an additional, separate 60KB of memory. System prices range from \$15,000 to \$35,000, with a typical single user 32KB system, including 1MB of floppy storage, 4MB of Winchester disk, crt terminal, and 120cps printer, priced in the \$17,500 to \$19,000 range. Both SVP and LVP support a variety of communications

protocols.

The low end of the 2200 series is now the PCS-111, which supersedes the PCS-II. The BASIC speaking computer differs from its predecessor model by including a single-sided, double-density minifloppy drive with a 140KB capacity. Only a 32KB version is offered; a second diskette drive can be added. Pricing is the same as for the PCS-II, ranging from \$6,500 to \$10,500.

Up to three cpus of the 2200 VP/MVP/LVP line can share disk storage using the 2280 disk multiplexor. The 2280 supports one or two drives, each with formatted capacities of 26MB, 51MB, or 80MB. Each drive has a 13MB removable cartridge disk, with the remainder of its capacity on fixed disks. The 2280 sells for \$2,000, plus \$500 for each cpu supported.

The Inquiry Data Entry Access System—IDEAS—is a set of utilities that are said to allow even nonprogrammers to develop complete data entry, inquiry, file management, and report generating applications without using BASIC. Essentially a program generator, IDEAS runs on the 2200 series of small business computers. It licenses for \$1,000. WANG LABORATORIES, INC., Lowell, Mass.

FOR DATA CIRCLE 300 ON READER CARD

Take a close look at the Houston COMPLØT CPS-14 & 15

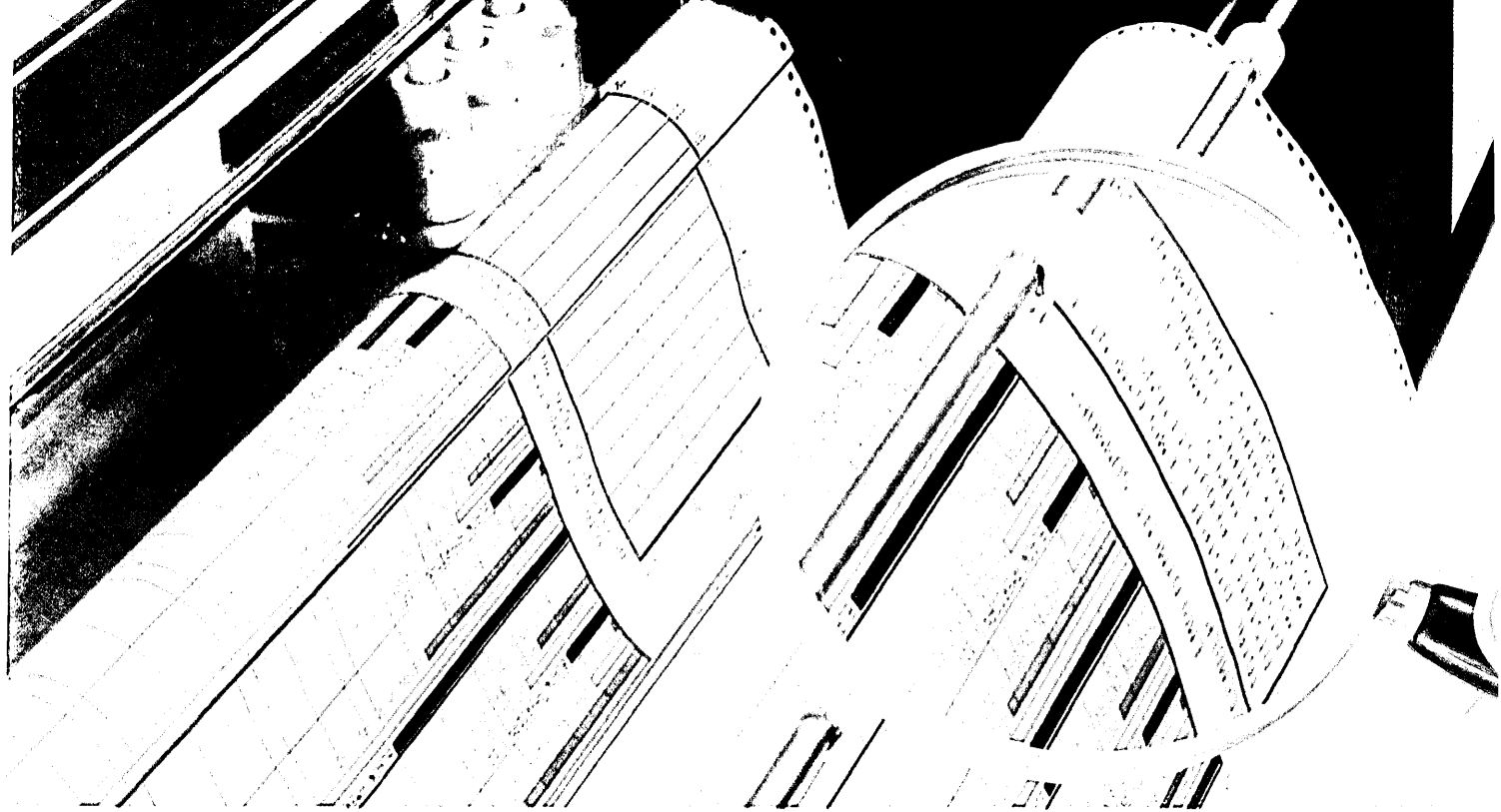

You'll see the real meaning of plot quality.

Drafting-like plot quality—that's the whole idea behind the new CPS-14 and 15 digital plotting systems. Make us prove it. Just take a look at the output from the CPS-14 and 15...you'll see plot quality comparable to or exceeding that of competitive plotters costing twice as much.

Four pens and a dual microprocessor controller with superior firmware functions combine to make this the ideal plotter for drafting, civil engineering, numerical control, mapping...any application where plot quality is vital.

Four pens at speeds of 15 IPS and a dual microprocessor controller with superior firmware functions combine to make this the ideal plotter for drafting, civil engineering, numerical control, mapping...any application where plot quality is vital. Scaling on both axes.

Houston Instrument, One Houston Square, Austin, Texas 78753. (512) 837-2820. For rush literature requests persons outside Texas call toll free 1-800-531-5205.

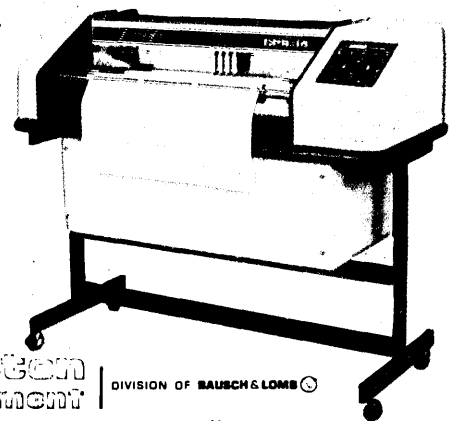

**Houston
Instrument** DIVISION OF BAUSCH & LOMB
"the graphics company"

**CIRCLE NUMBER 157 FOR LITERATURE
CIRCLE NUMBER 158 TO HAVE A REPRESENTATIVE CALL**

U.S. Domestic Price Only
®Registered Trademark of Houston Instrument

HARDWARE

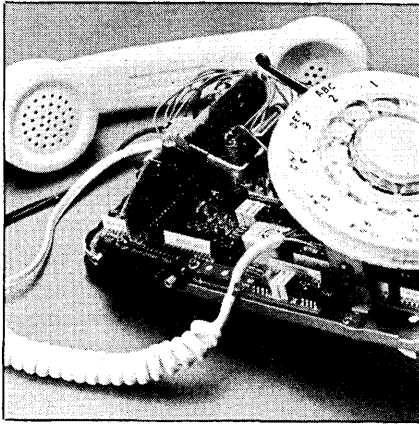

103J (as well as 113A through D) compatible modem. The VA103 ModemPhone is FCC-registered, and plugs into either a telephone company voice jack (RJ11C) or a programmable data jack (RJ41S or 45C). The modem itself has a wall-plug transformer for its power supply. An RS232 25-pin connector provides an interface to the user's terminal equipment.

The basic ModemPhone operates in full duplex at speeds ranging to 300bps; auto originate/answer is offered as an option for an additional \$80. A basic (originate only) dial phone version sells for \$250, and a touchtone version is \$300. RACAL-VADIC, Sunnyvale, Calif.

FOR DATA CIRCLE 305 ON READER CARD

MAINFRAMES

In the wake of its acquisition of ITEL's computer operations last fall, this vendor has announced a pair of 370-compatible mainframes falling in the performance spectrum between IBM's 4341 and its 370/158-3. Known as the AS/3000 series, the systems are manufactured by National Semiconductor's San Diego-based Computer Products Group. IBM-compatible firmware assists are included with the machines; popular IBM operating systems, including DOS/VSE, VS/1, MVS, VM/370, DOS, and OS, are supported by the AS/3000s. Both machines support five channels, have machine cycle times of 115 nsec, and memory cycle times of 690 nsec and 920 nsec (read and write, respectively). The entry level AS/3000N, rated a shade faster than a 4341, has 8KB of cache, and main memory sizes ranging from 2MB to 4MB. The AS/3000 is said to have performance equivalent to a 158-3; it has 16KB of cache and memory sizes ranging from 2MB to 8MB. An AS/3000N can be upgraded to an AS/3000 in the field.

Two support offerings were announced with the AS/3000s. The Central Program Support Service provides subscribers with 24 hour a day, seven day a week telephone assistance through a toll-free phone number; Local Program Support Service is offered to users desiring help

from a local system support representative. Local support goes for \$600 per month, central support is included in the machine's maintenance charge. With 2MB and five channels, an AS/3000N sells for \$325,000 and an AS/3000 goes for \$425,000; maintenance is \$1,550 per month and \$1,650 per month, respectively. Additional memory goes for \$50,000 per megabyte. NATIONAL ADVANCED SYSTEMS, Palo Alto, Calif.

FOR DATA CIRCLE 312 ON READER CARD

MICROCOMPUTER BOARDS

A low-end, single-board, 8-bit microcomputer and a more powerful general purpose 16-bit micro-on-a-board are the first two products built around this vendor's new 96-line bus structure; both boards have 96-pin high-density connectors that will allow them to work with future boards (I/O, memory, etc.) designed for the new bus.

The low-end, Z8-based board seems well suited for built-in controller applications and other dedicated uses. A BASIC/DEBUG interpreter is included on the board; additionally, the board supports up to 8KB of RAM, ROM, or EPROM in any combination. The board operates off a single +5 volt power supply, and includes two counter/timers, five 8-bit parallel I/O ports, and a programmable asynchronous port capable of meeting RS422 or RS423 interface standards. The board sells for \$695, or \$795

RENT • LEASE BUY

GENERAL DATACOMM MODEMS

	PURCHASE	36 MONTH LEASE RATE
212A DataSet	\$ 850	\$ 35
208B/A DataSet	\$3,275	\$110
201C DataSet	\$1,150	\$ 40
202S/T DataSet	\$ 565	\$ 20

DECwriterIII LA120	\$2,295	\$ 80
DECwriterIV LA34	\$1,295	\$ 45
DECwriterII LA36	\$1,895	\$ 65

DEC COMPATIBLE VIDEO DISPLAYS

VT100 Compatible Datagraphix	CALL	\$ 75
VT52 Compatible Hazeltine 1552	CALL	\$ 45

COMPUTER EQUIPMENT MAGNETIC MEDIA-ACCESSORIES

"DEC" Compatible Magnetic Media by NASHUA-RP06, RL01-RM03-RK05
ACOUSTIC HOODS-XEROX 1750-TI SILENT 700 PORTABLE

**CALL NOW • TOLL FREE
800-223-1696**

Qytel® 285 Madison Avenue
New York, N.Y. 10017
212-889-3888

CIRCLE 159 ON READER CARD

Software/Hardware MIS Professionals New England/East Coast/ Nationwide

Norton, Kleven and Co., Inc. has a wide variety of positions available with some of the top companies in the Industry. Our clients are seeking professionals who are well-versed in any of the following areas: Programming, System Analysis/Design, Data Base Applications, Applications Programming, Compiler Development, Language Design, Hardware/Firmware Design. If your experience covers one or more of the following areas at the state-of-the-art level, contact us: Software Design and development; Technical Support; COBOL/IMS, Computer Sciences; Assembly or Higher Language Programming; Data Base Design; Compilers, and/or Operating Systems Design; Digital Logic Design; Interface Design; Technical Writing; Microprocessor Utilization; Computer Architecture.

We've been providing confidential and industry-knowledgeable placement for, software/hardware/MIS professionals since 1969. We can also provide you with free resume preparation and career path counseling. Client companies assume all fees.

nk Norton, Kleven and Co., Inc.

INDUSTRIAL RELATIONS MANAGEMENT CONSULTANTS

Three Fletcher Avenue, Lexington, Massachusetts 02173
Telephone (617) 861-1020

Member:
Massachusetts Professional Placement Consultants
National Computer Associates,
(Offices Nationwide)
Representing Equal Opportunity Employers M/F

CIRCLE 160 ON READER CARD

Goldmine

for growth-minded software specialists.

When you become a software developer at TRW, you work with computer scientists, engineers, software designers, and other problem-solving types who relish complex and challenging tasks.

They're developing ways to make maxi, mini, and micro-computers work better in distributed data processing environments; ways to design large, dynamic data bases that are also highly reliable; ways to sort, correlate, and display sensor data of all kinds so that military and other decision makers can direct action in real time.

In short, we're a leader in C³I, digital communications, sensor data processing,

weapon system software and related disciplines, such as office automation for government applications.

To reduce the cost and risk involved in this state-of-the-art work, TRW has developed a large library of labor-saving software tools. In fact, designing new tools is another activity that may whet your appetite. You may want to help develop architectures, protocols, and operating and applications systems for very

large-scale processing networks...or horizontal microcode for special processors. TRW's work-study fellowship in Computer Architecture and Software Engineering combines half-time salary with a generous stipend for a Master's at UCLA— contact Lori Brown. For full-time opportunities, call Bob Chambers (213) 536-3081. Or write them at One Space Park, Redondo Beach, CA 90278.

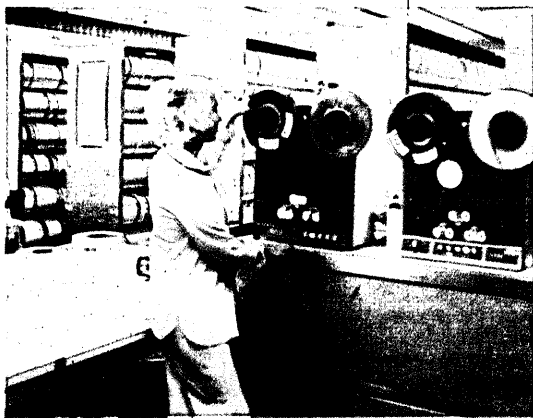

ADVANCED SOFTWARE
TECHNOLOGY

from

A COMPANY CALLED

TRW

DEFENSE AND SPACE SYSTEMS GROUP
An equal opportunity employer

HARDWARE

with an additional 4KB of RAM.

For applications requiring much more in the way of computing capabilities, the 16-bit Z8000 microcomputer board can be used as the basis of a computer system or as a node in a hierarchy of processors. The board includes 32KB of RAM (with parity), and room for an additional 8KB of RAM or ROM. The board's Z8001 microprocessor can address up to 8MB of memory. An on-board Z80A-S10 (serial I/O) controller provides two flexible serial I/O channels that can be independently programmed to support a variety of asynchronous or synchronous protocols, including bisync, SDLC, HDLC, and X.25; RS422 and RS423 also are supported. In singles, the Z8000 MPU board sells for \$2,295. ZILOG, Cupertino, Calif.

FOR DATA CIRCLE 306 ON READER CARD



PORTABLE SMART TERMINAL

Last year at NCC, this vendor introduced a programmable portable thermal printing terminal, dubbed the PRO. This year, the vendor has brought out a complementary offering, the model 1206/PAT (Programmed Applications Terminal) that, while not supporting program development, executes programs prepared on the PRO. This allows even non-dp types to use the PAT without being tempted to change its programming. Programs can be loaded through the PAT's integral tape drive, or down-line loaded. All operating characteristics are under program control, so an untrained user can't gum up the works by changing a switch position. Programs and data files can be transmitted via the unit's RS232 interface or its integral modem and acoustic coupler. The 1206/PAT includes 32KB of ROM and 32KB of RAM workspace; it can execute programs written in either BASIC or Motorola 6800 assembly language. The 17-pound PAT includes an 80-column, 50cps, upper/lower case ASCII thermal printer; options include switch-selectable 80-column printing, integral barcode reader, and a diskette operating system capable of supporting up to 1.44MB of mini-diskette storage. The 1206/PAT sells for \$5,195, quantity one. Deliveries are slated for the third quarter of this year. COMPUTER DEVICES, INC., Burlington, Mass.

FOR DATA CIRCLE 308 ON READER CARD

CRT TERMINAL

The VP 800/A is an intelligent crt terminal capable of emulating most currently available terminals; either the operator or host computer can specify the terminal's operating characteristics (parity, transmission rates, etc.). The VP 800/A can display 24 lines of 80 characters or 28 lines of 132 characters; in either instance, an additional line is provided for status information. Split-screen capabilities and a line-drawing character set are standard. The unit's

memory is packed for efficiency, and can be expanded to 32KB. The keyboard includes user-programmable function keys and a numeric keypad. Two RS232 ports are provided, allowing data communications at speeds of up to 19.2Kbps, as well as support for an auxiliary printer. A proprietary word processing package also is offered by the vendor. A basic VP 800/A with 8KB of memory, sells for \$2,250, with discounts offered to OEMs and distributors. DIRECT INC., Sunnyvale, Calif.

FOR DATA CIRCLE 307 ON READER CARD

Even Webster's Knows About QUEST

QUEST (kwest), v. 1. To make a search; to go on a quest.

QUEST SYSTEMS, INC. n. 1. Founded in 1968. 2. Among the largest professional recruitment firms in the U.S. functioning solely in the computer sciences; its client companies pay all employment fees, interviewing and relocation expenses. Quest is known for its deep personal commitment to relate to each candidate as an individual with individual goals. 3. Its professional staff averages over 6 years of experience in EDP recruiting (additionally, staff members have direct hands-on experience in programming, systems, hardware, sales, etc.). 4. Quest is presently searching for programmers and analysts (commercial, scientific, systems software) for over 3,500 client companies in the U.S. *Quest has openings in over 700 U.S. towns and cities; salaries to \$38,000.* 5. Methodology - see Questsystem.

QUESTSYSTEM (kwest sis'tem), n.1. Discussing with an individual what he/she would like to be doing in light of what he/she has been doing. 2. Analyzing the realities of his/her objectives as they relate to the current job marketplace. 3. Contacting client companies and other Quest staff personnel to identify positions of possible interest. 4. Introducing the job candidate to prospective employers by providing complete details to each about the other, ensuring the efficacious use of everyone's time. 5. Arranging interviews. 6. If employment offers are extended, Quest assists in evaluating the responsibilities, compensation and opportunities (and relates those to the initially stated objectives). The Questsystem has been working for thousands of professionals at no expense, whatsoever. Ask your friends of their past dealings with Quest. Then, put the Questsystem to work for you. For additional information on this subject, please inquire directly to Quest Systems, Inc. (All inquiries/resumes received will be responded to immediately and in confidence.)



Call Toll Free
(800) 821-7700, Ext. 114
QUEST SYSTEMS INC.

6400 Goldsboro Road
Washington, D.C. 20034 (301) 229-4200

Baltimore: (301) 788-3500 • Philadelphia: (215) 265-8100

CIRCLE 162 ON READER CARD

If you currently earn between \$20,000 and \$48,000 we've got a better job for you...NOW!

Every day you spend in the wrong job is a waste of time, money and talent...YOURS! Your talents and experience are in great demand and you can choose among many rewarding opportunities available in your field. But how?

Talk to the experts at Wallach. We've been successfully recruiting professionals like yourself for over 15 years.

Nationwide opportunities include technical/management consulting, project management, R&D, test and systems evaluation in the fields of Communications, Satellites, Weapons, Intelligence, Computer, Energy, and Aerospace systems. Specific skill areas include:

- Software Design
- Data Base Design
- Telecommunications
- Minicomputers
- Programming
- Signal Processing
- Digital Systems
- Microprocessor Design
- Systems Architecture
- Applications
- Command & Control
- Systems Programming
- Compiler Design
- EW/SIGINT/ELINT
- MIS/OPs Research
- Diagnostics

Don't waste another day in the wrong job! Call Perri Reeder collect at (301) 762-1100 or send your resume in confidence. We can find you a better job. Let us prove it to you...NOW!

WALLACH...Your career connection
Equal Opportunity Employer Agcy.

WALLACH
associates, inc.

1010 Rockville Pike
Box 6016
Rockville, Maryland 20852
(301) 762-1100

CIRCLE 163 ON READER CARD



exporting your products in the 80's

ANNOUNCING:

A Workshop for International Marketing Decision-Makers, an opportunity to meet with experts from industry and government and obtain the latest information on:

- Identifying the best overseas markets for your products
- A long range forecast of the marketing climate around the world
- Support services available to your company from the US Dept. of Commerce
- An introduction to the newly-created International Trade Administration

This will all take place on September 8 and 9, at the Commerce Building in Washington DC. We suggest that you register early. For more information, call Carla Graydon, (201) 741-2690, or fill out the coupon below.

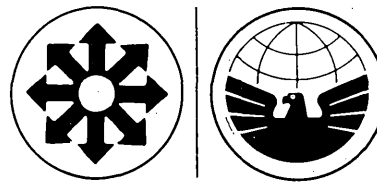

DATAMATION

c/o Graydon Associates, Inc.
PO Box 566
Red Bank, NJ 07701

Co-sponsored by:

DATAMATION MAGAZINE and the US Department of Commerce

In order to help us make this Workshop more productive, we are asking that you answer the following questions. All answers will be kept confidential.

- I am interested in attending
- Our company is an established exporter of our products for _____ years.
- Our company has products that we plan to export for the first time.

Name _____

Title _____

Company _____

Address _____

Telephone _____

CIRCLE 164 ON READER CARD

SOFTWARE AND SERVICES

UPDATES

Vintage humor from the annals of computing past: Roger A. Hopkins, vp at Information Associates International, unearthed a gem hidden in the 1961 IBM publication of the Reference Manual, IBM 7070/7074 Utility Programs. The general description of the tape print program informs users that "alphameric characters in the tape record will be printed in single-digit form, e.g., an I for an I, a 2 for a 2." Hopkins says this is the only bit of humor he's found in his collection of IBM manuals, and he wonders if anyone else can provide more examples.

Early on, observers of the emerging market for personal computer software pointed out the many problems a vendor faces when trying to protect software from unauthorized duplication and resale. Palo Alto-based Nestar Systems says it is now the victim of bootleggers in Europe. Nestar's BASIC Toolkit, a set of utility commands for the popular Commodore PET personal computer, reportedly is being sold on magnetic media; Nestar sells its version burned into ROM. In addition to the legal and ethical problems involved, Nestar says the unauthorized copies are incorrectly relocated into RAM, and may cause malfunctions under certain conditions. Caveat emptor.

Southern Pacific Communications Co. (SPCC) has applied to the FCC for authority to build and operate a \$200 million domestic communications satellite system. The dual-band satellites proposed are said to have twice the capacity of any domestic satellites currently in use or announced. If approved, the first satellite should be launched by the end of 1982.

SOFTWARE SPOTLIGHT

DESKTOP DBMS

Patterned after the IMAGE/3000 data base management system for this vendor's 3000 series computers, IMAGE/45 brings data base management to users of the desktop Series 9800 System 45. In addition to the set of system routines and statements for manipulating data base structures provided by IMAGE, users can interact with data bases through QUERY/45, an inquiry program that is intended to save users from having to write customized applications programs.

IMAGE runs on a 45B or 45C with at least 187KB of memory, mass storage ROM, and a pair of floppy disk drives; additional floppies and hard disks are supported. IMAGE itself is supplied in a pair of plug-in ROMs containing the code for enhanced BASIC statements for data base manipulation and maintenance. Depending on available storage, the system can handle a data base with up to 32 data sets, each having up to two levels of data files. Each data set can have up to 32,767 entries, depending on the length of each (1,022 bytes per entry maximum); data bases can contain up to 268MB.

Multiple volume data bases are supported, allowing even an entry-level twin-floppy system to have a data base in excess of the available on-line storage capacity. Imbedded pointers logically connect records into chained lists; up to 16 index files can reference a detail data set, and up to 16 details can be referenced to one master. File accesses are controlled by passwords, which can authorize different access modes (read-only or read-write) for each individual.

QUERY consists of roughly 500KB of BASIC code (making use of IMAGE enhancements). In addition to providing an inquiry mechanism, QUERY can be used to create data bases, data entry routines, and with an optional software link, select data for processing by existing System 45 statistics packages. A very interesting feature of the System 45 DBMS is its ability to use the system's printer to display a graphic map of the user's data base, including the links between related data records. The data base management package is priced at \$5,000. HEWLETT-PACKARD CO., Palo Alto, Calif.

FOR DATA CIRCLE 325 ON READER CARD

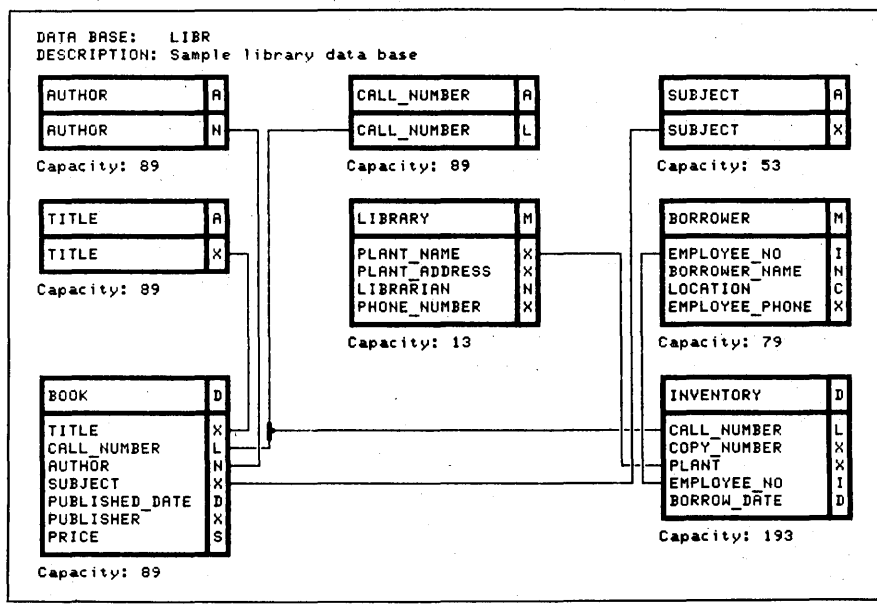

FINANCIAL HIGHLIGHTS

Significant Figures (000 omitted)

For the Year

Premiums written
 Premiums earned
 Underwriting income (loss)
 Investment income net of expenses
 Net operating income before taxes
 Net operating income after taxes
 Realized investment gains (losses)
 Extraordinary item
 Net income

Composite ratio
 Average shares outstanding

	1979	1978	Per Cent Change
	\$338,150	\$313,725	7.8%
	332,775	304,217	9.4
	(2,250)	(13,854)	83.7
	40,865	32,136	27.2
	38,957	17,054	128.4
	27,020	14,124	91.7
	1,551	1,300	
	\$ 25,467	\$ 17,705	43.8%
	99.8%	103.8%	
	5.167	5.455	

ASI-ST does most of the work; YOU reap the profit!

Easy to Use

More organizations are using ASI-ST more heavily than any other data management and report writer system. Why? Because ASI-ST is so easy to work with. You simply enter language statements and parameters; there are few rules to learn and remember. You can even omit many parameters entirely; ASI-ST picks the most commonly selected condition for those entries.

By eliminating up to 90 percent of the programming effort usually required to perform data management functions, ASI-ST is saving time and money for hundreds of users. Typical examples:

- COMBUSTION ENGINEERING, INC. (CE) currently executes from 18,000 to 22,000 ASI-ST runs every month. Some runs produce more than 100 reports in a single pass of one or more TOTAL data bases and conventional files.
- Using ASI-ST, AMERICAN EXPRESS COMPANY recently required only four minutes of CPU time to process over 12 million records. AMEX also uses ASI-ST with IMS.
- CORNING GLASS WORKS now executes an average of more than 16,000 ASI-ST runs monthly against TOTAL data bases and standard files.
- UNION CARBIDE's usage of ASI-ST averages over 6,000 runs per month at each of its worldwide data centers where ASI-ST is used with IMS.

Uses Less Machine Time

Although not originally intended to replace higher-level computer languages, ASI-ST can solve 70 to 90 percent of your commercial data processing problems. And ASI-ST can process your IMS or TOTAL data bases more economically — because it uses less machine time. In a single run, for example, it can create and update related or independent files; retrieve, manipulate, calculate, and display data; and generate detail and summary reports. How's that for versatility — and efficiency?

Hardware and Operating Environments

- IBM 43XX, IBM 30XX
- IBM 360/370, AMDAHL, ITEL
- OS/MVS, OS/VSI, OS/VS2
- DOS, DOS/VS, DOS/VSE

For complete time- and money-saving details on ASI-ST, call or write today.

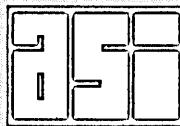

Applications Software, Inc.
 21515 Hawthorne Boulevard
 Torrance, CA 90503
 (213) 540-0111

Member SIA  Software Industry Association

CIRCLE 165 ON READER CARD

IF YOUR DATA PRESENTATIONS HAVE OUTGROWN THE SMALL SCREEN, READ ON.

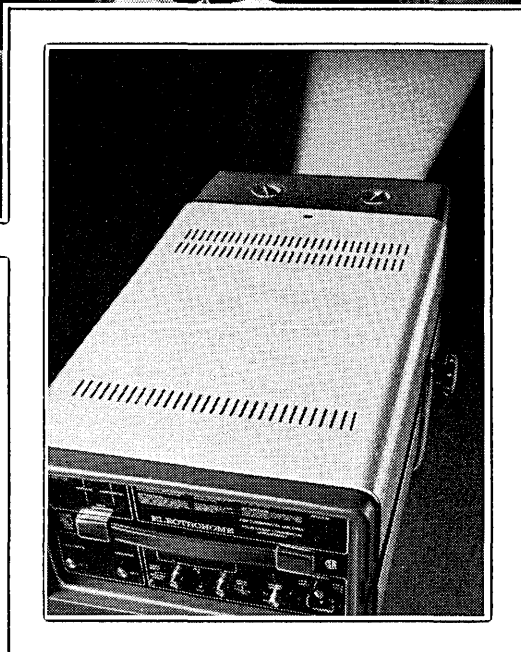
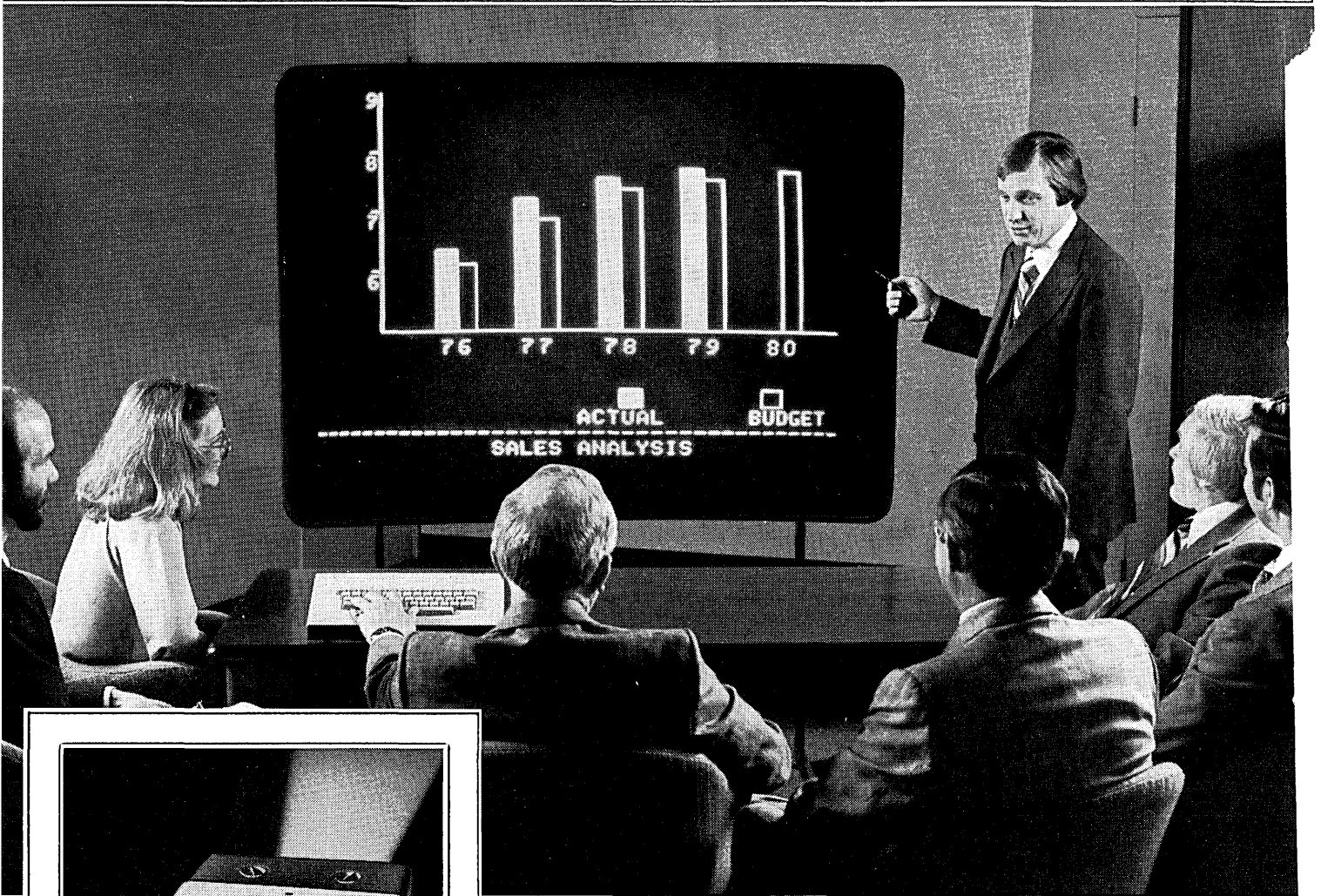

Some will settle for small CRT presentations. Anyone who knows anything about getting to groups, won't.

Meet the Electrohome EDP 56, the monochrome projection monitor that is specifically designed for large screen, high resolution data/graphic displays.

It synchronizes with almost all CRT-type computer terminals. This means you can punch up your presentations onto a big screen that commands the room.

We wouldn't begin to tell you how to use it - you're limited only by your imagination. What you should know is

that it's lightweight and compact. That says portability.

Versatile too. It's equally effective with standard or rear screen projection - literally at the flip of a switch.

You can hang it from a ceiling, use it on a stand, or stand it on a desk. How's that for options? All the advantages considered, one of the most impressive, is the remarkably competitive price of the Electrohome EDP 56.

The point being if you want to pull a meeting together to deliver information with maximum impact, we can show you how.

ELECTROHOME

ELECTRONICS

CIRCLE 166 ON READER CARD

809 Wellington St. N., Kitchener, Ontario, Canada N2G 4J6 Telephone (519) 744-7111 Telex 069-55449

SOFTWARE AND SERVICES

OFFICE AUTOMATION

Office automation is one of today's promising new markets, and this computer vendor has come up with an Office Automation System targeted at large users such as Fortune 1,000 companies and government agencies. The system comprises software for word processing, management communications and support, and advanced text management, as well as new hardware: two terminals and a letter-quality printer. The entire package works on the vendor's line of 32-bit computers.

Interaction with the office automation system requires use of one of the two new terminals. The PT65 administrative workstation (\$4,800) is an intelligent terminal that handles many word processing functions locally, while the PT45 management workstation (\$2,600) is a block mode terminal that will find its place in management locations away from heavy word processing and editing. Both terminals can access the computer system's dp facilities.

Word processing is human engineered to be key (as opposed to command) oriented, with functions selected through menus and function keys; as a safety feature, operations deemed "destructive" (of the text) are invoked by pressing both the shift key and the desired function key. An operator at an administrative terminal can create and edit documents, protect areas of a



page from alteration, and do cut-and-paste operations. The word processing software includes standard features such as page numbering and converting documents from one page format to another, as well as such niceties as automatically handling footnotes, which can be placed at the bottom of the current page or at the end of the document or chapter. The workstation's local intelligence offloads the host, providing consistent response times. The administrative terminal has a 24-line by 80-character display. Through the use of both horizontal and vertical scrolling, an operator can work on documents having pages as wide as 158 characters and as long as 66 lines. The word processing software goes for \$15,000. Utility programs can translate word processing files into data processing formats, and vice versa.

The management workstation

sports fewer function keys than the administrative workstation and includes a memory good for two pages (80 characters by 24 lines). It should find its place primarily in the area of management communications and support, which includes electronic mail, document filing and retrieval, maintaining a manager's personal appointments calendar, and scheduling meetings. Electronic mail can be sent to more than one recipient; the system maintains a single copy of the message that can be routed to each addressee. Recipients can annotate messages and send them on to others unless the originator has flagged the communication as confidential. Mail can be sent to users on remote systems by using the vendor's networking package, logging onto the remote system, and then sending the mail. The management communications and support software is priced at \$15,000.

A 60,000-word dictionary, used for proofreading, hyphenating, and word-by-word language translation, is an integral part of the advanced text management package. The dictionary can be used to scan a document for misspelled words, with unrecognized words either displayed on the terminal's screen or listed in a printed report. Hyphenation happens at print time (using the dictionary), so end-of-line hyphenations are not present in the actual document on file. The advanced text man-

MOVE THE GOODS.



**USE THE DATAMATION
MARKETPLACE
ADVERTISING SECTION
CALL FRANCI: (212) 489-2200**

MONITORING THE T-H FACTOR IN COMPUTER ROOMS

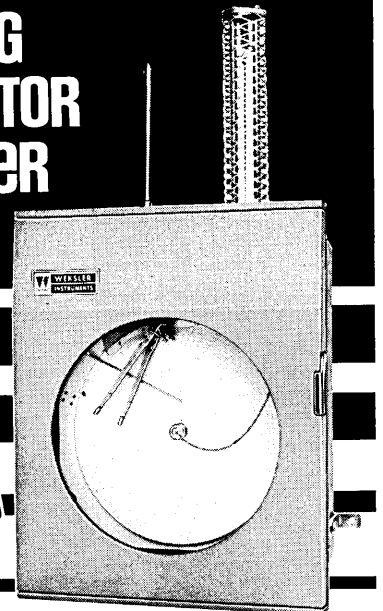

Computer room malfunctions, parts failure, and downtime due to temperature and humidity variations are virtually eliminated with a Weksler Thermo-Hygrograph. This two-pen instrument simultaneously measures and permanently records temperature and humidity, and may be surface mounted or furnished as a portable instrument. For additional information, send for Catalog #325D.

WEKSLER INSTRUMENTS CORP. • Freeport, NY 11520 • 516/623-0100

SOFTWARE AND SERVICES

agement system is priced at \$10,000.

For letter-quality output, the 3175 impact printer (\$6,000) provides printing at 55cps. Initial deliveries of the Office Automation System begin next month. PRIME COMPUTER, INC., Newton, Mass.

FOR DATA CIRCLE 326 ON READER CARD

PERFORMANCE ANALYSIS

Capture/MVS, a performance analysis and reporting package, helps users analyze their MVS system's performance and identify high overhead areas; it can also generate input files compatible with the vendor's predictive performance modeling package, BEST/1. Capture/MVS directly processes job accounting information from SNF records and resource utilization data from RMF records. The package breaks out total processing activity (for any user-selected interval) into the various workloads represented by batch, TSO, IMS, CICS, and other categories. Reports include information on cpu time per transaction for Task Control Block (TCB) processing and system overhead, I/O processing and EXCP counts per transaction for each device and channel, capture ratios (total cpu time divided by TCB time) for each workload, and overhead percentages for the cpu, and each I/O device and channel. With Capture/MVS, users can take base-line readings and see how changes in workload af-

fect system utilization. Capture/MVS carries a price tag of \$6,500. BGS SYSTEMS, INC., Lincoln, Mass.

FOR DATA CIRCLE 327 ON READER CARD

ALMANAC

For Apple II personal computers (with at least 32KB of memory, Disk II, and Applesoft II in ROM), a package called the Almanac provides calendar and time calculations (of use to most), and a variety of general astronomy functions (primarily of interest to amateur astronomers).

Calendar calculations include printing calendar pages for any given month (even before the Gregorian calendar reformation), day of week calculations, calculation to and from Julian date, and the calculation of when Easter falls.

Astronomers should find sidereal time calculations, sunrise and sunset determination, and calculation of the phases of the moon of use in their hobby. The package also can calculate the dates and times of lunar and solar eclipses. A high resolution graphics model of the solar system can be used to display the location of the planets at a specified time. Finally, a software real-time clock can handle time zone adjustments (except political anomalies), and Universal (Greenwich) Time. Supplied on diskette, the Almanac sells for \$29.95.

WILLIAMSVILLE PUBLISHING CO., Fredonia, N.Y.

FOR DATA CIRCLE 328 ON READER CARD

DATA BASE SYSTEM

Access, a data base management tool for use on PDP-11s running RSTS/E, comprises a data dictionary, file handler, screen formatter, and report query language. The menu-driven system allows the user to define file structures, screen layouts, and report formats. Access loads these descriptions into a dictionary and builds the data base. Linking between screens and files is automatic; screen formats can specify default values and edit checking. A multiple-key file structure allows data retrieval based on any key value; a sorted list of alternate keys can be generated to speed retrieval. The report generator can accept up to 100 logical conditions for record selection; the output can be presorted, with user-defined breakpoints and subtotals. Data security features allow the restriction of data usage by program, terminal location, operator number, or data in a record. A program generator can create skeletal BASIC programs to speed applications development. A binary license and documentation for Access goes for \$9,800; update support is \$2,500 per year. Leases are offered. LOGICAL SYSTEMS, La Jolla, Calif.

FOR DATA CIRCLE 329 ON READER CARD

Cut DP Center Downtime By 50% In 6 Months, Or Your Money Back.



How do we do it? For complete details, call or write for more information on Johnson Systems' ALARM® Hardware Reliability Measurement System and our unprecedented 6 month money back Performance Guarantee.

 **Johnson
Systems, inc.**

7923 Jones Branch Drive • McLean, Virginia 22102
Phone: (703) 821-1700 • Telex: 89-9100

D002

CIRCLE 169 ON READER CARD

The Atlas UPC. Anything less is power pinching, anything more is extravagant!

Until now choosing power protection equipment has been limited to inexpensive (and often ineffective) transformers and regulators, or a very costly and complex UPS.

But Atlas has a better alternative—the new Atlas UPC/Uninterruptible Power Conditioner. Atlas has combined the stored energy of the UPS with the unquestionably superior power conditioning of a motorgenerator to provide both 100% guaranteed

clean computer power and up to 500 milliseconds of ride-through to bridge damaging electrical flickers.

When compared to all available power protection systems the Atlas UPC clearly provides the most comprehensive computer power protection—and at a very affordable price.

Write or call for more information including power technology comparisons and detailed UPC literature.

 **ATLAS
ENERGY SYSTEMS**



Home Office: 9457 Rush Street, South El Monte, CA 91733 Phone (213) 575-0755
Regional Centers: Boston (617) 492-2525 Chicago (312) 372-2237

CIRCLE 170 ON READER CARD

"United Technologies uses the same Financial Reporting System in Bogota, Paris, and the Corporate Office."

"United Technologies Corporation, managing a 5.5 billion dollar business which employs over 138,000 people and operates more than 180 plants worldwide, requires responsive, standardized financial control.

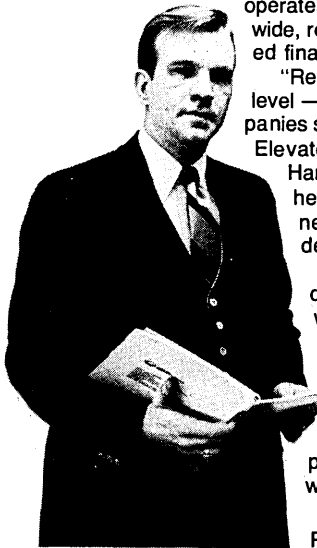

Roger E. Brady
Manager, Financial Information Systems
United Technologies Corporation

"Regardless of the decision-making level — from operations at UTC companies such as Pratt & Whitney, Otis Elevator, Essex, Sikorsky Aircraft and Hamilton Standard — to corporate headquarters, we get the details necessary for day-to-day decision-making.

"We also complete the consolidation of the corporation's worldwide financial statements on the same day that the books are closed.

"The General Ledger and Accounts Payable Financial Reporting products provide us with the software we need."



John Gritman
Manager of Financial Services
United Technologies Corporation

"Here in the Corporate Treasurer's office, we use Software International's General Ledger and Accounts Payable systems to support the financial activities of six of the smaller UTC subsidiary companies. In addition, we have taken advantage of the accounts payable system to use it for Job Order Costing, maintaining complete traceability for specific contracts. The combination of Ledger and Payables provides an effective reporting tool, particularly useful in budgeting applications."

"An illustration of the General Ledger's flexibility is its operation in Bogota. Annually, the Colombian Government requires a detailed report of all payments made to vendors. One of the General Ledger system's standard reports enables the Bogota office to prepare this report automatically, thereby eliminating significant clerical effort. The system can also produce financial reports in either Spanish or English, as well as perform the necessary currency conversions. "Naturally, all user-interface with the system is in Spanish. Yet this is the same system that operates in English — or other native languages — at other UTC facilities around the world."

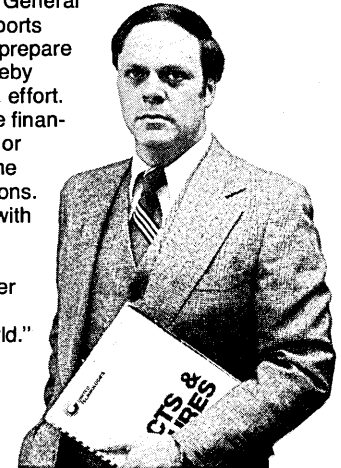

Jerome Kelly
Manager, Management Information Systems
United Technologies Corporation

General Ledger and Financial Reporting Fixed Asset Accounting • Accounts Receivable Accounts Payable • Payroll/Personnel Net Change Manufacturing Resource Planning

It takes more than great systems for successful implementation. Software International supports all of its products with a world-wide network of local offices staffed with professionals whose wide range of experience covers both data processing and business. Users benefit from this expertise with training, technical support, comprehensive documentation, maintenance and regular enhancements.

It all adds up to more than just software. Call or write today, and see how easy it is to get the complete systems that achieve results.

More than software... results.

Please send me your *free* literature about these SOFTWARE INTERNATIONAL SYSTEMS:

For users of:
IBM, BURROUGHS, DEC, HONEYWELL, UNIVAC, ICL, HEWLETT-PACKARD, INTERDATA, WANG and most popular large and small business computers.

Financial

- General Ledger
- Accounts Payable
- Accounts Receivable
- Payroll/Personnel
- Fixed Asset Accounting

Manufacturing

- Material Requirements Planning
- Master Production Scheduling
- Capacity Planning
- Shop Floor Control
- Purchasing

Call Today!

Atlanta (404) 955-3705
Boston (617) 683-2447
Chicago (312) 298-3500
Columbus, OH (614) 773-2167
Houston (713) 444-3348
New York (914) 332-0040
San Jose (408) 249-7501
Toronto (416) 924-1461

Name _____ Title _____

Company _____

Address _____

City _____ State _____ Zip _____

Computer System _____

Phone _____

SOFTWARE INTERNATIONAL®

Elm Square, Andover, Mass. 01810 (617) 475-5040 D680

The 7 most common mistakes made in designing computer room environment.

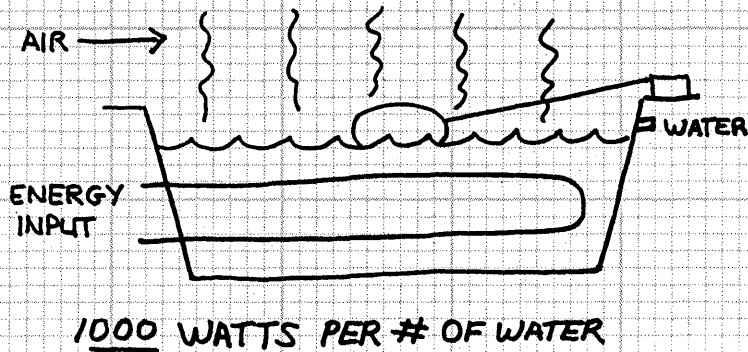

Diagram 1 Electric Humidifier.

Mistake No. 5 Using unnecessary power for humidification.

All computer manufacturers recommend that relative humidity be maintained at 50% ± 5% in the computer room. A humidifier must be used to maintain the 50% requirement to offset air changes and equipment dehumidification.

Electric humidifiers of the immersion heater (Diagram 1), or quartz lamp variety, flash water to vapor which is used to add humidity to the air. These have a number of disadvantages: costly electric energy is used; the cooling load is increased due to the added heat; they are difficult to maintain; the components are expensive; operating costs are higher; and they are

unreliable because if the humidistat sticks, steam is generated continuously causing over-humidification.

The EDPAC Solution

The panel humidifier (Diagram 2) used in EDPAC process cooling systems provides moisture by simultaneously passing air and water through an evaporative pad. The heat necessary for water vaporization comes from two sources: warm water (up to 140°F.) from a hot-gas-to-water heat exchanger and adiabatic heat transfer from the air stream.

In addition to the EDPAC humidifier being nonelectric in nature,

the heat removed from the air stream reduces the number of compressor hours and lowers costs.

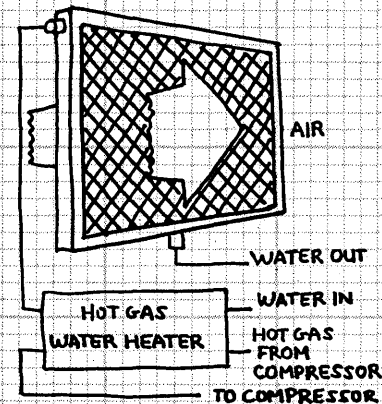

Diagram 2 EDPAC Panel Humidifier

EXAMPLE: Typical 50-ton data center requiring average humidification of 20 lbs./hr. for about eight months.

	EDPAC Evaporative Panel Humidifier	Electric Immersion or Quartz Lamp Humidifier
Btu/h required for humidification	19,600	22,640
Heat from electricity	None	27,610
Heat from water	8,800	None
Heat from air stream	8,800	None
Heat added to air stream	None	4,970
kW Required at 82% Efficiency	None	8.1
Power cost over ten years based on 5¢ per kilowatt hour doubling in ten year period	0	\$34,992

In addition, the electric heater adds 4970 Btu/h to the air stream. The evaporative panel humidifier cools the air stream!

For a brochure detailing the solutions to all seven "mistakes," contact your local EDPAC representative or write to the address below.

The 7 most common mistakes made in designing computer room environment.



EDPAC

Energy Efficient Process Cooling for Computers

EDPAC is a product of AC Manufacturing Company, Cherry Hill, New Jersey 08034, Telephone (609) 428-9800

EDPAC also offers products for mini-computer rooms and water-cooled computers.

SOURCE DATA

BOOKS

CONCISE NOTES ON SOFTWARE ENGINEERING
by Tom de Marco

PROGRAM MODIFICATION
by Jean-Dominique Warnier

THE ART OF SOFTWARE TESTING
By Glenford J. Myers

A hoary joke among editors is the author's preface that begins, "This book fills a much needed gap." Here are three gap fillers from the volatile literature of programming techniques.

Tom de Marco is the guy who wrote *Structured Analysis and Systems Specification*, a rich and charming book that captures much of the flavor of his Yourdon seminars. What he has given us this time is much slimmer, a glass of chablis as it were. *Concise Notes* as a title is an understatement; shorn of its comprehensive bibliography and a vermiform appendix, it consists of 57 pages that attempt to summarize the varied fields that comprise what is now called software engineering.

As an overview, it's not bad. De Marco understands better than most what are truly important contributions to the field, so his emphasis is well placed. He does, however, linger much more over structured analysis and structured coding than over topics others might consider at least as important; since these are among his specialties, one can understand his bias.

Comprehensive it's not. But for someone in the market for a quick overview of the field, it's worth an hour's study. Yourdon Press, New York (1979, 104 pp., \$6).

Jean-Dominique Warnier is known among the cognoscenti as one of the pioneers of the data structuring approach to orderly program design. His *Logical Construction of Programs* is dry reading and was slow to be translated from the French; nevertheless, it inspired the likes of Michael Jackson and Ken Orr to develop their more

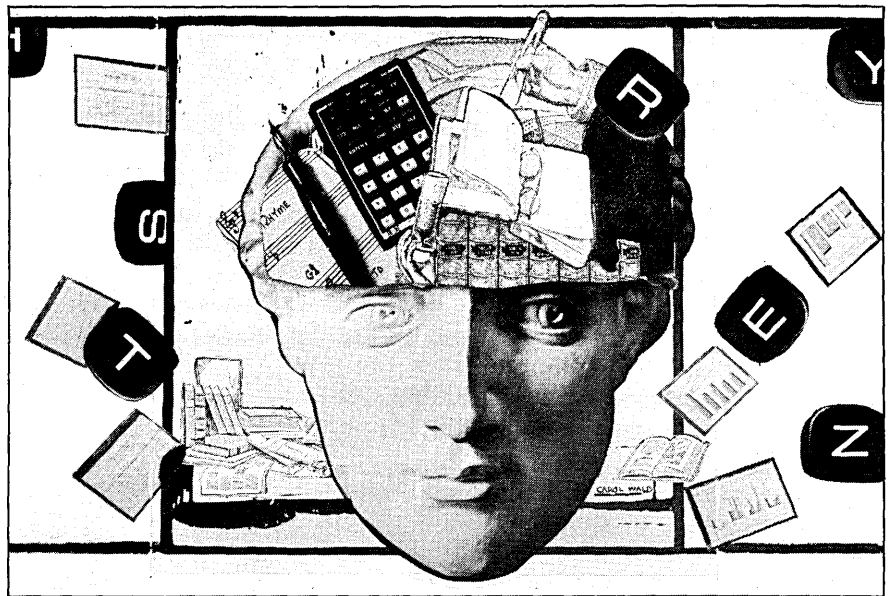

commercially packaged versions of his techniques.

Now Warnier is breaking new ground by trying to teach program modification. Managers of software shops should breathe a collective sigh that this long neglected discipline is finally addressed, and they should hand out a few copies of this book to their more receptive programmers. Perhaps some of it will be digested.

While this is the meatiest of the three offerings, it is unfortunately the driest, akin to overcooked roast beef. Warnier makes the reader work for his insights. In this case there are four comprehensive programming problems that all too accurately reflect the tedious workload of commercial shops. Each is designed in an orderly fashion, then attacked with one or more believable sets of changes, which are also worked into the original design.

The greatest contribution of this book is the recognition that often the very structure of a program must be altered to accommodate a change, whereas programmers go to great lengths to preserve a bad structure in the face of all attacks. The worst flaw is that Warnier, like most wizards in this field, is blind to the limitations of his

model; he can't see where his ingenious foresight has paved over difficulties that innocents are sure to stumble over. Couple this with his penchant for writing loops upside down (a weakness shared by Ken Orr, for some mystical reason), and one has a recipe for potential disaster in the field. Martinus Nijhoff, Boston (1978, 160 pp., paper, \$21.50).

Glenford J. Myers is IBM's resident guru on matters of programmer productivity and a perennial generator of books on related topics. His *Reliable Programming Through Composite Design* beat everyone else to press with the first detailed composition of what is now called structured design.

This time he is taking on *The Art of Software Testing*, a much more nebulous field than design, albeit no less important. The lesson that comes through from reading this book is that software testing barely qualifies as an art; it is nowhere near a science despite oodles of money spent by government and large industries.

Unfortunately, the lesson comes through only slowly, kind of like eating tapioca. The best chapter is the last, which communicates the bad news about the state of this art with a pleasant economy of words and a rich sprinkling of references. Wiley-

SOURCE DATA

Interscience, New York (1979, 177 pp., \$17.95).

So much for the three course meal, and back to the gap metaphor. The gap in question is the one that always exists between theory and practice, between teaching and everyday living. Many people have preached the gospel of improved programmer productivity (this reviewer included); few have faced the problems of getting code out and supporting it in all its dreary detail.

Each of these books is an attempt to cross the gap by sacrificing some theoretical purity for a bit more practical believability. Whether the attempts are successful or whether they merely dilute the message remains to be seen. It could well be that the gap is much needed.

—P.J. Plauger

DOCUMENTATION STANDARDS AND PROCEDURES FOR ONLINE SYSTEMS

by Martin Rubin

Let's clean up this documentation mess, I often want to shout at corporations. Let's get serious about this business!

Most batch processing computer systems will usually have some sort of functional operations guides. Often enough, any updates are only understood by an in-group of operators and appear in the margins in four colors of ink. But the well-documented on-line system, one that can be readily understood by all users, is a bit of a rarity. Now comes a book that provides a clear start.

Everyone directly involved in dp wants and needs good documentation. Non-dp management doesn't always understand why documentation, on-line or otherwise, is really so important. Corporations that staff technical writers or who have had the foresight to keep their documentation and standards abreast of developments are at an advantage. But a company deeply involved in just keeping a large system alive and well will often put documentation last. It lies in the slough pile and then rears its head, sometimes after years of development, when a time-sharing system is to be marketed or a lucrative turnkey system already has potential users needing procedure guides. Consultants are called in, handed a four week deadline and a small sheaf of outdated material on a very large system. And then, of course, the problems start developing.

Rubin says he considers his book "a starting point in the development of standards which are tailored to on-line systems." He has done an excellent job. Chapters cover project planning and review, system development, documentation aids, operations, data base, man-machine dialogue, and data communications. The chapter layout itself can be used as a model for run books, overviews, procedure guides, and the like.

The author starts right at square one in structuring his documentation procedures: for example, in the chapter "Data Base" he begins, "The Data Base Administrator is an individual whose prime responsibility is to design and manage data base operations." But he proceeds quickly and logically to system monitoring and system reorganization in the same chapter. Rubin is very clear and precise, without being overly detailed; excellent qualities for dp documentation. This book is not just for beginners or for those faced with a crisis in their documentation closet.

The author expresses the hope that his book "will inspire organizations to review their existing standards and procedures, and initiate major revisions." This is quite probable because the standards he presents are broad enough to be adapted by different kinds of staff organizations as well as other hardware and software environments.

This is not the complete book on on-line documentation, nor is it intended to be, but is a very necessary addition to any data center library. I only wish it were twice as long; perhaps Rubin has a sequel. Van Nostrand Reinhold Co., New York (1979, 251 pp., \$21.95).

—Sally Williams-Haik

INFORMATION MANAGEMENT SYSTEMS/VIRTUAL STORAGE

by Myles E. Walsh

The problem with writing a book on a subject about which a lot of other books have been written is that you are inevitably judged to some extent by what your predecessors have done and said. This is good news if you think of news things to say, or new ways to say them; it's bad news if you don't.

First the bad news. In any treatment of data base management systems (DBMS), certain topics are simply mandatory. One of these is the concept of data independence. The improved capacity for maintenance of application systems that data independence can provide is seen by many as one of the major productivity benefits of a DBMS. Yet the topic is entirely avoided by Walsh—it is not even listed in the index. This is a serious omission.

Now for the good news. As Walsh explains in the introductory section, the level of this book falls somewhere between the idealized vision of a James Martin seminar and the nuts-and-bolts perspective of a systems programmer. What is left between these extremes is practical how-to in using and managing IMS/VS, IBM's DBMS. As a practical guide for managers, the book hits its mark.

Walsh is at his best speaking directly to the generation of computer professionals that came of age before the data base revolution of the late '70s, and in many cases before the explosion in commercial

data processing that occurred in the 1960s. There is a critical need in the industry to bring these seasoned and capable veterans, now often found among dp management, up to speed on data base. Walsh successfully avoids the increasingly abstract language of contemporary dp thinking and talks straight to these practitioners.

Overall, Walsh's style is easy and not unlively, and only slightly more rigorous than the conversation one might hear at cocktail hour during a dp conference. His language is unconsciously sprinkled with dp-isms of an earlier era. While some technical specifics escape uncaptured, the main messages come through. Generous illustrations and quotations from other data base experts help in this regard.

One of the most important of these messages is the chapter on data dictionary systems. Few books on data base systems have done as much on this vitally important management topic. Also well done are the chapters on using IMS and on staffing, educating, and organizing the IMS shop. Walsh's comments in these areas have the force of "battlefield conditions" (his description), rather than a textbook or theoretical treatment. Walsh's comments on the IMS management issue should be well worth reading even for those who don't entirely agree with his view.

A number of technical sections complement the book's management topics, including chapters on IMS data base and data communication facilities, the IMS DB/DC Data Dictionary, and IMS utilities. Chapters, on other DBMSs and data base futures, as well as appendices on master terminal operations, are also presented.

The book is not appropriate for the person who is primarily a technician. IMS is a complex system—on this point everyone but the staunchest IBMer agrees—and simplified discussions cannot do its technical features justice. But for the manager who must come to grips with IMS (and all available evidence suggests that IMS is here to stay), this book is an excellent place to start.

Despite some glaring errors (DBMS-11, for example, is not offered by Burroughs but rather by DEC) and some questionable editing (some figures are labeled and other are not), Mr. Walsh's book is overall an excellent source for managers who need to do their homework on data base and IMS/VS.

—Ronald G. Ross

REPORTS AND REFERENCES

IC UPDATE

A new report has been published on the semiconductor industry and its growing relevance to business. Entitled *Status '80: A Report on the Integrated Circuit Industry*, the volume is exceptionally well done. Clear writing, informative illustrations, and a spectacularly nice printing job in soft brown tones make the report pleasant to

SCHLAGE

The Name You Know For Access Control

A half century of leadership in security.

For over 50 years the name *Schlage* has been recognized around the world for the highest quality in locks and keys. The Schlage name stamped on the distinctive key has become a symbol of reliability and craftsmanship. The Schlage standards and reputation are behind the world's most advanced access control system.

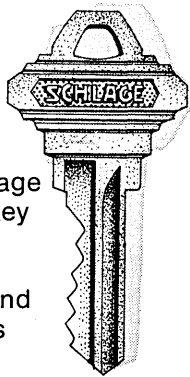

This is another type of "Key"!

Just as the conventional Schlage key unlocks doors, so too does the revolutionary Schlage Electronics "command key."

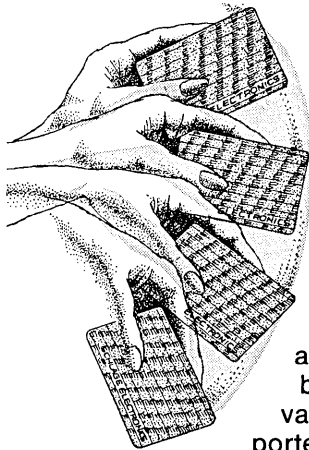

The "command key," however, requires no keyhole. It operates without card slots or push buttons. Simply hold a valid electronically coded card within close proximity to a hidden sensor and the entry point is instantly activated. The command key is almost as personal

as your fingerprint and both valid entry and invalid attempts are reported and keys can be

programmed for specific access points and time periods. There is a Schlage electronic access control system for from 1 to 32 doors, gates or control points and for up to 8,000 employees! Moreover, the system not only controls critical access areas, but can also monitor and report on fire and burglary alarms, parking and a myriad of other applications.

The Schlage "systems" concept takes the nightmares out of access control.

When Schlage introduced the solid-state reliability of the proximity concept, we enabled users to customize an entire security system, rather than resort to a piecemeal purchase of hardware. Thousands of successful installations throughout the world have greatly enhanced security and provided needed operational data. The Schlage system's ease of installation has reduced the monstrous costs, too.

A single coaxial cable connects the "vandal-resistant" sensor to the control unit located in an interior secure zone. Sensors may be installed in walls, on plate glass or external surfaces.



Easy to program and change.

The basic system consists of command key, sensor and control unit and can be integrated into existing or planned security and environmental systems. Programming is flexible to the user's needs and reporting is communicated in easy-to-read

English text in either hard copy and/or visual display.

Call or write for further information and the name of your local Schlage

Electronics representative.

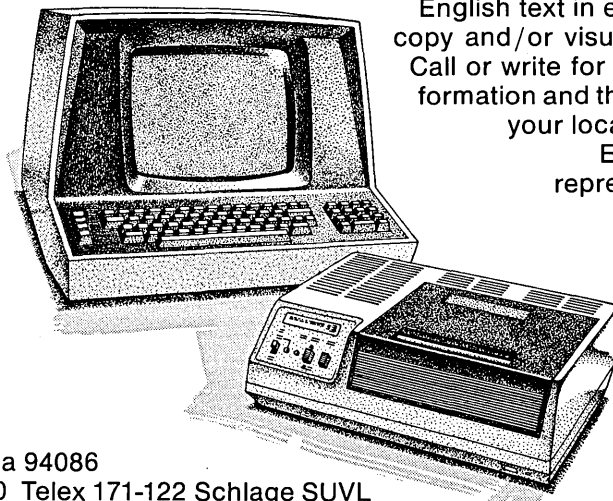

SCHLAGE ELECTRONICS®

Part of worldwide Ingersoll-Rand

1135 East Arques Avenue Sunnyvale, California 94086

Toll Free (800) 538-1755 In Calif. (408) 736-8430 Telex 171-122 Schlage SUVL

CIRCLE 173 ON READER CARD

SOURCE DATA

read, while the technical content is straightforward and comprehensive.

The first chapter outlines the international IC market, beginning with 1979 financial results and detailing the present business climate, including discussion of inflation, pricing, new products, invento-

ries, investment, manufacturing resources, consumption, and foreign influence.

The IC markets in computers and data communications, consumer products, industrial applications, telephony, and military/aerospace are all discussed. Suppliers are profiled and extensive coverage is given

to captive suppliers, those IC manufacturers supplying only in-house needs. The report points out that the open and captive markets are beginning to merge, as evidenced by IBM's search for parts to supplement its internal production. The technology of IC fabrication is also covered.

This figure from the chapter on the economics of IC manufacturing correlates to a table which compares costs of the different wafer patterning systems shown and includes information on typical wafer throughput and resolution capability. The statistics show a great disparity between types of wafer with respect to depreciation per completed wafer—about \$1.33 for the projection printer to \$50 per wafer for an E-beam direct writing system. This is one reason, it is pointed out, that major investments in capital equipment will be required for future processing technologies. \$95. Integrated Circuit Engineering Corp., 6710 East Camelback Rd., Suite 211, Scottsdale, AZ 85251, (602) 945-4564.

WAFER PATTERNING SYSTEMS

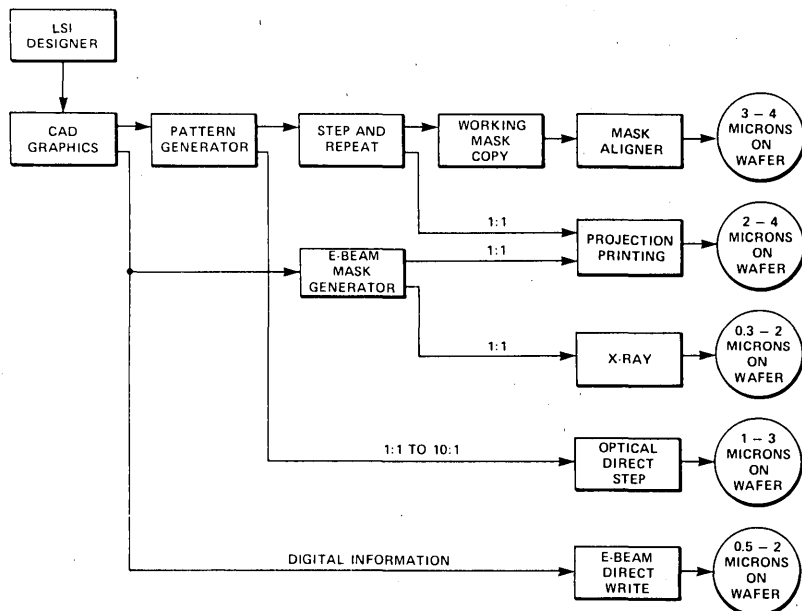

MICROCOMPUTER BUSINESS SYSTEM DEVELOPMENT

A marvelously written if unattractive handbook on microcomputer systems analysis and design and programming is available from this consultant programmer who also offers a few TRS-80 software packages. The book's appearance is due to its having been

RENT • LEASE BUY

IBM 3101 TERMINALS

Model Number & Type	Purchase	Monthly Rates	
		36 Months	24 Months
3101-10 Display	\$1,295.	\$39.	\$49.
3101-20 Display	\$1,495.	\$49.	\$59.
3102 Printer	\$1,295.	\$44.	\$54.

Rental Rates are based on receipt of a \$100. down payment. ON-SITE SERVICE IS AVAILABLE IN THE NEW YORK METROPOLITAN AREA.

COMPUTER EQUIPMENT

XEROX Printers • DECwriters • Texas Instruments Printers
• General DataComm Modems • 212A • 208 B/A
• 201C • 202 S/T

CALL NOW • TOLL FREE
800-223-1696

Qytel® 285 Madison Avenue
New York, N.Y. 10017
212-889-3888

CIRCLE 174 ON READER CARD

computer stands

You can count on Est for stationary or movable computer stands that are as sturdy and functional as they are handsome. Your choice of style and anchor plate. Let us design a base to your specifications.

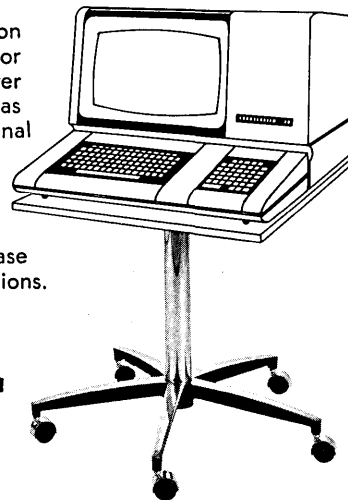

EST

Write or phone for literature
EST COMPANY, BOX 25D, GRAFTON, WI. 53024
(414) 377-3270 A DIVISION OF LEGGETT & PLATT, INC.

CIRCLE 175 ON READER CARD

Wang 2200 Development Group

2200 Systems Software and I/O Firmware Development

The Wang 2200 development group provides a unique opportunity to participate in and actively contribute to the overall product development of the very popular 2200 series minicomputer. One very interactive team of systems programmers and microprogrammers is responsible for the systems specification, design, and development of the system software and CPU and peripheral firmware. The net result is one of the most powerful and interactive small computers available today, (and one of the most popular, over 40,000 installed). Many opportunities are now available to participate in the development of operating systems, COBOL and BASIC languages, file management, data base management, I/O controller firmware, systems interface firmware on one of the most exciting minicomputers on the market.

Systems I/O Designer/ Programmers

We have several positions open in a group which designs and implements firmware for new I/O devices and interfaces. These interfaces will be progressively more intelligent, distributing the burden of a multiprogramming operating system, and providing more high level features than ever before on our powerful small business computer. These people will work in a small interactive group with vertical systems responsibility. Coding will be at a number of levels, including high level language, interpreter microcode, operating system microcode, microprocessor code, and hardware sequencer instructions. Responsibility will range from language definition through hardware specification. All phases of design, coding, and debugging are included; we provide a good opportunity to understand an entire product.

An entry level candidate should have a degree in either engineering, computer science, or math, with adequate course work in operating systems principles. A senior level candidate should have several years in either operating systems or in microprocessor firmware design, preferably both. Some hardware background is very helpful, but direct digital design experience is not a prerequisite.

Systems Support Programmers/ Firmware Programmers

We are looking for people who wish to become involved in a software support capacity with a minicomputer development group. Positions are available in the design and coding of systems utilities in upper level languages. Candidates should have a working knowledge of BASIC or FORTRAN. Positions are also open in the design and coding of firmware for a variety of microprocessors (8080, Z80, etc.). Some experience with coding in a low level mnemonic assembly language is necessary, and a basic familiarity with hardware would be helpful.

Candidates would be working on a variety of projects involving both upper and lower level languages. The relatively small size of the support groups affords an excellent opportunity for individual project responsibility with a successful, growing company.

Candidates should have a degree in Computer Science or one to two years relevant experience.

Language Development

Openings exist at both the entry and senior levels in the design, development, and support of microprogrammed language interpreters for Wang 2200 minicomputers. Functional enhancements are currently being made on an advanced BASIC, and development of a COBOL processor is just beginning. Emphasis is on developing a high performance interactive system for the small business and distributed processing markets.

The small group environment is emphasized providing the opportunity for a high level of individual responsibility and visibility. Interaction with all 2200 development groups is encouraged.

The candidate should have a technical degree; 1-5 years assembly or microprogramming experience; knowledge of BASIC, COBOL, and interpreter design; and an understanding of Operating Systems.

Systems Diagnostic Programmer

The successful candidate will join a small group whose responsibilities include Performance Analysis, Internal Quality Assurance, Special Testing, and Systems Diagnostics.

The candidate will have responsibility for evaluating existing and defining/coding new diagnostics in such areas as Remote, CPU and selected Peripheral diagnostics.

This opportunity exists in a small department with good communication between all functions enabling one to broaden their awareness and horizons.

The ideal candidate should have a technical degree (BSCS, BSEE), assembly and some higher level language, some experience with micro-processor based software and some prior diagnostic experience with CPU and peripheral devices (e.g. intelligent controllers, terminals, disks).

We offer excellent salary and benefits including profit sharing, stock purchase plan, stock bonus plan, medical and dental insurance and relocation benefits. Please send resume including salary history, to Tom Bahlo, Professional Recruiter, Wang Laboratories, Inc., Dept. DM, One Industrial Avenue, Lowell, MA 01851.

We are an affirmative action employer

WANG

Making the world more productive.

CIRCLE 176 ON READER CARD

SOURCE DATA

reproduced from rather poor quality matrix printer output. This has however enabled the book to be produced quite inexpensively—it is selling for a mere \$2.95.

The handbook is mostly for TRS-80 users. It is largely addressed to consultants, but is likely to prove valuable to anyone trying to construct a microcomputer business system.

The writing is exceptionally clear and the presentation reflects a well-organized and detailed understanding of the systems development process in the context of real life. For example, "... installation ... can be the most traumatic experience of the system development cycle because this is where the phrase 'Oh, I thought you said ...' is most frequently heard." Special emphasis of the handbook is on random files, random accessing techniques, and optional file structures. *Lemonade or Champagne: The Anatomy of a Microcomputer System*. Nepenthe Programs, 3014 Biggs Ct., National City, CA 92050.

EIA DIRECTORY

This year's Electronic Industries Association Trade Directory and Membership list is now available. Member company descriptions include corporate division locations, phone numbers, top management personnel, products manufactured, trade names and EIA divisional assignments. EIA officers

and committees are also detailed. \$10. EIA, 2001 Eye St. N.W., Washington, DC 20006. (202) 457-4981.

SMALL BUSINESS COMPUTER SELECTION

A basic guide called *Computer Selection Handbook* attempts to detail the small business computer installation process from goal setting through vendor selection all the way to systems management. The guide claims to be useful to "data processing professionals and their clients," though aimed at a thoroughly nontechnical audience. Much of the handbook consists of checklists and questionnaires for assessing and cataloging vendor interaction and for keeping track of system specifications and operations. \$35. Decision Resources Corp., 28203 Ridgefern Ct., Rancho Palos Verdes, CA 90274, (213) 377-3533.

PERIODICALS

COMMUNICATIONS MANAGEMENT

A monthly newsletter devoted to networking and communications will focus on management issues. The new publication, *Trends in Communications Management*, is a companion to this publisher's *Trends in Communications Regulation*.

The first issue is a practical and thor-

ough discussion of how to do a quick feasibility study when considering a cbx-dependent tie-line network. Upcoming issues are expected to feature case studies, surveys on "the functional evolution and training of telecom managers," and articles by guest authors.

Annual subscription, \$48. Economics and Technology, Inc., 101 Tremont St., Boston, MA 02108, (800) 225-2496 [in Massachusetts call (617) 423-3780].

EFT

A special issue of the *Computer/Law Journal* has been published on the subject of electronic funds transfer systems. Articles include "Terminal-Based EFT Services: The Need for Uniform Federal Legislation," by Theresa A. Einhorn, coauthor of *The Law of EFT*; "A Legal Framework for Check Truncation," by George White, vice president, Chase Manhattan Bank; "Competitive Implications of EFT," by James Pierce, professor of economics, University of California at Berkeley; and "Implications of the Informational Nature of Payment," by James L. Brown, director, Center for Consumer Affairs, University of Wisconsin at Milwaukee.

The single issue, \$16 (\$17 outside the U.S.), The Center for Computer/Law, 530 West Sixth St., 10th floor, Los Angeles, CA 90014, (213) 623-3321.

MONITORS

\$168 @ unit / \$2016 @ dozen / \$13.00 @ pound (retail)



Any way you look at it, the Javelin Monitors are a real value for you and your customer. A value you can't get from the "big guys." Add it up: **Three models to choose from, 9", 15", 19"; Front panel controls; High linearity; Improved circuitry; Home and professional computer capability; plus a one-year warranty.** It's worth it for you to find out how we offer the highest value per dollar... And you need that today.

JAVELIN ELECTRONICS

Subsidiary of Waller Kidde & Company, Inc.

KIDDE

19831 Magellan Drive, Torrance, CA 90502/(213) 327-7440

CIRCLE 177 ON READER CARD

TERMINAL STANDS



Every type of terminal requirement from complete dedicated operator work stations to simple auxiliary stands can be provided by Wright Line. Designed to provide correct keyboard and viewing heights, adequate work surface and filing space, stands are available in a variety of sizes and configurations. For further information, circle the readers' service number or write: Wright Line, Inc., 160 Gold Star Boulevard, Worcester, Massachusetts 01606.

FOR DATA PROCESSING ACCESSORIES AND SUPPLIES, YOUR...
single source with super service

Wright
LINE

A Subsidiary of Barry Wright Corporation

CIRCLE 178 ON READER CARD

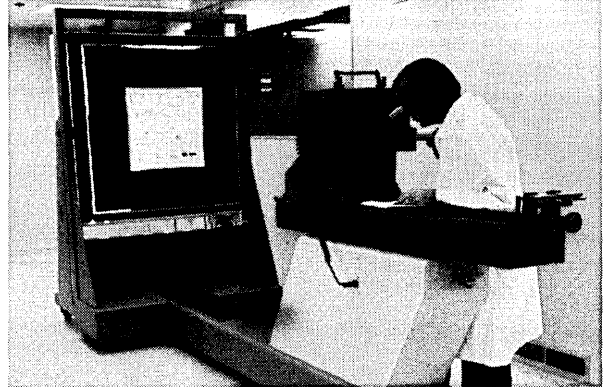
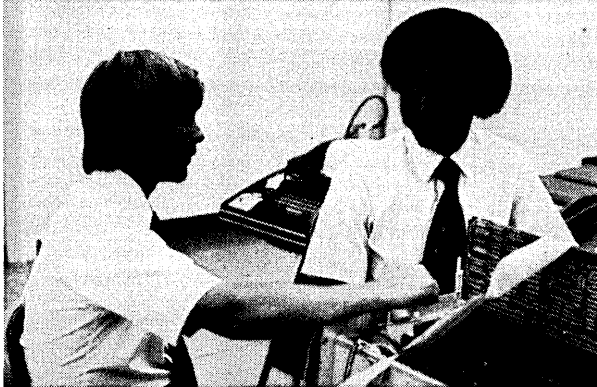
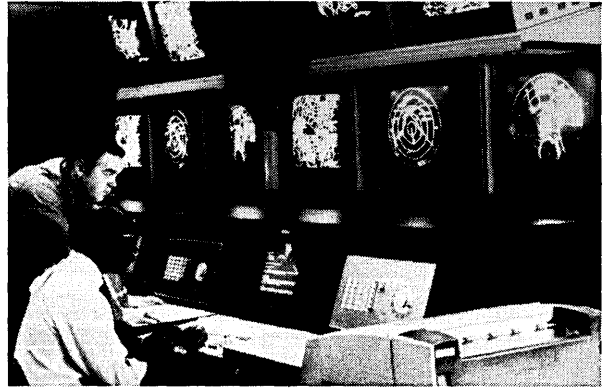
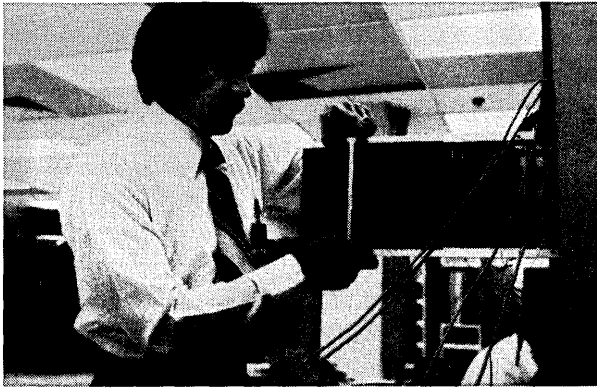

*Grow With Us.
Join E-Systems for a
new dimension in the 1980's*

The Garland Division of E-Systems in Dallas specializes in the development and delivery of high-technology electronics. Our long-range programs involve many of the world's toughest one-of-a-kind problems. Problems that require some of the world's most advanced technological solutions.

We need career-minded people who are problem solvers... Software, Electronic and Mechanical Engineers plus R&D Technicians in these programs:

- High speed logic design
- Special purpose digital processing
- Analog and synthesizer design
- Electronic reconnaissance
- Passive electronic warfare
- Product software embedded in electronic systems on IBM-370, Perkin-Elmer 3220, HP-21 MX, and microprocessors
- Communication and data-base management systems on DEC and TANDEM
- Advanced digital communications
- Audio/digital voice processors
- Command and control systems

If you want to make problem solving your career, send this coupon to:
Employment Manager, E-Systems, Inc.,
Garland Division, P.O. Box 226118, Dallas,
Texas 75266. Or call COLLECT
(214) 272-0515.



The problem solvers.

An equal opportunity employer M/F, H, V

Please send more information about E-Systems Garland Division.

NAME _____

ADDRESS _____

CITY _____ STATE _____ ZIP _____

PHONE _____



TTI: THE EXPERIENCED SYSTEMS AND SOFTWARE PROFESSIONALS

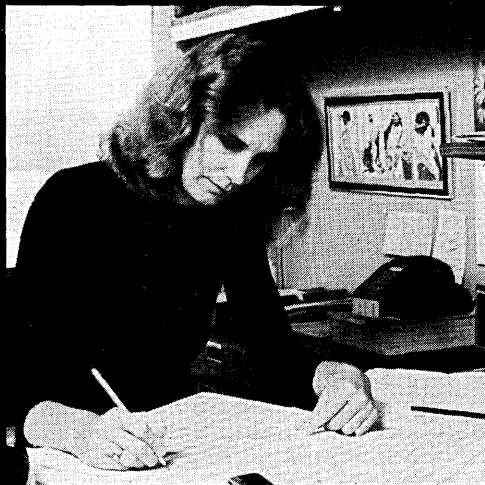
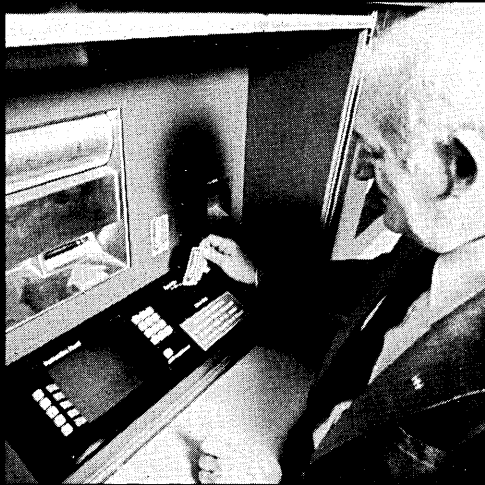

Experience — it comes from years of continuous exploration and achievement. And in the case of TTI — part of Citibank, one of the world's largest financial institutions — that achievement lies in the field of sophisticated electronic banking systems. Many companies may follow in our footsteps, but the truth is, no other company has successfully pioneered this area more thoroughly than TTI. In order to maintain this prestigious position, we recognize the fact that we must constantly move forward and strive for new innovations. We need your years of exploration and achievement — your experience. Consider the following career assignments:

- SYSTEMS PROGRAMMING
- ON-LINE APPLICATIONS PROGRAMMING
- TEST ANALYSIS
- PRODUCT DESIGN
- DIAGNOSTIC PROGRAMMING
- TECHNICAL MANAGEMENT
- SYSTEMS ENGINEERS

Selected candidates will find an outstanding environment offering total career satisfaction. For an immediate professional review, qualified individuals are invited to forward a detailed resume, complete with salary history, in confidence to: Nancy Stockinger, DM61 Professional Staffing.

TTI

CITICORP

TRANSACTION TECHNOLOGY, INC.
10880 WILSHIRE BLVD.
LOS ANGELES, CA 90024

Equal Opportunity Employer M/F

"Where the future of electronic banking is...Today"

CIRCLE 180 ON READER CARD

ADVERTISERS' INDEX

SOFTWARE & SERVICES

Allen Services Corporation	255, 257
Atlantic Software Inc.	256, 257
Bancroft Computer Systems, Inc.	256
C-S Computer Systems Inc.	257
Computer Support Systems Inc.	256
Dataware, Inc.	255
Dylakor	257
EDP Security	255
Evans, Griffiths & Hart, Inc.	256
Finar Systems	257
Raymond G. Lober Inc.	258
Mathematica Products Group	257
MBS Consulting	258
Polymorphic Computer Systems, Inc.	256
Andrew Rubel & Associates, Inc.	255
System Support Software, Inc.	256
Tomark Inc.	258

BUY, SELL, LEASE

Electrocon Inc.	258
Unitronix Corporation	258

DP MARKETPLACE

A.P. Publications Ltd.	258
C.D. Smith & Associates, Inc.	258

JOB MARKETPLACE

Social Security Administration	258
--------------------------------	-----

SOFTWARE SERVICES



Make The Right Move

Check Dataware for an economical answer to your tough conversion problem. Here's one winning move:

(any) COBOL to (any) COBOL

One of the many successful Translators offered by Dataware is our COBOL-Converter a table-driven conversion system designed to convert COBOL programs from one version or level of COBOL to another. For more information please call or write today!

The Conversion Software People
Dataware, Inc.

2565 Elmwood Ave., Buffalo, NY 14217 (716) 876-8722 | TELEX 91519

CIRCLE 210 ON READER CARD

RSX-11M speaks

DCL*
*DIGITAL
 COMMAND
 LANGUAGE

MAKES RSX-11M SIMPLE TO USE
 SAVES YOU TIME AND MONEY

- English commands
- like VAX/VMS and RSX-11M-PLUS
- on line help, hints, and examples
- easy to install NO SYSGEN required
- fully supported
- complete documentation
- \$750, available immediately

ANDREW RUBEL & ASSOCIATES, INC.
 One Soldiers Field Park 605
 Boston, MA 02163 (617) 876-7993
 RSX and Digital® trademarks Digital Equipment Corp.

CIRCLE 211 ON READER CARD

DISASTER PLAN METHODOLOGY

Gives you what you need to implement, maintain & test a Disaster Plan--tasks, procedures and guidelines

Learn how to develop a disaster recovery plan at our 3 day workshops:

- Chicago, IL—June 4-6, 1980
- San Fran., CA—June 11-13, 1980
- Denver, CO—July 16-18, 1980
- Montreal, Can.—Aug. 13-15, 1980
- Chicago, IL—Sept. 15-17, 1980
- Boston, MA—Sept. 24-26, 1980
- Atlanta, GA—Oct. 22-24, 1980

Also on-going Seminars on:

- Implementing a Computer Security Risk Program
- Risk Analysis

EDP SECURITY, INC.

400-2 Totten Pond Road, Waltham, MA 02154 (617) 890-6466

PREVENT "Wild Cards" IN YOUR DATA



© "Wild Cards" - Allen Services Corporation, 1979

ALLEN SERVICES CORPORATION

with... SUPER-MSI

Multiple Systems Integrity Facility™

SHARED DASD USERS:

- Consider - SUPER-MSI...
- **PROTECTS YOUR DATA INTEGRITY** by preventing simultaneous destructive updates by jobs in different systems.
 - **Eliminates RESERVE Lock-outs** (both performance Lock-Outs and "deadly embrace").
 - **DOES NOT SACRIFICE RELIABILITY** as do other approaches to the problem.
 - **Now has extended VSAM Dataset Integrity** to specifically handle the internal VSAM Dataset SHR options.
 - **Informs Operators and/or TSO users** (as appropriate) about the precise task (job, TSO user, etc.) causing dataset conflicts.
 - **Provides powerful operator commands** to Control and Monitor performance and activity.
 - **Is TRANSPARENT** to users, and almost transparent to operators.
 - **Is Independent of system environment** — for example, it works equally well with MVS, MVS-SE, SVS, MVT, VS1, MFT, HASP, ASP, JES2, JES3, etc.
 - **Can be installed in 10 minutes** without an IPL and with **NO SYSTEM CHANGES** whatsoever.
 - **MSI is already being used in well over 400 installations** throughout the world.

For More Information, or to Order a No-Obligation FREE TRIAL...

In Europe:
 Mr. J.A. Kaluzny
 UNILEVER GMBH • 15 Dammtorwall
 2 Hamburg 36 • West Germany
 Tel: 040 3490 2229

From Anywhere Else:
 ALLEN SERVICES CORPORATION
 Software Dept#212 W. National Rd.
 Vandalia, Ohio 45377

Toll-Free: 800-543-7853 x 203 (in OH: 513-890-1200)

CIRCLE 212 ON READER CARD

MANUFACTURING SYSTEMS REQUIRED

Urgently, by large Australian Engineering Company, involved in both fabrication and process manufacturing.

Systems must be comprehensively documented and fully implemented.

Hardware is Data General and language must be either COBOL or Business BASIC.

Applications should include:

- Order entry/billing
- Inventory control
- Bill of materials (full)
- Costing (including options on B.O.M.)
- M.R.P.
- Purchase order control
- Production scheduling
- Capacity planning
- Accounts payable and receivable
- General ledger (not essential)
- Usual ancillary commercial systems

Preferably systems will be 'on-line' as opposed to 'batch'.

Interested parties are requested to forward all details to:

Group E.D.P. Manager
 c/o P.O. Box 182
 Crows Nest 2065
 N.S.W. Australia

CIRCLE 213 ON READER CARD

**TIRED OF
REINVENTING THE WHEEL?**

Our new multicompany FINANCIAL REPORTING SYSTEM will help end your General Accounting Problems. (in RPG II) (Compatible A/P and other systems)

13 Digit Acct. #, Budgets, Comparative, Quarterly, Allocations, Consolidations, Departments, Billion \$ amounts, Recurring entries, Change in financial position.

BANCROFT COMPUTER SYSTEMS, INC.
P. O. Box 1533, W. Monroe, LA 71291
(318) 388-2236



CIRCLE 214 ON READER CARD

Quikjob

REPORT-WRITER
UTILITY
MINI LANGUAGE
DATA BASE UTILITY
FOR IBM 360/370
UNIVAC 90
OVER 600 USERS
WORLDWIDE

FREE TRIAL
AVAILABLE

NOW SUPPORTING
4300
SERIES IBM

SSS

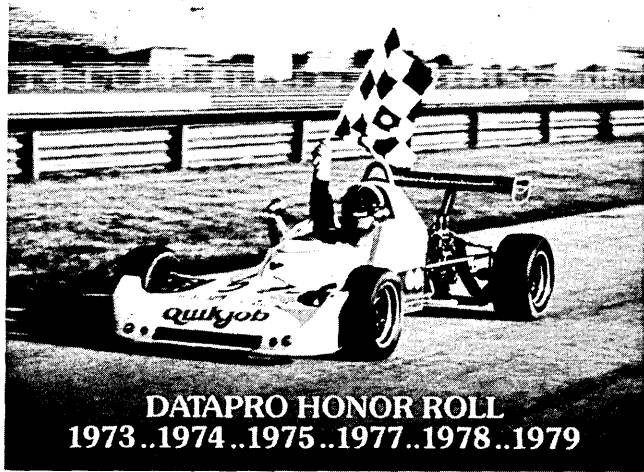

DATAPRO HONOR ROLL
1973..1974..1975..1977..1978..1979

SYSTEM SUPPORT SOFTWARE, INC.
5230 SPRINGBORO PIKE
DAYTON, OHIO 45439
(513) 435-9514 (TELEX 288-324)

CIRCLE 215 ON READER CARD

**BUSINESS SOFTWARE
IBM* 5110 & 5120**

Significantly enhanced versions of the Osborne & Associates systems. Price is \$300 per system or all four \$1000. Demo disks \$15.00. Documentation books \$20.

General Ledger/Cash Journal: Flexible organization and reporting. Nine levels of user defined totals by month, quarter and year. Detail transactions report with descriptions.

Accounts Payable: Good reporting aged reports. Fully integrated to General Ledger.
Accounts Receivable: Open item apply payments by invoice or without invoice. Aged reports & statements. Fully integrated to general ledger.

Payroll: Regular, overtime & piecework pay. Departmentalization. Open ended number deductions & special pay with quarter and year totals.

**COMPUTER SUPPORT SYSTEMS,
INC.**

Box 2134
N. Mankato, MN 56001
(507) 625-2205

*IBM trademark of International Business Machines

CIRCLE 216 ON READER CARD

**PC/70™
PROJECT PLANNING & CONTROL SYSTEM**

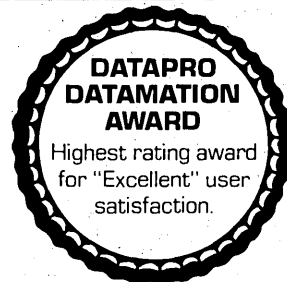
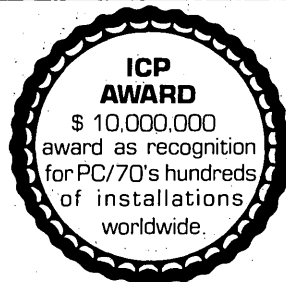

You are cordially invited to also join our award winning client group.

ASI



Atlantic Software, Inc.
Lafayette Building
Fifth & Chestnut Sts.
Philadelphia, PA 19106
215-922-7500

CIRCLE 217 ON READER CARD

**Now
Eclipse
Time-Sharing**

- Only time-sharing system for Mapped RDOS, unmapped RDOS and DOS which allows simultaneous FORTRAN, ALGOL, BASIC and assembler program execution
- Supports all standard Data General software
- Can utilize any RDOS-supported hardware
- Multi-user record lockout, multiuser spooling, and shared code support

**POLYMORPHIC COMPUTER
SYSTEMS, INC.**
P.O. Box 3584
Boulder, CO 80307
(303)422-1182

CIRCLE 218 ON READER CARD

**RSTS/E
ON VAX
ROSS/V**

(RSTS/E Operating
System Simulator
for VAX)

ROSS/V is a software package, written in VAX-11 MACRO, which provides a RSTS/E monitor environment for programs running in PDP-11 compatibility mode on DEC's VAX-11.

ROSS/V runs under VMS and interfaces to programs and run-time systems at the RSTS/E monitor call level. ROSS/V makes it possible for DEC PDP-11 RSTS/E users to move many of their applications directly to the VAX with little or no modification and to continue program development on the VAX in the uniquely hospitable RSTS/E environment. Most BASIC-PLUS programs will run under an unmodified BASIC-PLUS run-time system.

RSTS, PDP-11, VAX-11, and DEC are trademarks of Digital Equipment Corporation.

ROSS/V SUPPORTS:

- The BASIC-PLUS interactive environment.
- Concurrent use of multiple run-time systems.
- Update mode (multi-user read/write access to shared files.)
- CCL (Concise Command Language) commands.
- An extensive subset of RSTS/E monitor calls.

ROSS/V IS AVAILABLE FROM: (EASTERN U.S.)
Evans Griffiths & Hart, Inc.
55 Waltham Street,
Lexington, Mass. 02173
(617)861-0670

(CENTRAL U.S.)
Interactive Information Systems, Inc.
10 Knollcrest Drive,
Cincinnati, Ohio 45237
(513)761-0132 or
(800)543-4613 outside Ohio

(WESTERN U.S.)
OnLine Data Processing, Inc.
N. 637 Hamilton,
Spokane, Wash. 99202
(509)484-3400

CIRCLE 219 ON READER CARD

ESTIMATE PROJECT TIME and COST

- FASTER
- EASIER
- MORE ACCURATELY

with the **ESTIMATOR™**

ANOTHER PRODUCTIVITY TOOL FROM
THE PROJECT MANAGEMENT SPECIALISTS AT:

ASI  Atlantic Software, Inc.
Lafayette Building
Fifth & Chestnut Sts.
Philadelphia, PA 19106
215-922-7500

CIRCLE 220 ON READER CARD
SOFTWARE SERVICES

MSM

The MULTIPLE SYSTEMS MANAGER

for Shared TAPE and DISK Mounts

Transparently Manages Shared TAPE and DISK Mounts

- MSM automatically controls TAPE ALLOCATIONS among your systems. MSM also works for SHARED MOUNTABLE DISKS.
- Allows more EFFICIENT TAPE DRIVE UTILIZATION. Your tape drives will be treated as a single combined pool, rather than several smaller ones. This will have a tendency to reduce overall tape drive requirements.
- Alleviates confusing operator burdens. Without MSM, operators must manually coordinate device usage among the various systems.
- ELIMINATES COSTLY JOB RE-RUNS due to inadvertent multi-system tape allocation.
- Provides a SINGLE-SYSTEM IMAGE with respect to device allocations.
- MSM is COMPLETELY COMPATIBLE with the standard operating system allocation philosophy. MSM simply extends it to cover all systems in your complex.
- MSM is the ONLY TRANSPARENT APPROACH to handling SHARED TAPE and SHARED DISK allocation.
- MSM now runs with MVS, SVS, MVT, VS1 and MFT.
- New SOFTSWAP feature allows MSM to reduce the scope of allocation "blockage" when a DDR tape SWAP occurs.
- MSM can be installed in 10 MINUTES — NO IPL is required.
- Requires NO SYSTEM MODIFICATION whatsoever.
- Additional overhead caused by MSM is INSIGNIFICANT.
- MSM is now being used in well over 100 installations throughout the world.



ALLEN SERVICES CORP.
Software Dept. 212 W. National Rd.
Vandalia, Ohio 45377

To Acquire MSM, or for more information . . .

Toll-Free: 800-543-7853 x 203
(in OH: 513-890-1200)

CIRCLE 221 ON READER CARD

NEW LIFE FOR 1401 PROGRAMS

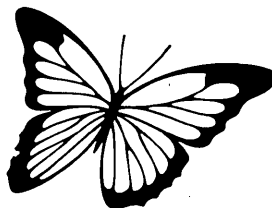

CS-TRAN converts your 1401 *object* programs to COBOL for the main-frame or mini of your choice.

CS-TRAN is the *only* translator that accepts your object programs, patches and all, yet allows you to include actual COBOL paragraph names and record definitions.

If you'd like more details about new life for your 1401 programs just call or write Russ Sandberg.



C-S Computer Systems Inc.

90 John Street, New York, NY 10038 • 212-349-3535

CIRCLE 222 ON READER CARD

Report Writer/ EDP Audit Software Tools for 360/370/4300*

Dylakor

16255 Ventura Boulevard
Encino, California 91436
(213) 995-0151



Over 1000
Installations

*303X, AMDAHL, ITEL, etc.

CIRCLE 223 ON READER CARD

How to count your chickens before they hatch.

All you need is a DEC PDP-11 with RSTS and FINAR — the financial analysis and reporting language.

- Budgets
- Project evaluation
- Cash flow
- Forecasts
- Planning
- Consolidation

FINAR SYSTEMS

132 Nassau St., Suite 212
New York, NY 10038
(212) 222-2784

Chicago
(312) 698-2023
Houston
(713) 960-0848
San Francisco
(415) 348-6810

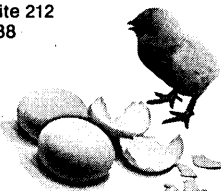

CIRCLE 224 ON READER CARD

MPGSWIFT for TP applications

Maximize staff productivity
and customer service with MPGSWIFT

- | | |
|-----------------------------|--|
| Ease of Use | Learn to write TP applications in one day |
| Ease of Installation | Install in one hour |
| Maintenance | Add terminals, files, programs while MPGSWIFT continues to operate |
| Language Support | Cobol, Assembler, PL/1, Fortran, RPG, RAMIS |
| Evolution | Entry level to large network without reprogramming |
| Productivity | Online program development with one-half the effort |
| | Over 100 installations. DOS, DOS/VS, and DOS/VSE |

Productive software for business data processing from

Mathematica Products Group

P.O. Box 2392 • Princeton, New Jersey 08540 • 609/799-2600



CIRCLE 225 ON READER CARD

SERIES / 1

Customized Programming

project management systems
general business applications
event driven executive
computer graphics

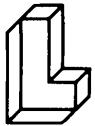

Raymond G. Lorber,
Incorporated
Systems & Programming Design

333 Market Street
San Francisco, CA 94105
(415)434-2607

CIRCLE 226 ON READER CARD

PSYPHER

R4>9SZ</T<FJ)AOZC'M"O+Z/JW;F11G1SF=
Z8SN6Y1UJ2&OK * W;JIM@06/K5MX"<8HV;
R;.<7/LY;P&8PSV7B->3G.FY+-LQ9.JJ=-Y7
L;C 7 ZHS<=&\$)@U@2=-. NO+AT@#PT 9BU=
%O"U@#C7C8;1'D.CM"D)J'6HQ&R;HR2J;??
DJ)U=-7W>IP#&NK'Y7'SH2%E"=-K.D;.<LSL6'
14DN/CA;@.LS=-<9Y6U5+C

—from Edgar Allan Poe's masterpiece of
cryptographic fantasy, "The Gold Bug."

Challenge: Decipher it.

Solution: First, attempt to discover
an extraordinarily elegant and complex
encoding algorithm. Second,
guess the "keys"—4 numbers between
1 and 2,100,000,000.

- PSYPHER• Protects your valuable data files and programs. It provides privacy and insurance against theft.
- PSYPHER• Operates on binary or ASCII (EBCDIC) files and produces encoded files in binary or ASCII (EBCDIC) form.
- PSYPHER• Is distributed as a load module ready to run on most mini computers and some main frames. Interactive and batch versions are available.

For further information contact:

• MBS • Consulting
8407 Irwin Ct.
Oakland, CA 94609
(415) 658-4622

Please provide your computer make, model and operating system.

CIRCLE 227 ON READER CARD

IBM OS USERS

Abend-Aid Can Get You Out of The Dumps.

Cut the high cost of abends
with the dynamic software
Package Abend-Aid.

Prints in English the cause
of abends and data
needed to correct them.

Call 313-559-9050
TOMARK

Another Service of Compuware

CIRCLE 228 ON READER CARD

WHEN YOU NEED DEC...

TERMINALS

- VT-100
- LA36
- LA120
- LA180

PDP11/03 SYSTEMS

LSI/11 MODULES

Demand...Delivery Demand...Discounts
Demand...UNITRONIX



UNITRONIX
CORPORATION
(201) 874-8500

198 Route 206 ■ Somerville, NJ 08876
TELEX 833184

CIRCLE 229 ON READER CARD

IBM Users MG Set - 415Hz

IBM approved type Piller Silentbloc (can be used right next to mainframe - 58 DbA) Dual 75KVa motor-generators with paralleling, used two years designed for 20 years. Input 460V, 3 phase, 60Hz. Output 120/208, 3ph, 415Hz. Price new \$77,000. Your price \$43,500 + freight.

Call us for any and all line conditioning requirements

Line Conditioning Div.
ELECTRO CON INC.

400 County Line R Box 305
Deerfield IL 60095 (312) 948-0920

CIRCLE 230 ON READER CARD

BROKER IN DEC SYSTEMS & COMPONENTS

C.D. SMITH &
ASSOCIATES, INC.
730 N. Post Oak Road,
301
Houston, TX 77024
713-686-9405

CIRCLE 231 ON READER CARD

FREE

Data booklet on specialized software information systems covering:

- * GENERAL SOFTWARE
- * DATABASE SOFTWARE
- * MICRO & MINI SOFTWARE

A.P. Publications Ltd
322 ST. JOHN STREET · LONDON, E.C.1

CIRCLE 232 ON READER CARD

JOB MARKETPLACE

Computer Systems Analysts/ Computer Specialist/ Operations Research Analyst

\$25,000 - \$45,000

Planned replacement of 15 large scale computers including a nationwide tele-processing network and systems reconfigurations related to the move to a new computer center have created unprecedented opportunities for computer professionals at the beautiful suburban headquarters of the Social Security Administration in Woodlawn, Maryland.

Immediate openings exist for senior technical and supervisor personnel with a very rapid advancement potential. These positions in a high visibility group provide an excellent opportunity to handle challenging technical problems in the field of ADP/telecommunications systems capacity management.

Enjoy a comprehensive benefits package, liberal leave policy, flexible work hours, free parking, recreational and cultural advantages unique to the Baltimore and Washington, D.C. area.

Please send confidential resume listing your qualifications and experience to:

SOCIAL SECURITY ADMINISTRATION

Attention: Lois Diritto
Division of Personnel Operations
Room G-216, West Highrise
Building
6401 Security Boulevard
Baltimore, Maryland 21235

An Equal Opportunity Employer M/F

CIRCLE 233 ON READER CARD

ADVERTISERS' INDEX

Able Computer	57	Cincom	122, 123	Datafusion Corporation	4
AC Manufacturing Company Inc.	246	Cincom Systems, Inc.	103	Datagraphix, Inc.	105
Adage Interactive		City of Farmers Branch	142	Datapoint Corporation	10, 11, 25
Computer Graphics	68	Codex Corporation	148	*Dataaab	*236H, 236I
A.M. Jacquard Systems	144	CompuMart	32	Datum, Inc.	Cover 3
Anderson Jacobson, Inc.	14	Computer Communications	186	Delta Data Systems Corporation	38
Applications Software, Inc.	241	Computer Devices	168	Dennison Kybe	116
Applied Data Communications	43	Computer Sciences Corp.	110, 111	Digital Communications	
Aramco Services Co., General Trade .	58	Computer Task Group	197	Association	134
Arizona Public Service Co.	259	Condition Power	210	Digital Equipment Corp,	
Atlas Energy Systems	244	Control Data Corporation,		Technical Products	
Avanti Communications Corp.	53	Peripheral Products Group	177	Group	60, 61, 194, 195
		Control Data Corporation, Systems		Digital Research	84
Boeing Computer Services	165	& Services	71	Drexel Burnham Lambert	104
BTI Computer Systems	16	Cromenco Incorporated	2	DuPont RECRON COM SilverFilm ...	129
Burroughs	151	Cullinane Corporation	78		
*Butler Cox & Partners Ltd.	*236G			E Systems, Garland Div.	253
		DASD Corporation	268	Eastman Kodak Co.	145
Canadian Computer Information		DataCorp	44	EDP-Export	239
Processing Society	200	Data General Corporation	40, 41	Electrohome	242
*Case	*236B	Data Systems Design, Inc.	47	Electronum	212

Programmer/Analysts For Professionals Who Enjoy a Challenge ...

...APS offers you more. As a growing public utility company located in Phoenix, Arizona, we intend to remain on the leading edge using the very latest in software techniques. Exceptional growth and challenge are available to the dedicated professional, and our location in Phoenix features an excellent year-round climate.

Currently, we have an outstanding opportunity for Programmer/Analysts. The qualified applicant should have a minimum of 2 years experience in business applications programming and analysis with payroll experience desirable. Familiarity with IBM 370 hardware and PL/1, TSO, Panvalet and JCL software required with PL/1 and COBOL preferred.

If you'd like to work in a dynamic and rewarding environment, please send your resume along with salary history and requirements in strictest confidence to: Bryan Turgesen, Arizona Public Service Company, P.O. Box 21666, Station 1102DM6, Phoenix, Arizona 85036.

aps.

An Equal Opportunity Employer M/F

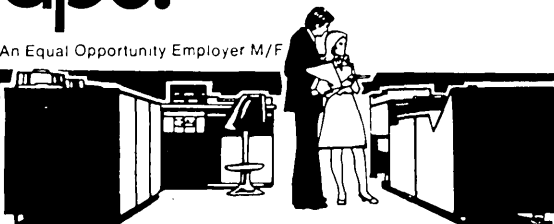

CIRCLE 181 ON READER CARD

Business Opportunity . . .

Kwik-Kopy Printing . . . the Professional Difference

As the owner of a Kwik-Kopy Printing center, you run a business, not a printing press. Like our over 500 owners in the U.S., Canada and England, who come from all walks of life, you will enjoy the professional difference that owning your own Kwik-Kopy Printing center offers.

See for yourself how an initial investment of \$17,500 (includes some working capital) can put you in your own Kwik-Kopy Printing center. (Total investment is about \$60,500). Several financing plans available.

Professional Services Provided Kwik-Kopy Owners

- Market research, site selection, lease negotiation
- Three weeks of comprehensive training including transportation and lodging
- Fully equipped, color-coordinated facility and use of copyrighted name that says it all
- Proven systems and programs that help put you and keep you in business
- Money-saving national account purchasing
- Thorough, complete, continuing support activities

Write or call toll free: Tom Malone,
National Marketing Director.



KWIK-KOPY CORPORATION

5225 Hollister • Houston, Texas 77040

US-1-800-231-4542 TEX-1-800-392-6488

Except Alaska and Hawaii



PLEASE DIRECT CANADIAN INQUIRIES to:
Kent Harding, 109 Telson Rd., Markham, Ontario L3R1E4

CIRCLE 182 ON READER CARD

JUNE 1980 259

Emerson Electric	184
EST Div. of Liggett & Platt, Inc.	250
*Facit AB	236D
Federal Computer Conference ..	226, 227
Fox Morris	262
Gandalf Data Inc.	127
General Electric TermiNet	133

General Terminal	12, 13, 183
Graham Magnetics	215
GTE Telenet	263
Harris Corporation	206
Hazeltine Corporation	34, 35
Hewlett Packard ...	91, 92, 93, 94, 95, 96, 97, 98
Honeywell	178, 179
Houston Instrument	233

Hughes Aircraft Company	36
Hughes Aircraft Company, Support Systems	264
Human Designed Systems, Inc.	8
IBM, Data Processing	27, 28, 29
IBM, General Systems Division	152, 153
Image Resource	69
Informatics Inc.	19
Information Builders Inc.	72
Infotron Systems Corporation	33
Innovation Data Processing	270
Intel Commercial Systems Div.	5
Interface Mechanism, Inc.	99
International Data Sciences	42
International Entry Systems, Inc.	117
Interstate Electronics	187
ISSCO	67
C. Itoh	21

Javelin Electronics	252
Johnson Systems, Inc.	244

Kennedy	Cover 2
Koh-I-Noor Rapidograph, Inc.	15
Kuwait University	267
Kwik-Kopy Corporation	259

Lear Siegler Inc.	55, 65
*Lear Siegler	236K
Lee Data Corporation	109

*Magnuson	236U
Martin Marietta Aerospace	261
Matrix Instruments	159
Megatek Corporation	209
*Memorex	236M, 236O, 236Q
Micom	89
Micom Word Processing	163
Microengine Company	266
*Microperipherals	236CC
*Microtecnica	236FF
Mohawk Data Sciences	205
Moore Business Forms	185

National Advanced Systems	6, 7
NBI	107
NCR Corporation	141, 199
NEC Information Systems Inc.	9
*Norsk Data	236AA
North Holland Publishing Company ..	26
North Star Computers	193
Northern Telecom Systems Corp	160, 161
Norton, Kleven and Co., Inc.	234

Olivetti	22, 23
----------------	--------

Data Processing Professionals: Work at the World Headquarters of an international success!

The Ralph M. Parsons Company, one of the world's most successful engineering/construction firms, has immediate openings for career-oriented individuals. You would become a part of our Management Systems Department and work at our modern world headquarters complex located in Pasadena.

SENIOR SYSTEMS ANALYST

Will evaluate corporate systems and determine areas which would be better supported by existing or new computer applications. Bachelor's degree and 6 years analysis experience required. Must have COBOL background and supervisory experience. Effective communications skills needed for heavy user interface.

PROGRAMMER/ANALYST

Bachelor's degree (or equivalent) and 3 years COBOL programming and analysis experience with a system using IBM CS/VS or MVS is required. Background in TSO, DYL 260, or VSAM is helpful. Advancement opportunities available.

ENGINEERING PROGRAMMER

Bachelor's degree in Engineering and 2 years experience in solving engineering problems. FORTRAN and IBM 370 experience are required.

For prompt and confidential consideration, please call or send a resume including salary history to:

Gene Mitz
Professional Staffing Department DM 680
100 West Walnut Street
Pasadena, California 91124
(213) 440-2830

PARSONS

Pride in Performance

An Equal Opportunity Employer Male/Female

On Line Business Systems 102	Transaction Technology, Inc. 254	*Wabash Tape Corporation 236DD
On Line Software 70,80	TRW, Datacom Int'l 236V, 236W	Wallach Associates, Inc. 236
Ontel Corporation 219	TRW, Defense & Space Systems Company 235	Wang Laboratories 229, 251, 269
Optical Coating Laboratories 76		Weksler Instruments Corp. 243
		WESPERCORP., Div. of Western Peripherals 1
Pansophic Systems, Inc. 174	UBI 198	Western Electric Software 137
Ralph M. Parsons Co. 260	United Airlines 223	Wright line 252
Perkin Elmer Corp. Terminal Div. 124	United Technical Products 74	
Planning Research 140	University Computing 130, 131	Xerox 77, 79, 81, 83, 85
Prime Computer, Inc. 30	U.S. Robotics 138	
Program Products 86		Zentec Corporation 221
*Program Products Int'l 236J	Vector Graphic 73	

Quest Systems, Inc. 236
Qytel 234, 250
Qyx, Exxon Information Systems 171, 172, 173

Racal-Milgo Information
Systems, Inc. 115
Racal-Vadic 143
*RC Computer 236EE
Rixson, Inc. 201
Rockwell Int'l, Collins 108
Rusco 50

SAS Institute Inc. 87
Schlage Electronics 249
Shaklee 262
Shugart 118, 119
Sicob 214
Siggraph '80 224
Software House 100, 101
Software International 245
Spectrum 39
Storage Technology Corporation 154, 155
Sun Information Services Company 139
Swingline Company 142
Syncom 82
Systonetics 230

Tally Corporation 62
Tandem Computers, Inc. 59
TEC, Incorporated 54
*Techex 236X
TeKtronix CPI 167
Telcon Industries 225
Telesystems Network Inc. 56
Teletype Corporation Cover 4
TeleVideo Inc. 75
Texas Instruments 20, 191
3M, Data Recording 213
Timeplex 49
Tran Telecommunications Corp. 116, 175

Tomorrow-minded UNIVAC APPLICATION ANALYSTS



Martin Marietta Aerospace, NASA's Contractor on the Space Shuttle External Tank, has immediate openings for Univac Application Analysts.

Position requires designing and programming a variety of engineering and specific programs utilizing ANS/COBOL for application on Univac 11XX equipment.

Qualified individuals should possess a BS in Mathematics, Computer Science, or related discipline, and have a minimum of 3 years scientific and/or business programming utilizing data base methodology.

We offer competitive starting salaries and fully paid company benefits. These opportunities exist at the Michoud Assembly Facility located in Suburban East New Orleans. Qualified candidates interested in learning more about these opportunities at Martin Marietta...the tomorrow-minded aerospace people, should forward resumes including salary history to: Ms. Dottie McCann, Martin Marietta Aerospace, P.O. Box 29304, New Orleans, Louisiana 70189. We are an equal opportunity employer, m/f/h.

MARTIN MARIETTA

EDP SPECIALISTS career search opportunities \$18,000-\$50,000

MANAGER, DP OPERATIONS to \$40,000. Extraordinary oppty to develop own staff for large corp moving MIS from service bureau in house-twin IBM mainframes. Refer HG.

MANAGER, SYSTEMS DEVELOPMENT to \$35,000. Leading Mid-Atlantic div of "Fortune 200" company seeks manager to design, develop & implement business systems. Degree w/8-10 yrs systems exp w/2-3 yrs supervisory exp. Modern IBM shop. Refer RN.

MIS MANAGER to \$35,000. "Fortune 200" corp needs MIS manager for Chicago area division. Manage all MIS functions w/function responsibilities for remote facilities in progressive IBM state-of-the-art MIS environment. Must be deg'd w/solid cobol programming beginning, including 8 yrs of various levels of MIS exp. COPIC and 8100 skills a real +. Refer BS.

SR. SYSTEMS to \$30,000. Billion \$ prestige manufacturing corp in choice Virginia location seeks Sr. Analyst w/exp in financial, accounting, payroll or inventory areas. Exceptional growth oppty. Refer DM.

ANALYST to \$30,000. We currently have numerous oppty's for Analyst & Programmers at most levels of experience. Financial & manufacturing systems preferred. All costs paid by client co's. Refer JS.

TECHNICAL CONSULTANT, \$28,000. Major computer organization seeks consultant to determine client needs & support previously developed Engineering Application Software. Extensive training provided in use of Software Macro language. Req's BS Eng or Comp Sci degree; NASTRAN exp a must. Refer RS.

CONTACT OUR NEAREST OFFICE ABOUT THESE AND OTHER FEE-PAID OPPORTUNITIES.
OUR UNIQUE, COMPANY-OWNED OFFICE SYSTEM ASSURES PERSONAL, CONFIDENTIAL SERVICE.

PHILADELPHIA, PA 19102—S. Burns, 1500 Chestnut St., 215/561-6300
ATLANTA, GA 30346—R. Spang, 47 Perimeter Center, 404/393-0933
BALTIMORE, MD 21204—R. Nelson, 409 Washington Ave., 301/298-4500
CHARLOTTE, NC 28202—J. Schwab, 1742 Southern Nat'l Ctr., 704/375-0600
CLEVELAND, OH 44131—A. Thomas, 5755 Granger Road, 216/749-6030
MCLEAN, VA 22102—D. Miller, 1710 Goodridge Drive, 703/790-1335
NEW YORK, NY 10036—N. Shanahan, 1211 Ave. of the Americas, 212/840-6930
PITTSBURGH, PA 15222—B. Sayers, 4 Gateway Center, 412/232-0410
PRINCETON, NJ 08540—J. Dean, 3490 U.S. Rt. 1, 609/452-8135
WILMINGTON, DE 19810—H. Greene, 3411 Silverside Rd., 302/478-5150
HOUSTON, TX 77098—G. Smith, 3000 Richmond Ave., 713/523-5504
LOS ANGELES, CA 90017—W. McNichols, 707 Wilshire Boulevard, 213/623-3001
SAN FRANCISCO, CA 94111—W. McNichols, 601 Montgomery St., 415/392-4353

FOX-morris
personnel consultants

CIRCLE 185 ON READER CARD

ADVERTISING OFFICES

Sales Manager
John M. Gleason
New York, NY 10103
666 Fifth Ave.
(212) 489-2579

Eastern District Managers
A. Treat Walker,
Warren A. Tibbetts:
New York, NY 10017
420 Lexington Ave.
(212) 682-7760

New England District Manager
Warren A. Tibbetts:
Manchester, NH 03104
112 W. Haven Rd.
(603) 625-9498

Midwest District Manager
William J. McGuire
Chicago, IL 60601
3 Illinois Center Building
303 East Walker Drive
(312) 938-2900

Western District Managers
Alan Bolté, Jr.:
Los Angeles, CA 90035
1801 S. La Cienega Blvd.
(213) 559-5111

James E. Filiatrault:
Mountain View, CA 94043
2680 Bayshore Frontage Rd.
Suite 401
(415) 965-8222

U.K., Scandinavia, Benelux
Intergroup Communications, Inc.
Wallace K. Ponder, European Director
Paul D. Dimmock, Regional Manager
31 Lyncroft Avenue
Pinner, Middx, HA5 1JU
England
Tel: (01) 868 9289
Cables: PACOM, Pinner

Germany, Austria, Eastern Europe
Tullio Giacomazzi
130 Jermyn St.
London SW1 Y4UJ
Tel: (01) 839 3916

France, Italy, Spain
Gerard Lasfargues
32 rue Desbordes Valmore
750 16 Paris
France
Tel: (1) 504 97 94

Japan
Shigeru Kobayashi
Japan Advertising Communications, Inc.
New Grinza Building
3-13 Ginza 7-chrome
Chuo-ku, Tokyo 104, Japan
Tel. (03) 571-8748

James B. Tafel, Chairman
John K. Abely, President
Robert L. Dickson, Exec. Vice President
John R. Emery, Senior Vice President
Calverd F. Jacobson, Vice President-Finance
Walter Harrington, Vice President and Controller

Technical Publishing

DB a company of
The Dun & Bradstreet Corporation

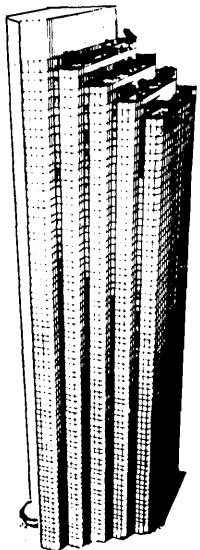

Project Manager/ Senior Programmer Analyst

Shaklee Corporation, a NYSE listed leader in the nutritional supplements area, will soon be establishing new corporate offices in the center of the San Francisco Financial District.

Move With Us!

Our growth has created immediate opportunities for senior level data processing professionals who can coordinate major systems development projects in our Sales, Financial and Manufacturing support organizations.

If you have proven analytical skills, can assume responsibility for projects from start to completion and have management/supervisory experience, we are looking for you. Additional opportunities exist at other San Francisco Bay Area locations.

Shaklee offers an outstanding benefit and compensation program including a complete relocation package. If you want to work in a healthy corporate environment offering excellent opportunity for growth, send your resume, including salary history to: **Professional Recruitment Department, 2201 Broadway, Oakland, CA 94612.**

We are an equal opportunity employer m/f.

Shaklee

CIRCLE 186 ON READER CARD

Data Communications Engineers

If you'd rather SWITCH than fight... join the packet-switching leader GTE TELENET

The fight is over. Packet switching is the winning technology in data communications. And GTE Telenet, the packet-switching pioneer, is now the national leader in a dynamic industry.

We're expanding the shape, scope, and capabilities of our nationwide data communications network, and we need YOUR help to meet our growth demands. By joining Telenet now, you can build a career of extraordinary potential while you enjoy the stimulation and challenge of life on the cutting edge of data communications technology.

We seek engineers with data communications backgrounds at junior to senior levels, with BS, MS, and PhD degrees (or equivalent experience). Positions are available at our metropolitan Washington, D.C. headquarters facilities.

- **Systems Engineers**
- **Network Engineers**
- **Design Engineers**
- **Product Engineers**
- **Switching Engineers**
- **Facility Engineers**
- **Electronic Engineers (Software Backgrounds)**
- **Field Service Engineers**
- **Project Engineers**

Positions are also open to Data Communications Marketing Professionals, Technicians, Programmers, and Analysts.

You will enjoy the GTE Telenet environment—innovative, stimulating, challenging. And you will enjoy the growth potential and advancement opportunities inherent in our national leadership. A generous compensation/benefit package is still another reason to join us now. Send your resume in complete confidence, including salary requirements, to: Douglas F. Macaulay, Manager of Employment, GTE Telenet, 8330 Old Courthouse Road, Vienna, VA 22180. An equal opportunity employer m/f/h.

GTE Telenet
The data network

A part of **GTE**

We're asking a lot. We'll give you a lot more.

Hughes Support Systems needs software professionals who are professionals.

Can you handle significant software responsibilities in our high-technology engineering environment?

We are responsible for automatic test systems in many areas: radar avionics, missile and electro-optical programs, and mission trainer-simulators. And those responsibilities keep growing, creating more and more good software jobs here.

In exchange for your desire and ability to do an outstanding job in real-time interactive graphics, computer-based test systems, and other complex applications, we're offering a great package:

- Small-company atmosphere where your contribution can be seen and will be rewarded
- At the same time, the stability that comes from being part of Hughes Aircraft, the electronics leader, with its \$4 billion backlog of work comprising more than 1500 different projects
- Excellent salary and benefits
- Great place to work, near LA Airport and beach communities

If that combination looks good to you, let us know which of these jobs you're qualified and eager for:

Programmers and Analysts

Experience in real-time systems development, quality assurance, or program validation is a must. You'll design, code, and check out computer programs and modules used in ATE and in trainers and simulators controlled by mini and microprocessors.

Senior Systems Programmers

If you've really learned your way around real-time executives, operating systems, and I/O device handler developments, we have plenty of programs to challenge you.

Senior Systems Analysts

You need a strong software engineering background with experience in modern systems development or heavy data-base management and distributed processing systems.

Senior Software Engineers

To get one of these jobs, you must be a senior-level professional who can generate clear and concise software requirements into a software implementation activity. Your experience must include conceptual and preliminary design, and real-time applications in both multi-programming and multi-processing. If you have that background and you're unusually good at applying it, the sky is the limit.

Don't let the future get away. Send your resume right away to: Professional Employment 130/4, Hughes Support Systems, Dept. O52, P.O. Box 90515, Los Angeles, CA 90009, or call collect at (213) 641-6691.

HUGHES

HUGHES AIRCRAFT COMPANY

SUPPORT SYSTEMS

U.S. CITIZENSHIP REQUIRED

Equal Opportunity M/F/HC Employer

CIRCLE 188 ON READER CARD

An exchange of readers' ideas and experiences. Your contributions are invited.

READERS' FORUM

GUIDING COLLEGE CAREER PROGRAMS

In July, the computing community will see the publication of a timely and important report. The Association for Computing Machinery intends to publish, in a single volume, the final versions of the separate Recommendations and Guidelines for Community and Junior College Career Programs in (1) Computer Programming, (2) Data Entry, and (3) Computer Operations.

Work on the first of these reports started in 1975, under the auspices of the Community and Junior College Subcommittee (CAJC) of the Curriculum Committee on Computer Education (C3E), of the ACM. Each of the three reports has progressed through roughly the same stages. Each appeared first as a "working paper," for the purpose of eliciting comments and criticisms from the computing community. After each working paper was modified on the basis of selected responses, it then had to be submitted to C3E, the parent committee, for final approval. In each case, the repeating cycles of draft—review—revise have taken close to three years for completion, and have required the dedicated participation of a great many volunteers and the availability of extensive free services.

In addition to some lively discussion, the guidelines should also prompt some constructive suggestions for implementation. For, as the guidelines emphasize, they have been prepared to allow flexible use by implementing organizations. A given item in a content outline, for example, may require some details before it can be useful to an instructor preparing a course.

As an example of suggestions that implementors of these guidelines might find helpful, I will take two issues that are becoming increasingly important to all computer users—computerized databanks, privacy, and fairness; and computer crime and computer security—and examine their treatment in detail.

As one would expect, the coverage of these two topics varies greatly among the three component guidelines. While privacy and crime/security receive only scant attention in the Computer Programming and Data Entry Guidelines (not mentioned at all in the Objectives, and appearing once and twice, respectively, in the Content Outline), they are given an important position in the Computer Operator Guidelines: they are mentioned in the introduction, again in the Objectives, and finally as items in the Content Outline.

Privacy and crime/security issues are first mentioned in the Working Paper's Introduction:

"This entry-level operator must be prepared to learn both the regulations of, and the implications of, the problems in the area of privacy and security, and be prepared to function in an ethical and

moral manner in a complex environment" [p. 2];

"The growth of new and more complex methods of computer crime places increased pressure on the operator to monitor informational security and to be watchful for unauthorized uses of the system. Lastly, the increased interest in privacy of the individual places a greater responsibility upon the computer operator, not only for personal ethical and moral action, but for maintaining it in others in the job environment who have easy access" [Section 1.1, p. 4].

Taken together, these two statements set the proper framework for the subsequent discussion. They approximately separate the "privacy" issue (citizens' concerns about the routine collection, storage, and dissemination of valuable personal data) from the "security" question (how to protect computer systems from unauthorized use, especially where such use constitutes a crime). And the first of the two statements places the proper emphasis on the growing body of "regulations" in these areas. While there surely is an "... increased interest in privacy . . .," of more direct and immediate concern to people in computer operations is the federal, state, and even local legislation which specifies how personal data is to be collected, stored, and disseminated.

The privacy and security topics are referred to twice in the Working Paper's Section 3, Goals and Objectives of Operations Curriculum. Under the heading Additional Operations Skills, we find:

"Recognize the necessity for, and know common procedures for computer recovery, security, and backup procedures" [3.2, C.5, p. 9].

The necessity for recovery and backup procedures is of an entirely different order than the necessity for security. Recovery and backup procedures specify actions to be taken when security fails; as such, they are integral components of any adequate security plan. The need for security is a far more global consideration, which may actually vary depending upon the nature of the data handled by the system. Later, under Personal and Social Skills, we read:

"Develop an awareness of the operator's responsibilities in data security and integrity" [3.4, A.1, p. 10].

Again, the computer operator's responsibilities in data security and integrity are of several kinds: (a) responsibility for overall professional conduct in the performance of his/her job; (b) responsibility to the particular needs of the employer; and (c) responsibility to observe the applicable laws. Clearly, the computer operator can face a serious decision when one of these responsibilities is in conflict with the others (a situation which arose most clearly in the Equity Funding fraud case).

Section 5 of the Working Paper contains the recommended Program Content in the form of a topical outline. Under 5.1, Required Computer Operations Related Topics, appears the following:

"F. Data Handling . . .

4. Security

- a. Data Confidentiality
- b. Access Limitations
- c. Security Equipment (fireproof safes, etc.)
- d. Backup
- e. External and Internal Labels, Passwords" [p. 15].

When we say
we deliver
within 30 days...
**WE
DELIVER
WITHIN
30 DAYS.**



WD/90 PASCAL MICROENGINE COMPUTER

The 16-bit WD/90 Pascal MICROENGINE™ Computer is the first microprocessor hardware designed exclusively for direct high-level language execution. P-code is directly executed (no interpreter), resulting in execution up to five times or more faster than equivalent systems.

The WD/90 Pascal MICROENGINE includes:

- Pascal MICROENGINE processor
- 64K bytes of RAM Memory
- Two RS-232 asynchronous/synchronous ports
- Two 8-bit parallel ports (500kHz maximum data rate)
- Floppy disk controller w/direct memory access
- Floating point hardware
- Memory Mapped I/O

PASCAL PERFORMANCE

CALL TOLL FREE 800-854-8300
(outside California)

**The
MICROENGINE
Company**

A Subsidiary of WESTERN DIGITAL

3128 Red Hill Avenue, Box 2180, Newport Beach, CA 92663
(714) 557-3550, TWX 910-595-1139

Dealer Inquiries Invited.

CIRCLE 189 ON READER CARD

FORUM

Unfortunately, the problems of security are difficult to cover in five items, especially when both *physical* security (as represented by "fireproof safes") and operating security (as enhanced by a system of "passwords") are indiscriminately mixed. And does "access limitations" refer to physical access (locks on doors), or operational access (authorization matrices)? The confidential nature of data in the system may be very important, and an adequate security plan must include measures to prevent unauthorized access to that data. But it should also be mentioned that highly successful frauds have been perpetrated without regard to the confidential status of stored data, by simply setting up spurious accounts and funneling assets into them, for the benefit of the defrauders. Here, then, is an area which could use some amplification when one attempts to convert the Guidelines topical outline into an actual course.

The second reference to privacy and security issues occurs in Section 5.2, Required Computer Operator Environment, where there appears the following:

"Computers in the Organization: A. Data Processing within the Organization . . .

3. Social Impact of the Computer

- a. Job Security
- b. Conformity and Dehumanizing of their [?] Jobs
- c. The Possibility of Complete Dependency on Computerized Data
- d. The Problem of Incorrect Computerized Data" [p. 22].

Without commenting on the adequacy of the above four items to cover the topic of computer impact on society, let us examine 3.d, "The Problem of Incorrect Computerized Data." Because computerized data systems are routinely used to make decisions that can have devastating effects on people's lives, incorrect computerized data can unfairly penalize the data subject. But the problem of incorrect (or, better, inaccurate, untimely, or incomplete) data arises in at least three different contexts. How the inaccurate data were acquired in the first place is a problem in the area of *data collection*. Some routine data collection practices are guaranteed to produce inaccurate data. Often data are collected which bear no reasonable relationship to the decision-making purpose for which they are used. On the other hand, whether or not data subjects are allowed to examine their records, and challenge any inaccuracies they



"Mr. Crittendon is not in at the moment but if you want to close a big deal or something, I'll be happy to handle it."

©DATAMATION

CARTOON BY HENRY R. MARTIN

STATE OF KUWAIT KUWAIT UNIVERSITY COMPUTER SERVICES

We are developing a new kind of system architecture at the University of Kuwait. We are seeking experienced dedicated Computer Science professionals to join us for a successful implementation of numerous projects in hardware and software and communications.

THE EQUIPMENT

A dual processor UNIVAC 1100/62 with 2 Mega Words of memory which will support Kuwait University's Centralized data processing functions in Administration and Academic areas.

THE ENVIRONMENT

The Computer Center is newly built and located in the Center of Kuwait City. The Kuwait University is the only institution of higher education in a country of continuous development.

THE JOBS

Various jobs in:

- Management of Computer Center Division: (3)

- Senior System Analysts and Project Leaders: (2)

- Communication Experts and Operating System Analysts (UNIVAC EXEC. OP SYSTEMS) (3)

- System Analysts and Programmer Analysts: (5)

- Senior Programmers: (5)

THE CANDIDATE

The successful applicant will:

- Have a thorough understanding of UNIVAC 1100 Systems,
- Have at least 5 to 10 years of experience dependent on the category of job,
- Be able to sign a two year minimum contract with Kuwait University.

THE SALARY

The salary will vary according to job designation and qualifications. Attractive salary and other benefits such as: free air fares, free air conditioned accommodation, one month paid holiday with air fare.

Please apply with brief resume and a photograph to:

Director of Computer Services
Kuwait University
P. O. Box 34251
Adeliyah
Kuwait

**Choose your
conversion software
as carefully as you
choose your
computing
hardware.**

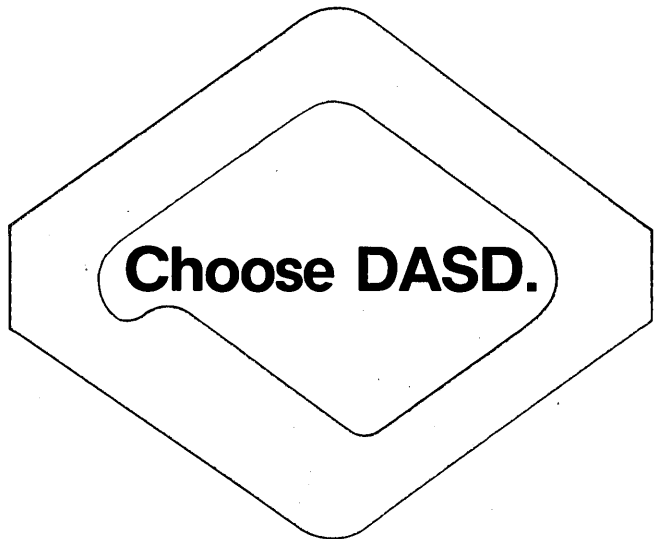

Faced with a conversion? Then select the conversion software that has proven itself time and again in actual applications... the DASD Conversion Software Products line.

Our complete library of well-designed, thoroughly developed software is among the most comprehensive available anywhere... a full range of safe, reliable conversion tools, along with utilities specifically designed to aid in conversion projects.

Our experienced personnel are the tops in the industry... qualified experts fully capable in a wide range of languages and applications, with practical experience with all major computing hardware.

We're fully staffed in most major U.S. cities, with the ability to go anywhere. So we're always there when, and where, you need us. And we offer a Turnkey Conversion approach that is truly unique in the industry.

If you'd like more information on how we can help with your conversion, circle the appropriate number on the Reader Service Card and return it today.

Conversion Programs Available	Reader Service No.
RPG/RPG II to COBOL.....	295
COBOL to COBOL.....	296
FORTTRAN to FORTRAN.....	297
NEAT/3 to COBOL.....	298
DIBOL to COBOL.....	299



PEOPLE/PRODUCTS/RESULTS

DASD Corporation • Corporate Services Center
9045 North Deerwood Drive • Dept. 228
Milwaukee, WI 53233 • (414) 355-3405

FORUM

discover, is a problem in the area of *record access*. When one organization *disseminates* inaccurate data to other organizations, the problem then becomes: what responsibility does the disseminating organization have to follow up by disseminating the correction?

What appears, then, to be one problem, turns out, upon analysis, to be a set of different problems, where the differences are a function of which particular phase of computer system operations is being addressed. Because there are other problems in the "privacy" area which share this characteristic, experience shows that it is more productive to organize the material by operational context. Thus the instructor will find it easier to discuss all of the problems which arise in connection with data collection, then those that concern record access, and then the problems in data dissemination.

To complete the picture, the student should then be introduced to the legislation in these areas. Under Privacy, the student should be familiar with the Fair Credit Reporting Act, the Privacy Act of 1974, the Family Educational Rights and Privacy Act of 1974, and the Financial Institutions Regulatory Act of 1978. Under Security, the Federal Computer Systems Protection Act (S. 240, introduced by Sen. Ribicoff) is a model, which several states have emulated.

Ironically, one result of taking these suggestions seriously is to place an even greater responsibility upon an already undercompensated instructorate. Community and junior colleges already face the problem of finding and retaining competent instructors, especially in an environment where, in a short time after graduation, the student is earning a better salary than the instructor. To require that these instructors become knowledgeable in additional areas, such as laws relating to privacy and security, may not be very realistic.

—James L. Rogers

TURNAROUND, TIMESHARING, AND TOLERANCE

As I write this, two compiler contracts—worth well over \$2 million—are stalled.

They are stalled because the compiler validation system—probably a \$50,000 contract—is also stalled.

The validator is stalled because it is being checked out on a batch computer system with one week turnaround.

For want of a nail, the war was lost.

This story is a familiar one to anyone in the computing field. Try as we will to point our fingers elsewhere, the moving fingers return to "turnaround" as the crisis point of most batch software development. It has been the crisis point for so long that the literature doesn't even bother to discuss it as a problem anymore. "Turnaround is bad—so what else is new?" is the prevailing attitude.

But there is a difference between the attitude and this story. The validator developers are going to move their checkout to an entirely different computer, one with a timesharing system. And, as we all know, their turnaround will drop from days to seconds. Of course, there will be pain connected with that transition. Moving even a validator system from one computer to another is not a trouble-free process. But on balance, the stalled validator, once moved, will rapidly be checked out.

All of that is well understood. Batch turnaround is notoriously bad; timesharing turnaround, by contrast, is almost unfailingly good.

Did anyone ever ask, "Why?" The question seems dumb. "Of course, timesharing turnaround is better," you may be thinking. "That's what timesharing is all about."

In the spirit of intellectual inquiry, though, let's for the moment assume the "why" question is not dumb. Let's explore the

Some computer companies seem to keep software groups isolated – even pit them against one another.

At Wang, we cooperate. No matter which group you're in, no matter what

project you're working on, we always encourage interaction. Because that's how great ideas happen.

We also offer high career visibility and plenty of personal freedom, plus day-to-day advantages like unlim-

ited computer time, your own terminal, generous work space, and more.

All because we realize that to have the best software in the industry, we need the best software developers. And the happiest.

For more information, contact Tom Bahlo, Wang Laboratories, Inc., Dept. #000, One Industrial Avenue, Lowell, MA 01851. (617) 459-5000.

At Wang, no software group is an island.

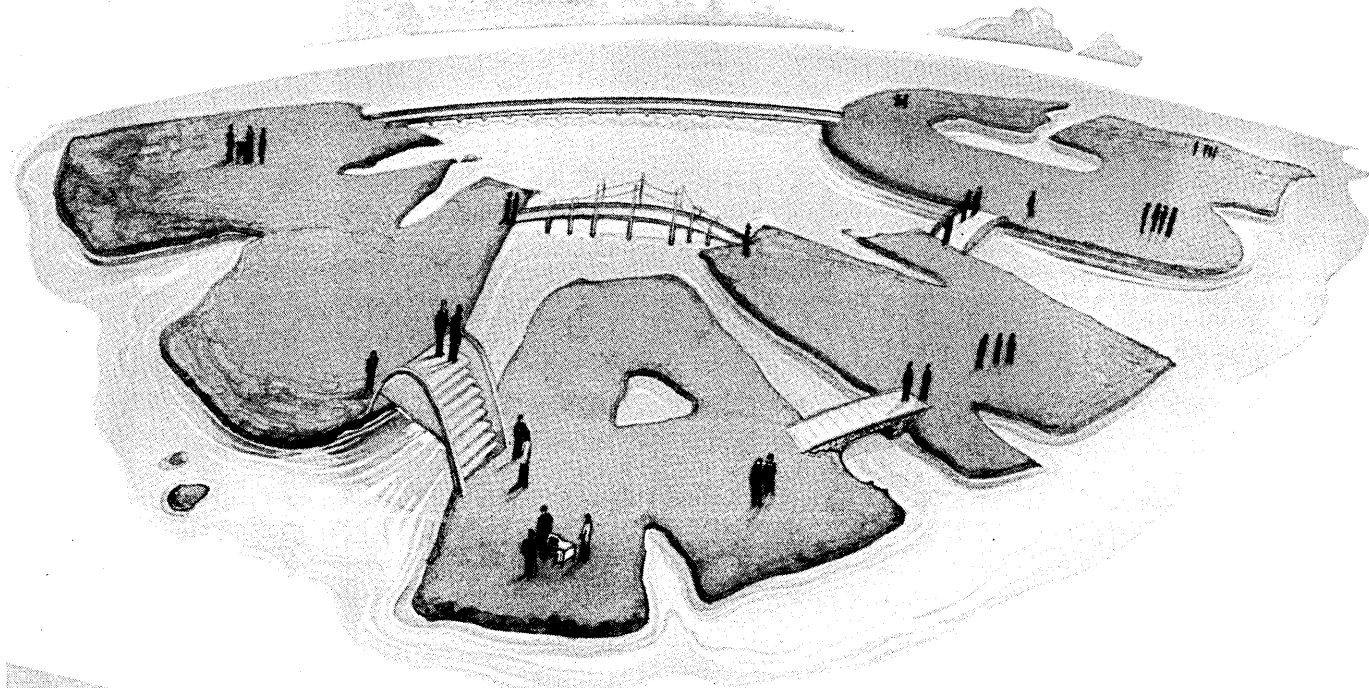

WANG

Making the world more productive.

©1980 Wang Laboratories, Inc., Lowell, MA 01851. We are an affirmative action employer.

Systems Software Development.

2200/Language Development

Openings exist at both the entry and senior levels in the design, development, and support of microprogrammed language interpreters for Wang 2200 minicomputers. Functional enhancements are currently being made on an advanced BASIC and development of a COBOL processor is just beginning. Emphasis is on developing a high performance interactive system for the small business and distributed processing markets.

The small group environment is emphasized providing the opportunity for a high level of individual responsibility and visibility. Interaction with all 2200 development groups is encouraged.

CIRCLE 191 ON READER CARD

2200/Systems I/O Development

Designers/programmers to design and implement firmware for new I/O devices and interfaces. These interfaces will be progressively more intelligent, distributing the burden of a multiprogramming operating system, and providing more high level features than ever before on our powerful small business computer. Coding will be at a number of levels, including high level language, interpreter/O.S. microcode, microprocessor code, and hardware sequencer instructions. Responsibility will range from language definition through hardware specification. All phases of design, coding, and debugging are included.

An entry level candidate should have a degree in either engineering, computer science, or math, with adequate course work in operating systems principles. A senior level candidate should have several years in operating systems and/or microprocessor firmware design.



PROVEN RECORD OF RELIABILITY

FAST DUMP RESTORE

FDR with over 3400 users and nominated to the DATAPRO HONOR ROLL for the 6th consecutive year, has a proven record of RELIABILITY and EFFICIENCY. FDR permits the user more opportunity to backup his files while using significantly less CPU and elapsed time.

COMPAKTOR

A disk management utility which reorganizes disks at FDR speed. COMPAKTOR permits the user to easily position and sequence data sets. Multi-extent data sets are changed to single-extent data sets and the user is also allowed to change both the size and location of a volume's VTOC.

Available for IBM OS, VS and MVS.

For Further Information
or Free 30 Day Trial, Call or Write...



970 Clifton Ave., Clifton, NJ 07013 • 201-777-1940

CIRCLE 192 ON READER CARD

FORUM

question of turnaround one step further.

Why is batch turnaround bad? The answer, most of us would agree, is that the computer has become saturated with work.

What happens, then, when a timesharing computer gets saturated with work?

Pause. The answer should be, of course, that the timesharing turnaround gets bad. Instead of one second turnaround, 10 second turnaround . . . or one minute . . . or 15 minutes. The evolution from good turnaround on a lightly loaded computer to bad turnaround on a heavily loaded computer should, by all reason, proceed in the same manner for timesharing as for batch.

We know it does not.

Now we are prepared to ask the question again. It is not dumb. Why is batch turnaround notoriously bad, and timesharing turnaround almost unfailingly good?

We asked this question, with this background, of several experienced software professionals. They answered, "Because timesharing users will not tolerate bad turnaround."

This is a sociological answer, not a technical one. The technology of software may have developed the timesharing system as a problem solution, this answer says, but in the long term it is sociological considerations and not technical ones that determine the success of timesharing. And in this case, the answer says, the sociology favors timesharing.

There is no need to explain why timesharing users will not tolerate bad turnaround. Any software professional who has experienced timesharing knows that the human tolerance level erodes rapidly as the seconds tick by.

There is, perhaps, some need to explain why batch users *will* tolerate bad turnaround. Once a batch user bids his job goodbye at the submittal window, he knows he must begin another activity . . . too much time will pass by (an hour, a day, a week) to sit and wait. Therefore, adding another hour or day to the turnaround is a tolerable annoyance. The batch user tolerates the erosion of his turnaround a percentage at a time.

Since the intolerant timesharing user insists that his turnaround not erode, his computer resources, as a result, evolve to satisfy that requirement.

Tolerance, we are all taught, is a laudable trait, but overdone it can be an affront to common sense.

—Robert L. Glass
Seattle, Washington



"It has been said that I look honest. But looking honest isn't enough. I can also act honest."

©DATAMATION

CARTOON BY HARLEY L. SCHWADRON

IBM VOLTAGE CONVERTER TAPE DRIVE

PARALLEL PROMPTER TAPE DRIVE

These units operate from 45 cps from your IBM Model 1400 system. They are designed to operate with compatible vacuum column tape systems operating at 75 and 120 cps, as well as 45 cps. They comply as standard in all 5 operating configurations.

A new concept in tape subsystems, the Model Series is compatible with IBM Model Models 1010, 2010, 2014, 2015, 2016 and 2018 MX minicomputers. A single I/O mechanism offers external control as the heart of the Drive system.

Along with integrated system design, Dynamic Series (DS) offers you multi-transport operation, using MTRZ, and an I/O interface up to four tape transports may be driven by each drive unit.

And you're getting more than just a Model 1400 operating system.

(See D) Drive Model 1400 IBM Model 1400 tape drive system from IBM's Model 1400 IBM Model 1400 system. And IBM Drive Model 1400 IBM Model 1400 system.

See Drive Model 1400 IBM Model 1400

IBM Corporation, 1100 North Dearborn Street, Chicago, Illinois 60610. Telephone: (312) 297-0000. Telex: 180000. Cable: IBM. In Canada: IBM Canada Limited, 100 King Street West, Toronto, Ontario M5X 1C9. In Europe: IBM Europe Limited, 11th Floor, 15, Abchurch Lane, London EC4N 3DF, England. In Japan: IBM Japan Limited, 5-1-1, Higashi-Shinjuku, Shinjuku-Ku, Tokyo 162, Japan. In Australia: IBM Australia Limited, 400 Collins Street, Melbourne, Victoria 3000, Australia. In South Africa: IBM South Africa (Pty) Limited, 111, Market Street, Johannesburg, 2001, South Africa. In India: IBM India Limited, 11, Park Road, Bangalore 560002, India. In Singapore: IBM Singapore (Pty) Limited, 11, Market Street, Singapore. In New Zealand: IBM New Zealand Limited, 11, Market Street, Auckland, New Zealand. In Hong Kong: IBM Hong Kong Limited, 11, Market Street, Hong Kong. In Taiwan: IBM Taiwan Limited, 11, Market Street, Taipei, Taiwan. In the Philippines: IBM Philippines Limited, 11, Market Street, Manila, Philippines. In Thailand: IBM Thailand Limited, 11, Market Street, Bangkok, Thailand. In Malaysia: IBM Malaysia Limited, 11, Market Street, Kuala Lumpur, Malaysia. In Indonesia: IBM Indonesia Limited, 11, Market Street, Jakarta, Indonesia. In Singapore: IBM Singapore (Pty) Limited, 11, Market Street, Singapore. In the Middle East: IBM Middle East Limited, 11, Market Street, Dubai, United Arab Emirates. In Africa: IBM Africa Limited, 11, Market Street, Johannesburg, South Africa. In Latin America: IBM Latin America Limited, 11, Market Street, Mexico City, Mexico. In the Caribbean: IBM Caribbean Limited, 11, Market Street, Kingston, Jamaica. In the Pacific: IBM Pacific Limited, 11, Market Street, Sydney, Australia. In the Far East: IBM Far East Limited, 11, Market Street, Hong Kong. In the Americas: IBM Americas Limited, 11, Market Street, New York, New York, USA. In the Europe: IBM Europe Limited, 11, Market Street, London, England, UK. In the Asia: IBM Asia Limited, 11, Market Street, Singapore. In the Africa: IBM Africa Limited, 11, Market Street, Johannesburg, South Africa. In the Middle East: IBM Middle East Limited, 11, Market Street, Dubai, United Arab Emirates. In the Latin America: IBM Latin America Limited, 11, Market Street, Mexico City, Mexico. In the Caribbean: IBM Caribbean Limited, 11, Market Street, Kingston, Jamaica. In the Pacific: IBM Pacific Limited, 11, Market Street, Sydney, Australia. In the Far East: IBM Far East Limited, 11, Market Street, Hong Kong. In the Americas: IBM Americas Limited, 11, Market Street, New York, New York, USA.

WE FOUND A HOLE IN THE OBSOLESCENCE THEORY

The business community is paying a high price for the rapid pace of developments in data communications. Because new equipment has a nasty habit of rendering current models obsolete.

Teletype Corporation is doing something about it. In our industry we're one of the few companies manufacturing its own customized MOS Chips. And it's helping us build future flexibility into our data terminals.

Modular design and built-in electronic adaptability let us redefine and enhance our equipment long after it's gone on line.

So our customers can have the newest features. Without absorbing losses in the form of early obsolete equipment. Or paying for brand new terminals. Or disrupting their entire system.

In business, keeping pace with data has become crucial. The distance between managers and critical information has widened to alarming proportions.

Teletype Corporation is helping bridge that gap. As a member of the Bell System, we're coupling their communications knowledge with our own research and development.

And it's working. We're making early obsolescence a thing of the past. So you won't have to fear the future.

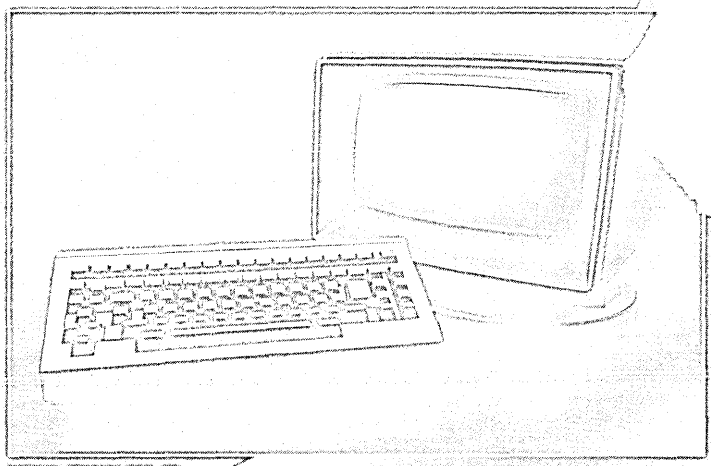

TELETYPE
WHERE DATA IS INFORMATION.



Teletype Corporation, 5555 Touhy Avenue, Dept. 3183A, Skokie, IL 60077, Tel. (312) 952-2000.
Teletype is a registered trademark and service mark of Teletype Corporation.