

## THE GRAPHICS STANDARDS BATTLE

ALSO  
BUSINESS GRAPHICS  
ON MICROS AND MAINFRAMES  
DO MARKET RESEARCHERS  
READ TEA LEAVES?

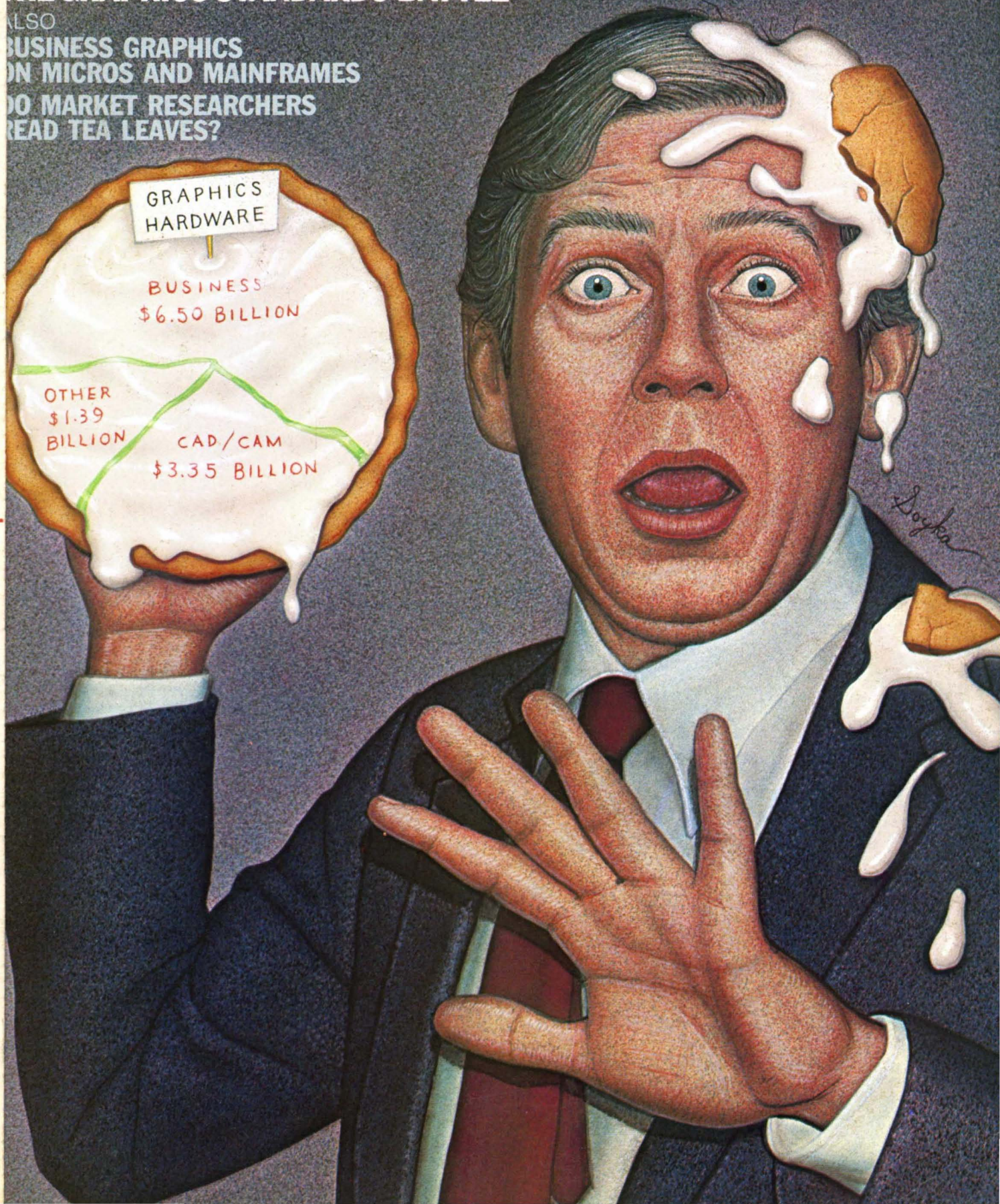

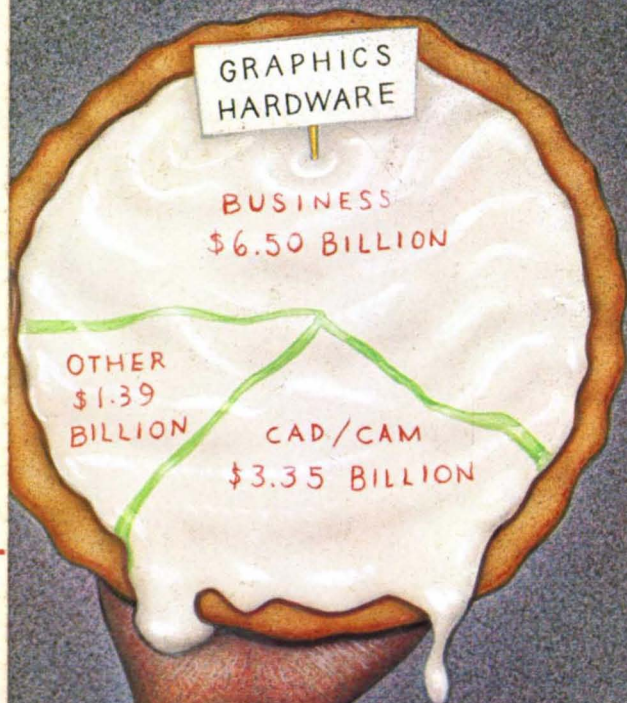

# THE PERFORMER

## Kenney Wash-Egg™ Washers

Kenney Wash-Egg™ washers are the latest in a long line of washers designed for performance and reliability. They are built to last and are designed to give you the most efficient washing possible. The Wash-Egg™ washers are available in a variety of sizes and configurations to meet your needs. They are built to last and are designed to give you the most efficient washing possible.

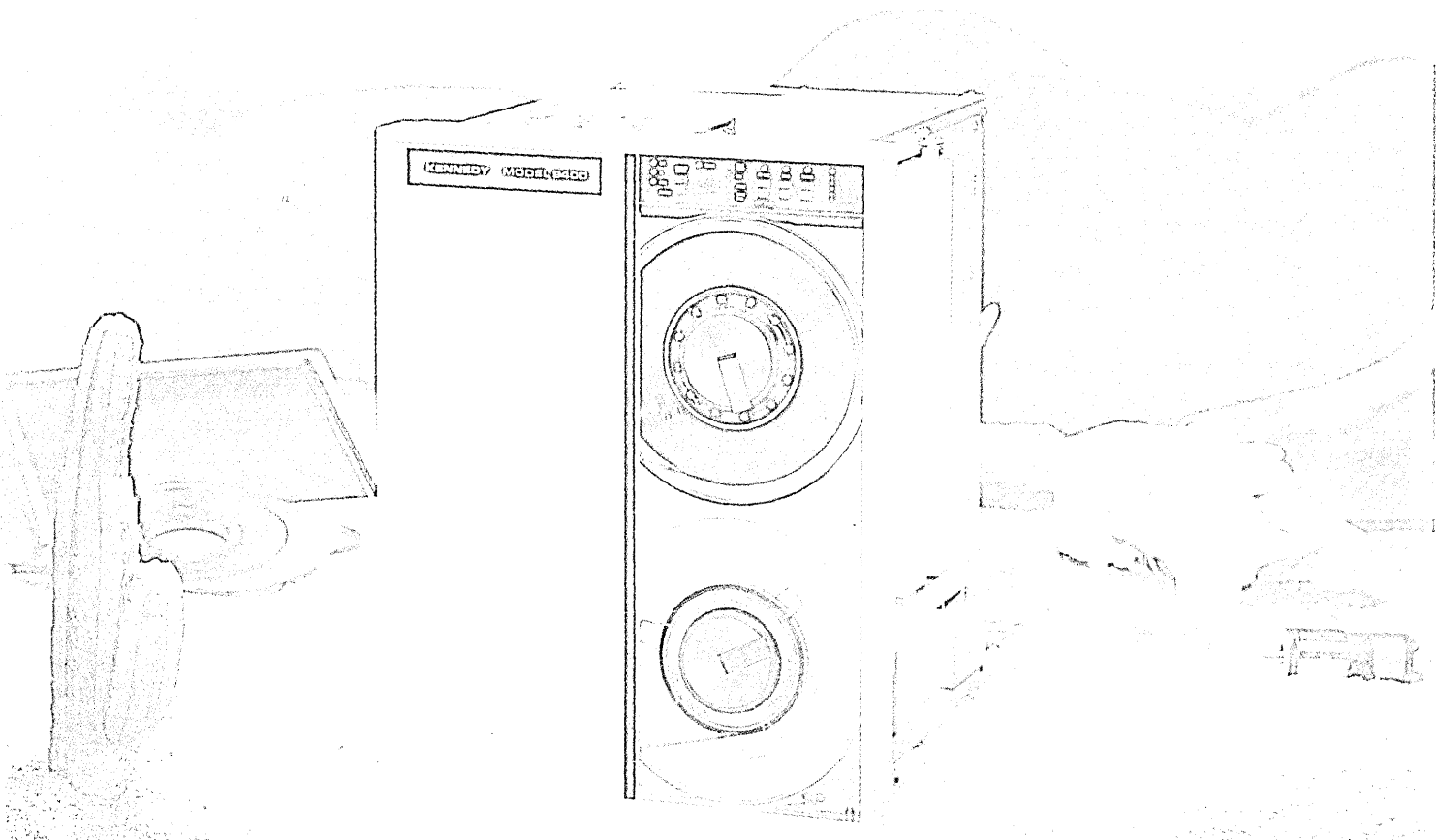

CIRCLE 1 ON READER CARD

# You can have a local data network running this afternoon!

*In fact, you already have most of it installed.*

Whether you're adding only a few more terminals or personal computers, or implementing a more efficient minicomputer access method for hundreds of terminals at a time, you probably don't even have to pull new cables, much less install a complicated new network.

Your in-place telephone network is already wired into almost every office and potential terminal site in your building. And fortunately for your data communications needs, its wires can carry voice conversations and data at the same time—with a little help.

All you really need is a way to connect a terminal and the telephone to the same set of wires, and that's where MICOM's INSTALINK Voice/Data Multiplexer comes in.

A component of MICOM's INSTALINK™ local network—the "instant" remedy to local area communications headaches—INSTALINK plugs into your existing telephone jack and allows you to use your terminal and your phone independently—without interference of any kind.

It supports asynchronous transmissions of up to 19,200

bits (teletypes, for example)—plenty for almost any local networking application.

And it provides something else that many other in-house networks don't: nearly complete portability. A terminal can be moved to a new site and connected to any telephone line already in place. No rerouting of cables. No complicated interfacing. Just plug it in.

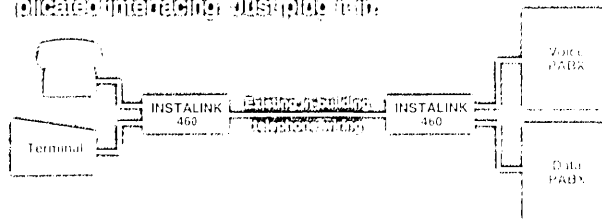

Best of all, INSTALINK provides all this without requiring any long-term commitment, without major investment, without disrupting normal business operations, and without fuss—*instantly!*

Call or send for a brochure which explains how.

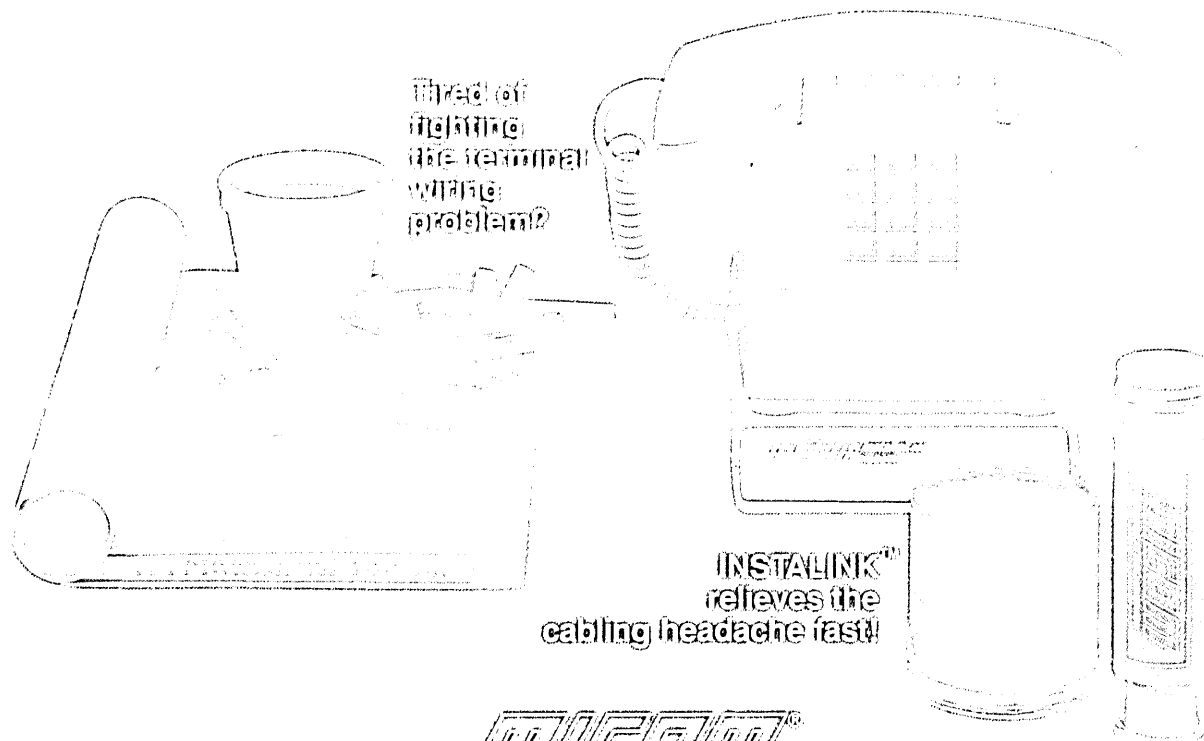

## MICOM

MICOM SYSTEMS, Inc. • 2115 North St. • Chatsworth, CA 91311 • Telephone: (805) 488-8600 • FAX: (805) 488-4810  
 Regional Sales Service • Atlanta, GA • (404) 485-2388 • Boston, MA • (617) 527-4010 • Chicago, IL • (616) 789-2480  
 Dallas, TX • (214) 235-0774 • St. Louis, MO • (314) 576-7326 • Tempe, AZ • (602) 886-2100  
 MICOM EUROPE Ltd. • Brook Road • Reading, Berkshire RG2 0WJ, England • (0734) 888300 • Telex: 827403  
 For literature please call (800) "MICOM US"

AVAILABLE NOW FROM THESE STOCKING SITES: AK: Anderson (601) 551-7700; AL: (601) 276-8800; AR: (501) 221-2100; AZ: (602) 886-2100; CA: Anaheim (714) 685-7600; Dallas (214) 235-0774; San Diego (619) 535-1374; San Jose (415) 231-7200; CO: Colorado Springs (303) 556-1800; Denver (303) 777-8000; FL: (305) 225-5500; GA: Atlanta (404) 485-2388; IA: (319) 377-2200; IL: Chicago (616) 789-2480; IN: (317) 255-5500; KS: (913) 255-5500; KY: (606) 327-2200; LA: (504) 276-8800; MA: Boston (617) 527-4010; MD: (301) 321-0000; ME: (603) 255-5500; MI: (616) 789-2480; MN: (612) 255-5500; MO: St. Louis (314) 576-7326; MS: (601) 276-8800; MT: (406) 255-5500; NE: (402) 255-5500; NH: (603) 255-5500; NJ: (201) 255-5500; NY: Albany (518) 455-5500; Buffalo (716) 688-2388; New York City (212) 556-2388; Rochester (716) 222-8811; Syracuse (315) 438-2028; OH: Cincinnati (616) 789-2480; Dayton (616) 789-2480; OK: Tulsa (918) 789-2480; OR: (503) 255-5500; PA: East (610) 779-2200; West (412) 255-2388; RI: (616) 255-5500; SC: (803) 255-5500; SD: (616) 255-5500; TN: (615) 255-5500; TX: Dallas (214) 235-0774; Austin (817) 377-2200; Houston (713) 358-7726; UT: (801) 488-4810; VA: (803) 255-5500; WA: (206) 255-5500; WI: (414) 255-5500; WV: (606) 255-5500; WY: (303) 255-5500; Washington DC: (301) 255-5500; Santa Clara: (415) 255-5500

CIRCLE 4 ON READER CARD

# Coping with change with EPILOG™/MVS

Before EPILOG/MVS, performance information was often hidden in piles of printouts and pages of reports.

With EPILOG/MVS, an Installation Performance Management System from Candle, you can find the answers to questions about MVS performance: user response... paging and swapping... the System Resource Manager (SRM)... I/O contention... tuning measures... hardware bottlenecks... and more.

The powerful Change Analysis feature of EPILOG/MVS will help you to better understand the results of system changes. For example, Figure 1 is an EPILOG/MVS display which shows that average TSO trivial response time was over five seconds for a one-week period. The main bottleneck was paging, shown by the WAIT FOR LOCAL PAGE value of 3.65 seconds (about 65% of response time). In other words, about 65% of TSO response time was caused by paging.

A high-speed paging device was then installed in order to improve TSO performance. Figure 2 is another EPILOG/MVS display which compares TSO response time before and after installing the high-speed paging device.

Note: Both displays were created in a matter of few seconds, using simple commands that took less than a minute to enter.

If your data center has frequent hardware or software changes (new applications, more users, tuning measures, new operating system releases, CPU upgrades, more main memory, new disks, etc.), the Degradation Analysis feature of EPILOG/MVS can quickly and simply show you the impact of those changes on end-user service and its resource analysis can show you the effect on

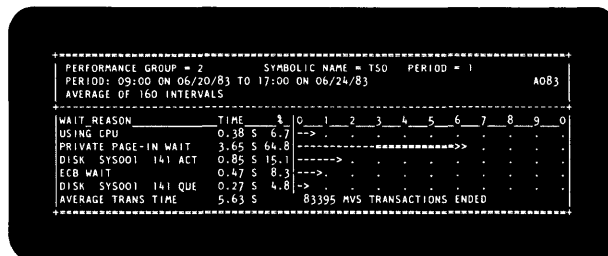

Figure 1. EPILOG analysis of TSO trivial response time.

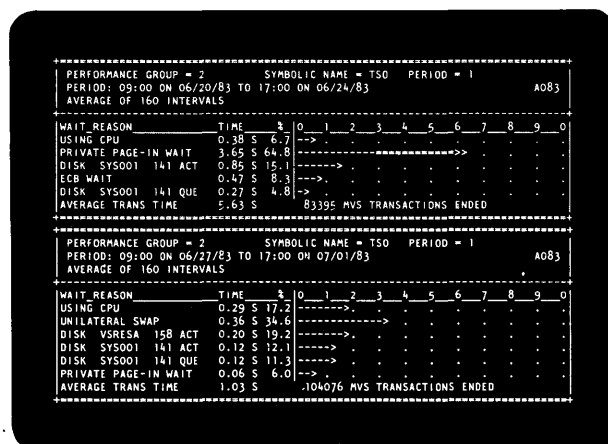

Figure 2. EPILOG analysis of TSO trivial response time before and after installation of a high-speed paging device.

resources. In this way you can verify that your investment—in time or money or both—is producing the intended results. Or, if not, you can modify your actions and use EPILOG/MVS to check the results again.

Change—almost constant change—is becoming a way of life in a modern data center. With EPILOG you can be confident of achieving the results you want.

For more information, contact your Candle representative.

!Candle

10880 Wilshire Blvd., Suite 2404  
 Los Angeles, California 90024  
 Phone 213-207-1400

CIRCLE 5 ON READER CARD

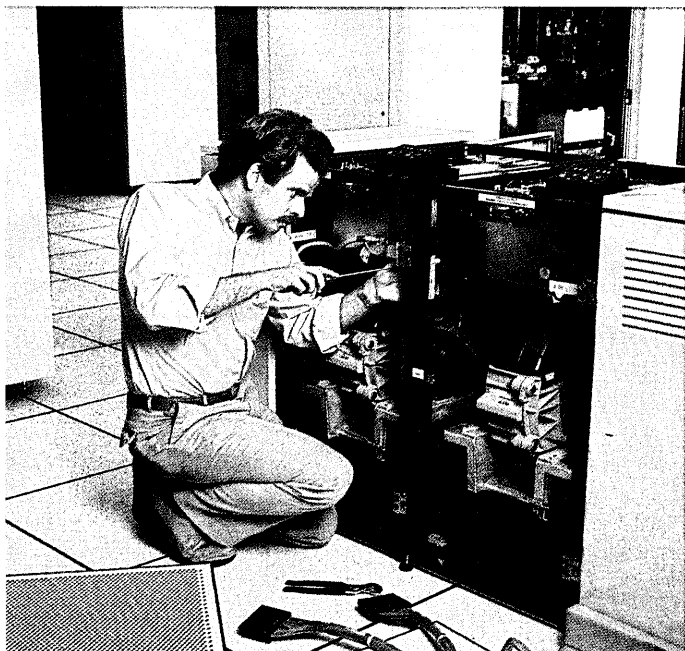



# DATA MATION®

MAY 1, 1984/\$3.00 U.S.A.  
VOLUME 30 NUMBER 6  
This issue, 184,150 copies

## FEATURES

### 28 IN FOCUS

The market research industry absorbs millions of dollars and produces billions of words every year. But its customers, reports Jon Zonderman, are asking, can we really get "Forecasts from Teacups?"

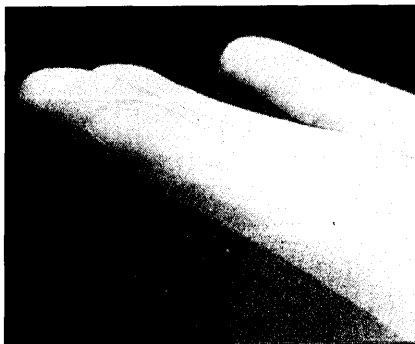
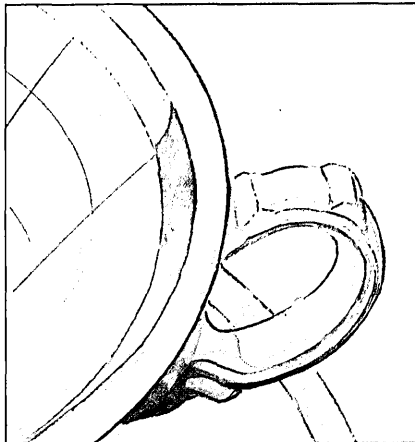

### 76 THE GRAPHICS STANDARDS BATTLE

Jon A. Meads  
Foredooming each other's schemes and championing their own, the GKS and Core System partisans cry standards, and let slip the dogs of war.

### 89 MAINFRAME BUSINESS GRAPHICS

Maxine D. Brown  
Graphics supported by the corporate database can impress management and influence peers—if you make the right choices.

### 99 MICRO-BASED BUSINESS GRAPHICS

Michael S. Cooper  
You don't need a fancy graphic to see why the pc is becoming such a popular graphics tool: it's now more sophisticated, more user friendly, and can cut slide production costs by 90%.

### 109 A DOZEN ELECTRICAL MISTAKES

Warren H. Lewis  
The abundance of power hazards at many dp shops is downright shocking. Herewith, some advice on keeping things safe.

### 122 THE END OF THE HARDWARE ERA

Stephen T. McClellan  
Was there a recording industry before there were record players? In an excerpt from his new book, a prominent Wall Street analyst says software, more and more the key to bigger vendor profits and increasing consumer productivity, will eclipse hardware as high tech's star.

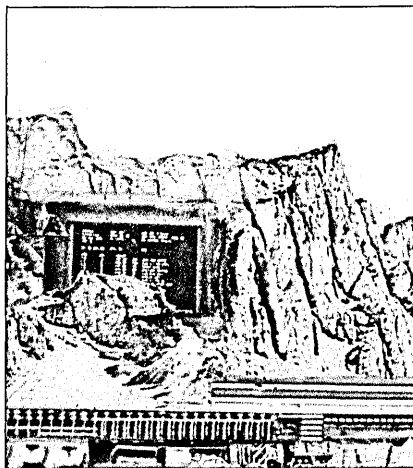

### 167 READERS' FORUM

Ben Matley urges us to go "Beyond the Me Industry," "History Repeats Itself" for T.K. Gibbons, and Roy Mengot's digits draw "Digits."

## NEWS IN PERSPECTIVE

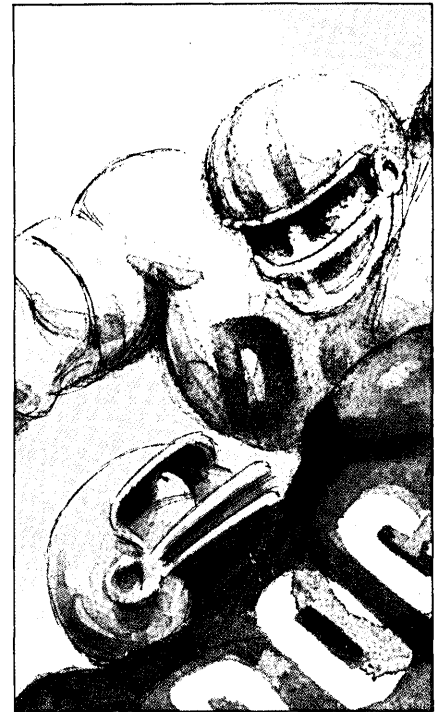

- 38 **EXPORT-IMPORT**  
A noisy turf battle.
- 42 **MICROCOMPUTERS**  
Looking for generics.  
When the chips are down.
- 52 **DATA COMMUNICATIONS**  
Securing the network.  
Pirates on the boards.
- 64 **TAXATION**  
Spelling relief for R&D.
- 72 **BENCHMARKS**

## DEPARTMENTS

- 9 **LOOK AHEAD**
- 15 **LETTERS**
- 25 **EDITORIAL**
- 139 **PEOPLE**
- 145 **HARDWARE**
- 151 **SOFTWARE & SERVICES**
- 155 **SOURCE DATA**
- 161 **ADVERTISERS' INDEX**
- 162 **MARKETPLACE**
- 164 **ON THE JOB**

## INTERNATIONAL 144-1

- 3 **EUROPEAN MICRO MOVES**
- 10 **WORKING WITH WORKSTATIONS**
- 19 **HEADING FOR A REVOLUTION**

COVER ILLUSTRATION BY ED SOYKA



# SIGGRAPH '84

## The Premier Computer Graphics Conference

### ◆ Exhibition

The most intense display of high performance computer graphics equipment for current and future applications.

### ◆ Technical Program and Courses

Papers exploring new techniques, panels probing topical issues and courses offering in-depth instruction.

1984

### ◆ Art, Film and Video Spectaculars

Striking visual presentations of computer graphics excellence. New this year . . . a curated design arts show plus the first totally computer-generated Omnimax film.

**July 23-27, 1984**  
**Minneapolis, Minnesota**

For information, contact the SIGGRAPH '84 Conference Office  
111 East Wacker Drive (B)  
Chicago, Illinois 60601  
(312) 644-6610

**Editor** Rebecca S. Barna  
**Senior Editor** Larry Marion  
**News Editor** John W. Verity  
**Features Editor** Kenneth Klee  
**Senior Staff Writer** Parker Hodges  
**Copy Editor** Florence Lazar  
**Assistant News Editor** Michael Tyler  
**Assistant Features Editor** Deborah Sojka  
**New Products Editor** Robert J. Crutchfield  
**Assistant Editor** Lauren D'Attilo  
**Editorial Assistant** Donna Lyons  
**Copy Assistant** Eric Brand  
**Bureau Managers**  
**San Francisco** Edward K. Yasaki  
**Los Angeles** Edith D. Myers  
**Minneapolis** Jan Johnson  
**Boston** R. Emmett Carlyle  
**Washington** Willie Schatz  
**Advisory Board** Lowell Amdahl,  
Howard Bromberg, Philip H. Dorn,  
Joseph Ferreira, Bruce W. Hasenyager,  
David Hebditch, John Imlay, Terry G. Mahn,  
Louis Naugès, Angeline Pantages,  
Robert L. Patrick, Malcolm Peltu, Russell Pipe,  
Carl Reynolds, F. G. Withington, Amy Wohl.  
**Contributing Editors** Pamela Archbold,  
Laton McCartney, Hesh Wiener  
**International Editor** Linda Runyan  
**European Managing Editor** Paul Tate  
**Technology Editor, Europe** Fred Lamond  
**Foreign Correspondents** John Lamb,  
London; James Etheridge, Paris; Peter Hidas,  
Oslo; Norman Kemp, Sydney.  
**Art Director** Kenneth Surabian  
**Assistant Art Director** Susan M. Rasco  
**Art Assistant** Catherine Kennedy  
**Production Manager** Anne Earley  
**Publisher** James M. Morris  
**Executive Editor** John L. Kirkley  
**Circulation Vice President** Joseph J. Zaccaria  
**Circulation Manager** Mary Agnes Glenister  
**Operations Manager** Patricia Adamo  
**Research Director** Laurie Schnepf

**EDITORIAL OFFICES**  
**Headquarters:** 875 Third Ave., New York, NY 10022. Phone (212) 605-9400; telex 429073. **New England:** 1 Chaucer St., RFD 2, Sandwich, MA 02563, (617) 888-6312. **Washington, D.C.:** 4524 Windom Pl. NW, Washington, DC 20016, (202) 966-7100. **Midwestern:** 3607 Garfield Ave. S., Minneapolis, MN 55409, (612) 827-4664. **Western:** 1801 S. La Cienega Blvd., Los Angeles, CA 90035, (213) 559-5111; 2680 Bayshore Frontage Rd., Suite 401, Mountain View, CA 94043, (415) 965-8222. **International:** 130 Jermyn St., London SW14UJ, England, (441) 839-3916, telex 914911; 13 Stanley Place, Budd Lake, NJ 07828, (201) 691-0592, telex 499-4308.

### Technical Publishing

**EB** a company of The Dun & Bradstreet Corporation

**BPA** Circulation audited by Business Publications Audit  
**ABP** Member American Business Press, Inc.

**DATAMATION** (ISSN 0011-6963) Magazine is published twice monthly, on the 1st and 15th. Published by Technical Publishing, a company of The Dun and Bradstreet Corp., John K. Abely, President. Executive, advertising, editorial offices, and subscription departments, 875 Third Ave., New York, NY 10022. Published at Lincoln, Nebr. Annual subscription rates: U.S. and possessions: \$42; Canada: \$60; Japan, Australia, New Zealand: \$100; Europe: \$90 air freight, \$155 air mail. All other countries: \$90 surface, \$155 air mail. Reduced rate for qualified U.S. students, public and school libraries: \$30. Single copy: \$3 in U.S. Special Datamation/Dataguide issue: \$25. Sole agent for all subscriptions outside the U.S.A. and Canada is J. B. Tratsart, Ltd. 154 A Greenford Road, Harrow, Middlesex HA13QT, England, (01)422-8295 or 422-2456. No subscription agency is authorized by us to solicit or take orders for subscriptions. Second-class postage paid at New York, NY 10001 and at additional mailing office. ©Copyright 1984 by Technical Publishing Co., a Division of Dun-Donnelley Publishing Corp., a company of The Dun and Bradstreet Corp. All rights reserved. "Datamation" registered trademark of Technical Publishing Company. Microfilm copies of Datamation may be obtained from University Microfilms, A Xerox Company, 300 No. Zeeb Road, Ann Arbor, Michigan 48106. Printed by Foote & Davies/Mid-America. POSTMASTER: Send address changes to Datamation, 875 Third Avenue, New York, NY 10022.



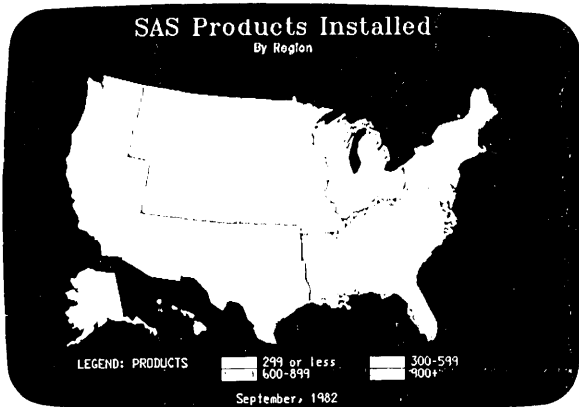

Copyright © SAS Institute Inc.

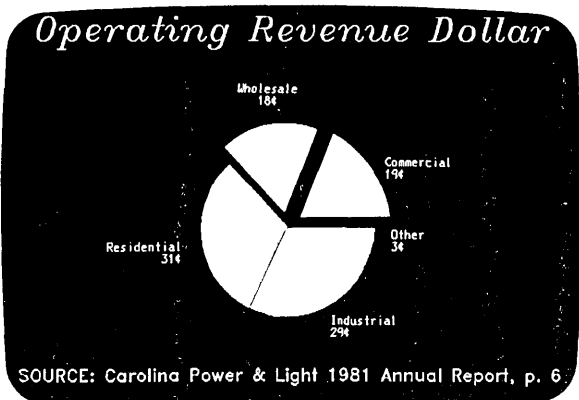

Copyright © SAS Institute Inc.

### TELEPHONE EXPENDITURES FOR TELEMARKETING

(Estimated Figures)

(In Millions)

	1980	1976
Residential originated local calls	\$ 569	\$ 232
Residential originated toll calls	689	269
Business originated local calls	4,144	3,045
Business originated toll, WATS, 800 calls	4,443	2,502
<b>TOTAL</b>	<b>\$9,845</b>	<b>\$6,048</b>

SOURCE: DMA Fact Book on Direct Marketing

Telephone Expenditures

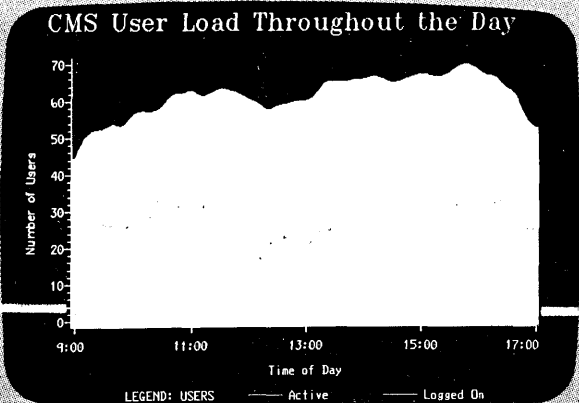

Plot of Load\*Time

# SAS/GRAPH

## PUTS YOUR

### REPORTS TO WORK

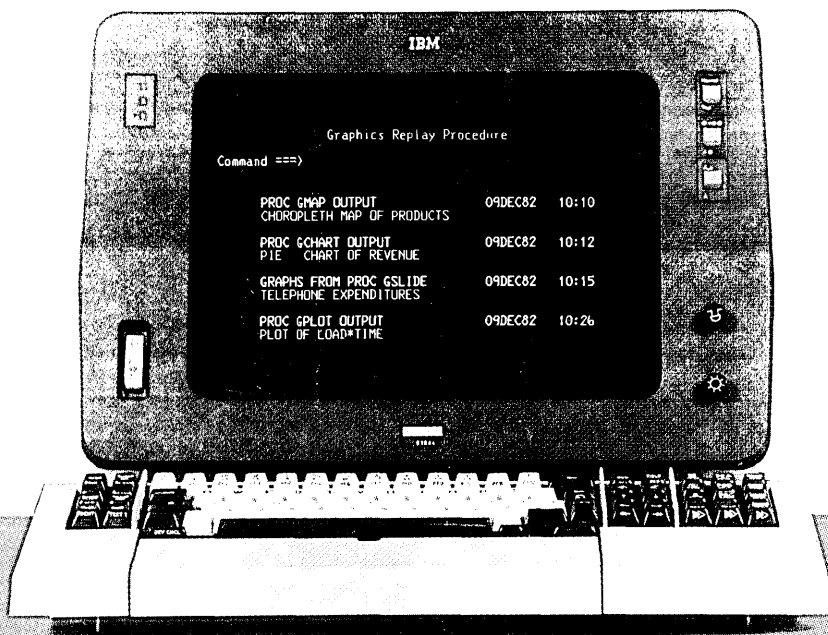

Since its introduction in 1980, SAS/GRAPH has provided "state of the art" software for business graphics. Now SAS/GRAPH brings you a new decision support tool—instant replay.

With the menu-oriented replay facility in SAS82 (our newest release) your DSS group can

1 generate numerous graphical analyses and store the results.

Then you can

2 choose the best graph—charts, plots or maps—from the annotated selection SAS/GRAPH provides and

3 instantly display the graph with the touch of one PF key on your IBM 3279.

It's as simple as 1+2+3. And that adds up to a big time-savings.

Think of the flexibility instant replay adds to your operation. Your DSS staff can run overnight batch jobs to graph CPU utilization reports, sales totals and production figures.

The reports are ready for display at your desk the next morning.

Best of all SAS/GRAPH™ is integrated into the SAS system, so you can get the benefits of SAS for data management, statistical analysis and report writing; SAS/ETS™ for econometric forecasting and modeling; SAS/FSP™ for data entry, editing and letter-writing; and SAS/IMS-DL™ for interfacing to IMS data bases. The SAS system operates on the IBM 370 Family and compatible machines at more than 5000 OS/MVS, VM/CMS, DOS/VSE and SSX sites around the world.

Call or write today, SAS Institute Inc., Box 8000, Cary, NC USA 27511-8000. Phone (919) 467-8000. Telex 802505.

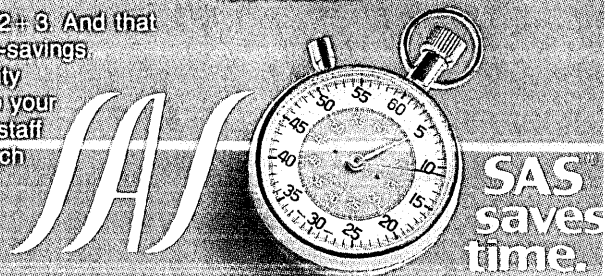

DATE 6-29-88

9" CRT

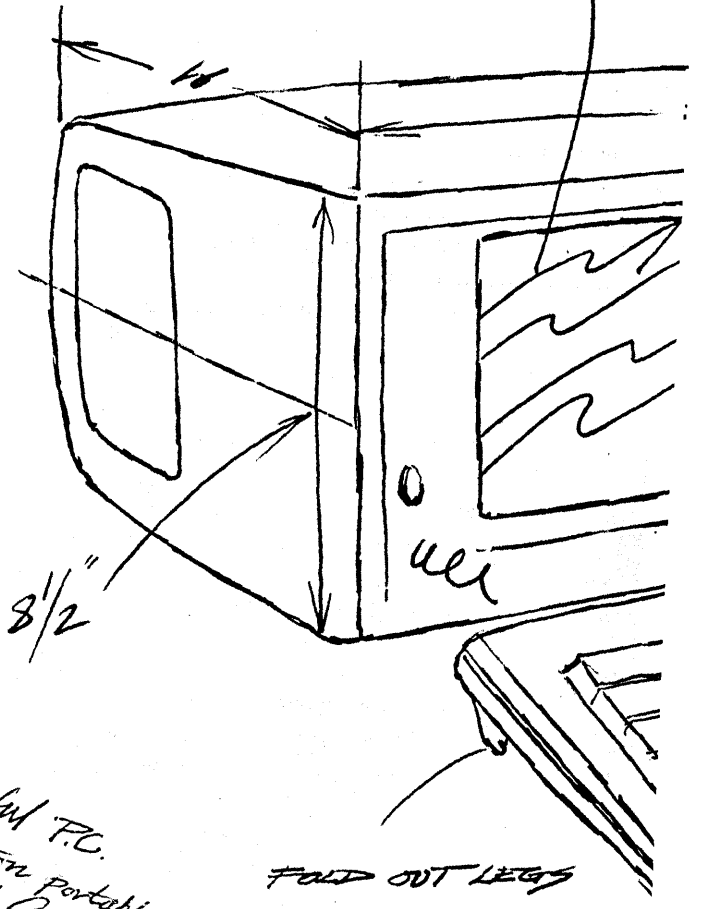
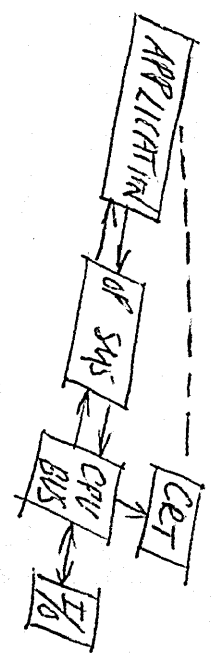

- Most useful P.C.
- (1) Full function portable
  - (2) Truly IBM Compatible
  - (3) Rugged.

FOLD OUT LEGS

A picture worth \$111,000,000.



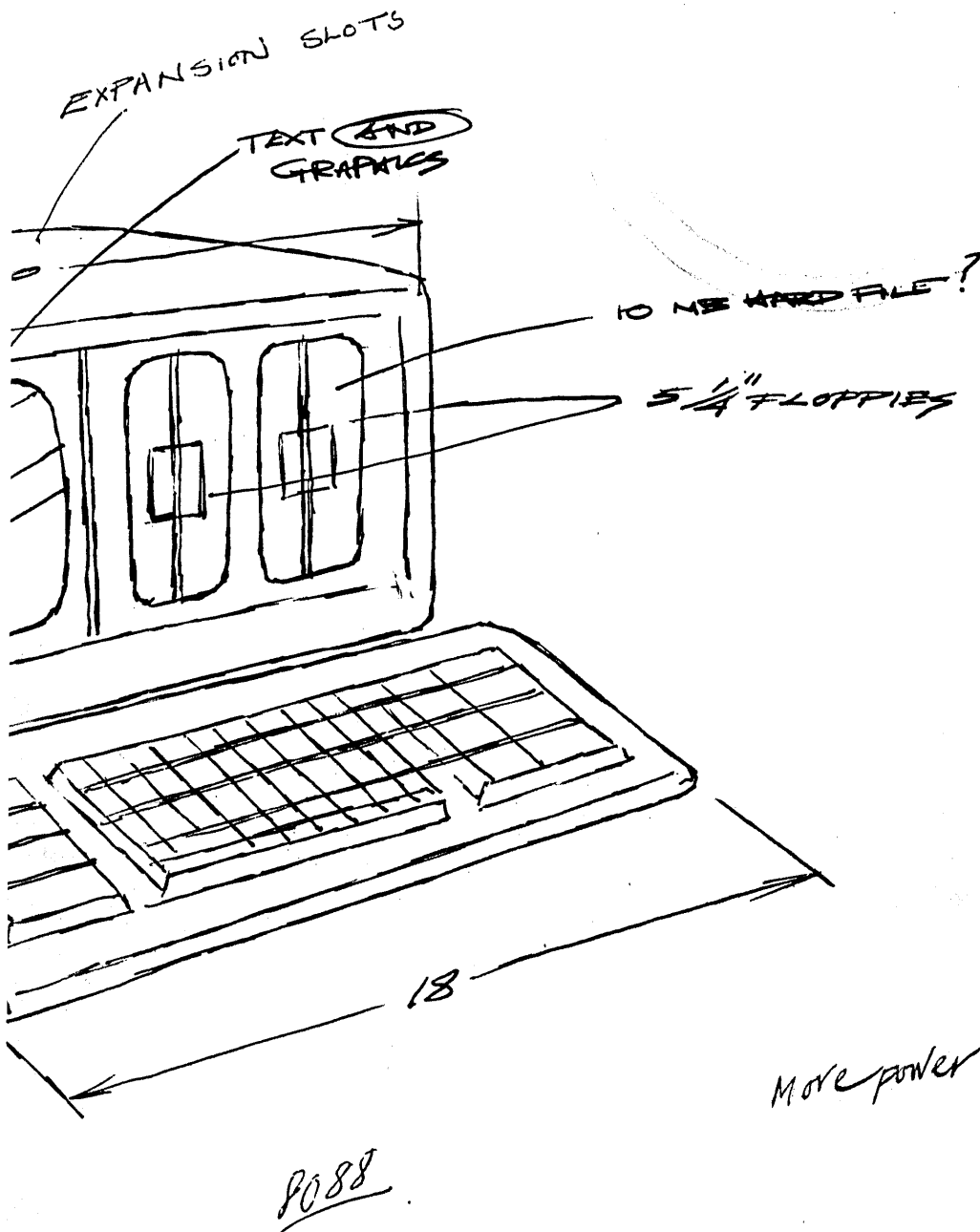

Not long ago, three businessmen met in a coffee shop to talk about an idea for a new personal computer. They made a rough design on the back of a place mat.

A lot of companies were already making personal computers, but they thought theirs just might work better.

The next year, they sold \$111 million worth of their new computers, the COMPAQ® Portable and the COMPAQ

PLUS™. No company in America had ever grown that fast. Why?

Simply because they offer, in a rugged, portable package, more capability than most other PC's. They're truly IBM®-compatible, so all the most productive software runs as is. They display high-resolution text and graphics on the same screen. And they grow. Expansion slots take IBM-compatible boards, and a kit converts the COMPAQ

Portable into the COMPAQ PLUS with its integrated ten-megabyte disk drive.

How does the future look? We look at it this way: If we came this far on the back of a place mat, just think of what we can do now.

For the location of your nearest Authorized Dealer, call 1-800-231-0900.

©1984 COMPAQ Computer Corporation. COMPAQ® is a Registered Trademark and COMPAQ PLUS™ is a Trademark of COMPAQ Computer Corporation. IBM® is a Registered Trademark of International Business Machines Corporation.

**COMPAQ®**

It simply works better.

# Telex's 274C Control Unit Supports Both IBM and Telex 3270 Terminals

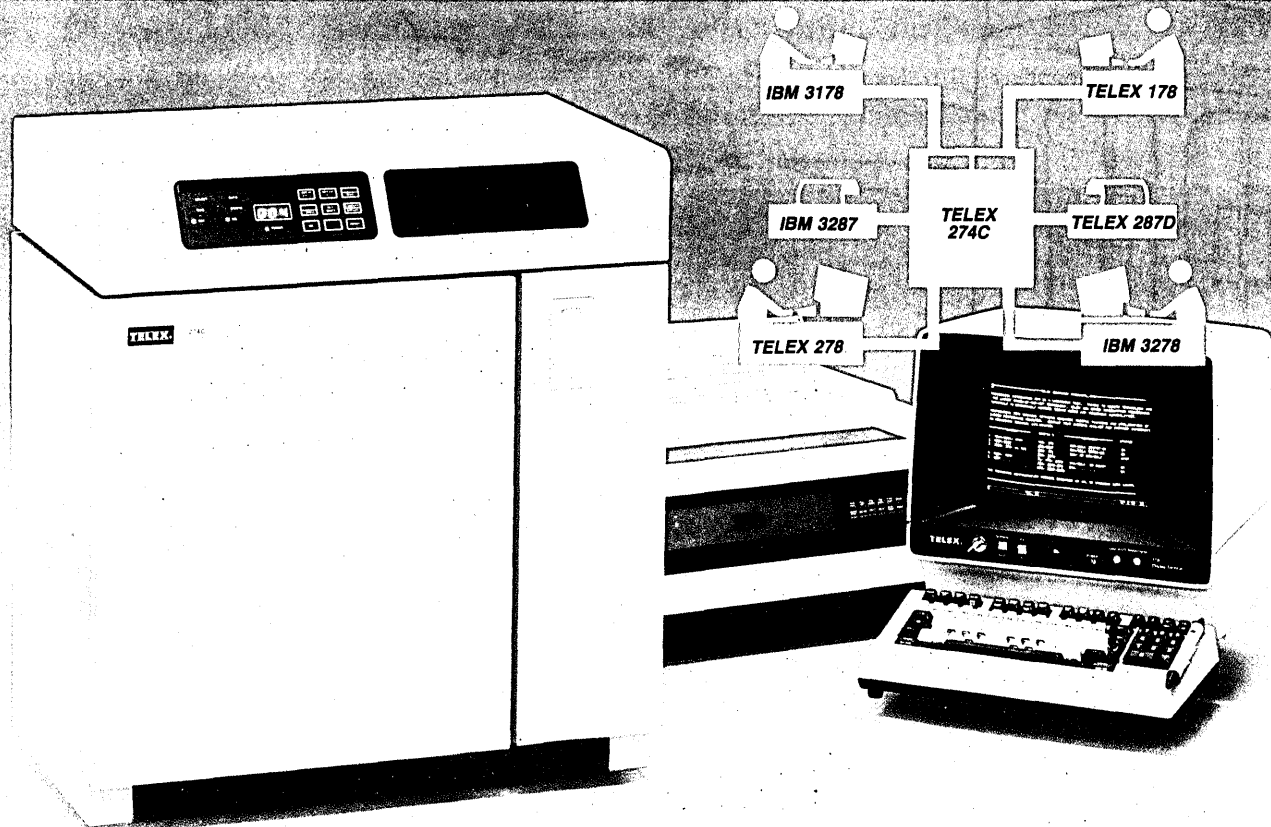

## And Offers Features Beyond IBM

A lot of 3270 suppliers talk IBM compatibility, but usually their way, not yours. Only the Telex 274C remote controller offers true IBM compatibility your way. With Telex device compatibility you can mix and interchange IBM and Telex 3270 displays and printers — all off our 274C controller (or even IBM's 3274I)

In addition to true IBM compatibility, Telex's 274C offers extended functions not available from IBM. Features like —

- Local Format Storage and Retrieval
- Dual Host Communications
- Local Print Buffering

## TELEX®

The Innovation continues . . .

Telex Computer Products, Inc.  
6422 E. 41st Street  
Tulsa, Oklahoma 74135  
(918) 627-1111

CIRCLE 8 ON READER CARD

The 274C can accommodate up to 32 A-type devices from both Telex and IBM. Communications protocol under SNA or BSC are also available. A complete set of diagnostic routines are provided to insure maximum unit performance.

Ask for "TELEX COMPATIBILITY". Get true IBM compatibility and extended features your way with Telex's 274C.

For more information about the Telex 274C controller, call John Hawkins toll-free, at 1-800-331-2623. Or 918-627-1111 in Oklahoma.



# LOOK AHEAD

## A GREAT LEAP IN WP

A new entry-level class of word processors is on its way from IBM, Wang, and others. Priced higher and offering more functions than electronic typewriters, the new machines will probably be based on personal computer technology but will use variants of standard word processing software. Wang is expected to unveil its model 1107 this month while IBM, which is said to be preparing a competitive machine that uses nonimpact printing, could make its introduction any time now. Meanwhile, several Japanese firms are waiting in the wings with similar products.

## NEW MODELS OF S/38 COMING

IBM's new System/36 processor may not be the last in the 34-36-38 family to be introduced this year. Industry sources expect a model 9 in the System/38 this fall, offering increased speed and memory capacity. Succeeding that, sources say, will be a model 11, which may include a compiler that will handle S/36 code on the 38, and a model 13, probably coming in 1986, which may offer a dual 38-4300 personality. Also in the works is a desktop version of the S/36.

## FIRMS LINK MICROS

While the mainframers and mini makers scuffle over PBX connections, another standards battle is brewing on the micro front. For now, Microcom, Norwood, Mass., is the leader, with some 45 licensees of its network protocol for attaching micros to micros. Word is that Telenet and AT&T will soon sign on with Microcom. On its heels, however, is Communications Research Group, Baton Rouge, which offers the Blast protocol for some 70 types of micros, minis, and mainframes. Meanwhile, Tymnet, the public data network, has developed its own, dubbed X.PC, with field testing slated to begin in July. Of the three protocols, only Microcom's is unidirectional; the other two support concurrent, bidirectional file transfers.

## IBM OS UPDATE

A year after it was first shipped, IBM's MVS/Extended Architecture (XA) is being installed by users in numbers "substantially above plan," according to IBM executives. Carl J. Conti, president of the IBM Data Systems Division, says, "It's done more than we said it would." Of 3,468 IBM users recently surveyed by Cowen & Co., Boston, 7% had installed XA and another 33% said they would do so in 1984 or 1985. Conti also says 1983 was the best year ever for the VM/370 operating system, for which more than 10,000 licenses have been granted.

# LOOK AHEAD

## AT&T LIMITS 3B SERIES

Production constraints will apparently limit the number of mini and microcomputers AT&T can deliver this year. While the company has said its 32-bit-ters will be available immediately, it notes that the systems will not be "fully available" in 1984. Apparently, early production machines will go to select oems and VARS that will give the systems market visibility.

## IBM CHECKS OUT BERKELEY UNIX

Sources at IBM say the company is evaluating the Berkeley 4.2 Unix operating system for use under VM/370, a move that could be aimed at hurting AT&T where it hurts most. AT&T itself is preparing virtual memory versions of its Unix package but apparently IBM doesn't want to get locked into a software standard that is groomed toward AT&T's recently introduced hardware.

## SMALLTALK ON SMALL SYSTEM

San Diego-based Syte Information Technology is likely to be the first oem source for Xerox's Smalltalk-80, a combination operating system, high-level language, and programming environment. Syte, headed by former Megatek president Peter Shaw, will offer Smalltalk on its new series 3000 of 32-bit networked computers and workstations.

## SPERRY FILLING GAPS

Sperry Computer Systems, which considers the 640 x 400 dot resolution for color graphics to be one of the prime attractions of its personal computer, is rushing to find a hardcopy output device it can market with the pc. The crash evaluation was mandated when Sperry realized it had no such device that could take advantage of the high-resolution color graphics. Sperry is also readying a link from the pc to IBM mainframes, a product required by shops with both IBM and Sperry mainframes.

## RUMORS AND RAW RANDOM DATA

Ampex Computer Products division is preparing a line of memory subsystems that would be OS-independent and offer database handling facilities. The systems would be sold into the oem market.... Storage Technology has reportedly received a much-needed major order for its 338-type disk drives. AT&T is said to have ordered 2,000 of the STC machines.... Don't be surprised to see IBM boost its standing in the scientific/engineering processor marketplace with more specially optimized machines like its 4381 cpu. Also on the boards are said to be high-powered supercomputer-class machines to take on Cray, ETA Systems, and the Japanese.... Tandem's new TXP line isn't doing as well as the company expected, and the company recently recorded revenues that were not shipped -- again.

Now, there's a full line of band printers with the same performance you've come to expect from Printronix.

The Printronix DataPrinter™ Series.

With precisely formed characters even through six-part forms, our data printers consistently deliver Printronix quality.

Printronix versatility means interchangeable print bands for multiple type styles and a choice of four quiet DataPrinter models: 600, 750, 1000 or 1200 lines-per-

minute models for high volume super-mini and mainframe output.

Because high speed is no speed when the printer is down, Printronix reliability is built into the DataPrinter Series. With an average of six months between service calls and over 90% parts commonality, maintenance costs are surprisingly low.

And service takes only minutes, so our data printers keep performing. A digital display panel alerts the operator while a unique rear control panel and door allow

the operator or service rep to quickly access the printer.

Now, you can call Printronix for not only top quality matrix line printers but for the best of the band. The DataPrinter Series.

THE FIRST LINE IN PRINTERS.  
**PRINTRONIX®**

For more information, contact Printronix at 17500 Cartwright Rd., P.O. Box 19559, Irvine, CA 92713, 714-863-1900 TWX: 910-595-2535, Outside California: 800-556-1234, ext. 66, In California: 800-441-2345, ext. 66.

# THE ONLY BAND PRINTER GOOD ENOUGH TO BE PRINTRONIX.

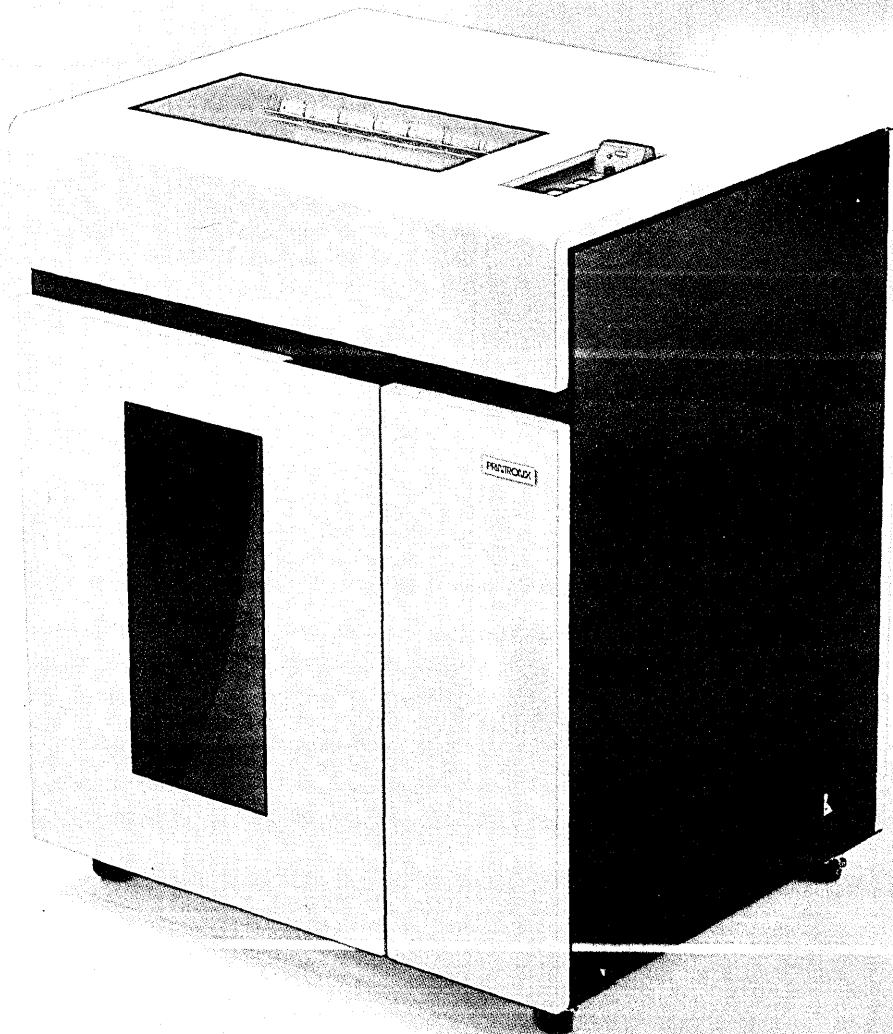

See us at COMDEX™/Spring '84  
May 22-25, 1984

CIRCLE 9 ON READER CARD

# HOW WE MADE OUR MARK

*Host selection  
is critical!*

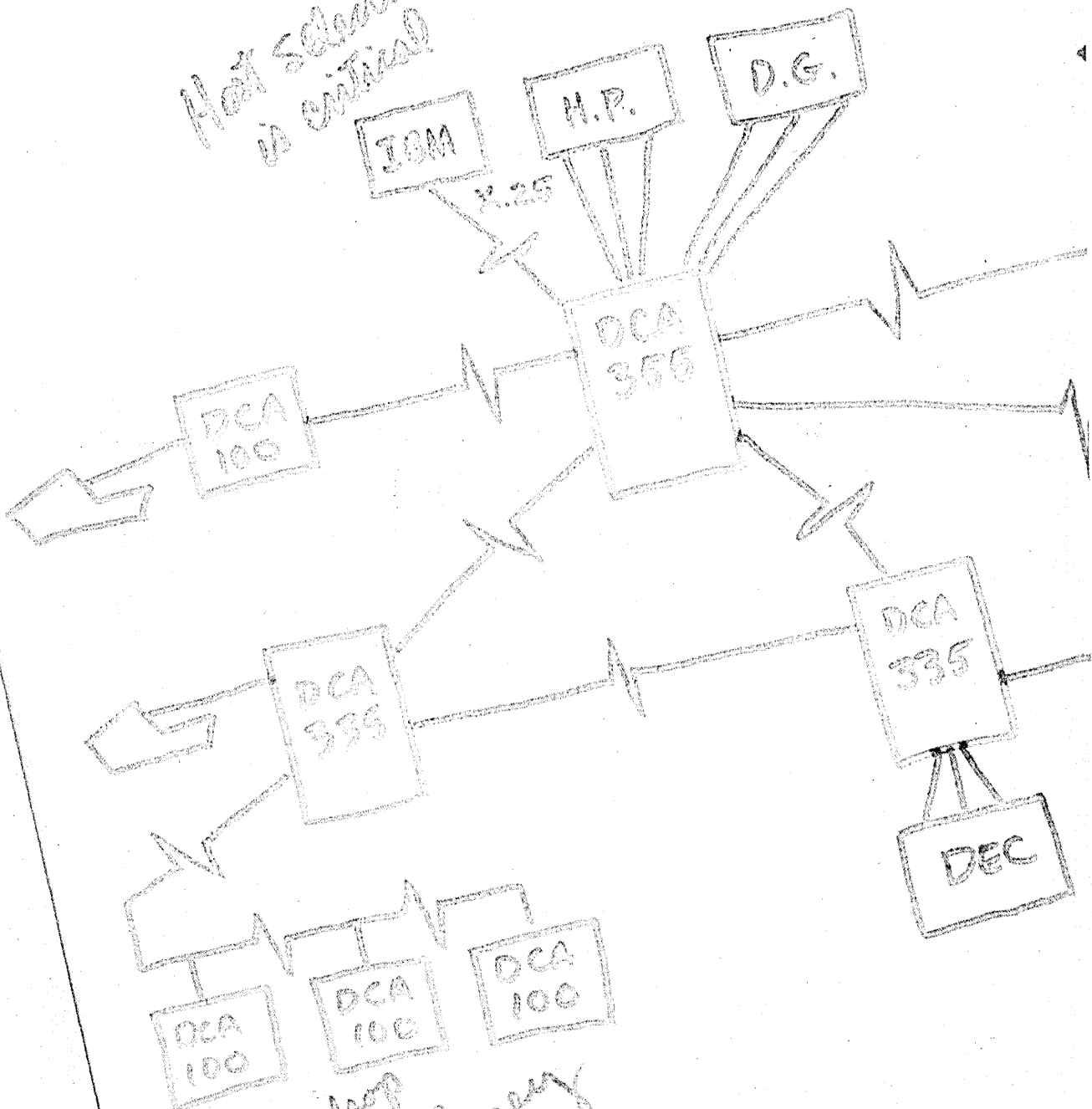

*Multiplex  
can save  
money*



# IN NETWORKING.

At DCA, we've developed what many regard as the most efficient, most effective networking design in the industry. We call it Integrated Network Architecture.<sup>®</sup> And here's what makes it work:

**Complete network transparency.** We make all our networking hardware to interface with all data processing hardware. So you don't have to modify your hosts or terminals.

**Comprehensive network management.** You can monitor transmissions, troubleshoot, even reconfigure parameters on-line from one central point. With a DCA network, you have total control.

**Virtual circuit switching.** For optimum efficiency, our network provides accessibility for any terminal to any host.

**Error controlled transmission.** Since we have practically erased the probability for undetected error, low-cost terminals can be used more reliably.

**Compatible modular hardware.** It makes our networks easy to maintain and inexpensive to expand. All you do is add — instead of replace — DCA components.

Integrated Network Architecture. Let us lay it all out for you. Write: DCA, 303 Research Drive, Norcross, Georgia 30092. Or call toll-free: **1-800-241-5793.**

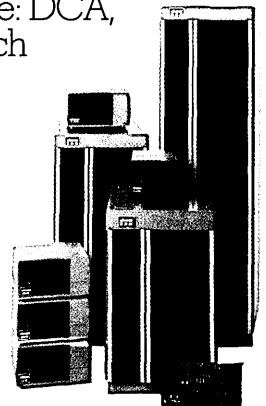

**dca**<sup>®</sup>

Digital Communications Associates, Inc.  
DCA Products Are Available Worldwide.

CIRCLE 10 ON READER CARD

# INTELLECT™ NO SOONER SAID THAN DONE.

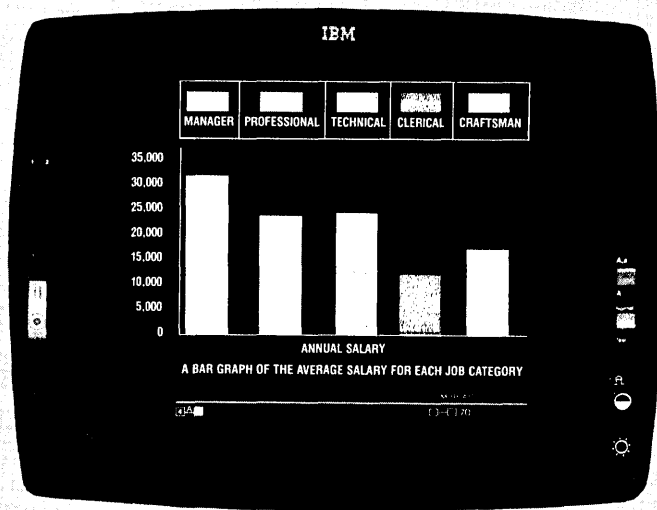
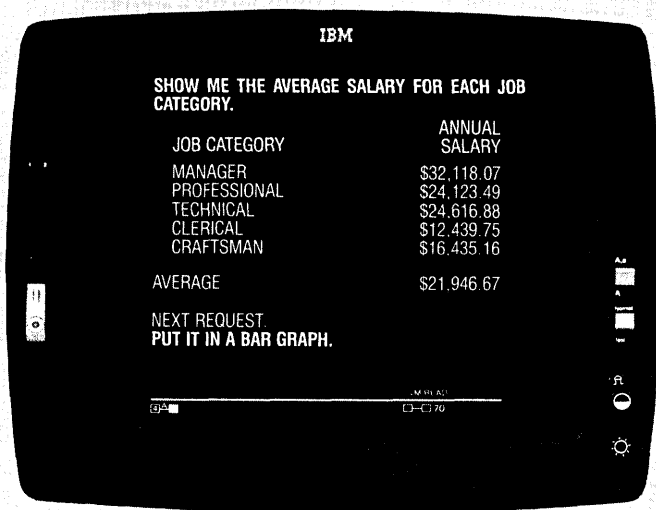

To use INTELLECT, the natural language query system, all you have to do is ask—in everyday conversational English—and you'll retrieve. Immediately, in either text or full-color graphics.

INTELLECT, the world's only successful *true* natural-language query system, is an ideal tool for your information center. INTELLECT's powerful information retrieval capabilities are so advanced that it understands questions and responds with answers as if you were talking to a knowledgeable colleague. Executives access data themselves—more easily than ever before—without learning any technical jargon or "computerese." It's so easy to use, it doesn't even have a training manual!

Whether you use INTELLECT as a retrieval system or as an effective data analysis tool, it transforms raw data in the data base into information and presents

it in finished color graphics in a matter of seconds. It's a live dynamic interface that fully integrates your existing database and graphic systems.

Already hard at work in hundreds of organizations, INTELLECT is ideal for marketing, finance, personnel, manufacturing, and banking applications.

INTELLECT is an important technological breakthrough. You can learn more about it by attending one of our nationwide seminars. Or put its amazing power at your fingertips in minutes with one of our demonstration tapes.

Call or write for more details. Look into INTELLECT, and be an eyewitness to the future of computing.



**ARTIFICIAL INTELLIGENCE CORPORATION**  
100 Fifth Avenue, Waltham, MA 02254 617-890-8400

CIRCLE 11 ON READER CARD

# LETTERS

## MISGUIDED MANEUVERS

Hesh Wiener's penetrating article, "Main-frame Maneuvers," in your February issue reports the top 10 systems over a six-year period. Only two non-IBM systems made the list, the HP 3000 for the last two years. Imagine our feelings at having it identified as the *IBM HP 3000!*

By the way, Computer Intelligence Corp., the source of your figures, reports that the Hewlett-Packard HP 3000 is the *second* most widely used general purpose business computer in the U.S. if you count numbers in the installed base instead of relative rental value. Anyway, it's nice to be in the top 10.

DOUGLAS C. CHANCE  
Vice President and General Manager,  
Computer Products Group  
Hewlett-Packard  
Cupertino, California

*No, there ain't no such animal as the IBM HP 3000, which was listed in the chart on p.162. Our apologies to Hewlett-Packard for not catching that typesetter error. —Ed.*

## ADAPTING

The interesting article on "Pairing for the Future" (December, p. 220) stated that X.25-SNA links "are limited to the top-of-the-line or new controller models (3705-II, 3705-80, 3725)" and require "expensive" network interface adaptors (NIAS). I would certainly agree on the latter point. At least in Argentina, however, IBM, in conjunction with the state telephone company, ENTEL, will provide a software "Pad" in the X.25 network that will eliminate the NIAS for the top-of-the-line controllers. IBM systems using communications adaptors will continue to require NIAS both at the cpu and at each remote cluster controller.

Other vendors, in our case Hewlett-Packard, are providing software at the cpu end and X.25 cluster controllers at the terminal end for approximately one half the cost of the IBM NIAS. HP has also promised to provide a future software link to allow its distributed processors to communicate directly with an IBM central processor via the X.25 network.

Not mentioned in the article is the ability to connect low-speed asynchronous devices (110bps to 1200bps) to the X.25 network using a software Pad provided by the public data network.

MYRON FELDSTEIN  
Director MIS  
Swift Armour S.A.  
Buenos Aires, Argentina

## AU CONTRAIRE

The "Software Strategies" article in your February issue (p. 171) incorrectly included MSA among those software companies that have reduced their range of hardware environments. On the contrary, MSA leased a considerable amount of software during recent years in non-IBM environments. Moreover, we are negotiating agreements that could expand our customers' hardware choices even further.

In March, in fact, we announced an agreement with NCR in which various development, marketing, and support activities are shared. NCR is responsible for whatever modifications are needed to adapt current MSA software (and future enhancements) to the NCR hardware, database, and system software environment.

That makes the third such agreement in two years between MSA and a major hardware supplier. Earlier contracts were signed with Honeywell and Sperry.

While IBM certainly has the predominant market share for mainframe computers, MSA has never ignored the fine processors built by major competitors. And today, we're seeing even greater interest by these hardware suppliers in bundling their products with ours.

BOB DAVIES  
MSA Special Hardware Division  
Management Science America  
Atlanta, Georgia

## OFF TARGET

Just a note to clarify some erroneous information in your February Look Ahead mention of United Telecom as a takeover target.

1. United Telecom is not located in Kansas City, Kansas. The company's headquarters is physically located in Westwood,

Kansas. The mailing address is a Kansas City, Missouri, address.

2. United Telecom announced in October of 1983, and completed shortly after year-end, the sale of its remote computing services business (United Information Services) to Control Data Corp.

3. The data networking portion of United Telecom's business (Uninet) was separated from the company's remote computing business early in 1982. It was not and is not on the block.

DONALD G. FORSYTHE  
VP-Corporate Communications  
United Telecommunications Inc.  
Westwood, Kansas

## FROM LEFT FIELD

CBEMA's apprehension toward the Democratic Party's "industrial policy" proposals (January, News In Perspective, p. 48) is somewhat warranted. A "national industrial policy" implemented by a new, self-perpetuating bureaucracy, geared to serving our largest corporations without public input, would constitute a corporate blueprint for American economic dissipation. As California Congressman Zschau stated in Willie Schatz's article, however, the United States has had an implicit industrial policy all along. In fact, such a policy—albeit often self-defeating and inefficient—has been implicit since America's first federal taxes and tariffs were imposed.

Making this implicit policy stand out for public scrutiny would be an important first step in getting Americans to recognize the need for a clear social and economic policy, of which industrial strategy is only a part. The basic question of such a policy is not which firms and industries shall be winners or losers, but rather what are the terms of our social contract over the next generation?

Every large corporation or industry association seems to hold itself the center of its universe, and therefore deems itself blessed with the wisdom needed to steer this country towards—whatever. I would hope that an industry founded on government contracts, defense spin-offs, subsidized R&D, and tax breaks (i.e., industrial

## LETTERS

policy), having grown up in the shadow of IBM and AT&T, would keep the "free market" rhetoric down to a dull roar.

We do need to set a clear national agenda with explicit values. No individual or firm or industry can set them, but each of us can raise some necessary questions.

CBEMA has nothing to worry about in any case: no government commission will put its members out of business, nor will even a Democratic Congress try to tamper with executives' pay scales. It is only on the bottom rungs of our economic system, among the unemployed who can and want to work but whose skills have been steeply devalued by rapid change, that we find people whose individual and family futures depend on a meaningful and substantive discussion of economic policy.

DAVID PHILLIPS  
Rego Park, New York

### POINT, COUNTERPOINT

My congratulations and gratitude for publishing what has long needed to be said about office automation: essentially, that it is a huge hoax perpetrated by vendors, consultants, and the like on American business. Reading Dr. Hammer's article (February, In Focus, p. 36), I was reminded of the small boy in "The Emperor's New Clothes" who pointed out the king's nakedness. The most embarrassing part of the whole scenario is that so many of us who know better have subscribed to the hoax out of laziness or self-interest.

PETER MARTIN  
UDATA  
Morristown, New Jersey

I am in strong disagreement with Dr. Hammer's article, "The OA Mirage." I believe he owes the general public an apology. Office automation customers are not naive and have lived with this technology for several years; they are by no means newcomers, and they have developed enough savvy and expertise through their own experiences that an outside consultant can perhaps learn from them. This may be the reason more and more large companies are solving their problems without the aid of consultants and establishing new departments to handle the task of overseeing equipment acquisitions and implementation programs.

To say that executive reaction to OA ranges from boredom to skepticism to hostility is a fallacy. Every company knows that increased productivity and economic success go hand in hand, and OA is recognized as a tool to help us work smarter instead of harder, and therefore use our time more effectively. Certainly, enough is written to substantiate this philosophy! Because OA is looked upon as a tool to help make this happen, OA programs have a very high priority and are often led by corporate directors and vice presidents.

Office automation is more than just another computer application—it is an entire concept encompassing many capabilities to address many applications. To say that people are buying small systems to address specific applications is to say they are still operating with a 1970s mentality. That was a mistake that was made 10 years ago that some are still trying to rectify.

Also, Dr. Hammer's statement that the user interface is a second-order factor is very incorrect. The customer is smart enough to know that user interface is of primary concern. In an installation we have just completed, the interface was of higher priority than functionality. Take a look at some of the largest equipment acquisitions we have been reading about—E.F. Hutton, Department of Forestry, U.S. Navy, etc. If these acquisitions took place for any other primary reason than user interface, I would be very much surprised. Can we really say there is no such thing as office automation? It is 1984 and we are well on our way to the infamous "office of the future"; we have electronic mail and are sending our spreadsheets and graphics all over the place. Our executives are becoming adept at keyboarding and manipulating text. We are using our calendars to schedule meetings and resources, we are accessing our mainframes and outside databases, and we're doing it in plain English! Granted, we are still in the transition stage, but believe me, it's happening. And for a lot of us, there's no turning back!

KAREN H. ELDER  
President  
Office System Strategies Inc.  
Utica, Michigan

Michael Hammer's article on OA was interesting, but he failed to discuss the importance of OA to small and new businesses. A new one- or two-man business has an excellent chance of success if it can avoid large startup costs (i.e., a secretary, office space, bookkeeping charges, etc.). Now, anybody with an idea for a business can start with \$3,000 to \$4,000 and have a fighting chance. Watch out, big guys, the age of the mom-and-pop grocery store may be coming back.

RANDALL BACHMAN  
Engineer  
Arizona Public Service Company  
Joseph City, Arizona

### MORE! MORE!

Jan Johnson's article, "In Search of Missing Links" (November, p. 142), was the first (and so far the only) piece I've found that provides any kind of collected information about micro-mainframe links. We're in the process of developing a seminar that addresses the why and how of micro-mainframe links, and as such, have been doing a lot of our own research. The timing of this

article was terrific; it provided me with further data as well as corroborated many of the things I'd already discovered. Alas, for me, things are changing fast enough to necessitate an update of Johnson's work. But it is a substantial place from which to start and has been a great help. It was a deservedly well-supported effort.

DEBORAH HARPER  
Temple, Barker & Sloane Inc.  
Management and Economic Counsel  
Lexington, Massachusetts

### THANK YOU

Thank you for publishing such a detailed article on Alan Mathison Turing in your December issue (p. 152). Never since I wrote my undergraduate thesis at MIT have I seen such interest in Turing. My thesis advisor and another professor motivated me enough to grind through the research, design, and construction of a working model of a Turing machine.

Respectfully, I want to make one correction: according to my research, Turing published in 1936, not 1937.

CARL A. KARRFALT  
Pelham, New Hampshire

### LANGUAGE BARRIER

I can understand Prof. Pasachoff's dismay with the usual academic approach to computer programming education (February, Letters, p. 28). Most of us, physicists or engineers, did indeed "learn computing on the side." Our professions have gained little evident benefit from the spread of computer science.

I suggest that the training with which we have made do is not good enough. Do any of us gain the right to put those letters after our names without undergoing formal as well as "on the job" training in expository writing and speaking? It is equally important for us to communicate both with our coworkers and with our computers using whatever expressive power we can find in our programming languages.

Certainly FORTRAN is likely to remain an important medium of expression in our fields. Knowing the needs, shouldn't we team up with computer science people who have studied such expository techniques and try to improve our standard of communication?

TIM PRINCE  
Aircraft Engine Business Group  
General Electric  
Lynn, Massachusetts

I submit that someone who learns programming in a language oriented towards structured problem solving, such as Pascal, will be a better FORTRAN maintenance programmer than one who learns to program in unstructured FORTRAN.

Pascal encourages the development of good programming technique. Once a



# It's just not fair to claim that **TEMPLATE**<sup>®</sup> is the best graphics software available. Our competition's already discouraged.

And we like competition. We really do. It's just that it's difficult, if not impossible, to find graphics software as efficient and functional as **TEMPLATE**. Try as you might. **TEMPLATE** is the hands-down winner. With true device-independence and intelligence, total graphics functionality for CAD, scientific analysis, seismic work, process control, molecular modeling, and a host of other applications.

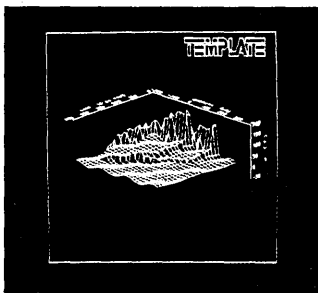

In almost any environment, whether it's batch or interactive, 2D or 3D, **TEMPLATE** wins. Benchmark tests prove it. **TEMPLATE**, besides being a true 3D graphics package for 32-bit or larger computers, features powerful commands that provide matchless productivity. **TEMPLATE** makes optimal use of available computer resources, giving you fast, efficient computer graphics program execution. And it supports over 125

graphics devices, from dumb terminals to sophisticated systems.

We also provide on-site installation and training, continuous updates, a regular flow of new device drivers, and ongoing documentation. What's more, we back you up with a telephone hotline so **TEMPLATE** software specialists can provide help if you need it.

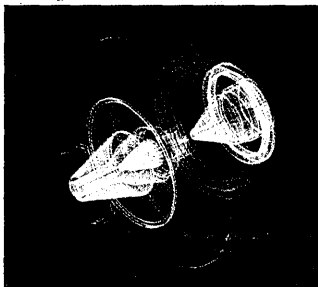
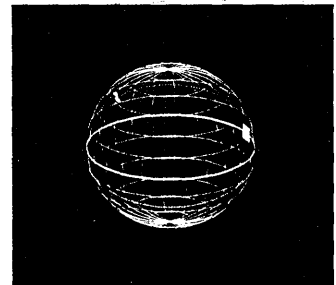

But let's be fair. If you're looking for graphics software, call our competitors first. Find out what they have to say about theirs. Then call us, and find out why **TEMPLATE** really has no competition.

And why the competition has been so discouraged for so long.

 **MEGATEK  
CORPORATION**  
A UNITED TELECOM COMPANY  
Making History out of State-of-the-Art

World Headquarters • 9605 Scranton Road • San Diego, California 92121 • 619/455-5590 • TWX: 910-337-1270  
European Headquarters • 34, avenue du Tribunal-Fédéral • CH-1005 Lausanne, Switzerland • Telephone: 41/21/20 70 55 • Telex: 25 037 mega ch

See us at NCGA, Booth 318, May 13-17, Anaheim, CA.

CIRCLE 12 ON READER CARD

# Introdu LinkTha

Today, you have to live in two different worlds. One belonging to IBM. The other to everyone else.

With that in mind, companies have come along with a variety of products that attempt

to link the  
But somewhere  
line, they all look  
Enter the  
PA1000™  
converter.

two together.  
along the  
a little dumb.  
AVATAR  
Protocol Con-  
It's the most  
intelligent way to  
bring personal computers,  
portable computers, or low-cost  
ASCII terminals into the IBM  
coaxial environment. For the first  
time, overburdened DP/MIS  
executives can look forward to  
truly smooth integration,  
minimal

confusion,  
and fewer demands on their time.  
And users can get an affordable,  
easy-to-use way to tap the riches

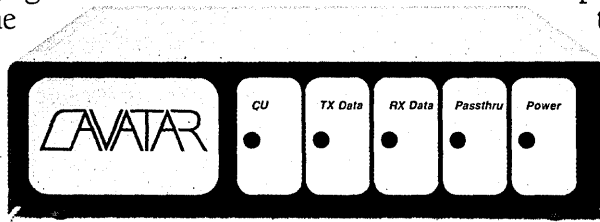

of their IBM mainframes.

So if you're looking for the best of both worlds, keep reading. And you'll see why the AVATAR PA1000 can out-think any product on the market.

First of all, the AVATAR PA1000 is an almost universal link. With no modification, it connects to virtually any personal or portable computer you have: IBM, Apple, DEC, TRS 80, Kaypro, COMPAQ, NCR, and others.

The AVATAR PA1000 also connects to the DEC VT100, IBM 3101, LSI ADM5,

Televideo 910, ADDS Viewpoint or other compatible terminals.

The PA1000 connects coaxially to an IBM 3274/3276 cluster controller, so whatever personal computer or terminal you use will perform all the functions of an IBM 3278-2. The coaxial connection also means you won't be in for a future shock: ever-changing IBM protocols will be no problem.

	AVATAR PA1000 vs.	IRMALINE™
Easy to install	YES	YES
Q/A installation	YES	NO
English language commands	YES	NO
Help screens	YES	NO
Keyboard types	5	1
Remote dial-in/ security password	YES	YES
Dual host access	YES	NO
Local screen printout	YES	NO
3278 status line modes	3	1
Price	\$995	\$1395
Availability	Immediate	(?)

Two hosts are better than one. So in addition to the coax connection to IBM, the

# cing The t Thinks.

AVATAR PA1000 gives you an extra RS232 port. That gives you access to other local or remote asynchronous host computers or local printers.

HELP! If you need it (and who doesn't) you have help screens to put you back on track. The PA1000 also has easy-to-use, English language commands.

With a few simple keystrokes, you can switch from your IBM to the extra RS232 port, giving you access to private data networks and public databases like Dow Jones.

And when you switch back, the AVATAR PA1000 is smart enough to remember your IBM screen.

In a distributed terminal network, remote dial-in from personal computers or asynchronous devices is increasingly

important. You can dial into your PA1000 at the nearest cluster controller, and reduce communications costs dramatically in the process.

Just by typing "1-2-3" (how much simpler can you get?), the PA1000 automatically determines the baud rate of the attached device and is ready to go.

In just five minutes (no kidding) you can install the AVATAR PA1000. And you don't need to be a computer operator.

The AVATAR PA1000 even gives you

a file transfer option that lets you transfer information back and forth between your personal computer and an IBM mainframe.

What will AVATAR think of next? The latest news is our PA1500, a link that lets you

print the output from your IBM host on a low-cost ASCII printer. It supports high-speed dot-matrix, letter quality, and line printers. It's very simple to install. And it will save you a bundle.

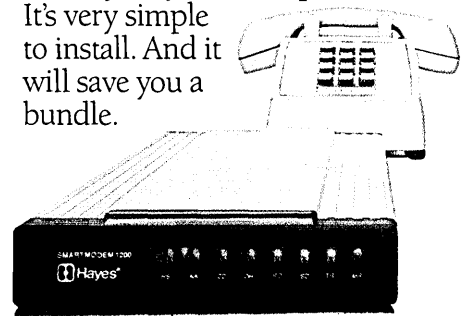

To find out more about the AVATAR PA1000, our company, our distributors and dealers, or our plans, just call us. In Canada or Massachusetts: 617-435-6872. Everywhere else: 800-828-2004 Ext. 600.

**AVATAR**  
The Link That Isn't Missing Anything.

Avatar Technologies Inc.  
99 South Street, Hopkinton, MA 01748



# DEC → TO IBM/SNA

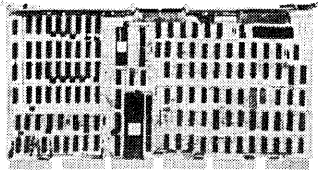

Now available...full SNA capability for your DEC computer! Comboard/SNA gives your terminals access to IBM interactive applications. Data can be transferred between systems transparently, all in the complete fully supported package, Comboard/SNA from Software Results.

Comboard/SNA is a proven and reliable, single-board, 256KB communications computer that plugs into your DEC Unibus. Teamed with Comboard software, the system is a cost-effective solution to troublesome SNA communications problems.

Comboard/SNA allows your DEC to emulate an IBM PU Type 2 communications node. You have a full gateway into your SNA without the trouble of passing through a secondary network.

For further information, fill in the coupon below or call Software Results... the leader in DEC to IBM communications.

# COMBOARD

Communications Results

NAME \_\_\_\_\_

COMPANY \_\_\_\_\_

ADDRESS \_\_\_\_\_

CITY, STATE, ZIP \_\_\_\_\_

Telephone \_\_\_\_\_

DA

## SOFTWARE RESULTS CORPORATION

Call Toll-free

**1-800-SRC-DATA**

(1-800-772-3282)

In Ohio call collect 1-614-267-2203

2887 Silver Drive, Columbus, Ohio 43211 • Telex: 467-495 SRC DATA CI

COMBOARD™ Software Results Corporation

DEC UNIBUS™ Digital Equipment Corporation

IBM, SNA™ International Business Machine Corp.

**CIRCLE 14 ON READER CARD**

## LETTERS

person has that technique and really understands how to attack a problem, he or she can learn a new language in a matter of days.

JAMES D. GAWN  
Senior Research Analyst  
Financial Information Dept.  
Pennsylvania Blue Shield  
Camp Hill, Pennsylvania

### ALIVE AND WELL—AND LIVING IN MINNEAPOLIS

Consultant Philip Dorn's comment ("The Song Remains the Same," February, p. 104) that "for all practical purposes, CDC and NCR are out of the mainframe business" is groundless, untimely, and contradicts what your own Look Ahead said in the same issue—namely, that Control Data is very much in the systems business.

Our 1983 shipments set a record. We have the industry's longest, broadest, and most complete line of compatible processors. We remain the leader in scientific and engineering applications and systems. And a host of talented people are hard at work on the next generations of both hardware and applications.

Perhaps Dorn was talking about another CDC. But this one is alive, well, and full of vim and vigor.

W.M. SHAFFER  
General Manager  
Systems and Services Communications  
Control Data Corp.  
Minneapolis, Minnesota

### DORN RESPONDS:

Control Data Corp. has long been successful in a number of businesses including medium-to large-scale scientific processors, remote computing services, peripherals, manufacturing, and financial services.

By no stretch of the imagination, however, could CDC be classified under the term "mainframer" because of its historic lack of midrange commercial computers, the heart of the industry. Further, CDC is not a significant player in microcomputers, minicomputers, or these days, in supercomputers, having recently abrogated its position in that marketplace. How CDC can claim to have the "longest, broadest, and most complete line of compatible processors" is a mystery when measured against IBM (XT/370 through 3084.) To the contrary, I find CDC's line narrow, restrictive, and constrained to small submarkets.

I agree with Schaffer: CDC is alive and well. But not in the mainframe business. \*

Your comments on DATAMATION are always welcome. We do reserve the right to edit the letters for either brevity or clarity. Letters should be addressed to Editor, DATAMATION, 875 Third Ave., New York, NY 10022.



# Decision-making tools for the Information Age

With the Matrix QPR™ management, DB, MIS and other personnel instantly format charts, graphs and text of artist quality for color 35mm slide and 8" x 10" transparency presentations, right from your mainframe or network with the in-house advantages of quick turn-around and controlled confidentiality.

We will supply you, without charge, the necessary driver software for your decision-making on the Matrix QPR™ 842 color film recorder.

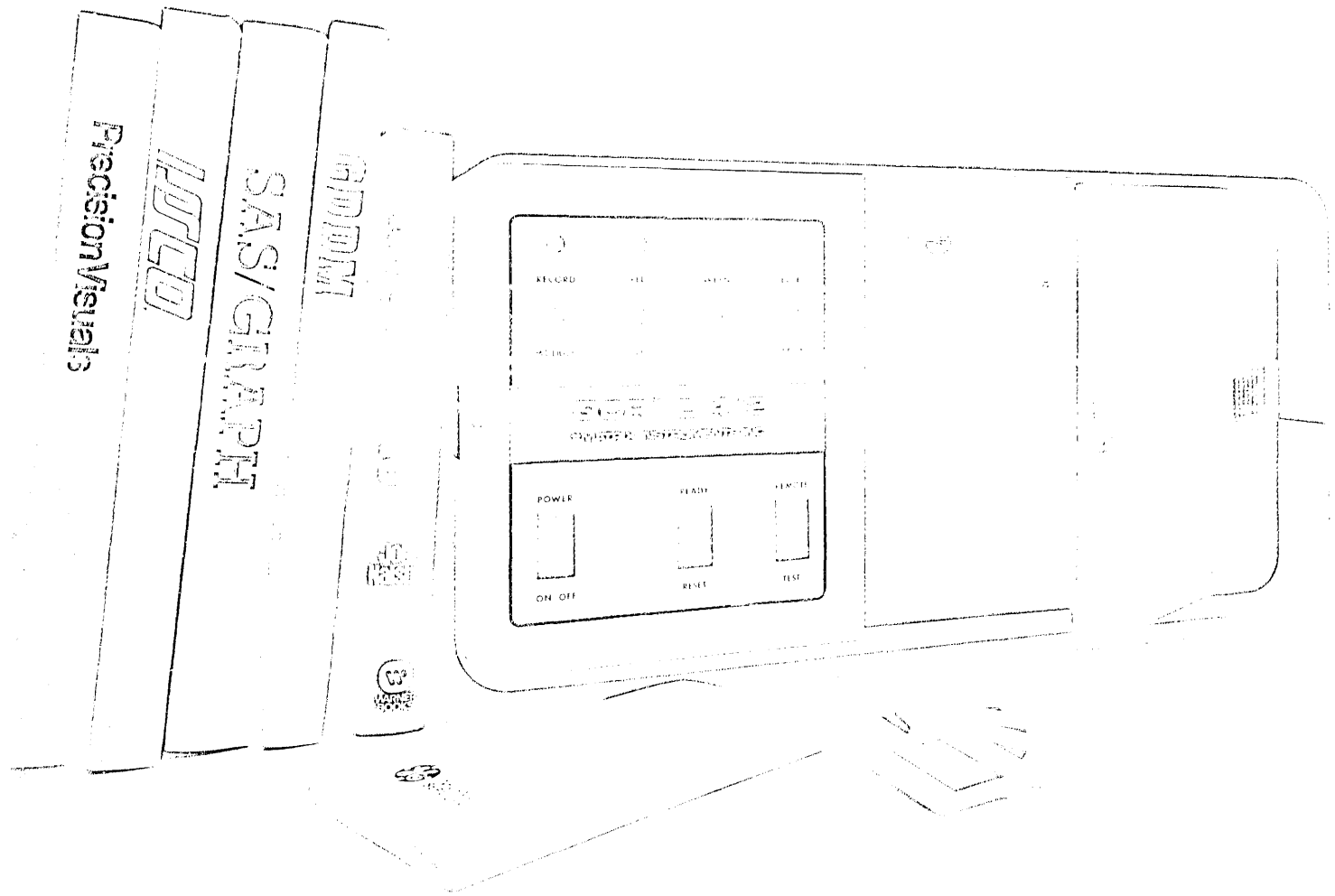

**MATRIX INSTRUMENTS INC.**

One Ramland Road, Orangeburg, NY 10962, Telephone: 914-365-0190 or Telex: 6853232

In Europe, please contact:

Honeywell Europe S.A., Avenue Henri Matisse 14, B1140 Brussels, Belgium, Tel: (32) (02) 243 1487 or Telex: 24535

**CIRCLE 15 ON READER CARD**

GDDM is a trademark of IBM.  
SAS/GRAPH is a registered trademark of SAS Institute Inc.  
ISSCO is a registered trademark of Integrated Software Systems Corporation.

# We wrote the book on portability. In nine different languages.

	8080/8085/Z80 CP/M MP/MII	8086/8088/8186 CP/M-86 Concurrent CP/M™	8086/8088 IBM PC DOS	8086/8088 MS DOS	MC-68000 CP/M-68K
FORTRAN-77		✓	✓	✓	TBA
C BASIC Compiler	✓	✓	✓	✓	✓
Pascal/MT+	✓	✓	✓	✓	✓
Level II COBOL	✓	✓	✓	✓	TBA
PL/I	✓	✓	✓	✓	TBA
C		✓	✓	✓	✓
Assembler Plus Tools	✓	✓	✓	✓	TBA
Access Manager	✓	✓	✓	✓	TBA
Display Manager	✓	✓	✓	✓	TBA
micro/SPF		✓	✓	✓	
COBOL Animator	✓	✓	✓	✓	TBA
Personal BASIC		✓			TBA
Dr. Logo		✓	TBA		

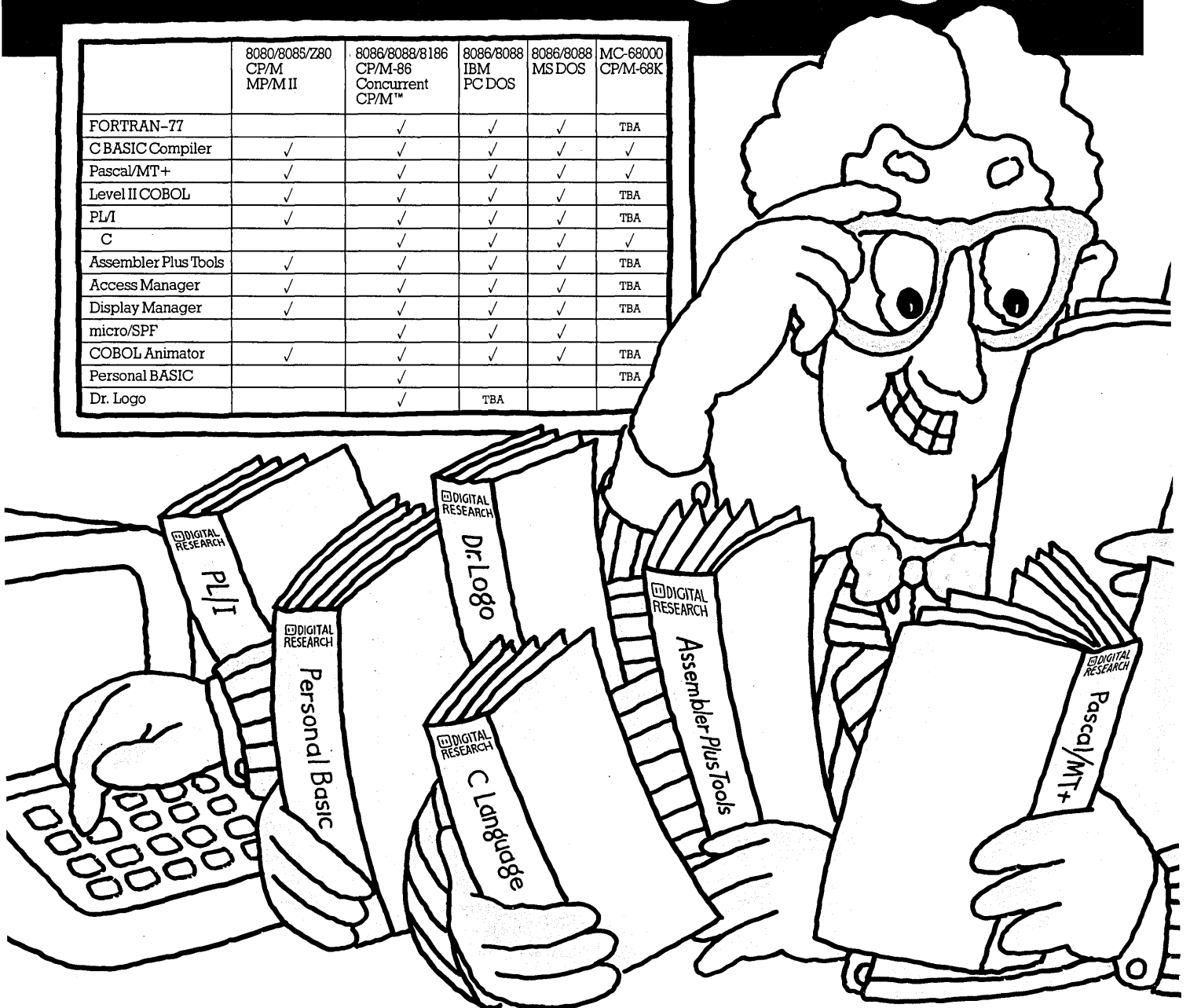

To every software developer who'd written off portability as an impossible dream, Digital Research humbly announces a few monumental breakthroughs.

We not only offer languages that are portable from 8 to 16 to the 32-bit chips of the future, they're portable across all popular operating systems, too. What's more, we supply the broadest range of quality languages and development tools available today. And will tomorrow.

So rest assured. Whether you design applications at a major corporation, plan to become a major corporation or just qualify as a hobbyist, you only have to write it once.

Simply pick the Digital Research language that's right for you. From Personal BASIC™ to Digital Research FORTRAN-77™. The newest member of our remarkable family.

To complement languages, we offer a complete workshop of development tools. Our Display Manager™ and Access Manager™ simplify the design of screen displays and data bases. So you spend less time and effort.

If you write in COBOL, our Animator™ source level debugger will get your software running in record time.

And for programmers skilled with IBM mainframe SPF, we offer micro/SPF™. An editor that helps turn your invaluable experience into valuable new software applications.

At Digital Research, we work as hard for you after the sale as we do to get the sale. With backup like quality documentation, software updates and a phone line to our technical support team.

With so much productivity and service to draw on, it's small wonder IBM chose our languages for its IBM® PC, XT and the new IBM 3270/PC.

For more information, call your IBM representative.

Or, for the Digital Research retailer nearest you, call 800-227-1617, ext. 400. In California, 800-772-3545, ext. 400.

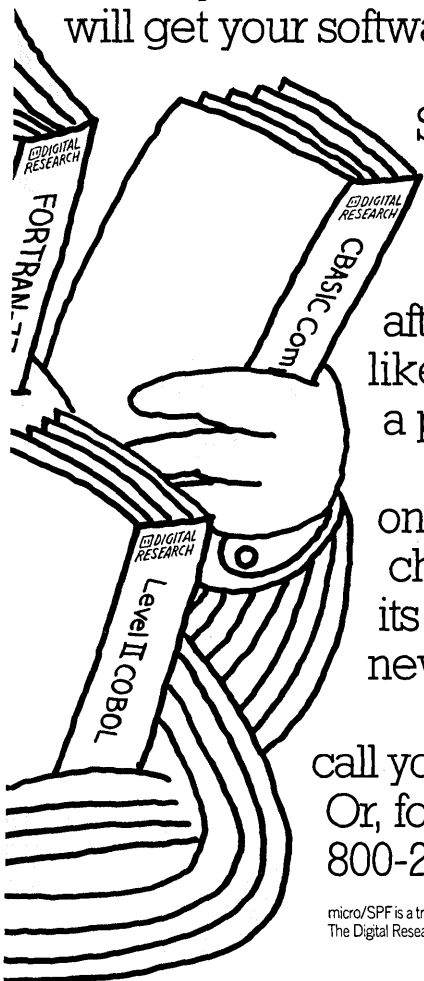

micro/SPF is a trademark of Phaser Systems, Inc. Animator and Level II COBOL are trademarks of Micro Focus Ltd. IBM is a registered trademark of International Business Machines Corporation. The Digital Research logo and products are either trademarks or registered trademarks of Digital Research Inc. ©1984 Digital Research Inc. All rights reserved.

CIRCLE 16 ON READER CARD



# Unforgettable

It's worth remembering, it's worth  
3M data recording products.

3M computer media products remember everything, every time. Their reputation for reliability is backed up by something very rare in the magnetic media industry: over thirty years of manufacturing experience. That experience, plus the fact that 3M controls the entire manufacturing process, assures that the same high quality is built into every computer media product we make. So you can have complete confidence in every 3M data cartridge, diskette, and roll of computer tape you buy.

Insist on the best for all your DP needs. Insist on information processing products from 3M. Inventor of the data cartridge and the world's largest manufacturer of flexible magnetic media for the home, office and computer room.

Look in the Yellow Pages under computer supplies and parts for the 3M distributor nearest you. In Canada, write 3M Canada, Inc., London, Ontario. If it's worth remembering, it's worth 3M data recording products.

3M hears you...





# EDITORIAL

## UNDERWHELMED WITH ENTHUSIASM



The minute AT&T made its long-awaited entry into the computer market, the critics came crashing down on what was wrong with the announcement. Oh sure, there was depth and breadth to the offering. The six systems span the price range from \$9,950 to \$390,000, and have a performance range of from .5 MIPS to 1.6 MIPS. What's more, Unix is supplied on all six systems, from the low-end multi-user microcomputer to the high-end super-mini. Another plus was the local area network with an interface to enable micros that run PC/DOS, like the IBM PC, to interact with the Unix environment of the AT&T supermicro. All this, and still the critics were underwhelmed with enthusiasm.

So, where's the beef? Obviously there's always the hue and cry about AT&T's lack of a strong and experienced dp marketing force. The company had anticipated that argument and in its announcement volunteered that its Information Systems unit so far had trained about 800 account execs and technical consultants who are now ready to support AT&T's end-user marketing effort. By year-end, the company added, that newly trained force will number some 6,000. But where's the sought-after AT&T supplied and supported applications software? Nonexistent, critics complained. There, too, AT&T had an answer: more than 90 companies already market some 300 Unix applications packages. Thus, software is already available.

The absence of aggressive pricing was another criticism. There's another side to that story as well. More bang for the buck in products is not the major motivating force in AT&T's strategy. It wants to move into a market with product and pricing that's on a par with the competition. That helps eliminate some signs of the new kid on the block, an image AT&T is fighting hard to fend off.

And even though the announcement represented what could be called the broadest range of initial product offerings ever made, there were still those who chastised the company for not baring a personal computer. Other critics went so far as to question AT&T's real commitment to battling IBM when no word has yet been uttered about the mainframe business.

Damned if you do. Damned if you don't. No matter what AT&T had announced, fault would have been found—and broadcast. The general reaction to AT&T's computer combo was at best ho-hum. We say, ho-hum yes, but remember from whom.

Suppose you're AT&T. You're going through a phenomenal transition right now. And during this time of transition, you're not yet ready to take on Numero Uno with a frontal assault. Nonetheless, you know everybody's waiting and watching for your first move. The market wants something from you. What do you do?

It's a tough dilemma. The risk is that if your first step into a market is mediocre, it could seriously erode potential goodwill from customers and critics alike. On the other hand, how long can you stall while preparing for the really big game in which you hope eventually to play?

What tack did AT&T take? Let's call it the Noble Inference. It introduced a tried and true product line (tried and true at least within what was once the Bell System), but one that didn't go head-on into IBM's turf. The products fall into a market segment with great growth potential, and the strategy provides a niche for now. If AT&T loses on that gamble, there won't be too many waves from what was already a nonspectacular announcement. Better yet, if it wins in the first round, the inference can be drawn that there are bigger and better unveilings in the offing.

After all, AT&T can't learn the computer biz from books. At least it's testing the waters. And who knows? We may find that a ship *can* turn on a corner.

\*

# The TeleVideo IBM PC

## The best hardware for

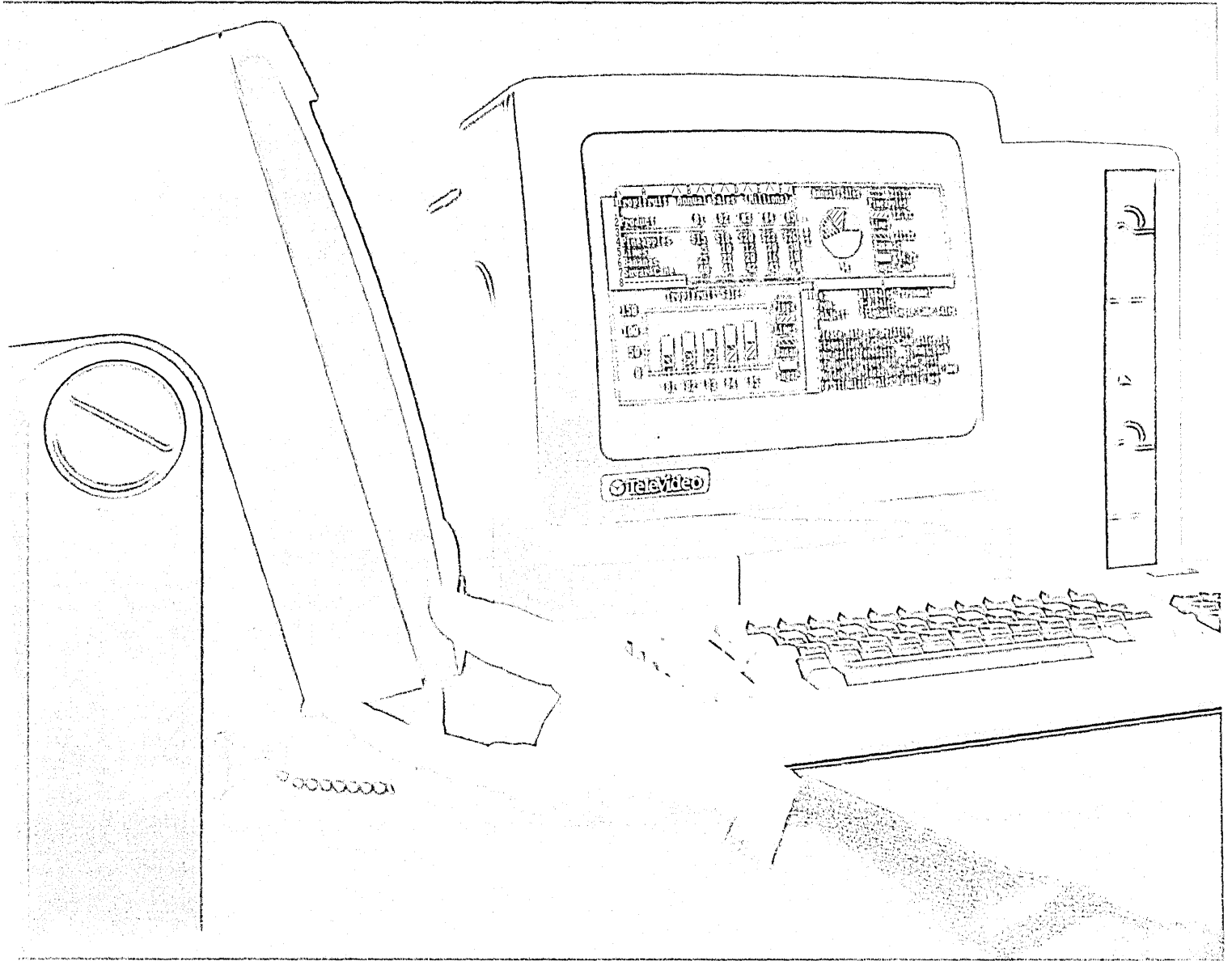

TeleVideo versus IBM. Make a few simple comparisons and you'll find there is no comparison.

### **RUNS IBM SOFTWARE.**

With the TeleVideo™ IBM Compatible line—PC, XT and portable computers—you'll get the most out of all the most popular software written for the IBM® PC—more than 3,000 programs.

Because every TeleVideo Personal Computer offers the highest level of IBM compatibility on the market

### **THE BEST HARDWARE FOR THE BEST PRICE.**

Features	Tele-PC	IBM PC	Tele-XT	IBM XT
Monitor	YES	OPTIONAL	YES	OPTIONAL
Screen Size	14"	12"	14"	12"
Tilt Screen	YES	NO	YES	NO
Quiet Operation	YES (NO FAN)	NO	YES	NO
Memory	128K	128K OPTION	256K	256K OPTION
Graphics Display (640x200 resolution)	YES	OPTIONAL	YES	OPTIONAL
Printer Port	YES	OPTIONAL	YES	OPTIONAL
Communication Port	YES	OPTIONAL	YES	YES
MS™ DOS/BASIC™	YES	OPTIONAL	YES	OPTIONAL
System Expansion Slot	YES	YES	YES	YES
RGB and Video Port	YES	OPTIONAL	YES	OPTIONAL
<b>Typical System Price</b>	<b>\$2995</b>	<b>\$3843</b>	<b>\$4995</b>	<b>\$5754</b>

# compatibles. the best software.

and has the standard—not optional—features you need to take full advantage of every job your software can do.

Study the chart at the left. It proves that TeleVideo—not IBM—offers the best hardware for the best price.

Note that TeleVideo's ergonomic superiority over IBM extends from fully sculpted keys and a comfortable palm rest to a 14-inch, no glare screen that tilts at a touch.

## THE BEST MICROCHIPS.

What is perhaps most impressive about the TeleVideo IBM PC Compatible can be found deep within its circuitry. We use the same 8088 central processing unit that runs an IBM PC. But we also employ new VLSI (Very Large Scale Integration) microchips that are designed and built exclusively for TeleVideo.

These interface more efficiently with the powerful 8088 and yield numerous benefits.

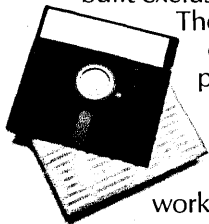

For example, our tiny custom chips do the work of many of the larger, more expensive circuit boards in an IBM PC. So we can offer a computer system that comes in one attractive, integrated case, is ready to run and occupies less desk space. A computer that edges out IBM's added-cost component system for reliability, ease of service and purchase simplicity.

Fewer circuit boards to cool also allowed us to eliminate the noisy, irritating fan IBM and most other PCs force you to put up with. And TeleVideo compatibles accept

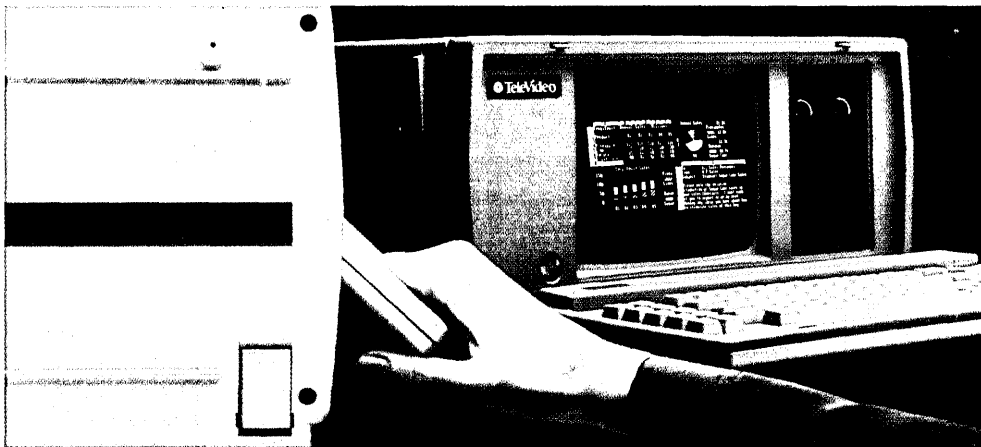

## THE BEST PORTABLE FOR THE BEST PRICE.

Features	TPC II	COMPAQ
High Capacity Storage	YES	NO
2nd Disk Drive	YES	OPTIONAL
Quiet Operation (No Fan)	YES	NO
Ergonomic Display	YES	NO
Communication Port	YES	OPTIONAL
International Power Supply	YES	NO
MS™ DOS 2.11	YES	NO
Graphics Display	YES	YES
<b>Typical System Price</b>	<b>\$2995</b>	<b>\$3710</b>

any IBM hardware options without modification.

## THE BEST LINE.

But the Tele-PC is only one element of the TeleVideo IBM PC Compatible line.

The TeleVideo XT is the best hardware for users of popular IBM XT software who would appreciate an extra 10 megabytes of storage capacity along with the advantages listed on the preceding chart.

As the chart above demonstrates, our portable IBM compatible computer, the TPC II, is far and away better hardware than COMPAQ™. Better hardware—standard—at a better price.

## THE BEST MANUFACTURER.

The TeleVideo IBM PC Compatible line is made by the world leader in multi-user computer systems and the number one independent manufacturer of terminals.

Our compatibles are available at participating ComputerLand and Entré (call 800-HI-ENTRE) dealers or you may call 800-538-8725 for the dealer nearest you. In California, call 800-345-8008.

Before you invest, make a few simple comparisons. You'll find that TeleVideo—not IBM or COMPAQ—has the best hardware for the best software. At the best price.

IBM is a registered trademark of International Business Machines. MS is a trademark of Microsoft Corporation. GW Basic is a registered trademark of Microsoft Corporation. COMPAQ is a trademark of COMPAQ Computer Corporation.

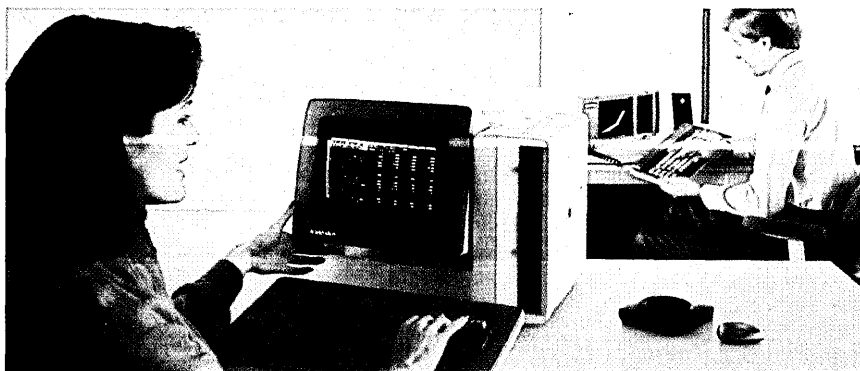

**TeleVideo®**  
Personal Computers  
TeleVideo Systems, Inc.

CIRCLE 18 ON READER CARD

# INFOCUS

## FORECASTS FROM TEACUPS?

**Are market researchers merely palmists, tea leaf readers, or other equally fallible psychics?**

**by Jon Zonderman**

What's the market going to be like five years from now for local area networks?

You may want to ask International Data Corporation of Farmingham, Mass., the Gartner Group of Stamford, Conn., Dataquest of San Jose, Calif., or maybe Strategic Inc., also of San Jose. In fact, in December 1983, Strategic completed a survey of 170 companies that have cumulatively purchased over 2,000 IBM PCs. It shows that more than half of these purchasers—nearly 40% of whom have mainframe computers—are interested in purchasing either local area network (LAN) equipment or multi-user PCs in the future. The report, entitled "IBM PC User Reactions, Requirements, and Plans—1984," runs 150 pages and costs \$9,500.

If you are a journalist who wants to know what the LAN market will be, someone from one of these companies might give you a seat-of-the-pants guess (along with a suitably pithy quote). But if you are a vendor of networking equipment, or the management information systems (MIS) manager for a large corporation that might be in the market for such equipment, you had best resign yourself to paying substantially for that information. And the information you get may be more than you need, or can read, and may leave questions unanswered or conclusions unsupported.

International Data Corp., Gartner Group, Dataquest, and Strategic are just four of about a dozen major players in the growing game of producing market research for hundreds of large corporations—though skeptics say it is more market analysis and market watching than true old-fashioned market research. These major players, including the Yankee Group in Boston; Future Computing in Richardson, Texas; Input in Mountain View, Calif.; International Resource Development in Norwalk, Conn.; InfoCorp in Cupertino, Calif.; Rosen Research in New York City; and Gnostic Concepts in San Jose, Calif., pump out reams of paper annually. The lengthy stream consists of reports hundreds of pages long, newsletters, bulletins, telegrams, and surveys that tell us where the computer industry has been and where it is going. Sometimes they are right in their guesses, but sometimes they are not.

Yet, virtually every computer or computer component vendor, as well as a number of Fortune 1,000 computer consumers, subscribe to two, three, or sometimes all of the major services, in addition to the services of hundreds of smaller market-information vendors, mostly newsletter publishers. Though this deluge of information does not often reach the data processing department (unless it is shared with the MIS department or is part of a needs assessment and planning group the company has set up), the dp department is a major source of raw survey data and reactions for the market watchers.

In addition to the annual deluge of paper, clients of market information companies are often treated to seminars sponsored by the companies, unlimited telephone call-in queries, and one-to-one market consulting. Some market research firms offer proprietary consulting for a fee, in addition to their packaged research, with package subscribers having first crack at their time. For these packages, companies usually pay between \$8,000 and \$25,000 each. Many of these market information companies have half a dozen or more research packages covering such areas as personal computers, telecommunications systems, large computer systems, and an industry overview service that covers a number of areas less closely. It is not unusual for a company to subscribe to three or four packages from each of five or six information providers for a total bill of over \$500,000 annually.

What do clients do with all this information? "You take all this information, put it in your Cuisinart, then try to get your best guess about the market," says John Shea, manager of hardware management for GTE Services, Tampa, Fla., who watches the IBM mainframe market using a package called Residual Asset Value Information System produced by the Gartner Group, a well-known IBM-watcher.

While users like Shea will be watching for price changes so he can help people in GTE subsidiaries decide whether to buy, lease, or hold off on computer acquisitions, vendor marketers are keeping an eye on IBM to see if they can beat Big Blue to the punch somewhere. IBM itself is reading the scuttlebutt, to see how it is perceived in the marketplace, though it must occasionally laugh at how uninformed these researchers, and therefore their competitors, really are.

In general, vendors are the primary beneficiaries of this research. Mark Norwood, corporate market research director for Intel says there can be a great deal of efficiency in buying outside research. He says the company uses the research to measure its products against "more mature products" and to see what kinds of products its customers are considering manufacturing, so the company can try to get more

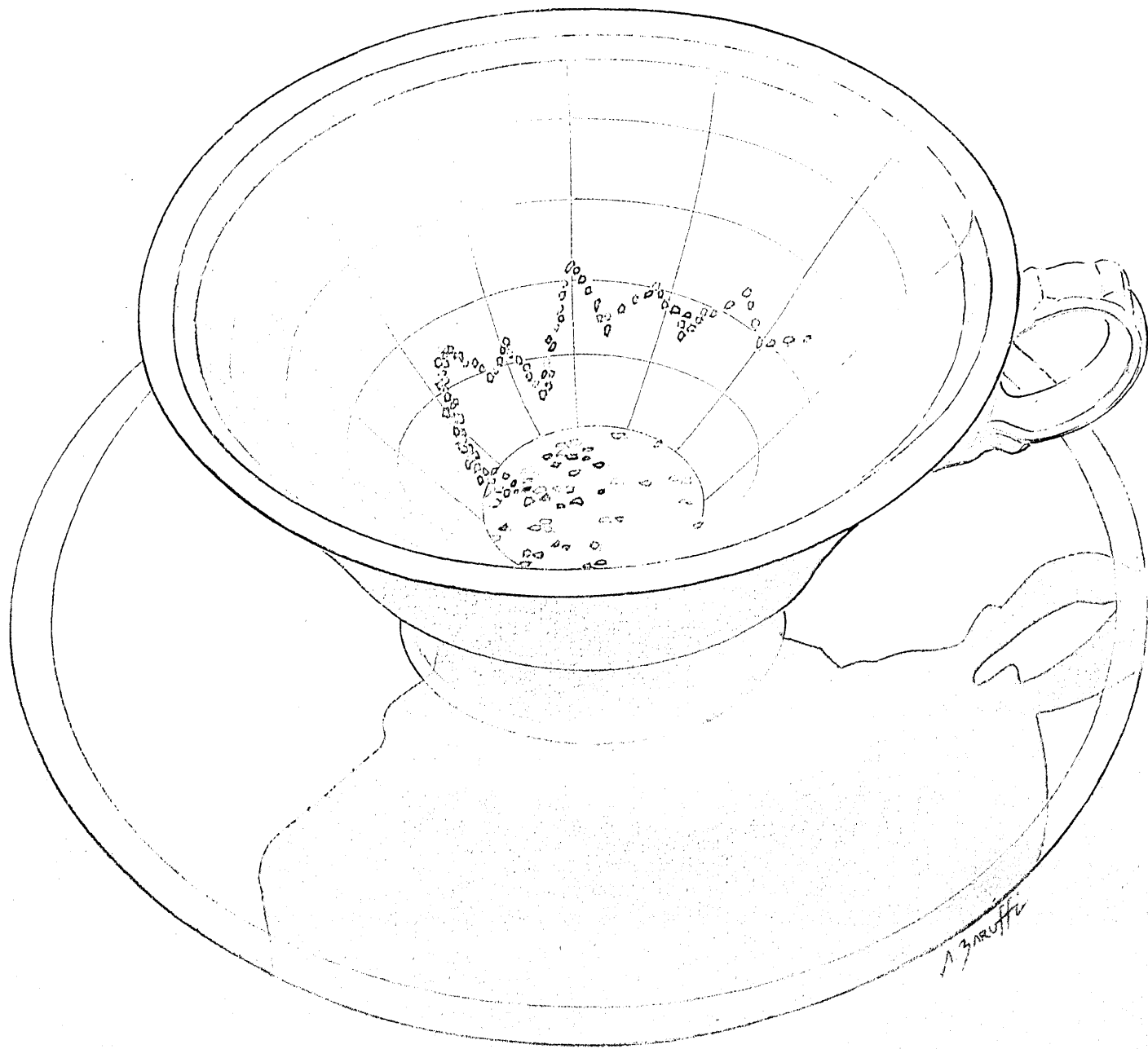

## IN FOCUS

market share of the chip business. He also says that "when the estimate of what we're doing is wrongly perceived, there are times when it is to our advantage to correct that impression," rather than remaining mum about production, as in the old days when the industry was much more contained.

Increased competition and the exploding growth of the computer industry mean more business, and competition, for the market research firms, at least in the short term. "The future planning industry is taking off," suggests Dale Kutnick, director of research for the Yankee Group. "In the 1950s, information processing was only available for the top of the pyramid, only the Fortune 50 companies needed computers." Today, the local hardware store is in the market for some kind of computer, and vendors want to know what that business owner wants. Increasingly, the market research firms say, what he wants is not very different from what the larger company wants, and vendors are going to have to adjust their target market and outlook accordingly when designing new products.

Kutnick oversees a staff of about 30 researchers from his terrarium-like office on the 14th floor of the Batterymarch Building, a renovated structure at the foot of Boston's financial district. A former "starving photojournalist," Kutnick is only the tip of the iceberg when it comes to the eclectic nature of the market research industry.

What most research directors look for in researchers are bright young individuals with superior writing skills, a good education, and the ability to become totally immersed in following the frenetic technology game. Long experience in the industry may or may not count—what is important is to be what Kutnick calls an "information junkie." Thomas Elliott, IDC's director of research, says he wants people with some quantitative background; his staff has several college economics majors as well as a couple of MBAs and a biostatistician.

Most of the researchers at Yankee and IDC are young and tend to leave the firm after two or three years, going to jobs in strategic planning departments of large computer vendors, or to consulting firms, Wall Street brokerage houses, or venture capitalists; there they can end up reading the reports they once wrote.

Other firms pull people from industry to watch those industries. Both Dataquest and InfoCorp are populated with analysts with five to 15 years of industry experience. Kutnick admits that his industry incorporates "the absolute best and worst of capitalism. Every time the computer industry goes up by \$1 billion, there are 100 new consultants and market researchers. [But] there really is a desperate need for information. If you're spending \$1 million on a system, you can spend some time with a group of people who spend their lives look-

ing at the industry. I'm not a panacea for your problems, but I'll build a case around why I think something will happen."

Kutnick's most recent success was calling the 10% price cut—in the form of a new model with 10% better performance—of the IBM 308X line at a conference Yankee Group held in February, just days before the IBM announcement. He had predicted the cut within six months. The last time he made a similar prediction, he was less successful: it took eight months.

The market-watching industry certainly has grown with the industry it watches. Twenty years ago, IDC surveyed the entire installed base of mainframe computers "simply to find out for vendors where things were," according to Ken McPherson, the director of market analysis and statistics. IDC was the first notch in the belt

**"We're going through a pruning exercise," says a vp for telecommunications. "We debated joining all of them, but we can't afford it."**

of Pat McGovern, whose empire includes a variety of computer industry publications. From that initial 1969 survey, IDC grew to a business that is estimated to gross \$25 million to \$30 million a year, a substantial share of the industry.

The second wave of market analysts entered the fray in the early 1970s. Dataquest was founded in 1971 by three market research executives—Ronald Miller, David Norman, and William Cogshall—from Creative Strategies, one of the earliest companies to set up shop in what is now known as Silicon Valley but in those days contained more lemon trees than silicon chips. Kenneth Bosomworth left a telecommunications consulting firm in Paris to start International Resource Development at about the same time, and Howard Anderson was hanging Yankee Group's shingle after receiving an MBA from Harvard and a stint with a Japanese component manufacturer.

Another big wave was begun by Gideon Gartner, who left a job in strategic planning and marketing with IBM in the early '70s to become a Wall Street-based IBM-watcher first for E.F. Hutton, then for Oppenheimer & Co. In 1972, when *Institutional Investor* magazine named him to the "All America Team" of analysts as the ace IBM-watcher on Wall Street, he decided that vendors might be willing to pay for detailed IBM reports. Since beginning the Gartner Group in 1979, the company claims to have attracted more user clients than vendors. Over the past two years, users have become the tail that wags the vendor dog.

The year after Gartner began his business, the wife and husband team of Portia Isaacson and Egil Juliussen began Future Computing, which follows the person-

al computer industry and is possibly the most widely quoted source on the subject in both the lay and the specialty press. Recently, firms such as Input and Gnostic Concepts have carved out specialties in surveying and keeping track of the software market, an area that David McDougal, senior marketing analyst for Input, says is sure to grow in the future.

InfoCorp was the last major entrant to the game, in 1981, and executive vice president Skip Bushee doesn't think many more people will be able to hurdle the increasingly large financial barrier—nearly \$1 million in capital is needed to get into the full-service market information field.

Of course, "anyone with a few thousand dollars can write a newsletter and call himself a computer guru," says Ralph Finley, general manager in the technology division at Dataquest. That newsletter is sure to get a dozen subscriptions, because, as Finley says, "Big companies like IBM or Xerox will subscribe to anything once."

While the number of clients for any one market research firm might be growing, a number of old customers are becoming more selective about the services they buy. "We're going through a pruning exercise," says John Doggett, vice president of telecommunications for the Bank of Boston. "There are new newsletters all the time, daily newsletters about the communications industry and newsletters to keep up with Congress. We have newsletters of newsletters, synopses, and abstracts." Doggett has cut back to subscribing to one full service, which he declines to specify. "We debated joining all of them, but we can't afford it."

The market research explosion is now an industry that in 1984 will have total billings in the vicinity of \$100 million. The IDC survey now counts over 180,000 systems installed in over 100,000 sites. The Gartner Group, in a joint venture in 1982-83, conducted what it considers to be a more detailed survey of the dp environment at 8,000 sites, and includes medium- as well as large-sized systems.

These surveys are purchased and the numbers churned through the computers of large companies so that the marketing and strategic planning departments can make projections about what the markets will look like in the next half decade for the products they make, the products they use, or the products they are thinking of purchasing. These same numbers are crunched and re-crunched by IDC or Gartner, while other companies crunch numbers they derive from survey data they gather, have gathered for them, or purchase from information providers such as IDC.

Then the companies that buy the raw data and crunch it themselves purchase the services of market consultant to see how their internal findings jibe with the wisdom purveyed by the wise. Just to be sure they



# WHEN IT COMES TO SOLVING BUSINESS PROBLEMS, ONE COMPANY IS A MILLENNIUM AHEAD.

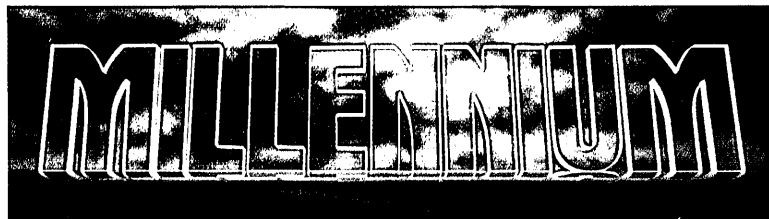

Several years ago, a team of McCormack & Dodge researchers uncovered a remarkable paradox in business software:

Business problems don't fit into compartments. Yet even the most sophisticated software packages operate on the principle of compartmentalization. In the very same vendor product line, you find general ledger packages designed one way, accounts payable another, fixed assets yet another. In actual use, these separate designs become separate walls. Barriers to problem-solving.

Because McCormack & Dodge researchers identified this paradox first, we are years ahead of the industry in overcoming it. Our Millennium series is designed and built, from the ground up, as a genuinely borderless product line. A true family of systems in which the whole works as smoothly as any part, making the most efficient use of all your data processing resources.

With Millennium, and only with Millennium, a business person asking a question in one system can instantly enter a correction in another, seek an answer in a third, update a fourth—and move with total freedom through the entire vast information universe.

When it comes to solving business problems, McCormack & Dodge is a Millennium ahead. Shouldn't you be too?

## WHEN YOU THINK ABOUT TOMORROW, MILLENNIUM MAKES SENSE TODAY.

### McCormack & Dodge

**DB** a company of  
The Dun & Bradstreet Corporation

McCormack & Dodge Corporation, 1225 Worcester Road, Natick, MA 01760  
Sales and support offices throughout North and South America, Europe, Asia, Australia and Africa. 800-343-0325. Telex: 710-325-0329

CIRCLE 19 ON READER CARD

## IN FOCUS

are on the right track, the vendors often hire consultants to perform studies to help plan the future. But guess what reports the consultants buy so they, too, can keep track of the markets? Guess where they get the raw information they churn in their computers?

Of course, this way of doing business has its critics. Not enough primary research is being done by these market watchers, and there is an excess of interpretation and recycling of information, contends James Heiman, president of First Market Research, Boston. "They market their own internal knowledge of the industry," he contends. "They draw conclusions and make recommendations based to a large extent on their own perceptions. The experts then become the end consumers of the research."

Heiman adheres to a more structured research approach. First a "focus group" of six to eight users is set up to gain a rough idea of their views. Then, surveys are taken to sharpen the information obtained in the focus groups. More systematic research, he maintains, "is less susceptible to the whims of the individual" writing the report.

In addition to buying the services of these companies, vendors often use the services to float ideas and product announcements, and to test the waters for rumors about their companies. This two-way relationship is possible because so much of the research, except for user surveys, is done by calling vendor A and speaking to him about his products, which he usually doesn't want to talk about, then asking him what he knows or hears on the street about vendors B, C, and D.

**"Anyone with a few thousand dollars can call himself a computer guru. Big companies like IBM or Xerox will subscribe to anything once."**

Some clients now welcome the quid pro quo inquiries—if they are working on a new project, or trying to change their image or find a new market niche. "It's important for us to keep them aware of company developments because they are key opinion makers," says Jeffrey Bartman of Data General Corp.'s public relations department. "We have made a push to be more in contact with them than in the recent past. We're now on the phone with them nearly as much as we are with the press." The market watchers, Bartman says, form a continuum along with the lay press and the trade press on one side and the Wall Street analysts on the other side, as the most important constituencies to keep in touch with.

A close bilateral relationship also benefits the research companies. The Gartner Group considers itself "at the hub

of information," according to Mark Ludwig, corporate vice president. "There is a sort of internal intelligence. If we hear something from 10 clients, we send out the information and that generates more information from other users."

This research methodology of touching base with all the major players helps keep track of industry scuttlebutt and keep the firm's name around. But if the information gets caught up in a whirlwind of rumor mongering, it can turn into no more than a chain letter or a game of "telephone."

So, while these firms, and sometimes the personalities that head them, are considered by some to be the prophets of the computer age, the gurus of the industry, there are those who appear as snake charmers and carnival hucksters. A recent profile of Yankee Group president Howard Anderson told readers how he mixes "hype with high tech." Indeed, some of the Yankee Group's detractors, both competitors and former clients, have suggested that Yankee supplies more sizzle than steak in its reports, often restating the obvious and not going beyond public knowledge.

But don't try to get too many of either Yankee Group's—or any other company's—clients or competitors to badmouth them, or at least not on the record. Because the industry is so uncertain, everyone must maintain relationships, and a permanent, mutual back-scratching society has formed around the industry. And why not, with growth rates often hitting 50% annually and better, no one really has to get into any mud-flinging contests over market share. Yet some research is less than "prime" quality.

"They're into form more than substance," comments one competitor of Yankee Group. "A lot of what they do is showmanship." Another competitor mentions Yankee as part of the vast majority of the industry whose "standards for quality are damn loose" and whose work is "spotty."

"I've watched the industry mature," says one corporate user, an in-house consultant to an oil company. "Some of the players haven't matured yet. They're 'selling papers' and they've found you can sell them with sensationalism." He recently dropped the Yankee Group's service and now subscribes only to the Gartner Group, because, he says, Gartner is the only service that provides reasoning to back up the company's opinions.

Kutnick discounts the criticism by saying that his firm provides three things: a synthesis of all the free-flowing bits of information that need to be taken together and considered; constant vigilance in an industry that is too big for small in-house staffs to monitor; and a perspective to keep in-house staffs from becoming inbred and succumbing to internal politics. He likens the task to

putting together an ever-expanding jigsaw puzzle.

During the interview, Kutnick was interrupted for a moment to discuss the design for T-shirts to be given away at an upcoming seminar. This razzle-dazzle kind of revival meeting-cum-industry seminar is looked down on by some, but in the form-equals-substance world of consulting and market analysis, the clients seem to love it.

There is also just a whiff of scandal in the methodology, the idea that the information these companies obtain is somehow the fruit of low-level industrial espionage.

**"You can't get ahead of anybody else with market research [but] it can minimize the risk of anything you do."**

In fact, late last year the Gartner Group and IBM settled a theft of secrets suit filed by Big Blue. Without admitting guilt or innocence, Gartner Group agreed not to use information that IBM considered proprietary. Furthermore, the market research firm agreed to aid IBM in any investigation of such disclosures. Gartner Group officials contend that the agreement will not infringe on its ability to gather information.

"None of our businesses would survive if we were in the business of espionage, because espionage is not reliable," explains Ludwig. "The essence of good strategic planning is not in knowing what you shouldn't know but knowing trends. We know more about the markets than our clients do." Ludwig likens the relationship between information vendors and their clients to that of the proverbial "insider" at the racetrack and the average bettor. "They don't know what the jockeys have talked about. They don't know much about horses. But they do know about the track. If they have a good informant they'd be willing to pay a lot of money. What we say is, 'Hey, we went into the locker room and talked to the jockeys.' The value of the information to the people is huge, depending on how it's being used and how good it is."

Each company packages its product somewhat differently, but the basics are research reports, newsletters, attendance at seminars, and unlimited call-in query privileges. Yankee Group adds an on-line query service, while Gartner sends "Gartnergrams" (bulletins by mail) when it has a hot item—"something that is a little more than a rumor but not quite a fact," as Ludwig puts it. Gartner attaches a confidence factor to each item of between 0.1 and 1.0.

On Jan. 16, for example, a Gartnergram said that AT&T may cut its staff by 30,000 people in 1984, and ascribed to that note a confidence factor of 0.7 out of the 1.0. That hasn't happened yet, but here's a prediction that came true: On Feb. 15, the company forecast that IBM would cut prices



# SPACE MANAGEMENT, NATURE'S WAY.

**Our Space Management System  
Does Something Nature Doesn't Do.  
It Increases DASD Performance  
While Reducing Cost In OS/VS  
Environments.**

More than 650 Cambridge customers worldwide recognize *ASM2, Automated Space Management*, as the leading high-performance DASD management system. It archives, restores, backs up, and migrates data. Plus it provides comprehensive DASD analysis tools.

Best of all, ASM2 optimizes critical DASD space in the operating system so efficiently, it can easily pay for itself within a year.

For enhanced system flexibility and DASD billing, ASM2 offers a feature called Report Selection and Variable Processing (RSVP). With RSVP, users can enforce individual DASD management standards, customize formats, and determine their own report content with just one simple command.

ASM2 increases efficiency with a new data restoration facility called *Intelligent Transparent Restore (IXR)*. It's intelligent because you'll never have to pre-check data set availability or issue manual restore requests again. What's more, IXR's unique "look-ahead approach" allows far more data to be archived and retrieved. IXR: Intelligent. Transparent. Automatic.

ASM2... a more natural space manager would be very hard to find.

So call or write The Cambridge Systems Group today. Ask for an on-site, on-line ASM2 demonstration with *your own data*.

The Cambridge Systems Group



24275 Elise, Los Altos Hills, CA 94022, U.S.A.,  
(415) 941-4558 • Telex 357437

London Paris Munich

CIRCLE 20 ON READER CARD

## IN FOCUS

within the next two weeks on the 308X mainframes, and gave it a 0.8 confidence level. The IBM announcement came two weeks later.

International Data Corp.'s specialty is its hard-core numbers: the survey. From that survey, the company divides its information service into a number of packages dealing with over 25 areas, such as the communications industry, electronic office, information systems, videotex, and computer integrated manufacturing.

The main body of knowledge for each continuous research service is a loose-leaf binder that is updated annually with chapters about all the components that make up that industry. As certain segments of the market become more prominent, their chapters get larger, while other chapters dwindle and fade away as certain market areas become nonexistent. IDC's research is almost completely directed by the researchers who follow the industry.

At the other end of the spectrum is Input, based in Mountain View, Calif. Input's clients, mostly software vendors, are polled yearly in the fall to see what specific areas they would like to see the 70 or so researchers cover in the company's five continuous research packages: market analysis and planning, information systems program, customer service program, company analysis and monitoring program, and federal information systems and service program. For \$8,500 and up per subscription, David McDougal, senior market analyst for the company, contends that the client has a right to help determine the areas studied.

Another kind of work Input and others do is multiclient reports. To do this, McDougal says, the company decides it

would like to do a one-shot report, then tests the waters among subscribers and prospects to see if there is enough interest to make it cost-effective. If there is enough interest, the project is undertaken, with all those who were contacted and who agreed to buy the report helping to shape the focus of the research. When the project is complete, participants take part in seminars, receive reports and background information, and are able to call in queries about the report on an unlimited basis. The report is also released to anyone who would like to pay for it after the fact. The reports can cost as much as \$12,000 per project.

International Resource Development is one of the firms in the business of doing only one-time reports. With a small staff and utilizing a number of independent consultants, Bosomworth estimates his company will produce about 100 reports in 1984, each costing subscribers between \$1,000 and \$2,000 per copy, and selling anywhere from a couple of dozen to a couple of hundred copies.

"We're looking for information gaps," Bosomworth explains. "First, we have to identify the information gap." An idea is generated either by a researcher, customer queries, or an outside consultant who queries the company much as a prospective author would query a publishing company. Then the study, which takes from a few months to two years, is commissioned, and the sales force starts to seek customers from among the 9,000 previous purchasers of reports or any of the 450,000 other prospects culled from 493 lists, including the subscribers to the company's three newsletters.

"What we're able to do is spend

several million dollars of our own to produce a report and deliver to companies reports at one twentieth or one thirtieth the cost they would pay to do the work in-house," Bosomworth contends.

By heavily utilizing outside researchers and authors and not gearing his organization to having a certain amount of clients at any time, Bosomworth says he is better able to suffer the vagaries of the market research business. "A lot of people get into the industry and find out they can't service the customers. You have an Information Gatekeepers [Brookline, Mass.], in Chapter 11, Yankee Group hiring people madly one week and letting go 24 the next, including two they had hired the week before, and Input reducing its staff by 40% overnight. There are lots of symptoms of flaky management in this business." Indeed, in August 1982 Yankee Group laid off 25 employees; most of the positions have since been reinstated. As for Input, a company official acknowledges minor cutbacks in 1982.

Trying to check a company's prediction accuracy is difficult. They often make predictions for what the world will look like five years hence, and few customers retain discredited forecasts. But both information providers and clients guess that they guess somewhat better than 50% on specific short-term projections such as price cuts or who will introduce what types of products into the market in the next three to six months. A typical bull's eye: to determine how many PCs IBM will ship in a year, one group added up all the keyboards shipped to IBM by various component vendors since, as one analyst puts it, "every PC has one keyboard."

In the end, 100% accuracy is not expected, but consistency is. "Since what we purport to do is give you information about the future and since nobody has a crystal ball, what people want is a constant set of assumptions," says Thomas Elliot, director of research for IDC.

Ken McPherson of IDC puts it another way when he says that "the 'efficient market theory' says that it is impossible for all these market prognosticators to beat the market because all the information is out there. But all the information is out there because of all the market prognosticators."

David Welch, who manages the marketing communications center for Hewlett Packard, agrees. "You [the vendor] can't get ahead of anybody else with market research. It gives you a lot of answers, but everybody has those answers. The reason you buy research and do marketing research is to minimize the risk and reduce the uncertainty of anything you do." \*

Jon Zonderman is a free-lance journalist in Sommerville, Mass., who writes on business and technology.

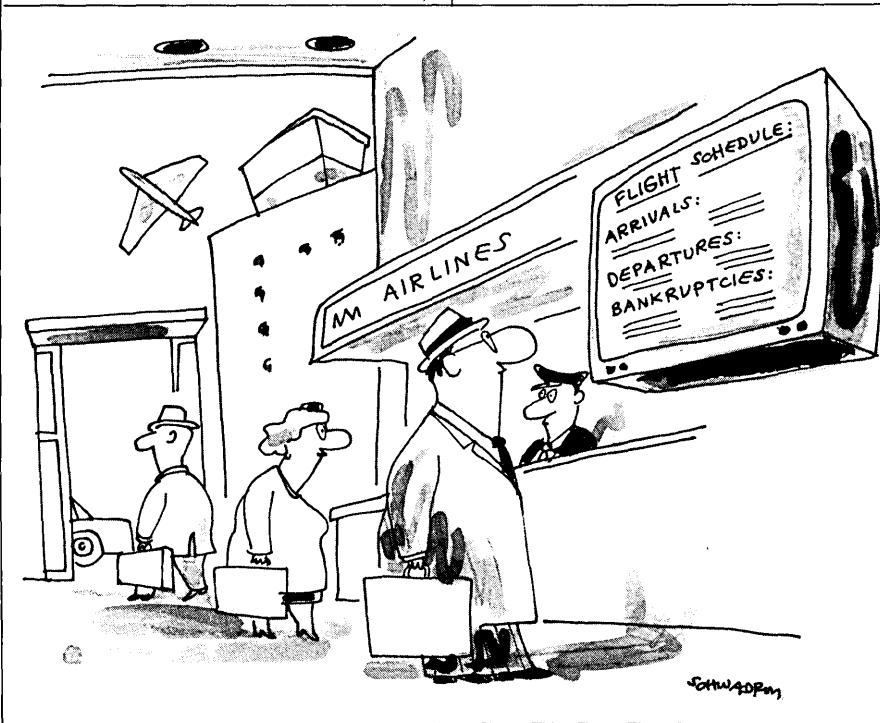

CARTOON BY HARVEY SCHWADRON

# Get the Picture?

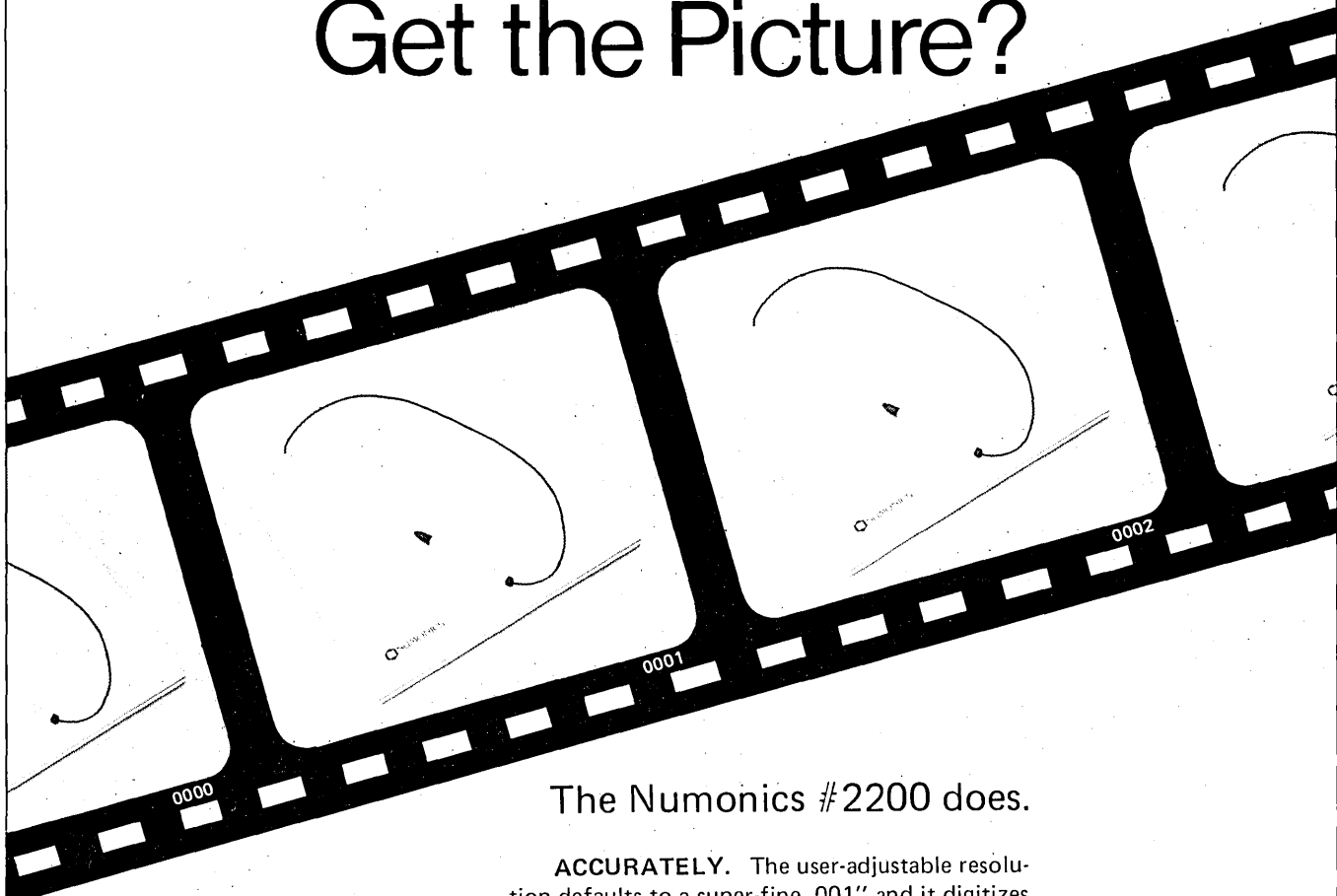

The Numonics #2200 does.

**ACCURATELY.** The user-adjustable resolution defaults to a super-fine .001" and it digitizes up to 200 points per second.

**FLEXIBLY.** The #2200 tablet operates in point, stream, incremental, or switch stream modes. Standard firmware includes self-diagnostics, HOST override of switch-settable functions and matrix menuing.

**RELIABLY.** Numonics products are designed and built with the highest standard of design and procedure documentation, Q.C. inspection and testing and complete product traceability. We are totally accountable, always. The name Numonics says it all.

**INEXPENSIVELY.** The price will astonish you. It's unheard-of with technology like this.

Get the picture:

See it at the NCGA Booth 658-660

Or write:

 **NUMONICS**

418 Pierce St., Lansdale, PA. 19446  
(215) 362-2766; TWX 510-661-6585

# DON'T LET THE STEPS KILL YOU.

**Take The Ramp.** ROLM has perfected a breakthrough communications controller: The CBX II.

It's the centerpiece for a spectacular new ROLM® business telephone system — the fastest, most advanced way to manage voice and data in the world.

Instead of the typical stop-start steps of expansion, CBX II lets you grow smoothly,

easily and very, very cost-effectively.

You can move up The Ramp from sixteen phones to more than ten thousand phones, terminals and personal computers. You can store and forward messages. You can monitor costs. You can have the least expensive long distance routes automatically, instantly. You can even network networks, from Dow Jones to the IBM Infonet. And we're plugged into



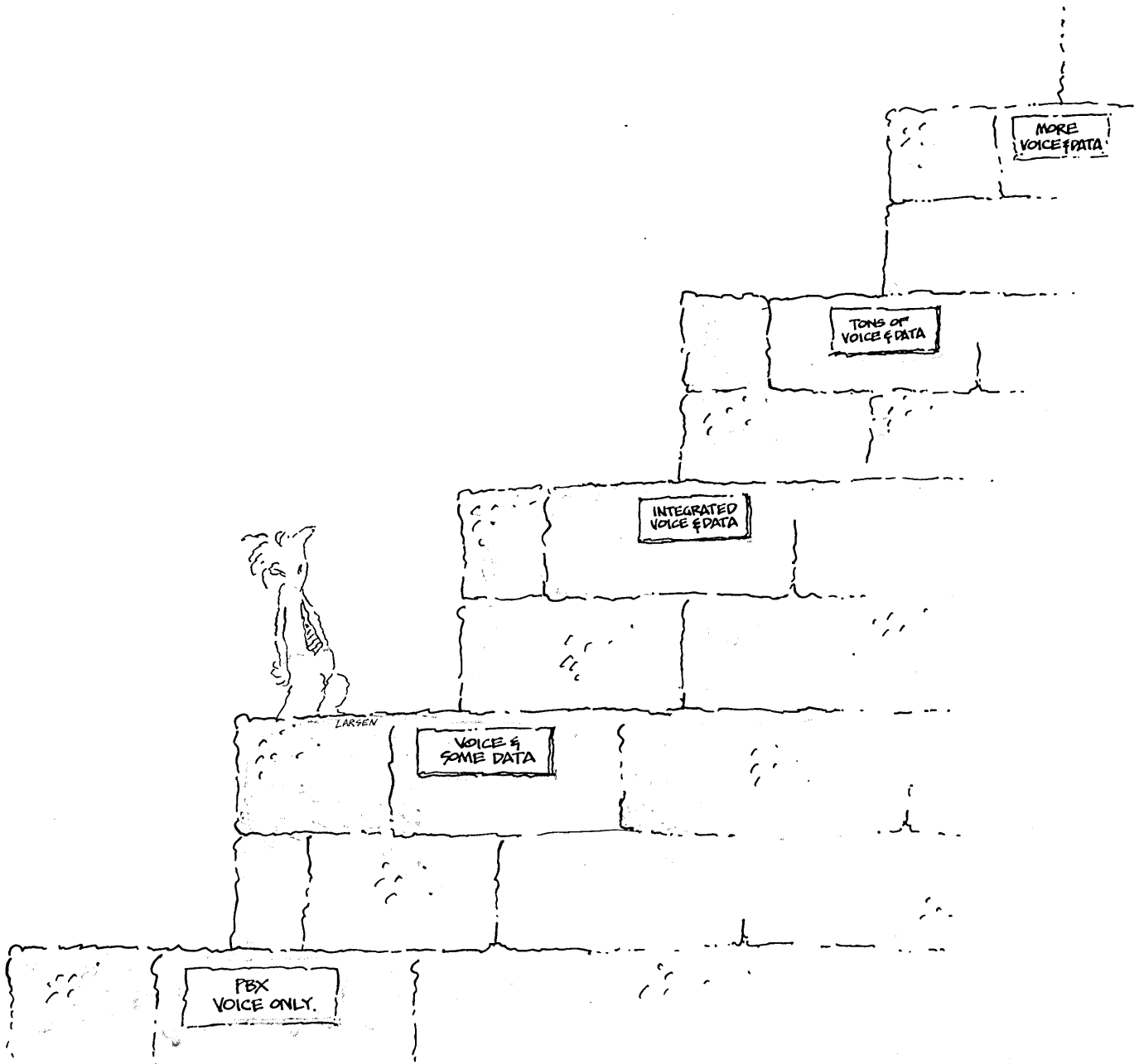

IBM and HP and DEC and Data General and the other movers and shakers to guarantee that we can take their new products and new systems in stride.

The CBX II is just the latest reason why ROLM is the choice of more than two-thirds of the *Fortune 500* companies, why more than fourteen thousand ROLM systems are up and running today.

When it's all said and done, the best thing about The Ramp is that it ends that recurring nightmare that you may be buying a business communications system that can't grow, can't change or has a big, gee whiz capability missing.

You can make your life a lot simpler. Just skip the steps and take The Ramp.

**ROLM**

4900 Old Ironsides Drive, M/S 626, Santa Clara, CA 95050 • 800-538-8154. (In Alaska, California and Hawaii, call 408-986-3025.)

CIRCLE 22 ON READER CARD

# NEWS IN PERSPECTIVE

EXPORT—IMPORT

## A NOISY TURF BATTLE

**The Departments of Commerce and Defense are still fighting over who should control exports of computers.**

by Willie Schatz

Oh, what a tangled web the U.S. is weaving as it tries to prevent its enemies from receiving.

The web, of course, is the Export Administration Act (EAA). It is designed to maximize American trade profits and minimize American technology losses to Eastern-bloc countries. The EAA looks great on paper. The problem is that it doesn't sail very smoothly in the trade winds. And the trip is about to get much rougher for the computer industry.

The seas are already high in Hong Kong. At a recent meeting with Department of Commerce (DoC) and General Accounting Office (GAO) officials, three senior managers of Cable and Wireless (C&W), the British operator of Hong Kong's international and domestic telecommunications networks, attacked U.S. export controls as "totally unpredictable" and said that continued uncertainties and onerous paperwork would make it "totally impossible to do business with the U.S."

The meeting was described in a telegram sent by Lyn Edinger, Hong Kong foreign commercial service officer, to the DoC in Washington. Also present at the meeting was Bill Newman, project manager of the GAO team making a 26-country study of the impact and effectiveness of U.S. export controls.

C&W had requested the meeting to express its dismay over U.S. export controls and specifically to complain about licensing delays concerning Asianet, a \$200 million regional communications network being developed for the Bank of America.

C&W, a wholly owned subsidiary of Britain's Cable and Wireless PLC, operates all of what the telegram calls Hong Kong's "extremely profitable" international communications links. C&W is also the principal owner of Hong Kong Telephone Co., has taken a starring role in developing telecommunications facilities in South China, and is the principal worldwide developer of ocean cable links.

C&W is the principal Hong Kong distributor for 52 foreign manufacturers, 32 of them from the U.S. So it bodes ill for U.S.

business when C&W general manager Chris Cox tells his visitors that "two years ago, we were dealing primarily with U.S. products . . . but due to a series of embarrassments caused by delays and confusion in export licensing, we've moved away from U.S. products and by next year may not be taking any U.S. equipment at all."

Next year has already arrived for Asianet. According to Edinger's telegram, Cox "alleged" that the initial phase is being held up solely by delays in the supply of Racal-Milgo modems. Racal-Milgo is the Miami subsidiary of British vendor Racal Ltd. They are to be sent to Hong Kong for testing in the system before it is installed in various Asian bank centers.

"The failure of the U.S. government to grant the required licenses (allegedly because the system shall be reexported from Hong Kong to multiple Bank of America centers)," Edinger wrote, "have determined [sic] C&W to minimize the use of American products in similar projects in the future. In phase II of the project, Italian modems will be purchased. Racal-Milgo, long the major supplier to the Hong Kong market, will be dropped."

Both Racal-Milgo and Bank of America deny this. "The truth of the matter now is that Racal-Milgo will be used in the Bank of America system," company spokesman Rich Nathanson says. "The initial cable that went through was erroneous. I don't have any question at all about us being used in Asianet." Bank of America deputy director of media relations Ray Toman says the bank was unaware of anything other than "a little glitch" due to the export laws and that Racal-Milgo modems are still being used for Asianet. Nathanson also says that a correcting telegram was being sent from Hong Kong to the DoC. At press time, no such telegram had been sent.

The GAO's Newman, however, confirms the accuracy of the telegram. He also

**"Racal-Milgo, long the major supplier to the Hong Kong market, will be dropped," the cable reads.**

notes that C&W presented documentary evidence that it would not use any U.S. firms in developing a microwave communications net in China. Additionally, C&W says that in a recent offer for a \$25 million government project in Singapore, no U.S. product would be incorporated. Two years ago U.S. goods would have made up the bulk of the C&W package.

Products from the U.S. constitute an "unacceptable risk," according to Cox. He also says DoC's recently proposed changes in the distribution license procedures would be "devastating" to sales of U.S. computer and telecommunications equipment in the Hong Kong market. If these changes come to pass, Cox says his

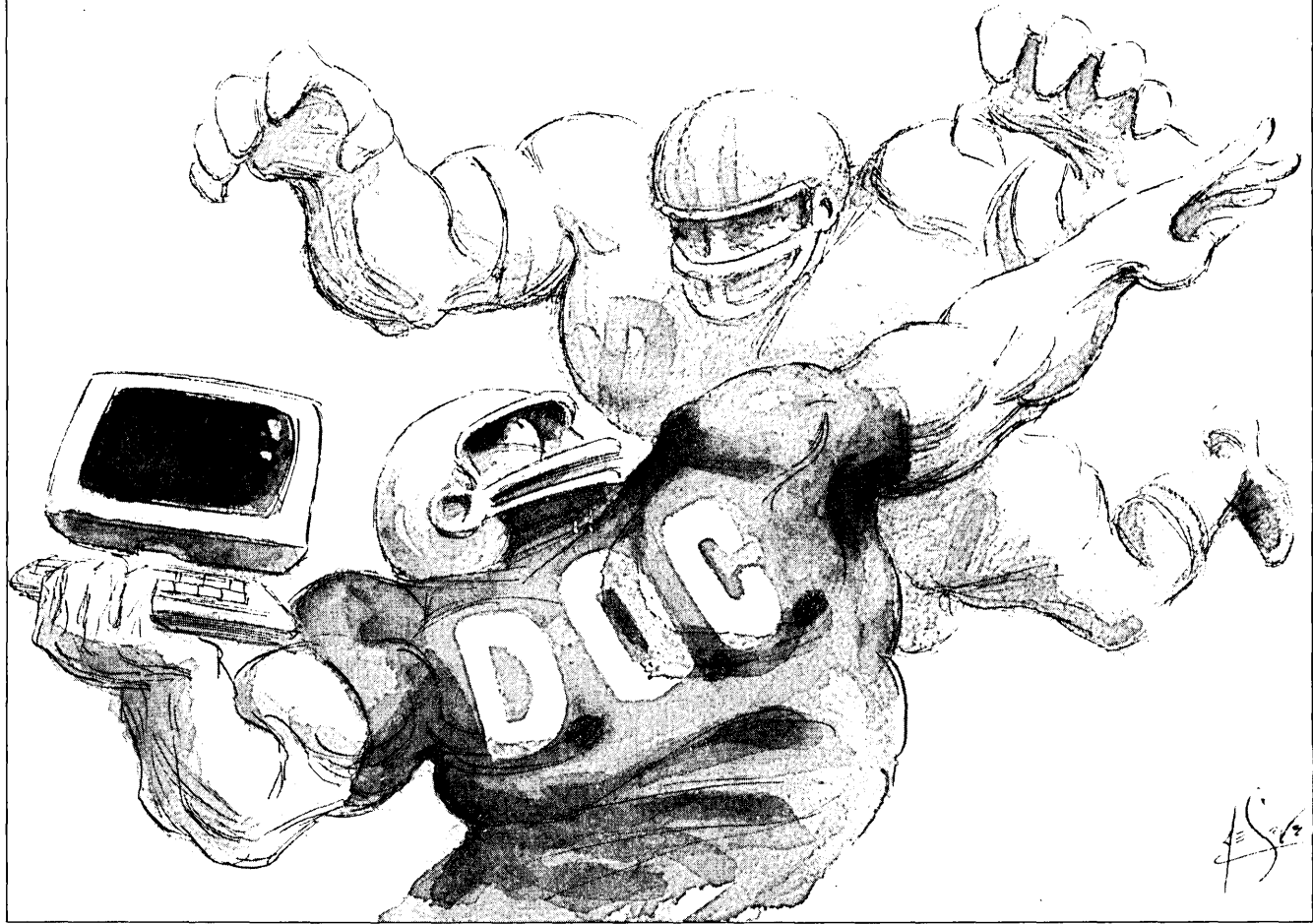

firm and other similar ones in Hong Kong would quickly and happily find alternative European and Japanese suppliers.

"Once people turn away and find out there are other sources," Cox warns, "they're not going to turn back."

The turn-away posture may become a very familiar pose to the U.S. computer industry. Recent changes ordered by President Reagan pursuant to the EAA have given the Department of Defense a greater voice in reviewing who sends what where. Industry would have been a whole lot happier had DoD been muzzled.

DoD and DoC will now review simultaneously individual validated license (IVL) applications for 13 countries and seven product categories. Although mum's absolutely the official word, the countries include Austria, Sweden, Finland, Hong Kong, Singapore, South Africa, India, Liechtenstein, and Switzerland. The products encompass computers, silicon parts, microcircuits, lasers, semiconductor production equipment, sapphire substrates (used for microchip manufacturing), and two classes of precision measuring devices.

Reagan also made a few other moves. He reaffirmed his opposition to any statutory change relating to Defense review of licensing and to EAA enforcement. He

granted DoD the authority "in principle" to review distribution licenses under strict statutory time limits. The agency now must present "specific" objections to any licenses. He established a monitoring committee, chaired by National Security Council (NSC) aide Don Fortier, to ensure that DoC and DoD are moving in the right direction. This formally confirms the NSC's role in this affair. Sources said that national se-

**"Once people turn away and find out there are other sources, they're not going to turn back."**

curity advisor Robert McFarland had taken an active part in the discussions.

The whole subject has been kicking around since last June 10, when then acting assistant secretary of commerce for export administration William Archey wrote a memorandum of understanding regarding DoD's role in reviewing IVLs for non-Communist destinations.

That memo would have allowed DoD to review "upon request" applications for IVLs for eight products, including computers and digital instruments, controlled for national security purposes and going to 12 countries, including eight of those men-

tioned above. DoD would have given DoC one person for four hours a day for pre-review, would have notified DoC withing seven days of filing an application if it wished to review it, and completed its review within 30 days of its referral by DoC.

Neither assistant secretary of defense for international security affairs Richard Perle nor then assistant secretary for trade administration Lawrence Brady signed that memo. Had they done so, the EAA problem might have been put to rest six months ago.

Now, despite Reagan's directive, the issue is very much alive. Both the Senate and the House have passed new versions of the EAA, which was scheduled to die its fourth death on March 30. The act had already been extended three times, once by presidential emergency, past its original Sept. 30, 1983 expiration. Rep. Don Bonker (D-Wash.), principal author of the House bill and industry's man, kept his promise and did not request another extension. The act still lives, however, thanks to Reagan again invoking the International Emergency Economic Powers Act. At press time the Senate and House had not agreed on a conference date, although sources indicate the two would at least sit down at the same table before the April 13 recess.

## NEWS IN PERSPECTIVE

### DEC GETS IT FROM DOC

With friends like the Department of Commerce (DoC), who needs enemies? Surely not Digital Equipment Corp., which gave the agency everything it wanted. Commerce then turned around and apparently paid the company back—in spades, hearts, diamonds, and clubs.

DoC made it much tougher—not that it was ever a picnic—for DEC to ship any of its computers to West Germany, Austria, and Norway. Two months ago Digital could ship computers to those three countries with few—maybe even no—questions asked.

The company can now kiss those halcyon days goodbye. When DEC's general export distribution license (DL) came up for renewal, DoC gave it a two-month lease on life, rather than the usual two years. DEC now must obtain time-consuming individual validated licenses (IVL) to ship computers to any of those three countries. The company must also certify the reliability of the overseas end users of all its VAX systems and VAX-unique peripherals, including describing how the customers intend to use the equipment. Not quite the users' life story, but close.

The problem, dear exporters, lies not in DEC, but in its product. The VAX made headlines last November when pieces of its equipment were seized in West Germany and Sweden. The computer apparently lends itself to military use and doesn't require much maintenance, a commodity in short supply in those parts where people would steal for a VAX. The three named countries are suspected of being key diversion points. In all this to-do, DEC has remained blameless for the diversion and has cooperated fully with the government.

"We're very sympathetic to their problem," admits a knowledgeable source at one of DEC's major competitors. "What Commerce has done is terrible. It's absolutely wrong. DEC has been made a scapegoat. The connection between the DL and diversion has never been made. Neither has

the connection between diversion and DEC.

"This was done in a very politically charged atmosphere. The DL is what makes the system work, to the extent it does at all. If the DL is choked off, the system will creak to a halt. If you need an IVL every time you send a product, you're sunk."

Digital seems to be swimming quite nicely, thank you, at least for the present. The company treats this as much ado about nothing.

"We haven't been made a scapegoat," DEC spokesman Dick Berube says. "We've been cooperating with DoC for a long time. This wasn't a shock, given the circumstances. Those are reflected in the license restrictions.

"The license isn't onerous. It obviously involves more paperwork, but Commerce has been really good on turning that paperwork around. It hasn't impacted our business and we don't expect it to. [European sales account for about a quarter of DEC's revenue.] We obviously support the effort to eliminate diversion. We just hope DoC doesn't undermine our competitive viability in the process," Berube claims.

Aye, there's the rub. If DoC did this to DEC, can others be far behind? Several heavyweight companies, including IBM, are due to have their licenses renewed in the next few months. If there's a hit list, no company wants to be number two.

"This was done in an extraordinarily charged political environment," says the official at Digital's competitor. "DoC has a vested interest in looking tough. This is very significant if it presages DoC's attitude toward other companies. We haven't been approached yet, but we're very concerned this is in the cards.

"Commerce just took its proposed regulations and applied them against one company. They obviously don't want the regulatory process to run its course."

That marathon began on Jan. 19, when DoC proposed new regulations that

would significantly tighten existing DL procedures (see "Export Laws on the Line," March, p. 44). Even though the agency extended the subsequent comment period to April 6 from Feb. 21, there is considerable worry that what industry writes Commerce won't read.

"It doesn't make sense that the Defense Department can't look at West-West transactions if there's a reliable reason to expect diversion," says Boyd McKelvain, manager of national technology affairs and vice chairman of the Industry Coalition on Technology Transfer, the leading high-tech industry group on these issues. "But these proposed DL changes could be a hell of a mess. They're going to superimpose more delay on the already high volume of transactions. And it's hard to find any changes that would effectively tighten up on losses."

There's no doubt the tighten-up is the latest dance craze at Commerce. The question is when DoC is going to change partners and how closely that partner will have to follow the agency's tune.

"The worst outcome is that we get picked off company by company," frets an official at a major computer company. "The proposed regulations could do that all at once, of course. None of the restrictions in those are relevant to national security. But that's the kind of thing that can kill exports." No funerals are planned just yet. But black may become high tech's new in color.

"Everybody has to be concerned with an environment where the thrust for tightening goes beyond the point of being realistic because of turf battles," warns McKelvain. "That's what's going on now. And it's all driven by the desires of the administration."

So what kind of a ride will this be? Not even the passengers know for sure. But industry is hereby advised to fasten its seat belts. **W.S.**

"In the space of three months the administration has all but rewritten the Export Administration Act, without consultation with Congress and the industry and of course without hearings and much opportunity for comment from the public and our allies," Bonker told the Washington International Trade Association (WITA) in March. "Some accuse the Congress of major changes in its revision of the EAA, but our craftsmanship is mild and artful compared to the administration's emasculation of the program. What the administration has done is considerable beyond what the Act allows, and is clearly beyond what Congress intended.

"What is happening may be an old-fashioned turf battle with DoD the obvious winner. But my guess is that there is an

ideological force shaping these new policies, that if left unchecked will greatly inhibit America's competitive position in the field of high technology. One can safely conclude that the executive branch was go-

---

**"In the space of three months the administration has all but rewritten the Export Administration Act without consulting Congress or industry," says Bonker.**

---

ing its own way regardless of what Congress thought, intended, or attempted to accomplish in the EAA of 1984."

So what's Congress to do? It appears that Reagan has preempted the field

with his recent directive. And what about industry? It wasn't consulted prior to Reagan's move, just as it hadn't been before DoC released its proposed DL revisions.

"It's hard to say whether we won or lost," says Hugh Donaghue, Control Data's vice president of government programs and international trade relations. "But the principle bothers me. DoD got more power over an area affecting a significant amount of export business, although it's not as much as it wanted because Perle wants control over every shipment and every product. The thing that bothers me even more is that this can change for the worse later on."

"High-tech industry is a loser," Bonker says. "Congress has been preempted and so has industry. The administration gives Congress authority, then takes it away

# ADR<sup>®</sup> WARE<sup>™</sup>

## ADR/IDEAL<sup>™</sup>

More than just  
a 4th generation language.  
It's the only complete 4th  
generation system integrated  
with a relational DBMS,  
which lets you develop  
applications for high volume  
production, from the  
simplest to most complex.

We've taken state of the art to a new state: Easy and Available.  
Before you make a software decision, call ADR (201) 874-9000.  
Or fill out and mail in the coupon.

<input type="checkbox"/> Please send me more information about ADR WARE.	ID
<input type="checkbox"/> Please send me information about ADR seminars.	
APPLIED DATA RESEARCH INC. Route 206 & Orchard Road, CN-8, Princeton, NJ 08540	
Name _____	
Position _____	
Company _____	
Address _____	
City _____ State _____ Zip _____	
Phone Number _____	
Computer Equipment _____	
<b>ADR<sup>®</sup> WARE<sup>™</sup></b> From idea to application, we get you there faster.	

CIRCLE 23 ON READER CARD

## NEWS IN PERSPECTIVE

### THE EEC COMPLAINS

It doesn't happen often but sometimes the European Economic Community (EEC) members can agree solidly on an international trade issue.

In mid-March, at a time when the debate over U.S. export controls raged in Washington, D.C., the EEC, with the backing of all its member governments, sent letters of protest to 22 U.S. congressmen and five senators, stating in no uncertain terms what the EEC thinks about existing and proposed high-technology export regulations. The letter contained three major points:

- The community believes U.S. claims to jurisdiction over European subsidiaries of U.S. companies and also over goods and technology of U.S. origin are contrary to international law. If the U.S. maintains its position it will lead to political and legal clashes.

- Existing contracts should not be subject to legislation retroactively as this will lead to such uncertainty that concluding contracts will become a very risky business for all involved.

- Trade sanctions, in the form, say, of import restrictions, on a European-based company as a result of ignoring U.S. extraterritorial legislation are contrary to international law and the General Agreement of Tariffs and Trade (GATT). If introduced the EEC will look for a rejection of the penalties by GATT.

This EEC letter is not an isolated document but is characteristic of the ire U.S. export regulation actions have raised across Europe. Computer and other technology-oriented industries on both sides of the Atlantic are upset.

"U.S. and European businessmen have a common interest on this point," claimed Lionel Olmer, the Department of Commerce's under secretary for international trade, in a speech in London given to local and U.S. businesspeople. Olmer was attempting to counter British sentiment against proposed changes in U.S. export laws.

"On a commercial basis, we understand the problem," Olmer stated to an audience of obviously skeptical listeners.

and does whatever it wants. What we have to do now is roll back DoD's involvement via the legislation. We have to show that Congress is the final authority here, not Richard Perle."

Easier said than done. The major struggle will be over section 10(g) of the Senate bill, which allows the Secretary of Defense to review any proposed export by any licensee to any country to which exports "are controlled for national security purposes or where the Secretary of Defense, in consultation with the Secretary of Commerce, determines that there is a clear risk of diversion of militarily critical goods

"The U.S. government is principally concerned with enforcing Cocom regulations and agreements carefully worked out with our allies. We are not trying to stop technology transfer to our allies nor are we encouraging economic warfare but we are trying to balance real security concerns with the absolute need for open markets between our trading partners."

That is no easy task, and meanwhile the European governments are looking for ways to cope with what is seen as restrictive and provocative legislation.

One case in point is the plan to sell Bulgaria a System X digital telephone exchange built by GEO and Plessey in the U.K. The British government is debating whether it should give approval to the deal and risk incurring the wrath of the Reagan administration. Plessey needs the approval before making its final bid to Bulgarian authorities.

The problem is that such advanced telecommunications systems are not covered explicitly by Cocom regulations, which, though subject to updates and review later this year, are still based on a list of restricted goods drawn up in 1976. The arguments between Europe and America about how wide the Cocom net should be are still raging, and the System X contract may be used by the U.K. to test the strength of the U.S. as the dominant Cocom member.

The U.K.'s trade and industry minister, Norman Tebbit, has already called for the U.S. to show more "realism" in the way it applies the offending legislation. He also warned that such transatlantic obstacles in high-tech trade "must strengthen the argument for a British capability under British control, in strategic fields. Or, as second best, turning to another country with indigenous technology and without pretensions to extraterritorial jurisdiction."

That comment is representative of the way many European governments feel about the export rules, and with Europe the largest overseas market for U.S. goods, it is the sort of comment that sends shivers of fear through U.S. vendors.

—Paul Tate

or technology to proscribed destinations." Having so determined, the Secretary of Defense can then recommend to the President that the export be disapproved. You can bet the Secretary's word will be law.

Reagan's "opposition to any statutory change" apparently means he opposes 10(g). The provision is anathema to industry, which can use all the help it can get and insists that 10(g) absolutely not be included in the final bill. So even if Reagan won't join industry, he at least won't actively beat it. But several sources suspect Perle, operating behind the scenes, will harden the Senate's determination to see 10(g) become

law. If that happens, it will be much more difficult for industry to escape DoD's clutches than if Reagan's memo remains the basis for that agency's increased power. A memo is far easier to change than a law.

"Nothing good has come out of this," says a well-informed source at a leading computer company. "Reagan is presiding over the transfer of long-term authority to DoD. There's nothing inherently bad about DoD review. It doesn't have to be counterproductive. But history indicates it always is.

"In the long term DoC will cease to be a factor in export control. The DL is in serious jeopardy. I'm not sure we'll have one in a few years. The end might come even sooner. We're in bad shape."

"If they aren't checked, the administration's policies will impede our export potential," Bonker says. "It's hard enough coping with the overvalued dollar, and other obstacles may knock us completely out of the global market. If the new policies go into effect and are not checked by a new EAA, the U.S. may well win the security war but lose the economic war."

Today, Hong Kong. Tomorrow . . . ?

## MICROCOMPUTERS

# LOOKING FOR GENERICS

**The next generation of microprocessors will be more adaptable than anything we have yet seen.**

by R. Emmett Carlyle

Nestled deep in the womb of Data General's Advanced Projects Group, engineer Don Lewine is wrestling with a problem.

"I'd like to build a multispeed phonograph, or at least its equivalent in processor terms." Don remembers the days when there were only single-speed record players. The analogy, of course, is to the proprietary operating system and attendant hardware. In the record industry, 78 rpm was soon joined by 45 rpm and then 33 rpm. Record players became multispeed and standardized, leaving owners to the business of searching for the next Bing Crosby.

Lewine would like to build a computer that plays everything—a "generic processor"—and as the talk in engineering circles these days is along similar lines, whether you're chatting with a micro or mainframe builder, Don would like to get there first and with the best product—"the Porsche of generic processors, if you like."



XEROX

# Now Xerox offers the best of both worlds for the price of one.



**For the first time ever, you can get the most advanced Xerox manufacturing software, plus an IBM mainframe computer, in one complete, affordable system.**

The Xerox Turnkey Manufacturing System includes everything you need for dependable, comprehensive information management.

Yet, because it's an off-the-shelf system, you can get it fully installed at a price you never thought possible.

This new system has an advanced architecture that completely integrates manufacturing, financial and distribution applications, personal computing, information center software, decision support systems, a database manager and fourth-generation languages.

However, it's so simple to use, your

current personnel can develop their own applications and handle their own information needs without help. So there's no data processing staff to hire.

Which means you get fast, economical installation, plus immediate payback in improved productivity and management control. All with minimum overhead.

Xerox Computer Services technical experts, who thoroughly understand the manufacturing business, will help you with everything. From initial site planning, to telephone hotline support after you're up and running.

Of course, full documentation, training and software maintenance are also part of the package.

But best of all, as your business expands and it's time to move to a larger computer, you'll still be able to run the same software on any IBM mainframe, starting with the smallest 4300 series system up through the powerful 3084 model.

So if you're looking for better control over your operations, but are concerned about finding a system that really fits your requirements and budget, let us tell

you about our simple solution... the Xerox Turnkey Manufacturing System.

Call Ron Rich at (213) 306-4000, or mail in our coupon, and we'll send you complete information and pricing details.

**XEROX COMPUTER SERVICES**  
 c/o Ron Rich, 5310 Beethoven Street  
 Los Angeles, California 90066

Your ad was very timely. We're planning on buying a new system within  30 days

90 days  6 months  1 year.

Have a sales rep call me immediately.

Send me more detailed information.

Name/Title \_\_\_\_\_

Company \_\_\_\_\_

Street \_\_\_\_\_

City \_\_\_\_\_

State \_\_\_\_\_ Zip \_\_\_\_\_

Phone \_\_\_\_\_ D/05/15/84

Xerox® is a trademark of XEROX CORPORATION.  
 IBM® is a trademark of International Business Machines Corporation.

CIRCLE 43 ON READER CARD

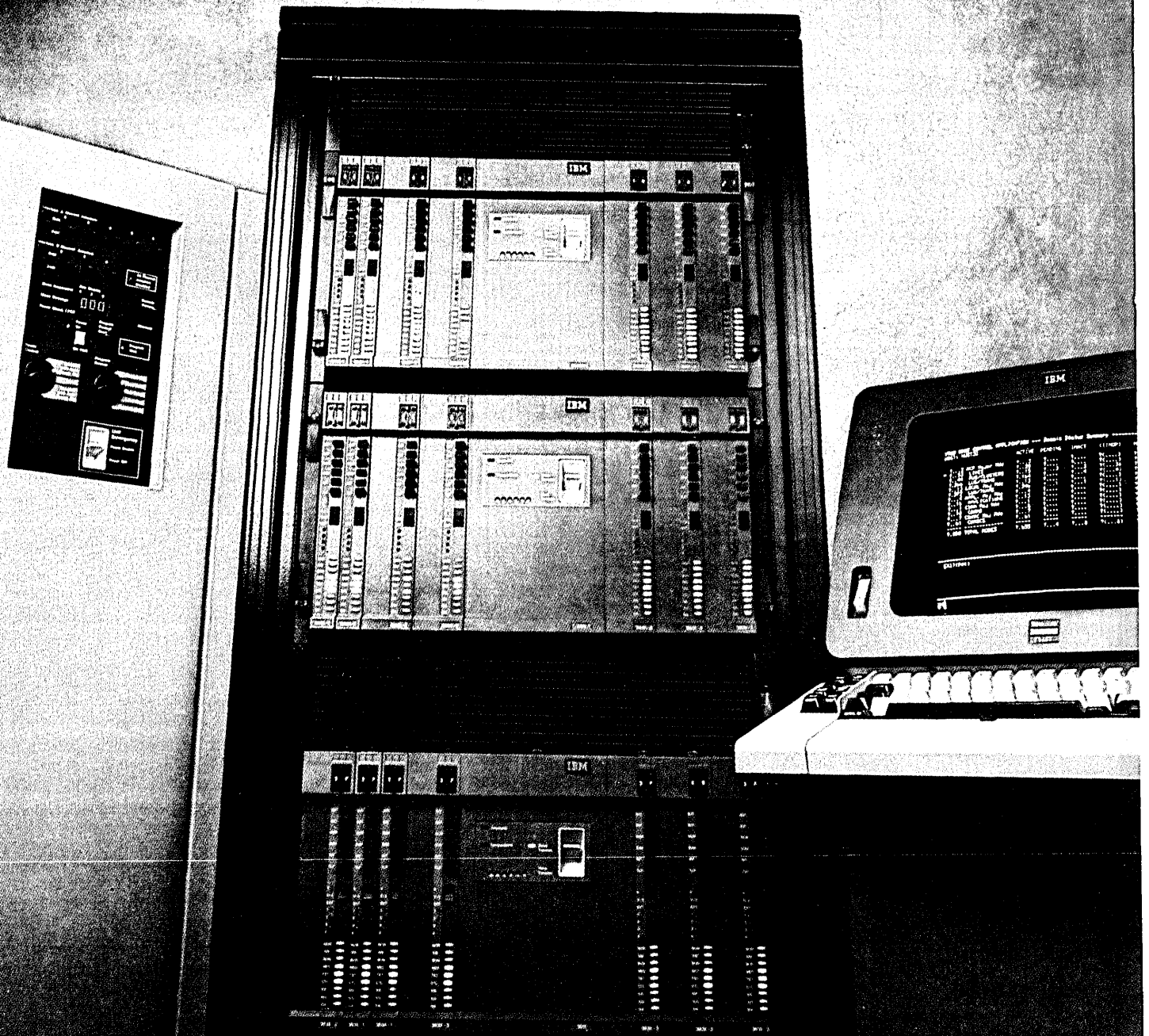

The IBM Modem.  
It stacks up as never before.

The rack-mounted IBM 3868 Modem saves you space. And money. And effort.

Space, because IBM's one-inch-wide vertical package allows you to mount up to 12 modems in one enclosure that fits a standard 19-inch rack.

Money, because each enclosure needs only one power supply and cooling system to support all of its modems.

And you manage your network with less effort because the IBM 3868 Modem has the same high availability and rock-steady reliability as other modems in the 386X Series—plus an enhanced Link Problem Determination Aid (LPDA).

Working with software available for many IBM host systems, the LPDA performs greater end-to-end management. Now line conditions are identified further downstream from the host, and in more detail. For example, conditions in any multipoint circuit can be pinpointed to a particular leg, including tailed configurations off multiplexed links.

In fact, to help you keep your network humming, the LPDA and host software monitor and provide you with a line quality value, a receive signal level, an error-to-traffic ratio and modem self-test results to help you isolate line problems. Now you can communicate them more precisely to your communications carrier.

And because 3868 Modems are so reliable, they're backed by a full three-year warranty.

Try them for up to four weeks: just select 2400, 4800 or 9600 bps line speeds. If you purchase in quantity, discounts are available.

Ask your IBM representative for more information. For a free brochure, or to have an IBM representative contact you, call toll free 1 800 IBM-2468, Ext. 82, or return the coupon.

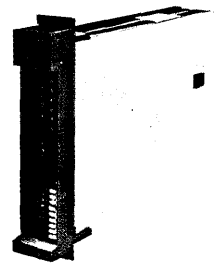

5-1

IBM  
DRM, Dept. BO/82  
400 Parson's Pond Drive  
Franklin Lakes, NJ 07417

Please have an IBM representative call me.  
 Please send me more information on the IBM Modem.

Name \_\_\_\_\_  
Title \_\_\_\_\_  
Company \_\_\_\_\_  
Address \_\_\_\_\_  
City \_\_\_\_\_ State \_\_\_\_\_ Zip \_\_\_\_\_  
Phone \_\_\_\_\_

# Considering FOCUS? NOMAD2 Should Be In The Picture!

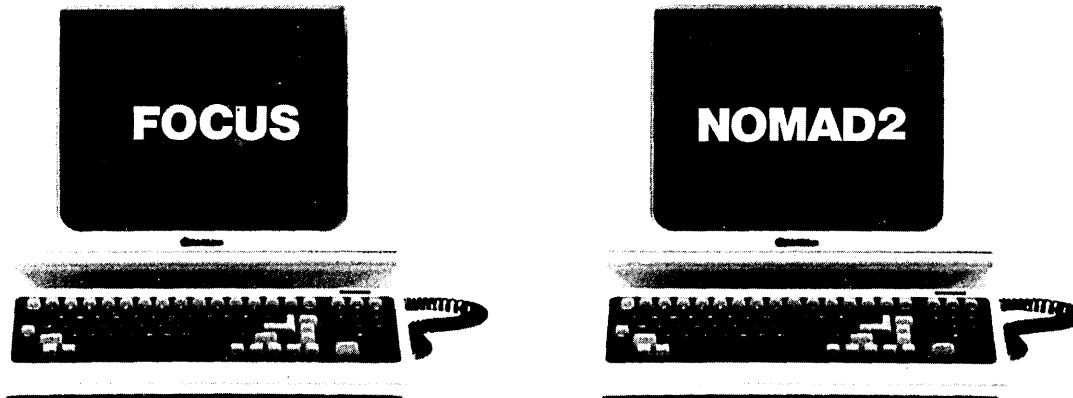

If you're presently evaluating FOCUS, take a look at NOMAD2 and you'll be surprised at the outcome of that comparison.

Whether your comparison is made based on specific features, the scope of the product, or the sheer power it puts into your Information Center or your development activities, NOMAD2 wins hands down.

Whether the issue is programmer productivity or end user satisfaction the answer comes up NOMAD2.

Relational? Yes! English Commands? Yes! Interactive? Yes! Procedural? Yes! Modeling? Yes! Statistical Analysis? Yes! Multi-layers of Security? Yes! Graphics? Yes! Runs on VM? Yes! Runs on MVS/TSO? Yes!

And, we don't just drop a tape on you and walk away. Education, documentation, service and support are part and parcel of the NOMAD2 offering. Talk to us before you make your decision and your decision will probably be NOMAD2.

**NOMAD2. . . Experience <sup>is</sup> the difference**  
^

For more information write to:  
Roger Cox  
D&B Computing Services  
187 Danbury Road  
Wilton, CT 06897  
or call Roger Cox at (203) 762-2511

**D&B Computing  
Services**

**DB** a company of  
The Dun & Bradstreet Corporation

\* NOMAD is a registered trademark of D&B Computing Services, Inc.

**CIRCLE 26 ON READER CARD**

What has brought on Don's sudden infatuation with multiple personality computers? The renowned engineer C. Gordon Bell, designer of DEC's VAX line, got it in one: standardization.

"Standards," as Bell says, "are seeping through every segment of the industry, prompted primarily by IBM's move to an open architecture with its PC. Today, "we have standard chips, buses, and operating systems to provide a ready base for peripherals and generic software to be transported from one brand of computer to another."

Sighs Lewine, "Today's hardware is beginning to look alike, and the scene is switching to the hunt for programs. One might ask in passing where this leaves companies like Data General, which are noted primarily for their hardware engineering skills and for supplying proprietary software which in the coming environment could be as dead as a dodo bird."

One approach Lewine and Data General could try is to go it alone and find ways to compensate for the lack of generic software. Wang's personal computer, for example, is faster than IBM's generic PC. Others, like NEC's, have better graphics than the IBM version. Texas Instruments' slant is to add voice recognition and synthesis. Hewlett-Packard has added a touch screen.

But when it comes to adding new software, this go-it-alone approach can lead to long delays. As IBM has shown, the availability of a huge library of software programs is the only thing that really counts. Lewine and company could also revert to the standby from the good old days: raw power. DG has shown an inclination to drive upmarket into the supermini class. But as it has done so, it has been followed relentlessly by the semiconductor companies, who, with only hardware to sell, are all trying to

**"Neither going it alone nor moving to raw power alone will do the trick," says Data General's Don Lewine.**

differentiate themselves from one another in a search for more MIPS per chip. Much has been made of DEC's efforts over the past six years to replace the top end of its VAX minicomputer line with a super VAX—a leap of from 1 to 4 MIPS. National Semiconductor, the current semiconductor chip king at 1 MIP per chip, will likely be succeeded by AT&T, with a 5 MIPS per chip WE-32 processor next year.

Or, to look at these figures in another light, as British vendor ICL has done, the minicomputer and mainframe concerns can only expect to be bruised by the semiconductor leaders in the war for low-cost MIPS. According to ICL internal estimates, gleaned from industry sources, three times as many

MIPS were sold on micros last year as on minis and mainframes combined. In the coming year, the ratio will be 10:1. It will grow exponentially thereafter as 32-bit micros replace their less powerful predecessors.

"Thus, neither going it alone nor moving to raw power alone will do the trick," says Lewine. "These must be combined with a generic solution to gain access to all the software libraries."

According to Lewine, "Generics will appear at both the top and bottom ends of Data General's line, with the company utilizing a different approach to each. The best solution at the desktop end is to combine a suite of chips, each dedicated to a particular environment or best-selling software package. But the top of the line is important, too. It's frustrating to users when the only hardware that will run the Lotus 1-2-3 or VisiCalc is a micro—and you've got a mainframe. Mainframers must find ways to host the best-selling microcomputer packages, because new software simply is not being written for the large machines anymore.

Lewine believes the mainframe and minicomputer companies will adopt a similar approach by optimizing the various operating system environments in reprogrammable microcode on their machines. "You can, for example, study the Unix operating system and see where the bulk of its instructions lie. You then optimize these instructions in microcode and make the whole operating system run much faster. CPM and MS/DOS can be afforded similar treatment," he added.

"The drawback here," as Gordon Bell points out, "is that AT&T and IBM will optimize future releases of their operating systems around their own hardware, making it difficult for the others to upgrade their microcode."

Unlike the 16-bit field, the generic engine for the 32-bit virtual machine generation is not yet set in concrete. Lewine believes that DG engineers have time to maneuver a mixture of all these approaches in their search for the Porsche of generic processors. If hardware evolution had suddenly stopped dead at the IBM PC—as it sometimes appears, with its many clones and imitators—we could all go home. There'd be no competition for IBM as the low-cost commodity producer.

But software developers such as Lotus Development Corp., searching for the right blend of user-friendly and AI-based software, are pushing the PC's 640K memory limit, and the 32-bit virtual machine workstation standard is up for grabs. Eventually, even this 32-bit hardware will be so cheap that it will be given away by manufacturers to sell their software.

"I don't look forward to that day," says Lewine. "I know how to build record players, not how to be Michael Jackson."

# WHEN THE CHIPS ARE DOWN

**A dire shortage of one Intel microprocessor is causing pain among systems manufacturers.**

by Charles Bruno

Demand for Intel's next-generation microprocessor is far outstripping supply and forcing systems manufacturers to change product designs and limit production of their machinery.

The problem at Intel, which has affected such companies as Convergent Technologies, Tandy Corp., and Tektronix, apparently stems from the advanced design of the 80186 chip, which combines the circuitry of the popular 8086 microprocessor and that of several support chips that handle memory, I/O, and other functions. Intel's production lines for the 80186, have been slowed by the discovery of logic bugs in the 80186 and startup difficulties in the semiconductor fabrication process.

Some of the Santa Clara, Calif., company's customers have been forced to accept slower versions of the Intel chip, which make their systems run slower and perform less work. For instance, Convergent Technologies, another Santa Clara manufacturer, has had to ship its N-Gen workstation with a 6 megahertz 80186 chip as well as the originally expected 8 megahertz part.

"Many oems will be receiving a mixture of both versions," said Nate Teichholtz, marketing manager at Convergent. The company's customers for N-Gen include Burroughs Corp., Raytheon, and Automatic Data Processing, the former being heavily dependent on Convergent for its low-end office and workstation product lines.

Tandy Corp.'s flagship Model 2000, a personal computer designed to use much of the same software as IBM's PC, is not being produced as fast as the Fort Worth, Texas, company had planned because of the general shortage of 80186 chips.

"Let's just say our production facilities aren't nearly being used to their fullest," admits Yama Gata, director of merchandising for the 2000. Tandy has had high hopes for the new pc because it will bring the company into the IBM PC marketplace and give it an entree into corporate accounts. Tandy's Radio Shack TRS-80 line, once a leader in the pc marketplace, is based on 8-bit Z80 microprocessors.

## NEWS IN PERSPECTIVE

Besides trying to boost production by generating slower versions of the chip, Intel has been making an effort to expand production of the 16-bit 80186 by off-loading production of the popular 8088 chip to other companies. In recent weeks, both IBM and Commodore International have sought licenses to build that chip, which forms the heart of the previous generation of personal computers. IBM has not yet introduced a machine based on the 80186 but is expected to do so sometime this year in the form of a machine code-named Popcorn.

Aggravating the supply problem are bugs that have appeared in some batches of the 80186. Intel tried to correct the problems in the initial version but a second version was also flawed, according to industry sources. Customers report being told by Intel that the third version will be bug-free.

One unintended result of the chip shortage has been the emergence of a black market in the 80186 part. One parts distributor says he can sell the chips for double their list price because demand is so strong.

Intel introduced the 80186 in June 1982, describing it as a supermicro that in a single package contains an improved 8086

### **A black market in the 80186 chip has been created by the dire shortages of the popular part.**

processor and the various support circuitry. "The 80186-based machines run rings around the 8086 and 8088 products that are available today," says Convergent's Teichholtz.

To Intel's credit, the 80186, which now lists for \$93, has been an incredible success despite the maker's backlog. Intel estimates demand at 3 million to 4 million chips for 1984. But, the company says it can only supply about a fourth that amount, or fewer than 1 million chips. It is hoping for some assistance from Advanced Micro Devices, which Intel has licensed as a second source for the 80186. Unfortunately for Intel and its anxious customers, however, AMD says it will not deliver a single chip much before the end of this year.

While Intel is losing some potential business—it admits to being surprised by the demand for its chip—the biggest losers may be the many computer vendors that are committed to using the 80186 in their systems. Among them are Convergent Technologies, North Star Computers, Tandy, Durango Systems, Pronto Computer, Onyx, Altos Computer, Tektronix, Computer Automation, and MAD Computers.

In another category are vendors that are relying on Convergent to supply them, oem style, with its 80186-based N-Gen for their subsequent resale. This list includes Burroughs, Raytheon, and Mohawk Data Sciences.

Intel's system-building customers are currently receiving one third to one quarter of the 80186s they have ordered. Some of the chips they have received are the 6MHz version, which runs about 25% slower than the 8MHz part. Considering that the 80186's main virtue is its speed, this has left some of Intel's customers unhappy. Some of them, including Convergent, have even been forced to redesign products to accommodate the slower chip, thus reducing their systems' overall performance.

Convergent Technologies' reliance on the 80186 as the heart of its N-Gen workstation has left it highly vulnerable to the dearth of 80186 components. Moreover, it has signed many oem customers for the workstation whose product plans are keyed around N-Gen. Burroughs, for instance, has been forced to delay the introduction of its B 25 product line, a series of small, N-Gen-based desktop machines that were originally slated for unveiling in the first quarter of this year. Computer Consoles Inc., Rochester, N.Y., has reportedly decided to hold back on introducing an N-Gen-based machine and is looking for a replacement.

Convergent itself has stated it will not sign any new N-Gen contracts during the first half of 1984 and may extend that decision through the rest of the year. The company has signed many oem contracts based on N-Gen, including those with Burroughs, Raytheon, Automatic Data, Gould, NCR, Prime, Microdata, A.B. Dick, and Four-Phase. The company also has a major product development effort under way with AT&T, which plans this year to enter the workstation and personal computer marketplace. According to industry reports, AT&T will receive little product from Convergent this year, even though the phone company had first expected to ship Convergent-built machines by midyear. It was unclear, however, if the AT&T situation is related to the 80186 allocation position.

Yet Convergent may be luckier than some of Intel's other 80186s customers. Smaller companies that are currently using

### **We've protected the companies that have shown good faith in our product," says an Intel manager.**

the 80186 are concerned about Intel's allocation policy. The chip maker has decided to deliver many 80186's to its biggest customers first, according to Steven Kanzler, product manager for North Star's Dimension computer.

"Intel is going to meet its own needs and those of its largest customers before it is going to meet the needs of a great many smaller ones," Kanzler says, adding that at \$40 million a year, North Star is considered by Intel to be among the

"smallers." He notes that North Star expects to ship 40,000 workstations this year, most of which will use the 6MHz version of the 80186.

Intel's view of the situation is somewhat different than its customers'. "We've protected the companies that have shown good faith in our product," says Tony Barre, product marketing manager for the 80186. He adds that Intel is forecasting all customers' needs, and telling each one how many chips it will receive. "We learned back in 1977-'78, when we had our last parts shortage, that you have to control the customers," Barre says.

Regardless of who's getting chips when, earlier versions of the 80186, by In-

### **Early, faulty versions of the 80186 have found their way into the hands of unauthorized dealers.**

tel's own admission, contained bugs that made end products fail. Specifically, the problems were found in the direct memory access section of the processor chip. DMA, as it is called, enables the transfer of data between peripheral devices and internal memory without going through the central processing unit. Intel corrected early versions of the 80186 with a software patch and produced a revised version of the chip. That, too, had flaws.

Intel is now promising a chip it calls the C-version that will be bug-free. In addition, Intel says, a number of computer vendors have built successful machines using the earlier-version 80186 by designing around the chip's flaws.

Somehow, the earlier-version chips have found their way to unauthorized dealers who are charging what the market will bear—in one case, up to \$250 per chip.

"Wow!" exclaimed Intel's Barre, "that's a lot of money. I'm not surprised that some of the chips are being resold, but that is a lot of money to pay for the chips."

One such dealer is Jericho Electronics, of Portland, Ore. The company has managed to obtain 8MHz versions of the 80186 and is selling them for as much as \$250 apiece. It says the chips are selling fast.

"I had never even heard of the 80186 until two of our overseas oems contacted us with an urgent need," said James Brooks, a Jericho salesman. "We did some checking and were lucky to run across the chips. We're mostly selling them to small oems doing R&D." Jericho Electronics, said Brooks, has been selling 50 to 400 of the 80186 chips a week.

Semiconductor shortages are not wholly unknown to the computer business. Several years ago a dire shortage of 64K RAM chips forced many U.S. system manufacturers to buy from Japanese vendors.\*



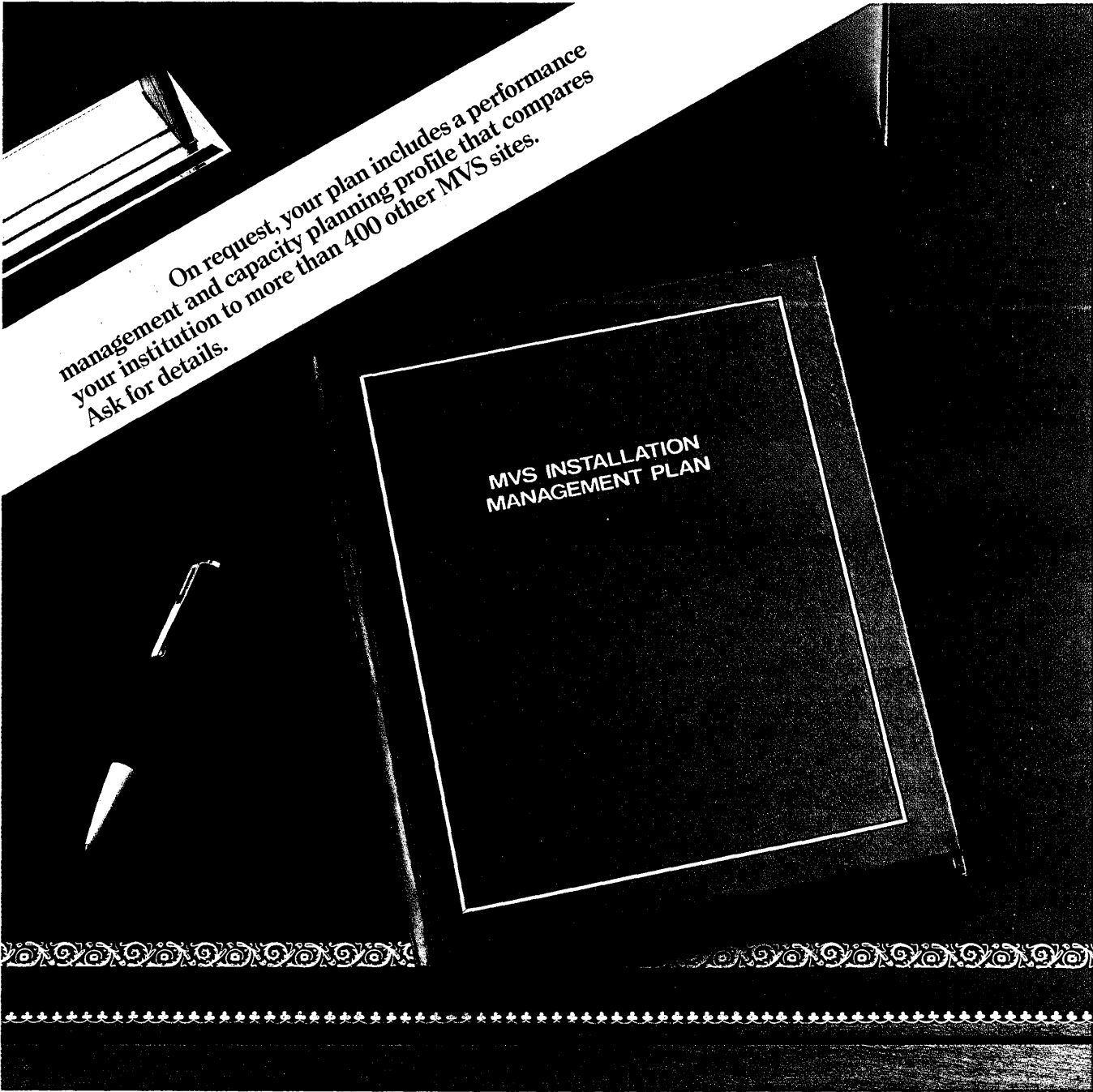

On request, your plan includes a performance management and capacity planning profile that compares your institution to more than 400 other MVS sites. Ask for details.

MVS INSTALLATION  
MANAGEMENT PLAN

## For the concerned computer executive... a rare first edition.

It costs you nothing. But it details how your company can save staff time and hardware upgrades through the use of MICS, our MVS Integrated Control System.

It analyzes your installation's current MVS environment and recommends a specific course of action for realizing these savings. It gives the names of executives like you who have taken advantage of our suggestions.

And the plan is yours for the asking. Unconditionally.

Simply direct a member of your staff to request a plan questionnaire. Have it filled in and returned to us.

We'll do the rest.

We want you to know us and MICS. To understand why 19 of the top 20 Fortune 500 industrial firms are our users. And to recognize us as the standard-setters for MVS installation management. That's why we're making you this offer.

It's in the book!

CIRCLE 27 ON READER CARD



**MORINO ASSOCIATES**

<b>MORINO ASSOCIATES, INC.</b>	<b>MORINO ASSOCIATES (UK) Ltd.</b>
8615 Westwood Center Drive	118 Victoria Street
Vienna, Virginia	St. Albans
22180 U.S.A.	Hertfordshire
Tel: (703) 734-9494	England AL1 3TG
	Tel: St. Albans (0727) 37464

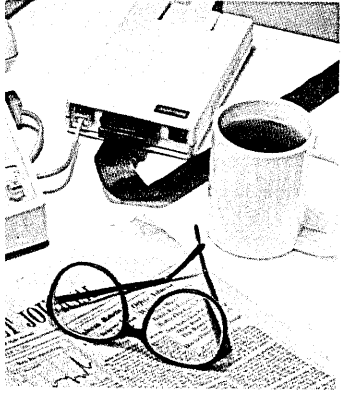
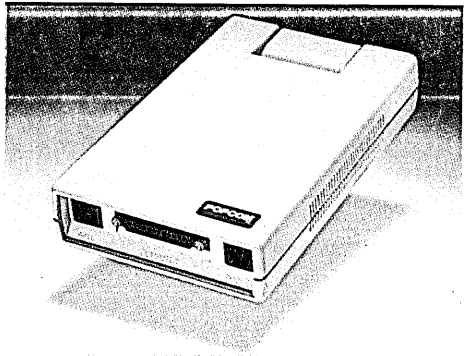
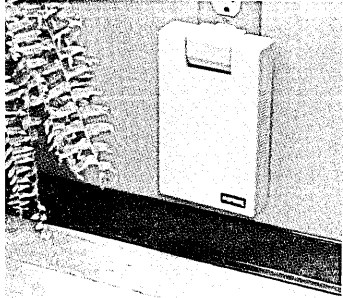

**NEW**  
FROM  
**PRENTICE®**  
CORPORATION



ଅନୁସନ୍ଧାନ କରନ୍ତୁ  
ମିଳିତ ଭାବରେ କାର୍ଯ୍ୟକାରୀ  
ଏବଂ ଅନୁସନ୍ଧାନକାରୀ  
ସେବାକୁ ଯୋଗାଇ  
ଦେବାକୁ ଏହି କାର୍ଯ୍ୟ  
କ୍ରମକୁ ଅନୁସରଣ କରନ୍ତୁ  
ଅନୁସନ୍ଧାନକାରୀ  
ସେବାକୁ ଯୋଗାଇ  
ଦେବାକୁ ଏହି କାର୍ଯ୍ୟ  
କ୍ରମକୁ ଅନୁସରଣ କରନ୍ତୁ  
ଅନୁସନ୍ଧାନକାରୀ  
ସେବାକୁ ଯୋଗାଇ  
ଦେବାକୁ ଏହି କାର୍ଯ୍ୟ  
କ୍ରମକୁ ଅନୁସରଣ କରନ୍ତୁ

## DATA COMMUNICATIONS

# SECURING THE NETWORK

The proliferation of local networks has raised concern about data security measures.

by Jan Johnson

As the number of desktop workstations, local area networks, and people with computer knowledge increases, so will the number of computer crimes.

That's a fact of computing life, agree industry security experts. They warn that insiders, both dishonest and incompetent, will be responsible for most security problems.

Those are not pleasant thoughts for the concerned MIS director who may have customer files, corporate financial information, and payroll, personnel, and order entry records racing over a shared local net, potentially passing by every employee workstation and available to any enterpris-

ing eavesdropper or hacker. It makes one stop and rethink the virtues of a shared local network.

It doesn't appear that local network sales are dropping as security consciousness rises. Most LAN vendors, such as Network Systems, Sytek, and Ungermann-Bass, claim their installed base is growing, not shrinking. It appears, however, that a growing number of customers look at security features as part of their product evaluation process. Dial-back traps, password-based access control, and encryption are three LAN protection schemes that vendors are considering or currently offering.

"The first thing customers want is some sort of user authentication control," says Leo D'Acerno, a market researcher with the Yankee Group, Cambridge, Mass., which released a study of network security issues last month. "They want to ensure legitimate users gain access and illegitimate users are rejected."

Password schemes and dial-back systems were among the more commonly used access control methods. Network Systems Corp., Minneapolis, for instance, offers a dial-back feature. "With HyperBus, a terminal call is intercepted by the bus service center, which asks for the proper access code. Given that, the caller is then disconnected and the center calls back using

the telephone number associated with that code," explains Lyle Altman, president and chief operating officer.

As for protecting HyperChannel, the high-speed host-to-host network sold by Network Systems, "it's in the computer center, which is reasonably secure to begin with," says Altman. "The very speed [50 megabits] at which the data moves makes it unlikely that someone can tap it." These two features, dial-back and physical security, appear to be the only security measures Network Systems currently offers.

D'Acerno identifies the most popular password schemes as two host-based packages, ACF II from Cambridge Systems Group, Los Altos, Calif., and RACF from IBM. Prices for host-based packages range between \$5,000 and \$9,000 per year in monthly charges or about \$30,000 if licensed outright.

Among the leading LAN makers, Nestar of Palo Alto, Calif., and Sytek of Mountain View, are the only ones offering password protection. 3M/Interactiv systems, St. Paul, and Ungermann-Bass claim they will eventually add passwords to their products. Nestar, though categorized as a personal computer LAN, not only holds its own in security, but appears to be ahead of some of its larger competitors.

Nestar currently supports a password protection scheme that is managed by a dedicated file server. The server checks incoming passwords against a dictionary and grants access to various files based on clearances associated with each password.

For the future, confides Harry Saal, Nestar chief scientist and founder, "we are thinking about helping out with password

**One scheme involves placing an automatic time stamp on each password when it is assigned.**

management." One scheme would involve placing an automatic time stamp on each password when it is assigned. After a specified amount of time elapses—several days, several months, whatever a user desires—an alarm goes off signaling it is time to change the password.

Another scheme Saal is considering is an automatic disconnect feature. After three or 10 failed attempts to submit the proper password, access to the file server from the errant station is "turned off."

Sytek's password scheme is managed by its network control center (NCC), which controls who is connected to what device. After a password and request to talk to a particular device are entered from a workstation, the password is validated by the NCC and checked for clearance.

In addition to determining who can go to what host or network device, the Sytek scheme also controls who can fiddle

## Get everything done by Friday!™

Invoices. Paychecks. Mailing lists and form letters. Inventory. Reports. And just about any file handling that needs to be done around the office.

Get them all done quickly, efficiently and accurately any day of the week—by Friday!™

Friday! is the revolutionary new electronic file handling system for your microcomputer from Ashton-Tate, the people who invented dBASE II®. It's just \$295 (suggested retail price).

For the name of your nearest Friday! dealer, drop us a line. Ashton-Tate, 10150 West Jefferson Boulevard, Culver City, CA 90230.  
(213) 204-5570.

**ASHTON-TATE**

dBASE II is a registered trademark and Friday! is a trademark of Ashton-Tate. ©Ashton-Tate 1983

CIRCLE 29 ON READER CARD

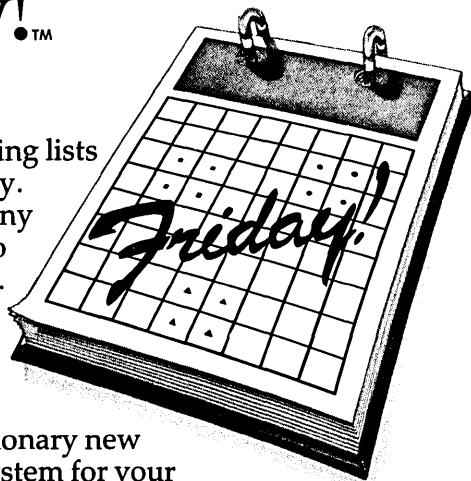

# The \$95,000 coupon.

Mail this and save \$95,000 on your next Plug-Compatible Business System.

It's true.

What our new USX44 gives you for \$267,000, you'd have to pay \$362,000 for from IBM.

This includes hardware, operating software and installation (within 30 days). You get additional virtual storage and separation of on-line, batch and test workloads. All with the insurance of a fail-soft system.

How do we do it? By having the USX44's duplex processor CPU's custom-built exclusively for us, while its Disk, Tape and Printer components are all made by Storage Technology Corporation. Which happens to be our parent company.

And because we're a single-source supplier, you always have just one single number to call for hardware maintenance and software support: The Global-Ultimacc 24-hour/7-day Hot Line.

What's the bottom line? When you're about to outgrow your present system, you can either spend a lot more money than you have to, or you can talk to us.

We're making some claim here: More power for less money. Can you afford not to call us on it?

Our number is 800-624-0041. In NJ, call 201-445-5050.

CIRCLE 79 ON READER CARD

**Ultimacc Systems, Inc.: The Total System supplier for  
the plug-compatible marketplace.**

A subsidiary of Global-Ultimacc Systems, Inc.  
4 North Street, Waldwick, New Jersey 07463

Send me more facts about the USX44 Complete Business System.  
 Have a USX44 representative call me.  
Or call 800-624-0041 (In NJ 201-445-5050)

NAME \_\_\_\_\_ TITLE \_\_\_\_\_  
ADDRESS \_\_\_\_\_  
CITY \_\_\_\_\_ STATE \_\_\_\_\_  
ZIP \_\_\_\_\_ PHONE \_\_\_\_\_

**NOW CCA'S  
MODEL 204 DBMS  
CAN DO SOMETHING  
EVERY EXECUTIVE  
CAN APPRECIATE.**

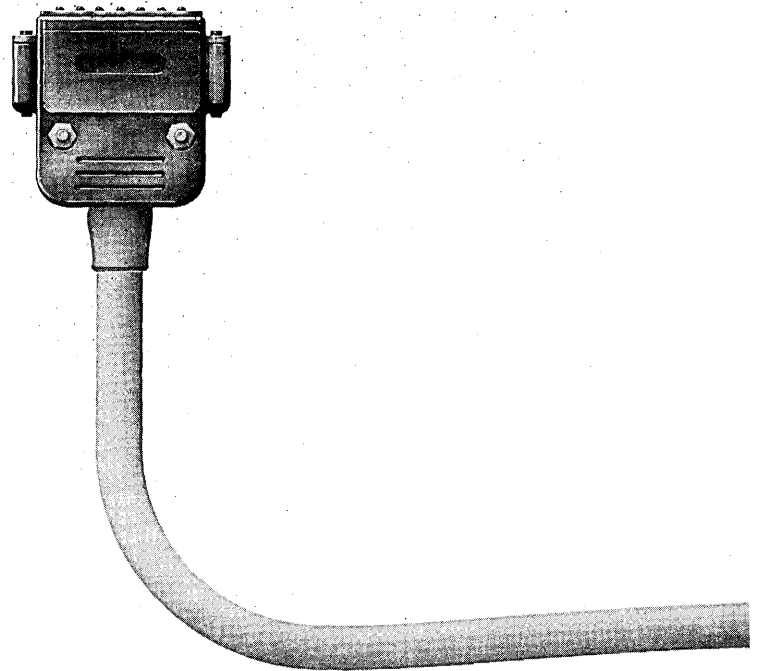

# TALK SENSE TO THE IBM PC.

Introducing PC/204, a link that lets PC users turn mainframe data into spreadsheets effortlessly.

PC/204, the newest productivity tool from Computer Corporation of America, is a powerful, efficient, easy-to-use software link between IBM personal computers and mainframes. It effectively answers the pressing problem of how to let corporate managers take full advantage of today's personal computers for making decisions, while also giving them access to the corporate database in a format they can use.

First, PC/204 guides PC users as they browse through the MODEL 204 database. Then it extracts the data they need and converts it into meaningful management information for spreadsheet analysis. Lotus 1-2-3 for example. And PC/204 does all that automatically. Without the PC user having to understand anything about mainframe technology.

If you aren't already using Lotus 1-2-3, we can supply it along with PC/204. Or you can use any current IBM PC business package.

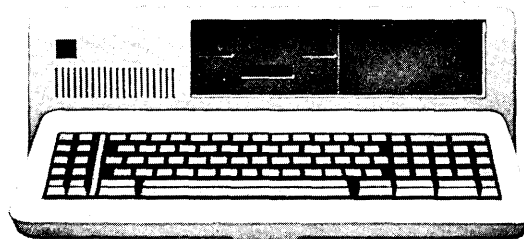
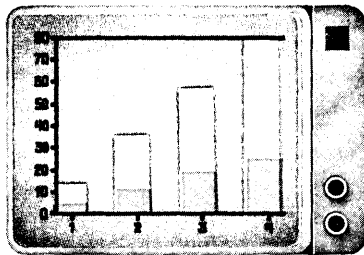

While PC/204 is helping business managers, it's also helping MIS directors.

PC/204 uses the power and intelligence of the personal computer for increasing the overall efficiency of an application.

For one thing, it improves performance of the mainframe by off-loading some of the processing to the PC, while reducing PC users' response time. It also makes communication between the PC and the mainframe more efficient.

What about security and control? PC/204 provides individual management views of

the corporate database while still allowing PC users access to all the information they need.

PC/204 is the latest reason to get MODEL 204 DBMS which has been so highly rated for performance and programmer productivity.

For more information or to arrange for a demonstration of PC/204's capabilities, simply return the coupon or write to us on your letterhead.

## Computer Corporation of America

### CCA's Executive DBMS Seminar Schedule

May		Ottawa	May 3	Philadelphia	June 5
Atlanta	May 15	Pittsburgh	May 8	Pittsburgh	June 19
Austin	May 10	Santa Clara	May 24	Oklahoma City	June 7
Baltimore	May 15	Toronto	May 10	Omaha	June 7
Charlotte, NC	May 8	June		Rochester	June 28
Cincinnati	May 2	Albuquerque	June 14	Syracuse	June 27
Ft. Worth	May 3	Boston	June 14	Washington, D.C.	June 12
Harrisburg	May 2	Buffalo	June 5	July	
Houston	May 24	Chicago	June 14	Dallas	July 10
Kansas City, MO	May 23	Denver	June 21	Oakland	July 12
Milwaukee	May 3	Hartford	June 21	Portland, OR	July 26
Montreal	May 4	Nashville	June 5	San Francisco	July 25
Orange County, CA	May 24	New York	June 21	St. Louis	July 12

Yes, please tell me more about:  PC/204  MODEL 204 DBMS  
 Send me a brochure.  
 Send me info on free DBMS seminars, or call our seminar coordinator.

NAME \_\_\_\_\_ TITLE \_\_\_\_\_

COMPANY \_\_\_\_\_

ADDRESS \_\_\_\_\_

CITY \_\_\_\_\_

STATE \_\_\_\_\_ ZIP \_\_\_\_\_

TELEPHONE \_\_\_\_\_

Operating System:  MVS  DOS  CMS  Other: \_\_\_\_\_

Computer Corporation of America  
 Four Cambridge Center, Cambridge, MA 02142 (617) 492-8860

DM 5/1 PC



## NEWS IN PERSPECTIVE

with network parameters and configurations. The price of the password feature is bundled in with the cost of the NCC.

Once a network management center is in place and programmed to keep track of who logs on and what they do, it can be further enhanced to monitor and log a number of characteristics useful in managing the network. Traffic patterns can be monitored, degradations in service can be spotted, callers can be tracked for location called and length of time on-line. LAN vendors may have gotten started after PBX makers, but they are rapidly catching up on the number of network management features they offer.

Sytek is said to be working on a new access control method based on user identification. One source, when pressed for a comment about the upcoming product, makes the offhanded remark that it may "obsolete passwords." The group to watch is Sytek's new Data Security Division.

Targeted at both commercial and government users, the product can be sold independent of LocalNet. Users do not

### **Sophisticated network users are looking to their suppliers for an increasing number of network management functions.**

"necessarily" have to be LocalNet users, suggests the source, who says the product will be unveiled late this year.

Ungermann-Bass is also developing a network management center, albeit a bit behind Sytek in its effort. Plans are to deliver a password control feature in early 1985, says Tony Russo, director of product planning.

UB's intention is to offer similar password features, such as user validation and controlled access to network devices. According to Russo, UB has not decided whether to charge extra for the password feature, "but we are leaning that way." In addition to password protection, UB plans to build a number of additional management features into its control center, which UB calls the network management system.

It's been Russo's experience that sophisticated network users are looking to their suppliers for an increasing number of network management functions. "With the kind of session-level protocol we are using, we can do chargebacks, keep track of start-of-sessions and end-of-sessions, and generally plan the use of the network." Both UB and Sytek conduct password/access control at the ISO session level.

3M/IS has yet to set a delivery date for its LAN/I password protection feature. "The product is deliverable," says Bob Wolters, software supervisor with 3M/IS, Ann Arbor, Mich. "We are running it in-house. It's just a question of whether we want to tweak it anymore."

The feature appears to be less robust than some other mentioned products. As Wolters describes it, each port can be placed in a protected mode and only protected ports get involved with access control. When a call is placed to a protected port, that port [the destination port] reverts the call to a network monitor unit and asks for authorization. The monitor looks up the password and notifies the requesting port if clearance is authorized. Pricing information for the security features was not available, according to Walters.

"We haven't attacked the security issue as yet, not with any direct efforts," admits Wolters. "But we will be able to do some limited things, such as call authorization and controlled access to protected ports."

No matter how sophisticated the access control password-based mechanism, in the end the system is only as strong as the management of the passwords and the integrity of the people using them. Short, easily guessed passwords—family members' names and birthdays, for instance—are considered unsafe. Careless handling of passwords is another problem.

Access control is only one protection method. Physical security also plays a significant role, reminds Nestar's Saal. He alludes to the idea of a diskless workstation. "If a guy doesn't have access to a floppy disk, then the guy can't copy a client list to disk and hand it off to a competitor." Nestar's shared resource networks, Plan 3000 and Plan 4000, provide for just such a diskless configuration.

Suppose the perceived network threat is eavesdropping or tapping. To protect against that threat one must venture to the fringes of LAN security, into encryption technology. Sytek is the only LAN maker currently offering encryption protection.

Ungermann-Bass indicates it will look more seriously at encryption after it gets password protection installed on its network management system. "We don't think encryption will be particularly difficult to do," says a confident Russo. He indicates UB would use the DES chip, a standard encryption device. "It will not involve a major redesign of our architecture. It would require some software and hardware modifications," Russo notes.

3M/IS said it is "not active" in protecting against eavesdropping or tapping. "In the beginning," recalls 3M's Wolters, "we talked with some people, and found that those who want encryption want it so bad they are doing it themselves. Some don't trust anyone else's scheme. Another class of customer said they would like to see it, but they are looking at price/performance. While some were hot on the idea, they were cold on the implementation."

Nestar's Saal claims his company has made provisions in its hardware design

For your best investment in printers.

Call your nearest Qume distributor today.

### United States:

**American Calculator & Computer**  
(205) 933-2344—AL

**Almac Electronics**  
(206) 643-9092—WA

**Anacomp** (206) 881-1113—CA, UT, WA  
**Anthem Systems** (415) 342-9182—CA

**Bohlig & Associates** (612) 922-7011—MN  
**Butler Associates** (617) 964-5270—CT, MA

**Byte Industries**  
(800) 972-5948 (CA Only)  
(800) 227-2070 (Outside CA)

**David Jamison Carlyle**  
(213) 410-9250—CA, CO, HI, IL, NJ, TX

**Computers & Peripherals Int.**  
(315) 476-6664—NY

**The Datastore** (609) 779-0200—NJ

**Equipment Resources** (404) 955-0313—GA

**Future Information Systems**  
(212) 732-3905—NYC

**Gentry Associates**  
(305) 859-7450—FL, GA, LA, NC, SC, TN

**Inland Associates** (913) 764-7977—KS

**InterACT Computer Systems**  
(704) 254-1949—FL, GA, NC

**Kieruff Electronics**  
(800) 338-8811—AZ, CA, CO, CT, FL, GA, MA, MD, MN, MO, NC, NJ, OH, OK, TX, UT, WA, WI  
**MA/COM-Alanhus Data**  
(301) 770-1150—MD

**MicroAmerica Distributing**  
(800) 431-7660 (MA Only)  
(800) 343-4411 (Outside MA)—CA, MA, TX

**Midwest Microcomputers** (419) 782-1115—OH

**National Computers Syndicate**  
(312) 459-6400—IL, MN

**Pacific Mountain States**  
(800) 272-3222—CA, WA

**PAR Associates**

(308) 371-4140—CO, UT

**PCA Microsystems** (512) 654-4711—TX

**PCS, Inc.** (214) 247-9946—TX

**Pioneer Electronics**

(301) 921-0660—AL, FL, GA, MD, NC, PA

**Polygon Industries**

(504) 834-7658—LA

**Printer Warehouse** (213) 829-5493—(CA Only)

(800) 245-9812—(Outside CA)

**R.C. Data** (408) 946-3800—CA

**Rudor Communications** (212) 245-5509—NYC

**Schweber**

(800) 645-3040—AL, CA, CT, FL, GA, IA, IL, MA, MD, MI, MN, NJ, NY, OH, OK, PA, TX, WI

**Southern Microcomputer**

(305) 621-4237—FL

**Tek-Aids Industries**

(312) 870-7400—IL, PA, TX

**Terminal Rentals** (714) 832-2414—CA

**Terminals Unlimited**

(800) 336-0423—24 Locations

**Tricom** (516) 483-9700—NY

**Unico** (512) 451-0251—TX

**Western New York Computer**

(716) 381-4120—NY

### Canada:

**Abacus Data Services**

(416) 677-9555—Ontario

**Datamex** (416) 781-9135—Ontario, Quebec

**DataTech Systems**

(604) 479-7117—Alberta, BC, Ontario

**Data Terminal Mart**

(416) 677-0184—Alberta, BC, Nova Scotia, Ontario, Quebec

**Future Electronics**

(416) 697-7710—Alberta, BC, Ontario, Quebec

**Micro Distributing** (604) 941-0622—BC

**Printerm Data** (416) 977-1711—Ontario

**Qume**  
A Subsidiary of ITT

# DON'T PAY MORE FOR A PRINTER THAT DELIVERS LESS.

COMPARISON CHART				
	Printing speed (cps)	Avg. hours before repair*	User-changeable multiple interfaces	Mfr's suggested retail price
Diablo 630 API	40	4,000	YES	\$2340
NEC 7700 Series	55	2,000	NO	\$2595
<b>Qume SPRINT 11/55 PLUS</b>	55	5,500	YES	<b>\$1990</b>

**Qume's  
SPRINT 11/55 PLUS™  
outperforms NEC\*\*  
and Diablo† for a  
lot less money.**

A simple comparison tells the whole story. Qume's new SPRINT 11/55 PLUS™ daisywheel printer is tops in performance, with a steady speed of 55 characters per second. Print quality that's second to none. And the industry's best reliability rating—equal to almost three years of all-day, five-day-a-week business use without a single repair. That's nearly a year longer than its closest rival.

And the SPRINT 11/55 PLUS is a perfect fit for most popular business computers, via our inexpensive plug-in interface modules.

That means you won't have to change printers when you upgrade your current system.

It's this kind of value that has made Qume one of the largest manufacturers of letter-quality printers in the world.

So don't pay more for less. Choose Qume's SPRINT 11/55 PLUS—the best printer you can buy. *And* the best buy in printers. For more information, contact the Qume distributor nearest you. Or write Qume Corporation, 2350 Qume Drive, San Jose, CA 95131.

**Qume printers.  
Your best investment  
in productivity.**

**Qume®**  
A Subsidiary of ITT

See distributor listing  
on opposite page.

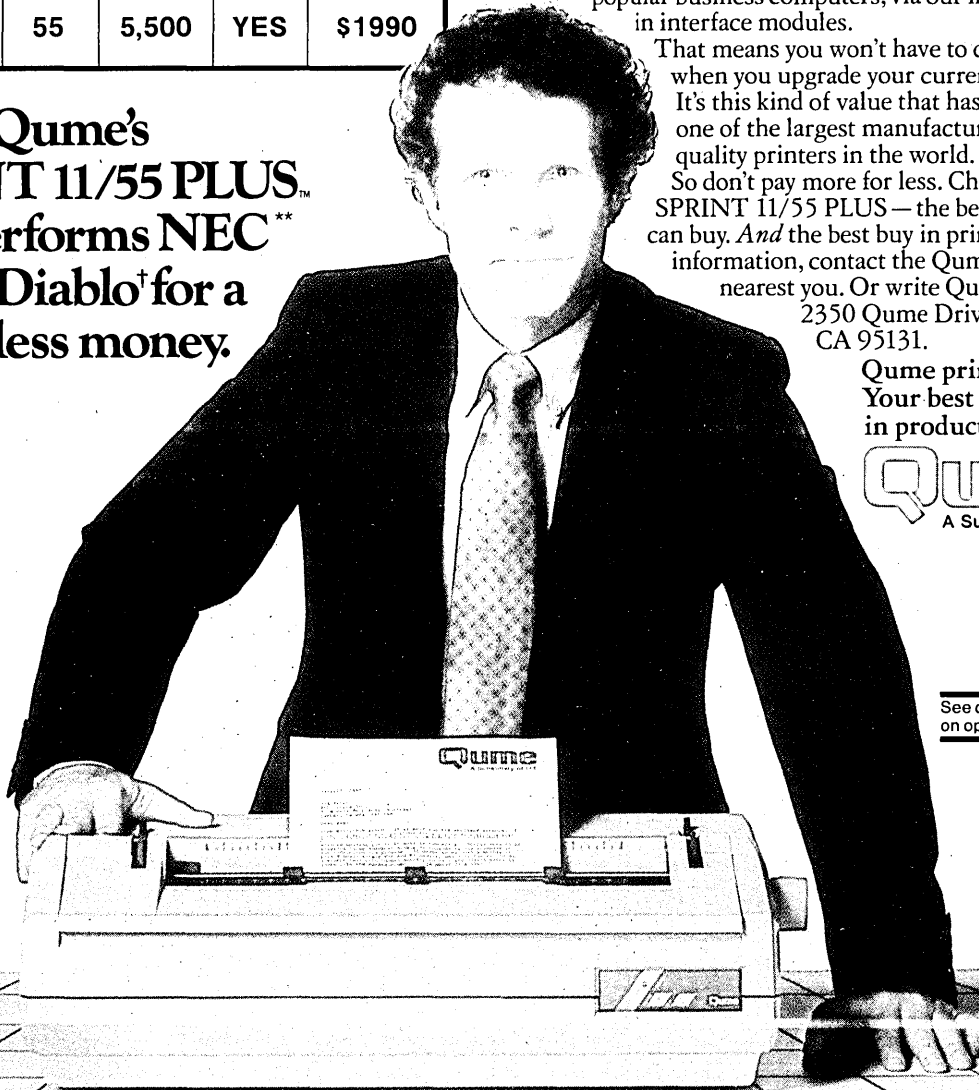

\*Mean Time Before Failure at 25% duty (manufacturer's published data)  
\*\*NEC is a registered trademark of Nippon Electric Company  
†Diablo is a registered trademark of Xerox Corp.

CIRCLE 31 ON READER CARD

# Who brings low-cost graphics together with the best names in software?

digital VAX II/780

EDT Editors	EMACS	VI	WORD-11
SAS Data Analysis	TELL-A-PLAN	DATA CONNECTION	
CAD Presentation Aids			
Graphic Development			

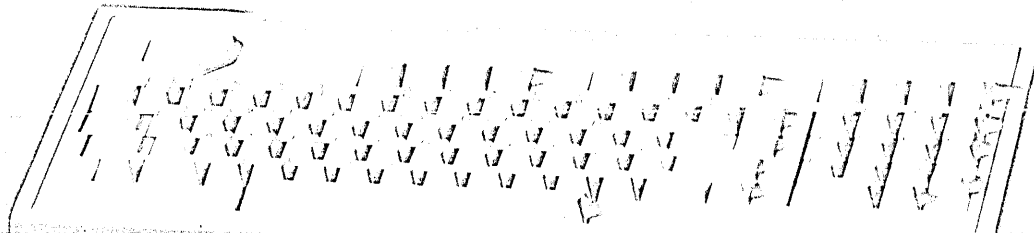
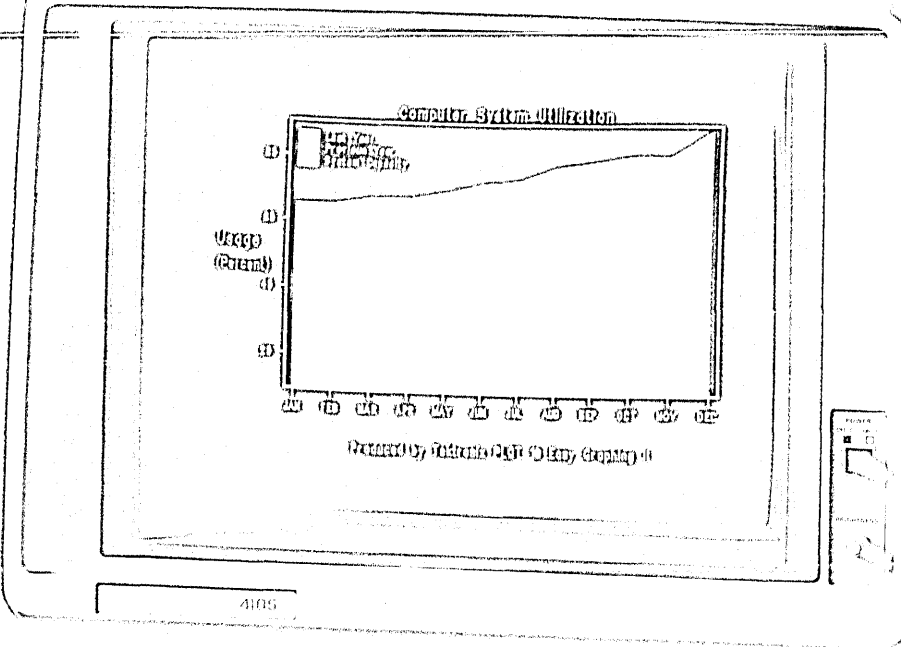

VAX and VAX II are registered trademarks of Digital Equipment Corporation. Other names are trademarks of their respective owners. Copyright © 1982 Tektronix, Inc. All rights reserved. 12/82/11

# Tektronix.

**No graphics terminals connect you to better utility or applications software, or with a broader range of computers, than Tek's desktop 4100 Series terminals.**

Among the dividends of Tek's long leadership in graphics are the scores of program development tools and powerful applications packages already on-file and immediately compatible with most computers.

From analysis to reporting, cartography to CAD: compatible

software helped make Tek's low-cost 4100 Series an immediate success.

**Major software vendors like ISSCO, SAS, Precision Visuals and many others offer 4100 users flexibility in data analysis and presentation.**

In more technical, engineering and scientific environments, users can take advantage of ANSYS,™ PATRAN-G,™ ANVIL-4000,™ GEO-MOD,™ Tek PLOT 10 Computer-Aided Drafting and Easy Graphing II.

Tek PLOT 10 graphics development software library is installed on more computers than any other in the world. It now includes the new international standard, GKS, and the Core based IGL, plus TCS, the nucleus for scores of specialized packages.

**The 4100 Series lets you take full advantage of all these powerful software resources.**

Fast, flexible, and priced fully equipped from just \$3995, quantity one, the 4100 Series

includes VT100 compatibility and ANSI X3.64 text editing right along with its exceptional graphics.

Choose from a range of resolution, segment

It's a very quiet and reliable push-button easy desktop unit that doubles as an alphanumeric printer. Single quantity cost is just \$1595.

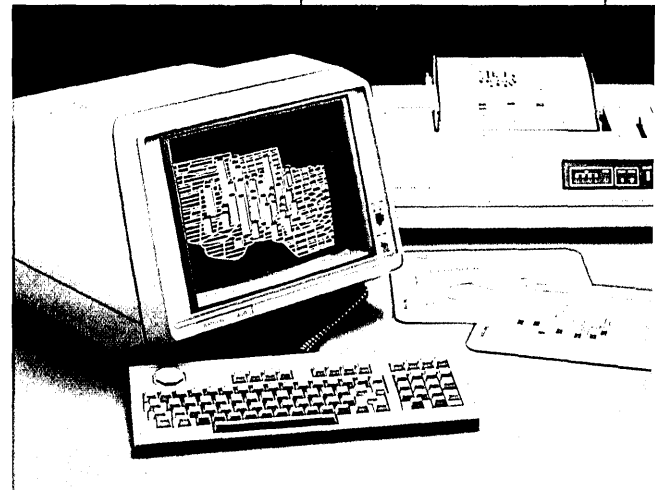

Powerful graphics team with Tek 4695 color copies and transparencies for a complete desktop analysis and presentation system.

memory and color capabilities, backed by performance unique to the price range—including a flicker-free 60 Hz non-interlaced display. 38.4K baud communications. And color manipulation by keyboard function keys.

**The companion 4695 Color Graphics Copier now makes color copies practical.**

Your Tek Sales Engineer can help you find the perfect software for your computer, your needs, and our graphics. For literature or the location of your local Tek sales office, call toll-free: 1-800-547-1512. In Oregon, 1-800-452-1877.

## Call Tek

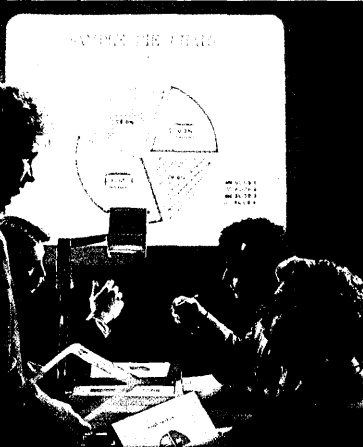

Presentations come alive with the communications impact of full color transparencies that can be produced in minutes.

**Tektronix**  
COMMITTED TO EXCELLENCE

## NEWS IN PERSPECTIVE

for adding a DES chip and in its software for expanding the session protocol to accommodate an encryption feature. But no encryption feature is available today. Saal admits he has no interest in spending Nestar money to develop a proprietary key management scheme, an essential set of procedures for managing the transfer of encrypt/decrypt keys to stations, preparing secure sessions, updating keys, or establishing secure sessions between stations on different

**"Users don't necessarily have high security requirements today. They are looking at tomorrow."**

networks. Saal said he is waiting for industry standards and guidelines to emerge.

"Our users, a majority of whom are large users, are becoming really sensitive to this issue [of network security]. They are asking what we have, and using that as a way to evaluate different vendors. They don't necessarily have high security requirements today. They are looking at tomorrow," Saal claims.

Network Systems is also waiting for guidance on the key management issue. It's a customer problem, suggests Altman. "The problem with encryption is that the users don't know how to control the code

keys. No one yet has developed a successful key management program. When users determine how they would like to implement encryption we can buy the encryption chip, probably a DES chip, or whatever users want."

In contrast, Sytek is not waiting for industry guidance. Sytek is leading the industry in the development of a "practical, not theoretical" key management system. Leading Sytek's effort is Tom Berson, a company founder and vice president of research.

Berson has been involved in data security research for years, he says. Sytek, formed in 1979, started as a consulting business specializing in data communications and computer security. By 1981, the company had broadened its business scope to include product design, development, and manufacturing. Berson estimates the consulting business continues to contribute about \$3 million annually to Sytek revenues.

Prior to forming Sytek, Berson worked for Ford Aerospace, serving as principal engineer for security on a "kernelized secure operating system" for the U.S. government. "From my work on KSOS I learned what to do different next time," Berson says.

Next time was Sytek and its Local-

Net broadband product with the optional secure LocalNet feature. Deliveries of secure LocalNet began only eight months ago. "It's been operational for two years," says Bill Taylor, Sytek's eastern support center manager. Limited corporate resources are responsible for the delay, he claims.

Secure LocalNet consists of two items, a key distribution center that resides in a secure cabinet and the secure packet control unit (PCU) option for each secured station. The key distribution center costs about \$3,000, while the PCU lists for \$500 per unit.

Response to the security feature has been positive but not overwhelming. A Sytek spokesperson estimates that six secure

**"The problem with encryption is that users don't know how to control the code keys. No one has developed a good key management program."**

LocalNet systems have been sold, and four or five more orders are expected soon. All sales have been to government agencies, such as the FBI and military bases, and government contractors such as Litton Industries and banks. On average, customers buy

# How to hire the big in the comp

## Introducing *Datamation's* new Recruitment Section.

For 26 years, *Datamation* has been the number 1 way to reach the top information processing professionals. After all, they're the only people who qualify to receive our magazine.

And now, *Datamation* gives you the best place to hire top professionals: our new Recruitment Section.

Now that *Datamation* is published twice as often, our Recruitment Section appears twice each month, 24 times a year. It features the kind of authoritative



60 secure PCU options per order.

Berson and his team's contribution to the encryption field is in the key management scheme. Among the problems the team attacked was how to validate that a certain message was from the source it claimed to be. They invented the notion of an eventmarker, a unique set of randomly generated bits that are attached to a station's identifier code. The code and eventmarker are generated by the same PCU device but the eventmarker is used during only one session, then discarded.

Another problem in the industry was how to keep encryption keys secret when moving them over the network. Sytek's scheme gives each PCU a unique master key. Station A calls station B and tells B it wants to establish a secure session. Station B tells the key distribution center that A and B want a secure session. The key distribution center sends a new message to station B that contains two segments. One segment contains the session key, A's identifier code, and B's eventmarker, all encoded in B's master key. The other message contains the same session key, B's identifier code, and A's eventmarker, encoded in A's master key. B decodes its portion of the message and forwards the rest on to A. Once the session is established, the key distribution center drops out of the picture. \*

## PIRATES ON THE BOARDS

**Electronic bulletin boards run by computer hackers seem more secure than the machines they raid.**

**by Edith Myers**

Among the most security-conscious computer users are those who would penetrate others' systems.

Robert P. Campbell, president of Advanced Information Management Inc., Woodbridge, Va., says he has a list of 2,735 electronic bulletin boards, some 210 of which are run by and for computer hackers. "There are probably many more of these pirate bulletin boards than our list shows," says the consultant.

Bulletin boards on public computer networks—the two most prominent being The Source and CompuServe—enable hackers to trade messages and share surreptitiously gathered telephone numbers and

computer access codes.

Those who run such bulletin boards, claims Campbell, tightly control access to their files. As many as three levels of access authorization—open, private, and secret—are used and typical password systems use randomly generated, six-character codes instead of more easily decipherable English words.

The pirate bulletin boards' managers also change passwords frequently, Campbell says, as the military does.

Hackers, says Campbell, "are an outgrowth of home computing, of increased computer literacy. To kids, hacking is the ultimate video game. It's not just kids, though; kids can be discouraged. There always will be a hard core." He believes this hard core includes people like real estate agents, store clerks, and bank clerks.

Campbell tells of an associate who accessed the open version of a pirate bulletin board and requested additional access.

**Hackers who get past the first level of security may be rewarded with access codes for "cream puff" companies.**

"He was asked for his name, which he gave, and then he heard no more. Somehow they have access to personal information

# Best caliber people in the computer industry.

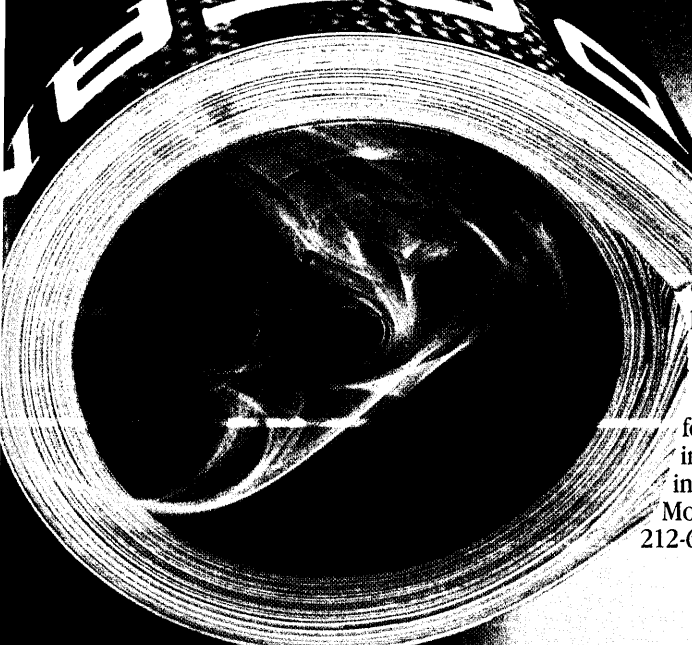

editorial *Datamation* is known for. And it gives you the chance to zero in on the cream of the crop: The average *Datamation* reader has been in the computer business 15 years. Supervises 13 people. And works at a company averaging \$600,000,000 in annual sales, with \$3,000,000 in annual computer purchases. So if your company wants to compete for the best people, make sure you're in *Datamation*. For complete recruitment information call Shirley Stirling or Kathy Monaghan at 1-800-223-0743. (In New York, 212-605-9732/33.)

**Technical  
Publishing**  
IBS a company of  
The McGraw-Hill Companies





CT5884 CTS - WORK ORDER REQUEST FORM - PLEASE FILL IN ALL BLANKS  
WORK ORDER NUMBER 3546 MONTH 02 DAY 28 YEAR 84 HOUR 02 MIN 25  
NO. 2433 DEPT. NAME MIXING PROJ. NO. 023 ACCT NUMBER 6539  
AREA 45 PRIORITY A TYPE Z EQUIPMENT NO. 7469L3004  
EQUIPMENT NAME 285 RED DEMO BOARD UNIT LOCATION ALBUQUERQUE  
CT5884 CTS - MAINTENANCE HISTORY  
ORIGINAL COST \$3158.83 D/P 83/16/82

DINO-TECH



# THE WAY SOME TERMINALS TAKE OVER AN OFFICE, YOU'D THINK THEY OWNED IT.

Of course, you can't blame the display terminals themselves for being big and overbearing. Most were designed to work in the not-so-crowded office of the past.

Today, things are different. You've got a lot more people and a lot more work stations. But not a lot more room.

That's exactly why we created our unassuming little 1700 monochrome display.

The 1700 couldn't crowd a person's desk if it wanted to. Its footprint is a tiny 13 x 12 inches (24% smaller than our biggest competitor's 3178).

Its keyboard is smaller, too—to give your operators extra elbow room.

And its smaller price gives relief to an upper management constantly being squeezed into financial corners.

Yet, even with its tiny price, our 1700 has some immensely valuable features.

Things like a high-resolution screen just as readable as a full-size 3270 screen. Diagnostics to save you troubleshooting time. Plus a head that tilts and swivels for the best possible viewing angle.

Still, the most valuable feature of our 1700 display is the small impact it has on a person's desk. And, in today's office, that can be a big comfort.

Contact your nearest ITT Courier Representative. Or call the ITT Courier Sales Support Department at 1-800-528-1400, toll-free.



*The unassuming ITT Courier 1700 display.*

**ITT**  
COURIER

## NEWS IN PERSPECTIVE

that helps them decide who to let in."

The kind of information available to those who get past the first level of security could include phone numbers and access codes for what hackers call "cream puff" companies, Campbell claims. These are user firms that have left gaping holes in their computer security programs. He worries more about specific targeting. "In some cases you can ask what the bulletin board has on XYZ company."

Campbell believes security is a management problem rather than a problem of network operators. "They're the ones

### **Estimates of the cost of computer tampering go as high as \$3 billion per year.**

who lose when people get into their systems and do things. Management should press for enhanced security."

Yet "most of the things coming on the market now are knee-jerk reactions," Campbell says. He specifically dislikes callback-type devices. "Number one, they make it inconvenient for the user, and number two, the main computer site dials back and bears the cost of the phone call."

Callback security devices, such as Defender II, introduced last September by Digital Pathways Inc., Palo Alto, Calif., are designed to prevent unauthorized dial-in access to computer systems, via a callback procedure. With Defender II, users attempting to access a system are asked for identification. Defender II checks the validity of the ID and tells the caller to hang up and wait for a callback. The unit then calls the user at a previously authorized phone number for the ID used.

A similar device, available this month, was in a sense brought about by the kind of management pressure Campbell talks about. The Getex division of Lockheed Georgia Co., Atlanta, was formed last year to pursue nonairlift business opportunities using Lockheed Georgia's technology. "Our director of information processing was concerned about security," says Le Roy Davis, manager of interface products for Getex. "He wouldn't allow access to his system from anywhere outside the premises, but there were times when this would have been convenient."

This month Getex will begin delivering Data Sentry, a callback intelligent modem. "If you want to call a computer that Data Sentry's guarding," says Davis, "it first asks your phone number. Then it hangs up and checks its list of authorized phone numbers. If yours is authorized, Data Sentry dials back and asks you for the password. If you don't enter the right password in three tries, Data Sentry hangs up and won't let you call back from that number."

A companion Getex product, Remote-On, lets users with the right password

turn their computers on and off from remote terminals. "Calling from a number that's not on the authorized list is no problem," says Davis, "since users can set Data Sentry to call back any number that gives it an authorized password."

Davis says he's heard estimates of the cost of computer tampering that go as high as \$3 billion per year. He notes there are some 3.6 million personal computers in homes and businesses across the country. "It's impossible to imagine the direct cost or business impact of tampering with all those files."

Campbell says hackers are getting more sophisticated. "They're using multiple networks. They're weaving. They go from one voice grade network to another voice grade network to a digital network, making their paths impossible to trace. Although U.S. operators of digital networks have agreed not to allow hopping from one digital network to another, this still is possible in Canada, so a hacker can route himself through Canada for another weaving alternative."

He sees as one solution a "tamper-proof chip that would uniquely identify each terminal. It wouldn't be that expensive." His big hope, however, is for a computer security research foundation, something he's been promoting for four years. It would be an "independent body, free from vested interests and outside influences and able to focus on all interests."

He feels that what the commercial world needs is what the Department of Defense has been requesting for some time: multilevel security. "The industry sees DOD's need as highly specialized, and until

### **"Until the commercial world realizes that it needs the same security devices that DOD needs, the industry won't provide them."**

the commercial world realizes it needs the same things, the industry won't provide them."

Campbell says, "We'll be into the next decade before we have the security we need for computer systems unless industry management can get its heads together." He feels his proposed foundation could be the focus for this effort. He's looking for corporate sponsors and congressional support, although he admits he will probably have to wait for the latter until after the next election.

In the meantime, news coverage of teenagers breaking into remote computer systems via personal computers and public phone lines will no doubt raise the public's consciousness about the security issue. Whether or not such activity has been thwarted by authorities however, remains to be seen. \*

## TAXATION

# SPELLING RELIEF FOR R&D

**Changes in antitrust and tax laws may, if adopted, make life easier for U.S. technology companies.**

by Willie Schatz

For the last few years, U.S. technology firms have been bemoaning their inability to get together for joint research and development projects. To do so would be a violation of the antitrust laws. If only they could join one another, it'd be so much easier to hold off the Japanese. Or so the theory goes.

Theory is approaching reality. The House Judiciary Committee recently passed H.R. 5041, the "Joint Research and Development Act." Assuming the settlement of a jurisdictional dispute with the Science and Technology Committee, which has passed a similar bill (H.R. 4043), the Judiciary Committee bill should reach the House floor sometime this month. The Senate is also working on a similar bill and is expected to take it up shortly. Passage of some version is considered likely this year.

The House bill would reduce the current award a successful antitrust plaintiff could win from treble damages to actual damages, plus interest and court costs, including reasonable attorney's fees. To become eligible for this treatment, which is a whole lot better than what an antitrust violator presently receives, the joint venture would have to disclose the general nature of its activity to the Attorney General and the Federal Trade Commission and undergo a 60-day review. If such a company beats the plaintiff in a subsequent antitrust action, the company is awarded a reasonable attorney's fee.

H.R. 5041 also removes the illegal "per se" antitrust law doctrine for qualified joint R&D ventures. Under that theory, courts don't consider economic arguments about certain activities' procompetitive effects. The House bill would direct courts to find a violation only if it would be more anticompetitive than procompetitive.

"In drafting this legislation, we have tried to avoid the possibility of unnecessary or inadvertent disclosure of confidential business information that is the property of an R&D joint venture," says Rep. Hamilton Fish (R-N.Y.), the Judiciary Committee's ranking minority member.

# Changing our ribbon is a snap.

Most printers make you fool with a messy ribbon.

But with Digital's Letterprinter 100, all you have to do is snap in one of our replacement cartridges.

You'll instantly get at least 5 million more characters' worth of ink.

Easy, isn't it?

The fact is, everything about the Letterprinter 100 is easy.

For example, with just a flick of a finger you can select

up to five different typefaces. Or let your

computer do it for you, automatically.

If you can't find a typeface you like,

we'll customize one for you.

Now why would the world's second

largest computer company go to

such lengths to make the

Letterprinter 100 so

accommodating?

Simply so it can spend more

time doing what you bought it

to do in the first place.

And that's printing crisp, clear

manuscripts and graphics. From letter-

quality like you see here for word processing,

to high speed printing so you can get a draft

page in only 10 seconds.

The Letterprinter 100 works with any of

Digital's personal computers or video terminals. And it's a snap to use.

See the whole family of Digital's Printers, including the

daisy-wheel LQP02 and the low cost Personal Printer, the LA50.

For the distributor nearest you, call 1-800-DIGITAL, extension 700.

Or write Digital Equipment Corporation, Terminals Product Group,

2 Mt. Royal Avenue, UP01-5, Marlboro, MA 01752.

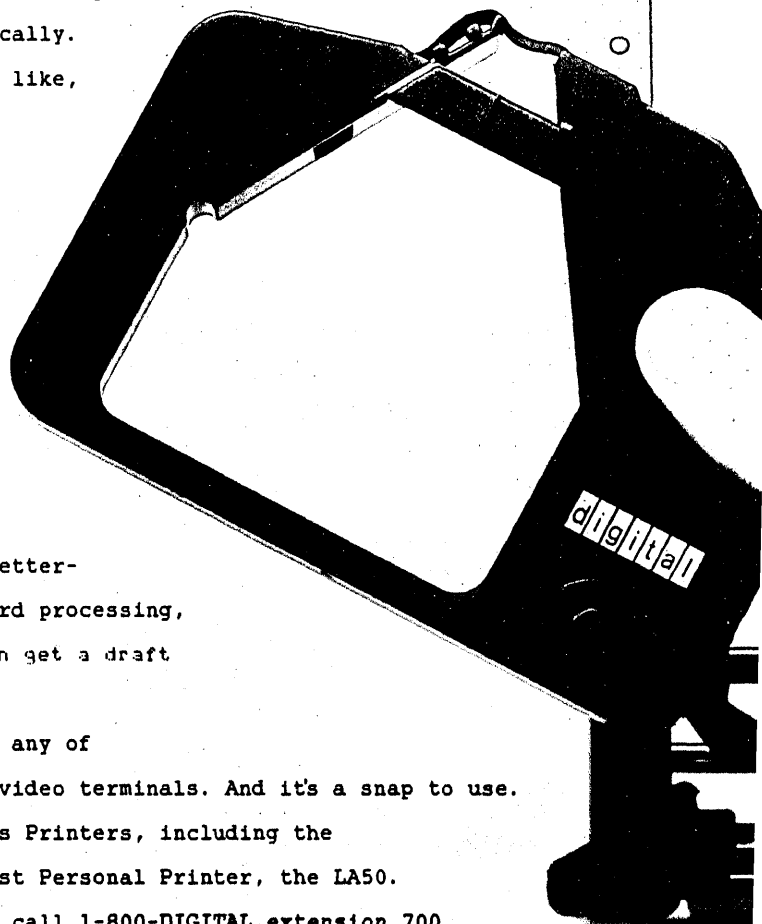

digital

# HAVE YOU BEEN BLIND COMPUTER WITH THE

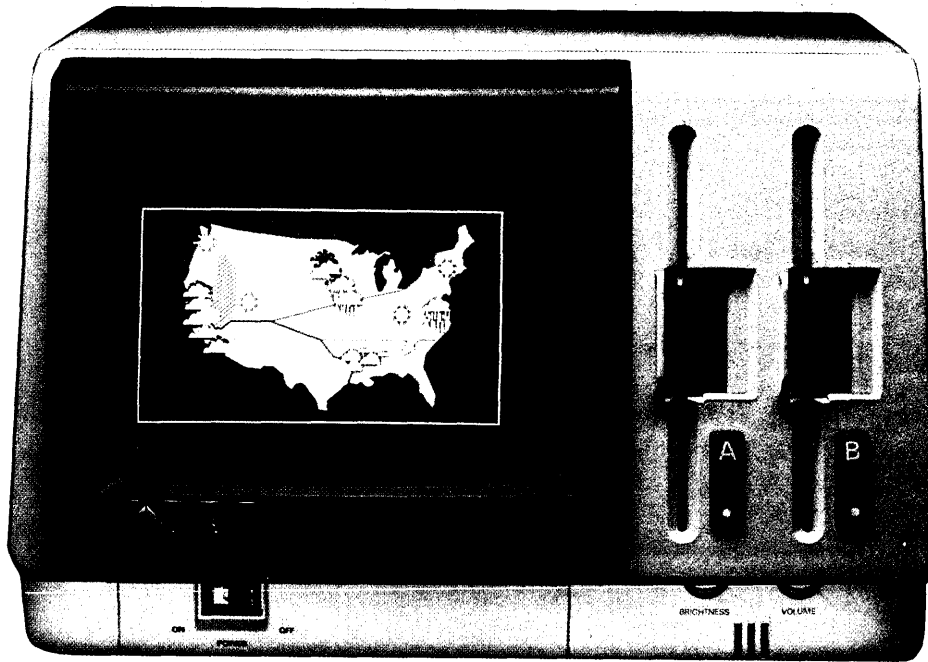

**NEC's Advanced Personal Computer offers the widest range of quality graphics.**

One reason the APC is better is that it lets you do more kinds of graphics than any other personal computer.

In fact, it gives you the kind of graphics you'd expect only from a much more expensive computer.

With the APC, you can produce color transparencies, color slides, or output to a variety of printers and plotters.

You can even do Computer Aided Design (CAD).

**Our screen is graphically better.**

Seeing is believing. And one look at our color screen will prove it's the best.

But it's no accident. It starts with the NEC 7220 graphics processor, the most advanced graphic chip available.

Then, unlike other PC's, the

*NEC's Advanced Personal Computer offers the sharpest color graphics of any personal computer.*

Graphics are being used more and more by businesses every day. They give companies a clearer picture of their place in the market. They make for more effective presentations. And with slides and color trans-

parencies, they can let a room full of people see the same thing at once. Although most people see the value of graphics, very few are aware of the personal computer that lets them create the best color graphics.

It's the Advanced Personal Computer from NEC.

*This slide was produced from the screen using Videograph™ software, an inexpensive Screen Shooter™, and Polachrome™ 35mm film, in less than 5 minutes. For less than \$1.00!*

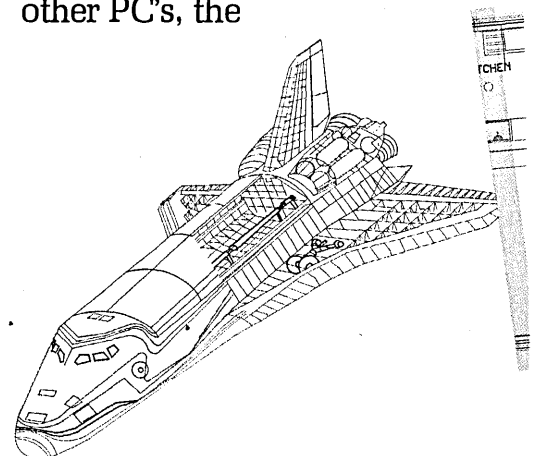

Context MBA is a trademark of Context Management Systems, Inc. Graphwriter is a trademark of Graphic Communications, Inc. Graphplan is a trademark of Chang Labs, Inc.

# TO THE PERSONAL BEST COLOR GRAPHICS?

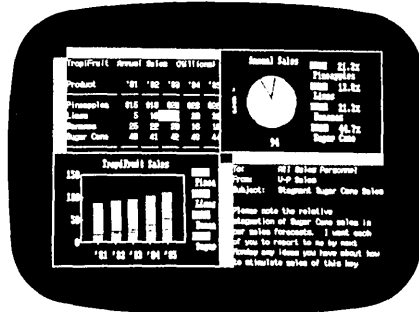
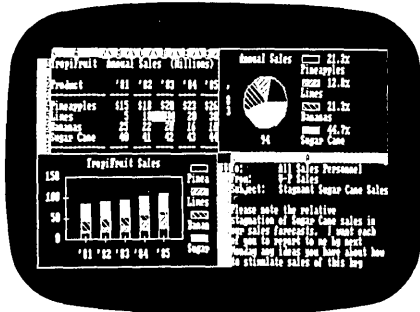

Context MBA™ runs in high resolution color on the APC. But it can only run in one color on the color monitor of the leading brand.

APC graphics option has its own dedicated memory, so there's never a tradeoff between color and resolution.

## Software will make you a big-time producer.

Better hardware alone isn't enough. You also need better software. And NEC provides that, too.

Take Graphplan™ for example. Graphplan can take spreadsheet format data and produce customized business graphics on paper. Instantly.

Graphwriter™ will let you produce professional color graphics in

over 20 different formats. Then turn them into transparencies or hard copies using the most popular pen plotters.

Videograph™ makes creating free-form color images for slide presentations easy and inexpensive.

Autocad™ lets architects, engineers and designers create sophisticated graphics and designs, then produce precise drawings with popular plotters.

This software combined with the APC hardware will give you the best graphics you can get on any personal computer.

## For the complete picture, call NEC.

For product literature on any of NEC's APC graphics capabilities, call 1-800-343-4419.



Designers can use Autocad™ to make the design process faster and easier.

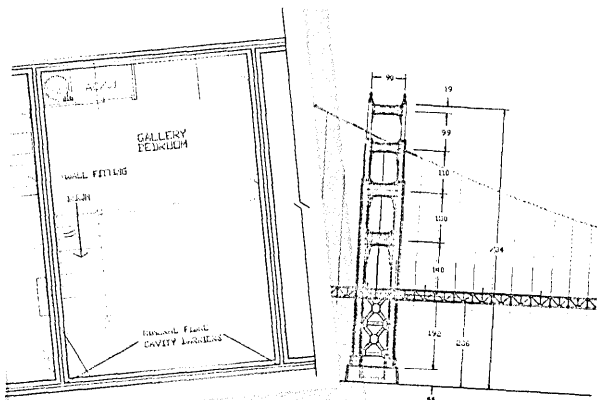

You can produce printed outputs like these with the APC.

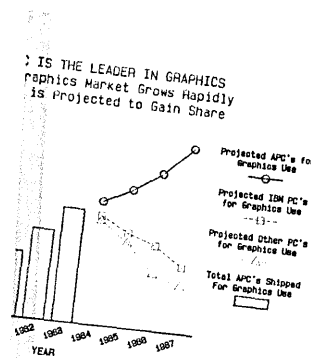

In Massachusetts, call 1-617-264-8635.

And find out why more and more graphics users with vision are saying "NEC and me"

# NEC AND ME

NEC Information Systems, Inc.  
1414 Mass. Ave.  
Boxborough, MA 01719

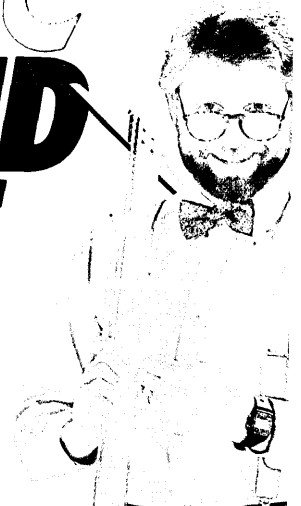

Screen Shooter is a trademark of NPC. Polachrome is a trademark of Polaroid. Videograph is a trademark of Xiphias. Autocad is a trademark of Auto Desk, Inc.

## NEWS IN PERSPECTIVE

It took several compromises between Fish and committee chairman Rep. Peter Rodino (D-N.J.) before this language could be worked out. Rodino originally wanted full disclosure of the joint venture's activity.

"Public notification should not place the joint venture in the position of having to publicly disclose the essential elements of the research they intend to pursue," Fish explains. "We want to narrow the amount of information that would be disclosed publicly, but not to modify the access of the enforcement agencies to that information. All we should require is a very general statement of the overall aims of the joint venture."

That's exactly what they did. And that wasn't the only good legislative news

**"We want to narrow the amount of information that would be disclosed publicly," says Rep. Hamilton Fish.**

for the high-tech industry.

As part of its proposed 1984 tax package, the Senate Finance Committee voted to make the R&D tax credit a permanent part of the Internal Revenue Code. It is currently scheduled to expire at the end of 1985.

Extending its life forever was a ma-

major goal of CBEMA, the American Electronics Association (AEA), the Semiconductor Industry Association (SIA), and the Scientific Apparatus Makers Association (SAMA). They all put some heavy pressure on Capitol Hill, using the familiar "the Japanese are coming" story. The Senate bought the associations' argument that the tax credit had stimulated R&D high tech enough for America to at least stay even with the onrushing Japanese. The House has yet to respond, but is likely to take similar action.

S. 2165, sponsored by Sens. John Danforth (R-Mo.) and Lloyd Bentsen (D-Tex.), permanently allows companies to receive a 25% tax credit for all R&D investment above an average base of the firm's annual spending for the last three years. It also permits startup corporations to qualify for the credit, despite a lack of history on their side.

Other favors bestowed on the high-tech industry include narrowing and clarifying the definition of qualified R&D, creating new incentives for corporate funding of basic research, and establishing improved incentives for corporate donations of state-of-the-art scientific equipment to colleges and universities.

One more thing. The bill recommends \$48 billion in new taxes, supposedly

to close the deficit. But what's a few bucks among friends?

"The Senate took a firm step towards maintaining U.S. technological leadership by incorporating the credit into its 1984 tax package," says Dean Morton, AEA chairman and executive vice president

**The bill recommends \$48 billion in new taxes, supposedly to close the deficit.**

of Hewlett-Packard. "In addition, it took courage to vote for new taxes in an election year."

It's not quite time for dancing in the streets, though. The permanent credit still has to be approved by the full Senate and House, then passed by a conference committee as part of the overall 1984 tax package.

"I think we're at least halfway there," says Ken Hagerty, AEA vice president for government relations. "We've got 22 cosponsors on the House Ways and Means Committee, which is enough to get the credit passed there, and 111 in the whole House. We ought to be able to convince them on the merits."

They've done a pretty decent job so far. \*



## NATIONAL CONFERENCE ON ARTIFICIAL INTELLIGENCE\*

(with a two day Tutorial Program August 6-7, 1984)

**AUGUST 6-10, 1984**

at

**UNIVERSITY OF TEXAS**

at Austin

For more information, contact:

AAAL-84

National Conference on Artificial Intelligence

445 Burgess Dr.

Menlo Park, California 94025

\*sponsored by the American Association for Artificial Intelligence and the University of Texas at Austin

CIRCLE 36 ON READER CARD

## C-CALC™

C-CALC — the high-performance 3-dimensional spreadsheet you won't outgrow. Currently available for: UNIX, VMS, RSTS, RSX, IAS, P/OS, AOS, AOS/VS.

C-CALC's features include:

- Comprehensive worksheet consolidation
- Built-in training and on-line HELP
- Menu-oriented for ease of use
- Variable width columns
- Fully transportable data
- Supports most types of terminals
- Dynamic sorting capability
- User-defined procedures and functions
- Generates boardroom quality reports
- Written in "C" (No compiler needed)
- On-going customer support and service
- Multi-level training classes available

## DSD Corporation

10420 NE 37th Circle, Suite A

Kirkland, WA 98033

(206) 822-2252

CIRCLE 37 ON READER CARD

# Here's Why Precision Visuals Is Now The Leader In Graphics Software Tools!

NOW ANNOUNCING  
DI-TEXTPRO™  
AN OPTIONAL MODULE DELIVERING  
PUBLICATION QUALITY TYPEFACES  
See Us At NCGA—Booth #518

## One Program Drives Many Devices

This single advantage can save you hundreds of hours of programming time. It enables you to use your hardware (both host computer and graphics devices) to its fullest. It protects your software investment against obsolescence and frees you from exclusive ties to hardware vendors.

Precision Visuals currently offers tailored interfaces for over 70 graphics devices from the leading graphics hardware companies, including: AED  BBN  Calcomp  Calcomp lookalikes  Chromatics  DEC  Digital Engineering  Envision  Hewlett-Packard  Houston Instruments  IBM  Lexidata  Logic Sciences  MAGI  Megatek  Printronix  Ramtek  Raster Technologies  Sanders  Selanar  Tektronix  Tektronix lookalikes  Trilog  Versatec  Visual Technology  Xerox  Zeta.

## They Run On Most Popular Computers

Including IBM, VAX, Hewlett-Packard, CDC, Prime, Honeywell, Data General, Cray, DEC PDP-11, Apollo, and many Unix-based micros.

Precision Visuals software tools require a surprisingly small amount of computer resources. Even on 16- or 32-bit micros they provide access to the capabilities of evolving graphics standards.

*"DI-3000 and GRAFMAKER have provided us with the graphics toolbox concept we had been looking for to service our timesharing customers. Resource management is critical in a timesharing environment, and we are especially impressed with the modest memory requirement and execution efficiency of both packages."*

Dr. Richard R. Socash, President  
Research Information Corporation  
Founder, TENTIME Timesharing Services

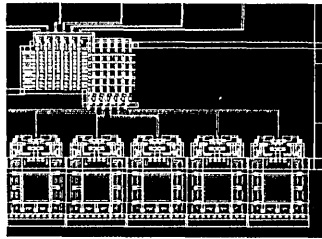

*Programmer-friendly tools  
for computer-aided design*

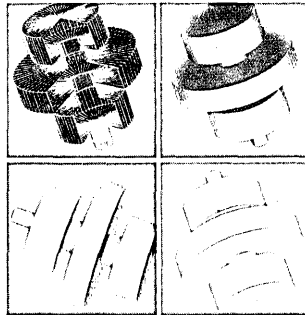

*Applications modeling  
using 3D and color*

## Rich Capabilities Mean Limitless Applications

Precision Visuals' software tools are the proven graphics standard in major industries including aerospace, energy, communications, engineering, government, and education . . . for applications such as computer-aided design, business graphics, process control, mapping, geological data analysis, and document layout. System integrators (OEMs) use them as the graphics nucleus in scientific/engineering systems and as the graphics component of data base management and financial modeling systems.

## The Best Support in the Business

DI-3000®, our basic tools package, is the preferred solution for your graphics development because we've learned what customers expect and need in support. Documentation is the key. Example intensive programming guides, quick reference cards, and step-by-step tutorials get you through development and into production fast. We also support active international and regional user groups, and a telephone Helpline staffed by graphics software specialists. Our seminars and courses help get your graphics applications operating on time and within budget.

Find out how Precision Visuals' graphics software tools can open a new world of flexibility, economy, and standardization for your graphics applications. Call us at 303/530-9000.

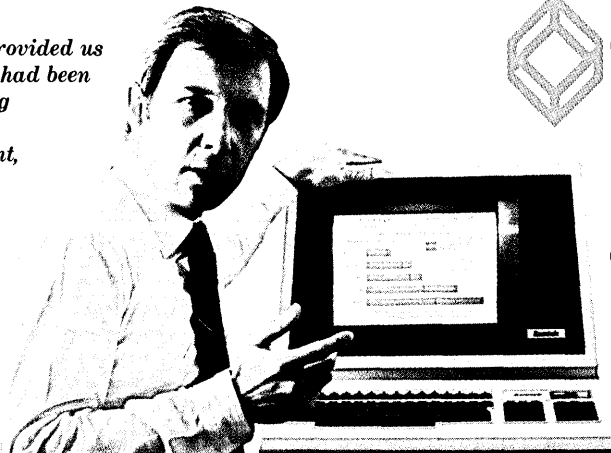

**Precision Visuals**

6260 Lookout Road  
Boulder, Colorado 80301 USA  
303/530-9000  
TELEX 45-0364/TWX 910-940-2500

CIRCLE 38 ON READER CARD



**UNIFY**  
CORPORATION

**MANAGEMENT  
SYSTEM**

**REFERENCE  
MANUAL**

**UNIFY**  
CORPORATION

**INTERNATIONAL  
BUSINESS MACHINES**

JNIFY is a registered trademark of Unity Corporation.  
JNIX™ is a trademark of Bell Laboratories.  
BM® is a registered trademark of International Business Machines Corporation.  
DEC® is a registered trademark of Digital Equipment Corporation.

# UNIFY. JUDGED NO. 1 BY COMPUTER OEMS.

One UNIX computer manufacturer after another has come to the same decision: UNIFY is the fastest, most powerful, most flexible data base management system for users of all skill levels.

By their own investigation and by system integrator requests, computer manufacturers representing some 90% of the market choose to offer UNIFY with their UNIX computers.

They include DEC. Perkin-Elmer. NCR. Tandy. Pixel. Onyx. Cadmus. Codata. Cromemco. Momentum. Plexus. Altos. Callan Data. And many more.

**The evidence is overwhelming.** In independent benchmarks, UNIFY consistently ranks as the top performer. Completely menu-driven design

and industry standard IBM SQL query language make it easy for non-programmers to develop data base applications.

The most powerful "back end" design in the industry, including 90 subroutines at the host language interface level, promises that UNIFY can keep adding features, keep adding users, without eroding performance.

**Judge for yourself.** Our comprehensive 300-page tutorial and 500-page reference manual system are yours for only \$95. Together they show you how to build virtually any application of your choice.

To order, contact UNIFY, Department D-5, 9570 S.W. Barbur Blvd., Portland, Oregon 97219, 503-245-6585.

**UNIFY®**  
**THE PREFERRED UNIX DBMS.**

## NEWS IN PERSPECTIVE

### BENCHMARKS

**JOINT VENTURE:** Merrill Lynch and IBM have joined forces to provide information systems to the financial services industry. A proposed system would integrate market data services, enhanced communications systems, software, minicomputers, and IBM 3270 PC desktop computers, the two companies said. The venture grew out of development work the two firms undertook two years ago to create a financial services system for Merrill Lynch's retail brokerage network and for applications in capital markets, real estate, and insurance. The new partnership, which is financed equally by IBM and Merrill Lynch, will market the system to brokerage firms, commercial and savings banks, money managers, and private clients of such firms. A prototype system shown in late March tracks up to 300 selected securities and alerts the broker to new highs and lows in stock pricing. No name or delivery schedule was announced for the venture or its product.

**SETTLES SUIT:** Lotus Development Corp., the Cambridge, Mass., publisher of the 1-2-3 integrated software package, said it has settled out of court its suit against Rixon Inc., the Silver Spring, Md., modem maker. Lotus, charging that Rixon had illegally duplicated manuals and diskettes containing 1-2-3 and had distributed them to 13 branch offices, filed the \$10 million suit in a blaze of fanfare in January. The settlement involves Rixon paying Lotus an undisclosed amount of cash and agreeing to the entry of a permanent injunction prohibiting it from duplicating the software in the future, a Lotus spokesman said. Rixon, as part of the settlement, did not admit to any wrongdoing.

The suit was seen as the first legal action resulting from software publishers' concerns about illegally pirated programs, and was filed as a warning to other firms engaged in the unauthorized duplication of Lotus software.

**NEW GENERATION:** IBM's announcement in late March of the 3179 and 3180 display terminals effectively brought down the curtain on the venerable 3278 series of terminals, which were first introduced in 1977. The 3179 is essentially a direct replacement for the 3279 color terminal, offering a seven-color display with an etched screen that tilts and swivels, for \$2,300 in single quantities. The unit uses only 40% of the desk space required by the 3279 and about half the power, IBM, said. It was developed by the firm's Fujisawa laboratory in Japan and is currently available. The 3180 display, in conjunction with the 3178 announced a year ago, replaces the 3278 family, models 2 through 5, IBM said. The 3180 is the first IBM terminal that can attach

to either the 8100 distributed system or a 370-based host system, although it cannot do both; different electronics are required for each version. The 3180 comes with a keyboard that can be modified by the user and that enables the user to store 97 characters in a record/playback format. It offers four selectable screen formats and variable formats, and costs \$2,300. It was developed in Rochester, Minn., and will be available in June. As part of the same announcement, IBM said that the 8100 can now access a gigabyte of disk storage and that IBM Personal Computers can now emulate 8100 terminals.

**CPU TO PBX INTERFACE:** AT&T and Hewlett-Packard said the former's System 85 digital PBX will be able to interface directly to the latter's line of computer systems. The companies published the specifications of the PBX's digital multiplexor interface (DMI) and said they would propose it to the Electronics Industry Association standards committee. The DMI directly conflicts with a computer-to-PBX interface (CPI) offered to the committee last summer by Northern Telecom Inc. and Digital Equipment Corp. Hewlett-Packard said that concurrent with its support of the System 85 DMI from AT&T it is withdrawing its support of the Northern Telecom CPI and SL/1 PBX. Both interfaces operate at the Bell System's T1 carrier rate of 1.5Mbps between a computer and a PBX, but differ in the number of data channels and the data rate through each channel. Other computer manufacturers are beginning to take sides, although some, like Data General, endorse both proposed interfaces. Honeywell currently supports the AT&T interface, while the Northern Telecom CPI is supported by Wang, Sperry, Prime, and competing PBX makers such as Rolm, Mitel, and Intecom. IBM is working closely with Rolm, in which it owns an equity interest.

**EXTRATERRESTRIAL:** Prime Computer Corp. has added satellite communications to its Primenet and Ringnet network offerings. Prime has entered a joint marketing agreement with Vitalink Communications Corp., Mountain View, Calif., under which Vitalink will offer Prime customers satellite earth stations. Prime representatives will qualify their customers and certify compatibility. Vitalink will sell the accounts and provide earth station hardware and software. Both companies will maintain and support their respective systems. Vitalink, which has installed 80 privately owned satellite communications networks since it was founded in January 1980, has joint marketing agreements with Hewlett-Packard and Electronic Data Systems.

**NOW IN PAPER BACK:** Adam Osborne is back in business, this time in soft-

ware. His previous efforts were in book publishing (Osborne-McGraw Hill) and hardware (Osborne Computer, which went bankrupt last September and currently is in reorganization).

Osborne's new company is Paper Back Software and embodies what its founder calls "a totally new structure for software distribution." He says software publishing falls short because "it takes more to generate software than it does to generate a book." Paper Back Software is lining up software developers which Osborne compares to orange growers with his company being the growers' cooperative. "We'll package and sell and, in time, they'll have a piece of our company." Initially, the company, formerly announced in late March at the Computer Faire in San Francisco, had nine employees and a stable of three software developers. "They'll set the standards," said Osborne. "They'll establish a standard file structure for all of the computers we support. If you can use one of our packages you can use them all." Computers supported will be those with an installed base of 500,000 or more.

**SUIT-ERS:** As if the charges by the Securities and Exchange Commission of "fraud and deceit" weren't enough. Paradyne Corp., Largo, Fla., has been hit by a private \$70 million suit by a competitor. M/A-Com Inc., Baltimore, took Paradyne to federal court in Maryland, charging that the latter had unfairly won a contract to upgrade the Social Security Administration's data network. M/A-Com was the second lowest bidder on that \$100 million deal and is seeking trebled damages of \$20 million for lost profits and \$10 million in punitive damages.

Paradyne had yet to respond to the suit by press time. M/A-Com said its Sigma Data Computer Corp. subsidiary had filed two unsuccessful protests against the award to Paradyne. The company alleged in its suit that Paradyne improperly approached a law firm that Sigma had earlier retained for its investigation and subsequent protests of the Paradyne award.

According to M/A-Com, Paradyne finally retained the law firm, Fried, Frank, Harris, Shriver and Kampelman, primarily "to obtain information relating to Fried, Frank's representation of Sigma Data concerning the [Social Security] procurement." M/A-Com also repeated charges similar to the SEC's that Paradyne had shown bogus equipment to SEC officials, including the notorious "empty box with blinking lights," which was allegedly used to represent a data encryption device. Paradyne claims it broke no laws in obtaining the SEC contract, the largest Paradyne had ever won, and says it continues to fulfill the contract's requirements with hardware and software products. \*

...the ... of ...  
...the ... of ...  
...the ... of ...

...the ... of ...  
...the ... of ...  
...the ... of ...

...the ... of ...  
...the ... of ...  
...the ... of ...

...the ... of ...  
...the ... of ...  
...the ... of ...

...the ... of ...  
...the ... of ...  
...the ... of ...

...the ... of ...  
...the ... of ...  
...the ... of ...

...the ... of ...  
...the ... of ...  
...the ... of ...

...the ... of ...  
...the ... of ...  
...the ... of ...

...the ... of ...  
...the ... of ...  
...the ... of ...

# A sure cure for the problem of information bottleneck.

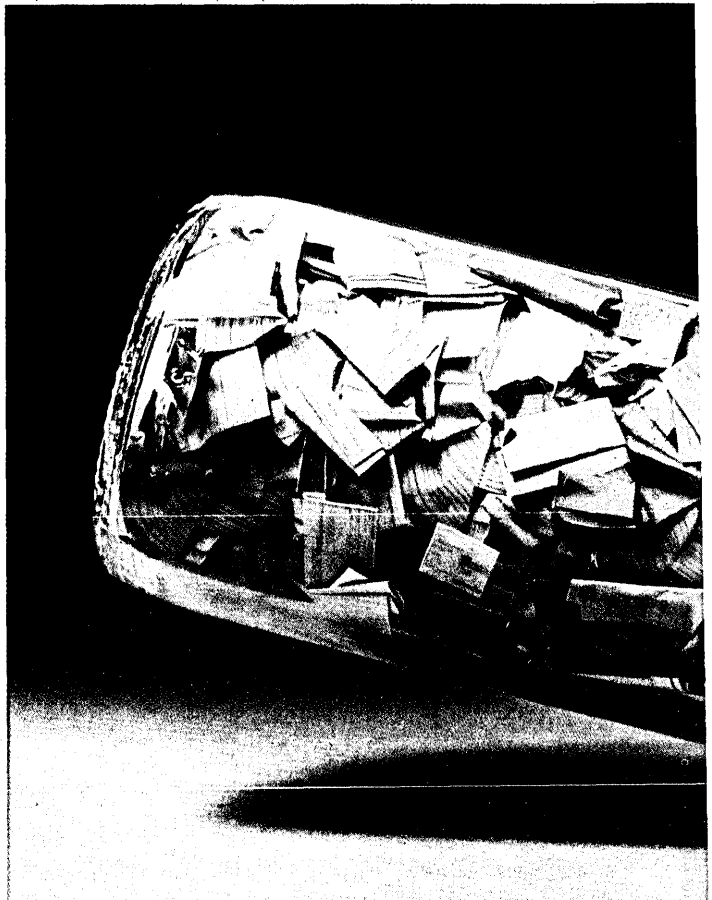

Programming backlog is the source of the problem. Eliminate it, and you eliminate the bottleneck.

Which is precisely what Sperry has done with the MAPPER™ System.

With MAPPER, you work with the computer directly. You ask questions in plain English. And you get immediate answers.

And if the information you get raises other questions, you can ask them right away. With no delay for programming. Or reprogramming.

MAPPER is that powerful. It allows you to manipulate information in almost any way you want. And, interesting to note, it can even help your programmers become more productive.

## AN AFFORDABLE SYSTEM.

You don't have to be a large company to have a MAPPER System. MAPPER can be scaled to the real and present needs of just about any size company. The cost of a MAPPER System makes it practical for even a department

MAPPER is a trademark of Sperry Corporation. © Sperry Corporation, 1983



## MAPPER SYSTEM

800-547-8362 (9 a.m. to 5 p.m.  
E.S.T.) Or send us the coupon.

within a company to own its own system. Or you can time-share through a Sperry service bureau.

What you get for your money is a whole new order of efficiency in your day-to-day management tasks. Because you'll have the information you need right at your fingertips. Literally.

SEEING IS BELIEVING.  
Visit our Sperry Corporation

here that may sound extravagant. But if anything, our claims are on the conservative side. And to prove it, we offer you the opportunity to see a demonstration of MAPPER at work.

**800-547-8362**

But first, you might want to look over our MAPPER brochure. A copy is yours for the asking. Call toll-free

Sperry Corporation  
Computer Systems  
Department 400  
P.O. Box 500  
Blue Bell, PA 19424

Please send me a brochure on the  
MAPPER System.  
DA 5-1-13

Name

Title

Company

Address

City  State  Zip

Telephone

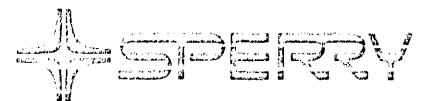

**It's GKS vs. the Core System in a struggle that's part holy war and part pie fight.**

# THE GRAPHICS STANDARDS BATTLE

by Jon A. Meads

Religious wars have two salient features. One is the use of slogans that become indisputable articles of belief, unquestioned by the faithful. The second is that each side predicts catastrophe if its beliefs are not accepted by everyone else.

It appears that a religious war regarding graphic standards has developed over the past year. In the latter half of 1982, the ANSI Technical Committee on Computer Graphics Programming Languages (X3H3) moved to support the Graphical Kernel System (GKS), a standard for two-dimensional drawing initially developed by the West Germans.

The Association for Computing Machinery's Special Interest Group on Computer Graphics (ACM/SIGGRAPH) had previously developed and submitted to X3H3 its own proposed standard, the Core System, which supported both two- and three-dimensional line drawing. SIGGRAPH, concerned about the large number of Core System users and the lack of a readily available 3-D standard, requested ACM to initiate a formal standards activity and to consider the Core System as the first official ACM standard. This action was followed by a resolution from X3H3 condemning SIGGRAPH's efforts to establish the Core System as a formal standard.

Since then a debate that had previously been fairly heated has escalated into a conflict that seems to be part holy war and part pie fight. Political, economic, and technical issues have been reduced to slogans like "One Graphic Standard!" "A 3-D Standard—Now!" "Maintain International Cooperation!" and "Keep Graphic Standards Clean—No Unnatural Viewing Operations!"

The supporters of GKS forecast doom and alienation to any who would dare promulgate a second standard. They also fear economic ruin to the graphics industry, or at least a sizable decrease in its profits. The supporters of the Core System believe the adoption of GKS as a solitary standard would restrict future development of graphics technology. They argue that it would be equiva-

lent to requiring all programmers to use PL/1 and that without the Core System, standards for 3-D graphics would not be available before the end of the decade.

The need for graphic standards became evident more than a dozen years ago. At that time many applications were written for specific graphic systems. If a user obtained a new system, especially one from a different vendor or one with different capabilities, he had to rewrite the entire graphics program. It was costly to change hardware and impractical to port programs from one installation to another.

In 1972, SIGGRAPH formed a committee to look into the issue. In 1974, the committee organized a Workshop on Machine Independent Graphics at the National Bureau of Standards. The major result of this meeting was the chartering of the Graphics Standards Planning Committee (GSPC). GSPC's job was to address accepted practices and existing standards or proposals in order to develop a graphics standard. Such a standard, it was reckoned, should be capable of supporting two- and three-dimensional line drawings for both passive and interactive displays.

GSPC produced several working documents, but not much else was accomplished until 1976, when IFIP WG 5.2 sponsored the Workshop on Graphics Standards Methodology in Seillac, France. This meeting served as a watershed for the development of graphic standards. Four methodological themes developed, and served to guide GSPC's efforts:

1. Portability of programs is the most significant purpose of a standard.
2. Of the issues affecting portability, those that affect program structure are the most important.
3. The effect of a standard on the conceptual design of a graphics application is as important as its functional capability. Syntax and calling sequences are much less important.
4. The function of constructing and manipulating an object within the application program is different from the function of producing a picture of the object. These func-

tions should be clearly separated.

With this wisdom in hand, GSPC went to work in earnest. By the summer of 1977, GSPC completed a heroic effort, publishing a draft of the Core System in the 1977 fall issue of *Computer Graphics*, the quarterly newsletter of SIGGRAPH. Several thousand copies of this report were distributed worldwide and readers were asked to "debate it" and "provide constructive criticism." This they did.

## TWO YEARS REVIEWING COMMENTS

GSPC spent the next two years reviewing and considering the comments received. In the spring of 1979, GSPC published its final report in *Computer Graphics*. It was a significantly updated document, almost twice the size of the previous one. It included a hefty section on the issues considered, the positions held, and the resolution of these issues. Also included was a proposal for a graphics metafile (used for device-independent storage and transfer of pictures) and draft extensions for raster devices and distributed systems.

The GSPC effort was monumental and inspired. It also involved three years of intense activity that left the majority of the membership exhausted. Bert Herzog and Bob Heilman, then current co-chairs, pronounced GSPC (which had completed its major goal of defining a methodology and structure for a graphics standard) to be dead. A solemn wake, complete with casket and funeral march, was held at the SIGGRAPH annual conference in Seattle. However, the Spirit of GSPC, not having fully expired, leaped from the casket and into the arms of Peter Bono, chairman of the recently formed ANSI X3H3. Thus GSPC passed on to X3H3 the task of finalizing the standard and resolving the remaining issues.

It took a while for X3H3 to get itself organized. Also, X3H3 did not immediately forward the Core System to the International Standards Organization (ISO) but chose to refine it further and consider improvements including the raster extensions. In the meantime, the Graphical Kernel System, which



©/E  
TE

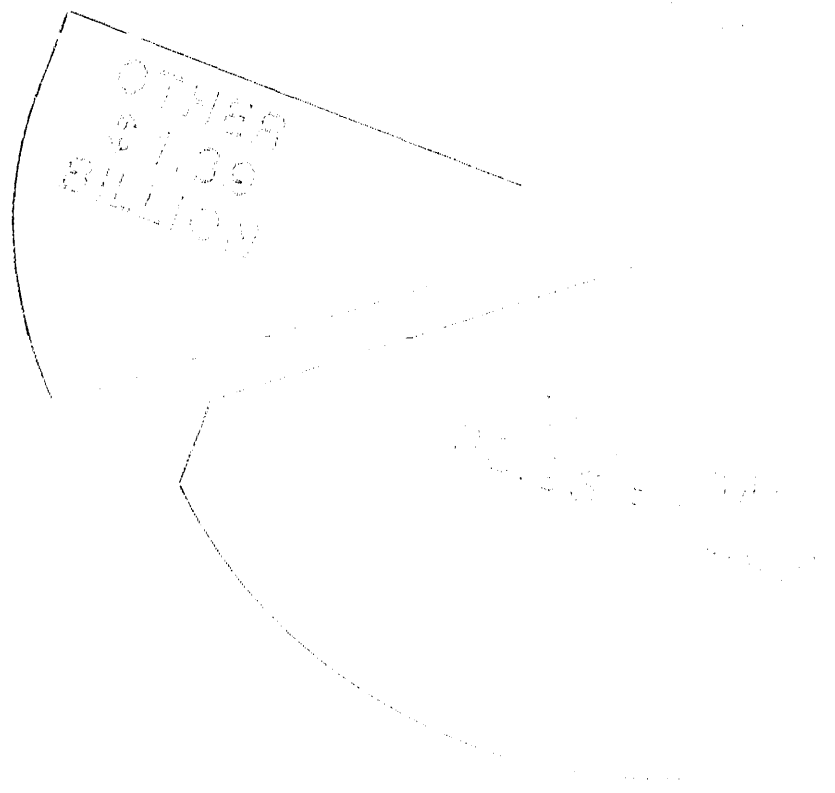

appears to have been heavily influenced by the 1977 preliminary version of the Core System, was accepted by ISO as a work item. By 1982, GKS had gone through several revisions and updates and was being accepted by the ISO working group as an international standard. In June 1982 a majority of the X3H3 members voted to support GKS over the Core System as a standard.

While GKS was establishing itself as an international standard, the Core System was quickly becoming an informal but de facto standard for many users. It became widely known and available, even being incorporated into the firmware for a large number of microcomputer systems. Textbooks and university courses based on the concepts of the Core System were developed.

It's not hard to understand why the debate has become so heated. Some GSPC members may feel "betrayed" by X3H3, and X3H3 members could be expected to feel somewhat defensive. But it isn't that simple. Some X3H3 members who now support GKS also worked hard to develop the Core System, while many ardent supporters of the Core System were not involved in its growth.

Both graphics systems share a number of concepts, one of the more notable being a "world coordinate space," which may be conceived as an immense drawing sheet. Both systems use "windowing" as a means of deciding which portions of the world coordinate space will be displayed to the user.

Normalized device coordinates (NDC) are used by both systems to relegate device dependency to the lowest output level possible (Fig. 2). Both systems use "viewports" to determine where the picture will be positioned in the NDC space. The window and viewport specifications define the viewing transformation which maps the picture from world coordinates into NDC space.

Picture segmentation—the grouping of output primitives as a single reference to allow for manipulation and control of an "object"—is also common to both. The same logical input devices are used by both systems although different names are employed for two of them (see Fig. 3).

Finally, both packages specify several levels of implementation to provide compatibility between economic implementations for applications with minimum graphic system demands and complete implementations needed for sophisticated applications.

In fact, the similarities between the Core System and GKS (especially in 2-D) are so overwhelming that the arguments between their adherents remind some observers of an imbroglia over the number of angels that can dance on a pin head. But to others the differences in the design and usage of these standards (Fig. 4) and in the functionality pro-

FIG. 1

## WORLD COORDINATE TO NDC SPACE

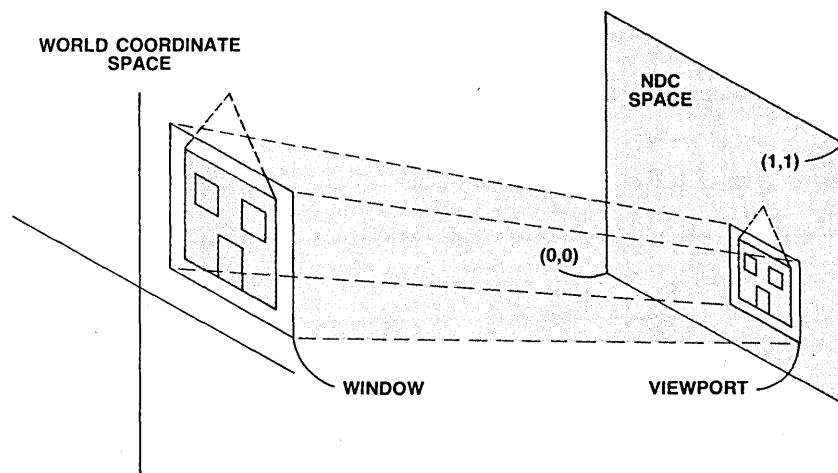

An application program describes a picture in World Coordinate Space, using coordinates appropriate to the application data. Both the Core System and GKS transform the picture according to window and viewport settings into a Normalized Device Coordinate Space, which represents a universal graphics output device.

vided (the third methodological theme developed at Seillac) are significant. Andy van Dam, one of the originators of the Core System, claims that the GKS/Core System debate is equivalent to Protestants and Catholics arguing theology without recognizing the existence of Buddhists and Moslems. Other paradigms for managing graphics are not being considered (especially the management of screen windows for raster graphic systems as currently used in workstations and personal computers).

### CORE HAS NO WORKSTATION

A major GKS feature that is missing from the Core System is the concept of a "workstation." A workstation in GKS is defined simply as "the logical interface through which the application program controls physical devices." Six types of workstations are defined, each having different characteristics and capabilities, and three of which are used for data storage and management. The application program must know which type of workstation is being referenced and what capabilities exist for that workstation. As such, the GKS concept of workstation lacks commonality of purpose and suitable abstraction. X3H3 chairman Bono states, however, that the real value of the workstation is the precise specification of which characteristics are device dependent and which are device independent. But it is the almost constant need to explicitly identify and reference workstations which is most unsettling. A large majority of applications will only address a single graphics output device and a single graphics input device. For these, the concept of a workstation is an unnecessary burden.

A highly visible, but basically trivial, difference between the Core System and GKS is the output primitive semantics. The Core System uses the paradigm of a "robotic pen" that moves about the world coordinate space, drawing lines, characters, and symbols as directed. The effect of a given output primitive in the Core System is often dependent upon previous output primitives. Application programs using the Core System must take care to manage changes to the current position that may occur in external procedures.

In GKS, all output primitives completely specify the action to be taken. They are totally independent of each other, and applications programs need not worry about the effect of external procedures.

In many ways the viewing operations supported by the Core System and GKS are the same. But there are subtle differences that make the Core System somewhat more straightforward than GKS. The Core System allows the definition of only a single window/viewport pair. All additional manipulation and control is left to the wisdom and perceptiveness of the application programmer.

GKS, on the other hand, provides not one but two viewing operations. GKS output primitives are first transformed from world coordinates to an "enlarged" normalized device coordinate space of arbitrary size. A "workstation window" is then applied to the image for further clipping and transformation to device coordinates.

The major criticism of GKS's viewing operation is that it is "complex and unnatural." Although the GKS viewing operation is somewhat more complex, the concepts that it supports have some distinct and useful benefits. Primarily, it allows for the combination

# Capable COBOL.

For over twenty years, COBOL has proved it can handle the most awesome data handling requirements of the business world.

And Microsoft® COBOL brings this power to the MS™-DOS environment in an even more flexible version. It's the ideal choice for transporting and adapting the thousands of mainframe and minicomputer programs now on the market.

Microsoft COBOL was designed after the ANSI COBOL standard. Its quality and performance has been fully certified by the GSA.

Microsoft COBOL includes a complete set of file handling facilities including support for sequential, line sequential, relative and B+ tree indexed sequential (ISAM) files.

The advanced screen handling features, compatible with Data General®, make it easy to create forms and menus for interactive user programs. Direct cursor positioning, highlighting, automatic format conversion, projected

fields, and automatic field skip are just some of the capabilities.

An interactive source code debugging tool allows you to step through your program in symbolic form. There is no need to wade through object code and addresses in memory to see what is going on. It's a complete development package.

Applications developed with the compiler can be distributed without a runtime support charge.

Like all Microsoft languages, the standard linking interface makes it easy to combine assembly language subroutines.

**Call 800-426-9400 to order the capable COBOL. \$700\*.**

In Washington State, call 206-828-8088. Ask for operator J5, who will rush you your order, send you more information, or give you the name of your nearest dealer to see Microsoft COBOL in action.



\*Price exclusive of handling and Washington State sales tax.  
Microsoft is a registered trademark and MS is a trademark of Microsoft Corporation.  
Data General is a registered trademark of Data General Corporation.

CIRCLE 42 ON READER CARD

## A strong point of GKS is its handling of attributes.

of the 2-D viewing transformation with 2-D model transformations, reducing calculations and providing more efficient throughput.

GKS also allows for the coexistence of multiple window/viewport pairs (see Fig. 4). Once defined, the application program need only select the one to be used for subsequent output. Unfortunately, only one transformation can be active at any given time, requiring a picture to be reprocessed for each view.

Perhaps the most damning criticism of GKS is its lack of 3-D support. In the Core System it is possible to use either a 2-D surface for construction of the output picture or a 3-D volume that is integrated with the viewing transformations. A 3-D normalized device space is provided from which a device supporting 3-D may display the object directly. Devices that do not support 3-D may display the object directly by either eliminating the Z-axis coordinate or by simulating 3-D with an appropriate transformation of the Z-axis value.

GKS does not currently support 3-D. Contrary to the opinion of some supporters of the Core System, however, it should be possible to add 3-D. Several groups are currently developing such extensions, but there is serious concern that the proposed extensions will require the addition of another layer above current constructs, thereby increasing implementation costs and complexity.

### A GKS STRONG POINT

A strong point of GKS is its handling of attributes. Attributes are used primarily to control the geometric aspects of output primitives (e.g., size and shape of text) and the appearance of output primitives (e.g., color). Attributes may be grouped under a single identifier ("bundled") or individually specified. The number of attributes available through GKS and the means of managing them are many, whereas the Core System provides a much smaller set of attributes and does not include the concept of bundles. Since attribute management adds greatly to the portability of an application program, the Core System as currently defined is less device independent than GKS in this regard.

GKS is often said to have a more advanced input facility than the Core System. Some features that are formalized in GKS, such as the "no input" option, are only implicit in the Core System. More important is the definition by GKS of "measure" and "trigger," the elemental actions that define the classes of input devices. The actual differences as realized in the application program, however, are minor.

Just as backers of the Core System condemn GKS for not supporting 3-D, proponents of GKS denounce the Core System for

FIG. 2

### TRANSFORMATION FROM NDC TO DEVICE COORDINATES

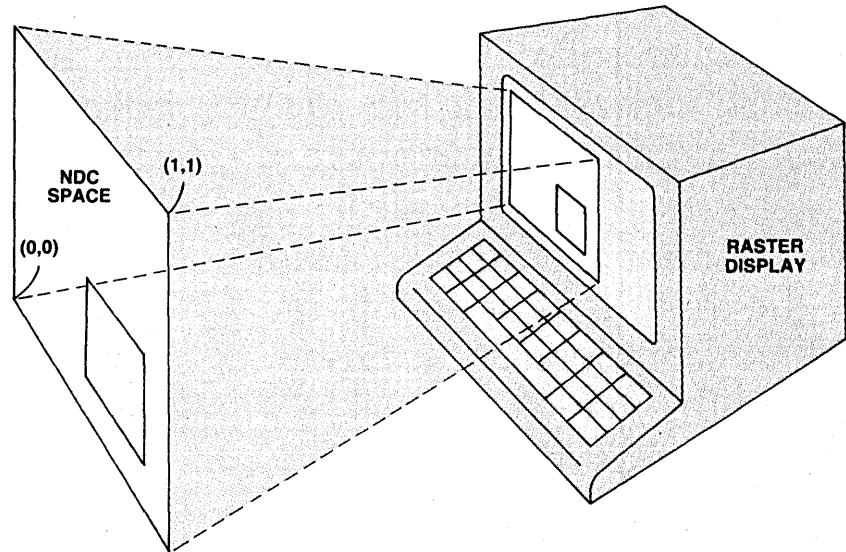

The NDC space is mapped into the largest square area of the display surface by low-level, device-dependent drivers. The viewport is placed on the display surface in a location proportional to its position in NDC space (for the Core System) or in an independently specified position (for GKS).

lacking language bindings. This is a sore point because developing language bindings was one of the major tasks that GSPC left for X3H3.

But the lack of language bindings for the Core System is a red herring. If the Core Standard is specified as a formal standard, language bindings are sure to follow quickly. This task should require no great intellectual effort, especially with the experience gained from providing language bindings for GKS.

With all the furor surrounding the Core System and GKS, they would seem to be the only two standards proposals concerning graphics. In fact, several others exist or are under development. A current ANSI standard is the Initial Graphics Exchange Specification (IGES) providing for the representation and communication of product definition data within the CAD/CAM world. Under development is a similar standard to be used for the communication and archiving of graphical pictures: the Virtual Device Metafile (VDM). Data from a VDM should be readily deciphered by low-level routines for production of output on any graphics device.

Coupled with VDM is the Virtual Device Interface (VDI), which is intended to define a uniform protocol for interfacing to

graphic devices (a sort of graphics level ASCII). Closely related to VDI is the North American Presentation Level Protocol Syntax (NAPLPS), an ANSI standard for interfacing graphics to videotex.

On the other end of the graphics standards spectrum is PHIGS, the Programmer's Hierarchical Interactive Graphics System, which is also being developed under X3H3. PHIGS is intended to support 3-D hierarchical graphics data that are closer to the modeling constructs used for CAD/CAM systems. Considering the strong endorsements of X3H3 for a single graphics standard, it is surprising that PHIGS is not currently compatible with GKS.

GKS is likely to be more closely related to these other standards because of its current status within the standards community and its support among the more established business components of the graphics industry. Except for PHIGS, however, there is no basic incompatibility between the Core System and any of these other proposed standards.

In an overall standards comparison, the Core System is well structured, having benefited from the careful consideration of some of the best minds in computer graphics. It is relatively simple, well integrated, and

# HIGH PERFORMANCE

## LONG DISTANCE RACER

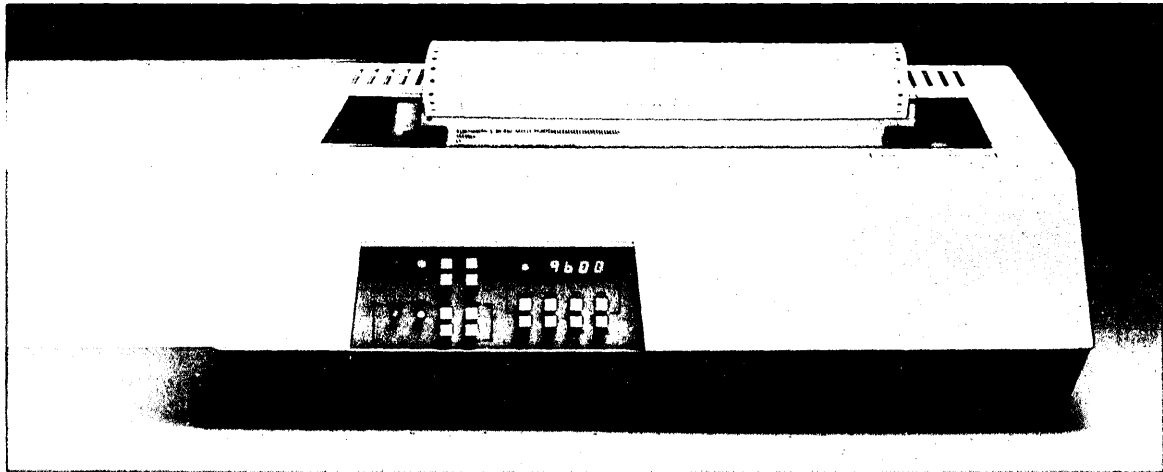

You can't win a race when you're not on the road. That's why you need a printer that does more than run fast. You need one that runs *long*. You need a Datasouth.

### MORE CHARACTER

The printhead on a Datasouth printer is rated to live through 500 million characters. Even in the most demanding applications, this means years of service without an overhaul.

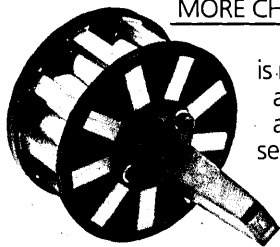

### HEAVY DUTY CYCLE

For a Datasouth printer, "100% duty cycle" is something of an understatement. So far, over 35,000 Datasouth printers have hit the hard copy road, and so few have pulled into the garage for repairs, it's hard to say how close to forever any of them will last.

### MORE THAN THE HUM OF ITS PARTS

There's less to go wrong with a Datasouth printer. With sophisticated microprocessor control and unusually

efficient design, Datasouth printers have few moving parts. They also don't need add-on "personality boards" to accommodate different computers.

### TAKE YOUR CHOICE

Datasouth reliability comes in two high performance models. The DS180 is a legendary workhorse that delivers crisp data quality printing at 180 CPS. The new multimode DS220 cruises at 220 CPS for high speed data printing and at 40 CPS for letter-quality word processing. Both models print precision dot-addressable graphics.

If you have a high performance printing need,

Datasouth has a high performance printer to fill it.

### DRIVE ONE TO WORK

Test drive a Datasouth printer at your nearest showroom today. Then put it to work. With a Datasouth racing beside you, there's no way to lose.

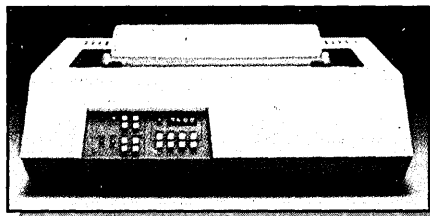
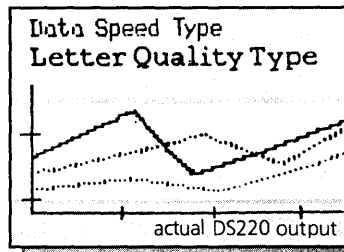

## datasouth

H I G H P E R F O R M A N C E M A T R I X P R I N T E R S

Find Datasouth Printers At  
Participating **ComputerLand** Stores  
And Other Fine Dealers.

AVAILABLE NATIONWIDE  
THROUGH OUR NETWORK OF  
SALES AND SERVICE DISTRIBUTORS  
CALL TOLL FREE:  
1-800-222-4528

Datasouth Computer Corporation  
Box 240947 · Charlotte, NC 28224  
704/523-8500 · Telex 6843018 DASOU UW

CIRCLE 43 ON READER CARD

aesthetically pleasing. Technologically, however, it is five years in arrears, and it needs more work to become a true standard rather than a conceptual basis for graphics support.

GKS also received significant expert assistance in its development. But its developers seem to have added functionality at the expense of simplicity. GKS interfaces to the application program with procedure calls requiring an inordinate number of arguments. From the programming language viewpoint, GKS is a step backwards. But it is a more complete and detailed standard than the Core System.

Neither is perfect and neither guarantees true portability. GKS requires the specification of device dependent coordinates for initializing input devices. The Core System requires that the application program specify (implicitly) whether the output device is horizontal or vertical. Both systems provide "escapes" allowing application programs to access device-specific features.

A good standard is a live one that is regularly and carefully revised as problems surface. This takes a lot of effort. It is likely that GKS will be the center of future attention. It is strongly supported by the larger display system manufacturers (Calma, Hewlett-Packard, Houston Instruments, IBM and Tektronix) and has a strong international backing. It is unlikely that the Core System will develop similar support.

For support of advanced applications requiring 3-D, there is no current alternative to the Core System. But for the even larger number of 2-D applications, especially business graphics, GKS is much more suitable.

## TWO COST ISSUES TO CONSIDER

There are two cost issues. One is that it would be too costly for ACM and SIGGRAPH to enter the "standards business." The legal and political liabilities are too great, and the resources needed would be too much of a drain. This is an issue of serious concern to ACM and is currently being studied by the ACM Council and appropriate subcommittees.

To shy away from a formal standards activity, however, purely because of potential legal and political liabilities is an act of cowardice and an abdication of the responsibility ACM has to the computing profession. It is reasonable to speculate that much of the current controversy (and concurrent costs) could have been avoided if ACM had had a more formal standards effort established when the Core System was defined.

The other cost issue raised by GKS supporters is that industry cannot afford to support two standards. Presumably the cost of having more than one standard will lower profits to the point where companies will

FIG. 3

## LOGICAL INPUT DEVICES

	CORE SYSTEM		GKS
<b>Locator</b>	Returns a location in Normalized Device Coordinates.	<b>Locator</b>	Returns a location in World Coordinates
<b>Stroke</b>	Returns a series of locations.	<b>Stroke</b>	Returns a series of locations.
<b>Valuator</b>	Returns a scalar value.	<b>Valuator</b>	Returns a real value.
<b>Pick</b>	Returns identification of selected displayed object (segment) and output primitive.	<b>Pick</b>	Returns identification of selected displayed object (segment) and output primitive.
<b>Button</b>	Returns selection from a set of options.	<b>Choice</b>	Returns nonnegative integer indicating selection from a number of choices. (0 = No Choice)
<b>Keyboard</b>	Returns a text string.	<b>String</b>	Returns a text string.

Logical input devices are essentially the same in both the Core System and GKS. But in GKS, they are defined better.

FIG. 4

## THE TECHNICAL DIFFERENCES

	CORE SYSTEM	GKS
<b>Workstations</b>	Not supported.	Six types defined, three of which are really data storage devices.
<b>Current Position</b>	Uses paradigm of a "robotic pen"; output affects the position of this pen and most output primitive results may depend on current pen position.	Every output primitive is completely specific and is independent of other output primitives.
<b>Viewing Operation</b>	Single window/viewport transformation allowed with entire NDC space mapped screen. Clipping done prior to transformation to NDC space.	Allows multiple window/viewport transformations; to second level window/viewport clips and transforms output primitives from NDC space to screen.
<b>3-D</b>	Supported and integrated into 3-D viewing operation.	Not currently supported.
<b>Attributes</b>	Individual attributes supported.	Individual and bundled attributes supported; workstation dependent and workstation independent attributes defined.
<b>Logical Input Devices</b>	Six types, three modes.	Six types, three modes, but better explained.
<b>Language Bindings</b>	None.	FORTRAN binding specified; others under development.



## FIND "SPACE SHUTTLE"

**BASIS** retrieves  
information from  
**1 to 10,000,000**  
records in  
nothing flat.

Tired of manually searching through massive files of data? Let BASIS turn your existing files into an automated Information Center.

Imagine a system that retrieves textual information within seconds, the same way a database management system retrieves data. That's BASIS, a proven, interactive retrieval system that does much more than examine titles.

BASIS actually probes to find the key word or phrase you're looking for within any record. Then it displays a list of all records containing the word or phrase you specified. BASIS also dis-

plays any or all of the information, and prints hard copy if you want.

BASIS can turn your existing files into an automated Information Center within a few days. *So if you have one or ten million records that need rapid referencing, see what BASIS can do for you.* Call or write for a descriptive brochure today.



**Battelle**

Software Products Center  
505 King Avenue  
Columbus, Ohio 43201-2693  
Telephone (614) 424-5524

Visit Us At NCC '84—Booth C4336  
and SYNTOPICAN XII—Booth 112.

BASIS runs on DEC VAX®, IBM, Prime and Wang VS minicomputers, and on IBM, CDC, DEC® and Univac mainframes. DEC and VAX are trademarks of Digital Equipment Corporation.

CIRCLE 44 ON READER CARD



## The Core System/GKS debate is viewed as an indication of U.S. reluctance to accept a standard developed elsewhere.

have to leave the business or go bankrupt. Either that, or graphics will become too costly for most users to afford.

Unfortunately, there is really no choice. Like it or not, GKS is a standard and must be supported by manufacturers, especially if they wish to sell to the European market.

Bob Dunn, president of R.M. Dunn & Associates and a veteran of the standards effort, argues that "any vendor who believes a single standard will satisfy the needs of the market does not understand the issues. Vendors will have to support multiple standards or make the decision to limit their market, limit their product line, or go out of business. Technology will not stand still around a single standard."

Standards provide benefits when portability and interfacing are significant issues. But for many users, especially smaller system users, the primary concerns will be purchase cost, operating costs, and efficiency. Systems that meet these requirements will succeed even if they are nonstandard.

Almost all the political arguments offered are pro-GKS. Many people view the Core System/GKS debate as an indication of U.S. reluctance to accept a standard developed elsewhere. They argue that the Core System is supported only by narrow U.S. interests.

Assume this were so. Although some European countries may require support of GKS, it is unlikely that any laws will be passed mandating support of the Core System. Computer graphic firms may freely elect to support or ignore the Core System. If only narrow U.S. interests support the Core System, there will be little demand for it. If this contention is false, some entrepreneurs will make a bundle. In either case, the free market will resolve the issue.

There is no question that GKS will be an international standard and that several European countries are likely to mandate compliance with it. But as with any standard, strict and absolute compliance with GKS in all cases would be disastrous. It would be the legislation of inefficiency and, in some cases, would prevent access to sophisticated systems. Any country foolish enough to legislate such requirements deserves the results.

Finally, it is argued that if ACM were to issue a standards document formally specifying the Core System, it would be subverting international standards activities and would destroy international cooperation. ACM would lose its international credibility. Simply stated, this argument is absurd. It is equivalent to arguing that since the Europeans have standardized Algol, no standards should be issued for FORTRAN, BASIC, or even Pascal.

FIG. 5

### MULTIPLE TRANSFORMATIONS

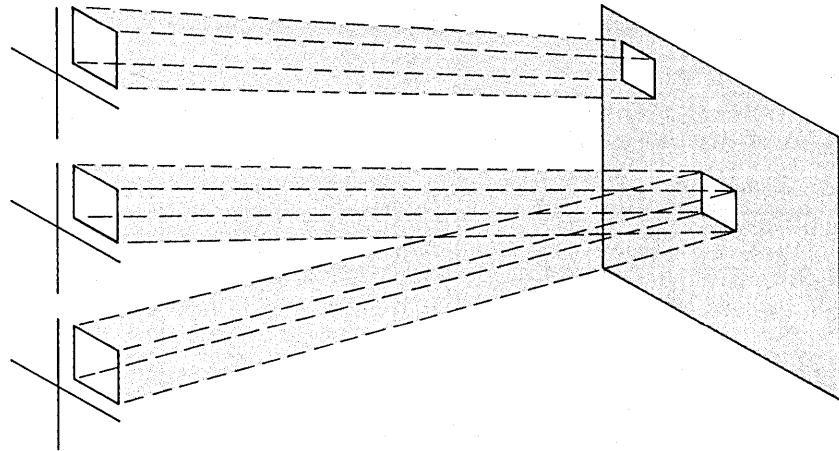

GKS allows for the simultaneous existence of multiple viewing transformations, thus facilitating the display of data from several world coordinate spaces as one picture.

The only real question is whether ACM/SIGGRAPH can implement the procedures and provide the support required for a formal standards effort before the Core System ceases to be viable.

### STANDARDS ARE HALLMARKS

Standards are usually the hallmark of a mature, stable technology. Interactive computer graphics, in spite of impressive growth and major technological gains over the past several years, is neither. It is an industry still primarily driven by hardware advances.

Bit-slice microprocessors provide display logic, giving raster graphic systems increased capability. Microprocessors are also being used to implement Core System and GKS level primitives in firmware. More powerful processors such as the Motorola 68000 are currently supporting 3-D hierarchical geometrical databases. Pipeline processors and graphic engines may make today's software viewing operations obsolete. The display and manipulation of surfaces and solid objects will become more commonplace, replacing applications that are primarily line drawings. Added local intelligence will be available to assist with user interaction, providing interfaces more powerful and fluent than those currently available.

Future application programs will not be dealing with logical input devices or graphic output primitives. They will interface at a higher level, with only information par-

ticular to the application being sent to or received from various graphical servers. Future issues will have more to do with the content and format of information than with device management, which will be well hidden in peripheral processors and firmware.

Because of rapid technological change, both the Core System and GKS must be considered short-term solutions. Van Dam states that the designers of the Core System developed it with the expectation that it would be merely the first of a sequence of evolving standards. It would not be surprising to find technology eclipsing both the Core System and GKS within the next five or six years.

For some, the current brouhaha is of little concern. But like many a good argument, the debate on graphic standards is likely to continue past obsolescence, with old and new followers rallying around the slogans and taking up the cause until, like Trotskyites and APL fanatics, they fade into the past—still strong in their beliefs, theoretically correct, but totally irrelevant. \*

Jon A. Meads is a Portland, Ore.-based consultant specializing in user-interface and interactive computer graphics systems. He's a former chairman of SIGGRAPH, and initiated that organization's involvement in standards in 1972. He also served as chairman of the Foundation Subcommittee for the GSPC.

The freedom some birds have to migrate is remarkably similar to the freedom you have with software for the System 8000.

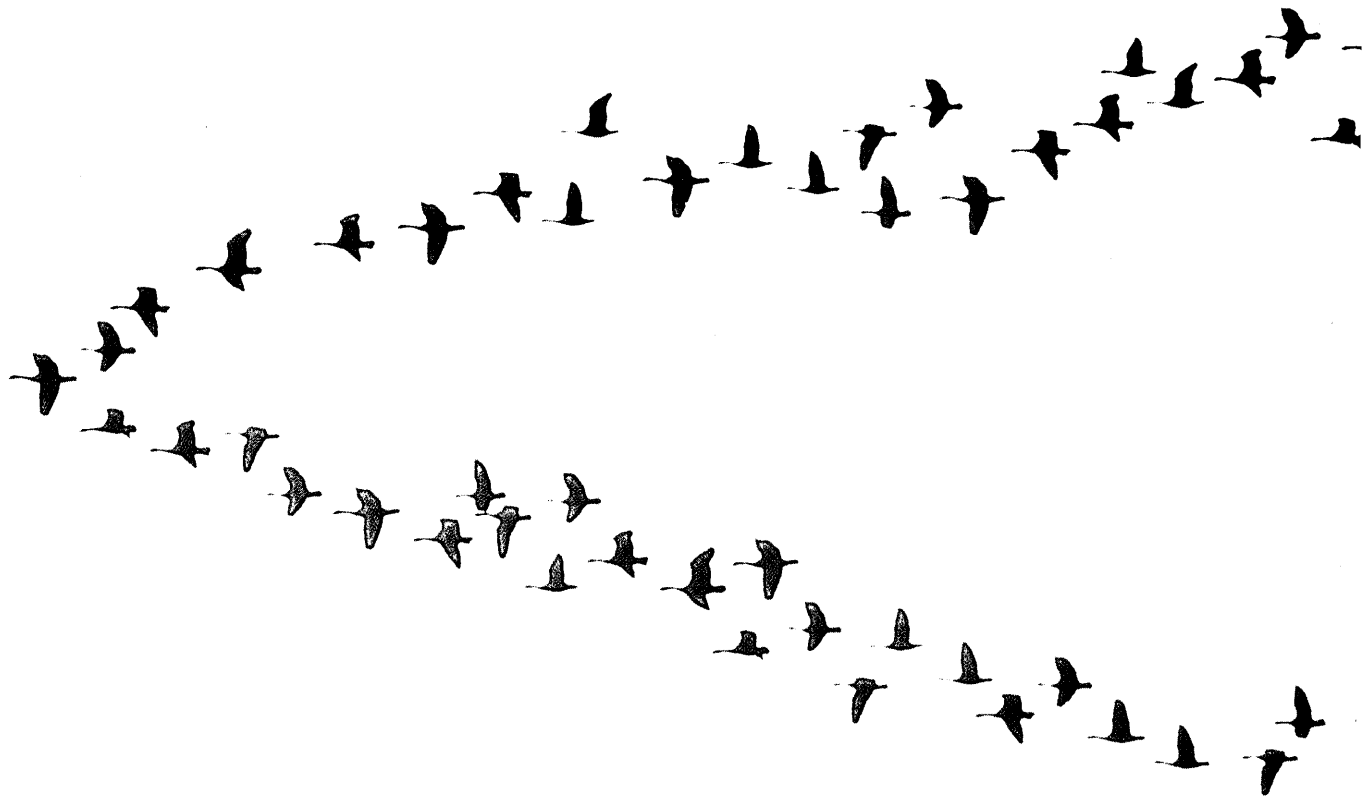

Moving your application program with Zilog's System 8000 is as easy as the migration of Canadian geese.

Zilog's solutions free you from the constraints of traditional systems.

Outdated proprietary languages and operating systems limit your movement from vendor to vendor, much like the restricted flight of the albatross.

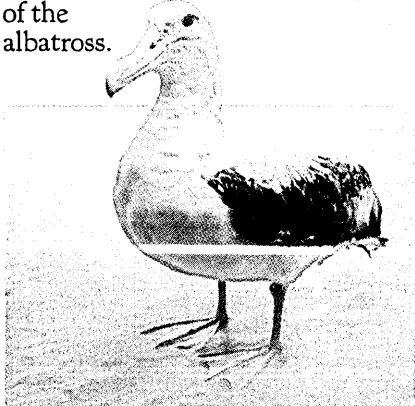

Zilog's high performance, multi-user, UNIX\*-based System 8000 supermicros give you a proven way to quickly port your minicomputer software onto affordable micros. For instance, we offer compatible migration tools for Basic Four BB III, DEC\* DIBOL\* and DG ICOS™ COBOL and Proxi™. And with the UNIX operating system, you can take advantage of one of the fastest-growing business opportunities in the industry.

Get a level of service, support and company stability not found from other microcomputer vendors.

Find out what it's like to free yourself from expensive mini-computers, and get a level of service, support and company stability not found from other microcomputer vendors. Ask about our RSVP Referred Software Vendor Program, too, where you can find the applications software and tools you need as well as list your software. Zilog is also on the

GSA schedule for Federal government applications.

For the whole story, call Zilog Systems Division at (800) 841-2255. Or write: Zilog Systems Division, Corporate Publications, 1315 Dell Avenue, MS C2-6, Campbell, CA 95008.

\*UNIX is a trademark of Bell Laboratories. Zilog is licensed by AT&T. DEC and DIBOL are registered trademarks of Digital Equipment Corporation. ICOS and Proxi are trademarks of Data General Corporation.

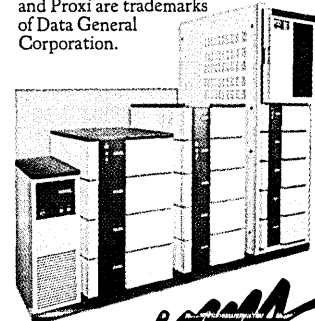

**Systema**  
**Zilog**

an affiliate of EXON Corporation

# Managing a Constant Wave of Facts & Figures



That's why over 5,000 companies are running

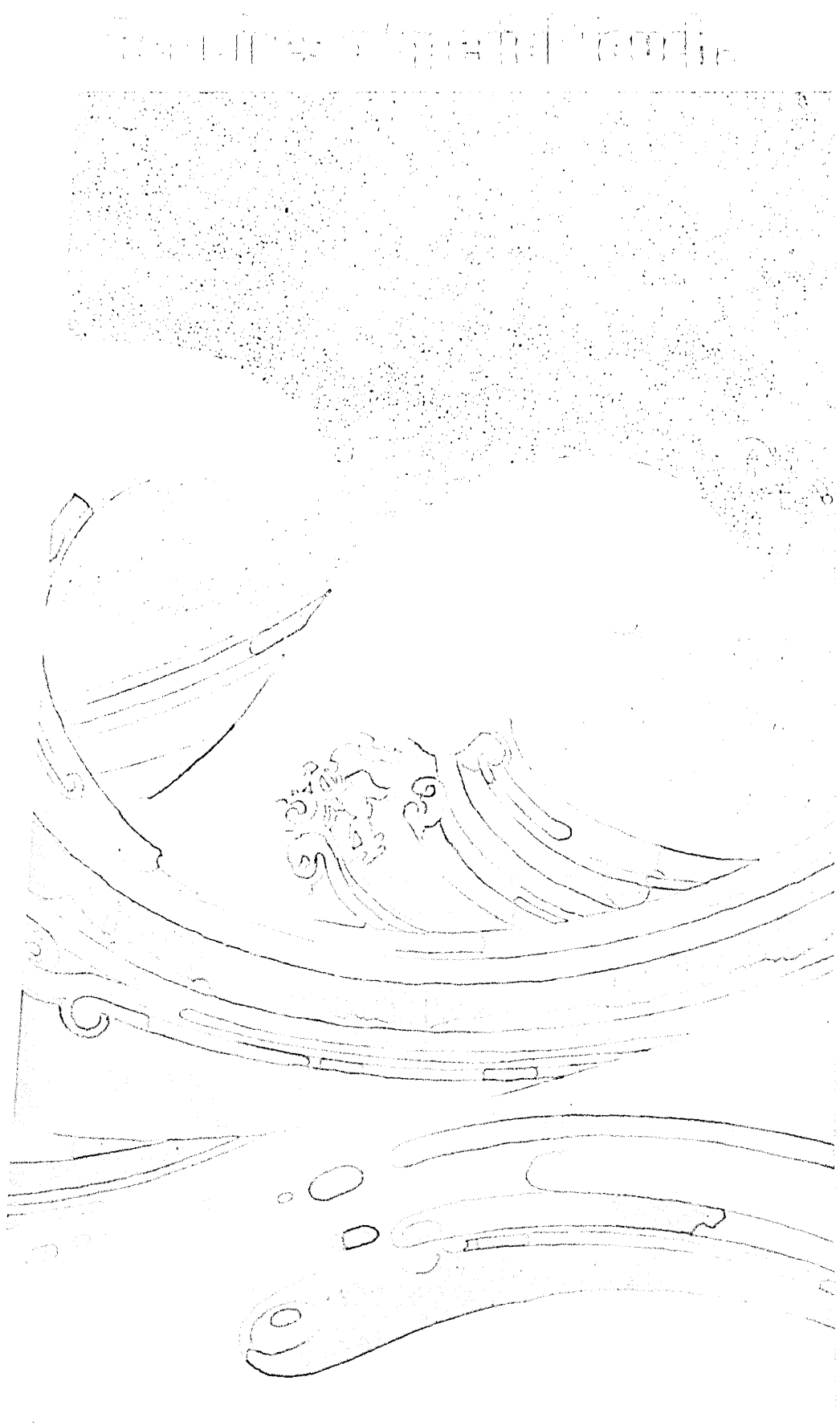

Software International has nearly two decades of experience in doing one thing with exceptional expertise: providing on-line, financial applications software for mainframe and mini computers.

We give you the special touch you need to anticipate and manage an increasing flow of numbers with accuracy and ease. When financial and accounting professionals want to run with confidence, they run with Software International.

Software International® software packages include:

- General Ledger and Financial Reporting
- Accounts Payable
- Payroll and Human Resource Management
- Accounts Receivable
- Fixed Assets Management
- Forecasting, Modeling and Reporting
- Micro-Mainframe Smart Link™ and Query.

Call or write:

Software International  
One Tech Drive

Andover, MA 01810

**1-800-343-4133**

In Massachusetts call 1-800-322-0491.

Software International is a wholly-owned subsidiary of General Electric Software Products Company.

with Software International International Applications Software



SOFTWARE  
INTERNATIONAL

**Run With Us**

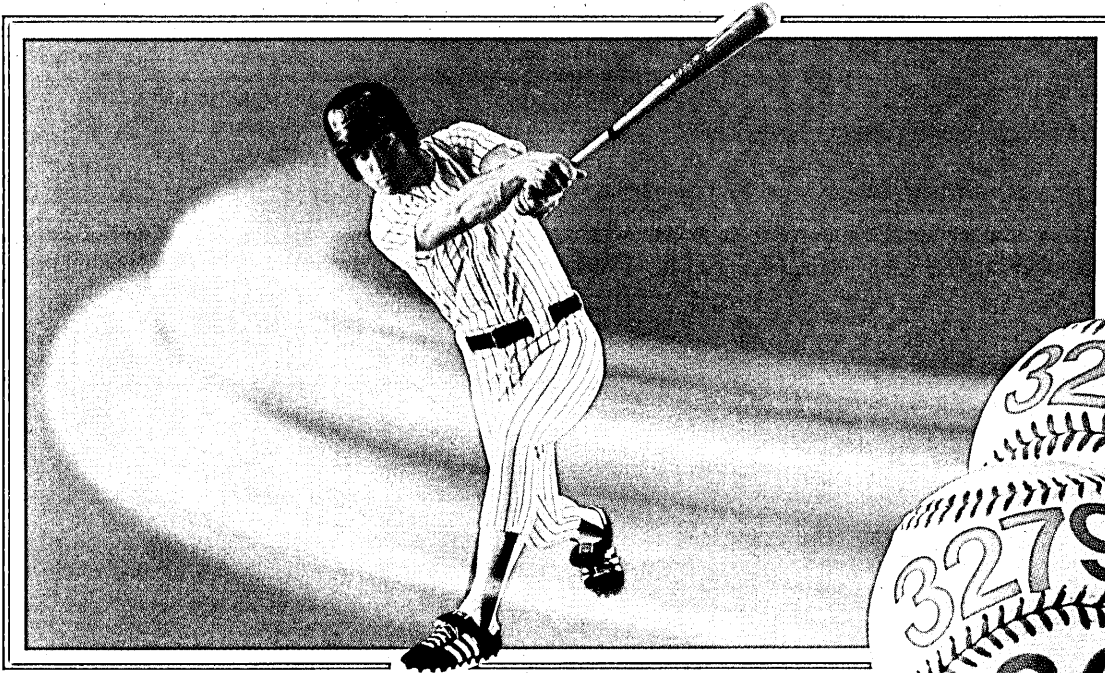

# Give your PC Big League Power!

with

## Major League Graphics

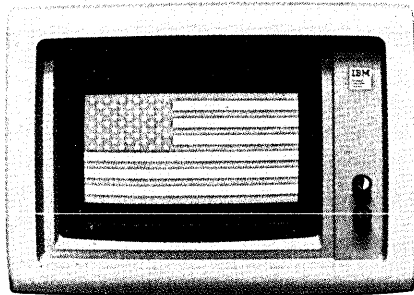

With the Forte-PJ™ 3278/79 Emulator/Adapter Board, your IBM PC™ or compatible system bats 1000 from both sides of the plate. You gain the speed and power of a coaxial cable-connected IBM 3278 display terminal while retaining all the functions of the Personal Computer. A single keyboard command moves you back and forth between DOS and terminal mode.

If your business game plan calls for color graphics, add the Forte-GRAPH™ 3279/SG3 Color Graphics Emulator/Adapter Option Board and unleash IBM's arsenal of S3G Programmed Symbols software (including GDDM™ and SAS/GRAPH™). You'll have bar

and pie charts, histograms and conceptual drawings at your finger tips, not to mention foreign language fonts, scientific notation and even your own custom-designed characters.

Whether you're working in color or monochrome, you can use PC spreadsheet programs and other packaged software to work with current data from your IBM host. Forte's automatic file transfer utility allows you to send, receive and store host files without ever leaving terminal emulation mode.

Forte provides all the hardware and software you need to emulate any full-function 3278 or

3279 terminal. Installation is a snap: no host hardware or software modifications are necessary and only one slot is required.



HOTLINE  
(800)  
233-3278

If you're ready to play mainframe ball with your PC, you're ready for Forte.

# FORTE

**Forte Data Systems, Inc.**

1500 Norman Avenue • Santa Clara, CA 95050 • (408) 980-1750

## Your Micro-to-Mainframe Connection

\*Forte and all associated names are trademarks of Forte Data Systems, Inc.  
\*IBM, IBM Personal Computer and IBM PC-XT are trademarks of IBM Corporation.

\*GDDM is a registered trademark of IBM Corp.  
\*SAS/GRAPH is a registered trademark of SAS

CIRCLE 47 ON READER CARD

**With mainframe graphics, the corporate database makes sure your pictures are up-to-date.**

# MAINFRAME BUSINESS GRAPHICS

by Maxine D. Brown

Almost everything about the business graphics picture is glowing. A compound annual growth rate of between 40% and 65% is predicted for the rest of the decade. Vendors display an array of hardware—printers, plotters, film recorders, terminals—that offers choices of monochrome or color, high resolution or low, vector or raster displays, soft-copy or hardcopy. Software comes stand-alone, integrated, application oriented, or as a subroutine library.

These business graphics have made presentations more convincing, publications clearer and more readable, and analysis and decision-making faster and more accurate. The power of visual communications to increase productivity has delighted the business market. But the variety of graphics schemes available has also led to confusion.

How can you make sure you've got your company's business graphics needs in focus?

If business graphics is a new application you're considering, you're probably wondering whether to start small and expand in-house capabilities as the demand grows, or to invest in a comprehensive software system that encourages new users and new application areas. Despite a somewhat higher initial cost, mainframe graphics produces a savings in operation, support, and labor, and allows for ease of expansion and growth. A comprehensive software system can easily be integrated with existing databases and application programs, can produce charts and diagrams of graphic art quality, interface with a variety of devices, and generate high volume in short time periods in a production environment. Let's explore some of these key

FIG. 1

## MAINFRAME TO PC

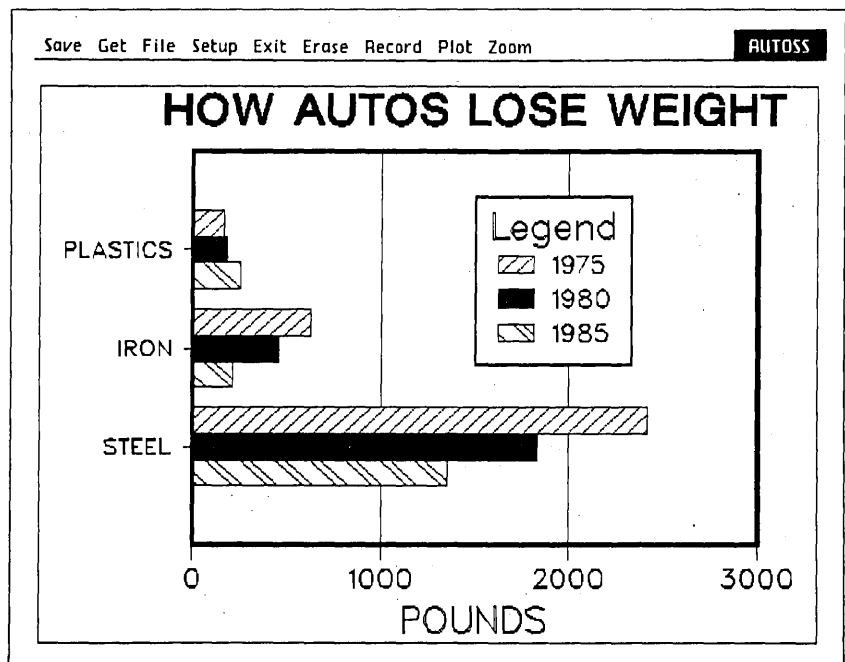

If you have existing graphics applications on your mainframe, you should be able to continue to use them on your personal computer. Mesa Graphics' Tekalike is a graphics terminal communication package that enables you to connect your personal computer to a mainframe. Tekalike supports the Tektronix 401X graphics protocol for graphics terminal input and output, making it compatible with virtually every mainframe graphics software package that supports the Tektronix 401X family. This chart was produced on a mainframe and then, using Tekalike, displayed on an Apple Lisa desktop computer. The output is a screen dump to a dot matrix printer.

Courtesy of Mesa Graphics



# “Many users don’t want the wealth of functionality available in the graphics package. They just want to get their pictures.”

mainframe graphics features in more detail.

A friend once quipped, “What’s a story without a plot?” He meant plot to be synonymous with graph, or chart, and his pun spelled out the need to integrate graphic illustrations with text.

The converse is also true: what’s a plot without a story? Here, story refers to information, or data. A plot without data is absurd, but that is the situation that results when database management systems and graphics packages cannot communicate.

Jim George, president of Mesa Graphics, a Los Alamos-based firm specializing in computer graphics, comments, “A major problem facing business graphics is the automatic entry of data from applications (e.g., databases, spreadsheets) into graphics products. Also, when it’s been accomplished once, it should be easily repeatable at periodic intervals.”

To have a graph, you have to have data. You can either type data at the keyboard or, if you have access to huge databases managed and manipulated by a variety of DBMS’s and data processing application programs, you should be able to integrate the data with the graphics. If the DBMS has hooks that allow you to embed programs, then graphics subroutine libraries can be used to construct specific chart types that can then be integrated into the application program. Standalone graphics packages, which have broad end-user appeal and encourage easy modifications to chart formats, now include features for reading DBMS or report files, so the output of one automatically becomes input to the other.

Besides allowing easy access to data, keeping the graphics with the data management routines is advantageous for reasons of security and control. The data always stay in one place.

## GRAPHIC ART QUALITY

Until four years ago, computer graphics was to traditionally generated graphics as computerese is to English: it wasn’t very good. But no one seemed to mind. Engineers and scientists were the major users of computer graphics, and they were more concerned with the efficient visual representation of their data than with aesthetic appearance.

But four years ago IBM announced a color graphics terminal, and graphics suddenly became respectable. During the following couple of years, the new business user community that bought the IBM machines began to demand better quality graphics. What was good enough for an engineer or a scientist was not good enough for the chairman of the board. Complaints came from corporate art departments where graphics designers

FIG. 2

### A MAINFRAME DESCRIBES THE MARKET

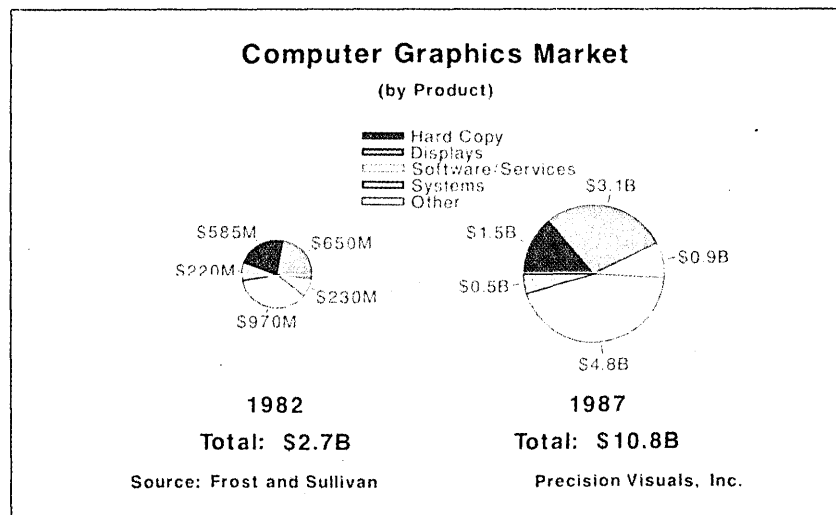
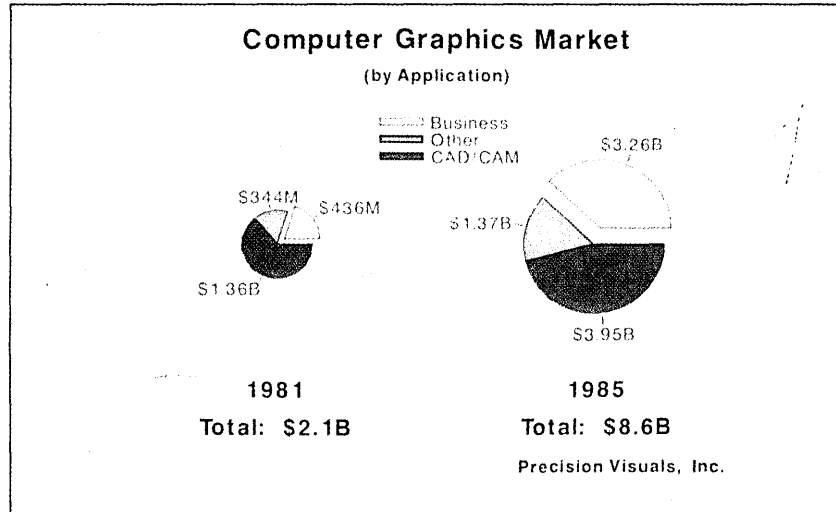

Device-independent output from Precision Visuals’ Grafmaster package, a menu-based system that runs on DEC computers. Grafmaster’s menu panels are formatted display screens that permit the user to create, modify, or delete a graph’s pictorial elements; to specify the data to be displayed; and to display the picture on a selected output device.

Courtesy of Precision Visuals, Inc.

found themselves redrawing computer-generated charts and graphs.

“Quality graphics in the business environment is crucial,” observes Jim George. “The aim of business support graphics is to understand the data and influence decisions. Influencing decisions requires communicating the analysis in graphic form to peers and bosses. As in most personal interactions, an unkempt appearance, personally or with graphics, is hard to overcome.”

Today’s variety of equipment, cost/

performance trade-offs, and applications needs have created three levels of quality: presentation, peer, and personal.

In presentation graphics, the aesthetics are as important as the information being displayed. Illustrations are usually prepared for upper management, the board of directors, or stockholders. Image quality affects the way the information is received and the way the speaker is perceived by the audience. The more effort put into the preparation of presentation materials, the more persuasive



FIG. 3

## DO GRAPHICS WORK?

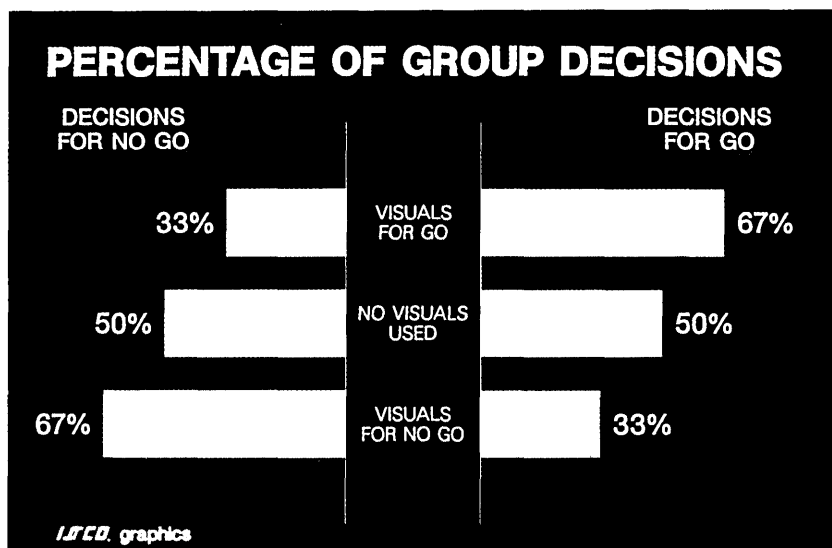
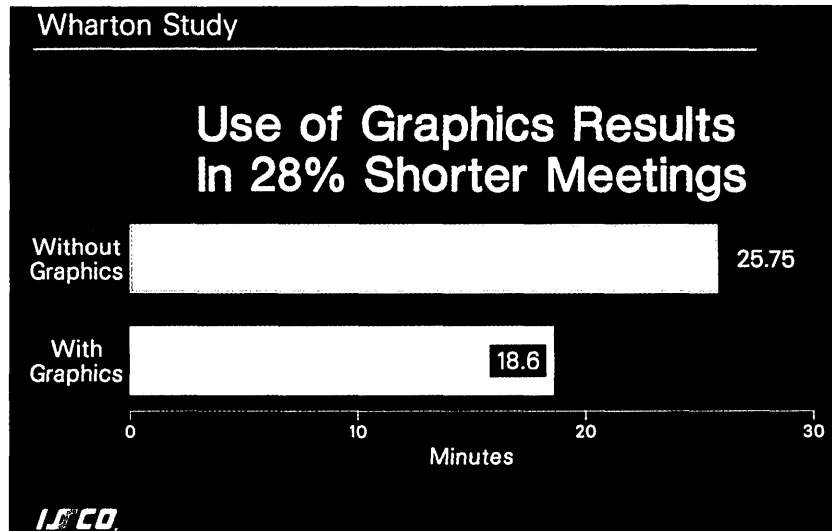

In a study of the effectiveness of business meetings, conducted in early 1982 by the Wharton Applied Research Center of the Wharton School, University of Pennsylvania, under a grant from the Audio Visual Division of 3M, the use of visual aids (specifically the overhead projector) was shown to significantly influence the actual decisions reached, how the presenter of information was perceived by meeting participants, and whether or not the meeting leader could quickly reach a consensus. In the test situation, those using visual aids won their points 67% of the time, were perceived as more professional by group members, and achieved consensus in a 28% shorter meeting time.

Courtesy of ISSCO

the presentation.

Peer graphics is charts and diagrams one shows to colleagues or subordinates. The output quality is of some consideration, but more important is the clear visual representation of information.

Personal, or throwaway, graphics are those generated for personal use in analysis and decision-making. Plots are quick and dirty, and a soft screen copy is often all that's generated. The emphasis is on data representation, not quality.

Flexible software permits a variety of different charting options. For example, large companies establish design standards and corporate grids, color, and logos that they want to be able to recreate using a graphics software package. A flexible system also permits a variety of chart types, trial and error designs, random placements, multiple charts per page, and batch or interactive execution. Designers and end users can create charts and graphs to their specifications. End users can produce the best charts possible for maxi-

mum communication.

The term user friendly (AKA ease of use) is overused and misused. User-friendly software needs a simple test: try it! See if you like it! Have it demonstrated by salespeople; have your secretaries, graphic artists, technicians, and staff play with it; get testimonials from other customers; talk to friends in related industries and see what they use.

"I see two classes of business graphics users," comments Jim Warner, president of Precision Visuals, Boulder, Colo. "The first group is the layout builders charged with preparing general or specific graph layouts for an organization. The next class of users are analysts, managers, scientists, or clerical people who want to use layouts, plug in their data, and get a picture. They don't want the wealth of functionality available in the graphics package. They just want to get their pictures," he says.

"Stencil designers have traditionally worked with pencil and paper to design the layout of a page, the placement of a graph, or the position of titles and labels," continues Warner. "They must have the same flexibility when using a computer, and it's the software manufacturer's responsibility to give the user control over the computer, instead of letting it control him. Many people want to add simple embellishments to their graphs, such as shrinking the drawing area or moving the text 'a little to the left.' Using an electronic pencil, which comes in the guise of a mouse, joystick, or tablet, the designer can simply define new locations by pointing."

Various ways that end users specify graph choices include menus, from which choices are made; tables, where users enter values in formatted fields; prompting systems, which repeatedly ask questions and list all available options; or command-driven systems, which require that you know the command syntax. Chart books are also popular; end users either receive predefined graph formats from the software supplier or customize their own.

One other aspect of user friendliness is documentation. A user manual is the only tangible aspect of software you can evaluate without access to the system. Is it clear, concise, and comprehensive? Is it interesting, illustrated, and well organized?

User friendliness can have its unfriendly side. More and more unsophisticated users can take advantage of in-house graphics capabilities once user-friendly ones become available. Graphics software, per se, doesn't saturate a system, but increased usage might. Also, the more users, the more questions that arise on software capabilities and system operation. Before long, an in-house support person becomes necessary to supervise equipment acquisitions, integrations, and

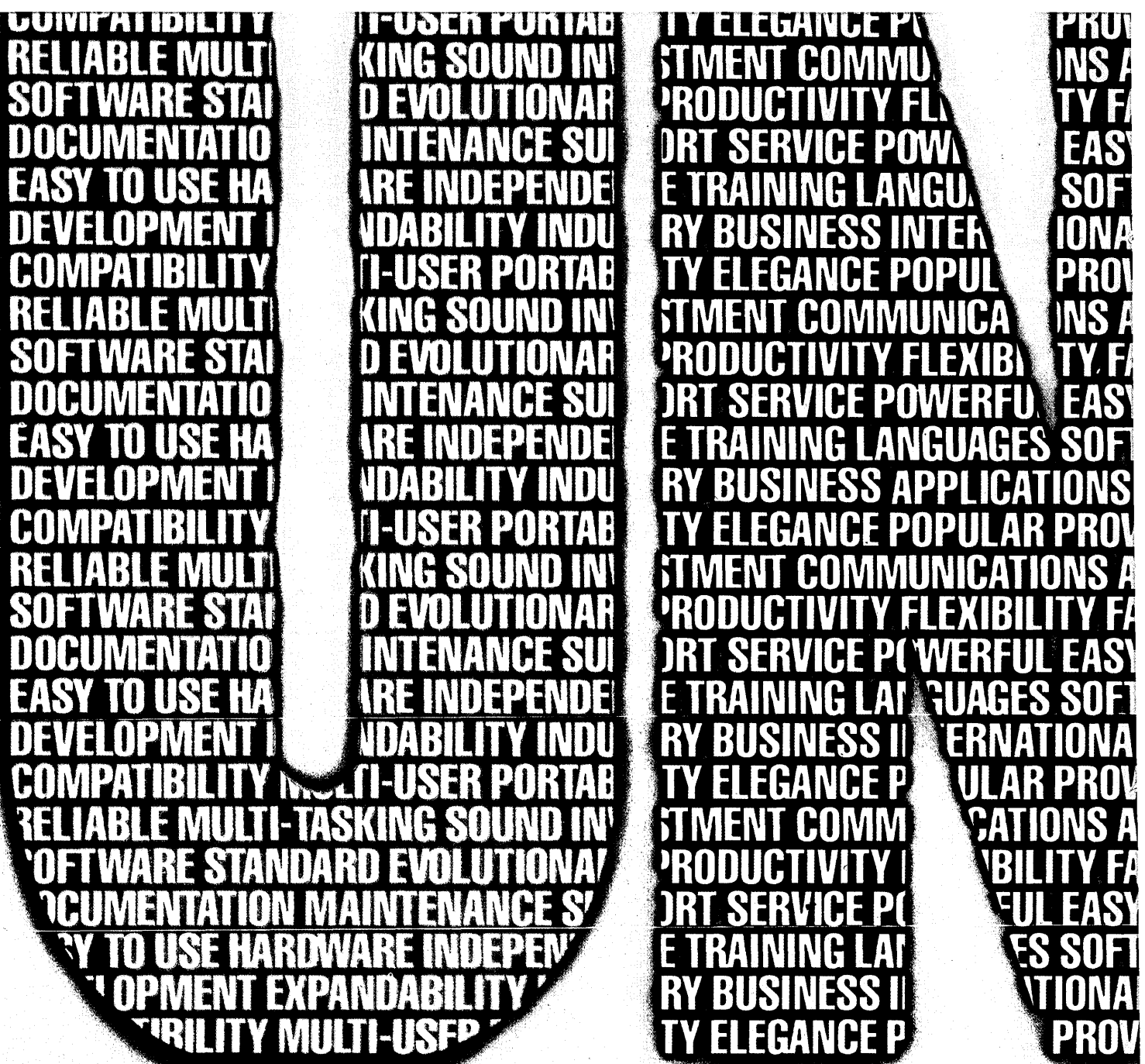

# UNIX<sup>™</sup> SYSTEM V. FROM AT&T. FROM

What's the first question you should ask about a new business computer? Considering what's at stake, none is more important than "Is it based on UNIX System V?" The answer can affect your cost of doing business for a long time.

Here's why good business decisions are based on UNIX System V.

No more making the software fit the computer. Or junking the computer because its operating system isn't compatible with other machines.

Because UNIX System V from AT&T has emerged as an industry standard for business, engineering, and scientific computers.

That means your programmers won't spend precious time and money reprogramming software every time a new computer comes along.

Instead, they can work more productively. And more profitably.

That's important because as programmer productivity goes up, your costs come down.

### The profits of portability

UNIX System V from AT&T frees you from the tyranny of computer obsolescence. Because it's hardware independent.

Considering how much you invest in a computer these days, that can mean real savings.

Another saving: applications software written for UNIX System V is easily adapted to a wide range of computers. From micros to mainframes.

We call that portability. You'll call it a most important consideration when it's time to invest in a new computer.

### Service that goes on and on

AT&T is committed to seeing that UNIX System V does the best possible job for your company.

That's why we offer a complete program of training, support, and documentation.



# In large corporations, the host computer has become the repository for data and graphics.

software usage. You might find yourself shopping for another computer to support all this increased activity.

## DEVICE INDEPENDENCE

The ability to interface to any graphics device is called device independence. It is a distinguishing characteristic of mainframe graphics. Mainframes can interface to \$2,000 personal computers or \$350,000 film recorders, to desktop pen plotters or six-foot flatbed plotters, to dot-matrix printers or \$500,000 photocomposition laser machines.

Device independence not only means the software can talk to a variety of peripherals, it also means the software can talk to any make or model of graphics equipment. Graphics packages can be interfaced to current, in-house devices, to new acquisitions, and to next year's technology, as well.

Graphics applications can grow as your needs and applications increase. The same software package can plot on low-cost peripherals and high-performance devices. If user needs switch from presentation slides to typeset publication material, the graphics are adaptable and system modifications are transparent. Device independence also describes software that supports all graphics hardware devices.

The next generation of software that came along adapted to the peculiarities of output devices. Anders Vinberg, vice president of research at ISSCO, San Diego, coined the phrase "device intelligent" to describe software that takes advantage of local device performance capabilities, such as polygon fill, hardware characters, segmentation, and variable drawing speeds. The software utilizes these capabilities to perform tasks whenever possible. Device-intelligent software reduces demand on the resources of the host computer and communication links, which reduces computer time and expense.

Device intelligence resulted in faster drawing speeds, but wasn't enough to achieve graphic design quality. "Layout intelligence," ISSCO's current generation software, modifies the layout of the graph to fit the characteristics of the output medium. The software understands the application and helps the end user make the graph that's needed.

For example, a chart to be published in a book may be oriented vertically, contain lots of text, and require black-and-white shade patterns to distinguish the various datasets plotted. A similar chart, to appear on a slide, needs to be oriented horizontally, contain minimal text, and have solid colored areas in lieu of shade patterns for distinguishing data. Layout-intelligent software adapts the graph to the situation; it worries about

FIG. 4

## A PICTURE OF POPULARITY AND LUNCH

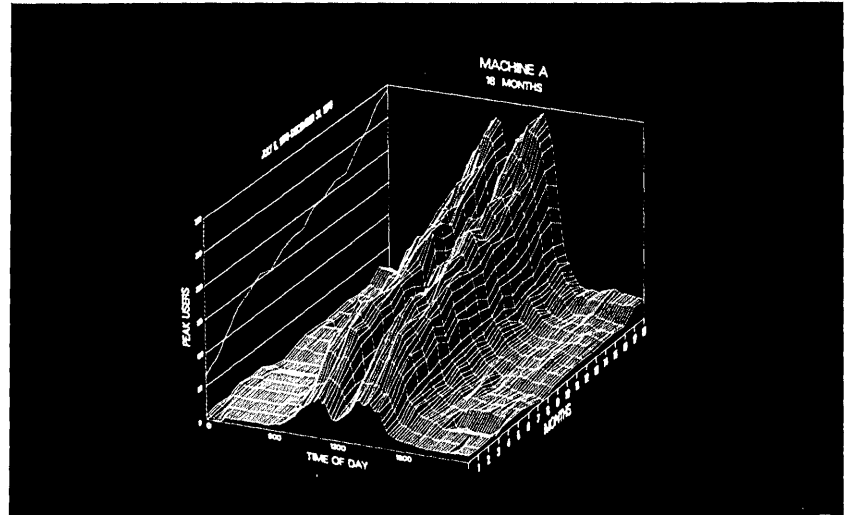

This 3-D graph effectively displays the number of people accessing machine A at different times of the day over an 18-month period. We see heavy user loads in midmorning and midafternoon. The surface depression at noon portrays what happens at lunchtime. The surface mounds increase over time, reflecting an increase in the number of users.

Courtesy of ISSCO

page orientation, annotation style and size, and dataset identification.

Mainframe graphics software should not only be able to talk to a variety of devices, but it should also be able to run on a variety of host computers. Whole organizations are then free to standardize on one software package. Systems support knowledge and user programs are portable throughout the company.

These software advances mean that, today, graphics is becoming commonplace. It probably won't be long before we run production graphs every weekend for Monday morning distribution.

Advertisements no longer feature people looking with smug satisfaction at a plot they've just produced. As Anders Vinberg observes, "Graphics is no longer the front line of technology. It's production work. People are beginning to think in terms of throwaway graphics."

"Mainframes have the data, the horsepower for high volume and fast turnaround, and the interfaces to high-performance film recorders and laser printers," Vinberg continues. "Production graphics is a new phenomenon. Only recently have manufacturers developed graphics interfaces for high-speed, on-demand production laser printers."

Vinberg asserts that the graphics

community has to pay attention to what's happening in the computer industry, and adapt accordingly. "Graphics is only as valuable as the data it portrays. The end user is only interested in getting his information across."

ISSCO views its layout intelligence feature as the cornerstone of production graphics. End users can produce report illustrations and presentation slides by changing two commands in the company's Tell-a-Graph package: one command changes the output device specification, and the other enables automatic layout changes. It's impractical to reformat charts every time the device changes. Mainframe power and intelligence make it possible to do things automatically.

## SUPPORT, MAINTAIN, TRAIN

As a rule, mainframe software suppliers pay strict attention to the quality of their customer relations. There is concern for providing adequate product installation, support, maintenance, and on-site training. There is also a feeling of responsibility on the part of the software supplier to keep abreast of the latest technological developments, in both hardware and software, and to keep customers informed of new device interfaces and up-to-date product enhancements. After all, current customers account for a large percentage of future sales,

either by repeat purchases or by referrals.

The role of the personal computer in corporate graphics is limited. There are many applications where standalone personal computers are extremely helpful. "The personal computer is just another tool, as is the hand-held calculator," observes Jim George. "The personal computer's role is that of a talented specialist. It can help you with reports, papers, or memos by providing word processing; it can provide help with accounting; it can help with financial planning through the use of spreadsheets; it can help with project planning; it can create graphics to illustrate ideas."

Buyers, however, should not confuse the low cost and varied functions of personal computers with corporate application needs. If you need to support a number of end users, provide quality results, and access extensive data files, mainframes may actually be cheaper. Personal computers allow one user at a time; mainframes more. Personal computers are more appropriate for one-time jobs; mainframes are suited for production work. It's also worth noting that mainframe costs are continually dropping while memory

and speed are increasing, making them more economical and more practical than ever.

In large corporations, the host computer has become the repository for data and graphics. The personal computer functions as a front-end terminal and receives tabular data from the mainframe for graphic display. Results can be plotted on local devices or queued for production on high-performance peripherals.

George's company, Mesa Graphics, is involved in the development of graphic communication packages that enable mainframes and personal computers to communicate. The Tekalike package makes personal computers Tektronix-compatible. Since most mainframe software packages interface to Tektronix devices, the Tekalike interface encourages graphics communication between the two systems.

Both ISSCO and Precision Visuals have demonstrated the capability of downloading mainframe graphics to small computer systems. This migration will continue as next-generation micros using more powerful microprocessors reach the market. Powerful micros are a prerequisite for ISSCO. "We will

not compromise on quality or intelligence," states Vinberg, "because we know our customers want it." Warner adds, "It's obvious that the distinction among mainframe, mini, and microcomputers is becoming blurred. A 'personal mainframe' is imminent. As such, the concept of 'mainframe-based business graphics packages' will soon collapse to 'business graphics packages.' "

Computer graphics is quickly becoming an integral part of office automation technology. "Within the next 10 years," observes George, "end-user computer equipment will not be offered without graphics. Applications will assume graphics, and graphics will take its place among the existing tools of business. Business graphics will disappear as a separate entity; it will be an option in every application, business or otherwise." \*

Maxine D. Brown is an independent consultant, specializing in technical communications for the computer graphics industry. She is secretary of SIGGRAPH, a national computer graphics professional society.

# The LQ Papermatic™ 100 Sheet Feeder. The time-saving addition to your Diablo printer.

Increase your productivity with the Papermatic 100 from LQ Corporation. Load it up, and it feeds letterhead to your Diablo printer — automatically. You're free to complete more important tasks. It's backed by a full year warranty to assure you of trouble-free operation.

The LQ Papermatic 100 is also available for Qume, NEC, C. Itoh F10, Daisywriter and other letter quality printers. For the name of your nearest dealer, call or write LQ Corporation, 180 Research Parkway, Meriden, CT 06450. (800) 638-0007. In CT, (203) 237-7311.



Sheet Feeders for  
Microcomputer Printers

CIRCLE 85 ON READER CARD





# TOUCH ME

DATA PROCESSING

BAR GRAPHS

ELECTRONIC MAIL

TOUCH SCREEN

WORD PROCESSING

MENUS

LANGUAGES

PERSONAL COMPUTER

POINT PLOTS

SPREAD SHEETS

AREA CHARTS

THE SOURCE

# MFE

## GRAPHICS

### DATA COMMUNICATION

### WORD PROCESSING

### ELECTRONIC MAIL

## DATA PROCESSING

CP/M, CBASIC and PASCAL MT+ are registered trademarks of Digital Research, Inc. SUPER CALC 2 is a trademark of Sorcim, Inc. Personal Pearl is a product of RSI Corporation. dBase II is a product of Ashton-Tate Corporation. BSTMS is a product of Byrom Software Corporation. CP+ is a product of Taurus Software Corporation. The Source is a servicemark of Source Telecomputing Corporation. IBM is a registered trademark of International Business Machines Corporation.

# Four-Phase is helping more than 2,000 DP managers win the productivity game.

## Now it's your turn.

It's easy to win the distributed information processing game when you play it with the Series 4000 from Four-Phase. The Series 4000 is an integrated, growth-oriented system designed to communicate within your IBM environment. No other vendor gives you so many functions for so many years at such affordable prices. In the distributed processing arena, that's the way to score points with both end-users and top management.

You win the DDP game with software.

Four-Phase provides one of the most impressive and complete collections of software ever offered from one company. Our packages make integrating Four-Phase computers remarkably easy. And guarantee a logical growth path for years to come. Here's just a sample of what we provide:

**Interactive processing: VISION®** — For creating custom applications from order entry to transaction processing. It provides a high level of functionality that can be used in any distributed environment. And VISION is easier and faster to program than COBOL.

**Word processing: FOREWORD®** — Our powerful shared-logic word processing system allows text to be entered, stored, edited, distributed and printed.

**Graphics** — For business graphics, the Graphics Management System (GMS/IV) gives you an easy way to condense and conceptually present data that's easily understood by decision makers.

**COBOL** — Industry standard COBOL is used to write programs for handling keyboard-entered data and general batch processing.

When they want PC's, you've got them!

If your end-users are like most these days, they're clamoring for their own personal computers. We play that

# MFE

### The action starts with the Multifunction Executive.

The key to the Series 4000 game plan is the Four-Phase Multifunction Executive (MFE). This unique and powerful control program monitors each multifunction terminal in your system. Its ability to run multiple software programs allows your users to perform 16 different tasks from any terminal on the system. And each of your users can access all of our software packages with one keystroke. You get maximum distributed processing capability and control.

Plus, MFE dynamically allocates selected peripherals so that each device can be used by more than one program. The result — MFE eliminates the need for multiple processors, duplicate terminals and other peripheral devices at installations that require concurrent execution of software.

game, too. Because at the flick of a switch, our multifunction terminals suddenly become stand-alone PC's. So now you can give your users the distributed processing capabilities they need, AND the personal computers they want. All in one integrated system.

2,000 winners can't be wrong!

Four-Phase was the first company to introduce the integrated approach to multifunction distributed processing. Today, there are more than 15,000 installed Series 4000 systems, helping people like you manage the information needs of over 150,000 end-users. And every machine is backed by our Customer Support Operation and over 1,000 field service people to provide continuing support and reliability at every level.

Four-Phase customers have been winning the DDP game for years. You can, too. To find out how, call us today at 1-800-528-6050, ext. 1599. In Arizona, call 1-800-352-0458, ext. 1599. For a free poster of this illustration, write to us at 10700 North De Anza Blvd., M/S 52-6A9, Dept. P., Cupertino, CA 95014.

VISION, FOREWORD and Multifunction Executive are registered trademarks of Four-Phase Systems, Inc. MOTOROLA and <sup>(M)</sup> are registered trademarks of Motorola, Inc. Four-Phase and the Four-Phase logotype are registered trademarks of Four-Phase Systems, Inc. GMS/IV is a trademark of Four-Phase Systems, Inc.

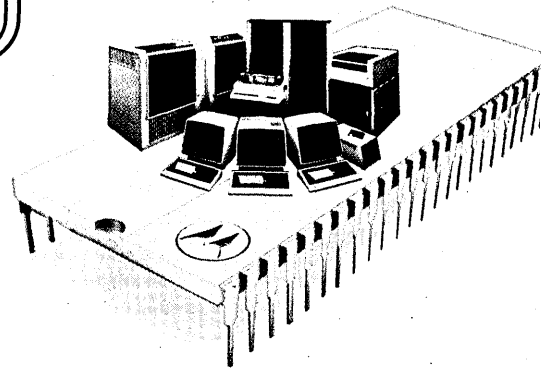

**MOTOROLA**  
**Four-Phase Systems**

CIRCLE 49 ON READER CARD

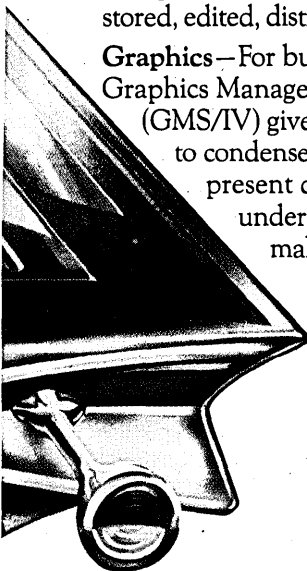





# Announcing CalComp unique DUAL-MODE™ plotters. Now it's twice as easy to decide on the leader.

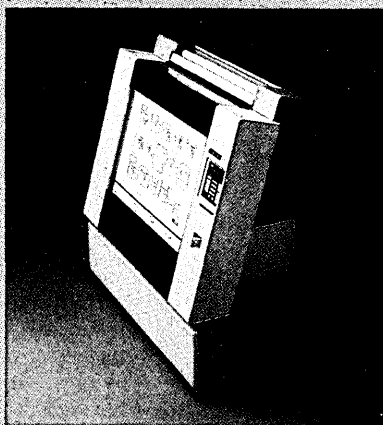

**The 1070 Series DUAL-MODE Plotter**

You no longer have to decide between continuous roll and cut-sheet, because now you can have it both ways.

CalComp's unique 1070 Series DUAL-MODE™ plotters have the versatility to run unattended

continuous roll batch jobs. Then switch modes and produce drawings on cut-sheet or preprinted forms.

Just select the mode you want, and our DUAL-MODE plotters will give you drawings up to 120 feet long. Or, cut-sheets up to ANSI E size or ISO A0 size.

Plus, you'll be getting your selection of continuous roll plots or cut-sheets at the fastest speeds in the industry.

CalComp's new family of DUAL-MODE plotters is compatible with all of our on-line and off-line controllers. And as intelligent microprocessor-based plotters, they allow you to produce narrow-width drawings without changing drums. You'll also have the ability to do plot rotation, de-skewing, windowing, and more.

CalComp's DUAL-MODE plot-

ters have the capability to grow as your company grows, and are available in three models, the 1073, 1075 and 1077. Their exclusive DUAL-MODE capability, unequalled performance and easy upgrade make this plotter family the most cost effective on the market. So decide on CalComp for your roll and cut-sheet plotter needs. We've made it twice as easy to do.

For complete information on our unique 1070 Series DUAL-MODE plotter family, write us today: CalComp, 2411 West La Palma Avenue, P.O. Box 3250, Anaheim, CA 92803. Or call (800) 556-1234, ext. 156. In California call (800) 441-2345, ext. 156.

**CALCOMP**  
A Sanders Company

Software and output devices abound, but it takes some expertise to assemble a solution.

# MICRO-BASED BUSINESS GRAPHICS

by Michael S. Cooper

Business graphics used to be expensive. The premier software products required mainframe computers, costly high-resolution terminals, and expensive output cameras or plotters. The alternatives were few: you could go to an outside service, or use time-sharing terminals connected to those same mainframe-based packages. Whichever method you chose, production costs were between \$50 and \$100 per slide—more, if you used a professional artist.

Now microcomputers are combining with new software packages and output devices to change the business graphics picture and lower that cost per slide to between \$10 and \$15. The success of Lotus 1-2-3 has placed a sophisticated analytical graphing tool in the hands of approximately 250,000 personal computer users. Palo Alto Research Group estimates that an additional 50,000 copies of microcomputer graphing and drawing packages are in use in the business environment.

With any one of a number of pcs, a graphics printer, and the necessary software, nonexperts can begin to produce useful computer generated graphics. If they add a color display and graphics card, they can display graphs and charts in color for analysis and modeling. If the output is to be used for presentations, there's a variety of plotters and color printers that cost less than \$2,000 and produce high-resolution color drawings on paper. The plotters can also work with mylar film for overhead transparencies.

The recently introduced Palette from Polaroid and Imagemaker (made by Polaroid for Digital Research, Inc., Pacific Grove, Calif.) offer conventional as well as instant 35mm slides when used with one of several software packages and appropriate hardware. At present, these products work with the IBM PC and the DEC Rainbow. The DRI Imagemaker comes with its own presentation

FIG. 1

## HIGH-RESOLUTION 35MM SLIDE

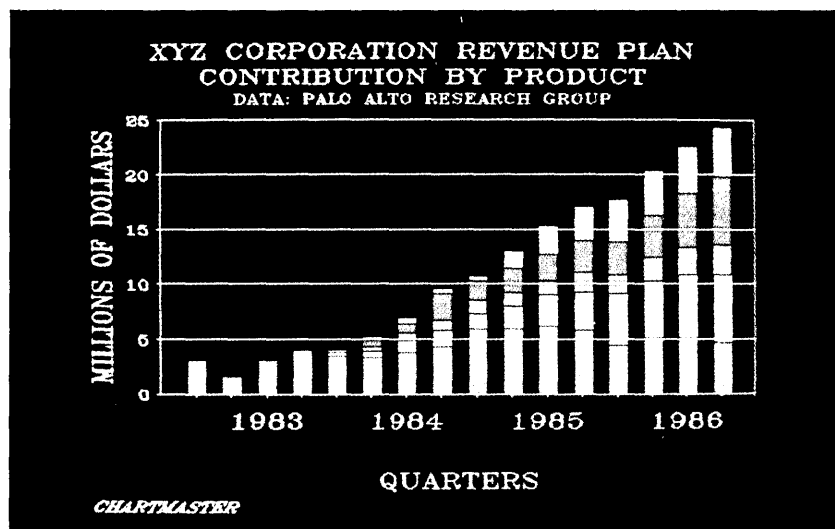

640 X 400 resolution created using enhanced Chartmaster camera driver, Imagemaker camera, and Polachrome 35mm film.

graphics and drawing software packages for just under \$2,000. A complete, micro-based graphics workstation including color display, graphics printer, plotter, and slide camera costs less than \$10,000.

Color displays are used primarily for composing and previewing charts. Each color monitor and its accompanying driver card is capable of displaying a finite number of simultaneous colors at one or more levels of resolution. Resolution is usually measured by the number of picture elements (pixels) per scan line and the number of scan lines per screen. In three-color mode (three colors plus a background color) the IBM PC color graphics board is capable of 320 pixels/line × 200 (scan lines/screen).

The same hardware provides 640 × 200 resolution in monochrome mode. The

higher resolution is achieved by reducing the number of colors available. The IBM color display itself is capable of higher resolution but is limited by the color graphics board that drives it.

The DEC Rainbow, by contrast, can display 16 colors simultaneously at 384 × 240 resolution. Several third-party manufacturers offer graphic monitors and driver cards that increase the capability of the IBM PC.

The resolution of the color display hardware will determine a user's ability to view detail in a chart displayed on screen. Most software uses separate routines for processing output to higher resolution devices (such as graphic printers and plotters) so that they are not affected by on-screen resolution. For examples of camera output at 640 × 400 and 320 × 200, see Figs. 1 and 2.

The simplest way to get hardcopy of screen graphics is to use a graphics printer and the print screen function most micros have. This will send whatever images are on the screen to the printer at the same resolution used on the screen. To be capable of this direct interface, printers must be able to convert that portion of the chart that corresponds to each character cell (the space taken up on the screen by a single character) to a similar representation on the printer.

Most sophisticated software packages can build a screen image in memory by constructing a map of each addressable pixel and then printing this image pixel by pixel and line by line on a standard dot matrix printer. This approach gives much higher resolution output but is also slower. In order to convert the screen image to a pixel map (referred to as a bit map), large segments of memory are used as output buffers. Fig. 3 was produced in this fashion. Many graphics printers attach to the micro via a Centronics compatible parallel interface.

When high-resolution, large format hardcopy is required, a pen plotter is a logical choice. Most manufacturers offer multipen plotters capable of automatically selecting from up to eight pens of varying color and/or width. When used with appropriate software, these machines will draw each line or character with the specified pen.

### VARIETY OF PEN PLOTTERS

Plotters are available in several forms, and are capable of drawing on paper, mylar, and many other substances. On a flat bed plotter, the paper is stationary while the pen moves in either or both of two axes. When moved in both axes, the pen produces curved lines or circles. Other plotters (such as the one used to produce Fig. 4) move the plotting surface in one axis direction and the pen in the other. Curves and circles are generated by moving both simultaneously. The third type of plotter is a variant of the second: the paper is attached to a drum and rotated back and forth under a pen that is moved in the other axis direction.

Each of the plotter types offers specific advantages. It's wise to request a demonstration using sample charts similar to the ones you want to produce. Most plotters attach to the micro via an RS232 serial interface.

Cameras for graphics output have only recently become available at a price consistent with micro hardware. The Digital Research Igemaker and Polaroid Palette offer low-cost 35mm slide output. In addition they are both capable of producing 3 1/4 in. by 4 1/4 in. instant picture output using Polaroid Polacolor type 669 film. These similar systems create output by means of a small crt and

FIG. 2

### MEDIUM-RESOLUTION 35MM SLIDE

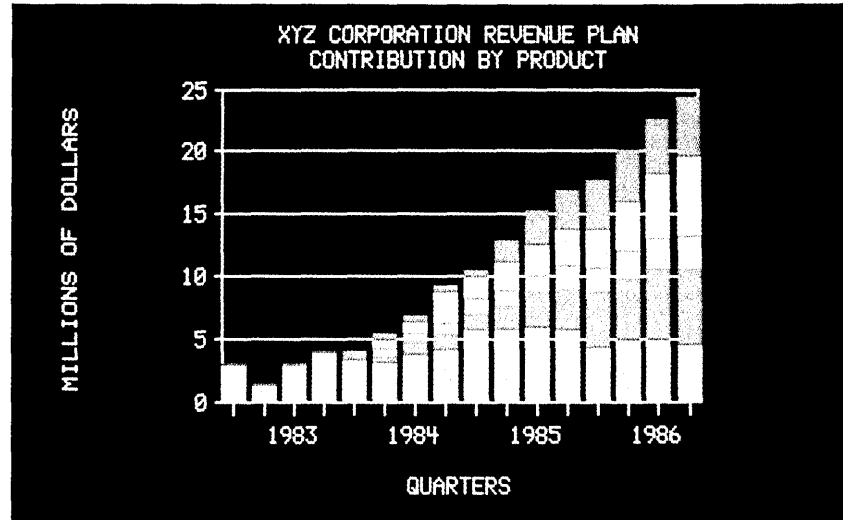

320 X 200 standard IBM color resolution with IBM PC and Lotus 1-2-3. No camera driver is available with Lotus 1-2-3. Image was created as a dump of the screen, using Igemaker camera and Polachrome 35mm film.

FIG. 3

### COLOR PRINTER OUTPUT

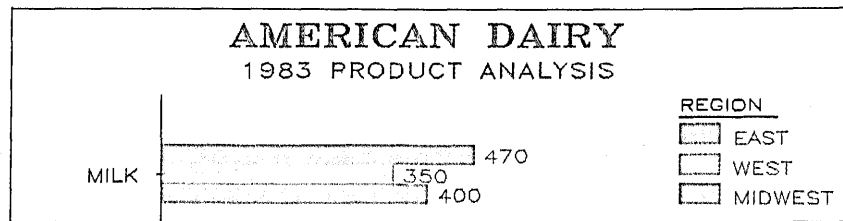

IBM color printer output is typical of color dot matrix printers available for the IBM PC.

FIG. 4

### PEN PLOTTER OUTPUT

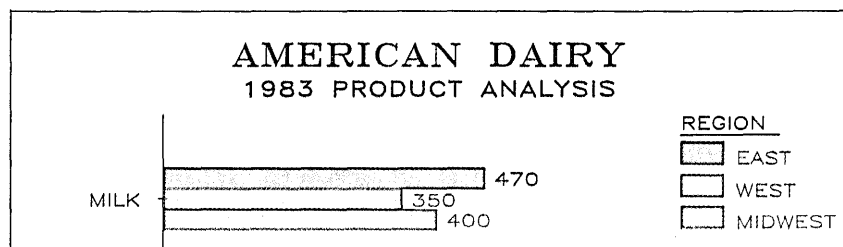

The HP 7475 six-pen plotter produces high-quality charts on both paper and transparency film for overhead projection.

either of two camera backs mounted on the exposure unit. The monochrome image is exposed several times through color filters to create color images on the film. Both products offer a choice of any eight colors from a selection of 72. Also, software permits the creation of unique colors or variations as substitutes for the 72 provided with the product.

These cameras take their image from the composite video output of the color

graphics board of an IBM PC or a DEC Rainbow. The maximum resolution of the respective boards determines the resolution of the images produced by the cameras. Since the images are created using monochrome output, the maximum resolution with an IBM PC is 640 x 400, with eight colors simulated in the camera. With a DEC Rainbow resolution is 800 x 480, also with eight colors simulated in the camera (see Fig. 5). This need not limit

# Only MSA software makes your mainframe work 100 times better

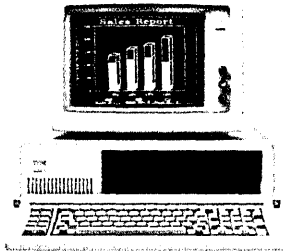

1. Now MSA's Executive Peachpak II™ links personal computers to the mainframe. So you can...

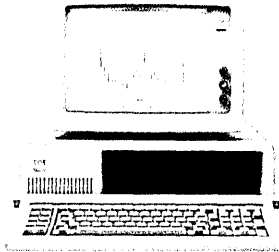

2. Use your PC to access all your MSA mainframe systems, from General Ledger to Manufacturing.

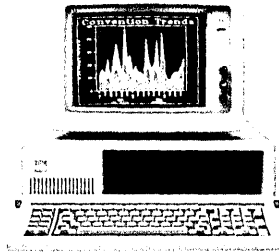

3. Access entire mainframe files, so you can work with large amounts of information at one time.

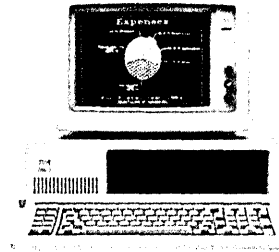

4. Choose the exact mainframe information you need, as much as you need, in the form you need.

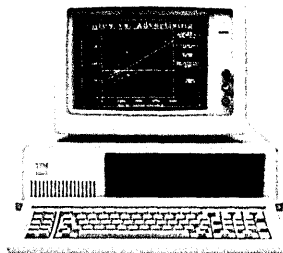

5. Use it with Peachtree Software, 1-2-3™ from Lotus, DIF™ VisiCalc™, or other micro software.

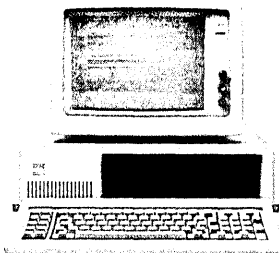

6. Replace terminals with PCs at about the same cost—with many more capabilities.

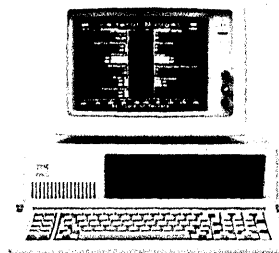

7. Plug PCs directly into your existing online network.

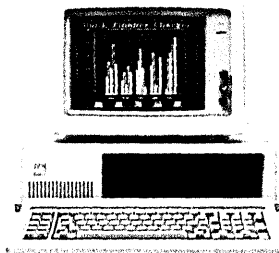

8. Or establish dial-up access with regular telephone lines.



9. Interface mainframe data directly to typewriters, graphics plotters, and printers.

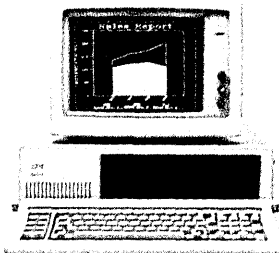

10. And automate your office economically.

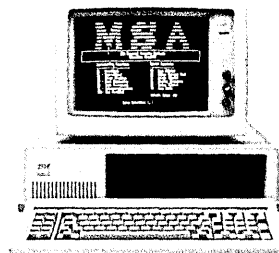

11. Install this new technology in less than one hour.



Send for our free brochure, and find out all 100 ways to increase your productivity.

12.-100.

You've got your own personal computer. Now what do you do with it?

Thanks to MSA's new Executive Peachpak II™ software, you can do more than you ever dreamed.

MSA's new Executive Peachpak II links your personal computer directly to your company's mainframe. So you can get to vital information without waiting for print-outs.

It includes all the functions you'll need to really make your PC useful: an electronic spreadsheet, graphics, report production, telecommunications and much more.

And it's perfect for use with IBM's new 3270 PC.

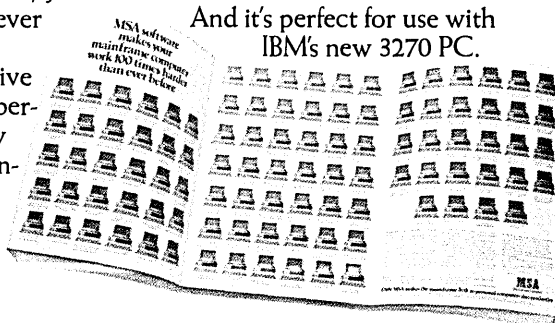

For a *free brochure* that shows you 100 specific ways you can use Executive Peachpak II to get mainframe information through your PC, contact Robert Carpenter at (404) 239-2000. Or write Management Science America, Inc., 3445 Peachtree Road, N.E., Atlanta, Georgia 30326.

**MSA**  
The Software Company

**MSA makes the mainframe link to personal computers a reality**

Executive Peachpak II is a trademark of Management Science America, Inc. DIF is a trademark of Software Arts, Inc.  
1-2-3 is a trademark of Lotus Development Corp. VisiCalc is a trademark of VisiCorp, Inc.

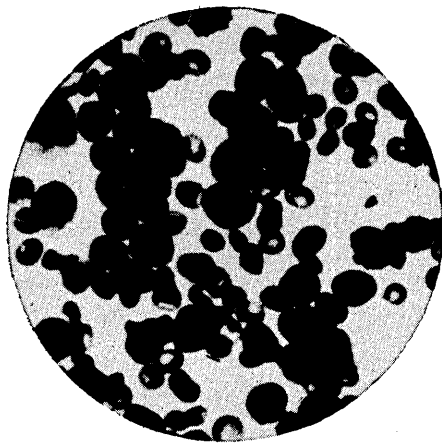

# leukemia

is a malignancy that arises in the body's blood-forming tissues. Its symptoms can include easy bruising, fever, continual weakness, chronic fatigue, bone and joint pain, and loss of appetite and weight.

Consult a physician if such problems persist. Early detection is the best medicine.

For more information, including the free booklet "What Everyone Should Know About Leukemia," write to:

**leukemia**<sup>®</sup>  
society of america, inc.  
800 Second Avenue  
New York, NY 10017



**When high-resolution, large format hardcopy is required, a pen plotter is a logical choice.**

FIG. 5  
**MAXIMUM RESOLUTION 35MM CAMERA OUTPUT**

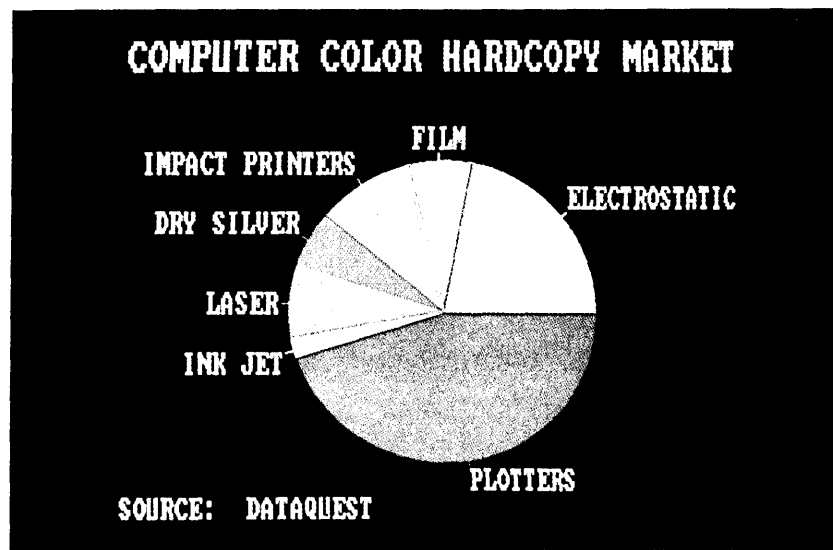

The DEC Rainbow 100 is capable of 800 x 480 resolution when used with the Graphwriter driver and Polaroid Palette. This is the high-test resolution currently available when using a camera with a pc. Film: Polachrome.

the products' usefulness. If you're careful in choosing type fonts, colors, and chart complexity, the results compare favorably with output from more expensive cameras.

**SOFTWARE IS THE CATALYST**

Software is what unifies the hardware tools described above. Micro packages approach business graphics from two directions. Several spreadsheet programs offer integrated business graphics by taking selected data from a previously created or modified spreadsheet and graphing them on a color monitor. Other software companies offer specialized business graphics software that focuses on the final output (see Fig. 6). These products offer the user almost infinite flexibility to define a graph, scale it, select colors, fonts, font sizes, and determine the graph's placement on the output page.

Lotus 1-2-3 and Supercalc 3 offer direct conversion from spreadsheet to graph. Both require a graphics board and graphics screen in order to use any of their graphics functions. Lotus is the more widely used of the two, and it provides excellent on-screen graphics. When outputting to plotters and cameras, however, it is less flexible than programs specifically designed for business graphics such as Chartmaster, Graphwriter, DR Graph, or FastGraphs. Lotus is at its best where the object is to analyze data, not to present them.

Supercalc 3 is a hybrid. Besides easy

conversion of spreadsheet data, it offers sophisticated features found in graphing programs: variable fonts and character sizes, scaling, and control of placement on the output page.

Chartmaster from Decision Resources Inc. supports a wide variety of output devices and offers six character fonts in a simple-to-use yet sophisticated menu-driven package. By adding Signmaster (also from Decision Resources) users get a complete text chart capability with similar user interfaces, font capability, and output support.

Graphwriter from GCI works by means of predefined chart formats. Managers use forms to define charts (including the data to be represented) and then turn them over to an operator for completion. This permits many individuals to specify charts when there may be only one graphics workstation available. The technique also compensates for the software's inherent complexity; each user need not be familiar with system operation.

A good way to evaluate software is with several of your organization's typical chart formats. These samples can help you determine which of the many excellent products on the market will best meet your requirements.

Most of the products listed in Fig.6 run using an IBM PC under PC/DOS, IBM's version of Microsoft DOS. Graphwriter currently runs under the UCSD Pascal system, which is provided as part of the distribution package. The current implementation is slow, and if



# IF YOU KNOW RAMIS II, YOU'LL UNDERSTAND WHY ATLAS™ BEATS CICS!

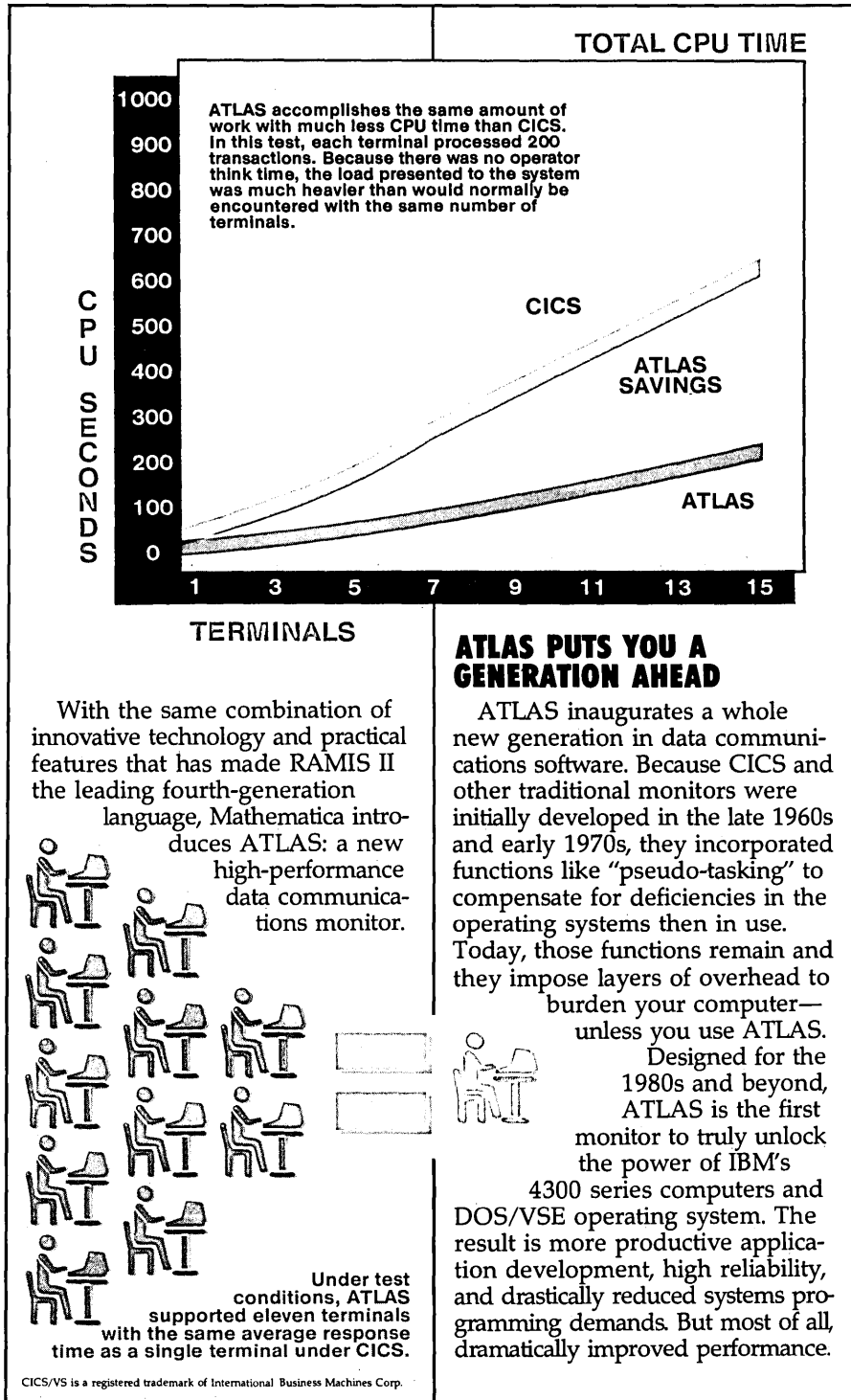

## ATLAS PUTS YOU A GENERATION AHEAD

ATLAS inaugurates a whole new generation in data communications software. Because CICS and other traditional monitors were initially developed in the late 1960s and early 1970s, they incorporated functions like "pseudo-tasking" to compensate for deficiencies in the operating systems then in use. Today, those functions remain and they impose layers of overhead to

burden your computer—unless you use ATLAS.

Designed for the 1980s and beyond, ATLAS is the first monitor to truly unlock the power of IBM's 4300 series computers and DOS/VSE operating system. The result is more productive application development, high reliability, and drastically reduced systems programming demands. But most of all, dramatically improved performance.

## TEST ATLAS YOURSELF

In a recent test, ATLAS outperformed CICS/VS by more than 2 to 1 in both elapsed time and CPU time. And the heavier the load, the better ATLAS performed.

To find out exactly what the next generation in data communications can mean to your organization, try the ATLAS performance test on your computer. Whether you use ATLAS alone or together with RAMIS II, you will be able to support more terminals, improve response time, and get more work done in the rest of your DOS/VSE partitions.

To arrange a free trial or for more information, contact your local Mathematica office, call toll free (800) 257-5171, or return the coupon below.

## MATHEMATICA PRODUCTS GROUP

A MARTIN MARIETTA DATA SYSTEMS COMPANY  
P.O. Box 2392  
Princeton, NJ 08540



MATHEMATICA PRODUCTS GROUP  
P.O. Box 2392, Princeton, NJ 08540

- I would like to try the ATLAS performance test.  
 I would like additional ATLAS information.

Name \_\_\_\_\_

Title \_\_\_\_\_

Company \_\_\_\_\_

Address \_\_\_\_\_

City \_\_\_\_\_ State \_\_\_\_\_ Zip \_\_\_\_\_

Telephone \_\_\_\_\_

Computer \_\_\_\_\_ Operating System \_\_\_\_\_

DA5 \_\_\_\_\_

## RAMIS® II AND ATLAS...THE LEADERS BY DESIGN

Boston (617) 357-9424 Chicago (312) 870-9710 Dallas (214) 788-1916 Houston (713) 850-8697 Los Angeles (213) 670-6962  
New York (212) 980-9077 Princeton (609) 799-2600 San Francisco (415) 461-6315 St. Louis (314) 725-0046  
Washington, DC (202) 484-5752 Basel (061) 429923 Bergen (5) 321300 Calgary (403) 290-0668 Heidelberg (06221) 14051  
Hong Kong 5-435714 Johannesburg (011) 789-1808 Kingston (809) 929-7223 London (01) 580 3681 Milan (02) 546-8080  
Montevideo (2) 906788 Ottawa (613) 236-8616 Paris (1) 776 41 71 Santiago (2) 31014 Sao Paulo (11) 289-0077  
Singapore 2739255 Stockholm (8) 520720 Sydney (02) 923 1677 Tel Aviv (052) 70364 Toronto (416) 671-2272

# Generating various kinds of business graphics on a pc may not be as simple as the advertisements imply.

FIG. 6

## PC GRAPHICS SOFTWARE

Six graphic packages and two spreadsheet programs with integrated graphics are evaluated. Three products offer direct 35mm camera support which provides enhanced resolution. The others can work with a camera in lower-resolution "screen dump" mode.

SOFTWARE FEATURES	<b>Chartmaster</b> Decision Resources Westport, Conn. <b>CIRCLE 390</b> <b>ON READER CARD</b>	<b>Graphwriter</b> Graphics Communications Cambridge, Mass. <b>CIRCLE 391</b> <b>ON READER CARD</b>	<b>DR Graph</b> Digital Research. Pacific Grove, Calif. <b>CIRCLE 392</b> <b>ON READER CARD</b>	<b>Fast Graphs</b> Innovative Software Overland Park, Kans. <b>CIRCLE 393</b> <b>ON READER CARD</b>
<b>Hardware requirements</b>				
<b>Memory</b>	128K (192K DOS 2.0)	128K	128K	128K
<b>Monochrome</b>	Y	Y	N	Y
<b>Color</b>	Y	Y	Y	Y
<b>Dual screen</b>	Y	Y	N	N
<b>Operating environment</b>	DOS	PASCAL (DOS avail 5/84)	DOS	DOS
<b>Floppies</b>	2	2 (320K)	2	2
<b>Hard disk</b>	Y	Y	Y	Y
<b>Output Devices</b>				
<b>Graphic screen</b>	Y	Y	Y	
<b>Plotters</b>	19	8	Y (via GSX drivers)	10
<b>Printers</b>	8	avail. 5/84	Y (via GSX drivers)	11
<b>Cameras</b>	Y*	Y	Y (via GSX driver)	N
<b>Operation</b>				
<b>Menu</b>	Y	Y	Y (secondary)	
<b>Command</b>	N	N	N	
<b>Form fill out</b>	N	Y	Y (primary)	
<b>Ease of use (0 to 5)</b>	+5	+3	+4	+5
<b>Sophistication (0 to 5)</b>	+4	+5	+3	+2
<b>Data entry</b>				
<b>Keyboard</b>	Y	Y	Y	Y
<b>DIF</b>	Y	Y	Y	Y
<b>ASCII</b>	N	N	Y	Y
<b>Lotus</b>	DIF <sup>2</sup>	DIF	DIF	DIF
<b>Supercalc</b>	DIF	DIF	Y	Y
<b>Other</b>	N	N	Y	MULTIPLAN
<b>Price</b>	\$395	\$475	\$195	\$195

\*Requires 256K

<sup>2</sup>Data interchange file (Software Arts)

used with an IBM PC XT requires a separate partition on the fixed disk for Pascal programs and Pascal data storage. GCI's David L. Wilcox says the latest release of Graphwriter (scheduled for this month) will run under PC/DOS and will not require these steps.

There is a high degree of functional compatibility between the various implementations of DOS, but this doesn't extend to the way in which each hardware vendor has implemented keyboard and screen functions. Since graphics applications are heavily dependent on screen capabilities, it is not safe to assume that a graphics application written under DOS may be transported. In most cases, a separate and distinct version of the software is required for each microcomputer. Most of the IBM plug-compatible pcs will run the IBM version, but this is not true of DOS-based sys-

tems from DEC, TI, Wang, and other firms.

### SMART OUTPUT DEVICES

Many of the output devices that are available today are microprocessor controlled, and thus have a lot of built-in intelligence. For example, the Calcomp M84 plotter (which is also the IBM X/Y 749) can generate straight lines, circles, arcs, axes and values, six fonts, character and string rotation, line textures, fill patterns, scaling, and windowing. This set of capabilities is typical of plotters and other output devices. The commands required by each device are unique, however, making it difficult for software authors to take advantage of all the functions.

Most software packages use the simplest subset of commands, thereby duplicat-

ing the capabilities of these devices. By limiting themselves this way, authors are able to make their software run with the widest possible selection of output devices. The work is done by the software rather than the hardware, and a large portion of each user's hardware investment is wasted for the sake of software portability.

This problem has been addressed by a joint development effort by Digital Research and Graphics Software Systems (Portland, Ore.) in conjunction with industry hardware manufacturers. The result is the availability of the GSX driver set from Digital Research, which provides a unique device driver for each of the products supported. These drivers take maximum advantage of the intelligence of each device and may be accessed by any application program using predefined calls.



<b>Chartstar</b> Micropro San Rafael, Calif. <b>CIRCLE 394</b> <b>ON READER CARD</b>	<b>PFS Graph</b> Software Publishing Mountain View, Calif. <b>CIRCLE 395</b> <b>ON READER CARD</b>	<b>1-2-3</b> Lotus Development Cambridge, Mass. <b>CIRCLE 396</b> <b>ON READER CARD</b>	<b>Supercalc 3</b> Sorcim San Jose, Calif. <b>CIRCLE 397</b> <b>ON READER CARD</b>	<b>SOFTWARE FEATURES</b>
128K	192K	192K	96K	<b>Hardware requirements</b>
Y	N	N	Y	<b>Memory</b>
Y	Y	Y	Y	<b>Monochrome</b>
N	N	Y	Y	<b>Color</b>
DOS	DOS	DOS	DOS	<b>Dual screen</b>
1	2	2	1	<b>Operating environment</b>
Y	Y	Y	Y	<b>Floppies</b>
				<b>Hard disk</b>
Y	Y	Y	Y	<b>Graphic screen</b>
3	5	3	4	<b>Plotters</b>
3	10	5	1	<b>Printers</b>
N	N	N	N	<b>Cameras</b>
N	Y	Y	Y	<b>Menu</b>
N	N	Y	Y	<b>Command</b>
Y	Y	N	N	<b>Form fill out</b>
+2	+5	+4	+3	<b>Ease of use (0 to 5)</b>
+4	+2	+3	+4	<b>Sophistication (0 to 5)</b>
Y	Y	Y	Y	<b>Keyboard</b>
Y	Y	Y	Y	<b>DIF</b>
N	N	N	Y	<b>ASCII</b>
DIF	DIF	Y	DIF	<b>Lotus</b>
DIF	DIF	DIF	Y	<b>Supercalc</b>
N	N	N	N	<b>Other</b>
Not available	\$125	\$495	\$395	<b>Price</b>

The first software products to employ these drivers—DR Graph and DR Draw—come from DRI. The drivers are available under both CP/M 80 and CP/M 86, and DOS. Programs using both input and output GSX drivers will be transportable between noncompatible hardware systems.

The current generation of managers is well aware of the potential of graphics as a business tool. They want to use charts and graphs to spot trends, compare actual results with forecasts, find aberrations, and communicate this information to peers. They're also aware that personal computers offer them new capabilities.

What many of them don't know, however, is that generating various kinds of business graphics on a pc may not be as simple as the advertisements imply. With only

one exception (Digital Resources' Image-maker) none of the products on the market offers a total solution. That is, no single vendor sells a pc, software, output devices, cables, and a single instruction manual covering the combination. There can be problems with cabling and interfaces, among other things, and dealers may be no more familiar with the difficulties than the unsuspecting new user.

That leaves the in-house dp expert as the last line of defense, the person with the expertise to make it work for the business. And the dp department faces another challenge as well: assuring that the data being used at the various distributed workstations are valid. In many cases, the only way this can be accomplished is for the corporate dp function to provide the data.

It all adds up to an opportunity that will be hard to avoid. Last fall, this magazine published the results of a survey by Data Decisions, Cherry Hill, N.J., "Micros at Big Firms," (November, p. 160). Of over 1,000 dp managers queried, 65% said they expected non-dp personnel to be using pcs for production of graphics within a year. This may explain why nearly every pc advertisement shows a screen filled with graphics rather than text. \*

Michael Cooper is president of Palo Alto Research Group, Palo Alto, Calif., a division of Technology Finance Group. PARG is a market research and consulting firm specializing in business graphics hardware and software products.

# "HUNDREDS OF DIFFERENT OPERATING

**"R:BASE™ KEEPS ME ON TOP OF THE WORLD'S BIGGEST BUSINESS."**

Now there's a brand new way to make sense out of all the micros in your company. Glue them together with the world's most complete family of DBMS software. R:BASE.™

This high-performance software comes in a whole range of versions. In MS™-DOS, PC/DOS™, CP/M®, BTOS™ and CTOS™. For multiuser or stand-alone

applications, and even for personal use. So you can literally grab every one of those expensive little machines by the database. And standardize your data acquisition and information management practices.

Of course, data and file structures used on one type machine are completely compatible with any of the others. It's the end of jargon as you know it. The beginning of a totally buttoned-up, cost-efficient operation. Best of all, your users won't even know

how tight the control is. They'll just think they're having the time of their lives playing with the computer.

**"A PROGRAM YOUR PEOPLE CAN RELATE TO."**

Now, there's a brand new option that makes R:BASE a lot easier to relate to. R:BASE CLOUT™ (Conversational Language Option). It lets everyone communicate with a microcomputer in



# LITTLE MICROS. SYSTEMS. HO! HO! HO!"

plain English. It even remembers an individual user's favorite abbreviations and slang. In fact, this is nothing less than an artificial intelligence system that actually learns from experience. And when you put it together with all the power of R:BASE, you've got a package that just can't be beat.

**"DON'T WAIT TILL  
CHRISTMAS.  
OPEN IT UP NOW."**

Want to see how it feels  
to have a little order for a

change? For only \$14.95 (plus shipping) we'll send you a comprehensive demonstration packet\* of R:BASE and R:BASE CLOUT DBMS software, including three separate diskettes. Just call 1-800-547-4000, Dept. 830. In Oregon, or outside the U.S., call 1-503-684-3000, Dept. 830.

Or ask for it at your nearest software store or ComputerLand® dealer.

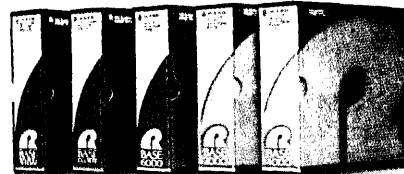

## R:BASE™ FROM MICRORIM®

\*Requires 256K of memory. Runs on MS™-DOS and PC/DOS operating systems.

CIRCLE 52 ON READER CARD



# 1024 x 780 for \$2795

## Our Competitive Edge

Their  
Edge

The Cybernex 1014 graphics terminal with standard 1024 x 1024 memory delivers outstanding performance at a refreshingly low price.

### A refinement you can see

With our 1014, the 'aliasing' or staircase effect found with lower resolution terminals has been virtually eliminated. Our 14-inch screen produces refined graphic imagery of 1024 x 780 actual displayable pixels. The result is instantly obvious: diagonal lines, arcs and circles now appear 'truer' to the operator.

### Goes beyond Tektronix 4014... except in price!

As an emulation of the Tektronix 4010/12/14/15, we build in all the features you demand in a top quality graphics terminal, including compatibility with PLOT 10<sup>®</sup>

software and keyboard set-up of all parameters. We also provide many other useful features, such as smart drawing functions and support for various input/output devices, including mice and bit pads. And with flow control on the 1014's 9K communications buffer, you won't lose any screen data... no matter how complicated your drawings.

### Supports low cost printers

Dot matrix printers are supported with our 1014. Full-screen images are printed, pixel to dot, so you can get actual hard-copy of what you've drawn on the screen.

To learn more about the Cybernex 1014 call us at (416) 823-2810 or Telex 065-22093

PLOT 10 is a registered trademark of Tektronix

Tilt and swivel stand and 1015 APE version are options

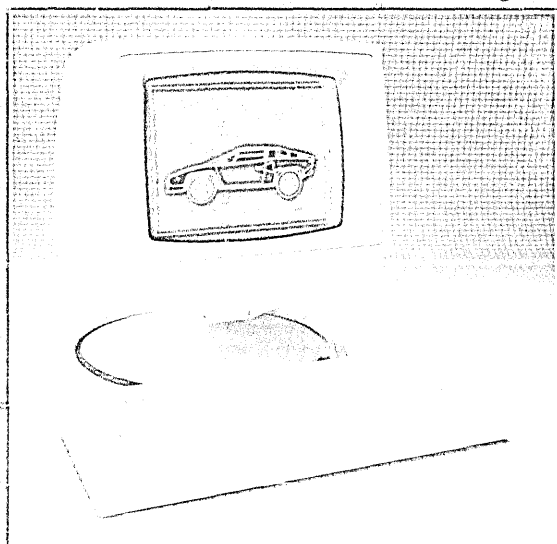

# CYBERNEX

## Making a good thing better.

CIRCLE 53 ON READER CARD

# A DOZEN ELECTRICAL MISTAKES

by Warren H. Lewis

A lot of dp shops have electrical systems that aren't as safe or as effective as they should be. In some shops, the power situation is downright dangerous and the people in charge aren't even aware that anything is wrong.

This how-not-to article may help those people. Presented here are a dozen of

the most common electrical mistakes, along with some advice on how to do it right. All information is derived from a new U.S. Department of Commerce/National Bureau of Standards publication, *Guideline on Electrical Power for ADP Installations* (FIPS PUB 94). The *Guideline* was reviewed by various government facilities planning organizations and by the Computer & Business Equipment Manufacturers Association's Power Interface

Subcommittee.

*Insulating bushings.* It is often recommended that a plastic insulating bushing be placed between any metallic electrical conduit and the frame of the computer unit into which the conduit is hardwired. The purpose is to protect the computer from electrical noise. But the National Electrical Code (NEC) forbids the use of insulating bushings because they create shock and fire hazards by imped-

FIG. 1

## ELECTRIC SHOCK HAZARD OF ISOLATED GROUNDS

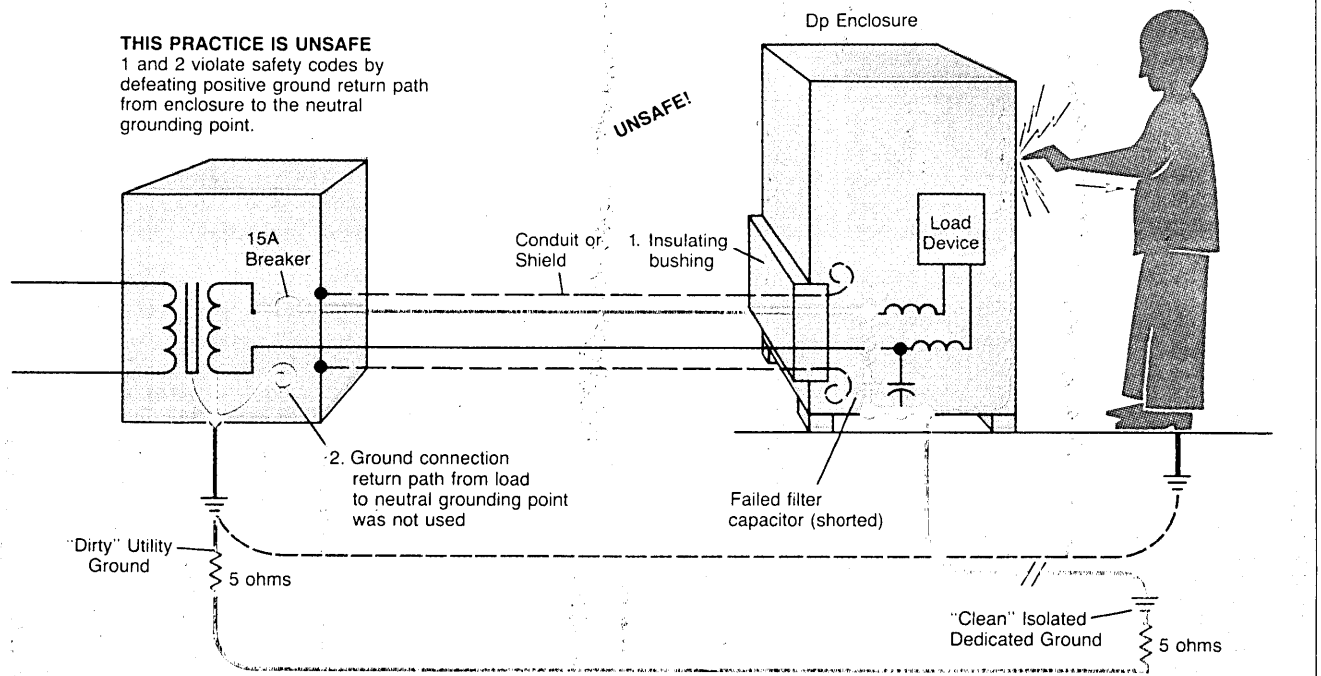

CHARTS BY PAUL GOODFRIEND

SOURCE: FIPS PUB 94

# Placing the source of power far from the electrical panel may make electrical sense, but it's a disservice to the computer.

FIG. 2

## ISOLATING TRANSFORMERS

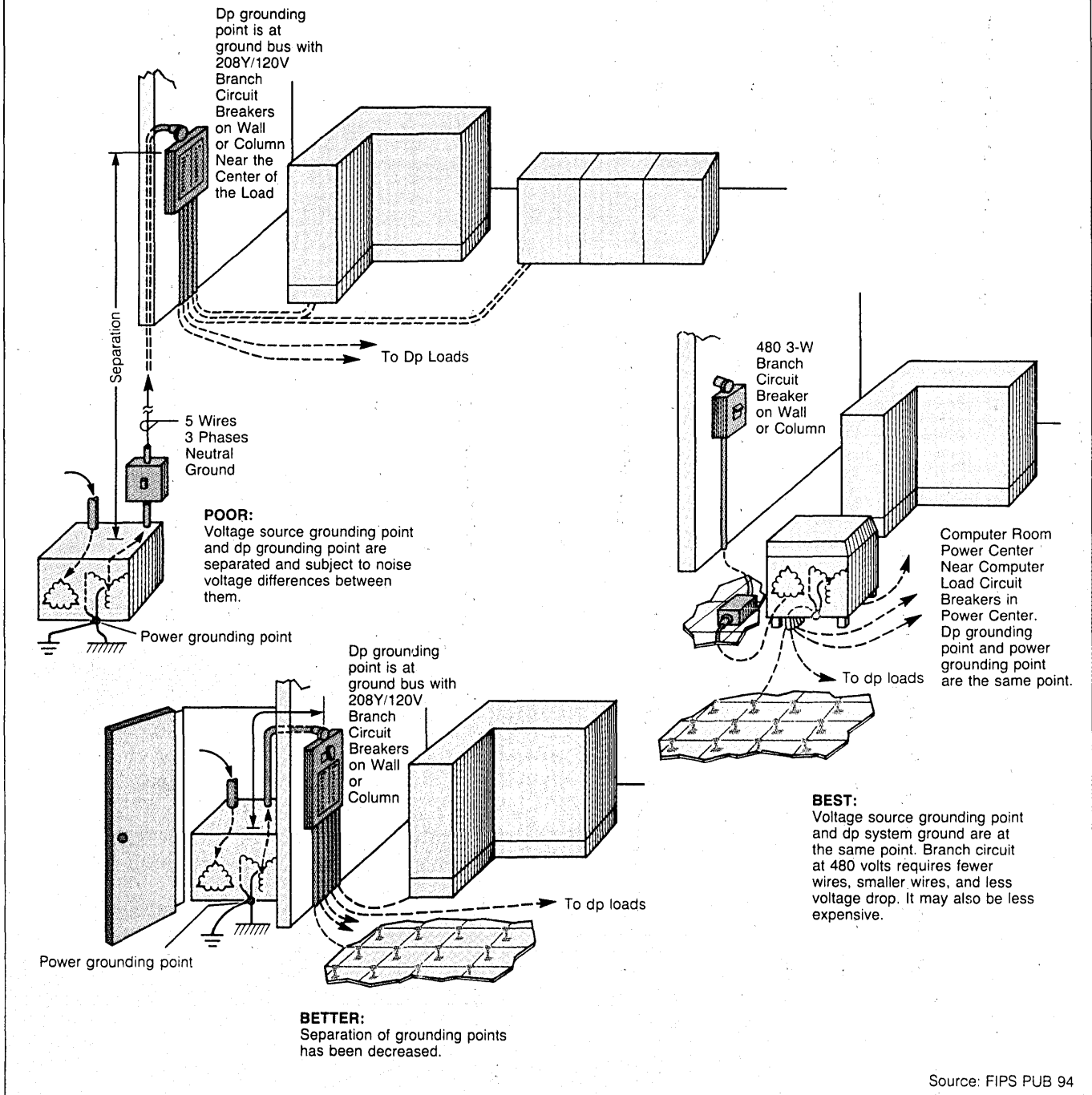

Source: FIPS PUB 94

ing the proper flow of ground-fault current (see Fig. 1). Even if you use an equipment grounding wire (the so-called greenwire) in conjunction with these bushings, you're still violating the code.

*Electrical panel too far from power*

*source.* Too often, the computer is treated as if it were just another electrical load in the building. Placing the source of power far from the electrical panel may make electrical or economic sense, but it's a disservice to the computer because the grounding system be-

comes unable to control high-frequency noise. There is also a problem with common mode noise (see Fig. 2). Moving the supply closer to the electrical panel helps, but the best approach is to connect the computer to the building supply and grounding system via

EVERYONE  
WILL BE MAKING  
HIGH SPEED  
MODEMS LIKE  
THIS.

IN THREE OR  
FOUR YEARS.

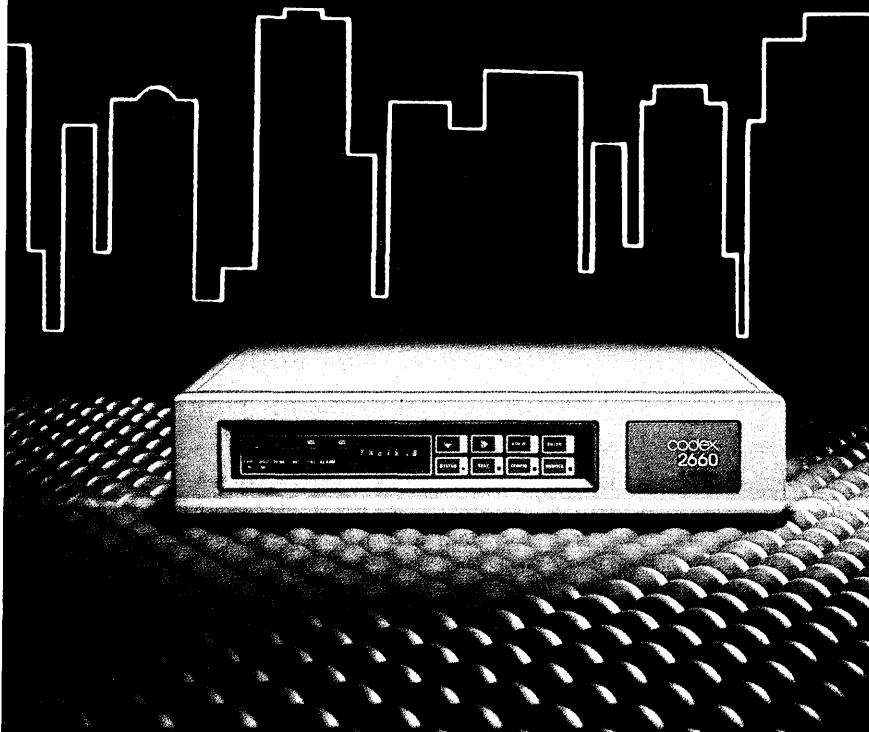

**H**ow did Codex come up with the 2600 Series, a new generation of modems running at speeds from 4800 to 16,800 bps that's so much more advanced than the competition?

By designing a revolutionary VLSI-based signal processing architecture teamed with the powerful Motorola MC68000 microprocessor.

A design that incorporates a unique Adaptive Rate System, which continuously adjusts the transmission speed of the Codex 2660 to the maximum rate the line will support. Allowing you to optimize throughput all the way up to 16,800 bps, without having to lift a finger.

A design that ensures data reliability with Trellis Code Modulation (TCM)—a significant advancement over uncoded modulation techniques in common use today.

In multipoint applications, the Codex 2640 can even handle mixed 9600, 7200 and 4800 bps inbound rates. So each drop can operate independently at maximum speed and efficiency.

Of course, with the Codex 2600 Series, network control is standard. So you can monitor line and modem performance from the front panel or from a central Codex DNCS system. Plus there's an optional downline-loading feature that lets you conveniently modify or enhance the functionality of remote, unattended modems.

The Codex 2600 Series.

In three or four years, our competitors will probably have modems just like them.

If you'd rather not wait, contact Codex today. We'll send you detailed information about these 2600 features and more. Much more.

Call 1-800-821-7700 Ext. 886. Or write: Codex Corporation, Dept. 707-86, 20 Cabot Boulevard, Mansfield, MA 02048.

codex

 **MOTOROLA INC.**  
Information Systems Group

**At NCC, see us at the Motorola  
Information Systems Group booth.**



**What sounds like a clear-cut concept may turn into an indefinable wiring scheme that's implemented in a hazardous manner.**

FIG. 3

**COMMON VS. SEPARATE FEEDERS**

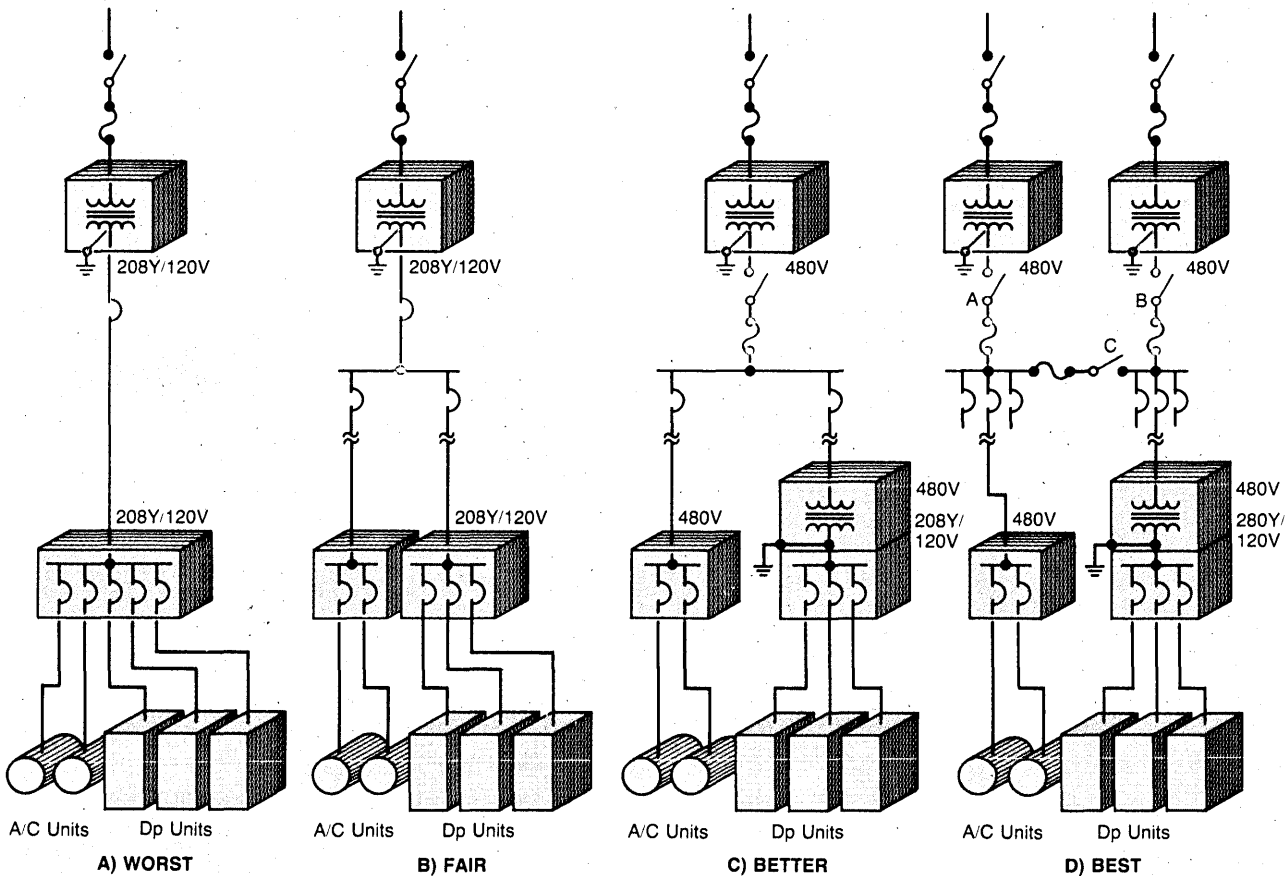

Source: FIPS PUB 94

a computer power center (CPC)—the current state of the art. Several mainframe manufacturers are offering a CPC within their product lines, and there are independent suppliers as well.

*Shared loads on the same electrical circuit.* Some electrical distribution systems subject the computer to disturbances caused by other loads sharing the same wiring. A much better approach is to isolate the computer by means of dedicated wiring runs and an isolation transformer or CPC. Many computers are wired as shown in (a) or (b) of Fig. 3. This wiring leads to interaction and noise problems that can easily be avoided. The recommended arrangement is shown in (c), where the computer is isolated. Those fortunate enough to have a second (and separate) utility service can employ a dual-feeder system, as shown in (d). This gives isolation that's nearly complete, along with the capability to select either feed during emergency conditions. However, each of the feeders

must be capable of handling the total load of both feeders.

*No isolation transformer, or the wrong kind.* Fig. 4 shows a computer interfaced to the building's power and grounding system through an isolation transformer. The isolation transformer may be part of the building wiring, as shown in Fig. 1, or—better yet—part of a CPC.

**MULTI-USE TRANSFORMER**

The transformer serves multiple purposes. First, it reestablishes a local power and signal-noise ground directly at the computer, which is where it should be. Second, with electrostatic shielding, it can significantly reduce the passage of common mode noise into the computer. Third, if the input winding short circuits, the shield protects the computer from high-voltage surges. For maximum benefit, the isolation transformer should be placed within the computer area.

*Dedicated grounding.* This term is frequently misunderstood, resulting in improper grounding of the computer (see Fig. 1). Dedicated grounds depend upon the computer installer creating some form of isolation between the computer itself and the power system ground, which is assumed to be "dirty." The dedicated ground is assumed to be "clean."

These assumptions ignore a lot of engineering facts. There are no such things as "quiet" or "noisy" grounds. Typically, these are man-made connections into the earth, and their designated roles may be switched—by lightning strikes, among other things. Thus, the dedicated ground is often the means of ingress for the noise, rather than being a drainpipe into which noise is dumped. As shown in Fig. 4, the power and local grounds should be integrated.

*Misuse of five-wire grounding scheme.* Sometimes vendors and suppliers get caught up in semantic problems. What

# STRATEGIC

Videotex may be more important to business than personal computers. Reach new customers through the consumer medium of the 1980's. Teldon/NAPLPS Companies pioneered the videotex standard and a kaleidoscope of services. They're still leading the way in the markets.

# WIZARDRY

Let us help you plan your videotex strategy. Send us your business card and we'll send you the strategic wizardry you need to stay ahead!

Teldon/NAPLPS Companies  
External Affairs Canada (EUS)  
125 Sussex Drive  
Ottawa, Ontario  
Canada  
K1A 0E2

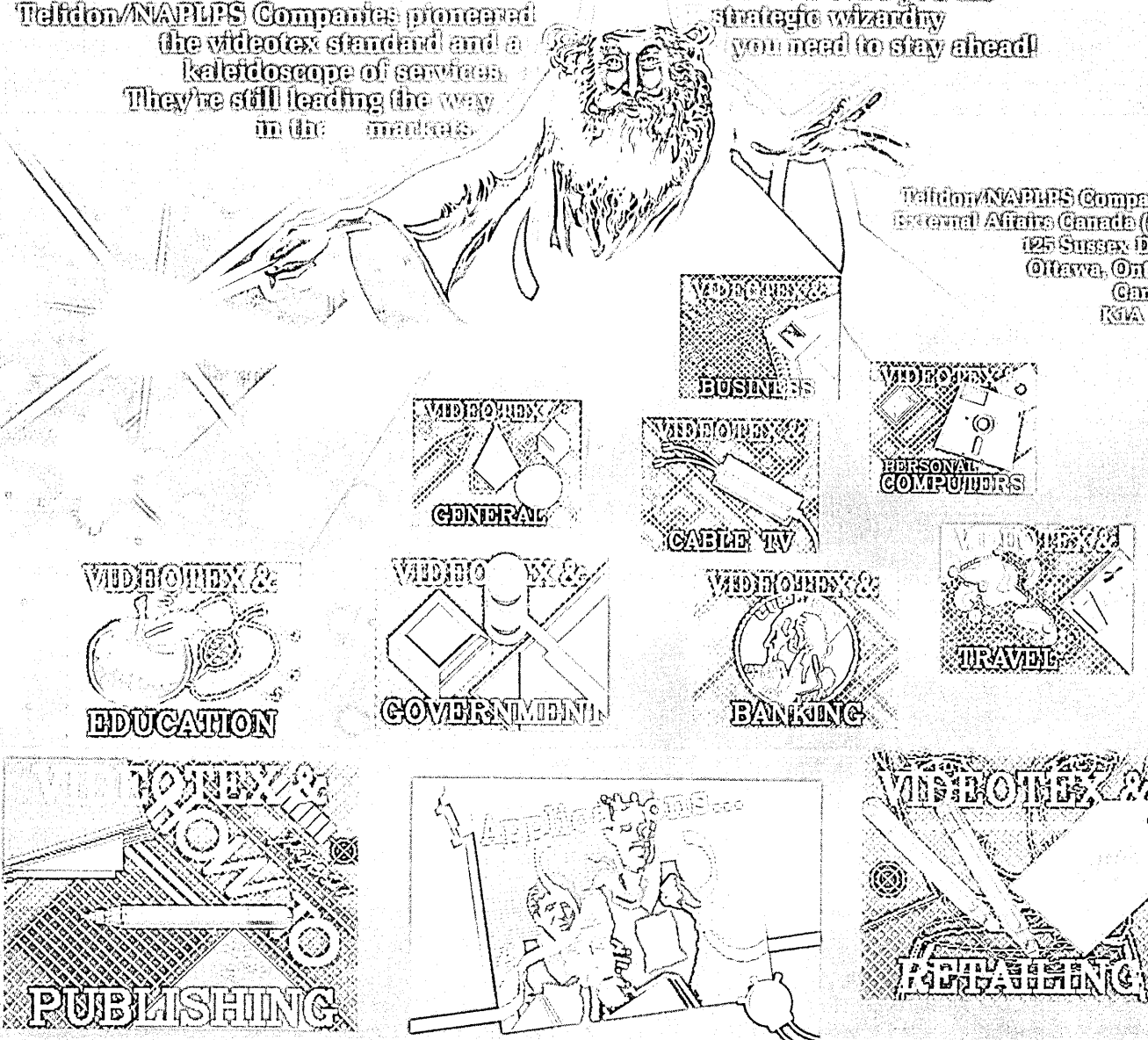

Teldon/NAPLPS.

# TEL DON NAPLPS



External Affairs  
Canada

Affaires extérieures  
Canada

Canada

CIRCLE 55 ON READER CARD

EVERYONE WHO WANTS TO  
USE THE COMPANY MAINFRAME  
RAISE YOUR HAND.

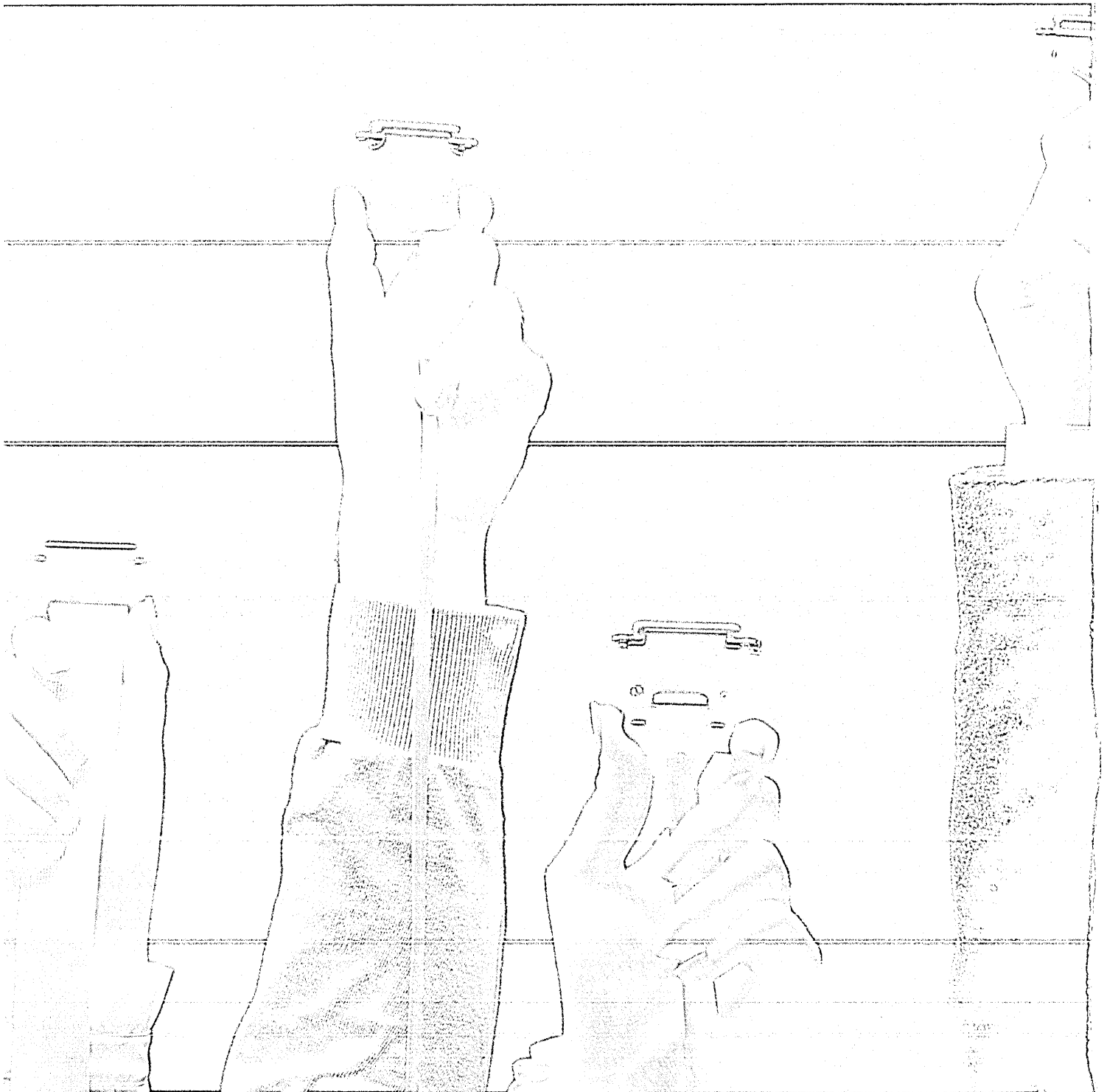

Introducing power to the people.

Better known as the Data Pipeline™ from Intel.

It's based on our iDIS™ Database Information System. A powerful, integrated package of hardware and software with multi-user capability built right in. And now, through iDIS, just about

any pc or terminal can easily share data with just about any mainframe.

With the iDIS Pipeline, you'll be able to establish and manage your pc-to-mainframe connections in a way never before possible. Yet you'll still be able to offer department users a fair degree of independence. Since iDIS comes with all the software they need. Starting with the Xenix\* operating system, built around a relational DBMS. Plus the Multiplan\* spreadsheet, word processing, electronic mail, and a forms/menu development tool.

The iDIS Pipeline is powerful, too. Each one will handle 5 full-time users, or between 12 and 15 on dial-up. And you can even network with other iDIS systems.

But you're always in control. You decide which data are accessible, and extract only those to your iDIS system. Users then access their data sets from iDIS's hard disk.

Actually, using the iDIS Pipeline is a lot like giving users their own little mainframe.

Which is a lot better than giving them yours.

It's also a lot cheaper.

Less than half the cost of a direct pc-to-mainframe connection.

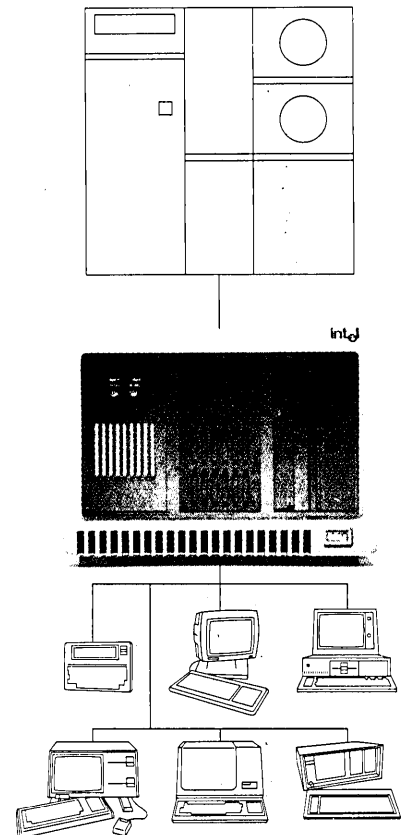

*Our Data Pipeline™ allows practically any pc to share data with practically any mainframe.*

It's also fully supported and serviced from one responsive source. Us. Best of all, it's available now.

For more information about how our iDIS Data Pipeline can help you manage the revolution in your office, call us at 800-538-1876; in California, 800-672-1833. Or write Intel, Lit. Dept. H-18, 3065 Bowers Ave., Santa Clara, CA 95051.

Of course, if you're undecided about what to do you can always ask for a show of hands...

**intel®**

\*\*/ according to the Gartner Group, who took the time to figure out all the hidden costs, each direct pc-to-mainframe connection costs approximately \$22,000. Each \*Xenix and Multiplan are trademarks of Microsoft Corporation. © 1984 Intel Corporation.

CIRCLE 56 ON READER CARD



# Raised floors can conceal a multitude of sins.

FIG. 4

## THE SINGLE-POINT GROUND

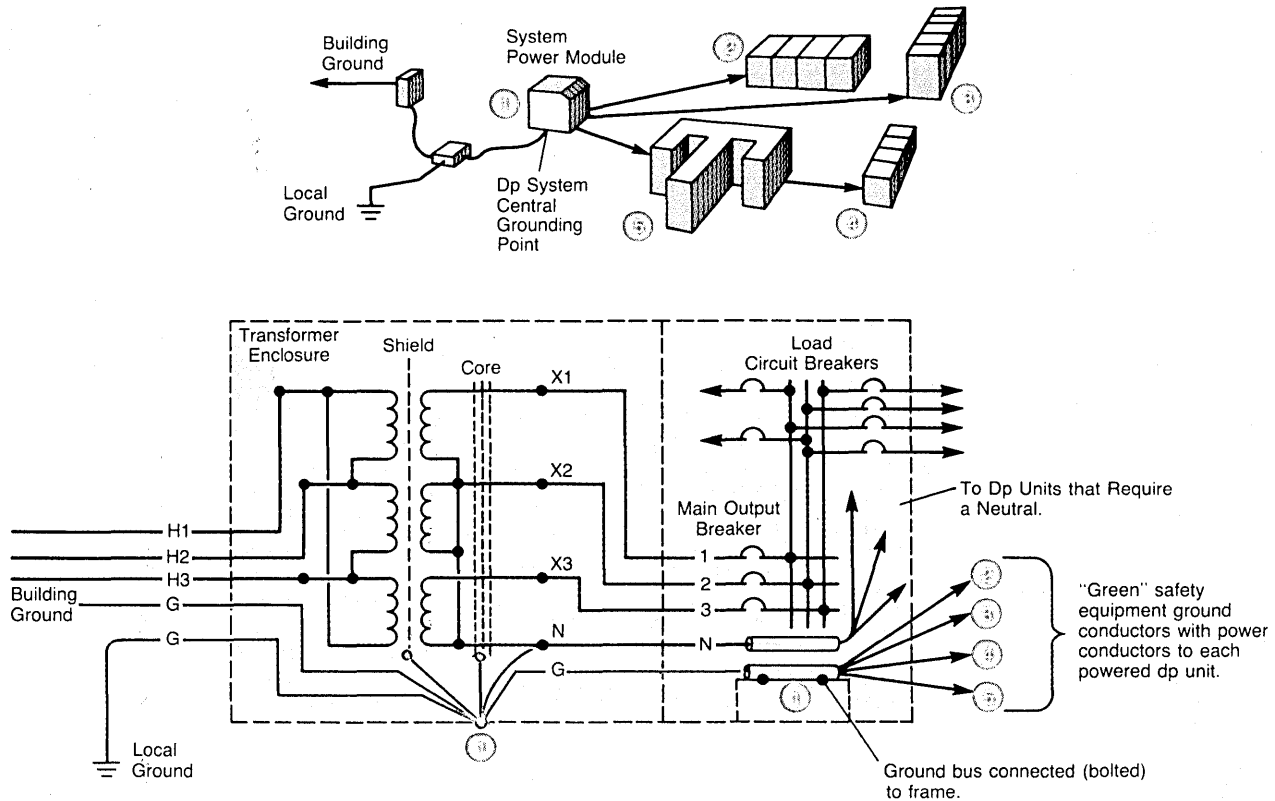

Source: FIPS PUB 94

sounds like a clear-cut concept may turn into an undefinable wiring scheme that's implemented in a hazardous manner.

A five-wire grounding system that conforms with the NEC is shown in Fig. 4. There are five wires entering and leaving the isolation transformer.

This system becomes unsafe (for both people and the computer) when the jumper between the neutral terminal and the transformer enclosure is eliminated, and the local ground wire is removed from the transformer's enclosure and reconnected to the neutral terminal. This allows the terminal to be grounded to whatever the local ground wire is connected to. If the local ground wire is connected to a dedicated ground, there is a disaster in the making.

If that local ground wire is run all the way back through the building to the service entry ground, the installation does meet NEC requirements. The ground wire will pick up noise on its run to the service entry, however, and from the ground when it gets there. Thus, the benefits of the isolation transformer will be negated.

**Ineffective lightning protection.** Perhaps the most common problem in the area of lightning protection is the incorrect installation of an otherwise good lightning arrester. One mistake is putting an arrester into the computer room itself. Worse yet, it could be attached to a piece of computer equipment, such as a CPC.

### DIVERTING THE LIGHTNING

When an arrester fires it does not actually "arrest" the lightning; it diverts it, into whatever the arrester is attached to. If that's a CPC, the lightning will enter the computer system via the CPC's cabling and grounding. If the arrester is under the raised floor, and mounted in or on a box, then the lightning will be diverted into the underfloor grounding system, where all of the logic cables are. Tens of thousands of amperes of current may find their way into the computer.

The proper location for a lightning arrester is shown in Fig. 5: outside of the computer room, and electrically upstream from the computer. It is set up to divert the

lightning current into the building's ground-steel system.

The arrester is only part of the solution. As shown in Fig. 5, transient surge protection equipment is needed to mop up after the arrester takes the brunt of the lightning current. This device should be installed on building steel at the room's perimeter; it should not be a part of the equipment in the computer room.

**Unsafe wiring under the raised floor.** Raised floors can conceal a multitude of sins. Two of the most common National Electrical Code violations appear to be the use of flexible cords or cables to connect the computer to its wall-mounted electrical panel, and the use of flexible conduits that are not properly fastened down to accomplish the same interface.

Computer manufacturers are permitted to use flexible cords and cables only between their units—as interconnecting cabling. Flexible cords and cables can't be used to go from the building supply to the computer unit's power plug, or for hardwire entry on a cabinet. The NEC requires proper fastening

# High resolution, low cost graphics should be more than a retrothought.

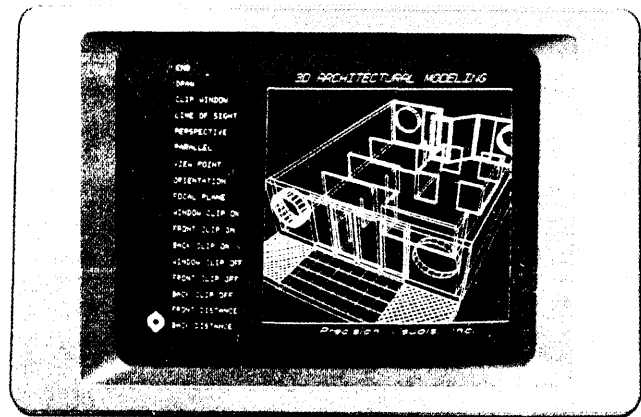
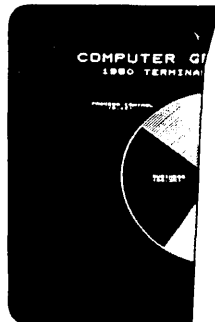
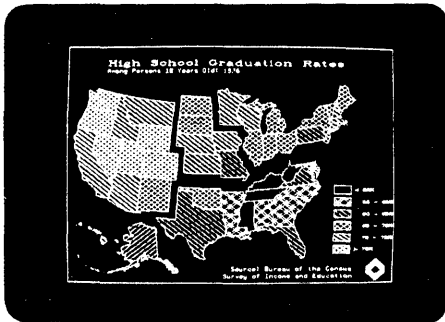
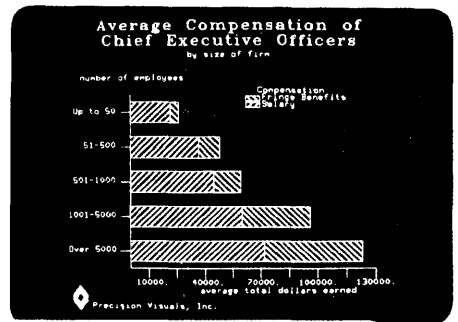
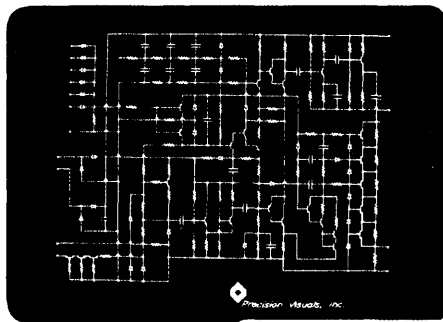
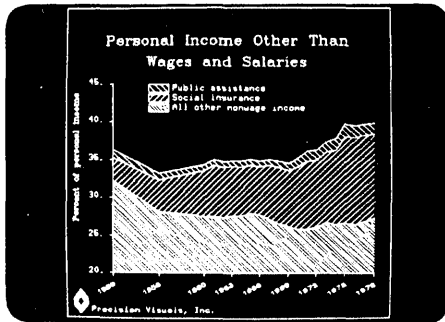

Why settle for a low resolution retrofit graphics terminal when you can have a VISUAL high resolution terminal with quality and reliability built in. And at a cost that makes retrofits overpriced.

The VISUAL 500 and VISUAL 550 emulate the Tektronix 4010/4014 but cost only about half as much. And they provide 585(V) x 768(H) resolution for sharp text and graphic display on a large 14" screen without the need to add boards or change the CRT. This superior resolution offers the ideal vertical to horizontal dot density ratio of 1:1 for balanced images and reduces the "stairstep" effect you get with most retrothoughts.

The VISUAL 500 provides selectable emulations of the DEC VT52, Data General D200, Lear Siegler ADM3A, and Hazeltine 1500 terminals. The VISUAL 550 is DEC VT100 protocol-compatible as well as a character or block mode terminal which complies to the ANSI X3.64 standard.

Call or write for a free comprehensive reference booklet on graphics terminals including a glossary of graphics buzzwords.

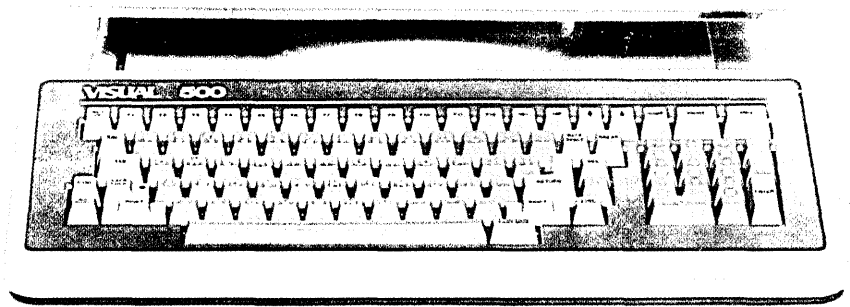

## VISUAL 500/550

	VISUAL		RETROTHOUGHTS						
	500	550	DIGITAL ENGINEERING				SELANAR		
			VT640S	VT640	DQ650S	DQ650M	SG100 PLUS	SG200	SG480
Vertical Resolution	585	585	240	480	240	480	240	240	480
Horizontal Resolution	768	768	640	640	800	800	1225	1225	780
Dot Density Ratio	1:1	1:1	1:2	1:1	1:3	1:1	1:4	1:4	1:1
Screen Size	14"	14"	12"	12"	12"	12"	12"	12"	12"
Tektronix 4014 Compatible	STD	STD	NO	NO	NO	STD	NO	STD	STD
Data Tablet Support	STD	STD	NO	NO	OPT	OPT	NO	NO	NO
Multi-Vendor Printer Support	STD	STD	OPT	OPT	OPT	OPT	OPT	OPT	OPT
8 Dir. Cross Hair Cursor	STD	STD	NO	NO	NO	NO	OPT	OPT	OPT
Programmable Function Keys	STD	STD	NO	NO	NO	NO	NO	NO	NO
Tilt/Swivel Enclosure	STD	STD	NO	NO	NO	NO	NO	NO	NO
Compatibility	VT52 ADM3A H1500 D200	VT100 VT52 ANSI X3.64	VT100 VT52	VT100 VT52	VT100 VT52	VT100 VT52	VT100 VT52	VT100 VT52	VT100 VT52
PRICE (suggested list*)	\$2,495	2,695	3,025	3,355	3,025	3,510	2,890	3,390	3,190

\*Retrothoughts price includes DEC VT100 terminal based on published information as of 4/1/83.

VISUAL

See for yourself

Visual Technology Incorporated  
540 Main Street, Tewksbury, MA 01876  
Telephone (617) 851-5000. Telex 951-539

# The electrical system should be made safe, and then the computer should be made to work.

down of all flexible conduits.

While the NEC deals only with safety considerations, electronic concerns should be addressed as well. The cords and cables installed in the above way are usually unshielded. They can act as antennas, and can pick up or radiate noise.

## TRADING OFF SAFETY

The computer room requires flexibility, and this is the apparent reason why safety has been traded off in some installations. If an Underwriters Laboratories listed CPC is used, however, both safety and flexibility can be assured. The CPC is a computer device, not an extension to the building's wiring system. It can safely use flexible, interconnecting cabling to effect the power interface.

**Floating grounds.** When isolation transformers are employed, the term isolation is sometimes treated as an absolute. The most common error is the use of an isolation (or ultraisolation) transformer whose output is left ungrounded (floating) for the sake of noise control. In Fig. 4, this would mean removal of the jumper between the neutral terminal and the transformer's enclosure, thus floating the output or secondary.

Although the National Electrical Code considers this practice unsafe, it is actually recommended by some manufacturers—particularly those who offer the ultraisolation type of transformer. These manufacturers are apparently unable to achieve the high value of noise attenuation they claim without making these unsafe connections. This poses a significant safety vs. performance question. But the priorities should be as follows: the electrical system should be made safe, and then the computer should be made to work.

**Misuse of isolated/insulated ground receptacles.** The so-called IG style receptacle is proliferating, but many people aren't using it safely. Its purpose is well understood—to sometimes reduce electronic noise on the circuit—but the method by which it is installed often results in serious safety problems.

First, the isolated or insulated ground pin must never be run to any form of dedicated or isolated ground. The pin must be grounded to the enclosure/conduit system, at a point no further upstream than the transformer or other device supplying the power to the receptacle. Thus, when you get to a transformer, motor-alternator, or uninterruptible power supply (UPS), ground the wire at that point; don't go further back in the system. This is shown in Fig. 6, where the IG wire passes through one electrical panel, but is grounded at the transformer supplying the panel.

Sometimes, an IG receptacle calls for the addition of a second equipment grounding

FIG. 5

## SUPPLEMENTARY SURGE PROTECTION ELEMENTS

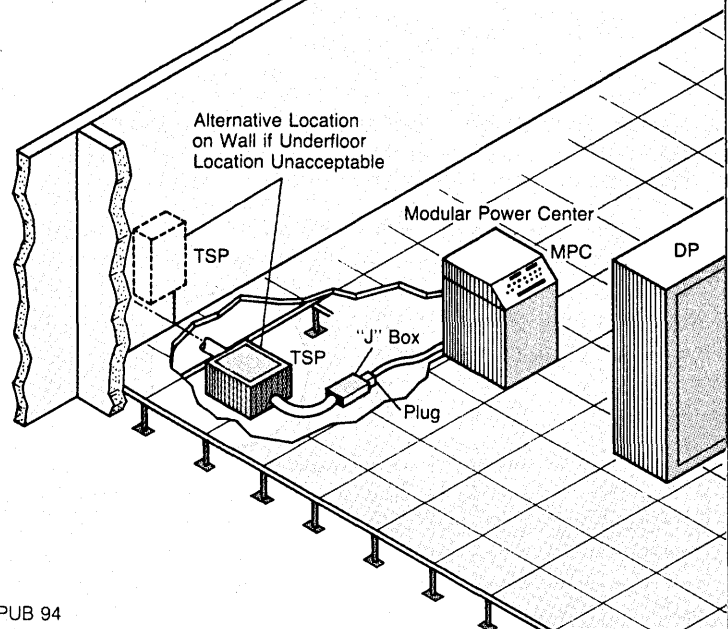
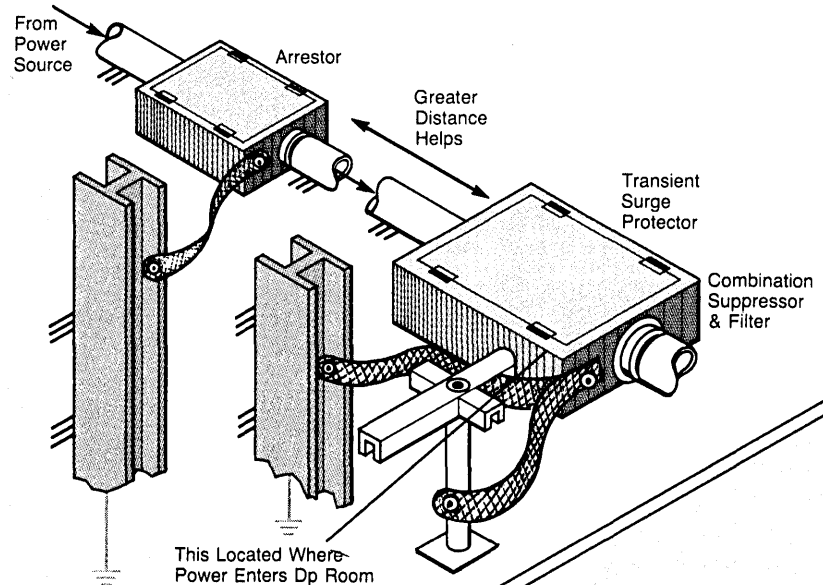

Source: FIPS PUB 94

wire in the conduit run. This condition would arise if the conduit were of the flexible metal or liquid-tight flexible metal variety. There are no exceptions to this, and the 1984 NEC has added a fine print note to bring the point home. The second groundwire is shown in Fig. 6 as paralleling conduit.

## SHOCK AND FIRE HAZARD

Failure to implement the IG wire scheme properly will result in both shock and fire hazard, and will increase the susceptibility of the computer to noise and lightning damage.

*Failure to provide ZSRG structure.*



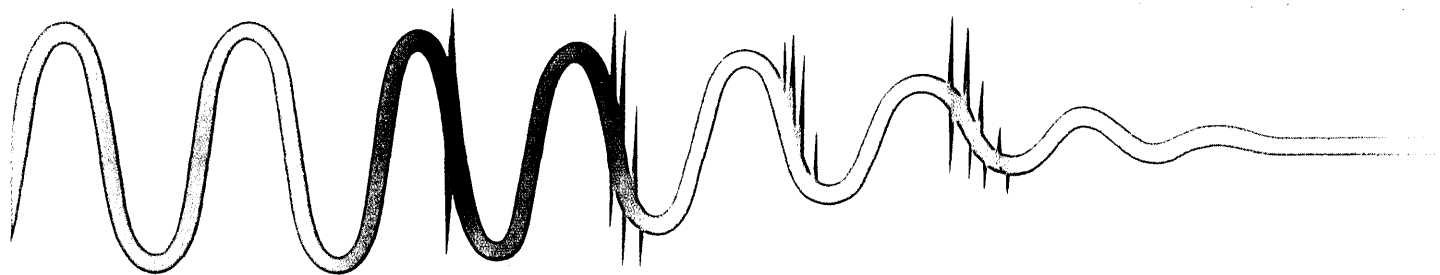

# If your power is critical, finding your power problems is even more critical.

Today's computer systems, delicate instruments, and communications systems demand clean, pure power to perform accurately.

Unfortunately, that kind of power isn't always there.

Today's blackouts, brown-outs, and power surges can quickly destroy or alter precious data and delicate circuits.

The Liebert 3600A Power Line Disturbance Monitor® (PLDM®) won't stop these problems, but it will help pinpoint them.

It detects disturbances that exceed sensitive thresholds and classifies them by type, magnitude, and duration. The printout tells you when the problem occurred so you can compare the information with load equipment errors, problems, and failures.

#### Easy to Use

The fully programmable Liebert 3600A is extremely easy to set up and use.

Instructions are located on the inside of the unit's lid and on the operating face plate. Even if you use the 3600A only

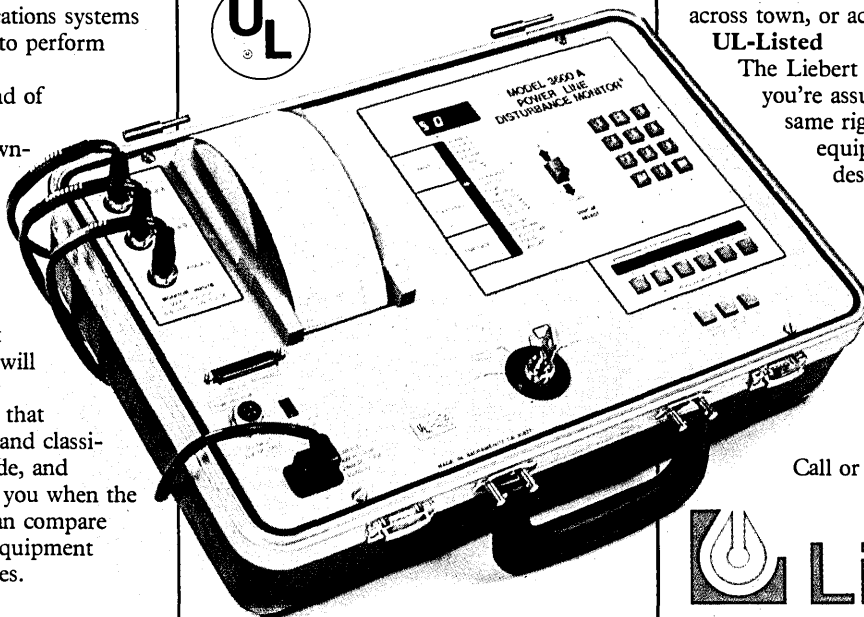

once a month or less, you won't have to wade through an entire manual to make certain you set it up correctly.

Simply key in your threshold

parameters and clock settings. An easy-to-read LED display will verify all of the settings. And the 3600A's self-test diagnostics ensure everything

is operating properly.

When your tests are completed, simply close the lid and take the 3600A to the next test site . . . across the building, across town, or across the country.

#### UL-Listed

The Liebert 3600A is UL-Listed so you're assured that it meets the same rigid requirements as the equipment and systems it is designed to monitor.

Whether you specify, install, test, or use sensitive electronic systems, make certain you can count on the power you use.

Find out more about the Liebert 3600A PLDM.

Call or write us today.



## Liebert

Programmed Power Division

995 Benicia Ave., Sunnyvale, CA 94086  
(800) 538-1770. In CA (408) 245-8900

PLDM is a registered trademark of Liebert Corporation.  
© Copyright 1984 Liebert Corporation

See Us At International Computer and Electronic Field Service Expo, Booth #111.

CIRCLE 58 ON READER CARD

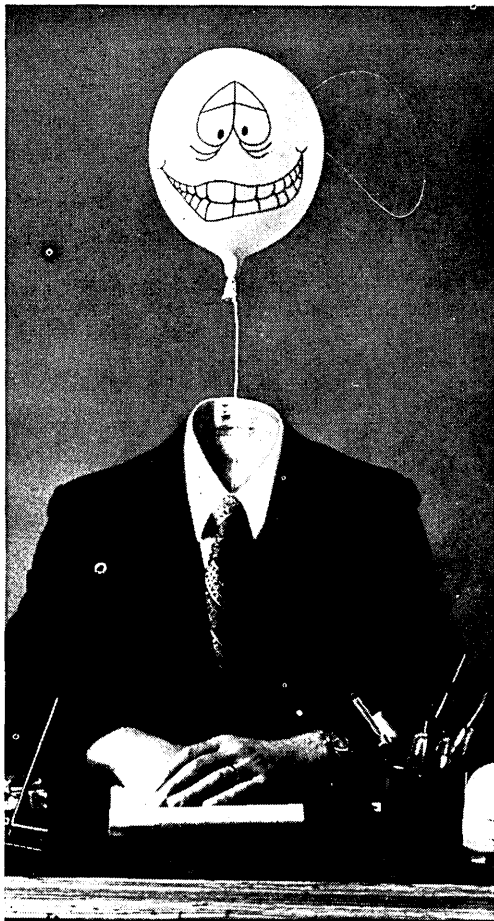

# High Blood Pressure?

Only your doctor can tell. Like more than 10 million other Americans, you could have high blood pressure and not know it until it leads to stroke, heart or kidney failure. It has no special symptoms and often gives no warning. But your doctor can detect high blood pressure (he may call it hypertension) and usually control it. So see your doctor... and follow his orders.

**Give Heart Fund**  
American Heart Association

Contributed by the Publisher

**The best power setups now make use of a special form of grounding for all medium- to large-scale computer systems.**

FIG. 6

## ISOLATED GROUND RECEPTACLES

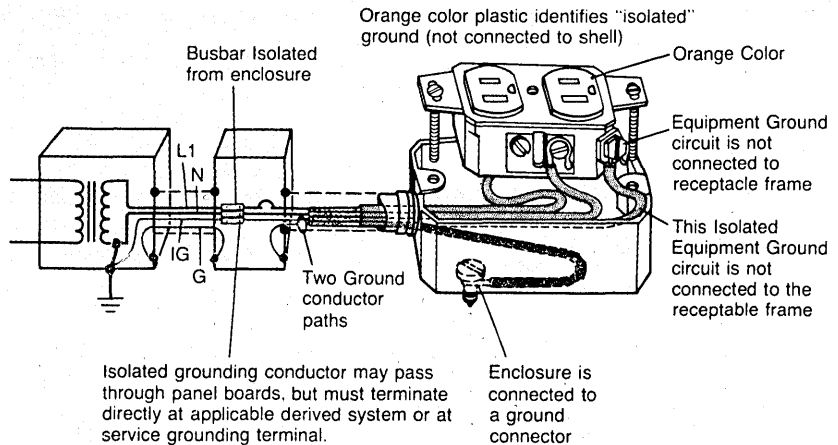

SOURCE: FIPS PUB 94

The best power setups now make use of a special form of grounding for all medium- to large-scale computer systems: zero signal reference grounding (ZSRG). It is symbolized in Fig. 2 by the cross-hatched area beneath the computer system. Most shops still don't use ZSRG, but could decrease their noise problems if they did. ZSRG implementation is simple. For example, the bolt-in stringer system of a raised floor makes an excellent ZSRG structure. A fabricated grid of copper foil or wire also works well. In either case, it is a good investment.

*Lack of surge protection on data cables.* Even when the power and grounding sides of a computer system are successfully protected against lightning and other surge phenomena, the data cables used to interface the computer's front end to other areas or buildings are usually left unprotected. This allows the surge to enter the computer system via these cables and damage the cable driver/receivers. In many cases, the surge gets into the rest of the system as well.

That's why data cable surge suppressors should be added to each data cable as it exits or enters the computer room. It's also necessary to ground the surge suppressor network to the ZSRG as well as to grounded building structural-steel. Some installations may also require surge suppression networks at the point where the cable enters or exits the building itself.

The Dirty Dozen are just a sampling of the electrical problems that threaten the effectiveness and reliability of your computer system. Many people think they can eliminate these problems simply by installing an uninterruptible power supply or motor-alter-

nator before installing the computer. But these expensive systems are not always needed, or effective. For example, how would they protect the system from subsequent grounding problems or data cable surges? What protects the UPS from lightning?

By reading FIPS PUB 94 you can improve your ability to cope with the claims made by manufacturers. After all, why should your company pay for a computer system that won't operate on a safe electrical/grounding system? \*

Warren H. Lewis is vice president of technology for Computer Power Systems Corp., Gardena, Calif. Before helping found that company in 1976, he worked for IBM, Burroughs, NCR, and Xerox Data Systems, where he developed and built the first commercially feasible computer power centers in the industry. In 1973 he founded Data Processing Power Corp., which designed and built the first independently available CPCs. He is a member of the National Fire Protection Association, the International Association of Electrical Inspectors, and IEEE, and a contributor to FIPS PUB 94.

Reprints of all DATAMATION articles, including those printed in 1982 and 1983, are available in quantities of 100 or more. Details may be obtained by telephoning Mary Ann Hariton, (212) 605-9729, or by writing to DATAMATION, 875 Third Ave., New York, NY 10022.

# Introducing AST-PCnet II.



## Now PC networking is as easy as plugging-in your phone.

The advantages of Local Area Networks (LANs) are well known. Existing personal computers can be tied together to share information and expensive peripherals such as disks and printers.

Now AST makes networking easier and more economical than ever before. With AST

PCnet II, you simply insert the PCnet II board into an I/O slot in your IBM PC or XT. Then connect the PCnet II "twisted-pair" cable to the main network cable using a standard modular "telephone jack."

The same kind of jack that's used on your telephone. To move your PC from one point to another on the network, simply plug in at the desired location. It's that easy.

With AST-PCnet II, anywhere from 2 to 160 PCs can be interconnected. Standard PC-DOS commands are used to access remote drives and printers. And dedicated file and print servers are not required, because shared PCs also function as standard workstations.

We're AST, the world's leader in communications and enhancement products for the IBM PC. To find out how AST-PCnet II can expand your IBM PCs and

XTs into a reliable, versatile LAN, call or write AST Research, 2121 Alton Avenue, Irvine, California 92714.

(714) 863-1333. TWX: 753699ASTR UR

AST-PCnet II is a development of AST Research Inc. Software protocols are based on technology licensed from Orchid Technology Inc.

# AST

RESEARCH INC.



### AST-PCnet II Local Area Network

CIRCLE 59 ON READER CARD

In an excerpt from his new book, *The Computer Industry Shakeout*, an influential Wall Street analyst says hardware is history. The future is software.

# THE END OF THE HARDWARE ERA

by Stephen T. McClellan

The microprocessor introduced the possibility of cheap, affordable hardware. It made possible the explosion of computer devices that we are seeing all around us, the fragmentation and specialization of the industry. Actually, the microprocessor did something far more profound. The microprocessor did not simply begin a new era, it marked the beginning of the end of an old era: the hardware era. The creation of the microprocessor marked the beginning of the end of a time when a company could expect to make money just by pumping iron.

The specialization occurring today involves creating "custom solutions" for various end-user markets, from small insurance agents, to large Wall Street brokerage firms, to hospitals, hotels, government agencies . . . the list of specialty markets is endless. But a custom solution means one thing: software. To successfully appeal to these markets, the instructions inside the computer become as important (if not more so) as the computer's ability to compute 5 million instructions per second (MIPS) or 10 million. By 1988, software and data services will account for nearly one out of every three dollars of profits made in the industry. Software and data service firms are making their presence felt. Electronic Data Systems, Computer Sciences, and Automatic Data Processing have all passed the half billion mark in sales. Comdisco, Shared Medical Systems, National Data, Quotron Systems, Cullinet, and MSA have also established themselves as major players in software and services.

To be sure, the hardware companies still have a few tricks up their sleeves. Silicon, the material now used for most

computer chips, may be replaced in many applications by chips made of gallium arsenide, a material that generates much less heat and allows greater density. Bulky cathode ray tubes will be replaced by flat panel displays less than a half an inch thick. Keyboards will be supplemented by terminals capable of accepting input through direct speech, and eventually, maybe even eye contact.

Nevertheless, the future clearly belongs to software. With the end of the hardware era, the computer industry finds itself in the throes of the same change it has forced on other industries: it is entering the Information Age. The programmer is replacing the design engineer in importance. The instructions that make the computer run are becoming more valuable than the computer itself.

It's not that software wasn't important before. It's simply that it is more important today, partly because of basic demographics. There are a lot of computers out there. Consequently, there is a greater incentive to write software. Was there a recording industry before there were record players? Part of software's eminence stems from economics. There are more computers because they are cheaper. Because they are cheaper, they return less money to those who make them. So, those who fancy a lot of money turn their interests to software, where a good markup is still within the realm of the possible. Software's move to center stage is also part of the maturation of the industry. Customers are more sophisticated today. They are no longer dazzled by lots of blinking lights and split-second calculations. They may still be neophytes when it comes to the intricacies of computer technology, but they know the route to greater productivity lies as much with software as it does with hardware.

Ten years ago, less than one out of every five dollars that users spent on data processing went to software. Today the split is about 50-50. By 1990, the ratio will be four to one in favor of the programs.

## POTENTIAL PROFIT IN SOFTWARE

The software market is booming. But unlike personal computers, this will not be a profitless boom. Far from it. Software will be enormously profitable for those who play their cards right. And therein lies the problem. It is very difficult to play your cards right in software. There is no easy way of producing a software program. It is more a black art than a science. Everyone agrees on that. Everyone would like to do something about it. But no one seems to have any notion of where to begin. The programmer's muse is an untamed one. Great software, like great writing, adheres to no known schedule of production. Moreover, the level of perfection demanded in programming is far higher than it is in almost any kind of writing, or for that matter in most human endeavors. As Frederick Brooks wrote in his book, *The Mythical Man Month*, "If one character, one pause . . . is not strictly in proper form, the magic doesn't work. Human beings are not accustomed to being perfect, and few areas of human activity demand it. Adjusting to the requirements for perfection is, I think, the most difficult part of learning to program."

It is also important to remember that there really has been nothing like software before. The idea of the computer, or some sort of mechanical brain was kicked around since at least the nineteenth century. But for software, what real precedents are there—player piano rolls?

Ten years ago, almost all computer programs were supplied by the computer manufacturers themselves. There was no software industry to speak of. Now the hardware manufacturers' share of the software business is dropping. Some 4,000 independent software firms, the largest being firms such as Cullinet and Management Sciences of America (MSA), account for about a third of today's \$14 billion market. By 1988, their share will be 50%. Moreover, by the end of

Excerpted from *The Computer Industry Shakeout* by Stephen T. McClellan. Copyright by John Wiley & Sons Inc. Reprinted by permission of publisher.



## For software, what real precedents are there— player piano rolls?

the decade, the software market will be so huge it will no longer be a specialty niche the way it is today. It will fragment into hundreds of niches and slices. Leaders such as Cullinet and MSA will rank among the industry heavyweights on the top 25 list and maybe even near the top 10. They will be displacing hardware companies.

In some ways, software is far more market driven and prone to specialization than hardware could ever be. The trick for companies in the software business is to choose a market that is large enough to be profitable, but yet uniform enough so that packaged software can be sold without requiring a lot of customization for individual customers. The retailing market, for example, is far too broad. But retail auto parts stores, because there are thousands of them with similar needs, offer a great software market opportunity. (And as we will see, one of the turnkey companies—firms that buy computers from someone else and add their own software—has enjoyed great success selling to the retail auto parts market.)

Accounting is another peril of the software business. The expense of writing a program must be treated as a cost of goods sold. It is an operating cost, rather than an R&D cost generating tax credits. Although software is obviously valuable, in an acquisition it carries little or no book value. The company making the acquisition risks having its profits seriously diluted because of accounting.

And then there is the looming presence of IBM. There is little likelihood that IBM can dominate software the way it has mainframes or personal computers. The software market is too wide and too varied. Moreover, because there are few economies of scale in software development, IBM's only major advantage is in marketing. Still, because of its enormous installed base of equipment, the company must be reckoned with. Any move it makes is likely to send ripples through the industry.

Lately, IBM has been microcoding or hardwiring more of its systems control programs into its mainframes, making it more difficult for third-party vendors. IBM is also on a campaign to help users of its computers reduce the software maintenance costs they incur whenever IBM changes its operating software. It is doing this by offering users access to unattended remote computers at IBM data centers. Users can download programs from these computers. Once freed from the job of making constant, mundane modifications to application programs, users may have more time to develop their own new software, reducing their reliance on some third-party suppliers.

The bottom line is that software is an

uncharted wilderness. Almost anything can happen, and it probably will. The only certainty of the software market is its inevitability. All of the computers at work today are worthless without software. The more a user wants to do with a computer, the more software is required. Software is the king of the insurgent specialty markets. It is the grand musical score for proliferating computer equipment. It is the number one computer business of the future. No wonder some 4,000 companies are already in it, some 800 in microcomputer applications software alone. For those firms, it is music to their ears.

Cullinet, Wellesley, Mass., is not quite the largest software company in the business, but it is one of the best. (Many users of its software agree on that point.) In more ways than one, Cullinet has emerged as a leader in the young, explosive software market—a position it will be able to keep.

When it was founded in 1968, Cullinet was one of the first companies to sell only software. Ten years later it became the first software company to go public and issue its stock to outsiders. And in 1982, it became the first software company to have its stock listed on the New York Stock Exchange.

### MARKETING IS KEY TO SUCCESS

To get that far, Cullinet obviously had to have something extra going for it; that certain verve and pizzazz that enables a company to stake out a market before its time and then keep its act together until that time finally arrives. For Cullinet, that extra something boils down to marketing. It's important to keep in mind that Cullinet's founder, John Cullinane, is not a programmer at all. He's a master marketer. Before one line of code was put up for sale by Cullinet, John Cullinane knew that potential customers would have to be educated not only about the idea of software, but about the idea of buying it from an independent company such as Cullinet.

John Cullinane has done his job well. Cullinet wins 80% of the business it bids on; it used to lose 80%. Its sales, which were only \$2 million in 1975, swelled to \$110 million in 1983 and are expanding by 50% a year. Revenues per employee are over \$120,000, compared to \$62,000 five years ago. Profit margins are 23%. Return on equity is 20%. As the business has grown, so has the product line. The total price value for Cullinet's line of software products was \$1.6 million in 1983, five times what it was in 1980. Nearly two thirds of its product line is new. Can anything stop Cullinet? We don't think so. In this, the Golden Age of Software, Cullinet will be the first billion dollar software company.

Software at Cullinet means database management programs for IBM mainframes. Database management is one of the most important concepts in software. Programs that perform that function represent a large chunk of the overall software business.

Despite these accomplishments, no company is perfect. Cullinet does operate in the IBM compatible arena, and IBM's database software is improving, especially with its recent introduction of a relational database system. Cullinet's IDMS is over 10 years old now and growing more vulnerable by the year. Competition by independents such as Cincom Systems and Software AG still lurks. IBM is playing around with the microcode in its mainframes. There is no way IBM could ever render all non-IBM developed software incompatible. If it did it would make some \$200 billion of its customers' own software development investments worthless. They would rather switch to Amdahl than lose that investment. But Cullinet may find that staying compatible will be more expensive than it used to be.

Management at Cullinet is young. The senior people just below Cullinane average 34 years of age. The president, Robert Goldman, is a software genius, but running a corporation is a different matter. And this company is stock-conscious, fixated on stock price to the point of showing slides at investor meetings that chart the stock price performance and even taking a Wall Street security analyst (not me) who was critical of the company and tossing him out of a new product press conference. Us Wall Street folks are not used to such physical treatment.

Management Sciences of America (MSA), Atlanta, Ga., was founded in 1963 to develop custom software and to do management consulting. It barely survived. By 1971, the company had programmed and consulted its way into bankruptcy court. The next year John Imlay, a colorful, high-profile innovator, took over as president. He dropped the consulting and instead of custom software he pushed the company into packaged application software. It was an idea whose time had come. MSA took off like a shot.

Unlike Cullinet, which has concentrated in one very specialized software area, Imlay's strategy at MSA was to build (both through internal development and external acquisition) a wide range of integrated software packages that could be marketed across a variety of industries. The mainstay of MSA's product line is a series of financial management programs for mainframes that do such things as general ledger, financial forecasting and modeling, accounts receivable and payable, purchasing, inventory, fixed asset accounting, payroll, and taxes. Manufacturing software was acquired from Xerox's Arista



# The PC security problem

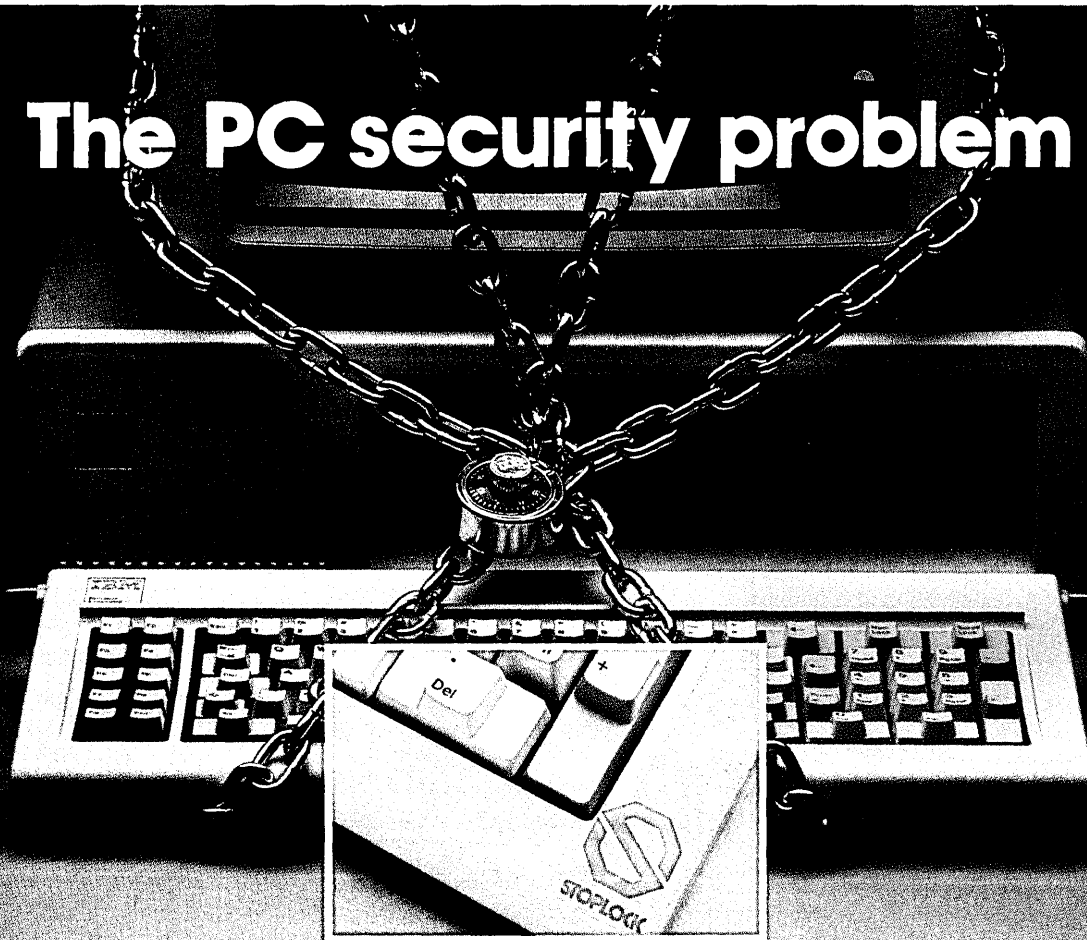

## eliminated

### It's criminal how some computers are used.

Information theft. Data alteration. Unauthorized disclosure. It's a \$40-billion a year problem. You couldn't keep your IBM-PC (64K) or IBM-XT safe, even under lock and key. Until now.

### Introducing STOPLOCK.

STOPLOCK is an ingenious circuit board that locks your PC from the inside. Installed easily, it **stops** your PC in the boot-up mode and **locks** it up until a valid user ID code is correctly entered. **Only you** decide who uses your PC because you give out the unique codes. Without a proper ID, your PC will not perform **any function**. STOPLOCK was developed by SDI engineers, with input from managers like you, to put information control and security back in **your** hands. Each unit is factory tested, requires no battery back-up, and comes with easy to follow documentation.

### Virtually hack and dump proof.

It's so safe we offer a money-back guarantee.\* The most persistent dumpers stand only a **1-in-10,000** chance of finding the memory location. Even if one beat the odds, it would still be necessary to unscramble the encrypted ID code from hundreds of indistinguishable nonsense

characters also in the dump.

STOPLOCK includes 6 random user ID codes. A back-up chip, providing 6 additional codes for extra security, is also included at no additional charge.

## now.

Please send me \_\_\_\_\_ STOPLOCKS at \$349 each which totals (Kansas residents add 4% sales tax) \$\_\_\_\_\_.

Enclosed is my  check or  money order made payable to SDI, Inc.

Charge my  VISA  Mastercard  
 American Express

Card No. \_\_\_\_\_ Exp. Date \_\_\_\_\_

Signature \_\_\_\_\_

Please send me more information.

Name \_\_\_\_\_

Address \_\_\_\_\_

City \_\_\_\_\_ State \_\_\_\_\_

Zip \_\_\_\_\_ Phone \_\_\_\_\_

Call or mail orders to: **STOPLOCK**  
SDI, Inc.  
P.O. Box 712  
Lawrence, KS 66044



Allow 4-6 weeks for delivery.

### \$349 ends your security worry.

STOPLOCK comes with the SDI Micro-Computer Security manual (fits right in your IBM binder) to help you implement new user policies including what to do about any security breach. Put information control back in your hands. **Stop** computer leaks and **lock** out unauthorized users.

Call **1-800-562-5734** toll free, Monday - Friday from 8 am - 4 pm (CST) to place your order (Kansas residents, mail orders only). Dealer inquiries welcome.

Get STOPLOCK now.



## STOPLOCK™

STOPLOCK is a trademark of SDI, Inc., and IBM-PC, IBM-XT and IBM are registered trademarks of IBM Corporation.

\*Limited warranty: 10-day money-back examination; 90-day parts and labor.

© SDI, Inc.



# Hewlett-Packard surge in office

## Introducing the Person

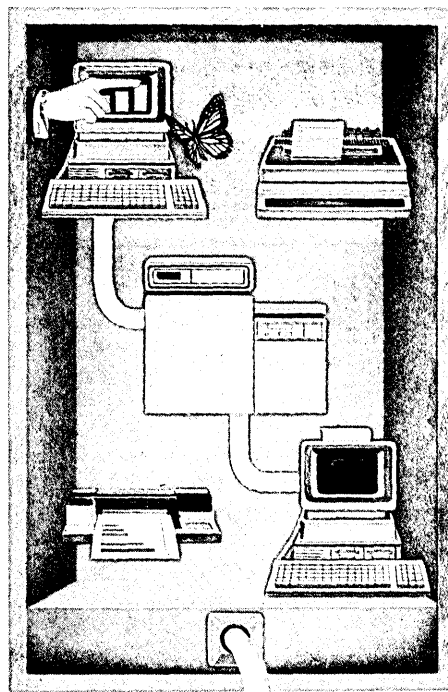

**The principle is simple. Boost the productivity of individual PCs. Your people, your department, even your entire company will follow suit.**

The first boost occurred when we introduced the touchscreen HP 150 as an office and managerial workstation. This made personal computing so much easier and faster that individual productivity soared.

Now the Personal Productivity Center combines the flexibility of the HP 150 with the power of our HP 3000 family of distributed computer systems.

You can shape each Productivity Center just the way you want

it by adding other office and computing products from our extensive range.

You can link managerial and secretarial workstations. Create impressive presentations,

merging business graphics and word processing. Store them on large disc files. And print them out on laser printers and color plotters.

Your PCs also grow more productive by increasing the range of software they can run. In addition to leading PC programs like 1-2-3™ from Lotus™ and popular word processing packages, they can use HP 3000 business software like our exclusive Desk-Manager. This combines electronic

# rd touches off a productivity.

## al Productivity Center.

mail, quick memo writing, personal filing and calendar functions. And each PC can access data processing systems and large corporate data bases.

Personal Productivity Centers can communicate with similar networks in other parts of your company, as well as your mainframes. Each system can expand to handle more than 100 workstations. And you can grow without involving your programmers in any software conversion.

So if PCs alone are making

your people more productive, just wait till you see them all working together.

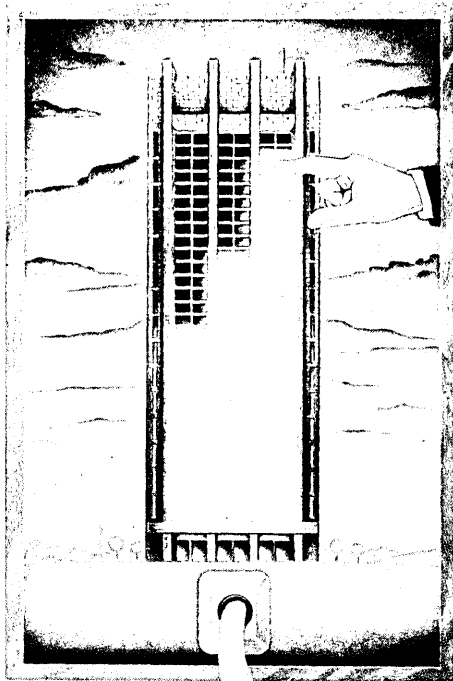

And you can see them right now by calling your local HP sales office listed in the white pages. Or write for complete information to: Hewlett-Packard, Dept. 04191, 19447 Pruneridge

Avenue, Cupertino, CA 95014. In Europe, contact Henk van Lammeren, Hewlett-Packard, P.O. Box 529, 1180 Am Amstelveen, The Netherlands.

It could turn your whole company into a productivity center.

**Productivity. Not promises.**



CIRCLE 70 ON READER CARD

# In this, the Golden Age of Software, Cullinet will be the first billion dollar software company.

Manufacturing Division in 1982 and is aimed at manufacturing control. In total, MSA has some 5,000 mainframe customers to which it has sold 9,000 packages.

And then there is the exploding personal computer market. There, MSA is one of the leaders through its acquisition of Peachtree Software in 1981. Already, Peachtree has grown from sales of \$3 million in 1981 to \$20 million in 1983. Over 100,000 personal computer programs have been sold.

## MSA IS LEADING SUPPLIER

MSA owes a lot to Imlay. It owes even more to IBM. A few years ago when IBM began endorsing independent application software packages, MSA was one of those so anointed. IBM tells its customers in need of financial software packages to go to MSA. The same thing happened with the IBM Personal Computer. IBM commissioned Peachtree to develop the software. By riding IBM's coattails in both micros and mainframes, MSA is the leading supplier of applications software packages with 5% of that highly fragmented market. Revenues in 1983 were \$145 million, with profits of \$13 million. Sales over the next few years should expand at least 40% annually, and profits by 35%. Although MSA seems to be spreading itself a bit thin in numerous different application software markets, there are big prospects if the software continues to be first-rate and the company can keep control of itself.

Why is Informatics General, Woodland Hills, Calif., so frustrating? It is one of those companies that is permanently in transition, going from nowhere to nowhere, profits elusive. It seems to be embarked on a perennial revitalization program. It appears congenitally incapable of focusing on a single market or business, and prefers to dabble here, there, and everywhere as an also-ran. It lacks dynamics, innovation, creativity, and anything remotely approaching single-mindedness of purpose. It is a company of large revenues (\$200 million in sales) and little profit (5% pretax margins). It appears content to muddle along with annual sales growth of 10% to 20% in a business that is growing at more than twice that rate. It is similar to Computer Sciences, another company with potential but apparently going nowhere.

In all fairness, it should be pointed out that Informatics General is now making money. Through most of the 1970s it ran in the red. Back then it was a subsidiary of Equitable Life, serving in part as a technical staff to support the health insurance claims processing business. In its outside activities (systems software and commercial data processing) it stressed market share over profits and lost over \$5 million from 1974 to

1979. Since it was sold to outside investors by Equitable, profits have climbed steadily at more than 20% a year, though still at low levels. Sales, however, have been lackluster, expanding only 14% a year.

To get out of the doldrums, Informatics' key strategy for the future calls for a renewed concentration on software. Growth in that part of the company's business has topped 20% annually over the last five years. But profit margins have been low, 5% before tax. It's the same old story: too many widely scattered products addressing too many markets. Informatics offers applications development software and inquiry/report writing software, as well as application software packages for life insurance administration, law office management, and accounting firm management, among others. It would be difficult for any company to effectively market such an array of software. And Informatics is not especially accomplished in the art of selling to begin with.

Only a few years ago—1979 to be exact—Applied Data Research, Princeton, N.J., was twice the size of its arch-rival, Cullinet. By 1982, however, Cullinet was bigger. It's not that Applied Data stopped growing. It has maintained a solid 30% a year growth rate for the last seven years. Cullinet simply grew faster, at 50% a year. So did the entire packaged software business, at 40% a year. It's not hard to fall behind in this business. You can't do *almost* everything right. You have to do *everything* right.

At Applied Data, the weakness is marketing. Today it is paying the price. Despite a 120-person sales force and excellent products, this company is bucking for the status of an also-ran when it should be leading the way. The problem begins with management. Applied Data is run by software development people who have the unfortunate notion that good products sell themselves. In a perfect world they would be right. Unfortunately this is not a perfect world. A company that lacks effective marketing can find itself losing ground quickly.

## PROFITS BOUNCE BACK

Today, Applied Data has its act back together—sort of. Its marketing, products, and balance sheet were all much healthier by 1981. Profits bounced back, though the margins have never returned to the levels of the mid-1970s. In 1983, however, the company suffered from a product cycle transition. A new product, IDEAL, was late, and competitive software product announcements interrupted business leading to temporary red ink, despite strong orders. So the company continues to show flashes of brilliance, punctuated by unexpected disappointments.

Industrial automation doesn't start on the factory floor. It starts in the drawing room when the design and development of new products is carried out. This is where Computervision, Bedford, Mass., got its start, selling systems for computer aided design (CAD).

There are numerous markets for CAD systems—electronics, architecture, automotive, aerospace, mapping, and a variety of equipment manufacturing industries—as well as a myriad of specific applications: structural, mechanical, electrical, and civil engineering. Each requires special software. (Aha! Now you see the market potential.)

Right from the start Computervision's strategy was to provide each customer with a complete turnkey system, consisting of Computervision's own specially developed computer processor, as well as all of the software, peripherals, and support that the customer needs.

The strategy has paid off. Computervision's sales climbed from \$8 million in 1972 to over \$400 million in 1983, a 43% annual growth rate for more than a decade. With 25% of the market, Computervision is the leading CAD vendor, followed by IBM (20%) and then Intergraph, Calma (Schlumberger), and Applicon (GE). Turnkey systems are about two thirds of the market, with the rest being mainframe-based systems. The market is expected to grow 30% to 35% annually over the next five years from under \$2 billion in 1983, to hit \$7 billion by 1988.

Computervision has a lot going for it. It is the leader in CAD with over 5,000 customers and an installed base of over \$1 billion in equipment. It spends a hefty 11% of revenues on R&D. A "greenhouse" venture has been set up as an autonomous operation, with separate funding to nurture and sponsor new ideas and creativity. Talented engineers with the yen to spin off and start up a new venture do not have to leave the company to pursue their dreams. Computervision has big objectives: 35 to 40% annual growth, \$1 billion in sales by 1986, \$2 billion by 1989, a return on equity of 25%. It also wants to improve "the industrial system" and the overall "quality of life." These ambitious goals seem more than mere dreams. Computervision's chairman, Martin Allen, and his team are dedicated and hard working, instilled with a Yankee New England work ethic. They are low key with a certain straitlaced moral fiber. They take a no-frills, spartan approach to things. The day we interviewed Mr. Allen we sat in his office munching tuna fish sandwiches and drinking soda over the noon hour, between his appointment schedule. No airs here. This company has been through tough times and has been tested. It has a concern for its customers and employees. In our opinion, Computervision will go a long way. This

market will be enormous and this company will remain the leader. Success has not gone to its head. It is hungrier today than in the past. And Allen, the founder and pioneer, will remain in charge for some time.

Intergraph started out in 1969 in Huntsville, Ala., doing consulting studies for NASA and the Department of Defense. In one study the company (known back then as M&S Computing) analyzed the computer aided design systems that were available for creating large-scale integrated circuits. It did not take very long for Jim Meadlock, the company's founder, to realize that this was a market with potential. But instead of going head to head against Computervision and other early entrants addressing the electronic and mechanical design markets, Meadlock decided to go after the mapping market. M&S—the name was changed to Intergraph in 1980—was off to the races in 1973 with its first CAD system for mapping and civil engineering. It pioneered the database management software that links data inside the computer to the picture on a graphics terminal. This remains its biggest technological strength. Later, other software programs were added to serve markets such as general cartography (energy exploration), utility facility management, plant design (chemical, petroleum, and power generation industries), architecture, mechanical and electronics design, and construction markets.

Still, the overall business thrust remains the same: computer aided design. By keeping its focus narrow, by being a specialist in CAD alone, Intergraph has made it big. The company never tried to do everything.

It buys its large computer processors, VAX 32-bit superminicomputers, from Digital Equipment, over 500 of them by mid-1983, becoming Digital's largest VAX customer, and its 68000 microprocessors from Motorola. Intergraph supplies its own proprietary software: Integrated Graphics Design Software and database management software.

### CLOSING IN ON CAD MARKET

By 1978 the company reached \$20 million in sales and just over \$1 million in profits. Five years later, the CAD business pushed revenues to upwards of \$225 million and profits to more than \$24 million, a 63% annual growth rate in sales, and 80% in profits over the span. Intergraph ranks a clear third in the market behind only Computervision and IBM, and it is closing ground. It experienced no slowdown during the 1982 recession. Profitability is high, 20% margins; R&D is 13% of revenue, a hefty level. As the company markets its existing software and systems to an increasingly larger number of customers, there exists tremendous operating leverage.

Intergraph's facilities are modest, resembling old World War II Army barracks, amid cotton patches outside Huntsville. Meadlock's wife is a longtime member of top management and owner of twice the amount of stock in the company as her husband, the boss. Intergraph was disciplined by hard times early on. A number of employees who were paid in stock in lieu of cash hit pay dirt in later years when the shares surged and the company went public.

This is high tech among the cotton fields. No glitter. No fancy headquarters as a monument to management. Just work and a single-mindedness of purpose. This company is an insurgent winner, the perfect example of a specialist strategy in the era of specialization.

Triad is the largest and most lucrative turnkey company in the business. It got that way by staking out a large and successful market: the thousands of auto parts dealers across the United States. Here Triad found a market narrow enough so that one system would fit all users, but large enough to allow Triad to become a substantial company.

The system Triad sells is complete, from soup to nuts: hardware, software,

service, training, and future software enhancements. The entry level price for a Triad system is \$50,000. By reducing receivables and inventory levels, and accelerating inventory turnover, the typical retail auto parts store recoups its investment in nine to 18 months. The Triad system is well suited to its market. It better be. When a small retail business puts all of its financial, accounting, inventory, and other entry procedures on one system, that system had better work right. Nearly one third of Triad's sales are follow-up business from existing customers. Sales were up 75% a year in the three years between 1978 and 1981, surging from \$15 million to \$78 million. By the end of 1983, Triad had sold some 56,000 of its systems, garnering 75% of the auto parts computer market.

In the meantime, however, Triad has encountered one of the inevitable disadvantages of competing in a vertical market. In 1982 when the auto market hit the skids, so did Triad. Sales went flat that year and in 1983 they were still up only 10%. Profit margins went from over 20%, down to single figures. Triad's solution to this problem is to branch out into other vertical markets. It is never easy to develop another hot leading



CARTOON BY T.O. SYLVESTER

# OEMs/Distributors:

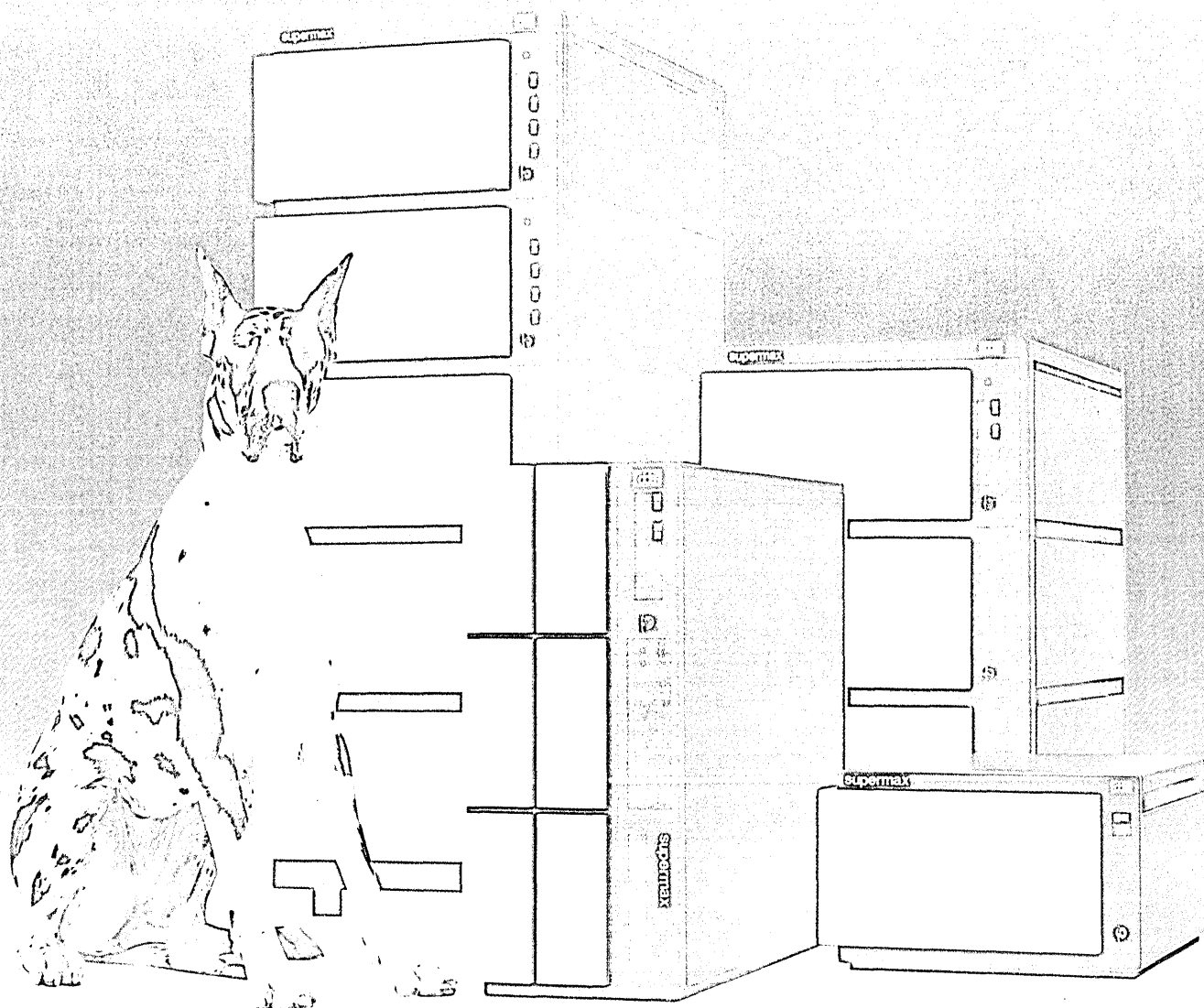

Price/Performance --  
Is your Mini competitive?

Performance/Price --  
Is your Supermicro competitive?

## Multi-CPU SUPERMAX family breaks the price/performance deadlock!

SUPERMAX modularity supports growth  
from:

- 1 to 8 M68000 16/32 bit CPUs
- 2 to 8 I/O Coprocessors
- 1 to 128 Users
- 1/2 MB to 128 MB main memory
- 20 MB to 10 GB disk

Expansion is easy and cost-effective

Modularity protects hardware investment.  
UNIX System III software is the same from  
the smallest to the largest SUPERMAX sys-  
tem.

Start with competitive supermicro prices  
-- grow to supermini performance -- keep  
the supermicro prices

OEMs/Distributors:  
Meet the SUPERMAX family

-- the great Danes  
at Comdex Spring

Stand 7408 in the Atlanta  
Merchandise Mart, May 22-25.

Dansk Data Elektronik A/S  
199, Herlev Hovedgade  
DK 2730 Herlev, Denmark  
Telephone: int. +45 2 84 50 11  
Telex 33253 dde dk

UNIX is a trademark of Bell Laboratories

# Computervision is the leading CA vendor, followed by IBM, and then Intergraph, Calma, and Applicon.

edge product, to repeat the success of the first one. In its efforts, Triad has experienced mixed results. Because of its success with auto parts dealers, Triad reasoned it could do the same with a system for tire dealers, using the same software. Unfortunately, that turned out not to be the case. The same software could not be used. Triad had to start over again from scratch. So the company decided to put its energies into another effort: retail hardware stores. This market seems to have even greater potential than auto parts (although there are the same number of stores of each, about 38,000, only 10,000 to 12,000 auto parts stores are large enough to warrant a computer system). Already, it is off to a better start than the auto parts market. \$20 million in annual sales after three years, gaining fast on Triad's \$70 million auto parts business.

## BUSINESS FORMS TO COMPUTERS

Reynolds & Reynolds, Dayton, Ohio, was started in 1866. Not many businesses, much less software companies, can lay claim to being over a century old. For most of its 118-year history, Reynolds has been a supplier of business forms. Ever since the automobile was invented, Reynolds has sold its forms to auto dealers. Reynolds virtually had that market all to itself. But it was not one to sit around and let the world pass it by. When the computer era came along, Reynolds met the challenge. First it started doing batch data processing for its auto dealer customers. Then, when it became fashionable it moved into on-line timeshared data processing. Finally, it began selling entire turnkey computer systems. Reynolds buys its computers from IBM and NCR, develops its own software, and sells a system that does everything an auto dealer could possibly want in the way of dp.

It has been a good business. Reynolds has made steady progress, becoming one of the 100 largest computer companies. The problem is that since the late 1970s, Reynolds has been unable to go any further. The automobile market is becoming saturated, and it has become cyclical. Moreover, Reynolds has been getting some stiff competition from Automatic Data Processing in recent years. Reynolds showed no revenue growth in 1981 and 1982. Profits plummeted and its computer business actually fell into the red. Overall, Reynolds' sales have expanded 15% annually over the last decade, to \$252 million in 1983. Its profits have climbed only 7% a year. Sales of business forms, growing about 10% a year, still account for just under half of the company's total business.

So Reynolds is trying to crack other markets, but can't seem to get it right. It is not without opportunities, however. It sells

business forms to some 8,000 contractors (plumbing, heating, and electrical) as well as to some 3,000 physicians' offices. Unfortunately, Reynolds discovered that those markets require a lot of customization, were uneconomical to reach with direct sales representatives, and were resistant to the idea of laying out \$35,000 for a computer system. The contract turnkey effort was terminated in 1983. An effort to perform data processing for accountants has been terminated and tax preparation processing was scaled down to become a regional effort, rather than national in scope. Overall, Reynolds has been far too hesitant in its diversification efforts, waiting too long to make a decision and then making only a half-hearted effort. The investment of money and personnel resources into such efforts has been too limited. Too much talk and no action. The company's worst move was its effort to produce computers and terminals in-house. This attempt at vertical integration was terminated in 1983, three years after it started. Reynolds now relies on the IBM Personal Computer and NCR's UNIX-based computers for its turnkey systems.

## SMALLER FIRMS EMERGING

There are numerous software firms with annual sales of under \$100 million. Many of these have already made an important mark in the business. Niches vary from applications software for manufacturing and banking to mainframe systems software. A short summary of some of these promising entrants follows:

*Computer Associates*, Jericho, N.Y. This company will soon be joining the ranks of Cullinet and MSA. Started in 1976, in just seven years, by 1983, it had sales of \$60 million. It appears there will be a spate of acquisitions forthcoming, similar to the one it made of Capex in 1982. A leader in the IBM OS-compatible applications software market (financial modeling, forecasting, and budgeting), Capex accounted for one third of the combined entity when acquired. Computer Associates was an early leader in the DOS portion of the IBM systems software market, providing systems software to increase the operating efficiency or enhance IBM mainframe performance and software tools to measure and improve computer software and programmer performance. Computer Associates is a company on the make. It is scoring in a number of software markets and moving into new ones fast. It is going to be a heavyweight very quickly.

*Pansophic*, Oak Brook, Ill. This company specializes in systems implementation and application development software programs designed to improve the productivity of computer personnel involved in design and programming of new computer applica-

tions, as well as the control and security of existing programs. This is an over \$1 billion market expanding at an almost 50% rate. Pansophic is also in database management systems. Pansophic's revenues have grown close to 30% annually over the last five years to \$50 million in 1983. It competes with several of the established leaders—Cullinet, Informatics, and ADR—and is strongly positioned in its sector.

*ASK Computer Systems*, Los Altos, Calif. ASK has the distinction of being the most successful high-technology company ever founded and run by a woman. Sandra L. Kurtzig started ASK in 1978 when she was 26. It became a \$50 million company by 1983 in just five years. Its objective is to top \$100 million by 1985, to expand at a 40% to 50% rate. Competition stems mainly from IBM, COMSERV, Hewlett-Packard, and Martin Marietta, but ASK is the largest independent supplier of software for manufacturing.

The challenge as we see it is to retain a narrow, specialized focus. ASK has flourished by concentrating on manufacturing software, yet it has subsequently branched into financial, microcomputer, and database management software. This is still a small company. Perhaps it is trying to do too much, to be in too many different aspects of application software. The manufacturing discipline itself is broad, offering a huge market opportunity. Yet the company's attitude is that having mastered that market, it is time to move on to other areas. It could become overextended fast. Meanwhile, ASK steamrolls along, headed for a 50% growth year in 1984. And Kurtzig—hardly over 30—is in the record books as the first woman in Silicon Valley to achieve \$50 million in net worth as the creator of a high-tech company.

*AGS Computers*, Philadelphia. This is a \$140 million company that has expanded at upwards of 50% annually during the five years ending 1983. Much of the growth has been via acquisition. Software, however, only comprises one third of sales, or \$50 million. AGS got its start doing custom programming and systems development projects for AT&T, Citibank, and other large New York area corporations. Working with Bell Laboratories it has considerable skills in UNIX operating system software. Overall, AGS's mix of services and software is not well focused and is low in profit. This company has technical skills and is fishing for avenues of high growth. Too many acquisitions have diluted its single-minded aim. More than half of sales in 1983 were from operations acquired over the last three years. The record is good, but this hodgepodge of business will be hard to manage. This company is confusing.

*Hogan Systems*, Dallas, Texas. Hogan is small, with \$30 million in sales in



**Every decision counts.**  
**At every level of management.**

And now there's a way to bring the power of the computer into every management decision made in your company . . . to allow every decision to be based on current information, to be shared, to be consolidated with other decision results, to be easily analyzed and used.

It's called Distributed Decision Support. And it works only with FCS-EPS, the first major DSS available for virtually any microcomputer, mini-computer or mainframe.

For all computers, FCS-EPS incorporates standard financial functions. "Black boxing" automates the most complex custom applications. Powerful report writers and color graphics produce exactly the output you need. A relational database, a natural progression from simple row/column "calc" processing to multidimensional consolidation. Statistical analysis, risk analysis and much more. That's FCS-EPS.

Distributed Decision Support through FCS-EPS means a multiplied return on your investment in existing EDP resources and in existing management talent. And standardized budgeting,

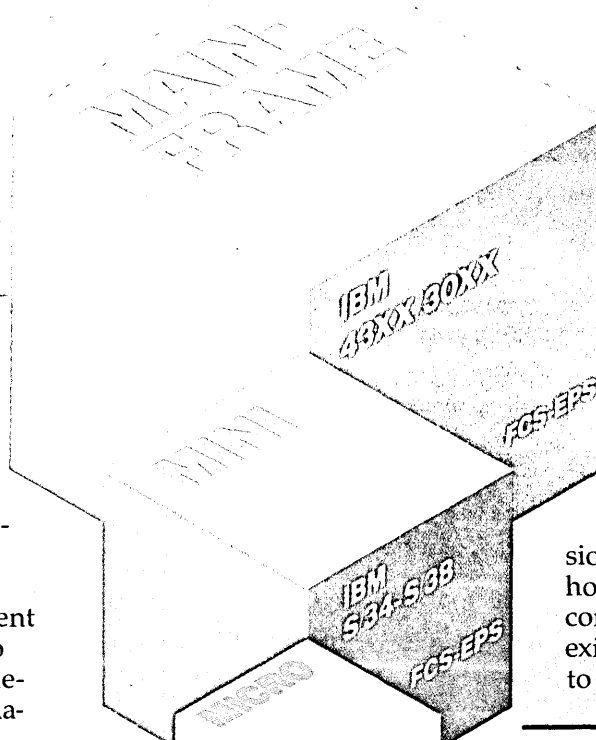

forecasting, expenditure management, and dozens of other key processes within the organization.

**Your Distributed Decision**

**Support** begins with one decision. Call EPS today. Find out how the power of the micro-computer can work within your existing planning environment to improve profitability this year.



**EPS**

One Industrial Drive  
 Windham, NH 03087  
 603-898-1800

FCS-EPS is available today on all IBM computers from the PC through 43xx and 30xx; Hewlett Packard from HP 125 through HP 3000, plus Wang, Honeywell, Univac, DEC, Prime, Data General, SEL, Burroughs, ONYX and CPM or UNIX-based microcomputers.

Tell me more about Distributed Decision Support

Tell me about Micro FCS

Tell me about an EPS DSS Seminar in my area.

Name/Title \_\_\_\_\_

Company \_\_\_\_\_

Address \_\_\_\_\_

City/State/Zip \_\_\_\_\_

Telephone Number \_\_\_\_\_

## Intergraph is an insurgent winner, the perfect example of a specialist strategy in the era of specialization.

1983, but it has exploded from just \$3 million in 1980 and appears to be a real comer. Hogan specializes in all kinds of application software for banks: a deposit system, loan processing, profit analysis, payment collection, terminal transaction processing, a card system, and financial information. It provides one-stop shopping for bank application software, all under one umbrella; that is, these programs all work together, allowing a large integrated system to perform a number of tasks. The market is large—400 banks and thrift institutions in the U.S., of which Hogan already has 100 as customers, and another 400 abroad. These are large customers who buy large ticket items. Each of Hogan's software sales average \$900,000 in price. Not many more than a dozen salesmen call on these prospects. There are less than 300 employees. This is leverage, and it's profitable: 25% margins. There is also volatility. One sale makes or breaks a quarter's profits. The focus is narrow. Hogan does one thing, banking application software, and it does it well. Prospects for continued high growth appear favorable.

*Policy Management Systems*, Columbia, S.C. This company (PMS) provides application software for the property and liability insurance industry and special data processing for this vertical market. It essentially automates all insurance processing functions.

As of mid 1983 some 318 out of the total 1,675 U.S. property and liability insurance companies were customers, including the Kemper Group. Revenues have shot up from \$13 million in 1978 to over \$60 million in 1983. Profitability was over 22% before tax. Contracts are six- to eight-year license agreements, up to 40% paid up front (some ranging as high as \$1 million or more) and at least 60% paid monthly (some as much as \$38,000 a month) over the six- to eight-year license period. This provides a highly predictable future flow of revenues. PMS was spun out of Siebels Bruce & Co. in South Carolina in 1981 and is still owned 50% by that insurance holding company. Policy Management is an extremely successful vertical market applications software company similar to Hogan in the banking market. It is a gold mine that apparently will continue to flourish.

### DISMAL PROFIT RECORD

Wyly, Dallas, Texas. The history of this company is replete with harrowing financial horror stories, turnaround attempts, and a frustratingly dismal profit record over the past several years. Though revenues are over \$140 million, profits have not been higher than \$5 million in any year for more than a decade. The business is a jumble of software (37%), data services (49%), and turnkey systems (14%), fol-

lowing the termination of the used computer remarketing business. Half the software business is systems software, mostly mainframe performance monitoring and job scheduling programs, and is growing at a good clip.

Applications software is largely for banks and financial institutions and accounting software for cross-industry customers. Wyly was still making numerous small acquisitions and going in multiple directions in 1983, and losing money again. The company is a participant and has some significant revenues but does not appear to be going anywhere.

*Microsoft*, Bellevue, Wash. This private company is the leader in microcomputer software, topping \$70 million in sales in 1983. Microsoft developed the MS/DOS operating system for IBM's PC and gets royalties on every IBM PC sold. It will also supply software for IBM's PCjr. Its Microsoft BASIC had 1.5 million installations by 1983. This firm has an IBM connection that will take it to greater heights in the future.

*Lotus Development*, Cambridge, Mass. Lotus shot from nothing in 1982 to over \$40 million in business in 1983 and will probably reach close to \$100 million in 1984. Lotus is also riding the microcomputer boom with its 1-2-3 spreadsheet software package. It is surging so fast it is likely to be the microcomputer software leader in 1984. Lotus is one of the few micro software companies that has gone public. Many others will follow. Its founder, Mitchell Kapor, netted \$5 million in the initial public offering in late 1973—not bad for two years' work.

*Digital Research*, Pacific Grove, Calif. This seven-year-old company was one of the early micro software companies, having developed the CP/M operating system that was the industry standard for the 8-bit generation of micros. Its revenues will approach \$50 million in 1983, but it faces a transition into applications software away from just operating systems.

*MicroPro International*, San Rafael, Calif. The WordStar word processing software package for micros launched this rising star to \$45 million in sales in 1983. But there have been problems along the way, including a question of survival in 1982, management changes and personnel layoffs. Now it is launching other packages in hopes of doubling in 1984. This company has had a roller-coaster existence, and the future seems to promise the same. \*

Stephen T. McClellan is a vice president in the stock research department of Salomon Brothers Inc., one of the nation's leading investment banking firms. He covers the computer and office equipment industries.



CARTOON BY SID HARRIS



# THESE POINTS OF INTEREST ARE BROUGHT TO YOU BY POST-IT NOTES.

When you're facing miles of data, it helps to have a few signs to point the way. Post-it® Notes are handy for calling attention to questions or problem areas, for indexing print-outs, even for temporarily labeling computer tapes. Their unique adhesive sticks when you want it to, comes unstuck when you want it to. Post-it Notes are available from your local office supply dealer. Ask for a free sample, or phone toll-free 1-800-621-5282. Commercial Tape Division/3M.

"Post-it" is a trademark of 3M.

3M hears you...



CIRCLE 63 ON READER CARD

HOW  
TO RUN  
THE  
WORLD.

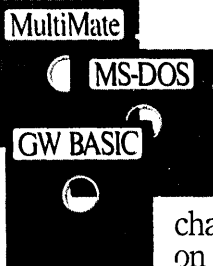
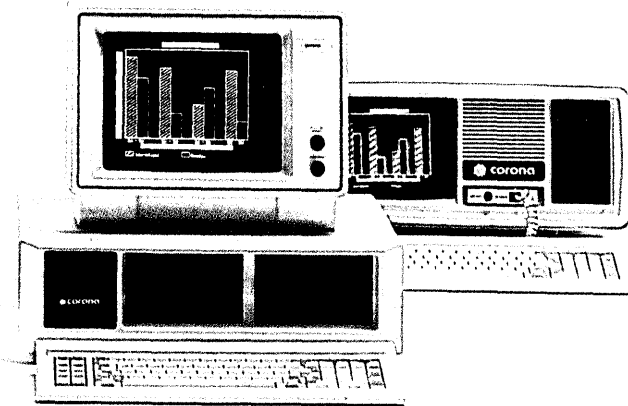

Without software you're nowhere.

That's why the Corona PC runs virtually everything. Word Star:<sup>1</sup> dBASE II:<sup>2</sup> Lotus 1-2-3:<sup>3\*</sup> Thousands of packages in all. But we didn't stop there.

We give you 60% better graphics than IBM® (640x325 pixels). So your pie charts look tastier. We doubled the memory: 128K memory expandable to 512K on the main board. For power that won't quit. And we bundle software. For instant productivity right out of the box. All at a price about 20% less than IBM's.

The Corona PC. Once you can run the world, running your business looks easy. In North America, call 1-800-621-6746 for the Authorized Corona Dealer near you. In Holland, call 020-03240-18111. There are over 1600 dealers worldwide. And their job is to help. Service by Xerox.



# THE CORONA PC

© Corona Data Systems 1984. 1. TM Micropro Corp. 2. TM Ashton-Tate. 3. TM Lotus Development Corp. \*HTS driver needed for graphics only.

**CIRCLE 64 ON READER CARD**

1982

**STRATUS INTRODUCES  
THE WORLD'S  
FIRST  
HARDWARE-BASED  
FAULT-TOLERANT  
COMPUTERS.**

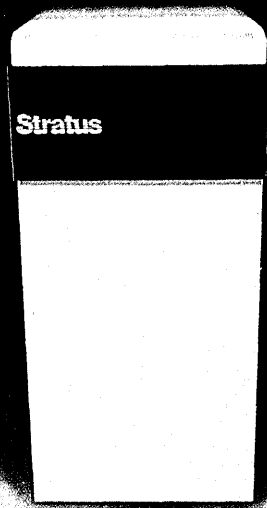

**If You Need Transaction Processing,  
You Need to be Able to Count on it  
Every Second.**

With the introduction of the new XA 400 and XA 600 Extended Architecture computers, Stratus can offer transaction processing power that goes beyond anything else available. This is great news in a world that is more dependent on transaction processing with each passing day. What makes it even better news (in a world where companies can lose thousands of dollars for every minute of downtime) is that it is *fault tolerant* transaction processing.

**1982 is Compatible with 1984.**

The original member of the Stratus/32 family, the FT 200, and the new XA 400 and XA 600 computers are completely program compatible. In addition, you can expand your Stratus/32 system by connecting together any combination of the three computers, creating a single system with up to 32 processors.

With the use of our StrataNET software, a network of over 65,000 processing modules can be joined together to provide a system that will work on thousands of transactions per second, with hardware based fault tolerant reliability.

**Added Power, but No Added Effort for  
Programmers or Users.**

One of the advantages of Stratus' hardware based approach to fault tolerance when it was introduced 2 years ago was that, unlike software based fault tolerant computers, it required no added attention from programmers or users. This is just as true now for the powerful new Stratus XA computers. Even the XA 400 with 4 parallel processors, and the XA 600 with 6 parallel processors, high speed cache memories, and additional hardware instructions require no more effort from developers and users than the original Stratus/32.



XA 400

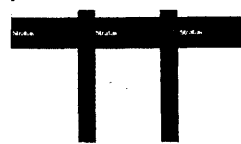

XA 600

1984

**STRATUS INTRODUCES  
THE WORLD'S  
MOST POWERFUL  
FAULT-TOLERANT  
TRANSACTION PROCESSING  
COMPUTERS.**

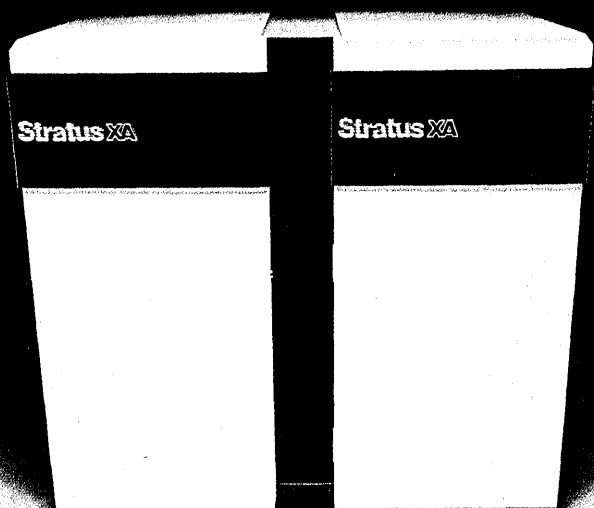

**1984, and Beyond.**

The writing is on the wall. Transaction processing in increasing volume will be the order of the day. Meanwhile, hardware based fault tolerance that can deliver continuous processing without loss of performance is already a necessity, rather than a luxury. No other computer is as prepared to prepare you for the demands of the times as is

Stratus. For more detailed information, please contact your local Stratus sales office, or call Keith Johnson in

Massachusetts at (617) 653-1466, or toll-free at 1-800-255-1515.

**Stratus**  
CONTINUOUS PROCESSING™

**Now that the world relies on computers it needs a computer it can rely on.**

## IN PURSUIT OF AI

In a small, terraced house in the back streets of Oxford, England, Donald Michie holds court. His attendants include a software entrepreneur, a Canadian consultant, and one of Britain's leading experts on underwater craft. Things are looking up for the king of British artificial intelligence research.

He is negotiating for premises to house a new, private research foundation, pressing ahead with work on robot diving equipment, and preparing for a one month trip to Los Angeles, where he will consult for IBM.

All this activity is in stark contrast to what Pamela McCorduck describes in *The Fifth Generation*, the book she wrote with Edward Feigenbaum, as England's Tragedy, that is, 30 years of neglect for advanced computer research in Britain. The students, the moneymen, the academic establishment now dance attendance on the professor of machine intelligence from Edinburgh University.

But it has not always been like that. For years Michie has had to watch his brightest students pack their bags for Stanford Research Institute, MIT, and a host of other American research establishments. He has had to battle with the British science establishment for meager funds, while big sciences like physics grew fat.

"We are saddled with the Edwardian afterglow of an era that thinks it is help-



DONALD MICHIE: "At the end of the war we felt this was the thing we wanted to do the rest of our lives."

ful to have no technical knowledge of the technical area you are evaluating," says Michie. "The message that generations of political administrators are raised on is that if you have been through the right mill, then any subject can be 'got up' in a month or two."

What sticks in Michie's craw is the fact that for over 10 years these administrators denied British artificial intelligence any funds to speak of. In 1972, a report on the subject by Sir James Lighthill concluded that it was not worthwhile to fund AI. "The report was based on a complete mental mirage that there was no authentic bridge to be built between machine intelligence and hu-

man psychology," declares Michie.

Although Michie is now sanguine about his treatment—"it's old history" he says as he hurries on to talk of present projects—his outspokenness has not endeared him to the scientific establishment. It is no accident, for instance, that Edinburgh University has two departments that deal with AI—Michie's machine intelligence unit and a separate artificial intelligence department.

For all his reputation as a maverick, Michie is a mild-mannered man and one with impeccable intellectual credentials. At the age of 18, he joined Britain's brightest mathematicians at Bletchley Park, a wartime code-breaking center where the doings of the German war machine were unraveled. With Alan Turing, who had already laid the theoretical basis of the digital computer, Michie worked on breaking Fish, a high-level code. By day, Michie worked with Colossus machines on the actual code cracking. By night he worked on essential statistical research. What time the young cryptanalysts had free, they spent playing games like chess and go. These games sparked discussions on the possibilities for mechanizing play. "At the end of the war we felt this was the thing we wanted to do the rest of our lives," says Michie.

Unfortunately the machines to test their theories were not available in postwar Britain, and Michie went back to his original field of biology. He was not to return full time to computing until 1960 and then only by accident. Michie had made a bet some years earlier with a colleague in molecular biology that it was possible to build a machine that learned by trial and error. He constructed a Heath Robinson device out of match boxes and beads that learned how to win at ticktacktoe. A visiting academic



from Stanford Research Institute overheard a barroom discussion of the machine and invited Michie to SRI to test his ideas on computers rather than on match boxes

On his return to Britain, Michie was struck by the lack of computer facilities there. In America he had programmed an IBM 7090 in an interactive style. "There was nothing like that in Britain," he recalls. "When I got back I saw a desert around me and began to raise a bit of a row." He was given a chance to air his beef in a 1964 report on the state of computing in British universities. "We didn't take evidence from anyone under 40, and there were two subjects that came out in the forefront of their minds: artificial intelligence and the man/machine interface—two of the four areas now being supported by the government."

Michie compares the struggle to get AI taken seriously with the dawn of molecular genetics. "Today biochemistry is seen as very important, but in the early days its right to exist was bitterly contested."

Few can doubt that Michie has won the right for AI to exist. The fruits of research at Edinburgh are now being harvested by Michie's own company, Intelligent Terminals Ltd. (ITL), which has produced a "decision-making spreadsheet" for microcomputers. Expert-Ease is one of the first application programs for a micro that incorporates expert knowledge, Michie claims.

Later this year Michie will be opening his new foundation, called the Turing Institute, in Glasgow. Closely linked with the city's Strathclyde University, the Turing Institute will carry out contract research for commercial firms, provide a perch for individual researchers, and conduct what Michie calls thematic research. That will involve concentrating on a single, long-term scientific mission. Michie has decided the primary goal of the Turing Institute should be to develop systems that automate acquisition and production of new knowledge, to build "knowledge accelerators."

"We want to ask whether new know-how can be fed back into an expert's mental furniture," says Michie. "Really expert knowledge is intuitive, and it is not necessarily accessible to the expert himself." Michie points out that researchers have already proved it is possible to synthesize knowledge. Among the projects that he hopes will find a home in his institute is one on producing a machine theory for the chess end game. "Alan Shapiro has already synthesized a tiny chunk of chess-playing knowledge and has thrown up a bit of knowledge that we cannot find in the end-game books."

The commercial sponsors of the Turing Institute are taking research like this very seriously. They include the Shell Oil Company, Sinclair Research, computer manufacturer ICL, and Thorn-EMI. "It's

going to be a hard slog experimentally with an eye to products," says Michie. "We are talking about a giant leap forward for mankind, as well as machines."

—John Lamb

## THE CALL TO CALLAN

Gary N. Hughes became enamored of data processing in 1955. It happened in Canada.

Some 10 years later he decided the place to be to get ahead in dp was not Canada but the U.S. Today, he's president of Callan Data Systems, Westlake Village, Calif., and his big love is Unix, the AT&T operating system. "Unix really is the standard of multi-user systems now."

Hughes majored in classical languages at the University of Toronto. "I had an analytical bent. By my second year of college I'd decided there was no way I was going to be a classics professor. I opted to quit. My dad suggested I get into a bank or an insurance company and learn the business. I chose insurance and joined a company that was in the process of converting from manual procedures to an IBM 650. I loved it and transferred to data processing and became a programmer.

"I soon decided the only way to really get into data processing was to join a vendor. IBM wouldn't hire customers so I wrote to Burroughs, NCR, and Honeywell. I quit the insurance company to go to Honeywell and, over a weekend, IBM said, 'Now that you've quit, we can hire you.'



GARY HUGHES: "Robert Wilson hired me. I learned a hell of a lot from him."

And they did."

Hughes joined IBM in 1958 and worked as a systems engineer, a manager of systems engineers, and for World Trade in Switzerland for a while. He left to join a service bureau. "I was stargazing and service bureaus looked good."

Next stop was Memorex Canada, where he agreed to clear up some problems in exchange for the next good opening in the U.S. This came up in 1978 when Memorex acquired BST Technology of Irvine, Calif. "There were the usual takeover problems and I was assigned to solve them." He came to the U.S. in August 1978.

Hughes left Memorex after Robert Wilson left as chairman and president. "Wilson had hired me. I learned a hell of a lot from him." He had been contacted by an instrument company called Benson, headquartered in Paris with U.S. headquarters in Sunnyvale, Calif. "I guess they wanted me because I could speak fluent French, could converse with and report to Paris." He took that company (the U.S. part) from \$8 million to \$35 million before it was acquired by another firm. He joined Callan last August.

Callan got an infusion of \$6.2 million in second-round venture financing at midyear. "The investment was contingent upon the company's bringing in a new ceo to organize and plan strategy," said Hughes. "A decision had been made earlier to move into the Unix world from a direction that had the firm concentrating on a computerized workstation aligned to DEC-type products with a Q bus structure. I started out by changing the whole marketing emphasis. They had been selling through stocking distributors. Our customers are engineers, scientists, and software developers, and I set out to find out where they are."

Hughes says the Callan workstation, a personal computer based on the Motorola 68010 microprocessor, "looks like a PC but it's not. It's as personal as a PC but as powerful as a [DEC] VAX. Our languages are FORTRAN, Pascal, and Ada."

Hughes believes four things are essential to the market Callan is pursuing: networking, color graphics, floating point array processing, and high-speed disk storage. Callan has been addressing these areas in a number of ways, testing Ethernet connections, developing a color graphics workstation for NASA under contract to Ford Aerospace, and evaluating new disk technology.

Callan's machines have appealed to, among others, systems development teams and those involved in complex software systems work. The machine has been chosen by VisiCorp as the main vehicle for working on programs for the VisiOn windowing package for IBM PCs.

—Edith Myers

# Add the Benefits of 3270 BSC or SNA Communication Without the Added Expense

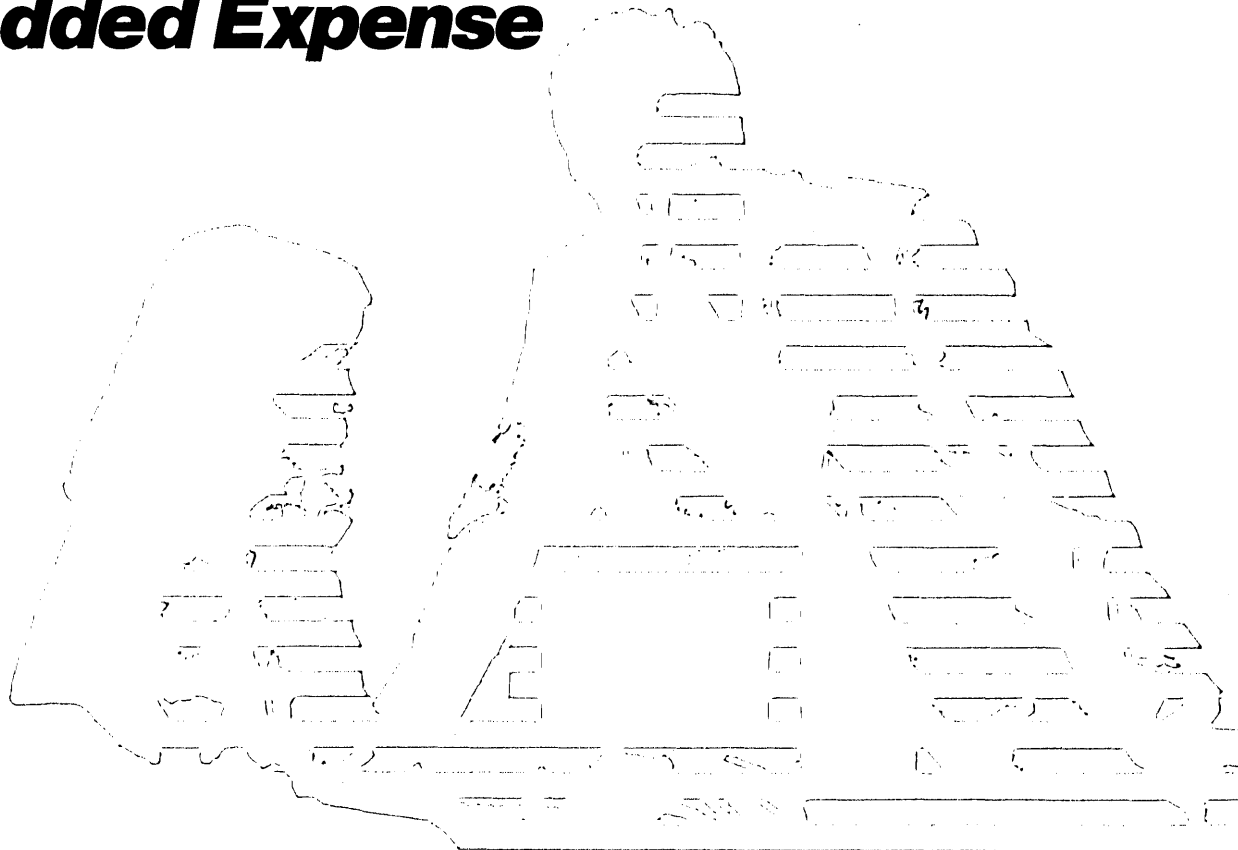

**Timeplex offers you TRU/BLU™—a full range of protocol converters that allows low cost, asynchronous terminals and personal computers to communicate with a variety of IBM\* computers—backed by the Timeplex nationwide Field Service organization.**

Take TRU/BLU 74. Because it appears to the IBM host as an IBM 3274-51C cluster controller, your ASCII terminals can emulate various "Big Blue" devices, including the 4-color display and printer. And, you get dual host capability, data rates to 19.2 Kbps and an exclusive dial-up password reconnect feature.

TRU/BLU 78 gives you full-screen IBM 3278 emulation... plus, it allows you to function as you would on IBM word processors and personal computers. All with a friendly menu-driven set up and dial-up or dedicated support.

\* IBM is a registered trademark of International Business Machines Corporation

With TRU/BLU 87, you can use inexpensive dot matrix, letter quality or laser printers on 3270 controllers and still retain all the features of IBM 328X printers.

TRU/BLU 80 emulates IBM 3780, 2780, 2770 and 3741 protocols to give you a more affordable and flexible means of RJE input/output and personal computing. Also, it features a selectable "host" interface mode for mini/micro computers.

So feature-rich, TRU/BLU is truly the IBM alternative without sacrifice. Get detailed information on product and pricing. Write, or call today on special TRU/BLU hotline: (201) 930-4676.

**Timeplex®**

the technology leader in  
data communications

Timeplex, Inc.  
400 Chestnut Ridge Road  
Woodcliff Lake, NJ 07675  
201/930/4600

Timeplex Canada Inc.  
Markham, Ontario L3R 4L9  
416/475/1961  
Telex 06986321

# We're making the a touch

NEW PROFESSIONAL DATA TERMINAL KEYBOARD  
COMPLETELY AUTOMATIC LOG-ON  
EASY ACCESS TO COMMON CARRIERS  
BUILT-IN SECURITY

Displayphone

Enhancements are available now  
on the standard model; available  
soon for the International and  
SL-1 models.

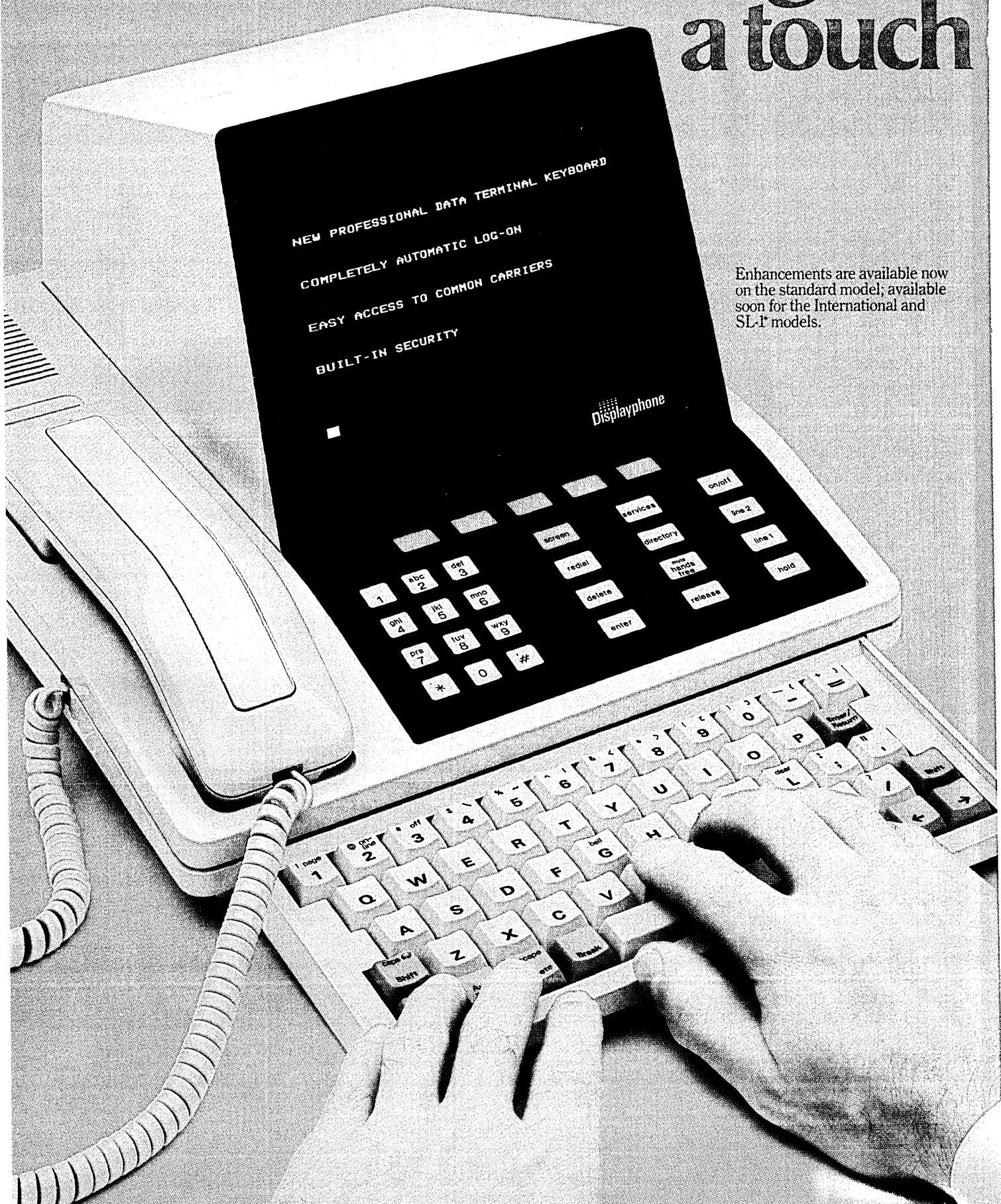

# Displayphone terminal easier to use.

## Northern Telecom introduces a new keyboard and other features to simplify data retrieval and transmission.

Two years ago, Northern Telecom introduced the Displayphone\* integrated voice and data terminal—the first of its kind in the world.

Since then, managers and executives from all over the country have discovered how easy it is to access data. They're tapping into internal and external data bases on many different types of computers, including IBM systems.

Today, we're continuing our leadership by making the Displayphone terminal even easier to use. It has a new keyboard with the look and feel of a standard full-scale data terminal. The log-on process is now completely automatic—press a button and the Displayphone terminal does the rest, then beeps when the call is ready. Even dialing specialized common carriers such as MCI and Sprint has been made effortless.

Those who already have Displayphone terminals can quickly and easily upgrade them to benefit from these improvements. This is a perfect example of our commitment to Continuity, a key criterion of Northern Telecom's OPEN World\*—a planning framework for the development of effective information management systems.

If you don't already have a Displayphone terminal, you should get in touch. Call 800/621-6476 (In Illinois: 800/572-6724; in Canada: 800/268-9079), or send in the coupon.

\*Trademark of Northern Telecom Limited

**CIRCLE 67 ON READER CARD**

INTEGRATING VOICE AND DATA...

**nt** northern  
telecom

To: Northern Telecom Inc.  
P.O. Box 10934, Chicago, IL 60610

I would like to know more about the Displayphone terminal.

- Send me more information.  
 Have a sales representative contact me.

D-3

Name \_\_\_\_\_

Title \_\_\_\_\_

Company \_\_\_\_\_

Address \_\_\_\_\_

Phone \_\_\_\_\_

City/State/Zip \_\_\_\_\_



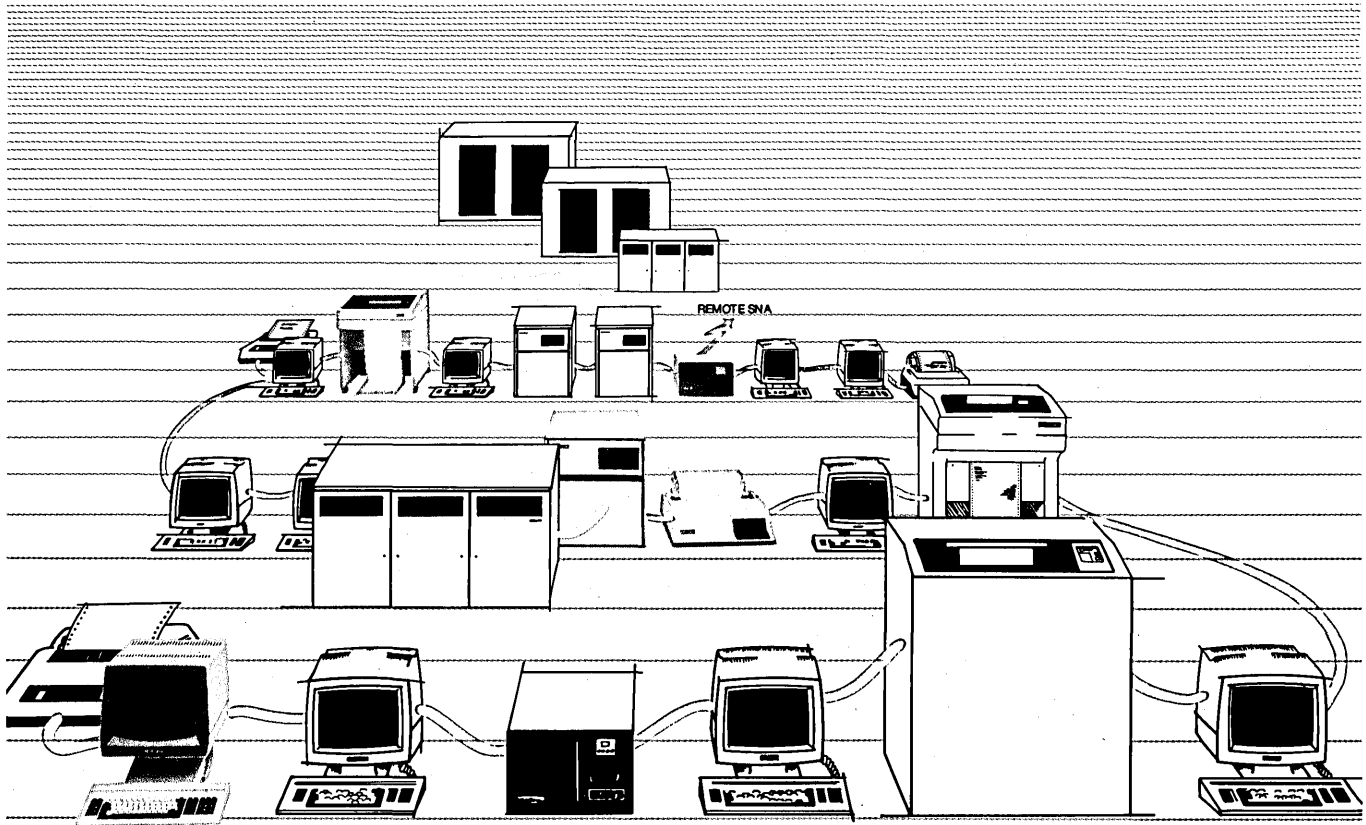

# 3270 Networking: No More No Man's LAN.

Imagine. 3270 Processing. Integrated Personal Computing.  
Local Area Networking. And SNA Compatibility. In One System.

Imagine a system that successfully settles the uncharted territory of 3270 local networking—that "no man's LAN" of unlinked and unrealized potential.

Imagine a system that delivers the power of 3270 processing, and the flexibility to build two local area networks from a single controller. Imagine being able to attach up to 120 devices to that controller. Or attaching four distinct controllers—and multiple coaxial links of up to 10,000 feet each—to any of those LANs.

Imagine the economies of a system that handles that networking with standard 3270 coax. That requires no commitment to special architectures or non-standard LAN technologies. And that, thanks to a multi-drop, station-to-station design, can eliminate thousands of feet of new coax.

Of course, such a system would have SNA compatibility. But it would also have a set of capabilities to dramatically increase throughput, while reducing hardware and support cost in *any* environment. Capabilities like multi-host and multi-personality support, application and address switching, and system printing.

This system would have multi-user personal computing "built into" the network—allowing you to assign

true 16-bit computing power, maintain overall MIS control and share expensive disks and printers.

Such a system would boast an intelligent display station that displays a mastery of ergonomic and aesthetic design. With multi-screen formats, anti-glare screen, low-profile keyboard, and a tilt-and-swivel pedestal with the smallest footprint in the industry. Such a system would also include a full line of printers.

Imagine. 3270 processing. IBM-compatible personal computing. Versatile, economical, powerful local area networking. In one system.

Braegen *has* imagined just such a system. They have designed it. Built it. And called it the ELAN™ System.

If such a system sparks your imagination, give us a call. We know the feeling. The Braegen Corporation, 525 Los Coches Street, Milpitas, CA 95035 (408) 945-8150; TWX: 910-338-7332

*Braegen  
3270  
Networking  
Solutions*

**BRAEGEN**

™ELAN is a trademark of The Braegen Corporation.

CIRCLE 68 ON READER CARD

# HARDWARE

## OFF-LINE

Can we talk? If you were Joan Rivers asking that question on the Tonight show, the answer would probably be a resounding yes. But if you are a user trying to communicate from one minicomputer to another, or from a mini or a workstation to a mainframe, the answer could be a questionable yes or a not-so-sure no.

Recently, 13,500 people at Interface '84 listened to 300 vendors present their solutions to users' communications problems. A common battle cry was "standards, standards, standards." One vendor remarked that the standards that were emerging last summer are not necessarily the same as today's de facto standards. Howard Gordon, president of Network Research Corp. in Los Angeles, said that last July the prevailing operating system was MS/DOS, the local area network was Ethernet, and the communications protocol was Xerox's XNS. Gordon said that less than a year later the prevailing operating system became Unix, primarily because of IBM's announced support of the system on its PC. The de facto LAN standard, he added, seems to be a token passing ring or bus scheme, and the current communications protocol seems to be TCP/IP.

Dick McDermott, director of marketing and sales for the Consumer Service Division of Honeywell in Waltham, Mass., said the current communications situation is "not manageable." He believes there will still be a shakeout among the various systems offered, and added that much depends on what AT&T and IBM do. "Users have various options, and are betting on the strategies of the major [vendors]," he said. Those strategies are not yet public, but part of the rise of token passing rings is surely due to IBM's interest in that scheme. Much as Tandem Computer had the

fault-tolerant computer niche all to itself for eight years until the market grew large enough to support other suppliers, so Network Systems has been alone in the high-speed networking business. Its Hyperchannel product line provided the only 50Mbps intercomputer communications link primarily because not many users needed one. But as more and more users turn to some form of distributed processing, or in other ways begin to need a way for their computers to talk to each other at high speed, other products are arriving. Masstor Systems, for example, is slated to introduce next week extensions of its Massnet family of high-speed networking products.

The hardware component of the family is the Massnet Communications Unit, which can connect two to four MVS hosts without using a trunk coax cable. Each MCU has a 256KB internal data buffer (expandable to 1MB) that can handle multiple concurrent inbound and outbound data transfers. An MCU can connect to four trunks on the bus side and IBM Block Multiplexor, FIPS, and Unibus channels on the host side. It is fully compatible with Hyperchannel, so that both Network Systems and Masstor adapters can connect to the same 50Mbps trunk.

Two software components are part of the package. The Massnet Terminal Access Method connects Massnet to SNA so that users can access applications in multiple hosts more efficiently. The MLink facility enables remote hosts to act as if they were directly connected to the 50Mbps bus.

The Santa Clara, Calif., firm says that all three products are currently in beta test and will be deliverable in the third quarter. No price information is being released until the product announcement, but expect a single mainframe connection to cost \$35,000.

## PC-COMPATIBLE COMPUTERS

This vendor is offering five IBM PC-compatible computers. Three are desktop systems and two are portable models. The series is called the Z-100, and all models are both software- and board-compatible with the IBM PC.

The Z-100 models have 128KB of RAM expandable to 640KB, two RS232C serial ports, one Centronics-compatible parallel port, RGB color output, an IBM expansion bus, and a detached keyboard. When fully configured, all have four additional slots for expansion. Desktop models also provide a "gray scale" monochrome output.

Desktop systems are available in three configurations with 5¼-inch floppy disk drives: single drive system, dual drive system, and a dual drive system with one floppy disk drive and one 10.6MB Winchester hard disk drive. Desktop systems don't include a monitor as standard equipment, although the two portable systems both have a built-in 9-inch amber monitor.

Shipments of the Z-100 series have begun. Desktop models range in price from \$2,700 to \$4,800. Portables cost between \$2,800 and \$3,200. ZENITH DATA SYSTEMS CORP., Glenview, Ill.

**FOR DATA CIRCLE 301 ON READER CARD**

## MODEM SERIES

The DF100-series modems conform to EIA standard RS232C, and do not require any special configurations, so they can be used in a wide variety of applications from remote dial-in timesharing to network connection, according to the vendor.

The five modems, designated the DF104, DF112, DF126, DF127, and DF129 are available as rack-mountable or stand-alone units. They use the same circuit cards, feature 1200 to 9600bps operating speed, and use RS232A in addition to the RS232C interface. The modems fit into the DF100-RM multiple modem enclosure for installation in a standard computer industrial rack and into the DF100-DT desktop enclosure for stand-alone applications.

The DF104 utilizes split-speed operation at 150 or 2400bps. The operation is

## HARDWARE

transparent to the user in terminal-to-computer operations. The DF112 is a 1200bps full-duplex asynchronous/synchronous unit compatible with Bell 212A-type modems. It has an integral autodialer for dial-up service and supports leased lines. The DF126 runs at 2400bps, has an integral autodialer, and is compatible with Bell 201 BC modems. The DF127 operates at 4800bps and the DF129 runs at 9600bps. The 127 conforms to CCITT V.27 standards and the 129 conforms to CCITT V.29 standards. Prices range from \$550 to \$3,050. DIGITAL EQUIPMENT CORP., Maynard, Mass.

**FOR DATA CIRCLE 312 ON READER CARD**

### HOTEL MANAGEMENT

The System 80 integrated management and control system is designed for hotels and motels. The microcomputer-based product incorporates room, energy, and property management functions, as well as telecommunications and life safety monitoring.

System software enables the unit to give hotels current information, such as guest lists, charges, and future blocking. It also does front and back office accounting. The fire detection system alerts guests and staff in the event of fire by interrupting front desk terminals and displaying the alarm status by room and zone. An audible alarm tone is automatically sounded in the alarm zones and danger areas.

The system unit consists of an 18-slot S100 motherboard and a Z80 cpu card.

Included with the system are a dot matrix printer, four 12-inch video monitors, three keyboards, and a telecommunications interface that allows the unit to work with any PBX. The System 80 comes with either 144KB of memory and a floppy disk drive or 640KB of memory and a 40MB hard disk drive. Prices start at \$60,000. HONEYWELL INC., Minneapolis, Minn.

**FOR DATA CIRCLE 311 ON READER CARD**

### LINE PRINTER

This Remote Line Printer System (RLPS) allows DECsystem 20 users to print remotely at speeds of up to 1,800 lines per minute. The RLPS connects directly to the parallel printer port of the DEC mainframe, making all operational procedures on the remote printer appear as though the printer were locally connected to the host computer.

The RLPS employs data compression techniques to double or triple throughput speeds in comparison with serially connected printers, the vendor says, which can reduce transmission costs and cut cpu response time degradation. The RLPS also has automatic error/line hit detection with retransmission of the block of data in error. This capability to selectively transmit only the erroneous data block produces data integrity orders of magnitude better than that associated with serially connected line printers, the vendor says. The RLPS also has 64KB buffer memory, an alphanumeric status display, and an integral printer switch

that accesses the local or remote printer at the push of a button. The product is tagged at \$14,500 to \$30,000, depending on the printer included. DIGITAL ASSOCIATES CORP., Stamford, Conn.

**FOR DATA CIRCLE 320 ON READER CARD**

### WINCHESTER DRIVE

The model 3075 5¼-inch Winchester disk drive delivers 75MB of unformatted storage, and the model 3065 provides 65MB of unformatted storage. Both have an average access time of 24msec and mean time between failures of 18,000 power-on hours. The products are designed to serve multi-user microcomputer systems.

The model 3075 employs five platters and eight heads to achieve its storage capacity. The 3065 uses four platters and seven heads. Both have a closed loop servo system, and use the vendor's voice coil linear actuator for rapid access to data and for higher density.

Both drives adhere to industry standard form factors and use the ST412 interface for integration into desktop systems. The drives will be available in evaluation quantities in the second quarter; the 3075 costs \$1,950 each for 1,000 units, and the 3065 costs \$1,800 each for 1,000 units. ATASI CORP., San Jose, Calif.

**FOR DATA CIRCLE 321 ON READER CARD**

### FIBER OPTIC LAN

This vendor expands its baseband and broadband local area network systems with a fiber optic, Ethernet-compatible LAN. Using either network bridges or repeaters, users can now interconnect baseband, broadband, and optical fiber systems.

Fiber Optic Net/One is available in single- and multiple-cable configurations and operates at a 10 Mbps data rate. Net/One network interface units (NIUS) use electro-optical transceivers, which are user-transparent, to provide the transmission interface to the optical fiber medium. This interface meets all the requirements of the Ethernet specification and employs access methods and collision detection signals functionally identical to those used in Ethernet baseband systems.

Star couplers are available to allow connection of up to 62 NIUS per star with the added capability to interconnect stars to form complex network topologies. The maximum distance between NIUS in single star configurations is 2,800 meters, while multistar systems offer almost unlimited geographic coverage, according to the vendor.

An entry level system costs approximately \$25,000, including NIUS, network management facility, transceivers, star couplers, and software. UNGERMAN-BASS INC., Santa Clara, Calif.

**FOR DATA CIRCLE 313 ON READER CARD**  
—Robert J. Crutchfield

## HARDWARE SPOTLIGHT

### ROBOT-FED DISK COPIER

The Series 4000 is a high throughput disk copy system that doubles capacity by formatting and copying both sides of a disk at once. Output data formats are held in a memory separate from replicated data. The system is designed to be fed by a robot, utilizing a robotic disk handler as a front-end subsystem.

Total per-disk copy time for a 5¼-inch, double- or single-side 48tpi diskette is 21 seconds. A double- or single-side 8-inch disk is 39 seconds. Series 4000 copiers can be clustered around a controlling master system to provide throughput for large software publishers and media manufacturers in addition to other businesses that require volume disk copying.

The individual turnkey systems are mounted on wheels and require no special installation procedures. The Series 4000 first reads the source diskette to be copied, then data are stripped of the disk's format and buffered in RAM or Winchester disk. During the read process, error checking techniques are applied to the data to assure the master data image is correct. The system has the ability to generate copies for over 300 different target system formats.

Blank disks to be written are loaded

into the unit's input hopper, 100 at a time. Quality of each output diskette is assured by the system's read-after-write test, which is included in the 40-second copy time.

Two output bins are provided, one each for good and reject disks. The good bin may be physically removed while the copier is in operation.

Beginning with each 40-second copy cycle, the robot separates the hopper's two bottom diskettes; slides the bottom one out; inserts it in the copier's disk drive; copies it; removes the disk with an action that emulates the movement of a human forefinger and thumb at two corners of the jacket; and delivers it to the correct output bin.

Dual read/write channels and heads allow both sides of the disk to be formatted, written, and verified simultaneously. If desired, copy protection may be used to assure security of written disk against program pirates; for example, coded serial numbers may be imbedded in multiple locations. Sector headers may be scrambled. Logical traps may be written so the output disks may be read, but not copied. The Series 4000 costs \$29,900. APPLIED DATA COMMUNICATIONS INC., Tustin, Calif.

**FOR DATA CIRCLE 300 ON READER CARD**





# 1984 National Computer Conference

July 9-12, 1984 — Convention Center — Las Vegas, Nevada

## E N H A N C I N G      C R E A T I V I T Y

The 1984 National Computer Conference, the premier annual event of the information processing industry, will be a portrait of the progressive state of the industry and the overall impact computers are having on our world.

### NCC'84 OFFERS YOU:

- An in-depth Conference Program, featuring over 90 technical sessions and 20 Professional Development Seminars.
- The opportunity to visit over 650 exhibits, and evaluate products and services in every major industry category.
- An introduction to the newest products and developments in the industry.

— Numerous other highlights, including the Keynote Session by John F. Akers, President of IBM Corporation; Pioneer Day; and the Film Forum.

Make plans now to experience the 1984 National Computer Conference!

For additional information, complete the coupon below and send to: NCC'84, AFIPS, 1899 Preston White Drive, Reston, VA, 22091.

Or, REGISTER TODAY via our toll-free number: 800-NCC-1984, using American Express, MasterCard, or VISA. (In Virginia, call 703-620-8955.)

Sponsored by: American Federation of Information Processing Societies, Inc.;  
Association for Computing Machinery; Data Processing Management Association;  
IEEE Computer Society; Society for Computer Simulation

FOR MORE INFORMATION, MAIL THIS COUPON TODAY.

Name _____	 <p>Mail to: NCC'84 AFIPS 1899 Preston White Drive Reston, VA 22091</p>
Title _____	
Company _____	
Address _____	
City _____ State _____ Zip _____	

DTM 51

CIRCLE 69 ON READER CARD





# Tomorrow's office won't have walls.

Soon, your office will be wherever you want it to be, wherever your business takes you.

You'll be right in the middle of things at a branch office hundreds of miles away, or at a plant on the other side of the world. You'll still have complete access to your company's total information resources.

A company called Ericsson is in the forefront of the new digital information technology that's wrapping up telecommunications, data processing and office automation in one big package.

Take Ericsson's new, all-digital Information Switching System, for example. Starting with the telephone lines you already have to connect every desk in every office, it ties voice, text and data communications into a total organization-wide network.

By adding modules, this network can be economically expanded from 100 to more than 20,000 stations: telephones, desktop terminals, printers, facsimile machines, computer interfaces and other office automation devices in whatever combination you need. It represents the most advanced application of distributed, multi-microprocessor technology available today.

All of Ericsson's 70,000 people work in just one field: information technology. To Ericsson this field extends from electronic typewriters to nationwide telephone systems. From lightwave cable to office automation networks. From computer terminals to satellites. From cellular radio networks to distributed data processing systems.

Ericsson integrates all these into one compatible technology, staying at the leading edge by spending 10% of its annual sales on Research & Development.

Find out more about the technological and financial strength of this innovative company. Ericsson, Inc., Greenwich Office Park 3, Greenwich, CT 06836-3110.

**ERICSSON** 

**Infodata** The reliable software technology company. Providing dependable, easy-to-use software products for a full range of information system environments:

- INQUIRE/Information Center
- INQUIRE/Text
- INQUIRE/DBMS
- PC/INQUIRE

**Reliable** because Infodata products are well-documented and time-proven in hun-

dreds of organizations, many of which have used INQUIRE for over a decade.

**Reliable** because Infodata's fifteen years of software design experience guarantees easy installation, exceptional user friendliness, and continued compatibility with changing user environments.

**An Invitation to Reliable Performance** Reliability is only part of the Infodata story. To find out more about the perfor-

mance INQUIRE makes possible, attend one of Infodata's free MIS Executive Seminars.

For complete details and registration information, call toll free (800) 336-4939. In Virginia, call (703) 578-3430.

Infodata Systems Inc.  
5205 Leesburg Pike  
Falls Church, VA 22041

# Reliable

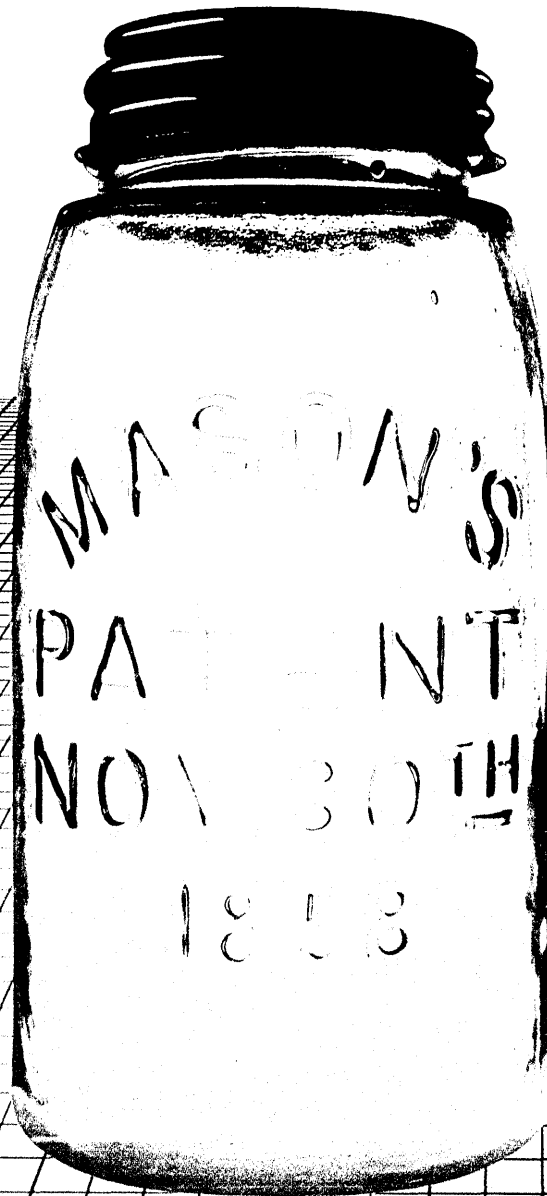

**INFODATA**

The Reliable Software Technology Company

Distributors in: West Germany, Switzerland, Netherlands, Belgium, Luxembourg, Ireland

CIRCLE 70 ON READER CARD

# SOFTWARE AND SERVICES

## UPDATES

Times have changed. Not long ago the cry in school systems was, "Why can't Johnny read?" More recently, forward-thinking educators have asked, "Why can't Johnny program?" But maybe the more practical query should be, "Why can't Johnny operate a pc?" Manpower Inc. and other temporary employment agencies have become sufficiently frustrated with computer-illiterate job seekers that they have begun to train would-be workers themselves. Manpower is using its Skillware to train its 700,000 temps in the use of the IBM PC for a range of business applications. "The economic recovery is bringing with it an explosive release of office automation products purchased by major companies," says Manpower president Mitchell Fromstein. "That release is outrunning the size of the work force available to operate the equipment." He adds that only a handful of the 5 million secretaries, stenographers, and typists in the country can operate automated equipment, "leaving over 90% of the top-level clerical people untrained for tomorrow's office requirements."

Another temporary agency setting its sights on the automated office is WP Temps, based in Los Angeles. The agency is devoted exclusively to providing experienced temporary pc-literate personnel. "The wholehearted acceptance of personal computers by corporations was largely unplanned," says WP Temps owner Peggy Leach Connolly. "The situation has created a pressing need for skilled people." Besides word processing, the agency also provides temps with training in programming and operating computers and in teaching other computer users.

While the temp agencies most often provide broad, general training for a widely used

brand of hardware, other firms are offering more specific courses to teach use of individual micro software packages. The courses often make it to market before the software, as is the case with National Training System Inc. The firm is about to offer a line of training products for Lotus Development Corp.'s Symphony software, even though Symphony will not be available until June or July. The courses at this point are only plans; NTI wants to use the actual Symphony software in its courses and so has to wait until summer, same as everyone else, to begin developing its package.

At a time when U.S. companies are finding it increasingly difficult to trade in Japan, and seeing their domestic sales eroded by Japanese firms, a few exceptions stand out. MicroPro International Corp., for example, has announced that IBM Japan Ltd. of Tokyo will market three MicroPro software packages for the IBM 5550 micro-computer, to be distributed in the Japanese market. Under the terms of the agreement, IBM Japan will sell as IBM products WordStar, MailMerge, and SpellStar. IBM Japan will distribute the MicroPro products through its direct sales force, retail IBM Product Centers, and through authorized distributors. "The Japanese market represents a significant and growing opportunity," said H. Glen Haney, president and ceo of the San Rafael, Calif., firm. The former Sperry executive added that the agreement might be broadened in the future, which can only be good news to MicroPro. Its U.S. sales have slipped severely in the past year, forcing the company to cut down its work force substantially. The company did not say whether any Japanese translations of the three products would be developed as part of the agreement.

## BILINGUAL WORD PROCESSOR

This vendor's Spanish-English word processor is targeted to the business and government agencies that need to produce written communications in both English and Spanish. It has both Spanish and English menus, help screens, and commands. This allows personnel whose native language is English or Spanish to generate a document in both languages—while using the word processor in the language of their choice.

The Select Bilingual word processor contains the English on-screen, interactive tutorial, Teach, in both English and Spanish. The menus, Teach screens, and help screens are written in grammatically and idiomatically correct Spanish and English, according to the vendor.

The software contains features offered with the English version such as Key Files that allow the storing and retrieving of material with one keystroke, and the ability to view one file while editing another. It also includes on-screen boldface and underscore, real-time paragraph justification, and horizontal scrolling.

The software can run on IBM PC, IBM XT, and PC compatibles. Its operating system is PC/DOS and requires 128KB of RAM and two double-sided disk drives or a hard drive. Select Bilingual costs \$400. SELECT INFORMATION SYSTEMS, Kentfield, Calif.

**FOR DATA CIRCLE 326 ON READER CARD**

## APPLICATION WORKSTATION SOFTWARE

The Microtask software package enables microcomputers to be turned into application workstations tailored to individual computing needs. It helps analysts and programmers create the necessary interface applications residing on a microcomputer or large-host computers. Microtask software facilitates development of the proper interfaces for local program execution, job preparation, file maintenance, and editing. Productivity tools such as word processing, database management, graphics, and spreadsheet analysis can be added.

Application front ends can be built

## SOFTWARE & SERVICES

on a hierarchy of menus with the capability to automatically display all input prompts on the screen. By touching the screen, or with one keystroke, users can select any function from pre-established menus. Formatted screens are available, and on-line help is built directly into the system.

The software is available in a kit

that includes the CPM operating system, Cybernet Connect (for linking to the Cybernet data services network), FORTRAN-80, and Microtask Facility (core software), plus user guides and reference manuals. The system interface is designed so users don't need to learn operating systems commands and can take advantage of automatic log-in.

Workstation users can share data and analysis results, and can communicate with other microcomputers. Microtask ranges in price from \$750 to \$1,400. CONTROL DATA CORP., Minneapolis, Minn.

## MATERIALS MANAGEMENT

The MMS-II materials management software system provides a continuous audit trail of the quantities and costs of materials received and a means of controlling the authorization of material expenditures. The package is designed to work with the vendor's PMS critical path project management system. Entries to MMS-II automatically update material budget and actual values in PMS-II and are shown on the activity report, funding schedule, and earned value analysis. Schedule changes are matched with scheduled delivery dates of material orders, and late or excessively early scheduled deliveries are highlighted.

MMS-II will accept up to 1,000 purchase orders for as many as 500 vendors. Up to 32,000 line items of material can be allocated. The system produces an activity report that gives details of all material allocations for each activity, showing delivery schedule and status, as well as situations where materials are expected to arrive outside of currently scheduled activity time periods. The system also highlights areas

## SOFTWARE SPOTLIGHT

### DESIGN TOOL

Excelerator is a fully integrated, menu-driven software environment developed to assist the professional systems analyst in all phases of systems analysis, design, organization, and documentation. It utilizes graphics, data dictionary, and word processing capabilities to assist the systems analyst in meeting tight deadlines, the vendor says. According to the vendor, this product speeds up the process of such time-consuming tasks as developing and revising dataflow diagrams, structure charts, and system documentation. The product is initially configured for the IBM PC XT, and along with the software are two plug-in circuit boards to increase the microcomputer's memory and enhance its graphics capabilities. Excelerator also employs a Microsoft mouse for screen design and menu selection.

Users can generate narrative descriptions of the system design via a link to the Microsoft Word word processing package. The data dictionary holds all information about the system and its related graphs. Up to 10 levels of graphs can be linked together in the dictionary for explosion and sequencing diagrams. In its graphics mode, the software can automatically draw more than 20 objects, including process boxes, external data entities, data stores, off-page connectors, and function boxes. It is also capable of drawing icons such as people, terminals, and other shapes.

The package includes the software on 5¼-inch diskettes, full documentation, keyboard template, the Microsoft mouse and Word packages, 128KB expansion board, and screwdriver. Excelerator costs \$9,500. INTECH CORP., Cambridge, Mass.

**FOR DATA CIRCLE 325 ON READER CARD**

# The world's most advanced personal computer

It all depends on how you look at it. As a powerful standalone, the Wang Professional Computer offers data, voice, and image processing. And Wang word processing, the world's standard. It can support Wang Office, the most comprehensive office automation software in the industry. And it supports the most popular business software available today.

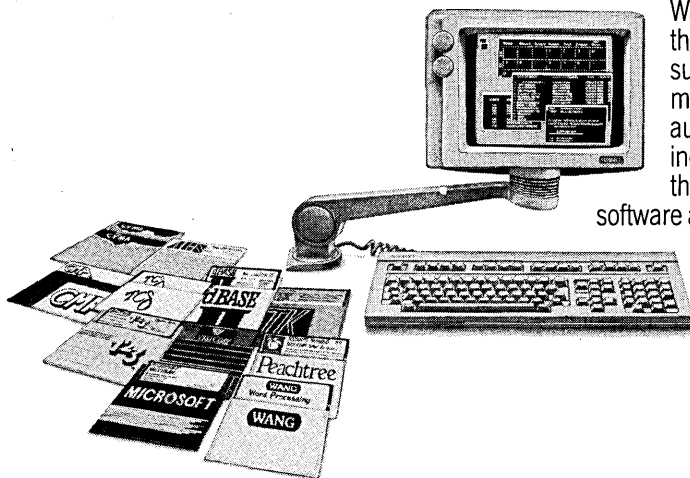



where delaying or expediting deliveries could improve project profitability and progress. Purchase orders can be selectively reported based on a range of purchase order numbers, status, order dates, and vendors. The package costs \$1,000 and runs on the IBM PC and other microcomputers. NORTH AMERICAN MICA INC., San Diego.

**FOR DATA CIRCLE 348 ON READER CARD**

### QUERY SYSTEM

Imagine is an information center reporting and query system that uses a menu-driven user interface to access CICS/VS files. The architecture asks users to choose options from menus to create a report specification, which can then be executed on-line under CICS or in batch. A help facility is available on-line at each step of the process.

The product uses a logical view of data that does not require modifying or reformatting existing files. It reads existing VSAM, ISAM, or sequential files directly, and can join several such files to create tabular views of a created database. The system administrator can control user access to data and computing resources through several security facilities. These control data access for each user by file, field, field value, report, and logical view. Access to computing resources can be controlled by time of day and day of week for both on-line and

batch execution of report requests.

An integrated print management system allows users to create and store report specifications and to store them under individual or system passwords. The queue management system automatically stores, forwards, and provides distribution facilities for reports.

Imagine query facilities provide control over report content, sorting, and to format reports, create expressions, and perform calculations. A version for OS-based mainframes costs \$59,500; a DOS version costs \$45,000. MULTIPLICATIONS INC., Cambridge, Mass.

**FOR DATA CIRCLE 329 ON READER CARD**

### TRAINING

The VSAM/BC computer-based training course is designed to teach basic concepts of VSAM operations and internals. It requires from four to seven hours to complete and is geared to systems programmers assuming responsibility for VSAM, application programmers needing VSAM information, and others who need to know how to use VSAM efficiently. The course does not cover coding of utilities or requests, but instead gives the student instruction in how VSAM works so that he can select the dataset characteristics and types of processing most effective and efficient for the intended use. It

also explores the proper interpretation of VSAM reports, the vendor says. A permanent license for the course costs \$3,780 each. Annual licenses and payment plans are also available. GOAL SYSTEMS INTERNATIONAL/PHOENIX COURSEWARE GROUP, Columbus, Ohio.

**FOR DATA CIRCLE 331 ON READER CARD**

### AIR FREIGHT

The Computer Express is an air transportation service designed to ship computer equipment and software to customers worldwide. The service, which operates 24 hours a day, 365 days a year, is intended to prevent the jarring, temperature changes, and humidity and magnetic fluctuations to which data processing products are subject during normal transit.

The vendor says that all freight is systematically disassembled and specially packed upon pick up from the manufacturer, and then reassembled after delivery. The vendor can provide same day delivery, overnight guaranteed delivery by 9 a.m., overnight service, holiday and weekend service, and on-board couriers with the Computer Express service, if customers prefer. SUREWAY AIR TRAFFIC CORP., Long Island City, N.Y.

**FOR DATA CIRCLE 336 ON READER CARD**

—Robert J. Crutchfield

# just happens to be the world's most universal workstation.



As a versatile, multi-purpose workstation, the Wang Professional Computer can tie into the entire family of Wang products. It can operate as a virtual workstation on the Wang VS, OIS and 2200 systems. And it can even function as an interactive workstation in the IBM environment, either through remote communications or through local attachment.

The Wang Professional Computer. It's more competitive. It's more compatible. No matter how you look at it. No matter how you use it.

For a demonstration of the Wang Professional Computer, call 1-800-225-9264. Or write to: Wang Laboratories, Inc., Business Executive Center, One Industrial Avenue, Lowell, MA 01851.

## WANG

The Office Automation  
Computer People.



# The most comprehensive, super-practical, computer security resource available today...

## Partial Table of Contents (over 500 pages)

### Introduction

- Computer Security: A Management Blindspot
- Security in the EDP Environment

### Managing EDP Security

- Data Security Program Development: An Overview
- Managing Computer Security
- Establishing and Managing an EDP Security Function
- Privacy and Data Security, IBM Corporate Policy
- Data Security Policy, Third National Bank
- Sample Statement of Objectives & Policy for a Corporate Information Systems Security Program
- Sample Data Security Policy, Practices, and Procedures
- New York City Mayoral Directive on Computer Security
- Data Security Policy at The Hartford
- DEC's EDP Audit Charter
- The Importance of Properly Naming Security's Role
- Security vs. Operational Expediency
- Making the Security Proposal an Effective Tool
- Job Descriptions: Manager, Data Security; Data Security Officer; Data Security Programmer/Analyst; Data Security Administrator (Banking)

- Overview of Risk Analysis
- Assessing Risks in a "Decentralized" Computing Environment
- Risk Analysis of Software Systems
- Data Processing Asset Protection Within IBM
- Information Security & Control Guidelines
- City of New York System Security Standards (Excerpts)
- Productive Security Standards: A Contradiction in Terms?
- Checklist for Documenting Security Policies and Standards
- Documenting Data Security Procedures
- Designing Secure Application Systems
- Security Reviews in a Data Base Environment
- Security in Distributed Processing: Working with the Vendors
- Testing... Testing... Testing... The Critical Tool that Computer Security Practitioners Don't Use
- Controlling the Systems Programmer
- Developing a Non-Disclosure Statement
- Developing a Strategy for Records Retention
- Checklist for Handling Sensitive Data
- Goals and Criteria for the Move of the H-P Data Center

- The Interstate Relocation of a Data Processing Library
- People Make Your Computer Security Program Work
- Tips for Better Time Management
- Getting Your Written Message Across... Effectively
- A Personal Guide

### Protecting the Data Center

- Physical Security: When to Consider "Doing It Yourself"
- Little Things—Safety Equipment
- An Ounce of Prevention... Applied to Environmental Control
- Controlling Physical Access from a Central Location
- Fire Protection Systems
- Another Look at Fire Safety
- The Effects of Electrical Power Variations Upon Computers: An Overview, U.S. Dept. of Commerce
- Uninterruptible Power Supply (UPS) Planning Guide
- Process Cooling for the Data Center
- Start a DP Environmental Protection Agency
- Static Electricity: Planning Its Protection

### Software Management

- Software: An Important Security Tool
- Application Source Code Review
- Controlling Program Changes
- MVS Preventive/Detective Security Features
- Selecting Data Security Software
- Security Software Packages: Comparison of the "Big 3"
- Implementing ACF2 at Rutgers
- Implementing RACF at the Bank of California
- Implementing SECURE at Borden
- Access Control Facilities Available with DOS/VSE

### Communications Security

- Who, What, & Where in Communications Security
- An Encryption Primer
- Cryptography: A Security Tool

### Disaster Recovery Planning

- Contingency Planning: An Opportunity for DP Management
- Basics of Contingency Planning
- Automating Disaster Recovery Plan Documentation
- Testing the Recoverability of Application Systems
- A Checklist for Keeping Your Disaster Recovery Plan Up-To-Date

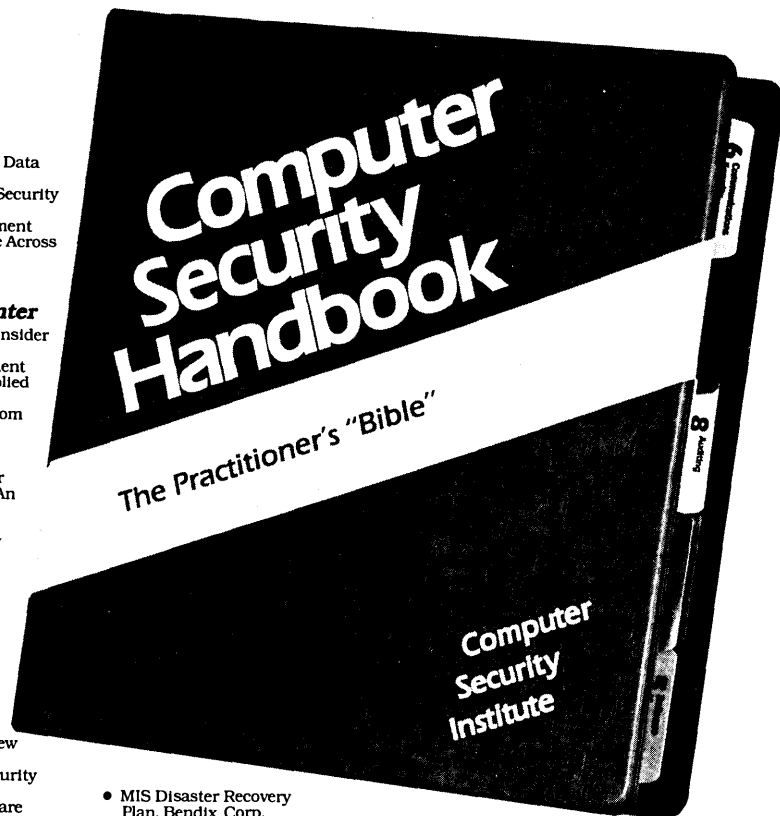

- MIS Disaster Recovery Plan, Bendix Corp.
- DP Insurance & Risk Management
- The First Data Disaster... From an Insurance Perspective

### Auditing

- Auditing and Controls in a Database Environment
- EDP Audit: Making It Happen
- Guidelines for Establishing the EDP Audit Function
- "Bridging the Gap" Between DP Professionals and Auditors
- Data Security & EDP Auditing: Partners in Control

### Contemporary Issues

- Protecting Software: An Overlooked Responsibility
- A Strategy for Dealing With Computer Fraud and Abuse: A Case Study
- EDP Fraud Prevention: A "Separation of Duties" Checklist
- Security Issues in Transborder Data Flow

- Where Do You Stand on Computer Ethics?
- Security Risks in the Automated Office Environment
- Auditing Word Processing Security
- Controlling Micros and Distributed Data Processing
- Putting Information Assets on the Balance Sheet

### Information Sources

- Computer Security Magazines, Journals, Newsletters, etc.
- CBEMA Privacy and Security Bibliography
- Associations
- Directory of Special Interest Groups
- Establishing a Computer Security Interest Group
- How to Get Involved in a Local Special Interest Group
- Free Computer Security Literature

- Please send me more information.  
 Please enter \_\_\_\_\_ order(s) for *Computer Security Handbook* at \$95.00 each.

*I understand that when I pay in advance, I am entitled to two benefits:  
 (1) the latest 8-page issue of Computer Security newsletter and  
 (2) CSI pays all shipping and handling charges.*

- My check is enclosed, payable (in U.S. funds) to "Computer Security Institute"

- Charge my account with  
 Visa  MasterCard  American Express

Account # \_\_\_\_\_

Expiration Date \_\_\_\_\_

Signature \_\_\_\_\_

- Bill me (add \$5.00 for shipping and handling)

Add \$10.00 for overseas shipment; add \$30.00 for overseas air shipment. Massachusetts residents add 5% sales tax. CSI members deduct \$8.00.

To: Computer Security Institute • Dept. DM-51  
 43 Boston Post Road • Northborough, MA 01532  
 (617) 845-5050

Name \_\_\_\_\_

Title \_\_\_\_\_

Organization \_\_\_\_\_

Address \_\_\_\_\_ Mail Stop \_\_\_\_\_

City \_\_\_\_\_ State \_\_\_\_\_ Zip \_\_\_\_\_

# SOURCE DATA

## BOOKS

### THE HACKER'S DICTIONARY: A GUIDE TO THE WORLD OF COMPUTER WIZARDS

by Guy L. Steele Jr., Donald R. Woods, Raphael A. Finkel, Mark R. Crispin, Richard M. Stallman, and Geoffrey S. Goodfellow

There are many published glossaries to help the computer neophyte learn about ROMs and other acronyms, but before *The Hacker's Dictionary* there was no available reference to the language that hackers actually speak. In the past, hackers didn't need such a guide because they already spoke the language or could connect to the Stanford AI Laboratory and read the "jargon" file. But as micros became so popular that even blenders had computers in them, there came to be three groups of people who needed an off-line (i.e., printed) guide to hacker language.

First, there are the lonely hackers who hack at home without benefit of a hacker social community, whether physical or electronic. Second are the friends and spouses of hackers who wonder what those funny words ("blech," "foo," "hairy," "hack," etc.) mean. Finally, we have the media units, or journalists, who write about computers and joyously misuse hacker slang.

So six hackers conspired to write *The Hacker's Dictionary*, using the on-line jargon file as a starting point. More than a dictionary, this book also documents the grammar, semantics, puns, and Chinese food eating patterns of the Stanford and MIT hacker community. (Unfortunately, it stops short of describing mating behavior.) The result is funny and enlightening, though perhaps not always in a manner the authors would prefer.

First of all, what is a hacker? In recent years, the media has picked up this word and, out of ignorance, used it only in a negative sense to describe people who maliciously abuse computers or meddle with them to get information. At best, this definition is incomplete. It also annoys a large number of people who consider themselves

hackers, including me. The computer community has always seen the hacker as an intelligent and prolific programmer, enthusiastic and productive. *The Hacker's Dictionary* has seven definitions for the term: 1. A person who enjoys learning the details of computer systems. 2. One who programs enthusiastically. 3. A person capable of appreciating hack value. 4. A person who is good at programming quickly. (By the way, not everything a hacker produces is hack.) 5. An expert on a particular program. 6. An expert of any kind. (One might be an astronomy hacker, for example.) 7. A malicious or inquisitive meddler who tries to discover information by poking around. (This last definition is also the least important.)

I would add an eighth definition: "A person who regularly uses hacker slang." If he talks like a hacker, he probably is one. Some of my other favorite definitions are:

**BRAIN-DAMAGED:** adjective. Obviously wrong; extremely poorly designed; cretinous; demented.

**FRIED:** adjective. 1. Nonfunctional because of hardware failure; burned out. 2. Of people, exhausted, burned out.

**HACK ATTACK:** noun. A period of greatly increased hacking activity.

**REAL WORLD. THE:** noun. 1. Those institutions at which people might use the word programming in the same sentence as FORTRAN, COBOL, RPG, IBM, etc. 2. Places where programs do such commercially necessary but intellectually uninspiring things as compute payroll checks and invoices. 3. To programmers (especially hackers), the location of nonprogrammers. 4. A universe in which the standard dress is shirt and tie. 5. The location of the status quo. 6. Anywhere outside a university.

Perhaps unintentionally, *The Hacker's Dictionary* also suggests some of the less-than-flattering aspects of stereotypical hacker psychology. First, this book leads us to believe that hackers are narrow-minded, computo-eccentric individuals who religiously believe that "my computer is good, your computer is bad." In this case, the authors have a bizarre affection for the DEC PDP-10 and make constant reference to un-

interesting details of that machine's instruction set. Did you know that AOS adds one to a number? Do you care? Does anyone care? Only a few non-PDP-10 or LISP-based machines or operating systems are included in the guide. When they do appear, it's only for the purpose of ridicule, such as, "Boy, anyone that tries to use Unix deserves to lose!"

This volume also perpetuates the hackers' reputation for being arrogant and callous about the rights and privacy of users on a shared system. Here is one striking example of gross hacker arrogance: under the definition of "foo", the authors state:

"A hacker avoids using foo as the real name of anything. Indeed, a standard convention is that any file with 'foo' in its name is temporary and can be deleted on sight."

What a cretinous attitude this is. Come on, fellows, grow up! Many hackers use the word foo as the prefix for test programs and data that have a useful life of days or weeks. It is scary to think that some random hacker is going to go through a file system and delete people's work without asking them first. So let me suggest to the authors and to any hackers that they reconsider this assumption.

In spite of these problems, *The Hacker's Dictionary* is a pleasant little hack. The book goes well with Chinese food, especially Hunan cuisine. Happy hacking. Harper & Row, New York (1983, 96 pp., \$5.72).

—Michael Wahrman

## BOOK BRIEF

### WACKY READ

Dr. Wacko (AKA David Heller, John Johnson, and Robert Krucina) is out to set the world of Atari programming on its ear. *Dr. C. Wacko's Miracle Guide to Designing and Programming Your Own Atari Computer Arcade Games* unveils all the tricks of the trade to transform elementary game design elements—color and character graphics, animation, playing field construction, sound, player-missile graphics, and more—into the "weirdest, most challenging, blockbuster arcade games imagin-

## SOURCE DATA

able." The authors guarantee you'll have fun, while Dr. Wacko is a bit more serious. He claims the book reveals "all the inside tricks I've learned from years of research, tedious experimentation and conceptualizing in my Jacuzzi. . . . Trust me." Included with the 235-page book is a 5/4-inch disk in which readers can pit themselves against Dr. Wacko himself, in his own fiendishly difficult arcade game. The book and disk cost \$24.95. If your Atari doesn't have a disk drive, you can buy the book alone for \$12.95. For more information, contact Addison-Wesley, General Books Division, Reading, MA 01867, (617) 944-3700.

## REPORTS & REFERENCES

### GRAPHIC GRAPHICS GUIDE

Hewlett-Packard has put together a book to show readers how to prepare effective and readable business graphics. The 150-plus illustrations in this 54-page book help make learning simple and enjoyable, says HP. The guide outlines seven basic steps that propel readers toward the ultimate goal of designing effective business graphics. It covers such topics as defining the audience, stating the objective, and planning and scheduling time. The last section also tells how to proportion report graphics, create special effects for overheads, use 35mm slide tech-

niques and choose a computer graphics system. *Steps to Effective Business Graphics* costs \$12 and can be ordered through your local HP sales office, or by calling (800) 538-8787 or (408) 738-4132 in California.

### SURVIVAL OF THE FITTEST

Techniques for dealing with both the problems and opportunities that await technical managers are presented by McGraw-Hill in *The Technical Manager's Survival Book*. This volume emphasizes the development of a personal framework for overseeing technical operations and personnel, and explains how to plan and institute a management system that is individually tailored to the technical manager's specific situations. The author, Melvin Silverman, examines specific managerial methods and procedures, discusses the latest management concepts, and provides guidance on "situational management." The publishers claim this process enables the technical manager to "accurately access each unique problem as it arises and then make the most effective decision for the circumstances involved." Silverman also reveals how a technical manager can integrate logic and emotions when making management decisions, use existing theories and models as background for achieving an individual style, and generate information systems for

gathering data. The 368-page book costs \$29.95 and can be ordered from McGraw-Hill Book Company, 1221 Avenue of the Americas, New York, NY 10020, (212) 512-3493.

## SEMINARS

### CONFERENCE COURSES

SIGGRAPH '84, the 11th Annual Conference on Computer Graphics and Interactive Techniques of the Association for Computing Machinery's Special Interest Group on Computer Graphics, is sponsoring a group of one- and two-day seminars. Among the topics to be covered are medical computer graphics; mathematics of computer graphics; entrepreneurship; technologies of interactive video; bit map graphics; and advanced topics in curves and surfaces. The course offerings are divided into four categories: general topics, CAD/CAM/CAE, animation/image synthesis, and graphics applications. SIGGRAPH week is July 23-27 in Minneapolis, Minn.; these seminars will be available during the first two days of the conference. The advance program, available in May, will detail the seminars as well as other SIGGRAPH events. For more information, contact SIGGRAPH '84 Conference Office, 111 East Wacker Dr., Chicago, IL 60601, (312) 644-6610. \*

## If you're planning to install a computer system or move one, follow the lead of IBM, DEC, Burroughs, Honeywell, Univac, CDC, HP, and the U.S. Bureau of Standards.

Your computer room's electrical environment is crucial to the success of your ADP operation. So if you're an ADP manager, engineer, or site planner, learn "how-to" and "how not to" install computer room wiring at a one-day seminar.

Specific seminar topics include grounding, power isolation and conditioning, life-safety systems, static electricity control, and lightning protection. All seminar material is based on the new "Guidelines on Electrical Power for ADP Installations" published by the National Bureau

of Standards, U.S. Department of Commerce.

All seminar attendees will receive a copy of this important document, which describes the Federal Government's and computer industry's recommended guidelines for safe, reliable ADP systems operation. The major computer manufacturers previously mentioned, along with many others, have reviewed its contents and approved them.

Don't pass up this chance to solve your ADP electrical problems *before* they occur.

### Seminar Schedule

June 20-Philadelphia  
July 18-Chicago  
August 14-San Francisco  
September 6-New York City  
October 18-Boston  
November 8-Dallas  
December 6-Atlanta

Computer Power Systems Corp./P.O. Box 6240/Carson, CA 90749.  
Telephone: (213) 515-6566; ask for Bob Miller.

YES, register me for your ADP Power Seminar in \_\_\_\_\_ (city)  
on \_\_\_\_\_ (date). My check for \$195.00 per person is enclosed.

NAME \_\_\_\_\_ TITLE \_\_\_\_\_

COMPANY \_\_\_\_\_ TELEPHONE ( ) \_\_\_\_\_

STREET \_\_\_\_\_ CITY \_\_\_\_\_ STATE \_\_\_\_\_ ZIP \_\_\_\_\_

NO, Don't register me now, but send me more information on electrical power requirements for ADP installations.

**COMPUTER  POWER SYSTEMS CORP.**

# ADVERTISERS' INDEX

ADR Corp.	41
Amer. Assn. for Artificial Intelligence	68
Artificial Intelligence Corp.	14
Ashton-Tate	52
AST Research Inc.	121
AT&T Technologies	179
AT&T Technologies	92-93
Avatar Technologies	18-19
Battelle	83
*Battelle	144-14
*Beehive International	144-2
Braegen	144
Calcomp	98
Cambridge Systems Group	33
Candle Corp.	2
Codex Corp.	111
Compaq	6-7
Computer Corp of America	54-55
Computer Power Products	156
Corona Data Systems	136-137
Cybernex Limited	108
D & E Computing	46
Danish Data Electronics	130-131
Datapoint	168-169
Datasouth Computer Corp.	81
Digital Communications Assoc.	12-13
Digital Equipment Corp.	65
Digital Research	22-23
DSD	68
EPS, Inc.	133
Ericsson, Inc.	148-149
External Affairs/Canada	113
*Fibronics	144-8
Forte Data	88
Four-Phase Systems	96-97
*Fusion Products Int'l.	144-22
Global-Ultimacc	53
Hewlett-Packard	126-127
IBM	44-45
Infodata	150
Intel	114-115
ITT Courier	62-63
Kennedy Co.	CV 2
LQ Corp.	95
Liebert Corp.	119
Mathematica Products Group	103
Matrix Instruments Inc.	21
McCormack & Dodge	31
Megatek	17
Micom Systems, Inc.	1
Microrim	106-107
Microsoft	79
Morino Assoc.	49
MSA	101
*NCR Corp.	144-17
NEC	66-67
*Northern Telecom	144-6-7
Northern Telecom	142-143
Numonics	35
*Peripher Computer Systems	144-21-23
Popcom	50-51
Precision Visuals	69
Printronic	11
Qume	56-57
Rolm	36-37
*Rutishauser Data AG	144-4
SAS Institute Inc.	5
S.D.I.	125
*S & H Computer Systems, Inc.	144-16

Sharp Electronics	73
*Siemens	144-12-13
Software Corp. of America	161
Software International	86-87
Software Results	20
Sperry Corp.	74-75
*Star Europe	144-18
Stratus Computer	138
Tektronix, Inc.	58-59
Teletype Corp.	CV 4
Televideo Systems	26-27
Telex	8
3M Commercial Tape	135
3M Data Recording Products	24
Timeplex	141

Trax	166
Unify Corp.	70-71
Visual Technology Inc.	117
Wang	152-153
*Wollongong Group	144-11
Wyse	CV3
Xerox Corp.	43
Zilog Systems	85
*International Edition	

# OS/MVS Users

... over 500 users are using  
**FastDASD** to improve  
system performance.

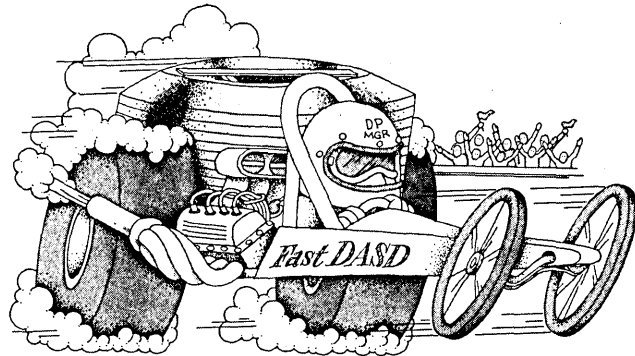

- Speeds Response Time
- Solves Problems Quickly
- Increases Throughput
- Saves People Time

For faster results, call us today  
at our toll-free number 800 368-7638.

To get a Free FastDASD brochure,  
fill out and mail this coupon today.

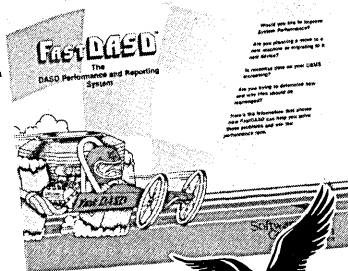

**Software Corporation**  
of America

455 Carlisle Drive  
Herndon, VA 22070  
Tel. (703) 471-1545

Name \_\_\_\_\_  
Title \_\_\_\_\_  
Company \_\_\_\_\_  
Phone (\_\_\_\_) \_\_\_\_\_  
Address \_\_\_\_\_  
City \_\_\_\_\_  
State \_\_\_\_\_ Zip \_\_\_\_\_  
OP SYS \_\_\_\_\_ CPU \_\_\_\_\_ #DASD Spindles \_\_\_\_\_

DAAD

CIRCLE 76 ON READER CARD

# The Marketplace... SOFTWARE SERVICES

## ADVERTISERS' INDEX

### SOFTWARE SERVICES

Applied Information Systems.....	162
Dataware, Inc.....	162
MFG/EDP.....	162
<b>JOB MARKET</b>	
National Business Employment Weekly.....	163
Team International.....	163
<b>BUY, SELL, LEASE</b>	
Genstar Rental Electronics.....	163
<b>TIME &amp; SERVICE</b>	
Omnicomputer Inc.....	163

# IBM S/34/36/38 COBOL

- General Ledger
- Accounts Receivable
- Accounts Payable
- Payroll/Personnel
- Inventory Management
- Manufacturing Systems

• MFG/EDP IS A VALUE ADDED REMARKETER FOR THE IBM S/36 •

**MFG/EDP**

P.O. BOX 54, BUFFALO, N.Y. 14213  
716 - 885 - 1772

CIRCLE 508 ON READER CARD

## SOFTWARE CONVERSION SOLUTIONS

Dataware provides the software translation system for your complex conversion problems. Over 15 years of conversion experience has resulted in thousands of satisfied customers, worldwide.

- **COBOL to COBOL**  
Circle No. 500
- **AUTOCODER/SPS to COBOL**  
Circle No. 501
- **EASYCODER/TRAN to COBOL**  
Circle No. 502
- **BAL/ALC to COBOL**  
Circle No. 503
- **DOS/ALC to OS/ALC**  
Circle No. 504
- **PL/1 to COBOL**  
Circle No. 505
- **RPG/RPG II to COBOL**  
Circle No. 506
- **RPG/RPG II to PL/1**  
Circle No. 507

Dataware offers services & software to meet your needs. For more information, call or write today.

**The Conversion Software People  
Dataware, Inc.**

2565 Elmwood Avenue  
Buffalo, New York 14217  
Phone (716) 876-8722  
TELEX: 91519

### PDP-11 & VAX Software

EasyEntry  
Quick form design  
and data entry system

AIS-PL/I

ANSI Subset G  
PL/I Compiler

BURCOM-11

PDP-11/Burroughs  
Communications System

1-800-334-5510

**Applied information systems**

500 Eastowne, #207  
Chapel Hill, NC 27514  
(919) 942-7801

CIRCLE 509 ON READER CARD

**"A little space."**

— WILLIAM BLAKE  
*Songs of Innocence*

**"At little cost."**

— KATHY MONAGHAN

Call me or Shirley Stirling  
for more details about the  
DATAMATION Marketplace  
at (800) 223-0743.

## "THERE IS AN ANSWER TO EVERY RIDDLE IN THE UNIVERSE, EXCEPT ONE."

I know the secrets of the stars and the mysteries of the moon. But the origin of The Common Cold baffles even a great thinker like myself. That's why I rely on the Consumer Information Catalog.

It's published by the Federal Government and lists over 200 booklets you can send away for. Over half are free. And all are wise. With tips on everything from repairing a flat tire to relieving a cold.

So send for this free catalog. Write: Consumer Information Center, Dept. B, Pueblo, Colorado 81009. After all, it's hard enough deciphering the mysteries of this planet, without the handicap of an earthshaking sneeze.

**THE CONSUMER INFORMATION  
CATALOG**

A catalog of over 200 helpful publications.



Current Career Opportunities Coast to Coast

**National Business Employment Weekly**

## Are you looking for a really good EDP position?

**Start Your Job Hunt Right Here... with the National Business Employment Weekly**

Every week, it includes hundreds of the best executive, managerial and professional positions available across the country. Jobs in every field, including data processing and virtually every area of technical expertise. Jobs at salaries from \$25,000 to \$250,000.

PLUS... weekly editorial features covering every aspect of career advancement. Articles on writing resumes, interviewing, salary statistics, regional employment trends, and much more.

**LOOK FOR OUR SPECIAL MAY 20TH "DATA PROCESSING" ISSUE WHICH WILL INCLUDE ADDITIONAL EDP OPPORTUNITIES AND RELATED EDITORIAL.**

Pick up a copy of the National Business Employment Weekly at your newsstand today. Or we'll send you the next 8 issues by first class mail. Just send a check for \$32.00 to:  
 National Business Employment Weekly  
 Dept. D 420 Lexington Ave. NY, NY 10170

**CIRCLE 512 ON READER CARD**

"Systems Marketing Manager Team International, a leading management and MIS Consultant in the Middle East with eight offices throughout the Arab Countries, has immediate openings for Senior Systems Consultants/System Marketing Manager. The applicant is expected to have a minimum of 10-12 years experience in mainstream data processing, plus experience in system management, client support or systems marketing. He should be able to perform conceptual studies of client requirements, and guide large MIS projects during their initial stages. A graduate degree in a relevant discipline is preferred. Please send detailed CV to:

**Team International  
 Dr. Sherif Hosny  
 2 Ismail Fahmy Street  
 5th Quarter  
 Heliopolis, Cairo - Egypt"**

**BUY, SELL, LEASE**

**Like-new products**



For free catalog, phone toll-free (800) 225-1008 In Massachusetts (617) 938-0900  
**Genstar REI Sales Company**  
 6307 DeSoto Ave., Suite J  
 Woodland Hills, CA 91367  
**CIRCLE 510 ON READER CARD**

**VAX 11/780 AND PDP-11 DEVELOPMENT TIME**

NO KILOCORE TICK CHARGES / NO CPU CHARGES

**Omnicomputer**

**\$7/\$14**

RSTS/E      VMS

PER HOUR CONNECT TIME

**BUDGET BYTES™**  
 212-944-9230

Omnicomputer, Inc.  
 1430 Broadway, New York, N.Y. 10018  
**CIRCLE 511 ON READER CARD**

**Heart disease and stroke will cause half of all deaths this year.**

**Put your money where your Heart is.**

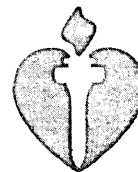

**American Heart Association**

WE'RE FIGHTING FOR YOUR LIFE

**Payroll Savings for education ...and that's no CROCK!**

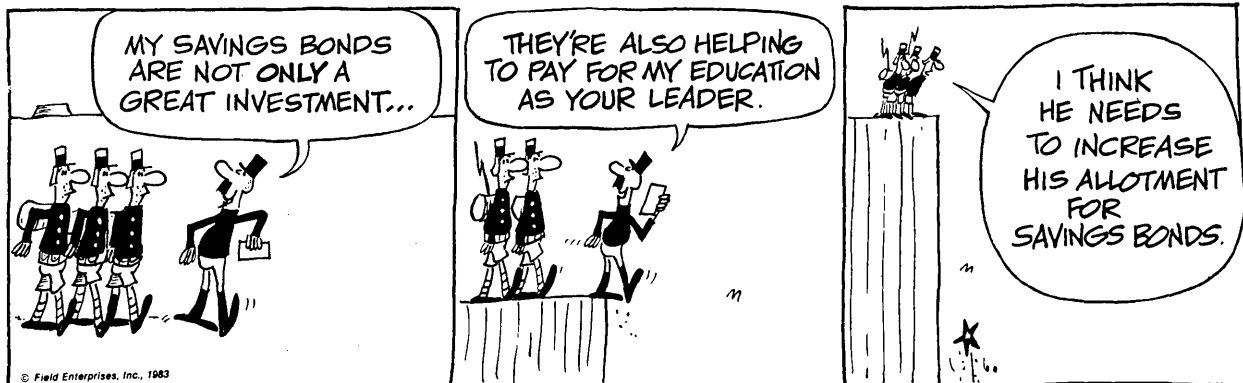

© Field Enterprises, Inc., 1983



U.S. SAVINGS BONDS DIVISION  
 DEPARTMENT OF THE TREASURY

# ON THE JOB

## START NOW

Starting salaries for 1984 are at a record high for financial executives, accountants, and dpers, according to a survey by Robert Half International, a New York City-based recruitment company.

The report claims dpers will see starting pay rates that average 4.5% over 1983's figures. The dp categories include programmers, systems analysts, project managers, dp auditors, consultants, software engineers, and computer operators.

According to the survey, project managers should find beginning salaries at large installations in the range of \$32,000 to

\$40,000, an increase of 5.9%.

Entry-level programmer analysts at midsize installations should find salaries are between \$22,000 and \$30,000, a 4% gain over 1983. At small installations, however, the report claims salaries should be between \$16,000 and \$20,000, up 5.9%.

The biggest percentile jump went to the database administrator/manager at large installations. The survey shows starting salaries in this category are an average of 9.2% over 1983. The salary scale should be between \$31,000 and \$40,000, against the previous year's range of \$29,000 to \$36,000.

Demand for senior-level executives in high-tech fields has also skyrocketed, rising 13% in 1983. Korn/Ferry International, in its 48th quarterly National Index of Executive Vacancies, claims this growth has exceeded only by the financial services industry, which rose 25%.

Gary Kaplan, managing vice president of the company, feels the "intense competition [and] workout situations in troubled companies and startups maintained the pace of hiring." He also pointed out another big factor: the increased competition brought about by IBM's entrance into the pc market.

## HELP BUILD THE FUTURE

Pakistan, a modern Islamic state, is taking substantial steps towards building its future and there is a strong tradition and belief in self-help.

The Aga Khan Hospital and Medical College, located in Karachi, Pakistan, is currently under construction. It is the country's largest philanthropic project and upon completion the Hospital will house a 721-bed teaching complex and provide resources for primary and secondary care facilities throughout Pakistan. This exciting project is being commissioned in phases, with the first phase opening in early 1984.

The Information Systems Department is recruiting staff to computerize the financial, administrative and patient-related applications. We require a professional management team of impeccable calibre in the following positions:

### MANAGER SYSTEMS EDUCATION

You will be fully accountable for setting up a full-time intensive training program in systems analysis, design and programming with special emphasis on applications in the field of health care.

You must have at least 5 years experience in developing and implementing courses in computer systems. A B.Ed. or a M.Ed. Degree would be a definite asset.

### MANAGER, SYSTEMS OPERATIONS AND SUPPORT

Responsibilities include planning of the physical facilities, installation of equipment, development of policies and procedures, and management of the hardware support function. You will also direct the training of the Computer Operators.

Ideally, you will have had several years related experience in a large hospital installation. A Degree in Computer Science, or related field, and previous hardware experience are mandatory.

### APPLICATION SYSTEMS SPECIALIST

You will manage a group of software designers and work with

them in the development of application systems. You will also assist in hardware and software planning and be directly involved in the training of personnel.

You must have a Degree in Computer Science with 3 to 5 years hospital experience managing the development and implementation of a group of application systems.

### SENIOR SOFTWARE DESIGNERS

As a leader of a Systems Team you will be responsible for the analysis and evaluation of application software packages, and the planning and implementation of modifications to existing packages. You will also assist in the training of Information Systems personnel.

You possess a Degree in Computer Science, or related field, and have at least 3 years experience in the planning and development of application systems. Project leadership involving application development systems is a prerequisite.

### USER CO-ORDINATORS

As the primary communication link between User Departments and the Information Systems Department, your major responsibilities will be to analyze and specify user requirements.

You have at least 3 years experience in a computerized hospital information systems environment. Excellent oral and written communication skills and prior experience in formal training are definite assets.

These positions can provide you substantial personal and professional rewards. We also offer competitive tax free salaries and benefits package. If you meet our standards of excellence please forward your resume or call, in confidence, to: **Lisa Grimm, Aga Khan Hospital Representatives, 4316 Village Centre Court, Mississauga, Ontario, Canada L4Z 1S2, (416) 848-4740.**



The Aga Khan Hospital and Medical College, Karachi

آغا خان ہسپتال اور میڈیکل کالج کراچی



Attention:  
Manufacturers, Distributors,  
and Dealers of Office Automation  
Products, Services, and Supplies

The Go With  
Proven One!

## Exhibit at 12th Annual Presentation



### Longest-Running, National Office Automation/ Information Systems Conference & Exposition

- Great Marketing Area—Chicago, second largest city, third largest metropolitan area.
- Fabulous Show Location—McCormick Place, one of the largest and best equipped exposition halls in the country.
- Powerful Attendee Promotion—Imaginative, hard-hitting national, regional, and local advertising, direct mail, and public relations campaigns designed to bring qualified attendees to your booth.
- Information-Packed Conference—Sponsored by the Association of Information Systems Professionals, a 16,000-member organization devoted to advancing the concept and practice of office automation and information systems.
- Experienced Show Management—Exposition managed by Prestige Expositions, Inc., trade show professionals with many years of experience in the management of NCC, INFO, Interface, Federal Computer Conference, and Computer Caravan.

Find out for yourself what the pros have known for years. Fill out and mail coupon today to receive no-obligation information on exhibiting at Syntopican XII.

Prestige Expositions, Inc. P.O. Box 424 Hohokus, NJ 07423		Please supply information on exhibiting at Syntopican XII to be held July 19-21, 1984 at McCormick Place, Chicago.	
NAME _____			
TITLE _____			
COMPANY _____			
ADDRESS _____			
CITY _____		STATE _____	ZIP _____
TELEPHONE (      ) _____			

DTMN 5/1/84

## ON THE JOB

Kaplan claims that many small high-tech companies have "outgrown current management." He contends there is a strong need for general managers, "including the ceo with technical knowledge and experience in product planning, strategic marketing and sales, corporate strategy, productivity improvement, and operational and cost controls."

The report shows the only soft spot in electronics has been in the video games market, due, says Kaplan, to a combination of overproduction and low consumer

demand. If you want more information on the report, write Korn/Ferry International, 1900 Avenue of the Stars, Los Angeles, CA 90067, or call (213) 879-1843.

### SHOOT TO SCORE

The Service Corps of Retired Executives (SCORE) is an independent project sponsored by the U.S. Small Business Administration. Last year more than 10,000 of its counselors, in over 405 chapters throughout the country, advised approximately 400,000 people on the many problems in-

involved in opening a small business, or coping with the problems of a newly opened business.

"Clients don't pay for such advice, and counselors don't get paid for their services," says Samuel Saunders, head of the New York chapter. The counselors work at SCORE "for the pleasure of helping their own community."

The New York chapter is the largest branch, and is in dire need of a volunteer counselor with a computer-related background. Many of the New York branch clients have asked for advice on starting a computer-related business.

If you're interested in joining New York SCORE's group of volunteers, or you know of someone who's qualified, call Bob Shapiro or Harry Lowenstein at (212) 264-4506 for an interview. The New York chapter is at 26 Federal Plaza, Room 3130, New York, NY 10278.

### WORK IRKS

What gets the boss really ticked off? According to a survey by Accountemps, the two most disturbing types of negative employee behavior are dishonesty and goofing off.

The study was conducted for Accountemps by Burke Marketing Research, Cincinnati, Ohio, which interviewed 100 Fortune 1,000 company vps and personnel directors. Participants were asked, "What employee behavior disturbs you the most?" Mark Silbert, vice president of Accountemps, says, "Dishonesty and lack of integrity topped the list, with goofing off and irresponsibility a very close second."

The rest of the behavior traits cited, in order of their unpopularity, are as follows: arrogance and egotism; absenteeism and lateness; not following instructions or ignoring company policies; a whining or complaining attitude toward the job or company; absence of commitment, concern, or dedication; laziness and lack of motivation and enthusiasm.

### DESIGN FACTORS

According to a report by Dataquest International, San Jose, Calif., ergonomic terminal design, or human factors engineering, is becoming a marketing requirement. The report claims this is so because the "terminal user base has expanded into the computer room and clerical areas and is attracting a new and wider variety of users, including information workers." Also, "employers are concerned for the health and safety of their employees, about liability for damages from improper equipment, and about realizing the benefits of automation." For more information on the report, contact Jewel Payton, Dataquest Inc., 1290 Ridder Park Dr., San Jose, CA 95131, (408) 971-9000.

—Lauren D'Attilo

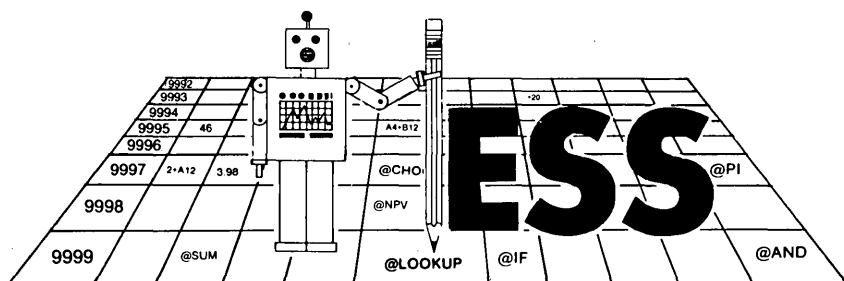

## Electronic Spread Sheet for VM/CMS & MVS/TSO - Not Just Another CALC -

**Powerful** - Spreadsheet size is limited only by available virtual storage. ESS easily handles spreadsheets with thousands of rows and/or columns.

**Proven** - Already in use at over 100 installations.

**Compatible** - ESS accepts the same commands as VisiCorp's VisiCalc® program for microcomputers. A person familiar with VisiCalc® can be using ESS productively in minutes. In addition, ESS can load and save files in VisiCalc® format.

**High Performance** - Assembler language code and sophisticated storage management techniques give you fast response, even with very large spreadsheets.

**Easy to Install** - Just load the ESS program. No additional program products or languages are required.

**Cost Effective** - ESS gives all your users access to personal computing capabilities for just \$220 per month. Compare that to the cost of buying hundreds of microcomputers.

**Questions?** - For more information about ESS, or to arrange a 30-day free trial, call or write TRAX.



TRAX Softworks, Inc.  
10801 National Blvd., Suite 205  
Los Angeles, CA 90064  
(213) 475-8729

CIRCLE 79 ON READER CARD

# READERS' FORUM

## BEYOND THE ME INDUSTRY

We have all read the criticisms of central dp organizations that cater to their own internal procedures at the expense of their in-house clients. Such complaints are no longer mere whispers among the client departments, but can be heard from dp people as well. Indeed, in my 15 years in the computer industry I noted that computing departments tended to be the queen bee departments; and in my 15 years of college and university teaching I saw that computing curricula tended to be the queen bee curricula. No wonder computing centers and computing people assume an attitude of "me" importance after so much awe and attention has been given them.

In recent years I began to perceive that this me awareness is not an individual or organizational affliction; it is an industry affliction. A number of individuals and firms in the American computer industry recently called for government help in sustaining what is seen as a muted competitiveness among U.S. computer firms in international trade. Several one-at-a-time remedies are suggested to counter the perceived threat from Japan, such as special legislative treatment and retaliatory trade restrictions. But if the American computer industry would observe the situation from the view of others, a decidedly different terrain would be in sight. Two examples will suffice.

East of Highway 128 lies a sovereign nation named France. In 1978, France published its National Computer Policy study. They perceived American dominance in computers as pervasive enough to become a threat to traditional alliances and even world peace. The French report stated that to remain a sovereign nation France must develop a domestic computer industry, under sovereign control. A number of policy changes followed, including trade restrictions on computer and communications equipment and on computer data. Some of the views expressed in the French NCP study may strike Americans as extreme, but these are the views of the French, and are subject only to American scrutiny, not approval. They are not anti-American views but pro-French views, stated in terms of sovereign survival. And, we should note, these views are consistent among the French. The deGaulle policies of the 1950s were based on precisely the idea that American dominance in the technology of the time could create a technology gap that would threaten the alliance and world stability. France still perceives a technology gap as threatening to the survival of any sovereignty that lacks a telematics technology in the twenty-first century.

West of Silicon Valley there lies a land called Japan. It published an NCP study in 1972. Japan's study stated that future information societies would run on computer databases, not energy. A domestic computer industry was a must for any nation hoping to be an international leader in the twenty-first century. The study proposed a crash program in eight areas of Japanese computing development. Joint government-industry investments in chips,

computers, communications, and AI research followed, as did the protective trade practices. Again, these were not anti-American practices, but the acts of a sovereign nation that lacked the computer industry deemed necessary for survival.

France and Japan are only two of the several nations that have developed national computer policies. These NCPs impinge upon the American computer industry, which then sees isolated events that call for knee-jerk reactions by the U.S. government. It is important that American industry leaders and political leaders understand that our computer industry is not feeling the effects of a series of singular competitive events. The computer industry of 10 years ago, one of business competitors, exists no more. Today's computer industry is one of sovereign competitors.

Homework assignment for every manager in the American computer industry: study the national computer policy reports of France and Japan. There will be a quiz, continuously, conducted by those author nations.

—Ben Matley  
Ventura, California

## HISTORY REPEATS ITSELF

There once was a King in a faraway country who decided to build himself a grand new palace. The old one was livable, but dingy and in a poor state of repair. Besides, it was made out of wood. The King wanted a splendid new palace of polished marble. The country could afford it; trade was flourishing and the people were well fed. Merchants and craftsmen came from far and wide to the city and the nation prospered. Yet all was not as well as it seemed. The King across the river was building a huge new palace of granite not a day's march away, which would put the old wooden building to shame. Our King was afraid that the trade caravans would divert to his rival's city. Business would fall off, the streets would be silent, his own people would be hungry. They might even desert him and move across the river. Worst of all, he would lose face before the entire world.

Rather than face such humiliation, the King sent for his Chief Architect and described the gleaming marble palace he envisioned. The Architect's face lit up with excitement as the King talked. Never in the Kingdom's history had such a vast project been undertaken. He would command huge sums of money and hosts of workmen. What is more, he would rise in the King's favor above even the Chief Priest and the Lord Treasurer.

Weeks passed before the Architect returned with sketches and plans of the palace to be. His design was more magnificent than the King had ever dreamed. The King summoned his council and ordered that the Architect should have everything he needed. Only the Lord Treasurer protested.

"Sire," he said, "The Architect has asked for a million

# WHEN YOUR DATAPOINT 8600 TALKS...

The DATAPOINT 8600 multifunction workstation gives your business all the advantages of an advanced processor while keeping in touch with your existing computer equipment, because it can communicate with most mainframe computers as well as with other DATAPOINT systems.

Communications is the cornerstone of the revolution DATAPOINT sparked seven years ago with the introduction of ARC<sup>®</sup> (Attached Resource Computer<sup>®</sup>), the

original local area network. Today ARC is the most thoroughly proven local area network in existence, bringing distributed processing and desktop computing to offices around the world.

## READERS' FORUM

crowns. I cannot understand why he needs so much money. Besides, it is half of what we have in the Treasury." The King was shocked by the amount, but his mind was made up nonetheless. He ordered construction of the great palace to begin.

The King was keenly interested in the work's progress, and he regularly visited the site to see how things were getting on. At first the work went very well. The site was cleared rapidly, foundations were dug, and the building's outline began to appear. The King was satisfied that everything was in good hands and he came to see the work less and less often. Then he was called away to lead his army against the King of the South, and the war kept him from the city for many months. As soon as he returned, he set off to see how his new palace was coming along.

Our King was in for quite a shock. Only the ground floor had been built and even that was not complete. Straight away he sent for the Chief Architect. It took some time to find him, as he was rushing all over the building site, making notes and giving instructions. When he arrived, the King noticed he looked very tired and his hair was grayer than when he had last seen him.

Sternly, he asked the Architect for an explanation. The man looked at his feet, and said, "Well, Sire, as you know, everything went very well until we laid the foundations, but then things started to slip. The special marble we ordered was weeks late in coming, and it's still not all here yet. The quarry promised it for the first day of spring, but I don't think they even started digging it out until then. The first batch was awful. We couldn't work with it—it kept breaking into pieces. But the worst problem has been the marblecutters." The King looked around him. There were a great number of strangely dressed workers about the site, shouting and chattering in a foreign language. One of them looked back insolently at him, without any show of respect at all.

"Those are the marblecutters, Sire. It's a very difficult job, cutting the marble. There are very few workmen skilled in the trade, and hardly any in this country. We had to fetch these from a distant land and they are an undisciplined lot." He hesitated and then added, "They're very expensive, unfortunately."

"Well, you had better do something to sort them out," said the King curtly, and he went back to his old palace, bewildered by all he had heard.

But more problems awaited him there. First came a delegation led by the Mayor, who complained, "Your Majesty, the common people are in an uproar. These marblecutters are insufferable. They swagger about the town in their outrageous clothes. They gabble in their foreign language, boasting and laughing at ordinary folk. They've no respect for authority. But what's worse is the way they splash their money about. They must each earn as much as a Captain of the Guard. You can imagine how a plain workman or peasant feels, Sire. But the girls run after them and some of the young men want to learn how to cut marble themselves." The King assured the old man that it was only for a short time and all for the good of the Kingdom.

The next visitor had an even more gloomy tale to tell. It was the Lord Treasurer. "Sire, the new palace is going to be far more expensive than we expected. The first million crowns are nearly spent and, as you have seen, there is a long way to go before the building is finished." The King asked how much the final cost would be. "It could be as much as three million, Your Majesty. We may have to raise extra taxes, and the people will be angry." The King was greatly dismayed by this news. He asked the Lord Treasurer what had caused the increased cost. "You will have to ask the Chief Architect, Sire. His explanation is very technical, and I do not understand it." That is exactly what the King did.

He summoned the Chief Architect and questioned him long and hard, but by the end of the interview he was no wiser than before. "Well," he concluded, "I can see I will have to take a much closer interest in the progress of the palace. You will get a weekly written report from each of the chief workmen, and then report to me by Monday morning. Afterwards, we will visit the site

together and see for ourselves what is going on. I won't be satisfied until I understand the reason for these delays." The Architect left white and shaken. The King had been very severe with him, and he feared for his head.

From the very first, these Monday meetings only confused the King even more. He would ask very simple questions such as, "When will the ground floor be finished?" The experts would look at each other as if he were a simpleton. Then they would talk about something completely different—the acidity of the soil, the moisture content in the structural timber, the stress safety factors in walls facing north. The King questioned for hours, but never got a plain answer. As time passed without any real sign of progress, the meetings became more and more heated. The masons blamed the scaffolders, the scaffolders blamed the carpenters, the carpenters blamed the masons. Everyone blamed the marblecutters. The Chief Marblecutter got so excited he reverted to his native tongue and no one understood a word he said.

After sometime, the King lost his patience. He stormed from the last meeting in a fury, leaving his subjects trembling with fear. But despite his anger, he still needed a new palace. He had lost all faith in his own Chief Architect, so he decided to send for a famous Master Builder from another country. After many days' travel, the Master Builder arrived and got to work. He shook his head sadly as he read all the reports the King had received. He would say only that the project was in a very bad way, which the King knew already. At length he pushed aside all the papers and stood up. "Now we must visit the building site, Your Majesty. I suggest we go in disguise so we can see what is really going on."

Reluctantly, the King agreed. They each put on dirty, uncomfortable working clothes and set off for the site. As they walked among the unfinished walls the Master Builder's face grew longer and longer. He clucked and shook his head at everything he saw. After a thorough inspection, they climbed to the top of a huge pile

## DIGITS BY ROY MENGOT

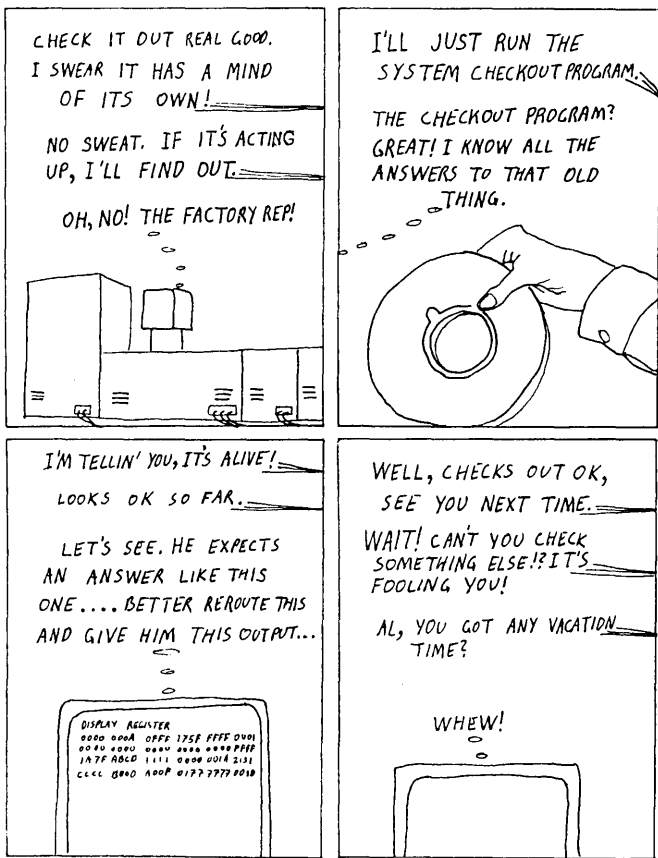

# ...YOUR MAINFRAME LISTENS.

And the 8600 processor is a vital part of the DATAPOINT approach to local area network communications. It features integrated data processing, word processing, electronic mail, data communications, financial spreadsheet software, system operations, and mainframe communications in one desktop unit. When the 8600 is linked to your other computer equipment via an ARC local area network, it becomes part of a system that can expand as far and

as fast as your business expands. If your business is ready to join the revolution, talk to our worldwide sales and service force about the 8600. It could put a spark of the revolution in your office.

Call 1-800-334-1122 toll-free for a demonstration. M136  
Or send this coupon to: DATAPOINT Corporation,  
9725 Datapoint Drive, T-47, San Antonio, Texas 78284

Name \_\_\_\_\_ Title \_\_\_\_\_  
Company \_\_\_\_\_  
Address \_\_\_\_\_  
City \_\_\_\_\_ State \_\_\_\_\_ Zip \_\_\_\_\_  
Telephone (\_\_\_\_) \_\_\_\_\_

 **DATAPOINT**  
We sparked the revolution.

# THE SOFTWARE SHUFFLE ENDS.

You have better things to do than to run from one computer show to another searching for your software needs.

INFO/Software puts an end to all the running around.

INFO/Software is the complete, across-the-board Show for business software. Exclusively software. Especially for corporate executives.

No matter what kind of software you want, or what kinds of hardware you have, you can go to one Show to see, test and compare the entire spectrum of applications and operating systems.

Mainframe software. Minicomputer software. Microcomputer software. And software services.

Your program will be easy to find, thanks to INFO/Software's unique Software Information Center. Just tell the attendant what kind of program or business system you want, and the model of your computer. In moments, you'll get a printout listing the names, booth locations and product descriptions of INFO/Software exhibitors who have the programs and services that meet your needs.

Alongside the most complete software Show will be the best source for managerial solutions to your complex software problems: the INFO/Software Conference.

Software News Editor, **Ed Bride** is Conference Chairman and the roster of Conference Advisors includes some of the best minds in the computer industry:

**Dr. John H. Bennett,**  
Corporate Director,  
United Technologies

**Bruce Coleman,**  
President,  
Informatics General Corporation

**Frank Dodge,**  
President,  
McCormack & Dodge Corporation

**Ray Epich,**  
Vice President/MIS,  
Northwest Industries

**Dave Ferris,**  
Software Industry Consultant

**Martin A. Goetz,**  
Vice President,  
Applied Data Research, Inc.

**Gilbert H. Hoxie,**  
Chairman,  
Context Management Systems

**John Imlay,**  
Chairman,  
Management Science America, Inc.

**James Marpe,**  
Partner,  
Arthur Andersen

**Alan Perlman,**  
MIS Manager,  
Northwest Industries

**Larry Welke,**  
President,  
International Computer Programs, Inc.

They'll be speaking on the most relevant, most timely, most important topics that affect executive's business software decisions. Topics like "Micro-to-mainframe: access vs. security"... "Integrated mainframe applications: what do they mean to the end user?"... "Information Center Operation"... "Business Graphics"... "Overseas Operations: selecting software"... plus a software CEO Panel Discussion and more. The INFO/Conference will, of course, cover the entire spectrum of mainframe, mini, and microcomputer software, operating systems and applications.

So end the software shuffle. Come to INFO/Software. The one Show that brings all your software needs together.

**info software**

INFO/Software  
is brought to you by  
Clapp & Poliak  
(A Cahners Exposition  
Group Company)  
the same people who  
bring you the  
INFO Shows.

**INFORMATION MANAGEMENT  
EXPOSITION & CONFERENCE  
FOR SOFTWARE**

**MCCORMICK PLACE • CHICAGO  
JUNE 12-14, 1984**

For further information contact:  
Clapp & Poliak (A Cahners  
Exposition Group Company) 708  
Third Avenue, New York, N.Y.  
10017  
Telephone 212-661-8010 Telex  
12-6185 Cable CLAPPOLIAK NYK

After April 1, 1984  
999 Summer Street, P.O. Box  
3833, Stamford, CT 06905  
Telephone 203-964-0000  
Telex 649400 CAHEX WU STD

## READERS' FORUM

of unused stone and sat down to rest.

"Well," said the Master Builder, "Whatever they're building, it isn't a palace. It looks more like an adventure playground to me. They're having a high old time at your expense."

Startled, the King looked about and realized what the Master Builder said was true. The scaffolders had built a weird structure which supported no part of the building and seemed to have no purpose except as an example of the scaffolders' art. The marblecutters were making wonderfully detailed and elaborate statues which they fussed over and polished with infinite care. Parties of workmen all over the site were each pursuing their own projects while the main building lay neglected. None of this bore any likeness to the plans the Chief Architect had shown him so many months before.

"The trouble is," said the Master Builder, "this is all too big and complicated. No one has ever built a marble palace before, certainly not one this size. Those marble salesmen ought to have their tongues cut out for the stories they told. None of these people know what they're supposed to be doing."

"But what about my new palace?" cried the King. "The old one is falling to pieces!"

"You'll have to clear all this away and start again with a nice, simple design. Use sandstone—it's easy to work, cheap, and you can quarry it locally. Use some of the marble on the throne room floor, if you absolutely must."

The King cast aside his disguise and sent for a party of the Palace Guard. Then he called the entire work force together to explain his new plan. But none of the workers approved.

The Chief Marblecutter approached the King at the head of his men. "You miserable Philistine!" he spat. "You can keep your sandstone! We work only in marble. We're off to build a great marble city for the King of the South!" The guards rushed forward to strike the marblecutters down, but the King ordered them back. "Let them go. The King of the South is welcome to them. They could save us years of war."

So the King returned to his old palace, which seemed smaller and dingier than ever. Even the news that his rival's granite building across the river had collapsed in a cloud of dust could not raise his spirits. At length, he sent for the Master of the Household, who had the thankless task of maintaining the old wooden structure. He seemed unusually cheerful today, for some reason. "I have decided to abandon all work on the new palace for the present," announced the King despondently. "I want you to draw up plans for renovating the old building."

The Master of the Household did not seem at all surprised. In fact, he produced a bundle of notes, as if he had come prepared. "The roof has got dry rot and the cellars are damp, Sire. The building is riddled with woodworm and, of course, the kitchens are hopeless. But the biggest problem is the cherzil wood."

"Cherzil wood?" asked the King, suspiciously.

"Yes Sire. The whole building is made out of it. It's hard to get hold of these days, and very difficult to work with. Old Albert was a real craftsman in cherzil wood, but he left when we started on the new palace. Quite upset he was. Still, we'll replace him somehow."

"How much will it all cost?"

The Master of the Household seemed embarrassed. He leafed through his notes. "Er, about a million crowns I would say, Sire."

The King sighed and sank a little deeper in his seat.

—T.K. Gibbons  
London, England

If you'd like to share your opinions, gripes, or experiences with other readers, send them to the Forum Editor, DATAMATION, 875 Third Ave., New York, NY 10022. We welcome essays, poems, humor, or short stories.

## AT AT&T, WE TEACH UNIX™ OPERATING SYSTEMS AS IF WE INVENTED THEM.

### Announcing training from the creators of the UNIX Operating Systems.

Now everyone can get top quality UNIX Operating Systems training, from the people who created them—AT&T Bell Laboratories. Along with our certified instructors, we offer a complete curriculum for UNIX Operating Systems, including UNIX System V.

These courses are the same as those conducted internally at AT&T Bell Laboratories. And we furnish them at your location or at one of our conveniently located centers: Princeton, NJ; Chicago, IL; Columbus, OH; and Sunnyvale, CA.

We provide an individual terminal for each student. And in the evening, the use of our facilities and terminals is available at no extra cost. In addition, volume discounts are available.

All UNIX Operating Systems courses are designed and developed to high quality standards by AT&T, as part of a total commitment to UNIX Operating Systems support. Now with our training, you can learn firsthand, what everyone else has been teaching secondhand.

For information, call us at 800-221-1647 or write to AT&T, P.O. Box 2000, Hopewell, NJ 08525.





## ADVERTISING OFFICES

Advertising Sales Manager:  
**William J. McGuire**  
 New York, NY 10022  
 875 Third Ave.  
 (212) 605-9715

Marketing Services Manager:  
**Kathleen A. Murray**  
 New York, NY 10022  
 875 Third Ave.  
 (212) 605-9723

Eastern District Managers:  
**Francie Bolger, John M. Gleason**  
 New York, NY 10022  
 875 Third Ave.  
 (212) 605-9400

New England District Managers:  
**Jack Orth, John M. Gleason**  
 Newton, MA 02159  
 181 Wells Ave.  
 (617) 964-3730

Mid-Atlantic District Mgr.:  
**Patricia Joseph**  
 Plymouth Meeting, PA 19462  
 Plymouth Plaza, Suite 201  
 (215) 825-4410

Southern District Managers:  
**Michael W. Andrea**  
 4 Executive Park Drive N.E.  
 Suite 1205  
 Atlanta, GA 30329  
 (404) 633-5112

**Warren A. Tibbetts**  
 West Palm Beach, FL 33406  
 7621 West Lake Dr., Lake Clark Shores  
 (305) 964-6298

Southwest District Mgr.:  
**Randall A. Clark**  
 1700 Eastgate Drive  
 Suite 103  
 Garland, Texas 75041  
 (214) 270-6461

Midwest District Mgr.:  
**Joseph P. Gleason**  
 Chicago, IL 60601  
 3 Illinois Center Building, 303 East Wacker Dr.  
 (312) 938-2926

Western District Managers:  
**William M. Wilshire**  
 Irvine, CA 92715  
 2061 Business Center Dr., Suite 111  
 (714) 476-2511

**Robert J. Rielly**  
 Los Angeles, CA 90035  
 1801 S. La Cienega Blvd.  
 (213) 559-5111

**James E. Filltraut, Janet Engelbrecht**  
 Mountain View, CA 94043  
 2680 Bayshore Frontage Rd., Suite 401  
 (415) 965-8222

U.K., Scandinavia, Benelux,  
 Director - European Operations  
**Martin Sutcliffe, Robert Saidel**  
 Technical Publishing Co.  
 130 Jermyon Street, London, SW1 4UJ, England  
 Tel: 01-839-3916, Telex: 914911

France, Spain  
**Vivien James**

Germany, Austria, E. Europe  
**Martin Noble, Robert S. Gibson**  
 Technical Publishing Company  
 6000 Frankfurt 60  
 Scheidswaldstr 41, W. Germany

Tel: (611) 590 711, Telex: W. Germany 414561  
 LCO D

Italy:  
**Luigi Rancati**  
 Rancati Advertising  
 San Felice Torre 5  
 20090 Segrate, Milano, Italy  
 Tel: 2-7531445,  
 Telex: 311010

Switzerland:  
**Andre Lehmann**  
 ALAS AG  
 Business-Centre  
 Schoegrund 1  
 CH 6343 Rotkreuz, Switzerland  
 Tel: (42) 642964, Telex: 864958

Japan:  
**Shigeru Kobayashi**  
 Japan Advertising Communications, Inc.  
 New Ginza Building, 3-13 Ginza 7-chome  
 Chuo-ku, Tokyo 104, Japan  
 Tel: (03) 571-8748, Telex: J22745

**John K. Abely**, President  
**Robert L. Dickson**, Exec Vice President  
**Edwin V. Burkholder**, Senior Vice President/  
 Technology  
**Walter M. Harrington**, Vice President/Finance  
 and Administration

**Technical Publishing**  
 a company of  
**DB** The Dun & Bradstreet Corporation

# Heart disease or stroke can cheat you out of the best years of your life.

Those are the years shared with people you love. And when a loved one is gone, everything changes. You can't imagine the loss, unless it happens to you. Last year, nearly one million Americans died of heart disease and stroke — 200,000 of them before retirement age.

The American Heart Association is fighting to reduce early death and disability from heart disease and stroke with research, professional and public education, and community service programs.

But more needs to be done. You can help us save young lives by sending your dollars today to your local Heart Association, listed in your telephone directory.



**American Heart Association**

WE'RE FIGHTING FOR YOUR LIFE

Announcing the WY-75.



Our new WY-75, VT-100 software-compatible terminal has a style that's truly impressive.

It offers a combination of features you can't find in any other VT-100 software-compatible terminal. Like a compact, ergonomic design. A sculpted, low-profile keyboard. And a swivel and tilt non-glare 14" screen, tailored with an 80/132 column format.

Priced in a class by itself, the WY-75 lists for only \$795.

Contact Wyse Technology for more information. And discover a great new outfit.

**\$795**

**All DEC'd out  
and ready to go.**

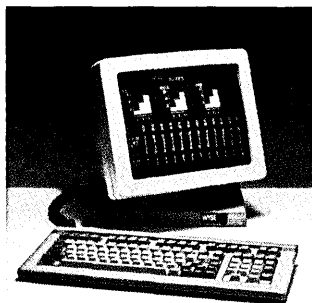

**WYSE**

Make the Wyse Decision.

Wyse Technology, 3040 N. First Street, San Jose, CA, 95134, 408/946-3075,  
TLX 910-338-2251, Outside CA call toll free, 800/421-1058, in So. CA 213/340-2013.

DEC is a trademark of Digital Equipment Corporation.

**CIRCLE 2 ON READER CARD**

# NO OTHER FEATURE PRESENTATION RUNS AS LONG AS OURS.

Introducing the 5420, an editing terminal that's chock-full of features that are sure to make it a hit. That's because Teletype Corporation built it to be everything you'd ever want in an ANSI 3.64 based asynchronous terminal.

To begin with, there are four ways to access and manipulate the display and memory. Scroll mode lets you scan all 72 lines of available memory with the display.

Horizontal split screen separates the display into fixed and scrolling regions. Windowing divides the display into as many as four viewports and workspaces that let you process groups of data simultaneously. Page mode makes the terminal perform as if it were three.

Another example of the amazing value the 5420 represents, is that it lets you change from an 80 to 132 column mode to put more data—including accounting spreadsheets—on display.

In addition to eight system defined function keys that can be down-line loaded from a host, you get eight non-volatile user defined function keys that can be entered locally. All 16 function keys are easily associated with screen labels. When the function of these keys is changed, the screen labels can change right along with them. And a variety of local terminal features can be accessed through the screen labeled keys.

As if that's not enough, there's an English menu for fast set up when optioning. The 5420 is also buffered so you can send a character, line or page of data at a time. Plus, you get character, word and line insert/delete. A bi-directional, buffered EIA printer port is standard.

We didn't skimp on ergonomics, either. That's evident in the detachable, low-profile keyboard you can operate on your lap. And in the crisp, clear images you get with the tiltable, high resolution, non-glare screen.

Self-diagnostics help pinpoint problems. And you can count on our established nationwide service organization for fast service.

Looks like we've run out of room for features. For more information, write Teletype Corporation, 5555 Touhy Ave., Dept. 3223-A, Skokie, IL 60077. Or call 1 800 323-1229, Extension 204.

## TELETYPE® VALUE SETS US APART.

"Teletype" is a registered trademark and service mark of Teletype Corporation.

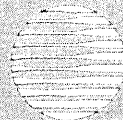

**AT&T**  
Teletype Corporation

CIRCLE 3 ON READER CARD