

EDN[®]

SCPI instruments ease ATE development	pg 39
Serial EEPROMs	pg 57
DSP-chip directory: Programs let you configure your own part	pg 104
Directory entries	pg 108

ELECTRONIC TECHNOLOGY FOR ENGINEERS AND ENGINEERING MANAGERS

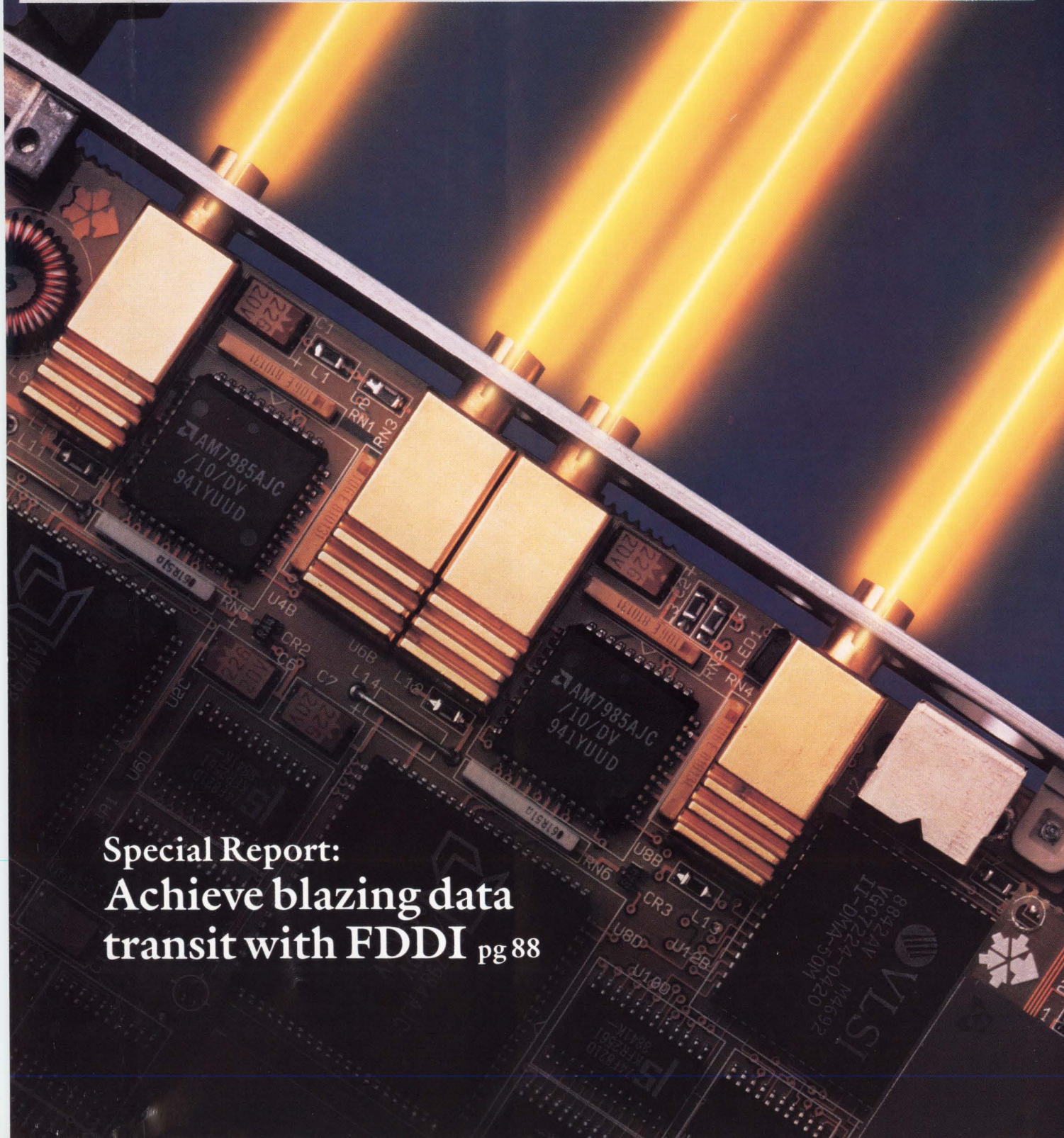

Special Report:
**Achieve blazing data
transit with FDDI** pg 88

Now catch the bugs that defy logic.



LOCK UP

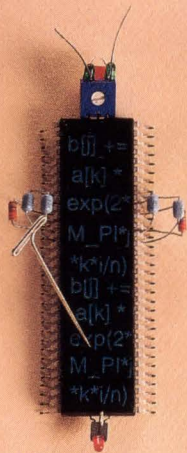

INCORRECT
REGISTER
VALUE

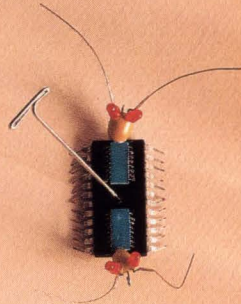

RANDOM
OUTPUT

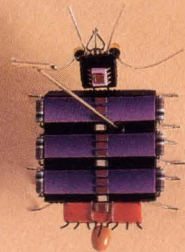

PARITY
ERROR



UNEXPECTED
EXCEPTION

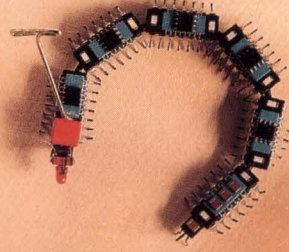

REPEATING
RESET

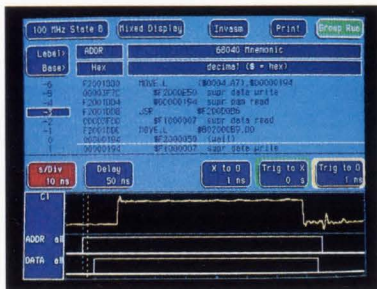

The HP16500A logic analysis system shows what's bothering your designs.

Power up a new design and you're in for a battle. That's when you need the HP 16500A logic analysis system. With one modular system, you can focus measurement power on those press-

ing problems. Before things get out of hand.

Choose from a wide range of modules. The state/timing module provides advanced capabilities, including 100 MHz state speed for debugging RISC and high-end CISC processors. There's a 1 GSa/s scope for single-shot troubleshooting. A 1 GHz timing module for precision time-interval measurements. And pattern generation for functional testing.

And you get the industry's broadest microprocessor and bus support...more than 100 solutions to speed and simplify debugging of virtually any microprocessor based design. Plus an intuitive

full-color, touch-screen interface to make setup and operation easier too.

So take control of the debugging process. Call 1-800-452-4844. Ask for Ext.2604 and we'll send a brochure on the analysis system that can catch the toughest bugs before they start bothering you.

There is a better way.



* In Canada call 1-800-387-3867, Dept. 429.
©1991 Hewlett-Packard Co. TMCOL123/EDN

STD 32[®]

FOR APPLICATIONS WITH
A FUTURE—**TODAY**

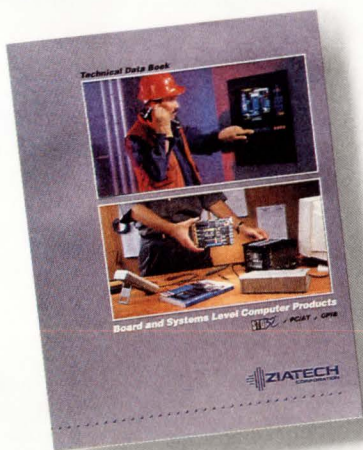

REAL PRODUCTS, NOW

Ziatech's STD and STD 32 industrial computers provide a compact, low-cost alternative to VME, MULTIBUS and the AT bus. 8-, 16- and 32-bit solutions with sophisticated multiprocessing are available now.

Call for our brand-new 200+ page technical data book.

PHONE: 805-541-0488
FAX: 805-541-5088

 **ZIATECH**
CORPORATION

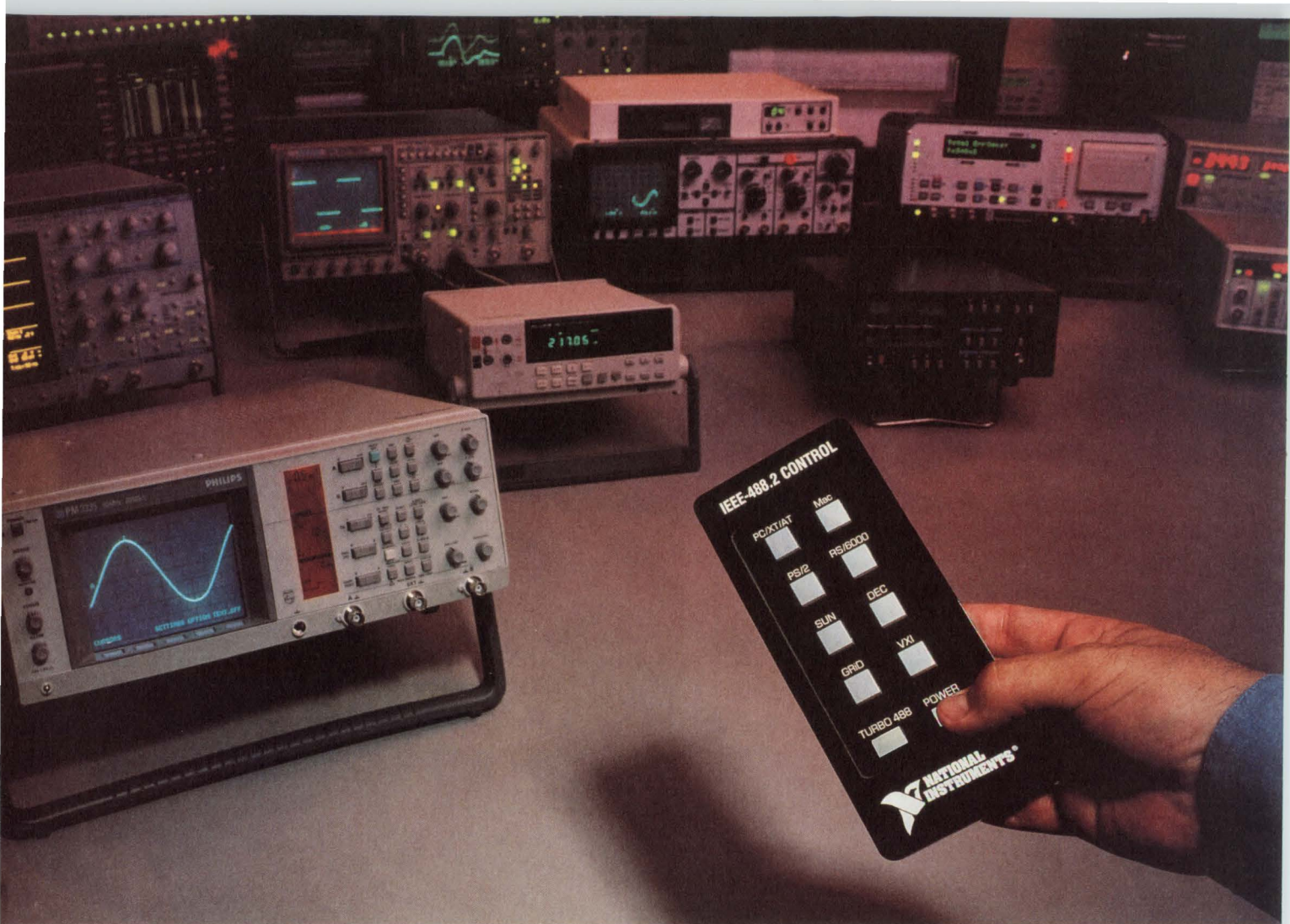

ULTIMATE CONTROL

No one can give you control of your GPIB test system like National Instruments can.

PERFORMANCE

The NAT4882™ chip makes our GPIB controller boards completely IEEE-488.2 compatible. When the NAT4882 is teamed with the Turbo488® performance chip, you get the maximum IEEE-488 transfer rate of 1 Mbytes/sec for both read and write operations.

Use our industry-standard NI-488® software to control your GPIB instruments and give your test programs maximum throughput, regardless of your choice of personal computers or workstations.

COMPATIBILITY

The NAT4882 controller chip is also compatible with the controller chips of the past, so you get the best of both worlds – complete compatibility with your existing applications and the ability to meet your future requirements.

And when your controller needs change, NI-488 programs are compatible across many different platforms and operating systems – without modification.

UPGRADE PROGRAM

Existing PC, PS/2, and Macintosh customers can upgrade to the benefits of IEEE-488.2 and increased performance through a special upgrade program.

TRAINING

Learn even more ways to improve your test system by taking our hands-on, IEEE-488 training course.

For more information on how you can have the ultimate GPIB control, call:
 (512) 794-0100 or
 (800) IEEE 488
 (Toll-free U.S. and Canada)

 **NATIONAL INSTRUMENTS®**
The Software is the Instrument®
 6504 Bridge Point Parkway
 Austin, TX 78730-5039

AUSTRALIA (03) 879 9422 • DENMARK (45) 76 73 22 • FRANCE (1) 48 65 33 70 • GERMANY (089) 714 5093 • ITALY (02) 4830 1892
 JAPAN (03) 3788 1921 • NETHERLANDS (01720) 45761 • NORWAY (03) 846 866 • SPAIN (908) 604 304 • SWITZERLAND (056) 45 58 80 • U.K. (0635) 523 545
 Product names listed are trademarks of their respective manufacturers. Company names listed are trademarks or trade names of their respective companies. © Copyright 1991 National Instruments Corporation. All rights reserved.

Circle No. 27
 See us at ISA booth 5949

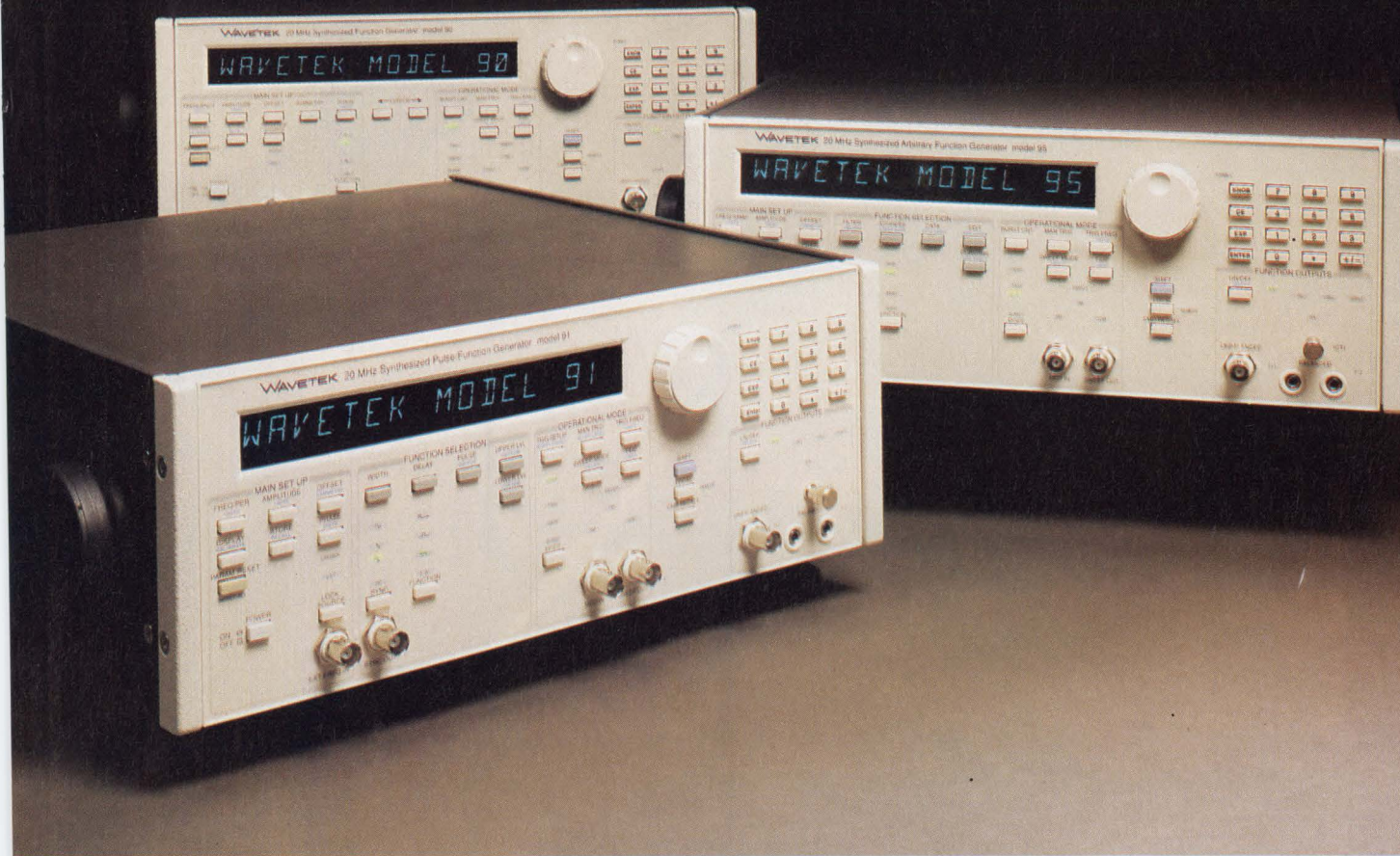

Our Model 91 will make your pulse race and help you function better.

Introducing the latest member of the 90 Series family: Model 91 Synthesized Pulse Function Generator. It delivers functions and pulses to 20 MHz with five digit frequency accuracy. Out the rear it has pulses to 50 MHz and a 100 MHz clock output. Choose ECL, CMOS or TTL levels, or set your own.

The functions and pulses can be swept or modulated,

and there is even GPIB programmability. Plus an external frequency input that lets you use the Model 91 as a frequency counter.

With all these capabilities, Model 91 redefines the concept of an all-purpose benchtop instrument.

About all it doesn't do is generate arbitrary waveforms, but there's the Wavetek Model 95 Synthesized Arbitrary Function Generator for that.

Of course if you want even greater pulse generation capability, our four-channel Model 869 is among the most accurate pulse generators in the world.

For more information about our multi-purpose function generators, high performance pulse generators, or test development and arbitrary waveform software, call Wavetek at 1-800-874-4835.





A core, two caps and
nickel chromium film
can't get you to market sooner.

Metal film resistance. Lots of people supply it, but at Dale® we have more ways to make it work to your advantage.

From the start, we'll give you more alternatives for fine-tuning resistance to your application — right out of the catalog. Low cost commercial to ultra precision.

High power. Ultra high or low value. Tight tolerance. Matched sets. Thick film chips, plus thin film chips for surface mounting. Qualifications include: MIL-R-10509, MIL-R-22684, MIL-R-39017, MIL-R-55182 and MIL-R-55342.

Dale® Can.



All guided by Statistical Process Control and Just-In-Time Delivery systems.

For high performance, high volume or both, Dale has products to meet your exact needs, plus

multiple sourcing to protect your production schedule.

Save time by contacting your Dale Representative or contact: Dale Electronics, Inc., Norfolk Division, 2300 Riverside Blvd., Norfolk, NE 68701-2242. Phone (402) 371-0080.



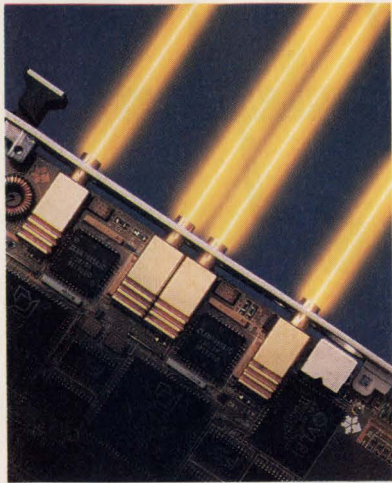

On the cover: Light traveling along fiber-optic highways lets FDDI (Fiber Distributed Data Interface) LANs transmit data at 100 Mbps. See our Special Report on pg 88. (Photo courtesy Interphase Corp)

SPECIAL REPORT

FDDI stations

88

Increasing network demands are straining the throughput of first-generation LANs. To meet high-performance requirements, network designers are starting to adopt the 100-Mbps Fiber Distributed Data Interface (FDDI). Unfortunately, FDDI stations don't come cheap.—*John Gallant, Associate Editor*

DESIGN FEATURE

EDN's DSP-chip directory

104

The tools needed to develop applications that use digital signal processing (DSP) continue to improve. Now, a choice of operating systems and interfaces to host operating systems is making DSP available to more applications.—*David Shear, Contributing Editor*

TECHNOLOGY UPDATES

SCPI instruments will ease ATE development 39

Engineers who want to minimize test-system development time and maximize system flexibility should use SCPI instruments whenever possible.—*Maury Wright, Regional Editor*

Serial EEPROMs: Serial memory offers cheap frills

57

You don't need a byte-wide interface or large devices to add a little nonvolatile memory to your system. Serial EEPROMs are an inexpensive option that offer a few extras.

—*Richard A Quinnell, Regional Editor*

Continued on page 7

EDN® (ISSN 0012-7515, GST Reg. #123397457) is published 48 times a year (biweekly with 2 additional issues a month, except for February, which has 3 additional issues and July and December which have 1 additional issue) by Cahners Publishing Company, A Division of Reed Publishing USA, 275 Washington Street, Newton, MA 02158-1630. Terrence M McDermott, President; Frank Sibley, Executive Vice President; Jerry D Neth, Senior Vice President/Publishing Operations; J J Walsh, Senior Vice President/Finance; Thomas J Dellamaria, Senior Vice President/Production and Manufacturing; Ralph Knupp, Vice President/Human Resources. EDN® is a registered trademark of Reed Properties Inc., used under license. Circulation records are maintained at Cahners Publishing Company, 44 Cook Street, Denver, CO 80206-5800. Telephone: (303) 388-4511. Second-class postage paid at Denver, CO 80206-5800 and additional mailing offices. **POSTMASTER: Send address corrections to EDN®, PO Box 173377, Denver, CO 80217-3377.** EDN® copyright 1991 by Reed Publishing USA; Ronald G Segel, Chairman and Chief Executive Officer; Robert L Krakoff, President and Chief Operating Officer; William M Platt, Senior Vice President. Annual subscription rates for nonqualified people: USA, \$119.95/year; Mexico, \$169.95/year; Canada, \$181.85/year; all other nations, \$209.95/year for surface mail and \$329.95/year for air mail. Single copies are available for \$15. Please address all subscription mail to Ellen Porter, 44 Cook Street, Denver, CO 80206-5800.

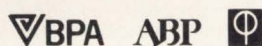

TAKE THE SPEED LEAD.

PAL™ 22V10: 7.5ns.

World's fastest programmable 22V10.

Here is the logic for high-performance systems running up to 111 MHz. Set-up is just 3 ns. Fast logic for fast systems. You get the same high speed and low noise with the 22VP10. It offers additional flexibility, including an I/O feedback path to accelerate state machine applications.

BiCMOS. The first BiCMOS 22V10, from the company that delivered the first CMOS 22V10. ECL core path for record-setting performance. CMOS logic outside the speed path, for low power. The speed of smaller PLDs, the convenience of the popular, flexible 22V10 and field programmable too.



The new 7.5 ns field programmable, PLD.

Broad 22V10 PLD family and more. Cypress's 15 ns CMOS 22V10 consumes less power than any electrically erasable alternative. It's just one of a broad range of low-power CMOS PLDs. Also get 28-pin applications-tailored PLDs, and our high-capacity MAX™ PLDs too.

Call Today. Order our PLD Kit and we'll ship it right away. Why wait?

Hotline: 1-800-952-6300.*
Ask for Dept. C4Q.



*1 (800) 833-0306 in Canada. (32) 2-652-0270 in Europe. ©1991 Cypress Semiconductor, 3901 North First Street, San Jose, CA 95134. Phone: 1- (408) 943-2600, Telex: 821032 CYPRESS SNJ UD, TWX: 910-997-0753. Trademarks: PAL, Advanced Micro Devices, Inc. MAX, Altera Corporation.



CYPRESS
SEMICONDUCTOR

VP/Publisher
Peter D Coley

Associate Publisher
Mark Holdreith

VP/Editor/Editorial Director
Jonathan Titus

Executive Editor
Steven H Leibson

Managing Editor
Joan Morrow Lynch

Assistant Managing Editor
Christine McElvenny

Special Projects
Gary Legg

Home Office, Editorial Staff
275 Washington St, Newton, MA 02158
(617) 964-3030

Tom Ormond, *Senior Editor*
Charles Small, *Senior Editor*
Jay Fraser, *Associate Editor*
John A Gallant, *Associate Editor*
Michael C Markowitz, *Associate Editor*
Dave Pryce, *Associate Editor*
Carl Quesnel, *Associate Editor*
Susan Rose, *Associate Editor*
Julie Anne Schofield, *Associate Editor*
Dan Strassberg, *Associate Editor*
Chris Terry, *Associate Editor*
Helen McElwee, *Senior Copy Editor*
James P Leonard, *Copy Editor*
Brian J Tobey, *Production Editor*
Gillian A Caulfield, *Production Editor*

Editorial Field Offices

Doug Conner, *Regional Editor*
Atascadero, CA: (805) 461-9669

J D Mosley, *Regional Editor*
Arlington, TX: (817) 465-4961

Richard A Quinell, *Regional Editor*
Aptos, CA: (408) 685-8028

Anne Watson Swager, *Regional Editor*
Wynnewood, PA: (215) 645-0544

Ray Weiss, *Regional Editor*
Woodland Hills, CA: (818) 704-9454

Maury Wright, *Regional Editor*
San Diego, CA: (619) 748-6785

Brian Kerridge, *European Editor*
(508) 28435
22 Mill Rd, Loddon
Norwich, NR14 6DR, UK

Contributing Editors
Robert Pease, Don Powers,
David Shear, Bill Travis

Editorial Coordinator
Kathy Leonard

Editorial Services
Helen Benedict

Art Staff
Ken Racicot, *Senior Art Director*
Chinsoo Chung, *Associate Art Director*
Cathy Madigan, *Staff Artist*

Production/Manufacturing Staff
Andrew A Jantz, *Production Supervisor*
Sheilagh Hamill, *Production Manager*
Melissa Carman, *Production Assistant*
Diane Malone, *Composition*

Director of Art Department
Robert L Fernandez
Norman Graf, *Associate*

VP/Production/Manufacturing
Wayne Hulitzky

Director of Production/Manufacturing
John R Sanders

Business Director
Deborah Virtue

Marketing Communications
Kathy Calderini, *Manager*
Pam Winch, *Promotion Assistant*

EDITORS' CHOICES

Multifunction optical drive	73
Waveform generator	77

PRODUCT UPDATES

Raster image-accelerator IC	81
IC test station	83

DESIGN IDEAS

High-frequency VCOs top 100 MHz	135
Three transistors convert ac to dc	136

EDITORIAL

Today's programming systems don't take advantage of engineers' inherent spatial-reasoning abilities.	33
--	----

NEW PRODUCTS

CAE & Software Development Tools	138
Computers & Peripherals	140
Integrated Circuits	142
Test & Measurement Instruments	145
Components & Power Supplies	146

DEPARTMENTS

News Breaks	17
Signals & Noise	27
Career Opportunities	154
EDN's International Advertisers Index	159

Cahners Publishing Company, A Division of Reed Publishing USA Specialized Business Magazines for Building & Construction Research Technology Electronics Computing Printing Publishing Health Care Foodservice Packaging Environmental Engineering Manufacturing Entertainment Media Home Furnishings Interior Design and Lodging. Specialized Consumer Magazines for Child Care Boating and Wedding Planning.

The Shot Heard



AMD Am386

AMD Introduces The Am386™ Microprocessor.

You say you want a revolution? We've got your ammunition: The Am386 microprocessor. And it stands for the same principles you value most—higher speeds, longer battery life, better price-performance, and the freedom to choose your own vendor.

The Am386DXL-40 microprocessor shatters the 33MHz 386 speed barrier with

a genuine, 40MHz, plug-in replacement. Which means you can easily offer the fastest 386 system available.

Thanks to its truly static operation, the Am386 microprocessor family uses very little power. So you can expect battery life up to 5.5 hours under normal working conditions with our 25MHz, low-power Am386SXL-25 CPU.

'Round The World.

MAGNUM

And the price you pay for such freedoms is small, and getting smaller. Because we've brought back aggressive learning curve pricing, anticipating at least a 20% price reduction each year for our Am386SXL-25 CPU.

What's more, the Am386 microprocessor family is available today, available in quantity, and available to everyone.

In truth, it's *the microprocessor for the masses*. So call AMD today at **1-800-222-9323**.

And start a revolution of your own with the Am386 microprocessor.



Advanced Micro Devices

"We're Not Your Competition."

Our pulse generators will test what you have.



High Speed Bi-polar

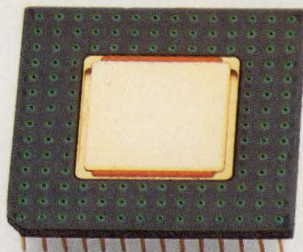

BICMOS



ECL



ECLips

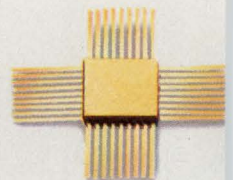

GaAs

That's a big statement. But these are powerful programmable pulse generators. Combined, they deliver top speed, high resolution and pulse-parameter flexibility. So you get accurate testing of your present and future high-speed designs, whether they're ICs, PCBs, or components.

Put the 500 MHz HP 8131A



HP 8130A Pulse Generator



HP 8131A Pulse Generator

to work on your hottest new devices. With a transition time of <math><200\text{ ps}</math>, plus pulse widths down to 500 ps with 10 ps timing resolution, you get the stimulus you've needed for accurate testing of your fastest designs.

For the most complete testing of your high-speed devices, choose the HP 8130A. It has

And what you have in mind.



© 1991 Hewlett-Packard Co. TMBID957B/EDN

the features you've wanted in a 300 MHz pulse generator, including variable transition times down to 1 ns, and 10 ps timing resolution. Which means you not only have the flexibility for high-speed parametric testing of digital devices, but for analog device testing as well.

So call **1-800-452-4844** today. Ask for **Ext. 2631** to get data

sheets and application information. Then get the programmable pulse generators you need for the fast devices you have in hand and mind.

There is a better way.



**HEWLETT
PACKARD**



ANY WAY YOU SLICE IT, GENERATION COVERS EVERY

The squeeze is on. Today the PC market is rapidly concentrating into three segments: Notebooks, Desktops and Workstations. And once again, Conner has anticipated these changes.

Which is why we're introducing our newest wave of high-performance 2.5-inch and 3.5-inch drives to meet the needs of each of these evolving market segments.

For the notebook market, take our newest Pancho drive.

With 85 Mbytes, it offers the highest capacity available in a light weight, patented 2.5-inch form factor. Low power consumption, rugged packaging and a compact form factor make it the ultimate choice for 386SX and 486SX-based notebook computers.

Then there's our new Jaguar Series for the desktop market—3.5-inch drives offering 85 and 170 Mbytes. A 17 msec. average seek time and a light weight, patented 1-inch



Summit 540 MB



Cougar 210 MB



Jaguar 85/170 MB



Pancho 85 MB

World Headquarters: 3081 Zanker Road, San Jose, CA 95134 Telephone: (408) 456-4500 FAX: (408) 456-4501 Sales Offices: Asia—Singapore: (65) 296-1992 • Taipei: (886) 2-718-9193 • Tokyo: (81) 3-3485-8901 • Seoul: (82) 2-551-0511 Europe © 1991 Conner Peripherals, Inc.



CONNER'S NEWEST SEGMENT OF THE MARKET.

high form factor make them ideal for a full range of desktop computers.

For workstations, we're introducing two new 3.5-inch drives—the 210 Mbyte Cougar and 540 Mbyte Summit. Cougar is the highest performance low-profile drive on the market today. While Summit delivers the greatest capacity and performance of any 3.5-inch drive. Both provide a fast average seek time of 12 msec., a 2.5 Mbyte per second sustained transfer rate and a SCSI-2 interface.

It's all a part of our innovative sell-design-build business philosophy. To identify our customer's needs sooner. Then

fill them faster with the most advanced products. In fact, we're the technological leader with nine patents issued and 27 pending. Which is why more and more PC users are asking for systems with Conner drives.

So if the changing market segments are putting the squeeze on your systems, call us today. We'll guarantee you the most refreshing results.

CONNER
Delivering A Generation Ahead

—London: (44) 071-409-0090 • Munich: (49) 89-129-8061 • Paris: (33) 1-47-47-41-08 • Aosta: (39) 125-800260 • U.S.—Boston: (617) 449-9550 • Dallas: (214) 680-2913 • Irvine: (714) 727-2462 • Minneapolis: (612) 449-5186 • San Jose: (408) 456-4500.

S A M S U N G

NOW

Once you've had a look at the Samsung line of EEPROMs, it's

easy to see why it's the broadest line available.

In commercial and industrial grades—and from 256K, 64K, and 16K parallel parts down to serial chips in many organizations—the Samsung EEPROM line represents a true commitment.

Which is good news.

Particularly at a time when major manufacturers are abandoning the EEPROM market and smaller companies are struggling.

We have enormous production capabilities. And as one of the largest chip makers in the world, also enormous staying power.

Which means that with Samsung EEPROMs, you're assured of a supply that's just not going to be threatened.

In the all-important 256K EEPROM, we are the only offshore supplier, and probably the only large manufacturer to offer it.

Both our 256K and 64K

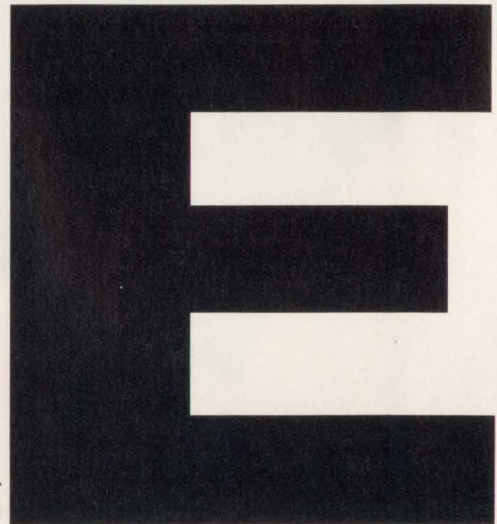

28C256

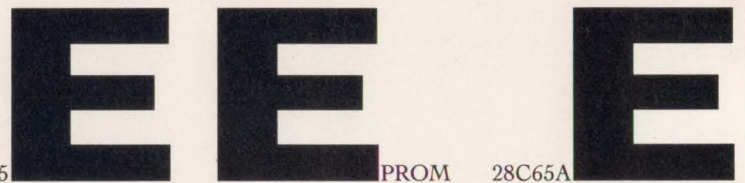

28C65

PROM

28C65A



28C64A

PROM

28C16

PROM

28C17

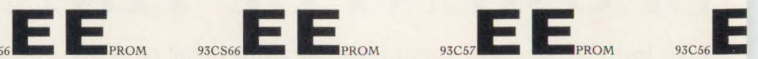

93C66

PROM

93C66

PROM

93C57

PROM

93C66

IF YOU'RE NOT FINDING THE LINE, MAYBE YOU SHOULD

EEPROM

E_{PROM} **28C64** **EE**_{PROM}

E_{PROM} **29C010** **EE**_{PROM} **93C67** **EE**_{PROM}

E_{PROM} **93CS66** **EE**_{PROM} **93C46** **EE**_{PROM} **93C46V** **EE**_{PROM}

chips are available with a high, 100K cycle rating. We will introduce the 1-meg EEPROM late this year. And in the flash EEPROM category, we're in development up to 8-meg right now.

Many of our serial parts are available in low voltage. On our 2K and 4K serial parts, we offer a secure access feature.

And across our entire line of both parallel and serial EEPROMs, our parts are available with industrial ratings.

If you make mainframes, or switching systems, or modems, or anything else that uses EEPROMs and is going to keep doing it—look no further for a supplier with the staying power you need. For data, contact us now at 1-800-423-7364 or (408) 954-7229.

Or write to EEPROM Marketing, Samsung Semiconductor, 3725 No. First St., San Jose, CA 95134.



SAMSUNG
CIRCLE NO. 6

Technology that works for life.

INDUSTRY'S BROADEST EEPROM HAVE YOUR EYES CHECKED.

SIEMENS



Globally Connected.

Siemens provides computer and peripheral manufacturers with a worldwide connection for state-of-the-art integrated circuits.

Siemens is building on a tradition of innovation with state-of-the-art technology in the workplace. And we back it with worldwide service and support, providing a global partner for all your system designs.

For applications such as laptop PCs, printers and disk drives, which require lower power consumption, we offer CMOS 8-bit microcontrollers based on the 8051 architecture. Like the SAB80C537, with advanced features

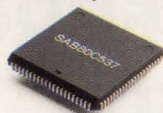

Innovative 8-bit microcontroller designs.

such as 16-bit hardware multiply/divide, and 8 data pointers.

We're also the only European DRAM manufacturer, providing high-quality 1-Mb and 4-Mb DRAMs. In fact, we're one of the world's leading suppliers, with DRAMs available worldwide, in volumes which have doubled since 1989. And we're continuing to advance this technology with our 16-Mb and 64-Mb DRAM programs.



Reliable 1-Mb and 4-Mb DRAMs.



80286 and integrated peripherals.

Siemens has a wide range of ICs for PCs. Our powerful 80286 microprocessors include a super-fast 16 MHz design. And we provide the 82C206 and the NEAT™ chipset for optimized, low-cost solutions.

Plus, Siemens offers an extensive line of CMOS ASIC devices.

For innovative solutions for computer and peripheral manufacturers, Siemens is the best connection you can make.

For details, call **(800) 456-9229**, or write:

Siemens Components, Inc.
2191 Laurelwood Road
Santa Clara, CA 95054-1514

Ask for literature package M14A013.



**Siemens
World Wise, Market Smart.**

NEWS BREAKS

EDITED BY SUSAN ROSE

VME BOARD TOPS 1.1 BOPS PERFORMANCE

A single V-C40 VME board from Ariel Corp sets a VME peak-performance mark—as much as 1.1 billion operations per second (BOPS). Additionally, it can move data at rates as high as 1.3 Gbytes/sec. The 6U VME board holds as many as four TI TMS320C40 32-bit floating-point DSP processors along with as much as 64 Mbytes of local dynamic RAM, and 8 Mbytes of static RAM (2 Mbytes per CPU). You can hook up processors and multiple boards in a number of multiprocessing configurations. Each board has six special byte-wide DMA communications ports, three of which are brought off board for 12 communications links, each capable of moving 20 Mbytes/sec. The board has a proprietary 24-bit bus for linking to analog converter cards. The board functions as both a VME bus master and slave and costs \$20 per million operations. Ariel Corp, Highland Park, NJ, (908) 249-2900, FAX (908) 249-2123.—Ray Weiss

PALM-SIZE INDUSTRIAL PC OPERATES FROM -40 TO +85°C

Suitable for use in rugged environments that present extreme temperatures, the 5012 Micro PC needs no keyboard, monitor, or disk drives to operate. With DOS embedded in its ROM, this computer includes two 512-kbyte solid-state data-storage locations that you can populate with RAM and EPROM. Housed on a pc-board, the computer comes with a built-in EPROM programmer, 1 Mbyte of dynamic RAM that you can expand to 2 Mbytes, a watchdog timer, battery backup for RAM, and a battery-backed calendar/clock. This board also contains ports for a printer, a keyboard, a speaker, and two serial ports. The basic board costs \$495, and you can order enclosures starting at \$45. Octagon Systems Corp, Westminster, CO, (303) 430-1500, FAX (303) 426-8126.—J D Mosley

MULTIPLY-ACCUMULATE UNIT ENHANCES SERVO CONTROLLER

An embedded multiply-and-accumulate unit (MAU) highlights a range of features of the HPC46100 16-bit microcontroller from National Semiconductor. Running off a 40-MHz system clock, the MAU provides 32-bit results from 16-bit, signed-integer multiply-and-accumulate operations in 400 nsec. Peripheral functions such as an 8-bit ADC with 5- μ sec conversion, three independent timers with separate frequency- and duty-cycle control registers, a programmable UART, and 1 kbyte of onboard RAM tailor the microcontroller to such embedded servo applications as found in automotive-chassis and hard-disk drive control. The ADCs convert as many as eight single-ended channels or four differential-channel pairs. You can trigger the converters for single readings, or you can perform these operations continuously. Eight dedicated registers let you store single-channel data for average reading calculations. The onboard UART can operate in synchronous or asynchronous modes and offers multiple character widths and stop bits, status reporting, error detection, an addressing mode, and diagnostic testing. The μ C is upward-source-code-compatible with the HPC family of controllers and includes such other features as watchdog logic, vectored interrupts, and HALT and IDLE power-down modes. Available development tools for the \$23 (1000), 14 \times 14-mm, 80-pin device include a development system, serial hook hardware, logic-analyzer interface board, HP logic-analyzer disassembler, and cross-development system. The device comes in a plastic quad flatpack. National Semiconductor, Santa Clara, CA, (408) 721-5185.—Michael C Markowitz

NEWS BREAKS

COLOR PANEL-MOUNT DISPLAY INCLUDES 80386SX PC

Computer Dynamics's Color Displaypac includes an IBM PC-compatible 80386SX single-board computer and a color LCD with infrared touch screen in a panel-mount package. The integrated package measures 11.5 × 8.5 × 2 in., and the display screen is 10.4 in. wide. The display provides VGA color graphics and includes a fluorescent backlight. The single-board computer includes as much as 4 Mbytes of dynamic RAM, two RS-232C serial ports, keyboard and printer ports, and hard- and floppy-disk interfaces. The computer can boot MS-DOS from an onboard RAM/ROM disk. A configuration with 1 Mbyte of memory and a 16-MHz μ P costs \$6174. Computer Dynamics, Greer, SC, (803) 877-8700, FAX (803) 879-2030.—Maury Wright

MPLD COMBINES AS MANY AS 40 ALTERA EPLDs

Altera's Mask-Programmable Logic Device (MPLD) can replace as many as 40 of the company's erasable programmable logic devices (EPLDs) or up to 700 of its macro cells. Offered as a synthesis service, the company will take EPLD designs at the netlist level and synthesize them into a single mask-programmed device. The company guarantees results from working designs using EPLD circuits, letting engineers prototype, and even put out as initial products, EPLD-based designs. For size reduction, they can then have the design reduced to a single, foundry-programmed mask-based chip. The conversion process is automated and the company will guarantee layout timing as well as 95%—or better—fault coverage for supplied test vectors. Prototypes will be delivered within 6 weeks of receipt of the design. The cost is \$0.06 per macro cell for production units; \$20,000 to \$60,000 for design conversions (NRE). Production units are delivered within 10 to 12 weeks. Initially, Classic and MAX 5000 EPLDs are covered, with MAX 700 devices added by the fourth quarter of 1991. Altera Corp, San Jose, CA, (408) 984-2800, FAX (408) 435-1394.—Ray Weiss

SOLID-STATE RELAYS SUIT LOW-CURRENT APPLICATIONS

The LH1500 family of <1A solid-state relays from AT&T Microelectronics each comprise a photodiode array, various switch control circuits, and DMOS switches. The relays use an LED for actuation control and an IC for the switch output. The family consists of 21 products, ranging in price from \$1.25 to \$4.75 (1000) and includes all the common switch forms: normally open, normally closed, and combinations of each. Each relay features 3750V of isolation, thereby meeting European standards and exceeding US standards. The relays are constructed on a dielectrically isolated process, which provides for breakdown voltages between 140 and 440V. Typical on-resistance varies from 2 to 23 Ω . Special features of some of the relays include current limiting, make-before-break switching, and dual packaging. The relays come in either 6- or 8-pin DIPs or surface-mount gull-wing packages. Sample quantities are available now; production quantities will be available by the fourth quarter of 1991. AT&T Microelectronics, Allentown, PA, (800) 372-2447.—Anne Watson Swager

CMOS PLDs ACHIEVE 7.5-NSEC SPEED

Intel Corp's faster versions of its \$10 85C244 24-pin and \$6.10 (1000) 85C220 20-pin PLDs have programmable I/O structures, letting them emulate a variety of 20- and 24-pin PLD architectures. They have a 7.5-nsec input-to-output propagation delay and support clock frequencies as great as 74 MHz using external feedback. The parts consume 105 mA at maximum operating frequency and come in plastic leaded chip carriers. Intel Corp, Santa Clara, CA, contact local sales office.—Richard A Quinnell

We Deliver Answers

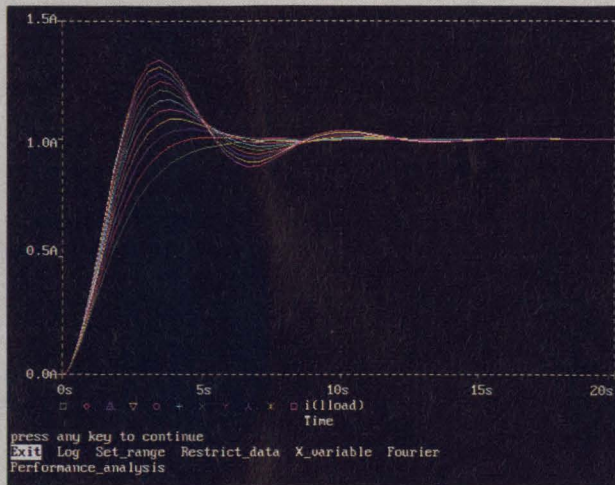

Current through an inductor with stepped resistance

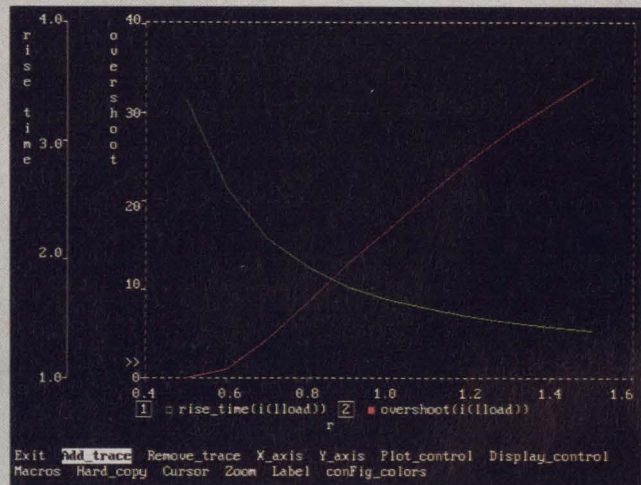

Rise time and overshoot as a function of resistance

Explore the Intricacies of Your Circuit Design...

Using PSpice's Probe 5.0 with Performance Analysis

With Probe's new **Performance Analysis** feature, in-depth examination and processing of PSpice simulations is at your fingertips. By applying any number of user-defined goal functions (such as pulse-width or overshoot) to multiple PSpice waveforms, a circuit's behavior can be tracked as a function of changing conditions (such as temperature, source voltage, or model parameter values). It becomes easy to plot quantities like propagation delay versus temperature, bandwidth versus Q, or pulse-width versus component value. **Performance Analysis**, along with Probe's well-known high-resolution graphical display of simulation and post-processed results, makes it easier than ever to visualize trends in the circuit's behavior.

Other features lending to Probe's popularity include multiple Y axes on a single plot (new for 5.0), fast Fourier transforms, and simultaneous display of analog and digital waveforms. Probe's interactive plotting capabilities offer the user complete control; axes can be freely defined and traces can be added to the display as functions of other waveforms or arithmetic expressions of voltages and currents.

Probe 5.0 is sold as an option to MicroSim Corporation's popular PSpice 5.0 circuit simulator— part of our Circuit Analysis package. Every copy sold comes with our extensive customer/product support. Our expert engineering team is always on hand to answer your technical product questions.

For further information on MicroSim Corporation's family of products, call toll free at (800) 245-3022 or FAX at (714) 455-0554.



MicroSim Corporation

Expanding the Standard for Circuit Simulation

20 Fairbanks • Irvine, California 92718 USA

DISTRIBUTION CENTERS

UNITED STATES

△ MINI-CIRCUITS

P.O. Box 350166
B'klyn., NY 11235-0003
(800) 247-6343
(718) 934-4500

Missouri
(800) 654-7949
(417) 335-5935



AMERICAN EXPRESS
VISA

EUROPE WEST & EAST

△ MINI-CIRCUITS/DALE

DALE ELECTRONICS LTD.
Dale House
Wharf Road
Frimley Green
Camberley, Surrey GU16 6LF
England
44-25-283-5094



MASTERCARD/VISA/
ACCESS/EUROCARD

LOCAL DISTRIBUTORS

NORTH AMERICA

UNITED STATES

MID-ATLANTIC

* MLC Distributors Ltd
Conshohocken, PA 19428
(800) 442-3177
(215) 825-3177

MIDWEST

* CFC Distributors, Inc.
Mundelein, IL 60060
(708) 540-9962

SOUTHEAST

* Component Distributors, Inc.
Huntsville, AL 35810
(800) 888-0331
(205) 851-7800

Palm Bay, FL 32905

(800) 558-2351
(407) 724-9910

Norcross, GA 30092

(800) 874-7209
(404) 441-3320

SOUTHWEST

TEXAS, OKLAHOMA,
LOUISIANA

* Component Distributors, Inc.
Dallas, TX 75243
(800) 848-4234
(214) 644-0373

WEST

ARIZONA, NEW MEXICO
Spirit Electronics
Scottsdale, AZ 85260
(602) 998-1533

△ CALIFORNIA
Mini-Circuits
Tustin, CA 92680

(800) 654-7949
(714) 838-5144
(417) 335-5935

Los Altos, CA 94022

(800) 654-7949
(415) 948-6533
(417) 335-5935

△ NORTHWEST

Mini-Circuits
Bellevue, WA 98004
(800) 654-7949
(206) 462-2118
(417) 335-5935

CANADA

Eastern
* Giga-Tron Assoc. Ltd.
Ottawa, Ontario
K2E 7T7 Canada
(613) 225-4090

Western

△ Mini-Circuits
Bellevue, WA 98004
(800) 654-7949
(206) 462-2118
(417) 335-5935

* participating distributors
△ Distribution Centers

INTERNATIONAL

EUROPE

BELGIUM, LUXEMBOURG
ETS Freddy Leger
B-1080 Brussels, Belgium
32-2-410-1421

FINLAND

Integrated Electronics, Oy AB
Helsinki, Finland
358-0-351-3133

FRANCE

SCIE-DIMES
91430 Igny, France
33-1-6-941-8282

GERMANY, AUSTRIA,
DENMARK, SWITZERLAND
Industrial Electronics GMBH
D-6236 Eschborn, Germany
49-6196-48689

ITALY

Dale Electronics, Ltd.
GU16 6LF, England
44-25-283-5094

NETHERLANDS

BFI IBECSA BV
2130 KA Hooftdorp
The Netherlands
31-0-20-6531350

SPAIN

BFI IBECSA Electronica, SA
28049 Madrid, Spain
34-1-358-47-77

SWEDEN

Integrerad Elektronik
Bromma, Sweden
46-8-804685

UNITED KINGDOM

BFI IBECSA GROUP
Aylesford, Kent
ME20 7NA England
44-622-882467

MIDEAST

ISRAEL
Vitel Limited
Shikun Dan
Tel Aviv 61131 Israel
972-3-479-153

JAPAN

Densho Kaisha Limited
Minato-Ku, Tokyo, Japan
813-3436-0041

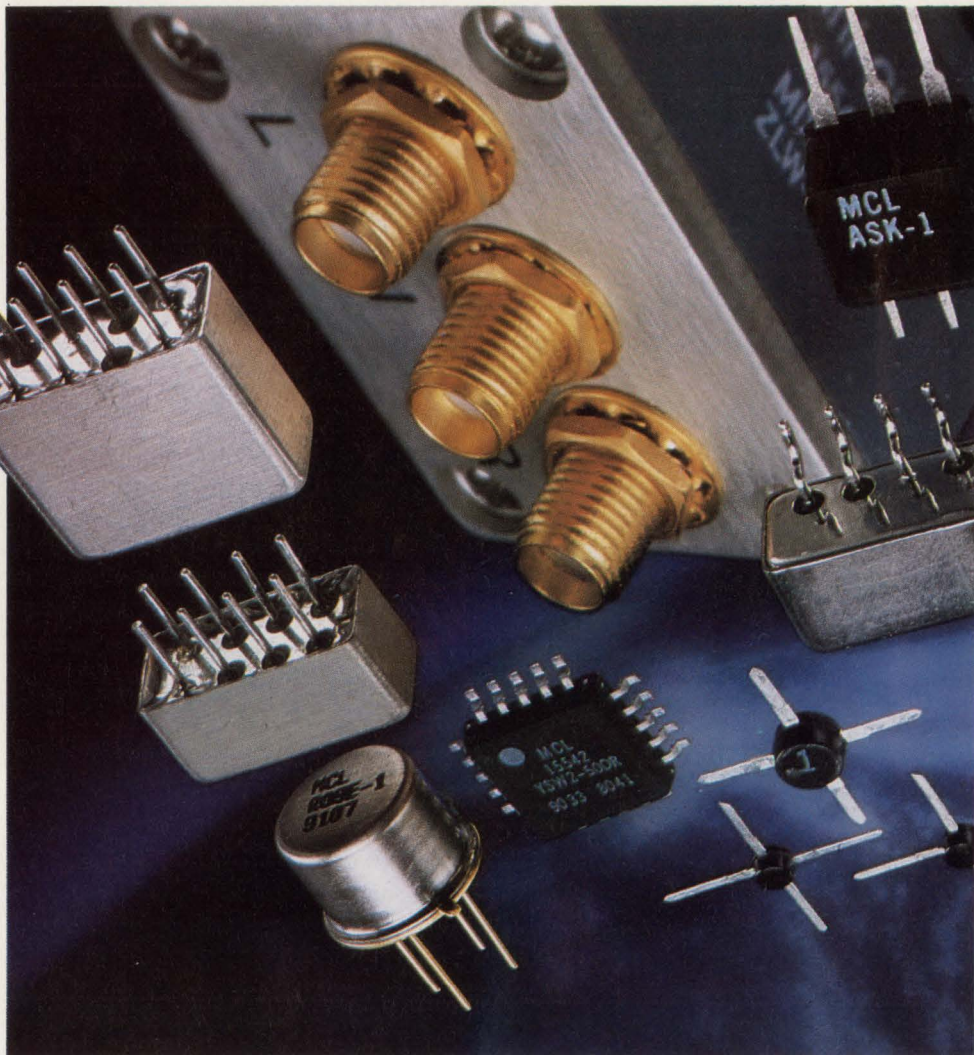

ALL MINI-CIRCUITS SHIPPED WITHIN

*Amplifiers
Frequency Mixers
RF Transformers
Frequency Doublers
Phase Detectors
Power Splitter/Combiners
&Q/QPSK Modulators
Fixed Attenuators
Precision TTL-Controlled Attenuators
Switches and Drivers
Directional Couplers
Terminations
Limiters
Filters*

All Mini-Circuits' components listed in the latest published catalog, in all configurations and connector types, will be processed and shipped within one week after an order is received, or if the order calls for scheduled shipments, we will ship on or before the due date. If we're late, we'll deduct one percent per day from your bill (maximum deduction up to 25%, as allowed by law); but don't count on this discount since we intend to meet each and every scheduled shipment.

What makes this fast turnaround possible? First, fast manufacturing throughput achieved using powerful statistical process-control techniques coupled with the latest computer-automated production and test equipment. Second, a worldwide distribution network, with a major Distributor Center in the U.S. and in England, backed by 16 regional distributors.

We wholeheartedly encourage you to place your orders with your local distributor. But let's be realistic. Although our distributors stock our products, not every distributor will carry every single catalog item, especially in substantial quantities. In such instances, when the need for components is urgent, contact a Mini-Circuits' Distribution Center listed and you will be covered by our shipment guarantee.

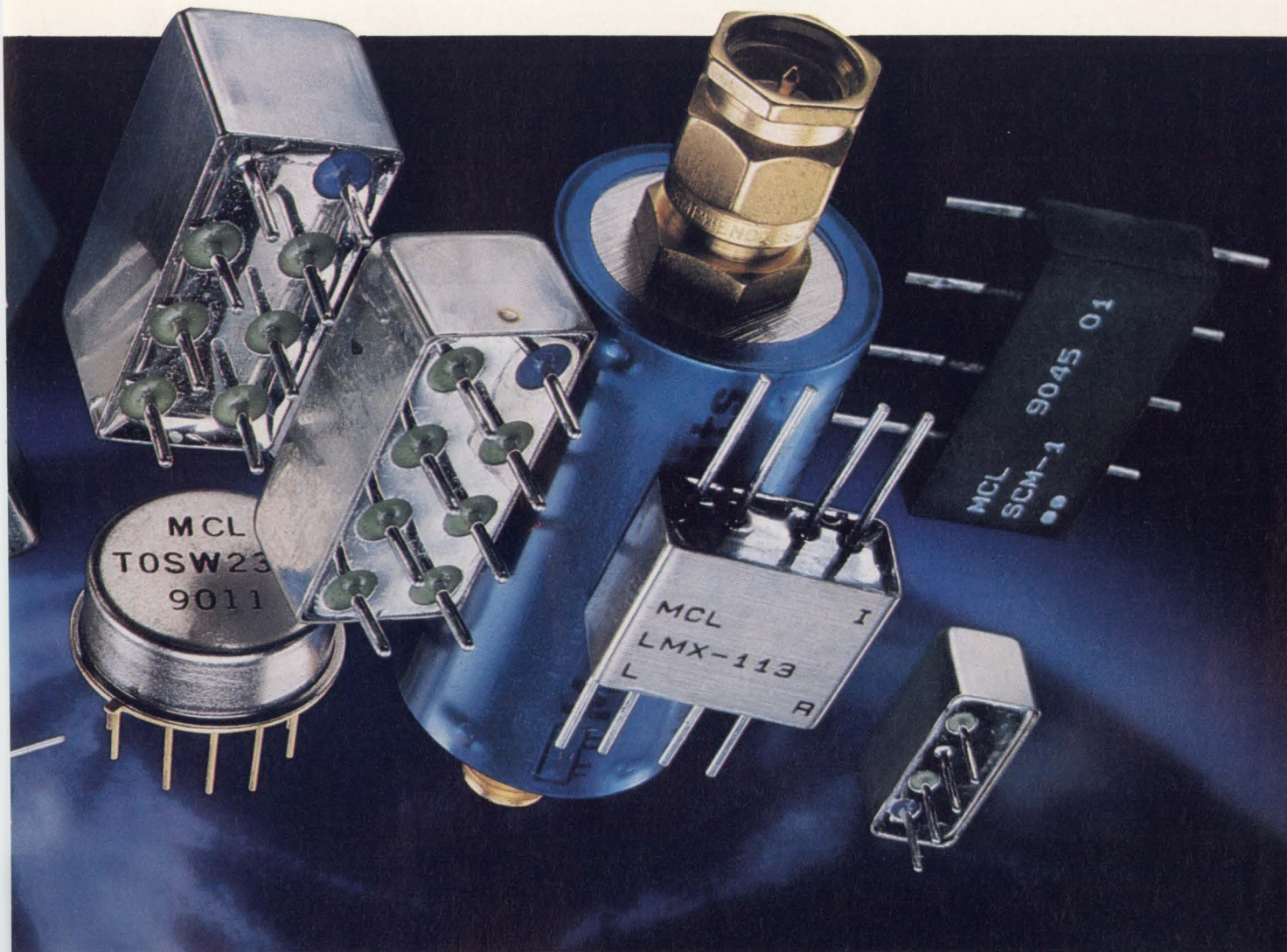

RF/IF CATALOG PRODUCTS ONE-WEEK... GUARANTEED!

United States

△Mini-Circuits

NEW YORK	MISSOURI
8AM-5:30 PM EST	9AM-8PM EST
(phone) 800-247-6343	(phone) 800-654-7949
(phone) 718-934-4500	(phone) 417-335-5935
(fax) 718-332-4661	(fax) 417-335-5945

Europe

△Mini-Circuits/Dale

8:30 AM-5:30 PM
(phone) 44-25-283-5094 (fax) 44-25-283-7010

Guaranteed order processing is another expression of Mini-Circuits' dedicated effort for world-class quality...meeting and exceeding customers' expectations. Write, phone, or fax your order and be confident that it will be shipped on time, every time by Mini-Circuits.

finding new ways ...
setting higher standards

Mini-Circuits

P.O. Box 350166, Brooklyn, New York 11235-0003 (718) 934-4500 Fax (718) 332-4661 Telexes: 6852844 or 620156

CIRCLE NO. 10

CONDITIONS OF GUARANTEE

- ORDER PLACEMENT—guarantee applies only to orders placed with Mini-Circuits' distribution center[△] or with a participating distributor.*
- ORDER REQUIREMENT—guarantee starts after all details of the purchase order is received complete.
- SHIPMENT TIME—guarantee applies for work days Monday through Friday, holidays excluded.
- TRANSPORTATION—does not apply to situations where shipping is inhibited due to strikes, weather, or conditions beyond our control.
- GOVERNMENT REGULATIONS—does not apply to purchase orders inhibited by government rules, regulations, export licenses, and/or customs approval.
- QUANTITIES—guarantee applies to normal distribution quantities, which vary according to product line.
- CREDIT RATING—guarantee limited to companies with approved credit rating at time of shipment.
- LETTERS OF CREDIT—guarantee limited to meeting terms of LC.

WHY THE FIRST 040 VME MIGHT AS WELL BE THE LAST.

*Memory modules available in 4 and
16 MB DRAM or SRAM.*

*DRAM memory module supports
burst fill mode for 50 Mbyte/sec
memory bandwidth.*

*On board DMA-based architecture
provides maximum performance and
parallel real-time operation.*

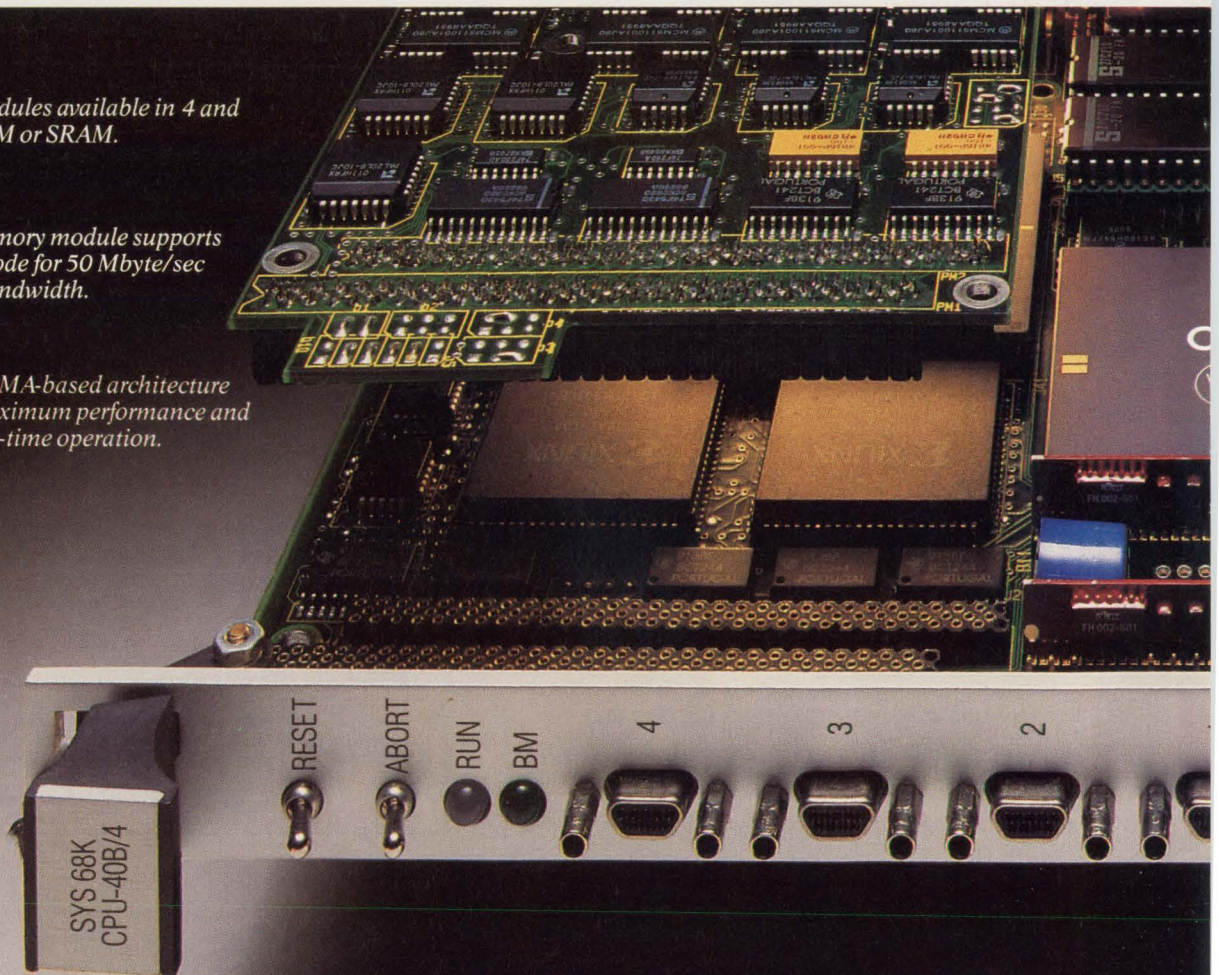



Second, setting else can

sustained at 25 MHz.* And DMA transfers at a screaming 50 Mbytes per second sustained (3 microseconds on the VMEbus).

So it might just be the last 040 board you'll ever need.

That's because we've fully optimized the on-board architecture. Thanks to our 281-pin gate array, DMA operations can be handled between on-board RAM, the VMEbus and on-board I/O devices. Or through our FLXi interface to other I/O drivers.

All of which means the CPU is free over 75% of the time to run your application.

First, we're delivering 040 VME single board computers today. In quantity. So you can get started while the rest of the world waits for a delivery date from other suppliers.

our new CPU-40 board is performance standards nobody touch. Like 30,000 dhrystones

Developing new applications is also a snap. Choose from the broadest range of third-party software in the business, including VMEPROM,[™] pSOS+,[™] VRTX32,[™] OS-9,[™] VxWorks,[™] UNIFLEX,[™] MTOS[™] and UNIX[®] 5.4.

Of course, we provide comprehensive support with the industry's best-rated documentation,* complete systems integration support and technical assistance.

CPU-40 PERFORMANCE CHARACTERISTICS

Data from	CPU	CPU	CPU	CPU	VMEbus	SCSI*	Floppy Disk*	Ethernet*	Shared RAM*	VMEbus*
Transfer to	Shared RAM	EPPROM	Serial I/O Timers	SCSI, Ethernet Controller, Floppy Disk	Shared RAM	Shared RAM	Buffer RAM	Dual-port RAM	VMEbus	VMEbus
Transfer Speed	53.7 MB/sec	16 MB/sec	2 MB/sec	2 MB/sec	5 MB/sec	4 MB/sec	500 KBit/sec	10 MBit/sec	15 MB/sec	15 MB/sec
Local 68040 CPU Operation	100%	100%	100%	100%	70%	80%	100%	100%	75%	100%

*DMA x FPS

So be the first in your company to turn 040. Call 1-800-BEST-VME, ext. 40, for more information or fax a request to (408) 374-1146 for an immediate response.

It'll be to your lasting advantage.



VME at its best.

FORCE Computers, Inc. 3165 Winchester Blvd. Campbell, CA 95008-6557
 *Actual dhrystone results may vary depending on compiler used. **Computer Design News, March 12, 1990. All brands or products are trademarks of their respective holders. © 1991 FORCE Computers, Inc.

CIRCLE NO. 11

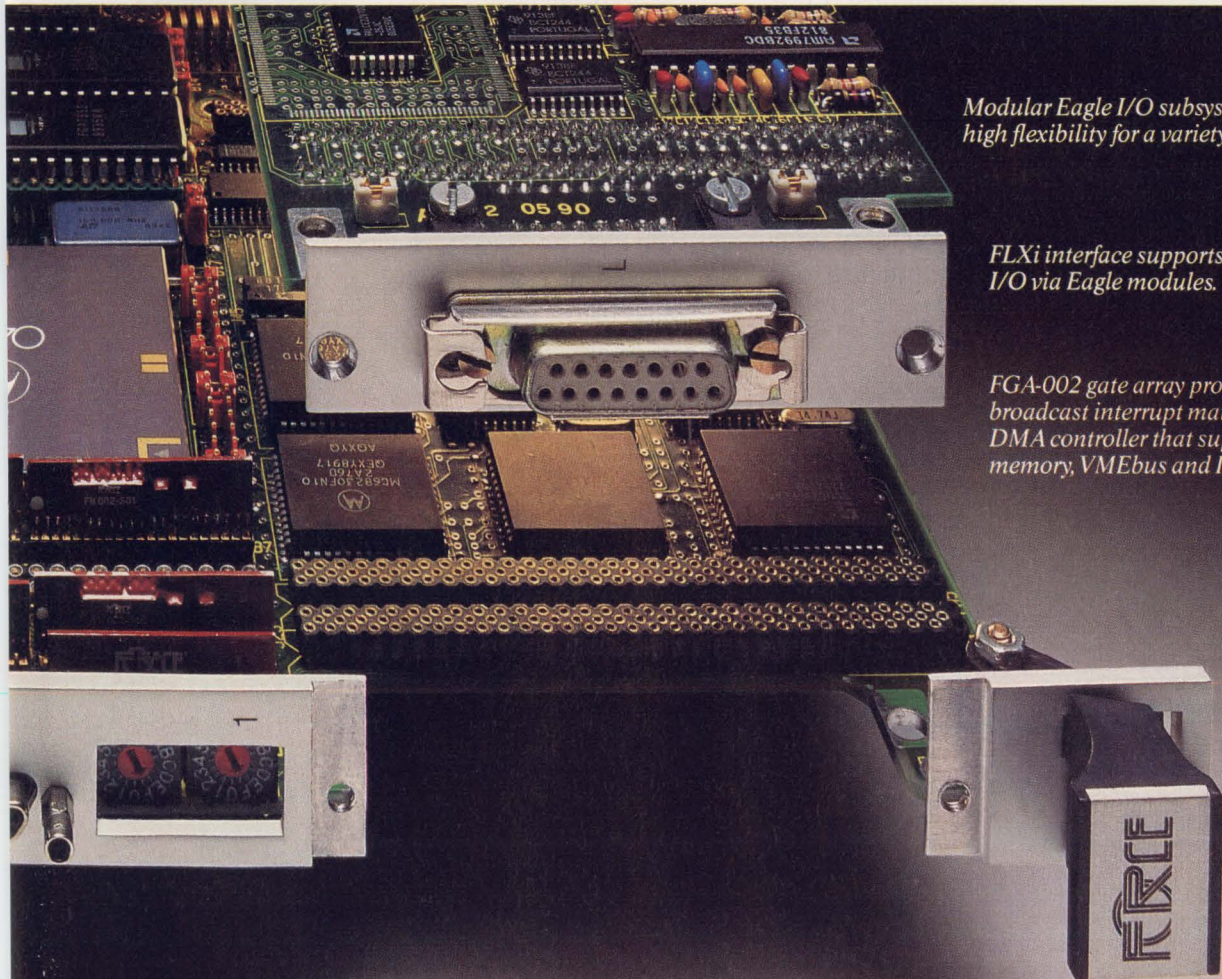

Modular Eagle I/O subsystems provide high flexibility for a variety of applications.

FLXi interface supports high-performance I/O via Eagle modules.

FGA-002 gate array provides message broadcast interrupt management. A 32-bit DMA controller that supports local shared memory, VMEbus and I/O data transfers.

People say boundary in low cost, high quality Now you can test that

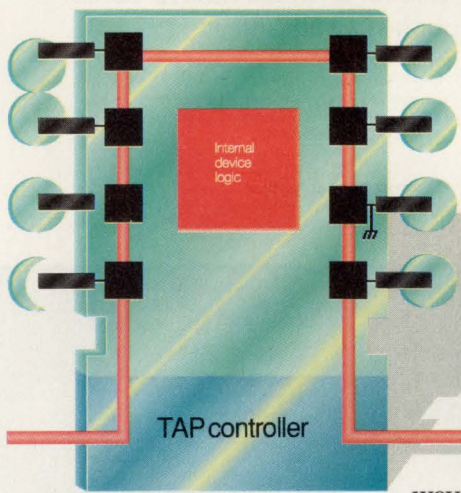

Find common manufacturing faults without test pattern libraries or physical test access with boundary-scan design and VICTORY software.

Increasing device complexity. Rising pattern development costs. High density packaging. Disappearing nodal access. These are the board test problems boundary scan was created to solve. Which is fine in theory. Only problem is there hasn't been any way to put boundary scan to the test. Until now.

VICTORY - the first software to automate boundary-scan testing.

Introducing VICTORY™ from Teradyne: the only software toolset ready to help you turn boundary-scan theory into a practical advantage. From the moment your first boundary-scan device is designed in, VICTORY starts to simplify the testing of complex digital boards. And the more boundary-scan parts you have, the more time and money you save.

The VICTORY toolset is the comprehensive solution for boundary-scan test and diagnostics.

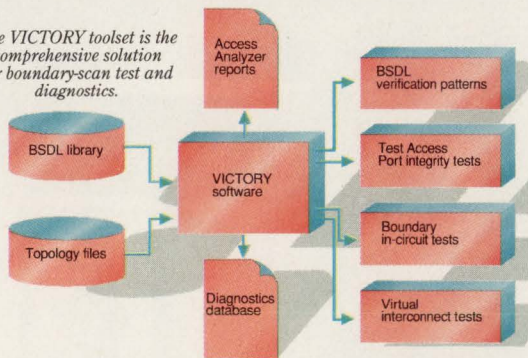

Delivers high fault-coverage.

Whether you're testing one boundary-scan part or boundary-scan networks, VICTORY software automatically gives you 100% pin-level fault coverage. Using the IEEE 1149.1 and BSDL standards, it takes VICTORY only a minute or two to generate test patterns. It would take a programmer days, even weeks to deliver the same fault coverage for conventional designs.

Now you can find stuck-at faults, broken wire bonds, wrong or missing components—even open input pins—all without manual diagnostic probing. VICTORY's fault diagnostics clearly spell out both fault type and fault location. And that's just the manufacturing process

Concurrent engineering takes on new meaning when you use VICTORY's Access Analyzer to optimize board layout for testability and cost-efficiency.

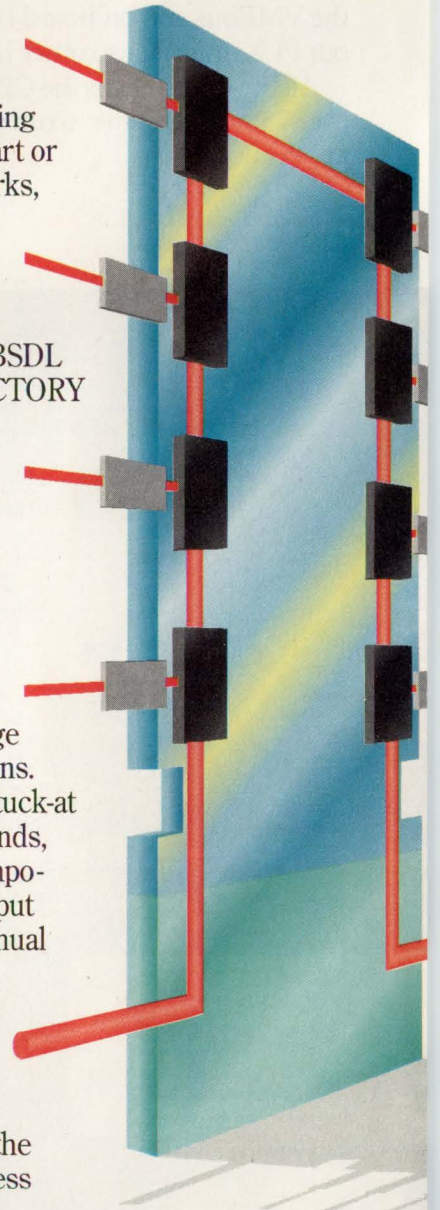

scan is a breakthrough board testing theory.

feedback you need to eliminate defects where it's most cost-effective—at the source.

Helps solve the test access problem.

With boundary-scan design and VICTORY software, you won't need bed-of-nails access on nodes where boundary-scan parts are interconnected. That means fewer test pads. Fewer test probes.

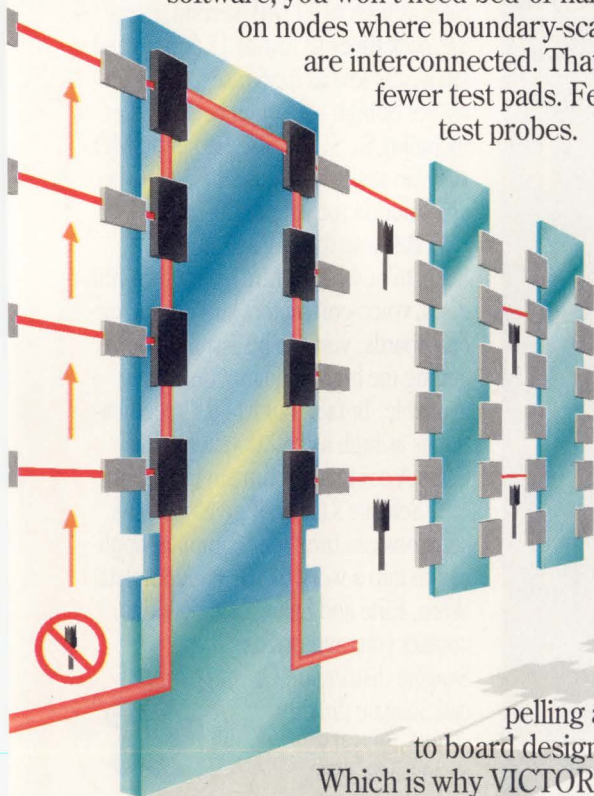

That's a compelling advantage to board designers.

Which is why VICTORY's Access Analyzer was developed. With this concurrent engineering tool, designers get testability information early in the design process. They can easily see where test points are required for visibility and where they can be dropped, for opti-

mized board layout without lowering fault coverage.

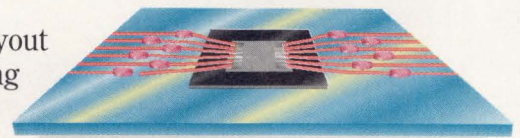

Boundary-Scan Intelligent Diagnostics identify faults by type and location without physical probing—even on high-density SMT assemblies

Good for the bottom line.

Shorter test programming time. Higher fault coverage. Lower PC board and test fixture costs. The bottom line on VICTORY is how positively it will affect your bottom line. And because VICTORY works with all Teradyne board testers, you're free to tailor a test process that's cost-effective for both your boundary-scan and non-scan boards. No matter what your test objectives. For example, with our new Z1800VP-series testers, a complete solution for in-circuit and boundary-scan testing starts at well under \$100,000.

Make the next logical move. Call today.

Boundary scan is the design-for-test breakthrough that promises lower cost, higher quality board testing. But don't take our word for it. Call Daryl Layzer at (800) 225-2699, ext. 3808. We'll show you how, with VICTORY software and Teradyne board testers, you can test this theory for yourself.



Get high fault coverage at low cost when you test boundary-scan boards with our new Z1800VP system and VICTORY software.

TERADYNE

©1991, Teradyne Inc. 321 Harrison Avenue, Boston, Massachusetts 02118. VICTORY is a trademark of Teradyne, Inc.

Seagate's Gigabyte Solutions

THE FINE ART OF DISC DRIVES

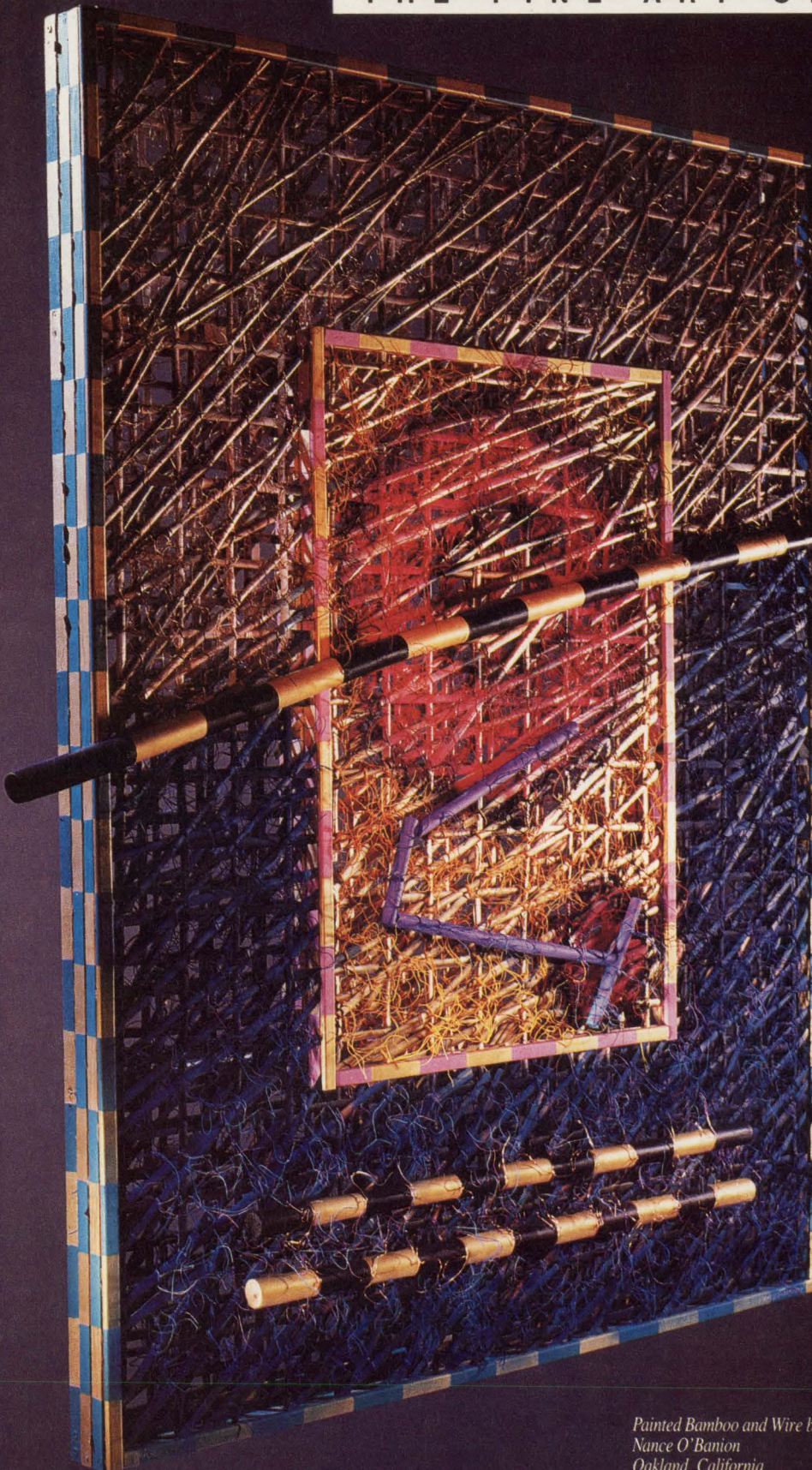

*Painted Bamboo and Wire by
Nance O'Banion
Oakland, California*

If your computer application has an insatiable appetite for disc storage, Seagate's got you covered.

Seagate produces more than twenty models of our Wren, Elite and Sabre disc drives with capacities greater than a gigabyte. Ranging in size from 1.1 to 3.2 GB, Seagate offers the industry's broadest range of high-capacity solutions for anything from a desktop PC to a world class supercomputer.

These 5.25" Wren and Elite drives and 8" Sabre drives feature data rates as high as 27 MB/second, average seek times as low as 11.5 msec and latency as low as 5.56 msec. With a choice of high performance interfaces including SCSI, SCSI-2, IPI and SMD, you can easily configure the ideal storage solution for your requirement.

Because these drives utilize Seagate's own thin-film heads, thin-film discs, voice-coil motors and printed circuit boards, you can be assured you're getting the highest quality disc drive available. In fact, our MTBF specification is as high as 250,000 hours in a Class A computer room environment.

Seagate's array of gigabyte-plus solutions can turn your computer application into a work of art. For complete Wren, Elite and Sabre specifications, contact your authorized Seagate distributor. Or call Seagate directly at 800-468-DISC, or 408-438-6550.



 **Seagate**

Wren, Elite, Sabre, Seagate and the Seagate logo are registered trademarks of Seagate Technology, Inc.
© 1991 Seagate Technology, Inc.

SIGNALS & NOISE

Juggling equation for better solution

Just as my subscription to EDN is reinstated, Peter Anderson shocks me with the equation on pg 31 of EDN (May 23, 1991), [which uses N to characterize a triode]. For example, the dual triodes 12AU7, 12BH7, and 5687 all have values of a μ of 20, but only one may work properly in a circuit.

The value of μ is the ratio of $g_m \cdot \text{MDSU} / \text{MDNM}$ to g_p or the product $g_m r_p$. You can double g_m and g_p or halve r_p by doubling the plate current, and the μ is unchanged. The point is that using the small-signal equation

$$I_p = g_m V_g + g_p V_p,$$

where I_p is plate-current change and V_g and V_p are voltage changes, [would make a better basis for a Spice model.] The equation is related to the equation noted by Peter Anderson, but expresses the operating characteristics of a tube, a bipolar, or a FET device in a much more useful form. The above equation expresses the way we have to operate a [tube,] anyway. We set the plate current, then adjust the bias voltage with degeneration as needed to give that plate current.

Keats A Pullen Jr, PE
Kingsville, MD

Engineer should look for higher paying job

The author of the letter "Engineers' salaries should be professional" (EDN, March 14, 1991, pg 26) suggests that, as a member of the engineering profession, he ought, by that very fact, to be paid a commensurate salary.

The thought is very lofty, but the fact of the matter is that salaries, like most economic matters, are ultimately a question of supply and demand. I really can't imagine a doctor or a lawyer saying, "Gee, guys, I'm a professional. You ought to pay me more."

If you feel you are worth more, then put it on the line and look for a higher paying job. Finally, your salary is a measure of your own capabilities combined with your marketing ability. The professionalism of the engineering profession has nothing to do with it.

Ted Ruel
Controls Inc
Logansport, IN

Battery of tests showed his true learning skills

I appreciated Charles Small's editorial, "Intelligences theory reshapes thought" (EDN's Software Engineering Special Supplement, June 20, 1991, pg 9). His article proves to be profoundly true in my case. I thought I was stupid until I received the results of a battery of tests in the Navy that showed I was not stupid—I just couldn't spell!

Engineers are a unique bunch who, if they cannot spell, will conceptualize, innovate, and design a software program to do it for them.

Charles Cutler
Bear Medical Systems Inc
Riverside, CA

Phone number changed

The phone number for Information Storage Devices Inc (EDN, July 4, 1991, pg 93) has been changed. The new number is (408) 428-1400.

NEXT IN EDN October 3

Look to EDN News Edition's October 3 issue for a Product Watch on ICs for automatic test equipment and a Career Opportunities article on multimedia.

More answers.
Every week in EDN.

LCD Proto Kit

Everything you need to start your LCD application ... create complex screens in just a few hours!

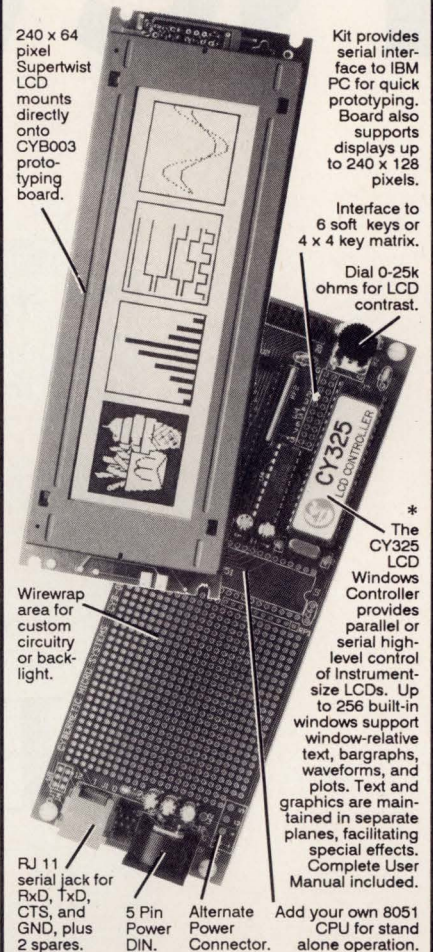

Kit also includes:



\$495 - Kit
Popular LCD Starter Kit.



(\$595 pre-assembled & tested)

*The CY325 40-pin CMOS LCD Controller IC is available from stock @ \$75/singles, \$20/1000s (Surface mount also avail in qty.)

CyberneticMicroSystems

Box 3000 • San Gregorio CA 94074
Tel: 415-726-3000 • Fax: 415-726-3003

News Flash

SPORTS	SCIENCE AND TECHNOLOGY
The 90 Nanosecond Workout An Exhaustive Look At High Tech Training Equipment	Virtual Reality Close But No Cigar
PAGE 2B	PAGE 8

Silicon Valley

25 CENTS

SERVING NORTHERN CALIFORNIA SINCE

FANTASTIC FLASH

AMD Ships 2 PLCC Flash

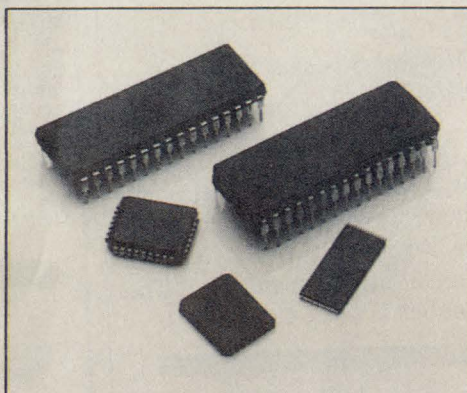

How Fast Is A Flash? A Direct Comparison

Density	AMD	Fastest Competitor
256K	90ns	120ns
512K	90ns	120ns
1 Mbit	90ns	120ns
2 Mbit	90ns	150ns

SUNNYVALE — The computer industry takes a giant leap forward in performance with the help of the new Flash memory family from Advanced Micro Devices, Inc.

Flash memory is a high-density, reprogrammable, non-volatile technology that has a bright future in computation, laser printers, network and telecommunications hardware. Many military systems use Flash technology in radar and navigational applications.

Flash memory also has the potential to eliminate mechanical hard disks and the need for cumbersome batteries. These are two of the biggest and heaviest obstacles in laptop and notebook computer applications.

Today, Flash memory is the most cost effective replacement technology for UV EPROMs and EEPROMs in applications that require in-system programming. Flash memories can literally be reprogrammed in a flash —

hence the name.

Standard, But With A Little More Flash

AMD's Flash memory family effectively etches in silicon the de-facto standard for this burgeoning technology that is compatible with Intel's initial Flash architecture.

Because AMD Flash memories are pin-for-pin compatible with the now standard architecture, AMD is positioned as an alternate source for design engineers and purchasing agents alike.

"Alternate source may be an inadequate term," said Jerry Sanders, chairman and CEO of Advanced Micro Devices. "Given our speed and feature set, our customers think of us as a superior resource."

Indeed, AMD's Flash memory family offers designers significant performance advantages (see chart), with speeds almost twice as fast as the nearest competitor.

Engineer Spontaneously Combusts At Meeting

Vice Pr At Le

EDN October 1, 1991

From AMD.

FOOD

Chips And Salsa

A Business Person's Guide To Silicon Valley Restaurants

PAGE 7F

zette

MORNING EDITION

ASHES! Megabit, 90ns, Memories

The AMD Flash family offers designers and purchasers many packaging options. Particularly popular is AMD's advanced 2 Megabit, PLCC part. Other packaging options include PDIP, CDIP and LCC in 256K, 512K, 1 Mbit and 2 Mbit capacities. TSOP packages will be available in the second half of this year. (LCC not currently available in 2 Mbit.)

AMD's 2 Mbit Flash memories come complete with embedded program and erase algorithms on board. These automatic algorithms speed up the design process and considerably shorten time to market. Previously, engineers were required to develop tedious and time-consuming algorithms to implement in-system reprogrammability. AMD's automatic algorithms also allow several Flash memories to be written or erased at once, without tying-up the CPU. The system is now free to perform other tasks while these operations are in

progress. AMD plans to include embedded algorithms in a future release of its 1 Mbit part.

The Ultra-Violet Blues

Flash technology is particularly suited to applications requiring reprogramming in place, because these devices can be reprogrammed in seconds, and within the system.

To update the code on a UV EPROM, the part must first be removed from the system. Once removed, erasure can take up to a full 20 minutes. After reprogramming, the part is then plugged back into the system. The process can result in damage to other components, costly service calls, and headaches.

Flash memories, on the other hand, can be bulk erased in about one to two seconds, without system disassembly. Reprogramming can then be accomplished via floppy disk, over phone lines, or even ISDN
(continued)

ident To Speak Spelling Bee

Stop the presses!

Advanced Micro Devices makes big news again—this time with an enhanced family of Flash memory devices.

That's good news for veteran and new Flash users alike.

Because our Flash devices are pin-for-pin compatible with Intel's existing Flash memory architecture, they establish the *de facto* industry standard.

Our standards, however, are a bit higher. And so are yours.

That's why our Flash Memory family offers densities, speeds and packaging options that improve performance and save board space. For instance, our advanced 2 Mbit PLCC part with a scant 90 nanosecond delay.

You can also choose from Flash devices in 256K, 512K and 1 Mbit densities. As well as packaging options that fit your design best, including CDIP, PDIP, LCC, TSOP, and PLCC.

And you'll find implementation faster and easier than ever, because we've included automatic programming algorithms on all our 2 Mbit devices, and soon on our 1 Mbit parts, too. So you'll spend less time writing code, and take less time getting products to market.

To keep up to date with all the latest and greatest in Flash memory, call AMD today at **1-800-222-9323**. And start making some headlines of your own.



Advanced Micro Devices

901 Thompson Place, P.O. Box 3453, Sunnyvale, CA 94088. © 1991 Advanced Micro Devices, Inc.

CIRCLE NO. 13

POWER SPLITTERS/ COMBINERS

the world's largest selection
2KHz to 8GHz from \$4⁹⁵

With over 300 models, from 2-way to 48-way, 0°, 90° and 180°, a variety of pin and connector packages, 50 and 75 ohm, covering 2KHz to 8000MHz, Mini-Circuits offers the world's largest selection of off-the-shelf power splitter/combiners. So why compromise your systems design when you can select the power splitter/combiner that closely matches your specific package and frequency band requirements at lowest cost and with immediate delivery.

And we will handle your "special" needs, such as wider bandwidth, higher isolation, intermixed connectors, etc. courteously with rapid turnaround time.

Of course, all units come with our one-year guarantee. Unprecedented 4.5 sigma unit-to-unit repeatability also guaranteed, meaning units ordered today or next year will provide performance identical to those delivered last year.

For detailed specs and performance data, refer to the MicroWaves Product Directory, EEM or Mini-Circuits RF/IF Signal Processing Handbook, Vol. II. Or contact us for our free 68-page RF/IF Signal Processing Guide.

CIRCLE NO. 14 finding new ways ...
setting higher standards

Mini-Circuits

A Division of Scientific Components Corporation
P.O. Box 350166, Brooklyn, New York 11235-0003 (718) 934-4500
Fax (718) 332-4661 Domestic and International Telexes: 6852844 or 620156

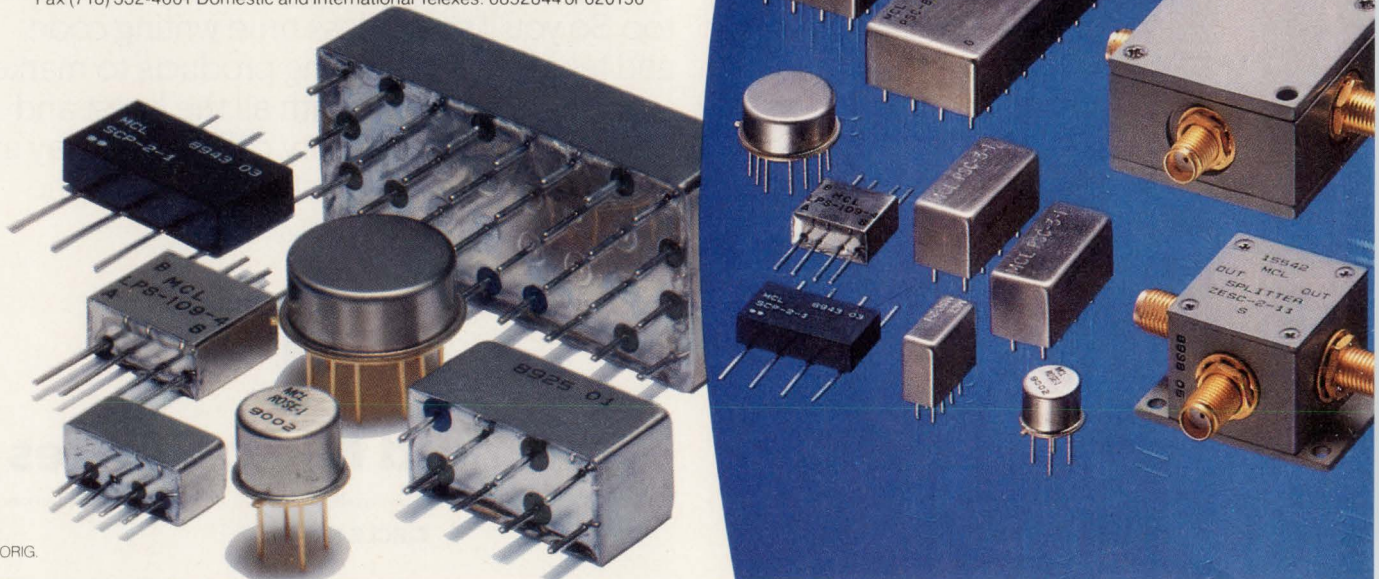

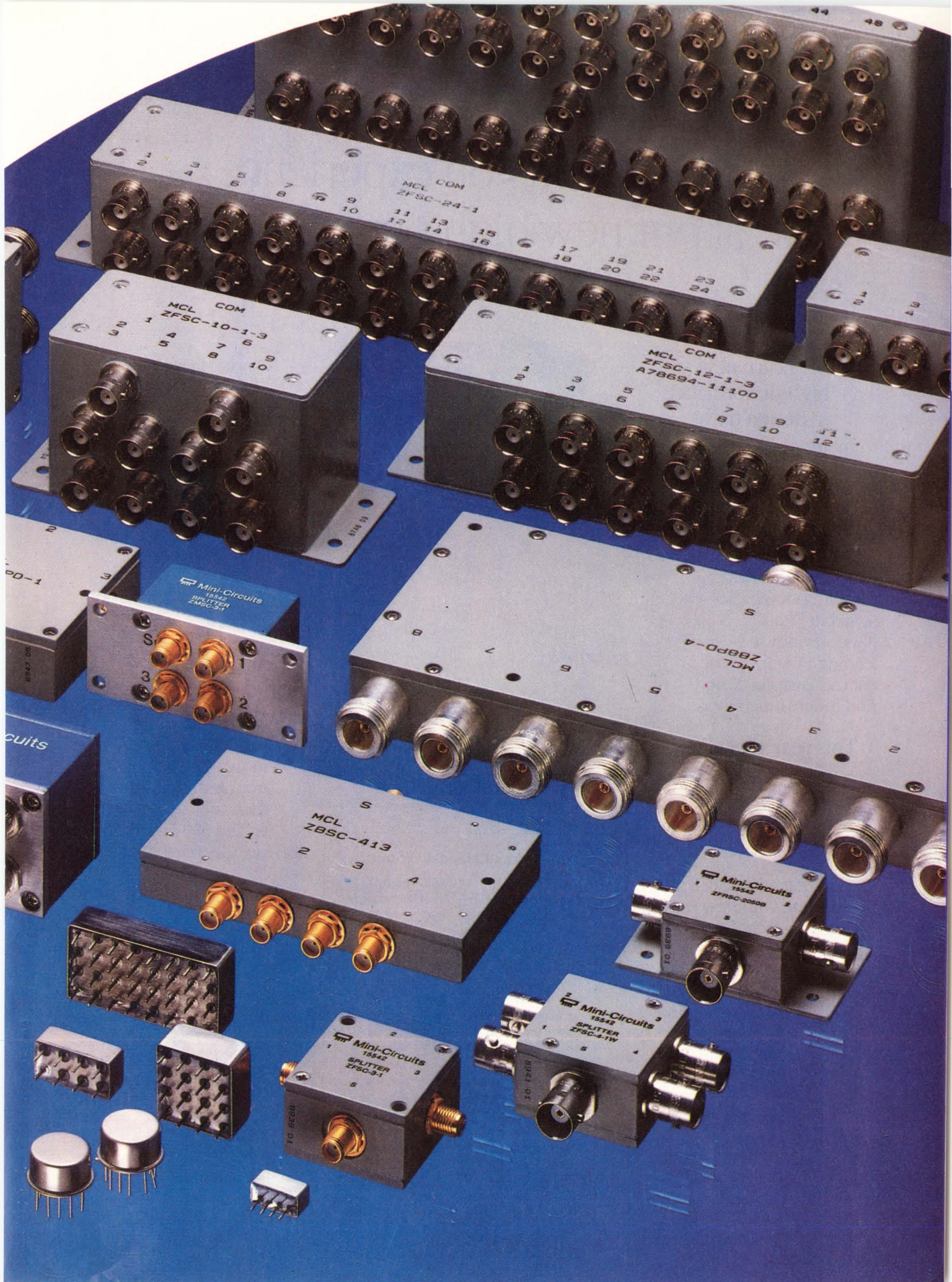

MCL COM
ZFSC-24-1

1 2 3 4 5 6 7 8 9 10 11 12 13 14 15 16 17 18 19 20 21 22 23 24

MCL COM
ZFSC-10-1-3

1 2 3 4 5 6 7 8 9 10

MCL COM
ZFSC-12-1-3
A78694-11100

1 2 3 4 5 6 7 8 9 10 11 12

Mini-Circuits
15542
SPLITTER
ZFSC-31

S 1 2 3

MCL
ZB8PD-4

1 2 3 4 5 6 7 8

MCL
ZBSC-413

1 2 3 4

Mini-Circuits
15542
ZFSC-2050B

1 2

Mini-Circuits
15542
SPLITTER
ZFSC-F-1W

1 2 3 4 5

Mini-Circuits
15542
SPLITTER
ZFSC-31

1 2 3 4 5

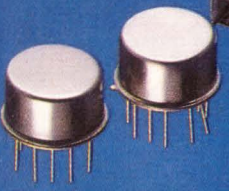

Get hands-on experience at our new high-performance linear seminar.

Learn new high-performance design tricks.

Roll up your sleeves. And mix it up with the leaders in high-performance linear at our all-new seminar.

It's a can't-miss event.

You'll get hands-on experience designing with our Simple Switcher™ family. Plus, our industry-leading 5V solutions for data acquisition design. And much, much more.

This year's agenda.

Our day-long event will consist of four sessions:

Analog Signal Processing

- National's new SPICE op amp models
- Modelling with SPICE
- Designing with new micro-power op amps

Data Acquisition and Conversion

- One-chip data acquisition systems
- Understanding ADC specs for DSP
- New solutions for single 5V operation



single 5V operation

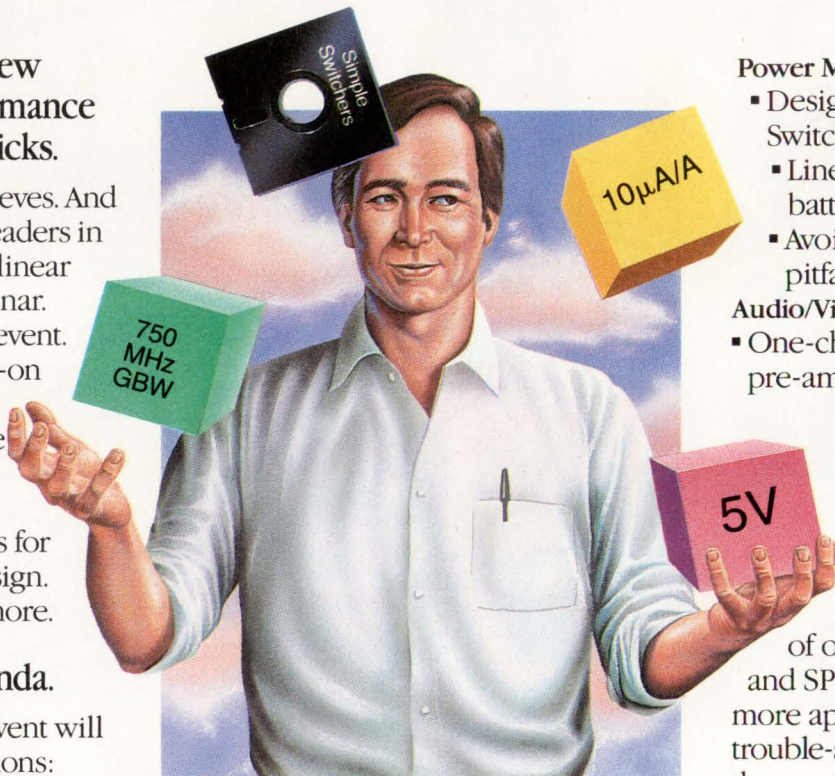

Power Management

- Designing with Simple Switchers
- Linear regulation for battery-powered systems
- Avoiding power supply pitfalls

Audio/Video

- One-chip video CRT pre-amp/drivers

**You won't
walk away
empty-handed.**

You'll be handed free copies of our Simple Switcher and SPICE floppies. And more applications and trouble-shooting handbooks than you can shake a circuit at. The \$59 enrollment fee also includes breakfast and lunch.

National's Linear Circuit

Sept. 25 Palo Alto, CA	Oct. 23 Austin, TX
Sept. 26 Newark, CA	Oct. 24 Richardson, TX
Sept. 30 Montreal, QC	Oct. 25 La Jolla, CA
Oct. 1 Boxborough, MA	Oct. 28 Cleveland, OH
Oct. 2 Rochester, NY	Oct. 29 Indianapolis, IN
Oct. 3 Edison, NJ	Oct. 30 Dayton, OH
Oct. 4 Ft. Washington, PA	Oct. 31 Dearborn, MI
Oct. 7 Schaumburg, IL	Nov. 1 Schaumburg, IL
Oct. 8 Ft. Wayne, IN	Nov. 4 Englewood, CO
Oct. 9 Dearborn, MI	Nov. 5 Scottsdale, AZ
Oct. 10 Toronto, ON	Nov. 6 Woodland Hills, CA
Oct. 11 Minneapolis, MN	Nov. 7 Los Angeles, CA
Oct. 14 Orlando, FL	Nov. 8 Costa Mesa, CA
Oct. 15 Reston, VA	Nov. 12 Burnaby, BC
Oct. 16 Linthicum, MD	Nov. 13 Bellevue, WA
Oct. 17 Newton, MA	Nov. 14 Beaverton, OR
Oct. 21 Longmont, CO	Nov. 15 San Jose, CA
Oct. 22 Houston, TX	

Reserve your spot today.

Space is limited, so give us a call: 1-800-NAT-SEMI, Ext. 200.

And be on hand for the linear event of the year.



Simple Switcher is a trademark of National Semiconductor Corporation. ©1991 National Semiconductor Corporation.

EDITORIAL

More diagrammatic programming tools for engineers

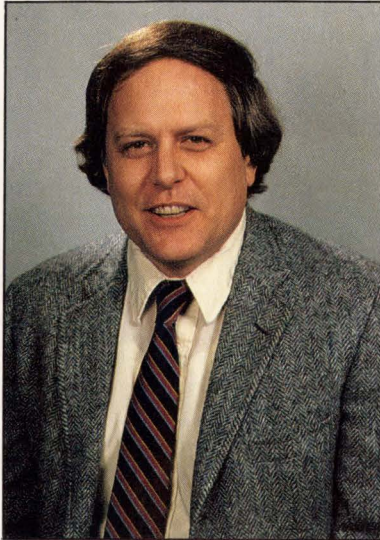

Jesse H. Neal
Editorial Achievement Awards
1990 Certificate, Best Editorial
1990 Certificate, Best Series
1987, 1981 (2), 1978 (2),
1977, 1976, 1975

American Society of
Business Press Editors Award
1988, 1983, 1981

Little known or appreciated outside the world of tool and die makers, machine tools were nevertheless crucial to industrial development. Now, engineering software assumes the crucial role of the machine tool of the next industrial revolution.

Engineering software is too important and too different from ordinary software to be left solely to programmers. Give a carpenter a problem, and he thinks of solving it with hammers and nails. Give a programmer a problem, and he thinks of solving it with written-out lines of code. Unfortunately, engineers do not think or express themselves in terms of language. Instead, they use visual symbols.

Although we associate programming with text files, that association is not a fundamental given. In reality, programmers' fixation on text is an artifact of the teletypewriter output of early computers. Today, textual programming is no longer mandatory; even inexpensive computers can handle complex graphics and symbols. Few good software tools take advantage of these capabilities to let engineers construct programs visually.

Proponents of textual ASIC and FPGA software tools say that the increasing complexity of today's devices is forcing engineers to abandon diagrammatic systems for textual ones. This false imperative rests on an unproven foundation. Text is not inherently more comprehensible, lucid, compact, and rigorous than diagrams are. Few developers seem to consider the possibility that more complex devices may lead to more powerful diagrammatic design systems.

Good engineers are in the 99th percentile for spatial ability, and good programmers are in the 99th percentile for linguistic ability. Thus, we often find software kluges masquerading as tools that let users mix textual and diagrammatic design. Such tools best suit designers who are exceptional in both spatial and linguistic areas, and not enough such people are available to do all the engineering that needs to be done.

Therefore, everyone who has a hand in developing software tools for engineers should become familiar with Harvard researcher Howard Gardner's Theory of Multiple Intelligences. Gardner has written several popular books on the subject, and his theories provide the scientific underpinning for the notion that engineers need visual—not textual—design tools. Engineering-tool companies need to research the mental activity of creative engineers and then develop new visual metaphors that support the ways engineers think.

Charles H Small
Senior Editor

References

1. Gardner, Howard, "Frames of Mind, The Theory of Multiple Intelligences," Basic Books, New York, NY, 1985. ISBN 0-465-02508-0.
2. Gardner, Howard, "The Mind's New Science: A History of Cognitive Revolution," Basic Books, New York, NY, 1987. ISBN 0-465-0435-5.

Send me your comments via FAX at (617) 558-4470, or on the EDN Bulletin Board System at (617) 558-4241 300/1200/2400, 8, N, 1.

PRESENTING A FASTER LOW-COST
D/A CONVERTER. FROM THE PEOPLE
WHO'VE BEEN THE LEADERS SINCE THE
BEGINNING OF DIGITAL TIME.

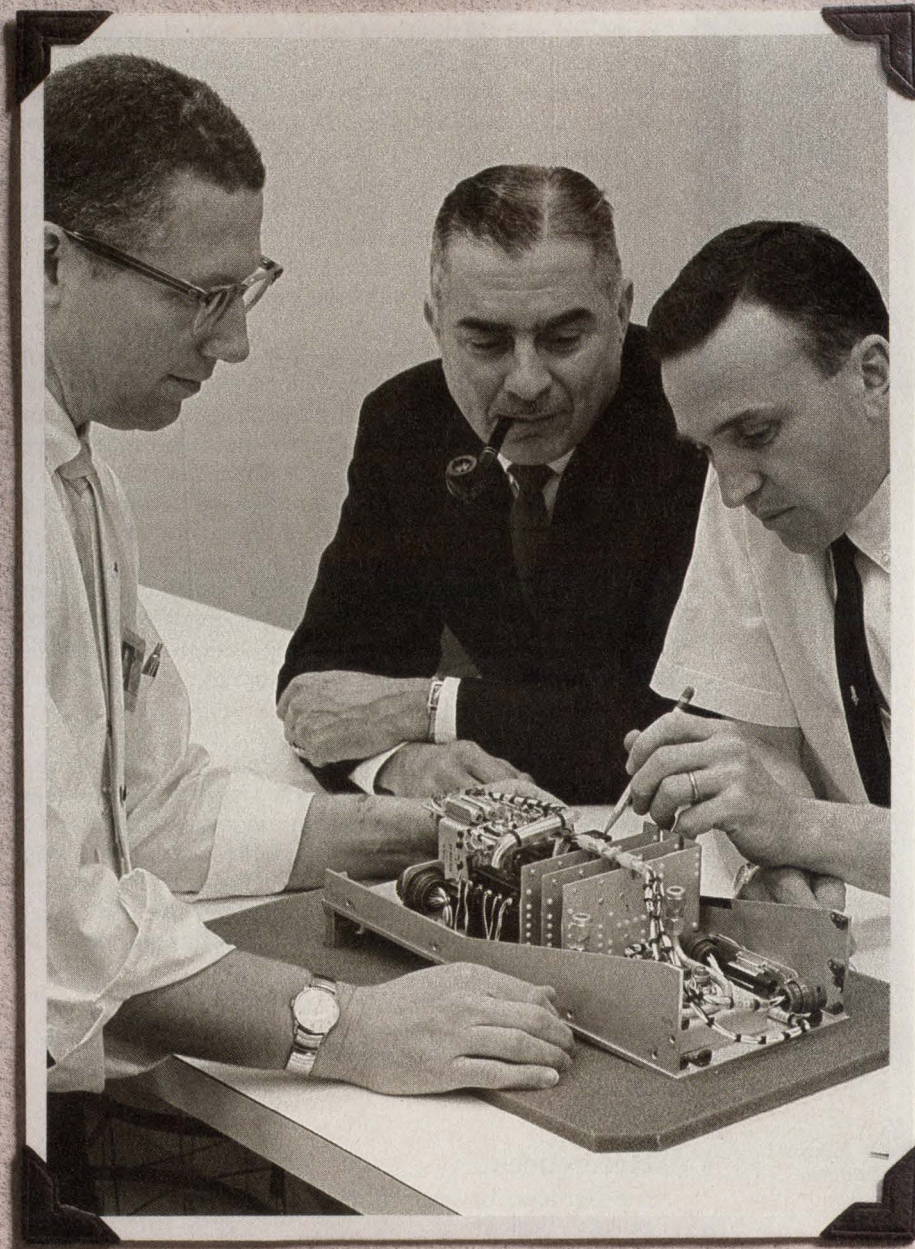

With 10-bit resolution and a speed of 40 Msps, a low-cost high-speed D/A converter is here. The TDC3310.

Another timely move from the company who pioneered the Monolithic Video D/A converter. TRW LSI Products, Inc.

Which means that now, you've got just what you need for low-cost video applications.

Because you know TRW LSI's standards. We provide more than innovation. We provide exactness. Performance specs with mins and maxes that you can rely on.

The TDC3310 requires only a +5 Volt power supply and has TTL-compatible inputs,

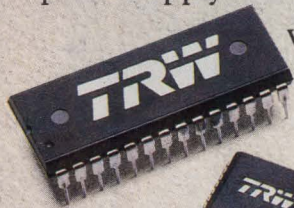

with a voltage output and a control that inverts video levels. It's ideal for reconstructing both composite and component wave-

forms, including NTSC, PAL, SECAM and RS-343A. And with data decoded and registered ahead of the current switches, the results are outstanding low-glitch characteristics.

In essence, you're getting studio video quality and performance. At a consumer price.

Furthermore, the TDC3310 has a low-cost high-speed A/D companion – the TMC1175. And add the TMC2242 for half-band digital filtering – reducing your design complexity and cost.

The TDC3310 is available in a 32-lead plastic J-leaded PLCC and 28-pin plastic DIP packages, and is guaranteed over the 0°C to 70°C temperature range.

All with the full spec performance that is synonymous with TRW standards.

Ask for the Data Sheet, applications and other information on the TDC3310 today. From the company whose standards get even better with time.

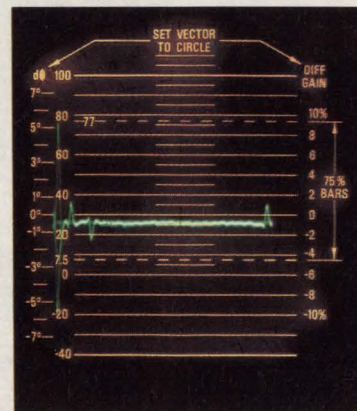

TDC3310 differential phase

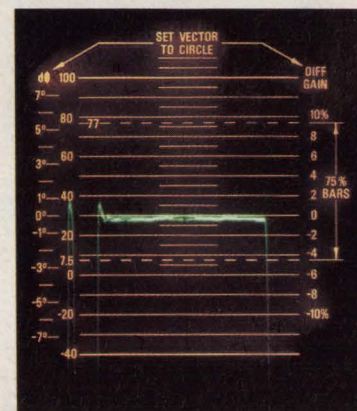

TDC3310 differential gain

Call or write: TRW LSI Products Inc.,
P.O. Box 2472, La Jolla, CA 92038
(619) 457-1000, FAX (619) 455-6314
(800) TRW-LSIP (800) 879-5747



TRW LSI Products Inc.

STANDARDS SET. STANDARDS TO BE MET.

From Conception to Realization— We Have Your Circuit Design In Mind

Let MicroSim Corporation help you achieve your circuit engineering goals with our family of CAE packages— Genesis, Circuit Analysis, and Circuit Synthesis.

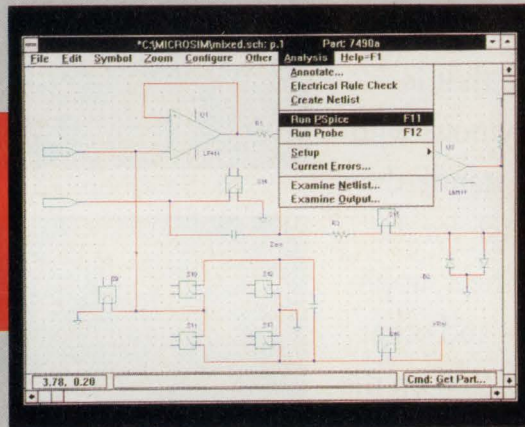

Schematics as a
Windows 3.0 application

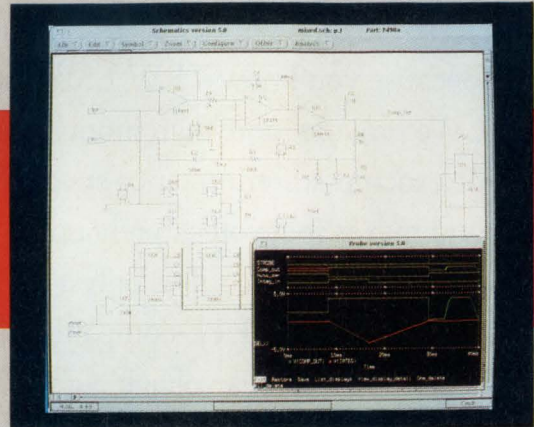

Schematics as an
OpenWindows application

Integrated Schematic Capture, Circuit Simulation, and Analysis

Our new Genesis package includes **Schematics**, a versatile schematic capture front-end to our popular Circuit Analysis programs, **PSpice** and **Probe**. Circuit definition is simple and flexible with Schematics' graphical circuit and symbol editors. Netlists for PSpice are generated automatically from the schematic drawing. Iterative adjustment of PSpice analysis parameters and invocation of PSpice simulations is convenient and direct through Schematics' pull-down menus and dialog boxes. Visual inspection of simulation results is just as straightforward since Probe is run directly from Schematics.

New Schematic Capture Program

Schematic drawings are easy to create and edit with **Schematics**. Features include general attribute handling, auto-incrementing of names and labels, auto-repeat with stepping, rubberbanding of wires and buses, and electrical rule-checking. Any mix of analog and digital components can be used. The Schematics library contains symbols for all parts contained in the PSpice model libraries— over 3,500 analog and 1,500 digital components. An integrated symbol editor allows new symbols to be created and new part attributes to be defined while working on a schematic drawing. Whether you are running Schematics as a "native" Windows 3.0 application on the PC or as an OpenWindows application on the Sun-4 or SPARCstation, you can count on an easy-to-use system to capture, simulate, and analyze your circuit design.

Expanded PSpice Analyses

PSpice and its options form an integrated package for analog and mixed analog/digital circuit analyses. Standard simulations include DC sweep, AC sweep, noise, and transient analyses which may be performed under varying temperature conditions.

Probe provides interactive viewing of PSpice simulation results with high-resolution graphics including these features: Performance Analysis (new!), multiple Y axes (new!), flexible plot control, simultaneous display of analog and digital waveforms, fast Fourier transforms, and more.

In-depth examination and processing of PSpice simulation results is more powerful than ever with Probe's new Performance Analysis feature. By applying any number of user-defined goal functions (such as pulse-width or overshoot) to multiple PSpice waveforms, a circuit's behavior

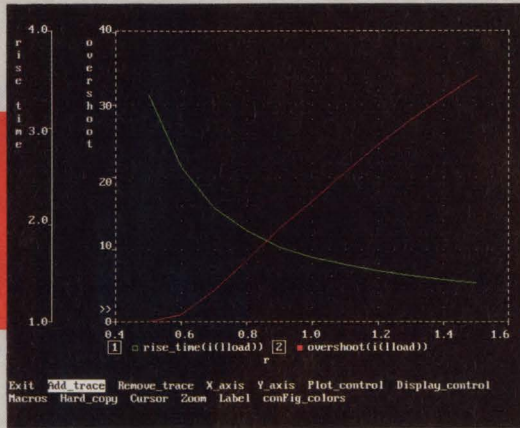

Performance Analysis: rise time and overshoot derived from multiple waveforms with stepped resistance

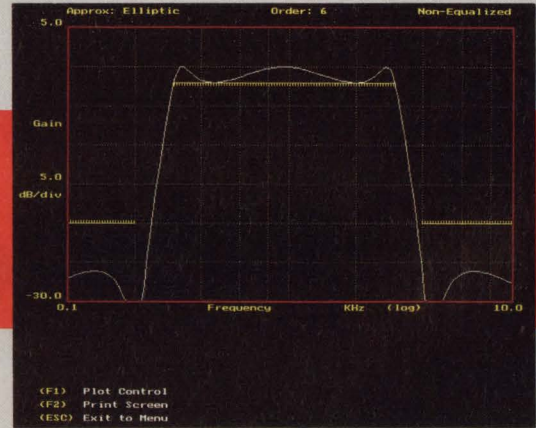

Bode plot in Filter Designer

can be tracked as a function of changing conditions (like temperature or model parameter values). Now it's easy to visualize trends in your circuit's performance by plotting quantities like delay versus temperature or pulse-width versus component value.

Digital Simulation supports mixed analog/digital circuit simulation including circuits with tightly coupled feedback between the analog and digital sections.

Monte Carlo Analysis performs statistical, sensitivity, and worst case analyses by accounting for component tolerances.

Analog Behavioral Modeling allows for the flexible definition of component models or entire circuit functions by formula or look-up tables.

Parts aids in the determination of model parameters from data sheet information for standard analog devices.

Filter Synthesis Made Easy

Active RC biquad and switched capacitor filters are a breeze to design and evaluate with **Filter Designer** in our Circuit Synthesis package. Low pass, high pass, band pass, and band reject filters are synthesized using classical approximations. Advanced features include Sensitivity Analysis (new!), Delay Equalization, and Non-Standard Functions for the synthesis of filters for which there are no fixed mathematical recipes. Using results from Filter Designer, your filter circuit design can be simulated and further analyzed with PSpice and Probe.

For more information on MicroSim Corporation's family of products, call toll free at (800) 245-3022 or FAX at (714) 455-0554.



MicroSim Corporation

Expanding the Standard for Circuit Simulation

The Most Diverse Family In Memory.

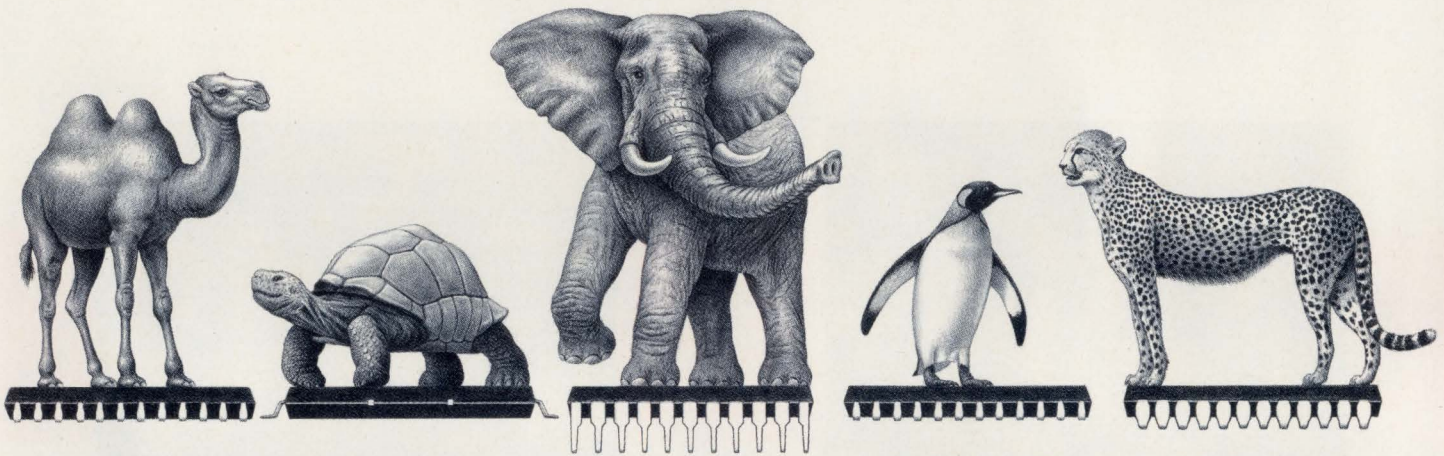

Designs That Endure
High Temperatures

Consistent Performance
At Low Powers

Massive And Reliable
Memory

Perfectly Suited For
Cold Climates

High Speed Processing
Performance

A Complete Line Of 1-Meg SRAMs.

Call Sony first. The largest selection of 1-Meg SRAM assures you can find the high performance, highly reliable memory you're looking for with just one call, so why go on a safari?

Fast or slow. Hot or cold. Even your massive memory requirements are right here.

And we can ship the package styles most in demand for your new designs today - and tomorrow. Our new production facility in San Antonio, TX will build on the reputation for timely delivery that has made us a breed apart.

The Best Selection Of New SRAMs.

-40° to +85°C, 3 volts and
X9.20 nsec

If your current designs
incorporate the latest

technology, call us. Virtually every new idea in SRAM will be here at Sony first. And our U.S. design team (with their 0.8 & 0.5-micron CMOS technology) stands ready to get you the right product for your design; whether it's for a laptop or workstation.

Call Sony First.

We've got the product, backed by the Sony commitment to quality and service. And at competitive prices that make us the King of the SRAM Jungle.

Call today 714.229.4190 or 416.499.1414 in Canada. Or fax us

your current requirements
for a quick response from
our technical staff
714.229.4285 (fax) or
416.497.1774
(fax/Canada).

1-Meg SRAM						
Model	Speed (ns)	Packaging	Data Retention Current	Special Features	Availability	
128Kx8 -- CXK581000P	100/120	DIP 600mil	L/LL	B/X	Now	
-- CXK581000M	100/120	SOP 525mil	L/LL	B/X	Now	
-- CXK581100TM	100/120	TSOP (normal)	L/LL	B/X	Now	
-- CXK581100YM	100/120	TSOP (reverse)	L/LL	B/X	Now	
-- CXK581001P	70/85	DIP 600mil	L/LL		Now	
-- CXK581001M	70/85	SOP 525mil	L/LL		Now	
-- CXK581020SP	35/45/55	SDIP 400mil			Now	
-- CXK581020J	35/45/55	SOJ 400mil			Now	
128Kx9 -- CXK77910J	17/20	SOJ 400mil		Sync ASM	3/Q '91	
256Kx4 -- CXK541000J	25/30/35	SOJ 400mil			3/Q '91	

L = Low LL = Low,Low B = 3 Volt X = Extended Temperature

SONY

Sony Corporation of America, Component Products Company, 10833 Valley View St., Cypress, CA 90630

Sony Canada, 411 Gordon Baker Rd., Willowdale, Ontario M2H 2S6

Prices and specifications are subject to change without notice. The purchase of products is subject to availability and Sony's standard terms and conditions of sale. Sony is a registered trademark of Sony Corporation.

SCPI instruments will ease ATE development

Engineers who want to minimize test-system development time and maximize system flexibility should use SCPI instruments whenever possible.

*Maury Wright,
Regional Editor*

The SCPI (Standard Commands for Programmable Instruments, pronounced "skippy") standard promises to simplify the programming of automatic test systems. Companies complying with the standard will ensure that similar instruments from different manufacturers have similar command languages. Thus, a programmer would need to learn how to program a voltmeter, frequency counter, or other instrument only once.

Most major instrument makers plan to use SCPI in all their new products. SCPI-compatible GPIB (General-Purpose Instrument Bus) and VXIbus test instruments have started to ship, but most types of SCPI instruments are still scarce. If you can find a SCPI version of a test instrument that you need now, buy it. SCPI compliance should be a determining factor when you choose instruments for a test system, and SCPI products cost the same as their non-SCPI counterparts.

The SCPI standard defines an extensible command language for the remote control of instruments. The language was developed independently of the front-panel terminology specific to individual instruments. The language uses a consistent style and English-like mnemonics, both of which make the language readable and easy to use. For example, the following command will read the dc voltage from any SCPI instrument that can measure voltage:

MEASure:VOLTage:DC?

The language's keywords can be written out in full or abbreviated to the 3- or 4-character strings indicated by the capital letters. Strings of keywords make up SCPI commands.

The creators of the SCPI standard sought to develop a language that offered what they termed vertical, horizontal, and functional compatibility. Vertical compatibility means that two instruments of the same generic instrument type, such as two digital oscilloscopes from different manufacturers, will have compatible command sets. A

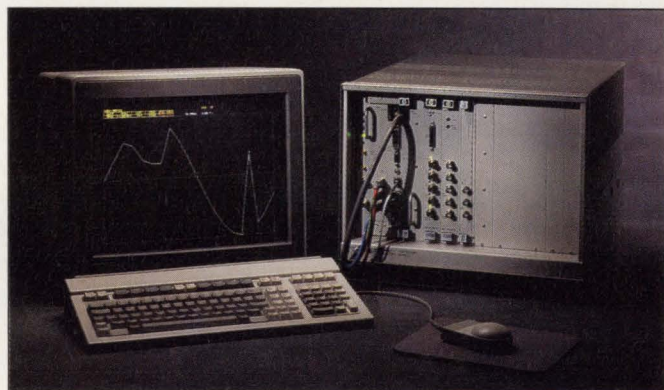

The SCPI VXIbus arbitrary waveform generator from Hewlett-Packard, the \$8000 E1445A, is one of a variety of HP instruments that comply with the SCPI standard.

single software driver could control either instrument.

Horizontal compatibility refers to a situation in which two different types of instruments can perform the same measurement. For example, both frequency counters and digital oscilloscopes can measure the frequency of a signal. The horizontal-compatibility goal mandates that the same frequency-measurement command will properly instigate a frequency measurement in either type of instrument.

Functional compatibility refers to the

0 1.0 2.0 3.0

COUNT ON IDT

When Every Nanosecond Counts

Squeeze critical nanoseconds from your high-speed logic interface with the fastest FCT logic available. IDT's FCT-CT family offers speeds that are 50% faster than standard FCT or FAST logic families — as fast as 3.4ns (typical)!

The Perfect System Solution

As a system designer, you need the perfect combination of:

1. **Fastest speed**
2. **Low ground bounce**
3. **Low power consumption**

FCT-CT logic has true TTL compatibility for ease of design. The reduced output swings and controlled output edge rate circuitry ensure low system noise generation. No other technology offers higher speeds or lower power consumption.

The FCT-CT family is completely pin- and function-compatible with FCT logic, and is available today in all standard packaging.

FUNCTION	PROPAGATION DELAY (Max)	OUTPUT ENABLE (Max)	OUTPUT DISABLE (Max)
Buffers	4.1ns	5.8ns	5.2ns
Transceivers	4.1ns	5.8ns	4.8ns
Registers	5.2ns	5.5ns	5.0ns
Latches	4.2ns	5.5ns	5.0ns

Free Logic Design Kit

Call our toll-free hotline today and ask for **Kit Code 3061** to get a **1991 High-Speed CMOS Logic Design Guide** and **free FCT-CT logic samples**.

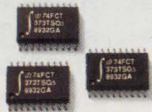

(800) 345-7015 • FAX: 408-492-8454

The IDT logo, CMOS, BiCMOS, and R3051 are trademarks of Integrated Device Technology, Inc.

CIRCLE NO. 18

12ns 256K SRAMS

Fastest cache solutions for RISC and CISC CPUs. 36+ ultra-high-speed sub-micron SRAMs for 33MHz processing & beyond are in the **SRAM Data Book**.



35mips RISC CHIPS AND MODULES

R3000A for the most mips at any MHz; R3051 for CPU, cache, & buffers on one chip. Modules, eval. boards & software complete the family. See them in the **RISC Data Book**.

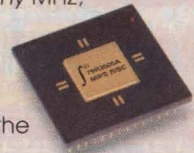

HIGHEST-PERFORMANCE MEMORIES

Fast FIFOs, dense dual-ports, BiCMOS ECL, & memory modules. 120+ FIFOs & multi-port memories, 5ns ECL, & multi-chip modules are in the



Specialized Memories Data Book.



Call today for your new IDT data books with complete technical specifications and application information.



Integrated Device Technology, Inc.

TECHNOLOGY UPDATE

The SCPI standard

compatibility of specific features in different types of instruments. For example, the same frequency and sweep commands can control a spectrum analyzer and a RF source because both types of instruments can sweep in frequency.

SCPI allows instrument updates

Designers who use SCPI-compatible instruments exclusively will realize several benefits. First, updating an ATE (automatic-test-equipment) system with the best voltmeter available will require minimal changes in system and test software. Second, the time required to develop software for new ATE systems should drop because SCPI leads to reusable code. Third, programmers will be more efficient when using SCPI instruments because of the three types of compatibility and the fact that the language is easy to read and consistent in style.

SCPI poses no larger challenge to the first-time user than do the one-of-a-kind command sets currently common in instruments. Senior Electronics Engineer Mike Hanus of Sundstrand Power Systems

Keyword	Parameter form
INPut	
:ATTenuation	< numeric_value >
:AUTO	< Boolean > ONCE
:COUPling	AC DC
:FILTer	
[:LPASSs]	
[:STATe]	< Boolean >
:FREQuency	< numeric_value >
:HPASSs	
[:STATe]	< Boolean >
:FREQuency	< numeric_value >
:GAIN	< numeric_value >
:AUTO	< Boolean > ONCE
:GUARd	LOW FLOat
:IMPedance	< numeric_value >
:LOW	FLOat GROund
[:STATe]	< Boolean >

(San Diego, CA) recently worked with a SCPI instrument for the first time. Hanus replaced a test set's programmable power source with a SCPI version. He reports that the software driver for the new source took no longer to write than did the original driver and that he wouldn't have had to write a new driver had the first source been SCPI compatible. Hanus says the experience has prompted him to write more modular code with the goal of reusing portions of his code for SCPI-compatible instruments.

The SCPI standard is independent of any physical interconnection specification. You will most often hear the term SCPI associated with VXIbus-based instruments and instruments that use the GPIB defined by the IEEE-488.1 specification. But SCPI works equally well on instruments connected to a controller via an RS-232C serial interface or any other interface.

Although the SCPI standard doesn't specify a physical interface, it does mandate the use of features defined in the IEEE-488.2 specification. The IEEE-488.2 standard defines controller functions, data formats, and status reporting—basically a common set of house-keeping commands for instruments. (See **Ref 1** for more information on the IEEE-488.2 specification.)

Alan Hoffman, director of engineering at IOtech, points out that SCPI offers a way for manufacturers to standardize the commands used for board-level PC instruments. IOtech offers a line of GPIB controller cards for IBM PCs. The Power488 and Power488CT cards also feature SCPI-compatible test-and-measurement capabilities. The

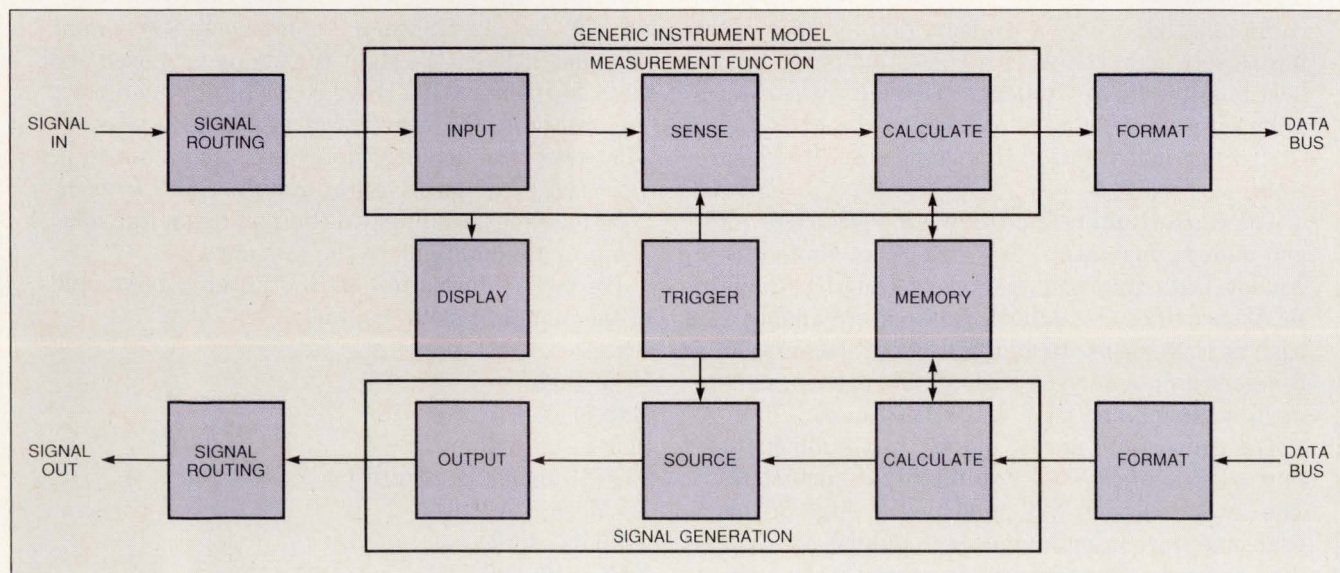

Fig 1—The generic instrument model depicted here guided the development of the tree-structured SCPI standard.

TECHNOLOGY UPDATE

The SCPI standard

Power488 costs \$495 and includes 40 digital I/O lines in addition to the GPIB controller and driver software. The \$595 Power488CT adds counter/timer features.

SCPI's creators based the language on the generic instrument model in Fig 1 (see box, "SCPI Consortium controls standard," for a history of SCPI's creation). The SCPI standard defines a tree-like structure that has more than 20 ma-

major subsystems as the main branches. The squares in Fig 1 correspond to major subsystems of the SCPI language. Additional major subsystems handle special instrument capabilities such as calibration and diagnostics. The box, "Major SCPI subsystems," lists the major command subsystems.

Look at Table 1 for a sample of a SCPI command subsystem taken directly from the specification. The

INPut command lets you program the conditioning an instrument applies to an incoming signal. Keywords in square brackets indicate default paths through the SCPI tree structure. A program can use one or more of the command options for the instrument in use.

Instruments don't need to implement commands from every SCPI subsystem. Instrument designers can choose the subsystems they

SCPI Consortium controls standard

A consortium of leading test-and-measurement instrument vendors defined SCPI and still controls the evolution of the standard. The consortium considers the standard to be "free and open"—any test equipment manufacturer can use SCPI commands in an instrument free of charge. The consortium continues to add to the SCPI standard to account for additional types of programmable instruments.

Customer demand led to the creation of SCPI. Sophisticated customers recognized that the time test programmers spent writing drivers for each new incompatible instrument was wasted. Hewlett-Packard reacted to the need for standardization among its varied instruments by creating its Test and Measurement Systems Language (TMSL), which the company introduced in August 1989. Simultaneously, a group of instrument vendors was contemplating a similar project. And for once in this intensely competitive electronics industry, the best possible thing happened. Hewlett-Packard contributed its TMSL work and joined the group of companies that went on to form the SCPI Consortium.

The consortium refined Hewlett-Packard's work and added capabilities. Tektronix contributed its Analog Data Interchange Format (ADIF) standard. ADIF provides a standard way to store analog data such as waveforms. In addition, ADIF includes environmental data such as scaling information, instrument settings, and time and date stamps.

The consortium moved quickly and published the first version of the SCPI standard in April 1990. The second version was published in June of this year, and the consortium plans to publish an updated spec annually. The consortium meets every two

months to discuss proposed additions to the SCPI standard. A private forum on the Compuserve dial-up service includes up-to-date information on proposals, meeting schedules, and newly approved commands.

The founding members of the consortium are Bruel & Kjaer (Naerum, Denmark), John Fluke Mfg Co (Everett, WA), Hewlett-Packard Co (Loveland, CO), Keithley Instruments Inc (Cleveland, OH), National Instruments Corp (Austin, TX), Philips (Almelo, The Netherlands), Racal-Dana (Irvine, CA), Tektronix Inc (Beaverton, OR), and Wavetek Inc (San Diego, CA). The consortium now has more than 20 members.

Any company can join the SCPI Consortium. Sponsor memberships cost \$20,000 annually and include one seat on the consortium's board of directors. A contributing membership costs \$5000 annually and includes the right to vote on proposed additions to the standard. Five contributing members are elected to the board of directors each year. The \$750 associate membership grants access to the private SCPI Compuserve forum only. SCPI Consortium meetings are open to the public, and anyone can propose additions to the standard.

For more information on SCPI and to buy copies of the standard (\$50), contact

Fred Bode
Executive Director
SCPI Consortium
8380 Hercules Dr, Suite P3
La Mesa, CA 92042
(619) 697-4301
FAX (619) 697-5955.

How Design Work Becomes Teamwork.



The DAZIX Simultaneous Engineering Environment (SEE) turns design work into teamwork.

SEE allows your departments to coordinate efforts during every phase of the design process. This helps to improve product quality, lower production costs, and get products to market faster.

SEE delivers the integration you asked for. Common database management. Common user interface across applications. And a complete

toolset, including solutions for front-to-back electronics design, mechanical design, manufacturing, and document management.

What's more, with SEE, your entire team can benefit from an open-system framework. A framework that integrates DAZIX, Intergraph, and Sun products –

as well as leading third-party tools – in a single environment.

There's more you should know. Call us today at 800-239-4111 for a free copy of *Simultaneous Engineering*.

In Europe, call 33-1-4537-7100. In the Asia-Pacific area, call 852-8661966.

DAZIX[®]
An Intergraph Company

Intergraph® and DAZIX® are registered trademarks of Intergraph Corporation. Other brands and product names are trademarks of their respective owners.
Copyright 1991 Intergraph Corporation, Huntsville, AL 35894-0001. DDAD03440.

TECHNOLOGY UPDATE

The SCPI standard

need to control an instrument's features. The SCPI standard requires only that an instrument implement the SYSTEM command subsystem.

Joe Mueller, a project manager at Hewlett-Packard and the com-

pany's representative to the SCPI Consortium, points out that SCPI allows for 100% control of an instrument's features. A typical instrument might implement 100 to 200 total SCPI commands, according to

Mueller. The average user may need no more than a dozen commands to develop a specific test program.

The most frequently used commands are those in the MEASURE

Major SCPI subsystems

The following list describes the major subsystems that make up the main branches of the SCPI tree. The beginning capital letters indicate the subsystem's abbreviated form.

CALCulate—The CALCulate subsystem includes commands that control data-processing functions performed on data typically acquired by a SENSE command. For example, a CALCulate command can control the conversion of data from the frequency domain to the time domain.

CALibration—Commands in the CALibration subsystem control system-calibration functions.

DIAGnostic—The DIAGnostic subsystem includes all the service and diagnostic commands for routine maintenance and repair.

DISPlay—Commands in the DISPlay subsystem control the selection and presentation of textual, graphical, and TRACe information.

FORMat—The FORMat subsystem commands set the data format for transferring numeric and array information.

INPut—INPut subsystem commands control the characteristics, such as the attenuation, of a sensor's input ports.

INSTrument—INSTrument subsystem commands are used for instruments, such as a dual-channel power supply, that support multiple logical instruments.

MEASure—The MEASure subsystem defines a set of high-level instructions that are used to acquire data. This subsystem includes the most commonly used SCPI commands. The concept of horizontal compatibility defined in the SCPI standard is implemented in the MEASure subsystem.

MEMory—The MEMory subsystem commands manage the semiconductor memory instruments use to store various types of data.

MMEMory—MMEMory commands manage mass-storage devices, such as disk drives, that are inside instruments or directly connected to instruments.

OUTPut—Commands in the OUTPut subsystem control the characteristics of a source's output port. For example, an OUTPut command can set the output source impedance of a signal.

PROGram—The PROGram subsystem commands provide control of one or more user-programmed tasks resident in an instrument.

ROUTE—ROUTE subsystem commands control instruments primarily designed to route signals. These commands also control signal routing on instruments that offer routing capability as a front end to input and output ports.

SENSe—The SENSe subsystem includes commands that directly set device-specific features before taking a measurement. An example of such a feature is an instrument's filter bandwidth.

SOURce—SOURce subsystem commands set device-specific features, such as modulation controls, on a signal source.

STATus—The STATus subsystem commands add status-reporting structures to those defined in IEEE-488.2.

SYSTEM—The SYSTEM subsystem includes the functions not related to instrument performance, such as the characteristics of an instrument's communications interface. This subsystem forms the command base required in all instruments.

TEST—The TEST subsystem extends standard instrument self-test procedures beyond those defined in IEEE-488.2.

TRACe—Commands in the TRACe subsystem control the definition and manipulation of trace data.

TRIGger—The TRIGger subsystem commands serve to synchronize instrument actions with other events.

UNIT—The UNIT subsystem provides a way to change the units of measure associated with an instrument feature.

VXI—Commands in the VXI subsystem include the administration functions associated with VXIbus-based systems.

Limited Only By Your Imagination



Remember how quickly you could turn a concept into reality with a set of quality building blocks? How you always seemed to have just the right parts and how well they fit together? How easily you could modify your creation to explore creative alternatives?

Our VI-200 and VI-J00 families of high density converters, along with a host of compatible modular peripheral products, are designed to "plug and play" perfectly... offering you the flexibility, ease-of-use, quality and repeatability needed to implement virtually any power system solution. And with hundreds of standard models to choose from...input ratings from 10 to 400 Volts, outputs from 2 to 95 Volts and power expansion from Watts to kiloWatts... you won't be stuck at the last minute with "missing" parts.

You're not playing with toys anymore...which may be the most important reason for specifying Vicor's component-level "building blocks" for your next power system.



Component Solutions For Your Power System



23 Frontage Road Andover, MA 01810
TEL: (508) 470-2900 FAX: (508) 475-6715

TECHNOLOGY UPDATE

The SCPI standard

subsystem. The MEASure subsystem enjoys special status although it is a major branch on the SCPI tree with the more than 20 other subsystems. The MEASure subsystem implements the horizontal compatibility the SCPI specification defines.

Hewlett-Packard's Mueller offers an example that illustrates the horizontal compatibility SCPI makes possible and the philosophy behind it. He describes the compatibility of an integrating digital voltmeter with a sampling digital voltmeter. A test programmer could use SCPI's capabilities to program the sampling meter to take 4012 samples to measure dc voltage.

A program that commanded the integrating meter to take 4012 samples, however, might receive an error as an answer because the integrating meter doesn't take samples. The instrument designer could be clever and use SCPI to design the integrating meter so that it would take a meaningful measurement after such a request. The SCPI standard doesn't require instrument manufacturers to take such precautions, however.

Mueller suggests a way to write the test program that ensures an accurate measurement from SCPI-compliant instruments. The reason the programmer set the number of samples was to limit the amount and frequency of the ac voltage rejection present in the dc voltage measurement. You could use a higher-level SCPI command to instruct either meter to account for 60-dB rejection at 52 Hz, for example. The instrument would then take the measurement in the best possible way.

The thousands of possible SCPI command combinations will always make exact compatibility of instruments impossible. No two instruments—not even two voltmeters—

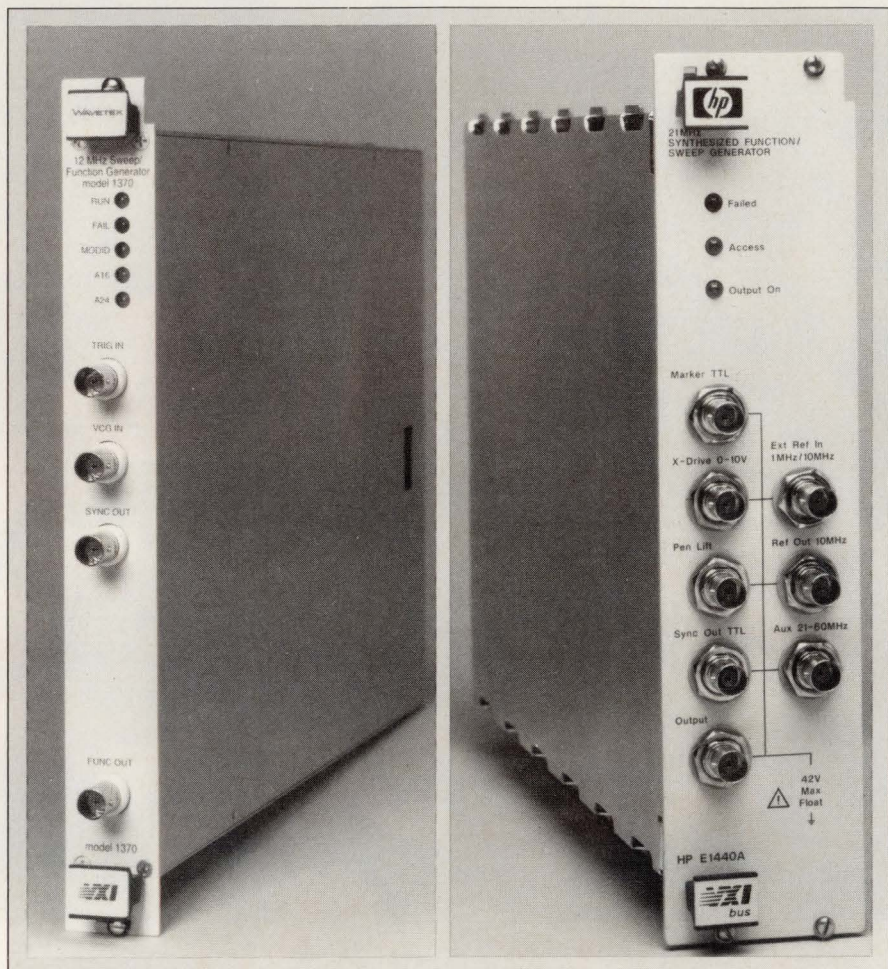

The synthesized sweep/function generator, Model 1378, from Wavetek demonstrates that SCPI's concept of vertical compatibility works. The command set of the VXIbus instrument on the left is compatible with that of the Hewlett-Packard E1440A sweep/function generator on the right.

have the exact same measurement capabilities. But SCPI does provide the means to achieve the vertical, horizontal, and functional compatibility of the specification.

Unfortunately, little evidence now exists that indicates how well SCPI will work in practice. Hewlett-Packard offers a line of VXIbus instruments and a few GPIB instruments that use SCPI. But HP had a head start on the industry because much of SCPI was derived from the company's Test and Measurement System Language (TMSL).

Other companies that now offer SCPI products include the Fluke

(Everett, WA) and Phillips (Almelo, The Netherlands) conglomerate. Between these two companies you can buy SCPI-compatible frequency counters, programmable power sources, and signal-switching systems. Finally, Wavetek, San Diego offers a line of VXIbus instruments for signal generation.

Thus far, the best example of SCPI success can be found in the compatibility between the Wavetek 1378 Synthesized Sweep/Function Generator (\$3295) and Hewlett-Packard's E1440A generator (\$5750). The products have a similar

Embedded Controllers

With these you can control the world.

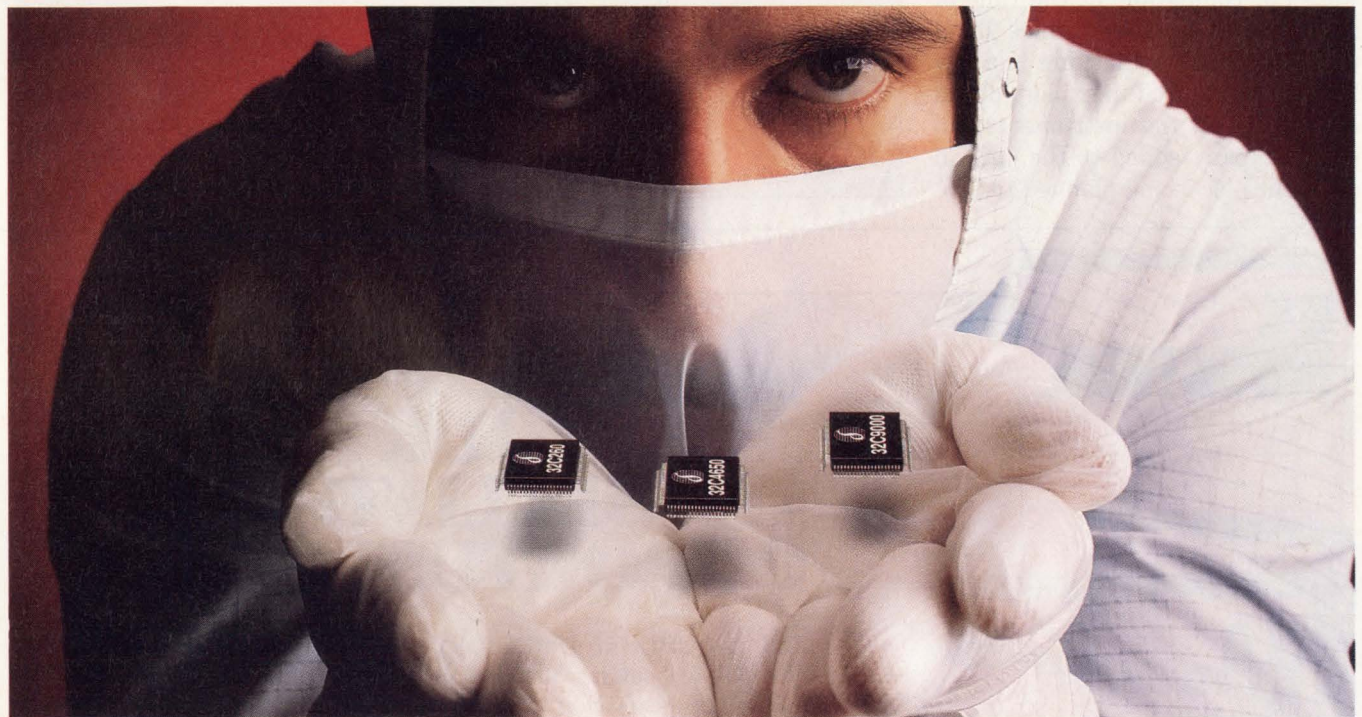

The world of disk drive electronics, that is. By implementing Silicon Systems' embedded interface controllers into your design you can achieve optimum performance in a low-power CMOS package.

Our complete line of embedded controller ICs—combining PC-AT/XT or SCSI interfaces with Buffer Manager and Storage Controller—gives you everything you need to span the entire spectrum of performance, power and

Circle #42 for Product Information

interface standards. Your design cycle for customized versions is shortened by our standard cell design method. You can easily port firmware from AT to SCSI designs. And, by keeping things all in the family, you're sure to come out better on pricing.

So take control, and learn more about our embedded controllers. Call us for literature package SPD-8. We'll connect you with your nearest Silicon Systems representative and

Circle #43 for Career Information

update you on our latest developments.
1-800-624-8999, ext. 151.

Silicon Systems, Inc.
14351 Myford Road, Tustin, CA 92680
Ph (714) 731-7110 Fax (714) 731-6925
European Hdq. U.K. Ph (44) 79-881-2331
Fax (44) 79-881-2117

silicon systems[®]
A TDK Group Company

TECHNOLOGY UPDATE

The SCPI standard

set of signal-generation capabilities and clearly demonstrate vertical compatibility. Bill Lee, Wavetek design engineer and the company's SCPI Consortium representative, points out that the SCPI standard includes explicit commands that let the companies implement all the desired functions. Thus, the instruments were compatible.

Both Hewlett-Packard and Wavetek also offer VXIbus arbitrary-function generators based on SCPI. The function generators were not compatible at the time of introduction. Both companies found the SCPI standard lacking in a few key areas required to exploit all the capabilities of the instruments. So each company added to the spec in different places and planned to pro-

pose the new commands to the SCPI Consortium as formal SCPI changes. Both companies worked on the new commands in secret because neither wanted to disclose features of an unannounced product.

Wavetek engineers added com-

mands to the TRACe subsystem to perform additional waveform functions. Hewlett-Packard engineers added similar capability in the SOURce subsystem. The resulting products were not vertically compatible. Both companies presented their propos-

For more information . . .

For more information on the SCPI-based products discussed in this article, circle the appropriate numbers on the Information Retrieval Service card or use EDN's Express Request service. When you contact any of the following manufacturers directly, please let them know you saw their products in EDN.

Hewlett-Packard Co
19310 Pruneridge Ave
Cupertino, CA 95014
(800) 752-0900
Circle No. 712

IOtech Inc
25971 Cannon Rd
Cleveland, OH 44146
(216) 439-4091
FAX (216) 439-4093
Circle No. 713

Wavetek San Diego Inc
9045 Balboa Ave
San Diego, CA 92123
(619) 279-2200
FAX (619) 565-9558
Circle No. 714

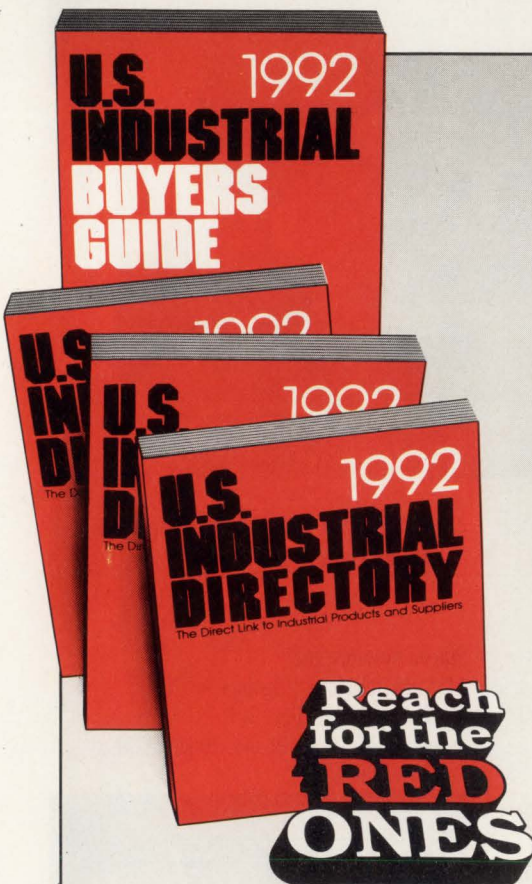

DOUBLE YOUR SELLING OPPORTUNITIES

The U.S. INDUSTRIAL DIRECTORY and The U.S. INDUSTRIAL BUYERS GUIDE now reach 115,000 key buyers in U.S. manufacturing. Nearly 50% of this reach is to individuals with buying influence in the all important Fortune 500 companies.

Your advertisement will reach all these people in an extremely cost effective way and will be seen 365 days of the year.

Call or write for more information on your many advertising options in the next edition of the U.S. INDUSTRIAL DIRECTORY and BUYERS GUIDE.

U.S. INDUSTRIAL DIRECTORY & BUYERS GUIDE
Reed International • Cahners Publications
8 Stamford Forum, P.O. Box 10277, Stamford, CT 06904 (203) 328-2500
Fax (203) 357-7864

TECHNOLOGY UPDATE

als to the committee, and a compromise ensued. Soon you will see revision B instruments from both companies that support the SCPI

Acronyms used in this article

ac—alternating current
ADIF—Analog Data Interchange Format
ATE—automatic test equipment
dc—direct current
GPIB—General-Purpose Instrument Bus
PC—personal computer
SCPI—Standard Commands for Programmable Instruments
TMSL—Test Measurement System Language
VXIbus—VMEbus extension for instrumentation

Consortium-approved compromise. The revision B function generators will be vertically compatible.

You can expect other conflicts to arise because of the competitive nature of the electronics industry and the constant influx of new products with new features. Also, the SCPI standard is admittedly short of commands that can control certain types of instruments, such as logic analyzers.

The SCPI Consortium, however, adds to the standard every two months. The consortium features an unprecedented level of cooperation in such a competitive industry. SCPI seems to be an idea with no drawbacks. Most major instrument vendors plan to use SCPI in all their new products, many of which will

be introduced over the next year. Shortly, designers who don't buy SCPI instruments exclusively will find the price, development time, and extensibility of their test systems lacking compared with SCPI-based systems. **EDN**

Reference

1. Leibson, Steven H, "IEEE-488.2 products are just now appearing," *EDN*, April 25, 1991, pg 91.

Article Interest Quotient (Circle One)

High 515 Medium 516 Low 517

Over 150 EMC shielding gaskets to choose from, to give you freedom of design. Off the shelf.

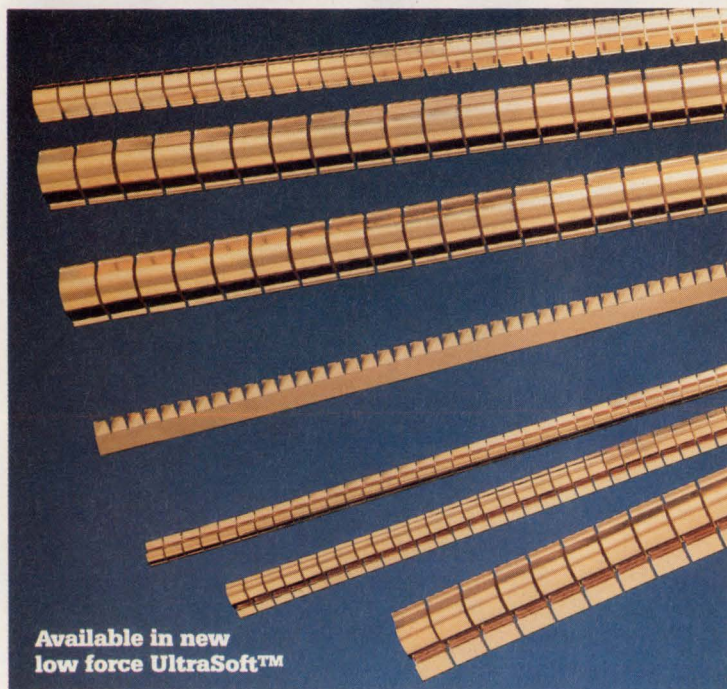

Available in new low force UltraSoft™

Performance that reads like a designer's wish list.

Outstanding thermal and electrical conductivity, for shielding effectiveness over the widest frequency range: > 110 dB at 10 GHz plane wave, and > 46 dB at 14 kHz magnetic. Excellent corrosion resistance, and easily plated to match any host metal if necessary. Low compression force requirements: from 5 to 20 lbs/linear foot to establish surface contact and provide adequate shielding. Finger gasket's compression range up to 90% of free height. Ideal for either shear or compression applications. Light weight. Superb fatigue strength.

Easily mounted with adhesive backing, (Sticky Fingers® Series shown at left), as well as with clip-on's and push rivets (not shown).

How can we help fill your wish list?

Call or write for full information and service. Or ask for our free brochure.



Where shielding is a science.

Instrument Specialties Co., Inc.

Headquarters

Delaware Water Gap, PA 18327-0136
TEL: 717-424-8510 FAX: 717-424-6213

Western Division—Placentia, CA

TEL: 714-579-7100 FAX: 714-579-7105

European Division—Liege, Belgium

TEL: 011-32-41-63-3021 FAX: 011-32-41-46-4862

®Sticky Fingers is a registered trademark of Instrument Specialties Co., Inc.

CIRCLE NO. 30

When it comes to microcontrollers... The Choice Is Not Always Plain.

Hitachi's new H8/300 Family of 8-Bit Microcontrollers is beefier, and includes all the extras: The best in price/performance. High-level language capability. ZTAT™ one-time user-programmable EPROM. The most on-chip peripherals.

Hitachi's new and growing H8/300 Family of Microcontrollers takes 8-bit beyond the ordinary, offering the right mix of ingredients to satisfy your embedded-control appetite. Hitachi's new H8/300 Series' recipe for success includes:

The best price-performance. Put more spice into your applications with the new CMOS H8/300 Family. These microcontrollers combine a modern, general-purpose register architecture with fast processor speeds, and include a CPU core with a maximum 10 MHz clock speed for minimum instruction cycle times of 200ns... 16-bit adds and subtracts in a mere 200ns... 8 x 8-bit multiplies or 16/8-bit divides in only 1.4μs...and up to 32 Kbytes of ROM.

High level language capability. Enjoy fast development and easy maintenance, without the slow program execution typical of old-fashioned software. Hitachi's H8/300 microcontrollers work with "C", Forth, and real-time operating systems, like Hitachi's μITRON. You can also use fuzzy logic compilers to put advanced capabilities,

such as artificial intelligence, into embedded systems—quickly and easily.

ZTAT. Get to market *fast* with Hitachi's ZTAT (Zero Turn-Around Time) one-time user-programmable EPROM. With these low-cost plastic package devices, production can start the very same day you finish development—with no mask charges, lead times, or large quantity commitments. You have a choice for every phase of your product's life cycle: Ceramic windowed devices for development...ZTAT for quick, small-to-medium-scale production...mask ROM devices for lowest-cost large-scale production.

On-chip peripherals. Now you can reduce your whole embedded control system to a single chip, thanks to the H8/300 Family's right mix of on-chip peripherals. Choose from a variety of timers, interrupts, and I/O ports, 8-bit A/Ds, serial communications channels, PWM timers, EEPROM, and much more.

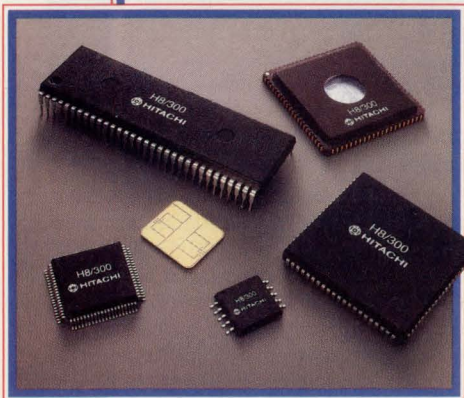

Description	H8/310 Smart-Card IC	H8/322 General-Purpose Real-Time Controller	H8/323 General-Purpose Real-Time Controller	H8/324 General-Purpose Real-Time Controller	H8/325 General-Purpose Real-Time Controller	H8/330 High-End Real-Time Controller	H8/350 Servo-Positioning Controller
ROM/RAM/EEPROM	10K/256/8K	8K/256/0	16K/512/0	24K/1K/0	32K/1K/0	16K/512/0	32K/512/0
Timers			3			5	10
Serial Channel			2			1	2
A/D Converter						8-Bit, 8 Channel	8-Bit, 16 Channel
Interrupts			4 External 16 Internal			9 External 19 Internal	9 External 47 Internal
I/O Ports	1-Bit I/O Common		47 I/O 4 Input Only			58 I/O 8 Input Only	50 I/O 16 Input Only
Other Features	Security Function		Parallel Handshake Port Programmable Pull-up for All I/O			15-Byte DPRAM, Prog. Pull-up for I/O	One 19-Bit Timer, Timer Network
Package	Die Form COB* SOP-10		DP-64S QFP-64 DC-64S w/Wwindow			PLCC-84 QFP-80 LCC-84 w/Wwindow	PLCC-84 QFP-80 LCC-84 w/Wwindow

*Call your Hitachi representative for availability.

Serving it up... The H8/300 Family includes comprehensive development support: Documentation, easy-to-use cross-development tools, in-circuit emulators, and evaluation boards (with additional choices from third-party vendors).

The new Hitachi H8/300 Family of Microcontrollers. We've added all the right ingredients, so your next design can go beyond the ordinary. For more information, call or write today.

Literature Fast Action: For product literature only, CALL TOLL FREE, 1-800-285-1601; ask for literature number M21A001.



Hitachi America, Ltd.
Semiconductor & I.C. Division
Hitachi Plaza
2000 Sierra Point Parkway
Brisbane, CA 94005-1819

 **HITACHI**[®]
Our Standards Set Standards

CIRCLE NO. 31



The basic idea behind our new

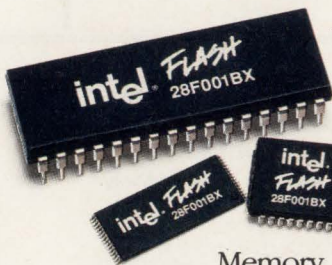

Updating your system code, to say the least, has been a pain. Well, erase those painful memories.

Introducing Intel Boot Block Flash Memory. The first blocked flash memory architecture that includes four separately erasable blocks with one "lockable" block for

critical boot code. A remarkable design that allows one 1Mb Boot Block Flash Memory chip to eliminate up to three memory chips.

It also allows you to reconfigure your system quickly and easily so you don't lose precious time getting to market. Also, future updates—whether it's for hardware or software—are easy. For instance, updating a PC BIOS is as easy and cheap as sending your customers a floppy disk. And all

Intel386 and Intel486 are trademarks of Intel Corporation. Pink Pearl® is a registered trademark of Eberhard Faber Inc. © 1991 Intel Corporation.



block-erasable Flash Memory.

you need to change your embedded program code is a serial link. Life should be so simple.

Intel Boot Block Flash Memory has two configurations compatible with microprocessors and microcontrollers that boot from either high or low memory. Such as the i960™ microprocessor or the industry-standard Intel386™ and Intel486™ microprocessor families.

Now that you have the basic idea, we'd like

you to know more. So call (800)548-4725 and ask for Literature Packet #A6A38. And be the first on your block to make updating easy with Intel's new Boot Block Flash Memory.

intel®

The Computer Inside.™

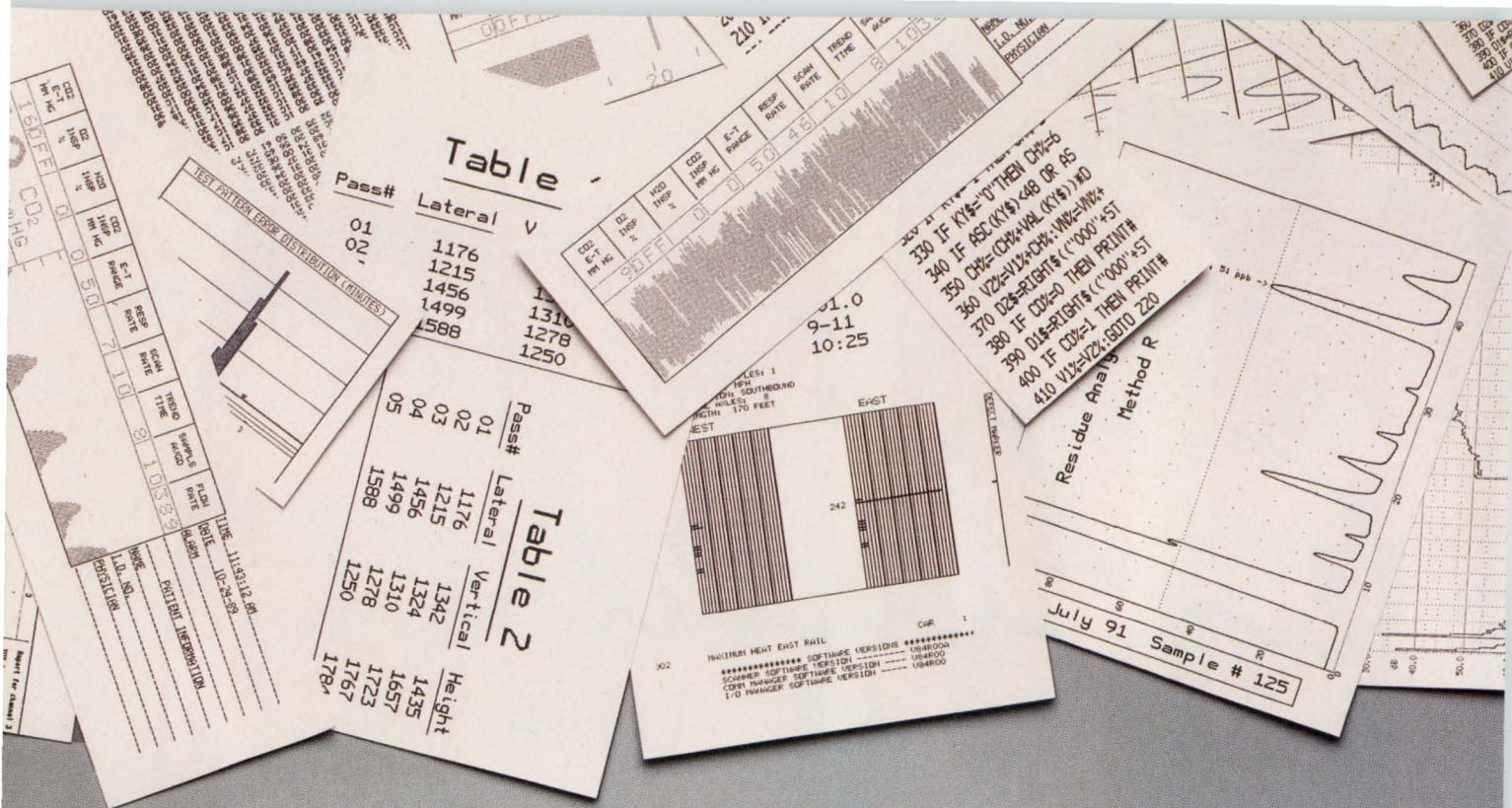

Hard Copy Was Never Easier.

Here's how B-G Instruments' OEM printer family can simplify production of high-quality data printout.

Simple from the start. Our unique DataPlot software cuts development time and effort to a minimum. Just 14 commands let you create printouts with multiple columns, orientations, fonts and graphics. And if you'd prefer, we'll write a custom program for you.

Multiple choices. Hardware options include print mechanisms like those listed here — plus a powerful array of control boards and accessories. So custom systems can be configured quickly and easily to meet your precise needs.

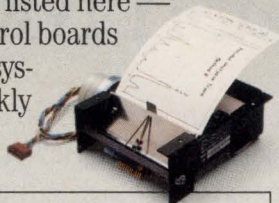

DataPlot Thermal Print Mechanisms

Model Number	Paper Width	Columns Across ²	Dots / Inch	Dots / Line	OEM Price ¹
PM1224	2.6 inches	18 to 37	100	224	\$311
PM1320	2.6 inches	23 to 53	150	320	\$296
PM1416	4.5 inches	29 to 69	100	416	\$443

¹ This is the 300-piece OEM price. It is subject to change without notice.
² The maximum number of columns depends on the font and size selected. The higher number is for 5 x 7 characters, approximately 16 characters/in.



Instantly apparent quality. Features like thick-film printheads, high-torque stepper motors and heavy-gauge construction provide long life. While permanently

lubricated gear trains and gold-plated connectors ensure reliable operation. And special touches such as automatic paper loading simplify operation.

Smart solutions. The power of our software and microprocessor control electronics have helped many customers use our printers to create smart instrument systems. So the same basic tools can serve a variety of different applications.

Get the details. For brochures, sample printouts and an OEM price list, or to arrange for a demonstration at your facility, call or write: B-G Instruments, P.O. Box 1867, Vashon, WA 98070. Phone 206-567-5000. FAX 206-567-5010.



SERIAL EEPROMs

Serial memory offers cheap frills

You don't need a byte-wide interface or large devices to add a little non-volatile memory to your system. Serial EEPROMs are an inexpensive option that offer a few extras.

*Richard A. Quinnell,
Regional Editor*

Serial EEPROMs provide an opportunity to add nonvolatile memory to your system at very low cost, both in terms of price and system resources. Newer devices also have the ability to protect your data, speed the data-transfer rate, and operate at lower voltages.

As the name implies, you interact with a serial EEPROM by clocking addresses, data, and commands into a single data line. A complete interface requires from two to five wires, depending on the type of device you use. The most common interface type, Microwire (developed by National Semiconductor), uses four lines. Some devices add a status pin to bring the total to five. Alternatively, you can reduce the number of lines needed by tying together the data input and output lines (see **box**, "Interfacing alternatives"). The Philips interintegrated circuit (I²C) bus, running a close second to Microwire in availability, uses only two lines. Other available interfaces include UART-compatibles and those that work with Motorola's serial-pipeline interface (SPI).

The compact nature of the serial interface is vital if you're trying to produce a minimal system and still provide nonvolatile memory. For many microcontrollers, the CPU's address and data buses are not available outside of the IC, in order to conserve I/O pins.

Most microcontrollers offer parallel ports, however, and designers needing off-chip memory use those ports to generate the needed address and data bits. Interfacing to a conventional memory device would consume at least 8 bits of the parallel port, versus the 2 to 5 bits for serial memory. Using a microcontroller with on-chip EEPROM is a possibility, but CPU vendors such as Zilog admit that a 2-chip design is less expensive than a CPU with onboard EEPROM.

In addition to offering a compact interface, the serial EEPROMs themselves are compact. Almost all of them, regardless of their bit density, are available in 8-pin DIPs, and many come in small-outline (SO) packages. The variety of bit densities having a common physical interface gives you the option of changing the amount of memory in

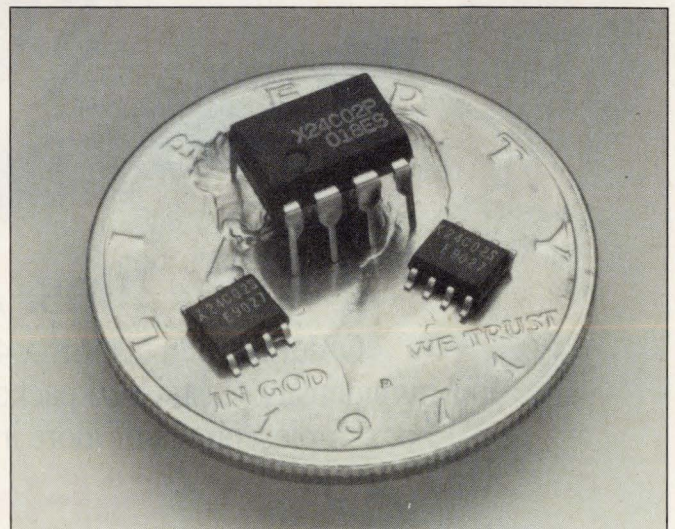

Compact and nonvolatile, serial EEPROMs let you add memory without using up your system's I/O resources. These 2-kbit devices from Xicor need only two wires for complete access.

At 1 Meg There's Simply No Faster SRAM.



1 Meg. 20ns. Available Now!

Order them in a 256K x 4 or 128K x 8 configuration.
In a high density plastic SOJ package. Part of a full line of fast SRAMs.
For samples, orders or more information, call 1-206-834-8959.

SHARP
FROM SHARP MINDS
COME SHARP PRODUCTS™

SRAMs • MROMs • FIFOs • PSRAMs • Core Micro • Displays • Opto • RF

Sharp Electronics Corporation Microelectronics Group 5700 N.W. Pacific Rim Blvd. Camas, WA 98607 (206)834-2500

CIRCLE NO. 34

TECHNOLOGY UPDATE

Serial EEPROMs

your design to increase capacity or decrease cost without affecting board layout or wiring. If you use devices having the I²C interface, you may not need to change software, either, because the I²C command protocol uses a fixed-length address field.

Nothing in life is free, however, including the serial EEPROM's advantages. There are a number of design considerations you must confront before deciding to incorporate serial EEPROM in your design. For example, using a serial interface extends the time required for memory access. In addition to the time needed to shift the data in and out, you must include the time to clock in a command code and an address for each transaction. Further, the serial protocols aren't always amenable to the use of byte-oriented serial peripherals. Therefore, you'll have software overhead for converting the serial data to parallel, and vice versa. Finally, storing data in an EEPROM requires a considerable amount of time, on the order of 10 msec (Ref 1).

Page mode speeds data storage

Manufacturers of serial EEPROMs have implemented a number of improvements addressing the first of these considerations: access time. Some offer clock rates as fast as 1 MHz, for example, reducing the time required for shifting data out. Manufacturers have also reduced the command and address overhead by giving some of the serial EEPROM the ability to perform both page-oriented write transactions and sequential reads. Devices

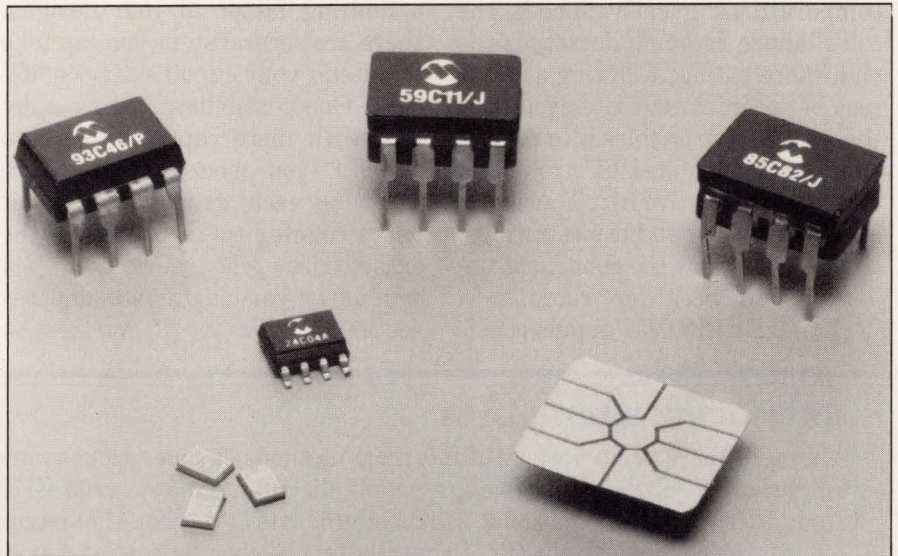

Packaging options abound for serial EEPROMs. Microchip Technology, for example, offers DIP, small-outline (SO), chip-on-board (COB), and bare die for its products.

with the sequential-read capability let you specify a single address, then read all the data between that address and the end of memory without further addressing.

Access time is not the only consideration, however. Serial EEPROMs, like all EEPROMs, have a limited service life. EEPROMs store their data on a floating gate in each memory location. During erasing and writing, charge moves to or from the gate using quantum mechanical tunneling through the surrounding insulators. Each time an EEPROM cell is erased or written to, some electrons may become permanently trapped in the insulator. Over time, these trapped electrons build up enough charge to prevent the cell's proper operation. Using an EEPROM, therefore, requires careful attention to system design in order to

minimize the number of erase/write cycles needed at a given memory location.

Manufacturers specify the lifetime of an EEPROM in terms of endurance: the minimum number of erase/write cycles a cell is guaranteed to provide. Read cycles do not affect a cell's endurance. As shown in Table 1 (see pg 64), the endurance ratings of available serial EEPROMs range from 10,000 to 1 million cycles. Realize, however, that these are minimums; you may get a much greater lifetime in your application.

Endurance ratings vary

Ratings expressed by different manufacturers aren't always directly comparable, though, because their test methods differ. The differing conditions result in differing test results. Operation at elevated

Acronyms used in this article

CPU—central processing unit
DIP—dual in-line package
EEPROM—electrically erasable read-only memory
EIAJ—Electronic Industries Association of Japan

I²C—interintegrated circuit
JEDEC—Joint Electron Device Engineering Council
SO—small-outline package
UART—universal asynchronous receiver/transmitter

TECHNOLOGY UPDATE

Serial EEPROMs

temperatures greatly speeds the cell's failure rate and decreases the endurance rating. Allowing a cell to rest between erase/write cycles, on the other hand, enables it to release some of the trapped electrons and extends its effective life. Therefore, when examining endurance ratings, be sure you know the conditions under which devices were rated.

If the EEPROM's endurance is

a limiting factor in your designs, there are several steps you can take to extend your circuit's service life-time. One possibility is to use a device with more capacity than you need. If you check for cell failure following each write operation, or use a counter to keep track of the erase/write cycles you've used, you can move your data into another section of memory if one section

starts failing, then resume operation.

Alternatively, you may wish to use a nonvolatile RAM that offers a serial interface, such as the Catalyst CAT24C44 (\$1.50) and the Xicor X24C4 (\$1.11). These devices operate like a serial RAM, but have an EEPROM array backing the RAM array. If you need a nonvolatile copy of the data in RAM, you simply signal the device to copy the

Interfacing alternatives

Although there are a variety of interface methods for serial EEPROMs, only two are widely distributed: Microwire from National Semiconductor and the interintegrated circuit (I²C) from Philips. Each method has its own strengths and weaknesses.

Several fundamental differences exist between the two interfaces, the most obvious being the number of signals required. The Microwire interface uses four signals: data in, data out, chip select, and a shift clock. You activate the device by asserting chip select and clocking in an opcode and data address (if applicable). You then clock data in or out as applicable. The I²C bus uses only two wires, a clock and a data line. The I²C protocol calls for the bus master to send a slave address to activate the device desired, then the opcode and data. The slave device acknowledges reception of the address and each byte of opcode and data, then supplies any data requested. The I²C protocol prevents any contention on the shared data line.

You can reduce by one the number of I/O lines needed to connect to a Microwire device by tying the data-in and data-out lines together. This reduction is possible because the data-out line remains in a high-impedance state unless supplying read data. The danger in this approach is that the data-out line begins by supplying a dummy-zero bit as soon as the last address bit of the read command has entered the data-in line. If that address bit is high, the resulting bus contention may prevent the device from reading the address properly, or may result in excessive current being drawn into the device. Placing a current-limiting resistor in the connection between the data-in and data-out lines can help prevent damage, but may slow the data bus.

The two interfaces also differ in the way they indicate device status. Because EEPROMs require a relatively long time to complete erase or write

operations (worst case can be as long as 10 msec), most serial EEPROMs offer a method of indicating when the operation is complete. Using this status indication can speed your overall access to the memory; you don't have to wait for the worst-case time period to elapse before using the EEPROM again.

The Microwire interface requires you to poll the data output line following an erase or write instruction. The line changes state to indicate the device's readiness. Some older devices use the interface developed by General Instruments. They communicate with a Microwire-like serial protocol, but have separate busy/status lines. They are handy if you wish to use an interrupt to signal the processor to the memory's readiness, rather than poll a status line. I²C-compatible devices don't offer any specific signal—they simply fail to acknowledge a command string if they are still busy.

The speed of the interface and depth of memory are other differences. The I²C specification limits the serial clock rate to 100 kHz. Further, its fixed addressing protocol limits the total amount of memory that can reside on a single bus to 16 kbytes. The fixed protocol is not entirely a disadvantage, however. It enables you to make your interface software independent of the EEPROM's bit density, letting you increase or reduce memory without changing software. Microwire devices have a variable-length address, dependent upon their bit density.

The Microwire interface has no clock and addressing limits. Clock rates as high as 3 MHz are available, and the number of devices on a bus is limited only by your bus driver's capability. Recall, though, that each Microwire device needs a chip-select signal, so you'll need additional I/O ports to handle the additional memory.

Real World "Isolutions"

THE WIDEST SELECTION OF ANALOG ISOLATION SOLUTIONS

Burr-Brown offers the industry's most complete line of low-cost analog isolation solutions available from any single company.

Whether you're protecting equipment from high voltage transients, breaking ground loops, or reducing noise interference, Burr-Brown has the right "isolution" for the job.

Free Selection Guide, Application Notes

Now, you can learn all about Burr-Brown's "isolutions" in this informative brochure. It contains comprehensive product specifications and many useful applications tips.

Choose the performance and functionality to fit your requirements.

- isolation ratings from 750 to 3500Vrms
- signal and DC/DC power supply, signal only, voltage-to-frequency conversion, or DC/DC power supply conversion

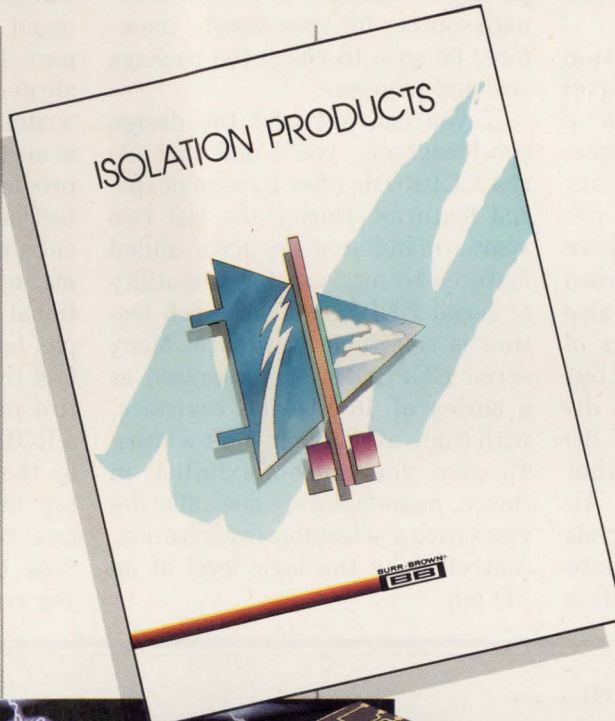

Matched tungsten capacitors, as low as 1pF, are embedded in ceramic and galvanically isolate input from output stage, creating a rugged, completely hermetic barrier.

- transformer, optical, or capacitive barrier technologies
- economical plastic DIPs, rugged hermetic DIPs, or state-of-the-art SOICs.

Here's a preview of what you'll find:

- ISO122P, the lowest cost 1500V "isolution" at under \$10*
- ISO212, a combined signal and DC/DC power supply combination featuring low power consumption and a streamlined plastic ZIP package
- Low cost PWS740 and PWS750 multi-channel component power systems

The Leader in Analog Isolation

Burr-Brown's leadership spans thirty years in analog manufacturing and design innovation. The revolutionary capacitive isolation barrier is but one example.

For your free copy of the *Isolation Products* guide, ask your salesperson or call **1-800-548-6132** toll-free for immediate assistance.

Burr-Brown Corp.
P.O. Box 11400
Tucson, AZ 85734

*USA OEM prices in 1000s.

BURR-BROWN®
BB

TECHNOLOGY UPDATE

Serial EEPROMs

RAM into EEPROM. Similarly, you can load the RAM from the EEPROM array. This dual-array structure lets you make many changes to the contents of memory, using the EEPROM only when needed.

Another system consideration when choosing to use serial EEPROMs is the relative lack of standards for them. For example, the devices use a variety of interface protocols. Even with devices using the same protocol, there may be timing differences between manufacturers. Packaging is also nonstandard. The DIP versions of the EEPROMs are uniform, but surface-mount packages are diverse. There are two sizes of SO packages available, based on either the JEDEC or EIAJ standards. Although, by sizing the solder pads properly, you can accommodate either size device, the problem

doesn't end there. The pinout of the SO packages is not standardized. Two pinout patterns are available, corresponding to the direction the manufacturers' die fit within the SO package. If you are looking at alternate sources for your design, therefore, be sure to check the package size and pinouts.

If you can get past the design considerations, you'll find that serial EEPROMs offer a range of special features. During the last two years, manufacturers have added features to increase the versatility of serial EEPROMs. One such feature is selectable word size. Many serial EEPROMs are organized as a series of 16-bit-wide registers, with some available in 8-bit widths. To give you more flexibility in choice, manufacturers now offer devices with a selectable organization, controlled by the logic level at an I/O pin.

Another frill is the ability to write-protect a section of memory. Most serial EEPROMs will protect memory from inadvertent write access when the supply voltage is low. Further, they have a software command to disable write access to a part. Both of these features are designed to prevent inadvertent writes to the memory when power is unstable and logic behavior is unpredictable. The newer write-protection feature is the ability to lock out a portion of memory during normal operation. Parts from International CMOS Technology, for example, have a pin-controlled write protect that prevents writing to the entire memory, letting you use it as a ROM. Some parts from Microchip, on the other hand, protect only the top half of memory, allowing you free access to the lower half. This type of write-protect scheme lets you create calibration tables or con-

For more information . . .

For more information on the serial EEPROMs discussed in this article, circle the appropriate numbers on the Information Retrieval Service card or use EDN's Express Request service. When you contact any of the following manufacturers directly, please let them know you saw their products in EDN.

Atmel Corp
2125 O'Neil Dr
San Jose, CA 95131
(408) 441-0311
FAX (408) 436-4300
Circle No. 700

Catalyst Semiconductor Inc
2231 Calle de Luna
Santa Clara, CA 95054
(408) 748-7700
FAX (408) 980-8209
Contact Krish Panu
Circle No. 701

Exel Microelectronics
2150 Commerce Dr
San Jose, CA 95161
(408) 432-0500
FAX (408) 432-8710
Contact Reggie Huff, x4658
Circle No. 702

VOTE . . .

Please also use the Information Retrieval Service card to rate this article (circle one):
High Interest 518 Medium Interest 519 Low Interest 520

Fujitsu Microelectronics Inc
Microelectronics Div
3545 N 1st St
San Jose, CA 95134
(800) 642-7616;
(408) 922-9000
FAX (408) 432-9044
Circle No. 703

**International CMOS
Technology Inc**
2125 Lundy Ave
San Jose, CA 95131
(408) 434-0678
FAX (408) 432-0815
Contact Ed Nieda
Circle No. 704

Microchip Technology Inc
2355 W Chandler Blvd
Chandler, AZ 85224
(602) 345-3400
FAX (602) 345-3390
Contact David Lee
Circle No. 705

National Semiconductor Corp
2900 Semiconductor Dr
Santa Clara, CA 95052
(800) 272-9959;
(408) 721-5000
FAX (408) 721-6346
Contact Bryan Liddiard
Circle No. 706

Oki Semiconductor
785 N Mary Ave
Sunnyvale, CA 94086
(408) 720-1900
FAX (408) 720-1918
Circle No. 707

Samsung Semiconductor
3725 N 1st St
San Jose, CA 95134
(408) 954-7229
FAX (408) 954-7873
Circle No. 708

SGS-Thomson Microelectronics
1000 E Bell Rd
Phoenix, AZ 85022
(602) 867-6100
FAX (602) 867-6101
Contact John Green
Circle No. 709

Signetics
811 E Arques Ave
Sunnyvale, CA 94086
(408) 991-5396
FAX (408) 991-2069
Contact Joe Resendes
Circle No. 710

Xicor Inc
851 Buckeye Ct
Milpitas, CA 95035
(408) 432-8888
FAX (408) 432-0640
Contact Rick Orlando
Circle No. 711



How single-chip fuzzy logic can move your product to the head of its class

Need to make your product more intelligent? Fuzzy Logic is the solution of choice. Need to do it quickly and economically, with maximum flexibility? Then the NeuraLogix NLX230 Fuzzy MicroController™ is in a class by itself!

The NLX230 is a single-chip solution. One 40-pin package delivers Fuzzy Logic mastery to the most complex control problems.

The NLX230 is flexible. It can be easily configured for your specific control problem, usually in a matter of hours.

The NLX230 is fast. Its rule processing time is 30 to 40 times faster than typical software-based or software/hardware hybrid solutions.

The NLX230 is economical. In production quantities, this remarkable Fuzzy MicroController is priced under \$4 per unit.

As the first true hardware based Fuzzy Logic controller, the NLX230 makes artificial intelligence available and simple. For most applications it can be an affordable high-performance replacement for 8-bit microprocessors. See how easily it adapts to your requirements; evaluate how the NLX230 can meet your demands with our low-cost Applications Development System.

Move your product to the head of its class with hardware-controlled Fuzzy Logic. Call now for specifications and price quotation on the NLX230 and other fuzzy logic and neural network devices.

CIRCLE NO. 48



NeuraLogix

American NeuraLogix, Inc.
411 Central Park Drive
Sanford, FL 32771
Telephone 407/322-5608
FAX 407/322-5609

TECHNOLOGY UPDATE

Serial EEPROMs

figuration data, then lock them into the EEPROM.

A more flexible version of the write-protect scheme comes in the form of a programmable write-protect. This scheme, offered by several companies including Exel, National Semiconductor, Samsung, and SGS-Thomson, lets you select the beginning address of protected memory, thus protecting only the amount of memory you desire. This protection can be temporary or, by programming a special register, made permanent.

A unique data-protection scheme is available from Catalyst Semiconductor in its CAT33C704/804 series.

These devices offer programmable write protection. Then, by programming the device with a password, you can convert the write-protected area of memory to read-protected memory, accessible only with the proper password. The remaining section of memory becomes write-protected. This secure-access feature is particularly useful if your EEPROM is to contain proprietary information, serial numbers, or access codes that you want to deny to the user.

Another relatively new feature of serial EEPROMs is low-voltage operation. Manufacturers have extended the operating voltage range

of some serial EEPROMs to include typical battery voltages. Many now come in 3V versions, with some tolerating as low as 2.5V. Others, like the Exel parts, offer full operation to 3V and allow read-only operation as low as 2V. **EDN**

Reference

1. Leibson, Steven H, "Nonvolatile, in-circuit-reprogrammable memories," *EDN*, January 3, 1991, pg 88.

Article Interest Quotient
(Circle One)

High 518 Medium 519 Low 520

Table 1—Representative serial EEPROMs

Company	Part	Size (bits)	Organization (bits)	Interface compatibility	Serial clock rate	Supply current		Endurance (cycles)	Data retention (years)	Operating voltage range ¹ (volts)	Package styles ²	Special features	Price (10,000) (DIP)
						Active (mA)	Standby (μ A)						
Atmel	AT93C46	1k	64x16	Microwire	1 MHz	3	100	10k	10	5	DIP, SO	100k/100 year endurance option	\$0.77
	AT93C46-3	1k	64x16	Microwire	1 MHz	2	100	10k	10	3	DIP, SO	100k/100 year endurance option	\$0.96
	AT24C02	2k	256x8	I ² C	100 kHz	1.5	150	10k	10	5	DIP, SO	100k/100 year endurance option	\$0.99
	AT24C02-3	2k	256x8	I ² C	100 kHz	1	150	10k	10	3 to 6	DIP, SO	100k/100 year endurance option	\$1.51
	AT24C04	4k	512x8	I ² C	100 kHz	1.5	150	10k	10	5	DIP, SO	100k/100 year endurance option	\$1.70
	AT24C04-3	4k	512x8	I ² C	100 kHz	1	150	10k	10	3 to 6	DIP, SO	100k/100 year endurance option	\$2.46
Catalyst Semiconductor	CAT32C101	1k	64x16 or 128x8	Microwire	700 kHz	1	2	10k	10	2 to 4	DIP, SO	100k/100 year endurance option	\$1.69
	CAT33C101	1k	64x16 or 128x8	Microwire	700 kHz	2	50	10k	10	3	DIP, SO	100k/100 year endurance option	\$0.85
	CAT33C201	1k	64x16 or 128x8	General Instruments	700 kHz	2	50	10k	10	3	DIP, SO	100k/100 year endurance option	\$0.79
	CAT59C11	1k	64x16 or 128x8	General Instruments	250 kHz	5	100	10k	10	5	DIP, SO	100k/100 year endurance option	\$0.63
	CAT93C46	1k	64x16 or 128x8	Microwire	700 kHz	3	100	10k	10	5	DIP, SO	100k/100 year endurance option	\$0.77
	CAT93C46A	1k	64x16	Microwire	700 kHz	3	100	10k	10	5	DIP, SO	100k/100 year endurance option	\$0.77
	CAT24C02	2k	256x8	I ² C	100 kHz	3	40	100k	100	5	DIP, SO	Page mode	\$1.13
	CAT24C02Z	2k	256x8	I ² C	100 kHz	3	0	100k	100	5	DIP, SO		\$1.40
	CAT24LC02	2k	256x8	I ² C	100 kHz	3	50	100k	100	3 to 6	DIP, SO		\$1.40
	CAT35C102	2k	128x16 or 256x8	Microwire	1 MHz	3	100	10k	10	5	DIP, SO	100k/100 year endurance option	\$1.13
CAT35C202	2k	128x16 or 256x8	General Instruments	1 MHz	3	100	10k	10	5	DIP, SO	100k/100 year endurance option	\$1.44	

Table continued

Notes:

1. Operating voltages have $\pm 10\%$ tolerance unless a range is shown.

2. DIPs listed are 8-pin, dual in-line packages unless noted, SOs are 8-pin, small-outline packages unless noted, and COB means chip on board.

The FS700 LORAN-C frequency standard

10 MHz cesium stability

\$4950

Cesium long term stability at a fraction of the cost

Better long-term stability than rubidium

Not dependent on ionosphere position changes, unlike WWV

Complete northern hemisphere coverage, unlike GPS.

The FS700 LORAN-C frequency standard provides the optimum, cost-effective solution for frequency management and calibration applications. Four 10 MHz outputs from built-in distribution amplifiers provide cesium standard long-term stability of 10^{-12} , with short-term stability of 10^{-10} (10^{-11} optional). Reception is guaranteed in North America, Europe and Asia.

Since the FS700 receives the ground wave from the LORAN transmitter, reception is unaffected by atmospheric changes, with no possibility of missing cycles, a common occurrence with WWV due to discontinuous changes in the position of the ionosphere layer. Cesium and rubidium standards, in addition to being expensive initially, require periodic refurbishment, another costly item.

The FS700 system includes a remote active 8-foot whip antenna, capable of driving up to 1000 feet of cable. The receiver contains six adjustable notch filters and a frequency output which may be set from 0.01 Hz to 10 MHz in a 1-2-5 sequence. A Phase detector is used to measure the phase shift between this output and another front panel input, allowing quick calibration of other timebases. An analog output with a range of ± 360 degrees, provides a voltage proportional to this phase difference for driving strip chart recorders, thus permitting continuous monitoring of long-term frequency stability or phase locking of other sources.



FS700: The optimum frequency management system



STANFORD RESEARCH SYSTEMS

1290 D Reamwood Avenue ■ Sunnyvale, CA 94089 ■ Telephone: (408) 744-9040
FAX: 4087449049 ■ Telex: 706891 SRS UD

CIRCLE NO. 37

Table 1—Representative serial EEPROMs (continued)

Company	Part	Size (bits)	Organization (bits)	Interface compatibility	Serial clock rate	Supply current		Endurance (cycles)	Data retention (years)	Operating voltage range ¹ (volts)	Package styles ²	Special features	Price (10,000) (DIP)
						Active (mA)	Standby (μ A)						
Catalyst Semi-conductor (continued)	CAT93C56	2k	128x16 or 256x8	Microwire	1 MHz	3	100	10k	10	5	DIP, SO	100k/100 year endurance option	\$1.13
	CAT93LC56	2k	128x16 or 256x8	Microwire	250 kHz	2	50	10k	10	3	DIP, SO	100k/100 year endurance option	\$1.25
	CAT24C04	4k	512x8	I ² C	100 kHz	3	40	100k	100	5	DIP, SO	Page mode	\$2.25
	CAT24C04Z	4k	512x8	I ² C	100 kHz	3	0	100k	100	5	DIP, SO		\$2.50
	CAT24LC04	4k	512x8	I ² C	100 kHz	3	50	100k	100	3 to 6	DIP, SO		\$2.50
	CAT33C104	4k	256x16 or 512x8	Microwire	250 kHz	2	50	10k	10	3	DIP, SO	100k/100 year endurance option	\$2.50
	CAT33C704	4k	256x16 or 512x8	Synchronous	1 MHz	3	200	10k	10	3	DIP, SO, COB	100k/100 year endurance option, password protection	\$4.50
	CAT33C804A/B	4k	256x16 or 512x8	UART	9600 Baud	3	200	10k	10	3	DIP, SO, COB	100k/100 year endurance option, password protection	\$5.63
	CAT35C104	4k	256x16 or 512x8	Microwire	1 MHz	3	100	10k	10	5	DIP, SO	100k/100 year endurance option	\$2.25
	CAT35C704	4k	256x16 or 512x8	Synchronous	3 MHz	3	200	10k	10	5	DIP, SO, COB	100k/100 year endurance option, password protection	\$3.60
	CAT35C804A/B	4k	256x16 or 512x8	UART	9600 Baud	3	200	10k	10	5	DIP, SO, COB	100k/100 year endurance option, password protection	\$4.05
	CAT24C08	8k	1024x8	I ² C	100 kHz	3	40	100k	100	5	DIP, SO	Page mode	\$2.95
	CAT24C08Z	8k	1024x8	I ² C	100 kHz	3	0	100k	100	5	DIP, SO		\$3.25
	CAT24LC08	8k	1024x8	I ² C	100 kHz	3	50	100k	100	3 to 6	DIP, SO		\$3.25
	CAT24C16	16k	2048x8	I ² C	100 kHz	3	40	100k	100	5	DIP, SO	Page mode	\$3.50
CAT24C16Z	16k	2048x8	I ² C	100 kHz	3	0	100k	100	5	DIP, SO		\$3.75	
CAT24LC16	16k	2048x8	I ² C	100 kHz	3	50	100k	100	3 to 6	DIP, SO		\$3.75	
Exel Micro-electronics	XL93LC06	256	16x16	Microwire	1 MHz	2	2	100k	10	5	DIP, SO	Read operation to 2V, auto-increment	\$0.47
	XL93LC06-3	256	16x16	Microwire	250 kHz	2	2	100k	10	2.7 to 5.5	DIP, SO	Read operation to 2V, auto-increment	\$0.52
	XL93C46	1k	64x16	Microwire	1 MHz	2	2	10k	10	5	DIP, SO	Read operation to 2V	\$0.50
	XL93C46-3	1k	64x16	Microwire	250 kHz	2	2	10k	10	2.7 to 5.5	DIP, SO	Read operation to 2V	\$0.55
	XL93CS46	1k	64x16	Microwire	1 MHz	2	2	10k	10	5	DIP, SO	Read operation to 2V, programmable data protection	\$0.70
	XL93CS46-3	1k	64x16	Microwire	250 kHz	2	2	10k	10	2.7 to 5.5	DIP, SO	Read operation to 2V, programmable data protection	\$0.75
	XL93LC46	1k	64x16	Microwire	1 MHz	2	2	100k	10	5	DIP, SO	Read operation to 2V, auto-increment	\$0.50
	XL93LC46-3	1k	64x16	Microwire	250 kHz	2	2	100k	10	2.7 to 5.5	DIP, SO	Read operation to 2V, auto-increment	\$0.55
	XL35LC102	2k	128x16	Microwire	1 MHz	2	2	100k	10	5	DIP, SO	Read operation to 2V, auto-increment	\$1.15
	XL35LC102-3	2k	128x16	Microwire	250 kHz	2	2	100k	10	2.7 to 5.5	DIP, SO	Read operation to 2V, auto-increment	\$1.23
	XL90C21	2k	128x16	Microwire	1 MHz	3	100	10k	10	5	DIP, SO	Read operation to 2V	\$0.90
	XL93C56	2k	128x16	Microwire	1 MHz	2	4	10k	10	5	DIP, SO	Read operation to 2V	\$0.90
	XL93C56-3	2k	128x16	Microwire	250 kHz	2	4	10k	10	2.7 to 5.5	DIP, SO	Read operation to 2V	\$1.35
	XL93LC56	2k	128x16	Microwire	1 MHz	2	2	100k	10	5	DIP, SO	Read operation to 2V, auto-increment	\$0.90
	XL93LC56-3	2k	128x16	Microwire	250 kHz	2	2	100k	10	2.7 to 5.5	DIP, SO	Read operation to 2V, auto-increment	\$0.98
	XL90C41	4k	256x16	Microwire	1 MHz	3	100	10k	10	5	DIP, SO	Read operation to 2V	\$1.25
	XL93C66	4k	256x16	Microwire	1 MHz	2	4	10k	10	5	DIP, SO	Read operation to 2V	\$1.25
	XL93C66-3	4k	256x16	Microwire	250 kHz	2	4	10k	10	2.7 to 5.5	DIP, SO	Read operation to 2V	\$1.88
	XL93LC66	4k	256x16	Microwire	1 MHz	2	2	100k	10	5	DIP, SO	Read operation to 2V, auto-increment	\$1.25
	XL93LC66-3	4k	256x16	Microwire	250 kHz	2	2	100k	10	2.7 to 5.5	DIP, SO	Read operation to 2V, auto-increment	\$1.35

Notes:

1. Operating voltages have $\pm 10\%$ tolerance unless a range is shown.
2. DIPs listed are 8-pin, dual in-line packages unless noted, SOs are 8-pin, small-outline packages unless noted, and COB means chip on board.

Company	Part	Size (bits)	Organization (bits)	Interface compatibility	Serial clock rate	Supply current		Endurance (cycles)	Data retention (years)	Operating voltage range ¹ (volts)	Package styles ²	Special features	Price (10,000) (DIP)
						Active (mA)	Standby (μ A)						
International CMOS Technology	93C46A	1k	64x16	Microwire	2 MHz	3	50	10k	40	5	DIP, SO	3V version available, hardware write protect	\$0.60
	93C56A	2k	128x16	Microwire	2 MHz	3	50	10k	40	5	DIP, SO	Hardware write protect	\$1.65
	93CX56	2k	128x16	Microwire	1 MHz	4	50	10k	40	2.5 to 6	DIP, SO	Hardware write protect	\$2.25
	93C66A	4k	256x16	Microwire	2 MHz	3	50	10k	40	5	DIP, SO	Hardware write protect	\$2.30
	93CX66	4k	256x16	Microwire	1 MHz	4	50	10k	40	2.5 to 6	DIP, SO	Hardware write protect	\$2.90
Microchip Technology	93C06	256	16x16	Microwire	1 MHz	4	100	100k	10	5	DIP, SO		\$0.53
	24C01A	1k	128x8	I ² C	100 kHz	3.5	100	100k	10	5	DIP, SO	Sequential read, page mode	\$0.98
	24LC01	1k	128x8	I ² C	100 kHz	2	100	100k	10	2 to 5.5	DIP, SO	Sequential read, page mode, hardware write protect	\$1.05
	59C11	1k	64x16 or 128x8	General Instruments	1 MHz	4	100	100k	10	5	DIP, SO	Sequential read, page mode, hardware write protect	\$0.55
	85C72	1k	128x8	I ² C	100 kHz	3.5	100	100k	10	5	DIP, SO	Sequential read, page mode	\$1.03
	93C46	1k	64x16	Microwire	1 MHz	4	100	100k	10	5	DIP, SO	Sequential read, page mode, hardware write protect	\$0.55
	24C02A	2k	256x8	I ² C	100 kHz	3.5	100	100k	10	5	DIP, SO	Sequential read, page mode, hardware write protect	\$1.02
	24LC02	2k	256x8	I ² C	100 kHz	2	100	100k	10	2 to 5.5	DIP, SO	Sequential read, page mode, hardware write protect	\$1.10
	85C82	2k	256x8	I ² C	100 kHz	3.5	100	100k	10	5	DIP, SO	Sequential read, page mode	\$1.07
	93C56	2k	128x16 or 256x8	Microwire	2 MHz	4	100	100k	10	4 to 5.5	DIP, SO	Sequential read	\$1.05
	24C04A	4k	512x8	I ² C	100 kHz	3.5	100	100k	10	5	DIP, SO	Sequential read, page mode, hardware write protect	\$1.44
	24LC04	4k	512x8	I ² C	100 kHz	2	100	100k	10	2 to 5.5	DIP, SO	Sequential read, page mode, hardware write protect	\$1.52
	85C92	4k	512x8	I ² C	100 kHz	3.5	100	100k	10	5	DIP, SO	Sequential read, page mode	\$1.52
	93C66	4k	256x16 or 512x8	Microwire	2 MHz	4	100	100k	10	4 to 5.5	DIP, SO	Sequential read	\$1.28
	24LC16	16k	2048x8	I ² C	100 kHz	2	100	100k	10	2 to 5.5	DIP, SO	Sequential read, page mode, hardware write protect	\$3.56
National Semiconductor	NM93C06	256	16x16	Microwire	1 MHz	0.4	25	500k	40	2 to 5.5	DIP, SO	5V-only version available	\$0.63
	NM93CS06	256	16x16	Microwire	1 MHz	0.4	25	500k	40	2 to 5.5	DIP, SO	Sequential read, programmable write protect, 5V-only version	\$1.57
	NM59C11	1k	64x16 or 128x8	General Instrument	1 MHz	0.4	25	500k	40	5	DIP, SO		\$0.82
	NM93C46	1k	64x16	Microwire	1 MHz	0.4	25	500k	40	2 to 5.5	DIP, SO	5V-only version available	\$0.75
	NM93C46A	1k	64x16	Microwire	1 MHz	0.4	25	500k	40	5	DIP, SO		\$0.82
	NM93CS46	1k	64x16	Microwire	1 MHz	0.4	25	500k	40	2 to 5.5	DIP, SO	Sequential read, programmable write protect, 5V-only version	\$1.82
	NM95C12	1k	64x16	Microwire	1 MHz	0.4	25	40k	10	5	14-pin DIP, 14-pin SO	8 onboard DIP switches	\$3.13
	NM24C02	2k	256x8	I ² C	100 kHz	0.4	25	500k	40	5	DIP, 14-pin SO	Page mode	\$0.90

Notes:

1. Operating voltages have $\pm 10\%$ tolerance unless a range is shown.

2. DIPs listed are 8-pin, dual in-line packages unless noted, SOs are 8-pin, small-outline packages unless noted, and COB means chip on board.

Table continued

Table 1—Representative serial EEPROMs (continued)

Company	Part	Size (bits)	Organization (bits)	Interface compatibility	Serial clock rate	Supply current		Endurance (cycles)	Data retention (years)	Operating voltage range ¹ (volts)	Package styles ²	Special features	Price (10,000) (DIP)
						Active (mA)	Standby (μ A)						
National Semiconductor (continued)	NM24C03	2k	256x8	I ² C	100 kHz	2	60	500k	40	5	DIP, 14-pin SO	Page mode, hardware write protect	\$1.05
	NM93C56	2k	128x16	Microwire	1 MHz	0.4	25	500k	40	2 to 5.5	DIP, SO	5V-only version available	\$1.19
	NM93CS56	2k	128x16	Microwire	1 MHz	0.4	25	500k	40	2 to 5.5	DIP, SO	Sequential read, programmable write protect, 5V-only version	\$3.07
	NM24C04	4k	512x8	I ² C	100 kHz	2	60	500k	40	5	DIP, 14-pin SO	Page mode	\$1.45
	NM24C05	4k	512x8	I ² C	100 kHz	2	60	500k	40	5	DIP, 14-pin SO	Page mode, hardware write protect	\$1.60
	NM93C66	4k	256x16	Microwire	1 MHz	0.4	25	500k	40	2 to 5.5	DIP, SO	5V-only version available	\$2.25
	NM93CS66	4k	256x16	Microwire	1 MHz	0.4	25	500k	40	2 to 5.5	DIP, 14-pin SO	Sequential read, programmable write protect, 5V-only version	\$5.00
	NM24C08	8k	1024x8	I ² C	100 kHz	2	60	500k	40	5	DIP, 14-pin SO	Page mode	\$2.85
	NM24C09	8k	1024x8	I ² C	100 kHz	2	60	500k	40	5	DIP, 14-pin SO	Page mode, hardware write protect	\$3.05
Oki Semiconductor	MSM16881	1k	64x16 or 128x8	Microwire	250 kHz	3	100	10k	10	5	DIP, SO		\$0.80
	MSM16911	1k	64x16 or 128x8	General Instruments	250 kHz	3	100	10k	10	5	DIP, SO		\$0.80
	MSM16812	2k	128x16 or 256x8	Microwire	1 MHz	3	100	10k	10	5	DIP		\$1.50
	MSM16912	2k	128x16 or 256x8	General Instruments	1 MHz	3	100	10k	10	5	DIP		\$1.50
Samsung Semiconductor	KM93C06	256	16x16	Microwire	250 kHz	5	100	100k	10	5	DIP, SO		\$0.42
	KM93C07	256	16x16	Microwire	250 kHz	5	100	100k	10	5	DIP, SO		\$0.43
	KM93C46	1k	64x16	Microwire	250 kHz	5	100	100k	10	5	DIP, SO		\$0.45
	KM93C46V	1k	64x16	Microwire	250 kHz	5	100	100k	10	2.7 to 5.5	DIP, SO		\$0.47
	KM93C56	2k	128x16	Microwire	1 MHz	1	50	100k	10	2.7 to 5.5	DIP, SO		\$0.80
	KM93CS56	2k	128x16	Microwire	1 MHz	1	50	100k	10	2.7 to 5.5	DIP, SO	Programmable write protect	\$1.00
	KM93C57	2k	128x16 or 256x8	Microwire	1 MHz	1	50	100k	10	2.7 to 5.5	DIP, SO		\$0.82
	KM93C66	4k	256x16	Microwire	1 MHz	1	50	100k	10	2.7 to 5.5	DIP, SO		\$1.30
	KM93CS66	4k	256x16	Microwire	1 MHz	1	50	100k	10	2.7 to 5.5	DIP, SO	Programmable write protect	\$1.50
	KM93C67	4k	256x16 or 512x8	Microwire	1 MHz	1	50	100k	10	2.7 to 5.5	DIP, SO		\$1.32
SGS-Thompson Microelectronics	ST93C06	256	16x16 or 32x8	Microwire	1 MHz	2	50	1M	10	5	DIP, SO		\$0.50
	ST24C01	1k	128x8	I ² C	100 kHz	2	100	1M	10	5	DIP, SO	Page mode, sequential read	\$0.62
	ST93C46A	1k	64x16 or 128x8	Microwire	1 MHz	5	50	1M	10	5	DIP, SO		\$0.62
	ST93CS46	1k	64x16	Microwire	1 MHz	2	50	1M	10	5	DIP, SO, 14-pin SO	Page mode, programmable write protect	\$0.84
	ST93CS47	1k	64x16	Microwire	1 MHz	2	50	1M	10	2.5 to 5.5	DIP, SO, 14-pin SO	Page mode, programmable write protect	\$1.10
	ST24C02A	2k	256x8	I ² C	100 kHz	2	100	1M	10	5	DIP, SO	Page mode, sequential read, programmable write protect	\$0.84
	ST25C02A	2k	256x8	I ² C	100 kHz	2	100	1M	10	2.5 to 5.5	DIP, SO	Page mode, sequential read, programmable write protect	\$1.10
	ST93CS56	2k	128x16	Microwire	1 MHz	2	50	1M	10	5	DIP, SO, 14-pin SO	Page mode, programmable write protect	\$0.94

Notes:

1. Operating voltages have $\pm 10\%$ tolerance unless a range is shown.
2. DIPs listed are 8-pin, dual in-line packages unless noted, SOs are 8-pin, small-outline packages unless noted, and COB means chip on board.

Company	Part	Size (bits)	Organization (bits)	Interface compatibility	Serial clock rate	Supply current		Endurance (cycles)	Data retention (years)	Operating voltage range ¹ (volts)	Package styles ²	Special features	Price (10,000) (DIP)
						Active (mA)	Standby (μ A)						
SGS-Thompson Microelectronics (continued)	ST93CS57	2k	128x16	Microwire	1 MHz	2	50	1M	10	2.5 to 5.5	DIP, SO, 14-pin SO	Page mode, programmable write protect	\$1.40
	ST24C04	4k	512x8	I ² C	100 kHz	2	100	1M	10	5	DIP, 14-pin SO	Page mode, sequential read, programmable write protect	\$1.85
	ST25C04	4k	512x8	I ² C	100 kHz	2	100	1M	10	2.5 to 5.5	DIP, 14-pin SO	Page mode, sequential read, programmable write protect	\$2.40
Signetics	PCF8581	1k	128x8	I ² C	100 kHz	1.6	10	10k	10	5	DIP, SO	Page mode, sequential read	\$0.94
	PCF8581C	1k	128x8	I ² C	100 kHz	1.6	10	10k	10	2.5 to 6	DIP, SO	Page mode, sequential read	\$0.94
	PCF8582B	2k	256x8	I ² C	100 kHz	1.6	10	500k	10	5	DIP, SO, 16-pin SO	Page mode, sequential read	\$0.99
	PCF8582C	2k	256x8	I ² C	100 kHz	1.6	10	500k	10	2.5 to 6	DIP, SO, 16-pin SO	Page mode, sequential read	\$0.99
Xicor	X24C01	1k	128x8	I ² C	100 kHz	1	50	100k	100	5	DIP, SO	3.3V and 3.5 to 5.5V versions available	\$0.65
	X24C01A	1k	128x8	I ² C	100 kHz	1	50	100k	100	5	DIP, SO	3.3V and 3.5 to 5.5V versions available	\$0.77
	X24C02	2k	256x8	I ² C	100 kHz	1	50	100k	100	5	DIP, SO	3.3V and 3.5 to 5.5V versions available	\$0.94
	X24C04	4k	512x8	I ² C	100 kHz	1	50	100k	100	5	DIP, SO, 14-pin SO	3.3V and 3.5 to 5.5V versions available	\$1.55
	X24C08	8k	1024x8	I ² C	100 kHz	1	50	100k	100	5	DIP, SO, 14-pin SO	3.3V and 3.5 to 5.5V versions available	\$2.40
	X24C16	16k	2048x8	I ² C	100 kHz	1	50	100k	100	5	DIP, SO, 14-pin SO	3.3V and 3.5 to 5.5V versions available	\$3.36

Notes:

1. Operating voltages have $\pm 10\%$ tolerance unless a range is shown.

2. DIPs listed are 8-pin, dual in-line packages unless noted, SOs are 8-pin, small-outline packages unless noted, and COB means chip on board.

EDN REPRINTS

A Designer's Guide to Linear Circuits

Volume I

This original, 186-page collection by Jim Williams offers a wealth of analog design information. It includes practical and efficient ways to use op amps, comparators, data converters, and other analog ICs.

A Designer's Guide to Linear Circuits

Volume II

Jim Williams' analog design articles - from 1983 to 1986 - in Volume II. Volume II covers more complex circuits and systems in 66 pages.

Surface-Mount Technology Design Project

This 48-page, four-color reprint follows the progress of EDN editor Steve Leibson as he designs a 2M-byte memory board using surface-mount technology. He includes typical problems you might encounter and objectively reports about both good and bad design decisions made along the way.

Mail coupon to: Cahners Reprint Services, 1350 E. Touhy Ave., Des Plaines, IL 60018. Or call 708/390-2777. FAX: 708/390-2779. US currency only.

Please send the following:

_____ copies of *A Designer's Guide to Linear Circuits*.

Volume I

- \$7.70 (USA)
 \$10.70 (non-USA)

Volume II

- \$10.70 (USA)
 \$13.70 (non-USA)

_____ copies of the combined set of *A Designer's Guide to Linear Circuits Volumes I&II*

- \$12.70 (USA)
 \$16.70 (non-USA)

_____ copies of *Surface-Mount Design Project*

- \$6.70 (USA)
 \$8.70 (non-USA)

Note: All prices above include shipping & handling.

Please print clearly.

- Payment enclosed Bill me Visa Mastercard

Credit Card Number _____ Exp. Date _____

Signature _____

Name _____

Title _____

Company _____

Address _____

City _____ State _____ Zip _____

How AMD Keep Up With

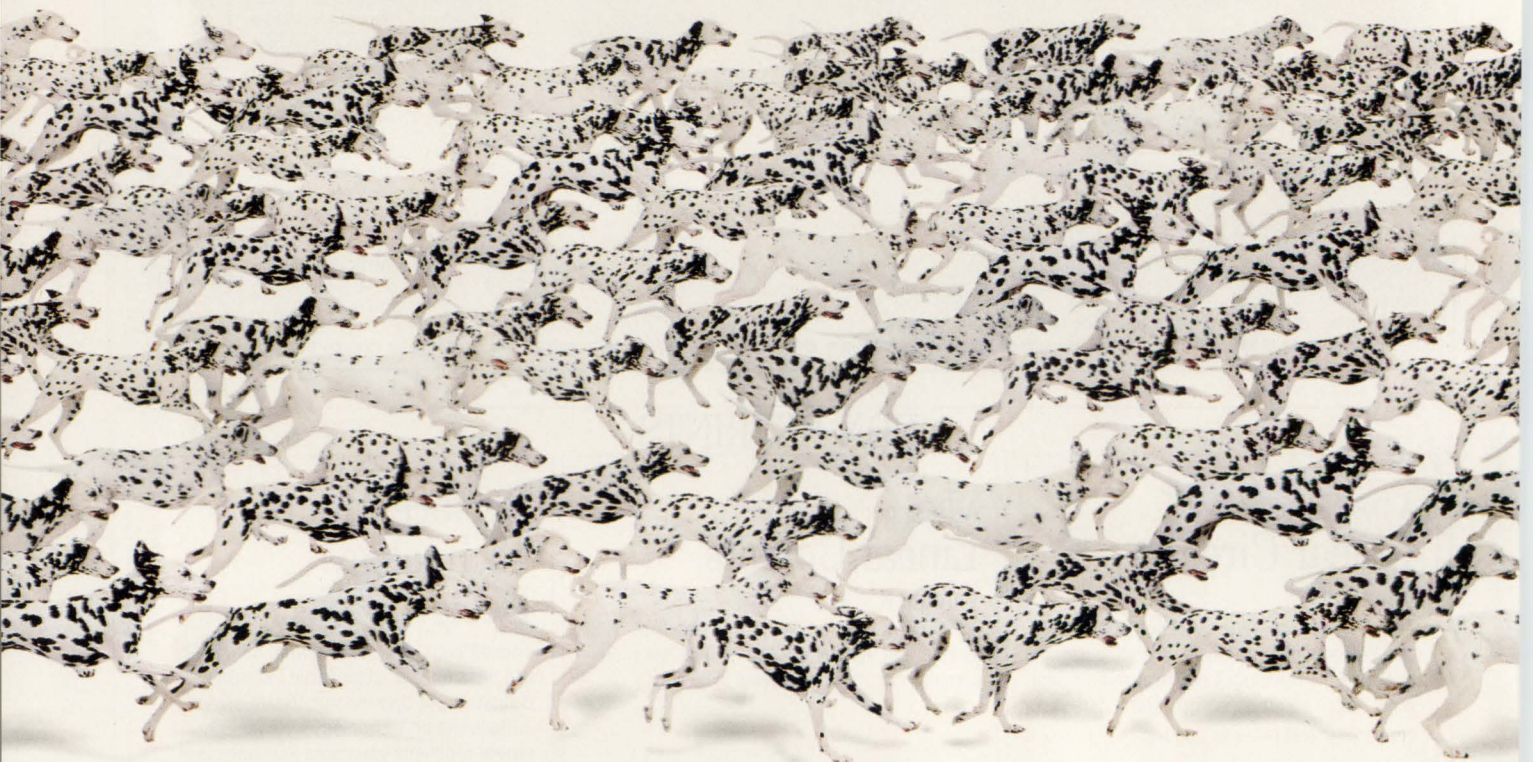

The Elegance Inside The HP LaserJet III Si™ Printer: The 29K™ RISC Microprocessor Family.

29K

HP's customers were on the prowl.

And Hewlett-Packard knew exactly what they were hunting for—a faster, PCL5 and PostScript® compatible, affordable desktop laser printer.

So they built the HP LaserJet III Si printer. And naturally, they built it around the most versatile, high performance embedded RISC processor ever:

The 29K™ 32-bit microprocessor from AMD.

Only the 29K Family gives you the widest range of performance—thanks to its innovative register file and high-velocity memory interface. That's how HP achieves its blistering 17 page-per-minute throughput, even with complex PCL5 and PostScript documents.

Only the 29K Family keeps your system costs

Helps HP Its Customers.



low, while keeping performance high. Features like AMD's unique on-chip caches and burst mode give you maximum performance from less expensive memory.

Only the 29K Family helps bring your product to market so fast. You'll breeze through development with AMD's own tools, or the hardware and software tools provided by over 50 Fusion29KSM Partners. And the 29K Family continues to grow, with new members offering even higher performance and integration.

So make sure your customers are happy puppies, and start designing with the 29K Family from AMD. Call **1-800-292-9263 Ext. 3** for more information.



Advanced Micro Devices

901 Thompson Place, P.O. Box 3453, Sunnyvale, CA 94088. © 1991 Advanced Micro Devices, Inc.
29K is a trademark and Fusion29K is a servicemark of Advanced Micro Devices.
LaserJet III/IIi is a trademark of Hewlett-Packard Co. PostScript is a registered trademark of Adobe Systems, Inc. All other brand or product names are trademarks or registered trademarks of their respective holders.



IMAGINE BLINKING A MILLION TIMES A DAY FOR TWENTY YEARS, AND YOU'LL BEGIN TO UNDERSTAND THE DURABILITY OF OUR OPTICAL SWITCHES.

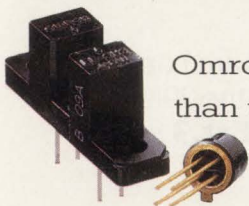

Omron optical switches keep an eye on innovation. They work by sight rather than touch. Which means they won't wear out like electromechanical switches in tough applications such as duplicating, fax machines and computer peripherals. In fact, our optical switches operate thousands of times faster than electromechanical switches. And, they perform reliably for up to twenty years or more, exceeding the lifetime of the product itself.

Omron's optical switches dramatically improve the reliability of your end product by virtually eliminating switch failure. Take switches. There are over 50 Or ask us about the more than components we produce. You

OMRON
WE HAVE THE FUTURE IN CONTROL.

a closer look at Omron optical standard types to choose from. 100,000 different types of control can reach us at 1-800-62-OMRON.

3½-in. optical drive offers MO and read-only modes

The OD-3000 optical disk drive lets designers buy optical technology in the increasingly popular 3½-in. form factor. The multifunction drive uses read/write MO (magneto-optical) technology and reads O-ROM (optical read-only memory) disks, whose features are similar to those of 5¼-in. CD-ROM disks. The drive stores 128 Mbytes on a removable optical disk that looks much like a 3½-in. floppy disk.

MO technology gives the OD-3000 several advantages compared with 5¼-in. products that use other types of rewritable optical media. MO technology uses magnetic-flux transitions to store data on the physical medium. The optical system writes to the disk using a laser beam to change the magnetic polarity of data bits on the disk. Likewise, the optical system reads data by sensing the reflection of the laser beam from the surface of the disk. Disks that use MO technology can withstand 10 million write cycles and still record data reliably. Other rewritable optical technologies typically limit media to 10,000 write cycles.

The drive can also read O-ROM disks that store prerecorded information, much like CD-ROM drives do. Mass duplication of O-ROM disks uses a stamping production technology. This technology is similar to the process used to make CD-ROM disks and audio record albums. Therefore, manufacturing costs of prerecorded O-ROM disks should soon drop to less than \$2 each.

Both CD-ROM and O-ROM disks store data via pits in the physical

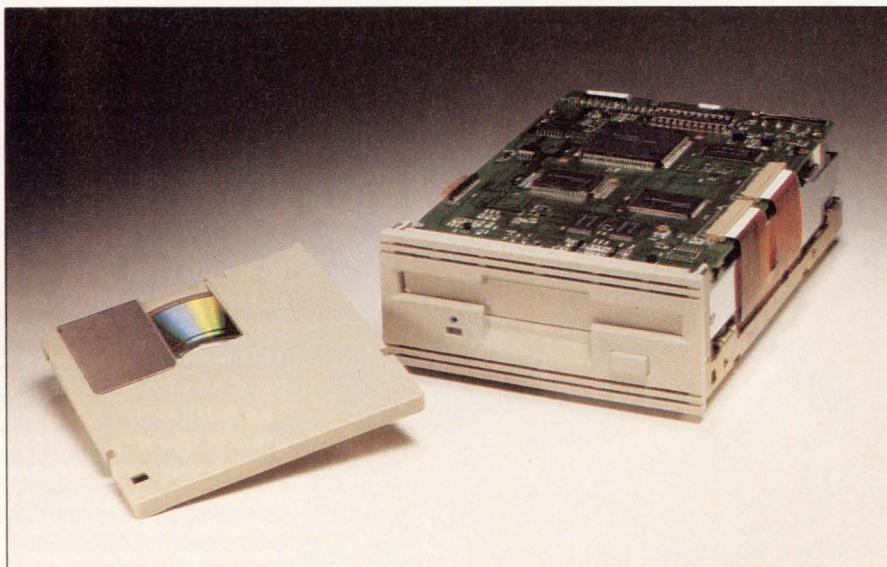

A 42-msec seek time and 10-msec latency spec make the OD-3000 multifunction optical drive useful in some primary-storage applications.

medium's surface. O-ROM offers some advantages compared with CD-ROM technology, however. CD-ROMs employ a long spiral track; O-ROM disks feature a format with tracks and sectors, like magnetic disks. The track-and-sector configuration results in superior seek times for computer applications. O-ROM technology also leads to a third type of medium that you can use with the OD-3000. Partial-ROM disks have O-ROM and rewritable technology mixed on a single surface. Users can add their own information such as graphics to the rewritable sections of a partial-ROM disk.

The OD-3000 features a 3000-rpm rotational speed, which minimizes latency during seek operation. The drive's average rotational latency is 10 msec. The drive's optic components are in two different physical

locations to minimize seek time. The semiconductor laser, photodiode detector, lens, and prism are fixed in place away from the actuator arm. Only minimal optical components that provide focus and tracking functions reside on the actuator, resulting in a lower-mass actuator. The drive has a 42-msec seek time compared with specs greater than 60 msec for some optical drives.

Other key specs include 11W power dissipation during read/write operations and 2.6W when the drive is inactive. A Reed-Solomon error-correction scheme results in less than 1 error bit per 10¹² bits. The drive can read data continuously from disk at 640 kbytes/sec and write data continuously at 203 kbytes/sec. Write operations require the erase, write, and verify passes common to all rewritable optical drives and

HIGH PERFORMANCE TECHNOLOGY

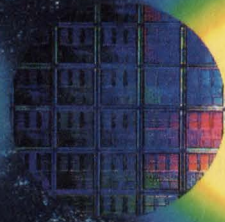
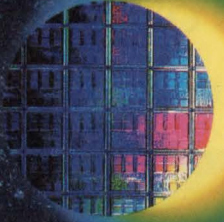
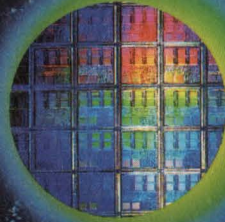

THAT SHEDS A NEW LIGHT.

In-depth VLSI experience and process technology enable MHS to offer 0.7 μ CMOS/ BiCMOS devices TODAY!

This is the driving force behind our balanced product offering.

The MHS OPEN ASIC concept, supported by market leading CAD tools, offers smart solutions for system integration: composite/gate arrays, sea-of-gates, PLD replacement, standard cells and full custom devices.

Our range of application-specific DATACOM products includes voice combos, network protocol controllers and compressed imaging. And when it comes to fast and/or very low power SRAMs, FIFOs or Dual Port RAMs, we can provide versions down to 8ns access time or down to 1 μ A stand-by.

We have chosen the RISC 32 bit SPARC architecture to produce chip sets and embedded solutions, in addition to 8 bit microcontrollers built around an 80C51 core.

MHS HIGH RELIABILITY products and services are an integral part of today's most sophisticated programs in Aerospace, Defense and Avionics, based on RAQ1/AQAP1, 883C, CECC, ISO 9001 and SCC certifications or standards.

Want more information about our service-oriented organization and highly skilled teams?

Call us today, we'll send you our brochure.

Tel. : 800 554 44 50



THE EXPERT
IN SUBMICRON CMOS

CIRCLE NO. 46

NANTES · PARIS · LONDON · MILAN · MUNICH · STOCKHOLM · SANTA CLARA · HONG KONG

EDN EDITORS' CHOICE

account for the slower speed.

The drive features a 128-kbyte buffer on the SCSI-2 controller. The controller can transfer buffered data to the host at 2 Mbytes/sec in asynchronous mode and at 5.3 Mbytes/sec in synchronous mode. The drive's MTBF spec is 30,000 power-on hours.

The key to the acceptance of 3½-in. optical drives will eventually be price. The OD-3000 costs \$1050 (1000) and the rewritable disks cost \$60 each. The company hopes to drop the prices by 50% or more within the next 18 months.

—Maury Wright

Teac America Inc, 7733 Telegraph Rd, Montebello, CA 90640, (213) 726-0303, FAX (213) 727-7621.

Circle No. 733

EDN's Editors' Choice

On occasion, a new product will show a great deal of innovation and thus appear as an EDN Editors' Choice selection. To qualify for special coverage by our editors, an innovative product must:

- Offer significantly higher levels of performance in ways not previously available
- Solve a continuing problem much more effectively than its predecessor
- Exhibit a marked degree of cleverness, which differentiates it from earlier products
- Embody new technology that advances the state of the art or use older technology in a unique and innovative way.

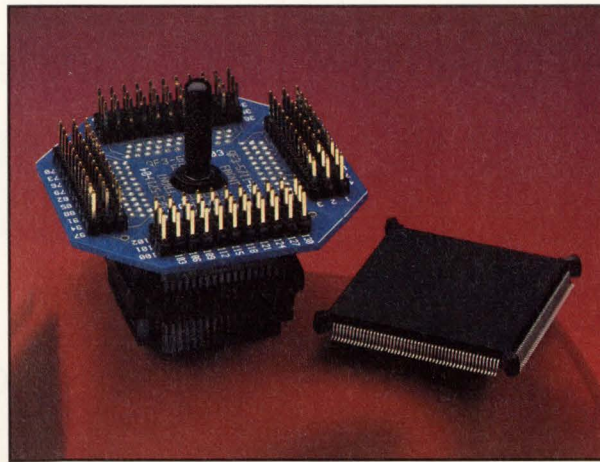

The PQFP Test Clip Solution...

... for hands-free testing of SMT PQFP packages.

- Clips directly onto your soldered-on PQFP device.
- Support for testing, logic analysis, and emulation.
- Converts JEDEC and EIAJ PQFP package footprints to standard test points .1" apart.
- Available in package sizes 80 pin--160 pin.
- Custom sizes also available!



Call for FREE Catalog and Quotation:

Emulation Technology Inc.
2344 Walsh Ave. Santa Clara, CA 95051
Phone: 408 982-0660 FAX: 408 982-0664

Call your Emulation Technology Distributor:

AUSTRIA
222-603-1953
AUSTRALIA
613-764-5199
BELGIUM
15-212223
CANADA
613-725-2177
DENMARK
44-532244
ENGLAND
234-266455
FINLAND
0-334133
FRANCE
1-69412801
GERMANY
89-4602071
89-61208199
HONG KONG
3-460985
HUNGARY
361-116-2287
KOREA
2-516-1144
INDIA
11-6421114
ISRAEL
3-260-148
ITALY
2-353-8041
JAPAN
33-988-7534
33-791-6411
NETHERLANDS
10-450-1444
NORWAY
2-900900
SINGAPORE
281-7244
SOUTH AFRICA
11-789-1743
SPAIN
1-555-8112
SWEDEN
8-744-0300
SWITZERLAND
55-48-52-00
TAIWAN
2-507-9556
2-721-9533

CIRCLE NO. 47

The World's Smallest Fax Machine

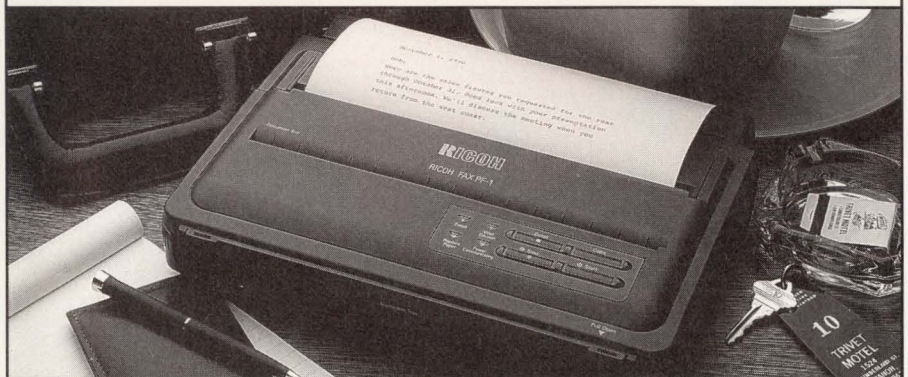

Check with the Guinness Book Of Records*. The new RICOH PF-1 weighs just 5½ pounds, and faxes 8½ x 11 documents. So call 1-800-63-RICOH ext. 1340 and put the smallest fax in the world in your briefcase.

RICOH[®]
Where Imagination Becomes Reality

Worldwide Facsimile Sponsor
1992 Olympic Games



36 USC 380

* As certified by the Guinness Book Of Records

Who's Behind The Simulation Acceleration Movement?

MENTOR GRAPHICS

SYNOPTSYS

DAZIX AN INTERGRAPH COMPANY

VALID

VANTAGE

GENRAD

LSI LOGIC

VLSI TECHNOLOGY

COMPASS

NEC

SEATTLE SILICON

EXPERTEST



And Who's Leading It?

ZYCAD

Generator owes accuracy and versatility to DSP and arbitrary-waveform technology

Analogic Corp's 2030 harnesses technology not yet widely used in function generators to make daunting waveform-generation tasks seem rather straightforward. You can set it up to produce complicated waveforms with no more difficulty than you can get classical generators to output sine, square, and triangular waves. Moreover, the waveforms that the unit produces exhibit unusually low distortion and few artifacts. The firm accomplishes this feat by using digital technology—*DSP* technology—and playing tricks such as predistorting the samples fed to the unit's D/A converter to compensate for sampling effects and for the inherently nonideal transient response of the anti-imaging filter that follows the DAC.

Hidden within the half-rack-width enclosure is a Motorola 56001 DSP μ P. The μ P earns its keep; it executes algorithmic routines stored in ROM and fills the generator's dual-ported memory with samples that represent the output waveforms. The algorithms are much more compact than are point-by-point signal representations; therefore the generator can store an extensive waveform repertoire. If the individual waveforms stored this way don't meet your needs, you can add the waveforms to each other and multiply them by one another. Moreover, to remove artifacts that would otherwise appear, before routing the calculated waveforms to the DAC, the μ P convolves them with the reciprocal of the output filter's impulse response.

This technique and other numeric

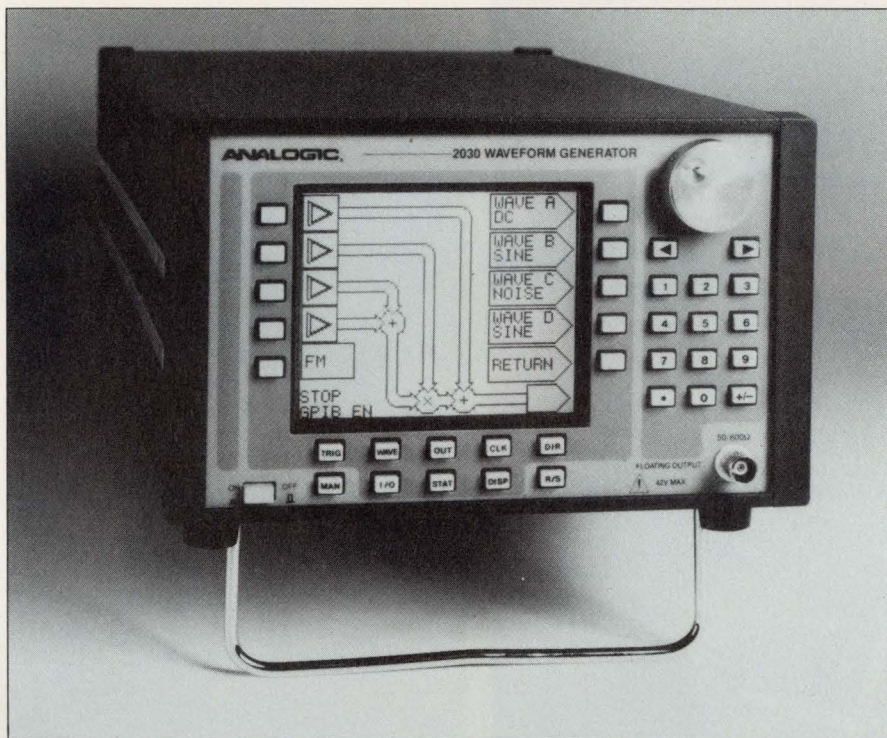

Adding and multiplying waveforms to produce even more complex waves is a snap with the block diagrams that appear on the bit-mapped, backlit LCD screen of the 2030 function generator. You make your selections using soft keys next to the screen.

slights-of-hand let the generator produce a long list of modulated and swept-frequency waves—in addition to dc and the familiar sine, square, ramp, triangular, pulse, and pseudo-random-noise waveforms. The modulated waveforms include double-sideband AM (amplitude modulation) with full and suppressed carriers; single-sideband AM, also with full and suppressed carriers; FM (frequency modulation); phase modulation; exponentially decaying waves; the $\sin(x)/x$ function; and both linear and logarithmic sweeps.

The sine-wave distortion level, although dependent on amplitude

and frequency, is 80 dB below the output level at or below 100 kHz, regardless of amplitude. There are four amplitude ranges, from 10 mV to 10V full scale into an open-circuit. You can set the amplitude with 4-digit resolution, and you can select either 50 Ω or 600 Ω output resistance.

The generator's frequency range starts at 0.001 Hz and extends to 20 MHz for sine waves and to 5 MHz for pulses and for square, triangular, and ramp waves. Pulse rise time is approximately 15 nsec at and below 100 Hz; 10.0 to 10.4 μ sec from 100 Hz to 1 kHz; 1 to 1.04 μ sec from 1 kHz to 10 kHz; and 46

Why make
users
do this?

When
they can
do this!

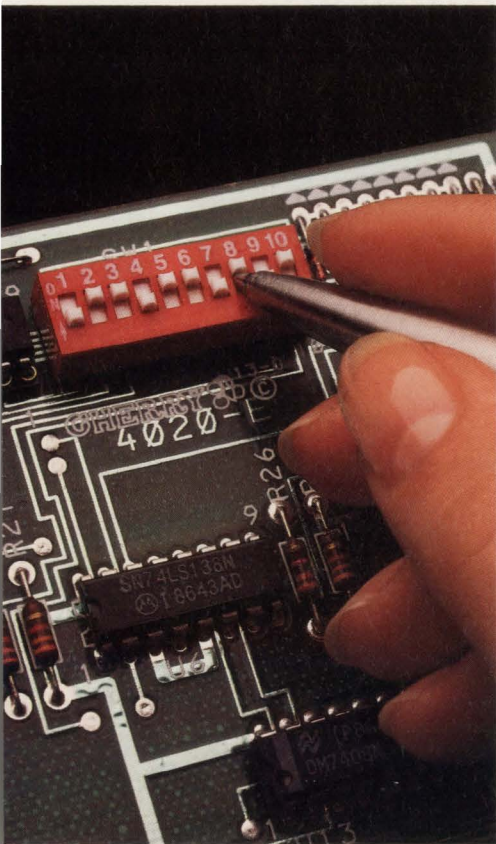

Changing DIP switches is a five stage process: disconnect the device, remove outer housing, reset the DIP switches, reassemble unit, and reconnect the device. Minimum downtime: 20 minutes.

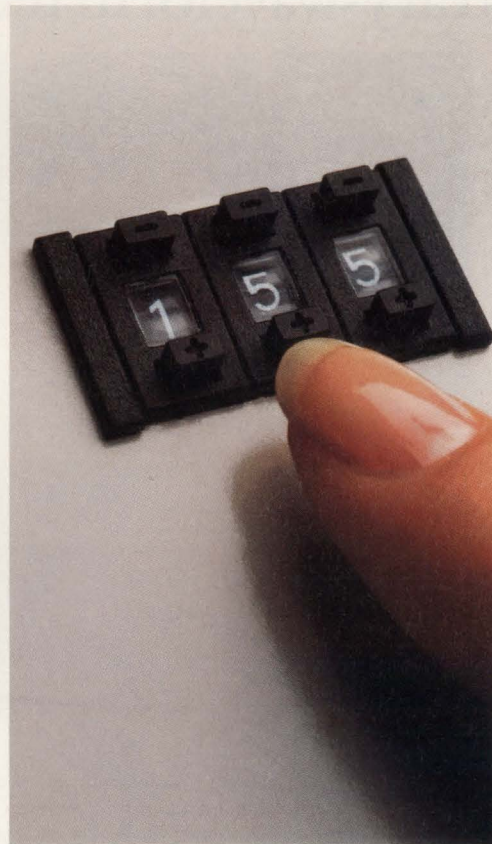

Changing an *Address Switch* takes only one step: punch in the "address" on the back of the computer. Maximum downtime: 20 seconds.

Introducing the *Address Switch*™

It's a user-friendly world. At least, users insist it be that way. So they look for "user-friendly" features when they shop for computers and computer products. That's why one major company introduced our *Address Switch* on the back panel of their personal computers. Users designate the "address" of their computers and peripherals with a simple, one-step press of the *Address Switch*.

Wouldn't the *Address Switch* make your product much more user-friendly?

Make "Switch-Addressable" One of Your Selling Features.

Just as users look for "IBM®-compatible" on today's computers and peripheral devices, they will soon start looking for "switch-addressable". As local area networks continue their rapid growth, the need to change "addresses" on network devices in a quick and easy manner is becoming increasingly important. The *Address Switch* puts your device in the "preferred" category.

The *Address Switch* Adapts to Your Design.

Panel-mounted and easily accessible, the *Address Switch* adds value to your product by replacing internal DIP switches on IC boards with instant access on the external housing. Available in a variety of colors to match your product, gang-mountable in virtually any configuration, the *Address Switch* uses the standard SCSI design to adapt readily to any product line.

Give Us Your Address, and We'll Give You Ours.

Don't you owe it to your product to stay competitive? Call us today at 708-360-3500, and we'll send you a Specifications Sheet describing the *Address Switch* in detail. Don't get left behind in the user-friendly race—the competition is already off and running.

"Switch Addresses with the *Address Switch*."

CHERRY 
THE CHERRY CORPORATION

Cherry Electrical Products
3600 Sunset Avenue
Waukegan, IL 60087
Phone: 708-662-9200
Facsimile: 708-662-2990

IBM is a registered trademark of the International Business Machines Corporation.

Circle #49 for Immediate Need
Circle #50 for Future Need

EDN EDITORS' CHOICE

to 50 nsec from 10 kHz to 5 MHz. Peak pulse and square-wave overshoot is 0.1% at and below 100 kHz and 0.2% above. You can set the output frequency of any waveform with a resolution of 1 part in 10^7 (0.1 ppm).

The vendor's earlier waveform generators relied heavily on algebraic definition of signals. If you could represent a signal as an equation and key it in, the generator would synthesize it. With the new instrument, which has a backlit, bit-mapped LCD screen, instead of fumbling with formulas, you make selections from menus of stored functions and from block diagrams of multiplication and addition operations. The unit has soft keys with functions designated by legends that appear on the screen, fixed-function keys, a numeric keypad, and, for those who prefer it to the keypad, a rotary control.

Because it incorporates the technology of a 12-bit-resolution arbitrary-waveform generator, the instrument can synthesize signals that are not in its library and that are not producible by manipulating the library functions. The vendor doesn't emphasize this arbitrary-function-generation capability, however. To use it, you must load waveform-definition files from an external source, such as a PC, via the unit's IEEE-488 or RS-232C ports. The generator includes both ports as standard equipment. The ports let you use terse commands to recall any of 15 complete setups from non-volatile memory. You can retrieve the setups manually by pressing a few keys. The unit costs \$3995.

—Dan Strassberg

Analogic Corp, 8 Centennial Dr, Peabody, MA 01960. Phone (508) 977-3000. FAX (508) 531-1266. TLX 6817021. Doug Estrich.

Circle No. 731

Get TV reception you never had before, with...
Antenna Multiplier™
 only \$29.95*

*But read this ad for an even better deal!

You won't need it if you are connected to a cable system, but if you are not you will now get TV reception that you could never enjoy before. Inside its unprepossessing housing, the *Antenna Multiplier™* hides a small technical miracle—an array of electronic components that literally multiplies the reception power of your TV. The *Antenna Multiplier™* stabilizes your TV picture, eliminates "ghosts" and static, and brings in stations that were until now only visible as flickers and annoying shadows. In most areas you will be able to eliminate any outdoor antenna completely, making yourself independent of bad weather interference and atmospheric disturbances. The *Multiplier™* needs no outside power—it gets its "juice" right through your TV set. You place the *Multiplier™* on the television set itself, lay it on a nearby table, or hang it on the wall. And, of course, you can bid your messy and ineffective rabbit ears, loop, rod, or dish antennas good-bye. *Antenna Multiplier™* will not just enhance your TV reception manifold, it also vastly improves AM/FM radio reception and brings in new stations on multiband and shortwave receivers.

We are the exclusive importers of the *Antenna Multiplier™* in the United States and can therefore bring you this outstanding TV accessory for just \$29.95. But we have an even better deal: **Buy two for \$59.90, and we'll send you a third one, with our compliments—absolutely FREE!** Unleash the full power of your television with *Antenna Multiplier™*. Order it today!



• The Antenna Multiplier significantly boosts UHF, VHF Television and AM, FM, & Shortwave radio reception.

FOR FASTEST SERVICE, ORDER

TOLL FREE (800) 882-3050

24 hours a day, 7 days a week

Please give order #1429B007. If you prefer, mail check or card authorization and expiration. We need daytime phone number for all orders and issuing bank for charge orders. Add shipping/insurance: \$5.95 for one, \$6.95 for three. Add sales tax for CA delivery. You have 30 day return and one year warranty. We do not refund shipping charges.

Looking for a bargain? Come in and visit our Catalog Outlet in San Francisco.



139 Townsend Street, San Francisco, CA 94107

CIRCLE NO. 25

Why it takes legwork to flatten your stomach.

You can't reduce stomach fat by exercising abdominal muscles alone.

Research has shown that exercises that work only the abdominal region are not effective. They simply don't involve enough muscle mass to burn the calories necessary to trim fat. Instead of flattening, they merely strengthen underlying muscles, providing no reduction in girth, fatfolds, or total body fat percentage.

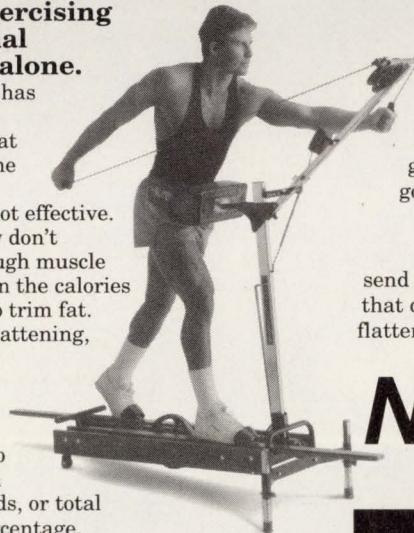

major body muscles. Which means you burn more body fat in less time than with many other in-home exercise machines. And while you're at it, you're toning and defining those muscle groups, as well. So you feel as good as you look.

Free information.

Call or write us today. We'll send you a free brochure and video that describe how NordicTrack can flatten your stomach and make you look and feel your best.

NordicTrack
 A CML Company

"The World's Best Aerobic Exerciser."™

Call or Write for a

FREE VIDEO & Brochure

1-800-328-5888 EXT 144J1

NordicTrack, Dept. #144J1
 141 Jonathan Blvd. N. Chaska, MN 55318
 ©1991 NordicTrack, A CML Company

The exclusive NordicTrack® total-body aerobic exerciser is the most effective way to flatten your stomach.

The total-body motion involves all

Killer Specs.



Panther[®] SCSI

Stalking system performance is your goal. That's why Maxtor's 1.2GB SCSI Panther was designed to perform a data seek in just 13ms. No other drive in its class features such lightning speed.

Panther's hunting prowess of 2ms track-to-track seek time stands out compared to Seagate's Wren 7 seek time of 2.5ms. And Panther outruns the competition with a 30Mb/sec. internal transfer rate.

Experience counts. Panther uses the reliable head disk assembly used in the Maxtor XT-8000, which boasts more than 300,000 units in the field. Panther shreds the competition with the widest range of available controllers, an MTBF of 150,000 hours, Novell certification and a highly competitive price.

Call about the full line of Panther drives that range from 1.2GB to more than 1.7GB capacity. If you're stalking performance, check out Panther's killer specs. *Call your nearest Authorized Maxtor Distributor.*

1GB-plus Disk Drive Comparison Criteria	Maxtor Panther P0-12S	Seagate Wren 7
Capacity (unformatted)	1.2GB	1.2GB
Seek Time	13ms	15ms
Track-to-Track	2ms	2.5ms
Internal Transfer	17.4 to 29.7Mb/s	15-23Mb/s
Maximum Seek	26ms	34ms



© 1991 Maxtor Corporation
© Panther is a registered trademark of Maxtor Corp.

We Drive Harder.
Maxtor[®]



**Call
Your
Authorized
Maxtor
Distributors**

- A.D.P.I.**
1-800-275-2374
301-258-2744
- Anthem Electronics**
408-452-2287
- Arrow Commercial Systems Group**
1-800-323-4373
- Arrow/Kierulff**
1-800-777-2776
- Avnet Computer**
1-800-422-7070
- B.S.M./Business Solutions in Micro**
1-800-888-3475
214-699-8300
- Cal Abco**
818-704-9100
800-669-2226
- Compac Micro Electronics**
1-800-426-6722
415-656-2244
- Computer Brokers of Canada**
416-660-1616
1-800-663-0042
1-800-361-6415
- CPC**
714-757-0505
800-582-0505
- D & H Distributing Co.**
717-236-8001
- Data Storage Marketing (D.S.M.)**
1-800-543-6098
303-442-4747
- Firstop Computer**
1-800-832-4322
- Future Electronics**
514-694-7710
- Intelect**
011-525-255-5325
- Marshall Industries**
1-800-522-0084
- Microware Distributors**
1-800-777-2589
503-646-4492
- Mini-Micro Supply Co.**
408-456-9500
1-800-628-3656
- Pioneer Standard Electronics**
1-800-874-6633
- Pioneer Technologies**
1-800-227-1693
- S.E.D.**
1-800-444-8962
404-491-8962
- Tech Data**
1-800-237-8931
813-539-7429
- Technology Factory**
1-800-848-2073
1-800-227-4712
- U.S. Computer**
305-477-2288
- Wyle Laboratories**
1-800-289-9953

PRODUCT UPDATE

Raster image-accelerator IC renders fonts in real time

The D7001 IC renders outline fonts in real time for graphics display and printer applications. The device is the first IC in the company's RIDA (raster image device accelerator) family of ICs that accelerate the rendering of graphic objects. It can produce outline fonts scaled to any size fast enough for laser printers to print at speeds of 17 pages/minute and slower. The IC can also be used in mother board graphics applications to directly drive WYSIWYG display and printer engines.

The IC accepts Bezier curves, B-spline curves, and vectors. You can use the chip in TrueType, Postscript, and Intellifont page-description-language applications. Multiple filling algorithms handle both Roman characters and Kanji glyphs, and on-chip hardware compensates for pixel dropouts—a key feature for Kanji applications in which slight changes affect the meaning of glyphs. Scaling capabilities enable the chip to produce fonts ranging in size from 0.25 to 999.99 points.

Currently, most display and printer controllers use software or

firmware to render fonts. The D7001 provides 1000-to-1 font-rendering acceleration compared with firmware- and software-based designs. The IC treats outline fonts as objects rather than using graphics primitives.

The IC uses on-chip parallel processors with pipelined hard-wired instruction sets (Fig 1). When producing 300-dpi-resolution fonts at 12 points, the IC can render more than 7500 cps. Such a speed lets you implement a printer controller without the traditional 1- or multiple-line font cache. In fact, the IC can essentially render fonts in real time and requires only an 8-kbyte single-character font cache.

The D7001 comes in a 144-pin quad flatpack. Samples cost \$35. Expect production quantities to be available by year's end for \$25 (1000). The company hopes to offer a companion IC next year that can accelerate the drawing of graphic images.—*Maury Wright*

Destiny Technology Corp, 300 Montague Expressway, Suite 150, Milpitas, CA 95035, (408) 262-9400, FAX (408) 262-0221.

Circle No. 730

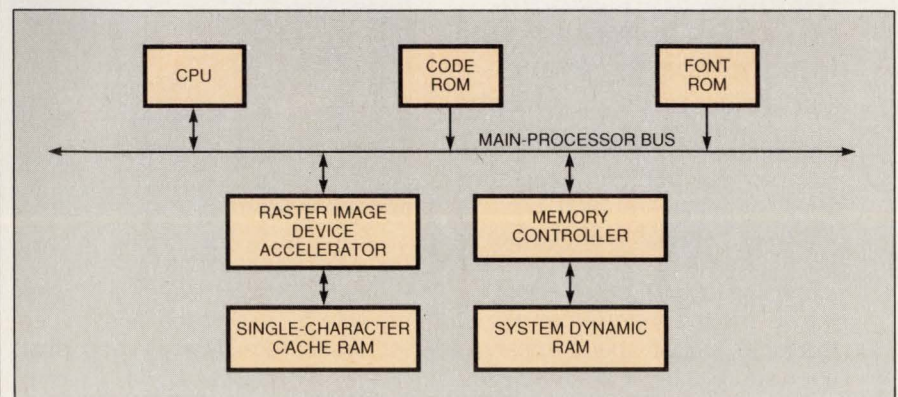
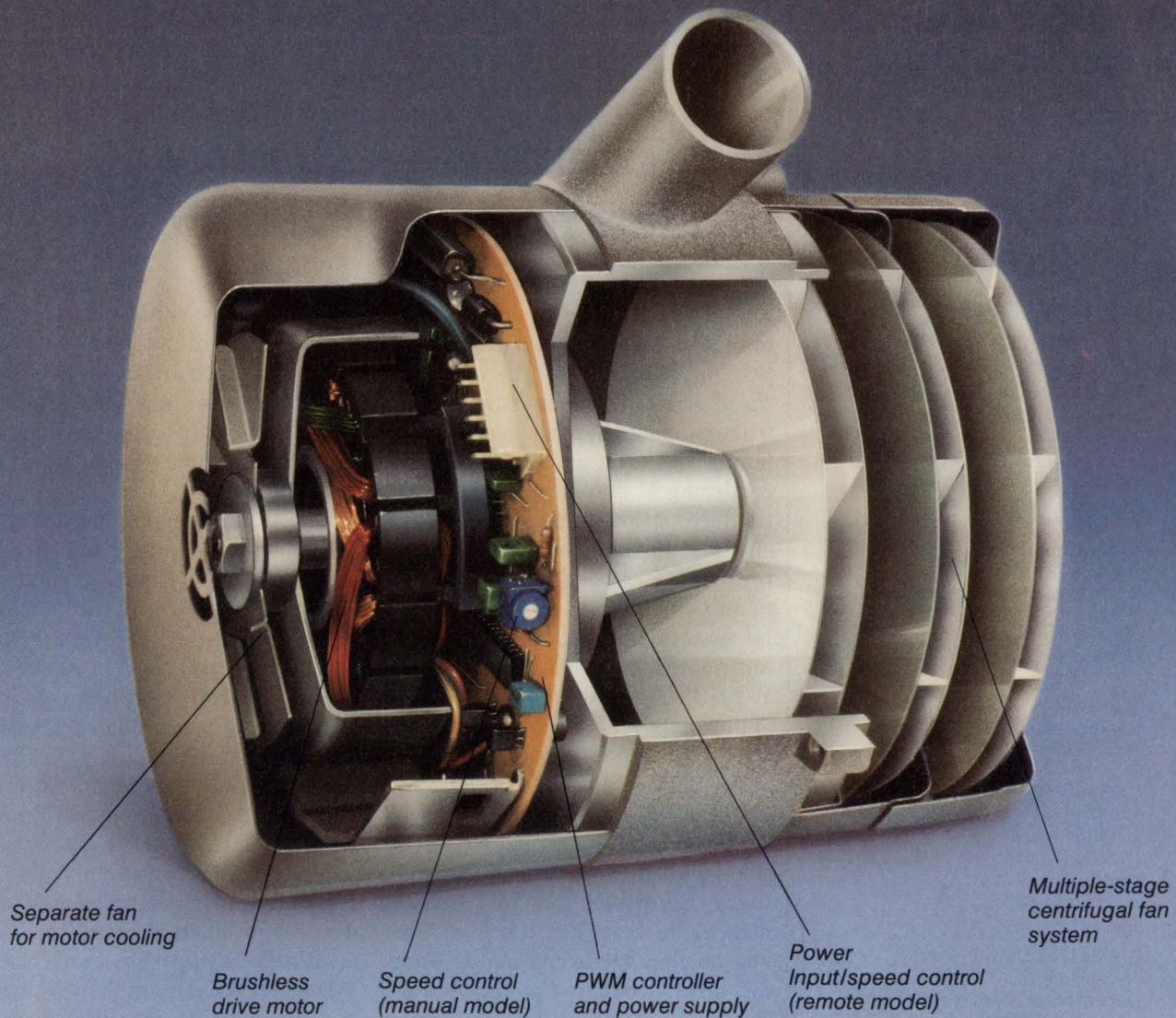

Fig 1—A parallel-processor architecture lets the D7001 render outline fonts in sizes ranging from 0.25 to 999.99 points. The IC can keep up with 17-page/minute printers and requires only a single-character font cache.



Now, high performance vacuum/pressure blowers that operate from 120 VAC

Compact units feature brushless dc motors with integral controller and variable speed capability

These new Windjammer® blowers combine electronics, motor, and fan system in a compact, cost-effective package that operates from a standard 120 VAC input. An exclusive Lamb Electric design, they were developed from demanding, limited space applications such as business machines, medical equipment and materials



handling applications.

Just 5.7" in diameter, the blowers have 1-, 2-, or 3-stage fans for performance from 75" H₂O vacuum at 0 CFM to 125 CFM at 0" H₂O. With one version, a 0 to 10 VDC signal

from a sensor or other device will control motor speed and adjust air performance from 0 to 100%. Or, a second model provides manual speed control by means of a potentiometer located in the blower housing.

These blowers also feature low noise performance and are UL/CSA component recognized. Get complete details by contacting AMETEK, Lamb Electric Division, 627 Lake Street, Kent, OH 44240. (216) 673-3451. Fax: 216-673-8994. Telex: 433-2140. Cable: LAMETEK.

AMETEK
LAMB ELECTRIC DIVISION

CIRCLE NO. 54

IC tester offers 200-MHz testing for analytical applications

The Logic Master ATS test station provides characterization of new chips, failure analysis, quality assurance, and low-volume production tests for devices requiring clock rates as high as 200 MHz. Proper device characterization requires clock rates and accuracy comparable to a production tester.

Although production testers can perform characterization and other applications, they often have two drawbacks. First, they are expensive—the demand for high clock rates, high accuracy, and high throughput place requirements on production test systems that are difficult to achieve at any price. Because the high throughput capability of a production tester is not used during characterization, the cost of a production tester is difficult to justify. Second, because production test-system software is designed for test engineers, it's not always easy for a design engineer to use when evaluating a new chip design.

This test station is priced at \$2600 to \$3200 per pin. It offers 200-

MHz clock rates without multiplexing channels and data rates as high as 400 Mbits/sec. Standard system accuracy is ± 500 psec. The system has 50-psec edge-placement resolution and ± 100 -psec stability and linearity, allowing you to fine-tune the calibration for special applications.

The test system uses the highest performance for the pin drivers and uses custom GaAs drivers and receivers. Other parts of the tester use ECL standard-cell devices, CMOS gate arrays, and FPGAs.

The GaAs drivers let you program driver rise and fall times between 1 and 3 nsec for 5V swings. For 600-mV signal swings, the rise and fall times are programmable from 500 psec to 1 nsec. Each driver and comparator is independent and can have its own drive and compare levels set with 10-mV resolution between -1.5 and $+6.5$ V for drive high and -2.5 and $+4.5$ V for drive low. Dual threshold comparators let you perform timing-window comparisons.

The tester also provides dynamic

current loads for testing output pins under real-world load conditions and for testing the time required for 3-state outputs to switch to their high-impedance state. Two optional parametric measurement units (PMUs) are available for the tester. One is a "per-pin" PMU that uses comparators to test voltage or current levels to programmed limits. The other PMU analyzes and measures absolute current or voltage levels.

The tester operates with dual formats for channels running at twice the clock or data rate of other channels. This feature is useful when you need to test microprocessors and other devices with multiple phase clocks.

The system is hosted by a Sun workstation and has an Ethernet port for network operation. A 502-Mbyte hard disk is standard.

Software included with the tester provides simulator pattern conversion, system setup, pattern generation, and graphical waveform editing. The system has built-in soft-

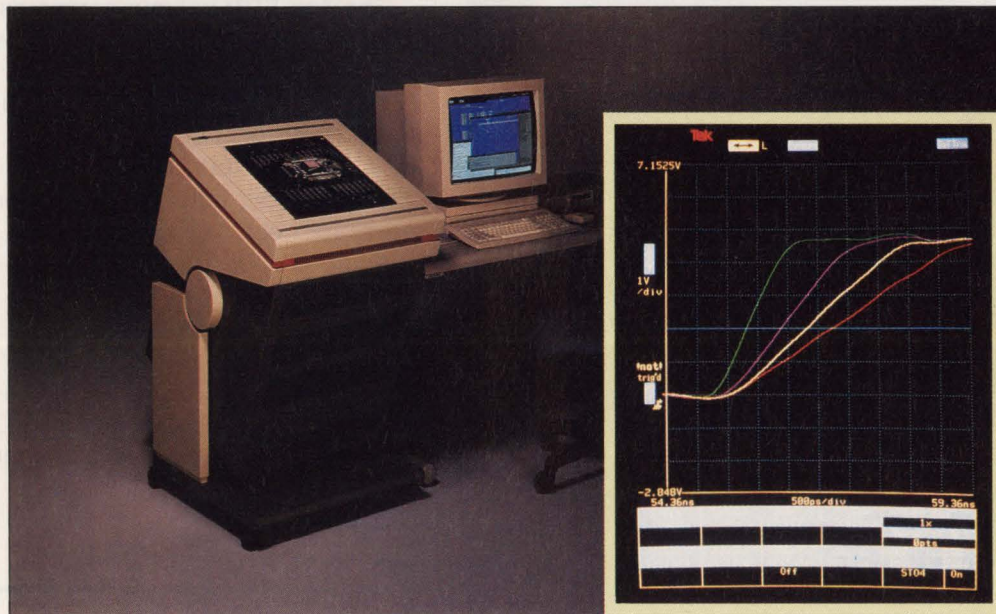

As many as 448 channels of 200-MHz testing is possible with the Logic Master ATS. The drivers have programmable slew rates so you can use the optimum value for your test setup.

- Crystals
- Crystal Oscillators
- Crystal Filters
- Ceramic Resonators

RALTRON

WHEN IT COMES TO HIGH ACCURACY CRYSTAL UNITS, ONLY RALTRON HAS IT ALL.

RALTRON manufactures one of the industry's most complete lines of high quality crystal units. Call us for all your crystal needs from micro-processor to AT strip to tuning fork to high accuracy. Or call us for our 28 page catalogue.

HIGH ACCURACY CRYSTAL UNITS

- Frequency Range: 1.0 MHz-360 MHz
- Mode of Oscillation: Fundamental to 9th O.T.
- Frequency Tolerance: @ 25°C: ± 2.5 ppm to ± 100 ppm
- Frequency Stability: ± 3 ppm (-10°C to +60°C) to ± 50 ppm (-55°C to +105°C)

SURFACE MOUNT CRYSTAL UNITS HC-45/U SMD, TT SMD, HC-49S SMD

- Frequency Range: 3.5 MHz-360 MHz
- Mode of Oscillation: Fundamental to 9th O.T.
- Frequency Tolerance: @ 25°C: ± 2.5 ppm to ± 100 ppm
- Frequency Stability: ± 3 ppm (-10°C to +60°C) to ± 100 ppm (-10°C to +70°C)

The Products. The Prices. The People. Only RALTRON has it all.

RALTRON ELECTRONICS CORP.

2315 NW 107th Avenue, Miami, Florida 33172
FAX (305) 594-3973 TELEX 441588 RALSENSUI
(305) 593-6033

CIRCLE NO. 51

UPDATE

ware for measuring standard device parameters such as setup, hold, and propagation-delay times. Software is also available for translating test programs written for mainframe testers.

The test station is available in two versions. The ATS 1 supports 16 to 224 I/O channels and has 12 timing generators providing 24 timing edges. The ATS 2 supports 16 to 448 I/O channels and has 24 timing generators. Each channel in either system can select timing edges from 12 timing generators. A 128-I/O-channel system with 128k-deep pattern memory costs \$360,000.—**Doug Conner**

Integrated Measurement Systems Inc, 9525 SW Gemini Dr, Beaverton, OR 97005. Phone (503) 626-7117. FAX (503) 644-6969.

Circle No. 732

JUST ASK

Have you been stumped by a design problem? Can't interpret a spec sheet? Ask EDN. Our editors are ready to help.

The Ask EDN column serves as a forum to solve nagging problems and answer difficult questions. EDN's editors will provide the solutions. If we can't solve a problem, we'll find an expert who can, or we'll print your letter and ask your peers for help.

Address your questions and answers to Ask EDN, 275 Washington St, Newton, MA 02158; FAX (617) 558-4470; MCI: EDNBOS. Or, send us a letter on EDN's bulletin-board system. You can reach us at (617) 558-4241 and leave a letter in the /ask_edn Special Interest Group.

IEEE-488

HARDWARE **SOFTWARE**

You can control any IEEE-488 (HP-IB, GP-IB) device with our cards, cables and software for the PC/AT/386, EISA, Micro Channel and Macintosh II. You get fast hardware and software support for all the popular languages, plus a software library of time saving utilities. Instrument control has never been easier.

FREE
Informative Catalog **800-234-4232**
Applications help **(617) 273-1818**

cec Capital Equipment Corp.
Burlington, MA. 01803

Micro Channel is a trademark of IBM

CIRCLE NO. 52

SOLID STATE RELAY

Our FB Series military solid-state relay features high speed and low off-state leakage.



Here's what you get:

- Availability to pending DESC drawing 89116 with screening to "W" and "Y" levels of MIL-R-28750.
- High-voltage output
- Very-low leakage current (200 nA)
- DC or bi-directional power FET output (see wiring diagrams)
- Ideal for ATE applications
- Optical isolation
- Fast switching speed
- Adjustable turn-on times
- Low profile 6-pin mini-DIP
- Cost efficiency

Review the electrical characteristics below and call us for immediate application assistance.*

INPUT ELECTRICAL CHARACTERISTICS (-55° to +105° unless otherwise noted)				
	Min	Max	Units	
Continuous Input Current (I_{IN})	10	50	mA_{DC}	
Input Current (Guaranteed On)	10		mA_{DC}	
Input Current (Guaranteed Off)		100	μA_{DC}	
Input Voltage Drop at (I_{IN}) = 25mA		3.25	V_{DC}	
OUTPUT ELECTRICAL CHARACTERISTICS (-55° to +105° unless otherwise noted)				
Part Number	FB00CD	FB00FC	FB00KB	Units
Bidirectional Load Current (I_{LOAD})	± 1.0	± 0.50	± 0.25	A_{DC}/A_{PK}
DC Load Current (I_{LOAD})	2.0	1.0	0.5	A_{DC}
Bidirectional Load Voltage (V_{LOAD})	± 80	± 180	± 350	V_{DC}/V_{PK}
DC Load Voltage (V_{LOAD})	80	180	350	V_{DC}
ON-Resistance (R_{ON}) at (I_{LOAD}) max.	0.72	1.8	12.9	Ohms
Turn-On Time (T_{ON})	800	800	500	μs
Turn-Off Time (T_{OFF})	300	600	500	μs

Notes: 1. A series resistor is required to limit continuous input current to 50mA (peak current can be higher).
 2. Rated input current is 25mA for all tests.
 3. Loads may be connected to any output terminal.
 4. ON resistance shown is for the bidirectional configuration. The DC ON resistance is 1/4 of these values.

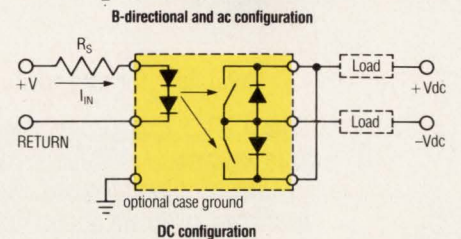
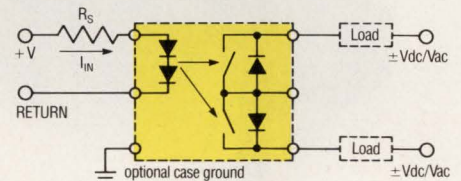

"CREATING THE STANDARD OF THE FUTURE"

TELEDYNE SOLID STATE
A Division of Teledyne Relays

*For immediate application assistance call 1-800-284-7007.

Teledyne Solid State, 12525 Daphne Avenue, Hawthorne, California 90250.



FDDI.

From deskwork to network.

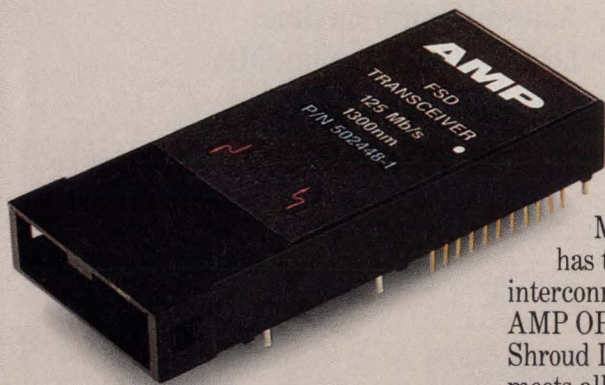

Good news for networks!

The X3T9.5 Task Group, under the procedures of ANSI Accredited Standards Committee X3, has reaffirmed approval of the Media Interface Connector (MIC) for the proposed FDDI (Fiber Distributed Data Interface) Physical Layer Medium Dependent (PMD) document.

More good news! AMP has the complete fiber optic interconnection system—the AMP OPTIMATE Fixed Shroud Duplex System—that meets all FDDI PMD requirements. And includes all the physical components you need to make your fiber optic network a reality.

Of special note: the transceiver is capable of operating at data rates up to 125 Mb/s. Available in standard or raised (+5v) ECL logic, it gives you a compact, board-mount data link in an industry-standard 22-pin package. Reliable duplex mat-

ing and electro-optic conversion are now easier than ever.

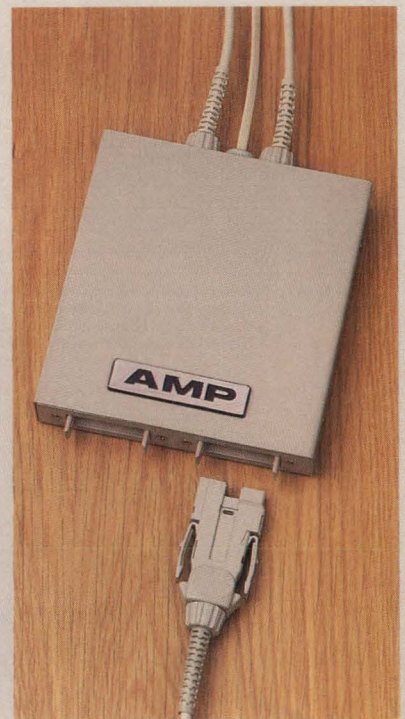

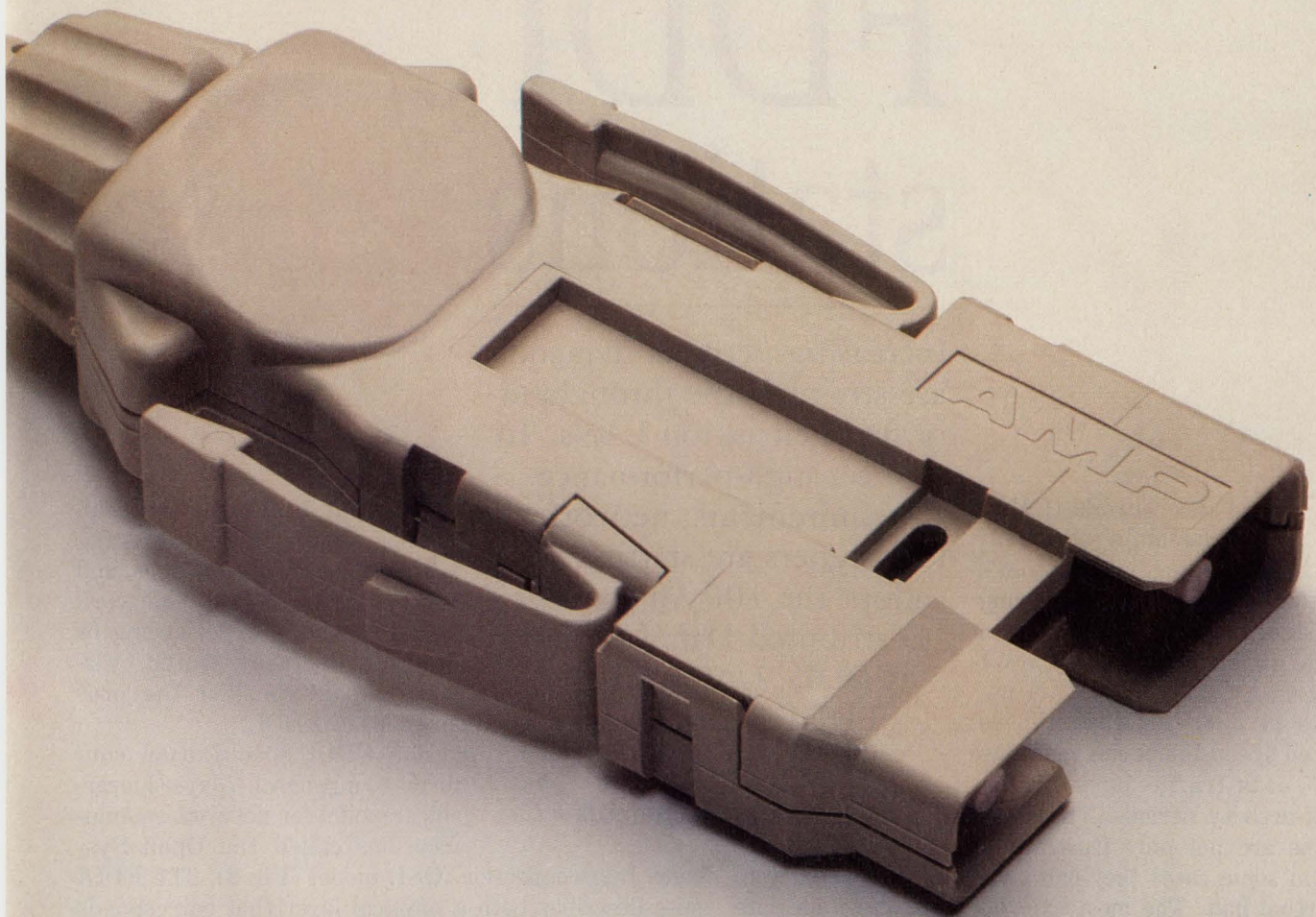

All system components, in fact, are easy to install and reconfigure. Our field termination kit makes short work of attaching duplex connectors to fiber cable. And because all interconnections use a floating interface, you get consistent, low-loss mating (0.6 dB typical) throughout.

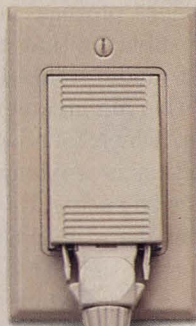

You can also order complete, custom-built cable assemblies from us. Either way, you'll have the assured compatibility that comes from dealing with only one supplier for all your FDDI interconnection components. A supplier whose capability

in fiber optic technology is everything you'd expect from the world's largest connector company.

For technical literature and more information, call 1-800-522-6752. AMP Incorporated, Harrisburg, PA 17105-3608.

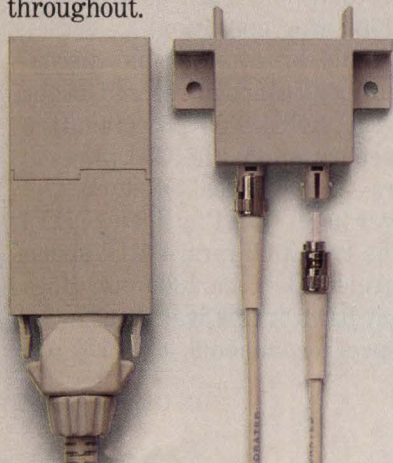

THIS IS AMP TODAY.

AMP

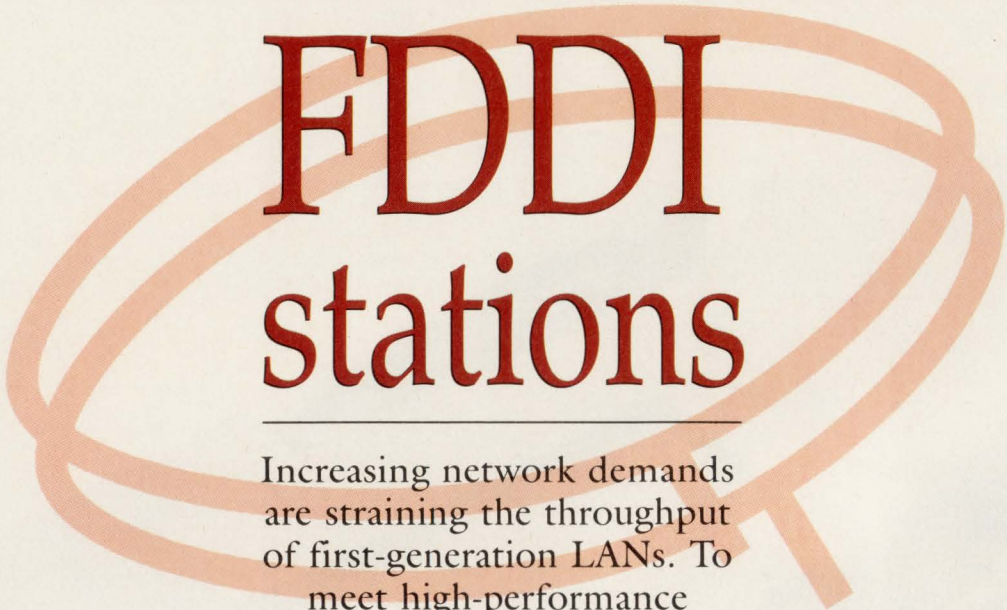

FDDI stations

Increasing network demands are straining the throughput of first-generation LANs. To meet high-performance requirements, network designers are starting to adopt the 100-Mbps Fiber Distributed Data Interface (FDDI). Unfortunately, FDDI stations don't come cheap.

John Gallant, Associate Editor

Local-area networks (LANs) are becoming as congested as our nation's highways. Packet data traveling on Ethernet LANs must share a single 10-Mbps pathway. Packet data on a Token Ring LAN migrate at 4 or 16 Mbps. These posted speed limits can cause severe data-traffic jams during peak activity periods. The slowdowns are not only frustrating, but in some cases they can bring network activity to a virtual halt. The most expedient option to alleviate congestion is to move data faster—an option that, if employed in highway management, would have disastrous consequences.

In 1982, the X3T9.5 committee of the American National Standards Institute (ANSI) recognized these impending logjams and set about defining a set of protocols that lets packet data whiz over a LAN at 100 Mbps. This super highway is the Fiber Distributed Data Interface (FDDI). The ANSI X3T9.5 standard for FDDI defines a dual counter-rotating ring LAN that uses a fiber-optic medium and a token-passing protocol. (For definitions of FDDI terms, see **box**, "Glossary of FDDI terms.")

An FDDI LAN can stretch 100 km and connect more than 500 nodes spaced by as much as 2 km. In contrast, first-generation LANs such as Ethernet, defined by IEEE standard 802.3, and Token Ring, defined by IEEE standard 802.5, operate over a more limited distance. Ethernet can stretch only 2.5 km and connect as many as 1024 nodes spaced by as much as 0.5 km. Token Ring can stretch only 1.2 km and connect as many as 96 nodes spaced by as much as 0.46 km. FDDI's long distance specification coupled with its 100-Mbps data transmission rate make it suitable as a fast-

throughput backbone that can transport data between existing LANs via gateways, bridges, and routers (**Fig 1**). Any network manager who is experiencing or projecting network traffic overloads should consider the pros and cons of FDDI.

The FDDI specification conforms to a general, 7-layer hierarchical model for network communications called the Open Systems Interconnection (OSI) model (**Fig 2**). The FDDI spec describes both a physical layer that corresponds to the OSI model's physical layer and a media-access-control (MAC) sublayer that corresponds to the lower half of the OSI model's data-link layer. The spec also describes a Station Management (SMT) network supervisory function, which falls outside of the OSI model. The SMT function is implemented in software. This software resides on each station of the ring and creates logical paths between the physical layer and the MAC sublayer to permit SMT-to-SMT communications between stations. SMT software connects and disconnects the station to the ring, monitors network operations for reporting status to the host computer, isolates network faults, and detects conditions such as duplicate addresses that would inhibit ring operation.

Realizing that there would be considerable discussion about the types of fiber, connectors, and other interconnect hardware, the ANSI X3T9.5 committee decided to break the specification for the OSI physical layer into two sublayers—the Physical Medium Dependent (PMD) sublayer and the Physical (PHY) sublayer. The lower of the two sublayers, PMD, specifies the transmission wavelength to be 1300 nm. Both LEDs and lasers can emit light of this wavelength.

The PMD sublayer spec recommends 62.5/125- μ m

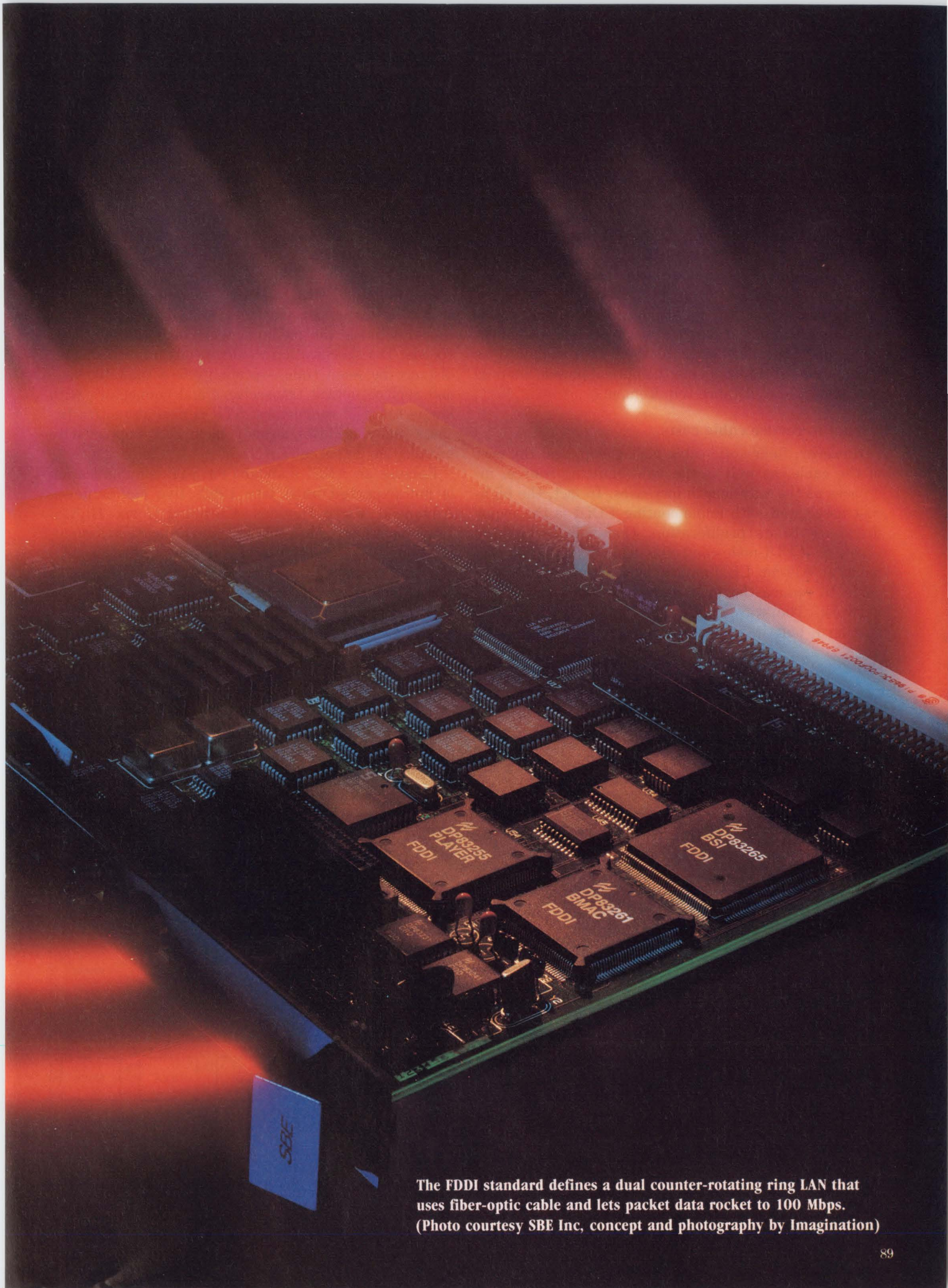

The FDDI standard defines a dual counter-rotating ring LAN that uses fiber-optic cable and lets packet data rocket to 100 Mbps. (Photo courtesy SBE Inc, concept and photography by Imagination)

The ANSI X3T9.5 FDDI standard defines a dual counter-rotating ring LAN that uses a fiber-optic medium and a token-passing protocol.

(core diameter/cladding diameter) multimode cable and has advice on using 50/125-, 85/125-, and 100/140- μ m cable. The dispersion in multimode 62.5/125 micron cable is small enough to ensure FDDI's 10^{-9} bit error rate. Debate continues over cable size. The PMD document is written so that any size cable capable of 1300-nm transmission conforms to the FDDI standard as long as the cable also meets the optical power, channel bandwidth, and distance requirements.

Trying to reduce cable costs

However, fiber-optic cable isn't cheap, and the cost of the cable, as well as the light-emitting source, increases as the wavelength increases. In fact, the high-cost associated with implementing FDDI is the major drawback to its proliferation. Codenoll Technology Corp, an FDDI-node-controller vendor, has proposed using an 830-nm LED emitter and 830-nm multimode cable to reduce the high materials cost of an FDDI network. The wavelength does not meet the FDDI standard, but the company claims that the only effect

of the wavelength change is the shortening of the maximum allowable distance between nodes from 2 to 0.5 km.

A working group of the ANSI X3T9.5 committee is trying to lower FDDI costs by developing a PMD spec that uses less-expensive shielded twisted-pair (STP) copper wire as the medium while maintaining FDDI speeds. The specification would specify a much shorter distance between nodes—probably less than 100 m—and replace optical transceivers and connectors with lower-cost STP connectors. STP is also attractive because many facilities already have STP copper wire installed for Ethernet LANs.

Because an ANSI standard for STP communication is not expected until late 1992, five companies—Advanced Micro Devices, Chipcom Corp, Digital Equipment Corp, Motorola Inc, and Synoptics Communications Inc—recently defined and published an STP standard for 100-Mbps data. Products conforming to this standard, which is open for public use, will be able to communicate with each other.

Copper wire costs much less than fiber cable, but

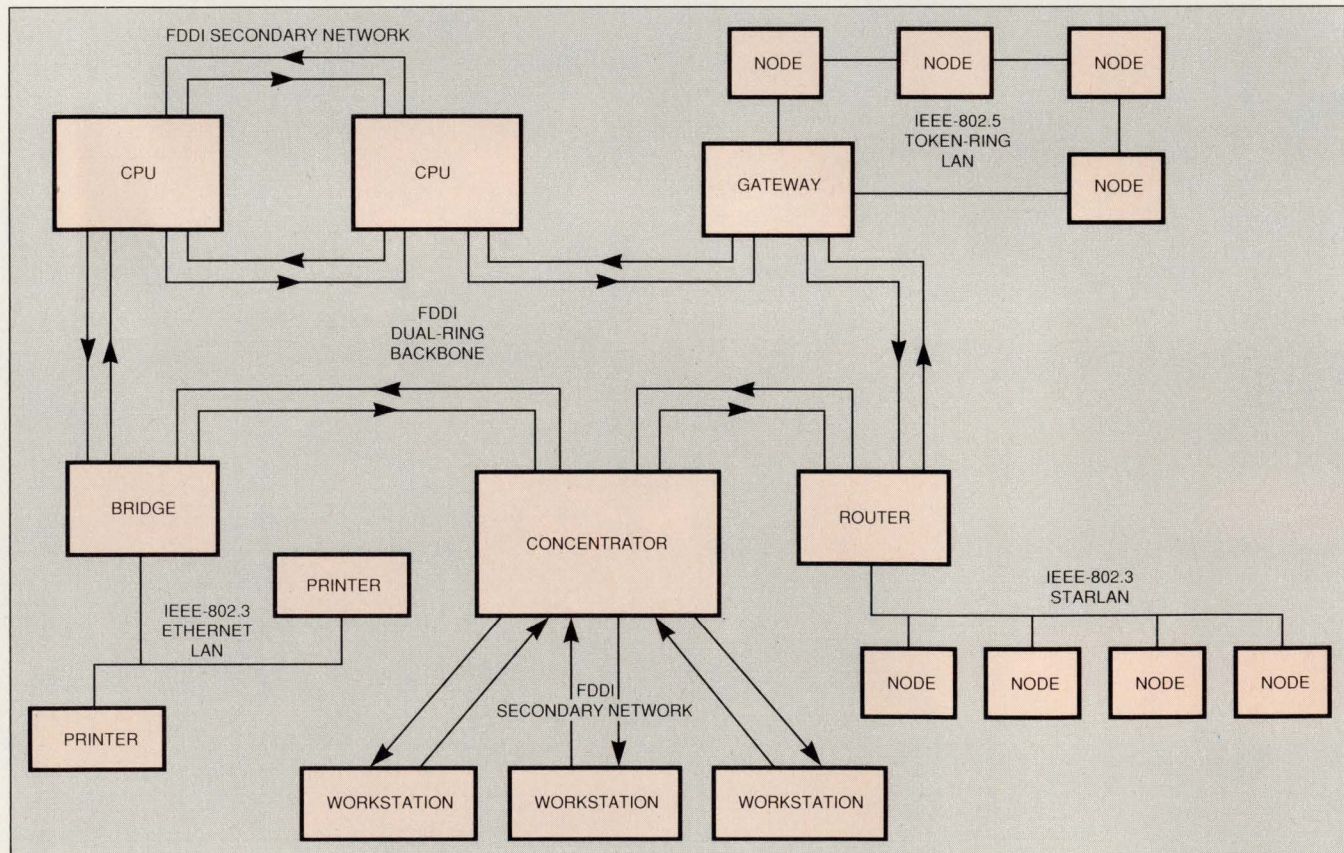
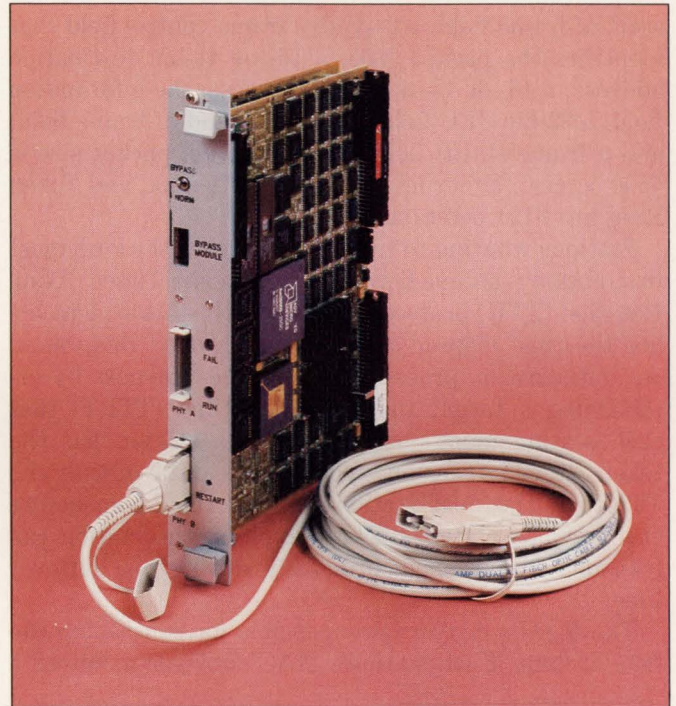

Fig 1—A 100-Mbps FDDI backbone can interconnect multiple disparate LANs using gateways, bridges, and routers.

metal-based networks are susceptible to electromagnetic interference and are less secure than fiber-optic communications—two of FDDI's big pluses. In addition, because FDDI's ring topology demands that each station operate as a repeater, nonstandard PMD implementations can't be used on the FDDI backbone.

Group encoding limits bandwidth

PHY, the upper sublayer of FDDI's physical-layer specification, defines a 4B/5B group-encoding scheme for representing 4-bit data and control symbols. The scheme doesn't use Manchester encoding, which is typical of other LAN protocols. Manchester encoding would require a 200-MHz clock to transmit 100-Mbps data. The 4B/5B group-encoding scheme requires the transmission of a 5-bit code word for each 4-bit symbol, thereby achieving a 125-Mbps rate. The code word is converted to a nonreturn-to-zero-inverted (NRZI) signal for network transmission. The PHY sublayer also defines how to decode the 4B/5B NRZI signal from the network into symbols that the station can recognize.



FDDI specifies a media interface connector (MIC) to attach a station to the dual ring. Formation Inc's Fibernet fv1000 node controller for the VMEbus has two MIC connectors. The controller can operate as a dual- or single-attachment station.

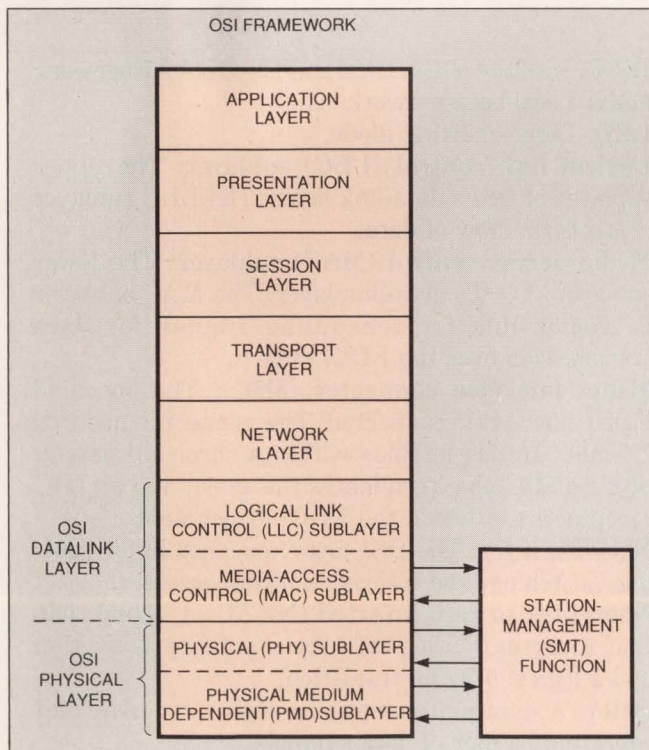

Fig 2—The FDDI specification defines three sublayers that correspond to the data-link and physical layers of the 7-layer OSI model. FDDI also specifies an SMT function, which supervises sublayer and ring-management operations.

Because an NRZI signal has no transitions when all zeros are present in the data, the 4B/5B encoding scheme guarantees that data have no more than three consecutive zeros. Although the encoding scheme uses less bandwidth than Manchester encoding, clock recovery is more difficult. Therefore, instead of using one master clock to generate data as the IEEE 802 standards specify, PHY sublayer specifies that each station in the FDDI ring regenerate the data with a frequency-stable reference to prevent frequency-jitter from accumulating around the ring. Each station has a phase-locked loop, which clocks the received data into an accordion buffer, and a crystal-controlled frequency source, which clocks the data out of the buffer.

MAC sublayer delivers frames

The FDDI media-access-control (MAC) sublayer defines the token-passing protocol for data transmission over the ring. The MAC spec defines packet-frame fields such as headers, trailers, addresses, and cyclic redundancy checking (CRC). An FDDI information-packet frame comprises a preamble having 16 or more IDLE (5-bit group code of all 1s) symbols, a 2-symbol

The PHY sublayer must decode a 4B/5B NRZI signal from the network into symbols a station can recognize.

start-of-frame field, a 2-symbol frame-control field that identifies the packet type, a 16- or 48-bit destination address, a 16- or 48-bit source address, the information field, a 32-bit CRC field, a 1-symbol end-of-frame field, and a frame-status field. The maximum packet size is 4500 octets. (Ethernet has 1514 octets max, and Token Ring has 8191 octets max.)

Stations wanting to transmit data over the ring must first obtain a unique 6-symbol token. The Timed Token Rotation (TTR) protocol requires each station to measure the time elapsed since it last received this token. An initialization procedure guarantees fairness by establishing a target token-rotation time (TTRT) that each station must observe. When a station has the token, it can transmit synchronous data during the TTRT. If the next station receives the token before the previous station's TTRT expires, the station can transmit frames asynchronously during the leftover time.

The MAC sublayer is responsible for controlling the flow of data. Each station's MAC sublayer monitors a

packet's destination address, copies the packet into the station's memory if the packet is addressed to the station, and then relays the packet to the next station on the ring. The sending station's MAC sublayer deletes the packet once it comes full circle.

Chip set implements FDDI sublayers

Three vendors currently offer chip sets that implement the FDDI MAC and PHY sublayers—Advanced Micro Devices, National Semiconductor, and Motorola. These chip sets interface directly to the logical-link-control (LLC) sublayer of the OSI model's data-link layer. All vendors offering stations that connect to an FDDI network employ one of these chip sets. The stations implement the SMT functions in software or firmware. Most stations employ the media interface connector (MIC) defined in the FDDI PMD specification. The MIC is a shrouded fiber-optic coupling in which a male plug terminates the cable and a female receptacle resides on the FDDI module. Some stations employ an ST connector to reduce cost. The ST connec-

Glossary of FDDI terms

ANSI: American National Standards Institute.

Backbone network: A primary network that interconnects two or more secondary networks via gateways, bridges, and concentrators.

BNC: Bay n connector.

bps: Bits per second.

Concentrator: A node on the FDDI ring that provides connections for multiple FDDI stations to communicate with other stations on the dual ring.

Connection management (CMT): That portion of the SMT software that controls station insertion and removal as well as the connection of a station's PHY and MAC sublayers.

CRC: Cyclic redundancy checking.

Data-link layer: The OSI layer that implements data transfer between two stations on an FDDI network.

Dual-attachment station (DAS): A station that provides two physical attachments to accommodate the dual counter-rotating FDDI ring.

Fiber Distributed Data Interface (FDDI): A standard for a 100-Mbps token-ring LAN based on a fiber-optic medium. The ANSI X3T9.5 standard employs a dual counter-rotating ring, which provides fault tolerance. FDDI conforms to the OSI model.

IEEE: Institute of Electrical and Electronics Engineers.

LAN: Local-area network.

LED: Light-emitting diode.

Logical link control (LLC) sublayer: The upper sublayer of OSI's data-link layer. The LLC sublayer controls the flow of data.

Media access control (MAC) sublayer: The lower sublayer of OSI's data-link layer. The MAC sublayer is responsible for scheduling frames for data transmission over the FDDI ring.

Media interface connector (MIC): The specified FDDI fiber-optic connector. The connector has two 2.5-mm ceramic ferrules within a shrouded assembly. An MIC plug terminates the cable, and an MIC receptacle resides on the FDDI attachment.

Network layer: The OSI layer responsible for routing, switching, and internetworking access.

Nonreturn to zero inverted (NRZI): A signal code that represents a logical 1 by a polarity transition and a logical 0 by no transition.

Octet: A data unit comprising eight bits. An octet represents a pair of data symbols.

Open Systems Interconnection (OSI) model: A general, 7-layer model that defines a hierarchy of services necessary to exchange information between

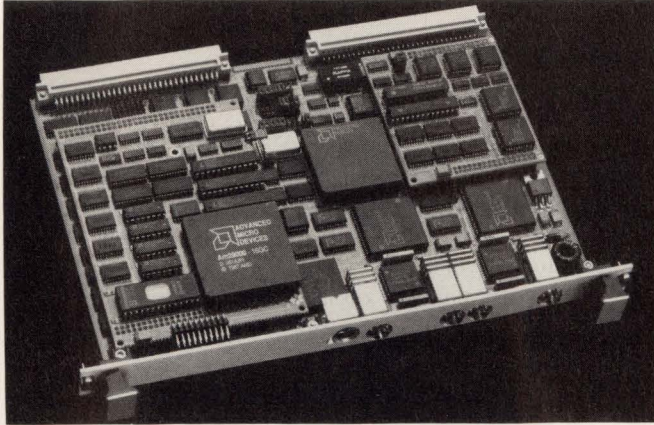

You can configure some FDDI node controllers, such as the V/FDDI 4211 Peregrine board for the VMEbus, as single- or dual-attachment stations. The Interphase Corp board uses the Advanced Micro Devices FDDI chip set.

tor is a spring-loaded twist-and-lock coupling similar to a BNC connector.

FDDI permits two types of stations: Class A and Class B. Class A stations are dual-attachment stations (DAS), which have dual physical layers that connect to the primary and secondary rings in FDDI's dual counter-rotating ring topology. All the stations attached to the FDDI's dual-ring backbone must be Class A stations. A Class A station on the dual-ring backbone

can function in one of three ways: as a node controller that adapts a computer or peripheral to the ring, as a concentrator that acts as the hub of a star topology when connecting multiple FDDI stations to the ring, or as an internetworking module, such as a gateway, bridge, or router. Class B stations are single-attachment stations (SAS) and have a single physical layer. They attach to a concentrator's SAS port (Fig 3) and can be node controllers or internetworking modules.

Although the FDDI specification doesn't prohibit Class A stations from transmitting data on both the primary and the secondary ring, this mode of operation isn't wise. Theoretically, you could double the data-transmission rate to 200 Mbps by using both rings, but you would defeat one of FDDI's most attractive features. FDDI's secondary ring is meant to provide fault tolerance, which is a critical need in high-performance applications. If a fault occurs in the primary ring, the SMT ring-management protocol recognizes that the TTRT is violated and notifies the network manager. The SMT software isolates the fault

computers. The International Organization for Standardization (ISO) defined the model in 1979 as a framework for defining network protocols.

PC: Personal computer.

Physical (PHY) sublayer: FDDI's upper sublayer that corresponds to the OSI model's physical layer. This sublayer is responsible for delivering symbols from the MAC sublayer to the FDDI network.

Physical layer: The OSI layer that permits the physical connection of a station to a LAN.

Physical Medium Dependent (PMD) layer: FDDI's lower sublayer that corresponds to OSI's physical layer. The PMD sublayer specifies optical power, cable specifications, the MIC connector, and optical bypassing.

RAM: Random-access memory.

Ring management (RMT): That portion of the SMT software that manages a station's MAC sublayer. RMT software detects faults, such as duplicate addresses, at the MAC layer.

Shielded twisted pair (STP): Describes copper wire commonly used in LANs.

Simple Network Management Protocol (SNMP): Software for managing a TCP/IP network.

Single-attachment station (SAS): A station that

offers one attachment to an FDDI network.

Station: An addressable node on an FDDI network that is capable of transmitting, repeating, and receiving information.

Station management (SMT): Describes the supervisory software that monitors an FDDI station and controls station activity.

ST connector: A fiber-optic connector employed in many fiber-optic LANs. The AT&T connector contains a ceramic ferrule encased in a twist-and-lock assembly similar to a BNC connector.

Target token-rotation time (TTRT): The maximum time an FDDI station has to transmit data on the ring. The TTRT is established by the lowest bidding station during an initialization process.

TCP/IP: The US Department of Defense's Arpanet suite of protocols for implementing the transport and network layers of the OSI model.

Token: A unique 6-symbol frame that circulates around the FDDI ring. A station must have the token to transmit data.

4B/5B: The symbol encoding method specified by the FDDI standard in which each set of four bits is encoded as five bits.

FDDI stations

and wraps the upstream primary ring into the downstream secondary ring to reconstruct a ring network.

Multiple failures on the ring can segment the network. In these rare cases, the network manager may have another ring-reconstruction option at his or her disposal. The PMD specification provides for an optional optical bypass switch that can be activated to bypass a Class A station completely. Activating the optical bypass switch would let the network manager service the faulty station off line.

FDDI stations can be node controllers, concentrators, or internetworking modules. Node controllers are adapter boards for popular computer buses, such as the ISA bus, VMEbus, and Multibus (Table 1). One of the three commercially available FDDI chip sets provides the PHY and MAC sublayers for the station. The board's PMD hardware determines whether the node controller is an SAS or a DAS. A node controller generally has a microprocessor unit and enough RAM to run the LLC sublayer and offload communications tasks from the host computer.

Some node controllers contain EPROM for SMT

firmware; others download the SMT software into the onboard RAM. All of these boards communicate with the host at the network layer of the OSI model. Although the ANSI committee has not yet drafted protocols for the network layer, the TCP/IP suite of protocols is the most popular method for transferring files. FDDI node controllers support other network-layer protocols as well.

Concentrators play a crucial role in an FDDI network by letting you connect multiple stations to an FDDI backbone via one DAS port (Table 2). FDDI defines four types of concentrator ports: A, B, S, and M ports. The A and B ports provide the DAS connection to the dual ring. The M (master) and S (slave) ports let you cascade concentrators and SAS stations in tree topologies. A concentrator can have as many as 255 M ports. These ports can connect to the primary or secondary FDDI ring or to an S port on another concentrator.

Concentrators are either computer bus boards or stand-alone chassis containing expansion boards. Because a concentrator is a critical link for connecting

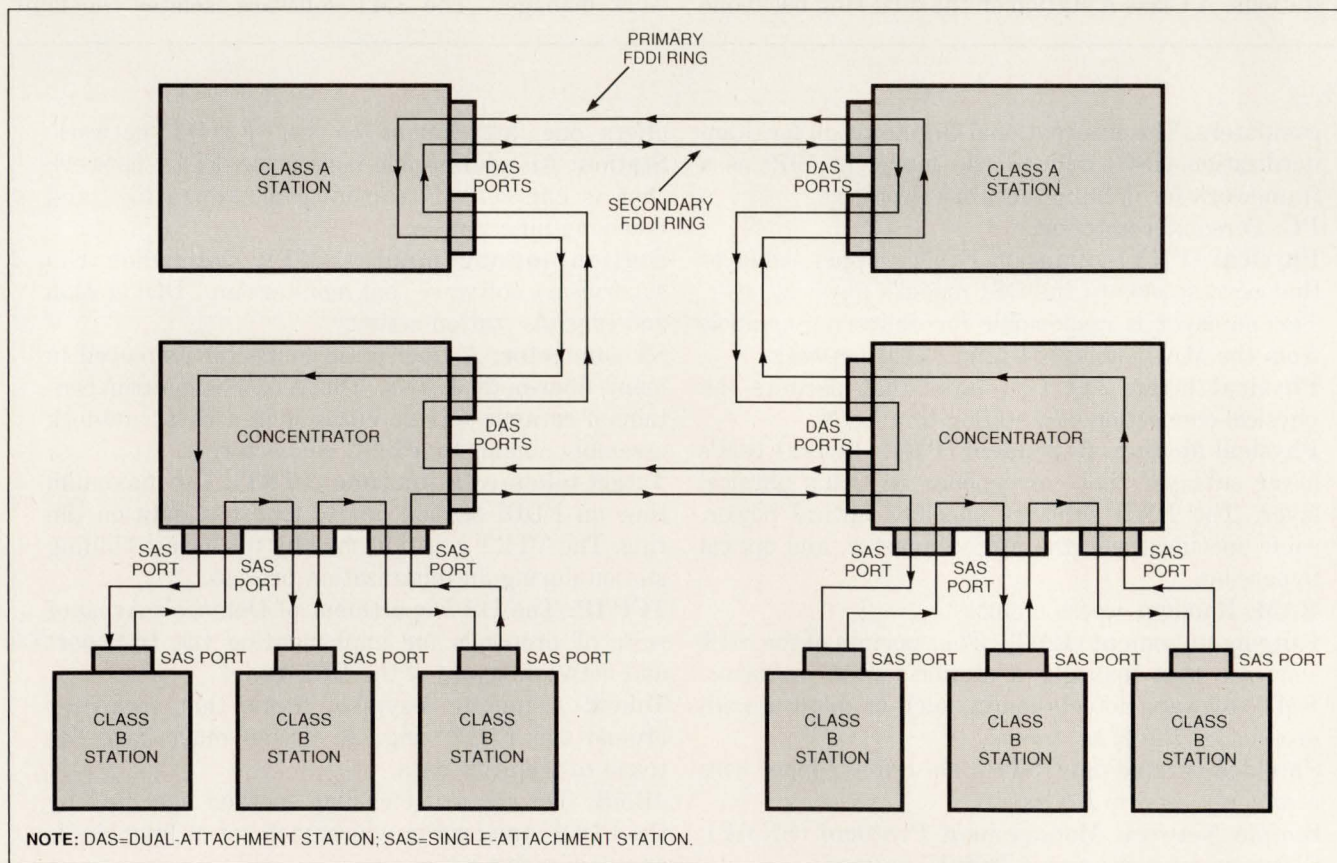

Fig 3—You can attach multiple Class B stations to an FDDI dual ring by using a concentrator. Class A stations have dual-attachment-station (DAS) ports, which connect directly to the dual ring.

Table 1—Representative FDDI node controllers

Company	Model	Computer Bus	Protocol support	Micro-processor unit	FDDI chip set	Connector type	Power	RAM buffer	Inter-operability tests ¹	Price	Features
CMC	1150 Series	VMEbus (6U)	TCP/IP (onboard SMT firmware)	Am29000	AT&T (PHY), AMD (MAC), CMC (LLC)	ST (SAS or DAS)	32.5W	2 Mbytes	ANTC	\$11,245 to \$11,955	Link-level firmware interfaces to host-based TCP/IP. Micro-processor unit can implement network- and transport-layer protocols on board. Integrated SMT and SNMP software.
	1050 Series	VMEbus (9U)	TCP/IP (onboard SMT firmware)	Am29000	AMD	ST (SAS or DAS)	140W	1 Mbyte	ANTC, UNH	\$8950 to \$9950	Integrated SMT and SNMP software. Link-level firmware interfaces to host-based TCP/IP.
Codenoll Technology Corp	Code-net-9540	EISA or ISA bus	TCP/IP	None	AMD	MIC (SAS)	10W	128 kbytes	None	\$4995	Optional support for 830-nm fiber. Optical bypass switch support.
	Code-net-9543	EISA or ISA bus	TCP/IP	None	AMD	MIC (DAS)	15W	128 kbytes	None	\$7495	Optional support for 830-nm fiber. Optical bypass switch support.
Concurrent Technologies	CL 386/DAS	Multibus II (6U)	TCP/IP (end of 1991) (onboard SMT firmware)	80386	AMD	MIC (DAS)	45W	4 Mbytes	None	\$7140 (100)	Optical bypass control. Two RS-232C serial ports.
CXI	CX-MBII	Multibus II (6U)	GOSIP, TCP/IP (onboard SMT firmware)	80386	AMD	MIC (DAS)	NA ²	4 Mbytes	NA	\$11,280 to \$12,280	Optical bypass control. Implements Intel's iNA 960 Networking software.
Digital Equipment Corp	FDDI Controller 400	XMI bus	XTP, TCP/IP (onboard SMT firmware)	68020	Digital (licensed to AMD and Motorola)	MIC (SAS)	65W	1 Mbyte	ANTC, UNH	\$19,900	Operates in VAX 6000 and VAX 9000 computers.
	FDDI Controller 700	Turbo Channel bus	TCP/IP (onboard SMT firmware)	68000	Digital (licensed to AMD and Motorola)	ST, BNC (SAS)	20W	1 Mbyte	ANTC, UNH	\$4500 to \$6000	Operates in VAX 6000 and VAX 9000 computers. Board supports shielded twisted-pair connections.
Formation Inc	Fiber-net fv1000	VME bus (6U)	TCP/IP (onboard SMT firmware)	Am29000	AMD	MIC (SAS or DAS)	35W	2 Mbytes	ANTC	\$8500 (SAS) \$9500 (DAS)	Optical bypass control. VRTX operating system. Optional Sun OS drivers.
Interphase Corp	M/FDDI 2211	Multibus I	SNMP, TCP/IP, XTP (onboard SMT firmware)	Am29000	AMD	ST BNC (SAS or DAS)	42.5W	1.0 Mbytes	ANTC, UNH	\$8995 (SAS) \$10,995 (DAS)	Connection for dual PHY and dual MAC operation using two boards. Board supports shielded twisted-pair copper wire.
	V/FDDI 4211 Peregrine	VMEbus (6U or 9U)	SNMP, TCP/IP, XTP (onboard SMT firmware)	Am29000	AMD	ST BNC (SAS or DAS)	NA	1.0 Mbytes	ANTC, UNH	\$8995 (SAS) \$10,995 (DAS)	Connection for dual PHY and dual MAC operation using two boards. Board supports shielded twisted-pair copper wire.
SBE Inc	VCOM 100	VMEbus (6U)	TCP/IP, XTP (onboard SMT firmware)	68030	National Semiconductor	ST (SAS)	32.5W	4 Mbytes	ANTC	\$4500 (100)	Runs Synernetics's implementation of SMT. Two RS-232C serial ports. An optional mezzanine board provides DAS operation.
Summit Microsystems Corp	smFd-AT201	ISA bus	Onboard SMT firmware	None	AMD	ST (DAS)	10W	128 kbytes	ANTC	\$5950	Host-to-RAM block transfer rate is 3.0 Mbytes/sec (sustained).

Notes: 1. ANTC=Advanced Networking Test Center; UNH=University of New Hampshire.
 2. NA=not applicable.
 3. See box, "Glossary of FDDI terms," for definitions of other abbreviations.

multiple stations to the ring, some concentrators have fault-tolerant power supplies and let you insert and remove boards on the backplane while the power is on—a process called live insertion. In addition to the FDDI PMD, PHY, and MAC sublayers and the SMT function, concentrators also provide the Simple Network Management Protocol (SNMP) software for managing a TCP/IP network.

Internetworking modules let you integrate multiple disparate LANs onto an FDDI backbone—in effect creating a hybrid network (Table 3). A bridge is the

oldest method for transparently interconnecting two networks. Bridges communicate at the data-link layer of the OSI model. An FDDI bridge reads each destination field in an FDDI frame to infer a destination address for the frame. By comparing this information with an address table, the bridge determines whether to ignore the frame or forward it to a station on an interconnected network.

Routers operate at the network layer of the OSI model. Routers forward data packets not based on the destination address but according to a network identi-

Table 2—Representative FDDI concentrators

Company	Model	Housing	Fault-tolerant power supply	Live insertion	Protocol support	Number of ports (max)	Power	Connector type	Interoperability tests	Price	Features
Codenoll Technology Corp	Codenet-9041	EISA or ISA bus boards	No	No	SNMP, TCP/IP	12	10W	MIC (SAS or DAS); ST optional	No	\$1995 (software); \$2795 (1-port card); \$4995 (2-port card)	Optional support for 830-nm fiber. Runs on VRTX software.
Digital Equipment Corp	DEC concentrator 500	Standalone chassis	Yes	No	Protocol independent	18	120W (AC power)	MIC FC/PC, ST, BNC (DAS)	ANTC, UNH	\$9000 to \$52,500	Supports shielded twisted-pair and thinwire.
Interphase Corp	Fiber hub 800	Standalone chassis	Yes	Yes	SNMP	8	NA	MIC (SAS or DAS)	No	From \$12,000	Supports shielded twisted-pair and 830-nm fiber.
Network Systems Corp	FDDI concentrator	Standalone chassis	No	No	SNMP	16	150W	MIC or ST	ANTC	\$3000 (chassis and motherboard) \$2200 (2-port board)	Optional optical-bypass switch.
Summit Microsystems Corp	smFD-AT301	ISA bus boards	No	NA	Onboard SMT firmware	12M ports, 2 DAS ports	10W	ST	ANTC	\$12,900 (DAS plus four M ports); \$6950 (4-M-port card)	Mapped to the ISA bus I/O space.
Synoptics Communications Inc	3000-05	Standalone chassis	Optional	Yes	SNMP (on-board SMT firmware)	40 SAS ports; 1 A/B port	460W supply	MIC	No	\$4495 (housing); \$14,995 (network-management module); \$7495 (4-M-port FDDI card); \$4995 (4-M-port STP card)	Backplane accepts cards for connection to FDDI, Ethernet, and Token Ring modules. Optical bypass support. Three MAC sublayers permit dual homing to identify redundant links.

Notes: 1. NA=not applicable; ANTC=Advanced Networking Test Center; UNH=University of New Hampshire.
 2. See box, "Glossary of FDDI terms," for definitions of other abbreviations.

Call now for
a free 85C060/090
sample kit 1-800-548-4725.

A question for designers who aren't yet using high-performance μ PLDs.

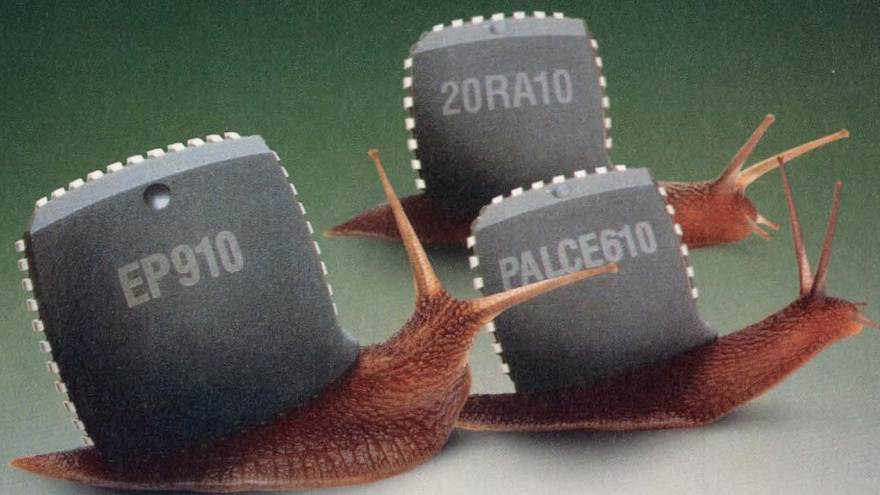

Why the big delay?

Ever feel like your system designs aren't quite up to speed, so to speak? It's probably not your fault. Because PLDs have typically forced designers to sacrifice performance to achieve higher integration.

But not any more.

Now, with Intel's μ PLD family of programmable logic devices, you can finally achieve the higher integration you need—with the low total propagation delay you want.

In fact, with t_{PD} figures as low as 10ns, Intel's 16-macrocell 85C060

and 24-macrocell 85C090 are, without question, the fastest integrated PLDs in the industry.

So what are you waiting for? Call (800) 548-4725 and ask for Literature Packet #IA81.

We'll send you everything you need to know about how to improve system performance. Without delay.

PLD Performance	
PLD	t_{PD}^*
Intel 85C060	10ns
PALCE610	15ns
20RA10	15ns
EP610	16ns
Intel 85C090	15ns
EP910	33ns
*Propagation Delay	

©1991 Intel Corporation. All product names are trademarks of their respective owners.

FDDI stations

fier. Routers are more versatile than bridges: They also perform packet fragmentation and reassembly, packet control, and priority routing. In some cases, both bridge and router functions are appropriate for

internetworking. In these cases, a hybrid bridge-router can provide routing services for two or more network-layer protocols or can implement a transparent data-link connection.

Table 3—Representative FDDI internetworking products

Company	Model	Product description	Network Support	Power	Inter-operability tests ¹	Price	Features
Cisco Systems Inc	AGS+	Router	Appletalk, DEC net, Novell, IPX, Token Ring, Ethernet, Cheapernet, DDN X.25, Apollo Domain, Ultratnet	500W	ANTC, UNH	\$12,300	Routes 16 protocols over an FDDI network. Supports 9600-bps, 48-kbps, 56-kbps, 64-kbps, T1, E1, and fractional T1 wide-area networks. Maximum aggregate forwarding rate is 75,000 packets/sec.
Digital Equipment Corp	DEC bridge	Bridge	Ethernet, Appletalk	390W	ANTC, UNH	\$25,000 to \$45,000	Supports dual-homing to identify redundant links. Supports Internet protocol fragmentation. Single-mode fiber option permits 40-km distance between stations.
Fibercom Inc	Ring Master 7200	Bridge	Token Ring, Ethernet, DECnet, Novell	NA ²	NA	\$15,000	Maximum forwarding rate is 20,000 packets/sec. Filtering rate is 500,000 packets/sec. Supports Internet Protocol fragmentation. Self learning for as many as 4000 addresses. Supports spanning tree algorithm.
Fibronics International Inc	FX8210	Bridge	Token Ring, Appletalk, DECnet, Novell, Ethernet	250W	ATNC, UNH	\$14,990	Down-line loadable across networks. Performs protocol-translation bridging. Comes with Interview Network Management System software.
	FX8210B Brouter	Bridge-router	Token Ring, Appletalk, DECnet, Novell, Ethernet	250W	ANTC, UNH	\$27,000	Down-line loadable across networks. Protocol-translation bridging Interview Network Management System.
In-net Corp	Fiber Talk 5000	Bridge	Token Ring, Ethernet, DECnet	360W	ANTC	\$17,500	Down-line loadable across networks. Filtering rate is 100,000 packets/sec. Forwarding rate is 6000 packets/sec.
	Fiber Talk 3000 Channel Bridging Unit	Gateway	Ethernet	360W	ANTC	\$35,000	Down-line loadable across networks. Connects an IBM 360/370 mainframe computer to an FDDI ring. Software provides Telnet Virtual Terminal, File Transfer Protocol, and Electronic Mail services.
Network Systems Corp	6400 Family	Bridge-router	Ethernet, DECnet, Appletalk, Novell, T1, T3	500W	ANTC	\$30,000	400-Mbps, 6-card backplane. Ethernet forwarding rate is 15,000 packets/sec/port. Supports the Spanning Tree Algorithm. Dynamically learns packet addresses.
	6600 Family	Bridge-router	Ethernet, DECnet, Appletalk, Novell, T1, T3	500W	ANTC	\$23,000	FDDI-to-FDDI bridge. Single-board chassis. Ethernet forwarding rate is 15,000 packets/sec/port. Supports the Spanning Tree algorithm. Dynamically learns packet addresses.
	6800 Family	Bridge-router	Ethernet, DECnet, Appletalk, Novell, T1, T3	500W	ANTC	\$46,000	Supports the Spanning Tree algorithm. Deletes undeliverable packets on the network after a preset period. Dynamically learns packet addresses. 800 Mbps, 16-card backplane.
Synneretics Inc	LANplex 5004	Bridge-concentrator	Ethernet, Token Ring	NA	ANTC, UNH	\$25,500	Backplane has three FDDI paths, three Token Ring paths, three Ethernet paths, and a VMEbus that operate in parallel. Backplane accepts four plug-in modules. Connects as many as 24 Ethernet segments to an FDDI network. Modules support line insertion.
	LANplex 5012	Bridge-concentrator	Ethernet, Token Ring	NA	ANTC, UNH	\$32,900	Backplane has three FDDI paths, three Token Ring paths, three Ethernet paths, and a VMEbus path that operate in parallel. Backplane accepts 12 plug-in modules. Connects as many as 24 Ethernet segments to an FDDI network. Modules support line insertion.

Notes: 1. ANTC=Advanced Networking Test Center; UNH=University of New Hampshire.
2. NA=not applicable.



See us at
Booth #2500

FDDI

AVAILABLE NOW!
*From Interphase,
of course.*

It's no bigger than this ad (6U VMEbus to be exact). It doesn't suck power like less efficient controllers. It's RISC-based for super performance. It connects single or dual attached stations from a single VME slot. It supports a variety of media, from fiber to twisted pair. It's ANSI X3T9 FDDI standard compliant. It's certified by the Advanced Networking Test Center™ and the University of New Hampshire Interoperability Lab (Interphase is a charter member of both).

And,
IT'S AVAILABLE...RIGHT NOW.

The Interphase V/FDDI 4211 Peregrine is at work **right now** in some of the industry's leading open systems networks. Put Interphase high performance expertise to work for you.

Call or FAX us today for information about Interphase FDDI solutions, including VME and Multibus controllers, the new fiberHUB FDDI Concentrator and the FDDI System Designer's Kit. We've also got proven Ethernet and Token-Ring products to tell you about.

(214) 919-9000

FAX: (214) 919-9200

In Europe:

(44) 869-321222 FAX: (44) 869-247720



INTERPHASE
CORPORATION

© 1991 Interphase Corporation. Specifications subject to change without notice. Interphase is a registered trademark of Interphase Corporation. Advanced Networking Test Center is a trademark of Advanced Micro Devices, Inc.

Because FDDI is a fairly new LAN standard and multiple versions of the SMT function exist, the issue of interoperability is a concern. To ensure that FDDI stations from various vendors operate together properly, two groups are testing these FDDI products. Both the Advanced Networking Test Center, which Advanced Micro Devices sponsors, and the University of New Hampshire (Durham, NH) have test centers that run a suite of tests on vendor products they connect to an FDDI cable installation. The test centers try to ensure that there is one worldwide FDDI rather than multiple versions that don't interoperate.

If you already have an FDDI LAN installed and need an analyzer to troubleshoot the network in real

time, Digital Technology Inc offers the Lanhawk-5700 Network Analyzer family. The portable 5733 and 5732 analyzers cost \$28,300 to \$50,000 and passively couple into the ring. The analyzers monitor, analyze, and collect data on FDDI networks. They also let you collect traffic statistics to evaluate ring performance and maximize ring utilization.

Nice—but expensive

The high cost of FDDI networks necessitates a wait-and-see attitude, but if projected trends for the 1990s pan out, network administrators may soon be upgrading existing LANs to the 100-Mbps standard. For example, PCs are emerging that exceed the power of

Manufacturers of FDDI products

For more information on FDDI products such as those described in this article, circle the appropriate numbers on the Information Retrieval Service card or use EDN's Express Request service. When you contact any of the following manufacturers directly, please let them know you saw their products in EDN.

Advanced Micro Device Inc
Box 3453
Sunnyvale, CA 94088
(800) 538-8450
(408) 732-2400
TLX 34-6306
Circle No. 650

CXi
10260 Old Columbia Rd
Columbia, Maryland 21046
(301) 290-9500
(301) 621-8588
FAX (301) 290-7012
Circle No. 656

In-net Corp
15150 Avenue of Science
San Diego, CA 92128
(800) 283-3334
(619) 487-3693
FAX (619) 487-3697
Circle No. 662

SBE Inc
2400 Bisso Lane
Concord, CA 94520
(800) 347-2666
(415) 680-7722
FAX (415) 680-1427
Circle No. 667

Cisco Systems Inc
1525 O'Brien Dr
Menlo Park, CA 94025
(415) 326-1941
FAX (415) 326-1989
Circle No. 651

Digital Equipment Corp
550 King St
Littleton, MA 01460
(508) 493-7161
Circle No. 657

Interphase Corp
13800 Senlac
Dallas, TX 74234
(214) 919-9000
FAX (214) 919-9200
Circle No. 663

Summit Microsystems Corp
710 Lakeway, Suite 150
Sunnyvale, CA 94086
(408) 730-4900
FAX (408) 730-1675
Circle No. 668

Chipcom Corp
118 Turnpike Rd
Southborough, MA 01772
(508) 460-8900
Circle No. 652

Digital Technology Inc
2300 Edwin C Moses Blvd
Dayton, OH 45408
(513) 443-0412
Circle No. 658

Motorola Inc
Technical Information Center
Box 52073
Phoenix, AZ 85072
(512) 928-7726
Circle No. 664

Synernetics Inc
85 Rangeway Rd
North Billerica, MA 01862
(508) 670-9009
FAX (508) 670-9015
Circle No. 669

CMC
125 Cremona Dr
Santa Barbara, CA 93117
(805) 562-3104
FAX (805) 968-6478
Circle No. 653

Fibercom Inc
Box 11966
Roanoke, VA 24022
(703) 342-6700
FAX (703) 342-5961
Circle No. 659

National Semiconductor Corp
Box 58090
Santa Clara, CA 95052
(800) 272-9959
(408) 721-5000
FAX (408) 730-0764
Circle No. 665

Synoptics Communications Inc
Box 58185
Santa Clara, CA 95052
(408) 764-1046
FAX (408) 988-5525
Circle No. 670

Codenoll Technology Corp
1086 N Broadway
Yonkers, NY 10701
(914) 965-6300
FAX (914) 965-9811
Circle No. 654

Fibronics International Inc
1 Communications Way
Hyannis, MA 02601
(508) 778-0700
FAX (508) 778-0821
Circle No. 660

Network Systems Corp
7600 Boone Ave N
Minneapolis, MN 55428
(612) 424-4888
FAX (612) 424-2853
Circle No. 666

Concurrent Technologies
701 Devonshire Dr
Champaign, IL 61820
(217) 356-7004
FAX (217) 356-6238
Circle No. 655

Formation Inc
121 Whittendale Dr
Moorestown, NJ 08057
(800) 257-0452
(609) 234-5020
FAX (609) 234-8543
Circle No. 661

VOTE . . .

Please also use the Information Retrieval Service card to rate this article (circle one):

High Interest 497 Medium Interest 498 Low Interest 499

Futurebus +.

Now you can start your design without waiting for the future.

Putting the standard to work today.

National has long been the industry leader in BTL and mixed analog + digital technology. Now we've drawn on that heritage to make the most highly integrated Futurebus + ICs available today. We've also put together a full range of development tools to help you put that chipset to work. And the entire package is available now.

Making high-speed buses reliable and affordable.

With our new chipset, Futurebus + gives you more bandwidth for your money, making it—for the first time—fully cost-competitive with VME and Multibus®. In addition to an Arbitration Controller, our chipset contains four advanced BTL devices: two 9-bit Data Transceivers (latched and unlatched), a Handshake Transceiver, and an Arbitration Transceiver.

Between them, they offer you a variety of features designed to break the throughput bottleneck in high-performance computer systems:

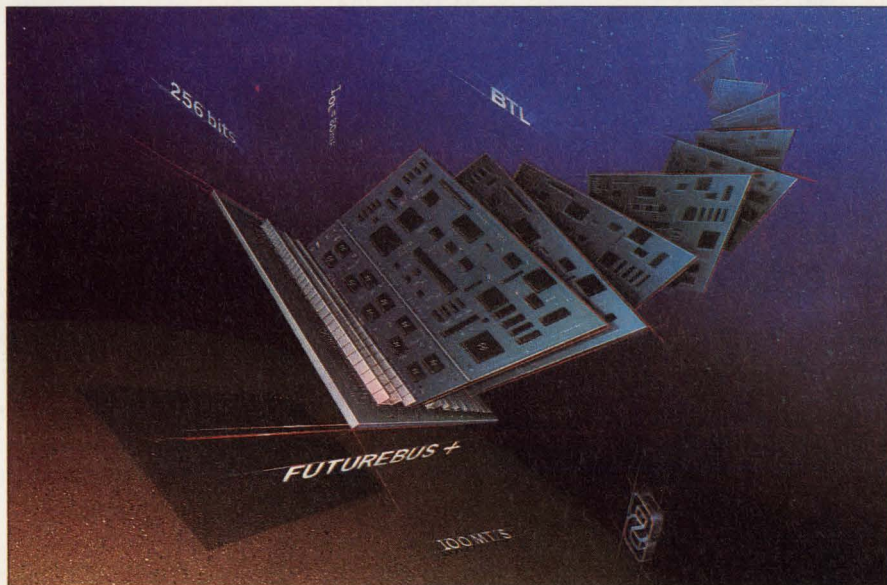

- Glitch filters (to eliminate wire OR-ing effects)
- Filtered and non-filtered receiver outputs
- Efficiently partitioned arbitration logic (the fastest available)
- Fault-tolerant circuitry
- Live-insertion support

Providing a broad range of development tools.

Start with our Designer's Handbook, with a slave-memory-board application note, product data sheets, and application notes on BTL design technology. Other tools include wire-wrap

boards from Mupac and Hybricon, Spice models, and Verilog® behavioral models.

Bringing Futurebus + into the present.

Call us at 1-800-NAT-SEMI, Ext. 127. We'll send you a Designer's Handbook, and you can start your Futurebus + design today.

Because there's nothing left to wait for.



Multibus is a registered trademark of Intel Corporation. Verilog is a registered trademark of Cadence Design Systems, Inc.
© 1991 National Semiconductor Corporation

NORTH AMERICA: P.O. Box 7643, Mt. Prospect, IL 60056-7643 (Tel: 1 800 628 7364, ext. 127; Fax: 1 800 888 5113); EUROPE: Raiffeisenstraße 10, D-8016 Feldkirchen, Germany (Tel: 49 8141 103 0; Fax: 49 8141 103 515); HONG KONG: 15th Floor, Straight Block, Ocean Center, 5 Canton Rd., Tsimshatsui, Hong Kong (Tel: 852 737 1600; Fax: 852 736 9921); JAPAN: 4-15, Nishi-shinjuku, Shinjuku-ku, Tokyo, Japan 160 (Tel: 81 3 3299 7030; Fax: 81 3 3374 4303).

SWITCHING POWER INC. DELIVERS POWER & VALUE...

- BPO magnetics
- Power to grow with you.
- Field proven products
- Fully self protected

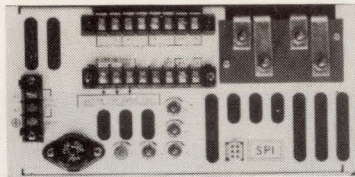

DS
5VDC @ 120A
5VDC @ 30A
2VDC @ 30A
12VDC @ 15A
12VDC @ 6A



GS
5VDC @ 120A
5VDC @ 35A
12VDC @ 5A
12VDC @ 15A
2VDC @ 15A

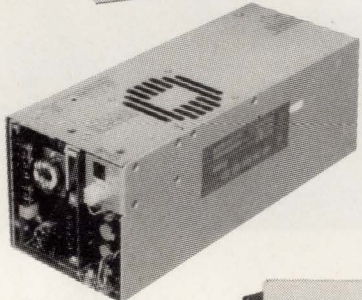

OFSX625IECF
5VDC @ 75A
2VDC @ 20A
12VDC @ 15A
24VDC @ 3A
5VDC @ 3A



POWERSAVER®

Reduces AC line current by 25%
Extended computer operation
Reduces conducted EMI
Meets proposed standard IEC 555-2

- * 50°C Operation
- * Modular
- * Economical
- * Short Circuit Proof
- * Lightweight
- * Efficient
- * 115/230 VAC Input
- * Reliable

Call or write for our free Catalog—

SWITCHING POWER INC

3601 Veterans Highway, Ronkonkoma, NY 11779
516/981-7231, Fax: 516/981-7266
1-800-456-8118
Sunnyvale, California Sales Office
408/732-1230, Fax: 408/732-5712

FDDI stations

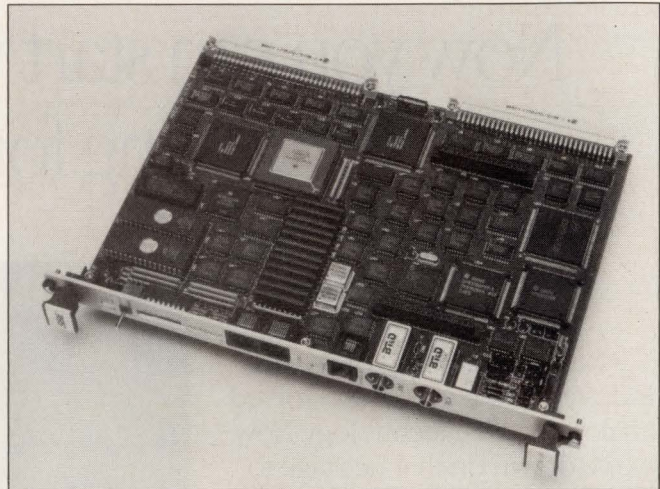

The FDDI chip set from National Semiconductor implements the VCOM-100 VMEbus node controller. The SBE Inc board has a microprocessor unit and enough dynamic RAM to execute SMT software as well as the network- and transport-layer protocols.

80386-based computers. These PCs can manage a sea of documents and images that were traditionally the province of mainframes and minicomputers. Many applications must send the images and data to multiple locations on a LAN that has insufficient bandwidth to handle such bit-heavy traffic. In addition, multimedia applications, which integrate voice, data, and video, require a bandwidth way beyond what Ethernet and Token Ring networks can offer.

Many analysts say FDDI deployment will occur in multiple stages. In the early stages, FDDI backbones will interconnect smaller token-ring LANs that employ existing STP copper wiring for horizontal distribution. In the later stages, companies having intensive graphics and CAD communications needs will invest in a full fiber-optic LAN. The attendant drop in FDDI-product prices will encourage the widespread use of FDDI networks.

EDN

Article Interest Quotient (Circle One)
High 497 Medium 498 Low 499

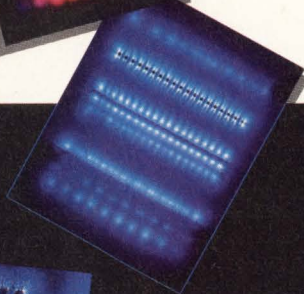

United States Europe Japan Korea Singapore

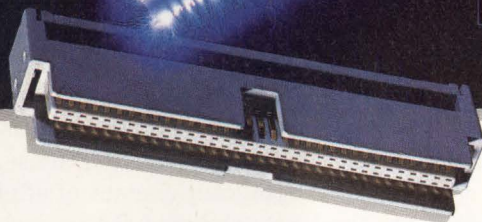
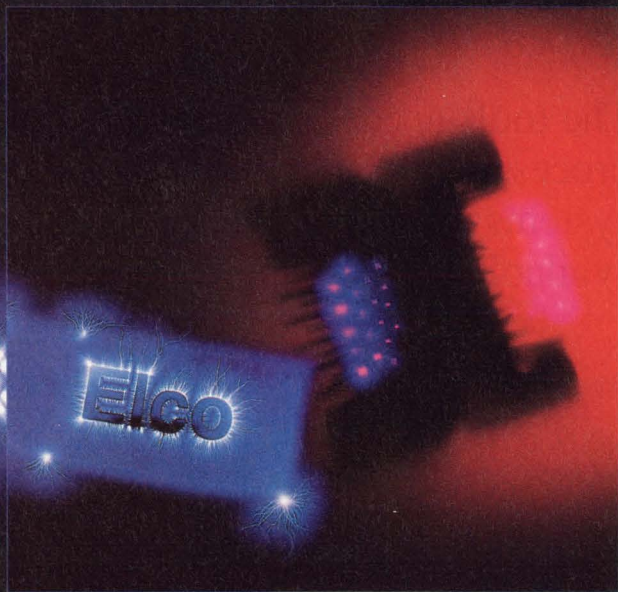

***GREATER
WORLD CLASS
POWER FROM
OUR NEW
GLOBAL
CONNECTIONS***

The recent alliance of Elco and AVX with Kyocera forms a solid business relationship that gives us even stronger connections to today's exciting world of technology.

These connections strengthen our own high quality standards and link us to new sources of innovation throughout the world.

Together we combine our talents, energies, and experience to provide you with an ever-expanding line of advanced connector products of unsurpassed value. These new connections also contribute to a fresh spirit of efficient service and delivery and assure you of timely response to your ever-evolving needs.

From a new source of energy emerges a powerful new Elco.



Elco Corporation

A Kyocera Group Company

World Class Connections

- U.S.A.** 814 643-0700 (FAX 814 643-0426)
- Germany** 49-2741-2990 (FAX 49-2741-299299)
- U.K.** 44-638-664514 (FAX 44-638-661233)
- Japan** 81-45-543-7185 (FAX 81-45-545-1499)
- Korea** 82-2-868-0147 (FAX 82-2-868-6600)
- Singapore** 65-353-8312 (FAX 65-353-8315)

Copyright 1990, Elco Corporation. All rights reserved.

EDN'S DSP-Chip Directory

The tools needed to develop applications that use digital signal processing (DSP) continue to improve. Now, a choice of operating systems and interfaces to host operating systems is making DSP available to more applications.

David Shear, *Contributing Editor*

This year there are many new DSP parts that add to the array of optional word formats, peripherals, and memory sizes. Naturally these family members are created to fit an existing or perceived market. In the past, if your application didn't fit easily within an existing device, you were out of luck. Now, almost all DSP manufacturers have programs that will let you configure your own DSP μ P. You can select from the available peripherals and memory options, or you can use an ASIC approach and put a gate array on the DSP chip.

Before DSP μ Ps can move into general use, however, it is essential that the functions of the algorithm developer and the end-user-application developer are separated. It is hard enough for algorithm developers to keep up with DSP algorithm development. It is rare for them to have the luxury of maintaining expertise in the creation of end-user applications that use the latest whiz-bang graphical user interface.

Likewise, the end-user-application developer must be able to concentrate on his applications. He must not be distracted with new algorithms and DSP μ Ps. That is the algorithm-developer's domain.

Ideally, a DSP operates as if it is just another peripheral. When the end-user-application developer uses a hard disk, he doesn't have to know how the data is

stored on the disk. He just wants to use the hard-disk function: store data and retrieve it later.

Using a DSP must be the same. The algorithms must be available via a well-defined and standard method. If the end-user application needs a modem or a fax, speech or an image compressed, or whatever, the developer must be able to call the DSP as if he were sending data to a disk.

Right now, if an engineer creating an end-user application wants the application to use a DSP μ P, he must devote a significant amount of effort (and time) to create the DSP portion of the project. At the same time, he has less time to develop his product. It doesn't make sense—in terms of time and effort—for him to spend months, or more, getting up to speed in DSP.

New software interfaces

Soon, software interfaces between your DSP μ P and the end-user application will let you develop DSP code that the end-user-application developer can use off the shelf. A separate group, or even a separate company, can use the DSP functions that you create. OSPA (Open-Signal Processing Architecture) from Spectron Microsystems (Santa Barbara, CA) and VCOS from AT&T are two current interfaces.

OSPA is a set of interfaces and protocols that lets

your DSP μ P communicate with an end-user application. You must use the Spox real-time, multitasking operating system on the DSP μ P.

Spox was introduced by Spectron Microsystems three years ago. It was first introduced to run on TI's TMS320C30. Spox has grown in acceptance to include Motorola's DSP96002, Analog Devices' ADSP-21020, and TI's TMS320C40.

Spox runs on the DSP μ P while the Spox Server runs on the host. The DSP functions that you write interface to the end-user application via the Spox Server. Host- and DSP- μ P independence is achieved if you create OSPA-compatible DSP programs and use the Spox server. Your DSP μ P can be transported to any computer that has a Spox Server for the host operating system.

Separate the experts

David Wong, president of Spectron Microsystems, says that Spox and OSPA separate the functions of the end-user-application developer and the algorithm developer (Fig 1). By using high-level commands and data-stream conventions described by OSPA, you can develop the application software and the real-time DSP functions independently.

Even if the end-user application moves to another host computer, the Spox server for the new host operating system lets you transport your DSP μ P. You can also use more powerful DSP μ Ps as they become available to create more capable DSP solutions. The end-user-application developer will then be able to use the more capable DSP solution without modifying his code.

The near industry-wide acceptance of OSPA and Spox places them in a great place to become the standard. The host independence of OSPA and the DSP- μ P independence of Spox further strengthens their positions.

VCOS is another approach to separate your efforts from the end-user application. Frank Ferro, DSP Mar-

keting Manager at AT&T, says that VCOS is not intended to be an operating system that is all things to all people. It is an approach to implement AT&T's 32-bit floating-point DSP3210 on the mother board of a PC or workstation.

The major emphasis of VCOS is to make the hardware implementation of the DSP3210 inexpensive and the software easy to create. The DSP3210 interfaces directly to Motorola and Intel μ P buses and shares the host memory. This approach does away with the cost of high-speed static RAM (SRAM).

The VCOS kernel is a small program (fewer than 400 32-bit words) that runs on the DSP μ P. It handles execution control, caching, and buffer I/O. The VCOS Application Server runs on the host, loads and links the DSP tasks, and performs all memory-management functions. A debugger and library are also included to ease development.

The DSP program is loaded into the internal RAM of the DSP μ P. The internal RAM is used to run the program, usually in sections. The DSP μ P has access to the host memory where it can store data. Taking over the slower host bus reduces the performance of both the DSP μ P and the host μ P. But AT&T claims that the performance of both is not reduced significantly.

Two workstations already have DSP μ Ps on the mother board: Next Inc's Next and Silicon Graphics' Iris Indigo computers both have Motorola's DSP56001.

Many chip vendors feel that it is too early to place the DSP μ P on the mother board, and that add-in boards should be used for some time. The workstation market will see DSP chips on the mother board first. The workstation market traditionally has proprietary systems and can make its own decisions about how to implement a DSP μ P. Apple also has considerable control over what will end up on the mother board of its Macs. The PC market is different—with so many different manufacturers, it will take some time before a consensus is reached.

Acronyms used in this article and in the chip directory

ADC—analogue-to-digital converter
ALU—arithmetic and logic unit
ASIC—application-specific integrated circuit
CMOS—complementary metal-oxide semiconductor
CPU—central processing unit
CQFP—ceramic quad flat pack
DAC—digital-to-analog converter
DIP—dual in-line package
DMA—direct memory access
DSP—digital-signal processing
EPROM—erasable PROM

FFT—fast Fourier transform
FIFO—first in, first out
FIR—finite-impulse response
IC—integrated circuit
IIR—infinite-impulse response
I/O—input-output
JTAG—Joint Test Action Group
 μ P—microprocessor
NMOS—n-type metal-oxide semiconductor
OSPA—Open-Signal Processing Architecture
PC—personal computer

PGA—pin-grid array
PLCC—plastic leaded chip carrier
PLL—phase-locked loop
PQFP—plastic quad flat pack
PROM—programmable read-only memory
QFP—quad flat pack
RAM—random-access memory
ROM—read-only memory
SOP—small-outline package
Spox—real-time multitasking operating system

EDN's DSP-chip directory

It is doubtful that the next year will bring a DSP μ P to the mother board of a majority of computers. But watch for a number of announcements along these lines. Within a few years, applications will require these high speed devices.

DSP in real time

If you need a real-time operating system that can run directly on the DSP μ P in embedded applications, you have the choice of Spox for floating-point chips and VRTX32 for Motorola's fixed-point DSP56001. Bryant Wilder, Motorola's DSP operations manager, says that VRTX32/DSP56000 from Ready Systems (Sunnyvale, CA) is the only real-time operating system available for fixed point DSP μ Ps. It is basically the same as the other versions of VRTX32, which have been available on a number of μ Ps for many years. Users of VRTX32 can use their existing tools and experience and just add the DSP56000 version.

High-level-language options grow

Whichever operating system you choose, you will still be able to take advantage of the productivity gains from using a high-level language. By far, the most common high-level language for DSP μ Ps is C. Nearly all of the floating-point DSP μ Ps have an ANSI C compiler. You can also use an Ada compiler. Eric West, C40 Marketing Manager at TI, says that the company plans to develop a Fortran compiler for the C30 and C40.

C is not standing still. ANSI C (more appropriately called Standard C) allows program transportability. But there are an ever growing array of C variations,

Numerical C, Concurrent C, C++, C*, and GNU C, to name a few.

Numerical C is intended to make C more applicable to calculation-intensive applications, like DSP. Tim Counihan, strategic marketing manager for DSP at Analog Devices, says that Analog Devices is actively supporting Numerical C. He feels that the standard is well enough defined to produce a product. He does admit that Analog Devices will probably have to make some changes by the time a standard is available. The Numerical C Extensions Group (NCEG) is working within ANSI (X3J11.1) on a technical report, not a standard, so an actual standard is still in the future.

Other DSP- μ P manufacturers are not supporting Numerical C yet. They are waiting for either their customers to request it or a standard to be available. TI says the company will definitely support Numerical C when it becomes a standard.

All of the C compilers for DSP μ Ps claim to be optimizing compilers. It is difficult to determine how well the optimizing compilers will work in your application. You will often have to optimize some sections of your high-level code by hand. On one recent project, a DSP consulting group was able to prototype the system with C code in a matter of hours. This C version proved the concept, but would only run at 12 frames/sec. The customer needed 15 frames/sec. The group spent three months optimizing the code to meet the 15 frames/sec requirement.

The Comdisco (Foster City, CA) DSP Procoder is an option to the company's Signal Processing Worksystem (SPW). The SPW is a block-diagram-based devel-

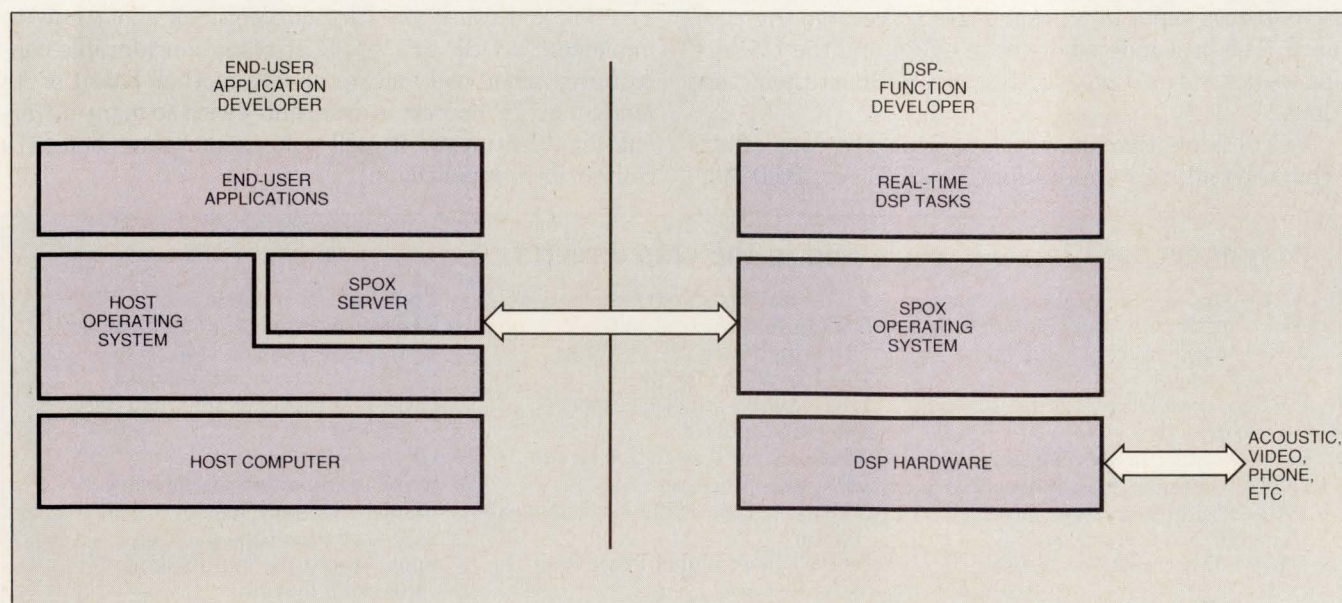

Fig 1—Separating the DSP function developer from the end-user application developer lets each expert concentrate on his speciality.

EDN's DSP-chip directory

opment system. The DSP Procoder will take a block diagram of a DSP algorithm and create assembly code. Comdisco claims the resulting code is production-quality. The DSP Procoder presently uses Motorola's DSP56001. Other fixed-point DSP μ Ps will be used in the future.

Multiprox is another option for SPWs used to partition a block diagram to run on multiple processors. When used with the Code Generation System, you can automatically produce C code for multiple floating-point DSP μ Ps. The generated code includes the inter-processor-communication code to pass data between the processors. The TMS320C30, TMS320C40, and DSP96002 are supported.

Need quadruples performance every 18 months

As soon as you finish designing a product, you will often be called upon to start the next generation. Rick Rinehart, floating-point DSP marketing manager at Texas Instruments, points out that the market window today averages about 18 months. The market window is the length of time from when a company introduces a product until they begin ramping down production. Each new generation of a product needs about a four times increase in performance to remain competitive. The improvements in design and processes used to build ICs will double performance every three years. Rinehart feels the only way to meet the quadrupling performance needs of their customers is with parallel processing.

Making products that can see, talk, and listen is difficult. Much of that type of development is possible

Index to DSP μ Ps included in this directory

Supplier	Device	Type	Page
Analog Devices	ADSP-2100 family	16-bit fixed-point	108
Analog Devices	ADSP-21020	32-bit floating-point	121
AT&T	DSP16 family	16-bit fixed-point	109
AT&T	DSP32C/3210	32-bit floating point	122
Motorola	DSP56156	16-bit fixed-point	110
Motorola	DSP56001/2	24-bit fixed-point	111
Motorola	DSP96002	32-bit fixed-point	125
NEC	77C25	16-bit fixed-point	112
NEC	77220	24-bit fixed-point	113
NEC	77240	32-bit floating-point	126
SGS-Thomson	ST18 family	16-bit fixed-point	114
Texas Instruments	320C1X	16-bit fixed-point	117
Texas Instruments	320C2X/5X	16-bit fixed-point	118
Texas Instruments	320C3X	32-bit floating-point	129
Texas Instruments	320C40	32-bit floating-point	130
Zoran	34325	32-bit floating-point	133

today, but it requires expensive parallel processing systems. Prices will continue to drop until today's expensive systems become tomorrow's low cost peripherals. For example, the TMS32010 started sampling at \$500. Now you can buy them in single quantities for \$4.90. **EDN**

Article Interest Quotient (Circle One)
High 494 Medium 495 Low 496

Key to abbreviations used in block diagrams

AB—combined program and data address bus
ACC—accumulator
ADC/DAC—analog-to-digital and digital-to-analog converter
ADDR GEN—address generator
ALU—arithmetic logic unit
BIT MANIP—bit manipulation
BS—barrel shifter
CDB—control data bus
CM—cache memory
CPUB—CPU bus
DAB—data address bus
DB—combined program and data bus
DDB—data data bus
DM—memory for data only
DMAAB—DMA address bus

DMADB—DMA data bus
DMAC—direct-memory-access controller
FX—fixed-point
FP—floating-point
GDB—global data bus
HOST INTER—host interface
IDB—instruction data bus
INT—external interrupt
MAC—multiplier accumulator
MULT—multiplier
PAB—program address bus
PDB—program data bus
P/DM—memory for program and data
PIO—parallel I/O
PM—memory for program only

PPCP—parallel processor communication port
PRAB—peripheral address bus
PRDB—peripheral data bus
REG—register
REGB—register bus
SIO—serial I/O
TIM—timer
XAB—external address bus
XDB—external data bus
XDAB—external data address bus
XDDB—external data data bus
XIOAB—external I/O address bus
XIODB—external I/O data bus
XPAB—external program address bus
XPDB—external program data bus

ADSP2100 FAMILY

16-BIT FIXED-POINT CMOS DSP μ P

AVAILABILITY: The ADSP2100/A, 2101, 2102, 2106, 2111, 2112 are in production now. The 21msp50 and the 21msp51 are now sampling.

COST: ADSP2100, \$45 (1000); 2101, \$36 (1000); 2102, \$34 (5000); 2105, \$9.90; 2106, \$11.39 (25,000); 2111, \$48 (1000); 2112, \$46 (5000); 21msp50, \$57 (1000); 21msp51, \$40 (25,000).

SECOND SOURCE: None.

Analog Devices Inc
1 Technology Way
Norwood, MA 02062
(617) 461-3074
Circle No. 671

DESCRIPTION: The ADSP2100 family ranges from the 2100 with no on-chip memory and an off-chip Harvard architecture to the 21msp51 with program and data ROM, data RAM, and peripherals, including an analog-to-digital and digital-to-analog

converter and host interface port on-chip. The data memory has a 16-bit width, but the program memory has a 24-bit word width to control the parallel operations. Low-voltage versions are now sampling.

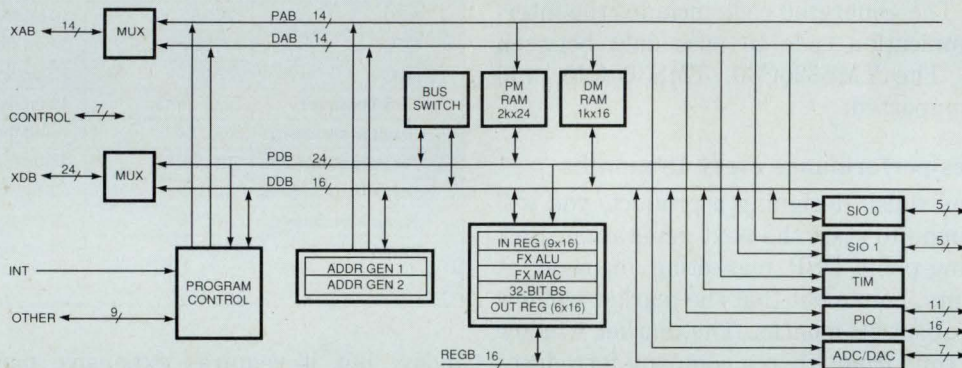

FEATURES: 60-, 77-, 80-, 100-, 125-, and 167-nsec cycle-time versions.

Separate on-chip program and data buses. On-chip memory: The 2100/A has no on-chip memory. The 2101 has a $2k \times 24$ -bit program RAM and a $1k \times 16$ -bit data RAM. The 2102 has a $2k \times 24$ -bit program ROM or RAM and a $1k \times 16$ -bit data RAM. The 2105 has a $1k \times 24$ -bit program RAM and a 512×16 -bit data RAM. The 2016 has a $1k \times 24$ -bit program ROM or RAM and a 512×16 -bit data RAM. The 2111 and 21msp50 have a $2k \times 24$ -bit program RAM and a $1k \times 16$ -bit data RAM. The 2112 has a $2k \times 24$ -bit program ROM or RAM and a $1k \times 16$ -bit data RAM. The 21msp51 has a $2k \times 24$ -bit program RAM, $2k \times 24$ -bit program ROM, and a $1k \times 16$ -bit data RAM.

Separate program and data buses brought off the chip only on the 2100/A. All other parts combine program and data buses off the chip.

Off-chip memory capacity: The 2100/A has $32k \times 24$ -bit program and $16k \times 16$ -bit data memory capacities. All others have $16k \times 24$ -bit program and $16k \times 16$ -bit data memory capacities.

Boot memory controller loads program from external byte-wide EPROM (except 2100/A).

On-chip peripherals: The 2100/A has no on-chip peripherals. The 2101 and 2102 have two serial I/O ports and a timer; the 2105 has one serial I/O port and a timer. The 2111/2 have two serial I/O ports, a timer, and a host interface port. The 21msp50 has two serial I/O ports, a parallel I/O

port, a timer, and a 16-bit ADC/DAC (linear codec).

Multiplier/accumulator accepts 16-bit fixed-point input and creates 32-bit fixed-point results within a 40-bit accumulator. 16-bit ALU. 32-bit bidirectional barrel shifter. 40-bit accumulator.

Multiplier/accumulator, ALU, and shifter are separate blocks connected by the 16-bit R-bus and the data bus.

Zero-overhead looping.

Only the 2100/A has a 16×24 -bit on-chip cache.

Direct, indirect, immediate, circular, and bit-reversal addressing modes.

Two address generators.

No on-chip DMA. Serial port and codecs have auto buffer, which transparently transfers data to and from memory.

16-level hardware stack. Status stack limits interrupts to four levels of nesting on the 2100/A, seven levels on the others.

Four external interrupts on the 2100/A; three external interrupts on others.

The 2100/A has only hardware wait states. Others have only software-programmable wait states.

No on-chip emulation port.

Only the 21msp50 has power-down mode to CMOS standby levels. The 2101, 2105, 2106, 2111, and 2112 have an idle mode, which lowers power until an interrupt is detected.

Packaging: 2100/A, 100-pin PQFP and 100-pin PGA. 2101/2, 68-pin PGA and 68-pin PLCC. 2105/6, 68-pin PLCC. 2111, 100-pin PQFP and 100-pin PGA. 21msp50/1, 100- and 132-pin PQFPs, 144-pin PGA.

HARDWARE

Full-featured in-circuit emulator.
Low-cost in-circuit emulator board.
Demo board.
Evaluation packages.
Third-party support: Contact Analog Devices for a list of third-party vendors.

SUPPORT

C compiler.
Simulator.
Macroassembler/linker.
Application libraries.
Upcoming Numerical C.

SOFTWARE

16-BIT FIXED-POINT CMOS DSP μ P

AVAILABILITY: The DSP16, 16A, and 16C are in production. The DSP1610 and 1616 are sampling with production starting in 1992.

COST: DSP16, \$9.60; DSP16A, \$16.70; DSP1610, \$125; DSP1616, \$35 (10,000).

SECOND SOURCE: None.

AT&T Microelectronics
 Dept 52AL040420
 555 Union Blvd
 Allentown, PA 18103
 (800) 372-2447, ext 802;
 in Canada, (800) 553-2448, ext 802
 Circle No. 672

DESCRIPTION: The members of the DSP16 family have long been the fastest fixed-point DSP chips. The DSP16A has a 25-nsec cycle time. The DSP16A and DSP16C also have the largest on-chip program memory at 12k \times 16 bits. Many applications that would require external ROMs with other DSP chips can fit within the DSP16 family's on-chip memory. The DSP16C

has an A/D and a D/A converter on chip. The DSP16C also has a 4-pin JTAG interface, which assists in testing tightly packed boards. A 3.3V version of the DSP16A is available. The DSP1610 and 1616 are enhanced versions intended for digital cellular telephones.

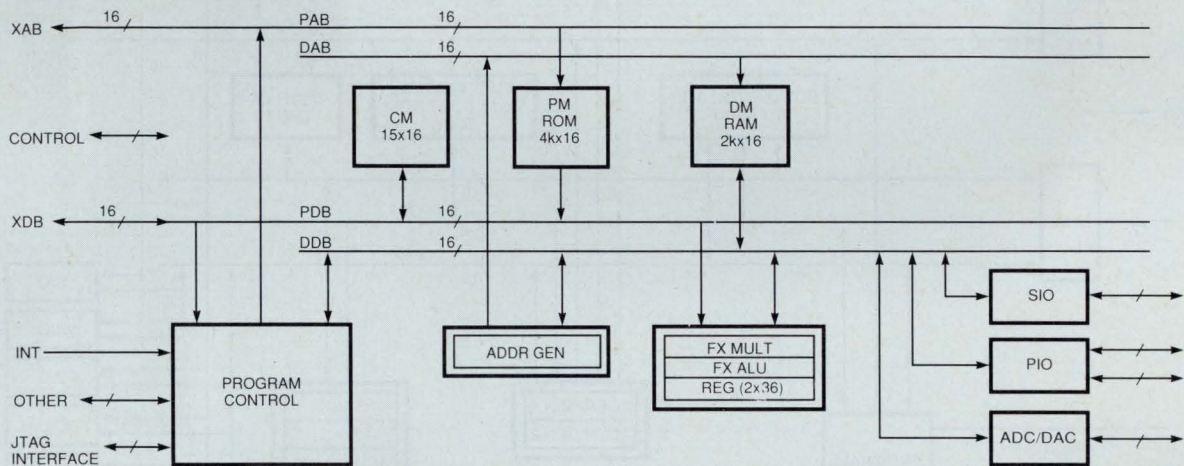

FEATURES: 25-, 33-, 55-, and 75-nsec cycle-time versions. The DSP16C has 38.5- and 76.9-nsec cycle-time versions.

Separate on-chip program and data buses.

On-chip memory: The DSP16 has a 2k \times 16-bit program ROM and a 512 \times 16-bit data RAM. The DSP16A and -16C have a 12k \times 16-bit program ROM and a 2k \times 16-bit data RAM. The DSP1610 has a 512 \times 16-bit boot ROM and an 8k \times 16-bit dual-port RAM. The DSP1616 has a 12k \times 16-bit ROM and a 2k \times 16-bit dual-port RAM.

The program ROM on the DSP16 can be replaced with as many as 64k words of external memory.

The program ROM on the DSP16A and 16C can be replaced or augmented with as many as 64k words of external memory.

The DSP1610/1616 can access two external 64k address spaces.

Parallel and serial I/O port.

The DSP16C has an on-chip codec.

The DSP1610 and 1616 have an on-chip timer.

The multiplier accepts 16-bit fixed-point data and creates 32-bit

fixed-point results within a 36-bit accumulator. 32-bit ALU.

Only the DSP1610 and 1616 have a 36-bit barrel shifter and bit-manipulation instructions.

Two 36-bit accumulators.

Zero-overhead cache looping as many as 127 times.

15-word instruction cache.

Immediate, register-indirect, and circular addressing modes.

No on-chip DMA.

Single-level hardware stack is software expandable into main memory.

One external interrupt.

DSP1610 has hardware and software wait states. DSP1616 has software wait states.

DSP1610 and 1616 have on-chip emulation ports.

The DSP16A, 16C, 1610, and 1616 have power-down mode.

The DSP1616 will run from 3.3 to 5V.

Packaging: DSP16 and 16A, 84-pin PLCC or 133-pin PGA. DSP16C, 100-pin PQFP. DSP1610, 132-pin PQFP. DSP1616, 100-pin PQFP or PLCC.

HARDWARE

SUPPORT

SOFTWARE

Development system with in-circuit emulation.
 Evaluation board that plugs into a PC.

Assembler/linker.
 Simulator.
 Application library.
 Third-party support includes filter-design packages. Contact AT&T for a list of third-party vendors.

DSP56156

16-BIT FIXED-POINT CMOS DSP μ P

AVAILABILITY: Now.

COST: 40 MHz, \$104.50 (180); 60 MHz, \$135.85 (180).

SECOND SOURCE: None.

Motorola Inc
Microprocessor Products Group
6501 William Cannon Dr
Austin, TX 78735
(512) 891-2030
FAX (512) 891-3874
Circle No. 673

DESCRIPTION: The 56156 is a 16-bit subset version of the 56001. It is intended for cellular telephone and other communication applications. It has a built-in codec and phase-locked

loop. Development tools are similar to the 56001 and the 96002. The 56156 has been available to select customers and is now moving into general availability.

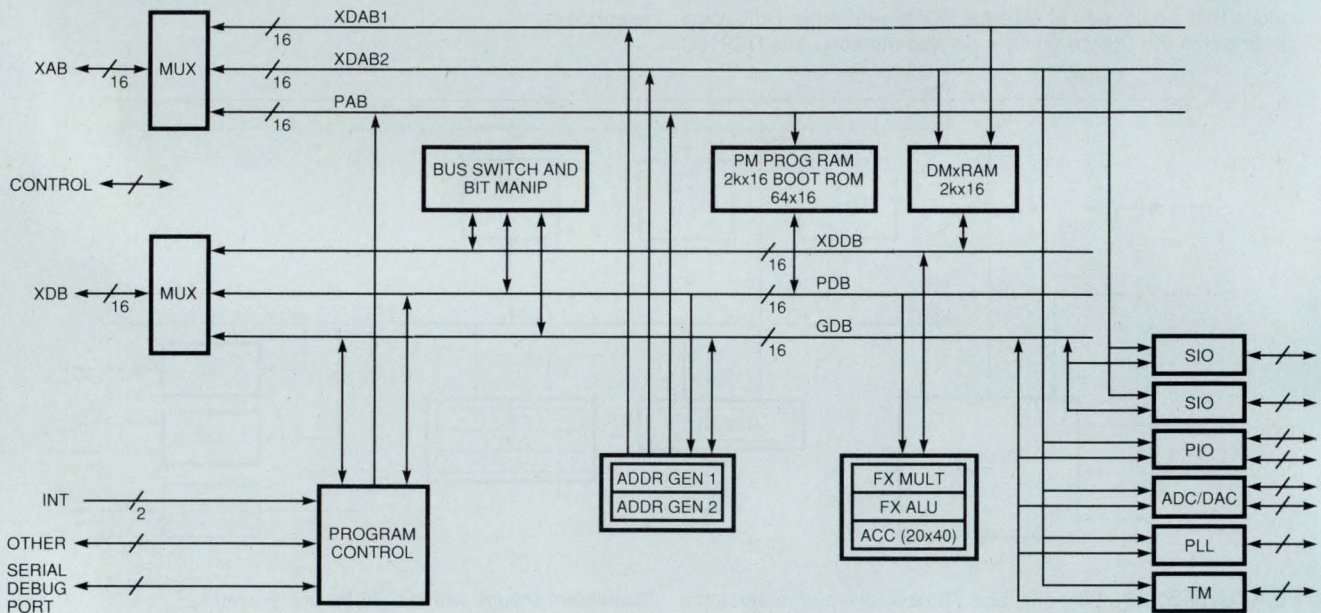

FEATURES: 33- and 50-nsec cycle-time versions.

Three address buses and three data buses.

On-chip memory includes a $2k \times 16$ -bit program RAM and a $2k \times 16$ -bit data RAM.

ROM-based version (DSP56156ROM) contains a $12k \times 16$ -bit program ROM.

Separate external program and data memory spaces. Each can address $64k \times 16$ -bit locations.

Can load program from external EPROM.

Asynchronous and synchronous serial I/O ports.

Parallel port can interface with a host μ P.

Has on-chip PLL.

On-chip, sigma-delta voice-band codec.

Multiplier accepts 16-bit data and returns 40-bit results to 40-bit accumulator.

ALU performs arithmetic operations on 40-bit data and logical operations on 16-bit data.

No barrel shifter.

Two 40-bit accumulators.

Zero-overhead looping.

Immediate, direct, indirect, circular, and bit-reversed addressing modes.

No DMA support.

Two external vectored interrupts.

Has on-chip emulation.

Low-power mode.

Packaged in a 112-pin CQFP.

HARDWARE

SUPPORT

SOFTWARE

Application-development system includes in-circuit emulator.
Contact Motorola for a list of third-party vendors.

Macro cross-assembler.
Linker.
Application-development board.

24-BIT FIXED-POINT CMOS DSP μ P

AVAILABILITY: Now.

COST: DSP56001: 27 MHz, \$52.00 (180) and 33 MHz, \$62.40 (180); DSP56002: in PGA, \$166 (180) and in CQFP, \$91 (180).

SECOND SOURCE: None.

Motorola Inc
Microprocessor Products Group
6501 William Cannon Dr
Austin, TX 78735
(512) 891-2030
FAX (512) 891-3874
Circle No. 674

DESCRIPTION: The 56001 provides one 24-bit data word and two 56-bit accumulators. This extended precision lets the chip process 16-bit data more easily than the 16-bit machines can. The 24-bit word width eases scaling, and the 56-bit accumulators

prevent overflow. The 24-bit data width suits digital audio applications. The 56002 is a high-speed, low-power, low-voltage version of the 56001, which is 100% software compatible, and includes a PLL and on-chip emulation.

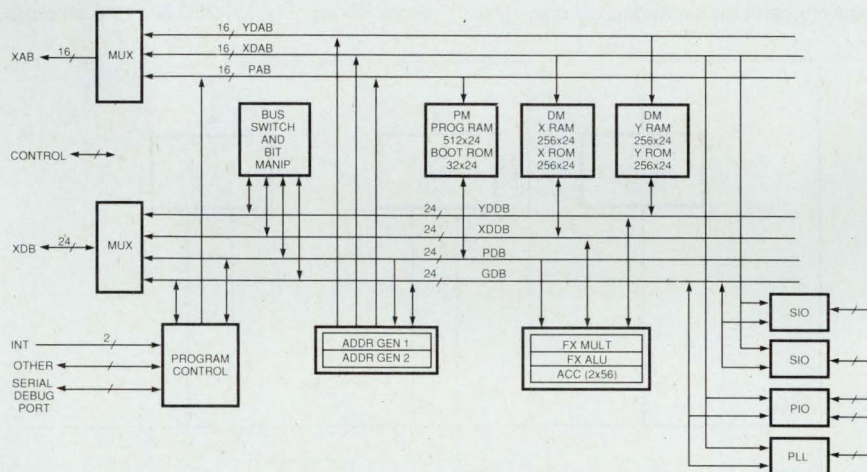

FEATURES: 60- and 74-nsec cycle-time versions.

Three address buses and four data buses.

Separate address buses for program ROM and the two data RAMs.

Separate data buses for program ROM, the two data RAMs, and global data.

On-chip memory includes a 512 \times 24-bit program RAM, a 32 \times 24-bit boot ROM, dual 256 \times 24-bit data RAMs, and dual 256 \times 24-bit data ROMs.

ROM-based version (56000) available.

Three separate memory spaces (X, Y, and P). Each can address 64k \times 24-bit locations.

Can load program from external EPROM.

Asynchronous 8-bit serial I/O port.

Synchronous 8- to 24-bit serial interface.

Parallel port can interface with a host μ P.

56002 has on-chip PLL.

Multiplier accepts 24-bit data and returns 48-bit results to 56-bit accumulator.

ALU performs arithmetic operations on 56-bit data and logical operations on 24-bit data.

No barrel shifter.

Two 56-bit accumulators.

Zero-overhead looping.

Immediate, direct, indirect, circular, and bit-reversed addressing modes.

Two address generators.

No DMA support.

System stack is 15-levels deep, but can be read by program to extend stack into main memory.

Two external vectored interrupts on 56001, three on 56002.

Hardware and software-programmable wait states.

Only the 56002 has on-chip emulation.

Low-power mode.

56002 operates on 2.0 to 5.5V power supplies.

Packaging: 56001, 132-pin CQFP or 88-pin PGA. 56002, 132-pin PGA, CQFP, or PQFP.

HARDWARE

SUPPORT

SOFTWARE

Application-development system includes in-circuit emulator. Contact Motorola for a list of third-party vendors.

C compiler.
GNU C compiler and source-level debugger.
Macro cross-assembler.
Linker/librarian.
Simulator.
Code translator from TMS320C10 to 56001.
Third-party support includes filter-design software, and VRTX32/DSP56001 real-time operating system.

μPD77C25

16-BIT FIXED-POINT DSP μP

AVAILABILITY: The 77C25 is available now. A 3V operation version is planned for 1992.

COST: 77C25, \$9 (5000); 77P25, \$45 (1000); 77P25C, \$20 (1000).

SECOND SOURCE: Oki Semiconductor (Sunnyvale, CA) also makes the 7720.

NEC Electronics
401 Ellis St
Mountain View, CA 94039
(800) 632-3531;
(415) 965-6158
FAX (800) 729-9288
Circle No. 675

DESCRIPTION: The 77C25 is an upgrade of the 7720, which was one of the first successful DSP chips. The basic architecture is out of date and its memory can't be expanded off chip. The

manufacturer says there is still interest in new 77C25 designs because of the chip's low cost. The 77P25 is an EPROM version of the 77C25. The 77P25C is a one-time-programmable version.

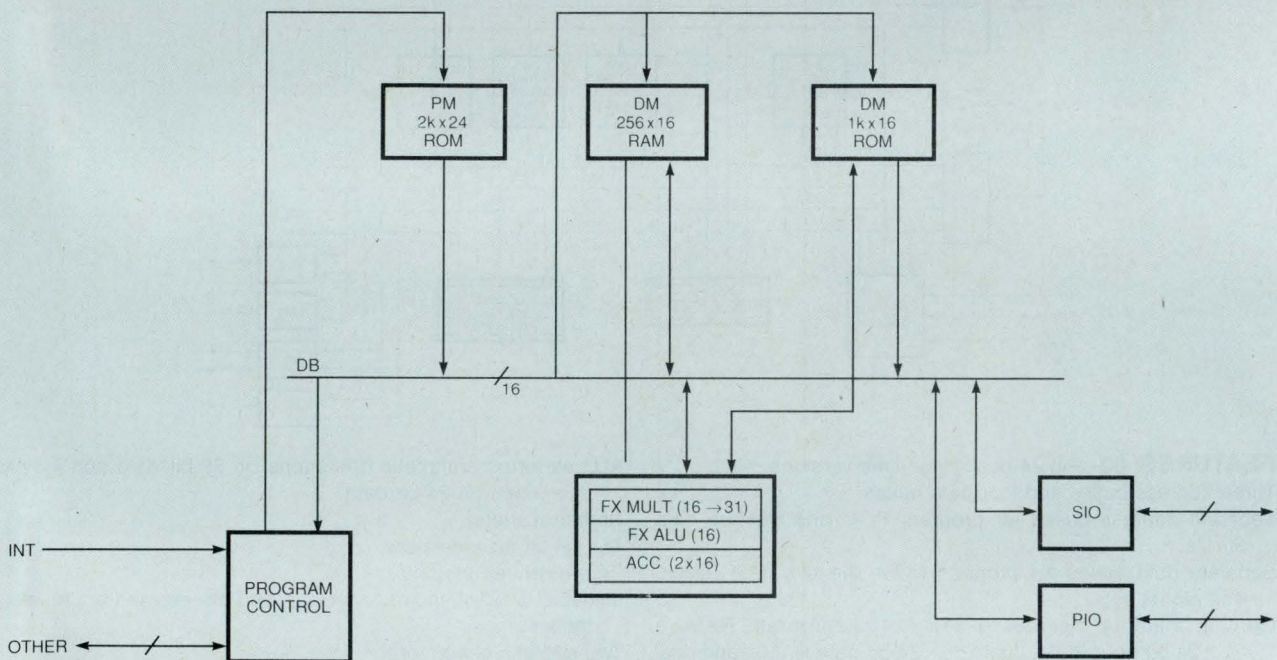

FEATURES:

- 100- and 122-nsec cycle time.
- Single address bus only for program memory.
- Pointers address data memory.
- Single data bus for both program and data.
- On-chip memory: The 77C25 has a 2k x 24-bit program ROM, a 256 x 16-bit data RAM, and a 1k x 16-bit data ROM. The 77P25 has the same memory as the 77C25, but replaces ROM with EPROM.
- No external memory expansion.
- One 8-bit serial I/O port.
- Parallel I/O port.
- Multiplier accepts 16-bit fixed-point data and produces 31-bit fixed-point results within two 16-bit accumulators.
- 16-bit ALU.

- No barrel shifter.
- Two 16-bit accumulators.
- No zero-overhead looping.
- No address generators.
- No on-chip DMA controller.
- 4-level stack stores the program counter during subroutines and interrupts and is not expandable.
- Single external interrupt.
- No wait states.
- No on-chip emulation port.
- No low-power mode.
- Packaged in 28-pin DIP, 28-pin PLCC, 44-pin PLCC, and 32-pin SOP.

HARDWARE

SUPPORT

SOFTWARE

Evaluation kit for application development also functions as in-circuit emulator.

Assembler/linker.
Third-party simulator available.

24-BIT FIXED-POINT CMOS DSP μP

AVAILABILITY: 100- and 122-nsec versions available now.
COST: \$27 (1000).
SECOND SOURCE: None.

NEC Electronics
401 Ellis St
Mountain View, CA 94039
(800) 632-3531; (415) 965-6158
FAX (800) 729-9288; (415) 965-6130
Circle No. 676

DESCRIPTION: The 77220 is a scaled-down version of the 32-bit floating-point 77230. The chip size and pin count are reduced by using 24-bit data and removing the floating-point exponent hardware. The 24-bit word width suits the digital audio market. The instruction set is a subset of the 77230 and is

source-code compatible with the floating-point device. The vendor says the 77220's architecture is optimized for adaptive filter applications. The 77P220R EPROM version and the 77P220L one-time-programmable version are for prototyping and low-volume applications.

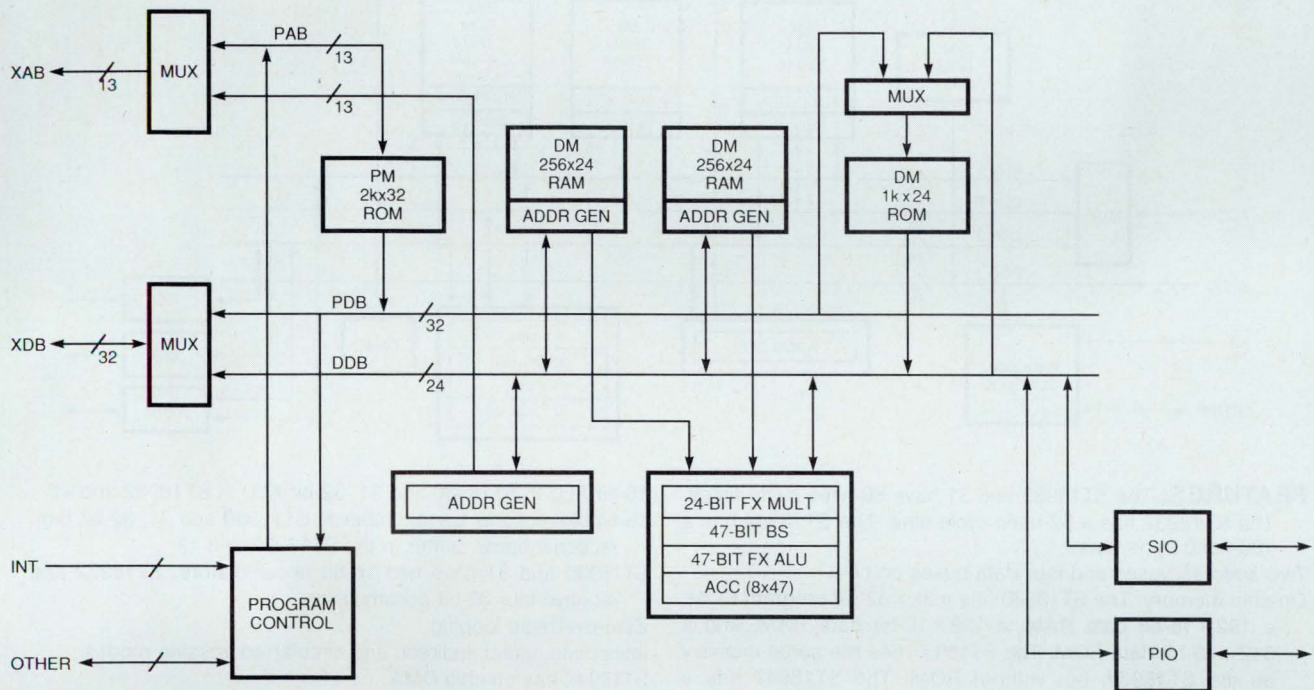

FEATURES: 100- and 122-nsec cycle-time versions.
 Separate on-chip program and data buses.
 On-chip memory includes a 2k × 32-bit program ROM, dual 256 × 24-bit data RAMs, and a 1k × 24-bit data ROM.
 Off-chip memory can be expanded to 8k × 32-bit program memory and 8k × 24-bit data memory.
 One serial I/O port.
 Parallel I/O port can be used as host μP interface.
 Multiplier accepts 24-bit fixed-point data and creates 47-bit fixed-point results within a 47-bit accumulator.
 47-bit ALU.
 47-bit bidirectional barrel shifter.

Eight 47-bit accumulators.
 Direct, indirect, immediate, circular, and bit-reversal addressing modes.
 Three address generators.
 No on-chip DMA.
 Hardware stack is eight levels deep and is not expandable.
 Two external interrupts.
 No supported wait states.
 No on-chip emulation port.
 No low-power mode.
 Packaged in a 68-pin PGA or 68-pin PLCC.

HARDWARE SUPPORT SOFTWARE

Evaluation kit and PC evaluation board.

Assembler/linker.
Simulator.
C compiler available by mid 1992.

ST18930/31/32/42

16-BIT FIXED-POINT CMOS DSP μ P

AVAILABILITY: Now.

COST: ST18930, \$15 (10,000); ST18931, \$75 (100); ST18942, \$35 (10,000); ST18R942, \$80 (100). The ST18932 is only available for ASIC designs.

SECOND SOURCE: None.

SGS-Thomson Microelectronics
1000 E Bell Rd
Phoenix, AZ 85022
(602) 867-6340
Circle No. 677

DESCRIPTION: The ST18 family consists of four devices. The ST18930 and 31 are CMOS versions of the NMOS original with a few enhancements and twice the speed. The ST18932 is a core for custom DSP μ Ps. The CMOS ST18942 offers

further enhancements in its arithmetic capabilities, addressing modes, and I/O functions. All family members can operate on complex and double-precision data. The ST18932 and 42 have a 32-bit ALU and 16-bit data buses.

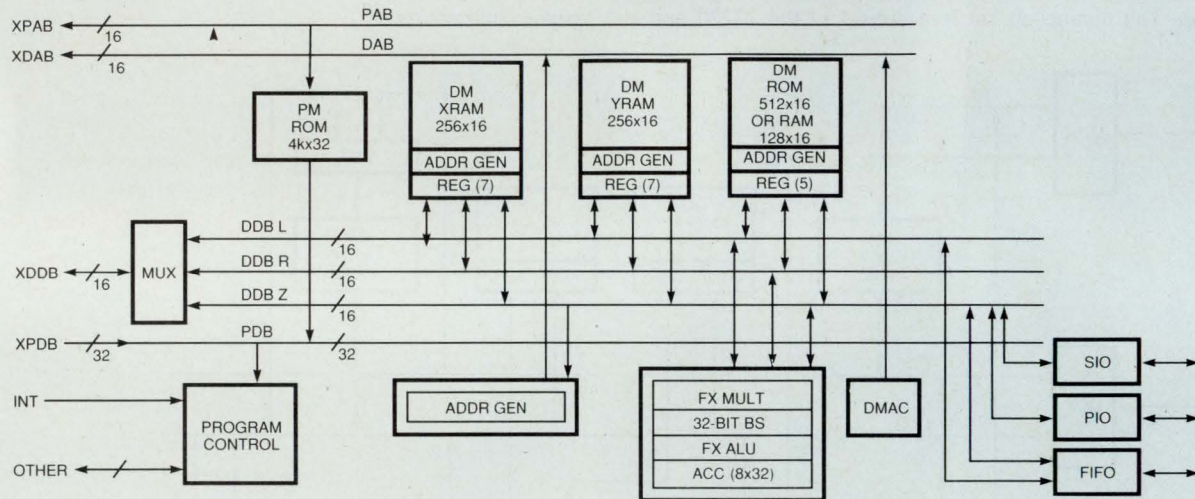

FEATURES: The ST18930 and 31 have 80-nsec cycle times. The ST18932 has a 50-nsec cycle time. The ST18942 has a 100-nsec cycle time.

Two address buses and four data buses on chip.

On-chip memory: The ST18930 has a $3k \times 32$ -bit program ROM, a 192×16 -bit data RAM, a 128×16 -bit data RAM, and a 512×16 -bit data ROM. The ST18931 has the same memory as the ST18930, but without ROM. The ST18942 has a $4k \times 32$ -bit program ROM, two 256×16 -bit data RAMs, and a 512×16 -bit data ROM. The ST18R942 is a ROMless version of the ST18942 and has two 256×16 -bit and one 128×16 -bit data RAMs.

64k \times 32-bit external program memory (except ST18930).

The ST18930 and 31 have $4k \times 16$ -bit external data memory space. The ST18932 has $8k \times 16$ -bit external data memory. The ST18942 and ST18R942 have $64k \times 16$ -bit external memory.

Only the ST18942 has both a serial I/O port and a parallel I/O port.

ST18932 and 42 multipliers accept 16-bit fixed-point data and return 32-bit fixed-point results to 32-bit accumulator. The ST18930 and 31 return 16-bit results.

In complex mode, the multiplier multiplies two complex numbers in two cycles.

16-bit ALU in ST18930 and 31. 32-bit ALU in ST18932 and 42. 16-bit bidirectional barrel shifter in ST18930 and 31. 32-bit bidirectional barrel shifter in the ST18932 and 42.

ST18930 and 31 have two 16-bit accumulators. ST18932 and 42 have four 32-bit accumulators.

Zero-overhead looping.

Immediate, direct, indirect, and circular addressing modes.

ST18942 has on-chip DMA.

ST18930 and 31 have a 1-level, ST18932 has a 2-level, and ST18942 has an 8-level hardware stack for interrupts and subroutines. All can be expanded into main memory with software.

Three external interrupts on the ST18930 and 31 and eight on the ST18932 and 42.

Hardware and software-programmable wait states.

Only the ST18932 has on-chip emulation port.

Low-power mode.

Packaging: ST18930, 48-pin DIP and 52-pin PLCC. ST18931, 124-pin PGA. ST18942, 160 PQFP. ST18R942, 160 PQFP and 144-pin PGA.

HARDWARE

SUPPORT

SOFTWARE

Hardware-development system provides in-circuit emulation of as many as three DSP chips in real time.

Stand-alone emulator board connects to PC.

EPROM module. A ROMless version with EPROMs on a small board that plugs into a ROM-version socket.

Macroassembler/linker.
Simulator.

Only one of these bug killers runs on Sun.

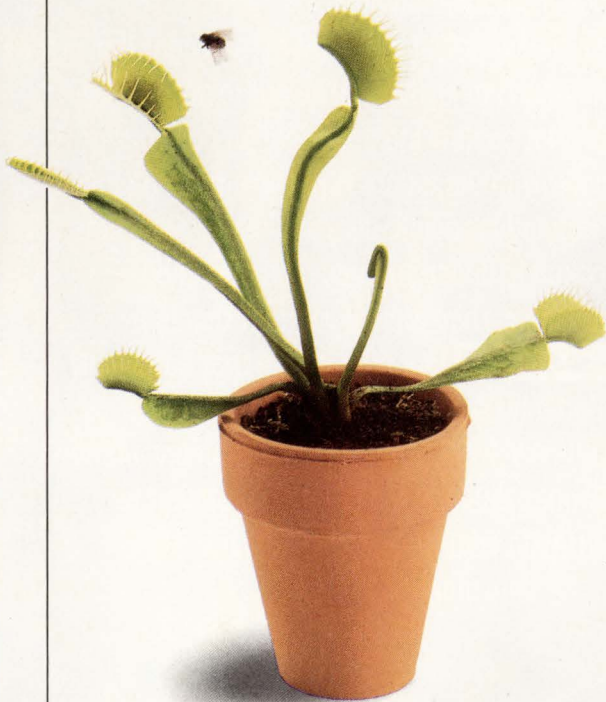

Your deadline is looming. The budget stopwatch is ticking. The scope and the complexity of your project are mounting. To weed out your design problems, you need sophisticated system analysis and integration tools which run on your Sun workstation.

Hewlett-Packard's latest emulators provide just that. They control time-critical functions in your target system. Cover the Motorola chips 020, 030, 040. As well as the 68000, 68302, 68331 and 68332. And their real-time

analysis capabilities will make sure you catch the bugs in your software.

Because logic and performance analysis tools and code coverage are consolidated, and with C cross compilers, simulator/debuggers and branch validators also available, you'll never have to worry about bogging down when performing comprehensive evaluations.

And thanks to HP's LAN, you'll be platform independent. Now everyone on the network can share information and link up

with essential team members.

So if you want an emulator with the service, support and reliability you've come to expect from Hewlett-Packard, call our Micro-processor Development Hotline at **1-800-447-3282, Ext. 104**. We'll send you a free demo disk and information package. You'll see that with our emulators, killing bugs is a snap.

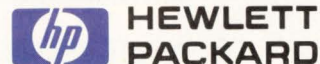

INTRODUCE YOURSELF TO THE ALL-NEW BONNEVILLE.

If you've always believed the only way to get an agile, aero-styled, high-performance sedan was to buy small, you're in for a big surprise. It's time to forget the past, and get to know the all-new 1992 Pontiac Bonneville.[®]

Under its beautifully redesigned shape lurks a potent 170-horsepower 3.8L **3800 V6** with tuned port sequential fuel injection locked onto an advanced 4-speed automatic. Available **anti-lock brakes** and a precision-engineered, road-gripping sport suspension for outstanding control, stopping or steering. Available advanced **traction control** for superb power application on slippery surfaces. Bonneville even

features a standard **driver's airbag** for additional safety assurance.

That's the technical side. But to really get the feel of the new Bonneville, you've got to get behind the wheel. Notice how the solid-feeling controls react smoothly to the touch. How the analog gauges are well-defined for quick, decisive reads. How the whole cockpit is driver-oriented, and designed for performance. Then remind yourself this is a **full-sized** four-door sedan that can easily and comfortably carry six adults.

The all-new 1992 Bonneville. Introduce yourself at your Pontiac dealer soon. Just be prepared for an attitude adjustment to take place. Very, very quickly.



PONTIAC *We Build Excitement* 



Call Toll-Free 1-800-762-4900 for your own 1992 Bonneville brochure.
*BUCKLE UP, AMERICA! © 1991 GM CORP. ALL RIGHTS RESERVED.

16-BIT FIXED-POINT CMOS DSP μ P

AVAILABILITY: The C10, C15, C16, C17, E14, E15, E17, P15, P17, P14, LC15 (3.3V), and LC17 (3.3V) are available now. The C14 will be available in the fourth quarter of 1991.

COST: C10 (20 MHz), \$4.90; C10 (25 MHz), \$6; C14, \$9; E14, \$45; P14, \$22; C15 (20 MHz), \$7; C15 (25 MHz), \$6; E15 (20 MHz), \$35; E15 (25 MHz), \$45; P15, \$20; C16, \$9; E17, \$38; P17, \$20 (1000).

SECOND SOURCE: Microchip Technology (Chandler, AZ) for the C10, C14, and E14. No second source for other parts.

Texas Instruments Inc
Semiconductor Group, SC-001
Box 809066
Dallas, TX 75380
(800) 336-5236, ext 700
Circle No. 678

DESCRIPTION: This first generation of the vendor's DSP family was introduced in 1982. Although this family is difficult to use and slower than similar devices, the chips' cost—which has dropped to \$3 in high volumes—and the large body of associated software and expertise will keep this family going.

Newer family members have additional memory and peripheral options. EPROM (TMS320E1X) and one-time-programmable (TMS320P1X) versions are also available. 3.3V versions of the C1X family are now available.

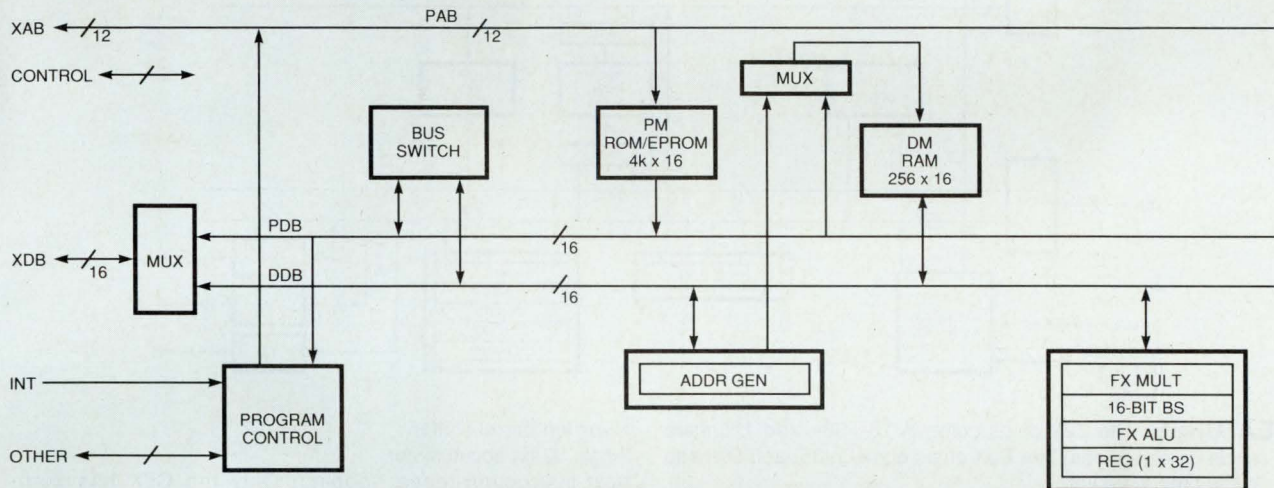

FEATURES: 114-, 160-, 200-, and 280-nsec cycle-time versions. Separate on-chip program and data buses.

On-chip memory: The C10 has a 1.5k \times 16-bit program ROM and a 144 \times 16-bit data RAM. The C14, C15, and C17 have a 4k \times 16-bit program ROM and a 256 \times 16-bit data RAM. The E14, E15, and E17 have a 4k \times 16-bit program EPROM and a 256 \times 16-bit data RAM. The C16 has an 8k \times 16-bit program ROM and a 256 \times 16-bit data RAM. P1X versions are one-time programmable.

Program and data buses are combined off chip.

4k \times 16-bit total external memory, except the C16, which has 64k \times 16-bit external memory, and the C17, which has no external memory.

On-chip peripherals: The C10, C15, and C16 have parallel I/O. The C14 has serial and parallel I/O. The C17 has two serial I/O ports, parallel I/O, and a compander.

Multiplier accepts 16-bit fixed-point data and creates 32-bit fixed-point results within a 32-bit accumulator.

32-bit ALU.

16-bit left barrel shifter.

Single 32-bit accumulator.

No zero-overhead looping.

No DMA.

4-level hardware stack except the C16, which has an 8-level hardware stack.

Single external interrupt.

No wait states.

No on-chip emulation.

LC1X devices operate at 3.3V.

Packaging: C10, 40-pin DIP or 44-pin PLCC. C14, 40-pin DIP or 44-pin PLCC. C15, 40-pin DIP or 44-pin PLCC. C16, 64-pin QFP. C17, 40-pin DIP or 44-pin PLCC.

HARDWARE

SUPPORT

SOFTWARE

In-circuit emulator.

Evaluation module.

Software-development system.

Many third-party support tools. Contact Texas Instruments for a list of third-party vendors.

Assembler/linker.

Simulator.

Application library.

Many third-party support tools.

TMS320C2X/320C5X

16-BIT FIXED-POINT CMOS DSP μ P

AVAILABILITY: The C25, C26, and E25 are available now. The C50 and C51 are sampling now and will be in production in the fourth quarter of 1991.

COST: C25 (33 MHz), \$14; C25 (40 MHz), \$15; C25 (50 MHz), \$17; E25, \$55; C26, \$16; C50, \$130; C51, \$40 (1000).

SECOND SOURCE: None.

Texas Instruments Inc
Semiconductor Group, SC-9053
Box 809066
Dallas, TX 75380
(800) 336-5236, ext 700
Circle No. 679

DESCRIPTION: These chips make up the second generation of the vendor's DSP family. They offer higher performance than the first-generation chips and are easier to use. For many applications, the C25's price has dropped to a point where the chip is replacing the C1X. The C5X parts are enhancements to the

C25. They use the same basic core architecture as the C25, but have double the performance level, additional on-chip peripherals, and expanded memory. An EPROM version of the C25, the E25, is also available.

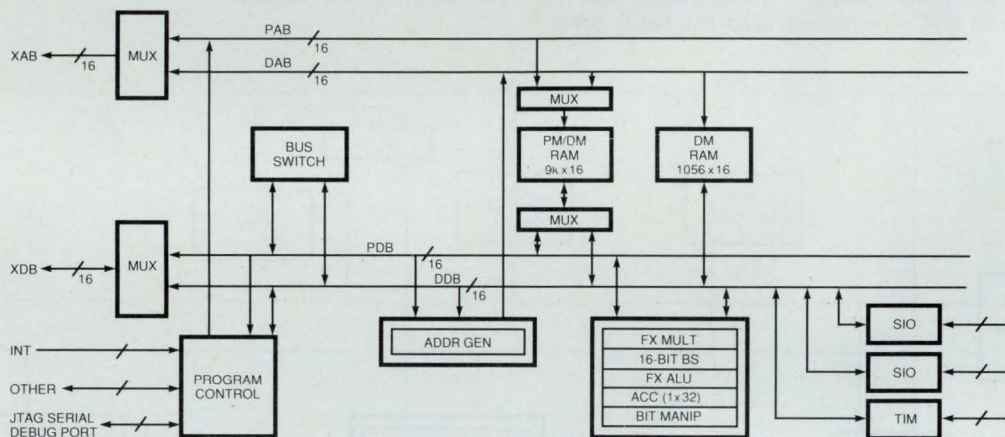

FEATURES: The C2X chips come in 78-, 98-, and 125-nsec cycle-time versions. The C5X chips come in 35- and 50-nsec cycle-time versions.

On-chip memory: The C25 has a $4k \times 16$ -bit program ROM and a 544×16 -bit data RAM. The C26 has a $1.5k \times 16$ -bit program RAM with boot ROM to load programs from external memory and a 544×16 -bit data RAM. The C50 has a $9k \times 16$ -bit program/data RAM and a 1056×16 -bit dual-access RAM. The C51 has an $8k \times 16$ -bit program ROM, a $1k \times 16$ -bit program/data RAM, and a 1056×16 -bit dual-access RAM.

Program and data memory are combined off chip.

The C2X and C5X can address $64k \times 16$ -bit programs and $64k \times 16$ -bit data memories.

The C25 and C26 have one serial port each. The C5X has two serial ports.

Multiplier accepts 16-bit fixed-point data and creates 32-bit fixed-point results within a 32-bit accumulator.

32-bit ALU.

The C5X has a separate 16-bit parallel logic unit for manipulating bits without affecting the contents of the accumulator.

16-bit left barrel shifter.

Single 32-bit accumulator.

Next-instruction-repeat looping. Only the C5X has zero-overhead block looping.

Immediate, direct, indirect, and bit-reversal addressing modes. C5X also has circular addressing.

No DMA.

8-level expandable hardware stack.

C5X has a 1-level-deep shadow RAM, which stores some registers.

C2X has three external interrupts; C5X has five.

Hardware wait states. C5X also has software-programmable wait states.

The C5X has an on-chip emulation port.

The C2X is source-code compatible with the C5X.

The C5X has a JTAG interface.

The C25 and C26 have an idle mode. The C5X has a power-down mode.

Packaging: C25 and C26, 68-pin PGA or PLCC. C50, 132-pin QFP.

HARDWARE

SUPPORT

SOFTWARE

Both the C2X and C5X have an in-circuit emulator.

Both also have a software-development board for PCs.

Many third-party support tools. Contact manufacturer for a list of third-party vendors.

C compiler for both C25 and C5X.

Source-level debugger for C5X.

Assembler/linker.

Simulator.

Application library.

Many third-party support tools.



Finally, a SPARC chip set that comes equipped with everything you need for the Sun.

Now, from the Advanced Products Division of Fujitsu Microelectronics — something new under the Sun. A SPARC® chip set that offers the world's most advanced, cost-effective solutions for Sun-compatible workstation designs and specialized, compute-intensive applications. Including voice response, medical imaging and pattern recognition systems.

Our new SPARC chip set is packed with all of the advanced features you need to differentiate your systems from Sun and yesterday's Sun clones. Such as higher integration. More system flexibility. Clock speeds of up to 40 MHz. And graphics options. All at a price to help



FUJITSU

Delivering the Creative Advantage.

you outshine the competition.

Plus, to get you to market faster, we offer three distinct hardware designs: Busless, Sbus and VME bus. What's more, from our alliance with INTERACTIVE Systems Corporation — the premier independent UNIX® source — comes the latest SunOS™ 4.1.1 ported to each design.

And with comprehensive documentation and training, you'll find your place in the Sun more quickly.

So equip yourself with everything you need to develop the highest performance SPARC-based systems. Call us at 1-800-523-0034. And discover why our new SPARC chip set is the perfect Sun set.

FUJITSU MICROELECTRONICS, INC., Advanced Products Division, 77 Rio Robles, San Jose, CA 95134-1807. Ph: 408-456-1161 Fax: 408-943-9293.
 FUJITSU MICROELECTRONICS ASIA PTE LTD. (Head Office, Singapore): Ph: 65-336-1600 Fax: 65-336-1609. HONG KONG SALES OFC: Ph: 852-723-0393 Fax: 852-721-6555.
 TAIPEI SALES OFC: Ph: 886-2-757-6548 Fax: 886-2-757-6571. JAPAN SALES OFC: Ph: 81-3-3216-3211 Fax: 81-3-3216-9771. KML CORP. (Rep., Korea): Ph: 82-2-588-2011 Fax: 82-2-588-2017.
 PACIFIC MICROELECTRONICS, PTY LTD., (Rep., Australia): Ph: 61-2-481-0065 Fax: 61-2-484-4460.
 FUJITSU MIKROELEKTRONIK GmbH (Dreieich-Buchsschlag, Germany): Ph: 06103-6900 Fax: 06103-690122.
 SPARC is a registered trademark of SPARC International. UNIX is a registered trademark of UNIX System Laboratories, Inc. SunOS is a trademark of Sun Microsystems, Inc.

A grayscale photograph of a microcircuit component, possibly a surface-mount device, is shown in the background. It has a rectangular body with several pins extending from the bottom. The image is slightly out of focus and serves as a backdrop for the main text.

***MINI-CIRCUITS
RF/IF PROCESSING
GUIDE
WITH THIS ISSUE***

**IF THE GUIDE IS MISSING, OR FOR
MORE INFORMATION
CONTACT**

finding new ways ...
setting higher standards

 **Mini-Circuits**

The logo icon is a stylized, blocky representation of a microcircuit package with four pins at the bottom.

**P.O. BOX 350166, BROOKLYN, N.Y. 11235-0003
TEL 718-934-4500 EXTENSION 231
FAX 718-332-4661**

32-BIT FLOATING-POINT CMOS DSP μ P

AVAILABILITY: The ADSP21020 is available now.

COST: \$147 (1000).

SECOND SOURCE: None.

Analog Devices Inc
1 Technology Way
Norwood, MA 02062
(617) 461-3074
Circle No. 680

DESCRIPTION: This device is the vendor's first floating-point DSP μ P. It has an off-chip Harvard architecture and is similar to the fixed-point 2100 family. On-chip emulation supported via a JTAG port. The device conforms to the IEEE-754 floating-point standard.

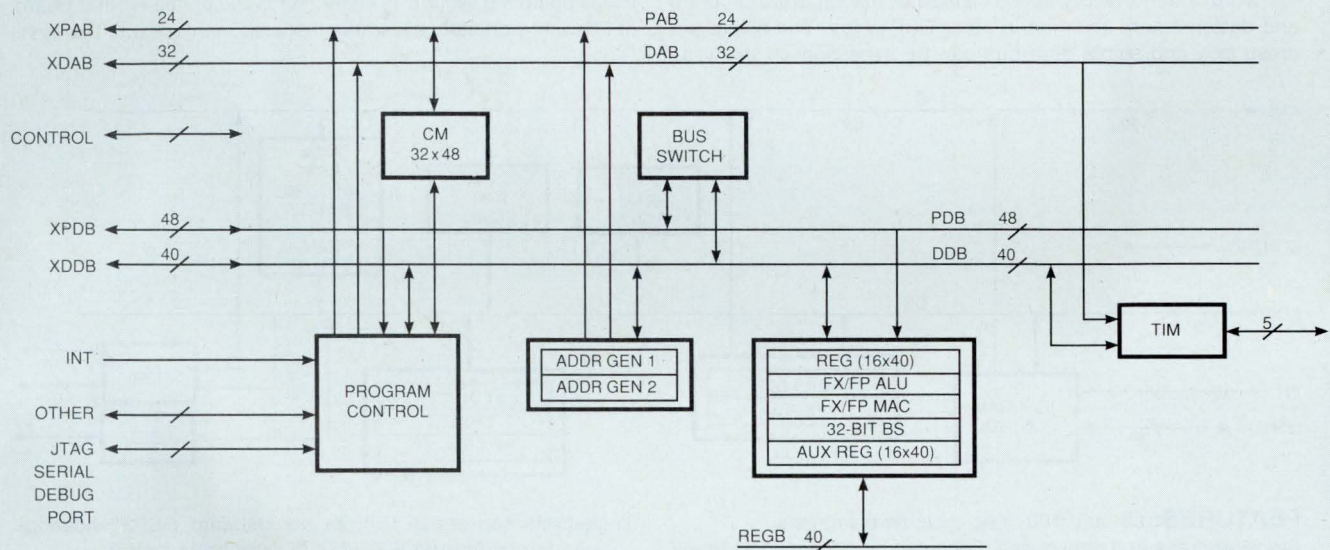

FEATURES: 40-, 50-, and 66-nsec cycle-time versions.

One 32-bit and one 24-bit address bus.

One 40-bit and one 48-bit data bus.

Seven 40-bit additional buses in the CPU.

Separate program, and data buses (off-chip Harvard Architecture).

4G \times 40-bit external data memory and 16M \times 48-bit external program memory.

One 32-bit timer.

IEEE-754 32-bit and 40-bit floating-point format.

Multiplier accepts 32-bit and 40-bit floating-point data and returns 32-bit or 40-bit results. 32-bit fixed-point operands produce 64-bit fixed-point products. The multiplier also incorporates dual 80-bit fixed-point accumulators.

ALU accepts 32-bit and 40-bit floating-point data and returns 32-bit or 40-bit results. 32-bit fixed-point operands produce 32-bit results.

Parallel multiplier and ALU operate in single cycle.

32-bit bidirectional barrel shifter.

32 40-bit register-based accumulators.

Zero-overhead looping.

32 \times 48-bit instruction cache.

Cache optimizes performance by selecting only 3-bus-operation instructions for storage in cache. Cache can be frozen to keep often-used instructions in cache.

Register, direct, indirect, immediate, relative, circular buffer, and bit-reversed addressing modes. Two independent address generators.

The hardware stack is 20 deep and can be expanded into main memory.

Four external vectored interrupts.

Four bidirectional I/O flags.

Hardware and software programmable wait states.

JTAG support of in-circuit emulation.

Idle state for low-power mode.

Packaging: 223-pin PGA, plastic and ceramic. PQFP available in 1992.

HARDWARE

Full-speed in-circuit emulator.

Demo board for PCs.

Evaluation package.

Third-party support: Contact Analog Devices for a list of third-party vendors.

SUPPORT

Optimizing ANSI C and Numerical C compilers.

Source-level debugger for ANSI C and Numerical C.

Simulator, assembler, linker, PROM splitter.

Application libraries.

Third-party support includes Spox, filter-design packages with code generation, and block-level algorithm development packages.

SOFTWARE

DSP32C/3210

32-BIT FLOATING-POINT CMOS DSP μ P

AVAILABILITY: The DSP32C is available now. The DSP3210 is sampling now with production by the fourth quarter of 1991.

COST: DSP32C, \$70 (1000). DSP3210, \$50 (100,000).

SECOND SOURCE: None.

AT&T Microelectronics

Dept 52AL300240

555 Union Blvd

Allentown, PA 18103

(800) 372-2447;

in Canada, (800) 553-2448

Circle No. 681

DESCRIPTION: The DSP32C has one of the simplest architectures of the 32-bit floating-point DSP chips. It uses a single 4M-word linear-memory space instead of the separate program and data memory common in other DSP chips. The single address bus and single data bus can be accessed as many as

four times per cycle. Each internal memory can be accessed as many as two times per cycle. The DSP3210, along with the VCOS operating system, is intended for use on the mother board of PCs and workstations, where it shares memory with the host.

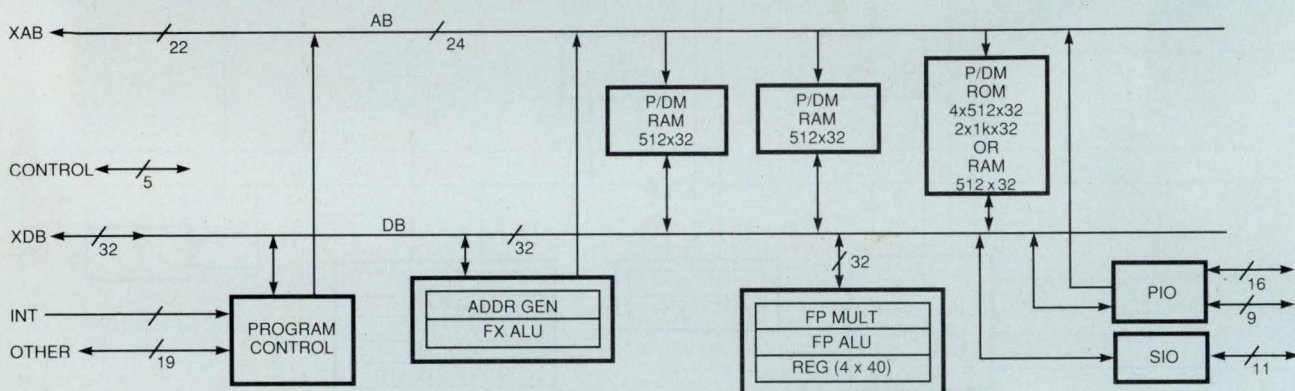

FEATURES: 80- and 100-nsec cycle-time versions.

Single address and data buses. Each can be accessed as many as four times per cycle to imitate separate buses.

DSP32C has three on-chip 512×32 -bit RAMs. Optional ROM-based DSP32C replaces one RAM with a $4k \times 32$ -bit ROM. DSP3210 has two $1k \times 32$ -bit RAMs and a 256×32 -bit boot ROM.

The DSP32C can address as much as $4M \times 32$ -bits of external memory. The DSP3210 can address 4 Gbytes of external memory.

All memory is a general resource; both program and data can exist anywhere.

Data addressable as 8-, 16-, or 32-bit words.

DSP3210 can load program from external EPROM.

The DSP32C has on-chip serial and parallel I/O. The DSP3210 has serial I/O, timer, DMA controller, and a 32-bit bus interface that is compatible with Motorola and Intel μ Ps.

The serial I/O is a double-buffered port that allows concurrent input and output of 8-, 16-, 24-, or 32-bit data widths.

The DSP32C has an 8- or 16-bit parallel I/O port that an external μ P can control.

Proprietary 32-bit floating-point format.

Single-cycle conversion to/from nonstandard DSP32 floating-point format from/to IEEE-754 floating-point format.

Multiplier accepts 32-bit floating-point data and creates 45-bit floating-point results.

Separate floating-point adder accepts 40-bit floating-point data and creates 40-bit floating-point results.

Fixed-point ALU accepts 16- or 24-bit data.

Does not have a barrel shifter.

Four 40-bit accumulators.

Zero-overhead looping. As many as 2048 repeats of a block with a maximum size of 32 words.

Immediate, memory-direct, register-direct, register-indirect, and bit-reversal addressing modes.

DMA can be used with both the serial I/O and the parallel I/O.

No hardware stack.

1-level-deep shadow RAM of some registers.

Two external interrupts.

Hardware wait states. DSP3210 has software-programmable wait states.

No on-chip emulation port.

Only the DSP3210 has a low-power mode.

DSP32C packaged in a 164-pin PQFP, 133-pin PGA, or 68-pin PLCC (microcontroller version, no external memory).

HARDWARE

SUPPORT

SOFTWARE

In-circuit emulator.

IBM PC-based development board.

VME bus-based development board.

Many third-party support tools, including the HP64773 in-circuit emulator from Hewlett-Packard. Contact AT&T for a list of third-party vendors.

Optimizing C compiler.

Assembler/linker.

State simulator.

VCOS operating system.

Many third-party support tools.

Experience 32-bit RISC Performance in Your 16-bit System at a Cost That'll Thrill You

Intel has given designers another exciting product breakthrough. This time it's Intel's i960™ SA/SB 32-bit embedded processors -- the products that let you design-in high performance in cost-sensitive applications.

With a full 32-bit internal architecture and a 16-bit data bus, the i960 SA/SB processors provide more performance than any other 16-bit embedded processor. And they're part of the complete i960 family, which spans 5 to 66 MIPS while preserving software compatibility.

Hamilton/Avnet has the i960 SA/SB processors and evaluation boards in stock, and the development tools to start your design now! From compilers and simulators, to debuggers and emulators, we offer the development tools you need to take full advantage of your design, while reducing time to market.

So get high performance, at a cost you'll be thrilled about with Intel's i960 SA/SB and development tools. For the Hamilton/Avnet branch nearest you or further information, call toll free, 1 (800) 442-6458.

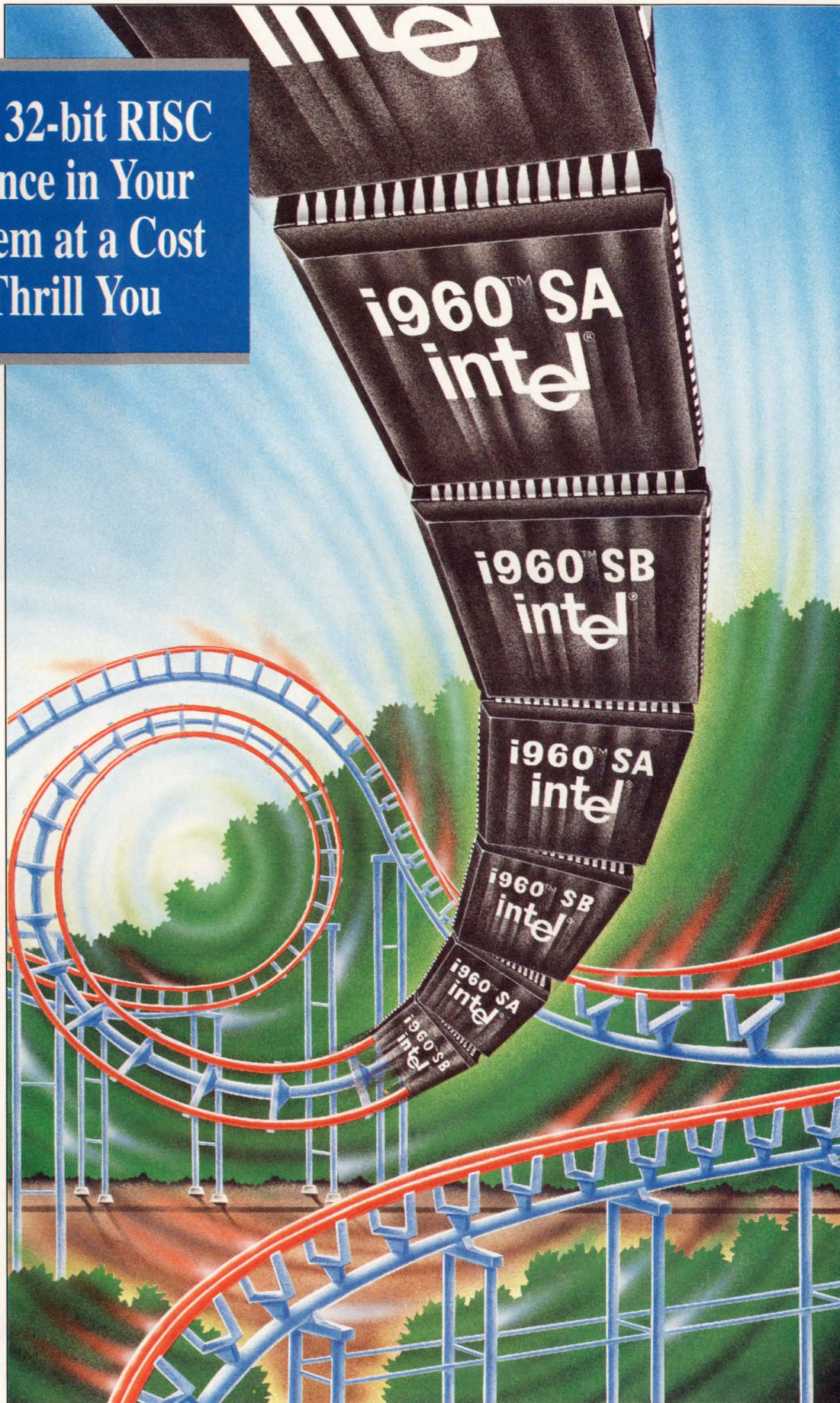

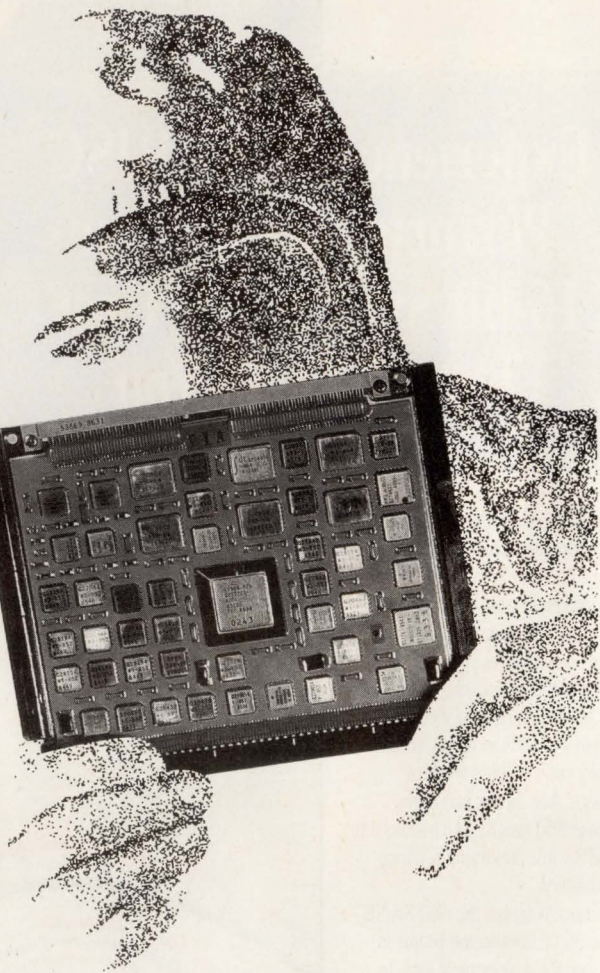

Yes we do!

Provide complete services for electronic modules -- from design, to prototyping, through to production for a complete line of SEMs. From the MIB (bare board) to a completed, fully qualified module -- regardless of quantities.

We literally program our total capabilities to meet your specific needs. Provide design to specifications; partial and complete design services; build- to-print production; manufacturing, integration and testing operations.

A self-contained group is devoted exclusively to modules. It draws upon Raytheon's 20 years' experience in the design of more than 600 module types. Their imaginative engineering, combined with cost-cutting design concepts and manufacturing methods, assures you modules cost-effectively made to unsurpassed standards of quality and reliability. All work is done in facilities baseline-certified for MIB's to NWSC (Naval Weapons Support Center) requirements. We're also certified for Formats A, B, D & E.

A phone call will get things moving. **OEM's or system integrators should call or write: Marketing Manager, Production Components, Raytheon Company, Submarine Signal Division, 1847 West Main Road, Portsmouth, RI, USA 02871-1087. Phone 401 847-8000, Extension 2054.**

Raytheon

32-BIT FLOATING-POINT CMOS DSP μ P

AVAILABILITY: Available now. Enhanced revision available the first quarter of 1992.

COST: 96002 (33 MHz), \$368; 96002 (40 MHz), \$441.

SECOND SOURCE: None.

Motorola Inc
Microprocessor Products Group
6501 William Cannon Dr
Austin, TX 78735
(512) 891-2030
FAX (512) 891-0400
Circle No. 682

DESCRIPTION: The 96002 is an architectural superset of the fixed-point 56001. The 96002 continues Motorola's emphasis on precision. The 96-bit accumulators will support future double-precision parts. The 32-bit floating-point device conforms to the IEEE-754 floating-point standard. The dual 32-bit external buses support glueless multi-96002 systems. The ex-

ternal buses can access external memory and peripherals or communicate with a host μ P. A revision of the 96002 provides some enhancements, including increased speed and letting the internal RAM act as an instruction cache. It will remain software compatible with the existing 96002.

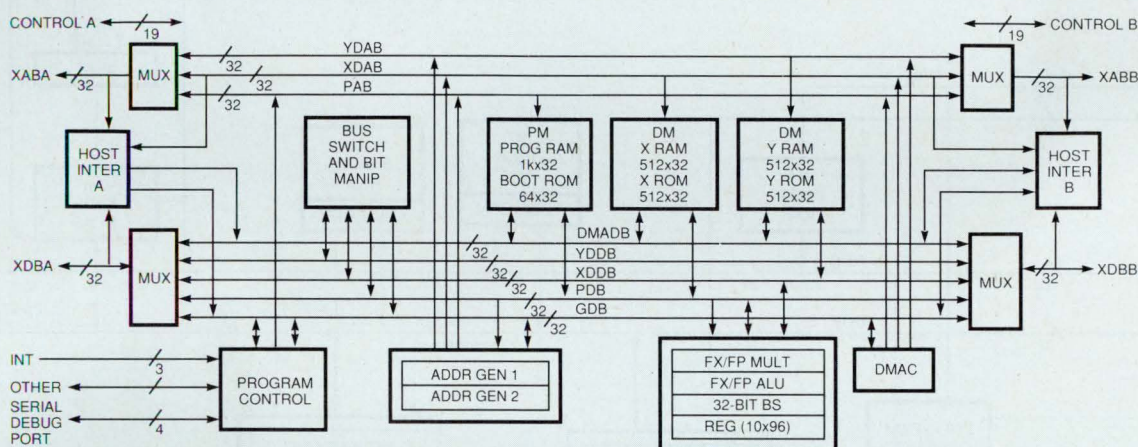

FEATURES: 50-, 60-, and 74-nsec cycle-time versions. 50-nsec cycle-time version scheduled for the fourth quarter of 1991.

Three 32-bit address buses and five 32-bit data buses on chip. Separate address buses for program and the two on-chip RAMs. Separate data buses for program, the two on-chip RAMs, global data, and DMA.

On-chip memory includes a 1k \times 32-bit program RAM, a 64 \times 32-bit boot ROM, dual 512 \times 32-bit data RAMs, and dual 512 \times 32-bit data ROMs.

On-chip boot ROM loads program from external byte-wide EPROM.

Revised version will let the internal 1k \times 32-bit program RAM function like an instruction cache.

Two complete 32-bit external expansion ports for memory and I/O.

Three separate memory spaces (X, Y, and P). Each can address 4G words.

Each memory space is divided into eight 0.5G-word areas. Each can be programmed to either the A or B expansion ports.

Two host interfaces allow interface to μ P or other 96002s. No other on-chip peripherals.

IEEE-754 32-bit floating-point format.

Multiplier accepts 32-bit floating-point data and returns 44-bit results. Multiplier accepts 32-bit integer data and returns 64-bit results.

32-bit bidirectional barrel shifter.

Ten 96-bit or thirty 32-bit register-based accumulators.

Zero-overhead looping.

Immediate, direct, indirect, circular, and bit-reversal addressing modes.

Two address ALUs.

Supports DMA. Uses its own internal bus and doesn't cycle-steal. Can use all of the addressing modes, including bit-reversal, with the DMA controller.

The stack is 15 levels deep and can be expanded into main memory.

Three external vectored interrupts.

Hardware and software-programmable wait states.

Serial debug port for in-circuit debugging.

Low-power mode.

Packaged in a 223-pin PGA. 256-pin CQFP available in 1991.

HARDWARE

Hardware-evaluation system includes in-circuit emulator. Some third-party hardware products are available. Contact Motorola for a list of third-party vendors.

SUPPORT

Optimizing C compiler.
Assembler/linker.
Simulator.
Application library.
GNU C compiler and source-level debugger.
Third-party support includes optimizing C compiler, block-level diagramming language, filter-design software, and Spox.

SOFTWARE

μPD77240

32-BIT FLOATING-POINT CMOS DSP μP

AVAILABILITY: The 132-pin PGA package is available now. The PQFP will be available in 1992.

COST: \$75 (1000).

SECOND SOURCE: None.

NEC Electronics
401 Ellis St
Mountain View, CA 94039
(415) 965-6158;
(800) 632-3531
Circle No. 683

DESCRIPTION: The μPD77240 is a 32-bit CMOS floating-point DSP chip. The internal instruction and data ROM are pre-programmed with math matrix routines. It has two external

buses: one for data addressing up to 16M × 32-bit, and the other for instruction addressing up to 64k × 32-bit. The vendor says the architecture suits adaptive filter applications.

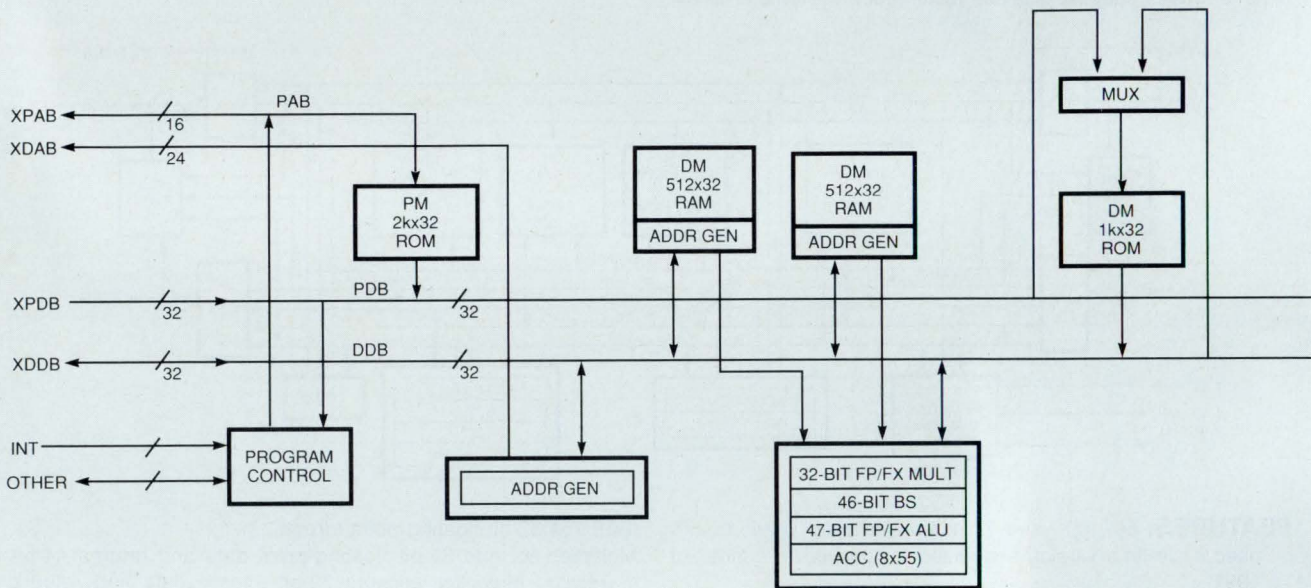

FEATURES: 90-nsec cycle time.

Separate on-chip program and data buses.

On-chip memory: 2k × 32-bit program ROM (preprogrammed), dual 512 × 32-bit data RAMs, and a 1k × 32-bit data ROM (preprogrammed).

External memory expansion: 64k × 32-bit program memory and 16M × 32-bit data memory.

Separate external program and data buses.

The 77240 has no on-chip peripherals.

Proprietary 32-bit floating-point format.

Multiplier accepts 32-bit floating-point data and creates 55-bit floating-point results.

Multiplier accepts 24-bit fixed-point data and creates 47-bit fixed-point results.

47-bit ALU.

47-bit bidirectional barrel shifter.

Eight 55-bit register-based accumulators.

Direct, indirect, immediate, circular, and bit-reversal addressing modes.

Three address ALUs.

No on-chip DMA.

The stack is eight levels deep and is not expandable.

Two external interrupts.

No wait states.

No on-chip emulation port.

No low-power mode.

Packaged in a 132-pin PGA.

HARDWARE

Evaluation kit, which includes an in-circuit emulator.

SUPPORT

Assembler/linker.

Simulator.

C compiler scheduled for 1992.

SOFTWARE

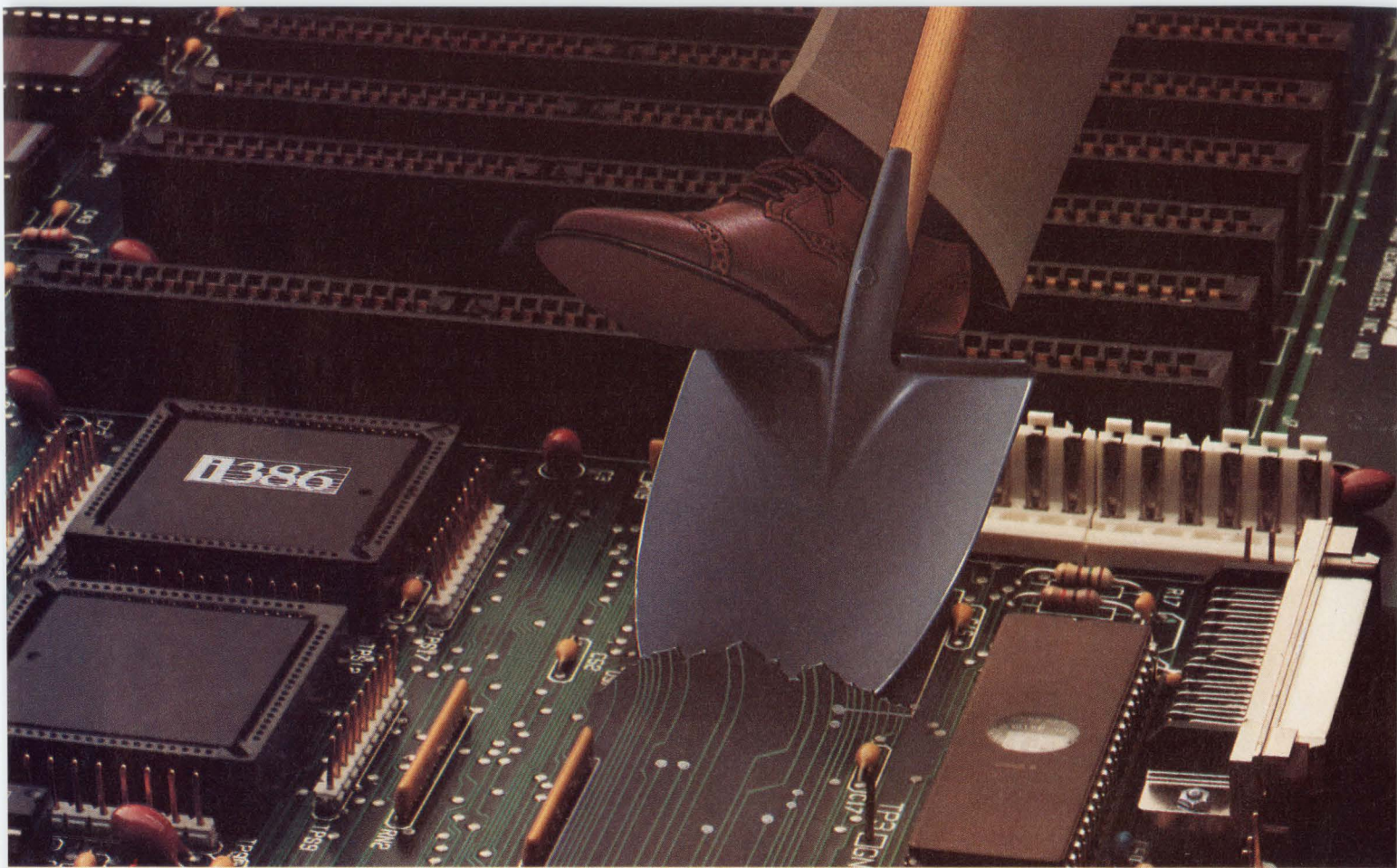

WE'RE BREAKING NEW GROUND BY MAKING IT EASY TO PUT SCSI ON THE MOTHERBOARD.

Introducing Adaptec's new AIC-6260.

You're already a big believer in the performance and connectivity of SCSI. But you're also digging around for an uncomplicated way to design-in SCSI to your AT motherboard. Well...Eureka! Now with Adaptec's new AIC-6260, you've just hit pay dirt.

After all, it makes a lot of sense that a single-chip solution is easier to design-in than multiple chip packages. They're also more reliable. And take up less real estate. Plus, since we've built the AT bus in, designing SCSI in is as easy as connecting signal lines dot-to-dot.

What's more, we get you to market in the fastest

possible time. That's because industry-standard, Adaptec-developed SCSI software drivers and BIOS are ready and available. For all major peripherals—under all major operating systems. All this, and a complete design-in package, too. Which means, you can now afford to design the performance and connectivity of SCSI in your system as a standard feature.

So step on it. And call us at **1-800-227-1817, ext. 52** today. We think you're going to really dig it.



adaptec

When you're serious about SCSI.

To control vibration, get your hands on this brochure.

Improve product performance with Scotchdamp™ brand Vibration Control Systems



3M

Discover why more engineers are designing Scotchdamp® brand Vibration Control Materials into electronic equipment. From disk drives and circuit boards, to video cameras, sensitive measuring devices and even jet engines, thin, light-

weight 3M damping materials efficiently dissipate vibrational energy. Mechanical fatigue, performance loss and unwanted noise are virtually eliminated.

For a free brochure loaded with application and technical information, circle

the number below, call 612-733-4076 or write: 3M Industrial Specialties Division, Scotchdamp Vibration Control Systems, 3M Center Bldg. 220-7E-01, St. Paul, MN 55144-1000. Our FAX number is 612-733-1771.

32-BIT FLOATING-POINT CMOS DSP μ P

AVAILABILITY: The C30 and C30-27 are available now. The C30-40, C31, and C31-27 are sampling now.

COST: C30, \$160; C30-27, \$125; C30-40, \$210; C31, \$70; C31-27, \$55 (1000).

SECOND SOURCE: None.

Texas Instruments Inc
Semiconductor Group, SC-91011
Box 809066
Dallas, TX 75380
(800) 336-5236, ext 700
Circle No. 684

DESCRIPTION: This device is the floating-point member of the vendor's TMS320 family. It was the first sub-100-nsec 32-bit floating-point CMOS DSP. It is not code compatible with the fixed-point chips. The C30 is available in a slower, lower-cost version called the C30-27. The C31 is object-code compatible

with the C30 and C30-27, but has only one serial port, one parallel port, and one timer. This feature reduction decreases the chip size and pin count, which allows TI to offer a floating-point DSP for \$35 in high volume.

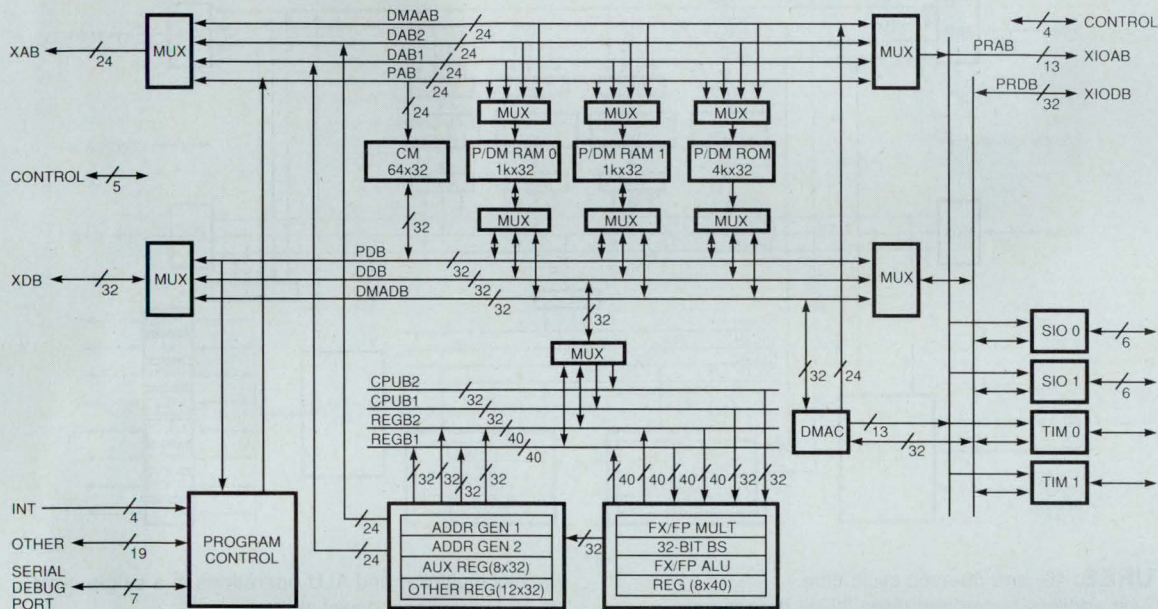

FEATURES: 50-, 60-, and 74-nsec cycle-time versions. Four 24-bit address buses and three 32-bit data buses. Two 32-bit and two 40-bit additional buses in the CPU. Separate program, data, and DMA buses. Each internal RAM and ROM allows two accesses per cycle. Any of the separate memories can be used for program or data. Two on-chip $1k \times 32$ -bit RAMs and an on-chip $4k \times 32$ -bit ROM. 24-bit external memory-address bus provides $16M \times 32$ -bit total address space. 13-bit external-I/O address bus provides $8k \times 32$ -bit I/O ports, which are mapped into the 16-Mbyte address space. Two 8-, 16-, 24-, and 32-bit serial I/O ports. Two 32-bit timers. Proprietary 2's-complement 32-bit floating-point format. Multiplier accepts 32-bit floating-point data and returns 40-bit floating-point result. 24-bit integers result in 32-bit fixed-point results. ALU operates on 40-bit floating-point and 32-bit fixed-point data.

Parallel multiplier and ALU operations in a single cycle. 32-bit bidirectional barrel shifter. Eight 40-bit register-based accumulators. Single-instruction and zero-overhead block looping. 64×32 -bit instruction cache. Cache can be disabled when not needed and frozen to keep an often-used portion of code available in the cache. Register, direct, indirect, immediate, relative, circular, and bit-reversed addressing modes. Two address ALUs. DMA controller allows concurrent I/O and CPU operation. Hardware pointer to software stack. Four external vectored interrupts. Hardware and software-programmable wait states. Serial debug port can provide in-circuit emulation. Packaging: C30, 180-pin PGA. C30-27, 180-pin PGA. C31, 132-pin QFP.

HARDWARE

SUPPORT

SOFTWARE

Full-speed in-circuit emulator for PCs and Sun workstations. Evaluation module plugs into a PC. Significant third-party support. Contact Texas Instruments for a list of third-party vendors. Hewlett-Packard has a version of the HP64700 in-circuit emulator for the C30.

Optimizing ANSI C compiler. Source-level debugger and code profiler. (PC or Sun). Assembler/linker. Simulator. (PC or Sun). Application library. Third-party support includes Spox, Ada compiler, filter-design packages, and block-level diagramming language.

TMS320C40

32-BIT FLOATING-POINT CMOS DSP μ P

AVAILABILITY: Samples available now. Production quantities in 1992.

COST: Samples cost approximately \$500. \$250 (5000).

SECOND SOURCE: None.

Texas Instruments Inc
Semiconductor Group, SC-9026
Box 809066
Dallas, TX 75380
(800) 336-5236, ext 700
Circle No. 685

DESCRIPTION: This device was designed for applications that require the performance of parallel processing. It is upward compatible with the C30, but adds six 32-bit FIFO dual-buffered communication ports, two complete 32-bit external buses, an analysis module that supports multiprocessor debugging via a

JTAG interface, and a 4G-word address space. The chip also features single-cycle conversion to and from the IEEE floating-point standard and a cycle time of 40 nsec. Each communication port can transfer data to and from another C40 at 20 Mbyte/sec without any external logic.

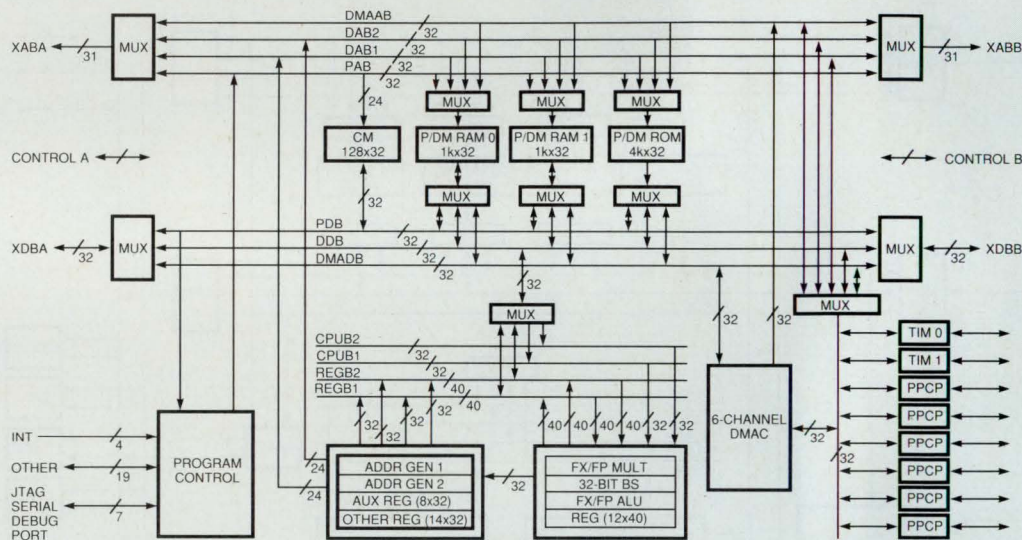

FEATURES:

- 40- and 50-nsec cycle time.
- Four 32-bit address buses and three 32-bit data buses.
- Two 32-bit and two 40-bit additional buses in the CPU.
- Separate program, data, and DMA buses.
- Each internal RAM and ROM allow two accesses per cycle.
- Any of the separate memories can be used for program or data.
- Two on-chip 1k x 32-bit RAMs and a 4k x 32-bit ROM.
- Dual 32-bit external buses. Each has a 31-bit address, so the 4G-word memory is equally divided between the two buses.
- Six independent 32-bit communication ports for glueless communications between C40s. Separate 8 x 32-bit FIFOs for input and output buffering.
- No on-chip serial ports. Two 32-bit timers.
- Proprietary 2's-complement 32-bit floating-point format.
- Single-cycle conversion from and to the IEEE-754 32-bit format.
- Multiplier accepts 32-bit floating-point data and returns 40-bit floating-point data. 24-bit integers result in 32-bit fixed-point results.
- ALU operates on 40-bit floating-point and 32-bit fixed-point data.

- Parallel multiplier and ALU operations in a single cycle.
- 32-bit bidirectional barrel shifter.
- Twelve 40-bit register-based accumulators.
- Single-instruction and zero-overhead block looping.
- 128 x 32-bit instruction cache.
- Cache can be disabled when not needed and frozen to keep an often-used portion of code available in the cache.
- Register, direct, indirect, immediate, relative, circular, and bit-reversed addressing modes. Two address ALUs.
- 6-channel DMA controller for concurrent I/O and CPU operation. Transmitting DMA can control the operation of the receiving DMA, so setup for DMA transfer will not affect CPU.
- Hardware pointer to software stack.
- Four external vectored interrupts.
- Hardware and software-programmable wait states.
- JTAG-based debug port controls the analysis module, which functions as an in-circuit emulator. Multiple C40s can be debugged via JTAG interface.
- Packaged in a 325-pin ceramic PGA.

HARDWARE

Development system includes in-circuit emulation via JTAG interface.
4-processor host-independent evaluation board.

SUPPORT

Optimizing ANSI C compiler with parallel-processing runtime support.
Source-level debugger. Assembler/linker.
Simulator.
Application library.
Third-party support includes Spox with drivers for parallel processing.

SOFTWARE

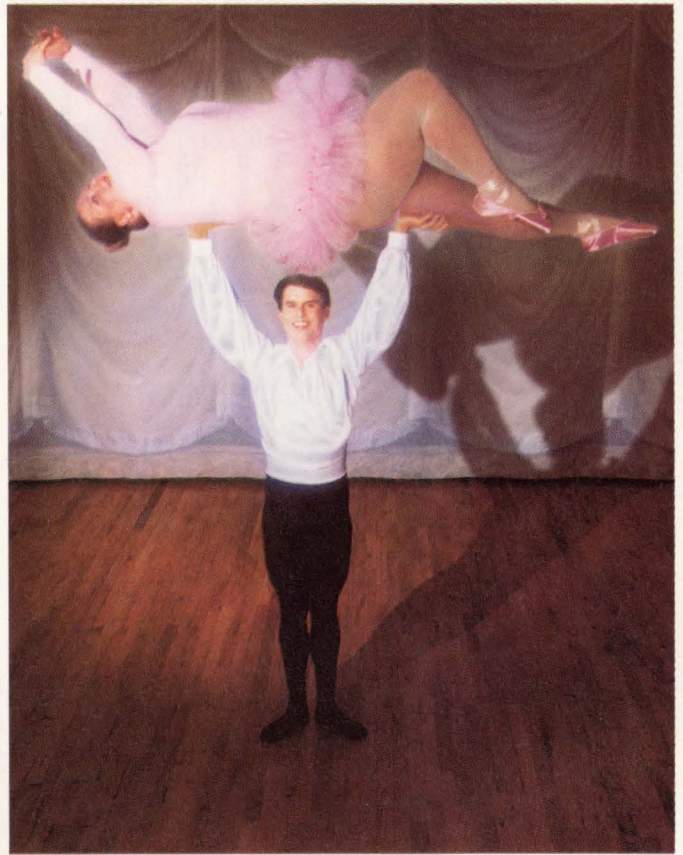
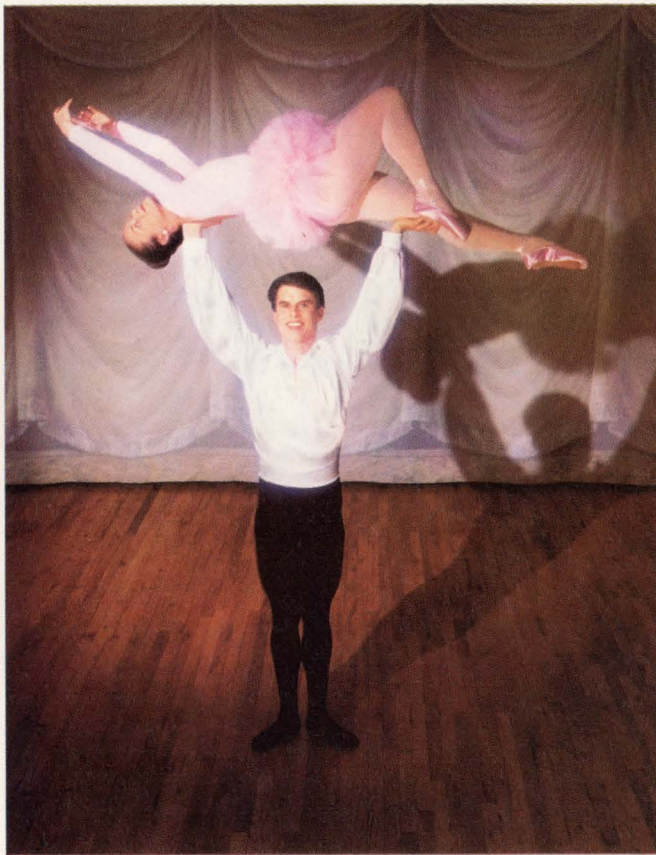

Now, up to twice the power of a standard battery.

Introducing Nickel-Metal Hydride and ULTRAMAX™ Nickel-Cadmium batteries, two new rechargeables from Gates that are certain to give you a lift.

Ni-MH offers up to 100% more capacity than a standard Ni-Cd battery, while

our ULTRAMAX line offers up to 70% more capacity.

And, with this increase in power comes unequalled design flexibility, such as longer run time, additional features, or downsizing without sacrificing performance. To contact a sales engineer near you, give us a call at 1-800-67-POWER. And see for yourself why no other battery carries as much weight.

 **Energy
Products**

THINK FAST. THINK LINEAR.



15 New High Speed Op Amps.

No Sacrifice For Speed. Not with Linear's new family of high speed op amps. LT1122, 1220, 1221, and 1222 provide 12 bit performance with nsec settling and bandwidths to 45 MHz. The LT1224, 1225 and 1226 are general purpose parts with the capability to drive unlimited capacitive loads. LT1190, 1191 and 1192 are video speed op amps with differential gain and phase errors of 0.1% and 0.06°. The LT1223, 1229 and 1230 are single, dual and quad current feedback amplifiers with high output drive current (50mA) and professional video quality differential gain and phase.

LT1228 is a high speed gain controlled amp with guaranteed operation down to $\pm 2V$ or 4V single supply and output swing to within 1V of the rails.

LT1122 is a JFET input op amp which slews 80V/ μs . LT1193 and 1194 are video differential input amplifiers with programmable or fixed gain powered from single 5V or $\pm 5V$ supplies with $\pm 50mA$ output drive.

Singles and duals are available in 8-pin DIP and 8-pin SOIC package, quads in 14-pin. For data sheets and a comprehensive 132 page application note contact Linear Technology Corporation, 1630 McCarthy Blvd., Milpitas, CA 95035. Or call 800-637-5545.

Parameter	1220	1224	1191	1223	1122	Units
S.R. Slew Rate (Typ)	250	400	450	1000	80	V/ μsec
G.B.W. Gain Bandwidth (Typ)	45	45	90	100	14	MHz
t_s Settling Time (to 0.1%) (Typ)	90	90	100	75	340*	nsec
AVOL Open Loop Gain (Typ)	50	7	45	28	450	V/mV
VOS Offset Voltage (Max)	1	2	6	3	0.9	mV
IOS Offset Current (Max)	0.3	0.4	1	—	.00005	μA
IB Bias Current (Max)	0.3	8	1.7	3	.0001	μA
e_n Voltage Noise (f = 10KHz)	17	22	25	3.3	15	nV/ \sqrt{Hz}
i_n Current Noise (f = 10KHz)	3	1.5	4	2.1	.002	pA/ \sqrt{Hz}
Min Gain Stable	1	1	1	1	1	
IS Supply Current (Max)	10.5	9	40	10	11	mA
Price (100's) \$ (PDIP)	3.85	2.85	2.40	2.85	2.50	

*12 Bit Settling Time



TOUGH PRODUCTS
FOR TOUGH APPLICATIONS.

32-BIT FLOATING-POINT CMOS DSP μ P

AVAILABILITY: Now.

COST: 34325 (25 MHz), \$137; 34325 (20 MHz), \$124 (10,000).

SECOND SOURCE: None.

Zoran Corp
1705 Wyatt Dr
Santa Clara, CA 95054
(408) 986-1314
FAX (408) 986-1240
Circle No. 686

DESCRIPTION: The ZR34325 is a vector-signal processor, which is a DSP chip that operates on complex data and large blocks of data with single high-level instructions. The instruction set includes a single instruction to calculate an FFT, FIR filter, IIR filter, and other complex functions. The highly specialized

architecture is optimized to perform these functions quickly. The architecture also eases programming because the programmer doesn't have to write code for complex DSP functions. The 32-bit floating-point data conforms to the IEEE-754 standard.

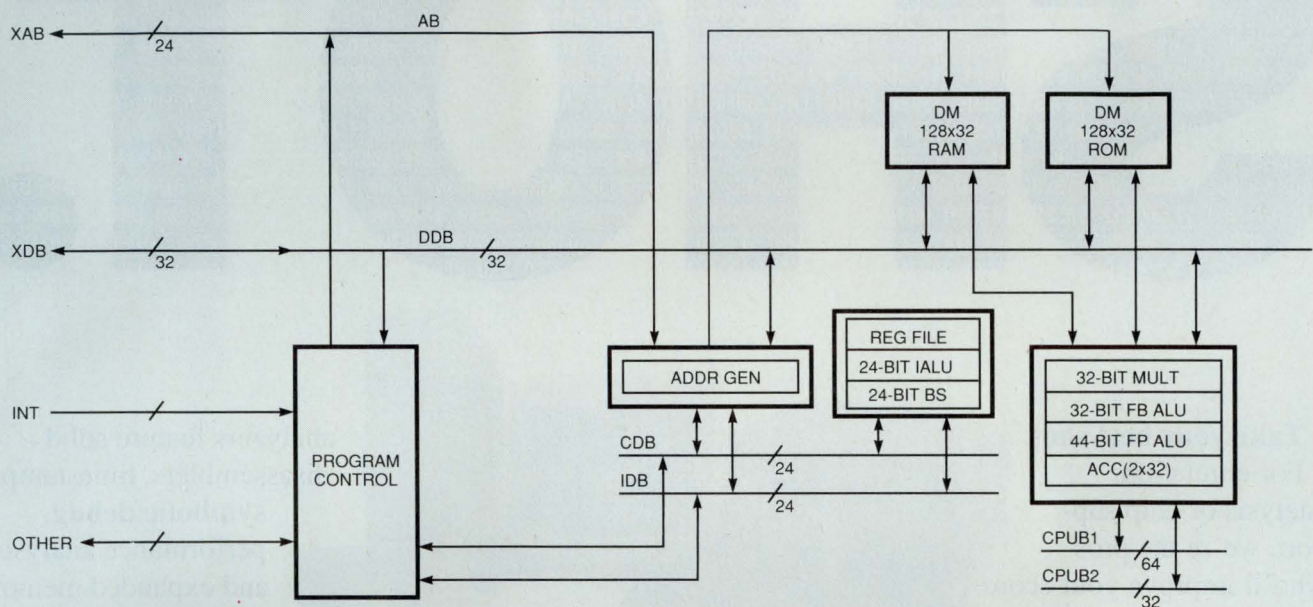

FEATURES: 80- and 100-nsec cycle-time versions.

Single address and data bus.

Vector instructions generally take longer to execute than to fetch, so little speed penalty is incurred with this simple bus architecture.

High-level instructions, such as those to calculate FFTs and FIR and IIR filters, simplify programming:

256 x 32-bit coefficient dual-port ROM and 128 x 32-bit dual-port RAM on chip.

No on-chip program memory.

Internal memory can be directly accessed by external device.

16M x 32-bit memory space.

No on-chip peripherals.

IEEE-754 32-bit floating-point format.

Multiplier accepts 32-bit floating-point data and creates 44-bit results.

Three ALUs: two floating point and one integer. 32-bit floating-point data can be added to 32 bits with one ALU and to 44 bits with the other.

24-bit bidirectional barrel shifter.

Two 32-bit accumulators.

No zero-overhead looping.

Direct, indirect, register, immediate, circular, and bit-reversed addressing modes.

Address generators for internal RAM and ROM.

On-chip DMA.

Slave mode opens chip to external access.

Hardware stack maintained in main memory.

Single external interrupt.

Hardware wait states.

No on-chip emulation port.

No low-power mode.

Packaged in an 84-pin PGA or 84-pin QFP.

HARDWARE

Hardware-development-system board.
VME bus-based product for development.
Third-party hardware available.

SUPPORT

Assembler/linker/simulator (MS-DOS and VAX/VMS).
Application library (MS-DOS and VAX/VMS).
Ada Compiler for VAX/VMS.

SOFTWARE



Take your best shot.

For emulation, analysis or chip support, we're the pros who'll improve your score.

We're American Arium, and we've created a winning combination: EZ-PRO® development software and emulators from American Automation and high-performance logic analyzers from Arium.

From the RCA 1802 to the Intel i960, the **Motorola 68040** to the MIPS R3000A, we now deliver support for virtually any chip you select.

Our development systems will keep your embedded projects on course with compilers, assemblers, **C source level debug**, variable tracking, extensive triggering and selective trace. To give you an easy shot at debugging, our logic

EZ-PRO is a registered trademark of American Automation



Arium's ML4400 configurable logic analyzer for 80486. Priced from \$9,785

EZ-PRO Development System for 68302. Priced from \$9,940

analyzers feature solid disassemblers, timestamp, **symbolic debug**, performance analysis and expanded memory with high-speed timing to **400 MHz**. And to keep you clear of hidden traps, we've developed a fully integrated set of relocating

linkers, assemblers, language translators, disassemblers and more than 20 different cross compilers.

Make your next project an easy chip shot. Call the pros: American Arium.



Formerly American Automation & Arium

"See us at Wescon booth #2134 & 2136"

**14281 Chambers Road, Tustin, CA 92680 Fax: (714) 731-6344
EZ-PRO Division (714) 731-1661 • Arium Division (714) 731-2138**

© American Arium 1991

Circle #44 for Logic Analyzer Information

Circle #45 for Development Systems Information

DESIGN IDEAS

EDITED BY ANNE WATSON SWAGER

High-frequency VCOs top 100 MHz

Di Paolo Franco
Ericsson Fatme, Rome, Italy

VCOs that use surface-acoustic-wave (SAW) filters have higher operating frequencies and higher pull ranges than do circuits that use crystal oscillators. Figs 1 and 2 present two practical realizations of SAW-filter-

based VCOs. The circuits' operating frequencies are 140 and 181 MHz, respectively. The differences between the two figures stem from that fact that two types of SAW filters are available. Fig 1's circuit uses a SAW filter that has 180° of phase shift. The filter in Fig 2 has a phase shift of 0°. Both circuits draw about 20 mA and operate from a 5V supply.

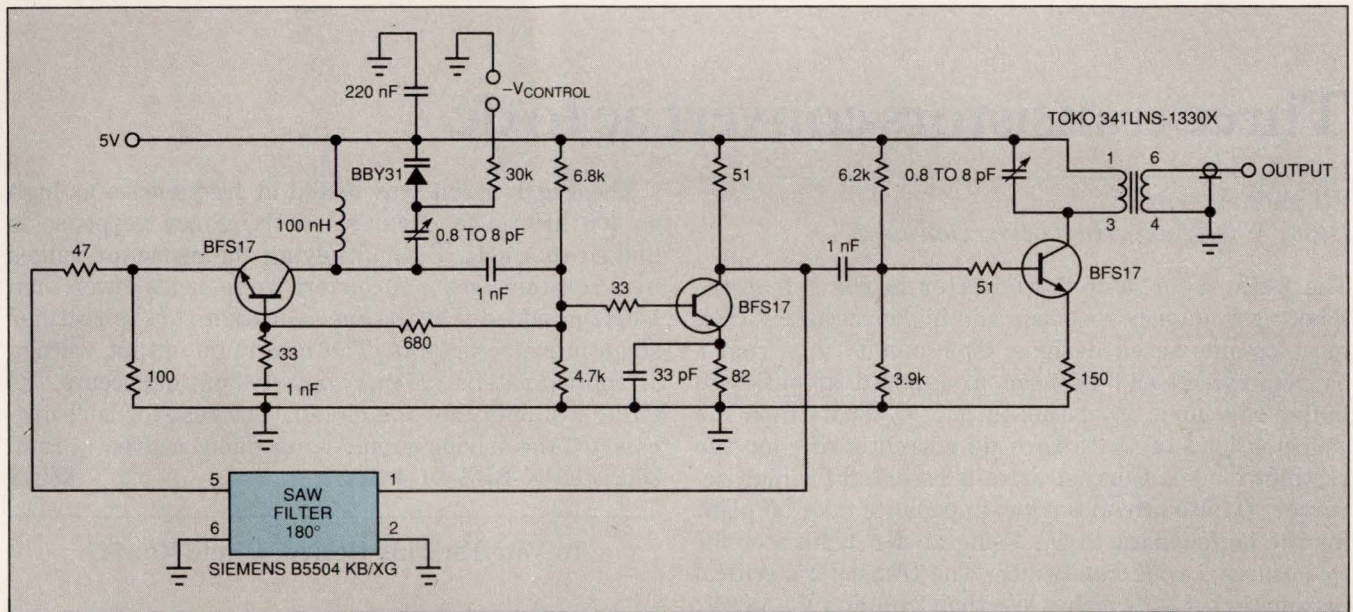

Fig 1—This oscillator is based on a 180° phase-shift SAW filter and has a free-running frequency of 140 MHz.

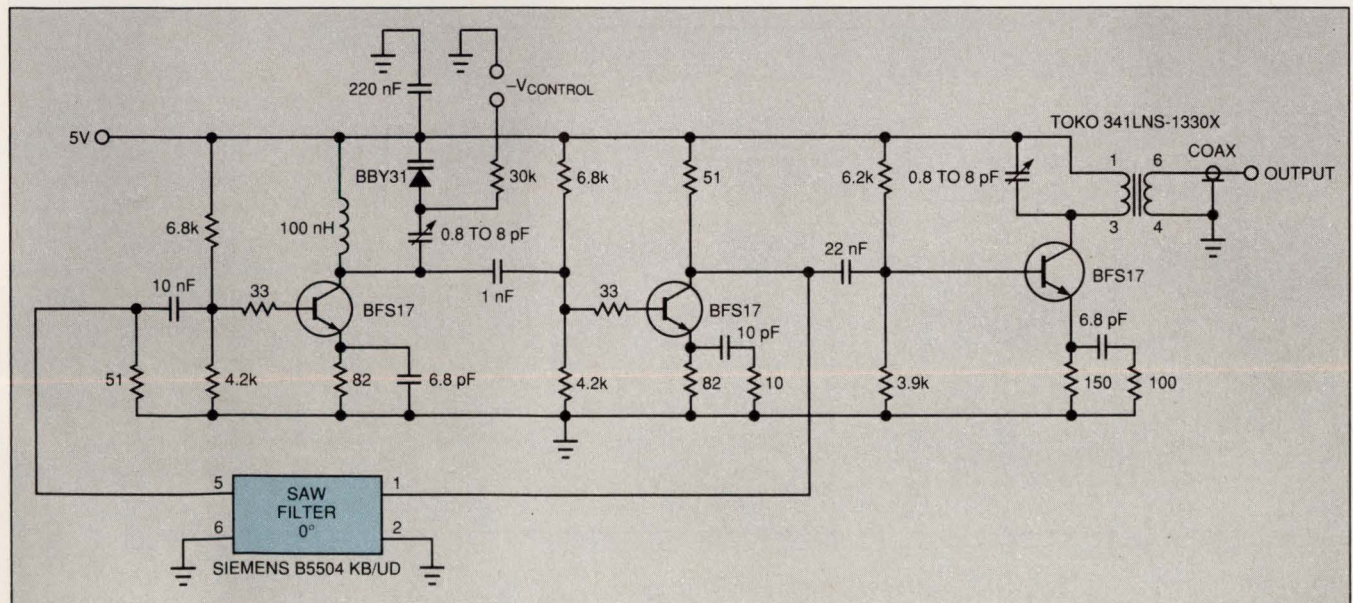

Fig 2—This oscillator is based on a 0° phase-shift SAW filter and has a free-running frequency of 181 MHz.

DESIGN IDEAS

Each circuit's operating frequency is solely dependent on the SAW filter's passband center frequency, which can be higher than 1000 MHz. The SAW filters have a pull range near 500 ppm when the BBY31 varactor diode's control voltage, $V_{CONTROL}$, varies by 4V.

These circuits' typical p-to-p voltage when driving a 50 Ω load is 600 mV. The spectrum of the output signals is such that all the harmonics are below 25 dB with respect to the carrier. The variation with temperature when the circuits run in the free-running mode is 100 ppm, which is typical for SAW filters.

Crystal oscillators tend to be more stable over their operational frequency range than are SAW-based oscillators. However, that range is limited compared with the range of SAW-based oscillators. SAW filters are available with center frequencies starting at 120 MHz. The components cost of **Fig 1** and **Fig 2**, without the SAW filter, is about \$1 each. SAW filters cost about \$25. EDN BBS DI #1030

EDN

To Vote For This Design, Circle No. 746

Three transistors convert ac to dc

Stephen Theobald
Bang & Olufsen, Harboøre, Denmark

The 3-transistor ac-to-dc converter in **Fig 1** features a better frequency response and higher accuracy than most op-amp-based designs. The circuit runs from a 5V supply. Q_1 and Q_2 form a standard amplifier to buffer the input from the output. Q_3 bootstraps the collector load of Q_2 to provide current drive for the rectifier diodes. Current drive is essential for high accuracy. Q_2 also provides a low-impedance take-off point for the dc feedback to Q_1 . Using an RF transistor for Q_2 ensures a wide bandwidth. The transistor's critical parameter is C_{OB} , which is less than 2 pF at a V_{CE} of 2V.

The **Fig 1** circuit was tested at frequencies as high as 300 kHz. The circuit's low-frequency response is limited to 1 kHz. By multiplying the capacitor values by a constant, you can convert frequencies lower than 1 kHz provided that the time constants of the rectifier stage prove acceptable. The maximum output voltage is approximately 800 mV before limiting occurs. R_1 ensures stability for the circuit. The resistor isn't necessary if the driving circuit's impedance is greater than 300 Ω . EDN BBS DI #1033

EDN

To Vote For This Design, Circle No. 747

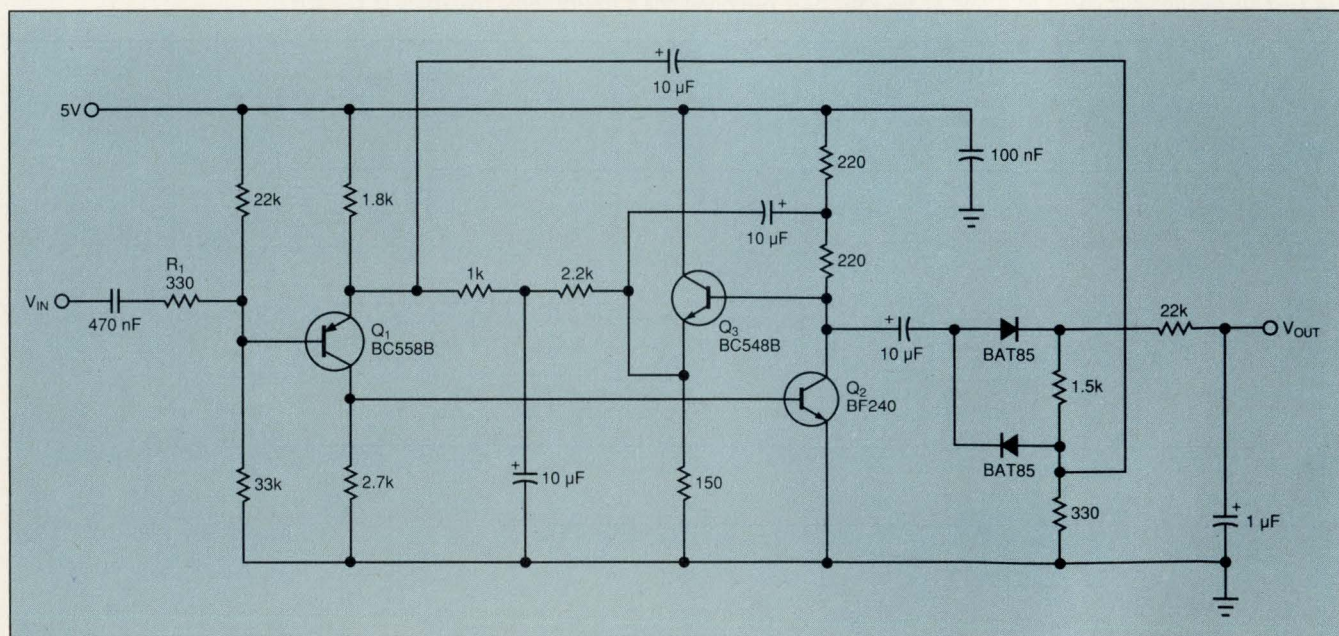
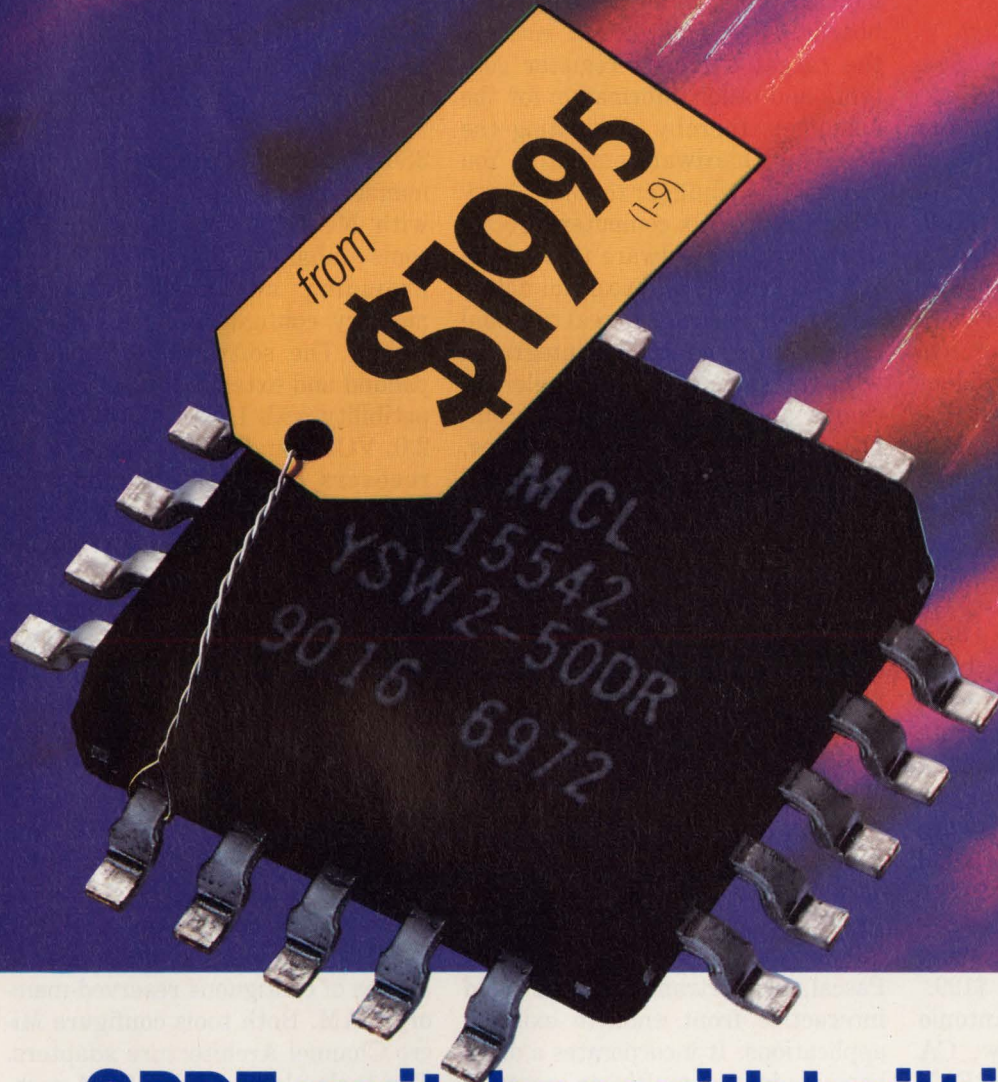

Fig 1—To ensure accuracy, Q_3 of this ac-to-dc converter bootstraps the collector load of Q_2 to provide current drive to the rectifier diodes.

incredible!



SPDT switches with built-in driver

ABSORPTIVE or REFLECTIVE dc to 5GHz

Truly incredible...superfast 3nsec GaAs SPDT reflective or absorptive switches with built-in driver, available in pc plug-in or SMA connector models, from only \$19.95. So why bother designing and building a driver interface to further complicate your subsystem and take added space when you can specify Mini-Circuits' latest innovative integrated components?

Check the outstanding performance of these units...high isolation, excellent return loss (even in the "off" state for absorptive models) and 3-sigma guaranteed unit-to-unit repeatability for insertion loss. These rugged devices operate over a -55° to +100°C span. Plug-in models are housed in a tiny plastic case and are available in tape-and-reel format (1500 units max, 24mm). All models are available for immediate delivery with a one-year guarantee.

SPECIFICATIONS (typ)

	Absorptive SPDT YSWA-2-50DR ZYSWA-2-50DR			Reflective SPDT YSW-2-50DR ZYSW-2-50DR		
	dc-	500-	2000- 5000	dc-	500-	2000- 5000
Frequency (MHz)						
Ins. Loss (dB)	1.1	1.4	1.9	0.9	1.3	1.4
Isolation (dB)	42	31	20	50	40	28
1dB Comp. (dBm)	18	20	22.5	20	20	24
RF Input (max dBm)	20			22	22	26
VSWR "on"	1.25	1.35	1.5	1.4	1.4	1.4
Video Bkthru (mV,p/p)	30	30	30	30	30	30
Sw. Spd. (nsec)	3	3	3	3	3	3
Price, \$	YSWA-2-50DR (pin) 23.95			YSW-2-50DR (pin) 19.95		
(1-9 qty)	ZYSWA-2-50DR (SMA) 69.95			ZYSW-2-50DR (SMA) 59.95		



finding new ways ...
setting higher standards

Mini-Circuits

P.O. Box 350166, Brooklyn, New York 11235-0003 (718) 934-4500 Fax (718) 332-4661 Telexes: 6852844 or 620156

CIRCLE NO. 71

F141 REV. C

NEW PRODUCTS

SOFTWARE DEVELOPMENT TOOLS

Data-Transfer Program

- *Converts Macintosh to DOS*
- *Requires no hardware or software modifications*

The PC version of Common-Link, Mac-In-DOS, lets you format Macintosh disks in your IBM PC or compatible disk drive. The software runs under Microsoft Windows 3.0. No special hardware is needed to perform conversions. The software shows listings of two directories of files side by side on the screen. On one side are the Mac files resident on a Mac disk in the drive; on the other side are the DOS files in a selected directory on the hard drive or on a disk in another drive. Files are copied from one side to the other; conversions take place automatically. Because Mac files have three parts and DOS files have one, during Mac to DOS transfers, tutorial notes pop up with prompts to let the user select the appropriate conversion level. In DOS-to-Mac transfers, the DOS files are placed in a dummy Mac file. The software comes on a DOS disk and is loaded on the DOS computer. No hardware modification is needed for either machine, but both machines must have 1.44-Mbyte disk drives. \$199.

Pacific Micro, 201 San Antonio Circle C250, Mountain View, CA 94040. Phone (415) 948-6200. FAX (415) 948-6296. **Circle No. 351**

C Compiler And Source-Level Debugger

- *Connect DOS or Unix computer to target hardware*
- *Software provides source-level debugging on target system*

The Crosscode C compiler and Freeform source-level debugger are tailored specifically for Motorola MVME-165 VME CPU and 6800-series evaluation boards. The tools provide source-level debugging directly on the target system. The de-

bugger includes a transparent-monitor program for the evaluation boards. The monitor can retrieve the target system's register contents and other information for the debugger, thereby eliminating the need for a hardware emulator. You can use the debugger to connect any MS-DOS or Unix computer directly to the target hardware through an RS-232C cable. The tool can debug fully optimized code in real time and can run on a laptop. It is integrated with the compiler; the compiler includes an ANSI-standard C compiler, a macro relocating assembler, linker, librarian, download, symbol listing routines, and startup routine. The tools come bundled together. \$3490.

Software Development Systems Inc, 4248 Belle Aire Lane, Downers Grove, IL 60515. Phone (708) 971-8170. **Circle No. 352**

Visual Programming Tool

- *Object-oriented, visual system*
- *Imports C, Pascal, Fortran code*

This version of Prograph 2.5 can graph code, including interfaces. It allows you to import existing C, Pascal, or Fortran code and build interactive front ends to existing applications. It incorporates a database engine for multiuser access to tables, indices, and data types. The software is compatible with the Macintosh System. The system lets you define program classes and modules graphically. Modules are defined as data-flow diagrams, using processing nodes. Prograph has an interface builder for the automatic generation of interface objects from a set of supplied System Classes. Prograph 2.5, \$495; C and Pascal interfaces, \$75 each; Fortran interface, \$149.

TGS Systems, 2745 Dutch Village Rd, Suite 200, Halifax, Nova Scotia, Canada B3L 4G7. Phone (902) 455-4446. **Circle No. 353**

Memory-Management Software

- *Manages multiple memory resources*
- *Compatible with MS- and PC-DOS*

386Max and Bluemax memory-management tools are compatible with MS-DOS and PC-DOS. The tools enhance DOS's abilities by providing advanced automatic memory configuration and optimization. The software provides expanded and extended memory compatibility with LIM EMS 4.0, XMS 2.0, VCPI, and VDS. The software recovers available memory resources and automatically relocates resident software into previously unused memory regions. Automatic ROM caching improves system performance. Video RAM and ROM, other adapter RAM and ROM, and the system ROM BIOS are located within the reserved-memory region. Both tools automatically recover the monochrome area of DOS memory. The 386Max identifies and recovers unused filler patterns within the ROM BIOS; Bluemax automatically compresses the PS/2 BIOS and provides an additional 80 kbytes of contiguous reserved-memory RAM. Both tools configure Micro Channel Architecture adapters. The tools also perform ROM caching and resident software instancing and can swap the fastest system memory into the first megabyte of memory. The tools require 1 kbyte of memory. The tools come bundled with the ASQ system analyzer and memory-management tutorial and the 386Cache disk-cache program. The cache program loads its executable DOS into high DOS while leaving track buffers in conventional memory. 386Max, \$130; Bluemax, \$155.

Qualita Inc, 7101 Wisconsin Ave, Suite 1386, Bethesda, MD 20814. Phone (301) 907-6700. FAX (301) 907-0905. **Circle No. 354**

ANNOUNCING THE NEW
PADS-UNIX

WE'LL GIVE YOU THE WORLD

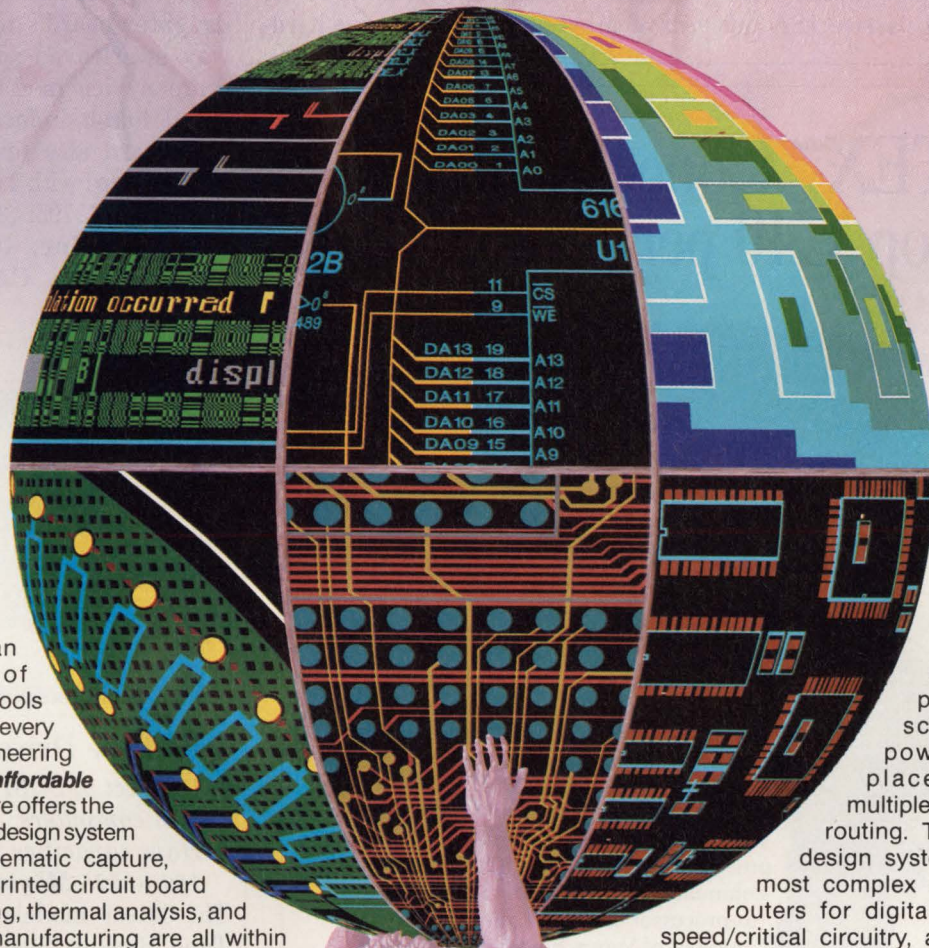

... Of Electronic Design

You asked for an integrated set of CAE/CAD design tools which could deliver every aspect of your engineering design needs **at an affordable price**. CAD Software offers the highest performing design system for your PC. Schematic capture, logic simulation, printed circuit board design, auto-routing, thermal analysis, and computer aided manufacturing are all within the PADS Design system.

Your design begins with **PADS-Logic**, the only PC-based schematic capture system which has a true multi-sheet database for quick and accurate design capture and data transfer to your PCB design. PADS-Logic has a large circuit capacity of over 1,000 equivalent IC's per design, a Hierarchical design ability with an unlimited number of levels, superb analog design capability, forward and backward annotation, a Part Editor and Graphical Library browsing.

PADS-PCB sets the standard for affordable high performance PCB design. A one mil database, 30 layers, automatic design rules checking, SMD ability, excellent interactive routing, and a set of ECO routines which ensure fast accurate changes, are just some of the features which have made PADS-PCB the #1 selling PC based PCB design system.

NEW! PADS-UNIX operates on the Sun Sparc Station family and contains all of the advanced features of the widely used **PADS 2000** product, including schematic capture, powerful component placement aids, and multiple approaches to track routing. This advanced PCB design system can handle the most complex designs, with auto-routers for digital, analog and high speed/critical circuitry, an unlimited design capacity, ERC and DRC checking, intelligent copper pour and T-routing, 0.1° parts/pads rotation, and much more!

Call CAD Software today for your local Authorized Reseller, or for a no-cost Evaluation Package, and experience the world of electronic engineering design:

CAD
Software, Inc.

(800) 255-7814
Inside MA
(508) 486-8929

119 Russell Street, Littleton, MA 01460

NEW PRODUCTS

COMPUTERS & PERIPHERALS

Industrial 80486 Single-Board Computer

- Has eight SIMM sockets for as much as 32 Mbytes of DRAM
- Operates at 25 or 33 MHz

The QPC-5160 single-board computer (SBC) for a passive ISA bus

backplane contains an Intel 25- or 33-MHz 80486 μ P. It also has eight SIMM (single-inline-memory-module) sockets for as much as 32 Mbytes of dynamic RAM (DRAM). Memory options are 1, 2, 4, 8, 16, or 32 Mbytes. In addition, the hard-

ware supports the LIM 4.0 specification. You can expand the memory to 64 Mbytes, using a piggy-back daughter board. The SBC's DRAM features page-mode and 2-way interleaved access modes, and the daughter-board's memory has a 4-way interleaved access mode. The company designed the SBC to withstand harsh industrial conditions. The board also features a shadow RAM. Board with 4 Mbytes of DRAM (25 MHz), \$3795; (33 MHz), \$4195.

Qualogy Inc., 109 Bonaventure Dr., San Jose, CA 95134. Phone (408) 434-5200. **Circle No. 355**

VORTEX™ Concentrates I/O for top 'C40 performance

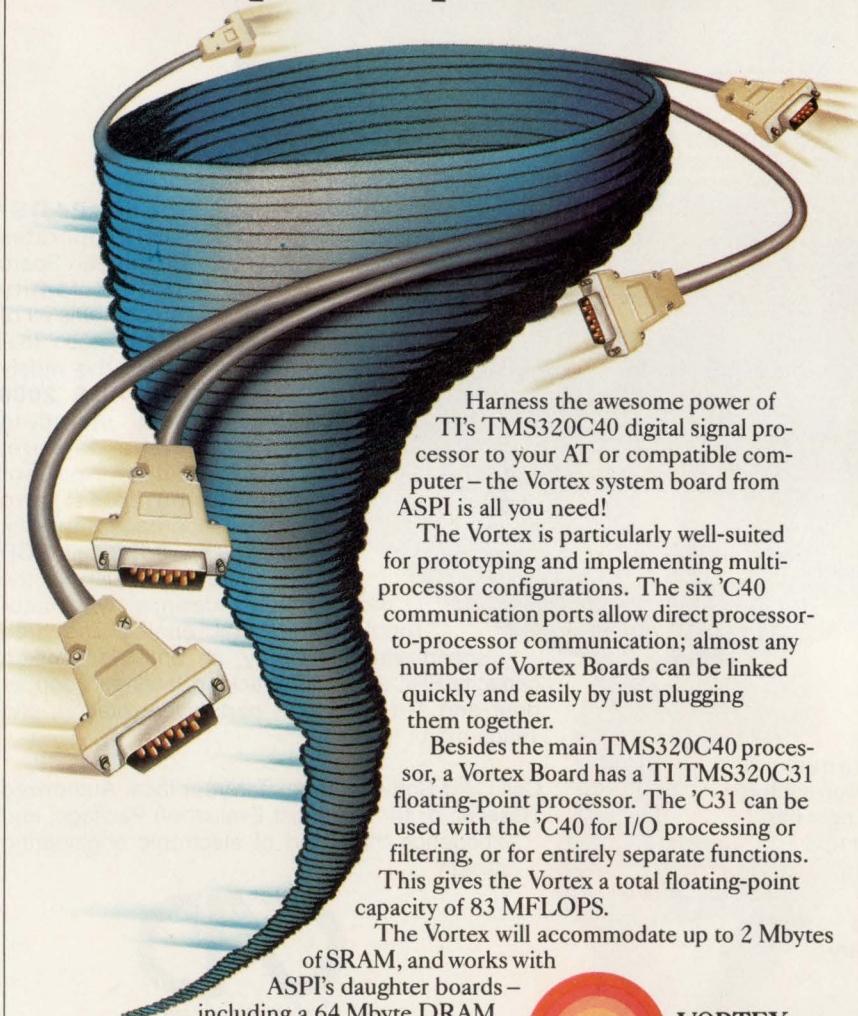

Harness the awesome power of TI's TMS320C40 digital signal processor to your AT or compatible computer – the Vortex system board from ASPI is all you need!

The Vortex is particularly well-suited for prototyping and implementing multi-processor configurations. The six 'C40 communication ports allow direct processor-to-processor communication; almost any number of Vortex Boards can be linked quickly and easily by just plugging them together.

Besides the main TMS320C40 processor, a Vortex Board has a TI TMS320C31 floating-point processor. The 'C31 can be used with the 'C40 for I/O processing or filtering, or for entirely separate functions. This gives the Vortex a total floating-point capacity of 83 MFLOPS.

The Vortex will accommodate up to 2 Mbytes of SRAM, and works with ASPI's daughter boards – including a 64 Mbyte DRAM board, digital audio interface and general A-D/D-A systems.

Ask today for full details on this remarkable new DSP system.



Atlanta Signal Processors, Inc. • 770 Spring Street
Atlanta, GA 30308 USA
(404) 892-7265 • FAX: (404) 892-2512

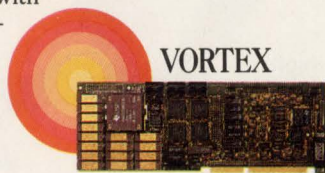

QIC Tape Drives

- Connect to SCSI port on Macintosh computers
- Have capacities ranging from 150 to 525 Mbytes

The latest models of the Panther Tape Backup System are compatible with Apple's Macintosh Macplus, SE, SE 30, MAC II, IICX, IICI, and portable computers. Because the 5¼-in. drives employ the SCSI bus, you can attach them directly to the computer's SCSI port without using a host adapter board. The drives have capacities ranging from 150 to 525 Mbytes. The 525-Mbyte model can back up the entire tape in less than 45 minutes. Backup and restore rates range from 5 Mbytes/minute to 12 Mbytes/minute. The drives perform file-by-file and image backups, and they are compatible with the A/UX operating system. The

units use DC 6000 or equivalent tape medium, and the MTBF is 80,000 hours. Bit error rate is less than 10^{-15} . 150-Mbyte drive, \$2145; 525-Mbyte drive, \$2695.

Tandberg Data Inc, 2649 Townsgate Rd, Suite 600, Westlake Village, CA 91361. Phone (805) 495-8384. **Circle No. 356**



386 Personal Computer

- Employs AMD's 40-MHz 80386 μ P
- Has 4 Mbytes of DRAM and one 64-kbyte cache RAM

The 386WB-40SL ISA bus personal computer employs AMD's 40-MHz 80386 μ P. The computer comes with 4 Mbytes of dynamic RAM, a 200-Mbyte hard-disk drive, a 14-in. super VGA monitor, a 1-Mbyte VGA Freedom Card, and 64 kbytes of cache RAM. The RAM is expandable to 64 Mbytes. In addition, the computer has FCC Class B approval, a parallel port, and two serial ports. Other features include a mouse, and DOS 4.01 and Windows 3.0 software. A 6-month GE on-site service contract, which is optionally expandable to five years, is also available. \$2999.

Bell Computer Systems, 6615 Valjean Ave, Van Nuys, CA 91406. Phone (818) 909-3501. **Circle No. 357**

80386 Mother Board

- Employs AMD's 40-MHz 80386 μ P
- Has 64-kbyte cache RAM expandable to 128 kbytes

The 386 Cache 40 Mini-AT mother board uses AMD's 40-MHz 80386 μ P. It has 64 kbytes of cache RAM

that's expandable to 128 kbytes. You can install as much as 32 Mbytes of dynamic RAM, using single inline memory modules. The board has eight 16-bit ISA bus expansion slots and a socket for an 80387 coprocessor. A shadow RAM for the system BIOS and video BIOS increases the execution speed as much as three times. The

mother board runs Windows, OS/2, MS-DOS, Unix, Xenix, and Novell software. Performance figures include a 63.6 Landmark Speed (1.14), 8.55 Power Meter MIPS (1.5), and a Norton SI rating (4.5) of 48. \$855.

Pioneer Computer Inc, 49066 Milmont Dr, Fremont, CA 94538. Phone (415) 623-0808. **Circle No. 358**

*Looking for a way to
reduce shorting potential
in a modular jack?*

We've got it covered.

Because contacts are exposed in most modular jacks, the chance of a thousand volts jumping from the jack to the nearest conductor is very real.

Molex's 41314 series of modular jacks greatly reduce the risk of shorting because their top is covered by the jack's plastic housing. This cover not only protects, but adds an extra margin of design flexibility by allowing PCBs to be stacked together more closely.

Each Molex Modjack must pass three functional tests, including on-line hi-pot testing. Jack contacts are plated after stamping, eliminating bare edges in critical areas. Molex Modjacks also meet all FCC 68.5 and UL 1863 requirements.

Assembly to board, both robotic and manual, is more efficient because contact tails lock securely into housing, assuring precise location.

For the widest selection of modular jack sizes, types and configurations, contact Molex.



Bringing People & Technology Together, WorldwideSM

Corporate Headquarters: 2222 Wellington Ct., Lisle, IL 60532 U.S.A., Tel: (708) 969-4550

European Headquarters: Munich, West Germany, Tel: 49-89-413092-0

Far East North Headquarters: Tokyo, Japan, Tel: 81-427-21-5539

Far East South Headquarters: Jurong Town, Singapore, Tel: 65-660-8555

© 1991, Molex Incorporated

Technical calculations made easy!

ALL NEW VERSION 3.0!

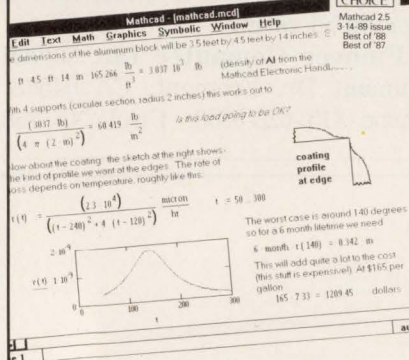

Now it's easier than ever to perform faster, more reliable engineering and scientific calculations.

- **Windows graphics features make Mathcad 3.0 the simple solution to complex analytic needs.** Dialogs, pull-down menus, and mouse point-and-click capabilities make it easy to combine equations, text, and graphics right on your screen and print it all in a presentation-quality document.
- **New Electronic Handbook Help facility serves as an on-line reference library.** Paste standard formulas, constants, and diagrams from searchable, hypertext Electronic Handbooks for instant use in your Mathcad worksheet.
- **Symbolic calculations with a simple menu pick.** Use expressions resulting from symbolic derivations in your numeric calculations or for further symbolic manipulation.
- **Mathcad works on PC DOS, PC Windows, Macintosh, or UNIX.** More than 120,000 engineers, scientists, and educators already use Mathcad for a variety of technical applications. Applications packs are also available to customize Mathcad for particular disciplines, including electrical, mechanical, and civil engineering and advanced math.

Call 800-MATHCAD or use this coupon to request a free 3.0 demo disk!

In Massachusetts, call 617-577-1017. Please specify diskette size:

3 1/2" 5 1/4"

For a free Mathcad 3.0 Introductory kit, clip this coupon and mail it back to us, or fax it to 617-577-8829. Or circle your reader service card.

Yes! Tell me more about Mathcad 3.0!

Name _____

Title _____

Company or Institution _____

Address _____

City _____ State _____ Zip _____

Phone(_____) _____

MathSoft
+ * v - - x f = &

Mail this coupon to:
MathSoft, Inc.
201 Broadway
Cambridge, MA 02139
USA

TECH 3.0

CIRCLE NO. 75

NEW PRODUCTS

INTEGRATED CIRCUITS

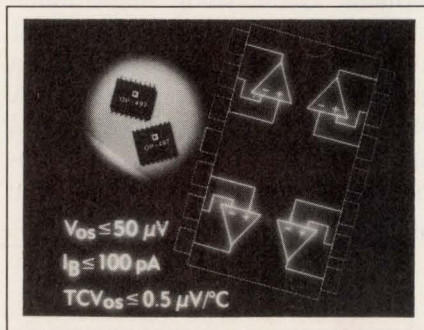

Quad Op Amp

- Offset voltage is 50 μV
- Bias current is 100 pA

According to the company, the OP-497 is the industry's highest precision quad op amp. Guaranteed specifications at 25°C include 50 μV maximum offset voltage with offset drift of 0.5 $\mu\text{V}/^\circ\text{C}$; maximum bias current of 100 pA (450 pA at 125°C), and 2000V/mV minimum open-loop

gain. The maximum per-channel supply current is 625 μA . The low offset voltage and high gain eliminate offset trims and additional gain stages in many designs. The super-beta input stage includes bias-current cancellation circuitry that maintains low (pA) bias current over the full operating temperature range. This action contrasts with traditional FET-input amplifiers whose bias current is initially low but typically doubles for every 10°C rise in temperature. Other features include a supply-voltage operating range of ± 2 to $\pm 20\text{V}$, and a 120-dB PSRR and CMRR. The common-mode range extends to within 1V of the operating supply. The quad op amp is available in industrial and military temperature ranges. Package options include 14-pin plastic

Fast Logic Variable Pulse Generator

Features:

- Continuously adjustable.
- Pulse-width variation range: 200 ns.
- Pulse-width resolution: .12 ns.
- Rising-edge trigger.
- Input & output TTL buffered.
- Commercial & military type.

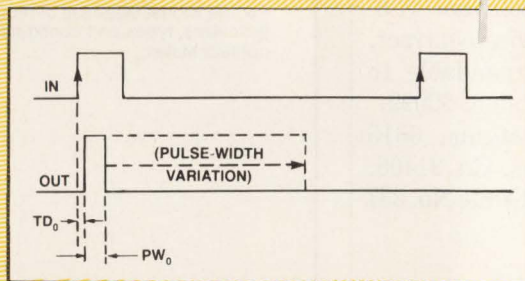
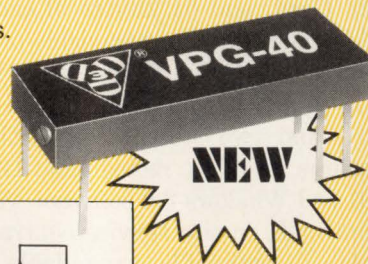

data delay devices, inc.

(201) 773-2299
FAX (201) 773-9672
Clifton, New Jersey 07013

CIRCLE NO. 76

“We saved over \$19,000 at the demo!”



C A H N E R S
CAPS[®]
Computer Aided
Product Selection

Cahners Technical Information Service • 275 Washington Street • Newton, MA 02158-1630
Telephone: 617-558-4960 • Facsimile: 617-630-2168 • Telex: 940573 • Toll-free: 800-245-6696
CAPS is a registered trademark of Reed Publishing (USA) Inc.

EDN October 1, 1991

CAPS[®] is a productivity-boosting engineering tool that helps you find, select, and specify ICs and semiconductors faster and easier than ever before.

“The microfilm system we purchased for IC and semiconductor search and selection just wasn’t working out. It was hard to use and there weren’t enough people using it to justify the cost. So, we decided to evaluate CD-ROM-based systems.

“While all this was happening, our purchasing people found a new IC vendor. They wanted to know if the new vendor made equivalents for some of our most commonly-used components. They thought we could get a better price. It would take us hours to find equivalents on the microfilm system, so we decided to challenge a couple of new CD-ROM-based systems.

“The first demonstration was a flop. Their system didn’t even include the new vendor. Needless to say, we weren’t impressed.

“Then Cahners came to demonstrate the CAPS system. In less than 20 minutes, CAPS found equivalents for the components we wanted. **I figure we saved over \$19,000 at the demo!**

“Oh yes . . . we bought the system!”

— *Frank Lucas*
Test Engineering Manager
Welch Allyn
Data Collection Division



Updated monthly, the CD-ROM (Compact Disc – Read-Only Memory) based CAPS system gives you fast, easy, query-driven access to technical specifications and applications data for over 575,000 ICs and semiconductors made by nearly 500 companies worldwide. Best of all, CAPS provides instant access to hundreds of thousands of pages of complete, unabridged manufacturers’ datasheets, so you have everything you need right at your fingertips.

CIRCLE NO. 77

143

DIP, 14-pin ceramic DIP, 16-pin SOIC, and 20-contact LCC. OP-487GP in 14-pin plastic DIP specified for industrial range, \$4.75 (100).

Analog Devices, PMI Div, 1500 Space Park Dr, Santa Clara, CA 95052. Phone (408) 727-9222.

Circle No. 359

SONET Chip Set

- For STS-3 and STS-12 applications
- Satisfies both SONET and SDH requirements

This 3-piece chip set, consisting of the VP15301, VP15311, and VP15323, satisfies both SONET (Synchronous Optical Network) and SDH (Synchronous Digital Hierarchy) standards. Optimized primarily for STS-3 and STS-12 applications at 155 Mbps and 622 Mbps, respectively, the chip set is usable

at other standardized rates and has been tested to comply with ANSI, CCITT, and Bellcore standards. The VP15301 is used for terminating the section overhead of SONET data streams. The VP15311 is used for terminating line overhead, and

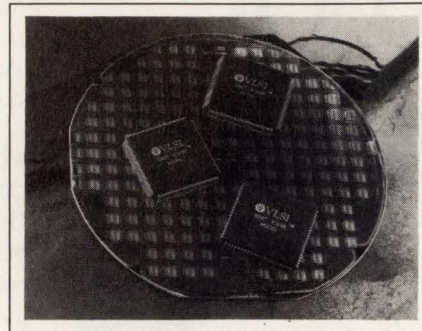

the VP15323 is used for processing and aligning SONET payloads to system timing. The VP15323 can also process concatenated data streams for handling asynchronous transfers and for SDH compatibil-

ity. Package options, which vary by chip and application, include an 84-pin plastic leaded chip carrier, a 144-pin plastic pin-grid array, and a 160-pin plastic quad flatpack. VP15301, VP15311 and VP15323, from \$56, \$90, and \$69, respectively (2000).

VLSI Technology, 1109 McKay Dr, San Jose, CA 95131. Phone (408) 434-3000. FAX (408) 263-2511. Circle No. 360

Power Switching Regulator

- Output switch handles 5A
- Duty cycle is adjustable

Featuring an output-switch rating of 5A, the MC34167 switching regulator comes in a 5-lead TO-220 power package, which simplifies heat sinking. The regulator operates at a fixed frequency of 72 kHz. Because the timing components are on the chip, you don't need an external resistor and capacitor to set the oscillator frequency. In addition to the oscillator and on-chip timing, the regulator contains a latching pulse-width modulator, a high-gain (80 dB) error amplifier, and a high-current (5A) output transistor. The duty cycle is adjustable from 0 to 95%. Protective features include cycle-by-cycle current limiting, under-voltage lockout, and thermal shutdown. A low-power standby mode reduces current drain to 36 μ A. In addition, the regulator has an internal resistor divider, which sets the output at a nominal 5.05V, eliminating the need for an external divider and providing an extra 50 mV to compensate for a 1% voltage drop in external wiring. The regulator is available in two temperature ranges; the MC34167T for 0 to 70°C operation, and the MC33167T for -40 to +85°C operation. MC34167T, \$2.03; MC33167T, \$2.19 (10,000). Delivery, stock to six weeks ARO.

Motorola Inc, EL340, 2100 E Elliot Rd, Tempe, AZ 85284. Phone (602) 897-3615. FAX (602) 897-4193.

Circle No. 361

Dependable

In a molded cable assembly, that means strong and reliable.

Belden's molded cable assemblies give your products the two things they need most: superior mechanical strength at the connector, and reliable electrical performance matched to your system. Belden also gives you more shielding options than anyone else, plus a choice of finishes (textured or smooth). So, when the reputation of your products rides on the quality of the molded cable assemblies you buy from somebody else, there's simply nobody else to consider but Belden.

For more information about Belden's new line of molded cable assemblies, call: 1-800-BELDEN-4



BELDEN

Copyright © 1991, Cooper Industries, Inc.

NEW PRODUCTS

TEST & MEASUREMENT INSTRUMENTS

Enhancement For Jitter-Spectrum Analyzer

- Unit computes spectra of jitter in time measurements
- Instrument requires no external computer

When equipped with Option 040, the HP 5372A modulation-domain analyzer uses FFT techniques to determine the frequency spectrum

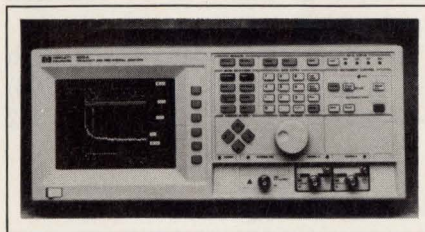

of the jitter in a series of time measurements. The unit requires no external computer and works with jitter that has a bandwidth as high as 2 MHz. When the data stream is nonrepetitive, the analyzer does not require a clock. HP 5372A, \$30,000. Option 040, \$2000 (if installed by factory in new analyzer). Option 040 field upgrade for existing analyzers, \$3000.

Hewlett-Packard Co, 19310 Pruneridge Ave, Cupertino, CA 95014. Phone (800) 752-0900. **Circle No. 365**

68HC11 Emulators

- Interface to MS-DOS PCs via 115.2-kbps RS-232C link
- Work with μ Ps that generate a 3.3-MHz E-clock

There are two versions of the Ice-master 68HC11 in-circuit emulator: The Model 200 is a basic emulator; the Model 400 contains all of the basic unit's features and a 4k frame trace buffer, two real-time performance analyzers, and watchdog-timer support. Both emulators work with 68HC11s that generate a 3.3-MHz clock. You connect the instruments to an MS-DOS PC via an RS-232C link that supports host communica-

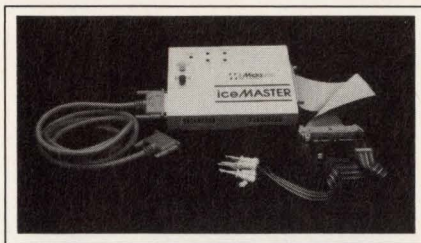

tion at speeds to 115.2 kbps. Both models have trace-on and trace-off triggers, 64 kbytes of emulation memory, 64k hardware breakpoints, and 64k write-access triggers. The emulators include symbolic and source-level debuggers that display dynamically annotated code in a source window. Model 200, \$1999; Model 400, \$4199; probe cards, from \$599.

Metalink Corp, Box 1329, Chandler, AZ 85244. Phone (602) 926-0797. **Circle No. 366**

Pocket-Size 3.5-GHz Counter

- Operates as long as five hours from NiCd battery
- Measures $3.4 \times 3.8 \times 1$ in. and weighs 9 oz

The Model 3500 8-digit, 3.5-GHz frequency counter operates as long as five hours from a rechargeable NiCd battery. The unit, which offers a display-hold function, will operate while connected to its battery charger. Input resistance is 1 M Ω to 12 MHz; a second 50 Ω input works from 10 MHz to 3.5 GHz. You can choose among three gate times, the longest of which gives 0.1-Hz resolution at 12 MHz. \$3500.

Startek International Inc, 398 NE 38th St, Fort Lauderdale, FL 33334. Phone (305) 561-2211. FAX (305) 561-9133. **Circle No. 367**

To a T

Belden's new T-Mark rating is your ticket to the Orient!

Belden now has power supply cords for appliances and electrical equipment featuring a "T" Mark rating, conforming to the Dentori law which regulates appliance and materials control in Japan. Belden "T" Mark cords are available in both standard and custom colors and lengths, and can be used on a variety of products manufactured anywhere in the world for export to Japan. It's another "first" from Belden.

For more information about Belden's complete line of international power cords for worldwide markets, call: 1-800-BELDEN-4

 **BELDEN**

Copyright © 1991, Cooper Industries, Inc.

We want to knock you down to size.

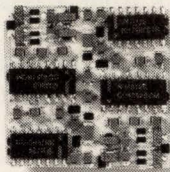

When you need to fit a big idea into a little space, talk to the people who work small miracles.

Pacific Hybrid Microelectronics.

We're experts in all facets of hybrid and surface-mount technology.

Simply send us your design parameters, and within 6 weeks you'll get a prototype that's up to 10 times smaller than a conventional circuit.

And far more economical.

So call Pacific today at 1-800-622-5574 for a free quote or more information.

And see how just enjoyable getting knocked down to size can be.

10575 SW Cascade Blvd. Portland, OR 97223
(503) 684-5657 FAX (503) 620-8051



We do small miracles.™

Copyright © 1990 Pacific Hybrid Microelectronics

CIRCLE NO. 80

NEW PRODUCTS

COMPONENTS & POWER SUPPLIES

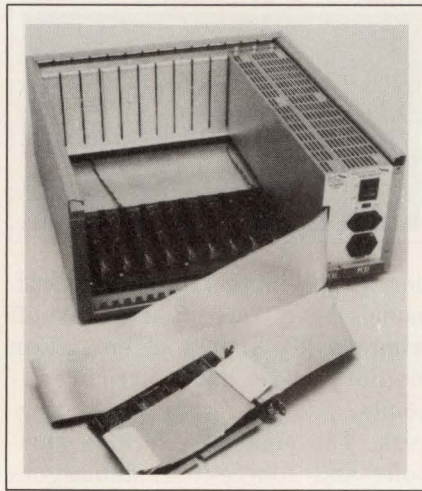

passive backplane and a 200W modular power supply. It also includes an expansion card module and one expansion card with the cables necessary to extend from the PCXI chassis to EISA/ISA desktop or rackmount PCs. The chassis provides EMI/RFI shielding, vibration protection, and industrial cooling with filtered fans. The unit accommodates as many as 10 function cards. \$2395.

Rapid Systems Inc., 433 N 34th St, Seattle, WA 98103. Phone (206) 547-8311. **Circle No. 362**

Expansion Chassis

- *Designed for EISA systems*
- *Includes a backplane*

The PX1591 expansion chassis is designed for EISA/ISA systems. It includes a 13-slot, rack-mountable

Voltage Suppressors

- *Will handle 300A*
- *Respond in 1 nsec max*

Transguard multilayer-ceramic, transient-voltage suppressors have

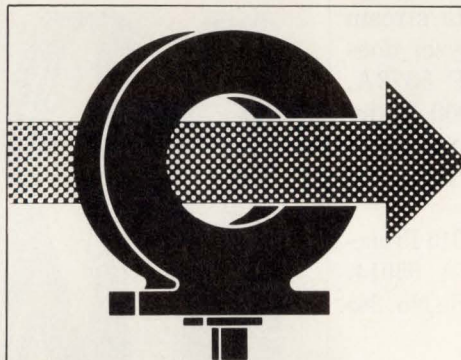

PEARSON

Wide Band, Precision

Current Monitor

With a Pearson current monitor and an oscilloscope you can make precise amplitude and waveshape measurement of ac and pulse currents from milliamperes to kiloamperes.

Currents can be measured in any conductor or beam of charged particles, including those at very high voltage levels.

A typical model gives an amplitude accuracy of +1%, -0%, 20 nanosecond rise time, droop of 0.5% per millisecond, and a 3 db bandwidth of 1 Hz to 35 MHz. Other models feature 2 nanosecond rise time, or a droop as low as 1% per second.

Contact us and we will send you engineering data.

PEARSON ELECTRONICS, INC.

1860 Embarcadero Road, Palo Alto, Calif. 94303, U.S.A.
Telephone (415) 494-6444 · Telex 171-412 · FAX (415) 494-6716

CIRCLE NO. 81

EDN October 1, 1991

Announcing a night to recognize greatness

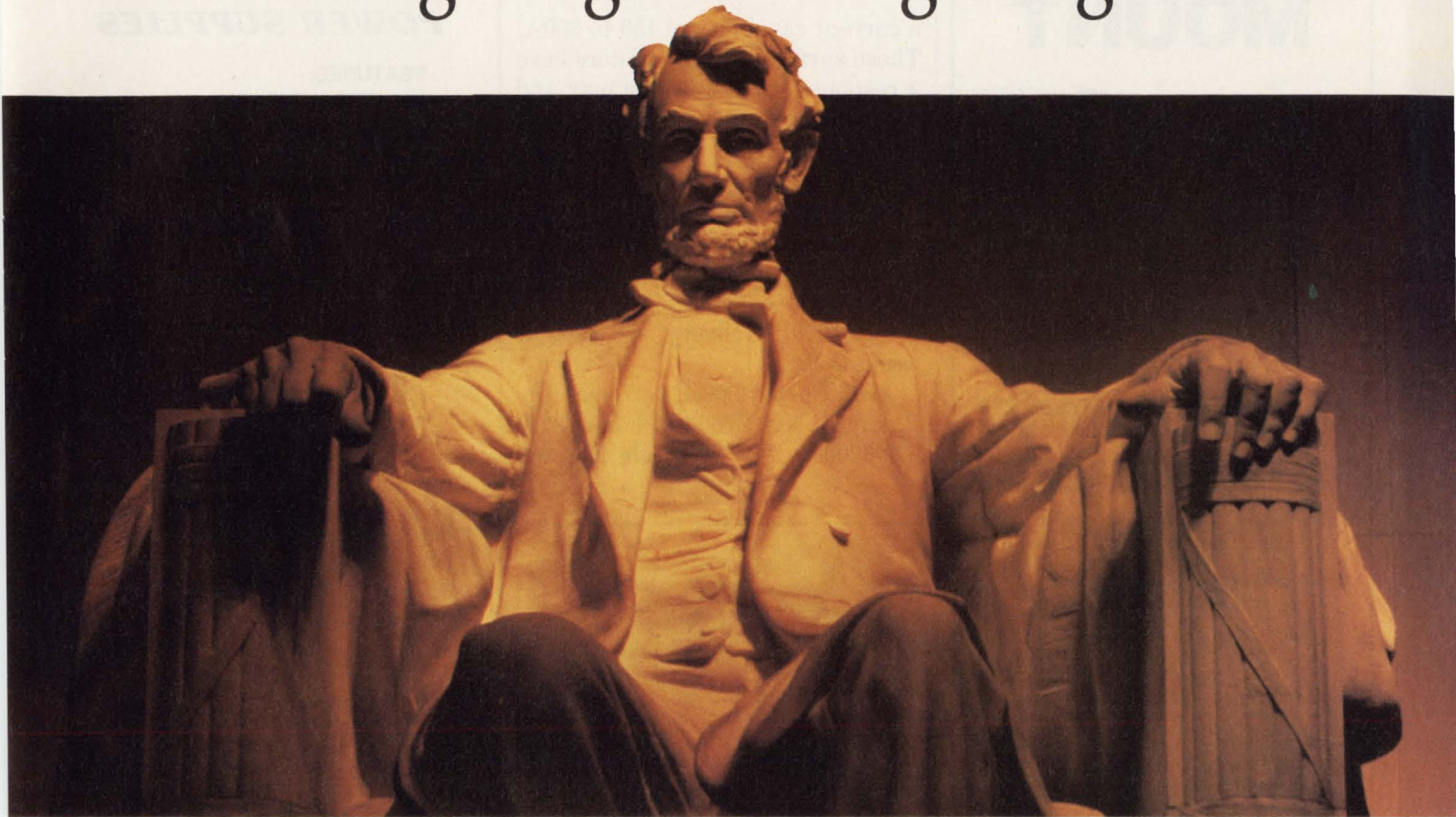

EDN's Innovation and Innovator of the Year Awards Ceremony

On the night of November 19 during Wescon, EDN will present the 1991 Innovation and Innovator of the Year awards at the Mark Hopkins Hotel in San Francisco. You are invited to show the finalists that you support greatness in innovation by attending the awards ceremony that is the culmination of their hard work. Through its Innovation Crusade, EDN hopes to inspire

engineering professionals within the electronics field to reach for higher plateaus of inspiration and creativity.

The dedication and involvement of EDN readers, like yourself, have made the Innovation Crusade and awards ceremony a reality. By taking the time to nominate your peers and, in

fact, select the winners, you show commitment to quality and creativity in electronics and are driving this crusade. But don't stop there ... order your ticket to the industry event of the year and show these innovators that greatness does not go unrecognized. All proceeds of the dinner will be donated to the EDN Scholarship Fund.

To receive a reservation order form to the EDN 1991 Innovation Dinner and Awards Ceremony, fax Pam Winch at (617) 558-4470.

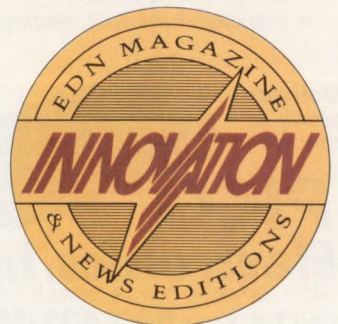

EDN Magazine
Edition
News
Edition

ULTRA-MINIATURE SURFACE MOUNT

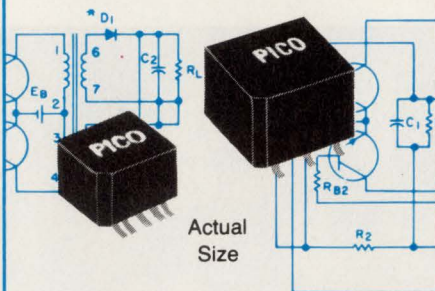

DC-DC Converter Transformers and Power Inductors

These units have gull wing construction which is compatible with tube fed automatic placement equipment or pick and place manufacturing techniques. Transformers can be used for self-saturating or linear switching applications. The Inductors are ideal for noise, spike and power filtering applications in Power Supplies, DC-DC Converters and Switching Regulators.

- Operation over ambient temperature range from -55°C to $+105^{\circ}\text{C}$
- All units are magnetically shielded
- All units exceed the requirements of MIL-T-27 ($+130^{\circ}\text{C}$)
- Transformers have input voltages of 5V, 12V, 24V and 48V. Output voltages to 300V.
- Transformers can be used for self-saturating or linear switching applications
- Schematics and parts list provided with transformers
- Inductors to 20mH with DC currents to 23 amps
- Inductors have split windings

Delivery—
stock to
one week

SEE EEM,
THOMAS REGISTER
OR SEND DIRECT FOR
FREE PICO CATALOG

PICO Electronics, Inc.

453 N. MacQuesten Pkwy. Mt. Vernon, N.Y. 10552

Call Toll Free **800-431-1064**

IN NEW YORK CALL **914-699-5514**

COMPONENTS & POWER SUPPLIES

a current capability of 150 to 300A. These surface-mount varistors have a response time of 1 nsec max and are available in a variety of package sizes. These low-voltage devices have a circuit-operation capability ranging to 60 working volts. Clamping-voltage figures range from 15.5 to 30V. Transient-energy figures span a 0.3 to 1.2J range. \$0.45 to \$0.55 (1000). Delivery, six to eight weeks ARO.

AVX Corp, 3900 Electronics Dr,
Raleigh, NC 27604. Phone (919)
878-6200. **Circle No. 363**

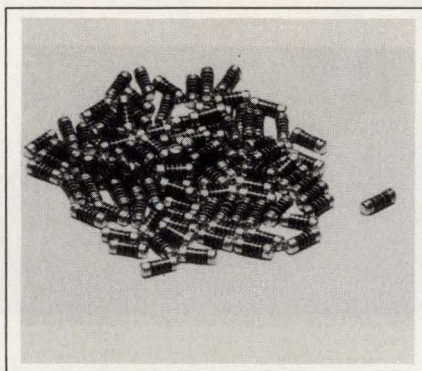

Surface-Mount Resistors

- Rated for 250 mW
- Have a 0.1% tolerance

SMM0204 MELF-type surface-mount resistors are rated for 250 mW at 70°C . Resistance values range from 1.2Ω to 2 M Ω and tolerances range from 0.1 to 5%. Temperature coefficients vary from ± 15 to ± 100 ppm/ $^{\circ}\text{C}$ depending on resistance value and tolerance. The resistors measure 0.142×0.059 in. and have end caps that are reflow and wave solderable. The units are color-banded for easy identification and are available on 8-mm tape-and-reel or bulk packaging. 10-k Ω units with a 1% tolerance and a ± 50 ppm/ $^{\circ}\text{C}$ temperature coefficient, \$0.023 (10,000). Delivery, stock to six weeks ARO.

Dale Electronics Inc, 2300 Riverside Blvd, Norfolk, NE 68701.
Phone (402) 644-4247.

Circle No. 364



UNIVERSAL VOLTAGE POWER SUPPLIES

FEATURES:
UNIVERSAL INPUT
HIGH EFFICIENCY
BUILT-IN- EMI FILTER
LOW OUTPUT RIPPLE
OVER VOLTAGE AND
SHORT CIRCUIT PROTECTION
SMALL FOOT PRINT



PSA-093

PSA-4031

FOR NOTEBOOK PC

WATTS	MODEL	O/P1	O/P2	O/P3	O/P4	DIMENSION
30W	PSA-093	9.5V/3A				149x75x45H
	PSA-161	16.5V/1.8A				
	PSA-181	18V/1.65A				
(7 MODELS)						
40W	PSA-4641	18V/1.4A	CHARGER 1A			166x80x45
(3 MODELS)						
50W	PSA-124	12V/4.2				166x80x54
	PSA-242	24V/2.2A				
	(7 MODELS)					

FOR PC, HARD DISK & FLOPPY DISK DRIVES, INDUSTRIAL, TELECOMMUNICATION

WATTS	MODEL	O/P1	O/P2	O/P3	O/P4	DIMENSION
40W	PSA-4031	5V/3V	12V/2A	-12V/0.5A		127x76x30
	PSA-4005	5V/6A				
	(8 MODELS)					
50W	PSA-5031	5V/5A	12V/2.5A	-12V/0.5A		160x100x45
(3 MODELS)						

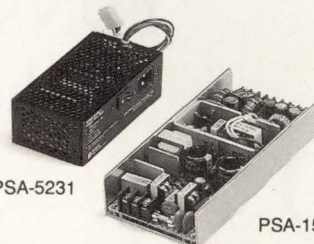

PSA-5231

PSA-1500U

WATTS	MODEL	O/P1	O/P2	O/P3	O/P4	DIMENSION
50W	PSA-5231	5V/4A	12V/2A	-12V/0.5A		144x80x48

WATTS	MODEL	O/P1	O/P2	O/P3	O/P4	DIMENSION
150W	PSA-1500U	5V/15A	-5V/1A	12V/1A	12V/5A	198x97x38
	PSA-1503U	5V/30A				
	PSA-1509U	5V/15A	-5V/1A	-12V/1A	12V/5A	
(10 MODELS)						
200W	PSA-2041U	5V/25A	-5V/2.5A	-12V/2.5A	12V/5A	203x114x51
(3 MODELS)						

SAFETY:

* ALL APPROVED BY UL/CSA/TUV (PSA-2041 IS IN PROCESS)

* PSA-40XX AND PSA-50XX APPROVED BY UL/CSA/TUV/VDE



PHIHONG ENTERPRISE CO., LTD.

TAIWAN:

16, LANE 530, CHUNG CHENG NORTH ROAD,
SAN CHUNG CITY TAIPEI, TAIWAN, R.O.C.

FAX: 886-2-9817086 & 886-2-9833222

TEL: 886-2-9882126 & 886-2-9805255

EUROPE:

HN ELEKTRONIK
POSTFACH 1113 D-6456
LANGENSELBOLD W. GERMANY
TEL: 06184-2872 FAX: 06184-62316

CIRCLE NO. 83

EDN October 1, 1991

EDN PRODUCT MART

This advertising is for new and current products.

Please circle Reader Service number
for additional information from manufacturers.

UNIVERSAL PROGRAMMER

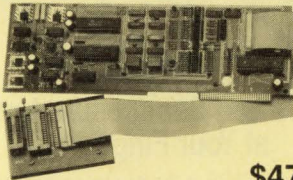

\$475

PAL
GAL
PROM
EEPROM

EPROM
8748/49
87C51...
EXOTIC's

5ns PALs
4 Meg EPROMs
Parts added at your request.

FREE software updates on BBS.
Powerful menu driven software.

Call — (201) 808-8990
Link Computer Graphics, Inc.
369 Passaic Ave., Suite 100
Fairfield, NJ 07004 FAX: 808-8786

LATTICE - MMI - INTEL - TI
AMD - DALLAS - ALTERA

CATALYST - XICOR
WSI - ICT - and MORE

CIRCLE NO. 325

☆☆☆☆
"The Best 8051 Emulator"



5 ft. cable

FULL
80C51
FA/FB/FC
SUPPORT

8051

SEE EEM 91/92
Pages D 1300-1303

PC based emulators for the 8051 family

8031, 8032, 8051, 8052, 80C152/154/321/451/452/51FA/51GB/515/517/535/537/
552/562/652/851, 80532, 83C451/552/652/751/752/851, 8344, 87C451/552/751/
752, 8751, 8752, DS5000 + CMOS ... more.

- PC plug-in boards or RS-232 box.
- Up to 33 MHz real-time emulation.
- Full Source-level Debugger w/complete C-variable support.
- 64 bit wide, 256k deep trace, with time stamp.
- Bond-out/hooks pods for 8051, 83C552, 83C451, 83C652, 83C751, 80C515/80C517, 83C752, 80C51FA/FB/FC, and more.

Prices: 32K Emulator 8031 \$1790; 4K Trace \$1495* (*US only)

CALL OR WRITE FOR FREE DEMO DISK!

Ask about our demo VIDEO

NOHAU CORPORATION
51 E. Campbell Avenue
Campbell, CA 95008
FAX (408) 378-7869
(408) 866-1820

Call 408-378-2912
Nohau's 24-hour
information center to
receive info via your FAX

CIRCLE NO. 326

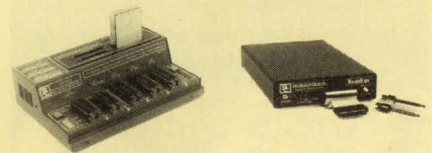

RS232 EE/EPROM, MICRO &
MEMORY CARD PROGRAMMER \$345/495

- Programs EE/EProms, Flash EProms, ZPRams, Intel Micros, Memory Cards.
- Stand-Alone Mode for EE/EProms and Memory Card Duplication / Verify.
- All 24/28/32 pin EE/EProms to 8 MBits (upgradable to 32 Megabits).
- Micros 87A1A, 2/A, 4, 8, 9, 51, CS1, CS1F, A/B, S2, S3, S5, CS21, CS41, 9761.
- Accepts dedicated modules: Memory Card Programming Module (Seiko/Epson) - \$145, Eraser/Timer Module - \$50, Gang Module (4 sockets) - \$145. Simultaneously duplicates up to 5 devices in stand-alone mode (with Gang).
- Can be operated with any computer containing an RS-232 serial port.
- User friendly Menu-Driven Interface Program for IBM-PC or compatible.
- Full 1 year warranty. Customer support via voice line, fax or dedicated BBS.

INTELLIGENT ROM EMULATOR \$395

- Emulates 2716 through 27512 EProms with a single unit. Access time 120ns.
- Connects to the standard parallel printer port via a standard printer cable.
- User friendly software. Command set includes: Load(data), Write(data), Display(memory), Type of EProm, Edit(memory), Fill(memory), Calculator, Reset(target system), Activate(debugging feature), Monitor(selected feature).
- Address Compare with Halt output, Address Snapshot, Trigger input.
- Fast data loading via parallel printer port (64k bytes in less than 10 sec).
- Cascadable up to 8 units. Includes target cable with Trigger/Reset/Halt clips.
- CMOS (stand-alone) model with rechargeable NiCad battery backup: \$495



B&C MICROSYSTEMS INC.
750 N. Pastoria Ave., Sunnyvale, CA 94086 USA
TEL: (408) 730-5511 FAX: (408) 730-5521

CIRCLE NO. 327

WORLD'S
SMALLEST

SMT QUARTZ
CRYSTALS
and
CLOCK
OSCILLATORS

708-
806-1485

- 10kHz-32MHz
- ceramic & metal packages
- hermetically-sealed
- hi-temp mounting
- tape & reel
- thru-hole versions
- shock resistant

MICRO CRYSTAL
702 W. Algonquin Road
Arlington Heights, IL 60005

FREE CATALOG

CIRCLE NO. 328



Precious
Metal Ball
Contacts

Abbott balls are precision-ground to virtually eliminate elliptical, out-of-round and dimpled shapes. Use them in, electrical contacts, relays or reed switches.

- Easily adaptable to automated assembly and feed mechanisms
- No orientation of parts required
- Uniformity reduces line shut-downs

Let our engineers work with your samples or requirements to develop the right balls for your contacts.

ABBOTTBALL

Railroad Place, P.O. Box 330100, West Hartford, CT
06133-0100 U.S.A. Phone: 203/236-5901

CIRCLE NO. 329

320C10/15 320E17 320C16 DSP

In-Circuit Emulators

- Real-time emulation up to 35 MHz.
- IBM-PC/XT/AT/386 windowing interface
- Complex hardware real-time breakpoints
- 32K*80 trace buffer with filtering control
- Program performance analysis
- also: 8051/52 family, Super-8, 8048/49

SIGNUM SYSTEMS

171 E. 1000 Oaks Blv, #202, Thousand Oaks, CA 91360
(805) 371-4608 fax: (805) 371-4610

CIRCLE NO. 330

To advertise in Product Mart, call Joanne Dorian, 212/463-6415

EXTRUDED ALUMINUM PANEL MOUNT ENCLOSURES

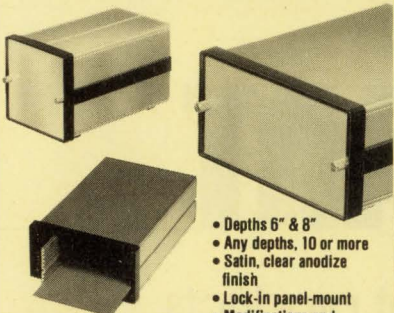

- Depths 6" & 8"
- Any depths, 10 or more
- Satin, clear anodize finish
- Lock-in panel-mount
- Modifications and screen printing available

DIN STANDARDS

Bezel	Case
48 x 96 mm	44 x 91 mm
72 x 144 mm	67 x 136 mm
96 x 192 mm	91 x 184 mm
96 x 96 mm	91 x 91 mm
	184 x 184 mm

FREE CATALOG

Buckeye

555 Marion Road
Columbus, OH 43207
Fax: 614/445-8224
1-800-728-0776

CIRCLE NO. 331

Plug and Play!

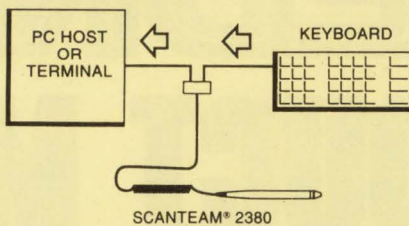

Welch Allyn's SCANTEAM family of Instant Interface products plugs your business directly into bar coding.

- For laptops, PCs or terminals
- Bar code scanning and decoding in a compact wand scanner
- No footprint; single cable connection

SCANTEAM 2380 keyboard wedge.
SCANTEAM 6180 for RS-232 compatible output.

Welch Allyn

4619 Jordan Road, P.O. Box 187
Skaneateles Falls, NY 13153-0187
Telephone: 315-685-8945

CIRCLE NO. 332

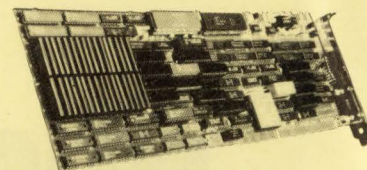

4MEG VIDEO Model 10 Flexible Image Processor and Application Accelerator For The PC/AT

- 8 to 8000 Pixels per Line
- 2 to 19 MHz sampling/display rate
- 10 MIPs Programmable Accelerator
- 4 Megabytes of Reconfigurable Image Memory
- RS-170, RS-330, and CCIR input/output
- Variable timing for nonstandard formats
- Genlock to external timing sources
- Analog or digital inputs
- Software programmable timing/resolution

EPIX

3005 MacArthur Blvd., Northbrook IL 60062
708-498-4002 FAX: 708-498-4321

CIRCLE NO. 333

Surface Mount Chip Component Prototyping Kits— Only \$49.95



CC-1 Capacitor Kit contains 365 pieces, 5 ea. of every 10% value from 1pf to .33µf. CR-1 Resistor Kit contains 1540 pieces; 10 ea. of every 5% value from 10Ω to 10 megΩ. Sizes are 0805 and 1206. Each kit is ONLY \$49.95 and available for Immediate One Day Delivery!

Order by toll-free phone, FAX, or mail. We accept VISA, MC, COD, or Pre-paid orders. Company PO's accepted with approved credit. Call for free detailed brochure.

COMMUNICATIONS SPECIALISTS, INC.
426 West Taft Ave. • Orange, CA 92665-4296
Local (714) 998-3021 • FAX (714) 974-3420

Entire USA 1-800-854-0547

CIRCLE NO. 334

NOBLE SLIDE POTENTIOMETER BROCHURE

Technical brochure details VJ Series High and Low Profile Slide Potentiometers.

Potentiometers function as volume, balance, brightness/contrast, temperature and equalizer controls. Slide travel varies with model. Sliding force is 50-350 gf, minimum operating life is 15,000 cycles, and maximum operating voltage is 10 VDC.

NOBLE

Contact Bob Burdick, Noble U.S.A., Inc.
5450 Meadowbrook Industrial Court
Rolling Meadows, Illinois 60008
Tel: 708/364-6038 Fax: 708/364-6045

CIRCLE NO. 335

Now
Networkable!

Facts about 500,000 ICs and Semiconductors at Your Fingertips

Cahners CAPS is the newest component search and selection tool for electronic design engineers:

- PC-driven, CD-ROM-based
- Includes unabridged manufacturers' datasheets
- Represents more than 450 manufacturers worldwide

Call toll-free: 1-800-245-6696

CAHNER'S

CAPS

Computer Aided
Product Selection

275 Washington Street
Newton, MA 02158-1630
Telephone: 617-558-4960
Facsimile: 617-630-2168
Telex: 940573

CIRCLE NO. 336

A STEP BEYOND.



PROMICE takes ROM emulation a step beyond. It's an affordable, multi-operational development tool with:

- on board intelligence
- modular design
- source level debugging
- future expandability

PROMICE. The Firmware Development System of Tomorrow...

Grammar Engine Inc

3314 Morse Road
Columbus, Ohio 43231
614/421-1113
FAX: 614/475-6871

CIRCLE NO. 337



MultiTask!™ Executives Accelerate Design

Get standard real-time services on 68xxx, 68HC11, Z80/180/64180, 8051, 80x86/V-Series, 8096/196, i960 and ProtoTask!™ PC design executive. Source code keeps you in control. Call: 503-641-8446; FAX 503-644-2413; or 800-356-7097 for free EasyTask!™ Info Diskette.



14215 NW Science Park Drive
Portland, OR 97229
U.S. SOFTWARE

© 1991 US Software Corporation. MultiTask!, ProtoTask! and EasyTask! are trademarks of US Software Corporation.

CIRCLE NO. 338

Now Doubled in Library Size

DC/CAD

CAD Showdown Results!

HIGH DENSITY EXPERTS!

Integrates Schematic Capture,
PCB Layouts & Autorouting

This top-rated CAD out-routed the competition in the 1990 CAD Showdown. DC/CAD displayed its power and flexibility when routing a double-sided board while competing routers used four to six layers. This non-copy protected package with surface mount support includes:

- Multi-strategy 1-mil parts autoplacer
- "1-mil" autorouting w/ripup & retry
- Thorough annotating design rule checker
- Full 2-way GERBER and DXF support
- Optional autoground plane support with cross-hatching
- Optional simulation capability & protected mode for 386 users

Call today
DC/CAD \$595
(priced from \$395)

LEASE PROGRAM & SITE LICENSE AVAILABLE
30 DAY MONEY BACK GUARANTEE

**DESIGN
COMPUTATION**



Rt. 33, Sherman Square Farmingdale, NJ 07727
(908) 938-6661 • (908) 938-6662 (FAX)

DC/CAD... Innovative, Intelligent & Integrated Software

CIRCLE NO. 339

To advertise in Product Mart, call Joanne Dorian, 212/463-6415

Lifetime FREE software updates via BBS/US Mail
Unlimited toll-free technical support in USA

EP-1132 E/EPROM Programmer

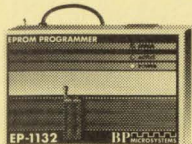

\$695.00

Supports over 800 devices including:

- 1, 2, & 4 megabyte EPROMs
- FLASH EPROMs • E/EPROMs
- High-speed CMOS PROMs
- DSP microcontrollers
- Works under Windows • Parallel Interface
- Single Executable file

Call 1-800-225-2102 for information.

BP MICROSYSTEMS

BP Microsystems, Houston, TX 77043-3239
Phone: (713) 461-9430 Fax: (713) 461-7413

CIRCLE NO. 340

16 MHz CPU
DRAM to 512K

20 MHz DSP
SRAM to 96K

DAPL™ Operating System
100+ standard commands
Custom commands in C

The Intelligent Solution For Data Acquisition

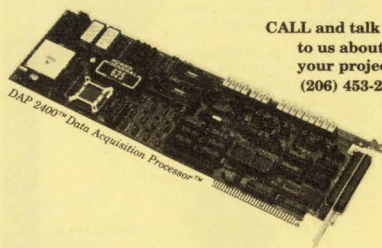

CALL and talk to us about your project.
(206) 453-2345

ANALOG I/O
DIGITAL I/O

Inputs to 235K samples per second
Outputs to 250K samples per second

Or call for FREE demo diskette.

MICROSTAR LABORATORIES
2265 116th Avenue NE
Bellevue, WA 98004
FAX (206) 453-3199

CIRCLE NO. 341

Palm-Sized Embedded Controller

5080 is an easy-to-use embedded controller for applications where small size, rugged packaging, wide temp. range, & low cost are important factors. Use stand-alone or access a variety of industrial I/O.

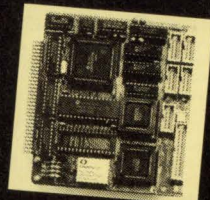

"Instant on" mode lets you write your program, test it and save it in EEPROM. CAMBASIC™ multi-tasking software supports all hardware features.

- ▶ EEPROM programmer
- ▶ 512K static RAM
- ▶ 24 digital I/O lines
- ▶ 2 serial ports
- ▶ Display/keypad ports
- ▶ Drives opto module racks
- ▶ 5V only operation
- ▶ -40° to +85° C

Tel: 303-430-1500, Fax: 303-426-8126

OCTAGON SYSTEMS CORPORATION™
6510 W. 91st Ave., Westminster, CO 80030

CIRCLE NO. 342

4 Color Product Mart Ads Are Now Available In EDN's Magazine and News Editions!

Call Joanne Dorian for more information
(212) 463-6415

CIRCLE NO. 343

MICROPAK™
SMALL ELECTRONIC INSTRUMENT ENCLOSURES

"If I didn't have a product to put in it, I'd design one."

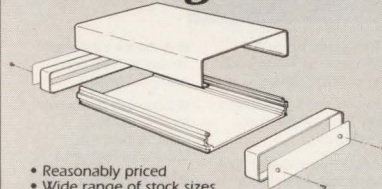

- Reasonably priced
- Wide range of stock sizes
- Readily customized by you or us
- Shortens time for prototyping and production
- For literature, pricing, and No-Risk Offer, call:

800-847-3535
Anywhere in the US or Canada

LANSING

Copyright © 1991, Lansing Instrument Corp., P.O. Box 730, Ithaca, NY 14851-0730

CIRCLE NO. 344



Schematic Capture for the Macintosh

DESIGNWORKS

Schematic features Menu-driven, mouse-controlled operations • cut/copy/paste between circuits • right-angle rubberbanding. **Digital simulation** 13-state, event-driven simulation • logic analyzer-style timing window • PLD support. **Libraries** Fully-simulated 7400, 4000, 10K series, PLDs, PROMs and RAMs, non-simulated analog and discrete components • User-definable, simulated custom symbols. **Interfaces** Formats for Douglas CAD/CAM, Cadnetix, Calay, Orcad, Tango, Racal Redac, Spice. • user-definable printers, dot-matrix printers, HP, Houston, Roland pen plotters.

CALL (800) 444-9064 TODAY FOR YOUR FREE DEMONSTRATION KIT!

CAPILANO COMPUTING
(604) 522-6200 Fax (604) 522-3972

CIRCLE NO. 345

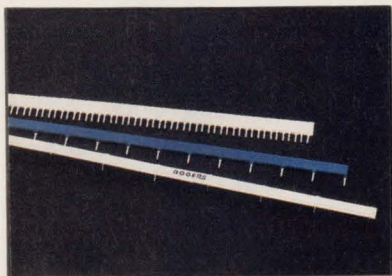

SAVE SPACE WITH MINI/BUS® BARS

Improve power distribution
Reduce required board layers
Eliminate up to half the decoupling capacitors

Fit between or beneath IC's
Also available in surface mount
Send for Rogers Mini/Bus® Bars Application Bulletin.

Rogers Corp., 2400 S. Roosevelt St.
Tempe, AZ 85282 602/967-0624

CIRCLE NO. 346



300 MHz Programmable Pulse Generator from LeCroy

3 Good Reasons to buy your next pulse generator from LeCroy: 1. **PERFORMANCE** (300 MHz, 300 psec) 2. **PRICE** (around \$8,000) 3. **RELIABILITY** (backed by a 5 year warranty). The LeCroy 9210 Programmable Pulse Generator Mainframe (\$5,900) accepts up to two plug-in modules that feature combinations of repetition rates (to 300 MHz) edge transition times (to 300 psec) and output swings (to 16 Volts P-P into 50). Modules are priced from \$1,000 to \$2,200. Contact Art Pini at LeCroy Corporation: (914) 578-6020.

CIRCLE NO. 347

Transmission Line Problems?

Glitchy clocks?
Overshoot and undershoot?
Flaky system operation?



New! LineSim Pro spots problem signals and helps find solutions before you build boards.

LineSim Pro features:

- simulation of 100's of transmission line segments per electrical net
- push-button schematic
- oscilloscope display
- device-model library
- circuit-board-impedance calculators
- extended-memory support
- uses 386/486 protected mode

Or choose **LineSim**, a simplified version (2 lines).

LineSim Pro: \$995 (U.S.) Requires 386/486 PC w/EGA/VGA; min. 2 Mb extended memory; mouse.
LineSim: \$495 (U.S.) Requires IBM PC w/EGA; min. 640k memory.

30-day money-back guarantee, w/\$25 restock fee.

HyperLynx

Attention: Sales Dept.
P.O. Box 3578
Redmond, WA 98073-3578
Tel. (206)869-2320
Fax (206)881-1008

CIRCLE NO. 348

To advertise in Product Mart, call Joanne Dorian, 212/463-6415

Relax Reliability Software

Innovative Software Designs offers an unbeatable set of reliability analysis software tools with its Relax product line. The Relax line includes electronic reliability analysis according to MIL-HDBK-217, Bellcore, and CNET, mechanical reliability, and failure modes and effects analysis. Also available are packages for thermal and Weibull analysis.

Relax products are noted for their outstanding quality, ease-of-use, flexibility, and comprehensive array of features. A wide range of packages are available to meet your price and product requirements. And all products are fully guaranteed!

Call today for more information and join ISD's long list of satisfied customers!

217
CNET
Bellcore
FMECA
Mechanical
217 Parts Count
Calculs Simplifiés
BETAsoft Thermal
WeibullSMITH Analysis

Innovative Software Designs, Inc.
One Kimball Ridge Court • Baltimore, MD 21228
(301) 747-8543 • Fax (301) 747-8599

CIRCLE NO. 349

UNIVERSAL PROGRAMMER, EMULATOR & TESTER

TUP-300

\$ 695.00

- Programs virtually any device in the market today.
Programs PLD (PAL, GAL, FPL, EPLD, PEEL, MAX, MACH...), E (EPROM, up to 16 Mbit), Flash EPROM, Special PROM, MPU (87XX, 68XX, Z8, PSD301...)
- Covers DIP, PLCC, QFP and PGA with 8 to 84 pins. Gang programming adapters available also.
- EPROM EMULATION capability.
- Tests digital ICs and DRAMs (SIMM/SIP adapter available).
- Free software updates and new devices added upon request!
- IC Manufacturers' approval.
- \$695 includes 40 pin ZIF socket programmer, s/w, and parallel interface card with D-25 cable.

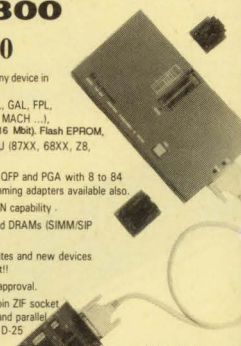

Distributors are welcome!
1 year warranty,
30 day money back guarantee.
Call today for a free demo diskette.



Tribal Microsystems Inc.
44388 S. GRIMMER BLVD. FREMONT, CA 94538
TEL (510) 623-8858 FAX (510) 623-9925

CIRCLE NO. 350

The power of a
consistent
and colorful
campaign can be
yours with EDN's
Product Mart
Section.

CIRCLE NO. 751

Analog Circuit Simulation SPICE FOR THE PC

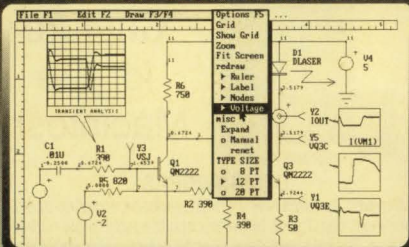

- Schematic Entry • SPICE Simulation
 - Model Libraries • Waveform Graphics
- Intusoft has it all at an Affordable Price!

INTEGRATED, EASY TO USE SIMULATION ENVIRONMENT, FEATURING:
A powerful SPICE (IsSpice) simulator performing AC, DC, Transient, Noise, Fourier, Distortion, Sensitivity, Monte Carlo, and Temperature analyses. Extensive model libraries. Schematic entry, and Waveform processing. Starting at \$95 for IsSpice, complete systems are available for \$815.

Call Or Write For
Your Free Demo and
Information Kit!



P.O. Box 710 San Pedro,
CA 90733-0710

Tel. 213-833-0710

Fax 213-833-9658

CIRCLE NO. 752

ROM-IT

EPROM EMULATION SYSTEM



NEW 4-MEGABIT VERSION

- Emulates up to 8 4-Megabit EPROMs with one control card.
- Downloads 2-Megabit programs in less than 23 seconds.
- Allows you to examine and modify individual bytes or blocks.
- Accepts Intel Hex, Motorola S-Record and Binary files.
- Software available for IBM PC and compatibles and Macintosh systems.
- Base 27256 EPROM System \$395.00 Other configurations available.

ORDER TODAY—IT'S EASY
CALL OR FAX FOR MORE INFORMATION



Incredible Technologies, Inc.
(708) 437-2433
(708) 437-2473 Fax
VISA now accepted.

CIRCLE NO. 753

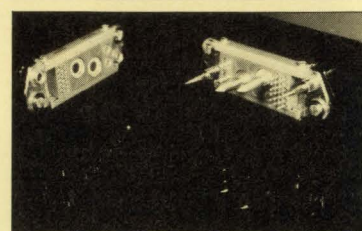

BLIND MATABLE POWER SUPPLY CONNECTOR

L Series rack & panel connectors provide optional 8, 15, 25, 50 and 200 amp contacts in a rugged float mountable assembly. L Series connectors use the Hypertac® hyperboloid, low force contact which offers high cycle life, immunity to shock and vibration, and contact resistance in the .4 to 2.5 milliohm range.

FOR ADDITIONAL INFORMATION, CONTACT:
HYPERTRONICS CORPORATION
16 Brent Drive, Hudson, Massachusetts 01749
(800) 225-9228 (In MA & Canada (508) 568-0451)
FAX: (508) 568-0680

CIRCLE NO. 754



Easy Emulator Pods & Adapters

- Plug your PLCC and LCC packages into your PC board in minutes, with these easy-to-use adapters.
- Emulator/logic analyzer users: Adapt-a-Pod™ converts one package type to another (LCC, PLCC, PGA, and DIPs).
- Emulator pods and adapters are available in all standard pin counts, with ribbon or ribbon cable headers.
- Custom engineering services and do-it-yourself emulator pod converters. Free catalog.

Emulation Technology, Inc.
2344 Walsh Ave. Santa Clara, CA 95051
Phone: 408-982-0660 FAX: 408-982-0664



CIRCLE NO. 755

Instant Microcontroller

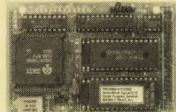

Instant C Programming

Don't use a microprocessor, use a SmartBlock™ microcontroller module to build your custom controller. Our low cost Dynamic C™ makes programming a snap. 3.5 x 2.5 inch module includes microprocessor, memory, time/date clock, eeprom, watchdog, serial ports and more. As low as \$59 in quantity. The efficiency of a custom design without the headaches.

Z-World Engineering

1340 Covell Blvd., Davis, CA 95616 USA

Tel: (916) 753-3722

Regular Fax: (916) 753-5141

Automatic Fax: (916)-753-0618

(Call from your fax, hear computer voice, use touchtone dial to request desired data sheets.)

CIRCLE NO. 756

Now
Networkable!

Facts about

500,000

ICs and Semiconductors at Your Fingertips

Cahners CAPS is the newest component search and selection tool for electronic design engineers:

- PC-driven, CD-ROM-based
- Includes unabridged manufacturers' datasheets
- Represents more than 450 manufacturers worldwide

Call toll-free: 1-800-245-6696

CAHNER'S



Computer Aided
Product Selection

275 Washington Street
Newton, MA 02158-1630
Telephone: 617-558-4960
Facsimile: 617-630-2168
Telex: 940573

CIRCLE NO. 757

To advertise in Product Mart, call Joanne Dorian, 212/463-6415

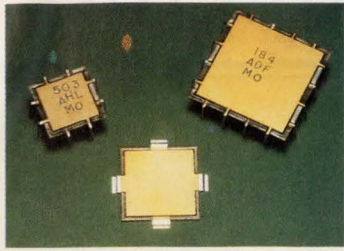

CUT PGA NOISE

Micro/Q (R) 3000 capacitors reduce noise associated with PGA and PLCC devices. Designed to be mounted under the device, take no extra board space. Can be used under MPUs, Gate Arrays, and ASICs. Choose from Z5V, X7R, and P3J dielectrics. Available in both thru-hole and surface mount versions. Several sizes available to fit all devices.

Rogers Corp.

2400 South Roosevelt St., Tempe, AZ 85282

(602) 967-0624

CIRCLE NO. 758

LEMO'S NEW CIRCULAR CONNECTOR CATALOG

LEMO's new circular connector catalog highlights expanded shell and insert designs. Insert configurations are available in single, multi or mixed designs including signal, coaxial, triaxial, high voltage, fiber optic and fluidic/pneumatic. Shell styles are available in standard chrome plated brass, anodized aluminum or stainless steel.

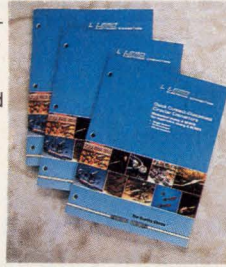

P.O. Box 11488, Santa Rosa, CA 95406
Phone (800) 444-LEMO, Fax 707/578-0869

CIRCLE NO. 759

PLCC LoClip - PLCC Probe

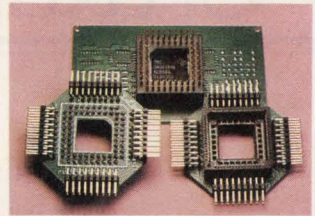

NEW PRODUCT

The PLCC-LoClipXX line from Ironwood is a new product line allowing probing of surface mount PLCC's at a fraction of size of other clips. The U and L ver. have right angle leads (cable connect or probing). Device heights of 0.75", 0.57", and 0.45" for S, U, and L boards respectively enable probing of boards in backpanels. Interdevice spacing of 0.10" allowed. PLCC's from 24 to 84 pins supported. Kits of 10 with different sizes/carrying case available at substantial discount.

IRONWOOD ELECTRONICS

P.O. BOX 21151, ST. PAUL, MN 55121
(612) 431-7025

CIRCLE NO. 760

4 Color Product Mart Ads Are Now Available In EDN's Magazine and News Editions!

Call Joanne Dorian for more information

(212) 463-6415

CIRCLE NO. 761

27010 EPROM EMULATOR

UNIT CAN BE DAISY-CHAINED FOR 16 & 32-BIT SYSTEMS

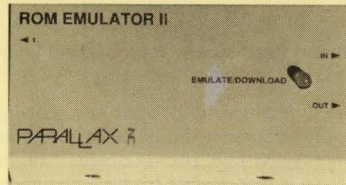

Emulates 2764, 27128, 27256, 27512, & 27010. **\$349**

Other emulators from \$199

Parallax, Inc.
Citrus Heights, California
(916) 721-8217



CIRCLE NO. 762

"Tango-PLD is the price/performance leader in logic design tools."

"I regularly put this program through its paces. It's inexpensive and works great. I'm telling as many friends as I can that Tango-PLD is the best value in program-able logic design."



John Weirbach
Chief Engineer

Tango-PLD is a universal PLD design tool with sophisticated features including schematic entry or "C-like" language design options. Its affordable price includes great documentation and tech support and a money-back guarantee.

Tango

See for yourself. Call today to order your free PLD design evaluation package.

800 488-0680

619 554-1000 • FAX: 619 554-1019

ACCEL Technologies, Inc.
6825 Flanders Drive • San Diego, CA • 92121 • USA
Contact us for the representative nearest you.



CIRCLE NO. 763

LOW COST INTERFACE CARDS FOR PC/XT/AT

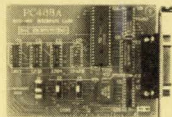

RS-485/422 Card [PC485] \$95/125

- Serial Async. Communication up to 4,000ft; 2 or 4 wires; NS16450 UART;
- COM1-4; Max. Baud Rate 56KB. High speed version (256KB) - \$165;
- Dual drivers/receivers; Handles 64 devices; Compatible with most comm S/W;
- DB9 or phonejack. Sample programs included. Optional sourcecode - \$150

Dual-Port RS-485/422 [PCL743] \$175

- Two independent channels/UARTs; 2 or 4 wire operation. Max. Baud 56KB.
- Dipswitch configurable as COM-4 (IRQ2-7). On board terminator resistor.

IEEE-488 Card [PC488A/C] \$145/445

- Includes DOS Device Driver and sample Communication program in BASIC.
- Additional sample programs in C, Pascal & Assembly - \$50.
- Selectable IRQ (1-6). DMA channel 1 or 2. Up to four boards per computer.
- Compatible with most IEEE-488 Software packages for IBM-PC.
- I/O Addresses and Control registers compatible with NI's GPIB-PC/ISA
- PC488C card version with Built-In Bus Analyzer hardware and software

Stepper Motor Card [PCL838] \$395

- Capable of independent and simultaneous control of up to 3 stepper motors.
- Programmable speed from 1 to 10,000 pps; Steps per command 1 to 65535.
- DIP switch selectable I/O port base address and wait state. 24 bit TTL I/O port
- Crystal based timing; All control signals opto-isolated.

144 Bit Digital I/O [PCL722] \$345

- 144 lines (24 bits x 6 ports) of TTL compatible digital I/O. Output buffers sink 24mA, source 15mA. Interrupt handling capability. Opto-22 module compatible.

MC / VISA / AMEX

Call today for datasheets!



B&C MICROSYSTEMS INC.
750 N. Pastoria Ave., Sunnyvale, CA 94086 USA
TEL: (408) 730-5511 FAX: (408) 730-5521

CIRCLE NO. 764

Pick Of The Week

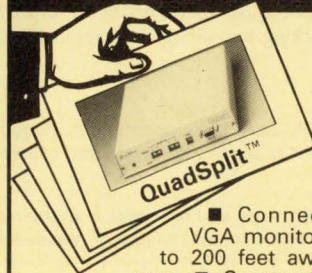

Connects 4 VGA monitors up to 200 feet away at once Supports all VGA/SVGA cards and monitors 2 and 8 output models available only \$495, 1 year warranty

Communications
Specialties, Inc.

TEL: 516-273-0404 FAX: 516-273-1638

CIRCLE NO. 765

Telecom Solutions from Teltone

Telecom IC Data Book

The reference for telecom design engineers. Includes:

- DTMF and call progress tone receivers and transmitters
- MF trunk receivers and transmitters
- DC signaling devices
- Key system/PBX enhancements
- Test and demonstration equipment
- Telecom signaling application notes

1-800-426-3926

Or: 206-487-1515 Fax: 206-487-2288

TELSTONE

INNOVATING SOLUTIONS
In Telecom Interface Components

Teltone Corporation, 22121-20th Avenue SE, Bothell, WA 98021

CIRCLE NO. 766

To advertise in Product Mart, call Joanne Dorian, 212/463-6415

CAREER OPPORTUNITIES

Call today for information on Recruitment Advertising:

East Coast: Janet O. Penn (201) 228-8610

West Coast: Nancy Olbers (603) 436-7565

National: Roberta Renard (201) 228-8602

Powerful People. Powerful Products.

Many choose to compromise their lifestyle to achieve success. Intel professionals in the greater Sacramento area don't make concessions. We work with the most advanced design tools and techniques to keep our technology at the leading edge, and leave the others trying to catch up.

POWER MOVE

Successful products require a strong foundation and fresh ideas. Our foundation, your ideas. Make a Power Move and consider the following openings.

We currently have opportunities available within the following dynamic and growing product areas. Our Entry Level Products Group designs microprocessors for the portable, notebook and palm-top computer markets, communication components and Intel network cards. The Integrated Microcomputer Division/Microprocessor Products Group is responsible for high-end microprocessors, bus chip sets, peripherals, and programmable logic component products for desktop computers and workstations of the future.

System Architects

Combine customer needs with emerging technologies to define future system requirements. Interact with Design and Marketing to determine cost/performance trade-offs, and create the optimized component-level partitioning. Define the components and follow-up through implementation. Keep up with market requirements to create derivative products. Specific development areas are high integration desktop, notebook, and palm-top computers, and multiprocessor servers. Requires a BS/MS in EE/CS, and at least 4 years of system design experience, knowledge of PC hardware, and familiarity with low-level programming in DOS and/or UNIX.

Component Design Engineers

Join a team designing peripheral devices for a wide range of single or multiprocessing applications on the PC, workstation and high-end system areas. Responsibilities include CMOS, VLSI component design on products such as mp chips, EISA bus chips, DMA controllers, or cache controllers. Requires a BSEE/CE, or equivalent, and a working knowledge of computer architecture and system design concepts preferred.

System Validation Engineer

Support the verification of Intel's newest Notebook PC-based microprocessors. Requires a BSCS/BSEE and at least 3 years' experience with Intel385™ based PC hardware and software. Must have MASM and C programming experience.

Make a Power Move to Intel in the greater Sacramento area and experience all the personal perks of California's recreation capital. Our area happens to be ranked as one of *Newsweek's* top urban areas with a relatively lower cost of housing, a lower cost of living, and a rush hour that's not so rushed. For immediate consideration, please FAX or send your resume to: **Intel Staffing, P.O. Box 1141, Dept. F644, Folsom, CA 95630, FAX (916) 351-5522.**

Intel Corporation is an equal opportunity employer and fully supports affirmative action practices. Intel also supports a drug-free workplace and requires that all offers of employment be contingent on satisfactory pre-employment drug test results.

intel®

The Computer Inside.™

UNIX is a trademark of UNIX Systems Labs

Electronic Engineer Analog/RF

EE sought with minimum of five years experience with analog circuit design, including thorough understanding of RF circuits. Will join small (<10) team of engineers in fast-paced project to establish altitude record for unmanned aircraft. Send resume to:

Brian Duff
Aurora Flight Sciences
Box 4134
Manassas, Virginia 22110

Knock, Knock.

In EDN's
Magazine
and News
Editions,
opportunity
knocks all
the time.

EDN Magazine
Edition
News
Edition

Quality design and advanced technology. Because lives depend on it.

More than a name, Pacemaker is our way of viewing our mission and applying technology. Beginning with the first internal cardiac pacemaker, to the application of advanced NASA technology to medical science, to our present programmable, dual-chamber pacemaker, the tradition continues with our commitment to up-to-the-minute life-assisting and life-critical bio-medical technology.

Proud of these technological achievements, our greatest satisfaction is knowing our products have enriched and extended the lives of millions. In fact, the very first pacemaker recipient, Arne Larsson, is still enjoying an active lifestyle in his 70's.

With the support of the multi-billion dollar Siemens Company, we're totally committed to living up to our name, and fulfilling the promise of quality made to the people who depend on our products every day. If you're looking for an exciting challenge in an innovative environment, you'll find your future here. Opportunities include:

AUTOMATIC TEST ENGINEER

To perform analog and digital circuit design, SW development and test system integration. Requires BSEE and 3+ years ATE experience in the design/development of computer-based automatic production test equipment. **Respond to Dept. EDNMAG/ATE.**

IC DESIGN ENGINEER

Responsible for circuit design and technology development for low power implantable custom ICs, including microcomputers, switched capacitor filters, A/D and DC/DC energy converters. Requires BS/MSEE or PhD and 3+ years experience in design/development of analog/digital CMOS ICs. **Respond to Dept. EDNMAG/ICDE.**

PROCESS ENGINEER

Will handle machine design projects utilizing electro-pneumatic mechanisms/processes involving YAG laser welding. Requires BSME/EE with 5 years experience in CNC machine control, diagnostics, mechanical fixture design and repair of digital/analog circuits. **Respond to Dept. EDNMAG/PE.**

SR. ANALOG POWER ENGINEER

Engineering duties involve switching power supplies/hybrid power circuits for implantable medical devices. Background

must include BS/MSEE or PhD and 5+ years experience in analog circuit design, prototype, test and debug. **Respond to Dept. EDNMAG/APE.**

SR. COMPONENT RELIABILITY ENGINEER

Selected candidate will have BSEE with 5 years experience in reliability engineering, failure analysis techniques and rate predictions. Knowledge of IC and hybrid design/evaluation/qualification techniques and CMOS is essential, as well as ability to establish test requirements and evaluate results. **Respond to Dept. EDNMAG/CRE.**

SR. ELECTRONIC DESIGN ENGINEER

Requires proven expertise in design, prototype, test, debug and documentation of analog, digital, CMOS and microprocessor-based circuitry for implantable medical products. BS/MSEE and 5+ years experience also necessary. **Respond to Dept. EDNMAG/EDE.**

SR. ELECTRONIC PRODUCT ENGINEER

BSEE and 3-5 years experience in analog/digital design, CMOS/TTL devices and microprocessor-based systems essential. Ideal candidate will have knowledge of hybrid micro-electronics involved in the manufacture of high-reliability electronic devices. Electronic test procedure experience would be a plus. **Respond to Dept. EDNMAG/EPE.**

SOFTWARE ENGINEER

Utilizing Assembly and C languages, will design/develop system and application SW for real-time embedded microprocessor-based pacemaker support products. Requires BSEE/CE or equivalent and 3+ years experience in embedded microprocessor and system-level SW design/development. **Respond to Dept. EDNMAG/SE.**

In addition to our desirable Southern California location, we offer competitive compensation, paid relocation and an excellent benefits package, including employer-contributed pension plan, 401(k), tuition reimbursement, vision care and a choice of dental/health plans. Send resume (NO PHONE CALLS, PLEASE!) to the appropriate department: **Greer A. Brooks, Employment Representative, Pacemaker Systems, Inc., 12884 Bradley Avenue, Sylmar, CA 91342. AA/EOE**

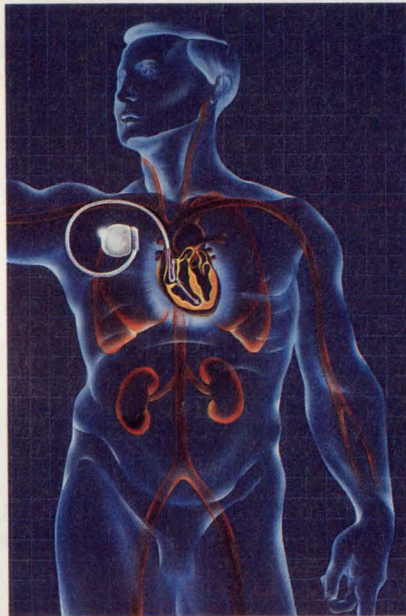

 **Pacesetter Systems, Inc.**
A Siemens Company

Where Reliability is a Way of Life®

Pushing The Limits Open Systems

Leading Edge, High Performance,
Open Systems...That's

INTERPHASE CORPORATION!

We are a rapidly growing, public held manufacturer of a broad line of high-performance disk, tape and networking controllers and subsystems for the worldwide OEM computer industry. If you are innovative and have the drive to push the limits of high technology, the following openings are for you!

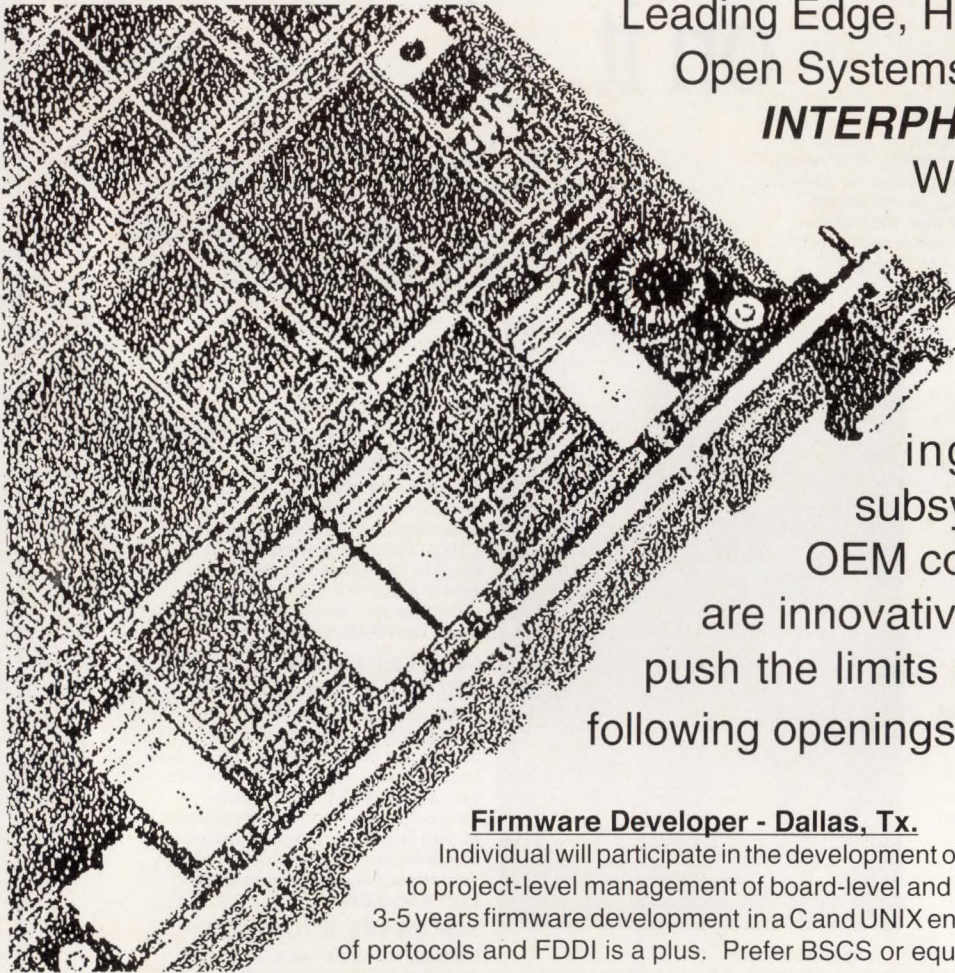

Firmware Developer - Dallas, Tx.

Individual will participate in the development of FDDI VMEbus products. Position leads to project-level management of board-level and standalone FDDI products. Minimum of 3-5 years firmware development in a C and UNIX environment required. Working knowledge of protocols and FDDI is a plus. Prefer BSCS or equivalent experience.

Senior Hardware Design Engineer - Dallas, Tx.

Candidate will design and simulate ASIC devices and interface to ASIC vendors. Minimum of 3-5 years experience in board-level design and high speed CMOS design using ASIC technologies (gate array or standard cell). Knowledge and use of schematic capture, logic simulation and fault simulation tools (Verilog and/or Synopsys) desired. Working knowledge of μ P and related architecture required. Disk, communication, VMEbus, Sbus and EISA bus experience are pluses. Prefer BSEE or equivalent experience.

Product Marketing Manager - Dallas, Tx.

Senior level candidate who can: formulate strategic plans, develop markets and size markets for *INTERPHASE*'s EISA products, technologies, and protocols. Represent *INTERPHASE* at various national and international forums, committees and working groups. Act as Product Line Champion within the corporation. 8-10 years applicable engineering and/or marketing experience with VAR, VAD, and dealer channels desired. Prefer BSEE, BSCS or equivalent experience. M.B.A. is a plus.

of Performance!

Applications Engineer - Dallas, Tx.

Individual will provide second level technical assistance for customers and liaison between Customer Service and Engineering. Will maintain an in-depth product and system knowledge in order to identify and solve software and hardware problems. Assemble hardware, generate test scripts or programs (C, assembler, or shell language), and modify software drivers. Minimum of 3 years experience with C in an UNIX environment required. Systems administration experience a plus. Prefer BSCS or equivalent experience.

Systems Administrator - Dallas, Tx.

Candidate will be responsible for the administration of Engineering Service's UNIX based workstation network. Primary duties will involve VALID systems administration, training engineers, developing and maintaining on-line help, writing behavior models in C, supporting schematic entry, component packaging and simulation. Minimum of 2 years experience with UNIX, O/S administration, C programming, shell programming and networking required. Experience with PC-NFS, modeling and simulation desired. Prefer BSEE, BSCS or equivalent experience.

Software Engineer - Dallas, Tx.

Candidate will develop device drivers for various *INTERPHASE* products. Experience with UNIX, Kernel I/O, TCP/IP or other protocol experience on super-minicomputer or mini-computer required. Minimum five years writing UNIX device drivers required. BSCS required. MSCS preferred.

Networking Programmer - Mountain View, Ca.

Individual will participate in the development of networking coprocessor products in a real-time environment. 3 years experience developing networking software in a real-time UNIX environment required. Working knowledge of TCP/IP, UDP and NFS/RPC desirable. Prefer BSCS, BSEE or equivalent experience. MSCS or MSEE a plus.

Software Performance Engineer - Mountain View, Ca.

Candidate will benchmark and test networking products as well as interface with all OEMs/customers regarding performance issues. Minimum of 5 years experience with UNIX and C programming and 2 years of performance evaluation and benchmarking. Prefer BSCS, BSEE or equivalent experience. MSCS or MSEE a plus.

Software Engineer - Mountain View, Ca.

Individual will install and patch install product related utilities, network management agents and user interfaces. Minimum of 3 years UNIX and C programming required. Experience with Bourne shell scripts, sed, awk, and systems administration desired. Exposure to NFS a plus. Prefer BSCS or equivalent experience. MSCS is a plus.

Systems Programmer - Mountain View, Ca.

Candidate will be responsible for integration of networking products into System V, Release 4 (VR4). VR4 driver experience and networking driver experience required. Knowledge of protocols is desired. Minimum of 4 years experience required. Prefer BSCS, BSEE or equivalent experience. MSCS is a plus.

INTERPHASE CORPORATION offers competitive salary and excellent benefits. For immediate consideration, send resume to:



INTERPHASE
CORPORATION

Human Resources - Dept: ES10
13800 Senlac
Dallas, TX 75234
Fax: (214) 919-9200

Check Out What Hamilton/Avnet Has in Storage for You.

Hamilton/Avnet now has, in stock, the industry's first 1 megabyte and 4 megabyte, PCMCIA-compatible flash memory cards to help you achieve higher functionality in portable and dedicated applications. In fact, when it comes to data acquisition and firmware updates, Hamilton/Avnet has the knowledge and expertise to help you design-in flash memory cards...today!

And for applications incorporating DOS, Intel offers a flash system developer's kit that enables you to check out how easy it is to design-in flash memory cards.

To order your flash system developer's kit, a \$499.95 value, simply call Hamilton/Avnet. For the branch nearest you, call toll free, 1 (800) 888-9236. Or, for further details, simply send in the coupon below.

I'd like additional information on Intel's Flash Memory Card offering.

Name _____

Title _____

Company _____

Address _____

City _____

State _____ Zip _____

Phone _____

Application _____

Hamilton/Avnet, Dept. 175
P.O. Box 9000
San Fernando, CA 91341-9981



CIRCLE NO. 84

EDN's INTERNATIONAL ADVERTISERS INDEX

Abbott Ball	149	Micro Crystal	149
ACCEL Technologies Inc	153	Microstar Laboratories	151
Adaptec Products Co	127	MicroSim Corp	19, 36-37
Advanced Micro Devices	8-9, 28-29, 70-71	Mini-Circuits Laboratories	20-21, 30-31, 120, 137, 160
American Arium	134	Molex Inc	141
American Neurologix	63	National Instruments	2
Ametek	82	National Semiconductor Corp	32, 101
AMP	86-87	NEC Corp**	115
Atlanta Signal Processors Inc.	140	Nohau Corp	149
B&C Microsystems	149, 153	Noble	150
Belden Wire & Cable	144, 145	NordicTrack	79
B-G Instruments Corp	56	Octagon Systems	151
BP Micro	151	Omron Electronics Inc	72
Buckeye Stamping Co	150	Pacific Hybrid Microelectronics	146
Burr-Brown Corp	61	Pearson	146
Butterworth Heineman**	148N	Phihong Enterprise Co Ltd	148
CAD Software Inc	139	Philips**	148E-H
Cahners CAPS	143, 150, 152, 153	Pico	148, 159
Capital Equipment Corp	84	Planar Systems**	148L
Capilano Computer Systems Inc	151	Pontiac	116
Cherry Electrical Products Inc	78	Raltron	84
Communications Specialties Inc	153	Raytheon	124
Communication Specialists	150	Ricoh	75
Comptech**	148M	Rogers Corp	151, 153
Conner Peripherals	12-13	SAAB**	148I-K
Cybernetic Micro Systems	27	Samsung Semiconductor	14-15
Cypress Semiconductor	6	Seagate Technology	26
Dale Electronics Inc	4	Sharp Electronics	58
Data Delay Devices	142	Siemens Corp*	16
Data I/O Corp	C4	Signum Systems	149
Deltron Inc	148A-D	Silicon Systems Inc	47
Design Computation Inc	150	Sony Corp of America	38
Elco Corp	103	Stanford Research Systems Inc	65
Emulation Technology Inc	75, 152	Switching Power Inc	102
EPIX Inc	150	TEAC Corp**	16
Force Computers Inc	22-23	Teledyne Solid State	85
Fujitsu APD	119	Teltone Corp	153
Gates Energy Products Inc	131	Teradyne Inc	24-25
Grammar Engine Inc	150	3M ISD	128
Hamilton Avnet Electronics	123, 158	Tribal Microsystems	152
Haverhills of San Francisco	79	TRW LSI Products Inc	34-35
Hewlett-Packard Co	C2, 10-11, 115	US Industrial Directory	48
Hitachi America Ltd*	50-53	US Software	150
HyperLynx	151	Vicor	45
Hypertronics Corp	152	Wavetek	3
IDT	40	Welch-Allyn	150
Incredible Tech	152	Ziatech Corp	1
Innovative Software Systems	152	Z-World	152
Instrument Specialties Co Inc	49	Zycad	76
Intel	54-55, 97		
Intergraph Corp	43		
International Rectifier	C3		
Interphase Corp	99		
Intusoft	152		
Ironwood	153		
Kepeco Inc	18A-D		
Lansing Instrument Corp	151		
LeCroy Corp	151		
Lemo USA Inc	153		
Linear Technology Corp	132		
Link Computer Graphics Inc	149		
MathSoft Inc	142		
Matra MHS	74		
Maxtor	80, 81		

Recruitment Advertising 154-157

Intel
Interphase Corp
Pacesetter Systems
Aurora Flight Sciences

*Advertiser in US edition
**Advertiser in International edition

This index is provided as an additional service. The publisher does not assume any liability for errors or omissions.

High Voltage DC-DC Converters

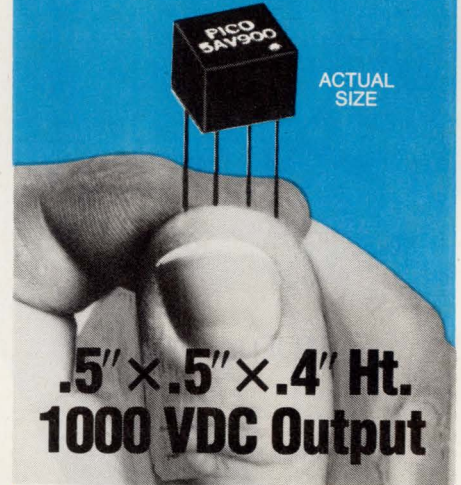

- **New Series AV—**
56 Standard Models
- **100 VDC to 1000 VDC**
Output
- **Ultra-miniature Size**
Weight: 4 Grams
0.1 Cubic Inch Volume
- **Standard Input Voltages**
5, 12, 24 and 28 Volts DC
- **Operating Temperature**
Standard: -25°C to +70°C
Optional: -55°C to +85°C
- **MIL-STD-883**
Screening Available
- **Isolated: Input to Output**
up to 1500 VDC

PICO also manufactures over 800 regulated and isolated DC-DC Converters and AC-DC Power Supplies and over 2500 standard ultra-miniature Transformers and Inductors.

Delivery—
stock to
one week

SEE EEM,
OR SEND DIRECT FOR
FREE PICO CATALOG

PICO
Electronics, Inc.

453 N. MacQuesten Pkwy. Mt. Vernon, N.Y. 10552
Call Toll Free **800-431-1064**
IN NEW YORK CALL **914-699-5514**

99¢

from

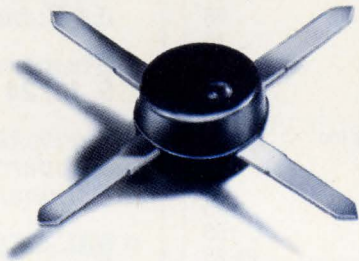

dc to 2000 MHz amplifier series

SPECIFICATIONS

MODEL	FREQ. MHz	GAIN, dB				• MAX. PWR. dBm	NF dB	PRICE \$ Ea.	Qty.
		100 MHz	1000 MHz	2000 MHz	Min. (note)				
MAR-1	DC-1000	18.5	15.5	—	13.0	0	5.0	0.99	(100)
MAR-2	DC-2000	13	12.5	11	8.5	+3	6.5	1.50	(25)
MAR-3	DC-2000	13	12.5	10.5	8.0	+8□	6.0	1.70	(25)
MAR-4	DC-1000	8.2	8.0	—	7.0	+11	7.0	1.90	(25)
MAR-6	DC-2000	20	16	11	9	0	2.8	1.29	(25)
MAR-7	DC-2000	13.5	12.5	10.5	8.5	+3	5.0	1.90	(25)
MAR-8	DC-1000	33	23	—	19	+10	3.5	2.20	(25)

NOTE: Minimum gain at highest frequency point and over full temperature range.

- 1dB Gain Compression
- +4dBm 1 to 2 GHz

designers amplifier kit, DAK-2

5 of each model, total 35 amplifiers
only \$59.95

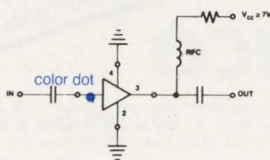

finding new ways...
setting higher standards

Mini-Circuits

A Division of Scientific Components Corporation
P.O. Box 350166, Brooklyn, New York 11235-0003 (718) 934-4500
Fax (718) 332-4661 Domestic and International Telexes: 6852844 or 620156

Unbelievable, until now... tiny monolithic wide-band amplifiers for as low as 99 cents. These rugged 0.085 in. diam., plastic-packaged units are 50ohm* input/output impedance, unconditionally stable regardless of load*, and easily cascable. Models in the MAR-series offer up to 33 dB gain, 0 to +11dBm output, noise figure as low as 2.8dB, and up to DC-2000MHz bandwidth.

*MAR-8, Input/Output Impedance is not 50ohms, see data sheet.
Stable for source/load impedance VSWR less than 3:1

Also, for your design convenience, Mini-Circuits offers chip coupling capacitors at 12 cents each.†

Size (mils)	Tolerance	Temperature Characteristic	Value
80 × 50	5%	NPO	10, 22, 47, 68, 100, 220, 470, 680, 1000 pF
80 × 50	10%	X7R	2200, 4700, 6800, 10,000 pF
120 × 60	10%	X7R	.022, .047, .068, .1µF

† Minimum Order 50 per Value

• Designers kit, kcap-1,50 pieces of each capacitor value, only \$99.95



What good is a power switch that makes jellies and jams?



Whether you're designing controls for a line of catsup, lightbulbs, tires or jellies, we've got the power switch to preserve uptime. The IR8400 Quad Supervisory switch.

Its serial diagnostics keep you current at all times. From error flags for flash reporting through the detailed follow-up report on load, switch,

voltage, and temperature status.

And it's not just smart, it's tough. The IR8400 is completely self-protected. Short-proof. Open-circuit proof. And practically bullet-proof, with power-limiting to operate and protect high-in-rush loads.

But that's not all. With one to four-amp flexibility, you get the super-

visory controls to manage any industrial application, or office and medical equipment over a 6V to 28V operating range.

Watching your uptime? Write or call for a data

sheet on the terrific IR8400:

1-800-245-5549.

Even if you're not in jellies, it'll keep you out of jams.

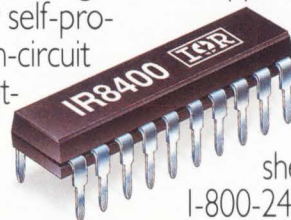

IR International Rectifier

WORLD HEADQUARTERS: 233 KANSAS ST., EL SEGUNDO, CA 90245, U.S.A. (213) 772-2000. TWX 910 348-6291, TELEX 472-0403. EUROPEAN HEADQUARTERS: HURST GREEN, OXTED, SURREY RH8 9BB, ENGLAND TELEPHONE (0883) 713215, TELEX 95219

CIRCLE NO. 86

Recommended by
Actel
for ACT™ FPGAs
ACT is a trademark of Actel.

Program your hot new parts here.

And Now. Just one thing stands between you and your "hot" new design: a device programmer that can handle it. That's why the UniSite™ Universal Programmer is the designer's first choice.

UniSite is always first to support the latest devices like the Altera Max, AMD MACH,™ and the newest FPGAs. It also supports more



packages—including PLCCs and LCCs up to 84 pins, pin grid arrays, and SOICs. UniSite is designed for the future.

Data I/O's universal pin-driver technology eliminates pinout adapters, for single-site programming of each device type. And its new PinSite™ programming module uses Data I/O's new Universal Package System,™ to support all surface-mount packages from one site.

Adding device support is easy too, with UniSite's update diskettes. They're released quarterly, so you'll always have support for the latest devices—first.

FREE Programming Tutorial. For a FREE copy of our programming technology tutorial and more information about UniSite, call now.

1-800-3-DataIO
(1-800-332-8246)

The Personal Silicon Experts

DATA I/O
Corporation

Data I/O Corporation 10525 Willows Road N.E., P.O. Box 97046, Redmond, WA 98073-9746, U.S.A. (206) 881-6444
1-800-3-DataIO (1-800-332-8246)

Data I/O Canada 6725 Airport Road, Suite 302, Mississauga, Ontario L4V 1V2 (416) 678-0761
Data I/O Europe World Trade Center, Strawinskylaan 537, 1077 XX Amsterdam, The Netherlands +31 (0)20-6622866
Data I/O Instrument Electronic Systems Vertriebs GmbH Lochhamer Schlag 5A, 8032 Graefelfing, Germany, +49 (0)89-858580
Data I/O Japan Sumitomoseimei Higashishinbashi Bldg., 8F, 2-1-7, Higashi-Shinbashi, Minato-Ku, Tokyo 105, Japan
011-81-3-3432-6991/Telex 2522685 DATAIO J

©1991 Data I/O Corporation

CIRCLE NO. 88