

EDN[®]

ELECTRONIC TECHNOLOGY FOR ENGINEERS AND ENGINEERING MANAGERS WORLDWIDE

PROCESSOR UPDATE
PG 93

A CAHNERS PUBLICATION
January 20, 1992

Special Report:
**Evaluation boards help
you hatch new designs**
pg 104

SPECIAL REPORT

**8-bit μ C
evaluation
boards**
pg 104

DESIGN FEATURE

**Programmable-
logic device
masters
high-speed
data transfers**
pg 121

TECHNOLOGY UPDATES

**Self-calibrating
A/D converters**
pg 53

**Surface-mount
sockets expand
design options**
pg 71

**Buscon show
preview**
pg 82

DEPARTMENTS

New: Inside EDN
pg 11

**New: Acronyms
& Abbreviations**
pg 186

New: Hands On!
pg 189

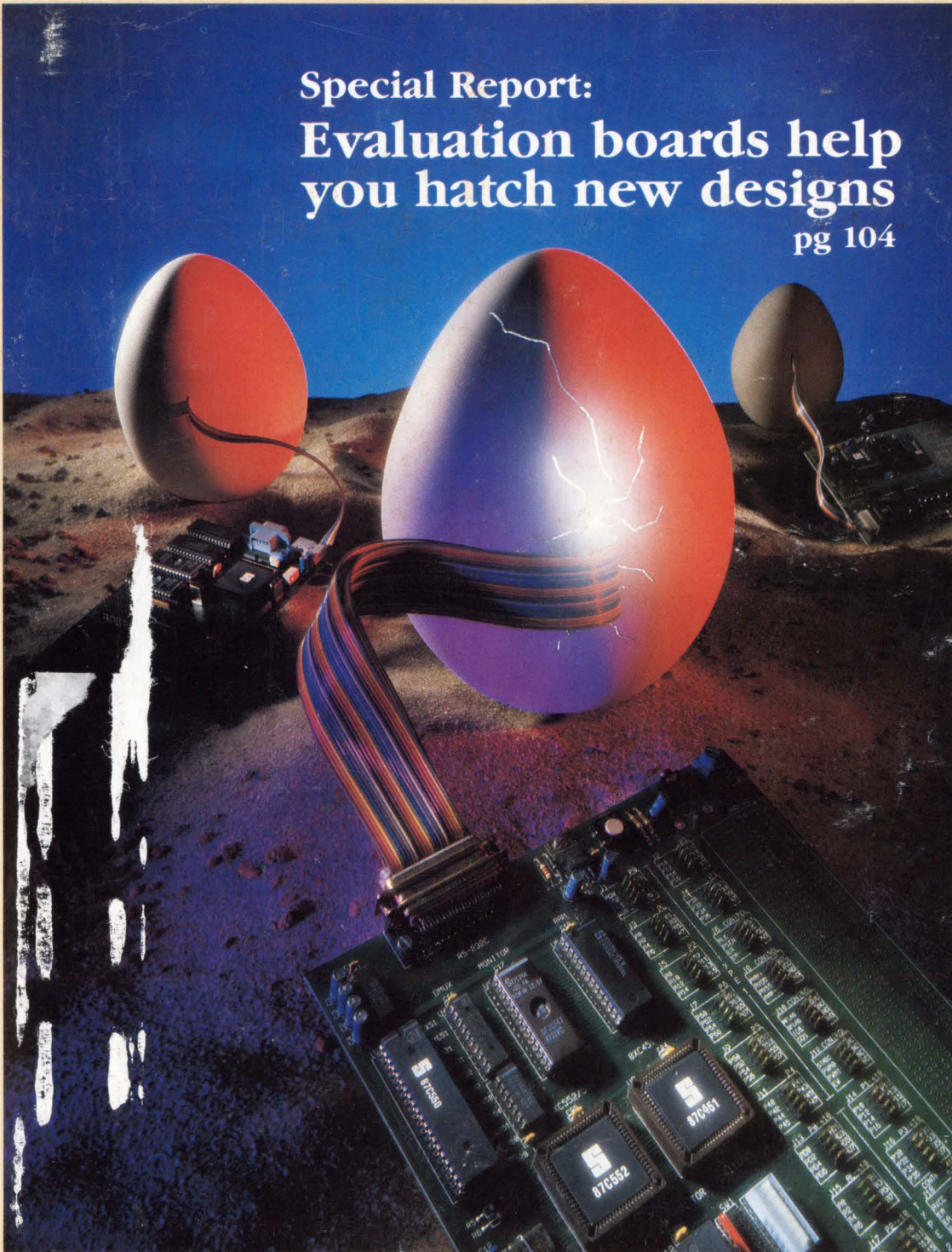

Now catch the bugs that defy logic.

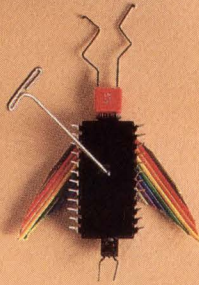

LOCK UP

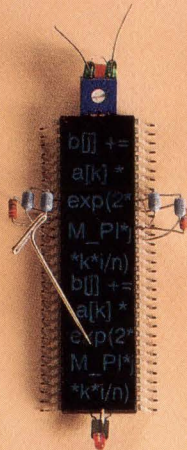

INCORRECT
REGISTER
VALUE

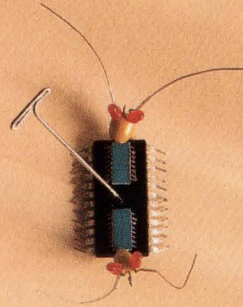

RANDOM
OUTPUT

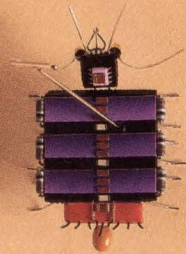

PARITY
ERROR

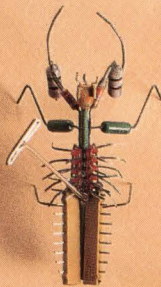

UNEXPECTED
EXCEPTION

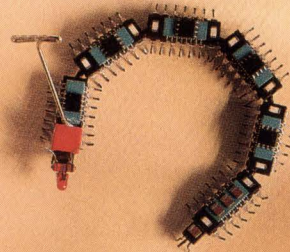

REPEATING
RESET

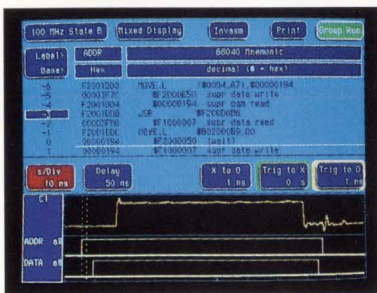

The HP16500A logic analysis system shows what's bothering your designs.

Power up a new design and you're in for a battle. That's when you need the HP 16500A logic analysis system. With one modular system, you can focus measurement power on those press-

ing problems. Before things get out of hand.

Choose from a wide range of modules. The state/timing module provides advanced capabilities, including 100 MHz state speed for debugging RISC and high-end CISC processors. There's a 1 GSa/s scope for single-shot troubleshooting. A 1 GHz timing module for precision time-interval measurements. And pattern generation for functional testing.

And you get the industry's broadest microprocessor and bus support...more than 100 solutions to speed and simplify debugging of virtually any microprocessor based design. Plus an intuitive

full-color, touch-screen interface to make setup and operation easier too.

So take control of the debugging process. Call **1-800-452-4844**. Ask for **Ext.2604** and we'll send a brochure on the analysis system that can catch the toughest bugs before they start bothering you.

There is a better way.



* In Canada call 1-800-387-3867, Dept. 429.
©1991 Hewlett-Packard Co. TMCOL123/EDN

2 WAYS TO COMPACT 7 PCs FOR REAL-TIME CONTROL, NETWORKING, AND DATA ACQUISITION, WITH A USER INTERFACE INTO ONE VERY SMALL BOX



THE ALTERNATIVE TO BRUTE FORCE

Ziatech's new STD 32 STAR SYSTEM™ provides a simple-to-use, DOS-based, multiprocessing approach to automating real-time control applications. And it doesn't require a complex multitasking operating system, an expensive LAN, or the crushing of 7 PCs into a twisted bale of heavy metal.

A WINDOW INTO REAL-TIME CONTROL

Each processor in the STAR SYSTEM contains its own RAM, ROM, and DOS, while uniquely sharing disks, video, and equal access to I/O. This lets system designers segment a real-time control application into as many as seven separate computing modules. In a Microsoft Windows environment, the STAR SYSTEM becomes a Real-time Windows computer that puts real-time where it belongs, on processors separate from the user interface.

MULTIPLE COMPUTERS MEAN FAST DEVELOPMENT

The ability to run separate development tools such as Borland C++ or Microsoft QuickBASIC on each STAR SYSTEM processor helps OEM products get to market fast.

MAKE THE ONLY MULTIPLE CHOICE

Call or FAX today for a free data sheet or to arrange an on-site demonstration.



TEL 805-541-0488
FAX 805-541-5088

Circle No. 1

Product names of other companies may be trademarks of those companies.



Build a Better Test System

Developing a PC-based test system with standard hardware and software saves valuable development time and produces a higher quality system. That's why National Instruments hardware and software products are built upon industry standards.

Our GPIB boards use the NAT4882™ chip for complete IEEE-488.2 compatibility. And our LabWindows® software combines powerful development tools with standard programming languages.

With LabWindows, you have the software tools you need to integrate all of the hardware in your test system. Use high-level 488.2 routines to simplify system programming or use drivers from the LabWindows Instrument Library to control your GPIB and VXI instruments without programming them at all.

LabWindows has tools for all phases of your development—data acquisition, analysis, and presentation. You can even create a graphical user interface so your test system is easy to operate.

To learn how to build a better test system, give us a call.



Corporate Office
6504 Bridge Point Parkway
Austin, TX 78730-5039
512) 794-0100
(800) 433-3488 (U.S. and Canada)

International Branch Offices
AUSTRALIA (03) 879 9422 • DENMARK (45) 76 73 22
FRANCE (1) 48 65 33 70 • GERMANY (089) 714 5093
ITALY (02) 4830 1892 • JAPAN (03) 3788 1921
NETHERLANDS (01720) 45761 • NORWAY (03) 846 866
SWITZERLAND (056) 45 58 80 • SPAIN (908) 604 304
UNITED KINGDOM (0635) 523 545

© Copyright 1991 National Instruments Corp. All rights reserved.



Our Model 91 will make your pulse race and help you function better.

Introducing the latest member of the 90 Series family: Model 91 Synthesized Pulse Function Generator. It delivers functions and pulses to 20 MHz with five digit frequency accuracy. Out the rear it has pulses to 50 MHz and a 100 MHz clock output. Choose ECL, CMOS or TTL levels, or set your own.

The functions and pulses can be swept or modulated,

and there is even GPIB programmability. Plus an external frequency input that lets you use the Model 91 as a frequency counter.

With all these capabilities, Model 91 redefines the concept of an all-purpose benchtop instrument.

About all it doesn't do is generate arbitrary waveforms, but there's the Wavetek Model 95 Synthesized Arbitrary Function Generator for that.

Of course if you want even greater pulse generation capability, our four-channel Model 869 is among the most accurate pulse generators in the world.

For more information about our multi-purpose function generators, high performance pulse generators, or test development and arbitrary waveform software, call Wavetek at 1-800-874-4835.

© 1991 Wavetek Corporation

Circle #3 For Literature

Circle #4 For Demonstration

WAVETEK

from
Noritake

Express yourself ...
With VFD Graphic Module flexibility,
a new world is at your command.

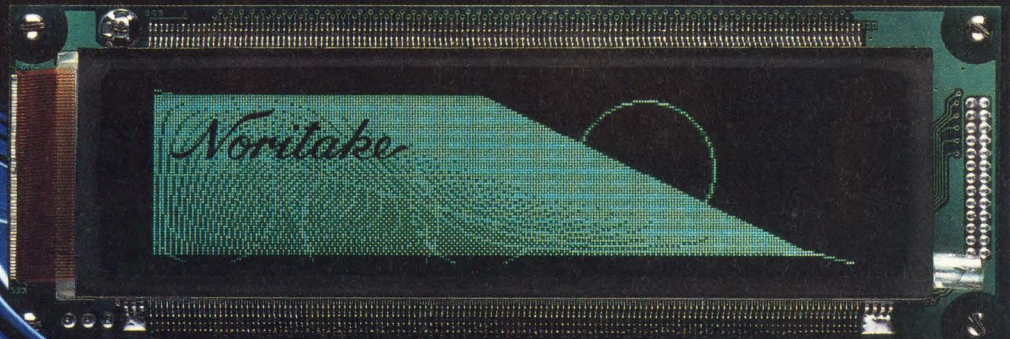

One module that will do the work of several.

itron[®] VFD Graphics Module

- Low cost
- Easy, flexible programming
- High visibility, high brightness
- Six models to choose from
- Controller, character generator and RAM on board
- Simultaneous graphic and character overlay

Call or write to see our entire line:

Noritake

Los Angeles
23820 Hawthorne Blvd.
Suite 100
Torrance, CA 90505
Tel. 213-373-6704
Fax 213-772-3918

Chicago
2635 Clearbrook Dr.
Arlington Heights, IL 60005
Tel. 708-439-9020
Fax 708-593-2285

Boston
263 Winn St.
Suite 1D
Burlington, MA 01803
Tel. 617-270-0360
Fax 617-273-2892

Dallas
2454 Trade Mart
Dallas, TX 75207
Tel. 214-742-9389
Fax 214-747-5065

Europe
Frankfurter Strasse 97-99
6096 Raunheim
F.R. Germany
Tel. 06142-43095/96/97
Fax 06142-22799

CIRCLE NO. 5

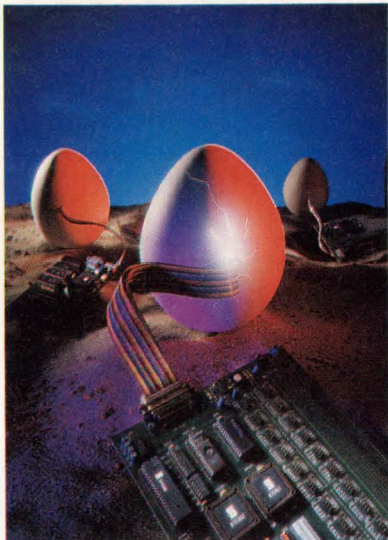

On the cover: Evaluation boards give you the luxury of experimenting with different 8-bit microcontrollers before cutting the cord on your old standby. Photo courtesy Signetics, Philips Semiconductors; photographer, Geoffrey Nelson; art director, Ottip Ramos. **PAGE 104**



High-resolution systems get a boost from autocalibrating A/D converters **PAGE 53**

SPECIAL REPORT

8-bit μ C evaluation boards

You no longer have to be tied to a single microcontroller (μ C) family. It's easy to try another architecture to fill out your design tool kit. Pick an evaluation board and try out a new processor.—*Ray Weiss, Technical Editor*

104

DESIGN FEATURE

Programmable device masters the art of high-speed data transfers



The MicroChannel Architecture defines a high-speed data-transfer protocol for moving data between a bus master and a slave. Implementing this protocol in programmable logic gives you design flexibility in addition to high-speed data transfers.—*Vinita Singhal, Altera Corp*

121

TECHNOLOGY UPDATES

Self-calibrating A/D converters: Monolithic devices enhance accuracy and linearity

Self-calibrating ADCs can offer outstanding performance, particularly with regard to linearity specifications. To get the most out of these devices, however, you need to understand how they work and what they can actually do in a system application.—*Dave Pryce, Technical Editor*

53

Continued on page 7

EDN® (ISSN 0012-7515, GST Reg. #123397457) is published 48 times a year (twice monthly with 2 additional issues a month, except for March and October, which have 3 additional issues and July and December which have 1 additional issue) by Cahners Publishing Company, A Division of Reed Publishing USA, 275 Washington Street, Newton, MA 02158-1630. Terrence M McDermott, President/Chief Operating Officer; Frank Sibley, Executive Vice President; Jerry D Neth, Senior Vice President/Publishing Operations; J J Walsh, Senior Vice President/Finance; Thomas J Dellamaria, Senior Vice President/Production and Manufacturing; Ralph Knupp, Vice President/Human Resources. EDN® is a registered trademark of Reed Properties Inc., used under license. Circulation records are maintained at Cahners Publishing Company, 44 Cook Street, Denver, CO 80206-5800. Telephone: (303) 388-4511. Second-class postage paid at Denver, CO 80206-5800 and additional mailing offices. **POSTMASTER: Send address corrections to EDN®, PO Box 173377, Denver, CO 80217-3377.** EDN® copyright 1992 by Reed Publishing USA; Robert L Krakoff, President and Chief Executive Officer. Annual subscription rates for nonqualified people: USA, \$119.95/year; Mexico, \$169.95/year; Canada, \$181.85/year; all other nations, \$207.95/year for surface mail and \$329.95/year for air mail. Single copies are available for \$20 USA and \$25 foreign. Please address all subscription mail to Ellen Porter, 44 Cook Street, Denver, CO 80206-5800.

FLUKE®



PHILIPS

Introducing SCOPEMETER™

There's More Than One Reason to Reach for It.

In fact, there's *every* reason to reach for ScopeMeter™. Because only ScopeMeter combines the expertise of Fluke and Philips to bring you a dual-channel digital scope along with everything you've come to expect from Fluke digital multimeters.

The result: an integrated scope-and-multimeter that lets you see a waveform and digital meter display at the same time from the same input. Or switch between dedicated high-performance Scope and Meter functions with the touch of a key. That makes it faster and easier than ever to capture, store and analyze precisely what you're looking for. At a price that looks good, too.

To get your hands on a ScopeMeter, contact your Fluke sales office or your nearest Fluke distributor. For more product information, call **1-800-44-FLUKE**.

SCOPEMETER. Now there's only one to reach for.



Built to Take It.

- Completely sealed against water, dust and contaminants.
- EMI protected and measures up to 600 volts rms.
- Rugged construction with shock-resistant holster.
- Three-year warranty from Fluke.

Simply Easy.

- Intuitive front panel layout for simple, straightforward operation.
- Pop-up menus and five function keys for easy control.
- Autoset automatically sets voltage, time and trigger functions.
- Safety-designed BNC connectors and probes simplify floating measurements.

Double Duty.

- 50 MHz digital storage scope and 3000-count digital multimeter in one handheld package.
- Precision Min Max Record and 40 ns Glitch Capture make it easy to troubleshoot intermittent failures.
- Simultaneous waveform and digital display on a backlit screen you can read across the room.

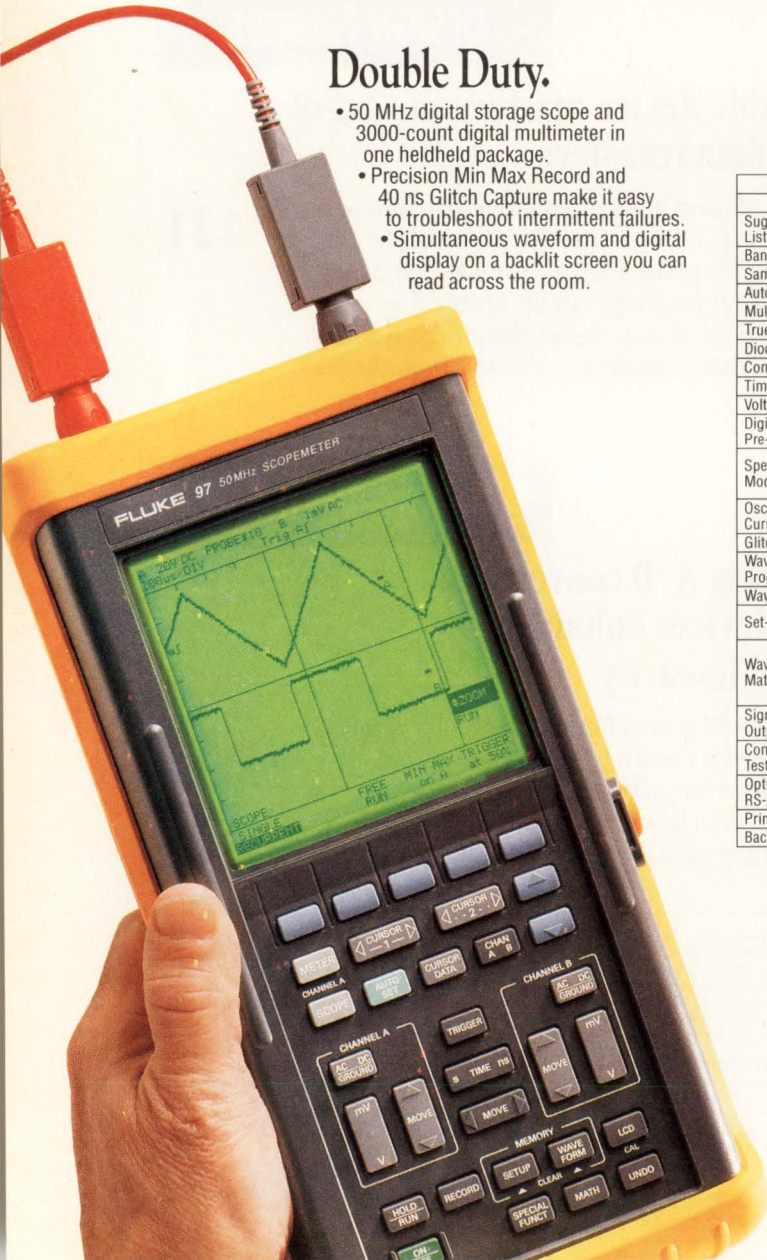

FLUKE 90 SERIES SCOPEMETER SELECTION GUIDE			
	FLUKE 97	FLUKE 95	FLUKE 93
Suggested List Price	\$1795	\$1495	\$1195
Bandwidth	50 MHz Dual Channel		
Sample Rate	25 Megasamples/second		
Autoset	Automatically sets Voltage, Time and Trigger		
Multimeter Display	3 2/3 digits (>3000 Counts)		
True RMS Volts	AC or AC+DC up to 600V (1700V Pk-Pk)		
Diode Test	Up to 2.8V		
Continuity Beeper	Yes		
Time/Division	10 ns/div to 60 sec/div		
Volts/Division	1 mV/div to 100V/div		5 mV/div to 100V/div
Digital Delay or Pre-Trigger	By Number of Cycles, Events, Time, or Zoom Mode		By Time
Special Multimeter Modes	Min Max Average Record, Relative (zero), dBm, dBV, dBW, Audio Watts, % Scale, Frequency, Smoothing™, Change Alert™		Frequency, Smoothing™, Change Alert™
Oscilloscope Cursors	12 Measurements, Display 5 Simultaneously		
Glitch Capture	>40 ns		
Waveform Processing	Average, Variable Persistence, Min Max Record		
Waveform Memory	Store and Recall 8 Waveforms		
Set-Up Memory	Store and Recall 10 Front Panel Set-Ups		
Waveform Mathematics	Add, Subtract, Multiply, Invert, Filter or Integrate Waveforms		
Signal Generator Output	Sinewave or Squarewave		
Component Tester Output	Voltage or Current Ramp		
Optically Isolated RS-232-C Interface	Full Operation by Remote Control		
Printer Output	Serial		
Backlit Display	Electroluminescent		

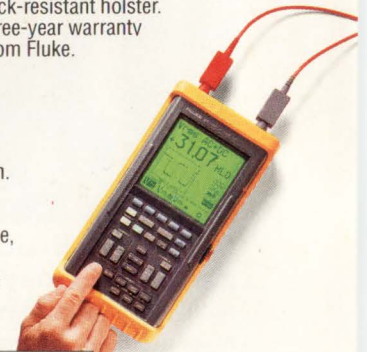

Goes Wherever You Go.

- Runs on rechargeable NiCad Batteries, standard C-cells or the included line voltage adapter/battery charger.
- Adjustable tilt-stand comes in handy as a hanger, too.
- Compatible with a wide range of Fluke multimeter accessories.

©1991 John Fluke Mfg. Co., Inc. Ad No. 00075.

FLUKE®

CIRCLE NO. 6

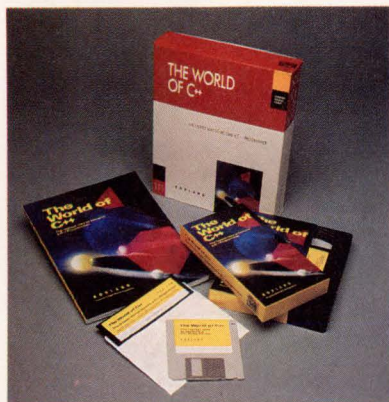

In our new Hands On! section, EDN's editors review books, software, music, and more . . . **PAGE 189**

EDN Magazine offers Express Request, a convenient way to retrieve product information by phone. See the Reader Service Card in the front for details on how to use this free service.

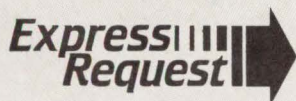

TECHNOLOGY UPDATES

Surface-mount sockets expand design options

Surface-mount sockets ease package replacement and system expansion, protect ICs from temperature damage during soldering, and make test points readily available.—*Tom Ormond, Senior Technical Editor*

71

Show preview: Buscon beefs up technical program

Buscon West now features more than 60 technical sessions and tutorials.—*Julie Anne Schofield, Associate Editor*

82

EDITORS' CHOICE

Rapid-charge controller for NiCd batteries

87

PRODUCT UPDATE

RISC-based workstation

91

PROCESSOR UPDATES

8-bit microcontroller for 16-pin DIPs and SOICs

93

MIPS-based chip in 84-pin package

94

4-bit microcontroller

96

16-bit microcontroller for high-end performance

98

Programmable I/O processor chip

100

Continued on page 9

Cahners Publishing Company, A Division of Reed Publishing USA □ Specialized Business Magazines for Building & Construction □ Research □ Technology □ Electronics □ Computing □ Printing □ Publishing □ Health Care □ Foodservice □ Packaging □ Environmental Engineering □ Manufacturing □ Entertainment □ Media □ Home Furnishings □ Interior Design □ and Lodging. Specialized Consumer Magazines for Child Care □ Boating □ and Wedding Planning.

HOW SUN SNAPPED UP THE LEAD IN SPARC MULTIPROCESSING.

Sun Microsystems's™ new 90 SPEC thruput multiprocessing SPARCserver is powered by our new SPARCore Modules.

We have consistently delivered a performance advantage in SPARC RISC chipsets. Now, we are introducing SPARCore™ high-performance uniprocessing and multiprocessing Modules. Cypress modules provide you (and Sun) with significant competitive advantages based on innovative technology:

1. Short-Cut to Market. With this much complexity running at 40+MHz speeds, there are non-trivial issues to integrating the CPU chipset. Using our fully integrated, tested SPARCore modules, you save time, not to mention manufacturing and testing costs. We deliver fully tested modules, with MPU, FPU, MMU, and Cache, for the price of the chipset.

2. Plug and Play on MBus. You design your system to the MBus standard, and you can plug in modules offering a range of speed/power options, to keep your product current without major redesign. This modular approach provides a designed-in upgrade path to keep you on the leading edge.

Call for your Free SPARCore Whitepaper and Data Sheets. Hotline: 1-800-952-6300.* Ask for Dept C4W.

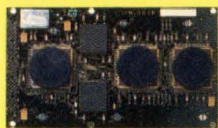

CYM6001K Uniprocessor SPARCore Module

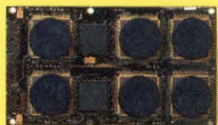

CYM6002K Dual Processor SPARCore Module

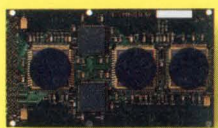

CYM6003K Uniprocessor SPARCore Module for Multiprocessing systems



CYPRESS SEMICONDUCTOR

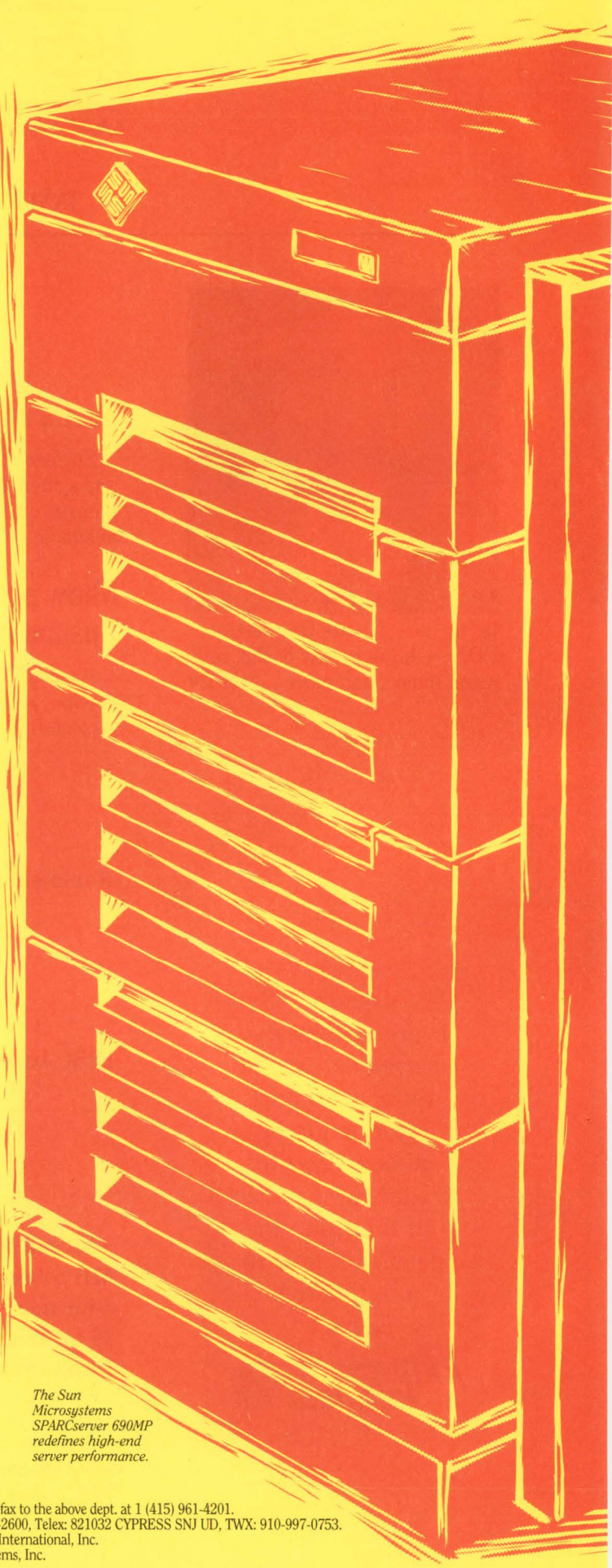

The Sun Microsystems SPARCserver 690MP redefines high-end server performance.

*In Europe fax your request to the above dept. at (32) 2-652-1504 or call (32) 2-652-0270. In Asia fax to the above dept. at 1 (415) 961-4201. © 1991 Cypress Semiconductor, 3901 North First Street, San Jose CA 95134. Phone: 1 (408) 943-2600, Telex: 821032 CYPRESS SNJ UD, TWX: 910-997-0753. SPARCore is a trademark of Cypress Semiconductor. SPARC is a registered trademark of SPARC International, Inc. Products bearing the SPARC trademark are based on an architecture developed by Sun Microsystems, Inc.

Home Office

275 Washington St, Newton, MA 02158
 EDN Bulletin Board: (617) 558-4241
 MCI: EDNBOS
 (617) 558-extension

VP/Publishing Director

Peter D Coley -4673

VP/Publisher

Roy Forsberg -4367

VP/Editor/Editorial Director

Jonathan Titus -4573

Executive Editor

Steven H Leibson -4214

Managing Editor

Joan Morrow Lynch -4215

Assistant Managing Editor

Christine McElvenny -4741

Gary Legg, *Senior Technical Editor* -4404
 Tom Ormond, *Senior Technical Editor* -4414
 Charles Small, *Senior Technical Editor* -4556
 John A Gallant, *Technical Editor* -4666
 Michael C Markowitz, *Technical Editor* -4743
 Dave Pryce, *Technical Editor* -4326
 Dan Strassberg, *Technical Editor* -4205
 Jay Fraser, *Associate Editor* -4561
 Carl Quesnel, *Associate Editor* -4484
 Susan Rose, *Associate Editor* -4738
 Julie Anne Schofield, *Associate Editor* -4619
 Helen McElwee, *Senior Copy Editor* -4311
 James P Leonard, *Copy Editor* -4324
 Gillian A Caulfield, *Production Editor* -4263
 Brian J Tobey, *Production Editor* -4309

Editorial Field Offices

Doug Conner, *Technical Editor*
 Atascadero, CA: (805) 461-9669
 MCI: EDNDCONNER

J D Mosley, *Technical Editor*
 Arlington, TX: (817) 465-4961
 MCI: EDNMOSLEY

Richard A Quinnell, *Technical Editor*
 Aptos, CA: (408) 685-8028
 MCI: EDNQUNNELL

Anne Watson Swager, *Technical Editor*
 Wynnwood, PA: (215) 645-0544
 MCI: EDNSWAGER

Ray Weiss, *Technical Editor*
 Woodland Hills, CA: (818) 704-9454
 MCI: EDNWEISS

Maury Wright, *Technical Editor*
 San Diego, CA: (619) 748-6785
 MCI: EDNWRIGHT

Brian Kerridge, *Technical Editor*
 (508) 28435
 22 Mill Rd, Loddon
 Norwich, NR14 6DR, UK
 MCI: EDNKERRIDGE

Contributing Editors

Robert Pease, Don Powers,
 David Shear, Bill Travis

Editorial Coordinator

Kathy Leonard -4405

Editorial Services

Helen Benedict -4681

Art Staff

Ken Racicot, *Senior Art Director* -4708
 Chinsoo Chung, *Associate Art Director* -4446
 Cathy Madigan, *Staff Artist* -4599

Marketing & Business Director

Deborah Virtue -4779

Marketing Communications

Kathy Calderini, *Manager* -4526
 Pam Winch, *Promotion Assistant* -4660

DESIGN IDEAS

Battery-powered μ P turns itself off	133
Single 1.5V cell powers crystal oscillator	134
Active filter eases component selection	136
Feedback & Amplification	138

EDITORIAL

Winds of change blow strong

We may not like the turbulence of the Bell System's breakups, but even today, the telecommunications industry needs more competition and less government interference.—*Jon Titus, Editor*

49

NEW PRODUCTS

Integrated Circuits.	140
Test & Measurement Instruments.	144
CAE & Software Development Tools.	150
Components & Power Supplies.	156
Computers & Peripherals.	162

DEPARTMENTS

Inside EDN.	11
News Breaks.	23
Signals & Noise.	33
Ask EDN.	43
EDN's International Advertisers Index.	184
EDN's Acronyms & Abbreviations.	186
Hands On!.	189

Still the Leader

in DOS based Electronic Design

Introducing Schematic Design Tools version 4.10

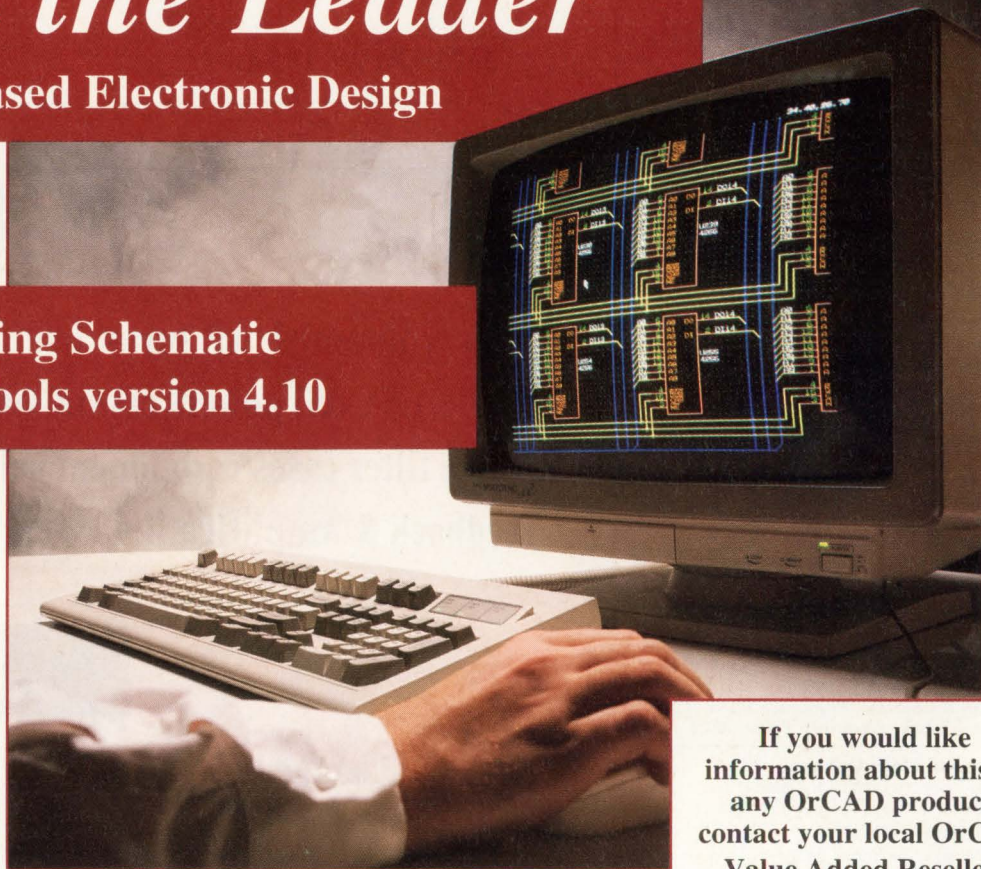

If you would like information about this or any OrCAD product, contact your local OrCAD Value Added Reseller.

The leader in PC based EDA tools.

Why? Because we never stop improving our products. One example is our world famous *Schematic Design Tools* package with the *ESP framework*.

OrCAD has just released version 4.10 with these new features.

- dramatic increase in capacity
- utilities like netlist output have increased speed
- introducing new "hotkeys" in the ESP framework

The ESP Framework

The *ESP framework* is the first PC based framework that allows seamless integration between OrCAD tools and those of third party vendors. ESP framework is a part of Schematic Design Tools; no need to pay extra.

The OrCAD Difference

Schematic Design Tools still comes with the features you'd expect to pay more for:

- A library of over 20,000 unique parts you can browse through in a breeze.
- Utilities to generate Bill-of-Materials, electrical rules check, create custom library parts.
- Support for over 30 netlist formats.
- Over a hundred supported display adapters, 50 printer drivers, a dozen plotter drivers.
- User definable "smart" macros

As ever, all OrCAD products come with one year of product updates, telephone technical support and 24 hour BBS, and a subscription to The Pointer newsletter.

WA, OR, MT, ID, AK, WY
Avcom/EDA
(206) 828-2726

N. CA, HI, Reno NV
Elcor Associates Inc.
(408) 980-8868

So. CA
Advanced Digital Group
(714) 897-0319

Las Vegas NV, UT, AZ, NM, CO
Tusar Corporation
(602) 998-3688

TX, OK, AR, LA
Abcor, Inc.
(713) 486-9251

ND, SD, MN, MI, WI, IL, IN, OH, KY, WV, W. PA, NE, KS, IA, MO

MacKellar Associates, Inc.
(313) 335-4440

VA, TN, NC, SC
Tingen Technical Sales
(919) 870-6670

E. PA, NJ, NY, DE, MD, DC
Beta Lambda, Inc.
(800) 282-5632

CT, RI, MA, VT, NH, ME
Tri-Logic
(508) 658-3800

CANADA
Pegasus Circuits
(416)567-6840

Call (503)690-9881
or write today for your
FREE demo disk!

OrCAD 

3175 N.W. Aloclek Drive
Hillsboro, OR 97124
FAX (503)690-9891

CIRCLE NO. 7

Welcome to the enhanced EDN. By now, you've probably noticed that we've made some changes to the magazine, starting with the cover. We've spent the last three years talking to you, our readers, to find out how we could better serve your needs. The enhancements we've made to EDN's magazine and news editions represent the fruits of that research.

All of the changes you see are enhancements. In other words, we didn't omit any of the parts of EDN magazine you already enjoy. We'll continue to cover the critical topics of the electronics industry, and we're continuing our in-depth coverage of products and technology. The enhancements are designed to make it easier for you to read EDN and to provide you with even more of the information you need to do your work.

For example, the cover of EDN's magazine edition now carries much more information about the articles inside to help you find the stories that interest you. You'll find that the article titles are consistent from the cover, to the table of contents, and on to the article itself. You'll also see colored title bars at the top of each editorial page to help you keep track of where you are in the magazine. We think the consistent title treatment and the title bars will eliminate any problems you may have had finding articles in EDN.

However, the enhancements to EDN go far beyond these cosmetic changes. We've reorganized the News Breaks and short products sections so that we can provide you with even more of the information you want. We've also added several new sections we think you'll like. Because EDN has always been the industry leader in μ P coverage,

EDN has undertaken several hands-on projects over the years, and we are committed to giving you as much first-hand exposure to new products as we can. Our editors, who are also engineers, will use this section to give you personal advice about products they've tried. Further, we thought we'd have some fun with this section, so you'll find

reviews of engineering-related recreational products mixed in with the reviews of software and development products.

The section you're reading right now, "Inside EDN," is also new. We plan to use this page to give you some added insight into each issue's articles. For example, in this issue's Special Report, Ray Weiss looks at development boards for 8-bit processors. These boards help you quickly evaluate competing processor architectures by giving you ready-made, operational platforms for your test software. You don't need to waste any time designing hardware for processors you ultimately won't use in a final product. Ray says he had a blast trying out all of



This issue's Special Report covers 8-bit μ C evaluation boards.

these evaluation boards and their associated software tools. He tells you about his experiences starting on page 104. Ray continues his narrative in our next issue by looking at boards for 16-bit processors.

we're introducing a Processor Update section, starting with this issue. In this section, we plan to introduce every new μ P, μ C, and all related development tools. We're starting this section with a bang. You'll find five Processor Updates in this issue.

In the back of the magazine, you'll find our new "Hands On!" review

these evaluation boards and their associated software tools. He tells you about his experiences starting on page 104. Ray continues his narrative in our next issue by looking at boards for 16-bit processors.

Steven H Leibson
Executive Editor

Soon, Eight Ho Computing Will

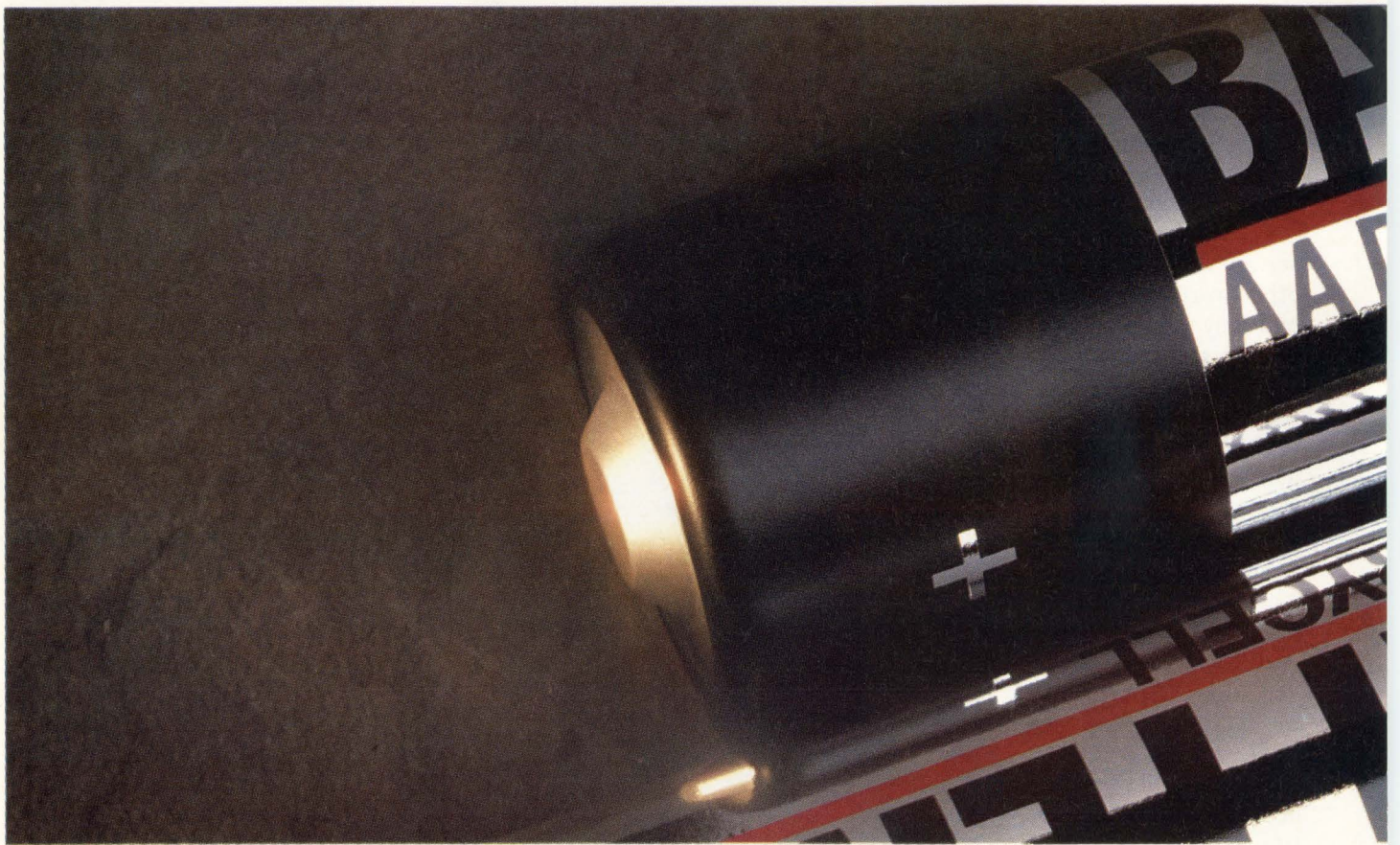

AMD Introduces The World's First 386 Microprocessor With 3-Volt Technology.

Two standard dry-cell batteries. There's really nothing special about them. Aside from the fact that they can run a powerful, portable 386 computer for a full eight hours. Provided, of course, that portable is built around a low-voltage Am386™ microprocessor.

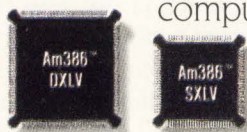

The 25MHz DXLV and the 25MHz SXLV are available in POFPP packaging.

Thanks to the low-voltage Am386 microprocessors, laptop, palmtop and notebook computer designs will become smaller, lighter, and more powerful than ever before.

With battery life of up to eight hours or more. That's a full day's worth of 386 performance—the per-

urs Of Portable Look Like This.

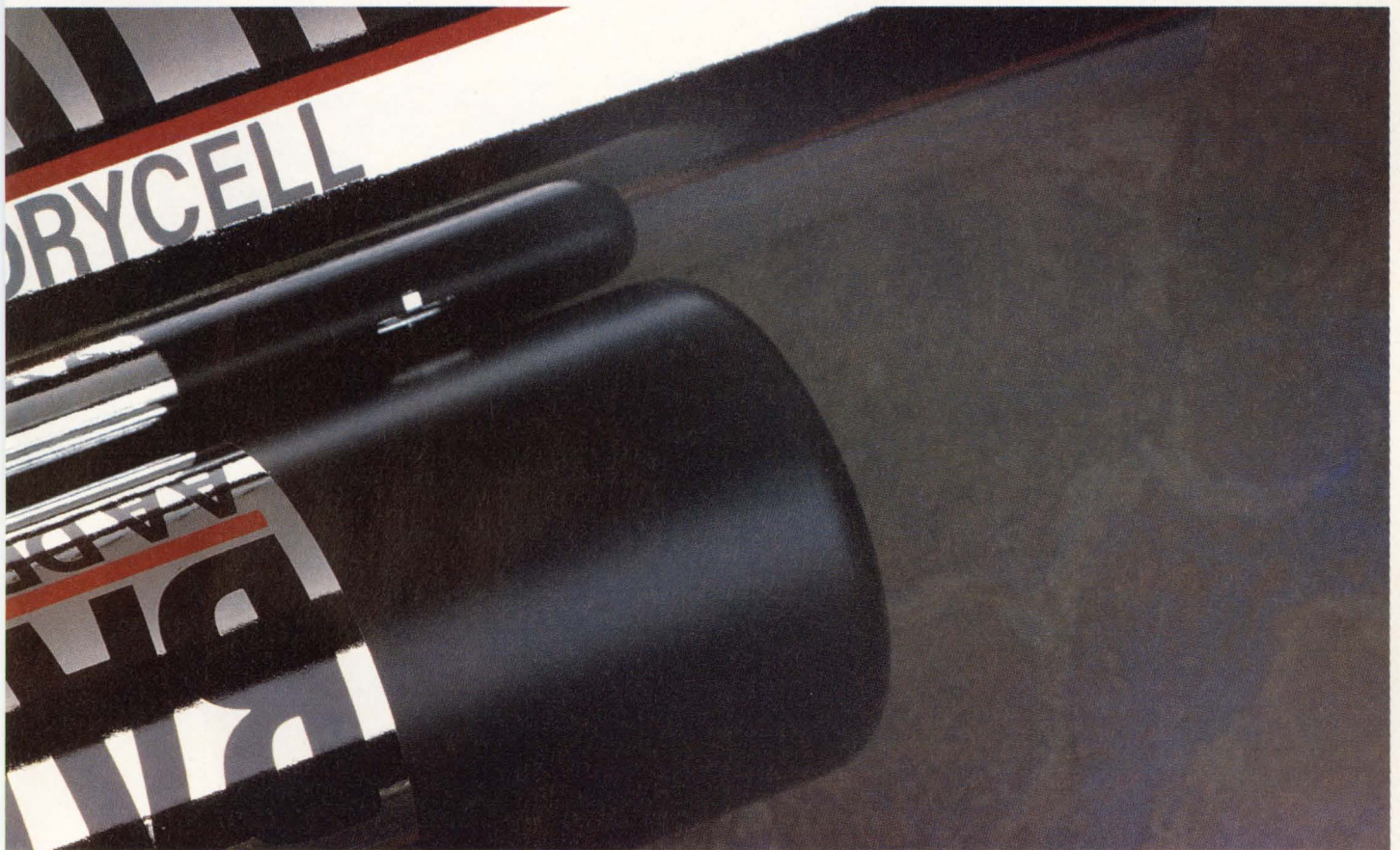

formance you need to run sophisticated applications like Windows™ 3.0.

And rest assured, the low-voltage Am386 microprocessors are proven compatible and comply fully with JEDEC standards for low-power, 3-volt computing. We can even supply you with the 3-volt EPROMs your systems will need. Other 3-volt system logic is also readily available.

For more information on the low-voltage

Am386 microprocessors call AMD today at **1-800-222-9323**. You'll never look at dry-cell batteries the same way again.



Advanced Micro Devices

"We're Not Your Competition."™

is a trademark of Advanced Micro Devices, Inc. All brand or product names mentioned are trademarks or registered trademarks of their respective holders.

A close-up photograph of a red, textured tape dispenser. The dispenser is filled with a roll of white tape, and a strip of tape is being pulled out from the right side. The dispenser is set against a background of a textured, shimmering gold surface. The lighting is dramatic, highlighting the texture of the dispenser and the background.

**Power
tool**

KEPCO LOW-PROFILE SWITCHING POWER SUPPLIES

Our power tools will help you solve critical space problems. Sometimes there is not a whole lot of room in your project for the power supply. We're used to that, it happens all of the time. Our solutions are low-profile ac to dc, and dc to dc power supplies so skinny that they'll slide into the most impossible places.

100 watts and only 1-inch thick — including the fins ... that's our FPD dc to dc converters.

Some units are so small and light that a little double faced tape or Velcro is all you need to mount the power supply. Provision for conventional screw mounting provided.

Power tools

SEE OUR PAGES IN VOLUME D **eem**

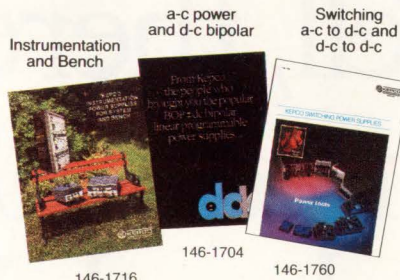

Call/fax/write to Dept. MBM-12 for any of our three catalogs

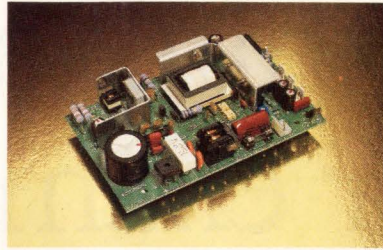

ac to dc power, triple outputs 35W, 50W

- +5V, $\pm 12V$ and $\pm 15V$ output
- Wide range 90-264V ac input
- UL/CSA/TÜV certified to international safety standards

Kepeco Group MRW Power Supplies

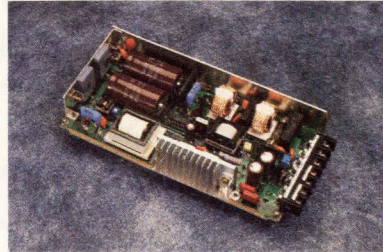

ac to dc power, single output 15W, 25W, 50W, 100W, 150W

- 5V to 48V output
- Wide range 85-264V ac input
- UL/CSA/TÜV certified to international safety standards

Kepeco Group FAW Power Supplies

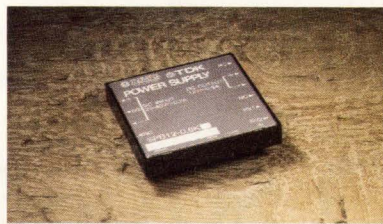

dc to dc power, single output 5W, 10W, 50W, 100W

- 5V to 24V output
- 12-150V dc input
- UL/CSA

Kepeco Group FPD Power Supplies

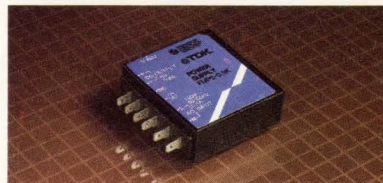

ac to dc power single output/dual output 3W, 10W

- 5V to 24V output
- $\pm 12V$, $\pm 15V$ output
- 85-132V ac input
- UL/CSA

Kepeco Group FMP/FCP Power Supplies

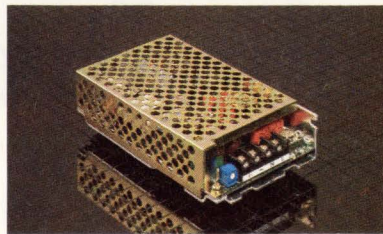
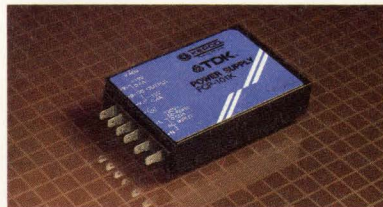

ac to dc power, single output 15W, 25W, 50W

- 5V to 24V output
- 85-132V ac input
- UL/CSA

Kepeco Group FAK Power Supplies

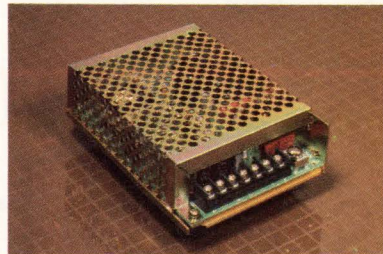

ac to dc power, triple outputs 16W

- +5V, $\pm 12V$ and $\pm 15V$ output
- 85-132V ac input
- UL/CSA

Kepeco Group ECM Power Supplies

Kepeco, Inc., 131-38 Sanford Avenue, Flushing, NY 11352 USA • Tel: (718) 461-7000 • Fax: (718) 767-1102 • Easylink (TWX): 710-582-2631
Eastern Region: 131-38 Sanford Avenue, Flushing, NY 11352 USA • Tel: (718) 461-7000 • Fax: (718) 767-1102 • Easylink (TWX): 710-582-2631
Western Region: 800 West Airport Freeway, Suite 320 LB 6018, Irving, TX 75062 USA • Tel: (214) 579-7746 • Fax: (214) 579-4608
Kepeco Europe, Ltd., London, England: Salamander Quay West, Park Lane, Harefield, Middlesex UB9 6NZ • Tel: + 44 895 825046 • Fax: + 44 895 825045



"When I think about den-
sity, I think about the human
mind. For example, Earth's
solar system—it's 5.515 times
more densely populated than
Macao, on the coast of China,
with an area of 6.5 square miles. How
dense is programmable logic,
density goes to Altera's
to 20,000 usable gates. An
PLD family. Bye-bye mas-
sive as it gets. Well, there
old college roommate. 30-
beer cans into his head. Y

sity, a few things come to is the densest planet in our es denser than water. The ace on the densest planet is hina. 479,000 people in an ope they like each other. As the award for the highest ew MAX 7000. With 1,000 d more I/O than any other ked gate arrays. That's as is Rocko Miller, my inch neck, crushed ou know the type."

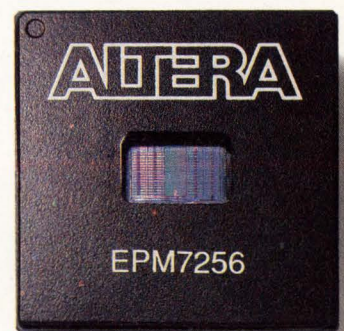

MAX7000

They're big. They're fast. They're everything you've asked for. Find out more big news. Call 1-800-800-7256.

IN THE ERA OF MegaChip™ TECHNOLOGIES

We've squeezed more ABT Widebus as fast

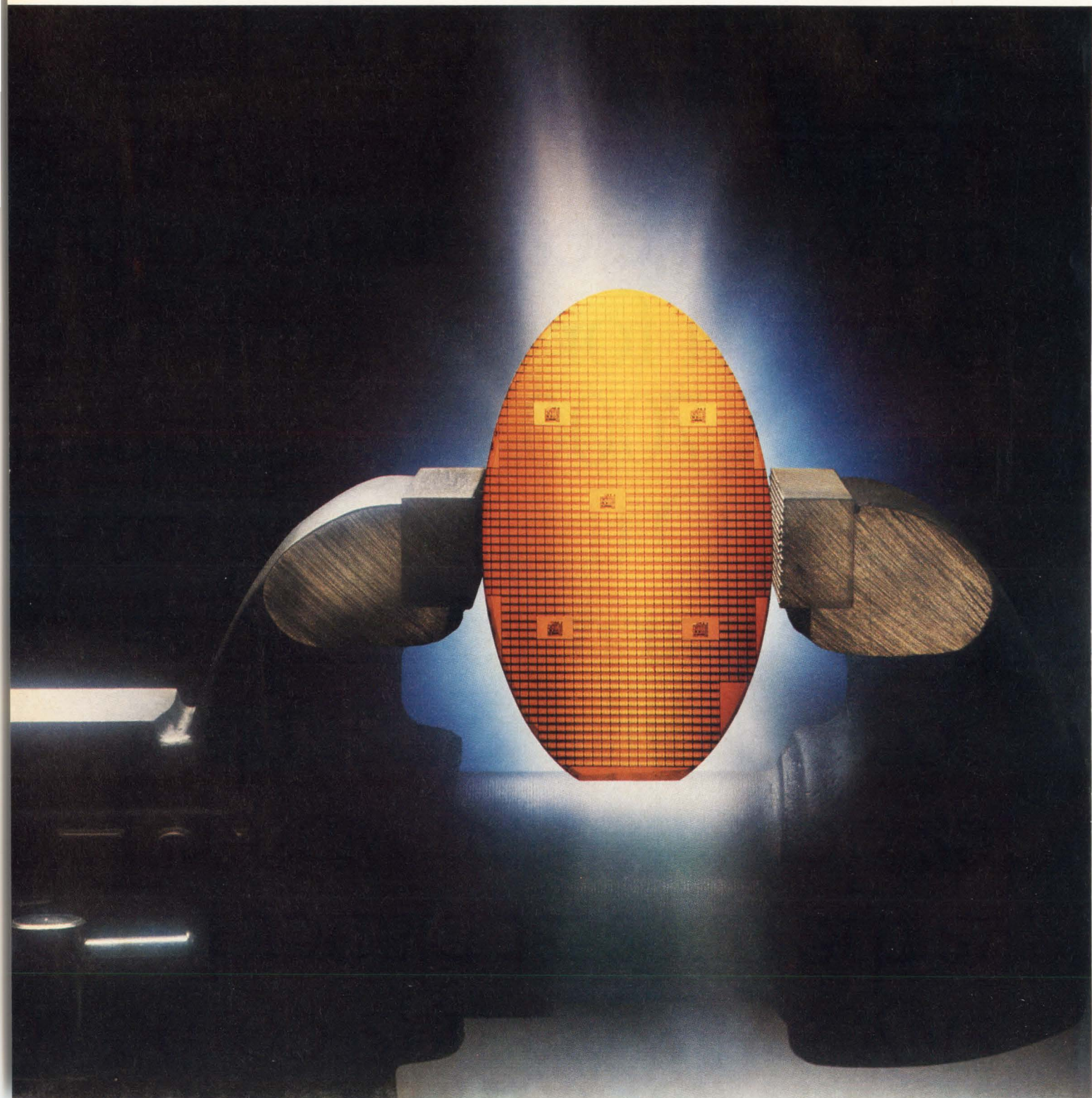

speed from our logic. as 4.1 ns!

With our new Advanced BiCMOS interface logic (ABT) family, you get the speed, drive and low power you need to optimize the performance of processors operating at 33 MHz and above.

Fabricated in our 0.8-micron BiCMOS process, this new family delivers maximum speeds down to 4.1 ns over recommended operating conditions. Typical performance of the devices is in the 2.5- to 3.0-ns range.

Other critical performance parameters are as impressive. Drive capability is 32 to 64 mA. Static power consumption is typically 2 mA (I_{CCH} , I_{CCZ}) and 30 mA (I_{CCL}). Ground bounce is less than 800 mV typ.

All this in Widebus

Our ABT family, a second-generation advance of our leadership BiCMOS (BCT) family, includes versions of our 16-, 18- and 20-bit-width Widebus™ functions.

Among the many ABT Widebus functions released is the 'ABT16244, a 16-bit buffer and line driver. It exhibits much greater stability of propagation delay (see chart), which results in a lower derating factor across the number of outputs switched.

Also in volume production are the Widebus 'ABT16245 16-bit bidirectional bus transceiver and the 'ABT16543 and 'ABT16952 16-bit bidirectional registered bus transceivers.

As in our successful Advanced CMOS Logic (ACL) Widebus family, these devices come in our leadership surface-mount shrink small-outline package (SSOP) that gives you twice the number of I/Os as a standard small-outline package in the same space.



Unique additions included

There are also new devices in our ABT Widebus family featuring greater density and functionality. Our 'ABT16500A is a good example. An 18-bit registered transceiver, it combines D-type latches and D-type flip-flops to allow data flow in transparent, latched and clocked modes.

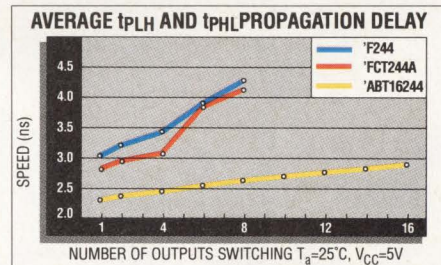

TI's speed advantage: In a one-to-one comparison, a TI 'ABT16244 16-bit Advanced BiCMOS driver proves to be much faster and more stable than Advanced Bipolar and standard CMOS octal drivers.

To complement our full line of Widebus products, our ABT family will include at least 39 octal buffers/drivers, flip-flops, transceivers and registered transceivers.

Squeeze more out of your system with a free sample 'ABT16500A: Call 1-800-336-5236, ext. 3009

To learn firsthand how our new ABT family can boost the performance of your bus-interface designs, get a free 'ABT16500A transceiver and data sheet. Just complete and mail the return card or call the number above.



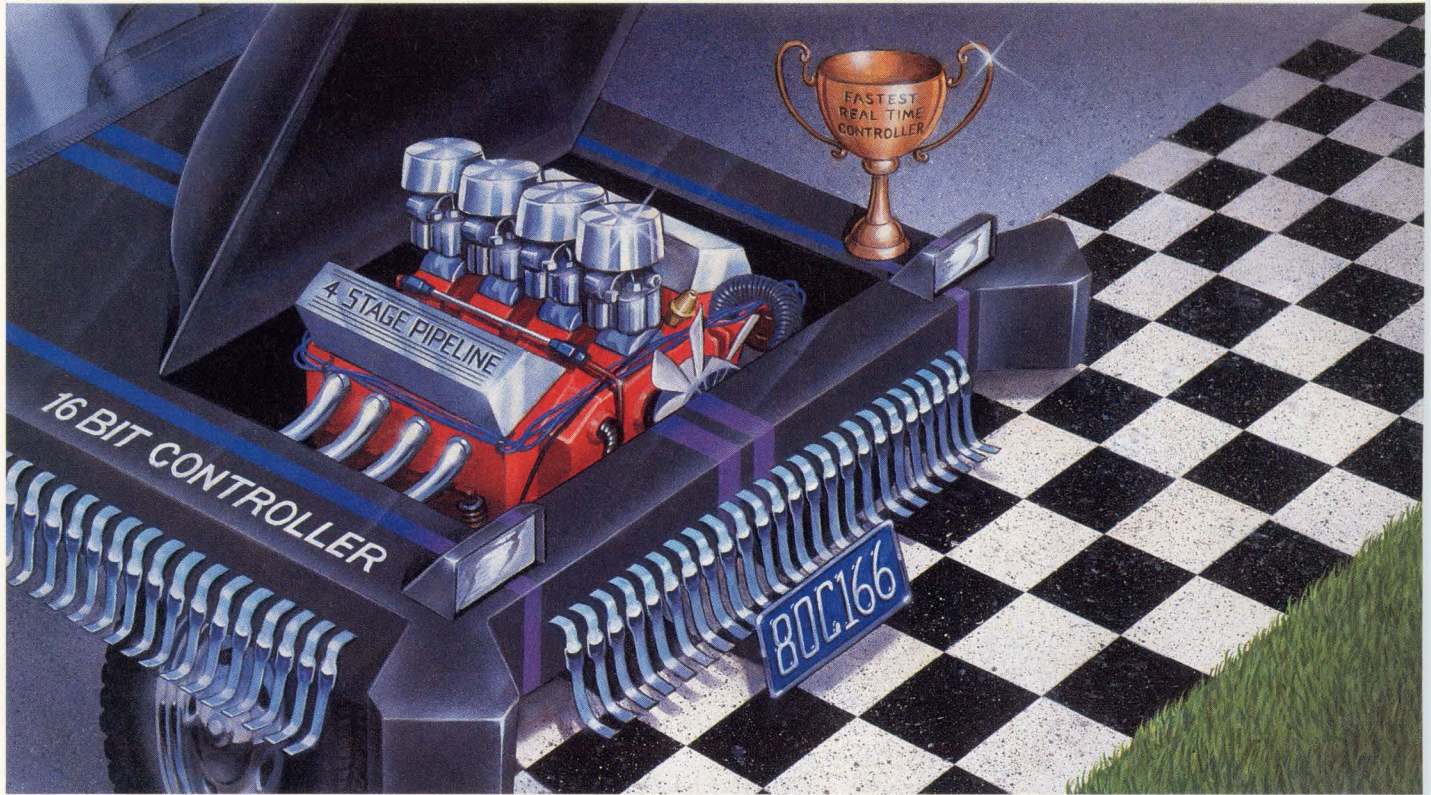

Introducing A New Level Of Performance, And The World Speed Records To Back It Up.

With the world's only 16-bit microcontroller 4-stage pipeline, the 80C166 gives you winning performance, from start to finish.

With its innovative combination of blazing CPU performance and peripheral functionality, the SAB80C166 has blown past the competition in embedded control speed and performance.

The Fastest Real-Time Controller In The World.

One reason for its amazing speed, up to 10 native MIPS, is a 4-stage CPU pipeline which can process four instructions simultaneously. This allows 90% of instructions to execute in 100 ns, letting you complete tasks in record time.

The 80C166 also gives you the most effective interrupt performance anywhere, with speeds as fast as 250 ns because the 64 levels of priority are arbitrated each machine cycle.



16- and 8-bit Microcontrollers

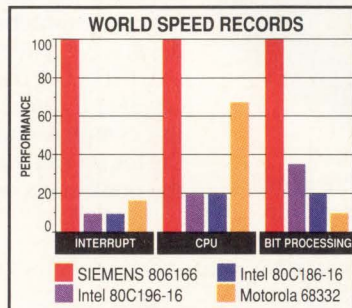

The fully vectored interrupt system allows the fastest identification of interrupt sources. Plus, through the use of a Peripheral Event Controller, which 'steals' just one machine cycle from the CPU, it lets you service peripherals without going through a standard interrupt procedure.

And with a full suite of development tools from world-class vendors, it's no wonder the competition can't keep up.

The Highly-Integrated 80C517A.

With the Siemens SAB80C517A, we've also brought this high-performance to the 8-bit microcontroller. It offers 10-bit A/D conversion, 32K ROM, 2.2K onboard RAM, and 32- and 16-bit arithmetic functions, while still retaining 8051 software compatibility. And it has 8 data pointers and 68 ports—more than any competitor.

To find out how Siemens can help you set some speed records of your own, call us at **800-456-9229**, and ask for literature package M14A016.

**Siemens
World Wise, Market Smart.**

2-state op amp sleeps or wakes up on demand

Increasing numbers of low-power applications benefit from component features such as shutdown pins and sleep-mode states. Each independent amplifier in Motorola's dual MC33102 op amp takes these features one step further by requiring no additional external components or device pins. The op amps don't require any active shutdown command. Instead, they operate in a sleep mode that consumes just enough power to detect incoming signals and automatically shift to a higher performance mode when the load's current exceeds a certain threshold. The company is applying this sleep-mode concept to other ICs for low-power applications. In sleep mode, the amplifier is active and waiting for an input signal.

In this state, each op amp operates with a current drain of 45 μA per amplifier and features a slew rate of 0.16V/ μsec , gain bandwidth of 0.33 MHz, and output current of 0.15 mA. If an input signal causes either amplifier's output to source or sink 160 μA (when operating from $\pm 15\text{V}$ supplies), that amplifier automatically switches to the awake mode. In this mode, the amplifiers exhibit a slew rate, gain bandwidth, and output drive of 1.7V/ μsec , 4.6 MHz, and 50 mA, respectively. Current drain in this higher-performance state is typically 750 μA . The amplifiers automatically return to sleep mode when output current drops below 142 μA . A delay circuit contains a capacitor with a 1-sec discharge time that prevents unwanted returns to the sleep mode. Applying this device requires some care because the output's switching threshold voltage will depend on the load resistance. Samples of the \$1.60 (10,000) device are available for commercial applications in both 8-pin plastic DIPs and SOICs. The specifications hold over -40 to $+85^\circ\text{C}$. Quantity delivery is from stock to 6 weeks. Motorola Inc, Tempe, AZ, (602) 897-3615, FAX (602) 897-4193.—Anne Watson Swager

SRAM-based FPGAs run at 50 MHz

Concurrent Logic's static-RAM-based FPGAs (field-programmable gate arrays) are capable of clocking counters at rates as high as 70 MHz. The CLi6000 family has equivalent gate densities ranging from 1200 to 10,000 gates with 64 to 160 I/Os. The FPGAs use internal RAM to program routing connections. The architecture is like a

Text continued on pg 24

Silicon microvalve has proportional flow control

IC Sensors has produced an electrically activated, normally closed valve on a silicon chip using micromachining techniques. The valve has a silicon diaphragm with diffused-in heating resistors. The diaphragm is part of a bimetallic structure that moves when heated. By controlling the power dissipated in the resistors you can control gas flow over the range of 0 to 150 cc/minute at pressures as high as 50 psi. IC Sensors, Milpitas, CA, (408) 432-1800, FAX (408) 432-7322.

—Richard A Quinnell

Transistor demonstrates 20-GHz peak f_T

At the International Electron Devices Meeting in Washington, DC last month, IBM researchers described a silicon-on-insulator (SOI), lateral-bipolar transistor with a maximum switching speed of 20 GHz. Unlike most previous lateral-bipolar devices, which have a wide base region or high base resistance, the IBM device features a narrow base and emitter. As a result, the transistor offers minimal resistance—emitter resistance is 8Ω —and

junction capacitances are less than 33 fF.

Although commercial applications are several years off, the transistor offers promise in areas such as high-speed, low-power applications. In addition, because SOI protects circuits from Cosmic-radiation-induced soft-errors, the transistor offers promise in space and hostile environment applications. IBM Research Div, Yorktown Heights, NY, (914) 945-2885

—Michael C Markowitz

Logic family includes boundary scan

National Semiconductor introduced a family of logic devices that incorporates the IEEE 1149.1 (JTAG) boundary scan test circuits. The Scan18xxx series' initial issue has five parts, four 18-bit transceivers, and a serial-to-parallel test access-port converter.

The devices are based on National's Fact-QS CMOS technology and offer TTL-like output swings and drive. They come in both DIP and surface-mount packages. Samples are available now; production is scheduled for the second quarter. Logic devices cost \$5.75 (100); the converter costs \$9.95. National Semiconductor, Santa Clara, CA, (408) 721-5000.

—Richard A Quinnell

Continued from pg 23

gate array in that it comprises a large matrix of small, fine-grain, logic cells. A 10,000-gate equivalent part will have 64,000 logic cells. These cells consist of a multiplexer, bus logic, and a flip-flop. The FPGAs have a matrix of 8×8 elements with special block routing resources. The FPGA has global routing resources for signals and clocks. These resources link into the blocks via signal repeaters. Chip clock skew is held to less than 1 nsec across a chip. Gate delays are on the order of 2.1 nsec, with 2- and 0-nsec setup and holds.

These FPGAs suit register-intensive designs: They have 576 to 64,000 logic cells, each with one flip-flop. Toggle rates are as high as 150 MHz, and the FPGAs can run sequential logic at 50 MHz. The family has a set of design tools, including schematic capture, synthesis, schematic regeneration, automatic place and route, and post-layout timing and functional verification. These tools run on the View-logic tool set and include the Viewlogic schematic capture and simulator. The 5000-equivalent-gate CLi6005 is available now and costs \$108 in volume. The CLi6002 and CLi6003 are available in sample quantity from \$58. Concurrent Logic Inc, Sunnyvale, CA, (408) 522-8700, FAX (408) 732-2765.—Ray Weiss

Flat-panel VGA controller offers interface choices

The 65520 flat-panel VGA controller from Chips and Technologies gives you a range of interface choices. The device has separate I/O ports for ISA, Micro Channel Architecture, or 386SL peripheral interface buses. It will work with two or four memory devices and either volatile or dynamic RAM, which lets you choose between cost and performance. The device handles LCD, electroluminescent, and plasma flat panels, and drives flat-panel and CRT displays simultaneously. It supports 1024×768 -pixel resolution on both displays with 16 colors on the CRT. At 640×480 resolution, the device provides 64 gray levels on flat panels and 256 colors on CRTs.

The controller offers backward compatibility with all older graphics standards. It uses horizontal compensation to center lower-resolution images on the panel and vertical compensation to expand low-resolution images to fill a 480-line display. The vertical compensation methods include centering, line replication, and blank-line insertion. The \$45 (1000) controller is available in sample quantities now and will be in production in April. Chips and Technologies Inc, San Jose, CA, (408) 434-0600.—Richard A Quinnell

Chip set handles serial link at 1.25 Gbit/sec

The GaAs Taxi chip set lets you replace a parallel data link with a high-speed serial link over coaxial cable or optical fibers. The 4-chip set, based on AMD's Taxi chip set, includes a multiplexer, a demultiplexer, a transmitter, and a receiver. The devices work in teams to convert a 32- or 40-bit parallel-data bus into a 1.25 Gbit/sec serial link. The transmitter's output signal will drive a coaxial cable directly, or drive a fiber-optic transmitter. The bus interface devices have TTL-compatible interfaces, but require both 5 and 2V supplies. The set costs \$995 in sample quantities and \$603 (1000). Sets are available now, as are development boards. Vitesse Semiconductor, Camarillo, CA, (805) 388-3700, FAX (805) 987-5896.

—Richard A Quinnell

Making math work for you

Mastering the algebra for an analysis derivation is a vexing problem for some engineers. To master the math, you can attend a 3-day, \$995 course taught by Dr R D Middlebrook of the California Institute of Technology.

The course, Structured Analog Design, teaches how to get design value out of the formal methods you already know—and with much less work. The insights gained will help you to obtain maximum benefit from CAD programs. The course is offered February 19 to 21 in Santa Clara, CA, and September 9 to 11 in Boston, MA. Part 2, a workshop in the techniques covered in part 1 plus additional material is offered March 4 to 6 in Los Angeles, CA, and September 14 to 16 in Boston, MA. Ardem Associates, (714) 592-0317, FAX (714) 592-0698.

—Susan Rose

Technique provides fast Spice analysis

The AWE (Asymptotic Waveform Evaluation) technique provides Spice-like accuracy with simulations that are orders-of-magnitude faster. Professors Lawrence Pilage of the University of Texas (Austin, TX) and Ronald R Roher of Carnegie Mellon University (Pittsburgh, PA) developed the technique. The technique uses a frequency-domain analysis based on an RLC interconnect model to approximate circuit performance.

Currently, Quicklogic Corp's upgraded pASIC FPGA (field programma-

Text continued on pg 26

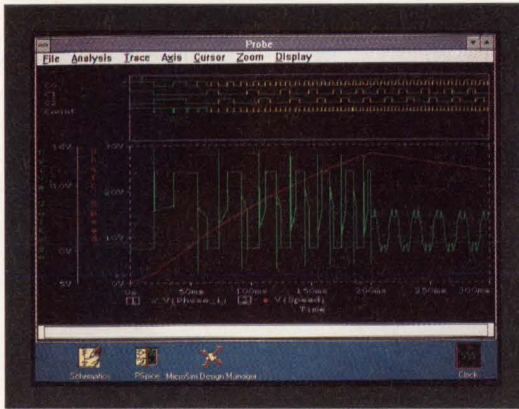
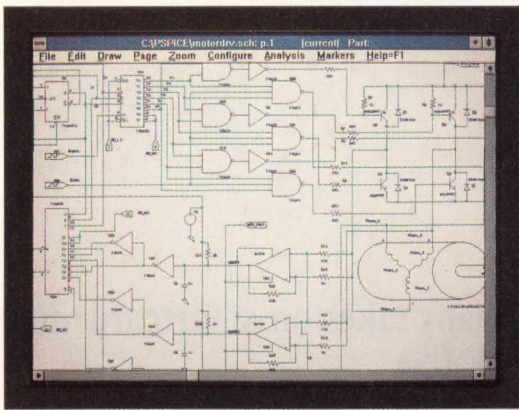

Where would you go to answer all of your analog and digital circuit design questions?

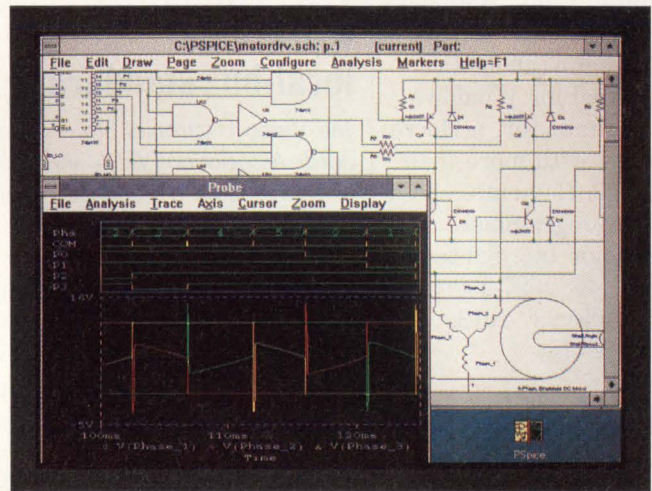

THE DESIGN CENTER™!

We brought you PSpice — the world's most popular mixed analog and digital circuit simulator. Now we bring you the **Design Center** — the universal analog and digital circuit design environment! Offering integrated schematic capture, mixed-mode simulation, and graphical waveform analysis, the **Design Center** will take you and your circuit design from conception to realization with ease and efficiency. Here's how!

- Define circuits graphically, selecting from over 4,000 analog and 1,700 digital devices and symbols maintained in our libraries (or create your own).
- Run PSpice simulations directly from the circuit drawing. These features are standard: analog behavioral modeling, Monte Carlo and sensitivity/worst-case statistical analyses, and event-driven digital simulation including worst-case timing.

- View analog and digital waveforms simultaneously along a common time axis, while remaining within your circuit drawing environment. With graphical waveform analysis, you'll be able to interactively visualize simulation results in a variety of ways by applying expressions, user-defined functions, performance analysis, and many more functionalities.

Whether you run with our full-featured configuration with schematic capture (available on Windows 3.0 and OpenWindows), or with one of our reduced configurations (available on a variety of platforms), the **Design Center** will provide you with the most comprehensive system for circuit design available today.

We're making mixed analog and digital circuit design the standard! Why not make it yours! For further information on MicroSim Corporation's **Design Center**, call toll free at (800) 245-3022 or FAX at (714) 455-0554.

 **MicroSim Corporation**
The Standard for Circuit Design
 20 Fairbanks • Irvine, CA 92718

PSpice is a registered trademark of MicroSim Corporation

CIRCLE NO. 12

EDN January 20, 1992 • 25

Text continued from pg 24

ble gate array) design kit uses the analysis technique for fast Spice simulation. Results are within 10% of a Spice simulation's results. The \$3995 tool kit's logic synthesizer creates FPGA circuits from VHDL (VHSIC Hardware Description Language) and Boolean equation forms. It also has a schematic entry tool for Windows 3.0, a simulator, a Macro Library with more than 200 logic elements, and a device programmer. Quicklogic Inc, Santa Clara, (408) 987-2000, FAX (408) 987-2012. —Ray Weiss

Light sensor connects directly to μ Ps

A single TSL220 light-to-frequency converter reduces the number of external components necessary to detect and measure minute changes in light intensity. Because the device itself comprises a large-area photodiode and a patented BiMOS current-to-frequency converter, it replaces a discrete photodiode, amplifier, and A/D converter. You can directly connect the sensor to a μ P or a digital-control circuit. The device features a dynamic range of 118 dB and a linearity of 2% over the full-scale range and can detect intensity changes of 0.01% over the full-scale

range. The \$4.61 (1000) device comes in a clear plastic 8-pin DIP. Texas Instruments Inc, Semiconductor Group, Dallas, TX, (800) 336-5236, ext 700, (214) 995-6611, ext 700. —Anne Watson Swager

VESA committee will create local-bus standard

The Video Electronics Standards Association (VESA) intends to create a standard for a graphics local bus. A technical committee will define a bus for graphics peripherals that connects directly to the host's CPU via a 32-bit data bus. The standard will ensure compatibility between third-party peripherals for high-performance graphics. The Local Bus Committee includes Applan Technology, Binar Graphics, Chips and Technology, Cirrus Logic, Desktop Electronics, Everex Systems, Headland Technology, Integrated Information Technologies, Micronics Computer, Media Vision, National Semiconductor, Orchid Technology, Panacea, Tseng Labs, and Weitek. The committee chairman is Ron McCabe, Graphics Product Manager at Everex Systems. The committee plans to submit a proposal to the VESA general membership at VESA's August, 1992, General Meeting. VESA, San Jose, CA, (408) 435-0333, FAX (408) 435-8225. —John Gallant.

Company takes on smartcard market in the USA

SGS Thomson has expanded its ST16XYZ family of smartcards with two microcontrollers for applications requiring effective data security. The ST16623 and ST16301 have 8-bit CPUs with 6 and 3 kbytes of ROM, 224 and 128 bytes of RAM, and 3 and 1 kbytes of EEPROM, respectively, on board. These memory capacities are combined with built-in hardware and software security features. A non-maskable security interrupt that is generated whenever an unauthorized access is attempted lets the devices restrict data accesses across the RAM/ROM/EEPROM area. Other

features include compliance with ISO standards, 5-MHz operation, 100,000 write/erase cycles, and a 10-year data retention. The devices come in die or micromodule form. In micromodule form, the chips cost \$2.78 and \$3.28 (5000), respectively.

The company has been active in smartcard development for more than 10 years. The recent formation of the Smartcard Products Business Unit marks an effort to take more control of smartcard applications in the US. SGS Thomson Microelectronics, Carrollton, TX, (214) 466-7210. —Susan Rose

Synthesize waveforms at 2 nsec/point

The Flexstar 7000 can step through waveforms at 2 nsec per point, letting you generate high-speed waveforms. You program the first half of the waveform with as many as 128 data points, and the instrument generates a mirror image of the second half automatically. You can also disable the second half of the waveform. The instrument lets you create arbitrary waveform patterns (waveform present or no waveform) to one-million waveforms long. The \$20,000 instrument gen-

erates waveforms by consecutively summing the outputs of 128 DACs. Resolution for each DAC is 8 bits plus sign, and the overall resolution is approximately 12 bits for a full-scale waveform. Because the instrument creates the waveform using a summing method, it automatically generates the overlapping waveform effects of pulse crowding when you make the period shorter than the pulse length. Flexstar, San Jose, CA, (408) 433-0770, FAX (408) 433-1766.—Doug Conner



PROFILES IN PARTNERING

Raytheon and Dale[®]

PRODUCTS: Metal film and wirewound resistors.

OBJECTIVE: Develop efficient systems for supplying and procuring MIL-style components.

UNITS INVOLVED: Raytheon and Dale Electronics, Inc.

For more than two decades, Raytheon and Dale[®] have developed a strong manufacturer/vendor relationship focused on close communication and a common goal to continually improve quality.

Today, Dale works closely with other Vishay companies (including Angstrom and Ultronix) in supplying established reliability resistors used in the *Patriot*, *Sparrow* and other programs of the Raytheon Missile Division. Military specifications involved include: MIL-R-39005, MIL-R-39007, MIL-R-39009, MIL-R-39017,

MIL-R-55182, MIL-R-55342 and MIL-R-83401.

In helping Raytheon meet the exacting requirements of these programs, Dale, in 1984, became the first OEM vendor to Raytheon to install an on-line computer terminal, allowing direct-order capability with several Dale plants.

Since then, this system has been tailored to allow Raytheon purchasing locations to obtain a wide range of information on orders to Dale including everything from price, to production status, to a shipping date.

"In essence," a Dale spokesperson commented, "Raytheon can access anything we can in relation to any or all of their orders. More recently, Dale helped Raytheon pioneer their first system for electronic data interchange (EDI)."

Quality, also, has played a big part in the relationship. With a history of tens of millions of parts shipped to Raytheon, Dale has maintained exceptionally high quality levels. This is why Raytheon has chosen Dale for several quality and service awards over the last few years.

For more information on how Dale's commitment to effective partnering can benefit your operation, please contact Joe Matejka, Vice President, Quality Assurance, Dale Electronics, Inc., 1122 23rd Street, Columbus, Nebraska 68601-3647. Phone 402-563-6511. Fax 402-563-6418.



FILTERS



dc to 3GHz from \$1145

lowpass, highpass, bandpass

- less than 1dB insertion loss • greater than 40dB stopband rejection • surface-mount • BNC, Type N, SMA available
- 5-section, 30dB/octave rolloff • VSWR less than 1.7 (typ) • rugged hermetically-sealed pin models • constant phase
- meets MIL-STD-202 tests • over 100 off-the-shelf models • immediate delivery

low pass, Plug-in, dc to 1200MHz

Model No.	Passband MHz loss < 1dB	Stopband, MHz loss > 20dB	loss > 40dB	Model No.	Passband MHz loss < 1dB	Stopband, MHz loss > 20dB	loss > 40dB
PLP-5	DC-5	8-10	10-200	PLP-250	DC-225	320-400	400-1200
PLP-10.7	DC-11	19-24	24-200	PLP-300	DC-270	410-550	550-1200
PLP-21.4	DC-22	32-41	41-200	PLP-450	DC-400	580-750	750-1800
PLP-30	DC-32	47-61	61-200	PLP-550	DC-520	750-920	920-2000
PLP-50	DC-48	70-90	90-200	PLP-600	DC-680	840-1120	1120-2000
PLP-70	DC-60	90-117	117-300	PLP-750	DC-700	1000-1300	1300-2000
PLP-90	DC-81	121-137	167-400	PLP-800	DC-720	1080-1400	1400-2000
PLP-100	DC-98	146-189	189-400	PLP-850	DC-760	1100-1400	1400-2000
PLP-150	DC-140	210-300	300-600	PLP-1000	DC-900	1340-1750	1750-2000
PLP-200	DC-190	290-390	390-800	PLP-1200	DC-1000	1620-2100	2100-2500

Price, (1-9 qty), all models: plug-in \$14.95, BNC \$32.95, SMA \$34.95, Type N \$35.95

Surface-mount, dc to 570MHz

Model No.	Passband MHz loss < 1dB	Stopband, MHz loss > 20dB	loss > 40dB	Model No.	Passband MHz loss < 1dB	Stopband, MHz loss > 20dB	loss > 40dB
SCLF-21.4	DC-22	32-41	41-200	SCLF-190	DC-190	290-390	390-800
SCLF-30	DC-30	47-61	61-200	SCLF-380	DC-380	580-750	750-1800
SCLF-45	DC-45	70-90	90-200	SCLF-420	DC-420	750-920	920-2000
SCLF-135	DC-135	210-300	300-600				

Price, (1-9 qty), all models: \$11.45

Flat Time Delay, dc to 1870MHz

Model No.	Passband MHz loss < 1.2dB	Stopband MHz loss > 10dB	loss > 20dB	VSWR Freq. Range, DC thru 0.2f _{co} X	0.6f _{co} X	Group Delay Variations, ns Freq. Range, DC thru f _{co} X	2f _{co} X	2.67f _{co} X
PBLP-39	DC-23	78-117	117	1.3:1	2.3:1	0.7	4.0	5.0
PBLP-117	DC-65	234-312	312	1.3:1	2.4:1	0.35	1.4	1.9
PBLP-156	DC-94	312-416	416	0.3:1	1.1:1	0.3	1.1	1.5
PBLP-200	DC-120	400-534	534	1.6:1	1.9:1	0.4	1.3	1.6
PBLP-300	DC-180	600-801	801	1.25:1	2.2:1	0.2	0.6	0.8
PBLP-467	DC-280	934-1246	1246	1.25:1	2.2:1	0.15	0.4	0.55
▲BLLP-933	DC-560	1866-2490	2490	1.3:1	2.2:1	0.09	0.2	0.28
▲BLLP-1870	DC-850	3740-6000	5000	1.45:1	2.9:1	0.05	0.1	0.15

Price, (1-9 qty), all models: plug-in \$19.95, BNC \$36.95, SMA \$38.95, Type N \$39.95

NOTE: ▲ -933 and -1870 only with connectors, at additional \$2 above other connector models.

high pass, Plug-in, 27.5 to 2200MHz

Model No.	Stopband MHz loss < 40dB	loss < 20dB	Passband MHz loss < 1dB	VSWR Pass-band Typ.	Model No.	Stopband MHz loss < 40dB	loss < 20dB	Passband MHz loss < 1dB	VSWR Pass-band Typ.
PHP-25	DC-13	13-19	27.5-200	1.8:1	PHP-400	DC-210	210-290	395-1600	1.7:1
PHP-50	DC-20	20-26	41-200	1.5:1	PHP-500	DC-280	280-365	500-1600	1.8:1
PHP-100	DC-40	40-55	90-400	1.8:1	PHP-600	DC-350	350-440	600-1600	2.0:1
PHP-150	DC-70	70-95	133-600	1.8:1	PHP-700	DC-400	400-520	700-1800	1.6:1
PHP-175	DC-70	70-105	160-800	1.5:1	PHP-800	DC-445	445-570	780-2000	2.1:1
PHP-200	DC-90	90-116	185-800	1.6:1	PHP-900	DC-520	520-660	910-2100	1.8:1
PHP-250	DC-100	100-150	225-1200	1.3:1	PHP-1000	DC-550	550-720	1000-2200	1.9:1
PHP-300	DC-145	145-170	290-1200	1.7:1					

Price, (1-9 qty), all models: plug-in \$14.95, BNC \$36.95, SMA \$38.95, Type N \$39.95

bandpass, Elliptic Response, 10.7 to 70MHz

Model No.	Center Freq. (MHz)	Passband I.L. 1.5 dB (MHz)	3 dB Bandwidth Typ. (MHz)	Stopbands I.L. > 20dB at MHz	I.L. > 35dB at MHz	Model No.	Center Freq. MHz	Passband MHz loss < 1dB	Stopband loss > 20dB at MHz	VSWR 1.3:1 Total Band MHz
PBP-10.7	10.7	9.6-11.5	8.9-12.7	7.5 & 15	0.6 & 50-1000	PIF-21.4	21.4	18-25	1.3 & 150	DC-220
PBP-21.4	21.4	19.2-23.6	17.9-25.3	15.5 & 29	3.0 & 80-1000	PIF-30	30	25-35	1.9 & 210	DC-330
PBP-30	30.0	27.0-33.0	25-35	22 & 40	3.2 & 99-1000	PIF-40	42	35-49	2.6 & 300	DC-400
PBP-60	60.0	55.0-67.0	49.5-70.5	44 & 79	4.6 & 190-1000	PIF-50	50	41-58	3.1 & 350	DC-440
PBP-70	70.0	63.0-77.0	68.0-82.0	51 & 94	6.0 & 193-1000	PIF-60	60	50-70	3.8 & 400	DC-500
						PIF-70	70	58-82	4.4 & 490	DC-550

Price, (1-9 qty), all models: plug-in \$18.95, BNC \$40.95, SMA \$42.95, Type N \$43.95

Constant Impedance, 21.4 to 70MHz

Model No.	Center Freq. MHz	Passband MHz loss < 1dB	Stopband loss > 20dB at MHz	VSWR 1.3:1 Total Band MHz
PIF-21.4	21.4	18-25	1.3 & 150	DC-220
PIF-30	30	25-35	1.9 & 210	DC-330
PIF-40	42	35-49	2.6 & 300	DC-400
PIF-50	50	41-58	3.1 & 350	DC-440
PIF-60	60	50-70	3.8 & 400	DC-500
PIF-70	70	58-82	4.4 & 490	DC-550

Price, (1-9 qty), all models: plug-in \$14.95, BNC \$36.95, SMA \$38.95, Type N \$39.95

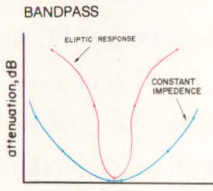
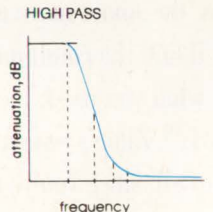
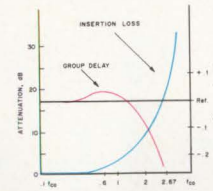
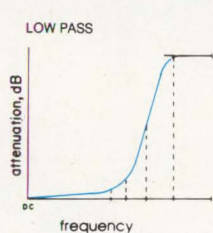

finding new ways ...
setting higher standards



WE ACCEPT AMERICAN EXPRESS AND VISA

P.O. Box 350166, Brooklyn, New York 11235-0003 (718) 934-4500 Fax (718) 332-4661

CIRCLE NO. 14

Get Smart. Fast.

Zilog's Z80[®] MPU Family. It's the smartest way to add impressive performance and innovation without having to spend time learning and writing new code.

It's little wonder the Z80 8-bit MPU is the world's most popular 8-bit microprocessor. It's the only CPU with an architecture that makes task switching so fast, simple and accurate. In fact the Z80 outperforms many 16-bit parts. And that makes it especially valuable as the core for the wide range of Superintegration[™] devices that make up the industry's leading family of intelligent peripheral controllers.

So if you're looking for a way to upgrade an existing design, or for the extra performance you need for some-

thing entirely new, the smart move is to look to the Z80 MPU family. You'll find the combinations of features that will give you just what you need, including the high-performance Z181,[™] Zilog's Smart Access (SAC[™]) Controller. And best of all, since you're already familiar with the Z80 code, the migration path couldn't be quicker.

Others may choose to concentrate on highly complex solutions for workstation and PC environments. But we think the wiser strategy is to go on developing high integration, value added 8- and 16-bit solutions for the intelligent peripherals, datacommunication and consumer microcontrollers markets. At the same time, we're continuing to develop 32-bit RISC and DSP devices and to produce some of the most sophisticated ASSPs in the industry.

Z8 is a registered trademark and Superintegration is a trademark of Zilog, Inc.
©1991, Zilog, Inc.

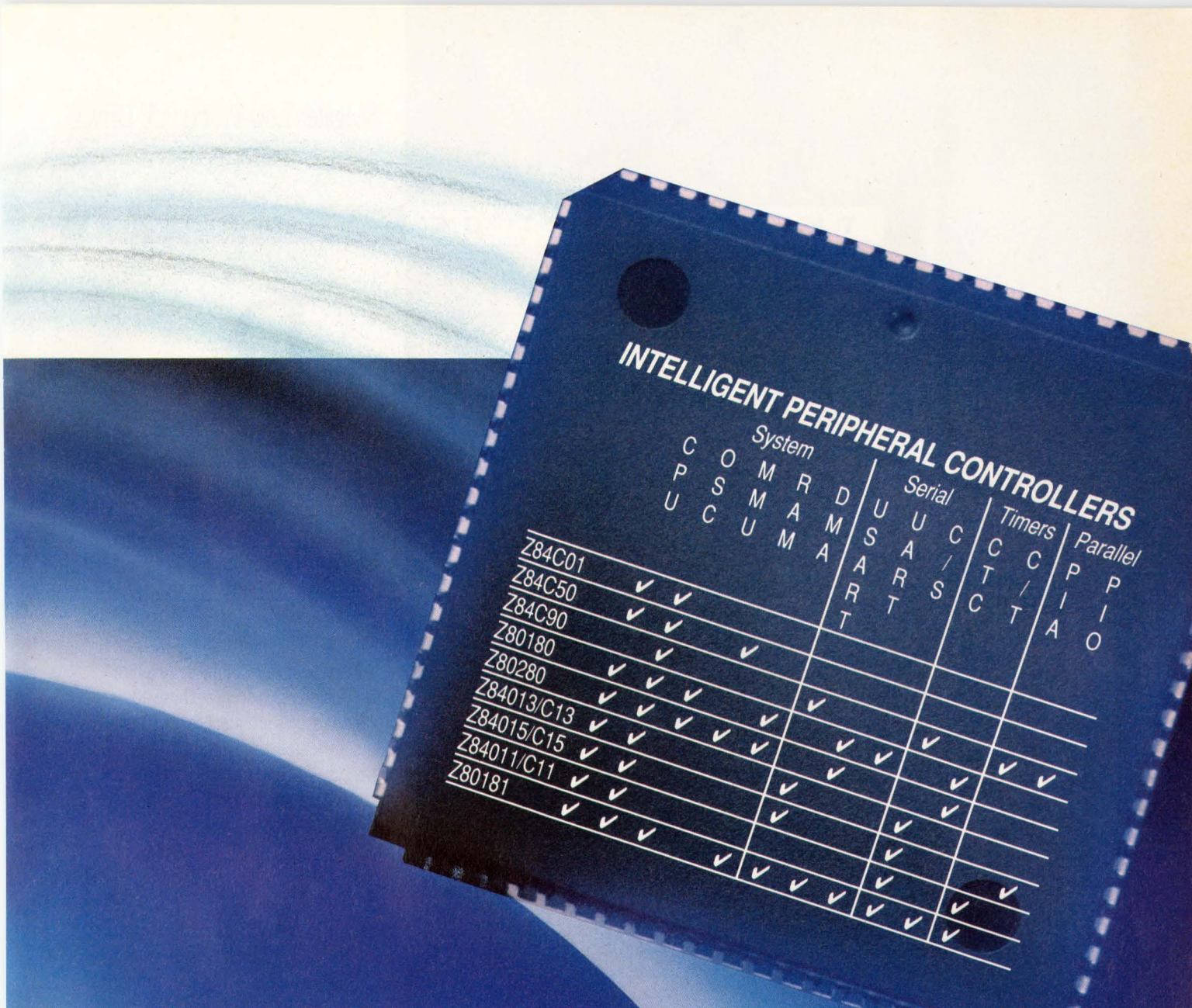

It's very clear that ASSPs are the best option for a rapidly growing number of designs. At Zilog we've been producing ASSPs and developing Superintegration design methodology longer and better than anyone, which is why we have the largest library of familiar cores and cells in the industry. You can be sure Zilog will continue to develop new members of the Z80 MPU family. And, because we have our own fabrication facilities, you know that every new part will have the same high standards for quality, cost/performance and reliability for which

Zilog has always been known.



The smart thing to do is to find out more about the Z80 family of Intelligent Peripheral Controllers, or any of Zilog's rapidly growing Superintegration product families. Contact your local Zilog sales office or your authorized distributor today. Zilog, Inc., 210 East Hacienda Ave., Campbell, CA 95008-6600, (408) 370-8000.



Seagate's Low-Profile 3.5" Drives

THE FINE ART OF DISC DRIVES

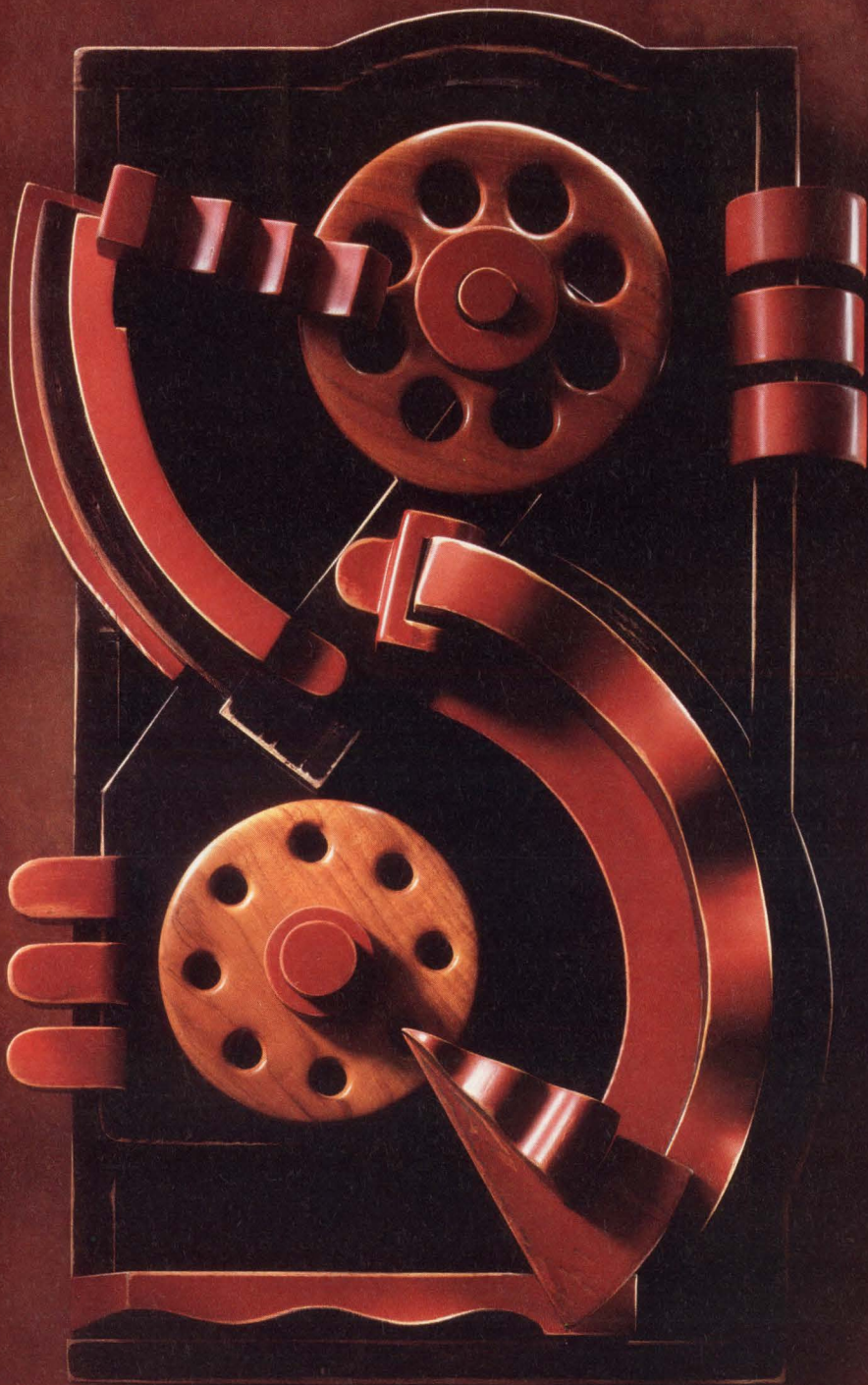

Balance, motion, volume: the raw materials

of art—and technology. At Seagate, we've consistently excelled in packing the features you want, plus the performance you need, into an elegantly compact package.

Seagate's 1" high, 3.5"-inch disc drives—the ST3120, ST3144, ST3283, ST3500 and ST3600—offer performance levels unusual even in full-form-factor drives. These advanced drives are ideal for performance-oriented applications where size, weight and power must be kept to a minimum, such as high-end laptops and portable workstations.

Available in AT, SCSI-2 and Fast SCSI-2 interfaces, the drives combine a 3,600 RPM or 4,500 RPM spindle motor with Zone Bit Recording (ZBR) to offer access times as low as 9.9 msec. Power consumption is from 3.5 to 5 watts, and capacities range from 106 to 525 formatted megabytes.

When creativity and craftsmanship combine, the result is art. For complete product specifications, contact your authorized Seagate distributor or call Seagate directly at 800-468-DISC or 408-438-6550.



Seagate

Wood Sculpture by
Daryl Kalmus
Cincinnati, Ohio

AT is a trademark of International Business Machines Corporation. Seagate and the Seagate logo are registered trademarks of Seagate Technology, Inc.
© 1991 Seagate Technology, Inc.

Company notes new phone area code in New Jersey

Please note the new area code for the phone and FAX numbers of Ariel Corp, 433 River Rd, Highland Park, NJ 08904: Phone (908) 249-2900; FAX (908) 249-2123.

Questions raised by "PLD metastability" article

Several points need to be made about the article "Determine PLD metastability to derive ample MTBFs" (EDN, August 5, 1991, pg 147). To begin with, a more accurate and faster way to measure metastability is to use a digital scope with histogram capability. Signetics uses the HP 54120; the Tektronix CSA 803 is another scope that will work. You don't need a specially designed test-fixture circuit and the associated costs to build and use it.

If we want to measure state-of-the-art parts, we are dealing with products that have t_{sws} of 115 psec. The number of metastability data points drops by a factor of 6000 with a 1-nsec change of t_R . This problem makes data collection very time consuming and inaccurate if it's done by the method demonstrated in the article.

The asynchronous data is a problem because data leading the clock at the device by a hair's breadth often causes dramatically different metastability readings than the data lagging the clock. Either one or the other of these cases always occurs if both the clock and the data are produced by pulse generators at fixed frequencies.

The t_{sw} will vary rather dramatically over temperature, perhaps 40% from 0 to 70°C. A 40% change in t_{sw} will have an explosive—that is, exponential—effect on MTBF. (It's unlikely that the part you are interested in will be operating at room temperature in your system.) It's difficult to set up a test with a home-made board and still be able

to change temperatures. In addition, the parts begin to heat up significantly at higher frequencies, causing the t_{sw} to change. To rely on your measurements, the part under test should be measured in a controlled environment.

Finally, some parts do not respond in a classical manner, and the best way to determine this is by viewing a metastability histogram with incremental steps smaller than the part's t_{sw} .

One further note on the last page of the article, a formula for a 2-stage synchronizer was given as:

$$MTBF = \frac{e \left(\frac{t_R}{t_{sw}} \right)^2}{W f_C f_D}$$

Although this formula has appeared in other papers, it is in error and will calculate extremely optimistic MTBFs that don't represent real-life failure rates. A more reasonable formula is

$$MTBF = \frac{e \left(\frac{t_R + t_C - t_P}{t_{sw}} \right)}{W f_C f_D}$$

where t_C is the clock period and t_P is the normal propagation delay through the device.

Charles Dike
Senior Design Engineer
Signetics Corp

Comments about EMC Law and its effects

In reference to Brian Kerridge's article about the EMC (Electromagnetic Compatibility) Law (EDN, September 16, 1991, pg 57), my impression of his understanding of this law is that he regards it as a new obstacle to free trade. I think this is untrue.

First, in densely populated Europe, there is an urgent need for strict EMC rules.

Second, for the many manufacturers in the US that are not as multilingual as they should be for exporting, it will be easier [for them] to qualify because qualifying

LCD Proto Kit

Everything you need to start your LCD application ... create complex screens in just a few hours!

240 x 64 pixel Supertwist LCD mounts directly onto CYB003 prototyping board.

Kit provides serial interface to IBM PC for quick prototyping. Board also supports displays up to 240 x 128 pixels.

Interface to 6 soft keys or 4 x 4 key matrix.

Dial 0-25k ohms for LCD contrast.

* The CY325 LCD Windows Controller provides parallel or serial high-level control of instrument-size LCDs. Up to 256 built-in windows support window-relative text, bargraphs, waveforms, and plots. Text and graphics are maintained in separate planes, facilitating special effects. Complete User Manual included.

Wirewrap area for custom circuitry or back-light.

RJ 11 serial jack for Rx, Tx, CTS, and GND, plus 2 spares.

5 Pin Power DIN.

Alternate Power Connector.

Add your own 8051 CPU for stand alone operation.

Kit also includes:

Power supply provides +5v and Gnd for board, -12v for LCD, and +12v spare.

Sample routines in 8051 Assembler and QuickBasic.

LCD Paint™ for creating your own graphics images.

4-wire RJ11 style cable with DB25F connector for your IBM PC.

Demo routines preprogrammed into 8751 for immediate gratification.

\$495 - Kit
Popular LCD Starter Kit.



(\$595 pre-assembled & tested)

*The CY325 CMOS 40-pin DIP and 44-pin PLCC LCD Controller IC are available from stock @ \$75/singles, \$20/1000s.

CyberneticMicroSystems

Box 3000 • San Gregorio CA 94074
Tel: 415-726-3000 • Fax: 415-726-3003

PRESYS 1000

Data Acquisition System With A Thousand Faces.



Here is a microprocessor-based data acquisition, simulation, and control system so flexible, so versatile, and so user friendly that it literally becomes all things to all users.

MULTIPLE FUNCTIONS

The PreSys 1000 chassis has 15 slots for thousands of possible card combinations: A/D conversion, D/A conversion, multiplexers, computer interfaces, FIFO memory expansion, diagnostics, chassis expansion logic, plus many others. And any card works in any slot!

MULTIPLE USERS

PreSys 1000 can handle up to six unique



PRESTON SCIENTIFIC

805 E. Cerritos Ave., Anaheim, CA 92805 • Phone (714) 776-6400, Fax (714) 776-3660

users, each with their own inputs, outputs, and internal processing. This makes the system ideal for use by individuals or teams in research and engineering applications.

MULTIPLE INTERFACES

PreSys 1000 can interface with any computer system used in the instrumentation field. Interface options include CSPI, DEC, VME, HP, DG, IEEE488, and RS232.

If you want a data acquisition system you can configure to today's needs, with full scope for tomorrow's requirements, you want PreSys 1000. Request our informative, full-color brochure today.

CIRCLE NO. 16

AT BUS EXPANSION THAT REALLY WORKS!

Now you can expand your PC-AT system without timing or noise problems and without time-consuming system reconfiguration with the new ETRC-AT active Expansion Bus Interconnect Kit from ACCES.

Hardware and Software Transparent.

No need to add drivers or modify software.

No Address Restrictions.

Put disk drives, video controllers and other computer resources into open slots in your expansion chassis.

No Initializing Software.

Just plug in the cards and you're all set to go.

Expansion
Transmitter

Expansion
Receiver

It Really Works!

Operation has been verified with cable lengths up to 12 feet and zero wait states in 386 systems running at 25 MHz CPU clock rate!

ACCES

Acquisition Control Communication Engineering/Systems

9400 Activity Rd. San Diego, CA 92126 (619) 693-9005
FAX: 619-578-9711 Toll free (800) 326-1649

in just one European country is sufficient to qualify throughout the EEC (European Economic Community). So, no more language barrier.

In the Editor's Note to Berlin reader, Guido Körber (EDN, June 20, 1991, pg 31), the Editor asked "Which side of the Wall were you on?" In Memoriam to the Cold War situation: In the eastern part of this city, possession of EDN could have led to troubles; in the western part, the transfer of EDN to the eastern part could have caused "COCOM" (Coordinating Committee for Multilateral Export Controls) troubles.

*Friedrich Widmann
Berlin, Germany*

Reader extols editorial

Charles Small's editorial, "Make FPGA design easier" (EDN, October 10, 1991, pg 49), is the best editorial for quite a long time. As a designer and user from early 1983, I completely agree with him. And what [should we] say about the problems of teaching in the schools?

P Aviolat

*Aviolat Electronique
CH-1056 Epalinges, France*

HAVE YOUR SAY

EDN's Signals & Noise column provides a forum for readers to express their opinions on issues raised in the magazine's articles or on any topic that affects the engineering industry. Send your letters to Signals & Noise Editor, EDN Magazine, 275 Washington St, Newton, MA 02158, or leave a note via MCI mail at EDNBOS. Or use EDN's bulletin-board system at (617) 558-4241: From the Main System Menu, enter SS/SOAPBOX, then W to write us a letter. You'll need a 2400-bps or less modem and a communications program set for 8,N,1.

EDN

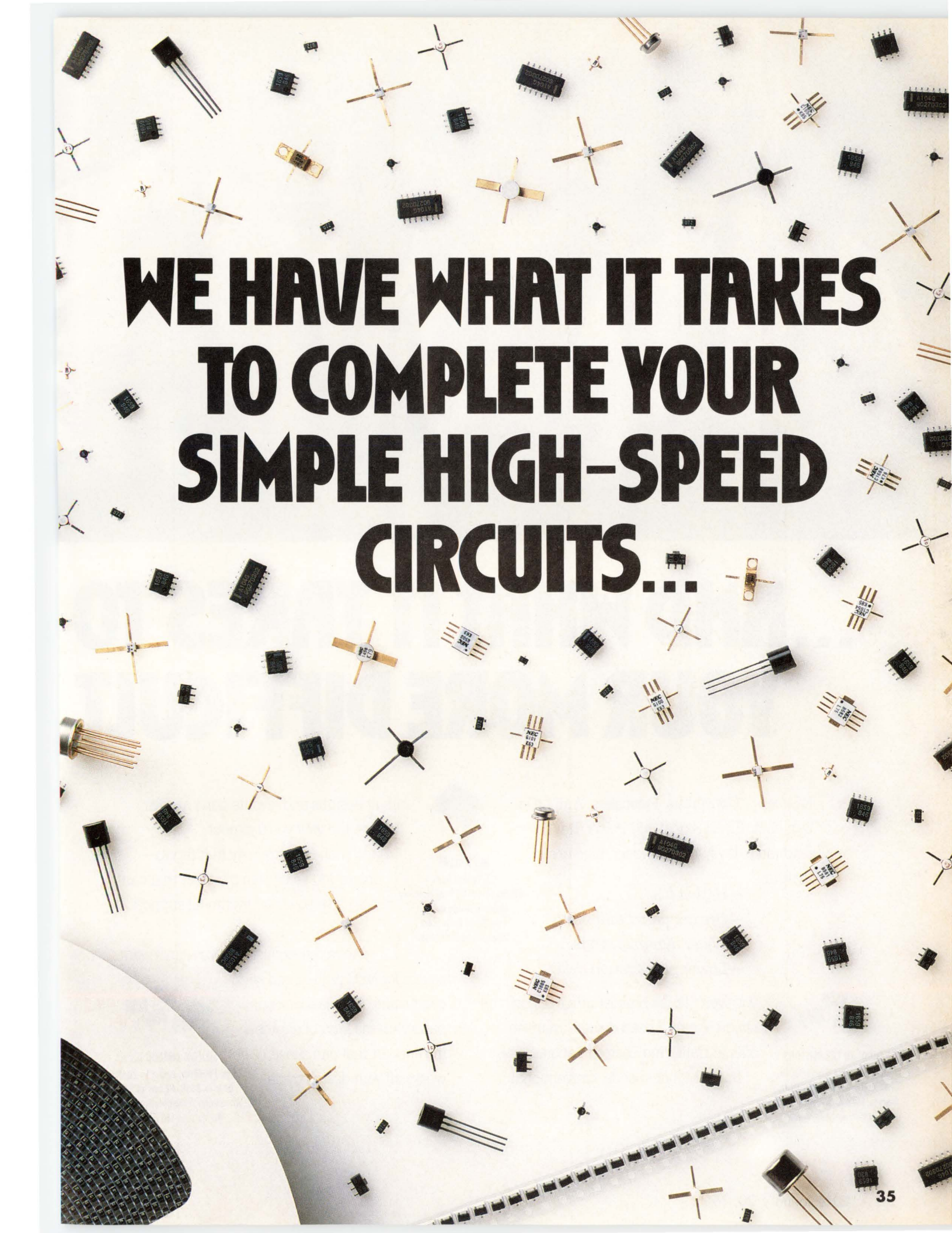

**WE HAVE WHAT IT TAKES
TO COMPLETE YOUR
SIMPLE HIGH-SPEED
CIRCUITS...**



...AND WHAT IT TAKES TO YOUR MORE DIFFICULT

Frequency Convertors. Prescalers. Amplifiers. Switches. Small Signal and Power Transistors. And more. If you're looking for more design margin...

- Higher f_T 's
- Greater gain bandwidth
- Wider dynamic range
- Lower propagation delay



PRESCALERS
Silicon and GaAs,
100MHz to 14GHz, Dual Modulus,
Multiple Divide Ratios,
Low Phase Noise, Low
Supply Current/Voltage.

circuit designs and layouts don't always behave the way you'd expect.

Which can be extremely frustrating—unless you've chosen a vendor that can also give you solid technical support.

We can.

We're the exclusive North American source for NEC high-speed semi-conductors. And we back our parts with the kind of engineering support that can shave weeks off your design cycle.

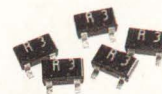

SILICON ANALOG ICs
DC to 1900MHz, Power to 20dBm,
Gain to 24dB, NF low as 2dB.
Amplifiers, Frequency Convertors,
Arrays, and LED Drivers.



BIPOLAR TRANSISTORS
Over 40 types, f_T 's to 11GHz,
NF under 1.0dB at 500MHz,
Gain to 18dB at 500MHz, dozens
of different packages.

... you won't find a broader range of cost-effective high-speed devices than we offer at California Eastern Laboratories.

But at higher speeds, conventional

NEC



COMPLETE ONES.

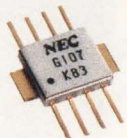

GaAs ANALOG ICs
10MHz to 20GHz,
Power to 18dBm, 35dB isolation.
Amplifiers and Switches.

Just call.
We have 25 years worth of applications information, all within an arm's reach.
So there's no waiting for answers to your questions.

And when it comes to data, our lab can provide device characterization specific to your project. And, if necessary, special selections specific to your circuit.

Best of all, most parts can be shipped immediately, direct from onshore stock.

So if your projects demand parts with higher speeds and greater design margin, our *Product Selection Guides* are a good place to find them. To get a set, just fill out and mail this card.

California Eastern Laboratories
4590 Patrick Henry Drive,
Santa Clara, CA 95056-0964
Phone (408) 988-3500
FAX (408) 988-0279



**California
Eastern
Laboratories**

RF TRANSFORMERS

Over 50 off-the-shelf models...

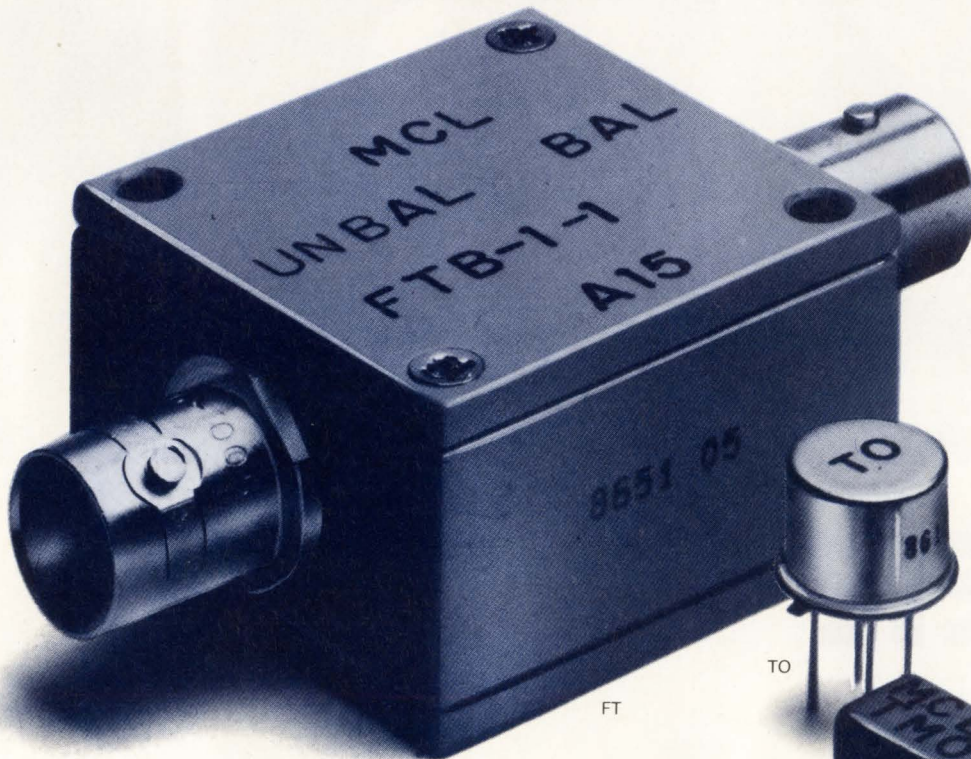

Having difficulty locating RF or pulse transformers with low droop, fast risetime or a particular impedance ratio over a specific frequency range? ... Mini-Circuits offers a solution.

Choose impedance ratios from 1:1 to 36:1, connector or pin versions (plastic or metal case built to meet MIL-T-21038 and MIL-T-55831 requirements*). Ultra-wideband response achieves low droop and fast risetime for pulse applications. Ratings up to 1000M ohms insulation resistance and up to 1000V dielectric voltage. For wide dynamic range applications involving up to 100 mA DC primary current, use the T-H series. Coaxial connector models are offered with 50 and 75 ohm impedance; BNC standard; request other types. Available for immediate delivery with one-year guarantee.

Call or write for 68-page catalog or see our catalog in EEM, or Microwaves Product Data Directory.

*units are not QPL listed

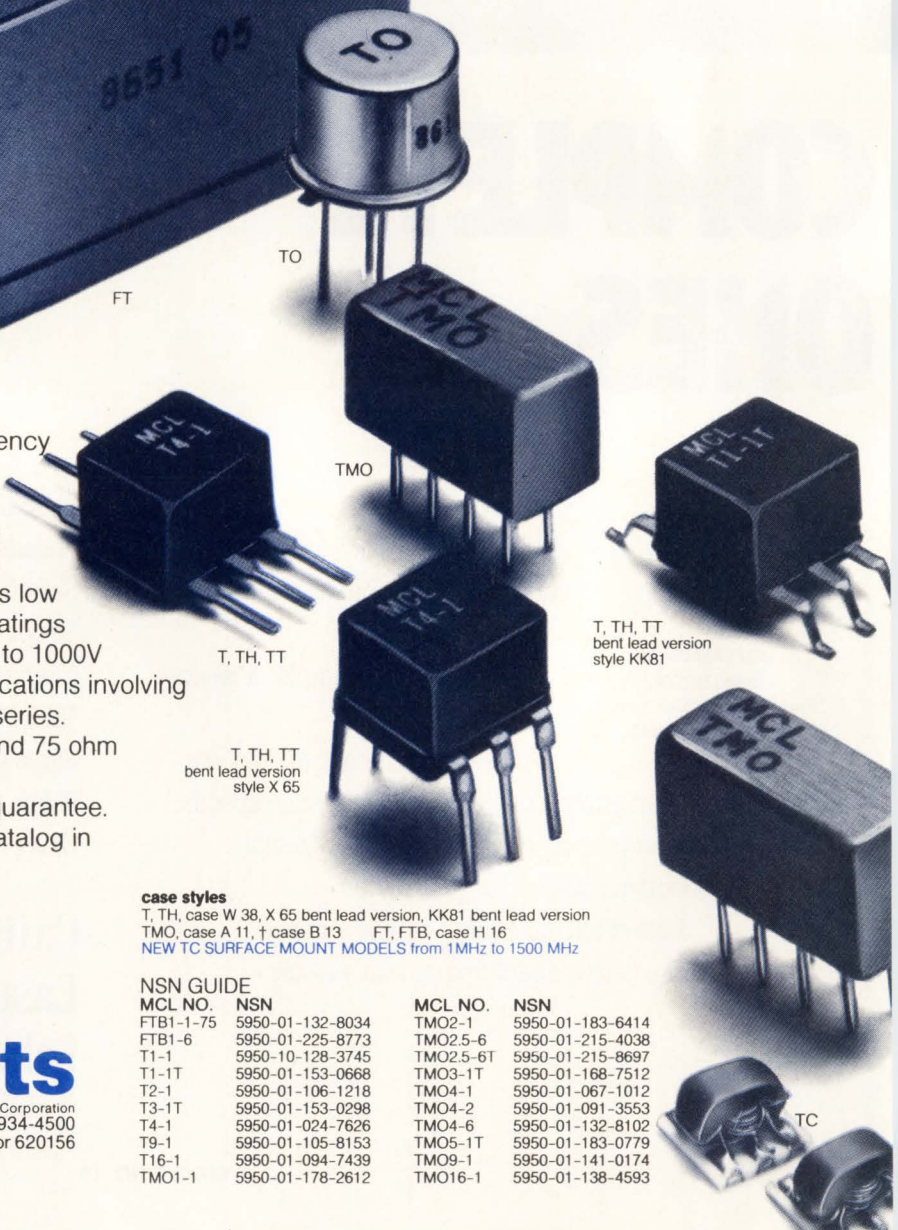

case styles

T, TH, case W 38, X 65 bent lead version, KK81 bent lead version
 TMO, case A 11, † case B 13 FT, FTB, case H 16
 NEW TC SURFACE MOUNT MODELS from 1MHz to 1500 MHz

NSN GUIDE

MCL NO.	NSN	MCL NO.	NSN
FTB1-1-75	5950-01-132-8034	TMO2-1	5950-01-183-6414
FTB1-6	5950-01-225-8773	TMO2.5-6	5950-01-215-4038
T1-1	5950-10-128-3745	TMO2.5-6T	5950-01-215-8697
T1-1T	5950-01-153-0668	TMO3-1T	5950-01-168-7512
T2-1	5950-01-106-1218	TMO4-1	5950-01-067-1012
T3-1T	5950-01-153-0298	TMO4-2	5950-01-091-3553
T4-1	5950-01-024-7626	TMO4-6	5950-01-132-8102
T9-1	5950-01-105-8153	TMO5-1T	5950-01-183-0779
T16-1	5950-01-094-7439	TMO9-1	5950-01-141-0174
TMO1-1	5950-01-178-2612	TMO16-1	5950-01-138-4593

finding new ways ...
 setting higher standards

Mini-Circuits

A Division of Scientific Components Corporation
 P.O. Box 350166, Brooklyn, New York 11235-0003 (718) 934-4500
 Fax (718) 332-4661 Domestic and International Telexes: 6852844 or 620156

FORMERS

3KHz-800MHz from \$3²⁵

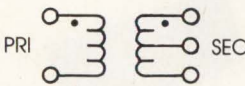
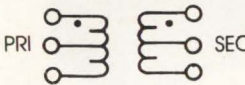
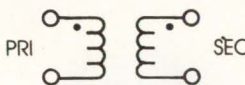
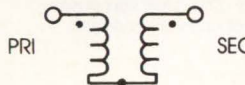
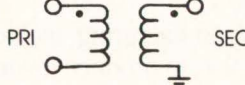
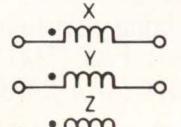
case style number see opposite page	MODEL NO.	Ω RATIO	FREQUENCY MHz	INSERTION LOSS			PRICE \$		
				3dB MHz	2dB MHz	1dB MHz			
A* 	T	T1-1T	1	.05-200	.05-200	.08-150	2-80	4.45	
		T1-6T	1	.003-300	.003-300	.01-150	02-50	6.95	
		T2-1T	2	.07-200	.07-200	.1-100	5-50	4.95	
		T2.5-6T	2.5	.01-100	.01-100	.02-50	50-20	4.95	
		T3-1T	3	.05-250	.05-200	.1-200	5-70	4.95	
		T4-1	4	2-350	2-350	.35-300	2-100	3.25	
		T4-6T	4	.02-250	.02-250	.05-150	0.1-100	4.45	
		T5-1T	5	3-300	3-300	6-200	5-100	4.95	
		T8-1T	8	.03-140	.03-140	.10-90	1-60	7.95	
		T13-1T	13	3-120	3-120	.7-80	5-20	4.95	
		T16-6T	16	.03-75	.03-75	.06-30	1-20	5.65	
		TH	T4-1H	4	10-350	10-350	15-300	25-200	5.95
		TMO	TMO1-1T	1	05-200	05-200	08-150	2-80	7.95
			TMO2-1T	2	.07-200	.07-200	.1-100	5-50	8.45
			†TMO2.5-6T	2.5	.01-100	.01-100	.02-50	05-20	8.45
			†TMO3-1T	3	.05-250	.05-250	.1-200	5-70	7.95
TMO4-1	4		2-350	2-350	.35-300	2-100	6.25		
TMO5-1T	5	3-300	3-300	6-200	5-100	8.45			
TMO13-1T	13	3-120	3-120	.7-80	5-20	8.45			
B* 	TT	TT1-6	1	.004-500	.004-500	.02-200	1-50	6.95	
		TT1.5-1	1.5	.075-500	.075-500	.2-100	1-50	5.95	
		TT2.5-6	2.5	.01-50	.01-50	.025-25	05-10	6.45	
		TT4-1	3	.05-200	2-50	.2-50	1-30	5.95	
		TT4-1A	4	0.1-300	0.1-300	0.2-250	0.3-180	6.95	
		TT25-1	25	.02-30	.02-30	.05-20	1-10	9.95	
		TTMO	TTMO25-1	25	.02-30	.02-30	.05-20	1-10	11.95
			TTMO1-1	1	.005-100	.005-100	.01-75	05-40	11.45
			TTMO4-1A	4	0.1-300	0.1-300	0.2-250	0.3-180	13.95
			T	TT1-1	1	.15-400	.15-400	.35-200	2-50
C 	T	TT1.8-3	1.18	0.01-250	0.01-250	0.02-200	0.03-50	5.65	
		TT1-6	1	.01-150	.01-150	.02-100	05-50	5.65	
		TT1.5-1	1.5	.1-300	.1-300	2-150	5-80	4.45	
		TT1.5-6	1.5	.02-100	.02-100	.05-50	0.1-25	5.65	
		T2.5-6	2.5	.01-100	.01-100	.02-50	05-20	4.45	
		T4-6	4	.02-200	.02-200	.05-150	1-100	4.45	
		T9-1	9	.15-200	.15-200	3-150	2-40	3.95	
		T16-1	16	3-120	3-120	7-80	5-20	4.45	
		T36-1	36	.03-20	.03-20	.05-10	1-5	6.95	
		TO	TO-75	1	10-500	—	40-250	—	6.95
		TH	TH1-1H	1	8-300	8-300	10-200	25-100	5.95
			TH9-1H	9	2-90	2-90	3-75	6-50	6.45
			TH16-H	16	7-85	7-85	10-65	15-40	6.45
			TMO	TMO1-02	1	1-800	1-800	2-500	—
		TMO1-1	1	.15-400	.15-400	.35-200	2-50	6.25	
		TMO1.5-1	1.5	.1-300	.1-300	2-150	5-8	8.45	
		†TMO2.5-6	2.5	.01-100	.01-100	.02-50	05-20	7.95	
		†TMO4-6	4	.02-200	.02-200	.05-150	1-100	7.95	
		TMO6-1	6	3-200	3-200	5-150	5-50	7.95	
		TMO9-1	9	.15-200	.15-200	3-150	2-40	7.95	
TMO16-1	16	3-120	3-120	7-80	5-20	7.95			
D 	T	T2-1	2	.050-600	.050-600	.1-400	5-200	3.95	
		T3-1	3	5-800	5-800	2-400	—	4.45	
		T4-2	4	2-600	2-600	5-500	2-250	3.95	
		T8-1	8	.15-250	.15-250	25-200	2-100	3.95	
		T14-1	14	2-150	2-150	5-100	2-50	4.95	
		TMO	TMO2-1	2	.050-600	.050-600	.1-400	5-200	7.95
			TMO3-1	3	5-800	5-800	2-400	—	8.45
			TMO4-2	4	2-600	2-600	5-500	2-250	7.95
			TMO8-1	8	.15-250	.15-250	25-200	2-100	7.95
			TMO14-1	14	2-150	2-150	5-100	2-50	8.45
		FT	FT1.22-1	1.22	.005-100	.005-100	.01-50	05-25	35.95
FT1.5-1	1.5		.1-400	.1-400	5-200	1-100	35.95		
E 	FTB	FTB-1	1	2-500	2-500	.5-300	1-100	36.95	
		FTB1-6	1	.01-125	.01-125	.05-50	1-25	36.95	
		■FTB-1-75	1	5-500	5-500	5-300	10-100	36.95	
F 	T	T-622	1	0.1-200	0.1-200	0.5-100	5-80	3.25	
		T626	1	0.01-10	0.01-10	0.2-5	0.4-2	3.95	

■ Denotes 75 ohm models

* FOR A AND B CONFIGURATIONS

Maximum Amplitude Unbalance
0.1 dB over 1 dB frequency range
0.5 dB over entire frequency range

Maximum Phase Unbalance
1.0° over 1 dB frequency range
5.0° over entire frequency range

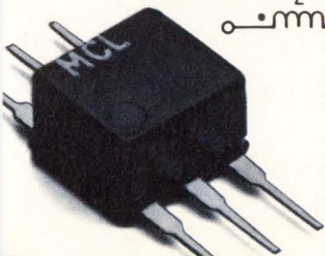

No guts.

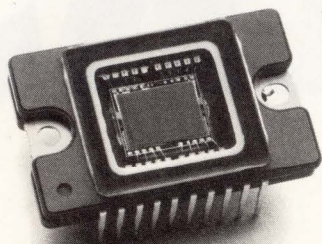

CCD Image Sensors

The CCD technology that led to Sony's leadership in color video cameras is now available to you.

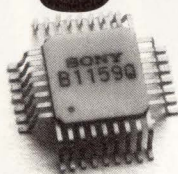

ECL Standard Logic

Wide range of high-speed, high-performance ECL logic devices. Low cost and design simplicity.

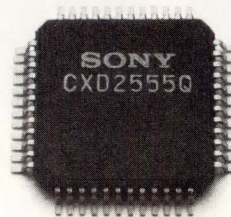

Digital Audio

Consumer-based leading-edge technology. Compact design. Small package. Capable of CD-ROM interface.



High Speed SRAMs

Broad family covers all your fast-processor, cache-memory requirements.



ECL Gate Arrays

Super high-speed operation combined with low power consumption and extensive I/O interfaces.



Interactive Video

Sony's A/V IC leadership applies directly to new multimedia systems. Superior bipolar linear technology in encoder/decoder.



1-Meg SRAMs

Largest, most diverse family in the industry. The first products scheduled to come from our new San Antonio fab.



STRAM

High speed performance, self-timed RAM with register, synchronous SRAM.

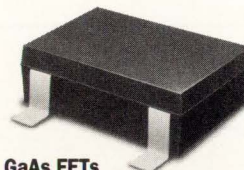

GaAs FETs

State-of-the-art performance, reliability and uniformity. Ideal when low noise is critical.



D/A Converters

High speeds to 500 MHz, low glitch energy, and low power consumption in very small packages.



A/D Converters

18 models including the world's fastest. Fewer pins, smaller packages, low power consumption, and guaranteed low error rates.

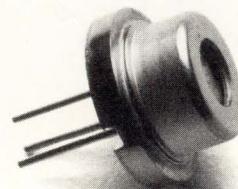

Laser Diodes

Wide power range, high reliability, huge selection. Ideal for optical disk, laser printer and microsurgery designs.

No glory.

If you can't get the parts you need, you can't get your best designs out the door.

And that's where we can help. With complete families of semiconductors like these. The same components that have made Sony's consumer electronics so successful.

Perhaps more important, we're always here to help. With a design center to help develop your applications through production.

With a service department to answer your questions and expedite your orders.

And with world-class manufacturing, including new facilities in San Antonio, Texas, to produce the technology you'll need in 1992 and beyond.

Let Sony semiconductors bring glory to your products. Call us today at (714) 229-4331, FAX (714) 229-4285. In Canada (416) 499-1414, FAX (416) 499-8290.

SONY®

Sony Corporation of America, Component Products Company, 10833 Valley View Street, Cypress, CA 90630.
Sony Canada, 411 Gordon Baker Road, Willowdale, Ontario M2H 2S6.

Sony is a registered trademark of Sony Corporation. Prices and specifications are subject to change without notice. The purchase of products is subject to availability and Sony's standard terms and conditions of sales.

How damp is damp?

We have developed a product that measures relative humidity for our custom control system and require a reliable humidity-sensor element. The initial design used a Minicap² from Panametrics (Waltham, MA), but the device did not meet specifications and is now unavailable in Australia. The sensor measured 5 to 95% relative humidity with a linear change in capacitance (200 pF \pm 15% at 33% RH).

Unfortunately, the only alternative device obtainable here is the Philips H1, which is capacitive but is also nonlinear. Can you please advise us of any known sources for humidity-sensor elements—not those built into modules—in the US?

Stuart White
EMS Control Systems
Osborne Park, Australia

Three companies that sell relative-humidity sensors are

General Eastern Instruments
20 Commerce Way
Woburn, MA 01801
(617) 938-7070
FAX (617) 938-1071

Newport Scientific Inc
Hydrodynamics Div
8246-E Sandy Ct
Jessup, MD 20794
(301) 498-6700
FAX (301) 490-2313

Ohmic Instruments Co
508 August St
Easton, MD 21601
(301) 820-5111
FAX (301) 822-9633

Gone, but not forgotten

In the August 19, 1991, issue you ran a question about pc-board layout. You suggested the 3-part Designers' Guide to Transmission Lines and Interconnections pub-

lished in the June 23, 1988, issue. How can I obtain this article or back issue?

Dan Cavaliere
Tempustech Inc
Naples, FL

To get a copy of an article, contact University Microfilm. The charge is \$11.75 per article, regardless of the article's length.

University Microfilm
300 N Zeeb Rd
Ann Arbor, MI 48106
(313) 761-4700
FAX (313) 665-7075

For a back issue published within the past 10 years, contact EDN's Helen Benedict at our Newton, MA, address (phone (617) 558-4681, FAX (617) 558-4470). Back issues cost \$10 each and must be prepaid.

Nerd stumps editors

Since you answer "nagging questions," here are several real naggers. What's worse, I get the idea that I'm supposed to know the answers because they're so obvious, but no one seems to know what the numbers are or where to look.

1. Devices connected to the dial-up telephone network are specified as to their "ringer equivalency," an indication that the load is the same as that many bells. Should the load be an impedance, probably all real, at a particular frequency (such as 8 k Ω at 40 Hz) or an RLC combination for the frequency-selective ringing (not used on single-party lines) like 10,000 Ω and 20 μ F at 5Hz.

2. Telecommunications devices for the deaf have been around for a long time and operate half duplex (one transmits at a time, both ends receive at all times) through the phone lines. The code used is Baudot (although now they sometimes also use ASCII). But what are the mark and space tone fre-

quencies? How do these devices compare to a 300-baud asynchronous modem, which uses two frequency pairs? What is the bit rate? The phone-company people who deal with the stuff don't know and can't tell me who to ask. I'd like to make my computer and modem operate this way, and I'm sure others who either are hearing impaired or communicate with those who are would too.

3. What is the carrier deviation for transmission of a satellite-relayed television signal? Since the television waveform is asymmetrical, what is the position of blanking with regard to the band edges of the channel? Does white cause a positive deviation of the carrier frequency or a negative one?

Since I am a nerd (a term that, as far as I'm concerned, isn't negative but simply informational), I worry about these questions while trying to get to sleep nights, so any information you could provide would be appreciated.

James Rieger
Telemetry Div
Naval Weapons Center
China Lake, CA

We hate to shake your faith in us, but the EDN editors are stumped and believe that the answers to your three questions are lost in the mists of time. Ask EDN urges any reader who has any information at all about the topics keeping Mr Rieger up nights to contact us at once.

Ask EDN solves nagging design problems and answers difficult questions. Address your letters to Ask EDN, 275 Washington St, Newton, MA 02158. FAX (617) 558-4470; MCI: EDNBOS. Or send us a letter on EDN's bulletin-board system at (617) 558-4241: From the Main System Menu, enter SS/ASK_EDN and select W to write us a letter.

Toshiba SRAMs Move Yo

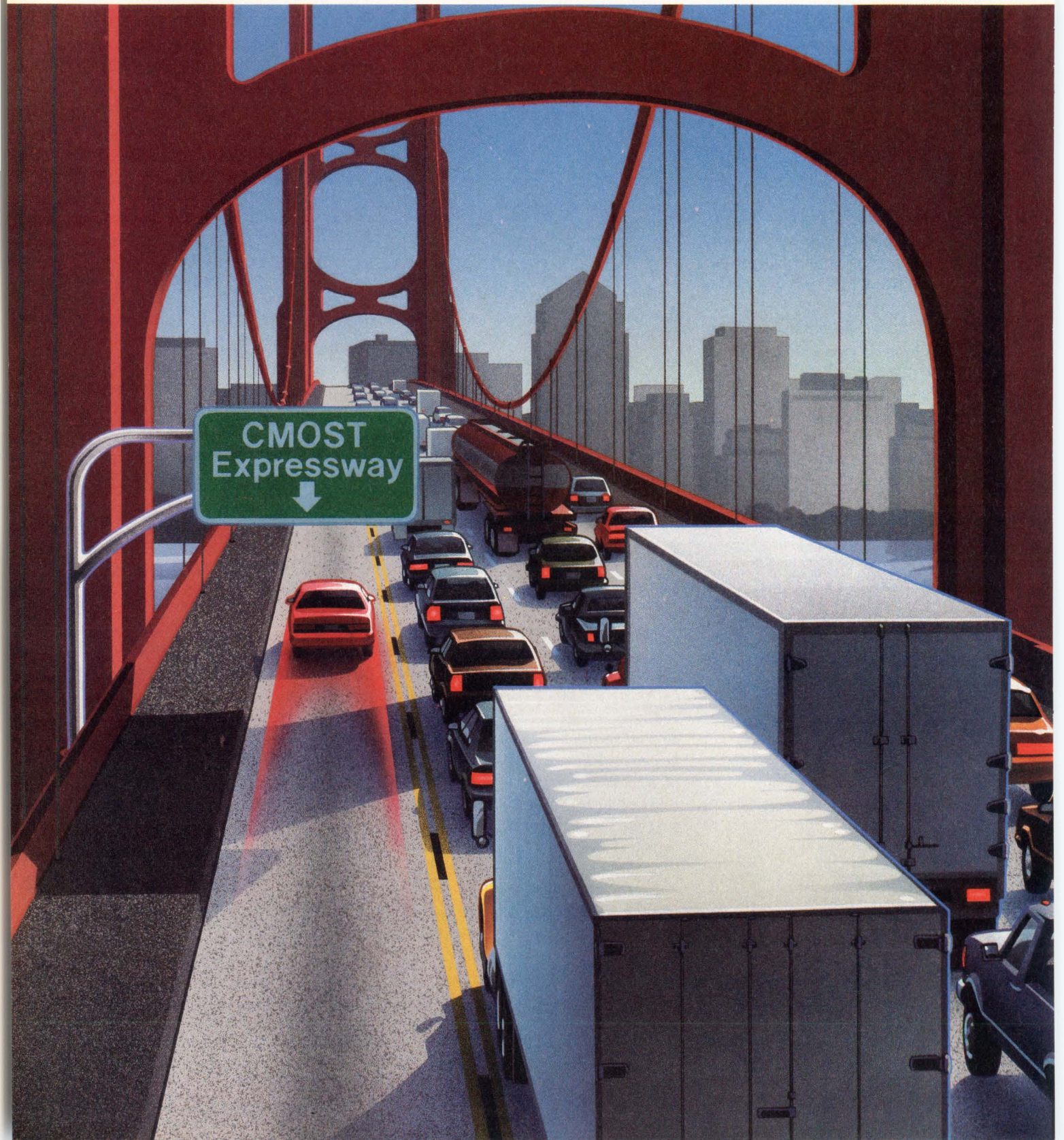

u Into The Fastest Lane.

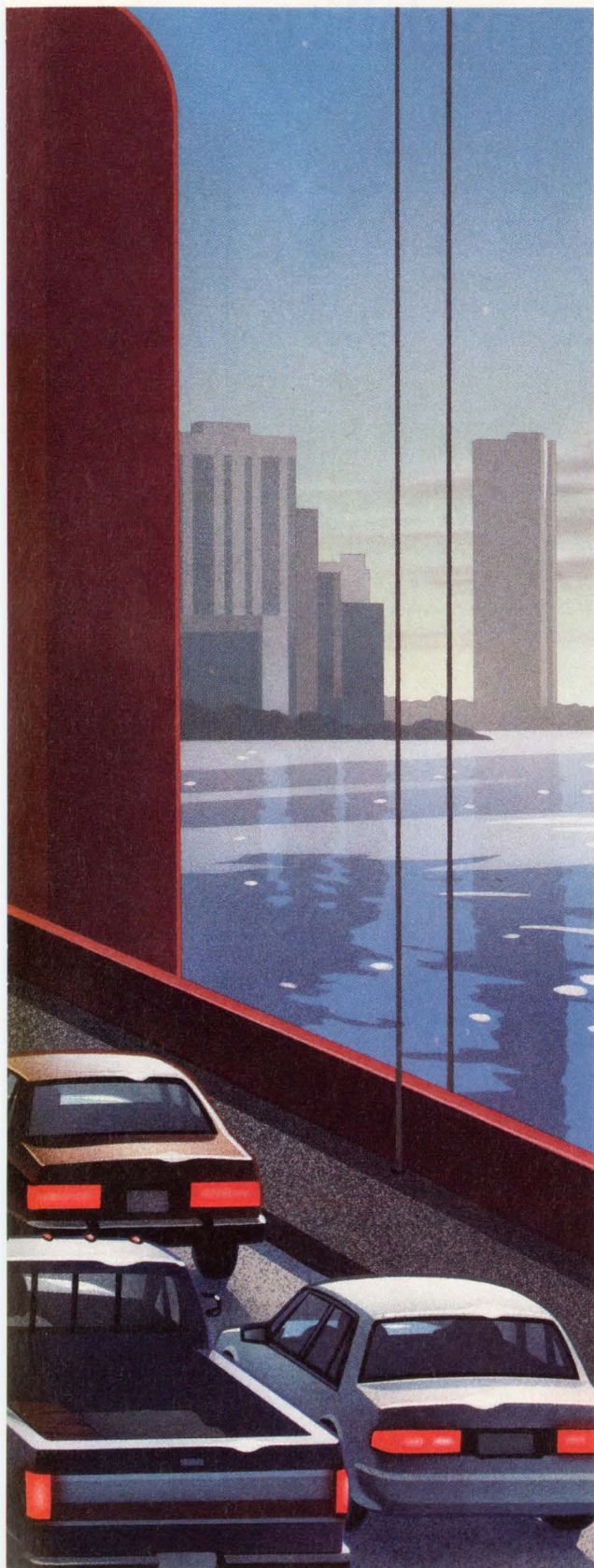

BiCMOS technology shifts our speedy, powerful SRAMs into high gear. Who'd have thought you could speed past your competitors' designs at 10-12ns access times? Toshiba, of course. Our new, faster



We at Toshiba are fond of establishing new speed limits.

SRAMs are helping the latest generation of high performance applications get a quick start. The range of uses for these parts include 32-bit workstations, fast cache, buffer memory and telecommunications. You can probably add a few ideas of your own.

Toshiba's CMOS-based SRAMs are no slouches, either. Our new 1Mb, 15ns SRAM is more than 25% quicker than anyone else's. It's available in a x16 configuration to fit into today's wider applications. The revolutionary pinout has been used to reduce wire lengths and cut noise. And it's based on the same 0.7 micron process as our 4Mb DRAM, so it will be following another established leader on Toshiba's CMOS Expressway.

Now, we wouldn't want you to think there are just a few densities and organizations to choose from. You can also light a fire under your design with 10ns 256K BiCMOS, or 10ns 64K BiCMOS organized in x4 or x8. You choose. And ultimately, you win.

Of course, if your design doesn't require such breathtaking speed, Toshiba also offers 1Mb SRAMs at 80-100ns, or Pseudo Static RAM up to 4Mb.

When you're ready to really get moving on your next design, call Toshiba.



Toshiba CMOS keeps any project running smoothly.

For technical literature, call 1-800-321-1718.

In Touch with Tomorrow
TOSHIBA

TOSHIBA AMERICA ELECTRONIC COMPONENTS, INC.

© 1991 Toshiba America Electronic Components, Inc.

MST90-047

CIRCLE NO. 21

EDN January 20, 1992 • 45

10-BIT ANALOG-TO-DIGITAL CONVERTER

So easy-to-use, it opens a new window of software programmability.

Dynamic Reconfiguration

A: >reconfig ADC10158 \01011010

Software-Programmable Functions

Conversion speed/resolution

- 4.4 μ s max at 10-bit plus sign
- 3.2 μ s max at 8-bit plus sign

Multiplexer	Output Data Format
- Single-ended	- Left or right justified
- Differential	
- Pseudo-differential	

Key Features

- Single +5V or \pm 5V operation
- 33mW power consumption at 5V
- 166KHz sampling rate (10-bit plus sign)
- On-board 2.5V voltage reference
- Sample-and-hold
- 0-5V input with 5V supply
- -5V to +5V input with \pm 5V supply
- Ratiometric or absolute voltage measurements
- \pm 1.5LSB total unadjusted error
- Guaranteed no missing codes over temperature
- ADC10154 - four input channels
- ADC10158 - eight input channels

ADC10158 Block Diagram

Introducing the industry's first software-programmable 10-bit ADC.

Simply put, our latest ADCreation — the ADC10158 — is open to suggestions.

Now you can change your conversion speed, reconfigure your mux, or adjust your out-

put data format. All with just a few easy keystrokes. However and whenever you'd like.

Which means you get "on-the-fly" optimized system performance, while consuming just 33mW of power.

It also means that — now — you can put design flexibility at your fingertips.

Our lines are open.

For free samples and datasheets, call: 1-800-NAT-SEMI, Ext 145. Or, fax: 1-800-888-5113.

Winds of change blow strong



The winds of change continue to blow. Events throughout the world show that change is continuous, whether it's revolutionary or evolutionary. Even small changes force us to do things differently. But most of us don't like change, and we resist it until we either adapt to it or get swept away by it.

Changes can be big, too, and the break-up of the Soviet Union's satellite countries is one of the best recent examples. At the time that Eastern Europe was in the midst of its turbulent changes, many people here in the US couldn't understand why the people involved didn't welcome the changes. Let's not get too smug. Here in the US we're still going through a big change—the break up of the Bell Telephone System into regional operating companies, or “baby Bells”—and people are still resisting it.

I've heard people talking about which long-distance phone company they should choose, which phone sets they should buy, what they can wire up themselves, and how to get phone equipment repaired. Life was so much simpler when the Bell System answered all our phone needs. Many people would like

to abandon the competitiveness of today's communications industry for the peaceful time when one company provided for all their communications needs. It's no wonder that the telephone company became known as “Ma Bell.” The change to a competitive market forces us to adapt and to make choices, not all of which are clear or easy.

What is clear is that the US Congress should stop meddling in the telecommunications industry and stop telling the telephone companies what they can and cannot do. If these companies want to sell computer equipment, database services, and even access to cable-TV programs, let them. Yes, there are inequities among telecommunications companies, and yes, competition may favor some Bell companies. But it has always been this way. Some companies are always stronger and more competitive than others. No new industry starts with all the competitors on equal footings. It's time for the telecommunications industry to grow up, to welcome all entrants, and to let companies compete freely. As a friend of mine used to say, “Adapt or die.” So it should be among telecommunications companies.



Jesse H. Neal
 Editorial Achievement Awards
 1990 Certificate, Best Editorial
 1990 Certificate, Best Series
 1987, 1981 (2), 1978 (2),
 1977, 1976, 1975

American Society of
 Business Press Editors Award
 1991, 1990, 1988, 1983, 1981

Jon Titus
 Jon Titus
 Editor

Send me your comments via FAX at (617) 558-4470, or on the EDN Bulletin Board System at (617) 558-4241 300/1200/2400, 8, N, 1.

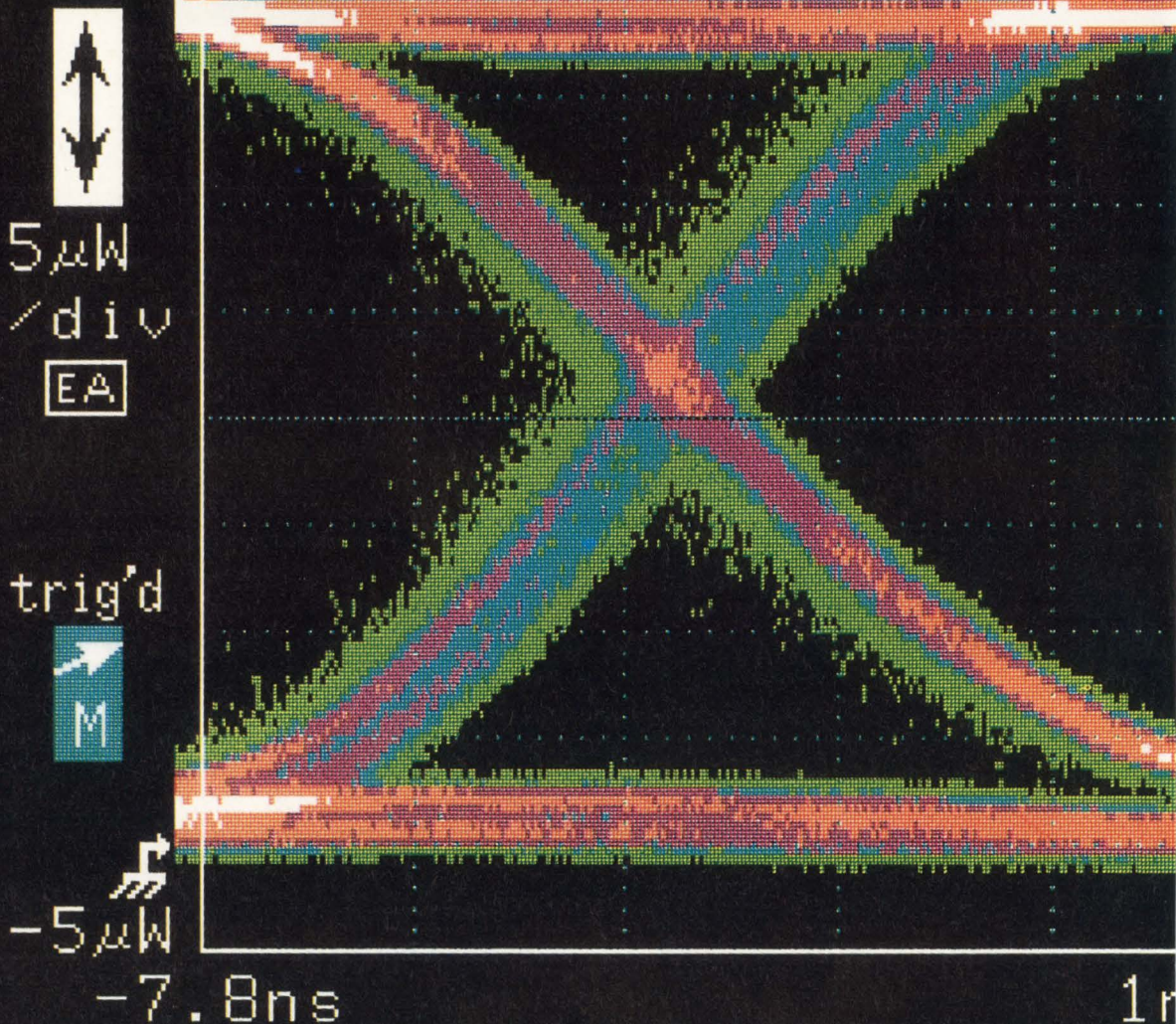

Rise (S)	Jitter (S)	Noise (S)
2.760 ns	144.8 ps	912.2 nV

WE'LL GIVE YOU

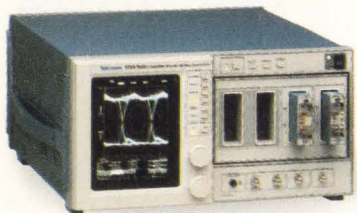

In a world so dependent on communicating, your customers don't take kindly to interruptions. So in the interest of keeping folks in touch with one another, Tektronix makes communications signal

analyzers that let you measure jitter and noise automatically. And bit error rate testers that can lock onto and test specific or pseudo-random patterns—even those millions of bits long. But these devices are just part of a sophisticated collection that includes optical-to-electrical converters, SDH/SONET reference



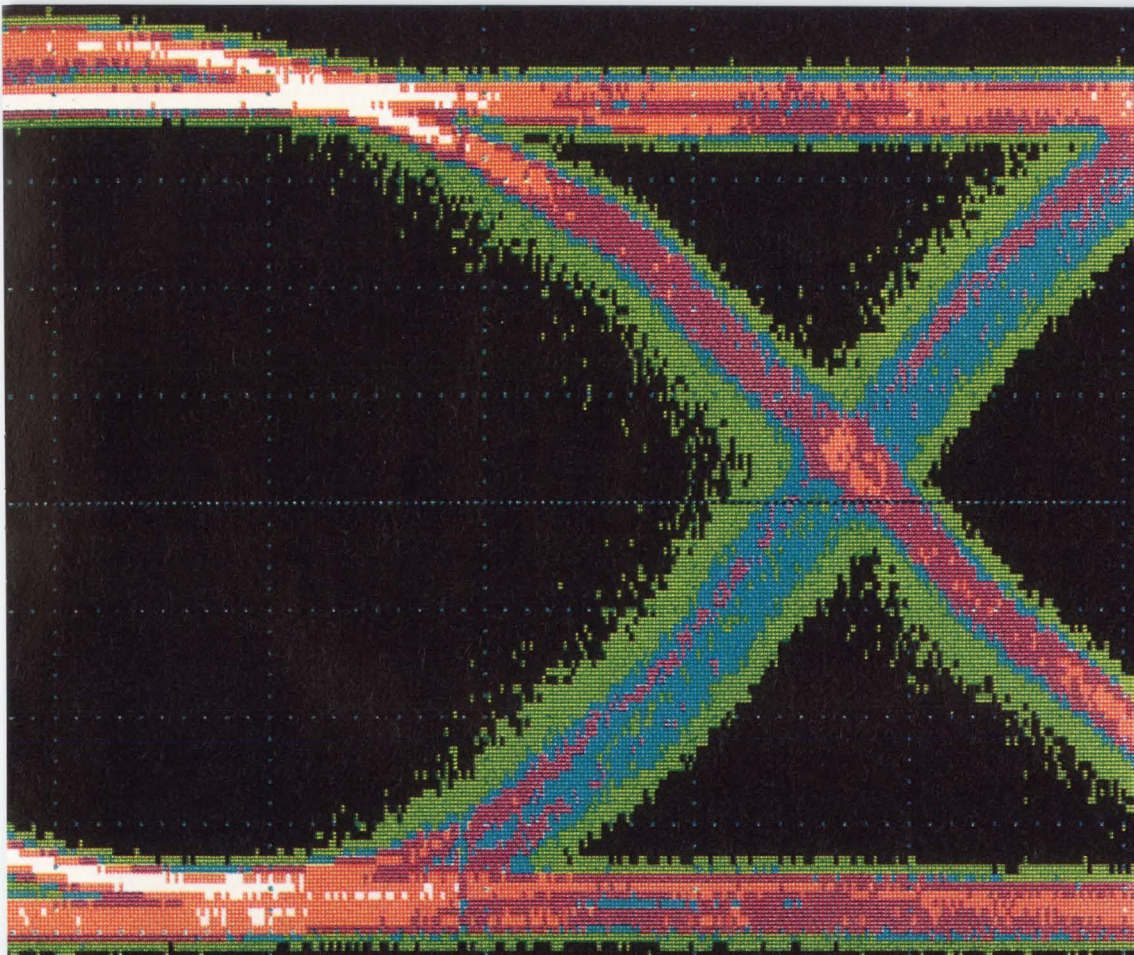

s/div	2.2ns
Measurements	Vert Size: R3
	5 μ W/div
	Vert Offset: R3
	20 μ W

THE JITTERS.

receivers, optical attenuators, and optical and metallic time-domain reflectometers.

High-performance equipment for everyone from design engineers to field service technicians.

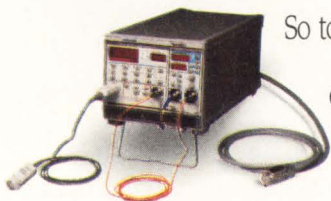
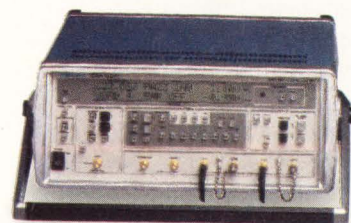

So to make sure your customers are getting all the right messages, talk to Tek today. We promise, we'll do everything we can to help you keep the lines of communication open. **TALK TO TEK/1-800-426-2200**

Tektronix
Test and Measurement

CIRCLE NO. 22

EDN January 20, 1992 • 51



*No Matter
What the
Application,
SBE Fits.*

Matching your high-speed data communications requirements with a quality supplier has never been easier. Whether you're a manufacturer of mini/superminicomputers, workstations or high-performance data communications products, *only* SBE provides a perfect fit.

Only SBE offers a complete line of intelligent high-performance communications controllers for all major interface technologies: FDDI, Token Ring, Ethernet and High Speed Serial. Only SBE adds premium features, without a premium cost, for the best price/performance in the industry.

Add integrated hardware/software solutions; availability in VMEbus, Multibus and SBus; plus legendary development assistance and continuing product support.

Discover how SBE's intelligent high-performance controllers can meet your LAN and WAN interface requirements. Turn to SBE today.

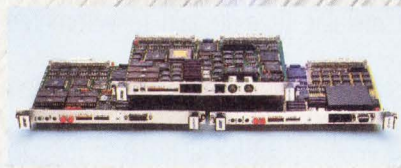

For fast action, call: 1-800-347-COMM

Germany: 0130-810588

United Kingdom: 0800-378-234

SBE, Inc., 2400 Bisso Lane, Concord, CA 94520

CIRCLE NO. 23

SELF-CALIBRATING A/D CONVERTERS

Monolithic devices enhance accuracy and linearity

DAVE PRYCE, Technical Editor



Self-calibrating ADCs can offer outstanding performance, particularly with regard to linearity specifications. To get the most out of these devices, however, you need to understand how they work and what they can actually do in a system application.

Although self-calibrating (autocalibrating) A/D converters are establishing a presence in many high-resolution applications, they don't necessarily constitute a panacea for all of the ills that can afflict a complete data-conversion system. For example, a monolithic self-calibrating ADC does not usually correct for external gain and offset errors—and most gain and offset errors arise from other elements in the system such as op amps or instrumentation amplifiers. Nevertheless, autocalibrating ADCs can greatly enhance the performance of systems having 12-bit or greater resolution, particularly in terms of accuracy and linearity.

For an in-depth view of device characteristics and system considerations from a manufacturer's viewpoint, see "Autocalibration—fact and fiction."

Analog Devices, a company that makes both monolithic and hybrid ADCs, claims there is no real need for autocalibration at resolutions less than 12 bits. The characteristics of the A/D conversion process support this contention. A converter has 2^n states, where n equals the number of bits of resolution. A 12-bit converter has only 4096 states, but a 16-bit converter has 65,536 states. The accuracy of a converter depends on the

bit weight—the least significant bit (LSB)—and is equal to $1/2^n$. For a 12-bit converter, the LSB is equal to 0.0244% of the full-scale range (FSR), but for a 16-bit converter, the LSB is only 0.0015%. For a 10V FSR, the LSB of a 12-bit converter is equal to 2.441 mV; for a 16-bit converter it is only 152.588 μ V.

Achieving the required accuracy gets increasingly difficult for higher-resolution converters and for lower full-scale ranges. For example, the LSB of a 20-bit converter with a FSR of 5V is less than 5 μ V. Analog Devices states that, even with precise laser trimming of the



This 12-bit self-calibrating ADC, the ADS7803, is available from Burr-Brown. The low-power device can sample to 100 kHz and features a 4-channel multiplexer.

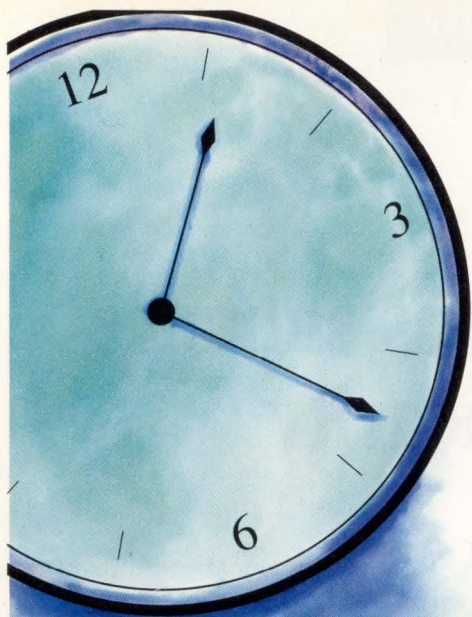

SAVE TIME.

Introducing the CAPSTONE-WS Component Information Systems.

TCP/IP Local Area Network

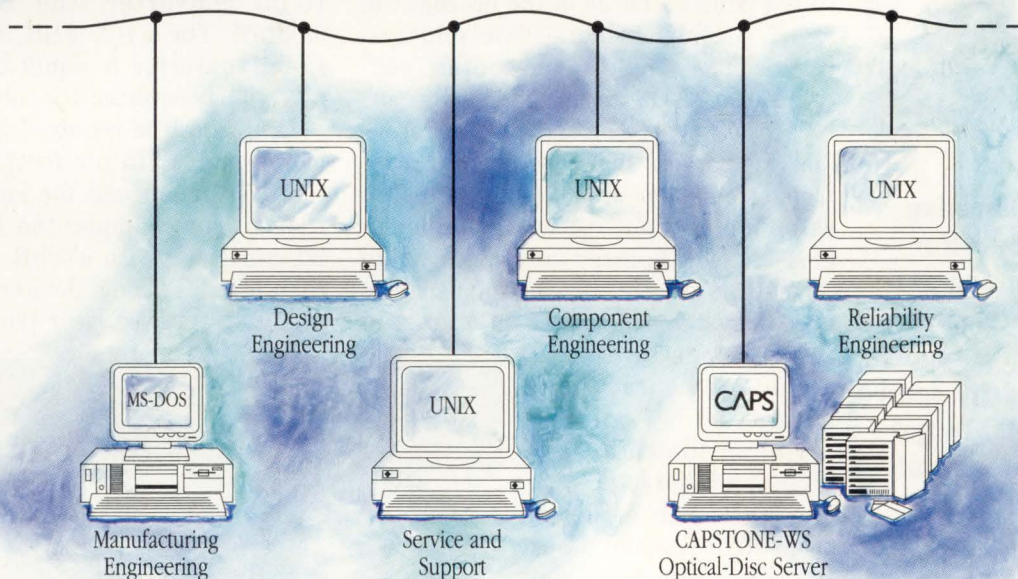

Here's a component information management system that lets everyone on your team do more. The new CAPSTONE-WS™ family of networkable IC and semiconductor component management solutions gives you the features you need to boost your organization's productivity.

- Save hours of time and effort with complete, current, and comprehensive information on more than 625,000 components right at your fingertips. That's information from over 500 manufacturers worldwide and more than 700,000 pages of manufacturers' datasheets and application notes on-line, at all times.
- Based on the CAPS® (Computer-Aided Product Selection) system running within a TCP/IP (Transmission Control Protocol/Internet Protocol) network environment, CAPSTONE-WS helps workstation and PC users manage IC and semiconductor information faster and easier than ever before.

- CAPSTONE-WS also accommodates preferred parts lists (PPLs) to encourage consistent component selection practices throughout your organization.

To find out more about how CAPSTONE-WS can help you make the most of your valuable engineering time and to ask for your free demo disk, call Jill Adams at 800-245-6696.



C A H N E R S

CAPS[®]

Computer Aided
Product Selection

Cahners Technical Information Service
275 Washington Street
Newton, MA 02158-1630
Phone: 617-558-4960
Facsimile: 617-630-2168
Toll-free: 800-245-6696

CAPS is a registered trademark and CAPSTONE-WS is a trademark of Reed Publishing (USA) Inc.

SELF-CALIBRATING A/D CONVERTERS

resistors on its monolithic chips, problems arise at 16-bit resolutions because of changes in transistor and resistor characteristics following package assembly.

Laser trimming also adds complexity to the design and manufacture of resistor-based ADCs. The trimming requires accurate real-time control and constant monitoring of resistance values. Moreover, the equipment needed for laser trimming is expensive and requires skilled operators. These factors can add cost to the product and a degree of uncertainty to product yield. Of equal importance is the problem that once a laser-trimmed device is packaged, you can't make further adjustments to the device to compensate for changes that might occur over time.

ICs eliminate laser trimming

These considerations and the previously mentioned accuracy problem have spurred a few manufacturers to develop self-calibrating ADCs that do not rely on laser-trimmed resistors. Instead of using resistors to set the initial accuracy, self-calibrating chips use capacitors implemented in a CMOS process

that features a switched-capacitor DAC architecture to maintain continuous accuracy.

Crystal Semiconductor was the first company to introduce a self-calibrating ADC based on capacitor-DAC CMOS technology and is a major supplier of monolithic chips to hybrid manufacturers. Other companies, such as Analog Devices, Burr-Brown, Harris Semiconductor, National Semiconductor, and Texas Instruments, offer devices that employ similar architectures.

The capacitor-DAC architecture used by Analog Devices in its 16-bit AD1876/AD676 series is typical of most self-calibrating A/D converters that digitally correct for nonlinearities. To accomplish the calibration, the device includes a 9-bit capacitor array and 11 16-bit words of on-chip RAM. **Fig 1** illustrates the basic circuitry of the front end of the AD1876 in the sample configuration.

In this configuration, V_{IN} charges all of the capacitors in CapDAC except the most-significant-bit (MSB). The MSB capacitor charges to V_{REF} , introducing a bipolar offset. To take the sample, the top-plate switches are opened, trapping the charge on

the CapDAC. The device switches the sample/convert switch to analog ground and runs a successive-approximation algorithm on the nine capacitor switches, testing the top-plate voltage with respect to ground on each cycle. SubDAC is a resistor-string DAC that obtains the bottom 7 bits. The CalDAC corrects for errors in the CapDAC, using codes determined during the calibration operation. To isolate the input and reference from initial charging currents, the buffer switches insert a buffer between the inputs and the capacitors each time the capacitor configuration changes. The Dummy DAC balances the input to the comparator to ensure low offset and provide a remote ground sense.

The AD1876 and AD676 are members of a family of four devices that provide options for ac and dc specifications, output configuration, and package choices. The AD1876, which comes in a 16-pin DIP, is specified only for ac parameters and has a serial output. The AD676 comes in a 28-pin DIP, is specified for both ac and dc parameters, and has a 16-bit parallel output. Both

Text continued on pg 58

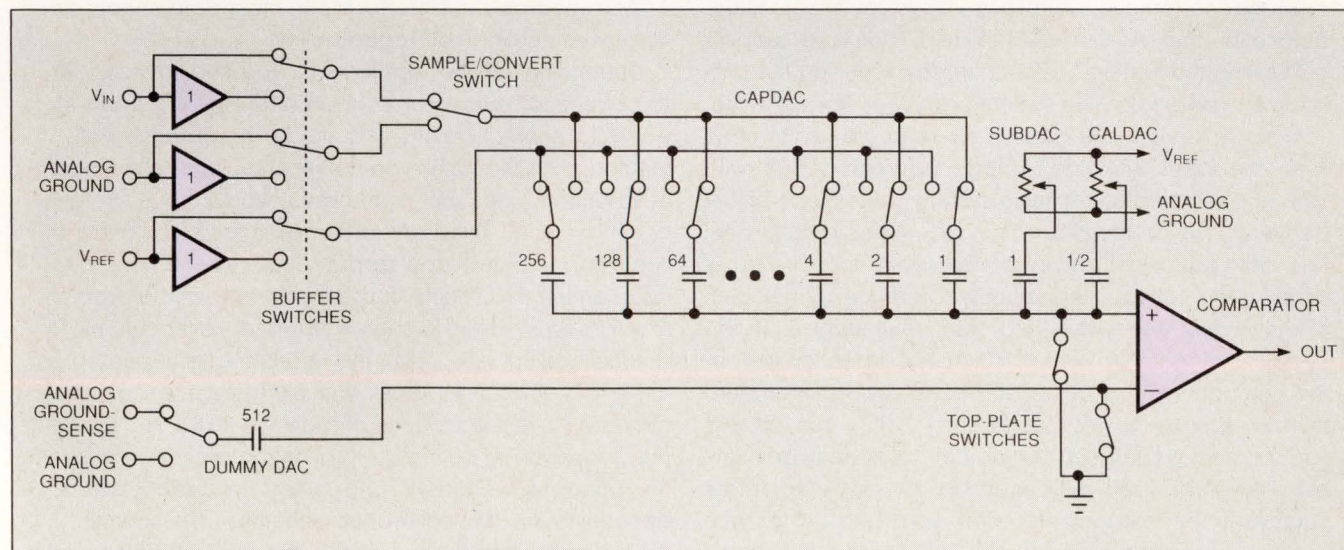

Fig 1—This capacitor-DAC architecture is typical of self-calibrating A/D converters that digitally correct for nonlinearities. Shown here is the 16-bit AD1876 from Analog Devices, which uses a 9-bit capacitor array and 11 16-bit words of on-chip RAM to accomplish the calibration.

Autocalibration—fact and fiction

GEORGE HILL, Burr-Brown Corp

Autocalibrating ADCs can offer outstanding specifications, with linearity foremost. However, as with other new techniques, autocalibrating's advantages can be oversold. The key to extracting real advantages from the hype is to understand what autocalibration does and why manufacturers use it. Autocalibrating ADCs can be the right choice in many applications, but a user experienced with conventional ADCs needs to consider the characteristics of calibration to get the most out of autocalibrated converters.

Although the data-sheet specifications for autocalibrating ADCs may show great linearity and low offset and gain errors, the use of these devices will not always eliminate the need to calibrate the complete system. For example, op amps or instrumentation amplifiers usually dominate the system's offset, and the voltage reference—typically external to the ADC—dominates the gain error. As a result, most precision applications need a system-calibration cycle to achieve overall accuracy.

To calibrate a system's offset, you need circuitry that grounds the input as close to the signal source as possible. This action should produce a 0V input to the ADC. By converting with the input of the system grounded, the output of the ADC represents all of the offsets contributed by the system. The system processor can store this data and later subtract it during normal operation to remove the effects of system offset. Future autocalibrating ADCs will include circuitry to simplify calibrating the system's offset, thereby reducing the calibration overhead on the system processor and software.

Gain error is more difficult to calibrate accurately. Even the best available voltage references drift with time and temperature, limiting system gain-error stability between visits to the calibration lab. Also, if the system has any gain, calibrating system gain error requires dividing the value of the voltage reference by the gain and injecting the result into the input stages of the system during calibration. Fortunately, signal-conditioning components in front of the ADC usually contribute minimal gain error. Autocalibrating ADCs can correct for the second largest contributor to system gain error—the ADC itself. Still, they do not adjust for error sources in the voltage reference, so a good reference remains important in any system whose absolute accuracy is critical.

One of the major features of autocalibration, accord-

ing to data sheets and other press, is that the ADCs can recalibrate themselves to remove errors at any temperature. This capability raises several questions that are not always clearly answered in the data sheets. First, how often must the ADC recalibrate to maintain a certain accuracy? The answer depends on how stable the ADC is over time and with changes in temperature. Most autocalibrated ADCs have excellent linearity stability, which is fortunate because linearity is the second most difficult error to remove by means of a system-level calibration routine (after voltage-reference error), and system-linearity error comes mostly from the ADC. Typically, it isn't necessary to recalibrate linearity more often than every few days, unless the ambient temperature changes more than 30 to 40°C. Linearity is a specification where autocalibration really can approach—or even exceed—the levels commonly available with conventional ADCs.

Autocalibration accuracy and repeatability

A related question concerns what happens if an ADC is recalibrated several times at any given temperature. How much can the accuracy change from calibration to calibration? A ± 0.5 -LSB calibrated-accuracy specification means that the accuracy of the ADC can change as much as 1 LSB between calibrations, depending on the calibration resolution and its immunity to noise in the system. A system built using a 16-bit ADC with a ± 0.5 -LSB accuracy could thus yield a system with only 1-LSB repeatability. Unfortunately, most data sheets do not specify calibration repeatability.

Depending on the application, you should consider the effects of autocalibration on differential linearity in particular. Early versions of some autocalibrating ADCs yielded parts that achieved no-missing-codes after most calibration cycles but sometimes would have a few codes missing. This type of performance could be a problem in control-loop applications, where a missing code on the ADC could cause the loop to cycle around the missing code and never stabilize. Although most autocalibrating ADCs on the market can repeatedly achieve no-missing-codes, this performance can depend on system conditions outside the ADC. For example, system noise during the calibration cycle can affect the differential linearity and other calibrated errors, depending on the calibration scheme. The source of this noise is often the voltage reference, but noise can also come from digital clocks, changing levels on the bus, and fluctuating ground currents.

Another question designers must face is how to absorb the overhead downtime in the system when the ADC is recalibrating. At a minimum, the system requires this delay each time it powers up. To get maximum results from an autocalibrating ADC, other components of the system, particularly the voltage reference and the power supplies, must be sufficiently stable during calibration to achieve the required system accuracy. Because of this need for stability, calibration is not usually done until some time after system turn-on, and you need to include appropriate circuitry, or software, in the system to generate the delayed calibration command. In most systems, the extra milliseconds are usually no problem at power-on.

If an autocalibrating ADC needs periodic recalibration during normal operation or needs recalibration after temperature changes to meet system-accuracy requirements, you need to take this additional downtime into account when designing and specifying the system. This downtime is critical where you need to do conversions continually or where some external event triggers the conversions. Where conversions must be done continually over long periods of time, the stability of the initial calibration is of major importance. In signal-analysis applications, a series of samples is taken periodically, after which the data is analyzed. In these cases, it may make sense to run a calibration cycle after each set of samples, if there is enough time available. In systems where an external event triggers conversions, either the stability of the ADC after power-up must be good enough to maintain accuracy until the system is powered-down, or the system must be specified for limits on how often trigger events can come, to leave time for recalibration.

In applications where the total power consumption of the system is important, you need to include the calibration time in determining the system's power requirements. Unlike many conventional ADCs, self-calibrating ADCs can't be simply turned off between conversions to save power, although some of the newer parts have power-down modes that retain the calibration data while drawing very little supply current between conversions.

Avoiding laser trimming's trimmings

Also, remember that manufacturers choose autocalibrating architectures for reasons beyond what they promote in the data sheets. Some start-up firms have cho-

sen the autocalibrating approach in part to avoid having to develop methods to trim the thin-film resistors often used in conventional architectures, perhaps because digital-logic designers are easier to find than laser-trim experts. The alternative is to use digital logic on chip to trim linearity. The start-ups accept larger die sizes, more complex design tools and more expensive fabrication; they plan to offset these higher costs by eliminating trim times, the equipment needed to deposit the resistors and trim them, and the costs of developing the thin-film experience base.

A manufacturer's decision to use autocalibration logic to avoid thin-film resistors has a direct impact on system designers. The elimination of thin-film resistors means that these converters can't easily handle most of the standard industrial analog-input ranges, because of the digital CMOS processes used for the ADCs. In many industrial applications, analog signals pass between various equipment in 0 to 5V, 0 to 10V, $\pm 5V$ and $\pm 10V$ ranges, in part to improve system noise immunity compared with lower voltages. The problem occurs when the supply to the autocalibrating ADC is below the voltage level of the input signal. Even for a 0-to-5V analog input range, there is a problem if an external part transmits a full-scale 5V signal to the ADC when its power supply has fallen to 4.5V or 4.75V. In this case, the system must divide down the input signals before they get to the ADC. Thus, in many applications, removing the resistors from the ADC means the system designer will have to use them externally to attenuate the standard industrial voltage ranges to the level the autocalibrating ADC can tolerate.

Autocalibrating ADCs will be increasingly valuable alternatives as their calibration capabilities are extended to include adjustment for system offset and gain errors, providing full system calibration in more applications. Manufacturers are starting to offer these features on some newer, very-low-speed ADCs, but not on the autocalibrating ADCs now on the market. However, in the general-purpose range of 12 to 16 bits and 1- to 100- μ sec conversion rates, autocalibrated ADCs allow a new approach to providing excellent linearity.

George Hill is strategic marketing engineer for Burr-Brown in Tucson, AZ.

SELF-CALIBRATING A/D CONVERTERS

devices feature a sampling rate of 100 ksamples/sec, total harmonic distortion (THD) of 0.002%, a S/N ratio of 90 dB, and a full-power input bandwidth of 1 MHz. To optimize performance, Analog Devices partitions these devices into two monolithic chips, a digital control chip fabricated in CMOS and an analog ADC chip fabricated in BiMOS.

Device minimizes all errors

Taking self-calibration to a higher level is National's ADC1241, a 12-bit + sign converter that minimizes errors in gain, linearity, and offset. The ADC performs a conversion in 8.7 μ sec and produces all 13 bits in parallel. A S/H circuit simplifies the analog interface. The internal self-calibration system reduces linearity errors to less than ± 0.5 LSB, and gain and offset errors to less than 1 LSB.

The block diagram in Fig 2 shows the converter's main components. In addition to the main DAC, the converter includes a linearity-correction DAC and an offset-cancellation DAC that connect to the comparator. During a conversion, the successive-approximation register (SAR) controls the output of these DACs, which correct the output of the main DAC for gain and linearity errors and cancel the comparator's offset voltage. Under microprocessor control, the converter can initiate a calibration procedure at any time to correct for errors.

During normal operation, switch S_1 connects the comparator to the analog input, and switch S_2 connects the comparator to the main DAC. To enable the offset-correction system and perform an auto-zero routine, S_1 and S_2 are switched to ground, disconnecting the analog input and the main DAC from the comparator's input. The SAR then controls the offset-DAC's output. A successive-approximation algorithm (similar to the one used to control

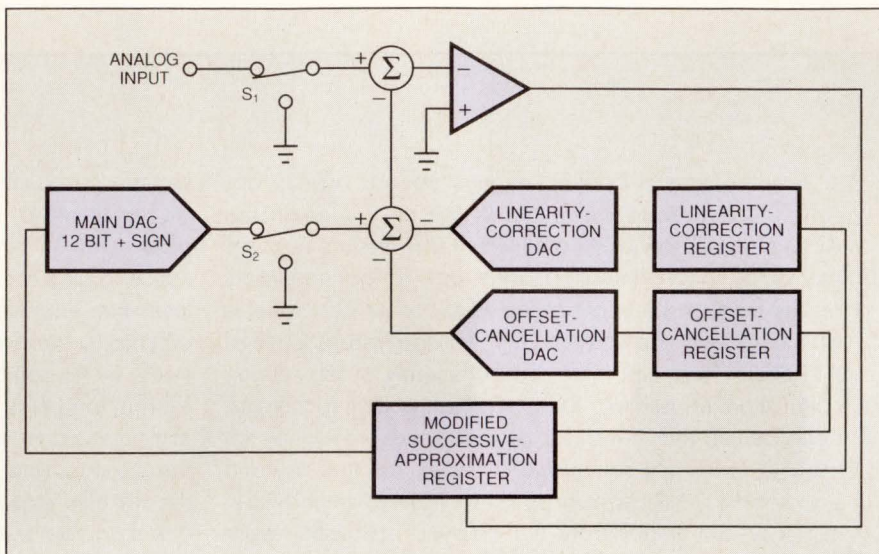

Fig 2—A linearity-correction DAC and an offset-cancellation DAC both connected to a comparator are main components of National Semiconductor's 12-bit ADC1241. During a conversion, the successive-approximation register (SAR) controls the output of these DACs, which correct the output of the main DAC for gain and linearity errors and cancel the comparator's offset voltage.

the main DAC during a conversion) finds the offset-DAC input code that results in the lowest offset error and stores this code in the offset register. A complete offset-correction cycle requires 13 μ sec.

To eliminate linearity errors, the ADC1241 uses a more complex procedure than the one just described for offset correction. As a simplified example, consider a 3-bit A/D conversion. To perform the correction routine, S_1 is switched to ground and the main DAC is given an input code of 010. Because capacitive DACs allow subtraction of the result of one code from that of another on successive clock cycles, the circuitry applies a second code, 001, to the DAC and subtracts its output from the output produced by the first code. If the DAC has no errors, the difference between the two output voltages (in this case the mismatch between the MSB and all of the less significant bits) will be 1 LSB. Any mismatch will cause an error voltage.

The linearity-correction DAC then follows a successive-approximation routine to find a correction

voltage that will cancel this error. The procedure repeats for each bit until it finds all of the necessary correction factors. For this 3-bit example, the next test will be 100-011. The correction codes are stored in the correction register for use during subsequent conversions. A complete linearity error-correction cycle requires 698 μ sec.

Most monolithic self-calibrating ADCs operate in a similar fashion. Another common feature is their lack of an on-chip reference. Manufacturers cite various reasons for the absence of a reference, including process incompatibilities and noise constraints—particularly at the 16-bit level. Digital CMOS technology, for example, does not lend itself to the fabrication of an accurate, low-drift reference. In some cases, the need for an additional pin to bring out the reference restricts packaging choices. Fig 3 shows the typical block diagrams of the functions in a traditional ADC (a), a self-calibrating ADC (b), and a delta-sigma ADC (c).

In the traditional ADC, the reference is typically on chip, but other

Our new GP switchers have everyone's approval!

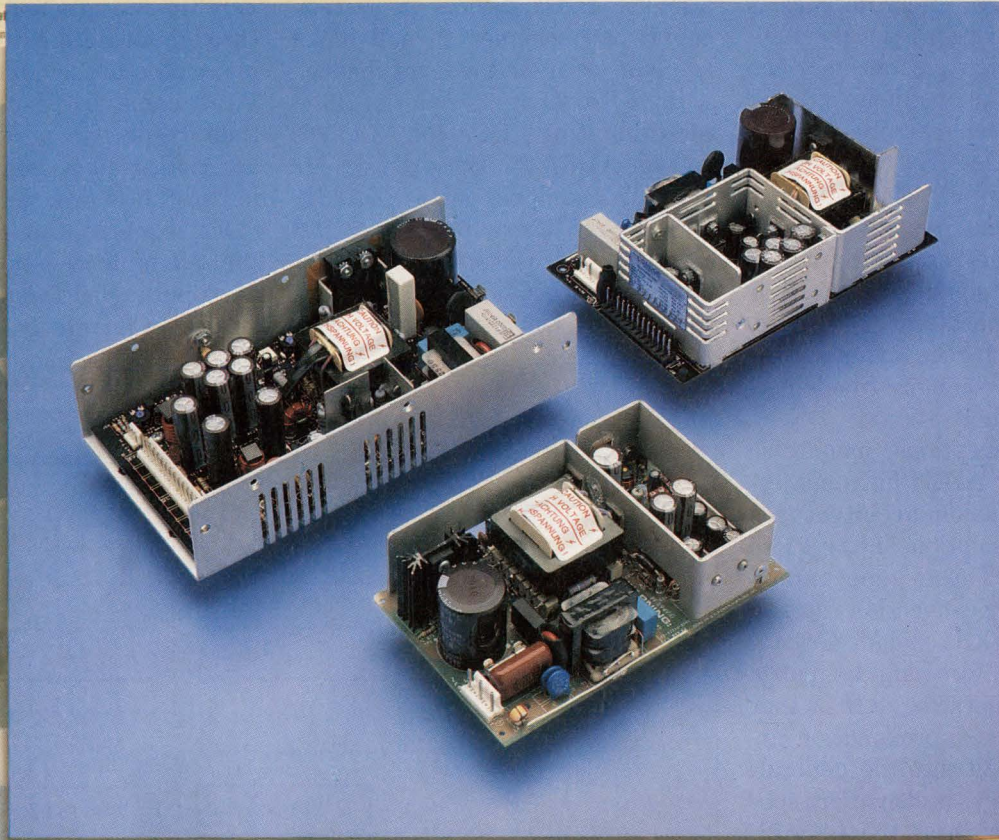

Condor's Global Performance (GP) switching power supplies offer full agency approvals, continuous range input and more!

Our newest switchers have the approvals you need (UL 1950, VDE Level B EMI, IEC 950, CSA and TUV) and the features you want, including:

- 71 models (single- and multi-output)
- Industry-standard packages
- 6 power levels (40 to 200W)
- Continuous input voltage (85-264V)
- OVP on all 5V outputs and single-output units

- Fully regulated outputs
- MTBF 100,000+ hours per Mil Hndbk 217E
- 8-hour burn-in with cycling (24 hours on medical versions)
- Computerized testing (data sheets furnished)
- 2-year warranty
- 30-day FREE evaluation (call us for samples)

If you're looking for world class performance, quick turnaround and competitive pricing, try our new GP switchers — the only approval they're missing is yours!

CIRCLE NO. 25

UL 544/IEC 601 MEDICAL VERSIONS ALSO AVAILABLE

All Global Performance switchers are available in full medical configurations. Call us for details.

CALL FOR OUR FREE CATALOG!

CONDOR

Condor D.C. Power Supplies, Inc.
2311 Statham Parkway
Oxnard, CA 93033 • (805) 486-4565
CALL TOLL FREE:
1-800-235-5929 (outside CA)
FAX: (805) 487-8911

EDN January 20, 1992 • 59

SELF-CALIBRATING A/D CONVERTERS

functions are not—although many devices now include the track and hold circuitry. Calibration circuitry is done in software. In the self-calibrating ADC, the reference is off chip for reasons previously cited. In the delta-sigma converter, the calibration circuitry adjusts only for offset and full-scale errors; there is no capacitor-DAC to compensate for linearity errors. The reference may, or may not be on chip, depending on whether the converter is designed for signal-processing or dc-accurate applications. Of course, for hybrid circuits the manufacturer has essentially complete freedom as to what to include.

With some exceptions, monolithic self-calibrating ADCs have successive-approximation architectures and provide resolutions in the 12- to 16-bit range. These general-purpose types have conversion rates in the 20- to 100-kHz range. Crystal Semiconductor, for example, makes several self-calibrating ADCs that use a successive-approximation architecture and fit into the general-purpose category. It also offers specialized types such as the CS5412, a 12-bit 2-step flash converter that features a 1-MHz sample rate, and the CS5501/CS5503 16/20-bit devices that use a delta-sigma architecture.

Designed for accurate dc measurements, the CS5501 and CS5503 feature a 6-pole, lowpass Gaussian filter with an adjustable corner frequency from 0.1 to 10 Hz. The 16-bit CS5501 features a maximum linearity error of $\pm 0.0015\%$ and offset and full-scale errors of ± 0.5 LSB. The differential nonlinearity of a 16-bit, no-missing-codes performance is ± 0.125 LSB.

The 20-bit CS5503 has higher offset and full-scale errors of ± 4 LSB but offers greater dynamic range, often eliminating the need for external gain scaling. The typical linearity error is $\pm 0.0003\%$. For both the CS5501 and CS5503, you

can initiate the on-chip, self-calibration circuitry at any time or temperature to ensure the specified offset and full-scale errors. You can also use these devices in system-calibration schemes to null offset and gain errors in the input channel.

Burr-Brown offers a pair of 12-bit self-calibrating ADCs, the ADC7802 and the ADS7803. These devices are actually Siemens parts SDA0812 and SDA1812, respectively. Because of its expertise and penetration in the ADC and DAC market, Burr-Brown has an agreement with

Siemens to market and sell these devices. Both the ADC7802 and ADS7803 feature multiplexed 4-channel analog inputs and can convert in 8.5 μsec for a 117-kHz throughput rate. Although identical in architecture and pin-out (both devices come in 28-pin packages), their respective performance characteristics show some subtle and not-so-subtle differences.

For example, the ADC7802 is optimized for dc precision and can handle input-signal frequencies only to 500 Hz. Conversely, the ADS7803

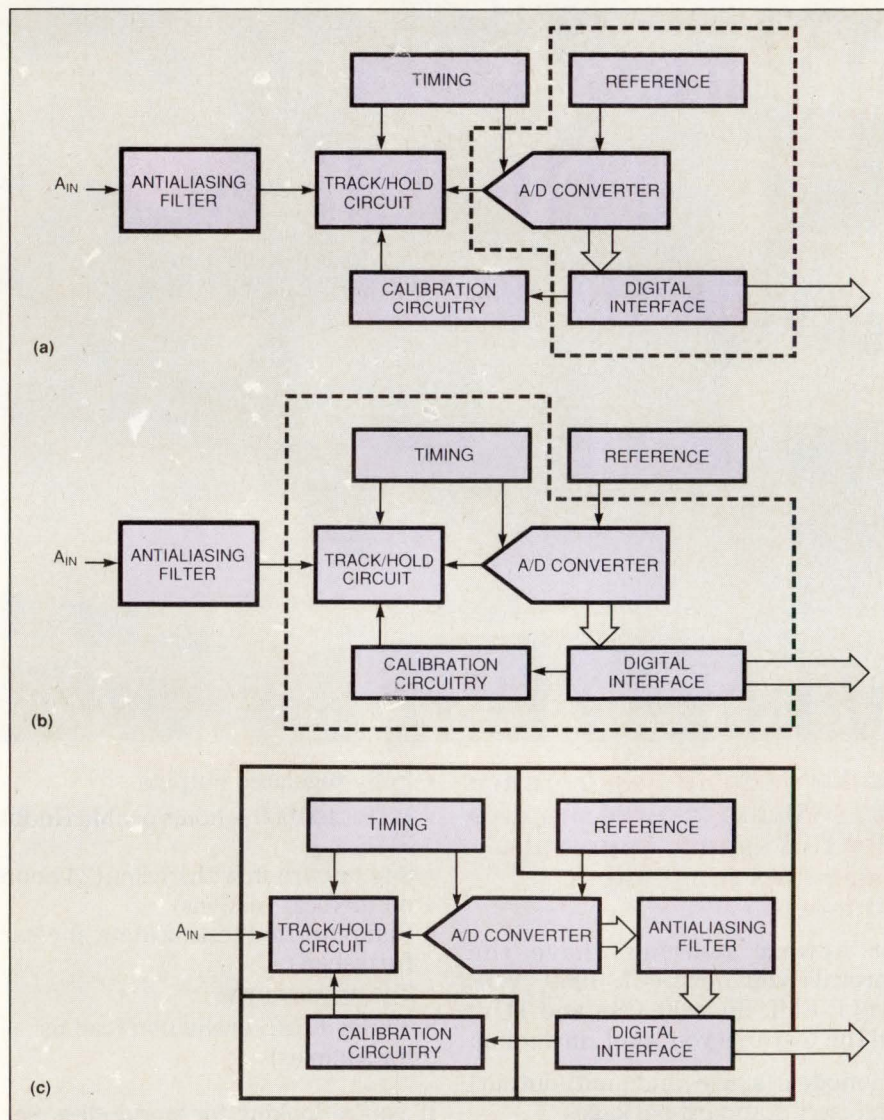
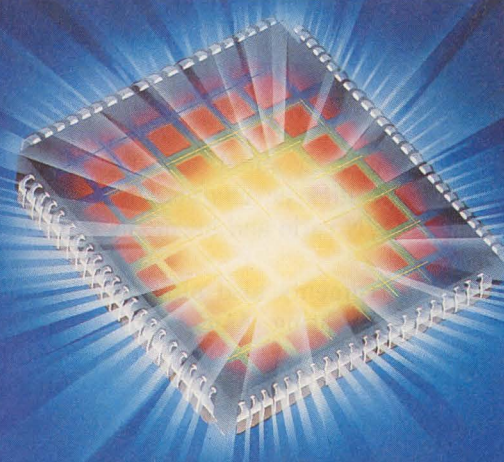
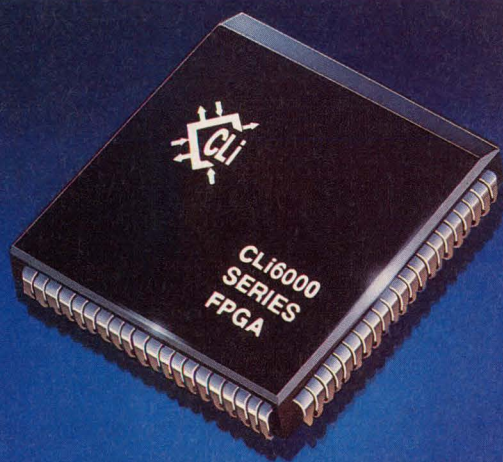

Fig 3—The partitioning of A/D converter architectures varies widely. Shown here are the traditional approach (a), a self-calibrating device (b), and a delta-sigma converter (c). The Reference in c may or may not be on chip.

Finally, FPGAs designed for both kinds of engineers.



**Push-The-Button
People.**

**Push-The-Envelope
People.**



If you're being pushed to the wall on FPGA designs, here's good news.

Concurrent Logic introduces FPGAs that achieve the fastest in-system performance of any SRAM-based FPGA today—with speeds of up to 70 MHz.

For *push-the-button people*, we offer easy-to-use tools that take you from design entry to configured circuit in record time. For basic circuits, you use just the basic tools—including familiar VIEWlogic modules. Plus our automatic place-and-route tools, which optimize silicon usage.

Push-the-envelope people will appreciate the CLi6000 Series' symmetrical, register-rich architecture, which makes pipelining and other complex designs easier to create.

You select powerful interactive tools for design editing, verification, timing analysis, and post-layout schematic regeneration. Quickly exploring multiple design options, for maximum speed and density. With no risk. And no NRE.

So why not have it both ways? To order your CLi6000 Series Evaluation Kit, call (408) 522-8703 or fax (408) 732-2765 today.

Or write Concurrent Logic, Inc.,
1290 Oakmead Parkway, Sunnyvale, CA 94086.

All product and company names are trademarks of their respective holders.



Concurrent Logic, Inc.

SELF-CALIBRATING A/D CONVERTERS

is optimized for dynamic performance and can handle input-signal frequencies to and beyond 50 kHz. Although both devices operate from a 5V supply and have a typical power consumption of 10 mW, the ADS7803 adds a power-down mode that reduces consumption to 50 μ W—a desirable feature for portable equipment. Also, although both devices feature input-channel matching to within ± 0.25 LSB, the total unadjusted error (all channels) of the ADC7802 is ± 0.5 LSB, somewhat better than the ADS7803's ± 0.75 LSB. Unlike the ADC7802, however, the data sheet for the ADS7803 specifies ac characteristics such as S/N ratio and harmonic distortion.

Texas Instruments also offers a 12-bit self-calibrating ADC. Optimized for industrial control and data-communications applications

that require minimum system noise, the TLC1225 features differential inputs that reduce system error created by common-mode noise. The ADC is compatible with most microprocessors and digital signal processors (DSPs), including the company's TMS320 family. The TLC1225 accommodates both unipolar and bipolar operations, outputs data in a parallel word, and interfaces directly to a 16-bit data bus. Output code for bipolar conversion is in 2's-complement format, which facilitates numerical computations by DSPs and microprocessors. Output code for unipolar conversion is in standard binary format.

The self-calibration technique of the TLC1225 affords simultaneous automatic calibration of seven internal capacitors in the A/D conversion circuitry. This calibration occurs during a nonconversion cycle and

requires 300 clock cycles to complete. A conversion period requires only 24 clock cycles, and the ADC initiates either cycle at any time by writing a command to the data bus. The chip's self calibration produces a typical integral nonlinearity error of ± 1 LSB, a maximum offset error of ± 1.5 LSB, and unadjusted positive and negative full-scale error of ± 2 LSB.

Somewhat out of the mainstream of most monolithic self-calibrating converters is the HI-7159A from Harris Semiconductor. Designed for use in laboratory instruments, industrial process control, and weight and part-counting scales, this 5½-digit ADC uses a dual-slope integrating technique that enables it to resolve input changes as small as 1 part in 200,000 (10 μ V for a 2V full-scale reading). This degree of resolution is nearly equivalent to

Table 1—Representative self-calibrating A/D converters

Manufacturer	Part number	Resolution (bits)	Conversion rate (kHz)	Input bandwidth	Linearity error (\pm LSB)	S/N ratio (dB)	THD (dB)	Output data format	Comments	Cost
Analog Devices	AD676	16	100	1 MHz	1.0	88	-95	16-bit parallel	Characterized for ac and dc.	\$38 (100)
	AD1876	16	100	1 MHz	1.0	90	-95	Serial	Characterized for ac only.	\$33 (100)
Burr-Brown	ADC7802	12	117	500 Hz	0.5	NS	NS	Two 8-bit bytes	Optimized for dc precision, has 4-channel multiplexer.	\$18.95 (100)
	ADS7803	12	117	50 kHz	0.75	71	-75	Two 8-bit bytes	Optimized for ac performance, has 4-channel multiplexer.	\$19.95 (100)
Crystal Semiconductor	CS5012A	12	100	NS	0.5	73	-82	Parallel, serial	3-state I/O	\$19.50 (1000)
	CS5412	12	1000	4 MHz	0.75	70	-74	Parallel	2-step flash, 3-state I/O.	\$60 (1000)
	CS5501	16	4	10 Hz	0.125	NS	NS	Serial	Delta-sigma type, 6-pole filter.	\$13.60 (1000)
Harris Semiconductor	HI-7159A	≈ 18	15 or 60 conversions/sec	NS	Digital auto-zero	NS	NS	Parallel, Serial, UART	Dual-slope integrating type, has 200,000-count resolution, 5½ digit.	\$15 (100)
Micro Networks	MN6450	16	50	NS	1.0	88	-98	16-bit parallel	Hybrid IC includes reference, analog input buffer, control logic, μ P interface.	\$175 (100)
National Semiconductor	ADC1241	12+sign	55	25 kHz	0.5	76	NS	13-bit parallel	1-LSB gain and offset error.	\$15.90 (100)
	ADC12451	12+sign	83	25 kHz	0.5	76	-82	Two bytes	Characterized for ac and dc.	\$14.90 (100)
Texas Instruments	TLC1225	12+sign	83	NS	1.0	NS	NS	13-bit parallel	Differential or single-ended inputs, compatible with TMS320 DSP family.	\$16.74 (1000)

Note: NS = Not specified



© 1991 Brooktree Corporation.

Just What Your Customers Need, Another Outlet For Their Creativity.



What's in? Video Out. Outputting video to a VCR and displaying video on a composite monitor are the newest capabilities every computer will need to compete in the Multimedia Age.

Now you're just a single chip away from adding Video Out to your very next computer design. Introducing Bt858, a monolithic digital device that packs in a board full of analog circuitry and puts out studio quality composite video.

Bt858 is a tweakless all-digital chip that bridges the video gap between RGB computers and composite or S-VHS outputs in the NTSC/PAL formats. It accepts multi-format digital inputs from 24, 16 or 15-bit RGB, 24 and 16-bit YCrCb and 8-bit VGA.

And because it has a programmable clock rate it adjusts for the 1:1 square pixels in computers and 4:3 rectangular pixels on TV without distortion.

Bt858 gives your system an image quality advantage, too. Studio quality output is a step

above tape decks and TV monitors so images always look "first generation."

You've read the book. Now see the picture. Call **1-800-VIDEO IC** and we'll send you "The Ins and Outs of Video Out," a revealing presentation of Bt858's capabilities.

That's all folks.

Brooktree Corporation, 9950 Barnes Canyon Road, San Diego, CA 92121, (619) 452-7580, FAX (619) 452-7294

Brooktree®

CIRCLE NO. 27

SELF-CALIBRATING A/D CONVERTERS

18-bit accuracy. The ADC's auto zeroing features virtually eliminate zero-drift with temperature changes, and its integrating architecture minimizes the long settling times commonly seen in delta-sigma converters.

To enhance microprocessor compatibility, the HI-7159A includes four interface options: 8-bit parallel, UART serial, 32-device UART serial, and synchronous serial. The UART serial modes are user programmable for baud rates to 19,200. The 32-device serial mode permits connection and individual addressing of as many as 32 devices on a 2-wire serial line. The host may direct the ADC to measure and report the internal offset voltage, the input voltage plus the offset voltage, or the default. In the default mode, the ADC measures the internal offset and input voltages and subtracts the offset voltage from the input voltage. The HI-7159A's resolution is switchable between a high-resolution 200,000-count (5½-digit) mode and a high-speed 20,000-count (4½-digit) mode.

Manufacturers of hybrid ADCs are free to include other circuit functions in addition to the com-

monly used monolithic self-calibrating chip. For example, Micro Networks' MN6450 16-bit A/D converter includes an analog input buffer, a 4.5V reference, timing, and control logic, a microprocessor interface, and 3-state output buffers that provide a 16-bit-wide data output. The hybrid circuit provides true 16-bit performance, including no missing codes and 0.0015% integral linearity. The MN6450 features a 50-kHz sampling rate, an 88-dB S/N ratio, and -98-dB harmonics and spurious noise. As with most high-performance hybrid devices, the MN6450 is available in several temperature and performance grades, including MIL-STD-883. **EDN**

References

1. Linear Applications Seminar Handbook, 1989 and 1991, National Semiconductor, Santa Clara, CA.
2. Analog/Digital Conversion Data Book, Crystal Semiconductor, Austin, TX.

Article Interest Quotient (Circle One)

High 476 Medium 477 Low 478

For more information . . .

For more information on the self-calibrating ADCs discussed in this article, circle the appropriate numbers on the Information Retrieval Service card or use EDN's Express Request service. When you contact any of the following manufacturers directly, please let them know you saw their products in EDN.

Analog Devices

1 Technology Way
Norwood, MA 02062
(617) 329-4700
FAX (617) 326-8703

Circle No. 716

Burr-Brown Corp

Box 11400
Tucson, AZ 85734
(602) 746-1111
FAX (602) 889-1510

Circle No. 717

Crystal Semiconductor Corp

Box 17847
Austin, TX 78744
(512) 445-7222
FAX (612) 445-7581

Circle No. 718

Harris Semiconductor

Box 883
Melbourne, FL 32901
(800) 442-7747, ext 1035

Circle No. 719

Micro Networks

324 Clark St
Worcester, MA 01606
(508) 852-5400
FAX (508) 853-8296

Circle No. 720

National Semiconductor Corp

Box 58090
Santa Clara, CA 95052
(408) 721-2273

Circle No. 721

Siemens Components Inc

2191 Laurelwood Rd
Santa Clara, CA 95054
(408) 980-4547

Circle No. 722

Texas Instruments Inc

Semiconductor Group (SC91009)
Box 809066
Dallas, TX 75380
(800) 336-5236, ext 700

Circle No. 723

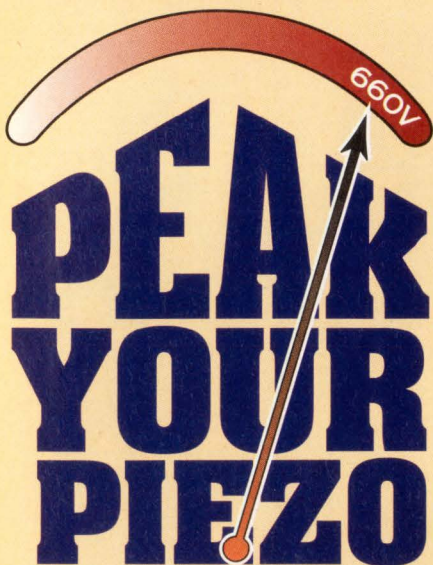

And do it for
just \$29.85

The PA41 from Apex is the industry's first monolithic operational amplifier to explode the voltage/cost barrier. Capable of 350V, at a 100-piece price of \$29.85 each, the PA41 is just the thing for driving piezo electric devices efficiently and economically.

Compared to bipolar high voltage amplifiers, the PA41 does not suffer from second breakdown because of its MOSFET design. Externally adjustable current limiting and compensation is available to optimize the trade-off of available current and protection.

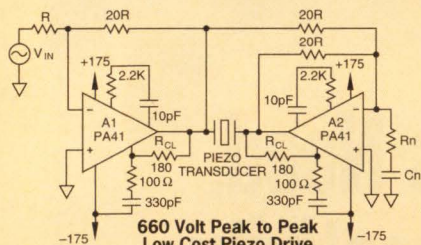

SPECIFICATIONS CHART	PA41	PA41A
SUPPLY RANGE	350V	350V
OUTPUT CURRENT	60mA	60mA
OUTPUT VOLTAGE SWING	±V _S -12V	±V _S -10V
SLEW RATE	40V/μs	40V/μs
QUIESCENT CURRENT	2mA	1.8mA
OFFSET VOLTAGE (max)	60mV	30mV
DRIFT (max)	130μV/°C	65μV/°C
PRICE IN 100's	\$29.85	\$39.75



For Immediate Product Information
Call 1-800-448-1025 or FAX (602) 888-3329

For Applications or Product Selection
Assistance Call 1-800-421-1865

DC/DC Converters ■ Power Amplifiers
Voltage Boosters ■ High Voltage Amplifiers

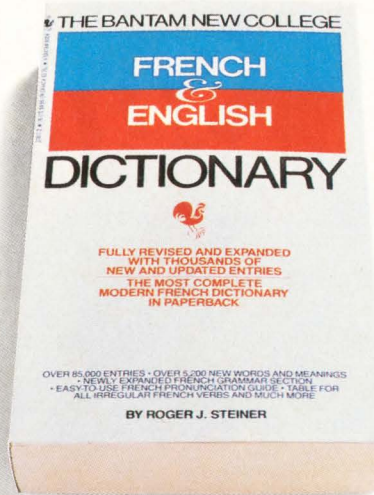

We offer the most complete line of debuggers, emulators and languages.



When you need development tools, Intel's selection runs the gamut. In fact, we offer the most extensive line available for Intel architectures—from i386,[™] i486,[™] i860,[™] i960,[™] and 186 microprocessors, to MCS[®]-51 and MCS-96 microcontrollers.

Because they're all from Intel, our tools work better together to help you get to market quickly. No other vendor can give you a better view of what's going on inside the processor. Plus, you save time by ordering tools from our catalog with a simple phone call.

What's more, Intel offers support from start to finish, including a 30-day, money-back guarantee, hotline assistance, training, field consulting, and support contracts. Which makes your purchase virtually risk free. So if your debugging needs can't be met by a shoe, call Intel at (800)874-6835 or fax (503)696-4633 for our free catalog. You'll find all the tools you need. And then some.



The Computer Inside.[™]

©1991 Intel Corporation. MCS is a registered trademark, and i386, i486, i860, and i960 are trademarks of Intel Corporation. All brand names shown are registered trademarks of their respective holders.

Super Silicon



Our new six-inch wafer fab line is longer than two football fields end-to-end.

Roseville, 1992.

Field of champions.

If there were a championship Bowl for semiconductors, they'd have to play it in Roseville, California. Our new six-inch wafer fab line is longer than two football fields end-to-end.

With a total of 676,000 square feet, Roseville is the largest semiconductor manufacturing facility in America. And, this advanced 0.6 micron line is capable of astonishing DRAM production – trillions of bytes per month.

We've spent \$600 million to bring world-class IC manufacturing closer to you. No other Japanese semiconductor maker has invested as heavily in America.

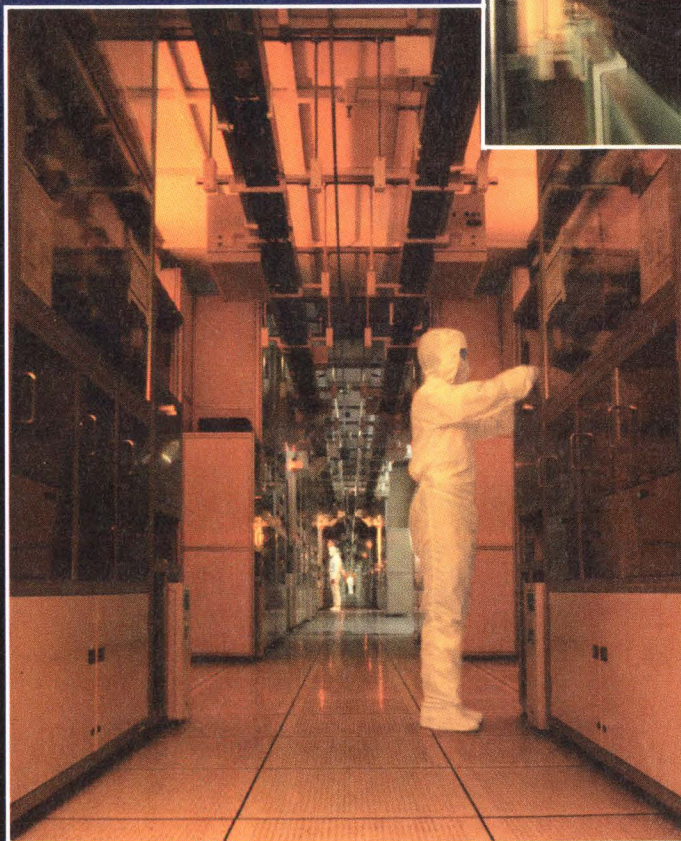

The future is now.

Roseville is capable of your most demanding requirements, including 4- and 16-megabit DRAMs, 64-bit microprocessors, 4-megabit SRAMs, and submicron standard cell and gate array ASIC devices.

So now you get the home field advantage, because traditional Japanese quality manufacturing is now within easy driving distance of Sacramento, San Francisco and San Jose.

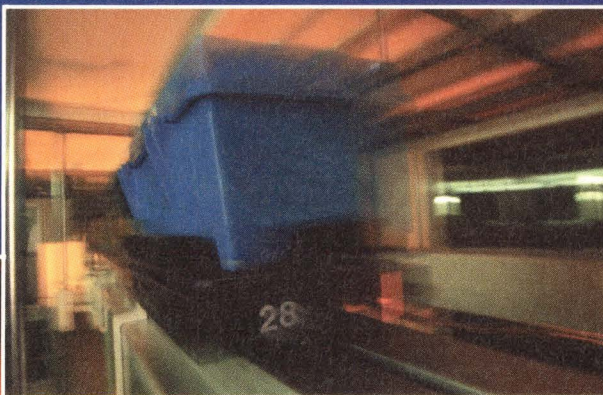

Wafer-bearing robots glide noiselessly overhead on a state-of-the-art ceiling railway.

A muscular line.

Just like a quarterback protected by a powerful offensive line, you'll face the competition behind the technology of a \$26 billion global corporation that won't fall down on the job. We're proud to be part of the charming community of Roseville, California, where we employ more than 1,000 local residents. To learn more, send for your free 1992 Roseville calendar today.

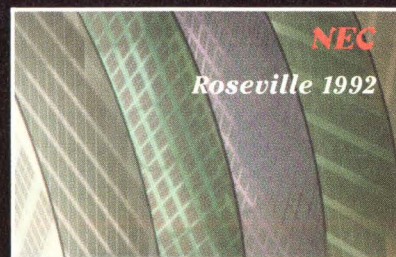

*Free Roseville Photo Calendar
Call 1-800-632-3531
Ask for Info Pack 004*

NEC

POWER-ONE Offers 2 Million Voltage/Current Combinations Within 2 Weeks.



Modular High Power Up To 2000 Watts

You're in the initial stages of design. You need a prototype and you're facing a deadline. You also need a power supply with specific voltage/current outputs. And you need it fast!

That's where POWER-ONE's fully modular SPM High Power Series comes in. Single, dual, or triple output modules enable you to specify up to 15 DC outputs...from stock. With delivery time as little as two weeks.

And there's more. The incredibly versatile SPM represents the industry's highest power density—up to 2000 watts of multiple output power in the most compact package available today. There's even an optional on-board UPS capability. And no matter what configuration you require, be assured this internationally recognized power supply will meet the toughest safety regulations, worldwide.

So remember...whatever your requirements, we're keeping our shelves stocked for those urgent, limited-quantity deliveries. You'll get the exact voltage/current combination you need, on time. Every time.

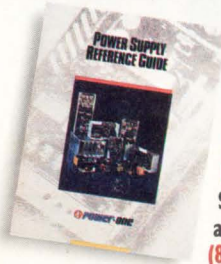

Get Complete Details Today. Call our Toll Free LITERATURE HOT-LINE for our Sensational New Tutorial and Product Catalog! (800) 678-9445

"Innovators in Power Supply Technology"
POWER-ONE
D.C. POWER SUPPLIES

POWER-ONE, INC.
 740 Calle Plano • Camarillo, CA 93012-8583
 Phone: (805) 987-8741 • FAX: (805) 388-0476
 CIRCLE NO. 31



Surface-mount sockets expand design options

TOM ORMOND, Senior Technical Editor

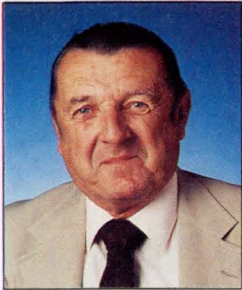

Surface-mount sockets ease package replacement and system expansion, protect ICs from temperature damage during soldering, and make test points readily available.

SMT-socket manufacturers are making pin geometries tighter to accommodate the latest generation of complex ICs. They're also using high-performance engineering plastics to let socket housings withstand harsh board soldering and cleaning, and have developed a class of solderless surface-mount sockets. Land-grid-array (LGA) sockets employ compression-mount techniques to provide the socket-to-board interface. The lack of hidden solder joints greatly eases inspecting and repairing or replacing such sockets.

Selecting an SMT socket means considering about half a dozen factors. Some of these factors—such as heat resistance, lead coplanarity, and mounting technology—are unique to surface-mount technology. Other factors such as size, solder-joint reliability, ease of assembly, and contact quality are not. However, these last factors are more critical in applications involving surface-mount sockets than those using through-hole sockets.

Conventional glass-filled polyesters are more than adequate for socket-housing service as long as the sockets are going to go through a wave-soldering system during board assembly. These materials cannot handle the rigors of IR or vapor-phase reflow soldering, the processes more common for SMT assembly. During wave soldering, only the leads are raised to a temperature that exceeds the solder's melting point; during reflow soldering, the entire socket assembly is heated.

Surface-mount sockets should be able to handle 230°C temperatures for at least 30 seconds and 260°C for 10 seconds in extreme cases. Deviating from these figures to any marked degree is a mistake. Extending the time spent above the solder melting point can damage the board as well as other sensitive components. Also, increasing the time or temperature can cause intermetallic compounds to form in the solder joint. These compounds can lead to premature solder-joint failure.

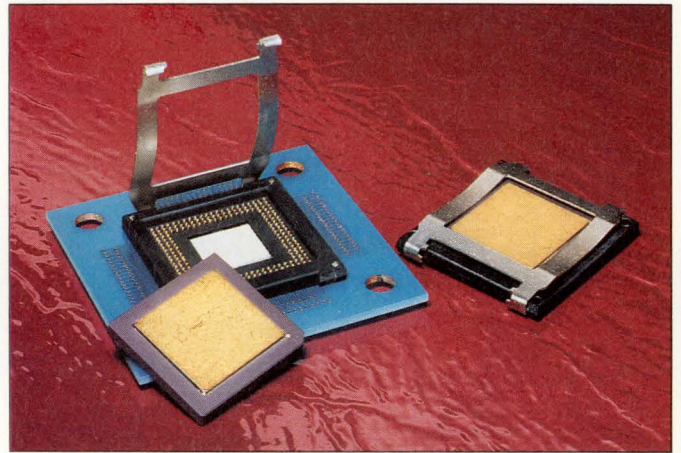

Designed specifically for Intel's 80386 μ P, Cinch Connector's land-grid-array (LGA) socket interfaces the processor to a pc board without using solder.

Today, most surface-mount sockets use high-performance engineering plastics for the housing material. Polyphenylene sulfide (PPS), one of these plastics, is a high-strength thermoplastic compatible with surface-mount assembly operations. It has a heat-deflection temperature in excess of 260°F, good chemical resistance, and high dimensional stability—all key parameters for surface-mount sockets.

Lead coplanarity is a second consideration in surface-mount assembly

With 546 different standard product configurations, our *Piezoresistive Silicon Pressure Sensors* meet almost anyone's spec. DIP and surface mount packages help cut your assembly costs, too. Which makes you more competitive—and more profitable. Find out why so many engineers are designing these sensors into their OEM applications. Circle the number below.

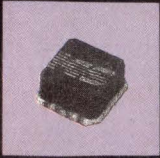

We'll send you product literature and data sheets.
Or call 800-767-1888.

SENSORS

1701 McCarthy Blvd. Milpitas, CA 95035-7416

546 Different Silicon Pressure Sensors. One Phone Call.

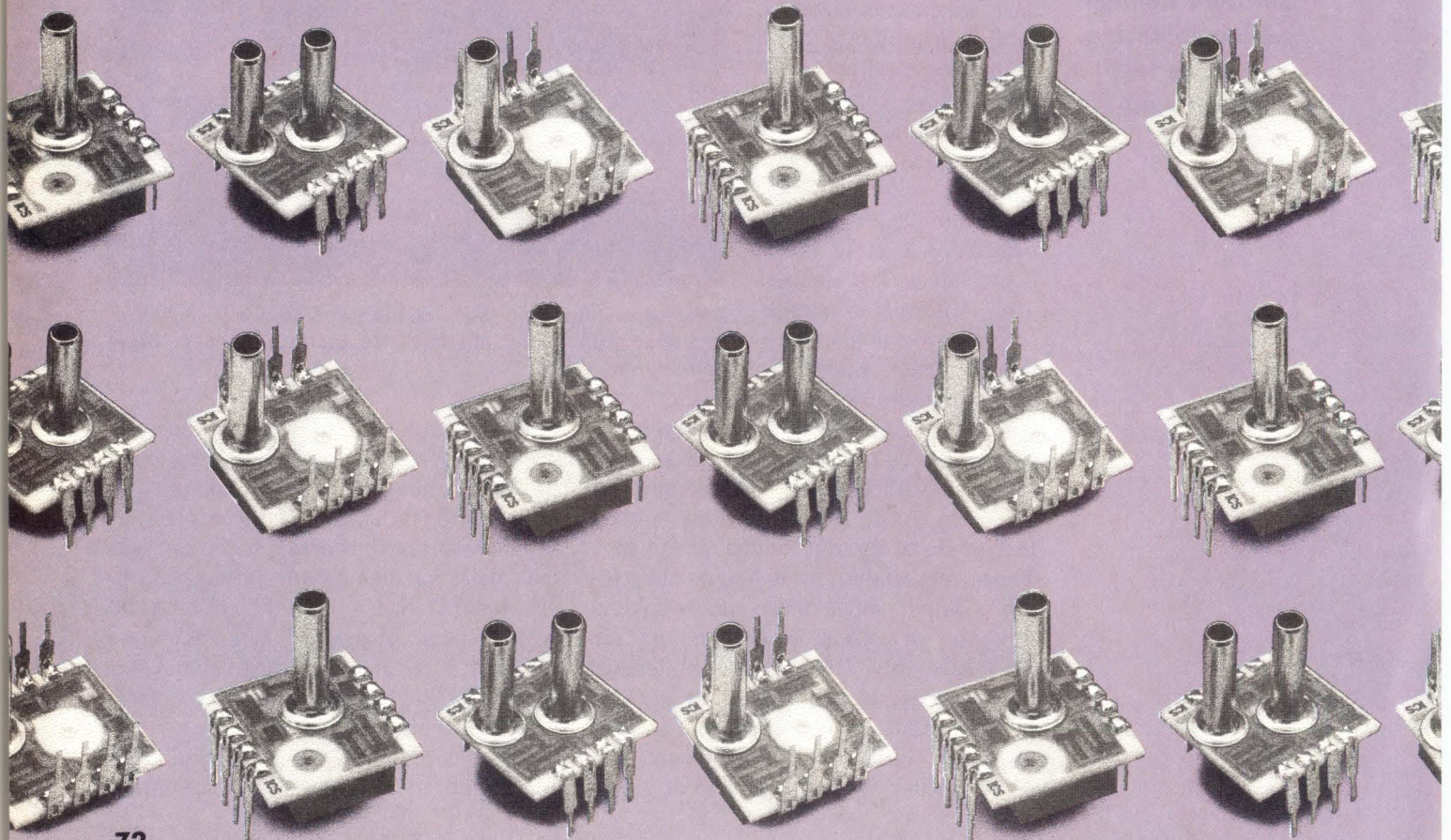

SURFACE-MOUNT SOCKETS

operations. The quest for flat pc boards faces all designers involved with surface-mount technology (SMT). Mirror-flat boards represent the ideal, but the physics of real-world materials is such that board warping and twisting is a fact of life.

Through-hole sockets are forgiving of lead-length variations—you can always bend the leads enough to get them through the holes in the board. Not so with surface-mount sockets. Ideally, the tips of all the socket leads should lie on the same plane. Open solder joints can result if a single lead is significantly higher or lower than this plane. Unfortunately, you'll rarely find coplanarity specifications on data sheets. The best way to realize a successful design and minimize problems is to maintain stringent control of solder-paste application, component placement, and solder-reflow operations.

A socket's overall size is another important selection consideration. One of the prime reasons for going the SMT route in the first place is high

packing density. If a socket housing a DIP device with row-to-row spacing of 0.3 in. measures 0.5 in. wide, the real-estate increase for using the socket is a significant 40%.

Some ICs are available in more than one surface-mount package. Your task is to select the package that is going to maximize socket packing density. Also consider socket height, especially in applications involving boards racked-mounted on 0.5-in. centers. SMT assemblies can have components mounted on both sides of the board, so you can't assume that a socket less than 0.5 in. high will cause no problems.

Solder joints can fail

In most cases, the weakest link in a surface-mount system is the solder joint between the lead and the board. This interface deserves special attention with sockets because these devices must accommodate extreme stress levels even in normal usage. In addition to lead coplanarity, lead configuration plays a

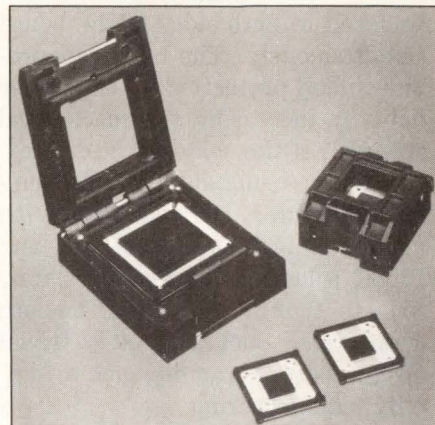

Suitable for automated surface-mount assembly, Series 550/560 sockets from CTI Technologies meet all JEDEC specifications. The sockets have an open-body design, which maximizes air flow across the IC under test.

major role in establishing solder-joint reliability.

Designers have several lead-configuration options, including gull wing, J lead, and butt. The gull-wing option is the popular choice for reliability. Gull-wing leads can be formed on standard and fine pitches, have a low profile, and tend to self-align during soldering. Gull-wing leads are also easy to clean and can simplify solder-joint inspection. On the negative side of the ledger, gull-wing leads require more board space than the other types. As is the case in many areas of electronics, you have to make a tradeoff between solder-joint reliability and board packing density.

When it comes time to select surface-mount sockets, also keep assembly needs in mind. Several seemingly mundane socket features can greatly simplify manufacturing. For example, look for sockets whose body design exposes the lead-pad interface. Such a socket can simplify board cleaning and solder-joint inspection and also reduce the effects of IR shadowing.

Some sockets have locking clips that hold them to the board prior to soldering. This feature is especially useful in high-vibration as-

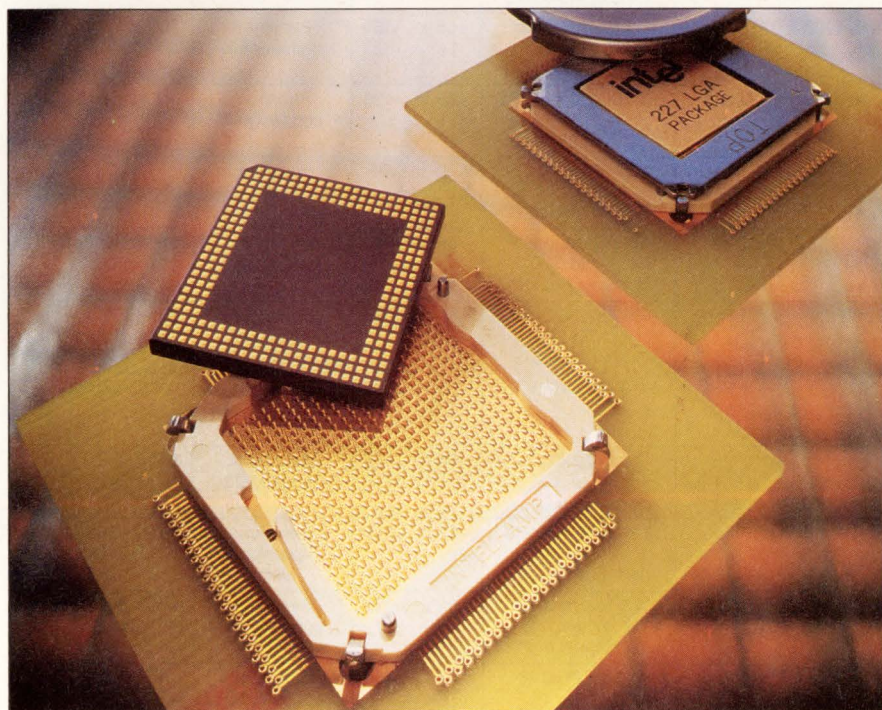

Featuring an above-board profile of 0.2 in., AMP's LGA socket assembly accommodates packages having as many as 484 pins spaced on a 0.05-in. centerline grid.

SURFACE-MOUNT SOCKETS

sembly and when components are soldered to both sides of the board simultaneously. The clips can provide added protection for the solder joint by increasing the mechanical strength of the soldered interface.

If you're using automated assembly, consider DIP sockets with molded-in pick-and-place pads and PLCC (plastic leaded chip carrier) sockets that feature large smooth open areas. Such seemingly trivial design features can do much to simplify manufacturing.

The final point to consider when choosing SMT sockets is contact quality. Table 1 lists some typical

parameters for a representative sampling of surface-mount sockets. As you can see, most vendors employ beryllium copper or phosphor bronze as the contact material.

Beryllium copper contacts have the best spring characteristics over the widest temperature range (-65 to +125°C), so they are well suited for military and computer applications. Phosphor bronze contacts suit industrial applications; they feature good spring characteristics over a moderate temperature range—-65 to +105°C—and they're less expensive than beryllium copper contacts.

As the data in Table 1 illustrate, surface-mount sockets accommodate a variety of IC package styles including DIPs, SOICs, LCCs, PLCCs, and PQFPs (plastic quad flatpacks). Most of the sockets in Table 1 are designed to be soldered to the pc board. However, another class of surface-mount sockets is rapidly gaining popularity—the land-grid-array (LGA) socket, which employs compression-mount techniques to provide the socket-to-board interface.

These sockets mechanically fasten to the pc board, usually with screws or plastic studs. A cover

Table 1—Representative surface-mount sockets

Manufacturer	Model	Type ¹	Pin count	Insulator ²	Size (in.)	Operating range (°C)	Contact (material/plating)	Price
Advanced Interconnections	2819	PLCC	28, 44, 52, 68, 84, 100, 124	PPS	0.5×0.5×0.2 to 1.8×1.8×0.2	-60 to +220	Beryllium copper/tin lead	\$16.38 for 68-pin unit
AMP Inc	Dip-lomate	DIP	8, 14, 16, 20, 24, 28, 40	PCT	0.395×0.394×0.21 to 1.995×0.694×0.21	-25 to +105	Phosphor bronze/tin or gold	\$1.45 (1000) for 28-pin unit
Aries Electronics Inc	Series 518	DIP	6 through 64	PET	0.3×0.4×0.165 to 3.2×1×0.165	-30 to +140	Beryllium copper/gold	\$0.46 to \$0.81 for 14-pin unit
Augat Inc	PSU Series	PLCC	20, 28, 32, 44, 52, 68, 84	PPS	0.613×0.613×0.175 to 1.413×1.413×0.175	-55 to +105	Beryllium copper/gold	\$2.34 (1000) for 68-pin unit
CTI Technologies Inc	550/560 Series	PLCC	128, 168, 192, 248, 256, 328	PPS	1.89×1.5×0.92 to 2.84×2.31×1.02	-55 to +150	Beryllium copper/gold	\$56.36 (250) for 128-pin unit
Emulation Technology Inc	SOR/SOL Series	SOIC	8, 14, 16, 20, 24, 28	Ultem	0.275×0.425×0.225 to 0.79×0.525×0.26	-55 to +125	Beryllium copper/gold	From \$4.80
Hirose Electric USA Inc	DL3 Series	SOIC	28, 32	PPS	0.59×0.957×0.196 to 0.59×1.05×0.196	-55 to +85	Phosphor bronze/tin lead	\$4.07 for 32-pin unit
Kycon Inc Cable & Connector	SMP Series	PLCC	20, 28, 32, 44, 52, 68, 84	PPS	0.62×0.62×0.177 to 1.42×1.42×0.177	-55 to +125	Phosphor bronze/tin	\$1.68 (1000) for 32-pin unit
McKenzie Technology	ADP Series	PLCC	44, 52, 68, 84	PPS	0.665×0.665×0.282 to 1.17×1.17×0.282	Not specified	Phosphor bronze/gold	\$15 (500) for a 68-pin unit
Methode Electronics Inc	Low profile SM	PLCC	32	PPS	0.7×0.8×0.15	-50 to +125	Beryllium copper/tin lead	\$1.33 (10,000)
Mill-Max Manufacturing Corp	Series 110	DIP	4 through 64	PPS	0.4×0.2×0.22 to 1×3.2×0.22	-50 to +150	Beryllium copper/gold	\$0.73 (2500) for 20-pin unit
Nepenthe	NEP Series	LCC	32, 44	Ryton	0.612×0.713×0.213 to 0.813×0.813×0.23	-65 to +200	Beryllium copper/gold or tin	\$3.22 (1000) for 32-pin unit
Samtec Inc	ICF Series	DIP	8 through 48	LCP	0.375×0.8×0.195 to 0.675×4.8×0.195	-65 to +125	Beryllium copper/gold	From \$0.11 per pin
3M Co	Type B	LCC	68	PPS	1.21×1.21×0.36	-55 to +105	Beryllium copper/gold	\$6.78 (5000)

Notes: 1. LCC=Leadless chip carrier; PLCC=plastic leaded chip carrier.

2. LCP=Liquid-crystal polymer; PCT=polycyclohexane terephthalate; PET=polyethylene terephthalate; PPS=polyphenylene sulfide.

New Family of 12-Bit Dual and Quad DACs

DAC4815

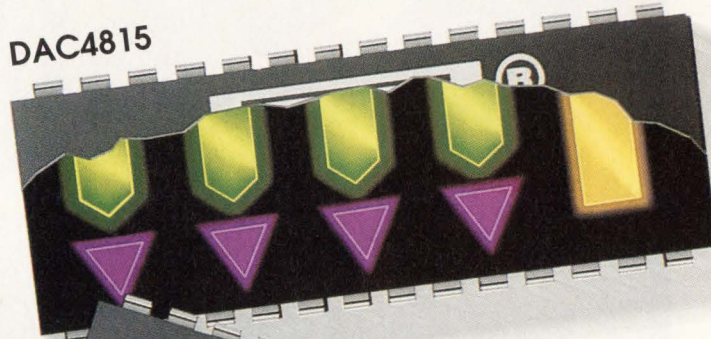

DAC2815

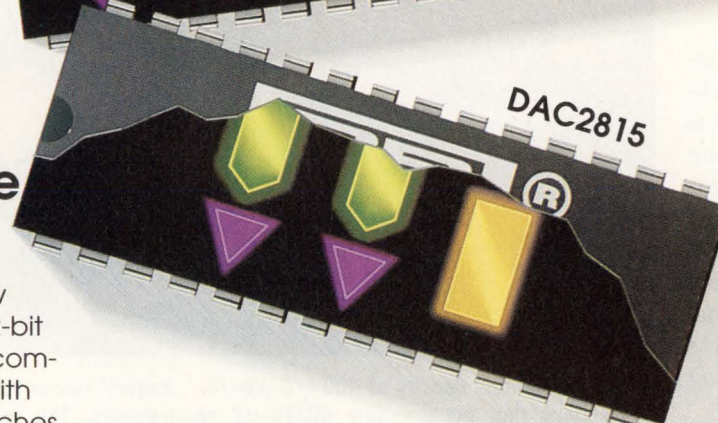

Complete Solutions

Burr-Brown's new generation of 12-bit multi-DACs are complete solutions with CMOS logic switches, high performance buried-zener reference, and low-noise bipolar output amplifiers in cost-saving plastic packages. All are fully specified and monotonic over the extended industrial temp range of -40/+85°C.

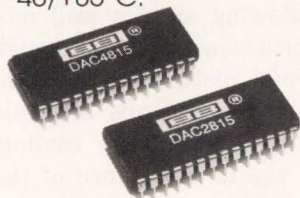

Save Space, Cut Costs

You save space and money with these complete, compact multi-DACs. They're ideal for applications requiring more than one DAC...ATE pin drivers, medical diagnostic and lab instrumentation, industrial control, and general purpose circuits.

Interface Options

Choose a high speed serial interface (10MHz clock) or a 2-byte (8+4) double-buffered interface. All models feature an asynchronous CLEAR control for power-on-reset or system calibration purposes.

Free Samples, Selection Guide

Sample the best DAC for your application. And, ask for a copy of our *High Performance D/A Converters* guide with key specs, performance diagrams, and applications information on our newest DACs. Just contact your local Burr-Brown sales office, or call for immediate assistance, **1-800-548-6132**.



Model	Function	Digital Interface	Output Range
DAC2814	Dual	Serial Port	-10V to +10V, 0 to +10V, 0 to -10V
DAC2815	Dual	8-bit Port	-10V to +10V, 0 to +10V, 0 to -10V
DAC4814	Quad	Serial Port	-10V to +10V, 0 to +10V, 0 to -10V
DAC4815	Quad	8-bit Port	-10V to +10V

Duals from \$16.95. Quads from \$24.95. U.S. OEM prices, in 100s.

Burr-Brown Corp.
P.O. Box 11400
Tucson, AZ 85734



SURFACE-MOUNT SOCKETS

plate clamps down the IC. The advantages of compression mounting as opposed to solder mounting are twofold. Compression-mount sockets result in no hidden solder joints and are easier to replace should a repair be necessary. With solder connections, inspection and repair tasks are almost impossible.

Solderless sockets

The Ampflat LGA socket assembly from AMP accommodates packages with as many as 484 pins spaced on 0.05-in. centers. When mounted, the assembly measures 0.2 in. above the board. The contact array is 0.009-in. high when fully compressed and provides less than 10-psec delay and 200°C/W thermal resistance per contact. The contacts provide 0.006 in. of wipe during mating.

The socket assembly comprises a heat clamp/pressure plate, a chip-carrier nest that holds the LGA package, the contact array, and an insulator/spacer, all of which are sandwiched between a cover plate and a base plate. The thickness of the insulator corresponds to the thickness of the pc board for a given assembly. Thus, the resultant thickness of the assembly yields the required normal force under compression.

The clamping cover of the assembly is a single piece that you can install and remove with an ordinary screwdriver. Both the top and bottom plates are made of stainless steel. The bottom plate insulator is assembled with adhesive on its top and bottom surfaces so that the bottom plate is permanently attached to the pc board after initial socket assembly. The socket transfers heat from the carrier package to the pc board.

At \$20 to \$26, the Ampflat socket assembly is an economical interconnect device. The devices feature easy field replacement of the chip without special tools, low-cost replacement of the contact array, and

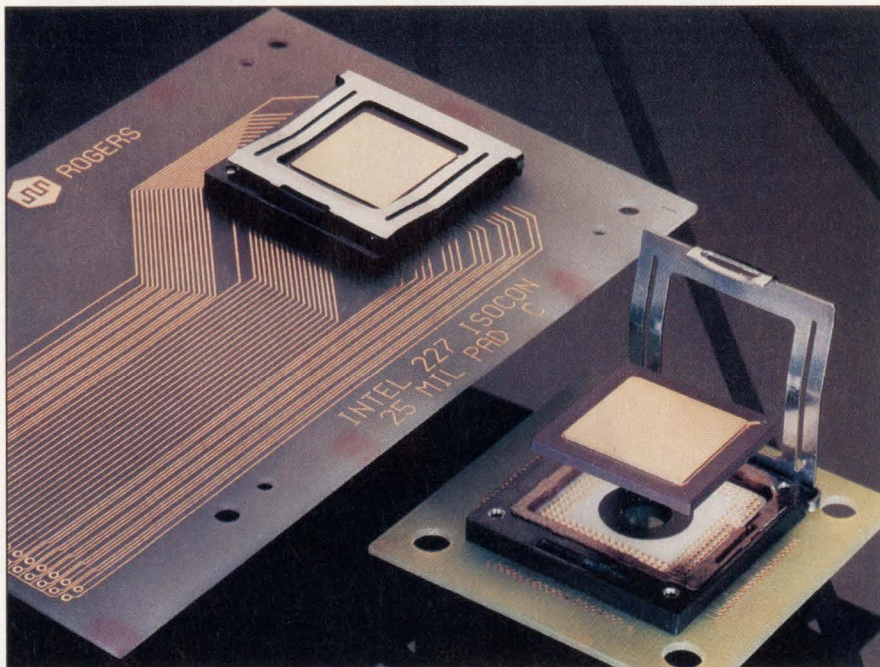

Offering a contact density of 400 I/O pins/in.², Rogers' Isocon LGA sockets are available in versions that accommodate 80386- μ P requirements. The sockets have a mounted height of 0.23 in. and feature a wiping action at the contact interface.

the choice of gold or tin contact interfaces.

Cinch has developed an LGA socket specifically for the Intel 80386 μ P. You attach the socket to the board with conventional mounting hardware or with plastic studs that are an integral part of the socket body. The socket is available in two sizes: one uses the Intel-recommended mounting footprint; the second has a smaller footprint for applications in which board space is at a premium.

The socket's button contacts are single strands of randomly bent wire that resemble cylindrical Brillo pads. The nature of the wire formation yields a number of mechanical and electrical advantages. Mechanically, the wire structure comprises many spring segments, all of which share the stress of the contacts' deflection during mating cycles. The random structure also provides redundant points of contact at the mating surface. Compressing the button contact axially causes the spring segments to move laterally

at the mating surface. This motion results in a wiping action, which improves the reliability of the contact.

Electrically, the nature of the wire formation creates a structure particularly well suited for transmitting high-speed signals. Unlike a coil spring, the random structure cancels the effects of inductance, thereby allowing signals well into the gigahertz range to pass through with minimal distortion. In addition, because there are multiple contact points within the random structure, the dc resistance of the contact is very low.

The button contacts are available in two diameters—0.04 in. for placement on straight or staggered patterns in which the spacing between contacts is 0.075 in. or greater, and 0.02 in. for placement on patterns with spacings of 0.04 in. or greater. The contacts come in a variety of materials and can accommodate a range of applications in which temperature ranges from 200°C down to the cryogenic temperature of liquid nitrogen. The contacts are avail-

MILITARY PRODUCTS OPERATION



Five Star DSP

DSPs don't come any better than Motorola's high-performance Military 96002. It's our premier 96-bit floating-point digital signal processor, ideally suited for array processing and intense digital signal processor applications such as radar and communications.

Electrical samples of this single-chip, dual-port, low-power HCMOS general purpose IEEE DSP will be available third quarter 1991,

with the MIL-STD-833 and SMD versions slated for introduction in early 1992.

Ada Supported

Motorola understands the unique demands placed upon Military systems and works closely with software vendors to ensure that its products are fully supported.

Now Available

Available now in the "Pin Grid Array" (PGA) and "Ceramic Leaded Chip Carrier" (CLCC) is the Military 56001 HCMOS, low power, general purpose DSP in full MIL-883 and SMD versions. For price and delivery information and Brochure #BR912/D, contact your local sales office.

For more information on the 96002, order our DSP Brochure #BR1402/D by calling toll-free 1-800-441-2447.

Or complete and return the coupon below to Motorola, P.O. Box 20912, Phoenix, AZ 85036.



To: Motorola Semiconductor Products, Inc., P.O. Box 20912, Phoenix, AZ 85036

Please send me Motorola's DSP Brochure # BR1402/D.

507EDN012092

Name _____
Title _____
Company _____
Address _____
City _____ State _____ Zip _____
Call Me () _____



MOTOROLA

MOTOROLA and  are registered trademarks of Motorola Inc.

EDN January 20, 1992 • 77

SURFACE-MOUNT SOCKETS

able with a variety of plating options, including gold.

The Cinch socket's mounted height, including the package and compression mechanism, is 0.2 in. A nickel-plated compression spring snaps open or closed to help you insert or remove the microprocessor. To assist in the transfer and dissipation of heat from the package to the pc board, an integral chip-to-board heat-transfer pad is available as an option. The socket withstands operating temperatures of -55 to +100°C and meets MIL-STD 1344 for shock and vibration levels. Prices for the sockets range from \$10 to \$15.

Rogers Corp also offers an LGA socket for the Intel 80386 SL μ P. The Isocon connector consists of flat S-shaped beryllium copper conductors plated with nickel or gold and suspended in a high-stress-retention microcellular silicone.

As you apply downward pressure to insert a chip, the conductors rotate and provide a wiping action at each contact interface. The wiping scrapes dust particles and nonconductive oxides from the contact surfaces, which improves reliability in field-replacement applications where such materials exist. A force of 15.6 lb clamps the Intel μ P in place. The microcellular silicone maintains the contact force and provides a gas-tight seal.

Key features of the Isocon socket include conductor pitches between 0.1 and 0.05 in. and variable conductor location within a grid. The 0.05-in. pitch translates to a density of 400 I/O pins/in². The socket has approximately 15 m Ω of total electrical resistance and 0.5 nH of total pin inductance.

When mounted to the pc board, the socket's profile is approximately 1.6 x 1.6 x 0.215 in. With such a

small footprint, the socket suits notebook computers. According to Rogers's test data, long-term temperature, humidity, and corrosion result in minimal increases in total connection resistance. The socket can also withstand an average of 10,000 mate-unmate cycles without failure. The sockets cost \$16.90 (1000).

With increasing interest in system upgrades, sockets will become even more of a priority in the years to come. In addition, several vendors say that associated density and performance issues will accelerate the growth of surface-area array interconnects and increase the interest in surface compression as a surface-mount technique. **EDN**

Article Interest Quotient
(Circle One)

High 473 Medium 474 Low 475

"386SX" FULLY INTEGRATED CACHE-LIKE PERFORMANCE

Inquire About DTI's
486 EISA, 486SX & 486DX
Single Board Computers
-NOW SHIPPING-

Up to 16M
RAM On-board

IDE Port

Future Domain
SCSI Port

Floppy Port

Parallel Port

Design Enhancement
For FCC/UL Approval

Slotpro™
SERIES

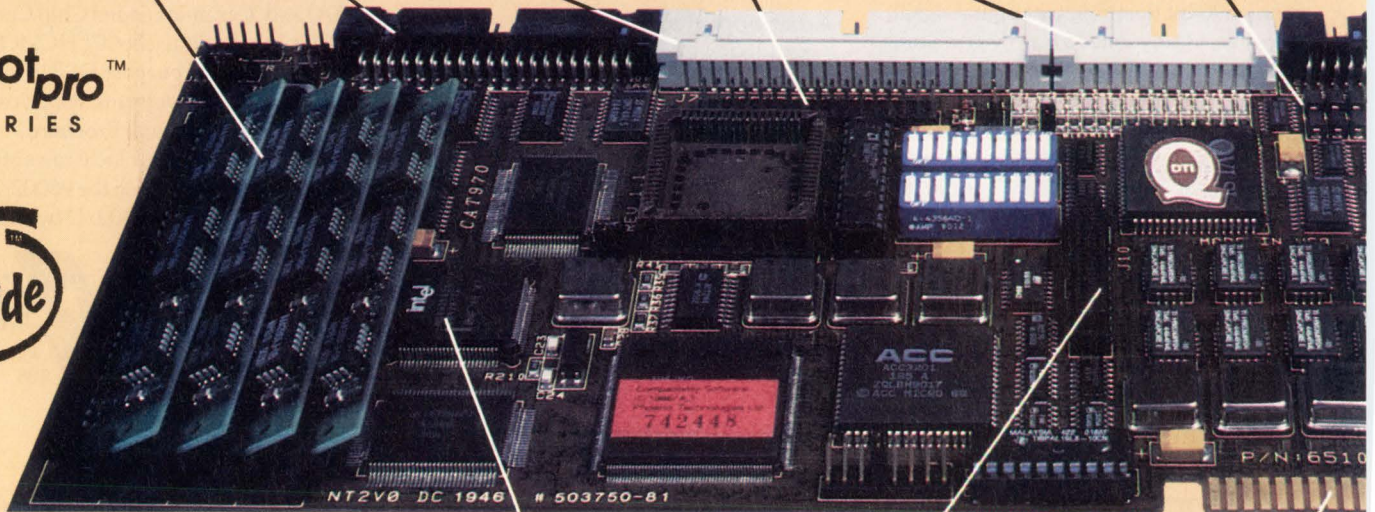
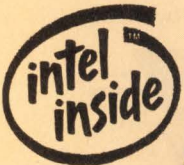

High Performance Intel
80386SX 20MHz

Flat Panel Adapter
Connection To Support
LCD, EL, Plasma Displays

/AT Bus Architecture

Product names are trademarks or registered trademarks of their respective companies.
386 & 486 are trademarks of Intel Corp.
SLOTpro is a trademark of Diversified Technology

For more information . . .

For more information on the surface-mount IC sockets discussed in this article, circle the appropriate numbers on the Information Retrieval Service card or use EDN's Express Request service. When you contact any of the following manufacturers directly, please let them know you saw their products in EDN.

Advanced Interconnections

Box 1342
West Warwick, RI 02893
(401) 823-5200
FAX (401) 823-8723

Circle No. 700

AMP Inc

Box 3608
Harrisburg, PA 17105
(800) 522-6752

Circle No. 701

Aries Electronics Inc

Box 130
Frenchtown, NJ 08825
(908) 996-6841
FAX (908) 996-3891

Circle No. 702

Augat Inc

Interconnection Products Div
Box 779
Attleboro, MA 02703
(508) 222-2202
FAX (508) 222-0693

Circle No. 703

Cinch Connectors

1500 Morse Ave
Elk Grove Village, IL 60007
(708) 981-6000
FAX (708) 981-4266

Circle No. 704

CTI Technologies Inc

7855 E Evans Rd
Suite A
Scottsdale, AZ 85260
(602) 998-1484
FAX (602) 483-2731

Circle No. 705

Emulation Technology Inc

2344 Walsh Ave
Bldg F
Santa Clara, CA 95051
(408) 982-0660
FAX (408) 982-0664

Circle No. 706

Hirose Electric USA Inc

2685-C Park Center Dr
Simi Valley, CA 93065
(805) 522-7958
FAX (805) 522-3217

Circle No. 707

Kycon Cable & Connector Inc

1772 Little Orchard St
San Jose, CA 95125
(408) 295-1110
FAX (408) 295-8054

Circle No. 708

McKenzie Technology

44370 Old Warm Springs Blvd
Fremont, CA 94538
(510) 651-2700
FAX (510) 651-1020

Circle No. 709

Method Electronics Inc

Interconnect Products Div
1700 Hicks Rd
Rolling Meadows, IL 60008
(708) 392-3500
FAX (708) 392-9404

Circle No. 710

Mill-Max Manufacturing Corp

Box 300
Oyster Bay, NY 11771
(516) 922-6000
FAX (516) 922-9253

Circle No. 711

Nepenthe

2479 E Bayshore Rd
Suite 800
Palo Alto, CA 94303
(415) 496-6666
FAX (415) 856-8650

Circle No. 712

Rogers Corp

Circuit Components Div
2400 S Roosevelt St
Tempe, AZ 85282
(602) 967-0624
FAX (602) 967-9385

Circle No. 713

Samtec Inc

Box 1147
New Albany, IN 47150
(812) 944-6733
FAX (812) 948-5047

Circle No. 714

3M Co

Electronic Products Div
Box 2963
Austin, TX 78769
(800) 328-7732

Circle No. 715

SINGLE BOARD COMPUTER FOR LESS CASH

COM 1; COM2 Serial Ports

Digital VGA Port

Keyboard Port

On-Board Battery for CMOS RAM

16 or 20MHz!

Analog VGA Port

PS/2 Mouse Port

High Performance VGA Supports Digital or Analog CRTs to 800 X 600 Resolution

Industry Standard/ Custom Phoenix BIOS

CIRCLE NO. 34

FUNCTIONS	CAT970 386SX
16, 20MHz CPU- Shipping Now!	✓
Up to 16M RAM Onboard	✓
Noise Reduction Circuitry For FCC Class B	✓
PS/2 Mouse Support	✓
/AT-PS/2 Keyboard Support	✓
On-Board Battery Real Time Clock	✓
Bi-directional PS/2 Printer Port	✓
2 Serial Ports - Up to 115K Baud	✓
Future Domain SCSI	✓
IDE Interface	✓
Floppy Interface	✓
VGA/Flat Panel Interface	✓
80387SX Math Coprocessor Optional	✓
Double Sided Surface Mount Technology	✓
Manufactured In-House(U.S.A.)	✓
Landmark V1.14 Speed at 20MHz	25.6

1 Year Warranty

Diversified Technology
An Ergon Co.

Call us toll free for orders and information.

1-800-443-2667

OUTSIDE USA PH.-(201)891-8718 • FAX-(201)891-9629

We Increased The Memory To One Megaword, So You Can Increase The Bandwidth.

LeCroy's one megaword acquisition memory means higher sampling rates over most time base settings. The results: greater useable bandwidth and increased aliasing protection. *These are the kind of facts the competition can no longer ignore...or match.*

Whether you choose our new 300 MHz 9300 Series or the 2 GS/sec 7200A Series, both offer you the world's longest memories and are available in 2 and 4 channel configurations.

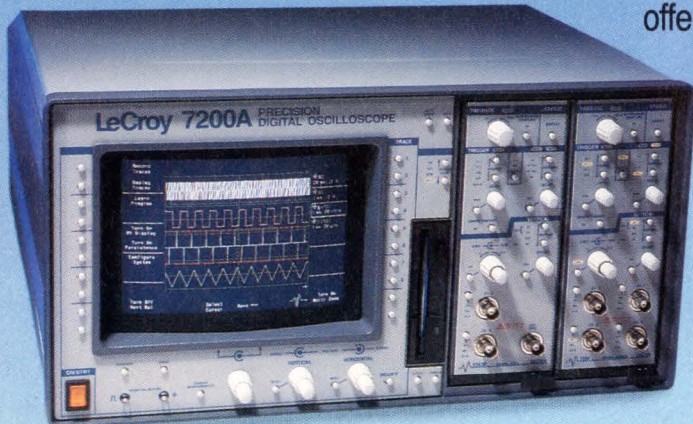

The new 7200A Series, our high performance line with high resolution color display, features 500 MHz bandwidth at 2 GS/s with 200k memory standard and 1 Meg/channel optional. Modular architecture allows the user to choose 2, 4 or even 8 channels, all with super-long memory. Floppy and hard disk drives are standard features.

LeCroy DSOs offer the best displays in the business: bigger – crisper – more pixels, and now – color! These large, bright, easy-to-view displays eliminate text and signal overlap and, at the same time, allow multiple grids for simultaneous viewing of traces and their expansions.

Equally impressive is the fact that LeCroy DSOs give you answers, not just data. And the reasons are simple: LeCroy DSOs incorporate massive multiprocessor power, resulting in live-updating waveform parameters, time zooming, frequency analysis (FFT), fast averaging, arithmetic, histogramming, and PASS/FAIL testing. All this...over multiple

Taking DSO Memor



channels simultaneously and...without ever losing precious source data.

PC compatibility is yet another LeCroy advantage. Whether you're using memory cards (9300 Series), or floppies (7200A Series), you can dump your waveforms and other data directly into your PC or word processor, or personalize your instrument for your dedicated measurements.



The new 9300 Series offers 300 MHz bandwidth and 100 MS/s per channel, with memories from 10k to 1 Meg/channel. All versions feature DOS compatible memory cards and automatic PASS/FAIL testing. Prices start below \$5,000.

LeCroy

Competition

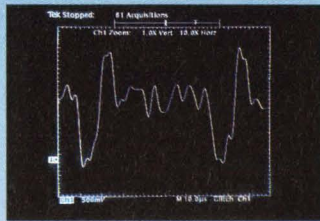
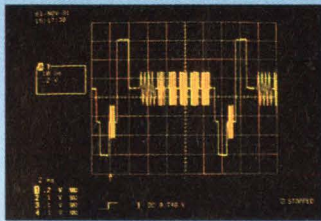
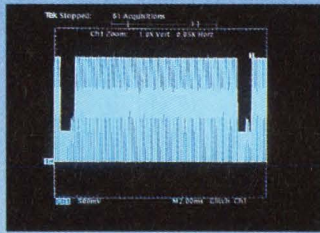
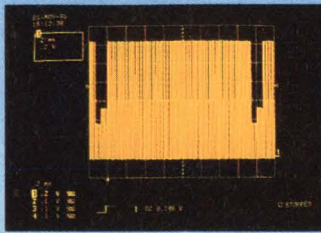

In many applications, there's no substitute for a really long memory. The screens above show a complete TV field captured at 2 ms per division. The benefits of the long memory are shown when the waveform is expanded to view a single TV line.

For a copy of our new information guide, or a demonstration of LeCroy digital oscilloscopes, call 1-800-5-LeCroy; fax (914) 578-5985.

LeCroy Corporation – Dept. A
World Headquarters
700 Chestnut Ridge Rd.
Chestnut Ridge, NY 10977-6499
CIRCLE NO. 35

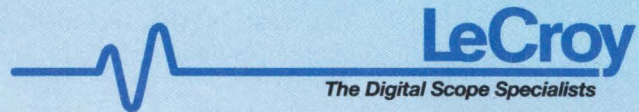

y To A Higher Plane.



Buscon beefs up technical program

JULIE ANNE SCHOFIELD, Associate Editor



Buscon West now features more than 60 technical sessions and tutorials.

This year's Buscon West features a much-expanded technical program and more than 100 exhibitors showing their latest products. The show will be held from Tuesday, February 4, to Thursday, February 6, at the Long Beach, CA, Convention Center.

As with last year's Buscon West, an all-day Futurebus+ workshop will be held Monday, February 3—the day before the official opening of the show. The session will present a complete engineering discussion of the architectural and protocol design concepts behind Futurebus+, the physics of backplane transmission, a study of bus acquisition (arbitration and allocation), the parallel protocol, cache coherency, and message passing.

The rest of the technical program comprises 3-hour tutorials and 1-hour lectures. The tutorial topics are the Sbus, the VMEbus and VME64 (a proposed addition to the VMEbus spec), Multibus enhancements, the Micro Channel Architecture, LAN communications strategies, and the Scalable Coherent Interface (SCI) high-speed bus architecture. Lecture topics include the major bus architectures, CPUs, real-time software, and development issues

of concern to designers working with backplane buses.

More than 100 exhibitors will occupy 30,000 square feet of floor space. These exhibitors will show off the latest bus technology, boards, components, systems software, and development tools. Exhibit-hall hours are 10 am to 6 pm Tuesday and Wednesday and 10 am to 4 pm on Thursday.

Your Buscon badge will get you into the Buscon Bash, which organizers herald as the "Mother of All Industry Parties." The Bash will happen Wednesday, February 5, from 5:30 to 7 pm.

You can register for Buscon in several ways. Passport #1 costs \$695 and lets you attend the preconference Futurebus+ workshop as well as any of the sessions and half-day tutorials on all three program days. You'll also get a copy of the official conference proceedings and admission to the exhibition and the Buscon Bash. Passport #2, \$545, doesn't gain you admission to the Futurebus+ workshop but otherwise allows you the same privileges as passport #1.

The \$145 half-day option lets you attend one half-day tutorial or any four 1-hour sessions on one of the three program days, and it gets you into the exhibition. The \$225 full-day option lets you attend any one half-day tutorial and three 1-hour sessions on one of the three program days and admits you to the exhibition. Registering for the exhibition costs \$10 at the door.

For more information on Buscon, contact Conference Management Corp at (203) 852-0500; FAX (203) 857-4075. To register, phone (800) 243-3238. 



Article Interest Quotient
(Circle One)

High 470 Medium 471 Low 472

Table 1—Buscon/West '92 program schedule

Day	8:30 to 9:30 am	9:45 to 10:45 am	11 am to 12 pm	12:15 to 1:15 pm	2:45 to 3:45 pm	4 to 5 pm	5:15 to 6:15 pm
Mon Feb 3	PCW Preconference Futurebus+ workshop 8:30 am to 6 pm						
Tues Feb 4	101 Technical aspects of SBus 8:30 am to 12:30 pm				501 Factors in choosing external buses for high-speed data capture and processing	601 Bus-interface solutions utilizing fine-pitch SMT packages and advanced semiconductor processes	701 Bridging Futurebus+ I/O to high-performance multiprocessor systems
	102 VME64 and VMEbus 8:30 am to 12:30 pm				502 Imaging and graphics—the technologies combined	602 VXIbus in high-performance data-acquisition applications	702 Design and integration of mixed-bus systems on high-performance HP-UX W/S
	103 SCSI-2 on the SPARCstation SBus	201 Overwhelming case for a single-piece thermal plane for conduction-cooled models	301 Futurebus+ implementations	401 Mezzanine bus implementation in full military specification boards	503 Live insertion in Futurebus+ design	603 Graphical interfaces in real-time programming	703 Implementing a SCSI LAN protocol: SCSI Net
	104 Multiple DOS processors for industrial control	202 SCSI design—A chip perspective	302 Software development, testing, and integration issues for real-time multi-tasking systems	402 Overcoming "Gotchas" in VMEbus multi-processor design	504 Frequency-domain filtering and 2-D FFT image processing	604 Trident, 3-pronged attack on VMEbus system bottlenecks	704 Considerations for remote devices drivers in a real-time environment
Wed Feb 5	801 Enhancements to Multibus 8:30 am to 12:30 pm				1201 An integrated Ada environment for the '90s	1301 Advanced hardware process synchronization primitives for VMEbus systems	1401 Developing control applications without programming
	802 Micro Channel Architecture 8:30 am to 12:30 pm				1202 Upcoming multiprocessing support in Unix System V	1302 Open Boot/Forth	1402 High-performance DSP-based image classifier
	803 Unix vs kernels for real time	901 Using Windows DDE to provide GUI for real-time VMEbus applications	1001 Designing for worst case: The impact of real-time O/S performance on real-world embedded systems	1101 Utilizing a new standard: EISA-based PCXI vs VXI for testing	1203 Strategies for testing and monitoring VMEbus systems	1303 The I/O bus in Futurebus+	1403 Token Ring networking
	804 SSBTL—The next VME performance push	902 Chip vs board vs software decisions on Futurebus+	1002 Busless computing environment	1102 Bus analyzers solve system-development needs	1204 Benchmarking real-time systems	1304 Closely coupled UNIX in real-time systems	1404 Advanced networking
Thurs Feb 6	1501 Communications strategies 8:30 am to 12:30 pm				1901 Porting RTOS to the MIPS R3000	2001 Real-time RISC factors	2101 VMEbus and computer automation
	1502 SCI (Scalable Coherent Interface) 8:30 am to 12:30 pm				1902 Serial channel extends VMEbus, adding additional 400 Mbyte/sec transfers	2002 High-speed serial communications and WANs	2102 Practical considerations in the implementation of VME64
	1503 Futurebus+/VME bridge	1601 FDDI gives bus-based systems new opportunities	1701 DRAM control in high-performance systems	1801 Designing FDDI adapter cards	1903 Embedded firmware using hierarchies of message-driven state machines	2003 Distributed micro-kernel technology in a real-time Unix environment	2103 Futurebus+ electrical considerations for high performance
	1504 A real-time multiprocessor interface using the buffered pipe protocol	1602 A comparative anatomy of RISC processors for real time	1702 P1212.1: IEEE standard for using shared memory	1802 Architectural and performance considerations of SCSI-2 peripheral interfaces, controllers, and I/O boards	1904 DSP + processor technology—optimized for mixed media	2004 Hard metric mezzanine board standard	2104 Futurebus+ from a perch in Texas

*Our six-row connector
lets you change the ground rules.*

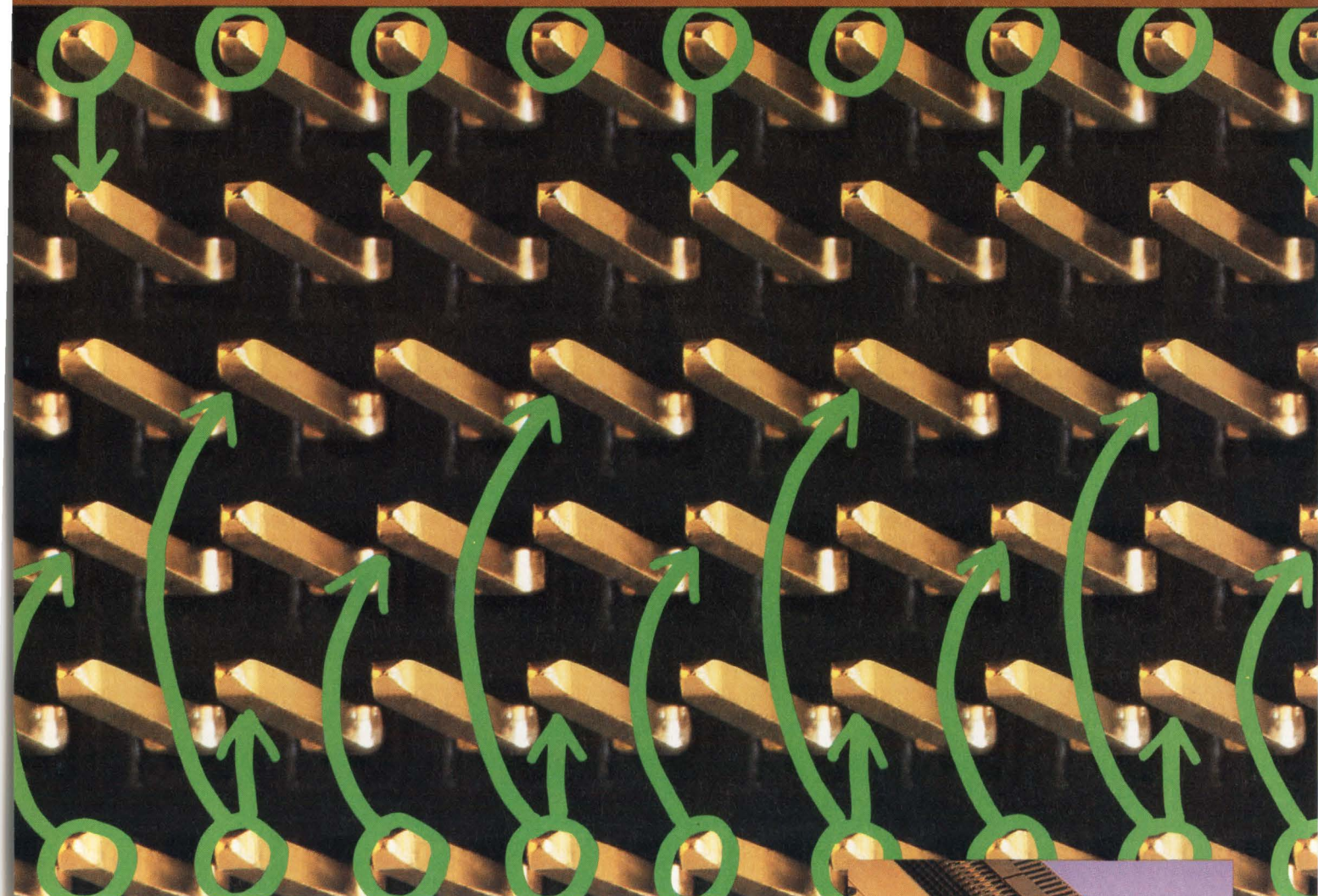

THIS IS AMP TODAY.

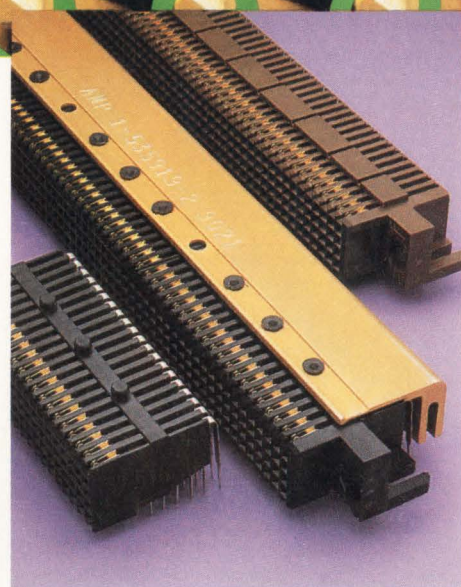

AMP is a trademark of AMP Incorporated.

84 • EDN January 20, 1992

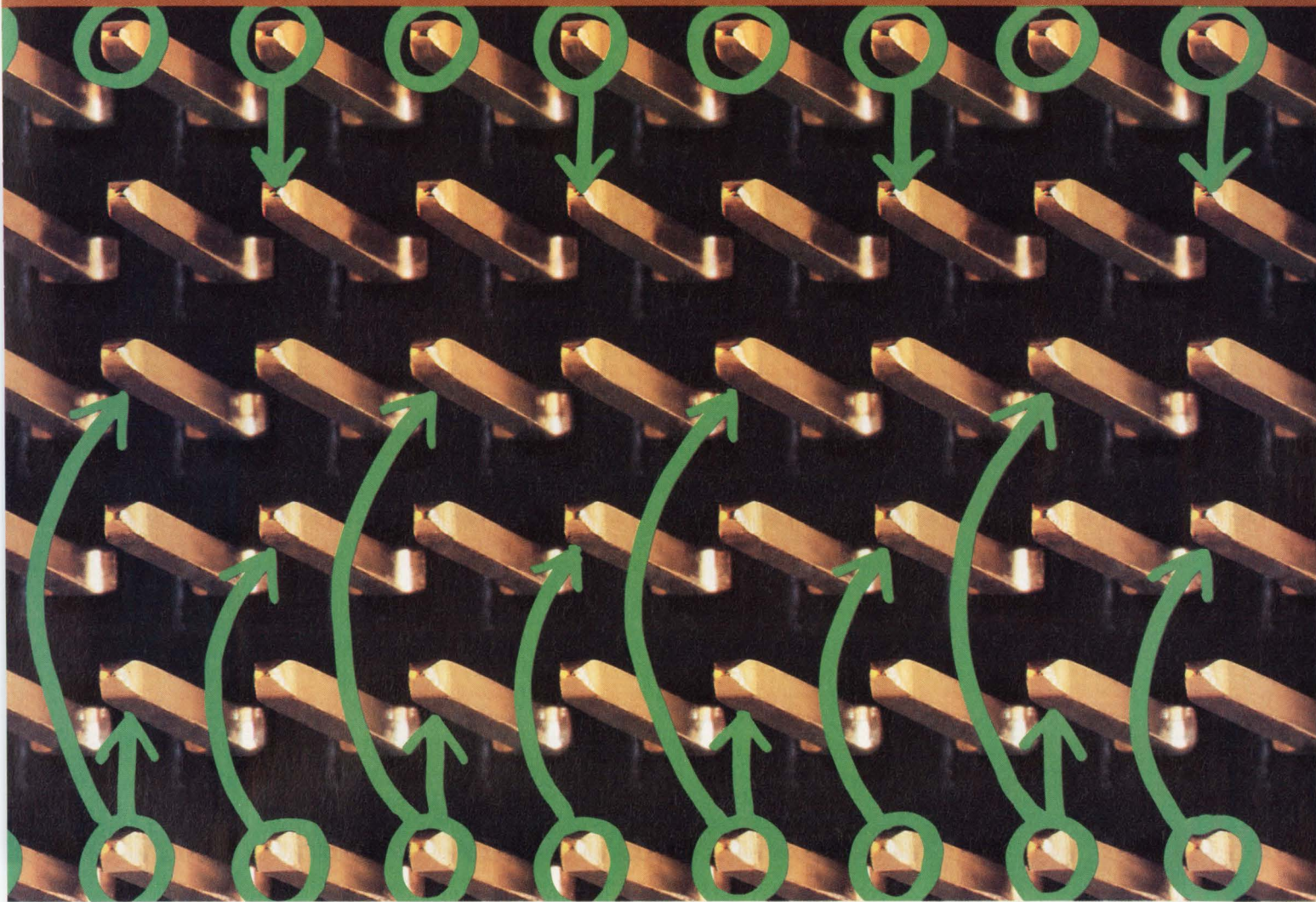

AMP TBC Plus connectors give you complete freedom in ground and signal assignment, so you can write your own 'ground rules' for outstanding electrical performance in high-speed, high-density backplane applications.

Because they are true 6-row connectors and you assign ground where you need it, near end and far end noise voltage figures in the <10 ns risetime range are far below connectors that limit ground to the outer rows or 'planes' (TBC Plus performance is even better when configured the same way!).

Our economical twin-beam receptacle

design is unique in offering greatly reduced inductance in the outermost 'long' row of pins, and matched propagation delay in all lines.

Note performance of AMP TBC Plus connectors with evenly dispersed 'checkerboard' grounding: some competitive styles don't allow this.

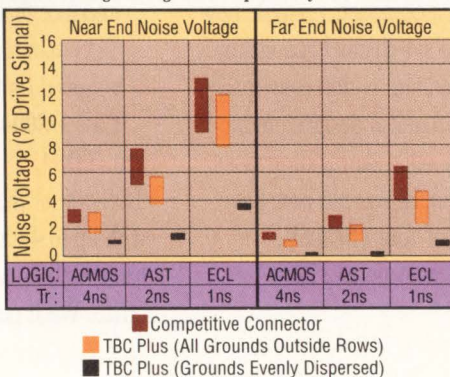

Capacitance is a mere 2pf, max, line-to-line.

Modular configuration (90- and 120-position sections) provides 'building block' flexibility, with applications to 810 positions or more. Header posts in staggered heights allow four-level sequenced mating.

For the Plus in high-speed performance, call our Product Information Center at 1-800-522-6752 (fax 717-986-7575). AMP Incorporated, Harrisburg, PA 17105-3608. In Canada call 416-475-6222. For design assistance in characterized back-plane assemblies, contact AMP Packaging Systems, 512-244-5100.

Tek's new encore TDS 400. Extraordinary 4-channel power. Ordinary 2-channel price.



Tek's new TDS 400 Series oscilloscopes make TDS performance from 150 MHz to 350 MHz more portable and affordable than ever.

Now you can pick up where Tek's breakthrough TDS 500 Series left off — with a compact, versatile new series that puts the TDS platform's 4-channel acquisition, multiprocessing and intuitive operation within easy reach of digital, analog and electro-mechanical design, production test, field service, and many other demanding tasks.

For the usual price of *two* channels, you can now have:

- 100 MS/s sampling on each of four channels.
- On-the-fly signal processing with up to 12-bit vertical resolution.

- Record lengths to 30,000 points.
- Video trigger option with back-porch clamp and dial-up line/field selection.
- 22 time-saving automatic measurements.
- The unique graphical user interface that lets most TDS manuals stay shrink-wrapped on the shelf.

Call 1-800-426-2200

Ext. TDS4, for more information on either the new TDS 400 or the recently-announced TDS 500 Series — with up to 4 channels, 1 GS/s sampling and 500 MHz bandwidth — and for the number of your nearest Tek sales office. We'll put you through to all the right channels, fast!

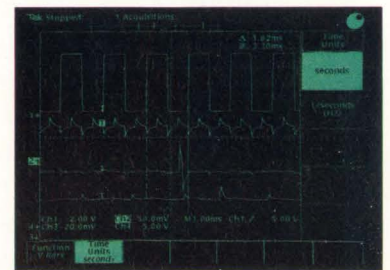

Tektronix

Test and Measurement

Controller quickly charges NiCd batteries using current pulses and time derivatives

Quickly charging a NiCd battery requires controlled application of charging current and careful monitoring of the cell's condition. The ICS1700 rapid-charge controller meets these two requirements by using a pulsed current to charge the cell and by calculating the first de-

rivative of the battery voltage to assess the cell's state of charge.

The controller's use of both techniques allows you to charge NiCd batteries safely in approximately 20 minutes by preventing undue build-up of pressure and temperature within the battery. The controller

can charge NiCd cells at 1/2, 1, 2, and 4C. (The C rate is defined as the current-flow rate that is equal to the rated battery capacity. For example, applying a 2A charge to a 1 Ahr battery is a 2C rate.) When charging at a 4C rate, the approximate charge time is 20 minutes.

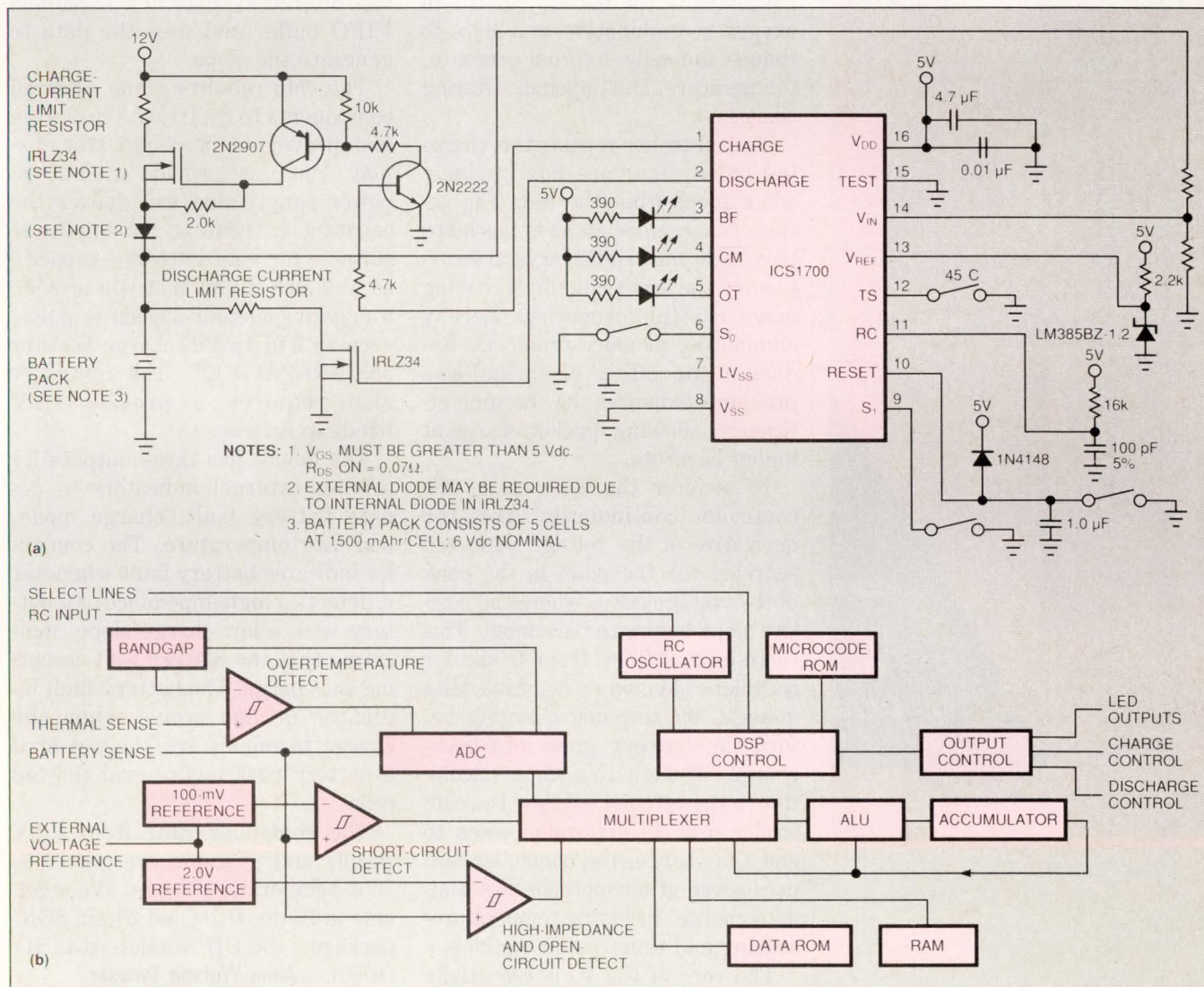
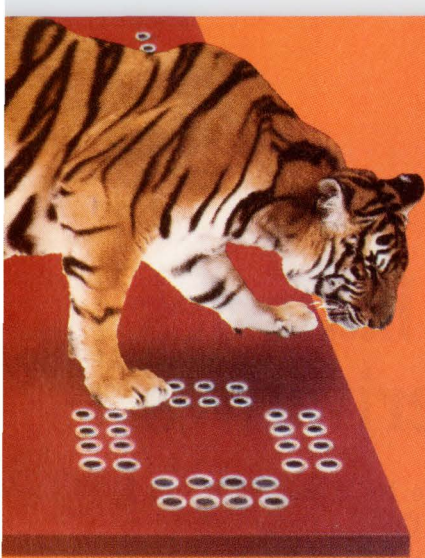

Fig 1—In a typical application, the ICS1700 quickly charges NiCd batteries working in conjunction with other circuitry (a), such as a power supply, discharge FET, and simple transistor switches. The IC itself (b) consists of an ADC to read in the battery state and a controller optimized for the efficient numerical calculations necessary to derive the linear regression slope and determine the correct charge-termination point.



Ready to
make the
jump to
surface
mount?

Note that not all batteries can handle 4C charging rates, so you must select an appropriate battery.

The controller works in tandem with a power supply to implement a patented pulse-current technique that consists of a positive-current charging pulse followed by a high-current, short-duration discharge pulse. (The company licenses the patented reflex charging pulse from Christie Electric Corp, Gardena, CA.) This short pulse prevents the build-up of gas bubbles on the internal plates of the battery, assists in oxygen recombination, and helps to reduce the cell's internal pressure, temperature, and impedance during charge.

The controller repeats this charging-pulse sequence continuously while monitoring the cell. The series of charge/discharge cycles helps to restore the original crystal structure of the cell plates by breaking down crystal formation, thereby eliminating memory problems. Reducing the effect of crystal-size problems enhances the charging efficiency, allowing quicker charge at higher currents.

To monitor the cell's state, the controller continuously takes the derivative of the voltage slope and searches for the point in the peak of the voltage curve where the positive slope begins to flatten out. This technique differs from a similar technique, known as negative delta voltage, by stopping charging before the battery goes into overcharge. Though this slope calculation is the primary method the controller uses to determine when to end the charge, the controller also uses seven other methods to terminate charge, including temperature-sensing and timer-cutoff methods.

The core of the IC is essentially a RISC microcontroller optimized for the efficient numerical calculations needed to derive the linear regression slope and determine the

correct charge-termination point. The controller uses a 10-bit successive-approximation ADC to sample the analog voltage of the battery. The IC averages the result of successive conversions to limit the effect of voltage jumps caused by battery and ADC noise. The number of successive voltage samples that the controller averages depends on the charge rate. An IIR filter weights the averaged voltage to filter out any large aberrations in the cell-voltage curve. The IC stores this filtered average in a 12-sample FIFO buffer and uses the data to generate the slope.

The chip requires some external components to control the clock rate and provide a fault-indicator display. You must provide an external power supply that can deliver the constant current at an amplitude suitable for your battery's capacity as well as a circuit that will provide a negative current-discharge pulse, such as Fig 1a's discharge resistor and IRLZ34 FET. The controller also requires a precise 1.2V bandgap reference.

The device has three outputs for driving external indicators to denote battery fault, charge mode, and overtemperature. The controller indicates battery fault whenever it detects a high impedance or a battery with a low charge slope, indicating that the battery isn't accepting the charge. The battery-fault indicator is also active when the charge terminals are shorted or if a battery pack has several shorted cells.

The controller runs from a 5V supply and operates over the 0 to 70°C temperature range. It's available in 16-pin DIPs and 20-pin SOIC packages; the DIP version costs \$11 (1000).—**Anne Watson Swager**

Integrated Circuit Systems Inc,
2626 Van Buren Ave, Valley Forge,
PA 19482. Phone (215) 666-1900.
FAX (215) 666-1099. **Circle No. 731**

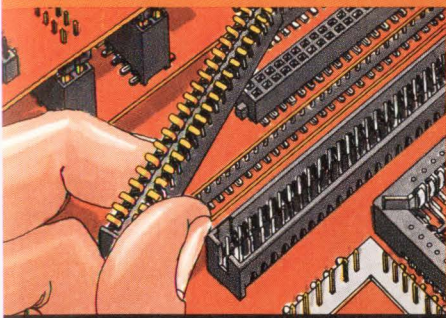

.050" CENTERLINE

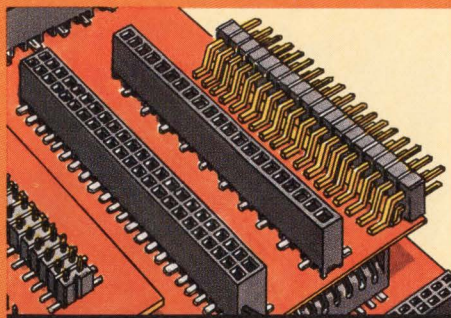

2mm CENTERLINE

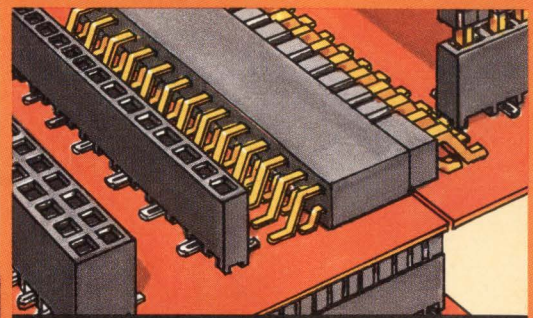

.100" CENTERLINE (.025" SQ)

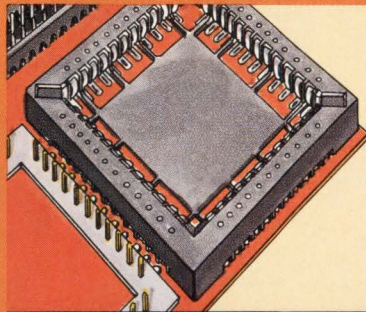

PLCC's

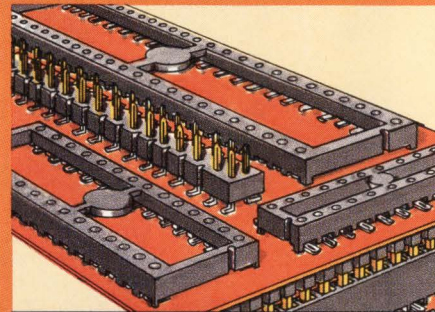

DIP's

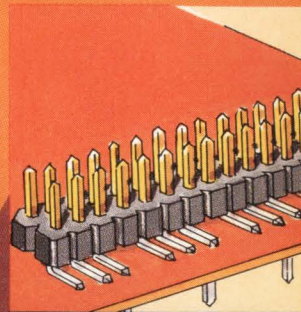

CUSTOMS

Samtec
SMT
solutions
assure a
safe landing!

Nobody knows more about
surface mount interconnects
than Samtec.

Samtec surface mount Strips, DIP's and PLCC's are designed for automated assembly, VP or IR soldering and to optimize electrical and mechanical properties.

Our new Surface Mount Guide shows thousands of Interconnect solutions. And, if you don't see the solution you need, we'll design one to satisfy your most demanding application. Call today.

1-800-SAMTEC-9

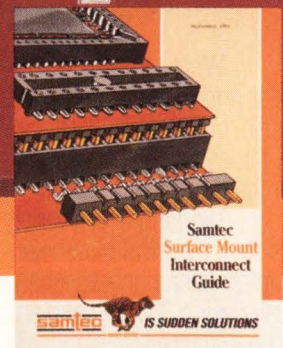

samtec

IS SUDDEN SOLUTIONS

SUDDEN SERVICE

New Albany, Indiana USA • Cumbernauld, Scotland UK • Singapore

SAMTEC, INC. P.O. Box 1147 • New Albany, IN 47151-1147 USA • Phone 812-944-6733 • Fax 812-948-5047 • TWX 810-540-4095 • Telex 333-918

CIRCLE NO. 38

EDN January 20, 1992 • 89



The Bettman Archive, Inc.

Balancing mechanical and electrical requirements keeps us on the leading edge of interconnect technology.

What a challenge: making cable systems smaller, lighter, and more flexible without compromising signal fidelity, flex-life, or reliability. At Precision Interconnect we do it every day, for leading electronic equipment manufacturers all over the world.

Working with a variety of mechanical requirements, plus strict electrical parameters, we custom-design and produce complete interconnect systems. Micro-miniature cables, usually using 38 AWG and smaller conductors, can be terminated to standard or micro connectors and protected with flex-strain

reliefs. Custom overmolds and sealing designs have been developed to protect interconnect systems in harsh environments. These cable assemblies provide the critical link in hand-held applications on diagnostic instruments, sensors, and medical and surgical devices.

Our expertise, increasing with each unique problem we solve, ensures that reliability is designed in, built in, and tested.

So we can keep our balance. And assure a great performance every time.



**PRECISION
INTERCONNECT**

16640 S.W. 72nd Avenue
Portland, OR 97224
(503) 620-9400

Interconnect assembly for Medical Dynamics' hand-held surgical camera is sealed against sterilization solutions.



Workstation brood adds low-end machine and servers

An entry-level workstation, four servers, and two high-end, 24-plane graphics boards expand the utility of the HP 9000 Series 700 family of PA-RISC-based workstations. The Series 700 Model 710 has an entry-level price of \$7490 and delivers 49.7 SPECmarks, 57.9 MIPS, and 12.2 Mflops from its 50-MHz CPU. These metrics contrast with the \$11,990 Model 720, whose performance of 59.5 SPECmarks, 57.9 MIPS, and 17.9 Mflops represents a compiler-enhancement-based improvement from its introductory numbers. Two mechanisms that reduce price and improve performance of the Model 710 workstation are the smaller caches: the 32-kbyte instruction cache and 64-kbyte data cache are from one-quarter to one-half the size of those of the other family members.

The base machine comes diskless, with 16 Mbytes of memory, graphics supporting eight image planes, and a 19-in., 1280 × 1024-pixel-resolution gray-scale monitor. Graphics options allow you to configure the machine with color monitors: a 16-in. 1024 × 768-pixel monitor (\$4000) or a 19-in. 1280 × 1024-pixel monitor (\$6500). All three graphics options are integrated into the CPU and utilize hard-coded graphics primitives to achieve 7292 X11 performance and 950,000 2- or 3-D vectors/sec. Integration onto the CPU is another cost-saving feature.

You can add as much as 840 Mbytes of internal disk storage in four half-height slots or 9.4 Gbytes using external disk arrays. The low-end workstation also supports 1.44-Mbyte, 3½-in. floppy-disk drives, CD-ROM storage, or 2-Gbytes of 3.5-in. DDS (direct-digital-synthesizer) tape. You can also increase

your main memory from 16 Mbytes to as much as 64 Mbytes, using error-correction code SIMMs.

The four servers come in four configurations ranging in price from \$23,440 to \$87,638. The servers enhance network capacity via an internal disk capacity of as much as 2.6 Gbytes and an external capacity of 236 Gbytes. All servers offer two 8-Gbyte, 4-mm DAT (digital-audio-tape) drives and a 600-Mbyte CD-ROM. You can stuff the main memory with 32 to 384 Mbytes of RAM.

The existing workstation family previously offered three graphics choices. These choices featured circuit boards with 8-plane gray-scale or color and a board with as many as four i860 CPUs.

Two new boards for the higher-end 720, 730, and 750 workstations are called the CRX-24 and CRX-24Z. They provide a 24-plane single buffer or 12 + 12-plane double buffer and offer eight overlay planes for additional storage. The CRX-24Z supplements the features

of the CRX-24 with a hardware Z-buffer, accelerated shading, and antialiasing.

Because both boards operate at greater than 30 frames/sec, they both support video. These two graphics options range in price from \$13,500 to \$21,500. A \$2000 software product called Power Shade adds shading capabilities to the existing graphics products or to the new CRX-24; it comes with the CRX-24Z.

In contrast to the relative dearth of software vendors committed to the Series 700 at introduction, HP announces that almost 2000 applications are possible on the workstations today.

Prices are not yet firm and could be lower than quoted. All products are available except for the graphics boards, whose delivery takes four to eight weeks ARO.

—Michael C Markowitz

Hewlett-Packard Co, 19310 Pruneridge Ave, Cupertino, CA 95014. Phone (800) 752-0900. **Circle No. 732**



Extending the low end of its RISC-based workstation line, Hewlett-Packard's Series 9000 Model 710 runs at almost 50 SPECmarks.

**NO
BUS!**

80C186EB

**NO
FUSS!**

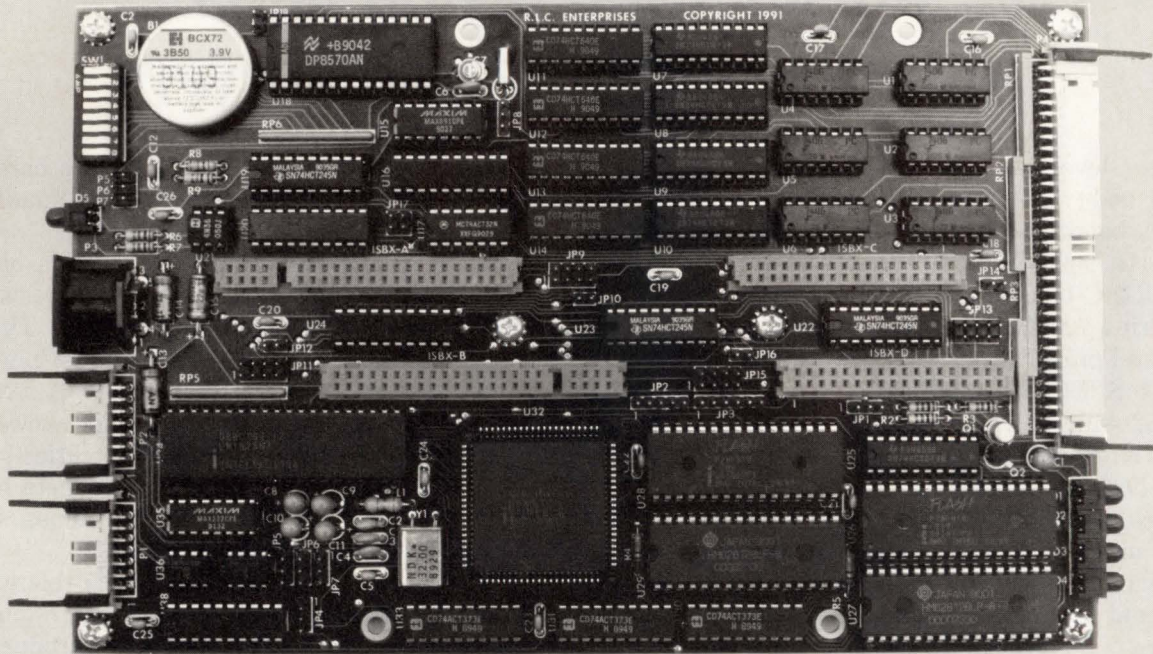

DARE TO COMPARE!

Compare our new SBX-C186EB to ANY Single Board Computer on ANY bus. Our new **Powerful, Expandable, Inexpensive, Easy to Program** Single Board Computer was designed to eliminate expensive and complicated Bus systems. All of the basic functions needed for most embedded applications are on-board. Additional I/O expansion is provided by four on-board iSBX ports which may be used to accommodate any of the iSBX modules currently available.

HARDWARE FEATURES

- * 16-Bit 80C186EB Up To 16 MHz
- * On-Board 80C187 Co-Processor
- * 8570 Real Time Clock
- * Four 8/16-Bit iSBX Expansion Ports
- * Watch Dog Timer And Power Fail Detect
- * Two Serial Ports (RS-232/422/485)
- * 10 Year Lithium Battery For RTC And RAM
- * Up To 512K Of EPROM/FLASH EPROM
- * Up To 512K Of Battery Backed Static RAM
- * 32 Parallel I/O Lines With Open-Collectors
- * Five 16-Bit Interrupt Timers
- * Program Controlled Dip-Switch And LED's
- * Available In -40 to +85 C Temperature Range

SOFTWARE FEATURES

- * On-Board FLASH EPROM Programming
- * Borland Turbo C++ Fully Supported
- * Borland Turbo Debugger Supported
- * I/O Driver Library Provided Free
- * Demo Programs Provided Free
- * No Software Royalties
- * No DOS Required

QTY (1) \$425
QTY (100) \$319
EXCLUDING OPTIONS

Turbo C++ and Turbo Debugger may be trademarks of Borland, DOS is a trademark of IBM, iSBX is a trademark of Intel

R.L.C. Enterprises

4800 Templeton Road Atascadero, CA 93422 Phone (805) 466-9717 FAX (805) 466-9736

8-bit 68HC05K microcontroller minimizes cost and fits in 16-pin DIPs and SOICs

Engineers who need to watch their design pennies will like a low-end version of the Motorola 68HC05 8-bit microcontroller (μ C). The 68HC05K series brings the μ C's architecture down to a 16-pin DIP, the smallest pin package for any 8-bit μ C. In large OEM volumes, these μ Cs' cost will fall to less than \$0.90. In addition, the μ C's design minimizes the need for extra components.

Motorola's 68HC05 is a simple μ C with a single accumulator and index register. It comes with limited on-chip ROM or EPROM and RAM, typically with 2 to 4 kbytes of ROM and 176 bytes of RAM. It has no provisions for accessing off-chip memory and has four 8-bit I/O ports and a counter/timer system.

The series takes the 68HC05 architecture down another level. Although it has the standard 6805

processor core, the 68HC05K's peripherals have been cut back. It has two I/O ports—one has eight and one has two I/O lines. On-chip memory has been reduced to a 1-kbyte address space, with 504 bytes of ROM or EPROM (including eight interrupt vectors) and 32 bytes of RAM. A new μ C option is a 64-bit personality EPROM, which holds version or design data.

Reduced stack-pointer size is a result of the series' limited addressing space. The μ Cs have a reduced, multifunction 15-stage timer. A programmable watchdog timer catches runaway software. Both watchdog-timeout and timer-overflow conditions trigger interrupts.

The μ Cs feature the standard IRQ external-interrupt line as well as a programmable option for four I/O lines. The I/O lines can be ORed to IRQ, creating five external-

interrupt sources. The μ C series runs with a 4-MHz external oscillator or clock; internal clocks are 2 MHz divided down from the rate.

Three new μ Cs enlarge the 68HC05K family: the base level 68HC05K0; the 68HC05K1 with personality EPROM; and a one-time-programmable 68HC705K1 with EPROM.

To save external components, four of the I/O lines can sink 4 mA to drive LEDs directly, eliminating drivers. Port I/O pins have software-programmable pull-down resistors (100 μ A), eliminating external pull-down resistors.

Shortly, the company will introduce a new PC-based integrated-development-software package for the 68HC05K. Developed by P&E Microsystems (Woburn, MA), the package includes a macro assembler, an editor, a simulator, and a

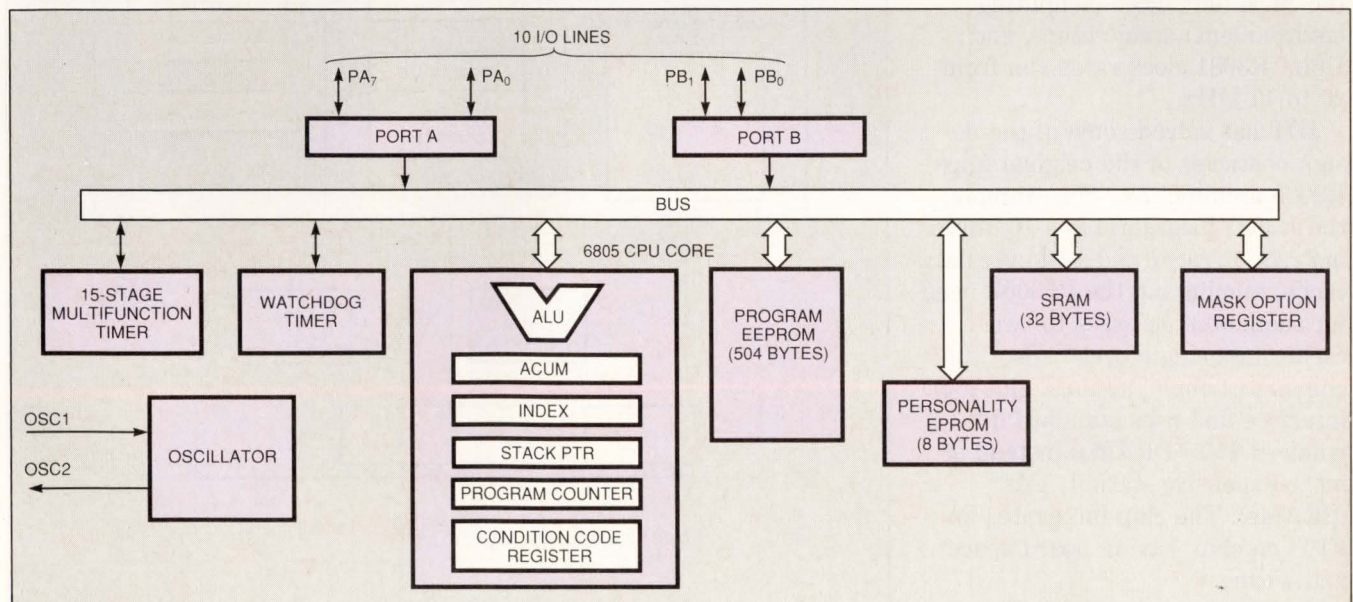

This low-end, 8-bit μ C family, the 68HC05K microprocessor series, has a 1-kbyte address range with 504 bytes of ROM or EPROM and 32 bytes of RAM. The series also has a reduced set of peripherals and 10 I/O pins.

windowed source-code debugger, all combined in an integrated environment.

The low-end 68HC05 parts cost \$1.20 for the 68HC05K0, \$1.85 for the 68HC05K1, and \$2.75 for the one-time-programmable 68HC705K1 (10,000). Samples of the chips are available now.

—Ray Weiss

Motorola Inc, Microprocessor Products Group, 6501 William Cannon Dr, Austin, TX 78735. Phone (512) 891-3434. Circle No. 733

MIPS-based chip in 84-pin package runs to 40 MHz

The MIPS-architecture-based ACE, a RISC alternative to PCs, may not have to wait for the Mips R4000 superpipelined RISC (reduced-instruction-set computer) chip. The R3081, a MIPS-based chip, is a high-end version of IDT's R3051/2 family of embedded RISC CPUs. The R3081 is compatible with the Mips R3000 and can run the emerging Microsoft Windows/NT operating system, the core of the ACE (advanced-computing environment) architecture, and Unix. R3081 clock rates run from 20 to 40 MHz.

IDT has solved some of the design obstacles of the original Mips R3000 architecture. For example, the R3081 incorporates a 16-kbyte instruction cache and a 4-kbyte data cache, eliminating the R3000's need for sequential accesses to two caches in a single cycle. Also, the chip has a simple, minimal glue logic interface and uses standard dynamic RAMs (DRAMs) instead of more-expensive static RAMs (SRAMs). The chip integrates an FPU on chip, saving board space and wiring.

The R3081 is pin compatible with earlier R3051 CPUs; existing designs can be upgraded without re-

design. The R3081 has one of the largest instruction caches among RISC processors. The R3081's caches can be dynamically modified to an 8-kbyte instruction and data cache configuration, creating a more-balanced configuration. Thus, the operating system can configure the hardware for large-scale applications; the only limitation is that the caches must be flushed before reconfiguring them.

The R3081 caches are direct mapped (only one cached item per address) and are physically, rather than virtually, addressed. This relieves the requirement that virtual caches be flushed on a process context switch. The instruction cache has a 4-word, 16-byte line size (smallest cached element is four words). The data cache has a word or 4-byte line size. The R3081 has a write-through cache policy—

writes to the cache are also written through to main memory. For cache coherency, DMA writes from the cache can be programmed to invalidate the cache lines written, eliminating potential data conflicts (the main memory data now is the valid data).

Like the R3051, the R3081 CPU uses a multiplexed address and data bus to help minimize pin count. This approach does not markedly hamper CPU-memory performance: It shifts from address to data in 1/2 a clock cycle and has read/write buffering. With fast enough DRAMs, reads can take two memory cycles, and writes two or three cycles, depending on decode-logic times. The multiplexed bus does, however, require external logic to latch the address and hold it during the data-presentation phase of a memory cycle.

IDT designers improved CPU

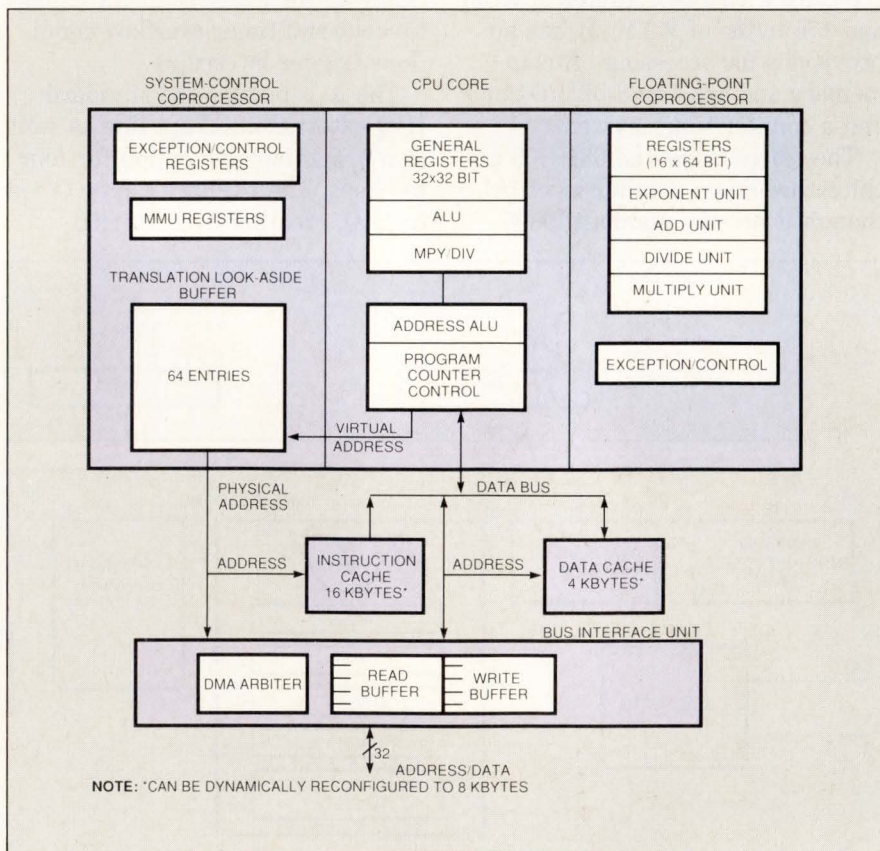

The latest IDT revision of the MIPS RISC architecture, the R3081 combines large on-chip cache with an FPU and a multiplex bus, fitting a small-package IC.

WORLD'S SMALLEST 8th-ORDER LOWPASS FILTERS - \$2.95*

Butterworth & Bessel with No External Parts

Maxim's new MAX291/MAX295[†] (Butterworth) and MAX292/MAX296[†] (Bessel), 8th-order low-pass switched-capacitor filters, come in space-saving small-outline 8-pin miniDIP and SO packages. And to save even more space and design time, no external resistors or capacitors are needed.

- ◆ 8-Pin miniDIP and SO Packages
- ◆ No External Components
- ◆ Corner Frequency Range:
0.1Hz to 25kHz (MAX291/292)
100:1 Clock to Corner Ratio
0.1Hz to 50kHz (MAX295/296)
50:1 Clock to Corner Ratio
- ◆ THD + Noise: -70dB Typ.
- ◆ +5V or ±5V Supply Operation
- ◆ Cascadable for Higher Orders

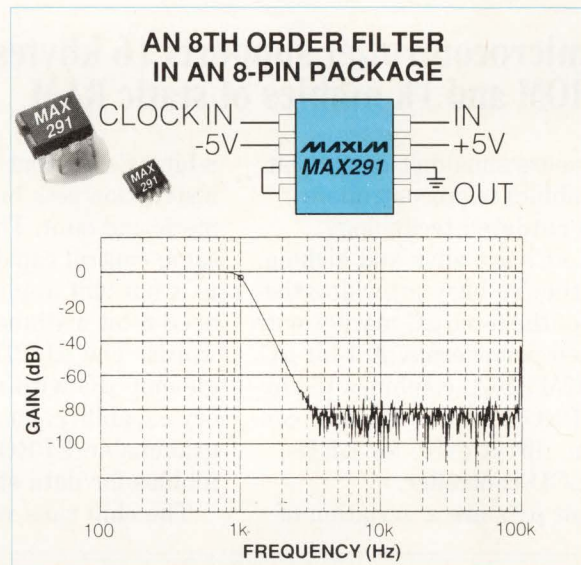

MAX291's 8th-order Butterworth response has 48dB/octave rolloff with no passband ripple.

FILTERS ANALOG

Data Sheets • Applications Notes • Free Samples

96dB Dynamic Range Analog Filter
Satisfies 12-Bit Data-Acquisition Needs

Continuous-Time Filtering Blocks When Switched-Capacitor Filters Fail

See how our new 96dB dynamic range analog filter can help you overcome the limitations of switched-capacitor filters. This filter provides a dynamic range of 96dB, a passband ripple of 0.1dB, and a stopband attenuation of 96dB. It is available in a small, surface-mount package.

Universal-Filter Designs Offer µP or Pin-Strap Programmability

Frequency Range: 0.01Hz to 140kHz

MAXIM

FREE Analog Filter Design Guide

Includes: Application Notes ◆ Data Sheets ◆ Cards For Free Samples

To receive your design guide, simply circle the reader response number, or contact Maxim Integrated Products, 120 San Gabriel Drive, Sunnyvale, CA 94086, (408) 737-7600, FAX (408) 737-7194.

MAXIM

Distributed by Arrow, Bell/Graham, Elmo, Hall-Mark, Nu Horizons, Pioneer, and Wyle. Authorized Maxim Representatives: Alabama, (205) 830-0498; Arizona, (602) 730-8093; California, (408) 248-5300, (619) 278-8021, (714) 261-2123; (818) 704-1655; Colorado (303) 779-8060; Connecticut, (203) 384-1112; Delaware, (609) 778-5353; Florida, (305) 426-4601, (407) 830-8444; Georgia, (404) 447-6124; Idaho, (503) 292-8840; Illinois, (708) 358-6622; Indiana, (317) 844-8462; Iowa, (319) 393-2232; Kansas, (816) 436-6445; Louisiana, (214) 234-8438; Maryland, (301) 644-5700; Massachusetts, (617) 329-3454; Michigan, (313) 352-5454; Minnesota, (612) 941-9790; Mississippi, (205) 830-0498; Missouri, (314) 839-0033, (816) 436-6445; Montana, (503) 292-8840; Nebraska, (816) 436-6445; Nevada, (408) 248-5300; New Hampshire, (617) 329-3454; New Jersey, (516) 351-1000, (609) 778-5353; New Mexico, (602) 730-8093; New York, (516) 351-1000, (607) 754-2171; N. Carolina, (919) 851-0010; Ohio, (216) 659-9224, (513) 278-0714, (614) 895-1447; Oklahoma, (214) 234-8438; Oregon, (503) 292-8840; E. Pennsylvania, (609) 778-5353; W. Pennsylvania, (614) 895-1447; S. Carolina, (919) 851-0010; Tennessee, (404) 447-6124; Texas, (214) 234-8438, (713) 782-4144, (512) 346-9186; Utah, (801) 561-5099; Virginia, (301) 644-5700; Washington, (206) 823-9535; W. Virginia, (513) 278-0714; Wisconsin, (414) 476-2790; Canada, (416) 238-0366, (613) 225-5161, (604) 439-1373, (514) 337-7540.

Maxim is a registered trademark of Maxim Integrated Products. © 1992 Maxim Integrated Products.

* 1000-up FOB. USA suggested resale.

† MAX295/MAX296 will be available after February, 1992.

performance by adding read and write buffers. These 4-word-deep read and write buffers allow the CPU to continue processing: Writes are buffered for later execution and burst or block reads can be picked up independently of the CPU.

In addition, the R3051 and R3081 support DMA for peripherals (the DMA takes over the CPU's external bus). Also, the bus interface has been improved with a higher drive, clock output, a half-frequency bus operation option (to have memory

bus speeds relative to the CPU bus rates), and a slow bus turnaround feature that eliminates 3-state contention problems for external memory reads followed by writes. The 20-, 33-, and 40-MHz parts cost \$98, \$146, and \$196, respectively, (10,000). Samples of the R3081 will be available in March.—**Ray Weiss**

Integrated Device Technology Inc, 3236 Scott Blvd, Santa Clara, CA 95052. Phone (408) 727-6116. FAX (408) 492-8674.

Circle No. 734

clock and has an execution cycle of 0.95 μ sec. The CPU has a set of general-purpose registers, eight 4-bit registers, or four 8-bit registers. These are not minimal processors; they have more than 100 instructions, including bit manipulation and table-reference operators. Six data-addressing modes comprise 1-, 4-, and 8-bit direct; 4-bit register indirect and 8-bit register indirect; and bit-manipulation addressing.

This chip is an extension of an existing 4-bit μ C, the μ PD75P316. The new chip has doubled data memory and additional EPROM. Both chips can run at low voltages, minimizing operating power dissipation: Voltage ranges are 2.7 to 6V.

RAM is organized into four banks of 256 nibbles each. The first bank is for CPU registers, interrupt vectors, and the program stack. The μ C peripherals are memory mapped and are in memory bank 15.

The μ PD75P316A chip comes with peripherals that include an LCD controller, a watchdog timer, an 8-bit binary counter with comparator and count register, a serial bus for interfacing with other processors, and three 4-bit I/O ports.

4-bit microcontroller supports 16 kbytes of EPROM and 1k nibbles of static RAM

Engineers shouldn't treat 4-bit (1-nibble) microcontrollers (μ Cs) as outdated technology. Four-bit μ Cs are alive and kicking. In fact, they're busy attacking the low end of the 8-bit μ C market with specialized peripherals. A 4-bit μ C, the μ PD75P316A, combines 16 kbytes of EPROM with low power consumption, direct drive for LEDs, and an LCD controller.

Four-bit μ Cs are a variation of

8-bit μ Cs, in that they sport 8-bit instruction sets but use 4-bit arithmetic and data. Thus, they have the same control capabilities of 8-bit μ Cs but suit applications that don't need 8-bit arithmetic or long data words. The μ UPD75P316A, a single-chip μ C with no external memory capability, has 16 kbytes of programmable EPROM on chip and 1k nibbles for data storage.

The chip runs with a 4.19-MHz

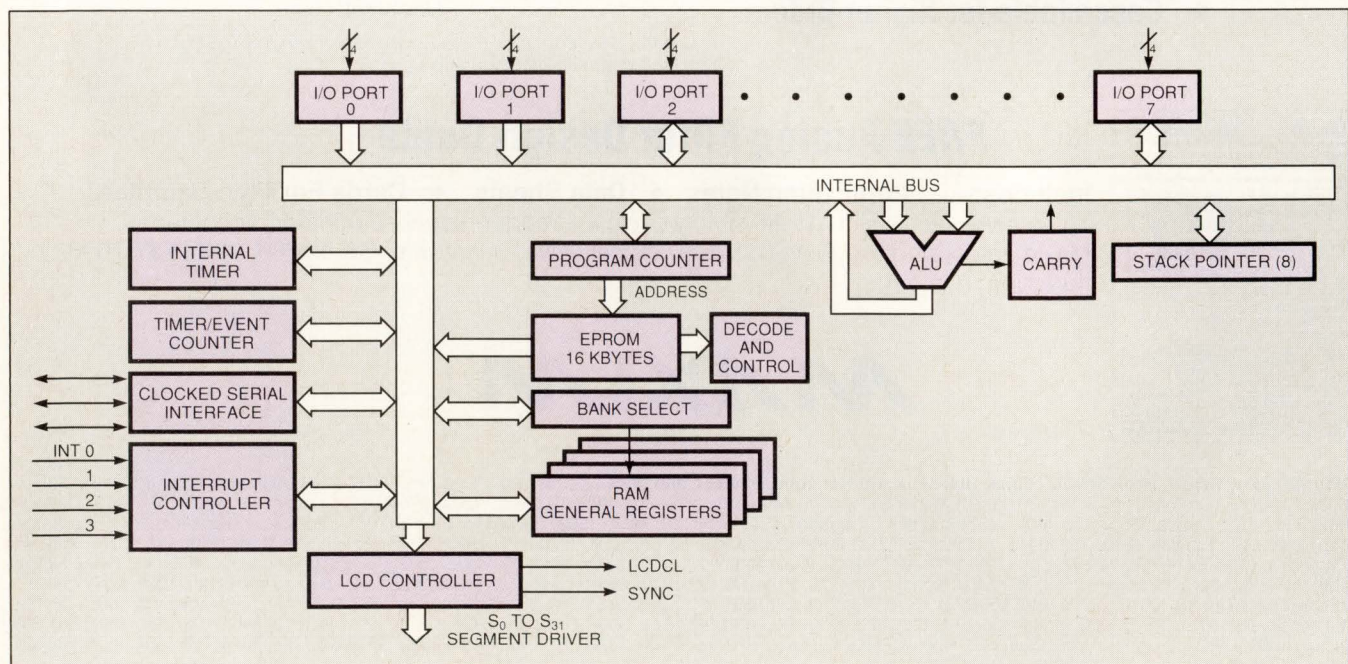

This 4-bit μ C, the NEC μ PD75P316A, is a full-fledged microcontroller with sophisticated peripherals, including an LCD controller.

QUAD VOLTAGE-OUTPUT 12-BIT DACS REPLACE 4 OP AMPS AND 4 DACS!

Save Valuable Board Space With 24-Pin SO Package

Maxim's new MAX526 quad voltage-output A/D converter replaces 4 digital-to-analog converters (DACs) and 4 op-amps with a single CMOS monolithic IC! The new DAC delivers performance you'd expect from hybrid and module quad DACs. Maxim guarantees monotonic 12-bit performance with 1/2LSB relative accuracy over temperature for all 4 outputs, and 1LSB total unadjusted error with no zero- or full-scale adjustments. And, 10V outputs settle to 1/2LSB in 5 μ s.

- ◆ Four 12-Bit DACs in One Package
- ◆ Buffered Voltage Output
- ◆ 1LSB Total Unadjusted Error
- ◆ Double-Buffered Logic Inputs
- ◆ 24-pin DIP and SO Packages
- ◆ Parallel μ P Interface

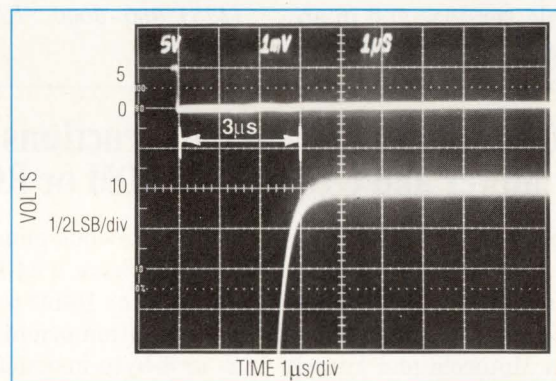

Typical MAX526 performance-output settling to 1/2LSB (1.2mV) in less than 3 μ s with a 5k Ω + 100pF load.

Input Double Buffering & Output Amplifiers Simplify Design

The MAX526's double-buffered 8-bit parallel interface simplifies digital connections by eliminating "glue" logic. The analog interface is also simplified by built-in output amplifiers, eliminating external op-amps and providing the speed and drive needed for most applications.

D/A CONVERTERS ANALOG

Data Sheets • Applications Notes • Free Samples

Quad DAC Replaces 8 ICs!

12-Bit Voltage Outputs Settle to 1/2LSB in Less Than 5 μ s

Maxim's MAX526 is a single 24-pin CMOS monolithic DAC/ADC converter that replaces 8 ICs (4 DACs and 4 op-amps) with a single IC. It features 12-bit digital-to-analog conversion, 10V outputs, and 100pA current sources. The MAX526 is available in 24-pin SO and DIP packages.

Quad 8-Bit DACs Digitally Adjust On-Chip Comparator Thresholds

Build Window Comparators and Limit Detectors with Minimum Part Count and Simple Logic

Maxim offers the MAX526 in a range of pin packages including 24-pin SO and DIP. For more information, contact your local Maxim representative or call (408) 737-7600.

ANALOG

1. DACs

2. ADCs

3. Comparators

4. Op-Amps

5. Timers

6. Voltage Regulators

7. Voltage Detectors

8. Voltage Monitors

9. Voltage Transceivers

10. Voltage Followers

11. Voltage Sources

12. Voltage Sinks

13. Voltage Dividers

14. Voltage Buffers

15. Voltage Amplifiers

16. Voltage Comparators

17. Voltage Limiters

18. Voltage Limiters

19. Voltage Limiters

20. Voltage Limiters

21. Voltage Limiters

22. Voltage Limiters

23. Voltage Limiters

24. Voltage Limiters

MAXIM

FREE Analog D/A Design Guide

Including: Application Notes ◆ Data Sheets ◆ Cards For Free Samples

To receive your free design guide, simply circle the reader response number, or contact Maxim Integrated Products, 120 San Gabriel Drive, Sunnyvale, CA 94086, (408) 737-7600, FAX (408) 737-7194.



Distributed by Arrow, Bell/Graham, Elmo, Hall-Mark, Nu Horizons, Pioneer, and Wyle. Authorized Maxim Representatives: Alabama, (205) 830-0498; Arizona, (602) 730-8093; California, (408) 248-5300, (619) 278-8021, (714) 261-2123, (818) 704-1655; Colorado, (303) 779-8060; Connecticut, (203) 384-1112; Delaware, (609) 778-5353; Florida, (305) 426-4601, (407) 830-8444; Georgia, (404) 447-6124; Idaho, (503) 292-8840; Illinois, (708) 358-6622; Indiana, (317) 844-8462; Iowa, (319) 393-2232; Kansas, (816) 436-6445; Louisiana, (214) 234-8438; Maryland, (301) 644-5700; Massachusetts, (617) 329-3454; Michigan, (313) 352-5454; Minnesota, (612) 941-9790; Mississippi, (205) 830-0498; Missouri, (314) 839-0033, (816) 436-6445; Montana, (503) 292-8840; Nebraska, (816) 436-6445; Nevada, (408) 248-5300; New Hampshire, (617) 329-3454; New Jersey, (516) 351-1000, (609) 778-5353; New Mexico, (602) 730-8093; New York, (516) 351-1000, (607) 754-2171; N. Carolina, (919) 851-0010; Ohio, (216) 659-9224, (513) 278-0714, (614) 895-1447; Oklahoma, (214) 234-8438; Oregon, (503) 292-8840; E. Pennsylvania, (609) 778-5353; W. Pennsylvania, (614) 895-1447; S. Carolina, (919) 851-0010; Tennessee, (404) 447-6124; Texas, (214) 234-8438, (713) 782-4144, (512) 346-9186; Utah, (801) 561-5099; Virginia, (301) 644-5700; Washington, (206) 823-9535; W. Virginia, (513) 278-0714; Wisconsin, (414) 476-2790; Canada, (416) 238-0366, (613) 225-5161, (604) 439-1373, (514) 337-7540.

Maxim is a registered trademark of Maxim Integrated Products. © 1992 Maxim Integrated Products.

To save on component costs, the I/O-port pins have programmable pullup resistors. Three ports can drive LEDs directly, eliminating the cost of drivers or buffers.

The on-chip LCD controller has four modes, which drive 32, 64, 96, or 128 LCD segments. The controller saves the LCD data in the upper 32 nibbles of RAM bank 1. The controller has built-in timer functions (using the μ C timer) to refresh the LCD displays automatically. Signals coordinate multiple μ Cs acting as LCD controllers.

The μ PD75P316A comes in an 80-pin quad flatpack for one-time-programmable versions and in an 80-pin leadless chip carrier with a

window for reprogramming. To program the EPROM, 12.5V are needed. The chips meet commercial -40 to +85°C temperature ranges.

Development support for the 4-bit μ C includes a structured assembler preprocessor, which incorporates high-level control constructs into assembly code, making it easier to structure a program.

The μ PD75P316A costs \$27.95 (10,000) for the one-time-programmable part and \$65 for the reprogrammable part (small qty).

—Ray Weiss

NEC Electronics Inc, 401 Ellis St, Mountain View, CA 94039. Phone (415) 960-6000. FAX (800) 729-9288.

Circle No. 735

16-bit μ C combines 200-nsec instructions with low power and 64-kbyte EPROM or ROM

American engineers can now design in Hitachi's 16-bit, high-end microcontroller (μ C) H8/500 series. Because a patent-infringement suit between Motorola and Hitachi has been settled, the H8/500 is now available in the United States. The H8/500 is a 16-bit μ C having a 200-nsec basic instruction cycle backed up with as much as 62 kbytes of on-chip EPROM or ROM and 2 kbytes of static RAM.

The previous-generation 300 series μ Cs have a 64-kbyte address space, 8- or 16-bit registers, a register operation orientation, and fixed 2- or 4-byte instructions. In contrast, the 500 series can address 16 Mbytes using paged addressing. The series also features an orthogonal instruction set, a 32-bit-long word for 32-bit processing, and a peripheral set.

The H8/500 μ Cs support a single

address space—with as much as 16 Mbytes of external memory—using memory pages. The CPU works within a 64-kbyte page, which is defined by page registers. The three major memory modes of the chip include Expanded Minimum, which addresses 64 kbytes of external memory; Expanded Maximum, which addresses 1 Mbyte of external memory (16 pages); and Single Chip, which addresses on-chip memory only. The μ Cs have an 8- or 16-bit external memory bus. Internal-memory accesses take two internal clock cycles, and external-memory accesses take three cycles.

The series has eight general-purpose 16-bit registers—two of which are dedicated as stack and frame pointers. Running at 10 MHz, the μ Cs deliver a 200-nsec add, a 1.6- μ sec multiply, and a 2.6- μ sec divide. The series has a variable instruction length with 63 instructions. The μ Cs' seven addressing modes include a register indirect with an increment/decrement option, which is effective for optimized table-entry processing. The instruction set also includes bit manipulation and test instructions.

The instruction-processing rate increases by laying out instruction object code in reverse order in memory. Instead of having the op code as the leading byte for an instruction, it is presented last, trailing the effective address information. This reversal speeds execution because the effective address fetches can parallel instruction decoding.

The μ Cs have as much as 62 kbytes of on-chip program memory, which is the largest amount of on-chip memory for any commercial 16-bit μ C. This factory-programmed memory is either mask ROM or one-time-programmable EPROM (zero turn-around time) for fast delivery and prototyping. For program development, windowed reprogrammable EPROM parts will be available in 80-pin, plastic-led-chip-carrier versions of standard 84-pin, zero-

Table 1—Hitachi H8/500 Series Microcontrollers

H8 Version	Features	Price (quantity)
Common to all	Seven or more ports, duplex serial channel, 10-bit A/D converter (13.8 μ sec) watchdog timer, 9 external interrupts, DMA controller, wait-state controller, 8-bit multifunction timer, 2 or more 16-bit timers, 3V power versions	NA
510	ROMless controller 16-bit external bus, on-chip DRAM refresh 112-pin quad flatpack	\$11.85 (5000)
520	Low-end controller 64-pin package 16-kbyte ROM/EPROM, 512 bytes of RAM	\$11.45 ROM (10,000) \$22.22 EPROM (1000)
532/534	Midrange controller, 3 PWM timers, extra 16-bit timer, 32-kbyte ROM/EPROM, 1- to 2-kbyte RAM 84-pin plastic leaded chip carrier or 80-pin quad flatpack	\$14.20 ROM (10,000) \$25.80 EPROM
536	High-end controller, 3 PWM timers, extra 16-bit timer, 62-kbyte EPROM/ROM	\$19.40 ROM (10,000) \$34.10 EPROM (1000)

Note: NA=Not applicable.

WORLD'S LOWEST COST 12-BIT 3 μ S A/D

The Next Industry Standard for Only \$15.00*

For applications demanding blazing speed and low cost, Maxim offers the new MAX183, the lowest-cost 3 μ s 12-bit A/D ever! Built with a proprietary BiCMOS process, the new A/D provides high speed and low code-edge noise, while consuming only 90mW of power. For applications that don't require 3 μ s conversion times, Maxim offers the 5 μ s MAX184 and 10 μ s MAX185, two new lower-priced ADCs that are otherwise identical to the MAX183.

- ◆ $\pm 1/2$ LSB Max Integral Nonlinearity
- ◆ "No Missing Codes" Performance Over Full Operating Temperature Range
- ◆ 100ns Max Data Access Time and Three-State Data Outputs for Parallel Microprocessor Interfaces

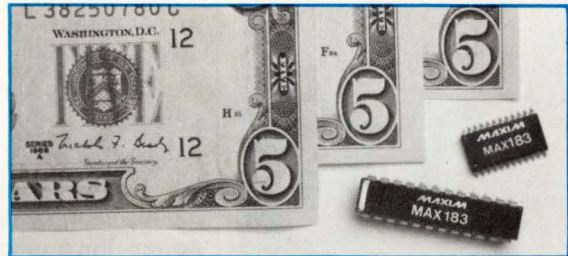

Simplify Your Design

The MAX183 reduces design complexity and time with flexible +5V, +10V, or ± 5 V input ranges and an internal reference buffer that allows one system reference to drive multiple ADCs. The A/D works with an external voltage reference, so you can choose the optimum one for each application.

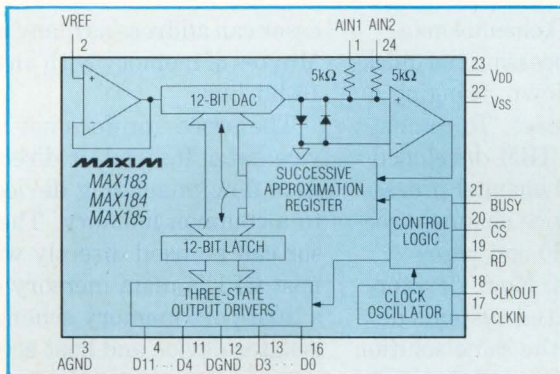

- ◆ Flexible +5V, +10V, ± 5 V Input Ranges
- ◆ Operates with +5V, and -12V or -15V Supplies
- ◆ Drive A/D from a Crystal or an External Clock Source
- ◆ Small-Footprint 24-Pin DIPs and SOICs

A/D CONVERTERS ANALOG

Data Sheets • Application Notes • Free Samples

Self-Contained 8-Ch 12-Bit Data-Acquisition System Simplifies Design: "Analog In/ Data Out"

Each 100kbit Channel is 2¹² Configurable for Differential/Single Ended and Unipolar/Bipolar Input Ranges.

Maxim's new MAX183 provides a 12-bit, 3 μ s conversion time, 90mW power consumption, and a 100ns max data access time. It is the lowest-cost 12-bit A/D ever! Built with a proprietary BiCMOS process, the new A/D provides high speed and low code-edge noise, while consuming only 90mW of power. For applications that don't require 3 μ s conversion times, Maxim offers the 5 μ s MAX184 and 10 μ s MAX185, two new lower-priced ADCs that are otherwise identical to the MAX183.

New BiCMOS Design Makes a Better 574A: 8 μ s Fast, 3-Times Less Power, Space-Saving SOIC Package

MAX174 Drops In 574A and 574A Applications, Improving Performance with No Design Effort

MAXIM

FREE A/D Converter Design Guide

Includes: ◆ Application Notes ◆ Data Sheets ◆ Cards For Free Samples

Simply circle the reader response number, contact your Maxim representative or Maxim Integrated Products, 120 San Gabriel Drive, Sunnyvale, CA 94086, (408) 737-7600, FAX (408) 737-7194.

MAXIM

Distributed by Arrow, Bell/Graham, Elmo, Hall-Mark, Nu Horizons, Pioneer, and Wyle. Authorized Maxim Representatives: Alabama, (205) 830-0498; Arizona, (602) 730-8093; California, (408) 248-5300, (619) 278-8021, (714) 261-2123; (818) 704-1655; Colorado (303) 779-8060; Connecticut, (203) 384-1112; Delaware, (609) 778-5353; Florida, (305) 426-4601, (407) 830-8444; Georgia, (404) 447-6124; Idaho, (503) 292-8840; Illinois, (708) 358-6622; Indiana, (317) 844-8462; Iowa, (319) 393-2232; Kansas, (816) 436-6445; Louisiana, (214) 234-8438; Maryland, (301) 644-5700; Massachusetts, (617) 329-3454; Michigan, (313) 352-5454; Minnesota, (612) 941-9790; Mississippi, (205) 830-0498; Missouri, (314) 839-0033, (816) 436-6445; Montana, (503) 292-8840; Nebraska, (816) 436-6445; Nevada, (408) 248-5300; New Hampshire, (617) 329-3454; New Jersey, (516) 351-1000, (609) 778-5353; New Mexico, (602) 730-8093; New York, (516) 351-1000, (607) 754-2171; N. Carolina, (919) 851-0010; Ohio, (216) 659-9224, (513) 278-0714, (614) 895-1447; Oklahoma, (214) 234-8438; Oregon, (503) 292-8840; E. Pennsylvania, (609) 778-5353; W. Pennsylvania, (614) 895-1447; S. Carolina, (919) 851-0010; Tennessee, (404) 447-6124; Texas, (214) 234-8438, (713) 782-4144, (512) 346-9186; Utah, (801) 561-5099; Virginia, (301) 644-5700; Washington, (206) 823-9535; W. Virginia, (513) 278-0714; Wisconsin, (414) 476-2790; Canada, (416) 238-0366, (613) 225-5161, (604) 439-1373, (514) 337-7540.

Maxim is a registered trademark of Maxim Integrated Products. © 1992 Maxim Integrated Products.

PICO Transformers & Inductors

**PLUG-IN
SURFACE MOUNT
AXIAL INDUCTORS
TOROIDAL
INSULATED LEADS**

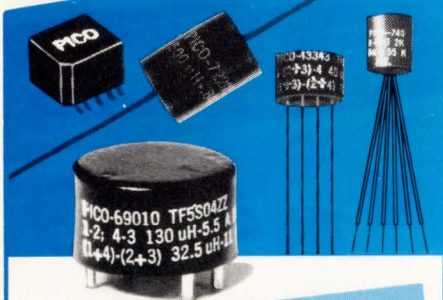

TRANSFORMERS

QPL standards available
MIL-T-27/103-1 thru 16, MIL-T-27/172-1 thru 50,
MIL-T-27/357-1 thru 114, MIL-T-27/358-1 thru 123,
MIL-T-27/359-1 thru 147

- Audio Transformers ranging in size from $\frac{1}{4}'' \times \frac{1}{4}''$ to $\frac{3}{4}'' \times \frac{1}{16}''$. 20 Hz to 250 KHz. Up to 3 watts.
- Pulse Transformers .05 μ SEC to 100 μ SEC miniaturized construction.
- Ultra-miniature DC-DC Converter Transformers. 40 watts.
- Miniaturized Switchmode Inverter Transformers. 60 watts.
- 400 Hz Power Transformers. Primary voltages of 115V or 26V. Plug-in construction. Ultra-miniature
- Microphone/Transducer Audio Input.
- MIL-STD-1553 Interface Multiplex Data BUS Pulse Transformers.

POWER INDUCTORS

QPL standards available MIL-T-27/356-1 thru 63

- Inductance values to 20mH with DC currents to 23 amps

COMMON MODE INDUCTORS

HIGH "Q" INDUCTORS

**PICO
Electronics, Inc.**
453 N. MacQuesten Pkwy. Mt. Vernon, N.Y. 10552

Call Toll Free **800-431-1064**

IN NEW YORK CALL **914-699-5514**
FAX **914-699-5565**

CIRCLE NO. 45

100 • EDN January 20, 1992

EDN-PROCESSOR UPDATE

turnaround-time parts. These devices can be programmed in a standard 27256-type EPROM programmer.

These 16-bit μ Cs also have a large set of on-chip peripherals, which include two or three 16-bit timers, an 8-bit free-running timer, a DMA controller, seven to nine I/O ports, an interrupt controller, a 10-bit A/D converter, a serial communications interface (duplex), and a watchdog timer.

The μ Cs have built-in power management. You can choose three programmable power-down states: Sleep, where the clock and support peripherals run, but the CPU is halted; Software Standby; or Hardware Standby—in both standby modes everything is halted. In all power-down modes, RAM and reg-

ister values are held. Recovery is triggered by combinations of interrupts and special pin inputs. Typical current dissipation is 30 mA running, and 20 mA and 0.01 μ A, respectively, for sleep and standby modes.

Software tools are available for the μ C series: two C compilers from Avocet Systems Inc (Rockport, ME) and Software Environments Ltd (Dallas, TX), as well as a Forth system, and a Fuzzy-Logic compiler from Togai Infralogic (Irvine, CA). In-circuit emulators are also available from a number of vendors.

—Ray Weiss

Hitachi America Ltd, Semiconductor and IC Div, 2000 Sierra Point Pkwy, Brisbane, CA 94005. Phone (415) 589-8300. FAX (415) 583-4207.

Circle No. 736

Programmable I/O processor services device interrupts

Device and I/O channel management processing can quickly load a system down, bringing a host CPU to its knees. To combat this, in the 1960s, IBM developed programmable I/O channel processors to offload device channel processing from the 360 and later-version host CPUs. Now, desktop, server, and dedicated-systems designers can apply the same solution to their designs with an I/O processor chip, the Signetics SC26C460.

When a device needs service, it triggers a request line; the SC26C460 processor will then queue these requests, servicing them by assigned priority. The chip can interrupt the host CPU to pass data or request service.

The chip is a dedicated I/O processor that can handle as many as 32 device channels, directing and controlling their I/O data streams. The chip is programmable, with 15 instructions; the processor offloads the host CPU by fielding device interrupts and managing the device data transfers between the peripherals and main memory. The proc-

essor can address as many as 16 Mbytes of memory with an 8- or 16-bit bus.

The processor does not buffer device data. Instead, it directs the data flow, managing device access to a common memory. The processor can be used directly with the host CPU's main memory or with a dual-port memory scheme, which isolates device and host access without creating contention on the host memory bus.

The processor stores separate memory addresses and buffer lengths for each device channel; each device channel has a separate channel program-entry point. The processor can interrogate and check device status, read and write a peripheral, and branch to a different processing stream. It can also translate device code via decision tables.

The SC26C460 I/O processor comes in a 68-pin plastic leaded chip carrier and costs \$18.50 (1000).—Ray Weiss
Signetics, Box 3409, Sunnyvale, CA 94088. Phone (408) 991-2000. FAX (408) 991-2311. Circle No. 737

SMALL 5TH-ORDER LOWPASS FILTERS WITH NO OFFSET

Simplify High-Order Filter Designs

When you need high-order lowpass filters in compact miniDIP and SOIC packages, choose Maxim's new MAX280 or MAX281. Both achieve accurate 5th-order responses with minimal design time for either Butterworth or Bessel lowpass filters. Maxim's filter architecture removes DC offset, improving accuracy while eliminating trims in precision applications.

- ◆ **Choose Your Response:**
Maximally Flat - MAX280
Fast Settling - MAX281
- ◆ **Zero DC Offset**
- ◆ **Zero Insertion Loss**
- ◆ **Adjustable Corner Frequency to 20kHz**
- ◆ **100 : 1 Clock/Cutoff Frequency Ratio
Minimizes Noise**
- ◆ **Internal or External Clock for
Synchronous or Asynchronous
Applications**

EASY 5TH-ORDER FILTER DESIGN IN TWO STEPS:

- Step 1:** Choose corner frequency and C.
Step 2: Calculate f_{CLOCK} and R.

DONE!

And DC offset is only a few microvolts!

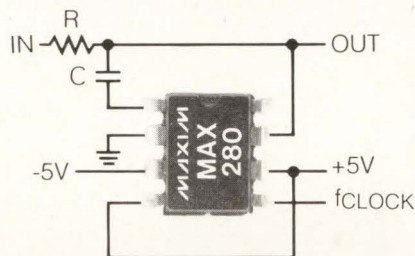

Choose the Best Lowpass Response - Bessel or Butterworth

The MAX281's Bessel response provides low overshoot and rapid settling for pulse and step input signals from weigh scales and multiplexed input sources. The MAX280 Butterworth lowpass offers flat frequency response for audio, telecom, and dynamic signal analysis.

FILTERS ANALOG DESIGN GUIDE

Data Sheets • Application Notes • Free Samples

96db Dynamic Range Analog Filter Satisfies 12-Bit Data-Acquisition Needs

Continuous-Time Filtering Excels Where Switched-Capacitor Filters Fail

Universal-Filter Designs Offer μP or Pin-Strap Programmability

Frequency Range: 0.01Hz to 10kHz

MAXIM

FREE Analog Filter Design Guide

Including: ◆ Application Notes ◆ Data Sheets ◆ Cards For Free Samples

Simply circle the reader response number, contact your Maxim representative or Maxim Integrated Products, 120 San Gabriel Drive, Sunnyvale, CA 94086, (408) 737-7600, FAX (408) 737-7194.



Distributed by Arrow, Bell/Graham, Elmo, Hall-Mark, Nu Horizons, Pioneer, and Wyle. Authorized Maxim Representatives: Alabama, (205) 830-0498; Arizona, (602) 730-8093; California, (408) 248-5300, (619) 278-8021, (714) 261-2123, (818) 704-1655; Colorado (303) 779-8060; Connecticut, (203) 384-1112; Delaware, (609) 778-5353; Florida, (305) 426-4601, (407) 830-8444; Georgia, (404) 447-6124; Idaho, (503) 292-8840; Illinois, (708) 358-6622; Indiana, (317) 844-8462; Iowa, (319) 393-2232; Kansas, (816) 436-6445; Louisiana, (214) 234-8438; Maryland, (301) 644-5700; Massachusetts, (617) 329-3454; Michigan, (313) 352-5454; Minnesota, (612) 941-9790; Mississippi, (205) 830-0498; Missouri, (314) 839-0033, (816) 436-6445; Montana, (503) 292-8840; Nebraska, (816) 436-6445; Nevada, (408) 248-5300; New Hampshire, (617) 329-3454; New Jersey, (516) 351-1000, (609) 778-5353; New Mexico, (602) 730-8093; New York, (516) 351-1000, (607) 754-2171; N. Carolina, (919) 851-0010; Ohio, (216) 659-9224, (513) 278-0714, (614) 895-1447; Oklahoma, (214) 234-8438; Oregon, (503) 292-8840; E. Pennsylvania, (609) 778-5353; W. Pennsylvania, (614) 895-1447; S. Carolina, (919) 851-0010; Tennessee, (404) 447-6124; Texas, (214) 234-8438, (713) 782-4144, (512) 346-9186; Utah, (801) 561-5099; Virginia, (301) 644-5700; Washington, (206) 823-9535; W. Virginia, (513) 278-0714; Wisconsin, (414) 476-2790; Canada, (416) 238-0366, (613) 225-5161, (604) 439-1373, (514) 337-7540.

Maxim is a registered trademark of Maxim Integrated Products. © 1992 Maxim Integrated Products.

Now you can afford to

Presenting a very small development in Ethernet.*
Chipsets that are matched to your system and your budget. In fact, they cost you as little as 5 square inches. Which, by the way, is less total real estate than any competitive solution. But sizable reductions don't stop with board space, because we're also reducing the price up to 30 percent.

Needless to say, true plug-and-play simplicity requires an intelligent network interface. So our new high-integration 82503 Dual Serial Transceiver goes beyond IEEE 802.3 to include automatic port selection, polarity switching and a jumperless interface to AUI or TPE.

For unmatched desktop performance, we offer

© 1992 Intel Corporation. Intel386 and Intel486 are trademarks of Intel Corporation. *Ethernet is a registered trademark of Xerox and Diamond is a registered trademark of Diamond Brands, Inc.

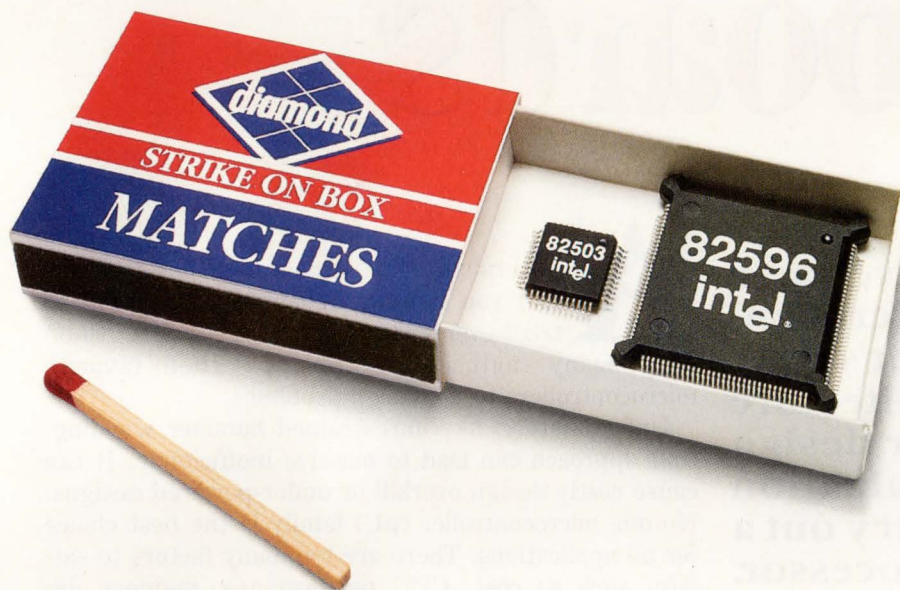

put Ethernet in any box.

a complete family of 82596 LAN coprocessors, each optimized to a specific Intel486™ CPU for maximum throughput. And our 82593 is the perfect LAN controller for Intel386™ SL notebooks.

Best of all, these true two-chip solutions give you the flexibility to simplify your design and deliver your product to market in the smallest of timeframes.

So look into today's hottest Ethernet chipsets. Call (800) 548-4725 and ask for Lit. Packet #YA23. And learn why we have the perfect match for your next box.

intel®

The Computer Inside.™

8-bit μ C evaluation boards

You no longer have to be tied to a single microcontroller (μ C) family. It's easy to try another architecture to fill out your design tool kit. Pick an evaluation board and try out a new processor.

RAY WEISS, Technical Editor

As Abraham Maslow noted, "When the only tool you have is a hammer, you tend to treat everything as if it were a nail." Similarly, many engineers try to apply their favorite microcontrollers to all design problems.

Unfortunately, like unrestrained hammer wielding, that approach can lead to massive inefficiency. It can cause costly design overkill or under-powered designs. No one microcontroller (μ C) family is the best choice for all applications. There are too many factors to satisfy, such as cost, CPU performance, memory demands, peripheral needs, and board space. Even so, many engineers are reluctant to try new μ Cs, to go through the painful process of integrating a new CPU and software into their design environment.

However, today it's easy to try out a new μ C. There's a variety of choices, ranging from small, low-cost, minimal-pin-count μ Cs to fast, high-memory density μ Cs loaded with peripherals. And, today's μ Cs have far better documentation and software.

Low-cost evaluation boards and software also put trying out a new system within any engineer's grasp. Most evaluation sets cost less than \$500. Almost all are below a lab manager's sign-off limits.

New μ Cs = PCs + Software

These days it's far easier to add a new μ C family to your design stable. A major enabling factor is the IBM PC, which provides a common base for μ C development tools. PCs and clones also provide a common

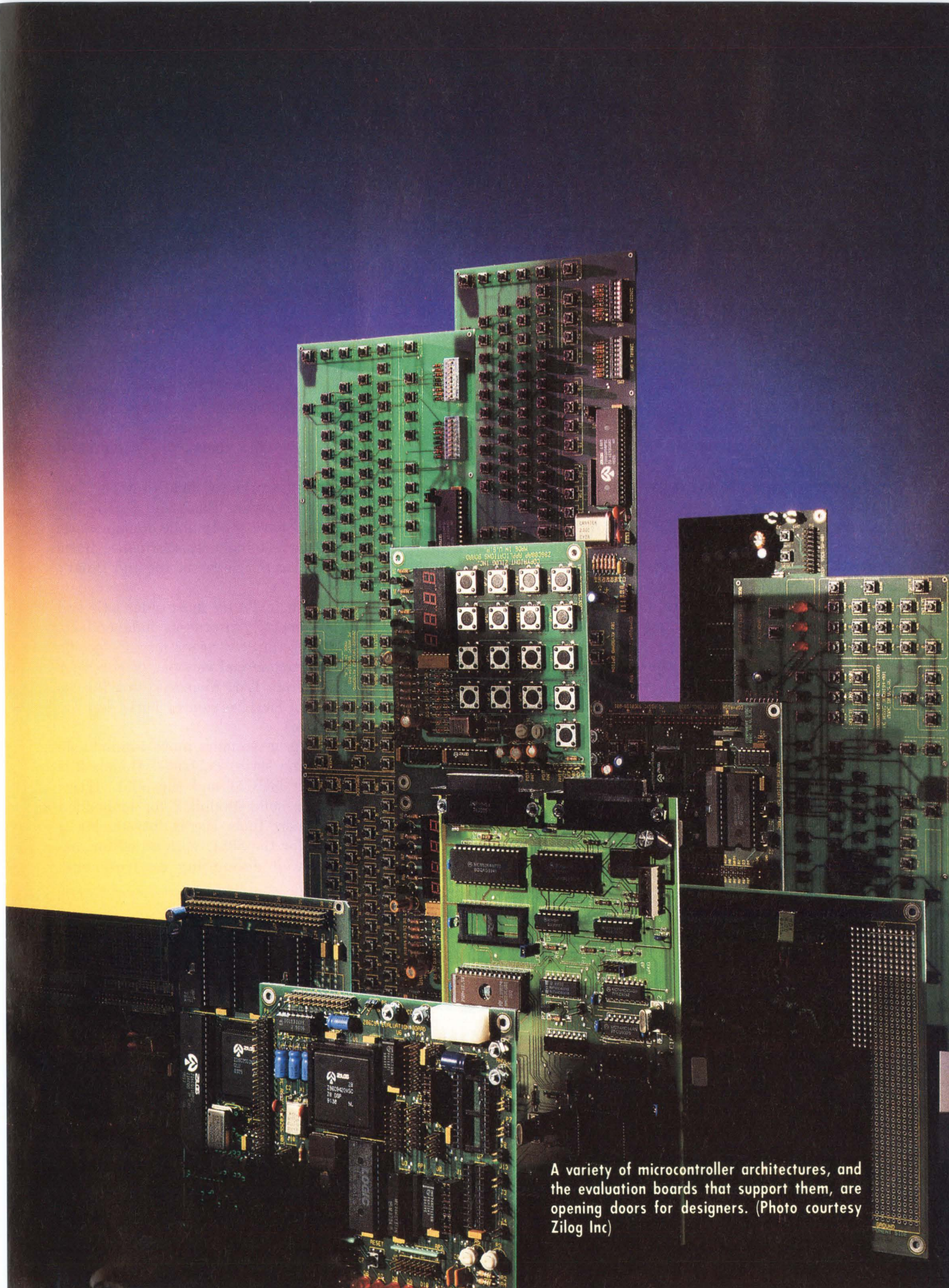

A variety of microcontroller architectures, and the evaluation boards that support them, are opening doors for designers. (Photo courtesy Zilog Inc)

8-BIT μ C EVALUATION BOARDS

operating methodology for tools, unlike years ago in the age of "blue boxes," where each chip vendor had their own proprietary development stations.

Most evaluation boards link to a PC via its serial port. Users on the PC host interact with the target board through terminal emulator software. Typically, the target μ C runs a target monitor, a software kernel that controls the μ C and links to the host. Through a terminal emulator, users link to the monitor and interactively start, stop, set breakpoints, and interrogate the target μ C processor. They can also read or set memory and registers.

These monitors provide ICE (in-circuit emulator)-like capabilities for debugging. Monitors are not free: The penalty for monitor use is that they take up program memory and are intrusive—taking CPU cycles to run.

Easing the transition to new μ Cs is a new generation of development software—assemblers, compilers, and utilities. Much improved over early generations, these tools have increased reliability and usability. PC-based, many tools are taking on common interfaces and operating characteristics, making it easier to add new tools.

In addition, many tool kits now incorporate μ C instruction-set simulators. These simulators let engineers play with a new architecture in a highly controlled simulation environment before tackling the hardware. With a simulator you can interactively monitor your running code.

One advantage of evaluation boards is that they can also serve as low-cost pseudo ICEs. For example, the Motorola evaluation modules also serve as low-cost ICEs for target μ Cs running in single-chip mode. They come with a cable that plugs into a target board's μ C

socket. Programs running under monitor control on the evaluation-module μ C can drive a target board via the cable.

Languages make it easier

Another major factor opening up μ C use is an increasing use of high-level languages for embedded applications. C is the new de facto high-level language for embedded systems. High-quality C compilers are available for embedded μ Cs such as the 8051, the 68HC11, and even the 68HC05. With C, users can move algorithms and large blocks of code between μ Cs. However, there are portability problems with μ C-specific code, especially with memory segmentation and peripherals.

C, however, doesn't have the μ C field to itself. Two major language competitors are Basic and Forth. The 8051, 68HC11, and Z80 have solid public-domain Basic interpreters. There are also higher-performance Basic compilers for the 8051 from Systronix Inc and Binary Technology Inc.

Forth implementations exist for most older μ Cs and μ Ps. Forth code is generally processor independent, with special word (procedure) versions for μ C-specific hardware. There are commercial versions of Forth for the Z80 and 68HC11 from LMI Microsystems Inc, as well as a public-domain 8051 version of Forth (on the Signetics bulletin board).

For those 8-bit μ C programmers more comfortable with a Pascal-like coding style, PC-based Modula-2 is available for both the 68HC11 and the 8051. Introl Corporation supplies a solid Modula-2 for embedded applications. Vail Silicon Tools Inc is introducing a Modula-2/51 compiler for the 8051, with an editor, assembler, and windowed debugging environment.

Getting started easily

Getting started on a new microcontroller (μ C) has some barriers to overcome. These include learning its architecture, a new instruction set, and the μ C peripherals and how to use them. Databooks are notoriously dense reading. Here are some books for a quick start:

The 8051 Microcontroller: Architecture, Programming, and Applications by Kenneth J Ayala, West Publishing, Minneapolis, MN, 1991. \$49.

This is an excellent professional

introduction to the 8051 μ C. The book discusses simple hardware and software applications with sample code. Applications include Keypads, LCDs, D/A, A/D, and serial communications. A limited 8051 simulator/debugger and an assembler come with the book, letting you try out 8051 programs without hardware.

Single- and Multiple-Chip Microcomputer Interfacing by GJ Lipovski, Prentice Hall, Englewood Cliffs, NJ,

1988. The book costs \$34.90, and the laboratory manual costs \$12.70. Both are available either directly from Motorola or from bookstores.

This set is a beginning class text for μ C applications with some elementary material. The book may be for beginners, but it includes excellent code and logic-design examples. It provides a fast start-up for the 68HC11 μ C.

Modula-2 code generally matches 8051 C efficiencies.

But languages are only a means to effectively use the underlying μ C hardware. Engineers must analyze the different microcontroller architectures for specific applications. Evaluation boards give them a chance to try out a μ C before actually building hardware and coding full applications.

At the low end with the 68HC05

The Motorola 68HC05 is considered by many to be the leading 8-bit μ C. It's a minimal architecture with only two active registers (A and X), supplemented by control registers. It is self contained with a minimal pin count: there's no external memory. On-chip memory runs from 2 kbytes to 15,936 bytes of ROM, EPROM, or EEPROM, with 176 bytes of static RAM (SRAM).

The basic 68HC05C4 μ C features four I/O ports, a programmable timer (with compares), and two specialized serial-communications ports. Motorola uses the 6805 core in custom ASICs, many of which have become standard parts. Consequently, there are more than 100 variations on the 6805. Chip pin counts for the 68HC05 run from 24 to 40.

Motorola has evaluation boards and modules for the 68HC05: The modules are equipped with a programmer for writing the μ C's EPROM. Motorola's 68HC05EVM is built around a 68HC05C9, which has 15,936 bytes of on-chip EPROM. The evaluation module simulates the single-chip mode (on-chip memory) of operation using external memory. User code and data are downloaded into the evaluation module's RAM or pseudo ROM from a host PC or terminal. The μ C's ROM is simulated using write-protected, evaluation-module RAM. The μ C switches back and forth between the monitor and the user-address maps during execution. There are 16 kbytes of evaluation-module RAM available for each space. Motorola is moving to evaluation systems, 2-board equivalents to evaluation modules, with a personality daughter board for each 6805 μ C.

With the evaluation modules, Motorola supplies a terminal emulator, a target monitor for debugging, and a macroassembler. P&E Microsystems Inc supplies these tools. Motorola will soon supply an integrated tool set that combines these packages into a single development environment for the 68HC05. This tool set includes an editor, a debugger, a simulator and a communications link to a monitor-based target system. The debugging interface is the same for both the simulator's and the evaluation module's μ C.

Surprisingly, even for a such a simple μ C, there's a first-class C compiler: C6805 from Byte Craft. By rely-

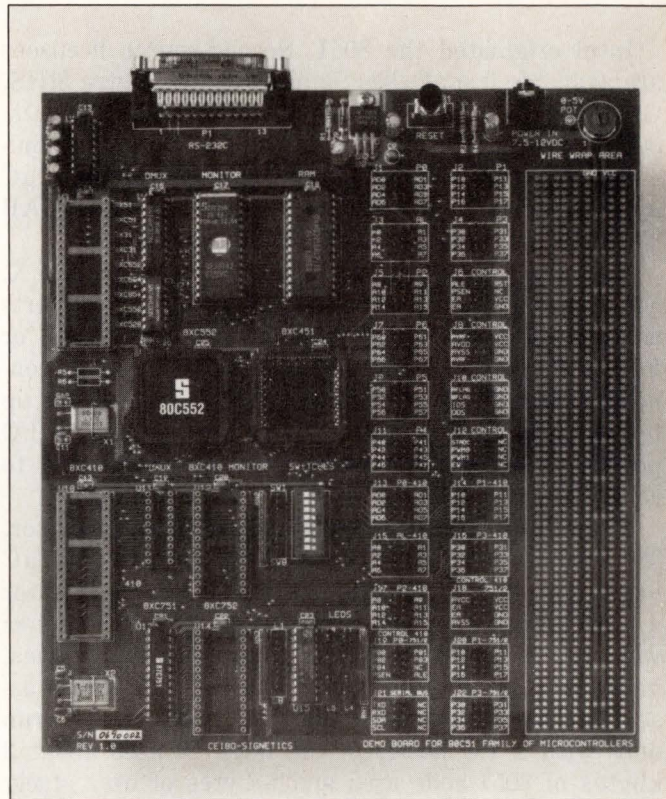

In addition to a limited assembler/disassembler and symbolic debugger, the DB51 development board has a large prototyping area and easy to reach test points. The board also supports a raft of Signetics 8051 derivative chips.

ing on three built-in expert systems to optimize code, the Byte Craft compiler approaches hand-coded code efficiency. It is a very clean and easy-to-use compiler. C6805 comes with a development environment—E6805 Symbolic Host Support. It is compatible with the evaluation module-based P&E tools.

The 8051 still lives

The 8051 is one of the more popular microcontrollers. It is still a powerful 8-bit architecture with four memory-based memory banks (8 registers per bank), special bit operations (with a dedicated memory area), and a dual-memory space with as much as 64 kbytes each for data and external memory. I/O and peripherals are memory mapped and addressed as Special Function Registers.

The 8051's instruction set is fairly easy to learn. It has complex addressing, including register indirection, indexing, and immediate forms. External memory references, however, cost an additional instruction cycle, need register indirection, and pass through the accumulator (A).

8-BIT μ C EVALUATION BOARDS

Intel originated the 8051. Second-source licensees are available from Dallas Semiconductor, Matra MHS, Oki Semiconductor, Siemens, and Philips/Sigmetics. 8051 applications range from low-end μ Cs using minimal-pin-count ICs from Sigmetics to high-end, 8-bit μ C applications using advanced 8051s, like the SAB 80C517 from Siemens with a 16/32-bit math unit.

Intel supplies an evaluation board, the EV80C51FX. The board is built around an 80C51FA and supports as much as 64 kbytes of external memory, RAM, or EPROM. Also on board are 10 LEDs which are connected directly to μ C output ports and can be lit up to test the I/O-port lines. There are two serial I/O ports, one to link to the host PC and the other to connect to the 80C51FA's UART.

The board comes with an embedded-control monitor. This monitor lets a PC host-based user control μ C execution on the evaluation board. With the monitor a user can set as many as 16 software breakpoints as well as read and set registers and memory values, including bits. The software includes a single-line assembler/disassembler. The monitor is designed to run only with a PC host. On the 8051, it uses about 3 kbytes of 8051 code area and 8 bytes of user stack. Sigmetics sells a range of 8051s, including minimal pin configurations. The Sigmetics DB-51 development board supports 16 or more 8051 variations, including μ Cs with the I²C serial bus. The board comes with a host debugger.

If you want to try the high end of 8051 processing, you can get the EMOD-C517 evaluation board from Siemens. This board is built around the Siemens 80C537 ROMless version of the 80C517. This is an 8051 heavyweight with a 32/16-bit math processor,

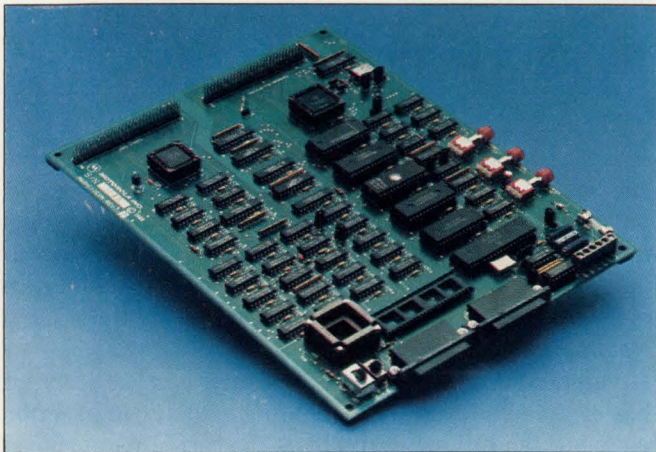

You can directly program or run the Motorola 68HC11EVB μ C with on board EPROM and RAM. The evaluation board includes an on board programmer.

eight 16-bit pointers, seven I/O ports, and a full collection of timers. The board comes with Franklin Software's ROM monitor, Monitor 51, and a terminal emulation program. Franklin C has been ported to this processor and board. The board furnishes 32 kbytes each for program and external data.

The 8051 has solid C compilers. Franklin makes a C development system that delivers efficient code. It comes with a source code debugger, an assembler, and monitor. Commercial simulators and macroassemblers are available from Archimedes and others.

An interesting 8051 evaluation system is Dallas Semiconductor's DS5000KT. Dallas took a new tack, incorporating an 8051 core in a hybrid chip, along with μ C peripherals, SRAM (static RAM) for program and data memory, and a battery. The DS5000 chip is a self-contained unit. The chip is easy to program and debug because it uses SRAM—you can just change your code without having to program an EPROM or EEPROM.

The DS5000KT is built around the DS5000 chip. It connects to the host via a phone cable and has a DIP plug for target systems. It runs either stand-alone or as a target board μ C. Systronix has ported its BCI51-compiled Basic for the DS5000KT. This compiled Basic is fast and eliminates a lot of μ C bookkeeping, such as initialization. It makes a potent development combination with the DS5000KT.

Industrial-strength 8 bits: the 68HC11

Like the 6805, the Motorola 68HC11 is a descendant of the pioneer 6801 μ C. It's more complex than the lean 6805 and has a raft of peripherals for industrial control. These peripherals include five 8-bit I/O ports, an A/D converter, a timer system (with a watchdog timeout), and two serial interfaces. The 68HC11 acts as a single-chip μ C or accesses as much as 64 kbytes of external memory. However, the 68HC11K4 bank switches out to 1 Mbyte of external memory. Like the 8051, an external pin shifts addressing to external memory, making it easy to build RAM- or EPROM-based debugging systems. Unlike the 8051, there's no penalty for off-chip memory accesses.

The 68HC11 is a straightforward CPU architecture that has two 8-bit accumulators and four 16-bit registers (X and Y index, SP stack pointer, and a program counter). Two 16-bit index registers ease 64-kbyte addressing for the 8-bit CPU. On chip, the 68HC11 supports as much as 24 kbytes of ROM or EPROM, 640 bytes of RAM, and 1 kbyte of data EEPROM.

Motorola ships evaluation boards and modules for

the 68HC11. The modules incorporate programmers to program on-chip EPROM. There are boards and modules for different 68HC11 versions. The 68HC11EVM is built around a 68HC11A1FN chip with an EVBbug monitor EPROM, 16 kbytes of SRAM for user ROM, and 8 kbytes of SRAM for the monitor scratch pad or user EEPROM. The evaluation module links to a PC host for monitor-based debugging. The target-board μ C can run in single-chip mode with internal memory or in expanded mode using on board memory. The board accommodates 48-pin DIPs or 52-pin plastic leaded chip carriers (PLCCs).

The evaluation module comes with the Buffalo Monitor and IASM, an integrated debugger, editor, and cross-assembler. IASM, which P&E wrote, is a windowed environment for source-code debugging—monitoring and controlling μ C execution. P&E also sells a 68HC11 simulator. The company is integrating

IASM and the simulator into a single development environment, which will be supplied with Motorola evaluation modules. With the new tool set, developers will be able to easily shift from simulation to direct execution in the same environment. They can test code in the simulator and then run it directly in the 68HC11 in the same test environment.

A number of C compilers are available for the 68HC11, including one from Motorola. Archimedes Software (San Francisco, CA) has an ANSI C compiler. This compiler is similar to Archimedes 8051 and Z80 versions, making it easy to shift code between the μ Cs. Archimedes C is very easy to use and has good documentation. Other 68HC11 C compiler vendors include American Automation, Franklin Software, Introl Corp, and Intermetrics.

Visiting an old friend: the Z80

The Z80 is an old engineering favorite and is heavily used in communications and control applications. Zilog has created a set of embedded Z80-based controllers. These include the Z8 and the super Z8 μ Cs. Second-source Z80 licensees include Hitachi, Goldstar, NEC, SGS Thompson, Sharp, and Toshiba.

Hitachi and Zilog have upped the original 64-kbyte Z80 address space to 1 Mbyte by adding a bank-switching memory-management unit (MMU). The Hitachi HD64180 and the Zilog Z80180 μ Cs have built-in MMUs and are heavily used in high-level embedded systems. Both rely on off-chip program memory, and have two DMA channels, two UARTs, two 16-bit timers, and a clocked serial port. Zilog further extended the architecture with the Z80180 for communications applications with the Z80180. It is a complete Z80180 with additional peripherals: 16 I/O pins, a counter-timer-controller, and a multiprotocol serial communications channel (like the Z85C30 chip).

The core Z80 architecture is surprisingly robust, with a complex instruction set that puts a lot of capability in the engineer's hands. There are more than 155 instructions, including block moves and memory data searches. The Z80 has a duplicate set of program registers: there are two sets of eight 8-bit registers (A, flag, and six general). The CPU also has four 16-bit registers: two index, a stack pointer and a program counter. These registers simplify 16-bit addressing for the 8-bit CPU.

There are lots of evaluation boards for the Z80 family. One is Zilog's Z80181 evaluation board, which contains a Z80181 μ C, 32 kbytes of ROM with the ROM monitor, and 32 kbytes of RAM. Zilog furnishes a terminal-emulator program to control the board. The com-

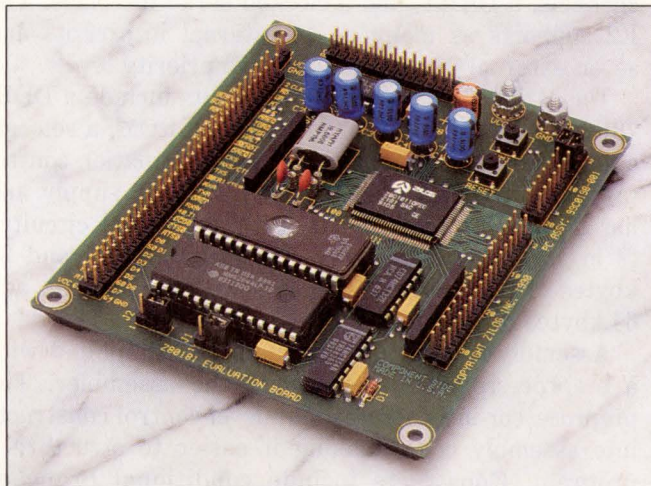

This evaluation board can ring Zilog's Z80181 through its paces. The board holds 32 kbytes of RAM and ROM for the processor. A ROM monitor links control to a PC host.



This evaluation board is a complete system. The Dallas DS5000KT has an 8051 μ C, 32 kbytes of SRAM, and a backup battery. Systronix Basic or Franklin C can be used for higher-level languages.

8-BIT μ C EVALUATION BOARDS

pany also furnishes an assembler and linker/loader for the μ C. You can relocate the code to map into the board RAM.

Because of the Z80's popularity, there are numerous software tools, including C compilers, Forth systems, and assemblers. One is the Archimedes' ANSI Z80/Z181C compiler, which includes an assembler, linker/loader, and librarian.

Zilog also fields a highly innovative package for Zilog communications μ Cs. The Electronic Programmers Manual eliminates a major problem—configuring and using μ C peripherals. Using it, you can set up and use the μ C peripherals directly without having to get into the details of setting the memory-mapped peripheral-control registers. The manual is implemented in an easy to use, windowed environment. It generates a set of C functions or assembler tables for application code.

Many keyboard controllers use the Z80. The Z8602 μ C is designed for keyboard control and comes with code for PC 101/102 keyboards. If you want to play with keyboard control, the ZD86D2 Keyboard Kit evaluation board holds the Z86602, ROM code, and a set of keyboard keys.

NEC K2: The next generation

The 78K2 series is NEC's second generation of 8-bit microcontrollers. A high-end 8-bit μ C, the 78K82xx's CPU can address as much as 1 Mbyte of data memory and 64 kbytes of program memory. K2 μ Cs hold as much as 32 kbytes of ROM, EPROM, or one-time programmable memory, and as much as 1 kbyte of RAM. The external access bus is similar to an 8085, but with separate spaces for data and program. Some versions hold as much as 512 bytes of EEPROM for program and data constants. With a 12-MHz clock, minimal instruction execution is 333 nsec. The μ C packages range from 64-pin DIPs to 74-pin plastic quad flatpacks.

The K2 has an innovative Peripheral Management Unit. A programmer can program the unit to service peripherals directly. In peripheral-management mode, flagged peripheral interrupts don't interrupt program flow or require coding. Instead, the peripheral is serviced as defined by structured tables. The processing is automatic, stealing cycles from the CPU. The macro-service routines transfer data directly between memory and the peripherals independent of program execution.

The K2 has as many as 71 I/O pins. Its peripherals include an A/D converter (8 bits, 16 channels), D/A converter (8 bits, 2 channels), a 16-bit timer, as many as three 8-bit timer/counters, as many as four PWM

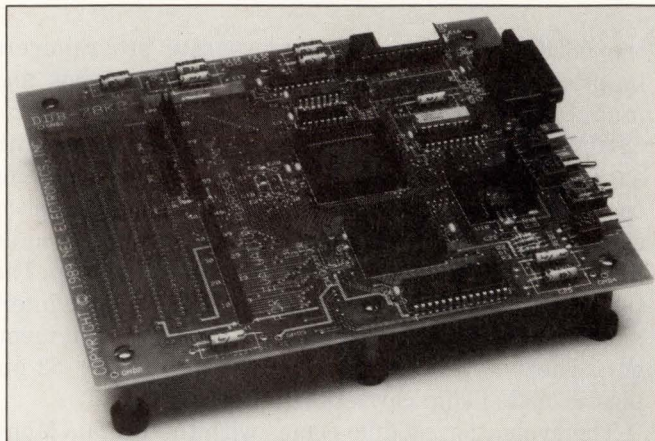

This board comes with a ROM monitor, EPROM, and 32 kbytes each of EPROM or ROM and user SRAM. The board holds an additional 64 kbytes of user data ROM. The DDB-78K2 evaluation board supports the NEC K2 8-bit μ C.

channels, a UART, and a clocked serial interface. The K2 supports as many as 14 internal interrupts and seven external interrupts with two priority levels.

The NEC μ PD782xx evaluation kits include a DDB-78K2-2xx evaluation board, a monitor ROM, a relocatable/structured assembler, and a PC emulation control program. The board comes with a power supply and has a small prototyping area for additional circuitry (9 in.²). The board holds 32 kbytes of ROM and 32 kbytes of RAM. For larger applications, you can add 64 kbytes of data RAM.

Assembly-language programming is simplified with a preprocessor that comes with the assembler. The preprocessor incorporates high-level control constructs into assembly code, making it easier to structure a program. Constructs include conditional branches (if_elseif_endif, if_bit_elseif_endif, and switch_case), loop control (for_next, while_endw, repeat_until, and repeat_until_bit), and loop breaks (break, continue, and goto).

Structured assembly also simplifies coding by letting users work at the symbol rather than the register and instruction level. You can set a variable directly (Drek = #7), instead of coding K2 assembly language (MOV Drek, #7).

And then there were more

Other evaluation boards include these architectures:

PIC

Microchip Technology's PIC 16C5x 8-bit μ C is a third-generation, low-end μ C. The PIC architecture traded simpler internal structures—pipelining, Har-

Table 1—Representative 8-bit evaluation boards

Vendor	Microcontroller (μ C)	Hardware	Software	Price	Comments	Circle number ³
Dallas Semiconductor 4350 Beltwood Pkwy Dallas, TX 75244 (214) 450-0400 FAX (214) 450-0470	DS5000 12 MHz 32-kbyte SRAM ¹ on-chip battery	DS5000KI		\$160	The DS5000 chip is a system with 32-kbyte SRAM and battery backup. It comes with an emulation plug, and you can plug it into the target system and control it with a monitor.	662
		Emulation plug ZIF socket	Host loader (loads, interrogates μ C) basic compiler (optional)			
Echelon Corp 4015 Miranda Ave Palo Alto, CA 94304 (415) 856-6153	Neuron 3150 10 MHz 10-kbyte ROM 2-kbyte RAM 512-byte EEPROM ²	Lonbuilder Starter Kit		\$17,995	This is a hardware/software development environment for the Neuron distributed control chips made by Toshiba and Motorola. The company offers a lease/rental program.	663
		64-kbyte RAM 64-kbyte control RAM 2 ICes 2 nodes	Assembler Neuron-C linker/loader source debugger network manager protocol analyzer			
Intel Corp Embedded Processor Group 5000 W Chandler Blvd Chandler, AZ 85226 (602) 554-2649	80C51FC 16 MHz 32-kbyte ROM 256-byte RAM	EV80C51FX		\$260	iRiSM-integrated monitor and host interface.	664
		32-kbyte SRAM configurable board programmable LED sensor	Line assembler/disassembler symbolic debugger iRiSM-monitor/terminal emulator			
Microchip Technology Inc 2355 W Chandler Blvd Chandler, AZ 85224 (602) 963-7373 FAX (602) 899-9210	PIC17C42 16 MHz 4-kbyte EPROM 232-byte RAM	EDP-17		\$395	3-digit LED display for test. 16-bit instruction word, 8-bit registers/ALU (250-nsec instruction cycle).	665
		64k \times 16-bit SRAM or EPROM EPROM Programmer Wrapped-wire area	Linker/loader assembler			
Motorola Microprocessor Products Group 6501 William Cannon Dr W Austin, TX 78735 (512) 440-2000	68HC05C4 4 MHz 4-kbyte ROM 176-byte RAM	M68HC05EVM		\$500	Can use as a pseudo ICE. Software package from P&E integrates the assembler/editor/simulator/debugger. Onboard programmer accommodates 40-pin DIPs, 44- and 52-lead PLCCs.	666
		16-kbyte monitor EPROM 8/16-kbyte user pseudo ROM programmer emulation pod	Integrated communications/ assembler/editor source-code debugger monitor			
(Same as above)	68HC11A8 4 MHz 8-kbyte ROM 256-byte RAM 512-byte EEPROM	M68HC11EVM		\$500	Can use as a pseudo ICE. Software package from P&E integrates the assembler/editor/debugger/simulator. Onboard programmer handles 48-pin DIPs, 52-lead PLCCs.	667
		8-kbyte monitor EPROM 8/16-kbyte user pseudo ROM programmer emulation pod	Integrated communications/ assembler/editor source-code debugger monitor C compiler (optional)			
National Semiconductor Corp 2900 Semiconductor Dr Santa Clara, CA 95051 (408) 721-5000 FAX (408) 730-0764	COP800 10 MHz 4-kbyte ROM 128-byte RAM	COP800 Designers Kit		\$295	First pass kit with assembler and simulator.	668
		(Simulation kit)	Assembler simulator symbolic debugger			
NEC Electronics Inc 401 Ellis St Mountain View, CA 94039 (415) 960-6000 FAX (800) 729-9288	μ PD78213 12 MHz 16-kbyte EPROM or ROM 512-byte RAM	DDB-78K2-21X		\$295	Wrapped-wire area. Can add 64-kbyte ROM. Comes with ac/dc power supply.	669
		96-kbyte ROM 32-kbyte RAM	Assembler link/loader monitor symbolic debugger C compiler (optional)			
Ok! Semiconductor Inc 650 N Mary Ave Sunnyvale, CA 94086 (408) 720-1900	65511 10 MHz 4-kbyte ROM 128-byte RAM	EVA65K		\$300	16 programmable LEDs 8 assignable DIP switches assignable potentiometer μ C is redesign of 8051. Has 400-nsec instruction cycle and 64-kbyte address spaces.	670
		32-kbyte SRAM 16 programmable LEDs assignable DIP switches potentiometer	Line assembler/disassembler monitor			
SGS-Thompson Microelectronics Inc 1000 E Bell Rd Phoenix, AZ 85002 (602) 867-6259	ST-6220 8 MHz 3876-byte ROM 64-byte RAM	ST-6 Starter Kit		\$195	Elegant μ C programming system with a simulator to try code. Comes with four μ Cs.	671
		μ C EPROM programmer only	Assembler linker/loader source-code debugger simulator			

Notes: 1. SRAM=Static RAM

2. EEPROM=Electrically erasable PROM

3. For more information on 8-bit evaluation boards such as those described in this table, circle the appropriate numbers on the Information Retrieval Service card or use EDN's Express Request Service.

Table continued

8-BIT μ C EVALUATION BOARDS

vard architecture, load/store, and fixed-length instructions—for faster instruction execution. It has a 2-stage pipeline with only 33 instructions. Programs are held in on-chip EPROM of 512 to 2k 12-bit words. And there are as many as 80 bytes of on-chip RAM. PIC peripherals include an 8-bit counter, watchdog timer, and as many as 20 I/O pins. Pin counts run from 18 to 28 pins.

Microchip has brought out a higher-level PIC, the PIC17C42. It is a 16/8-bit μ C, with 16-bit instructions (as many as 64k words) and 8-bit data (as much as 64 kbytes). On-chip memory is 2k words of EPROM and 256 kbytes of data SRAM. It has 55 instructions.

The PICPAK-17 is an evaluation board and programmer for the PIC17C42. It provides two external

EEPROMs to hold program memory. These EEPROMs hold the object code to program the μ C's internal EPROM. You can use SRAMs on the board as well. The board has a small prototyping area, as well as a 3-digit, 7-segment display for testing I/O.

TI TMS370

TI's TMS370 is a simplified architecture for low- to mid-size applications. It has a 64-kbyte address space, with as much as 16 kbytes of on-chip program ROM or EPROM, and as much as 512 bytes of RAM. Also, it has as much as 512 bytes of EEPROM for data constants. The TMS370 has three external interrupts for real-time applications.

Table 1—Representative 8-bit evaluation boards (continued)

Vendor	Microcontroller (μ C)	Hardware	Software	Price	Comments	Circle number ³
Siemens Components Inc Semiconductor Group 2191 Laurelwood Rd Santa Clara, CA 95054	80C517 12 MHz 32-kbyte EPROM or ROM 2-kbyte RAM	EMOD-C517		\$250	Can test high-end 8051—with 16/32-bit math unit, eight 16-bit pointers and seven I/O ports.	672
		16-kbyte EPROM 32-kbyte RAM (+ optional 32 kbytes)	Terminal emulator line assembler			
Signetics 811 E Arques Ave Sunnyvale, CA 94088 (408) 991-2000 FAX (408) 991-2311	8051 family 12 MHz 4-kbyte ROM 256-byte RAM	Ceibo BD-51		\$320	8-pin plastic leaded chip carrier. Supports Signetics 8051 family. Serves 24-, 48-, 40-pin DIPs and 68-pin plastic-leaded-chip carrier wrapped-wire area.	673
		32-kbyte RAM 32-kbyte EPROM potentiometer programmable LED bank 8 switch bank for I/O	Loader symbolic debugger monitor			
Texas Instruments Inc Box 1443, MS 719 Houston, TX 77251 (713) 274-2000 FAX (713) 274-2445	TMS370C356 20 MHz 16-kbyte ROM or EPROM 512-byte RAM 512-byte EEPROM	TMS370 Design Kit		\$370	Handles all TMS370 devices.	674
		16-kbyte ROM 512-byte RAM 512-byte EEPROM programmer	Terminal emulator symbolic/source debugger			
	TMS7000 6 MHz 4-kbyte ROM 256-byte RAM	TMS 700 EVM		\$795	Simple 2-register μ C architecture. Low- to mid-range μ C, 1.25- μ sec minimum instruction cycle at 6 MHz.	675
		32-kbyte RAM 24-kbyte EPROM programmer	Assembler terminal emulator symbolic/source debugger			
Toshiba America Inc Semiconductor Products Div 9775 Toledo Way Irvine, CA 92718 (714) 455-2000	TLCS-90 12.5 MHz 32-kbyte ROM 1-kbyte RAM	EDB-90		\$400	The TLCS-90 series comprises high-end μ Cs. The μ Cs are register oriented, with a 320-nsec minimum instruction cycle. 64-kbyte instruction and 1-Mbyte data-address space. Wrapped-wire area, 13 programmable LEDs.	676
		256-kbyte EPROM 256-kbyte RAM Darlington drivers for stepper motors Analog bus for A/D converter	Assembler source-code debugger linker/loader C compiler monitor			
Zilog Inc 210 Hacienda Ave Campbell, CA 95008 (408) 370-8000	Z80181 12.5 MHz MMU (to 1 Mbyte memory) no on-chip memory	Z8018100ZC0		\$150	Z80181 smart access controller for communications. Board header for expansion software to set up peripherals.	677
		32-kbyte EPROM 8-kbyte SRAM	Assembler link/loader monitor (in EPROM, + source code)			
	Z08602 4 MHz 2-kbyte ROM 124-byte RAM	Z0860200ZC0		\$231	Keyboard controller. Comes with software (EPROM and source code). Board has miniature keyboard on it. Models 101/102 are PC keyboards.	678
		Three LEDs two 8-position-DIP software	Assembler link/loader monitor keyboard-control code			

Notes: 1. SRAM=static RAM
2. EEPROM=Electrically erasable PROM
3. For more information on 8-bit evaluation boards such as those described in this table, circle the appropriate numbers on the Information Retrieval Service card or use EDN's Express Request Service.

8-BIT μ C EVALUATION BOARDS

The TMS370 application board uses two TMS370 μ Cs: a master controller for the host interface, and a slave as the target interface. The board takes one of three different slave μ Cs (28-pin DIP, 28-pin PLCC, or 68-pin PLCC). It supports both EEPROM and ultraviolet EPROM memories, as well as RAM for code and data. You can directly program the EEPROMs and EPROMs. There is also a wrapped-wire prototyping area for additional circuitry.

The board comes with a PC-based, window-oriented development tool set, including an assembler, disassembler, and symbolic debugger. The μ C contents, including its register file and stack contents, are visible via a monitor. The μ C can directly execute and define expressions on line. It has a reverse assembler to convert object code to assembly-readable source code, and a patch assembler for quick fixes. The debugger is sophisticated—users can single-step inside a loop while an expression stays true or false. A C compiler and source code debugger are available.

ST6

The SGS ST6 is a low-end, single-chip μ C, with as little as 20 pins. The μ C holds 2 to 4 kbytes of on-chip EPROM or ROM and 64 bytes of RAM. The μ C has no off-chip memory bus. It's a simple, minimal register architecture with an accumulator, four memory registers, and a 12-bit PC. The μ C supports as many as 21 external interrupts. Peripherals include an A/D with as many as 16 input channels, one or two 8-bit timers, a watchdog timer, and LCD drive capability. Running at 8 MHz, an average instruction takes 13 clocks for execution.

SGS doesn't make an evaluation board. Instead, they furnish a low-cost programmer, complete with PC-based development software. The ST6 starter kit includes a programmer board and three windowed EPROM ST6 μ Cs. The board links to a PC for downloading code into a μ C. The development software includes a 1-pass, macroassembler, a loader, and a simulator.

National COP800

The National COP800 family consists of low-end μ Cs. Pin counts range from 20 to 44 pins and have 39 I/O lines. Running at 10 MHz, the minimum instruction execution time is 1 μ sec. The COP800 is built around a minimal register set—A, B, and index—along with Stack Pointer, Control, and Program-Status Word registers. The COP800 has a Harvard architecture with a single, 32-kbyte address space. The μ C has 1 to 8 kbytes of ROM or EPROM and 64 to 256 bytes of SRAM on chip. Versions with as much as 4 kbytes of program EEPROM are also available. The μ C family

includes a programmable UART, PWM timers, a watchdog timer, an 8-bit A/D converter, and a proprietary serial I/O scheme. The device supports as many as 16 interrupts.

For initial evaluation, National furnishes a COP800 Designer's Tool Kit. This kit includes an assembler

For more information . . .

For more information on software such as the programs described in this article, circle the appropriate numbers on the Information Retrieval Service card or use EDN's Express Request service. When you contact any of the following manufacturers directly, please let them know you saw their products in EDN. For a listing of hardware vendors, see **Table 1**.

American Automation
14731 Franklin Ave
Tustin, CA 92680
(714) 731-1661
Circle No. 650

Archimedes Software Inc
2159 Union St
San Francisco, CA 94123
(415) 567-4010
Circle No. 651

Binary Technology Inc
Main St
Meriden, NH 03770
(603) 469-3232
Circle No. 652

Byte Craft Ltd
421 King St
Waterloo, ON, Canada N2J 4E4
(519) 888-6911
FAX (519) 746-6751
Circle No. 653

Franklin Software Inc
888 Saratoga Ave, Suite 2
San Jose, CA 95129
(408) 296-8051
FAX (408) 296-8061
Circle No. 654

Hitachi America Ltd
2000 Sierra Point Pkwy
Brisbane, CA 94005
(415) 589-8300
FAX (415) 583-4207
Circle No. 655

Intermetrics Microsystems Software Inc
733 Concord Ave
Cambridge, MA 02138
(617) 661-0072
FAX (617) 868-2843
Circle No. 656

VOTE . . .

Please also use the Information Retrieval Service card to rate this article (circle one):

High Interest 479 Medium Interest 480 Low Interest 481

Introl Corp
647 W Virginia St
Milwaukee, WI 53204
(414) 327-7171
Circle No. 657

LMI Microsystems Inc
Box 10430
Marina del Rey, CA 90295
(213) 306-7412
Circle No. 658

Matra-Harris Semiconductor
2895 Northwestern Pkwy
Santa Clara, CA 95051
(408) 748-9362
FAX (408) 748-0439
Circle No. 659

P&E Microcomputer Systems Inc
Box 2044
Woburn, MA 01888
(617) 944-7585
Circle No. 660

Systronix Inc
Box 526398
Salt Lake City, UT 84152
(801) 487-7412
FAX (801) 487-3130
Circle No. 661

Vail Silicon Tools Inc
1280 S Powerline Rd
Pompano Beach, FL 33069
(305) 491-7443
Circle No. 679

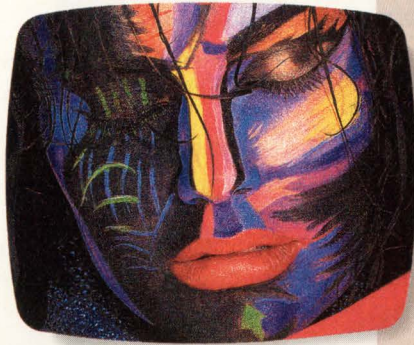

SUPER VGA



GUI ACCELERATOR

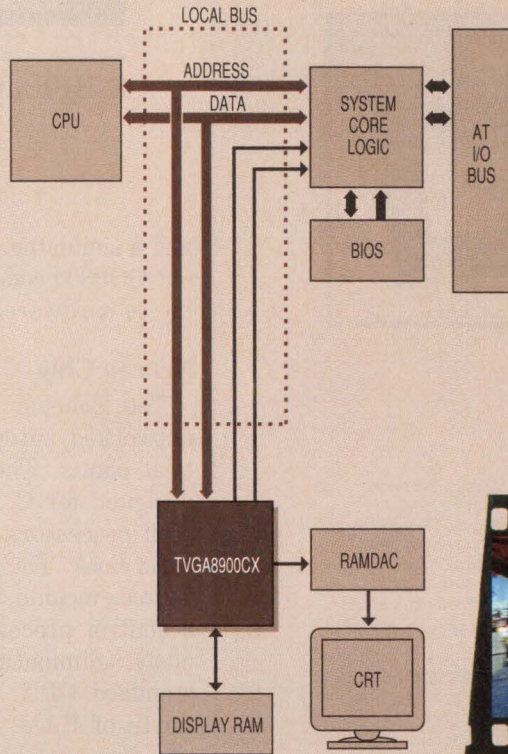

LOCAL BUS VGA



NOTEBOOK



MULTIMEDIA IMAGING

Graphically speaking, more chips for more applications.

The #1 Selling Super VGA Goes Local Bus and TrueShade™

The Trident TVGA8900C is the largest selling 1MB Super VGA controller on the market. For higher end systems, the upgraded TVGA8900CX offers a 16-bit local bus interface and supports resolutions up to 1280x1024 non-interlaced.

Soon to be available is the TVGA8900CXi (sampling Q2 '92), our 32-bit local bus Super VGA graphics controller with our integrated TrueShade™ 65,000 color RAMDAC and clock.

To round out our Super VGA line, the low-cost TVGA9000i offers the on-chip TrueShade™ RAMDAC and clock with a 256K to 512K DRAM interface—excellent for motherboard applications.

© 1992 Trident Microsystems, Inc. 205 Ravendale Drive, Mountain View, CA 94043 Tel: 415.691.9211 Fax: 415.691.9260. TARGA+ is a trademark of Truevision®, TVGA, TrueShade, and Smart Power Management are trademarks of Trident Microsystems, Inc.

Windows Accelerator Features Extensive BitBlt, Line Draw, and Area Fill Functions

The TGUI9400 Graphics Controller greatly improves GUI intensive applications performance. Supporting both VRAM and DRAM, the TGUI9400 can be used in low and high-end systems. (Sampling Q2 '92.)

Higher Performance LCD Controllers

The new TLCD9100 is the first LCD/CRT controller with an ISA and local bus interface for fast memory-to-display transfers with true 64 grayshades, Smart Power Management™, 1024x768x16 color CRT support, and aggressive pricing. It is the perfect chip for cost effective, yet high performance notebook designs.

Our TLCD9300 (sampling Q3 '92) is an ultra-high performance local bus, color LCD/CRT controller with SimulView™ LCD and CRT display. The integrated TrueShade™ RAMDAC, 3.3V operation, and support for TFT and STN panels, make this chip ideal for next generation mono or color notebooks and pen-based systems.

Multimedia Imaging Chip Merges TARGA+ Compatibility With Video Windowing

Our VideoView Multimedia Imaging chipset offers video windowing, TARGA+ compatibility, frame capture, VGA/XGA overlay, advanced chroma keying, real-time digital special effects, and genlock of multiple video sources. It supports RGB, NTSC, PAL and S-Video signals. VideoView is the new standard for quality, cost-effective live video production on the PC.

For detailed specifications and to see firsthand how Trident can help, graphically speaking, on your next project, call (415) 691-9211.

 **Trident**
Graphics & Imaging Solutions

8-BIT μ C EVALUATION BOARDS

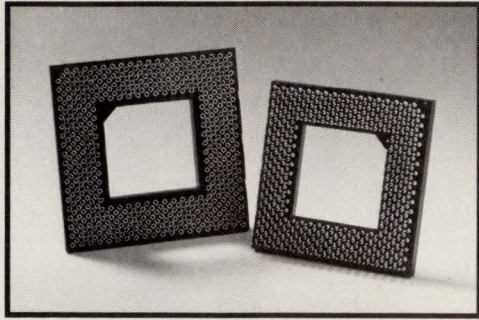

Take the next step,
Fill in the gap,
Go interstitial

When you need a high density socket now, go with proven technology. McKenzie's Interstitial Pin Grid Arrays are the socket solution, offering a 55% increase in pin density over conventional pin grid arrays. This family of sockets utilizes our new ultra low insertion force contact to greatly reduce the insertion force necessary for these high pin count devices.

Now available in a cost effective, molded body version for production applications.
Immediate availability — call or fax for samples.

mckenzie
TECHNOLOGY

44370 Old Warm Springs Blvd., Fremont CA 94538
(510) 651-2700 • Fax (510) 651-1020

A Subsidiary of Elco Corporation
A Kyocera Group Company

See us at **Nepcon '92, Booth #3351**

©1991 McKenzie Technology. All rights reserved.

CIRCLE NO. 50

MIX & MATCH ANY SOCKET TYPE COMBINATION

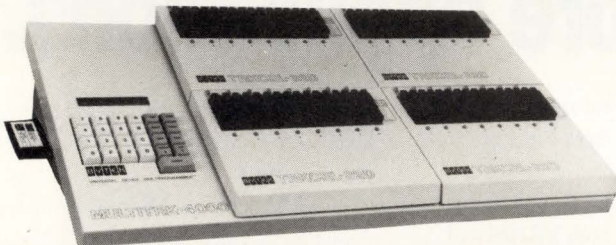

The BYTEK MULTITRK-4000™'s "mix & match" capability sets a new standard in programming. Using 8-socket attachable "TRAKCels", the MULTITRK lets you program unusual package types, and mix EPROM/Micro technology in combinations of 8-32 devices.

We built the future into our features. Get only the support you need today and as new device technologies come along, easily upgrade the MULTITRK with the switch of a TRAKCel. Program EPROMs, FLASH Devices, Single Chip Micros, CMOS PLDs and more - all on one site.

Precision Programming with the MULTITRK-4000:

- High Volume - Embedded Controller (8/16/32Bit), EPROMs, PLDs.
- High Density - GANG/SET Operations, High Speed Up/Download.
- High Thruput - 32 program sites, regardless of pin-count or pitch.
- Custom Packages - DIP, PLCC, PQFP, PSOP, TSOP, PGA, etc.
- All Computer Environments - SUN, VAX, HP, APPLE, PCAT/PS2.
- 3.5" Micro Disk Drive to facilitate Device Library Updates.
- Parallel/Serial Port. Data Transfer Rate in excess of 100K Bits/Sec.
- High Speed DMA Port with a Transfer Rate of 12 MBit/Sec. (Opt.)

30-day Money Back Guarantee

1-800-523-1565

BYTEK

Corporation

543 NW 77th St. • Boca Raton, FL 33487 • (407) 994-3520

CIRCLE NO. 51

and a simulator. With the simulator, engineers can try out COP800 code in a secure environment before moving to hardware.

Neuron Chip

The Echelon Neuron-Chip is designed for low-end, networked automation for homes, offices, and industrial plants. The 8-bit chip is one of the first to be designed for C. The μ C consists of three interleaved 8-bit processors, sharing common resources with a 10-MHz clock. The CPUs time-share resources. These resources include a main CPU, a network processor, and a control processor. Three tasks can run simultaneously, eliminating the task-switching overhead in a standard CPU. The 3120 has 10 kbytes of ROM, 1 kbyte of RAM, and 412 bytes of EEPROM. The μ C also has an 8-bit data bus and a 16-bit address bus, letting it address as much as 64 kbytes of memory with no external memory access. The 3150 is a ROM-less part with 2048 bytes of RAM. The 3120 and 3150 are built by Motorola and Toshiba as Echelon licensees.

Echelon's Neuron C is an extended C for programming Neuron chips. Neuron C has built-in functions and scheduling for network communications and control I/O. Echelon is fielding a complete development environment, Lonbuilder's Developers Workbench, for network-control applications. The environment includes PC-host software with a Neuron C and a source-code debugger, a network manager, a protocol analyzer, and two emulators. Lonbuilder can support as many as 32,000 nodes. Echelon has transceivers for twisted pair, RF, and power-line media. **EDN**

Author's biography

Ray Weiss, one of EDN's West Coast Technical Editors, can be reached at (818) 704-9454.

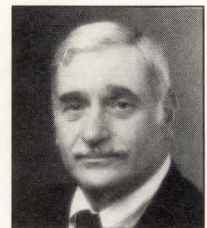

Article Interest Quotient (Circle One)
High 479 Medium 480 Low 481

Presenting Two
Plans For
IC Development
Guaranteed To
Reduce Your...



What others promise, we guarantee.

Time-to-Market.



Our prototype services can take your designs from tape to packaged parts in 20 calendar days or less. Guaranteed.

So you get your products to market faster. Or regain time lost to engineering delays.

- Prototypes in 20 days
- Custom processes
- Non-competitive second source
- Fast pre-production quantities

Cut your development cycle with Orbit Semiconductor's prototyping service. Call (800) 331-4617. In California (800) 647-0222 or (408) 744-1800. FAX (408) 747-1263.

NRE.

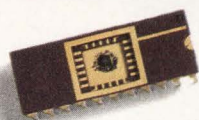
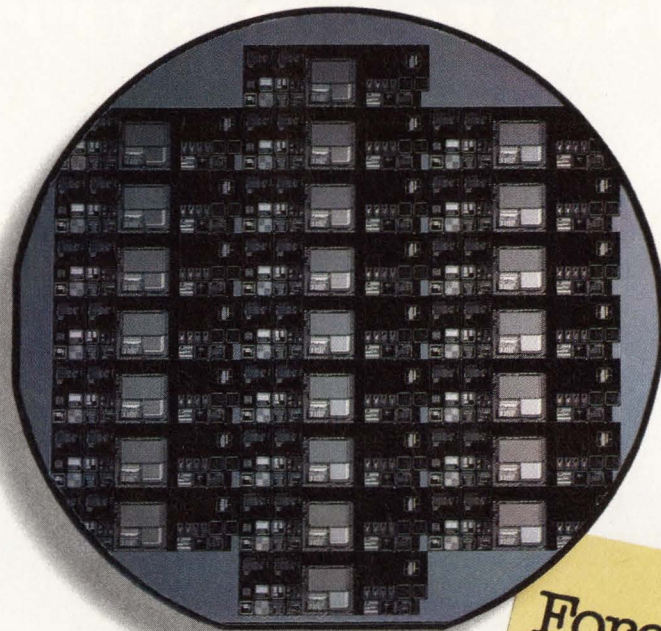

Get twelve packaged parts in five weeks—for as little as \$1500.

Our Foresight multi-project wafer processing program can dramatically cut the cost of IC prototyping while reducing your time to market.

- Foresight runs start every Wednesday
- Five week turnaround
- Dramatic reductions in prototyping costs
- Debug mixed signal ICs while in design

Don't wait to start cutting your NRE.

In fact, call (800) 331-4617, and you can start right away. In California (800) 647-0222 or (408) 744-1800. FAX (408) 747-1263.



What others promise, we guarantee.

SPEC THE BEST!

HIGH POWER / HIGH DENSITY

SWITCHING POWER SUPPLIES



Meets IEC 555-2

- 1 to 9 Outputs
- 750 to 3000 Watts
- 2V to 56VDC Outputs
- Auto Current Share (N + 1)
- New -- Three Year Warranty
- Compact: 5" x 5" or 5" x 8" Cases

Qualidyne delivers feature-rich supplies to the most rigid specs. Margining, inhibit, input power fail signal, and an integral ball-bearing fan are standard features. Options include power factor correction, DC input, and automatic current sharing with an isolated power supply fail signal -- ideal for redundant power (N + 1) applications.

0.99 Power Factor Option *

AC to DC Switchers

DC to DC Converters



User Configurable

- User-Adjustable
- Wide Range Outputs
- 400 to 1000 Watts
- AC or DC Inputs
- 1 to 9 Floating Outputs

Low Profile

- Compact: 2" to 3" High
- 250 to 1000 Watts
- Single & Multi-Outputs
- 2V to 56V Outputs
- Auto AC Line Selection

Multi-Output Models-3, 4, or 5 outputs (Partial Listing)						
Size (HxWxL)	Total Watts	Output 1	Output 2	Output 3	Output 4	Output 5
5x6.5x10"	750W	5V/100A	5-15V/20A	5-15V/20A	5-24V/5A	5-24V/5A
5x5x11.5"	1000W	5V/120A	5-15V/20A	5-15V/20A	5-24V/5A	5-24V/5A
5x8x11"	1000W	5V/150A	5-15V/20A	5-15V/20A	5-24V/10A	5-24V/10A
5x8x11.5"	1500W	5V/200A	5-15V/20A	5-15V/20A	5-24V/10A	5-24V/10A
5x8x13.75"	2500W	5V/400A	5-15V/20A	5-15V/20A	5-24V/10A	5-24V/10A

Single Output Models (Partial Listing)						
Size (HxWxL)	Total Watts	Output Voltage Range/Max. Amps (select one)				
		2-4VDC	4-6VDC	7-12VDC	12-28VDC	28-56VDC
5x6.5x10"	750W	2-4V/187A	4-6V/150A	7-12V/63A	12-28V/27A	28-56V/14A
5x5x11.5"	1000W	2-4V/250A	4-6V/200A	7-12V/84A	12-28V/36A	28-56V/18A
5x8x11.5"	1500W	2-4V/375A	4-6V/300A	7-12V/125A	12-28V/54A	28-56V/27A
5x8x11.5"	2000W	2-4V/400A	4-6V/400A	7-12V/167A	12-28V/72A	28-56V/36A
5x8x15.5"	3000W	2V/700A	5V/600A	12V/250A	24V/125A	48V/65A

FREE CATALOG

Complete line of quality power supplies from 100 to 3000 Watts.



Qualidyne
Lambda Group of Unitech plc

Qualidyne Systems, Inc.
3055 Del Sol Blvd., San Diego, CA 92154
(619) 575-1100 fax: (619) 429-1011

Programmable device masters the art of high-speed data transfers

Vinita Singhal, Altera Corp

The Micro Channel Architecture defines a high-speed data-transfer protocol for moving data between a bus master and a slave. Implementing this protocol in programmable logic gives you design flexibility in addition to high-speed data transfers.

Recent enhancements to the Micro Channel Architecture bus have created a system that supports independent bus masters. One of the main enhancements is the streaming-data procedure (SDP), which allows faster data transfer. Implementing this protocol needn't greatly complicate your design. You can generate essential signals for a bus-master adapter with SDP capability using an EPLD-based design. (Check the EDN BBS for an Altera Hardware Description Language state-machine description of this circuit.)

Streaming is a high-speed data-transfer mode for data (bytes, words, or double words) that reside at consecutive address locations. An SDP cycle needs only the starting address; the protocol assumes subsequent

data packets are at sequential addresses. One streaming-data cycle consists of multiple 16-, 32-, or 64-bit sequential data transfers. The cycle time for each packet transfer is half (100 nsec) that of the default (zero-wait-state, 200-nsec) cycle. The streaming-data procedure is transparent to devices that do not use or transmit the data. Streaming-data participants must support basic transfer to operate with nonstreaming-data participants.

The SDP increases data-transfer rates by a factor of 2, 4, or even 8 over the 5 Mbyte/sec baseline bus throughput (which assumes 8-bit transfers). Any bit in the POS (programmable-option-select) register space can enable SDP. Data streaming can occur only by mutual consent between a master and a slave device and requires several signals. These signals are:

Signal	Description
-SDR(0)	Streaming-data request bit 0; input to MCA_BM_EPLD
-SDR(1)	Streaming-data request bit 1; input to MCA_BM_EPLD
-MSDR	Multiplexed streaming-data request; for 64-bit SDP using address and data buses
-SD STROBE	Streaming-data strobe; MCA_BM_EPLD output
CD CHRDY	Card channel ready; from slave adapter to MCA bus
CHRDYRTN	Card channel ready return; input to MCA_BM_EPLD (generated by the system as a logical AND of all adapter CD CHRDY signals)
-CD DS 16	Card acknowledge, 16-bit data stream
-CD DS 32	Card acknowledge, 32-bit data stream

The following streaming-data-signal combinations (X is "Don't Care") are valid:

-SDR0	-SDR1	-CD DS 16	-CD DS 32	-MSDR	Description
0	0	X	X	X	Reserved
0	1	0	0	0	64-bit SDP
0	1	0	0	1	32-bit SDP
0	1	0	1	1	16-bit SDP
1	0	X	X	X	Reserved
1	1	X	X	X	Basic transfer



The software listings in this article are available on EDN's computer bulletin-board system (BBS). Phone (617) 558-4241 with modem settings 300/1200/2400,8,N,1. Access /freeware SIG and specify (r)ead option followed by (k)ey-word search for "MS #346."

HIGH-SPEED DATA TRANSFERS

Although the Micro Channel Architecture specification permits data transfers between unequal bus widths, it does not direct unequal bit-width data through the data-byte lanes during the SDP; the master or slave must implement this control. In general, the wider side of the transfer controls where the data end up. For example, in the case of a 16-bit master executing streaming-data transfers with a 32-bit slave, the slave provides steering control.

Five signals control the bus

Once a bus master gains control of the bus, it drives all bus-control signals and the address and data buses. On the Micro Channel Architecture bus, a bus master must drive five bus-control signals. These signals are the -S0 and -S1 status signals; the -ADL address decode latch; the -CMD command strobe; and the M/-IO memory or I/O-cycle indicator.

Fig 1 illustrates a complete interface to the Micro Channel Architecture bus using three major functional

blocks: An I/O or memory slave interface, an arbitration-controller block (both available from Altera and several other sources), and the MCA_BM_EPLD (Altera's Micro Channel Architecture Bus Master Erasable Programmable Logic Device), which implements bus-master control logic having SDP capability.

When the arbitration controller signals to the MCA_BM_EPLD, using -BUSGNT, that the EPLD has won the bus, the EPLD drives the bus-control signals. If you enable streaming-data capability (via a POS register bit), the MCA_BM_EPLD determines whether the slave can perform streaming operations. If so, the MCA_BM_EPLD generates the -SD STROBE (streaming-data strobe) signal. If the slave introduces wait states (CD CHRDY=low), -SD STROBE continues to strobe; however, the master maintains data on the bus until the slave activates CD CHRDY.

The MCA_BM_EPLD is a synchronous state machine that runs off a 20-MHz clock (CLK_20) and gen-

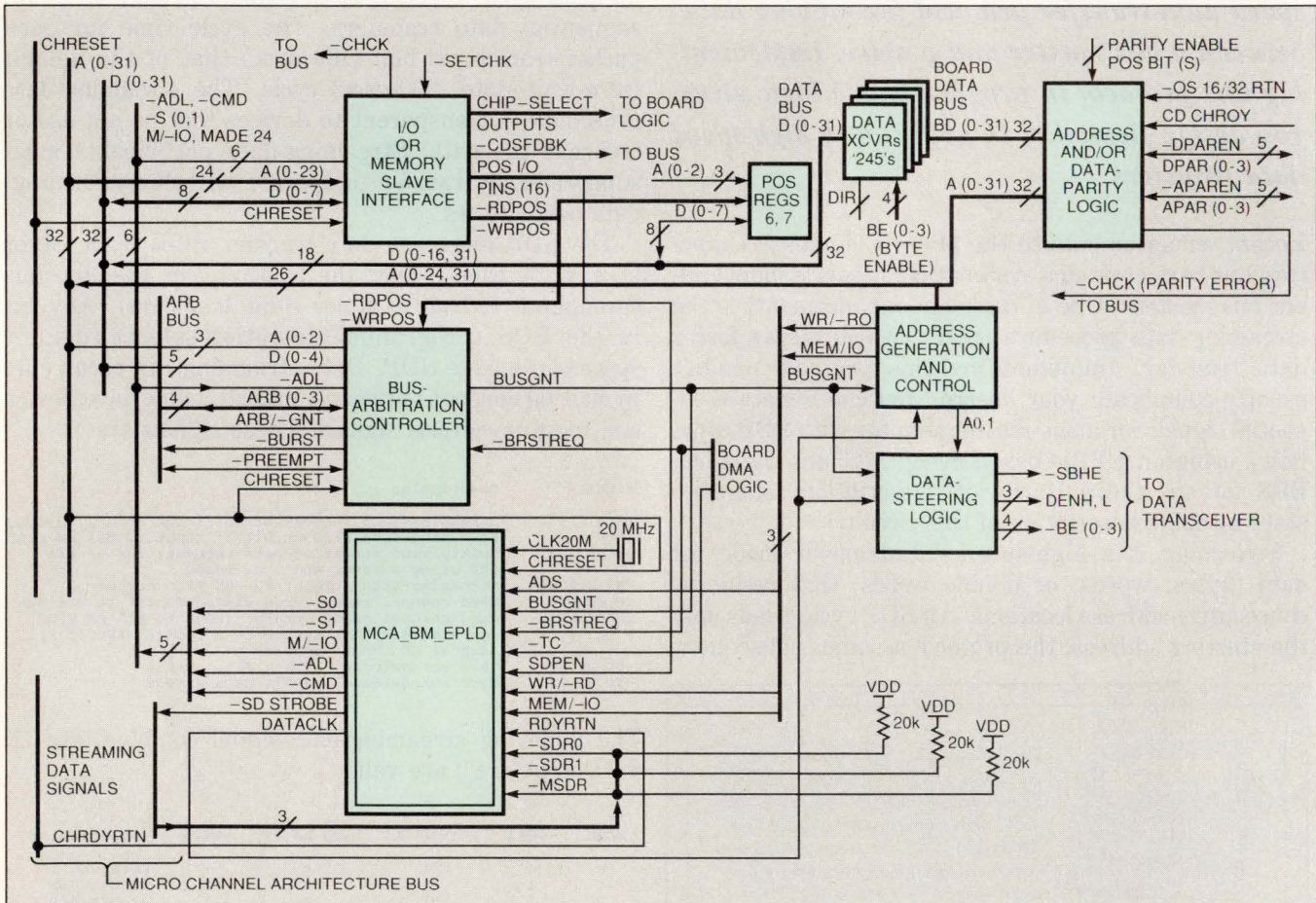

Fig 1—The Micro Channel Architecture bus interface uses three major functional blocks. These blocks are the memory/I/O slave interface, an arbitration-controller block, and the MCA_BM_EPLD.

erates the signals necessary for a bus master with streaming-data-transfer capability. These signals are:

Signal	I/O	Description
-ADL	O	Micro Channel Architecture address-decode latch
-CMD	O	Micro Channel Architecture command strobe
-S0	O	Micro Channel Architecture status signal bit 0
-S1	O	Micro Channel Architecture status signal bit 1
M/-IO	O	Micro Channel Architecture memory I/O signal
-SD STROBE	O	Micro Channel Architecture streaming-data strobe
DATA_CLK	O	Master internal clock; to board logic
-ADS	I	Address stable; from CPU or controller or address-generator logic
BUSGNT	I	Bus arbitration controller output; signals bus won
-BRSTREQ	I	Board logic; burst request
-TC	I	Board logic/Micro Channel Architecture; terminal count
CHRESET	I	Micro Channel Architecture channel reset
CLK_20M	I	20-MHz synchronizing clock
WR/-RD	I	Write/read from CPU/controller or address-generator logic
MEM/-IO	I	Memory or I/O cycle; generated by CPU or DMA controller or address generator
-SDR0	I	Micro Channel Architecture streaming-data request bit 0
-SDR1	I	Micro Channel Architecture streaming-data request bit 1
-MSDR	I	Micro Channel Architecture multiplexed streaming-data request (64-bit streaming-data transfers)
RDYRTN	I	Micro Channel Architecture CD CHRDRYRTN
SDPEN	I	From any user-defined POS bit

Within an SDP cycle, the -SD STROBE clock times each transfer. SDP cycles are of several types that depend on the conditions under which the SDP commences and whether the slave introduces wait states.

These types are deferred cycle, where the SDP start is delayed; data pacing, where wait states are inserted in SDP cycles; and combined deferred cycle and data pacing. Additional SDP qualification depends on how the cycle is terminated. Termination can be requested by the master, the slave, or by the master because the slave isn't ready. The MCA_BM_EPLD supports all variations of the SDP cycles.

The MCA_BM_EPLD's outputs are decoded as a function of the present state. The next state results from the present state and the inputs. The main states of the MCA_BM_EPLD state machine (Fig 2) are:

State	Description
IDLE	Idle; wait for cycle start
STATUS	Cycle start; drive status signals
ADLTCH	Generate address-decode latch
BXFER	Distinguish the cycle to be nonstreaming
WAIT	Determine synchronous or asynchronous extended
CMDCLK1	Default cycle timing state
SYNEXT	Synchronous-extended cycle
SYNEXT1	Synchronous-extended cycle timing state
ASYNEXT	Asynchronous-extended cycle
SDDEFVCYC	Deferred start for SD cycle
SD STROBE	Streaming-data strobe (active low)
STRBHI	Streaming-data strobe (high)
MTERM	Master-terminated SD cycle
STERM	Slave-terminated SD cycle
MSTERM	Master-terminated SD cycle; slave not ready
MSTRBHI	Streaming-data strobe (high; slave not ready)
CMDTR1	Trailing edge of -CMD
EBC	End of basic transfer cycle
ESDC	End of streaming-data-transfer cycle

Several details of the state-transition diagram in Fig 2 are worth emphasizing.

The signals -BUSGNT and -BRSTREQ tell the

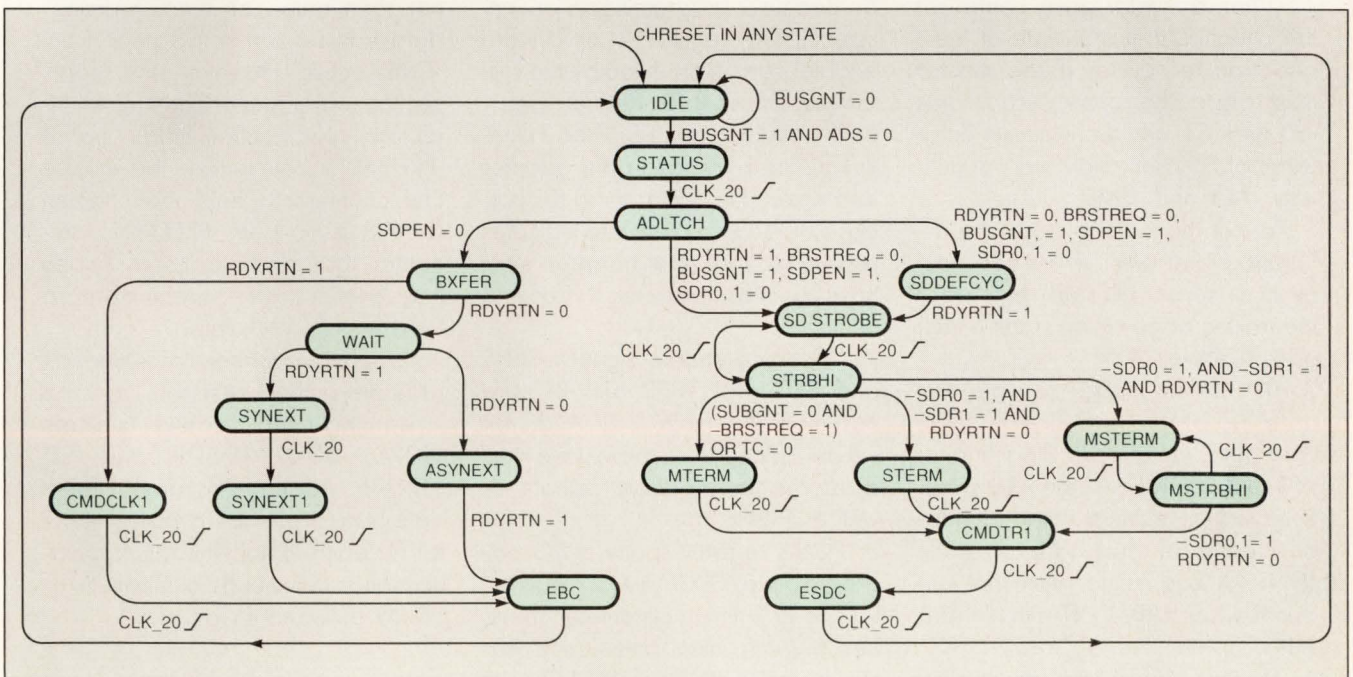

Fig 2—The bus-master state machine contains 19 states that perform streaming- and nonstreaming-data transfers.

HIGH-SPEED DATA TRANSFERS

MCA_BM_EPLD when it is the bus master for block (burst) transfers. -BUSGNT is an output from the Micro Channel Architecture bus-arbitration controller logic signaling that the EPLD has won the bus. The -BRSTREQ input to the arbitration controller indicates an active -BURST transfer request.

-ADS starts the transfer cycle

The -ADS input to the EPLD (Fig 1) indicates a valid address on the address bus. Functionally, -ADS is similar to the -ADS signal on the 80386 processor. This signal indicates the start of a data-transfer cycle and the MCA_BM_EPLD device uses it to latch the state of the WR/-RD and MEM/-IO signals. Subsequently, the MCA_BM_EPLD drives the status and control signals. The EPLD decodes the status signals (-S0 and -S1) and M/-IO from the state of the write/read signal (WR/-RD) and MEM/-IO inputs, respectively. One cautionary note, the Micro Channel Architecture bus doesn't provide pullup resistors for the streaming-data-related signals (-SDR0, -SDR1, -MSDR, and -SD

STROBE). As a result, adapters that receive these signals must provide pullup resistors for each signal. The Micro Channel Architecture specification recommends a minimum of 20-k Ω pullup to 5V dc.

The DATA_CLK output on the MCA_BM_EPLD device provides stretched-out -SD STROBE pulses by tracking the status of the CHRDRYRTN signal. The address and byte-count increment logic can use DATA_CLK directly. However, when -MSDR is low, indicating 64-bit data streaming, the Micro Channel Architecture specification (and hence, the MCA_BM_EPLD) does not support data pacing. In this case, the DATA_CLK output is identical to the -SD STROBE output.

The bus-master transfer controller indicates termination of the SDP cycle to the MCA_BM_EPLD device by either of two conditions. One condition is the deactivation of BUSGNT followed by deactivation of the -BRSTREQ signal. If the master is -PREEMPTed or no longer needs the bus, the bus-arbitration controller deactivates BUSGNT. If another device

Designer's do's and don'ts

The following design pointers highlight important information gleaned from Micro Channel-related literature. They are summarized here for your convenience.

1. When a master gains control of the channel, it must initiate at least one transfer cycle. If the master must abort the cycle, it activates -S0 and -S1 with the minimum pulse width of 85 nsec and does not activate -ADL and -CMD.
2. To exit the inactive state, the arbitration controller of the bus master must sense -PREEMPT high after the trailing edge of the status line(s) goes inactive.
3. The system master can perform data transfers, and system logic can perform refresh operations, while ARB/-GNT is in the ARB state. Selected slaves must respond independently of the state of ARB/-GNT. A bus master must not run cycles when ARB/-GNT is in the ARB state.
4. Status-signal timing during

streaming-data transfers is completely different from nonstreaming-data transfers. So don't use status signals -S0 and -S1 to hold CD CHRDRY low.

5. Because programmable-option-select (POS) register 2, bit 0 (card enable) can be modified by the system, don't use it for device reset.
6. If possible, don't use the Fixed-Resources keyword in the adapter description file. Contrary to the purpose of POS, the keyword indicates resources that the adapter must have, such as hardwired INT or ARB levels.
7. The byte-enable signals -SBHE and -BE0, -BE1, -BE2, and -BE3 are not mutually exclusive. A 32-bit master talking to a 16-bit slave must drive the byte-enable signals as well as -SBHE.
8. POS's register space is I/O address space XXX0 to XXX7 (hex).
9. The T79 timing parameter specifies the maximum time length for streaming-data transfers. For a

master-terminated cycle, the master must de-assert -S0 and -S1, to indicate end of cycle, within 7.8 μ sec (max) from -CMD active (start of cycle). Therefore, the master must signal termination of the streaming-data transfer within 7.8 μ sec from -CMD active. However, the Notes section in the Micro Channel Architecture specification adds that if -PREEMPT goes active, the master can continue to hold the channel for 7.8 μ sec from -PREEMPT, indicating that basic transfer cycles may continue after streaming-data transfers are complete.

10. The Micro Channel bus doesn't provide pull-up resistors for the streaming-data-related signals -SDR0, -SDR1, -MSDR, and -SD STROBE. Adapters receiving these signals must provide a pullup resistor for each signal. The MCA specification recommends a minimum of 20-k Ω pullup to 5V dc.

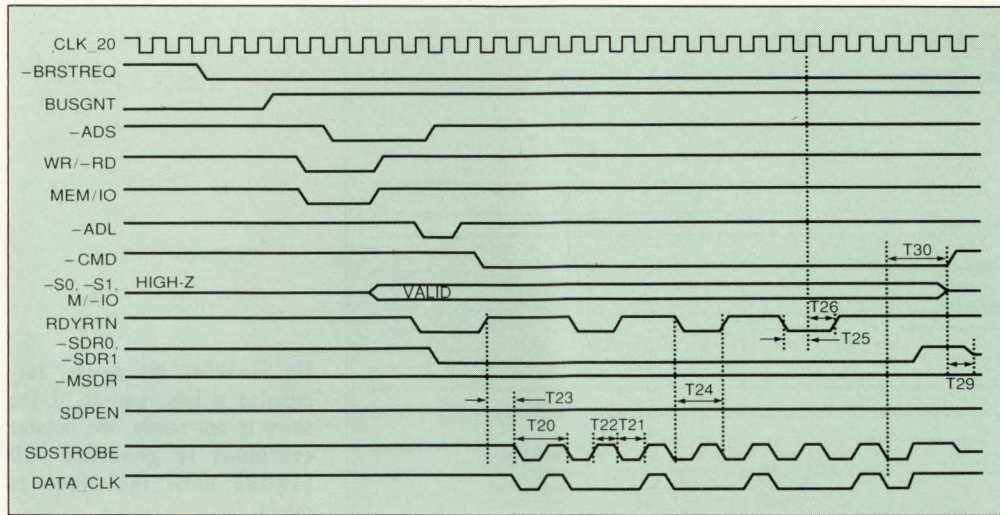

Fig 3—This diagram illustrates the timing of a 16- to 32-bit streaming-data transfer, with deferred start and data pacing, terminated by the slave.

-PREEMPTS the bus master, the adapter has up to 7.8 μ sec to complete transfers. Under -PREEMPTION, the arbitration controller de-asserts BUSGNT but may continue to assert -BURST on the Micro Channel bus. You can use the falling edge of BUSGNT to start a 7.8- μ sec timer to monitor the requesting device's deassertion of its bus request (-BRSTREQ). To maximize bus throughput, the MCA_BM_EPLD uses BUSGNT inactive and -BRSTREQ inactive to terminate the cycle. The second termination condition is an active low pulse on the -TC input pin. The local-transfer controller generates this active-low, terminal-count signal to indicate the last streaming-data-transfer cycle.

According to the Micro Channel specification, a slave that introduces wait states during SDP should not deassert -SDR0 and -SDR1 while CD CHRDY is inactive. Following an active CD CHRDY, the slave may deassert the -SDR0 and -SDR1 signals. This restriction leads to the "Master-terminated, slave-not-ready" spe-

cial case of a master-terminated streaming-data cycle.

The timing diagrams in Fig 3, 4, and 5 illustrate the bus cycles the chip supports along with all relevant timing parameters. Several of these timing parameters are dictated by the Micro Channel specification. They are not specific to the MCA_BM_EPLD; their inclusion makes the interface timing description complete and easy to understand. For cross-referencing, Table 1 contains the Micro Channel Architecture streaming-data timing parameter numbers.

Fig 3, 4, and 5 illustrate timing parameters for SDP cycles. For a deferred SDP cycle, the Micro Channel Architecture specification does not have a maximum number (minimum specification=0 nsec) for the first active -SD STROBE pulse after CHRDYRTN becomes active. The timing of -SD STROBE after CHRDYRTN is MCA_BM_EPLD's T23 (Fig 3). T24 refers to a Micro Channel Architecture specification that the slave wait-state logic must adhere to for CHRDYRTN tim-

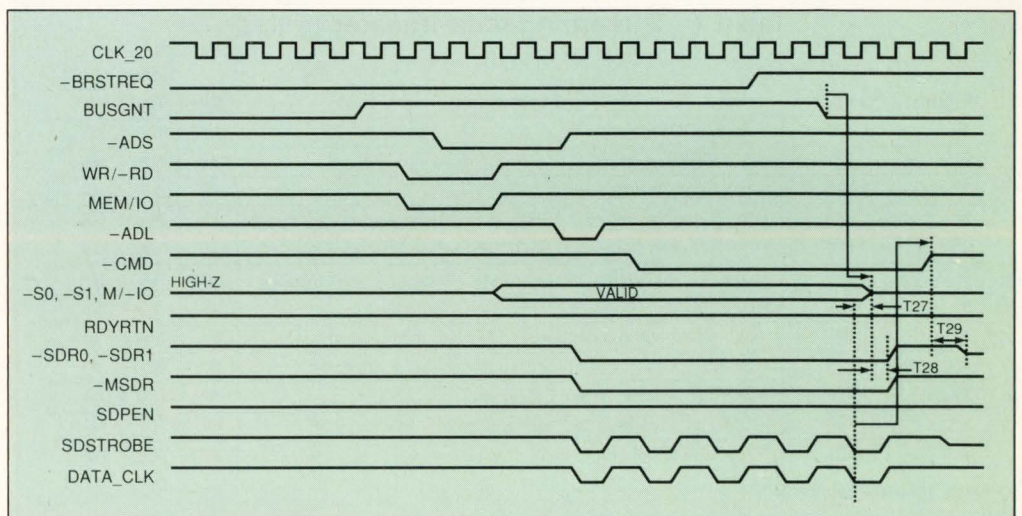

Fig 4—The bus master forcing -BRSTREQ high terminates a streaming-data transfer.

HIGH-SPEED DATA TRANSFERS

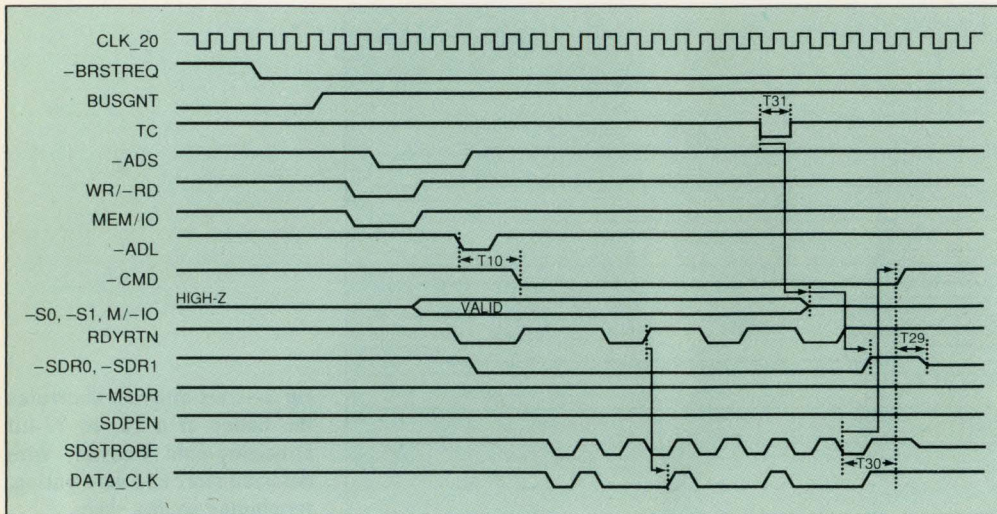

Fig 5—When the master terminates a bus request, if the slave is not ready, the master continues to generate -SD STROBE until the slave is ready.

ing. Timing parameters T25 and T26 specify setup and hold times for the slave wait-state logic for data-pacing, that is, introducing wait states during SDP cycles.

In a slave-terminated SDP cycle, the slave indicates the end of the SDP transfer by de-asserting -SDR0, -SDR1, and -MSDR. In response, the bus master de-asserts status signals -S0 and -S1 and the -CMD strobe. MCA_BM_EPLD's T30 timing parameter adheres to the Micro Channel Architecture specification stating that -CMD inactive from the last falling edge of -SD STROBE should be 100 nsec minimum. T30 also applies to the case when the master terminates the cycle but the slave is not ready, which is illustrated in Fig 5.

In a master-terminated SDP cycle (Fig 4), the SDP transfer ends when the master deactivates -S0 and -S1. T27 refers to a Micro Channel Architecture specification that states -S0 and -S1 should be de-asserted within 10 nsec of the last -SD STROBE pulse. This

parameter makes it necessary for the transfer controller on the bus-master adapter to signal the end of SDP transfer (by de-asserting the BUSGNT signal) more than one CLK_20 period (50 nsec + EPLD-register setup time) before the last -SD STROBE pulse.

Timing parameter T28 is a Micro Channel Architecture specification for the slave adapter to de-assert -SDR0, -SDR1, and -MSDR signals within 40 nsec of the bus-master adapter's de-assertion of the -S0, -S1 status signal. T29 is a parameter common to all of the SDP cycles. This parameter refers to a Micro Channel Architecture specification that states after the -SDR0 and -SDR1 signals are de-asserted, the slave must drive the -SDR0 and -SDR1 signal to a high-impedance state within 40 nsec from the trailing edge of the -CMD strobe. The timing parameter T31 specifies the minimum required pulse width for -TC, the terminal-count signal that indicates the end of the SDP transfer, to

Table 1—Streaming data-transfer cycles

Figure	Parameter	Explanation	Timing		
			Min	Typ	Max
3	T20	-SD STROBE period	NA	100	NA
3	T21	-SD STROBE active	50	NA	NA
3	T22	-SD STROBE inactive	50	NA	NA
3	T23	RDYRTN active to -SD STROBE falling edge (deferred cycle)	78	NA	NA
3	T24	RDYRTN valid from -SD STROBE low for data pricing	3	NA	45
3	T25	RDYRTN inactive low setup to CLK_20 high	9	NA	NA
3	T26	RDYRTN inactive low hold from CLK_20 high	9	NA	NA
4	T27	-S0, 1 inactive from last -SD STROBE falling edge	NA	NA	10
4	T28	-SDR0, 1 and -MSDR inactive from -S0, 1 inactive	NA	NA	40
3,4,5	T29	-SDR0, 1 3-state from -CMD	NA	NA	40
3,5	T30	-CMD inactive from last falling edge of -SD STROBE	100	NA	NA
5	T31	-TC pulse width	60	NA	NA

Note: NA=Not applicable.

WHEN WE SAY CHASSELEON, WE MEAN CHASSELEON.

englisch

One solution in detail:

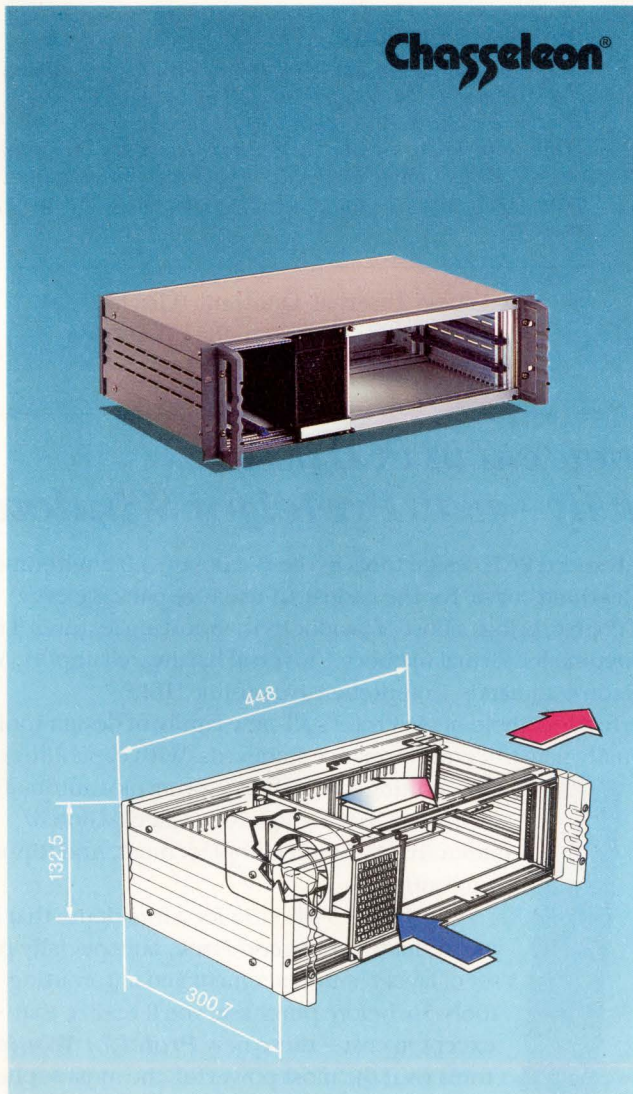

You require a computer case for simultaneous installation of vertical and horizontal cards.

The solution: **Chasseleon "cardset", 19", 3 U***.

Supply schedule in detail:

- 19" Modular case with vent slots in the side extrusions (**optimum heat dissipation**).
- **Rear panel with five subdivisions** (1x42 HP**, 3x10 HP**, 1x12 HP**) with integrated appliance inlet (4 A, 240/250 V) mains filter, switch and two fuses.
- **Handles with 19" adaptor** for easy conversion of bench case to 19" chassis without complex assembly operations.
- **Front-intake fan cassette** 12 V, 14 HP**, with filter (optimum cooling for horizontal plug-in units).
- **Mounting kit for horizontal installation of double Eurocards**, may be positioned as required on the horizontal pitch**.
- **4 Pairs of guide rails** for holding cards and cassettes, pushfit as required.
- **4 Tapped strips** for mounting front and rear panels.

Dimensions (in mm)	W x H x D
External	448 x 132.5 (3 U*) x 300.7
Internal	427.2 (84 HP**) x 112.5 x 295.2

* 1 U = 1 3/4" = 44.45 mm
** 1 HP = 2/10" = 5.08 mm

Order number: 2.311.180.3
How supplied: fully assembled

We are at your service, wherever you wish to purchase your enclosure. World-wide.

bfr 8.704,- Knürr NV. Tel. 03-326.02.99 Fax 03-325.55.43	ff 1.465,- Knürr s.a.r.l. Tel. (1) 43 77 85 85 Fax (1) 43 39 02 10	£ 151,- Knürr (UK) Ltd. Tel. 04 80-49 61 25 Fax 04 80-49 63 73	nkr 1.693,- Knürr Norge A/S Tel. 02-19.89.00 Fax 02-19.69.66	sfr 374,- Knürr AG Tel. 01-8 25 07 07 Fax 01-8 25 08 03	US \$ 285,- Knürr USA Inc. Tel. (8 05) 5 26-77 33 Fax (8 05) 5 84-83 71	DM 395,- Knürr AG Tel. (0 89) 4 20 04-0 Tel. (0 89) 4 20 04-1 18
---	---	---	---	--	--	---

All prices exclusive of VAT, packing and carriage.



® KNÜRR - MECHANIK FÜR DIE ELEKTRONIK AG

Schatzbogen 29
D-8000 München 82
Telefon (0 89) 4 20 04 - 0
Telex 5 29 608 - 10
Telefax (0 89) 4 20 04 - 1 18

HIGH-SPEED DATA TRANSFERS

be 60 nsec minimum. **Table 1** gives device-specific timing information for the bus-cycle timing diagrams illustrated in **Fig 3, 4, and 5.**

You could implement this design in several different technologies. However, using programmable logic offers you the ability to add other functions, remove unnecessary features, or modify parts of the design to meet your design needs. **EDN**

References

1. Micro Channel Adapter Handbook, April 1990, Altera Corp.
2. 1991 Altera Data Book, Altera Corp.
3. IBM Micro Channel Bus-Master Design-Seminar Notes, February 1990.
4. Personal System/2 Hardware Interface Technical Reference, May 1988.
5. IBM Micro Channel Architecture Supplement for the Personal System/2 Hardware Interface Technical Reference, November 1989.

6. Heath, C., "Overview of Extended Micro Channel Functions," Personal Systems (IBM Personal Systems Technical Journal), Issue 4, 1989.

7. "Micro Channel Bus-Master Design Guidelines," Application Note 23, January 1991, Altera Corp.

8. "Micro Channel Bus Master and SDP Logic with the EPM5032 EPLD," Application Note 24, January 1991, Altera Corp.

Author's biography

Vinita Singhal is an MPLD Design Manager at Altera Corp who supervises the design group that transfers designs from EPLDs to Mask-Programmed Logic Devices. She has a B.Tech with honors from the Indian Institute of Technology and an MSEE from Pennsylvania State University. In her spare time, Vinita enjoys reading, technical writing, and traveling.

Article Interest Quotient (Circle One)

High 482 Medium 483 Low 484

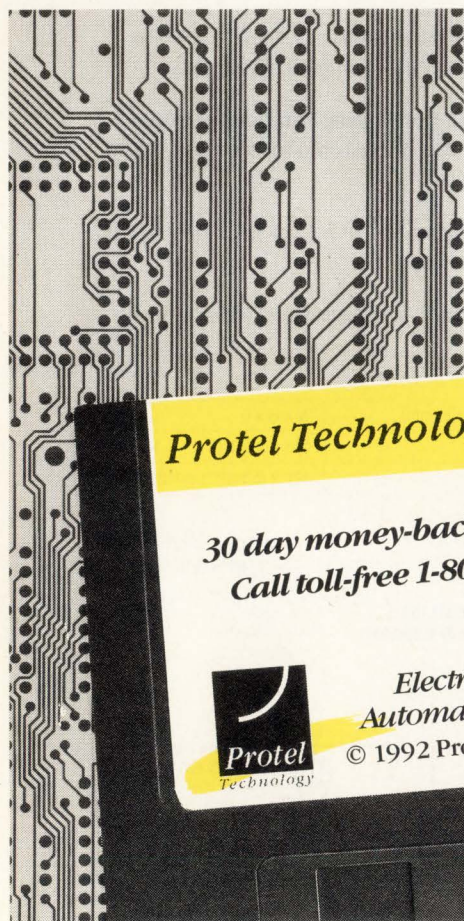

Begin a new era in PCB design productivity—with Protel for Windows.™

It's a first—advanced PCB design tools in the Windows™ 3.0 environment. For the shortest learning curve. For the easiest-to-use EDA package ever.

Windows, of course, brings a host of productivity-boosting features. Like multiple open documents. Virtual memory. Universal hardware support. Multi-level Undo and Redo commands. Comprehensive on-line HELP.

Windows perfectly complements Protel's all-new family of design tools—tools that set equally new price/performance standards. With capabilities like global editing. "WYSIWYG" print/plot automation. More layers. Fast Design Rule Check. Global/interactive AI-based autoplacement. And Rip-up Autorouting.

Call 1-800-544-4186 for a free demo that lets you evaluate *Advanced Pack*, our specially priced set of layout, autoplacement and autorouting tools. So, before purchase, you'll realize that—except in cost—these new *Protel for Windows* tools rival the most powerful, the most sophisticated, available.

Protel Technology Inc
151 Bernal Road
San Jose, CA 95119



Windows is a registered trademark of Microsoft Inc.

CIRCLE NO. 89

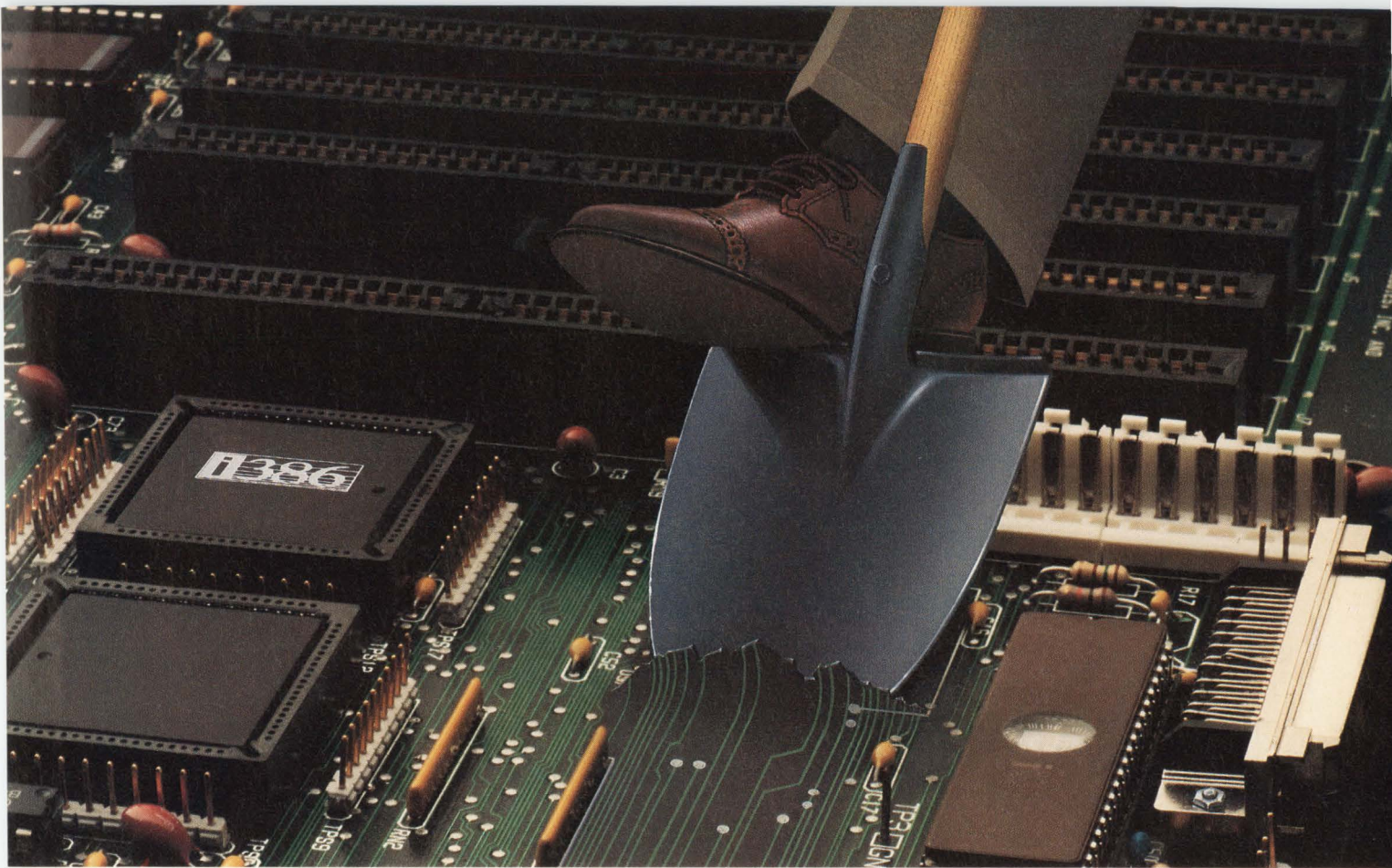

WE'RE BREAKING NEW GROUND BY MAKING IT EASY TO PUT SCSI ON THE MOTHERBOARD.

Introducing Adaptec's new AIC-6260.

You're already a big believer in the performance and connectivity of SCSI. But you're also digging around for an uncomplicated way to design-in SCSI to your AT motherboard. Well...Eureka! Now with Adaptec's new AIC-6260, you've just hit pay dirt.

After all, it makes a lot of sense that a single-chip solution is easier to design-in than multiple chip packages. They're also more reliable. And take up less real estate. Plus, since we've built the AT bus in, designing SCSI in is as easy as connecting signal lines dot-to-dot.

What's more, we get you to market in the fastest

possible time. That's because industry-standard, Adaptec-developed SCSI software drivers and BIOS are ready and available. For all major peripherals – under all major operating systems. All this, and a complete design-in package, too. Which means, you can now afford to design the performance and connectivity of SCSI in your system as a standard feature.

So step on it. And call us at **1-800-227-1817, ext. 52** today. We think you're going to really dig it.



adaptec

When you're serious about SCSI.

NEW RISC/CISC
DEVELOPMENT TOOLS

BEWARE!

Are you buying a Logic Analyzer for RISC or high-speed CISC* Development? Compare...

Features	American Arium	Tektronix ¹	Hewlett Packard ²
100 channels, 100 MHz sync	YES	YES	YES
No. of cards for 100 channels	1	1	3
Dynamic cache control	YES	NO	NO
Data cycles fully labeled in disassembly	YES	NO	NO
Maximum trace depth	128K	128K	8K
Maximum synchronous rate	200 MHz	100 MHz	100 MHz
Split timebase on a single card	YES	NO	NO
Setup+Hold time	3 nsec	5 nsec	4 nsec
High price	NO	YES	YES

(1) 92A96 (2) 16540/41

Introducing Paladin™ —

American Arium's new single card capture system for the ML4400 Logic Analyzer featuring 100 and 200 MHz synchronous and 1 GHz asynchronous data capture. With 100 channels of 100 MHz synchronous capability per capture card, plus the powerful features of the ML4400, Paladin delivers the maximum capability available today for state and timing measurements on high-performance μ P-based designs.

Fully Labeled Disassembly

The ML4400 boasts fully automatic synchronizing disassemblers for all major families of μ Ps, including RISC, CISC, DSP and GSP. These are the *only* disassemblers available that completely identify and label all data cycles including task switches, exception processing, page translation and other complex CISC instructions.

*Such as 80486 or beyond, or 68040 or beyond.

Circle #58 for Development Systems Info



Dynamic Cache Control

The ML4400 provides dynamic control of cache fill on many processors, allowing complete disassembly of some program segments while the majority of the program runs fully cached.

Total Versatility

Paladin cards may be paralleled to form analyzers with up to 200 channels per timebase. You can configure the ML4400 to fit your needs, with the flexibility of 5 different types of capture cards.

Compare First

Paladin delivers the speed and power you'd expect from the leader in Logic Analyzer technology. And you can save thousands of dollars. For a demo, call (714) 731-1661.

American Arium

Formerly American Automation and Arium Corporation
14281 Chambers Road, Tustin, California 92680

Circle #57 for Logic Analyzer Info

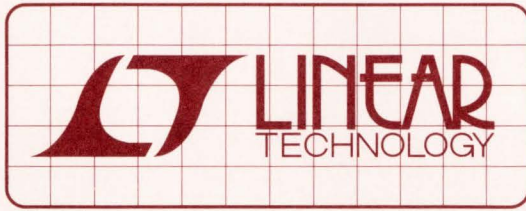

DESIGN NOTES

New Low Cost Differential Input Video Amplifiers Simplify Designs and Improve Performance – Design Note 55

John Wright

The LT1190 is a family of high speed amplifiers optimized for video performance on $\pm 5V$ or single $+5V$ supplies. The family includes three voltage feedback op amps and two video difference amplifiers. All amplifiers slew at $450V/\mu s$, and deliver $\pm 50mA$ output current for driving cables. The LT1193 video difference amplifier features uncommitted high input impedance (+) and (-) inputs, and can be used in differential or single-ended configurations. In addition, the LT1193 has an adjustable gain of two or greater, with a $-3dB$ bandwidth of $80MHz$.

Wideband Voltage Controlled Amplifier

The LT1193 video difference amplifier combined with an MC1496 balanced modulator make a low cost $50MHz$ Voltage Controlled Amplifier (VCA), shown in Figure 1. The input signal of the MC1496 at pin 1 is multiplied by the Control Voltage on pin 10, and appears as a differential output current at pins 6 and 12. The LT1193 acts to level shift the differential signal and convert it to a single-ended output. Resistor R_B is used to set the bias current in the MC1496 to $1mA$ in each 200Ω R_L , while R_{CM} is used to shift the differential output into the common mode range of the LT1193. Resistors R_1

through R_4 bias the MC1496 inputs so that the Control Voltage V_C can be referenced to $0V$. Positive V_C causes positive gain; negative V_C gives a phase inversion ($-A_V$), while $0V$ on V_C gives maximum attenuation (within the V_{OS} of the MC1496 control inputs). The value of R_e is chosen by knowing the maximum input signal:

$$R_e = (V_{IN \text{ max}})/1mA$$

For the example shown the maximum input signal is $100mV$ peak, therefore, $R_e = 100\Omega$. At this maximum input signal there is significant distortion from the r_e modulation of the input pair. Linearity can be improved by increasing R_e at the expense of gain. The maximum voltage gain of the VCA is:

$$\frac{V_O}{V_i} = (A_V \text{ of LT1193}) \left(\frac{2R_L}{R_e + 2r_e} \right)$$

$$V_O/V_{IN} = 2(2 \times 200)/(100 + 52) = 5.26 = 14.42dB$$

Figures 2 and 3, show the frequency response and harmonic distortion of the VCA.

The voltage gain of the VCA can be increased at the expense of bandwidth by changing the value of load

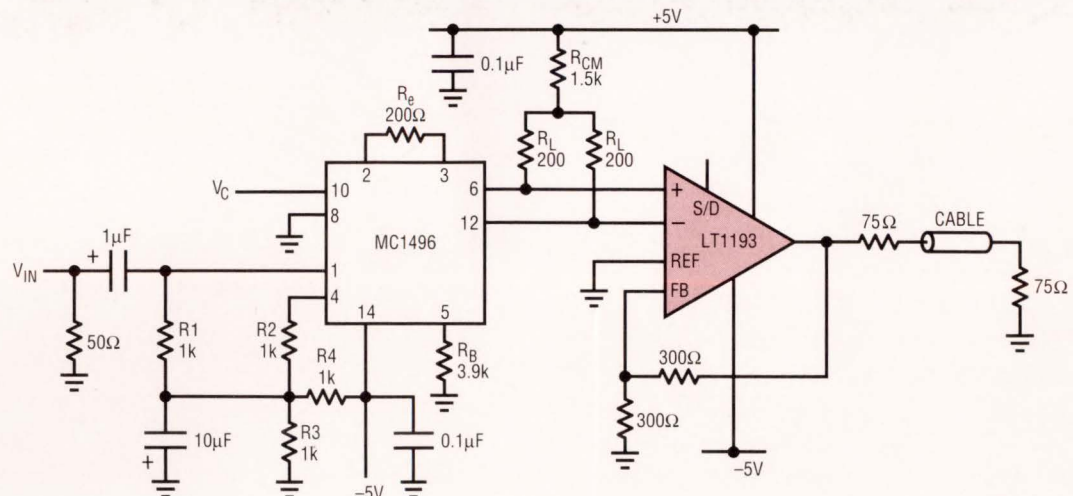

Figure 1. Low Cost 50MHz Voltage Controlled Amplifier

DN55 · 01

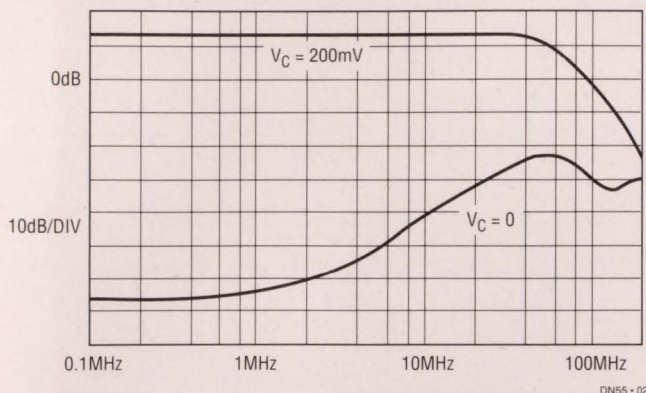

Figure 2. Gain and Attenuation of VCA

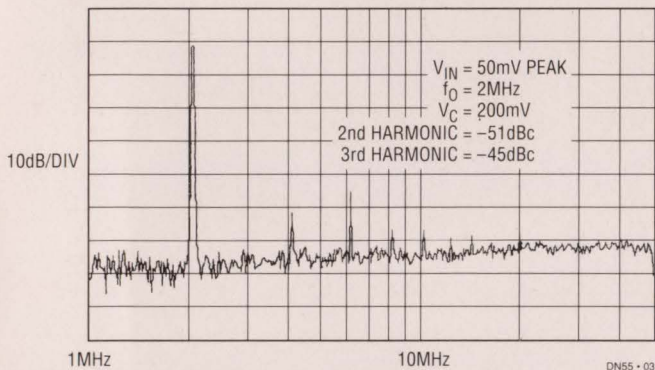

Figure 3. VCA Output Spectrum

resistors R_L . Shorting R_{CM} and increasing R_L to 2k will increase the maximum gain by 20dB and the -3dB bandwidth will drop to approximately 10MHz.

The LT1193 has a shutdown feature that reduces its power dissipation to only 15mW and forces a three-state output. The three-state output occurs when pin 5 is taken to V^- . The high Z state, dominated by the impedance of the feedback network, is useful for multiplexing several amplifiers on the same cable. The impedance of the feedback resistors should not be raised above 1k Ω because stray capacitance on the (-) input can cause instability.

Extending the Input Range on the LT1193

Figure 4 shows a simplified schematic of the LT1193. In normal operation the REF pin 1 is grounded or taken to a DC offset control voltage, while differential signals are applied between pins 2 and 3. The LT1193 has been optimized for gains of 2 or greater, and this means the input stage must handle fairly large input signals. The maximum input signal occurs when the input differential amplifier is tilted over hard in one direction, and 1.2mA flows through the 1k Ω R_e . The maximum input swing is therefore 1.2Vp or 2.4Vp-p. The second differential pair is running at slightly larger current so that

when the first input stage limits, the second stage remains biased to maintain the feedback.

Occasionally it is necessary to handle signals larger than 2.4Vp-p at the input. The LT1193 input stage can be tricked to handle up to 4.8Vp-p. To do this, it is necessary to ground pin 3 and apply the differential input signal between pin 1 and 2. The input signal is now applied across two 1k resistors in series. Since the input signal is applied to both input pairs, the first pair will run out of bias current before the second pair, causing the amplifier to go open loop. This effect is shown in Figure 5 for the amplifier operating in a closed loop gain of 1. The LT1193 has a unity gain phase margin of only 40 degrees, so when operating at unity gain, care must be taken to avoid instability.

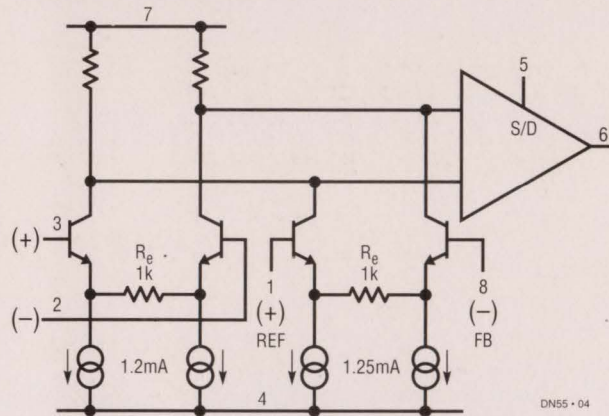

Figure 4. LT1193 Simplified Schematic

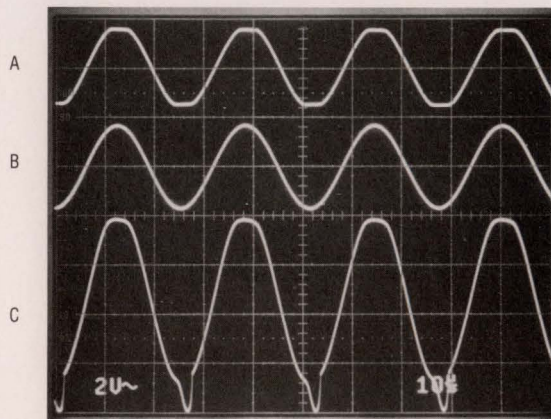

Figure 5. LT1193 in Unity Gain
(A) Standard Inputs, Pins 2 to 3, $V_{IN} = 3.6V_{p-p}$
(B) Extended Inputs, Pins 1 to 2, $V_{IN} = 3.6V_{p-p}$
(C) Extended Inputs, Pins 1 to 2, $V_{IN} = 7.0V_{p-p}$

For literature on our High Speed Amplifiers, call (800) 637-5545. For applications help, call (408) 432-1900, Ext. 361

Battery-powered microprocessor turns itself off

Carl Hallman, Network Systems Corp, Brooklyn Park, MN

Combining a 3-terminal micropower regulator with a simple 2-transistor switch yields a very low-leakage, auto-power-off circuit for a battery-powered μP (Fig 1). This circuit requires about 10 mA of additional battery current to operate when power is on. However, the circuit extends the battery life for short power-on cycles by reducing the leakage current when power is off to a minimum.

The LP2950/LP2951 regulators from National Semiconductor are 3- and 8-pin micropower regulators, respectively, that are suited for battery-powered devices. The 8-pin version has a shutdown pin that would be very useful except for its relatively high leakage current that will drain a 9V battery in about six months with no use. This shutdown pin also requires an active-high signal. This circuit uses the 3-pin version with a 2-transistor switch in front of the regulator.

switch results in virtually no measurable leakage currents and features an active-low shutdown pin.

The circuit uses a momentary-contact switch to force Q_2 , which powers the LP2950 regulator, to conduct. Once powered up, one of the μP 's initial instructions sets an output pin to a logic high. This pin connects to the base of Q_1 . Q_1 then starts conducting and keeps Q_2 turned on after the momentary-contact switch is released. The μP 's program keeps the level of the output pin high for a predetermined length of time. When this power-on time expires, the μP forces the power on this pin low. This low logic level shuts off Q_1 , which lets the base of Q_2 rise to the emitter voltage. Shutting off Q_2 removes the power to the regulator and shuts down the μP . EDN BBS /DI_SIG #1076

To Vote For This Design, Circle No. 746

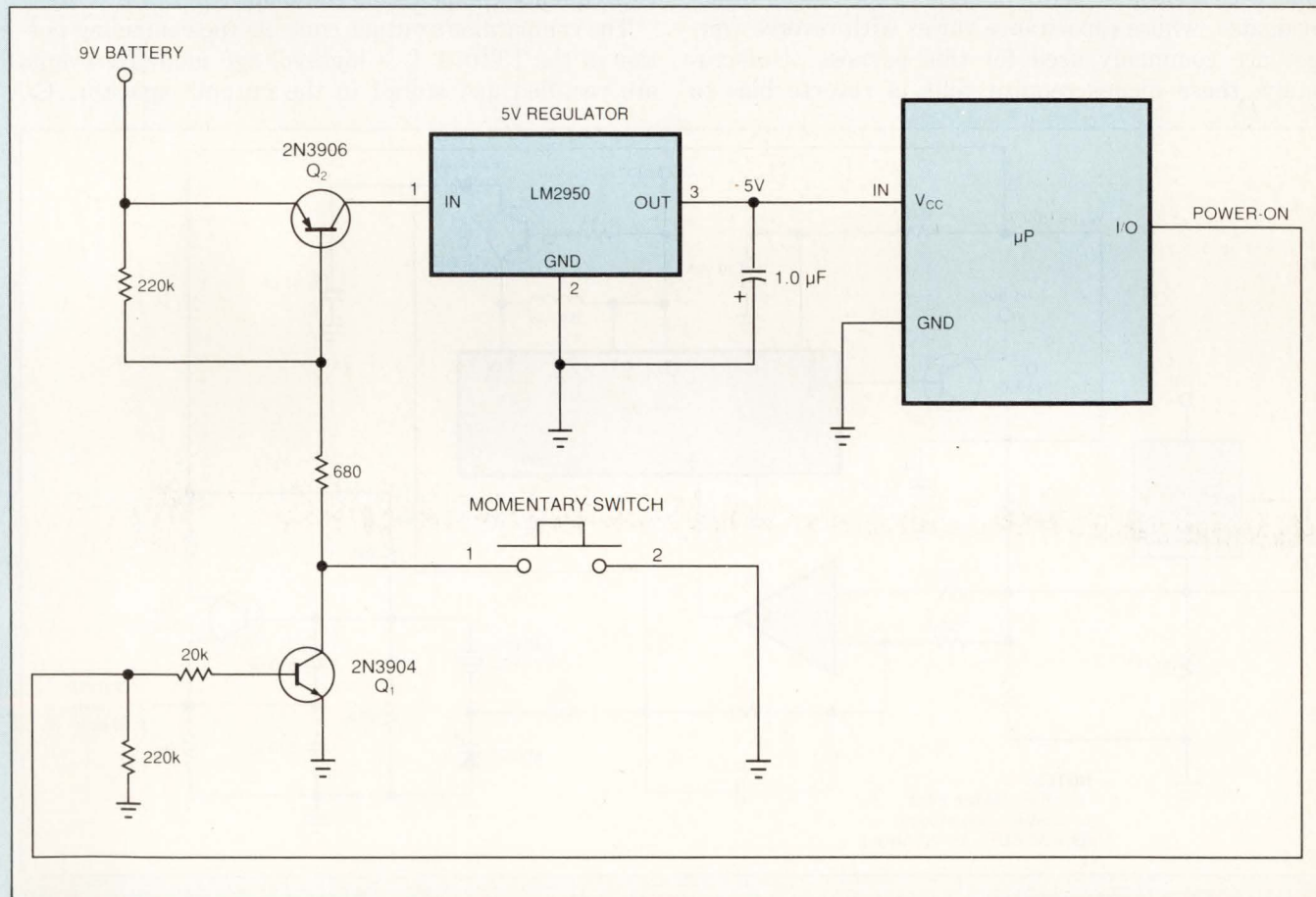

Fig 1—Using a low-leakage regulator with an active-low shutdown pin, this battery-powered μP with transistor switches extends battery life for applications that require only short power-on periods by preventing leakage when the power is off.

Single 1.5V cell powers crystal oscillator

Jim Williams, Linear Technology Corp, Milpitas, CA

Many single-cell systems require a stable clock source. Such applications include portable high-accuracy clocks, survival radios, and secure communications. Crystal oscillators that run from 1.5V are relatively easy to construct. However, designing one with good stability over temperature is much more difficult. Ovenizing the crystal is one approach, but power consumption is excessive.

Fig 1's circuit presents an alternate method that provides frequency-correcting bias to the oscillator. The circuit improves the temperature stability of a 1.5V-powered crystal oscillator by a factor of 20 by slightly tuning the crystal's resonance as ambient temperature varies. The bias value is determined by absolute temperature and corrects for the oscillator's repeatable thermal drift. The simplest way to correct for the drift is by slightly varying the crystal's resonance point with a variable shunt or series impedance. Varactor diodes, whose capacitance varies with reverse voltage, are commonly used for this purpose. Unfortunately, these diodes require volts of reverse bias to

generate significant capacitance shift, making direct 1.5V-powered operation impossible. Fig 1 uses an LT1073 configured as a step-up switching regulator to derive the necessary bias from 1.5V.

Q₁ and its associated components form a 1-MHz Colpitts oscillator, which normally has a temperature coefficient of about 1 ppm/°C. The remainder of the circuit implements the temperature correction. The LM134 adjustable current source senses ambient temperature, converting it to a current that then flows through the 30.1-kΩ resistor. The LT1017 comparator subtracts this resistor's voltage from a reference potential. The stable subtraction voltage is derived from the LT1073's internal 212-mV reference via Q₂ and the 73.2- and 27.4-kΩ resistors. Feedback from Q₂'s collector to the LT1073's auxiliary-amplifier output, AO, closes the reference loop, which also powers the Colpitts oscillator. C₁ frequency-compensates the loop.

The comparator's output controls the remaining portion of the LT1073. L₁'s high-voltage inductive events are rectified and stored in the output capacitor, C₂,

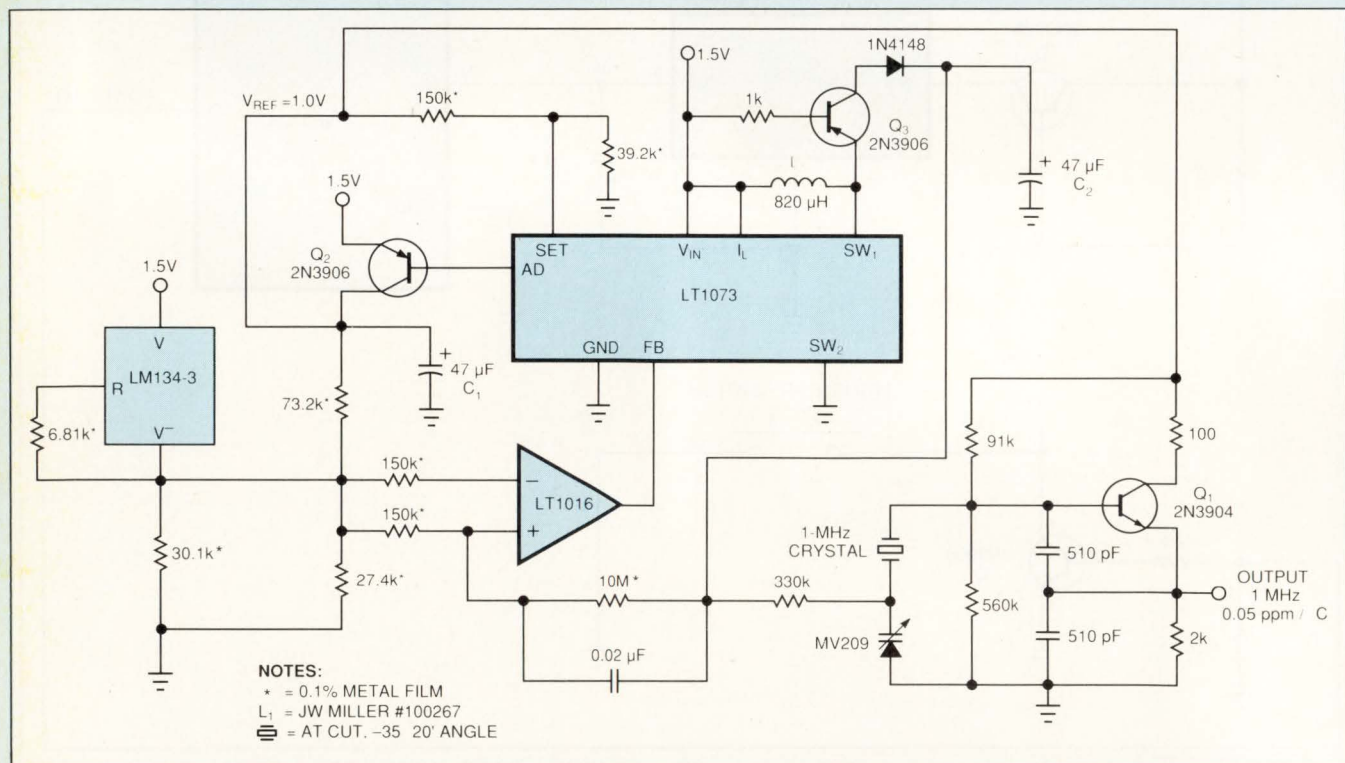
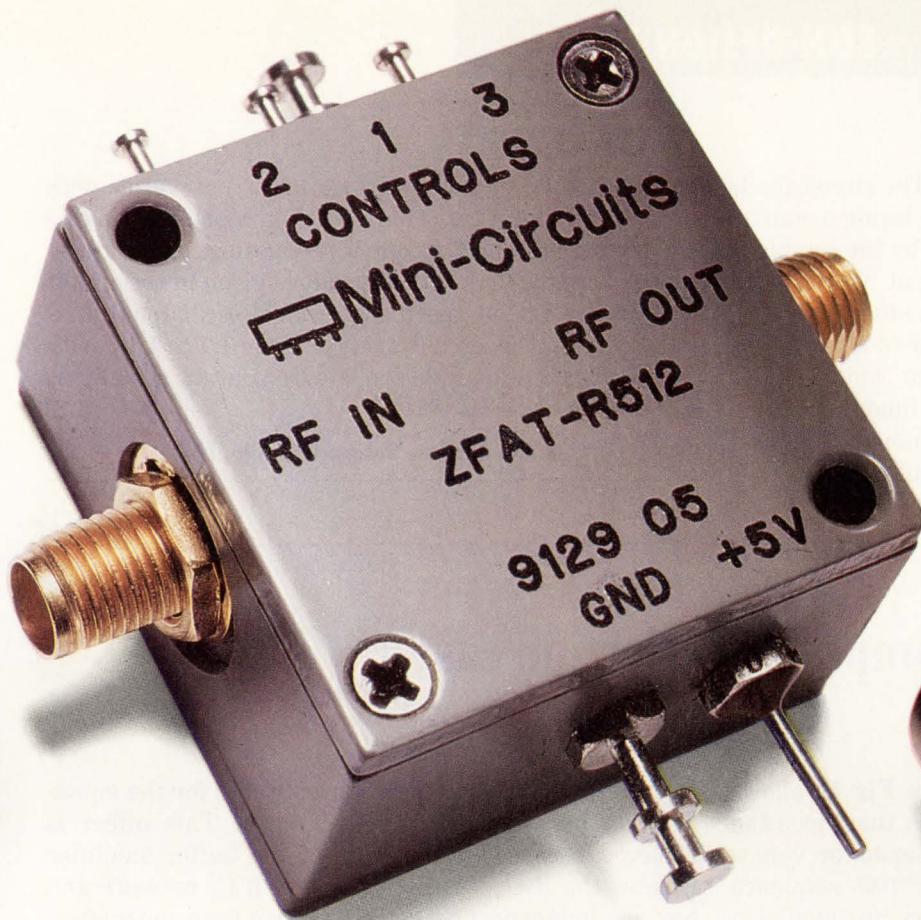

Fig 1—A step-up switching regulator provides the necessary bias voltage for a varactor diode operating in a 1.5V-powered circuit. The varactor diode's change in capacitance, controlled by a feedback loop including a temperature-sensing LM134 current source, opposes the crystal's drift with temperature to provide for an output that changes 0.05 ppm/°C.



PRECISION TTL- CONTROLLED ATTENUATORS

up to 35dB
10 to 1000MHz
FROM **\$5995**

TOAT-R512 ZFAT-R512 Accuracy (dB) (+/-dB)		TOAT-124 ZFAT-124 Accuracy (dB) (+/-dB)		TOAT-3610 ZFAT-3610 Accuracy (dB) (+/-dB)		TOAT-51020 ZFAT-51020 Accuracy (dB) (+/-dB)	
0.5	0.12	1.0	0.2	3.0	0.3	5.0	0.3
1.0	0.2	2.0	0.2	6.0	0.3	10.0	0.3
1.5	0.32	3.0	0.4	9.0	0.6	15.0	0.6
2.0	0.2	4.0	0.3	10.0	0.3	20.0	0.4
2.5	0.32	5.0	0.5	13.0	0.6	25.0	0.7
3.0	0.4	6.0	0.5	16.0	0.6	30.0	0.7
3.5	0.52	7.0	0.7	19.0	0.9	35.0	1.0

Price \$ (1-9 qty) TOAT \$59.95/ZFAT \$89.95
bold faced values are individual elements in the units

Finally... precision attenuation accurate over 10 to 1000MHz and -55°C to +100°C. Standard and custom models are available in the TOAT(pin)- and ZFAT(SMA)-series, each with 3 discrete attenuators switchable to provide 7 discrete and accurate attenuation levels.

The 50-ohm components perform with 6µsec switching speed and can handle power levels typically to +10dBm. Rugged hermetically-sealed TO-8 units and SMA connector versions can withstand the strenuous shock, vibration, and temperature stresses of MIL requirements. TOAT pin models are priced at only \$59.95 (1-9 qty); ZFAT SMA versions are \$89.95 (1-9 qty).

Take advantage of this striking price/performance breakthrough to stimulate new applications as you implement present designs and plan future systems. All units are available for immediate delivery, with a one-yr. guarantee, and three-sigma unit-to-unit repeatability.

finding new ways ...
setting higher standards

 **Mini-Circuits**

WE ACCEPT AMERICAN EXPRESS AND VISA

CIRCLE NO. 59

P.O. Box 350166, Brooklyn, New York 11235-0003 (718) 934-4500 Fax (718) 332-4661 Telexes: 6852844 or 620156

F 140 REV. A

resulting in a stepped-up dc potential. The circuit feeds this potential back to the comparator, closing a control loop. Because the comparator is biased by the temperature-sensitive LM134, the loop's output varies with ambient temperature in a controlled manner.

Q_2 's drop forces the step-up converter to always run, regardless of the loop's required output voltage. This characteristic permits smooth and continuous varactor bias from 0 to 3.9V over the 0 to 70°C ambient temperature range. The circuit applies this output to the MV209 varactor diode in the oscillator circuit. The varactor's

capacitance, a function of its dc bias, thus varies with ambient temperature. This change in capacitance shifts the crystal's resonant frequency, opposing temperature-induced crystal drift. For the values given in the circuit and the crystal cut specified, residual oscillator drift is 0.05 ppm/°C. The circuit functions from 1.7 to 1.1V with no specification degradation. Current drain is 230 μ A. **EDN BBS /DL_SIG #1077** **EDN**

To Vote For This Design, Circle No. 747

Active filter makes component selection easier

Michael Wyatt, SSO Honeywell Inc, Clearwater, FL

The modified Sallen-Key active filter in **Fig 1b** allows greater freedom in component selection than does the original Sallen-Key filter of **Fig 1a**. Capacitor values are generally available in the familiar 10% sequence of 1, 1.5, 2.2, 2.7, . . . ; resistor values are available in the 1% sequences of 1, 1.02, 1.05, Sallen-Key filter designs based on equal capacitor values rather than the more common equal resistor values would benefit from better fidelity and lower cost. However, the original filter in **Fig 1a** is restricted when using equal capacitors to damping factors greater than or equal to 1. This restriction limits the filter's usefulness for practical designs. In the more common equal-resistor case, the damping is unrestricted and equals $\sqrt{C_2/C_1}$. However, capacitor values that fit this equation may not be available at reasonable costs.

Fig 1b's modification lifts those component-value re-

strictions. Filter damping is unrestricted for the equal-capacitor or the equal-resistor case. This effect is achieved because the addition of the buffer amplifier isolates the R_1C_1 network from the R_2C_2 network and lets you independently select the two time constants.

You design the filter by selecting a standard value for C_1 and C_2 , then computing the ratio R_2/R_1 , and finally solving for R_2 and R_1 from the natural frequency equation. For example, to design a second-order low-pass Butterworth filter with a corner frequency of 1 kHz, first choose convenient values of 0.01 μ F for C_1 and C_2 . Then compute the ratio of $R_2/R_1 = 2$ for damping of 0.707. Now solve for $R_1 = 11.25$ k Ω and $R_2 = 22.50$ k Ω from the equation for natural frequency ($\omega_N = 2\pi f$) included in **Fig 1b**. **EDN BBS /DL_SIG #1075** **EDN**

To Vote For This Design, Circle No. 748

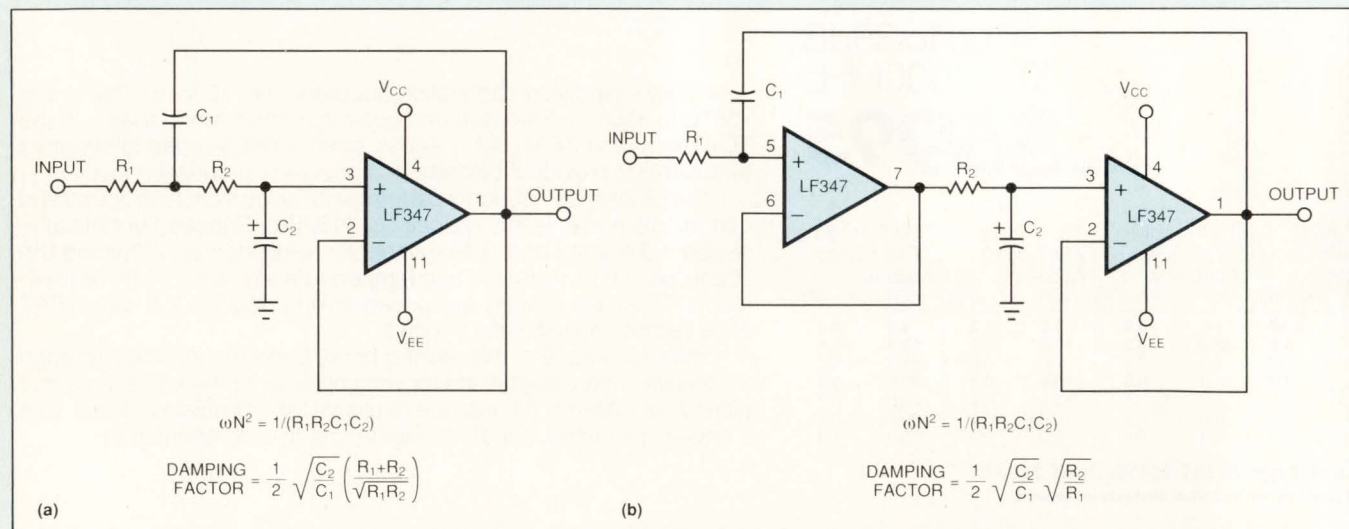
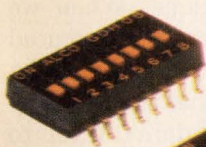
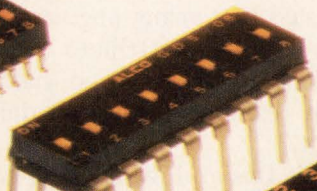

Fig 1—Adding a buffer to the original Sallen-Key filter in (a) removes component-selection restrictions. The filter in (b) lets you choose either equal resistor or equal capacitor values for any desired filter-damping factor.

Our new GD DIPs let you have it your way!



**GDH
SERIES**



**GDS
SERIES**

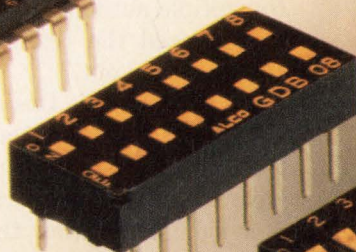

**GDB
SERIES**

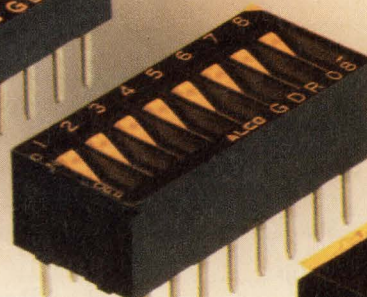

**GDR
SERIES**

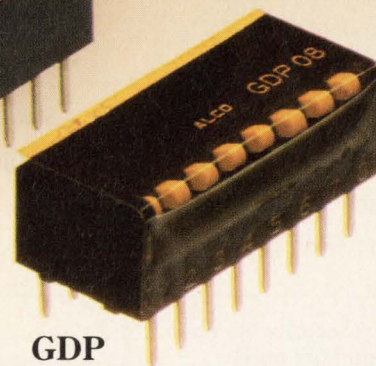

**GDP
SERIES**

Slide, piano, rocker, button,
thru board or surface mount.
Augat/Alcoswitch's GD Series DIP
switches give you the choices and
options that you've been looking for.

SAVE PCB REAL ESTATE.

The end stackable GDS
model is up to 26% smaller
than other low profile dip
switches. This space
saving design lets you
reduce the size of your
PCB or place more

components on
it. Also,

laying
out your
board now be-
comes easier. All holes
are on a .100 x .300 grid
regardless of how many
switches you stack.

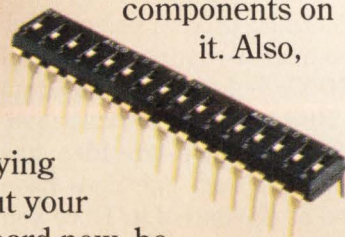

SAVE EVEN MORE.

For surface mount boards
the GDH half pitch DIP is
only .244"Wx.444"L
for the 8 position
version. All GD
series DIPs are
molded in high
temperature polymer
which withstands 260°
reflow soldering
temperatures.

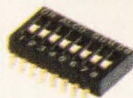

EASE OF REMOVAL

No cumbersome tape tab to
interfere with component
placement equipment. Our
unique corner notch allows
easy tape removal.

Learn how to buy it your way.
Call or write for a copy of the
new GD Series Dip switch
brochure.

AUGAT® Alcoswitch®
Quality and Innovation

Augat Inc., Interconnection
Product Division

452 John Dietsch Boulevard
Attleboro Falls, MA 02763 USA
Tel. (508) 699-9800 FAX (508) 699-6717

INTERNATIONAL SALES OFFICES

AUGAT LIMITED	England	44908676655
AUGAT SA	France	33146683090
AUGAT GMBH	Germany	49896129090
AUGAT AB	Sweden	468960270
AUGAT SRL	Italy	39396058029
AUGAT ELECTRONICS INC.	Canada	4166701500
AUGAT PTY LTD.	Australia	6129137100
AUGAT KK	Japan	81448338671
AUGAT PTE LTD.	Singapore	657530688
AUGAT TAIWAN	Taiwan	88625812373

Design Entry Blank

\$100 Cash Award for all entries selected by editors. An additional \$100 Cash Award for the winning design of each issue, determined by vote of readers. Additional \$1500 Cash Award for annual Grand Prize Design, selected among biweekly winners by vote of editors.

To: Design Ideas Editor, EDN Magazine
 Cahners Publishing Co
 275 Washington St, Newton, MA 02158

I hereby submit my Design Ideas entry.

Name _____

Title _____ Phone _____

Company _____

Division (if any) _____

Street _____

City _____ State _____

Country _____ Zip _____

Design Title _____

Home Address _____

Social Security Number _____
 (US authors only)

Entry blank must accompany all entries.

Design entered must be submitted exclusively to EDN, must not be patented, and must have no patent pending. Design must be original with author(s), must not have been previously published (limited-distribution house organs excepted), and must have been constructed and tested. Fully annotate all circuit diagrams. Please submit software listings and all other computer-readable documentation on a 5¼-in. IBM PC disk in plain ASCII.

Exclusive publishing rights remain with Cahners Publishing Co unless entry is returned to author, or editor gives written permission for publication elsewhere.

In submitting my entry, I agree to abide by the rules of the Design Ideas Program.

Signed _____

Date _____

ISSUE WINNER

The winning Design Idea for the October 1, 1991, issue is entitled "High-frequency VCOs top 100 MHz," submitted by Di Paolo Franco of Ericsson Fatme (Rome, Italy).

ISSUE WINNER

The winning Design Idea for the October 10, 1991, issue is entitled "PC printer port performs I/O," submitted by D Fletcher of IDS Inc (Dallas, TX).

Credit individuals, not companies

A spokesman for an electronics company recently submitted a Design Idea and neglected to include a signed entry blank. When we called him, he stated that his company wanted the company's name to appear as the author rather than an individual's name. When we asked why, he said that many engineers contributed to the idea. We offered to attribute the Design Idea to multiple authors. He then replied that his company "emphasized the team approach and didn't want to single anyone out."

We rejected this Design Idea because it didn't fulfill our criteria for publication. In addition, we believe that engineers, not companies or anonymous teams, have ideas. And we want to be able to give these individual innovators the credit they deserve in our Design Ideas section.

Charles H Small and Anne Watson Swager
 Design Ideas Editors

Reader rises to challenge

I love it when people say there is no simpler solution; that is my best motivator. Shu Zhen Ping can replace his two TIL13s in DI #994 (EDN, August 19, 1991, pg 164) with a single H1AA4.

Robert A Bonetti
 Tru-Data Systems
 42724 Mound Rd
 Sterling Heights, MI 48314
 (313) 254-0590

Design Ideas are just that: ideas, not necessarily complete or optimal solutions. Nothing makes us happier than for one Design Idea to spark other, perhaps better, ideas.

Charles H Small and Anne Watson Swager
 Design Idea Editors

How to use our bulletin board



This icon identifies those Design Ideas that have computer-readable material posted on EDN's bulletin-board system (BBS). Call our free BBS at (617) 558-4241 (300/1200/2400 8,N,1). Not every Design Idea has downloadable material, but each one does have a BBS number printed at the end of it. Once you get into the system, you can use that number to find more information on a particular idea. If you'd like to comment on any Design Idea, include the number in the subject field of your message.

Oh no. Please, not now. Not with manufacturing release next week.

THE PROTOTYPE DOESN'T WORK.

Six ASICs, fifteen PLDs and the whole thing's gone south. Maybe I should go south too. Yeah, hop a bus. Head for Mexico.

THE PROTOTYPE DOESN'T WORK.

Software? Could be. Hardware? Might be. So where do I start? At the beginning, of course. And just where is that, smart guy?

THE PROTOTYPE DOESN'T WORK.

And my performance review comes up next month. Maybe they'll just forget about all this, right? Yeah. Sure.

THE PROTOTYPE DOESN'T WORK.

Wait. What about that glitch in the handshake on the first pass? Couldn't reproduce it. Maybe it just reproduced itself.

THE PROTOTYPE DOESN'T WORK.



These are just a few of the reasons Tek makes a complete line of scopes, logic analyzers and signal sources. Instrumentation that can quickly get to the core of your prototype's problems. Whether they're digital, analog or software. Because even when your prototype doesn't work, Tek does. **TALK TO TEK/1-800-426-2200**

Tektronix
Test and Measurement

Integrated Circuits

Dual/Quad 12-Bit DACs With Serial Interface

- Feature clock speeds to 10 MHz
- Unipolar or bipolar output

The DAC2814 and DAC4814 are dual and quad, respectively, 12-bit A/D converters. Both models have a high-speed serial interface that can handle clock speeds to 10 MHz. The DACs include CMOS logic latches, a buried zener reference, and low-noise bipolar output amplifiers. Output ranges are 0 to 10V and 0 to -10V (unipolar) or $\pm 10V$ (bipolar). Serial data are clocked MSB-first into the bit registers, then strobed to each DAC separately or simultaneously as needed. Key specifications include a settling time of 3.5 μ sec; integral and differential nonlinearity of ± 0.5 and ± 1 LSB, respectively; and offset error of ± 5 mV. Both DACs are specified and monotonic over the -40

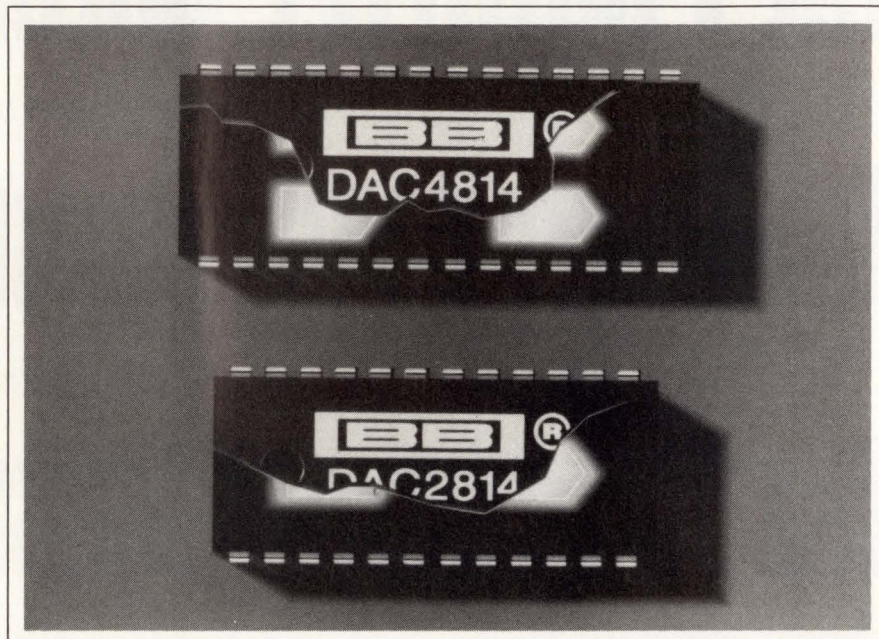

to +85°C temperature range. DAC2814, in a 24-pin DIP, \$16.95; DAC4814, in a 28-pin DIP, \$24.95 (100).

Burr-Brown Corp, Box 11400, Tucson, AZ 85734. Phone (800) 548-6132; (602) 746-1111. FAX (602) 889-1510. **Circle No. 374**

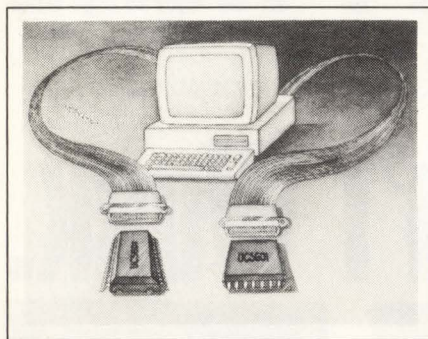

Active Terminator

- Meets SCSI-2 standards
- Includes a disconnect feature

The UC5601, an active terminator for SCSI connections, terminates all 18 lines in a SCSI bus to an internally regulated voltage source through on-chip, thin-film resistors. In addition to meeting the SCSI-2 standard, the IC includes a disconnect feature that, upon an activation command, isolates all 18 resistors from the cable. This feature allows users to make changes to the equipment configuration by means

of a software programming command. During disconnection of the terminating resistors, the supply current drops to less than 150 μ A, effectively putting the circuit into a "sleep" mode while the cable lines are open. Other features include negative clamping on all signal lines, current limiting, and thermal shutdown. UC5601, in a 28-pin plastic leaded chip carrier, \$4.25; in a 28-pin SOIC, \$4.40 (1000).

Unitrode Integrated Circuits Corp, 7 Continental Blvd, Merrimack, NH 03054. Phone (603) 424-2410. **Circle No. 375**

Variable-Gain Amplifier

- Has 75-MHz bandwidth
- Control range is 60 dB

The LT1228 combines a 100-MHz current-feedback amplifier with a 75-MHz gain-controlled, differential-input amplifier. The 60-dB control range is set by an external re-

sistor. The amplifier, which has an output-drive capability of 30 mA, is specified for operation from ± 2 to $\pm 18V$ supplies. The differential

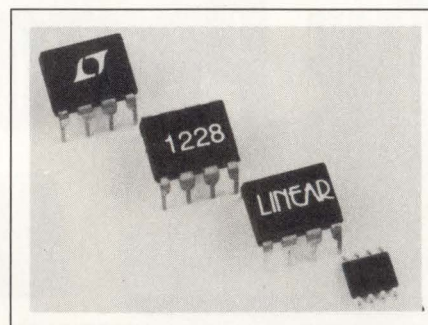

gain and phase of the current-feedback amplifier are 0.04% and 0.1° while driving a 75 Ω cable. Rise time is 3.5 nsec. LT1228, in 8-pin DIP and SO packages, from \$3.95 (100).

Linear Technology Corp, 1630 McCarthy Blvd, Milpitas, CA 95035. Phone (800) 637-5545; (408) 432-1900. FAX (408) 434-0507.

Circle No. 376

Text continued on pg 143

EDN-NEW PRODUCTS

Integrated Circuits

8-bit CMOS ADC. The HI-5700 features a conversion rate of 20 Msamples/sec. A parallel architecture provides high speed and eliminates the need for an external sample-and-hold circuit. An overflow bit allows series connection of two converters for 9-bit resolution. The device operates from a 5V supply and consumes 550 mW. The HI-5700 comes in a 28-pin plastic DIP. Commercial or industrial temperature grades, \$13 and \$16.90 (100), respectively. **Harris Semiconductor**, Box 883, Melbourne, FL 32901. Phone (800) 442-7747, ext 1096.

Circle No. 377

Low-power GAL. The GAL16V8S-15E is an electrically erasable PLD that can emulate most types of 20-pin PLDs. The GAL device features an input-to-output propagation delay of 15 nsec and a maximum supply current of 27 mA. The company guarantees a 100% field-programming yield, data retention of 20 years, and 100 erase/write cycles. The PLD comes in 20-pin DIPs and plastic leaded chip carriers. 15-nsec version, \$2.72; 25-nsec version, \$1.84 (5000). **SGS-Thomson**, 1000 E Bell Rd, Phoenix, AZ 85022. Phone (602) 867-6100. FAX (602) 867-6290.

Circle No. 378

T1 frequency translator. The PLXO (phased-locked crystal oscillator) provides frequency translation between telephone-standard reference clocks and North American DS1 (1.544 MHz) and DS1C (3.152 MHz) transmission rates and Europe's CEPT1x2 (4.096 MHz) transmission rate. The PLXO provides a loss-of-lock signal, which the designer can use as a system warning. Pricing varies according to the frequency range. The 1.544- to 4.096-MHz version, \$21 (10,000). **AT&T Microelectronics**, Dept 52AL040420, 555 Union Blvd, Allentown, PA 18103. Phone (800) 372-2447, ext 819; in Canada, (800) 553-2448, ext 819.

Circle No. 379

Modem chip set. The 4-chip SQ6987 modem enables voice, facsimile, and data transmission and can detect DTMF tones during voice transmission. The chip set can transmit and receive facsimile information at 9600 bps and data communications at 2400 bps. The modem supports V.21, V.29, V.27ter, and V.27 signaling for facsimile operation and includes MNP-5 and V.42bis error correction and data compression. The SQ6987 operates from $\pm 5V$ supplies and comes in plastic leaded chip carriers,

DIPs, and quad flatpacks. \$45 (10,000). **Sierra Semiconductor**, 2075 N Capitol Ave, San Jose, CA 95132. Phone (408) 263-9300. FAX (408) 263-3337. TLX 384467.

Circle No. 380



SCSI disk-drive controller. The CL-SH450 supports 40-MHz NRZ disk-transfer data rates and the 10-Mbyte/sec SCSI-2 standard. An intelligent buffer manager decreases access times between the host and disk interfaces by allowing the transfer of noncontiguous blocks of data. A proprietary split-data-field technique allows zone recording formats and 88-bit Reed-Solomon error correction. In a 100-pin quad flatpack, \$30 (100). **Cirrus Logic Inc**, 1463 Centre Pointe Dr, Milpitas, CA 95035. Phone (408) 945-8300. FAX (408) 263-5682. TLX 171918.

Circle No. 381

Programmable-gain D/A converters. This series of 8-bit D/A converters features a programmable gain to any one of four levels. The chips, which operate from a 4.5 to 13.2V supply, have a settling time of 2.5 μ sec within 1V of V_{cc} and analog ground. The output range extends from 0 to V_{cc} . Edge-triggered latches have 30-nsec write times and 0-nsec hold times. The ML2340 (single latch) and ML2341 (double latch) have a programmable reference of 4.5 or 2.25V. The ML2350 (single latch) and ML2351 (double latch) have a programmable reference of 5 or 2.5V. The devices come in 18- and 20-pin packages. From \$3.75 (100). **Micro Linear Corp**, 2092 Concourse Dr, San Jose, CA 95131. Phone (408) 433-5200.

Circle No. 382

12-bit D/A converters. The MAX507 and MAX508 are 12-bit voltage-output converters that combine a laser-trimmed DAC with a 10V-drive-capable

output amplifier and a buried zener reference. The DACs have double-buffered logic inputs and acquire data in 12-bit-wide (MAX507) or 8+4-bit-wide (MAX 508) format. The devices have a settling time of 5 μ sec to ± 0.5 LSB and a slew rate of 2V/ μ sec. Package options include 20- and 24-pin DIPs and wide SO packages. From \$7.55 (1000). **Maxim Integrated Products**, 120 San Gabriel Dr, Sunnyvale, CA 94086. Phone (408) 737-7600.

Circle No. 383

Low-power 20-pin PAL. Especially useful in portable-computer applications, the PLC18V8Z-25 universal PAL device has a 25-nsec (max) propagation delay and a current drain of less than 100 μ A. The device includes 10 inputs, 74 AND gates, and 8 output macrocells. Input-transition-detection circuitry automatically adjusts the device's current consumption to the presence or absence of an input signal. From \$3.75 (1000). **Signetics/Philips**, Box 3409, Sunnyvale, CA 94088. Phone (408) 991-2000.

Circle No. 384

Synchro-to-digital converter. Featuring a 14-bit or programmable 14- or 16-bit resolution, the SDC-14575 synchro/resolver-to-digital converter comes in a 1.0 \times 0.8-in. package. The converter's velocity output provides a 4V dc signal that is linear to 1%. The device is available in 4- or 8-arc-minute accuracy grades. For resolver use, the SDC-14575 accommodates inputs of 2 and 11V rms. For synchro inputs, a solid-state Scott-T transformer accepts signal levels of 11.8 or 90V rms. The frequency range is 47 Hz to 5 kHz, and the closed-loop bandwidth is 103 kHz. From \$365. **ILC Data Device Corp**, 105 Wilbur Pl, Bohemia, NY 11716. Phone (516) 567-5600, ext 383. FAX (516) 567-7358.

Circle No. 385

12-bit, 3-MHz A/D converter. Featuring a 3-MHz (330 nsec) sampling speed, the HI-5800 12-bit converter contains a 2-step subranging 7-bit flash ADC, a 7-bit DAC with digital error correction, an on-chip voltage reference, and a sample-and-hold circuit. Key specifications include differential nonlinearity of 0.5 LSB, a 71-dB S/N ratio, -72-dB THD, and a 74-dB spurious-free dynamic range. The HI-5800, in a 40-pin ceramic DIP, \$110 (100). **Harris Semiconductor**, Box 883, Melbourne, FL 32901. Phone (800) 442-7747, ext 1139.

Circle No. 386

60-MHz Handheld DSO

- Weighs 4.4 lb.
- Runs for 3 hours from rechargeable batteries

Model 224 2-channel, 60-MHz-bandwidth handheld digital storage oscilloscope weighs 4.4 lb and meets the shock and vibration requirements of MIL standard T28800D. It operates for 3 hours from a pair of rechargeable batteries and features ohmic isolation to 600V rms between each channel and the chassis. The scope has automatic trigger settings and stores four front-panel setups for later recall. You can control the scope through its RS-232C port. The vendor's CAT200 virtual-instrument software lets you use a PC for this purpose. \$2750.

Tektronix Inc., Box 1520, Pittsfield, MA 01202. Phone (800) 426-2200. **Circle No. 387**

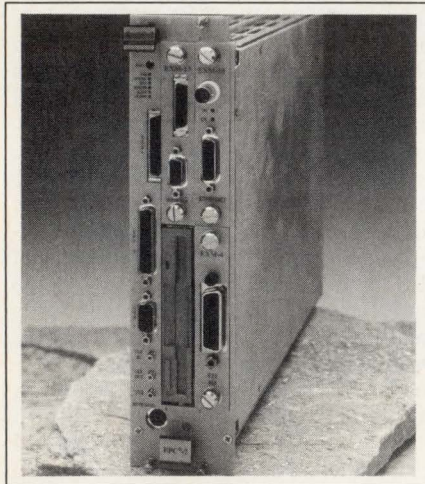
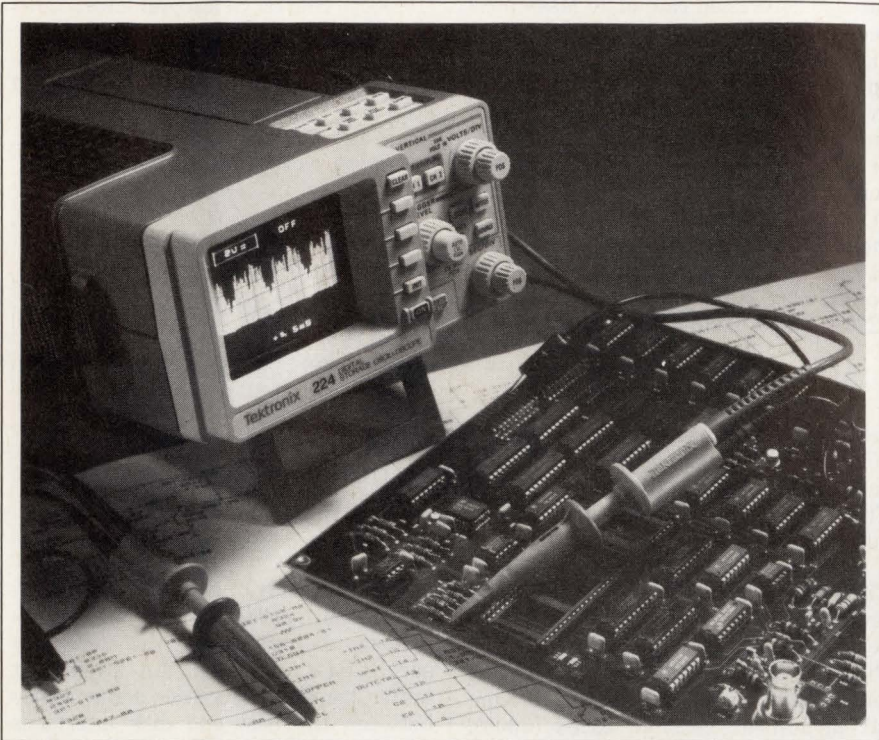

i486-Based VXI Controller

- Occupies two C-size slots
- Includes hard disk that stores as much as 240 Mbytes

The EPC-7 VXIbus controller uses an i486 μ P as its CPU, running at either 33 or 50 MHz. The 2-slot C-size module optionally contains a 3 1/2-in. floppy-disk drive and a hard disk that can store as much as 240 Mbytes. In addition, the controller includes four EXMbus slots. The

EXMbus is similar to the 16-bit ISA bus except that EXMbus cards support a module-identification sequence when you power them up. Although it can't take advantage of the module IDs, software for ISA bus cards works with EXMbus cards. An adapter lets you plug a full-length ISA bus card into the controller. 33-MHz, 2-Mbyte RAM, 52-Mbyte hard-disk and floppy-disk drive, and runtime software, \$6995; 640 \times 480-pixel graphics controller, \$450.

Radisys Corp., 19545 NW Von Neumann Dr, Beaverton, OR 97006. Phone (800) 950-0044; (503) 690-1229. **Circle No. 388**

6 1/2-Digit DMM

- Basic dc accuracy is 15 ppm for 24 hours
- Takes 1000 readings/sec

The HP 34401A 6 1/2-digit multimeter works as a stand-alone or a computer-controlled instrument. Both IEEE-488 and RS-232C ports are included. The meter can take a

reading in 1 msec, change its range in 20 msec, and respond to the standard commands for programmable instruments (SCPI). Programs written for the HP 3478A and the Fluke 8840A meters work without modification. The unit's basic dc accuracy is 15 ppm for 24 hours. In addition to dc measurements, the meter measures wideband ac. Other functions include measuring deci-



belts, and testing diodes and continuity. \$995.

Hewlett-Packard Co., 19310 Pruneridge Ave, Cupertino, CA 95014. Phone (800) 752-0900. **Circle No. 389**



After all, it's Sun.

That's right, FORCE and Sun have teamed up to offer one of the brightest new products in embedded systems.

The SPARC™ CPU-1E engine. It's a complete implementation of SPARCstation™ 1, fully supported by the powerful SunOS™ and the real-time expertise of FORCE.

For the first time, you can design with SunOS and real-time on the same VME backplane. With industry-standard SPARC technology, no less.

And that's just the beginning. FORCE will spark embedded systems for generations to come, based on our partnership with Sun. In fact, we're already designing the SPARC CPU-2E. Of course, our entire family of SPARC-based products is 100% SunOS-compatible.

So nothing stands between you and the most powerful development environment in embedded systems. With SunOS and the SPARC CPU-1E, you can program, debug and observe real-time code. All within the same development and target system, thereby slashing costs and development time.

The SPARC CPU-1E accommodates up to 80 Mbytes of DRAM. You can run real-time, UNIX®, Sun Windows™ and utility programs. Standard DMA-driven SCSI and Ethernet interfaces give you full network access. There's even an SBus™ interface for I/O expansion.

We also provide such leading real-time operating systems as VxWorks,™ VADSWorks,™ VRTX,™ MTOS,™ PDOS™ and OS-9/9000™ products. Along with over 2100 third-party applications from Sun's Catalyst™ program.

Finally, we can supply all your system components. Everything from SPARCstations and mass storage modules to expansion boards, monitors and keyboards.

But that's what you'd expect from the vendor with the broadest, most flexible line of embedded systems solutions. So call 1-800-BEST-VME, ext.10 for more information or fax a request to (408) 374-1146.

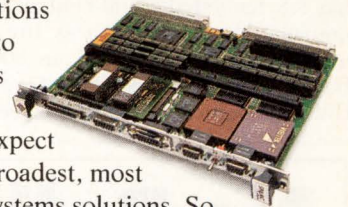

VME at its best.

And put the heat on your competition.

FORCE Computers, Inc. 3165 Winchester Blvd., Campbell, CA 95008-6557

All brands or products are trademarks of their respective holders.
© 1991 FORCE Computers, Inc.

OUR NEW PARTNERSHIP IS AS HOT AS IT GETS.

CIRCLE NO. 62



EDN-NEW PRODUCTS

Test & Measurement Instruments

IEEE-488 digital-control interface. The Digital488/80A 80-channel digital I/O interface communicates with the controlling computer via the IEEE-488 bus. The unit, which you can mount in an equipment rack, divides its inputs into 40-channel groups, each of which has six handshake and control lines. A nonvolatile memory stores the power-up state of all lines and an 8000-byte buffer captures 1000 80-bit readings, thus relieving the bus interface of the

need to poll the unit constantly. \$995; high-voltage option for handshake and control signals, \$295. **IOtech Inc.**, 25971 Cannon Rd, Cleveland, OH 44146. Phone (216) 439-4091. FAX (216) 439-4093.

Circle No. 390

ISA bus audio-input boards. The AT-A2150 series uses delta-sigma A/D conversion to achieve a 93-dB S/N ratio and -95-dB total harmonic distortion.

There are two versions; one for general audio work (flat within ± 0.015 dB to 20 kHz); the other for voice measurements (flat within ± 0.015 dB to 4 kHz). \$1995. **National Instruments Corp.**, 6504 Bridge Point Pkwy, Austin, TX 78730. Phone in US and Canada, (800) 433-3488; (512) 794-0100. FAX (512) 794-8411.

Circle No. 391

No Bells & Whistles. Just great Buzzers.

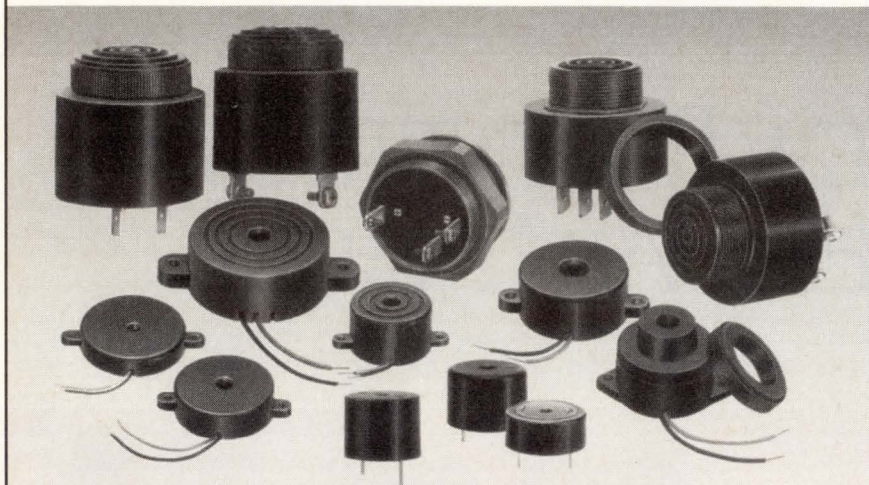

OHM-O-TONE® Piezo Audio Indicators

Introducing **OHM-O-TONE®**, our great new piezo audio indicators. We're proud to have this fine collection of audio indicators in the Ohmite family. Clear, high quality tones in high quality packages. Competitive pricing is part of the Ohmite strategy, along with a wide selection of the most popular sizes to match your range of design requirements.

OHM-O-TONE® Audio Indicators are available from your authorized Ohmite stocking distributor.

Buy Ohmite. It's the soundest decision you'll make today.
Tel 708-675-2600 Fax 708-675-1505

OHMITE®

Since 1925, Ohmite Manufacturing Co. has been in the forefront of innovative electronic component technology. Progressive and competitive, Ohmite maintains a tradition of quality and service.

Ohmite Manufacturing Co., 3601 Howard St., Skokie, IL 60076 Tel 708-675-2600 Fax 708-675-1505

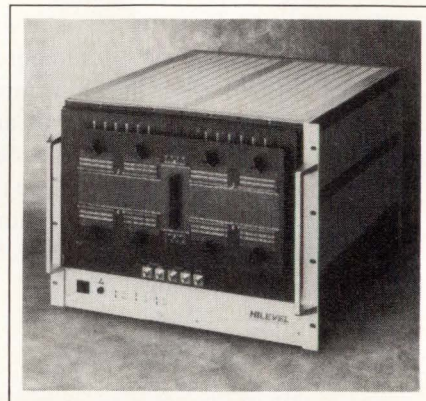

Benchtop ASIC tester. The ETS370 provides as many as 512 pins and features a 25-MHz bidirectional data rate, a 50-MHz clock, and programmable timing generators with 500-psec resolution and per-pin programmability. The unit's device and user interfaces conform to those of the vendor's ETS and Topaz families. A 256-pin system with 16 timing generators and a 33-MHz i486-based PC controller sells for less than \$95,000. **Hilevel Technology Inc.**, 31 Technology Dr, Irvine, CA 92718. Phone (714) 727-2100. FAX (714) 727-2101. TLX 655316.

Circle No. 392

DSP and audio I/O board for 16-bit ISA bus. The AT-DSP-2200 provides 25 Mflops of computation capability via a WEDSP32C DSP μ P. The board also includes two channels of 16-bit delta-sigma A/D conversion with a S/N ratio of 92 dB and total harmonic distortion of -95 dB. Two analog-output channels incorporate 8 \times oversampling filters. \$2495. **National Instruments Corp.**, 6504 Bridge Point Pkwy, Austin, TX 78730. Phone in US and Canada, (800) 433-3488; (512) 794-0100. FAX (512) 794-8411.

Circle No. 393

Half-size ISA bus digital I/O boards. These 5.512 \times 3.9-in. boards use 5V dc power only; no 12V supplies are needed, so they work in several laptop PCs. Each board has 32 channels configured as four 8-bit ports. Two mod-

True portables are totally off the wall.

No outlets. No rechargers. No reliance on AC whatsoever. That's true portability. It's what the world is coming to. And it runs on easy-to-replace primary batteries. The next generation promises even smaller, lighter weight, more convenient portables. That depends on you, and you can depend on us.

Duracell is the primary source for primary power. We offer you a world of technical expertise and marketing experience in developing powerful solutions for computers, cellular phones and more. Let us help you

select a primary battery system from our broad line that includes alkaline and high power lithium manganese dioxide batteries.

Call us for application-specific data, design-in assistance, or just more information. Our OEM hotline number is (800) 544-5454, Ext. 3281. Or fax us at (203) 791-3273.

True portability is the cutting edge. And it's in your power.

DURACELL[®]
PORTABILITY IS PRIMARY



EDN-NEW PRODUCTS

Test & Measurement Instruments

els provide inputs; two provide outputs; and two mix inputs and outputs. In each pair, one unit works with TTL levels, and the other unit provides 5-kV isolation and works with 12 to 24V levels. TTL outputs sink 40 mA; isolated outputs handle 200 mA. Unit for TTL levels, \$225; isolation unit, \$295. **Contec Microelectronics USA Inc**, 2188 Bering Ave, San Jose, CA 95131. Phone (800) 888-8884; (408) 434-6767. FAX (408) 434-6884. **Circle No. 394**

Data-acquisition board. The DAS-1600 digitizes eight differential or 16 single-ended analog inputs with 12-bit resolution at 100 kHz. It also provides a pair of 12-bit analog outputs, 24 digital I/O lines, four dedicated digital inputs, and four dedicated digital outputs. A pacer clock and two 16-bit counter-timers facilitate triggering conversions and counting events. \$899; advanced software, \$200. **Keithley Instruments** Data Acquisition Div, 440 Myles Stan-

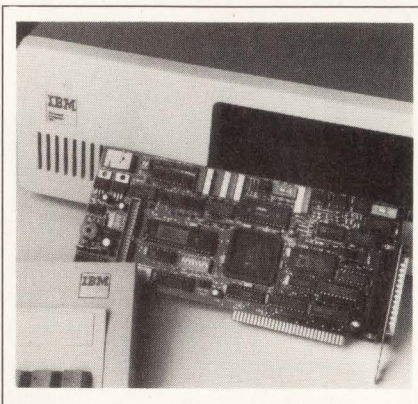

dish Blvd, Taunton, MA 02780. Phone (508) 880-3000. FAX (508) 880-0179.

Circle No. 395

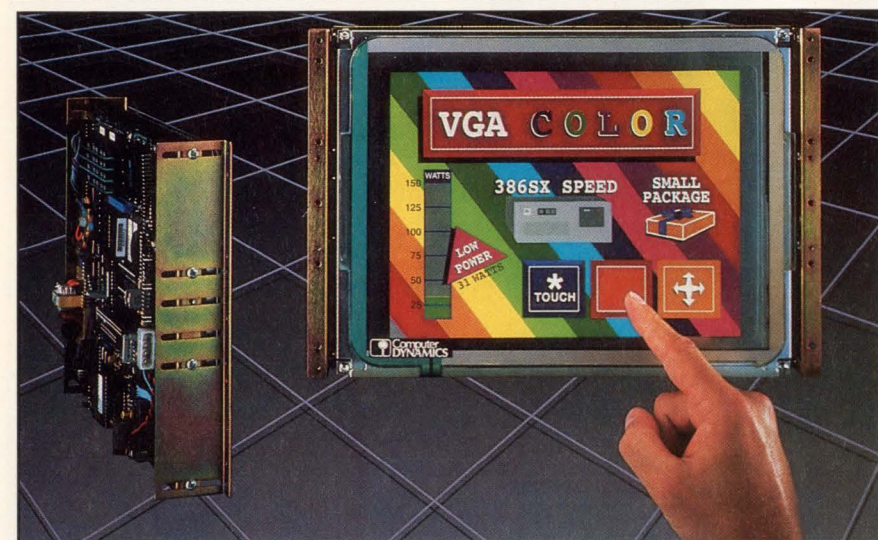

One Operator Interface Is a '386 PC, Too!

The Color DisplayPac™ has the looks, the touch and the brains. It combines a powerful '386SX PC/AT, plus full color LCD display, plus touchscreen in one highly flexible, ready to drop in package. It's the operator interface for places where a standard PC, CRT and keyboard can't go.

It's small. (11.5" x 8.5" x 2") and embeds easily in your OEM product.

It's colorful. The 10.4" active matrix TFT LCD display features cool operation and excellent visibility under many viewing conditions.

It's powerful. The PC engine behind the display gives you all the PC/AT standard functions, plus disk and video interfaces, and up to 4 megabytes of DRAM.

It's rugged. The ideal operator interface for the factory environment, easily withstands vibration.

It's low power. Compare the complete Color DisplayPac, drawing only 31 watts, to a CRT alone at 150 watts.

It's configurable for your application. DisplayPacs come with bright electroluminescent (EL) and monochrome LCD displays, too. Infrared, resistive and capacitive touchscreens are available. '286 AT and 8088 XT versions also offered.

"The Flat Panel Experts"

Call for your **FREE DisplayPac™** brochure, information on other configurations, and pricing.

Computer DYNAMICS

107 SOUTH MAIN STREET, GREER, SC 29650
(803) 877-8700 • FAX (803) 879-2030

High-voltage digital I/O board for VMEbus. The VMIVME-2128 has 16 8-bit bidirectional digital ports, each addressable via a pair of bytes on 8-, 16-, or 32-byte boundaries. The output driver circuits handle 990-mA surges before shutting down. Built-in test circuits isolate faults in real time. \$1295. **VME Microsystems International Corp**, 12090 S Memorial Pkwy, Huntsville, AL 35803. Phone (800) 322-3616; (205) 880-0444. FAX (205) 882-0859.

Circle No. 396

80186EB emulator. You can use the 186EB in-circuit emulator for firmware development of the 80186EB and 80188EB single-chip μ Ps. The emulator, which supports 131,072 hardware breakpoints and allows read, write, and fetch protection of specified areas of memory, comes with a source-level debugger for C and PL/M. \$7500. **Softaid Inc**, 8300 Guilford Rd, Columbia, MD 21046. Phone (800) 433-8812; (410) 290-7760. FAX (410) 381-3253. **Circle No. 397**

Event-timing controller/monitor.

The GT401 controller/monitor plugs into the 16-bit ISA bus. It includes a real-time clock with 1- μ sec resolution, four I/O channels, and three 16-bit timer/counters. You can instruct the I/O channels to output specific numbers of pulses at predetermined real times or to time-stamp the edges of the input signals with a resolution of 400-nsec. The unit places the time stamps in dual-ported RAM that can be read from the ISA bus. \$995. **Guide Technology Inc**, 920 Saratoga Ave, Suite 215, San Jose, CA 95129. Phone (800) 288-4843; (408) 246-9905. FAX (408) 246-0924. **Circle No. 398**

Ariel V-C40 Hydra Breaks the BOPS Barrier

1.1 billion operations per second sets the record for 6U VMEbus coprocessor cards

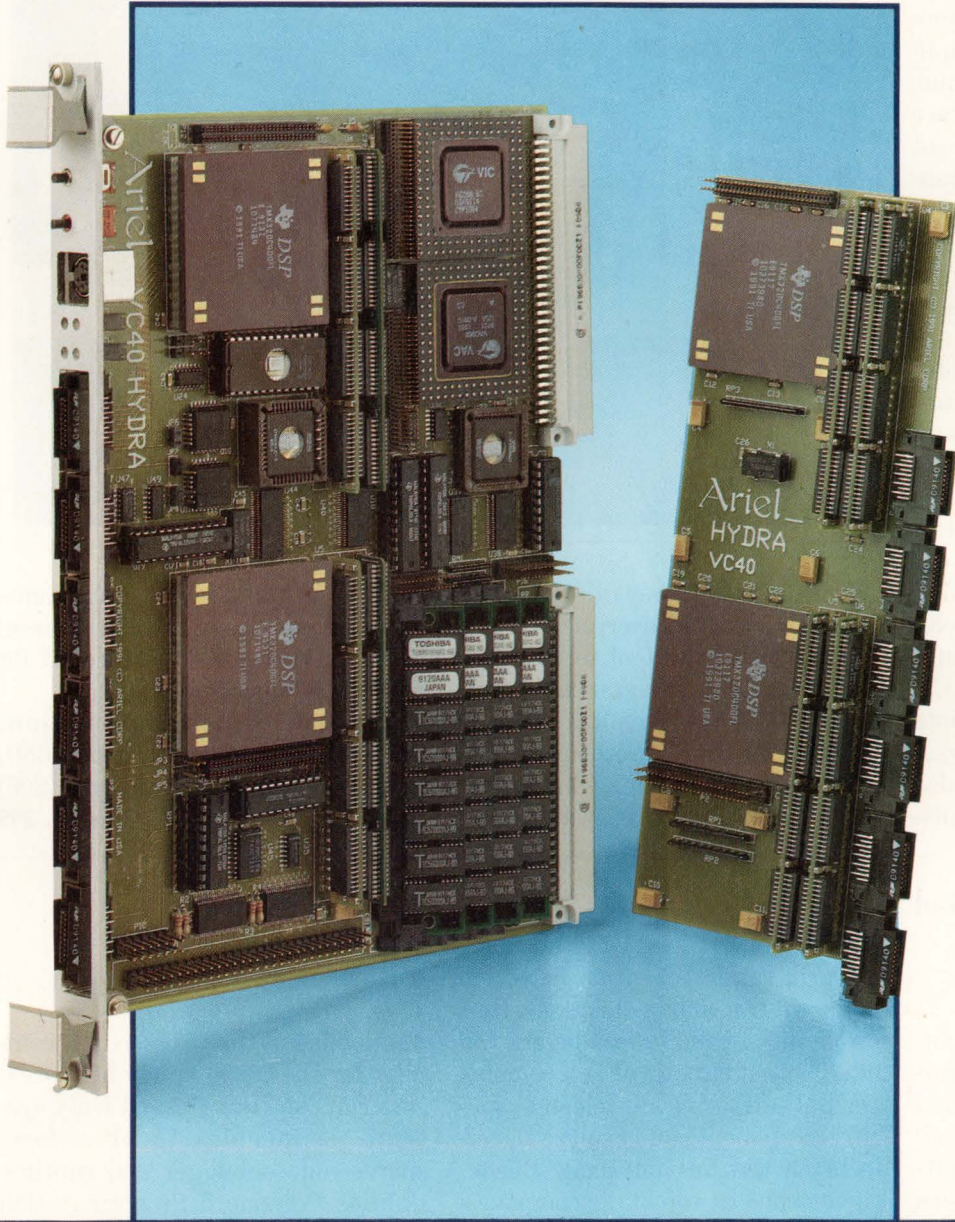

Only Ariel's Hydra combines four TI TMS320C40 DSPs to deliver twice the processing speed and four times the I/O bandwidth of any 6U VMEbus coprocessor card. It's the only choice for the most compute-intensive multiprocessor applications.

The V-C40 packs up to 64 Mbytes of DRAM as well as up to 5 Mbytes of SRAM in eight banks—two per processor. Each DSP has direct access to memory via dual 32-bit memory buses, as well as six parallel I/O ports and a high-speed six-channel programmable DMA controller. All six channels can transfer data simultaneously without interrupting program execution.

Hydra also includes a 24-bit parallel ADBus that lets you access a wide range of high-speed data acquisition cards. Development support includes an ANSI C compiler and the first PC-based XDS510 in-circuit emulator to support parallel processing. And of course, with Ariel's legendary technical support, you'll never work alone.

To learn more about the V-C40 Hydra, or any of Ariel's DSP products for ISA/EISA, VMEbus, SBus, Hewlett-Packard, NeXT, or Macintosh computers, send us a fax, leave us a message on the BBS or E-mail, or just give us a call.

Ariel

The DSP Authority

433 River Road Highland Park, NJ 08904
(908) 249-2900 FAX: (908) 249-2123
DSP BBS: (908) 249-2124
Email: ariel@ariel.com

Distributed in: **France**, REA Informatique, tel: 1 49 65 25 50, fax: 1 49 65 25 69; **Israel**, Militram Futuristic Technology Ltd., tel: 52-545685, fax: 52-574383; **Italy**, International Trading Device SRL, tel: 02-749 0749, fax: 02-761 0407; **Japan**, Marubun Corp., tel: 033-639 9816, fax: 033-661 7433.

See us at Buscon Booth #740

Migration Path For IC Silicon Compiler

- *Migrate Genesil designs to IC silicon compiler*
- *Features module libraries and IC place-and-route tools*

The Chiprafter IC design software provides a migration path for users of Genesil, for which Mentor Graphics has announced it will discontinue support. The Chiprafter software is an IC-design software tool set that features module libraries (standard cells, memories, and data-path elements), logic synthesis for glue logic (including finite state machines), and automated IC place-and-route tools. The libraries are technology and design-rule independent. The function-block library includes SSI standard cells and complex, high-performance data-path elements such as memories and analog functions. Users can modify these blocks for specific design needs and add the modified blocks to the library as new elements. The automatic place-and-route tools are user interactive. Users set the performance constraints to drive the tools and can interactively hand route. The tools also handle I/O buffer sizing, clock dis-

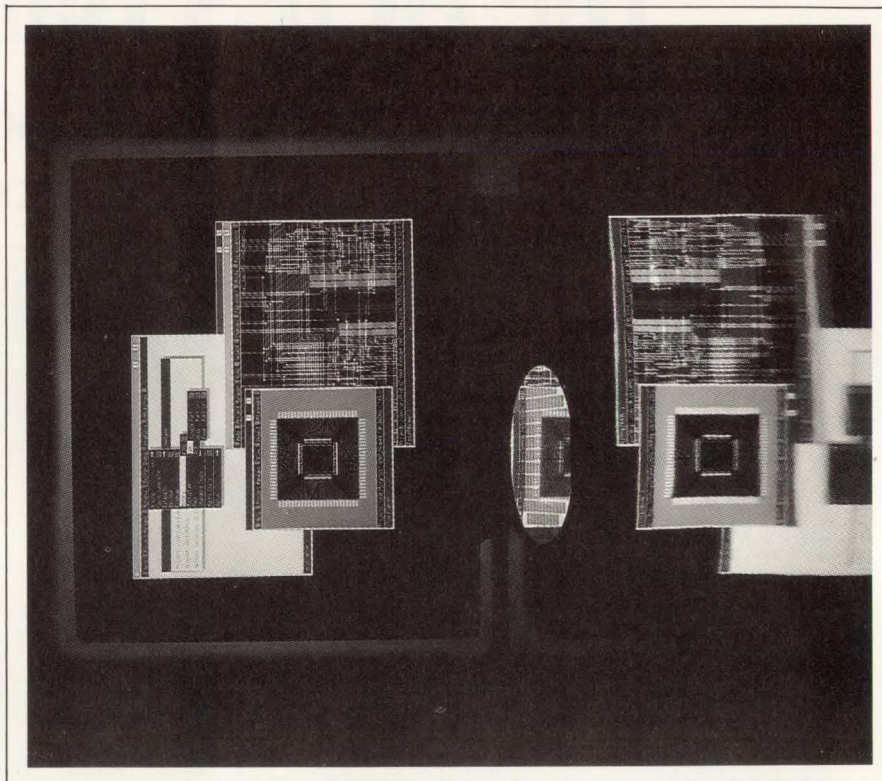

tribution, and power-rail sizing, all of which users can override for hand intervention. The tool set features a static timing analyzer and interfaces with Mentor Graphics and Valid Logic CAE tools for schematic capture and simulation. Chiprafter modules, from \$25,000; system, from

\$59,000. Until March 31, 1992, Genesil users can trade in their Genesil software to get a 45% discount for a special Chiprafter package.

Cascade Design Automation, 3650 131st Ave, Suite 650, Bellevue, WA 98006. Phone (206) 643-0200. **Circle No. 399**

Bus-Design Timing-Analysis Tool

- *Generates detailed timing diagrams for signal analysis*
- *User selects bus-cycle type*

Busdesigner/AT reduces the hundreds of stringent timing specifications of the IBM AT, ISA, and EISA bus standards into a small group of requirements. The software lets a designer rapidly check a variety of architectures during a board's design stage. Once the designer settles on an architecture, the tool automatically generates timing diagrams complete with all timing margins for each type of bus cycle. Timing models include I/O,

memory with wait states, DMA cycle, memory refresh, and bus-master arbitration. The tool flags and highlights all timing violations, thus providing a design check before you build actual circuits or run complex simulations. You can change specific components and analyze the effects on the bus interface. Busdesigner runs on top of the company's Timingdesigner graphical, interactive signal analyzer, which runs on PCs. Busdesigner/AT, \$695; Timingdesigner for Windows, \$995.

Chronology Corp, 2721 152 Ave NE, Redmond, WA 98052. Phone (206) 869-4227. **Circle No. 400**

C-Compiler Package

- *For 68000 series*
- *Offers increased compilation speed*

Version 5.1 of the Crosscode C compiler for the 68000 family of processors runs on IBM PC and Unix systems. It includes the Freeform source-code debugger and runtime utilities. Version 5.1's optimization techniques can provide a 40% speed up. IBM PC version, from \$1995.

Software Development Systems Inc, 4248 Belle Aire Lane, Downers Grove, IL 60515. Phone (800) 448-7733; (708) 971-8170. FAX (708) 971-8513. **Circle No. 401**

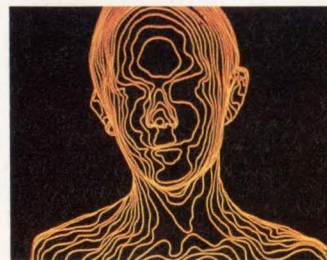
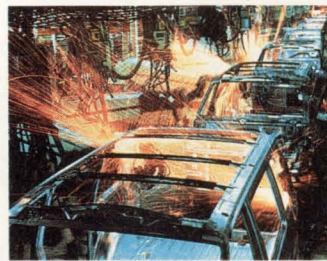
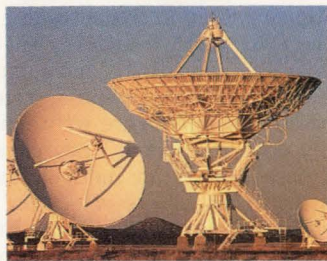
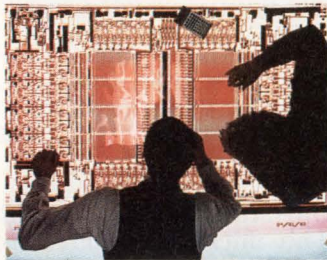

WHO NEEDS THE SIGNAL PROCESSING WORKSYSTEM?

Anyone involved in DSP and communications design can benefit from the Signal Processing WorkSystem.[®] Because SPW[™] is the only complete, integrated CAE software tool for signal processing design, simulation, analysis and implementation.

Satellite communications. Modems. Mobile radios. Cellular phones. Radar. Sonar. Speech encoding. Voice processing. Image processing. Digital audio. Multimedia. Automotive electronics. Robotics. Neural nets and pattern recognition. Data compression. HDTV. Biomedical instrumentation. All these and much more can be designed using SPW on industry-standard platforms from Sun, DEC and HP/Apollo.

That's why over 200 of the world's leading telecommunications, aerospace and electronics companies around the world now use SPW.

With SPW you first create a high-level, hierarchical design using its extensive libraries of DSP and communications function blocks, as well as your own custom blocks. SPW then automatically converts your design into an error-free simulation program that can accept real-world signals and parameters for accurate design analysis.

SPW also provides several optional paths to implementation, including bit-accurate fixed-point simulation, VHDL generation, logic synthesis and other ASIC/PCB support. A code generation system produces generic-C for fast prototyping on any DSP platform, links SPW to DSP chips from AT&T, Motorola and TI, and supports boards from leading vendors.

To preview the Signal Processing WorkSystem, call (415) 574-5800 for a free video demonstration tape. In fifteen minutes, you'll see how SPW can save hundreds of hours and thousands of dollars in DSP design.

COMDISCO[®]
SYSTEMS, INC

919 East Hillsdale Blvd., Foster City, CA 94404 (415) 574-5800

PC-board design package. The PADS-2000 pc-board design package, Version 3.0 supports curved design tracks. You can define an arced or beveled miter at each route corner for curved tracks. This feature allows you to define as many as seven different mitering radii to meet line-curve requirements. The design package also provides improved copper handling for pour islands, pad-stack modification for individual components, and drill-hole

checking. \$6995. **CAD Software Inc.**, 119 Russell St, Suite #6, Littleton, MA 01460. Phone (800) 255-7814; (508) 486-9521. FAX (508) 486-8217. **Circle No. 402**

Cross-development tools for MIPS architecture. The vendor has ported its C development tools for the MIPS architecture to other platforms. The R3000 RISC microprocessor software-development tools are now available on

Sun-4 workstations and DEC VAX systems running the VMS operating system. The R3000 RISCross-development tool set, including C compiler, architecture (instruction-set) simulator, cache-memory simulator, and development utilities, \$40,000. **Mips Computer Systems Inc.**, 950 DeGuigne Dr, Sunnyvale, CA 94086. Phone (408) 720-1700. FAX (408) 524-7950. **Circle No. 403**

Optimized cross-assemblers for 8-bit microcontrollers. The Professional Optimized Cross-Assemblers support 8-bit microcontrollers such as the 8051, 6805, 68HC11, 8080/85, 6800, X80/180, and others, including the 16-bit 68000. These 2-pass, relocatable, macro assemblers are written in assembly code for speed. They come with a 2-pass linker, an independent locate utility that allows relocating without relinking, and a librarian. From \$99. **Logisoft**, Box 61929, Sunnyvale, CA 94086. Phone (408) 773-8465. FAX (408) 773-8466. **Circle No. 404**

DSP application development tools for DSP 56001/96002. Hyper-signal, an algorithm development package for the Motorola DSP56001 and DSP96002 DSP processors, supports real-time DSP algorithm development, analysis, and measurement. It provides spectrum analysis, a digital oscilloscope, frequency-domain displays, waveform editing, and real-time signal filtering. From \$989. **Signalogic Inc.**, 9704 Skillman #111, Dallas, TX 75243. Phone (214) 343-0069. FAX (214) 343-0163. **Circle No. 405**

CASE tool for large projects. Cohesion ASD/SEE (Aerospace-Defense/Software Engineering Environment) is a CASE (computer-aided software engineering) tool for large software-engineering projects. It includes a set of integrated CASE tools and services. Designed for large Ada projects, it supports DoD standards for configuration management and documentation. The system spans the entire product life cycle from specification to maintenance. From \$25,000/seat. **Digital Equipment Corp.**, Maynard, MA 01754. Phone (508) 467-5164. **Circle No. 406**

PLD programmer software. The PROMlink-6 software package for programming and editing PLD/FPGA programming data drives a device pro-

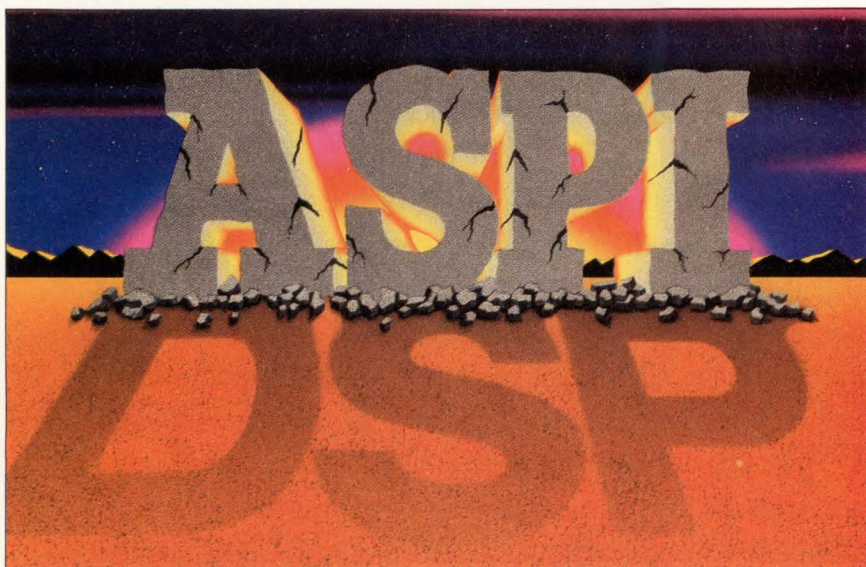

Each technological terrain has its most prominent landmark

The DSP landscape is dotted with vendors offering products and promises. But only one vendor has loomed large from the very beginning.

Atlanta Signal Processors' pioneering DSP experience dates back to 1969. In 1982, ASPI began creating leading-edge DSP design tools and established itself as the DSP workstation source.

Today, ASPI continues to cast the longest shadow across the DSP market. ASPI products support the entire range of TI and Motorola DSP processors. Banshee®, Vortex™, Cheetah™ and DFDP3/plus are our principal product lines. They represent the industry's most significant advancements in DSP development, from 83 MFLOPS processing to simple, intuitive filter design. A variety of daughter boards add extended features such as expanded memory, A-D/D-A conversion, and multiprocessor capability.

As a serious DSP craftsman, you can use this arsenal of design tools to lead the pack in today's emerging technologies - robotics, speech coding, image processing, etc. And, with new products continuously in development at ASPI, you can take the high ground in tomorrow's DSP landscape as well. Call now for detailed product specifications and pricing.



WORLD LEADERS IN DSP DESIGN TOOLS

770 Spring Street • Atlanta, GA 30308 USA • 404/892-7265 • FAX 404/892-2512

Simulator Multi-degree Analog-Structural Hierarchical on your personal workstation

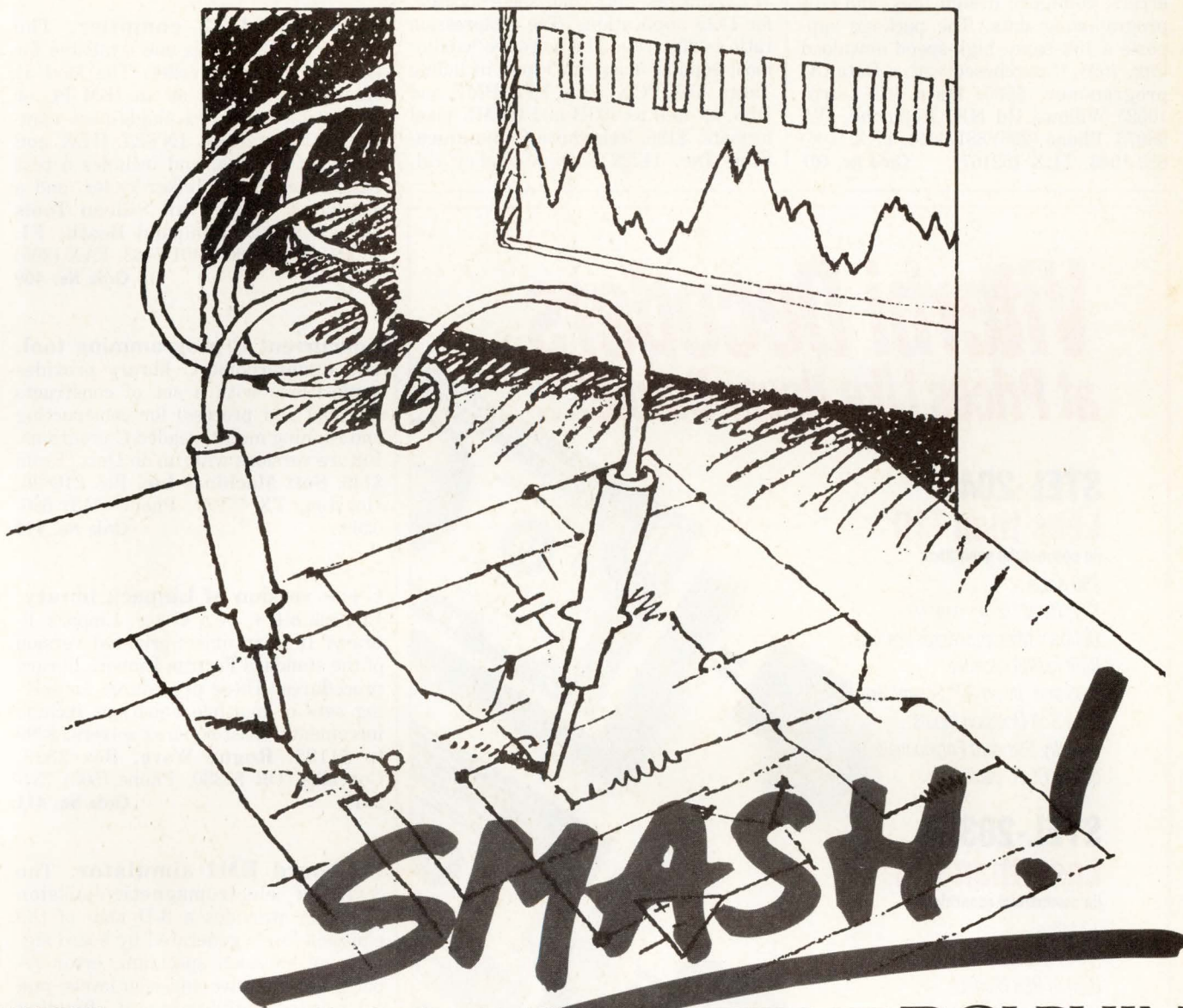
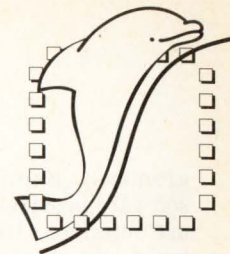

SMASH™ and your simulation becomes revelation...

Main features:

- Mixed electrical, structural, analog behavioral and digital behavioral simulation.
- Data base: SPICE-like and HILO-like (pending VHDL) netlists from various schematics editors with hierarchy.
- Libraries: compatibility with most common libraries of ASICs and PCBs, capability given to the user to write his own modules in a C-like language at behavioral degree, or available from Dolphin Integration upon request.

- Interactive set up and simulation display for all analyses: DC transfer function (including operating point and temperature analysis), AC transfer function, transient analysis.
- Delays at structural level.
- Processing capability in background mode.
- Device visibility through analog behavioral modeling.
- Modularly designed to enable separation of three modules: initializer, engine and visualizer (ICD).
- Results: EXCEL files, ICD format files.
- Available on your personal computer (Mac, PC) and UNIX workstation (SUN...).

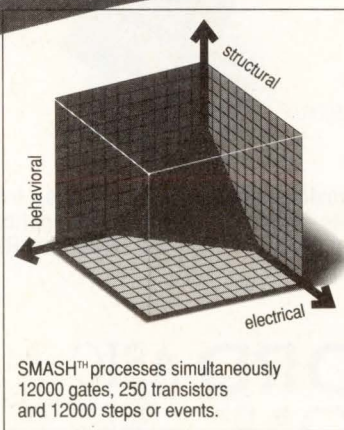

SMASH™ processes simultaneously
12000 gates, 250 transistors
and 12000 steps or events.

- Various complexity packages
- Evaluation (A and B)
 - Switch mode with digital syntax (U and V)
 - Full capability with C Compiler (Y and Z)

DOLPHIN INTEGRATION

The strategist for Circuitware™

Dolphin - US
Suite 130
3333 Bowers Avenue
Santa Clara - CA 95054
Phone: (408) 727 - 4123
Fax: (408) 727 - 2541

EDN-NEW PRODUCTS

CAE & Software Development Tools

grammer. Running under DOS, the software provides a windowed, easy-to-use interface. Users can select device types, download programming data, log errors, configure design files, and edit programming data. The package supports a 15k-baud, high-speed download link. \$695; if purchased with a Data I/O programmer, \$595. **Data I/O Corp.**, 10525 Willows Rd NE, Redmond, WA 98073. Phone (206) 881-6444. FAX (206) 882-1043. TLX 152167. **Circle No. 407**

Software JPEG image-compression package. The Alice-DOS software package for software image compression compresses and decompresses JPEG images, both color and grayscale, for DOS applications. The compression ratio is 25:1 typ. The software handles most popular image file types, including Targa, Tiff, PCX, VIA, EPS, BMP, and DIB, as well as RGB and CYMK pixel formats. \$195. **Telephoto Communications Inc.**, 11722 Sorrento Valley Rd,

Suite D, San Diego, CA 92121. Phone (619) 452-0903. FAX (619) 792-0075.

Circle No. 408

8051 Modula 2 compiler. The Modula 2 compiler is now available for the 8051 microcontroller. The Mod 51 cross-compiler runs on an IBM PC or compatible and is a single-pass compiler. It generates INTEL.HEX and INTEL.OBJ files, and includes a text editor, assembler, linker/loader, and a simulator. \$1495. **Vail Silicon Tools Inc.**, Box 165, Pompano Beach, FL 33069. Phone (305) 491-7443. FAX (305) 974-8531. **Circle No. 409**

Concurrent C programming tool. The Counterpoint C library provides applications with a set of constructs (parallel and process) for constructing and running multithreaded C programs. Future versions will run on Unix. From \$149. **Soft Machines Inc.**, Box 270806, Houston, TX 77277. Phone (713) 660-0269. **Circle No. 410**

C++ version of Linpack library. Linpack.h++ is a C++ Linpack library. It is an object-oriented version of the standard Fortran Linpack library procedures. These procedures for solving sets of multiple equations include incremental least-squares solvers. \$299 to \$1195. **Rogue Wave**, Box 2328, Corvallis, OR 97330. Phone (503) 754-2311. **Circle No. 411**

PC-board EMI simulator. The Swiftrad electromagnetic-emission simulator provides a 3-D map of the emission levels generated by board signals, an emission spectrum, error reports for excessive emission levels, and color-coded highlighting of offending track layouts. \$35,000. **Swiftlogic Ltd.**, Badenheath Pl, Cumbernauld, Glasgow, G68 9HX, Scotland. (0236) 720748. FAX (0236) 730983. **Circle No. 412**

Test synthesis compiler. Test Compiler, a logic-synthesis tool, builds in test for synthesized logic. Version 2.2 outputs test patterns for HDL (hardware-description-language) simulators. Optimizing and reducing test patterns saves test time. Test coverage is 99.5%. From \$40,000. **Synopsis Inc.**, 700 E Middlefield Rd, Mountain View, CA 94043. Phone (415) 962-50000. FAX (415) 965-8637. **Circle No. 413**

Viterbi Decoders at Prices Like Never Before!...

STEL-2040 Less than \$10

(in commercial quantities)

256 Kbps
K=7, Rates 1/3, 1/2 and 3/4
Optional Microprocessor Interface
Built in BER Monitor
V.35 and "Invert G2" Scramblers
3-bit Soft Decision inputs
Industry Standard Polynomials
68 pin PLCC package

STEL-2030A Less than \$20

(in commercial quantities)

12 Mbps
K=7, Rates 1/2, 3/4 and 7/8
Built in BER Monitor
V.35 Scrambler
3-bit Soft Decision inputs
Industry Standard Polynomials
Can be multiplexed for higher speeds
84 pin PLCC package

At Stanford Telecom we provide something for everyone - from the lowest cost Viterbi Decoders in the industry for commercial applications to Rad Hard devices for space applications, like the STEL-5269RH. For more information, call or write....

STANFORD TELECOM ASIC
Custom Products Division

ASIC & Custom Products Division
2421 Mission College Blvd.
Santa Clara, CA 95056-0968
Tel: (408) 980-5684
Fax: (408) 727-1482

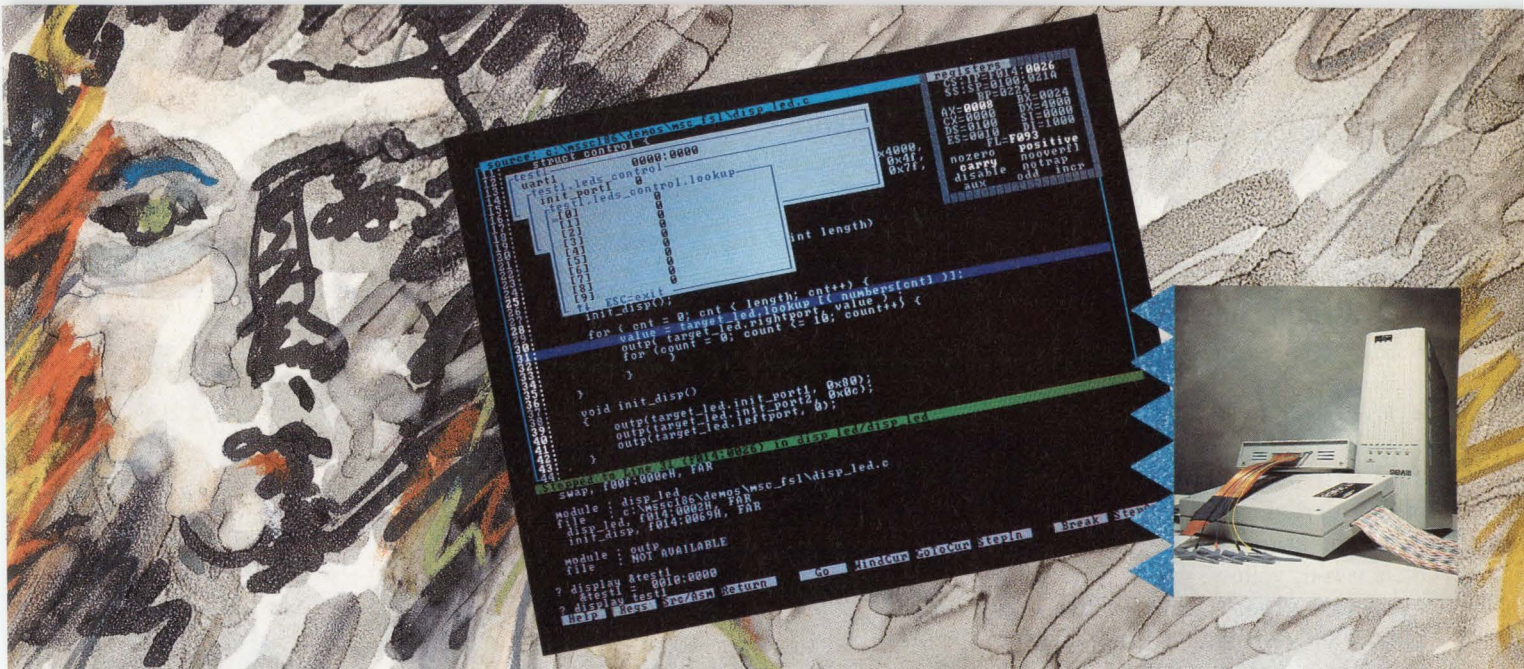

Power Debugging

... for Real-Time Targets

SOPHIA EMULATORS SUPPORT	
INTEL	
80C86/88	10 MHz
80C186/C188	20 MHz
80286	25 MHz
80386	25 MHz
80386SX	16 MHz
MOTOROLA	
68000/10/12	16 MHz
68020	20 MHz
NEC	
V20/V30	16 MHz
V40/V50	10 MHz
V25	16 MHz
V33	16 MHz
V53	16 MHz
86/V	16 MHz
... plus processors from AMD, Hitachi, Mitsubishi, Rockwell, Zilog.	

Do you need to debug a real-time embedded system? Do you use C along with assembly language?

Our emulation systems can help you complete your project faster.

Real-Time Target Control

- Emulate without stealing target resources or adding wait states.
- Step through your actual source code, comments and all.
- Choose from many popular compilers.
- View code, registers, data, and commands all at once with our windowed interface.
- Capture precise information using our powerful trace capabilities, including sequential triggers, all in real time.

- Use full symbolic debugging capabilities, including high-level trace.

Real-Time Technical Support

- Experienced software and hardware engineers.
- Step-by-step troubleshooting assistance.
- 24-hour Bulletin Board for users. Upload problem software, questions. Download code fragments, new releases, examples.

Sophia Systems' emulators give you the *power* to debug your target in your environment. And we're continuing to expand our capabilities to match your processor and debugging needs.

Call and tell us about **your** target.

Sophia
systems
and Technology

1-800-824-9294

LED Display Modules

- Capable of 10-character serial input
- Feature a 5×5 dot-matrix display

The SCD558X 8-digit and SCD5510X 10-digit LED display modules come in standard red, high-efficiency red, yellow, green, and high-efficiency green. The displays employ 5×5 dot-matrix LED arrays to reduce front-panel space by 60% and power consumption by 30% compared with figures for standard 5×7 dot-matrix displays. They work with the serial peripheral interface ports of most μ Ps. The units feature a 200-bit RAM to generate user-defined characters. The displays are X-Y stackable. The display modules feature a power-down mode that requires less than 250 mW. The units incorporate onboard

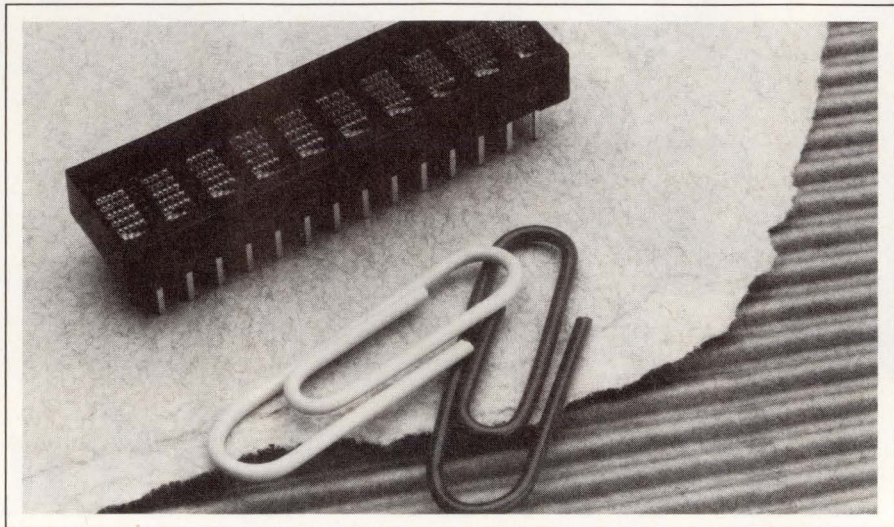

intelligence, which includes column and row drivers that are easy to access through the serial interface. Operating range spans -40 to +85°C. Both displays are housed in 28-pin plastic DIPs. 8-digit

model, \$23.70 to \$26.60; 10-digit model, \$29.60 to \$33.25 (100).

Siemens Components, Optoelectronics Div, 19000 Homestead Rd, Cupertino, CA 95014. Phone (408) 725-3423. **Circle No. 356**

Ethernet Transceivers

- Meet IEEE standards
- Receiver has 58-dB dynamic range

The AT-MX25F/MX26F Series Ethernet fiber-optic transceivers provide fiber-optic inter-repeater link (FOIRL) functions in accordance with IEEE standards. The receiver section has a 58-dB dynamic range at the optical input port. The unit automatically handles any transmission distance over a 0 to 1000m range without the need for any power-setting adjustments. Five diagnostic indicators continuously update unit status—LEDs indicate data-packet transmit and receive activities, collisions, timer expiration, and valid data links. A link monitor indicates low light-level transmissions. The transceivers are housed in a package that's less than 4 in.³ in size and weighs less than 3 oz. Electrical connections and power are supplied via a 15-pin D subminiature connector; the

MX25F and MX26F units have SMA- and ST-type optical connectors, respectively. \$495.

Allied Telesis Inc, 575 E Middlefield Rd, Mountain View, CA 94043. Phone (415) 964-2771. FAX (415) 964-0944. **Circle No. 357**

Optical Connectors

- Are ST compatible
- Designed for field termination

SLP Type II Series ST-compatible fiber-optic connectors consist of three pieces—housing, crimp ring, and boot. The units are designed for field termination and accommodate either multi- or single-mode fibers. The devices employ a zirconia ceramic ferrule to maximize ferrule hole concentricity. Connector insertion loss is specified at 0.2 dB typical for either type of fiber. Return losses are better than 40 dB. The housing incorporates a wraparound shell design that protects the adapter sleeve from dirt contamina-

tion. The connectors are available with either a 3-mm black boot or a 0.9-mm black boot; they can also be

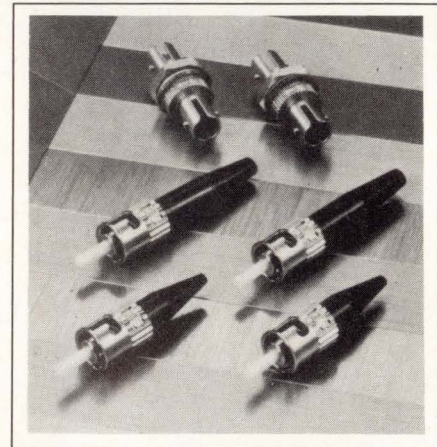

ordered in a kit that contains both boots. The connector is compatible with industry-standard tooling. \$6.50 (100).

Seiko Instruments USA Inc, Electronic Components Div, 2990 W Lomita Blvd, Torrance, CA 90505. Phone (213) 517-7786. FAX (213) 517-7792. **Circle No. 358**

ic[®] capacitors

"meeting your needs"

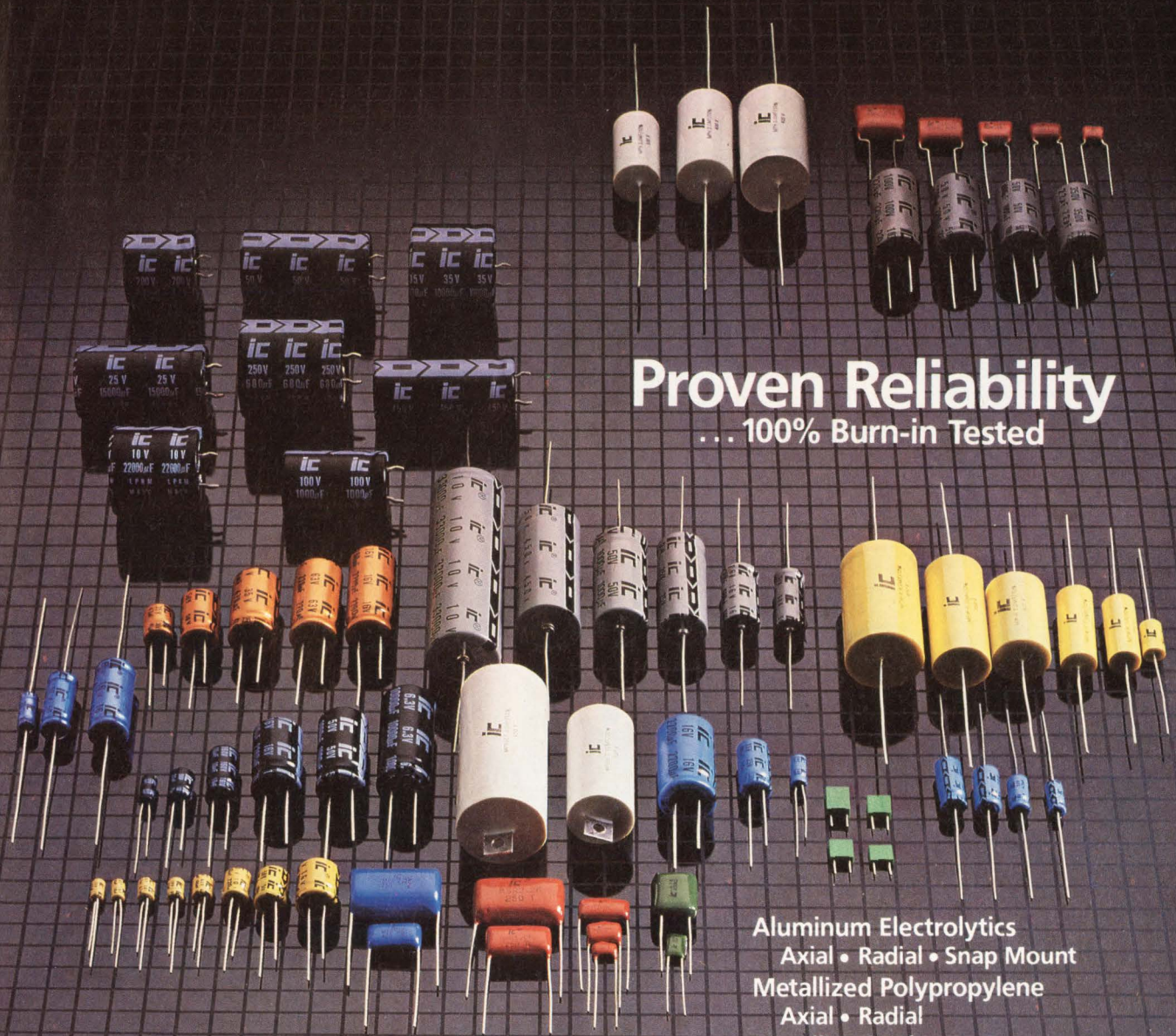

Proven Reliability
... 100% Burn-in Tested

Aluminum Electrolytics
Axial • Radial • Snap Mount
Metallized Polypropylene
Axial • Radial
Metallized Polyester
Axial • Radial • Mini-case
Polyester Film/Foil
Tape & Reel • Epoxy End Seals

ic[®]
ILLINOIS CAPACITOR, INC.

Your Certified Ship From Stock Supplier Since 1935.

3757 West Touhy Avenue, Lincolnwood, IL 60645
(708) 675-1760 / Telex: 72-4361 / FAX (708) 673-2850

© 1990 ILLINOIS CAPACITOR, INC.

DREAM METER.

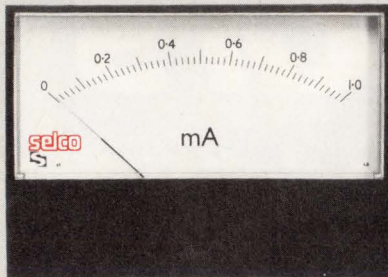

FRONT

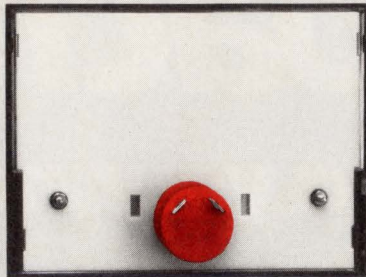

BACK

Advanced Meter

Selco's core-magnet meter gives you the design features you've always wanted in an analog instrument but were never able to get.

- Compact, powerful magnetic core, with taut band suspension, for dramatically reduced total volume and overall mechanical simplicity.
- Accuracy to $\pm 1.5\%$ of full scale, with improved reliability and longer service life.
- Four meter sizes with back- or front-of-panel mounting options, plus a wide selection of masks and bezels.
- Both AC and DC versions, with ranges as low as $50\mu\text{A}$ and as high as 600 V; all conform to

80% SMALLER MOVEMENT, 66% FEWER PARTS.

BS89:1977, IEC 51, and USA Standard ANSI C39.1-1972.

Special Services

Custom markings and special dials can be obtained in one to five weeks. Mail or fax your sketch and we'll convert it into a meter face, color and all. Attractive prices with OEM discounts, too.

Small Orders Welcome

You may only need a few pieces, but you're important to us. Contact Selco today for complete details and a quotation you'll like.

We'll make your dream come true.

selco
PRODUCTS CO.

Meters manufactured by SIFAM Ltd.

7580 Stage Road, Buena Park, California 90621. Phones (213) 921-0681, (714) 521-8673, Toll Free (800) 229-2332. Telex 655457. FAX (714) 739-1507.

CIRCLE NO. 71

EDN-NEW PRODUCTS

Components & Power Supplies

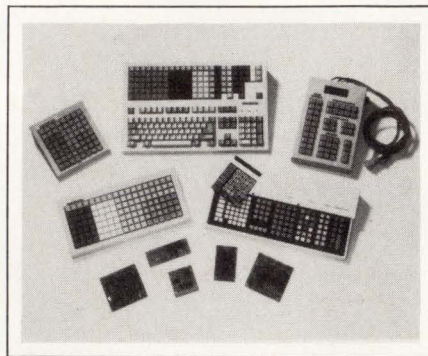

Modular keyboards. These POS (point of sale) keyboards are available in standard configurations of 8×8 , 18×7 , and 16×8 keys; however, you can specify units with positions ranging from a few keys to hundreds of keys. Each of the keyboards shares the same software, allowing for complete reprogrammability of each key and easy modification and upgrading. The base configuration features full-travel key switches rated for 20 million operations. Clear snap-on keytops allow easy insertion of user-created legends. \$200 to approximately \$500. **Genovation Inc.**, 17741 Mitchell N, Irvine, CA 92714. Phone (714) 833-3355. FAX (714) 833-0322. **Circle No. 359**

Insulation displacement connectors. These 50-position D subminiature connectors are available in male and female versions. They accept 0.05-in. pitch cable. The connectors are rated for 1 to 1.5A per contact depending on wire size. Operating range spans -50 to $+105^\circ\text{C}$. Contacts are beryllium copper with gold plating, and the polyester housing has a UL 94V-0 rating. \$5.53 and \$5.35 (1000) for male and female versions, respectively. **ODU USA**, 4620 Calle Quetzal, Camarillo, CA 93012. Phone (805) 484-0981. FAX (805) 484-7458. **Circle No. 360**

Wirewound surface-mount inductors. Series 1010 molded inductors are available in the standard 1010 EIA envelope size. Inductance values range from 0.01 to 0.1 μH for parts with phenolic cores and from 0.12 to 27 μH for parts with ferrite cores. Standard tolerance is 10%. Terminations are solder-coated copper per MIL-STD-202. \$0.70 (1000). Delivery, four to six weeks ARO. **American Precision Industries**, 270 Quaker Rd, East Aurora, NY 14052. Phone (716) 652-3600. **Circle No. 361**



You can control any IEEE-488 (HP-IB, GP-IB, 488.2) device with our cards, cables and software for the PC/AT/386, EISA, Micro Channel and Macintosh II. You get fast hardware

and software support for all the popular languages, plus a software library of time saving utilities. Instrument control has never been easier.

FREE

Informative Catalog **800-234-4CEC**
Applications help **617-273-1818**

cec

Capital Equipment Corp.
Burlington, MA. 01803

Micro Channel is a trademark of IBM

CIRCLE NO. 72



Actual Size

Which One Has More Chips In It?

If you guessed the TDK Multilayer Chip LC Filter on the right, you're correct.

This unique device integrates 7 capacitors, 2 inductors, and 2 transformers for a total of 11 chips into a single band pass filter.

How do we do it? Multilayers of ferrite material, dielectric ceramic material, conductive material and internal electrode are all woven together and sintered simultaneously.

Only TDK has the thick film composition know-how needed to manufacture chip LC Filters, Transformers, IFTs and other multi-layer components that save valuable design space while they increase overall product reliability.

Why not order a batch (of the components, that is) today? Call or write TDK for more information.



3M Reduces Solvents Used In Electrical Tape Manufacturing

Reduction of solvent usage assures users of future tape availability as worldwide environmental concerns heighten

AUSTIN, Tex. — The 3M Electrical Specialties Division is implementing solvent reduction processes in the manufacture of OEM insulating electrical tapes. The established goal is to reduce solvent purchases and usage by 80 percent.

Customers incorporating these insulating tapes in present products, re-designs and new products will be assured of a reliable source well into the 21st Century.

3M is also taking a holistic view of its efforts to achieve a cleaner environment, believing that it is important to examine the full scope of a product's impact on the environment — beginning with product design and the manufacturing process, and extending to product usage, packaging and disposal.

The tapes are designed for use in OEM electrical applications to insulate, hold, protect and identify electrical conductors, components and circuits. Solvent reduction processes will be extended to as many OEM electrical tapes as possible. The following tapes with a thermosetting rubber-resin adhesive have already been released:

- No. 2 and 38 Crepe Paper
- No. 27 Glass Cloth
- No. 46, MR 98 Polyester Film/
Glass Filament
- No. 44, 55, 1174, MR 93, MR 93B,
MR 94, MR 94B Polyester Film/MAT
- MR 96 Polyester Film

For more information, contact a 3M Electrical Specialties Division representative or authorized distributor, or call 1-800-233-3636.

3M Electrical Specialties Division
6801 River Place Boulevard
Austin, Texas 78726-9000



CIRCLE NO. 75

EDN-NEW PRODUCTS

Components & Power Supplies

Monolithic MOSFETs. TopFET devices feature a host of built-in protection features. They include overtemperature protection for junction temperature above 150°C, short-circuit load protection, overvoltage clamping for inductive loads, input ESD protection, and reverse battery protection. Maximum on-state resistance ranges from 28 to 100 mΩ, and maximum continuous drain-source voltage equals 50V. \$2.25 (1000). Delivery, 12 to 16 weeks ARO. **Philips Components**, 2001 W Blue Heron Blvd, Riviera Beach, FL 33404. Phone (800) 447-3762; (407) 881-3342.

Circle No. 362

PGA sockets. The PZA447H509B5-39C-R socket is designed for the Mips R4000 processor. Contact area is gold plated. The units are available with either FR4 and PPS thermoplastic housings. Both of these versions are compatible with vapor-phase and infrared soldering systems. \$35.18 (1000). **McKenzie Technology**, 44370 Old Warm Springs Blvd, Fremont, CA 94538. Phone (510) 651-2700. FAX (510) 651-1020.

Circle No. 363

Coaxial adapters. Model PE9342 type BNC female to type mini-UHF coaxial adapters feature low loss over a range of dc to 4 GHz. The 50Ω units have brass nickel-plated bodies and utilize Teflon insulators. The contact is gold plated. The adapters operate over a -65 to +165°C range. \$5.95. **Paster-nack Enterprises**, Box 16759, Irvine, CA 92713. Phone (714) 261-1920. FAX (714) 261-7451.

Circle No. 364

Power amplifiers. The solid-state Class AB linear amplifiers in the PA900 Series cover an 850- to 900-MHz frequency band. They operate from a supply voltage of 25V. Output power values range to 100W, and gain figures range from 19 to 45 dB. \$1010 to \$1230 (10). Delivery, 16 weeks ARO. **Motorola RF Products Div**, 325 Maple Ave, Torrance, CA 90503. Phone (213) 783-5785. FAX (213) 783-5790.

Circle No. 365

Transient-voltage suppressors and filters. PQI Series interfaces combine voltage suppression and RFI filtering in a single package. The units feature

LOW DROPOUT REGULATORS

TK114xx



- 200 mW Power Rating
- ON/OFF Switch
- Super Small SOT23L Package
- Internal Protection Features

TK115xx



- 600 mW Power Rating
- ON/OFF Switch
- Low Noise
- Active HIGH and Active LOW Control
- Internal Protection Features
- External Boost Transistor Connectable

TK116xx

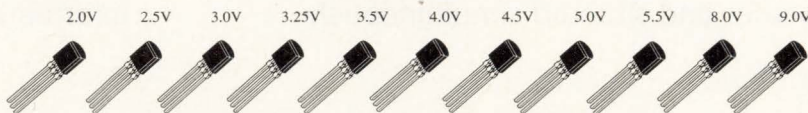

- 500 mW Power Rating
- Internal Protection Features

Call Your TOKO Representative For Data Sheets and Additional Information

TOKO AMERICA, INC.
1250 Feehanville Drive
Mount Prospect, IL 60056



MIDWEST: (708) 297-0070
EAST: (203) 748-6871
SOUTHEAST: (205) 772-8904
WEST: (408) 432-8281

EDN-NEW PRODUCTS

Components & Power Supplies

a 205V pk clamping level, 95J energy dissipation, less than 1-nsec single-stage response time, and a 3000A surge withstand capability. The units are housed in an ABS plastic package and come with a line cord. \$75 to \$229. **Superior Electric**, 383 Middle St, Bristol, CT 06010. Phone (203) 582-9561.

Circle No. 366

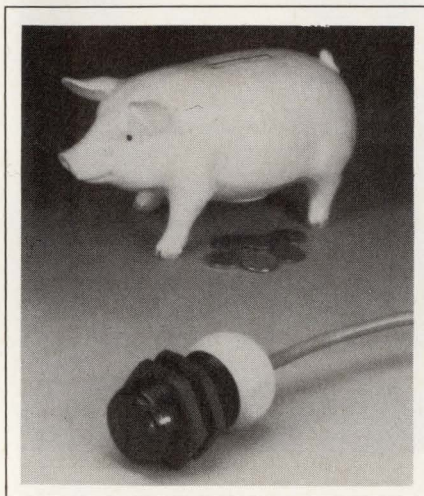

Photoelectric sensor. C30 Series infrared sensors operate in a retroreflective mode and have a 16-ft sensing range. The units are self-contained and operate from a 10V dc source. A red LED indicates the presence of a sensor output. The sensors are sealed against moisture and carry a NEMA 6 rating. The sensors are available for either light or dark operation. \$36. **Banner Engineering Corp**, Box 9414, Minneapolis, MN 55440. Phone (612) 544-3164.

Circle No. 367

Metal film resistors. Type ELR-07 metal film resistors, with values ranging to 22 M Ω , are rated for 250 mW, are available in tolerances of ± 2 , ± 5 , and $\pm 10\%$, and have a temperature coefficient of ± 350 ppm/ $^{\circ}$ C. \$0.51 (1000) for a 22 M Ω , $\pm 2\%$ model. Delivery, 11 to 12 weeks ARO. **Dale Electronics Inc**, Box 609, Columbus, NE 68602. Phone (402) 371-0080.

Circle No. 368

Bus connector. This Semconn connector is designed for the Access.bus link. The 71565 Series receptacle is available in through-hole and surface-mount versions with either full or partial shielding. Series 71564 plugs ground the cable shield to the plug shield to ensure a stable ground path. Receptacle, \$1992 to \$2775; plug, \$1409

(1000). **Molex Inc**, 2222 Wellington Ct, Lisle, IL 60532. Phone (708) 969-4550. FAX (708) 969-1352.

Circle No. 369

Optical switch. The EE-SA105 optical switch operates without a contact mechanism. It activates with a 15g operating force and has a 0.059-in. pre-travel. The LED operates with 50-mA forward current and develops an output of 0.5 mA min. The switch output is high when the actuator is in the rest position and has a dark current of 200 nA max when the plunger reaches the end-of-travel position. From \$0.99 (5000). **Omron Electronics Inc**, 1 E Commerce Dr, Schaumburg, IL 60173. Phone (708) 843-7900. FAX (708) 843-7787.

Circle No. 370

Circular connectors. These MIL-C-5015-style plastic circular connectors mate with metal-shell MIL-C-5015 style connectors in shell sizes 20-14 and 18-10. They feature a housing design that prevents mating when insert arrangements are incompatible. The pin and socket contacts are available in reel-mounted strip form as well as in loose-piece form connectors and are compatible with panel or cable applications. \$11 to \$16. Delivery, six weeks ARO. **AMP Inc**, Box 3608, Harrisburg, PA 17105. Phone (800) 522-6752.

Circle No. 371

Pin-grid-array sockets. GSM Series PGA sockets are surface mountable. They are available in standard footprints ranging from 8 \times 8 to 20 \times 20. The butt-style terminals are available with tin-lead plating and the FR-4 insulator meets the temperature requirements of vapor-phase soldering systems. \$0.030 per pin (1000). Delivery, four to six weeks ARO. **Augat Inc**, 452 John Dietsch Blvd, Attleboro Falls, MA 02763. Phone (508) 699-9800. FAX (508) 699-6717.

Circle No. 372

High-current connectors. EX5-R and IL-AG5 Series connectors are rated for 8 and 3A per contact, respectively. They feature nylon housings that have a UL 94V-2 rating. Additional specifications include an 1800V ac withstanding voltage, 109 Ω insulation resistance, and a 10 m Ω contact resistance. Less than \$1 (1000). **JA Electronics**, 142 Technology Dr, Bldg 100, Irvine, CA 92718. Phone (800) 523-7278 (except in CA and AK); (714) 753-2600. FAX (714) 753-2699.

Circle No. 373

Now up to
100V DC Output

PICO DC-DC Converters

Wide Input Range
5 to 72V DC

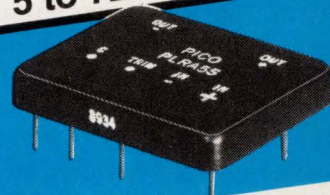

Regulated 5 to 30 Watts

- 365 Standard Models
- Single, Dual & Triple Output
- Remote Disable Pin Standard
- Up to 100V DC Output now Standard
- 500V DC Isolated Input to Output
- All Units Shielded

MIL-STD-883 UPGRADES AVAILABLE

- Expanded operating temp. (-55° C to $+85^{\circ}$ C)
- No Heat Sink Required
- Stabilization Bake (125° C ambient)
- Temperature Cycle (-55° C to $+125^{\circ}$ C)
- Hi temp., full power burn in (100% power, 125° C case temp.)

PICO also manufactures over 850 standard DC-DC converters and over 2500 ultra-miniature transformers, inductors and new AC-DC power supplies.

Delivery—
stock to
one week

See EEM or
FAX 914-699-5565
or send direct for
FREE PICO Catalog

PICO Electronics, Inc.

453 N. MacQuesten Pkwy. Mt. Vernon, N.Y. 10552

Call Toll Free 800-431-1064

IN NEW YORK CALL 914-699-5514

CIRCLE NO. 45

EDN January 20, 1992 • 161

Computers & Peripherals

Ink-Jet Printer

- Prints monochrome graphics at 300 dpi
- Prints at 360 cps in draft- and 120 cps in letter-quality modes

The DECjet is a monochrome ink-jet printer for DOS-compatible computers. The unit prints graphics at 30×300 dpi. The unit also prints four resident and seven optional fonts at 600×300 dpi. The four resident fonts are Courier, Landscape Courier, Letter Gothic, and Times Roman. The printer comes standard with a 150-pg sheet feeder, and you can opt for an additional 150-pg sheet feeder. Three modes print at 360 cps for high-speed draft, 240 cps for draft, and 120 cps for letter quality. The printer has a Centronics parallel port and emulates an HP Deskjet Plus printer (HP-PCL 3). Other features include 44-dBA operation and replaceable print head/ink supply cartridge, as

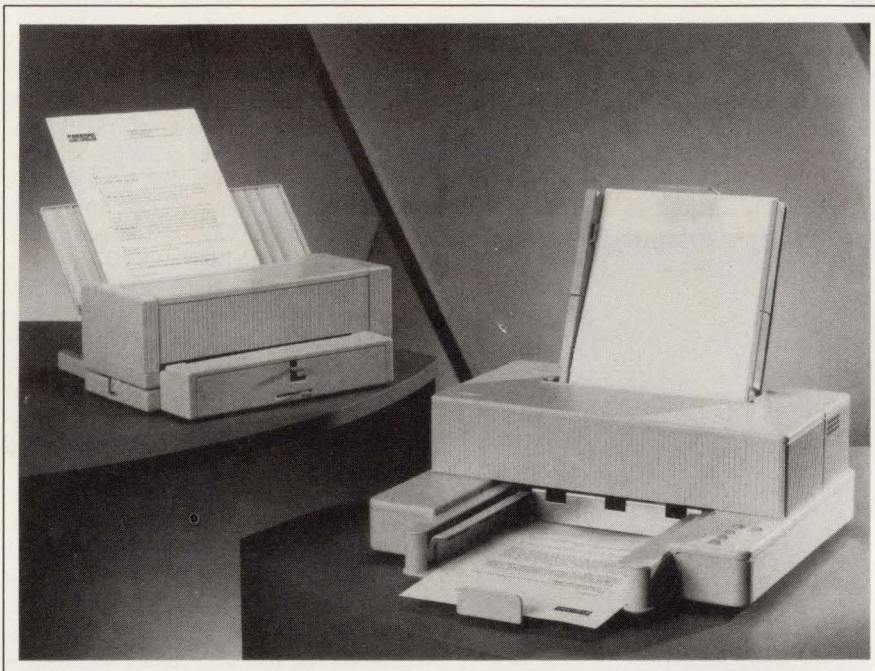

well as envelope, selected transparencies, letter, and A4 paper printing. \$795.

Digital Equipment Corp, Maynard, MA 01754. Phone (508) 635-8290. **Circle No. 414**

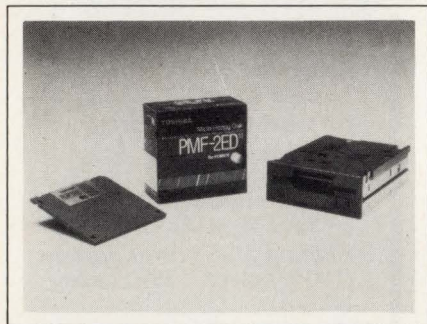

3 1/2-in. Floppy-Disk Drive

- Has 4-Mbyte capacity and 1-Mbps transfer rate
- Drive consumes 1.8W and resists 1.0g vibration while operating

The ND-3571 is a 3 1/2-in., 4-Mbyte floppy-disk drive. The drive uses the company's patented perpendicular-recording technology. The technology uses barium ferrite particles for the recording media, which permits the particles to be magnetized vertically. Vertical magnetization permits higher bit

density than conventional horizontal magnetization. The drive has a 3-msec track-to-track access time and transfers data at 1 Mbps. The drive consumes 1.8W and can withstand 1g vibration while operating. The unit measures 1×4×6-in. and weighs 1 lb. \$100 (OEM); \$160 with installation kit.

Toshiba America Information Systems Inc, Disk Products Div, 9740 Irvine Blvd, Irvine, CA 92718. Phone (714) 583-3000. **Circle No. 415**

Dual-Channel Ethernet Boards

- Communicate with two subnetworks simultaneously
- EISA bus master boards come with Netware v3.1 drivers

The 3032/EISA dual-channel Ethernet boards communicate with two subnetworks simultaneously. The 2-channel design conserves expansion slots and costs less than

two single-channel boards. The boards have dual transceivers that connect to twisted-pair or thin coaxial cable. An attached unit interface provides a connection to other media. The boards can automatically switch between bus-master burst mode (when transferring large blocks of data) and slave I/O mode (when transferring small blocks of data). Each channel has a 64-kbyte buffer, which permits double buffering of transmission packets during burst mode. The boards come with Netware v3.1 drivers and have automatic configuration and diagnostic-test programs. 10Base-T or coaxial model, \$945.

Standard Microsystems Corp, 80 Arkay Dr, Hauppauge, NY 11788. Phone (800) 762-4968; (516) 273-3100, ext 5317. **Circle No. 416**

Text continued on pg 170

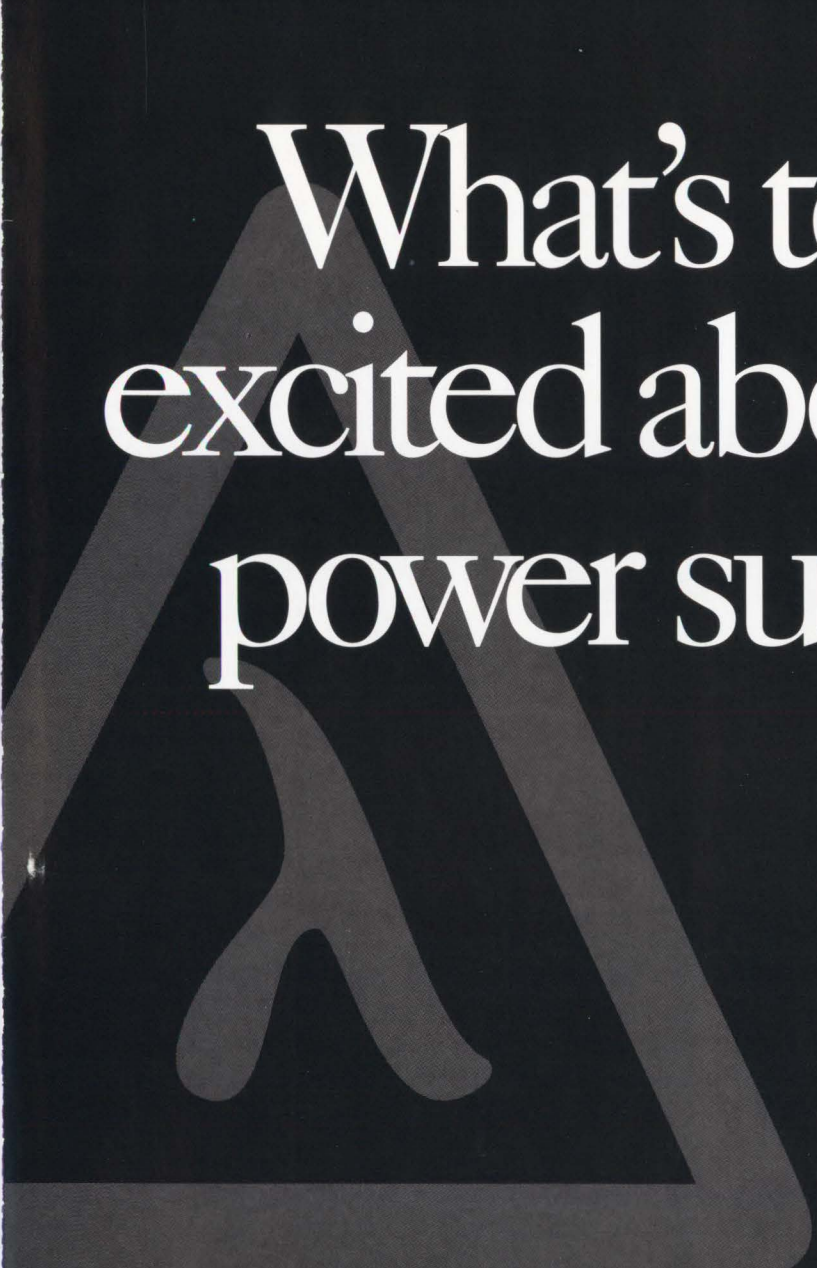

What's to get
excited about in a
power supply?



Ple

Auto-selectable AC input.

AC power fail signal.

DC overvoltage signal.

DC undervoltage signal.

Inverter good signal.

Overtemperature protection.



Lambda introduc

REGULATED VOLTAGE

Line: 0.1% from 85 to 132VAC or 170 to 265VAC.

Load: 0.1% from no load to full load.

Ripple and noise:

10mV RMS, 35mV pk-pk on LZS-1000-1;

10mV RMS, 50mV pk-pk on LZS-1000-2.

15mV RMS, 100mV pk-pk on LZS-1000-3.

Temp. coeff.: 0.025%/°C.

INPUT POWER

AC: 85-132VAC/170-265VAC auto selectable
single phase, 47-440 Hz.

DC: 220-375VDC.

EFFICIENCY

75% typical.

OPERATING TEMPERATURE RANGE

-30°C to +71°C with suitable derating above 40°C.

OVERTEMPERATURE PROTECTION

Via internal thermostat.

FUSING

Externally accessible.

OVERVOLTAGE PROTECTION

Adjustable.

OVERLOAD PROTECTION

External overload protection, automatic electronic current limiting limits the output to a preset value thereby protecting the load as well as the power supply.

COOLING

Integral fan.

IN-RUSH CURRENT LIMITING

Not to exceed 45A for 85 to 132VAC;
78A for 170 to 265VAC.

CURRENT SHARING

Single wire connection.

REMOTE SENSING

Compensation for 0.5VDC drop in
output load cables.

REMOTE ON/OFF

Logic "0" open or short = Off.

Logic "1" = On.

REMOTE PROGRAMMING

Resistive: 1000Ω/V.

Voltage: Volt per volt.

nty.



Current sharing.

-30°C to +71°C.

**EMI compliance to
FCC, VDE 0871, Class B.**

**UL/CSA/TUV/SELV
compliant.**

5 year guarantee.

ces the LZ Series.

POWER FAILURE

"-1" model will remain within regulation limits for at least 16.7 msec. after loss of AC power when $V_{out} \leq 5.25$, $V_{in} \geq 100VAC$.

INDICATORS

Overvoltage/overtemperature LED and output voltage good LED.

ENVIRONMENTAL SPECIFICATIONS

Per MIL-STD-810D.

EMI

FCC Class B; VDE 0871 Class B;
MIL-STD-461A, Part 7, CE04.

INPUT LINE DISTURBANCES

IEEE-587 Category A, VDE 0160.

PHYSICAL DATA

Dimensions: 4.75 x 5.63 x 10.50 inches.
Weight: 15 lbs.

SAFETY AGENCY APPROVALS

Under evaluation for UL, CSA, TUV.

GUARANTEE

Five year guarantee includes labor as well as parts. Lambda Grade 1 design.

Model	Output Voltage Adj. Range (VDC)	Max Current (Output Power) at Operating Temperature Of				Price*		
		40°C	50°C	60°C	71°C	Qty. 1	Qty. 10	Qty. 25
LZS-1000-1	4.75 - 6.30	200.0 (1050)	190.0 (998)	160.0 (840)	120.0 (630)	\$1130	\$1075	\$1025
LZS-1000-2	11.40 - 15.75	83.0 (1050)	80.0 (998)	67.0 (840)	50.0 (630)	\$1130	\$1075	\$1025
LZS-1000-3	19.0 - 29.4	50.0 (1050)	48.0 (998)	40.0 (840)	30.0 (630)	\$1130	\$1075	\$1025

* Consult the Lambda factory for OEM pricing.

**The LZ Series
from Lambda.**

Power supplies
with valuable
built-in features
that simplify
system
integration.



To order, or to find out more
about the exciting LZ Series, call
your local Lambda Sales Engineer.

8 AM to 6:30 PM EST

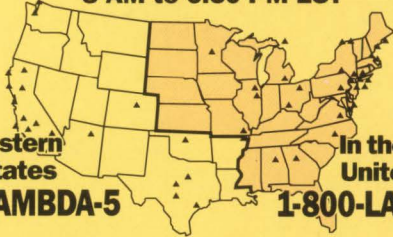

**In the western
United States**

1-800-LAMBDA-5

**In the eastern
United States**

1-800-LAMBDA-4

Canada
Lambda Electronics
(Canada) Inc.
4125 Cousens St.
St. Laurent,
Que. H4S 1V6
Tel: 1-800-361-2578
Fax: 514-337-1235
In Montreal:
514-337-0311

France, Orsay
Lambda Electronique S.A.
Tel: 6012-1487

Japan, Tokyo
Nemic-Lambda K.K.
Tel: 033-447-4411

England, Ilfracombe
Coutant-Lambda, Ltd.
Tel: 0271-65656

Germany, Achern
Lambda Electronics GmbH
Tel: 07841 / 68060

Israel, Tel Aviv
IsLambda Electronics Ltd.
Tel: (03) 544-7655

Singapore
Nemic-Lambda(S) Pte.Ltd.
Tel: 251-7211

Korea, Seoul
Nemic-Lambda
Tel: 02-556-1171

Malaysia
Nemic-Lambda(M)
Sdn. Bhd.
Tel: 03-756-6119
03-756-0739

LAMBDA
Electronics Inc. 
Lambda Group of Unitech plc

515 Broad Hollow Road, Melville, NY 11747-3700
Tel: 516-694-4200 Fax: 516-293-0519

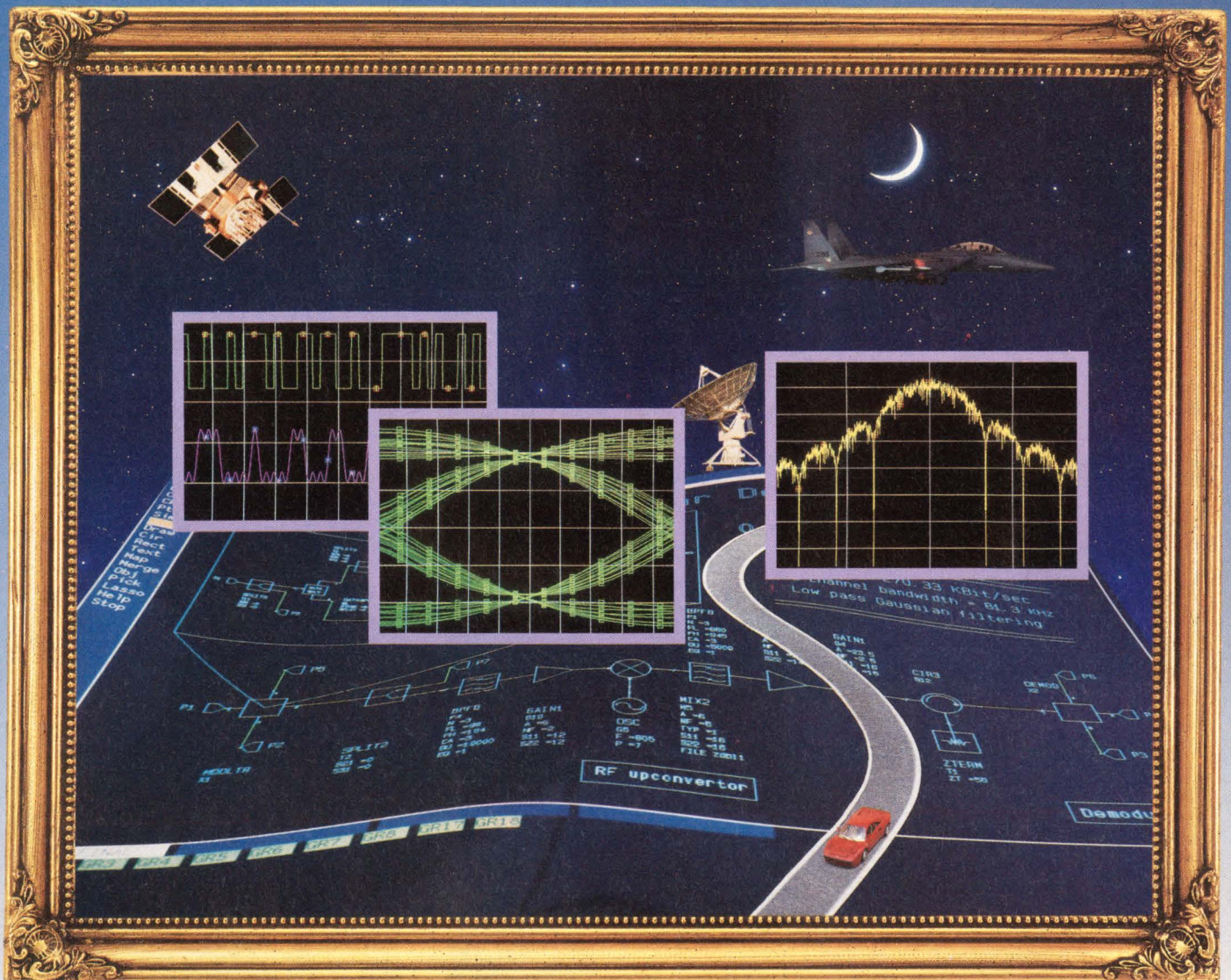

Modulation-Domain Simulation Gives You the Big Picture.

Introducing OmniSys Version 3.5.

Analyzing communication systems and complex modulated signals with the usual simulators? Time- and frequency-domain simulators like SPICE and harmonic balance are great, but circuit simulators don't give you the big picture. OmniSys®, EEsof's system simulator, gives you the new insight you need!

OmniSys lets you simulate system performance in the modulation-domain so you can see how your system will work with today's chirp, MSK, pi/4 DQPSK, and other complex modulated signals. Look at BER I-Q constellations, spectral regrowth, AM/PM distortion, and more. You'll see the effect of hardware trade-offs on your complete transmitter and receiver and you'll get your system to market faster without costly redesigns.

See the Big Picture with OmniSys.

Contact us for literature at (800) 34-EESOF...or, if you prefer, by FAX at (818) 879-6462. In Europe, call (49) 8105-24005 or FAX (49) 8105-24000.



Breaking the Barriers...

EEsof®

Dual-card adapter. The Model 467 interconnects two cards, an Sbus card and a 6U VMEbus card. Either card can be the master on the other bus. Memory mapping permits the Sbus or VMEbus host CPU to execute random access reads and writes to the destination bus as though it were local memory. A DMA controller transfers data as fast as 20 Mbytes/sec. You connect the two cards, separated by as much as 50 ft, via an EMI shielded cable. \$2850. **Bit 3 Com-**

puter Corp., 8120 Penn Ave S, Minneapolis, MN 55431. Phone (612) 881-6955. FAX (612) 881-9674. **Circle No. 417**

STD bus CPU board. The VL-186-1 transfers 16-bit data in an STD 80- or STD 32-compatible system. The board features a 16-MHz 80C186 μ P, as much as 1 Mbyte of EPROM or 256 kbytes of Flash EEPROM, and as much as 1 Mbyte of static RAM with battery back-

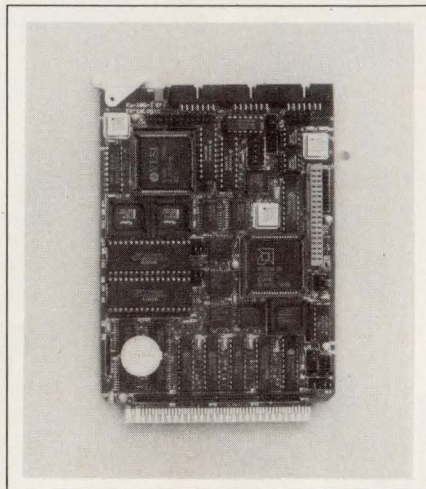

up. Other features include two COM ports, a parallel printer port, three 16-bit timer/counters, two programmable DMA channels, a watchdog timer, and an SBX expansion connector. \$645. **Versalogic Corp.**, 3888 Stewart Rd, Eugene, OR 97402. Phone (800) 824-3163. FAX (503) 485-5712. **Circle No. 418**

Good Sines & Bad Signs

Looking for a low-noise, fast-switching signal source?

Good Sines

Whether it's automatic test equipment, satellite uplinks, EW communications or imaging systems, **Programmed Test Sources** has a frequency synthesizer to fit your needs. GE MRI units, Teradyne Testers, Varian Spectrometers... all use **PTS** synthesizers.

Bad Signs \$\$\$

And while other manufacturers have big dollar signs, **PTS** synthesizers start as low as \$2,010.

PTS manufactures a complete line of precision synthesizers covering the 100 KHz to 1 GHz frequency range with switching times as fast as 1 μ second for our **direct digital** models. And plenty of other options as well, like resolution down to .1 hertz (millihertz available as special order), GPIB and digital phase rotation.

Just as important, along with every **PTS** synthesizer comes our "absolutely everything covered" **2-year warranty**. At the end of two years comes our flat \$350* service charge for any repair up to the year 2001! **PTS** has a commitment to quality you won't find anywhere else.

Find out how **PTS** synthesizers used the world over can help you in your application today. Call for our complete catalog, or to talk to an applications engineer.

*\$500.00 for **PTS** 1000.

Call (508) 486-3008 Fax (508) 486-4495

PTS

PROGRAMMED TEST SOURCES, Inc.
9 Beaver Brook Road, P.O. Box 517, Littleton, MA 01460

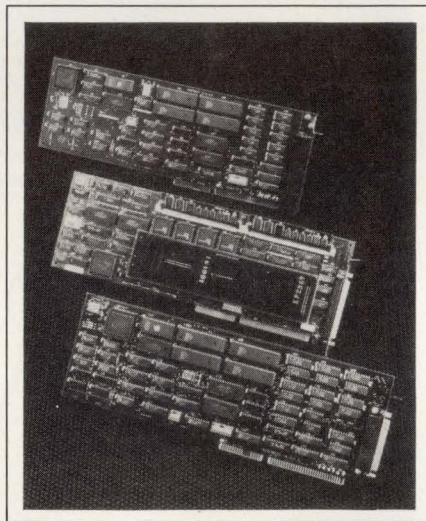

Multiport serial boards. The ACL II+, ACL IIR+, and ACL 16+ multiport serial boards use communication chips that can transfer and receive asynchronous data as fast as 115 kbaud. ISA, EISA, and Micro Channel boards are available. The ACL II+ has eight programmable ports and an RS-232C connector. \$1125 to \$1195. The ACL IIR+ has eight programmable ports and RJ-12 connectors. \$725 to \$795. The ACL 16+ has 16 programmable ports and three handshake options. \$1495 to \$1995. **Star Gate Technologies Inc.**, 29300 Aurora Rd, Solon, OH 44139. Phone (800) 782-7428; (216) 349-1860. FAX (216) 349-2056. **Circle No. 419**

- Crystals
- Crystal Oscillators
- Crystal Filters
- Ceramic Resonators

RALTRON

ONLY RALTRON HAS IT ALL.

THE PRODUCTS

RALTRON manufactures one of the industry's most complete product lines of high quality crystal units, oscillators, filters and ceramic resonators.

THE PRICES

Because our product line is so complete, our inventory so large, and our nationwide distribution system so streamlined, RALTRON can offer pricing that is always competitive, and often far lower than the competition.

THE PEOPLE

We've got some of the best people in the business – from technical support and sales to customer service and shipping. You can count on RALTRON people to come through for you on time, every time.

Call us today with your requirements or for our 28 page product catalogue.

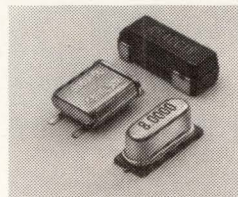

SURFACE MOUNT CRYSTAL UNITS HC-45/U SMD, TT SMD, HC-49S SMD

- Frequency Range: 3.5 MHz-360 MHz
- Mode of Oscillation: Fundamental to 9th O.T.
- Frequency Tolerance: @ 25°C: ± 2.5 ppm to ± 100 ppm
- Frequency Stability: ± 3 ppm (– 10°C to + 60°C) to ± 100 ppm (– 10°C to + 70°C)



WORLD'S SMALLEST OCXO, ROXO 210A

- Frequency Range: 1.0 MHz to 20.0 MHz
- Temperature Stability: ± 2 x 10⁻⁷ (– 20°C to + 65°C)
- Long Term Stability: ± 2 x 10⁻⁷ per year
- Phase Noise: – 145 dbc (10 KHz offset)
- Power consumption (stabilized): 2.0 W
- Size: 35.3 x 27 x 25.4 mm (1.40" x 1.06" x 1.0")



SMALLEST VCXO WITH HIGH SENSITIVITY VC-7025

- Frequency Range: 2 MHz to 35 MHz
- Frequency Stability: ± 25 ppm (0 to 70°C)
- Deviation Sensitivity: ± 50 ppm/V typ. (up to ± 70 ppm/V)
- Size: 14 pin DIP package

CRYSTAL UNITS

Microprocessor crystal units
 Microprocessor crystal units HC-49 short (AT strip)
 Microprocessor crystal units surface mount – "TT-SMD" family
 AT strip crystal units – cylindrical package
 Tuning fork quartz crystal units 32.768 KHz
 High accuracy crystal units

OSCILLATORS

Clock oscillators
 TTL compatible
 Clock oscillators HCMOS compatible
 Clock oscillators surface mount
 Clock oscillators enable/disable
 Clock oscillators dual output
 Clock oscillators ECL compatible
 Temperature compensated crystal oscillators – TCXO
 Oven controlled crystal oscillators – OCXO
 Voltage controlled crystal oscillators – VCXO

FILTERS

Monolithic crystal filters

CERAMIC RESONATORS

Ceramic resonators – 200 to 800 KHz
 Ceramic resonators – 2.000 to 6.000 MHz

RALTRON ELECTRONICS CORP.

2315 NW 107th Avenue
 Miami, Florida 33172
 FAX (305) 594-3973
 TELEX 441588 RALSENU I
 (305) 593-6033

Only RALTRON has it all.

Shrink Your Power Supplies with TOKIN SMDs

The continuous integration of high-density electronic equipment has created a burgeoning demand for thinner, more compact switching power supplies. To meet this demand, TOKIN has come up with an outstanding lineup of SMD (Surface Mount Devices) transformers. And to help you counter noise emissions

from compact, high-frequency power supplies, TOKIN offers a full selection of SMD-type EMC components including High-Capacitance Multilayer Ceramic Capacitors. Give us a call.

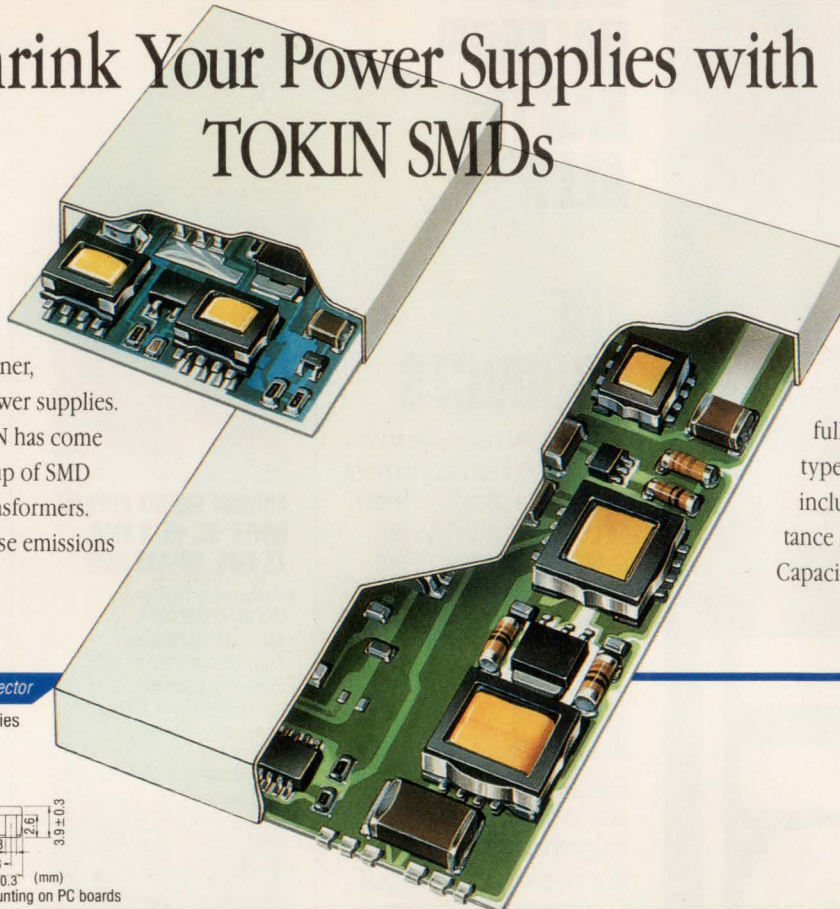

Common-mode Choke Coils at output sector

EMC Chip Filters • M-600 Series

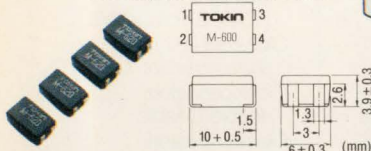

Common-mode chip filters ideal for surface-mounting on PC boards

Ceramic Capacitor for Converters

Multilayer Ceramic Capacitors

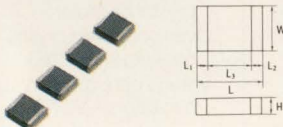

Chip-type ceramic capacitor with large capacitance using Y5U materials

Bead Inductors for eliminating switching/spike noise

Solid Chip Inductors • NZ Series

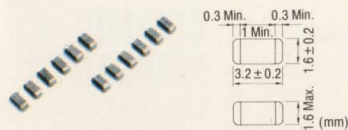

Thin, ultra-small, with monolithic structure and excellent frequency characteristics; designed for automatic mounting

Normal-mode Choke Coils at input/output sector

SN Coils • SN-S3M Series

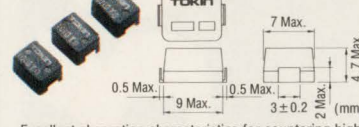

Excellent absorption characteristics for countering high impulse noise; ideal for high-density mounting

Transformers for Converters

SMD Transformers • FEY9.1/7.3

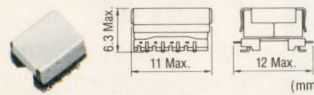

• FEY12.8/11.5

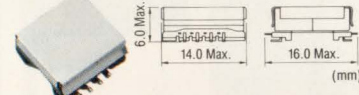

• FEY15.3/13.0

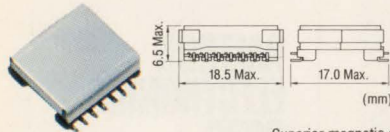

• FED11.6



• FEP7T

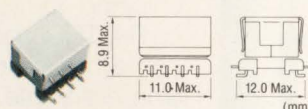

• FEE5

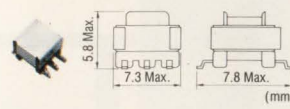

Superior magnetic circuit design technology ensures excellent frequency characteristics; compact, thin; ideal for ultra-high density mounting; SMD discrete monolithic structure



Tokin Corporation

Hazama Bldg., 5-8, Kita-Aoyama 2-chome, Minato-ku, Tokyo 107, Japan
Phone: 03-3402-6166 Fax: 03-3497-9756

Korea Representative Office

602, Champs-Elysees Bldg., 889-5, Daechi-Dong, Kangnam-gu, Seoul, Korea
Phone: (2) 569-2582 - 5 Fax: (2) 544-7087

Tokin America Inc.

155 Nicholson Lane, San Jose, California 95134, U.S.A.
Phone: 408-432-8020 Fax: 408-434-0375

Chicago Branch

9335 Capitol Drive, Wheeling, Illinois 60090, U.S.A.
Phone: 708-215-8802 Fax: 708-215-8804

Boston Branch

945 Concord Street, Framingham, Massachusetts 01701, U.S.A.
Phone: 508-875-0389 Fax: 508-875-1479

Tokin Electronics (HK) Ltd.

Room 806 Austin Tower, 22-26A Austin Avenue, Tsimshatsui, Kowloon, Hong Kong
Phone: 367-9157 Fax: 739-5950

Taiwan Liaison Office

3F-4, No. 57 Fu Shing N. Road, Taipei, Taiwan
Phone: (02) 7728852 Fax: (02) 7114260

Singapore Branch

140 Cecil Street, No. 13-01 PIL Bldg., Singapore
Phone: 2237076 Fax: 2236093, 2278772

Tokin Europe GmbH

Knorstr. 142, 8000 München 45, Germany
Phone: 089-311 10 66 Fax: 089-311 35 84 Telex: 5 24 537 tokin d

Software and hardware catalog.

This 1992 catalog offers an abundance of software and hardware products for developing instrumentation systems. It features five color-coded sections—Application Software, IEEE-488, Data Acquisition, VXI/MXI, and Training. The first four sections of the 544-pg publication provide tutorials on IEEE.488.2, SCPI (standard commands for programmable instruments), plug-in data-acquisition systems, VXI, and MXI. The tutorials deal with applications for instrument control, data acquisition, test and measurement, and similar applications. **National Instruments**, 6504 Bridge Point Pkwy, Austin, TX 78730. **Circle No. 351**

Listing of DSP development tools.

This "line card" for DSP development tools complements a DSP-processor line card that the company published previously. The card summarizes the software and hardware development tools that the vendor or third parties offer for fixed- and floating-point DSP families. Included in the listing are assemblers, linkers, simulators, C compilers,

debuggers, evaluation boards, emulators, PC plug-in boards, signal-processing software, filter design software, and a real-time kernel/operating system. **Analog Devices**, Box 9106, Norwood, MA 02062. **Circle No. 352**

Step-down-switching app note.

The application note, *AN35: Step Down Switching*, explores high-efficiency switching-regulator designs for stepping down the primary power supply of a system. Schematics with comments and advice for more than 20 power-supply systems show sources for the inductors used in the designs. Useful advice helps experienced—as well as inexperienced—power-supply designers to design pc boards, add-on cards, or system modules. **Linear Technology Corp.**, 1630 McCarthy Blvd, Milpitas, CA 95035. **Circle No. 353**

Calibration and instrumentation listings. Representing the TE Product Line, this catalog includes resistance and capacitance decade boxes, portable thermocouple simulators, and 11 differ-

ent voltage and current-calibrator models. It also details the range of programmable IEEE-488 Bus test equipment that is available. The publication provides specifications, illustrations, and features of each product listed. **Zi-Tech Instrument Corp.**, Box 51845, Palo Alto, CA 94303. **Circle No. 354**

Catalog of distributor products.

This 20-pg catalog provides information and photos for handheld and benchtop multimeters and digital thermometers and accessories. It also specifies Philips' timers and counters, frequency counters, and DMMs. **John Fluke Mfg Co Inc.**, Box 9090, Everett, WA 98206. **Circle No. 355**

Acronyms and abbreviations chronicled.

The 209-pg *Dictionary of Information Technology and Computer Acronyms, Initials, and Abbreviations* targets a plethora of potential users. Hardcover, \$24.95; paperback, \$12.95. **McGraw-Hill Inc.**, Professional Book Group, 11 W 19th St, New York, NY 10011. **INQUIRE DIRECT**

VALLEY Offers 40 MHZ VME Digitizer Module to compliment our DSP family... off the shelf.

VE-ADC-2110 A/D Module World Class Performance at \$4500.

Features:

- 10 bit ADC
- 40 MHz Sample Rate
- 55 dB SNR
- Harmonics; - 65 dBc
- 1K Data FIFO
- DAC Output
- VME 6U x 160mm

Applications

- Wideband Spectral Analysis
- Video Digitization
- RF Sampling and Downconversion
- Digitizing Scope
- CT & MRI Medical Imaging
- Radar Signal Digitization

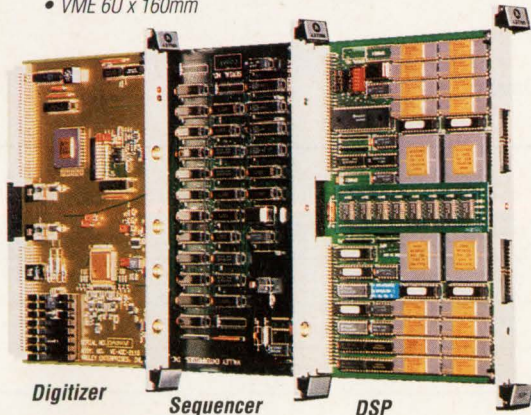

The VE-ADC-2110 is compatible with the VE-32-0xV series of DSP modules or can interface w/ other industry standard VME products.

VE-32C Series

VALLEY ENTERPRISES, INC. offers you the BEST choice... The VE-32C-0xV board starting at \$4K provides an excellent performance to cost ratio for VMEbus-based signal processing applications. This single board can perform up to 100 MFLOPS or 50 MIPS using four AT&T DSP32C digital signal processors.

Designers can put up to 16 VE-32C-01V boards in a VMEbus chassis for a total system performance of 1.6 GFLOPS. A 10 MHz FIFO-buffered input data port and a 10 MHz non-buffered output data port allow the board to capture, process, and generate high-speed data streams.

Software development tools and a DSP Library are available for the following host computers: SUN-3 and SUN-4, IBM-PC and compatibles, HP-9000 workstations, and Apple MacIntoshes. Target environments that are supported include VxWorks, OS/9, SunOS, and Motorola V/68 systems...



VALLEY ENTERPRISES, INC.

RD#4 ROUTE 309 • TAMAQUA, PA 18252, USA
PHONE: 717-668-3737 • FAX 717-668-6360



IEEE Power Electronics and
Industry Applications Societies



Power Sources
Manufacturers Association

Present **APEC '92**

**Seventh Annual
APPLIED POWER ELECTRONICS
CONFERENCE AND EXHIBITION**

February 23-27, 1992
Westin Hotel, Copley Place
Boston, Massachusetts USA

**The premier event in
Power Electronics!!!**

Featuring:

- Over **100** papers and seminars
- Speakers representing **14 nations**
- **Exhibition/Trade Show**
 - > 35 Leading Vendors
 - Wine & Cheese Reception
 - Exhibitor Education Seminars
- **Lively** Informal **RAP** Sessions
- Annual **MICRO-MOUSE** Contest
- An Evening at **Boston's Museum of Science**

The international source for valuable practical information

- 6 Sigma Design & Manufacturing Technologies
- Distributed Power
- Control Techniques
- IC and Discrete Power Devices
- Modeling and Simulation
- Power Circuit Packaging in Aerospace & Military Applications
- Magnetics
- High Power Inverters & Converters
- High Frequency and Resonant Converter Design
- Power Factor Correction and Power Quality
- Performance and Design of AC and DC Motor Drives

Please send complete APEC '92 information to:

Name/Title _____

Company _____

Address _____

Return this form to: APEC, Suite 300, 655 12th St., NW, Washington, DC 20005, 202/639-4990.

Photo courtesy of Massachusetts Office of Travel and Tourism

EDN PRODUCT MART

This advertising is for new and current products.

Please circle Reader Service number
for additional information from manufacturers.

Control Cross-C

Z280, Z180, Z80 & 8085 Full ANSI C Compilers

- ◆ Completely automatic MMU support (no programming effort) for UP TO ONE MEGABYTE Z180 programs.
- ◆ DOS based cross-compilers for ANSI and K&R C code.
- ◆ Complete with high-speed assembler, linker, and librarian. Includes macros to interface C and assembly.
- ◆ **NOT A SMALL C!! Full ANSI C at a small C price.**
- ◆ All ANSI .H files and applicable functions provided.
- ◆ Optimized code generation for all data types. Char types are not promoted to int. Generates inline port I/O.
- ◆ Allows in-line assembly with access to C variables.
- ◆ All code is reentrant and ROMable.
- ◆ Fast ANSI/IEEE 754/INTEL floating point support.
- ◆ Supports C interrupt service routines and pseudo variables to access registers at the C level. Can compile to user defined segments.

ANSI C Compiler, Assembler, Linker - \$699
Assembler and Linker Only - \$279

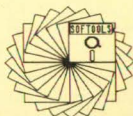

SOFTTOOLS, INC.
8770 Manahan Drive
Ellicott City, MD 21043
(410) 750-3733
FAX/BBS (410) 750-2008

CIRCLE NO. 325

☆☆☆☆
"The Best 8051 Emulator"

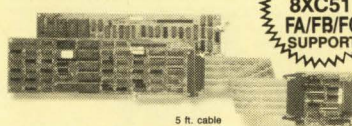

5 ft. cable

**FULL
8XC51
FA/FB/FC
SUPPORT**

8051

SEE EEM 91/92
Pages D 1300-1303

PC based emulators for the 8051 family

- 8031, 8032, 8051, 8052, 80C152/154/321/451/452/51FA/51GB/515/517/535/537/
552/562/652/761, 80532, 83C451/552/652/751/752/851, 8344, 87C451/552/751/
753, 8731, 8755, DS5000 + CMOS - more.
- PC plug-in boards or RS-232 box.
 - Up to 33 MHz real-time emulation.
 - Full Source-level Debugger w/complete C-variable support.
 - 64 bit wide, 256k deep trace, with time stamp.
 - Bond-out/hooks pods for 8051, 83C552, 83C451, 83C652, 83C751, 80C515/80C517, 83C752, 8XC51FA/FB/FC, and more.

CALL OR WRITE FOR FREE DEMO DISK!
Ask about our demo VIDEO

NOHAU CORPORATION
51 E. Campbell Avenue
Campbell, CA 95008
FAX (408) 376-7859
(408) 866-1820

Call 408-376-2912
Nohau's 24-hour
information center to
receive info via your FAX.

CIRCLE NO. 326



Model 8551 - by
Tabor Electronics

50MHz Pulse/Function Generators

- Two available models from under \$3000.
- High fidelity waveforms from 10.00mHz to 50.00 MHz and from 10.00mV to 32.0Vp-p.
- Auto-calibration preserves full accuracy from 0°C to 50°C.
- Fully complies with the new IEEE-488.2 standard.
- Built-in GPIB compiler makes model 8551 bus compatible with HP's model 8116A device - dependent commands.
- Provides sine, triangle, variable/fixed duty cycle pulses, positive and negative ramp waveforms; triggered, gated, and counted burst modes; pulse width, amplitude, and frequency modulation modes; lin/log sweep modes; automatic PLL to an external source with a ±180° phase offset range.

Tabor Electronics
25 Rutgers Ave. Cedar Grove, NJ 07009
Tel: U.S.A. (201) 239-0425; ISRAEL (04) 676868

CIRCLE NO. 327

ROM-IT

EPROM EMULATION SYSTEM



**NEW
4-MEGABIT
VERSION**

- Emulates up to 8 4-Megabit EPROMs with one control card.
- Downloads 2-Megabit programs in less than 23 seconds.
- Allows you to examine and modify individual bytes or blocks.
- Accepts Intel Hex, Motorola S-Record and Binary files.
- Software available for IBM PC and compatibles and Macintosh systems.
- Base 27256 EPROM System \$395.00 Other configurations available.

ORDER TODAY--IT'S EASY
CALL OR FAX FOR MORE INFORMATION



Incredible Technologies, Inc.
(708) 437-2433
(708) 437-2473 Fax

VISA now accepted.

CIRCLE NO. 328

UNIVERSAL PROGRAMMER, EMULATOR & TESTER

TUP-400 \$745.00
TUP-300 \$645.00

- New improved hardware and software.
- The most complete PC-based Universal Programmer. Programs PLD (PAL, GAL, FPL, EPLD, PEEL, MAX, MACH...), E(E) PROM (up to 16 Mbit), Flash EPROM, BPPROM, Special PROM, MPU (87XX, 68XX, Z8, PS3031, PIC16XX, TMS320CXX, UPD75PXXX, HD6370XX...)
- Covers DIP, PLCC, QFP, SOP, and PGA with 8 to 84 pins. Gang Programming adapters available also.
- EPROM EMULATION capability.
- Tests digital ICs and DRAMs (SIMM/SIP adapter available).
- Free software updates and new devices added upon request.
- IC Manufacturers' approval.
- 1 year warranty, 30 day money back guarantee.



CALL TODAY
FOR MORE INFORMATION.
Distributors are welcome!



Tribal Microsystems Inc.
44388 S. GRIMMER BLVD. FREMONT, CA 94538
TEL (510) 623-8859 FAX (510) 623-9925

CIRCLE NO. 329

Instant Microcontroller

+
Instant C

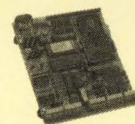

=
Instant New Product

Use our Little Giant™ and Tiny Giant™ miniature microprocessor-based computers to instantly computerize your product. Our miniature controllers feature built-in power supplies, digital I/O, serial I/O (RS232 / RS485), A/D converters (to 20 bits), solenoid drivers, time of day clock, battery backed memory, watchdog, field wiring connectors, and more! Designed to be easily integrated with your hardware and software. Priced from \$159. Core modules as low as \$59. Low cost, interactive Dynamic C™ makes serious software development easy.

Z-World Engineering

1724 Picasso Ave., Davis, CA 95616 USA
Tel: (916) 757-3737 Fax: (916) 753-5141
Automatic Fax: (916) 753-0618
(Call from your fax, request catalog #18)

CIRCLE NO. 330

To advertise in Product Mart, call Joanne Dorian, 212/463-6415

OPERATOR INTERFACE

INDUSTRY PROVEN RELIABILITY

- * 30 or 45 key Tactile Keypad
- * 80 Character (4 Line X 20 Character)
- * 300 to 19200 BAUD
- * Programmable Function Keys
- * RS-232 or RS-422 Interface
- * Simple Menu Set-up
- * Standard or Custom Keypad Graphics
- * 5 VDC or Extended 8-24 VDC
- * Less than 8 Ounces
- * Full Two Year Warranty

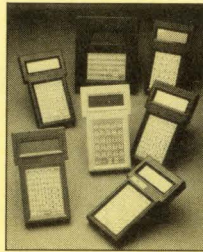

Two Technologies, Inc.
419 Sargon Way
Horsham, PA 19044
PHONE (215) 441-5305
FAX (215) 441-0423

CIRCLE NO. 331

Baby Bullet-386SX™

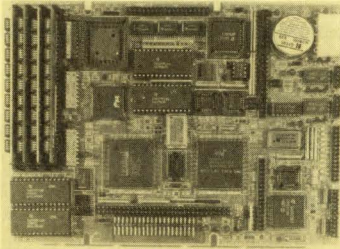

- Single Board Computer
- AT Compatible ▪ SCSI Interface
- On Board Serial (2), & Parallel (1) Ports
- On Board Multiple Disk Interface
- Solid State Disk ▪ Low Power — Only 5V
- Small Size — 5.25" Disk Form Factor
- Watch Dog Timer ▪ Keyboard Interface
- Up To 16MB DRAM ▪ AMPRO Compatible

Dyna Five Corporation
173 Freedom Avenue ▪ Anaheim, CA 92801
(714) 525-8795 ▪ FAX (714) 525-9310

CIRCLE NO. 332

smx simple multitasking executive v2.1

FULL FEATURED KERNEL

- task manager
- memory manager
- intertask comm.
- error manager
- i/o, events, & timing
- resource manager
- preemptive
- ROM'able

EASY TO USE

- libraries for Microsoft C, Borland C/C++, Zortech C/C++ and assembler
- Quick Start, User's Guide, and Reference manuals
- standalone, PC, and DOS platforms
- smxProbe task debugger
- 6 months free support and updates

FAST & SMALL

- 15 usec max. interrupt latency
- 150 usec typical task switch
- 8 to 25 KB code size

Ask about our \$95 evaluation kit.

MICRO **pd** DIGITAL
6402 Tulagi St.
Cypress CA 90630-5630

Call for information:

1-800-366-2491
FAX 714-891-2363

CIRCLE NO. 333

\$249. TERMINAL



- Featuring**
- Standard RS-232 Serial Asynchronous ASCII Communications
 - 48 Character LCD Display (2 Lines of 24 Each)
 - 24 Key Membrane Keyboard with embossed graphics
 - Ten key numeric array plus 8 programmable function keys
 - Optional RS-422 multidrop protocol mode
 - Keyboard selectable SET-UP features—baud rates, parity, etc.
 - Size (5.625" W x 6.9" D x 1.75" H), Weight 1.25 lbs.
 - 5 x 7 Dot Matrix font with underline cursor
 - Displays 96 Character ASCII Set (upper and lower case)
 - Optional Bar Code Wand (shown)

COMPUTERWISE, INC.

302 N. Winchester • Olathe, KS 66062 • 800-255-3739 • FAX (913) 829-0810

CIRCLE NO. 334

400 MHz Logic Analyzer

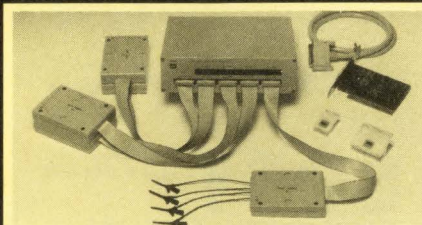

- upto 128 Channels, Timing and State
- 400 MHz Max Sampling Rate
- Timing and State Simultaneous on Same Probe
- 16K Samples/Channel (high speed mode)
- 16 Levels of Sequential Triggering
- Variable, TTL, or ECL Logic Threshold Levels
- 8 External Clocks
- FREE Software Updates on 24 Hour BBS

\$799 - LA12100 (100 MHz)

\$1299 - LA32200 (200 MHz-32channels)

\$1899 - LA32400 (400 MHz-32channels)

\$1950 - LA64200 (200 MHz-64channels)

\$2750 - LA64400 (400 MHz-64channels)

UNIVERSAL PROGRAMMER

PAL
GAL
EPROM
EEPROM
PROM
87xxx...

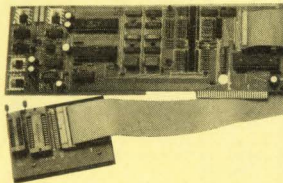

22V10
26CV12 **\$475**
16Bit EPROMs FLASH EPROMs
5ns PALs 4 Meg EPROMs
FREE software updates on BBS

Call - (201) 808-8990
Link Computer Graphics, Inc.

369 Passaic Ave., # 100, Fairfield, NJ 07004 FAX: 879-8786

CIRCLE NO. 338

IND-286 SBC

AT Compatible DISKLESS
SBC Includes DOS in ROM

Complete 16MHz 80C286 Single Board Computer for embedded PC applications features a 4M-byte PROMDISK disk emulator with battery back-up and an MS-DOS 3.3 compatible disk operating system in ROM.

Features Include:

- 4M-byte DRAM
- Keyboard Port
- 2 COM, 1 LPT
- IDE Disk Port
- 4M PROMDISK
- 100% PC/AT Compatible
- XT Size Board
- 80287 Socket
- WatchDog Timer
- Floppy Port
- Optional Video Daughter Bd.

Other Products:

- IND-88 PC/XT Single Board Computers
- PROMDISK III & IV Disk Emulators
- FlexScan I & II Bar Code Decoders

MSI micro computer specialists, inc.
2598-g fortune way vista, ca 92083
phone: 619/598-2177 fax: 619/598-2450

CIRCLE NO. 336

48 Channel 50MHz Logic Analyzer

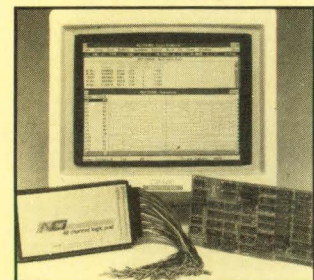

Complete System **\$1895.00**

New Windows 3.0 Compatible Software

- 48 Chnnls @ 50 MHz x 4K words deep
- 16 Trigger Words/16Level Trigger Sequence
- Storage and recall of traces/setup to disk
- Disassemblers available for: 68000, 8088, 8086, 6801, 6811, 280, 8085, 6502, 6809, 6303, 8031

NCI 6438 UNIVERSITY DRIVE,
HUNTSVILLE, AL 35806
(205) 837-6667 FAX (205) 837-5221

CIRCLE NO. 339



MultiTask!™ Executives Accelerate Design

Get standard real-time services on 68xxx, 68HC11, Z80/180/64180, 8051, 80x86/V-Series, 8096/196, i960 and ProtoTask!™ PC design executive. Source code keeps you in control. Call: 503-641-8446; FAX 503-644-2413; or 800-356-7097 for free EasyTask!™ Info Diskette.

US SOFTWARE

14215 NW Science Park Drive
Portland, OR 97229

© 1991 US Software Corporation. MultiTask!, ProtoTask! and EasyTask! are trademarks of US Software Corporation.

CIRCLE NO. 337

To advertise in Product Mart, call Joanne Dorian, 212/463-6415

THE EASY CHOICE

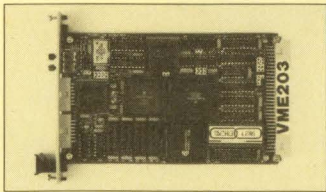

Micro-Link's VME203 SBC makes your design choice easy. Available in several configurations, VME203 prices start at less than \$1,025 in 100 piece quantities. Options include 68EC030 or 68030, FPU, 1 or 4 MB of DRAM with transparent refresh, burst mode Cache, up to 1 MB of EPROM, two RS-232 serial ports, and clock speeds of 16, 32 and 40 MHz. VME203 software support includes Microware OS-9[®], CrossCode[®] C FreeForm[™] and Microbug II.

Call For Your Free Configuration Guide:
1-800-428-6155 US & Canada
1-317-846-1721 International

CIRCLE NO. 340

16 MHz CPU
 DRAM to 512K
 20 MHz DSP
 SRAM to 96K
 DAPL™ Operating System
 100+ standard commands
 Custom commands in C

The Intelligent Solution For Data Acquisition

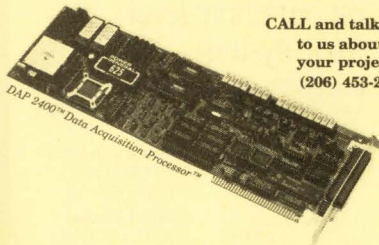

CALL and talk to us about your project.
(206) 453-2345

ANALOG I/O
 DIGITAL I/O

Inputs to 235K samples per second
 Outputs to 250K samples per second

Or call for **FREE** demo diskette.

MICROSTAR LABORATORIES
 2265 116th Avenue NE
 Bellevue, WA 98004
 FAX (206) 453-3199

CIRCLE NO. 341

"Instant On" SBC

You'll be programming in 30 minutes. We guarantee it !!

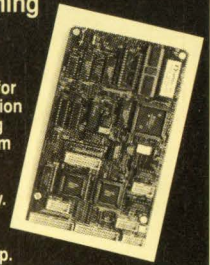

The 2300H has everything for an embedded data acquisition & control system, including its own development system & programming language. Set up time is quick and programming is fast & easy. Write your program, store it in nonvolatile memory and it autoruns on power up.

- ▶ 10 analog I/O, 12-bit
- ▶ 48 digital I/O lines
- ▶ 512K RAM
- ▶ EPROM programmer
- ▶ Keypad interface
- ▶ LCD interface
- ▶ 2 serial ports
- ▶ Calendar/clock
- ▶ Drives Opto 22 racks
- ▶ Network up to 32 units
- ▶ Low-power, CMOS
- ▶ -30° to 80° C operation

Free Single Board Computer Catalog
 Tel: 303-430-1500, Fax: 303-426-8126

OCTAGON SYSTEMS CORPORATION
 6510 W. 91st Avenue, Westminster, CO 80030

CIRCLE NO. 342

80C51

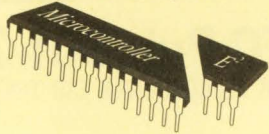

Low Cost, 80C51 + 64K Bits of E²PROM
 5 Volt, Single-Chip, Nonvolatile Memory Solutions
 For The 80C51 Family

X88C64 FEATURES:

- Organized 8K X 8
- Simultaneous Software Execution While Writing
- Multiplexed Address/Data Bus
- High Performance Low Power CMOS
- Software Data Protection
- Block Protection
- Toggle Bit Early End Of Write Detection
- 32 Byte Page Mode Write



Xicor, Inc., 851 Buckeye Court, Milpitas, California 95035-7493
 (408) 432-8888 X3549 FAX 408-432-0640

CIRCLE NO. 343

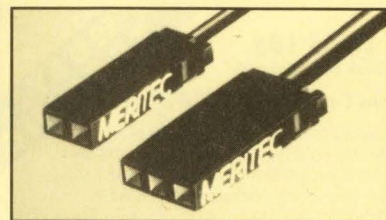

Single Signal Interconnects That Terminate High Cost

Meritec's economical 1x2 and 1x3 Single Signal Interconnects (SSI[™]) are engineered to match your requirements for controlled impedance and propagation rate while minimizing crosstalk. A spring latch connects the termination to the housing or to Meritec's Single Signal Carrier Systems (SSC[™]), which allow grouped interfacing with single, dual or triple row headers. Tel: 216-354-3148, Fax: 216-354-0509.

Meritec

CIRCLE NO. 344

8051 IN-CIRCUIT EMULATOR

NICE-51
 from **\$1195.00**



- Up to 12 MHz real-time emulation without intruding on any of your device's resources!
- SFR, Code Memory, External Data, Internal Data, and Bit Address can all be directly viewed and edited using the full screen editor.
- Downloads data to external data memory and processes BIN, HEX, and SYMBOL files in code memory.
- Up to 10 conditional S/W breakpoints and 64K HW breakpoints.
- 16K deep, 48-bit real-time trace buffer records Address Bus, Data Bus, Control Bus, and 18-bit external signal.
- Integrated programmer for EPROMs and 8751 available.

Distributors are Welcome!
 1 year warranty,
 30 day money back guarantee.
 Call today for a free demo diskette.



Tribal Microsystems Inc.
 44388 S. GRIMMER BLVD. FREMONT, CA 94538
 TEL (415) 623-8859 FAX (415) 623-9925

CIRCLE NO. 345

Library Doubled and WINDOW 3.0 with VMS

DC/CAD

CAD Showdown Results!

HIGH DENSITY EXPERTS!

Integrates Schematic Capture, PCB Layouts & Autorouting

This top-rated CAD out-routed the competition in the 1990 CAD Showdown. DC/CAD displayed its power and flexibility when routing a double-sided board while competing routers used four to six layers. This non-copy protected package with surface mount support includes:

- Multi-strategy 1-mil parts autoplayer
- "1-mil" autorouting w/ripup & retry
- Thorough annotating design rule checker
- Full 2-way GERBER and DXF support
- Optional autoground plane support with cross-hatching
- Optional simulation capability & protected mode for 386 users

Call today
 DC/CAD \$595
 (priced from \$495)

LEASE PROGRAM & SITE LICENSE AVAILABLE
 30 DAY MONEY BACK GUARANTEE



Rt. 55, Sherman Square Farmingdale, NJ 07727
 (908) 938-6661 • (908) 938-6662 (FAX)

DC/CAD... Innovative, Intelligent & Integrated Software

CIRCLE NO. 346

Interactive/Real-Time

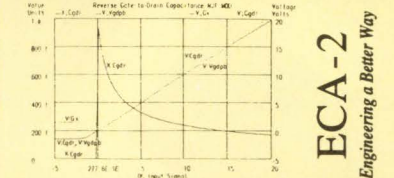

ECA-2
 Engineering a Better Way

Analog Circuit Simulation

- AC, DC, Transient, Fourier, Temperature, MonteCarlo and/or Worst-Case Analysis
- Interactive or batch modes
- Full nonlinear simulation
- On-line real time graphics
- Multiple plots • 2 to 50 times faster than SPICE
- Component optimization sweeping • New 424 pg. manual

All the Features, Twice the Speed
 at Half the Cost

Call for **FREE DEMO!**

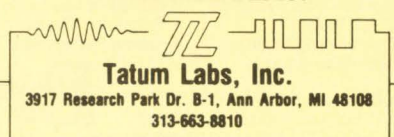

CIRCLE NO. 347

Tango

The Complete Electronic Design Solution.

For **FREE** evaluation software and product specs,
 call **800 488-0680**

Tango, the leader in PC-based tools for:

- Schematic entry
- PCB layout and autorouting
- PLD design
- Simulation, timing verification and thermal reliability



Q=ABC
 F=X+Y



ACCEL Technologies, Inc.
 6825 Flanders Drive
 San Diego, CA 92121-2986
 Service 619 554-1000
 Fax 619 554-1019

CIRCLE NO. 348

To advertise in Product Mart, call Joanne Dorian, 212/463-6415

Just
\$495!*



ABEL-PLD: Logic design for less.

- 150 PLD architectures supported (more than 4000 devices)
- Uses ABEL™ Hardware Description Language (ABEL-HDL™)
- Intelligent synthesis and optimization
- Upgradable to full-featured ABEL Design Software

Call for your FREE ABEL-PLD™ Design Software start-up kit!

1-800-3-DataIO
(1-800-332-8246)

*U.S. list price only.

DATA I/O
Corporation

CIRCLE NO. 349

Now
\$1495!*



Save \$1000 on our entry-level logic system.

- Includes the 212 Multi Programmer with logic module, ABEL-PLD™ and PROMlink™ Ltd. PC Interface Software
- Supports 20- and 24-pin CMOS logic devices
- Full-hex keypad for extensive editing
- Compatible with JEDEC standard programming files

- Optional EPROM and microcontroller modules

Call today to order!
No-risk, money-back guarantee!

1-800-3-DataIO
(1-800-332-8246)

*U.S. list price only.

DATA I/O
Corporation

CIRCLE NO. 350

A STEP BEYOND.



PROMICE takes ROM emulation a step beyond. It's an affordable, multi-operational development tool with:

- on board intelligence
- modular design
- source level debugging
- future expandability

PROMICE. The Firmware Development System of Tomorrow...

Grammar Engine Inc.

314 Morse Road
Columbus, Ohio 43231
614/471-1113
FAX: 614/478-6871

CIRCLE NO. 751

EP-1140 E/EPROM PROGRAMMER

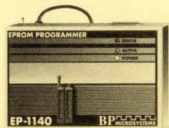

\$895.00

- ✓ Programs NEC's 27C8001, 8-Mbit EPROM and all 1, 2, & 4-Mbit, 16 bit EPROMs
- ✓ Supports all 87C51 derivative Microcontrollers, including Intel's 87C51GB
- ✓ Qualified and recommended by Intel, National Semi and Signetics.

- ✓ Supports encryption array programming for microcontrollers
- ✓ Call for a DEMO disk and literature packet
- ✓ Risk-free 30-day money-back guarantee
- ✓ Lifetime FREE software updates via BBS and US Mail

BP MICROSYSTEMS

10681 Haddington • Houston, TX 77043-3239
800/225-2102 • FAX 713/461-7413

CIRCLE NO. 752

CMOS 186 Single Board Computer

Runs C or QuickBASIC™ Programs

Powerful 16-bit computer directly executes EPROM's containing any C or BASIC .EXE file. NO LOCATORS! Software includes multi-tasking, multi-drop comm., PID control, OPTOMUX™

- 10, 12, 16 MHz 80C186
- CMOS design
- 512K RAM
- 384K EPROM
- STD BUS Expansion
- COM1 RS232/485
- COM2, LPT1
- RTC Avail
- 80C187 Avail
- OEM discounts

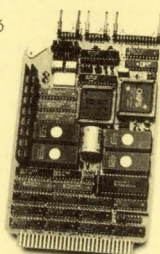

MICRO/SYS

1011 Grand Central Ave., Glendale, CA 91201
(818) 244-4600 FAX (818) 244-4246

CIRCLE NO. 753

NoiseKen

IEC Pub. 801-2 HIGH REPRODUCIBLE ESD TESTING.

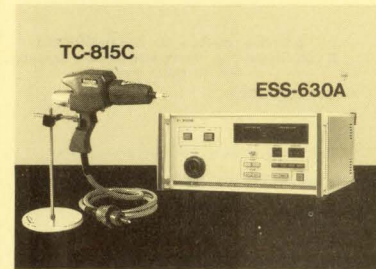

ELECTROSTATIC DISCHARGE SIMULATOR ESS-630A

U.S.A. WATAHAN NOHARA INTERNATIONAL, INC.
TEL (800)366-3515

CIRCLE NO. 754

Analog Circuit Simulation

- Schematic Entry
 - SPICE Simulation
 - Model Libraries
 - Waveform Processing
- only \$990

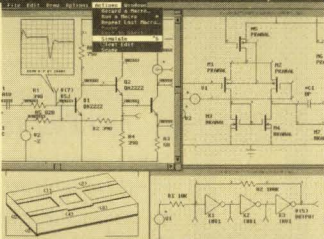

Powerful - Affordable

FULLY INTEGRATED, EASY TO USE, ANALOG CIRCUIT SIMULATION ENVIRONMENT, FROM ONE VENDOR, FEATURING: A powerful SPICE simulator performing AC, DC, and Transient, analyses, extensive model libraries, schematic entry, graphical waveform processing, and report quality printouts.

Call Or Write For Your Free Demo and Information Kit!
Tel. 310-833-0710

intusoft

P.O. Box 710 San Pedro,
CA 90733-0710
Fax 310-833-9658

CIRCLE NO. 755

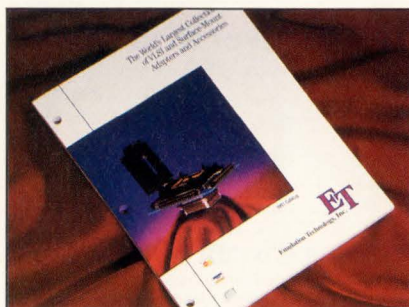

Free Catalog

The World's Largest Collection of Adapters & Accessories for VLSI/Surface Mount Devices

- Emulator Pods & Adapters
- Debug Tools
- Programming Adapters
- Socket Converters
- Debugging Accessories
- Prototyping Adapters
- Custom Engineering

Emulation Technology, Inc.
2344 Walsh Ave. Santa Clara, CA 95051
Phone: 408-982-0660 FAX: 408-982-0664

ET

CIRCLE NO. 756



Schematic Capture for the Macintosh

DESIGNWORKS

Schematic features Menu-driven, mouse-controlled operations • cut/copy/paste between circuits • right-angle rubberbanding. Digital simulation 13-state, event-driven simulation • logic analyzer-style timing window • PLD support. Libraries Fully-simulated 7400, 4000, 10K series, PLDs, PROMs and RAMs, non-simulated analog and discrete components • User-definable, simulated custom symbols. Interfaces Formats for Douglas CAD/CAM, Cadnetix, Calay, Orcad, Tango, Racal Redac, Spice. • user-definable printers, dot-matrix printers, HP, Houston, Roland pen plotters.

CALL (800) 444-9064 TODAY FOR YOUR FREE DEMONSTRATION KIT!

CAPILANO COMPUTING
(604) 522-6200 Fax (604) 522-3972

CIRCLE NO. 757

To advertise in Product Mart, call Joanne Dorian, 212/463-6415

**1000-W
4-OUTPUT
POWER
SUPPLY
WITH .99
POWER
FACTOR**

SUPERMAX 1000 is a superb, low-cost 1000-watt switching power supply designed with Power Factor Correction built in. The smallest in its class. Includes Universal AC input from 90 to 264 VAC; low AC line distortion per IEC 555-2; high MTBF; system air or self-cooling. Part of the MAX Series from 160 W.

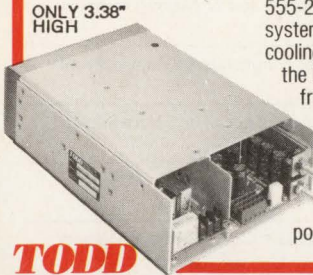

ONLY 3.38" HIGH

NY TEL.: 516 231-3366.
800 223-TODD
The 911 of power supplies.

TODD

Circle #119 for an Evaluation Unit Circle #118 for Info

8051 68HC11 COP8

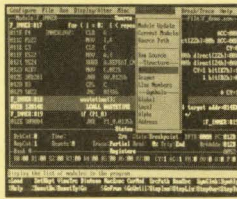

**iceMASTER
Your Window
To Emulation
Productivity**

- Easy to learn & use
- Windowed interface—user configurable
- FAST! Download—<3 sec. typ. at 115KB
- Source Level debug
- A 4K frame trace buffer with advanced searching capabilities.
- iceMASTER connects easily to your PC, requires no disassembly, or expansion slots. Works on any PC (DOS or OS/2), MicroChannel or EISA. Even laptops!
- iceMASTER is versatile: iceMASTER-8051, iceMASTER-68HC11 and iceMASTER-COP8 support most family derivatives.
- Rental and 10-day trials available.
- 68HC11 A,D,E,F; 8XC528; 8XC552; 8XC515A and 8XC517A support.
- Call today for free demo disk and ask about a free 8051 Macro Assembler! (800) 638-2423

MetaLink Corporation

MetaLink Corporation P.O. Box 1329 Chandler, AZ 85244-1329
Phone: (602) 926-0797 FAX: (602) 926-1198 TELE: 499050MTELM



CIRCLE NO. 759



**An Established Foothold In
The Device Programming Arena**

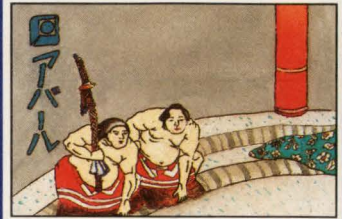

**The Traditional
Market Leader In Japan**

U.S. Tel./Fax 1-619-727-4683 / 5232
Europe Tel./Fax 353-1-2892136 / 2892070
Japan Tel./Fax 81-3-3344-2001 / 2007
Daisan Maruzen Bldg., 6-16-6 Nishi Shinjuku,
Shinjuku-Ku, Tokyo 160, Japan.

AVAL CORPORATION

CIRCLE NO. 760

**RELIABILITY
PREDICTION
SOFTWARE**

ARE YOUR PRODUCTS RELIABLE?

The RelCalc 2 Software Package predicts the reliability of your system using the part stress procedure of MIL-HDBK-217E, and runs on the IBM PC and full compatibles. Say goodbye to tedious, time consuming, and error prone manual methods! RelCalc 2 is very easy to use, and features menu windows, library functions, global editing for what-if? trials, and clear report formats. Try our Demo Package for \$25.

T-CUBED SYSTEMS, 31220 La Baya Drive #110, Westlake Village, CA 91362. (818) 991-0057 • FAX: (818) 991-1281

CIRCLE NO. 761

SCHEMA III 3.3

Schematic Capture

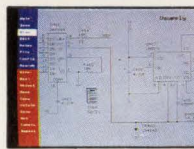

**COMPLETE
DESIGNS ON
YOUR PC OR
UPLOAD
TO YOUR
WORKSTATION**

FREE DEMO DISK

One schematic capture program stands alone in features, speed, user friendliness & performance - SCHEMA. The new SCHEMA III 3.3 is still only \$ 495.



800-553-9119

CIRCLE NO. 762

**Surface Mount Chip Component
Prototyping Kits—**



**Only
\$49.95**



CC-1 Capacitor Kit contains 365 pieces, 5 ea. of every 10% value from 1pf to 33µf. CR-1 Resistor Kit contains 1540 pieces; 10 ea. of every 5% value from 10Ω to 10 megΩ. Sizes are 0805 and 1206. Each kit is ONLY \$49.95 and available for Immediate One Day Delivery!

Order by toll-free phone, FAX, or mail. We accept VISA, MC, COD, or Pre-paid orders. Company PO's accepted with approved credit. Call for free detailed brochure.

COMMUNICATIONS SPECIALISTS, INC.
426 West Taft Ave. • Orange, CA 92665-4296
Local (714) 998-3021 • FAX (714) 974-3420

Entire USA 1-800-854-0547

CIRCLE NO. 763



Complex PLDs

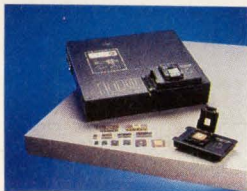

If your good old Data I/O can do the job, stay with it. If not, you can count on Advin. Our **PILOT-U84** supports all Altera/Cypress MAX devices, all AMD MACH devices, all Lattice LSI devices, Atmel 5000, Xilinx and others. Qualified by all major manufacturers. Please call and ask for a technical staff.



Advin Systems Inc.
1050-L E. Duane Ave., Sunnyvale, CA 94086

CIRCLE NO. 764

**Relax
Reliability Software**

Innovative Software Designs offers an unbeatable set of reliability analysis software tools with its Relax product line. The Relax line includes electronic reliability analysis according to MIL-HDBK-217, Bellcore, and CNET, mechanical reliability, and failure modes and effects analysis. Also available are packages for thermal and Weibull analysis.

Relax products are noted for their outstanding quality, ease-of-use, flexibility, and comprehensive array of features. A wide range of packages are available to meet your price and product requirements. And all products are fully guaranteed!

Call today for more information and join ISD's long list of satisfied customers!

**217
CNET
Bellcore
FMECA
Mechanical
217 Parts Count
Calculs Simplifiés
BETASoft Thermal
WeibullSMITH Analysis**

Innovative Software Designs, Inc.

One Kimball Ridge Court • Baltimore, MD 21228
(301) 747-8543 • Fax (301) 747-8599

CIRCLE NO. 765

**PEM® CONNECT'R WARE™
STANDOFFS**

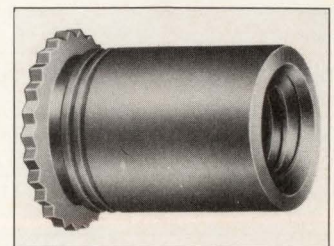

PEM® bulletin DSOS describes the new PEM CONNECT'R WARE™ standoff for D-sub connector mounting. These PEM standoffs replace the loose female screwlocks and washers currently being used, which greatly reduces handling, inventory and assembly costs. This brochure includes all specifications and installation data. For a free copy of bulletin DSOS circle the number below or contact us at: **1-800-237-4736**, FAX (215) 766-0143.

CIRCLE NO. 766

To advertise in Product Mart, call Joanne Dorian, 212/463-6415

EDN-CAREER OPPORTUNITIES

1992 Recruitment Editorial Calendar

Issue	Issue Date	Ad Deadline	Editorial Emphasis
News Edition	Feb. 6	Jan. 23, '92	STATE OF ENGINEERING Special Supplement • Computers & Peripherals • Communications Technology • Annual Salary Survey
Magazine Edition	Feb. 17	Jan. 23	EDN's 35th Anniversary Issue • ASICs • ICs & Semiconductors • Test & Measurement • Manufacturing Issues
News Edition	Feb. 20	Feb. 6	ICs & Semiconductors • ISSCC Hot Products • Computers & Peripherals • Regional Profile: Colorado, Utah, Idaho
Magazine Edition	Mar. 2	Feb. 6	COMMUNICATIONS SPECIAL ISSUE • Test & Measurement • Local-area Networks • Microprocessors • Memory Technology
News Edition	Mar. 5	Feb. 20	Memory Technology • CPU Boards • Computers & Peripherals • Diversity Special Series
Magazine Edition	Mar. 16	Feb. 20	COMPUTER & PERIPHERAL SPECIAL ISSUE • Multimedia • Components • Memory Technology • Computer Peripherals • International Technology Update—Japan
News Edition	Mar. 19	Mar. 5	DSP Software • Communications • Regional Profile: New York, New Jersey, Pennsylvania
Magazine Edition	Mar. 30	Mar. 5	Microprocessors • Analog Circuits • CAE • Test & Measurement
SOFTWARE ISSUE	Mar. 30	Mar. 5	SOFTWARE ENGINEERING SPECIAL ISSUE • (To be polybagged with the March 30th Magazine Edition issue)
News Edition	Apr. 2	Mar. 19	ICs & Semiconductors • Multimedia Software/Development Tools • Engineering Management Special Series
Magazine Edition	Apr. 9	Mar. 19	CAE • EDN Hands-on Special Project—Part I: Field-programmable Gate Arrays • Software • Memory Technology
Magazine Edition	Apr. 23	Apr. 2	Portable Computer Design • EDN Hands-on Special Project—Part II: Field-programmable Gate Arrays • Electromechanical Devices • Computer Peripherals
News Edition	Apr. 30	Apr. 16	ASICs SPECIAL ISSUE • FPGAs and EPLDs • CICC Hot Products • ASICs • Regional Profile: Northern California
Magazine Edition	May 7	Apr. 16	Communications/Networks • Test & Measurement • Surface-Mount Components • Power Sources • Electro Show & Products Issue
ELECTRO SHOWGUIDE & PRODUCT SPOTLIGHT		Apr. 3	A free page available to all advertisers running a full page in 2 out of 3 Electro issues
News Edition	May 14	Apr. 30	Graphics Technology • Computers & Peripherals
Magazine Edition	May 21	Apr. 30	Analog ICs • Analog CAE • PC Board CAE Tools • Programmable-Logic Devices
News Edition	May 28	May 14	Communication ICs • CAE Software • Regional Profile: Texas, Oklahoma, Kansas
Magazine Edition	June 4	May 14	ASICs/PLDs • DSP Software • CAE/Software/Interoperability • Digital ICs & Semiconductors
News Edition	June 8	May 21	CAE SPECIAL ISSUE • EDA/CASE Supplement • DAC Hot Products • Software Engineering • Diversity Special Series
Magazine Edition	June 18	May 28	Microprocessors • Electromechanical Devices • ICs & Semiconductors
SOFTWARE ISSUE	June 18	May 28	SOFTWARE ENGINEERING SPECIAL ISSUE (To be polybagged with the June 18th Magazine Edition issue)
News Edition	June 25	June 11	MILITARY ELECTRONICS SPECIAL ISSUE • DSP Hardware • Military Electronics • Regional Profile: Florida, Alabama
Magazine Edition	July 6	June 11	INTERNATIONAL PRODUCT SHOWCASE—Vol. I • Hardware & Interconnect • Software • ICs & Semiconductors • Power Sources

Call today for information on Recruitment Advertising:

East Coast: Janet O. Penn (201) 228-8610

West Coast: Nancy Olbers (603) 436-7565

National: Roberta Renard (201) 228-8602

**Commit To
Excellence**
Join

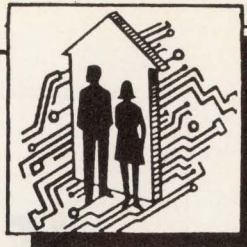

Materials Research Corporation is a leader in thin film deposition systems, dry etching systems and high-purity materials for applications in the microelectronics industry.

We offer experienced professionals unique opportunities to call on the full scope of their expertise to lead efforts that are truly on the cutting edge of the industry.

Director of Engineering

With approximately 60 people reporting to the function, you will lead the development of successful enhancements to current products, integrate new product introductions and establish strong relationships with Advanced Technology Development, Manufacturing and Applications Laboratory so that new product projects are transitioned to production smoothly; initiate and run Engineering project management system for new products or major product improvements; establish world-class concurrent engineering capabilities and drive PED efforts to reduce new production introduction cycle times; and provide engineering leadership for total quality programs.

To qualify, you should have excellent people skills, tact and be personable while at the same time setting high expectations and goals. You must also have an Engineering Degree, advanced degree desirable; and a proven track record of engineering responsibility for development design of capital equipment similar to that produced by MRC.

Senior Manager — Engineering

You will be responsible for directing the overall efforts of approximately 30 personnel engaged in the ongoing development of our semiconductor cluster tool equipment program. In addition, you will make formal presentations to management and customers, manage outside resources, handle all staffing issues, schedule cost management and conduct training in various areas of technology.

To qualify, you must have a BS in Physics, ME or EE, advanced degree desirable, and 15 years engineering technology experience. This experience should include 4 years managerial and 3 years program management involving the development of complex, computer controlled machinery. We prefer recent experience with high vacuum or semiconductor equipment, and "design for manufacturability" training/experience. Excellent presentation and communication skills are essential.

We offer excellent salaries, company paid benefits and relocation assistance to those that qualify in our state-of-the-art facilities located in suburban Rockland County, only 30 minutes North of New York City.

Send your resume and salary requirements, indicating position desired, to: Dick Feeney, Senior Personnel Manager, Dept. ED, Materials Research Corporation, 200 Route 303, Congers, NY 10920. We are an equal opportunity employer m/f/h/v.



**MATERIALS RESEARCH
CORPORATION**

"Defining Excellence In Thin Films"

ENGINEER

ACCELERATE YOUR FUTURE.

While other companies continue to stay "on hold" or cut back, we continue to grow. As a leading edge supplier of high speed simulation accelerators and software tools for CAE applications, we have helped increase productivity while shortening product development cycles. This allows our EDA customers a competitive edge and quicker time-to-market.

If you seek a company with strong technology, solid joint marketing agreements, a focused commitment to R&D, and an anticipated 1992 revenue increase of 30%+, then take advantage of the following opportunities now:

SOFTWARE ENGINEER SIMULATION TOOLS

You will develop software interfaces for our existing and future generation simulation tools. Responsibilities will include the design of the interface tools for the current XP products and algorithm design in CAE framework for our simulation partners.

Strong experience with C under UNIX®, a BSEE/CS (MSEE/CS preferred) or equivalent required, as well as at least 2+ years of developing and delivering CAE tools. Expertise in gate, mixed level or behavioral simulation would be ideal. Job Code JL.

SR. SOFTWARE ENGINEER TOOLS DEVELOPMENT

You will define architecture and tools, used by Model Development Engineers for the development of ASIC libraries used in the XP accelerator, provide support of library tools to internal Model Development Engineers, Application Engineers, and customers, and maintain and enhance tools to support library development methodology.

An MSCS/EE and 7+ years' experience in software system architecture, specification and implementation utilizing UNIX and C required, as well as excellent English communication skills. You must also be team-oriented and self-motivated. Job Code CA.

SENIOR LIBRARY DEVELOPMENT ENGINEER

You will develop ASIC libraries used in the XP accelerator, define library development methodology and tools to implement methodology, and provide library support to customers and Applications Engineers.

An MSEE with 7+ years' experience in ASIC library development or CAE design, kits and good working knowledge of UNIX and C required, as well as excellent English communications skills. You must also be team-oriented and self-motivated. Job Code CA.

For immediate consideration, please send or fax your resume, indicating Job Code of interest, to; Zycad Corporation, Human Resources Department, Dept. EDN-1, 1380 Willow Road, Menlo Park, CA 94025; FAX (415) 688-7550. We are an equal opportunity employer. Principals only, please.

Trade marks are registered to their respective companies.

ZYCAD

A Decade of Accelerating the Future.

ENGINEERING CAREER OPPORTUNITIES

Join an expanding high tech R&D/product engineering firm specializing in State-of-the-Art microprocessor based designs. We encourage employee initiative and creativity and offer opportunities for continued development of analytical and technical ability.

ANALOG DESIGN ENGINEER

Requires BS/BSEE and 3+ years experience in analog design.

- Semi Custom Analog Chip Design
- PSPICE Simulation
- DC to 50 MHz Analog Design

DIGITAL DESIGN ENGINEER

Requires BS/BSEE and 1+ years experience in digital design.

- High Performance Bus Design
- Xilinx FPGA Design
- Embedded Controller Application Design

SOFTWARE ENGINEER

Requires BS/BSEE/CS and 2+ years experience.

- OS/2 and Windows
- Intel Microprocessors
- C, C++ Programming

PCB DESIGNER

Requires 2+ years CAD experience.

- SMT Layout Experience
- Low Level Analog Circuit Design

Qualified applicants should forward a resume and salary history to:



Annapolis Micro Systems, Inc.

190 Admiral Cochrane Drive, Suite 130
Annapolis, Maryland 21401

(410) 841-2514 (301) 970-2672

FAX: (410) 841-2518

- Principals Only -

If You're Looking For a Job, You've Come to The Right Place.

EDN CAREER OPPORTUNITIES

Get a Job!

EDN Magazine Edition
News Edition

EDN Magazine Edition
News Edition

Knock, Knock.

In EDN's
Magazine
and News
Editions,
opportunity
knocks all
the time.

EDN Magazine
Edition
News
Edition

ENGINEERS

Talent and Technology Soaring Above The Rest

The Bendix/King Air Transport Avionics Division, a unit of Allied-Signal Aerospace Company, has positions available for qualified individuals seeking career advancement in a challenging technical environment.

SYSTEMS ENGINEERS

We are looking for systems engineers with a BSEE degree and the following capabilities:

- Experience in Avionics Systems Engineering including: Development and Integration of avionics systems such as Flight Controls, Navigation, Display, and Flight Management Systems. Knowledge of avionics hardware and software development including the certification process is desirable.
- Experienced in the use of "Structured Methods" for System Requirements development and specification is desirable.

SOFTWARE ENGINEERS

We are looking for engineers who have background in software engineering techniques including CASE and modular design approaches. One to five years experience in one or more of the following areas is desired:

- Embedded real-time software development using intel microprocessors
- Ada high-level language experience
- Raster graphics Software Design
- SUN Workstation (UNIX/C) tools experience
- FAA DO-178A software verification/validation

HARDWARE ENGINEERS

We are looking for digital/analog hardware engineers with a BSEE or MSEE. One to five years experience in one or more of the following areas is desired:

- Digital and Mixed Mode ASIC Design
- Logic Design and Simulation
- Microprocessor and Graphics Hardware Development
- Mentor Graphics CAE Environment

MECHANICAL ENGINEERS

Qualified applicants must have a BSME plus 7-10 years of mechanical engineering experience:

- Must be familiar with electronics packaging, engineering drawings, analyzing tolerances to improve manufacturability
- Should possess an awareness of manufacturing process design for manufacturability and also have the ability to interface with suppliers
- A background in mechanical design of commercial/military avionics equipment is highly desirable

RUSSIAN SPEAKING ENGINEERS

We are also seeking Russian speaking engineers with the Systems and Software skills listed above, who also:

- Speak Fluent English/Russian
- Have Translator Potential (Verbal)
- Are Willing and Able To Travel To Soviet Republics

If you are motivated by the challenge of developing state-of-the-art avionics systems and possess the required formal degrees and experience qualifications, you are invited to forward your resume to: **Ms. Rosalie Pratesi, Allied-Signal Aerospace Company, Bendix/King Air Transport Avionics Division, 2100 N.W. 62nd Street, Ft. Lauderdale, Florida 33309.** AN EQUAL OPPORTUNITY EMPLOYER. NO EMPLOYMENT AGENCIES OR CONTRACTORS PLEASE.

 **Allied
Signal Aerospace**

EDN-INTERNATIONAL ADVERTISERS INDEX

Shrink Electrical Tubing Fast!

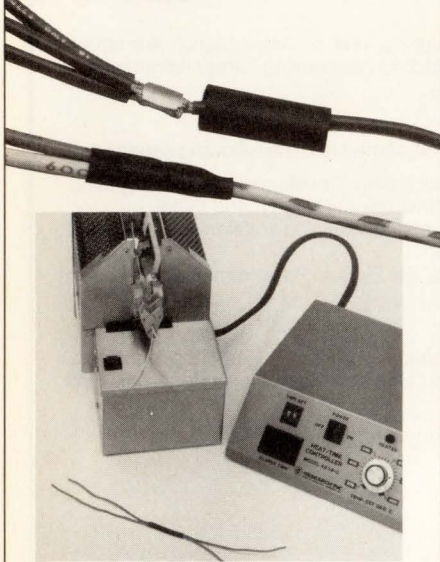

Assemblers can install and shrink more than 400 insulating shrink sleeves per hour with the Research Inc. *Tube Toaster*.

- Variable adjustment of precise time/temperature cycle
- Uniform heating and consistent results
- Simple operation requires minimal training

The *Tube Toaster* is portable, can be quickly set up for efficient production. Put one to work on your assembly line.

Research Inc., Box 24064,
Minneapolis, MN 55426.

612-941-3300

**Contact the
Energy Team!**



RESEARCH INC.

ACCEL Technologies Inc	177	Mini-Circuits Laboratories	28-29, 40-41, 135
Acces	34	Molex Inc	192
Adaptec Products Co	120	Motorola*	77
Advanced Micro Devices	12-13	National Instruments	2
Advin Systems	179	National Semiconductor Corp	46, 47-48
Altera Corp	16-17	NEC Corp**	183, 185
American Arium	130	NEC Electronics	68-69
AMP	84-85	NCI	176
APEC	174	Nohau Corp	175
Apex Microtechnology Corp	64	Noise Laboratory Co	178
Ariel	149	Noritake Electronics Inc	4
Atlanta Signal Processors Inc	152	Octagon Systems	177
Augat	137	Ohmite Mfg Co	146
Aval Corp of Ireland	179	Omaton Inc	179
BP Microsystems	178	Orbit Semiconductor	117-119
Brooktree Corp	63	OrCAD Systems Corp	10
Burr-Brown Corp	75	Penn Eng & Mfg Corp	179
BYTEK Corp	116	Pico	100, 161
Cadre Technologies	113	Power-One Inc	70
Cahners CAPS	54	Precision Interconnect	90
California Eastern Labs Inc	35, 36-39	Preston Scientific	34
Capilano Computer Systems Inc	178	Programmed Test Services	170
Capital Equipment Corp	158	Protel Tech Inc	128
Comdisco	151	Qualidyne Systems Inc	129
Communication Specialists	179	Raltron	171
Computer Dynamics	148	Research Inc	161
Computerwise Inc	176	RLC Enterprises	92
Concurrent Technology	61	Samtec Inc	88, 89
Condor	59	SBE	52
Cybernetic Micro Systems	33	Seagate Technology	32
Cypress Semiconductor	8	Selco Products Inc	158
Dale Electronics Inc	27, 186	Siemens*	22
Data I/O Corp	C4, 178	Softools	175
Deltron Inc	154A-D	Sony Corp of America	42
Design Computation Inc	177	Sophia Systems Inc	155
Diversified Technology	78-79	Stanford Telecom	154
Dolphin Integration	153	Synergy Computer Graphics	188
Duracell	147	Tabor Electronics	175
Dynafive	176	Tatum Labs	177
EEsof	169	T-Cubed Systems Inc	179
Electrical Specialties	160	TDK Corp of America	159
Emulation Technology Inc	178	Tektronix Inc	50-51, 86, 86A-B, 139, 141-142
Force Computers Inc	145	Texas Instruments Inc	18-21
Fujitsu APD	191	Todd Products Corp	179
Grammar Engine Inc	178	Tokin Corp	172
Hewlett-Packard Co	C2	Toko America Inc	160
IC Designs	187	Toshiba Corp	44-45
IC Sensors	72	Tribal Microsystems	175, 177
Illinois Capacitor	157	Trident	115
Incredible Tech	175	Two Technologies	176
Innovative Software Designs	179	US Software	176
Intel	65-66, 67, 102-103	Valley Enterprises	173
International Rectifier	C3	Wavetek	3
Intusoft	178	Xicor	177
IOtech Inc	187	Ziatech Corp	1
John Fluke Manufacturing Co Inc	6	Zilog Inc	30-31
Kepeco Inc	14-15	Z-World	175
Knuerr AG	127		
Lambda Electronics Inc	163-168		
LeCroy Corp	80-81		
Linear Technology Corp	131-132		
Link Computer Graphics Inc	176		
Maxim Integrated Products	95, 97, 99, 101		
McKenzie Technology	116		
MCSI	176		
Meritec	177		
MetaLink Corp	179		
Micro Digital	176		
Micro Link	177		
MicroSim Corp	25		
Microstar Laboratories	177		
Micry/Sys	178		

Recruitment Advertising 180-183

Allied Signal Aerospace
Annapolis Micro Systems

*Advertiser in International edition
**Advertiser in European edition

This index is provided as an additional service. The publisher does not assume any liability for errors or omissions.

Design in our fully static V20HL or V30HL microprocessor and you'll

Run rings around the competition.

Sparkling performance for handheld devices.

Our 16MHz V20HL and V30HL microprocessors run 60% faster than 10 MHz 80C88 and 80C86 devices.

But the V20HL/30HL give you more than just a faster clock. You'll blaze through multiply/divide operations in half the time, even if you choose to set the V20HL/30HL at the same clock rate as the 80C88/80C86.

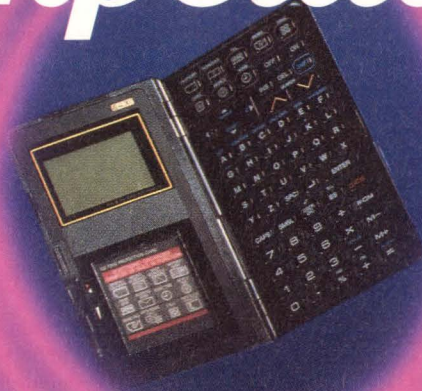

Just three little volts.

If your embedded controller or handheld PC must run on 3 volts, remember that only NEC offers both 3-volt and 5-volt operation for our V20HL/30HL microprocessors.

For any application requiring a fully static DOS-compatible cpu, you'll get lower power consumption and better performance when you specify V20HL/30HL.



Smaller. Lighter. Faster. Better.

Lower power consumption and 3-volt operation mean your design will weigh less and take up less space. And later, you can shrink even the smallest design by converting to NEC's DOS Engine™ (PC-on-a-chip) or application-specific standard product based on V20HL/30HL cpu core.

That's why Hewlett-Packard engineers chose our V20HL microprocessor as the heart of the amazing new 11 ounce HP 95LX "palmtop" PC, which runs Lotus 1-2-3 on just two AA batteries.

	V20HL	80C88
DOS COMPATIBLE	YES	YES
POWER (5V) (3V)	6mA/MHz 4mA/MHz	10mA/MHz N/A
# INSTRUCTIONS	101	90
MAX CLOCK SPEED	16MHz	10MHz
DEDICATED TEMPORARY REGISTERS	YES	NO
DUAL INTERNAL DATA BUS	YES	NO
BIT OPERATION	YES	NO
8080 MODES	YES	NO

Free Information Fast. Ask for Info Pack 155.
Call 1-800-632-3531. FAX 1-800-729-9288.

EDN-ACRONYMS & ABBREVIATIONS

ADC—analogue-to-digital converter
 ALU—arithmetic and logic unit
 ASIC—application-specific integrated circuit
 BiMOS—bipolar metal-oxide semiconductor
 CALDAC—calibration DAC
 CAPDAC—capacitor DAC
 CMOS—complementary metal-oxide semiconductor
 CPU—central processing unit
 DAC—digital-to-analog converter
 DIP—dual in-line package
 DMA—direct memory access
 DSP—digital signal processor
 EEPROM—electrically erasable programmable read-only memory
 EPLD—erasable programmable logic device
 EPROM—erasable programmable read-only memory
 FSR—full-scale range
 ICE—in-circuit emulator
 JEDEC—Joint Electron Device Engineering Council
 LAN—local-area network
 LCC—leadless chip carrier
 LCD—liquid-crystal display
 LCP—liquid-crystal polymer
 LED—light-emitting diode
 LGA—land grid array
 LSB—least significant bit
 MMU—memory-management unit

MSB—most significant bit
 PC—personal computer
 PCT—polycyclohexane terephthalate
 PET—polyethylene terephthalate
 PLCC—plastic leaded chip carrier
 POS—programmable option select
 PPS—polyphenylene sulfide
 PQFP—plastic quad flatpack
 PROM—programmable read-only memory
 PWM—pulse-width modulator
 RAM—random-access memory
 SAR—successive-approximation register
 Sbus—32-bit expansion bus for SPARC-chipset-based workstations
 SCI—Scalable Coherent Interface, a new high-speed bus architecture
 SDP—streaming-data procedure
 SMT—surface-mount technology
 SOIC—small-outline integrated circuit
 SUBDAC—resistor DAC
 THD—total harmonic distortion
 UART—universal asynchronous receiver transmitter
 VMEbus—32-bit data bus that has a theoretical maximum data-transfer rate of 40 Mbytes/sec
 VME64—a proposed addition to the VMEbus standard that will allow 64-bit data transfers

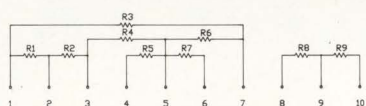

CUSTOM THICK FILM NETWORKS

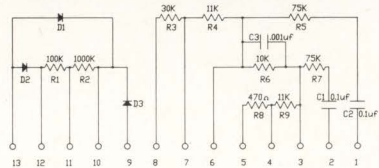

Fast turnaround on U.S. made DIPs and coated/molded SIPs. • Unlimited schematics combining resistors, inductors, capacitors and diodes. • Complete capabilities from design through production. • Lead lengths up to 0.290". • Special performance ranges, plus production and testing to M83401 levels.

Call or Fax your requirements to:

DALE ELECTRONICS, INC.

Techno Division
 7803 Lemona Avenue
 Van Nuys, CA 91405-1139



Phone (818) 781-1642 • FAX (818) 781-8647

books that work the way you work

Based on the EDN series -- 20% new material

Troubleshooting Analog Circuits

Robert A. Pease,
 National Semiconductor

Don't understand analog troubleshooting? Relax. Bob Pease does. Expanding on his popular series in EDN, this book includes all of Bob's battle-tested methods.

June 1991 208pp. cloth 0 7506 9184 0 \$32.95

Analog Circuit Design:

Art, Science, Personalities

Jim Williams, Linear Technology Corp.,
 Editor

24 masters of analog circuit design share their experience in this comprehensive and useful guide to analog theory and applications.

June 1991 352pp. cloth 0 7506 9166 2 \$44.95

for more information
 or to place an order call 1-800-366-2665

M-F 8:30-4:30 E.T.

BUTTERWORTH-HEINEMANN
 80 Montvale Ave. Stoneham MA 02180

The EDN Series
 for Design Engineers

Put All Your Clocks On One Chip



Replace multiple crystal can oscillators with a single frequency synthesis IC.

In computer graphics and general purpose timing applications, IC DESIGNS' multiple- and variable-frequency devices save board space and money. Which is why some of the industry's largest companies use our components.

ICD2061 Dual Programmable Graphics Clock Generator — TTL output to 120MHz with power-down capabilities.

ICD2062 Dual Programmable ECL/TTL Clock Generator — Complementary ECL outputs to 160MHz for video RAMDACs; TTL output to 120MHz.

Contact us for more information about these or other IC DESIGNS frequency synthesis components.

1-800-669-0557

IC DESIGNS

12020 113th Ave. N.E.
Kirkland, WA 98034-6920
FAX: 1-206-820-8959

CIRCLE NO. 87

Advertisement

PRODUCT HIGHLIGHT—New from IOtech IEEE 488.2, 100 kHz, 16-Bit Multichannel DAC

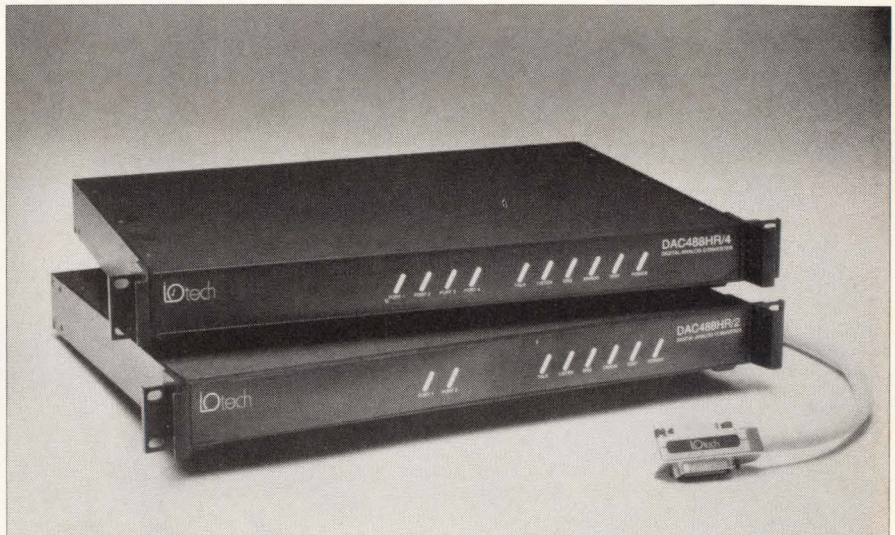

The 100 kHz, 16-bit DAC488HR digital to analog converter (DAC) offers IEEE 488.2 programmability and up to 4 isolated analog output channels in a 1.75-inch rack-mountable package. The unit features the capabilities of several traditional IEEE 488.2 instruments at a fraction of the cost. For example, the DAC488HR's step, burst, waveform, and continuous-trigger modes enable it to provide stepped voltages like a precision voltage source, long arbitrary waveforms like an arbitrary waveform generator, or sine, triangle, square, and sawtooth functions like a function generator.

High Resolution, Multiple Channel Analog Output

Unlike function generators and other signal source instruments, which typically provide only one output channel, the DAC488HR offers either 2 or 4 electrically isolated output channels, making it ideal for applications that require multiple channels that can operate synchronously. Similarly, in contrast to the 8- or 12-bit resolution provided by function generators and arbitrary waveform generators, the DAC488HR offers 16-bit resolution, making it ideal for use in amplitude-critical, audio-frequency applications.

Independent Buffer Management

The DAC488HR features an 8 Ksample/channel buffer that is optionally expandable to either 128 Ksamples or 480 Ksamples/channel. Waveforms can

be loaded into the DAC488HR's resident buffer from the IEEE 488 bus at up to 400 Kbytes/second, minimizing the data transfer time necessary to load large waveforms into its memory. For applications that require high speed output of very large waveforms, such as audio testing and speech research, the DAC488HR can continuously output data from the IEEE 488 bus to a digital to analog converter channel at 100 Ksamples/second.

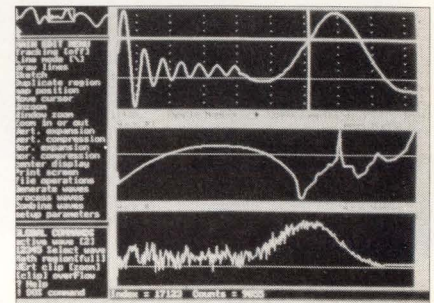

R4 software creates waveforms for generation by the DAC488HR

Pricing and Availability

The 2-channel DAC488HR/2 is \$2,495, and the 4-channel DAC488HR/4 is \$3,495. The optional MEMX3 128 Ksample/channel memory expansion is \$195 and the MEMX4 480 Ksample/channel memory expansion is \$395. R4 software for waveform generation is \$1,195. All are available from stock. For more information call IOtech at (216) 439-4091 or fax your request to (216) 439-4093.

CIRCLE NO. 83

EDN January 20, 1992 • 187

HOW TO GET IT RIGHT THE FIRST TIME, EVERY TIME.



There are a number of advantages inherent in doing it right the first time. Synergy's ColorWriter™ 400 series electrostatic plotting systems produce full color output in *one pass*.

Imagine getting your plot as much as four times faster, with better registration and more consistent color the first time out. And with fewer moving parts, the 36" wide format, 400 dpi ColorWriter is not only faster and more accurate, it's more reliable.

With *one connection*, and no special hardware or software, the ColorWriter 400 series performs as an

Ethernet® node on your network. Its built-in Sun SPARCengine™ lets you process and plot several data formats simultaneously, including HP-GL/2™, CalComp™, Versatec VRF™, GDS-II Stream™, Cadence™, PostScript®, AutoCAD™ and raster.

It made sense to us to build it right the first time, so you can get it right the first time. If that makes sense to you, we should talk. Call us at 800-926-0968.

SYNERGY
COMPUTER GRAPHICS CORPORATION
CIRCLE NO. 90

The pluses of C

You're a C programmer but you've been postponing a foray into the realm of C++. *The World of C++*—a package of two 1-hour VHS videotapes, an instruction manual, a workbook, and program disks—could be a good place to start. The tapes provide 21 lessons that correspond to chapters in the workbook. The programs on the disks let you test the principles learned from the taped lessons and book.

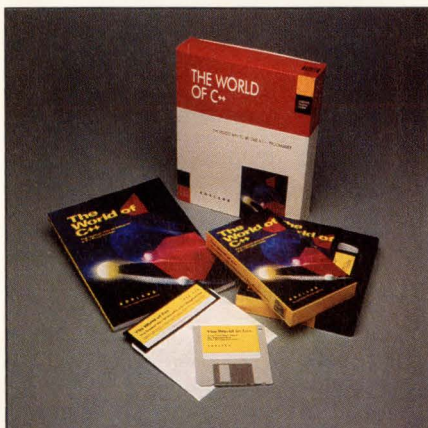

The video lessons move so quickly that it's easy to get left behind. Keep your VCR control handy so you can freeze the program frames and examine the listings. Put the lesson book aside and watch and listen to the taped lessons. You'll probably want to rewind and re-view each lesson more than once before you tackle the written problems and explore the solutions. The book also provides plenty of hands-on exercises and points you to solutions on the accompanying disks—the package supplies both 3½- and 5¼-in. disks. Don't look for extra tutorial materials in the book—you'll get that from the tapes.

Unless you're a fairly knowledgeable C programmer and are already

familiar with C++ concepts, you might want to start by reading some or all of an introductory book on object-oriented programming. Two books of particular note are *Object-Oriented Technology, A Manager's Guide*, by David A Taylor (Servio Corp, Alameda, CA) and *Object-Oriented Design with Applications*, by Grady Brooch (Benjamin/Cummings Publishing, Redwood City, CA). If you're not a C programmer, this package could confuse you. Get some experience using C before you tackle it.

The disks that accompany the package supply compressed files of the exercise programs. An installation program unzips the files for you and puts them on your hard disk. It should be obvious that the programs run with the manufacturer's Borland C++ or Turbo C++ compilers. As in any package such as this, you'll learn most by tinkering and experimenting with the provided programs rather than by just running the sample programs. You can adapt the programs to other C++ compilers, but in doing so you may find you're learning more about subtle compiler differences than about object-oriented programming. In sum, the package is worth the price, and you'll find it available at a discount from many mail-order software companies.

—Jon Titus

The World of C++, Borland, Scotts Valley, CA 95066, 1991, \$199.95.

Adventures in analog

If you do *any* analog circuit design, buy this book! But don't expect a reference work that's going to answer the kind of nagging questions that arise again and again on your job. This book may indeed

provide enough answers to warrant your classifying it as a reference, but that really isn't its main function. And don't shell out the cash for this book because you're looking for a definitive treatment of a narrow and arcane subject. You will certainly find several chapters that are thorough treatments of highly specialized topics, but such treatments aren't the book's main function either.

In fact, this volume defies characterization. It combines insights into little-understood technical areas with a look into the thought processes of some genuinely talented (even great) engineers. Then it spices this material with narratives of technical adventures that are every bit as entertaining and suspenseful as many mystery novels. I can't think of the last time I read an electrical-engineering book wondering how it was going to turn out! This book is what literary folk call a page turner.

Jim Williams has brought together 22 well-known analog designers; 23, if you count George Philbrick. (Philbrick died years ago, but because many regard him as the father of analog electronics; a bit of his work is included.) Each of these authors has his own interests and style. Each has his own agenda and biases. Each contributed one or more chapters. There were very few rules or constraints. Williams observes that the concept for the book was a formula for chaos. It's a tribute to the authors and editors that what emerged is not chaotic at all.

The well-indexed volume contains much useful information and provides a picture of analog design, in all its diversity, as a way of thinking and a way of approaching problems. What sets the book apart is that it brings to life the individual-

ism and eclecticism of analog designers. Moreover, it demonstrates that, beyond their common practice of the analog art, what brings these designers together is their inquisitiveness, their open-mindedness, and their willingness—in fact, their eagerness—to look at problems in unconventional ways.

Those with no real appreciation for analog design often deride its practitioners as engaging in a black art. Yet everything that goes on in analog circuits (as in *all* circuits) has a foundation in science. Those who seek to understand the lessons their circuits are trying to teach them are the ones who possess the stuff of which great designers are made. In a larger sense, engineers who pursue disciplines far removed from analog design—even disciplines far removed from electronics—are likely to find valuable lessons in Williams's book. So, even if you never do analog design, if you are an engineer, buy this book!

—Dan Strassberg

Analog Circuit Design: Art, Science, and Personalities; Jim Williams, editor; ISBN 0-7506-9166-2; 389 pgs; \$44.95; Butterworth-Heinemann Publishing; Boston, MA, 1991.

Advantages outweigh flaws in C pointer book

You might think that a topic that appears to be narrow wouldn't deserve a book of its own. However, don't be deceived by the title of the book *Mastering C Pointers*—it's a bigger subject than you might think. Because pointers play such an important part in complex programs, it's gratifying to find a book devoted to the subject.

Author Robert J Traister assumes that you know a bit of C, and he builds on that basic knowledge as he clearly explains new concepts that you may have heard about but may not understand

clearly. The examples are simple and straightforward, clear and concise. The short examples are easy to type into your computer and test. Unlike other authors of books on C, Traister avoids the temptation to show off his programming skills, an approach that usually discourages readers.

Traister spends a great deal of time on character and string pointers, not because string operations are so important on their own, but because character or byte operations are an integral part of most real-world applications. In addition, you'll find chapters on memory access, memory allocation, pointers and functions, and pointers to other objects.

Although I recommend this book highly, it does have a few flaws. The author's use of little men with knapsacks to explain how pointers locate information seems silly in a professional-level book. I would have rather seen clear diagrams that show how information is stored and how pointers locate it from within programs. There isn't a diagram in the book. By comparison, several of my favorite C programming books are replete with diagrams that show bit maps, structures, unions, and other C arrangements of information.

Traister ends the programming portion of his book with a chapter on pointers to other structures, but he doesn't go far enough. One of my reasons for reading the book was to prepare for learning more about data structures such as linked lists and trees, and about sorting algorithms. Handling an introduction to these topics as clearly as he introduced basic pointer principles would have made the book invaluable. All in all, I recommend the book, particularly to C programmers who are just getting the hang of the language.

—Jon Titus

Mastering C Pointers, Robert J Traister, Academic Press, San Diego, CA, 1990, 182 pgs, \$34.95.

Designer music

Very little techie humor is recorded commercially. That's why I snatched up *The Funniest Computer Songs* at the Computer Literacy Bookshop in San Jose, CA ((408) 435-1118). This audio cassette contains some of the most hilarious songs about electronic technology I've ever heard.

Even the song titles elicit a chuckle. Try to keep a straight face while thinking about songs with titles such as "Please, Mr Compatibility," "I'm A Mainframe, Baby," or "Uncle Ernie's Used Computers' Babbage's Birthday Bargain Bash."

Here are a few lyrics from the "Engineer's Rap" sung by the group Run GMC:

We all calculate,
and do design,
test that box,
and deliver it on time.

Back from lunch,
I need a rest,
but we're just in time,
for acceptance test.

Tweak the knob,
Turn the dial,
Hit return,
And wait for awhile ...

And wait for awhile ...
(hey, what's going on here)
And wait for awhile ...

It's, it's, it's usually much faster
than this.

Sometimes you need a big dose of humor to help you make it through the day. Keep this tape handy for the next time you smoke a chip or download the wrong code revision.—Steven H Leibson

The Funniest Computer Songs, \$8.98 (plus \$1 postage), Vince Emery Productions, Box 460279, San Francisco, CA 94146.

EDN

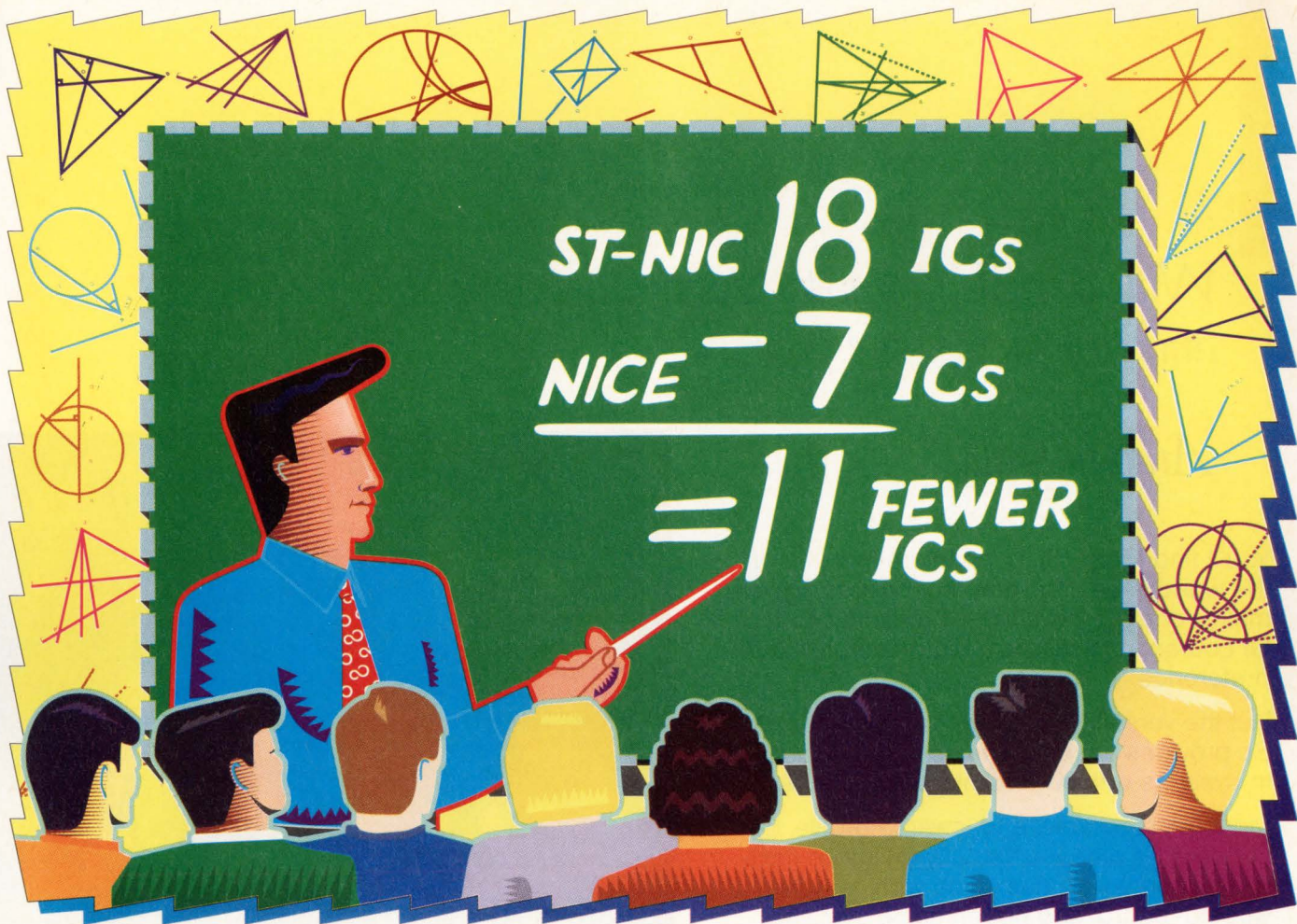

NICE and simple math exposes the myth of ST-NIC.

VISIT
BOOTH #532
AT
BUSCON

It doesn't take a mathematical wizard to see the superiority of the NICE® Ethernet solution from the Advanced Products Division of Fujitsu Microelectronics. We think the numbers speak for themselves.

Our NICE solution, for example, requires far fewer ICs than ST-NIC's so-called single-chip solution — 7 vs. 18.* And that means fewer passive components as well. Making Ethernet LAN board design easier. Faster. And more cost effective than ever before.

Then, add on another factor — that NICE products are competitively priced — and systems designers clearly have a proven formula.

What's more, the fewer the parts, the smaller the size — and the lower the power consumption. All of paramount importance for motherboard applications.

Plus, because NICE is a highly automated

controller, it offers substantially greater system performance for user applications — by freeing CPU and memory bandwidth. Fact is, benchmarks and customers report up to 33% higher performance over competitors' controllers. Quite an edifying statistic, don't you think?

And, unlike other available solutions, NICE has been designed to *fully* comply with Ethernet standards — ensuring international interoperability.

And that's no myth.

For more enlightening facts, here's one more NICE number: 1-800-866-8608. Or call your local sales office for our NICE Designer Kits. And discover the world's most advanced, highly-integrated, cost-effective Ethernet solution — the NICE family of high-performance products from Fujitsu. Because all it takes to expose a little myth is a little math.

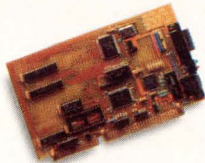

FUJITSU

Delivering the Creative Advantage.

FUJITSU MICROELECTRONICS, INC., Advanced Products Division, 77 Rio Robles, San Jose, CA 95134-1807. Ph: 408-456-1161 Fax: 408-943-9293. FUJITSU MICROELECTRONICS ASIA PTE LTD. (Head Office, Singapore): Ph: 65-336-1600 Fax: 65-336-1609. HONG KONG SALES OFC: Ph: 852-723-0393 Fax: 852-721-6555. TAIPEI SALES OFC: Ph: 886-2-757-6548 Fax: 886-2-757-6571. JAPAN SALES OFC: Ph: 81-3-3216-3211 Fax: 81-3-3216-9771. KML CORP. (Rep., Korea): Ph: 82-2-588-2011 Fax: 82-2-588-2017. PACIFIC MICROELECTRONICS, PTY LTD., (Rep., Australia): Ph: 61-2-481-0065 Fax: 61-2-484-4460. FUJITSU MIKROELEKTRONIK GmbH (Dreieich-Buchschlag, Germany): Ph: 06103-6900 Fax: 06103-690122. NICE is a registered trademark of Fujitsu Microelectronics, Inc. ST-NIC is a trademark of National Semiconductor Corporation. *Reference NSC app note DP839EB-ATT, 1/91.

With our SL™ connector system, design flexibility and cost savings are yours.

Automatically.

You'll find Molex SL connectors in some of the world's leading—and most dependable—makes of electrical and electronic equipment. Of course, reliability is a big reason for this preference.

But the versatility and lower applied cost that SL provides are critical factors, too, especially in systems with several interconnections.

Modular, stackable, and lower in profile, SL connectors give you virtually unlimited flexibility when you're designing wire-to-wire, wire-to-board, and ribbon cable systems.

The single-piece IDT connectors feature, pre-assembled terminals in the housings, and interconnects with locking shrouded headers. In short, they're ideal for high-speed, high-efficiency automated assembly.

Ask your Molex representative about SL connectors, and learn how they can multiply design options and automate assembly.

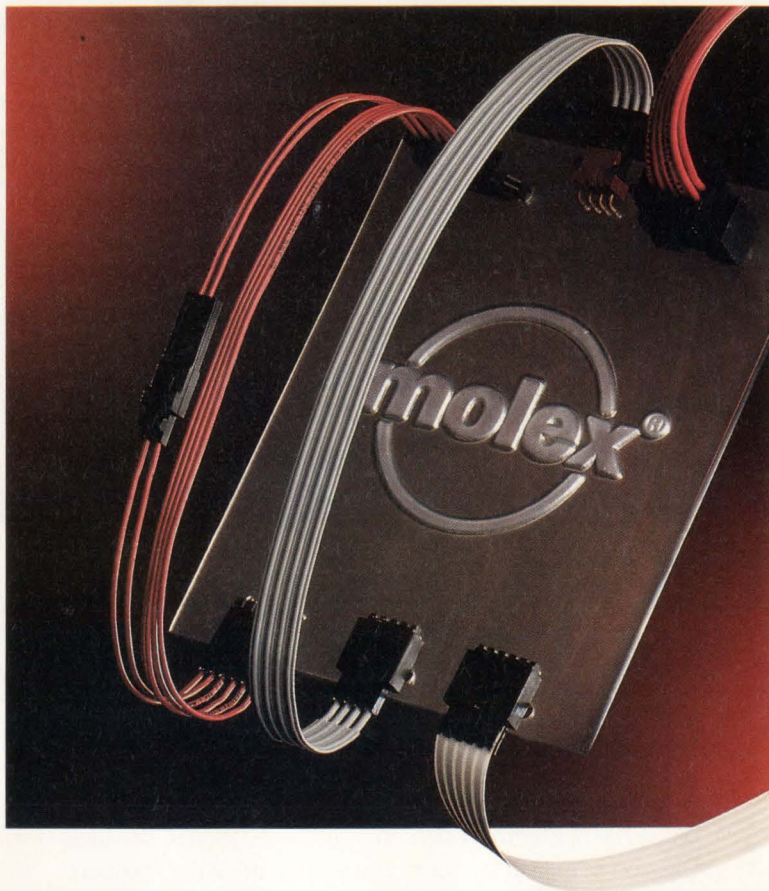

Bringing People & Technology Together, WorldwideSM

Corporate Headquarters: 2222 Wellington Ct., Lisle, IL 60532 U.S.A., Tel: (708) 969-4550 • **European Headquarters:** Munich, Germany, Tel: 49-89-413092-0
Far East North Headquarters: Tokyo, Japan, Tel: 81-427-21-5539 • **Far East South Headquarters:** Jurong Town, Singapore, Tel: 65-660-8555

© 1990, Molex Incorporated

CIRCLE NO. 92



Why is everyone switching from bipolar to IR IGBTs?

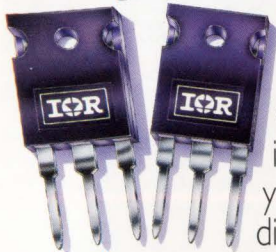

Ask three design engineers why they're switching to IR IGBTs and you may get three different answers:

Performance. IR IGBTs switch faster, generate less heat, and operate at higher frequencies than bipolars.

Simplicity. Our IGBT's MOS gate makes it much simpler to drive than a bipolar.

Size. Its smaller footprint and lower component count saves a lot of board space.

But all three answers add up to one: **Cost effectiveness.** Any way you look at it, the price/

performance ratio improves. Or, the bottom line is the bottom line.

For your high voltage, high current power transistor circuit designs, remember, cost efficiency has four initials: IGBT. Make that six. IR IGBT.

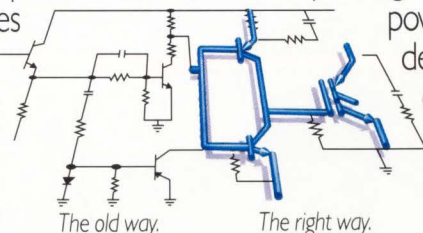

IR International Rectifier

WORLD HEADQUARTERS: 233 KANSAS ST., EL SEGUNDO, CA 90245, U.S.A. (310) 322-3331. TWX 910 348-6291. TELEX 472-0403. EUROPEAN HEADQUARTERS: HURST GREEN, OXTED, SURREY RH8 9BB, ENGLAND TELEPHONE (0883) 713215, TELEX 95219

CIRCLE NO. 93

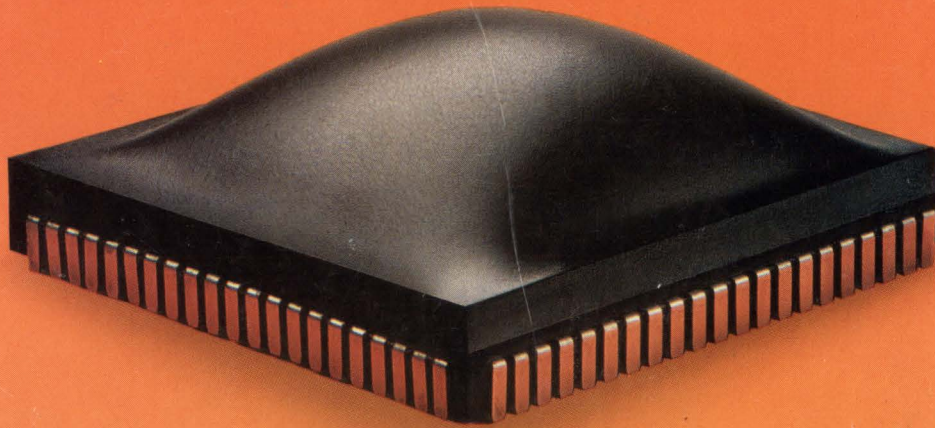

Pack more logic into every FPGA.

NEW ABEL-FPGA helps you get the most out of the latest FPGAs. If you want to take advantage of the sophisticated capabilities of today's FPGAs, only Data I/O's new ABEL-FPGA™ Design Software has the power to pack in maximum logic. It combines the industry-standard ABEL Hardware Description Language (ABEL-HDL™) with our new intelligent

FPGA Device Fitter™

technology. So, you can create more complex designs with less effort — ABEL-FPGA does the hard work for you!

ABEL-FPGA's powerful Device Fitters automatically optimize your circuits for minimum area or maximum speed. Fitters are available for all the leading architectures, including Actel, Altera, AMD, Atmel, ICT, National, Plus Logic, and Xilinx. And with built-in knowledge of its target architecture, each fitter masters the complex features of its device automa-

tically, intelligently.

Practical, detailed documentation, complete with FPGA design examples, also helps to ensure that you get the most from each architecture. And for added design power and flexibility, ABEL-FPGA lets you specify place-and-route constraints directly in your circuit description, so you can easily migrate the same design between multiple FPGA vendors.

Pack more logic into your next

FPGA design, with the single

solution to all your FPGA

behavioral entry needs:

ABEL-FPGA. Call today to find out more about NEW ABEL-FPGA.

1-800-3-DataIO
(1-800-332-8246)

**NEW
ABEL-FPGA
with FPGA
Device Fitters!**

ABEL-FPGA
Design Software

Data I/O Corporation 10525 Willows Road N.E., P.O. Box 97046, Redmond, WA 98073-9746, U.S.A. (206) 881-6444
1-800-3-DataIO (1-800-332-8246)
Data I/O Canada 6725 Airport Road, Suite 302, Mississauga, Ontario L4V 1V2 (416) 678-0761
Data I/O Europe World Trade Center, Strawinskylaan 537, 1077 XX Amsterdam, The Netherlands + 31 (0)20-6622866
Data I/O Instrumentic Electronic Systems Vertrieb GmbH Lochhamer Schlag 5A, 8032 Graefelfing, Germany, + 49 (0)89-858580
Data I/O Japan Sumitomosimei Higashishinbashi Bldg., 8F 2-1-7, Higashi-Shinbashi, Minato-Ku, Tokyo 105, Japan
011-81-3-3432-6991/Telex 2522685 DA'AI O J

©1991 Data I/O Corporation

The Personal Silicon Experts

DATA I/O
Corporation

CIRCLE NO. 95