

EDN[®]

THE DESIGN MAGAZINE OF THE ELECTRONICS INDUSTRY

NEW PRODUCT INTRO

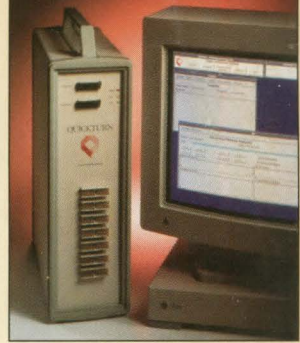

Low-cost, 50,000-gate ASIC modeler pg 13

TECHNOLOGY UPDATES

System simulation embraces real-time control prototyping pg 49

12-bit ADCs: Now may be the time to upgrade your 8- and 10-bit systems pg 67

DESIGN FEATURES

Designing 2.1V Futurebus+ termination system requires system-engineering approach pg 117

Energy gauges add intelligence to rechargeable batteries pg 125

Design Ideas pg 95

Hands On!

```
#RV#C[ uart_spec 18 / uart_spec 19 ][ m
Remember to check the range of frequenc
#RV#end
```

#A[uart_spec 0 / uart_spec 7][markd / 93.05
from this description, one decomposition for the top-
one to control the registers (reading and writing), one to
(transmitting and receiving data), and one to control the

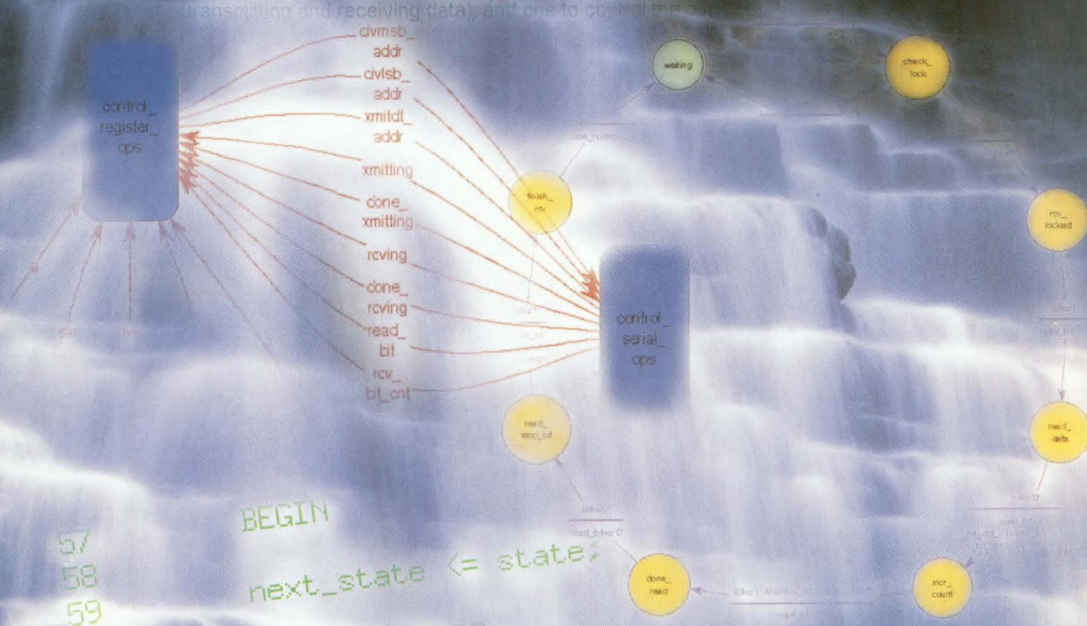

57
58
59
60
61
62
63
64
65
66
67
68

```
BEGIN
next_state <= state;
CASE STATE IS
WHEN waiting =>
IF ( start_write="1"
next_state <= writing_to
ELSIF ( start_read="1" ) THEN
next_state <= reading_from
ELSE
```

Special Report:
ESDA tools ease the flow of top-down designs pg 80

Start with OrCAD. Finish with OrCAD.

Schematics. PCB Layouts. FPGAs.
OrCAD has what it takes to get the job done. Fast.

OrCAD delivers the complete solution for all board, PLD and FPGA designs. Over the years more than 90,000 engineers have used OrCAD's design tools, making them the world's most popular EDA software. Today, OrCAD's enhanced 386+ software quickly handles your most complex designs, and gives you the fastest graphics of any PCB design tool. What's more, you can now design with OrCAD in a DOS session under Microsoft Windows. All this, plus a one-year product warranty, makes OrCAD the best value in PCB design solutions. From Start to Finish.

Speed your boards from Concept to Production.

Start with the enormous capacity of OrCAD's SDT 386+ schematic capture tool. Couple it with our powerful PCB 386+ layout solution to reduce your design cycle time. PCB 386+ gives you superior functionality, with over 1,000 footprints, automatic footprint generation, and on-line all object editing. And PCB 386+ boasts an embedded, 100% completion autorouter that tops all other PC-based solutions. OrCAD delivers all this, plus, you'll finish your design with complete manufacturing output.

Target virtually any FPGA device with OrCAD's new PLD 386+.

Capture your design in OrCAD schematics, OrCAD Hardware

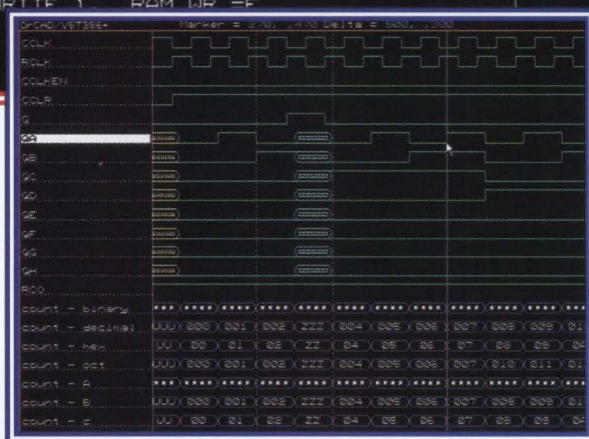
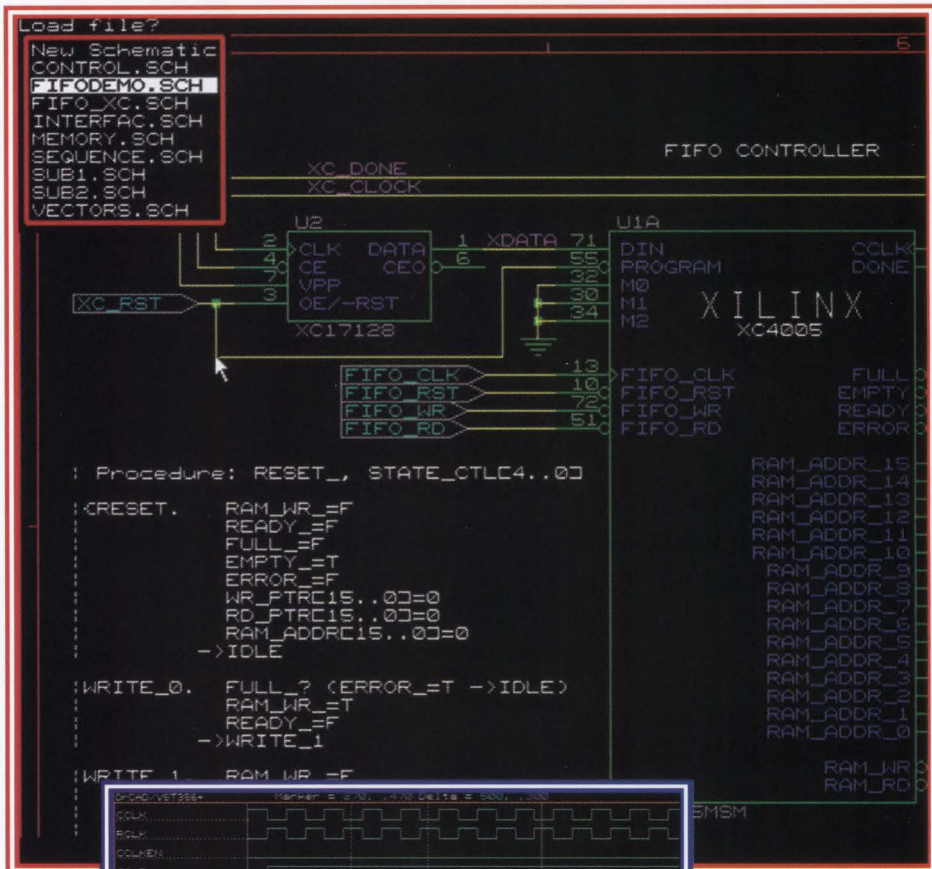

(Top) Combine SDT 386+ and PLD 386+ to design your boards and the programmable logic devices that populate them.
(Left) Design verification is fast and easy with VST 386+. And, it's supported by Xilinx, Actel, and other major FPGA vendors.

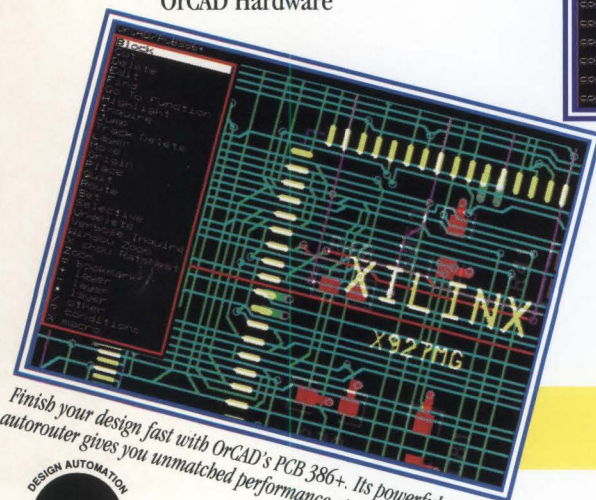

Description Language, or both. The multi-level synthesis capability of OrCAD's PLD 386+ 2.00 rapidly compiles your largest FPGA designs. And it delivers greatly expanded device support, including: Actel, Intel Flexlogic, Xilinx 2000, Xilinx 3000, Xilinx 4000, Xilinx EPLDs, AMD MACH, AMD MACHXL, Lattice PLSI, Texas Instruments, and many others. Finish your job with speed and accuracy using VST 386+ to verify the timing of your placed and routed design.

Isn't it time you got the whole job done with OrCAD? Call us today at (503)671-9500 and we'll rush you an OrCAD Demo Disk. Then try our Complete Solution. From Start to Finish.

CIRCLE NO. 113

Finish your design fast with OrCAD's PCB 386+. Its powerful 16-layer autorouter gives you unmatched performance at an unbeatable price.



Tools and ideas for design excellence
9300 SW Nimbus Ave. • Beaverton, OR 97005 • (503) 671-9500 • (503) 671-9501 - Fax
96, rue St. Charles • 75015 Paris, France • 33-1-45 75 50 00 • 33-1-45 77 82 89 - Fax
OrCAD is a registered trademark of OrCAD, Inc. Other brand and product names are trademarks of their respective owners.



PERFORMANCE YOU CAN MEASURE

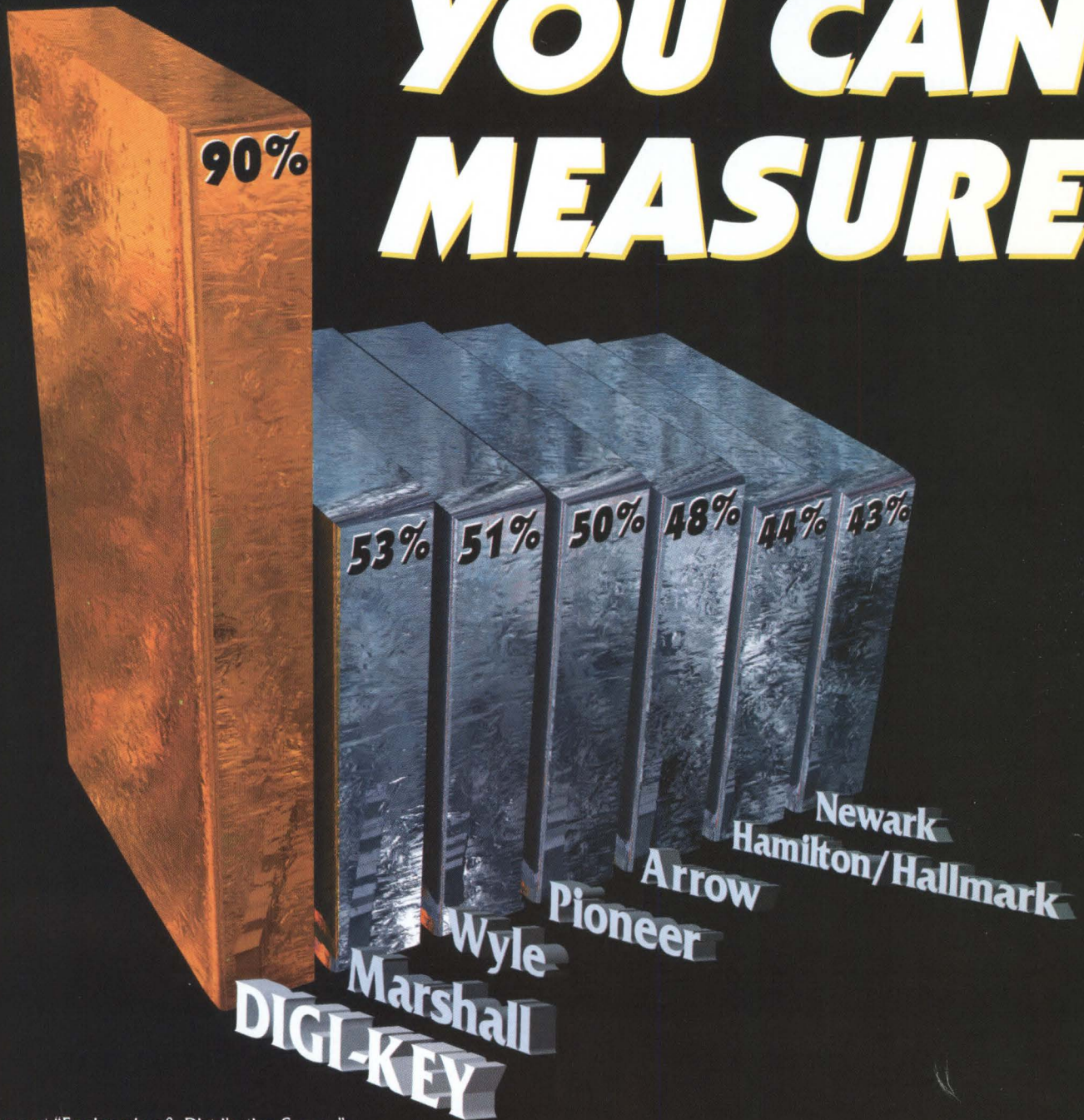

In a recent "Engineering & Distribution Survey" conducted by *Electronic Engineering Times*, engineering managers were asked to evaluate distributors they have done business with/are most familiar with on a wide range of criteria related to customer service and technical support. The bars above reflect the percentage of each distributor's customers that rated their distributor as excellent (6 & 5 responses) on a 6 point scale where 6=excellent and 1=poor in terms of OVERALL PERFORMANCE.

Note: Since the bases varied for each distributor, direct comparisons should not be made.

DIGI-KEY is a registered trademark of Digi-Key Corporation and is in no way affiliated with the other distributors evaluated in the survey or listed in this advertisement.

Put These Numbers to Work for You!

Digi-Key
CORPORATION

Quality Electronic Components, Superior Service

1-800-344-4539

701 Brooks Ave. South, Thief River Falls, MN 56701

Fax: 218-681-3380

CIRCLE NO. 69

DSP^x

Exposition & Symposium

...featuring the latest Digital Signal Processing applications and technology

June 13-15, 1994

Moscone Convention Center
San Francisco, California USA

What is DSP^x?

An Exposition and Symposium featuring the latest digital signal processing applications and technologies...state-of-the-art DSP products, systems & services with a focus on commercial uses.

Who should attend DSP^x?

DSP^x is for anyone who needs to know what's available and how to use it...for anyone who needs to make educated decisions to keep up and stay ahead:

Analog Systems Engineers/Designer • Product Champions
Design Engineers • Product Managers • Digital Systems
Engineers/Designers • Product Planners • Engineering
Managers • Sales Engineers • Marketing Managers
Senior Managers • Systems Developers

Why should you attend DSP^x?

DSP is out of the lab and now in the mainstream. Once limited to only a few industries, DSP is being integrated into everything from consumer electronics to communications systems. The possibilities are limitless. It's no longer a question of whether DSP will be part of your product...it's only a question of when.

What makes DSP^x different?

Focusing on the needs of the commercial market, DSP^x presents real world solutions and applications for real world problems and challenges.

For more information, simply complete and mail/fax in the form below or call (203) 352-8289.

DSP^x

Exposition & Symposium

...featuring the latest Digital Signal Processing applications and technology



YES!

I want to learn
more about DSP^x!

- Please send me information on attending the Conference.
- Please send me information on attending the Exposition.
- Please send me information on exhibiting.

Name _____

Title _____

Company _____

Address _____

City _____

State _____ Zip _____

Telephone _____ Fax _____

Mail to: DSP^x, PO Box 3833-999 Summer St., Stamford, CT 06905-0833

Fax to: (203) 352-8336

XNA

Managed and produced by Reed Exhibition Companies.

incredible!

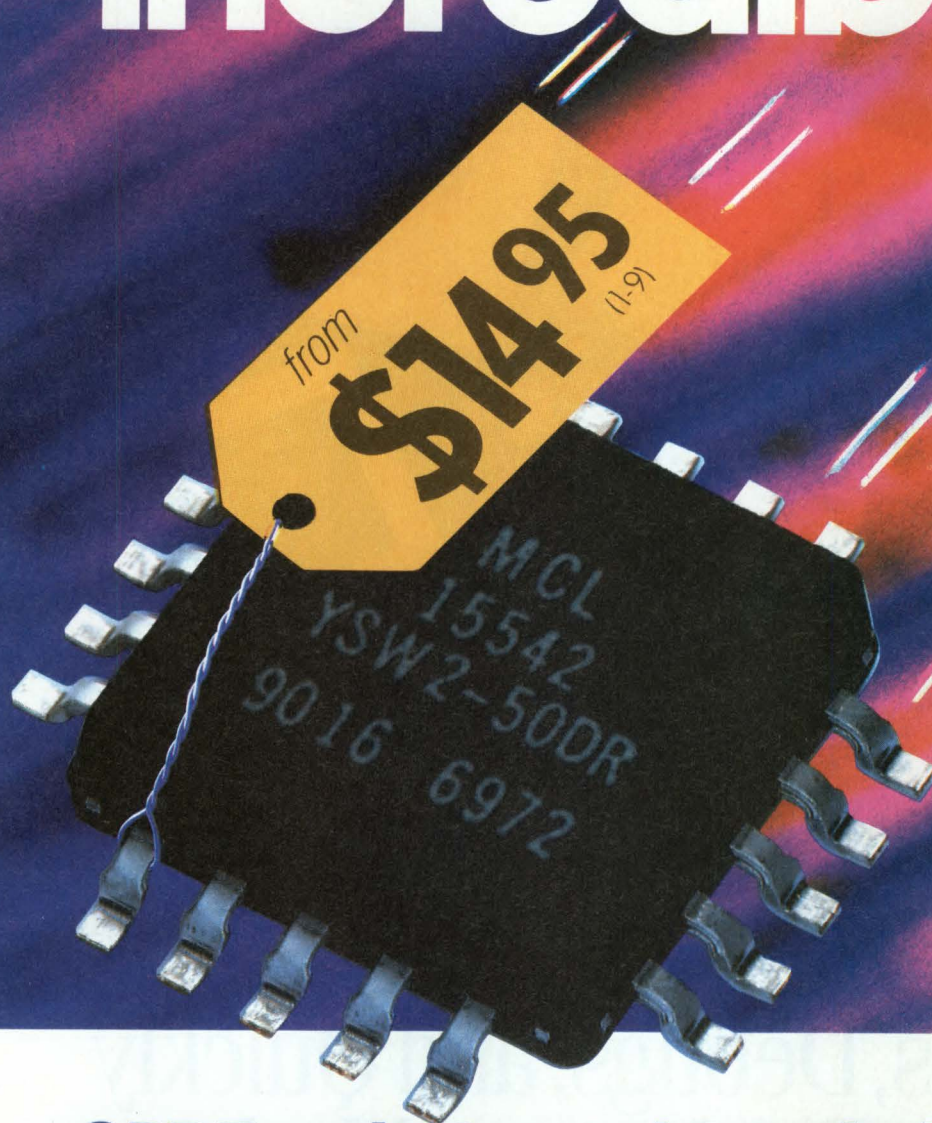

SPDT switches with built-in driver

ABSORPTIVE or REFLECTIVE dc to 5GHz

Truly incredible...superfast 3nsec GaAs SPDT reflective or absorptive switches with built-in driver, available in pc plug-in or SMA connector models, from only \$14.95. So why bother designing and building a driver interface to further complicate your subsystem and take added space when you can specify Mini-Circuits' latest innovative integrated components?

Check the outstanding performance of these units...high isolation, excellent return loss (even in the "off" state for absorptive models) and 3-sigma guaranteed unit-to-unit repeatability for insertion loss. These rugged devices operate over a -55° to +100°C span. Plug-in models are housed in a tiny plastic case and are available in tape-and-reel format (1500 units max, 24mm). All models are available for immediate delivery with a one-year guarantee.



finding new ways ...
setting higher standards

SPECIFICATIONS (typ)

	Absorptive SPDT			Reflective SPDT		
	YSAWA-2-50DR	ZYSAWA-2-50DR		YSWA-2-50DR	ZYSWA-2-50DR	
Frequency (MHz)	dc-500	500-2000	2000-5000	dc-500	500-2000	2000-5000
Ins. Loss (dB)	1.1	1.4	1.9	0.9	1.3	1.4
Isolation (dB)	42	31	20	50	40	28
1dB Comp. (dBm)	18	20	22.5	20	20	24
RF Input (max dBm)	—	20	—	22	22	26
VSWR "on"	1.25	1.35	1.5	1.4	1.4	1.4
Video Bkthru (mV,p/p)	30	30	30	30	30	30
Sw. Spd. (nsec)	3	3	3	3	3	3
Price, \$ (1-9 qty)	YSAWA-2-50DR (pin) 23.95 ZYSAWA-2-50DR (SMA) 69.95			YSWA-2-50DR (pin) \$14.95 ZYSWA-2-50DR (SMA) 59.95		

Mini-Circuits™

P.O. Box 350166, Brooklyn, New York 11235-0003 (718) 934-4500 Fax (718) 332-4661
WE ACCEPT AMERICAN EXPRESS AND VISA

Distribution Centers NORTH AMERICA 800-654-7949 • 417-335-5935 Fax 417-335-5945 EUROPE 44-252-835094 Fax 44-252-837010

For detailed specs on all Mini-Circuits products refer to • THOMAS REGISTER Vol. 23 • MICROWAVES PRODUCT DIRECTORY • EEM • MINI-CIRCUITS' 740-pg HANDBOOK

F141 REV D

The Ultimate Product Launcher.



Designs, Debugs, and Quickly Propels Products to Market.

The spec calls for an embedded controller designed and debugged in two weeks. Before you call it ridiculous, call Microchip. We offer an integrated set of hardware and software tools powered

MICROCHIP'S INTEGRATED DESIGN TOOLS

PICMASTER™ Emulator
PRO MATE™ Programmer
PICSTART™ Design Kit
Assemblers Simulators,
C Compiler
Fuzzy Logic Tools
Serial EEPROM Design Kit
Total Endurance™
TrueGauge™ Tools

to speed complex design, eradicate bugs and get products to market on time.

From our entry-level, low-cost PICSTART to our high-end, comprehensive PICMASTER Development Systems, Microchip supports its PIC16/17 8-bit microcontrollers, non-volatile memories and ASSPs with high-quality, easy-to-use Windows™-based, real time

emulation, simulation and programming tools. With functionality and power you've rarely seen before at a low-cost of ownership. Like our Total Endurance Software, our Serial EEPROM Design Kit and our Fuzzy Logic and C Compiler Tools.

When you need hands-on help, there's a Microchip FAE as close as the nearest phone. Or call in a cadre of third-party developers and consultants for additional support.

Get started now. Call Microchip and ask for our Product Launch Kit. Then get creative and design with it.

800-437-2767 x TOOL (8665)

Microchip Technology Inc. • North America • Asia/Pacific • Europe • Japan
2355 W. Chandler Blvd. • Chandler, AZ 85224-6199 • (602) 786-7200 • FAX (602) 899-9210
The Microchip logo and name and all other trademarked names are trademarks of Microchip Technology Inc. PIC is a registered trademark of Microchip Technology Inc. in the USA. Information subject to change. © 1994 Microchip Technology Inc. All rights reserved.
Windows is a trademark of Microsoft Corporation.



MICROCHIP

The Embedded Control Solutions Company
Microcontrollers • Non-Volatile Memories • ASSPs

FREE INFO, FREE POSTAGE
Use our postage-paid reader service card to get information on this issue's products.



On the cover: The top-down approach to system design is clean and logical. A new group of tools—electronic system design automation tools—supports this widely used design approach. See our Special Report, beginning on **pg 80**. (Photo courtesy Mentor Graphics)

THE DESIGN MAGAZINE OF THE ELECTRONICS INDUSTRY

Electronic-system-design-automation tools

SPECIAL REPORT

80

As system complexity grows, ESDA tool vendors try to convince you they can solve your design problems with a new class of tools. Maybe they can.—*Doug Conner, Technical Editor*

Designing 2.1V Futurebus+ termination system requires system-engineering approach

DESIGN FEATURES

117

Designing a termination system for a Futurebus+ power system can be a formidable task. Tight voltage tolerance and ripple-noise specifications require an approach that considers the power supply, backplane, termination, and backplane-transistor-logic drivers as interconnected units.—*Samuel H Duncan and Robert V White, Digital Equipment Corp*

Energy gauges add intelligence to rechargeable batteries

125

An energy gauge built into a rechargeable battery pack can tell you exactly how much charge remains available for use. It can also direct an inexpensive “dumb” charging device to charge the pack in an optimal manner. It can even store a history of battery health.—*Malcolm McClure, Span Inc*

DESIGN IDEAS

Low-distortion oscillator starts fast	95
Paralleling rms converters speeds settling	95
Circuit protects computer's input	96
RS-485 repeater extends standard's reach	98
Pulse generator verifies test setups	100
Simple module gives voice to PC	102
Security circuit eschews sophistication	104

Continued on page 7

EDN® (ISSN 0012-7515, GST Reg. #123397457, IPM #0280844) is published 38 times per year, bi-weekly with one additional issue per month, by Cahners Publishing Company, A Division of Reed Publishing USA, 275 Washington Street, Newton, MA 02458-1630. Robert L. Krokoff, Chairman and Chief Executive Officer; Timothy C. O'Brien, Executive Vice President/Finance and Administration; Michael Wisner, Senior Vice President/General Manager, Boston Division; Michael Wisner, Vice President/Publishing Director. Circulation records are maintained at Cahners Publishing Company, 8773 South Ridgeline Blvd., Highlands Ranch, CO 80126-2329. Telephone (303) 470-4445. Second-class postage paid at Highlands Ranch, CO 80126-2329 and additional mailing offices. **POSTMASTER: Send address changes to EDN®, PO Box 7500, Highlands Ranch, CO 80126-7500.** EDN® copyright 1994 by Reed Publishing USA. Rates for non-qualified subscriptions, including all issues: US, \$140.00 one year, \$238.00 two year; Canada, \$209.00 one year, \$355.00 two year (includes 7% GST, GST# 123397457); Mexico, \$195.00 one year, \$332.00 two year; Foreign surface \$245.00 one year, \$417.00 two year; Foreign air expedited surcharge add \$152.00 one year, \$304.00 two year. Except for special issues where price changes are indicated, single copies are available for \$10.00 US and \$15.00 foreign. Please address all subscription mail to EDN®, 8773 South Ridgeline Blvd., Highlands Ranch, CO 80126-2329. EDN® is a registered trademark of Reed Properties Inc., used under license.

(Printed in USA)

How to Tool Up For the Future of Embedded Control.

Back by popular demand, Microchip is expanding its highly-acclaimed PIC16CXX Microcontroller Seminar Series. It's a fast, low-cost way for you to tool-up for the future.

In half a day, you'll learn how to:

- Slash time-to-market by 75% using PIC16/17 OTP microcontrollers
- Dramatically reduce overall system cost
- Trim days, even weeks, off development time with PIC16/17 simple and efficient instruction set
- Design for high performance (5 MIPS) and ultra-low power (2V)
- Use ultra-small packaging to optimize space and quickly advance your application design

Your \$25 registration fee includes:

- Comprehensive seminar and applications handbooks
- The popular Microchip MPASM assembler
- Microchip's MPSIM discrete event simulator
- Special discounts on all Microchip development systems, including PICMASTER™ Universal Emulator
- Lunch, refreshments and valuable door prizes

For a \$99 registration fee, you'll also receive a PICSTART™ development system (\$200 value).

Call **1-800-437-2767 x7272** to register today and learn how to design more effectively in embedded control. Act quickly, seating is limited. Have your VISA or MasterCard ready.

Albuquerque, NM	June 29	Mexico City, Mexico	June 7
Atlanta, GA	June 14	Mexico City, Mexico	June 9
Andover, MA	June 21	Milwaukee, WI	June 14
Austin, TX	June 23	Minneapolis, MN	June 16
Bethesda, MD	June 7	Mississauga, Ontario	May 24
Bolton, MA	June 22	Montreal, Quebec	May 26
Bridgeport, CT	June 9	Orange County, CA	June 14
Charlotte, NC	May 26	Orlando, FL	June 15
Chicago, IL	June 15	Phoenix, AZ	June 28
Cincinnati, OH	May 26	Portland, OR	June 21
Cleveland, OH	May 25	Providence, RI	June 7
Dallas, TX	June 21	Rochester, NY	May 25
Denver, CO	June 8	Salt Lake City, UT	June 9
Detroit, MI	May 24	San Diego, CA	June 30
Fairfield, NJ	June 9	San Fernando Valley, CA	June 15
Ft. Lauderdale, FL	June 16	San Gabriel Valley, CA	June 16
Ft. Washington, PA	June 8	San Jose, CA	June 7
Hartford, CT	June 8	Seattle, WA	June 22
Houston, TX	June 22	St. Louis, MO	July 14
Kansas City, MO	July 12	Vancouver, BC	June 23
Lexington, MA	June 23	Waterloo, Ontario	May 25
Long Island, NY	May 24		

Microchip PIC16/17 Microcontrollers

DEVICE	PINS	I/O	MEMORY	
			PROGRAM	USER RAM
PIC16C54	18	12	512 x 12 (OTP)	25 x 8
PIC16CR54	18	12	512 x 12 (ROM)	25 x 8
PIC16C54A	18	12	512 x 12 (OTP)	25 x 8
PIC16C55	28	20	512 x 12 (OTP)	24 x 8
PIC16C56	18	12	1024 x 12 (OTP)	25 x 8
PIC16C57	28	20	2048 x 12 (OTP)	72 x 8
PIC16CR57A	28	20	2048 x 12 (ROM)	72 x 8
PIC16C58A	18	12	2048 x 12 (OTP)	73 x 8
PIC16C64*	40/44	33	2048 x 14 (OTP)	128 x 8
PIC16CT1(A/D)*	18	13	1024 x 14 (OTP)	36 x 8
PIC16C84*	18	13	1024 x 14 (EEPROM)	36 x 8
PIC17C42	40/44	33	2048 x 16 (OTP)	256 x 8

*These products will be the focus of this seminar series.



MICROCHIP

The Embedded Control Solutions Company

Microcontrollers • Non-Volatile Memories • ASSPs

Microchip Technology Inc. • North America • Asia/Pacific • Europe • Japan
2355 W. Chandler Blvd. • Chandler, AZ 85224-6199 • (602) 786-7200 • FAX (602) 899-9210

The Microchip logo, name and PICMASTER are trademarks of Microchip Technology Inc. Information subject to change. © 1994 Microchip Technology Inc. All rights reserved.
PIC is a registered trademark of Microchip Technology Inc. in the U.S.A.

Home Office

275 Washington St, Newton, MA 02158
 EDN Bulletin Board: (617) 558-4241
 MCI: EDNBOS
 Phone (617) 558-plus 4-digit extension below
 Fax (617) 558-4470

To send a message to an EDN editor via Internet, add "@MCI.MAIL.COM" to his or her MCI address.

Publisher

Jeffrey Patterson -4454

Editor-in-Chief

Steven H Leibson -4214

Managing Editor

Joan Morrow Lynch -4215

Gary Legg, *Senior Technical Editor* -4404

Charles Small, *Senior Technical Editor* -4556

MCI: EDNSMALL

Dan Strassberg, *Senior Technical Editor* -4205

MCI: EDNSTRASSBERG

John A Gallant, *Technical Editor* -4666

Frances T Granville, *Senior Associate Editor* -4344

James P Leonard, *Senior Associate Editor* -4324

Gillian A Caulfield,

Manager of Art and Editorial Production -4263

Patricia Shaughnessy, *Production Editor* -4206

Ken Racicot, *Senior Art Director* -4708

Chinsoo Chung, *Associate Art Director* -4446

Brian Kerridge, *Senior Technical Editor*

22 Mill Rd, Loddon

Norwich, NR14 6DR, UK

(508) 528435; fax (508) 528430

MCI: EDNKERRIDGE

Doug Conner, *Technical Editor*

Atascadero, CA: (805) 461-9669

fax: (805) 461-9640; MCI: EDNDCONNER

Richard A Quinell, *Technical Editor*

Aptos, CA: (408) 685-8028

MCI: EDNQINNELL

David Shear, *Technical Editor*

Corvallis, OR: (503) 754-9310

MCI: EDNSHEAR

Anne Watson Swager, *Technical Editor*

Wynnewood, PA: (215) 645-0544

MCI: EDNSWAGER

EDN Asia, Mike Markowitz, *Editor*

Cahners Asia Ltd

19th Floor, Centre Point

181-185 Gloucester Rd, Wanchai, Hong Kong

Phone (852) 838-2666; fax (852) 575-1690

Contributing Technical Editors

Robert Pease, Don Powers, Dave Pryce, Bill Travis

Assistant to Editor-in-Chief

Kathy Leonard -4405

Editorial Services

Helen Benedict, *Senior Secretary* -4681

Marketing & Business Director

Deborah Virtue -4779

Marketing Communications

Jean Graham, *Promotion Specialist* -4698

Director of Creative Services

Norm Graf, -4293

Production

Andrew Jantz, *Group Manager* -4372

Karen Banks, *Production Manager* -4441

Alice Dorsey, *Production Associate* -4601

EDN Products

301 Gibraltar Dr, Box 650

Morris Plains, NJ 07950

Phone (201) 292-5100; fax (201) 292-0783

Group Publisher

Terry McCoy, Jr

Associate Publisher

Steven P Wirth, (201) 292-5100, ext 380

Editorial Director

Richard Cunningham, (702) 648-2470

Editor-in-Chief

Bruce Bennett, (201) 292-5100, ext 390

Managing Editor

Jen Brinkman, (201) 292-5100, ext 330

Production Manager

Sheila Rodgers, (201) 292-5100, ext 287

Customer Service Manager

Tara Poli, (201) 292-5100, ext 318

Design Director

John M Angelini

Art Director

Beverly Blake



May 26, 1994

Continued from page 5

TECHNOLOGY UPDATES

System simulation embraces real-time control prototyping

49

Today's control-system simulators employ graphical modeling tools, automatic coding, and DSP "hardware-in-the-loop" simulation to narrow the gap between conceptual design and product reality.

—Brian Kerridge, *Senior Technical Editor*

12-bit ADCs: Now may be the time to upgrade your 8- and 10-bit systems

67

A substantial list of low-cost 12-bit devices with competitive power and speed makes upgrading 8- or 10-bit systems seem almost fool-proof. However, ensuring 12-bit accuracy means reevaluating many other aspects of a design.—Anne Watson Swager, *Technical Editor*

EDITORIAL

Technological proof of innocence: Part 1

45

When will we start using technology to protect us from the worst technological abuses?—Steven H Leibson, *Editor-in-Chief*

NEW PRODUCTS

Embedded Systems	132
Electronic Design Automation	134
Integrated Circuits	139
Boards and Buses	145

DEPARTMENTS

News Breaks	13
Signals & Noise	37
Hands On!	130
Literature	146
Career Opportunities	152
EDN's International Advertisers Index	155

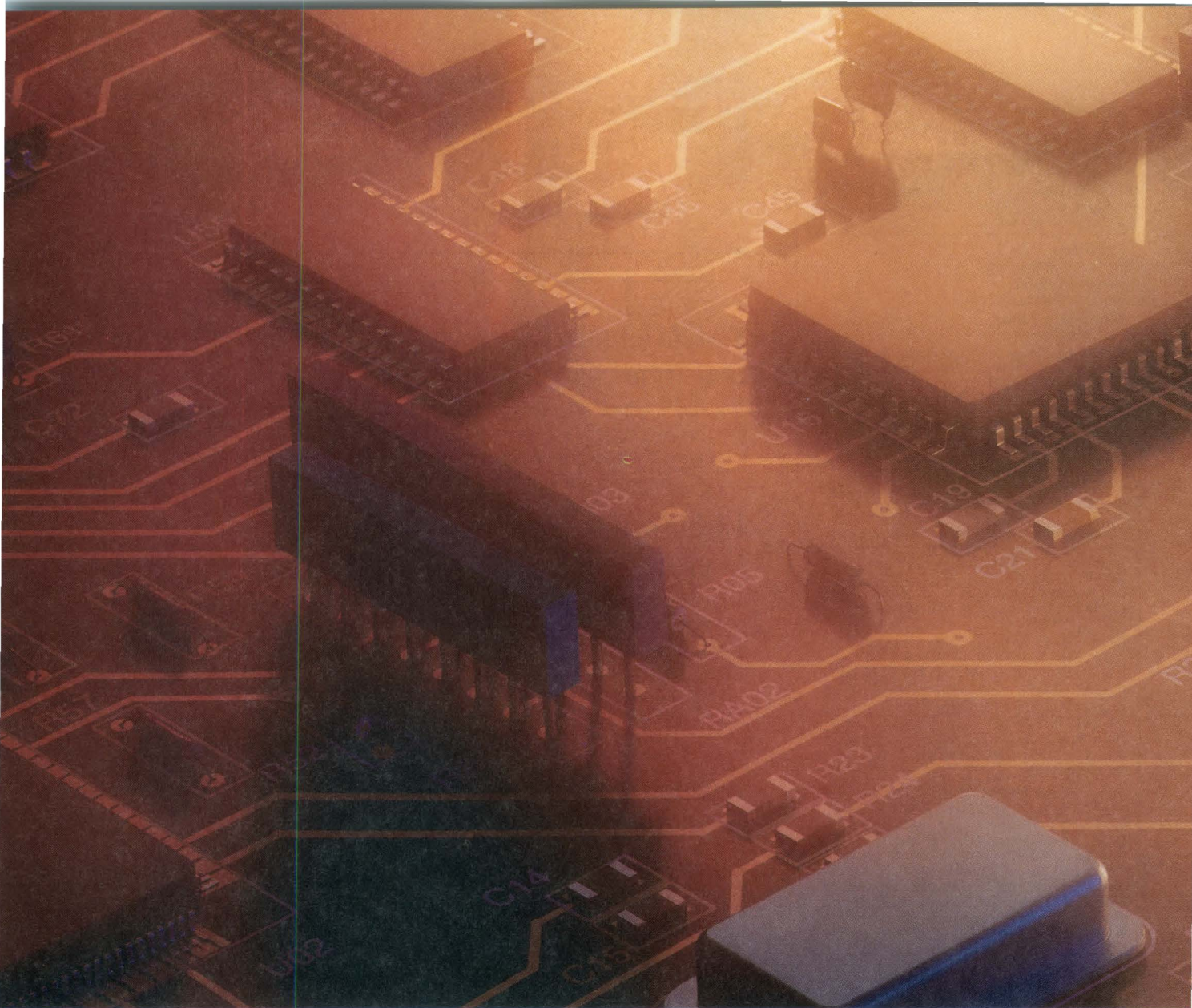

Introducing the first for embedded



The embedded Intel386™ EX processor:

We asked you what you wanted in an embedded processor, and your suggestions truly hit home. The result is the embedded Intel386™ EX processor. The first and only PC-compatible 386

that's optimized for embedded designs.

The integrated Intel386 EX processor offers power management and low-voltage operation for portable applications. It also increases your design flexibility by

allowing you to configure its on-board peripherals according to your own specifications.

For example, the Intel386 EX processor can be programmed to provide DMA-supported serial transfers to reduce the CPU load. Its Chip Select unit eliminates the need for external logic with address decoding, wait-state generation and ready-logic on chip. And its enhanced external bus supports dynamic bus sizing to interface with 8- and 16-bit peripherals.

And designing with an embedded Intel386 processor

© 1994 Intel Corporation. *Third-party trademarks are the property of their respective owners.

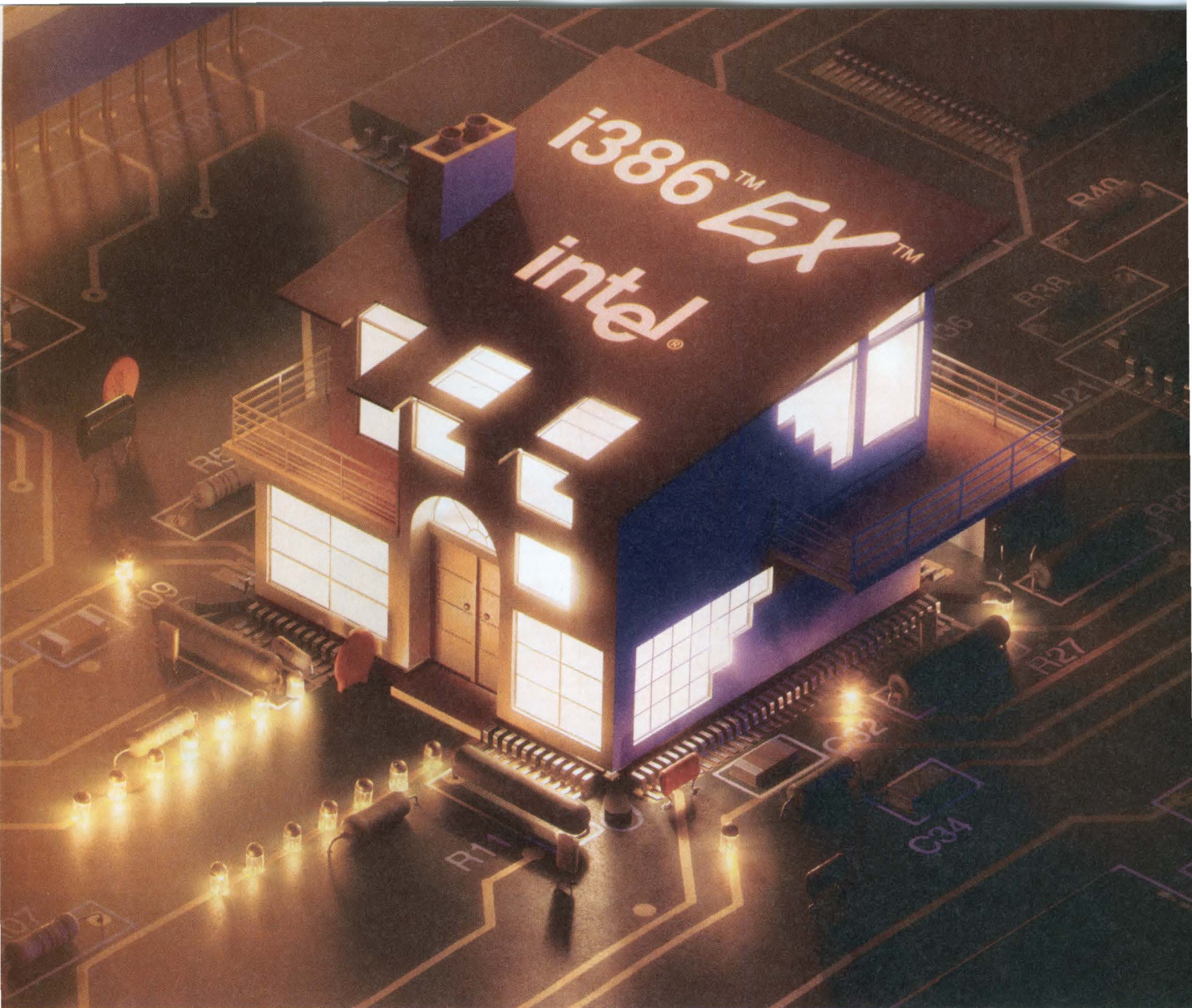

Best 386 custom built embedded applications.

couldn't be easier. The off-the-shelf tools and support of the PC architecture will allow you to get your designs out more quickly, and differentiate them with familiar interfaces like DOS and Windows*.

Dial the FaxBack* service at 1-800-628-2283, cat. #2312 to get additional information about the embedded Intel386 EX processor. Or contact your distributor to receive Intel386 EX processor

Embedded Intel386™ EX
Processor Block Diagram

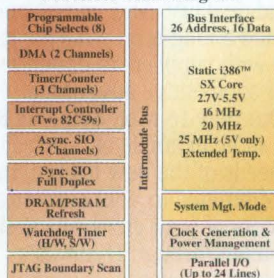

samples or to get current pricing of Intel386 SX and DX processors.

Move into an embedded Intel386 EX processor. Because when you want a solution that's optimized for embedded, nobody else is even in the neighborhood.

intel®

16 Mbit DRAMs from Hyundai.



Team Dy

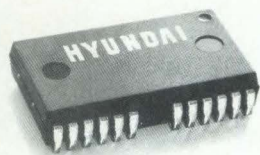

Sourcing used to be simple. The buyer and the design engineer got together for a few minutes. And that was it.

No more!

Now, virtually all of the make or break purchases for DRAMs and other major ICs in companies with over \$10M in sales* are the result of a cross-functional team dynamic. And remember, no company has a bigger commit-

ment to team dynamics than Hyundai.

Hyundai knows the engineer needs better performance from the technology. Production must have qualified, readily obtainable parts. Purchasing has to get the best possible price and delivery. And management must build a long term strategic partnership with suppliers to obtain a superior competitive advantage.

Our new 16 Mbit dynamic RAMs are one more example of our dedication to the needs of the new team dynamic. We're committed to your success and the success of your cross-functional buying team through Hyundai's commitment to quality, reliability, manufacturing capability and value added pricing.

Your Hyundai DRAM Source Guide

Size	Part Number	Speed ns	Refresh Cycles/ms	Production
16M x 1	HY5116100	60/70/80	4096/64	now
	HY5117100		2048/32	
4M x 4	HY5116400	60/70/80	4096/64	now
	HY5116410		4096/64, WPB	
	HY5117400		2048/32	
	HY5117410		2048/32, WPB	
2M x 8	HY5116800	70/80	4096/64	Q4 '94
	HY5116810		4096/64, WPB	
	HY5117800		2048/32	
	HY5117810		2048/32, WPB	
1M x 16	HY5116160	70/80	2CAS, 4096/64	Q4 '94
	HY5116260		2CAS, 4096/64, WPB	
	HY5118160		2CAS, 1024/16	
	HY5118260		2CAS, 1024/16, WPB	

All available in standard and low power versions. Packages include SOJ, TSOP II, reverse TSOP II.



namics.

New 16 Mbit DRAMs, designed with team dynamics in mind.

Evaluation samples of Hyundai DRAMs organized 16M x 1, 4M x 4 are available now. Coming soon are DRAMs organized 1M x 16 and 2M x 8. And many will operate off of a 3 volt source too.

Hyundai's new DRAMs feature speeds of 60, 70, or 80 ns. Immediately available, the HY5116100 and HY5117100 are organized 16M x 1 and provide 4096 refresh cycles per 64 ms and 2048 refresh cycles per 32 ms, respectively. New 4M x 4 parts include the HY5116400, with 4096 refresh cycles per 64 ms, the HY5116410 with write-per-bit capability, and the HY5117400 and write-per-bit capable

HY5117410 offering 2048 refresh cycles per 32 ms.

All parts are available in standard and low power versions, dissipating 495 mW operating at 60 ns, 440 mW at 70 ns, and 385 mW at 80 ns. Other features include operation from a single 5V \pm 10% power supply, TTL compatible inputs and outputs, fast page mode operating, multi-bit test capability, read-modify-write capability, and CAS-before-RAS, RAS-only, as well as hidden refresh. Packages include standard 24/28 pin plastic, TSOP II, and reverse TSOP II. TSOP will be available soon.

These new parts are products of Hyundai's 0.55 micron CMOS process, at one of

the most advanced electronics manufacturing plants in the world. So if purchase of 16 Mbit DRAMs is on your agenda, and you don't want to get caught short the way some did on 4 Mbit, start the team dynamics now.

Free 1994 16 Mbit DRAM Data Book.

Yours for the asking. Please phone, fax, or write for your copy today. Phone (408) 473-9274. Fax (408) 473-9370. Address Hyundai Electronics America, 166 Baypointe Parkway, San Jose, CA 95134.

Committed to your Success.

**HYUNDAI**

100 watts per cubic inch is meaningless if it's a big job to cool it.

Have you ever looked into using a board mounted power module (miniature DC/DC converter) with an advertised power density of 100 watts/cubic inch ...only to find out you need exotic cooling techniques to reach full rated output power?

Not so with AT&T's next generation of board mounted power modules.

They deliver up to 150 useable watts in a small 2.4 x 2.28 x 0.5 inch package. Their high efficiency (>84%) design provides 150 watts of

5 volt output power with an allowable base-plate temperature of 100° C. They provide power levels from 50 to 150 watts, output voltages from 2.0 to 24 volts, and

wide 2:1 input voltage ranges (18/36V and 36/72V).

So while others talk high density, AT&T delivers.

As always, with AT&T power modules, you're assured very competitive prices, plus the broadest offering: 0.5 to 200 watt products.

Give us a call at 1 800 526-7819

before you make your next power decision. From technical support to creative power solutions, we'll give you real reasons to make AT&T your power resource.

AT&T Power Systems. The power to do more.

For other AT&T power literature or power information, call 1 800 372-2447, ext. 910.



150 Useable Watts in a 50 Watt Package

EDITED BY FRAN GRANVILLE

Logic animator prototypes 50,000-gate ASICs

By throwing out assumptions built into its Enterprise family of ASIC emulation systems, Quickturn Design Systems has produced a less-expensive ASIC prototyping tool, the Logic Animation System Model S50, which models 50,000-gate ASICs at 8- to 16-MHz typ clock speeds. The company lowered the cost of this product by simplifying the hardware design, eliminating some features, and unbundling the software. Consequently, you can use the S50 to create several hardware prototypes that permit software development well before the actual ASICs emerge from fabrication.

In Quickturn's vision of rapid ASIC prototyping, you start with a netlist in one of several standard formats (currently EDIF, TDL, NDL, and Verilog) that your ASIC design tools create. You feed this netlist, properly massaged, into the S50, and it "becomes" your ASIC. If your ASIC design incorporates memory, standard-logic ICs, or logic cores for which "bond-out" parts exist, the S50 can directly make use of these ICs through an external interface module. This feature can extend the S50's modeling abilities beyond 50,000 gates. Like the company's larger emulation systems, the Logic Animation System connects to the target hardware through an emulation cable and plug. The S50 has 448 bidirectional I/O pins for logic animation.

Unlike the emulation systems, the S50 doesn't provide extensive internal debugging facilities. Instead, it makes

use of an instrument found in every hardware lab: a logic analyzer. A separate cable links the S50 to a logic analyzer and connects as many as 448 signals inside the modeled ASIC to the logic analyzer. Currently, the S50 software supports Hewlett-Packard's 1650 and 16500 logic-analyzer families. Support for the Tektronix DAS logic analyzers will appear this year.

The S50's software runs on a workstation and shares many of the

same features as the company's Enterprise emulation systems, such as single-pass compilations, correct-by-construction timing, interactive speed optimization, and incremental probe changes for debugging. The software produces 2- to 4-Mbyte files representing the ASIC model. You download these files to a PC, which then runs the S50. Thus, you may

need only one \$60,000 copy of the software to create several ASIC prototypes using \$30,000 S50s and PCs.

Once you have verified your design, you can continue to use the S50 ASIC prototypes while waiting for the actual ASICs to arrive from the foundry. This ability may save you weeks of system-development time by allowing software development and ASIC fabrication to occur concurrently. Because the ASIC model files are relatively small, you can even consider downloading the files over the phone. Consequently, you can provide regular and speedy design updates to software developers miles or continents away from your ASIC-development site.

One more characteristic differentiates the S50 from its larger brethren: It's not expandable. To drive down system cost, the S50's designers created a

single-board system with no expansion capabilities. However, more than half of the ASIC designs currently under way are below the S50's 50,000-gate limit.

—by Steven H Leibson

Quickturn Design Systems Inc, Mountain View, CA, (415) 967-3300.

Circle No. 434

Second-generation LONWorks μ P runs on half-power

Migrating to a 0.8- μ m fab process has reduced the cost and dropped (by one-half) the active power dissipation of Toshiba's second-generation Neuron μ P for Echelon's local-operating networks (LONs). The new μ P draws 16 mA typ at 10 MHz while operating and only 15 μ A (formerly, 500 μ A) in sleep mode. A Neuron μ P comprises three processors on one chip: two to run the networking protocol and one to run the application program for the application.

The second-generation Neuron is available in two forms: the TMP3150 and TMP3120. Both μ Ps contain 512 bytes of EEPROM and a unique 48-bit serial identification number. The TMP3150 also includes 2 kbytes of RAM and comes in a 64-lead QFP package. The TMP3120 includes 1 kbyte of RAM and 10 kbytes of ROM and is available in a 32-lead SOIC package. Both devices will sell for around \$5 (10,000).—by Steven H Leibson

Toshiba America Electronic Components Inc, Irvine, CA, (714) 455-2000.

Circle No. 435

Intel adds clout to PC/104

Intel Corp has raised the visibility of the PC/104 Consortium's modular-computer standard by joining the group as an executive member. Although PC/104 has more than 100 member companies, the addition of Intel, which is virtually synonymous with the μ Ps that control PCs, gives the group a big boost in credibility and presence. Intel's motivation, no doubt, is to gain a forum for promot-



The S50 Logic Animation System lowers the cost of ASIC prototyping.

SHORTS

More linear-IC price cuts. Joining Comlinear Corp in reducing prices (*EDN*, December 9, 1993, pg 16) is Harris Semiconductor. Enhancements and yield improvements to the company's complementary-bipolar technology are allowing price cuts of up to 50% for wideband amplifiers and buffers. Prices for the latest generation of 350-MHz op amps are approaching the level of older, 100-MHz devices. The price cuts affect op amps and buffers with 3-dB bandwidths in the range of 350 to 850 MHz. One example is the HFA1105/06/35/45 family of 350-MHz, 6-mA quiescent-current op amps whose new prices range from \$3.25 to \$4.12 (100). The new price for the HFA1100 850-MHz op amp is \$4.95 (100), down from the previous price of \$7.95. Harris Semiconductor, Melbourne, FL, (800) 442-7747. **Circle No. 436**

High-power semiconductor laser suits high-density optical-disk drives. Mitsubishi has announced the ML1412R, a high-power semiconductor laser that emits 690-nm wavelength red light, approximately 100 nm shorter than conventional wavelength. A single power supply drives the laser, which will find applications as a light source for writing and reading in next-generation, high-density optical-disk drives. Sample quantities cost ¥30,000. Mitsubishi Electric Corp, Tokyo, Japan, (3218) 2456. **Circle No. 437**

Booklet outlines EMI-shielding benefits of perforated metals. If you're a designer, specifier, or buyer concerned about EMI/RFI prevention, you might want to read this free handbook to familiarize yourself with the advantages of perforated metals. The 108-pg publication from the Industrial Perforators Association contains application photos, charts, and data detailing perforated metals' EMI-shielding effectiveness and other properties. Industrial Perforators Association, Milwaukee, WI, (414) 271-2263. **Circle No. 438**

ing its embedded-PC architectures. The chip company predicts a huge market for embedded 386-type processors, and it expects the PC/104 format to play a key role in that market. Stackable PC/104 modules, measuring 3.6×3.8×0.6 in., allow construction of embedded PCs without card cages or backplanes.

—by Gary Legg

PC/104 Consortium, Mountain View, CA, (415) 903-8304. **Circle No. 439**

25-Mbps ATM chip set available for LANs

Transwitch recently announced a technology-access agreement with IBM, which allows Transwitch to market a 25-Mbps asynchronous-transfer-mode (ATM) chip set to LAN-equipment vendors. The ALI-25 chip set permits communications over unshielded LAN cabling.

Transwitch offers an integrated family of standard chip sets that provide ATM access over high-speed channels, including synchronous optical network (SONET), DS-3, and E-3 channels. ALI-25 costs \$35 (10,000).

—by John Gallant

Transwitch Corp, Shelton, CT, (203) 929-8810. **Circle No. 440**

HyperSPARC modules top 100 MHz

Using multichip-module techniques, Ross Technology has packed a high-performance CPU with a 256-kbyte second-level cache into a 131-pin PGA (pin-grid-array) package, the RT629. The module fits sockets in workstations that accept HyperSPARC CPUs and runs a fully qualified port of Solaris 2.3. It draws 3.5W and runs 3.3V internally with a 5V external interface.

The modules are available in a variety of speeds. Modules offering 80-, 90-, and 100-MHz CPUs will be in full production by the third quarter. Samples are available now. Samples of a 110-MHz version will be available in July. Prices range from \$2511 to \$4019 in single quantities.

The module joins a family of the company's devices and modules that use the HyperSPARC architecture. The family

includes Mbus modules with single or dual CPUs as well as a single-chip version (RT628) with 128 kbytes of cache.—by Richard A Quinnell

Ross Technology Inc, Austin, TX, (800) 774-7677. **Circle No. 441**

Information Superhighway forum for building national infrastructure

The first conference on forming an infrastructure for the National Information Superhighway takes place September 26 to 28 in San Jose, CA. The summit features a keynote address by Dr John McQuillan, an expert in networking technologies; Ethernet inventor Dr Robert Metcalfe's program for building the infrastructure; tutorials; and seminars. In addition, the summit features

- Reviews of applicable technology and architectures
- Commentary from interexchange carriers, cable companies, and governmental agencies
- Assessment of possible foundations, such as telephone networks, cable systems, and Internet
- Debate on alternatives to delivering voice, data, and video via cable TV, copper-based telephone lines, fiber-optic cabling, and wireless
- Appraisal of new and expected industries and business ventures resulting from the superhighway.

—by Jim Leonard

IDG World Expo, Framingham, MA, (800) 545-3976; (508) 879-6700. **Circle No. 442**

Group promotes bare-die documentation

The DIE Industry Group, formed by ARPA (Advanced Research Projects Agency) to promote multichip-module technology, has developed a specification for providing models and design information on bare-die devices. That specification, DIE (Die Information Exchange) Format 1.0, provides a standard format and information content for bare-die documentation. The infor-

FOLD PAGE
HERE

TO
HERE

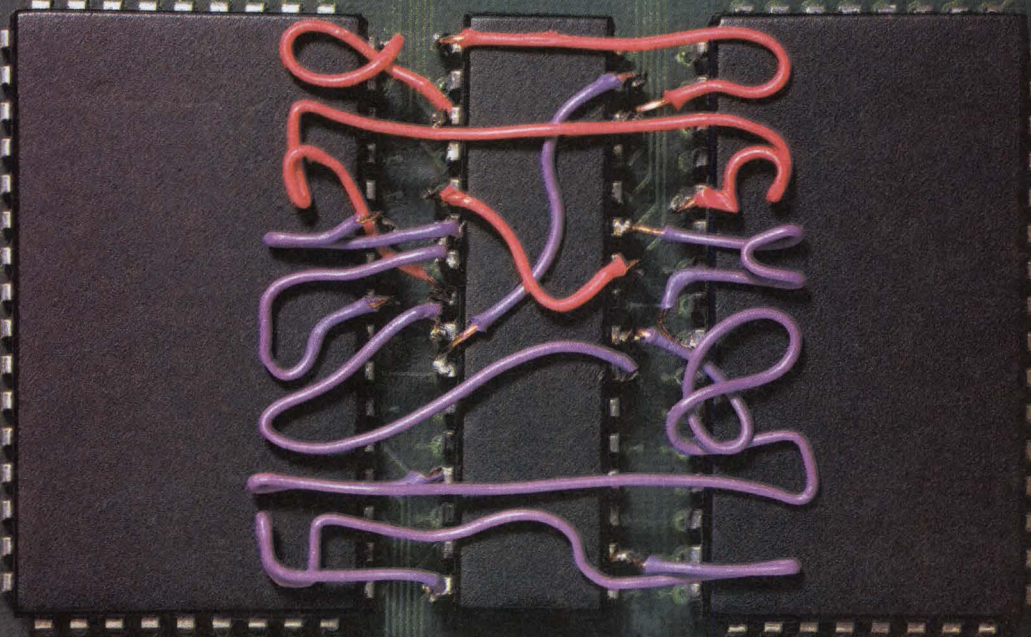

You found it! FLASH370 is a family of seven erasable complex PLDs—with up to a whopping 256 macrocells and 256 I/O pins. Even more remarkable is their 100% routability. This combines with the shortest pin-to-pin delays of any architecture through all speed paths—a blazing 8.5 ns for the 32-macrocell, 44-pin CY7C371. What's more, you get this high speed with 100% timing predictability. So you never have to struggle with variable timing again.

SURE, RECORD-BREAKING
SPEED IN A COMPLEX PLD IS A BIG PLUS
BUT IT SHOULDN'T
ROUTINELY BE A TEST OF YOUR ABILITY
TO HANDLE PLIERS.

(FOLD AS SHOWN FOR THE ALTERNATIVE.)

The FLASH370 family's exceptionally clean and simple architecture helps get your products to market faster. And as part of Cypress's comprehensive

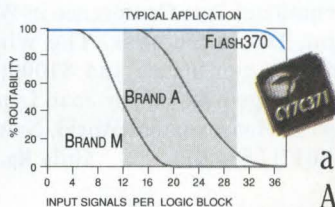

UltraLogic™ family, the FLASH370 is supported by Warp™ VHDL open design tools. So start designing with a data sheet instead of a soldering iron. And watch the competition fold.

Call for your free FLASH370 design kit: Warp2™ design tool for the CY7C371, sample certificate and product data. 1-800-858-1810*, Dept. C4H.

*In Europe, fax requests to the above Dept. at (32) 2-652-1504 or call (32) 2-652-0270. In Asia, fax requests to the above Dept. at 1 (415) 940-4337. Warp and UltraLogic are trademarks of Cypress Semiconductor © 1994 Cypress Semiconductor, 3901 North First Street, San Jose, CA 95134 Phone 1-408-943-2600.

ULTRA
L O G I C

 **CYPRESS**

EDN May 26, 1994 • 15

SHORTS

“Trojan horse” compromises Internet. The Federal Computer Emergency Response Team has announced a major breach of the Internet communications system. According to team members, perpetrators planted a “Trojan horse” program in various Internet users’ systems. The program gathered log-on information from users accessing a specific system through the Internet. The break-in could affect thousands of Internet users, according to the team, which serves as a clearing house for Internet security concerns. Federal Computer Emergency Response Team, Carnegie-Mellon University, Pittsburgh, PA, (412) 268-7080.

Circle No. 443

Aspec to offer \$40,000 ASIC design. Attendees at the Design Automation Conference, scheduled for June 6 to 8 at the San Diego Convention Center, will have a chance to win a \$40,000 design award. Aspec Technology Inc will offer a free design of as many as 100,000 gates based on the company’s proprietary high-density array, sea-of-gates technology. The design award comprises a complete package, from netlist to database tape. Alternatively, the winner can apply the \$40,000 to the purchase of an Aspec Portfolio family of ASIC design tools. Aspec Technology Inc, Santa Clara, CA, (408) 988-4411.

Circle No. 444

Yamaha asserts audio patents. With the expiration of the original patents covering FM sound synthesis, several manufacturers sought to break Yamaha’s virtual monopoly in supplying synthesis ICs to the sound-board market by making or incorporating OPL-equivalent devices. Yamaha has brought suit against them, asserting that still-active US Patents 4,249,447 and 4,813,236 cover the specific techniques used in its OPL chips and are being infringed. Hearings began on May 6.

Circle No. 445

mation includes administrative, geometric, electrical, thermal, and process data, as well as logic-simulation models. The format allows CAD systems to use the data, which is also human-readable.

The DIE Industry Group began its work with digital-logic ICs. It is now working to expand the specifications to include analog die as well as flip-chip and TAB devices. It expects to have the expanded specification available by year-end. The group comprises both semiconductor and CAD-tool vendors, including Cadence Design Systems, Logic Modeling, AT&T Microelectronics, Intel, IDT, Micron Semiconductor, Motorola, National Semiconductor, and Texas Instruments.—by Richard A Quinnell

DIE Industry Group, Beaverton, OR, (503) 531-2252. **Circle No. 446**

Recognize an outstanding peer

Test & Measurement World magazine is soliciting nominations for its fifth annual “Test Engineer of the Year” award. To qualify, individuals must spend most of their time working on test problems, but a specific test-engineer title is not mandatory. The nominee must work in the electronics industry and be involved with testing, measuring, inspecting, quality assurance, or another related function.

If you’re a peer, supervisor, or subordinate who knows a deserving engineer, send a fax to T&MW at (617) 558-4470 for a simple form to complete. All nominations are due by August 15. The magazine will present the award at the International Test Conference in Washington, DC in October. The winner receives a certificate and \$1000; the nominator gets \$250.—by Joan Lynch

Test & Measurement World, Newton, MA, (617) 558-4671. **Circle No. 447**

X terminals offer full-motion video

Human Designed Systems has added full-motion video to its line of RISC-based X Window terminals. Called HDS Video, the capabilities allow users to display full-motion video in as many as four windows on their HDS X terminal screens. HDS Video supports ana-

log and digital video with onboard compression and decompression.

Full-motion video suits applications such as presentations, training, monitoring, and teleconferencing. For teleconferencing applications, the company has also introduced HDS Conference video-teleconferencing application software, which allows multiple X terminal users to communicate over Ethernet and view each other in an X Window.

Users can connect a camera, a video CD-ROM, or a videocassette recorder to a terminal and display the video from this source on the screen in movable, resizable windows. The terminal supports full-screen display of video at 30 frames/sec with broadcast quality.

Digital video allows HDS X terminals to support video in networks for applications such as video teleconferencing. HDS supports the Intel/Microsoft Indeo compression standard and offers optional MPEG hardware decompression.

An optional capability, HDS Audio, allows recording and playback of stereo sound. With HDS Audio, each terminal has an internal speaker and connections for external speakers. Users can also connect an audio source, such as a stereo CD, a microphone, or a tape recorder, to the terminal.

Adding HDS Video or Audio to the company’s ViewStation multimedia terminals costs \$199 for stereo sound, \$199 for digital video, \$499 for analog and digital video, and \$199/user for the HDS Conference application.

—by Fran Granville

Human Designed Systems, King of Prussia, PA, (610) 277-8300.

Circle No. 448

“Smart batteries” lower portable-products’ costs

Duracell and Intel have announced the Smart Battery Data (SBD) and the System Management Bus (SMBus), two “smart-battery” specifications. End users can expect portable products, such as notebook computers, video camcorders, and cellular telephones, incorporating the specifications to have lower costs, more reliable battery-level information, and the ability to adapt to new battery technologies.

A smart battery is a rechargeable

STRANGE BUT TRUE

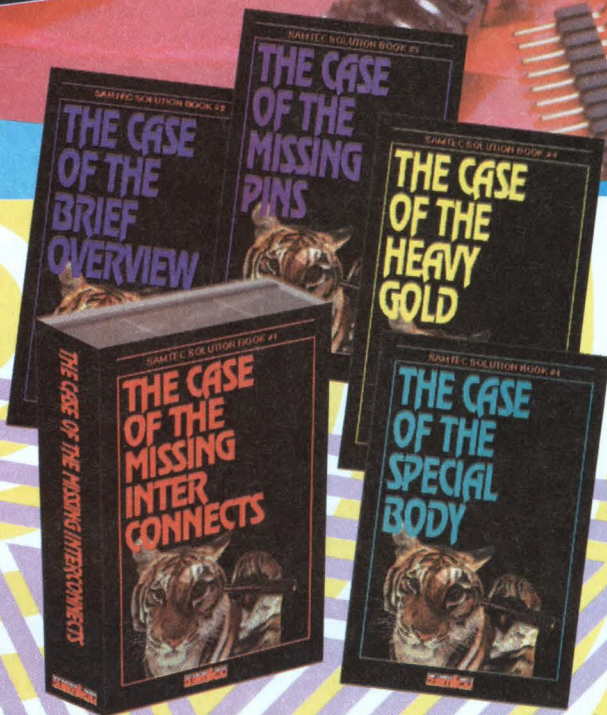

If your interconnect application is an odd-ball, throw it our way. Whether it's the plating, body or pins that are a little strange, our Solution Casebooks give you a head start on solving the mysteries. They're free and loaded with ideas on turning otherwise normal interconnects into the bizarre.

Call 1-800-SAMTEC-9 for our complete series of Solution Casebooks. Circle reader service number for our new Full Line Catalog F-193.

samtec



IS SUDDEN SOLUTIONS

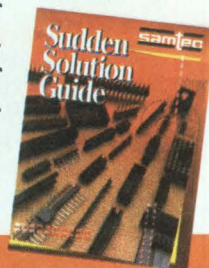

New Albany, Indiana USA • Cumbernauld, Scotland UK • Singapore
SAMTEC, INC. • P.O. Box 1147 • New Albany, IN 47151-1147 USA • Phone 812-944-6733 • Fax 812-948-5047

SHORTS

IC maker starts East Coast design facility. Linear Technology Corp is recruiting staff for its recently established Boston Design Center in Burlington, MA. The company seeks approximately 12 linear designers of MOS and bipolar data converters, power-supply and management products, references, comparators, and op amps. The Boston unit joins Linear's headquarters in California and a similar center in Singapore. Linear Technology Corp, Milpitas, CA, (408) 432-1900. **Circle No. 449**

ITT Cannon forms joint venture with ZCF. ITT Cannon, a supplier of electronic components, interconnection systems, and information-card technology, has formed a joint venture with Zhenjiang Connector Factory (ZCF), the largest connector company in China. ITT Cannon, Santa Ana, CA, (714) 261-5300. **Circle No. 450**

Digi-Key earns ISO 9002 certification. Digi-Key Corp recently earned ISO 9002 certification covering the purchasing, warehousing, and distribution of the company's electronic components, computer products, and accessories, including value-added assembly processes. Digi-Key Corp, Thief River Falls, MN, (800) 344-4539. **Circle No. 451**

Guide explains PCMCIA standard. *The PCMCIA Developer's Guide* provides a comprehensive overview of the Personal Computer Memory Card International Association (PCMCIA) standard. The 450-pg book also offers design examples for PC cards, hosts, and software drivers; it gives information on reference materials. \$89.95. Sycard Technology, Sunnyvale, CA, (408) 247-0730. **Circle No. 452**

DEC introduces Internet service. Digital Equipment Corp has announced the Internet Electronic

Connection, a set of free services allowing consumers in educational institutions and research laboratories to obtain information about—and place orders for—DEC's products and services directly over Internet. Digital Equipment Corp, Maynard, MA, (508) 493-5111. **Circle No. 453**

Consortium aims to advance technology. The Institute for Interconnecting and Packaging Electronic Circuits (IPC) has established the Interconnect Technology Research Institute (ITRI). ITRI's goal is to provide a vehicle for collaboration among the electronic-interconnection industry, government, and academia to develop and deploy advanced technology for printed-wiring boards and printed-wiring-board assemblies. IPC, Lincolnwood, IL, (708) 677-2850. **Circle No. 454**

Catalog lists more than 1200 software products. This 95-pg, indexed catalog, "Software for Science," lists more than 250 new products and 100 CD-ROM titles for astronomy, CAD, curve fitting, data acquisition, electrical engineering, and a variety of other disciplines. In addition, the catalog includes articles on software selection, such as "Equation Editor or Word Processor," "A Practical Guide to Survey Design," and "Choosing an Image-Analysis System for Remotely Sensed Data." Scitech International Inc, Chicago, IL, (800) 622-3345. **Circle No. 455**

Booklet helps Internet users get on-line. This 64-pg, \$2.95 booklet, "Internet Public Access Guide," defines Internet terms; describes Unix commands; and details electronic mail, Usenet news, remote-system access, and information searching. Specialized System Consultants Inc, Seattle, WA, (206) 527-2806. **Circle No. 456**

device with specialized hardware that provides present-state, calculated and predicted information to the host system under software control. This provides users with state-of-change information and an accurate prediction of the remaining operating time. Because the smart battery maintains its own information, a host device can accommodate multiple battery chemistries and appropriately charge them. Call Duracell or Intel for copies of the smart-battery specifications.—by Fran Granville

Duracell, Bethel, CT, (800) 422-9001, ext 423. **Circle No. 457**

Intel Corp, Mount Prospect, IL, (800) 253-3696. **Circle No. 458**

Zap confusing buttons from your remote control

How many buttons on your TV or VCR remote control go unused because you can't find the original documentation? What if you have the manual but don't understand what a button is for—or don't want to use it—anyway? In an effort to make electronic products easier to use and to battle "technophobia," Arthur D Little Enterprises has developed a technology that lets you eliminate unwanted or unused buttons from electronic products' keypads.

Called Custom Control, the technology lets you add, remove, and reposition unwanted or confusing controls from remote controls, telephones, calculators, and other products with buttons or keys. Custom Control supplies the target product with a set of buttons, each having its own electrical/mechanical identity, which corresponds to a feature or function of the product. You select only the buttons or keys you want from this set of controls and then place the controls on a "blank" control panel in whatever arrangement is most convenient. If you change your mind, you can recustomize the controls at any time.

The company is currently negotiating with major consumer electronics companies about licensing. The first implementation of the technology will hit the stores in September—in the form of a universal remote controller.

—by Fran Granville

Arthur D Little Enterprises Inc, Cambridge, MA, (617) 498-5000. **Circle No. 459**

Making Waves

INNOVATIONS IN ANALOG FROM NATIONAL



National
Semiconductor

75mW: A little power takes you a long way.

The world's lowest power 1MHz 12-bit ADC:

Designers of high-end instrumentation and communications systems no longer have to rely on expensive, power-hungry hybrids

to fulfill their high speed/high resolution requirements.

Because nothing combines low power, high speed, and precision like National's new 1MHz ADC12062.



Maximum power dissipation of just 75mW at 5V provides the low power consumption needed to improve overall system efficiency - Fast sampling rate of 1MHz is ideal for high-speed data acquisition - Patented EEPROM trimming architecture guarantees AC and DC specs unmatched in the industry: Gain error = ± 1 LSB (max.), offset error = ± 1.25 LSB (max.), INL = ± 1 LSB (max.), DNL = ± 0.95 LSB (max.), and SNR @ 100kHz is 69.5dB (min.), ensuring the accuracy of

the signal received by a microprocessor or DSP - On-board 2-channel MUX and sample/hold amplifier, and parallel

interface save board space and test costs - Power-down feature increases battery life in portable instrumentation designs.

In oscilloscopes, signal analyzers, and data acquisition boards for test and measurement applications, National Semiconductor's ADC12062 simply does more. On less. 1000-piece price (U.S.) starts at \$29.30.

5.5 μ s: The world's fastest DAS flies from A-to-D.

The world's fastest 12-bit data acquisition system: There are certain applications — diagnostic systems, portable instrumentation, industrial control — where nothing short of a high-speed, low-power, fully integrated data acquisition system will suffice. Fortunately for those applications, there's nothing faster, more power-efficient, or more fully integrated than the LM12H454/8.

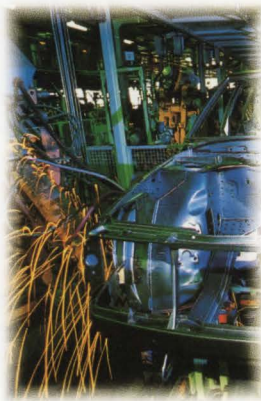

National's high-speed, low-power DAS is ideal for robotics and industrial control.

Maximum conversion rate of 5.5 μ s (minimum throughput rate of 140ksps) ~

The industry's lowest power

consumption: 34mW (50 μ W in powerdown mode) ~

Mixed analog and digital technology creates a complete system on a chip, fully capable of

providing stand-alone operation ~ High integration

simplifies complex designs by reducing testing and debugging ~ Analog front-end consists of a self-calibrating 12-bit plus-sign ADC with sample and hold, a reference, and a four- or eight-channel MUX ~ Digital

features include an eight-word instruction RAM, a sequencer, a 16-bit timer, and a 32-word FIFO ~

“Watchdog” comparison mode provides quick (1.4 μ s) threshold detection and alarm monitoring.

Guidance and control. Medical instrumentation. Energy management. For applications that demand it all, the LM12H454/8 delivers. 1000-piece price (U.S.): \$17.00.

The ADC12062 offers the industry's best combination of power consumption, speed, and precision.

The LM12H454/8 provides an unmatched mix of high speed and high integration. For more information, call 1-800-NAT-SEMI, Ext. 287.

The LM12H454/8 provides an unmatched mix of high speed and high integration. For more information, call 1-800-NAT-SEMI, Ext. 287.

The LM12H454/8 provides an unmatched mix of high speed and high integration. For more information, call 1-800-NAT-SEMI, Ext. 287.

The LM12H454/8 provides an unmatched mix of high speed and high integration. For more information, call 1-800-NAT-SEMI, Ext. 287.

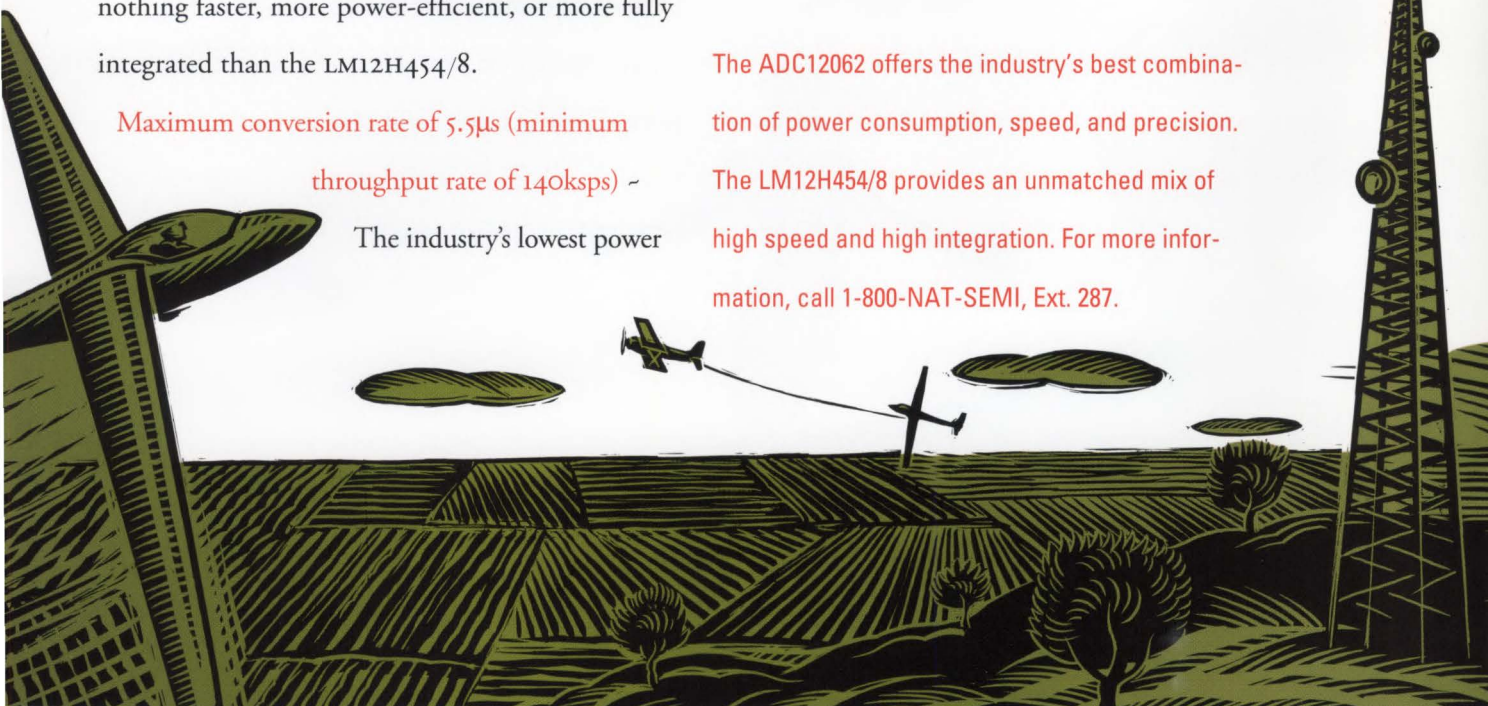

25fA: Input current reduced to its lowest level.

25 x 10⁻¹⁵ A — The new standard in low input current op amps: In highly sensitive measuring equipment, there's no room for error. Which means there's no room for an op amp with excess input current. That's why National Semiconductor designed the LMC6001 to have the world's lowest guaranteed input current. Low enough to improve system accuracy in such applications as pH meters, medical analysis equipment, gas detectors, and various types of photodiode-based systems.

Guaranteed I_B of 25fA (max.) at 25°C is 100% production tested ~ **Low input offset**

voltage of 350µV (max.) for

increased precision

~ Low voltage

offset drift of 10µV/°C (max.) ~ Increased dynamic range through **rail-to-rail output swing** ~ Low voltage noise ($e_n = 22\text{nV}/\sqrt{\text{Hz}}$ @ 1kHz)

provides higher signal-to-noise ratio than JFET input

type electro-

meter amplifiers ~ Low supply current of 750µA (max.) is ideal for power-sensitive applications and minimizes heating effects on input current and offset voltage ~

Available in plastic DIP ~ Designed and guaranteed for operation over the industrial temperature range (-40°C to +85°C) ~ Available in A Grade (25fA), B Grade (100fA), and C Grade (1000fA).

The LMC6001 is exactly what you need for transimpedance amplifier applications. In 1000-piece quantities, pricing (U.S.) starts at: A Grade - \$8.50; B Grade - \$5.15; C Grade - \$1.40 (8-pin PDIP).

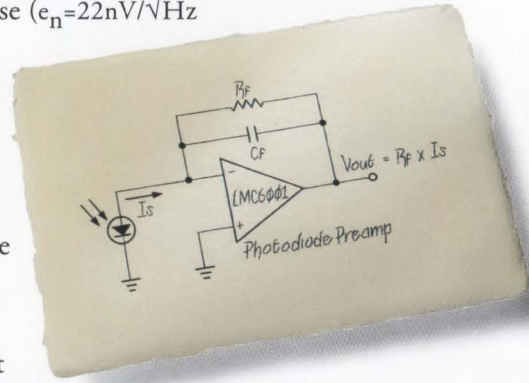

With a low input current of only 25fA (max.), the LMC6001 is ideal as a preamp for current output transducers.

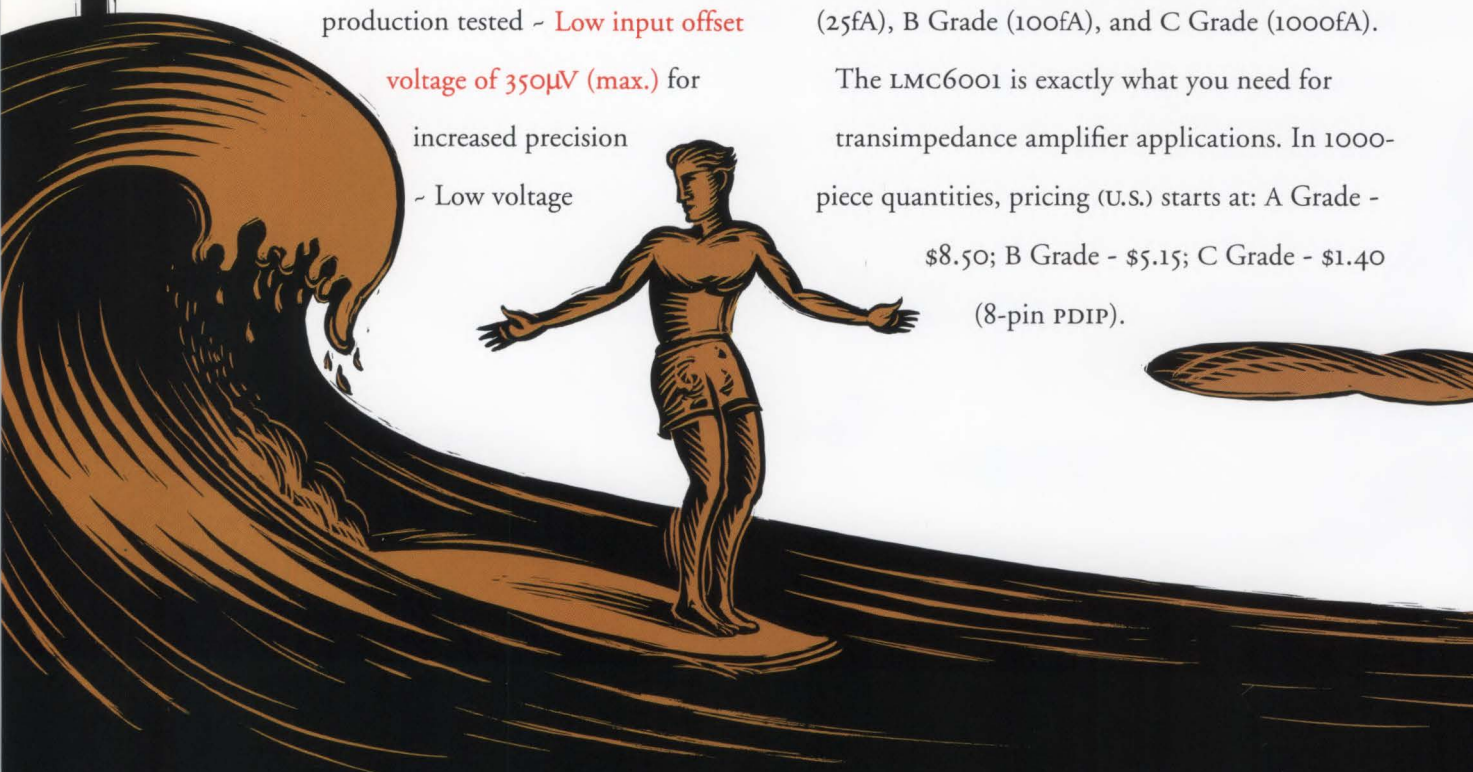

Versatile: High speed, high drive, low power.

The LM6181/2 and LMC6572/4: You no longer have to pay a premium for op amps that deliver solid, all-around performance.

LM6181/2: Single- and dual-current feedback amps for video, communications, and imaging systems ~ 100MHz unity gain bandwidth and 100mA of output current ~ No-hassle, one-chip solution eliminates output buffer ~ **Differential gain of 0.05% and differential phase of 0.04°** ~ 2000V/ μ s slew rate and 50ns settling time (0.1%) ~ Tight offset voltage (3mV max.) and input bias current (I_{b^+} = 2.0 μ A / I_{b^-} = 5.0 μ A max.) for precision needs ~ Fully specified for \pm 5V and \pm 15V operation ~ DIP and SOIC.

LMC6572/4: **Provides guaranteed 2.7V and 3V single-supply performance** for portables and mobile communications systems ~ Ideal for interfacing

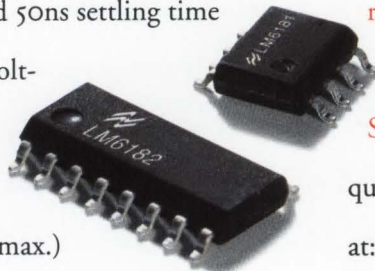

with 3.3V digital logic regulated or unregulated supplies ~ **Rail-to-rail output swing** maximizes S/N and dynamic signal range, providing an efficient interface to

ADCs ~ Wide input range from below ground to 800mV below the positive supply ~ **Low input current of 20fA** increases accuracy ~ Low supply current of 40 μ A ~ 120dB voltage gain/amp ~ **Specified for 100k Ω and 5k Ω loads.** In quantities of 1000, pricing (U.S.) starts at: LM6181 - \$2.00; LM6182 - \$3.60; LMC6572 - \$.90; LMC6574 - \$1.20.

For more information on the LMC6001, LM6181/2, and LMC6572/4, call 1-800-NAT-SEMI, Ext. 287 for free product sample kits.



Our LM6181/2 provides the performance you need for professional video applications.

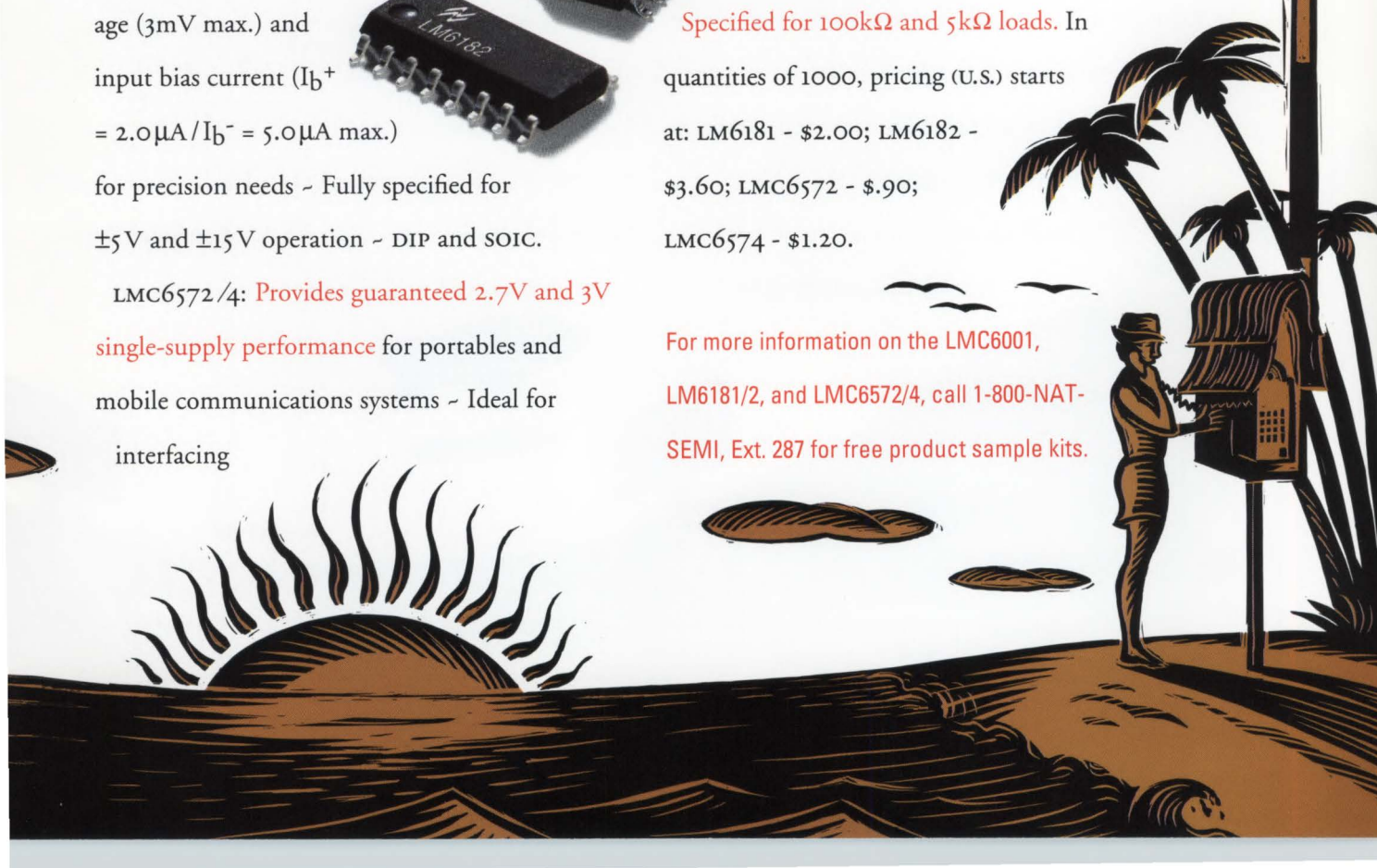

3-volt analog: Fueling the portable wave.

Maximum performance on a minimum of power:

The popularity of portability is rising fast. Portable computing, mobile communications, and hand-

held instrumentation designs need low-

voltage solutions that will

reduce system size and

extend battery life.

That's why National is

leading the way by offering

high-performance 3V analog

products in data acquisition, power

management, and amplifier ICs. Products that save

power without sacrificing performance.

LM12L454/8 12-bit plus sign data acquisition system:

Complete system on a chip with

106ksps throughput, 15mW (max.)

power dissipation (5μW in

power-

down mode), and all the functionality needed for

stand-alone operation ~ **ADC12LO30/2/4/8 12-bit**

plus sign A/D: Fastest 3V 12-bit serial A/D (maximum

conversion time of 5.5μs) at 15mW (max.)

power dissipation (40μW in powerdown);

configurable registers ~

LMC6572/4 op amp: Low

supply current of 40μA/op

amp minimizes power consumption; guaranteed 2.7V

and 3V single-supply performance;

low input current increases accuracy ~

LMC6482/4 op amp: Rail-to-

rail input and output

increases dynamic signal

range at 3V; lower offset

voltages and higher CMRR

increases precision ~ **LM2574/5/6 SIM-**

PLE SWITCHER® power converter: First easy-to-

use power converter family with 3.3V output

and guaranteed system performance; requires

just four external,

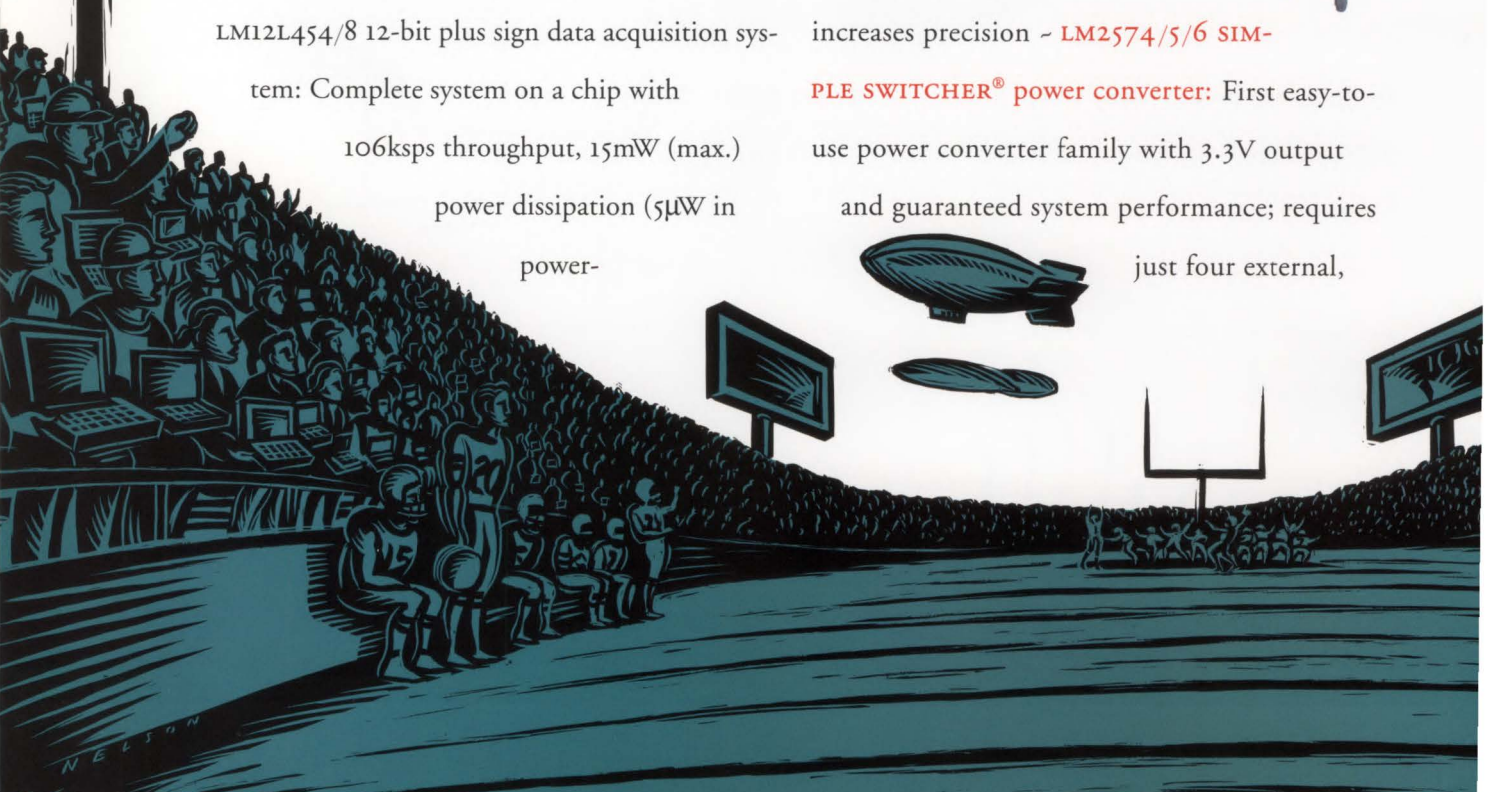
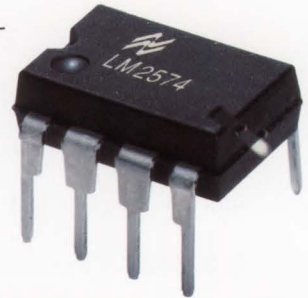
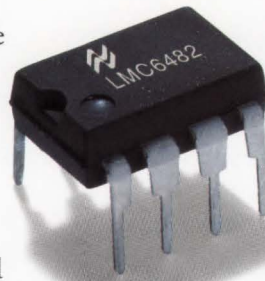

l o w - v o l t a g e s o l u t i o n s

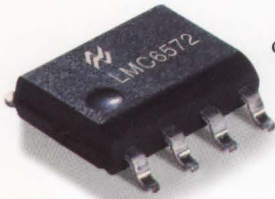

off-the-shelf components;
design software available ~

LP2950/51 low

dropout regulator: Very low dropout voltage of 380mV extends battery life; low quiescent current of 75µA reduces



your portable designs — while reducing power consumption. And all of them come with the

quality and reliability you expect

from the original leader in analog IC technology. For pricing

information, consult the

box to your left or call the number below.

3V analog ¹⁾	
DEVICE	PRICE*
LM12L454/8	\$15.00
ADC12L030	\$10.90
LMC6572	\$0.90
LMC6482	\$1.55
LM2574N-3.3	\$1.70
LP2951CN-3.3	\$1.23
LM4041	\$0.72

*QUANTITIES OF 1000, U.S. ONLY

power consumption and power dissipation ~

LM4041 voltage reference:

Subminiature SOT-23 package saves board space and reduces overall sys-

For 3V analog that will fuel your imagination as well as your designs, call 1-800-NAT-SEMI, Ext. 287.

We'll send you free product sample kits or information kits.

tem size; adjustable voltage option (1.24V to 10V) provides design flexibility.

All of National's 3V analog solutions are designed to increase the performance of



Magnetics: Opto-less chipset brings reliable power supplies offline.

The world's only 1MHz magnetically coupled offline power supply chipset: For the first time, high-speed pulse magnetics replace opto feedback devices. The result is smaller, more efficient, more reliable switchmode power supplies. The reason is National's LM3001/3101 offline power supply

chipset.

Two-chip solution: LM3001 primary side driver and LM3101 secondary side controller:

Fast AC feedback provides quicker response than optos ~ Up to 1MHz switching frequency enables the use of smaller inductors and capacitors.

LM3001: Accepts AC pulse feedback ~ 10ns rise and fall times provides greater efficiency and fast response to faults ~ On-board oscillator manages chip start-up ~ 2.5A peak current drives MOSFETS

at high speed ~ Dual-level current limit provides virtually fail-safe operation: Cycle-by-cycle current limit offers fast

current protection, while second-level

current limit initiates complete shutdown in the case of a major fault.

LM3101: Generates AC pulse feedback ~ Pulse-width-modulator (PWM) provides master pulse width control ~ $\pm 2\%$ voltage reference for high-precision control of output voltage ~ Trimmed on-board oscillator offers programmable frequency control ~ 8MHz bandwidth error amp ensures fast, stable, easy loop compensation ~ Frequency shift for short circuit assures the best possible overload protection. 100-piece pricing (U.S.) starts at: LM3001 - \$1.85; LM3101 - \$1.70.

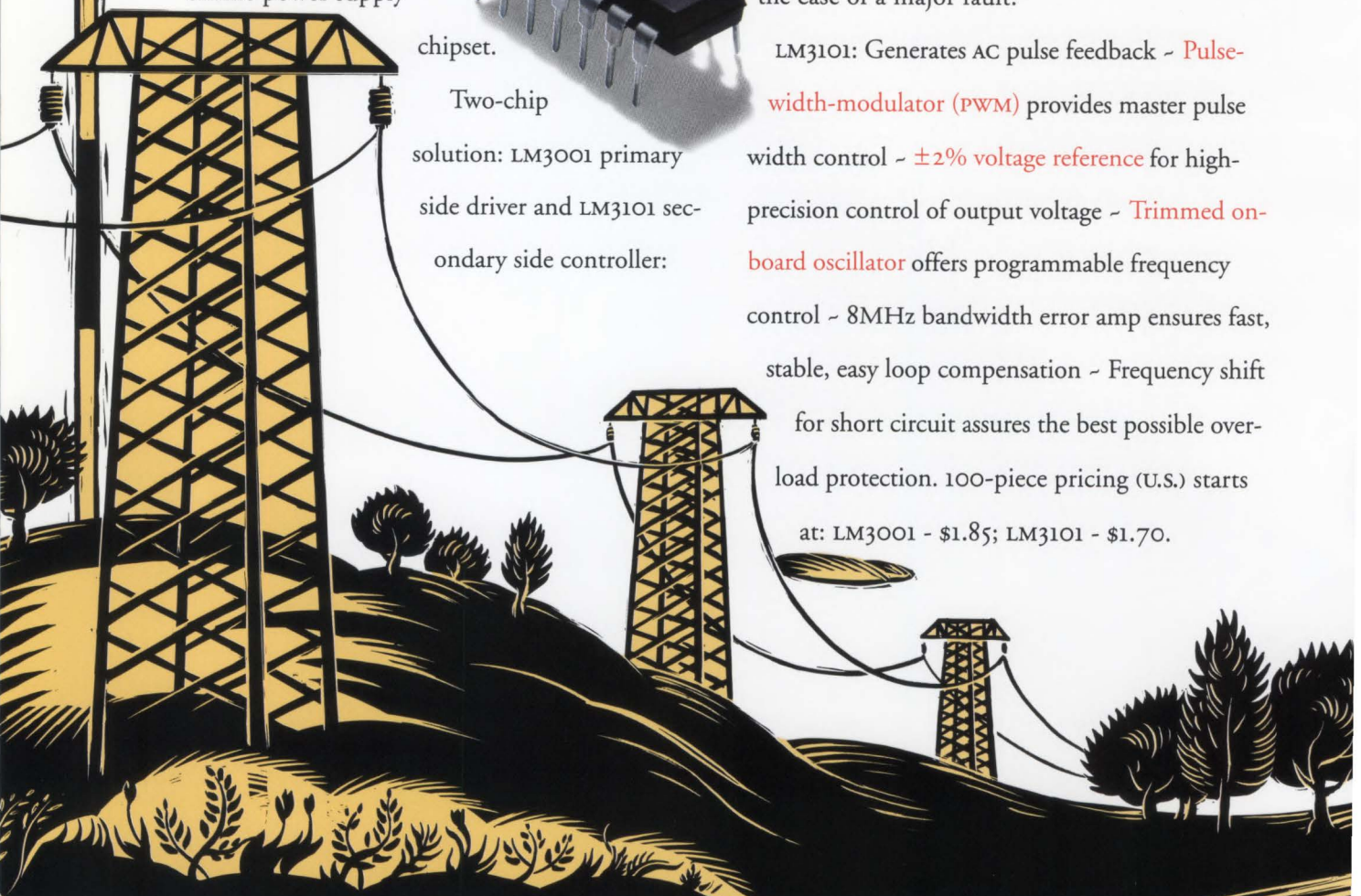
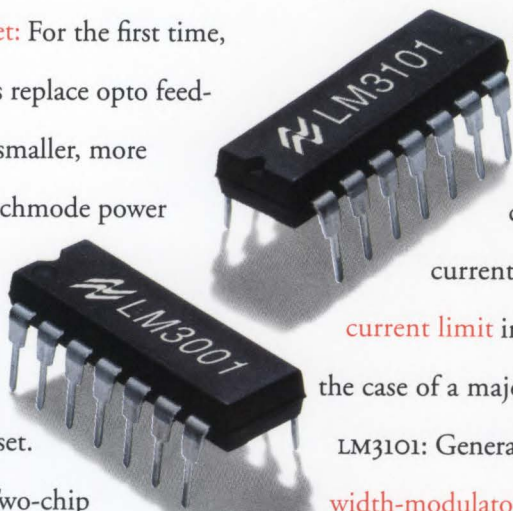

l o w d r o p o u t r e g u l a t o r s

Dual: µPower LDO does twice the work.

The world's first dual micropower low dropout regulator: When it comes to extending battery life in portable applications, two regulators are better than one. Case in point: National's LP2956. Two low dropout regulators in one package make it possible to shutdown one system and save power, while keeping a second system active.

Low dropout voltage of 470mV extends battery life ~ **Low quiescent current of 170µA** reduces power consumption and power dissipation ~

In portable applications, the dual LP2956 shuts down inactive systems while maintaining continuous power for essential functions.

second load (up to 75mA) to be driven while driving a primary load of up to 250mA ~ **Electronic shutdown** allows device to be turned on

and off as desired ~ Auxiliary comparator can be used for low-battery detection, fault detection, or as a reset signal to a microprocessor ~ Error flag for the main regulator indicates when it has fallen out of regulation by more than 5%.

The LP2956 is the highest performance dual low dropout regulator available. It's the best thing to happen to your battery-powered designs since the batteries themselves. 100-piece price (U.S.): \$2.95.

If your design plugs into a wall socket, we've got your power supply chipset. If it runs on batteries, we've got your low dropout regulator. To get your free product sample kits, call 1-800-NAT-SEMI, Ext. 287.

Independent, auxiliary low dropout regulator enables

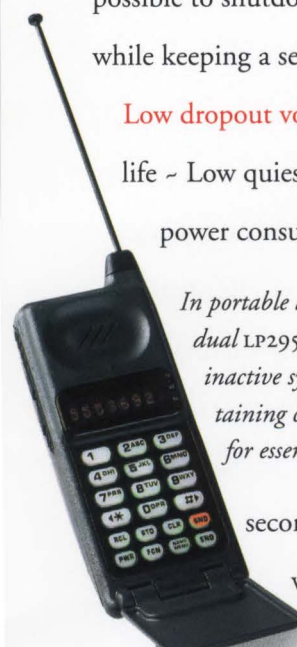
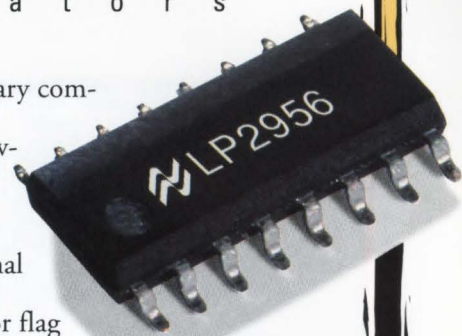

.03% THD: 60 watts never sounded as good as this.

The world's best sounding monolithic audio amplifier: See if you like the sound of this.

National's LM3886T provides a higher standard of high fidelity, as well as maximum power with

maximum protection.

Lowest typical total harmonic

distortion (THD) from 20Hz to 20kHz at 25, 40, and 60 watts of continuous power provides the industry's best distortion/power rating

~ Signal-to-noise ratio is greater than 95dB min.

The 60-watt LM3886T enables better, louder, longer sound in high-end audio applications like A/V surround sound receivers.

(noise floor of 2.0µV), meeting

the demands of CD-quality digital sound ~

Mute function eliminates transients at power up

and power down ~ Devices can be

easily bridged together ~ SPIKE™ self-protection

circuitry adjusts output drive capability according to operating conditions, protecting output transistor array from overvoltages, undervoltages, or current limiting conditions, and providing thermal

shutdown ~

Dynamic SOA protection ensures that power transistors won't be destroyed — even if faults continue for extended periods.

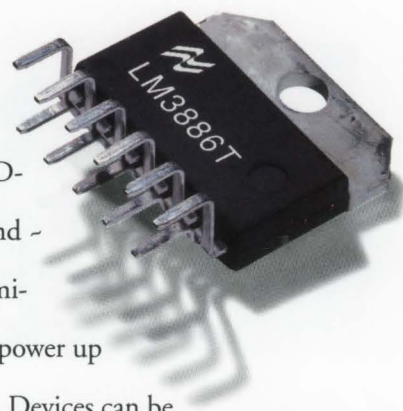

Typical THD*		
DEVICE	THD (typ.)	OUTPUT
LM2876T	0.05%	25W
LM3875T	0.05%	40W
LM3876T	0.05%	40W
LM3886T	0.03%	60W

* from 20Hz to 20kHz

In component and compact stereos, surround-sound amplifiers, and high-end stereo TVs, you get better sound with National's audio amplifiers.

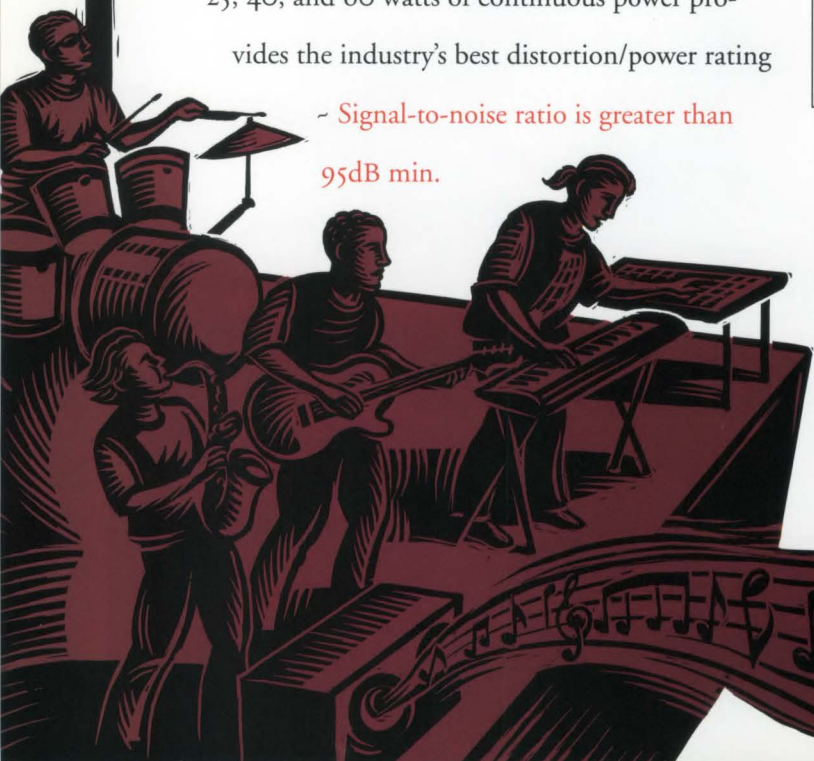

130MHz: High-speed LM1205 saves board space.

Complete broadband preamplifier system: When used with National's LM2419 CRT driver (see back cover), the LM1205 130MHz RGB video preamplifier replaces up to 36 components, compared to using standard preamps and discretes.

Provides the entire amplifier path

required between the rear chassis input and the cathode for 1024 X 768 monitors ~ Each channel contains matched video amplifiers ~ Gated, single-ended input and black-level clamp provide brightness control ~ Matched DC-controlled attenuators provide contrast control ~ DC-controlled sub-contrast attenuators provide white balance ~ All DC control inputs are high impedance and

Features	
BANDWIDTH	130MHz
DC CONTROLS	0-4V
VIDEO BLANKING	YES
CHANNELS	3
APPLICATION	HIGH-RES. DISPLAYS

operate over a 0 to 4V range for easy interface in microcontroller-based systems ~ Blanking circuit clamps the video output voltage to within 0.2V of ground ~ For high-speed, space-conscious designs.



The LM1205 provides the performance needed for multimedia applications.

In high-end, 17-inch RGB CRT monitors, 1280 X 1024 pixel systems, video AGC amplifiers, and wideband amplifiers with gain and DC offset controls, the LM1205 gives you more performance. While using less board space. In quantities of 1000, pricing (U.S.) starts at \$2.50.

To fully appreciate the sights and sounds of National's audio and video ICs, call us at 1-800-NAT-SEMI, Ext. 287 and we'll send you free sample kits containing product samples, a blank applications board, data sheets, and application notes.

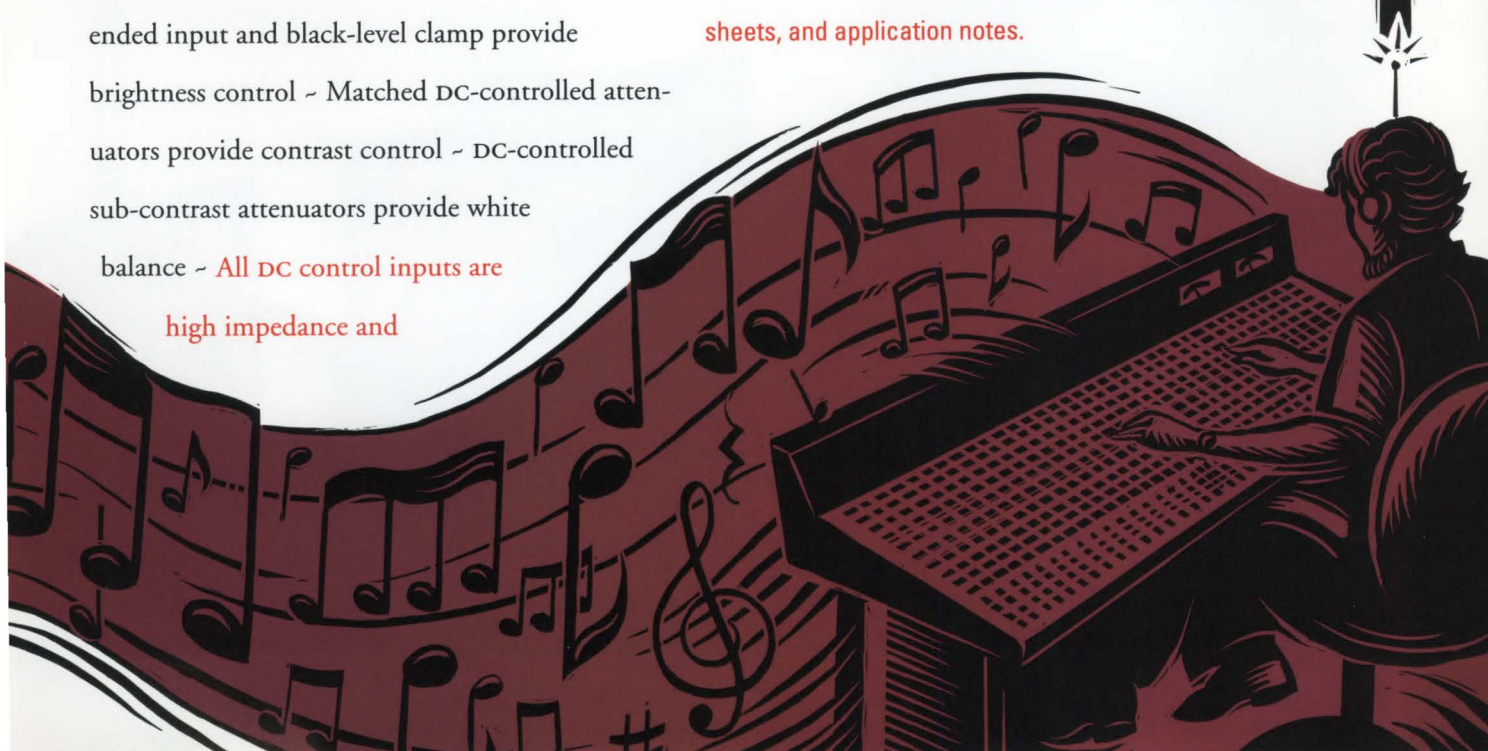

C R T d r i v e r s

5.0ns: For a picture everyone can appreciate.

High-performance triple CRT driver for high-resolution monitors: Picture a device that provides resolution up to 1024 x 768 in color monitors while simplifying overall design. You're picturing the LM2419, National Semiconductor's triple 65MHz CRT driver. Typical rise/fall time of 5ns provides clean, sharp signal transition edges for high-resolution images - 65MHz video bandwidth at 50Vpp output swing with 8pf load for a

bright screen and
a clear

image - Three drivers match red, green, and blue channels in one device - Available in industry-standard TO-220 molded power

packages - Electrically isolated heat sink may be grounded for ease of manufacturing and improved RFI/EMI shielding - Pin-for-pin compatible with LM2416, simplifying

upgrades - No low-frequency tilt compensation required. For direct cathode drive capability in VGA, SVGA, XGA, IBM and Macintosh monitors, nothing looks better.



The LM2419's 5ns risefall time provides clean, sharp signal transition edges for high-resolution images.

For high resolution in color monitors, your choice is clear. Call 1-800-NAT-SEMI, Ext. 287

for a free LM2419 product

sample kit.

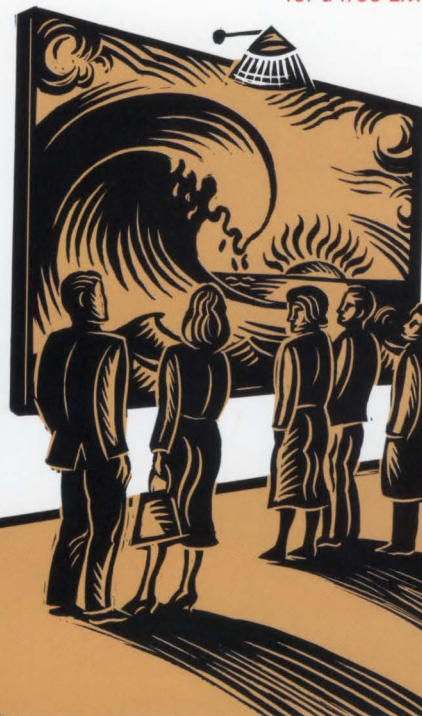
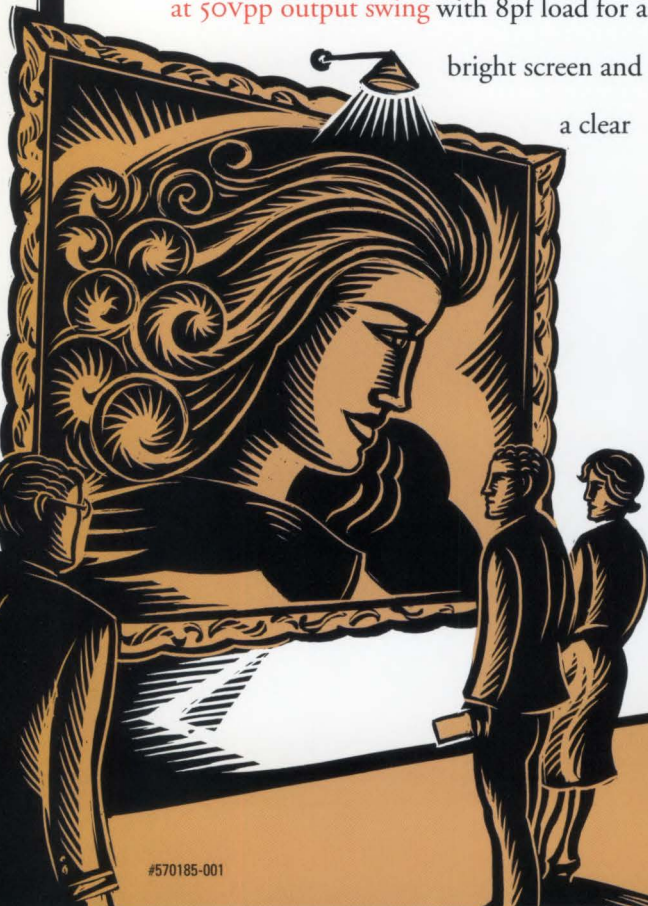

SIMPLE SWITCHER is a registered trademark of National Semiconductor Corporation. SPIke is a trademark of National Semiconductor Corporation. © 1994 National Semiconductor Corporation. NORTH AMERICA: P.O. Box 7643, Prospect, IL 60056-7643 (Tel: 1-800-628-7364, ext. 287; Fax: 1-800-888-5113). All rights reserved.



If You're Looking For Product Acceptance In North America, UL Holds The Key.

THE BIG NEWS TODAY IS THAT UL IS ACCEPTED ALL ACROSS CANADA. AND WITH THE SIGNING OF A COOPERATIVE ASSISTANCE AGREEMENT WITH THE ASOCIACION NACIONAL DE NORMALIZACION Y CERTIFICACION DEL SECTOR ELECTRICO (ANCE), THE FIRST INDEPENDENT STANDARDS AND PRODUCT CERTIFICATION ORGANIZATION ACCREDITED BY THE MEXICAN GOVERNMENT — UL IS THE FIRST ORGANIZATION OF ITS KIND TO OFFER MANUFACTURERS ACCESS TO CERTIFICATIONS FOR ALL OF NORTH AMERICA.

AND SINCE UL PROVIDES CERTIFICATION THAT ALLOWS IMMEDIATE ACCEPTANCE ACROSS THE ENTIRE UNITED STATES, SAVING TIME AND MONEY TO GAIN ACCEPTANCE ACROSS NORTH AMERICA HAS NEVER BEEN EASIER.

IN FACT, NO OTHER SAFETY CERTIFICATION SERVICE CAN DELIVER WHAT UL PROVIDES. AND BECAUSE WE OPERATE AS A NOT-FOR-PROFIT ORGANIZATION, YOU CAN BE ASSURED THAT OUR PRIMARY OBJECTIVE REMAINS SAFETY.

SO IF YOU'RE LOOKING FOR ONE SOURCE THAT NOT ONLY HANDLES PRODUCT SAFETY CERTIFICATION ACROSS THE UNITED STATES, BUT ALSO FACILITATES EXPANDING YOUR PRODUCTS' ACCEPTANCE BEYOND THE BORDERS, WE CAN HAND YOU THE KEY.

U.S. HEADQUARTERS: BARBARA OLDS
PHONE: 708-272-8800, EXT. 43319
FAX: 708-272-9562

CANADA: JOHN WOODS
PHONE: 613-742-6965
FAX: 613-742-6965



Underwriters Laboratories Inc.®

ACCREDITED AS A CERTIFICATION ORGANIZATION BY THE STANDARDS COUNCIL OF CANADA.

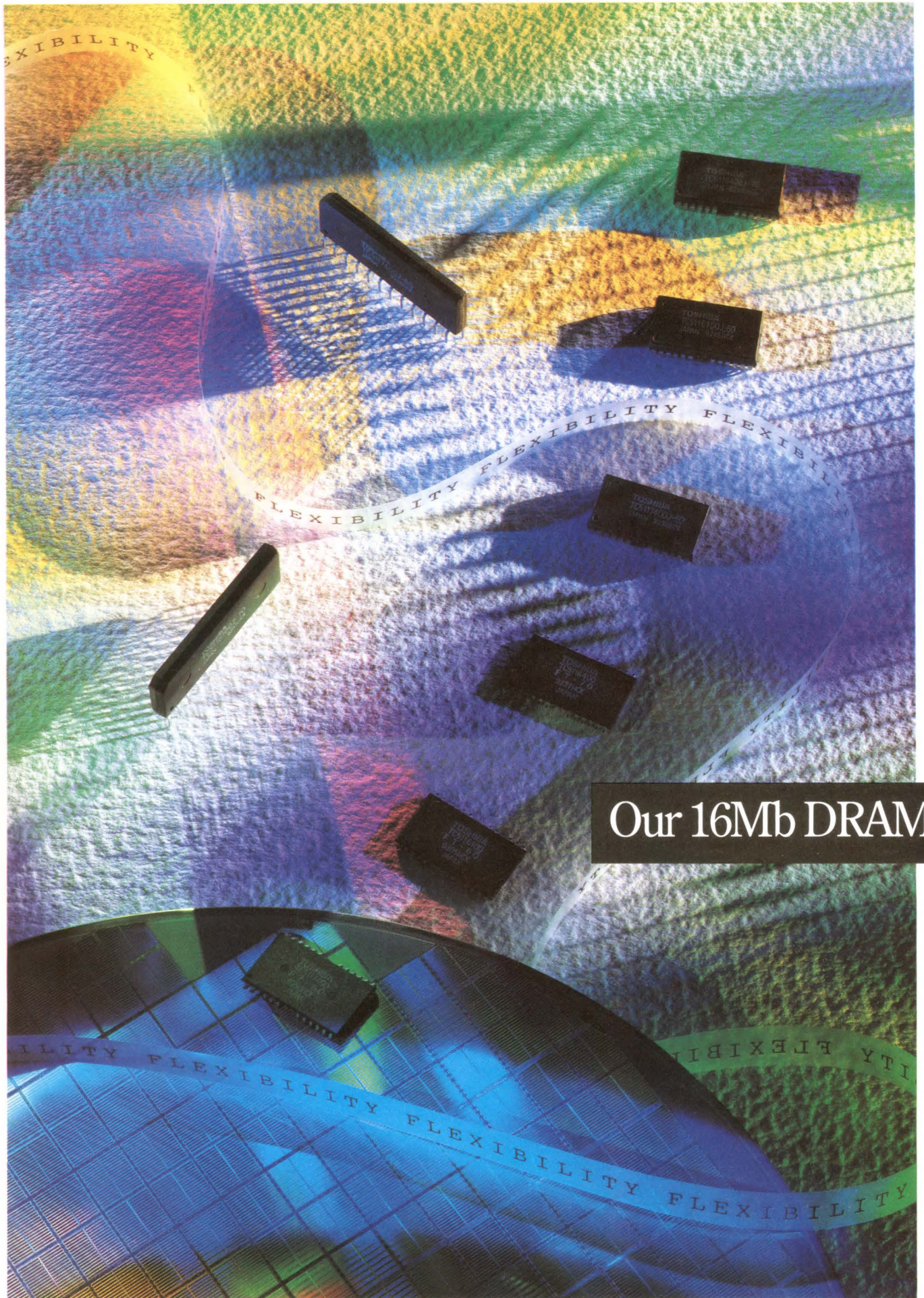

Our 16Mb DRAMs

We know the right time to cross over from 4Mb to 16Mb DRAMs.

It's when you can get access times as fast as 50ns. A greater than four-fold drop in power consumption.

And greatly increased design flexibility with byte-wide and word-wide organizations.

Which happens to be right now, with Toshiba.

For starters, we can help you save substantial board space by replacing four 1Mx4 parts with one 1Mx16 part.

Our 1Mx36 and 2Mx36 SIMM modules utilize 1Mx18 DRAM in place of 4Mb DRAMs, and fit

Plus, our 1Mx16 with self-refresh minimizes power consumption in standby mode, making it ideal for today's PDA applications. And our 3.3V 1Mx16 DRAM gives notebooks power to go.

<i>Organization</i>	<i>Refresh Rate</i>	<i>Access Time(ns)</i>	<i>Package</i>
<i>1M X 16, 3.3V</i>	<i>1K, 4K</i>	<i>70/80</i>	<i>SOJ, SOP</i>
<i>1M X 16, 3.3V</i>	<i>Self-Refresh</i>	<i>70/80</i>	<i>SOJ, TSOP</i>
<i>1M X 16, 5V</i>	<i>1K, 4K</i>	<i>60/70/80</i>	<i>SOJ, TSOP</i>
<i>1M X 18</i>	<i>1K</i>	<i>60/70/80</i>	<i>SOJ</i>
<i>2M X 8</i>	<i>2K</i>	<i>60/70/80</i>	<i>SOJ, TSOP</i>
<i>4M X 4</i>	<i>2K, 4K</i>	<i>50/60/70</i>	<i>SOJ, TSOP</i>
<i>16M X 1</i>	<i>4K</i>	<i>50/60/70</i>	<i>SOJ</i>

Naturally, all Toshiba DRAMs come with backward compatibility to the 4Mb generation, access times of 60, 70 and 80ns, and a wide variety of SOJ and TSOP package options.

And they all combine to deliver maximum design flexibility.

But that's what you always get with Toshiba. Because by staying in front of memory technology, we keep you in front of your competition.

go to great widths to offer you design flexibility.

just right into today's power-conscious systems.

And for your next generation of portables, Toshiba's 2Mx8 organizations are the best way to provide 8MB of base memory.

For more information, or to receive our DRAM specification guide, just call 1-800-879-4963.

And we'll help widen your sphere of influence.

In Touch with Tomorrow

TOSHIBA

TOSHIBA AMERICA ELECTRONIC COMPONENTS, INC.

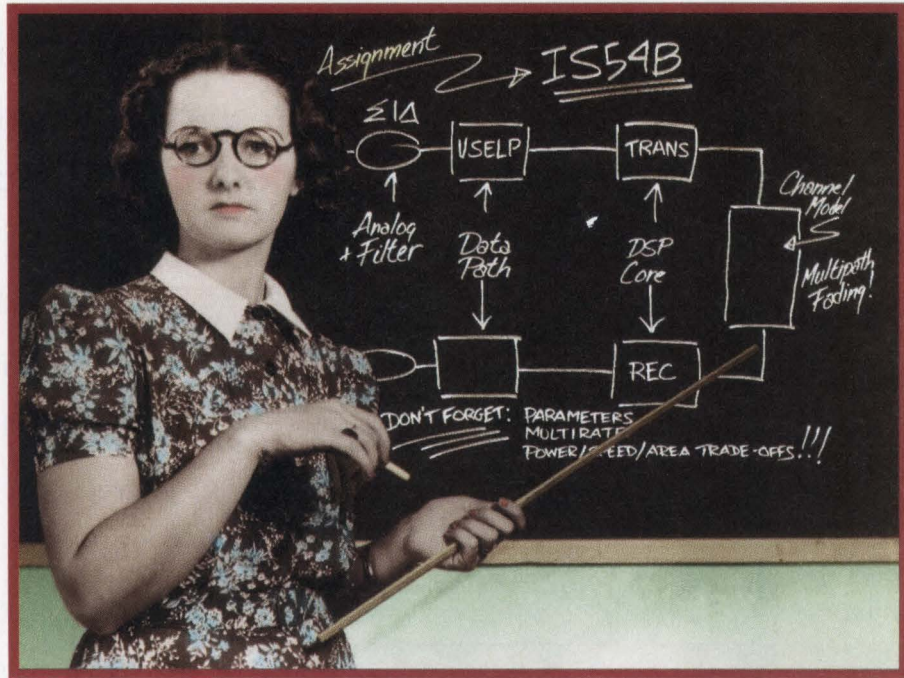

"Time's up. Please put your DSP design tools down NOW."

For DSP designers, the market is a strict disciplinarian. If you miss your schedule, you flunk. Perhaps permanently. But you can meet the test if you use *MENTOR GRAPHICS' DSP STATION*. Because unlike the competition, it gives you a fully integrated concept-to-silicon DSP design process. Plus the industry's only *TRUE ARCHITECTURAL SYNTHESIS* tools. A combination that not only enables what-if analysis, but also automates implementation including software/hardware co-design for embedded cores. As a result, the DSP Station design system can *TRIM YOUR DESIGN CYCLE 25 TO 30%* right away, so you can take your place at the head of the class. Call Mentor Graphics today at 1-800-547-3000 Dept. 326 or 1-503-685-8000 for more information.

"You may turn the page, now."

**Mentor
Graphics**

We mean business.



Make a note

We inadvertently neglected to include Lambda in our Special Report on distributed power (*EDN*, April 28, pg 54). You can contact the Melville, NY, company at (516) 694-4200. Or **Circle No. 357**.

It was also Lambda, not Calnex, that should have gotten the credit for the thermogram that ran on pg 56; we've reprinted the photograph here.

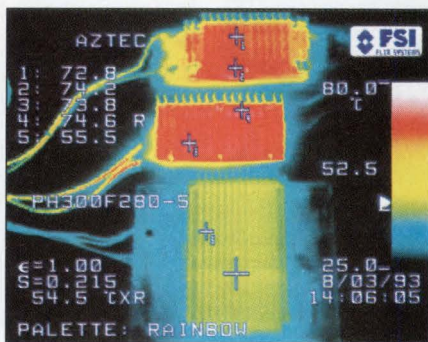

Debugging debate

I read your article titled "Teaming a logic analyzer with a debugger provides advantages to both tools" (*EDN*, January 20, pg 21). Excellent discussion.

I've spent about eight of my 12 years interested in embedded-system development tools. I've written and hacked around with ROM monitors for x86, 680x0, AMD29K, and MIPS. And I've written a full source-level debugger (COFF-based) for the same processor families. I've also built some trivial x86-based hardware that integrates some basic logic-analyzer stuff with the monitor for firmware debugging (address/data comparators, etc), and I've found that to be very useful.

I most definitely agree with you that the logic-analyzer/debugger combination is an extremely effective development environment. As a matter of fact, referring to the "Looking ahead" box in your article, my debugger has the "dashed line from the logic analyzer to the workstation." This feature isn't needed every day, but when there's a tough bug lurking, it is definitely a priceless capability. This can actually be a simple interface if it can be assumed that the logic analyzer can dump its trace data in some columnar format.

One of the nice things about the logic-analyzer/debugger combination is that the logic analyzer is not a piece of equipment that needs to be purchased solely for the person writing the drivers or really low-level firmware. It was probably already purchased for the hardware-design group and has been used for a lot more than just setting complex breakpoints. My point is that if the debugger "knows" a little about the logic analyzer, then there is no need for

an emulator; hence, no need to put out the extra money (which is not trivial). Emulators don't come cheap, especially for the high-speed stuff.

I see only two real deficiencies in the logic-analyzer/debugger approach. As you mentioned in your "Cons" list, the logic analyzer is helpless when it comes to the CPU's cache, and, along those lines, it can also be a bit confusing to deal with any kind of bus-unit prefetch (even without cache). In the case of cache, instruction/data access can occur without the logic analyzer's knowing it, and, in the case of prefetch, instructions can be fetched (seen by the logic analyzer) but not executed.

If you have a decent ROM monitor, then some of the cons mentioned can also disappear. If the trigger of the logic analyzer is tied into the same interrupt as the ROM monitor's UART, then it can look just like a breakpoint. Also, with a decent analyzer/debugger interface, you can debug at the high-level-language level.

This leaves me with two questions, and I'll follow them with the only answers I can think of.

1. Why aren't more CPU manufacturers providing a debuggable processor? All that is really needed is the equivalent of the "watch trap" on the MIPS R4000—the ability to set a data breakpoint. What is so difficult about that? I know the 386 has one, but why hasn't it become a generic feature like the breakpoint trap? I've always assumed that it must be cost, but I would also think that a feature like that could swing a potential customer from one CPU to another. I don't get it.
2. How can so many emulator companies stay in business? About the only

Get SMART[™]

REGULATORS

Enable...Reset...Watchdog

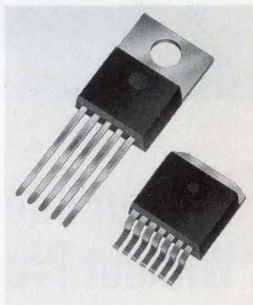

Cherry Semiconductor SMART Regulators, give you clean, tightly-regulated supply lines, sophisticated micro-processor monitoring & control, and energy conservation capabilities all in one IC! Available in a range of efficient power packages, simply select the best combination of logic functions for your application:

- **Get ENABLE** to control your system actuators as needed.
- **Get RESET** for your micro-processor during low voltage conditions.
- **Get WATCHDOG** protection against microprocessor misexecutions.

Call 1-800-272-3601 for your FREE Smart Regulator[™] Selection Guide!

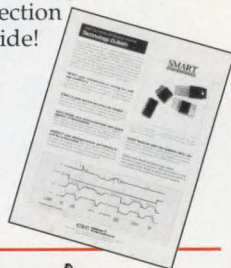

CHERRY SEMICONDUCTOR

Cherry Semiconductor Corporation
2000 South County Trail, East Greenwich, RI
401 885-3600

CIRCLE NO. 37

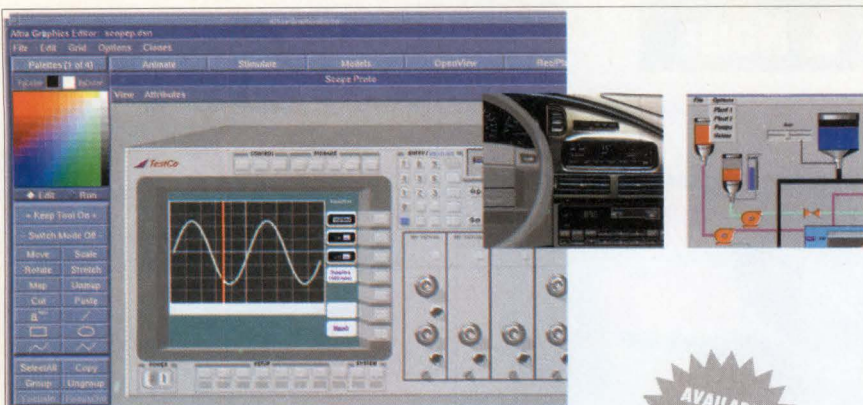

Human Interface Design... Without Programming

If you can use an interactive graphics editor, you can *design, animate and test* your product's human interface with Altia® Design - without programming!

And that's not all. With Altia Design you can *connect your interface to your own software or hardware*. Turn your prototype into a deliverable product - without delay.

From consumer electronics, to medical equipment, to manufacturing control, to simulation visualization, Altia Design means you *get better products to market faster*.

Available on Sun, HP and Windows.

For information or FREE DEMO SOFTWARE call 1-800-653-9957

AVAILABLE
ON UNIX
AND
WINDOWS



5030 Corporate Plaza Dr. #200
Colorado Springs, CO 80919
Tel: 719-598-4299
Fax: 719-598-4392

CIRCLE NO. 97

Free IEC 555-2

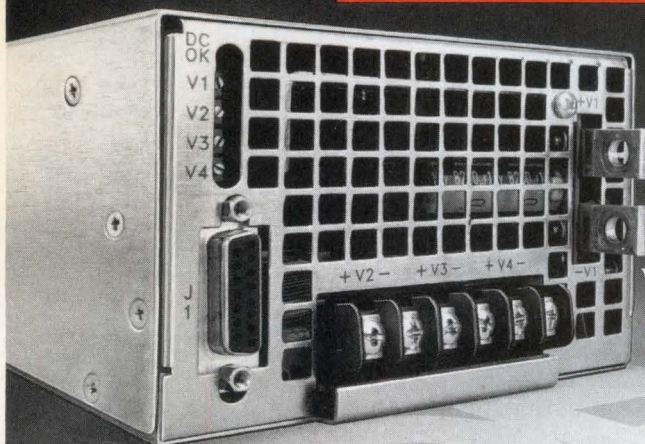

3.29TH, 600W
PFC Power Supply

With every PFC
power supply,
including:

- Compliance: 0.995 power factor correction and low line distortion
- Selection: From 600-3000W; 1 to 5 outputs; 2-48VDC
- Current: To 600A; output sharing
- Flexibility: 90-264VAC input at full rated power
- Economy: Use existing utility service; 1 & 3 phase operation
- Convenience: Many logic signals - e.g., DC OK and remote inhibit
- Safety: UL, CSA, IEC, TUV and VDE

To find out more, call or fax Jeta today.

JETA
POWER SYSTEMS, INC.

2675 Junipero Avenue • Signal Hill, CA 90806 • 310-427-0095 • Fax: 310-426-2417

advantage an emulator gives a firmware developer that a logic analyzer has trouble with is the fact that the logic analyzer is "external" to the processor; hence, it can't handle internally cached memory accesses. But based on the added cost, that doesn't justify the need for an emulator anyway. Usually, you can disable cache in some way to allow the logic analyzer to do its thing. My only conclusion here is that the hardware is not designed with debugging in mind. Some very simple up-front work can usually save a lot of debugging time down the road. As a result, when the time comes to put on some firmware, somebody has to dish out some big bucks.

My conclusion is that there really isn't much consideration for debugging at the hardware-design stage. Even if the addition of a debug UART and some RAM is out of the question for the actual production version of the hardware, facilities for a debug daughterboard can easily be justified in most cases. Then, depending on the energy level of the designer, the debug daughterboard can even eliminate the need for the logic analyzer in many cases. For a minimal cost (especially when compared to the price of an emulator or a logic analyzer), you can add real-time trace, multiple-state breakpointing, convenient logic analyzer connections (if still necessary), high-speed download, etc—the works!

Ed Sutter
AT&T Bell Labs

More to know about ATM...

The article in *EDN's* March 3 issue (pg 66) on the ATM convergence-sublayer and physical-interface devices was excellent. We are very excited about these products because they provide a complete, intelligent ATM termination when coupled to our ATMizer Architecture. The author of the article, however, was unaware of our ATM offerings.

The ATMizer is the first reprogrammable ATM cell-processing architecture. The heart of the architecture is an on-chip RISC-based ATM-processing unit, which allows customers to quickly and easily update their products as the

Local service through 77 US offices
One toll-free number for all offices

Instantaneous electronic order processing

Immediate access to over \$200 million in inventory

One-stop shopping for all electronics needs

Assistance finding parts not in our catalog

Customer satisfaction

Same day shipments

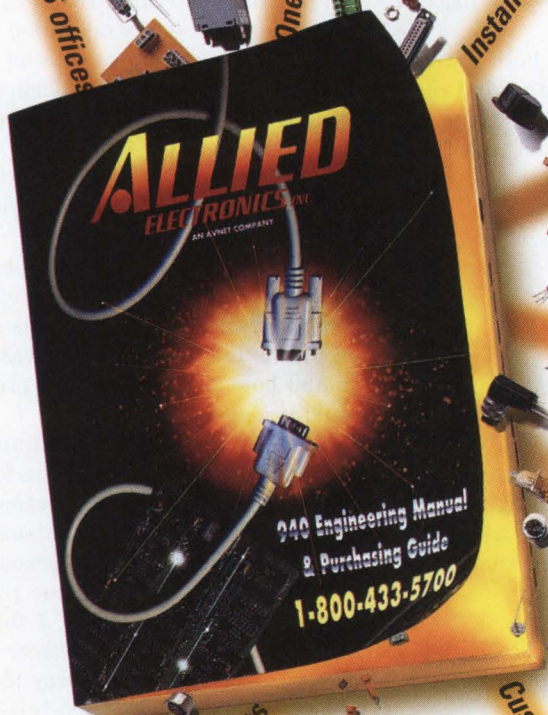

Money Can't Buy Everything That Comes With Our Catalog!

Some catalog distributors take pride in the thickness of their book. For others, if the part you need isn't in their catalog, you're out of luck. And if you'd like to drop in on your service rep one day, you might have to travel across the country.

ALLIED IS DIFFERENT.

We've been a catalog electronics distributor long enough to know that some of the most valuable things we offer aren't for sale.

You can't pay for that helpful voice at the other end of our toll-free number. And because of our 77 local service offices across the country, that voice may very well be right down the street from you.

What's it worth when you can't find that one critical part that's holding up your design? Or maybe a machine has gone down

and you need a part right away to fix it. Chances are it's in our catalog. But if it isn't, don't worry. We search until we find what you need. With immediate, on-line access to over \$200 million of inventory, we can have it on your desk the next morning.

In the end, it doesn't matter what our special brand of personalized service is worth. What matters to us is your satisfaction. That's simply our way of doing business better.

Let us show you the Allied brand of customer service. Call today for your free catalog. It's priceless.

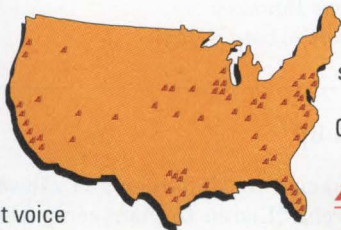

ALLIED ELECTRONICS INC.
AN AVNET COMPANY

Going by the book...And beyond!

1-800-433-5700

ATM standard evolves. Users simply download new code to accommodate changes in the ATM standard or congestion-control algorithms. The ATMizer performs segmentation and re-assembly and all layer operations up to 155 Mbps. It supports all ATM adaption layers and can process up to 64,000 virtual channels of voice, data, and video simultaneously.

The ATMizer Architecture is available as a single chip or as an ASIC architecture to complement products mentioned in *EDN's* article. In addition, this flexibility and performance is being used to address the open issues raised in the Special Report, including congestion control, LAN emulation, and traffic management.

Tony Stelliga
Vice President
Telecom Products Div
LSI Logic
Milpitas, CA

...and more

EDN has received some updated information for the ATM Special Report (March 3, pg 66). The correct phone number for AMCC is (800) 935-2622. Also, if you want to contact the ATM Forum, the company reports that it has moved to new quarters in Foster City, CA; phone (415) 578-6860.

Cooling hot μ Ps

We believe your coverage of the hot microprocessor problem ("Cooling hot microprocessors," *EDN*, January 20, pg 40 and "Shrinking devices put the squeeze on system packaging," *EDN*, February 17, pg 41) has shortchanged your readers in two areas. Among the fastest-growing techniques for cooling board-mounted processors and other hot devices is the use of low-profile, tape-mounted heat sinks and extremely compressible thermal-gap-filling materials.

The world's leading supplier of double-sided thermal tapes and thermal gap fillers is Chomerics Inc (Woburn, MA). In both thermal and adhesion properties, our Thermattach tapes have set the performance standards in PC markets worldwide. A unique, sta-

ble, thermally conductive, pressure-sensitive adhesive (PSA) makes them suitable for even high-temperature applications—where traditional acrylic PSAs have a tendency to lose their grip.

In thermal gap fillers, we believe our Cho-Therm T274 and A274 materials are the only commercially available, easy-handling alternatives to bags of fluorocarbon liquid.

In general, we found both articles well-written and informative, but their exclusion of references to Chomerics' thermal interface products left us somewhat overheated.

Robert A Rothenberg
Director of Market Development
Chomerics Inc
Woburn, MA

New number

ATI Technologies Inc, which was discussed in the article entitled "New chips give PCs TV-quality video" (*EDN*, March 31, pg 42), has a new telephone number. Contact the company at (905) 882-2600.

Call a different number

We appreciate the reference to our Video Integration Processor and our OEM customers, S3 and Xtec. We are great IBM chip designers, but alas, we are not part of IBM Microelectronics. We are part of IBM's Networking Hardware Div in Research Triangle Park, NC. Your readers will want to call a different number from the one listed in your manufacturers' listing to get information on the processor, which is offered as an OEM product. Readers can call (919) 543-7976.

George M Henke
Program Manager
IBM Networking Systems

Listen up

In response to Mr Green's (Unilever Research) "Listen to your computer" letter: We incorporated an audio monitor in our Texas Instruments seismic data processor (computer) in 1959. We drove a speaker from a signal counted

down from the AOC (Acquire anOther Command), the signal that initiated the next instruction fetch from memory.

We originally incorporated it to tell us when the computer had halted. How many times have you sat in from of that infernal machine, wondering if it were caught up in some endless loop, with no visible means of telling? In our case, we also had almost every operation blinking one or more lights, but the lights only told us *something* was happening. By having a predefined low-frequency tone generated, we could know if the machine had stalled. Also, if it did get into a loop, the constant, repeating sound would indicate a failure.

Our (and the customer's) operators soon got to know the sequence of tones generated in different portions of the programs and could tell what was going on and how long a particular program could be expected to continue.

Needless to say, but I will anyway, our smart-as-a-whip engineers found a way to make whimsy of this capability. During the 1964 Christmas season, I went back to the system-checkout area and heard Christmas music playing away. Upon investigating, I found it emanating from my computer. Those clever people had found a way to write programs that would exercise that sound monitor.

"Listening to your computer" is not as strange as it sounds. For what it's worth, and thanks for your column.

John Hargett
Agoura Hills, CA

Sound off

"Signals & Noise" lets you express your opinions on issues raised in the magazine's articles or on any engineering-related topic. Send letters to *EDN*, 275 Washington St, Newton, MA 02158; fax (617) 558-4470. Or use *EDN's* bulletin-board system at (617) 558-4241: From the Main System Menu, enter ss/soapbox, then W to write us a letter. You'll need a 2400-bps (or less) modem and a communications program set for 8,N,1. *EDN* reserves the right to edit letters for clarity and length.

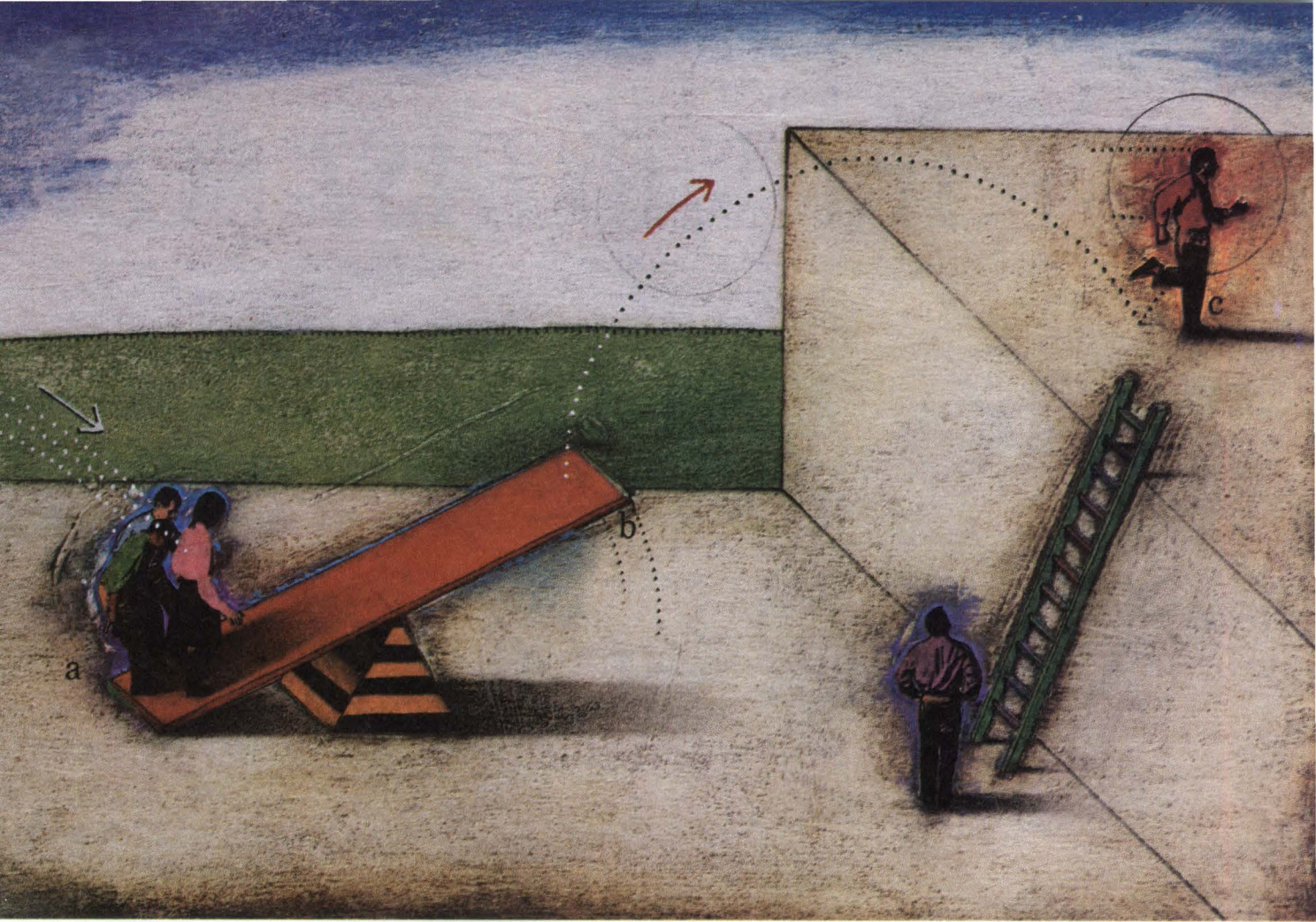

With the TMS320 Software Cooperative, it's easy to get a jump on your competition.

Now, beating your competition to market with a DSP-differentiated product isn't such a stretch. Just turn to the new TMS320 Software Cooperative. We've brought together information on more than 100 off-the-shelf, third-party-developed digital signal processing (DSP) algorithms for many of the applications you may be working on (or thinking about).

Once installed, these easy-to-use algorithms are C callable. And they help cut cycle time while allowing you



DSP Algorithms

- Speech Recognition
- MPEG Audio
- V.32 bis Modem
- V.17 Fax
- Text-to-Speech
- G.728 Speech Compression
- Run-Time Support Libraries
- And Many More

to differentiate your product instead of writing generic code for DSP functions. What's more, you'll deal directly with the third-party vendors who test, license and maintain the algorithms. Meaning you save time and product life-cycle costs.

To learn how you can get the jump on your competition and receive a FREE TMS320 Software Cooperative kit, which includes an index and data sheets on the algorithms, simply call **1-800-477-8924, ext. 3552.**

EXTENDING YOUR REACH WITH TOTAL INTEGRATION™

 **TEXAS
INSTRUMENTS**



FAST Track to *FAST* SCSI

90's Challenges. The 90's demand higher levels of performance and faster delivery than ever. Time-to-market, technological demands, and changing user needs make fast, simple SCSI seem as elusive as the horizon. To stay ahead in these challenging times, you need products you can count on, with proven ability to deliver the quality and reliability your customers require.

90's Products. After over a decade of industry leadership, NCR is still working hard to meet your needs and the challenges of the 90's. The NCR 53C90 family of SCSI Controllers is constantly evolving, implementing and offering state-of-the-art products. For example, the NCR 53C90 family supports multiple bus architectures, advanced SCSI-2 commands, fast SCSI data transfers and provides our exclusive TolerANT[®] SCSI driver and receiver technology, for reliable data transfers in every SCSI system.

90's Solutions. The SCSI challenges of the 90's can't be solved with silicon alone. NCR quality and service provide you with the competitive edge that can make your industry leading designs a reality. Whether you require SCSI-1 or fast SCSI-2, in any system architecture, NCR has the product to meet your needs today. You can count on us to keep you on the fast track with the right technology, at the right price, at the right time for all your SCSI requirements.

The NCR 53C90 Family

*Proven Performance
for the 90's and
Beyond*

CIRCLE NO. 112



NCR SCSI: Real Products, Real Solutions, Real Fast!

SCSI	FAST SCSI*	<small>*NCR Fast SCSI devices transfer SCSI data at 10 MB/s synchronous or 7 MB/s asynchronous</small>
53C90A	53CF90A	<i>Single-bus architecture; SCSI sequences controlled by hardware state machine to minimize host intervention</i>
53C90B	53CF90B	<i>Adds pass-through parity for increased system reliability</i>
53C94	53CF94	<i>Adds split-bus architecture for more flexibility</i>
53C96	53CF96	<i>Adds support for differential transfers</i>

*For more information about
NCR SCSI products
and a free poster,
call 1-800-334-5454.*



Technological proof of innocence: Part 1

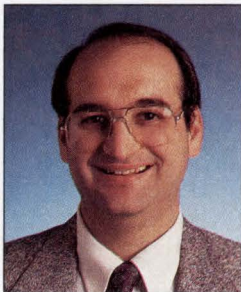

Life has certainly gotten more complicated since I moved to Massachusetts two and a half years ago. The fables about terrible Boston driving and parking don't tell half of the story. I've even received a parking ticket for parking in a place I've never been at 2 AM on February 27. Now I'm sure that my car and I were both safe, warm, asleep, and at home on that night, at that time.

On the designated day, I went to the town that issued the parking ticket and pleaded my case. Now, we're very efficient in Massachusetts. You don't appeal parking tickets in court; you go straight to the collector of fees, taxes, and fines. The person behind the desk listened to me, got up, looked on the computer, and assured me that it was indeed my car that was illegally parked.

I asked to see the ticket. Once again, the clerk got up, rummaged in a closet for 10 minutes and returned with the actual ticket. It was my license number on the ticket all right, if you ignored the unreadable third

character. However, the ticket identified the car as a brown Ford, and I drive a gold Toyota. "Aha," I said, "that's not my car!" The clerk replied, "Hey, you can't expect the officer to get everything right at 2 in the morning. That's your license-plate number. Pay up."

This experience prompted me to start thinking about the use of technology to prove innocence. Governments have plenty of technology for pressing guilt upon us. We could use some defense.

In the movie "Back to the Future," Doc Brown returns from the future in his time-traveling DeLorean with a bar-coded license plate. It seems to me that we ought to seriously consider adopting license plates that carry bar codes or other machine-readable identification in addition to human-readable numbers. Police could use scanners to read these plates at a distance with better accuracy than what I experienced from my brush with the parking patrol.

Steven H Leibson
Editor-in-Chief



Jesse H. Neal
Editorial Achievement Award
1990 Certificate, Best Editorial
1990 Certificate, Best Series
1987, 1981 (2), 1978 (2),
1977, 1976, 1975

American Society of
Business Press Editors Award
1991, 1990, 1988, 1983, 1981

*Note: This is the latest in a series of articles on C-Quad engineering. C-Quad (or C⁴) stands for the **convergence** of **computer**, **consumer**, and **communications** technologies.*

Send me your comments via fax at (617) 558-4470, or on the EDN Bulletin Board System at (617) 558-4241, 300/1200/2400 8,N,1. From the Main System Menu, enter ss/soapbox and select W to write us a letter.

Standard.



Introducing the 4Mbit Am29F040, The Newest Member Of The AMD® Flash Family.

Someone had to set the standard.

AMD did just that — establishing an industry standard by offering everything you need in the most reliable, most flexible Flash memory devices available. In fact, we've sold over 3 million Am29Fxxx devices already. And now AMD's 5.0 Volt-only, low-cost Flash family is available in 4Mbit densities.

The Am29Fxxx 5.0 Volt-only Flash design ends DC-to-DC conversion and

V_{pp} overshoot problems. In fact, the Am29Fxxx architecture is the JEDEC standard for pin-out and software for 5.0 Volt-only devices. Our *Embedded Program™* and *Embedded Erase™* algorithms make software implementation easy — forget erratic erase failures. Sector isolation ensures data integrity during write cycles. And sector protection guards specified code in applications.

What's more, the Am29F040 is the

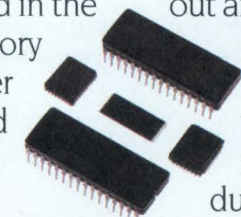

The Am29Fxxx Flash devices, available in 1Mbit and 4Mbit densities and in all industry-standard packages.

Poor.

Anything Less

most reliable Flash device available. We don't just promise 100,000 write-cycle endurance. We guarantee it. And we're the *only* one in the industry who does. Now that's a safe buy.

Flexibility is there, too. Densities to 4Mbits and 70ns access times make them perfect for today's, and tomorrow's applications. Eight-uniform-sectors adapt easily to both boot code and broad-base applications. Industry-standard packaging lets you use existing production equipment. And they're priced to compete with dual-voltage devices, so you'll standardize on AMD Flash.

Call now for details on the industry standard AMD Am29Fxxx and the new 4Mbit Am29F040. Because you just can't afford to invest in non-standard technology.

800-222-9323



Ask for
Literature
Pack 18X.



Advanced Micro Devices

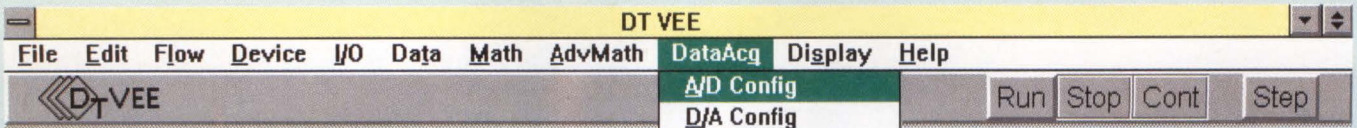

Fred Molinari,
President

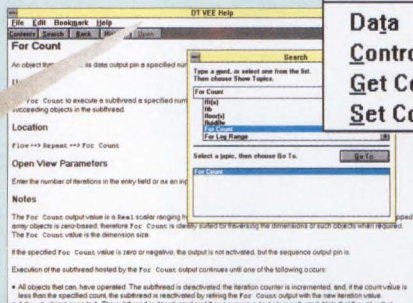

True Windows environment, including online Help, dialog boxes, DDE, and DLL support.

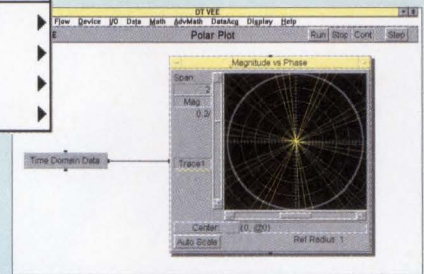

Intelligent objects accept any connection from another object or any data type; objects are self-labeled for quick identification.

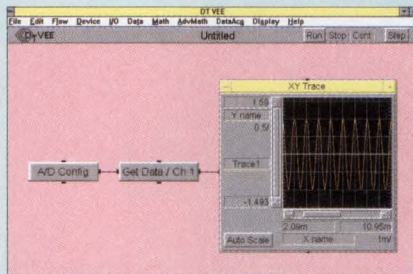

Powerful, high-level objects speed application development. Single window operation displays your program as you develop or run it.

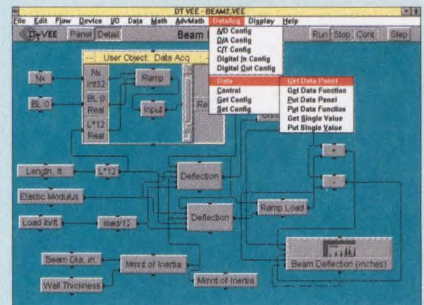

Create your own user objects. Automatic wiring makes connections foolproof.

Cut Your Development Time with DT VEE

DT VEE™ for Windows™ is a complete visual programming language for data acquisition that increases your productivity by speeding your application development.

With DT VEE, you easily create, debug, document, run, and maintain powerful applications. Its high-level objects represent logical constructs that acquire, process, display, and share data. Program development is intuitive—connect objects in a logical sequence, and run. It's that easy.

Change a program dynamically—add, replace, or delete objects on-the-fly. Create your own user objects—combine DLLs, other DT VEE objects, or your own tried-and-true algorithms. DT VEE's powerful objects let you reuse your code from application to application—pure productivity.

DT VEE's functionality is extensive. From a simple if/then/else loop to more complex mathematical processing to detailed displays, DT VEE has everything you need. DT VEE is based on HP VEE for Windows™, and is backed by the Hewlett-Packard and Data Translation commitment to quality.

FREE DEMO DISK

Call today for a
FREE demo disk
and more
information on
DT VEE
1-800-525-8528

DATA TRANSLATION®

World Headquarters: (508) 481-3700, UK Headquarters: (0734) 793838, Germany Headquarters: (07142) 95 31-0, Italy Headquarters: (030) 2425696. Sales Offices: Argentina (541) 322-3791; Australia 2699-8300; Austria (222) 367660; Belgium (02) 466.81.99; Brazil 011-564-6024; Canada (508) 481-3700, (800) 525-8528, (800) 268-0427; China 86-1-841-9884; Denmark (45) 42 27 45 11; Finland (0) 3511800; France (1) 69.07.78.02 or 69.07.92.12; Greece (1) 361-4300; Hong Kong (852) 515-0018; India 91-22-2831040; Israel 09-545685 or 09-581860; Japan: Tokyo (03) 5689-8000 or (03) 5379-1971; Osaka (06) 391-8511; Nagoya (052) 561-1595; Tsukuba (0298) 52-8521; Korea (2) 718-9521; Malaysia (3) 248-6786; Mexico 575-6091, 575-6099; Netherlands (70) 399-6360; New Zealand (9) 415-5362; Norway (22) 43 41 50; Portugal (1) 7934834, (1) 7934934; Singapore 773 4300; South Africa (12) 803-7680/93; Spain (1) 555-8112; Sweden 08-765 02 80; Switzerland (1) 908-1360; Taiwan (2) 3039836; Thailand (02) 281-9596, (02) 282-4834, (02) 282-4797; Turkey (212) 288-6213/15, (212) 274 9097

3/15/94

System simulation embraces real-time control prototyping

BRIAN KERRIDGE, Senior Technical Editor

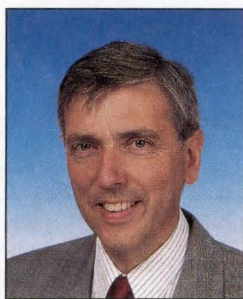

Today's control-system simulators employ graphical modeling tools, automatic coding, and DSP "hardware-in-the-loop" simulation to narrow the gap between conceptual design and product reality.

System simulation is an important design activity in control-engineering applications. But, while most simulation products focus on conceptual issues, relatively few readily assist you in implementing a design. The few products that do support implementation incorporate direct links to development hardware and, overall, form integrated rapid-prototyping systems.

The key feature of rapid-prototyping systems is fast transfer of a slow-motion "off-line" simulation running on a PC or workstation, to a "real-time" simulation running on dedicated DSP hardware. These simulators rely heavily on block diagrams for model building and automatic coding for generating source code, usually in C. These two features alone are instrumental in achieving rapid prototyping and, in consequence, enable a low-cost route to design iteration—an unavoidable feature of control-engineering developments. In practice, automatic coding takes only a few seconds, and, for a system that's already initialized, you can complete one design iteration in a matter of minutes. Fig 1 outlines the design-flow path of a typical rapid-prototyping system.

Simulating real-time control systems requires that you model not only a controller's functions, but also the dynamics of the plant you want to control. Such a system offers you the rapid-prototyping options of a simulated controller driving a real plant, an embedded real-time controller driving a

simulated plant, or a mixture of the two. Fig 2 illustrates these options.

No matter which option you choose, rapid-prototyping systems offer substantial timesaving benefits—from concept to reality—and other important benefits. Simulator vendors cite examples of 50% cuts and more in project time (see **box**, "Rapid prototyping shortens DC-X space-vehicle development").

As a prelude to adopting one of the prototyping options, it's useful first to transfer

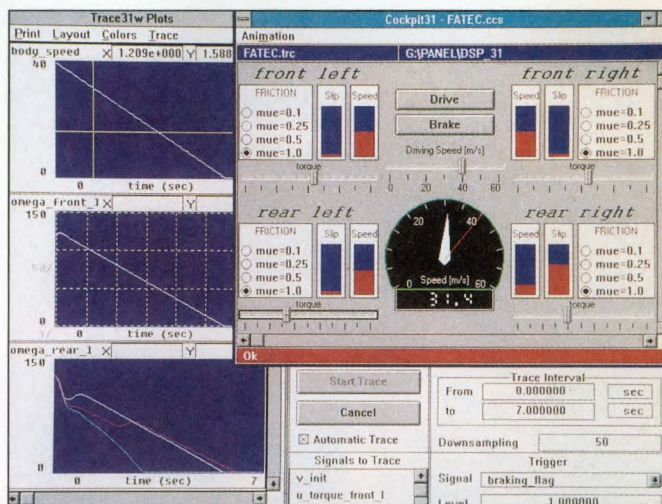

dSpace's MS-Windows Trace and Cockpit software allow you to gather and analyze data and adjust control parameters while running a real-time simulation. This example shows a vehicle antilock-braking-system simulation in progress.

an off-line simulation of the controller and the plant to a DSP test bed. This step moves the application closer to reality and allows you a first opportunity to examine critical timing in your overall control strategy. For example, at this stage, sampling-time parameters you build into your models may force elements of the simulation to require service in synchronism with the system

If you've got a head for VIDEO,

Push the limits of video technology with our full family of affordable ICs.

Get a head start on those hot new video products.



Choose Raytheon Semiconductor. We've combined the video technology and innovation that earned TRW an Emmy with Raytheon Semiconductor's own video design expertise and manufacturing capacity. That means no compromises between leading-edge performance and true affordability.

With highly-integrated analog and digital circuitry, you get a complete solution for all your video needs.

With just one call, you're set. Because for all of today's exciting applications, our full and growing family of video ICs gives you better designs at a lower cost.



have we got a line FOR YOU

PART	PRODUCT	DESC.	FEATURES
TMC 22071 Genlocking video digitizer	NTSC/ PAL	8 bit	10 to 15 MSPS/ sec
TMC 22x5x Digital video decoders	3-line comb filter	8 and 10 bits	10 to 18 Mhz
TMC 22080 Digital video mixer	RGB/ Y _C B _C R/ CI	9 bit Alpha channel	36 Mhz
TMC 22x9x Digital video encoders	NTSC/ PAL	10 bit	10 to 18 Mhz

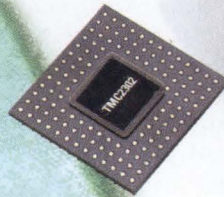

Your design partner for broadcast, video communication, desktop video, imaging and display ICs.

At every step of your design, we'll be there with our video experience and innovation. We'll even customize ICs to meet your exact need.



Call now and learn more about our advanced family of video products.

To make amazing headway in video, simply call 1-800-722-7074.

Raytheon

Raytheon Semiconductor Division

CIRCLE NO. 87

REAL-TIME SYSTEM SIMULATION

clock. Failure to meet model sampling times means your DSP test bed ceases to represent a real-time model and implies your system needs more DSP power.

In practice, monitoring software forewarns you of a system crash and, even before attempting a real-time simulation run, indicates when a system cannot execute in the sampling times you specify. Increasing system power is simply a matter of installing more DSP hardware, and all systems include multiprocessing expansion for this purpose.

Specifying model sampling times in relation to real-system response times requires modeling experience and lets you trade off modeling integrity and complexity with DSP power. For example, it would be overkill to specify a 10-msec sampling time for a model of a valve that takes several minutes to change state. On the other hand, a 10-msec sampling time is grossly inadequate for a crankshaft-sensor output on a high-performance auto engine.

DSP emulates control or plant

Of the main prototyping options, using a DSP test bed to emulate only a controller and its I/O functions is a fast route to proving a control concept and refining control parameters. However, using DSP to emulate a plant, or "hardware-in-the-loop" simulation, offers major development-time reductions.

Overall, the arrangement allows you to test the validity of controller electronics well in advance of the availability of the live plant. This feature is significant because most control-engineering applications accommodate the vagaries of a real-world environ-

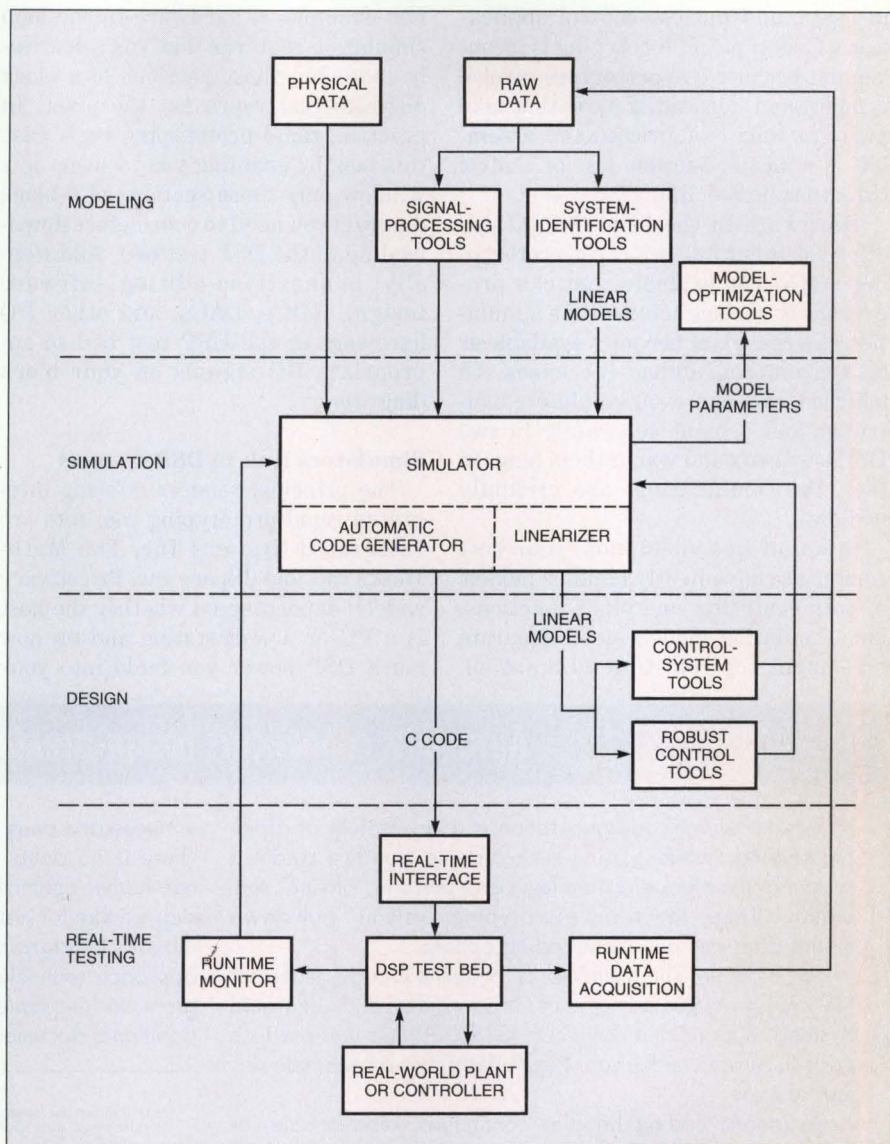

Fig 1—Rapid prototyping systems form an integrated environment for modeling, simulation, design, and real-time testing. (Courtesy dSpace Inc)

ment, thus increasing the likelihood of design flaws appearing late in a development cycle.

In addition, performing live-plant prototyping at the outset is often inconvenient and unsafe, as in automotive,

LOOKING AHEAD

MS-Windows is increasingly the preferred design-tool environment for engineering applications, yet Integrated Systems' Matrix_x remains for the time being a workstation-only product. The company is planning to add a multiprocessing TMS320C40 card to its RealSim low-cost PC test-bed product line. Additionally, Integrated Systems and Mentor Graphics will soon support links between Matrix_x and Mentor's System Design Station/QuickSim2 simulator. This combination will

allow you to cosimulate a system using the RealSim DSP test bed to simulate a plant and QuickSim2 to emulate control. QuickSim's VHDL model outputs will provide a fast route to custom-built controller chip sets.

The MathWorks plans further graphical-user-interface enhancements to some of its toolbox options, including its system-identification tool, as part of a general effort to attract engineers, as well as academics, to use these products.

REAL-TIME SYSTEM SIMULATION

in-flight, and nuclear-control applications. This type of prototyping is inconvenient because live prototypes involve complex and substantial parts that take many months to fabricate and assemble. It's unsafe because loss of control threatens human life.

Hardware-in-the-loop simulations offer you other interim rapid-prototyping steps. For example, you can progressively replace sections of a simulation as a real plant becomes available or as system confidence increases. In addition, you can even emulate a controller and a plant separately in two DSP test beds and watch them play. In fact, the combinations are virtually endless.

In an off-line simulation, your host computer conveniently handles models of both controller and plant functions, but simulation models need separate treatment for real-time simulation.

For example, a hardware-in-the-loop simulation requires that you selectively code only those sections of a block diagram that represent the plant. In practice, rapid-prototyping tools ease this task by enabling you to select in a window only those sections of a block diagram you need to code before downloading to the DSP test bed. Additionally, connections-editing software assigns ADCs, DACs, and other I/O hardware in the DSP test bed to appropriate I/O signals on your block diagram.

Simulators link to DSP systems

The principal vendors offering integrated rapid-prototyping tool sets are Integrated Systems Inc, The MathWorks Inc, and dSpace Inc. Prices vary widely, depending on whether the host is a PC or a workstation and on how much DSP power you build into your

test bed. Typically, though, expect to pay \$15,000 for a very basic setup to more than \$50,000 for a "power-user" setup. Automatic coding software adds \$10,000 or more to these prices (see **box**, "Automatic coding cuts design-iteration time").

Integrated Systems' Matrix_x modeling, simulation, analysis, and code-generation tools run on Sparc and VAX workstations and combine with the company's RealSim series of real-time hardware test beds. In addition, Matrix_x requires runtime software that includes a graphical user interface, cross compilers, device drivers, and an Ethernet interface. RealSim comes in a range of configurations from a 486-based portable PC with a single TMS320C30 processor card to a high-end Multibus chassis that accommodates one to 11 i860s. A wide range of I/O options includes ADCs, DACs,

AUTOMATIC CODING CUTS DESIGN-ITERATION TIME

Automatic source-code generation is a key feature of rapid-prototyping systems. Using such systems, you first create a system at the block-diagram level and perform "off-line" simulation. Then, the rapid-prototyping systems' pull-down menus offer you automatic-coding options.

For example, The MathWorks' Simulink C-code generator (\$9995) gives you a choice of C-code styles, and Integrated Systems' SystemBuild Autocode (\$15,000) lets you produce code in Ada, C, or Fortran. **Fig A (b)** shows an example section of code.

Automatic coding handles continuous, discrete-time, or hybrid-control systems. Coders also embody a task scheduler to prioritize separate operations in multirate systems, for example, acting on sensor inputs before less-frequent user inputs.

Vendors maintain that automatic coding produces code optimized for speed in real-time operation. For example, the coder unrolls loops, minimizes functions calls, and removes

unnecessary ones and zeros from numeric computations. There is no doubt that experienced real-time programmers can further optimize code for target processors, but vendors suggest that for most applications you modify your system at the block-diagram level and recompile automatically. This approach routinely maintains the status of your block diagram and implementation at a current level and eliminates additional documentation-control work.

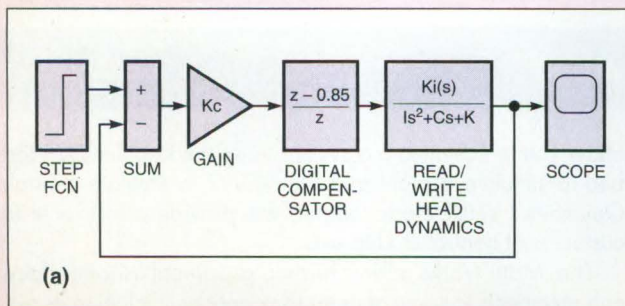

```

/* Function to compute block outputs */
static void simBlockOutputs (x, u, S)
double *x;
double *u;
SimStruct *S;
{
    double *B = ssGetBlockIO (S); /*Block inputs and outputs */
    double *P = ssGetBlockParam (S); /* Block parameters */

    /* Step input: Step Fcn */
    if (ssGetT(S) < P[0])
        B[0] = P[1];
    else
        B[0] = P[2];

    /* Transfer function: Read/Write Head Dynamics */
    B[1] = x[1];

    /* Summing junction: Sum */
    B[2] = B[0] - B[1];

    /* Gain block: Gain (Kc) */
    B[3] = P[5] * B[2];

#ifdef SINGLE_RATE
    if (ssGetSampleHitEvent(S, 0)) /* Is it a sample hit? */
    #endif
    {
        /* Transfer function: Digital Compensator */
        B[4] = P[6] * x[2] + B[3];
    }
}
    
```

Fig A—The block diagram (a) represents a disk-drive head and controller, modeled using The MathWorks' Simulink library functions. The C-code-generation tool transforms the block diagram to the source-code listing (b), which is comprehensible and well-commented.

The Winning Hand



IDT's QSOP... Your Ace In The Hole!

IDT adds the Quarter-Size Outline Package (QSOP) to complete its winning hand of surface-mount packages for its high-speed FCT Logic family. With products available in TSSOP, QSOP, SSOP, and standard SOIC packages, IDT now offers the industry's widest line of high-density packaging for both Octal and Double-Density logic.

Dramatic Space Savings!

At half the length and width of industry standard SOIC packages, the new QSOP package is the most compact Octal package available. In addition to the area savings, the new package is only 0.0645 inches high, making it ideal for low profile applications.

The Fastest 5V and 3.3V Logic

IDT's Logic family is the highest performing, lowest power bus interface solution. Available in a wide variety of 5V and 3.3V functions, and speed grades from 6.5ns to 3.2ns (t_{pd} max), IDT's FCT Logic family supports all levels of performance at competitive prices.

Quiet, Low-noise Outputs

IDT's FCT Logic is offered in a variety of low-noise output drive configurations to minimize ground bounce and to match

specific design requirements.

Output configurations include: standard TTL-compatible high drive and very low-noise balanced drive with source terminating resistors.

Call Today!

Call or FAX IDT today and receive a QSOP cross reference guide, sample package card, Logic Design Guide and Logic Data Book. Add IDT's Logic to your hand—you'll be the winner!

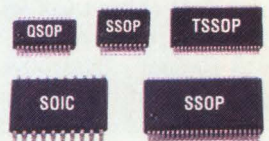

Actual Size

Compact IDT FCT Logic Packaging

Package	Ordering Code	Pin-Pitch (mm)	Area (mm ²)	Length (mm)	Width (mm)	Height (mm)
QSOP 20-pin	Q	0.635	52.1	8.7	3.9	1.6
SSOP 20-pin	PY	0.650	56.0	7.2	5.3	1.9
SOIC 20-pin	SO	1.270	133.1	12.8	7.5	2.5
TSSOP 48-pin	PA	0.500	102.1	12.6	6.2	1.1
SSOP 48-pin	PV	0.635	164.4	15.9	7.5	2.6

(800) 345-7015 • FAX: 408-492-8674

ASK FOR KIT CODE 3151

CIRCLE NO. 75



**Integrated Device
Technology, Inc.**

REAL-TIME SYSTEM SIMULATION

and digital and resolver-synchronous I/O. The product range also includes the DocumentIt software package, which automatically produces a textual description of a system, including tables, hierarchies, and subsystem lists.

The MathWorks does not produce a real-time test bed for its Matlab analysis and Simulink simulation software, but the company supports hardware from dSpace Inc. dSpace offers a wide range of PC plug-in DSP, memory, and I/O cards. Using these cards, you can site your DSP hardware within your PC host computer if it has enough expansion slots. For workstation and already-full PC hosts, the company offers Ethernet-linked, 6- and 20-slot expansion boxes and a de-powered 7-slot ruggedized version for field use.

dSpace's DSP cards include single-processor TMS320C30 and TMS320C40 models and a 4-processor TMS320C40 version. The company also provides essential software to process source

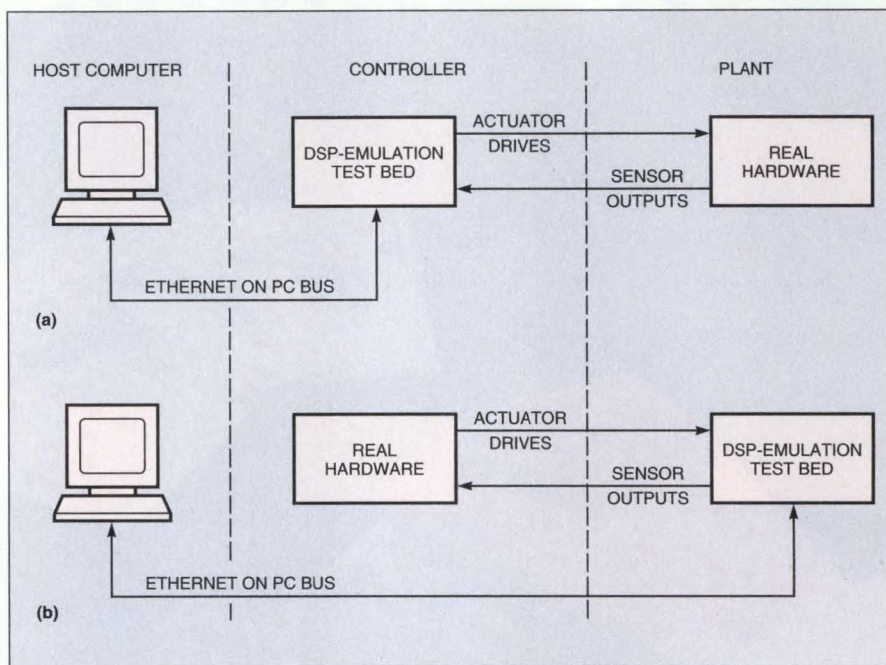

Fig 2—Real-time simulation offers you two main options: (a) using DSP hardware to mimic an embedded controller that interfaces with actuators and sensors in a real plant situation and (b) using DSP hardware to simulate the dynamics and I/O signals of a plant connected to a real embedded controller, known as "hardware-in-the-loop" simulation.

RAPID PROTOTYPING SHORTENS DC-X SPACE-VEHICLE DEVELOPMENT

Using Integrated Systems' Matrix_x rapid-prototyping tools, McDonnell Douglas Aerospace engineers developed flight-control software for the Delta Clipper Experimental (DC-X) space vehicle in 10 months. McDonnell Douglas engineers estimate that the cost of developing software using rapid prototyping is less than 50% lower than using conventional hand-coding. These productivity gains reflect similar reductions in overall project-development time down to less than two years, enabling first-flight trials last August.

The DC-X, a reusable, relatively low-cost, fast-turnaround vehicle, is the forerunner of next-generation satellite launchers. Vertical landing and take-off of the DC-X launcher pioneers new concepts in space-vehicle flight dynamics, requiring equally innovative control algorithms. Particularly demanding is the independent control of four rocket engines on gimbals that maneuver the launcher.

McDonnell Douglas designers used Matrix_x tools to develop around 30,000 lines of Ada code for the flight- and navigation-control algorithms. In addition to Matrix_x's core SystemBuild model-

ing and simulation tool, the company's designers used Interactive Animation, Autocode, and the RealSim test bed for real-time simulation.

Using SystemBuild, designers modeled the DC-X's flight behavior and control functions. After refining performance in off-line simulation runs, designers used Autocode to generate code for real-time testing. The Autocode feature generated separate code representing flight behavior and controller functions. Flight-behavior code was targeted to a RealSim test bed, and controller code was targeted to the real-world DC-X in-flight computer. Running RealSim and the in-flight computer as a closed-loop environment in real time demonstrated the performance of the overall control strategy far in advance of firing up real rocket engines.

Using automatic coding to produce 30,000 lines of Ada code, McDonnell Douglas achieved a 2-year concept-to-launch time with the DC-X space vehicle.



SONY

INTRODUCING THE GREAT SONY CACHE ADVANCE.

Now for the first time, high-speed data RAM, tag RAM and control logic — a complete, integrated cache subsystem — on a single chip.

Think of it as pure gold — cache-in-the-bank.

Sony Cache is based on our new Memory-intensive ASIC, or MASIC™ technology. With it, we can quickly turn new cache chips for the latest processors and keep memory from becoming a system bottleneck.

The first two 256KB Sony Cache chips (CXK784862Q-33/50) are available now for 486SX/DX/DX2 processors and a wide variety of chip sets. They deliver unheard-of performance for mobile PCs, yet take only about one-quarter the power and space of the modules they replace.

Call 1-800-336-SONY for your cache advance.

Sony. We make the chips. You make the history.

© 1994 Sony Electronics Inc. Reproduction in whole or in part without written permission is prohibited. All rights reserved. Sony and MASIC are trademarks of Sony.

CIRCLE NO. 16

FOR FREE INFORMATION...

For free information on the system-simulation products discussed in this article and other simulators that generate code, circle the appropriate numbers on the postage-paid Information Retrieval Service card or use EDN's Express Request service. When you contact any of the following manufacturers directly, please let them know you read about their products in EDN.

dSpace Inc
Southfield, MI
(313) 354-1694
Circle No. 358

Hyperception Inc
Dallas, TX
(214) 343-8525
Circle No. 359

Integrated Systems Inc
Santa Clara, CA
(408) 980-1500
Circle No. 360

i-Logix Inc
Andover, MA
(508) 682-2100
Circle No. 361

**McDonnell Douglas
Aerospace**
Huntington Beach, CA
(714) 896-6211
Circle No. 362

Mentor Graphics
Wilsonville, OR
(503) 685-7000
Circle No. 363

SES
(Austin, TX)
(512) 328-5544
Circle No. 364

The MathWorks Inc
Natick, MA
(508) 653-1415
Circle No. 365

VI Corp
Northampton, MA
(413) 586-4144
Circle No. 366

Visual Solutions
Westford, MA
(508) 392-0100
Circle No. 367

Super Circle Number

For more information on system-simulation products available from all of the vendors listed in this box, you need only circle one number on the postage-paid reader service card.

Circle No. 368

code from Simulink's code generator. This software includes a real-time interface, a C compiler, the Trace data-acquisition tool, and the Cockpit graphical instrument panel. Trace and Cockpit are essential to maintaining graphical contact with any real-time simulation.

Trace allows real-time analysis of any controller and provides hardware-in-the-loop simulation without disturbing system operation. The tool also allows you to record and continuously plot variables in the DSP processor's on- and off-chip memory. In practice, you can later analyze Trace records using Matlab and compare data with results from off-line simulation as a means of enhancing your models.

Cockpit allows you to animate controlling and monitoring a real-time simulation. You can design your own panel using a standard library of knobs, sliders, and meters. In operation, the software periodically updates meters and displays but, more important,

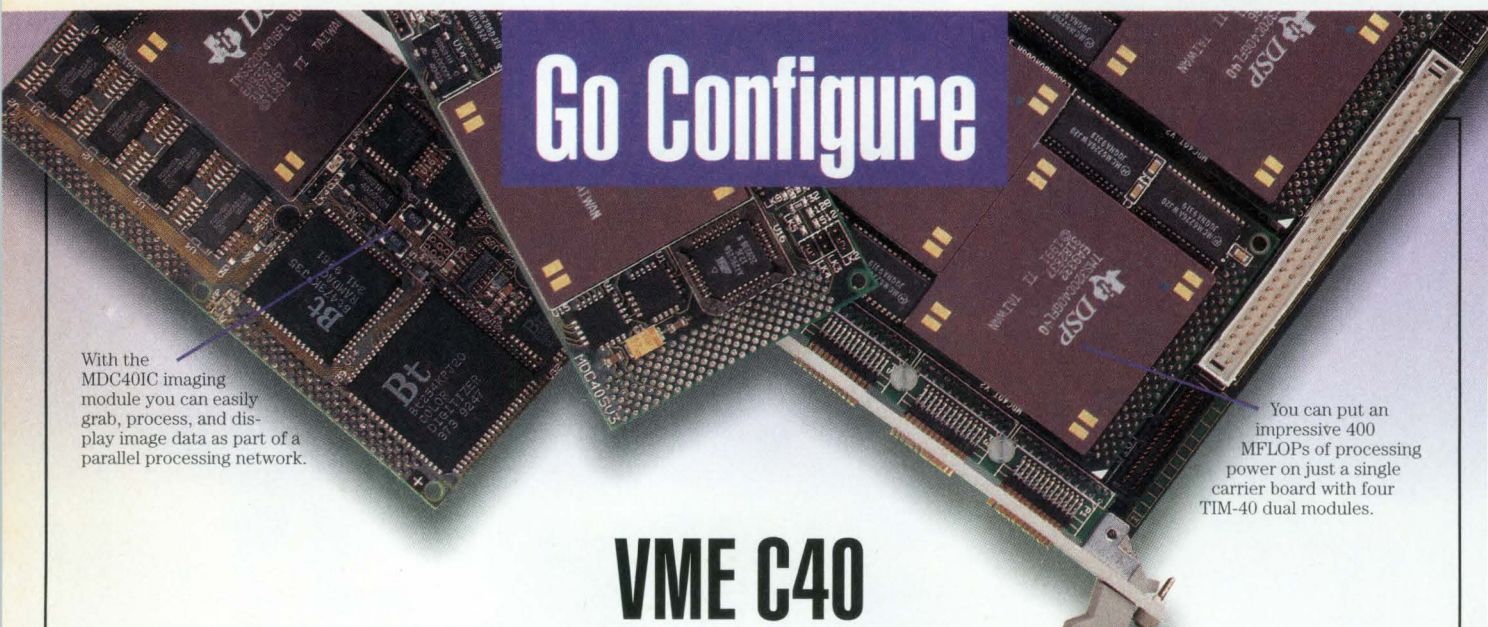

Go Configure

With the MDC401C imaging module you can easily grab, process, and display image data as part of a parallel processing network.

You can put an impressive 400 MFLOPs of processing power on just a single carrier board with four TIM-40 dual modules.

VME C40

Develop dual, quad, or even octal parallel processing DSP systems—all with powerful TIM-40™ modules from Spectrum. Where you'll find a wide range of embedded products. Plus development software you can work with easily in both the

PC and Sun environments.

Which means you'll get quick time-to-market and low-cost OEM C40 boards for the VME platform.

So before you configure, call **1-800-663-8986**, for the finest DSP hardware, development systems and experienced technical support in the industry.



Copyright © 1994 Spectrum Signal Processing, Inc. All rights reserved. TIM-40 is a trademark of Texas Instruments, Inc.

Putting DSP to Work

allows you to adjust control settings, which, in turn, modify control parameters on the fly during a real-time simulation.

One of the limitations of hardware-in-the-loop simulations is that the plant simulator may not be able to mimic sensor output signals accurately in high-speed systems. For example, in advanced automotive-engine management, it takes around 2- μ sec timing resolution to sense 0.1° angular rotation at 8000 rpm. Also, even seemingly mundane signals representing slow-changing temperature and pressure may require much higher bandwidth noise elements to preserve the integrity of the overall simulation. In general, there's no chance that the main DSP plant simulator can also generate such time-critical outputs, and, therefore, the system needs additional hardware.

dSpace has recently introduced such a product, DS2301, which uses six TMS320C31 processors and 16-bit DACs. The DS2301 autonomously pro-

duces six high-speed output waveforms with edge resolutions below 1 μ sec. C code programs the signal-generation algorithms, which are calculated on-line. dSpace calls the technique "direct digital synthesis" (Ref 2). **EDN**

References

1. Hanselmann, Dr Herbert, "Hardware-in-the-Loop Simulation as a Standard Approach for Development, Customization, and Production Test," Society of Automotive Engineers, Paper No. 930207, March 1993.

2. Hanselmann, Dr Herbert, "DSP-based Automotive Sensor Signal Generation for Hardware-in-the-Loop Simulation," dSpace Application Note, February 1994.

You can reach Senior Technical Editor Brian Kerridge in the United Kingdom at (508) 528435, fax (508) 528430.

Article Interest Quotient
(Circle One)

High 589 Medium 590 Low 591

What's AHEAD

June 9, 1994 . . .

EDN's DSP and Analog Special Issue

- ▶ DSP-chip directory
- ▶ Packaging for mixed-signal and analog ICs
- ▶ DSP^x preview and products

Interactive Analog Simulation

Windows - DOS - Macintosh

ICAP/4, The Virtual Circuit Design Lab, is a complete circuit design system featuring schematic entry, interactive analog and mixed signal simulator, extensive device libraries, and powerful data processing, all integrated in one easy to use environment. With ICAP/4 you can simulate all types of designs include Power, ASIC, RF, Mixed Mode, Control Systems, and Mixed Technologies.

- **Interactive SPICE 3F based Simulator** (AC, DC, Transient, Temperature, Noise, Distortion, Fourier, Monte Carlo, and Sensitivity (AC/DC) analyses)
- **Interactive Parameter Sweeping and Measurements**
- **Real Time Waveform Display**
- **Hot Links To Schematic Entry and Post Processor**
- **Real Time Cross Probing and Operating Point Display**
- **Over 5000 Models Available including special RF and Vendor Libraries**
- **Third Party Support - Works with all popular schematic entry systems**

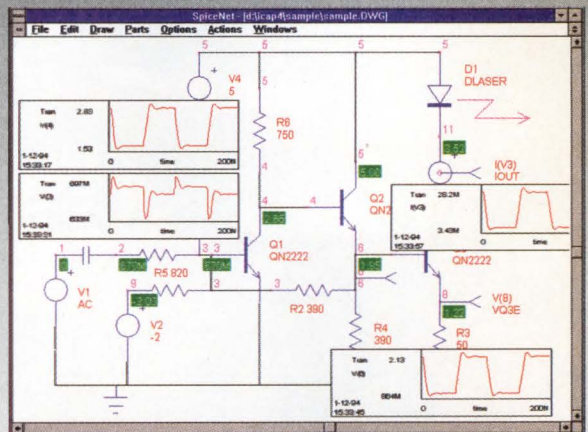
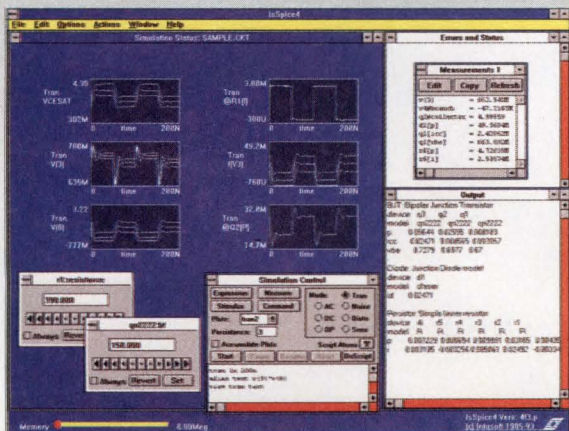

- **Easy To Use and Affordable - Full Systems from \$990-\$2595**
- **Multiple Platform Support (Windows (32s), Windows NT on the PC, DEC Alpha & MIPS, DOS, Macintosh, and Power Mac)**
- **Support - CompuServe BBS, FREE Modeling Service**

Call or write for your free information and demo kit.

intusoft The Future Is Interactive!
P.O. Box 710 San Pedro, CA 90733-0710
Tel. 310-833-0710, Fax 310-833-9658



 **4-Mbit
VRAM**

When you want fully compatible 4-Mbit VRAMs, TI delivers.

To meet the competitive demands of today's graphics market, TI delivers the only commercially available solution — our full family of 4-Mbit VRAMs. And puts you on the path to a higher level of graphics performance than 1- or 2-Mbit VRAMs can provide.

Compatibility means flexibility. The first to introduce the 4-Mbit VRAM, TI is also the first to meet the JEDEC 4-Mbit VRAM standard, including a 256-bit Serial Access Memory (SAM). So when you start your next-generation high-resolution graphics designs with TI, you get maximum future design flexibility. Something not all 4-Mbit VRAM manufacturers can deliver.

The right devices, right now. We deliver what we promise. Our family of 4-Mbit VRAMs has been in volume production

more than a year, so you can get the devices you need in full production quantity.

Higher integration, lower cost. The higher density of 4-Mbit VRAMs reduces chip count for more efficient use of board space and increased system reliability. The dual asynchronous data ports simplify the CPU interface and greatly reduce the memory bandwidth bottleneck. Add that to our Total Integration™ philosophy and it equals cost-effective designs.

Available today. TI offers you unprecedented service and support, along with timely information, when and where you need it. Just call **1-800-477-8924, ext. 3611.** We'll get the facts on TI's fully compatible family of 4-Mbit VRAMs delivered to you right away.



Available Features

- EDO page mode
- 18/22-ns serial cycle time
- 60/70-ns access speeds
- Programmable split register stop point
- 256K x 16 DRAM organization
- 256 x 16 SAM
- Write per bit
- (4 x 4) x 4 block write
- 2 WE • 2 CAS
- CAS before RAS refresh

EXTENDING YOUR REACH
WITH TOTAL INTEGRATION™

 **TEXAS
INSTRUMENTS**



New Product Update

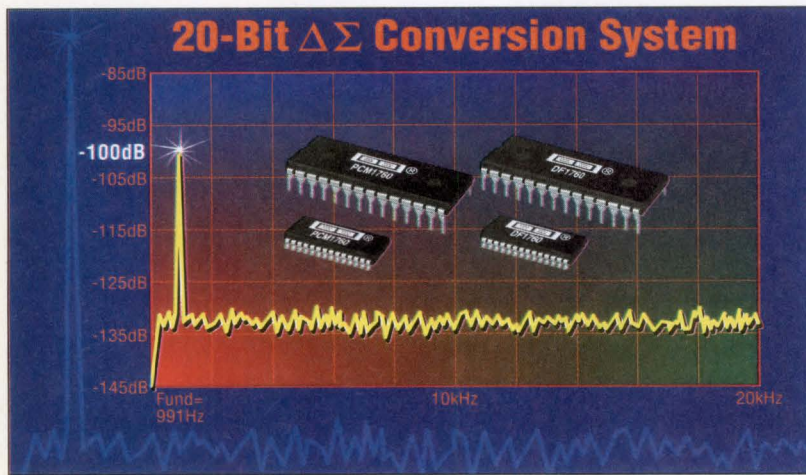

New 20-Bit Digital Audio ADC System

PCM1760 stereo delta-sigma modulator, together with its matched DF1760 digital filter, provide professional digital audio designers the best combination of analog-to-digital converter performance available for under \$30! The system offers 20-bit resolution, wide 108dB dynamic range, very low -92dB THD+N, and clear 110dB SNR. PCM1760 and DF1760 are available in 28-pin DIP and SOIC. PCM1760 operates from ±5V supplies, DF1760 from a single 5V supply. PCM1760 is priced from \$14.37; DF1760 from \$15.52 in 1000s. **CIRCLE NO. 185**

New Data Conversion Products IC Data Book

The Data Conversion Products IC Data Book contains complete product descriptions, specifications, applications tips, and ordering information for a broad line of high performance, high quality data conversion products.

With over 950 pages, it offers more than 25 new high performance data conversion solutions. New products profiled include: A/D and D/A converters, data acquisition components, sample/hold amplifiers, V/F converters, multiplexers, and demonstration boards. The Data Conversion Products Data Book is **FREE** from any Burr-Brown sales office or representative. Or, call the Literature Hot Line at **1-800-548-6132** to get your copy.



CIRCLE NO. 186

New



12- and 16-Bit Serial Out, 100kHz Sampling A/Ds

ADS7808 and ADS7809 are low cost, general purpose, serial output, CMOS sampling A/Ds. Both deliver 100kHz sampling rates with very low 100mW power dissipation using a single +5V supply. Ideal for many low power, portable applications requiring high sampling rates with superior accuracy and spectral purity, they're perfect for spectrum analyzers, portable oscilloscopes and vibration analyzers, medical electronics, and process control applications—where their serial output simplifies needed isolation. Available in 20-pin 0.3" plastic DIPs and SOICs. ADS7808 is priced from \$9.95; ADS7809 from \$28.85 in 100s. **CIRCLE NO. 187**

New 12-Bit, Low Power, 800kHz Sampling A/D

ADS7810's 800kHz sampling rate makes it the world's fastest, 12-bit, monolithic SAR ever—60% faster than its closest competitor! Its high speed, small size, low power, low cost, and excellent Nyquist performance make it ideal for data acquisition, DSP boards, and image processing/scanning applications. Key specs include: 800kHz min sampling rate, 12 bits resolution, 70dB min SINAD with 250kHz input, ±0.5LSB max INL, ±0.9LSB max DNL, and 250mW max power dissipation. Available in 28-pin 0.3" plastic DIP, SOIC and die. ADS7810 is priced from \$29.45 in 100s. **CIRCLE NO. 188**

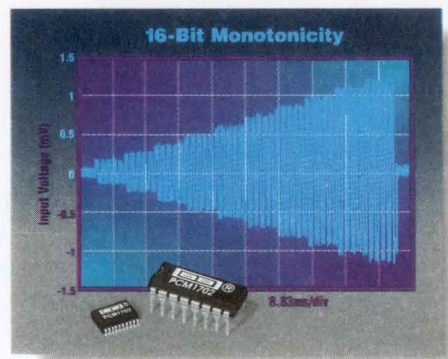

20-Bit BiCMOS DAC

PCM1702's unique architecture produces a 20-bit DAC with high dynamic range, high SNR, and very low distortion. Processed using BiCMOS technology, it has very low power consumption and is packaged in a compact 16-pin plastic DIP or 20-pin SOP. PCM1702 is an unbeatable choice for high-end CD players, musical instrumentation and professional audio applications. Key specs include: -96dB max THD+N, 104dB typ dynamic range, 110dB typ SNR, 200ns typ settling time, and 150mW typ power dissipation. Priced from \$11.64 in 1000s. **CIRCLE NO. 189**

New

+5V Voltage Reference Guarantees Long-Term Stability

REF05 is a precision +5V voltage reference that's a pin for pin replacement for the industry standard REF-05. Its guaranteed long-term output voltage drift of 25ppm/1000 hours max is 4 times more stable over extended use than the closest competitor. Key specs are: +5V ±0.1% max output voltage, 8.5ppm/°C max temperature stability, 10μVp-p (0.1Hz to 10Hz) noise, 0.008% max line regulation, 0.005%/mA max load regulation, 1.4mA max quiescent current, and 8VDC to 40VDC supply range. Available in an 8-lead hermetic TO-99 and priced from \$15.30 in 100s. **CIRCLE NO. 190**



New Product Update

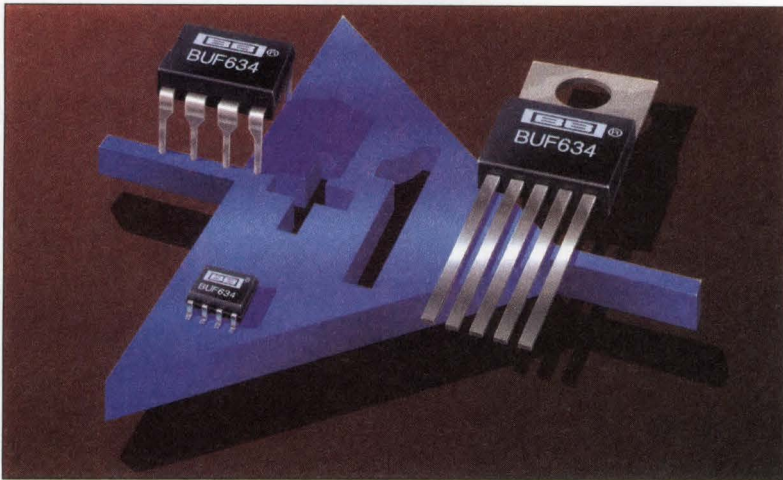

New 250mA Buffer Amp Slews at 2000V/ μ s

BUF634 is a high speed, unity-gain buffer amplifier that delivers 250mA output and 2000V/ μ s slew rate—all in a tiny SO-8 package. Its low price, high performance, rugged monolithic design, and ease of use make BUF634 ideal for a wide range of general purpose applications. It's an excellent driver for valves, solenoids, video, and even headphones. BUF634 comes in three different packages: an SO-8 surface mount, an 8-pin plastic DIP, and a 5-pin TO-220. Priced from \$2.60 in 1000s.

CIRCLE NO. 191

New



Low Noise, Precision Difet[®] Op Amp

OPA124 is a precision, monolithic FET op amp that delivers low bias current, noise, voltage offset, and drift plus high open loop gain and common mode rejection. Its versatility, small size, and low price make it ideal for analytical and laboratory instrumentation, data acquisition, test/medical equipment, and optoelectronics. Key specs include: 6nV/ $\sqrt{\text{Hz}}$ (10kHz) voltage noise, 1pA max bias current, 2 μ V/ $^{\circ}\text{C}$ max drift, 120dB min open loop gain, 100dB min common mode rejection, and 250 μ V max offset. Available in compact 8-pin surface mount and plastic DIP packages. Priced from \$3.12 in 1000s. CIRCLE NO. 193

2 x 1 Dual, Video Multiplexer

MPC102 is a dual, 2 x 1 signal multiplexer that distributes and routes wideband analog and digital signals at a high data rate. Designed for high-definition television and broadcast equipment, its excellent harmonic and dynamic specifications are also ideal for radar, communications, computer graphics, and data acquisition systems applications. Key specs include: 210MHz (1.4Vp-p) bandwidth, 640V/ μ s (2Vp-p) slew rate, 68dB channel crosstalk (30MHz), +6mV/-8mV switching transients, and $\pm 4.6\text{mA}$ (one channel)/ $\pm 230\mu\text{A}$ (no channel) quiescent current. Operating from a $\pm 5\text{V}$ supply, MPC102 is available in 14-pin DIPs, SOICs, and dice. Priced from \$7.41 in 100s. CIRCLE NO. 194

New Linear Products IC Data Book

The Linear Products IC Data Book contains complete product descriptions, specifications, applications tips, and ordering information for a broad line of high performance, high quality linear products. Its 1100+ pages give designers more than 30 new high performance linear ICs. New products profiled include: operational amplifiers, instrumentation amplifiers, isolation products, power operational amplifiers, references, regulators, and demonstration boards. The Linear Products Data Book is **FREE** from any Burr-Brown sales office or representative. Or, call the Literature Hot Line at 1-800-548-6132 to get your copy.



CIRCLE NO. 192

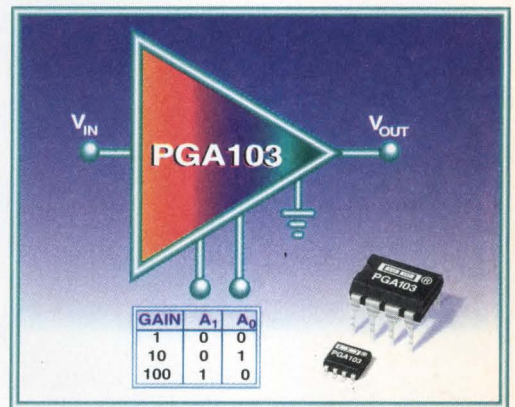

New "Easy-to-Use" Programmable-Gain Amplifier

PGA103 is a monolithic digitally programmable amplifier available in an 8-pin plastic DIP and SO-8 surface mount packages. Gains of 1, 10, and 100 are digitally selected by two TTL- or CMOS-compatible control lines. It's an "easy-to-use" simple solution for systems that handle wide dynamic range signals. PGA103's precision, versatility, size, and low cost make it ideal for process control, medical instrumentation, test/measurement equipment, and general-purpose analog boards. Dice also available. Priced from \$3.90 in 100s.

CIRCLE NO. 195

New

Dual, Isolated, Bi-Directional Digital Coupler

ISO150 is an ultra high-speed capacitively coupled digital device that provides high isolation with very low power consumption. Designed to replace optocouplers, its low power, high speed, and low cost make it a reliable alternative. Use it for A/D and D/A conversion, multiplexed data transmission, computer-to-peripheral interfaces, I/O port isolation in instruments, power inversion, and isolated data acquisition systems. Key specs are: 80M Baud typ data rate, TTL/CMOS compatibility, 25mW max power consumption per channel, tested at 2400Vrms isolated partial discharge per VDE0884, and 16.5mm creepage distance. Available in 24-pin single-wide plastic DIP, and priced at \$7.75 in 100s.

CIRCLE NO. 196





P u t t i n g I m a g i n a t i o n

©Digital Equipment Corporation, 1994. The DIGITAL Logo and Alpha AXP are trademarks of Digital Equipment Corporation. Microsoft Windows Logo, Windows and Windows NT are trademarks of Microsoft Corporation. 486 and Pentium are trademarks of Intel Corporation. PowerPC is a trademark of IBM.

Imagine A Microprocessor With The Horsepower To Harness Windows NT. Alpha AXP Does It Now.

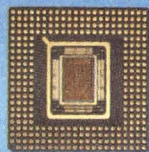

Windows NT™ puts tremendous power behind demanding corporate applications.

Don't compromise it. Go with the front-runner — the Alpha AXP™ microprocessor. Choose from a family of fast microprocessors with performance as high as 170 SPECint (est.) that leaves the fastest Pentium™ or PowerPC™ in the dust, yet is priced to compete. Alpha AXP runs Windows NT with unbridled speed, with hundreds of Windows NT-based applications shipping now and hundreds more on the way. Plus Alpha AXP runs MS-DOS and Windows™-based applications. And that's just the beginning of a long-term architecture based on a scalable RISC design and standards like the PCI local bus. And it's available to any PC



MICROSOFT
WINDOWS NT
COMPATIBLE

maker—from us now, and later this year from our second source Mitsubishi Electric Corp. With Windows NT, you have a choice. You can hang back with the herd, or you can choose Alpha AXP. And cut loose. So put the spurs to your PC maker. Ask them about Alpha AXP. Or call us at 1-800-332-2717. Your future is riding on it.

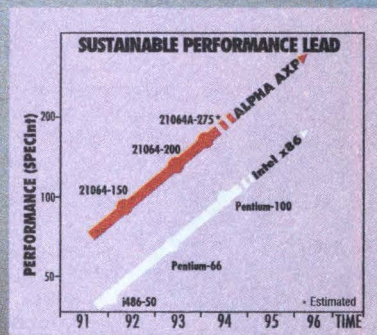

To Work

digital™

CURRENT SHOWCASE

Hall-Effect Latches For High-Temperature Operation — 3185

The 3185 Hall-Effect Latch is an extremely temperature-stable and stress-resistant sensor especially suited for operation over extended temperature ranges to +150°C. Superior high-temperature performance is made possible through a novel Schmitt trigger circuit that maintains operate and release point symmetry by compensating for temperature changes in the Hall element. Additionally, internal compensation provides magnetic switch points that become more sensitive with temperature, hence offsetting the usual degradation of the magnetic field with temperature. The symmetry capability makes these devices ideal for use in pulse-counting applications where duty cycle is an important parameter.

- Symmetrical Switch Points
- Superior Temperature Stability
- Operation From Unregulated Supply
 - Open-Collector 25 mA Output
- Reverse Battery Protection
- Activate With Small, Commercially Available Permanent Magnets
- Solid-State Reliability ... No Moving Parts
- Small Size
- Resistant to Physical Stress

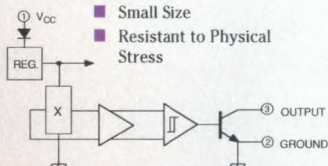

CIRCLE NO. 200

Ultra-Sensitive Bipolar Hall-Effect Switches — 3132

These Hall-Effect switches are designed for magnetic actuation using a bipolar magnetic field, i.e., a north-south alternating field. They combine extreme magnetic sensitivity with excellent stability over varying temperature and supply voltage. The high sensitivity permits their use with multi-pole ring magnets over relatively large distances.

- 4.5 V to 24 V Operation
- Reverse Battery Protection
- Superior Temperature Stability
- Superior Supply Voltage Stability
- Activate with Multi-Pole Ring Magnets
- Solid-State Reliability ... No Moving Parts
- Small Size
- Constant Output Amplitude
- Resistant to Physical Stress

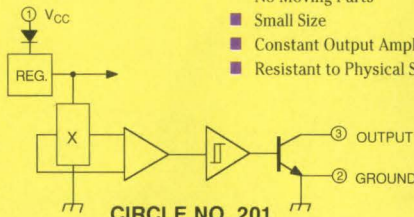

CIRCLE NO. 201

Hall-Effect Switches For High-Temperature Operation — 3121

These Hall-Effect switches are monolithic integrated circuits with tighter magnetic specifications and switch points, designed to operate continuously over extended temperatures to +150°C, and are more stable with both temperature and supply voltage changes. The unipolar switching characteristic makes these devices ideal for use with a simple bar or rod magnet.

- Superior Temperature Stability for Automotive or Industrial Applications
- 4.5 V to 24 V Operation ... needs only an unregulated supply
- Open-Collector 25 mA Output ... Compatible with Digital Logic
- Reverse Battery Protection
- Activate with Small, Commercially Available Permanent Magnets
- Solid-State Reliability ... no moving parts
- Small Size
- Resistant to Physical Stress

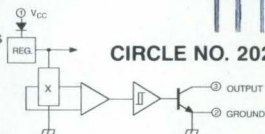

CIRCLE NO. 202

Ratiometric, Linear Hall-Effect Sensors — 3503

The 3503 Hall-Effect sensor accurately tracks extremely small changes in magnetic flux density—changes generally too small to operate Hall-Effect switches.

As motion detectors, gear tooth sensors, and proximity detectors, they are magnetically driven mirrors of mechanical events. As sensitive monitors of electromagnets, they can effectively measure a system's performance with negligible system loading while providing isolation from contaminated and electrically noisy environments.

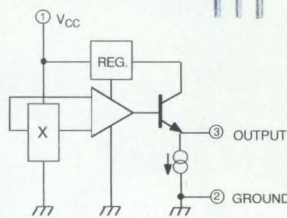

- Extremely Sensitive
- Flat Response to 23 kHz
- Low-Noise Output
- 4.5 V to 6 V Operation
- Magnetically Optimized Package

CIRCLE NO. 203

Take A Test Drive... Call For Samples

Try these Allegro ICs in your breadboard. You'll find that you'll reduce your component count, increase reliability through use of monolithic solutions and protection features, as well as potentially lowering overall manufacturing costs. Sample and detailed technical information are now available. Just give us a call.

THE PACE QUICKENS



FORMERLY SPRAGUE SEMICONDUCTOR GROUP

CALL 1 • 508 • ALLEGRO

115 Northeast Cutoff, Worcester, Massachusetts 01615

12-BIT ADCs

Now may be the time to upgrade your 8- and 10-bit systems

ANNE WATSON SWAGER, Technical Editor



A substantial list of low-cost 12-bit devices with competitive power and speed makes upgrading 8- or 10-bit systems seem almost foolproof. However, ensuring 12-bit accuracy means reevaluating many other aspects of a design.

Plunging prices of 12-bit monolithic ADCs with sampling rates from 10 kHz to 2 MHz are dramatically reducing the cost of 12-bit designs and breaking the barriers to upgrading 8- and 10-bit systems. Just two years ago, the price of a 100k-sample/sec ADC was around \$15 to \$20. That ADC today costs as little as \$5 to \$10, and 500k-sample/sec converters cost \$10 to \$20 (Fig 1).

However, price isn't the only parameter in decline; power is also going down, even for $\pm 10V$ systems. Although some of these ADCs require dual supplies, most operate from a single 5V supply; some, from 3V supplies. A number of these ADCs include devices with very-low-power consumption of 12 to 50 mW and can implement a complete power-down.

While concentrating on cost and power, the designers of these converters continue to

increase speeds above 500 kHz and, in many cases, integration. Attaining even higher speeds at low cost is a high priority on many companies' agendas for the immediate future. (See **box**, "Looking ahead: above and beyond 12-bit, 10- μ sec ADCs.")

Table 1 lists just a sample of some companies' 12-bit, 10-kHz to 2-MHz converters. By the latest count, Analog Devices' division in Ireland alone produces 12 12-bit ADCs and their various permutations. Burr-Brown's ADS78xx family currently comprises eight members (four of which are 12 bits and four of which are 16-bit pin-compatible partners), and the company will add more members by year-end.

An eclectic group

The **table** lists a somewhat-eclectic group of converters, ranging from extremely sim-

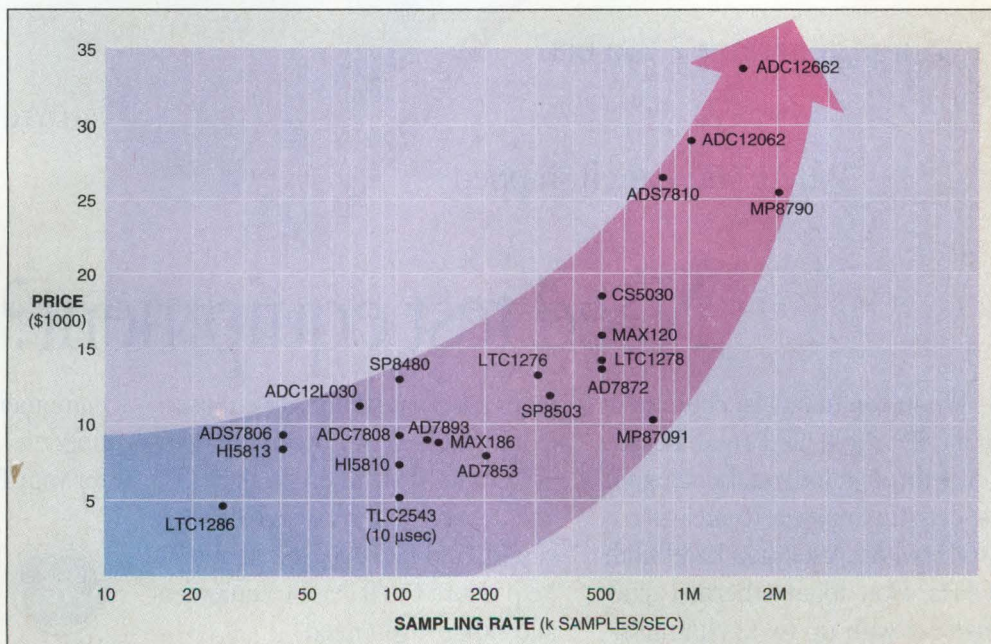

Fig 1—The costs of 12-bit ADCs with 10-kHz to 2-MHz sampling rates have dramatically decreased within the last few years. However, prices dramatically increase as the ADCs go even higher in frequency, easily passing the \$100 mark at around 5 MHz.

Daniel Guidera

“Four signal generators? No problem.”

“Done deal.”

“You’ll have ‘em tomorrow.”

“Network analyzers? Sure.”

“Logic analyzers? Absolutely.”

“You got it.”

“Surge generators? You bet.”

“Where you want it shipped?”

“Spectrum analyzers? We’ve got ‘em.”

“Oscilloscopes? You betcha.”

“All the leading brands.”

“Recorders? Right away.”

“No problem.”

“Environmental chambers? Yes.”

“We’ll have ‘em there.”

Need test equipment?

When you need test equipment for a critical job, GE Rental/Lease comes through for you. Looking for a spectrum analyzer to measure 40 GHz with a resolution bandwidth of 3 Hz? How about a thermal array recorder with up to 32 channels?

We’ve got more than 120,000 pieces of name-brand test equip-

ment and workstations to choose from. Available for overnight delivery to almost anywhere in the U.S. and Canada. Our seasoned technical experts and ISO 9002 registration help assure you’ll get the equipment and support you need.

Get the full picture in the new GE Rental/Lease catalog. Keep the

equipment you need right at your fingertips. Call **1-800-GE-RENTS** for your **free catalog** today.



GE Rental/Lease
Test Equipment & Workstations

12-BIT ADCs

ple, stand-alone types to highly integrated ICs, such as National Semiconductor's LM12434 and 12438. These converters offer much more than core-ADC and data-acquisition-IC features such as multiple input channels. Each also incorporates an instruction RAM, an event sequencer, and a 32-word conversion FIFO buffer. These recently introduced 3 to 5.5V power-supply versions also have a power-down output.

The **table's** converters also feature a

variety of input ranges, power-supply voltages (although single 5V is the most common), package sizes, and variations on or departures from the familiar successive-approximation-register (SAR) architecture.

Inputs range from 0 to 2V and ± 2.5 to ± 10 V, sometimes irrespective of supply voltage. For example, Analog Devices builds its 789x SAR-type converters on a BiCMOS process so that these 5V ADCs can handle inputs of ± 10 V. The process allows for the input

to go 10V above the supplies. ADCs built on standard CMOS processes usually have much more restricted input ranges that can go only 0.3V above the supply, for example.

These converters are also much smaller than their 12-bit predecessors. With just a few exceptions, virtually all of the converters come in both DIP and SOIC packages, and two fit into 8-pin SOICs: Analog Devices' 125k-sample/sec AD7893, and Linear Technology's 12.5k-sample/sec 1286/98. Maxim also

TABLE 1—REPRESENTATIVE LOW-COST 12-BIT ADCs

Vendor	Part no.	Speed	Key features	Power (mW max)	No. of pins	Price (1000)	
Analog Devices Circle No. 301	AD7893/6	125 k samples	Serial, 5V supply, T/H 0 to 2.5 to ± 10 V input range	50	8	\$9	
	AD7890	125 k samples	Eight single-ended channels, serial, power-down, T/H, reference	50	24	\$10.20	
	AD7853 AD7858	200 k samples	3 to 5V operation, serial, pseudo-differential inputs (7853), four pseudo-differential or eight single-ended inputs (7858), power-down	18 ($V_{DD}=3V$)	24	\$8 \$11.20	
	AD7891 AD7892	500 k samples	5V supply, T/H, 25-ppm reference, eight channels (7891), parallel and serial, power-down, selection of input ranges	75	44 24	\$16.15 \$13.60	
Burr-Brown Circle No. 302	ADS7806	40 k samples	Parallel and serial, power-down, 0 to 4 to ± 10 V input ranges, 5V supply	35	28	\$9.25	
	ADS7808	100 k samples	Serial, 0 to 4 to ± 10 V input ranges, 5V supply	100	20	\$9.25	
	ADS7810	800 k samples	Parallel data with latches, ± 10 V input range, S/H, clock, reference, ± 5 V supply	250	28	\$26.50	
Crystal Semiconductor Circle No. 304	CS5030 CS5031 CS5032	500 k samples	Reference (1 ppm 5030 and 5031; 60 ppm 5032); ± 5 V supply; input ranges of ± 2.5 (5030 and 5032) or 0 to 5V (5031); flexible serial, parallel, and byte interface	70	24	\$18.50 \$18.50 \$15.90	
	Harris Semiconductor Circle No. 306	HI5810	100 k samples	5 or 3.3V (5813) supplies, S/H, parallel	42 10 (typ) 9	24	\$7.30 \$6.95 \$8.41
		HI5812	50 k samples				
HI5813		40 k samples					
Linear Technology Circle No. 307	LTC1286/98	12.5 k samples	2.7 to 9V supplies, S/H, 2-channel multiplexer or differential inputs, serial	0.5/1.2	8	\$4.65	
	LTC1273 LTC1275 LTC1276	300 k samples	5 or ± 5 V supplies, S/H, 25-ppm reference, clock, parallel, inputs of ± 2.5 (1275), 0 to 5 (1273), and ± 5 V (1276)	75 (typ)	24	\$14.09 \$12.65 \$13.20	
	LTC1278	500 k samples	5 or ± 5 V supply, 5-mW power-down with instant wake-up, S/H, reference, clock, parallel	75	24	\$14.35 to \$17	
	Maxim Integrated Products Circle No. 308	MAX186 MAX188	133 k samples	Eight input channels, reference, (186), 5 or ± 5 V supplies, power-down, serial	12.75	20	\$8.95 \$8.45
MAX120		500 k samples	5 and -15 V supplies, T/H, 25- to 40-ppm references, ± 5 V input range, parallel (120 and 122), serial (176)	315	24	\$16	
MAX122		333 k samples		315	24	\$12	
MAX176		250 k samples		172	8 or 16	\$13.20	

table continued on pg 70

12-BIT ADCs

packages a number of its converters in shrink SOICs.

SAR architecture rules

The SAR architecture still dominates in this 10-KHz to 2-MHz frequency range. However, these SAR converters come in two implementations: those that implement the conversion using an R-2R ladder network and those that use switched-capacitor structures. Texas Instruments uses a patent-pending switched-capacitor SAR architecture to enable the TLC2543 to achieve 12 bits with a small die size (and thus the \$5.25 price). The converter also uses a fuse-blown technique, which prevents the need for expensive laser trimming.

Whether a converter is based on an R-2R or switched-capacitor structure doesn't change the way you communicate with and use the ADC. However, these structures, along with whether the converter uses BiCMOS or CMOS technology, do change power consumption, input range, and performance of internal references.

For example, those ADCs striving to achieve the lowest possible power consumption generally have a CMOS, switched-capacitor architecture. In general, these ADCs' internal references aren't as accurate as R-2R or switched-capacitor types built on bipolar or BiCMOS processes. Some companies use BiCMOS processes because they allow IC designers to build better references. ADCs built on BiCMOS processes, such as the AD7892/1, LTC1273/5/6, and MAX120/122, feature internal references with precision characteristics of 25 ppm/°C compared with 50 to 60 ppm/°C for other internal references.

But it doesn't always take a BiCMOS process to produce accurate reference performance. Crystal Semiconductor set out to produce a 12-bit SAR converter with absolute accuracy, including the drift characteristics of the reference. The company uses E²PROM-based calibration circuitry in the CMOS CS5030 and 31 to produce a 2.5V on-chip reference with an extremely low temperature coefficient of 1 ppm/°C

reference. The designers also brought the reference to an output pin, so you can use the reference for the rest of the system.

As these converters' sampling rates approach 1 MHz, other architectures start appearing, such as the 2-step conversion methods common to high-speed hybrid ADCs. Both National Semiconductor's and Micro Linear's 1-MHz devices use this method. Soon, some 200-kHz oversampling converters will also debut. (See **box**, "Oversampling converters quietly creep up in sampling rate.")

Differentiating features

The group of low-cost 12-bit ADCs often have competitive dc and ac specifications, including differential nonlinearity specs around ±1 LSB with no missing codes. (However, some converters' differential nonlinearity can be as high as ±4 LSBs.) Integral nonlinearity can vary from 1 to 2.5 LSB, and minimum S/N-ratio-plus-distortion (SINAD) specs can be as high as 72 dB with -80-dB THD.

TABLE 1—REPRESENTATIVE LOW-COST 12-BIT ADCs (continued)

Vendor	Part no.	Speed	Key features	Power (mW max)	No. of pins	Price (1000)
Micro Linear Circle No. 309	ML2230	31.5 μsec	μP compatible, 12-bit plus-sign ADC, S/H, ±5V supplies	400	24	\$7.65
Micro Power Systems Circle No. 310	MP3275	15 μsec	16 channels, 50V overvoltage protection, serial (3276) and parallel 5V supply, parallel (7091) or serial (7092), T/H Parallel, T/H, 5V supply	200	68	\$24.09
	MP3276	750 k samples		200	28	\$24.68
	MP87091/92			225	52	\$25.58
	MP8790 MP8791	2000 k samples			28	\$23.26
National Semiconductor Circle No. 311	ADC12L030/ 2/4/8	73 k samples	12-bit plus-sign, self-calibrating, 3.3V operation, T/H, 2-, 4-, and 8-channel multiplexers	15	16 to 28	From \$11.80
	ADC12062	1000 k samples	2-channel multiplexer, S/H, low-power standby mode, parallel 12-bit plus sign system with serial I/O and self-calibration, S/H, RAM, 8-channel multiplexer, FIFO buffer, 3 to 5V supply	75	44	\$25.50
	ADC12662	1500 k samples		200	28	\$29.30
	LM12434/38	140 k samples		34	28	\$18.90
Sipex Circle No. 313	SP8480	100 k samples	Eight input channels, parallel, S/H, reference	200	28	\$13
	SP8481	333/200/100 k samples	5V supply, bipolar (85xx) and unipolar (86xx), reference, S/H, parallel, clock	125	24	\$14
	SP8503/5/10 SP8603/5/10					\$10 to \$12
Texas Instruments Circle No. 314	TLC2543	10 μsec	Serial, 5V supply, S/H, clock, 11 input channels, power-down, built-in self-test	12.5	20	\$5.25

NEW

Op Amp Lowers the Cost of Precision



Low Specs, High Performance

OPA124 is our new, precision op amp that combines low prices with outstanding performance for critical instrumentation, data acquisition, and optoelectronic applications. Its low bias current, low noise, low voltage offset, and low drift mean the highest performance available in a surface mount package—superior even to BiFET and CMOS amps. And, OPA124's patented dielectric isolation (*Difet*[®]) processing and unique cascode design minimize input errors and simplify filtering requirements. You get the lowest drift with the best system performance you need.

2 packages, 3 performance grades

Available in both an 8-pin plastic DIP and surface mount package, OPA124 also comes in three performance grades. Our highest grade specs in SOIC can't be beat by any competitor! You pick the perfect performance grade for your specific application.

Low Prices, too!

All this performance plus low prices! With prices starting at \$3.12 in 1000s, OPA124 is the highest performing op amp out there with the lowest price around. You get the best for the lowest price.

OPA124 Key Specifications

- **Low** Input Voltage Offset250µV max
- **Low** Offset Drift2µV/°C max
- **Low** Input Bias Current1pA max
- **Low** Voltage Noise6nV/√Hz at (10kHz)
- **High** CMR100dB min
- **High** Open-Loop Gain120dB min
- Packages8-Pin Plastic DIP and SOIC
- **Low prices** from \$3.12 (1000s)

A New Low for You...FREE Samples

Try the lowest and the best! For your FREE SAMPLE, detailed data sheet, and *Operational Amplifiers* brochure, just call **1-800-548-6132**. Or, ask your local sales rep for more information.

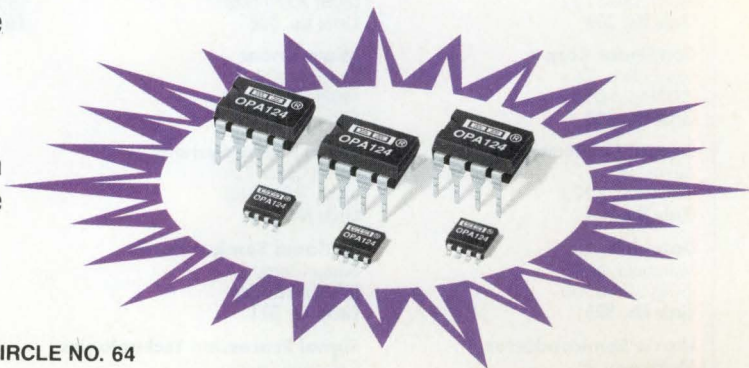

CIRCLE NO. 64



12-BIT ADCs

The issue of absolute accuracy can be bothersome to system designers who are used to using 8- or 10-bit converters in the 100-kHz to 1-MHz range. These lower-resolution converters, including the reference, generally have no trouble meeting a ± 1 - or ± 2 -LSB overall accuracy spec.

However, the same isn't true for 12-bit converters and systems. These ADCs' total unadjusted error (TUE)—the sum of integral- and differential-linearity, offset, and full-scale errors—covers a wide range. TUE can be as low as 1 LSB (as it is for Crystal Semiconductor's CS5030/31 with the 1-ppm reference) and as high as around 20 LSBs, roughly equivalent to an accuracy somewhat less than 8 bits ($2^N=20$ LSBs, where N is the number of bits equivalent to the TUE in LSBs. In this case, $N=4.3$, so overall accuracy is $12-4.3=7.7$ bits). So, many of these ADCs approach 12-bit accuracy only with a system calibration.

Although system calibration is common, reasonable accuracy without calibration is sometimes desirable. For example, to detect voltage drop-off, a battery-voltage monitor may require a resolution of 8 bits, but not quite 12. This means that you can buy an 8-bit converter and calibrate or buy a 12-

OVERSAMPLING ADCs QUIETLY CREEP UP IN SAMPLING RATE

A list of 12-bit converters with speeds exceeding 100 kHz doesn't normally include any oversampling ADCs (also known as delta-sigma and sigma-delta converters). Since their appearance as the latest ADC architecture, oversampling converters have assumed roles in very low-frequency and audio niches. However, companies are working on higher-than-audio-speed oversampling converters and two—one 12- and one 16-bit device—will shortly be available. Crystal Semiconductor also has some high-speed oversampling ADCs in the design phase. These converters will provide communications systems and others with the advantages of the oversampling architecture: a simple antialiasing filter and a low cost.

Analog Devices' 12-bit AD7721 (around \$15) has a 210-kHz input bandwidth. The output word rate is

468.75 kHz, and the sampling rate is 30 MHz (set by a nominal 15-MHz external clock.) The ADC features an internal reference, operates from 5V supplies, and accepts a differential input of 0 to 2.5V or ± 1.25 V. As with other oversampling converters, the on-chip filtering reduces the external antialiasing requirements to first order in most cases.

National Semiconductor's ADC-16071/471 (\$19.90 (100)) is a 16-bit ADC with a 192k-sample/sec throughput with 64 times oversampling of 24.576 MHz. (The company presented this part at this year's International Solid State Circuits Conference.) This IC also features a 2V reference and, operating on a single 5V supply, consumes 375 mW max (1 mW max in standby mode). S/N ratio is 94 dB, and THD is 0.0015% at 1 kHz.

bit converter with a fairly good TUE. The industrial and commercial grades of Harris Semiconductor's 3.3V HI5813 for example, have respective TUEs of 9 and 13 LSBs, which both

equate to around 9 bits of accuracy.

The wide variety of available low-cost 12-bit converters removes many barriers to upgrading to 12 bits. However, finding the right converter with a

FOR FREE INFORMATION...

For free information on the ADCs discussed in this article, circle the appropriate numbers on the postage-paid Information Retrieval Service card or use EDN's Express Request service. When you contact any of the following manufacturers directly, please let them know you read about their products in EDN.

Analog Devices Inc

Wilmington, MA
(617) 937-1428
Circle No. 301

Burr-Brown Corp

Tucson, AZ
(800) 548-6132
Circle No. 302

Comlinear Corp

Fort Collins, CO
(303) 226-0500
Circle No. 303

Crystal Semiconductor

Austin, TX
(512) 445-7222
Circle No. 304

Datel Inc

Mansfield, MA
(508) 339-3000
Circle No. 305

Harris Semiconductor

Melbourne, FL
(800) 442-7747, ext 7199
Circle No. 306

Linear Technology Corp

Milpitas, CA
(408) 432-1900
Circle No. 307

Maxim Integrated Products

Sunnyvale, CA
(408) 737-7600
Circle No. 308

Micro Linear

San Jose, CA
(408) 433-5200
Circle No. 309

Micro Power Systems

Santa Clara, CA
(408) 727-5350
Circle No. 310

National Semiconductor

Santa Clara, CA
(800) 628-7364
Circle No. 311

Signal Processing Technologies

Colorado Springs, CO
(719) 540-3999
Circle No. 312

Sipex Corp

Billerica, MA
(508) 671-1940
Circle No. 313

Texas Instruments

Dallas, TX
(800) 477-8924, ext 4500
Circle No. 314

VOTE . . .

Please also use the Information Retrieval Service card to rate this article (circle one):

High Interest 598
Medium Interest 599
Low Interest 600

Super Circle Number

For more information on the ADC products available from all of the vendors listed in this box, you need only circle one number on the postage-paid reader service card.

Circle No. 315

LONWORKS technology puts you in control.

How? Ask any of the cutting-edge companies who are using LONWORKS™ technology to design process control systems with Motorola's new NEURON® IC.

Accudyne/Ketek Division

Acromag, Inc.

Brooks Instruments

Grayhill

ITT Barton

Lakewood Instruments, Inc.

Metra Corporation

MICRO SWITCH, Honeywell Inc.

Motorola Wireless Data Group

Proteus Industries, Inc.

Smart Systems, Inc.

Weidmüller, Inc.

Echelon Corporation's LONWORKS technology is powered by the NEURON IC, Motorola's new control processor. It's your most cost-effective entree into the revolutionary world of intelligent distributed control.

Among the NEURON IC's many strong points: three on-chip CPUs, embedded communications protocol based on the OSI reference model, and high speed serial communications ports.

But best of all, the NEURON IC's surprising affordability means you can now economically add distributed control to applications that range from process control systems to complete factory and plant communications and automation networks.

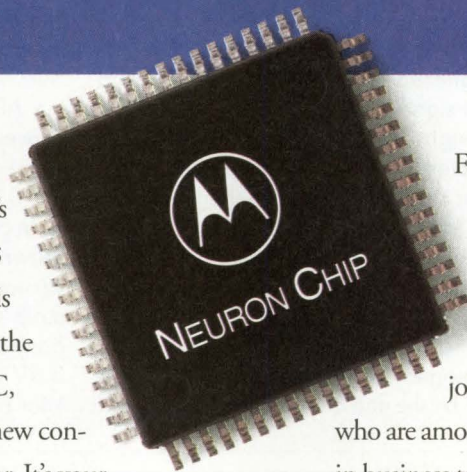

For a complete data package and information about Motorola's NEURON IC, mail or fax the attached coupon today. And join the ranks of companies who are among the most well-connected in business today.

Ready to take control? 638 EDN 052894

Return this coupon to:

Motorola, LONWORKS Technology Center
616 West 24th Street, Tempe, Arizona 85282
or fax to: Toll free fax number 1-800-492-9384

Name _____

Title _____

Company _____

Address _____

City _____

State _____ Zip _____

Telephone _____

Application _____



Coming through loud and clear.



MOTOROLA

**MOS Digital-Analog Integrated
Circuits Division**

12-BIT ADCs

low price is just a start; many additional factors determine the success of an upgrade. The ADC itself may not be the limiting factor. Remember that users of

10-bit systems expect them to be four times more accurate than 8-bit systems and 12-bit systems to be four times more accurate than 10-bit systems.

These expectations have ramifications, some of which go far beyond the converter itself.

An increase in system resolution

LOOKING AHEAD: ABOVE AND BEYOND 12-BIT, 10-MSEC ADCs

The future goal of most 12-bit ADC manufacturers is to increase the speed of their low-cost devices. By year-end, Linear Technology hopes to introduce a 12-bit, greater-than-1M-sample/sec converter; the company is currently evaluating the first silicon for this product. Micro Power Systems is designing devices in the 4- and 5-MHz range.

Numerous 12-bit higher-speed monolithic and hybrid ADCs exist, but they cost significantly more than the devices this article details. Although hybrid ADCs once dominated this high-speed arena, more ICs are beginning to appear. For example, Analog Devices recently introduced the monolithic 5-MHz, 12-bit AD871 (\$95), and Harris Semiconductor is working on a lower-power version of its 1W, 12-bit, 3-MHz HI5800 (\$85). Also, by the end of this summer, Comlinear Corp will introduce a monolithic 12-bit converter, the CLC950, capable of taking 25M samples/sec (\$185 (100)). Signal Processing Technologies also plans to announce a 12-bit, 20-MHz CMOS ADC by the end of the summer. This ADC

will join the company's line of bipolar 12-bit ADCs, the 10-MHz SPT7920, 20-MHz 7921, and 30-MHz 7922 (\$99 to \$161 (1000)).

Hybrid manufacturers include Datal and Comlinear. Datal will soon announce the 10-MHz ADS-119 (\$336) and is releasing a new design for the 5-MHz ADS-118 (\$238 to \$262), a spin-off of the ADS-119 design. After the release of the ADS-119, Datal's 12-bit ADS family will comprise five converters covering a 500-kHz to 10-MHz frequency range. Comlinear's CLC925 and 93X family covers a higher range of 10 to 30 MHz, with prices around \$450 to \$500.

In other future developments in low-cost 12-bit ADCs, Burr-Brown will continue to expand its ADS family by introducing versions covering 0 to 5, ± 2.5 , and ± 3.3 V input ranges; more serial-output devices in 20-pin packages; and the company's first multichannel devices. TI will soon introduce a 3.3V version of the TLC2543 and other 12-bit ADCs for cellular phones.

D68 Series

HIGH PRECISION DIP FIXED FREQUENCY ACTIVE FILTERS

FOR USE WITH A/Ds UP TO 16 BIT

- Anti-Alias
- Noise Elimination
- Signal Reconstruction

- Compact size reduces board space requirements.
- Plug-in ready-to-use, reducing engineering design and manufacturing cycle time.
- Factory tuned from 10 Hz to 100 kHz, no external clocks or adjustments needed.
- Low harmonic distortion and wide signal-to-noise ratio to 16 bit resolution for precision performance.
- Broad range of transfer characteristics to meet a wide range of applications.



Call Us Today at (508) 374-0761

25 Locust Street • Haverhill, MA 01830
FAX (508) 521-1839

Available 8-Pole Low-Pass Frequency Response

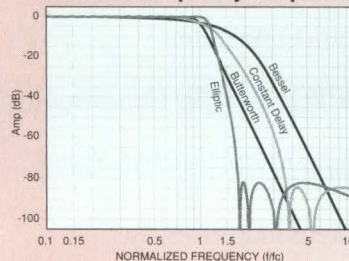

Available 8-Pole High-Pass Frequency Response

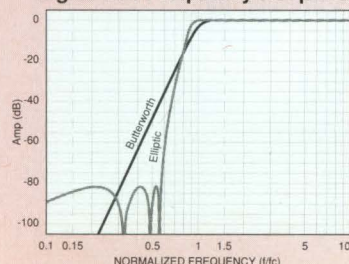

Quick Just Got Quicker ^{Ever}

Relative PREP Performance

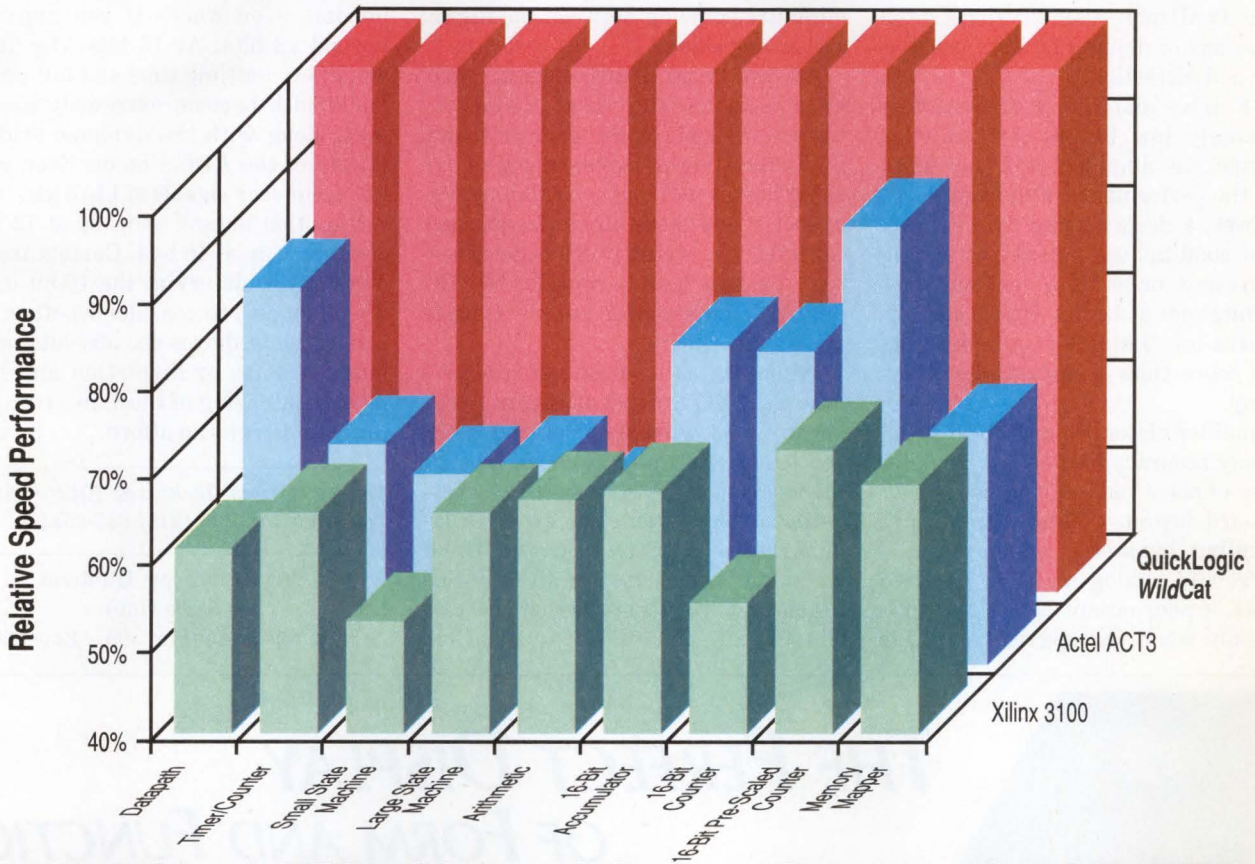

WildCat FPGAs Now Over 160MHz.

PREP™ benchmarks tell you who really has the performance.

And QuickLogic's WildCat series has beaten the best. Look at any of the nine standards and QuickLogic is #1.

Now that you know we are the fastest FPGA, you may be wondering just how fast is it? In speed tests, our WildCat 1000 is comparable to a 7 nanosecond PAL. Our 0.65 micron antifuse FPGAs widen the gap between QuickLogic and the competition.

Ease of Design

All this performance is blended with a suite of design tools that are truly fast and incredibly easy to use. Now QuickLogic takes the lead by offering Windows and NT versions running at 32 bit performance. This means for a fully utilized 1000 gate part, total run time is less than 2.5 minutes on a 486 machine. In addition, a wealth of interconnect resources effectively eliminate routing and pin-out problems.

Price and Performance

These new WildCat FPGAs provide the internal and external performance required by today's most demanding applications, at a price that will surprise you. Just ask for our \$99 starter kit to prove your next design.

Look to the company that lives up to its name for fast solutions to today's high speed, high density design requirements. For a QUICK response fax us at (408) 987-2012 or call 1-800-842-FPGA (3742) to learn more about WildCat SuperFast FPGAs.



TM

Presentations use or include the most recent PREP PLD Benchmark data which was measured according to Benchmark Suite #1, Version 1.2, dated 3/28/93. Any analysis is not endorsed by PREP.



QUICK LOGIC

We Live Up To Our Name

2933 Bunker Hill Lane, Santa Clara, California 95054

©1994 QuickLogic Corporation. PREP is a trademark of the Programmable Electronics Performance Company.

12-BIT ADCs

requires a reevaluation of signal-conditioning circuits, particularly the drive amplifier. Every 1-bit jump in resolution constitutes a 6-dB increase in S/N ratio. A 12-dB jump from 10 to 12 bits means 12 dB more visibility to potential limitations of driving circuits, such as noise and distortion.

If a drive amplifier's distortion is extremely low before a resolution upgrade, the amplifier probably won't limit the performance of the new ADC. However, a design using the cheapest signal conditioning possible to accommodate an 8- or 10-bit system may show its limitations at 12 bits. Unfortunately, an ultra-low-distortion op amp costs much more than a medium-distortion op amp.

Amplifier distortion and noise aren't the only accuracy limitations. Another source of noise and interference is poor pc-board layout, including improper grounding, bypassing, and coupling of digital and analog signals. The bad effects of poor circuit layout rise dramatically when you upgrade a system

from 10 to 12 bits. But, if the initial board design is based on a good layout, you may not need to change it. Good layout practices generally include keeping analog and digital signals separate to minimize coupling between the digital and analog sides.

An even more drastic measure may be to reevaluate the effects of a switching power supply on the analog circuits. Switching-power-supply designs are using higher and higher switching frequencies, and these higher frequencies can affect the accuracy of an analog system. You may have to consider how the quality of the power-supply voltage affects the ADC.

When switching from using a μ P's internal ADC to using an external one, be aware of what may happen when you join the ADC and the μ P. Despite the fact that the ADC may have 3-state output drivers, you can't expect a 12-bit accurate ADC to produce a 12-bit answer if its outputs are directly tied to some noisy system bus that also carries 10-, 20-, or 30-MHz signals. Con-

sider using digital buffers between the ADC and the μ P.

Moving up to 16 bits

These system-design problems become even worse if you upgrade beyond 12 bits. At 16 bits, the drive amplifiers' settling time and full-power bandwidth become extremely important, along with the dynamic loading effects of the ADC's input. Even with low-frequency signals of 1 to 3 kHz, distortion that doesn't show up at 12 bits does show up at 16 bits. Certain trade-offs are mandatory at the 16-bit level; it's important to consider whether the application requires the absolute minimum of noise or distortion and how much minimizing of those two parameters the design can afford. **EDN**

You can reach Technical Editor Anne Watson Swager at (215) 645-0544.

Article Interest Quotient
(Circle One)

High 598 Medium 599 Low 600

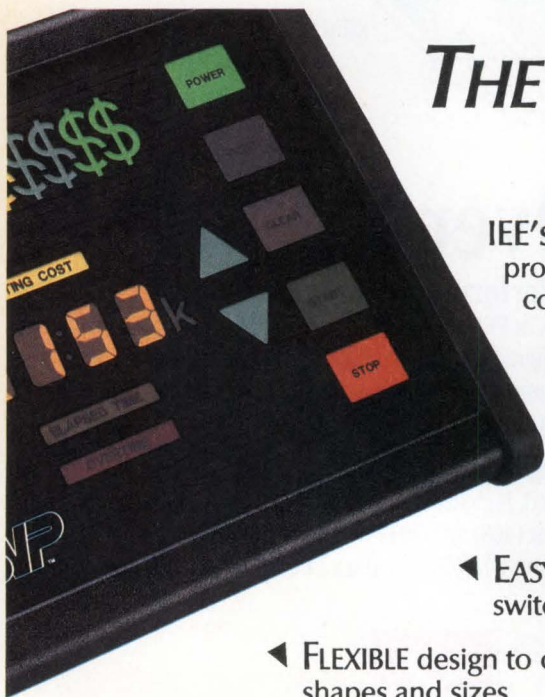

THE PERFECT DISPLAY OF FORM AND FUNCTION

IEE'S REFLECTIVE SYMBOLIC VISUAL PANEL is a unique LCD technology providing outstanding design flexibility in a fully integrated flat panel color display.

- ◀ SEVEN BRIGHT COLORS for visual impact and style
- ◀ THIN YET RUGGED construction is ideal for portable and industrial applications
- ◀ EASY TO USE in your design, with fully integrated switches and interfaces available
- ◀ FLEXIBLE design to create displays and switches in a variety of shapes and sizes
- ◀ GRAPHIC INTERFACE using icons, colors and integrated switches for customized menu-driven applications
- ◀ RUNS ALL DAY ON THREE AA BATTERIES.

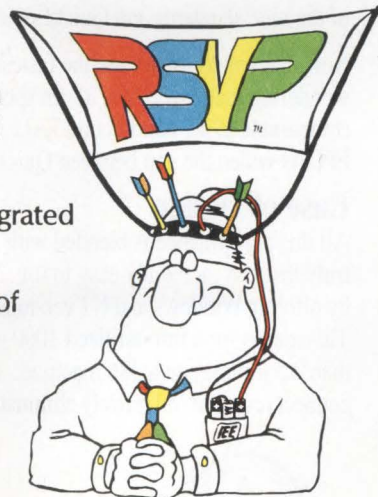

INDUSTRIAL ELECTRONIC ENGINEERS, INC. • Tel: (818) 787-0311 Ext. 418 • Fax: (818) 901-9046
Immediate, CIRCLE NO. 76 Reference, CIRCLE NO. 77

Contact us for a free brochure

P-CAD HELPED PUT TRIMBLE ON THE MAP.

You're never lost when you carry the SCOUT GPS™ global positioning system from Trimble Navigation. P-CAD helped Trimble's design engineers find what they were searching for – the world's most productive PCB design software. Trimble used P-CAD software to navigate through the design process, cutting time to market and positioning their new product as a market leader. P-CAD PCB design tools enjoy some unique positioning of their own, consistently ranking first in pins-per-hour benchmark surveys among independent service bureaus. In fact, compared to other PC-based systems, P-CAD software helps designers do their work in as little as half the time. Take P-CAD Master Designer™ for example. It includes enhanced auto-dimensioning so designers can document

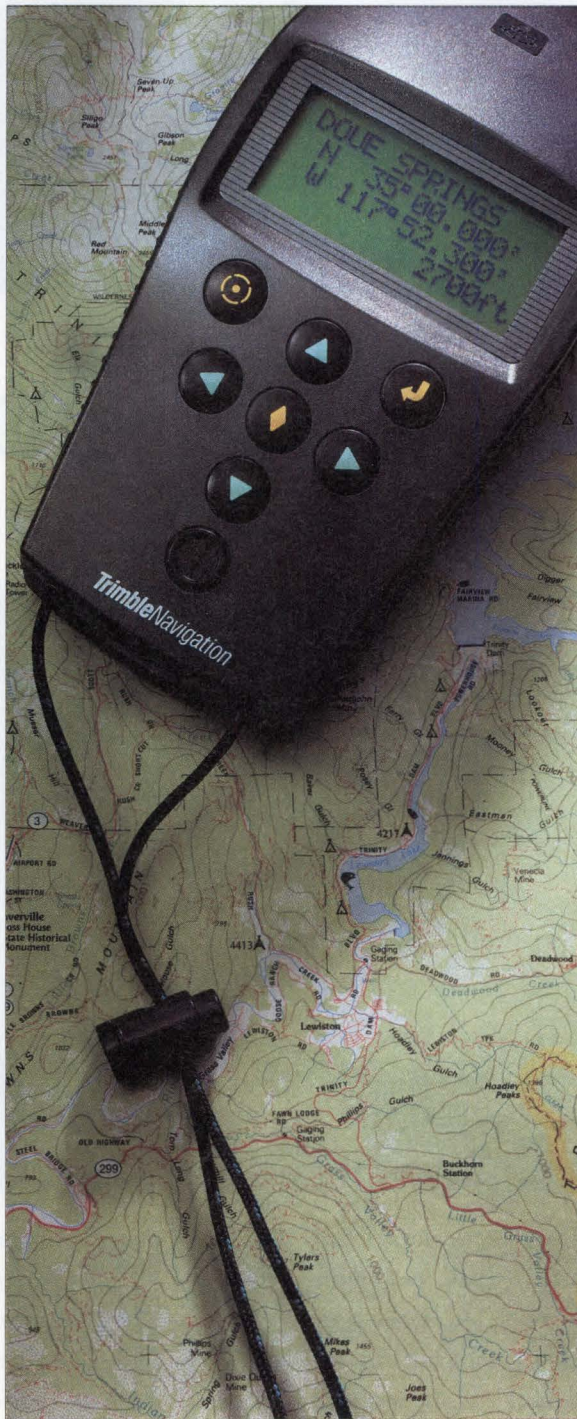

their work without mastering a separate mechanical CAD system. P-CAD offers a complete line of software tools for DOS, Windows™ and UNIX® platforms starting for as little as \$1,995. For the name of your nearest P-CAD reseller, call us toll-free. We'll tell you how you could win a free SCOUT GPS. And to help you map out your own winning design strategy, we'll send you a free copy of our booklet, "P-CAD – Productivity Across the Board." In today's competitive world, you could be lost without it.

(800) P-CAD-844

*More Productivity —
Across The Board*

p-cad®
From ALTUM, An IBM Company

Introducing the
Downsized 16-meg DRAM.
[At 300 mils, it's lost WIDTH.]

At 300 mils, our new 16-meg DRAM is, in a word, svelte. Especially when you compare it to the rather *fat* 400-mil part which has been the only way you could get a 16-meg.

And—size being size—the thin 300-mil gives you an advantage nothing

else does. It lets you put more into the same amount of space.

If you're a manufacturer of high-end workstations, mainframes, and supercomputers, you'll have the

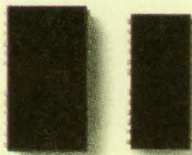

potential to increase your number of memory chips—and therefore your memory—by as much as 33 percent. Compared to what you get with the 400-mil part.

Samsung is among the first suppliers in the world to complete the 300-mil 16-meg. Partly because the



before

after



part's lead-on-chip construction—which is what makes it so much smaller than the now-standard part—is extremely difficult to manufacture. And building it marks one more in a long line of significant achievements in memory for Samsung.

We offer the 300-mil in both 5.0

and 3.3 volt. And if you build systems that benefit from a maximum of memory, you're probably going to want to take advantage of it—and all the width it lets *you* lose.

For more information, please call 1-800-446-2760 or 408-954-7229

today. Or write to DRAM Marketing, Samsung Semiconductor CA 95134.



SEMICONDUCTOR

A Generation AHEAD.

ESDA

ELECTRONIC - SYSTEM - DESIGN - AUTOMATION

TOOLS

As system complexity grows, ESDA tool vendors try to convince you they can solve your design problems with a new class of tools. Maybe they can.

Photo courtesy Mentor Graphics

Not content with "EDA" for "electronic-design automation," trade-publication editors have conspired with EDA-tool marketers to create "ESDA" for "electronic-system-design-automation," the newest in a never-ending stream of acronyms. Your job as a designer isn't to understand what ESDA means. That's backward. Instead, the ESDA vendors should understand what designers need. However, you do need to understand which ESDA tools and design methods might help improve your effectiveness as a designer.

You can best understand what you need from ESDA tools by focusing on a methodology that best fits the type of work you do. In the quick-paced world of electronics, rethinking your design methodology every few years is inadequate; the process must be ongoing. You must constantly hone your methodologies. After each design, evaluate the tools and methods you've been using to see what works, what doesn't, and what you need to fix.

Furthermore, the perfect methodology for one company may very well drive another company out of business. For example, a test-equipment vendor with relatively uncomplicated systems but with extremely tight timing requirements may

DOUG CONNER, TECHNICAL EDITOR

This needs to be variable by changing the
#RV#end

#RV#C[uart_spec 18 / uart_spec 19][
Remember to check the range of frequen
#RV#end

#A[uart_spec 0 / uart_spec 7][markd / 93.05,
from this description, one decomposition for the top-
one to control the registers (reading and writing), one to
transmitting and receiving data), and one to control the

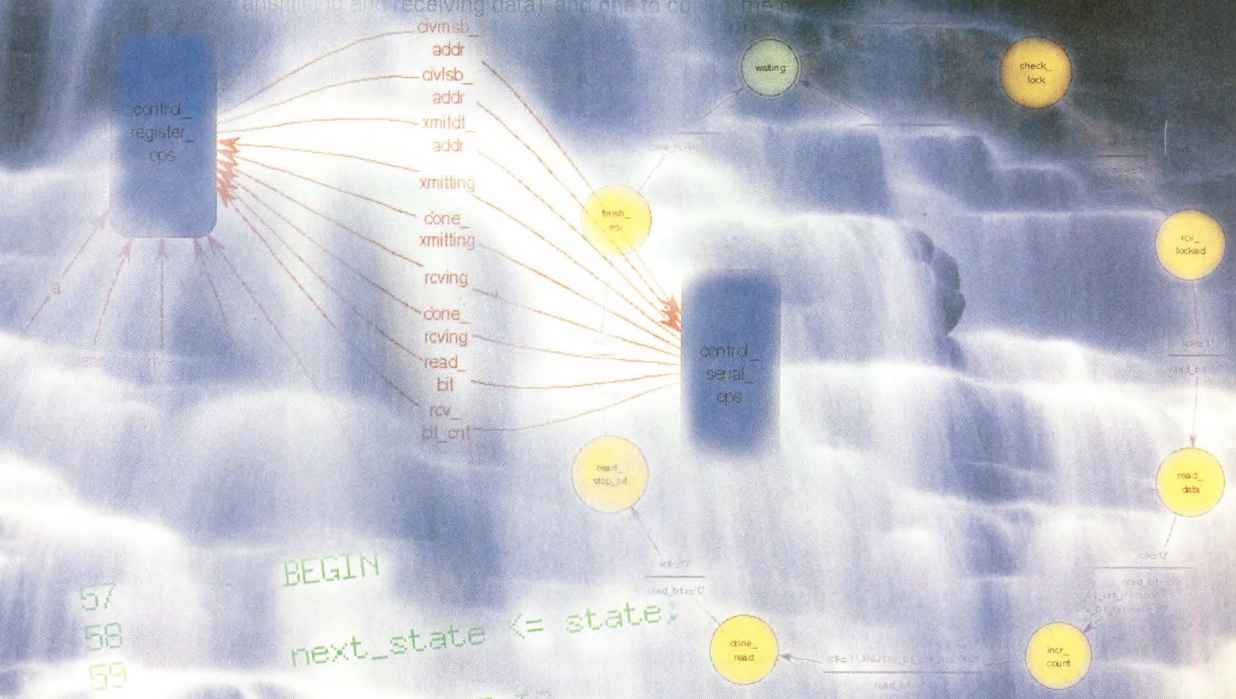

57
58
59
60
61
62
63
64
65
66
67
68

```
BEGIN  
next_state <= state;  
CASE STATE IS  
WHEN waiting =>  
IF ( start_write="1"  
next_state <= writing_to  
ELSIF ( start_read="1" ) THEN  
next_state <= reading_from  
ELSE
```

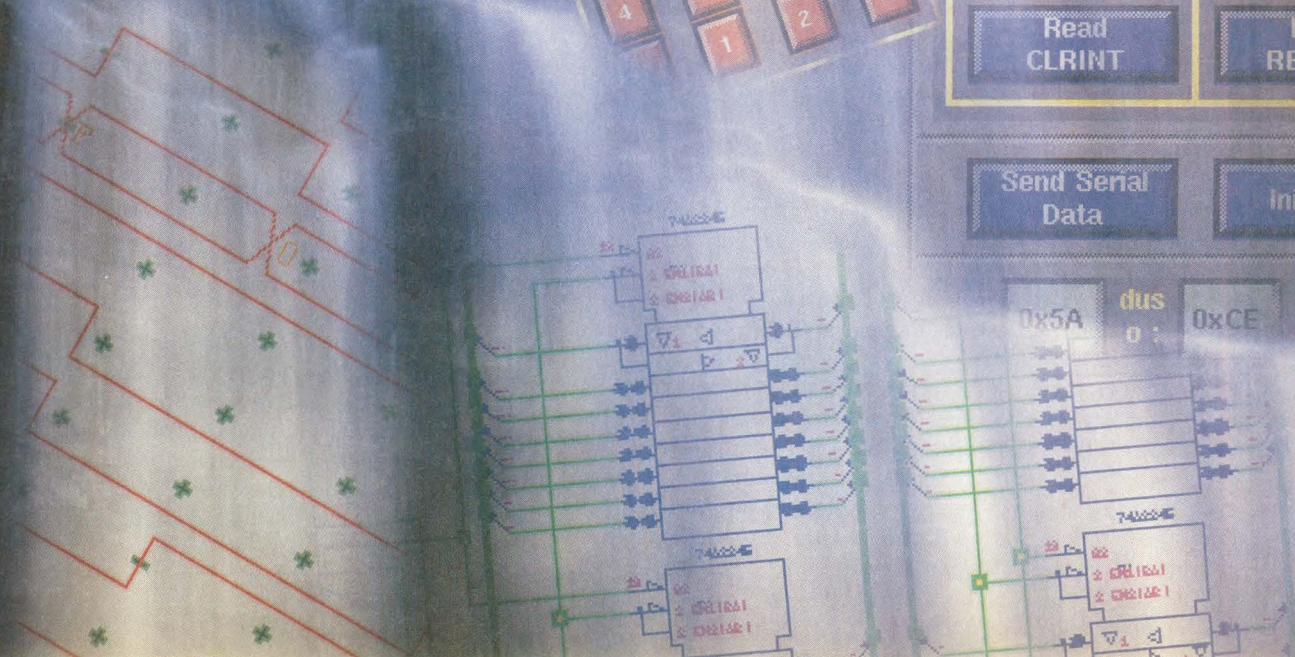

Electronic-system-design automation

still find that the best design method uses gate-level schematics and simulation. A company designing DSP systems may find system-level functionality a greater problem than is timing. That company may adopt a top-down design methodology using system-design tools, a hardware-description language (HDL), logic synthesis, and simulation, and the company may never descend to the gate level except to generate a netlist for device fabrication.

Every new-ESDA-product presentation starts by showing how time to market is your No. 1 enemy. Although reducing time to market is often vital, you must also understand the factors affecting time to market for *your* company's products—and whether the ESDA tool and any new methodology in question will help.

The first thing you need to do is evaluate where your company spends time in design work. (See box, "Where does the time go in your design group?") Your organization may suffer from some of the problems the box mentions or have problems unique to the type of systems your company designs. In either case, the first step toward improving your design tools or methodology is to identify the problem. Once you do that, you can look for tools to solve the problem.

Large, complex system designs generally cause—or at least magnify—the problems that so-called ESDA tools aim to solve. However, the term "ESDA" is much too general to tell you anything useful about a tool. For example, one ESDA tool may be strictly for graphical-design entry and have no simulation capability at all. Another may be for digital simulation of large systems; another, for analog simulation. But one of these tools may answer some of the needs of your design organization. **Table 1** (see pg 88) provides a representative listing of "ESDA tools," although not every manufacturer calls them ESDA tools.

Top-down design

A concept common to most ESDA tools is the use of top-down design. Although some tools can support both top-down and bottom-up design methods, most designers favor top-down design for using ESDA tools. You don't need ESDA tools to adopt a top-down design approach; however, most ESDA tools (and EDA tools in general) help you follow such an approach.

"Top down" means you start with a set of system-level requirements and develop high-level system block diagrams or a high-level architecture. After verifying that the architecture satisfies the system requirements, you treat each block as a subsystem and develop the architecture of each subsystem. You continue in this manner until you complete the specification of a design in whatever de-

tail is necessary and verify compliance to the specification.

The top-down approach to system design doesn't just *sound* clean and logical. It *is* clean and logical, and it's the approach that most designers adopt when possible. The top-down approach implies the separation of system design and implementation. First, you need to design the right system;

then, you must correctly implement it. The point between the design and implementation phases is where some tool vendors draw the line distinguishing EDA and ESDA tools. They claim that ESDA tools help you design the right system and that EDA tools help you design the system right. However, the distinction doesn't hold up under close scrutiny because many tools are useful for both system design and implementation.

The distinction between the system-level design phase and the implementation phase is, however, a useful one. During system-level

design, you determine the behavior of the system and high-level system architecture. Once you create and verify a satisfactory high-level architecture, you can proceed to implementation, during which you flesh out the details.

Sometimes, you need to mix bottom-up and top-down design approaches. The bottom-up approach is often necessary for designs built on a specific device or technology. For example, if you build a data-acquisition system around a high-speed A/D converter, a bottom-up design surrounds the converter, but you can design the remainder of the system using a top-down approach.

Many designers believe that a design starts with a set of requirements, but that simply isn't true. A design usually starts with a need, a vision, or a little of both. For example, a designer might see a problem that an electronic system can solve or see a way to improve an existing system. Another designer might envision a completely new system. From

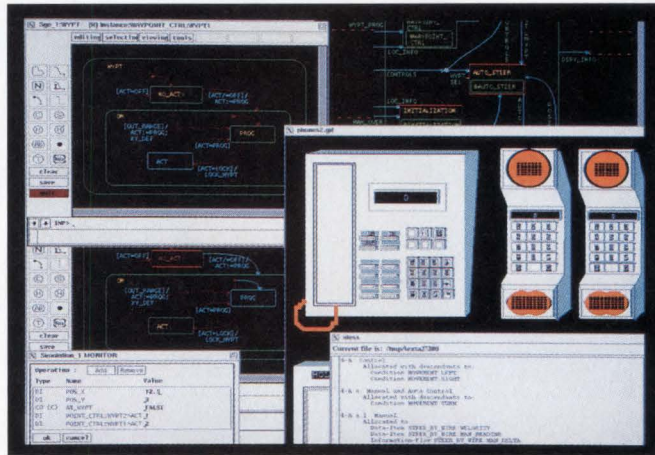

ESDA tools such as i-Logix's StateMATE ExpressV-HDL help you transform design requirements into a graphical block diagram. The tool generates HDL code for synthesizing your design, and you can create a graphic prototype for realistic simulation of the architecture.

LOOKING AHEAD

Most designers would welcome tools that let them simply specify a design at a high level of abstraction and provide some optimization directives; the tool would then generate the physical implementation. Electronic-system-design-automation vendors would love to be able to offer such tools, too, and the vendors are working hard on the problem: Tools with these capabilities should shortly start to appear. The problem is that unless a logic-synthesis tool can generate a high-quality implementation from a high-level description, designers will have to rework their designs.

Top Ten Reasons for Using MaxRoute II

The Interactive Autorouter

10. Quality – MaxRoute II will complete your design with a substantially lower via count and a lower total trace length than any other router. Quality routing = time well spent.

9. Platform Flexibility – MaxRoute II is a 32-bit Windows and Windows NT application offering you access to today's hottest RISC platforms. The speed is incredible!

8. Control – MaxRoute II's Interactive and manual routing give you the most productive routing tools in the industry bar none! Toggle between fully manual and interactive tools, *without ever releasing your trace*, to create the most productive union of expert designer and software possible.

7. More Control – “Fast Route” - flies through your design for quick feedback about your placement quality. “Manual Place” - lets you change your component placement in MaxRoute II and accurately back annotate your host PCB package. You do not need to leave MaxRoute II until your design is complete. “Strategy Files” - easily preset all of your critical routing criteria. MaxRoute II is designed work *with* your design expertise.

6. Speed – MaxRoute II is the new breed of Massteck router. In a recent benchmark MaxRoute II for Windows NT completed a 6,000 connection,

488 component, 4 routing layer SMT board in under 7 hours with 31% fewer vias than than the Unix “shape based” competitor that chugged along for over 25 hours.

5. Completion – Every good designer will edit an autorouted design to give it their “touch”. MaxRoute II works so intelligently there is always room on the board for those final edits or changes.

4. Support – Massteck offers technical support second to none. Whatever your level of question Massteck's dedicated support staff has the answer you need, when you need it!

3. Integration – MaxRoute II provides you tight communication with a wide variety of PCB packages.

2. Job Security – It is a safe bet that you would rather pass along a nicely completed board that used MaxRoute II, at under \$5000, than explain why your \$20,000 autorouter left you with an additional 2 weeks of hand to hand combat in your manual routing system before the design can be used.

1. Watching MaxRoute II autoroute is COOL!

◆ **Batch Autorouting**

◆ **Interactive Routing**

◆ **Manual Routing**

◆ **Manual Component Placement**

Your **FREE** demo of the most productive autorouting software is available today!

CALL 1-800-MASSTECK
(1-800-627-7832)



**The Best
Windows
Routing Tools
Since 1987***
\$4,850.00

*In 1987 MaxRoute was the first PCB application developed for Windows™

Electronic-system-design automation

these needs and visions, designers create system requirements or a specification.

The translation of a need or a vision into system requirements is the first risk of introducing an error—either an outright error or simply the omission of a detail—into a system design. This translation is also often the reason for system specifications to keep changing during a design. It's difficult to reach the finish line fast if you start by designing a system based on an incorrect specification, and more diligence does not necessarily solve the problem. Designers cannot typically eliminate all errors in a design before simulation, so they shouldn't expect a person or an organization to create an error-free specification for a complex system without first testing it against a working prototype or a simulation.

A corollary assumption of the top-down design approach is

that the earlier you find and correct errors, the more time and money you save. For example, finding an error in post-layout simulation of an ASIC is better than finding it after fabrication. Finding the error in prelayout simulation is even better. Finding an error at the architectural or system-requirements stage is better still.

As system complexity increases, the possibility of creating an error-free design without simulation or prototypes becomes more remote. ESDA tools for simulation offer some help by allowing you to create a system simulation early and giving you a means to test the system architecture, functional operation, and system specification against the original concept.

In theory, any simulator can help with system simulation, provided that it covers the domains in which you work, such

WHERE DOES THE TIME GO IN YOUR DESIGN GROUP?

Before you can fix a problem, you have to know what the problem is. The first step toward improving your design process is to identify the problems that eat design time in your organization. The following scenarios illustrate situations you might consider when evaluating your company's design methodology and possible ways to improve it:

Problem: My company has to design systems several times because the requirements keep changing.

Solution: Nail down the requirements earlier. Design engineers often feel helpless and frustrated about this problem because another department, such as product marketing, or even another company is causing those changing requirements. If the end result is that projects move slowly through your design organization because you have to design a complete system multiple times, you can and should do something about it.

Electronic-system-design-automation (ESDA) tools can help by showing you the implications of a design's requirements earlier. You create a system simulation and show it to a customer, get feedback, and make changes to the requirements earlier in the design cycle. System simulation doesn't keep requirements from changing but may let you zero in on the final set of requirements before you invest a lot of detailed design work implementing a design.

Problem: My organization knows what it wants to build (the system requirements don't change), and the design works when we build it, but we redesign it several times to reduce the cost or optimize the performance.

Solution: System-level design tools can help with the optimization stage, too, by providing a simulation of the system and evaluating its performance. Exploring alternative designs isn't a mistake; it's part of the design process. Sometimes, simple calculations or intuition can help you weed out unworthy design alternatives. Simulation provides even better insight into a design and how it performs, helping you decide which alternatives are worth pursuing. The earlier you weed out unworthy architectural alternatives and pursue winners, the more time you save.

Problem: My company knows what it is trying to build (the system requirements don't change), but the design doesn't work the first time—or the second.

Solution: Sometimes, you miss the bull's eye, but if you miss by a lot or you miss every time, there may be a problem you can correct. If you aren't simulating at all, then that's the problem. If you are simulating, then you probably aren't performing the exhaustive verification that the design requires. Implementation-level problems aren't typically a strength for ESDA tools; however, you can often uncover functional design problems with system-level simulation. If your problems are in timing, ESDA tools will not help.

Problem: The design works when we finally get it done, and we don't go through a lot of design iterations. It just takes a long time.

Solution: Determine in greater detail where all the time is going. You may need tools that streamline some time-consuming parts of your design process, or you may need a new design methodology. If you are still creating digital designs at the gate level, you might consider moving to a hardware-description language (HDL). If the thought of text-based design leaves you cold, consider one of the many ESDA tools that provides graphical-design entry.

Graphical-design tools let you connect high-level blocks in a diagram, much like a schematic. Each block performs a general class of functions, such as adding or counting. You fill in a parameter table to specify the exact function, how many bits wide, and other specifications. From this graphical block-level design, many of the ESDA tools generate VHDL or Verilog code for input to logic-synthesis tools. Using these tools lets you avoid learning an HDL or at least lets you learn them at your own pace while completing designs in a timely manner.

If your design cycle takes too long because you spend too much time simulating to eliminate all the bugs, you may have a simulation-speed problem. Some ESDA tools provide cycle-based simulators that are 100 to 1000 times faster than ordinary logic simulators; these cycle-based simulators find functional design problems.

If your simulation problems are in timing, ESDA tools probably won't help. Instead, look for fast simulators or hardware accelerators.



NEW [TDS 310]
2 Chan/50 MHz



NEW [TDS 410]
2 Chan/150 MHz

the TDS 500 series

Precision, extended record length and waveform analysis



[TDS 544A]
4 Chan/500 MHz



[TDS 644A]
4 Chan/500 MHz

the TDS 300 series

Our most affordable family of DSOs

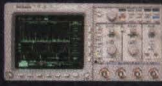

[TDS 420]
4 Chan/150 MHz



[TDS 520A]
2 Chan/500 MHz



[TDS 620A]
2 Chan/500 MHz

the TDS 800 series

Highest resolution and bandwidth



[TDS 320]
2 Chan/100 MHz



[TDS 460]
4 Chan/350 MHz



[TDS 524A]
2 Chan/500 MHz

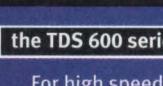

the TDS 600 series

For high speed digital/analog applications



NEW [TDS 684A]
4 Chan/1 GHz



NEW [TDS 350]
2 Chan/200 MHz



the TDS 400 series

2-/4-channel DSOs for bench and field applications



[TDS 540A]
4 Chan/500 MHz



[TDS 640A]
4 Chan/500 MHz



[TDS 820]
2 Chan/6 GHz

The Scope of Choice. No Matter Which One You Choose.

It should come as no surprise that Tektronix sells more high performance oscilloscopes than all other companies combined. Because, across the board, the Tektronix TDS family delivers superior performance and usability at every price point. And superior price at every performance point. ■ From the new \$2,300 TDS 310 to our 5 GS/s 1 GHz TDS 684A, every TDS scope has the same highly intuitive graphical user interface. Learn one TDS scope and you've learned to use them all. So it's easy to move from scope to scope. And from project to project ■ Our exclusive NuColor™ technology gives you the

New TDS 684A:
4 channels of
1 GHz real-time
acquisition, powerful triggering
and advanced
probing solutions.

industry's best full-color display, for about the same price as competitive monochrome scopes.

■ Using our new ultra small FET probes you can access today's highest density devices safely and accurately. TDS scopes even streamline documentation by saving screens in popular desktop publishing formats. ■ Of course the only way to get the full story is to contact your

nearest Tektronix representative today. Or call 800-426-2200, ext 284. Make your next scope the scope of choice.



Tektronix



03W-284512

Copyright 1994 Tektronix, Inc. All rights reserved. Tektronix, Tek and NuColor are trademarks.

Electronic-system-design automation

as analog, digital, mixed signal, or mechanical. In practice, an effective system simulator must be fast enough to run the simulation at an acceptable speed and have sufficient capacity for your system design. The simulator should also provide the information you need in a format that makes it easy to understand and evaluate a system's operation.

For most systems, behavioral-level models and cycle-based simulators can provide the required speed. Gate-level digital simulators and transistor-level analog simulators often cannot. Many companies use behavioral-level models in VHDL, Verilog, C, Spice, and proprietary languages.

Cycle-based simulators find functional design problems in synchronous systems. These simulators involve a tradeoff, however, because they sacrifice timing information for simulation speed in hunting down functional design problems. Cycle-based simulators are best suited to a divide-and-conquer approach of system design. First, you create and debug the functional design; then, you solve timing problems. For some systems, timing is the heart of the system, and trying to separate it from functional design is pointless.

How a simulator presents information is also an important selection criterion. Most logic simulators offer a waveform display for examining logic problems, but such a display is relatively inefficient for identifying system-level problems. You may need to show a system simulation to a customer who is not an electronic design engineer. With an easily understood format, such a customer can more likely find system problems in simulation instead of in the finished product.

Most ESDA simulators provide simulation results in a graphical format. Some tools, such as Redwood Design Automation's Race Simulator and Reveal Interactor, Mentor Graphics' System Design Architect, and i-Logix's Statemate family let you tailor a system's simulation output to almost any type of graphic display. These tools let you create a virtual-prototype system and test it against the specification and the original concept before investing the time in a full design implementation. These tools not only help you explore architectural approaches, but also let all members of the design work from a common vision of the finished system.

Implementing the design

Once you develop what appears an acceptable system architecture, you can move to the implementation phase. Most—but not all—graphical-ESDA tools are part of an implementation path. Conversion of graphical design information into a synthesizable design description is the reason many of these tools exist. With these tools, you provide a graphical block or state diagram, and the tool translates it

into synthesizable code, usually VHDL or Verilog.

Because logic-synthesis tools differ, graphical-design tools often develop code differently for each logic-synthesis tool. You should verify that any combination of design and synthesis tools you are considering using generates high-quality code.

Some high-level ESDA-simulation tools don't provide an implementation path through logic synthesis. These tools may be effective architectural tools to help verify that you are designing the right system, but they force you to create the physical design description separately.

Even before ESDA tools were in fashion, some designers created behavioral-level HDL models of systems for simulation and architectural verification and then created a register-transfer-level (RTL) description to implement the design. Because you cannot synthesize behavioral-level HDL designs, except for very low-level designs, this approach also leaves you without a direct implementation path. It does, however, let you insert

your RTL-logic blocks into the full system design for simulation as you transform the architectural design into an implementation.

If your goal is to work at a higher level and design more gates in a short time, consider using macros or building blocks having high gate counts to perform the functions you need. For example, Synopsys' DesignWare and Intergraph's MacroSyn include libraries of parameterized logic blocks that implement efficiently in synthesis.

Every component in Synopsys' ALU family has multiple architectures for each function. You can optimize these architectures for either performance or area to meet your design goals. If you find the building blocks you need, this design approach should raise your design efficiency.

A variation on the design-efficiency theme is design reuse. Salvaging parts of a design from a previous system and reusing them with relatively minor variations saves considerable time over generating them from scratch. In designs requiring greater variations, you can use Synopsys' DesignWare Developer, which lets you develop your own parameterized modules. The attraction of this approach is that you can implement the modules you need in the way you want. The disadvantage is that you invest time in creating the modules. If you will use the modules frequently, however, this time investment is probably justified.

EDN

(Tables follow on pg 88)

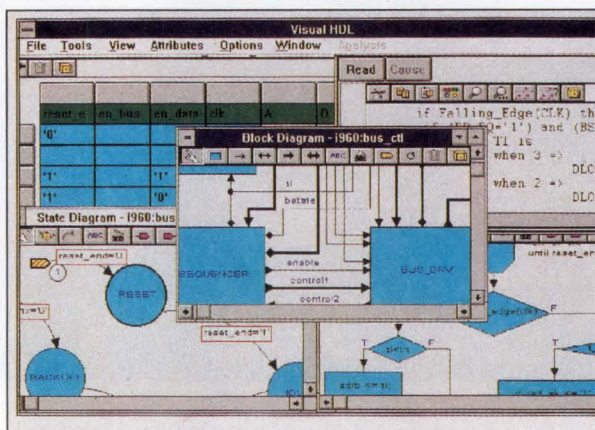

Accepting block diagrams, state diagrams, flow charts, truth tables, and VHDL text, Visual HDL from Summit Design helps you develop and simulate system designs while providing a smooth path to implementation.

You can reach Technical Editor Doug Conner at (805) 461-9669.

Article Interest Quotient (Circle One)
High 586 Medium 587 Low 588

Get a sample of reality.

Looking for analog confidence in a digital oscilloscope? Tektronix' TDS 350 sets the standard with Digital Real Time. ■ Its

incredible *one gigasample/second* sampling delivers real-life capture like never before—

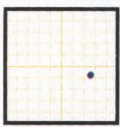

ONE POINT CAPTURED.
SINGLE EVENT CAPTURE USING EQUIVALENT TIME SAMPLING. 20 MS/S. 100 MHz DSO.

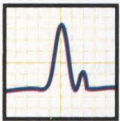

REAL LIFE CAPTURE.
SINGLE EVENT CAPTURE USING DIGITAL REAL TIME. 500 MS/S. 100 MHz DSO.

both for single shot or repetitive events.

Select peak detect for slow events, or push the scope to its full 200 MHz bandwidth — with

no aliasing. ■ And, like the entire TDS 300 family, the TDS

350 sets a new standard in price/performance: under \$4000.

Analog look and feel.

The TDS 300 family is simple and intuitive; just like your trusty analog scope. Even the digital interface is simplified with on-screen icons. You may never have to crack open the instruction manual!

High-end digital features. Each model features over 20 automatic measurements. Continuous update for hands-free opera-

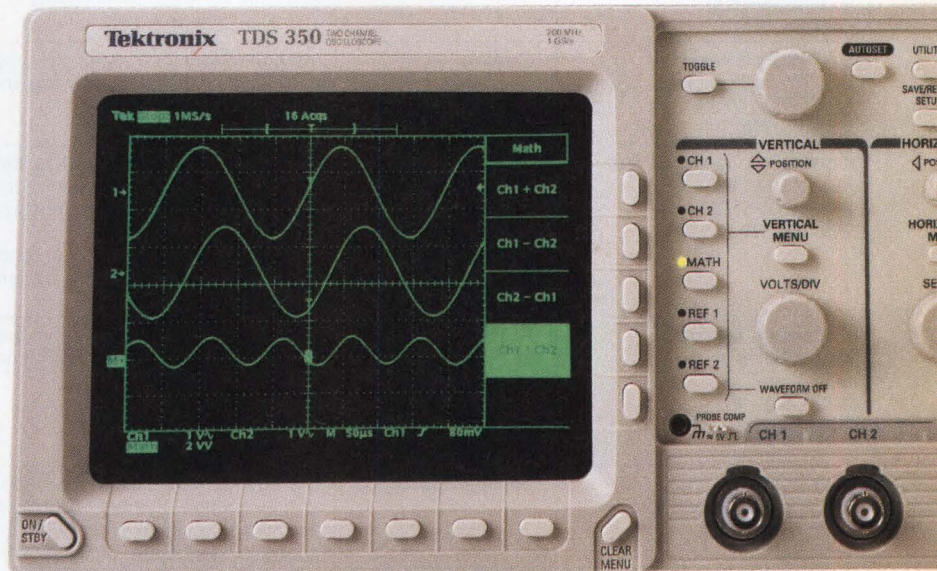

tion. Four acquisition modes and video trigger—perfect for tailoring the display.

And a communication option for hardcopy

to most printers, or to send/receive waveforms and setups.

Get real. For more real-time benefits of the TDS 300 family, call your authorized Tektronix distributor

There's a TDS 300 Series scope for every application. And every budget.

FEATURES	TDS 310	TDS 320	TDS 350
Bandwidth	50 MHz	100 MHz	200 MHz
Max Sample Rate	200 MS/s/chan	500 MS/s/chan	1 GS/s/chan
Sweep Speeds	10 ns/div - 5 s/div	5 ns/div - 5 s/div	2.5 ns/div - 5 s/div
Channels	2	2	2
Vertical Sensitivity	2 mV - 10 V	2 mV - 10 V	2 mV - 10 V
Vertical Resolution	8 bits	8 bits	8 bits
Record Length	1K/channel	1K/channel	1K/channel
Standard Advanced Features	TV Line & Field Trigger, Roll Mode, Autoset, 21 Automatic Measurements, Peak Detect		
Comm. I/O (Option 14)	GPIB, RS-232, Centronics and VGA video output		
Price	\$2295.	\$2895.	\$3995.

today. Or call Tektronix at (800) 426-2200, ext. 212.

Tektronix

Electronic-system-design automation

ELECTRONIC-SYSTEM-DESIGN AUTOMATION TOOLS

Manufacturer	Product	Description	Inputs
Anacad EES Milpitas, CA (408) 954-0600 Circle No. 396	HDL-A	VHDL-based analog behavioral modeling system for use with the company's Eldo simulator; models analog and mixed-signal systems, including electrical, mechanical, fluid, rotational, magnetic, thermal	VHDL and proprietary HDL-A language
Analogy Inc Beaverton, OR (503) 626-9700 Circle No. 397	Saber	Analog and mixed-signal simulation; works with logic simulators; model libraries and templates available for many applications	Spice models and proprietary modeling language (MAST)
CADIS Software South San Francisco, CA (415) 615-7789 Circle No. 398	Cossap	Integrated tool for the design, simulation, and implementation of digital-processing and communication systems	Graphical block diagrams
Comdisco Systems Inc Foster City, CA (415) 574-5800 Circle No. 399	System Design Architect	System-level design for ASICs, field-programmable gate arrays, and microcoded processors using a parameterized library of synthesizable blocks	Graphical function blocks, VHDL, C
	Signal Processing WorkSystem (SPW)	Interactive design, simulation, and implementation of DSP and communication systems	Graphical block diagrams
Compass Design Automation San Jose, CA (408) 433-4880 Circle No. 400	ASIC Navigator	Top-down ASIC design system with application to general-purpose design, DSP, image processing, and communication	Block diagrams for data path, state machines, memory templates, VHDL, Verilog, gate-level schematics, Boolean equations, and truth tables
Elanix Inc Westlake Village, CA (818) 597-1414 Circle No. 401	SystemView	Dynamic system simulator for conceptual design and evaluation of analog and digital designs; emphasis on signal processing, communications, control systems, and general mathematical modeling	Graphical block diagrams and graphical templates
HP-EESof Westlake Village, CA (818) 879-6200 Circle No. 402	OmniSys	System simulator for evaluating topologies of communication systems; analyzes complex waveforms in systems based on arbitrary topologies and modulation schemes	Graphical block diagrams
Hyperception Dallas, TX (214) 343-8525 Circle No. 403	Hypersignal for Windows Block Diagram	Graphically develops and simulates DSP and communication systems; generates source code for porting designs to other platforms or cross-compiled for specific DSP chips	Graphical block diagrams
i-Logix Inc Andover, MA (508) 682-2100 Circle No. 404	Statemate 5.0 ExpressV-HDL	Requirements traceability, graphical design, simulation, analysis, and code generation; hardware/software co-design	Architectural block diagrams, behavioral state charts, C
Intergraph Huntsville, AL (205) 730-2700 Circle No. 405	MacroSyn	Provides template-driven creation of synthesizable macros	Graphical symbols and templates
	Design Expressions	Design description allows entering of designs using truth tables, state tables, Boolean equations, VHDL, and Diablo for design descriptions	Truth tables, state tables, Boolean equations, VHDL; Diablo for analog behavioral descriptions
	ACEPlus Designer	Graphical creation of state-machine designs	State diagrams
Knowledge Based Silicon Inc Columbia, SC (803) 779-2504 Circle No. 406	FlowHDL	Creates system descriptions as a collection of hierarchically partitioned concurrent flow-diagram threads for general-purpose design	Graphical and textual design entry for state-machine, data-path clocking, memory, synchronous, and asynchronous, and resolution functions
	BlockHDL	Specifies high-level system descriptions as collections of hierarchically partitioned blocks; supports top-down and bottom-up design methodologies	VHDL, Verilog, block diagrams
Mentor Graphics Wilsonville, OR (503) 685-8000 Circle No. 407	System Design Station	Top-down system design from requirements through graphical or textual design to verification and implementation of general-purpose and DSP designs; VHDL-code generation	Graphical state and data-flow diagrams, state-transition matrix and table editor, VHDL

Outputs	Simulation	Provides an implementation path	Computer required	Price
Models compatible with the Eldo simulator	Mixed signal; also works with most logic simulators for large VHDL descriptions	Simulation only	Workstation	HDL-A development system: \$30,000, runtime version: \$8000, Eldo: \$22,000
Simulation	Analog and mixed signal	Simulation only	Workstation	Starts at \$20,000
VHDL, DSP-executable code	Yes	Yes	Workstation	\$30,000
VHDL, Graphical Waveform	Cycle-based simulator	Yes	Workstation	\$5000 plus \$25,000 for SPW
C or assembly code for DSP chips (VHDL optional)	Floating point (fixed point optional)	Yes	Workstation	\$25,000
Complete ASIC and field-programmable gate-array designs	VHDL and Verilog	Yes	Workstation	\$40,000
Mathematical models	Yes	No	PC/Windows	\$985
Simulation	Yes	No	Workstation	\$26,000
C optional	Yes	On path (software)	PC/Windows	\$1995, C-code generator: \$5000, Advanced Transmission library: \$1495
VHDL, Verilog; optional C and Ada code	Yes	Yes	Workstation	\$20,000 to \$40,000
VHDL, Verilog	No	Yes	Workstation	\$10,000
VHDL, Verilog, ABEL	No	Yes	Workstation	\$8000
VHDL, Verilog, ABEL	No	Yes	Windows NT, Unix workstations	\$3500
VHDL, Verilog	Cycle-based simulator	Yes	Workstation	\$10,000
VHDL, Verilog	Optional	Yes	Workstation	\$2800
ASIC and field-programmable gate-array libraries; interface to computer-aided software engineering, DSP, analog, VHDL	VHDL, gate-level simulator	Yes	Workstation	\$94,900

table continued on pg 90

Electronic-system-design automation

ELECTRONIC-SYSTEM-DESIGN AUTOMATION TOOLS (CONTINUED)

Manufacturer	Product	Description	Inputs
Mentor Graphics Wilsonville, OR (503) 685-8000 Circle No. 408	System Architect	Graphical and textual design of systems for DSP and general-purpose applications; state-machine verification and VHDL-code generation	Graphical state and data-flow diagrams, VHDL
NuThena Systems McLean, VA (703) 356-5056 Circle No. 409	Foresight 3.00	Development tool for constructing and analyzing executable system models for embedded and distributed systems	Proprietary modeling language, graphical entry
R-Active Cupertino, CA (408) 252-2808 Circle No. 410	Better State Pro	Generates C, C++, VHDL, or Verilog from state diagrams	Graphical state diagrams
Redwood Design Automation (408) 291-3650 San Jose, CA Circle No. 411	Race Simulator/ Reveal Interactor	Cycle-based simulation engine and graphical prototyping tool	VHDL, Verilog, C, C++
Scientific and Engineering Software Inc Austin, TX (512) 328-5544 Circle No. 412	SES/Workbench	Evaluates functionality and performance of architecture before prototyping of computers, complex software systems, large data-communication networks, bus-interfaces, communication protocols, μ Ps, and ASICs	Graphically models systems with a variety of node types; creates custom nodes in C; Verilog cosimulation optional
Speed Electronics Inc Oak Brook, IL (708) 990-1910 Circle No. 413	SpeedChart	Graphical design tool for generating VHDL and Verilog code	State diagrams, schematics, behavioral code, spreadsheet tables
Summit Design Inc Beaverton, OR (503) 643-9281 Circle No. 414	Visual HDL	Captures designs using four graphical languages, simulates and outputs designs in VHDL or Verilog	Block diagrams, state diagrams, flow charts, truth tables, VHDL text
Synopsys Mountain View, CA (415) 962-5000 Circle No. 415	DesignWare	Parameterized, fully synthesizable modules for general-purpose design; allows the addition of custom components to the library	Selects modules, then inputs parameters to customize them for a design
TD Technologies Inc Cleveland Heights, OH (216) 371-9777 Circle No. 416	Transcend	Design, analysis, and verification tool for complex electronic hardware- and software-systems design	Proprietary- graphical/textual-language, C++ VHDL, and Verilog submodules
Tesoft Inc Roswell, GA (404) 751-9785 Circle No. 417	Tesla	Block-diagram simulator for communication, signal-processing, and control systems	Proprietary-language and graphical-function blocks
Vantage Analysis Systems Fremont, CA (510) 659-0901 Circle No. 418	TD Connection/ TD Simulator	Transaction-based simulator allowing analysis of architectural tradeoffs, cosimulation with VHDL designs optional	Proprietary-graphical/textual-language, VHDL submodules
Viewlogic Systems Inc Marlboro, MA (508) 480-0881 Circle No. 419	ViewState	Graphical VHDL entry tool allowing graphical creation of complex behavioral models; supports hierarchical and concurrent state machines	State diagrams
	View Architect	Synthesizes hardware architecture from behavioral VHDL descriptions, producing architectural block diagrams and detailed register-transfer-level design structure ready for logic synthesis	Behavioral and register-transfer-level VHDL
Vista Technologies Schaumburg, IL (708) 706-9300 Circle No. 420	Design Vision	Graphically develops HDL models	Graphical entry of control-flow and data-flow diagrams
Visual Software Solutions Inc Coral Springs, FL (305) 346-8890 Circle No. 421	StateCAD	Graphically creates state diagrams and translates them in ABEL or C code	Graphical

EDN-SPECIAL REPORT

At last, edge rates, the wrong interfaces

Outputs	Simulation	Provides an implementation path	Computer required	Price
VHDL	State-machine animator	Optional synthesis	Workstation	\$34,900
Reports, animated data visualization	Yes	No	Workstation	\$25,000
VHDL, Verilog, C, C++	No	Yes	PC/Windows	\$1195
Simulation	Cycle-based simulation	Simulation only	Workstation	Race/Reveal combined: \$65,000
Simulation	Graphical animation	No	Workstation	SES/Workbench: \$37,000, Verilog cosimulation: \$6000
VHDL, Verilog; C optional	Yes	Yes	Workstation	\$26,000
VHDL, Verilog	Yes (presynthesis)	Yes	Workstation, PC/Windows	Unix: \$25,000, PC/Windows: \$12,500
VHDL	Optional	Yes	Workstation	Libraries: \$5000, developers tools: \$45,000
Simulation	Yes	Yes	Workstation	\$35,000
Graphical and text	Digital and analog	No	PC	\$695
Simulation	Yes	No	Workstation	TD Connection: \$12,000 TD Simulator: \$35,000
VHDL	Simulates state transitions	Yes	Workstation	\$11,000
VHDL, hierarchical block diagrams	No	Yes	Workstation	\$25,000
VHDL, Verilog	Compatible with standard VHDL and Verilog simulators	Yes	Workstation	\$15,000
ABEL, C, state diagrams	Functional state simulation	Yes	PC/Windows	\$995

At fast edge rates, the wrong interface takes on unexpected qualities.

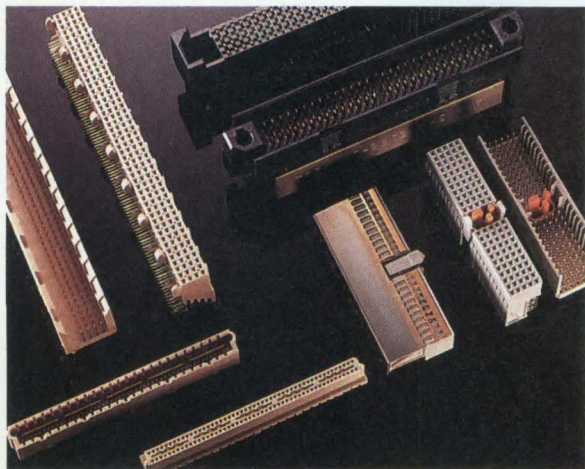
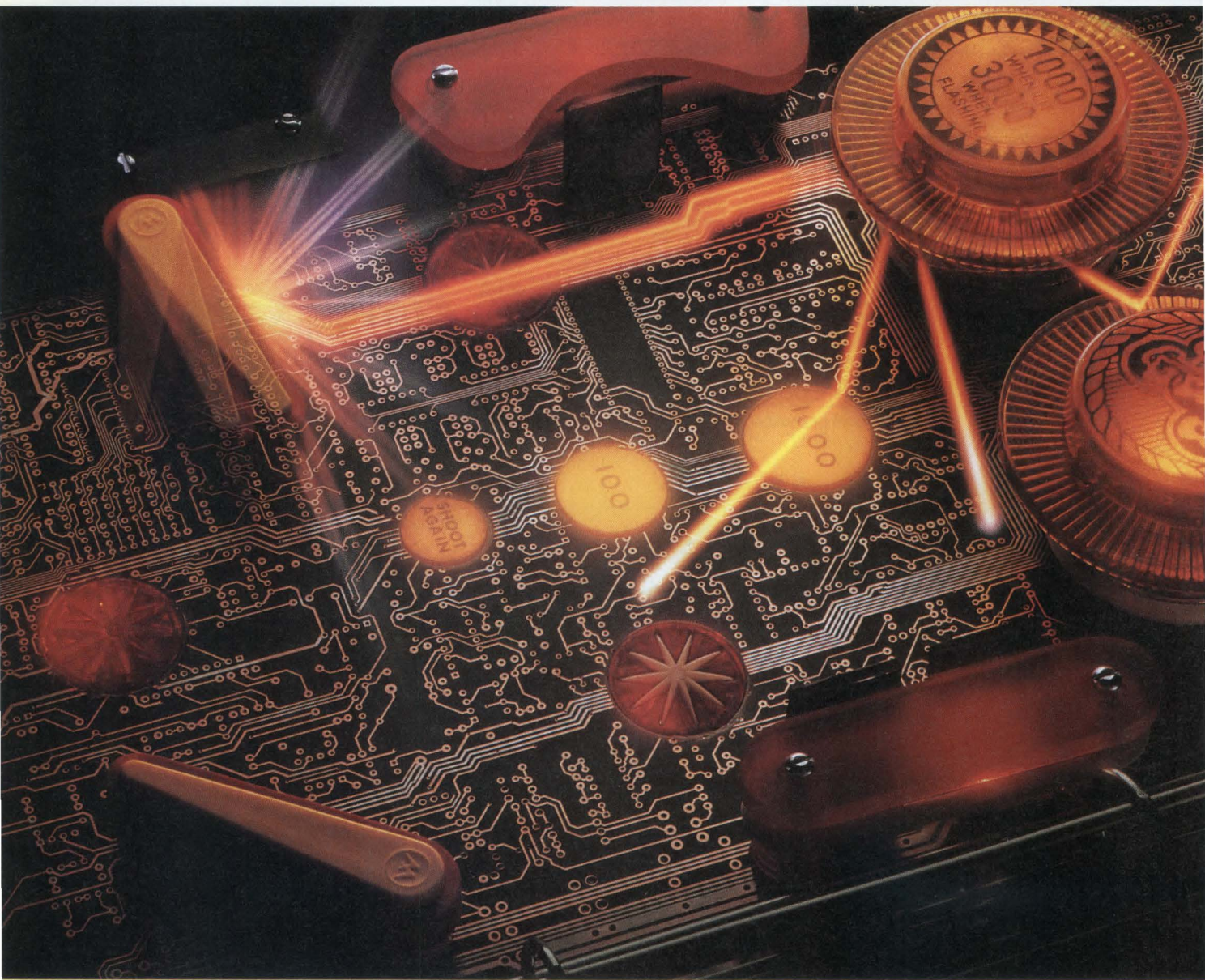

AMP high-speed connectors – in hard metric, shielded hard metric, Futurebus, stripline, and microstrip versions – offer a broad range of signal management solutions.

AMP high-speed board-to-cable connectors and cable assemblies minimize reflection, crosstalk, and propagation delay at critical interfaces.

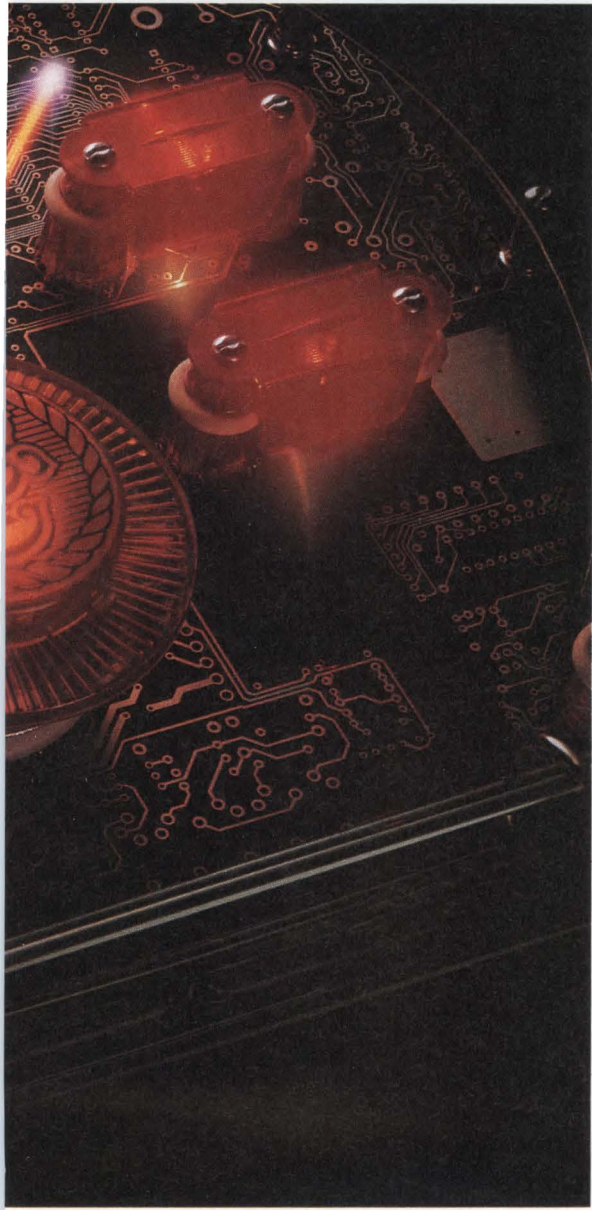

As the demand for performance pushes clock rates up, signal integrity can become a real challenge—especially when traffic moves from board to board, or board to cable. Interconnects that worked last time around suddenly act a lot like bumpers and flippers when your signal hits them. Fortunately, expert interconnect help is available.

We'll show you a broad range of technology solutions—the newest and best of subnanosecond interfaces. We'll work with you to choose the right combination of performance and features to meet tough circuit requirements. And our experience in design and in manufacturing can help make sure your choice works on the production line, as well.

Our high-speed and controlled-impedance interconnect solutions are engineered for hassle-free implementation, even with edge rates pushing 250ps. Our board-to-board selection includes high-



density open pin field types (shielded versions available), plus stripline and microstrip styles that allow you to match characteristic board impedances to minimize crosstalk, reflection, and groundbounce. Our board-to-cable selection includes precision miniature coax and transmission line offerings to maintain signal integrity with minimum propagation delay.

And we offer the simulation tools you need to confirm performance in software, before you build your first prototype. Talk with your AMP Sales Engineer today, or call; we're ready to help.

AMP is a trademark.

For more information on AMP signal management solutions, call our Product Information Center at 1-800-522-6752 (fax 717-986-7575). AMP, Harrisburg, PA 17105-3608. In Canada, call 905-470-4425.

CIRCLE NO. 104

AMP

No Oscillation With Any Load.

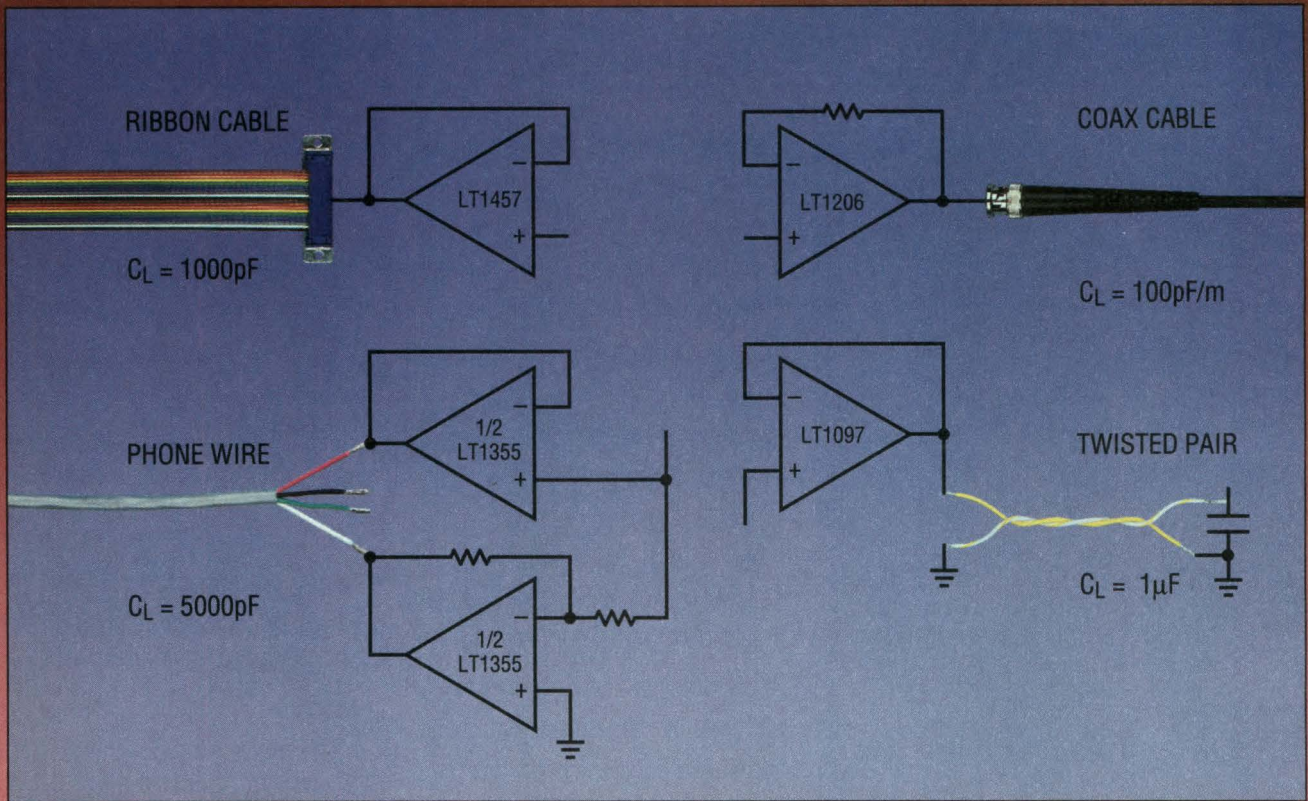

Our C-Load™ Op Amp Family Handles More Than 10,000pF.

Finally, op amps designed to operate with real world capacitive loads. LTC's C-Load family of op amps solves the problem of capacitive load induced oscillations. Our C-Load op amps slow down when capacitively loaded, while other op amps oscillate.

Driving coax, twisted pair and other difficult loads take no extra care when C-Load op amps are used. C-Load op amps are stable when driving loads of over 10,000pF, more than most applications require.

Capacitive load driving capability isn't limited to any one type of amplifier. LTC's family of C-Load op amps include devices from the 7pA, FET-input LT1457 to the 70MHz, 1000V/µsec LT1363.

The LT1206 with its 250mA minimum output current has enough drive to slew 10,000pF at 50V/µs. Precision instrumentation applications? The LTC1152 rail-to-rail input and rail-to-rail output zero drift op amp provides 10µV max offset as well as C-Load driving.

Part #	Max V _{OS}	Max I _B	Min I _{OUT}	Bandwidth	Slew Rate
LT1097*	60µV	350pA	5.7mA	700kHz	0.2V/µs
LTC1152	10µV	100pA	4mA	1MHz	1V/µs
LT1206	10mV	5µA	250mA	60MHz	900V/µs
LT1220	1.0mV	300nA	24mA	45MHz	250V/µs
LT1224*	2.0mV	8µA	24mA	45MHz	400V/µs
LT1354*	800µV	300nA	30mA	12MHz	400V/µs
LT1357*	600µV	500nA	30mA	25MHz	600V/µs
LT1360*	1.0mV	1µA	40mA	50MHz	800V/µs
LT1363*	1.5mV	2µA	70mA	75MHz	1000V/µs
LT1457	800µV	75pA	10mA	1.7MHz	4V/µs

*Duals and Quads are available.

Specifications for the table shown are low cost grades in plastic DIP. Prices for our C-Load op amps start as low as \$1.05 for the LT1097CN8. For details, contact Linear Technology Corporation, 1630 McCarthy Blvd., Milpitas, CA 95035/408-432-1900. For literature only, call 1-800-4-LINEAR.



FROM YOUR MIND TO YOUR MARKET
AND EVERYTHING IN BETWEEN.

Low-distortion oscillator starts fast

Mika Maaspuro, Helsinki University of Technology, Espoo, Finland

BBS Unlike a Wien-bridge oscillator, the phase-shift oscillator in **Fig 1** starts up quickly. Also, the circuit does not require that you adjust several trimming resistors just to tune the oscillator to a given frequency. Experiments show that the circuit's total harmonic distortion (THD) measures approximately 0.5% or less.

Connecting the output of a bandpass stage to its input via a phase inverter realizes a phase-shift oscillator. In practice, a phase-shift oscillator also needs a limiter stage. Unfortunately, the limiter can distort the output sine wave.

Diodes D_1 and D_2 in the feedback loop of IC_{1A} form a limiter that *does not* distort the output. The equation for the circuit is

$$f_{osc} = \frac{1}{2\pi C} \sqrt{\frac{1}{R_2 R_1} + \frac{1}{R_3 R_1}} \approx \frac{1}{2\pi C \sqrt{R_3 R_1}}$$

R_1 tunes the frequency of the oscillator.

To have a stable output voltage and minimum distortion, you must set the gain of the loop carefully. The gain needed for oscillation varies slightly with frequency; the circuit needs more gain for lower frequencies. You can leave R_1 fixed to a value that yields the lowest frequency.

The circuit can generate a good-quality sine wave at low frequencies. In those cases, the values of capacitors C_1 and C_2 may be several microfarads. With such large capacitors, the startup time increases to several hundred milliseconds. You can avoid this delay by connecting diode D_3 . With D_3 in place, startup always takes no more than a few milliseconds. D_3 does not distort the characteristics of the circuit because D_1 and D_2 already limit the output to a few hundred millivolts, peak-to-peak. With D_3 connected, the circuit needs a little more gain to develop a stable output.

EDN BBS/DI_SIG #1423 contains a writeup of this circuit and a comprehensive Spice model. (DI #1423)

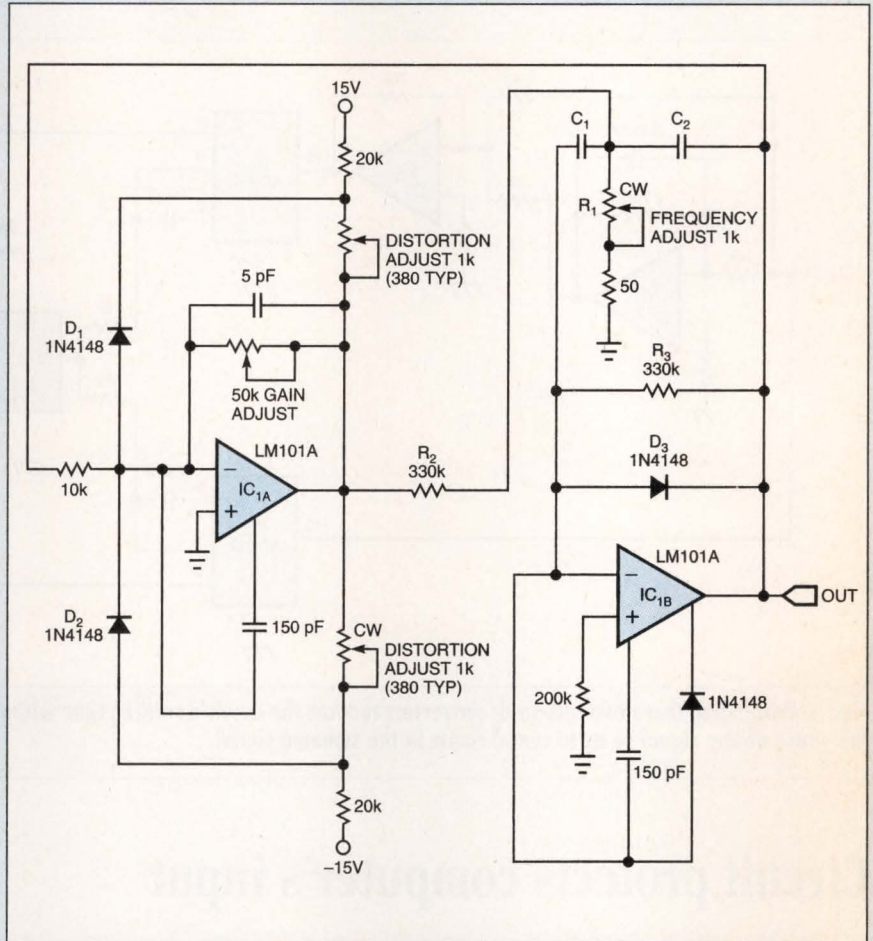

Fig 1—This fast-startup sine-wave oscillator does not exhibit the usual output distortion of phase-shift oscillators.

Reference

1. "Easily Tuned Sine Wave Oscillators," National Semiconductor, Linear Application Handbook 1986, pp 1118 to 1119, LB-16. EDN

To Vote For This Design, Circle No. 424

Paralleling rms converters speeds settling

Bernard Courtiol, Cegelec Soprano, Vaulx Milieu, France

An rms-to-dc converter requires an output lowpass filter, which sometimes leads to overly long settling times. Paralleling two converters reduces the circuit's settling time signal without increasing conversion errors (**Fig 1**).

The circuit in **Fig 1** monitors 50-Hz mains. IC_1 , IC_2 , and their associated circuitry compose a phase shifter. The phase shifter has a 90° delay for 50-Hz inputs and constant gain. The second-order, lowpass, state-variable filter, IC_3 , sums

and filters the outputs of rms-to-dc converters IC₃ and IC₄.

The circuit's settling time to 1% of final value is 20 msec.

$F(p) = 0.5 / (a^2 p^2 + 2kap + 1)$, where $k = 0.7$ and $a = 0.5$ msec.

If the circuit were to have only one rms-to-dc converter, its settling time would be 100 msec.

To reduce the circuit's settling time further, you could par-

allel more converters, each having a different phase shift. The trick is to set up the phase shifts so as to cancel ripple in the summed signal. (DI #1424) EDN

To Vote For This Design, Circle No. 425

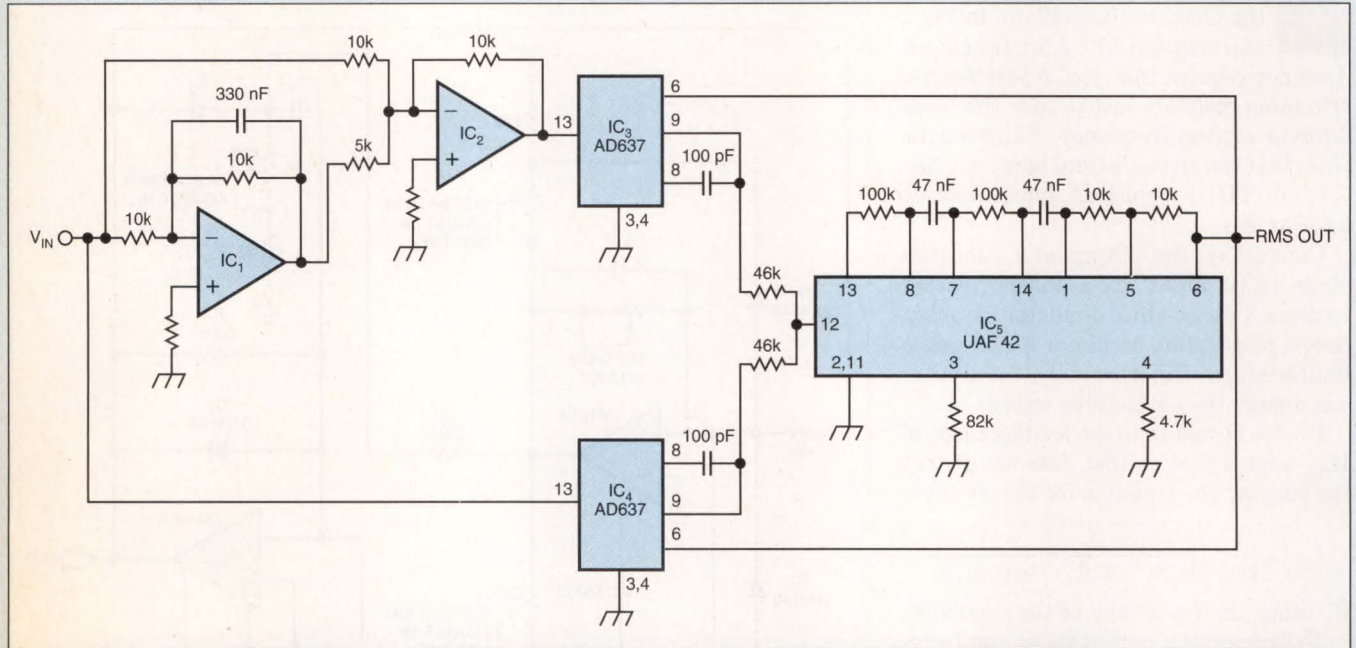

Fig 1—Paralleling these two rms-to-dc converters reduces the circuit's settling time without increasing conversion errors. The op amps shift the phase of one signal so as to cancel ripple in the summed signal.

Circuit protects computer's input

Ang Tzu Seng, Halliburton Drilling Systems, Singapore

The circuit in Fig 1 performs input protection, level translation, isolation, and debouncing. The circuit allowed the output of a relay driver to connect to a computer even though the relay driver delivered a voltage as high as 24V and the relay driver had no ground connection.

With the values in Fig 1, the low and high thresholds at the circuit's input were approximately 8 and 16V, respectively. The cutoff frequency was high enough to allow counting 1200 counts/min. The input withstood 110V ac continuously—the optoisolator's withstand voltage is 3 kV.

I tested the debouncing function with a microswitch in series with a 24V-dc power supply and the relay driver. I detected no switch bounce.

You can change capacitor C₁ to suit other applications' cut-off frequencies. Altering the resistors may be tricky because you will affect the circuit's low- and high-threshold levels. To use inputs other than 24V, change R₁. (DI #1425)

EDN

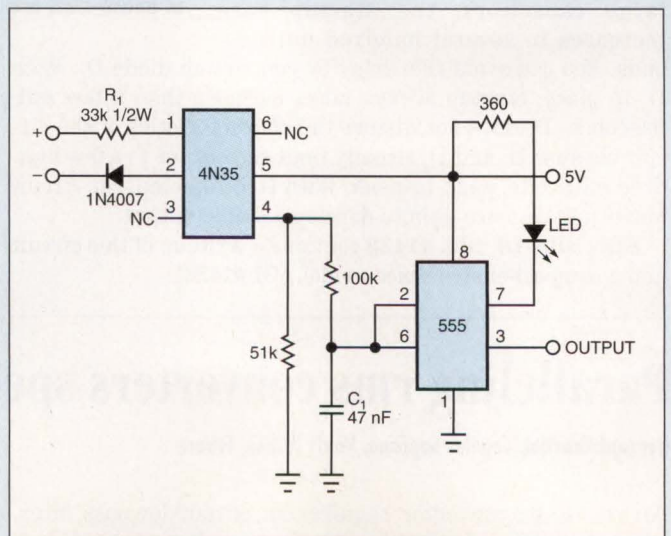
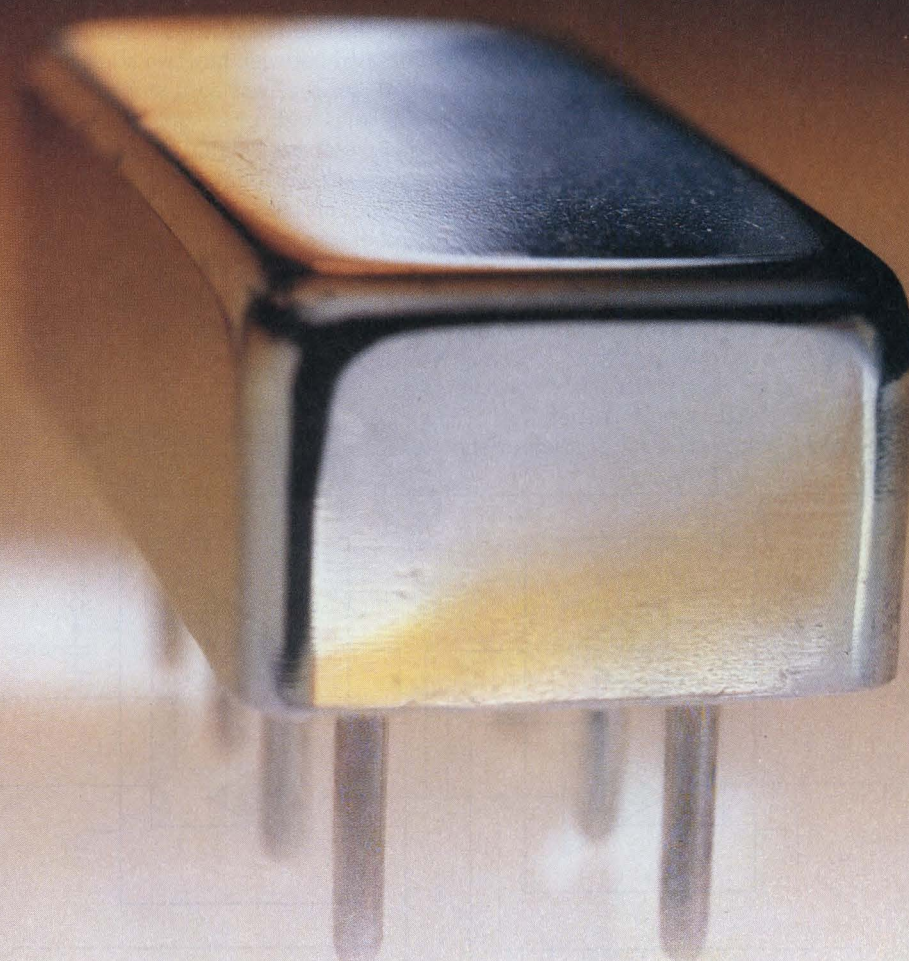

Fig 1—This circuit performs input protection, level translation, isolation, and debouncing for a computer's input.

To Vote For This Design, Circle No. 426

AMPLIFIERS

0.5 to 2000MHz



High Power, up to +15dBm Rugged, Plug-in Package from **\$13.95** (10-24 qty.)

Both inside and out, the high level of performance you've been looking for in a broadband, plug-in amplifier is right here in Mini-Circuits value priced MAN series...featuring gain to 28dB, reverse gain greater than 40dB and power output as high as +15dBm! These unconditionally stable units are built incredibly tough to meet full MIL-specs and packaged in miniature 0.4"x0.8"x0.25" hermetically sealed metal casings. Inside,

the MAN amplifiers consist of 2 stages including coupling capacitors and can withstand operational temperatures from a frigid -55°C to a scorching +100°C! MAN amplifiers are available from stock starting at the small price of just \$13.95. But, don't just read about this impressive list of features ...call Mini-Circuits and put the power of MAN amplifiers to work for you today!

Mini-Circuits...we're redefining what VALUE is all about!

Model	Freq. Range f_L to f_U (MHz)	Gain		Max. Output PWR** (dBm)	NF typ. (dB)	Isol. typ. (dB)	DC PWR (V/mA)	Price \$ ea. (10-24)
		min. (dB)	flatness* (+/-dB)					
MAN-1	0.5-500	28	1.4	8.0	4.5	41	12/60	13.95
MAN-2	0.5-1000	18	1.5	7.0	6.0	37	12/85	15.95
MAN-1LN	0.5-500	28	1.4	8.0	2.8	42	12/60	15.95
MAN-1HLN	10-500	10	0.8	15.0	3.7	16	12/70	15.95
MAN-1AD	5-500	16	1.0	6.0	7.2	50	12/85	24.95
MAN-2AD	2-1000	9	0.7	-2.0	6.5	33	15/22	22.50
MAN-11AD	2-2000	8	1.5	-3.5	6.5	27	15/22	29.95

CIRCLE NO. 103

* Midband $10f_L$ to $f_U/2$, +/- 0.5 dB ** At 1dB compression point ^ Case height 0.3 inch



Actual Size

Mini-Circuits

P.O. Box 350166, Brooklyn, New York 11235-0003 (718) 934-4500 Fax (718) 332-4661

For detailed specs on all Mini-Circuits products refer to • THOMAS REGISTER Vol. 23 • MICROWAVES PRODUCTS DIRECTORY • EEM • MINI-CIRCUITS' 740- pg. HANDBOOK.

CUSTOM PRODUCT NEEDS...Let Our Experience Work For You.

RS-485 repeater extends standard's reach

Mitchell Lee, Linear Technology Corp, Milpitas, CA

RS-485 specifies communications for distances up to 4000 ft. This limit is the consequence of losses in the twisted pair used to carry the data. Beyond 4000 ft, skin effect and dielectric losses take their toll, attenuating the signal beyond use.

Fig 1 shows a simple RS-485 repeater. Two RS-485 transceivers connected back-to-back relay incoming data from either side. A pair of cross-coupled one shots control the data flow so that only one transmitter turns on at a time.

A 1-to-0 transition at the output of either idling receiver signifies incoming data. The first receiver to spot such a transition triggers its associated one shot, which, in turn, activates the opposite transmitter to ensure smooth data flow from one side of the repeater to the other. At the same time, the one shot locks out the other receiver/transmitter/one-shot combination, so that only one data path is open.

Successive 1-to-0 transitions and start bits retrigger the

one shot, holding the data path in its present configuration. Set the one shots' time constants slightly greater than the interval between any two start bits.

When received data stops arriving, the previously active line idles high, producing a 1 at the receiver's output. The one shot resets, returning the opposite transceiver to the receive mode—ready for any subsequent data flow in either direction.

The software protocol must wait one word length after the end of any data transmission before responding to a call or initiating a new conversation to allow adequate time for the one shots to reset. The repeater in **Fig 1** handles 100-kbps data rates and a 8-bit word length, plus start and stop bits. (DI #1421) EDN

To Vote For This Design, Circle No. 427

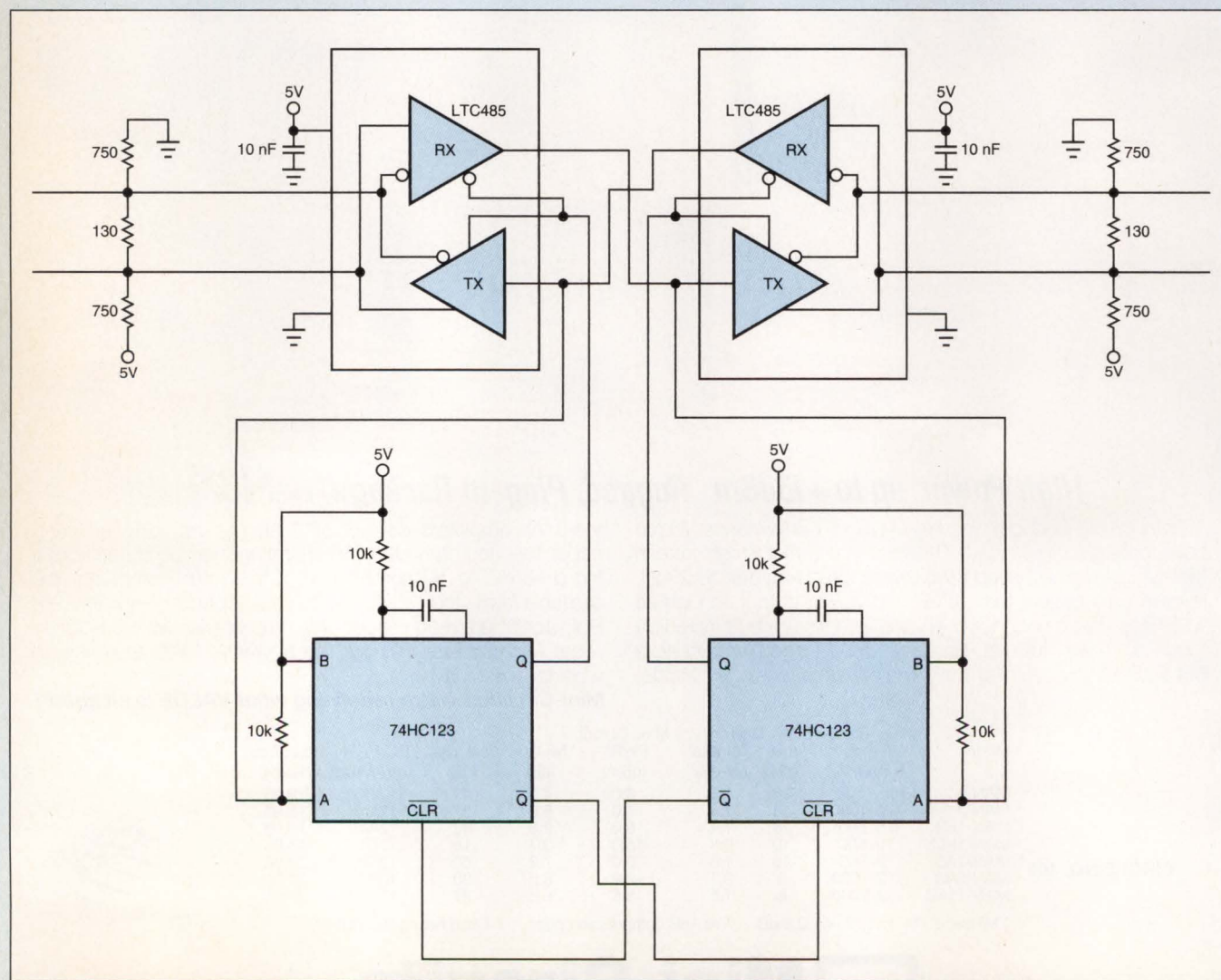

Fig 1—This simple RS-485 repeater can compete with μ P-based repeaters if you set up your software protocol properly.

Want A Similar View Of Your Embedded Real-Time Applications?



WindView™—The First Visual Analysis Tool For Real-Time Developers.

Thanks to Wind River Systems, you can see what makes your real-time application tick. With your very own eyes.

WindView lets you observe the precise sequence and timing of all the events in your application. Every interaction between tasks, interrupts, semaphores, message queues, including application-level events that you define. WindView captures information from applications running in real time. Then lays it all out in living color.

You can zoom in for micro-second-resolution detail. Or zoom out to get the big picture

on your software's execution. You'll see race conditions, deadlocks, performance bottlenecks and missed deadlines—those tough real-time problems that delay projects by days, weeks, even months—and diagnose them in a matter of minutes.

We call it a logic analyzer for embedded software. But WindView, by any name, is a visible breakthrough for real-time

development. And a truly ingenious addition to the WindPower Tools for VxWorks®. To try WindView for yourself, call us

and we'll send you our free demo. After all, seeing is believing. 1-800-677-1586.

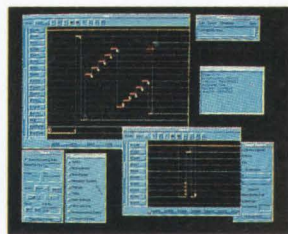

With WindView, you can quickly and easily visualize an application at the system level.

THE REAL POWER IN REAL TIME.



Pulse generator verifies test setups

Jim Williams, Linear Technology Corp, Milpitas, CA

Verifying the rise-time limit of wideband test-equipment setups is a difficult task. In particular, you must often know the "end-to-end" rise time of an oscilloscope/probe combination to ensure measurement integrity. Fig 1's circuit provides an 800-psec pulse having rise and fall times shorter than 250 psec. The pulse's amplitude is 10V, and the circuit's source impedance is 50Ω. The circuit is similar to the one Ref 1 details, except that this circuit is triggerable instead of free-running. This triggering feature permits synchronizing with a clock or another event. You can vary the delay of the output with respect to the trigger by 200 psec to 5 nsec.

The circuit requires a high-voltage bias for operation. A cascoded high-voltage transistor, Q_2 , combines with a switching regulator IC_1 to form a high-voltage, switched-mode supply. IC_1 pulse-width-modulates Q_2 at a 100-kHz clock rate. L_1 's inductive events get rectified and stored in the 2-μF output capacitor. The adjustable resistor divider provides feedback to IC_1 . The diode and RC combination at Q_2 's base damp inductor-related parasitic behavior. The 10-kΩ/1-μF pair filters noise from the supply line.

The R_3/C_1 combination applies high voltage to Q_1 , a 40V-breakdown device. Set the high-voltage "bias-adjust" control at the point where free-running pulses across R_4 just disappear. This setting puts Q_1 slightly below its avalanche point.

Subsequently, applying an input trigger pulse causes Q_1 to avalanche. The result is a quickly rising, very fast pulse across R_4 . C_1 discharges, Q_1 's collector voltage falls, and breakdown ceases. C_1 then recharges to just below the avalanche point. At the next trigger pulse, this sequence repeats.

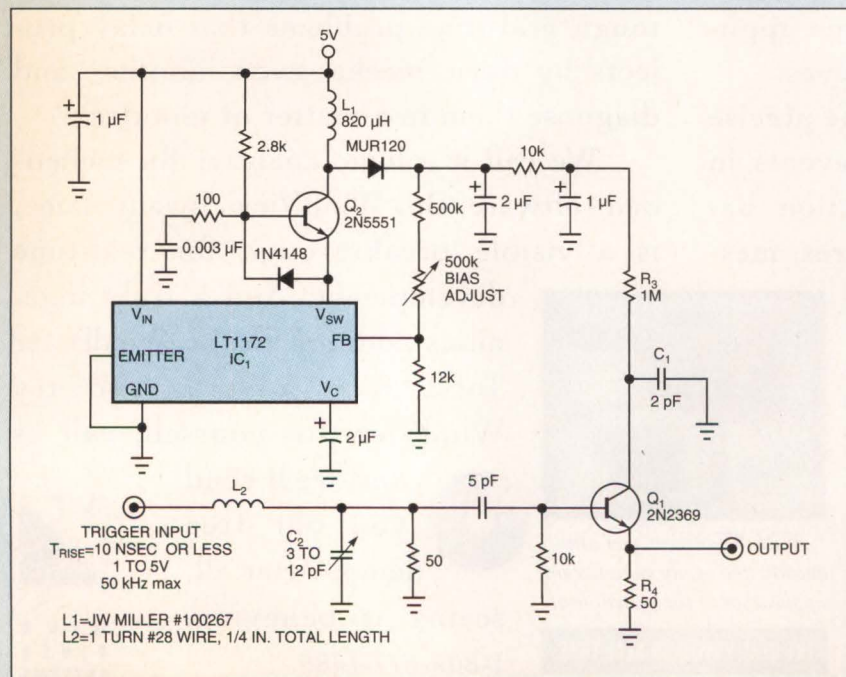

Fig 1—A trigger pulses causes the carefully biased Q_1 to avalanche, producing a fast, short 10V pulse suitable for verifying instrument setups.

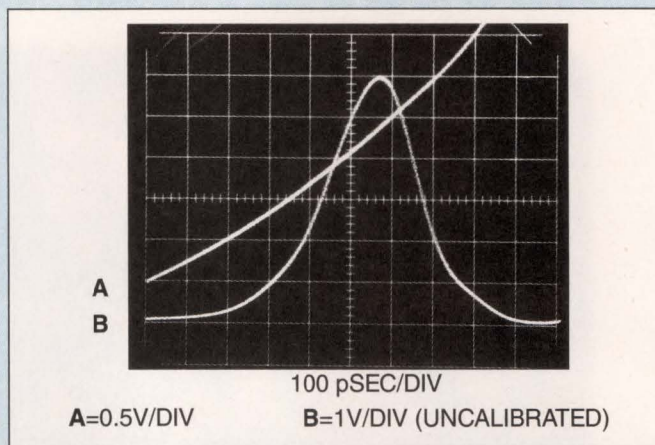

Fig 2—The input trigger pulse to the circuit in Fig 1 appears as Trace A. A 3.9-GHz Tektronix 661 sampling oscilloscope with 4S2 sampling plug-in measured the pulse, Trace B, as having a 10V amplitude and an 800-psec duration. Rise time is 250 psec, with fall time indicated as 200 psec. The times are probably slightly faster, because the oscilloscope's 90-psec rise time influences the measurement.

Fig 2 shows the circuit's waveforms. The input trigger pulse is Trace A. Its amplitude provides a convenient way to vary the delay time between the trigger and output pulses. A 1 to 5V setting range produces a continuous 5-nsec to 200-psec delay range.

The circuit requires some special considerations for optimal performance. L_2 's very small inductance combines with C_2 to slightly retard the trigger pulse's rise time. This retardation prevents significant trigger-pulse artifacts from appearing at the circuit's output. You should select C_2 for the best compromise between output-pulse rise time and waveform purity. You may also have to select Q_1 to get the desired avalanche behavior. Such behavior, while characteristic of the device, is not guaranteed.

A sample of 50 Motorola 2N2369s, spread over a 12-year date-code span, yielded 82% usable devices. All "good" devices switched in less than 600 psec. Select C_1 for a 10V output amplitude. C_1 is typically between 2 and 4 pF. Ground-plane construction with high-speed layout, connection, and termination techniques are essential for good results from this circuit. (DI #1427) EDN

Reference

1. Williams, Jim, "Measurement and Control Circuit Collection," App Note 45, Linear Technology Corp, 1991, pg 18.

To Vote For This Design, Circle No. 428

BEST 10-BIT SERIAL ADC FOR LOW-POWER DESIGNS – \$2.95[†]

MAX192 Defines "Best":

- ◆ **Best in Completeness:**
 - 10-Bit ADC with On-Chip
 - Voltage Reference
 - Track/Hold
 - 8-Channel Mux
- ◆ **Best in Low-Power:**
 - Single +5V Supply
 - 2 μ A Shutdown Current
 - 100 μ A Operating Current
 - (1 ksp, includes voltage reference!)
- ◆ **Best in Performance:**
 - 133ksp Throughput
 - Guaranteed No Missing Codes
- ◆ **Best in Saving Space:**
 - Small 20-Pin SSOP/SO/DIP Packages
 - Microwire[™], SPI[™], QSPI[™], TMS320-Compatible Serial Interface

Best Choice to Monitor Supplies, Temperatures, Batteries, and Sensors...

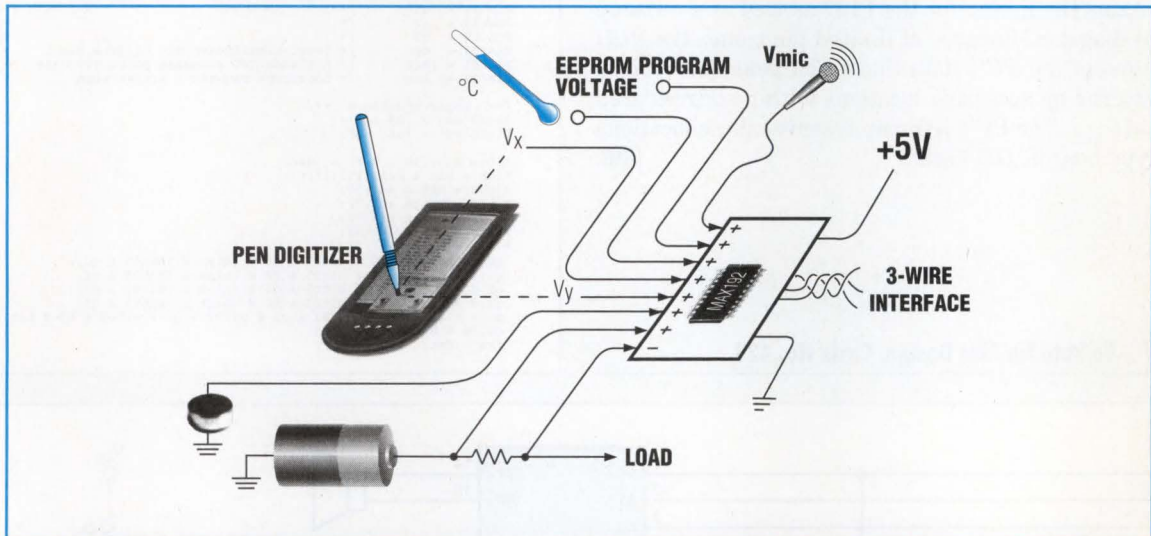

Eight analog inputs are independently programmable for differential or single-ended, unipolar or bipolar signals via the serial interface.



FREE A/D Converter Design Guide—Sent Within 24 Hours!
Includes: Data Sheets and Cards for Free Samples

CALL TOLL FREE 1-800-722-8266
For a Design Guide or Free Sample

MasterCard[®] and Visa[®] are accepted for Evaluation Kits or small quantity orders.

MAXIM



Distributed by Arrow, Bell, Digi-Key, Elmo, Hamilton Hallmark, and Nu Horizons. Authorized Maxim Representatives: AL, M-Squared, Inc. AZ, Techni Source Inc. CA, Mesa, Pro Associates, Inc., Infinity Sales, Inc. CO, Component Sales CT, Comp Rep Associates DE, TAI Corporation FL, Sales Engineering Concepts GA, M-Squared, Inc. ID, E.S. Chase IL, Heartland Technical Marketing Inc. IN, Technology Marketing Group IA, JR Sales Engineering, Inc. KS, Delltron LA, BP Sales MD, Micro-Comp, Inc. MA, Comp Rep Associates MI, Micro Tech Sales MN, Mel Foster Technical Sales, Inc. MS, M-Squared, Inc. MO, Delltron MT, E.S. Chase NE, Delltron NV (Reno, Tahoe area only) Pro Associates, Inc. NH, Comp Rep Associates NJ, Parallax, TAI Corporation NM, Techni Source Inc. NY, Parallax, Reagan/Compar NC, M-Squared, Inc. OH, Lyons Corporation OK, BP Sales OR, E.S. Chase PA (Pittsburgh area) Lyons Corporation, (Philadelphia area) TAI Corporation SC, M-Squared, Inc. TN, M-Squared, Inc. TX, BP Sales UT, Luscombe Engineering Co. VA, M-Squared, Inc. WA, E.S. Chase WI, Heartland Technical Marketing, Inc.
Distributed in Canada by Arrow. Authorized Maxim Representative in Canada: Tech Trek.

Austria, Allmos Electronics Belgium, Master Chips Denmark, Exatex A/S Finland, Yleiselektronikka Oy, France, Maxim France, France/Distributors: Maxim France, ASAP Germany, Maxim GmbH Germany/Distributors: Maxim GmbH, Spezial Electronic KG Ireland, FMG Electronics Italy, Consystem S.r.l., Italy/Distributor: Esco Italiana Electronics Supply Netherlands, Koning En Hartman Norway, Odin Electronics A/S Poland, Uniproduct, Ltd. Portugal, ADM Electronics, S.A. Spain, ADM Electronics S.A. Sweden, Egevo AB Switzerland, Laser & Electronic Equip. Turkey, Interex (U.S.A.) U.K. Maxim Integrated Products (U.K.), Ltd., U.K./Distributors, Maxim Integrated Products (U.K.), Ltd., 2001 Electronic Components, HB Electronic
†FOB USA direct resale for 25,000-pieces Maxim is a registered trademark of Maxim Integrated Products. © 1994 Maxim Integrated
™ SPI and QSPI are trademarks of Motorola, Microwire is a trademark of National Semiconductor.

Simple module gives voice to PC

Jerzy R Chrzaszcz, Institute of Computer Science, Warsaw University of Technology, Warsaw, Poland

BBS The circuit in Fig 1 uses the ISD1020A voice-record/playback chip (Information Storage Devices, San Jose, CA, (800) 825-4473) to allow an IBM PC to speak and hear. The analog part of the circuitry comes from the company's application notes. The host PC controls address inputs (A₀ through A₇), Chip Enable (CE), Playback/Record (P/R), and Power Down (PD). The host also—supposedly—monitors End Of Message flag (EOM).

The ISD1020A latches an address when CE goes low, requiring a 300-nsec setup time. Fortunately, the PC's bus controller automatically inserts several wait states (typically four wait states at 8 MHz) into I/O cycles. Consequently, the circuit needs no intermediate latching, allowing you to tie inputs A₀ through A₇ directly to the data bus.

A GAL20V8 PLD integrates other interface functions (Listing 1). The ZIPfile attached to **EDN BBS /DI_SIG #1433** contains the listing for the PLD as well as a writeup and circuit diagram. Because of limited pin count, the PLD uses only one of the PC's data lines. You generate various control patterns by accessing locations within address area 300_{HEX} to 31F_{HEX}. The PC's I/O map reserves these locations for prototype boards. (DI #1433) **EDN**

Listing 1—Interface-PLD program

```

Name      PRO;
Date      03/03/94;
Revision  2.3;
Designer  JCh;
Company   ICS WUT;
Device    g20v8;
Partno    ;
Assembly  ;
Location  ;

/** Inputs **/
Pin 2 = a0 ; /* system address bus */
Pin 3 = a1 ; /* . */
Pin 4 = a2 ; /* . */
Pin 5 = a3 ; /* . */
Pin 6 = a4 ; /* . */
Pin 7 = a5 ; /* . */
Pin 8 = a6 ; /* . */
Pin 9 = a7 ; /* . */
Pin 10 = a8 ; /* . */
Pin 11 = a9 ; /* . */
Pin 14 = aen ; /* address enable */
Pin 1 = !iow ; /* I/O write strobe */
Pin 23 = !ior ; /* I/O read strobe */
Pin 13 = !oen ; /* register output enable */
Pin 19 = !ext ; /* external input signal - active-low */

/** Outputs **/
Pin 15 = q0 ; /* register outputs - OEN controlled */
Pin 16 = q1 ; /* . */
Pin 17 = q2 ; /* . */
Pin 18 = q3 ; /* . */
Pin 20 = d0 ; /* least significant bit of data bus */
Pin 21 = !hit ; /* hit when CPU accesses ports 300..31F */
Pin 22 = !irq ; /* interrupt request - active-high */

/** Logic Equations **/
field adh = [a9..a5];
field adl = [a4..a0];

hit = adh:[300..31f] & !aen;
high = hit & adl:[10..1f];
hit00 = hit & adl:00;
hit01 = hit & adl:01;
hit02 = hit & adl:02;
hit03 = hit & adl:03;
hit1f = hit & adl:1f;

q0.d = high & a0 # hit00 & d0 # !high & !hit00 & q0;
q1.d = high & a1 # hit01 & d0 # !high & !hit01 & q1;
q2.d = high & a2 # hit02 & d0 # !high & !hit02 & q2;
q3.d = high & a3 # hit03 & d0 # !high & !hit03 & q3;
d0 = hit00 & q0 # hit01 & q1 # hit02 & q2 # hit03 & q3 # hit1f & !ext;
d0.oe = hit & !ior;
irq = ext;
    
```

To Vote For This Design, Circle No. 429

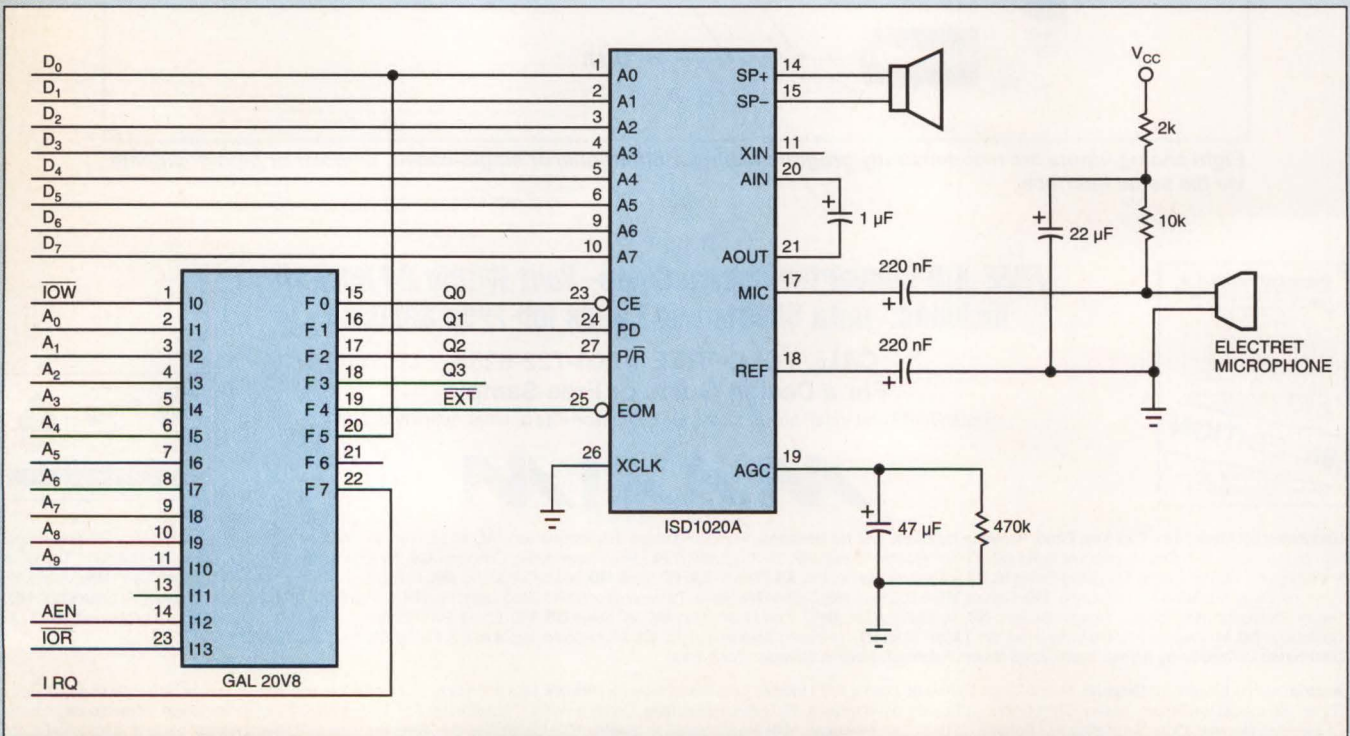
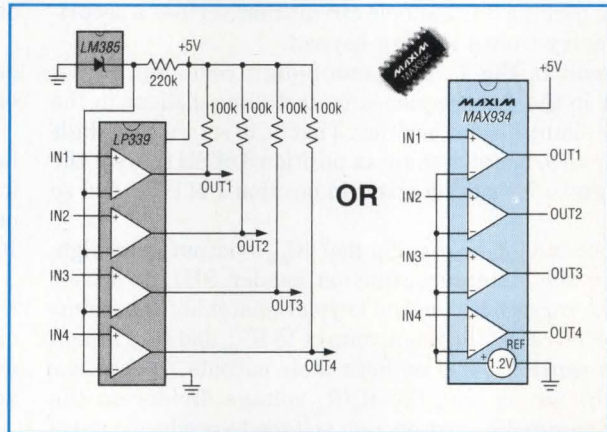

Fig 1—This simple interface circuit allows an IBM PC to control an advanced record/playback audio IC.

QUAD COMPARATOR & REFERENCE REPLACES 2 ICs AND CONSUMES 30-TIMES LESS POWER!

Low Voltage Comparators Plus 1.2V \pm 2% Reference Draw Less Than 6.5 μ A

- ◆ **Single-Supply: 2.5V to 11V**
 - * Input Range Includes GND
 - * Dual Supply: \pm 1.25V to \pm 5.5V
- ◆ **Programmable Hysteresis**
 - * No Effect on High-Z Inputs
 - * Independent of Supply Voltage
- ◆ **TTL/CMOS Outputs Source 40mA**
 - * No Pull-ups Required



MAX934 low-cost quad comparator + reference single IC solution: 30-times LESS power, less board space, easier to use!

Ideal for 3V and 5V battery-powered applications, the new MAX931, MAX932, MAX933, and MAX934 are the lowest power single, dual, and quad comparators available. These devices include a 1.2V \pm 2% reference, programmable hysteresis (MAX931/MAX932/MAX933), and TTL/CMOS outputs that source over 40mA and eliminate external pull-up resistors. The quad MAX934 replaces power-hungry, two-chip alternatives, such as the industry standard LP339 and LM385 reference, resulting in a greater than 30-times reduction in power.

Choose the Lowest Power Comparators for Battery-Powered Systems

DEVICE		TOTAL SUPPLY CURRENT (μ A Max, 25°C)	INTERNAL REF ACCURACY OVER TEMP	PROGRAMMABLE HYSTERESIS	PACKAGE
MAX931	Single + Reference	3.2	\pm 2%	YES	8-DIP/SO
MAX932	Dual + Reference	4.5	\pm 2%	YES	8-DIP/SO
MAX933	Dual + Reference	4.5	\pm 2%	YES	8-DIP/SO
MAX934	Quad + Reference	6.5	\pm 2%	NO	16-DIP/SO



FREE Op Amp/Comparator Design Guide—Sent Within 24 Hours!
Includes: Data Sheets and Cards for Free Samples

CALL TOLL FREE 1-800-998-8800
For a Design Guide or Free Sample

MasterCard® and Visa® are accepted for Evaluation Kits or small quantity orders.



Distributed by Arrow, Bell, Digi-Key, Elmo, Hamilton Hallmark, and Nu Horizons. Authorized Maxim Representatives: AL, M-Squared, Inc. AZ, Techni Source Inc. CA, Mesa, Pro Associates, Inc., Infinity Sales, Inc. CO, Component Sales CT, Comp Rep Associates DE, TAI Corporation FL, Sales Engineering Concepts GA, M-Squared, Inc. ID, E.S. Chase IL, Heartland Technical Marketing Inc. IN, Technology Marketing Group IA, JR Sales Engineering, Inc. KS, Delltron LA, BP Sales MD, Micro-Comp, Inc. MA, Comp Rep Associates MI, Micro Tech Sales MN, Mel Foster Technical Sales, Inc. MS, M-Squared, Inc. MO, Delltron MT, E.S. Chase NE, Delltron NV (Reno, Tahoe area only) Pro Associates, Inc. NH, Comp Rep Associates NJ, Parallax, TAI Corporation NM, Techni Source Inc. NY, Parallax, Reagan/Compar NC, M-Squared, Inc. OH, Lyons Corporation OK, BP Sales OR, E.S. Chase PA (Pittsburgh area) Lyons Corporation, (Philadelphia area) TAI Corporation SC, M-Squared, Inc. TN, M-Squared, Inc. TX, BP Sales UT, Luscombe Engineering Co. VA, Micro-Comp, Inc. WA, E.S. Chase WI, Heartland Technical Marketing, Inc.
Distributed in Canada by Arrow. Authorized Maxim Representative in Canada: Tech Trek.

Austria, Allmos Electronics Belgium, Master Chips Denmark, Exatex A/S Finland, Yleiselektronikka Oy, France, Maxim France, France/Distributors: Maxim France, ASAP Germany, Maxim GmbH Germany/Distributors: Maxim GmbH, Spezial Electronic KG Ireland, FMG Electronics Italy, Consystem S.r.l., Italy/Distributor: Esco Italiana Electronics Supply Netherlands, Koning En Hartman Norway, Odin Electronics A/S Poland, Uniproduct, Ltd. Portugal, ADM Electronics, S.A. Spain, ADM Electronics S.A. Sweden, Egevo AB Switzerland, Laser & Electronic Equip. Turkey, Interex (U.S.A.) U.K. Maxim Integrated Products (U.K.), Ltd., U.K./Distributors, Maxim Integrated Products (U.K.), Ltd., 2001 Electronic Components, HB Electronic

Maxim is a registered trademark of Maxim Integrated Products. © 1994 Maxim Integrated Products

Security circuit eschews sophistication

I-Cheng Chen, AEG, Ajax, ON, Canada

BBS Because of the many states involved in implementing sequential combination locks, most designers use a microcontroller or a PLD. But for those die-hard discrete designers who don't want to bother with debugging programs, here's a dead-simple circuit that verifies a security code's entry from a 10-digit keypad.

The circuit in **Fig 1** verifies an 8-digit code. You preset each digit in the code sequence by installing a shunt in the respective shunt-header position. That is, to set the first digit in the code to 3, install a shunt in position 3 of SH1; to set the second digit to 7, install a shunt in position 7 of SH2, and so on.

When the circuit resets, flip-flop IC_{2A}'s output goes high, energizing the shunted output on header SH1. If a user presses the correct key on the keypad (matching the shunted position on SH1), the input voltage to IC_{1B} and IC_{1C} is high enough to cause a pulse on both their outputs. If the user presses the wrong key, the R₁/R₂ voltage divider on the selected line supplies just enough voltage to produce a pulse only on IC_{1C}'s output.

The output of each op amp, IC_{1B} and IC_{1C}, clocks its own corresponding shift register, IC₄ and IC₃. IC₃ always advances when the user presses a correct or an incorrect key. However, IC₄ advances only if the user presses the correct key.

When IC₃ advances, its outputs energize the next shunt header (SH2, SH3, and so on) sequentially. Only when the user (or an intruder) presses the correct key on every stroke

does IC₄ advance at the same rate as IC₃. When the user correctly enters all the digits in the code, the last output of IC₄ toggles the output-control flip-flop. If any one of the digits is wrong, IC₄'s output does not advance far enough before IC₃'s output resets IC₄.

D₁ through D₈ provide isolation between the shunt headers, so that only the energized shunt header has high output on its shunted line.

C₁ debounces the keypad and introduces a small time delay between the output pulses of IC_{1C} and IC_{1B}. This delay is critical because the output of IC_{1B} must clock IC₄ to produce an output upon the last correct digit before IC₃'s output resets IC₄.

Resistor array R₃ is optional; it provides added security, so that if an intruder tries to press more than one key at a time on the keypad to bamboozle the circuit, the voltage drop across R₃ is sufficient not to trigger IC_{1B} because of the added load.

You can expand this circuit to as many keys and to as long a code sequence as you want by cascading multiple IC₃s and IC₄s. IC_{2A}'s output can drive an LED indicator to signal if the keypad is waiting for input or is in the middle of a code sequence. The ZIPfile attached to **EDN BBS /DI_SIG #1429** contains a writeup of this design and its schematic in OrCAD format. (DI #1429)

EDN

To Vote For This Design, Circle No. 430

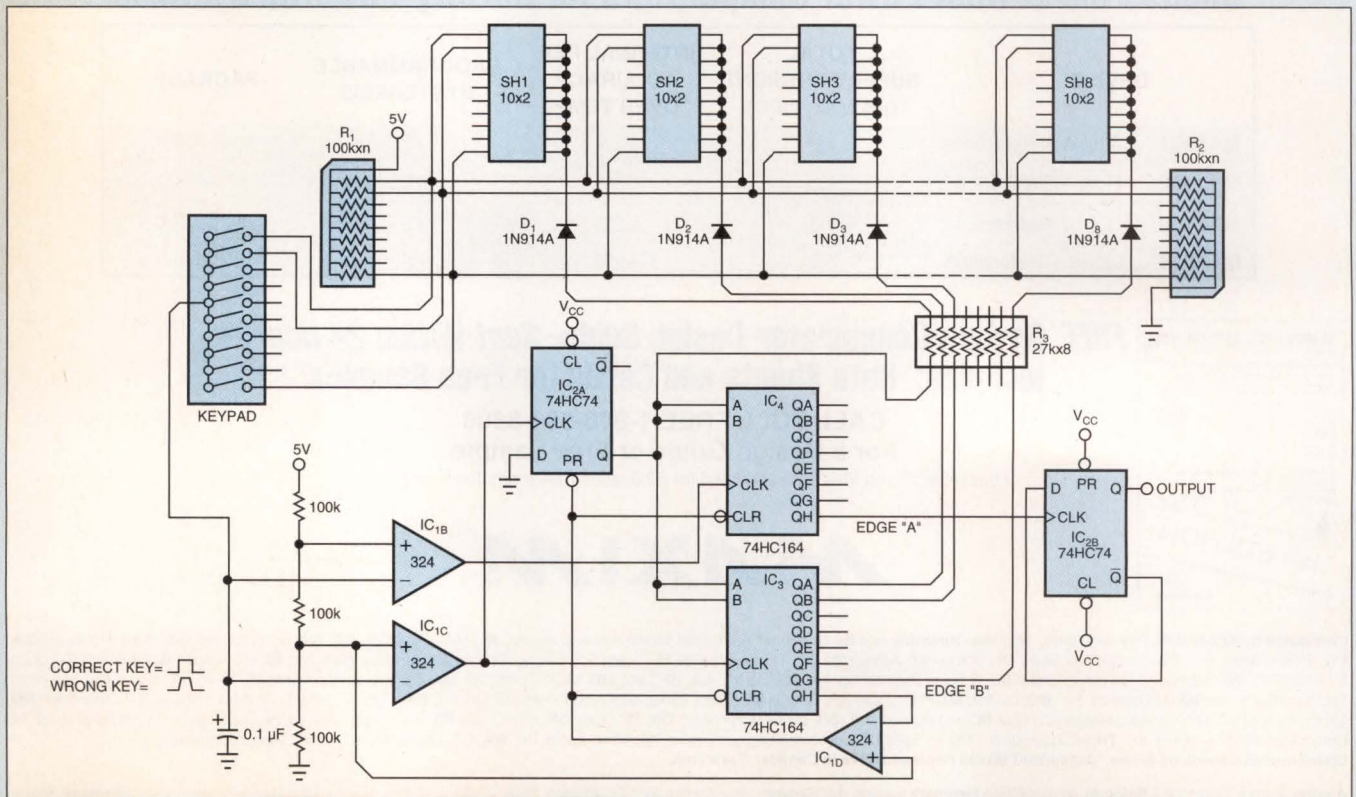
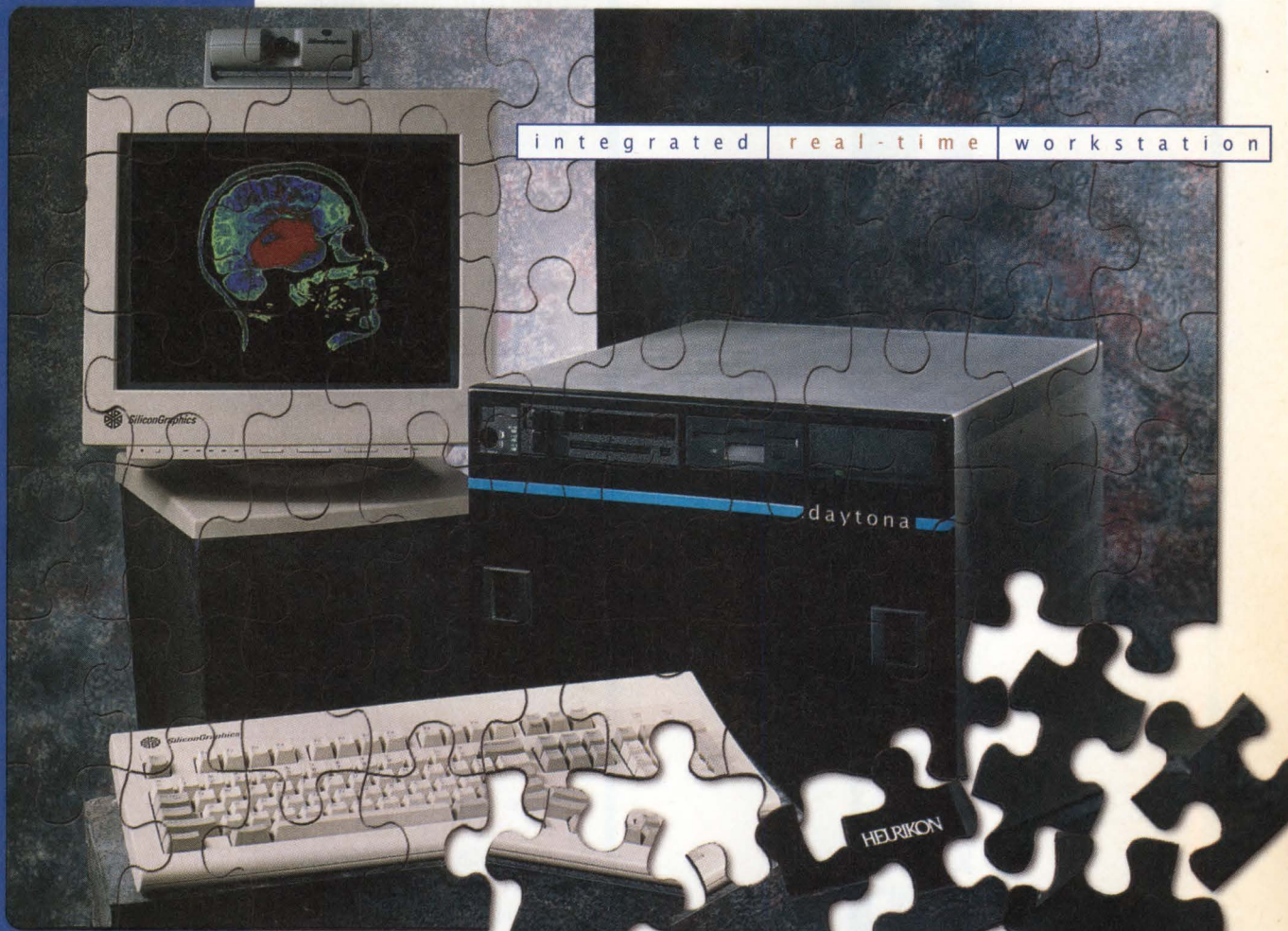

Fig 1—This circuit can verify a security code entered from a keypad yet uses no μ P or PLD.

daytona

Why struggle with the pieces when Daytona solves the puzzle?



- R4000®-based Silicon Graphics® Indy workstation with IRIX (UNIX® System V.4)
- Nine slot VME card cage
- 68K or MIPS® real-time processors
- Optional Wind River Systems' VxWorks real-time operating system
- Entire system supported by Heurikon
- Meets all safety and F.C.C. standards
- Heurikon has over 20 years of experience and is ISO 9001 certified

Introducing Daytona: The high productivity integrated real-time workstation.

Daytona brings together everything you'll need for developing hard real-time applications. And you won't find any pieces missing.

Daytona's a fully integrated system consisting of a Silicon Graphics® Indy™ workstation embedded in Heurikon's nine slot VMEbus enclosure. The result? All the power and performance you'll need to develop and implement the most demanding applications.

Manipulate medical images in 3D. Simulate advanced weapons systems or control printing in real-time. Whatever your application, the IRIX™

operating system and VxWorks® real-time development environment provide the functionality and freedom you require.

For multimedia, Daytona comes with real-time video, CD-quality audio and Media Mail™. A color digital camera is even included as standard along with a color monitor, keyboard and mouse.

So why waste time integrating and debugging when you could be completing projects? To take a closer look at how Daytona brings everything together on one real-time workstation, please call **1-800-356-9602** for our detailed brochure.

HEURIKON[®]
CORP
A COMPUTER PRODUCTS COMPANY

CIRCLE NO. 73

SELECTION

In Crystals and Oscillators.

Selection means choice and convenience. You can be confident you'll find just what you need for your application. With Ecliptek crystals and oscillators.

Uncompromising quality standards and competitive pricing you can rely on. Plus fast delivery to help you meet your deadlines.

We put crystals and oscillators in a whole new light. See EEM 1993/94 for technical details. Or call 714-433-1200.



The Crystal and Oscillator Specialists

CIRCLE NO. 71

Program simplifies microstrip calculations

B Brewster, Satellite Microwave & Communications Ltd Weert, The Netherlands

Written in Fortran, the simple, menu-driven programs in **EDN BBS /DI_SIG #1407** determine physical line-width and quarter-wavelength dimensions from input characteristic-impedance, frequency, and substrate parameters or returns characteristic impedance from given physical line width and substrate parameters.

To Vote For This Design, Circle No. 431

Breakpoints change Spice parameters during simulation

John R Stice, Physio-Control Corp Redmond, WA

The Spice switch subcircuits in **EDN BBS /DI_SIG #1408** allow simulation parameters to change on the fly when breakpoint voltages or other preset conditions occur.

To Vote For This Design, Circle No. 432

These Software Shorts listings are too long to reproduce here. You can obtain the listings from the Design Idea Special Interest Group on *EDN's* bulletin-board system: (617) 558-4241, 300/1200/2400 8,N,1. From Main Menu, enter ss/DI_SIG, then rknxxx, where xxx is the file referenced above.

Feedback & Amplification

Corrections

Make the following corrections to DI #1351, "Line driver economically synthesizes impedance," by Victor Koren, *EDN*, January 6, 1994. Add V_{OZ} to the schematic as the output of IC_1 . Change R_3 in the schematic to $R_3' \cdot R_3' + R_{ADD} = R_3$. Change R_5 to R_S in equations. The circuit uses feedback, not "... a second op amp," to synthesize the output impedance. V_{OZ} is the output of IC_1 , not "... the output voltage with the input shorted." Insert a parenthesis in equation 1 after the first R_3 . The last equation should be

$$R_3 = (R_S \times R_1 + R_O \times R_2) / (R_O - R_S)$$

The output resistance of the circuit is proportional to $1/(R_3 - R_2)$. R_3 and R_2 must be very accurate and are also close in value. An inexpensive and easy way to achieve these values is to split R_3 into R_3' and R_{ADD} . Then, making R_3' , R_1 , and R_2 the same value, you can use a resistor network and achieve good matching. The output resistance then becomes

$$R_O = R_S((2R/R_{ADD}) + 1).$$

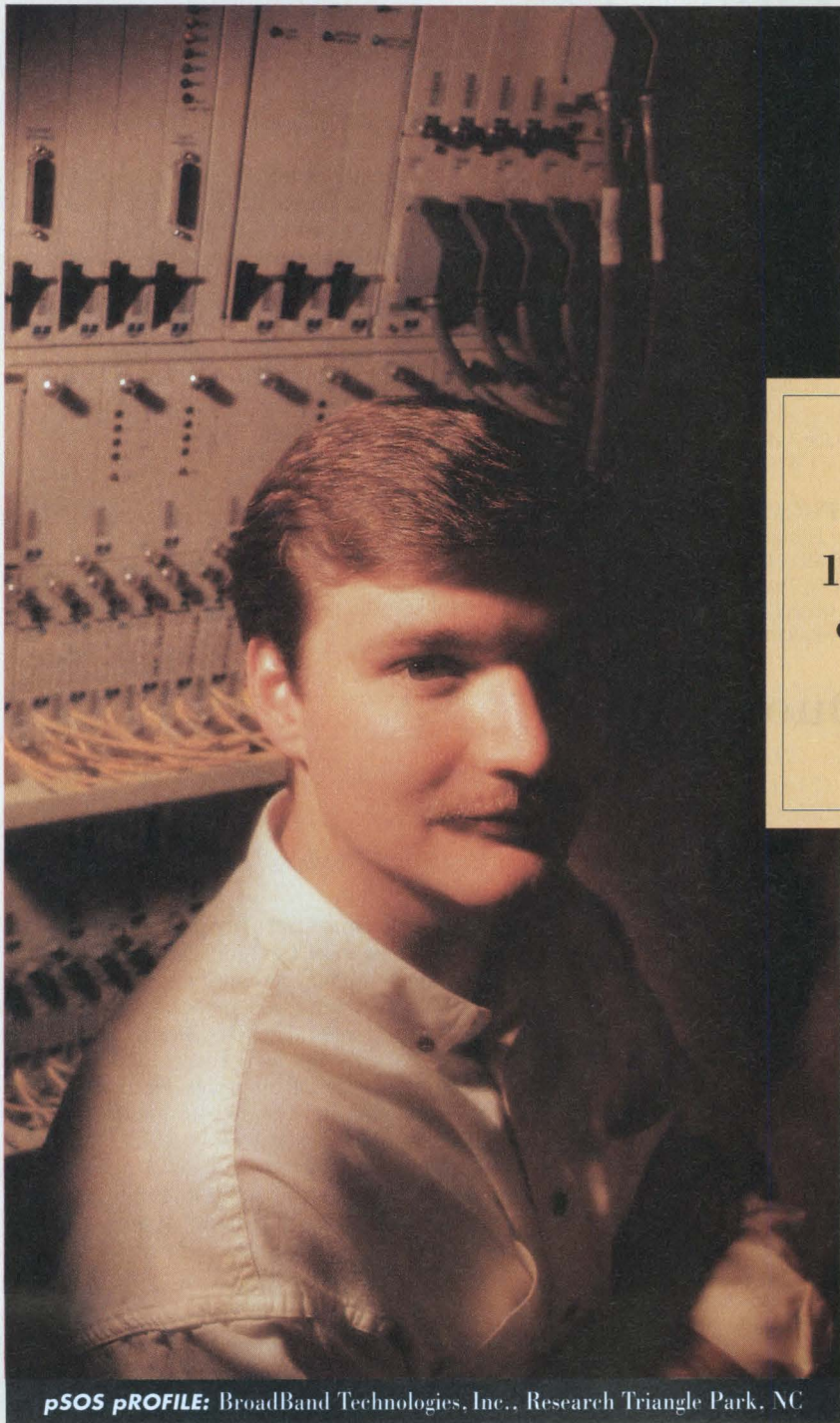

pSOS pPROFILE: BroadBand Technologies, Inc., Research Triangle Park, NC

Designing a switched digital video system that integrates telephone, broadcast and interactive video is a real challenge. So engineers at BroadBand Technologies use the real-time operating system you can rely on. pSOS+ from Integrated Systems. See what pSOS+ can do for you. Call 1-800-543-pSOS for complete information.

**“Offering
TV viewers
1500 interactive
channels starts
with basics
like pSOS+.”**

Mark Andrews
Senior Software
Engineer



One Stop Shopping!

All your circuit board needs under one roof.

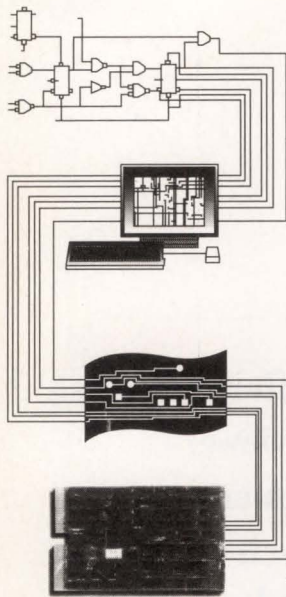

PCB MANUFACTURING

- 2 day turn on multi-layers
- Prototype and production
- Gerber Data Test
- FR4, Polyimide
- Turnkey assembly
- PCMCIA up to 6 layers

PCB DESIGN LAYOUTS

- Layouts for Economical manufacturing
- Backplanes
- Impedance Control
- Analog and ECL
- Surface Mount
- 3 CAD Workstations

TECHNICAL SUPPORT

- Free Design Layout Tips
- Free MFG Cost Cutting Tips
- We accept Gerber Data Via Modem

Call For A Quote!

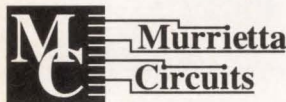

4761 E. Hunter Ave., Anaheim, CA 92807

Phone: (714) 970-2430
 FAX: (714) 970-2406
 MODEM: (714) 970-5015

A NONTRADITIONAL APPROACH TO EMI

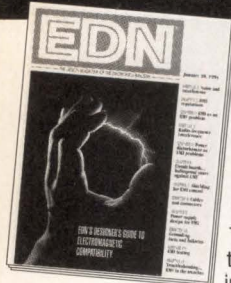

EDN's **DESIGNER'S GUIDE TO ELECTROMAGNETIC COMPATIBILITY** can help alleviate any electromagnetic interference problems you may encounter. With more than fifty years of collective experience under their belts, Daryl Gerke and Bill Kimmel focus on practical insights and ideas about EMI to help you identify, prevent, and solve your EMI problems as you design your equipment.

Topics include: noise and interference, EMI regulations, power disturbances, circuit boards, grounding, and troubleshooting. 88 pages.

Please send me _____ copies of EDN's DESIGNER'S GUIDE TO ELECTROMAGNETIC COMPATIBILITY @ \$19.95. _____

Sales tax (orders shipped to these states must include applicable sales tax : CA, CT, MA, NJ, NY) _____

Shipping/Handling: \$3.50/copy _____

Total _____

CALL TOLL FREE (800) 523-9654 (FAX 708-390-2779) to order. Or fill out this coupon and mail it to: Cahners Reprint Services, 1350 E. Touhy, Des Plaines, IL 60018

My check is enclosed payable to Cahners Reprint Services
 Charge my credit card: Master Card Visa Amex

CREDIT CARD # _____ EXPIRATION DATE _____ SIGNATURE _____

NAME _____ COMPANY _____

ADDRESS _____

CITY _____ STATE _____ ZIP _____ PHONE _____

Design Entry Blank

\$100 Cash Award for all published entries selected by editors. An additional \$100 Cash Award for the winning design of each issue, determined by vote of readers. Additional \$1500 Cash Award for annual Grand Prize Design, selected among biweekly winners by vote of editors.

To: Design Ideas Editor, EDN Magazine
 Cahners Publishing Co
 275 Washington St, Newton, MA 02158

I hereby submit my Design Ideas entry.

Name _____

Title _____ Phone _____

Company _____

Division (if any) _____

Street _____

City _____ State _____

Country _____ Zip _____

Design Title _____

Home Address _____

Social Security Number _____
 (US authors only)

Entry blank must accompany all entries.

Design entered must be submitted exclusively to EDN, must not be patented, and must have no patent pending. Design must be original with author(s), must not have been previously published (limited-distribution house organs excepted), and must have been constructed and tested. Fully annotate all circuit diagrams. Please submit software listings and all other computer-readable documentation on a 5¼-in. IBM PC disk in plain ASCII.

Exclusive publishing rights remain with Cahners Publishing Co unless entry is returned to author, or editor gives written permission for publication elsewhere.

In submitting my entry, I agree to abide by the rules of the Design Ideas Program.

Signed _____
 Date _____

How to use our bulletin board



This icon identifies those Design Ideas that have computer-readable material posted on EDN's bulletin-board system (BBS). Call our free BBS at (617) 558-4241 (300/1200/2400 8,N,1). Not every Design Idea has downloadable material, but each one does have a BBS number printed at the end of it. If you'd like to comment on any Design Idea, include the number in the subject field of your message.

Your vote determines this issue's winner. All designs published win \$100 cash. All issue winners receive an additional \$100 and become eligible for the annual \$1500 Grand Prize. **Vote now**, by circling the appropriate number on the reader inquiry card.

CONVERTERS

NOBODY DOES CONVERTERS LIKE ANALOG DEVICES

LOW POWER 3V/5V SIGNAL CONDITIONING 24-BIT ADC FOR LESS THAN \$3.00 PER CHANNEL

Signal Conditioning Applications? The AD7714 has everything you need: high resolution, low power, low component

CONVERTERS

This guide describes some of the new converters from Analog Devices – the most interesting and innovative integrated circuits for digital-to-analog and analog-to-digital conversion that you can find anywhere in the world, from any manufacturer.

High resolution, low cost, multiple channels, industry standard products, ground-breaking new devices — they're all here.

The only exceptions are our range of fast converters — you'll find them, together with companion products, in our High Speed Products guide.

And if you're interested in high speed data acquisition or control, you won't want to miss that.

count and incredible versatility — all at an astonishingly low price!

The AD7714 is a complete analog front-end for low-frequency measurement applications. It includes a 5-channel programmable-gain front-end, 24-bit “no missing codes” charge-balancing ADC, low-pass filter and a 3-wire serial interface. It is completely

under software control — gain settings, signal polarity, filter cut-off, calibration and channel selection can be configured using the input serial port.

Not convinced yet? The device operates from either 3V or 5V supply, and draws just 750µW (at 3V) and

50µW in sleep mode. RMS noise is typically 1.2µV and 300nV with gains of 1 and 128, respectively.

The AD7714 is available in a 24-pin DIP and SOIC, and is specified over the -40°C to +85°C temperature range.

1 AD7714 \$11.00 in 1000s

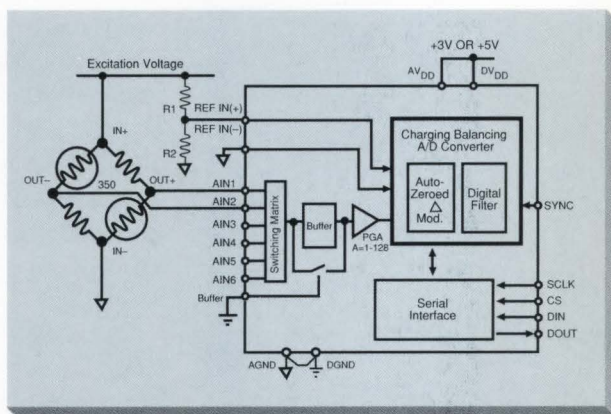

The diagram shows the AD7714 in a typical strain-gauge application, with four spare channels.

COMPACT 16-CHANNEL, 8-BIT MULTIPLYING DAC SAVES SPACE IN ATE, SONAR, ULTRASOUND, INSTRUMENTATION...

Multi-channel applications suddenly get a lot smaller, a lot better specified and a whole lot easier to design with the introduction of the AD8600.

Shoe-horning 16 independent 8-bit multiplying DACs into a compact (PLCC-44) package is impressive enough, but doing it with the performance we're offering is little short of a

miracle (admittedly, a small miracle).

The AD8600 contains 16 independent voltage-output digital-to-analog converters that share a common external reference input voltage. Each DAC has its own DAC register and input register to allow double buffering. An 8-bit parallel data input, four address pins and

control logic provide the high-speed digital interface. *Continued on back*

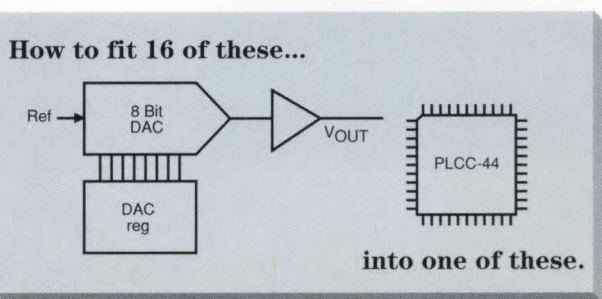

Squeeze 16 high-performance 8-bit DACs into less than 0.5 square inches (PLCC-44).

MAKE THE SWITCH TO 16 BITS

THE 16-BIT DACS YOU'VE BEEN WAITING FOR

The AD660 and AD669 are complete 16-bit, serial/byte and parallel input DACPORTs which provide leading-edge performance at down-to-earth prices. Their combination of high performance, complete functionality, flexible digital interface, small footprint and low price make them the perfect solution for 12-bit DAC users seeking to upgrade their systems without significantly increasing costs.

The AD660 and AD669 feature

15-bit monotonicity and accuracy over the entire industrial or military temperature range. They are fully AC and DC specified, and offer double-buffered latches, an on-board precision voltage reference and a pin-programmable output amplifier. Output can be either unipolar (0 to +10V) or bipolar ($\pm 10V$).

These devices provide low-cost performance for a wide range of applications including industrial control, wireless communication, ATE, robotics, data acquisition and instrumentation.

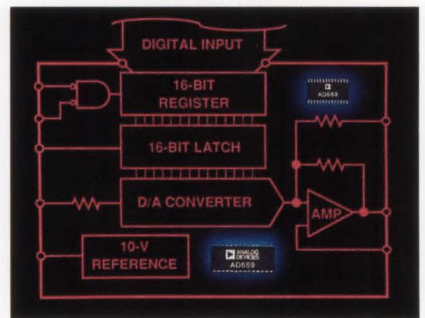

2 AD660/9 \$13.60 in 1000s

GROUND ZERO

Without a doubt, the single largest cause of problems in achieving the desired performance with data converters is grounding. At even low resolutions, good ground design is necessary to maintain the desired performance; for high-resolution devices it is absolutely crucial.

The best way to avoid them is to remember that "ground" isn't a magic current sink, but a connection through which currents flow to complete a circuit. Make their path smooth and your life easy!

- Have separate analog and digital grounds — and only connect them at one point.
- Check that noisy signals are kept away from sensitive ones — and that applies to return paths too.
- Where will the return currents flow?
- Are there any potential ground loops?
- Do the return paths have low enough impedance?
- Are the components well decoupled?
- Do you need a ground plane?

For more help call applications support: 1-800-ANALOGD.

TRUE 16-BIT ADCS AT A LOW PRICE (92dB AT 100KSPS FOR \$25)

Your customers are asking you to. Your competitors are doing it. Your boss is ordering you to. Soon even your mother will be telling you to make the switch to 16-bit resolution. Thankfully, with the AD676 and AD677, you can make that move successfully and affordably. What's more, with these elegantly designed devices you get a host of other benefits too.

The AD676 and AD677 are 16-bit sampling ADCs which provide industry-leading performance, cost and space efficiencies. Their 92dB signal to noise ratio combined with $\pm 1LSB$ integral non-linearity offer superior 16-bit performance at 100kps throughput rates.

This high accuracy is a result of auto-calibration, which improves performance without the wasted board space and cost of external trims. A "ground sense" pin is included — invaluable if the signal has to be carried some distance to the A/D converter.

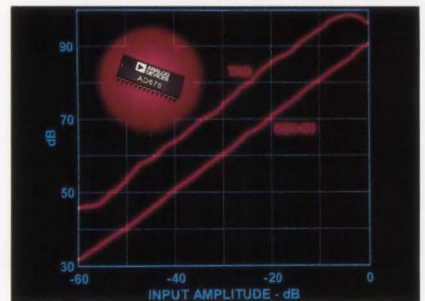

This combination of features makes the AD676 and AD677 the perfect solution for medical and analytic instrumentation applications as well as PC-based data acquisition and industrial applications like power supply monitoring and signal monitoring in transportation and industrial controls.

Both components are fully specified and tested for AC and DC parameters. The AD677 offers easy-to-interface three-wire serial output data. The AD676 offers full parallel output.

The AD676 is available in a 28-pin, ceramic, side-braced package as well as a 28-pin plastic DIP. The AD677 is offered in a 16-bit skinny ceramic package and plastic DIP and 28-pin SOIC packages.

3 AD676 \$27.14 in 1000s

4 AD677 \$25.08 in 1000s

F O R I N F O R M A T I O N

MAKE THE SWITCH TO 16 BITS

166KSPS AND 16-BIT RESOLUTION IN A LOW-POWER, LOW-NOISE ADC

The AD7884 and AD7885 are fast, monolithic 16-bit sampling ADCs. They offer true 16-bit resolution with 16-bit no missing codes, and a high throughput rate of 166kps.

The AD7884 and AD7885 dissipate only 250mW of power. Features include analog input ranges of $\pm 3V$ and $\pm 5V$ as well as parallel and byte interfacing (AD7884 and AD7885 respectively).

In medical and scientific instrumentation, noise is a critical requirement, and with their excellent noise performance ($78\mu V$ rms at $\pm 3V$ input range) the AD7884/5 are earning wide popularity. They also offer SNR of 86dB, while THD is -88dB.

The AD7884 is available in 40-pin cerdip and 44-pin PLCC packages. The AD7885 is available in a 28-pin DIP package while the AD7885A is available in a 44-pin PLCC package. Temperature ranges are $-40^{\circ}C$ to $+85^{\circ}C$.

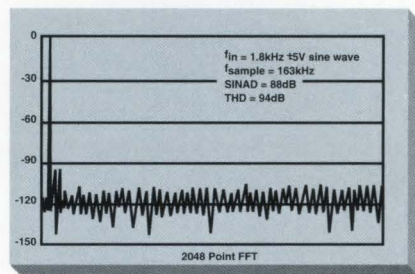

The AD7884/7885 are high performance 16-bit ADCs. Their high speed (6 μs conversion time) and low noise (88dB SINAD) make them ideal for wide bandwidth signal processing applications.

5 AD7884/AD7885 \$38.25 in 1000s

THE FIRST DIGITAL TO 4-20mA SYSTEM: NEW CHIP INTEGRATES DAC WITH LOOP DRIVER

16-Bit Industrial Control DAC

The AD420 is the only single-chip solution available for generating 4-20mA current loop signals from digital data. It is the first current-loop output DAC, and its high performance, low price and compact design make it perfectly suited for almost any industrial control application. It provides a single-chip solution for generating precision 4-20mA or 0-20mA signals, and runs on a single supply (up to 36V).

The AD420 has been designed to make the system engineer's life easier. It includes a 16-bit sigma delta DAC, for guaranteed monotonicity and excellent linearity. The loop driver circuitry includes a loop fault detect circuit, so a warning signal can be generated if the current loop is open circuited. It has an SPI[®]- and MicroWire[®]- compatible serial interface, and can interface seamlessly with most controllers. Furthermore, it is a completely specified part — there is no need to worry about component

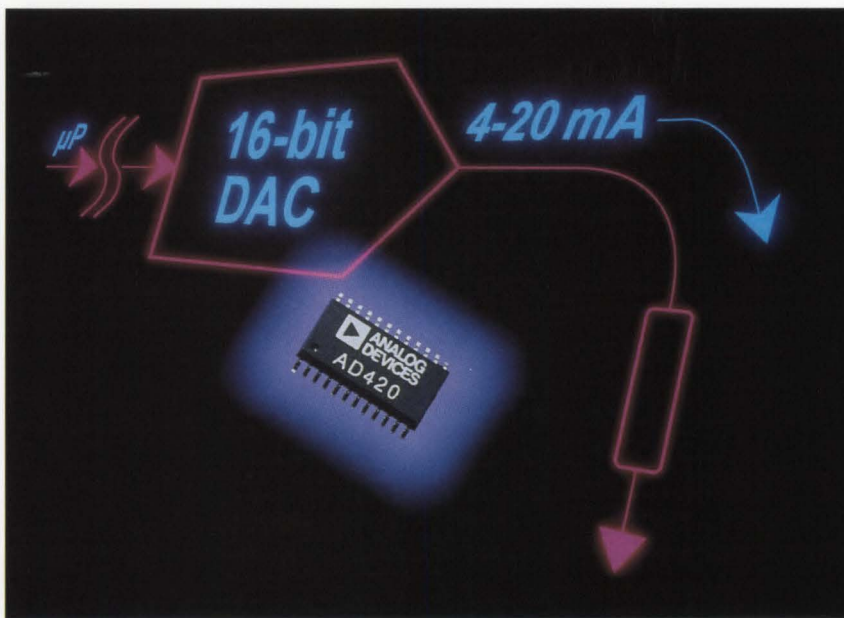

interaction or error budgets. Finally, although the chip can drive loops directly, it is a trivial matter to use an external boost transistor to extend the temperature range or obtain lower drift performance.

Typical applications for this unique product include valve and motor control in a wide variety of industrial applications. It is ideal for use in distributed control systems

(DCS), programmable logic controllers and data I/O cards and modules. Its uses range from plant or process automation to single PC-based control systems.

24 pin PDIP or SOIC, temperature range $-40^{\circ}C$ to $+85^{\circ}C$.

6 AD420 \$10 in 1000s

SPI is a registered trademark of Motorola Inc. MicroWire is a registered trademark of National Semiconductor Inc.

1 . 8 0 0 . 2 6 2 . 5 6 4 3

**FLEXIBLE, ACCURATE
QUAD 12-BIT DAC —
EASY TO SET OUTPUT
VOLTAGE RANGE**

**The Only DC Setpoint D/A
Converters You'll Ever Need.**

This family of quad 12-bit voltage-out D/A converters provides all the features most designs will ever need, plus the low cost every design requires — all in a small footprint package.

Because you may want unipolar, bipolar or asymmetric outputs, they provide separate V_{REF} high and V_{REF} low inputs and a single-supply output op amp — so it is trivial to set exactly the output range you need. And unlike some parts, that means both positive

and negative outputs are available.

The voltage-switched DAC architecture offers the best overall accuracy available from a quad 12-bit converter (including offset and temperature accuracy).

These DACs all operate from a wide range of supply voltages (+5V to $\pm 15V$). Their high speed (80ns data load timing for DAC8412/13, or 12MHz clock for DAC8420) combines with low power dissipation to meet performance requirements while reducing power supply and cooling demands.

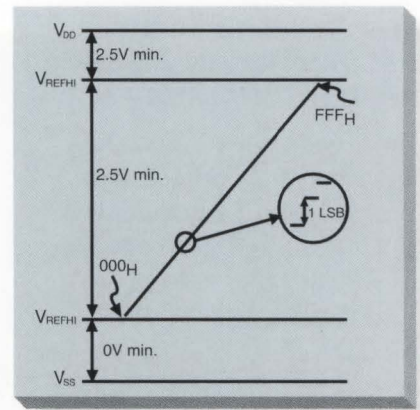

	Interface:	State at Reset (RST strobe):	Price:
7 DAC8420	Serial	Programmable (mode pin)	\$25.16 in 1000s
8 DAC8412	Parallel	Reset to zero	\$24.26 in 1000s
9 DAC8413	Parallel	Reset to midscale	\$24.26 in 1000s

MAKE IT EASY

Life is hard enough already — but when it comes to helping you get converter circuits to work, Analog Devices' applications engineers have more experience than anyone else in the world — just give them a call.

Some of this experience is available in ready made forms; evaluation boards allow you to easily appraise a component, but also offer a well-designed and fully tested circuit that can be used as a reference design. And data sheets give circuit designs and pcb layouts.

There are a number of application notes that offer ideas or advice. Some of the more popular include:

- Getting the most from high resolution digital-to-analog converters **A**
- Analog signal handling for high speed and accuracy **B**
- Differential and multiplying D/A applications **C**
- DAC ICs: How many bits is enough? **D**
- An IC amplifiers guide to decoupling, grounding and making things go right for a change **E**

**USING THE INDUSTRY
STANDARD AD574? THEN
MOVE UP TO THE AD1674**

When Analog Devices introduced the AD574, it quickly became the industry standard. Now, the AD1674 takes that standard to yet another level.

The AD1674 is a high-performance sampling 12-bit A/D which offers users of the AD574 family (AD574, AD674, AD774) an instant upgrade with up to three times the speed, along with lower power and greater accuracy. It utilizes the AD574 pinout for easy replacement in existing designs, providing increased capabilities while reducing costs through the elimination of external SHA and support circuitry.

The power and versatility of the AD1674 make it an ideal general-purpose converter for a wide variety of applications ranging from industrial control to data acquisition and instrumentation. Additional features include $\pm 5V$, $\pm 10V$, 0-10V and 0-20V

input ranges, internal reference, 8- and 16-bit microprocessor interfaces and a wide selection of package styles.

The AD1674 is available in 28-pin PDIP and 28-pin SOIC packages in commercial and industrial temperature ranges as well as in a 28-pin side-brazed ceramic package for industrial and military ranges. All specifications are both AC and DC guaranteed. Full MIL-883B and SMD devices are also available.

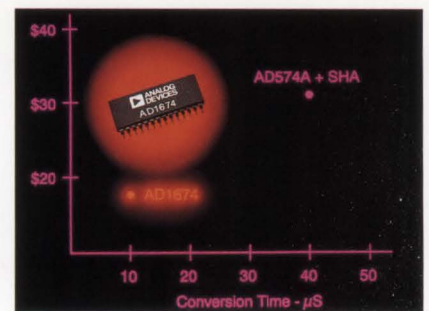

10 AD1674 \$11.60 in 1000s

A NEW GENERATION OF 12-BIT ADCS, WITH UNMATCHED PERFORMANCE, SINGLE 5V POWER SUPPLY OPERATION, ROBUST INPUT CIRCUITRY AND EASE OF USE IN A COMPACT DESIGN.

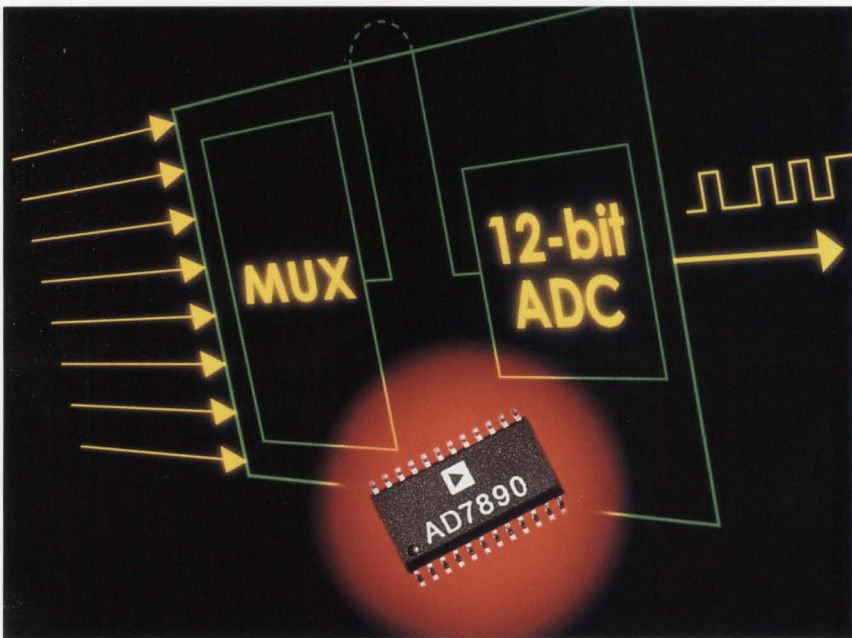

THE SMALLEST 12-BIT ADC

A single-channel ADC in a tiny 0.15" wide 8-pin SOIC package.

The AD7893 provides a throughput rate of 117ksps, with a power dissipation of less than 50mW. It handles data transfer via a two-wire serial interface.

OCTAL ADC-7X SAVINGS IN SIGNAL CONDITIONING

The AD7890 is an eight-channel version which offers a seven-fold savings in channel support circuitry over other integrated solutions. This economy is possible because access to MUXOUT means that the same signal-conditioning circuitry can be used for all eight channels. The AD7890 has a throughput rate of 100ksps. It also features a power dissipation of less than 50mW, and on-chip reference.

Robust Inputs

Both parts are available with three distinct input range options. Like the AD7892, they operate from a single 5V power supply, and their analog inputs are tolerant to voltages which extend well outside of the supplies, protecting them from overvoltage fault conditions (up to 17V outside for the -10 version).

- 11 AD7890 \$10.20 in 1000s**
- 12 AD7893 \$8.00 in 1000s**

AD7890-2	0-2.5 V
AD7890-4	0-4 V
AD7890-10	+/- 10 V
AD7893-2	0-2.5 V
AD7893-5	0-5 V
AD7893-10	+/- 10 V

FASTER SIGNALS AND CLEARER RESULTS — THE HIGHEST SINAD SPECS FROM A COMPLETE 12-BIT 1.25MSPS ADC

The AD1671 delivers leading-edge performance from a complete converter — with on-chip reference converter — with wide bandwidth, high impedance sample-and-hold amplifier.

The AD1671's exceptional dynamic performance includes 69dB SINAD, a full power bandwidth of 2MHz and a small signal bandwidth of 12MHz. This allows better, faster data acquisition — delivering sharper images from scanners or clearer signals from communication links.

The AD1671 performance and price breakthrough are enabling markets that were previously prohibited by cost, power or price constraints. They include communications systems (high speed modems, base stations, HDSL), imaging (color scanners, medical imaging, IR) and high-speed data acquisition.

The AD1671 is available in both a 28-pin cerdip and 28-pin PLCC package, in commercial, industrial and DESC versions.

13 AD1671 Less than \$40 in volume.

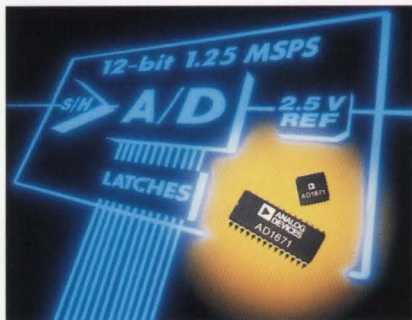

TINY, COMPLETE SINGLE SUPPLY DACS — SMALLEST PACKAGES, EASIEST TO USE

Total DAC System — In the Industry's Smallest Packages

The DAC8512, DAC8562, AD8522 and AD8582 are a set of single-supply 12-bit DACs, offering a complete "plug and play" output system. Everything there, everything included, everything tested and specified. And everything squeezed into a tiny SO-8 package (DAC8512).

Each part includes all the related circuits — bandgap reference, voltage-switched R-2R ladder DAC, and an output rail-to-rail op amp. Full-scale voltage of 4.095V with 1mV/bit output coding creates a programming-friendly environment while maximizing the analog output swing for all loads.

These parts also feature low power dissipation of 3mW/DAC and compact designs which make them ideal for portable or battery-operated equipment.

The 8- and 14-pin count DAC8512 and AD8522 serial parts also offer the industry's smallest surface mount packages to reduce space consumption.

	Channels:	Interface:	Package:	Price:
14	DAC8512	Single	Serial	SO-8 / DIP-8 \$4.49 in 1000s
15	DAC8562	Single	Parallel	SOL-20 / DIP-20 \$7.52 in 1000s
16	AD8522	Dual	Serial	SO-14 / DIP-14 \$7.86 in 1000s
17	AD8582	Dual	Parallel	SOL-24 / DIP-24 \$9.44 in 1000s

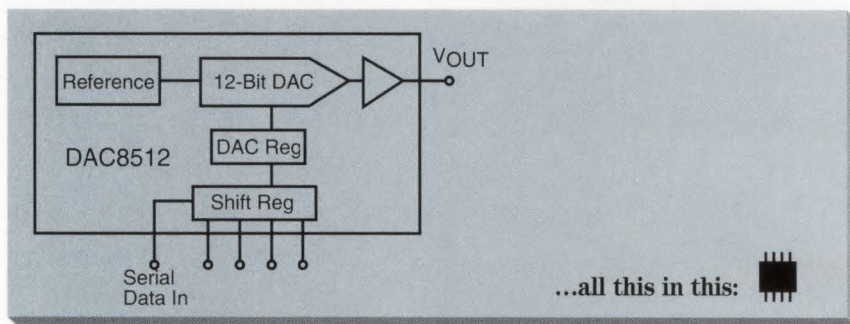

12-bit DAC in SO-8 package

PROBABLY THE BEST VOLTAGE REFERENCE IN THE WORLD

5V voltage reference — low dropout, low power, high accuracy

Many of our converters are available with built-in voltage references, but sometimes you want to use an external reference. And when that's true, there is no better choice than the REF-195.

To say that this has been popular would be an understatement — it has been a scorching success, with thousands of applications and millions shipped. And when you look at the specifications, it is obvious why — a 5V micropower reference with only 0.1V drop-out, low power (just 45µA) and high accuracy (±3mV). What's more, because it can source up to 30mA, the REF-195 can act as both a precision voltage reference and a highly efficient voltage regulator. And all that for an astonishingly low cost — what more could you look for in a reference?

18 REF195 \$1.94 in 1000s

HIGH PERFORMANCE 12-BIT ADC SAMPLES ACROSS WIDE DYNAMIC RANGE

The AD7886 is a high-speed, power-efficient 12-bit ADC with a throughput rate of 1MSPs. Its high performance makes it ideal for sampling applications requiring a broad dynamic range over a large bandwidth, as well as high-speed and multiplexed data acquisition systems. The full-power bandwidth of the on-chip sample-and-hold extends well above the 500kHz Nyquist limit, allowing the AD7886 to be used in undersampling systems in addition to the standard signal-processing applications.

The AD7886 has a low power dissipation of 250mW, and is comprehensively specified for AC and DC parameters. It features a high speed interface with 57ns bus access times, making it directly compatible with DSPs and microcontrollers.

It is available in 28-pin DIP and 28-pin surface mount packages. Temperature ranges are -40°C to +85°C for the industrial grades and -55°C to +125°C for the extended range.

19 AD7886 under \$40 in 1000s

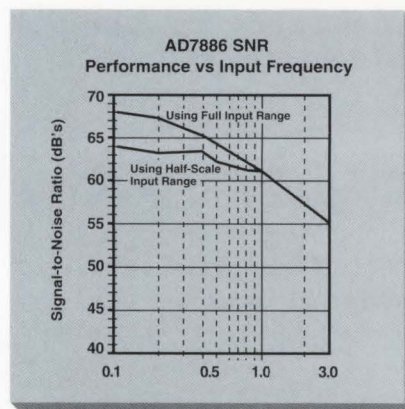

The full power bandwidth of the SHA allows the AD7886 to sample up to 1MHz bandwidth — ideal for undersampling applications.

FAST 12-BIT SIGMA-DELTA ADC ELIMINATES NEED FOR ACTIVE ANTI-ALIASING FILTER

The AD7721 is a 12-bit sigma-delta ADC with a 200kHz bandwidth and an output word rate of 470ksp/s.

It offers all the advantages of digital filter design, including freedom from the component matching or drift issues commonly associated with analog filters. It also drastically simplifies the design of the input anti-aliasing filter — in many cases no filter other than a simple RC roll-off is required. Other advantages include device-device repeatability, linear phase characteristics and dramatic improvement in SNR.

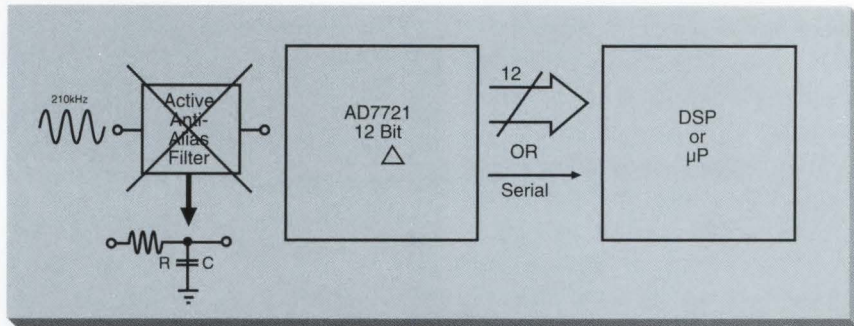

Operating from a single 5V supply, the AD7721 dissipates only 175mW of power while supporting a full-power signal bandwidth of 200kHz. Other features include an on-chip reference and a choice of either parallel or serial interfacing, a power-down mode and pseudo-differential inputs. It also offers a calibration

mode to minimize offset and gain errors.

The AD7721 is available in 28-pin plastic DIP, SOIC and cerdip packages. Temperature ranges are -40°C to +85°C or -55°C to +125°C for the extended grade.

20 AD7721 \$13.60 in 1000s

TRIMDACs REPLACE TRIMMERS AND POTS — FOR LESS THAN \$1.00 EACH

Question: What's the cheap, efficient and reliable way of removing adjustment trimmers and potentiometers from your designs?

Answer: Replacing them with TrimDACs.

The TrimDAC® Family of octal, 8-bit serial-input digital-to-analog converters provides a low-cost way to replace mechanical components, improving performance and reducing PC-board space. Not only can trimming now be digitally controlled, but performance and reliability can be dramatically improved. By using thin-film resistor technology, the TrimDAC family provides better temperature stability performance than traditional potentiometer solutions.

The TrimDAC family reduces space requirements by providing eight independent gain channels in 20- and 24-pin packages, guaranteed to operate over the extended temperature range (-40°C to +85°C). Other features include low-power dissipation and 3-wire serial μ controller interface to simplify periodic

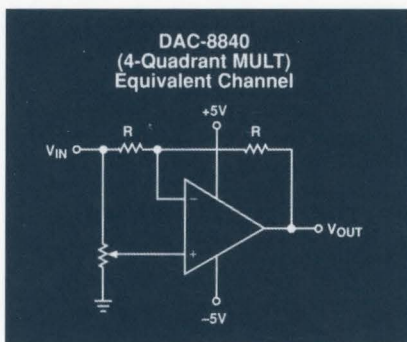

service or remote adjustment.

For DC adjustment, the DAC8800 provides high and low reference inputs to establish the output swing. For AC signals, the DAC8840 features 4-quadrant multiplying adjustment for inputs up to 1MHz, while the AD8842 is suited for lower bandwidths (50kHz) at a lower price and half the power requirement.

21 DAC8800 \$6.60 in 1000s

22 DAC8840 \$8.36 in 1000s

23 DAC8841 \$8.36 in 1000s

24 AD8842 \$5.69 in 1000s

TrimDAC is a registered trademark of ADI.

12-BIT MDACS — CHEAPER SMALLER, BETTER

Upgrading your design with the latest generation of 12-bit multiplying DACs couldn't be easier. The AD7943/45/48 set new standards in performance, power efficiency and cost. And feature pin-outs compatible with the industry standard AD754x DACs.

The AD794x series feature significantly improved accuracy, fast 600ns settling time, and low 60nV-secs glitch energy. They also feature the fastest digital interface available anywhere -40ns pulse width. Operating from a single +3V or +5V supply, power consumption is a miserly 1mW.

For new designs, the AD794x series lets you save valuable space; all devices are available in ultrasmall 20-pin SSOP packages, which use less than 0.1 square inch of precious board space.

The AD7943, AD7945 and AD7948 provide serial, parallel and byte digital interface, respectively. In addition to the SSOP, industry standard packages are available. These devices are specified over the -40°C to +85°C temperature range.

28 AD7943/45/48 \$4.90 in 1000s

12-BIT 500KSPS ADCS THAT SURVIVE OVERVOLTAGE!

Real-world data acquisition and control systems often have to cope with tough environments. It isn't always possible to guarantee which system will power up first. Sometimes signals on input lines can go out of range — even beyond the supply rails. Until now, this was a guarantee for destroying your ADC — and that was an expensive fuse!

The ADC7892 is a versatile, high-speed ADC expressly designed to cope with these circumstances. It is a 12-bit sampling A/D converter with a throughput rate of 500ksp/s, low power dissipation of only 60mW and the flexibility of both serial and parallel interface capability. Crucially its analog inputs are tolerant to voltages which extend well outside of the supplies;

this resilience protects them from overvoltage fault conditions (up to $\pm 17V$ outside supply range for the $\pm 10V$ input version). It also features an on-chip reference, as well as a power down mode.

The AD7892 is available in two versions. The AD7892-2 has an analog input range version of 0 to 2.5V for complete 5V single-supply systems. The AD7892-1 has input ranges of $\pm 5V$ and $\pm 10V$ for industrial-type systems where the larger LSB sizes are important.

Both versions are available in 24-pin plastic DIP, SOIC and cerdip pack-

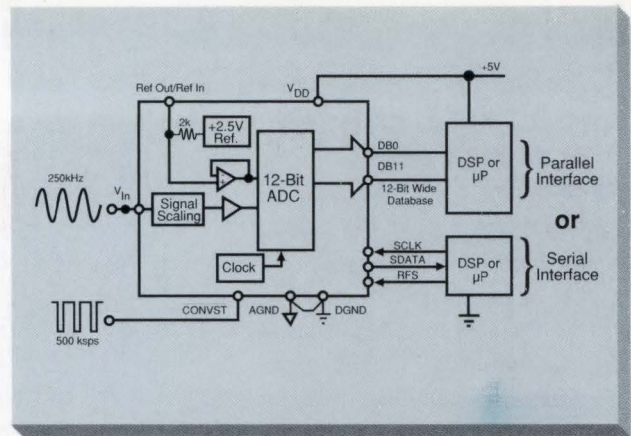

ages. Temperature ranges are $-40^{\circ}C$ to $+85^{\circ}C$ for the industrial grades and $-55^{\circ}C$ to $+125^{\circ}C$ for the extended range.

25 AD7892 \$13.60 in 1000s

A HIGH-RESOLUTION A/D CONVERTER, MOTOR CONTROLLER AND ISOLATION DEVICE FOR ONLY \$2.95

The AD654 provides designers with a converter that can be applied to solve a wide range of design problems at much lower cost than ever before possible.

It is a monolithic V/F converter which reduces space requirements by integrating an input amplifier, precision oscillator system and a high-current output stage. Its high performance, low cost, low power consumption and small size make it the perfect choice for an unlimited variety of applications.

The AD654 provides a square wave output and can drive up to 12 TTL loads, opto-couplers, long cables or similar loads. The input amplifier provides low drift, permitting operation directly from low level transducers like thermocouples, strain gauges and cur-

rent shunts. It also offers a high ($250M\Omega$) input resistance to positive voltage signals. Only 2.0mA of quiescent current is required using the single positive supply from 4.5V to 26V, and the output stage can sink up to 10mA with saturation voltage less than 0.4V.

The AD654 combines low cost with very high accuracy. Linearity error is only 0.03% for a 250kHz full scale frequency, and operation is guaranteed over an 80dB dynamic range. A single RC network is all that's needed to set up any full scale frequency up to 500kHz.

Applications for this product range from high-resolution A/D converters, process control systems, and isolation to energy management, motor speed controls and power monitoring.

The AD654 is available in 8-pin PDIP and 8-pin SOIC packages in commercial temperature ranges.

26 AD654 \$2.95 in 1000s

Continued from front

Finally, the AD8600 features a new DAC design (patent-pending) which reduces reference glitch during reprogramming.

Space savings is a major benefit of this part, since it provides all these capabilities in a PLCC-44 package. But other features include: simplified full-scale setting; fast 2 μ s settling time for fast updates for analog instrument systems; minimal (2mV) zero level system errors; and fast (30ns) data loading write times. A data readback feature allows system self-check at power-on.

The AD8600 operates from dual $\pm 5V$ or single +5V supplies, in extended temperature range ($-40^{\circ}C$ to $+85^{\circ}C$).

27 AD8600 \$25.28 in 1000s

WORLDWIDE HEADQUARTERS

Analog Devices, Inc.
P.O. Box 9106
Norwood, MA 02062-9106, U.S.A.
Tel: (800) 262-5643
Fax: (617) 326-8703

Printed in U.S.A.

 **ANALOG
DEVICES**

Designing 2.1V Futurebus+ termination system requires system-engineering approach

Samuel H Duncan and Robert V White, Digital Equipment Corp

Designing a termination system for a Futurebus+ power system can be a formidable task. Tight voltage tolerance and ripple-noise specifications require an approach that considers the power supply, backplane, termination, and backplane-transistor-logic drivers as interconnected units.

The demands placed on a 2.1V Futurebus+ termination power system require a system-engineering approach. With the Futurebus+, worst-case switching conditions can inject a transient on the power-supply backplane that has a current change vs time (di/dt) greater than 3A/nsec. Most power supplies can withstand only a 1A/msec load transient. To meet the Futurebus+'s demanding requirements, Digital Equipment Corp has designed a system that attaches a tightly integrated power supply directly to the Futurebus+'s backplane. The design procedure, although not exactly a "cookbook" approach, should help experienced engineers design a Futurebus+ system.

DEC's approach mounts only passive components onto the backplane because replacing defective active components requires expensive service. The design uses only one power supply, which, although not part of the backplane assembly, plugs directly into the backplane. Bypass capacitors on the backplane lower the impedance of the 2.1V power supply so that voltages at the terminators remain stable. A system approach considers the terminators, backplane, and power supply.

Before considering the power system, review the requirements for the 2.1V backplane. The two most important requirements are the voltage tolerance and the output-load current. The Futurebus+ standard specifies that the output voltage must be within $\pm 2\%$ of 2.1V and have a voltage ripple lower than ± 50 mV. The $\pm 2\%$ tolerance includes variations in

initial tolerance, line regulation, average dc regulation, temperature drift, long-term drift, and ripple and power-supply noise. Because of the switching actions of the bus, the design must meet the ± 50 -mV specification at the terminators, not at the power-supply output.

Meeting the $\pm 2\%$ power-supply tolerance can be challenging. DEC systems use reference voltages having a tolerance of only 0.25%. Although tight tolerance references are expensive, they eliminate voltage trimming in the factory. Bypass

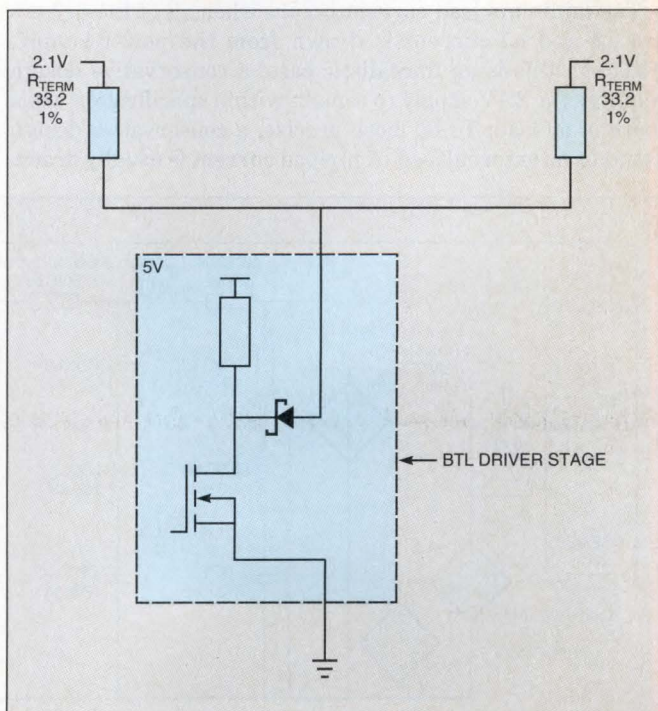

Fig 1—In the Futurebus+ configuration, a backplane-transistor-logic driver attaches to a signal line that is terminated at each end by 33.2 Ω resistors. There is one backplane-transistor-logic driver stage for each signal line on the trace.

FUTUREBUS+ TERMINATORS

capacitors that maintain the ± 50 -mV ripple specification attenuate power-supply and ripple noise. However, load current can introduce dc-distribution losses. You can calculate the minimum and maximum load current, even though the current is stochastic.

To determine the load-current bounds, consider a Futurebus+ active single driver and two backplane 33.2Ω resistor (Fig 1). When any signal line is in the low state, the driver draws current from the 2.1V supply. Typical current draw/signal line is:

$$I_{typ} = 2 \times (V_{term} - V_{low}) / R_{term}$$

$$I_{wc} = 2 \times (2.10V - 1V) / 33.2\Omega = 66.3 \text{ mA.}$$

The 66.3 mA is a typical current draw. In worst-case conditions, the terminator voltage can be as high as 2.142V, and the logic low voltage can be as low as 0.75V. In addition, the terminator resistors have a $\pm 1\%$ tolerance. Adjusting for worst-case parameters, the worst-case current is:

$$I_{wc} = 2 \times (2.142V - .75V) / 32.868\Omega = 84.7 \text{ mA.}$$

A 6-slot backplane having a 64-bit data bus has 130 signal lines that can draw current from the power supply when you include the arbitration signals. Generally, no more than 100 lines switch simultaneously, however. Therefore, 100 signal lines, each drawing 66.3 mA, typically draw 6.63A total current from the power supply. The absolute worst-case condition occurs when 130 lines draw 84.7 mA, resulting in an 11A current draw from the power supply. This is an unrealistic case, however. A worst case of 10A is more likely.

The minimum load current occurs when all of the drivers are off and no current is drawn from the power supply. Although this is an unrealistic case, a conservative design requires the 2.1V supply to remain within specification when there is no load. To be more precise, a conservative design assumes no external load. A preload current is usually drawn

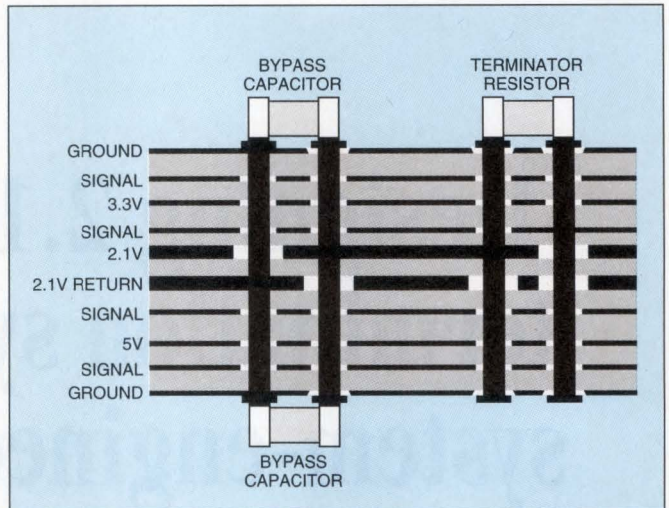

Fig 2—This backplane-layering and bypass-capacitor connection places dual bypass capacitors as close as possible to the termination resistor and 2.1V line.

from a switching power supply to keep the power supply operating in its linear, continuous mode. This design uses a preload current of 0.5A, which dissipates only 1W. If you use a linear regulator, the preload current biases the pass transistor into its active region.

To meet the 50-mV specification, assume that 100 signal lines can change at once and that the bus switches in a minimum of 2 nsec. The load transient under these conditions is $6.6A/2 \text{ nsec} = 3.3A/\text{nsec}$. In practice, the load transient is not this large. Because of bus skew, all the signals do not arrive simultaneously at the terminators. The terminator resistors' inductance also slows the rise of the current transient on the 2.1V backplane. However, to find the worst-case load transient, this design ignores these factors.

Consider the complete power-supply system when determining the voltage at the terminators.

Designing a backplane by throwing in some random bypass capacitors and hooking up a power supply using 1m of cable does not work. Designing a complete power system means considering the terminator resistors, 2.1V layers in the backplane, bypass capacitors, backplane to the power-supply connectors, and power-supply output. The DEC design uses Spice to simulate the system, although it can use a lumped-element model because the 2-nsec backplane doesn't require a transmission-line model. The Spice model describes the load as a series of resistance and time-varying voltages.

Locate the 2.1V power line and its return on adjacent layers and on inner layers of the backplane to minimize inductance and increase capacitance. The design requires a 2-oz-thick min

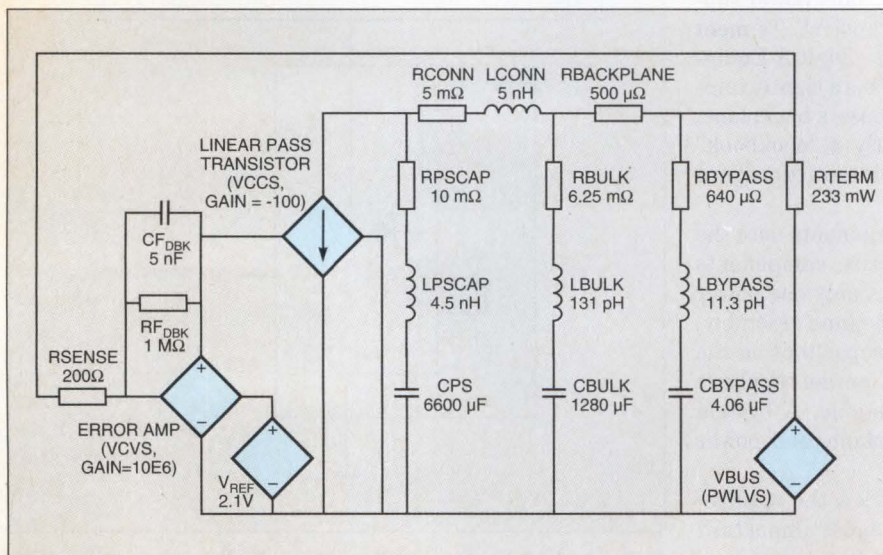
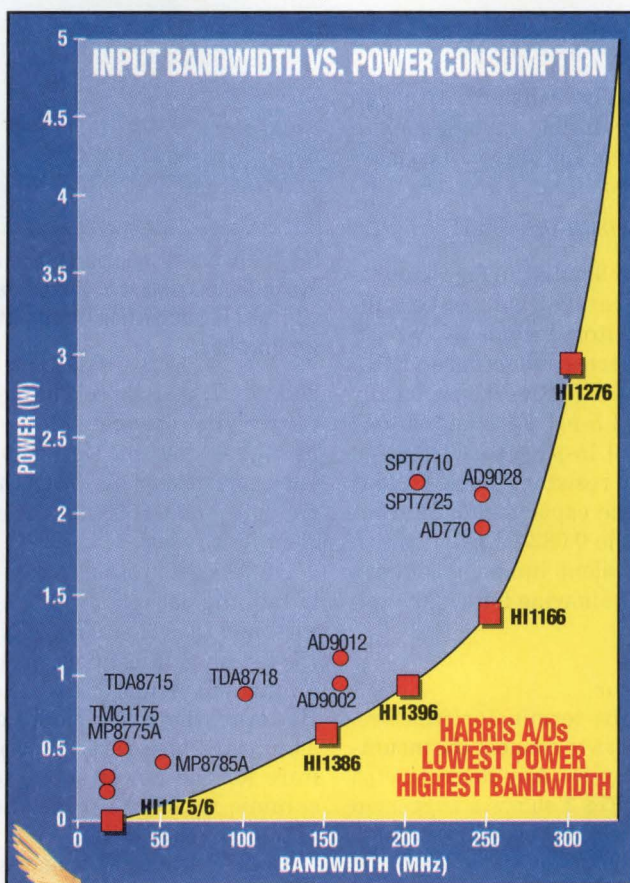

Fig 3—A Spice model uses lumped elements to describe the backplane impedance and the staggered arrangement of bypass capacitors. It also models a linear voltage regulator and the connector impedances.

WORLD'S HIGHEST BANDWIDTH, LOWEST POWER A/D CONVERTERS

SPEED DEMONS, POWER MISERS.

Tired of trading off power efficiency for bandwidth? Trade up to this family of high-speed A/D converters, designed for high-speed instrumentation, communications, and professional video applications. As a group, their speed is hard to beat. And when you combine that with their low power consumption, nothing else can touch them. There's a whole range of A/D performance, from 20 MSPS to 500 MSPS – in a variety of configurations and with lots of built-in extra features. So get the performance you need – and give your power supply a break.



A/D Family Features

HI1276, 8-bit, 500 MSPS
 • 300 MHz input bandwidth
 • 2.8 W power consumption

HI1166, 8-bit, 250 MSPS
 • 250 MHz input bandwidth
 • 1.4 W power consumption

HI1396, 8-bit, 125 MSPS
 • 200 MHz input bandwidth
 • 870 mW power consumption

HI1386, 8-bit, 75 MSPS
 • 150 MHz bandwidth
 • 580 mW power consumption

HI1175/6, 8-bit, 20 MSPS
 • 18 MHz bandwidth
 • 60 mW power consumption
 • Built-in voltage reference

D/As also available:

HI20201, 10-bit, 160 MHz update rate
 HI20203, 8-bit, 160 MHz update rate
 HI1171, 8-bit, 40 MHz update rate

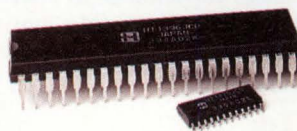

Nothing runs as far and as fast on so little power as a Harris data converter. Except maybe these high-energy in-line skates. On a single kick, they attain a theoretical straight-line speed of 115 mph, and maintain that speed for 45 minutes. (Actual specs will be available following the completion of a 86.25-mile test sidewalk.)



Try our AnswerFAX service!

Call 407-724-3818 and request document #7051.

Or call 1-800-4-HARRIS, ext. 7143.



FUTUREBUS+ TERMINATORS

copper line. Connect the 2.1V power supply to the backplane near the center of the board, which is equidistant from the terminators. Using this arrangement, the distribution resistance of the power-supply plane is about 500 $\mu\Omega$.

In selecting bypass capacitors, calculate the minimum capacitance to hold up the 2.1V terminator voltage until the power supply can respond, and calculate the maximum amount of inductance allowed on the 2.1V distribution line. The DEC design calculates the capacitance and inductance for a linear power supply to maintain a 50-mV ripple voltage. Supply response time is 50 μsec . Estimating the capacitance based on allowing no more than 50 mV of droop in 50 μsec yields:

$$C = I \times dt/dV = 6.6\text{A} \times 50 \mu\text{sec} / 50 \text{mV} = 6600 \mu\text{F}.$$

Estimating the inductance yields:

$$L = V \times dt/di = 50 \text{mV} \times 2 \text{nsec} / 6.6\text{A} = 15.2 \text{pH}.$$

The capacitance is large but physically realizable. Although the inductance is too small to be realizable, many terminators contribute to this lumped-element calculation. The maximum inductance for a terminator is:

$$L = V \times dt/di = 50 \text{mV} \times 2 \text{nsec} / 33.1 \text{mA} = 3 \text{nH}.$$

Although the 3-nH inductance is small, surface-mount-technology (SMT) capacitors are available with sub-nanohenry inductances. Such capacitors include a 0.082- μF capacitor with 0.7-nH effective series inductance (ESL) and 40-m Ω effective series resistance (ESR). The company also offers a 0.15- μF model with 1.5-nH ESL and 70-m Ω ESR. Designs incorporating the 0.15- μF capacitor need only one capacitor/two terminator resistors; designs with the 0.082- μF capacitors require one capacitor/four terminator resistors. This design uses the 0.082- μF part, which requires 62 capacitors. The equivalent lump-capacitance sum is 5.08 μF (4.07 μF worst case, allowing for a $\pm 20\%$ tolerance).

Place capacitor close to terminator

Place these capacitors close to the terminator resistors. The design requires at least three vias to connect the mounting pads to the 2.1V and return layers. Any discrete etch noticeably degrades performance. **Fig 2** shows a suggested backplane-layer and capacitor-connection scheme. Although the capacitors have a small enough inductance to support the load transient, they do not have enough capacitance to hold up the terminator voltage until the power supply can respond. Using the following approximation, the bypass capacitors at the terminators should hold up the voltage for only a few nanoseconds:

$$dt = C \times dV/I = 5.08 \mu\text{F} \times 50 \text{mV} / 6.6\text{A} = 38 \text{nsec}.$$

The above equation shows that the design requires at least another stage of capacitors to hold up the voltage. Each terminator requires no more inductance than that of the following equation:

$$L = V \times dt/di = 50 \text{mV} \times 38 \text{nsec} / 33.1 \text{mA} = 57 \text{nH}.$$

This is a reasonable amount of inductance to provide the

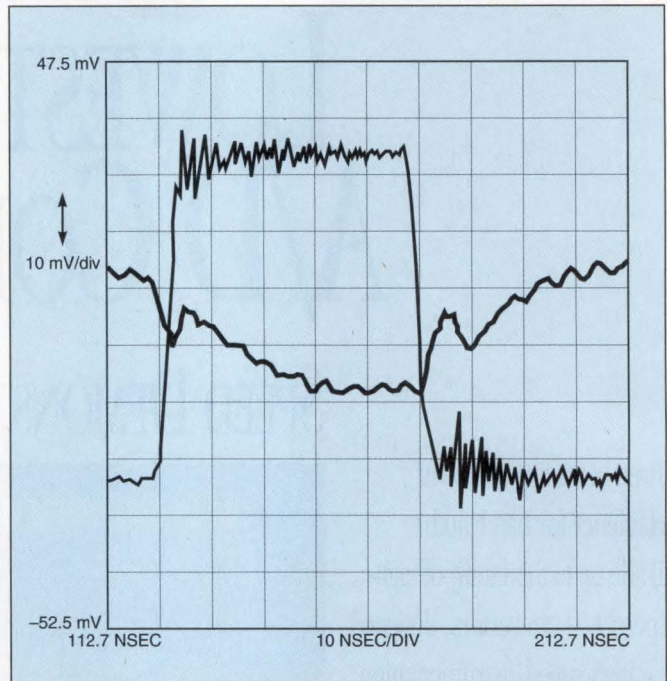

Fig 4—In the system backplane with all lines switching simultaneously, the maximum observed deflection on the 2.1V terminator is ± 24 mV. The deflection is comfortably within the 50-mV Futurebus+ specification.

additional hold time. The design includes 16 100- μF SMT electrolytic capacitors on the backplane between the termination resistors and the point at which the termination power enters the backplane. Even though the total capacitance does not quite equal 6600 μF , the electrolytic capacitors are sufficient for the task.

DEC's first systems use power modules that plug directly into the backplane. One system uses card-edge connectors, and the other uses DIN-style power pins and sockets. Direct plug-in connection to the backplane results in a minimum amount of resistance and inductance parasitics. However, the Spice model must include these parasitics. The design uses three 2200- μF , low-ESR aluminum capacitors for the power-supply output. It also uses 0.220- μF ceramic capacitors at the power-supply connection to filter high-frequency noise.

To meet the Futurebus+ specifications, the design staggers an array of capacitors throughout the backplane in three stages. The first stage comprises 0.082- μF , high-frequency bypass capacitors near the terminator resistors. The second stage, an array of 100- μF electrolytic capacitors, provides the bulk storage. The third stage includes the power-supply output capacitors. **Fig 3** shows a simplified schematic of the Spice model for the final design.

The Spice model predicts that the configuration can meet the Futurebus+ specification under worst-case switching conditions of the bus. You can test this condition by building an exerciser for the Futurebus+ that allows the simultaneous transition of any number of signal lines. When all lines are

Text continued on pg 122

Avoid future shock: Transvidiate* with XTK™

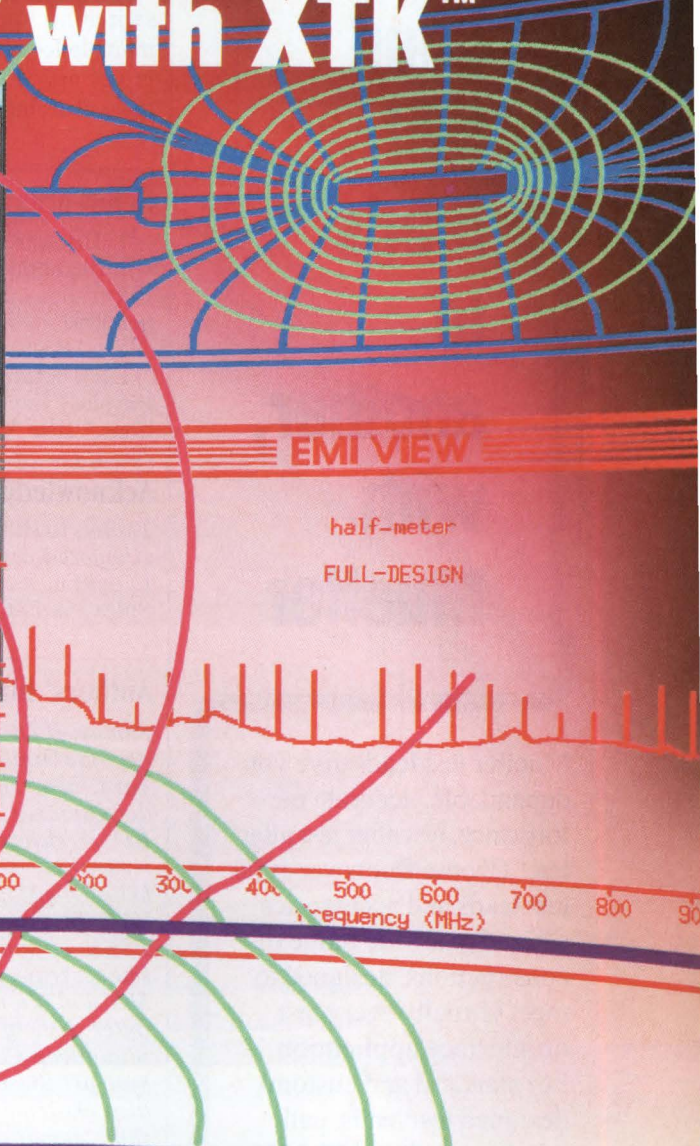
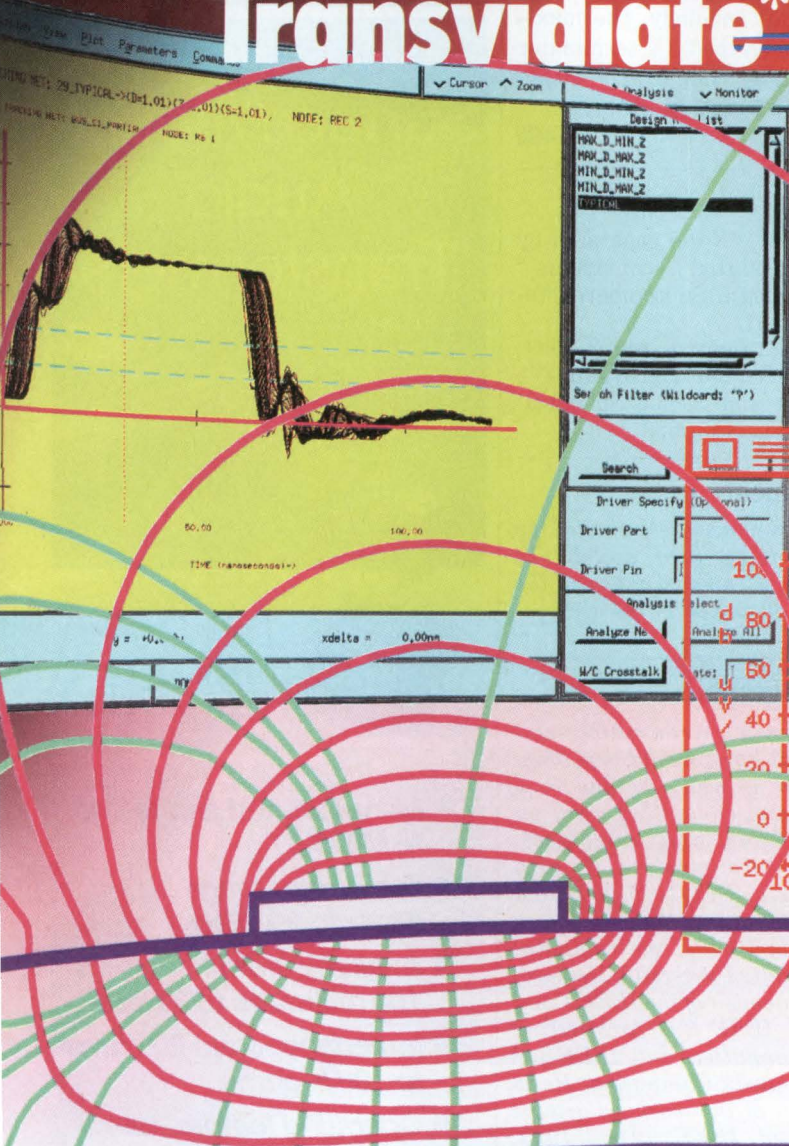

Identify signal distortions before they occur.

If the rigors of high performance design have you caught up in repetitive prototyping, break away with XTK (Crosstalk Tool Kit) from Quad Design. Simply stated, XTK is the most powerful and comprehensive signal integrity tool money can buy. It speeds your design cycle by pinpointing signal quality problems and predicting the effects of signal distortions prior to prototyping.

XTK automatically extracts topology and electrical parameters from PCB and MCM layout systems, allowing rapid and accurate simulation of lossy transmission line and crosstalk effects for entire digital systems. This, in addition to its speed and accuracy, makes XTK an essential element in increasing the quality of your high performance designs while decreasing product debug time.

For an even greater impact on your design cycle, XTK will soon be augmented by QUIET™, the industry's first integrated EMI tool kit. QUIET will not-so-quietly predict radiated noise from PCBs.

Avoid future shock by transvidiating with XTK. Call Quad Design at (805) 988-8250 and we'll send you a brochure on our whole fleet of predictive tools. 1385 Del Norte Road, Camarillo, California 93010... FAX (805) 988-8259.

CIRCLE NO. 9



SEE US AT DAC BOOTH NUMBER 735



* *transvidiate* (trans vid'è àl') vt. *-a ted, -a ting* [TRANS (L. across, over) + VID (L. videre, to see) + -IATE)] **1.** to bridge the present and future by knowing all signal distortion effects of your digital circuit design before they happen **2.** to avoid future design mistakes while the design is still a vision **3.** to exist in the future presently — *trans-vid'è-tion* n.

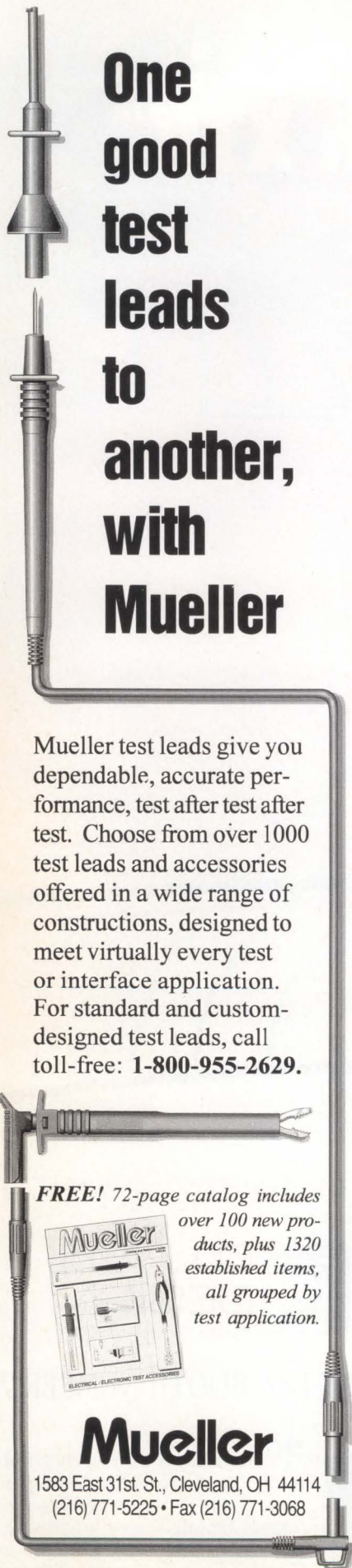

One good test leads to another, with Mueller

Mueller test leads give you dependable, accurate performance, test after test after test. Choose from over 1000 test leads and accessories offered in a wide range of constructions, designed to meet virtually every test or interface application. For standard and custom-designed test leads, call toll-free: **1-800-955-2629**.

FREE! 72-page catalog includes over 100 new products, plus 1320 established items, all grouped by test application.



Mueller

1583 East 31st St., Cleveland, OH 44114
(216) 771-5225 • Fax (216) 771-3068

CIRCLE NO. 81

122 • EDN May 26, 1994

EDN-DESIGN FEATURE

FUTUREBUS+ TERMINATORS

switching simultaneously, the maximum deflection on the 2.1V terminator is ± 24 mV (Fig 4), comfortably within the Futurebus+ 50 mV specification.

EDN

References

1. Hayward, C, "Noise generated by simultaneous signal transitions," Futurebus+ design, September/October 1992, pg 35-37.

2. IEEE Standard 896.2-1991, "IEEE Standard for Futurebus+—Physical Layer and Profile Specifications," New York, NY, 1992.

Acknowledgment

Thanks to Bill Samaras, who created the staggered-capacitor idea, and Bruce Loughlin, who performed much of the Spice simulation and other research.

Authors' biographies

Samuel H Duncan is a consulting engineer for Digital Equipment Corp, Maynard, MA. For 15 years, he has done development and consulting work on I/O architectures and interfaces, firmware, and diagnostics. He also helped develop the DEC 4000, 7000, and VAX 8800 computers. Duncan has a BSEE in applied math and computer science from Tufts University, Medford, MA, and is a member of the IEEE Computer Society, IEEE Bus Architecture Standards Committee, and IEEE μ P and μ C Standards Committee. He is also chairman of the working groups that developed IEEE 1212.1-1993, 896.1a-1993, and 896.2a standards. He is married; has three children; and likes to restore his home, sail, wind-surf, bicycle, and ski.

Bob White works for AT&T Bell Laboratories in Mesquite, TX. Before joining AT&T, White was a principal engineer in the Power Systems Engineering Group at Digital Equipment Corp in Maynard, MA. He served as DEC's internal consultant on power-related issues in the Futurebus+ specification development. He was also the power-system architect and technical-team leader for the DEC 4000 computer system. White is the technical vice president of the IEEE Power Electronics Society.

Article Interest Quotient
(Circle One)

High 595 Medium 596 Low 597

PICO

ULTRA-MINIATURE

Surface Mount Audio Transformers

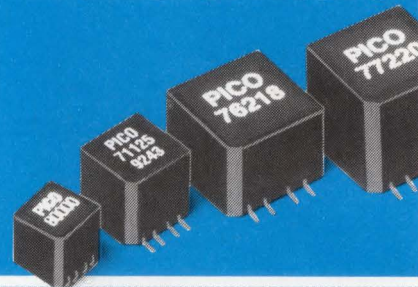

Low Profile
.2" Ht.

- Manufactured and tested to MIL-T-27
- Frequency range 20 Hz to 250 KHz
- Available from 100 milliwatts to 3 watts
- Impedance from 20 ohms to 100 K ohms
- Operating temperature -55°C to $+130^{\circ}\text{C}$
- Low profile .2" ht.

PICO surface mount units utilize materials and methods to withstand extreme temperature (220°C) of vapor phase, I.R., and other reflow procedures without degradation of electrical or mechanical characteristics.

Delivery—
stock to one week

See EEM
or send direct
for Free PICO Catalog.
Call toll free **800-431-1064**
in NY call **914-699-5514**
FAX **914-699-5565**

PICO Electronics, Inc.

453 N. MacQuesten Pkwy., Mt. Vernon, N.Y. 10552
CIRCLE NO. 89



WELCOME TO THE SUBMICRON WORLD OF COMPASS DESIGN

One million gates. Four million transistors.
All in 0.35μ technology.

Sound like the future? Hardly. That's the kind of design that companies worldwide are achieving with COMPASS' new generation of IC design tools.

Only COMPASS provides a seamless graphical specification and synthesis environment that integrates logic design, physical design, libraries and library development tools. Others make this claim but it's no secret they built their product line by acquiring technologies to fill in design "holes."

COMPASS tools were built from the top down. You get everything you need from one company, at one time. And all COMPASS tools are designed to work with the foundry of your choice.

Say good-bye to yesterday's mix-and-match design tools, endless hours of integration and empty promises. Say hello to tightly integrated tools that speed you from concept through synthesis, layout, verification and silicon. Break through today's design barriers - into the future of submicron design.

Call 1-800-433-4880 for more information on COMPASS design tools.

The shape of things to come.

COMPASS 
Design Automation

CIRCLE NO. 65

Synthesis to Silicon

COMPASS Design Automation,
1865 Lundy Avenue, San Jose, CA 95131
© 1994 COMPASS Design Automation, Inc.
The COMPASS logo is a registered trademark
of COMPASS Design Automation, Inc.

3M boardmount connectors come in all shapes, sizes and applications.



Naturally, we're giving samples.

We've always been known for our high-quality wiremount connectors. Shouldn't the world know about our *boardmount* connectors, too?

Well, we can get you a complete line of boardmount products: shrouded headers, in both low-profile and latch-eject models; shunts; pin strips. Polarized sockets, straight and right-angled.

We can get you high-temperature bodies, true surface-mounts and through-boards, top and bottom. Choose your pin length. Choose your plating. Great for board-stacking. Plus delivery when promised.

We're out to make your life much simpler when it comes to boardmounts. A call to 800-328-0016, ext. 100, will get you our new Boardmount Engineering Guide—it's free. And qualify you for samples of 3M boardmount connectors at the same time.

Energy gauges add intelligence to rechargeable batteries

Malcolm McClure, Span Inc

An energy gauge built into a rechargeable battery pack can tell you exactly how much charge remains available for use. It can also direct an inexpensive "dumb" charging device to charge the pack in an optimal manner. It can even store a history of battery health.

It's too bad laptop computers, camcorders, and cellular phones can't run for 20 hours on a battery the size, shape, and value of a quarter. But they can't, so manufacturers offer ICs and other components to simplify the job of efficient power management. Such products include dc/dc converters, battery-charging devices, and power-switch arrays that control energy-consuming components like disk drives and backlit screens.

But perhaps the most dramatic advance in power management is in battery-energy gauges. These units, which often reside inside a battery pack, actually monitor the amount of energy that flows into and out of a battery to make accurate estimates of the amount of charge remaining. These estimates are available not only to the user, via an on-pack display, but also to the battery-run device, via some sort of serial data link. To a designer, this data is valuable information because the battery pack is often a device's largest, heaviest, and most expensive component.

Voltage readings aren't enough

Most rechargeable batteries for portable electronic devices are nickel-cadmium (NiCd) or, more recently, nickel-metal hydride (NiMH). These batteries' chemistries allow fast recharging and offer a good combination of energy density, uncharged shelf life, and low cost. Unfortunately, a simple reading of terminal voltage, either open circuit or under load, yields little information about their present state of charge. To understand why, look at the discharge curve for a NiCd battery (Fig 1). (NiMH batteries, by the way, behave in almost the same way during discharge.)

As Fig 1 shows, terminal voltage drops rapidly for a brief

time and then is followed by a long period of slow decline. As the battery nears depletion, the voltage again falls off quickly. At first glance, it would appear a simple matter to translate the terminal voltage, especially in the central region of the graph, into a measure of remaining charge. Indeed, some manufacturers have marketed crude energy gauges that use this approach. The results are woefully unreliable, however, because the absolute cell voltages are a function of temperature, internal pressure, and battery age. The amount of deviation caused by these factors negates any meaningful information derived from voltage alone.

The situation during charging is similar, as indicated in Fig 2's typical charge curves for NiCd and NiMH cells. As in discharging, these two chemistries behave in an almost identical manner, an exception being that the NiMH batteries do not experience as much decline in voltage as they go into overcharge. Here, too, terminal voltage does not give a reliable measure of the state of charge, because the absolute values of the voltages vary with factors such as temperature and pressure.

The only accurate way to know how much charge is actually in a battery pack is to count the coulombs as they come and go. While this appears a conceptually easy task, a number of subtleties arise that quickly make it a formidable one.

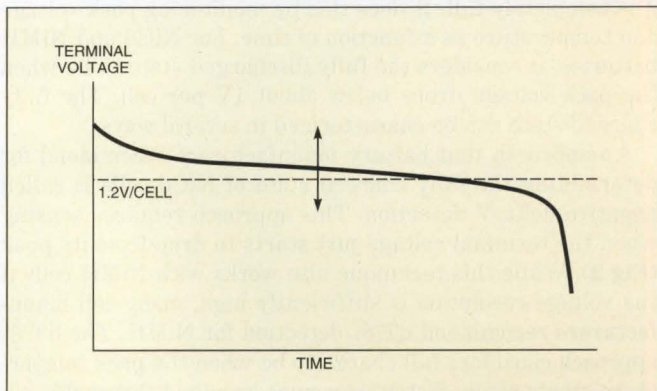

Fig 1—The absolute level of a battery's discharge curve depends on several variables, including temperature and pressure. The curve shown here is typical of NiCd batteries.

ENERGY GAUGES

Nonetheless, highly accurate gauges are now available that take these subtleties into account.

A simplistic way of viewing a rechargeable battery is as a tank of electrons. As the charge depletes, the tank drains. As it recharges, the tank fills. To know how full the tank is, you need to count the electrons as they go into the empty tank. If the size of the tank is also known, you can make an estimate of "percent full."

Electrical current is a measure of electron flow, where $1A=1.6 \times 10^{19}$ electrons/sec. To count electrons, the energy gauge must monitor battery current and then numerically integrate it over time. This process requires three elements of hardware to implement: a current-sensing device, an A/D converter, and a processor to perform the integration and send the results to the host.

For monitoring really large currents, a Hall sensor can measure the magnetic field surrounding the current path and translate it into a current reading. But Hall devices require cumbersome magnetic cores and support electronics, and they're not cost-effective for most applications.

By far, the least expensive and most common approach for current sensing is to insert a low-value resistor in series with the current path and measure the voltage drop across it. Since any resistance inserted in the main current path potentially wastes power and may even limit the amount of current that can flow under surge conditions, the minimum possible resistance is preferable. Typical values range from 0.01 to 0.5 Ω .

An A/D converter measures the voltage across the current-sensing resistor. To resolve currents of 1 mA over a range of $\pm 4A$, converter resolution of 13 bits is necessary. The signals involved may be minuscule, typically on the order of 100 μV . After conversion to digital form, it is relatively easy to numerically integrate the readings with a μP .

Battery capacities exceed ratings

Returning to the analogy of a battery as a tank of electrons, it is important for an energy gauge to be able to measure the actual size of the tank. Manufacturers of rechargeable batteries specify the capacity ratings for their cells in milliamp-hours (mA-H). These ratings are minimum values, and the actual pack capacity often exceeds its rated value by 20%. Also, the capacity usually decreases as the pack ages.

For the gauge to measure actual pack capacity, it must be able to sense when the "tank" is completely empty and when it is completely full. It does this by monitoring pack voltage and temperature as a function of time. For NiCd and NiMH batteries, it considers the fully discharged state to be when the pack voltage drops below about 1V per cell. The fully charged state can be characterized in several ways.

An approach that battery manufacturers recommend for determining the fully charged state of NiCd cells is called negative-delta-V detection. This approach requires sensing when the terminal voltage just starts to drop from its peak (Fig 2). While this technique also works with NiMH cells if the voltage resolution is sufficiently high, many cell manufacturers recommend dT/dt detection for NiMH. The dT/dt approach considers full charge to be when the pack temperature starts rising faster than some specified threshold.

Adding these capabilities for determining the fully charged state requires additional channels of A/D conversion or, perhaps, extending the resolution of the existing chan-

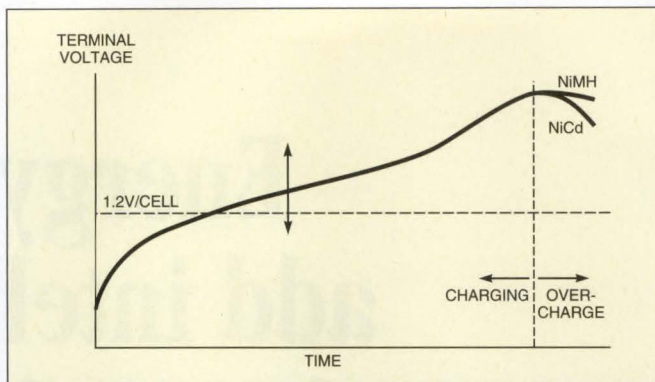

Fig 2—Charge curves, like discharge curves, depend on variables like temperature and pressure. NiCd and NiMH batteries charge almost identically except when they go into overcharge.

nels. For instance, to resolve voltage changes of 1 mV out of a battery voltage of, say, 20V (as is necessary for using negative delta V with NiMH batteries) requires an A/D resolution of 15 bits. By contrast, temperature sensing requires only about 9 bits of resolution. As it turns out, both temperature and voltage readings are necessary for proper gauging.

Energy gauges' advantages

Once an energy gauge has the ability to sense when a battery is fully charged and fully depleted, it can perform several other important functions. First, the gauge can automatically calibrate itself to the pack by measuring the actual amount of energy that can be extracted from the pack. In some gauging devices, the host must initiate this calibration; in others, calibration happens automatically whenever the pack runs from a fully charged state to a fully discharged one. With internal registers, a gauge can store capacity information for use in calculating present charge state as a percentage of capacity. A gauge can also monitor pack capacity over time as a barometer of battery health.

Once a battery gauge has the features just described, it has all the intelligence necessary for charging the battery pack. This intelligence need not be duplicated in external charging devices as long as some means exists for the pack to control an external "dumb" charger. The gauge can bring this control information out on a single hardware line or transmit it as part of a data stream.

Because determining actual pack capacity can take several hours, it would be unfortunate if this information got lost. This is a very real possibility, however, because the user can inadvertently let the pack discharge below the level necessary to keep the energy gauge working. Or, a static discharge could corrupt an internal register. For these reasons, some vendors have incorporated electrically erasable PROM (EEPROM) into their gauges for storing critical parameters. The addition of nonvolatile memory also lets the vendor offer a single standard product with a menu of features that the user can select through appropriate programming of EEPROM registers. For example, the menu might offer a range of charge-termination techniques, including negative delta V and dT/dt, with all the parameters selectable by the user.

Addition of EEPROM also allows the gauge to track battery history. This history might include basic information, such as how many charge cycles the pack has experienced, or

How do you replace a surface mount fuse in under 5-seconds?



Wouldn't it be great if you could replace a surface mount fuse without desoldering and resoldering?

The Littelfuse NANO² fuse and fuseholder makes that possible. Makes assembly and repairs easier. Makes space-saving circuit protection more reliable and affordable than resettable devices. We're ready to send you all the facts today, by fax, on the NANO² fuse and surface mount fuseholder, or on any of these other Littelfuse surface mount Slo-Blo[®] and fast-acting fuses.



Littelfuse
Electronic Products

ISO 9000
CERTIFIED

Get all the facts by FAX: 1-708-391-0894

Check the surface mount fuses you're interested in and fax us this ad and the following information. In minutes, we'll fax you back the information you want.

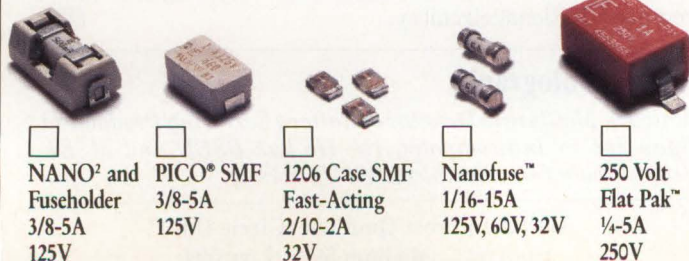

NANO² and Fuseholder
3/8-5A
125V

PICO[®] SMF
3/8-5A
125V

1206 Case SMF
Fast-Acting
2/10-2A
32V

Nanofuse™
1/16-15A
125V, 60V, 32V

250 Volt Flat Pak™
1/4-5A
250V

I'd like information on other Littelfuse Surface Mount products.

Name: _____

Company Name: _____

Company Address: _____

City: _____ State: _____ Zip: _____

Your return FAX: _____

Company phone #: _____

Application needs: _____

ENERGY GAUGES

more exotic things, like the maximum and minimum temperatures experienced by the cells. Such information is useful in projecting a pack's life expectancy and even for deciding whether to honor a warranty on a supposedly defective unit.

Using the measured information

Now that the energy gauge has amassed all this information about the battery, what happens to that information? The most fundamental piece of information, the percentage of full charge, is often directly available on an LED or LCD. LEDs draw significantly more current than LCDs, so they're usually accompanied by a pushbutton switch for momentary activation. LCDs, on the other hand, can run continuously, but they're more delicate (removable battery packs are highly susceptible to being dropped), and they don't behave well at temperature extremes. For these reasons, LEDs are currently the display of choice.

Battery information is also usually available to the host equipment via some form of serial link. Various protocols are available, ranging from custom versions to standard RS-232C. The amount of information provided also varies among manufacturers. Along with percentage of full charge, it may include instantaneous readings of voltage, current, temperature, pack capacity, charger-control information, multiple levels of low-battery warning, and indications of any potential battery-error conditions.

Because most energy gauges reside inside a battery pack and draw their operating power from the battery, they must use as little power as possible, especially when the pack is not in use. Good gauges, therefore, enter a low-power mode when they sense their host is turned off. Quiescent currents of 50 μ A are typical.

Operating voltage is also worth considering. Some energy gauges require a 5V source for their supply, which can require tapping into the battery string for 1.2V/cell NiCd and NiMH batteries. With packs of four or fewer cells, these gauges become unusable. Other gauges, however, can handle supply variations ranging from 3V or less to more than 25V.

You also have to consider the ways in which rechargeable batteries differ from the simple model of an electron storage tank. For example, all batteries, rechargeable or otherwise, exhibit the phenomenon of self-discharge. That is, a fully charged cell loses charge over time. The phenomenon is par-

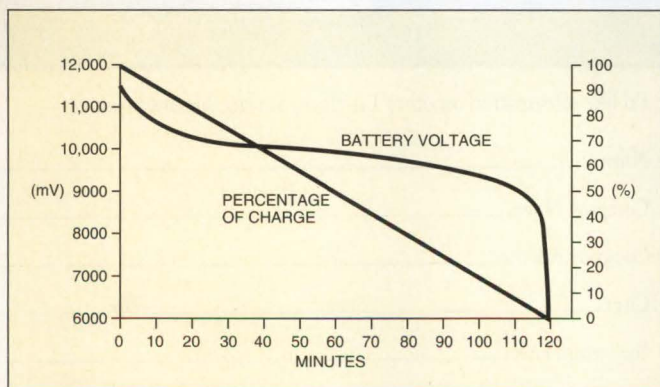

Fig 3—An energy gauge can accurately compute a battery's remaining charge (shown here as the straight line), but a simple reading of battery voltage (curved line) is unreliable. The data shown here resulted from discharging an 8-cell NiMH battery pack.

ticularly noticeable with NiCd and NiMH cells, which typically lose about 1 to 2% of their charge each day. After three months of sitting idle, a previously fully charged pack will be dead. Worse yet, the self-discharge rate is a strong function of temperature. Storing the pack at 40°C instead of 25°C will cause it to fully discharge in just a few days.

Because equipment used outdoors or left in the trunk of a car can experience high temperatures, energy gauges must monitor battery temperature and use it to account for self-discharge. However, the rate of self-discharge as a function of temperature varies with cell chemistry and manufacturing techniques. If an energy gauge has onboard EEPROM, an OEM can program the appropriate self-discharge parameters; other gauges must either approximate self-discharge with a "one-size-fits-all" algorithm or ignore it altogether.

Other factors that affect gauge accuracy include various charge and discharge efficiencies. For instance, charging efficiency is always less than 100% and drops off considerably as a pack nears full charge, because much of the energy pumped into the pack goes toward producing gasses rather than into a retrievable form. Likewise, temperature affects charge efficiency. All these parameters vary with chemistry and manufacturing techniques, but they can be accounted for if a gauge has the means to do so.

For an idea of the accuracy you can expect from an energy gauge, see the data in **Fig 3**. The plot shows pack voltage and percentage of remaining charge while a battery discharges at a constant rate of 1000 mA. This data, representing the fifth discharge cycle after calibrating a gauge to a battery pack, yields an overall accuracy of 0.22%. Under less ideal conditions, accuracies of 1 to 2% are typical.

The benefits of incorporating an energy gauge into a product line are several. First and foremost, both the user and the host equipment can know exactly how much charge is available from a battery pack. This is true whether the pack is currently in use or has been pulled from storage. A second benefit is that the extra battery capacity above rated value is available for use. In addition, an energy gauge eliminates the need for sophisticated charging equipment; it can control an external "dumb" charger at the cost of one extra terminal on the battery pack. Further, one charger can recharge various types of batteries.

The cost of adding an energy gauge to a product depends on several factors: sophistication and resolution of the hardware, desired current range, size and shape of the gauge, number of interface contacts with the host, communication protocol (if any), and type of display used. With all these variables, it is difficult to give specific price information. However, a typical energy gauge now adds about 25% to the cost of a pack, although prices are likely to drop rapidly over the next few years. Be aware, though, that some units come as fully assembled modules, while others are single ICs that require additional circuitry. EDN

Author's biography

Malcolm McClure is Director of Battery Servicing Products at Span Inc in Indianapolis, IN. He has BSEE and MSEE degrees, both from Northwestern University.

Article Interest Quotient (Circle One)
High 592 Medium 593 Low 594

“Ten years in PCB design has taught me what it takes to get the job done. You need tools that work as hard as you do.”

We design better PCBs in less time with TangoPRO™

Jeff Imes, Engineering Support Group Leader, Optelecom, Inc.

Optelecom is a leader in fiber optic telecommunications. In a tough, competitive market, their products excel in performance, reliability and functionality. For state-of-the-art analog and digital technology, and the productivity to meet the most demanding schedules, TangoPRO delivers.



POWER. “. . . all the features we need for dense, high-speed designs.” **EASE.** “Its Windows interface and intuitive structure made it fast to pick up and understand.”

VALUE. “We shopped around. TangoPRO costs less than the maintenance fees on some systems. It paid for itself on the first few designs.” **SUPPORT.** “ACCEL is committed to the customer and the product. Their tech support is great and they've implemented many of our suggestions.”

TangoPRO for Windows is becoming the popular choice for PCB designers and electronic engineers alike. Schematic entry, board layout, high-performance autorouting, CAM output. TangoPRO is the complete solution.

Workstation-class power. Windows ease. Priced for exceptional value. Friendly support. Call today for free evaluation software, or to set up an on-site demonstration.

Invest in TangoPRO.

“. . . it makes good sense.”

Tango PRO™

ACCEL Technologies, Inc.

800 488-0680 Sales
619 554-1000 Service
619 554-1019 Fax

CIRCLE NO. 47

Free Eval Package

Test drive TangoPRO with our full-function evaluation package.

Call

800 488-0680

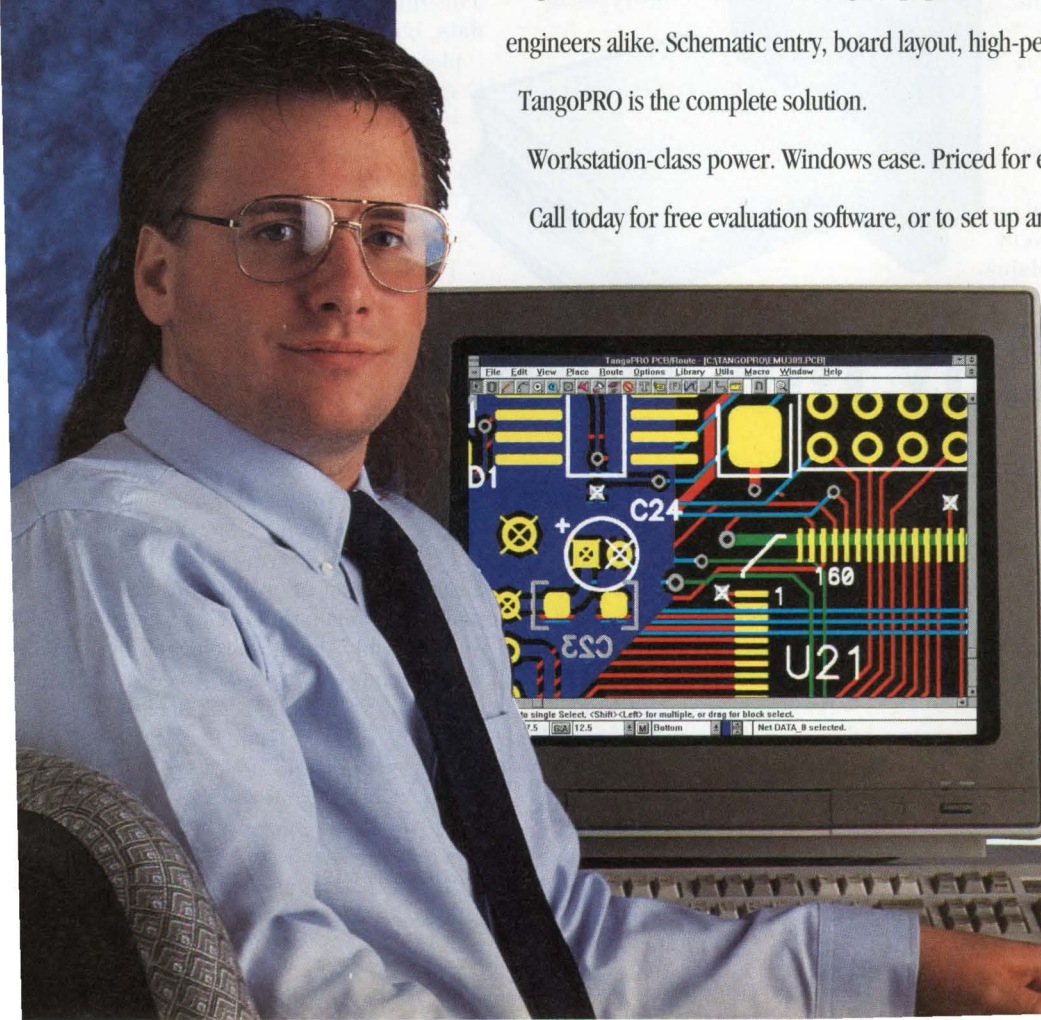

Product reviews from EDN's editors and readers

If you're planning to buy, use, or design products compatible with the standards of the Personal Computer Memory Card International Association (PCMCIA), you need a copy of *The PCMCIA Developer's Guide* by Michael T Mori. This self-published book (Tori is an independent design consultant) is by far the best collection of useful information I've seen on PCMCIA—a valuable blend of tutorial information, product information, and design guidelines. Moreover, Mori has obviously taken great care in choosing what *not* to include in the book, so you can plunge right in and learn quickly, without getting bogged down in details for which you're not yet ready.

The book begins by briefly summarizing the evolution of the association and the PCMCIA standard. Then, in 10 pages or so, it gives a remarkably clear overview of today's expanded standard. The standard itself isn't hard to read, but this summary quickly gives you a good perspective.

The real meat of the book begins in Chapter 3, "Designing a PCMCIA host adapter." A host adapter, in this sense, is simply something that connects to a host computer and accepts PCMCIA cards. It can be part of the equipment you're designing, or it can be an external unit. This chapter doesn't have every design detail you need, but it explains the major design issues, and it provides enough information at the block-diagram level to give you a sense of what you're up against.

Chapter 3's tutorial information is all the better for having just the right amount of basic information about some of the more popular PCMCIA ICs available for designers. (Later, in Chapter 8, there's more detail about a wider range of chips.) Most of the ICs this chapter discusses are socket-controller ICs, which provide the needed connections and signals between a PC bus and one or more PCMCIA card sockets. (PCMCIA applications aren't limited to the PC architecture, but commercially available socket controllers are. You can design PCMCIA interfaces for other buses, but you have to do a lot

more of the work yourself.)

The next chapter, "Designing a PC card peripheral," looks at the myriad issues of designing a plug-in PCMCIA card. In about 35 pages, it covers electronic design, mechanical design, software and compatibility issues, and agency approvals. Most of this information deals with electronic-design issues that are specific to memory cards and to what PCMCIA calls "I/O cards," which can contain practically any kind of peripheral device. You need to read the entire PCMCIA spec before you actually undertake a design, but this chapter boosts you up the learning curve.

Chapter 5, "PCMCIA software requirements," takes on what is undoubtedly the most confusing and troublesome aspect of using or designing PCMCIA products. PCMCIA has not reached all of its ambitious software goals—including plug-and-play operation and "hot swapping" of vastly dissimilar types of

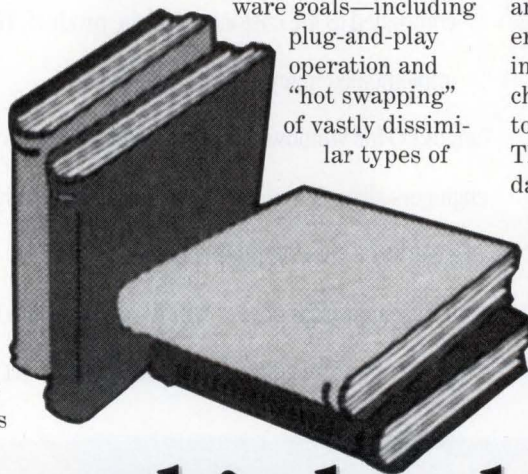

Buy this book!

cards—despite the existence of some very sophisticated and complex system software. This chapter explains, as well as 20 pages of text *can* explain, the software issues and which products are available to deal with them.

The chapter does an adequate job of describing succinctly what PCMCIA system software does and, in some cases, what it doesn't do. For example, a PCMCIA system-software module called Card Services (available from several software vendors) is not yet sufficiently general to control every type of card that you can possibly insert in a PCMCIA slot. To get

around the problem, card vendors provide specific card "enablers," essentially device drivers that defeat PCMCIA's hot swapping and plug-and-play goals. The issue of specific-vs-generic enablers is one that anyone involved with PCMCIA is going to have to address—a lot.

The future of PCMCIA gets a short chapter of its own in the book. The chapter's main topics are the recent and planned additions and modifications to the PCMCIA standard: additional operating voltages (more than just 5 and 3.3V), the 32-bit CardBus (which is patterned after the PCI-local bus and allows bus mastering), power management, multifunction cards, and more.

Next, the book provides an 80-pg product-information guide. A short chapter summarizes the types of PCMCIA products that are available, and a much longer chapter details several products. The product categories include all types of PCMCIA cards, chips, system software, development tools, and interconnection hardware. This information will soon be out of date, but it appears remarkably complete for now. The book's publisher expects to create revised and updated editions periodically, with the first one coming fairly soon.

Finally, appendices to the book contain almost 200 pgs of reference information, mostly from the PCMCIA specification. Having all this information in one book is handy, and the resulting single volume isn't all that bulky. It contains 400 or so 8.5×11-in. pages in all—about the size of a 1-in.-thick notebook.

The PCMCIA Developer's Guide isn't the only source of information you need to design PCMCIA products, but it's a good starting point. It assembles a lot of useful information, and that information is clear, concise, and probably the most relevant of all the information you need to get a quick start with PCMCIA design.

The book isn't cheap; it costs \$89.95 plus shipping. But if you need to learn about PCMCIA and you value your time, you'll get your money's worth and more.—Gary Legg

Sycard Technology, Sunnyvale, CA.
(408) 247-0730. **Circle No. 422**

Verify DSP-filter designs with SystemView

When performing DSP designs, you must weigh the tradeoffs of FIR vs IIR filters before committing to hardware. FIR filters lack a feedback path, thus ensuring inherent stability. FIR filters also provide an exactly linear phase response, so phase distortion does not occur. However, FIR filters typically require more computational time, especially in hardware that has only a single multiplier. A fast FIR requires a prohibitive number of multipliers to perform multiplications in parallel.

These drawbacks could also be a problem in DSP applications in which software performs the operations sequentially. The more instruction cycles needed to implement a filter, the fewer clock cycles you have for other processing tasks.

Using Elanix's SystemView (\$985), a dynamic system-level simulator, you can quickly address these problems and verify the merits of both types of filters. This graphical system simulator runs on PCs under Windows and lets you specify all relevant information and display the results simultaneously side-by-side.

The application I decided to simulate uses a lowpass filter having a 1-kHz cutoff frequency to operate with a sampling rate of 8 kHz. The first step in setting up the simulation was to select a sweep generator from the sources that the software offers. I configured the sweep generator to run from 10 Hz to 4 kHz. You select the sweep generator from a menu of source signals and specify its parameters by filling in a form. The sweep generator mirrors the actual method of evaluating the performance of the filter. An alternative source could have been the impulse, or "delta," function.

The next step was to quantize the input to 16 bits. I selected the quantizer from the appropriate function-token library and filled in its parameters. I then connected a signal-display token to the output of the quantizer. You can attach a display token anywhere in the simulation to aid diagnosis or to view intermediate results.

The next step in the simulation was designing the filters. I selected "linear system" from the operator-token library and then chose the types of fil-

ters from among FIR, IIR, and Laplace-transform filters. I then filled in another form for each filter with its critical frequencies, the amount of gain in the passband and the stopband, and the number of coefficients to use. The software can estimate the number of taps needed to meet the specifications in the FIR menu. You can select fewer taps than the software suggests, but doing so may mean the filter will not meet your specifications.

I examined four filter types: an 18-tap, lowpass FIR filter, a Butterworth IIR filter, a Bessel IIR filter, and a Chebychev IIR filter. All my IIR filters had eight poles, giving the same number of multiply-accumulate operations.

An important consideration when selecting a filter is the effect of quantizing the filter's coefficients to a specified number of bits. With this software, I simply entered the appropriate values in the text boxes. In this case, I set the coefficient quantization to 16 bits. The simulation showed that quantization has its biggest effect on the Chebychev filter's performance and a smaller effect on the FIR filter's.

After I specified all four filters, I started the simulation. The simulation injected the output from the quantized-frequency sweep signal into each of the filters and placed a display token at the output of each filter.

Once the simulation finishes, you can use the program's analysis window to examine—simultaneously or separately—the output response of each filter. You can view the signals in the time domain or the frequency domain, and you can view the frequency-domain data along a log or a linear axis.

The Butterworth and Bessel filters turned out to have a smooth inband response, but their frequency rolloff was slow. The FIR and Chebychev filters had a much steeper cutoff but had a significant passband-amplitude ripple. For the FIR filter, this ripple arises from the small number of taps. The application specified a 0.1-dB ripple, but the optimization routine could sat-

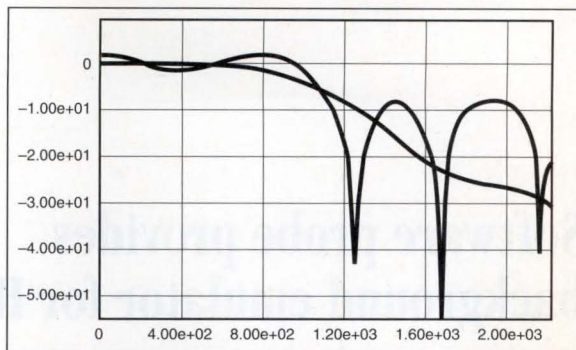

Fig 1—Comparing the frequency response of a basic FIR filter and the Hanning-windowed version shows that the windowed filter offers a vast improvement in ripple over the FIR filter. However, there is a penalty: The windowed filter does not roll off as sharply as the FIR filter does.

isfy this constraint only by averaging and by using 18 taps. The 16-bit word size also raised the out-of-band ripple of the FIR filter. The Chebychev filter's ripple comes from the 16-bit finite-word size of the filter-tap coefficients.

Another design feature you can apply to the FIR filter is "windowing." Windowing multiplies the given impulse response, $h(t)$, with a window function, $w(t)$, to produce a new filter response $g(t)=w(t)h(t)$. We usually think of windows as a means of reducing the spectral side lobes of Fourier transforms. In this context, multiplying by the window in the time domain convolves the frequency response of the window with the frequency response of the original filter. The lowpass nature of the window's response smooths the original response.

Fig 1 compares a Hanning-windowed filter and the original FIR filter. The windowed filter offers a vast improvement in ripple over the FIR filter, but the windowed filter does not roll off as sharply as the FIR filter does.

I chose the windowed FIR filter for this application because of its good cutoff, low out-of-band response, and low in-band ripple. The FIR filter is also inherently stable and has no phase distortion. The actual frequency response of the filter, when implemented in an Analog Devices AD-2101 EZ-Lab DSP evaluation board, exactly matches the SystemView simulation.

—Roger Hack

Elanix Inc, Westlake Village, CA.

(818) 597-1414.

Circle No. 423

Professor Roger Hack is a member of the Electrical Engineering Technology department at Purdue University (Fort Wayne, IN).

Software probe provides background emulator for HP tools

The HP3490A software probe provides a Motorola background-debug mode (BDM) interface to Hewlett-Packard's software-development tools. It provides run-control, memory-inspection/modification, and code-download-functions over a network.

The front panel of the instrument connects to a target's BDM port. The front panel also has two BNCs that connect to a logic analyzer. The logic analyzer can use a trigger-out signal as a qualifier to start an event, such as tracing. A trigger-in BNC allows the logic analyzer to force a breakpoint.

An interface for Unix or Microsoft Windows provides the same interface between the development tools and the software probe that exists for the HP 64700 series of emulators. The software probe supports 10Base2 and 10BaseT connections.

The HP3490A software probe costs \$3995. The interfaces for Unix and Windows cost \$3585 and \$1750, respectively.—David Shear

Hewlett-Packard Co, Palo Alto, CA. (800) 452-4844, ext 8322.

Circle No. 369

Automatically move from a Matlab simulation to an embedded system

Those using The MathWorks' Matlab and Simulink to simulate and analyze systems can now let their computers create the C code to implement models on targets running the VxWorks real-time operating system (RTOS). You can model the operation of the system you are developing by interconnecting block-level diagrams or by using the Matlab language.

You can rapidly prototype a design by letting the C-code generator produce C code, compile it, and run it on your target. Simulink's graphical user interface allows you to select and connect function blocks. It can generate continuous, discrete-time, or hybrid runtime code. Once the system simulation meets your satisfaction, you can move appropriate portions of the system to your target.

For example, you might also simulate real-world inputs when simulating a system. When you move the design to the target, the real world provides the real-world inputs, and you do not need code for these func-

tions. Once you generate the code, you can insert it back into your simulation to test it before letting it loose on the target.

You can use the C-code generator with VxWorks, and you can interface other RTOSs to the tool by modifying a file that defines the RTOS service calls the code generator uses. The C-code generator also includes documentation, source code, make files, and examples for creating RTOS support.

The Control Framework API automatically builds programs based on customizable make files. These make files define compiler options, source files, libraries, and automatic download options.

The C-code generator requires Matlab (starting at \$1695) and Simulink (starting at \$1995). The C-code generator costs \$9995 for either the PC or the workstation version.

—David Shear

The MathWorks Inc, Natick, MA. (508) 653-1415.

Circle No. 370

PowerPC simulator lets you test your system without the system

The PowerPC Virtual System from IBM allows you to simulate not only the code running on a μ P, but also the ASICs and other system components. The Virtual System is built around the PowerPC Visual Simulator (PVS). This simulator provides a simulated debug environment that allows you to test code, optimize system-design considerations, such as cache size and memory-access times, and interact with simulated I/O from a graphical user interface.

With Virtual System, you can model the complete I/O subsystems or just selected functions. A C-based application-programming interface (API) is a set of C-language functions that an I/O model can use to interact with the simulated PowerPC.

The PVS bus-model API can also connect the PVS to a simulation of your I/O. In this case, the bus-model interacts with the ASIC-simulation environment. This interaction lets you use actual ASIC models to provide the I/O simulation to the PowerPC.

The VHDL model for the bus of the PowerPC603 is now available free. Other models will become available in the future. As you debug your software, you can see how it reacts to a simulation based on the actual data used to create the ASIC. You don't have to worry about creating a new model to work with the simulator.

By simulating not only the μ P and the other subsystems, but also the actual VHDL-design data, you can check out more of the system before committing to hardware. Catching errors early in the game is a key factor in reducing development time. The PVS runs on IBM RISC System/6000 workstations and costs \$6000.

—David Shear

IBM Corp, Rochester, MN. (507) 253-7291, ext 330.

Circle No. 371

68300 68HC16

In-Circuit Emulators and Background Debuggers

Microsoft Windows 3.1 based user interface

Pull-down Menus

Speed bar (point and click)

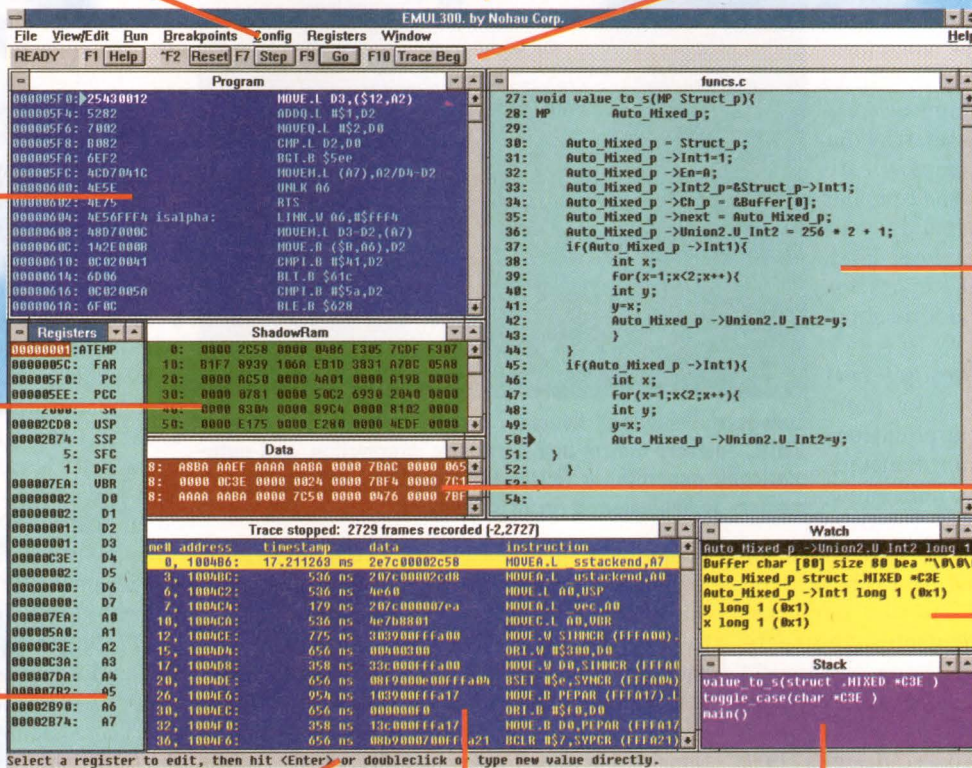

Disassembler, in-line assembler Window

Shadow RAM shows data changes in real-time. This data can be transported to other Windows programs through DDE.

Register Window

Context sensitive help line

Trace Buffer Window

C Call Stack

On line help

Source Window

Data Window

Watch Window for high level variables



FEATURES:

- Supports both the 683xx and 68HC16 families.
- User interface under Microsoft Windows.
- Modular approach: low cost (BDM) to full feature.
- Real-time emulation at maximum chip speed.
- High-level C, C++ support for HIWARE, Intermetrics, Introl, Microtec, SDS, Sierra and more.
- In-line assembler and disassembler.
- Hardware and software breakpoints.
- Up to 4 Mbytes of emulation RAM.
- Trace board up to 512K deep, 104 bits wide, including 40 bit timestamp.
- Real-time code coverage.
- Triggering and filtering with full pipeline decoding.
- Program performance analysis.
- Memory contents available in real-time (Shadow Ram) with DDE support to Excel.
- Hosted on PC's and workstations.

Also supported:

8051 68HC11 80C196

To learn more, please call (408) 866-1820 for a FREE Demo Disk. For more information via your Fax, call our 24-hour Information Center at (408) 378-2912.

NOHAU CORPORATION

51 E. Campbell Avenue
Campbell, CA 95008-2053
Fax. (408) 378-7869
Tel. (408) 866-1820

Argentina 1 312-1079, Australia (02) 654 1873, Austria 0277 20-0, Benelux (01858) 16133, Brazil (011)-458-8755, Canada 1-514-689-5889, Czechoslovakia 0202-2683, Denmark 43 44 60 10, Finland 90-4526-21, France (1) 69 41 28 01, Germany 49-7043-40247, Great Britain 0962-733140, Greece 1-924 20 72, India (0212) 422164, Israel (03) 491202, Italy (011) 437 15 51, Korea (02) 784-7841, New Zealand 09-3092464, Norway 22-67 40 20, Portugal 01-80 95 18, Romania 961-30078, Singapore 749-0870, S. Africa (021) 23-4943, Spain (93) 276 22 69, Sweden 040-92 24 25, Switzerland 01-740 41 05, Taiwan 02 7640215, Thailand (02) 281-9596.

Synthesize logic from behavioral description

The Behavioral Compiler from Synopsys provides the next step in design automation, offering potentially large improvements in designer productivity. Specifying an IC at the behavioral level requires only one-fifth to one-tenth as much time as specifying at the register-transfer level (RTL), the company estimates. In addition, the compiler lets you routinely simulate your design at the behavioral level, saving significant simulation time over structural-level simulation.

The tool suits designs that are best described by algorithms. Typical applications include telecommunications, high-end graphics, and multimedia. The tool frees you from designing the cycle-by-cycle behavior of a design. Instead, you can focus on algorithms while the tool performs multicycle optimization using techniques such as pipelining, multicycle operation, chaining, and resource sharing.

Many algorithm-based designs start as a C or a C++ language specification. Instead of translating the code into an RTL specification, you can write a

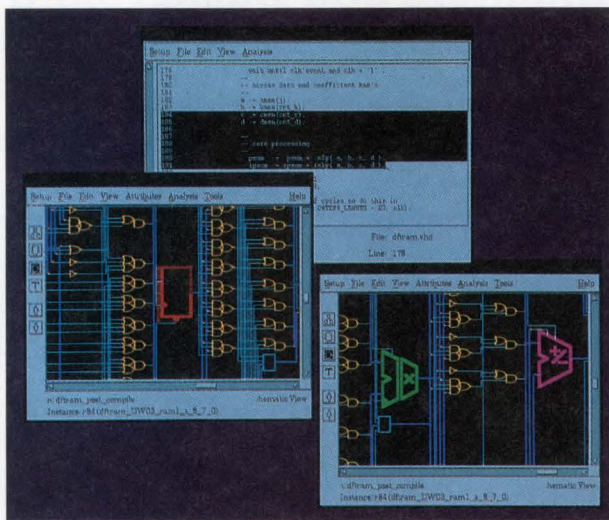

Synopsys' Behavioral Compiler accepts behavioral Verilog or VHDL, extracts control and data-flow information, and automatically generates a finite-state machine, data-path, and memory to implement a circuit's behavior.

behavioral specification in VHDL or Verilog that is very similar to the original language specification. According to the company, the behavioral specification may be only one-tenth as long as the RTL specification for the same design. Furthermore, the close relationship between behavioral-level hardware-description languages (HDLs) and software facilitates software/hardware system design.

The tool goes beyond the typical behavioral-level data-path designs available with other tools to include controller and memory interfacing. The tool automatically infers a design's controller from the behavioral specification and integrates it with the data-path portion of the design. The Behavioral Compiler also infers memory reads and writes from HDL-array accesses, allowing it to schedule memory access automatically. You no longer need to perform memory timing and scheduling manually.

Because the behavioral description does not imply an architecture, the synthesized architecture varies, depending on a few easily varied high-level constraints. This technique makes design reuse much more efficient than it is with RTL design.

Behavioral Compiler relies on and offers tight integration with the company's other architectural and logic-synthesis tools. It costs \$69,500 and is in Beta test. The company plans to begin shipments in the fourth quarter.

—Doug Conner

Synopsys, Mountain View, CA. (415) 962-5000.
Circle No. 340

Painlessly improve IC-test fault coverage

I_{DDQ} testing measures quiescent current while running selected functional vectors to identify defects. I_{DDQ} testing of ICs is off to a great start for two reasons. First, 60 to 80% of the faults in silicon are bridging and transistor problems detectable by using I_{DDQ} testing. Second, I_{DDQ} doesn't require the use of a special design for testability techniques. Because I_{DDQ} testing works on all logic types, your design can be synchronous or asynchronous.

Typically, all you need are 15 to 20 well-chosen test vectors for a 100,000-gate design to obtain high fault coverage with I_{DDQ} testing. Before we paint too-rosy a picture, however, note that I_{DDQ} testing does not actually deter-

mine whether a chip is functioning properly: You still need some level of functional testing. But you can use I_{DDQ} testing with other techniques to increase fault coverage.

Moving I_{DDQ} testing one step higher is Current Synthesis from CrossCheck. Although you don't need to use design-for-testability techniques to use I_{DDQ} , the Current Synthesis tool can make I_{DDQ} testing more effective for a small increase (3 to 5%) in silicon area. The tool creates synthesized test structures that improve testability and eliminate current-draining conditions that may exist in a design, reducing the device's power consumption during normal operation.

Many of the same current-drain concerns important to designers of battery-powered circuits are also concerns in I_{DDQ} testing. So, the tool improves a design's testability while reducing power consumption. The tool offers such changes as eliminating bus contentions and floating buses by synthesizing structures, such as control gates and bus keepers.

CrossCheck plans to ship Current Synthesis in the third quarter; prices start at \$15,000. The product is an option to CurrenTest (\$45,000), a currently available tool that develops the I_{DDQ} test vector. —Doug Conner

CrossCheck Technology Inc, San Jose, CA. (408) 432-9200.
Circle No. 341

REAL VHDL, REAL SYNTHESIS, REAL WINDOWS—STARTING AT THE UNREAL PRICE OF \$1,995.

PROsim™ delivers 28-state, high-performance, full-timing simulation. PROsim integrated with PROvhdl and PROcapture gives you a powerful, multi-level simulation package, with back-annotation to PROcapture for the fastest design and debug capability available on a PC. PROsim, \$4,995.

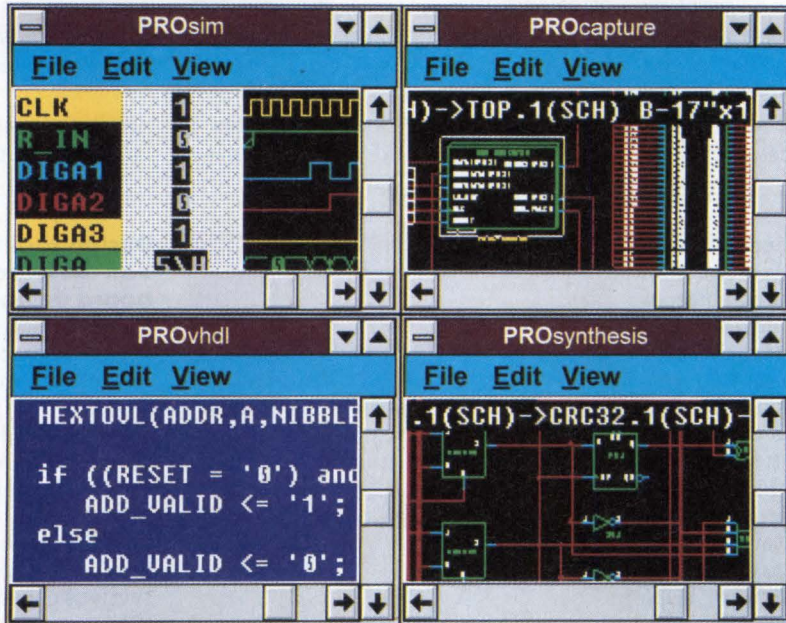

The newest member of the PRO Series™ family, PROvhdl™ brings the power of high-level design to your PC. Now you can develop more innovative FPGA and CPLD designs faster than ever before. Integrate it with other PRO Series tools for full system-level design. PROvhdl, \$1,995.

PROcapture™, our advanced, Windows-based design-entry solution gives you the widest variety of libraries available on the PC platform. EDN Reader's Choice Survey rated Viewlogic tools as the best schematic entry solution. PROcapture, \$1,995.

PROsynthesis™ produces gate-level representations from VHDL descriptions in a fraction of the time schematics would take. Create FPGAs and CPLDs in VHDL and have the freedom to target whatever silicon you choose from the broadest set of libraries available today. Incorporating FPGA architecture-specific algorithms, PROsynthesis optimizes silicon utilization in increasingly complex FPGAs. PROsynthesis, \$4,995.

VHDL, top-down design, programmable logic— your path to market has never been faster.

Power, integration, performance, product range, the broadest vendor support in design kits and libraries — you can't get a better suite of integrated design tools for the PC at any price, much less one as competitive as this.

Put major-league performance on your PCs. Call 1-800-873-8439 today and ask about the PRO Series.

SEE US AT
DAC SAN DIEGO
BOOTH #1113

VIEWlogic
PRO Series™

MICROSOFT®
WINDOWS.

CALL 1-800-873-8439 NOW FOR A FREE DEMO DISK

Logic emulator combines fast compiling with low cost

The Pegasus logic-emulation system from Arkos Designs takes a different approach from logic-emulation systems based on Xilinx field-programmable gate arrays (FPGAs). The emulator uses a massive array of custom logic processors designed specifically for emulation. Each logic-processor chip contains 32 logic-processing units. A fully configured system for emulating 200,000-gate designs uses 512 of the processing chips on eight pc boards for a total of 16,000 processing units. Depending on the size of the design, the processors perform four to 16 sequential operations, reducing the 50-MHz speed of the processing units

to a 3- to 12-MHz system-emulation speed.

According to the manufacturer, the emulator has ample routing resources, and compiling a 200,000-gate design takes less than 30 minutes. Instead of solving complex FPGA-routing problems, the system loads the functions into the processing units and assigns routing connections. Because the compiling speed is much higher than those of competitive systems, the emulator lets you find design problems interactively—something you can't do with long recompile times.

Each logic processor includes a 32,000-vector embedded logic analyzer,

providing access to every node in an emulated design, as well as on-chip RAM. In addition, each Pegasus board provides 4 Mbits of high-speed RAM for emulating RAM, ROM, FIFO buffers, or multiport RAM.

Pegasus requires a 486 PC or a Sun workstation for operation. Prices for a 25,000-gate version start at \$36,000, and a 200,000-gate version costs \$115,000. The price includes all hardware, software, and logic-emulation boards. The company will begin shipping the systems in October.

—Doug Conner

Arkos Designs Inc, Scotts Valley, CA.
(408) 461-8100. **Circle No. 342**

Verify design equivalence without simulation.

The Design Verifier tool verifies the functional equivalence of gate- or register-transfer-level (RTL) descriptions. The tool compares RTL to RTL, RTL to gates, or gates to gates. Typical applications include verifying RTL descriptions that have changed to improve synthesis results, testing gate-level implementations against RTL descriptions, and testing gate-level descriptions modified to alter timing or for scan insertion. Because the tool accepts VHDL and Verilog RTL descriptions, it lets you check the equivalence of VHDL and Verilog models. \$65,000. **Chrysalis**, Andover, MA. (508) 475-7700. **Circle No. 343**

VHDL simulator for Unix systems costs <\$1000.

The \$995 entry-level VHDL simulator runs on Sun and HP workstations. The compiled simulator includes an interactive source-level debugger. The software targets self-paced VHDL training and behavioral-model development. **Compass Design Automation**, San Jose, CA. (408) 433-4880. **Circle No. 344**

Complex-function library speeds ASIC design.

The MacroWare 2.1 library of 40 royalty-free complex functions comes in gate-level structural VHDL, gate-level Verilog, and EDIF 200 formats. Functions include the M8051 embedded microcontroller, M765A floppy-disk controller, M91C360 data separator, M16C450 UART, M85C30 serial communications controller, M8042 slave peripheral con-

FREE INFO, FREE POSTAGE

Use our postage-paid reader-service cards to get more information on any of these products.

troller, and 82xx peripheral-interface products. The macros include test vectors providing 98% min fault coverage. A single-node library license costs \$48,000. **3Soft Corp**, Santa Clara, CA. (408) 982-9017. **Circle No. 345**

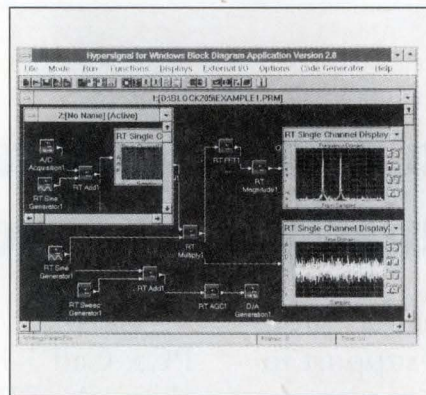

DSP block-diagram simulator offers real-time simulation.

The Hypersignal for Windows Block Diagram simulation software lets you run DSP algorithms designed with the tool on DSP boards. The software combines graphical programming with real-time algorithm-performance evaluation, speeding design development. The price for the software with real-time support ranges from \$1495 to \$7995. **Hyperception**, Dallas, TX. (214) 343-8525. **Circle No. 346**

Design tool improves communication between schematic and pc-board designers.

The Placement and Critical Route (PCR) 386+ tool lets you optimize placement and packaging of pc-board components before layout. The tool lets you move easily between schematic and physical-board form, letting you communicate critical information to the person who lays out the pc-board. You can also review pc-board-layout data from the board designer. The software lets you reuse sections of board designs as modules, so that you can pass them directly to the layout person. The introductory price for PCR 386+ is \$995. **OrCAD**, Beaverton, OR. (503) 671-9500. **Circle No. 347**

Software simulates EMC emissions before you build the product.

The Compliance electromagnetic-compatibility (EMC) simulator calculates radiated fields due to systems of printed-circuit boards and common-mode currents on cables and enclosures. The tool is fully integrated into the company's other signal-integrity tools. **Quantic Laboratories Inc**, Winnipeg, MB, Canada. (204) 942-4000. **Circle No. 348**

ASIC-test tool integrates front-end hardware synthesis and back-end test generation.

The ASICtest family of test-automation products includes three tools. Icrambist generates register-transfer-level (RTL) code for built-in self-test (BIST) of memories, including the BIST controller and any required memory interface logic. JTAGsyn generates the RTL code for

EDN-NEW PRODUCTS

ELECTRONIC DESIGN AUTOMATION

an IEEE 1149.1-compliant module incorporating the test-access port (TAP), the boundary-scan chain, all the I/O cells, and the call to the core module. ICscantest performs scan chain insertion, scan rule-checking, combinational test-pattern generation, and fault simulation. The tools begin at \$25,000. **Logic Vision Software Inc.**, San Jose, CA. (408) 453-0146.

Circle No. 349

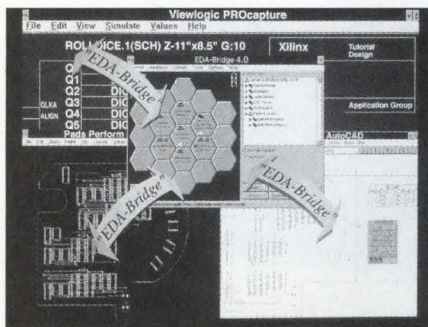

Tool provides standard communication links for design data under Windows and Windows NT. Version 4.0 of EDA-Bridge provides BridgeSpeak integration technology that allows design tools from multiple vendors to interoperate under Windows and Windows NT. Prices start at \$1495. **EDA CAD T E A M Ltd.**, San Jose, CA. (408) 437-1313.

Circle No. 350

Design kit simplifies timing analysis and verification of Pentium-based designs. The Pentium design-analysis kit works with Intel's Design Guide. The kit helps you perform timing analysis and verification on a wide range of Pentium-based designs. The tool provides timing verification across PCI, EISA, and Pentium host buses. \$6000. **Quad Design**, Camarillo, CA. (805) 988-8250.

Circle No. 351

Tool optimizes analog-circuit performance. The Paragon analog circuit optimizer lets you improve circuit performance at both the system (behavioral) and the component levels. For example, the software finds parameter values for an active filter design, satisfying center frequency, bandwidth, and gain. The tool iteratively and automatically changes design parameters to home in on an optimum solution. You can also use the tool while altering circuit parameters by interactively exploring circuits as the

tool provides graphical feedback. Paragon will be available in July and costs \$1900 on PCs and \$3900 on Sun workstations. Also available is a suite of analog- and digital-simulation and programmable logic-synthesis tools that run under Windows 3.1 and NT. **MicroSim Corp.**, Irvine, CA. (714) 770-3022.

Circle No. 352

Electronic conferencing software speeds communication. The Electronic design-for-manufacture (DFM) conferencing software helps users of the company's DFM tools communicate effectively with work locations. The software lets you share real-time workstation-based DFM applications over Transfer Control Protocol/Internet Protocol (TCP/IP) networks using 9.6- to 19.2-kbps bandwidth lines. The program requires no additional hardware or software, and it supports 10 remote stations and one host in a single conference. The software will be available in the third quarter and costs \$3500 for the host conferencing port and \$4500 for each remote conferencing station. **AT&T Design Automation**, Holmdel, NJ. (800) 336-5256.

Circle No. 353

Tool analyzes signal integrity and ground bounce. The Presto signal-integrity simulation software works with the Sprint simulator to analyze circuit boards. The simulator evaluates thousands of transmission lines and inductors in minutes, even when using complex models of pin-grid-array-package ground planes. The software runs on workstations; prices start at \$45,000. **Anacad EES**, (408) 954-0600.

Circle No. 354

SHORTS

TangoPRO Version 2.2 for pc boards (\$5950), Schematic (\$995), and Route (\$5,500) are available and run under Windows. **Accel Technologies Inc.**, (619) 554-1000.

Circle No. 355

VHDL Editor (\$2000) is a context-sensitive description-language editor that includes syntax error checking and a multivendor synthesis-subset-checking tool for VHDL. **Vantage Analysis Systems Inc.**, (510) 659-0901.

Circle No. 356

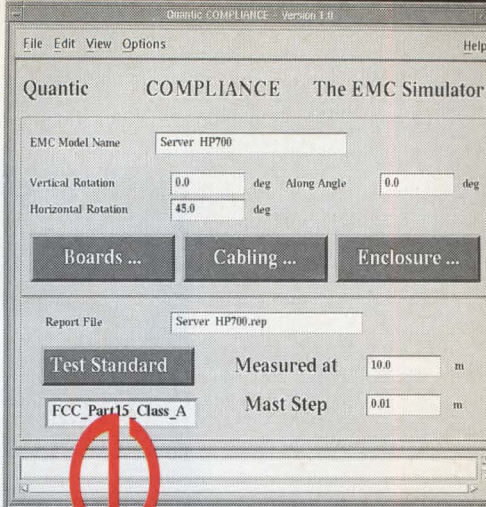

EMC simulation software...

COMPLIANCE™ simulates common-mode current radiation using Quantic's proven Boundary Element Method technology.

EMC COMPLIANCE under FCC, CISPR and user-defined standards.

APPLICATIONS to single PCBs, multi-PCB systems, backplanes, cables and enclosures.

INTEGRATION with Quantic's signal integrity environment and other major EDA vendors.

SIMULATE SYSTEM RADIATION. Compare with standards at the touch of a Compliance button.

GO INWARD SEAMLESSLY. Locate specific sources of excess radiation with Quantic's toolset - Boardscan, Greenfield® and Phidias® for board-level and system signal clean-up.

Save recurring test fees. Reduce time to market. Increase profits and expand market share.



QUANTIC LABORATORIES INC.
12th Floor, 191 Lombard Avenue
Winnipeg, Manitoba, Canada
R3B 0X1 Ph. (204)942-4000
Fax (204)957-1158
USA Ph. 1-800-665-0235
EMAIL market@quantic.mb.ca

CIRCLE NO. 30



Loral Makes a Replacement for the Versatec V80™ That Uses No Liquid Chemicals.

NEW FROM LORAL

The Loral 9080 is a plug-compatible, exact replacement for the Versatec V80. It gives you everything you want and need in a high speed printer/plotter. With the 9080, you get clean, crisp copies every time using an environmentally-friendly dry process. No chemical inks or toners.

EASY TO INSTALL AND USE

Installation couldn't be easier. Simply unplug the V80 and plug in the 9080. The 9080 is designed to work with all existing Versatec V80 software and hardware interfaces.

Powered by the Astro-Med Print Engine, the 9080 prints high-resolution documents at 200 dpi on fanfold or roll paper. Print Speed is 15 pages per minute. Plot speed is one inch per second. Price is under \$12,000.

To order the Model 9080, call (813) 378-6984. For more information write: Loral Data Systems, P.O. Box 3041 M/541, Sarasota, FL 34230 or call our hotline (813) 377-5590.

LORAL
Data Systems

Versatec and V80 are trademarks of Versatec, Inc.

EDN-NEW PRODUCTS

INTEGRATED CIRCUITS

Regulators supply high current with low dropout.

Two families of pnp-based medium- and high-current low-dropout regulators feature maximum dropout voltages of 450 mV at room temperature, 300 mV typ. The company guarantees that all of the regulators operate with <600 mV dropout over worst-case temperature extremes. All are available in 3.3, 5, and 12V fixed- and adjustable-output versions. The MIC2920A/37A/40A (\$1.14 to \$1.65 for the 3.3V versions (100)) supply 450, 750, and 1200 mA, respectively; the MIC29150/300/500/750 (\$1.93 to \$8.33) supply 1.5, 3, 5, and 7.5A, respectively. Package options include the 3-pin TO-220 and the 5-pin TO-220 and TO-263. **Micrel Semiconductor**, San Jose, CA, (408) 944-0800. **Circle No. 372**



MPEG decoder handles system tasks.

The ZR36100 provides video decoding and system operations for an MPEG I data stream for <\$30. The device separates the video and audio signals in the MPEG bit stream, provides the audio data to an external decoder and synchronizes that audio with decoded video. The decoder handles data rates as great as 5 Mbps, suitable for SIF-resolution format images. A \$1995 evaluation board is also available. **Zoran Corp**, Santa Clara, CA, (408) 986-1314, ext 356. **Circle No. 373**

Video decoder includes Digicipher II.

The CL9100 RISC-based programmable video decoder handles four decompression algorithms: MPEG I, MPEG II main and simple profiles, and General Instruments' Digicipher II. The chip handles CCIR 601 resolution, provides video and audio synchronization, extracts user data from the bit stream, and supplies decoded video in YCrCb format. A companion device, the CL9110, demultiplexes the audio and video data streams. Each chip costs \$35 in quantity. The CL9100 is available now, and the CL9110 will be available for sampling in the third quarter. **C-Cube Microsystems**, Milpitas, CA, (408) 994-8300. **Circle No. 374**

FREE INFO, FREE POSTAGE

Use our postage-paid reader-service cards to get more information on any of these products.

100-nsec comparators have rail-to-rail inputs.

The MAX941/942/944 comparators each consume <35 μ A. The outputs pull within 0.4V of either supply rail without external pullup circuitry, and all I/O pins can withstand continuous short circuits to either rail. The comparators incorporate internal hysteresis, and the single 941 also includes a latch and a 12- μ A shutdown feature. The devices come in 8- and 14-pin DIPs and SOICs; prices start at \$1.40 (1000). **Maxim Integrated Products**, Sunnyvale, CA, (408) 737-7600. **Circle No. 375**

High-voltage driver has 64 channels.

The HV57708 driver IC operates from 5V, provides output voltages up to 80V, and sources and sinks up to \pm 15 mA/channel. The cascadable, serial-to-parallel converter IC has four simultaneously clocked shift registers that allow for a 32-MHz equivalent data-throughput rate. Features include output blanking, latch enable, and polarity reversal. \$5.18 (1000). **Supertex Inc**, Sunnyvale, CA, (408) 744-1010. **Circle No. 376**

Crosspoint switch targets video designs.

The MT88V32 IC comprises 32 T switches in a digitally programmable, 8 \times 4 nonblocking array. The IC features a 200-MHz bandwidth and a digital control interface with maximum setup and hold times of 150 nsec. Differential phase and gain errors are typically 0.05 $^\circ$ and 0.11%, respectively. The IC interleaves analog signal lines with ground lines, which improves isolation and limits crosstalk. \$11.54 (1000). **Mitel Semiconductor**, Kanata, ON, Canada, (613) 592-2122. **Circle No. 377**

IC combines photodiode and amplifier.

The OPT301 IC eliminates leakage current, noise pickup, and gain peaking due to stray capacitance. Key features include a 1-M Ω feedback resistor, 2-mV dark errors, a 0.47-A/W responsivity, a 4-kHz bandwidth, a 400- μ A quiescent current, a 0.05% nonlinearity, and a \pm 2.25 to \pm 18V supply range. The device comes in a metal TO-99 with a glass window; prices start at \$11.10 (100). **Burr-Brown Corp**, Tucson, AZ, (800) 548-6132. **Circle No. 378**

SCSI terminator lowers capacitance.

The UC5613 9-line active terminator features a 3-pF channel capacitance. The IC meets all SCSI requirements and features a disconnect mode that reduces quiescent current to 10 nA. The IC features a 400-mA sink/source regulator, a low-dropout regulator of 0.7V, thermal shutdown, and current limiting. \$2.18 (1000). **Unipro Integrated Circuits**, Merrimack, NH, (603) 424-2410. **Circle No. 379**

PCI chip sets target all levels.

The 82420 PCIset family provides a range of options for creating 486-based PCI local-bus PCs. The EX chip set for 486 CPUs packs dynamic RAM control, cache control, Integrated Device Electronics control, and power management into a 2-chip set for low cost (\$25.20, 10,000). The 3-chip ZX chip set adds all standard ISA-bus signals and a datapath unit with write buffers. It also optimizes its interface for the DX4 processor (\$38.50). **Intel Corp**, Folsom, CA, (800) 628-2283. **Circle No. 380**

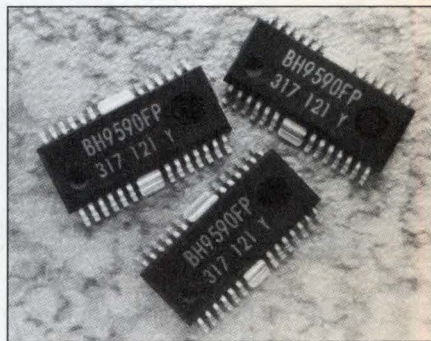

SCSI terminator reduces power to 90% of passive components.

The BH9590FP-Y dissipates 66 mW max when no signal is present. The IC actively terminates as many as 18 SCSI lines and meets all SCSI-I and -II standards. A programmable enable pin determines whether the IC is in a termination or a high-impedance-disconnect mode. Disconnect mode separates the SCSI lines from the terminator circuits. Line impedance is 100 to 130 Ω under standard operating conditions. Capacitance is <10 pF. \$1.80 (10,000). **Rohm Corp**, Antioch, TN, (615) 641-2020, ext 178. **Circle No. 381**

HDD read-channel IC fits small forms.

The IMP62C540 read-channel IC runs at 5V and handles data rates to 40 Mbps. The IC includes a servo controller with serial addressing to reduce I/O pin count. The device comes in a 64-

EDN-NEW PRODUCTS

INTEGRATED CIRCUITS

pin TQFP and costs <\$9 in large quantities. **International Microelectronic Products Inc**, San Jose, CA. (408) 432-9100. **Circle No. 382**

LED emits white light. The WhiteLED surface-mount LED with white-light emission offers blue, green, and red light sources on board. Simultaneously illuminating all three sources creates a white light. Illuminating the light sources separately or in pairs cre-

ates any color in the spectrum—from yellow to purple. \$2 (10,000). **Siemens Components Optoelectronics Division**, Cupertino, CA. (408) 725-3508. **Circle No. 383**

Synchronous pipelined burst SRAMs for Pentium and Power PC μ Ps. The KM732V588 and KM732V592 static RAMs (SRAMs) are for the Pentium and PowerPC cache memories, respectively. The 1M-bit synchronous

SRAMs have two stages of data and address pipelining. The units sample all data, address, and control inputs, and all outputs are valid at the positive-going system-edge clock. The SRAMs have a 32,768 \times 32-bit organization and have internal data, address, and control latches. Price is \$22 each for 66-, 60-, or 50-MHz versions. **Samsung Semiconductor Inc**, San Jose, CA. (408) 954-7000. **Circle No. 384**

CPLD runs at 143 MHz. The CYC371 version of the vendor's Flash370 complex programmable-logic devices (CPLDs) has 32 macrocells and an 8.5-nsec worst-case propagation delay. The flash CPLDs implement an advanced programmable interconnect matrix for routing signals between logic blocks. The devices also offer a product term route product terms to macrocells. The 143-MHz CY7C371 is available in 44-pin PLCC packages and costs \$31.50 (100). **Cypress Semiconductor Corp**, San Jose, CA. (408) 943-2600. **Circle No. 385**

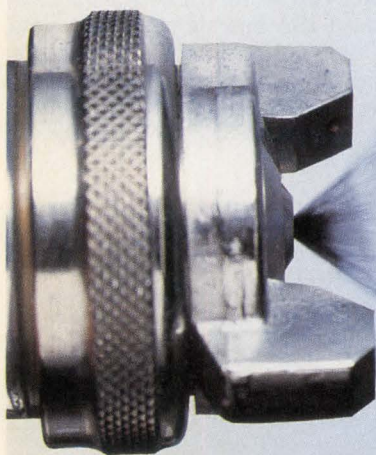
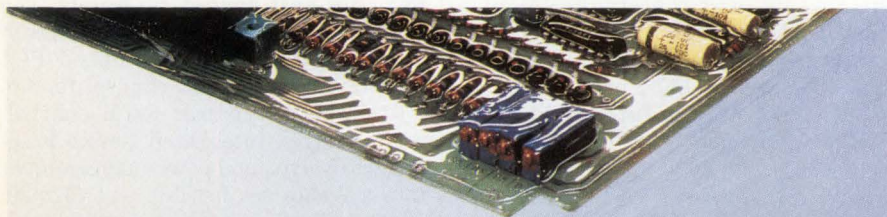

ECCOCOAT® Conformal Coatings.

All the
performance
you need without
all the solvents.

Everything you want in a one-component conformal coating is in the complete line of ECCOCOAT® products from Grace Specialty Polymers.

- Solvent free for low VOCs
- Easy to apply with dip, spray, flood or brush methods
- Complete line of chemistries and cure options
- MIL Spec listed and UL rated
- Reduced material and handling costs

Plus, ECCOCOAT UV-7900 is the only UV coating in the industry with a reliable secondary moisture cure — providing excellent cure under every component.

All you need to do now is call Grace Specialty Polymers — the company with a global perspective.



GRACE Specialty Polymers

North America
Woburn, MA
(800) 832-4929

Europe
Westerlo, Belgium
+32-(0)14-57 56 11

Asia-Pacific
Atsugi, Japan
(81) 0462-25-8800

©1994, W.R. GRACE & Co. - Conn.

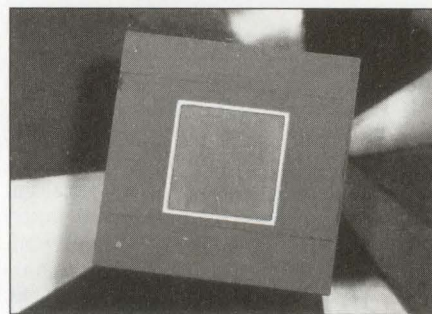

Decoder provides JPEG in single chip. The M65700 IC provides 30-frame/sec compression and decompression using the JPEG standard of images as large as 9640 \times 480 pixels. It includes color-space conversion for the YUV, RGB, and CMYK spaces and handles raster-to-block data conversion. The device holds both default and programmable Huffman and quantization tables and provides an on-chip DMA controller for fast bus access. The sample price is \$300. **Mitsubishi Electronics America Inc**, Sunnyvale, CA. (408) 730-5900, ext 2106. **Circle No. 386**

LCD controller handles video overlay. The Mustang family of LCD/flat-panel controllers provides a 256 \times 18-color palette, a 24-bit DAC, and a video input port. The devices can simultaneously display on CRTs and monochrome

CIRCLE NO. 95

RS-232 IC ELIMINATES MULTIPLE CABLES AND MAKES NULL MODEMS OBSOLETE

One IC connects directly with both DTE and DCE ports!

Maxim's new MAX214 changes from a DTE port to a DCE port with the flick of a switch, eliminating the need for null modem cables. The +5V powered MAX214 meets EIA/TIA-232 specifications, is guaranteed to run at data rates up to 120kbps, and has a low power shutdown mode that reduces supply current to 20µA.

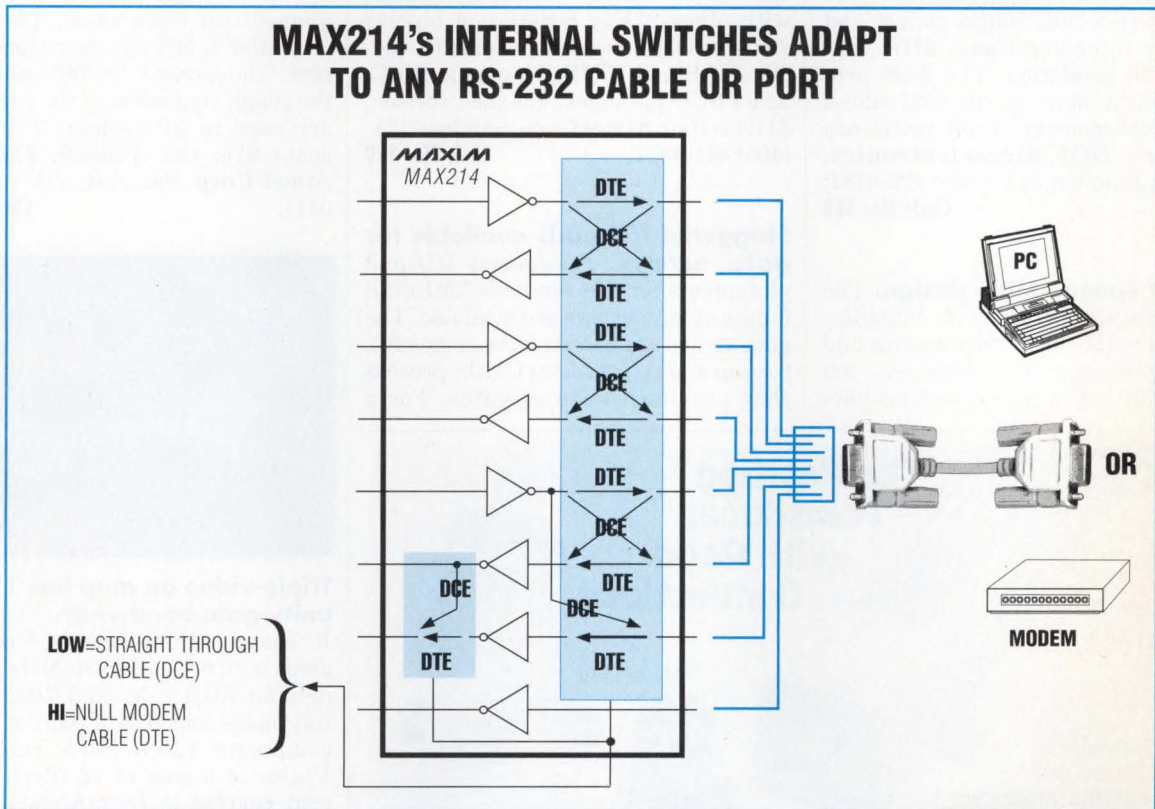

FREE Interface Design Guide—Sent Within 24 Hours!
Includes: Data Sheets and Cards for Free Samples

CALL TOLL FREE 1-800-998-8800
For a Design Guide or Free Sample

MasterCard® and Visa® are accepted for Evaluation Kits or small quantity orders.

MAXIM



Distributed by Arrow, Bell, Digi-Key, Elmo, Hamilton Hallmark, and Nu Horizons. Authorized Maxim Representatives: **AL**, M-Squared, Inc. **AZ**, Techni Source Inc. **CA**, Mesa, Pro Associates, Inc., Infinity Sales, Inc. **CO**, Component Sales **CT**, Comp Rep Associates **DE**, TAI Corporation **FL**, Sales Engineering Concepts **GA**, M-Squared, Inc. **ID**, E.S. Chase **IL**, Heartland Technical Marketing Inc. **IN**, Technology Marketing Group **IA**, JR Sales Engineering, Inc. **KS**, Delltron **LA**, BP Sales **MD**, Micro-Comp, Inc. **MA**, Comp Rep Associates **MI**, Micro Tech Sales **MN**, Mel Foster Technical Sales, Inc. **MS**, M-Squared, Inc. **MO**, Delltron **MT**, E.S. Chase **NE**, Delltron **NV** (Reno, Tahoe area only) Pro Associates, Inc. **NH**, Comp Rep Associates **NJ**, Parallax, TAI Corporation **NM**, Techni Source Inc. **NY**, Parallax, Reagan/Compar **NC**, M-Squared, Inc. **OH**, Lyons Corporation **OK**, BP Sales **OR**, E.S. Chase **PA** (Pittsburgh area) Lyons Corporation, (Philadelphia area) TAI Corporation **SC**, M-Squared, Inc. **TN**, M-Squared, Inc. **TX**, BP Sales **UT**, Luscombe Engineering Co. **VA**, Micro-Comp, Inc. **WA**, E.S. Chase **WI**, Heartland Technical Marketing, Inc.
Distributed in Canada by Arrow. Authorized Maxim Representative in Canada: Tech Trek.

Austria, Allmos Electronics **Belgium**, Master Chips **Denmark**, Exatec A/S **Finland**, Yleiselektronikka Oy, **France**, Maxim France, France/Distributors: Maxim France, ASAP **Germany**, Maxim GmbH Germany/Distributors: Maxim GmbH, Spezial Electronic **KG Ireland**, FMG Electronics **Italy**, Consystem S.r.l., Italy/Distributor: Esco Italiana Electronics Supply **Netherlands**, Koning En Hartman **Norway**, Odin Electronics A/S **Poland**, Unipro, Ltd. **Portugal**, ADM Electronics, S.A. **Spain**, ADM Electronics S.A. **Sweden**, Egevo AB **Switzerland**, Laser & Electronic Equip. **Turkey**, Interex (U.S.A.) **U.K.** Maxim Integrated Products (U.K.), Ltd., U.K./Distributors, Maxim Integrated Products (U.K.), Ltd., 2001 Electronic Components, HB Electronic
 Maxim is a registered trademark of Maxim Integrated Products. © 1994 Maxim Integrated Products

EDN-NEW PRODUCTS

INTEGRATED CIRCUITS

or color LCDs, plasma panels, and electroluminescent panels. The 65540 and 65545 are pin- and software-compatible; the 65545 has a hardware accelerator for Windows. Prices are \$24 and \$31, respectively (10,000). **Chips and Technologies Inc**, San Jose, CA. (408) 434-0600. **Circle No. 387**

DSP family grows. The MDSP2020 and MDSP2021 DSPs for notebook computers provide audio-speed DSP with a 3.3V supply. They also offer sleep and suspend operating modes. The devices offer 20 kbytes of program and data memory; ISA-bus, audio codec, and telephony interfaces; and MIDI-port and UART emulation. The 2020 provides built-in memory; the 2021 allows for external memory. Their prices are <\$30 each. **IBM Microelectronics**, Hopewell Junction, NY. (800) 426-0181, ext 500. **Circle No. 388**

Chip set speeds MIPS design. The Rab²it chip set provides an interface between the R4000 MIPS processor and the 486 processor bus. Designers can use the chip set to create systems hav-

ing peripherals for the ISA architecture. The 2-chip set includes the interface device and a dynamic-RAM controller. The set operates at 67 MHz at 3.3V but includes a 5V interface buffer. Samples will be available in the fourth quarter for \$120. **NEC Electronics Inc**, Mountain View, CA, (800) 366-9728. **Circle No. 389**

Flash version of the 22V10 is available. The ATF22V10B family, electrically erasable flash versions of the 22V10 PLD, offers 7.5- to 25-nsec speeds. The family is plug-compatible with other 22V10 CMOS and bipolar devices. The devices are available in 24-pin PDIP and CERDIP, plastic SOIC, and PLCC packages. 7.5-nsec version, \$11.45 (100). **Atmel Corp**, San Jose, CA. (408) 441-0311. **Circle No. 390**

Staggered I/O pads available for gate arrays. Staggered I/O-pad placements for the vendor's AMI8GxS family of gate arrays are available. The gate arrays are based on the company's 0.8- μ m and triple-metal CMOS process that provides a sea of gates. For a

design requiring 208 pad locations, the staggered I/O technique realizes a 39 percent savings in silicon area. Gate-array prices for various options range from <\$5 to \$25. **American Microsystems Inc**, Pocatello, ID. (208) 233-4690. **Circle No. 391**

FPGAs have 500- μ A standby current. The AT6002 and AT6005 field-programmable gate arrays (FPGAs) have 2000 and 5000 usable gates, respectively. The devices also offer thousands of registers for pipelining, 250-MHz toggle rates, and <1-nsec guaranteed clock skew. The devices also offer a 500- μ A max standby current. The devices' T6000 cache logic is the rough equivalent of the cache memory used in μ P designs. The AT6002 costs \$16; the AT6005, \$72 (5000). **Atmel Corp**, San Jose, CA. (408) 441-0311. **Circle No. 392**

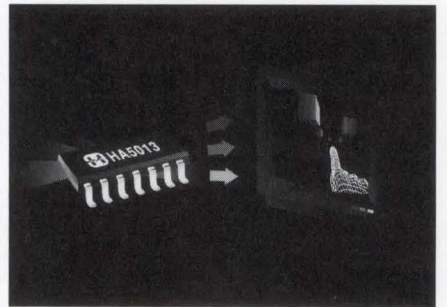

Triple-video op amp has 125-MHz unity-gain bandwidth. The HA5013 IC contains three current-feedback op amps with 0.07-dB to 20-MHz gain flatness for RGB video and 0.03° differential phase and 0.03% gain at ± 5 V for composite video. Slew rate is 475 V/ μ sec at a gain of +2. Typical quiescent current is 7.5 mA/amplifier, and output current into a 150 Ω load is typically 20 mA. In 14-pin DIPs and SOICs, the IC costs \$3.50 (1000). **Harris Semiconductor**, Melbourne, FL. (800) 442-7747, ext 7219. **Circle No. 393**

Modem chip set suits audio applications. The CL-MD1414BA chip set comprises three chips that combine a data, fax, and voice modem with a sound card. Adding a 32-kbyte static RAM provides complete modem functionality. The audio suits multimedia presentations. On-chip DMA increases the audio sampling rate and offloads the host μ P. The chip set supports all the popular standards for data, fax, and voice modes, including V.32bis. \$60 (1000). **Cirrus Logic Inc**, Fremont, CA. (510) 623-8300. **Circle No. 394**

The Position Transducer with Good Connections

Model LW & LWB

Model LWH

Novotechnik's LWH series of conductive-plastic position transducers comes with whichever connector you need: DIN 43 650 (models LWH & LWG), Binder (LWB & LW), or Amphenol (LWC). The LWH series also gives you high resolution (.01mm) and a range of stroke lengths from 75 to 900mm. The transducers may be built directly into your mechanical system, without need of motion conversion or linkage mechanisms.

Improved design of the LWH transducer eliminates offset errors and ensures reliable contact of the elastomer-damped wiper. Outstanding linearities of up to $\pm .05\%$ are available (up to $\pm .01\%$ on special order), as well as life expectancies of up to 100×10^6 operations. Robust construction ensures consistent reliability, in temperatures from -40 to $+100^\circ\text{C}$, 5 to 2000Hz vibration.

For Novotechnik's full line catalog of transducers, potentiometers and sensors, call or write:

novotechnik u.s., inc.

novotechnik u.s., inc.
237 Cedar Hill Street
Marlborough, MA 01752
Tel: 508-485-2244
FAX: 508-485-2430

CIRCLE NO. 19

STEP-UP/DOWN CONVERTERS: 3.3V OR 5V_{OUT} FROM 1.5V TO 6.2V_{IN}

Compact 8-Pin Solution: No Transformer, No External Diode

The MAX877/MAX878/MAX879 step-up/down DC-DC converters provide a regulated output from inputs above, below, and equal to the output, overcoming input-range limitations of conventional buck and boost converters. These 8-pin devices require only an input capacitor, output capacitor and 22μH inductor. An internal synchronous rectifier takes the place of the usual external diode, saving cost and space. The rectifier also disconnects the load from the input when in shutdown, stopping battery current drain associated with conventional step-up converters.

- ◆ **Regulated Output from Lower and Higher Input Voltages**
- ◆ **Compact:**
8-Pin SOIC Package
Internal Rectifier
No Transformer
- ◆ **1.5V to 6.2V Input Range**
- ◆ **Load Disconnected from Input in Shutdown**
- ◆ **Guaranteed 250mA Outputs:**
5V: MAX877
3V or 3.3V: MAX878
Adj. (2.5V to 6V): MAX879
- ◆ **195μA Quiescent Supply Current (18μA Shutdown Current)**
- ◆ **Up to 82% Efficiency**
- ◆ **Output is Short-Circuit Protected**
- ◆ **Evaluation Kit (MAX877EVKIT-S0)**

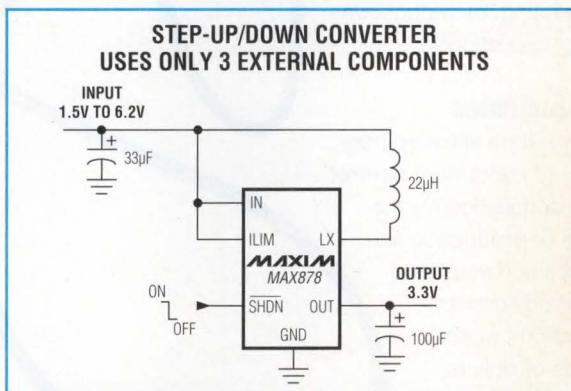
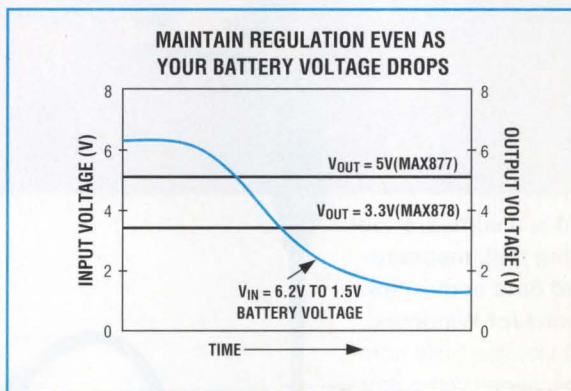

The MAX878 delivers a regulated 3.3V output for inputs ranging from 1.5V to 6.2V, and it does not require a transformer or an external diode.

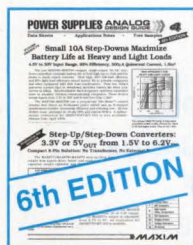

FREE Power Supply Design Guide—Sent Within 24 Hours!
Includes: Data Sheets and Cards for Free Samples

CALL TOLL FREE 1-800-998-8800
For a Design Guide or Free Sample

MasterCard® and Visa® are accepted for Evaluation Kits or small quantity orders.

MAXIM



Distributed by Arrow, Bell, Digi-Key, Elmo, Hamilton Hallmark, and Nu Horizons. Authorized Maxim Representatives: AL, M-Squared, Inc. AZ, Techni Source Inc. CA, Mesa, Pro Associates, Inc., Infinity Sales, Inc. CO, Component Sales CT, Comp Rep Associates DE, TAI Corporation FL, Sales Engineering Concepts GA, M-Squared, Inc. ID, E.S. Chase IL, Heartland Technical Marketing Inc. IN, Technology Marketing Group IA, JR Sales Engineering, Inc. KS, Delltron LA, BP Sales MD, Micro-Comp, Inc. MA, Comp Rep Associates MI, Micro Tech Sales MN, Mel Foster Technical Sales, Inc. MS, M-Squared, Inc. MO, Delltron MT, E.S. Chase NE, Delltron NV (Reno, Tahoe area only) Pro Associates, Inc. NH, Comp Rep Associates NJ, Parallax, TAI Corporation NM, Techni Source Inc. NY, Parallax, Reagan/Compar NC, M-Squared, Inc. OH, Lyons Corporation OK, BP Sales OR, E.S. Chase PA (Pittsburgh area) Lyons Corporation, (Philadelphia area) TAI Corporation SC, M-Squared, Inc. TN, M-Squared, Inc. TX, BP Sales UT, Luscombe Engineering Co. VA, Micro-Comp, Inc. WA, E.S. Chase WI, Heartland Technical Marketing, Inc.

Distributed in Canada by Arrow. Authorized Maxim Representative in Canada: Tech Trek.

Austria, Allmos Electronics Belgium, Master Chips Denmark, Exatex A/S Finland, Yleiselektronikka Oy, France, Maxim France, France/Distributors: Maxim France, ASAP Germany, Maxim GmbH Germany/Distributors: Maxim GmbH, Spezial Electronic KG Ireland, FMG Electronics Italy, Consystem S.r.l., Italy/Distributor: Esco Italiana Electronics Supply Netherlands, Koning En Hartman Norway, Odin Electronics A/S Poland, Unipro, Ltd. Portugal, ADM Electronics, S.A. Spain, ADM Electronics S.A. Sweden, Egevo AB Switzerland, Laser & Electronic Equip. Turkey, Interec (U.S.A.) U.K. Maxim Integrated Products (U.K.), Ltd., U.K./Distributors, Maxim Integrated Products (U.K.), Ltd., 2001 Electronic Components, HB Electronic

Maxim is a registered trademark of Maxim Integrated Products. © 1994 Maxim Integrated Products

TESTPOINT

TestPoint is a software tool for building test, measurement, and data acquisition applications for Windows.

TestPoint lets you build complete applications without drawing, connecting, or wiring icons or writing lines of code.

New Capabilities

TestPoint brings extraordinary capability to instrument control and data acquisition for the benchtop or production line. TestPoint's software functions can replace hardware functions worth thousands of dollars, provide new measurement capabilities and simplify testing.

Better Tests

Sharp graphics and clear indicators eliminate errors and improve accuracy.

Cut Through the Paperwork

TestPoint can "hot link" to your spreadsheets, databases and word processing files so the paperwork is done the instant the test is finished.

There is no faster, better or easier way to build applications. Guaranteed!

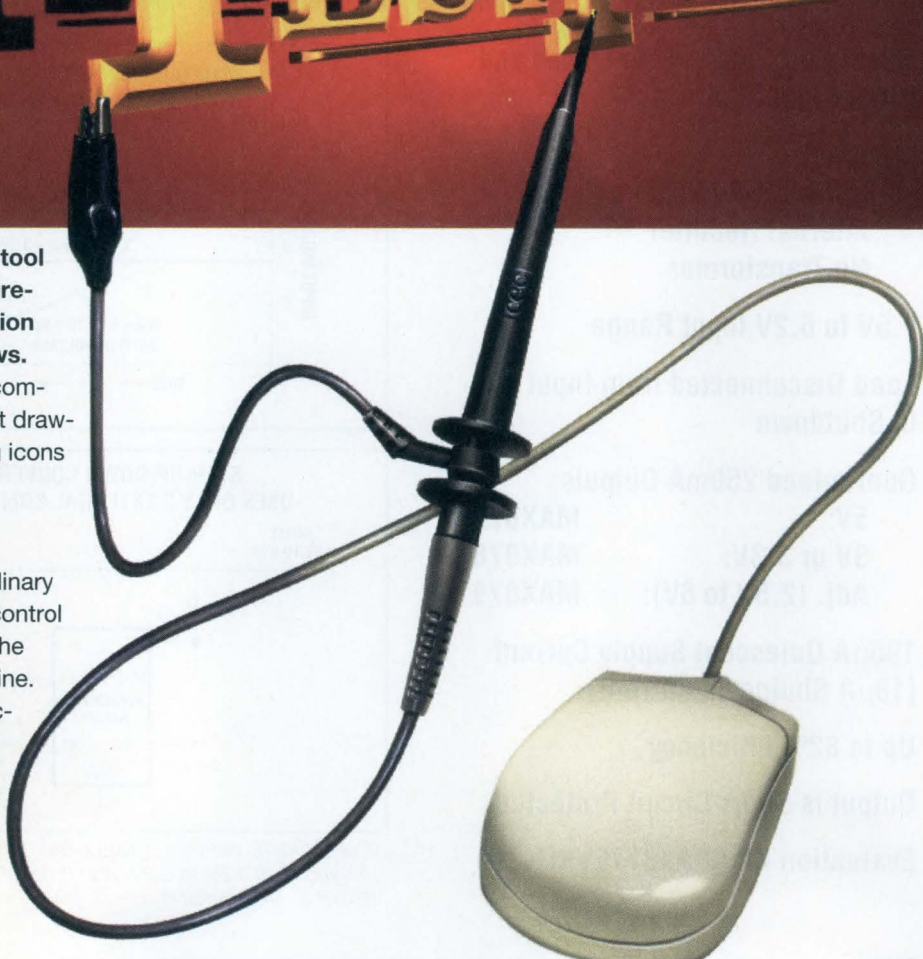

- **Data Acquisition**
Multitasking A/D, D/A,
Digital I/O
- **Instrument Control**
IEEE-488, RS232, RS485
- **Analysis**
Mathematics, DDE
- **Presentation**
Graphics Charts
Displays File I/O

Development System \$995
Free Unlimited Runtime License
Literature 1-800-234-4232
Applications 617-273-1818



Capital Equipment Corp.
76 Blanchard Road
Burlington, MA 01803

TestPoint is a trademark of Capital Equipment Corp.

BOARDS & BUSES

FREE INFO, FREE POSTAGE

Use our postage-paid reader-service cards to get more information on any of these products.

Dual-channel X.25 link fits in 3U VME. The VIX25 provides two telecommunications channels for use with packet-switched wide-area networks. The channels are full-duplex X.21bis links running the X.25 protocol and meeting Europe's NET2 certification tests. They offer data rates of 64 kbps over public networks and 2 Mbps over private networks. The 3U VME board requires 3.5W of power and costs \$2055. A license for OS-9 applications software costs \$180. **PEP Modular Computers**, Scottsdale, AZ. (602) 483-7100.

Circle No. 316

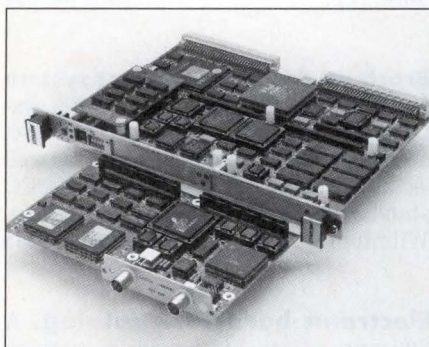

ATM comes to VME systems. By connecting to a DS3 telephone service, the CVME901 board brings asynchronous-transfer-mode (ATM) communications to VME systems. The board offers a hardware-based ATM adaptation layer (AAL) that handles packet segmentation and reassembly for service categories AAL 3/4 and AAL5. An on-board i960 processor handles congestion control, error checking, and the host interface. The board's DMA controller handles data at rates to 48 Mbytes/sec, ensuring that the board can handle communications traffic at the DS3 link's full speed. Price is \$4597 (100). **Cyclone Microsystems**, New Haven, CT. (203) 786-5536. **Circle No. 317**

VME module hosts Alpha RISC processor. The VMEAlpha64/SP, a 2-board module, is based on the 150-MHz Alpha AXP processor. The design separates the CPU, its local memory, and secondary cache from the VME I/O channel to avoid interference. The module offers a 512-kbyte secondary cache, 128-Mbyte main memory, and a variety of peripheral interfaces, including Ethernet and SCSI. An i960 CPU is available as an optional I/O coprocessor. With the DEC OSF/1 operating system and a 1-Gbyte SCSI disk, the board costs \$16,875. **Aeon Systems Inc**, Albuquerque, NM. (505) 828-9120.

Circle No. 318

Adapter boards provide fast I/O.

Working with standard peripheral and network interfaces, the 6U MVME-328XT and MVME385-120 boards provide high-speed I/O capability to the VMEbus. The 328XT (\$3600) is a Fast SCSI-2 host adapter that handles as many as 14 devices, providing a 10-Mbyte/sec synchronous data-transfer rate on each of two independent channels. The 385-120 (\$6895) uses dual 32-bit-wide static RAM (SRAM) buffers and dual-ported video RAM (VRAM) to match its memory I/O to the speed of its FDDI (fiber distributed data interface) port. The board can transfer data at 80 Mbytes/sec from SRAM, 60 Mbytes/sec from VRAM, and 50 Mbytes/sec from the VME interface to the FDDI. Prices start at \$3245. **Motorola Computer Group**, Tempe, AZ. (800) 759-1107.

Circle No. 319

Flash-memory board provides fault tolerance.

Fitting in a single 6U VME slot, the RM250 board provides as much as 128 Mbytes of static RAM (SRAM) or flash memory. Two RM250 boards work in parallel to provide fault tolerance by automatically duplicating memory writes to one board on the other board and providing a software disable command. The board's non-volatile memory works with either 5 or 12V flash memory or SRAM backed by two on-board lithium batteries. A control-status register reports battery failure. Prices start at \$1333. **RAMix Inc**, Chatsworth, CA. (818) 349-6772.

Circle No. 320

Board boosts performance with 68060 CPU.

The PT-VME161 carries a 68060 CPU, which provides a 250% performance boost while retaining software compatibility with previous 68040 versions. It also offers a Fast SCSI-2 interface with DMA, dual serial I/O ports, and a 60-Mbyte/sec VME64-bus interface. The board's memory capacity ranges from 4 to 64 Mbytes. Prices start at \$3245. **Performance Computer**, Rochester, NY. (716) 256-0200.

Circle No. 321

Frame-grabber board handles rough environments.

Designed for military and rugged commercial envi-

ronments, the SVME/DMV-674 frame-grabber board provides the front end to a digital imaging system. It handles 525-, 675-, or 875-line interlaced frame formats with images as large as 1280x1024 pixels. The image-acquisition section provides three monochrome analog input lines sampled at 35M samples/sec to 8-bit resolution. It also offers a 16-bit digital input port. The board comes in six software-compatible versions for diverse environmental conditions and ranging from air-cooled commercial to conduction-cooled full MIL-SPEC ratings. Prices start at \$6522. **DY 4 Systems Ltd**, Campbell, CA. (408) 377-9822.

Circle No. 322

Synchro/resolver accurate to 2 arc-minutes.

Handling as many as four channels of synchro or resolver rotational-position-transducer signals, the MPX5000 and 501 VME boards offer an accuracy of ± 2 arc-minutes. Each channel is programmable for 10-, 12-, 14-, or 16-bit resolution and offers an 8-bit turns counter. The boards track input signals to 15 rps with 16-bit resolution and to 960 rps with 10-bit resolution. Prices start at \$2500. **Pentland Systems Ltd**, Danville, CA. (510) 736-5113.

Circle No. 323

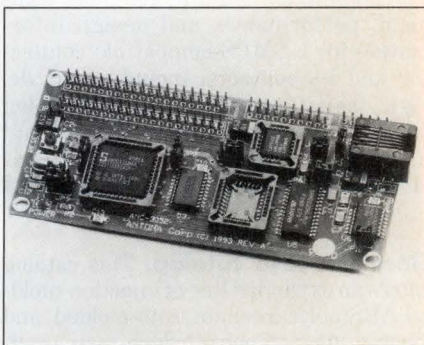

Single-board computer runs Basic.

Based on the 8032 processor, the ANC-3052B module allows designers to create applications programs in Basic. The module offers a 32-kbyte RAM bank and sockets for as much as 64 kbytes of PROM in addition to the Basic interpreter in ROM. The board includes two external interrupts, two counter/timers, and eight digital I/O lines, along with a 20-pin adapter that can be wire-wrap configured to meet the I/O signal's pinout needs. The board costs \$198 and is available without Basic for \$146. **Antona Corp**, West Los Angeles, CA. (310) 473-8995.

Circle No. 324

500-pg temperature-measurement guide includes technical data. This free guide includes more than 100 pgs of technical data and specifications and application data on thermocouples, RTDs, connectors, panels, and instrumentation. **Thermo Electric**, Saddle Brook, NJ. **Circle No. 325**

PCMCIA developer's guide. Guide gives comprehensive overview of the Personal Computer Memory Card International Association (PCMCIA) standard, along with design examples and reference materials. The 450-pg book also includes directories of PC Card, host computers, and desktop host adapters, as well as listings of ICs, development tools, and software. \$89.95. **Sycard Technology**, Sunnyvale, CA. **Circle No. 326**

Application selector guide. This application guide details an extensive line of high-performance adhesive compounds for tacking wires and attaching components to printed wiring boards. The publication details 1- and 2-component epoxies, UV-curable epoxies, reactive acrylics, and hot-melt and cyanoacrylate adhesives. **Master Bond Inc**, Hackensack, NJ. **Circle No. 327**

Hot-pluggable connector catalog. The publication contains complete technical, performance, and design information for a SMPS-compatible connector and its contacts, including ac, dc, logic, signal, and hot plug. The catalog also includes photos and dimensional drawings. **Elcon Products International Co**, Fremont, CA. **Circle No. 328**

Electronic-case catalog. This catalog shows an expanded line of injection-molded ABS/polycarbonate, roto-molded, and vacuum-formed polyethylene-resin products. The publication details lightweight construction, waterproof, airtight, water- and dust-resistant ATA 300 standards, 2000-lb stacking loads, operating temperatures from -20 to +160°F, ultraviolet- and ozone-stabilized materials, and recessive hardware. Free. **Cases Plus Inc**, Livermore, CA. **Circle No. 329**

Fiber-optics catalog. A new 132-pg catalog features performance information and technical specifications on a line of fiber-optic connectors and adapters, as well as cable assemblies, termination tooling, fiber-optic switches, and premise-wiring products. The catalog

FREE INFO, FREE POSTAGE

Use our postage-paid reader-service cards to get more information on any of these products.

also includes a glossary and a section describing connector-termination procedures, including tooling required. **Molex Inc**, Lisle, IL. **Circle No. 330**



High-power dc/dc converter catalog. This catalog introduces mountable and plug-in 100W dual-output dc/dc converters, transformers, and inductors. The dc/dc converter section details more than 1100 standard models with output voltages up to 1000V dc. This 136-pg catalog also offers an ac/dc power-supply section with linear and switchers in single, dual, and triple outputs. **Pico Electronics Inc**, Mount Vernon, NY. **Circle No. 331**

ISRs catalog. This catalog includes a new family of small, easy-to-use integrated switching regulators (ISRs) and a line of dc/dc converters. The 32-pg publication has complete product information, specifications, photos, and schematics on each power module; it also includes a section on product operation, applications, and special considerations. **Power Trends**, Batavia, IL. **Circle No. 332**

Catalog of passive components. This 93-pg catalog presents specifications and outline drawings on a variety of passive components in the frequency range of dc to 18 GHz. Commercial, industrial, and military components in the publication include fixed and tunable filters; fixed, high-power, programmable, and variable attenuators; high-power loads; SPDT, SP4T, and SP8T programmable switches; and

built-to-order switching and control, rack-mountable subsystems. **Trilithic**, Indianapolis, IN. **Circle No. 333**

User-input device-data book. A data book for custom and standard user-input devices is available for system designers. The literature contains protocol descriptions, scan-code listings, schematics, and detailed application notes on an extensive set of encoder ICs. Also included are a recommended matrix layout for types of keyboards or keypads. For those designing low-power systems, the data book provides techniques to produce low-power keyboards. **USAR Systems**, New York, NY. **Circle No. 334**

Brochure describes ESD test system for ICs. This free brochure details systems for testing to MIL-STD 883c, according to a number of models, as well as latch-up testing according to JEDEC standards. **KeyTek Instrument Corp**, Wilmington, MA. **Circle No. 335**

Electronic-hardware catalog. A 200+-pg, electronic-hardware catalog offers specifications for circuit-board spacers, captive panel screws and retainers, standoffs, chassis and cabinet handles, shoulder screws, and more. **RAF Electronic Hardware**, Seymour, CT. **Circle No. 336**

Catalog covers DSP hardware, software, and development tools. This free 134-pg catalog describes boards, boxes, systems, operating systems, design software, and development tools. **Sonitech International Inc**, Wellesley, MA. **Circle No. 337**

Product handbook. A 320-pg catalog describes the company's line of data-acquisition and imaging products. The handbook highlights software solutions, from programming tools to applications, and includes technical tutorials and products that help you choose the optimum solution for data-acquisition and imaging applications. Free. **Data Trans-lation**, Marlborough, MA. **Circle No. 338**

Preview of microterminals. The catalog details small, rugged microterminals designed as operator-interface/control panels and data-collection terminals; it also contains specifications, photos, and information on key features and applications. **Burr-Brown Corp**, Tucson, AZ. **Circle No. 339**

EDN

PRODUCT MART

This advertising is for new and current products.

Please circle Reader Service number for additional information from manufacturers.

Little Star™
NEW 30 I/O lines
Only \$195



Newest in Z-world's line of C-programmable miniature controllers, the Little Star™ has 16 protected digital inputs, 14 high-current driver outputs, RS232/RS485, battery-backed RAM and real-time clock, programmable timers, watchdog, and more. The Little Star is also available with enclosure and LCD/keyboard, expansion cards for additional I/O, and optional 18 MHz clock. Our easy-to-use, yet powerful Dynamic C™ development system (\$195) integrates an editor, compiler, debugger, and dozens of software libraries all in source code. The Little Star is ideal for OEM control applications, manufacturing automation, test and data acquisition.

24-Hour AutoFax 1724 Picasso Ave.
 916.753.0618. Call Davis, CA 95616
 from your FAX. 916.757.3737
 Request catalog 18. 916.753.5141 FAX



CIRCLE NO. 254

UNIVERSAL/GANG PROGRAMMERS



FLEX-700
 32 pin from \$595
 40 pin from \$845
 48 pin from \$945

TUP-400
 40 pin \$695

IC Manufacturer approved & under \$1000

- Supports Altera 7xxx, MACH 435, Xilinx, Intel FX7xx, nearly all FPGA/CPLD/PLD...
- Support EPROM, 28/29F FLASH, Serial PROM, PSD4XX/5XX, Intel/Motorola/TI/NEC/Hitachi MPU/DSP devices.
- Test 74/40/45 series, DRAM(SIP/SIMM), and SRAM.
- Parallel port connection to PC option.
- Free software updates via BBS.

Tribal Microsystems Inc.
 44388 S. GRIMMER BLVD., FREMONT, CA 94538
 Tel: (510) 623-8859
 Fax: (510) 623-9925



CIRCLE NO. 259

Don't drop that screw!

HOLD IT WITH A NON-MAGNETIC HJJ® MODEL X SCREW-HOLDING DRIVER for Types IA & II cross recess screws, and small diameter slotted screws.



No. 3X and No. 3EX DRIVERS — 3", 6", 8", 10" lengths, for #6, #8, #10, #12, #1/4" screws.
 No. 4X and No. 4EX DRIVERS — 3", 6", 8" lengths, for #3, #4, #5 screws.
 No. 5X and No. 5EX DRIVERS — 3", 6", 8" lengths, for #0, #1, #2 screws.

Available in both round brass and hexagonal plastic handles.

(Other models for larger slotted screws)
Send for literature H.J.J. CO. INC
 P.O. Box 60833
 Boulder City, NV 89006
 Phone: (702) 293-2588
 FAX: (702) 293-4224



CIRCLE NO. 238

EXPRESS
Best Value in the World for POLYIMIDE & FR4 1 to 5 DAY TURN
 1 to 12 Layers
PRINTED CIRCUIT PROTOTYPES
2 PIECE PRICES FOR FR4 .062 Th.

LAYERS	1	2	3&4	5&6	7&8
15	\$233	\$292	\$639	\$787	\$935
30	264	330	724	891	1059
60	311	389	853	1049	1137
90	358	448	980	1207	1434
120	385	486	1044	1311	1559

■ 5 PIECES x 1.34 ■ 5 DAY PRICES ABOVE
 10 PIECES x 1.67 ■ UL LISTED

EXTRAS ■ **CAPABILITIES** ■ **DISCOUNTS**

- Photo Plotting
- Testing
- Gold Contacts - \$50
- 25% - Below 8 Mil Hole
- - Below 15 Mil Hole
- SMOBC & LPI - \$50
- Buried & Blind Vias
- Polyimide Multilayer
- Full Body Gold
- Carbon Paste
- Tin nickel burn-in boards
- SMT-SMOBC
- Up to 22 layers
- Impedance control boards
-  **5%**
-  **10%**

FOR MORE INFORMATION CALL OR FAX
 Ken Bahl ■ 1108 W. Evelyn Ave., Sunnyvale, CA 94086
 Phone (408)735-7137 FAX (408)735-1408 Modem (408)735-9842

CIRCLE NO. 247

ROM-IT
EPROM EMULATION SYSTEM



The Most Flexible EPROM Emulator You Can Get Today

- Emulates up to eight 4-Megabit EPROMs through one standard serial port.
- Downloads 2-Megabit programs in less than 23 seconds
- Examine and modify individual bytes or blocks.
- Accepts Intel Hex, Motorola S-Record and Binary files.
- Software available for IBM PC and compatibles.
- Base 27256 EPROM System \$395.00. Other configurations available.

Incredible Technologies, Inc.
 Visa, Mastercard and American Express Accepted

Order Now - It's Easy
 Call (708)870-7027 Or Fax (708)870-0120
 For More Information

CIRCLE NO. 239

ANALYZER-EMULATOR



UniLab 8620

- PC Based, Zero-Wait-State Operation
- Non-Stop Analysis: Define & Refine Triggers & View Multiple Traces On-The-Fly
- Source Level & Symbolic Debug
- Built-In EPROM Programmer
- Same Base Unit Supports Most 8-bit µCs & µPs, including 8051, 68HC05, 68HC11, Z80, 80C196, 6502, 8085, etc.

1-800-729-7700

Tel: 415-327-8800
 Fax: 415-327-9881

ORION
 INSTRUMENTS

180 Independence Dr., Menlo Park, CA 94025 U.S.A.

CIRCLE NO. 245

200MSa/s Digital Oscilloscope

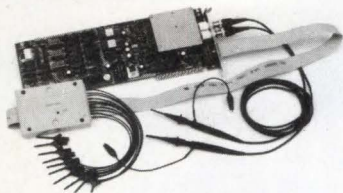

- 200 MSa/s Sampling Rate
- up to 128K Samples/Channel
- PC-BASED INSTRUMENT
- 2 Analog Channels (2 ch. Oscilloscope)
- 8 Digital Channels (8 ch. Logic Analyzer)
- All 10 channels can be used at same time
- Simultaneous use of all 10 channels
- Cross Triggering of Digital and Analog
- 125 MHz Single Shot Bandwidth

\$1799 DSO-28200 (200MSa/s, 4K/Ch)
\$2285 DSO-28264 (200MSa/s, 128K/Ch)

400 MHz Logic Analyzer

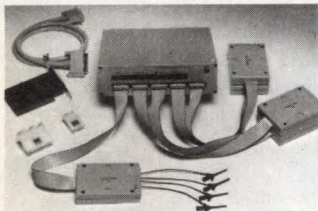

- up to 128 Channels
- up to 400 MHz
- up to 16K Samples/Channel
- Variable Threshold
- 8 External Clocks
- 16 Level Triggering
- Pattern Generator (Option)

\$1299 - LA32200 (200 MHz, 32 Ch) Pods & Software
\$1899 - LA32400 (400 MHz, 32 Ch) included
Also Available:
\$799 - LA12100 (100 MHz, 24 Ch, TTL only)

Universal Programmer

PAL - GAL - MICRO
EPROM - EEPROM - FLASH

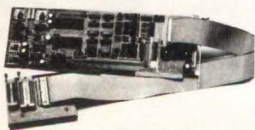

\$475

Call for full device support list

Free software updates on BBS

Call (201) 808-8990



Link Instruments

369 Passaic Ave, #100, Fairfield, NJ 07004 fax: 808-8786

CIRCLE NO. 243

BEST PRICE FOR PROTOTYPE CIRCUIT BOARDS

FR-4 • FLEX • POLYIMIDE

24 HOUR TO 120 HOUR

2 PIECES, FR-4, 062 THICK, 8/8 DESIGN, 5 DAYS

LAYERS	TOTAL SQ. IN. AREA				
	16	32	64	96	120
SINGLE	\$230	\$ 260	\$ 300	\$ 350	\$ 380
DOUBLE	\$290	\$ 320	\$ 380	\$ 440	\$ 480
FOUR	\$630	\$ 720	\$ 850	\$ 980	\$1,040
SIX	\$780	\$ 880	\$1,040	\$1,200	\$1,300
EIGHT	\$930	\$1,050	\$1,130	\$1,420	\$1,540

DISCOUNT 10%

CAPABILITIES:

- S.M.O.B.C.
- TIN LEAD
- TIN NICKEL
- GOLD BODY
- BLIND/BURIED VIAS
- ELECTRICAL TEST
- 4 MIL TRACES & GAPS
- 8 MIL THRU HOLES

MATERIALS:

- FR-4 & FR-5
- FLEX
- POLYIMIDE
- DUROID
- TEFLON

EXTRAS:

- ARTWORK
- ELECTRICAL TEST
- SMOBC WITH LPI \$50
- GOLD CONNECTOR \$50
- BELOW 8 MIL TRACES & 15 MIL HOLES 25% MORE

PLEASE CALL OR FAX:



MODEM (408) 988-3415

TEL. (408) 988-3980 • FAX (408) 988-4534

3391 KELLER STREET • SANTA CLARA • CALIFORNIA 95054

CIRCLE NO. 233

48 Channel 50MHz Logic Analyzer

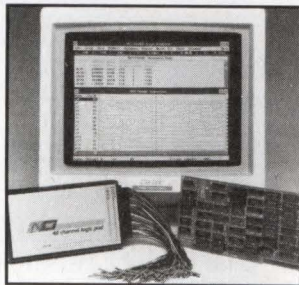

Complete System \$1495.00

New Windows 3.1 Compatible Software

- 48 Chnns @ 50 MHzx 4K words deep
- 16 Trigger Words/16Level Trigger Sequence
- Storage and recall of traces/setup to disk
- Disassemblers available for: 68000,8088,8086, 6801, 6811, Z80, 8085, 6502, 6809, 6303, 8031, 64180

NCI □ 6438 UNIVERSITY DRIVE,
HUNTSVILLE, AL 35806
(205) 837-6667 FAX (205) 837-5221

CIRCLE NO. 248

Windows Schematic Capture to PCB Layout Single System Dynamic Integration \$995

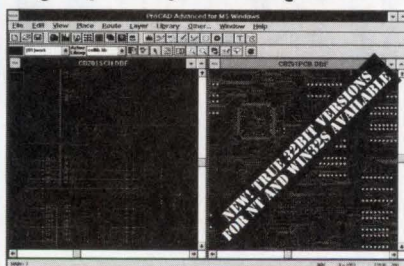

Before Spending a lot of money on 80's tech. PADS, Protel, P-CAD etc, You should take a look at our 90's Dynamic "One CAD Solution". Schematic capture, PCB, two sided SMT, Autorouter, Mechanical drafting ...

- Integrated Schematic, PCB, & Mech. drafting
- Real time Pin/Gate swap & Cross Probe, 1u Res.
- Real time Fwd & Bkwd Annotation, Network, etc
- OrCAD, PADS, PCAD, AutoCAD, Protel, etc Compt.
- True 32bits, No Limits!! Call for tradeup discount Full function eval. kit with complete manuals (4Bks) \$100.00 (Creditable towards purchase).

Interactive CAD Systems, P.O. Box 4182
Santa Clara, CA 95056. (408) 970-0852, FAX: (408) 986-0524

CIRCLE NO. 241

Combine your
Product Mart ads in
EDN Magazine and
Products Editions
for
higher impact
and a
lower rate!

*A Complete Line of Development
Boards, Programmers and
In-Circuit Emulators*

NEW...NEW...NEW...NEW...

DS-186 - In-Circuit Emulator for
80C186/8/XL/EA/EB/EC, V40/50
8086/8 and other μ Cs

*****NEW ADDRESS IN THE USA*****

Call today for your
free demo and
software update

Toll Free: 1-800-833-4084

CEIBO

7 EDGESTONE CT.
FLORISSANT, MO 63033
TEL: 314-830-4084
FAX: 314-830-4083

CIRCLE NO. 255

Communicate
Weekly
to the
electronics OEM
through EDN Magazine
and Products Editions'
Product Mart sections.

PROGRAMMABLE KEYBOARD ENCODER



The first truly universal keyboard encoder can accommodate any keypad layout with up to 24 lines (up to 144 keys). Supports PC XT/AT and RS232 interfaces, can operate in parallel with standard IBM keyboard. All key codes and interface parameters are stored in EEPROM and can be changed by the user at any time using a supplied utility. 2.4"x3.6", \$145 qty 1, volume disc. avail.

VG Controls, Inc.

34 Jenkins Rd., Hewitt, NJ 07421
Tel (201) 853-4600 Fax (201) 853-7913

CIRCLE NO. 251

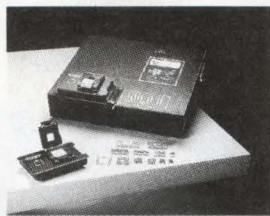

PILOT-U84 Universal Programmer

The Leader in New FPGA Support

- Altera 7064, 7128, 7160, 7192 in 84-, 100- and 160-pin packages
 - Xilinx 1765D, 17128 etc
 - Intel FLEX, 87C196 KC, KD, JR, MC etc.
 - Moto 68HC711D3, E9; 68HC705C8, C9, J2, P9 etc.
 - WSI PSD-3XX, -4XX, -5XX, PAC, SAM
 - Atmel 29C040, ATF22V10 etc.
 - AMD MACH435, 29F040, etc
 - Lattice pLSI-2000, -3000 etc.
 - All packages to 256-pin: PLCC, PGA, QFP, TQFP, TSOP, SOIC
- For immediate support, please call
800-627-2456 FAX: (408) 736-2503

CIRCLE NO. 230

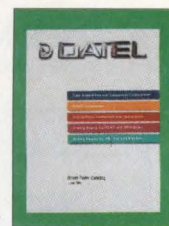

**NEW DATEL
CATALOG
HAS 50
NEW
PRODUCTS**

New 64-page DATEL catalog. New-product information and product-selection guides for data conversion components, DC/DC converters, DPM's and I/O boards for PC/AT, EISA and VME. ADC's up to 14 bits at 10MHz. Modular DC/DC's up to 50 Watts. Smallest 3 1/2 and 4 1/2 digit LED/LCD DPM's. EISA I/O boards to 12/14 bits at 10MHz. Detailed specs for many new products.

DATEL, Inc.

11 Cabot Boulevard
Mansfield, MA 02048
(508) 339-3000 • (800) 233-2765
FAX (508) 339-6356

CIRCLE NO. 260

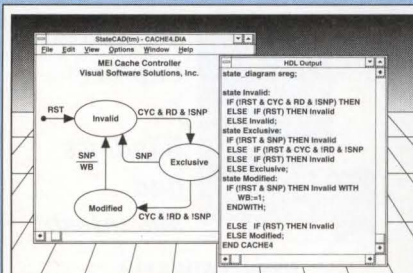

**Wouldn't you rather draw HDL?
With StateCAD™ you can!**

StateCAD enables you to draw state diagrams and automatically analyze them for design flaws. From state diagrams StateCAD produces synthesizable C, ABEL HDL, and professional documentation.

"CALL FOR A FREE DEMO DISK!"



Visual Software Solutions

3057 Coral Springs Dr. Suite 203
Coral Springs, FL 33065
Ph: (305) 346-8890 Fax: (305) 346-9394
Toll Free 1-800-208-1051

StateCAD is a trademark of Visual Software Solutions, Inc.
ABEL is a trademark of Data IO Corporation.

CIRCLE NO. 252

Fast & Friendly

The handheld programmer/emulator for demanding engineers.



**S4 programs EPROMs, EEPROMs, FLASH, PICs,
8751 micros. It emulates RAM and ROM too!**

To get S4 on your desk tomorrow, or to simply request literature, call:

800-328-2336 or 407-649-3335

Fax: 407-649-3310 BBS: 407-649-3159

Dataman
Dataman Programmers Inc.

Dataman Programmers Inc.,
22 Lake Beauty Drive,
Suite 101, Orlando,
FL 32806, USA.

15 years of innovative solutions in the palm of your hand.

CIRCLE NO. 237

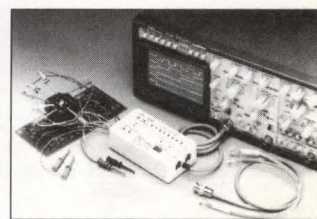

6004 Logic Scope Probe Kit converts analog oscilloscope into 8-channel real-time logic analyzer, trigger-probe or MUX-mode tool for digital analysis of newest circuits and ICs. Memory switch saves 3 readings. Daisy-chain up to 3 units for 24 channel system. Board powered (5V). Kit includes MX9100 probe assembly, Micrograbber® lead, comb BNC and phone jack/plug interface cabling.

ITT Pomona Electronics

1500 E. Ninth Street
Pomona, CA 91766-3835
(909) 469-2900 • FAX (909) 629-3317

CIRCLE NO. 261

Powerful PLD and CPLD design: \$1995

ABEL™, the industry-standard universal PLD design tool, now gives you more power for less:

- New StateCAD™ graphical entry option lets you draw state machines
- VHDL - Direct™ for full VHDL design entry and synthesis
- New fitter support includes AMD® MACH, Altera® MAX, and Lattice® pLSI devices

To order call **1-800-3-DataIO EXT. 602**
(1-800-332-8246)



CIRCLE NO. 235

*You Don't Have
To Burn Your
Devices Like This!*



LOGICAL



**Has a Full
Range of
High Quality
Universal & Gang
Programmers**
(EEPROMs, FLASH, PLD,
& MICRO CONTROLLER)

**LOGICAL
DEVICES, INC.**
TEL: (305) 428-6868
FAX: (305) 428-1811

digelec

1 800 331-7766 Ext: 103

CIRCLE NO. 244

LARGE SCREEN

First In A Family Of Larger Display Operator Interfaces

- 8 Lines by 24 Character or 16 Lines by 32 Characters (selectable)
- VT-100 Compatible (ANSI 3.64)
- User Programmable Keypad
- 20, 30, 32 or 45 Key Keypad
- Readily Customized to Suit Your Application
- RS-232 or RS-422 Interface
- Full line of Terminals Available

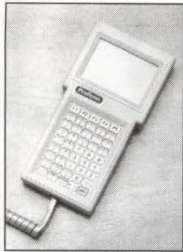

Two Technologies
419 Sargon Way
Horsham, PA 19044
Tel: (215) 441-5305
Fax: (215) 441-0423

CIRCLE NO. 262

Low-Cost Digital Multimeter Adapter

Quatech's new DMM-100 is a digital multimeter adapter for IBM PC/AT and compatible computers. Input functions include DC and AC voltage, DC and AC current, resistance, and diode/continuity tests. The DMM-100 provides a full 3 3/4 digit resolution and programmable sampling rates from 10 samples per second to over 1 hour between samples.

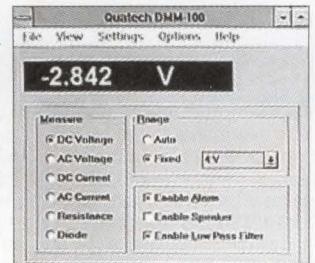
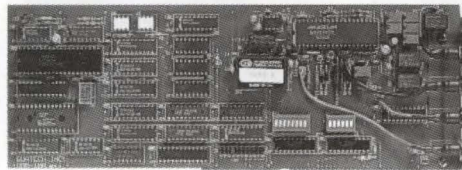

For more information and a free product catalog call: **1-800-553-1170**

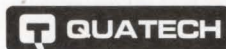

662 Wolf Ledges Parkway
Akron, Ohio 44311

FAX (216) 434-1409
BBS (216) 434-2481

CIRCLE NO. 246

Logical Choice

- ZL30B - the new industry standard in high speed PLD programmers
- Easily updated to reflect the latest device developments
- Expansion available for PLCC packages, ECL, Center Ground, etc
- 'Stand-alone' or PC operation

Stag Microsystems, Inc.
Tel: (408) 988-1118 Fax: (408) 988-1232

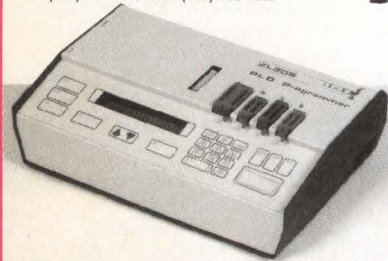

CIRCLE NO. 257

HiWIRE II

Schematic and PCB Software

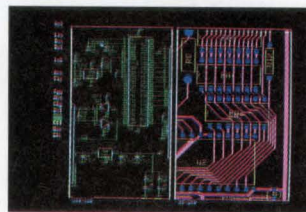

With support for expanded and extended memory, HiWIRE II can handle your most demanding schematic and PCB designs. The unique HiWIRE II editor allows you to display and edit schematics and PCBs simultaneously, using the same commands for each. HiWIRE II is \$995 and is guaranteed.



Wintek Corporation
1801 South Street
Lafayette, IN 47904
Phone: (317) 448-1903

1 - 8 0 0 - 7 4 2 - 6 8 0 9

CIRCLE NO. 253



Schematic Capture for Windows and Macintosh®

DESIGNWORKS™

The universal schematic capture front-end is now available for Windows. DesignWorks™ for Windows has all the same workstation functionality as its Macintosh counterpart, including full hierarchy with unlimited levels, automatic gate packaging and comprehensive symbol libraries. DesignWorks is built to work with PCB, FPGA, ASIC, and SPICE packages from any vendor. Custom netlist/report generation, back annotation, EDIF schematic support and a custom programming interface free your designs from being locked into one layout package or one simulator.

CALL (800) 444-9064 FOR YOUR FREE DEMO!

CAPILANO COMPUTING
(604) 522-6200 Fax (604) 522-3972

CIRCLE NO. 232

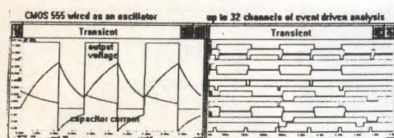

SpiceAge*4w

Analog Simulation for Windows
For Under \$1000 !!

- AC, DC, Transient, Fourier Analysis □ Monte Carlo and Worst Case Analysis □ Non-linear behavior models □ Component Sweeping □ Temperature sweeping □ Probe for voltages, currents, dissipations, dB gains, phase angle, group delay and power consumption □ Unlimited circuit size □ Generate families of curves □ Acts as "lab" full of "test equipment" □ Friendly editor □ Component library -BJT's, Darlingtons, MOSFET's, □ With Level 7 - SPICE Model & Subckts, BJT's, JFET's, etc. □ With Level 11 - 32 Channel logic analyzer-style display □ Bus groupings □ Digital signal input syntax

Tatum Labs Inc
1287 N. Silo Ridge Drive Ann Arbor MI 48108
Tel: 313 663-8810 Fax: 313 663-3640

CIRCLE NO. 258

RS-232/GPIB-488 SOLUTIONS FOR INSTRUMENTATION PROGRAM STORAGE & TRANSFER NEEDS



The Easi-Disk Simplifies Your Data Acquisition Transfer, and Retrieval Needs Completely

- IBM/MS-DOS PC Compatible
- RS-232, GPIB-488, 8-Bit Parallel, RS-485, RS-422, plus Host or Manual Controls
- Remote Polling
- 3 1/2" and 5 1/4" Floppy Disks or Removable RAM
- Stand-Alone, Rackmount or "Built-In" OEM
- 110VAC, 220VAC, 6VDC, 12VDC, or Battery Operation
- Stand-Alone Price is \$795, Controller Card Price is \$495, in Singles with Quantity Discounts

Also, ADPI offers New "ONE FOR ALL" Portable Optical Disk and Tape Drives on DOS, Macintosh, SCO-UNIX, OS/2, PICK, Peer to Peer LANs, and Novell LANs via Parallel & SCSI ports.

ANALOG & DIGITAL PERIPHERALS, INC.
P.O. BOX 499
TROY, OHIO 45373
PHONE 513/339-2241
FAX 513/339-0070



CIRCLE NO. 236

Looking for
BIG
results?

Getting lost in the crowd?

Find out how you can break through the clutter to get big results for a small price, by placing a 4-color ad in EDN Product Mart. Call Joanne Dorian at (212) 463-6415 for details.

CIRCLE NO. 234

PLCC LoClip – PLCC Probe

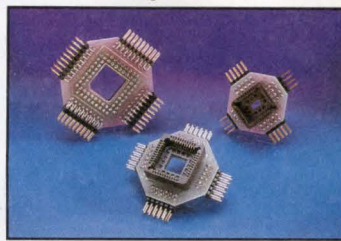

Probe in Place

- Probe surface mounted PLCC chips
- Lowest profile Clip (.45" – .75")
- Instrument VME bds. etc with no extender
- PLCC sizes from 20-84 pins
- Annotations available
- Mechanically and electrically reliable connection
- Ask about custom solutions

IRONWOOD ELECTRONICS
P.O. BOX 21151, ST. PAUL, MN 55121
(612) 431-7025; FAX (612) 432-8616

CIRCLE NO. 242

Smart TekMeter from Tektronix



The new TekMeter integrates the usability of a digital multimeter with the waveform display of an oscilloscope in a compact, easy-to-use, two pound battery-operated package. TekMeter has 25Ms/sec digitizer(s) automatic setup, spike detect and cursors. Prices for TekMeters range from \$859 to \$1,259. For more information, call Tektronix at 800-426-2200 or your local distributor.

CIRCLE NO. 250

8051 68HC11 COP8 68HC05



iceMASTER In-Circuit Emulators From \$851

- Easy to learn & use
- Windowed interface -- user configurable
- Real-time and non-intrusive
- Source level debug

- Support for structures, arrays, unions and pointers
- Trace buffer with advanced searching capabilities.
- Fast serial (RS-232) link to any PC, even laptops.
- Broad support of derivative devices/interchangeable probe cards
- Rental and 10-day trials available.
- Call today for free demo disk

(800) 638-2423

MetaLink Corporation

MetaLink Corporation
Phone: (602) 926-0797
Fax (602) 926-1198

MetaLink Europe GmbH
Telefon: (08091) 2046
Telefax (08091) 2386



CIRCLE NO. 256

Relex Reliability Software

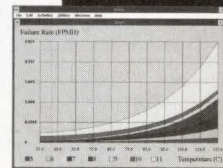

Mac!
DOS!
Windows!

Relex Reliability Software, long known for its power and flexibility, is now available for Windows, the Mac, and DOS! With features such as a powerful CAD interface, system modeling, impressive graphics, and unmatched user-friendliness, Relex is the ultimate, intuitive solution!

- MIL-HDBK-217 • Bellcore • Parts Count •
- Mechanical • CNET • FMECA • more •

Call 410-788-9000 Today For a Free Demo!

INNOVATIVE SOFTWARE DESIGNS, INC.

Two English Elm Court 410-788-9000
Baltimore, MD 21228 USA FAX 410-788-9001

CIRCLE NO. 240

High-Resolution Medical Color Monitors

X-Med's 14" and 15" low-radiation super VGA monitors are listed to UL 544 medical standards, and feature patented low-leakage EMI filters. Other features include:

- Small footprint fits any desktop.
- Ergonomically designed screen controls with easy pincushion correction.
- Built-in autosizing and autocentering.
- Multiscanning to maximize resolution, picture quality and graphics card compatibility.
- State-of-the-art surface mount technology.



Contact us today for additional information and specifications on these outstanding new monitors.

X-MED
SYSTEMS

X-Med Systems Division of
Condor D.C. Power Supplies, Inc.

2311 Statham Parkway, Oxnard, CA 93033
(805) 486-4565 • FAX (805) 487-8911

CIRCLE NO. 234

PCI Hardware & Software

Here is the definitive authority on the PCI bus. Written by the experts, this book contains all the details you won't find anywhere else! Like Ed Solari's book on the ISA and EISA buses, *PCI Hardware and Software* is bound to become the world wide reference for the PCI bus. This book is ahead of the official specification, and will probably stay that way for some time! Hardcover; introductory price \$87.95.

If you're going to use PCI,
you need this book!

Call Toll Free (800) 462-1042

We accept Co. PO's and:



Annabooks

11848 Bernardo Plaza Ct. Ste. 110
San Diego, CA 92128-2417
(619) 673-0870 • Fax: (619) 673-1432

CIRCLE NO. 231

PCB RUSH SERVICE Proto Manufacturing

- ☀ 24 hour Multi/Rigid
- ☀ 10 day std delivery
- ☀ Design & CAM
- ☀ Laser Plotting
- ☀ LPI/DFSM
- ☀ Mil GF & GI
- ☀ Nice People

Dial (800) PCB-RUSH
Sun Circuits Incorporated
5124 Calle del Sol
Santa Clara, CA 95054
(408)727-7784 fax (408)727-0347
BBS/Modem (408) 988-3591

CIRCLE NO. 249

EDN-CAREER OPPORTUNITIES

IOWA MIDWEST

MIDWEST

OPENINGS

RF DESIGN ENGINEERS

MSEE/BSEE. Experience levels to 10+ years. RF/Microwave circuit design, HF to 3.0 GHz. Areas of interest are: receivers, transmitters, power amplifiers, frequency synthesizers, modulation/demodulation, spread spectrum, DSP implementation of radio functions. Multiple openings with several of my Midwest client companies.

DON GALLAGHER, MSEE

Gallagher & Brei Associates

1145 Linn Ridge Rd., Mount Vernon, IA 52314
(319) 895-8042 • Fax (319) 895-6455

DESIGN ENGINEER

\$17.35/hr

8 am to 5 pm

40 hours per week

Design and development of embedded controller software. Research and design of signal processing algorithms. Master of Science degree, major in Electrical Engineering or equivalent. Two (2) years experience in job offered or two (2) years experience as engineer/scientist. Experience must have included 12 months of "C" language usage and real time system programming and graphics programming. Contact LA Office of Employment Security, Job Order 093762, 1991 Wooddale Blvd., Baton Rouge, LA 70806.

EDN reaches an audited circulation of 163,000 engineering professionals, assuring 100% qualified inquiries for specialized technical jobs.

Why not let EDN's Career Opportunities section help your clients hire the qualified engineering professionals they need!

If I can be of assistance in helping your clients with their recruitment advertising, please call:

Jackie Daniels
at 1-800-603-4859.

ENGINEER

THE FUTURE

OF TV

WE ARE LOOKING FOR HIGHLY TALENTED PEOPLE TO ENHANCE OUR GLOBAL ENGINEERING EFFORTS.

The Advanced Development Group at GI Communications Division in San Diego, is a small team of engineers who built the DigiCipher HDTV and the Channel Compatible DigiCipher HDTV systems which were tested by the FCC Advisory Committee.

Currently, we are looking for the following engineers to expand our horizon in new areas and fully utilize the digital compression technology we have developed:

TELECOMMUNICATIONS ENGINEER

Will define requirements as well as design and test telecommunication systems. Must have experience in ATM switches, packet networks and digital telephone signaling protocols. Experience in telecommunication standards is highly desirable. CODE: HDTVTEL

DIGITAL COMMUNICATIONS ENGINEER

Will design digital communication systems and hardware. Must have experience in QPSK, QAM, adaptive equalization, coding, computer simulation such as COMDISCO, and information theory. Experience in digital signal processing, "C" programming and/or video compression is a plus. CODE: HDTVCOM

DIGITAL DESIGN ENGINEER

Will perform a wide variety of digital circuit and signal processing tasks. Must have experience in complex gate arrays, FPGA, EPLD such as XILINX and ALTERA. Microprocessor and firmware background is preferred. CODE: HDTVDIG

SYSTEMS ENGINEER

Will design, test and integrate advanced digital communication systems for satellite, cable and broadcast TV and multimedia applications. Must have experience in communication system design, data communication protocols, telephony and networks, digital signal processing and digital video compression. CODE: HTVSYS

All positions require a minimum of MSEE or CS, or BS with 5 years' related experience.

Share our vision of global communications. Please send resume with salary history/requirements, REFERENCING APPROPRIATE CODE, to: General Instrument Corp., Human Resources, 6262 Lusk Blvd., San Diego, CA 92121. EOE. Principals only.

GI General Instrument

Quality design and advanced technology. Because lives depend on it.

Siemens Pacesetter is a world leader in technological innovation for cardiac arrhythmia management devices. Together with our parent company, multibillion dollar Siemens, we are bringing these life-saving and life-enhancing products to today's everchanging healthcare marketplace. If your vision matches ours, we offer a supportive, advancement-oriented environment to the professionals who join us as:

SR. SOFTWARE ENGINEER (Software Development Dept.)

Individual will use creativity and high-quality standards to design and implement software for implantable/external pacemaker applications. Responsibilities include developing product and software specifications, architecture design, detailed design, implementation, unit tests and integration tests suite. 5+ years experience in all phases of high reliability software development is required. BSCS/MSCS and C/C++ background preferred. Demonstrated systems development experience using OOP techniques in real-time systems desirable. **Respond to Dept. EDN/SSE.**

SR. STAFF SOFTWARE ENGINEER Advanced Product Development

Will design/develop software for new pacemaker/programmer interfacing and communications. Involves requirements definition, design, coding, testing and debugging. Will also perform large scale software integration to ensure functionality of final product. Requires a BS/MS degree in CS or equivalent and 5+ years experience with knowledge of Assembly and C. **Respond to Dept. EDN/SSSE.**

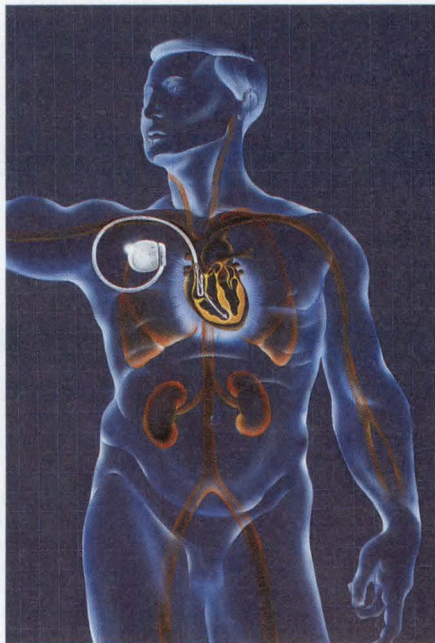

SR. MECHANICAL DEVELOPMENT ENGINEER

The selected candidate will be called on to design and develop new leads, as well as provide test protocols and documentation. Also entails coordinating leads project teams, and designing related tooling/fixtures. Related BS degree in Engineering required, with 5+ years directly related experience. **Respond to Dept. EDN/SMDE.**

TEST ENGINEER

Our selected candidate will develop and design new software/hardware to test new products, maintain existing software and test equipment, and generate related documentation and reports. BSEE or equivalent and a minimum of 5 years mixed signal test engineering experience strongly preferred. Knowledge of C program language (with a preference in Assembly) and precision analog test methods/circuits a must. **Respond to Dept. EDN/ATE.**

In addition to our desirable Southern California location, we offer competitive compensation, paid relocation and

complete benefits, including employer-paid pension plan, 401(k) savings, tuition reimbursement, vision care and a choice of medical/dental plans. Send resume (NO PHONE CALLS, PLEASE!) to the appropriate department: **Sue Mayes, Employment Representative, Siemens Pacesetter, Inc., 15900 Valley View Court, P.O. Box 9221, Sylmar, CA 91392-9221. AA/EOE.**

Siemens Pacesetter



Excellence in Cardiac Pacing

EDN-CAREER OPPORTUNITIES

Reach over 163,000 engineering professionals, in:

EDN Career Opportunities

Get the attention of qualified engineers and managers involved in designing or developing electronic products, who look to EDN Magazine's Classified section for career opportunities.

Only EDN can guarantee you're reaching the key design engineers in the Electronic Original Equipment Manufacturers market.

Let me help you fill those positions!

For more information, call:

JACKIE DANIELS

1-800-603-4859 Tel

1-617-630-3925 Fax

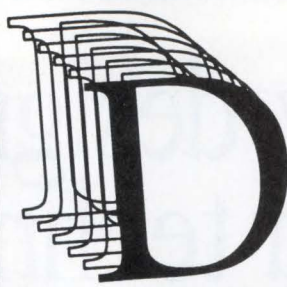
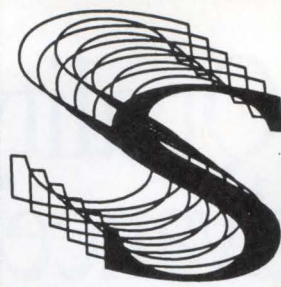
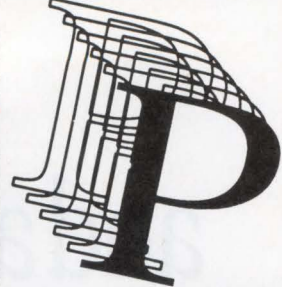
Without Tears™

Learn DSP and Put your Knowledge to work immediately!

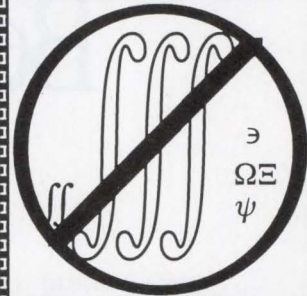

Coming to a Place Near You

Boston Dallas
Salt Lake City
Washington D.C.
Toronto Austin
San Jose

Call Z Domain Technologies, Inc.
(800)-967-5034
(404)-587-4812

Call 9-5 EST. Ask for brochure.

Our 2-Day Advanced Course is ready. Call for more info

By Taking This 3-Day Course You will really learn DSP. **Guaranteed!**

Design Engineers

AzTech is the U.S. subsidiary of a successful European recruiting group, which does not charge hiring fees to applicants or employers. For clients in the West, South-West and other parts of the U.S., we seek BS/MS level applicants for a wide range of research, design and/or development openings, including:

SEMICONDUCTORS

For hi-speed **Linear Products**, amplifiers & video processors
For hi-frequency **RF Transceiver IC's**, in silicon or GaAs
For **Mixed Signal IC's**, including parts of ADCs & DACs
For analog/mixed-signal, disk-drive read CMOS **Channel Products**
For **Hi-Resolution Converters**; range of CMOS/BiCMOS circuits

SYSTEMS

RF Engineers, with RF/analog/digital circuit/system design experience
Communications Engineers, with hardware design/systems integration
Systems Test Engineers, with Orcad SDT, Excel & Windows or DACs/ADCs
DSP Engineers for Cellular DSP applications; analog and/or digital
4 Project Leaders, for GSM, Analog, TDMA and CDMA sectors

SOFTWARE/FIRMWARE

Performance Engineer for SVR4, with UNIX systems software experience
Windows Device Drivers Applications; specialist with 10+ yrs experience
Human Machine Interface/HMI; specialist with Windows tools/languages
Software Integration; with ADA, C++ experience on Sun/VAX platforms
Firmware Engineers; C programming + microprocessor embedded systems

There are just a few of our client needs for EO/AA employers in the U.S. Mail or fax your resume, with salary indicator and location preferences to:

AzTECH
Recruitment Co.

AzTech Recruitment Company
3336 N. 32nd Street, Suite 115, Phoenix, AZ 85018
Call (602) 955-8080 or Fax (602) 955-9639

EDN-INTERNATIONAL ADVERTISERS INDEX

Company	Page	Circle	Company	Page	Circle
ADPI	150	236	Mini-Circuits	97	103
AMP Inc	92-93	104	Motorola Semiconductor Products Inc	73	
AT&T Microelectronics	12	49	Mueller Electric Company	122	81
Accel Technologies Inc	129	47	Murrietta Circuit Design	108	
Advanced Micro Devices	46-47	46	NCI	148	248
Advin Systems	149	230	NCR Corp	44	112
Allegro MicroSystems	66	200-203	National Semiconductor	19-32	
Allied Electronics	39	107	Nohau Corp	133	83
Altia Inc	38	97	Novotechnik US Inc	142	19
Analog Devices Inc	77-84		Omron Electronics Inc	156	84
Annabooks	151	231	OrCAD	C2	113
Atmel Corp	C3	48	Orion Instruments	147	245
Burr-Brown Corp	62-63	185-196	P-CAD	76A-B	
	71	64		77	85
CEIBO	148	255	Pico Electronics	122	89
Capilano				155	89
Computing Systems	150	232	Quatech	150	246
Capital Equipment Corp	144	108	Quad Design	121	9
Cherry Semiconductor	37	37	Quantic Laboratories Inc	137	30
Cirexx	148	233	Quicklogic	75	86
Compass			Raytheon Corp	50	87
Design Automation	123	65	Samsung		
Condor DC Power Supplies	151	234	Semiconductor Inc	78-79	91
Cypress Semiconductor	15		Samtec Inc	17	114
DSP*	2	109	Sierra Circuits	147	247
Data I/O Corp	149	235	Signal Transformer Co	C4	88
Data Translation Inc	48	66	Sony Semiconductor	55	16
Dataman Programmers	149	237	Spectrum Signal Processing	56	31
Datel Inc	149	260	Stag Microsystems Inc	150	257
Digi-Key Corp	1	69	Sun Circuits	151	249
Digital Equipment Corp	64-65		Tatum Labs	150	258
Ecliptek Corp	106	71	Tektronix Inc	85	93
Frequency Devices Inc	74	3		87	92
GE Rental/Lease	68	72		151	250
HJJ Co Inc	147	238	Texas Instruments	41-42	
Harris Semiconductor	119	4		43	
Heurikon Corp	105	73		58-61	
Hyundai			3M Electronic Products	124	1
Electronics Industries	10-11	74	Toshiba America		
IEE	76	76-77	Electronic Components	34-35	98-99
ITT Pomona Electronics	149	261	Tribal Microsystems	147	259
Incredible Technology	147	239	Two Technology	150	262
Innovative Software			Underwriters Laboratory	33	94
Design Inc	151	240	VG Controls	149	251
Integrated Device			Viewlogic Systems Inc	135	115
Technology Inc	53	75	Vishay Resistive Systems	132 A-B	
Integrated Systems Inc	107	110	Visual Software		
Intel Corp	8-9	36	Solutions Inc	149	252
Interactive CAD Systems	148	241	W R Grace	140	95
Intusoft	57	17	Wind River Systems	99	96
Ironwood Electronics	151	242	Wintek Corp	150	253
Jeta Power Systems	38	3	Zworld Engineering	147	254
Linear Technology Corp	94	78			
Link Instruments	148	243			
Littlefuse Electronics	127	79			
Logical Devices	149	244			
Loral Data Systems	138	80			
Massteck	83	105			
Maxim Integrated Products	101	26			
	103	27			
	141	28			
	143	29			
Mentor Graphics	36	34			
Metalink Corp	151	256			
Microchip Technology Inc	4	38			
	6	33			
Mini-Circuits	3	102			

Recruitment Advertising 152-154

This index is provided as an additional service. The publisher does not assume any liability for errors or omissions.

PICO

Free
136 pg.
catalog

SURFACE MOUNT & PLUG-IN TRANSFORMERS & INDUCTORS

DC-DC CONVERTERS

- Surface Mount • PC Board Mount
- Low Profile • Single and Dual Output
- Isolated • Industrial to Military
- up to 1000 Volts

AC-DC POWER SUPPLIES

- Linear • Switchers • Open Frame
- Low Profile • Up to 200 Watts

New HIGH POWER DC-DC CONVERTERS

- New Isolated **DUAL** Outputs
- Wide Input Voltage Range
- Regulated 100 Watts

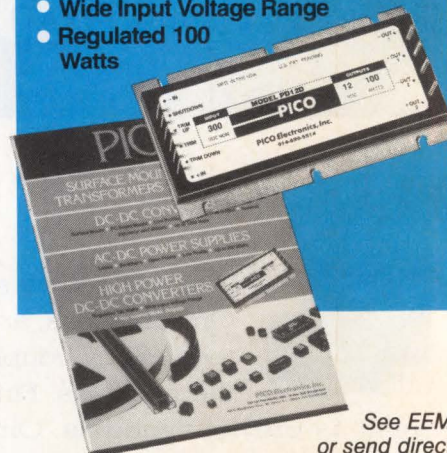

See EEM
or send direct
for **Free PICO Catalog.**
Call toll free **800-431-1064**
in NY call **914-699-5514**
FAX **914-699-5565**

PICO Electronics, Inc.

453 N. MacQuesten Pkwy., Mt. Vernon, N.Y. 10552
CIRCLE NO. 89

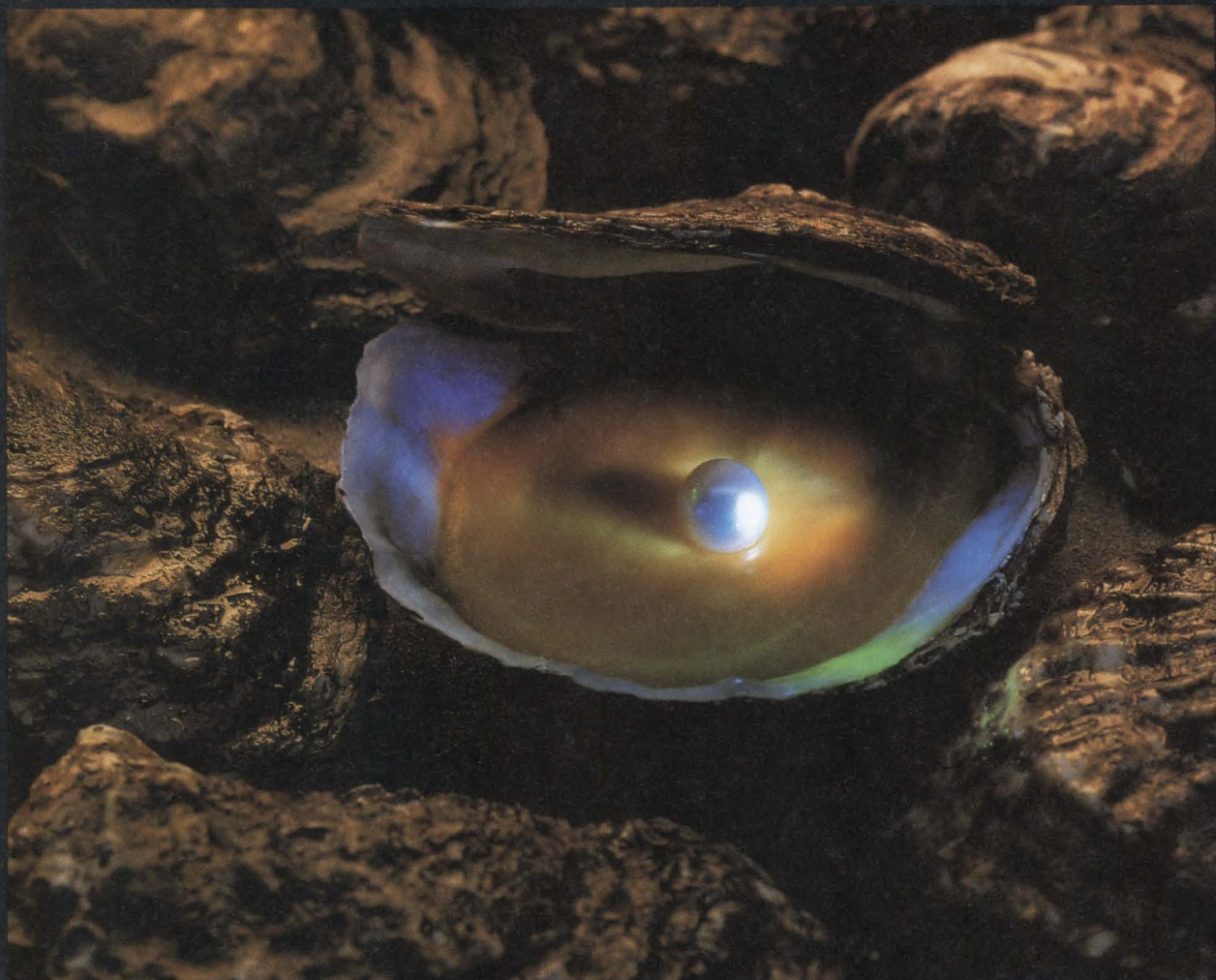

RELAYS ARE LIKE OYSTERS, YOU'VE GOT TO LOOK BENEATH THE SURFACE TO FIND THEIR REAL VALUE.

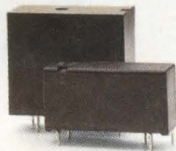

Think if you've seen one relay and you've seen them all? Take a closer look at Omron relays, and you'll find real value. The bottom line value of Omron's superior technology coupled with some of the most extensive customer support services in the business. Find, for instance, our new G6R and you'll discover a relay twice as small as previous models. One that allows for smaller circuit board requirements, leading to smaller products, and the kind of treasure that ultimately returns lower product costs. The G6R also meets or exceeds all major international standards. But the real value of Omron is our extensive customer support services. Real treasures like: Designed-in features to meet your requirements, Quality testing and that give tremendous value by and administrative costs. So if you take a closer look at Omron.

OMRON

WE HAVE THE FUTURE IN CONTROL.

CIRCLE NO. 84

custom stocking programs. Benefits reducing your application design think all relays are created equal, Call us at 1-800-62-OMRON.

CHAMPIONS COME IN ALL SIZES

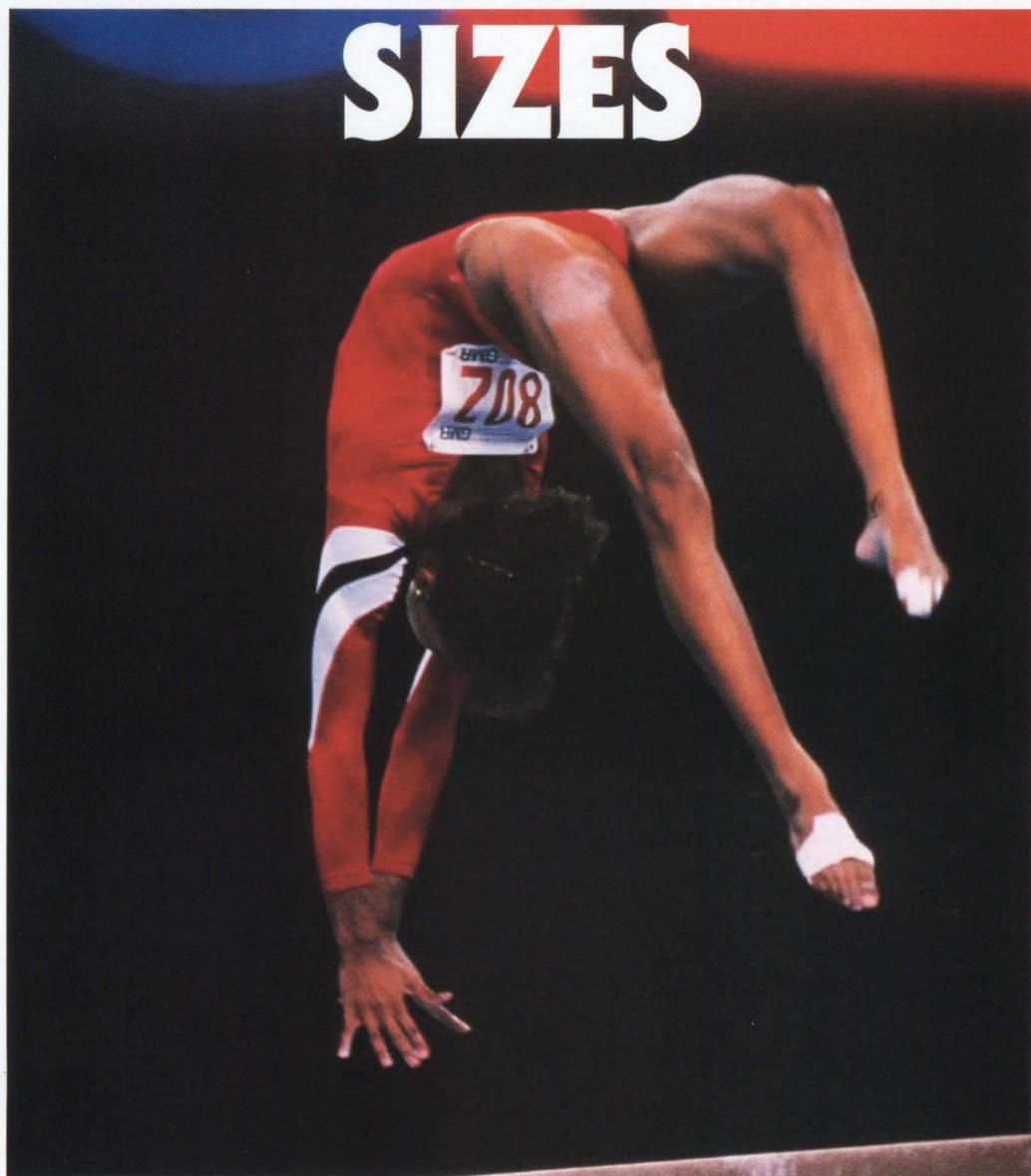

They took 90 pounds of power to new heights, and redefined the meaning of performance.

Atmel also offers championship performance. We married our 3-volt proprietary process with a four-megabit Flash so you can take your design to new heights.

The AT29LV040 is not some stripped-down version. It has all the stuff you've come to expect from Atmel's 3-volt Flash memory. A single power source for both read and write. The world's easiest algorithm, just load

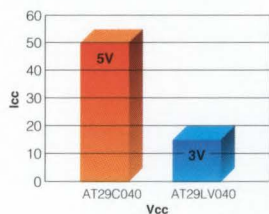

ATMEL
Flash

and go – there's no erase cycle. Small memory sectors for fast and easy reprogramming.

And, for you folks who are not working on carry-on equipment, we also make a 5-volt-only version of our four-megabit Flash, the AT29C040.

Take your pick, 3-volt or 5-volt, they're all in our new Flash record book. Write or give us a call at (800) 292-8635 for the book, then let Atmel Flash give your design the championship edge.

Signal's International Flathead™ Circles The Globe.

The whole world's going flat out for Signal's International Flathead transformers, because we went all out to win international approval.

These super rugged, low profile transformers, fully encapsulated and hermetically sealed, meet UL, CSA, VDE, IEC and EN standards for international use.

Thanks to their extremely low profile, these IF series transformers are ideally suited for use on densely packed PC boards.

Available in 2VA to 30VA configurations, these Flatheads feature dual primaries (115/230V, 50/60Hz) and non-concentric windings. The result: reduced inter-winding capacitance and the elimination of electrostatic shielding.

- Low profile (as low as 0.69")
- Precise pin alignment for drop-in applications
- Class B insulation (130° C)

For more information on Signal's International Flathead Series, contact Signal Transformer, 500 Bayview Ave., Inwood, NY 11696.

Sampling of products offered. A total of 80 part numbers are available off-the-shelf in 2, 4, 6, 10, 14, 18, 24, 30 VA sizes.

The World's Gone Flat.



Part No.	Size	SECONDARY		PRICE 100-249 Pcs
		Series	Parallel	
IF-2-10	2VA	10Vct. @ 200mA	5V @ 400mA	\$7.63
IF-2-12	2VA	12Vct. @ 170mA	6V @ 340mA	
IF-2-16	2VA	16Vct. @ 125mA	8V @ 250mA	
IF-2-20	2VA	20Vct. @ 100mA	10V @ 200mA	
IF-2-24	2VA	24Vct. @ 85mA	12V @ 170mA	
IF-2-30	2VA	30Vct. @ 70mA	15V @ 140mA	
IF-2-34	2VA	34Vct. @ 60mA	17V @ 120mA	
IF-2-40	2VA	40Vct. @ 50mA	20V @ 100mA	
IF-2-56	2VA	56Vct. @ 40mA	28V @ 80mA	
IF-2-230	2VA	230Vct. @ 9mA	115V @ 18mA	
IF-10-10	10VA	10Vct. @ 1.00A	5V @ 2.00A	\$9.49
IF-10-12	10VA	12Vct. @ 835mA	6V @ 1.67A	
IF-10-16	10VA	16Vct. @ 625mA	8V @ 1.25A	
IF-10-20	10VA	20Vct. @ 500mA	10V @ 1.00A	
IF-10-24	10VA	24Vct. @ 420mA	12V @ 840mA	
IF-10-30	10VA	30Vct. @ 335mA	15V @ 670mA	
IF-10-34	10VA	34Vct. @ 300mA	17V @ 600mA	
IF-10-40	10VA	40Vct. @ 250mA	20V @ 500mA	
IF-10-56	10VA	56Vct. @ 180mA	28V @ 360mA	
IF-10-230	10VA	230Vct. @ 45mA	115V @ 90mA	
IF-30-10	30VA	10Vct. @ 3.00A	5V @ 6.00A	\$13.99
IF-30-12	30VA	12Vct. @ 2.50A	6V @ 5.00A	
IF-30-16	30VA	16Vct. @ 1.90A	8V @ 3.80A	
IF-30-20	30VA	20Vct. @ 1.50A	10V @ 3.00A	
IF-30-24	30VA	24Vct. @ 1.25A	12V @ 2.50A	
IF-30-30	30VA	30Vct. @ 1.00A	15V @ 2.00A	
IF-30-34	30VA	34Vct. @ 900mA	17V @ 1.80A	
IF-30-40	30VA	40Vct. @ 750mA	20V @ 1.50A	
IF-30-56	30VA	56Vct. @ 550mA	28V @ 1.10A	
IF-30-230	30VA	230Vct. @ 130mA	115V @ 260mA	

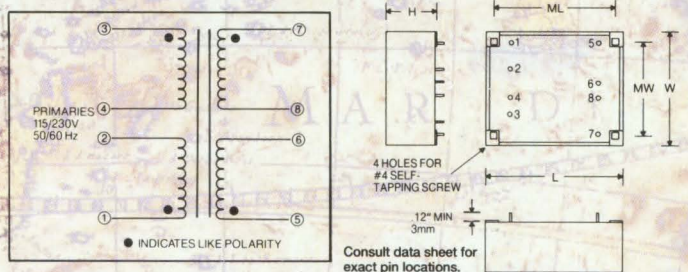

Size	L	W	H	ML	MW	WGT
2	2.09" 53.0mm	1.73" 44.0mm	0.69" 17.6mm	1.87" 47.5mm	1.48" 37.5mm	4.6oz 0.13kg
10	2.66" 67.6mm	2.24" 57.0mm	0.89" 22.6mm	2.46" 62.5mm	1.97" 50.0mm	10.3oz 0.29kg
30	2.68" 68.0mm	2.26" 57.5mm	1.39" 35.3mm	2.46" 62.5mm	1.97" 50.0mm	19.7oz 0.58kg

signal
TRANSFORMER
The American
Original.™

BUY DIRECT: 516-239-5777 ■ Fax: 516-239-7208