

# Electronic Design 29

VOL. 14, NO.

THE MAGAZINE OF ESSENTIAL NEWS, PRODUCTS AND TECHNOLOGY

DECEMBER 20, 1966

**Exploitation of the sea** leans heavily on electronic sensors, acoustic systems and other aids to pierce the mysteries of the deep. 'Monster' buoys that can collect and radio data remotely, as well as undersea craft that can see, sense and communicate, are helping man to roll back the frontiers of 'inner space' (p. 34).

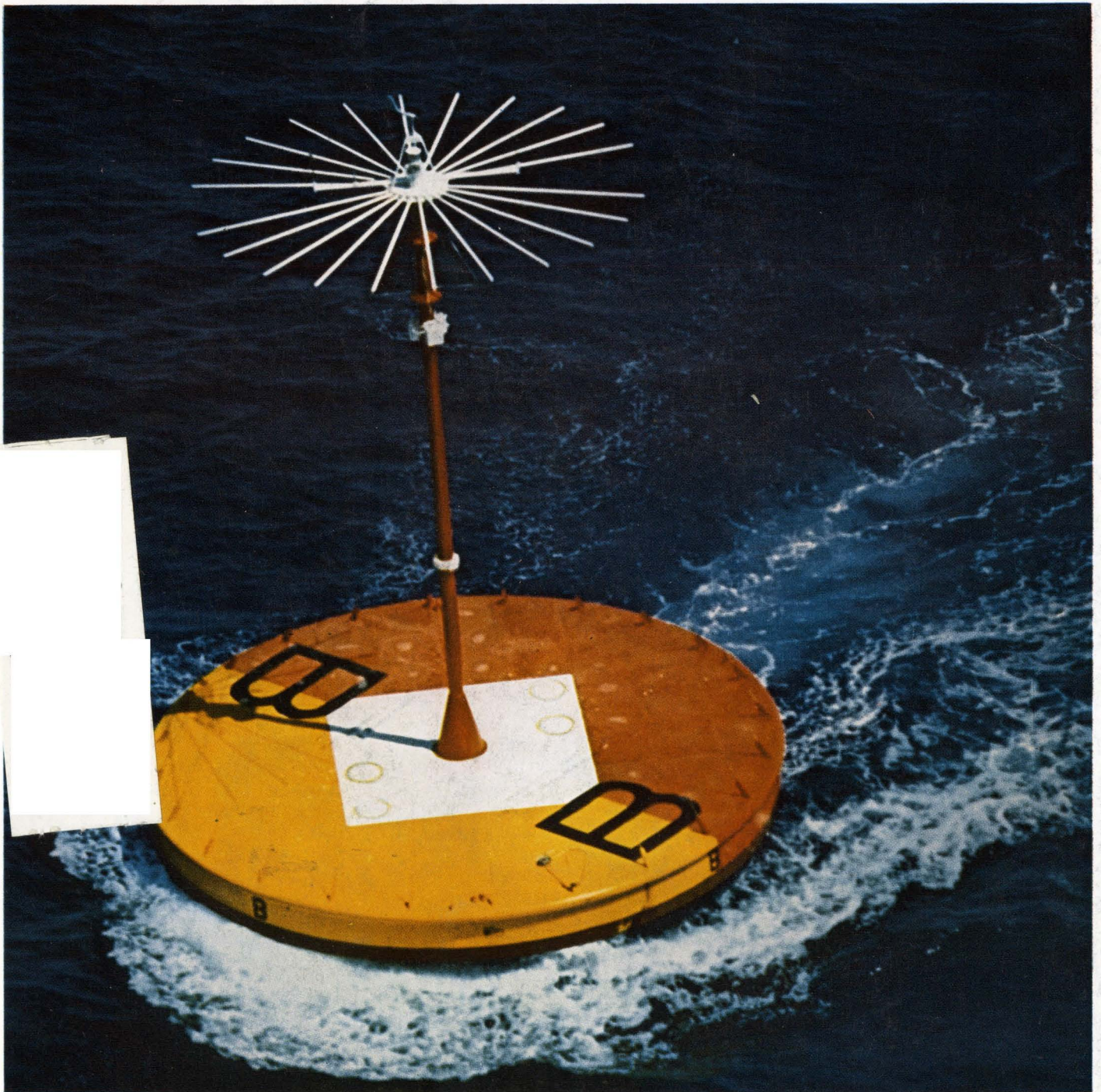

hp140A—The Scope System that gives you

# BETTER PERFORMANCE

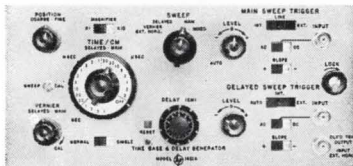
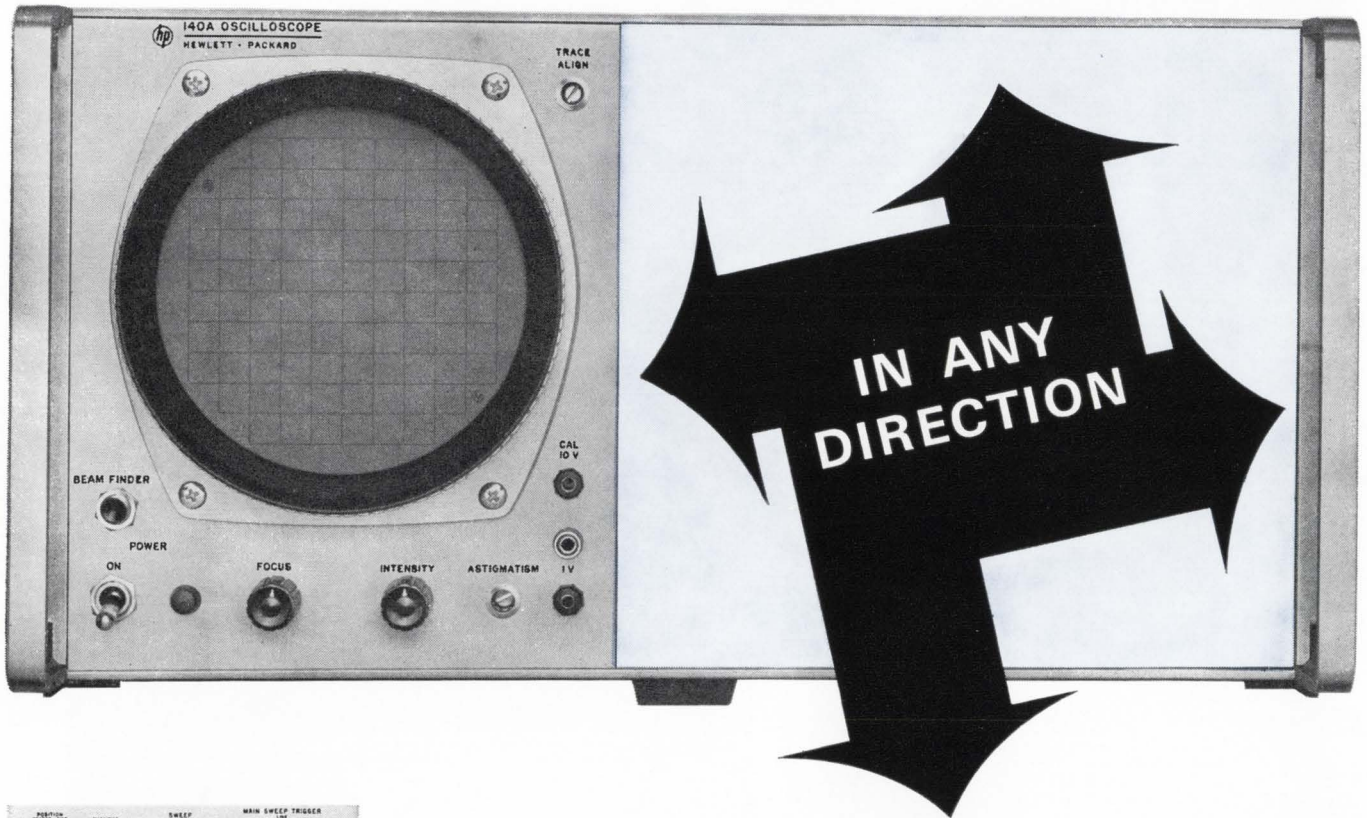

1421A—Time Base and Delay Generator

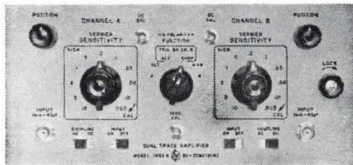

1402A—20 MHz Dual Trace Amplifier

Get 20 MHz bandwidth and delayed sweep readability. With this scope you can choose from 17 plug-ins that cover the entire measurement spectrum. If you need wideband performance, for example, you can use the dual-trace 1402A vertical amplifier and get DC to 20 MHz at 5 mv/cm, algebraic addition, built-in delay line for viewing fast-rise pulses, full 6 cm deflection and a wide dynamic range.

For easy readability of complex waveforms and accurate time interval measurements, Model 1421A time base provides extreme magnification and sweep speeds from 1 sec/cm to 20 ns/cm. It also offers the additional advantage of exclusive hp mixed sweep. This feature combines display of the first portion of a trace at normal sweep speeds and simultaneously expands the trailing portion of the trace at faster delayed sweep speeds to allow step-by-step magnified examination.

An alternate mainframe (141A) provides equal versatility plus the advantages of variable persistence and storage. Price of the wideband system with 140A mainframe, 1402A vertical plug-in and 1421A horizontal plug-in is \$1795. Price with the 141A mainframe is \$2475.

Ask your hp Sales Engineer for brochure (data sheet 140A) with specs on the 140A wideband system as well as 140A high-sensitivity, TDR or 12.4 GHz sampling systems. You'll find they give more and better measurements in less time. Hewlett Packard, Palo Alto, California, 94304. In Europe: 54 Route des Acacias, Geneva.

106A



hp 140A: PERFORMANCE IN ANY DIRECTION  
20 MHz Wideband • High-Sensitivity, no drift  
• 150 ps TDR • 12.4 GHz Sampling  
• Variable Persistence and Storage

HEWLETT  PACKARD  
An extra measure of performance

ON READER-SERVICE CARD CIRCLE 2



**Select the oscillator you want,**

then choose the power supply that gives the performance you need...power, frequency stability, pulse and/or square-wave modulation, amplitude-regulated output, 115-V or 230-V input.

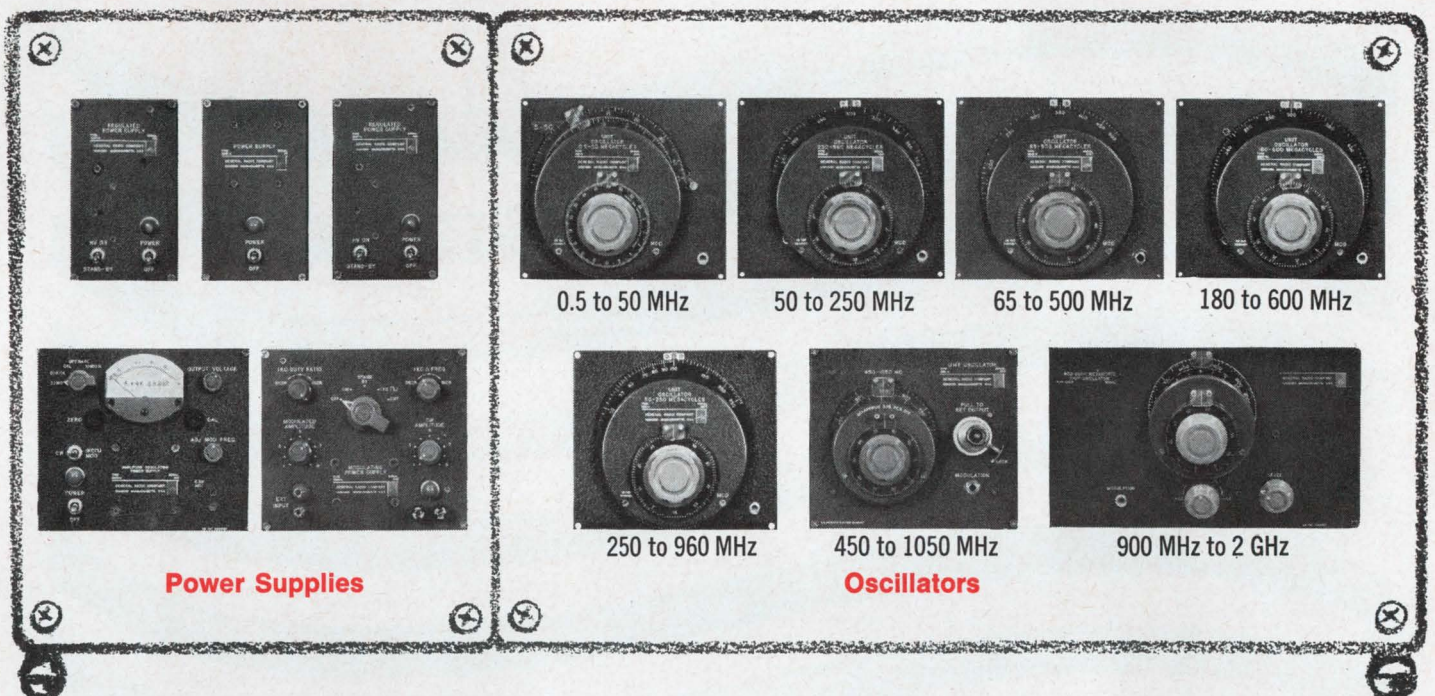

There are 32 different combinations offered here, each with a different set of features for your measurement needs. The seven oscillators from which you can choose provide continuous frequency coverage from 500 kHz to 2000 MHz and have typical outputs of several hundred milliwatts. All but two of these can be mated with any of five power supplies to provide a variety of operating conditions. Prices for oscillator/power-supply combinations range from \$355 to \$1104 in the U.S.A.

*Please write for complete information.*



**Typical Oscillator/Power-Supply Combination**  
Type 1361-A4 . . . \$680

450- to 1050-MHz oscillator with a power supply that provides stable CW and 100% square-wave and pulse modulation, bench model. This oscillator also usable with any of the other four power supplies, for bench use or rack mounting.

BOSTON • NEW YORK • CHICAGO • PHILADELPHIA • WASHINGTON, D.C.  
SYRACUSE • DALLAS • SAN FRANCISCO • LOS ANGELES • ORLANDO  
CLEVELAND • TORONTO • MONTREAL

BOURNE END, ENGLAND      ZURICH, SWITZERLAND

**GENERAL RADIO**

WEST CONCORD, MASSACHUSETTS

ON READER-SERVICE CARD CIRCLE 3

# *So you won't miss the boat on Class 155 Sleeving*

... You should know that Brand-Rex TURBOCRYL<sup>®</sup>, an acrylic coated sleeving, qualifies fully as Class 155.

Why specify two, when one will do?

For years, TURBOCRYL has been a favorite Class 130 sleeving. Now, more and more engineers are confidently switching to it for Class 155 applications, too. Latest test procedures prove it more than fills the bill.

You can simplify your inventory, with TURBOCRYL. Write us for details on this or any other sleeving or tubing requirement. Brand-Rex is in its 46th year of pioneering to bring you the exact types and sizes you need.

AMERICAN ENKA CORPORATION

BRAND-REX DIVISION

WILLIMANTIC, CONNECTICUT 06226  
PHONE 203 423-7771

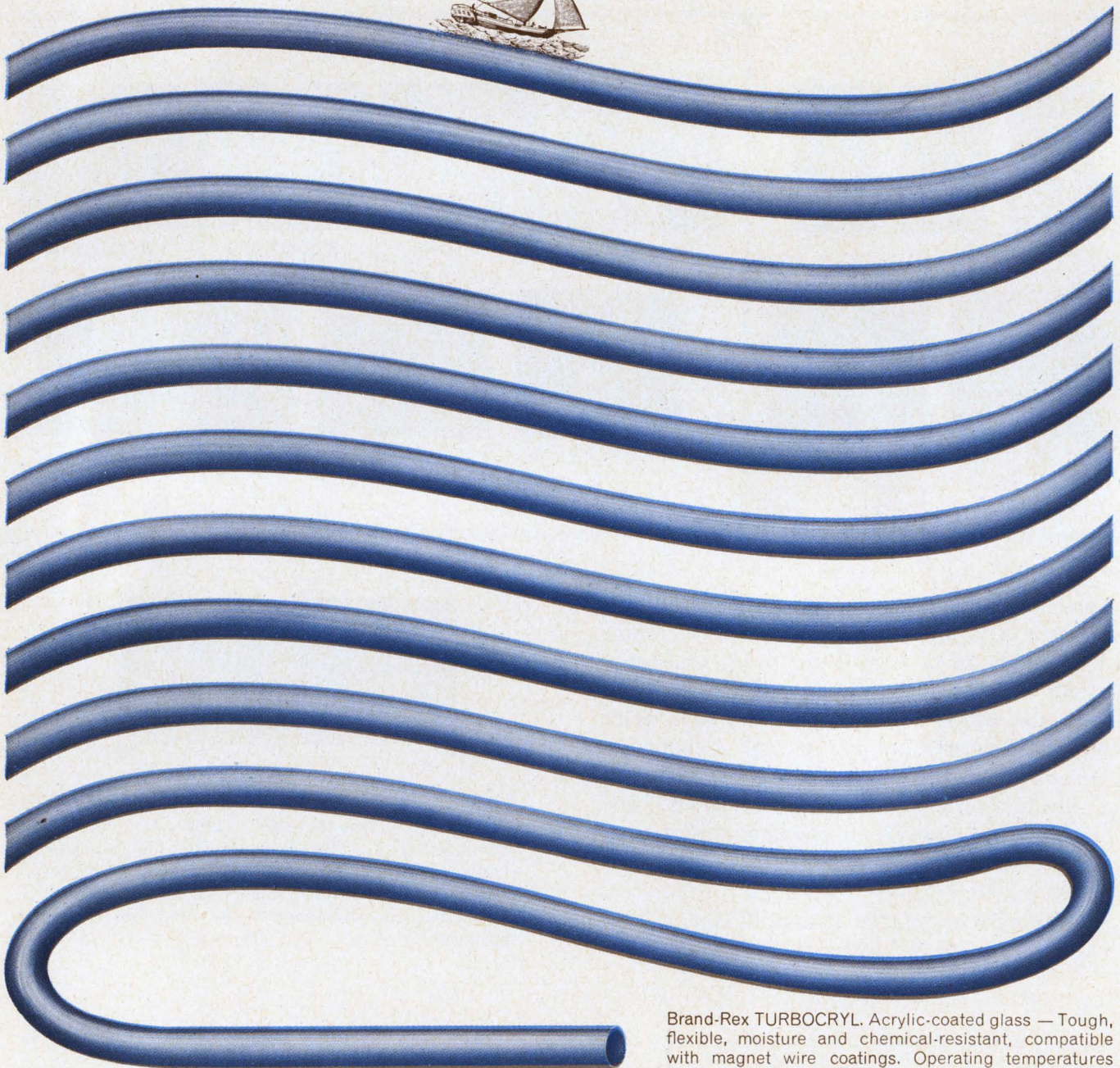

Brand-Rex TURBOCRYL. Acrylic-coated glass — Tough, flexible, moisture and chemical-resistant, compatible with magnet wire coatings. Operating temperatures  $-10^{\circ}$  to  $+155^{\circ}\text{C}$ . Dielectric strengths to 7,000 volts; sizes from #24 to 2" I.D.

ON READER-SERVICE CARD CIRCLE 4

ELECTRONIC DESIGN 29, December 20, 1966

---

## NEWS

- 13 News Scope
- 17 **Odd power FETs sprint toward 1 GHz**  
Five watts at 500 MHz imminent, at 1 GHz expected by midyear.
- 21 **Pencil-beam communications studied**  
Satellite phased array cuts power consumption and size, strengthens signal.
- 29 Washington Report
- 30 New Doppler VOR antenna reduces RF reflection errors.
- 30 System stores 3200 pages on tiny slide.
- 33 Laser system used as detonator device.
- 34 **Staff Report: Electronics and the sea**
- 36 Instruments probing oceans' unknowns.
- 39 Acoustics: Versatile underwater 'voice.'
- 47 Deep submersibles travel, 'see' and work.
- 54 Letters
- 59 **Editorial: 'Zero Defects':** More than patriotic back-slapping.
- 

## TECHNOLOGY

- 62 **Raise amplifier input impedance** by combining FETs and bipolars. The two together provide higher  $Z_{in}$  and wider bandwidth than is possible with either alone.
- 70 **Predict filter response exactly** by replacing conventional narrow-band assumptions with a plane transformation, plotted here for most filter types.
- 76 **Don't ignore thermal paths** in your integrated-circuit designs. Test fixtures and bonding techniques both have an important effect.
- 84 Ideas for Design
- 92 NASA Tech Briefs
- 

## PRODUCTS

- 96 **Semiconductors:** Tunnel diode pellets offer IC compatibility for 50¢.
- 112 **Test Equipment:** Oscilloscope records in a blur of light.
- |                      |                          |
|----------------------|--------------------------|
| 102 Components       | 118 Production Equipment |
| 110 Microelectronics | 120 Systems              |
| 116 Materials        |                          |
- 

## Departments

- 68 **Win a trip to Paris,** color TV, watch or other prize in "Top Ten" Contest.
- |                       |                         |
|-----------------------|-------------------------|
| 126 Design Aids       | 132 Reprints            |
| 127 Application Notes | 134 Advertisers' Index  |
| 128 New Literature    | 136 Designer's Datebook |

Reader Service card—inside back cover

---

# SERVO PACKAGE

When it comes to servo packages, we've got the technical considerations licked. That goes for both components and packaging design.

We can give you the "tightest" job at the lowest price and meet your delivery requirements, too.

We have literally thousands of different servo components to meet exact requirements. Motors: stepper, synchronous, braked, viscous-damped and inertial-damped. Motor generators: rate, damping, integrating and high-signal-to-noise. Synchros and resolvers of all descriptions. Related devices such as clutches, brakes and gearheads.

We design and build all the associated electronics: servo and buffer amplifiers, stepper-motor logic packages, phase-shifting capacitors, quadrature rejection circuits, electronic choppers and summing, isolation and switching networks.

Shown here are some of the servo assemblies we've designed and produced to customer requirements using standard Kearfott elements plus not-so-standard Kearfott experience.

All you have to do to solve similar problems is call one single source—Kearfott. Write for our new brochure "Kearfott Servos."

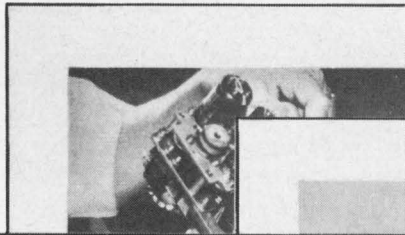

**Inertial Navigation System Coupler for side-looking radar used in RF4B and RA4C aircraft. Vibration snubbers overcome 500 cps, 30 g vibration.**

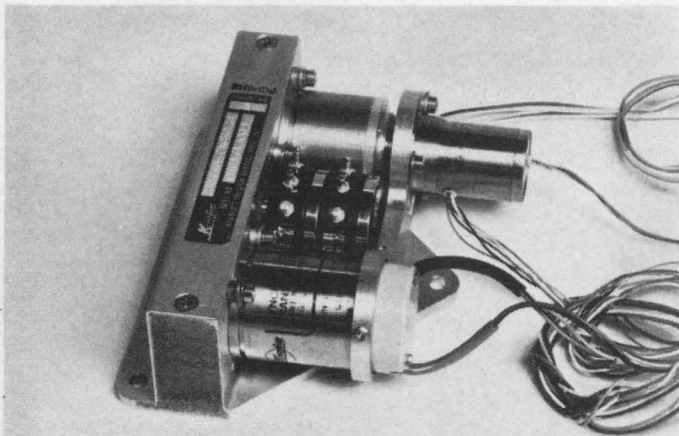

**Lead Sight Computer Tracking Servo for helicopter armament system. This servo reflects a special requirement for the command to come from the CT rather than the CX.**

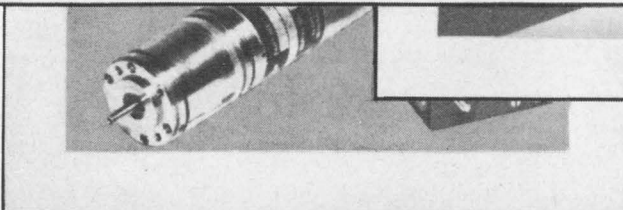
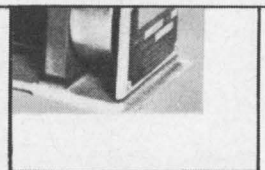
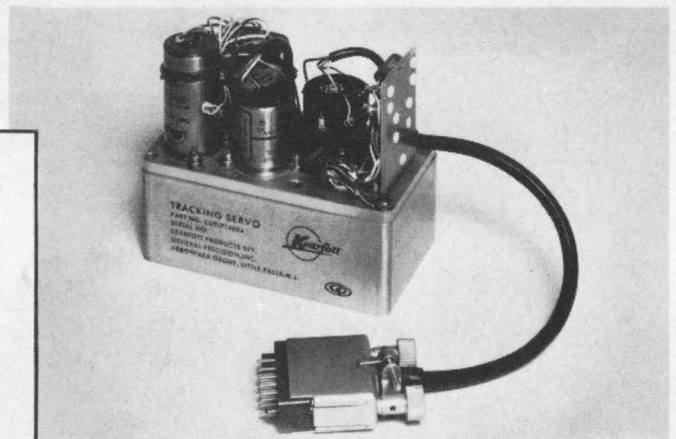

# PROBLEMS?

**ANSWER:** **KEARFOTT'S**

**“ALL-UNDER-ONE-ROOF” SERVICES.**

KEARFOTT PRODUCTS DIVISION

**GP GENERAL  
PRECISION INC.**

AEROSPACE GROUP

Little Falls, New Jersey

Three-Axis Coordinate Transformation Servo for airborne instrument landing system. Electrical inputs to CT's represent position in roll, pitch, and yaw. Electrical outputs are a coordinate transformation of the aircraft's coordinates with respect to ILS coordinates.

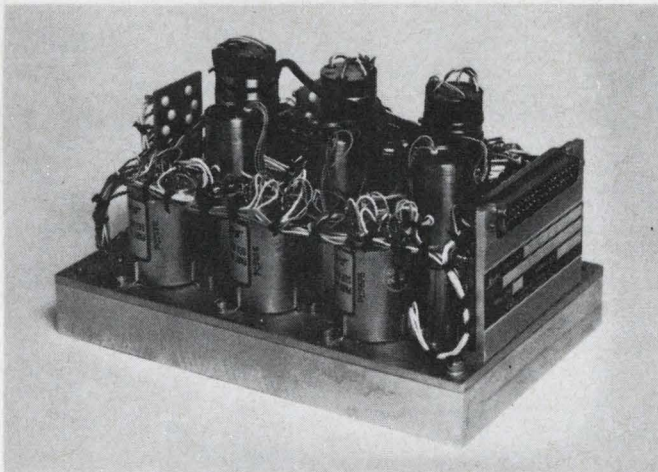

Synchronizing Drive used in flight control system of F4 series acts as a “reference” control for the autopilot. One of the many variations is a “Synchronizing Drive Azimuth Reference.”

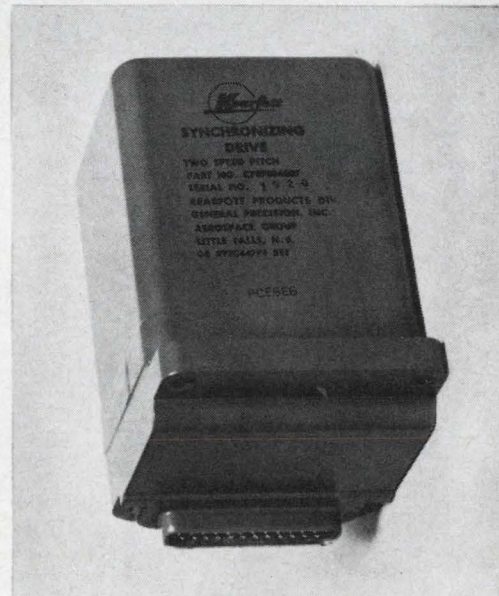

Here's the new "State of the Art" Fluke 540B Transfer Standard. AC-DC transfer accuracy is 0.01% to 50 kc without curves or tables. Fail-Safe overload protection prevents inadvertent damage to thermocouple and precision resistors. Internal galvo and thermocouple go together for perfect impedance match. DC input reversal switch. Turnover error <math><0.01\%</math>. Search meter marks percent of rated input. Low price, \$895 ready to go.

The battery-operated solid state Fluke 540B Transfer Standard is available in bench or rack versions. Voltage range is 0.25 to 1000 volts in 14 ranges. Galvanometer resolution is 0.0012%/scale division at rated input. Accessories include A40 Current Shunts for thermal AC/DC current transfers to 10 amps and A55 Thermal Converters for extension of frequency range to 50 MC.



FLUKE • Box 7428, Seattle, Washington 98133 • Phone (206) 776-1171 • TWX: (910) 449-2850

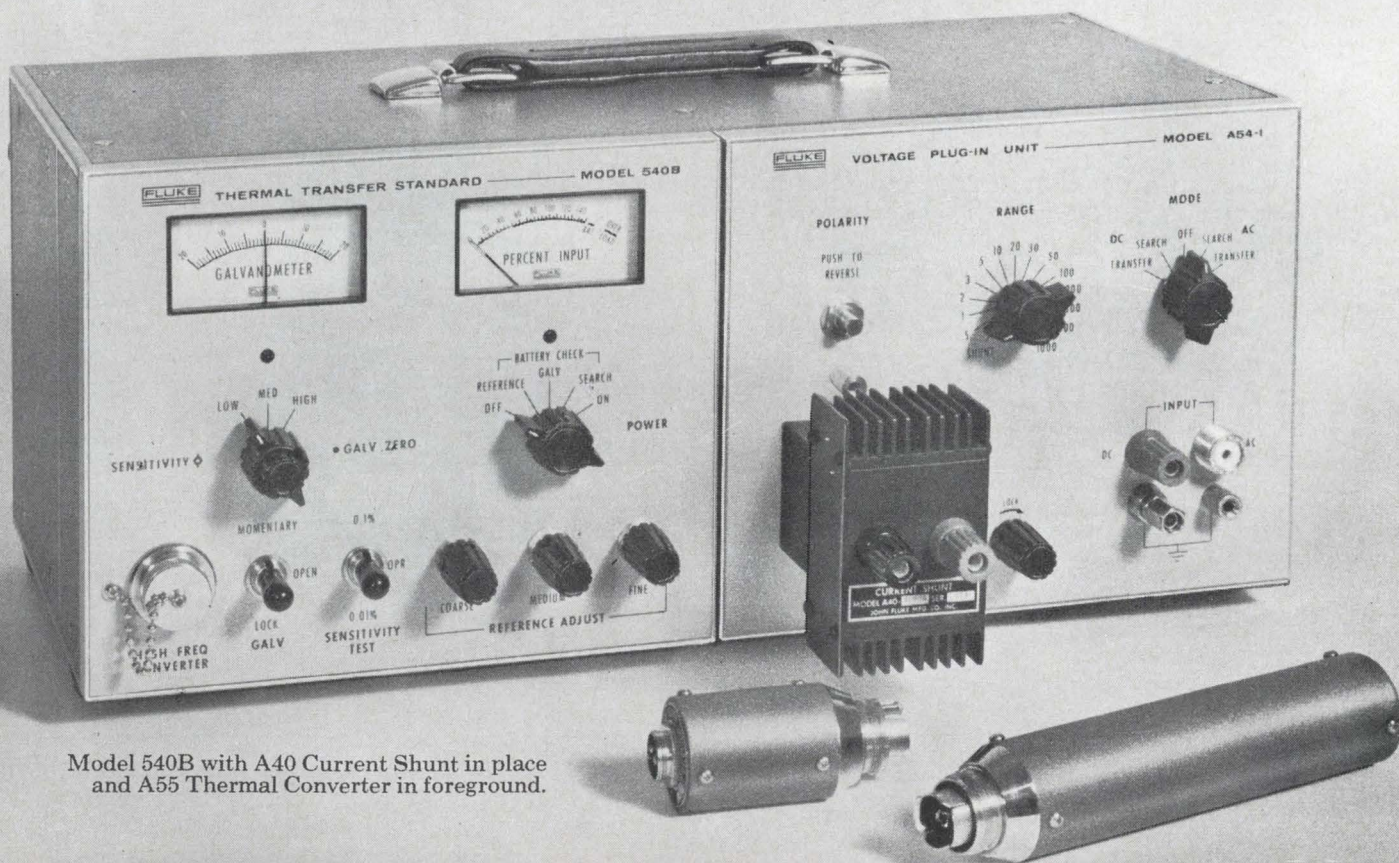

Model 540B with A40 Current Shunt in place and A55 Thermal Converter in foreground.





## HAPPINESS IS AN n-CHANNEL (HIGH-GAIN) 50¢ UNIBLOC\* FET!

Your customers will believe it when they discover the drift-free, low-distortion, low-noise audio you've achieved in your newest product — when you design with Motorola's new, low-cost field-effect transistors.

You'll be happy with the big initial savings you get with Motorola FET types MPF103-05 at 50-cents each (1,000 quantities) — plus the added savings you'll find when you can use smaller, lower-cost capacitors, due to the high input impedance of a FET (like a tube).

You'll also be happy about the design simplicity you get because your high-gain Motorola n-channel FET allows for direct pickup from the transducer, provides outstanding power gain and does not load the driver device. (Think about assembly time saved and the reliability of performance, too.)

Top this off with the knowledge that you're getting reliable Unibloc one-piece plastic-package transistors that provide long-life, rugged performance and *you see the total happiness picture!*

*— where the priceless ingredient is care!*

Here's a look at the performance-rated specifications that make it all possible:

Characteristic	Device Type	Symbol	Min	Typ	Max	Unit
Drain Current	MPF103	$I_{DSS}$	1	3	5	mAdc
	MPF104		2	6	9	
	MPF105		4	9	16	
Forward Transfer Admittance	MPF103	$ Y_{fs} $	1000	3000	5000	$\mu\text{mhos}$
	MPF104		1500	4000	5500	
	MPF105		2000	4500	6000	
Breakdown Voltage	All Types	$V_{(BR)GSS}$	-25			Vdc
Gate Reverse Current	All Types	$I_{GSS}$			-1	nAdc
Input Capacitance	All Types	$C_{iss}$		4.5	7	pF

\*Trademark of Motorola Inc.

Your nearest Motorola semiconductor distributor has units for immediate evaluation. For complete details on how *you can find happiness* with Motorola's new 50¢ FETs, call your local Motorola district office or send for our data sheet.



**MOTOROLA**  
**Semiconductors**

MOTOROLA SEMICONDUCTOR PRODUCTS INC. / P.O. BOX 955, PHOENIX, ARIZONA 85001 / (602) 273-6900 / TWX 910-951-1334

ON READER-SERVICE CARD CIRCLE 7



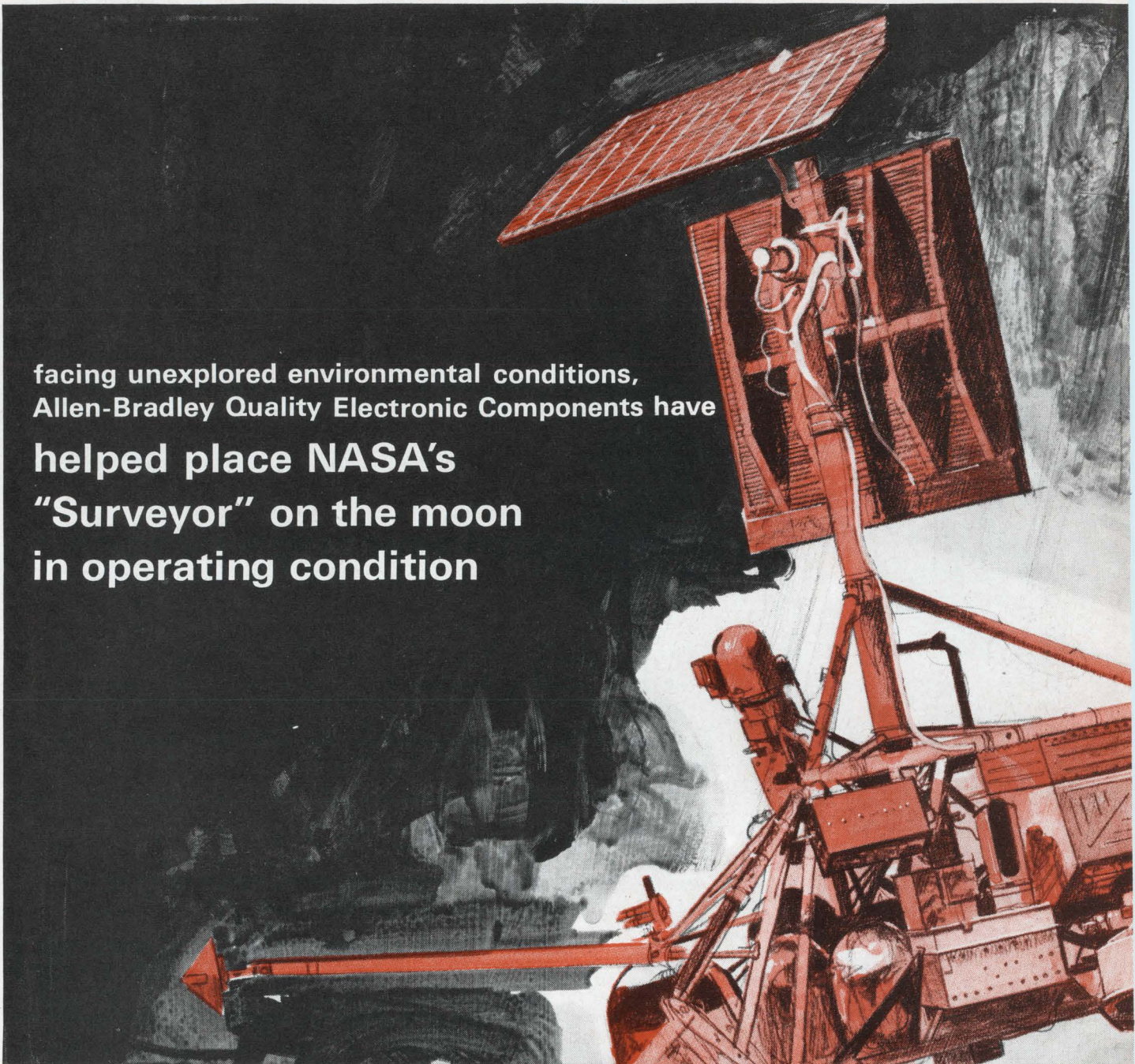

◀ ON READER-SERVICE CARD CIRCLE 6

7

facing unexplored environmental conditions, Allen-Bradley Quality Electronic Components have helped place NASA's "Surveyor" on the moon in operating condition



**A-B QUALITY ELECTRONIC COMPONENTS THAT CONTRIBUTED TO THE "SURVEYOR'S" SUCCESS**

	MIL TYPE RC 05
	MIL TYPE RC 07
	MIL TYPE RC 20
	MIL TYPE RC 32
	MIL TYPE RC 42

**ALL A-B HOT MOLDED FIXED RESISTORS** are available in all standard EIA and MIL-R-11 resistance values and tolerances, plus values above and below standard limits. Shown actual size.



**FEED-THRU CAPACITORS**

A-B feed-thru capacitors have a discoidal design that eliminates all parallel resonance effects at 1000 MHz and less. Insulation resistance exceeds 100,000 megohms. Standard values are 470 uuf  $\pm 20\%$  and 1000 uuf GMV. Special values from 6.8 uuf to 1500 uuf. Rated to 500 v DC maximum. A-B discoidal capacitors are also available in the stand-off construction.

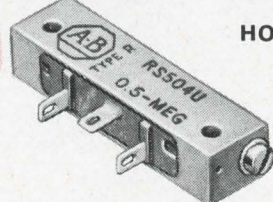

**HOT MOLDED VARIABLE RESISTORS**

Type R trimming potentiometers provide stepless adjustment and are essentially noninductive. Molded cases are dust-tight and watertight. Rated 1/4 watt at 70°C. Values from 100 ohms to 2.5 megohms. Tolerances of  $\pm 10\%$  and  $\pm 20\%$ .

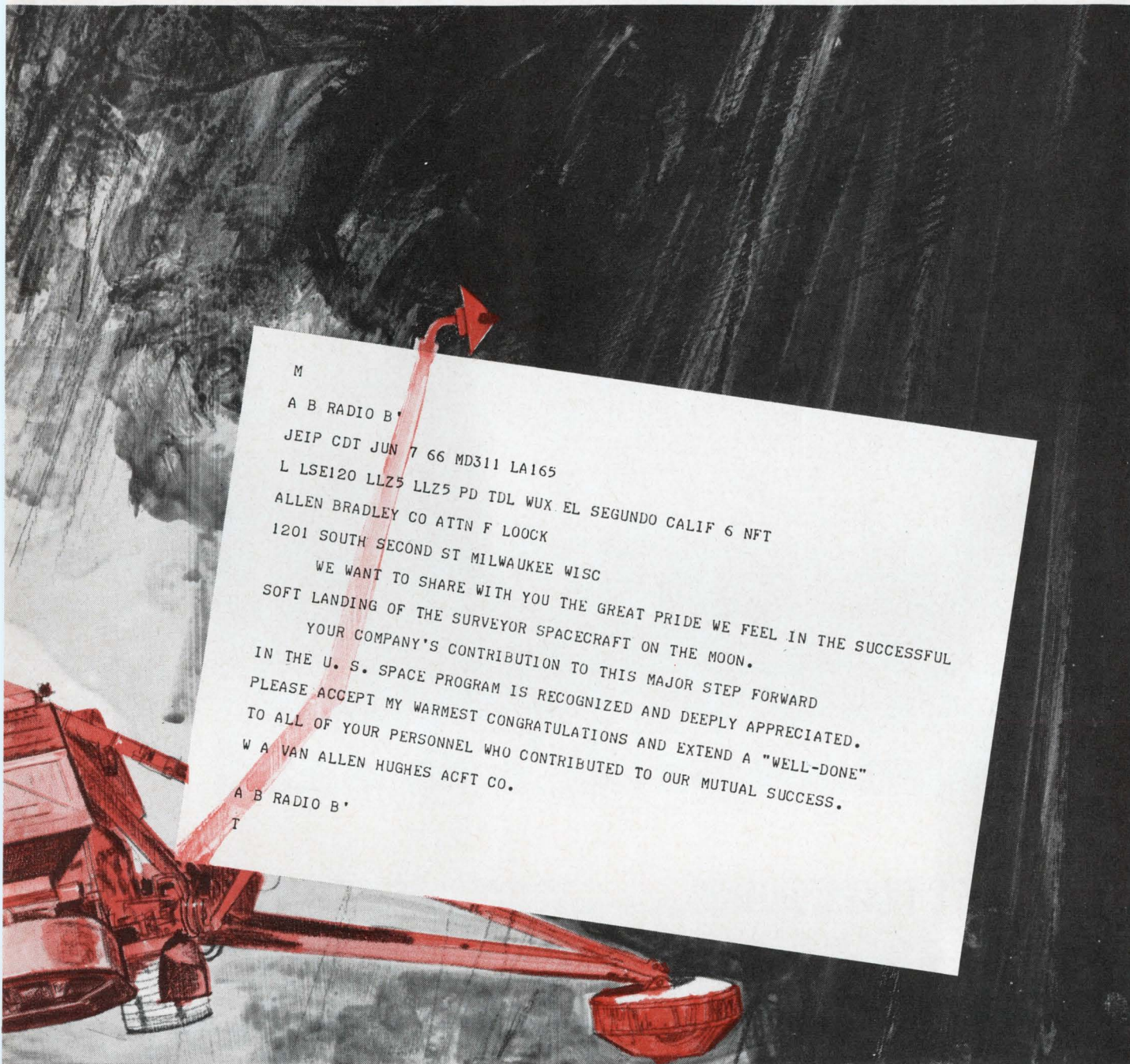

M  
 A B RADIO B\*  
 JEIP CDT JUN 7 66 MD311 LA165  
 L LSE120 LLZ5 LLZ5 PD TDL WUX EL SEGUNDO CALIF 6 NPT  
 ALLEN BRADLEY CO ATTN F LOOCK  
 1201 SOUTH SECOND ST MILWAUKEE WISC  
 WE WANT TO SHARE WITH YOU THE GREAT PRIDE WE FEEL IN THE SUCCESSFUL  
 SOFT LANDING OF THE SURVEYOR SPACECRAFT ON THE MOON.  
 YOUR COMPANY'S CONTRIBUTION TO THIS MAJOR STEP FORWARD  
 IN THE U. S. SPACE PROGRAM IS RECOGNIZED AND DEEPLY APPRECIATED.  
 PLEASE ACCEPT MY WARMEST CONGRATULATIONS AND EXTEND A "WELL-DONE"  
 TO ALL OF YOUR PERSONNEL WHO CONTRIBUTED TO OUR MUTUAL SUCCESS.  
 W A VAN ALLEN HUGHES ACFT CO.  
 A B RADIO B\*  
 T

Why were these A-B hot molded fixed and variable resistors selected for such critical service as in the "Surveyor"? First, because no A-B hot molded resistor component has ever been known to fail catastrophically under rated load—either mechanically or electrically. Second, due to the method of manufacture, you can select one A-B resistor from among ten or from ten million, and be confident there will be no variation in electrical characteristics. Incidentally, this is *not* the first "shipment" of Allen-Bradley resistors delivered to the moon—they are "standard equipment" in "space mission" service.

There are sound economic advantages to standardizing on A-B hot molded fixed and variable resistors for use here on Earth as well! As many electronic equipment manufacturers have learned—sometimes through sad experience—no other resistors will provide the consistently high reliability of Allen-Bradley hot molded resistors. They may cost a bit more, but—you must not expect to obtain "equivalent quality" at a lower price! Allen-Bradley Co., 1344 South Second St., Milwaukee, Wisconsin 53204. In Canada: Allen-Bradley Canada Limited. Export Office: 630 Third Avenue, New York, New York, U.S.A. 10017.



**ALLEN-BRADLEY**

QUALITY ELECTRONIC COMPONENTS

ON READER-SERVICE CARD CIRCLE 8

# New from Sprague!

the industry's lowest-cost SCR triggers...

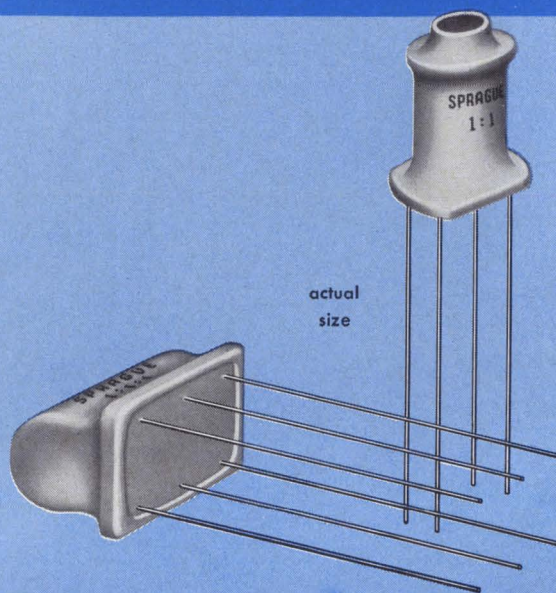

...now have pin leads for printed boards!

## TRIGATE\* PULSE TRANSFORMERS...

Dependable enough for industrial equipment, yet priced for high-volume commercial applications

Here's good news for designers of appliances, lighting controls; air-conditioning and heating controls; industrial controls. You can actually cut costs while upgrading your present method of SCR triggering! Type 11Z Trigate Pulse Transformers offer these outstanding features:

- Balanced pulse characteristics and energy transfer from primary to secondary and tertiary windings.
- Minimum saturation effect to allow operation where increased pulse widths are required.
- Fast pulse rise time and increased current capability to prevent SCR di/dt failure.
- Increased energy transfer efficiency.

\*Trademark

- Operating temperature range,  $-10\text{ C}$  to  $+105\text{ C}$ .
- 2- and 3-winding designs for half- and full-wave applications.
- Turns ratios — 1:1, 1:1:1, 2:1, 2:1:1, 5:1.
- Available for use with line voltages up to 240 VAC or 550 VAC.
- Inductances to 1 millihenry at 550 VAC, 5 millihenries at 240 VAC.

### New configuration for ease of mounting

To eliminate the need for mounting brackets, particularly on printed wiring boards, Trigate Pulse Transformers are now available in single-ended construction with pin leads. Conventional axial-lead units are also available for point-to-point wiring.

For complete information, write for Engineering Bulletin 40,003A to the Technical Literature Service, Sprague Electric Co., 347 Marshall St., North Adams, Mass. 01247.

## SPRAGUE COMPONENTS

PULSE TRANSFORMERS

CAPACITORS

TRANSISTORS

THIN-FILM MICROCIRCUITS

INTEGRATED CIRCUITS

4 SSC-6159

RESISTORS

INTERFERENCE FILTERS

PULSE-FORMING NETWORKS

TOROIDAL INDUCTORS

ELECTRIC WAVE FILTERS

CERAMIC-BASE PRINTED NETWORKS

PACKAGED COMPONENT ASSEMBLIES

BOBBIN and TAPE WOUND MAGNETIC CORES

SILICON RECTIFIER GATE CONTROLS

FUNCTIONAL DIGITAL CIRCUITS

# SPRAGUE®

THE MARK OF RELIABILITY

'Sprague' and '®' are registered trademarks of the Sprague Electric Co.

ON READER-SERVICE CARD CIRCLE 9

ELECTRONIC DESIGN 29, December 20, 1966

# News

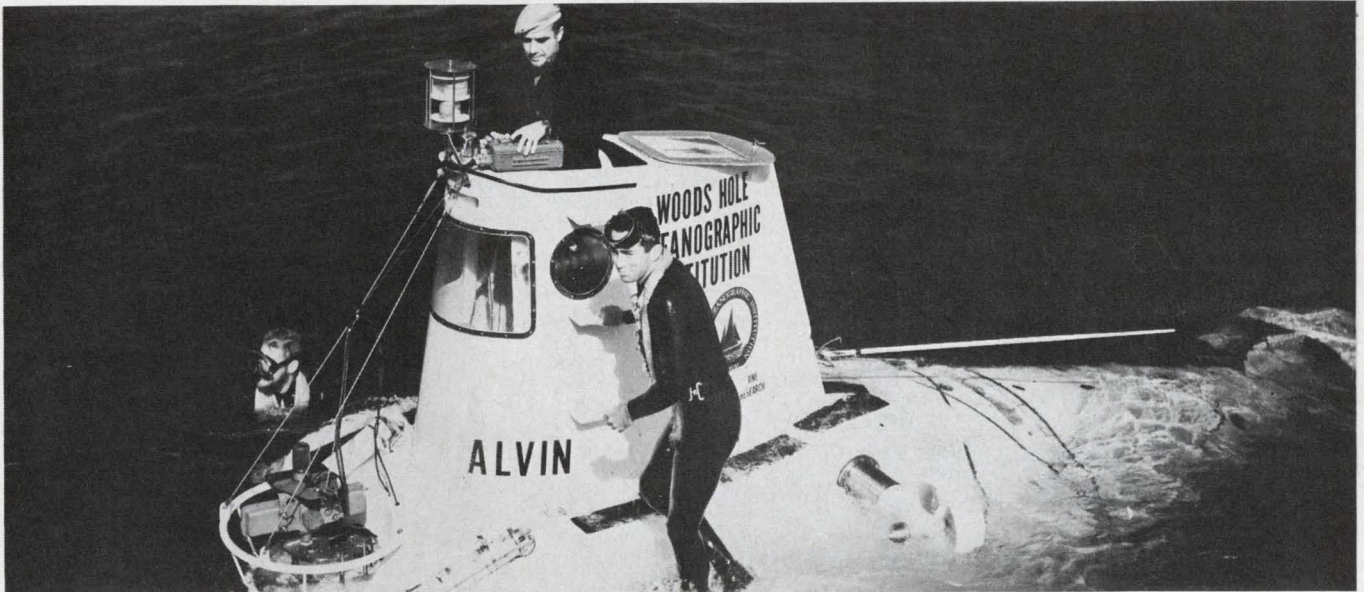

**Electronics has an increasingly important role in oceanography as man opens up the world's**

**least known element. This research craft operates down to 6000 feet. Page 34**

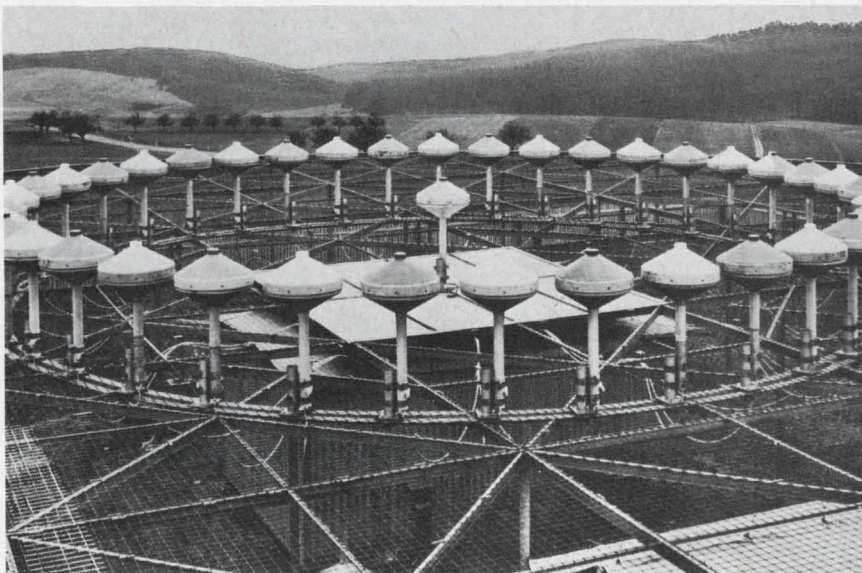

**This giant ring of antennas for VOR systems reduces site errors caused by RF reflections in mountain areas. Page 30**

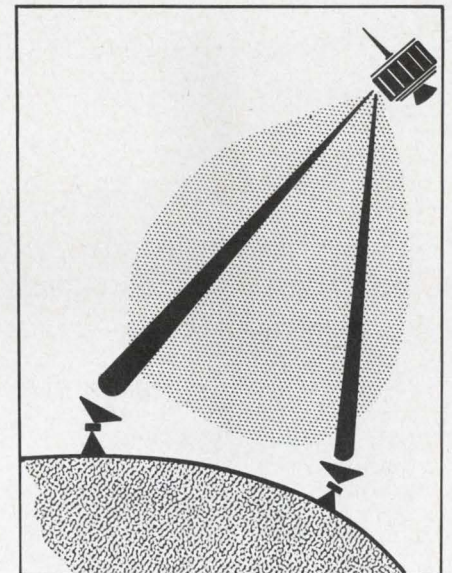

**Satellite phased array to aid communications. Page 21**

## Also in this section:

**New power FETs approach five watts at 500 MHz now, at 1 GHz soon. Page 17**

**Microform system compresses 3200 pages onto tiny slide. Page 30**

**News Scope, Page 13 . . . Washington Report, Page 29 . . . Editorial, Page 59**

# gigacycle counters

Only Systron-Donner can give you microwave frequency measuring systems, fully contained in one cabinet, that read directly in gigacycles. Just like this 11 gigacycle reading.

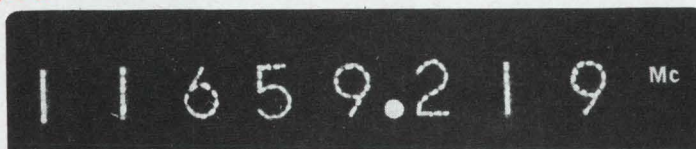

This one reads gigacycles instantly and automatically—eliminating all risk of human error. It's made possible by our unique plug-in, an Automatic Computing Transfer Oscillator called ACTO® for short.

There are three ACTOs, but you need only the one for the range you're working in: 0.3 to 3 GHz, 3 to 8 GHz, or 8 to 12.4 GHz.

The one at right requires simple tuning, but it measures FM, FM deviation, and pulsed RF as well as CW. The plug-in is our semi-automatic transfer oscillator with phase lock to get counter accuracy. The T.O. range is so wide that this cabinet will measure the entire spectrum from dc to 15 GHz.

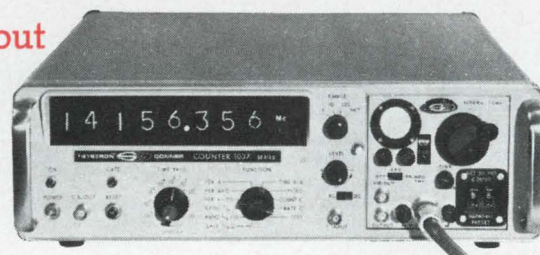

This group illustrates the Systron-Donner philosophy of advanced counter instrumentation. A basic counter or counter-timer measures to 100 MHz. Plug-ins add functions or extend the frequency range with unequalled convenience and economy.



Send for this instructive booklet.

Systron-Donner Corporation, 888 Galindo Street, Concord, California

**How to  
get digital  
readings  
of microwave  
frequency**

SYSTRON  DONNER

SYSTRON  DONNER

ON READER-SERVICE CARD CIRCLE 10

# News Scope

## New antiradar missile speeded for Vietnam

The Pentagon has decided to speed up development of a new air-launched antiradar missile for use in Vietnam. It would counter the increasingly effective communist anti-aircraft and SAM missile sites.

The new weapon, known as Interim ARM (antiradiation missile), has already been flight-tested, but several more months of development work are said to lie ahead. All signs point to a crash program to get the antiradiation missile in combat some time next year.

Pentagon sources say the ARM could turn into a billion-dollar program if the missile proves effective. The Naval Ordnance System Command is supervising the program.

The ARM missile is similar to—but an improvement over—Texas Instruments' Shrike antiradar missile, currently being used by U. S. fighter-bombers over North Vietnam. Shrike is designed to fly down an enemy's anti-aircraft radar beams and explode upon hitting the installation. The missile has reportedly been less effective recently, because

the North Vietnamese have adopted relatively simple countermeasures. These include blinking ground radars off and on to prevent the Shrike from locking on to them. The wide-open, tuned radio-frequency receiver in the Shrike's homing head then picks up signals from other emitters, and the missile is steered awry.

The Shrike system is also being "confused" by spurious reflections caused by multiple propagation paths from hostile emitters. Nevertheless, the Navy plans to buy more Shrike antiradar missiles until the ARM is ready to be put into operational use.

It is reported that the North Vietnamese are using large numbers of old U.S. SCR-584 ground-fire control radars to send up the decoy beam against incoming Shrikes. These radars are now used to direct conventional anti-aircraft fire against low-flying U.S. combat aircraft that seek to evade detection and tracking while attacking the SAM sites.

Sanders Associates is now report-

ed to the refurbishing SCR-584s to try to develop countermeasures that will prove effective against the conventional anti-aircraft fire that is directed by the North Vietnamese SCR-584 radars.

Pentagon officials view the new ARM missile as a further escalation of the quiet but grim electronics war, which is pitting U. S. ingenuity against that of North Vietnam, Russia and China.

## Electronics to help revive the Port of New York

Completely automated cargo-handling facilities may give a lift to New York City's shipping industry. According to the city's Deputy Transportation Administrator, Leo G. Brown, three large electronics firms are conducting studies to determine the feasibility of high-rise container warehouses.

These warehouses would be 10 stories high and located right on waterfront piers. Using computer-controlled, automated equipment, these facilities could receive and store a cargo container in 90 seconds. Operation would be similar to automatic parking garages where automobiles are handled by automatic elevators. Containers used for ocean-going cargo measure approximately 20 feet by 8 feet square and would be inserted and removed automatically from bins in the cellular type of warehouse.

Brown says that New York is now the nation's leading port but it will require an intelligent and aggressive development program to maintain and expand this lead over competing cities. According to Brown, New York's automated facilities could become a model for other ports about the country to follow.

Brown describes the electronic industry's role in this development as "very important since one of the main advantages is rapidity and rapidity depends on electronics."

Besides improving the employment and cargo-handling picture for New York, the vertically expanded facilities would make maximum use of costly waterfront real estate. The 10-story container terminals could, according to Brown, perform the same cargo-handling operations that presently require open areas from 10 to 15 acres for each large con-

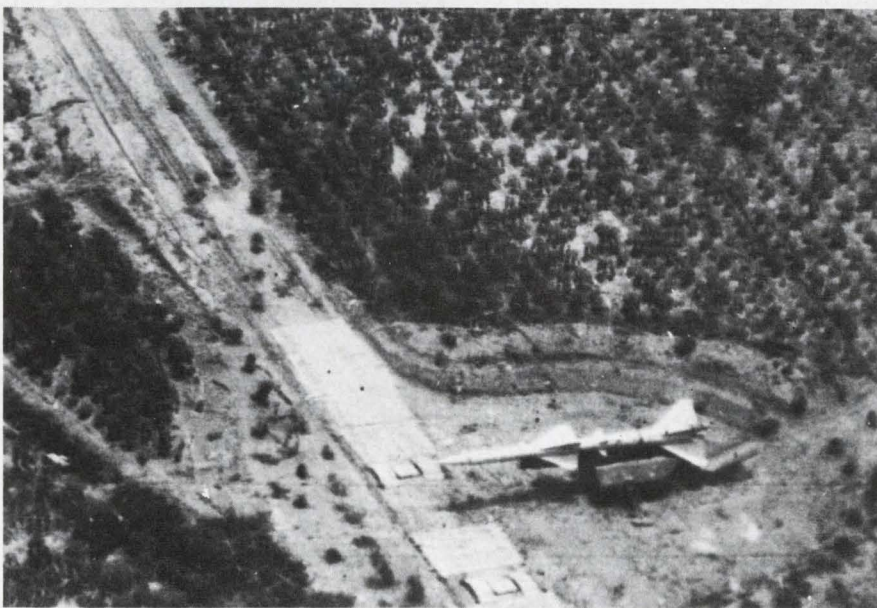

The target of U.S. military effort: SAMs in North Vietnam.

tainer vessel. This is a major consideration since companies operating container vessels have been moving to outlying areas where land is more available and less costly than in such built-up areas as Manhattan and Brooklyn.

Should the feasibility study yield positive results, Brown believes that the Federal Government might be asked to provide some financial support for development of the automated facilities.

Containerized cargo accounts for an increasing amount of the waterborne commerce handled in major ports both in the United States and abroad. This "modularization" of cargoes increases the opportunities for standardized, rapid-handling operations which include the terminal-cargo vessel interface.

## Supersonic jet skims peaks, guided by radar

Terrain-following radar has enabled a U.S. Air Force F-111A to fly at supersonic speed for 15 minutes at less than 1000 feet over mountainous country.

The longest low-level flight that has ever been made at supersonic speed, it was flown partly under automatic electronic control.

The radar was developed by Texas Instruments, Inc., Dallas. It scans ahead and to both sides of the aircraft. For manual flight control, radar signals are supplied to the pilot's cockpit display. For automatic flight, on the other hand, the signals are fed to the autopilot.

An analog computer generates climbing and diving signals after the altitude for the terrain-following flight is selected. The radar system automatically checks its own operation and commands the aircraft into a sharp climb to a safe altitude if the system malfunctions or if it senses any questionable topographical feature.

A ground-mapping feature gives the pilot a visual display of the terrain ahead. The system can also assist the pilot in descending under zero-visibility conditions.

The F-111A fighter-bomber tested the radar system over mountainous country in southern Nevada and California, where the peaks exceeded 8000 feet. The test plane flew more than 150 nautical miles on its first 15-minute dash. Half the time it was on automatic mode, the other half on manual.

Even lower flights are planned with the system in the future.

Fast, low-level flying capability is needed frequently on tactical missions to enable aircraft to "slip under" enemy detectors.

## Satellite observatories undergo close scrutiny

A NASA review board has recommended drastic action to salvage the agency's \$741.2 million observatory satellite program. It suggested:

- Redesign of outmoded electronic equipment that performed unexpectedly poorly in space.

- Institution of rigorous preflight testing with prototype models under conditions simulating those that exist in space.

- Stronger management of observatory programs within the space agency and sharper surveillance of performance at contractors' plants.

The review board was set up last April under Robert F. Garbarini, deputy for engineering to Dr. Homer E. Newell, NASA's associate administrator for space science, in the wake of growing concern by Congressmen, the scientific community, the budget makers and NASA alike.

Since 1959 a whole family of heavy and costly observatory spacecraft has been developed and launched at the space agency's Goddard Space Flight Center, Greenbelt, Md.—the Orbiting Solar Observatory (OSO), Nimbus (an advanced weather satellite), the Orbiting Geophysical Observatory (OGO), and the Orbiting Astronomical Observatory (OAO).

Of eight observatories successfully put into orbit, three failed to function. When OAO died last April two days after it was launched and with 12 more observatories still due to be launched, NASA called for the board to make its review.

The review board's report did point out one extenuating factor: all the observatories were designed

between September, 1959, and January, 1961, at a time when the spacecraft art was appreciably less advanced than it has since become.

## H-power trigger tests hit 100,000°K with RF

Experiments using hf waves to trigger thermonuclear fusion have inched nearer to success.

The University of Texas Center for Plasma Physics and Thermonuclear Research has determined an optimum excitation frequency to bring a hydrogen plasma to the extremely high temperatures needed to cause fusion. The absorption of energy by the plasma rises sharply at certain excitation frequencies, rather as resonance phenomena do.

Dr. Hans Schluter, professor of physics at the university, told a meeting of scientists at Austin that experiments to determine the optimum frequency had closely approximated theoretical predictions.

Current methods employing ion and electron cyclotron heating do not produce the requisite temperatures, which have been only on the order of 100,000°K, well below the requirement for fusion. The new method employs a frequency which is the geometric mean between the ion and the electron frequencies.

## Safety laser marks GE's entry into auto market

The General Electric Co.'s Semiconductor Products Dept. has crashed into the automotive electronics field with a number of solid-state devices designed to enhance driver convenience and safety.

Among the devices announced at a recent press conference were battery choppers, temperature controls, a propulsion control device, a solid-state ignition system and a system called LADAR (laser distance and ranging).

LADAR, designed to counteract tail-gating, uses infrared light pulses to detect distances between vehicles. It can touch off warning signals or start braking action when one vehicle approaches another too closely.

The signal-processing circuit used with LADAR would be employed to measure the rate of closure, or relative speed, between the vehicle and an object within the beam.





## A DC VOLT-OHMMETER WITH NO RANGE SWITCH!

**More time saved**—Put an end to tedious, time-consuming manual range switching with the new Hewlett-Packard 414A Autovoltmeter. Just touch and read... range and polarity change automatically. You read range and polarity on the digital readout above the analog meter.

**More accuracy**—And the analog meter lets you measure  $\pm 5$  mv to  $\pm 1500$  v full scale, 12 ranges, with an accuracy of  $\pm 0.5\%$  of full scale  $\pm 0.5\%$  of reading; 5 ohms to 1.5 megohms, 12 ranges, accuracy 1% of reading  $\pm 0.5\%$  of full scale.

### All this for just \$650!

**More uses**—The 414A is the world's first "touch-and-read" analog volt-ohmmeter with accuracy anywhere approaching what you require for trouble shooting, tweaking, peaking and nulling, probing a circuit without a schematic. Use it for maintenance testing, on the production line, in the lab.

In the dc voltage function you simply touch the point to be measured and in less than 300 msec read the range and polarity on the digital display and the precise dc measurement on the individually calibrated, mirror-backed taut-band meter. Automatic ranges are selected and displayed for resistance measurements, too.

**More noise rejection**—Ranges also can be selected and held manually, and a Down Range control feature lets you drop to the next lower range merely by pushing a front-panel button.

Input resistance is 10 megohms on the 5 and 15 mv ranges, 100 megohms on 50 mv range and above. The 414A is insensitive to 60 cps signals with peak value less than 7 times the full-scale dc level of range in use in "Hold" position (rejection is 20% of reading when using Auto-ranging).

To get the true significance of this automatic instrument, you need to see it perform on your bench. Call your Hewlett-Packard field engineer for that convincing demonstration. Or write for complete information to Hewlett-Packard, Palo Alto, Calif. 94304, Tel. (415) 326-7000; Europe: 54 Route des Acacias, Geneva.

*Data subject to change without notice. Price f.o.b. factory.*

**HEWLETT**  **PACKARD**  
An extra measure of quality

ON READER-SERVICE CARD CIRCLE 11

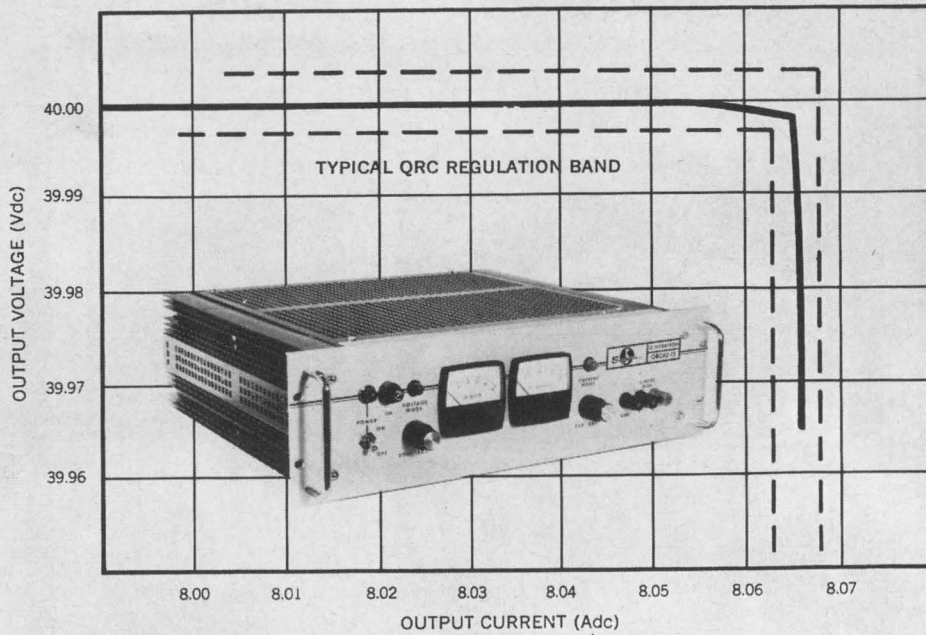

Automatic crossover between constant voltage and constant current modes

# Sorensen QRC Power Supplies offer $\pm .005\%$ regulation

ON READER-SERVICE CARD CIRCLE 879

The Sorensen QRC series—wide range, transistorized power supplies—provide constant voltage/constant current regulation so sharp the units operate without ever leaving the specified regulation band. Voltage regulation is  $\pm .005\%$  for line and load combined. The QRC's are provided with front panel dial set adjustment of voltage and current limits, as well as voltage/current mode indicator lights. Other design features include: Low ripple . . . 1 mV rms • No turn-on/turn-off overshoots • Remote sensing and

programming • Series/parallel operation • Input voltage 105-125 or 201-239 Vac, 50-400 c/s • Temperature capability to 71°C • RFI spec meets MIL-I-26600 and MIL-I-6181D. All Sorensen power supplies conform to proposed NEMA standards. For QRC details, or other standard/custom power supplies, AC line regulators or frequency changers, contact your local Sorensen rep, or write: Raytheon Company, Sorensen Operation, Richards Ave., Norwalk, Connecticut 06856 Tel: 203-838-6571.

#### ELECTRICAL & MECHANICAL SPECIFICATIONS

MODEL NUMBER	OUTPUT VOLTAGE RANGE (Vdc)	CURRENT OUTPUT RANGE (Adc)	VOLTAGE REGULATION (LINE & LOAD COMBINED)	RIPPLE VOLTAGE (rms)	CURRENT REGULATION	RIPPLE CURRENT (rms)	RACK HEIGHT (INCHES)	PRICE
QRC20-08A	0-20	0-8	$\pm .005\%$ or $\pm 1$ mv	1 mv	$\pm 0.5\%$ or $\pm 4$ ma	1 ma	3½	\$410.00
QRC20-15A	0-20	0-15	$\pm .005\%$ or $\pm 1$ mv	1 mv	$\pm 0.5\%$ or $\pm 8$ ma	2 ma	5¼	525.00
QRC20-30A	0-20	0-30	$\pm .005\%$ or $\pm 1$ mv	1 mv	$\pm 0.5\%$ or $\pm 16$ ma	4 ma	7	700.00
QRC40-4A	0-40	0-4	$\pm .005\%$ or $\pm 1$ mv	1 mv	$\pm 0.5\%$ or $\pm 3$ ma	1 ma	5 †	315.00
QRC40-8A	0-40	0-8	$\pm .005\%$ or $\pm 1$ mv	1 mv	$\pm 0.5\%$ or $\pm 4$ ma	1 ma	3½	450.00
QRC40-15A	0-40	0-15	$\pm .005\%$ or $\pm 1$ mv	1 mv	$\pm .05\%$ or $\pm 8$ ma	2 ma	5¼	575.00
QRC40-30A	0-40	0-30	$\pm .005\%$ or $\pm 1$ mv	1 mv	$\pm .05\%$ or $\pm 16$ ma	4 ma	7	775.00

†Half rack



FOR FOREIGN SALES AND PRICES consult nearest facility. CONTINENTAL EUROPE: Sorensen-Ard-ag AG, 8045 Zurich, Switzerland, Binzstrasse 18. FRANCE: Sorensen-France, 25 A Rue du Chablais, 74 Annemasse; GERMANY: Sorensen G.m.b.H, 6 Frankfurt am Main, Wilhelm-Leuschnerstrasse 93, UNITED KINGDOM: Cossor Instruments Ltd., The Pinnacles, Elizabeth Way, Harlow Essex, England. ALL OTHER FOREIGN SALES: Raytheon Company, International Sales and Services, Lexington, Massachusetts 02173, U.S.A.

# Odd power FETs sprint toward 1 GHz

**Five watts at 500 MHz are imminent—  
same power at 1 GHz is expected by midyear.**

**Roger Kenneth Field**  
Microelectronics Editor

Scientists are using two different approaches to develop high-frequency field-effect transistors capable of gains comparable to those of bipolar transistors.

■ One approach controls the flow of current through the FET with a grid structure embedded between the anode and cathode. Dr. Stanislaw Teszner, working under a U.S. Navy contract at the Centre National d'Etudes des Telecommunications in France, is outfitting a 12-by-12-mil chip with 3000 channels. Called a Gridistor, the device is to be capable of five watts at 500 MHz. It should be operating next month.

Meanwhile, though Teszner's Gridistor is protected in this country by U.S. patents 29380950 (1960) and

3274461 (1966), Reiner Zuleeg is doing parallel work with a team at Hughes Aircraft Co., Newport Beach, Calif.

They have obtained two watts at 100 MHz with a 500-channel FET and anticipate attaining five watts at that frequency with 1200 channels. Zuleeg terms his multichannel FET a MUCH-FET.

■ A radically different approach, being explored by Munny Mitchell at RCA, Somerville, N. J., uses no embedded grids at all. He has constructed a MOS tetrode by integrating two MOS triodes on a single chip. The resulting cascode circuit has already achieved a 12-dB gain at a startling 800 MHz. Mitchell furthermore expects to produce a MOS tetrode within half a year that will deliver five watts and sustain a gate voltage in excess of 70

volts without breaking down.

Teszner's Gridistor may look like a wafer maker's nightmare (see Fig. 1) but it is constructed in a modest number of simple steps: a layer of n-doped silicon is epitaxially grown to approximately half its ultimate thickness on an n+ substrate. A fine spiral groove is etched into the thin working surface and after proper masking, p+ silicon is grown into (and a little higher than) this groove. All but the p+ outer ring and the p+ bullseye are covered by a growth of additional silicon, the surface of which is then heavily doped by a diffusion that forms the cathode,  $K_{N+}$ .

Any positive potential on the grid establishes an electrostatic field between its elements and prevents the flow of holes from anode to cathode. Hence this FET, like the junction-FET, is a depletion device. The diameter of the grid strand is merely 10 microns; the total surface area of the grid is negligible; the gate capacitance is but a few picofarads. So, several chips can be mounted in one header and connected in parallel to obtain more power without impairing the excellent high-frequency response. Zuleeg makes similar observations about his device (see Fig. 2.)

The problem of dissipating the heat from four chips on one header is not insoluble because of the fairly high efficiency of the Gridistor—even an early version reached 49%. (Though the efficiency of the advanced model has not yet been determined, it is expected to be comparable to that of its predecessor. See Fig. 3.)

According to Teszner, the Gridistor is theoretically capable of from 50 to 100 per cent more power at high frequency than an overlay transistor of the same surface area. If the Navy gives him the go-ahead, Teszner plans to develop a 6000-channel Gridistor that delivers either 10 watts at 600 MHz or 5 watts at 1 GHz. This, he believes, could be accomplished in less than a year.

(continued on page 18)

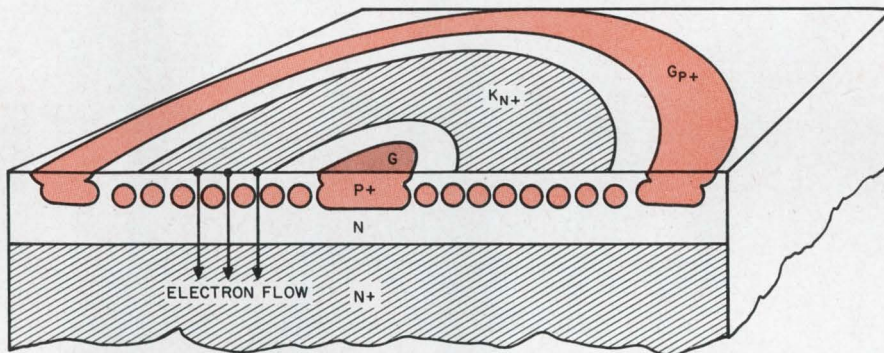

1. Electrons must pass between spiral grid elements to go from cathode,  $K_{N+}$ , to  $N+$  substrate. But small voltages on the gate,  $G_{P+}$ , create a field that can impede or stop the flow.

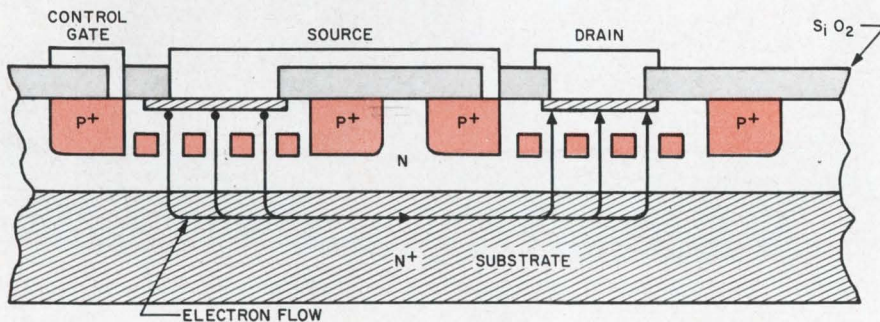

2. The Hughes MUCH-FET includes an insulating layer of silicon dioxide. Source and drain are on the same side of the chip.

Though both Teszner and Mitchell have successfully driven their FETs higher than 500 MHz, Mitchell's, at 800 MHz, is running very near the optimum theoretical frequency at which it can deliver good gain. "To increase the frequency to where we've got it, the

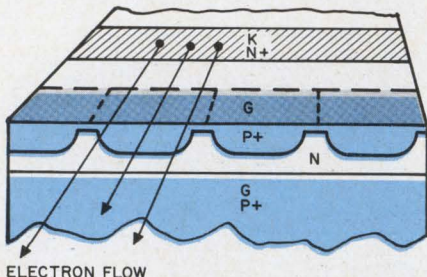

3. Electrons flow across the early CNET (French) Gridistor. The anode (not seen) is in front of the cross-section and is symmetric with cathode.

channel length must be minimized," he says. "Ours is down to 0.1 mil," he notes, "but any further decrease will make the electric field in the channel excessive. When that happens, the surface mobility of the charge carriers decreases and an excessive amount of power is needed to attain high-frequency performance."

To attain the present performance, Mitchell found he had to minimize the effect of the gate-to-source capacitance in the second MOS triode. This he did by placing an inductor between the second gate and ground. This tuning of the second gate reduces the noise figure and substantially improves the high-frequency power gain (see Fig. 4).

So far FETs have offered reduced feedback capacitance and output conductance along with better cross-modulation and dynamic

range than bipolar transistors. If these developments continue without faltering, the FET may also offer its user gain  $\times$  bandwidth comparable to, or even better than, that of its bipolar brother. ■ ■

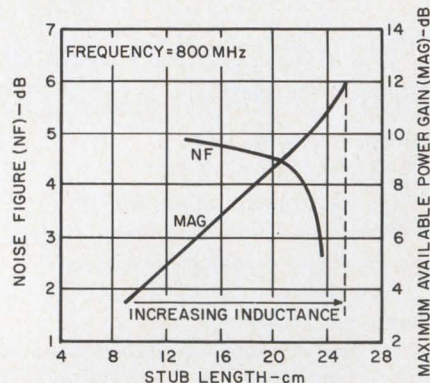

4. The stub length determines the inductance used to tune the second MOS triode. The inductance counteracts the gate-to-source capacitance.

## Synthetic quartz takes Q from natural product

Man-made quartz crystals are growing to full stature and are expected to rival the natural product soon, as a result of an improved growing process.

Researchers at Bell Telephone Laboratories and the Western Electric Company have shown that the Q of quartz crystals can be increased tenfold, to about one million—and, under special conditions of temperature and pressure, to two million.

The low Q values of previous synthetic quartz crystals are attributed to the absorption of water or hydroxyl in the growing process. In the new method, lithium nitrate is added to the sodium hydroxide solution in the hydrothermal crystal-growing process, to inhibit the absorption of water.

To detect the presence of water, infrared radiation is applied to the crystals. Those made without lithium nitrate absorb more radiation, indicating the presence of water or hydroxyl, and they have lower Q values.

The new method will make possible the use of man-made quartz crystals at frequencies hitherto confined to the natural product, according to the researchers. ■ ■

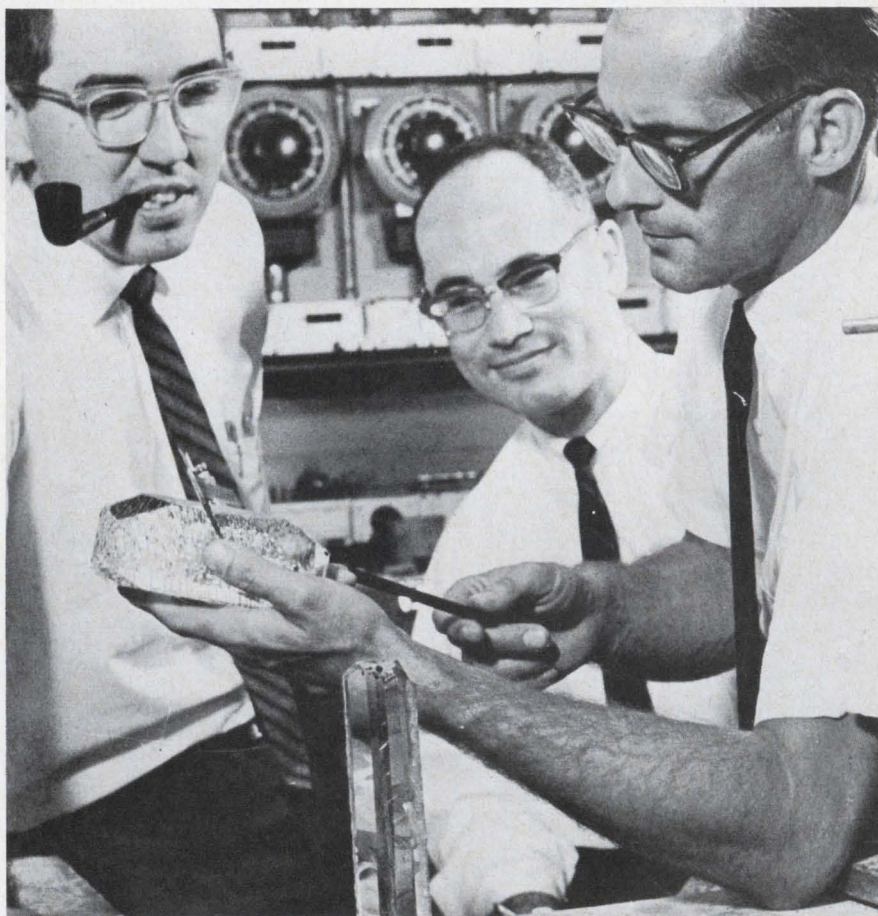

Man-made quartz crystals, with characteristics approaching those of the natural product, are inspected by Bell System men who developed them. The

new crystals will displace natural quartz in many critical, high-frequency applications, such as oscillators and highly selective wave filters.

# DC/AC/Ohms Standards Lab precision

# ... for automated systems measurements



**The Auto Data 5100 from 3M** Ultra precise electrical measurements with systems capability, convenience and flexibility.

- Full 5 digit readout incorporating precision continuous balance improved by "successive decade approximation" technique.
- DC Accuracy  $\pm 0.002\%$  of reading,  $\pm 0.002\%$  of full scale, with a sensitivity of  $10 \mu$  volts/digit.
- Decimal resistance ratio bridge switched by sealed reed relays to provide maintenance-free laboratory accuracy, linearity and stability.
- DC Ratio mode with same specifications as DC measurement.
- Wide-band AC Converter with accuracy  $\pm 0.05\%$  of reading,  $\pm 0.05\%$  of full scale, sensitivity of  $100 \mu$  volts/digit.
- Ohms measured by true Ohmmeter principle—4 wire input converter—entirely independent of voltage calibra-

tion. Ohms accuracy  $\pm 0.003\%$  of reading,  $\pm 0.003\%$  of full scale with a sensitivity of 1 milliohm/digit.

- Automatic ranging: 4 Voltage ranges; 6 Ohms ranges.
- Isolated digital output in decimal or BCD for data recording or processing.
- Guarded and floating measurement circuitry including programming input and electrical output logic to preserve high common mode rejection and accuracy for systems use.
- All modes: DC, AC, Ohms and Ratio as well as electrical outputs and remote programming can be incorporated simultaneously.

Get all the remarkable details on 3M's Auto Data 5100 Digital Multimeter. Circle the reader reply card now and drop it in the mail—or contact us direct.









**Instrument Products 3M**  
COMPANY

300 SOUTH LEWIS ROAD • CAMARILLO, CALIFORNIA 93010 • PHONE: (805) 482-1911 • TWX: 510-866-7099

ON READER-SERVICE CARD CIRCLE 13

# All from Sprague!

## TWELVE OF OUR MOST POPULAR METALLIZED CAPACITOR TYPES

SPRAGUE TYPE	Case And Configuration	Dielectric	Temperature Range	Military Equivalent	Eng. Bulletin
 <b>680P</b>	hermetically-sealed metal-clad tubular	metallized Metfilm* 'A'	-55 C, +85 C	no specification	2650
 <b>431P</b>	film-wrapped axial-lead tubular	metallized Metfilm* 'E' (polyester film)	-55 C, +85 C	no specification	2445
 <b>155P, 156P</b>	molded phenolic axial-lead tubular	metallized paper	-40 C, +85 C	no specification	2030
 <b>218P</b>	hermetically-sealed metal-clad tubular	metallized Metfilm* 'E' (polyester film)	-55 C, +105 C	CH08, CH09 Characteristic R	2450A
 <b>260P</b>	hermetically-sealed metal-clad tubular	metallized Metfilm* 'K' (polycarbonate film)	-55 C, +105 C	no specification	2705
 <b>121P</b>	hermetically-sealed metal-clad tubular	metallized paper	-55 C, +125 C	no specification	2210C
 <b>118P</b>	hermetically-sealed metal-clad tubular	metallized Difilm® (polyester film and paper)	-55 C, +125 C	CH08, CH09 Characteristic N	2211D
 <b>143P</b>	hermetically-sealed metal-clad "bathtub" case	metallized paper	-55 C, +125 C	no specification	2220A
 <b>144P</b>	hermetically-sealed metal-clad "bathtub" case	metallized Difilm® (polyester film and paper)	-55 C, +125 C	CH53, CH54, CH55 Characteristic N	2221A
 <b>284P</b>	hermetically-sealed metal-clad rectangular case	metallized paper	-55 C, +105 C	no specification	2222
 <b>283P</b>	hermetically-sealed metal-clad rectangular case	metallized Difilm® (polyester film and paper)	-55 C, +125 C	CH72 Characteristic N	2223
 <b>282P (energy storage)</b>	drawn metal case, ceramic pillar terminals	metallized paper	0 C, +40 C	no specification	2148A

\*Trademark

For additional information, write Technical Literature Service, Sprague Electric Company, 347 Marshall St., North Adams, Mass. 01247, indicating the engineering bulletins in which you are interested.

### SPRAGUE COMPONENTS

CAPACITORS  
TRANSISTORS  
RESISTORS  
THIN-FILM MICROCIRCUITS  
INTEGRATED CIRCUITS  
INTERFERENCE FILTERS

PACKAGED COMPONENT ASSEMBLIES  
FUNCTIONAL DIGITAL CIRCUITS  
MAGNETIC COMPONENTS  
PULSE TRANSFORMERS  
CERAMIC-BASE PRINTED NETWORKS  
PULSE-FORMING NETWORKS



\*Sprague and ® are registered trademarks of the Sprague Electric Co

### NEWS

## STATE allows planes to fly in all weather

The first portable all-weather approach and landing system, STATE (Simplified Tactical Approach and Tactical Equipment), that visually informs the pilot of his approach path range and range rate to touchdown while maintaining complete control of his aircraft has been announced by Honeywell Inc.

The system is currently undergoing technical and operational evaluation by the Defense Department as a means to deliver and pick up cargo and make low-visibility approach and landings during inclement weather.

STATE is a C-band pulsed instrument landing system that provides localizer and glideslope information to an aircraft from a minimum acquisition range of 10 nautical miles to touchdown. ■ ■

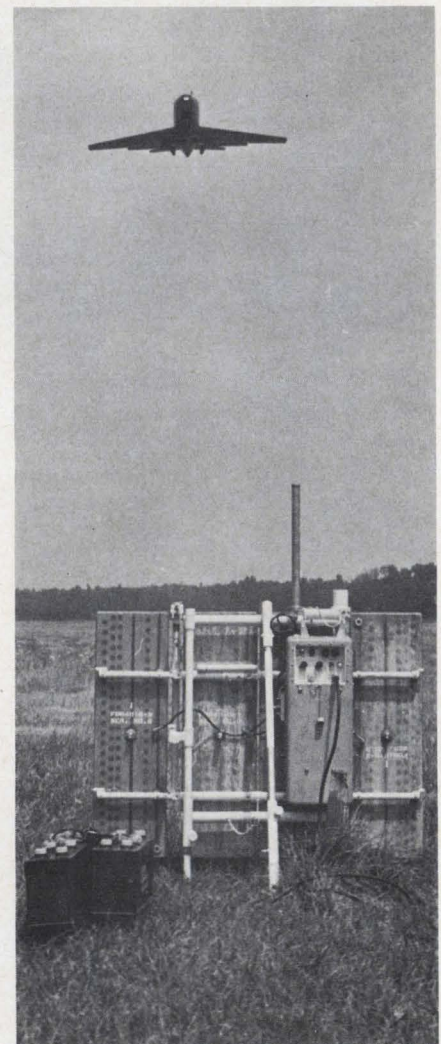

Portable all-weather ground station guides jet into landing.

# Pencil-beam communications studied

## Satellite antenna would cut power consumption and size while strengthening transmitted signal.

**Ron Gechman**  
West Coast Editor

In the continuing struggle to reduce the power consumption and size of satellite communications equipment, one approach under consideration is to employ a phased-array antenna to focus the transmitted signals into a pencil beam. The result would be to increase the power of the signal at the ground-station receiving antenna.

But the approach has been blocked by a big problem: the need for accurate aiming of the beam. As its name implies, the pencil beam transmits a narrow signal, and the receiving station antenna must be in the path of the signal to receive the satellite transmission.

Dr. Alan Lees, chief scientist at Electronic Specialty Co. in Los Angeles, believes he has a remedy. He has devised an "antenna phasing control system" that may make the use of satellite phased arrays more practicable. His simplified elec-

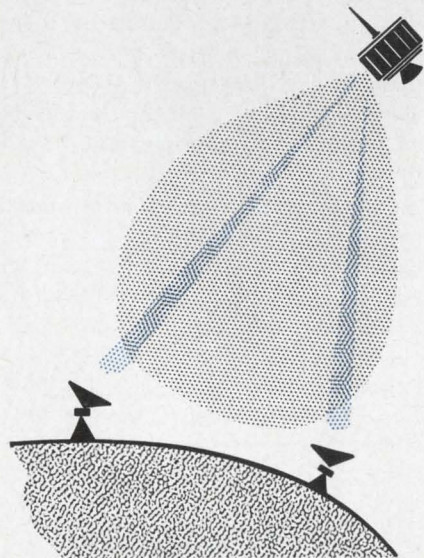

**Pencil-beam transmission** is compared with conventional communication satellite transmissions. Pencil-beam substantially increases the effective power. The on-board electronics accurately aim the signal to the ground receiving station.

tronic beam-steering circuit offers a means for an orbiting satellite to aim a focused beam accurately at any selected ground station on Earth. This approach to global communications makes it possible for an orbiting satellite to send out a focused wave, or beam, with an array of antennas, each two inches or smaller in diameter. The actual size of the antennas depends on the bandwidth and frequency at which the array operates.

### First phased-array antenna flown

Lees is not the only one developing phased-array satellite communication systems. Hughes Aircraft Co., for example, developed the first phased-array antenna installed on a satellite. Earlier this month it was launched aboard the first of five Application Technology Satellites (ATS) into a 22,300-mile-high synchronous orbit over the Pacific. This phased-array antenna provides not a pencil beam but an elliptical-shaped beam measuring about  $18^\circ$  north and south and  $23^\circ$  east and west. Such a shape allows the maximum of radiated signal to be directed toward Earth. Dr. Borris Subbotin, chief scientist at Hughes, said the antenna provides an effective gain that is about 10 times greater than that in communication systems used on the Early Bird and Telstar satellites. These latter systems transmit a  $180^\circ$  pancake-shaped beam. The Application Technology Satellites will be spinning in orbit at about 100 rpm, and the antenna array will be electronically despun, so the array "looks" stationary to both the on-board electronics and the ground stations.

This system still provides total earth coverage and only prevents signals from being radiated uselessly into space. Lee's system narrows this beam further, and it also provides the control electronics for ac-

curate aiming of the radio beam.

Sylvania also is developing a mechanically despun antenna. It is scheduled to be launched aboard another Application Technology Satellite in the spring of 1968. The antenna will spin at the same speed that the satellite is spinning, but in the opposite direction. Again, the antenna will appear stationary.

The principle of phased arrays for shaping transmitted signals into pencil beams has been used to a great extent in radar systems in recent years and is commonly referred to as "coherent focusing." This principle holds particular promise for increasing the effectiveness of satellite communication systems, Lee says.

### Compensates for phase shift

The antenna array, however, causes a phase shift in the received signal, which is compensated for by the on-board electronics. Radio waves approaching an array of antennas from an angle will impinge on the nearest antennas in the ar-

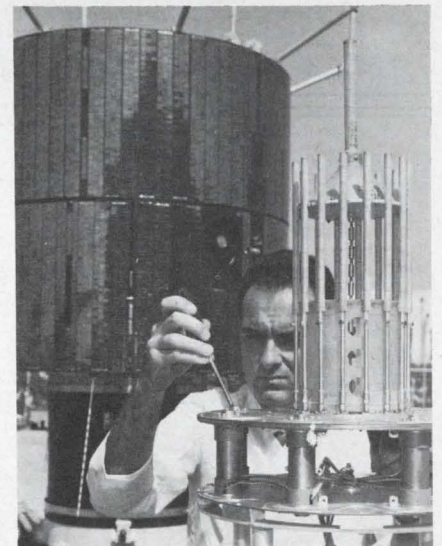

**The first electronically despun phased-array antenna** to be carried on a satellite is shown on the right. The Hughes-developed Applications Technology Satellite (rear) which carried this antenna was launched early in December.

**(Pencil-beam, continued)**

ray before impinging on the farthest. This will yield a relative phase difference in the signal as it appears to the different antennas.

If the relative phase difference between the antenna arrays, for example, is  $-k$ , the on-board electronics will transmit its response at a relative phase difference of  $+k$ , which is the phase conjugate of the received signal. The signal received at the ground station will therefore be in phase. In addition to being in phase, the pencil-shaped beam will be transmitted back in exactly the same direction that the received signal came from.

A phased-array antenna system on an orbiting satellite typically could have 100 elements arranged in a 10-by-10 configuration and about a square foot in size, Lees says. In addition, all the elements do not have to be on the same plane. This means that an antenna could be installed on the curved skin of a spherical satellite, thus simplifying installation requirements.

Such an array, operating at 5000 MHz from 1000 miles in space, would only require roughly 60 to 70

mW of power to transmit back to earth—less than 1 mW per element. Present systems, employing the latest in traveling-wave tubes, would use on the order of 10 to 20 watts.

For this example, Lees figures his phased-array antenna to have a 20-dB gain and the receiver to have a bandwidth of 1 MHz, a noise figure of 2 dB and a signal-to-noise ratio of 20 dB. In addition various types of modulation can be used. Pulse-code modulation, commonly used in satellite systems, would be suitable for the phased-array system, Lees emphasizes.

**Superheterodyne principle**

The block diagram of one of the units shows a transmitting-receiving antenna coupled to a duplexer, which could be a T-R switch or a directional coupler. The master oscillator, preferably voltage-controlled, is connected to a phase-stable RF amplifier which is connected to the duplexer.

Two reference signals are generated by the first and second reference oscillators. The oscillators do not operate in phase; therefore a fixed-phase relationship is established between them.

Since the communication frequency is generally in the micro-

wave region, possibly on the order of 10 GHz, the first reference oscillator can be of the klystron type. The second generates an IF frequency on the order of 30 MHz. This IF frequency was chosen because it is not particularly critical, and oscillators operating at this frequency are relatively simple and inexpensive.

The output of both reference oscillators are fed to a double-sideband balanced modulator, which produces the upper and lower sideband of the combined reference signals.

The upper sideband is heterodyned with the received signal in the first frequency converter, to produce an IF first signal component. The lower sideband is heterodyned with the output of the master oscillator in a second frequency converter, to produce an IF second signal component. The first and second signal components are amplified by IF amplifiers and compared in a phase discriminator.

**Operates as closed-loop system**

If the received signal has a phase difference of  $-k$ , the signal transmitted from the satellite must be the phase conjugate ( $+k$ ). If the two IF input signals have this relationship, the discriminator output is zero. If this phase relationship is not correct, an output control voltage from the discriminator is developed, and this is applied to the master oscillator to alter its relative phasing by changing the frequency. Thus the circuit operates generally as a closed-loop servo system driven to a null balance.

The output of the discriminator is coupled to a low-pass filter and hold circuit, to provide the control voltage for the master oscillator. Voltage-controlled oscillators suitable for use as the master oscillator typically utilize a voltage variable capacitor or inductor in the frequency determining portion of the circuit.

Two identical units would be used for each communication channel: one to receive the earth transmission, and the other to transmit the signal back to earth. A modulation transfer circuit is placed between the units; it takes the modulation signal off the receiver and transfers it to the transmitter. ■ ■

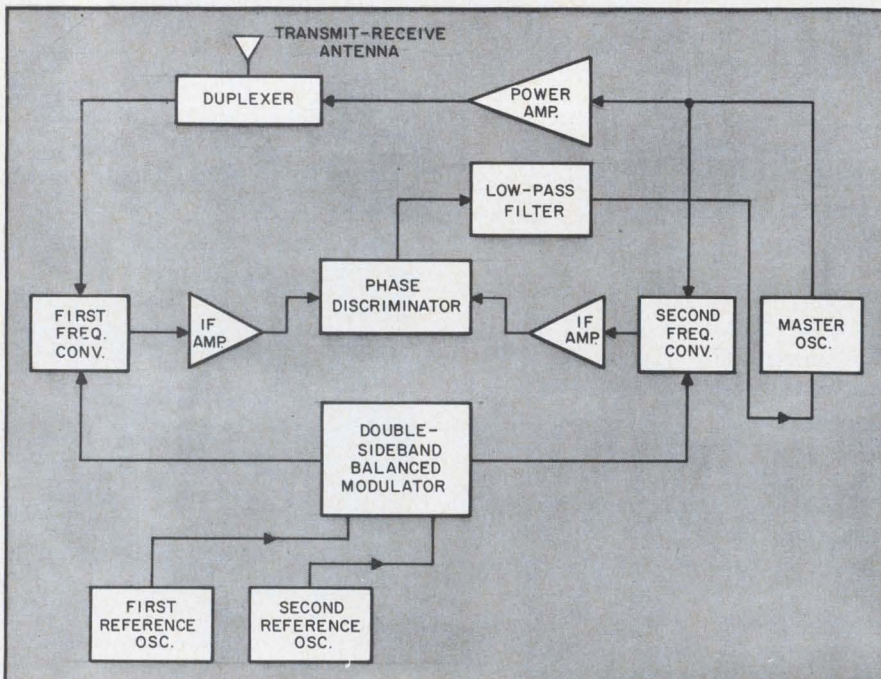

**Antenna phasing control system** operates as a closed-loop servo to generate the phase conjugate of the received signal. Two frequency converters use the superheterodyne principle to produce two IF frequencies. The discriminator compares the phase of each IF signal and adjusts the master oscillator frequency until the conjugate signal is produced.



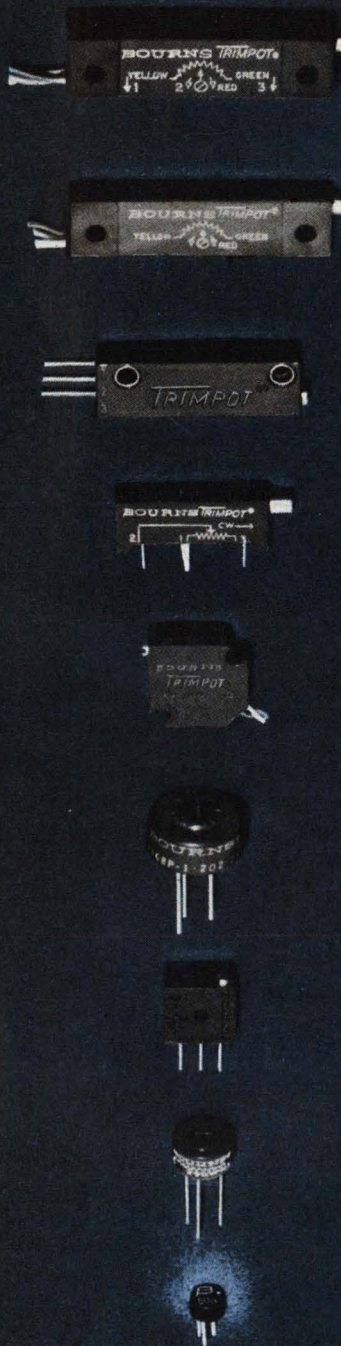



## WHO ELSE WOULD DEVELOP THE WORLD'S SMALLEST POTENTIOMETER?

It should come as no surprise that Bourns has introduced the world's smallest adjustment potentiometer. We started the trend in 1952 with the original compact TRIMPOT® Potentiometer. Now, the commercial, single-turn Model 3317 is Bourns' newest answer to industry's need for even smaller components. It measures  $\frac{3}{16}$ " in diameter, is less than  $\frac{1}{8}$ " high, has only six parts for greater reliability, and costs under \$2.00 in quantity. Offered with top or side adjustment, the wirewound 3317 has flat gold-plated grade A nickel leads for improved solderability and weldability.

While it is a true commercial potentiometer . . . not a downgraded military type . . . the Model 3317 receives the same closely controlled in-process and final inspections as all Bourns products. Periodic environmental requalification is provided by Bourns exclusive Reliability Assurance Testing Program. In size, price and performance, the model 3317 Adjustment Potentiometer is unmatched. Write today for complete technical data.

### Standard Specifications

	Model 3317P 	Model 3317W 
Resistance range	20 ohms to 5K ohms	
Resistance tolerance	±10 percent	
Temperature range	-65 to +105°C	
Power rating	0.2 watt at 25°C	
Shock	20G	
Vibration	10G	
Size — 3317P	.188" dia. x .105" high	
Weight — "	.08 grams	



BOURNS, INC., TRIMPOT DIVISION • 1200 COLUMBIA AVE., RIVERSIDE, CALIF.  
PHONE (714) 684-1700 • TWX: 714-682 9582 • CABLE: BOURNSINC.

**ONLY HONEYWELL OFFERS**  
**TOMORROW'S BREED**  
**OF I/C COMPUTER**  
**TODAY...AND AT**  
**OFF-THE-SHELF PRICE**

**... $\mu$ -COMP DDP-416**  
**\$15,000**

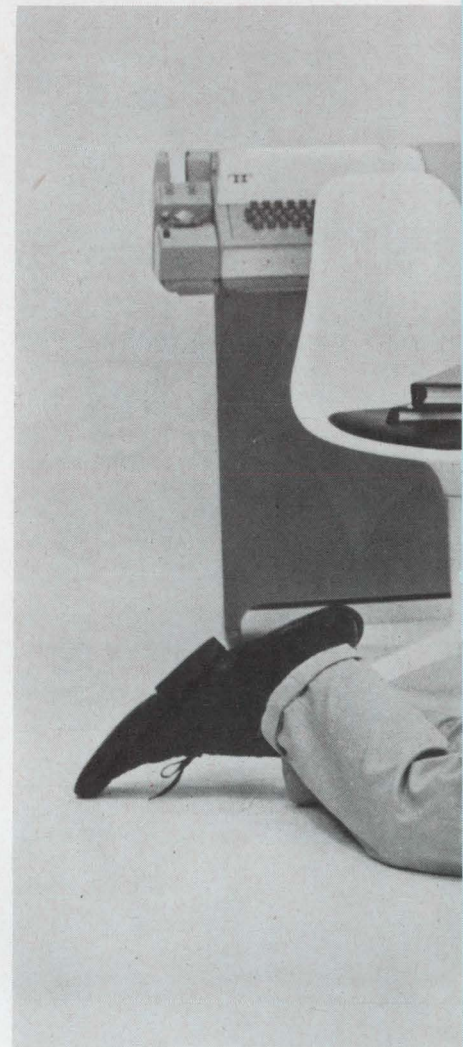

**SPECIFICATION SUMMARY**

Type	16-bit parallel, binary
Console	Movable
Addressing	Indirect
Memory Size	Up to 16,384
Cycle Time	960 nanoseconds
Add	1.92 $\mu$ secs
Single word I/O transfer	1.92 $\mu$ secs
Automatic (cycle stealing) I/O transfer	Over 1 mc (16 bit words)
Weight	250 lbs.
Temperature	0° to 45°C

BY ANY STANDARDS . . . the NEW  $\mu$ -COMP DDP-416 on-line, real-time computer gives you a price/performance ratio that can't be beat: full size 16-bit capability, nanosecond speeds, plus I/C size and reliability. Only \$15,000.

TAKE RELIABILITY . . . most manufacturers are just now planning their first I/C computer. Honeywell, Computer Control Division announced the first commercial I/C computer a year ago . . . DDP-124, the second last month . . . DDP-516, the third today. Result! Field proven reliability and a thorough knowledge of how to work with I/C's. Example . . . DDP-416 MTBF: 4,000 hours or two years under normal 40-hour week operation.

UNPRECEDENTED EFFICIENCY . . . quick response to external conditions . . . ability to process several inputs and outputs simultaneously . . . service I/O requirements in order of priority without hold conditions. This kind of efficiency is expected only in higher priced computers.

The DDP-416 is directly compatible with ASCII 8-bit character codes. And the 30-command repertoire includes many "big-machine" functions like memory reference instructions: Load, Store, Add,

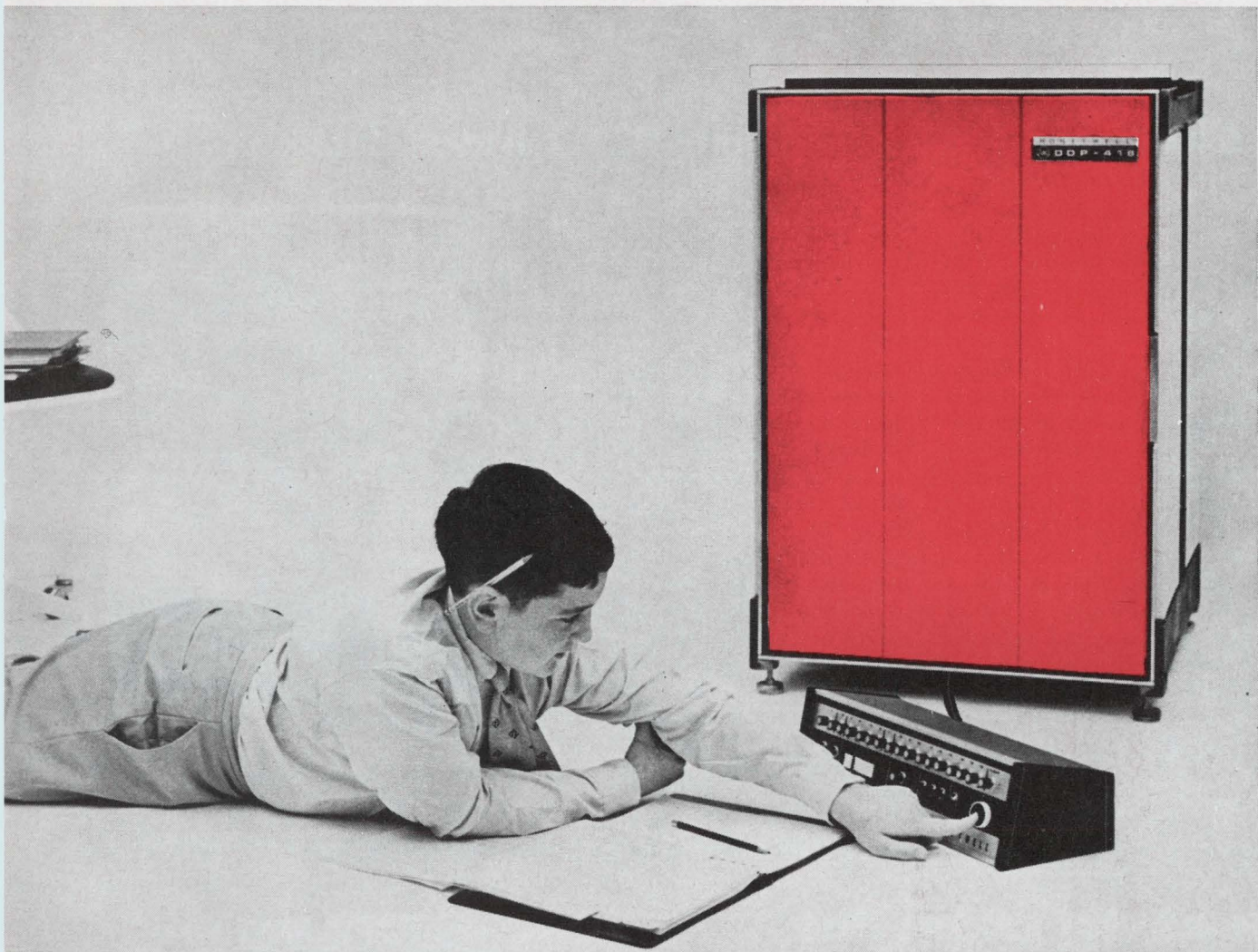

Donald, 12-year-old son of DDP-416 logic design engineer Bill Woods, writing software demonstration program for new  $\mu$ -COMP computer.

Subtract, Logical AND, Exclusive OR, Increment Memory and Skip, Jump, Jump-Skip. And two-cycle I/O commands that select device, test status, and transfer data without I/O hold-off. Priority interrupt and power-failure protection are standard.

**MODULAR CONSTRUCTION . . .** system power supply, central processor and a 4,096 word memory (expandable to 16,384 words) are mounted in a single 24" x 24" x 38" cabinet. Tilt out construction gives you easy front access to both modules and interwiring. The control console is moveable and the entire computer may be mounted in a standard 19" rack.

**EXPANSION CAPABILITY . . .** memory parity, memory lockout, real-time clock and multiplexed channel for multi-station time-shared I/O capability are all easy to add as plug-in options.

And if your problem is too big for the DDP-416, or if you think you'll grow out of it too fast, you may want the more powerful  $\mu$ -COMP DDP-516 for \$25,000.

**SIMPLIFIED SOFTWARE . . .** it may take a bright 12-year-old to work with the DDP-416, but you'll find it a snap to program. The package of 50 programs

is written in a simple format to give the real-time systems builder extended flexibility. You get mathematical and I/O subroutines, complete diagnostics, DESECTORIZING that lets you ignore memory addressing restrictions, a debug program, plus participation in our active users' group.

Best of all, if you decide to get the more powerful DDP-516 in the future, you can continue to use your DDP-416 programs because of direct compatibility.

**DELIVERY . . .** both hardware and software, second quarter of 1967.

### IMMEDIATE DELIVERY RESERVATION FILL OUT AND RETURN COUPON NOW

- Please reserve a DDP-416 and confirm approximate delivery date. Send more information by return mail. Hold this delivery date for me for 15-days so I can make a final decision and get my P.O. to you.
- Don't reserve a DDP-416 for me yet. I need more facts. Send me your DDP-416 summary brochure.
- I think I need a more powerful computer. Send me your DDP-516 summary brochure.

Name \_\_\_\_\_ Title \_\_\_\_\_  
 Company \_\_\_\_\_  
 Address \_\_\_\_\_  
 City \_\_\_\_\_ State \_\_\_\_\_ Zip \_\_\_\_\_

Please attach this coupon to your letterhead — we'll take it from there.  
 Honeywell, Computer Control Division  
 Customer Services  
 Old Connecticut Path  
 Framingham, Mass. 01701

# Honeywell

 **COMPUTER CONTROL DIVISION**

ON READER-SERVICE CARD CIRCLE 15

## 4-by-6-inch transparency slide stores 3200 pages of data

Want a set of 10,000 reference books in your desk drawer? That's pretty much what you can get with National Cash Register's new microform information storage and retrieval system.

Trademarked PCMI (Photo-Chromic Micro Images), NCR says the system can store up to 3200 8-in.-by-10-in. pages on a 4-in.-by-6-in. transparency. The transparency is read with the aid of a desk-top viewer; time required to single out any desired page of information is about five seconds. Viewers can be rented for an average of \$10 a month and transparencies can cost as little as \$1 each, depending on quantity.

The prime application of the PCMI system is where large volumes of information need to be frequent-

ly brought up to date. Catalogs, service manuals and reference libraries are typical examples.

NCR disclosed that the Boeing Company is currently completing its evaluation of the PCMI system. Boeing's first use of it will be for the maintenance manual for its 727 jet aircraft. National Airlines is taking part in the Boeing evaluation program by field-testing readers at the airline's Miami maintenance center.

A storage capacity of 6600 pages per cubic inch is claimed for PCMI compared with microfilm's 125 pages per cubic inch.

At present, copies of the transparencies are mailed to users. However, NCR scientists are reported to be working on methods to transmit slide data electronically. ■ ■



Up to 3200 letter-size pages of data can be stored on the 4-by-6-inch transparency being held by the model.

## Laser-actuated gateless diode switches electric power

Large blocks of electric power can now be switched by gateless silicon diodes. In this method, a tiny wafer called LASS (Light-Actuated Silicon Switch) is triggered by an infrared laser beam.

The switch was developed by a group of scientists headed by Dr. D. R. Muss at the Westinghouse Research Laboratories at Pittsburgh. The device, according to Dr. Muss, is a significant advance over con-

ventional thyristors currently used for power switching and conversion, in that the control element, or gate, has been eliminated.

In this way the switch is electrically isolated from its firing source, permitting faster rising surges at turn-on without damage. In addition, stacks of LASS switches can be triggered simultaneously by piping light pulses from a single source through a group of fibers.

The switch is a four-layer silicon wafer smaller and thinner than a dime. Infrared light is conducted to the wafer through a flexible fiber optics light pipe. The silicon wafer is most sensitive to the infrared range of the light spectrum, and this ensures against actuation of the switch by extraneous light. The light source is a solid-state laser; one is capable of actuating over a hundred switches simultaneously.

"One potential application for LASS," Dr. Muss said, "is for generating extremely short, high-energy pulses in radar." ■ ■

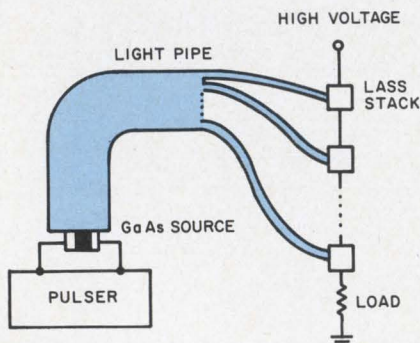

Light-actuated switches are stacked and simultaneously triggered by infrared radiation from a single source.

## Astronauts have a ball

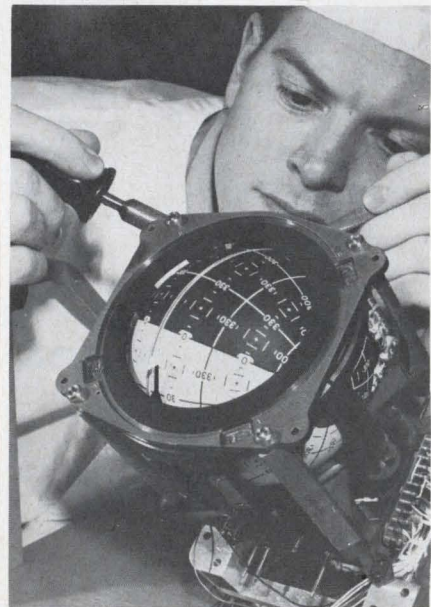

Flight director attitude indicator, examined by technician at Honeywell's Aeronautical Div. in Minneapolis, will help NASA's Apollo astronauts to keep their bearings in space. The electronic ball in the nine-pound cockpit instrument displays the Apollo spacecraft's attitude, attitude error and attitude rate along each of three axes—roll, pitch and yaw.

**DO YOU  
HAVE A  
PARTICULAR  
TORQUE  
MOTOR  
REQUIREMENT?**



Infantryman with Redeye in launcher.



Infrared sensor locks on target. Miniature computer directs steering fins to guide Redeye.

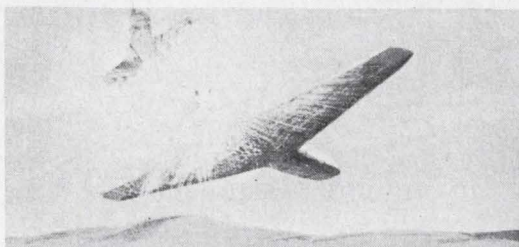

Redeye, traveling at supersonic speed, finds its target.

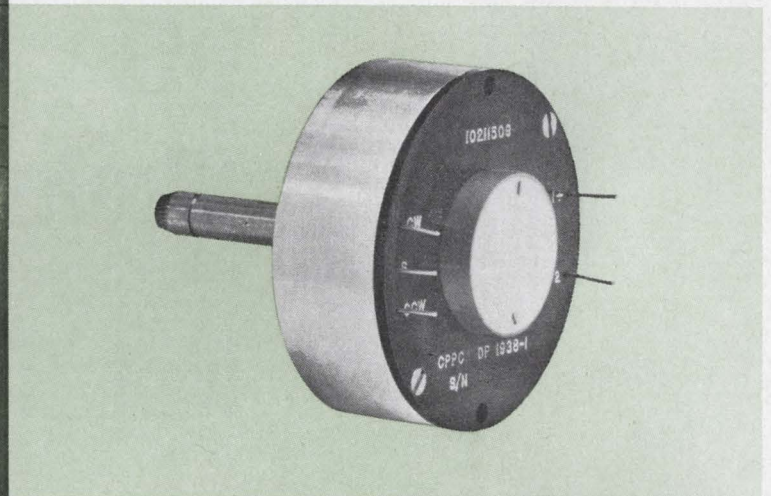
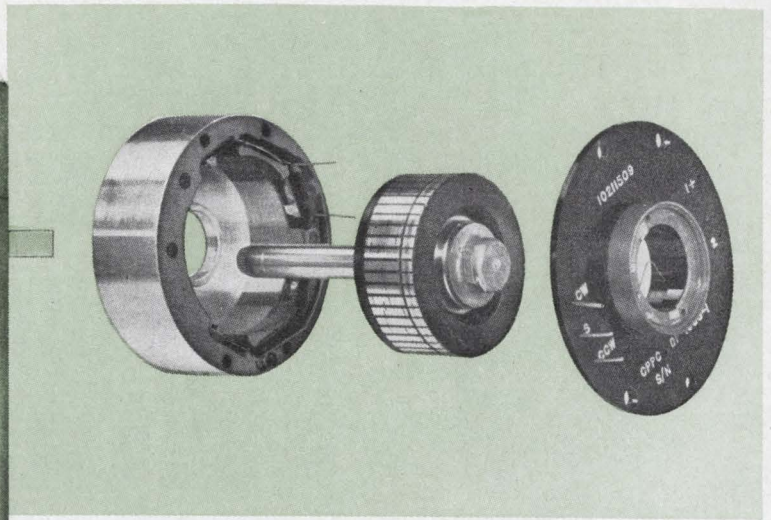
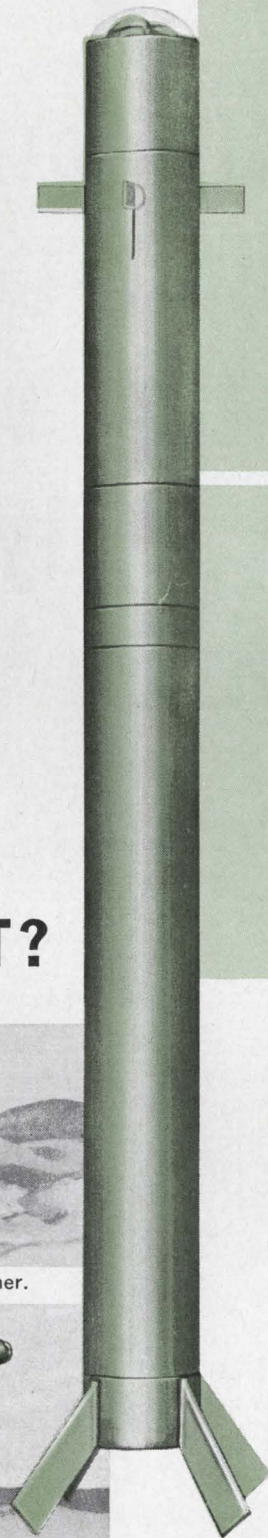

***Clifton designed this Torque  
Motor-Potentiometer especially  
for Redeye***

Clifton's deep experience with the "pancake" configuration gained from our leadership in gyro pickoff synchros and resolvers qualifies us to solve special problems in the torquer field.

A good example of our competence is this custom designed torque motor-potentiometer combination designed especially for Redeye. The torque generated meets the full demands of the missile spec. The packaging of the pot on the back shows the advantage of using a vendor who can supply imaginative design and a wide range of capabilities.

Call Clifton for your special needs in torquers. Area 215 MA 2-1000.

**cppc CLIFTON**   
DIVISION OF LITTON INDUSTRIES

ON READER-SERVICE CARD CIRCLE 16

# Do All Low-Cost Medium-Current Plastic Transistors Offer Only Skeleton Specs? Not These!

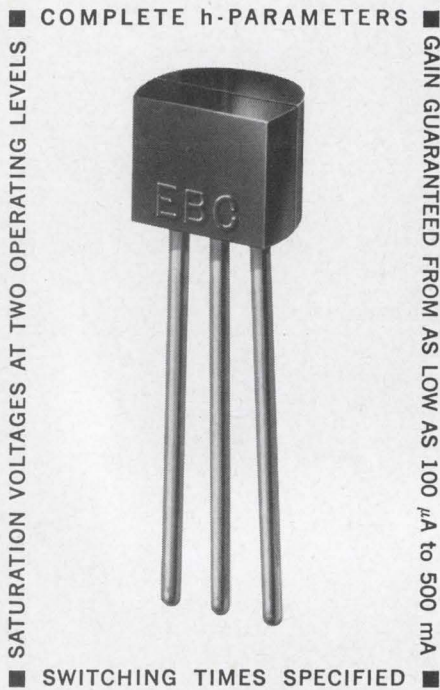

Scan all the data sheets — no other complementary plastic devices offer such complete specifications in the medium-current range as Motorola's UNIBLOC\* 2N4400-03 switching & amplifier series at this lower price. Look at the design freedom you have!

- Gain guaranteed from as low as 100  $\mu$ A to 500 mA
- Complete h-parameters
- Switching times specified
- Saturation voltages at two operating levels

Your circuit possibilities multiply . . . you can simplify your designs . . . achieve new levels of performance efficiency . . . cut down on preliminary trial and error or lengthy test procedures . . . use one device in place of many. But that's only the beginning — Look at the highest-level, state-of-the-art capability you get, as well!

	NPN		PNP	
	2N4400	2N4401	2N4402	2N4403
$BV_{CEO}$ ( $I_c = 1$ mA)	40 V min		40 V min	
$h_{FE}$ ( $I_c = 10$ mA)	40 min	80 min	50 min	100 min
$h_{FE}$ ( $I_c = 150$ mA)	50 min	100 min	50 min	100 min
$V_{CE(sat)}$ ( $I_c = 150$ mA)	0.4 V max		0.4 V max	

What's more these silicon annular<sup>†</sup> transistors have the rugged, solid, one-piece UNIBLOC plastic package to guarantee optimum reliability and performance . . . and an easy-to-take low price — 55¢ to 65¢ apiece in 100-999 quantities.

Check your franchised Motorola distributor. He has full stocks of the 2N4400-03 series. For production quantities, see your Motorola representative. Complete details available from Motorola Semiconductor Products Inc., Dept TIC, Box 955, Phoenix, Arizona 85001.

\*Trademark of Motorola Inc.

†Annular semiconductors are patented by Motorola Inc.

*— where the priceless ingredient is care!*



**MOTOROLA**  
Semiconductors

A new "Marshall Plan" for Europe?

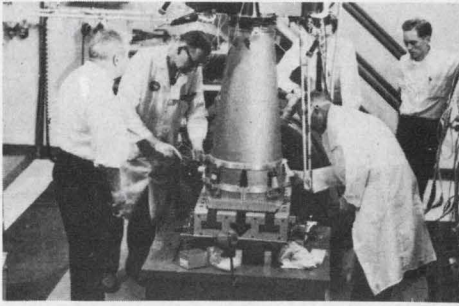

### Technical aid plan excites industry

Electronic and aerospace concerns are clamoring for more information about the "technological Marshall Plan" proposed by Italian Premier Amintore Fanfani and tentatively approved by President Johnson (Washington Report, ED 24, Oct. 25, 1966, p. 31). Within two days after the President appointed his science advisor, Donald Hornig, to head a committee to look into the proposal and to meet with European counterparts, at least four electronics and aerospace companies got in touch with a Washington firm that reports to industry on Federal technological programs. The companies wanted to know whom in Government and which embassies to contact. Each of their letters and telephone calls was prefaced by a statement of "extreme interest" in the plan. ITT/Federal Laboratories, Aerojet General and other leading concerns are seeking information.

The Fanfani proposal calls for cooperation among North Atlantic Treaty Organization members to help nations that lag industrially. As it applies to the United States, this country would transmit technological information and equipment to other NATO countries. The recipients of aid would, after upgrading themselves, assist lagging Eastern European nations. One goal would be to help bridge East-West political differences while opening markets in both directions. The chief source of information for U.S. industry is Hornig at the White House. The traditional sources, such as the Commerce and State Depts., are proving helpful only in showing companies the usual ways to do business in Europe and in providing marketing information.

Nor does anybody else yet know for sure what might result from meetings now under way in Europe (ED 28, Dec. 6, 1966, p. 27). Italy is slated to present concrete proposals at the NATO ministers' meeting. White House sources indicate that before President Johnson agreed

# Washington Report

S. DAVID PURSGLOVE,  
WASHINGTON EDITOR

even to acknowledge Fanfani's proposal publicly—and, again, before he endorsed it—he extracted assurances that it was a "two-way street" in which the most technologically advanced European nations would see that the U.S. benefited as much as Europe. So far, nobody knows what is to be sold and what is to be given. All that Hornig's associates can be sure of at this point is that the U.S. will divulge technical information to Europe and will, in turn, receive information in areas where European nations lead. One White House staffer "assumes" that there will also be large-scale sales of equipment and, in the case of data processing, software programs. Hornig's group is fairly certain, too, of the fields in which the plan will initially operate. Heading the list of information and equipment that the Europeans want from the U.S. are computers, data-processing systems and a wide range of aircraft technology, including avionics and high-energy physics. U.S. officials are less sure of what we will get from Europe but they believe it will involve help with organic chemicals, air and water pollution, water desalination, optics and machine tooling, including numerical control.

### Antimissile range increased?

Antimissile-missile advocates who are preparing for a Congressional push to produce and deploy a defensive missile system have added a new argument: The range of the Zeus antimissile has been increased. The significance is that Zeus could cope with incoming ICBMs farther from U. S. population centers and thus reduce the need for a fallout shelter program. The latter is estimated to be as expensive as the antimissile system itself. A major argument against deploying Nike-X for example, has been that the radioactive fallout produced from its own blasts against incoming missiles would kill as many Americans as would be killed by the enemy missiles.

Shortly after Congress convenes in January,

# Washington Report

CONTINUED

two Southern Senators are slated to reveal that Zeus now has a range of 400 miles, a 100 per cent increase in a year's development time. However, many observers believe that Zeus has had that range for several years but that, for security reasons, the public press has been permitted to estimate a range of only 200 miles. Now, these observers believe, the Army is preparing to waive security to provide seeming ammunition for supporters of an antimissile-missile system.

When the big debate opens in 1967, Defense Secretary Robert McNamara is expected to parade before Congress a star witness who may unbalance the antimissile-missile ground swell. Retired Air Force Gen. Bernard A. Schriever, former chief of the Air Force Systems Command and the man usually singled out as most responsible for the U. S. strategic missile program, is expected to tell Congress that the U.S. should not deploy an antimissile-missile. He probably will argue that such a system would have little chance of coping with a saturation attack of warheads and decoys. Already he has said that there "is a grave question with respect to the effectiveness" of a Nike-X system.

Schriever is expected to insist that the U.S. response to a reported Soviet antimissile system should be the development and deployment of more and improved offensive missiles.

## V/STOL activity getting warm

Vertical and short take-off and landing aircraft (V/STOLs) are being considered here as the big new field for avionics and ground control. For several years NASA and the Defense Dept. have contended that the development of operational V/STOL craft is linked to the development of the necessary electronics. It has become an old story and one that the electronics industry is not listening to very much nowadays, largely because both NASA and the DOD have suffered heavy cuts in V/STOL development funds. Now, however, the story is being told anew and by agencies that apparently are going to get the funds to put new life into V/STOL development, especially in large, commercial craft.

Both the Federal Aviation Agency and the Commerce Dept. are talking seriously and urgently about V/STOL. Observers believe that the FAA may become heavily committed to a large commercial craft venture that would also involve the new Dept. of Transportation. Part of the anticipated White House move may be an effort to mollify FAA for an expected slowdown in supersonic transport (SST) development. The agency already has been privately instructed to rein in its SST development until budget problems ease up and the noise problem is solved.

Much of the SST effort will be siphoned off in the new Dept. of Transportation and applied to V/STOLs operating from city-center terminals. Commerce officials, who will provide the policy-making cadre of the new transportation agency, see an 80- to 150-passenger V/STOL craft as the answer to intercity transportation in the Northeast Corridor. Even some officials in Commerce's High Speed Ground Transportation Office, which is supposed to be wedded to revolutionary railroad concepts, believe that city-center-to-city-center V/STOL may be a cheaper and faster solution.

However, any air system has one shortcoming when compared with rail, even the V/STOL advocates admit. There is no sense in developing a system that cannot operate in bad weather. That is why almost all students of V/STOL begin their Congressional testimony and other reports with a discussion of the need for new electronic developments to precede operational V/STOL.

## Needed: A swarm of drones

Navy anti-aircraft gunnery training crews have trouble keeping target drones in formation. Single target drones can be flown satisfactorily, but in actual warfare, attacks on ships are usually not carried out by single enemy aircraft. When the drone controllers try to simulate mass attacks, they find it all but impossible to maintain formations. The Navy has asked about a dozen electronics and aerospace companies to come up with a system that will—presumably from one control console—maintain a number of target drones in proper formation. Although the request for proposals is limited, and the Navy expects one of the companies to solve the problem ultimately, it will listen to any other company that already has a solution. Contact the Officer in Charge, U.S. Navy Purchasing Office, 929 S. Broadway, Metropolitan Station, P. O. Box 5090, Los Angeles, Calif. 90055.



# Philbrick Operational Amplifiers for comparison shoppers

Compare their prices†

Philbrick			Prices of Comparable Models				
Feature	Model	Price	A	B	C	D	E
Parametric	SP2AU	\$138.	\$195.	—	—	—	—
FET	PP25AU	\$ 79.	\$ 85.	\$ 95.	\$75.	\$85.	\$95.
High performance, high impedance	PP35AU	\$ 54.	\$ 35.	\$ 65.	\$85.	\$42.	—
High performance, ultra-high speed	PP45AU	\$ 89.	—	\$125.	—	\$90.	—
General purpose	PP55AU	\$ 15.	\$ 19.	—	\$18.	\$17.	\$19.
General purpose, high speed	PP55AHU	\$ 19.	\$ 58.	\$ 95.	\$31.	\$35.	—
General purpose, high performance	PP85AU	\$ 25.	\$ 26.	\$ 35.	\$29.	\$24.	\$46.

These Philbrick Operational Amplifiers, which meet more than 70% of all requirements, are available in quantity for immediate delivery. Conservatively-rated, they never fail to deliver the promised performance and reliability. Compare Operational Amplifiers and we know you'll concur . . . Philbrick is usually the lowest priced, always the best value.

†U.S. unit prices from published literature — 9/66

For more information, demonstration units, or engineering assistance, call your nearest Philbrick engineering representative or Philbrick Researches, Inc., 46-Dallied Drive, Route 128, Dedham, Massachusetts 02026. Phone (617) 329-1600.

**ENGINEERING REPRESENTATIVES** — Ala.: Huntsville (205) 536-8393; Ariz.: Phoenix (602) 265-3629; Cal.: Los Angeles (213) 937-0780, Mountain View (415) 969-9020, San Diego (714) 222-1121; Colo.: Denver (303) 733-3701; Conn.: West Hartford (203) 233-5503, Fairfield County (203) 661-5140; Fla.: Ft. Lauderdale (305) 564-8000, Ft. Walton Beach (904) 243-6424, Orlando (305) 425-5505; Ga.: Tucker (404) 939-1674; Ill.: Chicago (312) 676-1100, (312) 676-1101; Ind.: Indianapolis (317) 356-4249; Md.: Baltimore (301) 727-1999; Mass.: Wakefield (617) 245-5100; Mich.: Detroit (313) 838-7324; Minn.: Minneapolis (612) 545-4481; Mo.: Florissant (314) 831-0015; N.M.: Albuquerque (505) 268-3941; N.Y.: Buffalo (716) 835-6186, DeWitt (315) 446-0220, Valley Stream (516) 561-7791; N.C.: Winston-Salem (919) 725-5384, (919) 725-5385; Ohio: Dayton (513) 298-9964, Westlake (216) 871-8000; Okla.: Tulsa (918) 627-6199; Pa.: Conshohocken (215) 277-0559, Pittsburgh (412) 371-1231; Tex.: Dallas (214) 526-8316, Houston (713) 781-1441; Utah: Salt Lake City (801) 466-4924; Va.: Alexandria (703) 836-1800, Newport News (703) 245-8272; Wash.: Seattle (206) 723-3320.

**EXPORT:** N.Y.: New York (212) 246-2133. Cable TRIL 224326.  
**CANADA:** Quebec: Montreal (514) 482-9750, Ontario: Toronto (416) 789-4325.

**ELECTRONIC ANALOG COMPUTING EQUIPMENT for MODELLING, MEASURING, MANIPULATING and MUCH ELSE**



**PHILBRICK**

ON READER-SERVICE CARD CIRCLE 18

# new



**op amp  
measures  
 $10^{-13}$  amps  
handles  
 $10^{10}$  ohm  
sources**

Model 301's varactor input circuit virtually eliminates  $1/f$  noise, provides 100-fold better offset-current drift than FET amplifiers. Encapsulated, 3 cu-inch unit costs \$198, works from  $-25^{\circ}\text{C}$  to  $+85^{\circ}\text{C}$ , is P-C mounting.

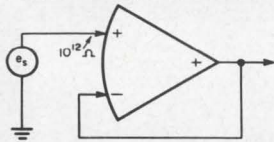

Electrometer's  $10^{12}$  ohms  $Z_{CM}$ , 0.06 pa/ $^{\circ}\text{C}$  drift at  $25^{\circ}\text{C}$ , develops low offsets from high impedance sources. Unit has only  $1 \mu\text{V}$  p-p noise,  $30 \mu\text{V}$  max drift, plus  $10^8$  CMRR.

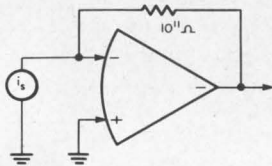

Current amplifier's 1 pa offset at  $25^{\circ}\text{C}$ , 0.01 pa p-p noise,  $10^{10}$  ohms differential impedance, and 30 pa offset change from  $-25^{\circ}\text{C}$  to  $+75^{\circ}\text{C}$ , permits  $10^{-13}$  amp resolution, builds 9-decade log amplifiers.

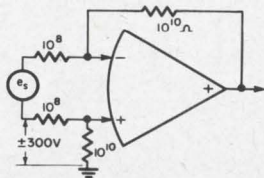

Differential amplifier's  $\pm 300$  Volts CM and  $10^{10}$  ohms  $Z_{DIFF}$ , permits use of  $10^8$  ohm input resistors, resolves millivolt signals on  $\pm 300$  volt inputs.

ANALOG

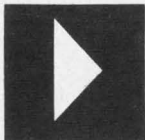

221 FIFTH STREET  
CAMBRIDGE,  
MASS. 02142  
617/491-1650

DEVICES

ON READER-SERVICE CARD CIRCLE 19

NEWS

## Doppler VOR antenna ring reduces RF reflection errors

A new antenna system designed for Doppler VOR (vhf omnidirectional radio range) systems is reported to reduce greatly dangerous site errors due to reflection of radio waves from mountain peaks.

The Doppler VOR system, developed by International Telephone and Telegraph's German subsidiary, Standard Elektrik Lorenz, is installed in mountainous terrain near Ruedesheim, Germany.

The system consists of 39 antennas shaped like huge mushrooms and arranged in a giant circle on a wire-mesh ground plane. A single reference antenna stands at the center of the ring.

The radiation pattern of the new antenna is reported to be identical to that of standard VOR. To use it, aircraft VOR equipment need not

be modified in any way, according to ITT.

Electronic commutation of the RF power around the ring of antennas results in a much "cleaner" radiation pattern, the company says.

Distortions in radio waves in mountainous terrain can prove critical in bad weather, if aircraft use the radio bearings for navigation.

Experiments conducted with a regular test VOR showed course variations on different radials of up to 5 degrees; with the Doppler VOR, bends and scallopings were reduced to about 0.5 degrees. A theoretical site error improvement factor of about 10 has thus been achieved with the Doppler VOR compared with the conventional setup, ITT says. ■ ■

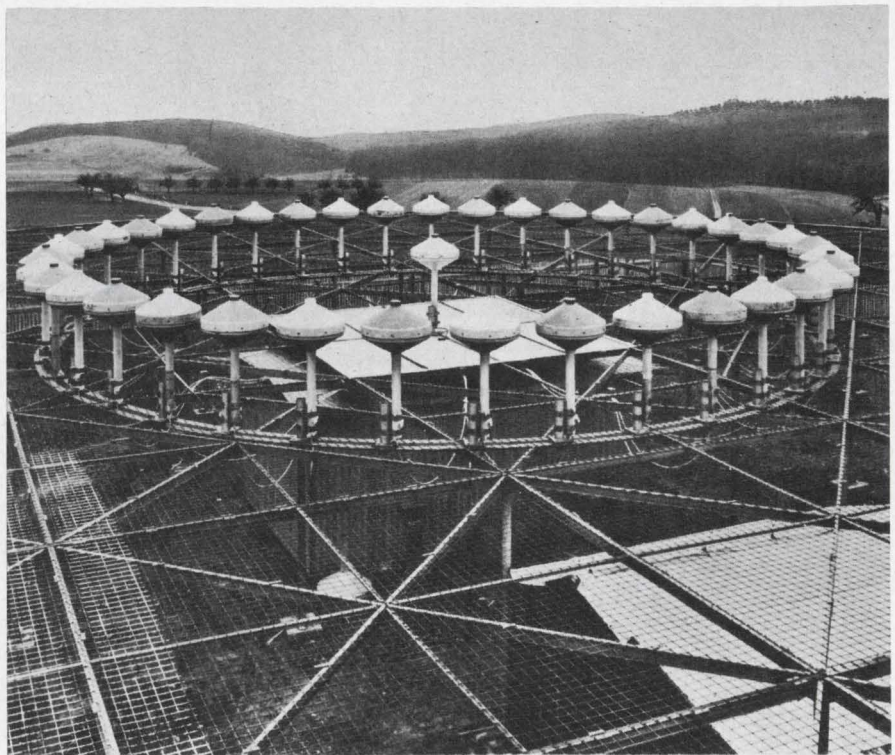

**Antenna array**, resembling a giant mushroom ring, guides jet aircraft near Ruedesheim, Germany. The new setup, used with a Doppler vhf omnidirectional radio range (VOR) system, is said to reduce greatly errors resulting from reflection of radio waves from rugged mountains nearby.

## Laser system used as detonator device

A laser-energized detonation system may prevent premature actuation of explosive devices by stray electrostatic or RF energy.

Developed at Space Ordnance Systems, Inc., El Segundo, Calif., the system is designated Laser Energized Explosive Device (LEED). It uses a fiber optic pipe to transmit energy from a remotely located laser generator to the explosive.

Explosives are usually detonated by heating or exploding a bridge-wire. No conventional electrical connections are used in the LEED system and it is said to offer complete and total immunity from any electrical environment.

Temperatures as high as  $10^5$ °K are available from the system for detonating the explosive material. These high reaction thresholds prevent actuation by stray sources of much lower magnitudes.

The major advantage of LEED, according to Space Ordnance's research director Donald Lewis, is that there is no need to shield the firing lines and electrical connectors to protect explosive systems from actuation by stray currents. The laser pipe fiber optics, used to transmit the laser energy, are internally and externally reflecting and reject outside light sources.

Lewis foresees uses of the LEED system in space vehicles, aircraft applications, fire prevention, the oil industry, oceanography and ordnance. ■ ■

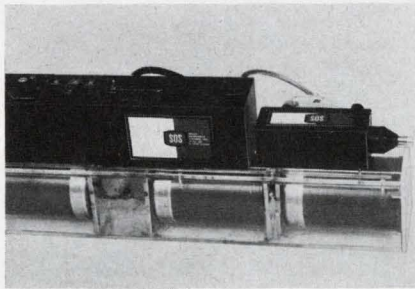

Laser-energized explosive device (LEED), demonstration unit contains a low-voltage and control section, high-voltage converter, automatic programmer and firing unit, energy storage unit and laser head. It has a 20-joule output.

# WHO DID THE NAVY TURN TO FOR 18 KW OF ULF POWER ?

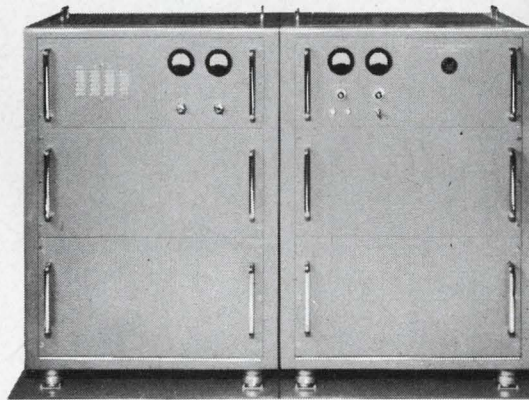

## CML, of course, the leader in high-power AC for the military!

This new ultra-low frequency transmitter by CML was designed especially for use by the Navy. It is rated at 18 KW for CW operation, with carrier frequencies ranging between 14 and 30 KC. This CML unit matches antenna

impedances of 100, 250, 500, 875, 1,400, 1,900 and 2,700 ohms, and is shock-mounted and completely ruggedized. Yet, with all this performance, the unit measures just 50" high, 66" wide and 26" deep—and weighs less than 1,800 pounds!

Couldn't CML solve **your** high-powered AC problem, too?

**CML** **CML, Inc.**  
A Subsidiary of Tenney Engineering, Inc.

350 Leland Avenue • Plainfield, New Jersey 07062  
(Area Code 201) 754-5502 • TWX 201 756-2064

AC POWER SUPPLIES • POWER AMPLIFIERS • TRANSMITTERS

ON READER-SERVICE CARD CIRCLE 20

# ***Electronics and the Sea***

Neil Sclater, East Coast Editor

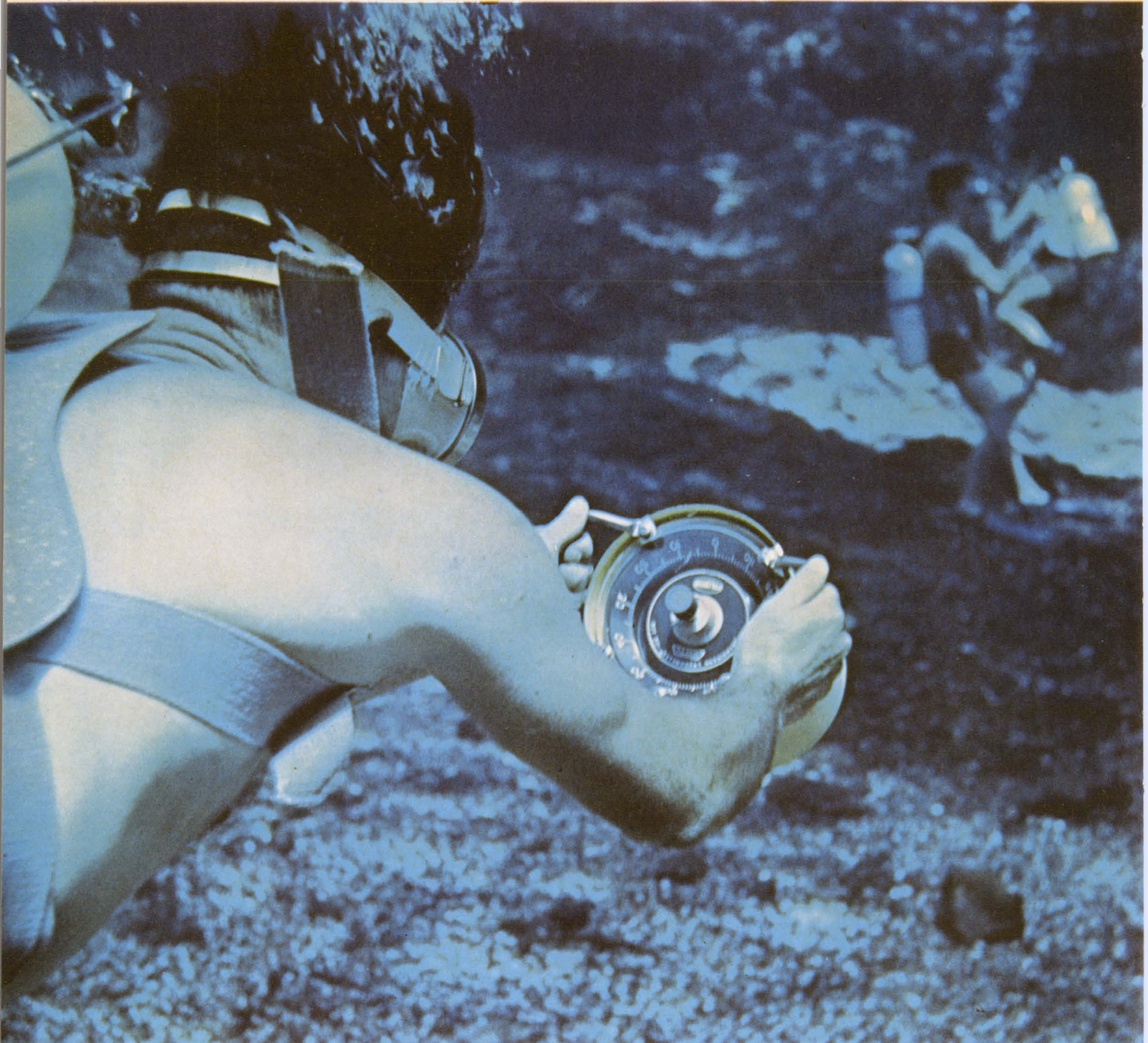

Like some huge, wet wilderness, the seas have, since the beginning of time, resisted man's attempts to tame them. The more scientists learn about them, the more they realize the limitations of their knowledge. But man is determined to change that. Spurred by dramatic successes in the conquest of space, scientists and engineers are turning to what has been described as the earth's final frontier—the deep seas.

The Navy needs to know more about the world's oceans to pursue its increasingly sophisticated antisubmarine warfare programs. Other Government agencies are seeking knowledge for such diverse projects as improving the fishing yield, weather forecasting and erosion studies. But perhaps of even greater importance, industry—in particular, the oil industry—eagerly seeks the deposits under the sea floor. Ocean electronics finds itself in the midst of all this activity.

The president of one leading company in the field, Robert A. Lapatina of Edo Western Corp., Salt Lake City, describes the picture this way:

"In the past, man has probed into the sea in a cursory way, searching for basic data. His instruments have been such as to limit the picture which he has been able to obtain to broad generalities. Increasing efforts by the offshore industry have created a need for tools and sensors which will produce clearer details of undersea areas. . .

"The industry is still in its infancy, but it is now probably at its greatest rate of growth. Large markets are not yet available, but we are in a period where we can see a tangible future. The talking period is over and now the work may start."

Despite growing interest by the large aerospace corporations, the business of making electronic tools and instruments for ocean research and engineering is largely a small, job-shop operation. The field is so new and unusual that a "production run" may mean anything more than two. The experimenter is still king.

### **It's an unpredictable effort**

A noticeable lack of over-all direction is evident. The big companies are waiting for contracts from the Navy, the Coast Guard, the Coast and Geodetic Survey and other Government agencies. Roughly \$220 million has been allotted this year by the Government for oceanographic work (not including antisubmarine warfare programs). Millions more, of which no reliable estimate is available, are being poured into the field by private industry. But there is no clearinghouse for electronic advances. There is no central planning, as there is in aerospace activities.

The head of one company prominent in oceanographic survey work was asked by ELECTRONIC

DESIGN: "Who will your customers be in the future?" His reply:

"This business is so unpredictable that I can't honestly say. We're just going to go along with the trends, wherever they lead."

In scientific exploration and commercial exploitation, the emphasis is on small, low-power-draw, high-definition equipment able to operate at great depths.

### **Equipment being improved**

At present, much of this equipment is prototype, largely hand-built. Modifications in the shop and alterations in the field are the rule rather than the exception. But progress is being made. There is this evidence of accomplishment:

- More sophisticated and accurate instrumentation, with improved packaging, is measuring ocean parameters.

- Remote-controlled instrumented buoys that gather data deep in the sea and radio the findings to shore are being operated successfully.

- New command and control devices that use solid-state logic are establishing acoustic links under the sea.

- Relatively small, self-contained manned and unmanned submersibles are being developed. They can "see" beyond optical range with new sonars, measure data and collect samples under the sea, perform work with remote-controlled tools, record results, navigate and communicate.

And, yet, so vast is the field of oceanography that the potential for growth is virtually unlimited. One research engineer, Herbert Antman of Edo, College Point, N. Y., summed up the feeling of enthusiasts recently. Acknowledging an industry tendency to lean on the Government for major support, he told ELECTRONIC DESIGN: "Prominent electronic corporations would do well to follow the lead of the oil-industry wildcatters in investing more of their own capital in ocean electronics."

Essentially the same view was expressed last month by Daniel J. Haughton, president of the Lockheed Aircraft Corp., in an address in New York to the American Petroleum Institute. He suggested that the aerospace and petroleum industries combine their technological might for joint exploration of the world's offshore continental shelves.

"We are not interested in producing oil for our own account," Haughton told the oilmen. "But we are interested in developing with you advanced systems that will make this production easier. And we would like to assist in operating and maintaining these systems as a major service to your industry."

The Lockheed chief estimated that such a business venture could lead to a \$3-billion-a-year program by 1975. ■ ■

# Instruments Probing Oceans' Unknowns

The seas contain many mysteries. There are gross unknowns, so vast that they all but defy complete definition. There are minute, highly specialized unknowns. There are unknowns within unknowns.

The greatest unknown is the lack of fundamental knowledge of the processes and physical characteristics of the oceans. What are the currents, say, at 14,000 feet in the Atlantic Ocean? How salty is the water in the Gulf of Mexico, 10 miles off Louisiana? How cold are the seas at different levels? And how are all these facts related? Reliable, watertight instruments are needed to find out and record the answers.

Electronics is deeply involved in the search for detailed information like this. Instruments are available—and more are needed—for the measurement and transmission of data on water temperature, salinity, pressure, sound velocity and other variables at different depths.

Most conventional oceanographic instrumentation is attached to a "long handle": the hydrographic wire. The measuring or sampling device is attached to this and lowered into the ocean. Other instruments—notably current-measuring sensors and some depth-temperature sensors (bathythermographs)—are cast adrift in the sea, tracked and interrogated by acoustic links. Radio and flashing-light beacons are attached to many of these free-floating or diving instruments. After the instruments have completed their measurements, they surface automatically, and the beacons make it easy to recover them.

Two platforms are available for lowering and monitoring instruments: the deck of a ship or an anchored buoy.

## Manned vs unmanned research

The manned research ship is still considered the most valuable platform because, with scientists present to evaluate the data instantly, experiments can be altered or the location shifted without delay. But the instrumented buoy is coming into vogue as a more economical platform for many studies, because it is unmanned and can

survive rough weather without maneuvering. Moreover, it is filling an important gap in ocean research: many of the seas' phenomena occur over long periods of time and must be observed constantly with instruments that can be kept in one location during that interval. At present deep-sea buoys are still in the prototype stage. But they hold promise of wide use in data gathering, when they are fully developed.

Nets, trawls, dredges, corers and nonelectronic water-sampling and temperature-recording devices are still the basic aids of the ocean explorer. In the last two years, however, oceanographers have been using increasingly sophisticated aids. In general, there has been progress in the following areas:

- Temperature, depth and salinity sensors have been improved at a cut in costs.
- Packaging has been improved through the use of glass and high-pressure plastic encapsulation.
- Instruments have been developed with no external seals. Information is being gathered and transmitted by inductive coupling of sensors.
- Automatic data processing is being used both at sea and on shore to analyze the results.

## New sensors on market

Among the sensors recently developed is a bathythermograph, capable of making accurate temperature-vs-depth measurements from moving ships—even at speeds of 30 knots—and yet low enough in cost (on the order of \$20) to be expendable after use. Bissett-Berman Corp. of San Diego, Calif., and Sippican Corp. of Marion, Mass., are among the companies that are marketing this device.

Another new sensor, a capacitance-coupled pressure transducer, gives direct frequency-vs-pressure outputs as part of a proprietary circuit—the Paraloc oscillator. Bissett-Berman is the maker.

Many other companies are turning out a variety of electronic sensors. They include Geodyne Corp. of Waltham, Mass.; Foxboro Co., Foxboro, Mass.; Ramsay Engineering Co., Anaheim, Calif.; Ocean-

ic Instruments, Inc., Houghton, Wash.; Braincon Corp., Marion, Mass., and GCA Corp. Bedford, Mass.

### Glass packaging developed

Most oceanographic instruments are packaged in heavy, cylindrical metal tubes to withstand the pressure. The cylinder must be capped with heavy flat disks. These end caps are often more than two inches thick. Engineers at Benthos, Inc., of North Falmouth, Mass., have devised a glass-sphere method, however, that gives the underwater instrument designer new latitude. Bulky objects and circuits can be housed in the thin-walled, lightweight glass spheres, which bob to the surface after completing their measurements.

The company's 10-inch glass package has survived testing to 10,000 psi and the subsequent impact of hammer blows. Various electronic circuit boards can be placed within the spheres on shock-absorbing rubber suction cups. An O-ring is placed between the mating spheres, and the spheres are, in turn, clamped with stainless steel straps. The pressure of the ocean compresses the seal to make it watertight.

One instrument that Benthos has successfully packaged in its glass sphere is an improved version of the Swallow float, used by scientists at Columbia University's Hudson Laboratories several years ago to perform long-term studies of currents. The float is weighted to remain neutrally buoyant at a preset depth, so that researchers can measure drift by listening to the float's acoustic signals. The earlier version used aluminum packaging; it was not only subject to corrosion but was also more costly than the new glass (Webb float) version.

### Plastic encapsulation gives protection

Plastic is also being used for packaging the newer instruments. Plastic-encapsulated circuitry for a marine beacon has been perfected by the GCA Corp. The encapsulation gives the electronics package positive buoyancy, in addition to protecting it against the pressure and corrosive action of the sea at depths up to more than three miles. The beacon and its instrument package rise to the surface on acoustic command, and the two-pound transmitter sends out homing signals of approximately 50 mW in the vhf band.

The break with the traditional instrumentation packaging extends to wire connections from the sensors to the sea cable. Wires are being eliminated by inductive-coupling methods, and a potential leakage problem in seals is being overcome as a result. An inductively coupled sensor mounting frame, called a "fish," has been developed by Bissett-Berman. It allows a cluster of



**Latest Bissett-Berman in situ salinometer** is held by its developer, Neil Brown. The unit incorporates a parameter-sensitive telemeter circuit. Instrument measures salinity of sea water by sensing its conductivity and automatically applying pressure and temperature compensation. Computed values are represented as frequency analogs.

oceanographic instruments to be mechanically clamped but electromagnetically coupled to a sea cable. The instruments in the fish are packed close to the sensing cable, and coupling takes place through the walls of the sealed pressure container. Thus no physically wired connections are needed in the sensor package. The sea cable—signal-conducting wire embedded in ordinary rope—is used both to position the fish and to transmit data. The fish contains a salinometer, a temperature sensor and a pressure sensor (see photo).

### Automatic data retrieval emphasized

Better instrumentation points to a logical counterpart: the need for better analysis of the results. Automatic data processing is finding increasing application in oceanography, and the full possibilities have barely been tapped.

The most advanced remote-control data retrieval today is being done under the U. S. Navy's so-called monster buoy program. Measuring 40 feet in diameter, the buoys are designed to be anchored far at sea in deep water. One is now on station off Bermuda in 14,000 feet of water. Approximately half the ocean is deeper than 14,000 feet, but about 98% is less than 20,000. However, from an operational point of view, success at 14,000 feet will give the buoy builders a clear indication of capabilities at greater depths.

At the buoy station off Bermuda, the Navy is studying a segment of the ocean from the surface

to the bottom—at lateral spacing small enough to give scientists a true “motion picture” of the total volume. This is an immense task for instrumentation, and it would be virtually impossible without electronic data retrieval.

The information will help the Navy to plan increasingly sophisticated antisubmarine warfare programs. But oceanographers both in and out of government see instrumented buoy systems as a way to obtain long-term data on the ocean as it relates to weather all over the world. Buoy networks, according to these observers, are a logical extension of permanent terrestrial and satellite weather stations and will permit not only improved forecasting but keener insight into the factors that combine to produce weather.

The Convair Div. of General Dynamics, San Diego, Calif., is the contractor for the monster buoy program. The first buoy built, Ocean Data Station Bravo, survived a hurricane while undergoing preliminary tests in the Gulf Stream off Florida. Bravo, anchored in 1000 feet of water, transmitted an uninterrupted flow of data, despite winds of up to 110 miles an hour and waves 50 feet high. This is the buoy now on station off Bermuda. A second monster buoy is under construction by Convair.

When fully operational, the data system of a monster buoy is designed to handle up to 100 data channels. Such measurements as temperature, salinity and depth are taken at different points in the sea. The channels are sampled once an hour, and the data are stored in two memories: one that holds the information for 24 hours, and another capable of storage for a year.

On radio command from shore, the short-term data are transmitted and recorded on standard magnetic tape, or are fed directly into a computer.

Data are telemetered in binary bits as pulse-code-modulated signals on a frequency shift-keyed subcarrier. The single-side-band radio equipment transmits 100 watts on the average.

Electrical power on the buoy is supplied by two four-cycle engine generators that also charge a nickel-cadmium battery. The engine is fueled with propane, and the electrical system is designed to produce 200 watts. A 40-foot-high snorkel supplies air to the engine generators and doubles as a disccone radio antenna support.

The Amecom Div. of Litton Industries at Silver Spring, Md., is working on another Navy buoy system, somewhat smaller than the monster buoy. Already successfully tested in 200 feet of water, two Litton buoys are to be anchored in the North Atlantic at depths of about 18,000 feet. An underwater sensor cable, suspended from these buoys, will measure water temperature in the upper 1000 feet at 27 discrete depths. In addition wind speed and direction, air temperature and barometric

## The challenge to designers

What are the broad problems that designers face in developing underwater electronics? A recent report, “Effective Use of the Sea,” published by the President’s Science Advisory Committee, Panel on Oceanography, lists these key areas:

*Navigation*—The need to locate a point on the surface of the ocean with an accuracy of 30 feet from a stationary ship within sight of land (for mining purposes); an accuracy of 150 feet from a stationary ship on the high seas (so the vessel can locate and return to a point accurately); and an accuracy, ultimately, of 30 feet from a moving ship at sea (for survey and research applications).

*Positioning*—The need to locate a point on the bottom with an accuracy of better than 10 feet when referred to a point on the surface in the same vicinity.

*Identification of objects*—The need for high-resolution image-making in turbid water: acquisition of 10-foot objects at one to five miles with a resolution of roughly one foot at a mile in muddy water.

The publication is available for 60 cents from the U.S. Government Printing Office, Washington, D.C. 20402.

pressure will be measured on the surface. Data will be converted first from analog signals to digital, then to teletype code and transmitted to a shore station.

The Litton buoys are designed to operate unattended for six months to a year and to transmit a total of 36 sensor outputs of oceanographic and meteorological data every three hours.

### Shipboard methods advance, too

Meanwhile shipboard instrumentation is not being neglected. Texas Instruments, Inc., Dallas, is providing new measuring and recording equipment for the Navy under a \$400,000 contract. While the ship is under way, special subsystems will simultaneously measure bathymetric depth, total magnetic intensity, gravity, sea-surface temperature and subbottom structure.

When the ship is on station at sea, sensors will continuously measure and record depth, temperature, salinity, sound velocity and ambient light to a depth of over three miles.

A digital computer will control data input and apply the necessary calibrations and corrections. The central data-recording system will display and process the information gathered. It will then record it on magnetic tape in a format compatible with computer facilities at the National Oceanographic Data Center in Washington, D. C. ■ ■



# Acoustics: Versatile Underwater 'Voice'

Acoustic links are the major means of communicating in the sea, and dependence on them is expected to continue for many years. Systems based on the transmission and reception of sound are performing the following essential tasks:

- Underwater obstacle avoidance and mapping of both the sea floor and subfloor. This is being done by echo-ranging equipment and is analogous to the use of radar on the surface of the earth.
- Command, control and monitoring of undersea activities—analogue to radio control.
- Positioning and distance measurement—analogue to radio-direction finding.

Most of the new acoustic devices and systems can be used with surface ships as well as the new submersibles. Better details of the sea floor are being obtained, "talking" markers are proliferating, and the deep-sea explorer can even command work to be done by sound telemetry.

The oceans impose severe restrictions on the acoustic-system designer. He must grapple with:

- Distortions caused by temperature variations.
- Reverberations, or internal reflections, from the sea floor and surface and from objects in the sea.
- Limitations on usable frequencies. Most of the frequencies suitable for transmission in the water are so low that the information content is limited by bandwidth.

▪ Shadowing effect. Objects in the underwater terrain can mask or "shadow" transmitting or receiving transducers, thus blocking effective communication.

Despite these obstacles, many effective systems have been devised, and more are being developed. Sonar and its many variations are being adapted from their well-known role in antisubmarine warfare to useful work under the sea and to scientific research. Engineers are using new coding and clarification techniques to overcome transmission problems.

As in radio frequency, the designer has many options, depending on his intended application: choice of frequency, choice of modulation (FM or AM) and continuous or pulsed transmission, to mention but a few. Selection is based on the objectives of the mission.

Lead zirconate titanate and barium titanate piezoelectric ceramics are favored for transducer construction for both sending and receiving in all systems. The projector and hydrophone are frequently the same transducer.

New echo-ranging equipment, an extension of the sonar principle, is giving sea explorers a clearer picture of what lies below the surface. Besides its use in undersea mapping, obstacle avoidance and depth sounding, the equipment can perform other functions such as navigating and

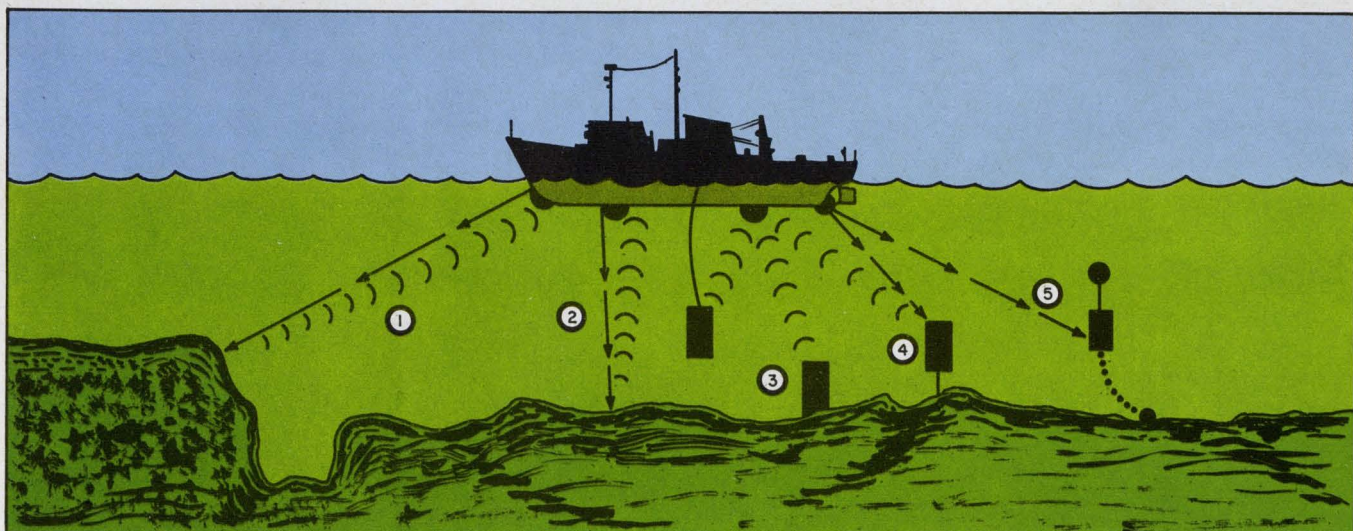

Underwater acoustic system versatility is indicated by sonar system (1) for obstacle avoidance and mapping and by echo sounding (2) for bottom and sub-bottom profiling. Listening (3) gives distance to pingers and beacons.

Coded commands elicit response signals from a transponder (4) for navigation, or they can release subsurface instruments (5) or initiate work. Acoustics in the ocean are comparable to RF above water.

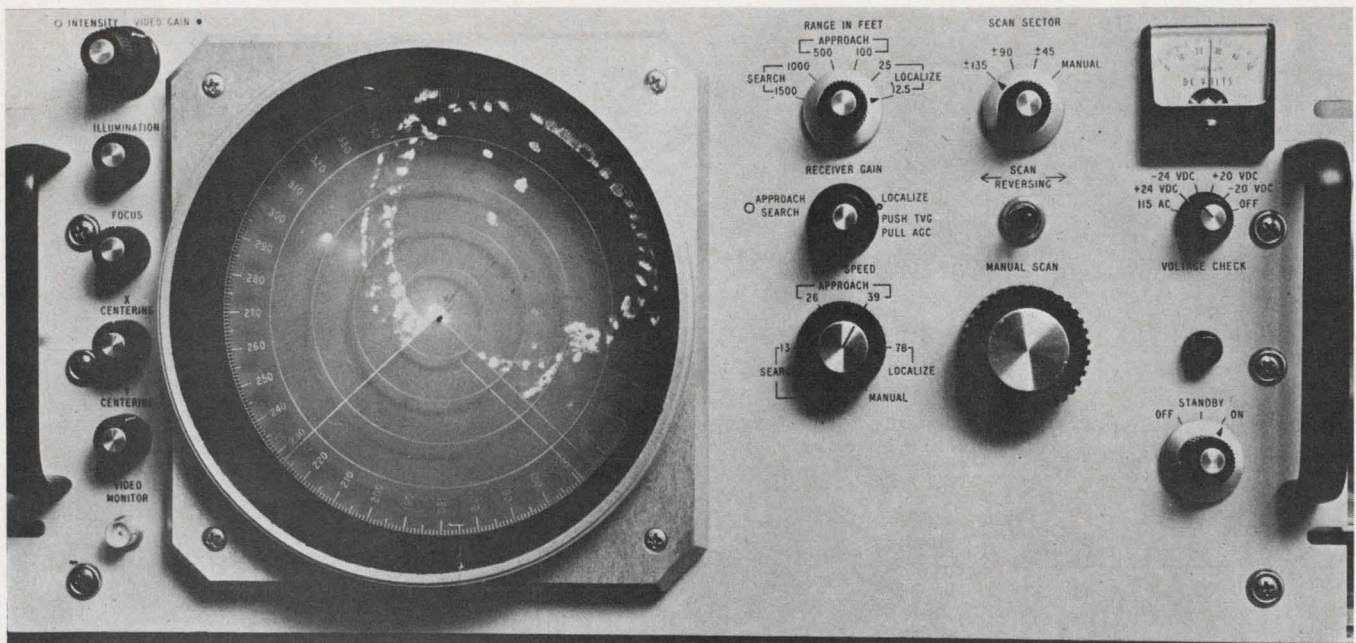

Sonar oscilloscope face shows a plan view of an underwater obstruction of cable and pipe. The Edo Western transceiver, part of a system designed for close-range

underwater investigation, is set here for a range of 12-1/2 feet. Suitable for either shipboard or submersibles, the sonar has a maximum range of 1500 feet.

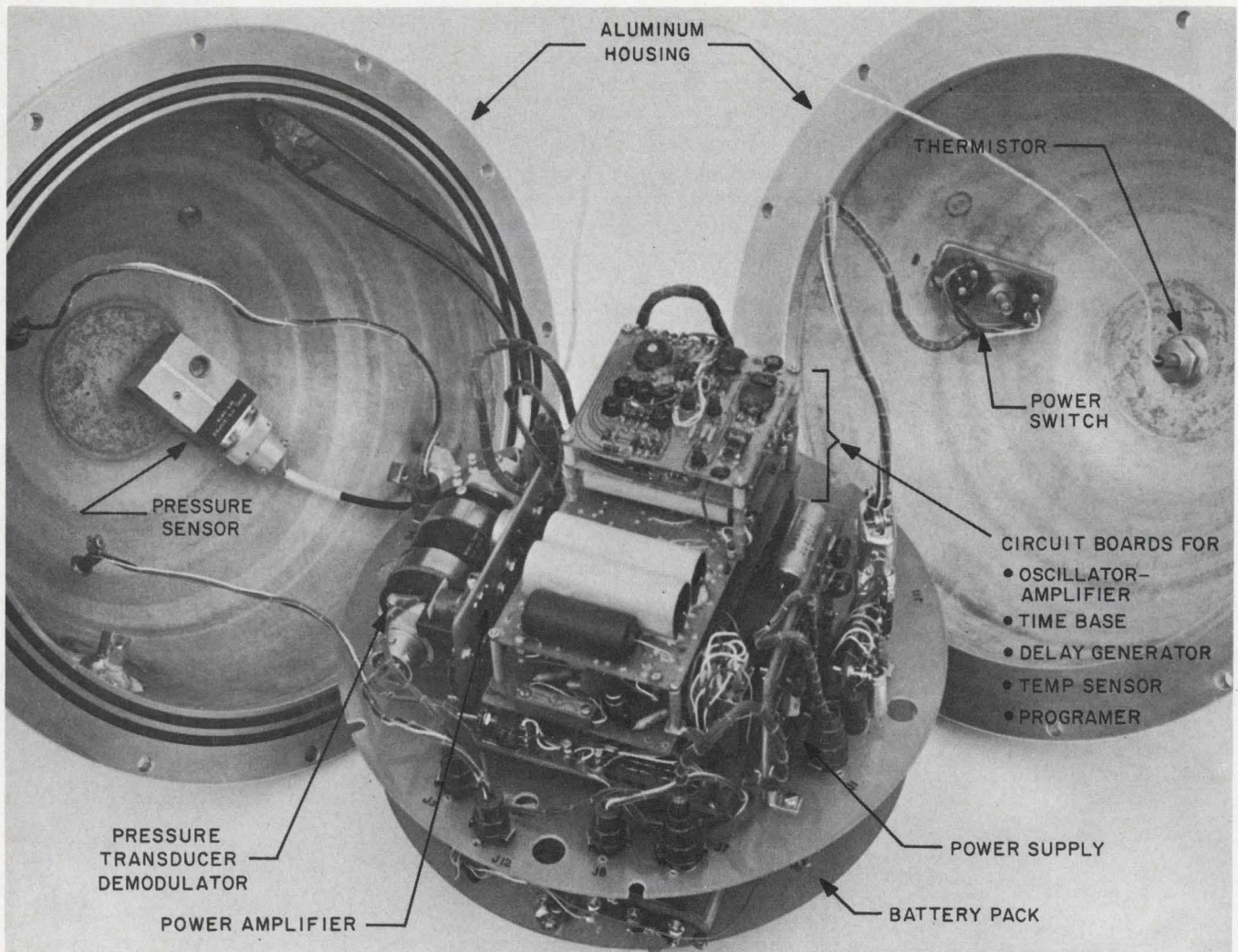

Net monitor electronics package with aluminum hemispherical covers. This unit is used to determine acoustically the depth of the net, the net's mouth opening and

temperature at the head rope. Analog signals are read out digitally in a programed cycle on board the trawler. Other parameters may be monitored with the system.

the locating of pinger beacons.

In general, oceanographic sonar is quite different from its military counterpart; it is simpler, smaller and requires less power to operate. Military equipment, with few exceptions, is not suited for oceanographic missions; it tends to be too big and too heavy, to consume too much power and to be incapable of the resolution and versatility needed for ocean search. Therefore special systems have been designed and built.

One special-purpose pulsed sonar system recently put on the market by Edo Western Corp. of Salt Lake City gives high resolution of underwater objects, even when the display is separated from the transducers by as much as 2000 feet of cable. This feature is especially valuable if the operator wants to investigate objects deep in the ocean while he remains aboard ship. The sonar can also be used in submersibles.

The key to the versatility of the Edo sonar is its high-operating frequency and the packaging of transducers, servos and transmitting amplifiers in a pressure-resistant case. This permits remote operation.

To observe objects at very close range, the operator switches the sonar to high frequency and very short pulse duration. When the range is set on the 12-foot scale, the sonar operates at 500 kHz with pulses measurable in microseconds. At this setting, objects as small as nine inches can be resolved. The projector beam at this frequency is a narrow fan, and the minimum range is two feet.

For ranges beyond 12 feet, transmission frequencies of 200 kHz are used. Out to 100 feet a fan that is 6 degrees wide and 15 degrees high is formed; out to 1500 feet a pencil beam of approximately 6 degrees is projected.

Honeywell's Ordnance Div. in Seattle, and Straza Industries of El Cajon, Calif., also make high-resolution scanning sets for the commercial and research market.

Side-looking sonar\* makes use of high frequency where higher-definition maps of the sea floor are desired. This sonar is presently more important for maps than obstacle avoidance.

### Sonic probes sound out the sea

The echo sounder determines water depths by measuring the time that it takes to send a sound pulse to the bottom and receive its echo. This time is converted to depth equivalents, and a strip chart is produced to give a profile of the hills and valleys of the sea floor.

Most oceanographic surveys employ depth sounding to obtain their profiles of the sea bottom and the subsea floor. Representative of this class is the AN/UQN-1, made for the Navy by Edo,

\*See "Sonar Looks Askance at Sea Bottom," *ELECTRONIC DESIGN*, XIV, No. 22 (Sept 27, 1966), pp 17-21.

Raytheon, General Electric and other suppliers. The system, developed more than 20 years ago, consists of a transceiver cabinet with a separate remote transducer. The cabinet contains the visual display and a precision graphic recorder that electronically etches out a depth profile on moving, sensitized paper. Improvements in reliability have been made since the system was introduced, and it is still being used in scientific and commercial oceanography.

### A variety of uses possible

This depth sounder, capable of giving a pictorial representation of the ocean floor down to about 36,000 feet (about as deep as the deepest ocean trenches) has been adapted to other tasks as well. It can monitor the drop rate of tools or cameras to the ocean floor, and in submersibles it can determine submerged depth from the surface and the altitude of the submersible above the ocean floor.

Operating at 12 kHz, its frequency is approximately in the center of the useful acoustic band, roughly the equivalent of X-band in radar. Most "working" sonar command and navigational sets operate in the 6-to-20-kHz region, because of the design trade-offs of resolution vs attenuation.

Variations of the basic depth-sounding system have been adapted to such tasks as fish finding. In this application the transducer is mounted so that it can be trained around to locate the fish.

Continuous seismic profiling, as practiced by geophysicists, represents yet another extension of the basic echo-sounding principle. Again, a sound pulse is used, but it is powerful and low enough in frequency to penetrate through the ocean floor to various depths. A portion of this sound is reflected from the different layers of sediment and rock under the ocean floor. These reflections, or echoes, when received at the surface, are amplified, filtered and recorded on a continuous record, or strip plot, very similar to an echo-sounder record.

Among the organizations active in the field of seismic profiling are EG&G International of Bedford, Mass., and Alpine Geophysical Associates, Inc., of Norwood, N. J. Both these organizations build custom seismic-profiling equipment and furnish skilled engineers to operate it.

### Improved telemetry is critical need

Because of attenuation, bending and reverberation, present undersea communication methods are limited to cables or acoustic links. Cable connections are at best awkward; at worst, they present insulation and mobility problems. There is a critical need for a variety of acoustic methods to initiate work and to monitor the progress of the work without the restraint of cables.

Many companies are developing such telemetric

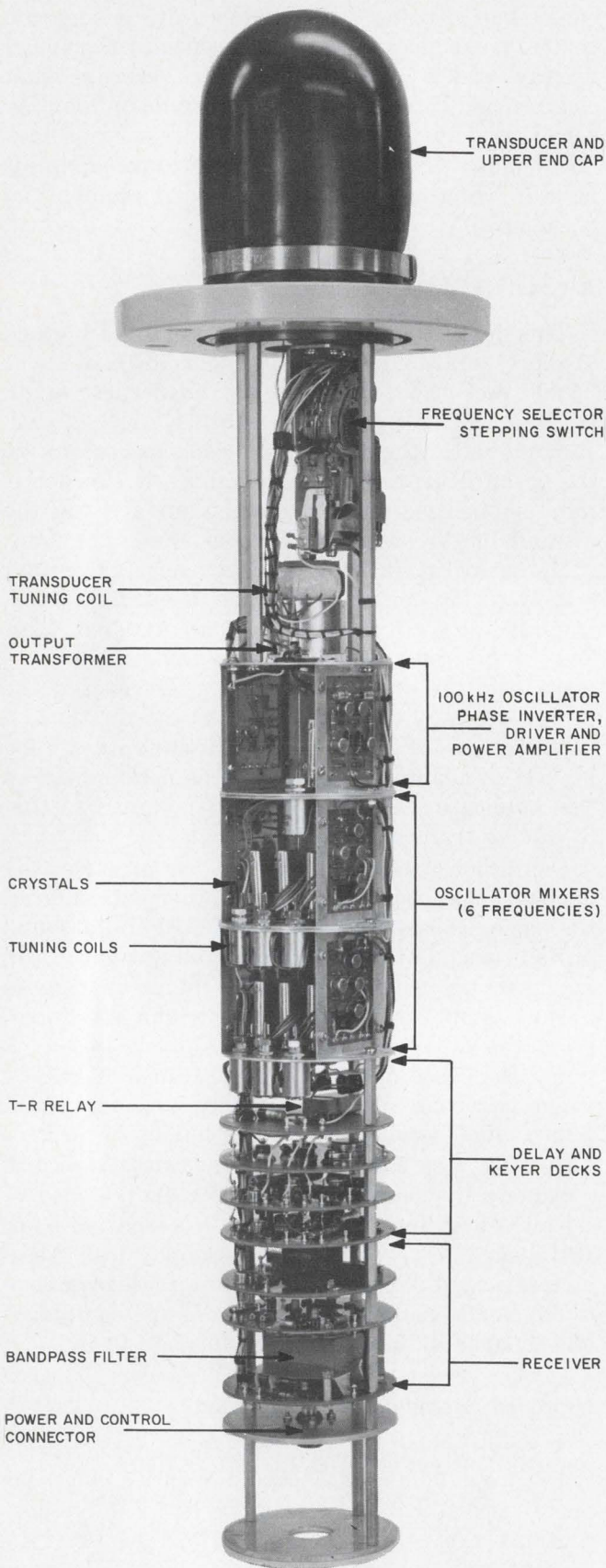

An acoustic transponder stripped of its protective housing. Useful in locating objects in the sea, the device is interrogated with a 16-kHz pulse. It can answer in any of six frequencies and has a virtually omnidirectional transmitting pattern.

systems. An example of a new development is a system made by Benthos that, by acoustic pulse coding, monitors the status of trawl nets at great depths. Others working on improved coded-pulse techniques for command and control systems include Ocean Research Equipment Co. of Falmouth, Mass., Alpine Geophysical Associates and Edo Western.

In the Benthos system the circuitry is designed so that a range of values can be monitored. With the use of logic circuitry, variables are read out sequentially. The analog values are converted to a pulse time code. The trawl-net system is organized to monitor temperature, pressure and the net's mouth opening. It could be adapted to other variables, depending on the needs of the user.

The telemeter produces a precise clock ping at one-second intervals, and within that time frame other pulses occur. The presence or absence of a ping within the first 20 ms after the clock ping represents parameter selection. In the time between 20 ms and 400 ms, the position of the parameter pulse is an analog of value within a preselected parameter range.

Equipment on board the trawl ship receives the ping trains and displays them digitally, eliminating the need for the surface operator to make any visual estimates or calculations.

#### Monitor saves time and money

"Ocean biologists were not certain that their sample trawl nets were properly deployed," explains Clyde Tyndale, chief electronics designer at Benthos. "The net monitor saves time and money, by letting the people on the surface know that the net is open and at its assigned depth."

The system, essentially an underwater analog-to-digital converter, can be adapted to measure and convert other parameters, such as conductivity and sound velocity.

Tyndale says that the net monitor, packaged in light, small aluminum hemispheres, can withstand pressures at 20,000 feet and yet be buoyant at all depths. He also says that the use of all-solid-state components, including some integrated circuits, keeps power drain low and permits the telemeter to operate continuously, as long as the net is in the water.

According to Tyndale, the basic unit of the monitor is a variable time-delay generator, which converts the analog variables to the time code. A programmer board in the package sequences the multiple variables (see photo, p. 40).

As an example of how this is done, Tyndale says that temperature is converted to a time delay, so that a temperature of 0°C is represented by a ping of 20 ms after the time pulse, and other temperatures within a limited range are represented by pings delayed in time up to 400 ms.

The measurement of the vertical mouth opening of the net is, in reality, the pressure differential between two depth sensors, one in the monitor at the top of the net, the other at the bottom. Pulse coding for this parameter reads out as a time analog of distance at the mouth opening or separation between the sensors.

Signals can be picked up from ranges as great as 6000 feet while the ship is under way at three knots. Twenty watts of acoustic power are produced in the basically omnidirectional pulses. Sixteen manganese alkaline cells power the remote monitor.

An anchor-release mechanism, activated by a three-step controlled code, has been developed by Ocean Research Equipment. It can control as many as 10 subsurface activities within acoustic range of one another, so that tasks can be commanded in sequence without interference or accident.

### Many tasks can be controlled remotely

Edo Western makes a command and release system that includes a remote-control unit made up of an encoder-transmitter and a command transducer. The watertight housing contains a command receiver and signal decoder. A variety of actuators can be attached, to perform such mechanical functions as operating solenoid-actuated valves and electrically actuated, explosive cable-cutting linkages.

Telemetry links are needed for remote-control operation of underwater installations, such as oil wells, mineral mines and salvage equipment. In many instances, valves and positional controls must be activated over distances through the water of one to five miles. The technique is also used to release instrument packages from anchors. These controlling functions must be reliably performed and reasonably secure from mistripping by random noise in the water. Several units are already available that make use of phase, frequency-shift and amplitude-modulating techniques.

Underwater control systems must provide positive control—a difficult problem because of the nature of the medium. Transmission through the ocean is adversely influenced by the boundaries of the sea bottom and surface. Multiple-path signals created by these reflective boundaries cause undesirable noise in the coded signals, and this tends to “confuse” the decoder circuits of the undersea package. At times, signals generated by the multiple-path channels arrive at the undersea package at amplitude levels of only slightly less power than direct-path transmissions.

Both the amplitude and phase relationships of the direct and multipath signals are dependent on the relative positioning of the different devices in

the underwater installation. Care must be taken to avoid unwanted reverberation of the sound energy.

The Ocean Research Equipment coding scheme, for example, uses a 7.8-kHz carrier amplitude modulated by 100-200 Hz. The signal is transmitted as a double-sideband, suppressed carrier signal, tuned to a particular activation channel at the receiver. This elaborate scheme gives three degrees of security to prevent accidental activation of the release by false signals, echoes, etc.

### Transponders used to pinpoint positions

Sonic pingers that “talk back” when they hear the right signal are establishing accurate reference points in the trackless sea. Men who work under the sea must establish “bench marks,” or points of known location, and be able to return to them. Transponder-interrogator systems are staking out the sea floor. Most present and future underwater navigation schemes are based on the use of these devices.

These systems usually include three basic elements: a remote transponder, usually located on the sea floor, an interrogator and a processor-receiver (a special-purpose active sonar). Displays coupled to the processor-receiver indicate distance to the transponder.

The transponder, a self-contained automatic receiver transmitter, sends out an acoustic signal in response to interrogation. The transponder's transmission circuitry remains cut off, except when it hears a preselected signal.

A transponder recently developed by Ocean Research Equipment responds in any one of six preselected frequencies when interrogated with a ping of 16 kHz  $\pm$  100 Hz of 15-ms duration. A 15-ms return pulse is triggered. The receiver uses a band-pass filter to reduce the effect of extraneous noise. The bandwidth is 600 Hz to the 3-dB points. Gating circuits prevent undesirable local oscillations and conserve the power of the self-contained battery. Both the sound-receiving and -transmitting patterns of the transducer are virtually omnidirectional. The reply frequencies range from 9.5 to 12 kHz  $\pm$  50 Hz in 0.5-Hz steps. The frequency is selected before each transponder is planted in the sea.

Normally the shipboard interrogator processor is used to monitor the time lapse between the transmission of the interrogation pulse and the receipt of the return pulse. This transit time can be converted directly to slant range. If desired, various hydrophone arrays at the surface can provide directional information by triangulation methods, using the distance and bearing obtained.

Depending on the applications, transponders can be used to fix the position of a ship relative to a point on the bottom. ■ ■



## Better styling by design with Alcoa Aluminum

Electronic equipment looks better and sells easier when it's designed with aluminum, Alcoa® Aluminum.

That's why designers everywhere use aluminum for styling cabinets, racks, decks, frames, panels, housings, grills, inserts or trim—practically any place where permanent good looks are important.

Aluminum gives the designer more to work with—more colors, more textures, more forms—in virtually any size or configuration. It can be easily and accurately fabricated by stamping, forging, extruding or casting; easily joined

by welding, brazing, soldering, or by various mechanical production systems.

Striking textures can be developed by mechanical finishing, such as embossing or coining, with surfaces ranging from smooth lustrous to rough matte. Subtle colors can be added by using any one or a combination of techniques—chemical, electrochemical, paint, enamel, lacquer, porcelain enamel, or Vynalate\* Sheet (a permanently bonded laminate of aluminum sheet and vinyl). And, aluminum is naturally light, uncommonly strong and cor-



rosion-resistant. Its applications are unlimited. That's why it's called "the designer's ally."

For your demanding design applications, particularly where the problem is one of cost and competitive styling, change for the better with Alcoa Aluminum. Call your nearest Alcoa sales office or write: Aluminum Company of America, 1780-K Alcoa Building, Pittsburgh, Pennsylvania 15219.



\*Trademark of Aluminum Company of America



**ALCOA**

**Change for the better with Alcoa Aluminum**

ON READER-SERVICE CARD CIRCLE 21

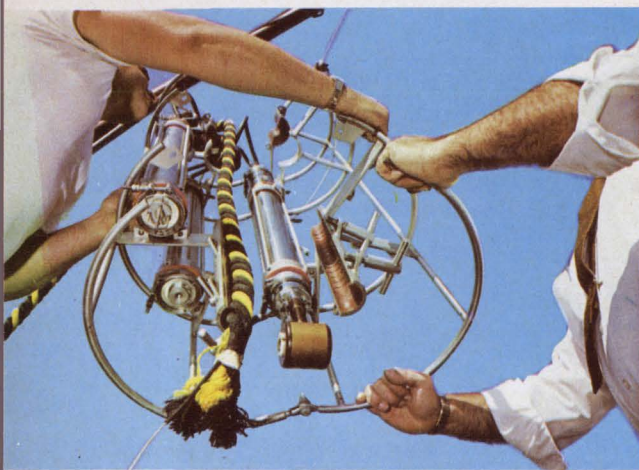
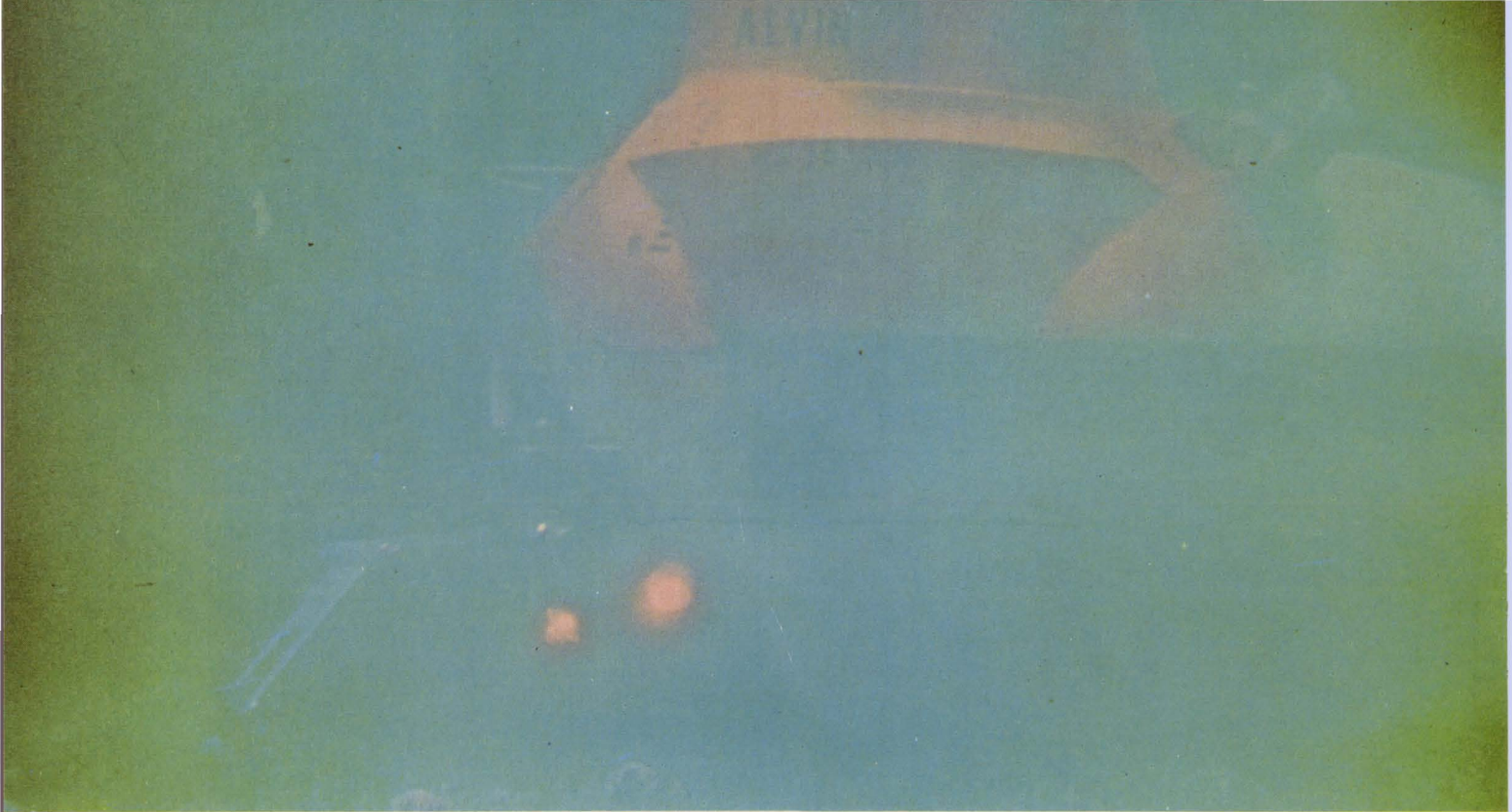

**Submersible Alvin**, its lights illuminating the darkness of the sea floor, prepares to work with its remote-controlled mechanical arm.

**Clamp-on ocean instruments** are coupled electromagnetically to a wire in the suspending sea cable. The Bisset Berman technique eliminates wires into the sensor.

**Alpine's research vessel Sea Scope** heads for a station at sea. Ships are considered good instrument platforms because scientists on board can evaluate data instantly.

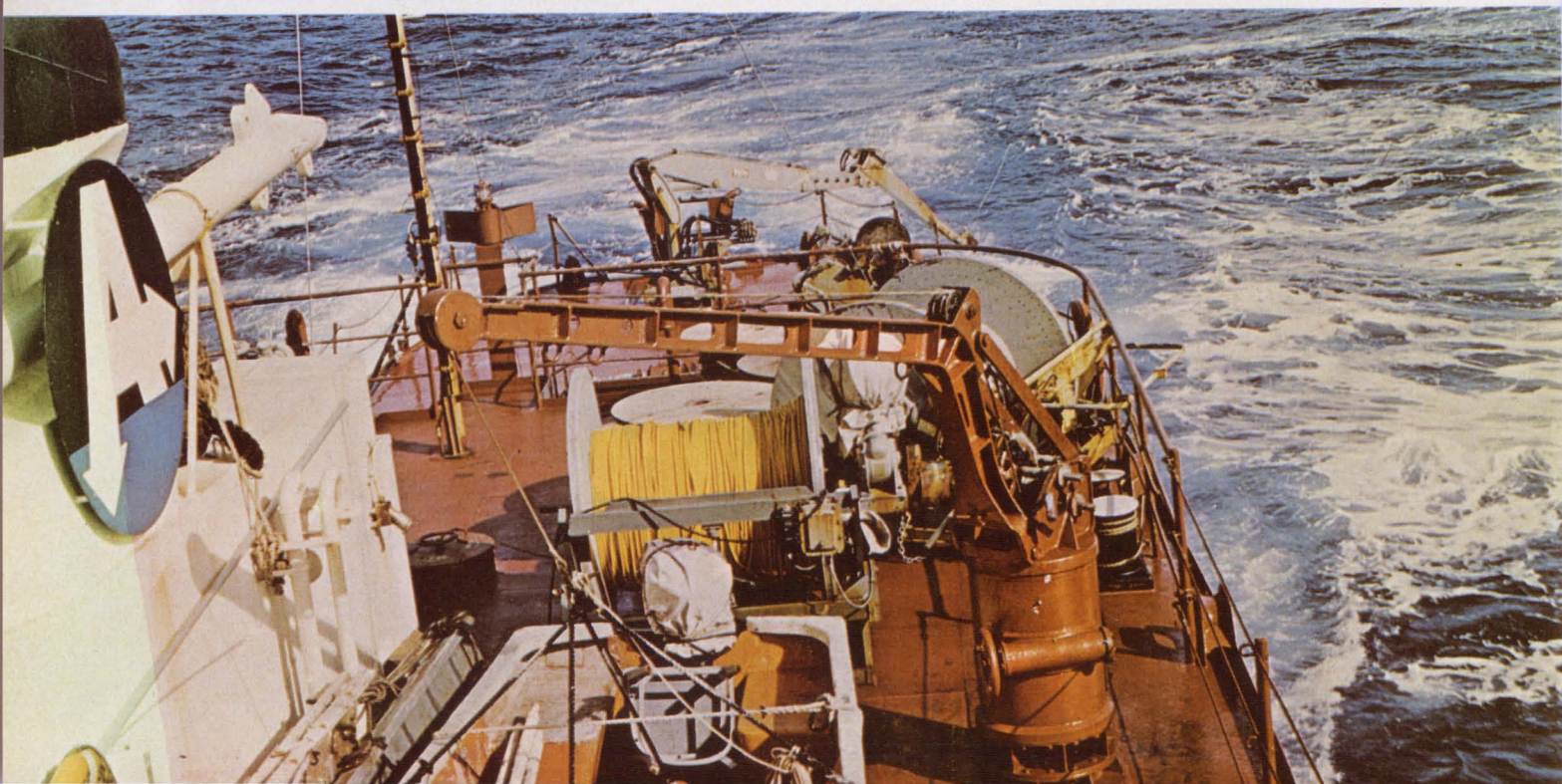



# Deep Submersibles Travel, 'See,' and Work

As recently as three and a half years ago, most people in the country were not even aware that the U.S. Navy and private industry were developing compact, useful, manned vehicles for exploration of the ocean depths. Two military accidents changed that.

In April, 1963, the nuclear submarine *Thresher* sank in more than 8000 feet of water off New England. The deep-diving, manned submersible *Trieste II* helped to pinpoint the submarine on the ocean floor and to retrieve telltale bits of wreckage for analysis.

Then, last February, the U. S. Air Force lost a hydrogen bomb off the coast of Spain. The manned submersibles *Alvin* and *Aluminaut* helped locate it in 2460 feet of water. The bomb was recovered with the assistance also of an unmanned submersible called *Curv* (Cable-operated Unmanned Recovery Vehicle).

The efforts demonstrated dramatically the versatility of the manned deep-diving submersibles. The Navy, encouraged by the initial success in the case of the *Thresher*, set up a Deep Submergence Systems Project, aimed at overcoming a general "lack of United States capability to explore the deep ocean and to rescue men trapped in the ocean depths." The program calls for construction of six advanced, manned submersibles and at least one unmanned vehicle. A total of \$50 million has been allocated for the work this year.

Typical specifications for electronic equipment inside the deep-diving submersibles call for ability to withstand relative humidity from 0 to 100%, ambient pressure from 10 to 30 psig and temperatures from 80°F to 167°F. The specifications include allowances for storage conditions—air shipment, surface exposure, etc. Most of the electronic gear that is designed for immersion in the water is tested to withstand 10,000 psi, the pressure equivalent of about a 20,000-foot depth.

Electronic equipment mounted inside or outside the submersible, regardless of whether its mission is scientific or commercial, falls into the following broad categories:

- Vision (remote TV, lights, sonar).
- Sensors (to measure ocean parameters).

- Recording devices (a variety of cameras, tape recorders, telemetry equipment).

- Navigation (gyrocompass and acoustic beacons).

- Communications (voice phone, applicable primarily to manned vehicles).

## The *Alvin* gives a typical picture

A visit to the submersible *Alvin* at the Woods Hole Oceanographic Institution in Massachusetts gives the observer a glimpse of the equipment that such research vehicles are using today. The 14-ton, 22-foot-long submarine, developed as part of a long-range underwater program of the Office of Naval Research, was built by Litton Industries in 1964.

The outside surfaces of the *Alvin* are festooned with electronic sensors, motor-propulsion units, lights, cameras and even a rather forbidding-looking remote-controlled mechanical arm.

Inside, the *Alvin* has a modified fathometer. It uses a high-power driver that shock-excites a 12-kHz transducer. Because of space limitation, the AN/UQN-1 recorder of the fathometer has been replaced by a miniature Tektronix oscilloscope to display the vehicle's altitude.

William Marquet, the engineer in charge of instrumentation and sensors on the *Alvin*, explains that the depth sounder is needed to provide an early warning of the approach of the bottom when the *Alvin* descends in its negatively buoyant condition.

A gyrocompass is used as the primary navigation aid, with a back-up magnetic compass. Developed originally by Sperry Gyroscope for use in small boats, the gyrocompass was the best unit available because of space and power limitations.

The underwater telephone, a 200-W, single-sideband suppressed carrier unit, operates on Navy underwater communication frequencies. Engineers at Woods Hole modified the packaging to fit the physical limitations of the *Alvin*.

The telephone has a carrier frequency of 8.0875 kHz and a standard audio pass band of 3 kHz. The telephone can also be used to detect fathometer signals, to transmit and receive telemetry signals,

and to listen to underwater navigation devices.

A horizontally scanning, continuous-transmission, frequency-modulated sonar is mounted aboard the Alvin. The display and transceiver have been placed in the personnel sphere, and the rotating mechanism, with hydrophone and projector, has been set on the nose of the submersible's outer hull.

Marquet says that the sonar, made by Straza Industries, is used not only to warn of obstacles before they can be seen visually but also as a navigation aid (see box).

A camera and closed-circuit TV system have been installed in the Alvin to record observed phenomena and to extend the vision of observers inside the sphere.

Incandescent and stroboscopic lights, designed by EG&G, Inc., for operation at great depths, illuminate the region directly in front of the submersible.

### Undersea navigation a chronic problem

Navigation has always been a serious problem with deep-submergence vehicles. Marquet says that this was clearly demonstrated in Alvin during operations to recover the missing hydrogen bomb this year.

"Many proposed navigation systems for bottom-operating submersibles assume that the bottom is flat or nearly so," he observes. "Navigating Alvin, particularly on the sea slopes, has been a three-dimensional problem."

The most effective approach used thus far, Marquet reports, is based on acoustic systems installed in a surface ship. The ship can then guide the maneuvers of the submerged vehicle.

At present all submersibles depend upon a surface vessel to help in underwater navigation. One of the best of the sophisticated navigation and tracking surface aids now available, Marquet says, is on Mizar, the Naval Research Laboratories' oceanographic ship. Mizar has a digital computer and an array of hydrophones on her hull for precise tracking. With a transponder on the submersible, Mizar can maintain a constant fix on the undersea craft's position and can guide it to any spot in the ocean.

The fix principle, Marquet says, works this way: "It is based upon the use of three hydrophones that fix a position in three dimensions by means of overlapping spherical co-ordinates. The digital computer is able to compute the ranges and print out three-dimensional co-ordinates on its typewriter."

An underwater telephone is used by personnel on Mizar to direct the submersible to specific underwater locations.

Because of economic considerations, all submersibles do not have access to computerized naviga-

tional equipment. One work submersible, Star III, recently built by the Electric Boat Div. of General Dynamics Corp. in Groton, Conn., solves its navigational problems with a less sophisticated approach.

### A two-way approach to navigation

Navigation on the Star III is broken down into two basic parts: the first, establishment of position reference, is performed on the surface ship or tender in a conventional way; the second, determination of relative position, is performed on the submersible by interrogation of transponders on the ocean floor.

The surface ship determines its position at the site of the survey by such surface navigation techniques as loran, radar, visual triangulation or celestial orientation. It then drops two active transponders, or beacons, to the ocean floor and plots their location on charts. The transponders provide a specific reference line on the ocean floor of known bearing and length.

Submersible operations are then planned to take place on one side of this reference line, using it as an outer limit of travel. When the submersible descends, operators on the ship are able to monitor or track it in three dimensions, by using two trainable hydrophones on the surface ship.

Using triangulation methods, personnel on the ship determine relative bearing and slant range to the submersible. They plot the distance from each of the ship's two hydrophones to the submersible. Depth information is obtained directly from the submersible over the underwater telephone.

On its own, however, the submersible's crew can obtain some idea of where it is by using on-board transponder interrogation equipment. It can interrogate each of the two base-line transponders and in response receive, on a panel, a digital read-out of range to each beacon. Since each transponder has a different interrogation frequency, the operators have no difficulty in identifying them. These two ranges provide a fix.

### Inertial improvement sought

The system has proved effective at depths of less than 1000 feet, but Star III operating personnel would like to see improvements. These include:

- A miniature inertial guidance platform to provide continuous read-out of position and bearing to minimize dependence on the surface ship.
- Submersible equipment to furnish digital read-out of distance from three or more transponders.

Raymond Loughman, chief underwater development engineer of Electric Boat's deep-submersible effort, says a miniature ship's inertial navigation system (SINS) would be desirable. However, size

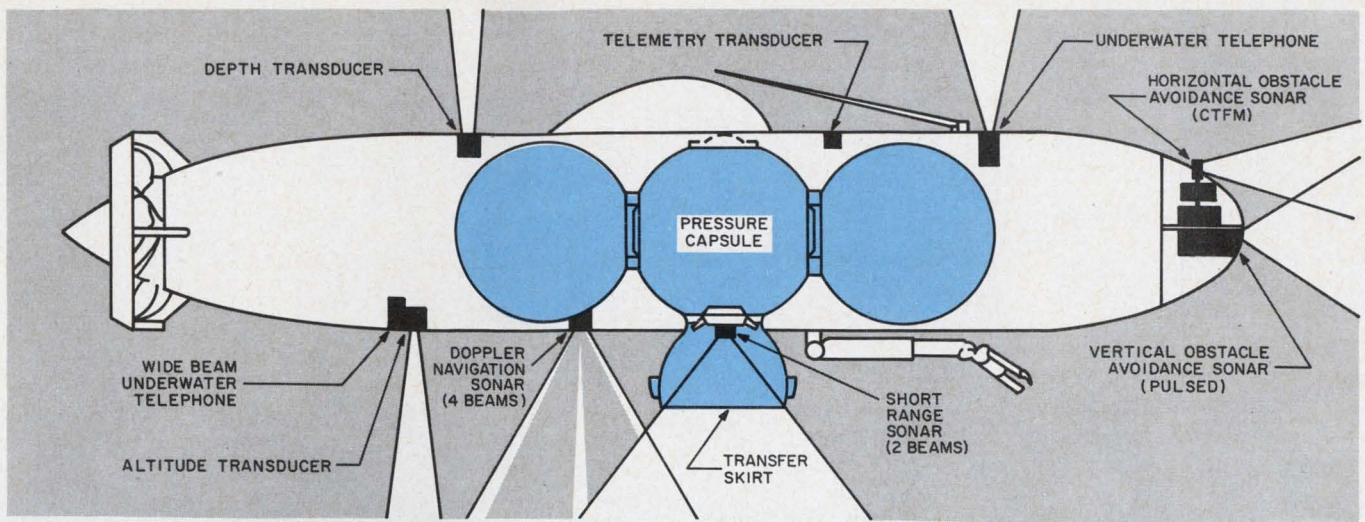

One concept of a deep-submergence rescue vehicle, showing only acoustic sensors. TV and motion-picture

and power requirements make the system unsuitable at present.

### Submersible men look to Navy program

The Navy's Deep Submergence Systems Project (DSSP) is attempting to solve many of the operational problems that confront submersibles like Star III and Alvin. The DSSP is seeking new and improved electronic sensors for a proposed fleet of six manned rescue submersibles and one unmanned vehicle.

The manned Navy vehicles would be 50 feet long, weigh 30 tons and consist essentially of three personnel spheres joined to an escape "skirt," which would project below the central sphere.

cameras and lights would be set along the bottom and top. The antenna is for surface radio.

This skirt, or hemisphere, would be set down over the hatch of a sunken submarine and then opened, to permit trapped personnel to be rescued.

The sonar and other electronic sensors would be used to help position the rescue submersible and guide it down in a helicopter-like maneuver. The first of the rescue submersibles is to be built by the Lockheed Missile and Space Div., Sunnyvale, Calif. (see drawing).

The Navy's deep-submergence program needs improved sensors, according to Joseph Cestone, head of the program's sensors and navigation branch. Although he acknowledges the value of lessons learned from present research submersibles, he would like to see private industry produce:

- A vertical-scanning, obstacle-avoidance sonar

*(continued on p. 52)*

## How continuous-transmission, FM sonar works under water

The manned submersible Alvin is equipped with a continuous-transmission, frequency-modulated sonar for aid in navigating on the bottom and avoiding obstacles. This sonar sweeps the forward horizontal area around the submersible continuously with a time-varying acoustic signal and receives returning echoes. These are translated into target range and bearing.

The Model 500A sonar, manufactured by Straza Industries of El Cajon, Calif., can operate in three modes: search, marker signal and transponder interrogation.

Designed for obtaining bearings and ranges at 10 to 1500 yards, the system presents a plan picture on an oscilloscope and gives a related audio signal. It can be used to maintain simultaneous contact with multiple targets, active markers or transponders.

When operating as a sonar search system, the set transmits and receives a linearly decreasing frequency from 87 kHz to 72 kHz. The audio output permits the operator to

monitor and analyze target returns.

A digital read-out of range is also furnished. The combined projector and hydrophone assembly at the nose of the submersible can be rotated 90 degrees on either side manually or automatically.

The transmitting pattern is fan-shaped horizontally, and the receiving pattern is fan-shaped vertically.

Straza continuous-transmission, frequency-modulated sonars are also installed on Trieste II and Aluminaut, other manned submersibles.

Pulsed sonar systems are also available for undersea exploration. Their backers say that they have these advantages over frequency-modulated systems: lower costs and simpler circuitry for short-range sets of comparable resolution. However, frequency-modulation supporters say that their equipment gives plan-view presentations of higher quality and meaningful audio response at close range.

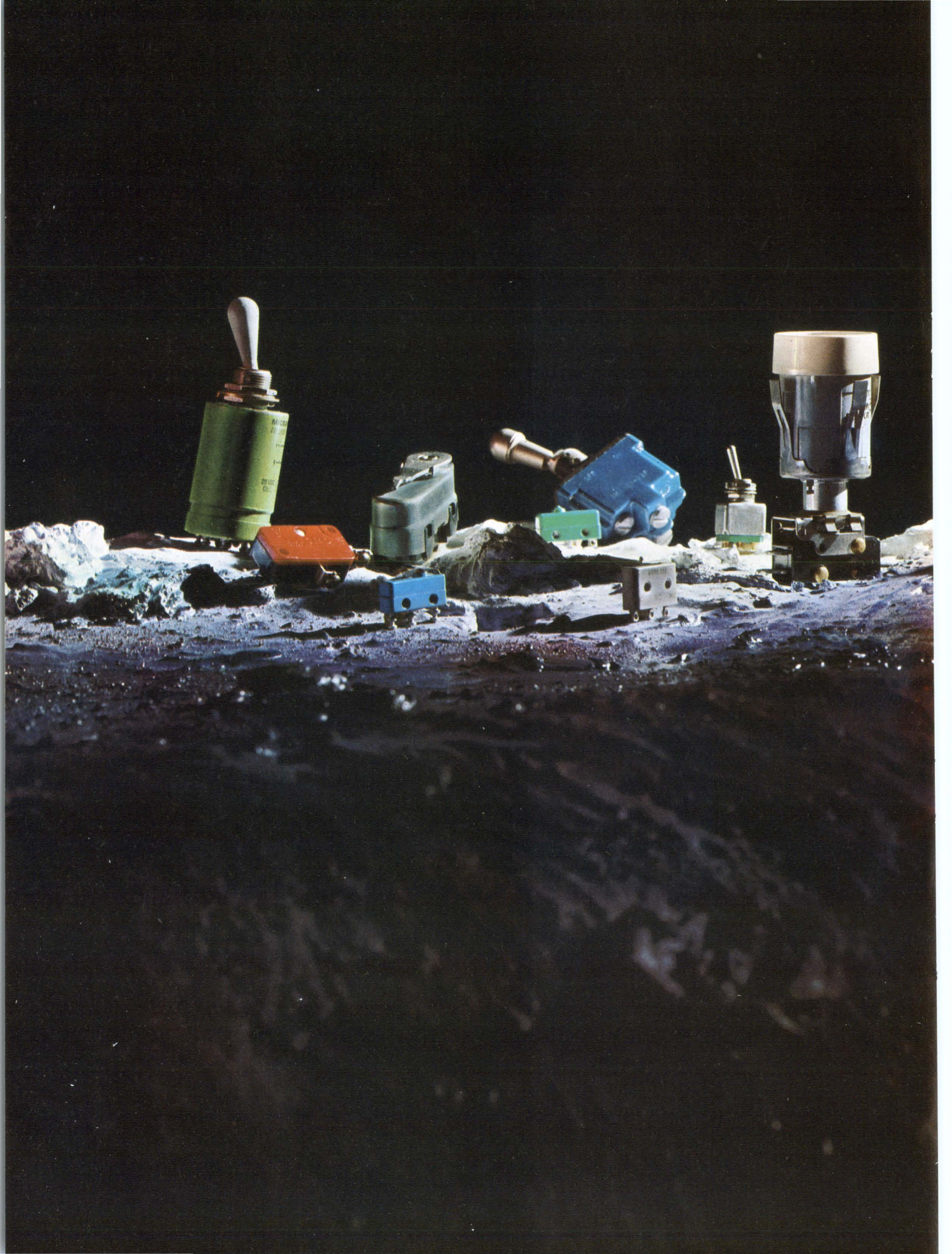

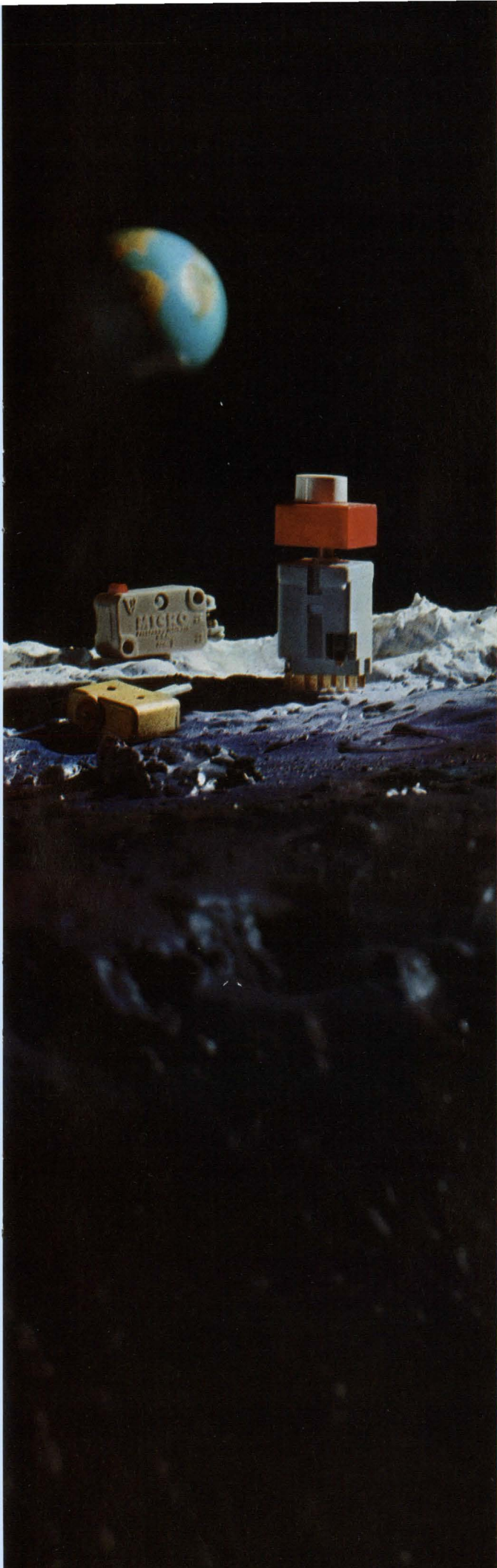

## Pioneering?

# Our switches have already been to the moon, to Mars... and then some

What we have learned about reliability in space age switching—and what we are learning today—should be helpful to you.

We've made important contributions in nearly all of the aerospace projects—Apollo, Mariner, Ranger, Surveyor, to name a few.

And, we've gone beyond. In our laboratories we are solving problems presented by future projects—sophisticated problems involving switch miniaturization, metallurgy, plastics, circuitry, human engineering, and many more.

Our quality assurance procedures and manufacturing experience and facilities are playing important roles in the Zero-Defects program.

Whatever industry you are in, you can benefit from this advanced capability by calling a MICRO SWITCH Field Engineer. He can also show you the largest selection of switches in the universe.

Call a Branch Office (see Yellow Pages, "Switches, Electric") or write us at Freeport.

## **MICRO SWITCH**

FREEPORT, ILLINOIS 61032

A DIVISION OF HONEYWELL

HONEYWELL INTERNATIONAL • Sales and service offices in all principal cities of the world.  
Manufacturing in United States, United Kingdom, Canada, Netherlands, Germany, France, Japan.

(continued from p. 49)

to help the crews of submersibles avoid objects high above or well below their vehicles. It would supplement the present horizontal-scanning sonar, which cannot detect objects effectively at elevations of more than 7.5 degrees above or below the course of a submarine.

■ A blue-green laser illumination scheme to supplement the incandescent and stroboscopic lighting now used under water. A laser would extend the range of visibility beyond the present 30-foot limit.

Cestone says that the deep-submergence program intends to use a continuous-transmission, frequency-modulated sonar similar to that used on Alvin and Aluminaut.

Because the system for vertical obstacle avoidance need not be as elaborate and costly as the horizontal unit, the Navy is asking for a new sonar that uses a pulsed technique. The Scripps Oceanographic Institute in La Jolla, Calif., has developed a prototype as a basis for industry bids.

As envisioned in the prototype, the vertical-scanning, obstacle-avoidance sonar will use a vertically oriented, fan-shaped projector beam and an interferometer receiving technique to give target location, angle and range. The forward-looking projector beam will define a 90-degree sector—45 degrees above the submersible's horizontal center line and 45 degrees below it.

The receiving system will use two hydrophones that will be vertically separated at the submersible's bow. An echo from some obstruction either above or below the bow will arrive at the separated hydrophones at slightly different times. The sum of these echo transit times will give range, and the difference will give a signal proportional to the elevation or depression of the reflecting object.

The blue-green laser is being studied by scientists at the Naval Ordnance Test Station, Pasadena, Calif., as a high-intensity illumination source.

Westinghouse's Underseas Div. is continuing work on a close-range, high-resolution sonar to help rescue submersibles locate and home on the hatch cover of sunken submarines. Cestone says that the specifications for this system will have two fan-shaped beams, one sweeping fore and aft and the other athwartships at 100 kHz.

### Unmanned undersea platforms wanted

The Navy is also encouraging the development of several types of unmanned submersibles. Deep-submergence program engineers are studying the possibilities of an unmanned, towed instrument platform, to be used strictly for survey work. The Navy already has other unmanned vehicles that can perform useful work deep in the ocean ranging from object recovery to survey and mapping.

Probably the most sophisticated unmanned

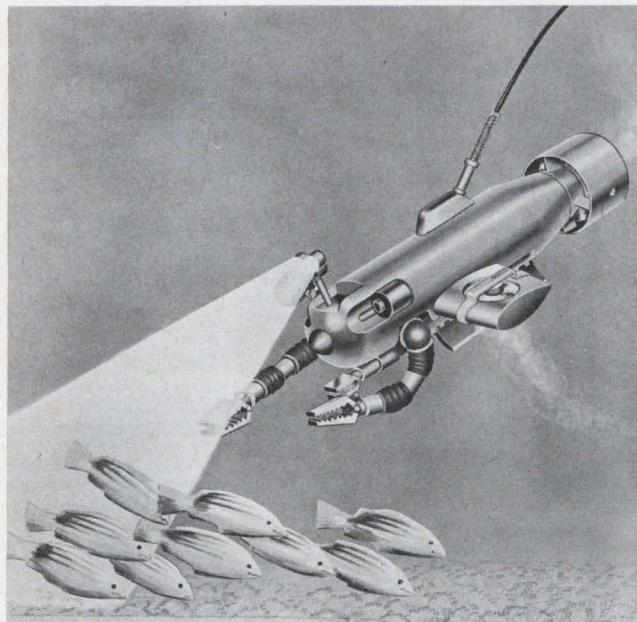

**It looks like some modern sea serpent.** It's a Battelle-Columbus drawing of an unmanned submersible. The cable-controlled vehicle will permit the operators to see and work at great depths from a shipboard console.

submersible at present is Curv, built for retrieving sunken torpedoes and other objects several thousand feet down. Self-propelled and directed by sonar and television, it represents a new class of undersea tools.

Curv carries optical equipment (lights, TV and still camera) and uses its sonar sensors to guide it into position, so that its hydraulically operated claw can be put to use. In addition to a continuous-transmission, frequency-modulated sonar, it is equipped with a locator, an underwater altimeter and a depth sensor.

Curv is directed by signals sent from the surface of the sea over an electrical cable. Active and passive sonars are used to guide it into the target region, where the target can be seen by a remote television camera after the lights are turned on.

Unlike Curv, the unmanned instrument platform that the Navy wants would perform no work—that is, it would have no remote-controlled arm or claw. But it would rival Curv in electronic sophistication, to enable it to perform the functions of observation and mapping. In addition to forward-scanning sonar and television, it would also carry side-looking sonar.

Completely integrated deep-submersible electronic systems are envisioned as the next leap forward by H. W. Volberg, vice president of Straza Industries. By integrated systems, Volberg means that the power supplies, controls and displays for the electronic systems will be considered in the initial design of the submersible, as they now are in the design of weapons systems for combat aircraft and ships. Then the hull will be designed around the electronic systems. ■ ■

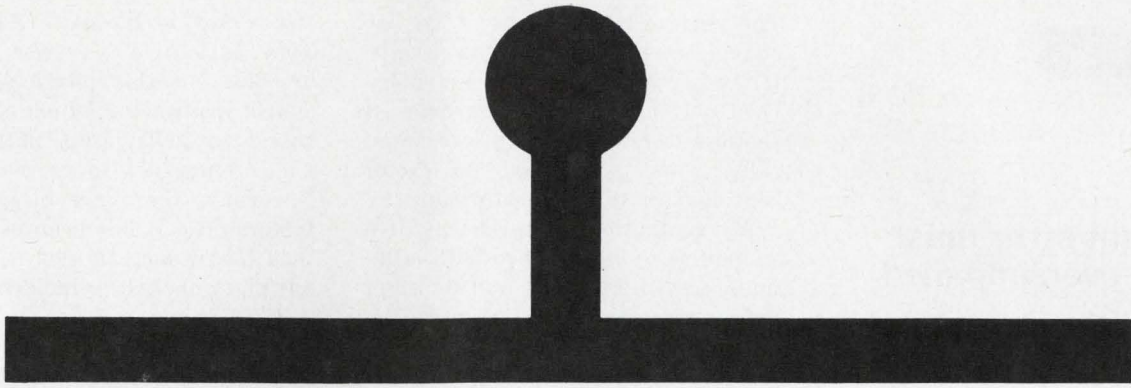

from .5 to 10,000  $\mu$ f  
nothing's as reliable  
as the CYFR

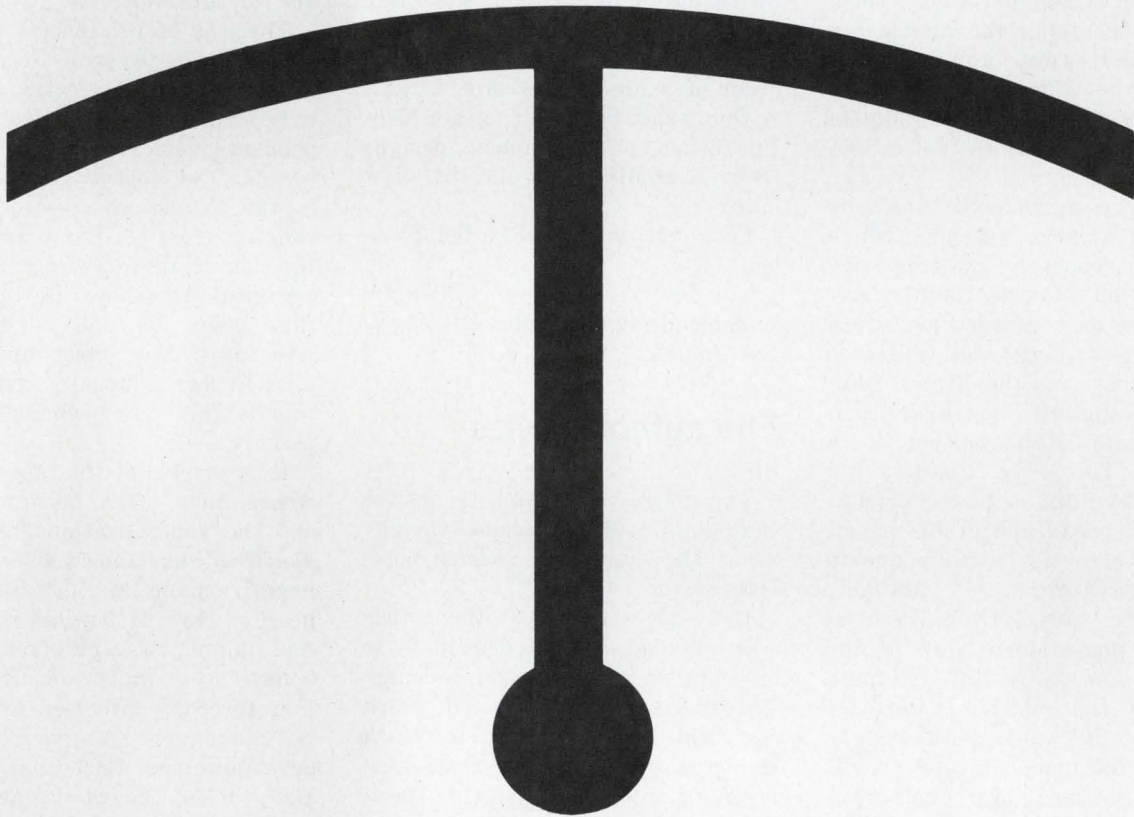

CORNING  
6405

Ask the men who designed the Surveyor, built the Minuteman, wired the Gemini, are testing the Apollo.

During the CORNING® CYFR Capacitor building process, we keep a constant eye on reliability and reproducibility with more than 200 continuous lot acceptance tests. Every CYFR meets or exceeds our J-950 and J-951 specs, which in turn exceed MIL-C-11272B.

All this documented reliability is yours, together with the precise *stability* that only a glass dielectric can manage.

After 2000 hours at 125°C with full voltage applied, capacitance change in a CYFR is less than 0.5% or 0.5  $\mu$ f; the dissipation factor is less than 0.0015 and insulation resistance is greater than 10<sup>11</sup> ohms.

Why ever risk an entire system on capacitors that can't give you the assurance of Corning dielectric stability? For complete CYFR Capacitor data in our new CORNING® Glass Capacitor Guide, send to Corning Glass Works, 3909 Electronics Drive., Raleigh, N. C.

**CORNING**  
ELECTRONICS

ON READER-SERVICE CARD CIRCLE 23

# Letters

## Boresight error must not be oversimplified

Sir:

I have read with interest the technical report on radomes and boresight error by Milton B. Punnett in ED 24, Oct. 25, 1966 ["Estimate the boresight error," pp. 84-86]. Mr. Punnett has scratched the surface of a very serious problem and has come up with some all too simple answers.

In the area of large, inflatable radomes with which he is concerned, most statements in the article are quite true. However, for every one of that type, there are hundreds, possibly thousands, of small radomes on aircraft and missiles that cannot be so easily analyzed.

The large radome is normally used with a large antenna, which connotes a relatively low frequency of operation. Concomitant wavelengths are on the order of inches, so that the radome wall falls into the category of the "very thin wall," or a dielectric much less than one-twentieth of a wavelength in thickness. Thus, Mr. Punnett can readily generalize, as he has done in the second paragraph of his paper, that "the error is basically due to radome curvature. . . ." Actually, the error is caused by differential insertion phase delay due to the curvature and to the different path lengths of the energy. It is these differences that cause the boresight shift, not the incidence angle itself.

Most radomes are half-wave walls or sandwich configurations. In these types of construction, the electrical thickness is a major consideration in designing for low boresight error and error rates. The author has never once in his article used the word "frequency." Errors are very definitely a function of frequency and antenna size, since these, in turn, determine the wall thickness and the tolerances to which it must be held.

At one point, he notes that nylon is hygroscopic. This is very true and is possibly one of the reasons for its poor boresight performance.

The dielectric constant, of course, changes radically, since the permittivity of water is in the neighborhood of 30. But more importantly, the loss tangent goes up astronomically. This is yet another factor contributing to poor performance.

My contention, then, is that, if a radome is to be designed with minimum boresight error and/or error rates, there are many more considerations that must be taken into account than those outlined in this excellent article. As of the present date, there are a few ways available for predicting radome performance by synthesis of far-field patterns from knowledge of the near fields and of the properties of the dielectric wall. But they, for the most part, presuppose an accuracy of information that is not generally true. Consequently, most computer programs are designed to determine order of magnitude of errors, rather than exact figures. They are helpful for comparison among designs from a qualitative point of view only.

Let's not oversimplify the problem!

Samuel S. Oleesky

Radome design consultant  
Los Angeles

## The author replies

Sir:

The following comments answer the points made by Samuel Oleesky about the article on radome boresight error.

It is quite true that the article was intended to apply principally to air-inflated, or thin-wall, radomes. This is the type of radome in which our firm specializes and to which the data refer. It was perhaps misleading that the original title specifying boresight error through air-supported radomes was deleted.

Many air-inflated radomes are used in applications below 8 GHz. In such cases, the general rule of thickness being less than  $1/20 \lambda$  often applies. There are cases, however, where this type of radome is in use with thickness greater than  $1/20 \lambda$ . Perhaps, then, the word "very" should be deleted and they should simply be called "thin-wall." Although the full derivation of the equation for  $D$  was not presented, it is obvious that thickness is an included term. The statement that

"the error is basically due to radome curvature. . ." was intended to point out this physical, or geometric, parameter which causes the single ray to deviate from the original, or parallel to original, path. Naturally, there are other critical factors once it has been established that the radome is not a perfectly flat plate, including incidence angle.

The point of difference here seems to be that Mr. Oleesky wishes to introduce a mechanism that I did not wish to include in the article, i.e., insertion phase lag. It would be my contention, however, that in dealing theoretically with a single ray only, use of the term "delay" is rather meaningless and tends to confuse the explanation. A similar argument might be used for scatter due to subreflections.

The lack of reference to frequency is admittedly poor. For example, measurement of dielectric constants is dependent on frequency. This dependence varies with different materials. The dielectric values given in the article are results of tests ranging from 3 GHz to 14 GHz. In the over-all design of a radome, the electrical thickness is important; this helps us sell air-supported structures. The effect upon transmission loss is usually critical, and this is the most common starting point.

It is my belief that thin-wall radomes have often been overlooked and the generalization "of negligible effect" has almost always been a negative point to the typical engineer, in that, if he does not have a real number first, he is not going to believe a generalization. It was not, therefore, my intention to oversimplify, but rather to give a better understanding of the situation, especially with regard to air-inflated radomes. The need for such information is quite evident from many of the inquiries that Birdair receives from engineers who must make logical and real decisions.

I have also received comments from R. S. Stegan, director of antenna research and development, Canoga Electronics Corp., Canoga Park, Calif. Mr. Stegan points out that by means of a Taylor expansion a simplified (approximate) form of the error equation may be developed. This form eliminates the need for such precise trigonometric

*(continued on p. 56)*





## Customers have proved our switches... all around the world!

Who are these customers? The Gemini family—and all of the U.S. manned space vehicles before them.

We've earned our part in aero-space projects. Starting in 1920, when we designed the first line of switches especially for airborne use. Today, nearly everything that flies uses Cutler-Hammer positive-action switches—full size and miniature.

For fast local service contact your nearby Cutler-Hammer Sales Office or Distributor. Or write for our comprehensive catalog, designed especially for military-switch users.

**CUTLER-HAMMER**

ON READER-SERVICE CARD CIRCLE 24

Milwaukee, Wisconsin 53201



taking  
the  
heat  
off

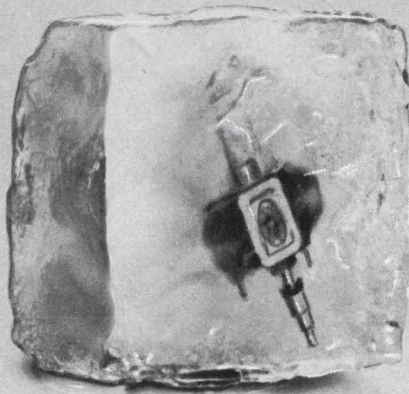

Keeping the temperature of sensitive electronic circuits constant while the ambient temperature wanders all over the lot, helps take the heat off design engineers. And that's the job Eastern refrigeration-type cooling systems do best.

These refrigeration units are the vapor-cycle, closed-system type. Years of tough testing in actual operation prove they sail through government military "specs" with flying colors. The rugged heart of these systems is a semi-hermetically sealed compressor, piston type — powered by a 400 cycle motor.



Send for  
Series C Bulletin.



**EASTERN INDUSTRIES**

A DIVISION OF LABORATORY FOR ELECTRONICS, INC.  
100 SKIFF STREET • HAMDEN 14, CONNECTICUT

BRANCH OFFICES: Topsfield, Mass., Lyndhurst, N. J., Wilmington, Del., Chicago, Ill., Torrance, Calif. IN CANADA: ENTERPRISE AGENCIES, INC., Montreal, Quebec

ON READER-SERVICE CARD CIRCLE 25

## LETTERS

values. The simplified equation is:

$$D = \frac{-t \sin i}{R\mu} \left[ \frac{\mu}{\cos i} - \left( 1 - \frac{\sin^2 i}{\mu^2} \right)^{-1/2} \right]$$

He also points out that there is a typographical error in the decimal point in the example [p. 86, col. 2]; it should read:  $D = 0.0007408^\circ$ .

Milton B. Punnett

Asst. Chief Engineer  
Birdair Structures, Inc.  
Buffalo, N. Y.

## Accuracy is our policy

In "Planar triode tubes," in the semiconductor listing of the Products section of ED 24, Oct. 25, 1966, p. 114, Engelhard Industries, Inc., points out that the devices were developed by Machlett Laboratories, not by Engelhard. Engelhard supplied only the gold solution used on the new tubes.

In "Here's a powerful design program," ED 23, Oct. 11, 1966, pp. 56-61, the author has made the following corrections:

Tables 3 and 4 and Figs. 2 and 3 are the results for the case where  $LS = 0$  (nodes 4 and 5 shorted), not  $LS = 0.001$  as stated. The results given are approximately the same, except that in Table 4 and Fig. 3, the value of  $F(t)$  at  $t = 0$  should be 0 for  $LS = 0.001$ .

In the equation on p. 59, the scale factor should be 200, not 0.8, which occurs when  $LS = 0$  and the pole at  $P_4 = -254.2$  is absent.

In Table 2, the title should be as specified in Table 1; and for the circuit topology given, only one extraneous root at 0 should occur in the numerator and denominator, not three extraneous zero roots.

In Fig. 4, the result for case 4 should read  $RS = 100 \Omega$  not  $RG = 50 \Omega$ .

In "Check the parameters of pads," ED 19, Aug. 16, 1966, pp. 200-203, the author has drawn attention to a printer's error in Eq. 14 on p. 201. It should read:

$$\frac{(K-1)(K^2+1)}{K^2(K+1)} \frac{aR}{100} + \frac{2(K-1)}{K(K+1)} \frac{cR}{100}$$

*Will  
the new  
Alfred  
6400 Series  
Sweeper  
make all  
other  
single-band  
sweepers  
obsolete?*

*(You be  
the  
judge)*

We've taken all the advanced features of the best selling Alfred 650 Series with plug-in oscillator heads and packaged them in a single-band sweeper, and users tell us the Series 650 is the most important breakthrough in sweeper technology yet.

Alfred 6400 Series Sweepers cover the frequency range of 1 to 40 GHz. Select from a full line of grid and PIN diode leveled units with internal and external sampling.

*Only Alfred offers all these features in a Single-Band Sweeper.* Fifty db power control range, leveled or unleveled ☞ Three independently controlled rf markers for broadband sweep, two for narrow band ☞ Low power consumption, no blower needed, 50/400 Hz operation for airborne or remote applications ☞ RF output frequency and marker accuracy better than 1% ☞ Frequency stability better than 0.01% ☞ Residual FM ranges from 0.001% to 0.003% ☞ Low prices start at \$2850.



*Your full service Alfred Sales Engineer has the rest of the story. Call him today to arrange a demonstration or get a complete technical description (see EEM or MEH for his phone). Or you may write Alfred Electronics, 3176 Porter Drive, Palo Alto, California.*

**ALFRED ELECTRONICS**

*Project responsibility opportunities exist for qualified engineers on our technical staff. An equal opportunity employer.*

ON READER-SERVICE CARD CIRCLE 26

## TRW Capacitors



### ...help report history as it happens.

Nearly everyone looks to TRW capacitors when he wants to build better communications systems. From space transmissions to cross-town phone calls, when man has

something to say, capacitors from TRW help him say it better.

Product information is available from TRW Capacitor Division, TRW INC., Box 1000, Ogallala,

Nebraska. Phone (308) 284-3611  
TWX: 910-620-0321.

# TRW

ON READER-SERVICE CARD CIRCLE 27

ELECTRONIC DESIGN 29, December 20, 1966

**Co-Publishers**

James S. Mulholland, Jr.,  
Robert E. Ahrensford

**Editorial Director**

Edward E. Grazda

**Editor**

Howard Bierman

**Managing Editor**

Robert C. Haavind

**Technical Editors**

Peter N. Budzilovich  
Joseph J. Casazza  
Maria Dekany  
Frank Egan  
Roger K. Field

**News Editors**

Ralph Dobriner, News Chief  
Neil Sclater

**West Coast Editor**

Ron Gechman

**Copy Editor**

Peter Beales

**New Products Editors**

David H. Surgan  
Daniel R. Butterly

**Washington Editor**

S. David Pursglove

**Editorial Production**

Dollie S. Viebig  
Karen L. Sherman

**Art Director**

Clifford M. Gardiner

**Art Assistant**

William Kelly

**Technical Illustrators**

Cheh Nam Low  
Douglas Luna

**Production Manager**

Thomas V. Sedita

**Asst. Production Manager**

Helen De Polo

**Production Assistants**

Bernard Wolinsky  
Robert M. Henry

**Circulation Manager**

Nancy L. Merritt

**Reader Service**

Diane Pellechi

## EDITORIAL



## 'Zero Defects': More than patriotic back-slapping

The signs seem to be everywhere in industry: "Zero Defects." The legend is emblazoned in brilliant red, white and blue. It says, in effect: "Our employees work to perfection on Government contracts and strive to make improvements. They are precise craftsmen who assure the Government that its funds are well spent."

Zero-defect campaigns are taking over where the World War II "E" (for excellence) pennants left off. Nor should one dismiss them as a mere public-relations device; they are about as close as some companies come to telling their employees that pride in workmanship is still needed to put out a quality product.

Employees in industry today—engineers and production workers included—sometimes find it hard to feel any personal identification with modern products and projects. As often as not, the project is so complex and involves the cooperative efforts of so many people that the individual cannot discern the importance of his contribution.

It is safe to assume that most technical persons do have an appreciation for craftsmanship and admire a device or system that works well, that shows the hallmarks of good design and quality construction. In our mechanized, automated society, however, the sense of personal involvement in the final product is denied to all but a few. A sense of frustration is the inevitable result.

Steinbeck in his recent book, *America and Americans*, says that the loss of the sense of pride in workmanship has led to the rise of such substitutes as the do-it-yourself craze. He says that Americans have a heritage of invention and improvisation and many believe that, at heart, they are all independent and resourceful craftsmen. Never mind the bent nails and sore thumbs; the illusion is not easily shattered.

Engineers are not immune to the assembly-line conformity that troubles and fascinates them at the same time. They can get a little careless, too. After all, why bother to check the calculation or strive for perfection? Someone up the line will catch a mistake. Management may elect to change the concept tomorrow anyway.

The big signs saying "Zero Defects" proclaim that in the final analysis, and despite some individual skepticism, the production of a perfect product is still dependent upon human abilities.

Industrial management, for its part, will do well to make certain that the working conditions are appropriate to the goal and that there is still an opportunity within the organization for the individual to satisfy his sense of pride in quality workmanship.

NEIL SCLATER

A whole litter of them, in fact. In the form of technical bulletins covering the most complete line of ferrite materials and shapes in the world. Included are core sizes and shapes not available as standard from any other manufacturer and ferrite materials made only by Indiana General.

Take flyback transformers, for example. In color-TV our 05 ferrite is the leading core material because of its high-voltage per-

formance. Where ferrites for filters are concerned, our TC-7 combines extremely high "Q" and low loss with the most linear temperature coefficient of inductance found anywhere.

In all, we list 11 ferrite materials in 315 standard shapes and sizes including: cup cores; toroids; transformer C cores; rods and strips; E, I, U, and C cores; the international series of cup cores, and cross cores.

Whether you are designing circuits or purchasing components, you can have our Ferramic® Materials Bulletins Nos. 100 thru 105 on your desk. Write Mr. K. S. Talbot, Manager of Sales, Indiana General Corporation, Electronics Division/Ferrites, Keasbey, New Jersey.

**INDIANA GENERAL** 

COPYRIGHT 1966, INDIANA GENERAL CORPORATION.

**We're ready to let the cat out on our 315 standard ferrite core shapes and 11 different materials.**



# Technology



Combining FETs and bipolars increases  $Z_{in}$  and widens the bandwidth in input amplifiers

to a greater degree than is achievable with either semiconductor used alone. Page 62

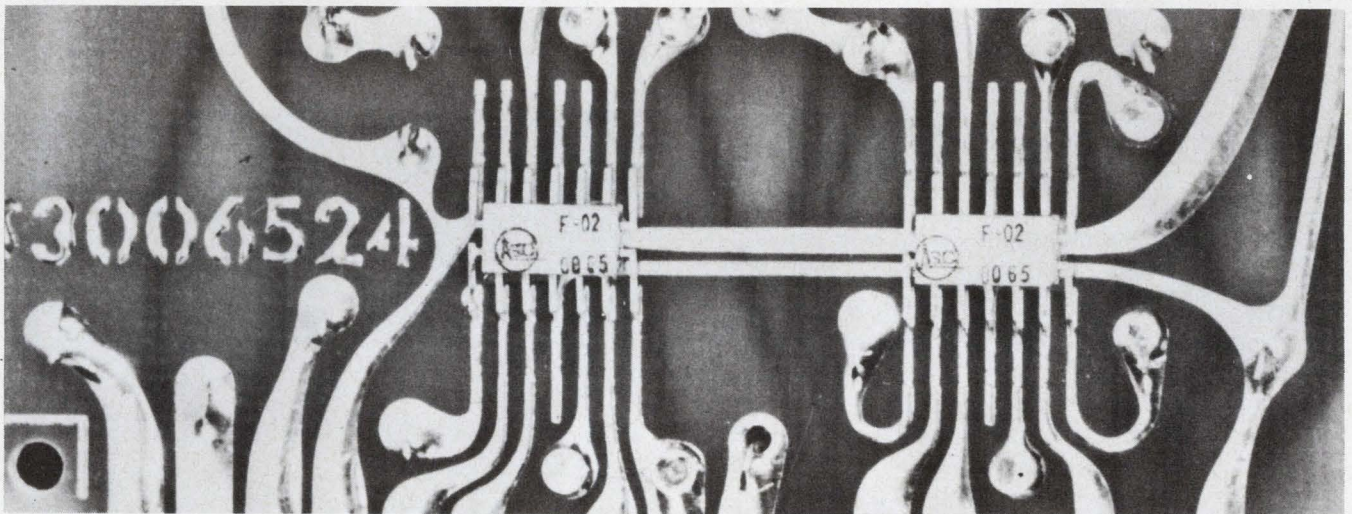

Thermal paths are a major consideration in integrated-circuit designs; test fixtures and

bonding techniques have a direct effect. Here a metal strip conducts heat away. Page 76

## Also in this section:

Predict filter response accurately regardless of bandwidth. Page 70

Ideas for Design. Pages 84 to 88

# Raise amplifier input impedance by combining FETs and bipolars. The two together provide higher $Z_{in}$ and wider bandwidth than is possible with either alone.

High input impedance, wide bandwidth and economy are the usual requirements for most input amplifiers. If the stage is to be used within a feedback loop, the gain must be highly predictable at both low and high frequencies, and the output impedance will also be of concern to the designer, to at least some degree. Some designers use field-effect transistors (FETs) to fill the requirements; others use bipolar transistors. But higher input impedance and wider bandwidth can be obtained by combining the two semiconductors in one amplifier.

## Op amp demonstrates requirements

In any amplifier system, the role of the input must be determined by total network specifications. As an example of this, consider the input requirement of an operational amplifier connected to maintain unity gain  $\pm 0.01\%$  from 20 Hz to 20 kHz with a 1-megohm input resistance ( $R_A$ ) and a similar feedback resistance ( $R_F$ ). The open-loop input impedance must be high for two reasons:

- A finite input impedance reduces open-loop gain and thus affects closed-loop gain stability.
- Anything less than infinite input impedance causes a reduction in closed-loop bandwidth.

To obtain a high input impedance and wide frequency response, the input stage shown in Fig. 1 was developed at a total cost of about \$6. Briefly the operation of the circuit can be described as follows:

Transistors Q2 and Q3 form a classical FET input configuration with a current-generator load. Their output is direct-coupled to Q4, an emitter follower, which drives the input to a dc amplifier and bootstraps the drain of the FET. The positive feedback arrangement uses another current generator (Q1) as FET drain load. This arrange-

ment results in definite benefits that will be shown later.

Because of its intrinsic high input impedance, the FET is appropriate as the leading input device. While the FET by itself is sufficient for many applications, the comparatively high input capacitance of economical devices requires some amount of bootstrapping for high-frequency use to negate the effect of gate-to-source and gate-to-drain capacitances. To achieve an input impedance at low frequencies that is higher than the intrinsic value, both the gate-to-source and gate-to-drain admittances must also be negated. Bootstrapping can also do this.

With the use of the Miller effect, bootstrapping can be accomplished through application of a positive gain of less than unity around the capacitor or resistor in question. The effective value of the component is then multiplied (capacitor) or divided (resistor) by a factor  $(1 - AV)$ , where  $AV$

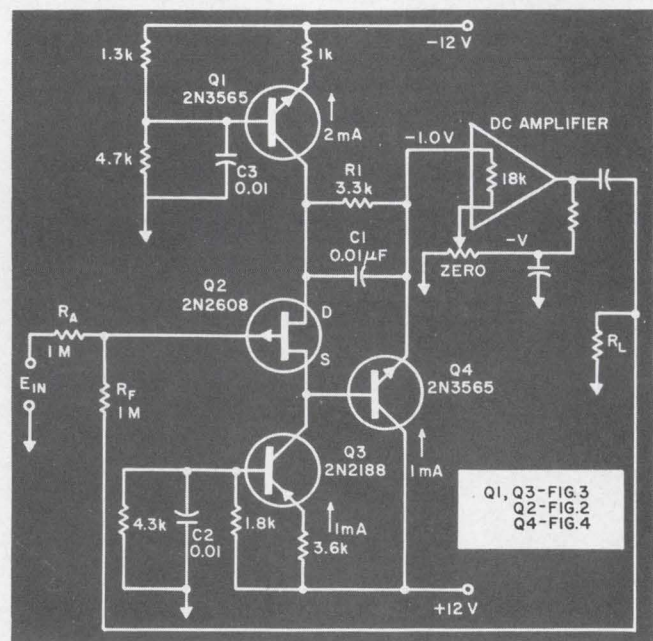

1. High-impedance stage uses bipolars and one FET. Transistors Q1 and Q3 are common-base current generators, Q4 is an emitter follower and Q2 serves as the leading input element.

David E. Smead, Development Engineer, 3M Co., San Diego, Calif.



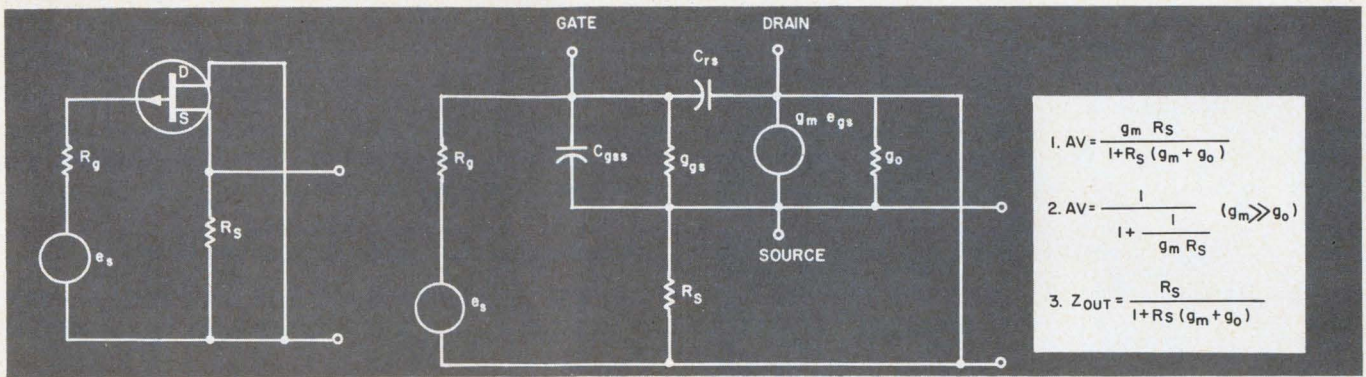

2. FET stage yields positive gain very close to unity when connected as a source follower.

is the voltage gain parallel to the component. If AV approaches unity from the positive direction, a significant reduction in effective value is realized. If bootstrapping can be described as keeping two terminals of a component at the same signal potential, then maintaining unity gain through a device can be classified as bootstrapping. The effect of the gate-to-source capacitance of the FET can therefore be reduced by unity gain in the device.

### Source follower has gain close to unity

Figure 2 is a model of the source follower, Q2. This configuration will yield a positive gain of less than one. Since the gain (AV) cannot become negative, care must be taken only to ensure a gain that is close to unity. The quantity gm has dimensions of μmhos, and one can see that for AV to approach unity either a high gm or large Rs is essential. For instance, if gm equals 1000 μmhos

and Rs is 50 kΩ, then a gain of 0.98 occurs.

However, letting Rs be large is contrary to the requirement that drain current be large. A high-voltage supply and a large Rs could be used; however, for gain of greater than 0.99, a more practical solution is to use the inherently high output impedance of a constant-current generator as Rs. This is the common-base configuration of a transistor circuit. Its model is illustrated in Fig. 3.

### High Zout needed from current generator

Figure 3 shows the equation for Zout. Preceding it are expressions relating data-sheet values (see Table 1) and the other terms used in Eq. 4. In this equation it should be noted that the terms inside the bracket have a limit of one as Rs is increased. In the configuration of Fig. 1, the emitters of the common-base amplifiers are not driven by a signal, and thus Rs corresponds to the emitter resistors of these amplifiers. If Rs is as low as re + rb, the bracket will have a value of about one half. Thus if re is large, so is Zout.

As in the actual circuit, if the base is not grounded, some feedback results, thus decreasing the value of Zout. While this is not drastic at low frequencies, it could compound the high-frequency problems. Bypassing the base bias circuit (Rb) eliminates this feedback. The low-frequency effect of rb on Zout is found by substituting rb + Rb for rb.

A near unity gain through the FET can be realized by maintaining the current generator Zout high. Capacitance Cgss of Fig. 2 will be reduced in turn by a factor (1 - AV), where AV is the voltage gain of only the FET.

Reduction of Cgss, largest of the FET model, leaves the effect of Crs accentuated. It cannot be bootstrapped directly from the source, since the gm generator would be shorted. In addition signal voltage at the source is not readily usable, for any loading at that point will decrease gain in the FET. An additional stage is necessary, with a slightly less stringent requirement of high input impedance. Its gain must still be positive if it is to

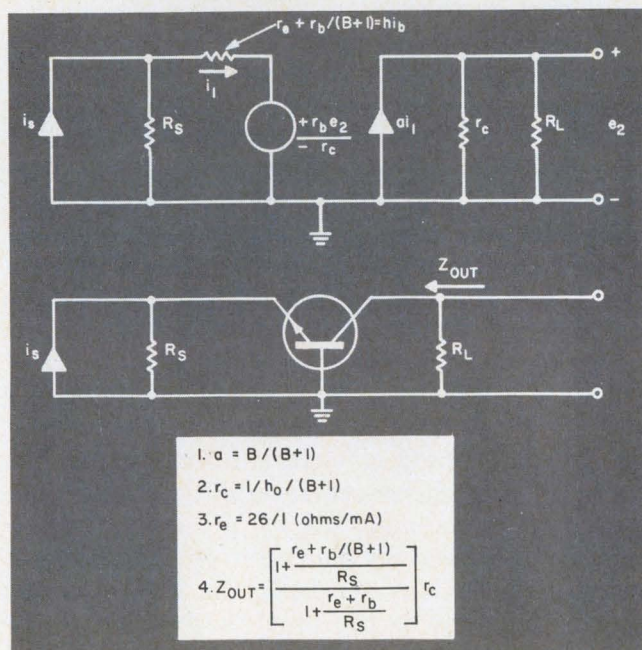

3. Common-base configuration acts as a current generator. Since the emitters of the current-generator stages (Q1 and Q2 in Fig. 1) are not driven by a signal, resistance RS in the model represents the emitter resistors.

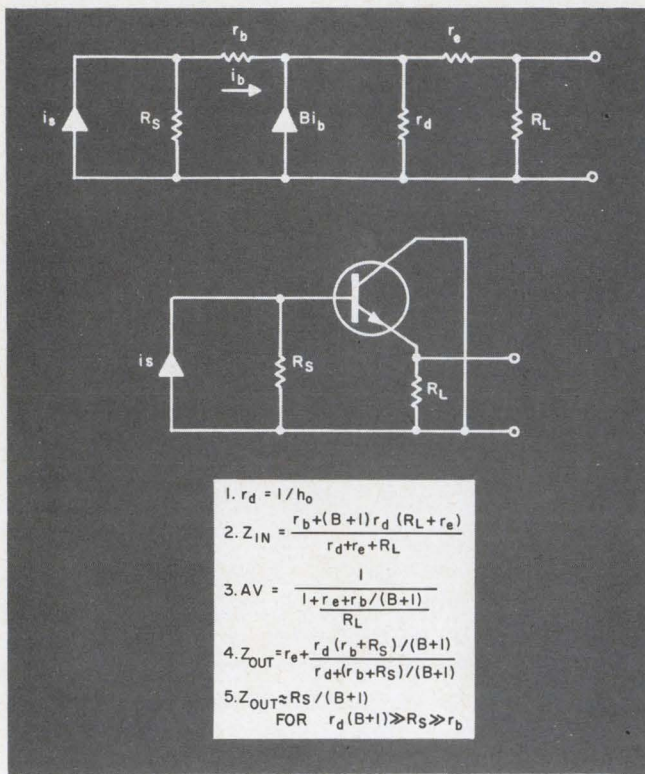

4. Emitter-follower configuration (Q4 in Fig. 1) serves two purposes: It provides the output drive of the amplifier and the bootstrapping of the FET.

Table 1. Circuit design values

Data sheet values					
Parameter	2N3565	2N2188	2N2608	Unit	
$h_o$ or $g_o$	11	18	15	$\mu$ mhos.	
$r_d$	91	56	—	K $\Omega$	
B or $g_m$	280	85	1000	all @ 1 mA	
			$\mu$ mhos		
$C_{te}$ or $C_{gss}$	2	—	12	pF	
$C_{ob}$ or $C_{rs}$	4	2	5	pF	
$r_e$	26	26	—	ohms	
$r_b$	280	300	—	ohms	
Calculated values					
Parameter	Q1	Q2	Q3	Q4	Total
$Z_{out}$	25 M $\Omega$	1K	4.5 M $\Omega$	30 $\Omega$	30 $\Omega$
$Z_{in}$	—	—	—	4 M $\Omega$	—
AV	—	0.9996	—	0.9985	0.9981
Measured Values					
AV = 0.9982					
$Z_{out} = 30$ ohms					
$0.2$ pF $\leq C_{in}$ (eff) $\leq 0.8$ pF					
$R_{in} > 4000$ M $\Omega$					

be used for bootstrapping  $C_{rs}$ . The gain must also approach unity while driving a larger load, and it has been shown that unity gain in the FET is impossible with a large load (low  $R_s$ ). The common collector configuration (see Fig. 4) does not have as severe a limitation.

#### Common-collector stage drives two loads

In Fig. 4 note that Eq. 2 reduces to the popular expression  $Z_{in} \approx (B+1) R_L$ , where  $R_L \ll r_d$ . From the equation for AV it is seen that this  $R_L$  need be but ten times the sum of  $r_e + R_b/(B+1)$  for AV to be 0.99. This indicates that unity gain will result if a load resistor acceptable to  $Z_{in}$  criterion is used.

Two loads are to be placed upon the emitter follower: the following amplifier stage, and the drain resistor that must be bootstrapped. The drain resistor can be increased by use of the same current generator discussed earlier (Fig. 3). That it need be as large could be questioned at this point. Certainly the same  $g_m$ -vs-drain current conflict must be considered; however, better arguments to justify usage are available. An analysis of the capacitor coupling or Zener diode coupling will provide them.

Suppose bootstrapping is to be accomplished with a large capacitor. Will the size of it necessary for low-frequency response also produce "bounce"? Can its low-frequency breakpoint be placed in a region where its interaction with other system capacitors will not cause oscillation? Will its use produce long delays from overload due to saturation charges? Will the resistor now necessary to bias the emitter follower reduce  $Z_{in}$  below a satisfactory value?

A Zener diode is obviously a better solution, although not without problems of its own. How low must the drain resistor be before a suitable Zener current is provided for low noise? Will that current provide a ratio of drain resistor to Zener impedance that will achieve an effective bootstrap? Is that current favorable to the gain bandwidth characteristics of the emitter follower? Will it cost less than the components used for the common base amplifier? Based on these questions, a current generator is a good choice.

Use of a second current generator creates a slightly larger bias instability than the capacitor or Zener would give. Its advantages, though, outweigh this introduced instability. First, bootstrapping is accomplished by a simple RC circuit. Furthermore the generator current is selected to provide bias for both the FET and the emitter follower, so the input impedance of the following amplifier is therefore the largest load placed upon the input stage.

The general considerations involved in determining circuit configuration would not be com-

## Table 2. Sample calculations

1. $Z_{out}(Q3) = [(1 + 29/3.6K)/(1 + 329/3.6K)] 56K (86)$	From Eq. 4, Fig. 3.
2. $Z_{in}(Q4) = [280 + (281)(91K)(18K + 26)]/(91K + 26 + 18K)$	From Eq. 2, Fig. 4.
3. $AV(Q2) = 1/[1 + (1/2.2M \times 10^{-3})]$ For $R_S = Z_{out}(Q3)$ in parallel with $Z_{in}(Q4)$	From Eq. 2, Fig. 2.
4. $Z_{out}(Q1) = [(1 + 27/1K)/(1 + 307/1K)] 91K (281)$	From Eq. 4, Fig. 3.
5. $AV(Q4) = 1/(1 + 27/18K)$	From Eq. 3, Fig. 4.
6. $Z_{out}(Q2) = 2.2M/(1 + 2.2M \times 10^{-3})$	From Eq. 3, Fig. 2.
7. $Z_{out}(Q4) = [91K(280 + 1K)/281]/[26 + 91K + (1K + 280)/281]$	From Eq. 4, Fig. 4.

plete without mentioning transistor capacitances. In Fig. 1, the effect of the output capacitance of Q3 and the input capacitance of Q4 on AV in the FET must be known. The total capacitance on the emitter of Q4 must be known as well. Although these will not be discussed in detail here; no design would be accurate without considering them.

### Component selection is important

Once circuit configuration is established, component selection and circuit biasing must be done. No amount of circuitry can undo faulty component selection. Noise figures, although not discussed, must also be considered from a selection and bias standpoint.

The 2N2608 FET cannot be chosen from a pure dollar-and-cents viewpoint; however, if all FETs with complete data sheets are considered, the 2N2608 will rank high, if not first. Its  $g_m$  is better than average at currents high enough for wide bandwidth in the surrounding transistors. Capacitances are low enough to be negated effectively by the amount of bootstrapping expected. In addition the spread of specified parameters from one unit to the next is not excessive.

Selection of the 2N2188 is made on a similar basis. Its dc collector current must be lower than the minimum drain current of the FET with zero voltage from gate to source. The drain current is 0.9 milliamps for the 2N2608, and at this level Q3 must operate efficiently. Low output capacitance, which is necessary, comes free with any transistor that exhibits a wide bandwidth at low current. The fact that the common-base configuration has, in general, good frequency response should not cause one to overlook the necessity for connecting low capacitance to the FET source.

As noted earlier, the input impedance of Q4 should be very high. Since the emitter load is fixed, only a high  $h_{re}$  can provide this. Low input capacity is also required and, again, wide frequency response. The number of specifications a device carries is reflected in its price, but, once more, when all necessary specifications for a complete design are considered, the 2N3565 fills the bill.

Contrary to belief in some engineering quarters, the selection of extra parameters for dc biasing is relatively straightforward. For high  $g_m$ , the drain current must be large. It must be equal to or lower than the minimum specified  $I_{dss}$ , which is the drain current with zero voltage from gate to source. Q3 is biased to provide this current. The emitter resistor of Q3 is a free parameter. As noted in Eq. 4 of Fig. 3,  $R_s$  should be large to maintain  $Z_{out}$  high. Another free parameter,  $V_{ce}$ , should be considered. The 2N2188 is specified at 9 volts  $V_{ce}$ . Since this voltage undoubtedly was chosen to reflect optimum figures, it would also be a good choice for circuit biasing. This also allows  $R_s$  to be fairly large (3.6 k $\Omega$ ).

Similar choices were made for Q4. All small-signal characteristics for the 2N3565 were given at 1 mA.

Current in Q1 is not a free parameter. It must be equal to the sum of current through Q2 and Q4. R1 was chosen, however, to leave 5 volts drain-to-source in Q2.

Bias stability is another area that should be analyzed for completeness. Only a few points will be made here. Collector-current stability is dependent upon changes in  $I_{co}$  and  $V_{be}$ . The use of a low ratio of base-resistance to emitter-resistance minimizes both. Since Q3 is germanium, this ratio was kept lower in its bias circuit.

Drain-current stability is also dependent on two factors: one is a change in the gate-to-source voltage ( $\Delta V_{gs}$ ) for a constant-drain current, and the other a change in mobility of the majority carriers. These changes oppose each other; however, at the chosen bias point,  $\Delta V_{gs}$  will dominate. The rate of change in  $V_{gs}$  is approximately 2.2 mV/ $^{\circ}$ C. The same rate of change is evident in  $V_{be}$  of Q4, and polarities have been chosen to provide cancellation.

### Stage performance analyzed

With biasing complete, total stage performance can be studied. A list of values has been compiled in Table 1. Some are taken directly from the data sheets, while others are parameter conversions

# who said quality plugboard programming systems have to be expensive?

## not MAC Panel engineers!

All they say is that they have to be better than all the others at less cost. And they are—all seventeen standard sizes of them.

MAC design engineers take pride in designing flexible and fixed plugboard programming systems that perfectly mate with your racks, that give you the most reliable program control of your electronic equipment.

Special attention is given to the design and engineering of each component in MAC systems: receivers, plugboards and plugwires. Meeting your precise requirements for number of circuits, installation space limitations, environmental conditions, signal levels, frequency range, and reliability is their prime objective.

Whether one of the standard systems meets your needs or you require a custom designed system, MAC Panel is the source. See your MAC representative, or write for MAC's full line catalog today.

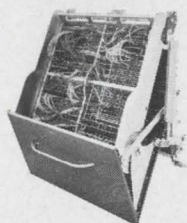

**MAC**  
O.E.M. DIVISION

**MAC PANEL CO. High Point, N.C.**

ON READER-SERVICE CARD CIRCLE 29

from those given on the sheets. Below the given values in Table 1 is a list of calculated values. Only the voltage gain and  $Z_{out}$  are completed. Table 2 is a list of equations necessary to find these values.

Voltage gain in the stage could be found with a somewhat messy equation and appropriate circuit reductions; however, a more explicit approach is that of analyzing each device separately, using only those models presented in the Figs. 2 to 4.

To find the voltage gain in Q2 of Fig. 1, the source resistance must be known. It is made up of the output impedance of Q3 and the input impedance of Q4, in parallel. Equations 1 and 2 of Table 2 are expressions taken from the models, with data-sheet values substituted. The parallel equivalent is then calculated and used in Eq. 3 to find AV in the FET.

To find AV for Q4 the load of Q4 must be known as well. Part of the load is the output impedance of Q1. It is calculated with Eq. 4. The result, which appears on Table 1, can be neglected when compared with the input impedance of the dc amplifier. There is, of course, channel resistance in the FET, but since there is positive gain in parallel with this resistance, the effective value will again be insignificant compared with 18 k $\Omega$ . The voltage gain in Q4 is then a straightforward calculation. The values used are given in Eq. 5 of Table 2. Total stage gain is merely the product of the two gains just found.

$Z_{out}$  calculations are performed only to demonstrate a close correlation between pencil values and measured values.  $Z_{out}$  for Q2 is calculated first, since its result is necessary to find that of Q4.

With gains known, the equivalent  $C_{gss}$  and  $C_{rs}$  can be found.  $C_{gss}$  will equal 12(1 - 0.9996) pF, or 0.0048 pF.  $C_{rs}$  will equal 5(1 - 0.9981) pF or 0.0095 pF. These values are merely academic, since total stage response can be represented by a lumped equivalent capacitance at the input. This is shown as  $C_{in(eff)}$  under measured values in Table 1.

The stage input impedance could not be calculated, since no specification was given for the intrinsic impedance of the 2N2608. The measurement technique consisted of determining the difference in output with changes in driving-point impedance. On a five-digit instrument, readings were obtained to indicate a low of 4000 megohms for a freshly soldered stage, and a high of 9000 megohms for a stage just cleaned with alcohol. ■ ■

### Bibliography

Blaser and MacDougall. *Applications of Silicon Planar Field-Effect Transistors*. (Fairchild Application Note APP 103), 1964.

Joyce and Clarke. *Transistor Circuit Analysis*. Reading, Pa.: Addison-Wesley, 1964.

*Communications Handbook*. Dallas: Texas Instruments, Inc., 1965. Part I, Chaps. 7 and 11.

*High-Impedance Unijfet Amplifiers*. Sunnyvale, Calif.: Siliconix, Inc., 1963.

# RCA LOW-COST OP AMPS GO HIGH VOLTAGE

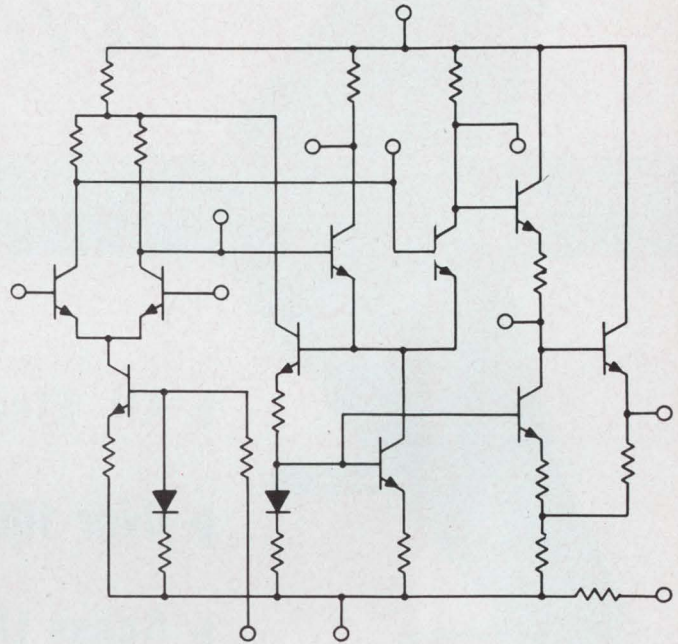

- 70dB typ open-loop voltage gain
- 320 kHz typ bandwidth at -3dB point
- 103dB typ common-mode rejection ratio
- 92 ohms typ output impedance
- 14 volts typ output voltage swing
- $\pm 3V$  to  $\pm 12V$  supply
- $-55^{\circ}C$  to  $+125^{\circ}C$  operation

The industry's biggest performance/dollar values  
in monolithic linear integrated circuits

New CA3015 12-lead TO-5 style...\$7.50 (1000+)

New CA3016 14-lead Flat Pack...\$8.50 (1000+)

FOR MORE INFORMATION, check your RCA Distributor for his prices on CA3015 and CA3016, or contact your nearest RCA representative. For Technical Bulletin and Application Note, write Commercial Engineering, Section ICG12-20 RCA Electronic Components and Devices, Harrison, N.J. 07029.

Look into RCA's growing linear line

CA3000	CA3001	CA3002	CA3004 CA3005 CA3006	CA3007	CA3008 CA3010	CA3011 CA3012	CA3013 CA3014
DC Ampl	Video Ampl	IF Ampl	RF Ampls	AF Ampl	Opr Ampls	Wide- Band Ampls	Wideband Ampl Discrim- inators

AVAILABLE THROUGH YOUR RCA DISTRIBUTOR



THE MOST TRUSTED NAME IN ELECTRONICS

**FIRST PRIZE:**

*win 2 round-trip  
New York*

- ▶ All Electronic Design subscribers are
- ▶ Over 100 other valuable prizes!
- ▶ Guess the top ten ads in Electronic Design's
- ▶ "ELECTRONICS IN THE WORLD OF TOMORROW"

## Electronic Design's 1967

### SEPARATE CONTEST FOR MANUFACTURERS AND ADVERTISING AGENCIES

Not forgotten in the "Top Ten" contest, advertisers and their agencies may also enter. In addition to prizes of a **flight to Paris, color TV, and electronic timepiece**, the top 10 ads, and the winning advertiser's ad (if run January 4, 1967) will be re-run in the April 1st issue. Watch for the special "Top Ten" contest rules and entry blanks appearing January 4, 1967



### 2ND PRIZE HOFFMAN COLOR TV CONSOLE

Hoffman 23" console, featuring 26,000 volts of picture tube power... 4" x 6" front-firing speaker... easy vision camera control for sharp color movies and positive, black and white picture shading... InstaVision on-off control... 32" x 29" x 19 1/2" cabinet. (Retail value: \$600.00.)



### 3RD TO 8TH PRIZES BULOVA ACCUTRON® ELECTRONIC TIMEPIECES

The "Spaceview" is an ideal timepiece for electronics engineers. Its clear-view dial reveals transistorized electronic circuit and tuning fork assembly. The tuning fork, advertising symbol and unique frequency standard of Accutron® timepieces, is the reason Bulova guarantees an in-use, on-the-wrist accuracy of within 60 seconds a month. (Retail value: \$150.00.)



### PLUS 100 ADDITIONAL PRIZES MICROELECTRONIC DESIGN

This clothbound, 8 1/2 x 11, 320-page, 1966 edition will be given free to 100 winners. "Microelectronic Design" offers a thorough overview of the field in six sections—has almost 90 outstanding articles compiled from the pages of *Electronic Design*. Edited by Howard Bierman. (Retail value: \$11.50.)



*tickets between*  
*and* **PARIS**  
**VIA AIR FRANCE**

**eligible!**

**January 4 issue**

**“Top Ten” contest**

**HERE'S ALL YOU HAVE TO DO TO ENTER:**

Rate the ads appearing in the January 4, 1967 issue of *Electronic Design*. Select the “Top Ten” . . . the ads that, in your opinion, will be best remembered by readers. Your choices will be measured against the 10 ads ranking highest in the “Recall-Seen” category of Reader Recall—Electronic Design’s scientific method of measuring readership. In making your predictions, be sure to consider your 54,000 fellow engineers’ interest in the subject matter of the ads, their effectiveness, impact, and attention-getting values.

Entry blanks and complete contest rules will appear in the January 4th issue. Don’t miss this opportunity to win one of the many valuable prizes shown at left. The first prize winner will receive round-trip tickets for two, between New York and Paris via Air France!

# Predict filter response exactly

by replacing conventional narrow-band assumptions with a plane transformation, plotted here for most filter types.

More often than not the response of bread-boarded broad-band filters does not even approach their calculated behavior.

The fault is not in the engineering; it is in the calculation, since conventional theoretical analysis is based on arithmetic symmetry. This is reasonably accurate for narrow-band filters, but yields an error that increases in proportion to bandwidth. Here is a simple transformation method that produces accurate calculated results regardless of the bandwidth of the filter.

Consider, for example, the design of a double-tuned (two-pole) filter. The distribution of its poles as well as the images is shown in Fig. 1. The images have to be included, because mathematically they contribute to the amplitude and phase response.

The distribution is taken to be semicircular (for Butterworth filters); under the assumption of arithmetic symmetry, the lengths of the vectors from the image poles to the frequency of interest between frequencies  $\omega_1$  and  $\omega_2$  are constant. ( $\omega_1$  and  $\omega_2$  represent the lower and upper 3-dB frequencies of the desired response.) Obviously, this is not exactly true for any bandwidth. But, if the 3-dB bandwidth is small compared with center frequency  $\omega_0$ , there will be only a small error in the calculations. For instance, the amplitude response may be found graphically by calculating the inverse of the product of the distances from the frequency of interest to the two poles in Fig. 1. If zeros were also present, the response is calculated by dividing the product of the distances to the zeros by the product of the distances to the poles from the frequency of interest.

The use of this familiar graphical construction technique for wide-band filters will result in a severe departure from the desired response shape. The conventional semicircular graphical representation of the loci is no longer valid for wide-bandwidth filters.

The S-plane must be transformed so that the real and image distributions fold over one on top of the other. Then the poles and zeros may again

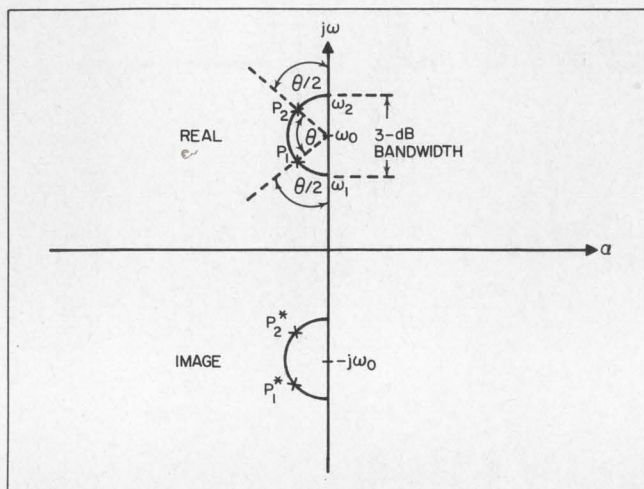

1. S-plane distribution of a typical double-tuned Butterworth filter shows two poles and no zeros. The image is included since it contributes to both amplitude and phase responses.

be handled in the usual manner; i.e., using semicircular loci for Butterworth filters and elliptical for Chebyshev filters.

Once the poles and zeros are located in the new plane (called Z-plane from now on), an inverse transformation will give their position in the S-plane for an exact design.

The transformation from the S- to the Z-plane is performed with the aid of the following relationships:

$$Z_m = (S_m/\omega_0) - (\omega_0/S_m), \quad (1)$$

where  $\omega_0 = (\omega_1\omega_2)^{1/2}$ .

This will result in a semicircle in the Z-plane which has a radius:

$$\delta = (\omega_2 - \omega_1) / (\omega_1 \omega_2)^{1/2}. \quad (2)$$

The inverse transformation—from Z- to S-plane—uses the following equation:

$$S_n = \omega_0 \{ (Z_n/2) \pm [(Z_n/2)^2 + 1]^{1/2} \}. \quad (3)$$

In terms of the coordinates of the Z-plane, the mapping equations back into the S-plane are:

$$S/\omega_0 = N/2 [R \cos \phi \pm \cos \theta + j(\sin \theta \pm R \sin \phi)], \quad (4)$$

where:

$$R = [1 + (N/2)^{-4} + 2 \cos 2\theta (N/2)^{-2}]^{1/4}, \quad (5)$$

William G. Meyers, Member, Technical Staff, Radar Development Group, TRW Inc., Redondo Beach, Calif.



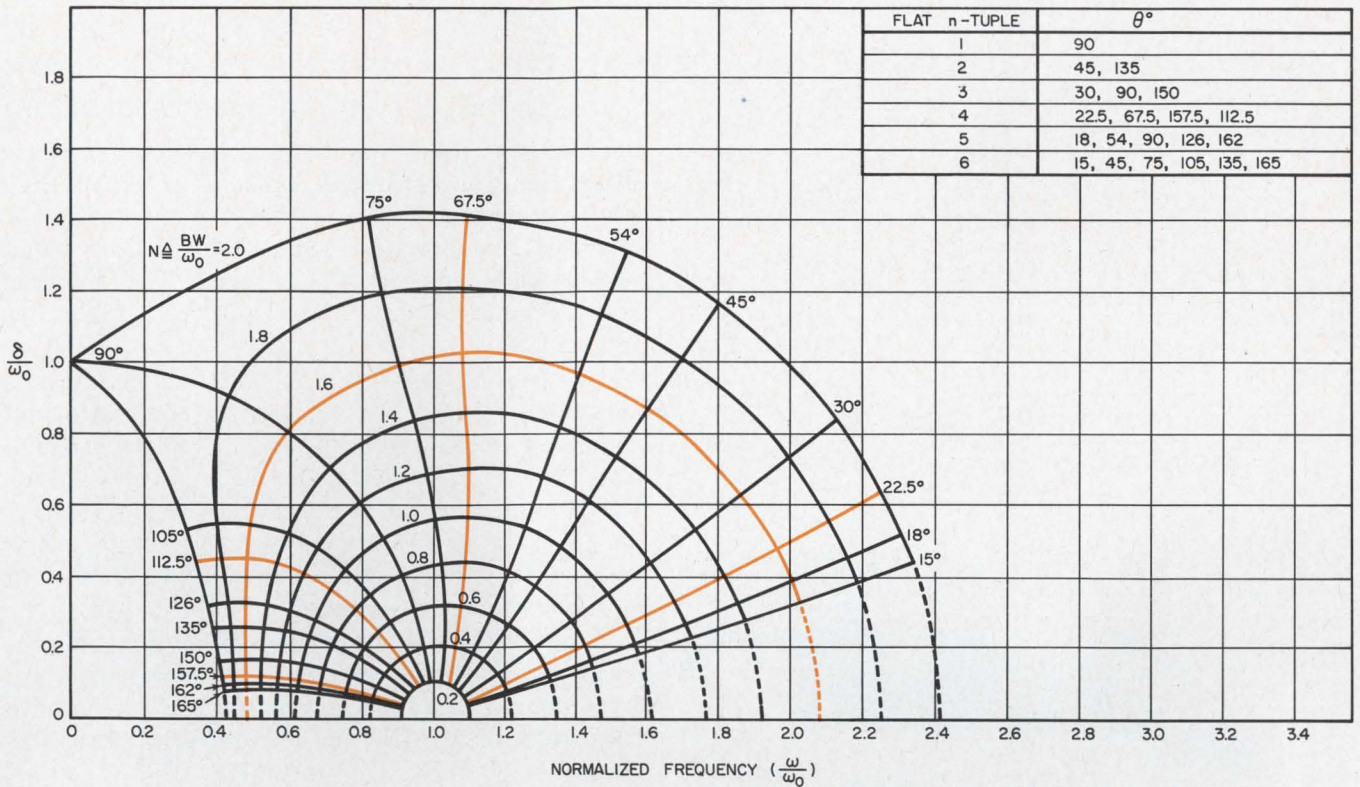

2. Exact roots of filters can be found with this representation of the Z-plane in the S-plane. The accuracy of the

results does not depend on the bandwidth of the filter.  $\theta$  is plotted for flat filters having up to six poles.

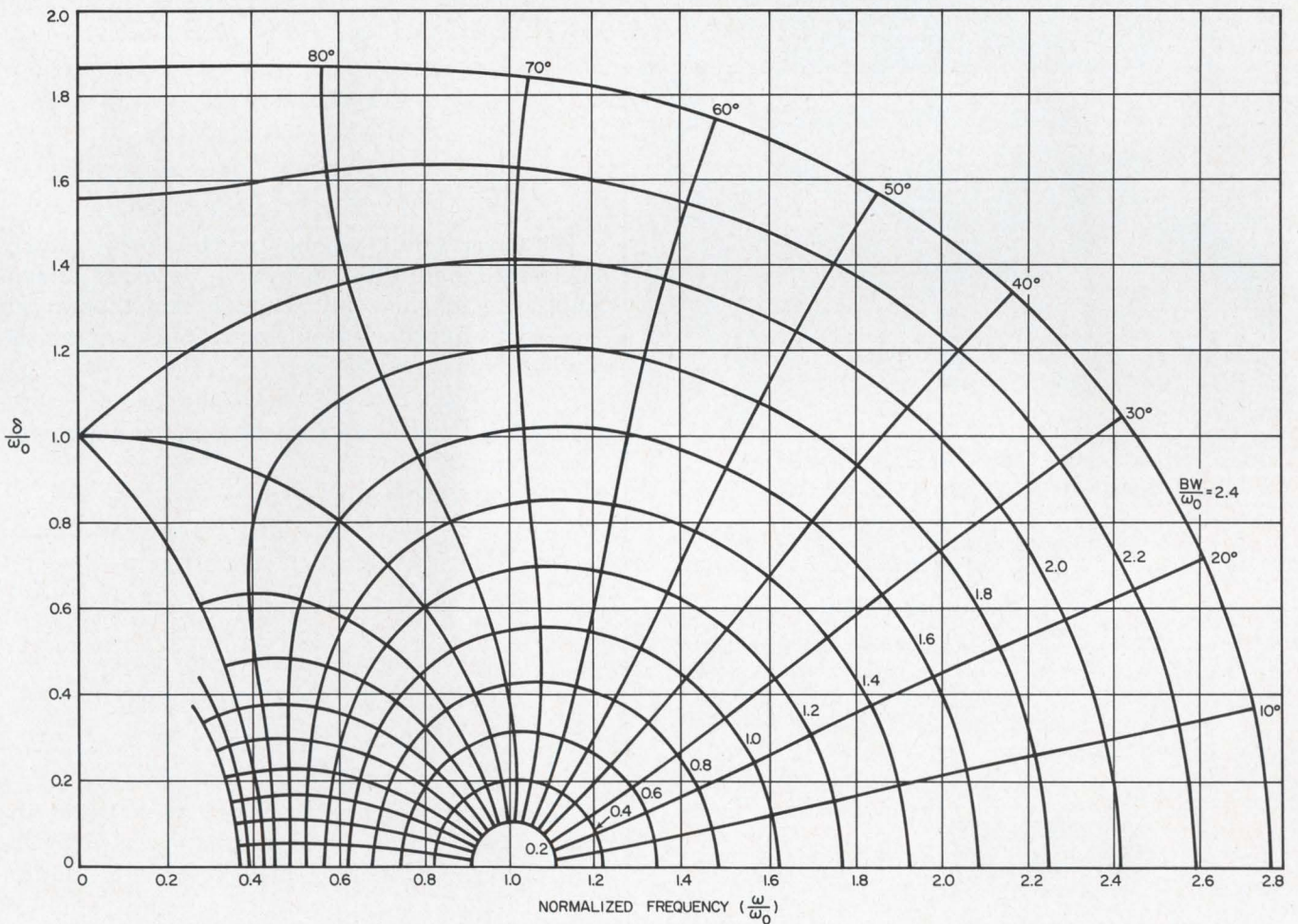

3. Evenly spaced angular indexing of the remapped Z-plane in the S-plane helps in the design of Chebyshev,

Gaussian and other filters by permitting more accurate extrapolation.

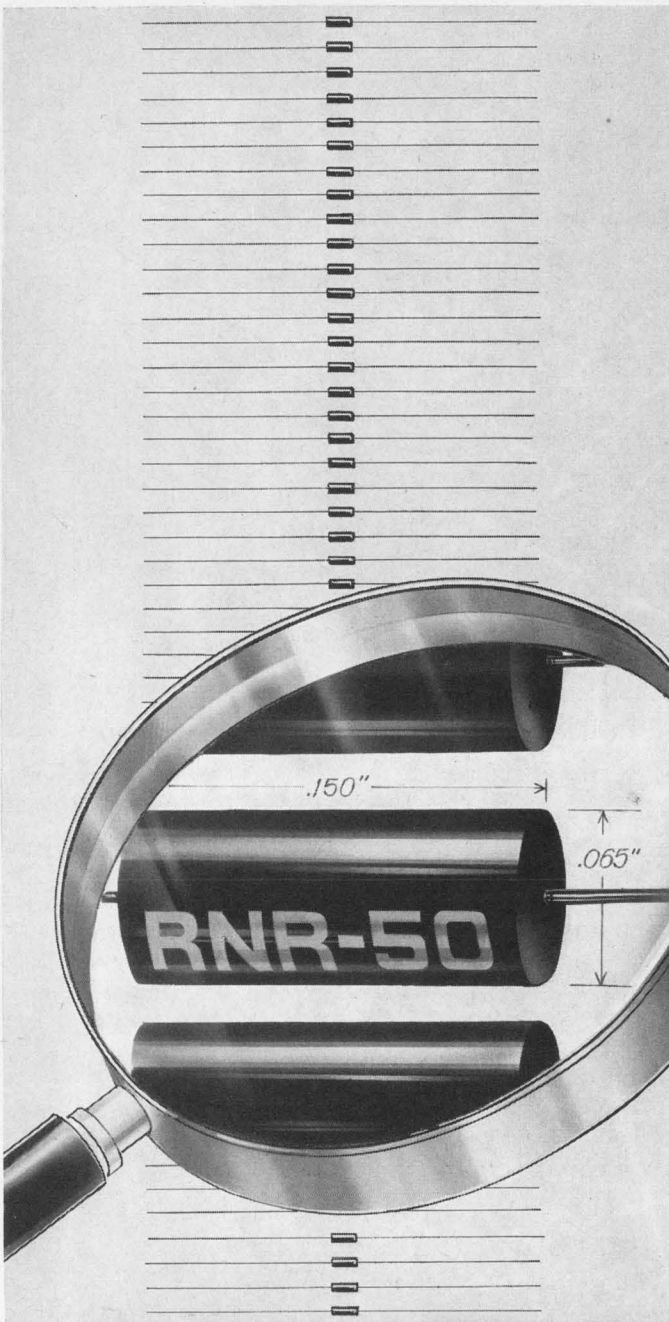

MEPCO HAS UNIFORM DIMENSIONAL CONFIGURATIONS EVEN IN ITS

**1/20 WATT**

METAL FILM RESISTORS.

■ Molded epoxy enclosure assures repeatable dimensions ■ Cap and lead terminations ■ Extensive moisture testing proves the superiority of Mepeco's transfer encapsulation enclosures ■ Meets RNR-50 (H Characteristic).

Write or call today for complete technical data

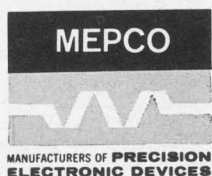

MEPCO, INC.  
Columbia Rd., Morristown,  
New Jersey 07960  
(201) 539-2000  
TWX (201) 538-6709

ON READER-SERVICE CARD CIRCLE 31

$$\phi = (1/2)\tan^{-1}\{\pm\sin 2\theta/[\cos 2\theta + (N/2)^{-2}]\}, \quad (6)$$

$$N = BW/\omega_0, \quad (7)$$

$$\theta = \text{phase angle} = 180^\circ/(\text{number of poles}). \quad (8)$$

Since both the  $Z$ s and  $S$ s can be complex quantities, the transformation process is tedious and time-consuming. To save effort, the entire  $Z$ -plane has been remapped for various normalized bandwidths and angles to the  $S$ -plane. The required pole locations can thus be read directly from either Fig. 2 or 3.

The loci of poles for various bandwidths is plotted in Fig. 2. The angle  $\theta$  is chosen to suit commonly encountered angles for usual pole multiples ( $n = 2, 3, 4, 5$ , etc.) of flat  $n$ -tuple filters. Fig. 3 is identical to Fig. 2, except that the angular indexing is evenly spaced to facilitate extrapolation for other distributions such as Chebyshev and Gaussian.

To illustrate the use of the charts, consider the problem of locating the exact pole positions for a four-pole (quad) Butterworth filter with a 3-dB bandwidth of 96 MHz and a geometric center frequency of 60 MHz. The parameter  $N$  is given as:

$$N = BW/\omega_0 = 96/60 = 1.6.$$

For quads ( $n = 4$ ), the intersection of the  $N = 1.6$  curve with the  $\theta$  radii of  $22.5^\circ$ ,  $67.5^\circ$ ,  $112.5^\circ$  and  $157.5^\circ$  yields the four poles, respectively:

$$S_1/\omega_0 = (\alpha_1/\omega_0) + j(\omega_1/\omega_0) = -0.491 + j 1.96,$$

$$\therefore S_1 = -29.4 \text{ MHz} + j 117.5 \text{ MHz},$$

$$S_2 = -61.2 \text{ MHz} + j 66 \text{ MHz},$$

$$S_3 = -27.2 \text{ MHz} + j 29.2 \text{ MHz},$$

$$S_4 = -7.2 \text{ MHz} + j 28.8 \text{ MHz}.$$

The exact pole locations are thus very quickly determined and the conversion to exact inductances, capacitances and loading resistances can proceed in appropriate fashion according to the chosen network synthesis.

By contrast, the pole locations which would evolve from the more conventional narrow-band approximation are:

$$S_1, S_4 = -(BW/2)\sin(180^\circ/2n) + j[60 \text{ MHz} \pm (BW/2)\cos(180^\circ/2n)],$$

$$S_2, S_3 = -(BW/2)\sin(3/2)(180^\circ/n) + j[60 \text{ MHz} \pm (BW/2)\cos(3/2)(180^\circ/n)],$$

or:

$$S_1 = -18.3 \text{ MHz} + j 104.3 \text{ MHz},$$

$$S_2 = -44.3 \text{ MHz} + j 78.3 \text{ MHz},$$

$$S_3 = -44.3 \text{ MHz} + j 41.7 \text{ MHz},$$

$$S_4 = -18.3 \text{ MHz} + j 15.7 \text{ MHz}.$$

It is readily apparent that the narrow-band approximation of arithmetic symmetry leads to errors as large as 100% or more. A network design based on such an approximation would exhibit a severely tilted frequency response of generally unusable and unrecognizable shape. ■ ■

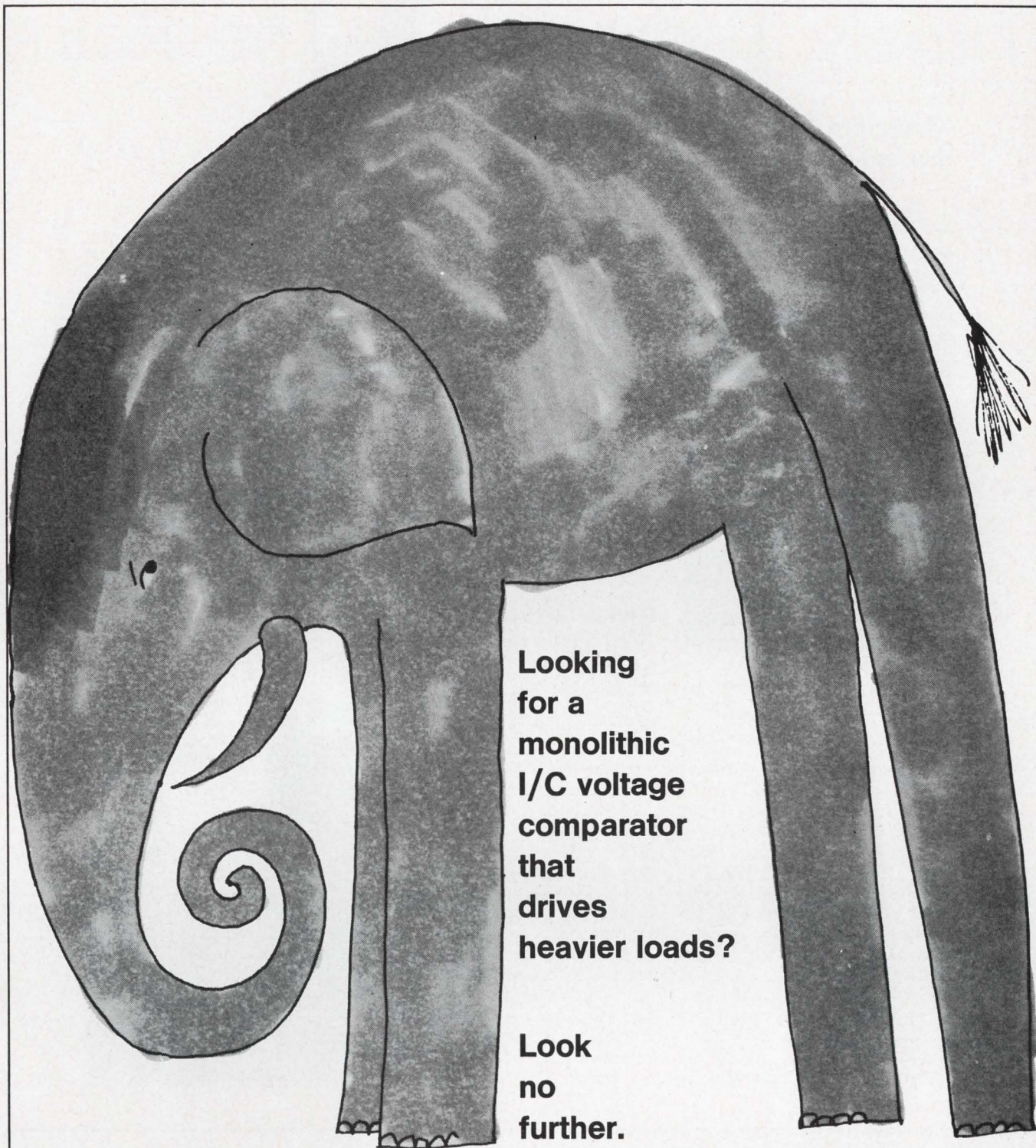

**Looking  
for a  
monolithic  
I/C voltage  
comparator  
that  
drives  
heavier loads?**

**Look  
no  
further.**

Signetics SE518\* provides much more than an unusual load-driving capability. It interfaces directly with all popular logic circuits—DTL, TTL, RTL, or any of several types of CML. For application ease and flexibility, the SE518 operates from standard logic power supplies, and provides a strobe control. No other I/C voltage comparator offers all these advantages in one package. We'd be happy to show you how to use it as a Schmitt Trigger, a Sense Amplifier, a Line Receiver, a Window Detector, or in dozens of other applications. Send for our application notes and data sheet today. Write Signetics, 811 E. Arques Ave., Sunnyvale, California.

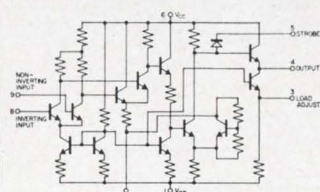

\*Just one of the Signetics product family that is also available from Sprague Electric Co. under a technology interchange agreement.

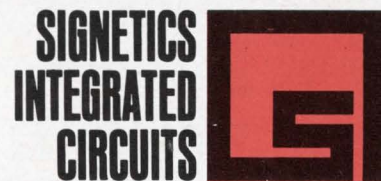

A SUBSIDIARY OF CORNING GLASS WORKS

ON READER-SERVICE CARD CIRCLE 32

# Timely, Thorough, To-The-Point

Three new books to keep you abreast of modern electronic theory and practice

## MATRIX ALGEBRA FOR ELECTRONIC ENGINEERS

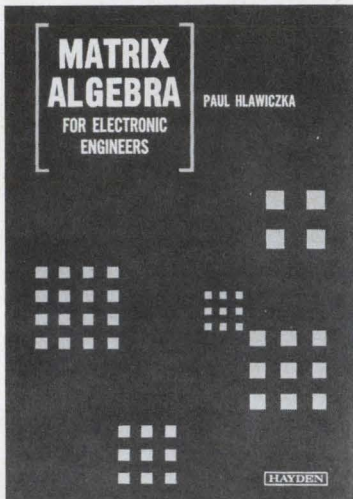

**PAUL HLAWICZKA.** A working knowledge of matrix algebra has become a useful and often indispensable tool for solving many problems in electronics. This introductory book gives a general orientation and shows the solution of numerous simple problems. Part I covers the essentials of matrix methods and their applications to various networks – requiring only a basic algebra background. Part II treats more complex methods, applying them to the differential equations of linear networks. 224 pages, illustrated, clothbound, \$8.75.

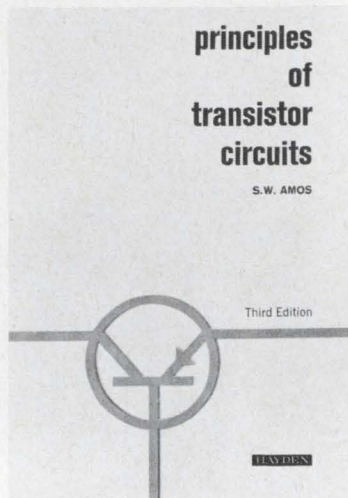

## PRINCIPLES OF TRANSISTOR CIRCUITS

**3rd Ed.**  
**S. W. AMOS.** Keeping up with the rapid advance in transistor technology, this updated revision contains fifty per cent more information than the second edition. Includes new material on dc stabilization of amplifiers by direct-coupled feedback, phase shift and Weinbridge oscillators, blocking oscillators and transistor sawtooth generators. New appendices of transistor parameters and transistor manufacture add to the completeness of this definitive work. 293 pages, illustrated, clothbound, \$7.95.

## THE ELECTRON IN ELECTRONICS

**M. G. SCROGGIE.** An engineer's introduction to the modern physical concepts such as wave mechanics, quantum theory and relativity. These give an entirely new view of the electron, the structure of atoms, and the radiation of energy – all insights of particular importance to the understanding of solid state electronics. This descriptive treatment is expressed in terms and symbols used by the practicing engineer rather than the mathematical physicist. 275 pages, illus., clothbound \$9.95.

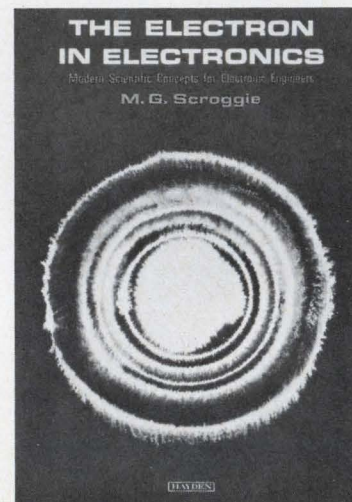

## 10-DAY FREE EXAMINATION – SEND NO MONEY!

Hayden Book Co., Inc., Dept. ED-72, 116 W. 14th St., N. Y., N. Y. 10011

Gentlemen:

Send me the book(s) checked below. At the end of ten days, I will remit payment (plus a few cents postage) or return the books with no further obligation.

- Matrix Algebra for Electronic Engineers, \$8.75       Principles of Transistor Circuits (3rd Ed.), \$7.95  
 The Electron in Electronics, \$9.95

Name \_\_\_\_\_ Title \_\_\_\_\_

Company \_\_\_\_\_

Address \_\_\_\_\_

City \_\_\_\_\_ State \_\_\_\_\_ Zip \_\_\_\_\_

Check here if payment is enclosed. Publisher will pay postage with same return guarantee.

# RCA Announces the NEW 3N128 (MOS) FET for VHF applications

features: □ low feedback capacitance (0.2 pF max.) □ high power gain (18 dB typ. at 200 MHz) □ high forward transconductance (5,000  $\mu$ mho min.) □ low noise (4 dB typ. at 200 MHz) □ low cross-modulation distortion □ a hermetically sealed metal case

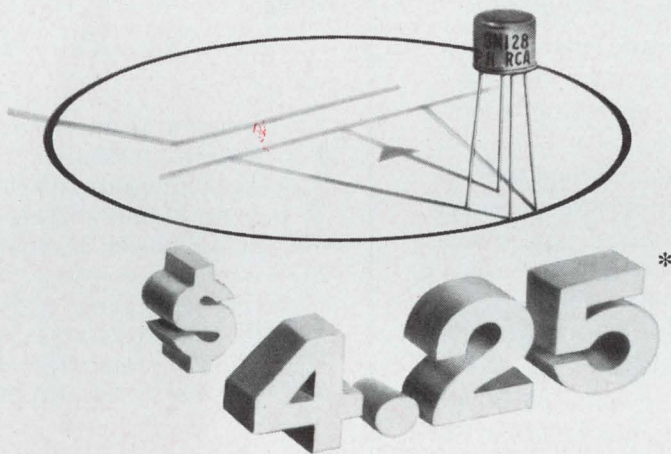

\*Price in quantities of 1,000 and up

RCA's 3N128 N-channel, depletion type, MOS field-effect transistor is now available in production quantities for communications and industrial applications. This new insulated gate MOS transistor exhibits (1) extremely low gate-leakage current (0.1 pA typ.) which permits stable operation over wide temperature ranges, (2) feedback capacitance substantially lower than that of conventional junction-gate devices, and (3) extremely high input resistance of  $10^{14}$  ohms typ.

The RCA 3N128 simplifies your designs because you can use conventional electron-tube type biasing techniques. In

addition, the drain current exhibits a negative temperature coefficient which makes thermal runaway virtually impossible. These attributes, combined with a large signal-handling capability and low cross-modulation distortion, make the 3N128 MOS a "must" for critical front-end designs.

Call your RCA Field Representative for complete technical information, price and delivery on the new 3N128 (MOS) FET. For Application Note AN-3193, or for a technical data sheet, write RCA Electronic Components and Devices, Commercial Engineering, Section EG 12-3, Harrison, N. J. 07029. SEE YOUR RCA DISTRIBUTOR FOR HIS PRICE AND DELIVERY



RCA Electronic Components and Devices

The Most Trusted Name in Electronics

# Don't ignore thermal paths in your integrated-circuit designs. Test fixtures bonding techniques—both have an important effect.

If you're considering an integrated circuit that dissipates 50 mW or more, take a close look at the internal temperature rise of the circuit; it's an important design and reliability consideration that engineers often ignore.

Device parameters vary directly with junction temperature, and junction temperature is a function of power dissipation, or in other words, of thermal resistance. The establishment of a dependable basis to accept or reject circuits requires a careful analysis of this dissipative mechanism. Chip-bonding techniques and the type of test fixture that is used greatly affect power dissipation and may cause a number of problems. These include:

- Unjust comparisons of different devices.
- Differences between vendor and buyer data.
- Changes in device characteristics in going from test conditions to actual operating conditions.

Chip-bonding techniques are the method used to fasten an integrated circuit chip to the package. The two techniques to be discussed are glass-bonds and gold-silicon eutectic bonds. The other major source of power dissipation problems to be dealt with stems from the variety of fixtures for handling, testing and breadboarding ICs. Since each test fixture has a different thermal path, the results of tests performed on the same circuit with different fixtures may vary widely.

## Tests compare identical packages

Silicon monolithic integrated circuits packaged in JEDEC type TO-84 flat-packs were used for tests to evaluate thermal effects. These circuits came from different makers but were functionally and schematically identical. Their external package, lead configuration, and chip size were also essentially the same.

The effect of the heat transfer mechanisms—

**R. P. Berkowitz**, Product Assurance Manager, and **A. J. Nasuti**, Reliability Engineer, Computer Control Div., Honeywell, Inc., Framingham, Mass.

## Equivalent thermal circuits

The idealized thermal schematic of an integrated circuit mounted on some sort of holding and test fixture (a) includes the thermal resistances of junction to case, case to ambient, case to fixture and fixture to air. The last three resistances can be added in series and parallel to achieve a total value of case to ambient thermal resistance (b).

The junction-to-ambient thermal resistance (c) becomes:

$$\theta_{ja} = \theta_{jc} + \theta'_{ca}, \quad (1)$$

where:

$$\theta_{ja} = (T_j - T_a)/P, \quad (2)$$

and

$T_j$  = junction temperature,

$T_c$  = case temperature,

$T_a$  = ambient temperature,

$T_f$  = fixture temperature,

$P$  = actual power dissipation,

$\theta_{jc}$  = thermal resistance, junction to case,

$\theta_{ja}$  = thermal resistance, junction to ambient,

$\theta_{ca}$  = thermal resistance, case to ambient,

$\theta_{cf}$  = thermal resistance, case to fixture, and

$\theta_{fa}$  = thermal resistance, fixture to ambient.

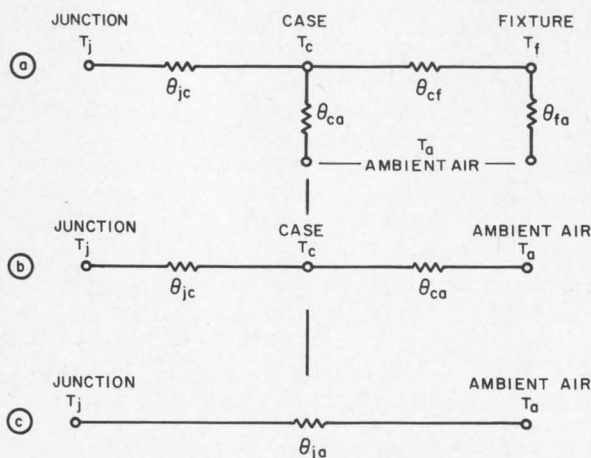

conduction, convection, and radiation—on integrated circuits depends on many variables, such as the material's thermal conductivity, package configuration, and material texture. A thermal analogy with Ohm's Law serves to analyze these mechanisms in ICs.

The accompanying box shows the important reference points of a circuit in progressively simplified thermal resistance diagrams. The resistance between any two reference points on the diagram represents the total thermal impedance between the two points and includes all three methods of heat transfer.

As shown in Fig. 1, the diode in many integrat-

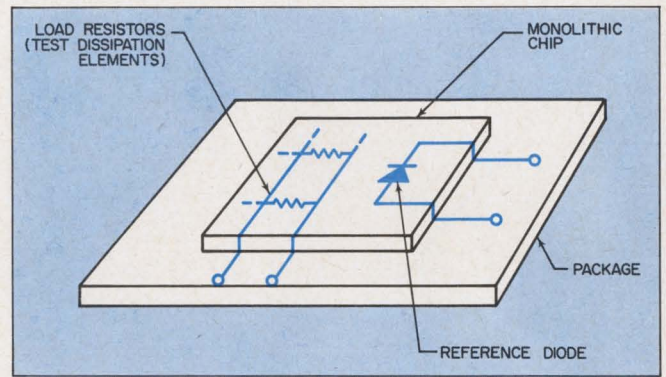

1. Dissipative resistance elements heat up substrate in this idealized version of an integrated circuit. Isolated diode serves as temperature sensor.

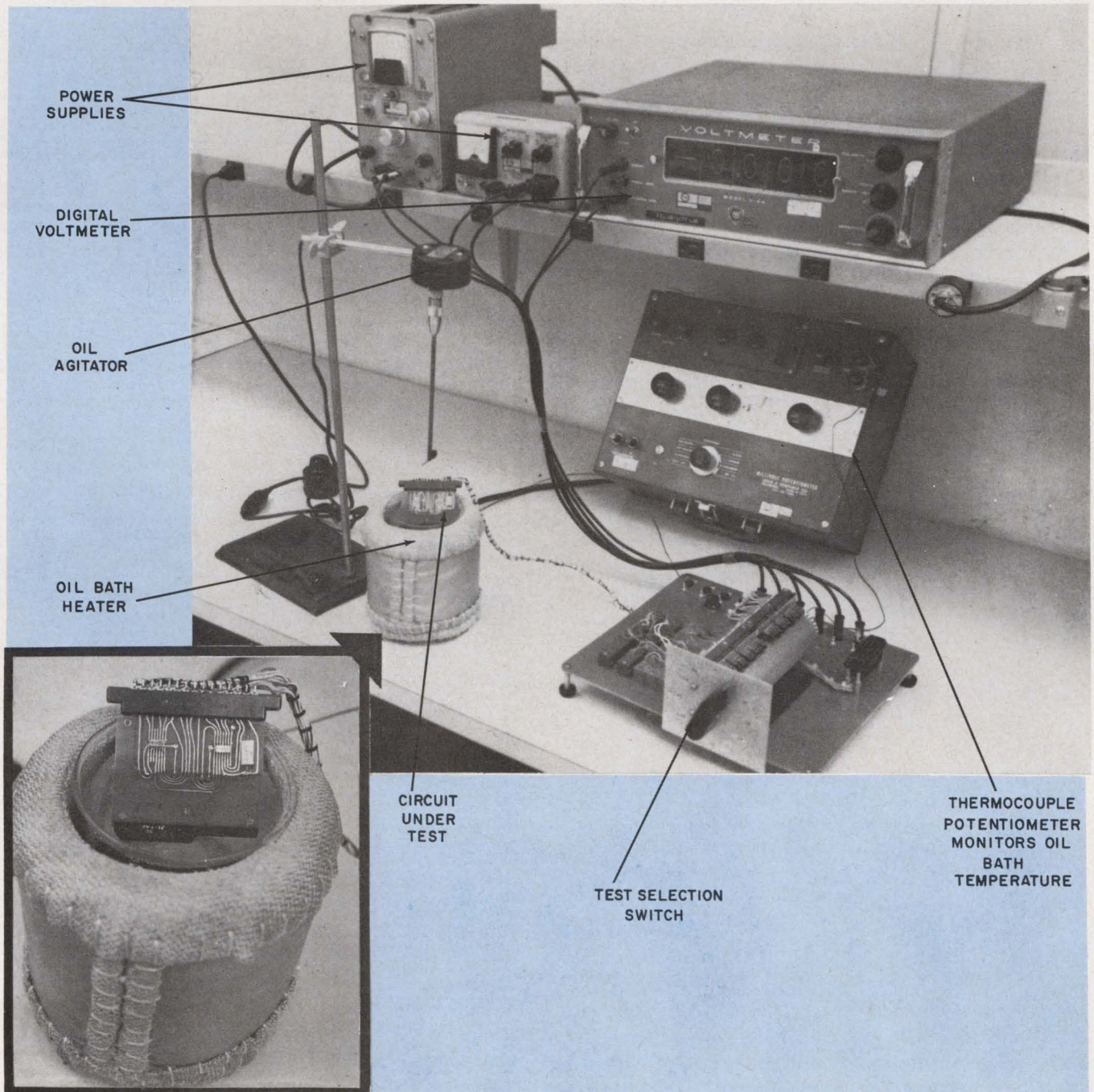

2. Calibration setup required precise temperature control and measurement. Oil bath provides constant ambient

temperature to circuits under test. The agitator keeps the oil from forming equithermal layers.

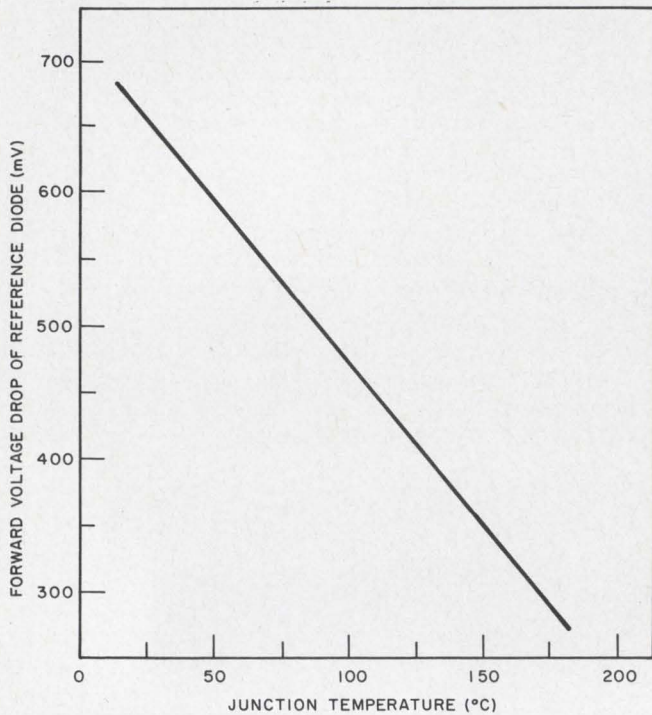

3. The forward voltage drop of the reference diode is an excellent temperature indicator. This method assumes that the integrated circuit possesses no thermal gradients: the diode and circuitry are at the same temperature.

ed circuits may be used as a temperature sensor to measure temperature and power dissipation simultaneously. This is possible because, although both devices are located on the same chip, the power dissipating elements can be electrically isolated from the temperature sensing diode. More conventional thermal-resistance-measuring techniques require that the applied power be cycled to accommodate the reference temperature measurement.

When power and temperature are monitored simultaneously, the following conditions must be fulfilled:

- The power-dissipation elements must be electrically isolated from the reference diode in the integrated circuit.
- The power rating of the dissipation elements must be high enough to sustain a power equivalent to the rating of the entire monolithic circuit.
- There must be no appreciable power dissipation in the reference diode.

It is also assumed that there are no thermal gradients on the chip.

For each device tested, a junction temperature calibration curve is required. This is obtained by measuring the forward voltage drop of the diode located on the chip as a function of junction temperature. To do this, the circuit is immersed in an oil bath (Fig. 2) and the bath temperature increased by predetermined amounts. During this process the forward voltage drop of the reference diode and the oil bath temperature are recorded.

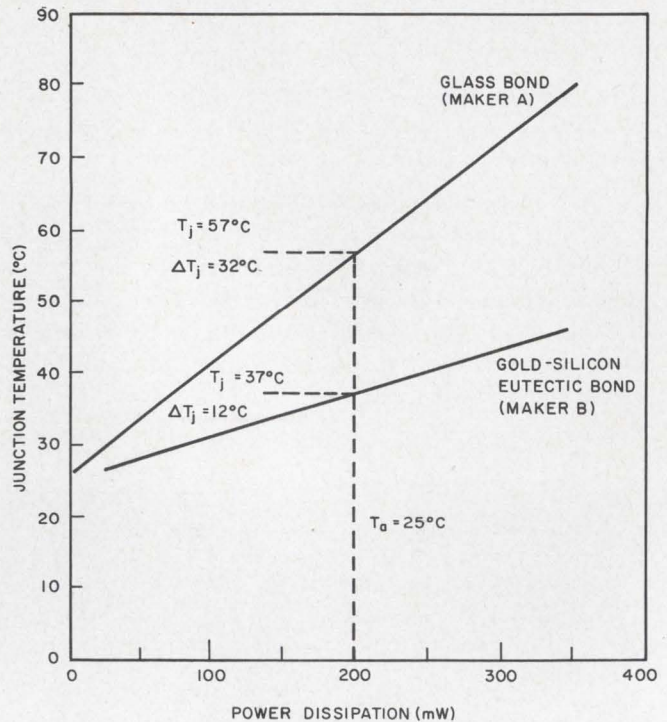

4. The variation in thermal resistance of two similar integrated circuits is directly dependent on the chip-bonding methods. The difference becomes more important with increasing power dissipation in the circuit.

Since the forward current is held constant at 100  $\mu$ A, the diode's power dissipation remains less than 0.1 mW. This produces a maximum temperature rise of 0.1°C, which may be ignored. Since no other dissipation is allowed during these measurements, the oil bath temperature and the junction temperature are, for all practical purposes, identical. Changes in forward voltage drop, then, are due entirely to variations in oil bath temperature. This relationship is plotted (Fig. 3) to provide a calibration of the junction temperature in terms of the voltage drop of the reference diode.

#### Results point to some of the problems

A calibration curve was generated in this manner for each of the two types of integrated circuits under discussion. Though both circuit types were alike in most respects, their chip-bonds were different. One used a glass bond (maker A), the other a gold-silicon eutectic bond (maker B).

Application of a voltage to each circuit's dissipative elements and simultaneous measurement of the temperature-reference-diode voltage enabled the relationship of junction temperature to power dissipation to be determined. Figure 4 graphically demonstrates this relationship; naturally, the junction temperatures were extracted from calibration curves like the one in Fig. 3. Since, by definition, thermal resistance is the change in temperature divided by the power dissipation, the thermal resistance of each circuit was determined



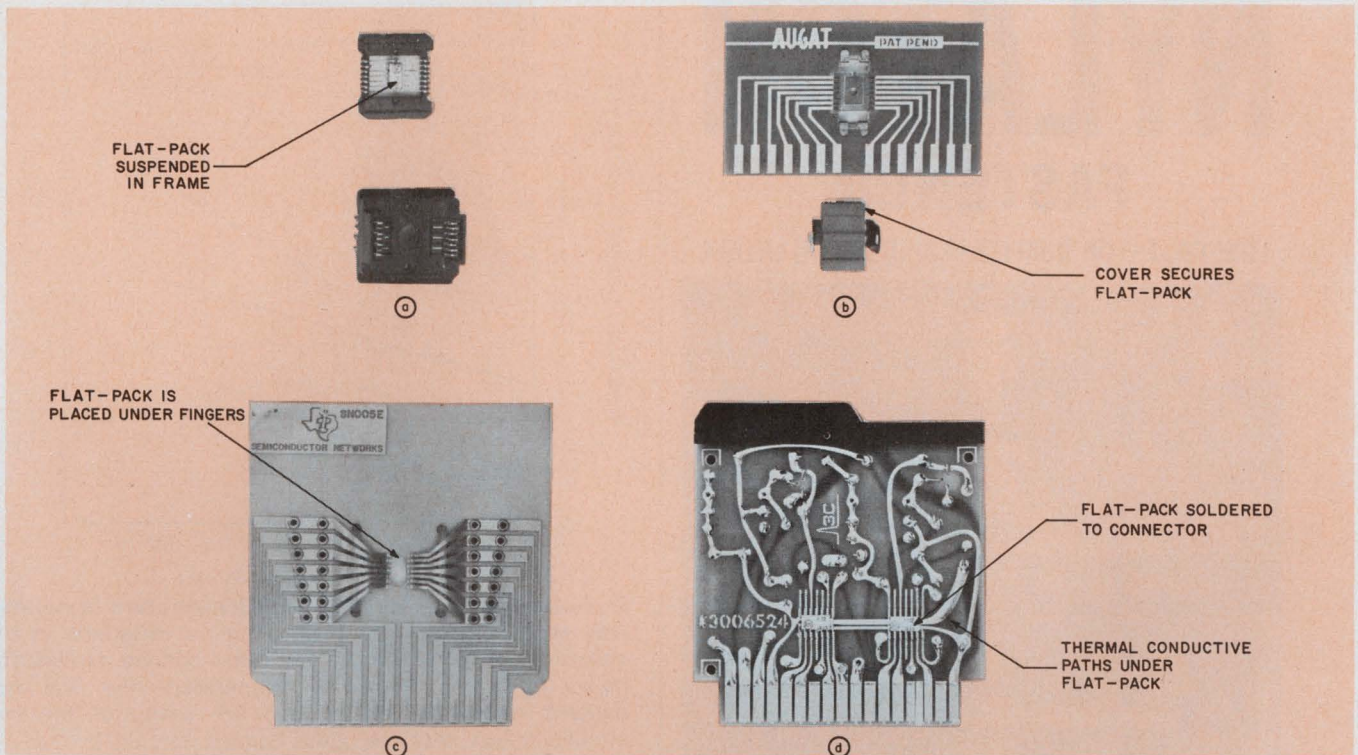

5. These four test fixtures are used to evaluate the effects of different test circuits on the temperature-

handling capabilities of the integrated circuits. Much heat is conducted through the bottom of the flat pack.

by measurement of their respective slopes in Fig. 4. Maker A's glass-bond circuit had a thermal resistance of  $0.160^{\circ}\text{C}/\text{mW}$ ; maker B's eutectic-bond circuit has a thermal resistance of  $0.060^{\circ}\text{C}/\text{mW}$ .

#### How well do test fixtures dissipate heat?

Integrated circuits are usually obtained along with commercially available fixtures. These test fixtures may either be an integral part of the device package or added by the device user. But it is likely that different fixtures will be used for evaluation, incoming test, and breadboarding of the same circuit.

The thermal evaluation of integrated circuits requires the measurement of the particular fixture's contribution to junction temperature rise. Four test fixtures were evaluated.

One of the tested fixtures was a carrier-handler combination, two were commercial circuit test holders, and the fourth was an in-house printed-circuit board, where the flat-pack was actually soldered to a conductive strip. The fixtures appear in Fig. 5 and are keyed by letters to the graphical results shown in Fig. 6.

Measuring the slope of the plots in Fig. 6 made it possible to determine the thermal resistance of circuit and fixture together. The thermal resistance of the fixture is equal to the total measured thermal resistance less the thermal resistance of the circuit. Since these tests were performed with

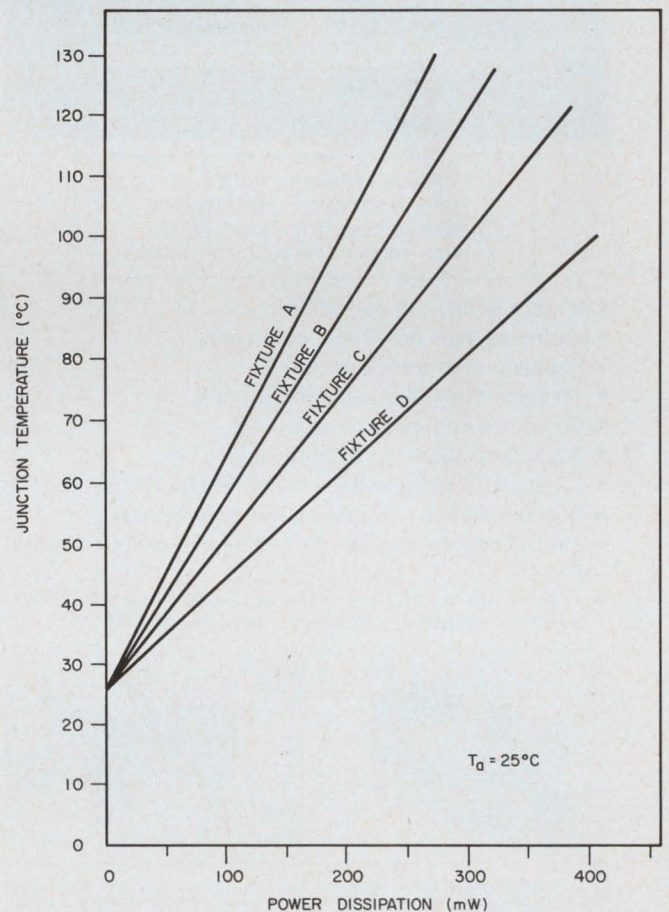

6. Results of tests on assorted test fixtures (see Fig. 5). Whereas fixture A leaves the integrated circuit in air, fixture D provides an intimate metal contact to conduct the heat away. Fixtures B and C provide intermediate thermal paths.

# NYLATCH<sup>®</sup>

## FASTENER

LOW COST • TOP QUALITY • RAPID INSTALLATION

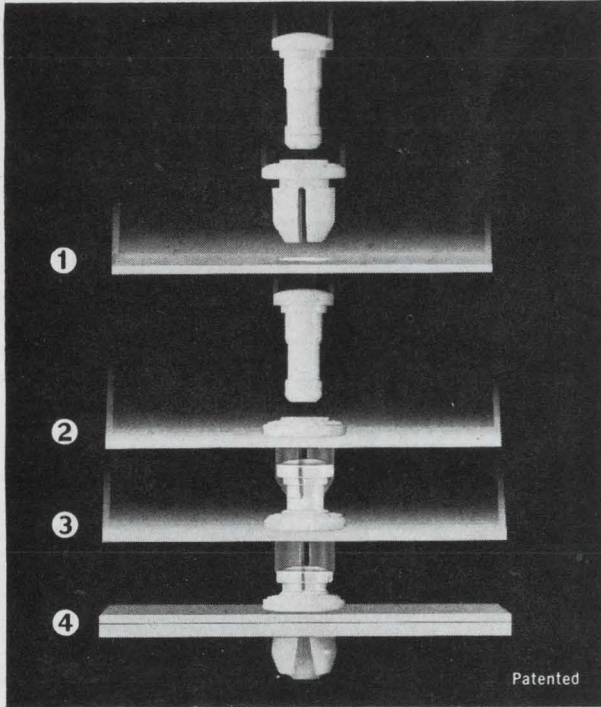

- ① PUNCH A STANDARD HOLE.
- ② PUSH IN GROMMET — CAPTIVATED!
- ③ PUSH IN PLUNGER — CAPTIVATED!
- ④ PUSH TO LATCH — PULL TO UNLATCH.

- Instant push/pull operation
- Improves your product — cuts costs
- Positive interference design
- 10-second installation without tools
- 60-pound minimum tension load
- 30,000 cycle-tested without failure
- Choice of 3 plunger head styles in black or white
- Accommodates variable material thicknesses
- Special adaptations can be engineered to your requirements
- Thousands used in electronics, business machines, lighting, vending machines, neon signs, etc.

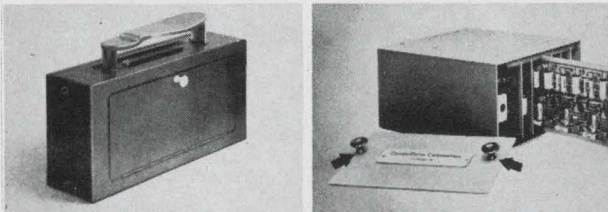

Nylatch is replacing many fasteners used in metal, wood and synthetics. The shoeshine kit and the electronic equipment package shown above are typical applications.

Write for sample and literature.

**THE HARTWELL CORPORATION**  
 9035 Venice Boulevard, Los Angeles, California 90034  
 Branch Offices: Hackensack, Fort Worth, Chicago

ON READER-SERVICE CARD CIRCLE 34

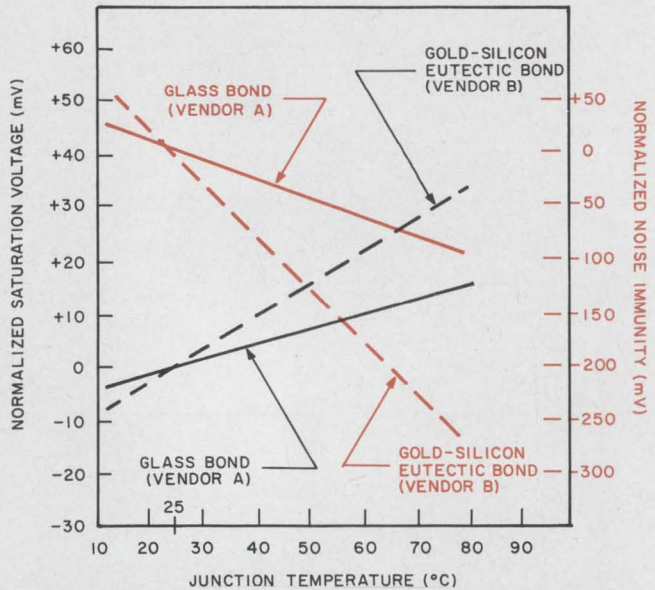

7. Noise immunity variation with temperature is normalized at 25°C (see right scale). Due to variations in the chip-processing technique, the glass-bonded circuit (by maker A) is less affected by temperature rise. The normalized saturation voltage (see left scale) of the two circuits shows that the glass-bonded circuit (maker A) happens to have less variation with temperature. This is also due to variations in the chip-processing technique.

maker A's circuit ( $\theta_{jc} = 0.160^\circ\text{C}/\text{mW}$ ), the thermal resistance of the fixtures is:

- Fixture A =  $0.230^\circ\text{C}/\text{mW}$ ,
- Fixture B =  $0.165^\circ\text{C}/\text{mW}$ ,
- Fixture C =  $0.095^\circ\text{C}/\text{mW}$ ,
- Fixture D =  $0.030^\circ\text{C}/\text{mW}$ .

Fixture A, a carrier that provides no intimate contact with the flat-pack, would allow the case temperature to rise  $23^\circ\text{C}$  above ambient for every 100 mW of power dissipated in the circuit. On the other hand, permanently attaching the flat-pack to a metal conductor as in fixture D, keeps the temperature rise down to  $3^\circ\text{C}$  for the same power dissipation. The other two packages provide intermediate dissipation capabilities.

### Parameter variation depends more on process

The parameters of an individual integrated circuit will vary with temperature. Though it has been shown that the temperature of an integrated circuit is dependent on device structure, power dissipation, test fixture, and ambient conditions, the temperature coefficients of these parameters are often independent of bonding methods and will instead vary with differences in chip-processing techniques. This can be clearly seen in the parameter curves of Fig. 7. It indicates the change in noise immunity of a digital circuit as a function of junction temperatures, normalized at  $25^\circ\text{C}$ . Figure 9 shows the change in saturation voltage as a function of normalized junction temperature. ■ ■

## This is the $\mu$ A703 radio R-F amplifier.

(cost: \$2.75)

As a basic power amplifier the  $\mu$ A703 operates to 150MHz, delivers 20db gain at 100MHz, and has a noise figure of only 7db. As a single component monolithic I-F stage for FM tuners, the  $\mu$ A703 provides superior isolation between stages due to its low reverse transadmittance (0.001 millimhos). It provides excellent phase distortion characteristics because it limits without saturation. You can also use it as a local oscillator to 150MHz.

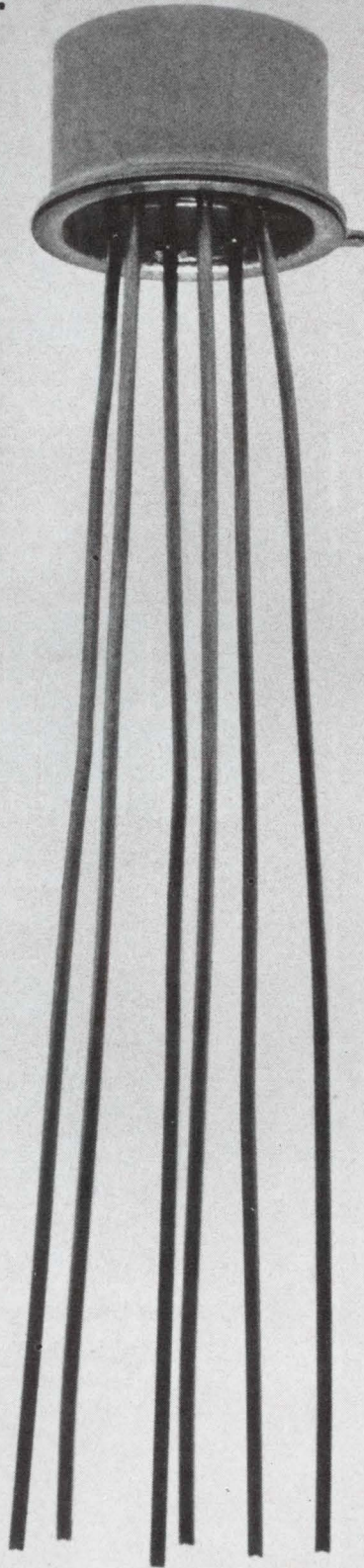

## This is the $\mu$ A703 TV I-F amplifier.

(cost: \$2.75)

Use it in the audio stages of your TV receivers or as a voltage controlled oscillator for color sets.

## This is the $\mu$ A703 radar I-F amplifier.

(cost: \$2.75)

Cascade several units and use as a logarithmic amplifier. It minimizes overdrive recovery and pulse distortion, and gives you improved dynamic range, because it limits without saturation.

For complete details  
on the  $\mu$ A703, the  
 $\mu$ A703, or the  $\mu$ A703,  
call any Fairchild  
distributor or  
write.

**FAIRCHILD**  
SEMICONDUCTOR

TO ORDER:  $\mu$ A703A -55°C to +125°C/U5D770331X ■  $\mu$ A703C 0°C to +70°C/U5D770339X  
FAIRCHILD SEMICONDUCTOR/A Division of Fairchild Camera and Instrument Corporation ■ 313 Fairchild Drive, Mountain View, California (415) 962-5011 ■ TWX: 910-379-6435

ON READER-SERVICE CARD CIRCLE 35



**“My neck  
might save  
your heart!”**

High blood pressure causes strokes and contributes to heart attack in man. But giraffes aren't hurt by the sky-high pressure pushing blood up their 10 feet of neck. Why? Medical scientists are searching for this and many other life-saving answers through research you make possible with your Heart Fund dollars.

**GIVE...**  
so more will live  
**HEART FUND**



Photo courtesy World Health Organization



**PARIS**  
porte de  
versailles  
From 5 April  
through  
10 April 1967

Visitors from the 4 corners of the world take part in the 2 most important shows of the year.

**INTERNATIONAL  
EXHIBITION OF**

# **ELECTRONIC COMPONENTS**

**and international  
Exhibition of**

## **AUDIO EQUIPMENT**

The Electronic Components Exhibition, created in 1934, but International since 1958, comprises 900 manufacturers, half of whom are non-French.

At the same time, the Audio Equipment Exhibition will take place in an adjacent area, where engineers & technicians from all countries will be welcomed.

### **International Seminar on Space Electronics**



Paris from 10 through 15 April, 1967.  
Reservations should be made.

The aim of the seminar is to study how the electronics industry has adapted and up-dated itself in relation to the development in aerospace activities.

**S.D.S.A. - RELATIONS EXTERIEURES  
16, RUE DE PRESLES - 75 - PARIS 15<sup>e</sup>**

**Official Carrier for the Exhibition: Call Air France for Information**

**ON READER-SERVICE CARD CIRCLE 36**

**ELECTRONIC DESIGN 29, December 20, 1966**

# Why does Bodine cut its own gears?

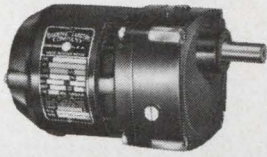

—to be sure Bodine Motors  
operate consistently...for a long time



To attain consistent performance and long life in Bodine motors, we design and hob our gears to very close mechanical tolerances. By means of check points at all stages of gear manufacture, we can be sure these tolerances are kept.

Such quality controls would be difficult and costly if gears were machined outside of our plant. So we do the job ourselves...to be sure. The effort pays off in low end-costs for Bodine motor users. Hobbing our own gears also gives us production flexibility—the reason why Bodine can offer a wide range of gearing specifications.

Constant attention to quality sets Bodine motors well above so-called "low cost" motors. Doesn't your product deserve a high quality motor? A Bodine motor. Bulletin S describes over 275 stock types and sizes from 1/2000 to 1/6 hp. Write Bodine Electric Company, 2528 West Bradley Place, Chicago, Illinois 60618.

ON READER-SERVICE CARD CIRCLE 37

*Bodine motors wear out—  
it just takes longer*

**BODINE**  
fractional / horsepower  
**MOTORS**



...the power behind the leading products

# Inexpensive active devices yield frequency conversion

This simple 100-kHz-to-60-kHz synthesizer uses three types of epoxy-encapsulated devices, all in the one-dollar price range. The three-fifth frequency conversion is very useful in making a phase comparison between a local 100-kHz crystal standard and the signals of WWVH.

The circuit comprises *Q1*, an isolation amplifier; *Q2*, a Schmitt trigger; *Q3*, a 20-kHz unijunction relaxation oscillator; and *Q4*, a 60-kHz tuned amplifier. In operation, the 100-kHz square-wave, developed by *Q2*, is differentiated by *C1* and *R1*.

The resulting negative spike triggers *Q3*, whose free-running frequency is slightly lower than 20 kHz. The sawtooth wave of *Q3* is directly coupled to the base of *Q4*, which selects the third harmonic of 20 kHz. Note that this stage is not a conventional class-C tripler, which creates the third harmonic power by hard-driving the base-emitter junction. In this circuit the emitter of *Q4* is in fact unbypassed and the sawtooth wave output of the unijunction is not distorted.

Since the free-running frequency of the unijunction depends only on  $\eta$  (intrinsic stand-off ratio), *C2* and *R2*, and the third harmonic content is not dependent on the drive level to *Q4*, the circuit provides a stable three-fifth ratio synthesis with any power supply voltage from 10 to 14 volts.

*Henry D. Olson, Research Engineer, Stanford Research Inst., Menlo Park, Calif.*

VOTE FOR 110

**VOTE!** Circle the Reader-Service-Card number corresponding to what you think is the best Idea-for-Design in this issue.

**SEND US YOUR IDEAS FOR DESIGN.** Submit your IFD describing a new or important circuit or design technique, the clever use of a new component, or a cost-saving design tip to our Ideas-for-Design editor. If your idea is published, you will receive \$20 and become eligible for an additional \$30 (awarded for the best-of-issue Idea) and the grand prize of \$1000 for the Idea of the Year.

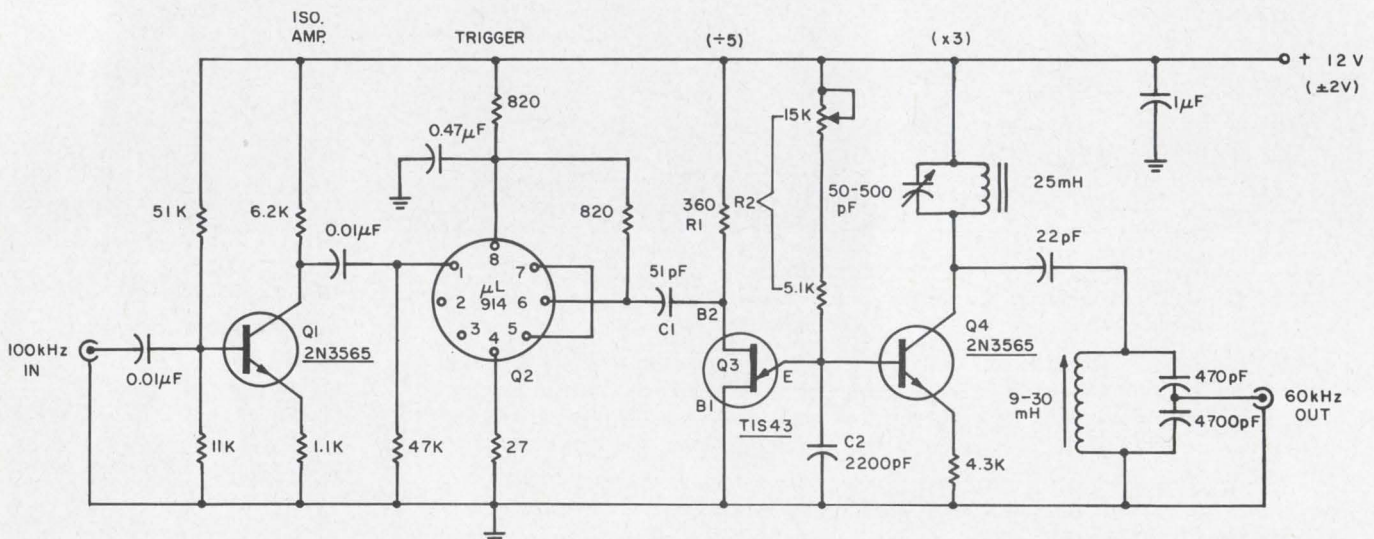

Synthesizer works with inexpensive components and over a large range of power supply voltage.

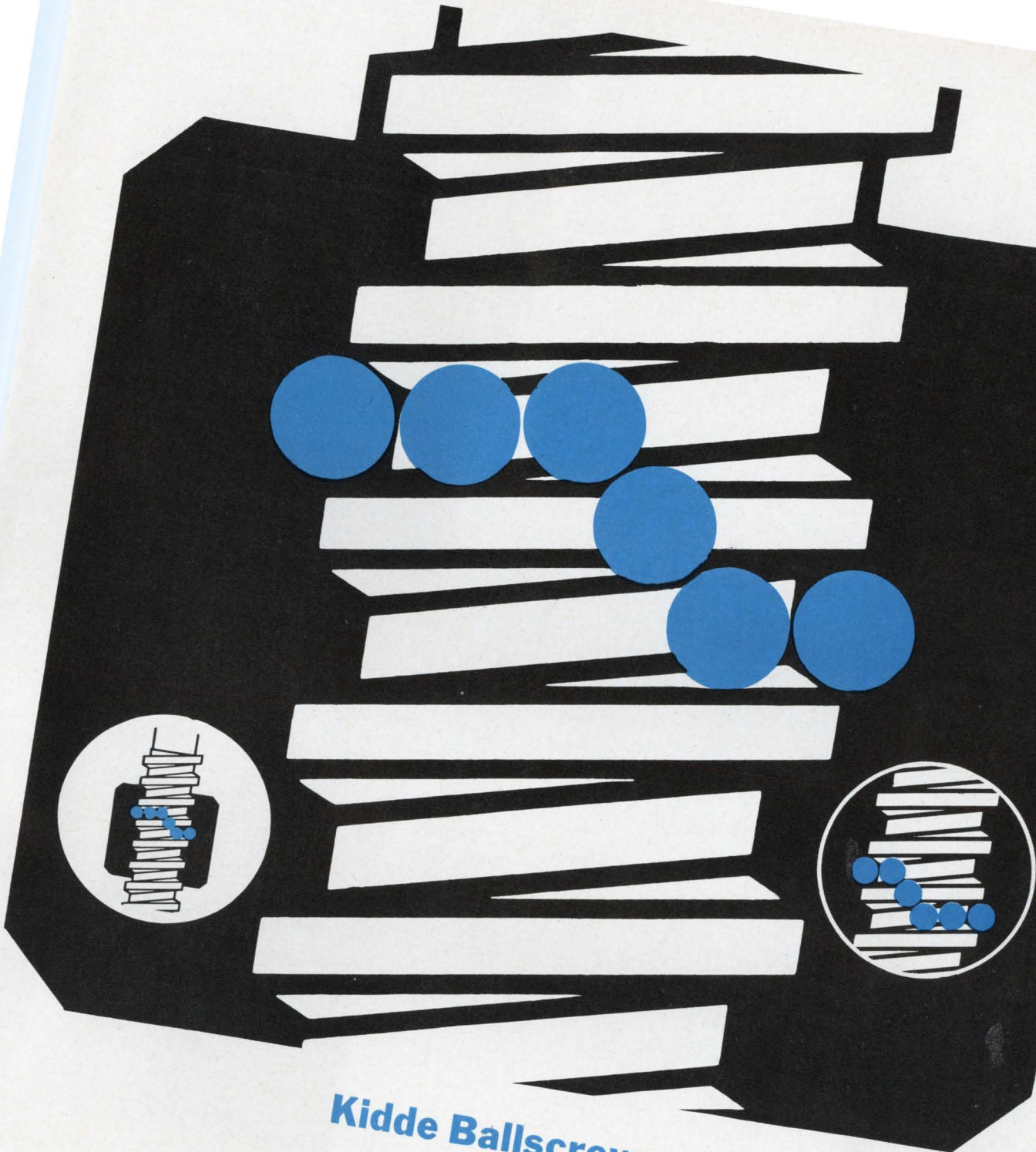

## Kidde Ballscrews

### SIZE AND WEIGHT PROBLEM SOLVERS

Kidde Ballscrews do more than solve friction problems of prime movers and drives. They can solve size and weight problems, too—and meet the demands for high efficiency transfer of motion and power. Here's why:

Their compact design results in smaller envelope dimensions. Weight is reduced because external tubes and fittings are eliminated. Kidde designs allow optimum usable power, due to extremely high efficiencies.

To solve these major problems, Kidde has designed a

wide range of Ballscrew sizes—from units less than 1" long to 32 foot custom assemblies. From 6" diameters down to 1/8"; sizes 3/16" to 1-1/2" (with various lead) are stocked.

Learn how Kidde Ballscrews can become your problem solver. Write for your free copy of "Standard and Precision Ballscrews." Walter Kidde & Company Inc., 675 Main Street, Belleville, New Jersey 07109.



## Strip fine Teflon wire with smooth-jawed pliers

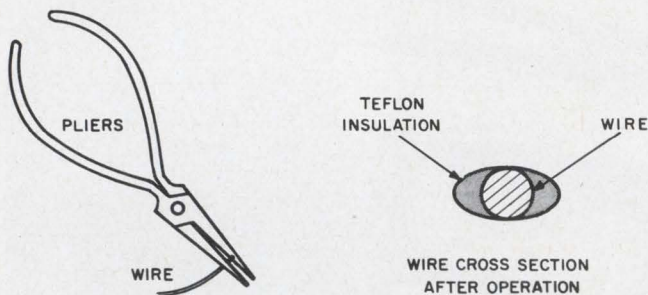

Pliers with unmilled inner jaws are better than a cutting-type stripper for small-gauge Teflon wire. Pressure on the pliers causes the wire to cut through the insulation.

The stripping of small-gauge solid (e.g., #22) Teflon insulated wire is often a problem if a thermal type stripper is not available. This is due to the thin wall and the slipperiness of the Teflon insulation. Cutting-type strippers are very difficult to use and often damage the conductor.

A very simple and practical method is to use a pair of pliers having smooth inside jaws (unmilled). Simply insert the end of the wire to be stripped and squeeze down on the pliers. A click will be heard, indicating that the wire has cut through the Teflon insulation. The insulation may then be pulled away from the wire and trimmed.

*I. Berner, Design Engineer, RCA, Electronic Record Products Div., Camden, N. J.*

VOTE FOR 111

## A lossless current sensor and monitor for less than \$1

A single-component, lossless current sensor and monitor can be built for about one dollar with a miniature magnetic reed switch and a few turns of large-gauge wire. The device has many uses including overcurrent protection of power sup-

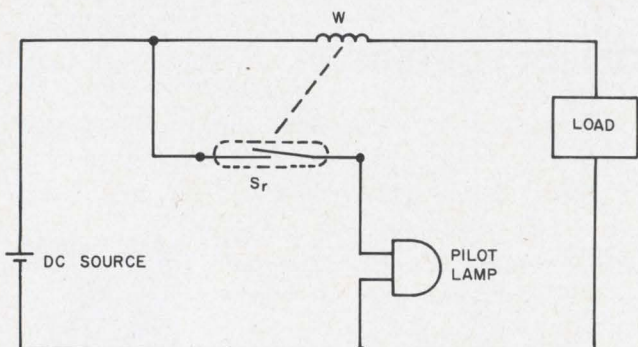

Single reed switch and a few turns of large-gauge wire sense the presence of current supplied to the load.

plies, current sensing and signaling, current measuring—in short, wherever a current value must be sensed.

The winding,  $W$ , of the magnetic reed switch,  $S_r$  (see Figure), consisting of the required number of turns of magnet wire, is placed in series with the load. If the pull-in of the reed switch is 20 ampere-turns and the load current is 1 ampere, then 20 turns of No. 18 wire around the glass envelope of the reed switch will suffice for switch closure whenever the load is energized. Obviously, in this particular application the device is used as a current-sensitive pilot light indicating the ability to draw 1 ampere, or more, of current.

A slight variation of this scheme demonstrates a simple control application of the device. If two equal loads draw 1 ampere each, the pull-in of the reed switch is 20 ampere-turns, but the reed switch is an spdt. With 12 to 15 turns, the ampere-turns will be 24 to 30 when both loads are operative and the normally open contact can be used to light a green pilot lamp to signal "A-OK" condition. Should one of the loads fail, the current will drop to one ampere producing only 12 to 15 ampere-turns and the reed switch will drop out. If the normally closed contact is connected to a red pilot lamp, an operator will be notified that one or both of the loads have failed.

The two-load application was used to monitor stop-light filaments and the stop-light switch. The presence of the current drawn by both stop lights was indicated when application of brakes lit a green lamp. If the green light did not come on, the stop-light switch, or the stop-light lamps, were inspected for failure.

This approach can be used to sense lower currents by magnetically biasing the reed switch. That is, the pull-in of the reed switch can be adjusted by varying the distance from the reed of a permanent magnet placed near the switch.

*Peter N. Budzilovich, Technical Editor, ELECTRONIC DESIGN.*

## Hearing aid electronics cured by an M.D.

A medical doctor simplifying a circuit? Yes, here it is. Hearing aid (and other speech devices) designers may learn something from the circuit shown in the accompanying figure. The design is very simple (see schematic). The circuit is a single, low-level audio stage, the output of which is fed back to the input via the paired diodes. Until the diodes conduct, the amplifier functions linearly. Once the diodes begin to conduct, the gain falls off rapidly, becoming less than unity. The net result is that any input waveform of more



# Librascope's new Series L210... when value is the object

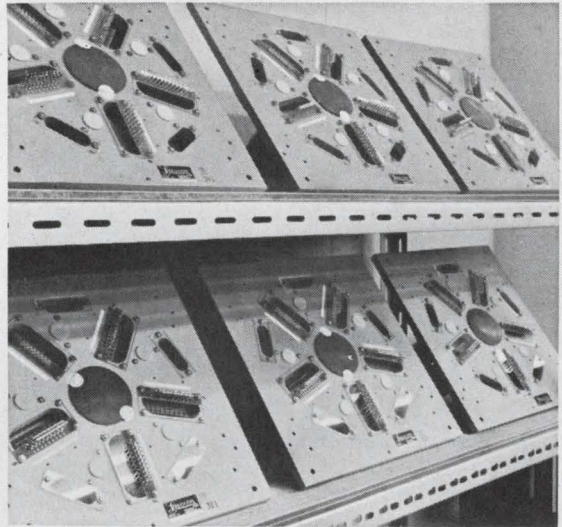

Librascope's new line of computer disc memory systems, designated the Series L210, offers the greatest cost savings in the industry.

Available in 15 different off-the-shelf models, the Series L210 provides the user low-cost disc memories with great flexibility in choice of access times, bit capacities, and number of recording heads. Their modular design enables a choice of storage capacities up to 2 million bits and a wide variety of combinations of recirculating registers and data tracks. Each memory system utilizes a single magnetic disc, 10 inches in diameter, in a compact package that measures less than 1 cubic foot and weighs 35 pounds.

Economically priced, 60 days delivery, and developed by the company which offers the largest line of disc memories in the computer industry... superior is the word for the Librascope Series L210. For complete details, write for our technical bulletin.

#### SERIES L210 MODELS

	ACCESS TIME (Milliseconds)	TOP PLATE	BOTTOM PLATE
L110-8-1	8	A	C
L110-8-2	8	B	C
L210-8-1	8	A	A
L210-8-2	8	A	B
L210-8-3	8	B	B
L110-17-1	17	A	C
L110-17-2	17	B	C
L210-17-1	17	A	A
L210-17-2	17	A	B
L210-17-3	17	B	B
L110-25-1	25	A	C
L110-25-2	25	B	C
L210-25-1	25	A	A
L210-25-2	25	A	B
L210-25-3	25	B	B

Head Plates A = 72 data heads including spares

9 clock heads including spares  
(in separate port)

B = 16 recirculating registers;

5 clock heads including spares

C = Blank Plate

#### COMPONENTS DIVISION

**GP** GENERAL  
PRECISION INC.

#### LIBRASCOPE GROUP

808 Western Ave., Glendale 1, Calif.

ON READER-SERVICE CARD CIRCLE 39

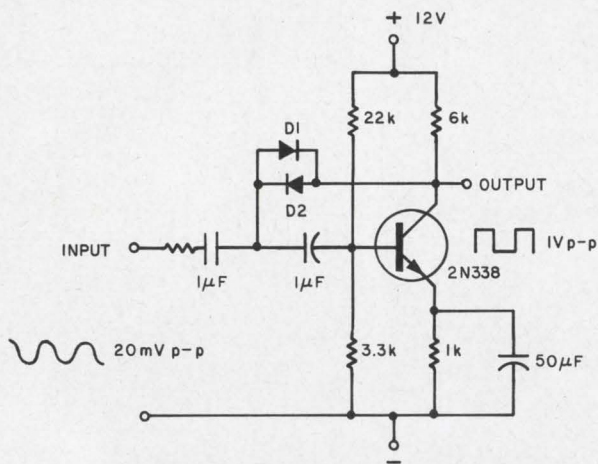

**Hearing aid speech clipper** utilizes paired diodes in the feedback path. Low impedance sources should not be used to operate this circuit.

than a few millivolts is symmetrically clipped around the zero axis.

The key to success is the symmetrical clipping. It has been known for some time that human speech can undergo severe clipping and still retain up to 98% of its intelligibility. What is not generally known, however, is that the slightest asymmetry of clipping will rapidly destroy the intelligibility—a fact brought home by listening to a cheap hearing aid.

It could be mentioned that this circuit should not be fed by a very low impedance source since this could easily revamp the feedback from the amplifier stage. Furthermore, the degree of clipping can be controlled by replacing the 6-kΩ resistor with a potentiometer and connecting the diodes to its center arm.

*John D. Griffith, M.D., Assistant Professor, Vanderbilt University, School of Medicine, Department of Psychiatry, Nashville, Tenn.*

VOTE FOR 112

## Wide-band oscillator needs only one pair of transistors

A pair of transistors can drive a crystal oscillator through its whole band from low to acoustic frequencies.

The circuit, shown in the figure, oscillates from 800 Hz up to 1 MHz, even if the equivalent series resistance becomes high at the upper end of the spectrum.

The simplicity of the design makes it useful as a low and acoustic frequency signal generator, marker generator and IF oscillator for superheterodyne receivers.

The only adjustment to be made through the

frequency range is the addition of the 2.8-MΩ resistor and the 15-nF capacitor (in the box) at the low end of the range, up to about 4 kHz. These two components act as a low-pass filter, suppressing unwanted higher-order harmonics of the crystal. Above 4 kHz, no capacitors are needed; thus good electrical coupling and small size are achieved even at acoustic frequencies.

The recommended crystal cuts are JT (duplex), HT or NT (see Peter J. Ottowitz, "A Guide to Crystal Selection," *ELECTRONIC DESIGN*, XIV, No. 11 (May 10, 1966), p. 48).

With a medium-precision crystal, oscillation can be obtained with only a 1.5-V supply. Environmental tests showed practically no change in performance from 0° to +50°C.

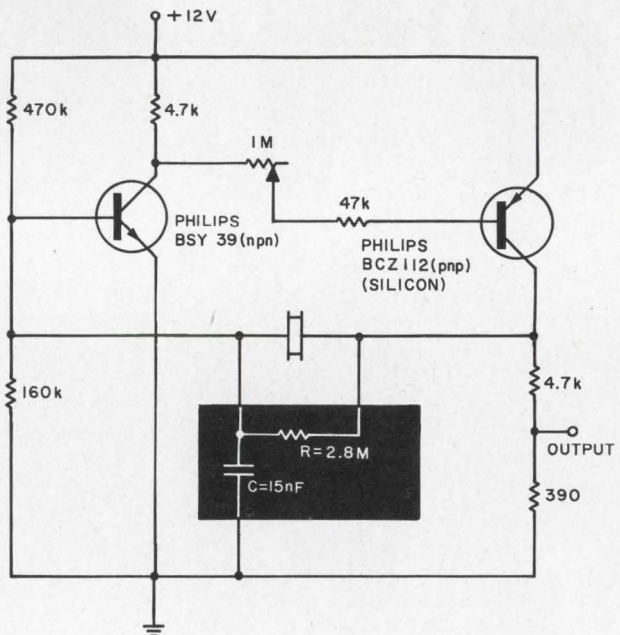

**Simple oscillator** uses two almost complementary transistors to cover the frequency range from 800 Hz to 1 MHz. The two components in the box are needed up to 4 kHz, to filter out unwanted harmonics of the crystal.

The npn BSY 39 Philips transistor can be replaced by 2N708 or 2N914 types; the silicon pnp BCZ 11 Philips is available here through Amperex.

*Carlo Scuri, Betron Industria e Ricerche Eletttroniche, Livorno, Italy.*

VOTE FOR 113

## IFD Winner for Sept. 13, 1966

**Jay Freeman**, Design Engineer, Sperry Gyroscope Co., Great Neck, N. Y.

His Idea, "Integrated dual-storage system solves synchronization need", has been voted the \$50 Most Valuable of Issue Award.

**Cast Your Vote for the Best Idea in this Issue.**

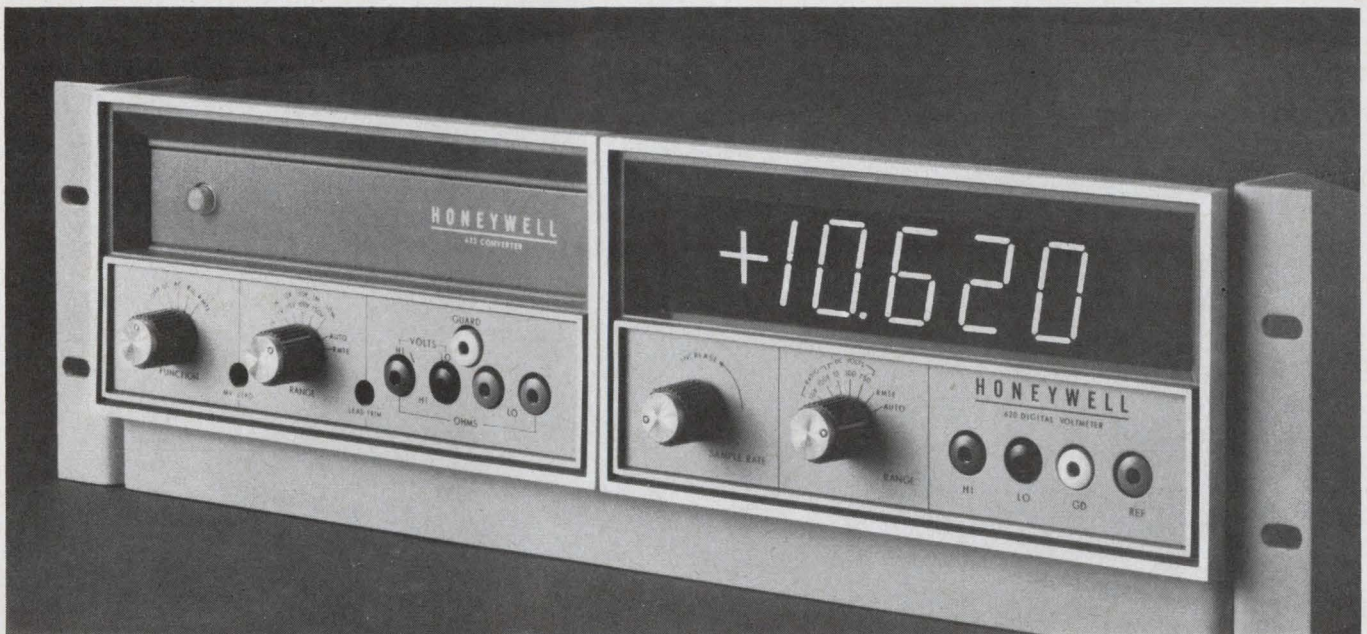

## Today's best DVM value plus AC, Resistance, and low-level DC measurements!

### Honeywell's New Autoject 620/623 package

We started with our outstanding 620 integrating DVM with Autoject — which provides greater than 60 db of normal mode rejection to noise of any frequency above 30 Hz in 250 msec!

Then we added the new companion 623 converter module with differential input to insure maintaining the 620's high CMR. Combined in a compact, fully portable cabinet for either bench use or rack mounting, the result is a highly versatile measuring instrument offering more performance per dollar than similar units.

**The 620 DVM is accurate to  $\pm .01\%$** , gives you 4 readings per second, and has 4 full digits, plus a 5th for 20% overrange. Solid-state throughout, its isolated-guarded differential input (140 db of CMR) provides foolproof operation, with ground loops, offset, or error due to noise completely eliminated. The

620's *constant* high input impedance of greater than 1000 megohms eliminates errors due to source of loading. Here are the highlights of the new 620/623 package:

- Low-level DC measurements to  $1\mu\text{v}$ .
- 3 full ranges on DC: 10, 100, and 750 volts with overrange.
- 3 full-scale ranges with DC pre-amp for 10, 100, and 1000 mv with 20% overrange. Speed: 3 rdg/sec.
- 4 full ranges on AC: 1, 10, 100, and 530 volts RMS full-scale with 20% overrange.
- 5 full-scale Resistance ranges: 1, 10, 100K, 1 megohm, and 10 megohms with 20% overrange. Speed: 3 rdg/sec.
- All full-scale values presented as 5-digit display; i.e., 1-volt range = 1.0000.

For automatic or systems use, the 620/623 provides these features:

- Automatic ranging on *all* functions, *all* ranges.
- Remote programming of all functions which include *automatic delays* to insure maximum accuracy on the first encoding.
- Electrical outputs for printer operation.

**Buy the package or add on at any time.** The 623 converter module utilizes plug-in circuit boards, one for each function desired (AC, Resistance, low-level DC). You can add measuring capability at any time, in any sequence, without field modifications. And, if you already own a 620 DVM, it's a simple matter to expand its capabilities through the addition of the 623 module!

*For full specs and price information, mail coupon today!*

*Need extra measuring capability? Add the 625 milliohm and 626 phase converters for a complete measurement system.*



Honeywell, Test Instruments Division  
Mail Station 418, Denver, Colorado 80217

12-12B

Please send 620/623 information to:

Name \_\_\_\_\_

Company \_\_\_\_\_

Address \_\_\_\_\_

City/State/Zip \_\_\_\_\_

DATA HANDLING SYSTEMS  
**Honeywell**

HONEYWELL IS WORLDWIDE • Sales and service offices in all principal cities of the world. Manufacturing in Brazil, Canada, France, Germany, Japan, Mexico, Netherlands, United Kingdom, United States.

ON READER-SERVICE CARD CIRCLE 40

# CAREER INQUIRY - confidential

Respond to the career opportunities advertised in this issue. Fill out and send us this handy resume. **Electronic Design** will do the rest - neatly typed copies of this form will be mailed to the companies of your choice, indicated by the circled Career Inquiry Numbers at the bottom of this page.

29

Name Home Phone

Home Address (Street) City State ZIP Code

Age U.S. Citizen Security Clearance  
 Yes  No

Prime Experience	Secondary Experience

Desired Salary Availability Date

**Employment History - present and previous employers**

Company	City, State	Dates	Title	Specialty
		to		
		to		
		to		

**Education - indicate major if degree is not self-explanatory**

Degree	College	City, State	Dates
			to
			to

**Additional Training - non-degree, industry, military, etc.**

---



---



---

**Professional Societies**

**Published Articles**

**Career Inquiry Numbers:**

- 900 901 902 903 904 905 906 907 908 909
- 910 911 912 913 914 915 916 917 918 919

**ELECTRONIC DESIGN**  
 850 Third Avenue  
 New York, New York 10022



To  
**ELECTRONIC  
ENGINEERS**  
with a sense  
of timing...

## **BENDIX** (KANSAS CITY DIV.) **IS ON THE MOVE!**

This is the opportune moment to investigate your career potential at Bendix, Kansas City Division. As prime contractor for the AEC, we have enjoyed an enviable, orderly 16-year growth. Now we are entering a unique developmental phase, opening new fields of activity in microminiaturization, microwave and logic circuitry. This situation adds up to a ground-floor opportunity in a well-established corporation noted for advanced engineering. Cooperative, professional atmosphere, plus excellent living conditions. Let us hear from you promptly so we may detail more clearly the many advantages we can offer you.

Please mail résumé at once to:

Mr. T. E. Mason, Tech. Personnel Repr.  
THE BENDIX CORPORATION, Box 303-NE  
Kansas City, Missouri 64141



AN EQUAL OPPORTUNITY EMPLOYER

ON CAREER-INQUIRY FORM CIRCLE 902

to your  
exact specifications...



at stock prices

### **METALIZED MYLAR CAPACITORS**

Unique, self-healing units that remain in circuit during voltage surges with little or no loss of electrical properties. Use the M2W's where size and weight are limiting factors and long life and dependability are required. The units utilize metalized Mylar\* Dielectric with film wrap and custom formulated epoxy resin end fill. Available in round and flat styles.

\*Du Pont Trademark for Polyester Film

Samples available on your letterhead request

**Standard** CONDENSER  
CORPORATION

DEPT ED-12, 1065 W. ADDISON, CHICAGO, ILLINOIS 60613

ON READER-SERVICE CARD CIRCLE 87

ELECTRONIC DESIGN 29, December 20, 1966

# Circuit Design Engineers

Don't answer this ad unless you personally want the challenge of an enormous variety of circuit design problems—and the freedom to seek out the solutions—with a growing midwest electronics OEM.

If you're interested, salary range is from \$8,000 to \$15,000, depending on type and amount of experience. Reply in confidence to:

Electronic Design  
Box-100-DP

850 Third Ave.  
New York, N.Y. 10022

## Come to **MELPAR** Where *PERFORMANCE* and *RECOGNITION* Come *FIRST!*

At Melpar, our emphasis on individual recognition of accomplishments is not just a printed policy statement nor just a talking matter. It represents the very foundation of our personnel management system.

For more than 20 years, Melpar has enjoyed an enviable reputation as a leader in Space and Defense.

Are you qualified to join us?

*Immediate openings exist in the following areas:*

Adaptive Systems • Antenna Systems • Communications • Countermeasures • Electro-Optical Data Processing • General Purpose Computer Applications • Information Systems • Intelligence Collection • Simulation and Training • Tactical Avionics

*Write, in confidence, to:*

Clarence Endsley, Professional Placement

**MELPAR**  **INC**

A SUBSIDIARY OF WESTINGHOUSE AIR BRAKE COMPANY

7734 ARLINGTON BOULEVARD, FALLS CHURCH, VIRGINIA

(10 miles S.W. of Washington, D. C.)

An equal opportunity employer M/F

ON CAREER-INQUIRY FORM CIRCLE 903

# We're winning our space race!

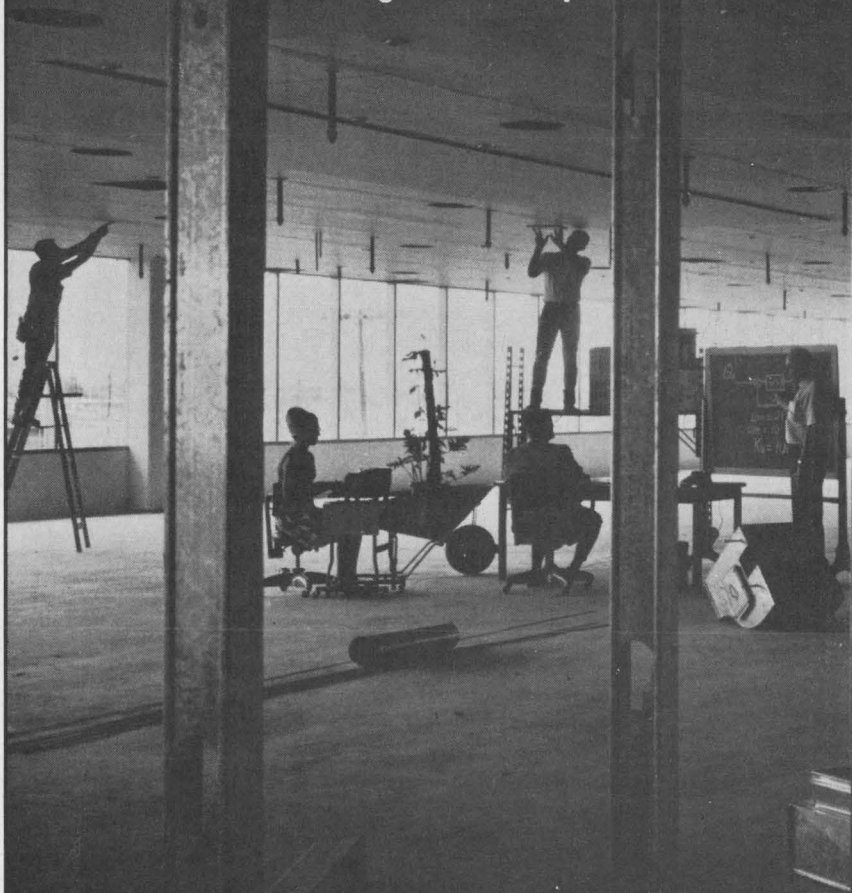

To keep pace with our expanding capabilities in advanced electronics — which keeps winning us more contracts — we are now completing the 3rd major addition in five years to our Aerospace Center facilities. Our swift, sound growth means broadened opportunities and accelerated advancement for the talented and imaginative people already on our front-running team — and also for the qualified scientists and engineers we are now seeking.

Specific Opportunities are:

Space Communications  
 Radar Systems  
 Tracking & Telemetry  
 Fuzing  
 Digital Data Transmission  
 Guidance & Navigation  
 ECM & Elint

Checkout Systems  
 Coherent Transponders  
 Radar Transponders  
 Integrated Electronics  
 Antennas & Propagation  
 Reliability & Components  
 Advanced RF & Microwave Techniques

**in PHOENIX**  **MOTOROLA**

Government Electronics Division · Aerospace Center

Write: Phil Nienstedt, Mgr. Recruitment, Dept. 6212, Box 1417, Scottsdale, Arizona  
 MOTOROLA ALSO OFFERS OPPORTUNITIES AT CHICAGO, ILLINOIS — AN EQUAL OPPORTUNITY EMPLOYER

## Push-pull output does not change with reference

**Problem:** Design a circuit that will provide a push-pull output, referenced to variable dc potential.

**Solution:** A dual-transistor difference amplifier with a feed-back circuit which can vary the operating points of the transistors by equal amounts, to provide variable reference potentials.

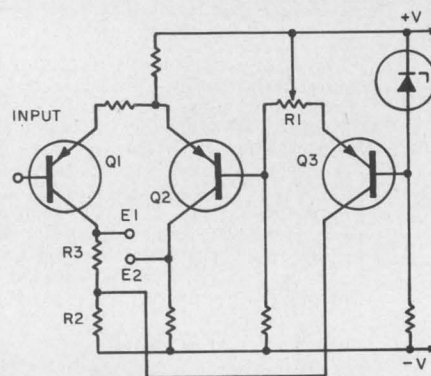

The difference amplifier consists of  $Q1$  and  $Q2$  and their associated components. The output signals,  $E1$  and  $E2$ , appear at the collectors of the respective transistors and are  $180^\circ$  out of phase. The operating points of  $Q1$  and  $Q2$  with respect to either  $+V$  or  $-V$  are varied by varying  $R1$ . If  $R1$  is varied in a direction that increases the positive bias on the base of  $Q2$ , it will make  $Q2$  conduct less and cause  $E2$  to become more negative. Moving  $R1$  in this direction also increases the emitter resistance of  $Q3$  which causes  $Q3$  to conduct less, and decreases the current flow through the common resistor,  $R2$ . The voltage drop across  $R2$  and  $R3$  will therefore decrease, and  $E1$  will become more negative. The reference potentials,  $E1$  and  $E2$ , have therefore varied in the same direction with respect to  $+V$  or  $-V$ , but the gains of  $Q1$  and  $Q2$  have not changed.

This circuit was designed to drive a dc-coupled push-pull deflection amplifier, using  $R1$  as a centering control.

For further information, contact Technology Utilization Officer, NASA Headquarters, 400 Maryland Avenue, S.W., Washington, D. C. 20546. Refer to: B66-10344.

Say you started out to design a hi-rel regulator that would replace bulky DO-7 and 13 cans.

But still deliver at commercial prices.

First you'd tap management for quite a few kilobucks and a room full of the best brains.

Then, after both were spent, you'd find you'd developed a thermally-grown, oxide-passivated, silicon wafer. With brazed leads. Snug fitting slugs. And exclusive hermetic seal.

And you'd pass the word along that it'd take more heat and current than the old metal cans.

Now what?

You'd expand the line and wind up with twenty-eight each HW 1 watt or HM 400mw micro-glass, micro-miniature regulators that you could deliver in a week.

Which is what we did right here.



**Hoffman** | SEMICONDUCTOR

A Division of Hoffman Electronics Corporation, Hoffman Electronic Park, El Monte, California 91734

ON READER-SERVICE CARD CIRCLE 42

# NEW Tektronix Spectrum Analyzer Plug-in Unit 50 Hz\* to 1 MHz Type 1L5

for use with Tektronix oscilloscopes accepting letter and 1-series plug-ins

\*Center frequency; displays from 10 Hz.

In a Tektronix oscilloscope, a Type 1L5 adds the convenience of calibrated vertical measurements to spectrum analysis in the frequency range of 50 Hz to 1 MHz.

Permitting simple and accurate measurements directly from the CRT display, the Type 1L5 offers such features as analyzer sensitivity of 10  $\mu$ V (RMS)/cm to 2 V (RMS)/cm in 1-2-5 sequence . . . dispersion range of 100 Hz (10 Hz/cm) to 1 MHz (100 kHz/cm) in 9 steps and variable . . . resolution range of 10 Hz to 1 kHz coupled to calibrated dispersion . . . center frequency range of 50 Hz to 1 MHz . . . and display flatness of  $\pm 0.5$  dB at 10 mV/cm to 2 V/cm, and  $+0.5$  dB,  $-3$  dB, 10  $\mu$ V/cm to 50  $\mu$ V/cm.

The Type 1L5 has a front panel output for obtaining chart

recordings of the spectral display. It provides a 10 mV signal at the output from a 6 cm display on the oscilloscope screen. (Direct coupled from 600  $\Omega$  source impedance.)

In addition to its use for spectrum analysis with the oscilloscope, the Type 1L5 can also be used for conventional displays at a bandwidth of 10 Hz to 1 MHz with sensitivity of 1 mV/cm to 100 V/cm.

A Type 1L5 in a Tektronix oscilloscope offers an outstanding measurement value and the oscilloscope can accept many other plug-ins for a wide variety of general-purpose or special-purpose applications.

Type 1L5 Spectrum Analyzer Plug-in Unit . . . . . \$950

U.S. Sales Price f.o.b. Beaverton, Oregon

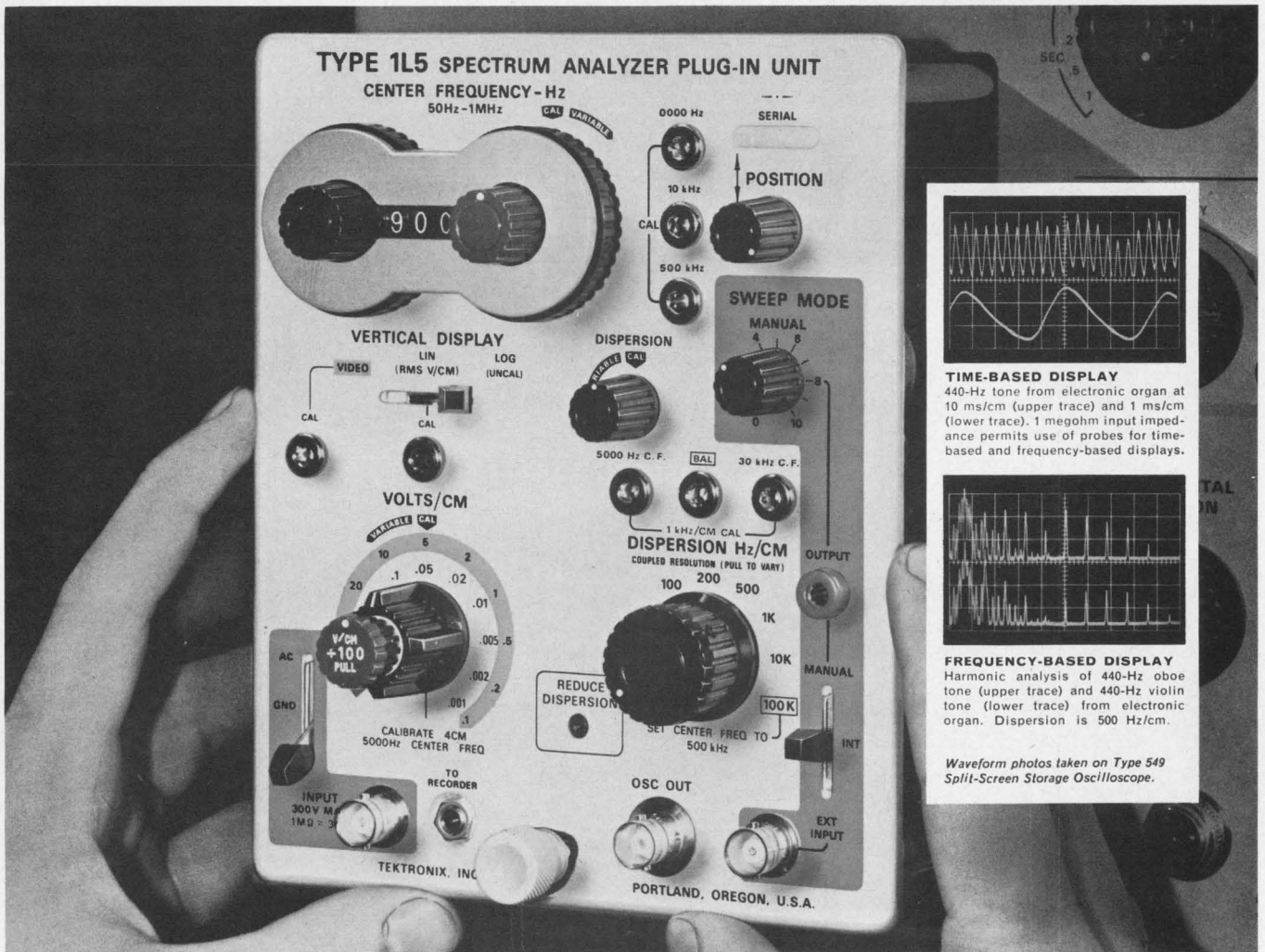

**Tektronix, Inc.**



For complete information, contact your nearby Tektronix field engineer or write: Tektronix, Inc., P.O. Box 500, Beaverton, Oregon 97005

ON READER-SERVICE CARD CIRCLE 41



# Products

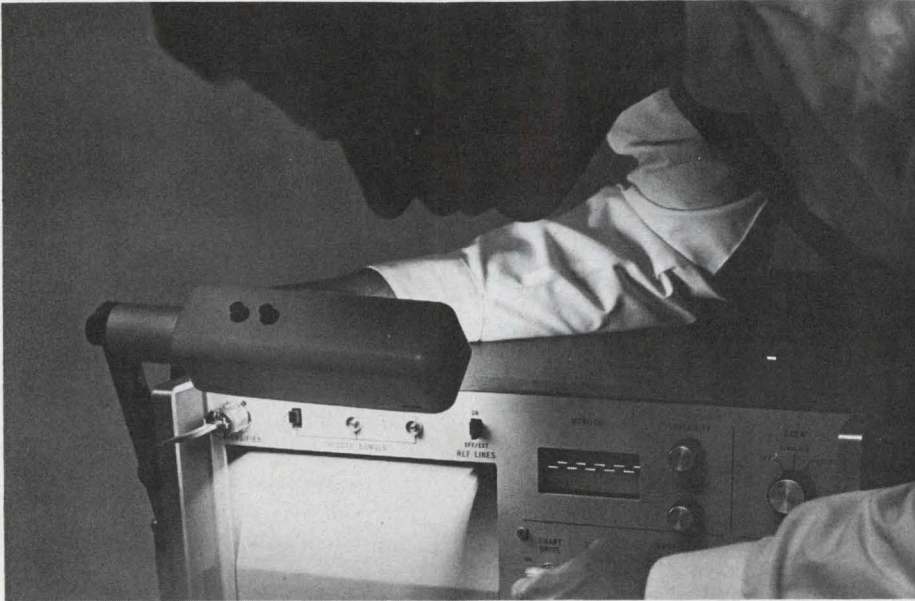

A blur of light is all you'll see as this fiber-optic CRT oscilloscope prints out at a million inches per second. Page 112

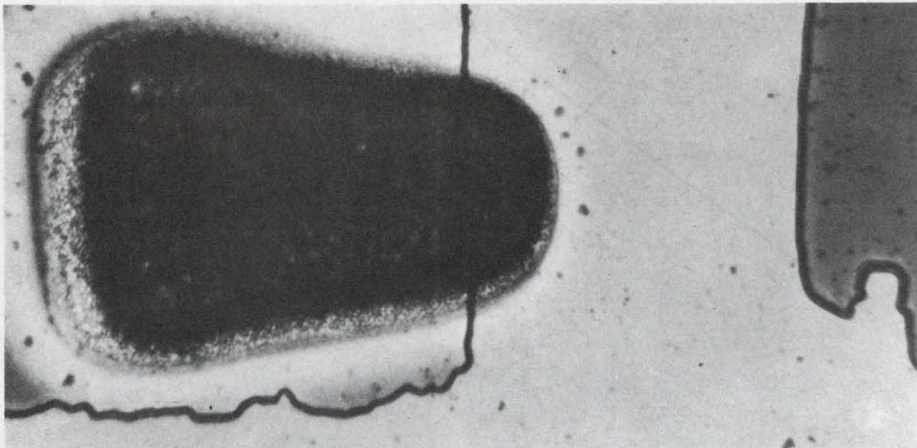

Batch-processed tunnel diode pellets are aimed at computer circuitry. IC compatibility is offered for 50 cents. Page 96

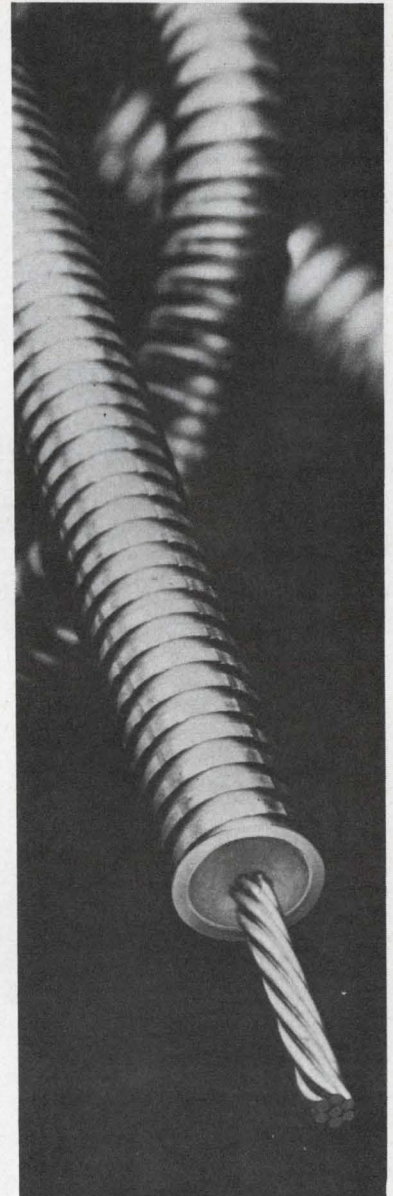

Corrugated coax stresses more flexibility. Page 116

## Also in this section:

Multiple-overlay uhf transistors reduce power costs. Page 98

Wideband differential op-amp has speedy response. Page 102

"Heat Spy" pistol gives instant temperature readings. Page 118

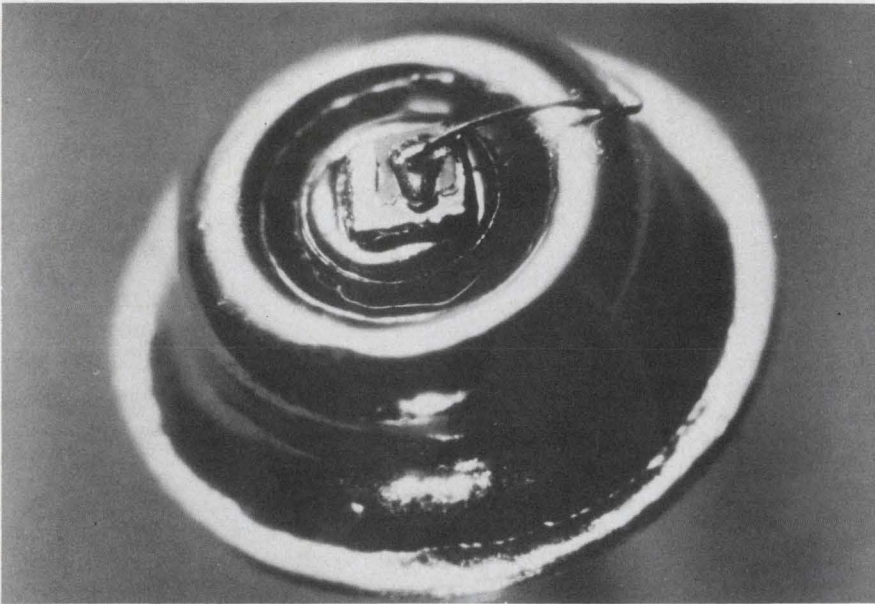

## Batch-processed tunnel diodes priced at 50 cents

General Electric, Semiconductor Products, Electronics Park, Syracuse, N. Y. Phone: (315) 456-2798. P&A: \$0.50; stock.

The first practical n-type tunnel diode priced as low as 50 cents in large volume is now available from General Electric.

Designated the "TD700 Line," the batch-processed units are available either in axial-leaded packages or as pellets for use in hybrid ICs.

A combination of planar and thin-film fabrication techniques is the basis of the new line. The key

development is a new technique used to form the tunnel silicon oxide/germanium junction. In addition, a proprietary junction dot metallic material gives the premium MIL-spec TD700H line 125°C operating capability. Both series are available with peak currents of 0.5, 1, 2.2, 4.7 and 10 mA.

The mass-production techniques used are breakthroughs in batch-processing. Several whole wafers of germanium are used. A thin film of silicon oxide is applied on each wafer by selective masks. With the

same technique, a thin film of chromium is then placed over the oxide. The junction-forming metal is applied next, overlapping the chromium and the exposed germanium. The wafers are passed through an oven which simultaneously alloys all the junctions. After the wafers are pelletized, the pellets are mounted on headers, leads are attached and the units are etched to the proper peak currents. To complete the unit, a cap is welded to the header.

Tunnel diodes offer advantages over other semiconductors in both speed and power consumption. Hybrid tunnel-diode logic circuits have already achieved clock rates of over 400 MHz at power dissipation levels under 50  $\mu$ W.

Immediate applications for the GE devices are seen in the computer industry, now that prices are competitive with other semiconductors.

The increased use of IC logic in high-speed computers permits very close component spacing that minimizes interconnection delays. The high heat dissipation and slower switching speeds of ICs thus automatically creates uses for the new hybrid tunnel diodes: in planar form with IC arrays, they couple the short delays of ICs with the switching speeds of tunnel diodes.

The TD700 line can operate at clock rates of 100 MHz with some functions approaching 400 MHz. Tunnel-diode power dissipation, a nominal 40  $\mu$ W per unit, will allow logic systems with an even greater function density.

CIRCLE NO. 211

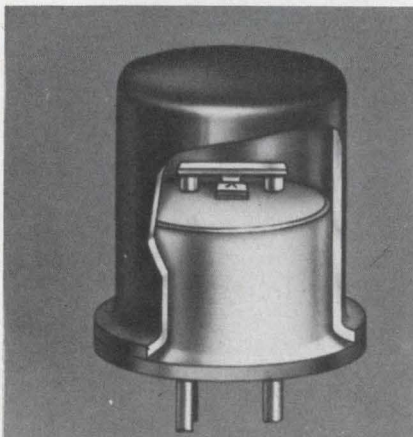

(a)

**Original tunnel diode** (a) used "golf ball and tee" construction. The 100-MHz devices cost about \$75. Later units (b) solved some reliability problems by wedging the

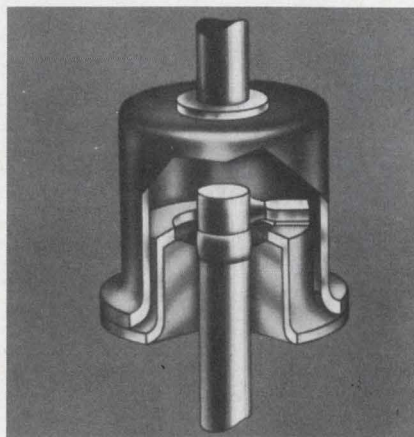

(b)

semiconducting sphere between the chip and header lead for support. The potted units cost about \$2.80. Batch-processed planar units (c) cost 50¢ and dissipate 40  $\mu$ w.

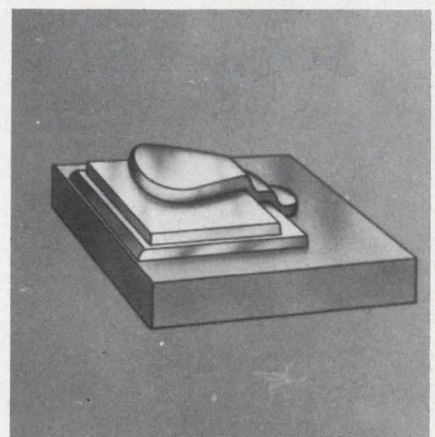

(c)



**These two  
heat shrinkables  
are hungry for  
tough mil-spec  
insulation  
problems.**

INSULTITE FROM E.C.C.

E. C. C. heat shrinkables are recognized  
under UL component file E39100.

**Feed them:**

New Insultite SR-350 eats up shock, strain, and vibration like only a semi-rigid, irradiated polyolefin can. It combines superior dielectric characteristics with high structural strength.

Insultite FP-301, on the other hand, has a flexible polyolefin appetite that devours mil-spec applications. Quickly. Totally.

SR-350 meets classes 3 and 4 of MIL-I-23053A and NASA MSFC 276A. FP-301 meets classes 1 and 2.

Both feature high abrasion resistance, superior voltage stand-off and excellent dielectric characteristics.

Both SR-350 and FP-301 shrink at a better than 2 to 1 shrink ratio when heat is applied.

Insultite SR-350 and FP-301 come in a variety of sizes and

colors. White, black, red, blue, and yellow, all easily printed for identification purposes, and clear where visual inspection is important. New SR-350 is available from  $\frac{3}{64}$ " to 1" ID. FP-301 comes in sizes from  $\frac{3}{64}$ " to 4" ID.

Whatever your insulation problem, think shrink with the Insultites. We offer commercial, military grade, flexible and semi-rigid tubing, heat-shrinkable end caps, and exclusive meltable inner-wall tape. Write today for free samples. (Specify diameters, please.)



**ELECTRONIZED CHEMICALS CORPORATION**

A subsidiary of High Voltage Engineering Corporation

Box 57, Burlington, Massachusetts, Area Code 617-272-2850

80%  
SMALLER!



## NEW **LEL** LOG AMPS

- 80 dB Dynamic Range
- Gain Matching (in pairs) to 1 dB
- 20 mV/dB Sensitivity
- Accuracy  $\pm 1$  dB

These miniature log amplifiers are especially well suited for use in microwave receivers where small size and weight must be achieved without sacrificing performance.

The ITL-4 units actually improve performance levels for reception of high speed pulses when substituted for the normal AGC'd IF amplifier.

Where size and weight are secondary, excellent performance is readily available with LEL's ITL-2 log amps listed at \$670.

### SPECIFICATIONS

Center Frequency	30, 60 or 70 MHz
Bandwidth	10 MHz
Input	50 Ohms
Output	Video Det.
Dimensions	6 $\frac{3}{8}$ x $\frac{3}{4}$ x 1 $\frac{1}{2}$
Connectors	OSM
Power Requirement	-15V @ 90 mA
Price	\$975
Delivery	Stock to 30 days

More than 100 other standard IF Amplifiers are available many with such special characteristics as broad bandwidth, gain-and-phase-match, low noise, extremely low power drain.

Send now for complete data book including full specifications and performance curves.



**LEL** DIVISION  
VARIAN associates

AKRON ST., COPIAGUE, L. I., NEW YORK 11726  
(516) AMityville 4-2200/(516) PYramid 9-8200  
TWX Code 516-691-5085

ON READER-SERVICE CARD CIRCLE 43

## SEMICONDUCTORS

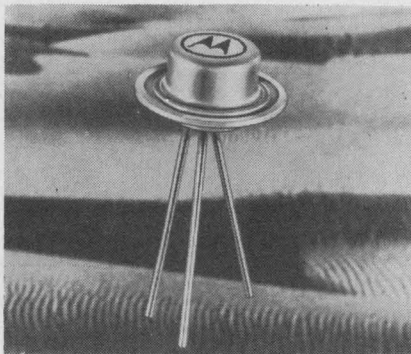

### Uhf transistors reduce power costs

Motorola Semiconductor Products, Inc. P. O. Box 955, Phoenix. Phone: (602) 273-6900. P&A: \$18 (MM-1501), \$28 (MM1500); stock.

Delivering 250 mW at 1.5 GHz, the \$28 MM1500 power transistor is said to bring uhf power into the price range of a greater number of solid-state designers. For lower power requirements the line also includes the \$18 MM1501 which delivers 150 mW at 1 GHz. The devices are housed in a wide flange case for easy cavity mounting. They are useful as local oscillators in radar systems, telemetry, and proximity fuses, and for varactor drivers. Increased power ratings are obtained by a multiple overlay design.

CIRCLE NO. 212

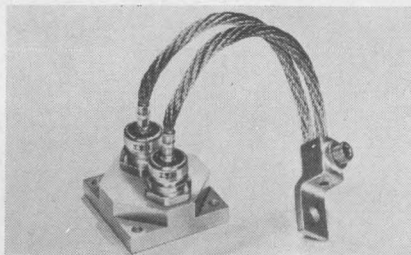

### Heat-sinked rectifiers rated up to 500 A

International Rectifier, 233 Kansas St., El Segundo, Calif. Phone: (213) 678-6281. Prices: \$30 to \$168.

Ratings up to 500 A are available in the 500UDF series of high current rectifiers. These units combine two matched diodes on a 3-inch square heatsink. 500UDF rectifiers are suggested for use in equipment such as battery chargers, welders, power supplies and electroplaters. Voltage ratings range from 50 to 1200 V PRV.

CIRCLE NO. 213



### General-purpose transistor sells for 25¢

National Semiconductor Corp., Danbury, Conn. Phone: (203) 774-0060. Price: about \$0.25.

This line of ten low-cost npn and pnp general-purpose transistors, priced about 25¢ each, is especially applicable for data processing, communications and home entertainment equipment. The "Gem" line of low-level, high-gain, uhf and diffused epitaxial transistors have typical power dissipation of 250 mW. The units are especially constructed to give access to the transistor connections from the top of the PC board for testing and troubleshooting.

CIRCLE NO. 214

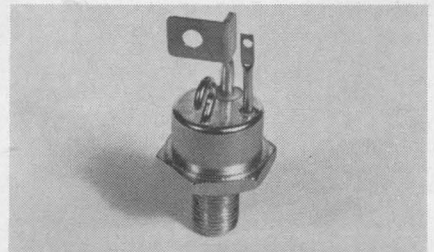

### Si power transistors handle 100 A

Solitron Devices, Inc., 1177 Blue Heron Blvd., Riviera Beach, Fla. Phone: (305) 848-4311.

Two JEDEC-registered power transistors are capable of controlling or switching a collector current of 100 A. Sustaining voltages are 80 V for the 2N4865 and 120 V for the 2N4866. Minimum cut-off for both is rated 10 MHz. These 1-1/16-in hex, stud-mount devices are characterized by a  $h_{FE}$  of 10 to 40 at 70 A and 5 at 90 A. The requirements of MIL-S 19500 are met.

CIRCLE NO. 215

## N-channel J-FETs have 1-pA max leakage

Siliconix, Inc., 1140 W. Evelyn Ave., Sunnyvale, Calif. Phone: (408) 245-1000. P&A: \$10.05, \$8.60 and \$7.80 in 100 lots; stock.

Gate reverse current less than 1 pA at 20 V is obtainable with these n-channel junction FETs, 2N4117A, 2N4118A and 2N4119A. The time-temperature stability and reliability of junction FETs is combined with the low gate input current usually associated with MOS-FETs. Designed primarily for low-power and audio applications, the series offers tight 3:1 ranges of  $I_{DSS}$  and  $g_{fs}$ . They are packaged in TO-72 cans.

CIRCLE NO. 216

## Small silicon diodes; high power ratings

Continental Device Corp., 12515 Chadron Ave., Hawthorne, Calif. Phone: (213) 772-4551. Availability: stock.

This silicon planar epitaxial device comes in a hermetically sealed glass package with dual-stud and ribbonless construction. The "Mono-diode" claims greater power dissipation, fewer parts (less potential failure), and smaller permissible size (less than one-fourth the volume of the DO-7), resulting from surface stabilization and protection processes in manufacture.

CIRCLE NO. 217

## Computer diodes 50% smaller in size

Texas Instruments, Inc., P. O. Box 5012, Dallas. Phone: (214) 235-3111. Price: \$0.25 to \$0.99.

The Uni/G epitaxial planar computer diodes are packaged DO-35, 50% smaller than the usual DO-7 package. The series of six high-speed computer switching diodes, 1N4148-49 and 1N446-49, have the electrical characteristics of the 1N914 family. Reverse breakdown voltage is 100 V min with  $I_r$  at 100  $\mu$ A. Reverse recovery time is 4 ns.

CIRCLE NO. 218

# Why IEE rear-projection readouts make good reading

Not the kind of good reading you'd curl up with on a rainy night. But a more important kind if you're designing equipment that requires message display. Reason is that IEE readouts are the most readable readouts around. If you've seen them, you know this to be fact. If you haven't as yet, here is why our readouts make such good reading:



### WIDE-ANGLE READABILITY

IEE's unique combination of single-plane projection, flat viewing screen, balanced ratio of brightness/contrast, and big, bold characters makes for wide-angle clarity and long viewing distances.

### OTHER WAYS IEE READOUTS MAKE GOOD SENSE

As if the superior readability of our readouts weren't enough, here are a few reasons why IEE readouts make good sense in other areas:

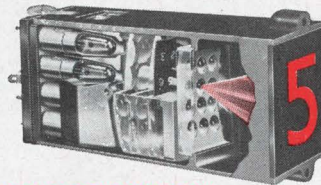

### SINGLE-PLANE PRESENTATION

No visual hash of tandem-stacked filaments. IEE readouts are miniature rear-projectors that display the required messages, one at a time, on a non-glare viewing screen. Only the message that's "on" is visible.



### INFINITE DISPLAY VERSATILITY

Because our readouts use lamps, lenses, film, and a screen, they can display literally anything that can be put on film. That means you have up to 12 message positions with each readout to display any combination of letters, words, numbers, symbols, and even colors!



### EASY-TO-READ CHARACTERS

Since IEE readouts can display anything that can be put on film, you're not limited to thin wire filament, dotted, or segmented digits. Order your IEE readouts with familiar, highly legible characters that meet human factors and Mil Spec requirements. This section from our sample type sheet gives you an idea of the styles available that offer optimal stroke/width/height ratio for good legibility.

### BALANCED BRIGHTNESS/CONTRAST RATIO

The chart below is a reasonable facsimile of character brightness and how



it affects readability. The background is constant, but the brightness increases from left to right. You can draw your own conclusions, armed with the fact that IEE readouts give you up to 90 foot lamberts of brightness. Brightness, however, isn't the sole factor in judging readability. Background contrast is equally important—a fact we've simulated below, reading from left to right.



Obviously, brightness without contrast or vice versa, doesn't do much for readability. A balanced ratio of both gives you the crisp legibility of IEE readouts.

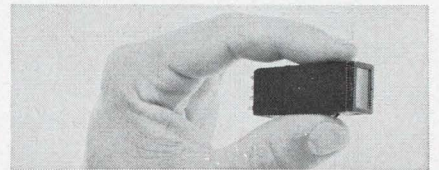

### FIVE SIZES TO PICK FROM

IEE readouts now come in five sizes providing maximum character heights of  $\frac{3}{8}$ ",  $\frac{5}{8}$ ", 1", 2", and 3". The smallest is the new Series 340 readout that's only  $\frac{3}{4}$ " H x  $\frac{1}{2}$ " W, yet can be read from 30 feet away. The largest, the Series 80, is clearly legible from 100 feet away.

### EASY TO OPERATE

IEE readouts are available with voltage requirements from 6 to 28 volts, depending on lamps specified. Commercial or MS lamps may be used, with up to 30,000 hours of operation per lamp. Lamps may be rapidly replaced without tools of any kind.

Our readouts operate from straight decimal input or will accept conventional binary codes when used with IEE low-current driver/decoders.

For more proof why IEE rear-projection readouts make good reading, send us your inquiry. You'll see for yourself why they've been making the best seller list, year after year!

**IEE INDUSTRIAL ELECTRONIC ENGINEERS, INC.**

7720 Lemona Avenue, Van Nuys, California  
Phone: (213) 787-0311 • TWX (910) 495-1707  
Representatives in Principal Cities © 1966 IEE

ON READER-SERVICE CARD CIRCLE 44

# From the recognized leader in C.P. Clare & Co. introduces

**FIVE CONTACTS IN .406 CU. IN.**

**ISOLATED SWITCHING**

*... no sensitivity to transients*

**INHERENT RELIABILITY**

*... no maintenance*

**FAST SWITCHING**

*... high microsecond to low millisecond range*

**HIGH SWITCHING CAPACITY**

*... one to five contacts per relay*



Relays, switch, and dime actual size

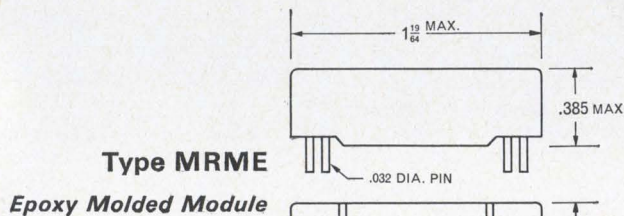

*Epoxy Molded Module*

**Type MRMC**  
*Open Coil Module*

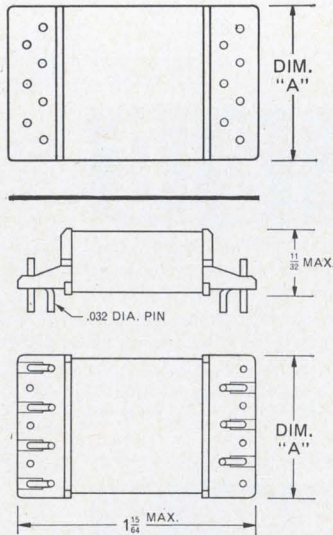

**Dimension A—Maximum**

No. of Switches	MRME	MRMC
1	13/32"	11/32"
2	33/64"	29/64"
3	39/64"	35/64"
4	45/64"	21/32"
5	13/16"	3/4"

- Contact arrangements: 1-5 Form A
- Maximum current rating: low level to 750 ma
- Maximum voltage rating: 200 vdc, 110 vac
- Maximum load: 10 va
- Life expectancy: .125 amp, 28v: 10 x 10<sup>6</sup> operations low level: 100 x 10<sup>6</sup> operations
- Contact resistance: 100 milliohms max, initial 1 ohm max, after life
- Operate time: .5ms to 2 ms\*
- Release time: .5ms max
- Coil voltage: 6 to 48 vdc
- Dielectric standoff: 250 v rms min.
- Insulation resistance: 10,000 megohms min.
- Shock: Type MRME: 50 g  
Type MRMC: 20 g
- Vibration: 10 g, 10-2,000 cps
- Temperature: -55°C to + 85°C  
(+ 125°C available)

\*Including bounce, rating dependent upon number of contacts and drive level

*sealed-contact reed relays—  
the new subminiature*

# MicroClareed<sup>®</sup>

## MRME

*and*

## MRMC

## Relays

Outstanding design and production capabilities have made Clareed Relays the recognized standard of quality in sealed contact reed relays. System and circuit designers have shown overwhelming preference for Clareed<sup>®</sup> Relays. And now you can have the same high standards of performance and reliability in only one-fifth the size!

The new MicroClareed Relays offer the identical features and same high quality. Isolation between coil and contacts prevent false actuation due to transient noise. Contacts are sealed in glass in an inert atmosphere under superclean conditions, so there is no contact contamination in manufacture, and complete protection from environmental contamination in use. Their extremely simple design and completely automated production eliminate need for adjustment or maintenance. Precious metal contacts assure long life and low contact resistance. Packaging of both types is ideal for low-profile, high-density printed circuits.

MicroClareed switching speeds (500 microseconds to 2 milliseconds) are completely compatible with other components in most process control applications, and are ample for many systems in instrumentation, circuit check-out, and similar uses.

*For complete information,  
ask your Clare sales engineer,  
circle the reader service  
number shown below, or  
write: Group 12A9, C. P.  
CLARE & CO., 3101 Pratt  
Blvd., Chicago, Illinois 60645*



*relays and related control components*

ON READER-SERVICE CARD CIRCLE 45

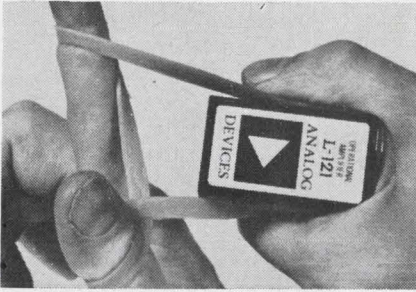

### Differential op-amp has speedy response

Analog Devices, 221 Fifth St., Cambridge, Mass. Phone: (617) 491-1650. P&A: \$165; 2 weeks.

The leading feature of the Model 121 dc differential operational amplifier is virtually all its specs. The unit is described as the only encapsulated op-amp on the market capable of delivering full output beyond 1 MHz, 10 V at 20 mA. Beyond this, the unit is capable of delivering full response at both terminals to 5 MHz in both inverting and non-inverting modes of operation. Output at 20 MHz is still a 5-V swing for both modes. Another feature is the unit's overload recovery time, 300 ns in both modes. With a minimum gain of 500, typically 1000, the 121 is said to be particularly suited for low-distortion work in the low MHz region.

CIRCLE NO. 219

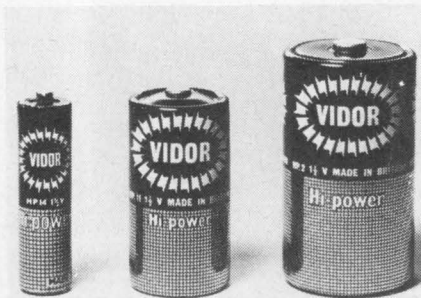

### High-power batteries offered D, C and AA

IRC, Inc., 401 N. Broad St., Philadelphia. Phone: (215) 922-8900. Price: \$0.50 to \$0.55.

Where relatively high battery current is needed, three new dry-cell batteries provide power in the most usual battery package designs. The 1-1/2-V units are offered in the D, C, and AA packages. All use an electrolytic manganese system.

CIRCLE NO. 220

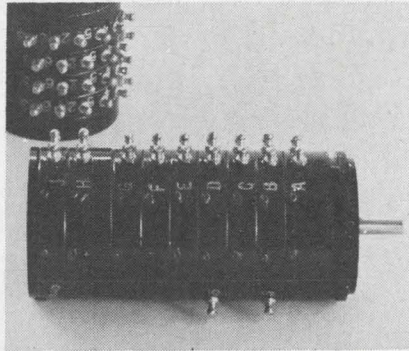

### Thin single-turn pots use conductive plastic

New England Instrument Co., Kendall Lane, Natick, Mass. Phone: (617) 655-1411.

For ganged-pot applications where space is at a premium, the "Waferpot" mounts 0.68-in. deep and each additional cup adds only 0.2-in. These conductive plastic components provide both linear and nonlinear functions and switch contacts can be molded into the elements as needed. Standard wafers are 7/8, 1-1/16, 1-7/16 and 2-in. in diameter. Life is rated at some 50 million revolutions.

CIRCLE NO. 221

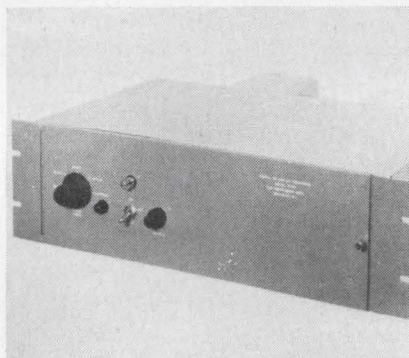

### 14-bit D/A converter accepts 19-bit input

Gap Instrument Corp., 17 Brooklyn Ave., Westbury, N. Y. Phone: (516) 333-8020.

The Model 773-1 digital-to-analog converter accepts 19 bits of binary input information, from which the appropriate 14 bits are selected. This is accomplished from either the front panel or remotely for one of four ranges. An external 90- to 140-V reference is used to generate the output which varies from zero and the reference.

CIRCLE NO. 222

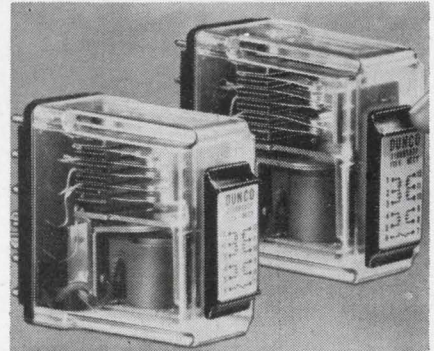

### Plug-in relays actuate manually

Struthers-Dunn, Inc., Pitman, N. J. Phone: (609) 589-7500. P&A: \$16.20; stock.

Manual actuators in the "Dun-control" line of plug-in relays are said to simplify circuit checkout in industrial control applications. The relays are offered dpdt, dpdt with two contacts normally open and dpdt with one open/one closed contact. Contact ratings are 10 A resistive at 115 V. Coils are available in popular voltages to 230 Vac and 115 Vdc.

CIRCLE NO. 223

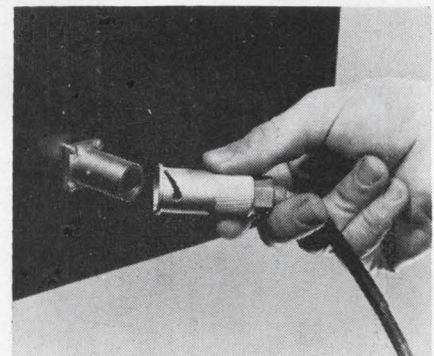

### Coax cable terminations free of corona effect

Rowe Industries, Inc., 1702 Wayne St., Toledo, Ohio. Phone: (419) 382-5666.

A coaxial cable termination design is said to handle high voltages in very restricted space with little or no corona effect. Corona-free operation is specified beyond 5 kV rms per MIL-C-17 (up to 50,000 feet over a range of -75 to 175°C). No sustained corona discharge appears at 30 kVdc. Other features include recessed contacts and silicone cable construction.

CIRCLE NO. 224



# Nobody but AE makes a Class E relay with all these terminals.

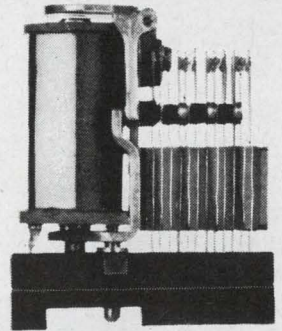

## Take your pick:

**1** *Solderless Wrap Terminals* eliminate the hazards of soldering. No splashes, heat or clippings. Faster, easier connections. And the technique is easy to learn.

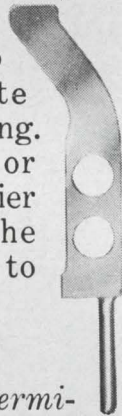

**2** *Taper Tab Terminals* accept solderless, slip-on connections which are crimped to each wire lead. Easy to connect or disconnect. Simplify circuit changes and relay substitutions.

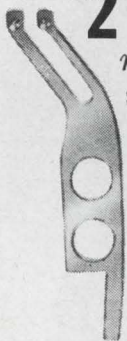

**3** *Solder Terminals*—the conventional way. For chassis and rack mounting where quick-connect methods aren't needed.



**4** *Printed Circuit Terminals* can be inserted directly into PC cards or boards. All terminals are soldered at one time by "flowing." This process can be automated.

You can get AE Class E relay with several types of plug-in sockets, too—that further in-

crease the number of mounting options.

But don't select the Class E relay because of wiring convenience alone. This is a miniaturized version of the premium-quality Class B—with most of its best features. Perfect contact reliability exceeding 200 million operations is common. That's why, even with ordinary solder terminals, the Class E is the most popular *quality* relay of its size!

For helpful information on the full line, ask for Circular 1942. Just write the Director, Relay Control Equipment Sales, Automatic Electric Company, Northlake, Illinois 60164.

## **AUTOMATIC ELECTRIC**

SUBSIDIARY OF  
**GENERAL TELEPHONE & ELECTRONICS GT&E**

ON READER-SERVICE CARD CIRCLE 46

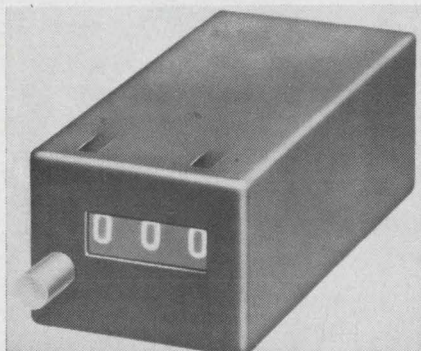

### Three-digit totalizer resets by pushbutton

Kessler-Ellis Products Co., 46 Center Ave., Atlantic Highlands, N. J. Phone: (201) 291-0501. Price: \$10 in 200 lots.

The miniature three-digit totalizer counter, ED-12, has a push-button reset feature. The counter registers pulses generated by a micro-switch, relay, reed relay or a solid-state driver. Max speed is 24 impulses/second. Unit dimensions are 1-1/16 x 7/8-in. on the panel and 2-3/4-in. deep. Life is rated beyond 40 million operations.

CIRCLE NO. 225

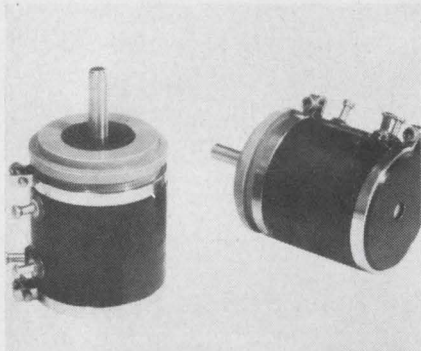

### Multi-turn pots housed in plastic

Technology Instrument Corp., 850 Lawrence Drive, Newbury Park, Calif. Phone: (805) 498-2165.

Lighter weight with high mechanical strength is said to be provided by a line of plastic-housed multi-turn pots. The phenolic housing meets MIL-M-14F and all units meet or exceed MIL-R-12934D. The pots are manufactured in standard resistance ranges from 1 to 30 kΩ as 3-turn units, from 1 to 200 kΩ as 5-turn units, from 1 to 100 kΩ as 10-turn units and 1 to 200 kΩ as 20-turn units.

CIRCLE NO. 226

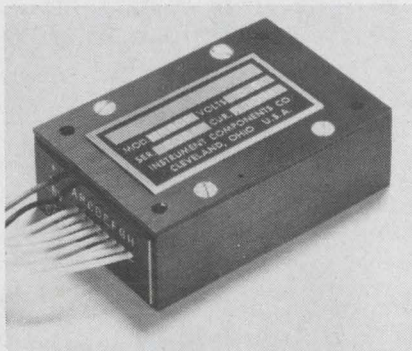

### Current regulator gives 8 outputs

Instrument Components Co., Lyndhurst, Ohio. Phone: (216) 442-4468.

Up to 8 individual 1-mA outputs are provided by the MN8CR1 current regulator module. Unit features ultrastable operation from -40 to +100°C and is designed for operation in such applications as missiles, aircraft and weapons. Total combined error is below ±1% for all disturbances. Input is 28 ±4 Vdc at 30 mA and unit size is 1 x 2 x 3-in.

CIRCLE NO. 227

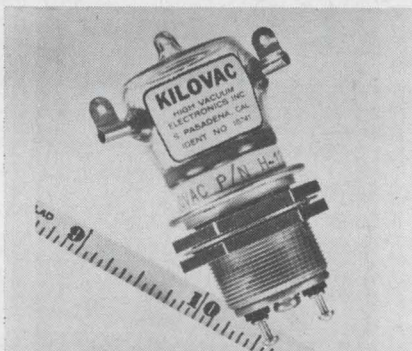

### High-voltage vacuum relay takes 4000-G shock

High Vacuum Electronics, 538 Mission St., S. Pasadena, Calif. Phone: (213) 682-3661. P&A: \$110 (1 to 9); 30 days.

Designed for high shock resistance (4000 G at 0.3 ms), this new model spdt vacuum relay, H-12/S4, is especially suited to airborne systems. It has an operating voltage of 8 kV in air, and 12 kV in oil, carrying 15 A rms at rated voltage, and is applicable to communication multi-couplers and transmitters, high-voltage and laser power supplies and microwave test equipment.

CIRCLE NO. 228

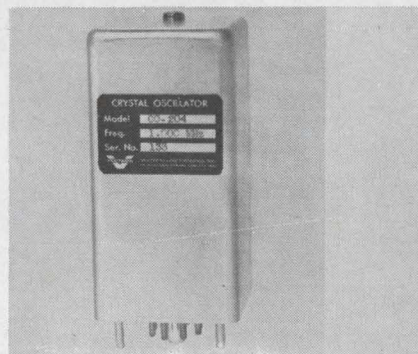

### Controlled oscillator uses IC for control

Vectron Labs, Inc., 146 Selleck St., Stamford, Conn. Phone: (203) 324-9225. Availability: stock.

An integrated circuit control oven is the basis of a 100,000-hour MTBF in the model CO-204 crystal oscillator. The 2 x 2 x 4-in. module offers a stability better than 1 x 10<sup>-9</sup> per day and standard units operate between -20 to 71°C. The oscillator stabilizes within 60 minutes of turn-on. Optional temperature tolerance from -54 to 75°C is also available.

CIRCLE NO. 229

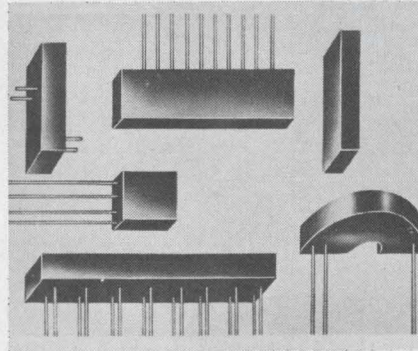

### Molded delay lines are heat-compensated

Valor Electronics, Inc., 13214 Crenshaw Blvd., Gardena, Calif. Phone: (213) 321-2280. Availability: 1 to 3 weeks.

In a newly expanded series, miniature molded delay lines conforming to MIL-D-23859 are designed for applications in computers, process control, radar, telemetry, business machines and related equipment. Delay lines featuring temperature compensation as low as 20 ppm are available. Leads are pure nickel, but tinned copper, Dumet, or others may be specified.

CIRCLE NO. 230

# Design a new circuit? It only takes 10 seconds to find out that maybe you didn't.

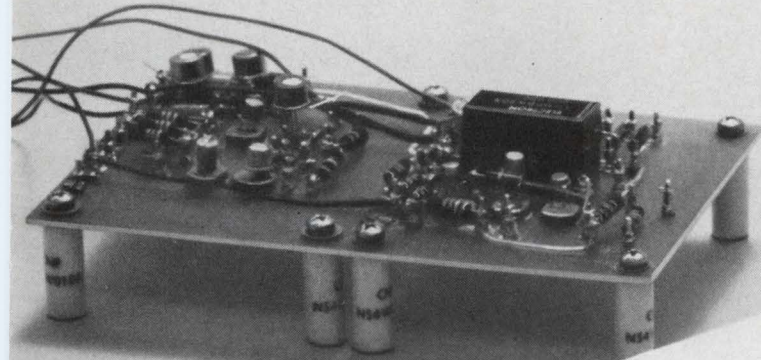

Polaroid Land film for oscillography is as quick to point out a mistake as it is to point out a success.

You never have to wait for darkroom development only to find out that your new breadboard needs more work.

You get your results in 10 seconds flat. And it's always a sharply detailed, high-contrast trace recording.

You can study it, attach it to a report, send it as a test record along with a product shipment, or file it for future use.

Choice of films? Yes. There are four different films for oscilloscope recording in pack, roll, and 4 x 5 formats.

The standard film speed has an ASA equivalent rating of 3000.

If you want to take a picture of a trace so fast you can't even see it, we've got a

special film called Polaroid PolaScope Land film with an ASA equivalent rating of 10,000. It's the fastest film around. It will actually record a scintillation pulse with a rise time of less than 3 nanoseconds.

To use these films on your scope, you need a camera with a Polaroid Land Camera Back. Most manufacturers have them (Analab, BNK Associates, Coleman Engineering, EG & G, Fairchild, General Atronics, Hewlett-Packard, Tektronix).

You can get complete details from one of these manufacturers, or by writing to Polaroid Corporation, Technical Sales, Dept. 30, Cambridge, Massachusetts 02139.

**Polaroid Land Film for Oscilloscope Trace Recording**

# An X-Y Scope With Perfectly Matched Price

**\$575**

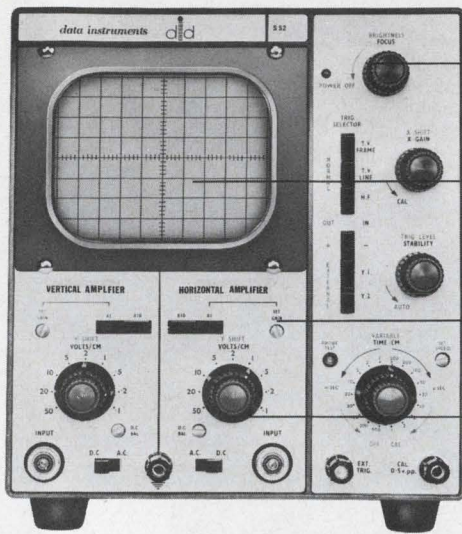

○ Low Cost

○ Solid State Reliability

○ 10cm x 10cm Viewing Area

○ Matched, Calibrated Attenuators

○ 1° Phase Error at 2MHz

Are your amplifiers out of phase with your budget? Here's a scope that's matched in every way—Data Instruments S52. Two identical, eight stage, high gain amplifiers permit measurements and comparisons all the way to 2MHz with a phase error of only 1°. The calibrated input attenuators are also matched to assure accuracy. And the sophisticated 5 inch PDA tube operates at 2.4kv and provides a 10cm x 10cm display area. The S52 can also be used as a conventional single beam scope. A front panel control allows the Horizontal Amplifier to be switched out and the Time Base to be switched in. The Time Base is a miller type giving excellent linearity and starting time, and features automatic synchronization to 3MHz. Extensive use of solid state circuitry gives the instrument a high degree of reliability and is backed up with a full year warranty. Field and Factory Service are also provided by Data Instruments. The specifications:

X-Y AMPLIFIERS				
BANDWIDTH	SENSITIVITY/CM	ATTENUATORS	RISETIME	IMPEDANCE
DC-3MHz DC-300kHz	100mv-50v 10mv-5v	9 position Matched	0.1μs	1MΩ + 3pf
TIME BASE		CRT		PHYSICAL
SPEED/CM	ACCURACY	DIA.	PHOSPHOR	VOLTS
1μs-0.5 sec. (18 cal. ranges)	± 5%	5" PDA	P31 P7 optional	2.5kv
				8½" x 9¼" x 15" 24 lbs.

Few other instruments have amplifiers so completely matched over such a broad bandwidth. Still, we're not perfect. We do have that 1° phase error in performance. But not in price. At \$575 the price is perfect. And it's unmatched.

**Data Instruments Division • 7300 Crescent Blvd. • Pennsauken, N.J. 08110**

ON READER-SERVICE CARD CIRCLE 48

## COMPONENTS

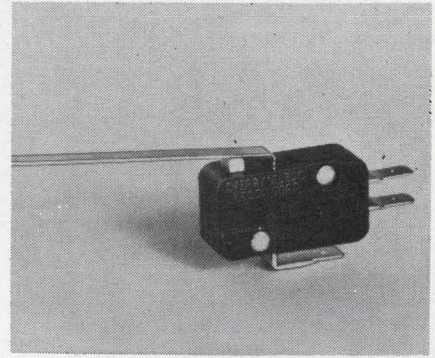

### Miniature switch operated by 6 grams

*Cherry Electrical Products Corp.,  
1650 Old Deerfield Road, Highland  
Park, Ill. Phone: (312) 432-8182.  
Price: \$0.56 in 2M lots.*

Using a coil spring mechanism and an internal actuator that alters the switch geometry, the E23-55HLX switch operates on forces as low as 6 grams. Contact forces, however, remain the same as in the original design and electrical ratings are 5 A, 1/4 hp, 125 to 250 Vac. An additional feature is that operating forces do not exceed 6 grams even when fully overtraveled.

CIRCLE NO. 231

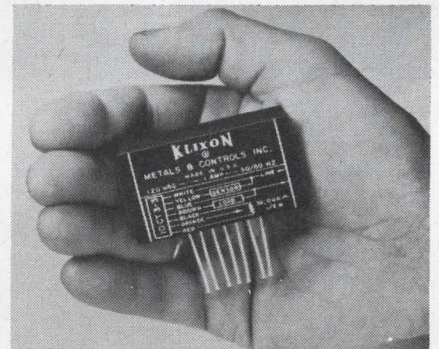

### Temperature control incorporates SCR

*Texas Instruments, Inc., 34 Forest  
St., Attleboro, Mass. Phone: (617)  
222-2800. Price: \$20 in quantity.*

A true proportional control is provided by the 10CT and 11CT temperature controllers based on SCR circuitry. Type 10CT is rated for 125 W and 11CT is rated 250 W. Both are furnished in a rugged 11/16-in. x 1-1/4-in. encapsulated package. Matching thermistors are available in a variety of temperature ranges.

CIRCLE NO. 232

# NEW

## Lambda high current LK Series power supplies 0-20, 0-36, 0-60 VDC • up to 35 amps • 5¼" height • starting at \$330.

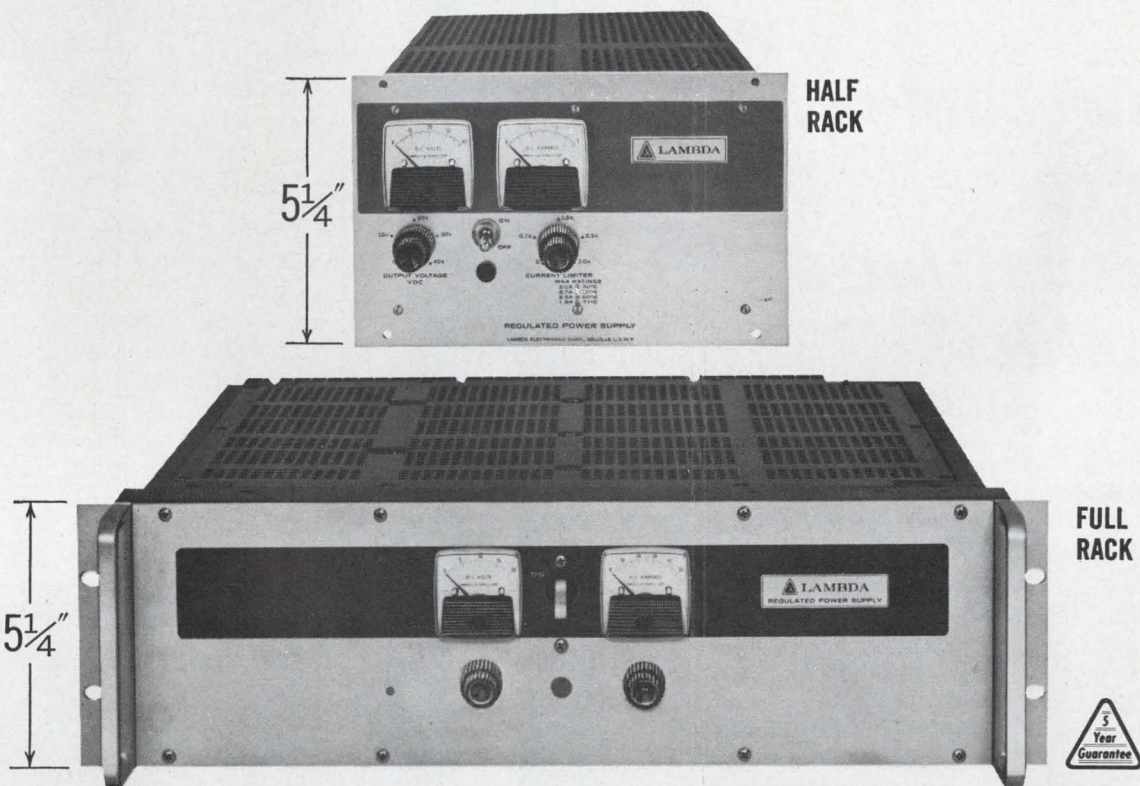

### Features

- All Silicon
- Convection cooled
- Remotely programmable
- Meet Mil-Environment specs

Vibration: MIL-T-4807A  
Shock: MIL-E-4970A  
• Proc. 1 & 2  
Humidity: MIL-STD-810  
• Meth. 507  
Temp. Shock: MIL-E-5272C  
• (ASG) Proc. 1  
Altitude: MIL-E-4970A  
• (ASG) Proc. 1  
Marking: MIL-STD-130  
Quality: MIL-Q-9858  
• Remote Sensing

- Series/Parallel Operation
- Regulation—.015% or 1 MV (Line or Load)
- Ripple—500 uV RMS.
- Temp. Coef. .015%/°C
- Transformer—designed to MIL-T-27 Grade 6
- Completely Protected—Short Circuit Proof—Continuously Adjustable Automatic Current Limiting
- Constant I./Constant V. by automatic crossover
- No Voltage Spikes or Overshoot on "turn on, turn off" or power failure
- Wide Input Voltage and Frequency Range—105-132 VAC, 47-63 cps

RACK OR BENCH USE—rubber feet included for bench use.

3 full-rack models—Size 5¼" x 19" x 16½"

Model <sup>2</sup>	Voltage Range	CURRENT RANGE AT AMBIENT OF: <sup>1</sup>				Price <sup>2</sup>
		40°C	50°C	60°C	71°C	
LK 350	0-20VDC	0-35A	0-31A	0-26A	0-20A	\$675
LK 351	0-36VDC	0-25A	0-23A	0-20A	0-15A	640
LK 352	0-60VDC	0-15A	0-14A	0-12.5A	0-10A	650

6 half-rack models—Size 5¾" x 8¾" x 16½"

Model <sup>2</sup>	Voltage Range	CURRENT RANGE AT AMBIENT OF: <sup>1</sup>				Price <sup>2</sup>
		40°C	50°C	60°C	71°C	
LK 340	0-20VDC	0- 8.0A	0- 7.0A	0- 6.1A	0-4.9A	\$330
LK 341	0-20VDC	0-13.5A	0-11.0A	0-10.0A	0-7.7A	385
LK 342	0-36VDC	0- 5.2A	0- 5.0A	0- 4.5A	0-3.7A	335
LK 343	0-36VDC	0- 9.0A	0- 8.5A	0- 7.6A	0-6.1A	395
LK 344	0-60VDC	0- 4.0A	0- 3.5A	0- 3.0A	0-2.5A	340
LK 345	0-60VDC	0- 6.0A	0- 5.2A	0- 4.5A	0-4.0A	395

<sup>1</sup> Current rating applies over entire voltage range.

<sup>2</sup> Prices are for non-metered models. For metered models add suffix (FM) to model number and add \$30.00 to price.

<sup>3</sup> Overvoltage Protection: Add suffix (OV) to model number and add \$70.00 to the price for half-rack models; \$90.00 for full-rack models.



**LAMBDA ELECTRONICS CORP.**

515 BROAD HOLLOW ROAD • MELVILLE, L. I., NEW YORK • 516 MYRTLE 4-4200

A  SUBSIDIARY

LA-173

ON READER-SERVICE CARD CIRCLE 49

# How come we're selling a competitor's product?

Very simple — we've joined Burnell's well known sophisticated design technology and its production facilities to our own to form a single superb organization for the manufacture of filters unsurpassed for performance and reliability. This represents a giant step forward in our continuing development program aimed at eliminating all limitations on filter specifications and volume production. As a result, Burnell-Nytronics can now make on-time deliveries of filters produced to the most exacting requirements, regardless of bandwidth or shape. Regardless of quantity.

Among the advanced classifications of filters being supplied our customers are: Linear phase band pass filters with arithmetic symmetry; matched filters such as pulse compression networks; subminiature thermally stable filters; zero phase shift harmonic suppression networks; constant resistance tapped delay lines; time domain waveform shaping filters; and shape factors of 1.002 to 1.

Send for literature describing our standard and custom products, and facilities.



10 Pelham Parkway, Pelham, New York 10803 ■ (914) 738-5000 ■ TWX: 914-235-3809

ON READER-SERVICE CARD CIRCLE 50

## COMPONENTS

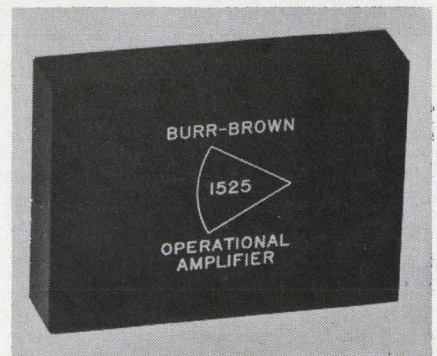

### Op-amp is wideband on both inputs

*Burr-Brown Corp., 6730 S. Tucson Blvd., Tucson, Ariz. Phone: (602) 294-1111. P&A: \$95; stock.*

Wideband operation in both inverting and non-inverting modes is possible with the Model 1525 differential operational amplifier. Applications include isolation of high-speed sensitive circuits (buffer) such as frequency standards, digital clocks, pulse generators, and others. Typical signal bandwidth is 10 MHz and rise time is 100 ns.

CIRCLE NO. 233

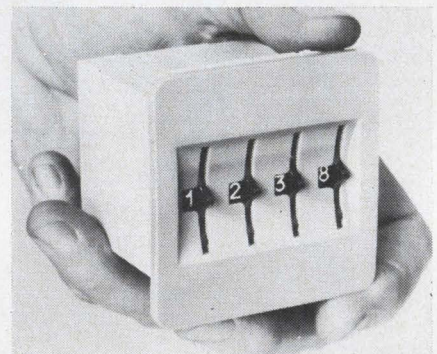

### Thumbwheel switches meet many needs

*Amperex Electronic Corp., Tube Div., 230 Duffy, Hicksville, N.Y. Phone: (516) 931-6200. Price: \$5.10 to \$5.50.*

A line of thumbwheel switches is offered for use in any single-pole or 4-pole switch application. They are available in decimal form or as coding switches, accepting either binary or decimal input. They feature a built-in decoding diode gate in the rotor, saving the user the trouble of mounting diodes externally. Four independent wipers provide a variety of decoding possibilities.

CIRCLE NO. 234

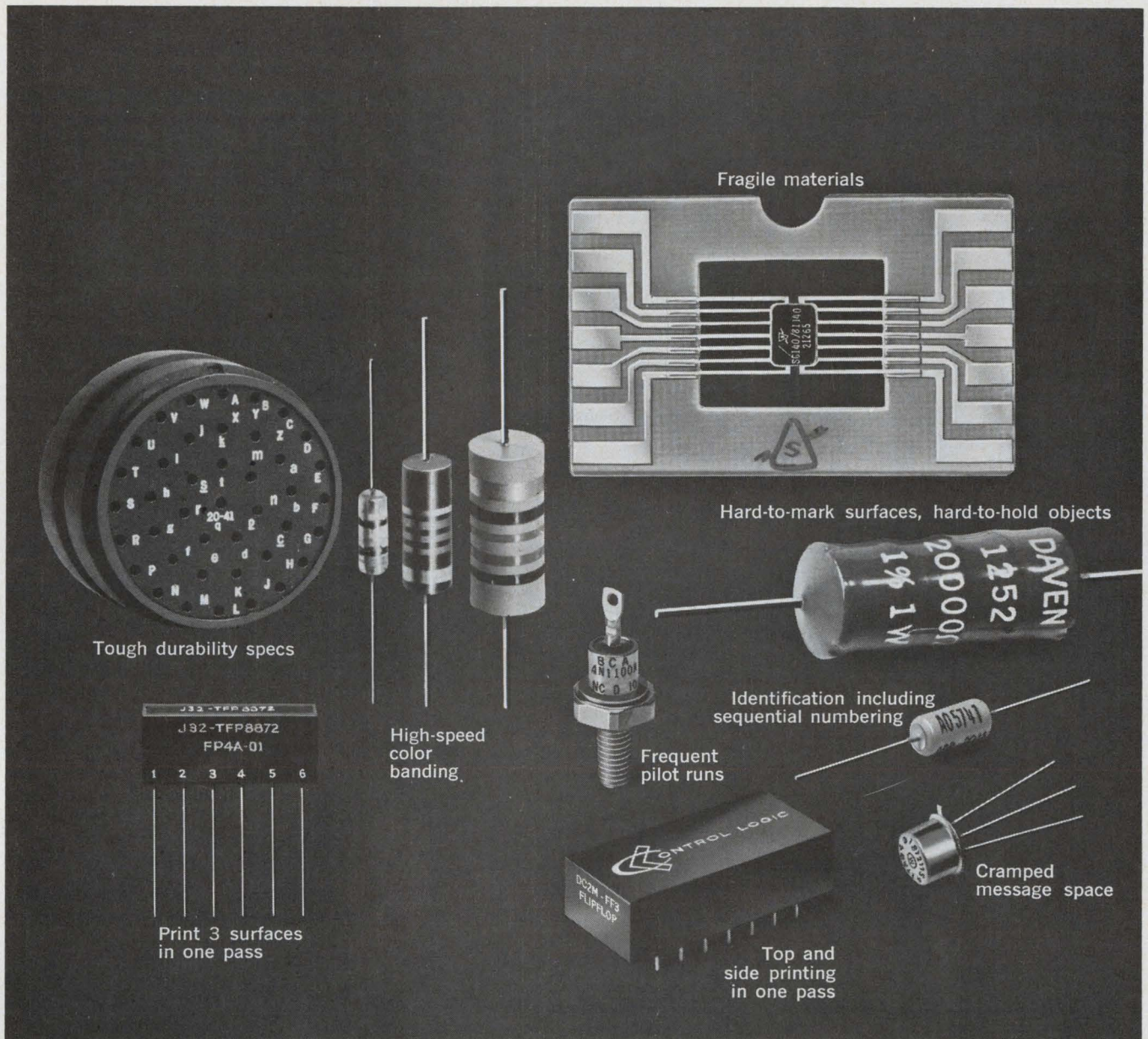

## What marking job can we help you do better?

These are only a few of hundreds of marking jobs you can do more efficiently and more economically with Markem machines. So why waste time improvising and experimenting?

Call in a Markem man and get acquainted with today's broadest line of marking equipment. New high-speed color banding machines — some capable of putting three tiny bands on a miniature diode. Machines that combine sequential numbering with identification. Type so small you can print 14 characters plus trademark in an 0.125" diameter area. Quick-change type for short or pilot runs. New techniques combining special ink with flash-curing to help you meet severe durability specs. A production-speed inprinter so gentle you can safely mark flat pack ceramic components. And many other machines, specialty inks and printing elements. Right now our research engineers and chemists are working on even better ways to mark components. We'd like to be working with you. Markem Machine Company, 319 Congress St., Keene, N.H.

# MARKEM<sup>®</sup>

HELPING YOUR PRODUCT SPEAK FOR ITSELF

ON READER-SERVICE CARD CIRCLE 51

# NEWEST from ARNOLD

—a power supply designed specifically for users of INTEGRATED CIRCUITS

Here's a unit with 8 amps. output and a choice of 4 voltages—all continuously adjustable... housed in a small size, low weight package. All-silicon circuitry.

### MODEL PHU

Size: 1½" x 3½" x 3¾". Designed to meet vibration and shock of MIL-E-5272C.

Weight: 27 oz.

Model No.	Output VDC	Output Current	Price Each
PHU-2WW	2	8 Amps	\$265.00
PHU-3WW	3	8 Amps	265.00
PHU-4.5WW	4.5	8 Amps	265.00
PHU-6WW	6	6.5 Amps	265.00

Input: 108-130 VAC @ 50-500 Hz.  
Output: adjustable +5 to -40%.  
Line Regulation: ±0.15 per volt.  
Load Regulation: less than 2.5%.  
Ripple: less than 1.5%.  
Operating Temp. Range: -55°C to +71°C.  
Delivery from stock. Ask for Art Heath.

ON READER-SERVICE CARD CIRCLE 91

### MODEL SHU

Size: 1½" x 3½" x 3¾". Designed to meet vibration and shock of MIL-E-5272C.

Weight: 27 oz.

Model No.	Output VDC	Output Current	Price Each
SHU-2WW	2	8 Amps	\$265.00
SHU-3WW	3	8 Amps	265.00
SHU-4.5WW	4.5	8 Amps	265.00
SHU-6WW	6	6.5 Amps	265.00

Input: 28 ±2 volts DC.  
Output: adjustable +5 to -40%.  
Line Regulation: ±0.06% per volt.  
Load Regulation: less than 2.5%.  
Ripple: less than 1.5%.  
Operating Temp. Range: -55°C to +71°C.  
Delivery from stock. Ask for Alan Schramm.

ON READER-SERVICE CARD CIRCLE 92

### 40 WATT DC-DC CONVERTER

8 MODELS—6.3V TO 5KVDC OUTPUT—ADJUSTABLE  
—senses overvoltage and current in MILLISECONDS!

Model No.	Output VDC	Output Current	Price Each
SHU-6.3	6.3	5.0 Amps	\$195.00
SHU-300	300	133 Ma.	200.00
SHU-1000	1000	40 Ma.	230.00
SHU-5000	5000	8 Ma.	390.00

SIZE: 3½" x 3½" x 1½" thick—Weight: 26 Oz.  
Input: 28 ±2.0 volts DC. Load Regulation: 1%-4%. Typical Ripple: 0.2% (of E<sub>out</sub>) Max. Delivery from Stock—Special Voltages—2 Weeks ARO.  
\* Ask for Steve Lee.

ON READER-SERVICE CARD CIRCLE 93

INQUIRIES FROM REPRESENTATIVES INVITED!

ARNOLD MAGNETICS

## ARNOLD MAGNETICS CORP.

6050 W. Jefferson Blvd., Los Angeles, Calif. 90016  
Telephone: 837-5313; 870-7014 (213)  
TWX: 213-836-0430

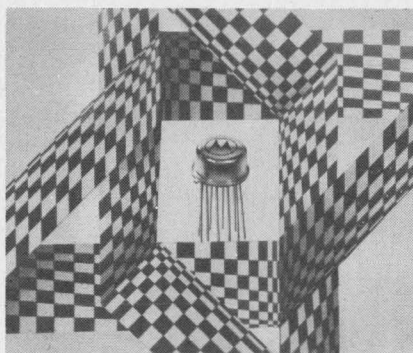

### Linear IC line for consumer use

Motorola Semiconductor Products, Inc. P. O. Box 955, Phoenix. Phone: (602) 273-6900. P&A: \$2.85; stock.

Narrow-band and wide-band tuned amplifiers, oscillators, amplitude modulators and video amplifiers are among the suggested uses for the MC1550G integrated circuit RF-IF amplifier. The circuit design of the amplifier is such that agc voltage has little effect on the input impedance and thus prevents detuning of the input circuitry. Power gain is 30 dB at 60 MHz and noise is 5 dB at that level.

CIRCLE NO. 235

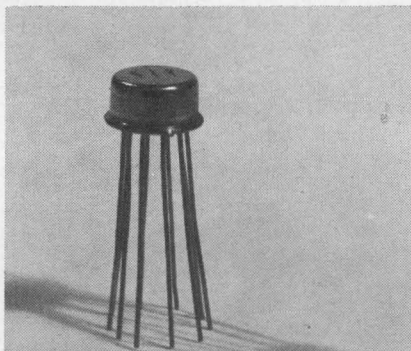

### Integrated amplifier operates to vhf

Amelco Semiconductor, 1300 Terra Bella Ave., Mountain View, Calif. Phone: (415) 969-9112.

This integrated amplifier is suitable for oscillator, video and IF applications, including frequencies in the vhf band. Typical output characteristics include a dynamic range of 4 V peak-to-peak over a temperature range of -55 to 125°C. Dc level at 25°C is typically 3 V and voltage gain is typically 15 dB.

CIRCLE NO. 236

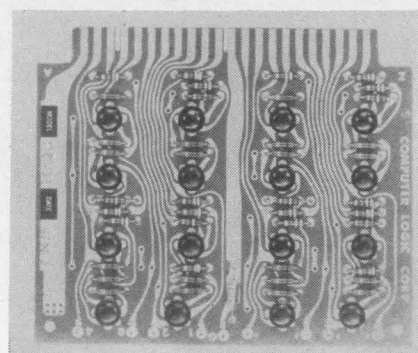

### Shift-bit IC card economizes a bit

Computer Logic Corp., 1528 20th St., Santa Monica, Calif. Phone: (213) 451-9754. Price: \$10.67/bit.

The economy-priced SB-31 shift bit integrated logic card accomplishes serial memory, conversion of serial to parallel or parallel to serial. Each output has a fan-out of 30 without power drivers. Each input represents one unit load and the card has 9 shift bits. Any gate-source can drive the clock line and any gate source or flip-flop can control any P or J or K.

CIRCLE NO. 237

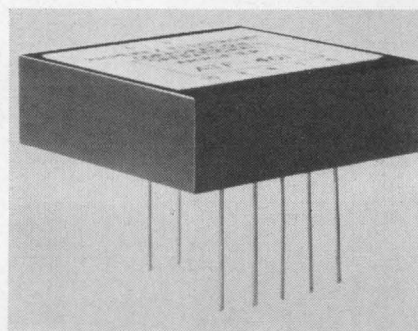

### Operational amps use LID technology

Amperex Electronic Corp., Slatersville, R. I. Phone: (401) 762-9000.

"Leadless Inverted Devices" are used to allow mechanized production of the thin-film hybrid ATF-401 operational amplifier. This unit is the first of a projected line. The ATF-401 has an open loop gain of 50,000 minimum, full output to 10 kHz, a gain bandwidth of 2 MHz, temperature drift of 10 μV/°C and 2 nA/°C, a max noise of 5 μV referred to input, and stability of 25 μV/day.

CIRCLE NO. 238



# Adlake Mercury Displacement Relays —Application Data

## Operates Under a Wide Range of Temperature Conditions

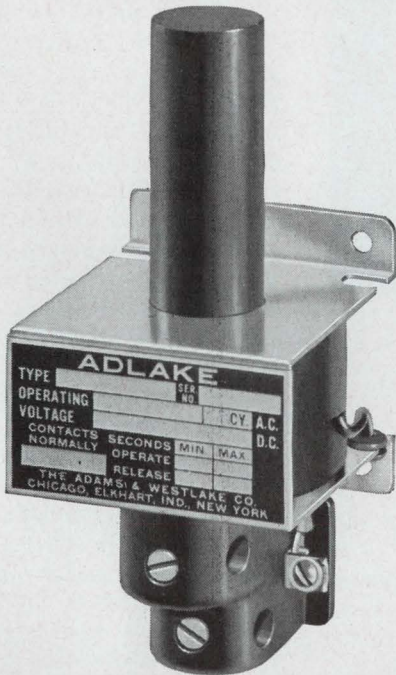

Varying ambient temperatures have little or no effect on Adlake Mercury Displacement Time Delay relays. From the graphic illustrations, ambient temperatures up to 200° F or down to -37.8° F (freezing point of mercury), the change in timing is less than 10%.

Adlake relays have been subjected to temperatures well below -37.8° F for extended periods. Upon raising the temperature to a point above the freezing point of mercury, the relay will again become operative. The relay will not suffer any damage as a result of the extended exposure to low temperature. This portrays the ruggedness of Adlake Relays due to their simplicity of design.

## Mercury Displacement Relays — Temperature vs. Time Delay

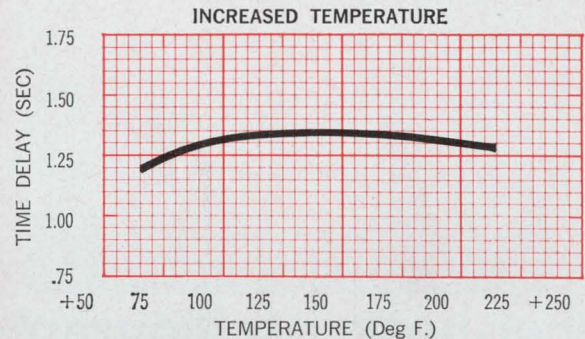

Effect of increased temperature on time delay characteristics. Curve is typical for a normally open, slow-make relay having nominal time delay of 1.25 seconds.

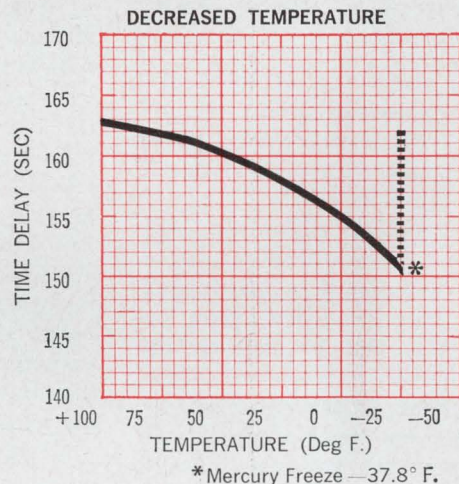

Effect of decreased temperature on time delay characteristics. Curve is typical for a normally open, slow make relay having nominal delay of 160 sec.

Backed by sound research and disciplined engineering, Adlake applies the industry's broadest line of mercury displacement and mercury wetted relays to the creative solution of design circuit problems. However unique or special your application, Adlake can assist you in

developing it. For prompt, personal and knowledgeable attention to your relay needs, contact the one source that is the complete source in the mercury relay field. Contact Adlake today for catalog and further information.



**THE ADAMS & WESTLAKE COMPANY**

Dept. 1126, Elkhart, Indiana, U.S.A. 46514 • (AC 219) 264-1141

TRANSPORTATION EQUIPMENT • ARCHITECTURAL PRODUCTS • MERCURY RELAYS • DOORS AND ENTRANCES • CONTRACT MANUFACTURING  
ON READER-SERVICE CARD CIRCLE 54

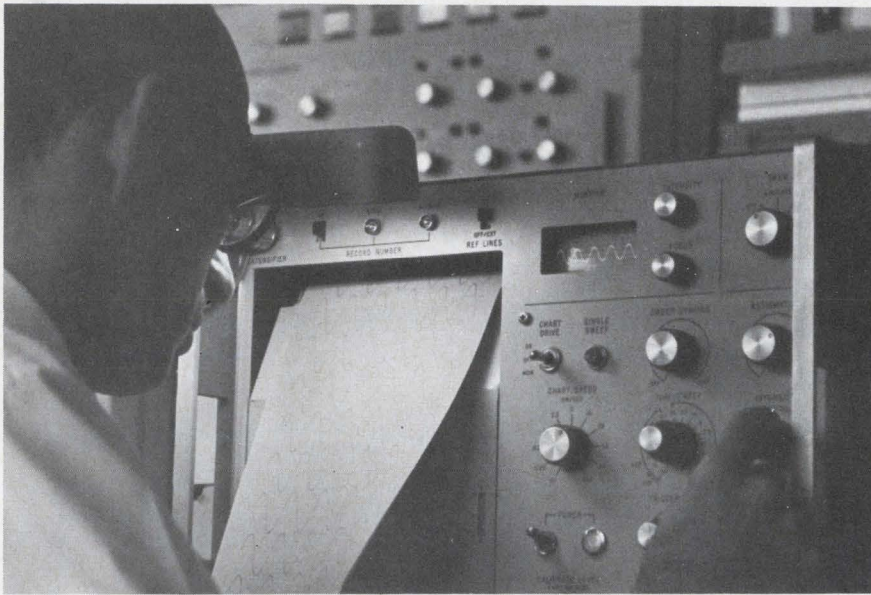

## Fiber-optic oscillograph prints at 1 million ips

*Honeywell, Test Instruments Div., 4800 Dry Creek Rd., Denver. P&A: \$20,000; 4 months.*

Writing speeds that exceed a million inches a second—a blur of light—are reported possible with a fiber-optic, cathode-ray-tube oscillograph developed by Honeywell.

The instrument, called the 1806 Visicorder, can record dc-to-1-MHz responses and single or continuous transient high-frequency analog or video signals, not to mention its other capabilities. It uses the CRT's electronic beam as its writing device.

The print-out speed is nearly 100 times faster than any other direct-writing system on the market, according to Honeywell engineers.

Basically, the single-channel, 4-axis instrument is a blend of the graphic direct-writing feature of other Honeywell oscillographs and the visual-display techniques common to the standard laboratory oscilloscope. The added ingredient is the specially designed fiber-optic CRT.

A new transverse recording technique is the key to the unit's performance. It permits writing across the paper, as well as in the standard downward mode. The technique permits the effective paper speed of oscillographic instruments to be increased from an industry norm of between 100 and 200 ips to 40,000,

with a corresponding increase of writing speed from 50,000 ips to 1 million.

It is the first oscillograph, Honeywell points out, that makes use of the transverse principle. Normally records are made solely by horizontal (X-axis) deflection. The transverse mode gives the 1806 Y-axis capability with a combination of vertical amplification and sweep speeds. Intensity modulation (Z-axis) is provided, along with control of the recording paper's motion (Y'-axis), to give the unit X, Y, Y' and Z recording capability.

In addition to its ability to record single or continuous X-Y plots and Lissajous patterns, the 1806 can record video pictures as a continuous series of individual 3-by-4-inch displays on direct-writing paper for immediate viewing. The cathode-ray tube makes use of an improved electronic gun to achieve initial fine spot resolution. A half-inch-thick, fiber-optic face plate, containing more than 35 million fibers, keeps the measured signal at its original size for recording purposes. An electronic beam, with a peak Z-axis modulation of 3.5 MHz, allows the unit to record standard TV transmission at the individual rate of 30 frames a second.

The measured signal—analogue or

video—is recorded on six-inch-wide photosensitive paper that passes over the CRT's face. As the paper, driven by a high-speed servo motor, emerges, it is developed by ultraviolet light, which causes the latent image of the signal to appear within seconds as a permanent record. This developing process is called "latensification" (latent image intensification).

Honeywell "envisions that completely new markets will open up for this versatile transverse recorder, especially in areas where oscillographic techniques are not now used because of limited frequency response or setup time." The instrument, no larger than two feet in any dimension and weighing 120 pounds, is applicable to almost any situation where scopes are used with cameras.

It can record signals longitudinally or transversely in either continuous or intermittent chart drive modes. The transverse mode is used primarily for high-frequency analog data recording and provides skew-corrected records. An external start-stop trigger automatically operates the paper-drive system for recording selected signals vertically. Vertical recording is used to analyze infrequently recurring waveforms or to compare repetitive low-or-high-frequency information.

Signals can also be recorded as a function of time or other parameters. Both X- and Y-signal inputs are used to obtain single or continuous records of X-Y plots and Lissajous patterns.

Video pictures can be presented, one frame at a time, as a continuous series of rasters on the direct-recording paper for immediate viewing.

A wide range of paper speeds (0.1 to 250 cm/s) and sweep controls (1  $\mu$ s/cm to 2.5 s/cm) permit recording of individual sweeps across the paper at almost any desired spacing. Compensation circuits correct any tendency of the records to "skew" due to instantaneous motion of the paper. Reference coordinates may also be recorded, along with the data to measure amplitude and time-displacement factors. Setup and signal monitoring is accomplished with a self-contained monitor scope that is also used for on-line monitoring during the recording cycle.

The 1806 incorporates solid-state electronics except for the CRT and cold-cathode devices.

CIRCLE NO. 299

# It's a bargain, no matter how you trim it

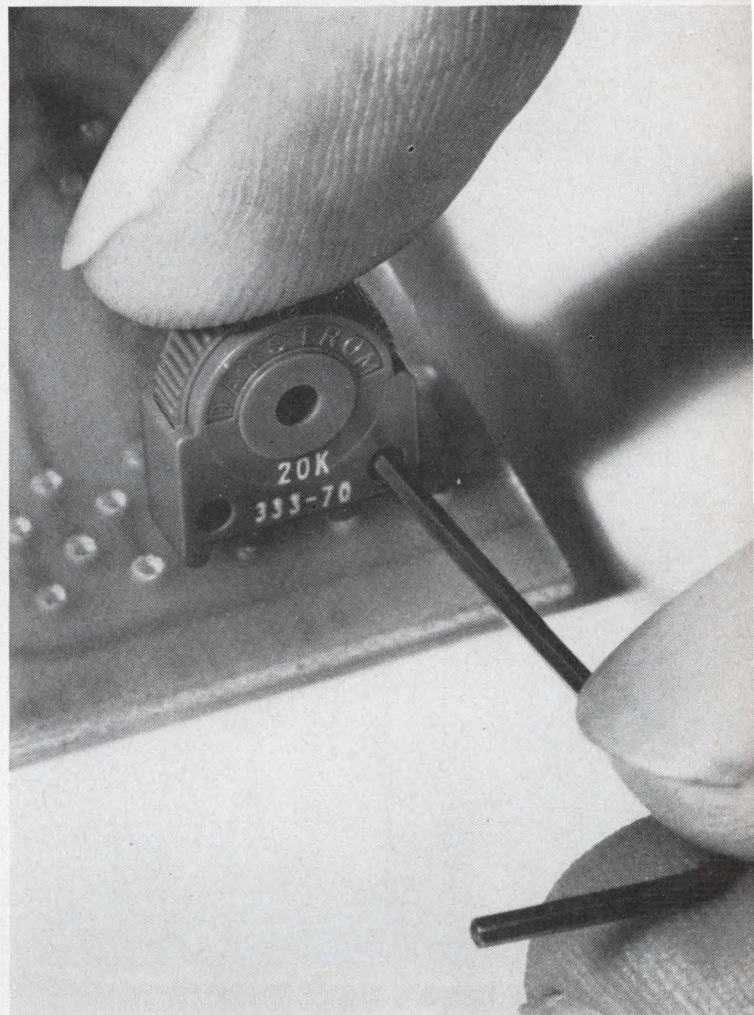
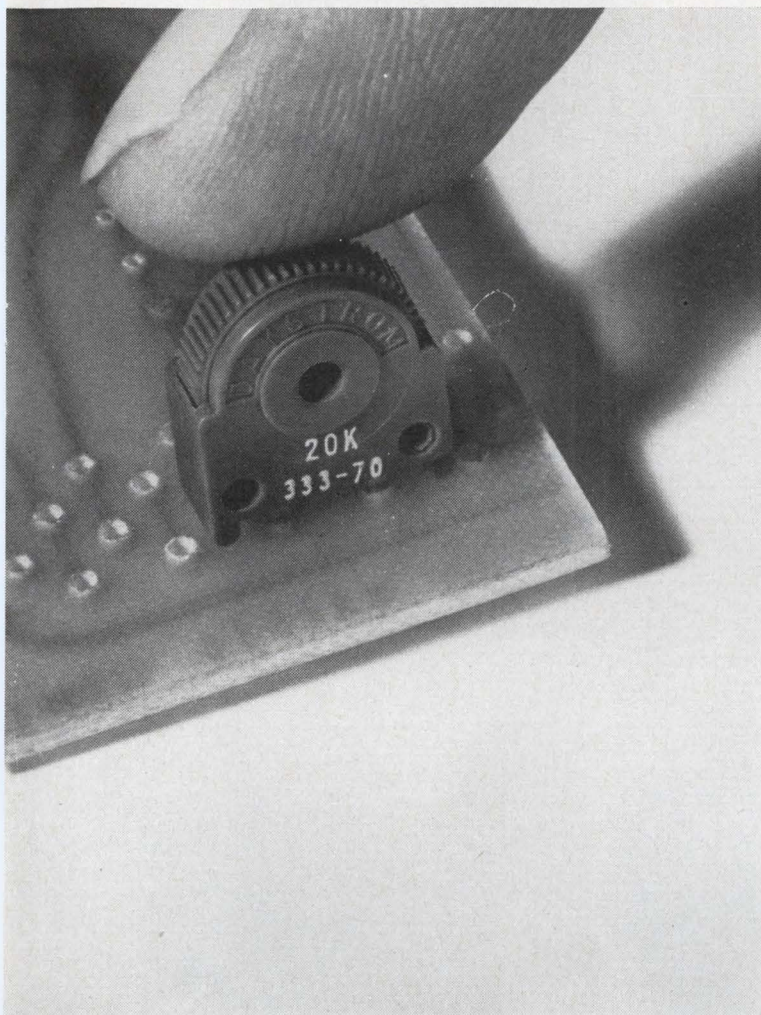

with the flick of a finger...

or the turn of a key.

You can trim the Daystrom Model 333 pot with your thumb on the convenient knurled knob. Or, use a hex-key on the Allenhead vernier for finer (4:1) settings.

But dual adjust is just one of the design features that make this low-cost commercial trimmer a bargain. Others are Weston's exclusive wire-in-the-groove construction which locks linearity in and contact noise out—even under shock and vibration... a slip clutch stop that protects the wiper at the end of rotation... Suregard™ terminations for long-life reliability.

You'll recognize these features as the same used in Weston's rugged MIL-type Squaretrim® pots.

In addition, compact 333 series pots take up less than 1/10 square inch on your PC boards. They're designed for edge mounting, with provision for dip soldering, so they're ideal for automated production techniques. And they'll handle 0.25 watt comfortably—in still air.

The price is a trim \$1.25 in lots of 500. Standard values range from 50Ω to 50K. For complete details or evaluation samples, contact your Weston distributor or call:

**Weston Instruments, Inc., Weston-Archbald Division**  
**Archbald, Pennsylvania 18403. Phone 717-876-1500**

**WESTON®** prime source for precision... since 1888

# 500,000 Bits/Second PCM SYSTEMS

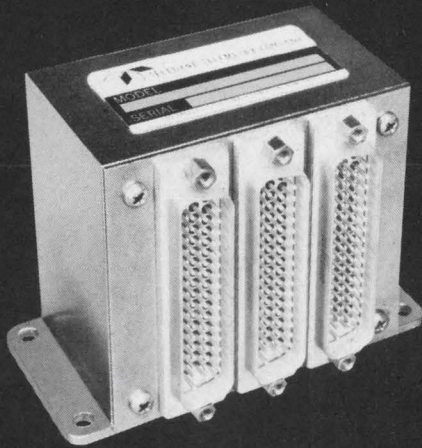

**710 PCM SYSTEMS** require as little as 26 cubic inches and weigh as little as 30 ounces. Space and weight are saved in Type 710 Microcircuit PCM Systems because they use MEMA.\*

Provides up to 256 channels of high, low and/or digital inputs.

FET analog input gates.

Offset and scatter below  $\pm 25$  microvolts.

Backcurrent below  $\pm 0.1$  microampere.

NRZ 10-bit word output.

Sample rates from 1 to 50,000 words.

\*Micro Electronic Modular Assemblies, a high density integrated circuit packaging concept developed by TELEDYNE, INC.

For complete information on Teledyne Telemetry components and systems contact:



**TELEDYNE TELEMETRY**  
A TELEDYNE COMPANY

12964 Panama Street  
Los Angeles, California 90066  
Phone (213) 870-9831  
TWX: 910 343 6855

ON READER-SERVICE CARD CIRCLE 56

## TEST EQUIPMENT



### Ragazzini phasemeter ignores form distortion

*Bramson Instrument Co., 176 Federal St., Boston. Phone: (617) 426-2644.*

Waveform distortion tolerance is the leading feature of the Model 910 wide-band phase meter, based on a design by Dean Ragazzini. The 910 will tolerate harmonics up to 1% of the second and 0.5% of the third. Basic accuracy is rated  $\pm 0.1^\circ$  absolute, better at low phase angles. Frequency coverage is 30 Hz to 20 kHz.

CIRCLE NO. 245

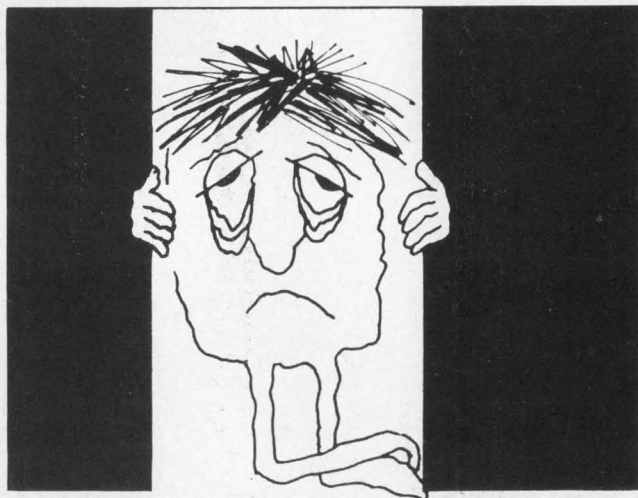

## R. F. INTERFERENCE PLAGUING YOU?



HOW ABOUT  
LITTELFUSE R.F.  
INTERFERENCE SHIELDED  
FUSE POSTS. MILITARY AND  
COMMERCIAL APPLICATIONS  
Write or phone for information

**LITTELFUSE**  
DES PLAINES, ILLINOIS

ON READER-SERVICE CARD CIRCLE 88

ELECTRONIC DESIGN 29, December 20, 1966

# THE Connector Thing

A periodical periodical designed, quite frankly, to further the sales of Microdot connectors and cables. Published entirely in the interest of profit.

# MICRODOT WELCOMES AMPHENOL

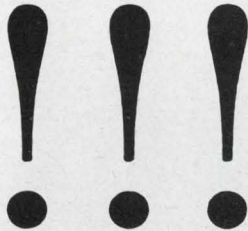

For over two years now, Microdot has had the subminiature, high density multi-pin connector market to itself. The sensational Microdot MARC 53 has been used on all the Gemini "Walks in Space" plus a multitude of military and NASA programs. Now, however, we've got competition...the brand new Amphenol Astro 348. Good to have you aboard.

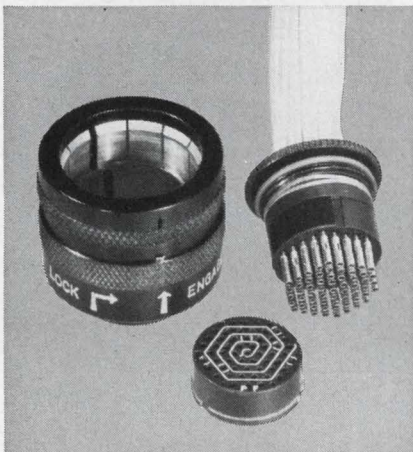

## IN HONOR OF THIS GREAT EVENT, MICRODOT IS HOLDING THREE (count 'em, three)



To be able to enter these contests, you've got to know a little something about the Microdot MARC 53. It's one of the real stars in the Microdot connector line...a high density (anywhere from 7 to 91 contacts in four shell sizes), subminiature, high-performance connector. The MARC 53 can save as much as 61% in weight and 54% in panel space. *Posilock*, a push-pull lock coupling, mates easily with high density inserts with no danger of damage.

The dual locking action eliminates accidental disconnect, *Posiseal*, a multiple, environmental sealing system, *guarantees* an interfacial seal.

MARC 53 is approved to MIL C-38300A (USAF).

### ...AND ABOUT AMPHENOL.

We wish we could also tell you all about the high density (two insert arrangements of 55 and 85 contacts in two shell sizes), subminiature, high performance, bayonet lock, bonded insulator Astro 348's but we're afraid that the Microdot officers, directors, stockholders, sales engineers and maintenance crew would hang us up by the thumbs. To find out more, write Amphenol.



### CONTEST #1

Open only to employees of Amphenol, their families, friends, reps, distributors and advertising agencies.

#### WIN A REVELL SCALE MODEL KIT OF THE GEMINI SPACE CAPSULE

In twenty-five words or more, tell us why the Astro 348 is the best subminiature multipin on the market. Neatness does not count. **TEN WINNERS...**the prize is calculated to tantalize you because the Microdot MARC 53 is used on the Gemini program. So there.

### CONTEST #2



Open only to employees, representatives and distributors of Microdot, their families, friends and advertising agencies.

#### WIN A REVELL SCALE MODEL KIT OF THE U.S.S. MIDWAY.

In twenty-five words or more, tell us why the MARC 53 is the best subminiature multipin on the market. Neatness counts. **Ten Winners.**

### CONTEST #3

Open to everybody except employees of Amphenol, Microdot, their families, friends and advertising agencies.

#### WIN A MODEL! SHE'S YOURS...

in perfect 1/8 scale, 8 x 10 glossy, perfect for your office wall, workshop or pool hall...inscribed "With Love and You Know What to

(your name here)  
from Marcia". All you have to do is write, in twenty five words or more a description of your application for the MARC 53. You notice how fast we forget the competition when we get down to business. Remember...everybody who enters Contest #3 wins!



## MICRODOT INC.

Microdot, Inc., 220 Pasadena Ave., So. Pasadena, Calif. 91030

- I want to enter Contest #1. My 25 words or more are attached. I am an employee of Amphenol.
- I want to enter Contest #2. Anybody who uses company postage for this one, gets docked.
- I want to enter Contest #3. My 25 words or more are attached. How does one go about getting Marcia in a slightly larger scale, say 1/1?
- I don't want to enter any contest. Just send specs on the MARC 53.

Name \_\_\_\_\_

Title \_\_\_\_\_

Company \_\_\_\_\_

Address \_\_\_\_\_

City \_\_\_\_\_

State \_\_\_\_\_ Zip \_\_\_\_\_

MARC 53, Posilock and Posiseal are trademarks of Microdot Inc. Astro 348 is not.

These contests are not valid in any locale where the local gendarmes take umbrage.

ON READER-SERVICE CARD CIRCLE 57

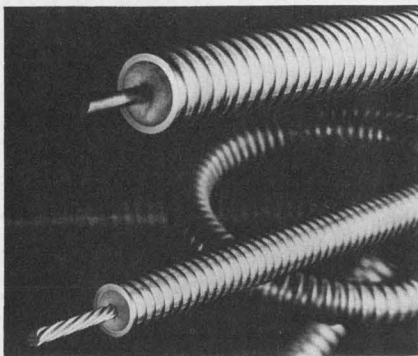

### Corrugated coax stronger, more flexible

Amphenol Cable Div., 6235 S. Harlem Ave., Chicago. Phone: (312) 261-2000.

In aircraft, CATV and broadcast applications, corrugated "Coro-Flex" cable is reported to be 30% stronger and 50% more flexible than coax of conventional designs. The cable is a seamless, metal-jacketed corrugated cable and is offered in both 0.5 and 0.325-in. OD. Available dielectrics include Teflon, polyethylene and Polyfoam.

CIRCLE NO. 246

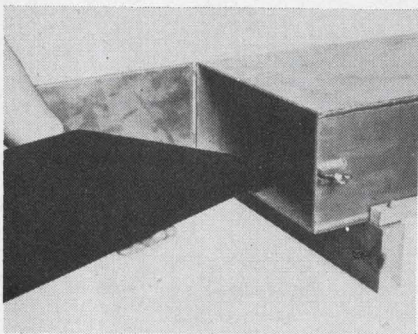

### Termination material extends to uhf

Emerson & Cuming, Inc., Canton, Mass. Phone: (617) 828-3300. Price: \$190 to \$320/ft.<sup>2</sup>.

Waveguide terminations made of "Eccosorb LF" are useful down to 300 MHz. The material is made from ceramic tiles laid in a resin, both components selected for their high values of magnetic loss in the uhf region. Eccosorb LF is available in one-foot squares with nominal thicknesses of 5/8 and 3/8-in. A termination made for a WR1150 waveguide would have a vswr of 1.1 at 640 MHz using the 5/8-in. material.

CIRCLE NO. 247

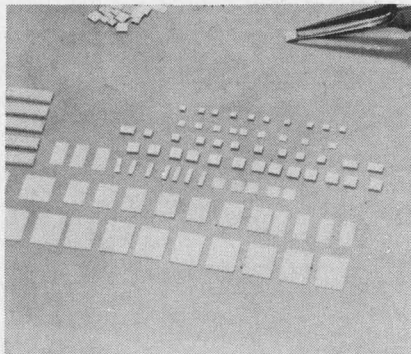

### Microcircuit substrates in 600 combinations

Glass Beads Co., P. O. Box 266, Latrobe, Pa. Phone: (412) 537-7791. Price: Typically \$0.12 (two sides metallized, 0.250 x 0.275 x 0.007-in.).

The C-100 series of standard microcircuit substrates comprises over 600 different combinations. These high-alumina substrates are available in sizes from 0.007-in. thicknesses to 0.050-in. with square areas up to 2-in.<sup>2</sup>. Three finishes are offered: bare, metallized and gold plated on one or on both sides.

CIRCLE NO. 248

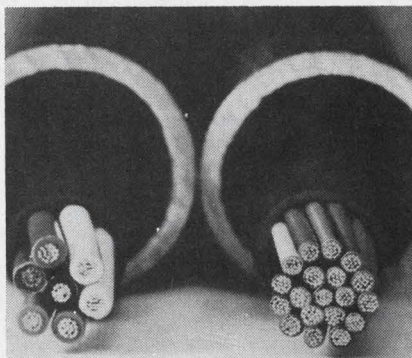

### Control cable miniaturized by half

Rockbestos Wire & Cable Co., Nicoll & Canner Sts., New Haven, Conn. Phone: (203) 787-1141.

Conduit capacity is said to increase 2 to 3 times through the use of a 600-V control cable called Mini-Trol. The cable uses heat-sealed film as primary insulation. This material in 7-mil thicknesses is specified to outperform 30-mil polyethylene. A 1-in. conduit will carry a standard 7-conductor 19/12 AWG cable or a Mini-Trol 19-conductor cable, according to the manufacturer.

CIRCLE NO. 249

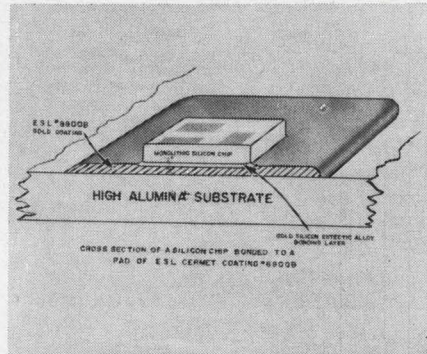

### No preforms needed with ceramic gold plating

Electro-Science Laboratories, Inc., 1133-35 Arch St., Philadelphia. Phone: (215) 563-1360. P&A: \$51/troy ounce in production quantities, \$65/1-ounce sample; stock.

You don't need gold or gold-alloy preforms to mount semiconductor chips with the 8800B coating. The coating, after application to a ceramic substrate, allows direct attachment of gold-backed silicon semiconductors. Attachments are made by ultrasonic bonding or scrubbing of the chip against the coating at 400°C under nitrogen.

CIRCLE NO. 250



### Needle-fine solder has 5 flux cores

Multicore Sales Corp., Westbury, N. Y. Phone: (516) 334-7450.

Solder small enough to pass through the eye of a needle in the Ersin Multicore line contains five cores of flux. The material is expressly designed for use in micro-miniature assembly operations. The solder is packaged on 1/2-pound reels and includes 63/37 and 60/40 tin and lead alloy in even gauges 24 through 34.

CIRCLE NO. 251

# CONTROL SYSTEMS ENGINEERS:

## WHY COMPROMISE JUST TO FIND POSITION FEEDBACK UNITS

### WITHIN BUDGET...OR WHY GO CUSTOM TO MATCH YOUR PERFORMANCE AND INSTALLATION REQUIREMENTS?

SATISFY YOUR **ELECTRICAL** REQUIREMENTS SUCH AS STROKE, INPUT VOLTAGE AND FREQUENCY, OUTPUT IMPEDANCE, ETC., WITH A SELECTION FROM THE MORE THAN 4500 WINDING CONFIGURATIONS.



FOR INTERNAL MOUNTING  
WITHIN ACTUATOR

CUSTOM-SELECT YOUR **MECHANICAL** INSTALLATION FEATURES FROM OUR COMPREHENSIVE VARIETY OF CASE AND PROBE-END CONFIGURATIONS. STANDARDIZED DESIGNS PROVIDE CHOICE OF DIAMETER, LENGTH, PRESSURE RATING, AND MOUNTING STYLE.

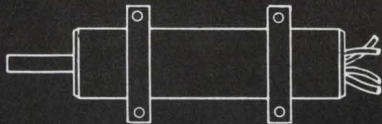

FOR SIDE-MOUNTING  
ON BULKHEAD

SPECIFY THE TRANSDUCER WITH YOUR **COMBINATION** OF ELECTRICAL AND MECHANICAL FEATURES, BY MODEL NUMBER AND PRICE, STRAIGHT FROM OUR M-SERIES CATALOG.



FOR INSERTING THROUGH  
PRESSURE BULKHEAD

You can specify a G. L. Collins Linear Motion Transducer right out of the catalog to satisfy both cost and design requirements. The G. L. Collins A.C. Linear Motion Transducer translates straight-line (linear) motion into an A.C. analog, which is useable as a feedback signal for control or display. This instrumentation component has infinite resolution, .0001-inch accuracy, billion-cycle reliability, and linearity to .2% of full stroke.

Through years of leadership in the design and manufacture of Linear Motion Transducers for commercial, industrial, and aerospace programs, G. L. Collins has developed **more than a million different configurations** that are available at **STANDARD UNIT PRICES**.

**Two-week delivery** is made possible by a controlled manufacturing system which perpetuates the same unexcelled accuracy and reliability that have made G. L. Collins transducers **FIRST CHOICE** among major aerospace control system engineers.

And remember... transducer selection is made easy by G. L. Collins' new specially designed catalog system.

Write for your **FREE M-series catalogs**.



## G. L. COLLINS CORPORATION

5875 OBISPO AVE., LONG BEACH, CALIF 90805 (213) 636-8141 or 630-3121 TWX (213) 634-4095

LISTED IN VSMF AND ASCAM MICROFILM CATALOGS.  
ON READER-SERVICE CARD CIRCLE 58

**“Just building a lipstick size relay that worked would have been easy.”**

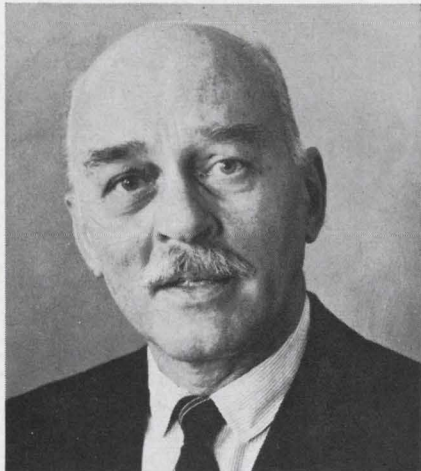

**Building one around our great high-rel idea was another story.”**

Wedge-action\*, our great high-rel idea, is 9 years old. Our 2PDT lipstick-case size relay has been around for less than 2 years. But it's already a standard replacement for the competition in lots of MIL-R-5757/8 applications.



Why? Because it outperforms every spec requirement for both high and low-level loads. Like all our wedge-action relays, it combines long contact wipe with high contact force to give you continually clean precious-metal mating surfaces throughout life. Competitively priced with fast delivery.

The lipstick is just one of our family of wedge-action relays, which cover almost every dry-circuit to 2 amp application. When you need a high-rel relay that really works, test one of ours and try your darndest to prove we're wrong. You won't be able to.

\* U.S. Patent No. 2,866,046 and others pending.



**Electro-Tec Corp.**

SLIP RINGS • RELAYS • SWITCHES • OPTICS

P. O. Box 667 • Ormond Beach, Florida  
(904) 677-1771 • TWX 810-857-0305

Manufacturing Facilities:  
Ormond Beach, Fla. • Blacksburg, Va.

PRODUCTION EQUIPMENT

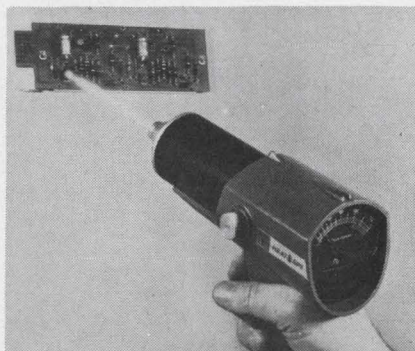

**“Spy” pistol measures temperature**

William Wahl Corp., 1001 Colorado Ave., Santa Monica, Calif. Phone: (213) 451-9711.

Called the “Heat Spy,” the model HS-8 noncontact thermometer senses infra-red emissions for instant temperature readings. The exact target area being measured is defined by a light beam that enables the operator to aim at objects 0.1 to 0.4-in. in diameter. Four models cover a range of 100 to 1000°F or the centigrade equivalents. Accuracy is rated  $\pm 2\%$ .

CIRCLE NO. 252

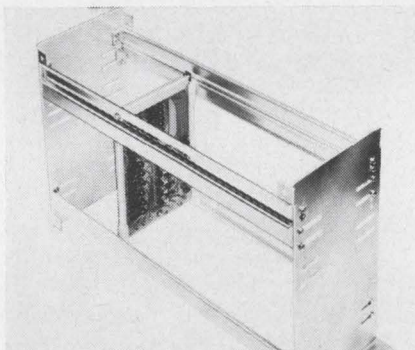

**PC rack holds 33 circuit boards**

Atlee Corp., 2 Lowell Avenue, Winchester, Mass. Phone: (617) 729-5800.

Up to 33 printed circuit boards with lengths from 4 to 9-in. can be mounted on the printed circuit Rak. The complete Rak consists of two side plates, four PCB holder locating brackets and two connector bracket mounting rails. Adjustments can be made to accommodate board widths from 3 to 5 in. A Rak can be supplied without side plates for custom-enclosure mounting.

CIRCLE NO. 253

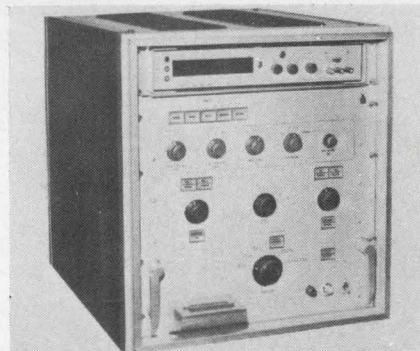

**Relay test unit has broad capabilities**

Sparton Corp., 2400 E. Ganson, Jackson, Mich. Phone: (517) 784-9131.

All major parameters of commonly encountered relays can be tested by the RTS-100 relay test instrument. It will test relays from spst through 6pdt, latching or non-latching, polarized or non-polarized. Tested parameters include coil resistance, operate and release time, contact bounce on operate and release, and contact resistance. Readout is taken from a 4-digit readout unit.

CIRCLE NO. 254

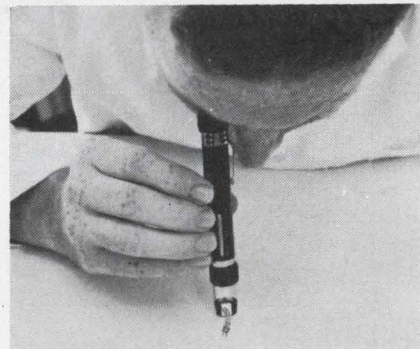

**Industrial microscope fits in your pocket**

Jensen Tools and Alloys, 3620 E. Indian School Rd., Phoenix. Phone: (602) 955-0180. Price: below \$10.

At work on the line, in the lab or out in the field, the 35-2 industrial microscope goes along with you in your pocket. Magnification is adjustable between 40 and 60 power. It is fitted with a reflecting mirror to illuminate the subject for viewing in ordinary daylight or desk light. A carrying case is provided.

CIRCLE NO. 255



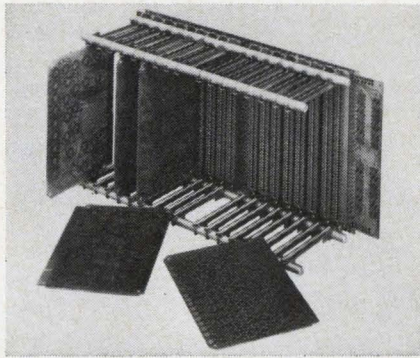

## Modular PCB rack is suitable mother-board

*Birtcher Corp., Industrial Div., 745 Monterey Pass Rd., Monterey Park, Calif. Phone: (213) 268-8584.*

Close tolerances and rugged construction are cited as the leading features of the Series 55 PCB rack for mother-board use. The rack is modular in design and a variety of configurations and board spacings can be assembled. The structural components of the Series 55 are steel and other parts are temperature-stable.

CIRCLE NO. 256



## Portable instrument checks commutators

*United Aircraft Corp., Vector Div., Southampton, Pa. Phone: (215) 355-2700.*

Either bench or on-location testing of PAM or PDM commutators is accomplished by the Model 845 "Comcheck." The fully-transistorized instrument is capable of 99-channel commutation checking within a frequency range of 90 to 10,000 Hz. It will accept a PMA input with positive or negative pedestal, 900-pps PDM or differentiated PDM. Input voltage can be read on a meter, scope or a null detector.

CIRCLE NO. 257



## Test set measures op-amp parameters

*Analog Equipment Corp., 7 Cypress Dr., Burlington, Mass. Phone: (617) 272-3776.*

Dc operational amplifiers, and most commercial discrete components, can be tested with this all-solid-state unit. Model 130A measures maximum output swing, input offset voltage, offset current of the inverting and noninverting inputs, and dc voltage gain from summing junction to output. Plug-in adapters are available for many existing dc operational amplifiers.

CIRCLE NO. 258

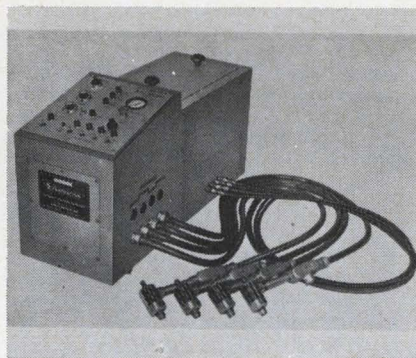

## Adhesive applicator handles hot-melt solids

*Spraymation, Inc., 52 Sindler Ave., Little Falls, N.J. Phone: (201) 256-1881.*

In assembly operations, the "Thermopulse" hot-melt applicator provides for permanent or temporary adhesive applications. It can also be used for encapsulating and potting with thermoplastics. The system consists of heating and control equipment, a high-pressure air operated pump, heated hose and the "Electromatic II" extrusion head.

CIRCLE NO. 259

# Sigmund Cohn Corp. Gold Bonding Wire (99.99%)

## Stays Put:

because every foot of wire is respooled on precision winding equipment designed by our plant engineers . . .

## Stays Put:

because winding tension and pitch are fully controlled; thus the single layer winding can not shift, can not slip . . .

## Stays Put:

because the wire is wound on **M.E.** Matched Expansion spools—another exclusive developed by our staff . . .



The single layer shipping package is designed for:

400 feet of .0007"  
400 feet of .0010"  
250 feet of .0015"  
150 feet of .002"

Write for Engineering Data

# Sigmund Cohn Corp.

121 So. Columbus Avenue  
Mt. Vernon, N.Y.



# PUT THE SWITCH WHERE THE ACTION IS!



## WITH SWITCHCRAFT PENDANT SWITCHES FOR REMOTE CONTROL VERSATILITY

Now, an all-new, ultra-versatile line of Pendant (Cord) Switches for control, indicating, counter and data entry applications without costly relays or custom engineering. A host of never-before-available features give remote switching the kind of reliable action, long life and broad range of functions you'd expect only from console-mounted

leaf-spring switches. By all odds, the best looking switches of their type—in a broad range of consumer- or industrial-oriented colors. Choose from momentary non-locking action, locking, push-to-lock/ push-to-release, or locking with remote electrical release . . . with standard circuitry arrangements from 1-A to 2-C plus 2-A.



**CORDMASTER SERIES**



**CORDETTE SERIES**

Most versatile line ever created. Top or edge button operation; exclusive remote lighting, standard illuminated, or non-illuminated models. Four different functions (including remote release), with choice of 5 different circuits. Lightweight, styled to fit the hand. Accepts cables up to .270 diameter.

Standout styling in a momentary-action remote switch with choice of A, B or C contact arrangements. Any length standard 2- to 4-conductor cable can be permanently molded on; or switch supplied with standard phono jack termination for use with any phono-plug equipped cable.

WRITE FOR BULLETINS E-534, E-537 and 165



**SWITCHCRAFT**  
INC.

5529 Elston Ave., Chicago, Illinois 60630

ON READER-SERVICE CARD CIRCLE 61

## SYSTEMS

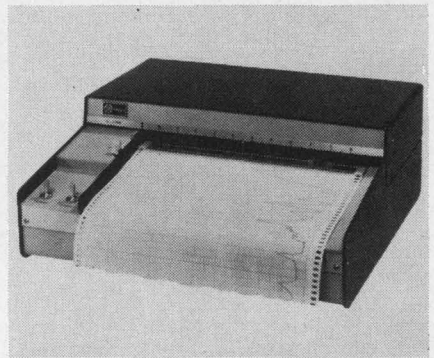

### Strip-chart recorders sensitive to 0.1%

*Varian, Recorder Div., 611 Hansen Way, Palo Alto, Calif. Phone: (415) 326-4000. P&A: \$995 to \$1445; January 1967.*

A series of 10-inch strip chart recorders are equally adapted to use with laboratory or process control instrumentation. The Series G-2000 recorders are sensitive to 0.1% of the 10-in. span and accuracy is rated 0.25% or better. Pen response is 0.5 s, full-scale. Standard chart-drive systems afford instant selection of up to 4 different speeds or up to 8 optional.

CIRCLE NO. 260

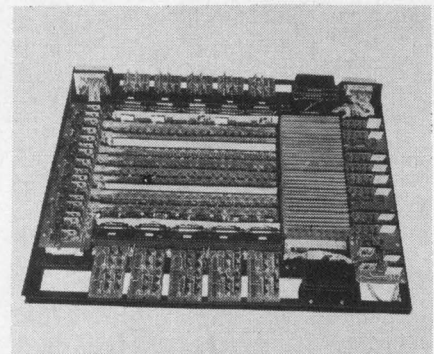

### Core memory systems range 0.6 to 1.0 $\mu$ s

*Burroughs Corp., Plainfield, N. J. Phone: (201) 757-5000.*

A new line of core memory systems covers the cycle time range of 0.6 to 1.0  $\mu$ s. The basic modular block in the memory is 8192 words by 20 bits using 20-mil ferrite cores in a 2-1/2 D organization. Up to 4 memory modules using the core memory along with sense amps, drivers and information registers can be accommodated in a standard 19 x 26-in. panel. Logic is monolithic ICs.

CIRCLE NO. 261

# 4 outstanding operational amplifiers from NEXUS

## 4 useful design benefits for YOU

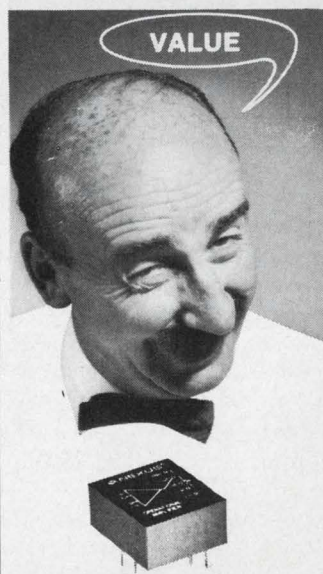

### THE NEXUS SQ-10a

The versatile SQ-10a — priced at *only \$17* in quantities of 1-9 — offers absolutely the highest performance per dollar in the industry.

You should consider the SQ-10a, or its low-profile brother, the SF-10a (only .375" tall), as a potential means of both improving your system performance and saving money.

#### TYPICAL PERFORMANCE

Open loop gain @ dc.....100,000  
 Output..... $\pm 11V$  @ 5mA  
 Differential input impedance.....0.3 megohm  
 Voltage stability ( $\Delta E_{OS}$ )..... $\pm 5\mu V/^\circ C$   
 Warm-up drift..... $\pm 100\mu V$   
 ft.....2.0MHz  
 $Z_{cm}$ .....30 megohms

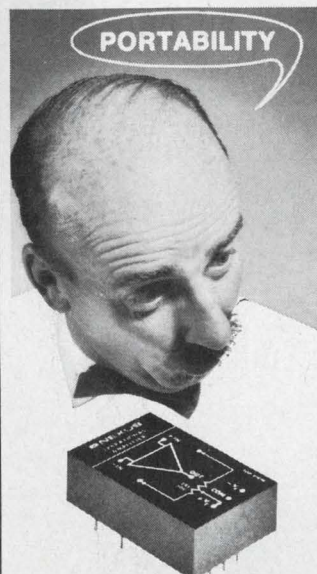

### THE NEXUS 2LV-1

Developed specifically for use in a wide range of remote and portable battery-powered electronic equipment, this unit combines high reliability, excellent performance, and economical low-power operation. It operates on a supply voltage of  $\pm 2.7V$ ; has a standby power drain of only 4 mW. Using all-silicon semiconductors it has an operating temperature range of  $-25^\circ$  to  $+85^\circ C$ .

#### TYPICAL PERFORMANCE

Supply voltage..... $\pm 2.7$  Volts (nom.)  
 Supply current (quiescent)..... $\pm 900\mu A$   
 Output ( $R_L = 1K$  @ 1Hz)..... $\pm 1.5V$  @ 1.5 mA  
 Input offset current..... $\pm 1.5$  nA  
 $\Delta E_{OS}/\Delta T$  ( $-25^\circ C$  to  $+85^\circ C$ )..... $\pm 5\mu V/^\circ C$   
 Differential input impedance.....0.2 megohms  
 Common mode input impedance......25 megohms  
 (@ 1 Hz)  
 Size.....2.02" x 1.14" x 0.62"



### THE NEXUS LFT-1

This low cost FET operational amplifier offers a happy combination of extremely high input impedance (well over 1000 megohms), low input leakage current (<100 picoamps at  $25^\circ C$ ), and a very favorable price (\$85, 1-9). It is ideally suited to applications requiring extremely low error currents, such as integrators, sample and hold circuits, and electrometer circuits.

#### TYPICAL PERFORMANCE

Differential input  $Z$  @ dc..... $10^{10}$  ohms  
 Input leakage current.....0.1 nA (max.)  
 Open loop gain @ dc ( $R_L = 10K$ )...50 k ft.  
 Output..... $\pm 10V$  @  $\pm 2$  ma (min.)  
 $\Delta E_{OS}/\Delta T$  ( $-25^\circ C$  to  $+85^\circ C$ )... $10\mu V/^\circ C$

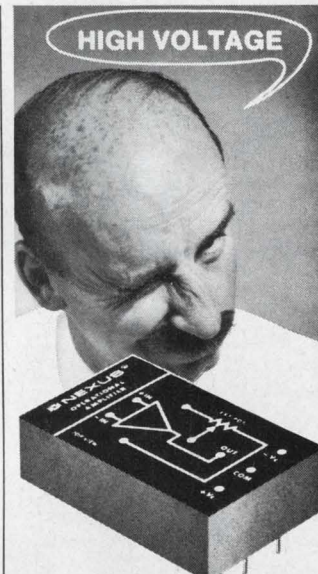

### THE NEXUS MLF-100

Another FET input device, this Nexus op amp offers an output range of  $\pm 100V$  @  $\pm 10$  ma. It features long-term short-circuit protection for both inputs and output. Input impedance is on the order of 1000 megohms, with associated low, low input error currents.

#### TYPICAL PERFORMANCE

Output voltage range..... $\pm 100V$  @  $\pm 10$  mA  
 Differential input impedance..... $10^8$  ohms  
 $I_{OS}$  @  $25^\circ C$ .....0.5 nA  
 DC Gain @  $25^\circ C$ .....200 K ft.  
 Output.....1 MHz  
 $Z_{cm}$ ..... $10^8$  ohms  
 Operating temp. range  $-25^\circ C$  to  $+85^\circ C$

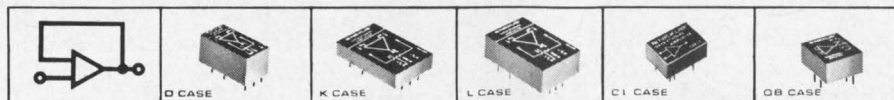

**NEXUS**  
 RESEARCH LABORATORY, INC.  
 480 NEPONSET STREET, CANTON, MASS. 02021  
 TEL: (617) 828-9000 TWX (617) 828-1022

Prices F.O.B. Canton, Massachusetts. Prices slightly higher outside North America.

ON READER-SERVICE CARD CIRCLE 62

op amp's  
noninverting  
response is  
10 MHz with  
full power  
to 500 KHz

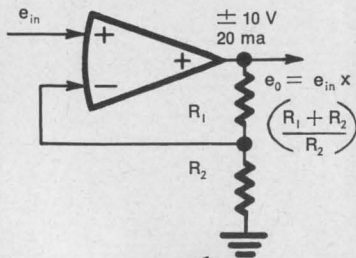

**Step  
Response  
of Model 102  
Settles to 0.1%  
within 1 μSec**

**SPECIFICATIONS**

DC Gain	126 db (2 x 10 <sup>6</sup> )
CMRR	20,000:1
Slewing Rate	30 V/μSec
Bandwidth	10 MHz
Max Full Powr. Freq.	500 KHz
Max Drift	± 0.4 na/°C
(-25°C to +85°)	± 5 μV/°C
Max Offset	± 2 na @ 25°C
(each input)	
Output	± 10 V, 20 ma
Input Impedance	500 Meg (C.M.)
	6 Meg (Diff.)
PRICE	5 μV/°C @ \$120
	20 μV/°C @ \$95

Model 102 is the only op amp (so far as we know), that provides fast response on the plus input. Fast noninverting response permits you to obtain both high input impedance (500 Meg), and 10 MHz bandwidth, simultaneously.

This remarkable amplifier has superlative specifications for every major performance category.

ANALOG

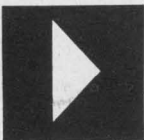

DEVICES

221 FIFTH STREET  
CAMBRIDGE,  
MASS. 02142  
617/491-1650

ON READER-SERVICE CARD CIRCLE 63

SYSTEMS

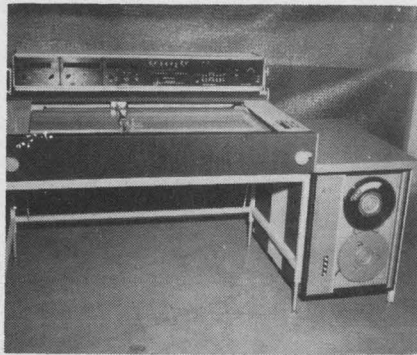

**Curve tracer  
digitizes graphics**

Auto-Trol Corp., 6521 W. 56th Ave.,  
Arvada, Colo. Phone: (303) 421-  
5670.

The Model 3400 curve tracer is designed specifically for reducing analog graphic data to digital form for computer processing and analysis. While the operator manually traces the curve, X and/or Y true plus and minus coordinate values are recorded onto magnetic tape, punched paper tape or punched cards. The data is formatted by patch-panel. Resolution is 0.001-in. and accuracy is ±0.002-in.

CIRCLE NO. 262

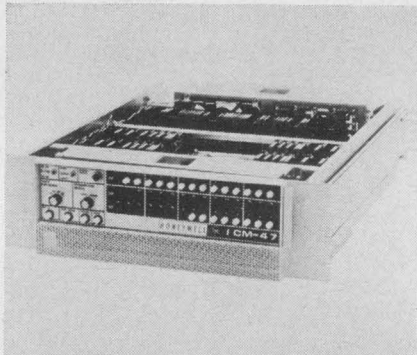

**Core memory  
for OEM use**

Honeywell, Computer Control Div.,  
Old Connecticut Path, Fram-  
ingham, Mass. Phone: (617) 879-  
2600.

A 750-ns integrated circuit core memory system is designed especially for OEM applications. Called ICM-47, the system offers a 400-ns access time. For 4096- and 8192-word memories; the max word length is 28 bits per module. In 16,-384-word systems, the lengths range up to 14 bits. For even greater capacity, a number of ICM-47s can be stacked.

CIRCLE NO. 263

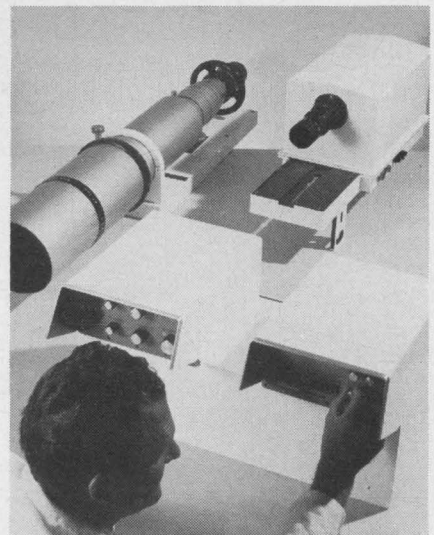

**Tracking system  
controls cameras**

Northrop Nortronics, 1 Research  
Park, Palos Verdes Peninsula,  
Calif. Phone: (213) 772-2321.

Hands-off photographic coverage of missile launches and stage separations are provided by a tracking error detector. The detector uses television to locate and follow the missile. It will follow missiles automatically once the operator locates the target on a small TV screen. Follow is attained by sensing the contrast of the target's leading edge.

CIRCLE NO. 264

**It may not think  
but now it can see**

Information International, Inc., 156  
6th Ave., Cambridge, Mass. Phone:  
(617) 868-9810.

A commercial computer can now look at the real world under program control and report its findings. A computer using the EYE camera system can plan its functions and actions based on what it has seen. EYE is an image dissector camera system. The "eye" is programmable, non-storing, and provides a real-time optical input to the computer. It operates at varying distances under varying lighting conditions. The system is randomly addressable to 12 bits and capable of over 1000-line resolution in both X and Y axes.

CIRCLE NO. 265

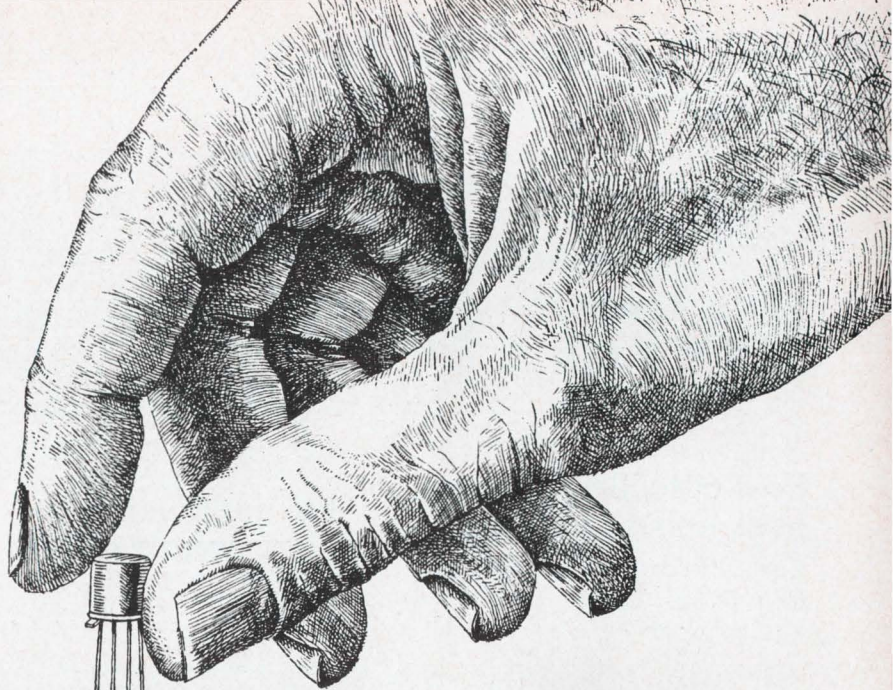

The new RCA **2N3839** for critical low-noise UHF applications in Military and Aerospace equipment is...

# directly interchangeable with the low-noise RCA 2N2857... **and has a 1.1 dB lower NF**

That's right! The famous, field-proved transistor family that brought you the low-noise RCA 2N2857, with types which meet requirements of MIL-S-19500/343 USAF, now gives you even lower noise capability in amplifier, oscillator and converter applications with the new RCA 2N3839.

Formerly known as developmental type TA2363, the new RCA 2N3839 silicon n-p-n epitaxial transistor offers the superior performance and reliability features of the 2N2857, with a substantially lower noise figure ... *only 3.4 dB max. at 450 MHz!* And power gain is 12.5 dB min. at 450 MHz. Furthermore, RCA can supply these new, high reliability UHF transistors in production quantities.

For complete pricing and delivery information on the new, low-noise 2N3839, call your RCA Field Representative. Ask him, too, about RCA developmental types which can meet even lower NF requirements, as well as information on ultra-reliable versions of the RCA 2N2857. For technical data sheets, write RCA Commercial Engineering, Sec. CG12-3, Harrison, N.J. 07029. Also available through your RCA distributor.

RCA Electronic Components & Devices



The Most Trusted Name in Electronics

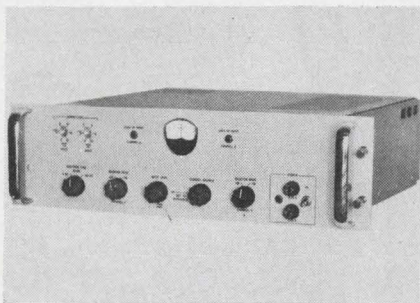

### Post-detection combiner uses noise sampling

Vitro Electronics, 919 Jesup-Blair Dr., Silver Spring, Md. Phone: (301) 585-1000.

The type DCA-5200A post-detection diversity combiner is a dual-diversity noise-controlled post-detection combiner designed to provide pseudo-optimal ratio combining of two audio signals. With equal input signals, this modular unit provides a dual-combined audio output at least 2.5 dB above either input. Response is 250 Hz to 11 kHz.

CIRCLE NO. 266

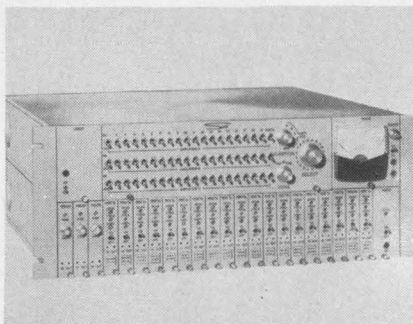

### FM multiplexer does double duty

Sonex, 20 E. Herman St., Philadelphia. Phone: (215) 843-6400.

An FM multiplexer is designed to serve in data acquisition or as a test instrument in a telemetry ground system. The Model 48 FM multiplexer contains 19 S-24 VCOs and an S-41 voice annotator, providing the means for generating three independent composite FM multiplex signals. Subcarrier frequencies between 300 Hz and 1.2 MHz can be provided through plug-in selectors.

CIRCLE NO. 267

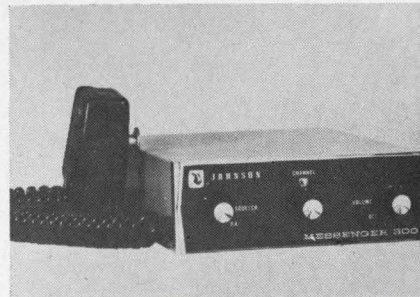

### Solid-state transceiver for solid citizens

E. F. Johnson Co., Waseca, Minn. Phone: (507) 835-2050. Price: from \$189.95.

This 12-channel citizens' band transceiver features a precision crystal filter for receiver selectivity. The "Messenger 300" has noise limiting, transmitter speech compression, a plug to accommodate the manufacturer's "Tone Alert" selective calling system, and a built-in PA amplifier. Push-to-talk microphone, and crystals for one channel are provided with the unit.

CIRCLE NO. 268

## NOW... Same-Day Shipment of Cyclohm FANS and BLOWERS



**THE AIR MOVEMENT UNITS GUARANTEED FOR 5 YEARS TO REQUIRE NO MAINTENANCE OR RE-LUBRICATION**

Expanded facilities, day and night operations, enable us to maintain stocks of standard CYCLOHM Fans and Blowers available for immediate shipment. All units are powered by the Howard Unit Bearing Motor, with a history of millions of successful installations.

For list of availabilities, address Standard Motor Product Sales, 23 Broadway, Des Plaines, Ill., 60016. TWX 910-233-1658. For Fan Bulletin 9-03 and/or Blower Bulletin 8-01 address



**HOWARD INDUSTRIES**  
MSL INDUSTRIES, INC./MOTOR GROUP  
1760 STATE STREET  
RACINE, WIS. 53404

ON READER-SERVICE CARD CIRCLE 66

## ANOTHER WORLD'S SMALLEST Soshin's Dipped Mica Capacitors/DM05

Developed by SOSHIN ELECTRIC, the only mica capacitor maker in Japan with MIL-C-5C qualifications. This newest and its bigger brothers will meet all your requirements. Volume orders accepted.

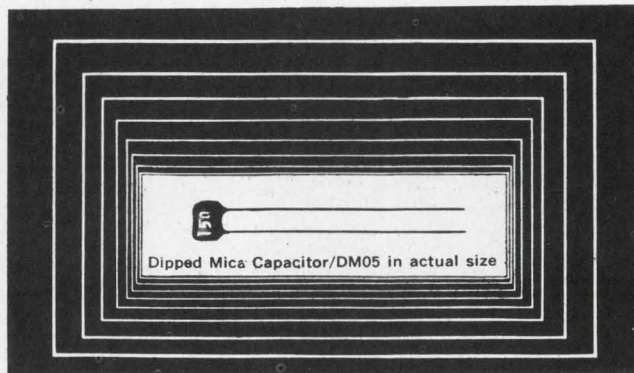

Types	Max Allowable Capacitance (pf)			Dimension (mm)								
	100 WV 300 WV 500 WV			100 WV			300 WV			500 WV		
	L	W	T	L	W	T	L	W	T	L	W	T
DM05	200	130	—	7.0	5.0	3.5	7.0	5.0	3.5	—	—	—
DM10	440	390	330	8.5	5.5	3.5	8.5	5.5	3.5	8.5	5.5	3.5
DM15 (C.M05)	2000	1700	510	13.0	11.0	6.5	12.5	10.5	6.0	12.0	10.0	6.5
DM19 (C.M06)	10000	6800	5100	18.0	15.0	8.5	18.0	15.0	8.0	17.5	15.0	7.5

For further information, write to  
**SOSHIN SOSHINELECTRIC CO., LTD.**  
18-18, Nakamagome 1-chome, Ohta-ku, Tokyo, Japan  
Cables: SOSHINCAPACITOR TOKYO

ON READER-SERVICE CARD CIRCLE 67

# From .5 to 10,000 $\mu$ f, the CYFM is the second best capacitor you can buy.



$\mu$ f for  $\mu$ f, you can't buy more stability and reliability per dollar than you get in the CORNING® CYFM Capacitor.

You get the kind of stability that only a glass dielectric can hold, that's invariable with time, temperature, and environment.

You get reliability that's inherent in the way they're made, which is basically the same process that turns out our ultra-high-reliability CYFR Capacitor.

But you save dollars on the CYFM because we don't put it through all the rigorous CYFR testing.

A CORNING CYFM Capacitor is practically indestruct-

ible under severe environmental stresses. We have boiled them in salt water, immersed them in saturated steam, subjected them to 96 hours of salt spray, without a failure or degradation.

After 2000 hours at 125°C with 150% of full rated voltage, capacitance change on a CYFM is less than 0.5%.

Why ever risk an entire system on capacitors that can't give you the assurance of Corning dielectric stability? Get all the economical facts on the CYFM Capacitor in our new CORNING® Glass Capacitor Guide. Send to Corning Glass Works, 3909 Electronics Dr., Raleigh, N.C.

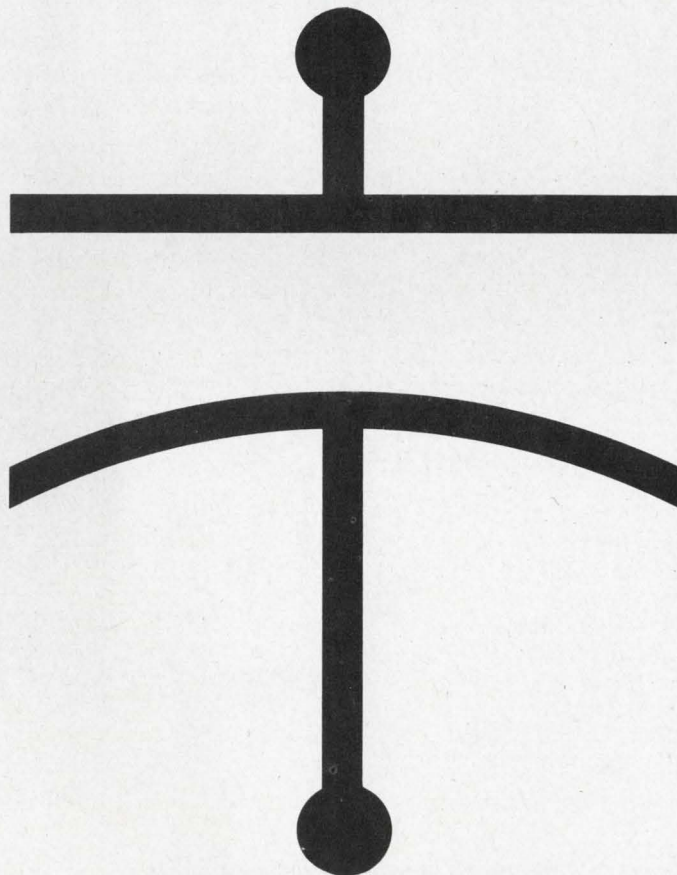

**CORNING**  
ELECTRONICS

ON READER-SERVICE CARD CIRCLE 68

**ZERO T.C.** **S/N**  
**SERIAL MEMORY** **20,000 BITS**  
**TORSIONAL DELAY**  
**UNITY GAIN** **BI-POLAR**  
**BULK & BUFFER**  
**VIDEO** **ZiZo**



**In a word, LFE  
 for glass and magnetostrictive  
 delay lines for digital applications**

These are just a sampling of the performance features of LFE's glass and magnetostrictive delay lines. We can supply you with standard delay lines or serial memories with the capacity, bit rate, mode, delay and other parameters you need . . . or, you can specify custom delay lines, with or without associated electronics, to meet your special design requirements.

For the complete story write for technical data.

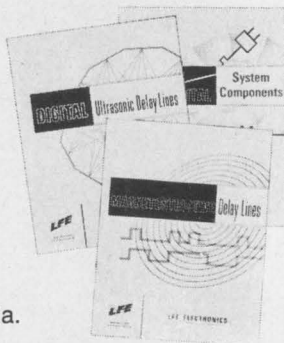

**ELECTRONICS DIVISION**

Laboratory For Electronics, Inc.  
 WALTHAM, MASSACHUSETTS 02154  
 Tel: 617-894-6600 • TWX: 710-324-0681

ON READER-SERVICE CARD CIRCLE 69

**Design Aids**

**CONVERSION  
 FACTORS**

CONTROLEX CORPORATION  
 OF AMERICA  
 BOX 511 WESTCHESTER COUNTY AIRPORT  
 WHITE PLAINS, NEW YORK  
 AREA CODE 914 WH 6-0220

**Conversion factor booklet**

Twenty pages of conversion factors enable the quick conversion of physical quantities. Units of weight, dimension, power, capacity, speed, distance, time and temperature are covered in this handy reference. Controlex Corp. of America.

CIRCLE NO. 269

**Terminal and splice selection**

Crimp terminals must not be selected by the fit of wire in the terminal barrel, but by the total circular mil area in cross-section of the wires used.

Here's a series of tables to assist in circular mil calculation. A nomograph simultaneously determines terminal size and circular mil area for rectangular wire. Also included are formulas and examples for computing circular mil area of various and combined wire sizes. A handy set of tables listing area for over 200 solid and stranded wire sizes from #26 AWG to 1000 MCM completes this useful design aid. Amp, Inc.

CIRCLE NO. 270



# Application Notes

## Fiber optics handbook

A fascinating "Fiber Optics Handbook" is a complete source of information on fiber optics transmission. The 14-page booklet discusses optical, thermal, mechanical and chemical considerations, explains how fiber optics are used and concludes with a compact glossary of terms. Mosaic Fabrications, Inc.

CIRCLE NO. 271

## Schottky barrier applications

A series of application notes covers Schottky barrier mixers, diodes and attenuators. The use of Schottky barrier diodes in mixer systems, in FM receivers and as attenuators and varilossers is covered. Descriptive illustrations and charts as well as specific data and usage are included.

Available on company letterhead from Solitron Devices, Inc., 256 Oak Tree Rd., Tappan, N. Y.

## Capacitance measurements

Exclusively concerned with capacitance measurement, this 4-page note includes sections on series, parallel, stray and guarded capacitance. Included are formulas for capacitor parameters and several circuit diagrams. Micro Instrument Co.

CIRCLE NO. 272

## Epitaxial film thickness

An evaluation procedure manual describes a new method of determining epitaxial silicon film thickness by spherical angle lapping.

The manual describes procedures and equipment necessary for accurate measurement of film thicknesses. Spherical angle lapping is also applicable to measuring multiple-layer epitaxial films where the infrared reflectance and stacking faults methods may not be. Monsanto Company, Semiconductor Materials Department.

CIRCLE NO. 273

# Direct answers . . .

Bausch & Lomb V.O.M. Recorders give just that. Without external converters, they will *directly* measure and record d-c voltage, current and resistance. They provide performance you can depend on with their multiple inputs, fast pen response, photoelectric chopper, high off-balance impedance, built-in paper take-up reel or instant reference tear-off.

V.O.M. Recorders come equipped with features that are usually sold as optional extras—five variable chart

speeds, an event marker, a zener stabilized reference supply, three-position operation and a full scale zero set. Low cost V.O.M. Recorders offer extra versatility at no extra cost.

Bausch & Lomb V.O.M. Recorders are available in a variety of models with different full scale sensitivity. A wide range of accessories further extend their usefulness. Customized models can be built to handle special applications. Write for Catalog 37-2194. Or, if you prefer, let us show you how to get direct answers with a personal demonstration. Bausch & Lomb, 91536 Bausch Street, Rochester, New York 14602.

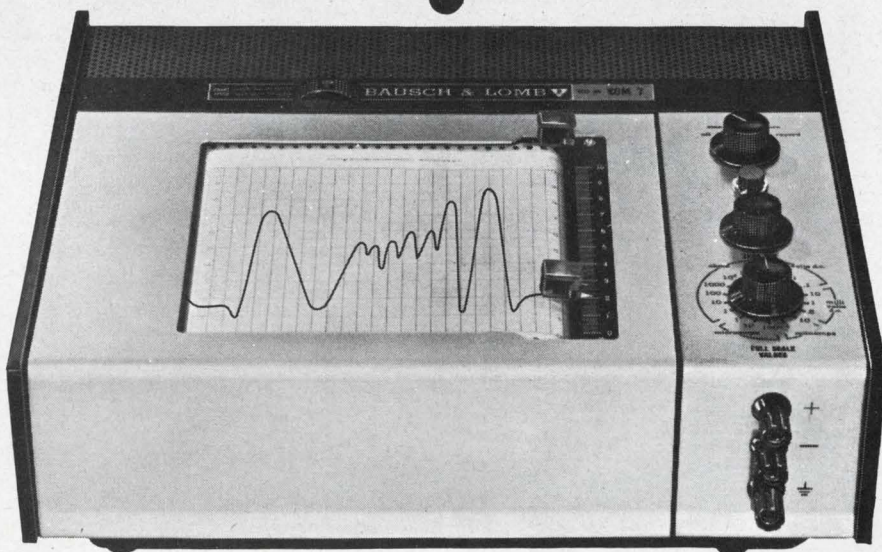

**BAUSCH & LOMB**   
ELECTRONICS DIVISION

In Canada, Bausch & Lomb Optical Co., Ltd., 16 Grosvenor St., Toronto, Ontario.

ON READER-SERVICE CARD CIRCLE 70

# \*NEW FROM HATHAWAY

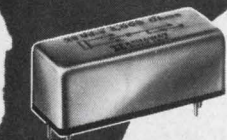

MINIATURE  
FORM  
\*  
C  
RELAY

SIGNIFICANT  
PERFORMANCE  
GAINS ESTABLISHED BY  
HATHAWAY'S CONTROLLED  
REED PROCESS ARE:

- A pure, inert contact environment resulting in no "film" buildup on contacts eliminating contact resistance irregularities and recurring infant mortality on dry circuit loading.
- The Drireed actuation avoids failure mechanisms characteristic of electromechanical devices.
- Whatever the switching assignment, Hathaway Double Throw relays will do it better and more economically.

Hathaway Form C Relays are available in all Series—"J" AXIAL, "K" PRINTED CIRCUIT, "R" COMPUTER GRADE, "GP" GENERAL PURPOSE

For detail information call or write

**HATHAWAY INSTRUMENTS, INC.**  
5250 EAST EVANS AVENUE  
DENVER, COLORADO 80222  
(303) 756-8301 • TWX 292-2935  
Distributed Nationally by  
**COMPAR CORPORATION**

## New Literature



### High temperature wire

Illustrated in this brochure is some of the latest equipment for extruding Teflon onto wire, tape wrapping and stripping facilities, high-speed braiding and test equipment. Harbour Industries, Inc.

CIRCLE NO. 274

### AF connectors

Standard and special plugs and jacks for audio frequency circuits are described in a 4-page plugs and jacks brochure. The 2-color illustrated data includes dimensional drawings as well as specs for standard and custom designed 4-conductor plugs and jacks. Also illustrated and referenced are 4- and 5-conductor military plugs and jacks and 2-conductor microphone connectors. MIL-specs for mating connectors are also listed. Nexus, Inc.

CIRCLE NO. 275

### PC connector catalog

A 52-page printed circuit connector catalog covers printed card and tape cable applications. The product line includes microminiature, miniature and standard size connectors. Complete electrical and mechanical specs, illustrations and outline drawings are included. Continental Connector Corporation.

CIRCLE NO. 276



### Plastics/ceramics

A ready reference guide to casting resins, adhesives, coatings, foams, silicones and controlled dielectrics is shown in a three-leaf fold-out pamphlet. Products of each group are listed together with 2 or 3 of the important characteristics given for each composition. Emerson & Cuming, Inc.

CIRCLE NO. 277

### Rheostat catalog

Fifty pages in two colors are devoted to wirewound rheostats. The introduction of the catalog displays rheostat construction and gives a step-by-step guide to selection. Six pages are devoted to listings of stock rheostats in 12 wattages from 7-1/2 to 1000. Taper-wound, tandem and "sequence-coupled" rheostats are covered. Control of motor speed with rheostats is discussed, complete with circuit diagrams. The subject of lamp dimming includes handy reference curves. Ohmite Manufacturing Co.

CIRCLE NO. 278

### Piezoelectric accelerometers

A 24-page handbook for users of piezoelectric accelerometers presents objective evaluations of current design, materials, theory and the applications of low-impedance piezoelectric accelerometers and amplifier requirements of conventional high-impedance piezoelectrics. Included are associated diagrams, curves, helpful formulas and definitions of terminology. Consolidated Electrodynamics Corp.

CIRCLE NO. 279

### EIA and JEDEC standards

The 22-page "Index of EIA and JEDEC Standards and Engineering Publications" includes over 300 technical documents available as of October 1966. It lists EIA bulletins on automation, components, electromagnetic compatibility, microelectronics, reliability, etc. The index also lists test charts (TV and facsimile) for color chips (standard), color registration, facsimile (IEEE), grey scale overlay and resolution linearity (Ball), linear and log reflectance and resolution (EIA). JEDEC publications on tubes and semiconductors, EIA recommended standards and JEDEC suggestions are included. Electronic Industries Association.

CIRCLE NO. 280

### Small computer handbook

Digital Equipment's 544-page handbook contains a wealth of data on small, general-purpose digital computers. The volume begins with a "primer," contains user's handbooks and concludes with a product run-down. Digital Equipment Corp.

CIRCLE NO. 281

### Carbon film resistors

A 4-page folder on hermetically glass-sealed, deposited carbon film resistors fully describes high-resistance and commercial and MIL types. It includes load life data, temperature coefficient data plus detailed specs. Pyrofilm Resistor Company.

CIRCLE NO. 282

### Fluid amplifiers

Technical data sheets are available describing two proportional units, three OR/NOR gates and three bistable elements. The illustrated, two-color, two-page sheets list the functions, principles of operation, and specifications of the fluidic devices. The pages are five-hole punched for ready filing. Fluidonics Div. Imperial-Eastman Corp.

CIRCLE NO. 283

## "BLUE CHIP" TRANSFORMERS NOW AVAILABLE IN CASE SIZE #7

IN STOCK—is the latest addition to the versatile family of Blue Chip transformers for printed circuit applications. This still smaller size; (Height .340 inch maximum, volume .060 cubic inches), transformer offers design engineers more flexibility for electrical and mechanical transistor circuit applications. The size #7 Blue Chip transformers provide a response of  $\pm 2$  db from 300 to 100,000 Hz in a number of impedance ranges and are designed to meet Mil-T-27B, Grade 5, Class S. Write for your copy of complete electrical and mechanical specifications.

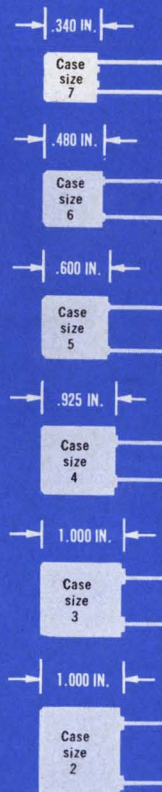
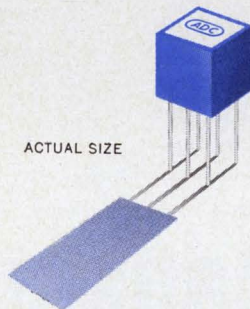

**ADC PRODUCTS**

A DIVISION OF MAGNETIC CONTROLS CO.

6405 Cambridge Street • Minneapolis, Minnesota 55426

ON READER-SERVICE CARD CIRCLE 72

**SAMPLE AND  
 HOLDHOLDHOLDHOLDHOLDHOLDHOLD  
 HOLDHOLDHOLDHOLDHOLDHOLDHOLD  
 HOLDHOLDHOLDHOLDHOLDHOLDHOLD  
 HOLDHOLDHOLDHOLDHOLDHOLDHOLD  
 HOLDHOLDHOLDHOLDHOLDHOLDHOLD  
 HOLDHOLDHOLDHOLDHOLDHOLDHOLD  
 HOLDHOLDHOLDHOLDHOLDHOLDHOLD  
 HOLDHOLDHOLDHOLDHOLDHOLDHOLD**

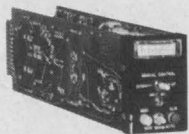

## **ANALOG CONTROL SIGNALS**

PD & C's new Model 102 Analog Memory Device makes continuous, trouble-free operation of process control a practical, economical reality. When a disruption of incoming data occurs, Model 102 retains the last valid signal to within 1% for over an hour, permitting service to be maintained until the input can be restored. Eliminates costly downtime and maintenance interruptions.

*Find out more today.*



**PACIFIC DATA  
& CONTROLS**

6406 S. E. Foster Rd. • Portland, Oregon 97206

ON READER-SERVICE CARD CIRCLE 73

# **Ceramic Capacitors**

## **MOLDED CERAMIC TUBULARS**

for computer applications. The ultimate in reliability (failure rate 0.001%/1000 hours at 85° C and twice rated voltage.)



## **DISC CERAMICS**

for all commercial and military applications. New production techniques give Skottie a big edge in price, quality and delivery. Ask for a quote and find out if it's not so.

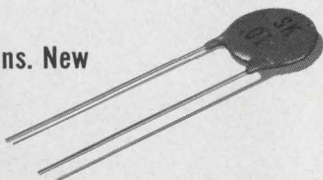

Do you have a problem in ceramic capacitors with special designs, quality, reliability, guaranteed delivery or price? If you do, it might pay you to look into Skottie Electronics. We specialize exclusively in the design and manufacture of ceramic dielectric capacitors. Skottie is a major supplier of ceramic capacitors to the largest computer and radio/TV manufacturers in the world.

Sure we do the military and commercial standards. But in ceramics, when you have special needs (particularly design or delivery) we think you'll find Skottie Electronics your best supplier. Representatives in major cities throughout the United States.

**SKOTTIE ELECTRONICS, INC.** / Archbald, Pennsylvania 18403  
 Phone 717-489-4726 TWX-510-656-2979

ON READER-SERVICE CARD CIRCLE 74

## **NEW LITERATURE**

### **Silicon transistor specs**

"Specs in Brief" on RCA's silicon transistors for AF, RF and switching applications are offered. The 8-page booklet covers in capsule format four families of silicon transistors. They include six vhf/uhf silicon transistors, including two forward age types, a family of high-current, high-dissipation silicon transistors, a MOS-FET for front-end use in TV and vhf equipment and a high-performance, low-cost family of silicon power transistors. RCA, Electronic Components and Devices.

CIRCLE NO. 284

### **IC directory**

This integrated circuit directory and price list covers over 600 devices manufactured by Texas Instruments, Motorola, Sylvania, General Electric and RCA. The 12-page directory specifies function and logic for each unit and provides price breakdowns on quantities to 999. Allied Electronics Corp.

CIRCLE NO. 285

### **Zener/rectifier catalog**

A 64-page catalog covers the entire IR zener voltage regulator, voltage reference element and low-power silicon rectifier line. Complete technical data, application and explanatory notes and graphs are included. International Rectifier.

CIRCLE NO. 286

### **Connector catalog**

A new catalog covers "DRA" subminiature connectors used in aircraft, missiles and ground support equipment. The 8-page booklet contains general information, dimensions and assembly instructions. ITT Cannon Electric.

CIRCLE NO. 287

### **PC board materials**

A new leaflet describes the reliability considerations involved in choosing a suitable material for printed circuit boards. Dodge Fibers Corp.

CIRCLE NO. 288

## Hand tools for electronics

This 48-page catalog covers many of the needs of production/manufacturing engineers and supervisors. It is also a handy reference for the design engineer and the purchasing agent. Featured is a complete selection of hand tools for microelectronics. Tweezers, pliers, scissors, vacuum pickups and semiconductive handling devices are included. The brochure also shows gold-plated mini-tools, air- and hand-operated epoxy syringes and dispensers, work positioners and circuit board holders, power tools and accessories, ultrasonic cleaners, soldering equipment, scalpels and knives, and wire and cable strippers. Henry Mann Co.

CIRCLE NO. 289

## Waveguide selection

A new brochure describes a complete waveguide product line and includes a waveguide reference chart and flange guide. The reference chart covers 0.49 to 260 GHz and includes MIL cross-reference information. All products are described in detail—waveguide to waveguide transitions, terminations, waveguide to coax transitions, flanges, straight sections, twists, bends, accessories and special configurations. Specialty Automatic Waveguide Corp.

CIRCLE NO. 290

## Plastic products

The 1966 "Plastic Supplies Catalog," 96 pages, includes descriptions, illustrations and prices on polyethylene, polypropylene, PVC, PVDC and teflon conduit, duct, pipe, and tubing in sizes ranging from 1/4-in. OD to 24-in. ID. U.S. Plastic Corp.

CIRCLE NO. 291

## Test equipment

Known brands of new and used industrial testing equipment are listed in this 47-page catalog. Oscillographs, transducers, power supplies, recorders and amplifiers are included. Lee Lab Supply, Inc.

CIRCLE NO. 292

# What's new from Technipower?

## 1. PC-80 SERIES

ultra-compact AC-DC power modules — all silicon.

25% smaller, 25% lighter, temperature rating 80°C, specifications to meet critical requirements. More than 200 models, with outputs ranging from 4.1 to 152VDC, and up to 60 watts.

## 2. MC-65 SERIES

more-watts-per-dollar AC-DC power modules — all silicon. This series will replace the former "standard" line of Technipower modules, and features 25% more power in the same volume. Improved circuitry and characteristics — for less money! More than 600 models, outputs 3 to 152VDC and up to 750 watts.

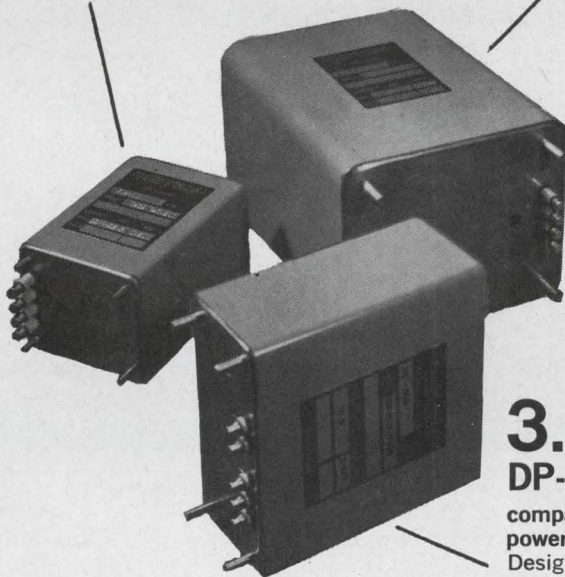

## 3. DP-80 SERIES

compact dual output AC-DC power modules — all silicon. Designed for operational amplifier and potentiometric applications, these doubtless will find other uses as well. Meet all applicable MIL environment specs. Models from 5.7 to 158VDC to 8 watts, each output.

**MIL Environment modules** — Series PM-95 and F/FD-115 modules were recently tested by an independent lab and proved fully qualified for MIL environment applications. If you're interested in this, write for our brochure Q-66 describing the tests and results.

**New 1967 Catalogs** — Our 56-page general catalog will be off press soon. Write now and a copy will be sent to you just as soon as it's available.



**TECHNIPOWER**

A BENRUS SUBSIDIARY

18 MARSHALL ST., NORWALK, CONN. 06856 PHONE 203-853-1201

ON READER-SERVICE CARD CIRCLE 75

# News in Pre-Detection Recording

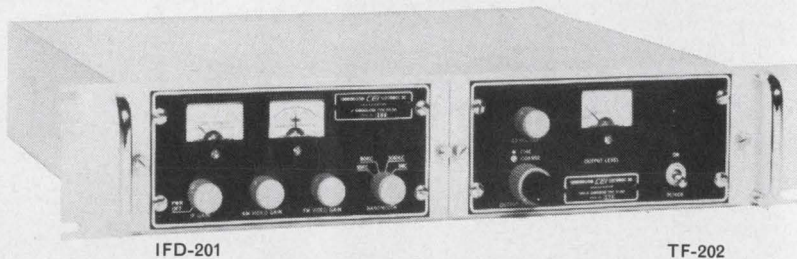

## CEI Tape Demodulator System

Here's a new duo from CEI, comprising a complete tape demodulator system.

The TF-202 Converter accepts a tape output signal with a center frequency of 750 kHz (other frequencies on request), and converts it to an output frequency of 21.4 MHz. The 21.4 MHz signal is fed to the IFD-201 Demodulator offering a choice of four IF bandwidths with both AM and FM detection modes.

IF to tape converters are also available in a similar configuration.

For further information about these units (available in both half-rack and 19" widths), please contact:



### COMMUNICATION ELECTRONICS INCORPORATED

6006 Executive Blvd., Rockville, Md. 20852 · Phone: (301) 933-2800 · TWX: 710-824-9603

ON READER-SERVICE CARD CIRCLE 76

## NEW LITERATURE

### SCR catalog

International Rectifier's complete line of silicon controlled rectifiers is listed in a new catalog. It devotes 40 pages to alloyed diffused and epitaxial SCRs, listing complete data, application notes, charts and graphs. International Rectifier.

CIRCLE NO. 293

### Reprints Available

The following reprints are available free and in limited quantities. To obtain single copies, circle the number of the article you want on the Reader-Service Card.

*Measure transistor y-parameters* (No. 294)

*Rid mixers of spurious signals* (No. 295)

*Try diodes for remote gain control* (No. 296)

### Accuracy Policy

It is the policy of ELECTRONIC DESIGN:

To make reasonable efforts to insure accuracy of editorial matter.  
To publish promptly corrections brought to our attention.

To reserve the right to refuse any advertisement deemed misleading or fraudulent.

All editorial correspondence should be sent to:

Howard Bierman, Editor  
ELECTRONIC DESIGN  
850 Third Avenue  
New York, N. Y. 10022

### Subscription Policy

ELECTRONIC DESIGN is circulated free of charge to qualified design engineers in the U.S., Western European Continent and Britain. To establish your qualifications, send ELECTRONIC DESIGN the following information on your company's letterhead: Your name, engineering title, description of your design duties and a list of your company's major products. The letter must be signed by you personally.

Subscription rates for nonqualified subscribers—\$25 a year in the U.S., \$35 in all other countries. Single copy, \$1.50.

### Change of Address

A subscriber's change of address requires a restatement of his qualifications. To expedite the change, and to avoid missing any issues, send along a label from a back copy.

### Microfilm Copies

Microfilm copies of all 1961, 1962, 1963, 1964 and 1965 issues of ELECTRONIC DESIGN are available through University Microfilms, Inc., 300 N. Zeeb Road, Ann Arbor, Mich. 48106

# Design Data from Manufacturers

Advertisements of booklets, brochures, catalogs and data sheets. To order use Reader-Service Card.

(Advertisement)

## Multi-Purpose DC Power Supplies 0-40 Volts

CAL-POWER Series TVR Power Supplies are general purpose transistorized voltage-regulated power sources. They convert 105/125 volt single-phase AC input power into adjustable regulated DC output power up to 100 amperes. Fully solid state in construction, these power supplies are suitable for laboratory applications, system tests, component testing, production line use and applications where automatic or manual remote programming is desired. They may be used to furnish power to transistor circuits which are voltage sensitive, current-sensitive or both.

Send for Brochures TVR and TVR-040 for complete details and ordering information.

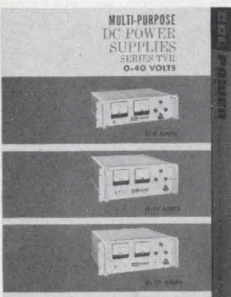

### Cal-Power Corporation

140 Kansas Street  
El Segundo, California

# 173

# Electronic Design

## Advertising Representatives

**New York 10022**  
Robert W. Gascoigne  
Thomas P. Barth  
Samuel M. Deitch  
Richard W. Nielson  
850 Third Avenue  
(212) PLaza 1-5530  
TWX: 867-7866

**Philadelphia**  
Fred L. Mowlds, Jr.  
P. O. Box 206  
Merion Station, Pa. 19066  
(215) MO 4-1073

**Boston**  
Richard Parker  
7 Redstone Lane  
Marblehead, Mass. 01945  
(617) 742-0252

**Chicago 60611**  
Thomas P. Kavooras  
Berry Conner, Jr.  
720 N. Michigan  
(312) 337-0588

**Cleveland**  
Robert W. Patrick  
8410 Treetower Drive  
Chagrin Falls, Ohio 44107  
(216) 247-7670

**Los Angeles 90303**  
Stanley I. Ehrenclou  
Terrence D. Buckley  
W. James Bischof  
2930 W. Imperial Highway  
Inglewood, Calif.  
(213) 757-0183

**San Francisco**  
Ashley P. Hartman  
175 South San Antonio Rd.  
Ste. 243  
Los Altos, Calif. 94022  
(415) 941-3084

**Southwestern 75206**  
Tommy L. Wilson  
6200 North Central Express-  
way  
Dallas, Tex.  
(214) EMerson 1-2311

**London W. 1**  
Brayton C. Nichols  
44 Conduit Street

**Tokyo**  
Yoshihiro Takemura  
International Planning  
Service, Inc.  
Room 231 Tokyu-Mita Bldg.  
1, Shiba-Mita Koun-cho  
Minato-ku, Tokyo



# ACHIEVEMENT '67 IN ELECTRICAL/ ELECTRONICS ENGINEERING

**EXHIBITS  
NEW YORK  
COLISEUM**

**TECHNICAL  
SESSIONS  
NEW YORK HILTON**

Monday through  
Thursday | **MARCH  
20-23  
1967**

- 69 Technical Sessions at the New York Hilton. Hours: Mon. 9:30-12:00 a.m.; 2:00-4:30 p.m. — other days 9:00-11:30 a.m.; 2:00-4:30 p.m.
- Free shuttle busses between the Hilton and the Coliseum — every few minutes.
- Registration — IEEE Members \$2.00 Non-members \$5.00 Ladies \$1.00 High School Students \$2.00 if accompanied by an adult. One student per adult Monday through Wednesday. Thursday only — limit of 3 students per adult. Good for all days — Technical Sessions and exhibits. In and out privileges.
- FOUR COMPLETE FLOORS OF EXHIBITS at the New York Coliseum including over 700 firms. Hours: 10 a.m.-8 p.m. 4 Days.
- Gala Annual Banquet — Wednesday 7:15 p.m. New York Hilton Grand Ballroom — \$15.00



**'67 International  
CONVENTION / EXHIBITION**

ON READER-SERVICE CARD CIRCLE 77

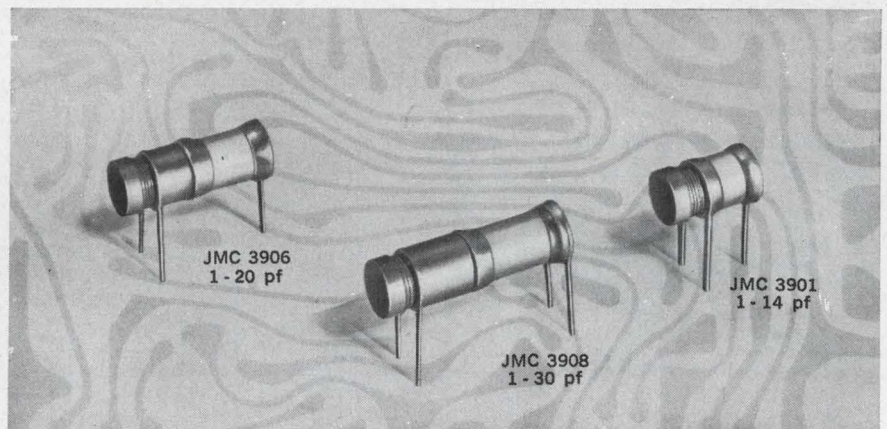

## High Q Air Capacitors!

Get accuracy and tuning stability with Johanson Variable Air Capacitors. High Q—Low Inductance makes units suitable for VLF to UHF applications. Low temperature coefficient.

Working Voltage 250 V DC at from -55° C to +125° C. All units are hermetically sealed. Here's top reliability for military and industrial applications.

Write for catalog on

*Johanson*

**VARIABLE AIR CAPACITORS  
MANUFACTURING CORPORATION**

400 ROCKAWAY VALLEY ROAD, BOONTON, N. J. • Phone: (201) DEerfield 4-2676  
ON READER-SERVICE CARD CIRCLE 78

# AMPERITE

## Thermostatic DELAY RELAYS

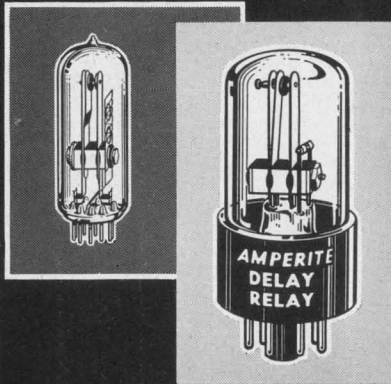

**Only a glass seal  
offers true hermetic sealing  
... assuring maximum stability and life!**

**Delays: 2 to 180 seconds** . . . Actuated by a heater, they operate on A.C., D.C., or Pulsating Current . . . Being hermetically sealed, they are not affected by altitude, moisture, or climate changes . . . SPST only—normally open or normally closed . . . Compensated for ambient temperature changes from -55° to +80° C. . . Heaters consume approximately 2 W. and may be operated continuously . . . The units are rugged, explosion-proof, long-lived, and—inexpensive!

**TYPES:** Standard Radio Octal, and 9-Pin Miniature.  
List Price, \$4.00

**PROBLEM? Send for Bulletin No. TR-81**

# AMPERITE

## BALLAST REGULATORS

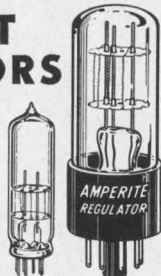
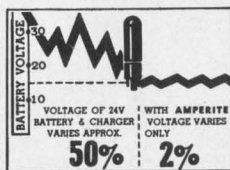

Hermetically sealed, they are not affected by changes in altitude, ambient temperature (-50° to +70° C.), or humidity . . . Rugged, light, compact, most inexpensive . . . List Price, \$3.00.

Write for 4-page Technical Bulletin No. AB-51

# AMPERITE

600 PALISADE AVE., UNION CITY, N.J.  
Telephone: 201 UNION 4-9503

In Canada: Atlas Radio Corp., Ltd.,  
50 Wingold Ave., Toronto 10

ON READER-SERVICE CARD CIRCLE 79

## Advertisers' Index

Advertiser	Page	Advertiser	Page
ADC Products, A Division of Magnetic Control Co. . . . .	129	Indiana General Corporation . . . . .	60
Adams & Westlake Company, The . . . . .	111	Industrial Electronic Engineers, Inc. . . . .	99
Alfred Electronics . . . . .	57	Johanson Manufacturing Corp. . . . .	133
Allen-Bradley Co. . . . .	8-9	Kearfott Division, General Precision, Inc. 4-5	
Aluminum Company of America . . . . .	44-45	Kidde & Company, Inc., Walter . . . . .	85
Amperite . . . . .	134	LFE Electronics, Division of Laboratory of Electronics, Inc. . . . .	126
Analog Devices, Inc. . . . .	32, 122	L E L Division, Varian Associates . . . . .	98
Arnold Magnetics Corp. . . . .	110	Lambda Electronics Corp. . . . .	107
Automatic Electric Company . . . . .	103	Littelfuse . . . . .	114
Bausch & Lomb Electronics Division . . . . .	127	3M Company, Instrument Products . . . . .	19
Bodine Electric Company . . . . .	83	Mac Panel Company . . . . .	66
Bourns, Inc. . . . .	23	Markem Machine Company . . . . .	109
Brand Rex, Division of American Enka Corporation . . . . .	2	Mepco, Inc. . . . .	72
CML, Inc., a Subsidiary of Tenney Engineering, Inc. . . . .	33	MicroSwitch, A Division of Hopeywell 50-51	
Cal Power Corporation . . . . .	132	Microdot, Inc. . . . .	115
Clare & Co., C. P. . . . .	100-101	Motorola Semiconductor Products, Inc. . . . .	7, 28
Clifton Precision Products, Division of Litton Industries . . . . .	27	Nexus Research Laboratory, Inc. . . . .	121
Cohn Corp., Sigmund . . . . .	119	Nytronics, Inc. . . . .	108
Collins Corporation, G. L. . . . .	117	Pacific Data & Controls . . . . .	130
Communication Electronics, Incorporated 132		Philbrick Researches, Inc. . . . .	31
Corning Glass Works . . . . .	53, 125	Polaroid Corporation . . . . .	105
Cutler-Hammer . . . . .	55	RCA Electronic Components and Devices . . . . .	67, 75, 123, Cover IV
Dale Electronics, Inc. . . . .	Cover III	Raytheon Company, Sorensen Operation . . . . .	16
Data Instruments Division . . . . .	106	Salon International des Composants Electroniques . . . . .	82
Eastern Industries, A Division of Laboratory for Electronics, Inc. . . . .	56	Signetics Integrated Circuits, A Subsidiary of Corning Glass Works . . . . .	73
Electro Tec Corp. . . . .	118	Skottie Electronics, Inc. . . . .	130
Electronic Design . . . . .	68, 69, 135	Soshin Electric Co., Ltd. . . . .	124
Electronized Chemicals Corporation . . . . .	97	Sprague Electric Company . . . . .	10, 20
Fairchild Semiconductor A Division Fairchild Camera and Instrument Corporation . . . . .	81	Standard Condenser Corporation . . . . .	91
Fluke Mfg. Co., Inc., John . . . . .	6	Switchcraft, Inc. . . . .	120
General Precision, Librascope Group . . . . .	87	Systron-Donner Corporation . . . . .	12
General Radio Company . . . . .	1	TRW Capacitors . . . . .	58
Hartwell Corporation, The . . . . .	80	Technipower, Inc., A Bensus Subsidiary 131	
Hathaway Instruments, Inc. . . . .	128	Tektronix, Inc., Oscilloscopes . . . . .	94
Hayden Book Company, Inc. . . . .	74	Teledyne, Telemetry Company . . . . .	114
Hewlett-Packard . . . . .	Cover II, 15	Weston Instruments, Inc., Archbald Division . . . . .	113
Hoffman Semiconductor, A Division of Hoffman Electronics Corporation . . . . .	93	Career Advertising: Bendix Corporation, The . . . . .	91
Honeywell, Computer Control Division 24-25		Melpar, Inc. . . . .	91
Honeywell Test Instrument Division, Annapolis Operation . . . . .	89	Motorola Government Electronics Division Aerospace Center . . . . .	92
Howard Industries, Inc. . . . .	124	IEEE . . . . .	133
ITT Jennings a Subsidiary of International Telephone and Telegraph Corporation . . . . .	136		



to your  
exact specifications...



at stock prices

### METALIZED MYLAR CAPACITORS

Unique, self-healing units that remain in circuit during voltage surges with little or no loss of electrical properties. Use the M2W's where size and weight are limiting factors and long life and dependability are required. The units utilize metalized Mylar\* Dielectric with film wrap and custom formulated epoxy resin end fill. Available in round and flat styles.

\*Du Pont Trademark for Polyester Film

Samples available on your letterhead request

**Standard** CONDENSER  
CORPORATION  
DEPT. ED-4, 3749 N. CLARK STREET, CHICAGO, ILLINOIS 60613

# \$13,000 IN ORDERS!

THIS AD IN **Electronic Design** BROUGHT STANDARD CONDENSER CORP. AN IMMEDIATE ORDER FOR \$2,400—PLUS MANY ADDITIONAL ORDERS, INCLUDING ALMOST \$13,000 FROM ONE CUSTOMER ALONE!



“Several months ago I received a call from a company in an area not covered by our sales representatives. They were calling in regard to our M2W series of Metallized Mylar capacitors which they had seen in a 1/4 page advertisement in *Electronic Design*. As a result of this one ad they placed a \$2,400.00 order. In just several months we have written almost \$13,000.00 in orders from this one account. We would never have reached this customer without *Electronic Design*.

This is just one instance of many orders traceable to our advertising in *Electronic Design*. That is why we rate *Electronic Design* as one of our top salesmen and say ‘Thank you!’.”

Richard T. McLean  
President  
Standard Condenser Corporation

## Electronic Design

### READERSHIP THAT SELLS!

a HAYDEN publication 850 Third Avenue, New York, N.Y. 10022 (212) PL 1-5530

# Designer's Datebook

JANUARY						
S	M	T	W	T	F	S
1	2	3	4	5	6	7
8	9	10	11	12	13	14
15	16	17	18	19	20	21
22	23	24	25	26	27	28
29	30	31				

FEBRUARY						
S	M	T	W	T	F	S
	5	6	7	8	9	10
11	12	13	14	15	16	17
18	19	20	21	22	23	24
25	26	27	28			

## Dec. 26-31

133rd Meeting of the American Association for the Advancement of Sciences (Washington, D. C.) Sponsor: AAAS; Mrs. Thelma C. Heatwole, 5110 W. Franklin St., Richmond, Va. 23226

## Jan. 4-7, 1967

Winter Meeting of the National Society of Professional Engineers (San Juan, P. R.) Sponsor: NSPE; Kenneth E. Trombley, National Society of Professional Engineers, 2029 K. St., N.W., Washington, D. C. 20006

## Jan. 10-12

1967 Annual Symposium on Reliability (Washington, D. C.) Sponsor: NASA; John E. Condon, Reliability and Quality Assurance (KR), NASA Headquarters, Washington, D. C. 20546

## Jan. 19-20

Institute—Computer Aid for Reliability Analysis of Electronics (Milwaukee) Sponsor: University of Wisconsin; C. L. Brisley, Director, Engineering Center for Post-graduate and Professional Development, The University of Wisconsin, 600 W. Kilbourn Ave., Milwaukee, Wis. 53203.

## Jan. 31-Feb. 2

Circuit Design by Computer—Tutorial Symposium (New York City) Sponsor: New York University; M. B. Goldin, New York University, University Heights, New York, N. Y. 10453

## Feb. 14-17

Electronic Packaging Conference (New York City) Sponsor: Society of Automotive Engineers, Inc.; A. J. Favata, SAE, 485 Lexington Ave., New York, N. Y. 10017

## Feb. 15-17

International Solid-State Circuits Conference (Philadelphia) Sponsors: IEEE, University of Penn.; Lewis Winner, 152 W. 42 St., New York, N. Y. 10036

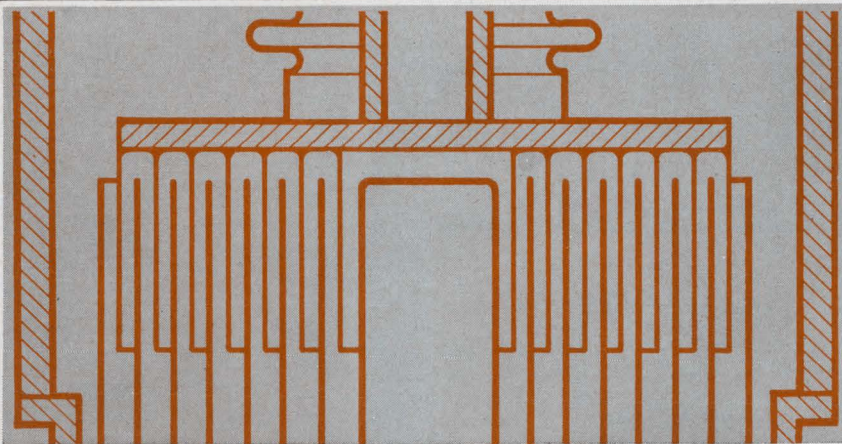

## Why do Jennings vacuum capacitors meet every requirement? There's nothing to it

Ultra high vacuum dielectric combined with Jennings exclusive capacitor design is the answer. This combination has been a major factor in the development of modern transmitters. New vacuum capacitor designs from Jennings will contribute even more to the advancement of transmitter design. They can also help solve some of your immediate problems.

Jennings has hundreds of standard fixed and variable vacuum capacitors in a wide variety of capacity, voltage, and current levels. In all probability the capacitor you need has already been designed, field tested, and proven reliable. If it hasn't you couldn't find a more experienced company than Jennings to design a new one.

### CFHP-1000



Capacity: 1000 pF  
Peak Test Voltage: 45 KV  
RF Current: 215 Amps RMS  
Height: 5-1/2"  
Width: 5-1/2"

### CVDD-500



Capacity Range: 20-500 pF  
Peak Test Voltage: 15 KV  
RF Current: 80 Amps RMS  
Height: 7-1/2"  
Width: 3-3/4"

### USL-500



Capacity Range: 5-500 pF  
Peak Test Voltage: 5 KV  
RF Current: 40 Amps RMS  
Height: 5-3/4"  
Width: 2-3/8"

### CVCC-2500



Capacity Range: 25-2500 pF  
Peak Test Voltage: 7 KV  
RF Current: 75 Amps RMS  
Vibration: 5G to 500 cps  
(with less than 3 pF capacity shift)

For complete information on ITT Jennings vacuum capacitors, write for our new catalog No. 101. ITT Jennings, a subsidiary of International Telephone and Telegraph Corporation, 970 McLaughlin Avenue, San Jose, California 95108.

# JENNINGS ITT

# Best sellers!



## When circuits need precision wirewounds, you can't beat **DALE RS RESISTORS**

When you need precision wirewounds—Dale's silicone-coated RS line offers the most for your money. For example: **Documented Reliability**—99.994% in tests patterned after Dale's famous Minuteman High Reliability Development Program (test report available). **Versatility**—There are 44 standard axial lead, radial lead and non-inductive styles plus 400 special RS variations already production engineered. **Competitive Price**—We invite you to match Dale RS wirewounds against any comparable part. Call or write us today for complete information.

### LATEST RS RELIABILITY REPORT

**Unit Test Hours:** 32,000,000 • **Reliability:** 99.994%  
**Stability:** Units will not shift more than initial tolerance after 1,000 hours load life.  
**Test Conditions:** 60% confidence level, 100% rated power, 25°C ambient, 1% Δ R failure point.

### RS SPECIFICATIONS

- **Applicable Mil. Spec:** MIL-R-26D, MIL-R-26C & MIL-R-23379
- **Wattage Sizes:** .4, .75, 1, 1.1, 2.5, 3, 3.25, 4, 5, 7 and 10 watt
- **Tolerances:** 0.05%, 0.1%, 0.25%, .5%, 1%, 3%
- **Operating Temperature Range:** -55°C to 350°C
- **Resistance Range:** .1 ohm to 273K ohms
- **Load Life Stability:**
  - Char. U: .5% max. Δ R after 2,000 hours at full rated power
  - Char. V: 3% max. Δ R after 2,000 hours at full rated power
- **Moisture Resistance:** .2% max. Δ R
- **Thermal Shock:** .2% max. Δ R
- **Dielectric Strength:** 500 volts, RS-¼ through RS-1B; 1000 volts RS-2 through RS-10
- **Insulation Resistance:** 1000 megohms minimum (dry)
- **Temperature Coefficient:** 20 ppm (high values); 30 ppm (intermediate values); 50 ppm (low values); 90 ppm (below 1 ohm).

Write for New Expanded Resistor  
Catalog A and RS Reliability Study



**DALE ELECTRONICS, INC.**  
1328 28th Avenue, Columbus, Nebraska  
In Canada: Dale Electronics Canada, Ltd.



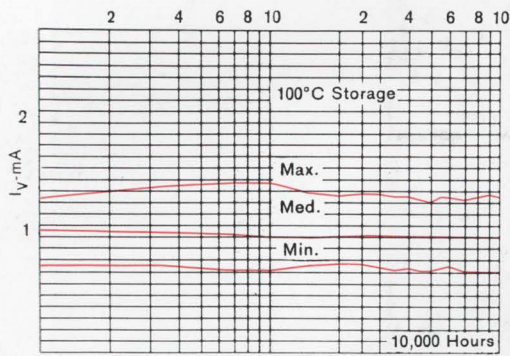

Long range life data for typical RCA TD-II tunnel diode.

# Unexcelled tunnel- diode reliability assured by **RCA** **TD-II** technology

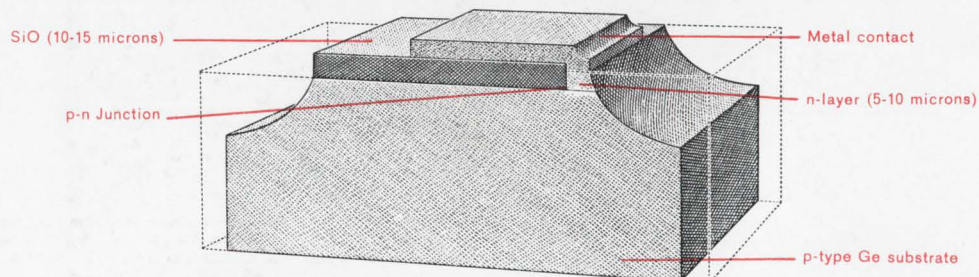

Cross-sectional view of RCA TD-II pellet before and after etching

RCA TD-II technology introduces a new standard of tunnel-diode reliability. Life tests exceeding one-million device hours have demonstrated the unprecedented stability of this epitaxial planar structure, an RCA-pioneered first for tunnel diodes.

In the TD-II process, a SiO layer is initially used to mask the surface of a p-type germanium wafer. Then an n-layer is epitaxially grown over all unmasked or inert areas to form many device junctions simultaneously. Even after individual etching, the diode retains the support of a massive stable substrate—without the “neck” structure found on earlier, less reliable tunnel diodes. Thermal resistance is improved. And, unlike previous designs, connection to a metallized contact can be easily made without placing all force di-

rectly on the junction. Because TD-II is a batch process, you benefit further from low cost and uniform characteristics. Other advantages include:

**Wide Applications**—With over 15 types having  $I_p$  of 5 to 100 mA and  $t_r$  of 100 to 1800 ps, RCA TD-II devices are ideal for high-speed switching and small-signal applications.

**MIL-Tested**—RCA TD-II units are designed to meet MIL-STD-750 including 1500 g shock and 20 g vibration.

**Immediate Availability**—Call your RCA representative today for off-the-shelf delivery. For data sheet and detailed reliability information, write RCA Commercial Engineering, Section I-G-12-3, Harrison, N.J. 07029.



RCA Electronic Components and Devices

**The Most Trusted Name in Electronics**

ON READER-SERVICE CARD CIRCLE 82