

# Electronic Design 25

VOL. 17 NO.

FOR ENGINEERS AND ENGINEERING MANAGERS

DEC. 6, 1969

**Electronic display components** are undergoing changes brought about by solid-state diodes, gas plasma panels, and liquid crystals. But the cathode ray

tube — so refined it can create images with 250 shades of gray (shown below) — remains the key display tool. But for how long? Turn to the report on page 68.

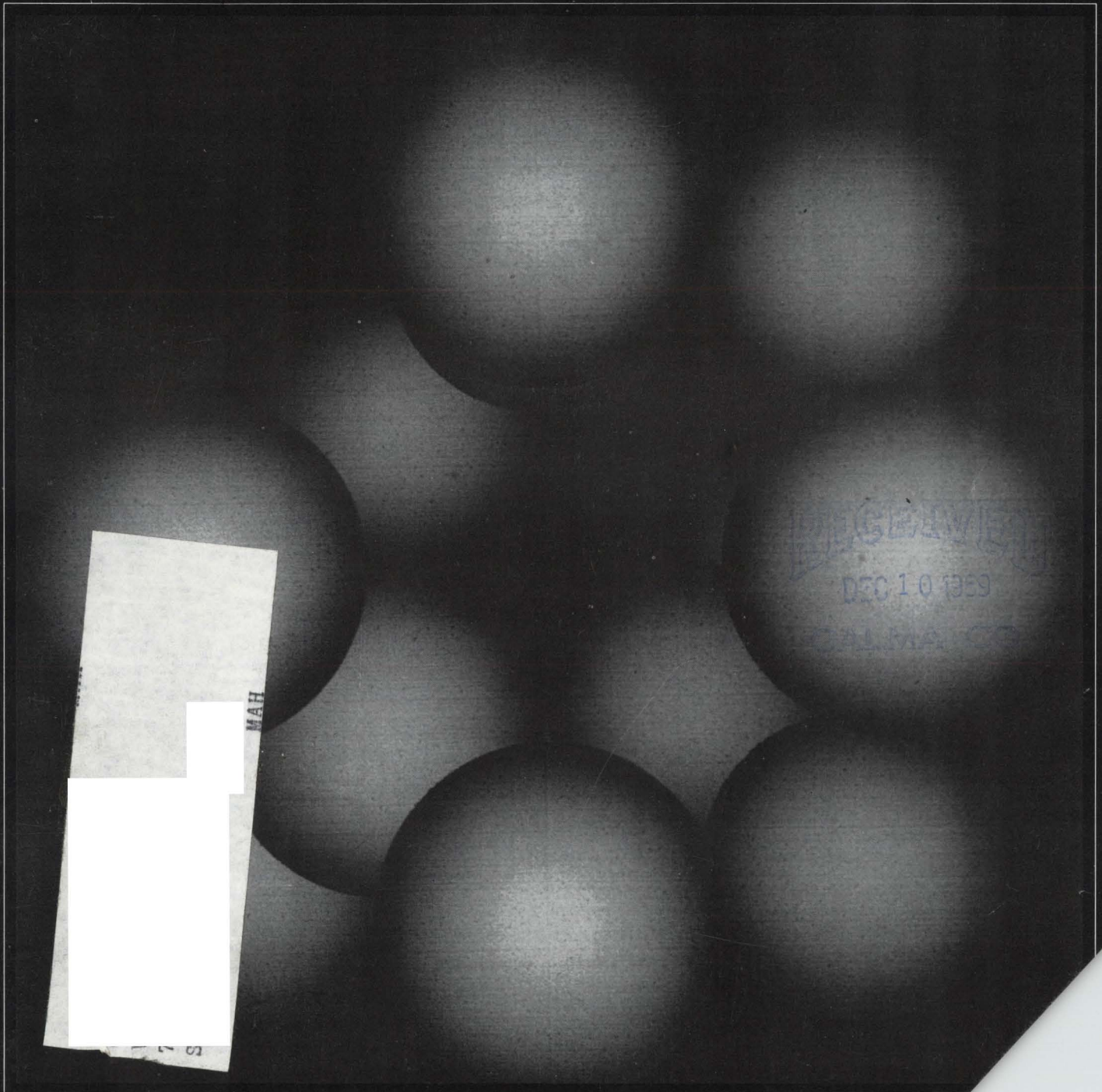



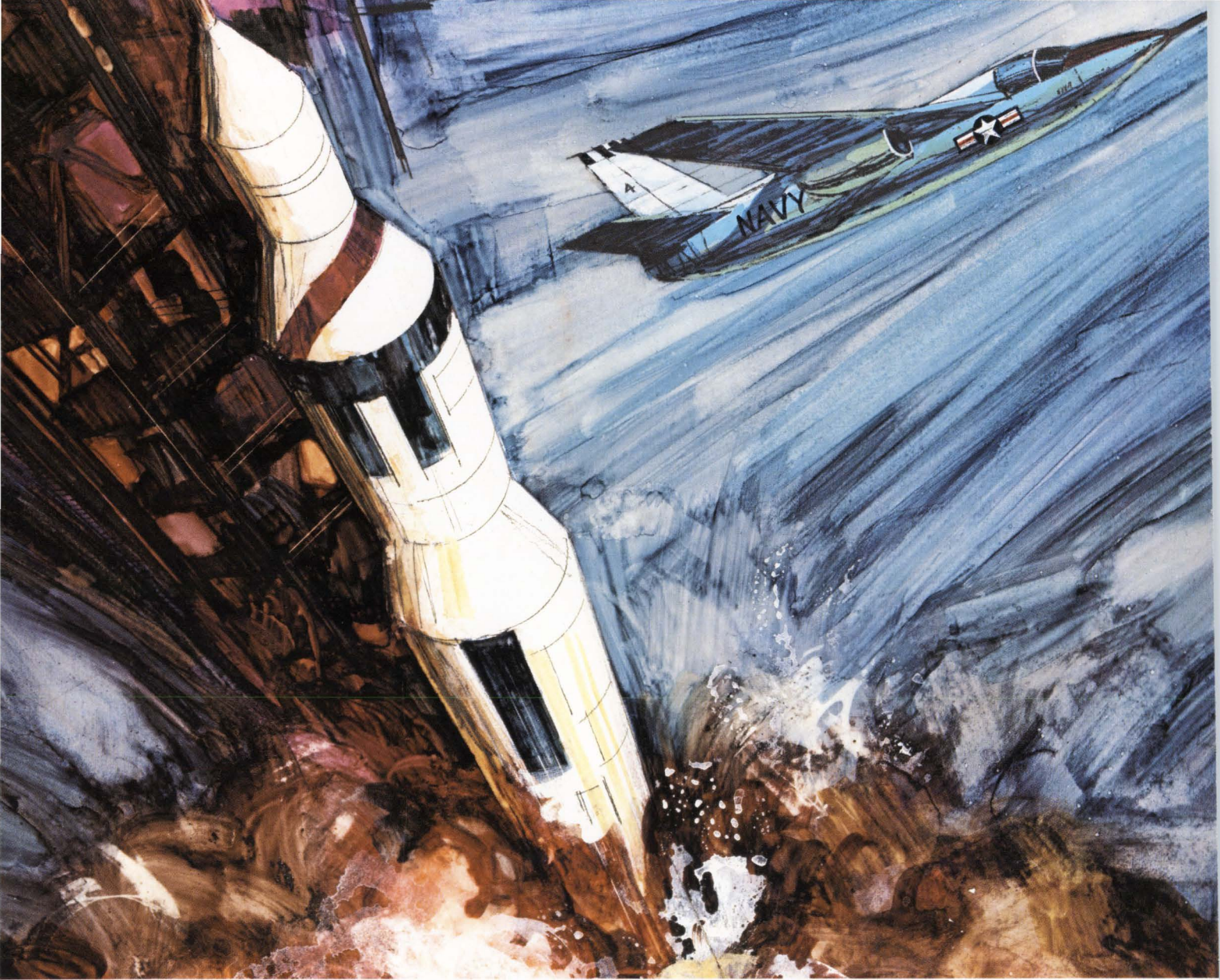

## QUALIFIED TO MIL-C-81511 CINCH-NULINE SUBMINIATURE ASTRO/348 CONNECTORS

The MIL-qualified, Cinch-Nuline Astro/348 series represent the highest state-of-the-art in round connectors. They have .085" contact centers with dielectric separation of .021" (equal to other connectors with .130" centers). The dielectric has a one-piece retention system that eliminates metal construction. Other important features include scoop-proof mating, grounding prior to electrical contact, removable crimp contacts and extreme environmental stability.

The complete line includes shell sizes for contact configurations of 4, 12, 37, 55, and 85 contacts, five receptacle styles and standardized accessories.

For additional information contact any Cinch Electronics Group Sales Office or write to Cinch-NuLine, 1015 S. Sixth Street, Minneapolis, Minnesota, 55415.

**MIL-C-26500 Omega Connectors** are also available from Cinch-NuLine on short delivery cycles (generally 6-8 weeks) for any shell style, contact size and insert configuration.

CN-7070



**CINCH-NULINE**  
DIVISION OF UNITED-CARR



# MEMO

FROM: THE PUBLISHER

---

December 6, 1969

Dear Marketer:

By now I hope all of you have had time to examine our first Product Source Directory on Measuring Instruments, which appeared in our November 22 issue. I'm sure you will agree that the completeness of this makes a worthwhile contribution to the industry.

Every issue of ELECTRONIC DESIGN through 1970 will carry a Product Source Directory. Due to specific subject matter, some will be larger than others.

The next sizable one, comparable to Measuring Instruments, will appear in our February 15, 1970 issue. It will cover Power Supplies - High Current, Lab Type, High Voltage, Constant Current, Modular AC - DC and other power supplies.

Manufacturers with product lines in the Power Supply area are offered a real opportunity to present their sales messages in this issue. Positions facing the Product Source Directory pages are available on a first-come no premium basis.

Advertising closing date for February 15 is January 12. However, why not call the Directory Manager, Greg Guercio, collect today at 212/751-5530 to assure yourself the best possible position.

Sincerely,

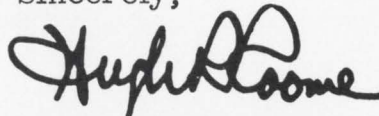

Hugh R. Roome  
Publisher  
**Electronic Design**

PUBLISHER TO ADVERTISER  
**MEMO**



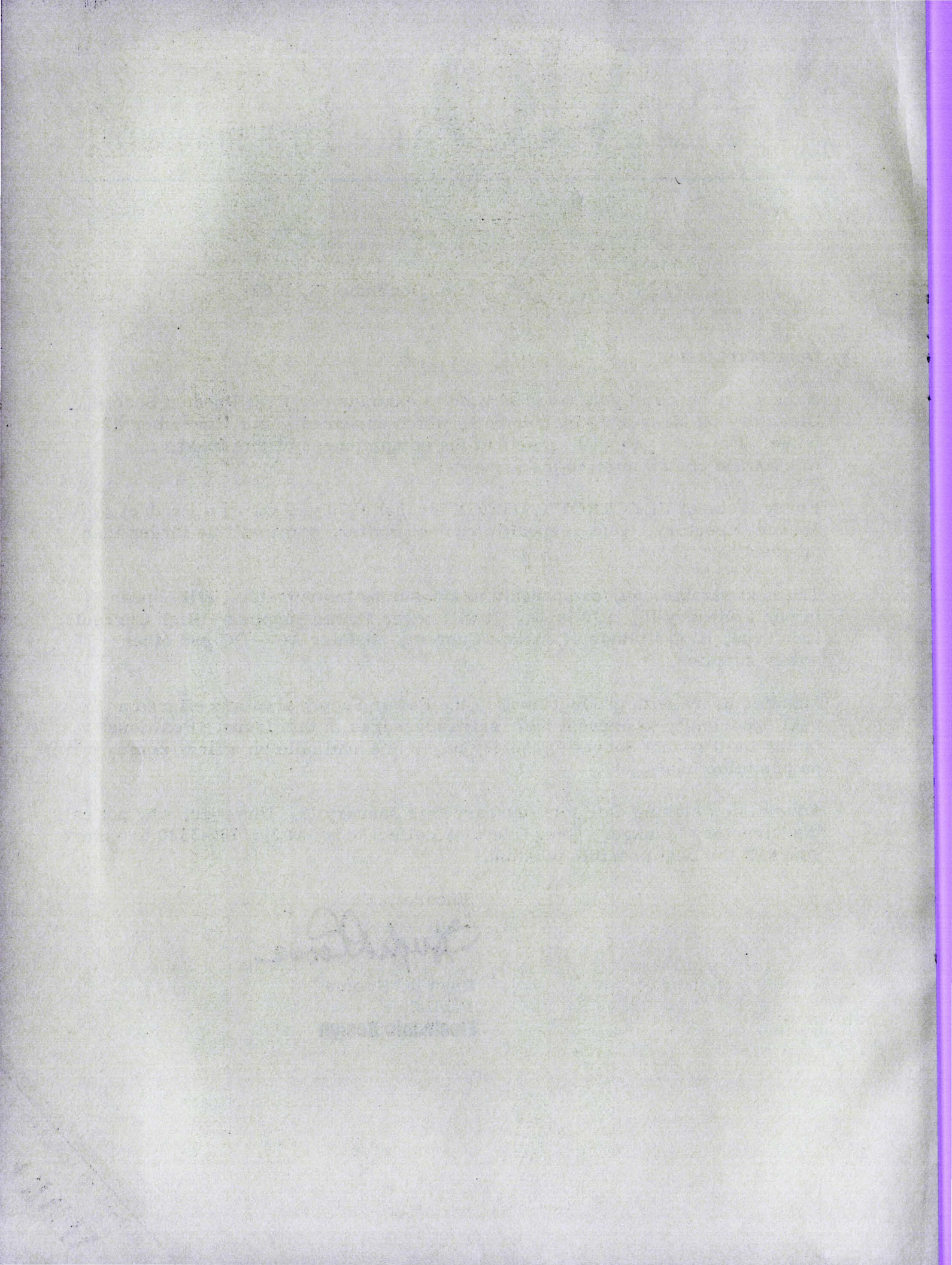





## Red Alert

A bright red light, visible across the room even at a 45° angle, switches on in less than 10 nanoseconds. No matter how long it's been sitting there, how many vibrations have jarred it, how severe the environment, the signal flashes the status of a circuit or a steady condition. Conceivably, it could shine a million hours before half-brightness.

Yet the HP 5082-4400 Visible Light Emitting Diode is packaged in a small hermetically sealed TO-46 can, uses only 15 mW drive power, combines with IC devices, and costs only \$2.90 in quantities of a 1000. You can use it anywhere you need high reliability, long life, small size, low drive power and resistance to shock.

If you'd like more information on an indicator light that never blows out, call your HP field engineer. Or write Hewlett-Packard, Palo Alto, California 94304; Europe: 1217 Meyrin-Geneva, Switzerland.

**HEWLETT**  **PACKARD**

SOLID STATE DEVICES

01905A

INFORMATION RETRIEVAL NUMBER 2



# Why are we advertising this Fairchild DVM?



Because it's now a Systron-Donner DVM. Along with its companions, the famous Model 7000A has been combined with S-D DVM's to form one big broad line. In fact, we can now fulfill more DVM needs than anybody else. And with **field-proven, state-of-the-art** instruments to boot!

The new S-D line covers everything from \$245 panel meters to 0.005% guarded multimeters to programmable systems meters. Every DVM uses **dual slope integration**, the best measurement technique yet developed.

What's more, only S-D offers you the true flexibility and economy of **plug-in cards** (not modules). For example, the Model 7000A expands from a basic DC voltmeter to a multimeter simply by slipping cards into already existing slots. You can add AC volts, ohms, current, 100 mv and many other options—at any time.

You get the most performance for the money, too. The proof is in our new catalog. For your copy, write Measurements Products Division, 888 Galindo Street, Concord, California 94520, or call (415) 682-6161.

SYSTRON  DONNER

**Another first! One of 157 S-D instruments.** Electronic counters/Pulse generators/Microwave frequency indicators/Digital clocks/Memory testers/Analog computers/Time code generators/Data generators/Digital voltmeters/Spectrum analyzers/Digital panel meters/Microwave signal generators/Laboratory magnets/Data acquisition systems/Microwave test sets.



# Electronic Design 25

VOL. 17 NO.

FOR ENGINEERS AND ENGINEERING MANAGERS

DEC. 6, 1969

---

## NEWS

- 21 **News Scope**
- 24 **Designing for the coming space-station era**  
Long-duration flights will require radically new approaches to data handling and on-board control.
- 30 **Solid-state microwaves advances on three fronts**  
Simpler circuitry, higher power and displacement of TWTs in some areas are reported at NEREM.
- 34 **Are company designers becoming obsolete?**  
NEREM session told that trend to computer-aided engineering is helping to spur rise of consultants.
- 43 **Washington Report**
- 46 **Letters**
- 48 **Sidelights**
- 51 **Editorial: Any of you evil engineers ready to defend yourself?**

---

## TECHNOLOGY

- 68 **'Turn on' designs with new displays**—a special report on the present state of displays and where they are going.
- 80 **Cut drift in your pulse radar** by slaving the magnetron to a precision oscillator. This feedback approach saves money, space and weight.
- 84 **Truth tables, Karnaugh maps and logic diagrams** all show you how to interconnect ICs for code conversion.
- 92 **LEND: a helping hand in aerospace.** This employee interchange program helps stabilize an industry that has its ups and downs.
- 99 **Ideas for Design**
- 107 **Product Source Directory: Sweep Generators**

---

## PRODUCTS

- 122 **Components:** Nonmechanical push-button switch operates at a touch.
- 132 **Instrumentation:** High-accuracy five-digit multimeter costs only \$1995.
- 142 **Microwaves & Lasers:** Solid-state sweeper spans 10 MHz to 18 GHz.
- 148 ICs & Semiconductors
- 153 Modules & Subassemblies
- 158 Packaging & Materials
- 164 Data Processing

---

## Departments

- |                        |                                   |
|------------------------|-----------------------------------|
| 16 Designer's Datebook | 172 New Literature                |
| 168 Evaluation Samples | 182 Advertisers' Index            |
| 169 Design Aids        | 184 Information Retrieval Service |
| 170 Application Notes  |                                   |

Information Retrieval Service Card inside back cover

**Cover:** Computer-generated art, by Jack Stifle of the University of Illinois, demonstrates that 256 shades of gray can be achieved on a CRT.

---

ELECTRONIC DESIGN is published biweekly by Hayden Publishing Company, Inc., 850 Third Avenue, New York, N.Y. 10022. James S. Mulholland, Jr., President. Printed at Brown Printing Co., Inc., Waseca, Minn. Controlled circulation postage paid at Waseca, Minn., and New York, N.Y. Copyright © 1969, Hayden Publishing Company, Inc. 80,244 copies this issue.



**We've been trying and trying  
105 TTL devices, including 41 MSI,**



**o think of another company that makes**

**but we've drawn a blank.  Signetics**

SIGNETICS CORPORATION / 811 E. ARQUES AVE., SUNNYVALE, CALIF. 94086 / A SUBSIDIARY OF CORNING GLASS WORKS

**INFORMATION RETRIEVAL NUMBER 4**



# When reliability and performance are essential, Airco Temescal specifies General Electric components

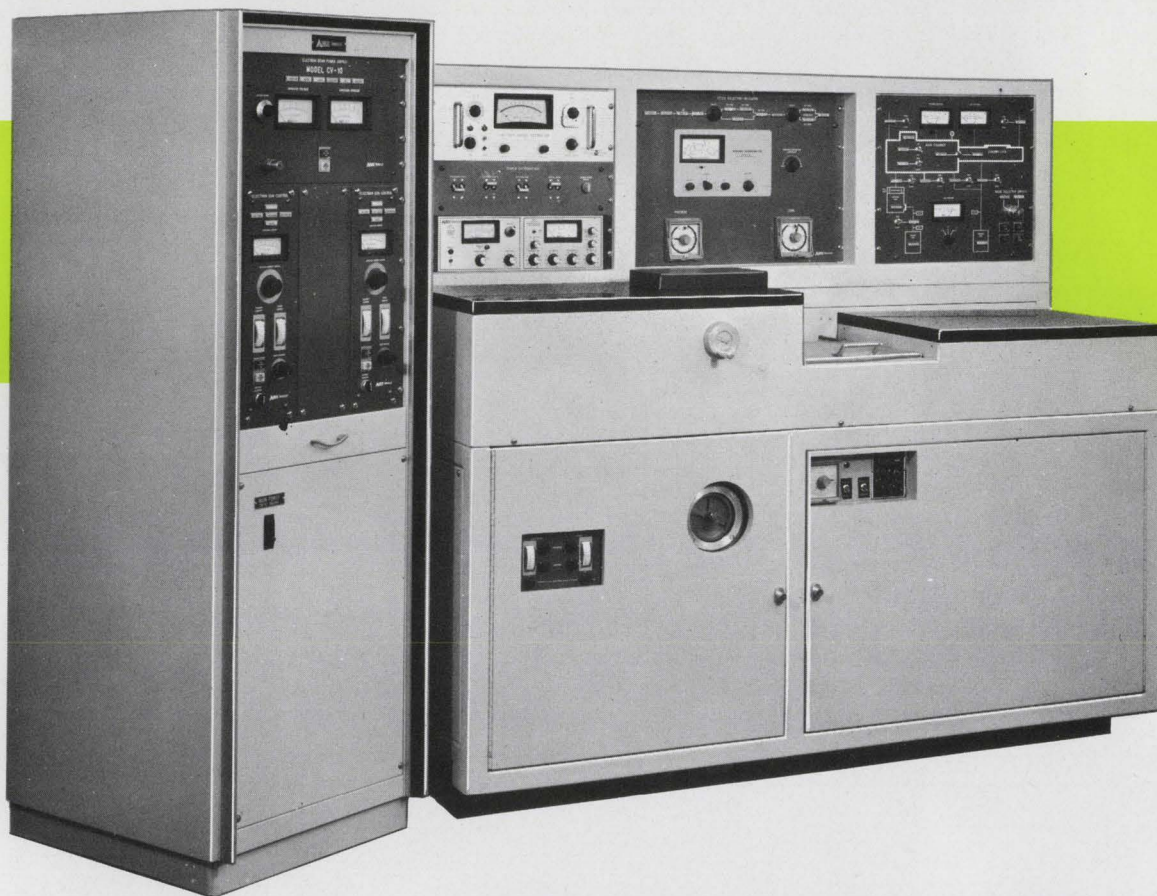

General Electric meters, SCRs, capacitors, selector switches, indicating lights, Volt-Pacs®, gear motors, current transformers and arc pilot devices are used in Airco Temescal's line of Integrated Electron Beam Systems and products such as this Thin-Film Electron Beam Deposition System. (For more information, circle 811.)

Contaminant-free, high quality, thin-film coated substrates are produced by Airco Temescal's Model FC-1100 Thin Film Deposition System with the CV-10 Electron Beam Power Supply. It was designed for either manual or automatic operation for research or production applications.

Systems such as this require hundreds of components — components that are rugged, reliable, capable of top-notch performance.

The complexity of this equipment requires many types of meters which constantly monitor various functions and controls. These meters, designed by General Electric, check such things as voltage, evaporation rates, current emissions, focus current, gun filament current, and others.

Systems designers, such as Airco Temescal's, look to General Electric when they need a certain component to meet specific criteria. They know, for example, GE SCRs are highly sensitive, very versatile . . . and more important, extremely reliable as well as economical.

Capacitors are another of the many GE components used in this equipment. Designers specified General Electric for this application because high capacitance was required in minimum space, and long life was important.

Companies like Airco Temescal specify General Electric components because the name, General Electric, stands for quality, reliability and performance.

**LOOK TO GENERAL ELECTRIC** — your best source for electronic components.

285-51

**GENERAL**  **ELECTRIC**





# What can GE do for you?



## GE's new magnetic material increases magnetic energy 75%

You can have either greater magnetic performance for the same size, or equal performance with less volume and magnet weight with GE's new Alnico 9 magnetic material. It increases the energy product of cast Alnico 8 to a minimum of 8 million gauss-oersteds—a 75% increase in magnetic energy.

Alnico 9 was developed especially for applications requiring superior performance with minimal space and weight, such as focusing of microwave tubes, motor fields and rotors, torque couplings, actuator couplings or other "radial gap" designs.

### TYPICAL DEMAGNETIZATION CURVE OF CAST ALNICO 9

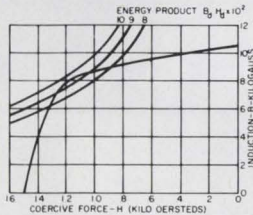

Consult our engineers about designing a Cast Alnico 9 magnet for your application. For details, circle 812.



## New "Hi-TECH" ceramics line... top-flight ceramics plus custom engineering

Need a customized ceramic-metal component to do a tough job? General Electric's Hi-TECH line offers a broad variety of alumina, forsterite and other special ceramic materials... sealed to virtually any metal... and custom-designed to your specifications.

End use and operating environment are all our engineers need to know in most cases to design and manufacture the exact component you need.

If your device is one that must operate in a severe environment; or if you need a dimensionally-stable abrasion-resistant machine part; or if you are working on electrical equipment, vacuum or gas-filled devices, or hermetically sealed electronic components... check the Hi-TECH line. Circle number 813.



## Now available—3SBV half-size relay for multiple applications

Attention, manufacturers of:

- COMPUTERS
- COMPUTER PERIPHERALS
- AVIONICS
- STUDIO & BROADCAST EQUIPMENT
- VISUAL COMMUNICATION PRODUCTS
- INSTRUMENTATION
- TEST EQUIPMENT
- MICROWAVE & MOBILE COMMUNICATIONS
- MOTOR CONTROLS
- PHOTO-ELECTRIC CONTROLS
- GEOPHYSICAL EQUIPMENT
- SECURITY WARNING EQUIPMENT

Specify the new 3SBV 200-grid half-size relay for those applications where high reliability, top performance and low cost are essential. The 3SBV is an adaptation of the 3SAV type, and has a nylon, heat-sealed metal case. It is ideal for use in environments less severe than aerospace and military applications. For more information on the GE 3SBV, DPDT, relay, circle 814.



## Solve unijunction design problems with the new programmable UJT

GE's D13T is a programmable unijunction transistor (PUT) with characteristics ( $\eta$ ,  $R_{BB}$ ,  $I_p$ ,  $I_v$ ) that can be selected to fit your circuit. Just two circuit resistors give the D13T1 and T2 programmability which permits the designer to:

- reduce a risk of thermal runaway
- use PUT in battery and other low-voltage circuits
- use base 2 as low impedance pulse output terminal
- use PUT in high volume applications.

Especially suited for long-interval timers, D13T2 features very low leakage and peak point currents. D13T1 is for more general use in high gain phase controls and relaxation oscillators.

Both are 3-terminal planar passivated PNP devices in the low-cost plastic TO-98 case. Circle number 815.

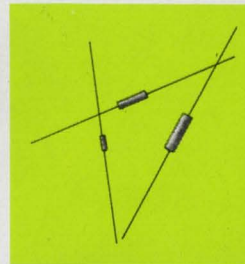

## GE 69F900 wet slugs give highest volumetric efficiency

69F900 wet slugs meet high-density application needs with highest volumetric efficiency of any capacitor. We halved the military (CL64) wet slug size, and essentially kept its electrical and performance traits.

The 69F900 has excellent capacitance retention at low temps... can be stored to -65C. Operating range is -55C to +85C. It's tough too—withstands vibration to 2000Hz; 15G acceleration!

GE's capacitor is fully insulated; has low, stable leakage current. Ratings are available from 6 to 60 volts; capacitance ranges from 0.5 to 450  $\mu$ f.

RATING	CASE SIZE	VOLUME
50V, 30 $\mu$ f		
solid (CS12)	.341X.750	100%
wet slug (CL64)	.281X.681	58%
69F900	.145X.600	15%
15V, 80 $\mu$ f		
solid (CS12)	.341X.750	100%
wet slug (CL64)	.281X.681	58%
69F900	.145X.600	15%
6V, 180 $\mu$ f		
solid (CS12)	.279X.650	100%
wet slug (CL64)	.281X.641	100%
69F900	.145X.600	15%

For data, circle 816.



## Miniature oil-tight push buttons control almost any function

GE's line of industrial miniature oil-tight push buttons, CR104, is available to control almost any function. They are suitable for use on machine tool control

panels — especially where space is limited. For example, twenty of these units can be easily mounted on a 6" x 5 1/2" panel.

Units are rated 5 amps carry, 115 volts max., 30 amps make and break at 115-125 volts. Double-break

1NO-1NC and 2NO-2NC contact blocks are available for pilot duty control.

Forms include push-buttons, select switches, indicating lights, special forms, and oil-tight enclosures and stations. Color-coding is easy: knobs and rings

come in many colors. Flush and surface-mounted stations make GE's miniature oil-tight push button line the most versatile in the industry.

For detailed information on the entire line of push buttons, circle reader card 817.



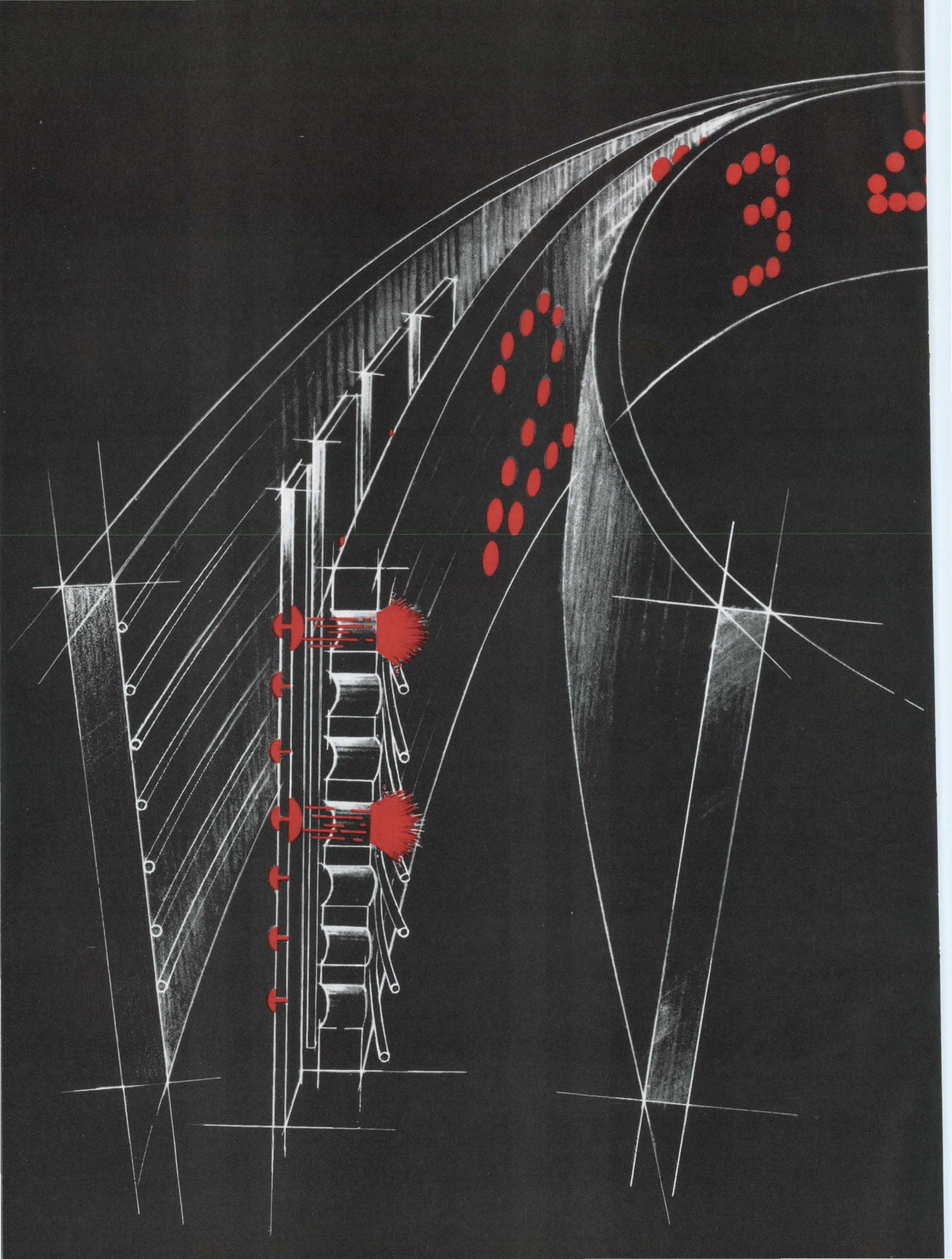



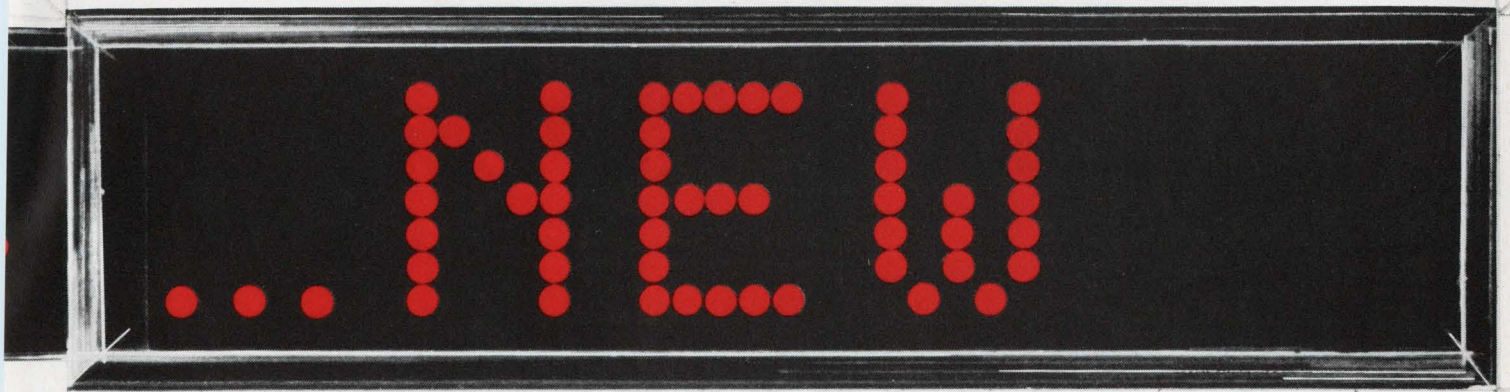

# SELF-SCAN™ PANEL DISPLAY eliminates up to 90% of drive electronics

SELF-SCAN panel displays represent a Burroughs invention of panel design and circuitry that permits time sharing of the cathode electrode drivers in a flat panel display using gas discharge light emitters. Consequently a savings of up to 90% of the electronics required to drive the dot matrix display is realized.

For informational purposes the SELF-SCAN panel display can be thought of as a dot matrix panel with common cathode strips capable of glowing on both front and back sides. The glow on each side of the cathodes is independently controlled by a set of anodes located on the front and back of the panel. The rear portion of the display consists of 7 glow-priming anodes which work in conjunction with 111 vertical cathode strips (common to both sets of anodes). These cathodes are interconnected in three groups of 37 cathodes each and connected to a three

phase clock which sequentially brings each cathode to ground potential. As each cathode is grounded in sequence, the glow is transferred to the adjacent cathode. This transferred glow at the rear of the panel is not discernible from the front. (The illustration shows the first cathode grounded and glow at the 7 rear anode intersections.)

When it is desired to display a dot on the viewing surface, the front glow transfer anodes are utilized. (The glow transfer anodes and common cathodes make up the front matrix.) The appropriate transfer-anode is selected in synchronism with the cathode and the glow transfers forward to the panel front for viewing. (The illustration shows the top and center dots on the first cathode trans-

ferred for viewing.) The whole display panel is refreshed and updated to produce a bright flicker-free display.

As a normal dot matrix panel requires a cathode driver for each cathode (80 high-voltage drivers required for a 16 digit display) and the SELF-SCAN panel display requires *only* 3 clock controlled cathode drivers regardless of the number of digits, the significance of this development is immediately apparent.

The SELF-SCAN panel display has unlimited applications, as alphanumeric and graphic messages can be presented with simplicity.

Write today for descriptive brochure, Burroughs Corporation, Box 1226, Plainfield, N.J. (201) 757-5000.



## Burroughs





# some designers want them for what they are

## MPSU01-U52 Penny Performers

- 5-8 W Uniwatt\* complements
- High, linear beta to 150 mA
- 150 MHz, Annular† capability
- 180 V sustaining voltage



## 2N5336-39, 2N5427-30 Switching Optimizers

- 100/200 ns rise/fall time
- 30-120, 60-240 beta @ 2 A
- 80-100 V sustaining voltage
- Complements MJ500/8100



## 2N5346-49 Insulated Isolectors\*

- Isolated or common collector
- 60 W, 30 MHz switching
- 3-point-beta-spec'd to 5 A
- Complements MJ6700

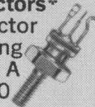

## 2N5629-34

### Stud Eliminators

- 10 or 16 A collector current
- 140 V sustaining voltage
- 1 V saturation voltage
- 25-100 beta @ 8 A

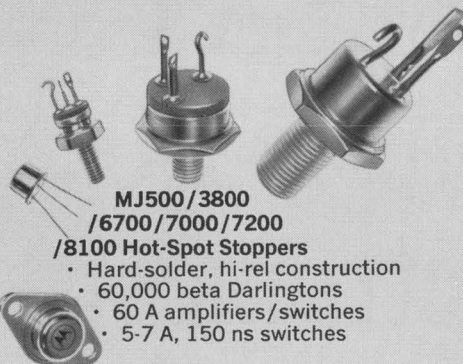

## MJ500/3800

### /6700/7000/7200

### /8100 Hot-Spot Stoppers

- Hard-solder, hi-rel construction
- 60,000 beta Darlington
- 60 A amplifiers/switches
- 5-7 A, 150 ns switches



## 2N5683-86 Current Complements

- 50 A, 300 W NPN/PNP pairs
- 15-60 beta @ 25 A
- 1 V saturation voltage
- EpiBase\* construction



## 2N5344-45 Energy Engineers

- 250/300 V sustaining voltage
- 550 ns typical total switching
- PNP polarity
- 60 MHz  $f_T$



## 2N3740A/41A Leakage Lickers

- 100 nA maximum leakage @ 80 V
- 0.6 V saturation voltage
- 30-100 beta @ 250 mA
- 25 W power dissipation



## 2N5655-57

### Unlimited Line Operators

- 350 V sustaining voltage
- 30-250 beta @ 50 mA
- 100 uA maximum leakage @ 250 V
- 150 V @ 65 mA SOA

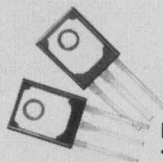

## MJE3055/2955 Metal-Pair Replacers

- 90 W Thermopad\* complements
- 10 A continuous  $I_c$
- 20-70 beta @ 4 A
- 2 MHz frequency response

\*Trademark Motorola Inc.  
†Patented Process

*- where the priceless ingredient is care!*





# others want them for what they can be

Motorola Silicon Power manages to do one important thing more successfully.

It combines the most impressive, individual, state-of-the-art performance features with the widest total application flexibility without one completely dominating the other.

To your advantage.

It offers you switches, amplifiers, high voltage, high current, PNP, NPN, high frequency, low frequency, consumer packages, industrial pack-

ages, military packages. Over 250 standard, preferred types in 10 different shapes and 18 current ratings.

Send for a Silicon Power Selector Guide/Application Note Index literature package. It can be the key to the exact silicon power device you'll want for your next design. Or point to the application note you'll need to help you design that design.

Box 20912, Phoenix, Arizona 85036. We tell it like it is.

**APPLICATION NOTE CATALOG**

MOTOROLA Semiconductor Products Inc.

- A 20-WATT AUDIO AMPLIFIER WITH COMPLEMENTARY-SYMMETRY, THERMOPAD SILICON POWER TRANSISTORS
- PULSE-WIDTH MODULATION FOR DC-MOTOR SPEED CONTROL
- THERMAL RESPONSE OF SEMICONDUCTORS
- MEDIUM POWER AUDIO AMPLIFIERS USING COMPLEMENTARY PLASTIC TRANSISTORS
- SILICON POWER TRANSISTORS PROVIDE NEW SOLUTIONS TO VOLTAGE CONTROL PROBLEMS
- HIGH-PERFORMANCE ALL SOLID-STATE SERVO AMPLIFIERS
- A METHOD OF PREDICTING THERMAL STABILITY
- THE ABC'S OF DC TO AC INVERTERS
- A 35-WATT AUDIO AMPLIFIER WITH COMPLEMENTARY-SYMMETRY THERMOPAD SILICON POWER TRANSISTORS
- LOW-COST HIGH VOLTAGE SERVO AMPLIFIERS
- AC OVERVOLTAGE AND OVERCURRENT PROTECTIVE CIRCUIT WITH AUTOMATIC RESET
- A HIGH-PERFORMANCE 10 W AMPLIFIER USING PLASTIC-ENCAPSULATED SILICON TRANSISTORS
- TRANSISTOR INVERTER — 40 WATTS, 400 Hz, SQUARE WAVE OUTPUT
- LINE-OPERATED 15-kHz INVERTER
- MOUNTING PROCEDURE FOR, AND THERMAL ASPECTS OF, THERMOPAD PLASTIC POWER DEVICES
- LOW-POWER AUDIO AMPLIFIERS USING COMPLEMENTARY PLASTIC TRANSISTORS
- HIGH POWER AUDIO AMPLIFIERS WITH SHORT CIRCUIT PROTECTION
- A REGULATED POWER SUPPLY USING A REFERENCE AMPLIFIER
- AC AND DC RELAY DRIVERS
- AVOIDING SECOND BREAKDOWN
- SWITCHING VOLTAGE REGULATOR USES DISCRETE AND INTEGRATED-CIRCUIT APPROACHES

## **MOTOROLA** Silicon Power Transistors

INFORMATION RETRIEVAL NUMBER 7



# ferrite reproducibility

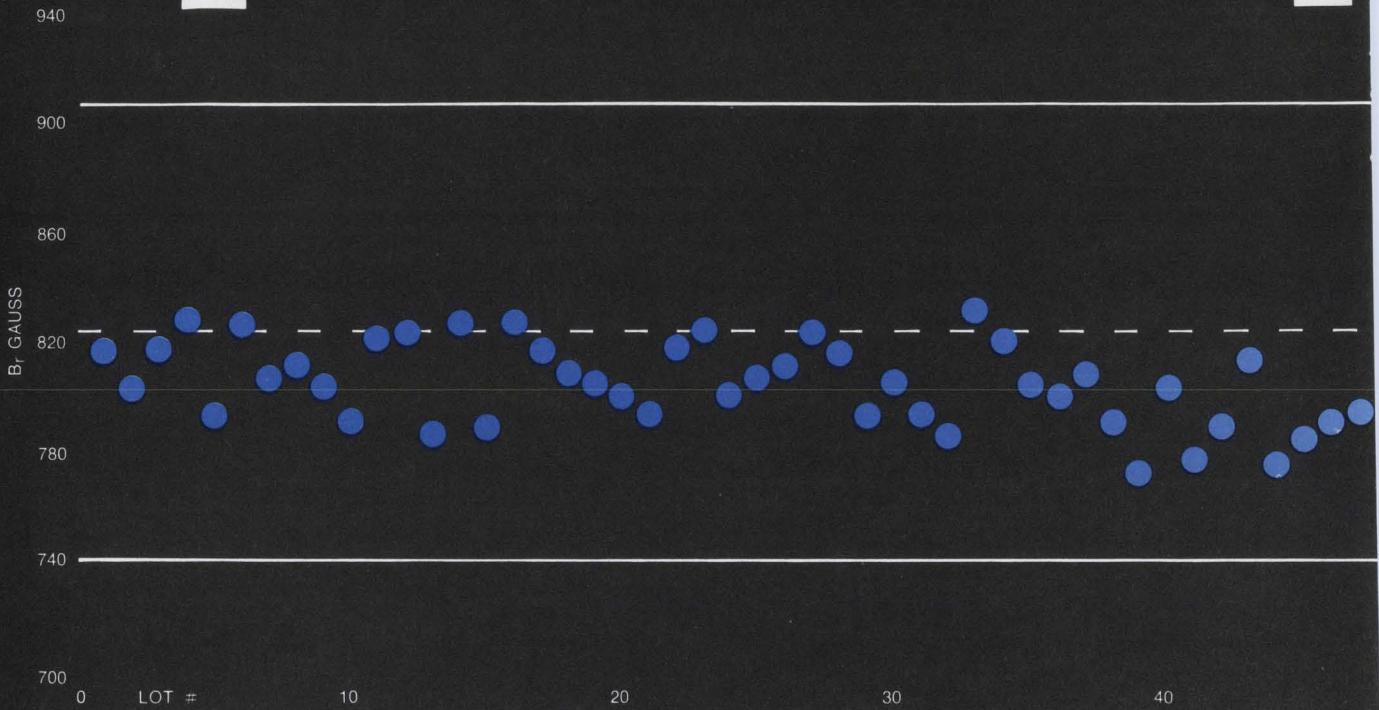

it speaks for  
itself.



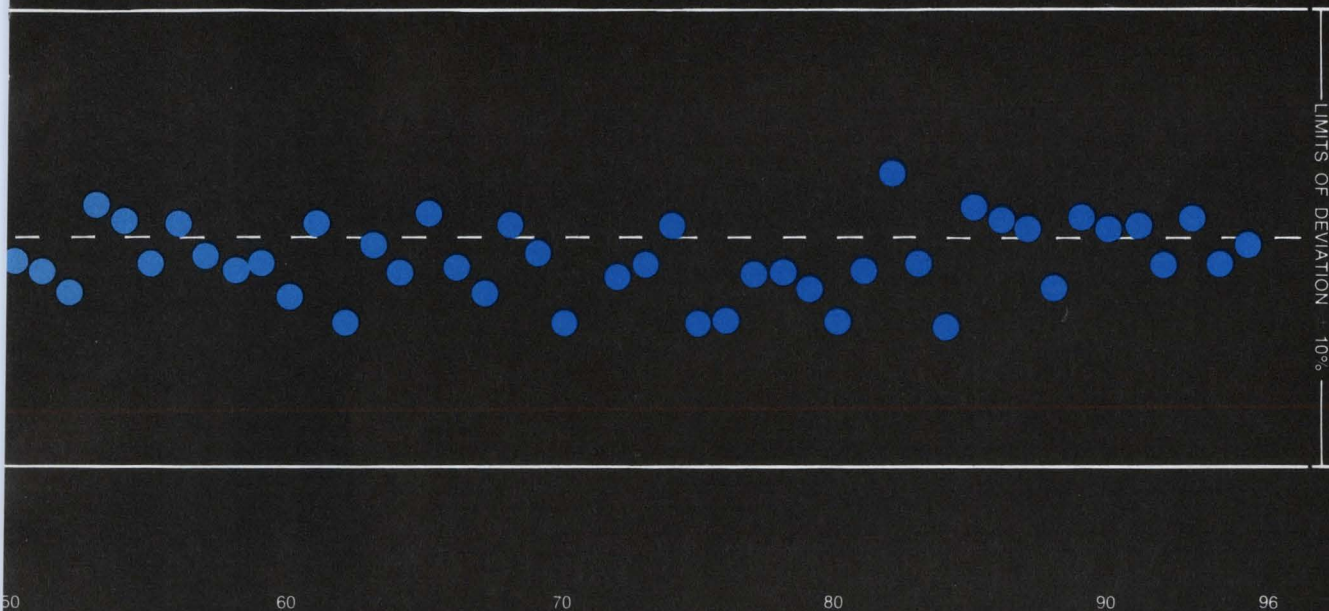

## case history: digital phaser bit production

material: TT G-1001 gadolinium doped yttrium garnet

quantity: 17,100 digital bits

gross weight: +700 lbs.

production period: approximately eight months

The critical parameter was remanent induction ( $b_r$ ). Actual specifications called for  $b_r = 825$  Gauss  $\pm 10\%$ . Here's the way 95 lots of 180 phase shifter bits each, looked in actual measurement. Nothing has been deleted, nothing added. What you're looking at is the QC profile of one contract assignment; more than 700 pounds of material produced over an eight-month period. Over seventeen thousand ferrite bits with an average  $b_r$  deviation of approximately  $\pm 6\%$  for the entire

run. Reproducibility that speaks for itself.

Reproducibility . . . consistent low deviation from specified values . . . the reason why Trans-Tech is one of the nation's largest suppliers of ferrite materials.

For further information on ferrite toroid reproducibility request Tech-Brief No. 692.

A complete catalog of Trans-Tech materials is available at your request.

**TRANS-TECH, INC.**  12 meem ave., gaithersburg, md. 20760 • (301) 948-3800

INFORMATION RETRIEVAL NUMBER 8



ELECTRONIC MATERIALS

DOW CORNING®

**3140** RTV coating

clear, flowable silicone rubber coating;  
non-corrosive to copper and other metals  
TWO OUNCES

DOW CORNING

ELECTRONIC MATERIALS

DOW CORNING®

**3140** RTV coating

clear, flowable silicone rubber coating;  
non-corrosive to copper and other metals  
TWO OUNCES

DOW CORNING®

**3141** RTV coating

white, flowable silicone rubber coating;  
non-corrosive to copper and other metals  
NET WT. 2 oz/57 g

DOW CORNING

DOW CORNING®

**3141** RTV coating

white, flowable silicone rubber coating;  
non-corrosive to copper and other metals  
NET WT. 2 oz/57 g

DOW CORNING®

**3144** RTV adhesive/sealant

translucent, room-temperature-curing  
silicone rubber adhesive sealant;  
non-corrosive to copper and other metals  
NET WT. 2 oz/57 g

DOW CORNING

DOW CORNING®

**3144** RTV adhesive/sealant

translucent, room-temperature-curing  
silicone rubber adhesive sealant;  
non-corrosive to copper and other metals  
NET WT. 2 oz/57 g

ELECTRONIC MATERIALS

DOW CORNING®

**3145** RTV adhesive sealant

grey, non-slump silicone rubber sealant;  
non-corrosive to copper and other metals  
TWO OUNCES

DOW CORNING®

**3145** RTV adhesive sealant

grey, non-slump silicone rubber sealant;  
non-corrosive to copper and other metals  
TWO OUNCES





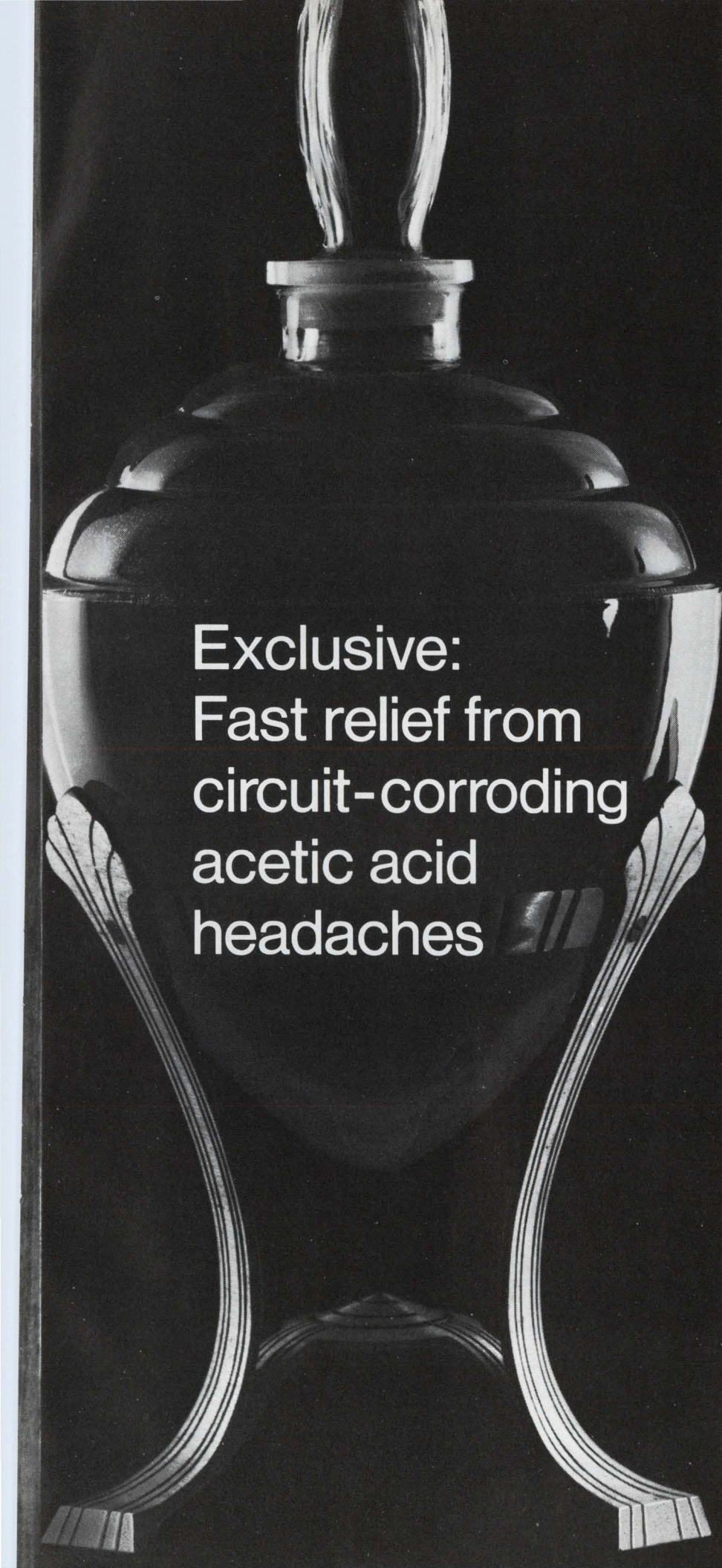

Exclusive:  
Fast relief from  
circuit-corroding  
acetic acid  
headaches

Dow Corning® silicone sealants and protective coatings are the only ones that do *not* release acetic acid or other corrosive by-products during cure. They were specifically developed to protect delicate circuit boards and other electronic components from corrosion, dust, dirt, abrasive particles, solvents and chemicals. They are strong, have excellent bond strength, electrical strength; are easy to apply, and cure quickly. There's no "vinegar" smell, either. Dow Corning 3140 (clear) and 3141 (opaque) RTV coatings are ready-to-use silicone rubbers that cure at room temperature. They are ideal for conformal coatings on printed circuit assemblies or for encapsulating small circuits or connectors. Dow Corning 3144 (clear) and 3145 (opaque) RTV adhesive/sealants are high-strength, non-corrosive, nonflowing silicone rubbers used to bond components and seal housings and connectors.

Stop component corrosion with these Dow Corning coatings and sealants. For more information, write Dow Corning Corporation, Dept. B-9342, Midland, Michigan 48640.

*Electrical / Electronic  
materials from*

***DOW CORNING***

DOW CORNING

INFORMATION RETRIEVAL NUMBER 9



# When You Buy a Power Supply, Why Not Get the Best?

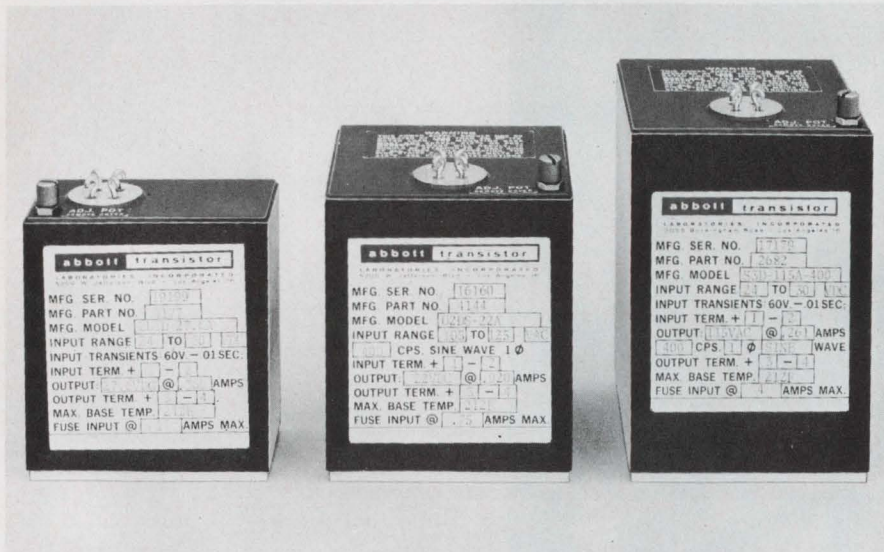

**BL1D-27.6A**  
(109,890 Hrs.)

**U2DS-22A**  
(73,585 Hrs.)

**53D-115A-400**  
(61,387 Hrs.)

## Abbott's New Family of 100°C Units—

are designed to operate in the stringent environment required by military and aerospace systems — (per MIL-E-5400 or MIL-E-5272C) from  $-54^{\circ}\text{C}$  to  $+100^{\circ}\text{C}$ .

**RELIABILITY** — MTBF (mean time between failures) as calculated in the MIL-HDBK-217 handbook can be expected in excess of 50,000 hours at  $100^{\circ}\text{C}$  for many of our power modules. The hours listed under the photos above are the MTBF figures for each of the models shown. Additional information on typical MTBF's for our other models can be obtained by phoning or writing to us at the address below.

**QUALITY CONTROL** — High reliability can only be obtained through high quality control. Only the highest quality components are used in the construction of the Abbott power module. Each unit is tested no less than 41 times as it passes through our factory during fabrication — tests which include the scrutinizing of the power module and all of its

component parts by our experienced inspectors.

**NEW CATALOG** — Useful data is contained in the new Abbott Catalog. It includes a discussion of thermal considerations using heat sinks and air convection, a description of optional features such as short circuit protection and remote output adjustment as well as operating hints for power supplies and a listing of environmental testing costs.

**WIDE RANGE OF OUTPUTS** — The Abbott line of power modules includes output voltages from 5.0 volts DC to 10,000 volts DC with output currents from 2 milliamperes to 20 amperes. Over 3000 models are listed with prices in the new Abbott Catalog with various inputs:

- 60 $\phi$  to DC, Regulated
- 400 $\phi$  to DC, Regulated
- 28 VDC to DC, Regulated
- 28 VDC to 400 $\phi$ , 1 $\phi$  or 3 $\phi$
- 60 $\phi$  to 400 $\phi$ , 1 $\phi$  or 3 $\phi$

TO: Abbott Transistor Labs., Inc., Dept. 67  
5200 West Jefferson Blvd.  
Los Angeles, California 90016

Sir:  
Please send me your latest catalog on power supply modules:

NAME \_\_\_\_\_ DEPT. \_\_\_\_\_  
COMPANY \_\_\_\_\_  
ADDRESS \_\_\_\_\_  
CITY & STATE \_\_\_\_\_

Please write for your FREE copy of this new catalog or see EEM (1969-70 ELECTRONIC ENGINEERS MASTER Directory), Pages 1834-1851.

**abbott transistor**  
LABORATORIES, INCORPORATED  
5200 W. Jefferson Blvd./ Los Angeles 90016  
(213) WEBSTER 6-8185 Cable ABTLABS

INFORMATION RETRIEVAL NUMBER 10

# Designer's Datebook

JANUARY 1970						
Sun	Mon	Tue	Wed	Thu	Fri	Sat
				1	2	3
4	5	6	7	8	9	10
11	12	13	14	15	16	17
18	19	20	21	22	23	24
25	26	27	28	29	30	31

FEBRUARY 1970						
Sun	Mon	Tue	Wed	Thu	Fri	Sat
	1	2	3	4	5	6
7	8	9	10	11	12	13
14	15	16	17	18	19	20
21	22	23	24	25	26	27
28						

For further information on meetings, use Information Retrieval Card.

**Jan. 14-16**  
**International Conference on Systems Sciences** (Honolulu, Hawaii) Sponsor: IEEE, Univ. of Hawaii. R. Chattopadhyay, Univ. of Hawaii, 2565, The Mall, Honolulu, Hawaii 96822

CIRCLE NO. 381

**Jan. 25-30**  
**Winter Power Meeting** (New York City) Sponsor: IEEE. Technical Conference Services, 345 E. 47 St., New York, N.Y. 10017

CIRCLE NO. 382

**Feb. 3-5**  
**Reliability Symposium** (Los Angeles) Sponsor: IEEE. W. R. Abbott, Lockheed Missiles & Space Co., POB 504, Sunnyvale, Calif. 94022

CIRCLE NO. 383

**Feb. 18-19**  
**Instrumentation Fair** (Los Angeles) Sponsor: Instrumentation Fair Inc., Calif. L. Courtney, Larry Courtney Co., 16400 Ventura Blvd., Encino, Calif. 91316

CIRCLE NO. 384

**Feb. 18-20**  
**International Solid-State Circuits Conference** (Philadelphia) Sponsor: IEEE, Univ. of Penna. L. Winner, 152 W. 42 St., New York, N.Y. 10036

CIRCLE NO. 385

**Mar. 11-13**  
**Scintillation & Semiconductor Counter Symposium** (Washington, D.C.) Sponsor: NBS, IEEE. R. L. Chase, Brookhaven National Laboratory, Upton, N. Y. 11973

CIRCLE NO. 386



# HAPPENINGS IN ELECTRONICS

December 1969

## Nixie® Appoints Schweber

Burroughs Corporation has authorized Schweber Electronics to inventory their NIXIE tube line and peripheral readout products. Burroughs is the leader in the world of displays. Their indicator tubes have remained the industry's most popular display devices for every digital readout application because of their high reliability (200,000 hours life); best readability; high constant brightness (200 ft. Lamberts); lowest cost, compact size, rugged construction, and availability of JAN types. The entire line will be stocked, including miniature and standard sized NIXIEs in rectangular and round configurations, as well as the side-viewing and alpha-numeric variations. Peripheral equipment such as one-packaged decoder-driver-readout units will also be stocked. For technical literature, circle #241.

## The Fairchild $\mu$ A741—Successor to the $\mu$ A709!

Are you still living with first generation 709s? They've been improved, you know. Frequency compensation is no longer a problem; it is now incorporated on the chip. Differential input signals which were once restricted to an absolute maximum of  $\pm 5v$  are now up to  $\pm 30v$ . The new op amp is fully protected against damage from short circuit conditions occurring at input or output. Latch-up has been eliminated over a wide range of common mode and differential mode input voltages. The new Fairchild  $\mu$ A741 is pin for pin identical to the  $\mu$ A709, but its high performance, flexibility of supply requirements, and electrical ruggedness lift its potential for new equipment designs far beyond first generation op amps. The commercial 741c in a TO-5 type can sell at 3.25 each in one hundred piece quantities. Two Fairchild booklets, one on "Some Applications of the 741 Op Amp" and the other describing "A New High Performance Monolithic Op Amp" can be yours by circling #242.

### $\mu$ A747

#### Dual Internally Compensated Op Amp

No Frequency Compensation Required  
Short Circuit Protected  
Offset Voltage Null Capability  
Large Common Mode and Differential Voltage Ranges  
No Latch-up

U6W7747393

1-24	25-99	100+
11.25	9.00	7.50

U6W7747312

27.00	21.60	18.00
-------	-------	-------

### Postscript to the $\mu$ A741:

Where important design considerations involve space, weight, and high reliability, why not consider using the new  $\mu$ A747 device? It has two 741s on a single monolithic chip while retaining the same internal frequency compensation and electrical characteristics. Whatever was said about the  $\mu$ A741 goes double for the  $\mu$ A747. But the double-sided nature of the  $\mu$ A747 can result in unique advantages by providing simple solutions to application problems that require two op amps in interdependent circuits such as dual tracking power supplies. Isothermal layout provides excellent channel separation of over 120 dB. For technical data, circle #243.

## Thin-Film Chip Inductors from Motorola.

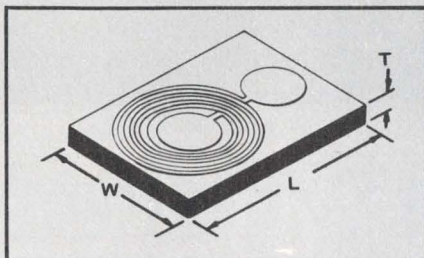

Motorola has another first in the microcircuit component field: unencapsulated thin-film inductors. These miniature spiral inductors have high Q and are available in six values of inductance from 28 to 230 nH. The L, W, and T dimensions in the drawing range from a minimum of 0.190" x 0.190" x 0.010" to a maximum of 0.240" x 0.240" x 0.010". They have been assigned catalog part numbers MCH5800 to 5805. Designed for use in UHF and microwave hybrid circuits for tuning and biasing applications, they are sold in minimum quantities of 25 pieces per type at 4.40 to 4.80 each. Shipment from Schweber stock. For technical information circle #244.

## New Pea-Sized Plastic SCR from General Electric.

Looking for a small SCR (TO-18 package) rated at 0.8A RMS up to 200v? We'll send you one attached to a data sheet for your evaluation. Gate trigger current is 200  $\mu$ A with low  $V_F$  and high  $dv/dt$  rate. General Electric epoxy has the ability to contend successfully with a wide range of environmental conditions. For free sample and data sheet circle #245.

## Review of New Catalogs:

1. UNION CARBIDE CONDENSED CATALOG OF SEMICONDUCTOR PRODUCTS. This 14-page catalog has a heavy concentration of Field Effect Transistors with short form listing of technical data. The numerical index of JEDEC and house numbers is also coded with legend symbols to enable the reader to select devices for specific applications. The back page contains a listing of application literature which is available from Schweber. Circle #246.

2. AMPHENOL has prepared a wall chart measuring 2 feet x 3 feet to illustrate their Astro/348® connectors to MIL-C-81511. The inserts are drawn at twice actual size to show contact sizes and arrangements. Large, clear photographs of the shell styles are also included. Both the military and the Amphenol part numbers are listed. Circle #247.





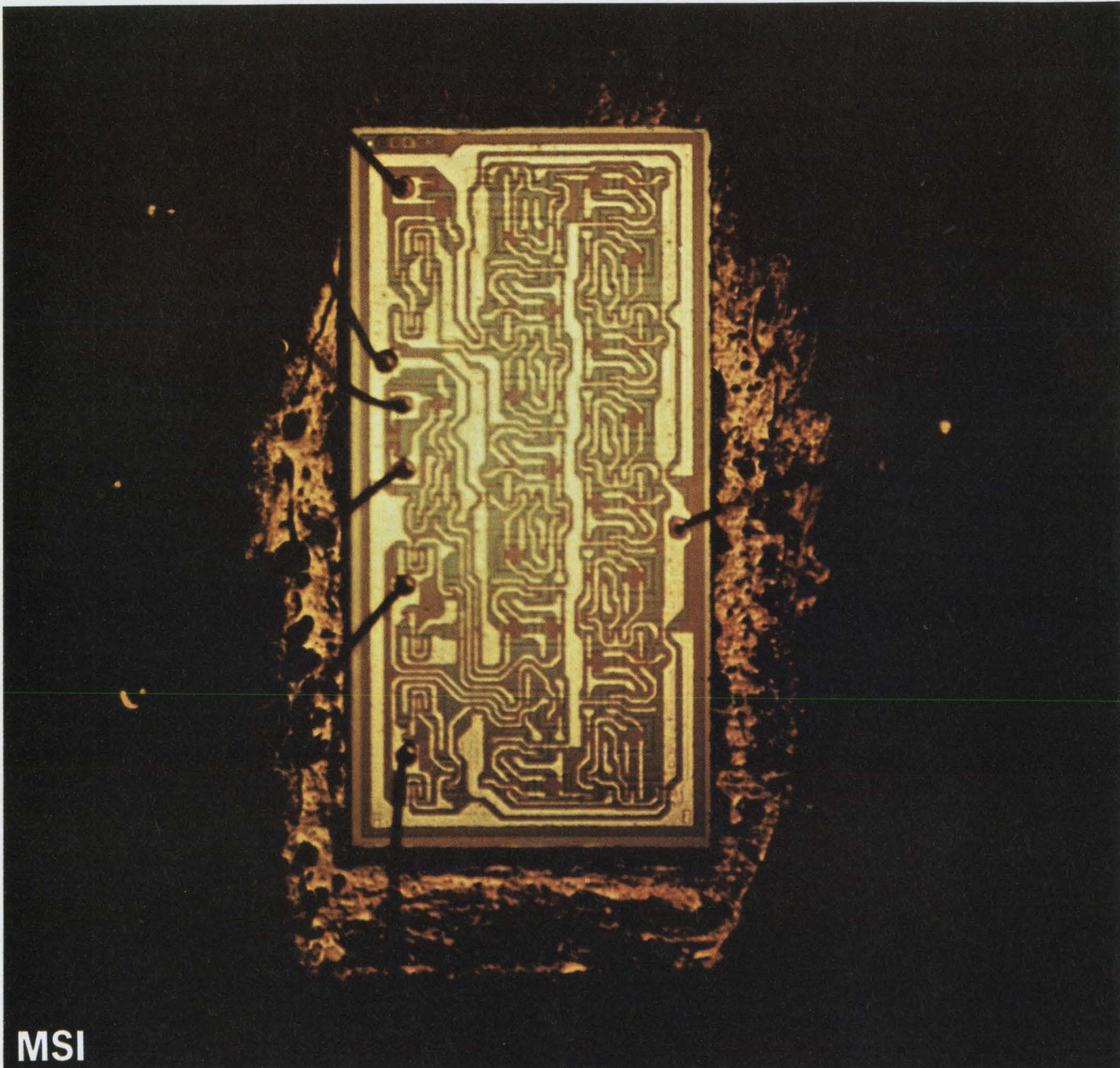

**MSI**

Sprague Series 54/74 ICs. Illustration: 54/7491 8-Bit Shift Register

## Choose from 13 Sprague Series 54/74 arrays.

Design is easier. Package count and costs go down. Equipment gets smaller, neater, simpler. Simply because you get more inside every DIP or flatpack with Sprague Series 54/74 arrays.

So buy fewer parts. And make every part count. Move into MSI. With Sprague Series 54/74 arrays. Get the straight answers on complex arrays. Types. Prices. Delivery. Call Sprague now.

Decade Counter	54/7490	4-Bit Right-Shift Left-Shift Register	54/7495	4-Bit Binary Full Adder	54/7483
Divide-By-Twelve Counter	54/7492	Quad Bistable Latch	54/7475	BCD Decoder/Driver	54/7441
4-Bit Binary Counter	54/7493	Gated Full Adder	54/7480	BCD-To-Decimal Decoder	54/7442
8-Bit Shift Register	54/7491	2-Bit Binary Full Adder	54/7482	BCD-To-Seven-Segment Decoder/Driver	54/7446
4-Bit Shift Register	54/7494				

Call Sprague Info-Central (617) 853-5000 extension 5474.



For complete specifications, circle the reader service number below.

INFORMATION RETRIEVAL NUMBER 11



# News

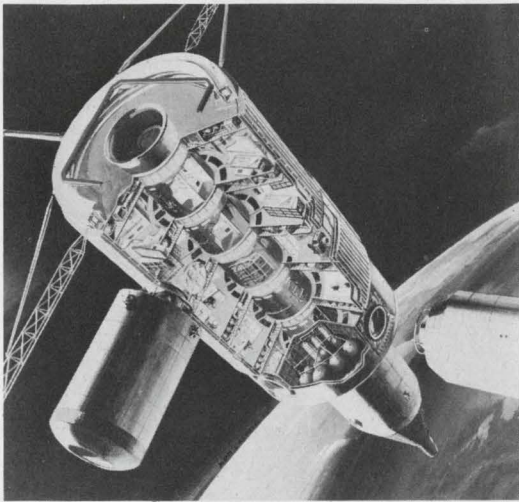

**Earth-orbiting space station** (left) for 12 men will have operational life of 10 years. Work-

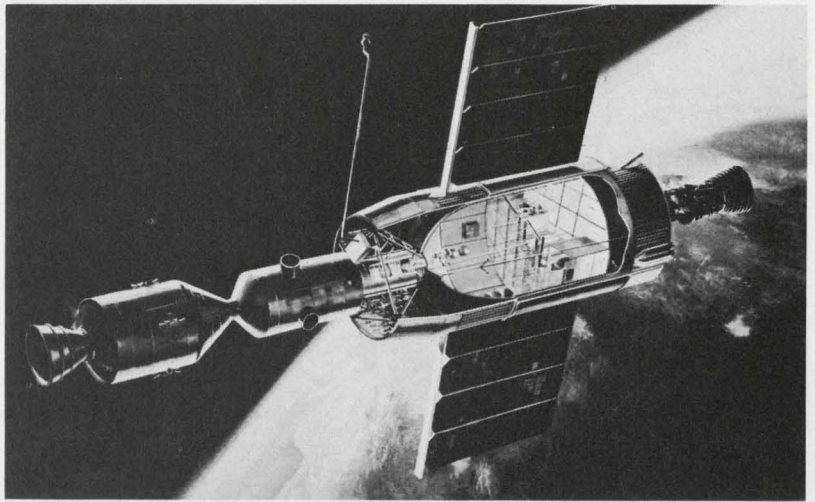

shop (right) will permit three men to stay in space up to 56 days. p. 24.



**Unless engineers become more competent** in using computer-aided design techniques to

solve their circuit problems their jobs could be in jeopardy. p. 34.

## Also in this section:

**Solid-state microwaves** advances on three fronts. p. 30.

**How to 'reap the wild wind'** and benefit. p. 38.

**News Scope**, p. 21 . . . **Washington Report**, p. 43 . . . **Editorial**, p. 51.



# VECTROL<sup>®</sup> gives you total capability in solid-state SCR control



## VSA Series

### SOFT START with AMPLIFIER

1. Ideal for transformer loads
2. For voltage regulation ( $\pm 1/2\%$ )
3. Built-in reference

ASK FOR BULLETIN RPB1013

## VTA Series

### OPERATIONAL AMPLIFIER

1. Built-in reference
2. General-purpose high gain amplification
3. Used in feedback systems

ASK FOR BULLETIN RPB1017

## VPH Series

### PHASETROL<sup>®</sup> SOLID-STATE SCR TRIGGERS

1. Single-phase or 3-phase
2. Hard firing
3. Closely matched
4. Compatible with all SCRs

ASK FOR BULLETINS  
86010, RPB1015, RPB1016

## VCL Series

### CURRENT LIMITER

1. Single-phase or 3-phase
2. Adjustable range—50% to 120%

ASK FOR BULLETINS  
RPB1011,  
RPB1019

## VVCR Series

### VOLTAGE and CURRENT REGULATOR

1. Automatic crossover
2. Dual independent adjustment

ASK FOR BULLETIN  
RPB1021

## VPA Series

### PULSE AMPLIFIER

1. For parallel firing of SCRs

ASK FOR BULLETIN RPB1000

VECTROL SCR Triggers plus accessory options offer the systems designer *all* the components needed to tailor complete controls to his own specific requirements. Predesigned by highly-experienced Vectrol SCR control specialists, they can cut down your valuable design time, thereby provide substantial cost reductions. These are standard shelf items with Vectrol, so delivery is no problem. Application engineering assistance is available to permit you to get optimum results from VECTROL SCR Triggers.

For additional information, write for those Bulletins in which you are interested to: Vectrol Operations, Sprague Electric Co., 1010 Westmore Ave., Rockville, Md. 20850.

**SPRAGUE<sup>®</sup>**

THE MARK OF RELIABILITY

45V-9184

'Sprague' and '®' are registered trademarks of the Sprague Electric Co.

**THE BROAD-LINE PRODUCER OF ELECTRONIC PARTS**

INFORMATION RETRIEVAL NUMBER 12



## New memory developments in the spotlight at SJCC

Memories appeared to be the "in" thing at this year's Fall Joint Computer Conference. Core, semiconductor, and plated-wire types were all there.

Three of the more interesting memories, though, were not yet for sale, but were announced as developments, to be available next year. Of these, the one that appears closest to large-scale production is a 8192-bit, semiconductor random-access memory system, developed by Motorola Semiconductor, and called the 8-k Memory Module.

Intended for main-frame memory applications, the hybrid unit contains both MOS and bipolar LSI circuits. The MOS circuits provide high density and low power dissipation for the storage arrays, and the bipolar circuits provide the high speed for driving, sensing and decoding. The resulting memory access time is about 120 ns, and the cycle time 150 ns.

According to Richard P. Abraham, Motorola's director of advanced integrated-circuits programs, "As the memory . . . goes into mass production we confidently expect a price on the order of 10¢ per bit for a speed of about 100 ns. By 1972 we hope that the price per bit will be reduced to about 5¢."

A new technique is used to interconnect the chips in the memory. The technique is called beam-lead laminate technology. However, the beams extend from the interconnection pattern to the chip bonding pads, instead of from the chip to the interconnect pattern. The beam leads are thus an integral part of the wiring pattern itself.

Another random-access semiconductor memory, being developed by Computer Microtechnology, Inc. of Sunnyvale, Calif., also combines the best characteristics of MOS

and bipolar chips. This 4096-bit unit will have a 200-ns access time and use beam-lead interconnections between the 16 MOS and 3 bipolar chips. Unlike the Motorola memory, which is a module containing six packages, all chips in the Microtechnology unit are in a single package.

The third memory, made by Cambridge Memories, Inc., of Newton, Mass., uses magnetic-domain memory techniques. Similar in many respects to Bell Laboratories' "bubble" memory technique (See ED 18, Sept. 1, 1969, p. 25) such memories store data in tiny magnetic spots (domains), which move through channels etched on an aluminum film. Although the immediate use for the technology will be shift register memories of about 4000 bits on a one-inch-square chip, mass memories storing up to 16-million bits should be available by 1972, says Joseph F. Kruey, president of Cambridge Memories.

### CW chemical lasers operated successfully

Two teams of scientists at opposite sides of the country have achieved a major scientific breakthrough—a successful all-chemical laser theoretically capable of producing unlimited amounts of electromagnetic energy directly from the energy of chemical reactions.

"This development is capable of ushering in a new era in atomic energy," said Dr. Sidney Benson, editor of the *International Journal of Chemical Kinetics*.

Dr. Benson, a renowned scientist at the Stanford Research Institute in Menlo Park, Calif., observed that the new laser may be capable of initiating controlled atomic fusion, thus opening the door, for instance,

for electrical power plants that use sea water as a fuel instead of uranium. With atomic fusion, one pound of sea water could produce the energy currently obtained from one million pounds of coal.

The breakthrough was reported in two brief papers published in the September-October issue of the *Journal*. One, entitled "Continuous Wave Chemical Laser," was written by D. J. Spencer, T. A. Jacobs, H. Mirels and R. W. F. Gross of The Aerospace Corp., El Segundo, Calif. The other paper, entitled "A Continuous-Wave Chemically Excited CO<sub>2</sub> Laser," was written by T. A. Cool and R. R. Stephens of the Laboratory of Plasma Studies, Cornell University, Ithaca, N. Y. and T. J. Falk of the Cornell University Aeronautical Laboratory in Buffalo, N. Y.

On May 9, 1969, the Aerospace team first saw lasing action. After that, they observed continuous radiation outputs in the three micron wavelength region at power levels of about one watt for periods of time arbitrarily limited to about 30 seconds.

The technique employed involves a supersonic nitrogen jet, containing a dilute concentration of fluorine atoms, flowing into an ambient hydrogen atmosphere and past an optical cavity. Diffusion of molecular hydrogen into the jet results in the generation of hydrogen fluoride, which lases in the optical cavity.

In the all-chemical laser, energy is released by chemical reaction, producing coherent light at conversion efficiencies considerably greater than conventional lasers.

### Cassette videoplayer demonstrated by Sony

Sony Corp.'s new cassette color video-tape player demonstrated in New York recently will reproduce a 90-minute movie-length color program on the screen with sound.

Akio Morita, Sony executive vice president, said the dual-head, helical scan player will be marketed in Japan by the end of 1970 and in the U.S. in about two years. The player, sans cassette, is expected to sell for as low as \$350 he said.

Sony plans to develop a library of prerecorded programs that it



will rent or sell. The customer will pay a basic \$20 price for the non-recorded, re-usable cassette which he keeps, and an additional indeterminate program fee, depending on the type of program he selects and the number of times the program is played. The cassette weighs a pound, is about the size of a paperback book and has a tiny built-in counter.

After a customer has played back the program, the cassette can be returned for rerecording another program.

Morita also disclosed that Sony has been working with Philips of Eindhoven in the Netherlands to develop a standard video magnetic cassette that eventually will be compatible with all future playback systems.

## Automatic transit may be tested in Milwaukee

The first rumble of what may turn out to be a revolution in transportation is being heard in Milwaukee County, Wis. Rep Henry S. Reuss (D-Wis.) has proposed that automated transit routes, or guideways, be tested from the outskirts of Milwaukee to the downtown area.

The basic means of transportation would be a "dual-mode" car, which could be connected to the guideway and automatically powered and guided from departure point to destination. Small buses, private cars or rental vehicles, each equipped with an electric motor in addition to its conventional engine, would have attachments for buckling itself onto the guideway. Automated parking garages in the downtown area would be used to store vehicles not driven off the guideway.

Allis-Chalmers, of Milwaukee, is ready to develop the guidance and power system, and American Motors of Detroit is willing to develop the vehicle.

The Highway Committee of the Milwaukee County Planning Board

has unanimously recommended that the county apply for federal and state funds to support research and development.

Preliminary experiments, conducted by Dwight M. Baumann, a professor of engineering at Massachusetts Institute of Technology, have demonstrated the feasibility of the system. The problems of city traffic, policing and pollution would be greatly alleviated, he says.

Reuss estimates that the project would take three or four years to complete, and that the costs would be \$10 to \$15 million.

## RCA plans European semiconductor plant

RCA Corp. of America has finally decided to join such U.S. giants as Fairchild, IBM and Motorola in setting up manufacturing facilities on the European continent.

The company announced that by mid-1970 it plans to have completed a \$10.7 million semiconductor manufacturing operation in the province of Liege, Belgium. The new 80,000-square-foot plant will supply customers in the European market with power semiconductor devices used in television, automobiles, data processing, industrial, military and aerospace electronic equipment.

According to C. E. Burnett, vice president at RCA's Electronic Components Div., "The rapidly expanding European market for semiconductor devices is expected to approach industry sales of between \$650 million and \$700 million by 1972 of which power devices will account for nearly \$120 million."

## Mars antenna upped in power and flexibility

A 20-fold increase in power and a three-fold increase in flexibility will be added to the 210-foot Mars antenna at the Goldstone Deep Space Tracking Network site in Goldstone, Calif.

Earl Jackson, head of the Venus Research and Development Station at Goldstone, pointed out that the transmitter power at the Mars station will be upped from 20,000 watts to a conservatively specified

400,000 watts of S-band power.

Increased flexibility comes from the development of a tri-cone antenna feed. At the present time only one feed cone at a time can be mounted on the cassegrain type of antenna. The normal cone is used for both transmission and reception in the frequency range of 2200 to 2300 MHz.

Since the transmit and receive frequencies are not the same, the cone is tuned over a broad band in order to handle both. When high sensitivity is required for receive-only operation, a new cone tuned exactly to the receive frequency is mounted in its place. When any other frequency of operation is desired, a new cone must be installed. Each time that the cone is changed, the antenna is off the air for up to 24 hours. Each cone weighs from 3000 to 5000 pounds and stands from 30 to 40 feet in height.

The tri-cone feed is, in effect, three cones mounted simultaneously on the antenna. In order to switch from one cone to another all that is required is a tilting of a subreflector to focus on the new cone. This can be done in a matter of seconds.

## Mortar barrage planned for the lunar surface

NASA scientists are planning to lay down a mortar barrage on the moon. It's for scientific, not military purposes.

The experiment is designed to study the structure of the moon and will be carried to the lunar surface during the Apollo 14 flight scheduled for next summer.

The vibrations from the explosions will be picked up by a seismometer that will transmit the signals to earth.

The astronauts will use a mortarlike device to shoot small rockets to a maximum distance of about a mile.

Scientists are particularly anxious to learn more about the "strange" geologic make-up of the moon. During the Apollo 12 mission the ascent stage of the lunar module was crashed on the lunar surface. Scientists were amazed to discover that reverberations from the crash continued for more than 30 minutes.



another  
A-B resistor  
enters the

exclusive  
circle

Here's the latest Allen-Bradley resistor—the Type BB  $\frac{1}{8}$  watt—to meet the requirements of MIL-R-39008 Established Reliability Specifications at the highest level—the S level. Now, A-B provides this "peak" performance in all four ratings—the 1 watt,  $\frac{1}{2}$  watt,  $\frac{1}{4}$  watt, and  $\frac{1}{8}$  watt. A clear demonstration of the type of leadership you've come to expect from Allen-Bradley.

An exclusive Allen-Bradley hot-molding technique ensures high uniformity from resistor to resistor—billion after billion. Their predictable performance makes them ideal for critical military applications.

For immediate delivery at factory prices, call your authorized A-B Industrial Electronics Distributor. For technical specifications write Marketing Dept., Electronics Div., Allen-Bradley Co., 1201 South Second Street, Milwaukee, Wis. 53204. Export Office: 1293 Broad Street, Bloomfield, N. J., U.S.A. 07003. In Canada: Allen-Bradley Canada Limited.

A-B hot-molded fixed resistors are available in all standard resistances and tolerances, plus values above and below standard limits. Meet MIL-R-39008 at S level for all values from 2.7 ohms to 22 megohms, except Type BB which is from 10 ohms to 22 megohms. Shown actual size.



Type HB 2 watts



Type GB 1 watt RCR32



Type EB  $\frac{1}{2}$  watt RCR20



Type CB  $\frac{1}{4}$  watt RCR07



Type BB  $\frac{1}{8}$  watt RCR05

© Allen-Bradley Company 1969



**ALLEN - BRADLEY**  
QUALITY ELECTRONIC COMPONENTS



# Designing for the coming space-station era

## Long-duration flights will require radically new approaches to data handling and on-board control

**John F. Mason**  
Military-Aerospace Editor

The advent of manned, earth-orbiting space stations will usher in a new era in space exploration—and with it, a new approach to electronic design.

Instead of designing for short earth-orbit trips or for brief visits to the moon, engineers will be asked to create space stations that will stay up for years. Instead of relying on hundreds of technicians on the ground at Houston to monitor telemetered data, ready to take over vital functions for astronauts aloft, the long-duration laboratory in space and the transportation shuttles that support it will have to be nearly autonomous.

"We can't afford the cost of a worldwide network of ground and ship-based stations supporting one or more orbiting laboratories for years on end," says Charles W. Mathews, deputy associate administrator in the National Aeronautics

and Space Administration's Manned Space Flight Office in Washington. "These vehicles will have to function more or less on their own."

NASA is reaching for this goal in stages. Here is the status of its efforts today:

- A three-man orbiting workshop is being built for launching in 1972. It is not a space station but the precursor of one.

- Studies are under way for a 12-man space station, to be operational in the mid-1970s.

- Development will begin soon on a space shuttle to carry men and cargo to and from the 12-man station.

### The data deluge

One of the staggering problems facing the space-station designers—and one that gives a rough idea of the difference between equipment for short and long-duration mis-

sions—is how to handle the mountains of data that a space station generates. Two engineers from IBM's Space Systems Center in Huntsville, Ala.—A. Adelman and A. J. Kemp—told the IEEE Electronics and Aerospace Systems Convention in Washington in October that "information generated by manned spacecraft has grown exponentially over the last decade, as have associated support personnel and facilities; if we let this trend continue unbounded, we can expect more than  $10^8$  bits per second of generated data." (Apollo missions now generate a little more than  $10^4$ .)

Looking at an "unbounded" future, Adelman and Kemp said: "To get one day's raw data down to earth, using three synchronous satellites continually with a 25-kilo-bit-per-second data link, it would take 10 years."

Obviously as much data as possible must be digested in the space station—but how much is still being debated. NASA's Mathews says:

"You can't afford to flood ground stations with raw data. You must have as much editing and data-compression capability on board the spacecraft as possible. What you want on the ground is information, not data."

### Computer satellites suggested

One possibility Mathews has mentioned is to transmit raw data to computer-processing satellites which would refine the information before sending it to earth.

Many other changes in electronic equipment will be required for long space missions, including these:

- Command and control will originate and be executed on board. This will require bigger computer memories, integrated subsystems, selective and computerized displays and a computer-actuated switching system to operate all aspects of the laboratory or the shuttle craft.

- Electronic equipment will be

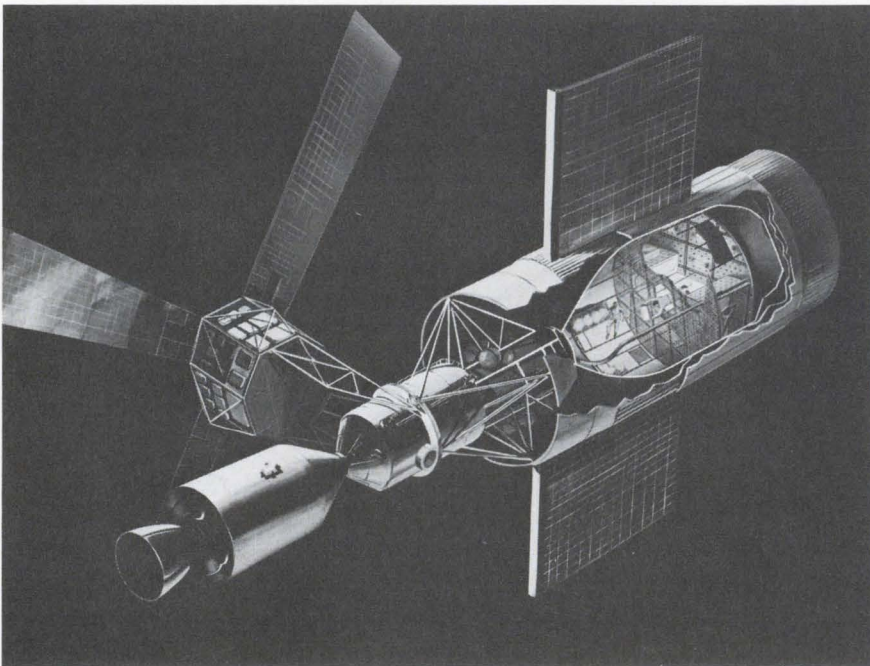

Workshop being built by McDonnell Douglas is scheduled to fly in 1972. Main experiment will be a study of the sun by telescope.



built with diagnostic, fault-isolation capability, to permit on-board repairs.

■ There will be far more redundancy, either built-in or stored on board in modular form.

■ Components won't be life-tested. "It would take too long and cost too much to life-test transistors for two years," says Robert Lovelett of NASA's advanced-missions engineering staff. "We'll just carry enough modular spares along to replace those that go bad."

### Wide benefits foreseen

When the big push for developing hardware for these stations will come depends on how much money Congress gives NASA next year. Naturally the space agency would like to move as fast as it can.

"We want manned, earth-orbiting stations for a number of applications," Mathews told *ELECTRONIC DESIGN*.

"We need them for extending our exploration of the solar system, to Mars and other planets, and for future visits to the moon. We might put a station similar to the earth-orbital station into orbit around the moon. This could serve as an operating base for trips down to the lunar surface rather than attempting to build facilities on the moon itself. The two orbiting sta-

tions could also enable men landing on the far side of the moon to communicate with the earth.

"Once outside the earth's atmosphere," Mathews continued, "the earth-orbiting base is useful for looking on out into space, unencumbered by the earth's atmosphere."

"It also provides a good vantage point for looking back to earth. The station should be helpful in monitoring agricultural changes, growth patterns, spotting water pollution, identifying geological features for locating mineral deposits."

Another application: "The weightless environment provides the opportunity to manufacture certain components with a perfection unattainable on earth. Materials might be melted free of the contamination of the crucible. Ball bearings, for example, might be made perfect within angstroms. Single large crystals with vastly reduced dislocations might be grown. And compacted powders might be converted into castings. Light and heavy metals could be alloyed, making a metal with new properties.

"A 'steel foam' could be made, like Styrofoam, by distributing bubbles of gas through the metal. It would have many different kinds of mechanical properties, different from a solid steel bar, the way balsa wood differs from hickory.

"Eventually, the cost of transportation might get low enough for larger-scale production and even renting portions of the laboratory out to industry to build components."

### Workshop being built

The basic work for laboratories in space is already under way. A three-man workshop, plus a backup, are being built by McDonnell Douglas for flight in 1972. The primary workshop is to be put into a 220-mile circular orbit by the first two stages of a Saturn V. The craft is to be fully outfitted on the ground, including its main experiment, an Apollo telescope mount for studying the sun.

The day after this workshop is launched, a three-man crew is to be sent aloft in an Apollo spacecraft atop the smaller Saturn 1B

vehicle. The crew will rendezvous and dock with the workshop, and the men will occupy it for up to 28 days. At the end of that time, the Apollo spacecraft is to return the crew to earth. Two revisits, each up to 56 days long, are also planned.

The cost for the total program is put at about \$2-billion over approximately six years.

### Going beyond Apollo

The workshop, which is part of the Apollo Applications Program, is to be more advanced than Apollo but it will not be a space station, Mathews explained. It will not, for example, have on-board capability for maintenance or for modifying equipment. The system can't be kept operating while major components and subsystems are being changed.

But it will have more on-board capability than Apollo has. For example, the workshop's command system will handle 230 discreet commands, whereas the system on Apollo can handle only 64.

Special sensors will warn the crewmen of fire, rapid changes in pressure and any solar flares detected by the telescope.

Guidance for the workshop will be no more complicated than that for Apollo. It will consist of an inertial platform, operating through both digital and analog computers and electro-optical sensors that gain positional data from the sun, the horizon and the stars.

Data is to be transmitted to earth by PCM telemetry in the 200-MHz band. It will be capable of real-time transmission and "data dump" at 22 times the recording rate. The telemetry system, which is being built by EMR, Inc., of Sarasota, Fla., can measure 1700 parameters and is equipped with 37 multiplexers.

"One of the biggest steps forward in the workshop," says Paul Schrock, a member of the engineering staff in the Apollo Applications Program, "is the exploitation of digital control. In the past we've used analog methods, but that requires heavy equipment that is relatively inflexible and usually designed for one purpose only. In the workshop our sensors, transfer devices, computers and actuation for

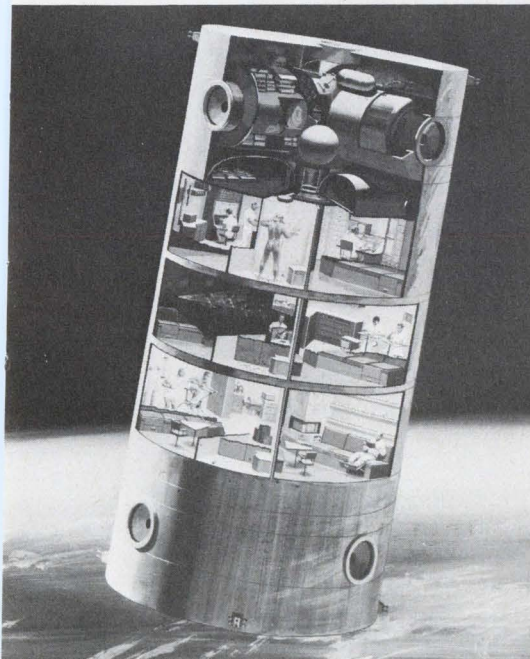

12-man space station envisioned by North American is roomier than Apollo's.



**(space stations, continued)**

control will all be digital. With a digital, general-purpose computer, we can program the system the way we want to. It's a matter of software. We will be able to use smaller, lighter instrumentation and sensors that require less power."

**Expandable station due**

The long duration space station, when it is built, will begin as a laboratory for 12 men orbiting the earth, expandable later for 50 men and, ultimately, for 100. The initial 12-man station will cost between \$1 billion and \$2 billion.

Eleven-month studies are being carried out for the station by two teams, one headed by McDonnell Douglas at Huntington Beach, Calif., and the other by North American Rockwell, Seal Beach, Calif. The studies, each costing about \$2.9-million, should be submitted to NASA by next summer.

The best conclusions of both studies will probably be merged and a new competition opened up for bid proposals to develop the station.

**Shuttles to be reusable**

Operating as a vital part of these long-duration space stations will be reusable space shuttles to

carry personnel and cargo back and forth.

As presently envisioned, a space shuttle will consist of a large vehicle to provide initial boost and a smaller vehicle to continue into orbit and perform space missions. Each vehicle, after completing its task, will fly back to earth to an airplane-like landing.

Each shuttle flight is to provide transportation for approximately 10 passengers and a cargo of 15,000 to 20,000 pounds.

Four \$300,000 studies for such a shuttle have already been completed by McDonnell Douglas, North American Rockwell, General Dynamics and Lockheed.

**Outfitting the space station**

For a crew of 12, NASA estimates it will need 10,000 cubic feet of space in the space station and total electrical power up to 30 kW or more.

"The primary power will be supplied by solar panel arrays and batteries, but nuclear power will be desirable for some applications," the space agency says.

The solar array is to be approximately 7500 square feet, backed up by electric batteries, chargers and regulators.

"A relatively high-accuracy attitude stabilization system will be incorporated for both earth-centered and celestial inertial orientations, according to the nature of

the experiment under way," NASA says. "This will call for horizon scanners, star trackers and rate gyros. Control moment gyros and conventional thrusters will be used to furnish actuation forces adequate for most station and experiment requirements."

**Handling the data**

The information-management system must do more than handle data; it must almost operate the entire space station. IBM's Adelman and Kemp say the system must help plan the whole operation, including the experiments; must automatically compute guidance, navigation and control information; and must analyze the information and then reproduce and disseminate it.

Future spacecraft and stations, according to George E. Mueller, NASA's associate administrator for manned space flight, will be so automated that the instruments and switches—which now total five times the number in a 707 or DC-8 jet liner—will be cut to "three cathode-ray tube displays."

"One display," Mueller says, "would be a digital input-output circuit and on-off switch for the computer. Two of the CRT displays would be used for attitude information—one for navigation and one for attitude control. These would operate interchangeably, so that if one failed, all information would be available from the other. And the third CRT would give the astronaut commander information about any part of the total system through his computer. This same display tube would be used to report the condition of all subsystems."

The internal communications system will provide the heart of the data management, NASA has told industry. The system will use a single coaxial cable to transfer information between all components.

"This gives increased flexibility and a means for expansion," the space agency notes. "The digital data will be multiplexed on to the cable by time-division multiplexing; video and voice will be frequency-division multiplexed. The switching center will actually be a computer that routes information

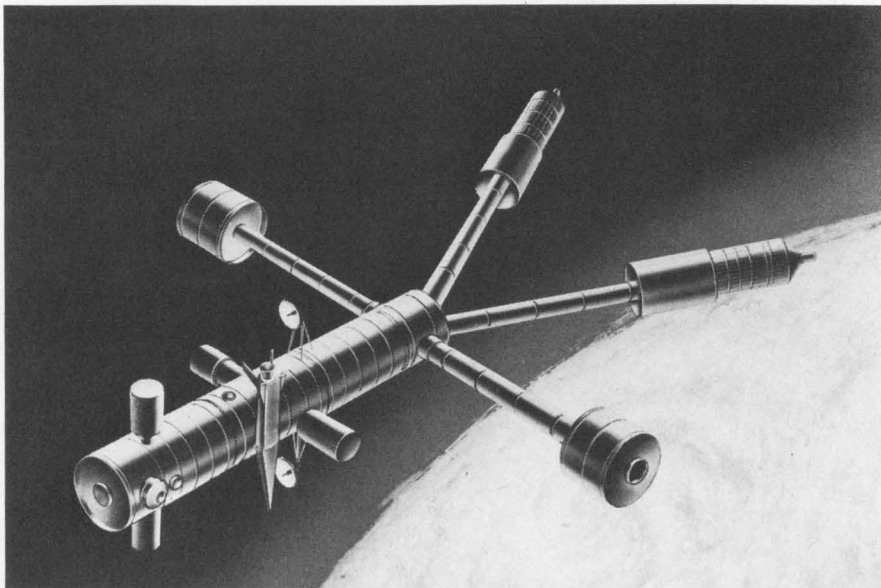

**50-man station concept** by McDonnell Douglas has artificial gravity for crew's quarters and a weightless laboratory for work.



# V CXOs

## Get 'em straight from Damon!

Whether you're in a sweat on a VCXO prototype for a tough application – or need a production run in a hurry, you can get 'em straight from Damon. Speedy proficiency in design and production of VCXOs allows Damon to deliver all-silicon solid state devices with linearity to within 1% of best straight line and frequency deviation to  $\pm 0.25\%$ .

Just glance at the specification guide below for more good news on available characteristics. Computer-assisted designs are available, too. Ask Damon today for a quote on VCXOs tailored to your specifications – and deadlines. Call or write: Damon/Electronics Division, 115 Fourth Ave., Needham, Mass. 02194. Phone: (617) 449-0800.

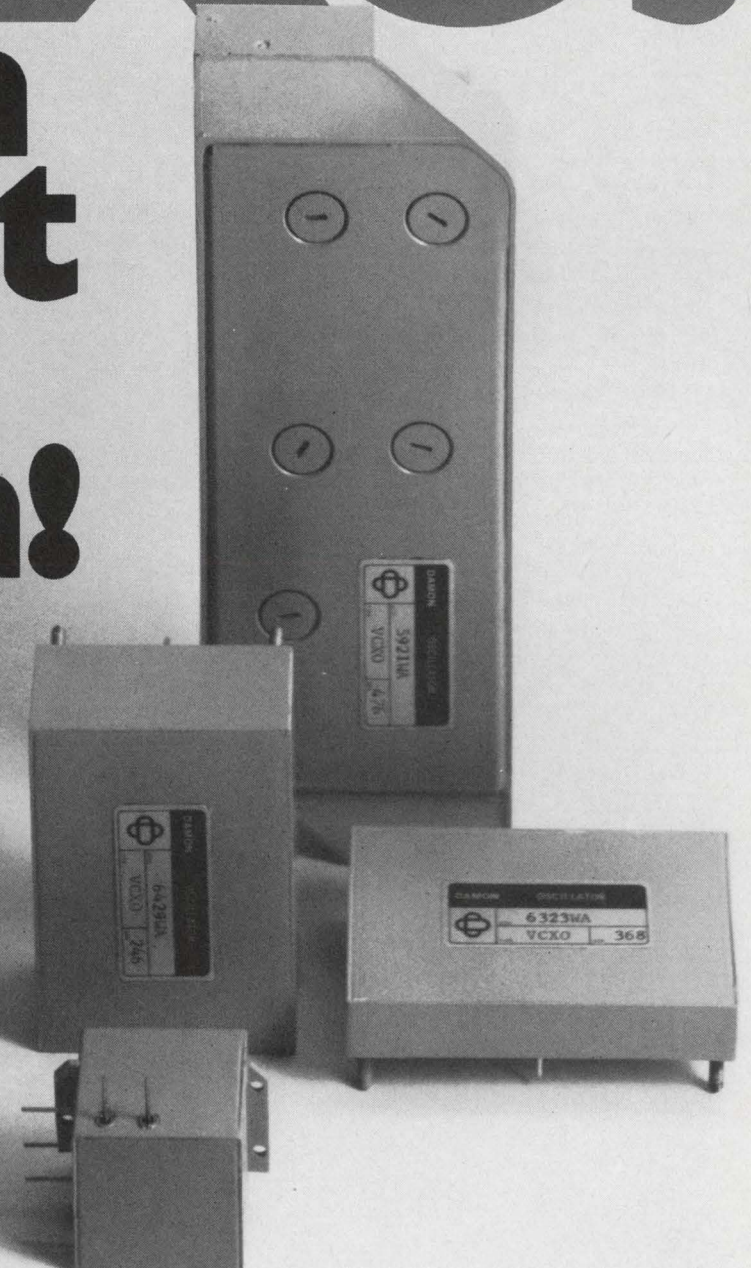

Shown approximately 3/4 size

### SPECIFICATION GUIDE\*

Parameter	Basic and Multiplier VCXOs	Mixer and Mixer-Multiplier VCXOs
Center Frequency	1 KHz to 300 MHz	100 Hz to 300 MHz
Frequency Deviation	$\pm 0.01\%$ to $\pm 0.25\%$ of C.F.	$\pm 10$ Hz to $\pm 1$ MHz
Frequency Stability 24 hr. @ 25°C	$\pm 1$ to $\pm 10$ ppm	$\pm 0.5\%$ of peak deviation
0 to 65°C (no oven)	$\pm 10$ to $\pm 50$ ppm	$\pm 2\%$ of peak deviation
Linearity	to within 1% of best straight line	to within 1% of best straight line
Minimum Deviation Rate	0 (dc)	0 (dc)
Maximum Deviation Rate	0.2% of C.F. (100 KHz max.)	10 KHz to 100 KHz
Mod. Voltage (Typical)	$\pm 5$ V peak	$\pm 5$ V peak
Mod. Input Impedance	$> 50$ K ohms	$> 50$ K ohms
Output Power Available	0.5 mw to 20 mw	0.5 mw to 20 mw
Load Impedance	50 ohms to 10 K ohms	50 ohms to 10 K ohms
Power Requirements (Typical)	$-25$ V $\pm 1$ V @ 30 ma	$-25$ V $\pm 1$ V @ 40-50 ma
C.F. Manual Adjustment Range	$\pm 0.01\%$	$\pm 5\%$ of peak deviation

\* Obviously, the limits are not absolute. The interrelationship of parameters for VCXOs are of such a nature as to permit optimization of any one or more characteristics to satisfy customer requirements.





## NEWS

(space stations, continued)

to the addressee in the internal communications system or to the external communications system for transmission.

"The coaxial cable will result in considerable weight savings. And the terminal units, which are to be built on micro-chips, will be light and have high reliability."

### Need for wiring cut

In describing the reduction of wires and cables, Mueller compares the space station with existing space vehicles. "In the checkout and launch of the Saturn V," he notes, "four large and 20 peripheral computers are used in the launch pad complex, requiring about three miles of cable, 1500 wires and four major radio telemeter links.

"Now, because of large-scale integrated circuits and thin-film memories, there will be no requirement for three miles of cables and 1500 wires."

Mueller urges that no more than six wires go into and out of any black box. One wire, he says, could evaluate all the information from inside the black box and tell the operational status of each component. The second would carry all the signals into the black box. The third would carry the total amount of the black box. The fourth and fifth would be used for standard

power supply—"standardizing the power supply will eliminate about 1000 connections from the inside of the spacecraft. The sixth wire would be a spare."

### Transmitting the data

NASA is studying four configurations for the communications network; money will decide which will be used. Looking from simplest to most complex, the number of duplex voice channels range from two to 12; reception capacity is from 10 kilobits per second to 100; transmission to earth runs from 100 kilobits per second to 1 megabit; TV ranges from none to two up and two down.

There is to be one omnidirectional, unified S-band antenna with a power output of 20 W; a 15-foot antenna with a 30-W transceiver. If there's a tie in with a Comsat satellite, there will be a 30-foot antenna with a 1-kW transceiver power. And if there's money enough, there will be a vhf transceiver with 50-W power.

A relay satellite system will undoubtedly be used. Whether NASA will build its own or use the Intelsat network, again depends on money. Intelsat's bandwidth is considered adequate, but it might not be powerful enough.

The main innovation planned in communications for the space station, NASA says, is data compression. A computer will sample meas-

urements in an experiment 10 times a second, for example, and if nothing has changed, nothing will be transmitted. Even so, plans are to transmit 150 to 200 kilobits of data per second, reduced from 10 million bits collected. This will be mainly from experiments, very little from operational data.

### Fasten your space belts

The shuttle to and from the space station will be enough like an aircraft to carry "anyone in relatively good health," Mathews says.

In line with this, L. E. Day, manager of NASA's Space Shuttle Task Group, says: "It isn't supposed to build up more than 3 gs when passengers are on board. It should have a shirt-sleeve environment for both crew [two pilots] and passengers. And guidance, navigation and checkout functions will be conducted on board."

The shuttle, like the space station, will be as autonomous as possible. And since it's to be reusable, it will be a relatively cheap investment. A round trip for the shuttle will cost about \$3-million, against \$20-million to \$45-million now for launches with an expendable booster.

Except for landing aids, the shuttle is to be self-contained.

"New technology is not required to develop any single element of the shuttle's electronic system," Day says, "but work is required to integrate all elements into a cohesive, well designed total system."

As in the space station, the shuttle will rely on computers to flip switches and check gauges. And "the necessary logic and multiple redundancy will be built into black boxes, so they can assume their own welfare and checkout," Day notes.

The push is also on in the shuttle to reduce the amount of wire. "Work is now under way to develop electronic multiplexing devices for use on data buss systems that are essentially totally immune to electromagnetic interference," NASA says. "Systems using fiber optics and shielded twisted pairs with isolating transformer systems are being developed for high-capacity and high-bit-density data buss requirements." ■■

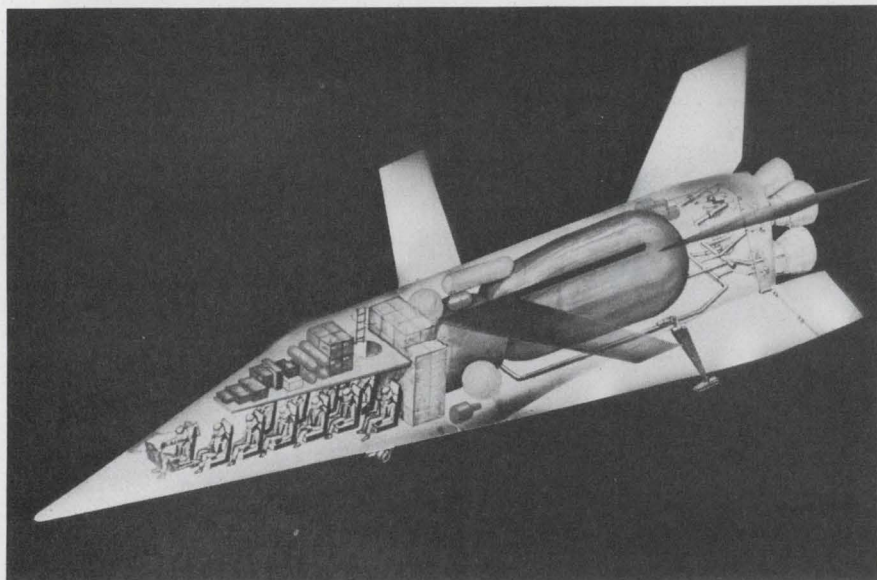

Space shuttle will carry 10 passengers and 20,000 pounds of cargo to and from stations. Except for landing aids, the craft will be autonomous.



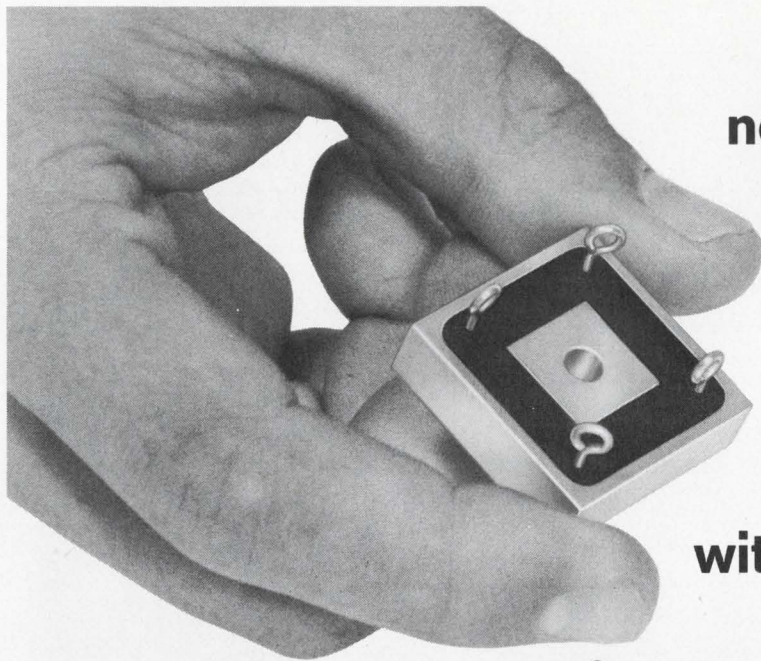

now . . . the fast-recovery  
**MAGNUM™**

**The first 20 amp,  
 500 nanosecond  
 rectifier assemblies  
 with full-power operation  
 up to 40kHz.**

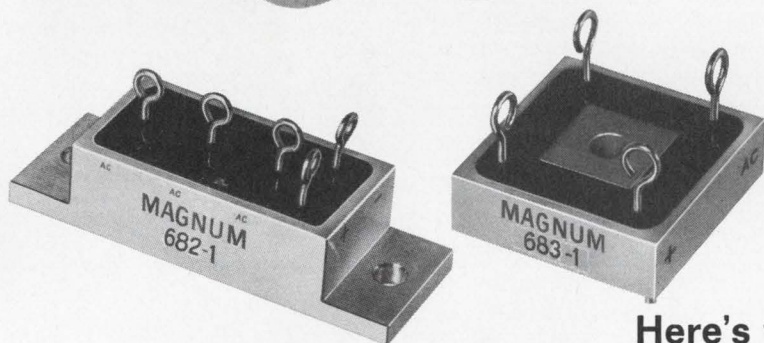

**Here's what we mean when we say  
 "They're reliability designed from the inside out."**

All four of the diodes in this aluminum heat-sink case are Unitrode's individually fused-in-glass controlled avalanche, fast-recovery high-surge diodes. So you start with monolithic parts that have typical failure rates of less than 0.0006%, and you have the added bonus of the convenience of the Magnum package.

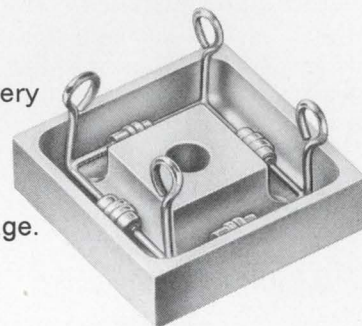

This is what's in the heart of our diodes

With the silicon die metallurgically bonded between terminal pins of the same thermal coefficient, the hard glass sleeve is fused to the entire outer silicon surface. Result — a voidless, monolithic structure.

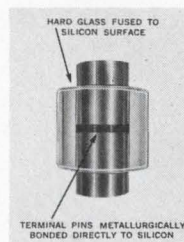

- #682 Series Three Phase 20 amp Bridges
- #683 Series Single Phase 20 amp Bridges
- #684 Series Single Phase 10 amp Bridges

PIV'S to 600V.  
 Standard Recovery 25 amp  
 Magnums also available

For fast action, call Fred Swymer COLLECT

**UNITRODE**

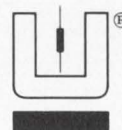

580 Pleasant Street, Watertown, Massachusetts 02172 • (617) 926-0404

INFORMATION RETRIEVAL NUMBER 15



# Solid-state microwaves gains on 3 fronts

## Simpler circuitry, higher power and displacement of TWTs in some areas are reported at NEREM

**Jim McDermott**  
East Coast Editor

Microwave designers at the 23rd annual Northeast Electronics Research and Engineering Meeting (NEREM) found the prospects encouraging: simplified circuitry . . . higher transmitting power . . . increased reliability through the elimination of tubes.

Progress in solid-state microwave power generation is making outstanding strides, according to papers presented at the Solid-State Microwave Power Generation Session in Boston. There was particular emphasis on Gunn, Impatt and LSA devices. Highlights of the presentations included discussions of these developments:

- A Gunn-diode stable local oscillator (Stalo) that replaces a complete chain of varactor multipliers.

- A new gallium arsenide (GaAs) diode that produces 1 W cw at X-band, thus doubling the output of the best previous silicon devices.

- An avalanche-diode amplifier that compares favorably with traveling-wave tubes.

### Adequate stability reported

The Gunn-effect Stalo, developed by Microwave Associates, Burlington, Mass., is designed for a stability of  $\pm 0.25$  MHz, according to Dr. Joseph F. White, the company's chief engineer for solid-state products.

Although crystal-controlled varactor multiplier chains have better stability—in the region of 10 to 20 kHz at X band—White told ELECTRONIC DESIGN that for applications in which Microwave Associates envisions using the new Stalo—such as in microwave-repeater receivers—the stability required does not exceed the available 0.25-MHz.

A standard Gunn diode was chosen for the Stalo because it is

exceptionally well suited as a local oscillator. Its a-m and fm noise compares favorably with the reflex klystron, and the Gunn unit draws only about 2 W for a 10-V supply. The Gunn Stalo output is in the region of 8 to 10 mW, since it is loosely coupled to the load to minimize frequency shift from loading effects.

The Stalo is a temperature-stabilized, humidity-proof, mechanically tuned oscillator that can provide essentially the equivalent performance of varactor chains, thus improving reliability.

Typical microwave tubes or triode sources built into an uncompensated structure have a frequency drift with temperature alone in the neighborhood of 1 MHz for each 5°C of change, according to White. The Stalo, however, was reported to have a temperature drift of only 0.5 MHz over a range of 0 to 60° C, compared with 12 MHz in an uncom-

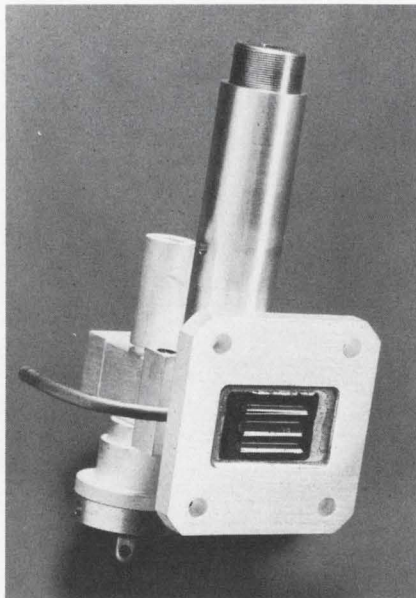

**Stabilized local oscillator** produced by Microwave Associates. Tuning is done with a screw at top, while bias is applied through the connector at bottom.

pensated cavity for the same variation. And in an unsealed cavity, White pointed out, an added drift due to humidity changes could contribute an additional 2 MHz. As a result, he said, the Stalo is 10 times more stable than a simple cavity.

Asked how Microwave Associates had accomplished this, White explained that the company had produced a mechanical structure that compensated for, or eliminated, the three major causes of drift: (1) The expansion and contraction of the cavity material; (2) Changes of humidity within the cavity, and (3) A precise means of tuning the cavity.

### Sealing was a problem

The cavity material was chosen for its temperature stability. And the humidity problem was solved by hermetically sealing the unit. But sealing posed problems, because the cavity had to be tuned; consequently a shaft had to go from the outside to the interior through these seals. To solve this problem, White said, Microwave Associates borrowed from its tunable microwave tube technology and finally came up with a sealed unit that was capable of precision tuning. The latter element posed a problem, too, because most X-band cavities can be tuned over a 1-GHz band with about 100 mils of motion. Which means that 1 mil (0.001 inch) produces a 10-MHz frequency change.

In present Stalo models an oven is being used to provide an additional margin of stability beyond the  $\pm 0.25$  MHz.

White envisioned major use of the Stalo for local oscillators in the microwave link towers sprouting up throughout the country. There is a constantly expanding market here, he reported, and as the need for more communications channels becomes more severe, even at X-band, the need for a more stable transmitter and receiver becomes





**NEW**  
 ...from CLARESEARCH  
 ...Ultraminiature  
 reed relays

■ Two new lines of Picoreed relays give you a wider choice in sensitivity, contact configurations and space-saving size. For example, note the new low profile of Types PRA and PRB—allows .375" pcb mounting centers. And note the new high sensitivity of Types PRAH and PRBH.

Both lines available in one to five Form A contacts with traditional Clare reliability. 100,000,000 operations at signal levels. 5 volt (must-operate 3.75v), compatible with standard 5 v DTL and TTL logic families. 6, 12 and 24 volt standard relays also available.

For information, circle Reader Service number, or write for Data Sheet 971A. C. P. Clare & Co., Chicago, Illinois 60645...and worldwide.

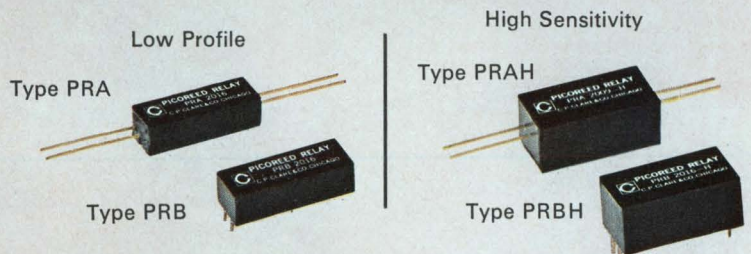

Electrical and Dimensional Characteristics	Types PRA/PRB—Low Profile		Types PRAH/PRBH—High Sensitivity	
	Form 1A	Form 5A	Form 1A	Form 5A
Operate time, including bounce	500 $\mu$ s	600 $\mu$ s	600 $\mu$ s	900 $\mu$ s
Average nominal power for 5 volt units	65 mw	250 mw	46 mw	140 mw
Pcb mounting centers	.375"	.375"	.500"	.500"
Length	.781	.800	.800	.800
Width*	.250	.675	.400	.800
Height	.187	.225	.350	.350

\*Widths vary according to number of switches. One through 5 available.





*(microwaves, continued)*

obvious. These microwave repeater units are operating in the 10.6-GHz-to-11.6-GHz region.

GaAs Impatt avalanche diodes have shown much promise as efficient devices for generating and amplifying microwaves. But compared with silicon, the GaAs Impatt yields have been low and the power rather limited. But a major advance here was described at NEREM by Wesley G. Matthei, manager of the engineering laboratories at Micro State Electronics, Murray Hill, N.J. He reported the development and production of a new GaAs diode amplifier that produces 1 W of cw power at X band—the highest output in such a device produced here or abroad. Comparable silicon diodes produce a maximum of 0.5 W.

The new diodes are more expensive—\$500 for a 0.5-W gallium arsenide unit, compared with \$300 for the same output in silicon diode. But Matthei predicted that prices should decline rapidly as production yields improve.

“The better yields we are getting will lower the cost,” he said. “Our processes have been improved only recently—so much so that we’re

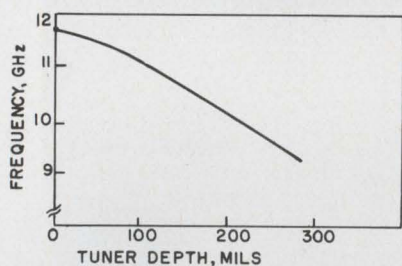

Range of tuning obtainable with Microwave Associates' stable local oscillator. The bias voltage is between 8 and 9 V.

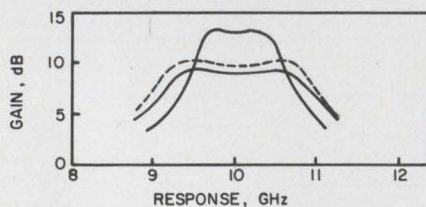

Responses of Sylvania avalanche diode amplifiers. The solid lines are measurements taken from an experimental, double-tuned amplifier. The dashed line is the computed value for a triple-tuned amplifier.

ready to produce as many as anyone wants to buy. Within six months to a year at the latest, the gallium arsenide diodes will be competitive with the silicon units.”

The efficiency of the gallium arsenide devices was reported as relatively high. In operation, a high dc input power density is required, and the output power is limited solely by the thermal-dissipation capability of the diode. Consequently the junction side of the diode must be mounted adjacent to the heat sink.

The only real limitation on power output, Matthei said, is in removing the heat fast enough to keep the diode stable. Outputs of 1 W cw have been obtained with a Schottky barrier diode when the junction temperature was cooled from 280° to 220°C. Room temperature operation lowered the output to 0.7 W.

### Reducing thermal resistance

Several techniques are available for reducing the thermal resistance of these diodes, according to Matthei. Heat pipes can be used in some instances, he said. And within the next two years, he predicted, high-power amplifiers and oscillators will be available with outputs of between 5 and 10 W.

Matthei emphasized that the efficiency of his company's new gallium arsenide diodes was 10%—about twice that of silicon devices.

As to applications, Matthei saw gallium arsenide diodes being used as amplifiers in microwave communications systems and as oscillators in microwave transmitters. However, of particular interest here, he noted, is their potential use as a transmitting amplifier in a phased array. Present systems use locked oscillators rather than amplifiers.

Micro State Electronics plans to market 1-W, X-band amplifiers within six months. These devices could work over 5 to 18 GHz. But such coverage would require a series of four or five diodes, each fabricated to the center frequency of interest.

Wideband, high-power, solid-state microwave amplifiers using avalanche diodes are already well established in a number of applications, according to Ernst F. Scherer, project engineer for solid-

state circuits at Sylvania Semiconductor Div., Woburn, Mass. He told ELECTRONIC DESIGN that several have been sold for application in microwave systems—and, according to reports, with successful results. One application of note was a microwave relay repeater, he said, and another was in a telemetry system for missile tracking.

Scherer cautioned, however, that wholesale replacement of TWTs by solid-state amplifiers—at least in the near future—was questionable.

The efficiency and wideband, high-power capabilities of the TWTs are difficult to top at present, he said. But for applications in which small size, light weight and reliability are of primary importance, Scherer said that the solid-state amplifier was on the way in.

The heart of these amplifiers—the avalanche diodes—have a reputation for being very noisy. But Scherer reported that in many applications, particularly in the output stage of a transmitter, the noise can be disregarded. He agreed that the avalanche-diode noise is undesirable in the local oscillator of a receiver, where a high signal-to-noise ratio is needed to maintain a good receiver noise figure. But in an a-m or fm system with from 60 to 80 dB signal-to-noise ratios, the limitation is not the noise from the transmitted source, but the receiver itself.

In a random selection of diodes, typical signal-to-noise figures are 30 dB, Scherer pointed out—close to the figure for standard TWTs.

To reduce solid-state amplifier noise, Scherer suggested using gallium arsenide or possibly germanium diodes in the first stages of a multistage amplifier, and he noted that RCA recently claimed to have achieved exceptionally low noise in some experimental gallium arsenide oscillators.

Distortion is a problem in these avalanche amplifiers, but Scherer said that the measurements compared favorably with TWTs.

As for future power trends, Scherer saw the development of multistage amplifiers with 30-dB gain, comparable to that of a TWT. He envisioned the final stage using some form of hybrid coupling to combine the outputs of several lower-power output stages. ■





The solid state numeric  
is ready at Monsanto.

So are 19 other LED's.

## Send a P.O.

MAN 1 shown 6x actual size.

You know we've been working on the MAN 1 visible diode numeric for several years. Well, now we're ready to take orders.

It offers all the good things you expect from microcircuits. Low power drain. Shock resistance. Happy interface with your solid-state circuitry. Plus it gives you design flexibility you've never had before. And the multi-segmented construction avoids the danger of a number being altered by a small circuit failure.

Send a P.O. and be the first designer on your block to give your

digital readout the look of the 70's.

The 19 other low-cost, long-lived LED's? Four are bright red light-emitting semiconductors that have ns switching time, diode reliability and million-hour\* life.

One of our LED's emits amber light, one green light. Five put out frequencies in the infrared. One is a coupled pair, with detector and emitter in the same package to give you a light-quick switch (5 ns rise and fall) with 3 kV isolation.

Six are room temperature lasers in a variety of miniaturized configurations. Number 19 is a bunch of new

CO<sub>2</sub> laser modulator components.

So there's the whole line. They're all currently available from Schweber, Kierulff, K-Tronics, or Semiconductor Specialists. Or from us: Monsanto Electronic Special Products, 10131 Bubb Road, Cupertino, California 95014. Phone (408) 257-2140.

Want more information on our new numeric, the MAN 1? Circle reader service #203.

For specs on the other 19 LED's, circle #204.

\* T<sub>A</sub> = 25°C, I<sub>F</sub> = 50ma. Result of step-stress testing with end of life projections.

# Monsanto



# Are company designers becoming obsolete?

## NEREM session told that trend to computer-aided engineering is helping to spur rise of consultants

Design engineers have spent years developing and perfecting the computer; now the machines are sophisticated enough to start replacing some designers.

This is one conclusion that might be drawn from new trends in computer-aided design, as reported at the 23rd annual Northeast Electronics Research and Engineering Meeting (NEREM) in Boston.

Other developments at the meeting included these:

- Designers complained that semiconductor manufacturers were not generally supplying sufficient data and modeling information to enable them to perform nonlinear circuit analyses.

- Electronic consultants reported that they were being called in increasingly by systems manufacturers to replace designers at company design-review sessions. The aim is to get competent objective inputs before a design is "frozen."

The wave of the future, speakers

at NEREM agreed, is toward computer-aided design. And because of a present lack of specialists in this field, plus big potential savings for the smaller electronic firms, new consultant engineering companies are rising to fill the gap. The heads of two such companies—Nathan N. Sokal, president of Design Automation, Inc., Lexington, Mass., and Richard R. Dickhaut, president of Dynetics, Inc., Bellevue, Wash.—said that the services they were offering might well displace many design engineers in the future, especially in small companies.

Dickhaut foresaw the larger companies in the electronics industry using the consultants not only to design circuits and systems but also to train the customers' own engineers in computer-aided designing. But for the smaller electronics companies, Sokal said, retraining of engineering staffs won't be economically feasible; these companies will simply call on the

consultants to do the design work, and the engineers with obsolete skills will be out of jobs.

An engineer at the meeting—Kirtland H. Olson, a group leader of the Lowell (Mass.) Technical Institute Research Foundation—agreed with this appraisal. He emphasized that the good electronic designer of the near future will have to be trained in computer-aided techniques to produce reliable, low-cost designs.

### More data sought

At the Device Modeling for Computer-Aided Design Session, many scientists and engineers in the audience questioned the panel of speakers on why semiconductor manufacturers were not supplying more data and models of their devices. On behalf of the panel, Dickhaut replied, "Semiconductor manufacturers are in the business of making semiconductors, not providing data."

He noted that historically, device manufacturers have supplied only the information that will support their sales efforts. Smaller device manufacturers, he added, might be more cooperative, because they are seeking a larger share of the market and, as a result, are aiming their sales efforts at the circuit designer. But the major manufacturers, he indicated, direct their efforts toward purchasing departments.

Some semiconductor manufacturers will develop device data and models for a customer, Dickhaut said, but they charge for this service.

The other panel members, who included Sokal, Emanuel Schnall, an engineer with Design Automation, and Philip Spiegel, an engineer with Honeywell, Inc., Waltham, Mass., were in complete agreement with the statements by Dickhaut.

Here too, the new consultant companies are moving to fill the gap, Dickhaut said later in an in-

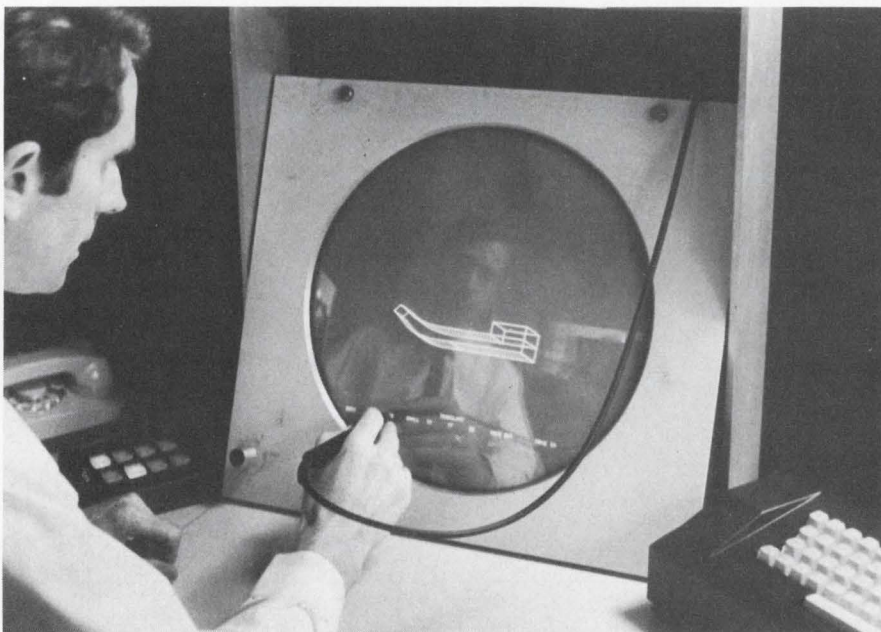

Specialists in computer-aided design, such as this engineer at Western Electric Co. Research Center in Princeton, are the wave of the future, NEREM speakers said.



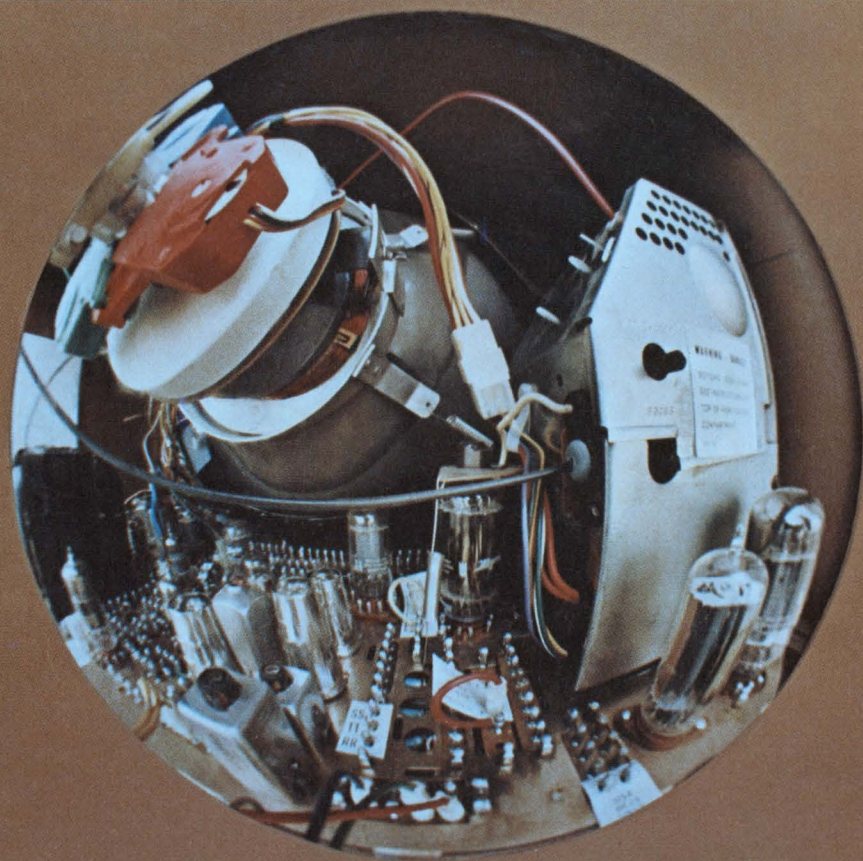

## It takes guts to build a TV set

Lots of 'em. Dozens of assemblies and sub-assemblies and components. Each as important as the other. From plug to picture every item must perform. And perform well. The customer buys what he sees. And what he sees is determined by what he does not see. That's the guts of the story.

Stackpole makes more than a dozen types of components for black and white and color television receivers. Since 1947 mostly. But even before that we produced millions of high quality fixed composition resistors for the booming radio market. Still are, in fact.

From the earliest days of television, Stackpole supplied the first ferrite horizontal output transformer cores. First for black and white. Then for color. In 1954 Stackpole introduced

Ceramag® ferrite components for the 70° color deflection system. And again in 1964, the 90° color components. Today we're working on the color 110°. In addition, we've been involved with such major television advances as Automatic Pincushion Correction.

Stackpole engineering and production know-how has contributed much to the technology of television. Our components can be found in every domestic TV set. Not only ferrites and resistors, but variable resistors and linear potentiometers; slide and rocker switches; capacitors and hard ferrite magnets. More than any other manufacturer.

Have you got what it takes to build a good TV set? Be sure. Specify Stackpole electronic componentry wherever possible. You'll get the value and performance you need. Write or call: Stackpole Carbon Company, Electronic Components Division, St. Marys, Pa. 15857. Phone 814-834-1521. TWX: 510-693-4511.



**STACKPOLE**  
ELECTRONIC COMPONENTS DIVISION

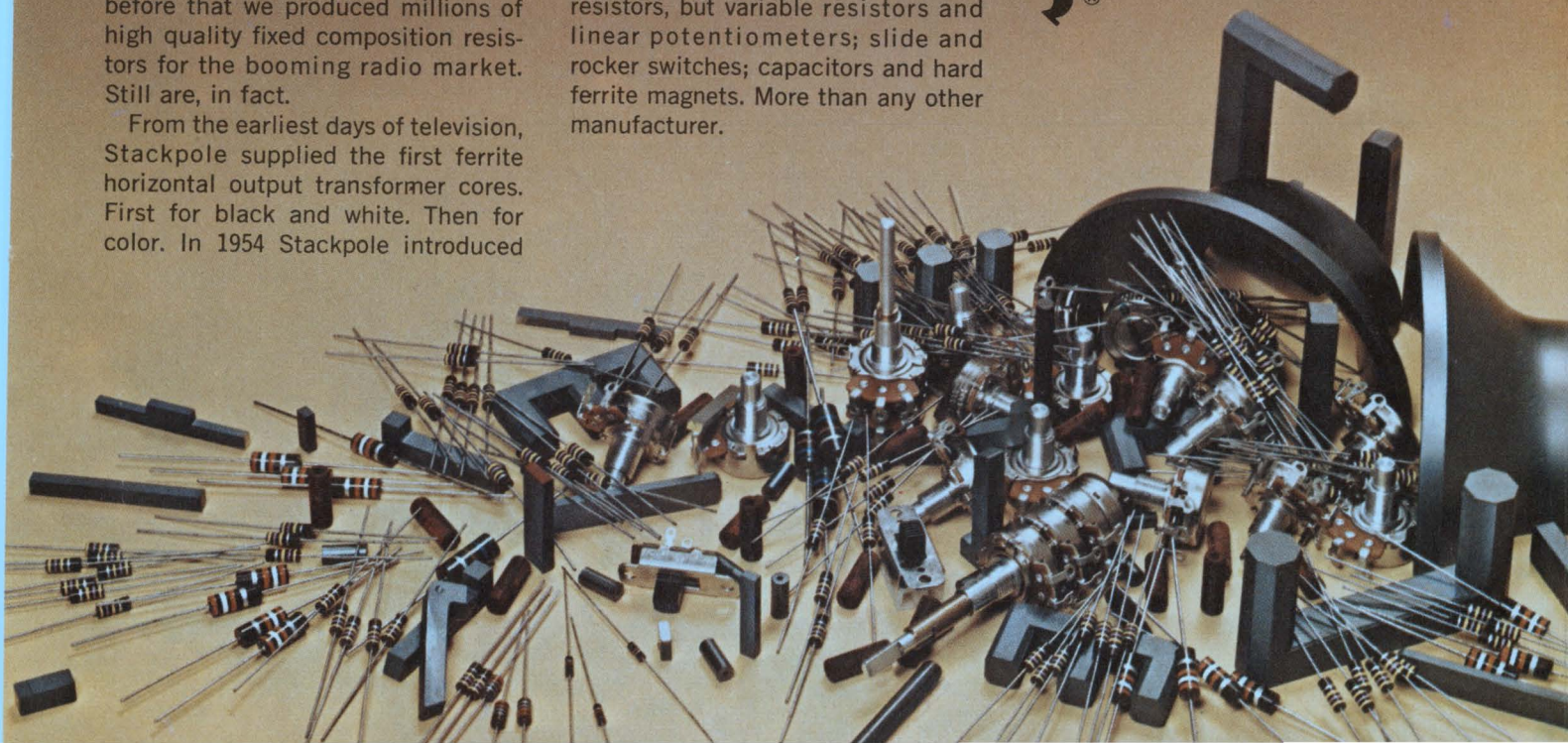



## NEWS

(designers, *continued*)

interview. For a fee, the consultants will test a semiconductor and come up with their own parameter specs.

Dickhaut asserted that not only did his company charge less for these tests than the device manufacturers but that the findings were also more timely and attuned to the needs of the circuit designers. As an example, he mentioned that his company had prepared an integrated-circuit chip so that measurements could be made at the major points of each transistor. The charge for this service was \$150, he asserted, while the same task performed by a major device manufacturer would have cost \$1000.

The representative of at least one semiconductor manufacturer at

the meeting disagreed with the panel's statements. D. Murphy, marketing manager for special products at Transatron Electronic Corp., Wakefield, Mass., said that although his company's policy was not widely advertised, engineers could obtain a designer's guide and set of application notes for every semiconductor produced by Transatron—in addition to device specification sheets. And if this information is not enough, he added, the company will provide additional data—even to the extent of designing the complete circuit free if the sales potential is high enough.

(A spokesman for Texas Instruments, Inc., Dallas, said that his company, "as a matter of policy," did not release modeling information and parameters on integrated circuits.)

As for the design-review func-

tion that consultants are performing, Sokal indicated in an interview that his company had "replaced" the customer's electronic designer in every case. Once a circuit or subsystem has been evaluated by his staff, he said, a consultant staff member attends the design-review conference and assumes responsibility for guaranteeing that the design will meet all specifications. If necessary, the consultant recommends redesigns.

In 80% of the circuit designs his company has been asked to review, Sokal reported, the designs were rejected either because they wouldn't work at all or wouldn't meet performance specifications.

Dickhaut agreed that this estimate was accurate. He said that the designs included systems in consumer TV and radio sets as well as in defense products. ■■

---

## Computer dispatches police cars in seconds

A computerized system that enables a police dispatcher, within seconds, to direct a patrol car to the scene of a crime or accident has been developed at the Western Div. of Sylvania Electronic Systems, Mountain View, Calif.

The equipment, which will be field-tested by the Mountain View Police Department this fall, includes a standard entertainment TV set, modified for a sharper picture, a Hewlett-Packard 2115 computer, typewriter keyboard and push-button entry.

The display console is an adaptation of Sylvania's Scanner color slide theater, which permits the display of 35-mm color slides through a standard TV tube. A map of the city or subdivision of any desired part is called up by computer from the 35-mm slides on file, and alphanumeric color symbols display the position and location of service calls and police cars.

"Many police departments are forced to rely on time-consuming card-index methods for assigning patrol units when complaints are received," says Jesse R. Lien, vice president of the Western Div. "After that, they consult status

boards to determine the position and availability of patrols."

### A quick reaction time

The new system, designed by Sam S. Anzelmo, Jr., greatly shortens the procedure. When a call comes in, a complaint clerk types the location into the keyboard—by street address, intersection or nearest public building. He then assigns the incident a priority—"urgent," "routine," etc.

The computer checks its directory for the location and requests further information, if necessary. Once the correct information has been entered, the computer assigns the incident a letter—A, B, C, etc.—indicating the relative time it was entered. It displays this letter, color-coded to indicate priority, on the map.

On the same map, the locations of the police cars are indicated by their identification numbers. These are also color-coded to indicate whether or not the cars are available for assignment. The dispatcher keeps track of each car by radio and changes the location as necessary by pressing a push-button.

When a new incident appears on the screen, the dispatcher selects the appropriate patrol car to handle the incident, radios that unit and alerts the computer, which displays the car assignment on the screen.

When a patrol car radios that it has completed its assignment, the dispatcher, by pushing a button, erases the event from the screen and notifies the computer to update the status of the patrol unit.

Anzelmo points out that beat changes can be made simply by changing the slides. In many police departments, he notes, beats change from one day to the next. On Saturday night, for example a three-beat area may be broken down into four.

The new system will record all processed events on magnetic tape for later analysis. City and county jurisdictional data can be programmed into the computer so that complaints are automatically relayed to appropriate law-enforcement agencies.

The system was demonstrated at the recent 1969 Association of Chiefs of Police Convention in Miami Beach. ■■



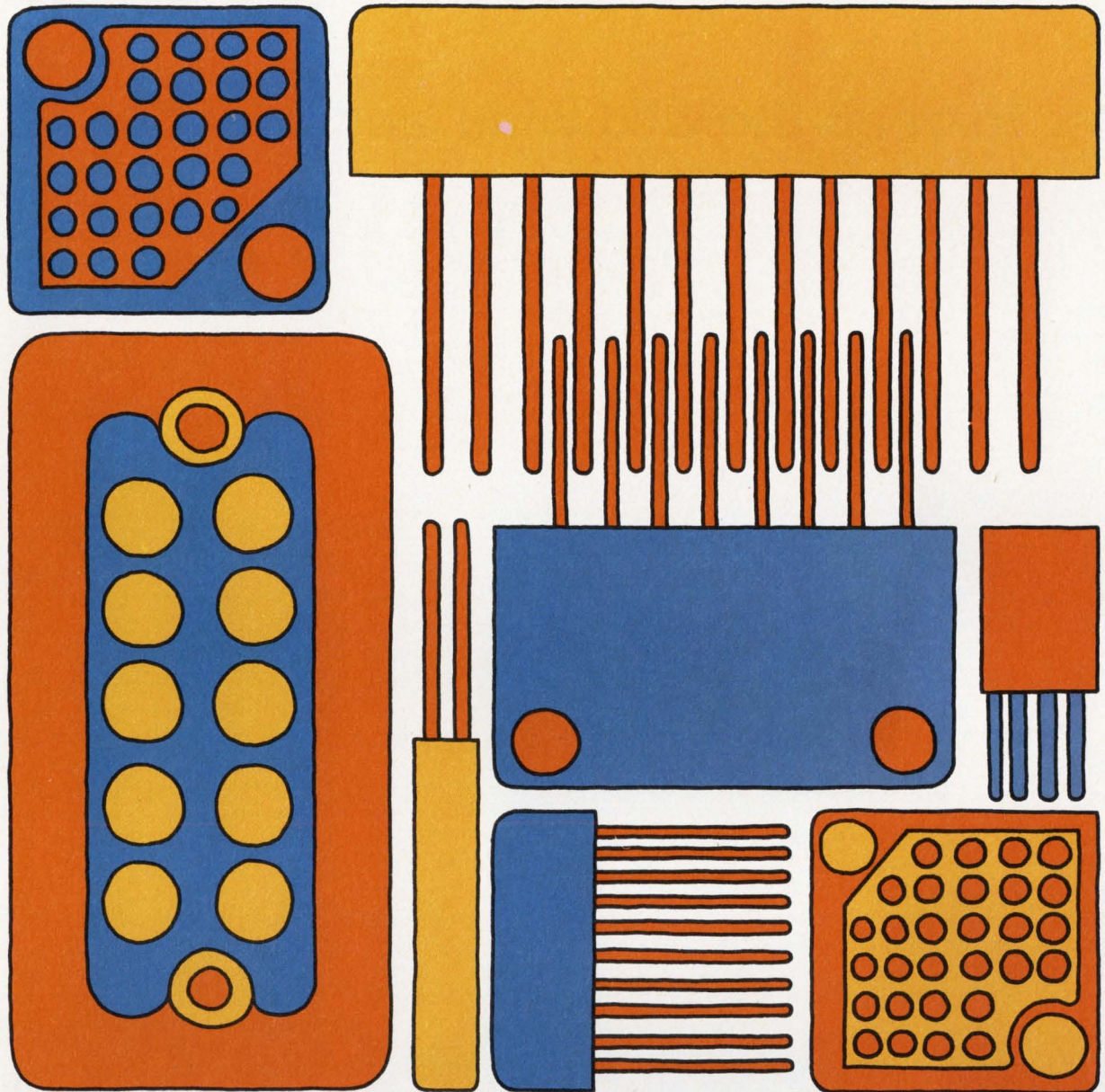

# Winchester Electronics

the long line that makes  
short work of today's problems

If you have any idea that Winchester Electronics specializes in just a special few connectors, forget it.

We make more than 31,000 different types of connectors—miniature, sub-miniature, hi-density, printed circuit. In the unlikely event you can't find just the one you need among these, say the word and we'll

make the odd ball you want. Faster than you ever thought possible—and in any quantity required, from ten to the hundreds of thousands!

Want to hear more about our capabilities in the connector field? Just write Winchester Electronics, Main Street and Hillside Ave., Oakville, Conn. 06779.



**WINCHESTER  
ELECTRONICS**

DIVISION OF LITTON INDUSTRIES

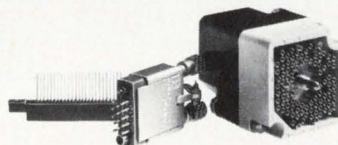

INFORMATION RETRIEVAL NUMBER 19



# How to 'reap the wild wind' and benefit

Charles G. Marrara  
Technical Editor

A power system designed for underdeveloped countries would permit farmers to "reap" the wind and use its effects at their convenience.

The system takes energy from the wind and converts it to gas fuel in this way: The wind drives a propeller, which in turn causes a generator to rotate. Current from the generator goes to an electrolytic cell, composed of positive and negative plates and a solution of potassium hydroxide and water. The current produces a chemical reaction that breaks down the solution in the cell into potassium, hydrogen and oxygen. The hydrogen and oxygen are then collected in storage tanks, to be used as fuel when needed.

The system's designers—four members of the electrical engineering staff at Oklahoma State University—say the gas fuel could be used in engines for drying grain and irrigating crops.

The system was described in a

paper, "A Wind Energy Storage and Conversion System for Use in Underdeveloped Countries," presented at the Fourth Intersociety Energy Conversion Conference, held in Washington, D.C.

According to Dr. R. Ramakumar, Dr. H. J. Allison, Dr. W. L. Hughes and Prof. K. A. McCollum, who developed the system jointly and tested it in Ethiopia, a prototype 20-kW grain drying installation could be built for \$11,930 and a 5-kW irrigation installation for \$5260. It's cheaper at present to use a diesel engine, the designers concede, but they point out that underdeveloped countries are traditionally oil-poor and that the cost of their prototypes could be reduced significantly if mass-produced.

In operation, the system's dc current or energy output is directly proportional to the propeller pitch, wind velocity and the efficiency of the generator. The rate at which gas is produced is a function of the electrical energy supplied, the concentration of potassium hydroxide and water, ambient

temperature and pressure and normal cell efficiency. At standard operating conditions, the maximum theoretically available storage system efficiency is less than 35%. Although the prototype system efficiencies measured during tests were less than the design values, the designers expect future models to yield higher efficiencies.

A gas internal combustion engine is used with the system. In the irrigation application, the engine drives a centrifugal pump that moves water from a reservoir or natural water source to the irrigation canals. In the grain-drying application, the engine drives a blower that pushes natural air to a hydrogen-burner-heat exchanger. The high-velocity dehydrated air is then fed to a grain-drying bin to remove the moisture from the stored grain.

Since the energy-supply capability of the system greatly exceeds the demands of grain-drying and irrigation applications, other uses are envisioned for it. The designers suggest that such applications as electrical power generation and desalination might prove feasible. This would further reduce the unit application cost of the system for users.

The paper also points out that solar cells, once they become available at moderate cost, could also be used as an energy source for these applications. ■■

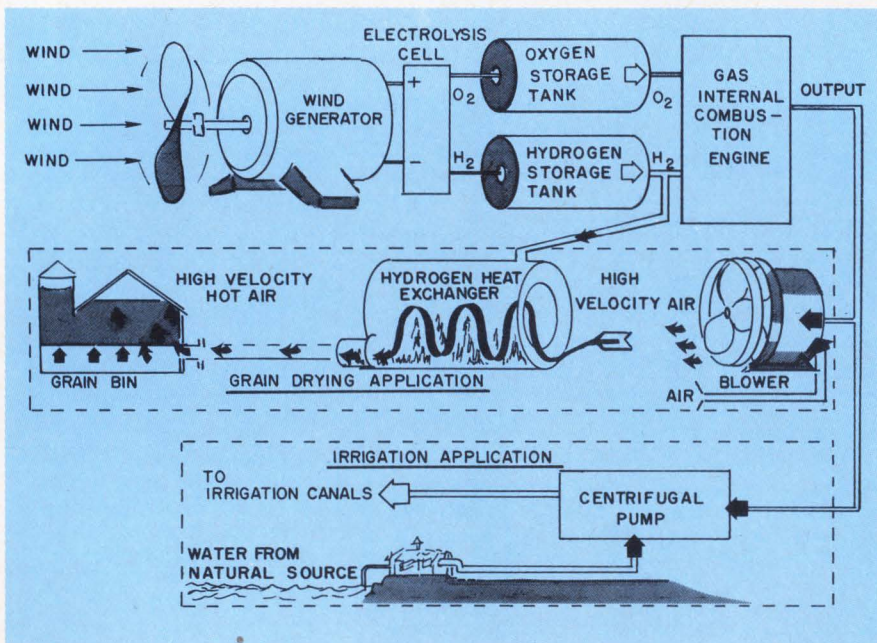

How wind is used to generate electrical current in an experimental system designed for underdeveloped countries. The power, stored in the form of hydrogen and oxygen gases, can be used in an engine to drive a blower for drying grain or to operate a pump for irrigation.

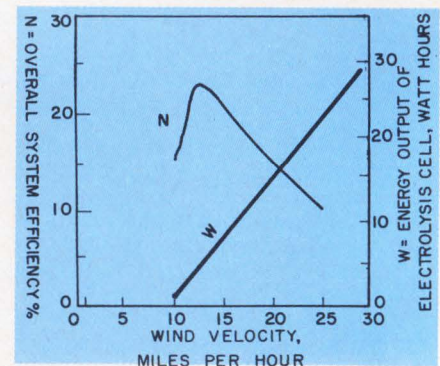

Wind velocity determines the efficiency of the gas-power system. The higher the velocity, the greater the energy output by the generator.



# WE'VE MADE DATA RETRIEVAL ABOUT 10 TIMES FASTER

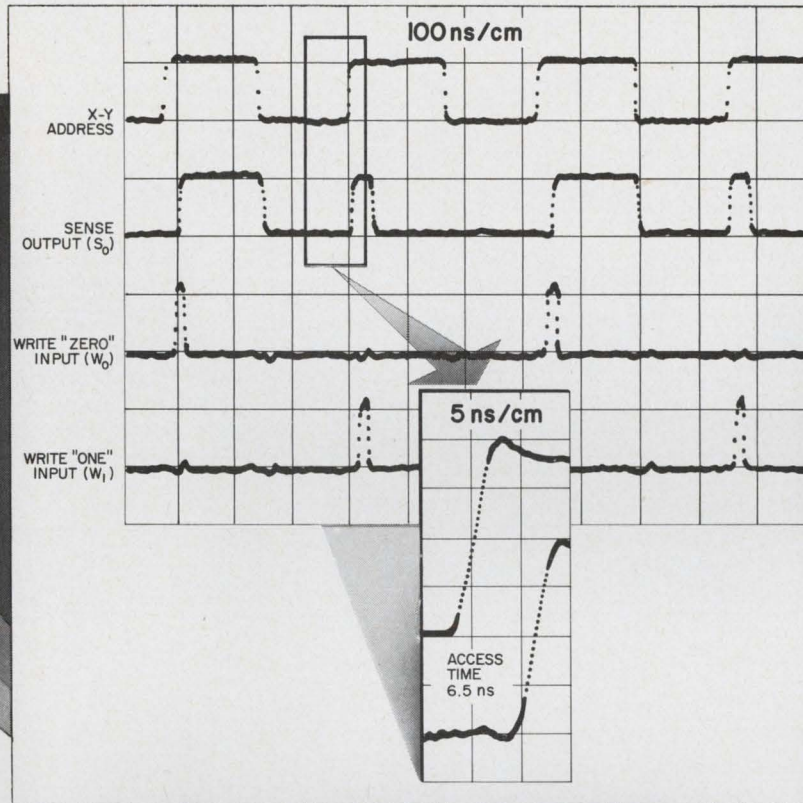

## The New RCA-CD2155D Ultra-High Speed Memory

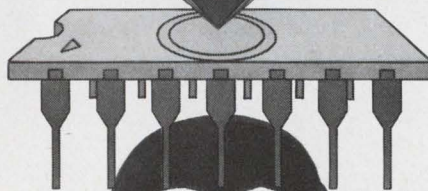

It's another IC breakthrough from RCA.

The new CD2155D can complete a write-read cycle in less than 20 nanoseconds with a typical access time of 6 nanoseconds.

That's better than 10 times faster than the best magnetic scratchpad memory; twice as fast as other "high-speed" semiconductor memories!

The CD2155D is an ECCSL (Emitter-Coupled Current-Steered Logic) Ultra-High Speed NDRO Random Access Memory compatible with RCA's CD2150 family of ECCSL Ultra-High Speed Gates. It is organized in a 16-word, 1-bit configuration and provides a "wired OR" capability for memory expansion. Other features include: low power dissipation—250 mW per package; high noise immunity—40%

of logic swing; high input impedance; advanced multi-layer metal processing and circuit design; welded hermetically sealed 14-lead dual-in-line ceramic and metal package; one-and-a-half mil aluminum wire ultrasonically bonded for extra reliability. And, the CD2155D is immediately available, the result of a full year of manufacturing experience, at a price of \$16.00 each in 1,000 unit lots.

For further details, see your local RCA Representative or Distributor, or write RCA Electronic Components, Commercial Engineering, Section G12-1./CD23, Harrison, N. J. 07029. In Europe: RCA International Marketing, S.A., 2-4 rue du Lièvre, 1227 Geneva, Switzerland.

**THINK ABOUT IT.**

**RCA** Integrated  
Circuits

INFORMATION RETRIEVAL NUMBER 20







# We make components for guys who can't stand failures.

There's no such thing as a little failure to some guys. Either your system will perform as you designed it, or it won't. Either the right answer comes out, or it doesn't. Anything less is too much to bear.

At Corning we make our resistors and capacitors like all your customers were just that demanding. We build in an extra measure of performance into everything we do. Because like you and the guys who use your equipment, we can't stand failures either.

Take our precision tin oxide resistors, for example. They're the best of the metal film class. Because the resistive tin film is completely oxidized and molecularly bonded to the glass substrate, our tin oxide resistors are impervious to moisture and environmental degradation. No other resistor can deliver the same stability and reliability over load life. They offer guaranteed moisture resistance across all ohmic values to set a standard of reliability that can't be matched by metal film, wire wounds, carbon comps or metal glaze resistors.

After a 56-day-long heat test in an environment of extremely high humidity, our tin oxide resistors

showed a resistance change of just 0.2 per cent. And in an ambient temperature test—now in its ninth year—not one of the 600 tin oxide resistors being tested has exceeded a resistance change of 1.5 per cent.

You can get this kind of extra performance in miniature size, too. With our CORNING® C3 Resistors, circuit designers are now reducing the volume and weight of their boards a full 65 per cent.

Our tin oxide resistors represent extremely good value. They offer long-term economy over metal film, precision wire wound and metal glaze resistors. And our miniature C3 resistors compete costwise with carbon comps.

And take our glass capacitors. In an extensive lab test program, the U.S. Air Force has found that our glass capacitors have much better stability and much higher insulation resistance than the ceramic, mica and the other capacitor-types they tested. That's why glass capacitors are being designed into so many major aerospace and missile projects.

Then there's our line of Glass-K™ capacitors that give you the volumetric efficiency and economy of monolithic ceramic

capacitors, but with the much improved stability and reliability that only a glass dielectric can add. They're now being used in a number of computer systems.

We have other developments, too. Like our flame proof resistors. Ideal for circuitry where functions, environments and duty cycles demand low power resistors with excellent frequency characteristics, our flame proof tin oxide resistors can withstand overloads of up to 100 times rated power without any trace of flame. And, because they open under overload, they provide protection for your other, more expensive components.

At Corning, we make components for guys who can't stand failures. Guys like your most important customers. Guys like you.

Next time you're designing a system, reach for your Corning capacitor and resistor catalogs and call your local Corning authorized distributor for off-the-shelf delivery. They'll help you design-in an extra measure of performance.

If you don't have our catalogs, ask your Corning distributor for copies or drop us a line at: Corning Glass Works, Electronic Products Division, Corning, New York 14830.

**CORNING**  
ELECTRONICS



33 3/8	26	EMP DIST	12	27 5/8	27 7/8	27 1/2	27 7/8	+	1/4
35 3/8	27 1/8	EMPOR C	1	30 3/4	30 3/4	30 3/4	30 3/4	+	3/8
46	24 1/8	END JOHN	2	24 1/2	24 1/2	24 1/2	24 1/2	+	1/4
44 1/2	47	END JOHN PF	210	51	51	51	51	+	1/2
34 1/4	18 7/8	ENGLH MIN	62	24 3/4	25	24 1/2	24 7/8	+	1/8
42 1/4	28 1/4	ENNIS BUS	59	39 1/4	39 3/4	39	39	+	3/4
39 3/4	33	EDUT GAS	4	34 5/8	34 5/8	34 1/8	34 1/8	-	1/4
24 3/4	22 5/8	ESS INC	14	25 1/2	25	25 1/2	25 1/2	-	1/4
31 1/8	18 3/8	ESQUIRE	71	21 7/8	22 3/8	21 3/8	22 1/4	-	1/8
46 3/8	31 1/8	ESSEX INT	63	35 1/8	36 1/4	34 3/8	36 1/8	+	5/8
36 3/4	22 3/4	ETHYL CP	165	25 3/4	28 1/4	25 3/4	28	+	2
53 1/4	34 3/4	ETHYL PF	46	34 1/2	40 1/2	34 1/2	40 3/8	+	3/8
27 5/8	15	EUROFOND	7	34 3/4	34 3/4	34 3/8	34 5/8	-	3/8
42	38	EVANS P	36	47	47 1/2	46 3/8	47 1/2	+	1/4
28 3/4	12 1/8	EVERSHARP	183	28	28 1/2	28	28	-	1/2
37 3/8	22 3/4	EXCELLO	16	24 5/8	25 3/8	24 5/8	25 3/8	+	1/2
38	26 3/4	FABERGE	48	37 1/8	37 1/2	36 3/4	37 3/8	+	1/4
47 3/4	33 3/8	FACTOR A	42	45	45 3/4	45	45 1/2	-	7/8
102 1/8	57 1/4	FAIRCHC	639	41 1/2	46 3/8	41	45 1/4	+	2
24 1/4	10 7/8	FAIRCH HILLER	222	15 5/8	17 1/8	15 3/8	17	+	1 1/8
27 1/4	16	FAIRMONT	31	18	18 3/4	18	18 1/8	-	1/8
17 3/8	10	FALSTAFF	148	13 1/2	13 3/4	12 7/8	13 3/4	.....	
28 1/8	18	FAN FIN	39	20 1/2	20 3/4	20 1/8	20 1/2	+	1/4
33 7/8	13 3/8	FAN STEEL INC	44	15 1/2	16	15 1/2	15 3/4	-	1/4
24	15	FAR WEST FIN	4	17 1/2	17 1/2	17 1/8	17 1/2	.....	
87 1/4	36 1/2	FARAH MF	53	56	56	54 1/2	55	-	1 3/4
43 1/4	19 1/2	FAS INT	27	26 5/8	27 1/4	26 1/2	27 1/8	+	1/8
33 5/8	22 1/4	FEDERS	78	31	31 1/4	30 7/8	30 7/8	-	1/2
37 1/2	26 1/8	FED MOG	17	27 1/2	27 5/8	27 3/8	27 5/8	.....	
24 1/2	18 3/4	FED PAC ELEC	49	21 1/2	22 1/4	21 1/4	21 7/8	+	1/8
24 1/2	19	F PAC PF	6	21 1/4	21 1/4	21 1/8	21 1/8	.....	
35	21 7/8	FED PAP BD	4	25 1/2	25 1/2	25 1/8	25 1/8	-	5/8
43 1/2	22 1/2	FED SIGNS	9	32 1/8	32 1/8	31 1/2	32	+	1/8
39 1/8	31	FED DEPT DTR	255	39	39 3/8	39	39	+	1/8
19 3/8	8 3/4	FED MTG INV	4	10 1/4	10 1/2	10 1/4	10 1/4	+	1/4
28 1/2	2181	FERRO CP	35	24 1/4	25 7/8	24 1/4	25 5/8	+	1 1/8
43 3/4	23 1/8	FIBREDD	74	25 1/8	26 1/4	25 1/8	26 1/4	+	7/8
43	23 1/4	FIELDCT M	6	29 1/2	29 1/2	29 1/4	29 1/4	.....	
54 3/8	31 3/8	FILTROL	1	34 1/2	34 1/2	34 1/2	34 1/2	-	1/4
37 1/2	23 3/4	FIN FEREDATN	146	24	24 1/8	23 5/8	23 3/4	-	5/8
46 1/2	46 3/4	FIRESTNE	36	54 5/8	55 1/8	54 1/2	55	+	1/4
50 3/4	32 3/4	FST CRT	114	45 1/2	45 5/8	45	45 1/8	-	1 3/8
42 7/8	58	FST N CITY	76	48	49 1/4	48	49	-	5/8
40 1/4	31 3/4	FST N STR	15	36 1/4	36 5/8	36 1/8	36 5/8	-	1/8
35 7/8	26 3/4	FISCHBCH	7	34 1/8	34 5/8	34	34 5/8	+	1/8
24 1/2	19 1/4	FISHR PD	26	22	22 1/4	21 3/4	22 1/4	+	3/8
27	13 1/8	FISHRS SCI	85	17 1/4	17 1/4	16 1/2	16 1/2	-	3/4
23 3/8	13 1/4	FISHING	13	14 5/8	14 5/8	14 1/4	14 1/4	.....	
32 1/2	23 1/8	FLINTKOTE	16	28 1/4	28 3/4	28 1/8	28 3/4	.....	
43 1/8	34 3/4	FLINT PF	1	36	36	36	36	.....	

CONTINUED ...

## You meet more characters in this business.

When you do business with Fairchild-DuMont, your display tube hang-ups dissolve, your horizon widens. You can think of computer readouts with 1000, 2000, even 4000 characters. You can think of tubes that are smaller than an inch across — or nearly three feet. You can choose magnetic or electrostatic deflection — or both. Most of all, you can think of Fairchild-DuMont — the prime source for *precisely* any display tube you need. Chances are the design is in stock. If not, we design it for you.

Every size and shape . . . the optics, resolution and phosphor type to suit your specific kind of alphanumeric or graphic display . . . and the parameters you need built into the *tube* rather than solved in the circuit . . . that's the kind of business we're in.

Fairchild-DuMont tackles your problem from all standpoints — glass, gun, phosphor and operating requirements. We've designed more guns, coated and modified more glass, and met tougher specs than anybody in the information display tube field.

But there's a way to find out for yourself. Discuss with us the CRT you need. We can usually have a sample on your desk in *ten days* . . . plus a quote . . . plus the fastest delivery of production tubes anywhere. Anything less would be out of character for us. Try us. And see. Call Computer Tube Sales at (201) 773-2000 for technical sales assistance.

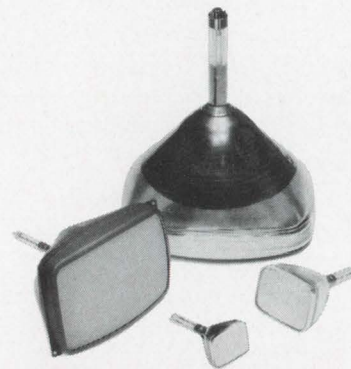

# FAIRCHILD

## DUMONT ELECTRON TUBES

A DIVISION OF FAIRCHILD CAMERA AND INSTRUMENT CORPORATION

750 BLOOMFIELD AVENUE, CLIFTON, N. J. 07015





## Is new agency to be a 'wet NASA'?

An argument between the Executive Branch and Congress over who is to handle a big new oceanographic program, and how it is to be handled, might shelve the whole project for a least a year. Nearly everyone approves the idea of a National Oceanic and Atmospheric Agency, but few agree how it is to be organized. Some refer to it as a sort of 'wet NASA,' but others say the Commission on Marine Science and Engineering Resources, which recommended the project, intended a smaller body capable of coordinating the activities of other agency efforts and providing direction to private industry.

The controversy is over the implementation of recommendations made earlier this year by the commission in a report, "Our Nation and the Sea," for a steadily expanded marine program.

Some 11 federal agencies are now involved in oceanographic and atmospheric studies. But interests vary from the scientific (the Environmental Science Services Administration) to the purely practical (Bureau of Fisheries). Meanwhile, it has been reported that even NASA is putting out feelers in an attempt to broaden its mandate and take over the national program. The variety of oceanographic and marine interests now in being most probably will be united under some agency with a transfer of people, facilities and programs.

Bills already have been introduced in the House and Senate for establishment of the National Oceanic and Atmospheric Agency. But still in question are the complexity and responsibility to be given to such an agency and to what extent it should be funded. The Administration is going its own way with a separate study to make such a determination. Congress has held hearings, but a floor fight can be expected in both houses, and there may be no determination

# Washington Report

CHARLES D. LAFOND  
WASHINGTON BUREAU

this year. Both House and Senate bills may be shelved as a result of the controversy.

## DOD plans large computer buy

A multimillion-dollar procurement to acquire, during the next two or three years, a family of standardized computer systems, has been announced by Defense Dept. Secretary David Packard. They will be used by the World-Wide Military Command and Control System and associated elements of the Intelligence Data Handling System. At the same time Packard revealed accompanying authorization to buy 34 systems and an option on 53 more.

The Air Force Electronic System Div., Hanscom Field, Mass., will be responsible for the program, and the Joint Chiefs of Staff will be responsible for system allocation and the development of common software. The computer systems will vary in size from medium to large, and in unit cost from \$1-million to \$5-million, Packard disclosed. The first large procurement is expected to be followed by a second competitive purchase, probably in fiscal year 1973.

A study of computer systems and practices has been under way at the Pentagon since 1966, Packard says. The result was the proposal for standardized computer acquisition and a recommendation that a broad competition among all major manufacturers be held. Preliminary specifications were sent out to computer manufacturers last year for comment. The ultimate procurement, the Pentagon says, will be from a single source.

The two Defense Dept. networks that will employ standardized computers presently involve 55 major activities using 131 computer systems. Through the new



procurement, the Defense Dept. hopes to improve data interchange and data distribution, reduce duplication, reduce unit cost of major systems, and eliminate the time and money now expended on a myriad of individual procurements.

## Procurement commission set for vote

Details have been ironed out for an act that would establish an investigative body to look into Government procurement procedures. The compromise bill is ready for submission to Congress.

Agreement has been reached, in conference committee, by representatives of both houses of Congress, on a revised bill to establish a Commission on Government Procurement (H.R. 474). While much of the wording of the original bill proposed by Rep. Chet Holifield (D-Cal.) was altered, the final act now proposed for passage in the Congress embodies two major changes: a commission consisting of 12 members (the House wanted 14, the Senate 9) and authorization to the commission of subpoena powers (not in the House bill).

The intent of the act is to establish an investigative body to look into all present Government procurement statutes and procedures, and into the organizations "by which procurement is accomplished to determine to what extent these facilitate" established federal procurement policy. The commission will have two years in which to make its study and submit a report to the Congress with recommendations to promote improved economy, efficiency, and effectiveness in procurements by the Government.

The act now calls for a commission consisting of three members appointed by the President of the Senate, three by the Speaker of the House, five by the President of the U.S. and the Comptroller General of the United States. Commission members appointed from each house of Congress include a member from each party,

plus a member from outside the Government. Similarly, the U.S. President would appoint two members from the Executive Branch and three from outside the Government.

## NASA to test backfire array

The first of three "backfire" antennas, each employing an array of 16 elements, has just finished preliminary testing at Goddard Space Flight Center, Greenbelt, Md. The antennas will be used to replace 32-element rod-disc arrays in a range and range-rate tracking system around the world.

The first array is being installed at the spacecraft tracking and data acquisition network facility at Rosman, N.C. The other two arrays will be installed at stations near Carnarvon, Australia, and Tananarive, Madagascar, next year.

Much of the original basic research on the backfire antennas has been performed by the Air Force at its Cambridge Research Laboratories, Mass., but NASA will be the first to field such an array as an operational system.

The basis for a backfire antenna design is the use of leaky-cavity resonators formed by pairs of planar reflectors. Energy is dipole-fed into the elements and is confined to the cavities by the surface wave structure. The advantage in such a design approach is the efficiency of the system, which permits gains of from 15 to 30 dB with comparatively simple elements.

## Color TV camera has low light level

A broadcast-quality color TV camera, designed to operate under ambient light conditions, may have a broad market in future educational TV and a variety of mobile outdoor uses. The complete camera head weighs 95 pounds, and requires only a few seconds' warm-up time.

The camera, built by Commercial Electronics, Inc., Mountain View, Calif., was shown last month at the annual National Association of Educational Broadcasters convention. The Model 270 uses three Westinghouse SEC vidicon tubes to provide full-color pictures. The cost, without lenses, will be around \$28,000.





## all fhp motors are alike?

Now that you're surprised at how different this Howard fhp motor looks on the *outside*, let's talk about *output*:

When Howard rates a motor 1/20 hp, we're not about to underpower your system with a 1/25 hp motor. We've always True Rated our fhp motors this way.

Now engineers and designers are finding that a carelessly overrated or underrated motor can cause system problems. And they want no part of either. That's why engineers look to Howard for True Rated fractional horsepower motors...

and they get them. Our computer guarantees it. And your products benefit.

Next time you look at the outside of a Howard motor, you won't find mod painting. You will find that if the label says 1/20 hp, we don't mean 1/25 hp. Or 1/15 hp, either.

Get the complete Howard True Rated story. Find out in detail why it makes no difference that all fhp motors *look* alike. It's the output that counts. Write or call Howard for Fractional Horsepower Motor Information Packet ED-129.



# HOWARD

HOWARD INDUSTRIES  
MSL INDUSTRIES, INC./MOTOR GROUP  
2420 18th STREET, RACINE, WISCONSIN 53403  
414-632-2731 TWX 910-271-2387

INFORMATION RETRIEVAL NUMBER 23



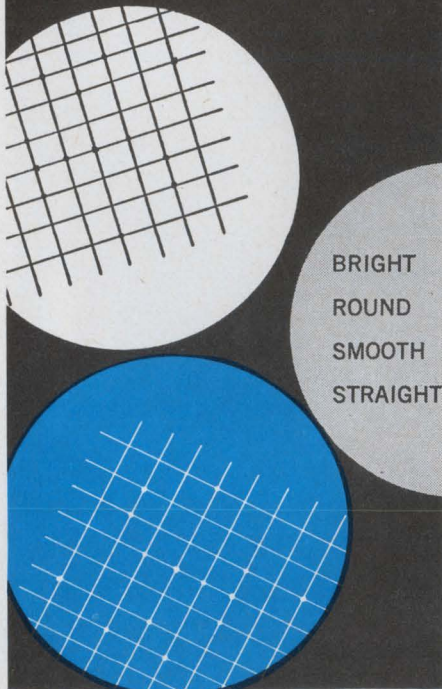

## Beryllium copper "memory" Wire

Under our quality-control each step in the production of Beryllium Copper Wire is carefully checked . . . Result: the wire is sure to conform with the high standards maintained in our plant for almost seven decades . . .



**Sigmund Cohn Corp.**

121 So. Columbus Ave.,  
Mt. Vernon, N.Y. 10553

Since 1901



INFORMATION RETRIEVAL NUMBER 24

# Letters

## Sorry, wrong plane—in the wrong place

Sir:

Regarding Jim McDermott's mid-air collision article in the Oct. 25, 1969, issue: Is not the photograph on page 25 the North Central Convair which collided with a light plane near Mitchell Field, Milwaukee, Wis.? The craft is obviously not a DC-9, the "Blue Goose" is clearly visible, and I do not believe North Central serves St. Louis.

*Daniel R. Saewert*

Motorola, Inc.  
Government Electronics Div.  
Scottsdale, Ariz.

*Thanks to Dan and the many alert readers who wrote us concerning the caption. Sorry, but we were "flying blind" on this one and our usually alert "surveillance radar" wasn't working. Dan's comments are indeed correct.*

*Jim McDermott*  
East Coast Editor

## Reader adds comments on air collisions

Sir:

When I received my copy of your Oct. 25, 1969 (ED 22) issue, I turned immediately to page 25 to read your report on mid-air collisions. I believe a few additional facts would have made this article much more clear to the average reader.

In bad weather (IFR, as defined by government regulations), only those planes under positive radar control are allowed to fly the airways and land at controlled airports (airports with control towers). There are very few mid-air collisions under these conditions, as I recall.

In good weather (VFR, as defined by government regulations), scheduled airliners make their en-

tire flight under IFR flight plans, while in general other aircraft fly under IFR flight plans only if they are flying at the higher altitudes that require these plans to be filed. When the scheduled airliners on IFR flight plans approach controlled airports, they are flying in air space that other aircraft are using under VFR flight rules. The jet airliners are descending at a high rate of speed (even though limited to certain speeds at certain altitudes and distances from the airport, according to existing government regulations), and they are approaching the airport with a nose-up attitude. This means that the pilots generally have to lean forward to look down into the flight path that their jet is taking. This is also true of high-performance propeller-driven aircraft, which many of our scheduled airlines are using extensively.

I believe the collision between the Cessna 150 and the Convair (not a DC-9) took place under these conditions. Incidentally, the collision occurred just west of Milwaukee, and not near St. Louis. The National Transportation Safety Board released its finding of probable cause of this accident on Sept. 4, and it indicated that the airliner overtook the smaller aircraft. As I recall, the testimony given at the hearing in this case indicated that the pilots of the airliner were carrying on a conversation concerning where each of them first learned to fly, while the Milwaukee approach control was advising them of the traffic. At that point, I believe both pilots should have had their noses glued to the windshield to find the other traffic, or they should have requested radar vectoring to avoid the other aircraft.

I believe that the collision over Indianapolis took place because the approaching airliner failed to see the small plane operating under visual flight rules—completely legal in every way.

*Charles E. Quentel*  
Milwaukee, Wis.



# To 150°C

CDE's Extended Temperature Range Aluminum Electrolytic Capacitors with Optimum Reliability and Low Cost.

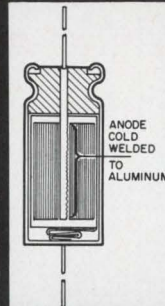

Featuring the exclusive CDE continuous cold weld connection of section to rod...insuring superior mechanical and electrical reliability. With far superior ESR to Temperature characteristics.

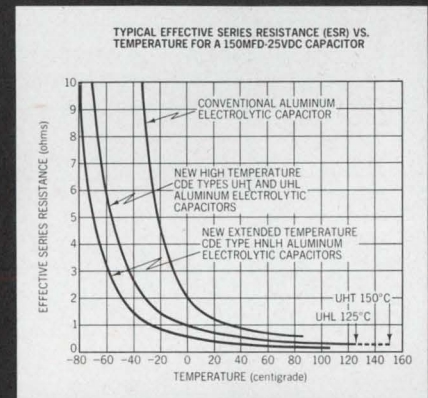

And with high ripple current capability, low DC leakage, Capacitance and DF stability. Low impedance, rugged design for vibration and shock endurance.

These units are now available for your design considerations.

**UHT**

Miniature Axial Lead Case Sizes:  $\frac{3}{8} \times 1\frac{5}{16}$  to  $\frac{3}{8} \times 2\frac{1}{16}$ ". Ratings: 3 mfd to 100 mfd, from 3 VDC to 100 VDC.

**-55 to + 150° C OPERATION**

**UHL**

Miniature Axial Lead Case Sizes:  $\frac{9}{32} \times 1\frac{5}{16}$  to  $\frac{3}{8} \times 2\frac{1}{16}$ ". Ratings: 3.3 mfd to 1000 mfd, from 5 VDC to 200 VDC, designed to meet and exceed Mil C-39018/1. (Already stock standards on our Distributor's shelves.)

**-55 to + 125° C OPERATION**

**UHR**

Large Axial Lead Case Sizes:  $\frac{5}{8} \times 1\frac{1}{8}$  to  $1" \times 3\frac{5}{8}"$ . Ratings: 10 mfd to 12,000 mfd, from 5 VDC to 200 VDC, designed to meet and exceed MIL C-39018/3.) (Also available in -55 to +85° C specifications.)

**-55 to + 105° C OPERATION**

**HNLH**

Miniature Axial Lead Case Sizes:  $\frac{1}{4} \times \frac{5}{8}$  to  $\frac{3}{8} \times 1\frac{1}{2}"$ . Ratings: 1 mfd to 600 mfd, from 3 VDC to 150 VDC. (Already stock standards on our Distributor's shelves.)

**-80 to + 110° C OPERATION**

**UFH**

Computer Grade Case Sizes:  $1\frac{3}{8} \times 2\frac{1}{2}$  to  $3" \times 8\frac{5}{8}"$ . Ratings: 5500 mfd to 300,000 mfd at 5 VDC 240 mfd to 9000 mfd at 150 VDC.

**-55 to + 105° C OPERATION**

For your design considerations, ask for details from your local CDE Sales Engineering Office. Or write:

**CDE** CORNELL-DUBILIER

50 Paris Street, Newark, N. J.



## Our D servomotor is mad with power.

That's our SU-680D-29 permanent-magnet D-C servomotor. We call it our D motor for short. It's small, rugged and powerful. It delivers 12.7 watts of continuous power output at 8600 rpm and is a natural for any servomechanism that requires a prime mover. It has a high repeatability-to-time ratio which makes it immensely stable, a 0-10,000 rpm speed range and a high acceleration Torque/Inertia. Torque peaks at 15 oz-in., 2 oz-in. continuous at 8600 rpm. It measures only 1½ inches in diameter and weighs just 8¼ ounces.

SERVO-TEK PRODUCTS COMPANY  
1086 Goffle Road, Hawthorne, New Jersey 07506.

**SERVO-TEK**  
PRODUCTS COMPANY

*For full details write for our interesting technical sheets and get mad with power yourself.*

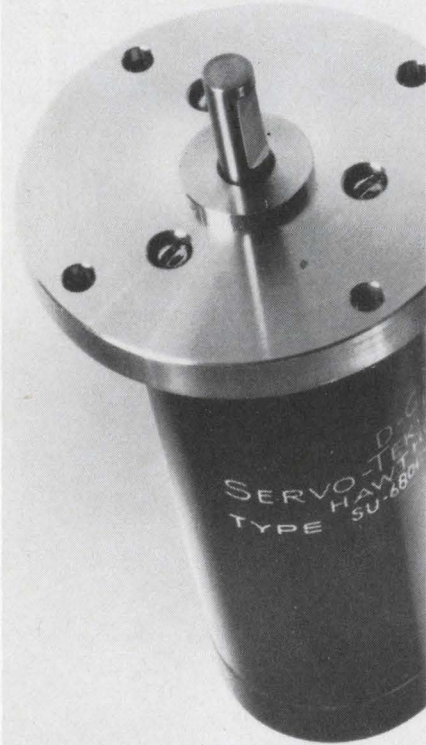

## It's a gas . . . (display, that is)

"What can you display on that panel?" ELECTRONIC DESIGN's John Kessler asked Arthur Shesser, marketing manager at Burroughs Corp., Plainfield, N. J.

"Try it yourself," said Art.

So Jack sat down at the typewriter keyboard and typed out "ELECTRONICDESIGN." He frowned. "There should be a space between the C and the D," he complained. But it couldn't be helped. Art reminded him that he had used up the 16 characters, which are all the panel will show at one time.

The machine, called Self-Scan, is a new gas-discharge display panel. It's one of the first new types of displays to come on the market—it will be sold early in 1970. And a description of it appears in Jack's special report that begins on p. 68 of this issue.

Jack began his research because information about all sorts of displays was trickling in. Gas-discharge panels are only one kind. Also in the running are light-emitting diodes and liquid crystals. CRT graphic displays are being used increasingly by all sorts of people, from airline pilots to stockbrokers, and just now the materials, the market and the money for new displays are all here at once.

Jack began his research in the New York area, visited the West Coast, stopped off in Chicago and finished up in New Jersey.

The crux of where displays are used and where they are headed depends of many factors. And how long the CRT will hold its present favored position is another question considered in Jack's story.

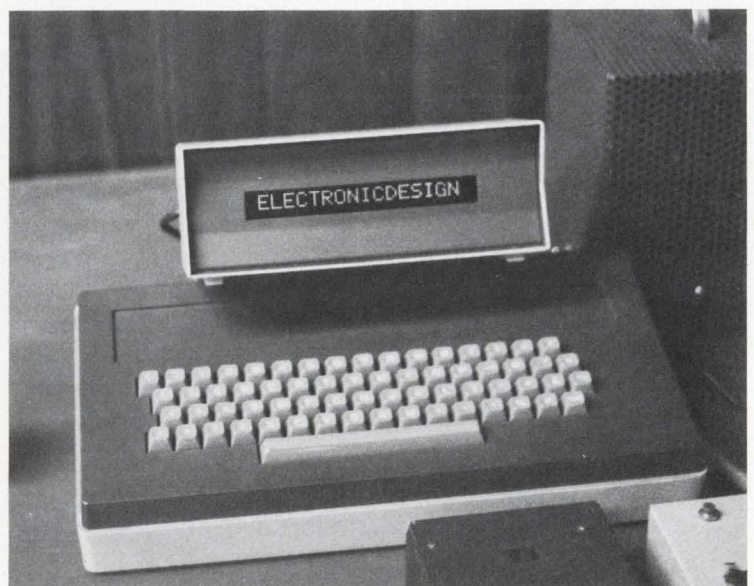

Burroughs' new Self-Scan, a dot matrix in which an array of gas-filled cells is arranged in a glass honeycomb, displays a familiar message. It's one of the first of several new types of displays that are headed for the marketplace.



**New from TRW**

**300 VOLTS**

**30 AMPS**

**$f_t > 100$  MHz**

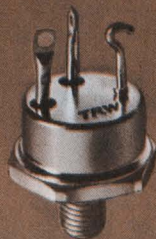

**...a new concept in power supply design**

The high switching speed and high operating voltage of TRW's new PT6905 transistor provides a major forward step in power supply performance.

You can do away with the bulky 60 Hz transformer and work directly from rectified ac power lines. Switching above 20 kHz will assure your circuit is free from audio noise.

Consider these outstanding

PT6905 characteristics:

- $V_{CE0}$  300 V
- Sat. switching time  $< 900$  ns.
- Triple diffused double oxide construction for superior second breakdown characteristics.
- Hard-solder construction and welded interconnections.

Available from stock in TO-63 or TO-3 non-isolated and TO-61 isolated collector packages.

For details and application as-

sistance contact TRW Semiconductors Inc., 14520 Aviation Blvd., Lawndale, Calif. 90260. Phone: (213) 679-4561, TWX: 910-325-6206, TRW Semiconductors Inc., is a subsidiary of TRW Inc.

**TRW**<sup>®</sup>

INFORMATION RETRIEVAL NUMBER 27





## Get plugged in on Beckman's new systems idea: Inclusivity.

The idea of "inclusivity" applies to compatibility of system modules. For such modules to be truly flexible and versatile, they must be compatible with one another; they must be compatible with modules made by all other manufacturers; and they must be compatible with the widest possible range of applications.

Beckman introduces inclusivity in its Model 3701 Universal Output Coupler (UOC), a system instrument that provides the interface between any known source of digital data and any known peripheral output device.

The UOC multiplexes up to ten sources of parallel data, with up to 32 bits per input word. Header data may be entered by front-panel switches. Other switches establish record length. Output rates range up to 100,000 characters per second.

### UNIVERSAL OUTPUT COUPLER SPECIFICATIONS

INPUT:	Up to 10 channels Up to 8 bits/character; 9 characters/word; 32 bits/word maximum
OUTPUT:	Up to 9 bits/character or up to 32 bits/word, in any format
INPUT COMMANDS:	Record; Channel Hold; Channel Skip; Format Control (changes between 2 formats on a channel to channel basis); Start; Stop; Error
OUTPUT COMMANDS:	Ready; Begin Scan; Scan Complete
DIMENSIONS:	19" wide x 7" high x 22" deep
OPTIONS:	Input multiplexer cards; Output device control cards for incremental magnetic tape, continuous magnetic tape, paper tape, teletype, on-line to computer.

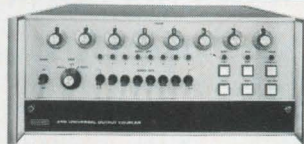

For full information on the Model 3701 or any of our systems modules, contact your local Beckman sales representative or the factory direct.

**Beckman**

**INSTRUMENTS, INC.  
ELECTRONIC INSTRUMENTS DIVISION**

2500 Harbor Boulevard  
Fullerton, California 92634

INTERNATIONAL SUBSIDIARIES: AMSTERDAM, CAPE TOWN, GENEVA, GLENROTHES, SCOTLAND, LONDON, MEXICO CITY, MUNICH, PARIS, STOCKHOLM, TOKYO, VIENNA

Major products include: voltage-to-binary converters, voltage-to-BCD converters, current-to-binary converters, current-to-BCD converters, frequency-to-BCD converters, events accumulator, binary-to-BCD converters, digital comparators, digital clocks, digital recorders, analog multiplexers, digital multiplexers, data formatter, teletype formatters, data processors



**Publisher**

Hugh R. Roome

**Editor**

Howard Bierman

**Managing Editor**

Frank Egan

**Technical Editors**

Milton J. Lowenstein

Charles G. Marrara

Don Mennie

Michael J. Riezenman

Raymond D. Speer

**Management Editor**

Richard L. Turmail

**News Editors**

Ralph Dobriner, Chief

John N. Kessler

**Washington News Bureau**

Charles D. LaFond, Chief

**Military-Aerospace Editor**

John F. Mason

**East Coast Editor**

Jim McDermott

**West Coast Editors**

Elizabeth deAtley

David N. Kaye

**New Products Editors**

Lucinda Mattera

Roger Allan

**Directory Manager**

Greg Guercio

**Copy Editor**

Marion Allen

**Editorial Production**

Dollie S. Viebig

Richard D. Grissom

**Art Director**

Clifford M. Gardiner

**Art Assistant**

William Kelly

**Technical Illustrators**

Rita Jendrzejewski

Lynn E. Thompson

JoJo Miskimmon

**Production Manager**

Thomas V. Sedita

**Asst. Production Manager**

Helen De Polo

**Production Assistants**

Bernard Wolinsky

Kathleen McConkey

**Circulation Manager**

Nancy L. Merritt

**Information Retrieval**

Genate Piccinetti

## EDITORIAL



## Any of you evil engineers ready to defend yourself?

Do you know what today's idealistic youth thinks about you? You're an engineer, and as such, you're in the mad business of making gadgetry that is polluting the world with noise, litter, and impure air and water. That's the feedback that the National Society of Professional Engineers is getting from campuses around the country.

Who's to blame for this distorted image? Well, ask yourself a few personal questions.

When was the last time you wrote a paper on the impact of your engineering job on society?

When was the last time you made a speech on this subject?

Now that we're asking—have you ever spoken out for your profession in answer to those who ridicule it? Have you ever pointed out that many engineers are engaged in solving the pollution problems that engineering is often accused of bringing about? If you've allowed someone else to speak for you, either because you were too busy in the lab or you didn't think your voice would matter, then you have an advanced case of lockjaw that has done the profession a disservice. No wonder America's youth is ready to believe only evil about engineering. Who can blame them for not being attracted to engineering as a career?

There's an old expression that "if you want it told right, you'd better tell it yourself." And as luck would have it, you have an ideal opportunity to do it now.

The National Society of Professional Engineers is sponsoring what it has forecast as the "largest National Engineers Week ever," to take place next Feb. 22-28—the week of Washington's birthday. (They say our first President was quite an engineer in his day). The 20th annual event will focus on "Engineering—Environmental Design for the 1970's."

The society suggests that professional engineers get in touch with the local chapters that are spearheading the national observance, which will feature career conferences in high schools; exhibits on engineering achievements; university seminars; open-house tours through engineering schools; talks by engineers to student and civic groups, and many other activities in which the engineer can describe his work.

How about it? Will you speak out for the good of engineering? Like it or not, the squeaky wheel always gets the grease.

RICHARD L. TURMAIL



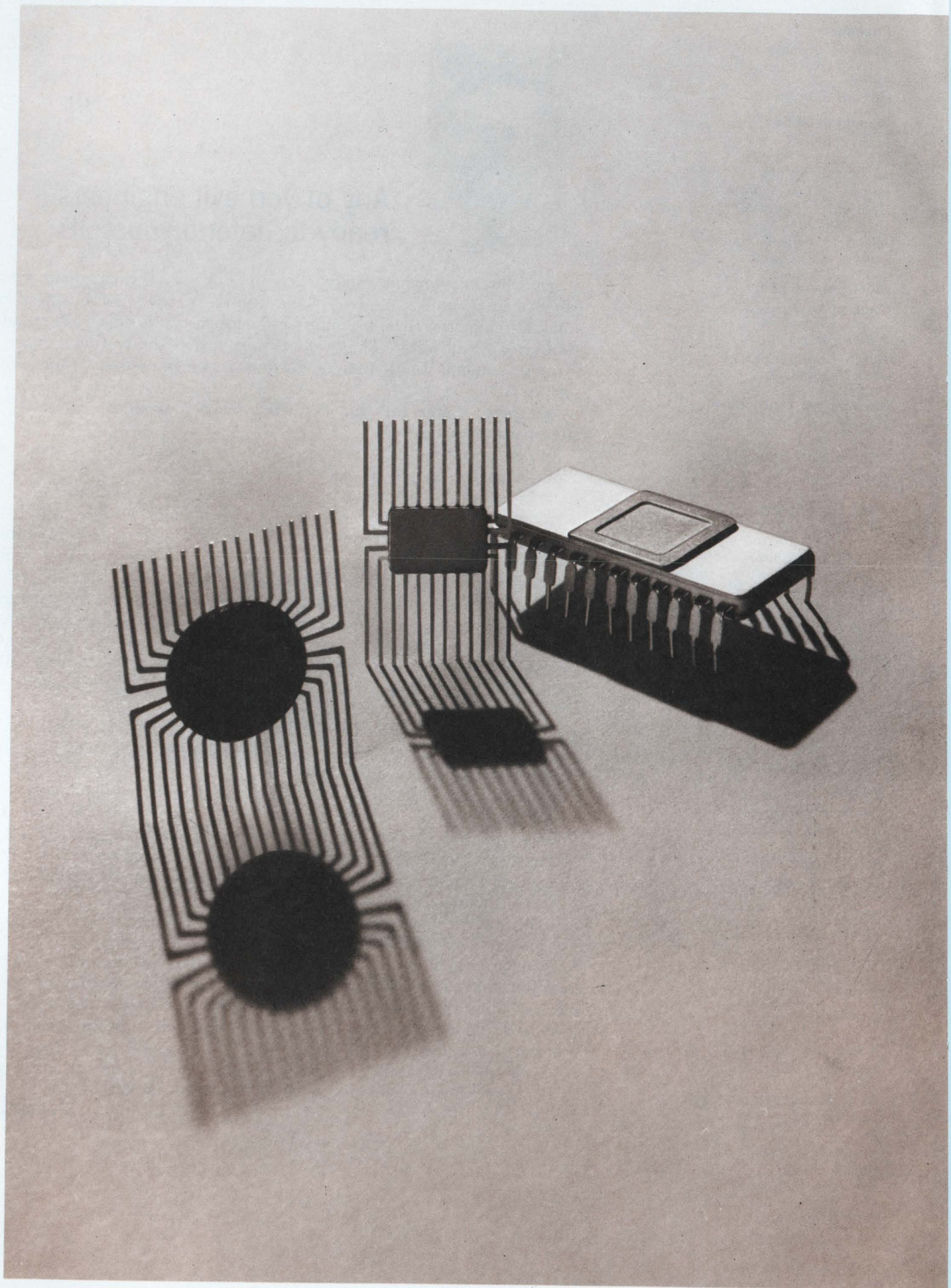



# The news-makers in MOS come from Philco.

Meet the most recent additions to our large line of standard MOS products . . . all in volume production right now.

#### **4-bit adder.**

This unique binary-BCD device does the work of four conventional full adders. It operates in either binary or BCD mode by means of a simple external control connection . . . without a converter.

Speedy? You bet! The pL4AO1C has a typical 4-bit parallel "add" time of 1.8 microseconds in the binary mode, 2.1 microseconds in the BCD mode . . . with an overall cycle time less than that required by two 2-bit adders.

Stack them to obtain any number of bits you need—in multiples of four. Packaging: 24-lead rectangular flatpack.

#### **16-channel multiplexer.**

Our 16-channel multiplexer is really versatile. You can use it for random access sampling or sequential sampling . . . just by changing the external wiring.

And you can stack them for switching in multiples of 16 channels. Or maybe you only need to switch from 2 to 16 channels—fine, no problem.

The pL4S16C is voltage-driven . . . so you don't need a complex drive network. Offset voltage is 0. Leakage current? Less than 10 nanoamps. Packaging: 34-lead flatpack.

#### **1024-bit static ROM.**

Output of our newest ROM is static . . . data remains valid as long as the selected address is held.

This means data is ready and waiting . . . when you need it.

Bit pattern is 128 8-bit words with typical access times of 2 microseconds. Packaging: 24-lead hermetic DIP.

#### **And . . .**

We make other highly reliable MOS products at our Lansdale plant—one of the largest facilities of this type in the country. Things like binary counters, gates, shift registers, and dynamic ROM's . . . for immediate delivery. Still more are in the works.

So if it's MOS, check us. We're probably doing it now. Write or call MOS Marketing, Philco-Ford Microelectronics Division, Blue Bell, Pa. 19422. (215) 646-9100.

**PHILCO** 

*The better idea people in MOS.*



# SWITCH CRAFT FORUM

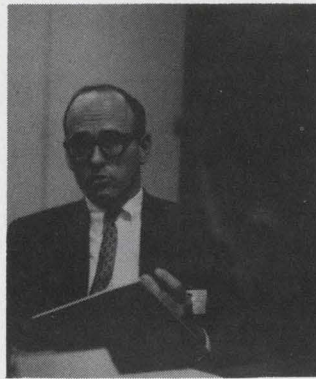

O.K., I'm convinced you've got something new. But, what if I need a miniature size lever switch, or special lighting? Would these have to be engineered from scratch?

Actually, Switchcraft makes a greater variety of lever switches than anybody else. (Just circle the reader service number for proof). Let's look at your requirements and see if we can match your specs from our regular line of switches.

Miniaturization poses no problems. Our miniature "Feather Lever" switch (Fig. 2.

Look, a lever switch is a lever switch is a lever switch. As far as I know, there hasn't been anything new or different in lever switch design since the old telephone type that was introduced over seventy years ago.

How about a totally new telephone type lever switch? Switchcraft recently intro. . . . .

Sorry to interrupt, but when I say "new", I don't mean just changes in the properties of materials or construction changes brought on by the value analysis people. Unless your lever switch is compatible with modern circuit procedures, then in my book it isn't "new".

Fair enough. Let's just look at one of the compatibility problems regarding lever switches and solid state switching devices.

Manual switching devices often introduce transients into the controlled circuit because of contact bounce, etc. Semi-conductor circuits are highly susceptible to these transients and false triggering can easily result.

The new Switchcraft Series 41000 "LT" Switch (Fig. 1) is a new telephone type lever switch that has a specially designed damping block to reduce contact bounce and a rugged "U" shaped frame for increased spring stack stability under conditions of vibration. Another feature is a unique "Can't Cheat" detent guide that prevents accidental actuator by-pass of a switching position. This protects your equipment from damage and guards against programming failures, too. Besides, this new switch extends only 2 7/8" behind the panel, providing the smallest telephone-quality lever switch on the market.

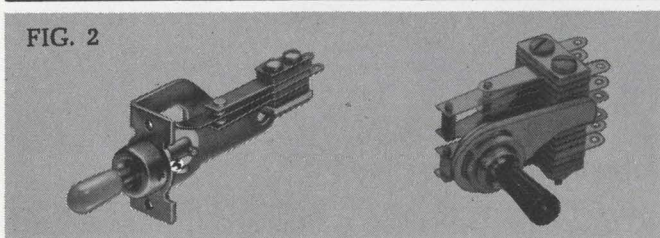
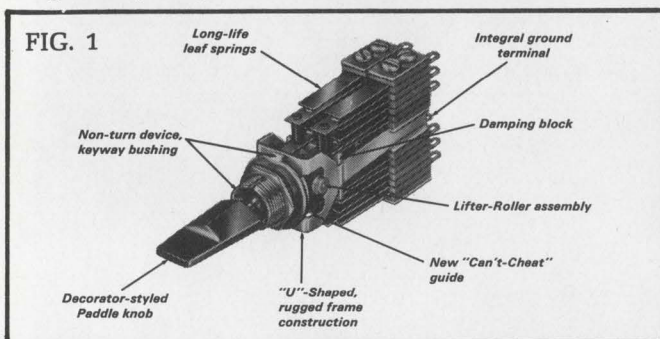

left) uses only 7/16" front panel mounting space. It's only 1 3/4" deep, and that's a lot less than the conventional type. When your behind-the-panel space really gets critical, just shift to our Series 12000 type (Fig. 2 right) that has the springs mounted parallel to the mounting surface. Behind-the-panel depth is only 7/8".

When you need lighted switches, take a close look at Switchcraft's "Lever-Lite" Series. They let one lamp do

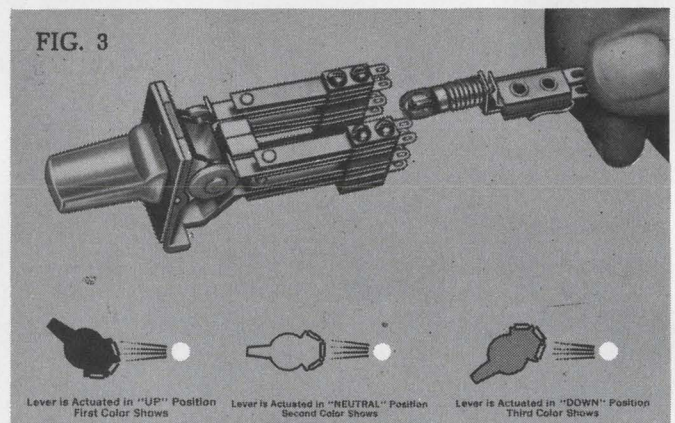

the work of three by a unique system of color filters. You can have a complete color change for each position, and need provision for only one light circuit. Fig. 3 shows how it works and, incidentally, the lamp assembly snaps out for quick replacement and has a spring loaded socket just to keep the lamp from jarring loose.

If you really want flexibility, then check the Switchcraft Series 16000 "Telever" switches. You can convert it from locking to non-locking right in the field, in just a matter of minutes. It requires only one mounting hole, too, and that's being pretty versatile for a standard telephone type switch. What more can we say?

**Just make sure my staff gets all the back-up information on your lever switch line. They'll want complete technical details.**

All we need is their request on your company letterhead for our "FORUM FACTS on Lever Switches" handbook. We'll also add their name to our TECH-TOPICS mailing list. This engineering-application magazine is received by over 10,000 design engineers every other month and features informative, technically oriented application stories on switches and related products.

**SWITCHCRAFT**  
INC.

5529 North Elston Avenue • Chicago, Illinois 60630



### MOLY-PERMALLOY POWDER CORES

16 standard sizes with ID's from .110" to 1.40", and OD's from .250" to 2.25". Guaranteed  $\pm 8\%$  inductance limits on toroids with permeabilities of 14, 26, 60, 125, 160, 200, 300 and 550. Available either stabilized or unstabilized with temperature.

### TAPE WOUND CORES

Made from nickel, silicon, or cobalt irons. We supply all AIEE standards plus special sizes in thicknesses from  $\frac{1}{2}$  through 14 mils. All sizes boxed in phenolic or plastic, aluminum or GVB-coated aluminum boxes.

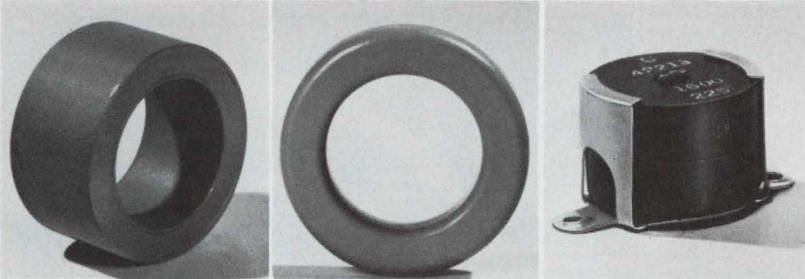

### FERRITES

Guaranteed linear temperature coefficients on 750, 1400 and 2000 perm materials. Flat temperature coefficient on 2300 perm material also guaranteed. A total of 175 part numbers to choose from.

### BOBBIN CORES

Made from Permalloy 80 and Orthonol<sup>®</sup> strip .000125" to .001" thick and .023" to .250" wide. Diameters range to less than .050", with flux capacities as low as several maxwells.

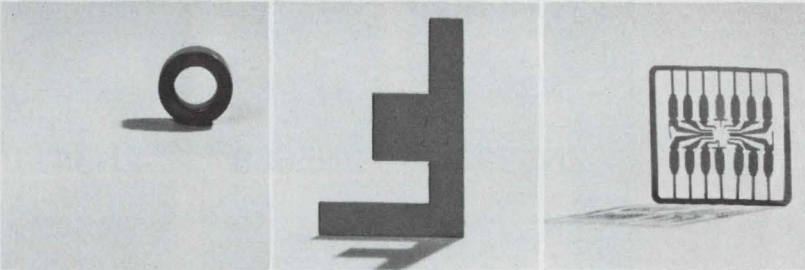

### PHOTOFAB<sup>®</sup> PARTS

Precision flat components chemically milled from almost any magnetic or specialty alloy. Thickness tolerances range from  $\pm 5\%$  to  $\pm 10\%$ , depending on thickness and type of material.

### MAGNETIC LAMINATIONS

Nickel-iron materials in thicknesses of .004", .006" and .014". 38 standard shapes in sizes from DU-87 and EI-12 down to EI-093, EE-30-31 and F-094.

## Magnetics Inc. gives you total quality control and single-source responsibility on every component

At Magnetics Inc., we're particular about what the finished component does for you. So particular that we maintain up-tight control right from the start. On ferrites and powder cores, we begin with the exact blending of powders. Our metal strip products also evolve from closely controlled custom blending and composition. This emphasis on precision, from start to finish, results in product uniformity—you get optimum characteristics and full-measure performance every time. That's what we mean by single-source responsibility. For additional information on any of our products, mail coupon today.

Magnetics Inc.  
Dept. ED-103, Butler, Pa. 16001

Please send me additional information on:

Tape Wound Cores  Bobbin Cores  Moly-Permalloy Powder Cores  Ferrite Cores  Magnetic Laminations  Photofab Parts  Specialty Metals

Name

Title

Company

Street

City  State  Zip



Tape, Powder, Bobbin, Ferrite Cores • Laminations • Photo-etched Parts • Specialty Metals • Engineered Control Systems

INFORMATION RETRIEVAL NUMBER 31



# There's a big difference in P-Channel JFETs

2N3330	2N4360	2N5462	2N5476
2N3909	2N5265	2N5463	MFE4007
2N3909A	2N5266	2N5464	MFE4008
2N3993	2N5267	2N5465	MFE4009
2N3993A	2N5668	2N5471	MFE4010
2N3994	2N5669	2N5472	MFE4011
2N3994A	2N5270	2N5473	MFE4012
2N4342	2N5460	2N5474	MPF161
2N4343	2N5461	2N5475	

## Motorola's 35 types are available NOW

Whether your requirements involve a familiar, established design or you are exploring new applications, Motorola's 35 standard P-JFET amplifiers offer the broad selection of metal can and Unibloc\* plastic types to do the job. Deliveries? You'll get what you order when its promised . . . from the "Production House of the Industry."

Here is the kind of variety we're talking about when we say broad selection. Yfs minimums range from 60 to 2500  $\mu$ mhos and maximums go from 180 to 8,000  $\mu$ mhos @ 1.0 kHz.  $I_{DSS}$  (min) is as low as 0.02 mA and as high as 7.0 mA. Gate-source breakdown voltages of 20 V, 40 V, and 60 V are available. Prices start at .37¢ and top out at \$5.85 in 1K-up quantities and nearly half are under \$2.00.

A combined FET cross reference and selector guide is available to tell Motorola's complete FET capability story, with full information on P-Channel JFETs included. Write to Motorola Semiconductor Products Inc., P. O. Box 20912, Phoenix, Arizona 85036, or to place an order contact your Motorola distributor or sales office.

*-where the priceless ingredient is care!*



**MOTOROLA**  
Field Effect Transistors



Progress Report  
**CERAMICS**  
That Conduct Heat!

## **BERYLLIA CERAMICS**

.....

In recent months there have been significant technical advances in AlSiMag® BERYLLIA Ceramics. AlSiMag® 794, an extremely dense and fine grained 99.5% BERYLLIA composition, has demonstrated its superior mechanical properties. Its modulus of rupture is typically 33,000 psi. It can be processed to close tolerances as fired. Where necessary for ultra precision, it can be ground and lapped.

### **HIGH THERMAL CONDUCTIVITY**

The high thermal conductivity of beryllia ceramics gives superior resistance to thermal shock and permits the ceramic to serve as a heat sink as well as an electrical insulator.

### **EXCELLENT ELECTRICAL CHARACTERISTICS**

The dielectric strength of AlSiMag 794 is typically 230 volts/mil on a sample 250 mils thick. Electrical losses are very low, the loss factor at room temperature and 1 MHz is .0011.

### **METALLIZED BERYLLIA**

AlSiMag® BERYLLIA Ceramics can be supplied metallized using the refractory metal process. Single source responsibility and integrated facilities, including ceramics, precision pattern generation plus plating (including gold) offer savings in time and cost.

### **NEW PRODUCTION CAPABILITIES**

AlSiMag® BERYLLIA Ceramics can now be processed, in general, in the same wide range of designs and to the same close tolerances as the well known AlSiMag® alumina ceramics.

### **PROTOTYPES**

Prototypes to your sketch or prints can usually be supplied at reasonable cost for your evaluation. Give us your operating requirements and our technical people will be happy to work with you.

**BULLETIN NO. 693**  
sent on request.



CODE IDENT. NO. 70371

PHONE 615 265-3411 • CHATTANOOGA, TENNESSEE 37405, U.S.A.

**American Lava Corporation**

A SUBSIDIARY OF



For service, contact American Lava representatives in Offices of Minnesota Mining and Manufacturing Company in these cities (see your local telephone directory): Boston: Needham Heights, Mass. • Chagrin Falls, Ohio • Chicago: Elmhurst, Ill. • Dallas, Tex. Indianapolis, Ind. • Laurens, S. C. • Los Angeles, Calif. • Metropolitan New York: Ridgefield, N. J. • Up-State New York and Canada: Phoenix, New York • Orange, Conn. • Philadelphia, Penna. • Roanoke, Virginia • St. Louis: Lee's Summit, Mo. South San Francisco, Calif. • International: c/o American Lava Corporation, Chattanooga, Tenn. 37405, U.S.A., TELEX 558432.

68th  
YEAR  
OF  
CERAMIC  
LEADERSHIP



# TWO ROUND TRIP AIRLINE TICKETS BETWEEN NEW YORK AND PARIS!

HEATHKIT® COLOR TV—EICO "CORTINA" STEREO RECEIVER  
ACCUTRON® WATCH—110 VALUABLE PRIZES IN ALL!

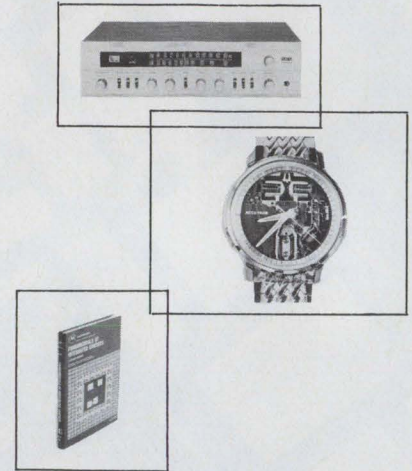
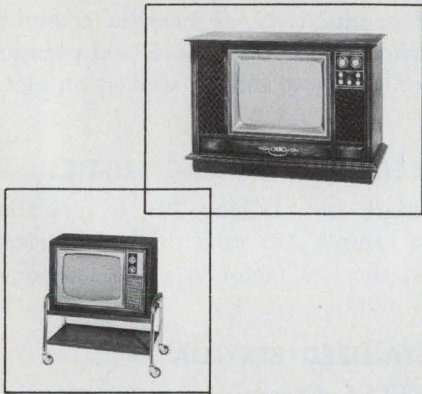

## Electronic Design

# 1970 TOP TEN CONTEST

COMING JANUARY 4

### HERE'S ALL YOU HAVE TO DO TO ENTER . . .

(1). Examine the January 4 issue of Electronic Design with extra care. (2). Pick the ten advertisements that you think will be best remembered by your fellow engineer-subscribers. (3). List these advertisements (in the rank order you think our readers will select them) on the special entry forms bound in the January 4 issue. Your *Top Ten* list will be compared with the ten ads ranking highest in the "Recall Seen" category of Reader Recall—Electronic Design's method of measuring readership.

See if you can pick the *Top Ten*—watch for the January 4 issue—then try your luck. 110 valuable prizes are waiting for the winners!

### PRIZES—READER CONTEST

- 1ST PRIZE:** Round trip airline tickets for two between New York and Paris.
- 2ND PRIZE:** New Heathkit® deluxe 295 sq. in. GR-681 color TV kit with cabinet.
- 3RD PRIZE:** Heathkit® 227 sq. in. GR-227 color TV kit with cabinet and cart.

**4TH & 5TH PRIZES:**

EICO "Cortina" No. 3770 all solid state 70 watt AM-FM stereo receiver plus HFS-8 two-way, two-speaker system.

**6TH THROUGH 12TH PRIZES:**

Bulova Accutron® "Spaceview" electronic timepieces. 99.9977% accurate.

**13TH THROUGH 110TH PRIZES:**

Copies of "Fundamentals of Integrated Circuits" by Lothar Stern. 198 pages, hardbound.

### NOTE TO ADVERTISERS AND THEIR AGENCIES

There's a separate *Top Ten Contest* for advertisers. All advertising personnel with manufacturers (companies) and their advertising agencies are eligible to enter. (You need not be an advertiser in Electronic Design to qualify.) Separate prizes will be awarded. **Each ad placing in the Top Ten will receive a free rerun.** In addition, if the first prize winner in the advertiser contest has an ad in the January 4 issue, he will receive a free rerun of a like ad of his choice. Contact your local Electronic Design sales representative for details—or check the January 4 issue.

**COMPLETE INFORMATION, RULES, AND ENTRY BLANKS  
WILL APPEAR IN ELECTRONIC DESIGN'S JANUARY 4 ISSUE**



## Digitally Controlled Power Sources Include Added Systems-Oriented Functions

Digitally Controlled Power Sources (DCPS's) are complete digital-to-analog links between a computer (or other digital source) and any application requiring a fast, accurately settable source of dc or low frequency ac power. Such applications generally require more than a programmable power supply or D/A converter with a power amplifier — the DCPS's include these added functions in a single compact trouble-free package:

**INTERFACE** Customized plug-in interface cards match the Digitally Controlled Power Source to the computer (8421 BCD or Binary).

**ISOLATION** All digital inputs are floating and isolated from the floating analog output, thus avoiding troublesome loops between the output ground and computer ground.

**STORAGE** Inputs from all digital data lines are stored upon receipt of a gate signal from the computer. Output levels are maintained until a new gate signal is received — thus, the computer is free to perform other tasks in the interval between voltage level changes.

**FUNCTION SELECTION** Selects the output voltage range, and isolates the three input bits to the current limit D/A converter.

**OUTPUT VOLTAGE D/A CONVERTER** Converts one polarity bit plus 16 BCD voltage bits or 15 binary voltage bits to an analog voltage for input to the power amplifier. Thus, resolution is 0.5mV for straight binary and 1mV for BCD operation.

**REFERENCES** Provide voltage for the Output Voltage and Current D/A Converters.

**CURRENT LIMIT D/A CONVERTER** Sets current limit of power amplifier to one of eight values.

**CIRCUIT POWER SUPPLIES** Provide all the necessary dc power — no external power supplies are required.

**FEEDBACK** Informs the computer when each programming operation is completed and when the output current is overloaded.

**BIPOLAR POWER AMPLIFIER** Programs either side of zero or through zero without output polarity switches or "notch" effects, with an accuracy of 1mV, 5mV, or 10mV depending on range and model. Outputs from -100V to +100V with currents up to 1A are available.

# all this

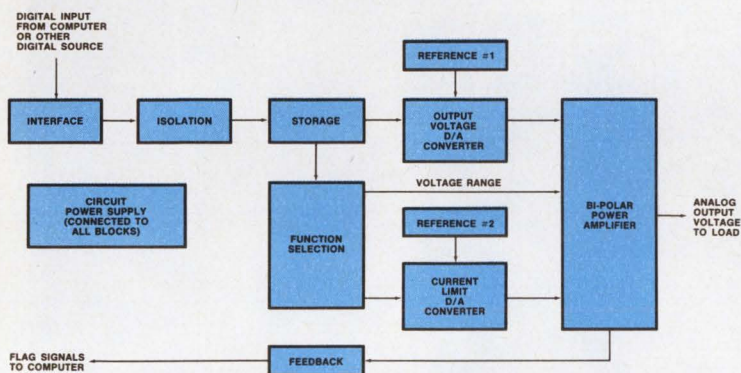

# in one compact package

Write for Digitally Controlled Power Brochure.

INFORMATION RETRIEVAL NUMBER 44

HEWLETT  PACKARD

COMPUTER INSTRUMENTATION

100 Locust Avenue, Berkeley Heights  
New Jersey 07922 • (201) 464-1234

21904A

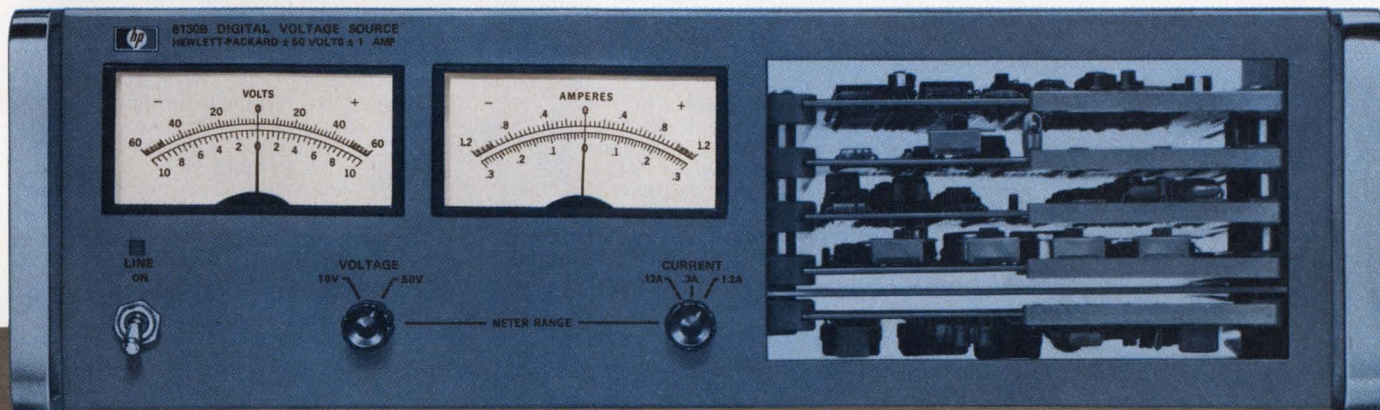



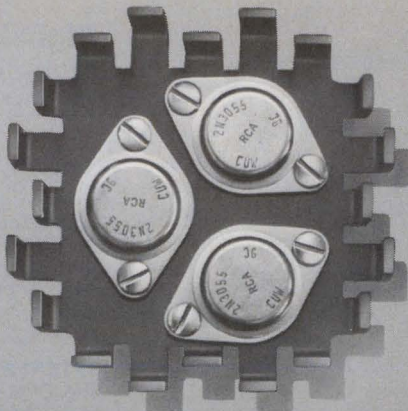

**IERC's HP Heat Dissipator is only 1/3 the weight and 2/3 the volume of extrusions—yet it dissipates the same amount of heat.**

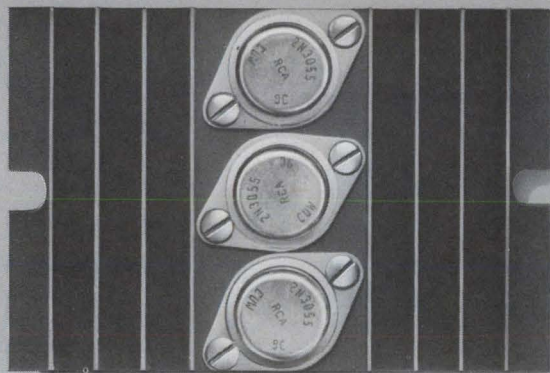

## Here's proof.

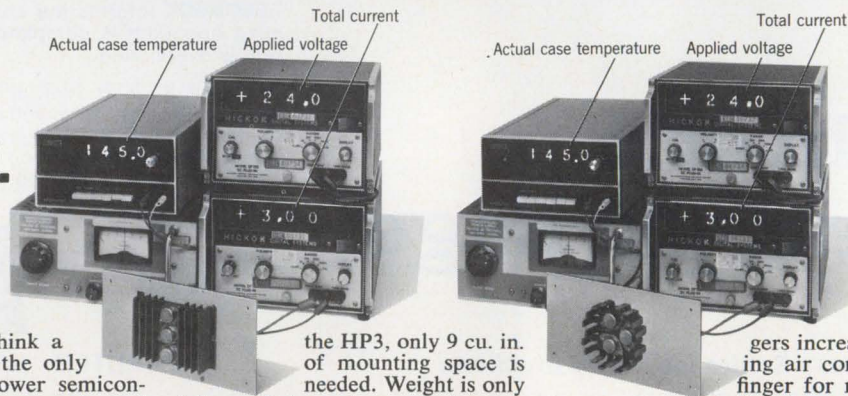

Many circuit designers think a hefty hunk of extrusion is the only thing to use to cool off power semiconductors. Of course, extrusions are big and heavy but that's the price one had to pay. No more.

The test setups shown above prove there is a better way.

On the left: A conventional extruded aluminum heat sink and three TO-3 case silicon transistors. 13.5 cu. in. (3 x 4.5 x 1) are required for mounting. Weight is 4.4 ozs. Total power dissipation is 72 watts with case temperature rise of 120°C (plus 25°C ambient).

On the right: IERC's efficient HP3 Dissipator with three TO-3s. (The HP3 will actually accommodate four TO-3s.) With

the HP3, only 9 cu. in. of mounting space is needed. Weight is only 1.5 ozs. But, as shown, performance is exactly the same. It's just that the HP3 does the job with only 2/3 the size and 1/3 the mass!

See the secret? It's the multiple staggered finger design. In still air the separate fingers dissipate, by radiation and convection, directly to the ambient—not to another finger surface. Conversely, extrusion fins radiate to each other. And, the free movement of convection currents is hampered by their being confined in the deep cavities between the fins.

In forced air the HP is even more efficient. The staggered fin-

gers increase turbulence, directing air completely around each finger for maximum dissipation. But with finned extrusions the forced air begins to leave the surfaces immediately. By the time it is part way down the extrusion it is hitting only the top edges of the fins, resulting in minimal dissipation.

Also, extrusions are directional. The HP is not. Mount it in any vertical or horizontal mode. It gives the same high efficiency with forced air from any direction.

Convinced? Then send for Technical Bulletin No. 139 and our new 4-page Short Form Catalog. They're loaded with ways to keep your transistorized circuitry cool and small.



**Heat Sinks/Dissipators**  
for all lead mounted and  
case mounted semiconductors



# The thinking man's filter.

We make filter pin connectors in both rectangular and circular subminiatures. Nobody else does it our way. Nobody else guarantees a 100,000 to 1 reduction of RF energy. Think about that.

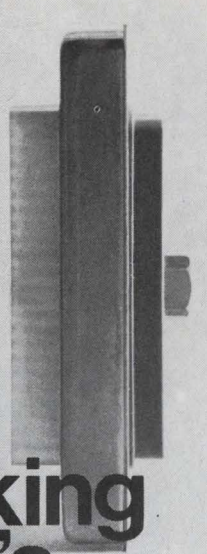

# We're getting to be known as rounders.

We invented the BULLS-EYE Connector and created a reputation as circular subminiature specialists. Goes to show you what a little concentration can do. (Like 102 contacts in a #18 shell.)

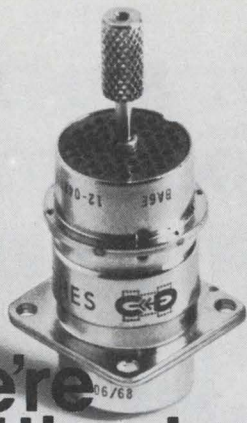

# We've got your number.

Show us a spec, and we'll show you miniature and subminiature printed circuit connectors in 10 sizes with 10 to 96 contacts. We're good at the numbers game.

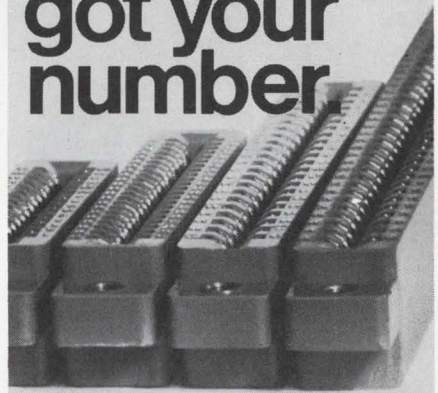

# We bend over backwards.

Contour Cable™ happened here first. Flexible etched flat cable. Flexible flat continuous cable. Custom cable/harness assemblies. Flexibility is a thing with us.



# We'll save your space.

The way we make subminiatures, they're more subminiature. More fully packed. Same contact size and spacing, only we get 110 contacts to the inch. Socket to 'em!

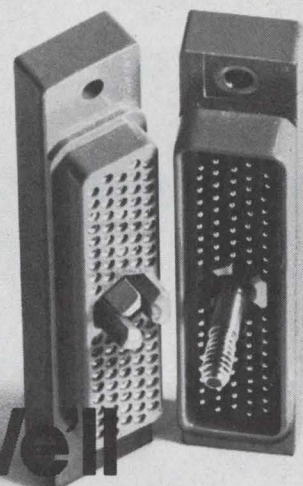

# The do-it-yourself connector kit.

With our Universal Connectors, you decide what goes where. The crimp removable contacts are interchangeable in either body. The big difference at Hughes is the positive way they get together. The PolarHex way.





# Have you priced chopper-stabilized op amps lately?



## Burr-Brown has!

These Burr-Brown chopper-stabilized operational amplifiers offer excellent performance at unheard of low prices. What's more, their 1.5" x 1.5" x 0.4" package is ideal for high-density card spacing. This unique combination of performance, price and size makes the model 3293 series highly attractive for use in a wide variety of applications. Shipments are being made from stock.

HIGHLIGHT SPECIFICATIONS	3293/14	3292/14	3291/14
Voltage Drift, max., -25 to +85°C	1.0	0.3	0.1 $\mu\text{V}/^\circ\text{C}$
Bias Current Drift, max., -25 to +85°C	2.0	1.0	0.5 pA/°C
Bandwidth, unity gain, min	3	3	3 MHz
Bandwidth, full power, min	100	100	100 kHz
Rated Output	All units $\pm 10\text{V}$ @ 5 mA		
Price, 1-9	\$49.00	\$59.00	\$89.00
100 Unit Price	\$36.50	\$44.00	\$66.00



**FOR 4-PAGE TECHNICAL BULLETIN** contact your Burr-Brown Engineering Representative or use this publication's reader service card.

**BURR-BROWN**  
RESEARCH CORPORATION

International Airport Industrial Park • Tucson, Arizona 85706  
TELEPHONE: 602-294-1431 • TWX: 910-952-1111 • CABLE: BBRCORP



Operational Amplifiers  
Instrumentation Amplifiers  
Function Modules  
Active Filters  
Power Supplies



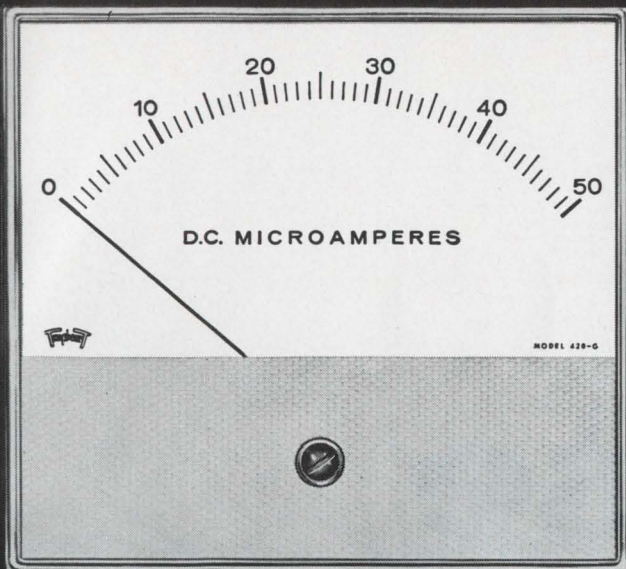

*now you see it*

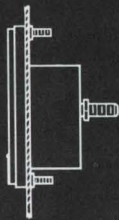

*now you don't*



## THE PANEL INSTRUMENT WITH BUILT-IN FLEXIBILITY

Triplet G-Series Panel Instruments offer a modern design that features a greater degree of flexibility and interchangeability.

- 1** Two types of mounting are available—conventional flush type or behind-the-panel with a bezel for modern picture window appearance.
- 2** The insert shield on the front of the meter can be custom painted or printed to meet customer's requirements.
- 3** Triplet's famous self-shielded Bar-Ring magnet, with one-piece die-cast frame, in all DC and DC suspension type instruments.

In five popular sizes: 5½" DC and AC; 4½" DC and AC; 3½" DC and AC; 2½" DC and AC; 1½" (conventional flush mounting only) DC and AC rectifier type.

# TRIPLET

NOW IN FIVE POPULAR SIZES:

1½" (Miniature); 2½"; 3½";  
4½"; & 5½".

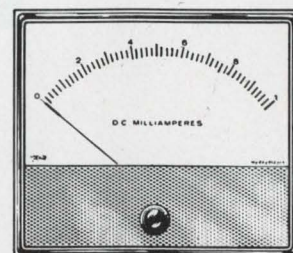
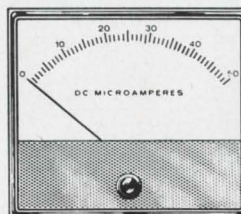
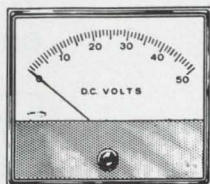

TRIPLET ELECTRICAL INSTRUMENT COMPANY, BLUFFTON, OHIO



# increase ic yield

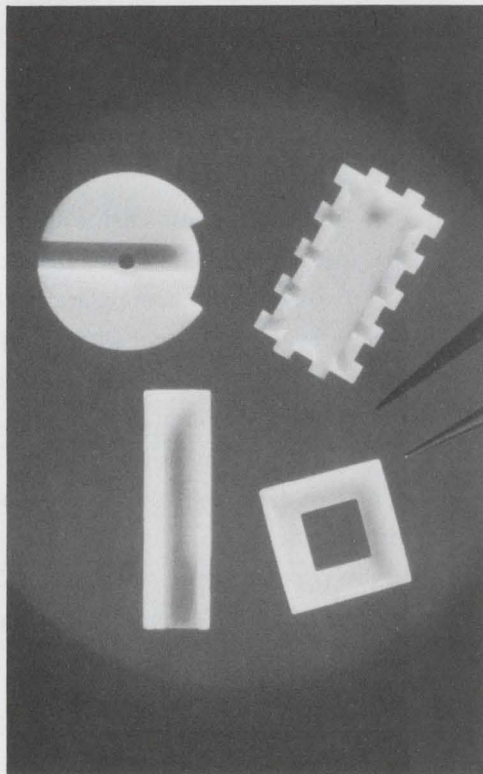

With Coors microceramics. Parts and complete packages. Of alumina and beryllia. Strong, chemically inert, dimensionally stable. Unaffected by age or environment. Part-to-part uniformity from 1st to nth. Precision-ground or as-fired surfaces. Easy to metallize, by you, by us. Most any size, any shape. Fast delivery. Prototype quantities, millions, or anything in between. Get higher yield, more profit. Start with the most reliable circuit packaging. Coors microceramics. Send for data pack.

**Coors Porcelain Company**  
Golden, Colorado 80401

**Coors**/CERAMICS



# How to catch a code in time

Feel a time code coming on? If you're tagging analog data for correlation and indexing, Datatron timing instrumentation can catch coding problems before they start.

Problems like the chronic congestion caused by enormous equipment. Or acute inaccessibility for maintenance. Or even progressive "inflexiblitis rigor mortis." And finally irritating costs.

Now there's fast, round-the-clock relief. Datatron timing instrumentation goes right to work with its proven 4-way action: Flexibility, ease of maintenance, size and cost.

To begin with, unparalleled versatility is afforded by Datatron's exclusive "main frame" construction. This approach features

identical logic, power supply and chassis for both the time code translator and generator.

What's more, Datatron generators handle up to five time codes simultaneously. And the translators change codes by the flick of a switch or by changing a printed circuit card.

Equipment maintenance is facilitated by a unique "pancake" design that permits simultaneous accessibility to all circuitry.

And when it comes to size, Datatron isn't a tough pill to swallow. Dosage is concentrated in only 3½" of vertical rack space.

Datatron's fast-acting ingredients? Dual in-line DTL and TTL integrated circuits. Wide dynamic range AGC Amplifier. And precision oven controlled crystal oscillator.

As for cost, just consider this one fact: Features that Datatron offers as standard are usually optional on more expensive competitive equipment.

So at the first sign of timing aches and pains, take one Datatron 16-page brochure. It completely details the Datatron timing family, including Tape Search Units, DC Code/Failsafe units and Remote Display units.

Send for it today. It won't hurt a bit.

## **Datatron Inc.**

1562 Reynolds Avenue  
Santa Ana, California 92705  
(714) 540-9330

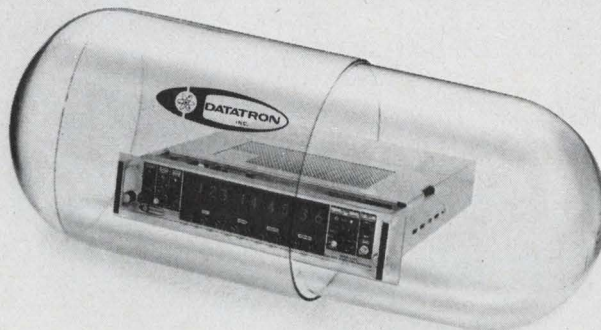



# Announcing a new panel savings plan.

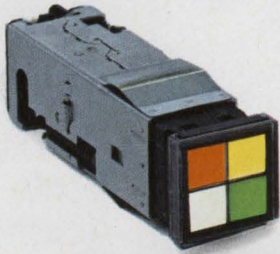

## Big dividends from small pushbuttons.

It doesn't take much to reduce the size of your control panels and cabinet fronts.

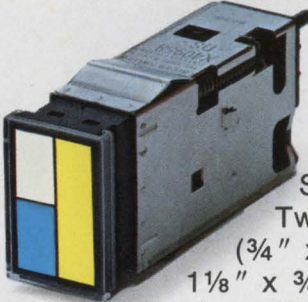

All it takes is compact miniature pushbuttons. Like the new MICRO SWITCH illuminated DS.

Two sizes are available ( $\frac{3}{4}$ " x  $\frac{3}{4}$ " for our 1-unit and  $1\frac{1}{8}$ " x  $\frac{3}{4}$ " for our  $1\frac{1}{2}$ -unit). And both can be matrix mounted on  $\frac{3}{4}$ " or  $1\frac{1}{8}$ " centers. So there's no need for spacers or barriers.

## A long-term investment.

A rugged metal housing encloses each switch and protects against the bumps and bangs of military and commercial use.

The housing also helps provide our DS pushbuttons with exceptional RFI attenuation capability. Incorporated into the housing are welded skirts that assure positive metal-to-metal grounding between the switch and adjacent units. And also between the switch and our rigid, box-girder matrix frame.

## Your choice of options.

Pick the mounting that best fits your application. Either individually mounted switches (meet the requirements of MIL-S-22885) or custom matrix configurations featuring plug-in switches that are best for remote stations or indicating functions.

You can have up to four lamps in every switch. And either one, two, three or four-way split section screens. (The  $1\frac{1}{2}$ -unit provides more than one-third additional legend area.) Full guards are available for single-unit switches.

Then save even more space by combining both 1-unit and  $1\frac{1}{2}$ -unit switches in the same matrix. A single frame will handle up to sixteen 1-unit switches or up to ten  $1\frac{1}{2}$ -units.

## Who can participate in the plan.

MICRO SWITCH DS pushbuttons meet both commercial and military requirements. So they can be used in almost any panel from power plant control to tactical ground support equipment.

For more information, call your MICRO SWITCH Branch Office or Distributor (in the Yellow Pages under "Switches, Electric"). He'll show you how little it takes to participate in our savings plan.

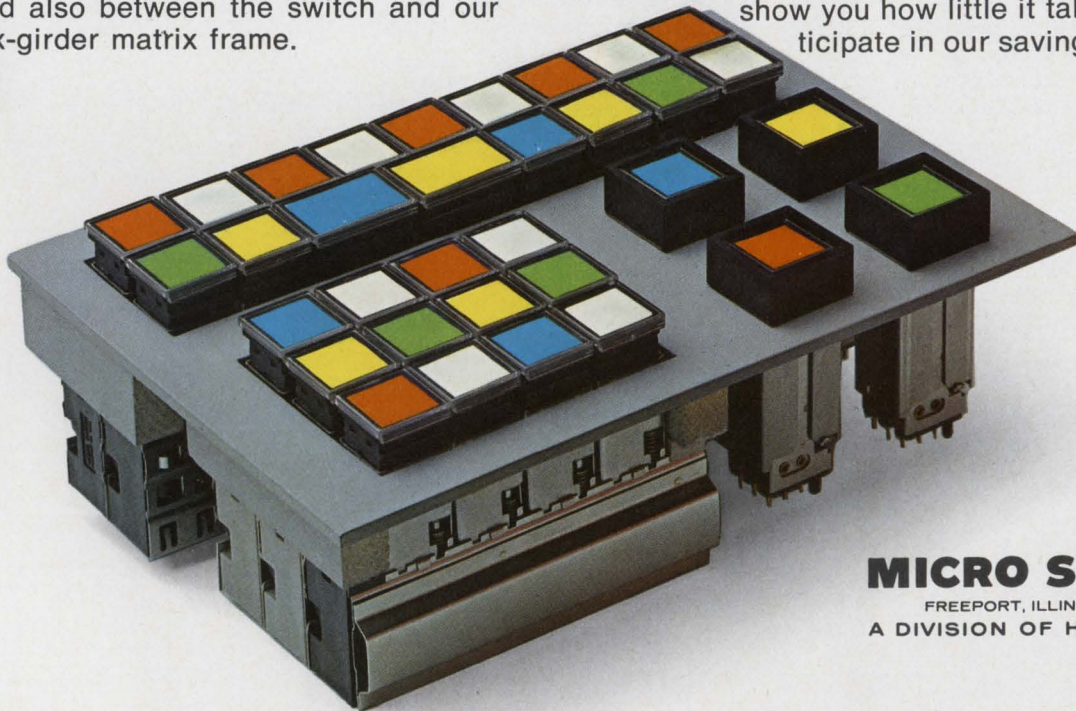

**MICRO SWITCH**

FREEPORT, ILLINOIS 61032

A DIVISION OF HONEYWELL



# Technology



The afc circuit being tested by F. H. Wolf can cut drift in your pulse radar. p. 80.

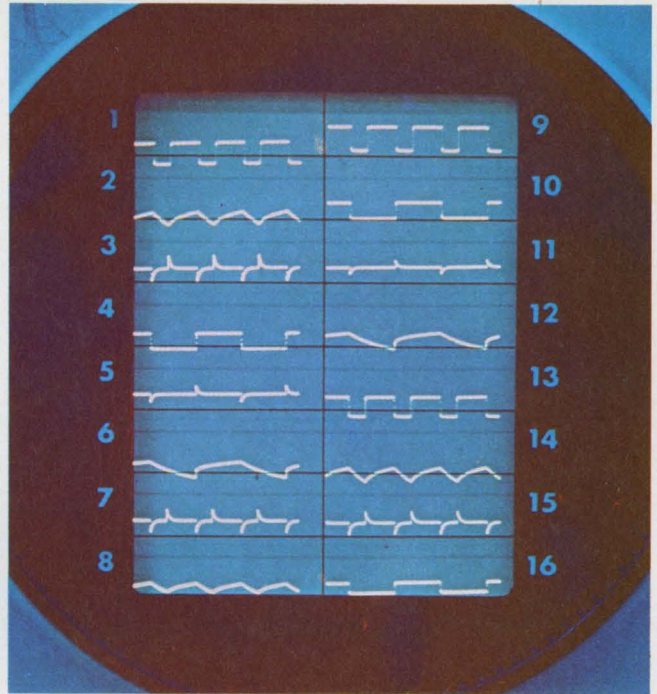

Display design is rapidly being "turned on" like this CRT. See special report, p. 68.

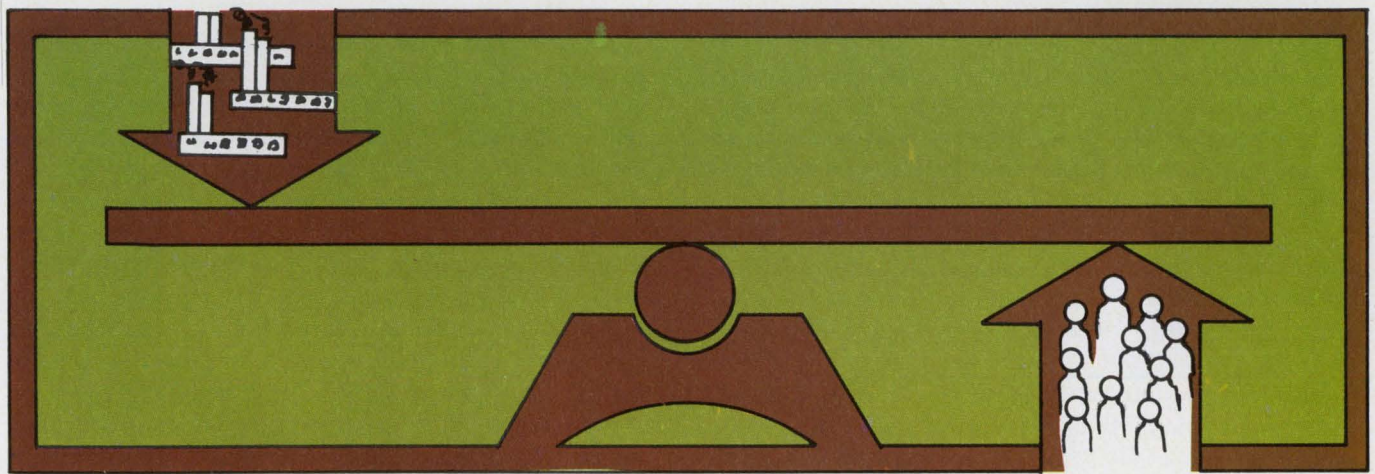

How does a company keep engineering talent on the payroll during slack periods? Read

about just such a stabilizing program in the aerospace industry. p. 92.

## Also in this section:

Various techniques to interconnect ICs for code conversion are shown. p. 84.

Ideas for Design. p. 99.

Product Source Directory: Sweep Generators. p. 107.



# 'TURN ON' DESIGNS WITH NEW DISPLAYS

By John N. Kessler

The materials, the market and the money for new displays are here. Light-emitting diodes and gas plasma panels have been under development for years; now the processing, efficiency and cost of materials is favorable for large-scale production.

Liquid crystals may be the next to move from the laboratory to development for production. Even now, with the present production of light-emitting diodes, experts are talking about new materials that haven't even been grown.

The design engineer must be on the lookout for new displays that may alter his future electronic systems. He's got to match the material to the application and help turn profits for his company. What's practical now may be outmoded soon. The tradeoffs between display components can be subtle; the wrong decisions can be costly. And experiments—when one's future is in the marketplace—can be perilous.

There are three major criteria by which electronic displays can be evaluated: performance, reliability and cost.

How much can the display do? For how long? For how much? The answer depends on where you're sitting, who's talking and what the application is.

Arthur B. Shesser, marketing manager at Burroughs Corp., Plainfield, N.J., draws three curves that get at the essence of applications for electronic displays. He considers Nixie tubes, matrix displays and CRTs, and says that his curves consider the packaging, performance and cost of associated electronics. The cost of adding Nixie tubes to a display increases incrementally, he says. With gas-plasma displays, he points out, the initial cost is much higher, but they provide more characters without an appreciable increase in the cost of electronics. CRTs, he demonstrates, have a higher cost than gas-plasma displays, but they become more favorable economically as the number of characters increases.

## Competition with Nixies and CRTs?

According to Shesser, if you want to display anything less than eight or 10 characters next year, Nixie tubes will be the best technique—on a cost basis alone. If you want to generate 10 to 500 characters, matrix displays will be best, and for generating more than 1000 characters, CRTs will dominate—at least for the next two or three years.

Shesser says packaging and power supply are





Part of 20-by-27-foot display for Expo '70, built by Canadian Westinghouse.

the biggest disadvantages of CRTs. Both factors depend largely on the size and brightness of the screen.

Burroughs will come out with its first gas-plasma display early next year, Shesser reports. Called Self-Scan, it is a dot matrix in which an array of gas-filled cells is arranged in a glass honeycomb. A 250-V dc power source is moved along columns of cells step by step. This ionizes the gas behind the panel. When horizontal electrodes are addressed, a glow discharge is pulled forward. Essentially, the addressing circuitry lights all lights in a raster-type scan, but only those cells that are needed to display information are visible. Addressing columns of dots rather than the individual dots, Shesser says, reduces the total associated electronics by 90%. Self-Scan will be a 16-character display about 8.5 inches long, 2.25 inches high and 1-inch thick. The package will contain all the display and driving circuitry, the scan circuitry and the interface to the panel.

#### Bigger displays by 1971

By mid-1971 says Burroughs' new products marketing manager, Williams Michaels, the com-

pany will have a 256-character display in production. Each character will be 0.2 inch high, and the characters will be arrayed in 32 columns and eight rows. The display, Michaels says, will be used for time-shared computers.

#### New markets to open

Shesser says Self-Scan will open up new markets where applications require displays of 10, 500 and, eventually, 1000 characters: computer terminals, stock-quotation displays, desk-top calculators, inventory control terminals, scientific instruments, cash registers, airline monitors, bank customer accounting, hotel and travel reservations, education and law enforcement. "And it is not inconceivable," says Michaels, "that this type of panel will be used in producing multiple-color displays—each four feet square—which can be directly accessed by computer and used by the military for command and control, or by such agencies as the FAA." Burroughs' president, Ray W. Macdonald, says: "Laboratory feasibility models already developed . . . clearly demonstrate the gray-scale and multicolor possibilities of the new Self-Scan panel display."

Although the concept of multicell gas-dis-





**Donald L. Bitzer, University of Illinois:** with H. Gene Slottow, he developed a gas-plasma panel for inexpensive computer terminal displays that may be used for computer-aided education.



**Peter Seats, Thomas Electronics:** "The electron beam is going to be around till the Day of Judgment—not withstanding the solid-state."



**A. B. Shesser, Burroughs:** "With matrix displays, the initial cost is higher, but they provide more characters without an appreciable increase in the cost of the associated electronics."

charge display devices goes back to the mid-1950s, it was the announcement of a panel gas-discharge display by Donald L. Bitzer and H. Gene Slottow at the University of Illinois in 1966 that definitely established the feasibility of manufacturing such devices.

The Burroughs gas-plasma panel used a dc dot matrix, with no memory, and fixed column driver circuitry. Bitzer and Slottow's plasma display is essentially a glass sandwich: two pieces of 1/4-inch glass with gold-plated electrodes and the gas between the layers. An ac sustaining signal is sent to all x and y electrodes. As with magnetic core memories, any cell may be addressed by selecting the desired pair of x and y conductors. A selection pulse causes a gas discharge where the two transparent conductors intersect.

A cell continues to emit light at each positive and negative half cycle of the sustaining signal. Although the light is emitted in a series of short pulses, the repetition rate is high enough so that the light appears to be continuous.

Bitzer and Slottow's latest design is a 10-inch cube with a 4-by-4-inch display area. Bitzer says that Owens-Illinois, Inc., of Toledo, Ohio, is developing this into Digivue Panels, which he expects will be eventually sold for about \$2000.

The Bitzer-Slottow gas panel has the following features:

- Projection of color images on the display in 0.2 second.
- Readout for both graphics and alpha- numerics.
- Imposition of a radar sweep scan (alpha-

numerics can be assigned to blips—without storage—via light pen or track ball).

- Inherent memory.
- The writing or erasing of information in microseconds.
- Computer addressability, with no digital-to-analog conversion.
- Adaptability for a remote terminal, connected to a computer by low-bandwidth telephone lines (transmission rates of 1200 bit/s). But it can also accept information at megabit rates.

#### Magazine made for color slides

Bitzer is fabricating an electro-mechanical magazine for storing and projecting color slides on the screen of the plasma display. This unit is 4 by 4 inches and holds 256 slides, each 1/4 inch square, in a 16-by-16 array. Slides can be randomly selected and projected in 0.2 s with positional accuracy of 0.001 in.

Bitzer says that the magazine can be operated directly from a digital computer. Electrical signals are converted to pneumatic signals, which digitally select the proper coordinates for the slide. The cost of the magazine, he says, will be several hundred dollars.

Jack Stifle, a senior research engineer at the University of Illinois Coordinated Science Laboratory, says that efforts are being made to develop images on the plasma panel with several shades of gray. Also, the next-generation package will be made somewhat smaller—9 by 9 by 8 inches with a larger screen—6 by 6 inches.



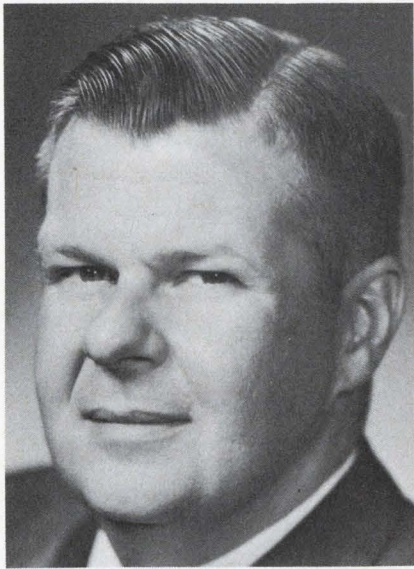

**B. J. Lechner, RCA:** "This chemical processing required to make liquid crystals is basically simple and the constituents are inexpensive."



**M. M. Atala, Fairchild:** "The cost of source elements (for matrix displays) will be very nearly zero . . . The prime engineering problem remaining is designing the access and driving circuitry and the package."

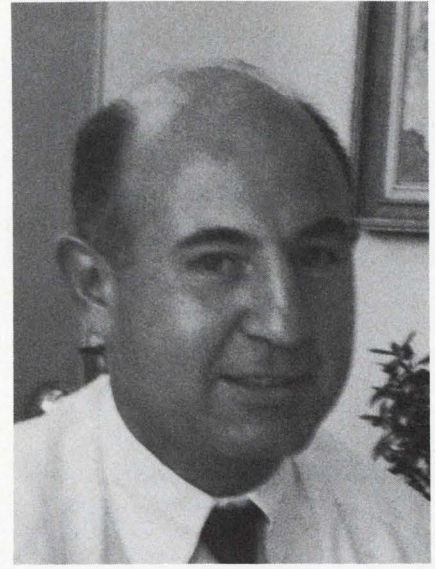

**E. I. Gordon, Bell Labs:** "We're working on gallium-phosphide electroluminescent lamps for key telephone sets."

Eventually, according to Bitzer, a 10-by-10-inch screen with a density of 2500 cells per square inch will be developed.

The work at the University of Illinois is an outgrowth of a computer-based teaching system called PLATO, developed at the Coordinated Science Laboratory.

This system may be the prototype of future computer terminals adaptable for broad consumer markets. Two sources of information—an electronic book (bank of slides) and an electronic blackboard (computer-controlled storage tube) are displayed on a student's television screen. At present there are about 60 terminals running off the computer.

Will plasma panels compete with CRTs? It depends on the application. For remote computer terminal displays, Slottow says, "Yes," though the competition will be very keen.

"In the mainstream of electronics," says Peter Seats, president of Thomas Electronics, Wayne, N.J., "The CRT is now dominant." There are now 78 million TV sets in the U. S. What about the future? "The tool we use here to display information is a high-energy beam of electrons; and that beam is going to be around till the Day of Judgment—notwithstanding the solid-state," says Seats.

The second major CRT market is that of electronic instruments. This is many times smaller in volume than the TV market, but it is still important. And here, such companies as Tektronix and Hewlett-Packard make their own tubes. The traditional classifications are: high-

resolution tubes, oscilloscopes, radar scopes and special-purpose tubes.

Seats estimates the current CRT market at \$15-million to \$20-million. "All markets are expanding—consumer, education, business machines, avionics—and it's hard to say where we'll be five years from now. But the trend is up."

The 1969 issue of *Information Display Buyers Guide* states that in less than 10 years, the digital graphic device market has grown 6000%. "This \$80-million market," they say, "will keep pace with the \$6-billion computer market, growing at a 35% rate per year."

#### More display-equipment markets

Outside of consumer TV, there are at least 10 markets for display equipment, and at the present time, according to Seats, the use of CRTs is virtually unchallenged. They are:

- Computer terminals—business machines displaying alphanumeric and graphics. This is the biggest market.
- Avionics displays.
- Medical electronics.
- TV studio and monitor equipment.
- Photocomposition and recording.
- Optical character recognition.
- Ground support systems for such agencies as FAA, NORAD, NASA.
- Government spare parts.
- Marine displays for radar and navigation.
- Simulation displays for pilot training in aircraft and spacecraft.



Even within each of the categories listed above, "there is no emerging standardization," according to Seats. He feels that each customer is unique, and he emphasizes dominating design characteristics for each application.

"We must decide: Do we use electrostatic or magnetic deflection? Does the application involve high voltage? High power? High or low resolution? Will it be used to produce hard or soft copy? Where will it operate—in bright sunlight? High humidity? Will it be used to produce color changes? How long must it last?"

### CRT disadvantages can be met

When confronted with the disadvantages of CRTs—cubic volume, high-voltage, power consumption and reliability—Seats contends that these problems can be handled. "If one designs a tube and related power supplies carefully, packaging is less of a problem, and handling high voltages is not as troublesome as it might seem."

Reliability for most military tubes is 30,000 hours mean time between failure (MTBF), he says. "We also make 'brute force' projection tubes for large-screen displays that operate at high power and high voltage and last only 50, 100, or 200 hours. The key is application." Although Seats did not discuss the tradeoffs between CRTs and matrix displays, he did mention the need for industry and the universities to invest more in fundamental CRT research.

### How to produce fine halftones

But there have been significant improvements in CRTs, particularly in the area of graphics. One of the finest examples of computer-generated halftones has been achieved at the University of Illinois (see cover). Jack Stifle of the Coordinated Science Laboratory developed a CRT display terminal that produces 256 shades of gray and has been programmed to produce many geometric designs.

Stifle uses a 4096-by-4096 element matrix, and 12-bit analog-to-digital converters. An eight-bit intensity control provides the 256 distinct voltages that control the shading of an image. Because the beam current, grid voltage, and film emulsion are all nonlinear, Stifle used what he calls a "distorting circuit" to match changes in shading with the nonlinear characteristics of the CRT and the film. The images are probably the finest halftones ever made on a CRT.

To handle the problem of addressing the more than 16-million points in the display matrix, Stifle only specifies the address of those points that must change. In other words, at a given

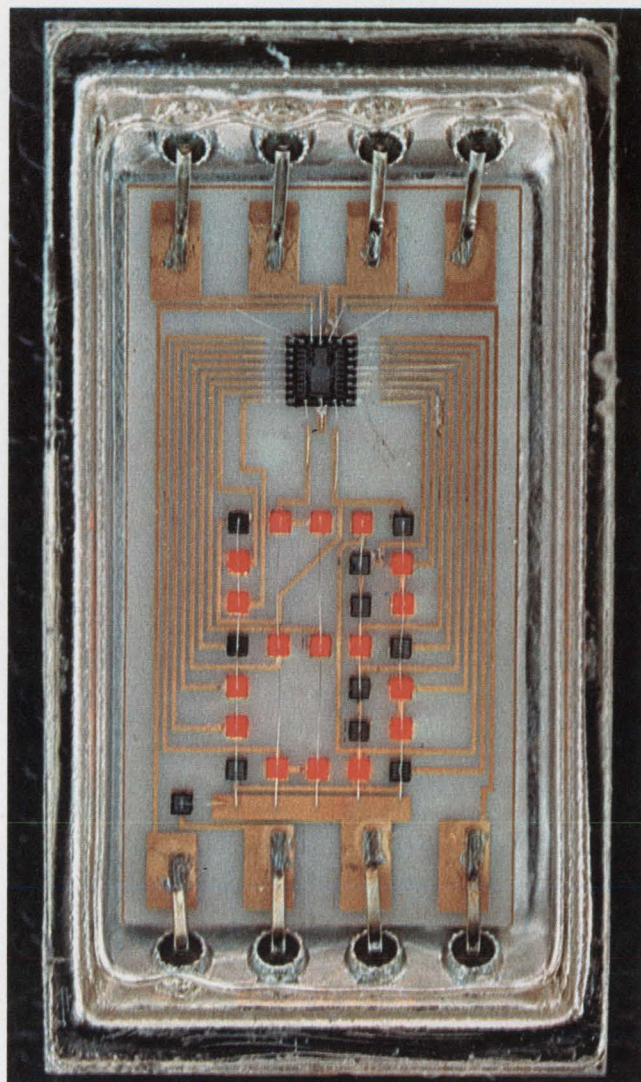

Hewlett-Packard integrated gallium arsenide phosphide with silicon technology in making its entry in solid-state display market.

intensity, the beam remains at the same voltage until instructed to change. This reduces by about 90% the amount of data that must be handled. Also, the display is synchronized to the 60-cycle power frequency.

But such precision still does not make cheaper, lower-power, smaller displays.

"In the long run," says Gene Gordon at Bell Labs, "LEDs will replace CRTs." But here Gordon is referring to what may happen by 1980. "If the problem is to do the job now, tungsten lamps, Nixies, and CRTs will likely come out on top for most applications," he says.

### "A very serious commitment"

At Fairchild Camera and Instrument Corp. in Mountain View, Calif., M. M. Atala, vice president of a newly formed Microwave and Electro-optics Div. has made "a very serious commitment to solid-state displays." But, he adds, "We are



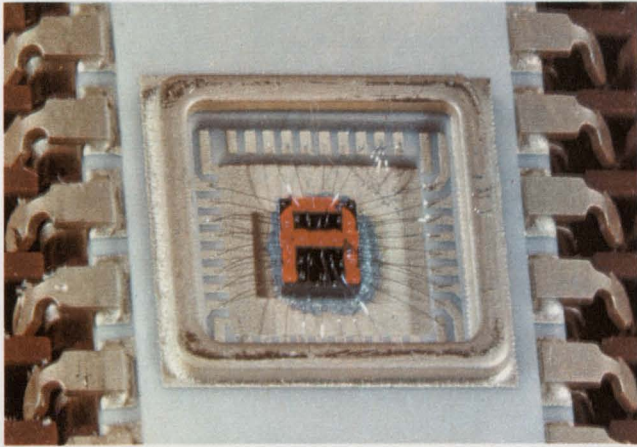

Curved segments of letters and numbers make shapely font in experimental alphanumeric display from Texas Instruments.

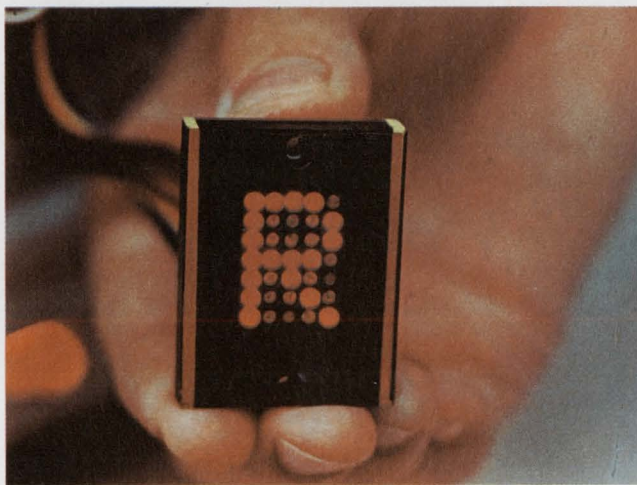

Gallium phosphide alphanumeric was fabricated at SERL in England. First commercial production of GaP was at Metals Research Instruments Corp.

not saying that solid-state displays are *it*." Atala's division is alert to the potential importance of gas-plasma displays and phosphors that can be placed over gallium-arsenide diodes to produce four colors.

The three basic kinds of solid-state electroluminescent materials are typified by: gallium phosphide, gallium arsenide phosphide, and phosphors that convert gallium-arsenide IR light to visible.

Gallium phosphide has an efficiency of 6 to 7% in the red and 0.6% in the green. (The eye, however, can see 50 to 80 times better in the green than in the red.)

Gallium arsenide phosphide emits only red light at about 4 to 7 V, whereas gallium phosphide can emit all colors at as low as 1.5 V. This means that a gallium-phosphide button on a telephone can be powered directly from a central office—a significant saving in power and in



Monsanto's Man 2 is a seven-segment gallium-arsenide-phosphide numeric indicator, second-generation from new facility in Cupertino, Calif.

copper wire. Such push-button displays represent a tremendous future market for solid-state electroluminescent materials.

The first commercial production of gallium-phosphide ingots was begun this spring at Metals Research Instruments Corp., a British concern that has opened a division in Monsey, N.Y. David Berry, the company's marketing manager, believes that in the next two or three years solid-state lamps will be as commonplace in instruments as tungsten filament types are now. Berry predicts the use of gallium phosphide lamps, not only in computers, but also in aircraft, automobiles and domestic appliances.

Each gallium-phosphide ingot weighs about 55 grams and is about three inches long and 15 mm in diameter. Berry predicts the market for gallium phosphide will total \$1-million in 1970 and rise sharply as the advantage of this material becomes known.



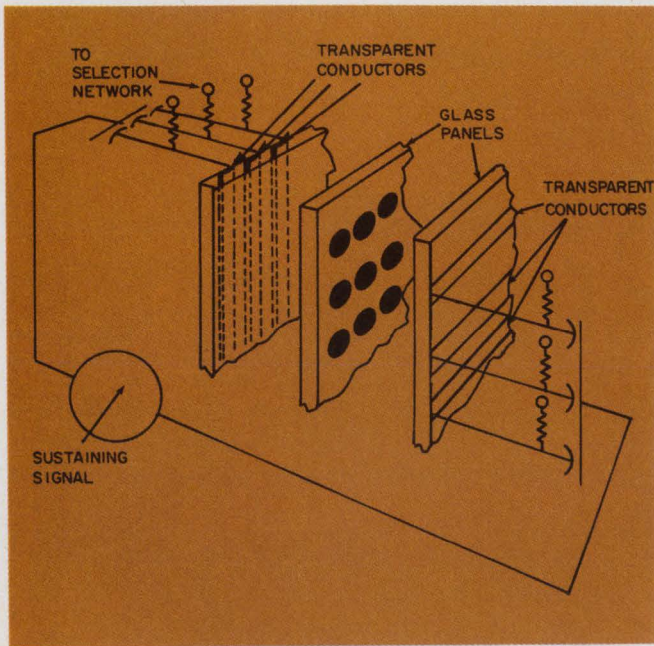

This gas-plasma panel with a built-in memory was invented at the University of Illinois.

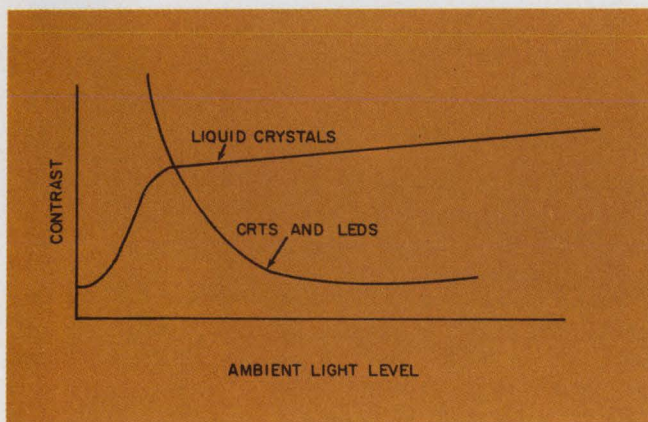

Contrast decreases with increasing light for CRTs and LEDs; but not with liquid crystal display.

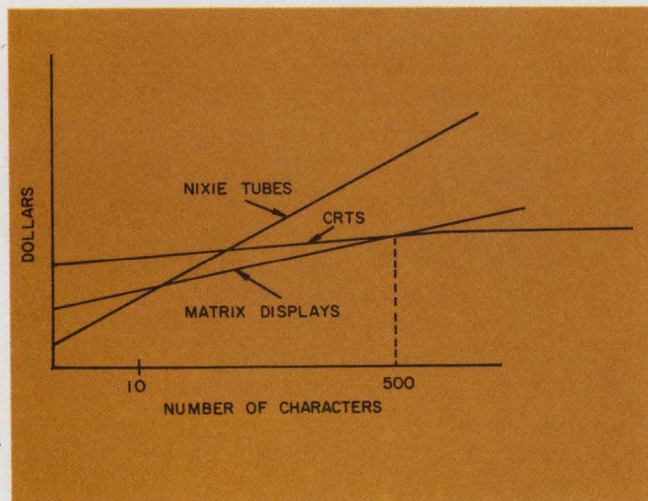

Curves show costs vs. number of characters generated by matrix displays, Nixies, and CRTs.

Fairchild's Atala feels that gallium phosphide will be an important material for light indicators and will also find a place in larger displays, such as numeric indicators 2 or 3 inches high. This is possible because the efficiency of the material is so high that lenses will be able to be used to magnify small displays.

"There's no question in my mind," says Atala, "that very high efficiency materials are going to find a home as light indicators for large-size displays. It is possible that these will be large enough to use as display boards or panels at airline terminals and stockbrokers' offices."

### Present solid-state material

The second major solid-state material for electronic displays is gallium arsenide phosphide. George McLeod, director of Monsanto's Electronics Special Products Div. in Cupertino, Calif., expects gallium arsenide phosphide to be the most widely used solid-state electroluminescent material over the next three to five years. Gallium arsenide phosphide is now grown by liquid epitaxy. Its efficiency is much lower than that of gallium phosphide, but, for the majority of applications, it is possible to get the light outputs at reasonably low currents. (With current densities of 1 amp per cm, light outputs of 50-foot-lamberts are obtained.) And the reliability of gallium arsenide phosphide is quite high. Electrical deterioration is not expected to be a problem.

But the biggest advantage of this material is that it is readily compatible with monolithic arrays. For example, to make gallium-arsenide-phosphide diodes, silicon is used as a mask; the photoresist and diffusion techniques are precisely the same as those used for ICs.

Also, the material is not transparent. This means that light comes out exactly where the material has been diffused and nowhere else. So one can get excellent definition. With gallium phosphide, on the other hand, light is emitted from all directions—sides, front and back. So when gallium-phosphide diodes are arranged side by side, some kind of shielding between diodes is essential.

The material, says Atala, will be used for multiline displays and compete with CRTs.

Although Fairchild does not yet have a product line of gallium-arsenide-phosphide devices, it has developed an experimental three-character monolithic array. The characters formed from a 5-by-7 matrix and 10-by-10-mil dots, are 140 mils high. Atala says the size can be reduced to a 1-by-1 mil dot that could be used, for example, to print directly on microfilm. But 1/4-inch-high characters, he says, will probably be standard for the industry.



Atala says that Fairchild has made experimental 1-by-1-inch displays with gallium arsenide phosphide, in which the whole area lights up uniformly. These displays are forward-biased diodes operating at 1.6 volts.

The third class of solid-state electroluminescent materials is gallium arsenide coated with phosphors. These coatings convert the infrared light to visible, and the early work was done some years ago at General Electric Research Laboratories. But the recent development at Bell Telephone Laboratories of phosphors that convert infrared from gallium-arsenide diodes to red, green, yellow and blue may turn out to be extremely important.

### Ideal LEDs

Other compounds that may be used, says Atala, will be extensions of gallium arsenide phosphide. These materials will permit displays in other colors besides red. The strongest candidate, he says, is gallium indium phosphide. By changing the composition of the various elements in it, one can vary the light outputs from the infrared all the way up to the green-yellow and yellow-green. This material also has the advantage of being adaptable to the planar technology of integrated circuits. It does not require the shielding needed with gallium phosphide devices and, "when made to work," it will permit batch-processing of solid-state displays, Atala says. "It is very possible that it will be the most important single material in the industry."

When it comes to an "ideal" solid-state material for displays, Egon Loebner, head of special projects in Hewlett-Packard's solid-state laboratory, suggests gallium nitride. "Chemists say you can grow it," Loebner complains. "So far there are no crystals larger than 0.5 mm."

### The prime engineering problem

Atala predicts that within the next two years the cost of source elements per bit (dot) will be "very nearly zero, no matter what the technique is." The materials problem, he says, is being solved. "The prime engineering problem remaining is designing the access and driving circuitry and the package." Concurrent with this problem is the need to hold down the currents and voltage requirements to permit materials to interface directly with ICs.

Fairchild and Hewlett-Packard both emphasize the hybrid integration of silicon technology and gallium arsenide phosphide. This will permit such devices as digital counters, where the display will be on the same substrate as the circuitry. Gallium arsenide phosphide diodes may

also be placed directly on an IC as local spot indicators that can be used to test a circuit. Also, small portable instruments will be made. But ultimately the consumer market is a prime target for light-emitting diodes: displays in automobiles, telephone pushbuttons or displays on top of touch-tone phones to indicate what digits were pressed.

The first company to market instruments with a solid-state display was Monsanto. It is selling a nine-digit counter-timer, a digital voltmeter and a 10-channel data selector. Joel Bloom, electrical standards manager at Monsanto Electronic Instruments, West Caldwell, N.J., says that the future in electronic displays will be toward "taking properties of general-purpose computers and producing them as separate instruments," such as automatic controls for processing manufactured items. Monsanto is focusing on numerics and has not disclosed plans to make alphabetic indicators.

"Since the fall of 1968," says Monsanto's McLeod, "we have been aggressively marketing solid-state devices." These products will compete in a \$160-million market in the next five years, he says.

### Solid-state displays go to market

Monsanto is now selling MAN 2—its second-generation display. Like its predecessor, it is made of gallium arsenide phosphide. Each digit consists of seven segments. Hewlett-Packard's display is a matrix of diodes. Unlike Hewlett-Packard's gallium-arsenide-phosphide displays, the addressing circuitry for MAN 2 is separate from the display itself. Bloom says this facilitates controlling the light output from each digit to make a more uniform display. Bloom says that the processing of solid-state material is still a relatively new technology: "If you take a production line of solid-state displays and pull two of them off and put the same power into both, one could have a significant difference in light output."

Hewlett-Packard, on the other hand, makes the point that its display is the first hybrid integration of gallium arsenide phosphide and silicon IC technology. From the standpoint of packaging and power, this kind of hybrid may be particularly important, according to Howard C. Borden, solid-state display manager at Hewlett-Packard Associates in Palo Alto, Calif. "Integratable displays," he says, are the best way to achieve compatibility with solid-state circuitry.

Bloom, however, says that this creates "potential reliability problems." Why? "Because it takes current to drive these displays, and if it's all on one chip, then the power density requirements—watts per unit area—are much more severe," he notes.



Borden, however, claims that the reliability of the Hewlett-Packard dot array is more precise, more reliable and brighter than the Monsanto design. He says that H-P has developed the planar technology for combining light-emitting diodes with ICs and that this, though essentially more expensive, results in more controlled yields and a more adaptable product.

Monsanto says that another advantage of separate addressing circuitry is usefulness in multiplexing. Rather than individual addressing circuitry for each digit, Bloom says, "Why not have one decoder for three or four digits and multiplex between the digits?"

Meanwhile Texas Instruments plans to market a new solid-state alphanumeric display—a monolithic device whose 29 diodes are diffused into a gallium-arsenide-phosphide epitaxial layer on a gallium arsenide substrate.

The type of font developed at TI provides shaping for the curved segments of letters or numbers. Each character is 0.1 inch high and 0.08 inch wide, but the height can be increased to 1/4 inch. "If you start making characters too big," says George A. Henderson, section head at TI's Opto-Electronics Laboratory, "you run into cost problems." Since TI's alphanumeric display is monolithic, it is possible to reduce the character size for close-view applications, such as in airplane cockpit readouts.

The current per character is 75 mA at about 1.6 V. This produces a light output of approximately 100 foot-lamberts.

So far there are no companies that have announced plans to market gallium-phosphide displays. But Eugene I. Gordon, director of the Electro-Optical Device Laboratory at Bell Telephone Laboratories, Murray Hill, N.J., says that engineers in his division are working on gallium-phosphide electroluminescent lamps. The main application would be for the Bell System's electronic key telephone set.

Gordon says that "the efficiency of tungsten lamps goes down as you try to miniaturize them." The appeal of light-emitting diodes as indicator lamps for telephone lies in their high efficiency at low power levels—2 V at a few millamperes.

Such lights would not only reduce the amount of hand-wiring presently required for key telephone sets, says Gordon, but would save significant quantities of copper-wire, since light-emitting diodes could be powered directly from a central location. Then there is the red light itself, which is more eye-catching than present white lamps. And the design possibilities are greater, with lighter, smaller circuitry.

Walter Rosenzweig, a member of technical staff at Bell Laboratories, has fabricated a gallium-phosphide alphanumeric display that is compatible in size with a telephone. It is 0.5-inch

high, and can be made to display as many characters as desired. The basic building block is a 5-by-7 matrix. The present display will produce 2500 alphabets in different languages at the rate of 50 symbols a second. The addressing and driving circuitry is all IC.

What inroads will such devices make in the display market? "With all due respect to plasma panels and light-emitting diodes, I think CRTs will dominate the electronic display field for at least the next five years," says Gary D. Wrench, assistant manager of Hughes Aircraft's Vacuum Tube Div. in Oceanside, Calif. "The progress made by Monsanto and Hewlett-Packard is really terrific," he says, "but there is a maturity curve their new displays will have to go through."

Wrench points out that even when new display techniques are perfected and commercially competitive, there will remain the problem of educating potential customers—of actually selling new products. And this, he says, will take time.

What happens after 1973? Hughes, as well as other major tube manufacturers, such as RCA, Sylvania, Westinghouse and General Electric, are looking into the newly emerging solid-state and gas-panel forms of electronic displays.

#### Advances in CRTs coming

Generally, he says, "Hughes is developing new approaches to storage CRTs to improve performance and/or reduce costs." Specifically he mentions "the resurrection of 'character-writing' tubes, similar to the Stromberg-Datagraphix Charactron. Hughes owns some of the basic patents on a beam-extrusion process similar to Charactron. The Hughes name is Typotron.

The Charactron type of character generation offers alphanumeric a resolution equivalent to 5000 to 8000 lines per screen, according to Dan Haflinger, staff scientist at Stromberg-Datagraphix in San Diego. Electron-beam extrusion techniques produce more clearly defined display, because the entire electron beam passes through a tiny stencil, or "micro-matrix," within the tube. Typically there are 64 characters in the Datagraphix stencil, but the company has made stencils with 250 characters, and says Haflinger, "recent research shows we can probably go higher."

Ruggedness and the danger of implosion are critical factors in supplying the military with CRTs for aircraft or for weapon-aiming systems. This is why CRT designers are "ruggedizing" their wares.

Rank Precision Industries, Inc., in West Nyack, N.Y., has developed a ceramic CRT that, according to Michael X. FitzPatrick, product manager, CRTs, "is highly resistant to shock and vibration because all metal parts are brazed in-



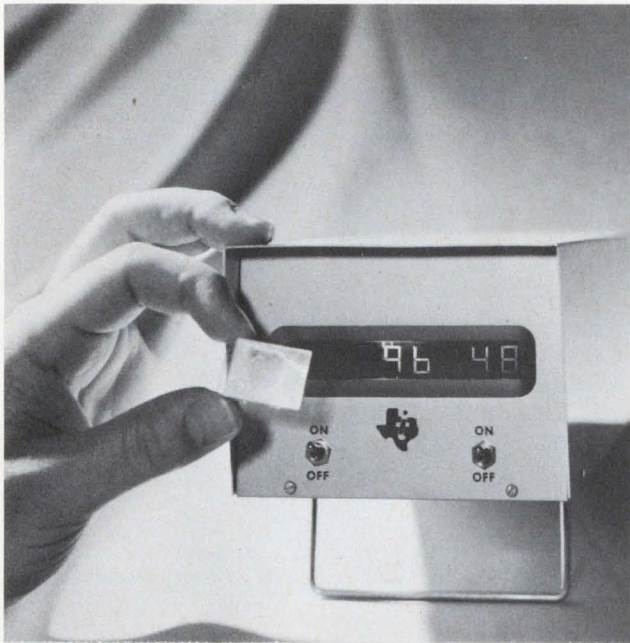

**New liquid crystal display** developed by Texas Instruments has characters that can form digits 0 to 9.

tegrally to the tube." This is the only ceramic CRT being sold currently, FitzPatrick says.

Storage of graphics or situation displays are often required for medical, tactical and civil aircraft, and educational applications. The Hughes Vacuum Tube Div. has a Multimode storage tube that can be used to write, selectively erase and display stored and real-time information. It can also operate with black writing on a white background, as well as vice versa. Westinghouse Electric Co., in San Francisco, recently announced a split-screen storage tube in which one half of the screen displays real-time information and the other half stored information.

While storage tubes can retain images for hours, some liquid crystal displays can retain images for days and even months with no current passing through the device. This may ultimately lead to commercially viable alphanumeric and graphic displays that draw power only when the image changes. Present liquid-crystal displays consist of a thin layer of nematic material (8 to 12 microns thick) sandwiched between two electrode glass plates. They require very low exciting power.

The uniqueness of the display is that it is reflective rather than active; like the printed page it cannot be viewed in the dark. However, its brightness and contrast increase with ambient illumination. So where there is normal room light or very bright sunlight liquid crystals can provide highly effective displays.

Bernard J. Lechner, group head at RCA Laboratories in Princeton, N.J., says that the addressing voltages for liquid-crystal displays are

30 to 40 V and that the current requirements are considerably less than those required for light-emitting diodes. "Less than 1 W of power is needed to light up a square foot of liquid-crystal display," he says. At 40 V, this is 25 mA per square foot. Lechner says that 1  $\mu$ A is all that is needed to excite one 1/4-inch square character on a liquid-crystal screen.

"The chemical processing required to make liquid crystals is basically simple, and the constituents are inexpensive," says Lechner.

Because the material is a liquid, he points out that large liquid-crystal displays can be readily made. This is presently a problem with light-emitting diodes, because single crystals divided up and arranged in arrays, tend to limit the character height. Lechner says, "A large area display based on single crystal technology is at present out of the question. It might be done in the laboratory but not commercially."

Texas Instruments has recently synthesized their own liquid crystals, according to H. Barry Bebb, director of advanced technology at TI. At their Corporate Research and Engineering Laboratory in Dallas, engineers in Bebb's division have made a prototype 8-character display. It consists of 1/2-inch high by 1/4-inch wide numerics. Each character has seven segments.

Liquid crystals material, contained between two tin oxide-coated glass plates, is activated by applying 15 to 20 V across two sets of electrodes. Characters are addressed by a TTL integrated circuit decoder/driver. Also, MOS driver circuitry may be used since the fully activated seven segment numeric draws about 1  $\mu$ A at 15 V.

"We're evaluating these liquid crystal displays for specialized computer terminals," says Bebb.

RCA has made a number of liquid-crystal displays, including a digital clock with four numerics, each about 1-1/4 inches high. RCA's largest display is a 2-by-18-element matrix that operates at TV rates and produces gray-scale images.

The problem in making liquid-crystal matrix is similar to that now facing most workers now developing solid-state and gas discharge matrix displays—the addressing and control circuitry. The liquid crystal does not have a switching threshold (like magnetic core) that enables an element to be turned on by row-column coincidence; so this control circuitry must be added to the display.

The market for new displays is here. But, as with many new products that are needed, the cost is going to be high until the volume goes up, and the volume is going to be low until the cost goes down. This dilemma, now facing display components manufacturers, may be resolved by the design engineer who comes up with the right materials. ■■



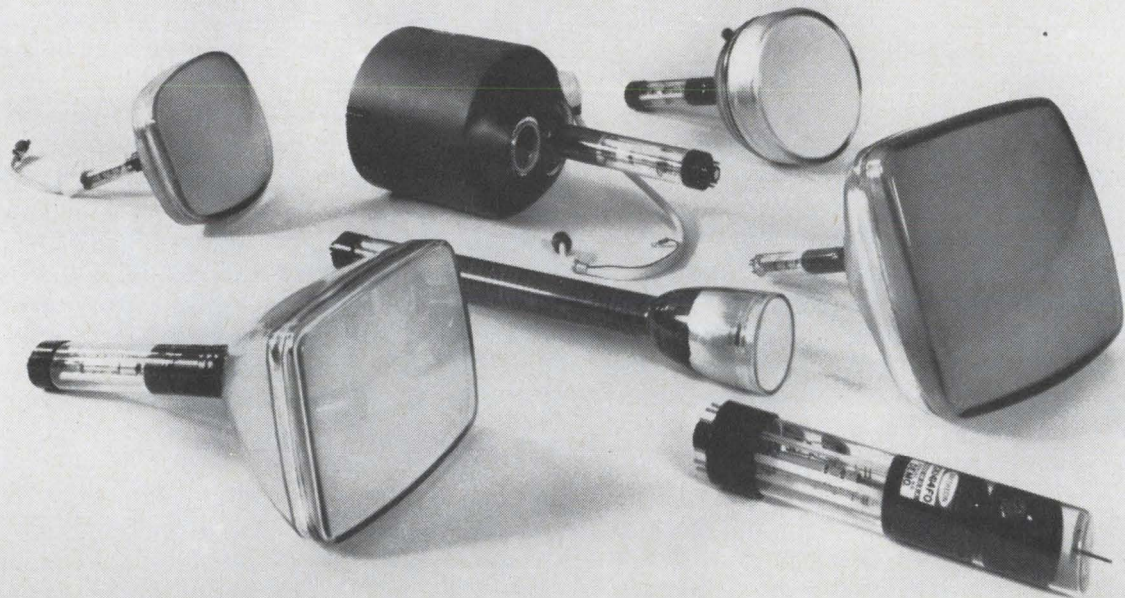

## These men specialize in developing CRTs for your toughest applications.

Together, they have a wide range of capabilities for cathode-ray tube design, application, and manufacture. In fact, they've developed CRTs for radar and avionics displays • air-traffic control and ground-support equipment • computer terminal CRT displays • large-screen and simulation display systems • flying spot scanners and photo recorders —among others.

They daily produce a large number of Dataray\* CRTs in a wide

range of standard and special types, in screen sizes from 2" to 24", and in all available phosphors. They also supply combination electrostatic and magnetic deflection types for writing alphanumeric while raster or random scanning.

For complete information on Dataray CRTs, call or write: *Raytheon Company, Industrial Components Operation, 465 Centre Street, Quincy, Massachusetts 02169. Tel: 617 479-5300.*

Tubes shown: CK1387P- for airborne cockpit display; CK1437P- with rear window for combined photo-recording and operator display; CK1355P- airborne display tube with anti-corona high-voltage connector; CK1439P- for computer CRT displays; QV367 test CRT for phosphor investigation; CK1447P- narrow-neck, high deflection sensitivity CRT for computer displays; CK1414F- Symbolray™ monoscope for alphanumeric generation.

\*Registered trademark of Raytheon Company

**RAYTHEON**



# It's time for a change in your digital displays! Increase versatility, decrease costs — with RCA's new NUMITRON Digital Display Devices

Compare these RCA product advantages:

- Sharper, cleaner displays
- Controllable high brightness
- Up-front planar numerals for wider viewing angle
- Unlimited filter-color selection
- Low voltage operation—designed for  $4\frac{1}{2}$  V
- Fully compatible with RCA's new Integrated Circuit Decoder/Drivers

- Rugged construction
- Long life—high reliability
- Designed for low-cost 9-pin miniature sockets

Interested? For more information on the new RCA NUMITRON Digital Display Devices, contact your local RCA Representative or write to RCA Electronic Components, Commercial Engineering, Section **L18DE-1**, Harrison, N.J. 07029. Also ask for

data on the new RCA Integrated Circuit Decoder/Drivers, especially designed for use with RCA's Digital Display Devices. Type Numbers of NUMITRON Digital Display Devices:

RCA-DR-2000—Numerals 0 through 9

RCA-DR-2010—Numerals 0 through 9, with decimal

RCA-DR-2020—Plus-Minus and Numeral 1

RCA-DR-2030—Plus-Minus

Unretouched photograph of operating NUMITRON devices mounted on plastic tubing.

**RCA**  
Digital Display Devices





# Cut pulse-radar frequency drift

by slaving the magnetron to a precision oscillator.  
This feedback approach saves money, space and weight.

Modern airborne radar systems often have frequency-stability requirements that conventional pulsed magnetrons cannot meet. To satisfy these requirements, the usual approach is to cascade a precision low-power oscillator with a power amplifier. This method works, but it's not as economical in either cost or size as a magnetron transmitter.

By slaving a magnetron to a precision oscillator through an electromechanical feedback loop, it is possible to obtain frequency accuracies on the order of 0.01% with a transmitter that is considerably smaller and cheaper than the power-amplifier type. The feedback system also makes it very easy to change frequency during operation. This capability can solve mutual interference problems, neutralize certain types of jamming and, in some instances, increase target visibility.

Of course, since it is electromechanical, the feedback loop is best suited to compensate for thermal drifts and other relatively slow effects.

## Electromechanical afc loop is the key

The heart of the transmitter is an afc loop that compares the magnetron output with the output of a stable frequency source (Fig. 1). The frequency error is converted into a control signal that mechanically tunes the magnetron to the desired frequency. The stable frequency source also serves as the local oscillator for the radar receiver. Thus, when the transmitter frequency is changed, the receiver's is changed at the same time.

Before the system can operate, the magnetron must be tuned close enough to the reference frequency for the i-f signal to be within the lockup range of the afc loop. This initial tuning is accomplished by the control circuitry, which has three separate functions: It performs the initial coarse tuning; it acts as part of the fine tuning

loop; and it decides when to switch from one role to the other.

## The initial positioning loop

The initial positioning is accomplished by a servo loop completed through a potentiometer (Follow Pot) geared to the magnetron tuner shaft (Fig. 2). The potentiometer output is a dc voltage proportional to the tuner position and hence, roughly, to the magnetron frequency. This output voltage is compared with a preset reference voltage by differential amplifier A1. The error voltage thus obtained is modulated at the power-line frequency, power amplified by A2 and applied to the control winding of the servomotor. The motor drives until the error voltage is nulled.

Clearly, the magnetron tuner will be driven to a position determined by the preset reference voltage. Hence the reference must be selected so the i-f signal will be within the aperture of the frequency discriminator. This requires a wideband discriminator because the magnetron frequency is a function of anode temperature as well as tuner position.

Magnetron frequency is such a strong function of temperature that, if the tube is not temperature-compensated, even the wideband discriminator will not guarantee lockup. A sweeping afc must then be employed.

Once the tuner is positioned so that there is an i-f signal within the passband of the i-f amplifier and discriminator, the signal verification circuit comes into play. This circuit recognizes the presence of an i-f signal and operates the afc lockup relay. The relay disables the tuner-position loop and closes the afc loop around the magnetron.

## Don't lock onto the image

The afc loop will keep the magnetron tuned to a frequency that is offset from the reference frequency by the i-f. Unfortunately, there are two such frequencies: the desired frequency and its image. Since it is possible to tune the magnetron

---

F. H. Wolf, Senior Engineer, Westinghouse Electric Corp., Baltimore, Md.



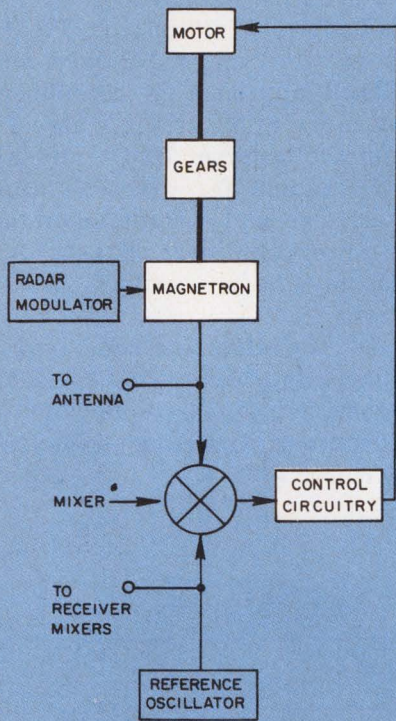

1. The afc loop comprises the mixer, the control circuitry, the motor and the magnetron. By turning the magnetron tuner, the motor drives the magnetron frequency toward that set by the reference oscillator. The heavy lines indicate mechanical connections.

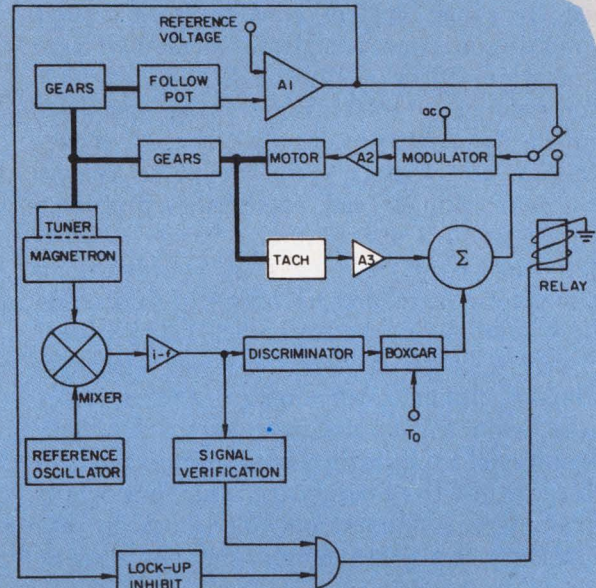

2. To avoid locking onto the image frequency, the inhibit signal is combined with the output of the signal verification circuit. The tachometer and its weighting amplifier, A3, are needed only in high-performance systems.

to the image frequency during initial positioning, logic must be provided to prevent the loop from locking onto it.

At the desired transmitter frequency, the output of amplifier A1 is near zero. At the image frequency it's at the negative saturation value. The large negative voltage can therefore be used to inhibit the operation of the relay, even though there is a signal verification.

The relay thus will not open the position loop and close the afc loop until two conditions are met: the tuner shaft is in at least approximately the right position, and an i-f signal is present.

Once the relay operates, the afc loop takes over. The i-f signal is frequency-discriminated to produce a dc voltage whose polarity and magnitude indicate the direction and size of the error in the i-f. Since radars usually have very low duty cycles, the signal into the i-f amplifier isn't a continuous wave but rather, a periodic series of short bursts with a lot of time between them. The discriminator output is thus not a dc level

but a train of short pulses. These are quite unsuitable for driving as slowly reacting a device as a motor.

The boxcar circuitry is included in the loop to stretch the pulses. This circuitry performs a sample-and-hold operation in which it peak-detects the discriminator output and then holds the level until the next pulse. Timing for this operation comes from the radar trigger pulse,  $T_0$ , which is the synchronizing signal used by the entire system to mark the period during which the radar is transmitting.

#### When is loop stability a problem?

The frequency variations that the servo loop must be able to follow are caused principally by temperature changes. Since these thermal drifts do not exceed 1 or 2 MHz/minute, even at turn-on, the system response time can be quite slow. This means that a large gear ratio can be used between the control motor and the magnetron—



effectively isolating the tuner's backlash and friction. Furthermore, the torque multiplication of the gear train allows the use of a small motor with a low-inertia rotor.

Because the thermal drift requirements are so slow, the actual tuning-rate specification is determined by other system considerations, such as the maximum time permitted to change frequency channels. For a typical X-band system, a tuning rate of 10 MHz/s might be specified. This can be done with a standard size 10 servomotor and a 100:1 gear ratio. Provided that a precision gear train is used, no stability problems should arise in such a situation.

On the other hand, if the system specifications dictate a tuning rate on the order of hundreds of MHz/s, trouble can be expected. The problem is two-fold: A larger motor is needed, with correspondingly higher rotor inertia, and a lower ratio gear train will be needed making the backlash, hysteresis, and static and dynamic friction characteristics of the magnetron tuner important loop parameters. As an example, for a tuning rate of 200 MHz/s a size 18 motor and a 4:1 gear ratio might be needed.

The solution to the stability problem is simply to include rate feedback in the servo loop, as indicated in Fig. 2. The rate-feedback damping signal is generated by a tachometer geared to the drive motor. It is weighted by amplifier A3 and then summed with the error signal coming out of the boxcar circuit. The sum is modulated at the power-line frequency, amplified and used to drive the servo motor.

### Tube characteristics are important

In applying the feedback technique to an actual radar set, several points of a practical nature should be borne in mind. First, the system is designed to eliminate the slow drifts caused by thermal effects—not the rapid changes that can be caused by, say, a scanning antenna. Thus, an isolator should be inserted between the magnetron and the antenna to reduce any frequency-pulling effects to an acceptable level.

Second, if a conventional vane-and-strap magnetron is used, a well-designed modulator is required to eliminate intra-pulse fm. The current pulse should have a fixed amplitude and should be rectangular in shape. Coaxial magnetrons are less sensitive to both the pulling effects of the antenna and the pushing effects of the modulator.

Third, for best operation, a magnetron with a precision tuning mechanism should be used. Backlash, inertia and friction should all be minimized so that the required drive torque is as low as possible. Additionally, a thermally compensated tube should be selected so that swept afc circuits aren't needed.

For the two systems that have been designed and produced in quantity using this technique, special tubes were employed. These were standard magnetrons with modified tuners, developed by Litton Industries, Williamsport, Pa. The tubes were an X-band unit and a Ka-band unit.

The feedback approach is recommended for noncoherent radar applications where frequency accuracies on the order of 0.01% are needed. It is especially suitable for airborne applications because of its size and weight advantages over microwave power-amplifier systems. A 200-kW X-band transmitter, for example, occupies only 1.5 cubic feet.

The cost is also attractive compared with the power-amplifier approach. The special 200-kW X-band magnetron costs less than \$2000; crossed-field amplifiers and traveling wave tubes cost many times more. ■■



Author F. H. Wolf, in his laboratory, is testing the portion of the system containing the afc circuits.

### Test your retention

*Here are questions based on the main points of this article. Their purpose is to help you make sure you have not overlooked any important ideas. You'll find the answers in the article.*

*1. Under what conditions is it usually necessary to add rate feedback to the afc loop?*

*2. Why is a boxcar circuit needed behind the discriminator? Would it be needed in a CW radar?*

*3. What is the function of the lockup inhibit circuitry?*

*4. Why is it highly desirable to choose a magnetron with a very low-friction tuner?*



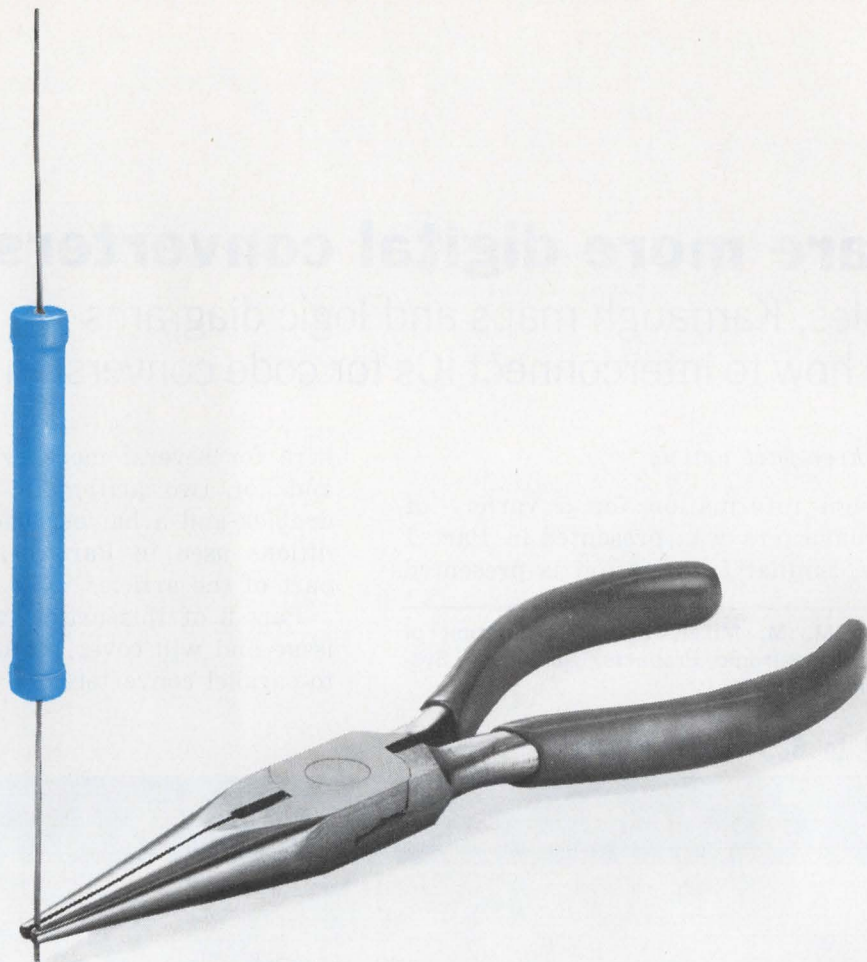

## The older it gets the more you'll appreciate it.

Victoreen now makes resistors which can work . . . and work . . . and never tire under the load. Or, they can sit . . . and sit . . . and never tire waiting around. We call them Mastermox — metal oxide glaze resistors.

When called upon to work, the stability of a Mastermox allows as little as 1% drift under full load in 2000 hours — with more than 40 watts power dissipation per cubic inch. On the shelf, Mastermox resistors' metal oxide glaze structure permits less than 0.1% drift per year.

Try Mastermox resistors. No permanent effect from voltage and temperature cycling. High resistance range accuracy — 10K ohms to 10,000 Megohms. Precision as good as  $\pm 0.5\%$ .

Mastermox. Even the old ones are new ones.

Model	Resistance Range	Power Rating @ 70°C	*Max. Oper. Volts	Length Inches	Diameter Inches
MOX-400	1 - 2500 megs	.25W	1,000V	.420 $\pm$ .050	.130 $\pm$ .010
MOX-750	1 - 5000 megs	.50W	2,000V	.790 $\pm$ .050	.130 $\pm$ .010
MOX-1125	1 - 10000 megs	1.00W	5,000V	1.175 $\pm$ .060	.130 $\pm$ .010
MOX-1	10K - 500 megs	2.50W	7,500V	1.062 $\pm$ .060	.284 $\pm$ .010
MOX-2	20K - 1000 megs	5.00W	15,000V	2.062 $\pm$ .060	.284 $\pm$ .010
MOX-3	30K - 1500 megs	7.50W	22,500V	3.062 $\pm$ .060	.284 $\pm$ .010
MOX-4	40K - 2000 megs	10.00W	30,000V	4.062 $\pm$ .060	.284 $\pm$ .010
MOX-5	50K - 2500 megs	12.50W	37,500V	5.062 $\pm$ .060	.284 $\pm$ .010

\*Applicable above critical resistance. Maximum operating temperature, 220°C. Encapsulation: Si Conformal. Additional technical data in folder form available upon request. Or telephone: (216) 795-8200.



**VICTOREEN INSTRUMENT DIVISION**  
**10101 WOODLAND AVENUE · CLEVELAND, OHIO 44104**  
 EUROPE: ARNDALE HOUSE, THE PRECINCT, EGHAM, SURREY, ENGLAND • TEL: EGHAM 4887



INFORMATION RETRIEVAL NUMBER 54



# Here are more digital converters.

Truth tables, Karnaugh maps and logic diagrams show you how to interconnect ICs for code conversion

Part 2 of a three-part article

Logical design information for a variety of digital code converters was presented in Part 1 of this article. Similar information is presented

A. H. Frim and M. M. Miller, Radio Corporation of America, Defense Electronic Products, Aerospace Systems Div., Burlington, Mass.

here for several more types of code converters and for two arithmetic converters—namely, a doubler and a halver. The conventions and definitions used in Part 1 are also valid for this part of the article.

Part 3 of this article will appear in the next issue and will cover parallel-to-serial and serial-to-parallel converters.

## 7. BCD (4221) to BCD (8421) converter

### Operation:

This converter uses three DTL 946 gates to convert from BCD (4221) code to BCD (8421) code. For the condition where the input code is 1110, Z3-1 and Z3-2 are HIGH, so that  $F_8$  is HIGH. All other outputs are LOW.

### Truth tables:

Input				Output			
$B_4$	$B_2'$	$B_2$	$B_1$	$F_8$	$F_4$	$F_2$	$F_1$
0	0	0	0	0	0	0	0
0	0	0	1	0	0	0	1
0	0	1	0	0	0	1	0
0	0	1	1	0	0	1	1
0	1	1	0	0	1	0	0
1	0	0	1	0	1	0	1
1	1	0	0	0	1	1	0
1	1	0	1	0	1	1	1
1	1	1	0	1	0	0	0
1	1	1	1	1	0	0	1

Don't Care = X = 4, 5, 7, 8, 10, 11

### Karnaugh maps:

	$B_4$	$B_2'$			
$B_2$	$B_1$	00	01	11	10
00		X		X	
01			X		
11		X	1	X	
10				1	X

$$F_8 = B_4 B_2$$

	$B_4$	$B_2'$			
$B_2$	$B_1$	00	01	11	10
00		X	1	X	
01			X	1	1
11		X		X	
10		1		X	

$$F_4 = \bar{B}_4 B_2' + B_4 \bar{B}_2$$

	$B_4$	$B_2'$			
$B_2$	$B_1$	00	01	11	10
00		X	1	X	
01			X	1	
11		1	X	X	
10		1		X	

$$F_2 = \bar{B}_2' B_2 + B_2' \bar{B}_2$$

	$B_4$	$B_2'$			
$B_2$	$B_1$	00	01	11	10
00		X		X	
01		1	X	1	1
11		1	X	1	X
10				X	

$$F_1 = B_1$$

### Logic diagram:

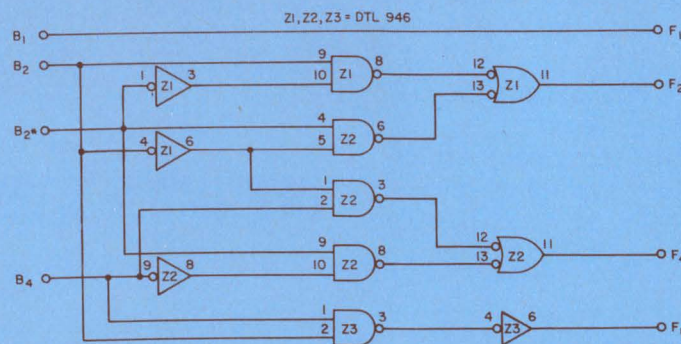



## 8. BCD (8421) to BCD (4221) converter

### Operation:

This converter uses three DTL 946 gates and one DTL 930 gate to convert from BCD (8421) code to BCD (4221) code. The 4221 code finds application in digital systems where a self-complementary code is desired, in which the complement of any digit is always the nine's complement of that digit. For example, the nine's complement of 2 (0010) is 7 (1101), and that of 6 (1100) is 3 (0011). In operation, if the 8421 input is 1000, for example, where  $F_8 = 1$ ,  $F_4 = 0$ ,  $F_2 = 0$ , and  $F_1 = 0$ , then 4221 output will be 1110, where  $B_4 = 1$ ,  $B_2 = 1$ ,  $B_2 = 1$  and  $B_1 = 0$ . Thus, when  $F_8$  is HIGH and  $F_4$ ,  $F_2$  and  $F_1$  are LOW, Z2-11 is LOW, so that Z3-10 is LOW and therefore Z3-8 is HIGH ( $B_4 = 1$ ). Similarly,  $B_2'$  and  $B_2$  are HIGH and  $B_1$  is LOW for this condition.

### Truth tables:

Input				Output			
$F_8$	$F_4$	$F_2$	$F_1$	$B_4$	$B_2'$	$B_2$	$B_1$
0	0	0	0	0	0	0	0
0	0	0	1	0	0	0	1
0	0	1	0	0	0	1	0
0	0	1	1	0	0	1	1
0	1	0	0	0	1	1	0
0	1	0	1	1	0	0	1
0	1	1	0	1	1	0	0
0	1	1	1	1	1	0	1
1	0	0	0	1	1	1	0
1	0	0	1	1	1	1	1

Don't Care = X = 10, 11, 12, 13, 14, 15

### Karnaugh maps:

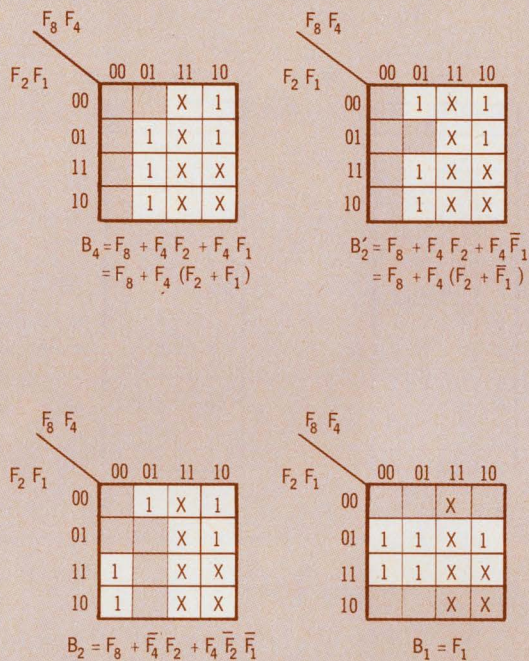

### Logic diagram:

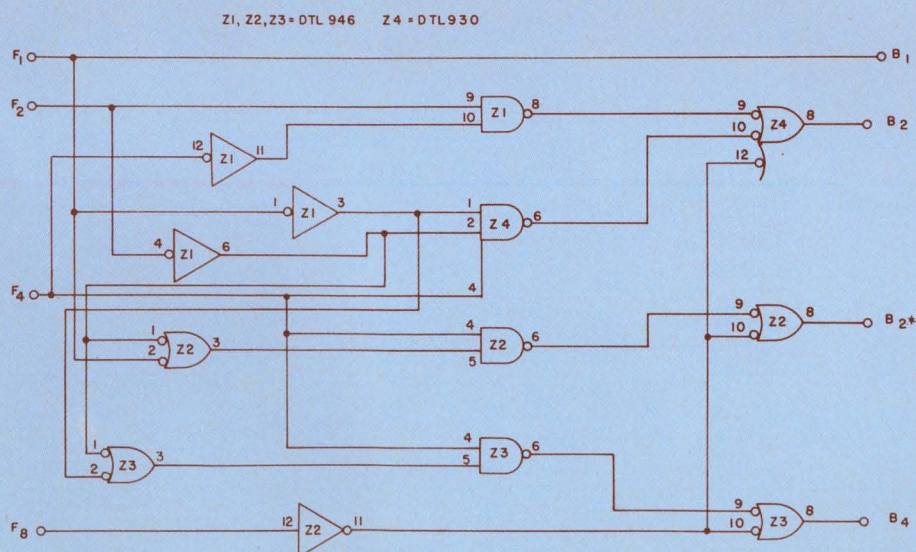

(illustrations continued on pp. 86, 87, 88 and 89)



## 9. BCD (8421) to excess 3 converter

### Operation:

This converter uses three DTL 946 gates and one DTL 930 gate to convert from BCD (8421) code to Excess 3 code. Excess 3 is a self-complementing code, like 4221, except that it is constructed by adding 3 to each digit of a straight BCD code. Thus, 0 in BCD is 3 in Excess 3; 1 in BCD is 4 in Excess 3; and so forth. Note that 0000 is non-existent in the Excess 3 code. For the condition where the input code is all zeros, the output code is 0011. That is, when  $B_8, B_4, B_2,$  and  $B_1$  are all LOW, then Z1-3 is HIGH, so that  $E_1$  is HIGH. Furthermore, Z1-9 and Z1-10 are HIGH, so that Z1-8 is LOW, Z1-13 is LOW, and hence Z1-11 is HIGH, making  $E_2$  HIGH.

### Truth tables:

Input				Output			
$B_8$	$B_4$	$B_2$	$B_1$	$E_4$	$E_3$	$E_2$	$E_1$
0	0	0	0	0	0	1	1
0	0	0	1	0	1	0	0
0	0	1	0	0	1	0	1
0	0	1	1	0	1	1	0
0	1	0	0	0	1	1	1
0	1	0	1	1	0	0	0
0	1	1	0	1	0	0	1
0	1	1	1	1	0	1	0
1	0	0	0	1	0	1	1
1	0	0	1	1	1	0	0

Don't Care = X = 10, 11, 12, 13, 14, 15

### Karnaugh maps:

	$B_8$	$B_4$		
$B_2$	$B_1$			
	00	01	11	10
00			X	1
01		1	X	1
11		1	X	X
10		1	X	X

$$E_4 = B_8 + B_4 B_2 + B_4 B_1$$

$$= B_8 + B_4 (B_2 + B_1)$$

	$B_8$	$B_4$		
$B_2$	$B_1$			
	00	01	11	10
00		1	X	
01	1		X	1
11	1		X	X
10	1		X	X

$$E_3 = \bar{B}_4 B_1 + \bar{B}_4 B_2 + B_4 \bar{B}_2 \bar{B}_1$$

$$= \bar{B}_4 (B_1 + B_2) + B_4 \bar{B}_2 \bar{B}_1$$

	$B_8$	$B_4$		
$B_2$	$B_1$			
	00	01	11	10
00	1	1	X	1
01			X	
11	1	1	X	X
10			X	X

$$E_2 = \bar{B}_2 \bar{B}_1 + B_2 B_1$$

	$B_8$	$B_4$		
$B_2$	$B_1$			
	00	01	11	10
00	1	1	X	1
01			X	
11			X	X
10	1	1	X	X

$$E_1 = \bar{B}_1$$

### Logic diagram:

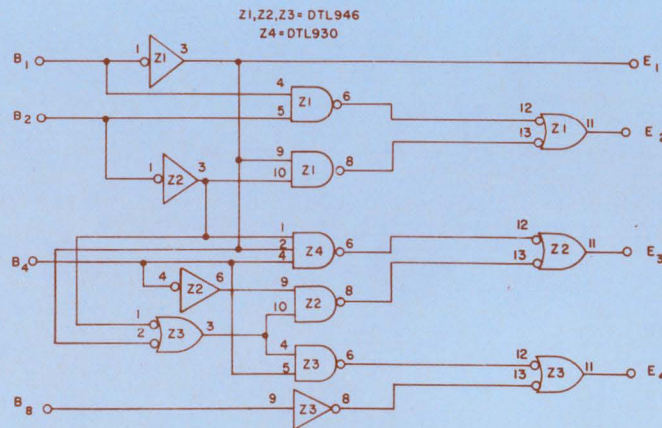



## 10. Excess 3 to BCD (8421) converter

### Operation:

This converter uses three DTL 946 gates and one DTL 930 gate to convert Excess 3 code to BCD (8421) code. When the input code is 0101, the Excess 3 code is 0010. That is, when  $E_3$  and  $E_1$  are HIGH, and  $E_4$  and  $E_2$  are LOW, then  $F_1$  is HIGH and all other  $F_i$  are LOW. Circuit wise, when  $E_2$  is LOW and  $E_1$  is HIGH, Z1-9 and Z1-10 are HIGH, so that Z1-8 and Z1-13 are low, hence Z1-11 is HIGH.

### Truth tables:

Input				Output			
$E_4$	$E_3$	$E_2$	$E_1$	$F_8$	$F_4$	$F_2$	$F_1$
0	0	1	1	0	0	0	0
0	1	0	0	0	0	0	1
0	1	0	1	0	0	1	0
0	1	1	0	0	0	1	1
0	1	1	1	0	1	0	0
1	0	0	0	0	1	0	1
1	0	0	1	0	1	1	0
1	0	1	0	0	1	1	1
1	0	1	1	1	0	0	0
1	1	0	0	1	0	0	1

Don't Care = X = 0, 1, 2, 13, 14, 15

### Karnaugh maps:

$E_4$ $E_3$	$E_2$ $E_1$			
	00	01	11	10
00	X		1	
01	X		X	
11			X	1
10	X		X	

$$F_8 = E_4 E_3 + E_4 E_2 E_1$$

$$= E_4 (E_3 + E_2 E_1)$$

$E_4$ $E_3$	$E_1$ $E_2$			
	00	01	11	10
00	X			1
01	X		X	1
11		1	X	
10	X		X	1

$$F_4 = \bar{E}_3 \bar{E}_2 + \bar{E}_3 \bar{E}_1 + E_3 E_2 E_1$$

$$= \bar{E}_3 (\bar{E}_2 + \bar{E}_1) + E_3 E_2 E_1$$

$E_4$ $E_3$	$E_2$ $E_1$			
	00	01	11	10
00	X			
01	X	1	X	1
11			X	
10	X	1	X	1

$$F_2 = \bar{E}_2 E_1 + E_2 \bar{E}_1$$

$E_4$ $E_3$	$E_1$ $E_2$			
	00	01	11	10
00	X	1	1	1
01	X		X	
11			X	
10	X	1	X	1

$$F_1 = \bar{E}_1$$

### Logic diagram:

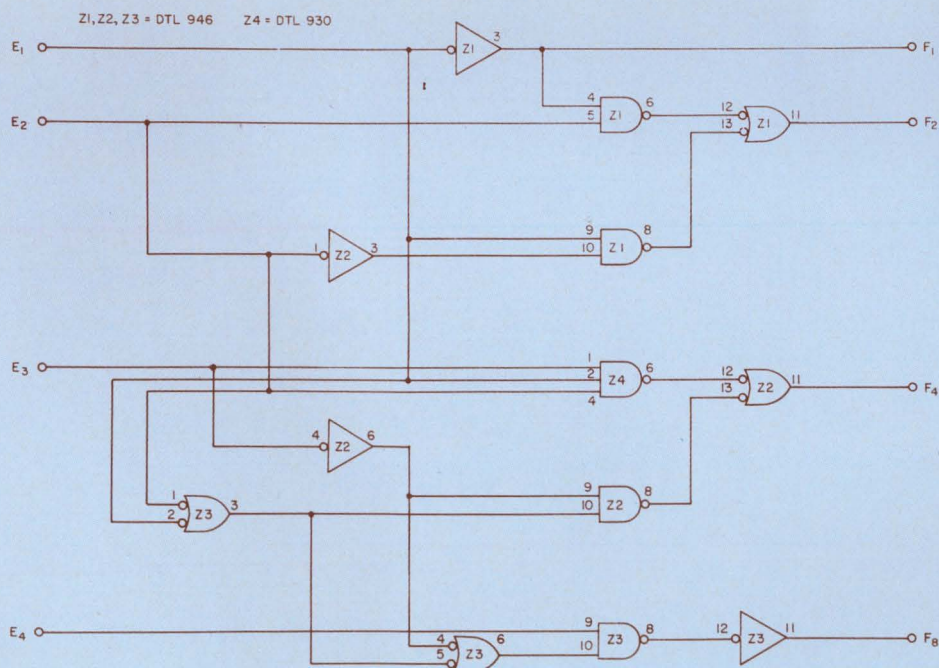



# 11. BCD doubler

## Operation:

In certain digital applications, such as those involving programmable signal and pulse generators, it is necessary to multiply a given BCD value by an integer. This can be accomplished by means of a BCD arithmetic converter, one type of which is the BCD doubler. When this circuit is used, the input BCD value is multiplied by a factor of 2. For example, when the BCD input is 24 (0010 0100), the BCD output is 48 (0100 1000). Other types of BCD multipliers can be designed by extending the logic of the basic circuit. The logic diagram below is a BCD doubler (x2) for a single BCD input (decade). For the condition where the BCD input is 0100, the BCD output is 01000. That is, when  $B_4$  is HIGH and  $B_8, B_2,$  and  $B_1$  are LOW, Z6-9,-10, and -12 are HIGH. This makes Z3-11 (or  $F_8$ ) is HIGH.  $F_{10}, F_4,$  and  $F_2$  are LOW, in this case.

## Truth tables:

Input				Output				
$B_8$	$B_4$	$B_2$	$B_1$	$F_{10}$	$F_8$	$F_4$	$F_2$	$F_1$
0	0	0	0	0	0	0	0	0
0	0	0	1	0	0	0	1	0
0	0	1	0	0	0	1	0	0
0	0	1	1	0	0	1	1	0
0	1	0	0	0	1	0	0	0
0	1	0	1	1	0	0	0	0
0	1	1	0	1	0	0	1	0
0	1	1	1	1	0	1	0	0
1	0	0	0	1	0	1	1	0
1	0	0	1	1	1	0	0	0

Don't Care = X = 10, 11, 12, 13, 14, 15

$F_1 = 0 =$  Not Used.

## Karnaugh maps:

$B_8 B_4$	$B_2 B_1$	00	01	11	10
00				X	1
01		1	X	1	
11		1	X	X	
10		1	X	X	

$$F_{10} = B_8 + B_4 B_1 + B_4 B_2$$

$$= B_8 + B_4 (B_1 + B_2)$$

$B_8 B_4$	$B_2 B_1$	00	01	11	10
00		1	X		
01			X	1	
11			X	X	
10			X	X	

$$F_8 = B_8 B_1 + B_4 \bar{B}_2 \bar{B}_1$$

$B_8 B_4$	$B_2 B_1$	00	01	11	10
00				X	1
01			X		
11		1	1	X	X
10		1		X	X

$$F_4 = B_2 B_1 + \bar{B}_4 B_2 + B_8 \bar{B}_1$$

$$= B_2 (B_1 + \bar{B}_4) + B_8 \bar{B}_1$$

$B_8 B_4$	$B_2 B_1$	00	01	11	10
00				X	1
01		1	X		
11		1	X	X	
10			1	X	X

$$F_2 = B_8 \bar{B}_1 + \bar{B}_8 \bar{B}_4 B_1 + B_4 B_2 \bar{B}_1$$

$$= \bar{B}_1 (B_8 + B_4 B_2) + \bar{B}_8 \bar{B}_4 B_1$$

## Logic diagram:

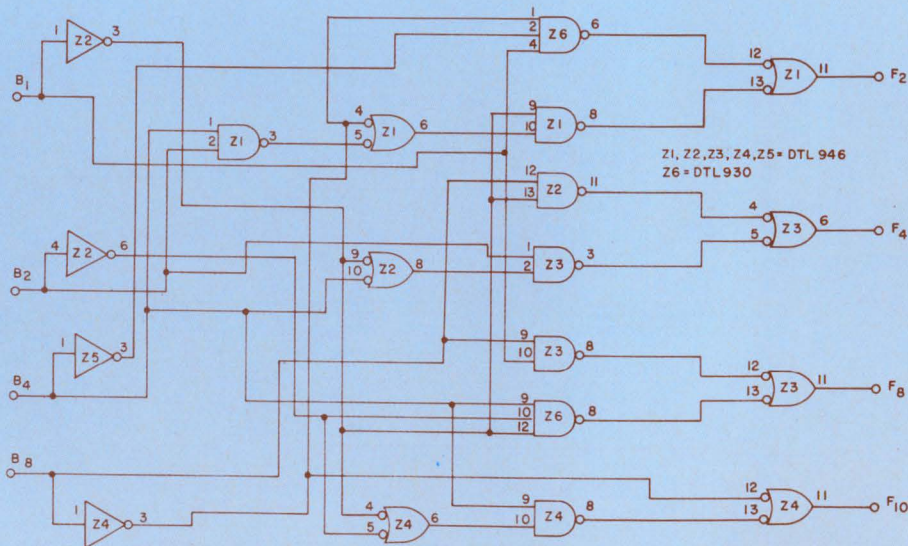



## 12. BCD halver

### Operation:

Division of a BCD value by an integer can be accomplished by a BCD arithmetic converter, such as the BCD halver. When this particular circuit is used, the input BCD value is divided by a factor of 2. For example, when the BCD input is 24 (0010 0100), the BCD output is 12 (0001 0010). Other types of BCD dividers can be designed by extending the logic of the basic circuit. The logic diagram below is a BCD halver ( $\div 2$ ) for a single BCD input (decade). For the condition where the BCD input is 00100, the BCD output is 0010. That is, when  $B_4$  is HIGH and  $B_{10}, B_8, B_2$  are LOW, then Z2-9 and Z2-10 are HIGH. This makes Z2-13 LOW, and therefore Z2-11 (or  $F_2$ ) is HIGH.  $F_8, F_4,$  and  $F_1$  are LOW, in this case.

### Truth tables:

Input					Output			
$B_{10}$	$B_8$	$B_4$	$B_2$	$B_1$	$F_8$	$F_4$	$F_2$	$F_1$
0	0	0	0	0	0	0	0	0
0	0	0	0	1	✓	0	0	0
0	0	0	1	0	0	0	0	1
0	0	0	1	1	✓	0	0	0
0	0	1	0	0	0	0	1	0
0	0	1	0	1	✓	0	0	1
0	0	1	1	0	0	0	1	1
0	0	1	1	1	✓	0	0	1
0	1	0	0	0	0	1	0	0
0	1	0	0	1	✓	0	1	0
1	0	0	0	0	0	1	0	1
1	0	0	0	1	✓	0	1	0
1	0	0	1	0	0	1	1	0
1	0	0	1	1	✓	0	1	1
1	0	1	0	0	0	1	1	1
1	0	1	0	1	✓	1	0	0
1	0	1	1	0	1	0	0	0
1	0	1	1	1	✓	1	0	0
1	1	0	0	0	1	0	0	1
1	1	0	0	1	✓	1	0	0

✓ = Delete = 1,3,5,7,9,11,13,15,17,19 (Only Whole Numbers Are Used)  
 $B_1 = 0$

Don't Care = X = 5,6,7,13,14,15 (Use Columns  $B_{10}, B_8, B_4,$  and  $B_2$ ; not  $B_1$ )

### Karnaugh maps:

$B_4$ $B_2$	$B_{10} B_8$ 00	$B_{10} B_8$ 01	$B_{10} B_8$ 11	$B_{10} B_8$ 10
00			1	
01		X	X	
11		X	X	1
10		X	X	

$$F_8 = B_{10} B_8 + B_{10} B_4 B_2$$

$$= B_{10} (B_8 + B_4 B_2)$$

$B_4$ $B_2$	$B_{10} B_8$ 00	$B_{10} B_8$ 01	$B_{10} B_8$ 11	$B_{10} B_8$ 10
00		1		1
01		X	X	1
11		X	X	
10		X	X	1

$$F_4 = \bar{B}_{10} B_8 + B_{10} \bar{B}_8 \bar{B}_4$$

$$+ B_{10} \bar{B}_8 \bar{B}_2$$

$$= \bar{B}_{10} B_8 + B_{10} \bar{B}_8 (\bar{B}_4 + \bar{B}_2)$$

$B_4$ $B_2$	$B_{10} B_8$ 00	$B_{10} B_8$ 01	$B_{10} B_8$ 11	$B_{10} B_8$ 10
00				
01		X	X	1
11	1	X	X	
10	1	X	X	1

$$F_2 = B_4 \bar{B}_2 + \bar{B}_{10} B_4 + B_{10} \bar{B}_4 B_2$$

$$= B_4 (\bar{B}_2 + \bar{B}_{10}) + B_{10} \bar{B}_4 B_2$$

$B_4$ $B_2$	$B_{10} B_8$ 00	$B_{10} B_8$ 01	$B_{10} B_8$ 11	$B_{10} B_8$ 10
00			1	1
01	1	X	X	
11	1	X	X	
10		X	X	1

$$F_1 = \bar{B}_{10} B_2 + B_{10} \bar{B}_2$$

### Logic Diagram:

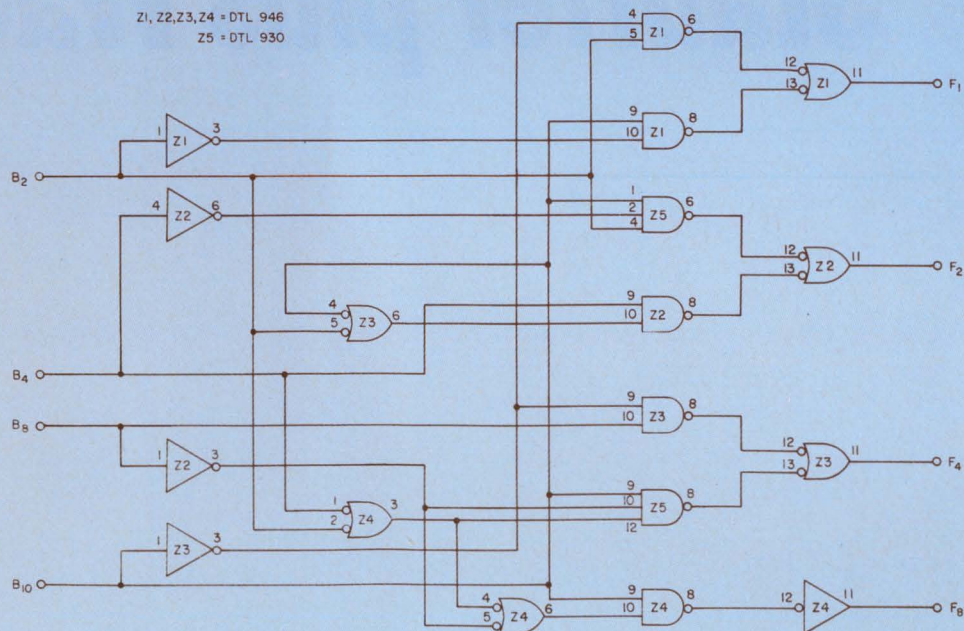



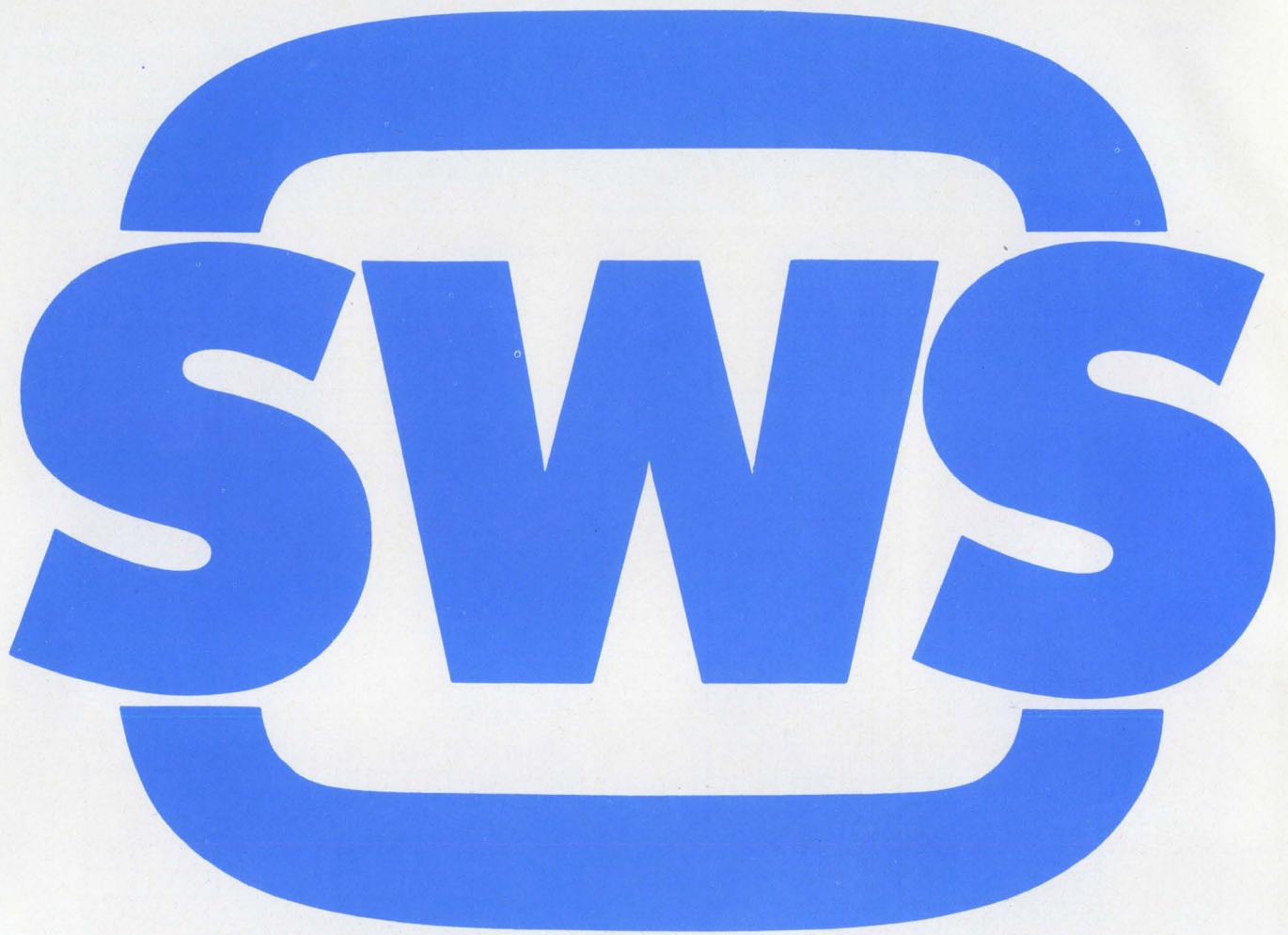

***Stauffer plus Wacker***





## ***...a new force in silicones***

The result is SWS, Stauffer-Wacker Silicone Corporation. A creative blend of one of the newest and one of the oldest silicone producers in the world.

Stauffer, five years in silicones, brings new ideas and the latest in engineering and manufacturing facilities to SWS. Wacker-Chemie GmbH, a leader in silicones in Europe, brings a wealth of research, development and technical experience that goes back 20 years.

This new force creates a unique, in-depth capability in silicones. SWS produces and markets, in the U.S.A., more than 200 different silicone products in a broad range of categories, including: Fluids, Antifoam Agents, Release Agents, Elastomers, Grease Compounds. For more information on what SWS makes—or could make to help you—drop us a line. Write to Stauffer-Wacker Silicone Corporation, P.O. Box 428, Adrian, Michigan 49221.





## LEND: a helping hand in aerospace.

This employee interchange program helps stabilize the work force in an industry that has its ups and downs.

Richard L. Turmail, Management Editor

Does this situation sound familiar to you?

You're an engineer, and you have a good design job working on an aerospace project with a company in St. Louis. Correction: you had a job. Why? Because when the project was finished, so were you. You move to another location to find work, but it's just a matter of time before you're the victim of another layoff. You move again, and again, and again. Before long you begin to feel like an "engineering bum" or a "technical transient" who has no roots, no fringe benefits and, most important—no future.

Layoffs have often been responsible for the cold-blooded murder of engineering careers. The massive "turndowns" that occur in the aerospace industry have not only forced competent engineers to change careers but, according to one manpower administrator at Lockheed, they have discouraged many a promising young student from electing an engineering profession.

A portion of what can be done to help solve the layoff problem that is inherent in the aerospace industry is explained in the following interview with Kaye Kiddoo, corporation manpower administrator of the Lockheed Aircraft Corp., Burbank, Calif.

### The way it all began

Kiddoo says that many people in the electronics field believe that large companies in the aerospace industry don't care or worry when they lay off large numbers of their employees. "Nothing could be further from the truth," he says. "Boy, do we worry, because at Lockheed, for example, layoffs lower employee morale, adversely affect our recruiting program and, at times, cause us to lose some of our best engineering talent."

In an attempt to stabilize the engineering work force of the entire aerospace industry, Kiddoo says Lockheed has come up with an employee interchange program called LEND—Lockheed Engineers for National Deployment.

"I think you can understand LEND better if you know something about the manpower needs of the industry over the past thirty years," Kiddoo says.

Lockheed has been studying the layoff problem ever since the end of World War II when the first major turndown in the industry occurred. Before the war the aircraft business, which would later transform itself into the business of aerospace, was fairly stable. Most of the companies were located in southern California mainly because ideal weather conditions permitted the construction of aircraft without the need for expensive sheds and hangars.

By the time one company finished the development phase of an aircraft program and moved on to the tool and production phases, it would either get another contract for a new program, or a company nearby would receive a contract for a new program. Engineering talent could easily move from one company to another without having to leave the area. Job security was built in because government expenditures were consistent and programs were numerous.

### There were some changes made

During the war the entire aircraft industry was busy. But since the war the aerospace industry has been what Kiddoo calls a "peculiar breed of cat" because:

- In order to spread the wealth, the government has, by plan and by design, spread the industry geographically by awarding many contracts to smaller companies that are located outside of California.

- Government expenditures have been erratic, forcing the industry's manpower needs to rise and fall.

- Programs have been getting larger. There are fewer of them, and they are getting more and more expensive. Example: Lockheed is working on the C5A, the world's largest cargo plane that will carry outsized pieces of military equipment anywhere in the world non-stop. Cost: \$2-billion to \$4-billion.

"Because of these changes in the industry,"



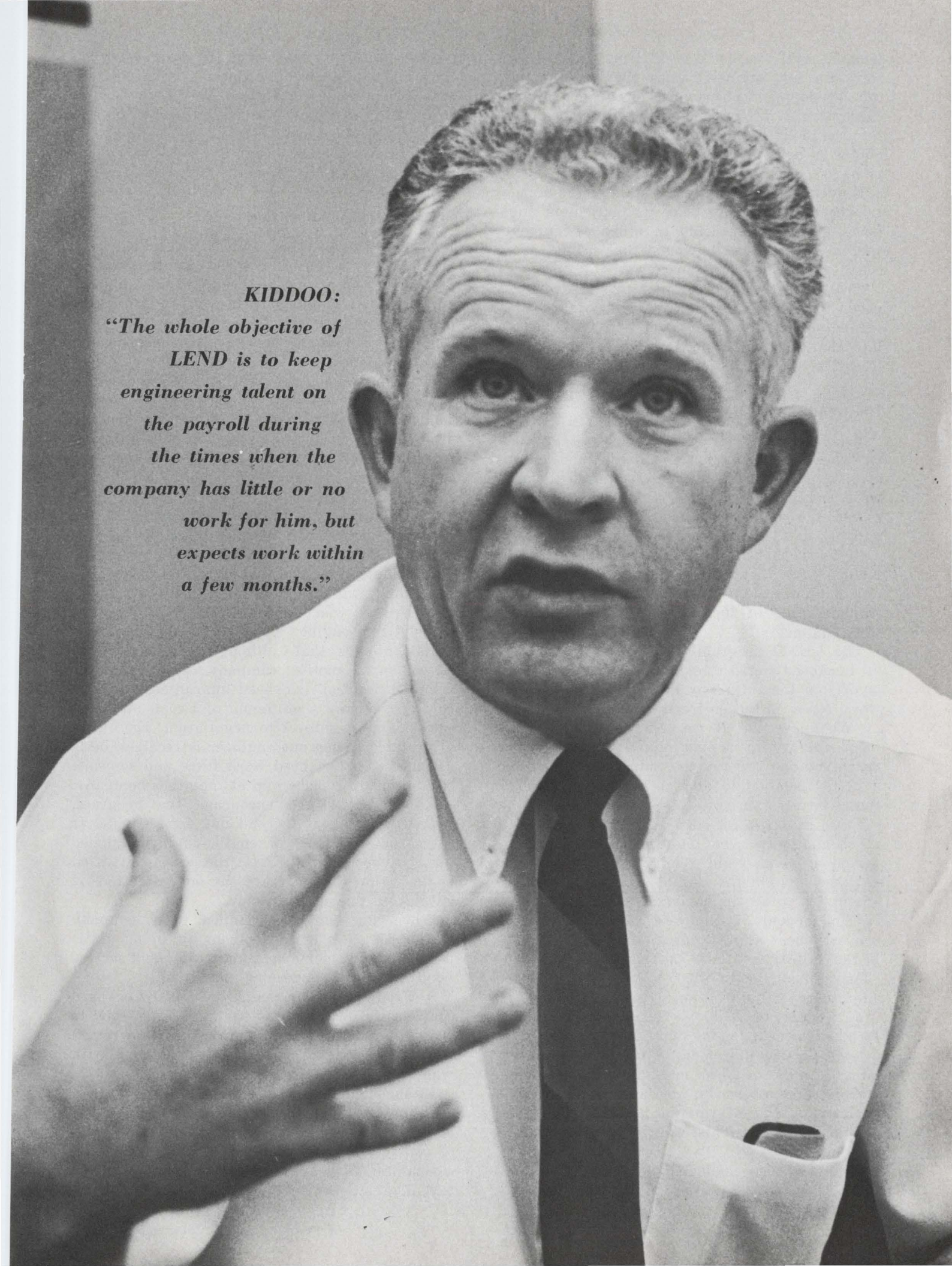

**KIDDOO:**  
*“The whole objective of  
LEND is to keep  
engineering talent on  
the payroll during  
the times when the  
company has little or no  
work for him, but  
expects work within  
a few months.”*



Kiddoo says, "we have a difficult time finding work for our engineers after they've completed the development phase of a program. Because there are few programs under contract, we move into the tooling, production and flight test phases before a new program enters the development phase."

Kiddoo says that, since the start of the decade, Lockheed has tried to place its phased-out engineers as best they could in other assignments within their nine divisions that range from oceanography to outer space.

"We have tried to spot our own employment needs," he says, "because we don't want to lay off personnel in one division and find out too late that we had a need for that engineering talent in another division."

### The trend to LEND

Lockheed experienced a major layoff in 1963-64 when all of the large ballistic missile programs, including the Minuteman and Polaris, were completed at about the same time. Experts placed the number of scientists and engineers laid off in the industry at 30,000.

"I think that figure is grossly exaggerated," Kiddoo says. "At Lockheed's Missile and Space Co. in Sunnyvale, Calif., we laid off about 7000 employees out of 30,000, but only 1000 of them were engineers."

The LEND program was the eventual result of Lockheed's effort to help prevent any large layoffs in the future by helping to stabilize the work force of the entire industry.

"We knew that if we could provide employment stability in our own industry," Kiddoo says, "each company within the industry would be in a better position to attract the talented people that we've got to have to survive."

But LEND wasn't born full-grown, nor did it reach maturity over night. It evolved over a period of about eight years during which time Lockheed sought the suitable mix that would be acceptable to all the companies.

"One of our first moves was to organize a consortium of about 20 of the largest companies in the industry on the West Coast," Kiddoo says. "They all agreed to work together if Lockheed administered the program."

According to Kiddoo, the companies called Lockheed every Monday morning to report either a layoff or a requirement. This input was tabulated on a list of 25 or so engineering job titles. On the same afternoon, Lockheed would prepare a matrix of the information and distribute it to all the companies. This brought need and supply together.

Lockheed also conducted an in-plant counseling session for engineers on how to write an em-

ployment resume. "We edited the resumes, typed them and sent them out to over a hundred companies that requested them," Kiddoo says.

Not all of our ideas worked, either because we didn't have a concrete plan or we couldn't get all of the companies to agree. "But," says Kiddoo, "I think LEND is on the right track now."

### How the exchange plan works

"The whole objective of LEND," Kiddoo says, "is to keep engineering talent on the payroll during the times when the company has little or no work for him, but expects work within a few months." Here's how LEND works:

1. Lockheed establishes reciprocal agreements with any company that uses the same kind of engineering talent. On request, Lockheed lends, if available, an engineer or engineers to another company at a cost that is based on the average of all salaries of engineers who have volunteered for the LEND program. Although the lending company pays the engineer's salary, the hiring company is billed for it.

Kiddoo says that LEND is a good plan for small companies who have a difficult time recruiting a specialist for a short-term program.

2. Volunteers are not bound to the program if they don't want to go when called. Both companies agree that there will be no attempt at proselytizing engineers.

Kiddoo says that, although engineers have stayed on at another company, such losses are a minor problem. Lockheed guarantees the borrowing company a minimum of two months for each engineer, subject to negotiation. Engineers are rotated. When one engineer is recalled, he is assigned to a Lockheed work force and someone else is sent to replace him at the other company.

Kiddoo says: "To encourage the program, we've been careful to send out good people. If there isn't any work when the highly qualified man returns from LEND, the lesser qualified engineers on the staff are the ones affected by any layoff that might occur."

When a volunteer is loaned to a company located 50 miles or more from his home, he is usually given a per diem and a 15% field service bonus. Each case is decided individually.

3. From a management viewpoint, Lockheed controls its own program by reviewing reports from its different company divisions that reveal if they're hiring or lending engineers and with what companies they're negotiating.

Management also keeps in touch with LEND coordinators, who are stationed at each of the divisions. These coordinators are the main points of contact for both the hiring and the lending companies. They are expected to know how the exchange engineers are being treated and how well



they are performing at their jobs. They also know what all the companies' daily employment requirements are, and know the companies to call when they need, say, 10 circuit designers. As a further control, Lockheed asks the hiring companies to appraise Lockheed's employees every 60 days.

"In the nearly two years the LEND program has been in operation," Kiddoo says, "not one of our employees has been rejected, and we have not rejected any employees on loan to us."

### Old "hangups" die slowly

"Although the benefits of LEND for the lending company, for the hiring company, and for the engineer are obvious," Kiddoo says, "we've had our problems. The program has not been the rip-snortin' success we had hoped it would be. There are only about 100 engineers on loan at any given time. It's the kind of program that will take time to put across—not only to companies but to most engineers."

Why? Kiddoo candidly lists a number of hangups that are keeping the program from growing:

- One engineer said that he felt he had been treated like a machine that could be traded, bartered for, sold or pawned.
- Companies sometimes suspect their competitors of using their engineers on loan to steal product secrets.
- Company lawyers have yet to decide what to do when the engineer on loan to another company comes up with a new invention. To whom do the patent rights belong? The engineer? The lending company? The hiring company?
- The Lockheed finance department says that anything the company does should show a profit. According to Kiddoo, Lockheed is not in the business of making money on lending people. In order for LEND to be popular and receive company support, a compromise was made. Lockheed must break even financially on the operation of the program.
- Although there are enough engineers to sustain the program, most employees are reluctant to volunteer because they don't want to be away from their families.

### Ring around the core

When you ask Kiddoo if he foresees a better plan for stabilizing the work force of the aerospace industry, he has a ready reply. The plan is divided into three parts:

"Lockheed," he says, "has made a rigorous attempt to identify our core, our heartland of technical people. These are the people who are absolutely essential, not only to our present ac-

complishments but to the future of the corporation. We're tied up in technology," Kiddoo says. "We're just as good as our engineers, and no better.

"If we can identify the core group," he says, "we can identify a ring around that group who are support personnel (writers, technicians, administrators). They are just a little less essential than the core group.

"The outer group around the ring is composed of LEND people and contract engineers who are needed for temporary build-ups."

Kiddoo says that once Lockheed is able to really define these three groups, it will be on its way to stabilizing its work force. For example: once the core group is selected, Lockheed would concentrate time and money on its engineers to help keep them up with the state-of-the-art.

A set staff (one that would never be laid off) would enable Lockheed to become better acquainted with each engineer. Thus, through familiarity with the engineering employees, management could motivate them through the proper mix of challenging assignments and compensation programs.

Since the support group might be affected by layoffs, a different managing approach should be made in that area. Kiddoo says that it behooves Lockheed to design a severance program that would be effective in retaining as many support personnel as possible. The offer of part-time work or half salary might be two solutions to the problems that layoffs create.

Because the people in the outer group would usually be hired on a limited basis, they probably would not accrue enough credits to be of worth toward their fringe benefits. To keep this group as satisfied as possible, Kiddoo suggests that Lockheed could offer them the cash equivalent of the benefits.

### Capability depends on stability

"There are all kinds of combinations that could make this plan work," Kiddoo says, "and as you can see we're still working on it. But let's face it," he continues. "Lockheed sells technical capability, and to be as capable as possible, our work force must be as stable as possible."

Lockheed's manpower administrator says that he believes it's a very healthy and encouraging sign when most of the large aerospace companies on the West Coast cooperate with one another on a program like LEND.

"It shows that they're worried about layoffs, and they care enough to do something about it," Kiddoo says. "The LEND program," he adds, "is only one building block in the serious business of aerospace company survival." ■■



# Low power TTL.



		<u>100 up</u>
SN54L00R	Quad 2-Input Gate	\$ 7.00
SN54L10R	Triple 3-Input Gate	7.00
SN54L20R	Dual 4-Input Gate	7.00
SN54L30R	Eight-Input Gate	7.00
SN54L51R	AND-OR-INVERT Gate	7.00
SN54L54R	AND-OR-INVERT Gate	7.00
SN54L55R	AND-OR-INVERT Gate	7.00
SN54L71R	R-S Flip Flop	11.50
SN54L72R	J-K Flip Flop	11.50
SN54L73R	Dual J-K Flip Flop	17.00
SN54L78R	Dual J-K Flip Flop	17.00

## We took the heat off.

National delivers the lowest speed/power product now available in any digital family: 1mW at 30 nsec. Power dissipation just one tenth that of standard TTL. Plus all circuits designed as pin for pin, spec for spec replacements for 54L low power TTL.

Low power, high rel. 54L devices from National pass Mil-Std-883's strict test/inspection requirements. Right down the line.

We take the heat off delivery too. Get on the hot line to your National distributor. He's got off-the-shelf delivery on all our low power TTL's. For specs and data sheets, write or call National Semiconductor, 2975 San Ysidro Way, Santa Clara, California 95051. (408) 245-4320. TWX: 910-339-9240. Cables: NATSEMICON.

# National/TTL



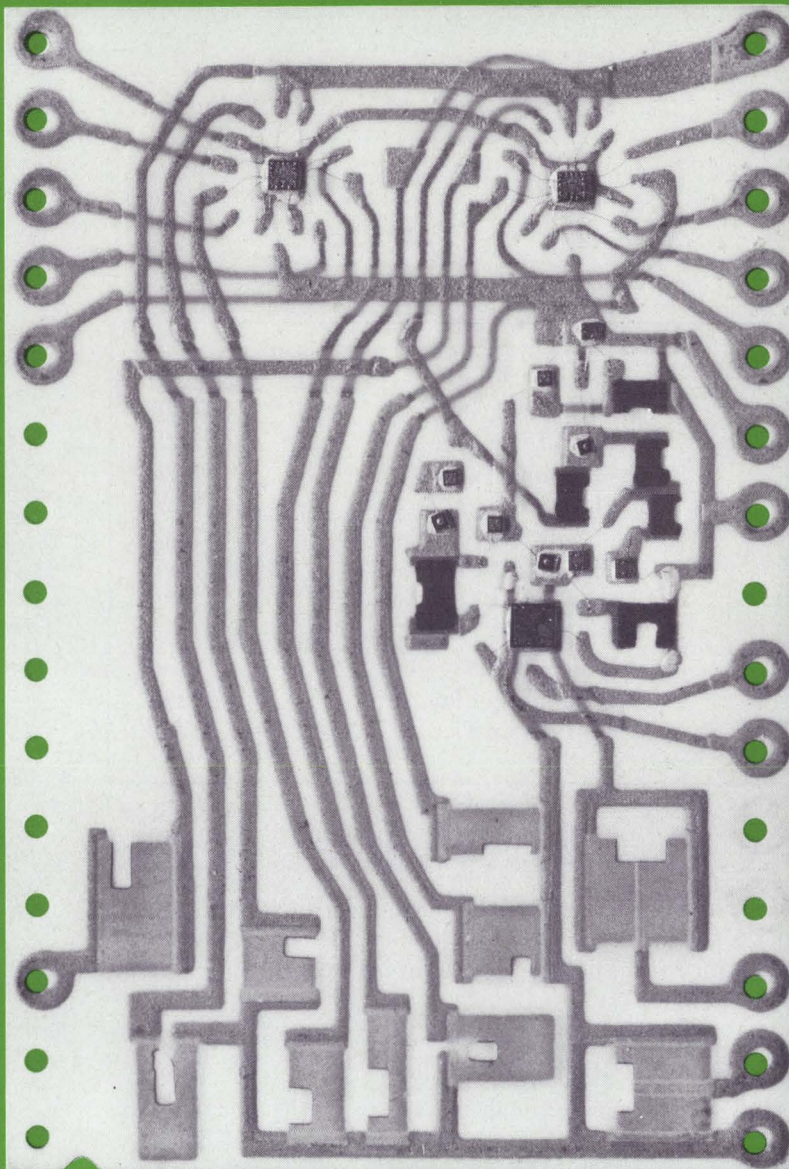

X Actual Size.

## A complete 8-bit Digital-to-Analog Converter for \$75!

The new Helipot Model 845 is a thick-film, miniaturized hybrid digital-to-analog converter (DAC) that converts an 8-bit binary word into an analog output. The input gates, switches, resistor network, reference voltage, and output amplifier are all in the hybrid module.

Because of its operating temperature range ( $-20^{\circ}\text{C}$  to  $+85^{\circ}\text{C}$ ), Model 845 can be used for any industrial digital-to-analog conversion, process control being a typical application. Price is \$75/unit in 1-9

quantities (less in greater numbers). The package size is 1.0 inch x 1.5 inches x 0.170 inch. The unit accepts an 8-bit, parallel, binary word that is TTL- and DTL-compatible, and an enable gate is provided. Four different output-voltage ranges are available as standard models: two unipolar (0 to +5 v, 0 to +10 v) and two bipolar ( $-5$  to +5 v,  $-10$  to +10 v). Power-supply requirements are +15 v at 60 ma and  $-15$  v at 10 ma. The output accuracy is  $\pm 1/2$  least-significant bit at  $25^{\circ}\text{C} \pm 1$  mv

per percent of supply-voltage variation. The output-current range is 0 to  $\pm 2.5$  ma, and the output slew rate is  $0.3$  v/ $\mu\text{sec}$ .

And, it's available from stock.

**Beckman<sup>®</sup>**

INSTRUMENTS, INC.

HELIPOT DIVISION

2500 HARBOR BOULEVARD

FULLERTON, CALIFORNIA 92634

INTERNATIONAL SUBSIDIARIES: AMSTERDAM; CAPE TOWN; GENEVA; GLENROTHES, SCOTLAND; LONDON; MEXICO CITY; MUNICH; PARIS; STOCKHOLM; TOKYO; VIENNA

INFORMATION RETRIEVAL NUMBER 57



## Program a time-shared computer terminal for easy curve plotting

The graph routine listed in the program of Fig. 1 can be added to any computer program using Extended BASIC. This routine is efficient in program length and print-out time—it contains only 21 BASIC statements and prints out in less than two minutes on the teletype.

The logical operation of the graph routine is relatively simple. Lines 10-70 and 310 in the listing of Fig. 1 are a simple main program to generate frequency ( $F$ ), gain ( $G$ ) and phase ( $P$ ) values for plotting a demonstration graph. Line 50 defines gain as a cosine function of frequency, and line 60 defines phase as a linear function of frequency. Other functions can be inserted at these lines to plot different curves.

The graph routine itself (lines 100 - 300) is composed of two parts: axes labels in lines 100 - 120 and 300, and a dual iteration loop for printing the data points in lines 130 - 290. The axis scale and labels for the dependent variables are printed at the top of the graph (Fig. 2a). In this case gain is plotted in dB (essentially a log scale) and phase is plotted in degrees (a linear scale). The axis scale and label for the independent variable, in this case frequency in kHz, are printed to the right and below the graph. Frequency is plotted on a linear scale. The *TAB* function used in lines 100 and 300 controls the start print position of the axes labels for proper centering. Line 170 determines the row and column positions where the grid intersections (+) are printed.

The data points are printed in a 13-row by 64-column matrix. Positioning of the points is exact on the independent variable axis (13 positions) but digitized to the nearest of 64 positions on the dependent axis. Straight lines connecting the curved points (Fig. 2) are drawn in later for clarity.

The program may be modified to print the data on a logarithmic frequency scale (Fig. 2b). The only required program change is the retyp-

```

10 REM MINI-GRAPH-ROUTINE FOR X-BASIC, F. SHIRLEY, 9/9/69
20 DIM F(12),G(12),P(12)
30 FOR K=0 TO 12
40 LET F(K)=.9*K
50 LET G(K)=20*COS(.7*F(K))
60 LET P(K)=60*F(K)-300
70 NEXT K
100 PRINT TAB(15);"GAIN (G) IN DB / PHASE (P) IN DEG*10"
110PRINT" -30 -20 -10 0 +10 +20 +30"
120PRINT" +-----+-----+-----+-----+-----+"
130 FOR K=0 TO 12
140 FOR K0=-31 TO 30
150 IF K0=INT(G(K)+.5) THEN 240
160 IF K0=INT(P(K)/10+.5) THEN 220
170 IF INT(K/2)+INT(K0/10)=K/2+K0/10 THEN 200
180 PRINT" ";
190 GOTO 250
200 PRINT"+";
210 GOTO 250
220 PRINT"p";
230 GOTO 250
240 PRINT"G";
250 NEXT K0
260 PRINT F(K)
270 PRINT
280 PRINT
290 NEXT K
300 PRINT TAB(53);"FREQUENCY (KHZ)"
310 END

```

1. Listing of extended BASIC program for plotting curves has only 29 lines.

ing of line 40, as follows:

```
40 LET F(K) = INT(10^(2+K/12) + .5)/100
```

The up-arrow (^) which indicates exponentiation, changes the linear scale of the variable  $K/12$  to a one-decade logarithmic scale. When  $K = 0$ ,  $F(K) = 1$ , and when  $K = 12$ ,  $F(K) = 10$ . The remaining components of the new line 40 are used to round the true logarithmic scale to a more convenient scale with only three decimal places. The constant 2 in the inner parentheses multiplies the value by 100; the *INT* and  $+ .5$  operations round the value; and the division by 100 returns the decimal point to the proper position.

The logarithmic scale may be made to cover a greater range than one decade by multiplying  $K$  by a constant. If  $K$  is multiplied by 3, for instance,  $F(K)$  would vary from 1 to 1000 instead of from 1 to 10. The scale may also be made to start at a value other than unity by changing



# When the chips are down, they ought to be on our IC packages.

It's not just because we want to sell our products (which we do).

Or because we're proud of them (which we are).

We think you should buy our IC packages for a number of reasons.

First of all, we make all our own parts. (Many of our competitors must buy frames and ceramics for assembly.)

We assemble the packages ourselves.

We test our packages for insulation, thermal shock resistance, hermeticity, lack of internal shorts, excess glass-ceramic flow.

And if one of our growing line of packages

doesn't fit your requirements, we'll design one that will.

One more thing. Just because you're getting the best IC package money can buy, don't think it takes a lot of money. In fact, ours probably costs less than any others.

Isn't that where you should put your chips?

Sylvania Metals & Chemicals, Parts Division,  
Warren, Pennsylvania 16365.

**SYLVANIA**  
GENERAL TELEPHONE & ELECTRONICS

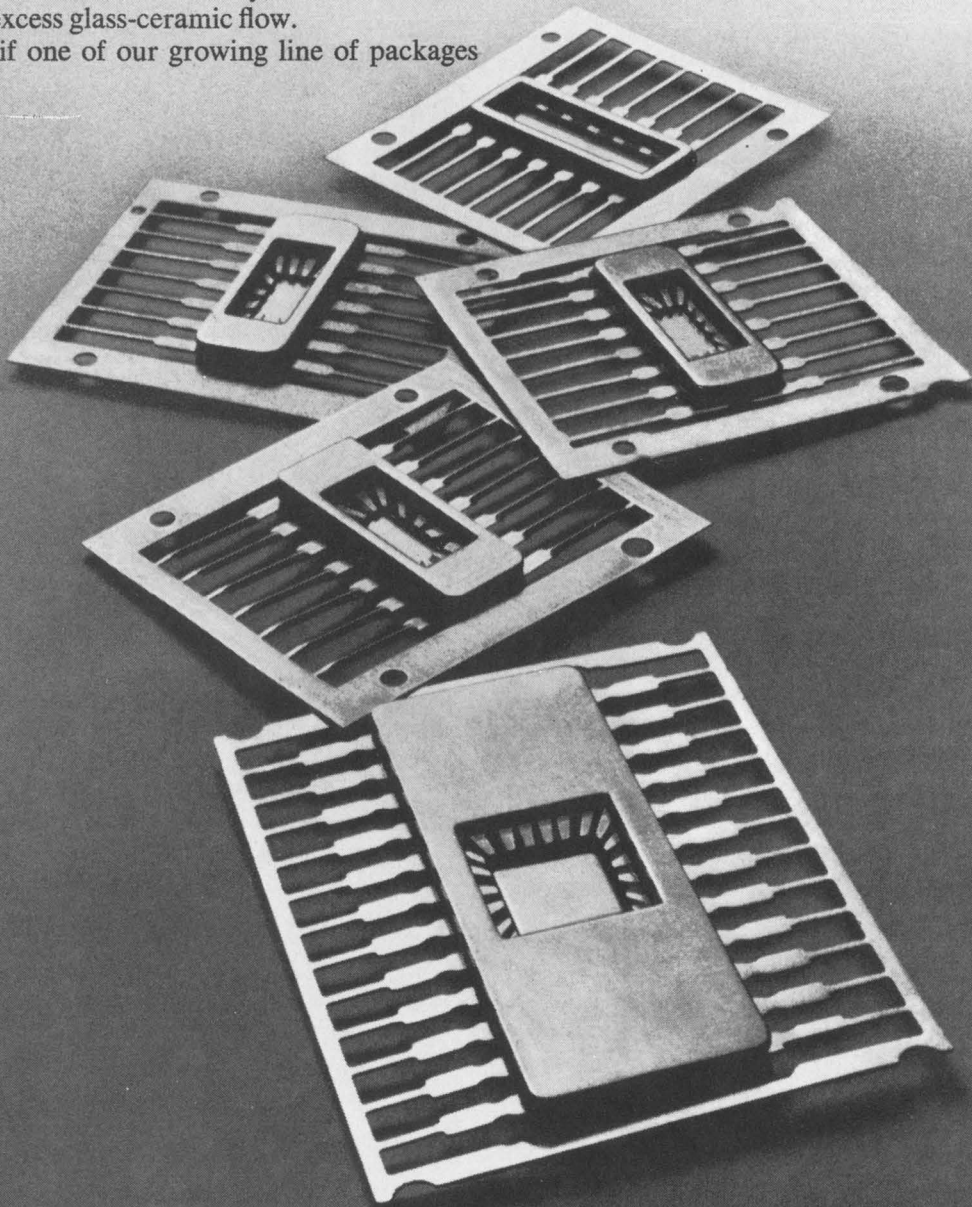



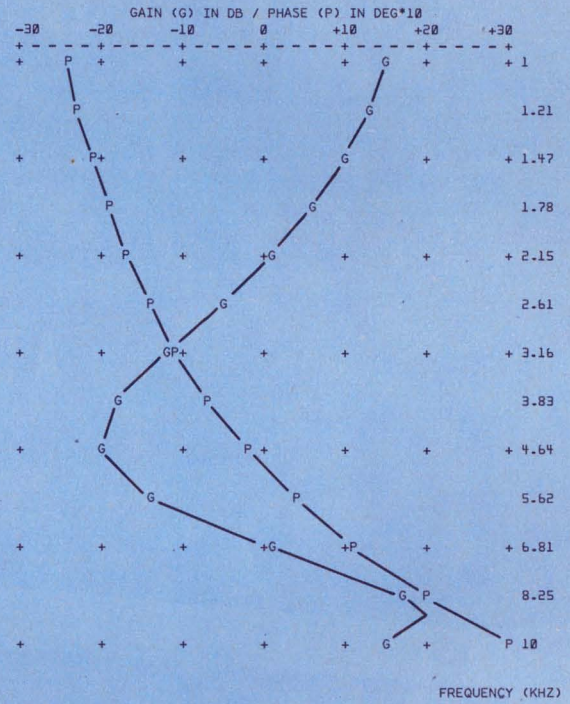
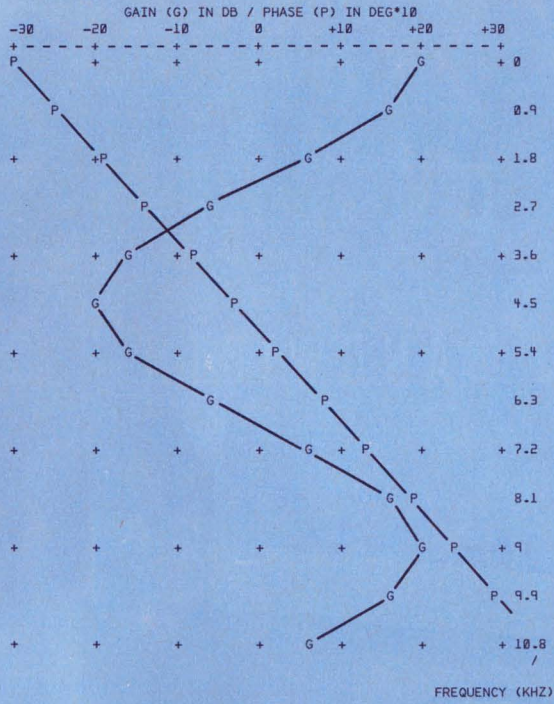

2. Curve plot performed by program is shown for linear (a) and logarithmic (b) frequency scale.

the constant 2 in the inner parentheses to a non-integer.

The program may be modified to print three variables by inserting another *IF* statement at line 165, a *PRINT* statement at line 215 and a *GO TO 250* at line 216. If two or more data

points coincide, the priority of printing is determined by the ordering of the *IF* statements in lines 150 through 170.

*Frederick R. Shirley, Technical Staff Member, Sanders Associates, Inc. Nashua, N.H.*

VOTE FOR 311

## Flip-flop measures frequency difference between two signals

It is possible to use a single flip-flop to measure the difference between two frequencies. When two square waves are applied to the D and T inputs of a D-type flip-flop, the Q output flips only when there is a 180° relative phase change at the inputs. Therefore, the frequency at the output is the difference between the two input frequencies.

As shown, the output of the flip-flop is the exact difference between the two frequencies applied to the input terminals. This technique is particularly useful for monitoring small frequency changes at higher frequencies. For example, to monitor ± 100

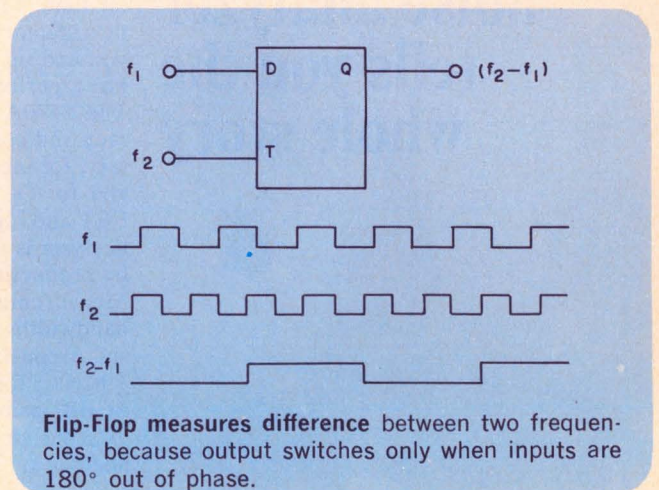







cycles of frequency drift at 1.01 MHz, we apply the frequency to the D input and a crystal-controlled 1-MHz reference to the T input. The Q output will be  $1000 \pm 100$  Hz, which may be accurately converted by a simple discriminator.

A J-K type of flip-flop could be used for the

same purpose with the addition of an inverter, so that  $f_1$  is fed to J,  $\bar{f}_1$  is fed to K, and  $f_2$  is fed to the T input as before.

*Kingsley P. Roby, Test Engineer, Data-Control Systems, Inc., Danbury, Conn.*

VOTE FOR 312

## Single op amp equalizes both amplitude and group delay

A single operational amplifier can be used as a combined amplitude and delay equalizer or as an all-pass delay equalizer. Positive or negative amplitude equalization can be achieved, resulting in either a boost or a null of a band of frequencies in the vicinity of a center frequency.

The basic circuit is shown in Fig. 1. The center frequency for the tuned circuit is:

$$F_o = 1/2\pi \sqrt{LC} \quad (1)$$

Group delay reaches a maximum value in the vicinity of  $F_o$  and is then equal to  $2RC$  (2)

The delay decreases above and below  $F_o$ .

The absolute magnitude of the gain (or loss) at  $F_o$  can be found from:

$$\left| \frac{E_{OUT}}{E_{IN}} \right|_{dB} = 20 \log_{10} \left( \frac{K-1}{2} \right) \quad (3)$$

Where  $K = R_b/R_a$

The actual values of  $R_a$  and  $R_b$  are not critical, except that they should be within the practical

confines of the operational amplifier. The magnitude of the gain approaches unity above and below  $F_o$  for any values of  $K$  and  $R$ . The circuit will become all-pass when  $K = 3$ .

An example illustrates the complete design procedure:

Required:

2-ms delay equalization at 1 kHz

+ 3 dB amplitude equalization at 1 kHz

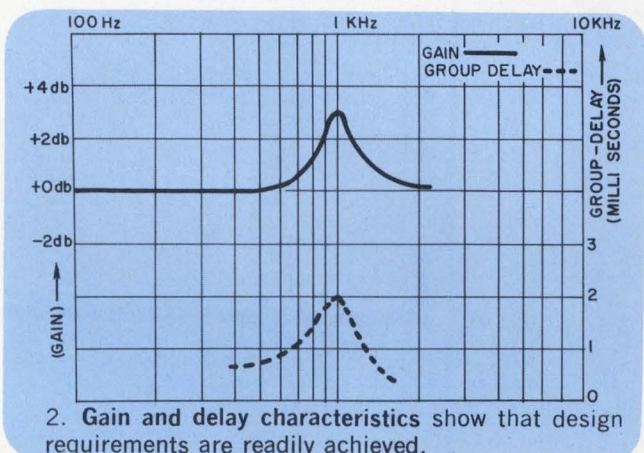
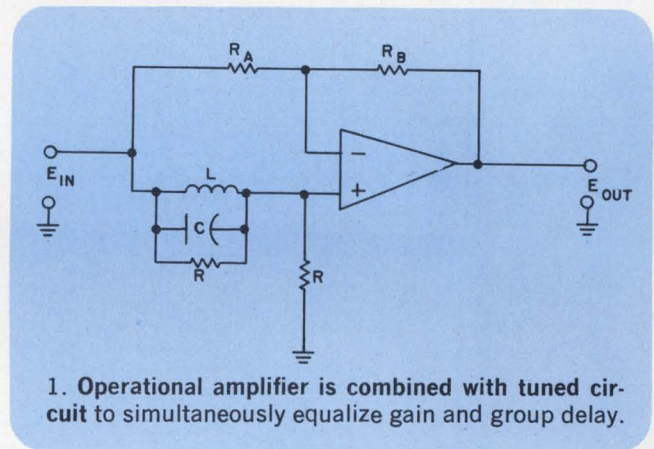

# VOTE

**VOTE!** Go through all Idea-for-Design entries, select the best, and circle the appropriate number on the Reader-Service-Card.

**SEND US YOUR IDEAS FOR DESIGN.** You may win a grand total of \$1050 (cash)! Here's how. Submit your IFD describing a new or important circuit or design technique, the clever use of a new component or test equipment, packaging tips, cost-saving ideas to our Ideas-for-Design editor. You will receive \$20 for each accepted idea, \$30 more if it is voted best-of-issue by our readers. The best-of-issue winners become eligible for the Idea Of the Year award of \$1000.



**This portable will record  
more facts in less time, at less cost  
than any other 2-channel recorder  
on the market.**

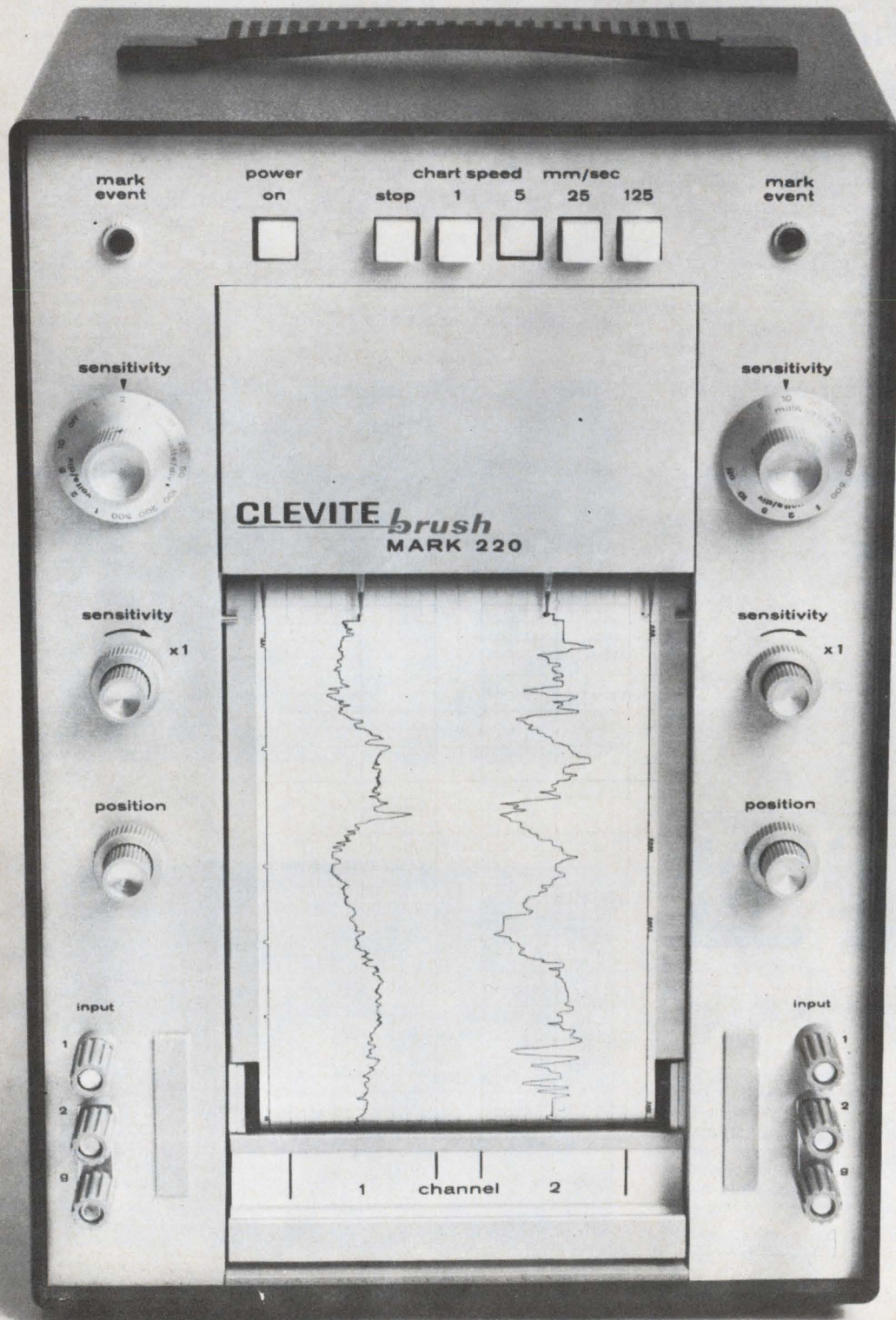

We call it the Mark 220.

And once we put it through its paces for you, you'll call it the most amazing piece of recording gear around.

To begin with, we *guarantee* the Mark 220 to be 99½% accurate. Which is a good deal better than almost anything else on the market . . . regardless of size or price. The pressurized ink-writing system is the same one you'll find in our six and eight channel systems. Instead of laying the trace on the

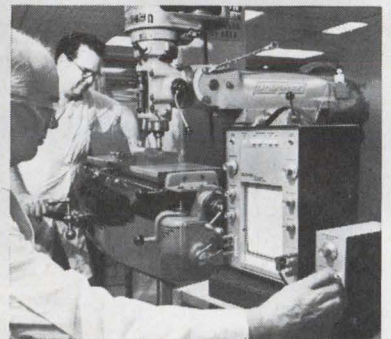

paper, it forces it *in*. Run your finger over it. There's no smear, no smudge. And trace crispness and uniformity is in a class by itself.

Built-in preamplifiers give you measurement range from 1 mV per division to 500 V full scale — and you never have to re-calibrate. Pushbutton controlled chart speeds. Two handy event markers. Ink supply is a disposable cartridge, good for a year.

Yes, for a 25 pound portable that's no bigger than a breadbox, the Mark 220 is quite a recorder. Ask your Brush representative for a demonstration. Or, write for complete details. Brush Instruments Division, Gould Inc., 3631 Perkins Avenue, Cleveland, Ohio 44114. We'll include our informative booklet "Elimination of Noise in Low-Level Circuits".

**GOULD BRUSH**



Procedure:

Let  $C = 0.1 \mu\text{F}$

$L = 0.253 \text{ H}$  (using Eq. 1)

$R = 10 \text{ K}\Omega$  (using Eq. 2)

$K = 3.83$  (using Eq. 3)

Let  $R_a = 1 \text{ k}\Omega$

Then  $R_b = 3.83 \text{ k}\Omega$

*Arthur Williams, Project Engineer, Singer Tele-Signal Corp., Woodbury, N.Y.*

VOTE FOR 313

## Inexpensive IC pulse generator uses DTL and TTL circuits

There are many different designs for monostable multivibrators. The circuit shown generates single pulses, using only inexpensive DTL and TTL ICs.

A negative-going pulse of about 200-ns duration is generated when the leading (falling) edge of the input level changes. No output exists when the input level rises above the down, or LOW<sub>i</sub> level. The first inverter is used for logical inversion only. Its output is applied to a NAND gate, as well as to five more inverters in series. These five produce logical inversions, and also introduce the necessary delay. DTL circuits are used for the inverters because they are slower than TTL, and thus introduce more delay.

As shown in the figure, the output of the NAND gate is LOW when both inputs A and B are HIGH. Input A is the inverse of the input level (delayed by one IC time delay). Input B is the same polarity as the input level, but it is delayed by six time delays. The NAND gate inputs will

both be HIGH between the time that A rises and B falls.

A typical circuit has a 200-ns pulse width. The variation of pulse width can be from a minimum of five times the specified minimum delay time of the DTL inverter to a maximum of five times the specified maximum delay time of the DTL inverter. Other pulse widths can be obtained by using fewer or more inverters for time delay.

*Saul Meyer, Chrono-log Corp., Broomall, Pa.*

VOTE FOR 314

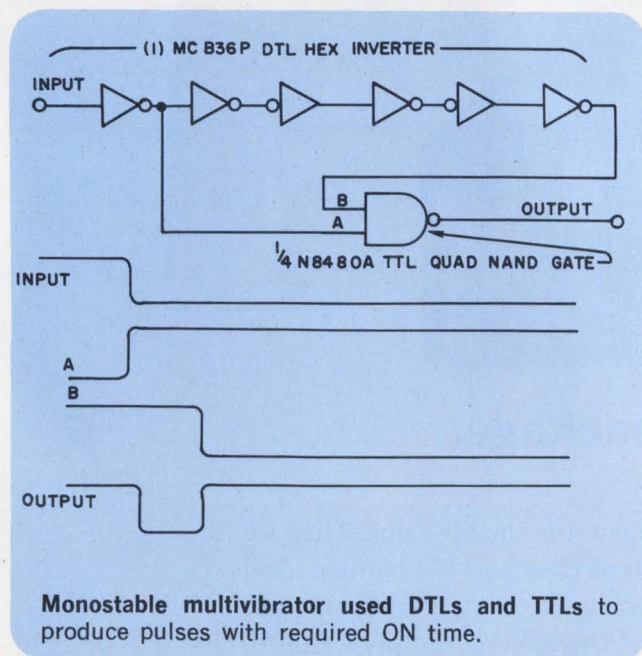

**IFD Winner for July 19, 1969**

**G. Colla, G. Tomassetti, Design Engineers, University Degli Studi Di Bologna, Bologna, Italy.** Their Idea "Agc controlled oscillator is extremely stable" has been voted the most Valuable of Issue Award.  
**Vote for the Best Idea in this Issue.**

**IFD Winner for August 2, 1969**

**A. J. Krygeris, Project Engineer, Gilmore Industries, Inc., Cleveland, Ohio.** His Idea "Pulse widths up to 10 seconds provided by hybrid one-shot" has been voted the Most Valuable of Issue Award.  
**Vote for the Best Idea in this Issue.**

**IFD Winner for August 16, 1969**

**G. V. Fay, Design Engineer, Motorola Semiconductor Products, Inc., Phoenix, Ariz.** His Idea "Reliable semiconductor replaces centrifugal motor starting switch" has been voted the Most Valuable of Issue Award.  
**Vote for the Best Idea in this Issue.**



Same big volts.



New little package.

We took everything in the big one and put it in the little one. Then we made the little one in all the same output ranges as the big one. And gave it the same price. And the same guarantee. And put all the details in our new catalog which is yours for the asking. Simply write to:

**acdc electronics, inc.** Oceanside Industrial Center  
Oceanside, California 92054, Telephone (714) 757-1880



# Sweep Generators Product Source Directory

Compiled and edited by  
**Greg Guercio, Directory Manager**

## How to use the tables

The tables in this section list the specifications for sweep generators.

Unless otherwise noted in the tables, all sweep generators have input requirements of 95-135 Vac, single phase. The following abbreviations apply to all instruments listed:

ina—information not available.

n/a—not applicable.

An index of models by manufacturer is included at the end of each table.

For each table, the instruments are listed in ascending order of one major parameter. The column containing this parameter is color-coded white. Manufacturers are identified by abbreviation. The complete name of each manufacturer can be found in the Master Cross Index

Abbrev.	Company	Reader Service No.
AIL	Airborne Instruments Labs. Comac Road Deer Park, N.Y. 11729 (516) 595-3215	447
Alfred	Alfred Electronics 3176 Porter Ave. Palo Alto, Calif. 94304 (415) 326-6496	448
Blonder-Tongue	Blonder-Tongue Labs. 9 Alling St. Newark, N.J. 07102 (201) 622-8155	449
Data Royal	Data Royal Corp. 8014 Armour St. San Diego, Calif. 92111 (714) 279-4020	450
Dynascan	Dynascan Corp. 1801 W. Belle Plaine Chicago, Ill. 60613 (312) 327-7270	451
E-H	E-H Research Labs. 163 Adelaide St. Oakland, Calif. 94604 (415) 834-3030	452
Electro/Data	Electro/Data Inc. 1621 Jupiter Garland, Tex. 75040 (214) 341-2100	453
EPSCO	EPSCO Inc. 411 Providence Highway Westwood, Mass. 02090 (617) 329-1500	454
GR	General Radio Co. West Concord, Mass. 01781 (617) 369-4400	455
Heath	Heath Co. Benton Harbor, Mich. 49022 (616) 983-3961	456

Abbrev.	Company	Reader Service No.
H-P	Hewlett-Packard Co. 1501 Page Mill Road Palo Alto, Calif. 94304 (415) 326-7000	Contact Local Sales Office
IFI	Instruments for Industries 151 Toledo St. Farmingdale, N.Y. 11735 (516) 694-1414	457
Jerrold	Jerrold Electronics Corp. 401 Walnut St. Philadelphia, Pa. 19105 (215) 925-9870	458
Key	Key Electric Co. Maple Ave. Pine Brook, N.J. 07058 (201) 227-2000	459
Kruse-Storke	Kruse-Storke Electronics 790 Hemmeter La. Mountain View, Calif. 94040 (415) 967-2299	460
Marconi	Marconi Instruments 111 Cedar Lane Englewood, N.J. 07631 (201) 567-0607	461
Micro-Power	Micro-Power Inc. 25-14 Broadway Long Island City, N.Y. 11106 (212) 726-4060	462
Narda	Narda Microwave Corp. Commercial St. Plainview, N.Y. 11803 (516) 433-9000	463
Polarad	Polarad/Nelson Ross 5 Delaware Drive Lake Success, N.Y. 11040 (516) 328-1100	464
Sage	Sage Labs. Instrument Division 14 Huron Drive Natick, Mass. 01760 (617) 653-0844	465

Abbrev.	Company	Reader Service No.
RCA	Radio Corp. of America Electronic Components & Devices Harrison, N.J. 07029 (201) 485-3900	466
R-S	Rohde & Schwarz 111 Lexington Ave. Passaic, N.J. 07055 (201) 773-8010	467
Servo	Servo Corp. of America 111 New South Road Hicksville, N.Y. 11802 (516) 938-9700	468
Spectral	Spectral Dynamics Corp. P.O. Box 671 San Diego, Calif. 92112 (714) 278-2501	469
Telonic	Telonic Industries 60 N. First Ave. Beech Grove, Ind. 46107 (317) 787-3231	470
Texscan	Texscan Corp. 2446 N. Shadeland Ave. Indianapolis, Ind. 46219 (317) 357-8781	471
Waveforms	Waveforms 11922 Valerio St. N. Hollywood, Calif. 91605 (213) 764-1500	472
Wavetek	Wavetek 9045 Balboa Avenue San Diego, Calif. 92123 (714) 279-2200	473
Wiltron	Wiltron Corp. 930 E. Meadow Drive Palo Alto, Calif. 94303 (415) 321-7428	474



# Sweep Generators

	Manufacturer	Model	FREQUENCY		Rated Output mW	Signal Source	Noise dB	Int Level-ing	Ext Level-ing	Output Flatness dB	Int Freq Markers	Output Conn Type	Misc Features	Price (\$)
			Min MHz	Max MHz										
S1	Spectral	SD104A-1	0	0.01	10V	VCO	ina	none	none	ina	yes	ina		1965
	Spectral	SD104A-2	0	0.02	10V	VCO	ina	none	none	ina	yes	ina		1965
	Waveforms	610B	20 Hz	0.02	2.5V	VCO	ina	none	none	±0.5	none	ina		1000
	Spectral	SD104A-5	0	0.05	10V	VCO	ina	none	none	ina	yes	ina		1965
	Kay	860/PC141	20 Hz	0.2	20	BFO	ina	none	none	ina	none	BNC	x	1030
	Kay	860/PC142	35 Hz	0.6	20	BFO	ina	none	none	ina	none	BNC	x	1030
	Kay	860/PC130	100 Hz	2	20	BFO	ina	none	none	ina	none	BNC	x	925
	Data Royal	F230B	0.005 Hz	3	5.2	ina	ina	ina	ina	ina	yes	N		1095
Wavetek	200	0.1	10	1V	VCO	30	none	none	±0.5	yes	BNC		795	
Dynascan	415	1	10	ina	ina	ina	ina	ina	ina	yes	BNC		ina	
S2	Kay	860/PC152	0.001	20	20	BFO	30	none	none	ina	none	BNC	x	925
	R-S	SWOF	0.02	20	1mV-1V	ina	60	none	none	±0.3	yes	dezi-B		5860
	Marconi	TF1099	0.1	20	12	ina	ina	none	none	0.02	yes	ina		640
	Alfred	6151-1/Q01	10	20	100	ina	50	yes	yes	±0.5	yes	BNC		
	Kay	860/PC855	2	32	20	BFO	ina	none	none	ina	none	BNC	x	1155
	RCA	WR-69A	0.05	50	0.1V	ina	ina	none	none	0.1	yes	ina		295
	Alfred	6151-1/Q02	20	50	100	ina	50	yes	yes	±0.5	yes	BNC		
	Wavetek	310	20	50	1.5V	VCO	30	yes	yes	±0.25	yes	BNC		1060
Heath	IGW-57	2.5	72	0.5V	ina	ina	ina	ina	±1	15	BNC		199	
GR	1003	0.067	80	180	ina	80	yes	yes	±1	yes	GR		2995	
S3	Wavetek	300	20	80	1V	VCO	ina	none	none	±0.25	yes	BNC		820
	Wiltron	6104-1	0.1	100	1	t	30	yes	none	±0.3	none	ina	lt	3140
	Wiltron	6104	0.1	100	20	t	30	yes	none	±0.3	none	ina	lt	2075
	Wiltron	6105	47	100	50	t	30	yes	none	±0.3	none	ina	lt	2590
	Wavetek	310A	88	108	1.5V	VCO	30	yes	yes	±0.25	yes	BNC		1060
	Kay	154-C	0.05	110	20	t	30	none	none	±0.25	yes	N	tuv	950
	H-P	8601A	0.1	110	100	VTO	50	yes	yes	±0.25	yes	BNC	jk	2250
	H-P	8698B/8690B	0.4	110	20	VTO	40	yes	yes	±0.3	2	BNC	jk	3150
Wavetek	SA-1312	4	110	1V	VCO	30	none	none	±0.25	yes	ina		1340	
Kruse-Storke	5000/5007	10	110	20	t	60	yes	yes	±0.1	yes	TNC	tu	2585	
S4	Kay	860/PC154	0.05	115	20	t	30	none	none	±0.25	none	BNC	tx	1155
	Kay	860/PC856	10	120	20	BFO	ina	none	none	ina	none	BNC	x	1155
	Alfred	6151-1/Q03	50	125	100	ina	50	yes	yes	±0.5	yes	BNC		
	Kay	860/PC857	1	175	20	BFO	ina	none	none	ina	none	BNC	x	1120
	IFI	M4025	0.2	220	100	VTO	20	yes	yes	±1.5	yes	ina		
	Kay	860/PC860	2	220	20	t	ina	none	none	ina	none	BNC	tx	1120
	Heath	IG-52	3.6	220	ina	ina	ina	none	none	ina	yes	N		70
	Jerrold	601-7F	12	225	0.5V	r	ina	none	none	±0.75	yes	F	rs	350
GR	1025A	0.7	230	0.3µV-1V	ina	ina	ina	ina	0.25	yes	GR874		3950	
Kay	1484B	40	230	20	ina	30	yes	none	±0.25	yes	ina		575	
S5	Alfred	6151-1/Q21	125	250	100	ina	50	yes	yes	±0.5	yes	BNC		
	Kruse-Storke	5000/5008A	45	255	20	t	60	yes	yes	±0.2	yes	TNC	tu	2585
	Wavetek	1001	0.5	300	1V	VCO	50	none	none	±0.25	yes	BNC		995
	Jerrold	SS-300-7F	0.5	300	+51dBm	VTO	ina	ina	ina	±0.3	yes	N		1095
	Kay	159-C	1	300	5	t	30	none	none	±0.25	yes	N	tuv	950
	Wiltron	6106	1	300	45	t	30	none	none	±0.3	none	ina	lt	2140
	Wavetek	SA-1401	1	300	1V	t	ina	yes	none	±0.25	yes	ina	dt	1490
	Telonic	PD-7	200	375	4	triode	ina	yes	no	±0.5	5	BNC		2500
R-S	SWOBI	0.5	400	3	ina	ina	none	none	±0.02	yes	dezi-B		2965	
Epsco	SG-132A	15	400	0.1µV-0.15V	triode	40	yes	ina	±1	3	BNC		2995	
S6	Micro-Power	221/H24MD	200	400	20	BWO	ina	no	yes	±0.1	2	N	a	3600
	Kay	860/PC867	220	470	5	t	ina	none	none	ina	none	BNC	tx	740
	Telonic	SH-1/SM-2000	0.5	460	2.45	triode	ina	yes	yes	±1	8	BNC	a	1260
	Texscan	VS-50	2	500	20	VTO	ina	yes	yes	±0.25	8	BNC	bc	1295
	Texscan	RS-50	3	500	20	VTO	ina	yes	yes	±0.25	6	BNC	bce	2250
	Telonic	3303/2003	5	500	5	t	ina	yes	yes	±0.5	14	N	a	920
Kruse-Storke	5000/5008-1	100	500	20	t	60	yes	yes	±0.2	3	TNC		2800	



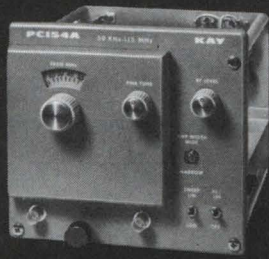

10 KHz — 115 MHz Sweep Plug-In



50 KHz — 110 MHz Sweep Synthesizer

# KAY



50 KHz — 110 MHz Sweep & Marker Generator

# 3 accurate 110 MHz sweepers!

## Require no markers!

For those with uncalibrated vision:

- VARIABLE PULSE MARKERS
- VARIABLE BIRDIE MARKERS
- CRYSTAL PULSE MARKERS
- CRYSTAL BIRDIE MARKERS
- HARMONIC MARKERS
- VERTICAL MARKERS
- HORIZONTAL MARKERS
- RF TURN-OFF MARKERS

10 KHz — 115 MHz  
SWEEP PLUG-IN

- Log Sweep To Below 10 KHz
- Two Band Sweep Function
- Residual FM 100 Hz

50 KHz — 110 MHz  
SWEEP  
GENERATOR

- Plug-In Markers
- Companion to 159C  
300 MHz Wide Sweep

All three  
all solid-state  
100 MHz wide  
sweeps

Full-time controls

50 KHz — 110 MHz  
SWEEP  
SYNTHESIZER

- Phase Locked Sweep & CW
- Drift < 5PPM/min.  
< 20PPM/hr.
- Residual < 10 Hz @ 10 MHz  
< 40 Hz @ 70 MHz

**KAY** ELECTRIC COMPANY  
Maple Avenue, Pine Brook, N.J. 07058 • (201) 227-2000



# Sweep Generators

	Manufacturer	Model	FREQUENCY		Rated Output mW	Signal Source	Noise dB	Int Level-ing	Ext Level-ing	Output Flatness dB	Int Freq Markers	Output Conn Type	Misc Features	Price (\$)
			Min MHz	Max MHz										
S6 cont	Telonic	E-4/SM-2000	150	500	20	triode	ina	yes	yes	±1	8	BNC	a	1225
	Alfred	650/651A-S2	250	500	25	VTM	40	yes	yes	ina	yes	N		3575
	Alfred	650/651AK-S2	250	500	20	VTM	40	yes	yes	±0.3	yes	N		4025
S7	Micro-Power	221/H25MD	250	500	50	BWO	ina	no	yes	±0.1	2	N	a	3600
	Alfred	6151-1/Q22	250	500	100	ina	50	yes	yes	±0.5	2	BNC		
	Micro-Power	221/H25SD	250	500	30	VTO	ina	no	yes	±0.1	2	N	b	3600
	Micro-Power	221/H37MD	350	700	100	BWO	ina	no	yes	±0.1	2	N	a	3600
	Blonder-Tongue	4122	10	890	3.3	Varactor	ina	yes	yes	±0.5	yes	BTF		1542
	Telonic	HD-1A	1	910	1.4	triode	ina	yes	yes	±0.4	8	BNC		995
	Telonic	1005	450	910	5	t	ina	yes	no	±0.5	yes	BNC		ina
Telonic	1006	450	910	5	t	ina	yes	no	±0.5	yes	BNC		495	
Telonic	E-5/SM-2000	460	920	20	triode	ina	yes	yes	±1	8	BNC		ina	
Wavetek	SA-1501	450	950	0.5V	t	ina	yes	none	±0.5	yes	ina	t	1375	
S8	Kay	1483B	440	960	5	ina	ina	none	none	ina	yes	ina	a	495
	Telonic	3005/SM-2000	460	960	1.2	t	ina	yes	yes	±0.75	8	BNC		1700
	R-S	SWOBIII	0.1	1000	12.8	ina	ina	ina	ina	0.50dB/MHz	3	dezi-B		ina
	Wiltron	6108	10	1000	20	t	30	none	none	±0.3	none	ina	lt	3075
	Alfred	6151	10	1000	100	t	50	yes	yes	±0.3	yes	BNC		ina
	Kay	860/PC123	100	1000	5	t	ina	ina	none	ina	none	BNC	tx	950
	Kay	121/P-123	100	1000	5	ina	ina	yes	none	ina	yes	N	u	1475
Telonic	PD-8	375	1000	4	triode	ina	yes	no	±0.5	5	BNC		2500	
Texscan	HS-85	400	1000	4	tube	ina	yes	no	±0.5	6	BNC	bc	2500	
Alfred	650/651A-S3	500	1000	50	VTM	40	yes	yes	ina	yes	N		3575	
S9	Alfred	650/651AK-S3	500	1000	40	VTM	40	yes	yes	±0.3	yes	N		4025
	Kruse-Storke	5000/5010	500	1000	20	t	60	yes	yes	±0.25	3	TNC		2640
	Micro-Power	221/H51B	500	1000	30	BWO	ina	no	yes	±0.1	2	N	a	3975
	Micro-Power	221/H51DB	500	1000	15	BWO	ina	no	yes	±0.1	2	N	a	4200
	Alfred	6151-1/Q23	500	1000	100	ina	50	yes	yes	±0.5	yes	BNC		
	Micro-Power	221/H51MD	500	1000	100	BWO	ina	no	yes	±0.1	2	N	a	3600
	Micro-Power	221/H51SD	500	1000	30	VTO	ina	no	yes	±0.1	2	N	b	3600
Telonic	3312/2003	500	1000	5	t	ina	yes	yes	±0.25	14	N	a	920	
Telonic	VR-50/SM-2000	500	1000	1.2	t	ina	yes	yes	±0.75	8	BNC	a	1920	
Texscan	HS-86	500	1000	8	tube	ina	yes	no	±0.5	6	BNC	bc	3200	
S10	Texscan	RS-70	500	1000	5	VTO	ina	yes	yes	±0.25	6	BNC	bce	2250
	Kay	121/P-121	0.5	1050	5	ina	ina	yes	none	ina	yes	N	u	1475
	Dynascan	E410C	3	1080	ina	ina	ina	ina	ina	ina	yes	BNC		ina
	Jerrold	900C-7F	0.5	1200	7 dBm	n	ina	yes	no	±0.5	none	BNC		2285
	Texscan	VS-80	1	1200	5	VTO	ina	yes	yes	±0.5	8	BNC	bc	1550
	Texscan	VS-70	290	1200	5	VTO	ina	yes	yes	±0.5	8	BNC	bc	1095
	Jerrold	900-A-7F	0.5	1200	0.5V	n	ina	yes	no	±0.5	none	N	np	1355
R-S	SWU	400	1200	3V	ina	ina	ina	ina	0.01dB/MHz	ina	dezi-B		1260	
Micro-Power	221/H41MD	400	1200	20	BWO	ina	no	yes	±0.1	2	N	a	4050	
R-S	SWOBII	0.5	1200	3.2	ina	ina	ina	ina	0.02/MHz	1, 10, 50 MHz	dezi-B		3700	
Telonic	E-6/SM-2000	600	1200	11.25	triode	ina	yes	yes	±1.5	8	BNC		ina	
S11	Kruse-Storke	5000/5010-3	750	1250	20	t	60	yes	yes	±0.25	3	TNC		2640
	Kay	121/P-122	900	1300	5	ina	ina	yes	none	ina	yes	N	u	1450
	Kay	1484A	0	1400	20	ina	30	yes	none	±0.25	yes	ina	z	575
	Wiltron	6109	775	1450	20	t	30	yes	none	±0.3	none	ina	lt	3140
	Telonic	3305/2003	5	1500	2.45	t	ina	yes	yes	±0.75	14	N	a	1745
	Kay	860/PC120	750	1500	13	t	60	yes	yes	ina	none	BNC	tx	1625
	Kay	121/P-120	750	1500	10	ina	ina	yes	none	ina	yes	N	u	2050
Telonic	3313/2003	800	1500	3.2	t	ina	yes	yes	±0.25	14	N	a	970	
Kay	121/P-124	1300	1700	5	ina	ina	yes	none	ina	yes	N	u	1475	
Telonic	E-1/SM-2000	460	1840	20	triode	ina	yes	yes	±1	8	BNC	a	1750	



We just got a good idea. We put metal shells on our Micro/Con D series rack-and-panel connectors. They're for when you put a connector in one of those unprotected places and it gets banged around a lot.

One side is stainless steel. One side is die-cast aluminum. And the big thing is, it's the first metal shell connector that will mate with any existing version. Interchangeable. Intermountable. You can use them with old and new equipment alike.

Our new shell comes in all the standard pin

sizes (9, 15, 21, 25, 31, 37, 51) and we've even got them on our flat cable connectors. If this excites you at all, maybe you'll enter our contest. Think of a new name for our new metal shell connectors, send it to us, and you'll have a chance at winning a case of scotch. And even if you don't win, we'll send you a genuine certificate recognizing your dumb idea.

Microdot Inc., 220 Pasadena Avenue,  
South Pasadena, California 91030.

MICRODOT INC.

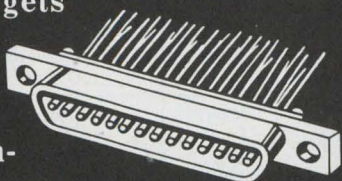

The new  
shell game.





	Manufacturer	Model	FREQUENCY		Rated Output mW	Signal Source	Noise dB	Int Level-ing	Ext Level-ing	Output Flatness dB	Int Freq Markers	Output Conn Type	Misc Features	Price (\$)
			Min MHz	Max MHz										
S12	Wiltron	6110	1000	2000	20	t	30	yes	none	±0.3	none	ina	lt	3040
	Alfred	650/651	1000	2000	80	BWO	40	yes	yes	ina	yes	N		3475
	Alfred	650/651C	1000	2000	60	BWO	40	yes	yes	ina	yes	N		3900
	Alfred	650/651CK	1000	2000	40	BWO	40	yes	yes	±0.3	yes	N		4200
	Alfred	650/651K	1000	2000	70	BWO	40	yes	yes	±0.3	yes	N		3775
	E-H	571	1000	2000	120	BWO	40	yes	yes	±0.1	3	N		3660
	Kay	860/PC125	1000	2000	13	t	60	yes	yes	ina	none	BNC	tx	1675
	H-P	8691A (8690B)	1000	2000	100	BWO	40	option	yes	±0.1	2	N	ad	3625
	H-P	8691B (8690B)	1000	2000	60	BWO	40	no	yes	±0.1	2	N	ad	3975
	Kruse-Storke	5000/5011	1000	2000	20	t	60	yes	yes	±0.25	3	TNC		3080
S13	Micro-Power	221/H102	1000	2000	100	BWO	ina	no	yes	±0.3	2	N	a	3600
	Micro-Power	221/H102D	1000	2000	60	BWO	ina	no	yes	±0.3	2	N	a	3950
	Kay	121/P-125	1000	2000	13	ina	ina	yes	none	ina	yes	N	u	2100
	Micro-Power	221/H102DL	1000	2000	60	BWO	ina	yes	yes	±0.3	2	N	a	4225
	Micro-Power	221/H102L	1000	2000	100	BWO	ina	yes	yes	±0.3	2	N	a	3900
	Micro-Power	221/H102SD	1000	2000	40	VTO	ina	no	yes	±0.1	2	N	b	3950
	Micro-Power	221/H1025DL	1000	2000	40	VTO	ina	yes	yes	±0.3	2	N	b	4225
	Sage	832-L-1	1000	2000	80-150	BWO	ina	yes	yes	±1.5	yes	N		7100
	Texscan	RS-120	1000	2000	5	VTD	ina	yes	yes	±0.25	6	N	bce	2250
	Electro-Data	OU-5501A (DU501)	100	2300	40 dBm	t	ina	no	no	±2	1	N	a	5075
S14	Telonic	E-2/SM-2000	600	2400	20, 1.25	triode	ina	yes	yes	±1	8	BNC, N		ina
	Kay	860/PC126	1200	2400	70	t	60	yes	yes	ina	none	BNC	tx	1800
	Texscan	VS-120	1200	2400	1.25	VTD	ina	yes	yes	±0.5	8	N	bc	1695
	Kay	121/P-126	1200	2400	70	ina	ina	yes	none	ina	yes	N	u	2225
	Kruse-Storke	5000/5012	1400	2400	20	t	60	yes	yes	±0.25	3	TNC		3180
	Alfred	650/651K-S1	1400	2400	70	BWO	40	yes	yes	±0.3	yes	N		3975
	Wiltron	6112	1400	2500	20	t	30	yes	none	±0.3	none	ina	lt	3140
	Alfred	650/651-S1	1400	2500	80	BWO	40	yes	yes	ina	yes	N		3625
	Micro-Power	221/H142	1400	2500	100	BWO	ina	no	yes	±0.3	2	N	a	3850
	Alfred	650/651C-S1	1400	2500	50	BWO	40	yes	yes	ina	yes	N		4075
S15	Micro-Power	221/H142D	1400	2500	60	BWO	ina	no	yes	±0.3	2	N	a	4150
	Micro-Power	221/H142L	1400	2500	100	BWO	ina	yes	yes	±0.3	2	N	a	4150
	Alfred	650/651CK-S1	1400	2500	50	BWO	40	yes	yes	±0.3	yes	N		4425
	Micro-Power	221/H142DL	1400	2500	60	BWO	ina	yes	yes	±0.3	2	N	a	4450
	Telonic	E-3/SM-2000	500	3000	11.25 0.8	triode	ina	yes	yes	±1	8	BNC, N		ina
	Kay	860/PC128	1500	3000	18	t	60	yes	yes	ina	none	BNC	tx	2015
	Kay	121/P-128	1500	3000	18	ina	ina	yes	none	ina	yes	N	u	2440
	H-P	8699B/8690B	100	4000	20	YIG-tuned transistor	40	no	yes	±0.1 ext level	2	N	ad	5200
	Wiltron	6114	2000	4000	20	t	30	yes	none	±0.3	none	ina	lt	3790
	Alfred	650/652	2000	4000	70	BWO	40	yes	yes	ina	yes	N		3275
S16	Alfred	650/652C	2000	4000	40	BWO	40	yes	yes	ina	yes	N		3725
	Alfred	650/652CK	2000	4000	30	BWO	40	yes	yes	±0.3	yes	N		4025
	Alfred	650/652K	2000	4000	60	BWO	40	yes	yes	±0.3	yes	N		3575
	Kay	860/PC127	2000	4000	13	t	60	yes	yes	ina	none	BNC	tx	2020
	E-H	572	2000	4000	90	BWO	40	yes	yes	±0.1	3	N		3460
	H-P	8692A/ 8690B	2000	4000	70	BWO	40	yes	yes	±0.2	2	N	ad	3425
	H-P	8692B/ 8690B	2000	4000	40	BWO	40	no	yes	±0.1	2	N	ad	3775
	Kruse-Storke	5000/5013	2000	4000	10	t	60	yes	yes	±0.3	3	TNC		3580
	Kay	121/P-127	2000	4000	13	ina	ina	yes	none	ina	yes	N	u	2445
	Micro-Power	221/H204	2000	4000	80	BWO	ina	no	yes	±0.5	2	N	a	3400

- a. Price includes basic unit with plug in.
- b. Solid state voltage tuned diode oscillator.
- c. Freq. markers are plug-in single freq. or harmonic type incorporating birdy by-pass system.
- d. Output flatness for external level, does not include coupler or detector variations.
- e. Incorporates dual sweep width feature and built-in log detector.
- f. Incorporates interchangeable plug-ins from 250 MHz - 40 GHz. Price is for mainframe, plug-in price varies with specification.
- g. If single octave bands are selected higher power output is available. 1-4 GHz, 60-70 mW; 4-14.4 GHz, 30-40 mW.
- h. Int. leveling performance improves if less than full range is being swept.



# The supreme sweeper.

Behold the Model 1001: 0.5 MHz to 300 MHz in one sweep; +13 dbm over the entire range at 0.25 db flatness; programmable in frequency, sweep width and 20 db of attenuation; usable as a signal generator with calibrated output attenuator. Sweeping supremacy for only \$995.





	Manufacturer	Model	FREQUENCY		Rated Output mW	Signal Source	Noise dB	Int Level-ing	Ext Level-ing	Output Flatness dB	Int Freq Markers	Output Conn Type	Misc Features	Price (\$)
			Min MHz	Max MHz										
S17	Micro-Power	221/H204D	2000	4000	40	BWO	ina	no	yes	±0.5	2	N	a	3750
	Micro-Power	221/H204DL	2000	4000	40	BWO	ina	yes	yes	±0.5	2	N	a	4050
	Micro-Power	221/H204L	2000	4000	80	BWO	ina	yes	yes	±0.5	2	N	a	3700
	Micro-Power	221/H204SD	2000	4000	20	VTO	ina	no	yes	±0.1	2	N	b	4075
	Micro-Power	221/H204SDL	2000	4000	16	VTO	ina	yes	yes	±0.5	2	N	b	4350
	Sage	832-S-1	2000	4000	100	BWO	ina	yes	yes	±1.5	yes	N		7100
	Alfred	650/652-S5	1700	4200	35	BWO	40	yes	yes	ina	yes	N		3625
	Alfred	650/652C-S5	1700	4200	15	BWO	40	yes	yes	ina	yes	N		4025
	Alfred	650/652CK-S5	1700	4200	15	BWO	40	yes	yes	±0.5	yes	N		4325
	Alfred H-P	650/652K-S5 H01-8692B/ 8690B	1700 1700	4200 4200	30 15	BWO BWO	40 40	yes no	yes yes	±0.5 ±0.1	yes 2	N N	ad	3925 4075
S18	Kruse-Storke	5000/5013-2	1700	4200	5	†	60	yes	yes	±0.5	3	TNC		3840
	Micro-Power	221/H204DA	1700	4200	15	BWO	ina	no	yes	±0.5	2	N	a	4050
	Micro-Power	221/H204DLA	1700	4200	15	BWO	ina	yes	yes	±0.5	2	N	a	4350
	Electro-Data	OU-C 501A (DU501)	3600	4200	40 dBm	†	ina	no	no	±2	1	N	a	5575
	Kruse-Storke	5000/501-3	3700	4200	10	†	60	yes	yes	±0.2	3	TNC		3640
	Wiltron	6120	3600	4300	80	†	30	yes	none	±0.3	none	ina	lt	4140
	Kruse-Storke	5000/5014-1	5900	6450	10	Gunn Diode	60	yes	yes	±0.2	3	TNC		3640
	Wiltron	6122	5900	6500	80	†	30	yes	none	±0.3	none	ina	lt	4140
	Polarad	1307	5500	6600	-127dBm	BWO	ina	ina	ina	±1	none	N		3100
	Alfred	650/653-S1	3500	6750	40	BWO	40	yes	yes	ina	yes	N		3575
Alfred	650/653C-S1	3500	6750	20	BWO	40	yes	yes	ina	yes	N		3825	
S19	Alfred	650/653CK-S1	3500	6750	15	BWO	40	yes	yes	±0.4	yes	N		4225
	Alfred	650/653K-S1	3500	6750	30	BWO	40	yes	yes	±0.4	yes	N		3975
	Micro-Power	221/H356	3500	6750	40	BWO	ina	no	yes	±0.5	2	N	a	3700
	Micro-Power	221/H356D	3500	6750	25	BWO	ina	no	yes	±0.5	2	N	a	3975
	Micro-Power	221/H356DL	3500	6750	25	BWO	ina	yes	yes	±0.5	2	N	a	4300
	Micro-Power	221/H356L	3500	6750	40	BWO	ina	yes	yes	±0.5	2	N	a	4100
	Polarad	1307-1	5200	7200	-127dBm	BWO	ina	ina	ina	±1	none	N		3750
	Electro-Data	OU-X501A (DU501)	7200	7800	40 dBm	†	ina	no	no	±2	1	N	a	5650
	Polarad	1308	7000	7800	-127 dBm	BWO	ina	ina	ina	±1	none	N		3100
	Alfred	650/653	4000	8000	40	BWO	40	yes	yes	ina	yes	N		3150
Wiltron	6126	4000	8000	10	†	30	none	none	±0.3	none	ina	lt	4390	
Alfred	650/653C	4000	8000	15	BWO	40	yes	yes	ina	yes	N		3575	
S20	Alfred	650/653CK	4000	8000	15	BWO	40	yes	yes	±0.5	yes	N		3925
	Alfred	650/653K	4000	8000	25	BWO	40	yes	yes	±0.5	yes	N		3500
	E-H	573	4000	8000	35	BWO	40	yes	yes	±0.1	3	N		3460
	H-P	8693A/8690B	4000	8000	30	BWO	40	yes	yes	±0.2	2	N	ad	3225
	H-P	8693B/8690B	4000	8000	15	BWO	40	yes	yes	±0.1	2	N	ad	3625
	Kruse-Storke	5000/5014	4000	8000	10	Gunn Diode	60	yes	yes	±0.4	3	TNC		3780
	Micro-Power	221/H408	4000	8000	30	BWO	ina	no	yes	±0.5	2	N	a	3200
	Micro-Power	221/H408D	4000	8000	20	BWO	ina	no	yes	±0.5	2	N	a	3600
	Micro-Power	221/H408DL	4000	8000	20	BWO	ina	yes	yes	±0.5	2	N	a	3950
	Micro-Power	221/H408L	4000	8000	30	BWO	ina	yes	yes	±0.5	2	N	a	3550
S21	Sage	832-C-1	4000	8000	100	BWO	ina	yes	yes	±1.5	yes	N		7100
	Alfred	650/653-S2	3700	8300	10	BWO	40	yes	yes	ina	yes	N		3525
	Alfred	650/653C-S2	3700	8300	5	BWO	40	yes	yes	ina	yes	N		3875
	Alfred	650/653CK-S2	3700	8300	5	BWO	40	yes	yes	±0.5	yes	N		4225
	Alfred	650/653K-S2	3700	8300	10	BWO	40	yes	yes	±0.5	yes	N		3875
	H-P	H01-8693B/ 8690B	3700	8300	5	BWO	40	option	yes	±0.1	2	N	ad	3925
	Micro-Power	221/H408DA	3700	8300	8	BWO	ina	no	yes	±0.5	2	N	a	3900
	Micro-Power	221/H408 DLA	3700	8300	8	BWO	ina	yes	yes	±0.5	2	N	a	4250
	Polarad	1308-1	7100	8500	-127 dBm	BWO	ina	ina	ina	±1	none	N		3750
	Alfred	650/654	7000	11000	35	BWO	40	yes	yes	ina	yes	N		3200

- i. From 1-4 GHz residual fm is <15 kHz peak. From 4-12.4 GHz residual FM is <30 kHz peak.
- j. 1/2% linearity; 1% frequency accuracy.
- k. Calibrated power output with 120 dB attenuator.
- l. Plug-in unit for model 610B main frame at \$1190.
- m. 1 kHz internal squarewave mod; external am/fm provisions (dc coupled).

- n. Electro-mechanical.
- o. Model 9500, rated output 10 mw, 1-8 GHz; 1 mW, 8-12.4 GHz; Model 9510, rated output 10 mw, 2-8 GHz; 1 mW, 8-12.4 GHz. Output flatness ±0.5 dB over any octave.
- p. Sweep width 10 kHz - 400 MHz.
- q. Sweep width 100 kHz - 400 MHz.
- r. Electronic saturable reactor.



# The Alfred 650: The only anti-confusion, utterly reliable sweep oscillator.

All controls, indicators, and r.f. plug-in on front panel.  
Alfred "total protection" circuitry used throughout.

Unique Alfred three story slide rule dial with 5 CW frequencies and 3 markers.

Internal or external leveling... PIN diode or grid leveling.

11 plug-ins cover total 250 MHz to 40 GHz. Plug-ins covering intermediate ranges available.

Front plug-in convenience eliminates additional wasteful handling and useless accessories required with now obsolete rear plug-in sweepers.

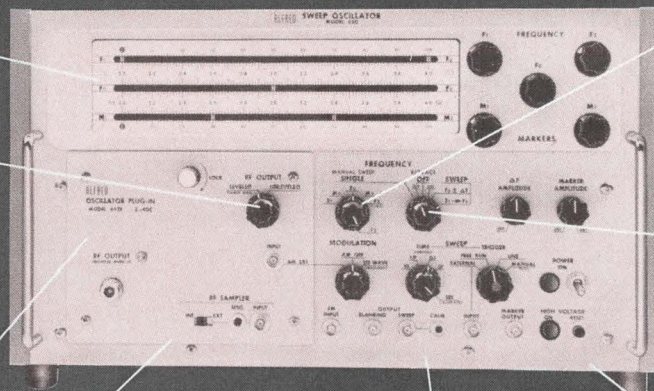

Unique  $F_0$  control which serves as a frequency marker, the center of the symmetrical sweep, and as a single frequency.

Broad band  $F_1$   $F_2$  sweep and narrow band symmetrical sweep,  $F_0 \pm F$ .

Operates from 50 to 400 Hz 115/230 volt power for convenient air, sea, or ground application.

Rugged construction. There is no sturdier sweeper on the market. Ask your Alfred sales engineer to demonstrate the 4" drop test.

## Ask for the six-page data pack.

A six-page data pack describing the Alfred 650 Sweep Oscillator and associated plug-ins is yours for the asking. Ask your full service Alfred sales engineer for a copy or write to Alfred Operation, Singer Instrumentation Group, 3176 Porter Drive, Palo Alto, California 94304. Phone (415) 326-6496.

Project responsibility opportunities are available for qualified engineers on Alfred Electronics' growing technical staff. An equal opportunity employer.

# SINGER

## INSTRUMENTATION



	Manufacturer	Model	FREQUENCY		Rated Output mW	Signal Source	Noise dB	Int Level-ing	Ext Level-ing	Output Flatness dB	Int Freq Markers	Output Conn Type	Misc Features	Price (\$)
			Min MHz	Max MHz										
S22	Alfred	650/654C	7000	11000	10	BWO	40	yes	yes	ina	yes	N		3600
	Alfred	650/654CK	7000	11000	10	BWO	40	yes	yes	±0.5	yes	N		3975
	Alfred	650/654K	7000	11000	25	BWO	40	yes	yes	±0.5	yes	N		3575
	H-P	H02-8694A/8690B	7000	11000	25	BWO	40	yes	yes	±0.2	2	N	ad	3250
	H-P	H02-8694B/8690B	7000	11000	15	BWO	40	yes	yes	±0.1	2	N	ad	3675
	Micro-Power	221/H711	7000	11000	25	BWO	ina	no	yes	±0.5	2	N	a	3240
	Micro-Power	221/H711D	7000	11000	10	BWO	ina	no	yes	±0.5	2	N	a	3650
	Micro-Power	221/H711DL	7000	11000	10	BWO	ina	yes	yes	±0.5	2	N	a	4025
	Micro-Power	221/H711L	7000	11000	25	BWO	ina	yes	yes	±0.5	2	N	a	3615
Kruse-Storke	5000/5015	8000	12000	5	Gunn Diode	60	yes	yes	±0.5	3	TNC		3590	
S23	Narda	9500	1000	12400	1	t	ina	yes	yes	1	yes	N	ot	9800
	Servo	404	1000	12400	25	BWO	40	yes	yes	±1	2	N	igh	11260
	Narda	9510	2000	12400	1	t	ina	yes	yes	1	yes	N	ot	8600
	Alfred	650/654-S1	7000	12400	35	BWO	40	yes	yes	ina	yes	N		3400
	Alfred	650/654C-S1	7000	12400	10	BWO	40	yes	yes	ina	yes	N		3825
	Alfred	650/654CK-S1	7000	12400	10	BWO	40	yes	yes	±0.75	yes	N		4225
	Alfred	650/654K-S1	7000	12400	25	BWO	40	yes	yes	±0.75	yes	N		3800
	H-P	H01-8694A/8690B	7000	12400	25	BWO	40	yes	yes	±0.2	2	N	ad	3500
	H-P	H01-8694B/8690B	7000	12400	15	BWO	40	yes	yes	±0.1	2	N	ad	3925
Micro-Power	221/H712	7000	12400	25	BWO	ina	no	yes	±1.0	2	N	a	3475	
S24	Micro-Power	221/H712D	7000	12400	10	BWO	ina	no	yes	±1	2	N	a	3900
	Micro-Power	221/H712DL	7000	12400	10	BWO	ina	yes	yes	±1.0	2	N	a	4300
	Micro-Power	221/H712L	7000	12400	25	BWO	ina	yes	yes	±1	2	N	a	3875
	Wiltron	6128	8000	12400	5	t	30	none	none	±0.3	none	ina	alt	4095
	Alfred	650/655	8000	12400	75	BWO	40	yes	yes	±0.5	yes	w/g		3150
	Alfred	650/655C	8000	12400	20	BWO	40	yes	yes	±0.5	yes	w/g		3600
	Alfred	650/655CK	8000	12400	20	BWO	40	yes	yes	±0.7	yes	w/g		3975
	Alfred	650/655K	8000	12400	50	BWO	40	yes	yes	±0.7	yes	w/g		3525
	E-H	574	8000	12400	50	BWO	40	yes	yes	±0.1	3	N		3580
H-P	8694A/8690B	8000	12400	50	BWO	40	yes	yes	±0.2	2	N	ad	3225	
S25	H-P	8694B/8690B	8000	12400	30	BWO	40	yes	yes	±0.1	2	N	ad	3650
	Micro-Power	221/H812	8000	12400	50	BWO	ina	no	yes	±0.75	2	N	a	3200
	Micro-Power	221/H812D	8000	12400	25	BWO	ina	no	yes	±0.75	2	N	a	3625
	Micro-Power	221/H812DL	8000	12400	25	BWO	ina	yes	yes	±0.75	2	N	a	4000
	Micro-Power	221/H812L	8000	12400	50	BWO	ina	yes	yes	±0.75	2	N	a	3590
	Sage	832-X-1	8000	12400	100	BWO	ina	yes	yes	±1.5	yes	N		7100
	Alfred	650/656	10000	15500	35	BWO	40	yes	yes	ina	yes	w/g		4075
	Micro-Power	221/H1015	10000	15500	20	BWO	ina	no	yes	±0.1	2	w/g	a	4125
	Wiltron	6130	12400	16000	2	t	30	none	none	±0.3	none	ina	alt	4340
Alfred	650/657	12400	18000	40	BWO	40	yes	yes	ina	yes	w/g		3325	
S26	Alfred	650/657K	12400	18000	25	BWO	40	yes	yes	±0.8	yes	w/g		3875
	E-H	575	12400	18000	48	BWO	40	yes	yes	±0.1	3	UG-419/U		3730
	H-P	8695A/8690B	12400	18000	40	BWO	40	no	yes	±0.2	2	UG-419/U	ad	3400
	Micro-Power	221/H1218	12400	18000	40	BWO	ina	no	yes	±0.1	2	UG-419/U	a	3375
	Sage	832-K-1	12400	18000	50	BWO	ina	yes	yes	±1.5	yes	N		7100
	Alfred	650/658	18000	26500	20	BWO	40	yes	yes	ina	yes	UG-595/U		4175
	E-H	576	18000	26500	12	BWO	40	yes	yes	±0.1	3	UG-595/U		4570
	H-P	8696A/8690B	18000	26500	10	BWO	40	no	yes	±0.2	2	UG-595/U	ad	4300
	Micro-Power	221/H1826	18000	26500	20	BWO	ina	no	yes	±0.1	2	UG-595/U	a	4250
AIL	210	250	40000	ina	BWO	ina	yes	yes	ina	ina	N, w/g	ft	1525	
S27	Alfred	650/659	26500	40000	5	BWO	40	yes	yes	ina	yes	w/g		5875
	E-H	577	26500	40000	6	BWO	40	yes	yes	±0.1	3	UG-599/U		6870
	H-P	8697A/8690B	26500	40000	5	BWO	40	no	yes	±0.2	2	UG-599/U	ad	6100
	Micro-Power	221/H2640	26500	40000	5	BWO	ina	no	yes	±0.1	2	UG-599/U	a	6000

- s. Suffix R for 70 dB attenuator, marker amplifier and built-in rf detector at \$100 extra.
- t. Solid state.
- u. Modulation available.
- v. Harmonic, birdy and variable marker plug-ins available.

- w. Marker plug-ins available.
- x. Main frame model 1500 at \$690 includes markers, main frame 860 with no markers at \$525. Plug-ins fit both units.
- y. K10237, unstabilized; 1.
- z. Selectable.



# BROADBAND GENERATION

Shown exactly half scale

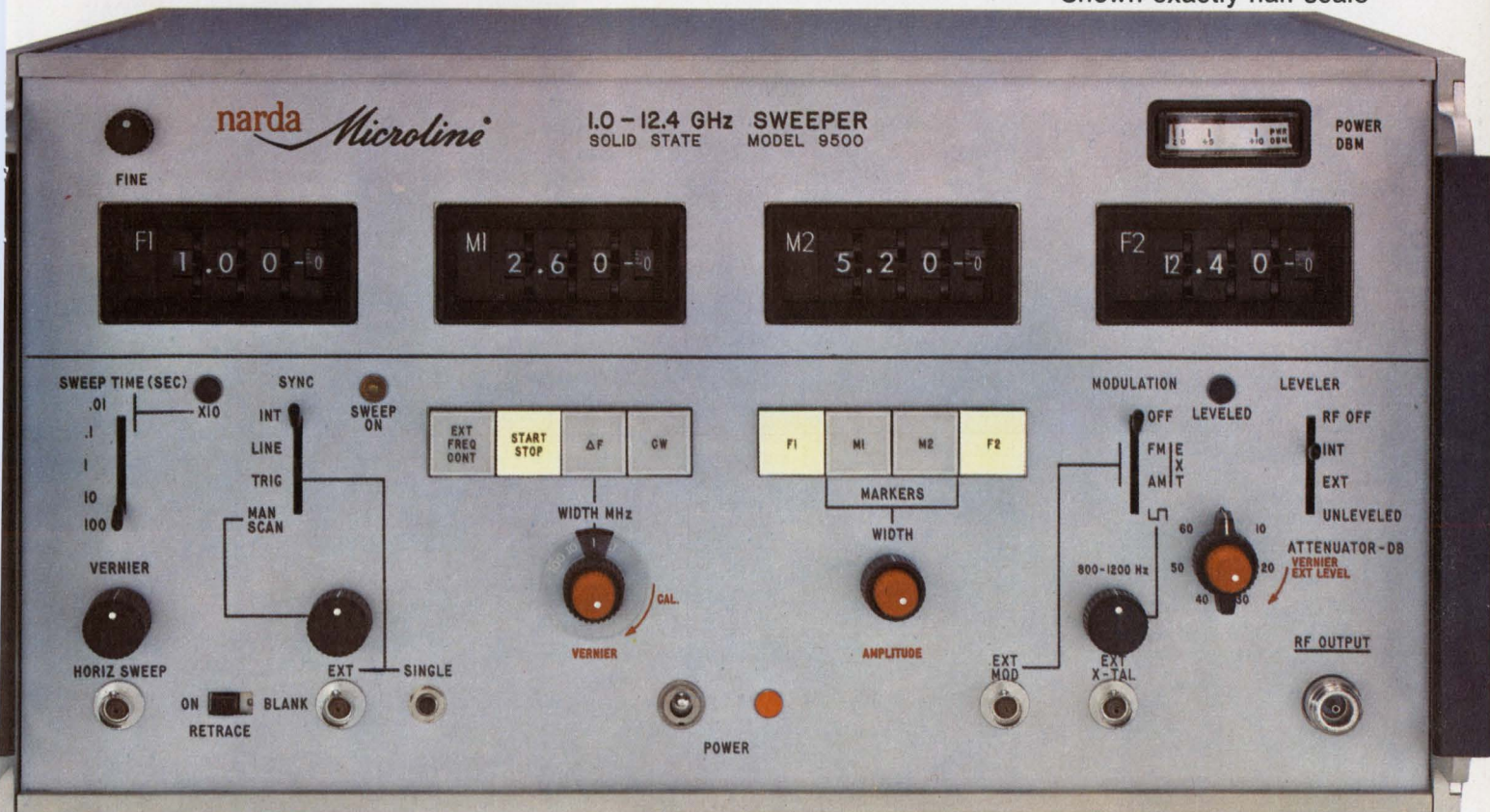

## sweep from 1.0 to 12.4 GHz—continuously

See for yourself how easy this Solid State Sweeper is to use — try it right now — dial F1 and F2 from 1.0 to 12.4 GHz or anywhere in between — now push F1 and F2 buttons — you have just swept your frequency without the interruption of changing plug-ins, cranking or dial resetting. *This is the new concept in sweepers* — you are not “octave” limited — everything is in one smart-looking box.

This broadband instrument is not only easy to use, it almost encourages you to make more complete measurements because of its speed and flexibility. Choose any combination of F1, M1, M2, F2 for any

preset bandwidth — just dial a frequency, push a couple of buttons and your swept measurement is made. Look at the front panel — start thinking what you can do with this “no octave” Solid State Sweeper — you can do evaluations of components and systems anywhere from 1.0 to 12.4 GHz.

**Want to see the most revolutionary thing in sweepers for yourself — we have demonstrators in the field now — right in your own vicinity . . . call for your personal demonstration.**

*Write for further details.*

217

Narda gives you more value — at no extra cost.

**narda** *Microline*®

THE NARDA MICROWAVE CORPORATION • PLAINVIEW, L.I., NEW YORK 11803



# Index of Model Numbers

Name	Model	Code	Name	Model	Code	Name	Model	Code
<b>AIL</b>	210	S26	<b>Labs</b>	573	S20		1484B	S4
Airborne instruments Labs				574	S24	<b>Kruse-Storke</b>	5000/5007	S3
<b>Alfred</b>	650/651	S12		575	S26	Kruse-Storke Electronics	5000/5008-1	S6
Alfred Electronics	650/651-S1	S14	<b>Electro/Data</b>	OU-C501A (DU501)	S18		5000/5008A	S5
	650/651A-S2	S6	Electro/Data Inc.	OU-S501A (DU501)	S13		5000/5010	S9
	650/651A-S3	S6		OU-X501A (DU501)	S19		5000/5010-3	S11
	650/651AK-S2	S6	<b>Epsco</b>	SG-132A	S5		5000/5011	S12
	650/651AK-S3	S9	EPSCO, Inc.				5000/5012	S14
	650/651C	S12	<b>GR</b>	1003	S2		5000/5013	S16
	650/651C-S1	S14	General Radio Co.	1025	S4		5000/5013-2	S18
	650/651CK	S12					5000/5013-3	S18
	650/651CK-S1	S15	<b>Heath</b>	IG-52	S4	<b>Marconi</b>	5000/5014	S20
	650/651K	S12	Heath Co.	IGW-57	S2	Marconi Instruments	5000/5014-1	S18
	650/651K-S1	S14	<b>H-P</b>	8601A	S3		5000/5015	S22
	650/652	S15	Hewlett-Packard	8691A/8690B	S12		TF 1099	S2
	650/652-S5	S17		8691B/8690B	S12	<b>Micro-power</b>	221/H24MD	S6
	650/652C	S16		8692A/8690B	S16	Micro-Power Inc.	221/H24MD	S7
	650/652C-S5	S17		8692B/8690B	S16		221/H25SD	S7
	650/652CK	S16		8693A/8690B	S20		221/H37MD	S7
	650/652CK-S5	S17		8693B/8690B	S20		221/H41MD	S10
	650/652K	S16		8694A/8690B	S24		221/H51B	S9
	650/652K-S5	S17		8694B/8690B	S25		221/H51DB	S9
	650/653	S19		8695A/8690B	S26		221/H51MD	S9
	650/653-S1	S18		8696A/8690B	S26		221/H51SD	S9
	650/653-S2	S21		8697A/8690B	S27		221/H102	S13
	650/653C	S19		8698B/8690B	S3		221/H102D	S13
	650/653C-S1	S18		8699B/8690B	S15		221/H102DL	S13
	650/653CK-S2	S21		H01-8692B/8690B	S17		221/H102L	S13
	650/653CK	S20		H01-8693B/8690B	S21		221/H102SD	S13
	650/653CK-S1	S19		H01-8694A/8690B	S23		221/H102SDL	S13
	650/653CK-S2	S21		H01-8694B/8690B	S23		221/H142	S14
	650/653K	S20		H02-8694B/8690B	S22		221/H142D	S15
	650/653K-S1	S19		H02-8694A/8690B	S22		221/H142DL	S15
	650/653K-S2	S21		H02-8694B/8690B	S22		221/H142L	S15
	650/654	S21	<b>IFI</b>	M4025	S4		221/H204	S16
	650/654-S1	S23	Instruments for Industries				221/H204D	S17
	650/654C	S22	<b>Jerrold</b>	601-7F	S4		221/H204DA	S18
	650/654C-S1	S23	Jerrold Electronics Corp.	900 A-7F	S10		221/H204DL	S17
	650/654CK	S22		900 C-7F	S10		221/H204DLA	S18
	650/654CK-S1	S23		SS-300-7F	S5		221/H204L	S17
	650/654K	S22	<b>Kay</b>	121/P-120	S11		221/H204SD	S17
	650/654K-S1	S23	Kay Electric Co.	121/P-121	S10		221/H204SDL	S17
	650/655	S24		121/P-122	S11		221/H356	S19
	650/655C	S24		121/P-123	S8		221/H356D	S19
	650/655CK	S24		121/P-124	S11		221/H356DL	S19
	650/655K	S24		121/P-125	S13		221/H356L	S19
	650/656	S25		121/P-126	S14		221/H408	S20
	650/657	S25		121/P-127	S16		221/H408D	S20
	650/657K	S26		121/P-128	S15		221/H408DA	S21
	650/658	S26		154-C	S3		221/H408DL	S20
	650/659	S27		159-C	S5		221/H408DLA	S21
	6151	S8		860/PC 120	S11		221/H408L	S20
	6151-1/Q01	S2		860/PC 123	S8		221/H711	S22
	6151-1/Q02	S2		860/PC 125	S12		221/H711D	S22
	6151-1/Q03	S3		860/PC 126	S14		221/H711DL	S22
	6151-1/Q21	S5		860/PC 127	S16		221/H711L	S22
	6151-1/Q22	S7		860/PC 128	S15		221/H712	S23
	6151-1/Q23	S9		860/PC 130	S1		221/H712D	S24
<b>Blonder-Tongue</b>	4122	S7		860/PC 141	S1		221/H712DL	S24
Blonder-Tongue Labs				860/PC 142	S1		221/H712L	S24
<b>Data Royal</b>	F230B	S1		860/PC 152	S2		221/H812	S25
Data Royal Corp.				860/PC 154	S4		221/H812D	S25
<b>Dynascan</b>	415	S1		860/PC 855	S2		221/H812DL	S25
Dynascan Corp.	E410C	S10		860/PC 856	S4		221/H812L	S25
				860/PC 857	S4		221/H1015	S25
<b>E-H</b>	571	S12		860/PC 860	S4		221/H1218	S26
E-H Research	572	S16		860/PC 867	S6		221/H1826	S26
				1483B	S8	<b>Narda</b>	221/H2640	S27
				1484A	S11	Narda	9500	S23
						Narda Micro-wave Corp.	9510	S23
						<b>Polarad</b>	1307	S18



Name	Model	Code
Polarad	1307-1	S19
/Nelson	1308	S19
Ross	1308-1	S21
Sage	832-C-1	S21
Sage Labs.	832-K-1	S26
	832-L-1	S13
	832-S-1	S17
	832-X-1	S25
<b>RCA</b>	WR-69A	S2
RCA Electronic Components & Devices		
<b>R-S</b>	SWOBI	S5
Rohde & Schwarz	SWOBII	S10
	SWOBIII	S8
	SWOF	S2
	SWU	S10
<b>Servo</b>	404	S23
Servo Corp. of America		
<b>Spectral</b>	SD104A-1	S1
Spectral Dynamics Corp.	SD104A-2	S1
	SD104A-5	S1
<b>Telonic</b>	1005	S7
Telonic Industries	1006	S7
	3005/SM-2000	S8
	3303/2003	S6
	3305/2003	S11
	3312/2003	S9
	3313/2003	S11
	E-1/SM-2000	S11
	E-2/SM-2000	S14
	E-3/SM-2000	S15
	E-4/SM-2000	S6
	E-5/SM-2000	S7
	E-6/SM-2000	S10
	HD-1A	S7
	PD-7	S5
	PD-8	S8
	SH-1/SM2000	S6
	VR-50/SM2000	S9
<b>Texscan</b>	HS-85	S8
Texscan Corp.	HS-86	S9
	RS-50	S6
	RS-70	S10
	RS-120	S13
	VS-50	S6
	VS-70	S10
	VS-80	S10
	VS-120	S14
<b>Waveforms</b>	610B	S1
<b>Wavetek</b>	200	S1
	300	S3
	310	S2
	310A	S3
	1001	S5
	SA-1312	S3
	SA-1401	S5
	SA-1501	S7
<b>Wiltron</b>	6104	S3
Wiltron Corp.	6104-1	S3
	6105	S3
	6106	S5
	6108	S8
	6109	S11
	6110	S12
	6112	S14
	6114	S15
	6120	S18
	6122	S18
	6126	S19
	6130	S25

Bell & Howell's look-alike laboratory tape recorders, VR-3400 and VR-3700, have a magnetic-head life that is guaranteed to exceed 1000 hours. (However, in the 3½ years since these heads were introduced, not one that we know of has had to be replaced.)

CEC/DATA INSTRUMENTS DIVISION

A few other goodies: tape handling is unsurpassed through use of linear, wide-range servo controls. Minimum maintenance is emphasized, so you spend more time being an instrumentation engineer and less a repairman.

 **BELL & HOWELL**

How are these two different? Well, VR-3700 costs a little more, but it does more. Its frequency range goes to 2 MHz. Anyway, you can convert a VR-3400 into a VR-3700 by a simple exchange of electronics and heads.

For all the facts, call our nearest office. Or write Bell & Howell, Pasadena, California 91109. Ask for Bulletin Kit 3306-X1.

## Heads, you win.

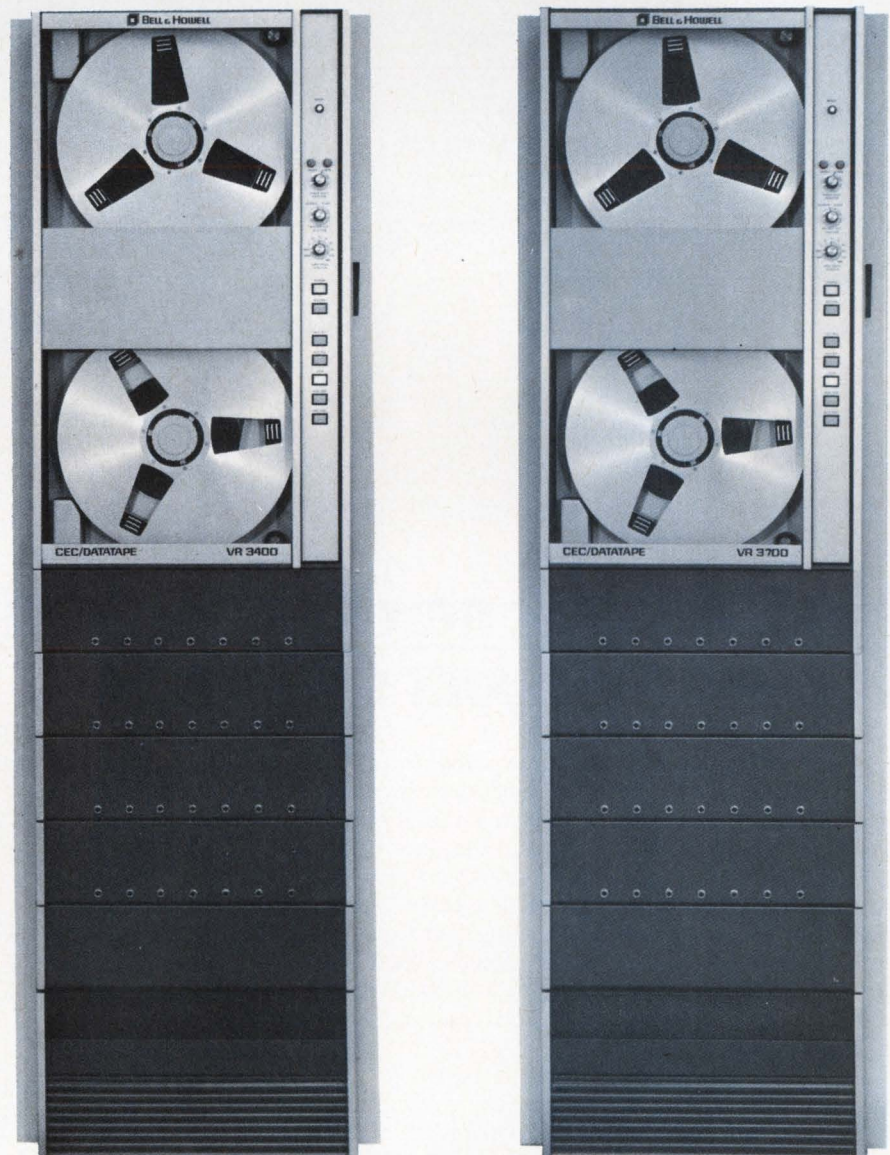

INFORMATION RETRIEVAL NUMBER 67



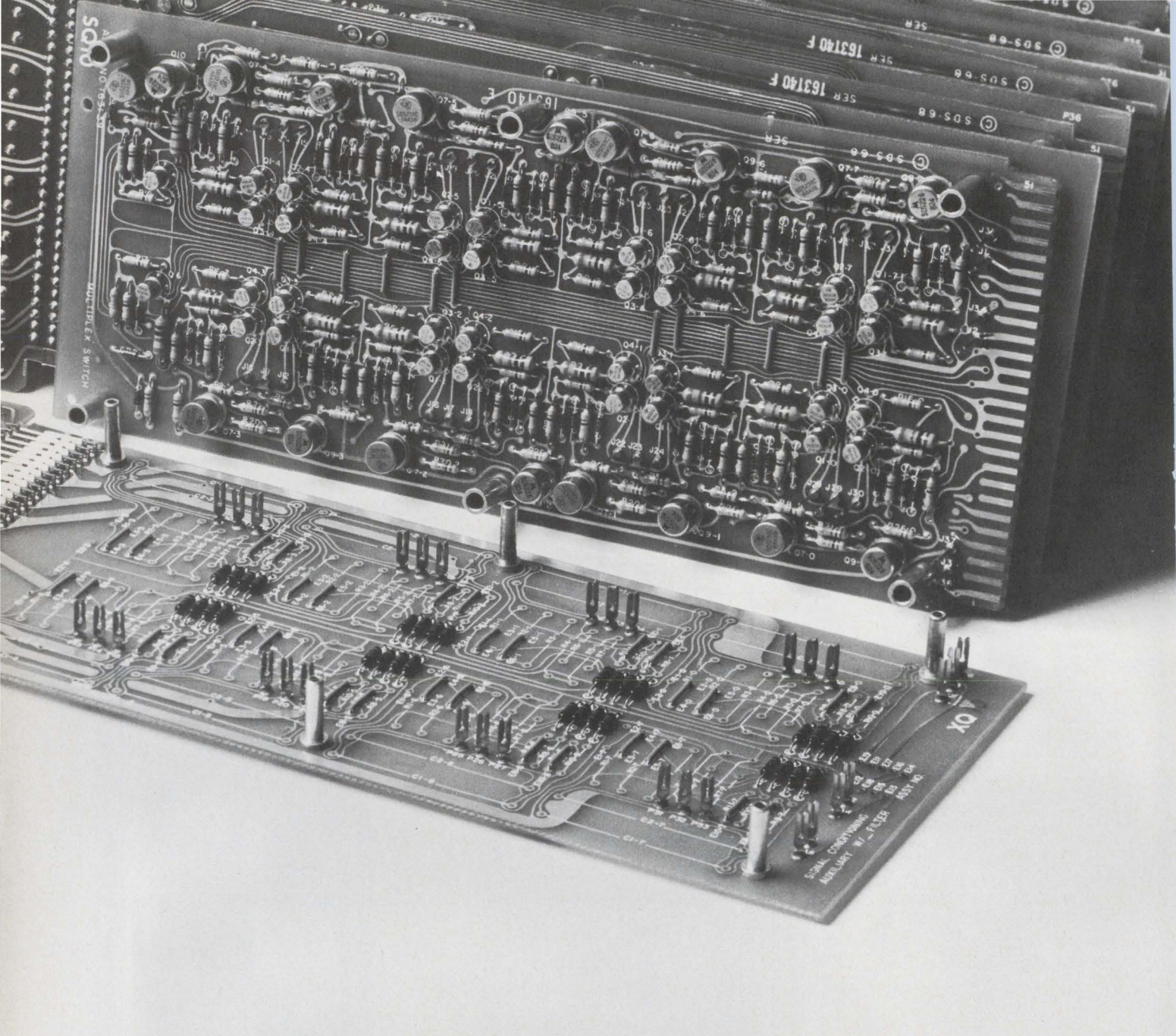

## Look into our new low level multiplexer. It's good for your system.

Our DM40 solid-state differential multiplexer makes a great front-end, with amplifier per channel performance. It accepts analog signals from thermocouples, strain-gauges, resistance bridges, transducers, amplifiers and the like. It has very low noise and you don't have to worry about acquisition errors due to previous channel overload. The DM40 takes 128 input lines and you can hook eight units together for a total of 1024 inputs. It multiplexes and amplifies each signal and transmits it to your digitizer at a rate up to 10KHz. When you use it with one of our controller-digitizers you can get 13 different gain ranges.

In fact, the DM40 is even better when you get all your system components from us. This way you can be sure they'll work as a system. No interface problems to solve, no missing hardware to engineer. Our components are made to get along together.

After all, they come from a good family.

### DM40 Minispecs:

Input signals:	From 2.5 millivolts full scale to 10 Volts full scale.
Gain Accuracy:	0.02% between steps.
Linearity:	0.005%
Zero Stability:	1 microvolt rti +20 microvolts rto/°C.
Crosstalk:	120db
Common Mode Rejection:	120db, DC; 100db, 60Hz.
Noise:	10 microvolts peak rti +100 microvolts peak rto.

Write for complete specifications.

**XDS**  
Xerox Data Systems  
El Segundo, California



# Products

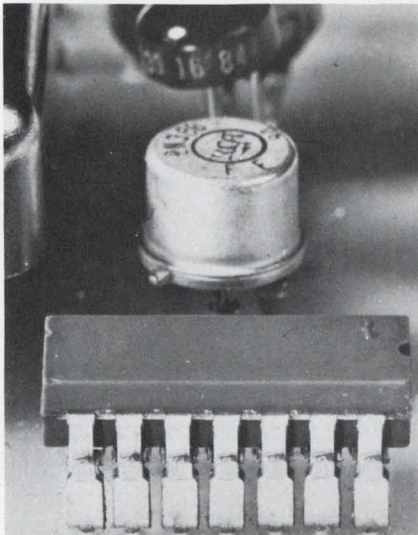

**Low-cost plug-in DIP IC connectors** are now free Evaluation Samples, p. 168.

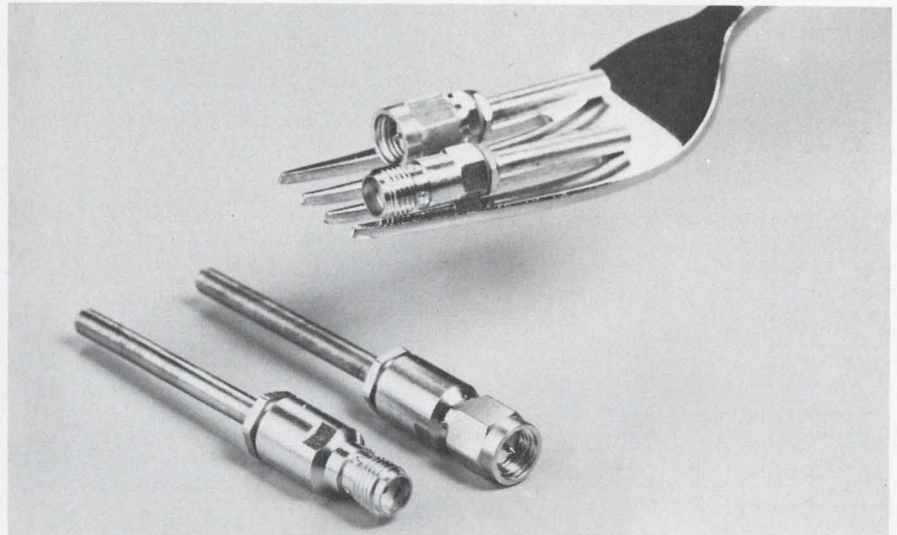

**Subminiature SMA coaxial connectors** improve electrical and mechanical performance over competitive designs. They feature a maximum of four parts per assembly, p. 158.

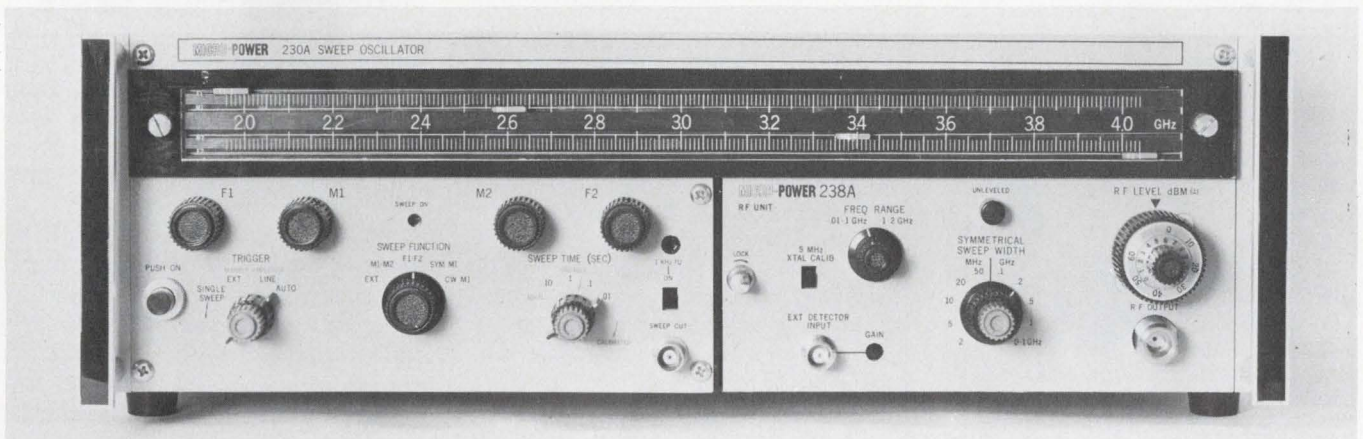

**Solid-state microwave sweeper** goes from 10 MHz to 18 GHz with a minimum of plug-ins.

Power output ranges between 20 mW up to 4 GHz and 5 mW up to 18 GHz, p. 142.

## Also in this section:

**All-electronic touch switch** is activated by fingertip capacitance, p. 122.

**Five-digit multimeter for \$1995** measures dc to 0.002% full scale, p. 132.

**Plastic silicon rectifiers** start at 15¢ each for 100-V units, p. 148.

**Evaluation Samples**, p. 168..... **Design Aids**, p. 169.

**Application Notes**, p. 170..... **New Literature**, p. 172.



If you don't  
find it here,  
give us a call.

# SILICON RECTIFIERS

Ask about our many  
types of custom  
rectifiers and rectifier  
assemblies.

FULL WAVE BRIDGE RECTIFIERS*		
50V	I <sub>0</sub>	1-99
W 111	1A	.95
<b>100V</b>		
VE 18	1A	1.00
VS 148	2A	1.00
VH 148	6A	1.93
<b>200V</b>		
VE 27	1A	1.20
VE 28	1A	1.10
VS 247	2A	1.20
VS 248	2A	1.10
VH 247	6A	2.25
VH 248	6A	2.15
IN 4436	10A	4.15
VT 200	25A	5.35
<b>400V</b>		
VE 47	1A	1.30
VE 48	1A	1.20
VS 447	2A	1.30
VS 448	2A	1.20
VH 447	6A	2.59
VH 448	6A	2.49
IN 4437	10A	5.45
VT 400	25A	7.00
<b>600V</b>		
VE 67	1A	1.59
VE 68	1A	1.49
VS 647	2A	1.60
VS 648	2A	1.50
VH 647	6A	2.98
VH 648	6A	2.88
IN 4438	10A	7.45
VT 600	25A	9.85

\*Available with fast recovery characteristic



SEMICONDUCTOR DIVISION, 1000 N. SHILOH  
ROAD, GARLAND, TEXAS 75040 (214) 272-4551

INFORMATION RETRIEVAL NUMBER 69

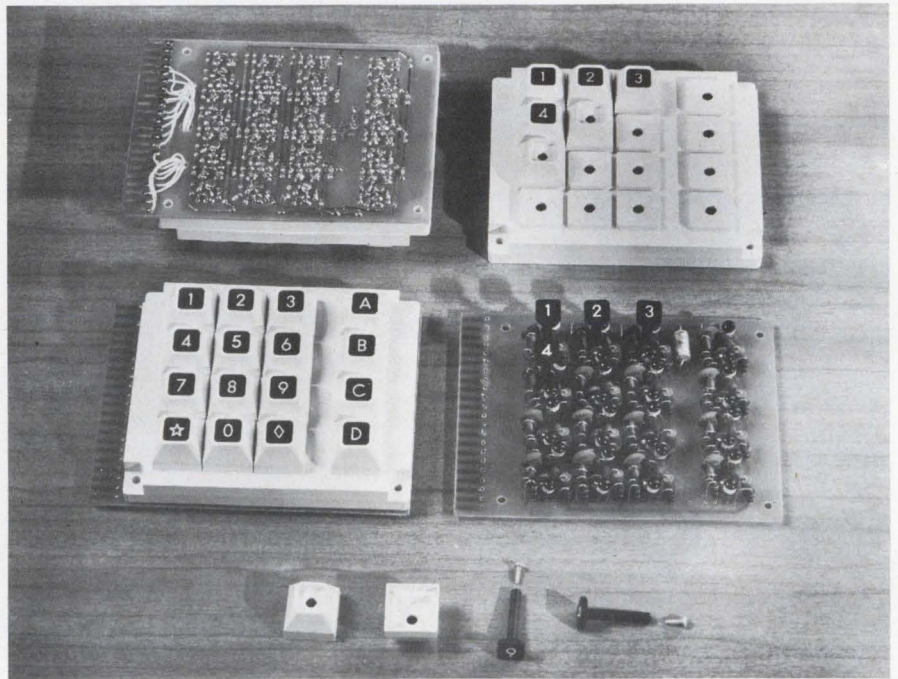

## Solid-state touch pushbutton senses fingertip capacitance

Raven Electronics Corp., P.O. Box  
5337, Reno, Nev. Phone: (702)  
786-1965. P&A: \$7 to \$8.50 for  
single switch, \$60 or \$80 for key-  
board; stock to 15 days.

Actuated by the mere touch of  
your finger, a new non-mechanical  
switch operates by accepting an  
input capacitance and converting it  
into an output voltage. The output  
voltage, in turn, drives a circuit  
that will switch a dc current of  
50 mA or less at any potential be-  
tween 3 and 30 V.

Unaffected by magnetic or elec-  
trostatic fields, the new touch  
switch is constructed of solid-state  
components and two small circuit  
boards. Basically, its switching ac-  
tion may be compared to a me-  
chanical pushbutton — touching  
with the finger turns it on; re-  
moving the finger turns it off.

Three single versions are avail-  
able: the model 202A, a normally  
off momentary switch; the model  
202B which provides a single pulse  
output on touch; and the model  
202C, a normally off unit that is  
activated when the finger is re-  
moved.

In addition, available multiple-  
switch arrays include: the model  
202L, a latching pair of units

(one turns a circuit on, while the  
other turns it off); the model  
203A, a 12-key keyboard; and the  
model 203B, a 16-key keyboard.

The touch switch operates from  
a dc supply of 10 to 30 V. Its pow-  
er consumption is 25 mW with a  
10-V supply, increasing to 75 mW  
with a 30-V supply.

When a capacitance of 8 pF or  
more is applied to its touch plate,  
the new switch will turn on. It  
turns off when the input capaci-  
tance drops to 4 pF. This differ-  
ence in on and off-capacitance pre-  
vents alternate on/off action as the  
finger is removed and capacitance  
decreases.

Since the touch switch has no  
moving parts or contacts, it is free  
of the noise normally caused by  
bounce contact in mechanical  
switches. Its life expectancy, which  
is not determined by a fixed num-  
ber of operations, matches that of  
the electronic circuits in which it  
is incorporated.

The new switch's electronic cir-  
cuit and metal touch plate are  
packaged in separate plastic hous-  
ings. These need not be directly  
behind each other, but may be lo-  
cated 4 to 6 in. away, with only a  
single wire connecting the two.

CIRCLE NO. 250



# The Fine Art of ONEUP MANSHIP

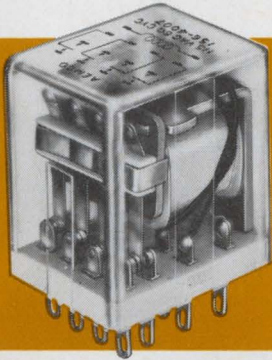

## ONEUP

### 4PDT Miniature 3 Ampere Industrial Relay—Type 156

All features of competitive models, *plus* U/L recognition through 240 VAC instead of a mere 125 VAC.

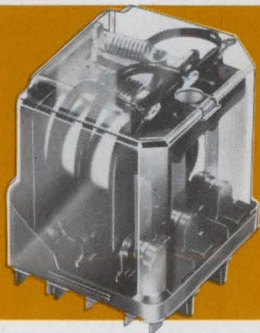

## ONEUP

### General Purpose 1,2&3PDT Industrial Relay—Type 157

All features of competitive models, with U/L recognition through 240 VAC, potential recognition through 600 VAC. Superior electrical performance.

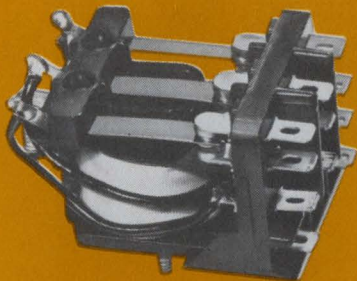

## ONEUP

### Magnetic Latching, General Purpose, 1,2&3PDT Industrial Relay—Type 157

Same electrical parameters as standard Type 157. Modern approach to magnetic latching does not employ hard permanent magnets.



## ONEUP

### 1&2PDT Coaxial Crystal Can Relay—Type 153

Only Coaxial Crystal Can Relay that will switch above 500 MHz with VSWRs below 1.2. Now improved to switch 2000 MHz with low VSWRs.

Who's ONEUP? MIDTEX/AEMCO . . . and *YOU*, when you get in touch with the MIDTEX/AEMCO distributor in your area. CALL ONE UP!

**MIDTEX**  **AEMCO DIVISION**  
INCORPORATED

10 STATE STREET  
MANKATO, MINNESOTA  
56001

PROGRAMMERS/TIME DELAY RELAYS/MINIATURE COAXIAL RELAYS/INDUSTRIAL RELAYS/MERCURY-WETTED CONTACT RELAYS

INFORMATION RETRIEVAL NUMBER 70



In Servo Pot performance

# MystR<sup>®</sup>

conductive plastic

is

# tomorrow, here today

MIL-R-39023

For servo requirements you get "Second Generation" Pot Performance with Waters' exclusive new MYSTR conductive plastic resistance material. This is tomorrow — here today!



- Infinite resolution
- Resistance ranges from 10 ohms to 5 megohms
- Excellent linearities
- Output smoothness, less than 0.1%
- Rotational life — upwards from 10 million cycles
- Dither life in excess of 400 million cycles
- Operational temperature to 150°C
- Hysteresis <math>< 0.25^\circ</math>



From Waters now — a complete line of MIL Spec rated precision potentiometers, standard or custom, wirewound, linear or non-linear or with MYSTR Conductive Plastic. Also Trimmers and Torque Measuring Devices.

**WATERS MANUFACTURING, INC. WAYLAND, MASS. 01778**

INFORMATION RETRIEVAL NUMBER 71

## COMPONENTS

### Silicon light switch turns on in 100 ns

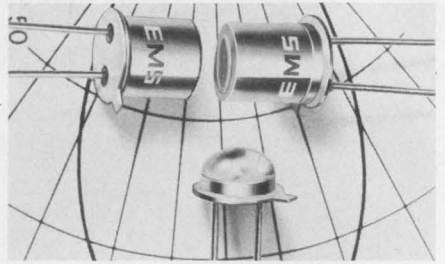

*Electronic Micro Systems, 1672 Kaiser Ave., Santa Ana, Calif. Phone: (714) 549-2295. P&A: \$4 to \$20; stock.*

Featuring high light-sensitivity and a 100-ns turn-on time, a new silicon planar dual-element light-controlled switch performs light sensing and load actuating. The LCS BiPhotran device has a 400-V rating, surge current of 2 A for 8 ms and independence of output light to input light above the planned triggering level.

CIRCLE NO. 251

### Pushbutton switch pulses logic loads



*Holiday Engineering, 2540 Teresina Dr., Hacienda Heights, Calif. Phone: (213) 336-0821. P&A: \$8.95; stock to 30 days.*

Able to drive up to 25 DTL or 20 TTL loads in a standard 5-V system, a new panel-mounting pushbutton switch module generates a transient-free momentary pulse. The model 105 switch accepts an input voltage of 3 to 8 V, has a 0-state output voltage of 0.4 V and a 1-state output voltage greater than 80% of the input voltage.

CIRCLE NO. 252





Meanwhile, back on earth.

Arrow-Hart scores a breakthrough in lighted push-button switches. Snap-on contact blocks make up to 4-pole double throw form Z switches. 31 stock components = 25,344 different variations. Six colored lenses in three shapes. Is your imagination beginning to run away with you? Write or wire for folder. We call all this Adapt-a-Switch. You'll call it ingenious.

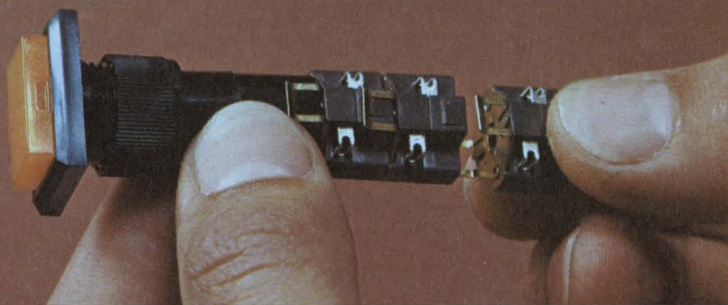

**Arrow  
Hart**

ARROW-HART, INC.  
HARTFORD, CONN.



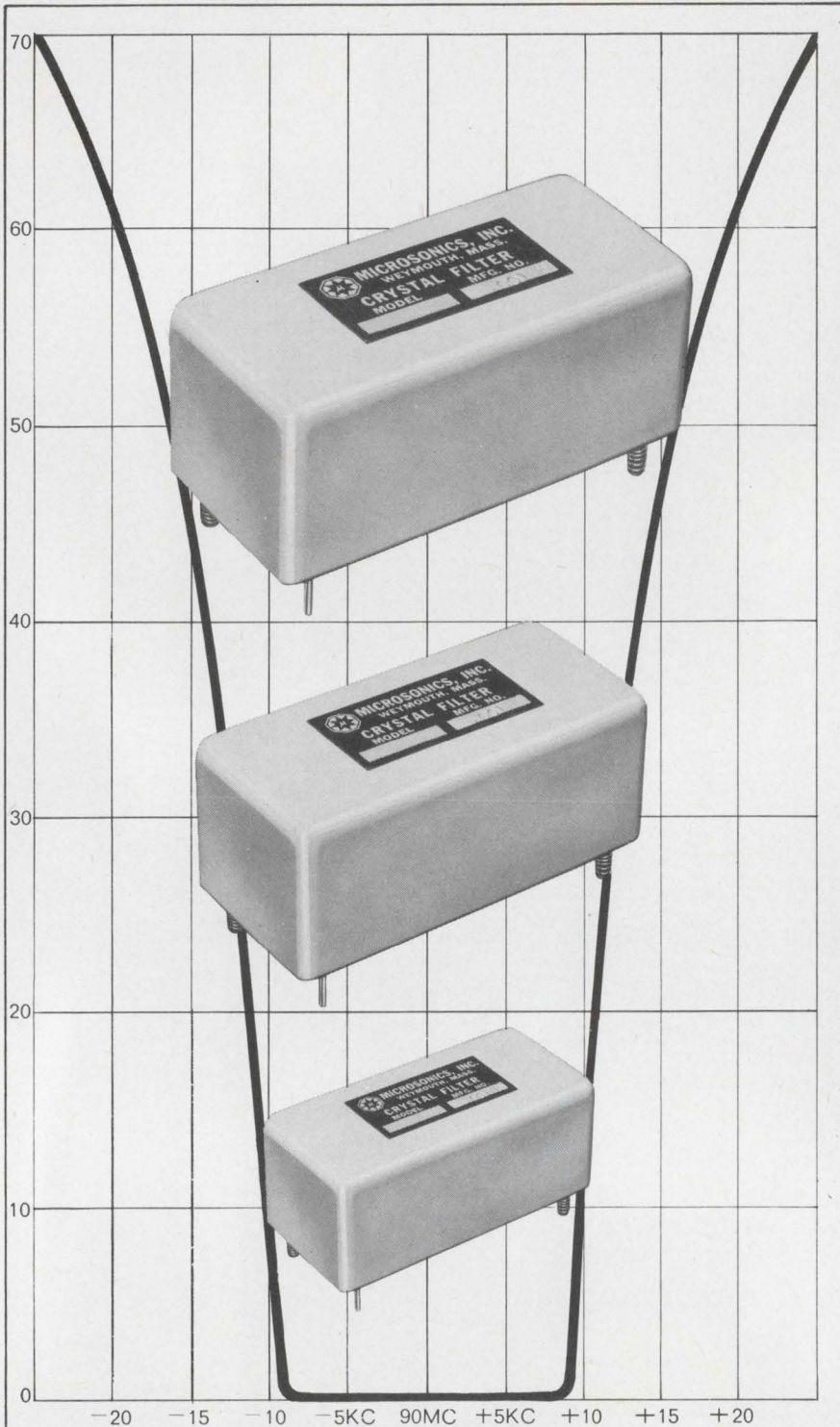

**MICROSONICS**  
*for proven design, reliability &  
 performance in*  
**CRYSTAL FILTERS**



Write for Bulletins today  
**MICROSONICS**  
 60 Winter Street, Weymouth, Mass. 02188  
 Tel: 617 337-4200  
 A division of the Sangamo Electric Company

INFORMATION RETRIEVAL NUMBER 73

COMPONENTS

**Ceramic chip capacitors  
 span 10 pF to 0.27  $\mu$ F**

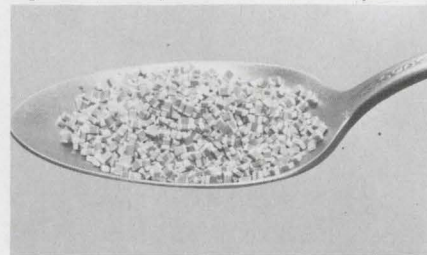

*Sprague Electric Co., 347 Marshall St., North Adams, Mass. Phone: (413) 664-4411.*

Four new series of monolithic chip-size capacitors span the capacitance value range of 10 pF to 0.27  $\mu$ F at 50 V dc. The series, types 225C, 228C, 232C and 233C, are available in four sizes of 0.08 by 0.05 in., 0.18 by 0.08 in., 0.225 by 0.25 in., and 0.18 by 0.05 in., respectively. All capacitors are 0.05 in. thick, and have silver and gold-coated terminals.

CIRCLE NO. 253

**Photo-array module  
 reads ten columns**

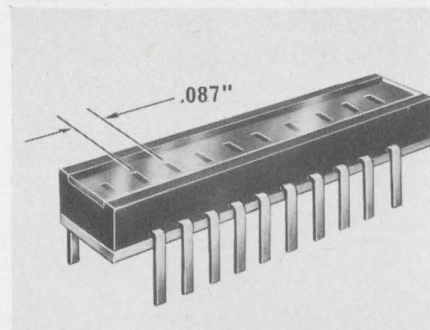

*HEI, Inc., Jonathan Industrial Center, Chaska, Minn. Phone: (612) 445-3510.*

Designed for stacking, three new series of card module photo-arrays with 0.087-in. centers read 10 horizontal columns of a punched card. The CM710, CM810 and CM910 series are for switching, high-sensitivity and medium-speed, and medium-sensitivity and high-speed applications, respectively. The modules have 10 sensors with transistor chips aligned within 0.002 in. in the X and Y axes.

CIRCLE NO. 254

INFORMATION RETRIEVAL NUMBER 74 ►



# Breach the current barrier

Fast-switching  
RCA SCR's  
have high di/dt  
capability

SCR families	Volts	Current (rms)	Typical Applications
TA7395	600 400 200	40A	modulators/inverters, small radars, sonars, high frequency inverters, pulse modulators
40555	600 400 200	5A	
40216	600	35A	
2N4101	600 400 200	5A	

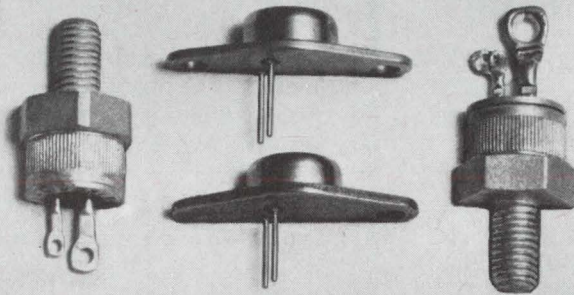

Stick most SCR's with a 400 A/ $\mu$ s pulse and they're destroyed—they can't turn off fast enough. Slam the developmental RCA-TA7395 with the same kind of pulse, and it keeps working... and working... and working... (It literally breaches the current barrier!) That's because RCA SCR's turn off in 10  $\mu$ s and spread forward current faster—so switching losses are low—and less heat is dissipated internally.

In addition to fast turn-off times, the TA7395 and other RCA SCR families have high dv/dt characteristics, and may be used at frequencies up to 25 kHz.

*Engineers take notice:* RCA SCR's are subjected to the most stringent quality assurance tests in the industry. With case temperatures held at 120°C, the SCR's are pulsed by 100 A/ $\mu$ s and 250 V/ $\mu$ s (up to rated voltage) signals to check turn-on switching losses and turn-off times.

For further details, see your local RCA Representative or your RCA Distributor. Or write RCA Electronic Components, Commercial Engineering, Section G12-1/UR5, Harrison, N.J. 07029. In Europe: RCA International Marketing S.A., 2-4 rue du Lièvre, 1227 Geneva, Switzerland.

The RCA logo, consisting of the letters 'RCA' in a stylized, outlined font.



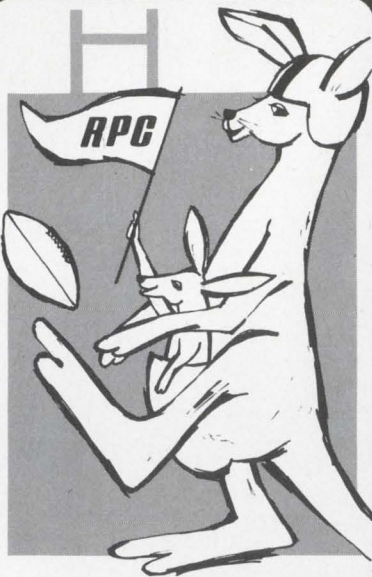

## kick off those resistance problems

**...WITH THE LARGEST LINE OF HIGH VOLTAGE, HIGH OHMIC CARBON FILM RESISTORS!**

For example, 15 basic styles are available:

**WATTS:** .25 to 100w.

**RESISTANCE:** 10 to  $10^{14}\Omega$

**TOLERANCE:** to  $\pm 1\%$

**STAND. SIZES:** .563" L x .1" dia. to 19.687" L x 2" dia.

A variety of terminal configurations are available such as: radial lugs or bands, axial wire leads and ferrule ends.

### SPECIALS

No order is too small . . . too large . . . or too unusual

Only RPC has a special interest in solving those "special" problems. Resistors up to 40" long have been manufactured on request.

### APPLICATIONS

Typical applications include those requiring high resistances, voltage capability from 250 to 125,000 v and high frequency or pulse circuits including power supplies, generators, X-ray equipment, electro-static air cleaners, paint sprayers, photo-copiers and high voltage-dropping monitors.

RPC's carbon film resistors will often exceed the requirements of metal oxide types, and with the lowest rejection rate in the industry.

For more information, call RPC . . . and give your resistance problems a real kick.

**RPC Resistance Products Co.**

914 South 13th Street  
Harrisburg, Pa. 17104 • (717) 236-5081

## COMPONENTS

### Quartz-halogen lamps reduce dia to 7/16 in.

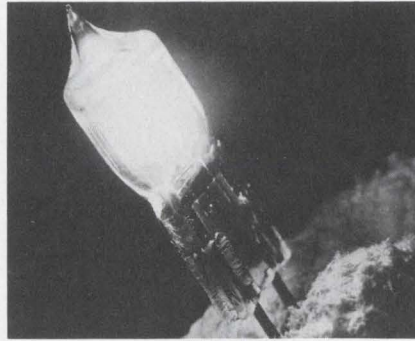

Lamps, Inc., 17000 S. Western Ave., Gardena, Calif.

Available in T-3-1/2 size and 7/16-in. diameter is a new series of quartz-halogen lamps with life ratings of 50 to 500 hours. They use a regenerative cycle design, where the evaporated tungsten filament is condensed on the lamps inner wall, then absorbed by the halogen atmosphere and redeposited on the filament, to maintain constant light intensity, and are available with bi-pin or wire terminals.

CIRCLE NO. 255

### Miniature chopper switches 10 volts

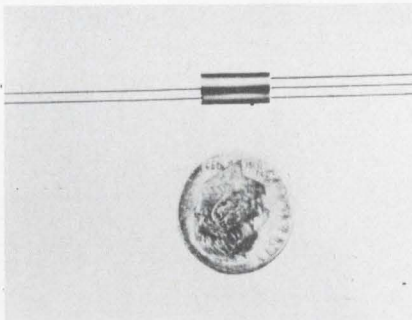

Solid State Electronics Corp., 15321 Ryan St., Sepulveda, Calif. Phone: (213) 894-2271.

Designed to alternately connect and disconnect a load from a signal source, a new miniature high-speed chopper linearly switches or crops voltages from fractions of a millivolt to  $\pm 10$  V. The model 30 is an inertialess device that can be driven from dc to 100 kHz, operates from  $-55$  to  $+90^\circ\text{C}$  and can be used as a synchronous demodulator to convert ac signals to dc.

CIRCLE NO. 256

### Synchronous motor doubles its usage

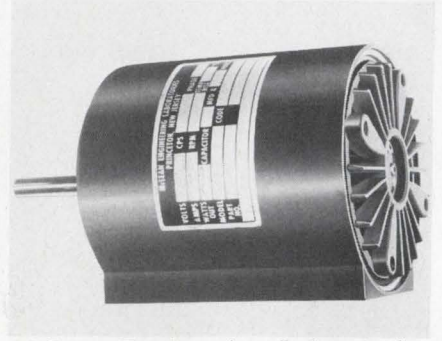

McLean Engineering Laboratories, P.O. Box 127, Princeton Junction, N.J. Phone (609) 799-0100.

Used where repeated phase synchronization is needed between line voltage and shaft position for one or more motors, a new motor combines the characteristics of an induction motor for starting and a reluctance and synchronous motor for polarizing and synchronizing. It is available with a single speed of 3600 rpm at 60 Hz and frame sizes of 47 and 59.

CIRCLE NO. 257

### Single-lamp lenses diversify selection

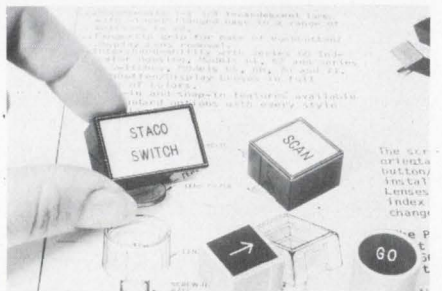

StacoSwitch, 1139 Baker St., Costa Mesa, Calif. Phone: (714) 549-3041.

Used as lighted switch actuators or indicators with single-lamp switches, a new series of lighted pushbutton/display lenses provides custom flexibility at low cost. Series 60 lenses are available in round and rectangular shapes, snap-in bases with a key for positive index, screw-on bases with a clutch for orientation and standard engraved or optional photographic legends.

CIRCLE NO. 258



# Draw your own conclusions with this new time-share terminal.

Now you can have a time-share terminal that lets you see your data graphically— instantly — as it prints out on your Teletypewriter. Now you can plot for comprehension, for meaningful report illustrations, for permanent records. And do it while the time-share data's coming in.

The HP 7200A Graphic Plotter is the first major advance in time-share flexibility since the Teletypewriter itself. The Graphic Terminal feeds from standard EIA ASCII inputs and automatically plots computer data in points, lines, curves, bar graphs, pie

charts, or any other useful engineering, mathematical or business graphics you need. Plot directly from the Teletype keyboard, too, or silence the Teletypewriter and use the plotter alone.

It's the end of the graphic time lag. The HP 7200A is easy to use and requires no special operating or programming/language knowledge. It plots smooth lines, not the staircase drawn by the incremental recorder. And it lets you position the graph where you want it on any type or size of graph paper up to 11" x 17".

Talk to your time-share service about

Hewlett-Packard's new 7200A Graphic Plotter. If your service doesn't offer it yet, have them give us a call. The Graphic Terminal. For people who can benefit from a dash of art with their cold hard data.

**HEWLETT**  **PACKARD**

**GRAPHIC RECORDERS**

11921





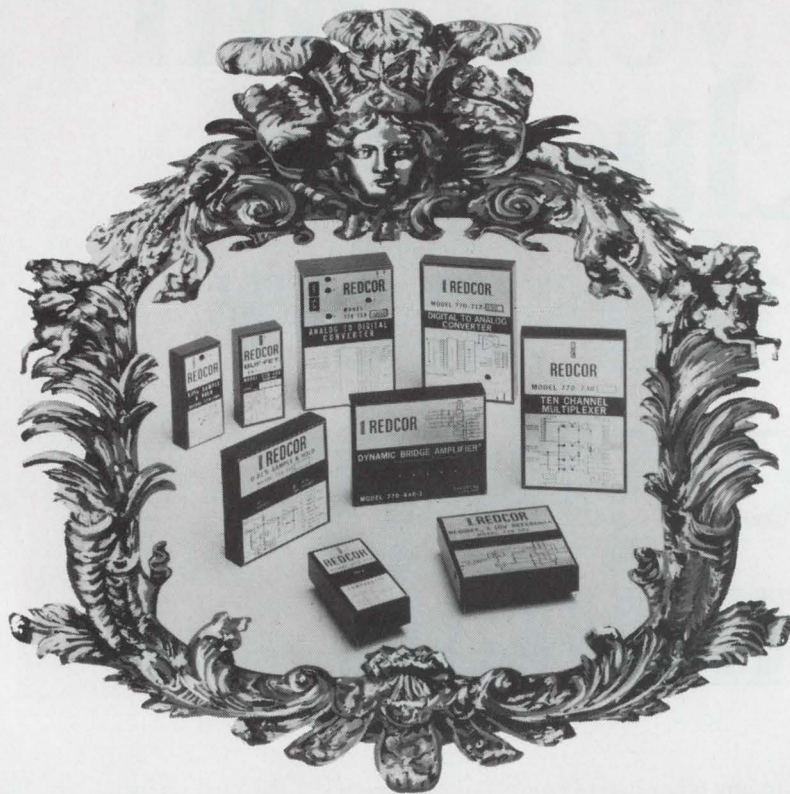

## The Family Portrait

### REDCOR Closed Loop Analog Modules

The REDCOR Module line has "guaranteed performance" for easy use by the system and instrument designer. The nine modules shown above are only part of the growing family. Meet some of the relatives:

- BUF-FET Amplifier/770-406
- Dynamic Bridge Instrumentation Amplifier/770-440
- 1MV High Speed Comparator/770-724
- 0.1% Sample and Hold/770-708
- 0.01% Sample and Hold/770-715
- 10 Channel Multiplexer/770-730
- 12-Bit Digital to Analog Converter/770-722
- REDIREF® ± 10V Reference Supply/770-501
- 12-Bit Analog to Digital Converter/770-724

The relatives can be combined in a variety of ways to solve your individual analog problem. They are all compatible, to each other, and the "outside world." If you would like to learn more about the members of our family, write or call:

**R**  
**C** **REDCOR**  
CORPORATION

Complete Systems Capability / 7800 Deering Avenue, P.O. Box 1031,  
Canoga Park, California 91304—(213) 348-5892

INFORMATION RETRIEVAL NUMBER 77

### COMPONENTS

#### Non-reactive resistors dissipate up to 60 kW



Lek Trol Inc., Microelectronics  
Div., Grapevine, Tex. Phone: (817)  
281-5320.

Available in lengths of 17.75 in. at a 2-in. dia, 12 in. at a 1.25-in. dia and 5.028 in. at 1.50-in. thick, three new cermet non-reactive power resistors dissipate 60,000, 25,000 and 500 W, respectively, with the use of water-cooling methods. Models CL 18, CL 12 and FL 5 units are made of a beryllium-oxide substrate and have palladium-silver contacts.

CIRCLE NO. 259

#### Compact attenuator uses pushbuttons

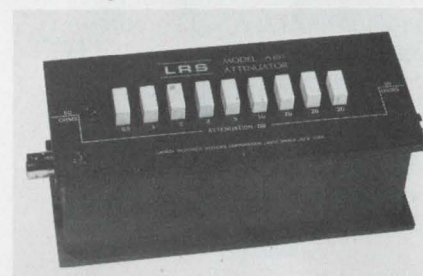

LeCroy Research Systems Corp.,  
126 N. Route 303, West Nyack,  
N.Y. Phone: (914) 358-7900.

Less than 7-in. long, a new variable pushbutton attenuator can be inserted in any 50-Ω cable system increasing its flexibility over fixed attenuators for the same space. The A105 attenuator affords 0-to-60-dB attenuation in 0.25-dB steps with an input and output impedance of 50 Ω ±5%. Reflection coefficient is less than 4% and insertion loss is less than 0.1 dB. Power rating is 0.25 W average and 1 kW peak.

CIRCLE NO. 260

INFORMATION RETRIEVAL NUMBER 78 ►



**They're new, Molex edge connectors. For printed circuit boards. Terminals crimped to wires automatically. We have straight-in and right-angle types. With and without mounting ears. It's another giant step by Molex in helping create high-speed, low-cost devices that simplify circuitry. Reliable? You bet. The connector has bifurcated terminals that provide solid contacts. Yet you can slip the connector on and off many times without damaging printed circuits. And it's not a preloaded unit. Carries only contacts required. From nine to twenty-two.**

**If you want to save assembly time, steps and money, take a close look at this new Molex edge connector. For free samples, write or you can make connections by calling (312) 969-4550.**



M155A

MOLEX PRODUCTS  
COMPANY  
Downers Grove, Ill. 60615



# Diversified Glass-to-Metal Hermetic Seals like these...

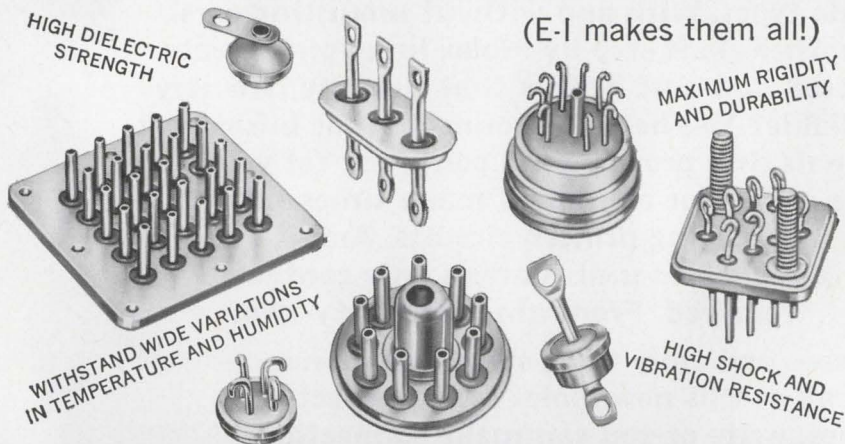

## Require Highly Specialized Engineering Capabilities...

(E-I has the know-how!)



### Specify E-I Sealed Terminations for Unusual Service Applications!

How does E. I. produce a quality line of hermetic seals? The answer is simple. A stringent program of testing and control! Above is shown an optical comparator being utilized to measure wire terminals for use in a hermetic seal. Testing in this manner assures that the finished hermetic seal will comply with all your requirements.

Available in thousands of standard types, E-I seals can be produced in 'specials' to meet particular component or equipment requirements.

Technical literature edited for the engineer/designer/specifier, and containing complete data and information, is available on request.

- Sealed Terminations
- Multiple Headers
- Transistor and Diode Bases
- Semiconductor Bases
- Compression-type
- Threaded End Seals
- Plug-in Connectors
- Vibrator Plug-in Connectors
- High Voltage Glass-bonded Ceramic Seals
- Hermetically-sealed Relay Headers
- Special Application Custom Seals
- Custom Sealing to Specifications



## Electrical Industries

A Division of Philips Electronics and Pharmaceutical Industries Corp.  
Murray Hill, N. J. 07971 — Tel. (201) 464-3200

Patented in U.S.A., No. 3,035,372; in Canada, No. 523,390; in United Kingdom, 734,583; other patents pending.

INFORMATION RETRIEVAL NUMBER 79

## Digital multimeter lowers cost to \$1995



Dana Laboratories, Inc., 2401 Campus Dr., Irvine, Calif. Phone: (714) 833-1234. P&A: \$1995; 90 days.

Featuring a low price of only \$1995, a new five-digit multimeter includes four ranges to measure ac and dc voltages and five ranges for resistance.

The 5200 series DMM highlights a normal-mode rejection of 100 dB and a common-mode rejection of 120 dB, and autoranging from 1 to 1000 V.

Dc voltages can be measured with 10- $\mu$ V resolution from 1 to 1000 V with a short-term accuracy of  $\pm 0.005\%$  of reading  $\pm 0.002\%$  of full-scale, and a long-term accuracy of  $\pm 0.01\%$  of reading  $\pm 0.002\%$  of full-scale.

Input resistance for dc voltage measurements ranges from 10 M $\Omega$   $\pm 0.025\%$  to 1000 M $\Omega$ .

Ac voltages can be measured with 10- $\mu$ V resolution from 1 to 1000 V with accuracies ranging from 0.25% of reading  $\pm 0.1\%$  of full-scale to  $\pm 2\%$  of reading  $\pm 0.1\%$  of full-scale, over the frequency range of 50 Hz to 100 kHz.

Input resistance for ac voltage measurements is 1 M $\Omega$  and input capacitance is 150 pF.

Resistance measurements are made with a 10-m $\Omega$  resolution from 1 $\Omega$  to 10 M $\Omega$  with accuracies ranging from  $\pm 0.02\%$  of reading  $\pm 0.003\%$  of full-scale to  $\pm 0.14\%$  of reading  $\pm 0.003\%$  of full-scale.

The multimeter is available in two package configurations: one suited for rack mounting and another suited for bench-type applications.



# Signalite

## Sets The Pace In Gas Discharge Tubes and Glow Lamps

Signalite started supplying neon glow lamps as an indicator device almost two decades ago. Since then, Signalite developed the neon lamp into a circuit component that has solved problems in areas from voltage regulation to photocell drivers . . . from SCR triggering to unregulated power supplies.

**Today, Signalite is a leading source** for Neon Glow Lamps as indicators and circuit components.

**Today, Signalite is a leading source** for spark gaps designed to transfer energies and act as voltage sensitive switches.

**Today, Signalite is a leading source** for noise tubes and miniature noise sources for noise figure test equipment and monitoring system receiver sensitivities.

Only Signalite offers you this in-depth experience, capability, facility and technology in gas discharge devices and glow lamps . . . backed by an R&D program to explore new markets and devices.

Signalite Application Engineers are available to you. Share your design problems with them. They'll choose the right product for your application or design custom units to meet unique requirements.

*Yours For The Asking . . . brochures on  
neon lamps, spark gaps, noise sources.  
Application Newsletter on technique and  
application of these products.*



**Signalite** INCORPORATED  
1933 HECK AVENUE  
NEPTUNE, NEW JERSEY 07753

A General  
Instrument  
Company





# CHECK NORTRONICS HEAD SPECS FOR YOUR MINI-DIGITAL APPLICATION—

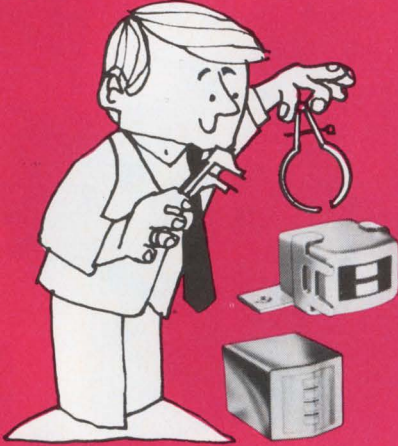

Model Number	BQQN	W2R
	B3187	B1884
Tape Width—Inches	.250	.150
Tracks on Tape	4	2
Channels in Head	4	2
Track Width—Inches	.037	.056
Channel Spacing (Center to Center)	.071	.088
Gap Spacer	0.5 Mil	0.2 Mil
Inductance, 1 KHZ	85 Mhy	10 Mhy
Resistance, D.C.	290 Ohms	39 Ohms
Saturation Current—ma. to Produce 90% Peak Output @ 200 BPI (Measured Zero to Peak, Alternate Polarity)	0.9	2.7
Write Current—ma. 150% Saturation Current @ 200 BPI	1.4	4.0
Read Output—mv. P-P (Open Circuit) 3.75 ips.	11.8	4.2
NRZI @ 200 BPI 15 ips.	44	15
Read Output—mv. P-P 800 BPI Ref. 200 BPI	85% min.	85% min.

These and  
7 MORE  
NOW AVAILABLE  
Request Bulletin #7253  
and Supplement #7310

available free from the  
World's Most Experienced Manufacturer of  
Magnetic Heads

**Nortronics**  
COMPANY, INC.

8101 Tenth Avenue North  
Minneapolis, Minnesota 55427

INFORMATION RETRIEVAL NUMBER 81

## INSTRUMENTATION

### Ten-channel scanner displays low levels



Monsanto Electronic Instruments,  
620 Passaic Ave., W. Caldwell, N.J.  
Phone: (201) 228-3800. P&A:  
\$595; 16 wks.

Displaying the active channel with Ga-As-P numerics, a new matrix/data scanner multiplexes 3 or 4 low-level analog signals, can be used for four-line per digit data transfer, commutation or steering. Model 508A ten-channel unit uses four-pole reed relays which are energized to connect a set of four input terminals to a corresponding set of four output ones.

CIRCLE NO. 262

### Three-digit DPM converts in 10 ms

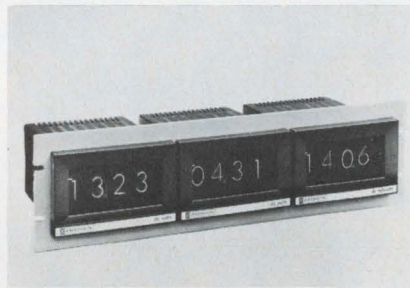

Prestin Scientific Inc., 805 E. Cer-  
ritos, Anaheim, Calif. Phone: (714)  
776-6400. P&A: \$225; stock.

Providing a three-digit display with 100% overranging, a new sign-integrating digital panel meter features a 10-ms conversion time and a sample rate to 100 readings per second. The model X-MOD/DPM unit has an accuracy of 0.1%  $\pm 1$  digit, automatic polarity, measures 1.999 mV to 1999 V dc and 19.99  $\mu$ A to 199.8 mA dc, 7/8-in. numeric readouts and an input filter.

CIRCLE NO. 263

### Regulated IC supplies are 3 by 6 by 7 inches

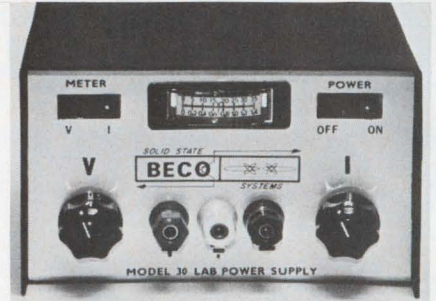

Beco Solid State Systems, P.O. Box  
686, Salem, Va. Phone: (703) 774-  
8625. Price: \$98.50.

Providing typical power outputs of 30 W at low costs, a new series of IC power supplies measures only 3 by 6 by 7 in. Series 300 supplies provide line or load regulation for voltage and current of 0.01% or 1 mV and 0.1% or 1 mA, respectively, 0.2 mV rms noise and ripple, 20  $\mu$ s transient recovery time and automatic crossover. Outputs range from 4 V at 7.2 A to 60 V at 600 mA.

CIRCLE NO. 264

### Bipolar a/d converter displays binary digits



Beckman Instruments, Inc., 2500  
Harbor Blvd., Fullerton, Calif.  
Phone: (714) 871-4848. Price:  
\$450.

Featuring a  $\pm 1000$ -count bipolar capability, a new device converts analog voltages and currents to equivalent binary numbers. Model 4027 has a range of 100 mV full scale, ten operating ranges, storage-type neon display lamps in octally coded groups of three which represent ten binary bits and a sign and a buffered command pulse of 60  $\mu$ s at the end of each conversion.

CIRCLE NO. 265



New from the **SPEC-TROLL!**



**A 10-TURN INDUSTRIAL WIREWOUND POT WORTH BLOWING OUR HORN ABOUT!**

Selling for only \$4.39 in quantity, our new Model 532 features "designed-in" reliability to give you top pot performance at bargain prices. The 532 offers:

- Longer element for "tighter" resolution.
- Precious metal contacts for minimum noise characteristics.
- Improved vibration-resistant slider design and dual slip ring contacts.
- Rugged mechanical stops for dependability.
- Passivated stainless steel shaft.
- A tough industrial design that can handle most of the requirements associated with MIL-R-12934.

**Brief Specs**

Size:	7/8" diameter
Resistance Range:	15 ohm to 180K
Resistance Tolerance:	±5%
Independent Linearity:	±0.25%
Power Rating:	3 watts @ 40°C

The model 532 is available through your local Spectrol distributor. For full specs, circle the reader service number. Qualified respondents may obtain a sample *free of charge* through their Spectrol representative.



**SPECTROL ELECTRONICS CORPORATION**  
 A subsidiary of Carrier Corporation  
 17070 EAST GALE AVENUE  
 CITY OF INDUSTRY, CALIF. 91745  
 (213) 964-6565 • TWX: (910) 584-1314

New from the **SPEC-TROLL!**



**A LOW-COST INDUSTRIAL WIREWOUND POT WITH PREMIUM FEATURES**

**Welded termination**—With heavy-duty ribbon taps welded to several turns of wire, the new single-turn Model 132 can better withstand high-level vibrations and short-term overloads.

**Unitized design**—With only 4 major subassemblies—a stainless-steel shaft and rotor, a coil, a molded housing, and a rear lid—the 132 offers a new simpler design for greater reliability, with rear terminals for better packaging.

**Rugged construction**—The materials used in the 132 have been selected for their ability to withstand impacts and abrasions during assembly or maintenance to assure the customer a trouble-free, serviceable pot.

**Low cost**—For less than \$6 (in quantity)—you can buy this precision industrial pot! Also, heavy-duty stops (8 in. lb. static) are optional at no extra cost.

For full specs, circle the reader service card. Qualified respondents requesting a sample will receive a Model 132 *free of charge* from their local Spectrol representative.



**SPECTROL ELECTRONICS CORPORATION**  
 A subsidiary of Carrier Corporation  
 17070 EAST GALE AVENUE  
 CITY OF INDUSTRY, CALIF. 91745  
 (213) 964-6565 • TWX: (910) 584-1314

New from the **SPEC-TROLL!**



**NOW CHOOSE BETWEEN THESE NEW LOW-COST INDUSTRIAL CERMET AND CONDUCTIVE PLASTIC POTS!**

Need a quality low-cost industrial pot with virtually infinite resolution, high performance, and long reliable service? Then your best choice is Spectrol's new conductive plastic Model 138 or cermet Model 139. Both single-turn models offer excellent linearity, high power rating, and a broad resistance range. But why not check the specs and decide for yourself.

<b>Brief Specs</b>	<b>C.P. Model 138</b>	<b>Cermet Model 139</b>
Size:	1-5/16"	1-5/16"
Resistance Range:	500Ω to 100KΩ	500Ω to 1 Megohm
Independent Linearity:	±0.5%	±0.5%
Power Rating:	2 w @ 40°C	5 w @ 40°C

With either choice you get the same "designed in" reliability and rugged construction as with our Model 132 wirewound—and all are priced lower than the competition! For full specs, circle the reader service number. Qualified respondents may obtain a sample *free of charge* through their Spectrol representative.



**SPECTROL ELECTRONICS CORPORATION**  
 A subsidiary of Carrier Corporation  
 17070 EAST GALE AVENUE  
 CITY OF INDUSTRY, CALIF. 91745  
 (213) 964-6565 • TWX: (910) 584-1314



# NEW VACTEC

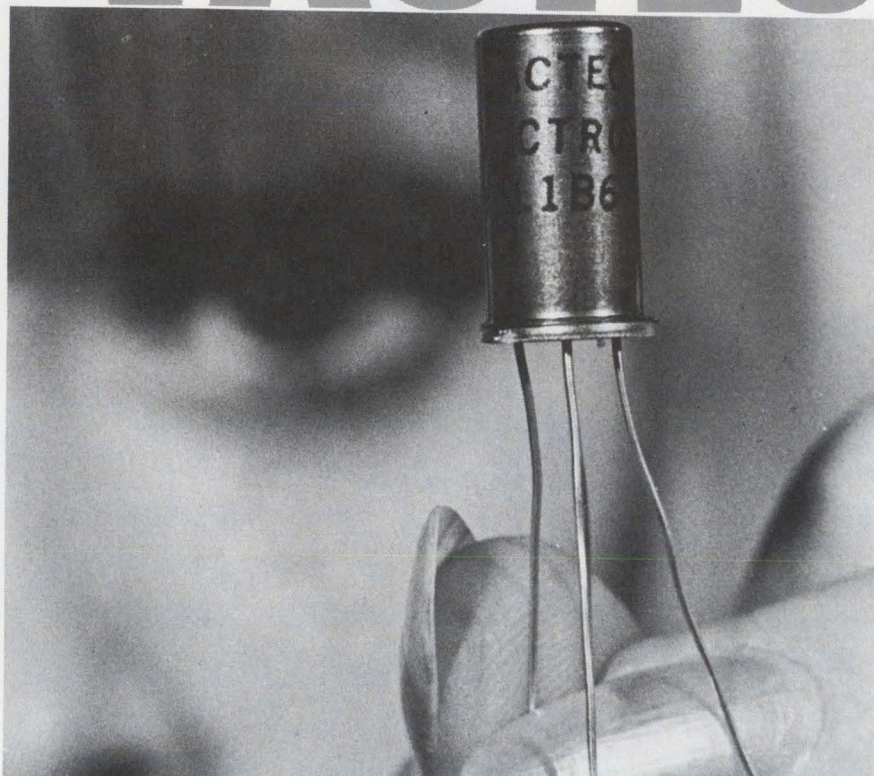

## Hermetic TO-5 Vactrol Photon Isolators

Vactec's new photocell-lamp control module is filled with clear flexible resin to provide high vibration immunity. It is hermetically sealed in a TO-5 enclosure, and available in low voltage (incandescent) and high voltage (neon) types.

These devices are widely used for signal isolation, audio level controls, SCR and triac turn on, and noiseless switches. They are priced less than \$1.25 in 1,000 quantities for some models. Write today for Bulletin PCD 4C3.

### Specifications at 25° C

Minimum off resistance	10 <sup>7</sup> ohms
Cell voltage max.	150 V.
Cell dissipation	100 MW.

Part Number	LAMP		PHOTOCELL		
	Voltage max.	Current (ma)	Max. ON (ohms)	Ascent Time ms	Decay to 100K ms
VTL1A1	1.5	50	400	80	350
VTL1A2	6.0	40	200	75	400
VTL1A3	10.0	14	800	60	150
VTL1A4	12.0	25	250	120	500
VTL1B5	150	1.2	1000	80	65
VTL1B6	90	.3	5000	6	50

## VACTEC, INC.

2423 Northline Ind. Blvd.  
Maryland Heights, Missouri 63042  
Phone: (314) 872-8300

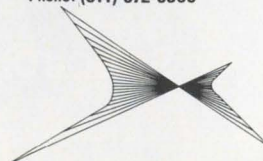

Specializing in standard Cds, Cdse, and Se cells; custom engineering for every photocell need.

Listed in EBG under "Semi-Conductors" and in EEM Sec. 3700.

INFORMATION RETRIEVAL NUMBER 83

## INSTRUMENTATION

### Pulse generator reps to 50 MHz

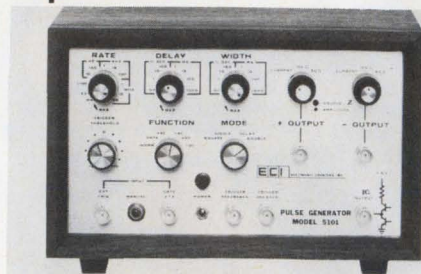

Electronic Counters, Inc., 235 Jackson St., Englewood, N. J. Phone: (201) 567-5300. Price: \$525.

Providing adjustable pulse widths of 10 ns to 1 s with a 10:1 variable control in 8 switchable ranges is a new pulse generator with repetition rates of 1 Hz to 50 MHz. Model 5101 provides outputs as positive or negative, single or double pulse, square wave, single pulse delayed with respect to a trigger pulse or double pulse with desired delay between pulses, and variable delay from 10 ns to 1 s.

CIRCLE NO. 266

### IC logic tester has many uses

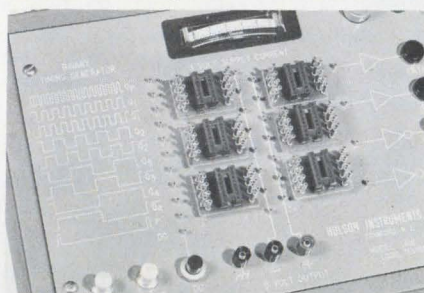

Hulson Instruments Inc., 20 Quine St., Cranford, N.J. Phone: (201) 276-1142. P&A: \$450; stock to 30 days.

Designed for testing and breadboarding IC logic circuits and components, the model 1416 tester diversifies its capabilities by its use as a digital system troubleshooter, an instructional aid for beginners in pulse and digital design, or for use in field service. It features synchronous function, pulse and clock generators, a power supply, data indicators and drivers, and IC sockets.

CIRCLE NO. 267



# We have a memory that will make design engineers look like heroes.



How about a small to medium size memory with an access time of 250 nanoseconds. Cycle time of 500 nanoseconds. With 4K to 16K words of from 10 to 60 bits. And the lowest price going.

The CE-50 state-of-the-art, 2 $\frac{1}{2}$ D, three wire memory is available now. That's immediate delivery for the latest and best small to medium size memory you can buy anywhere.

The CE-50's spec sheet is nothing less than heroic. But what else could you expect from the company that's delivered more than 100 million bits of 2 $\frac{1}{2}$ D memories. The numbers and facts are yours for the asking. Write: Memory Products, Lockheed Electronics Company, Data Products Division, 6201 East Randolph Street, Los Angeles, California 90022.

**LOCKHEED ELECTRONICS**  
A Division of Lockheed Aircraft Corporation



# Free! Money-Saving Guide

Working with logic modules? Then here's something you should have. It's a Guide for logic design applications.

Real handy!

The Guide outlines a procedure to assist you, the Systems Engineer, in transposing a logic design into an idealized listing of the logic cards needed to implement the design.

It's simple to use and you can really sock away the money you'll save on reducing the number of cards you need. That's right!

We're helping you to reduce the number of logic cards you have to buy.

But that's okay, sock it to us!

**( For Logic Design Applications )**

**Free Drafting Aid Symbol**

More free stuff? You better believe it!

Wyle also has a sample of stick-on logic drafting symbols for you, the only catch is that you have to request this item on your letterhead.

So just drop a line with your name and address on your company letterhead to our Marketing Manager, Gordon Elsner.

He'll sock a sample logic stick-on drafting symbol right back to you.

And if you're socked in with an immediate application call Gordon direct, Now!  
(213) 678-4251



**WYLE**  
COMPUTER PRODUCTS  
DIVISION OF WYLE LABORATORIES  
128 Maryland Street, El Segundo, California 90245

## INSTRUMENTATION

### Resistor test system cycles in 100 ms max



*Electro Scientific Industries, Inc., 13900 N. W. Science Park Dr., Portland, Ore. Phone: (503) 646-4141. Price: \$6000.*

Combining a digital Kelvin bridge and a resistance standard, a new automated resistor test system features a maximum measurement cycle of only 100 ms for an accuracy of 0.01%. Model 501 is a digital resistance deviation system that can serve as the basis for several automated applications—for example, rapid sorting of resistors, testing for environmental and temperature-coefficient characteristics, and computerized matching of resistors.

CIRCLE NO. 268

### Dc reference source stabilizes to 5 ppm

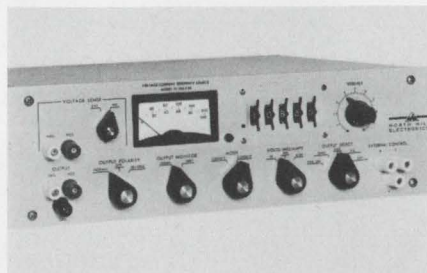

*North Hills Electronics, Inc. Glen Cove, L.I. Phone: (516) 671-5700. P&A: \$2200; stock.*

Featuring an output of 0 to 100 V at 200 mA and 0 to 100 mA at a compliance of 0 to 100 V, a new constant voltage/current dc reference source has a stability of 5 ppm per 100 hours and an absolute accuracy of 50 ppm in both constant voltage and current modes. The model TC-100.2BR dials its output with a resolution of 0.1 ppm with 5 decade switches and a vernier.

CIRCLE NO. 269



# Breakthrough For Automation!

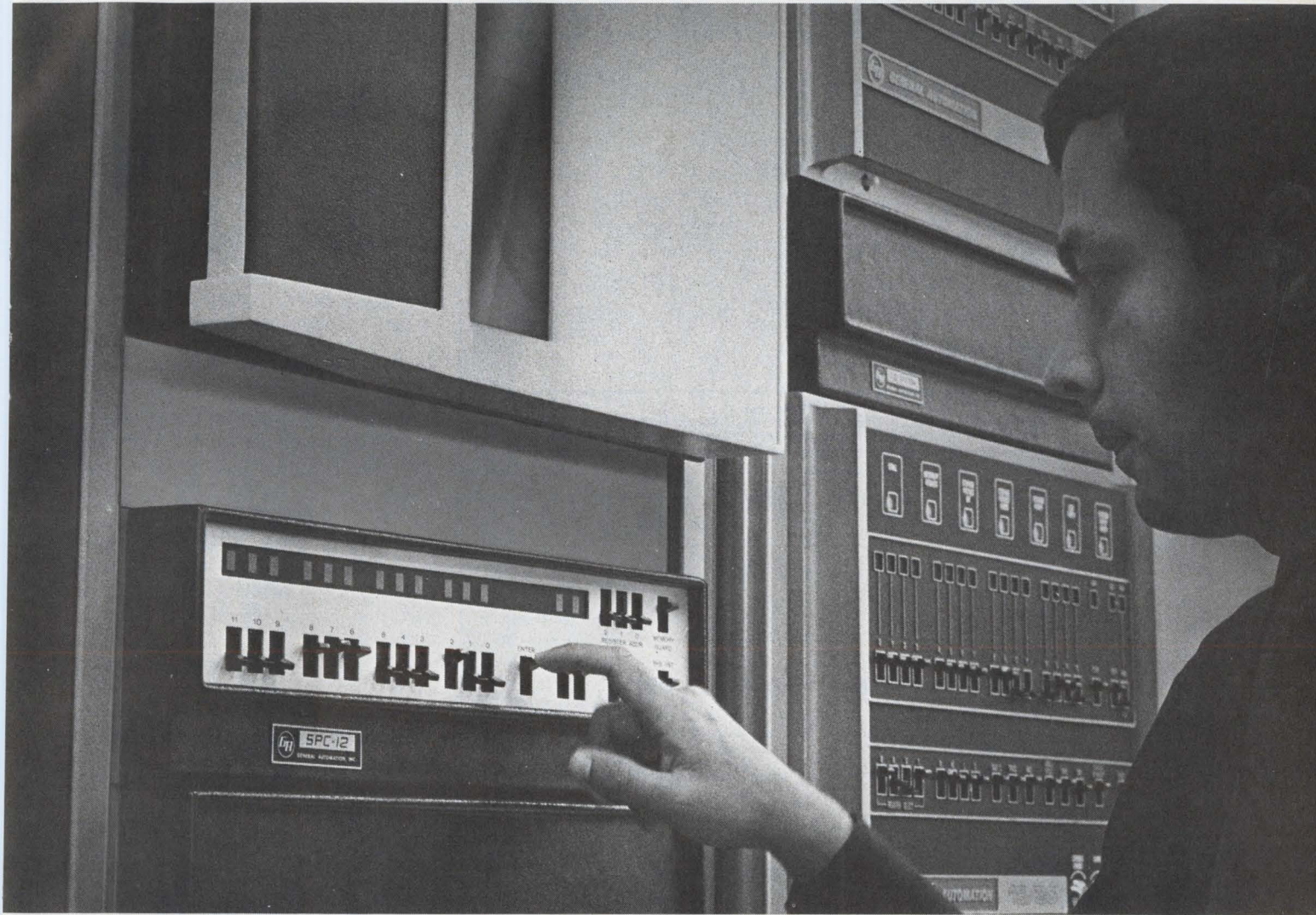

## A COMPLETE, LOW-COST AUTOMATION SOLUTION

If you need an OEM computer for your next automation product, General Automation has the complete, low-cost solution . . . pre-engineered and ready to install . . . and that includes all the computers, interfaces, software and services.

Our SPC-12 automation computer offers you new levels of computer value and reliability . . . it's specifically designed to work in industrial environments. The SPC-12 plugs in and works, the first time, and keeps on working. Hundreds are on the job working.

And to add even more value to your product, our unique family of mini-controllers tie the SPC-12 directly to

machines, devices, communications networks, sensors and instruments, eliminating excessive and redundant electronics. Your products can serve more markets.

If you require software or services our Automation Sciences Division will provide you with complete software programs and technological services to get your product to the market faster.

Put this complete low-cost automation computer in your product today for only \$5000.00 . . . and much less in OEM quantities. You'll be surprised just how easy it is. Call or write today, there's a General Automation office near you.



**GENERAL AUTOMATION, INC.**  
Automation Products Division

706 West Katella, Orange, Calif. (714) 633-1091, TWX 910-593-1601











**Save**

# BUY YOUR FEED-THRU CAPACITORS DIRECT FROM THIS GUIDE!

Spectrum Control has engineered a complete line of reasonably priced Feed Thru Capacitors for bypass and filtering applications. Ideal where quality and economy are design factors. Feature ceramic dielectrics with sintered silver electrodes and the "Spectra Seal" resin coating. Eliminates dripping wax problems.

**SPECTRA CAPACITOR VALUES SHOWN  
ARE SHIPPED FROM STOCK**

SIZE AND PART NUMBER	dc Current	Working Voltage +85°C	Capacitance pF - GMV	Price Each 1-49 Pcs.	\$
$\frac{3}{16}$ " HEX BUSH: #8-32 THD.  54 713 001	10A	200V	5000	.78	
			22,000	4.80	
$\frac{1}{4}$ " HEX BUSH: #12-28 THD.  54 743 001	10A	500V	7000	.54	
		200V	39,000	4.90	
$\frac{5}{16}$ " HEX BUSH: # $\frac{1}{4}$ -28 THD.  54 721 003	15A	500V	4000	.50	
$\frac{5}{16}$ " HEX BUSH: #12-28 THD.  54 747 001	25A	500V	6000	.39	
$\frac{5}{16}$ " HEX BUSH: # $\frac{1}{4}$ -28 THD.  STAND OFF 54 751 001	10A	500V	10,000	.42	
$\frac{5}{16}$ " HEX BUSH: # $\frac{1}{4}$ -28 THD.  54 752 001	10A	500V	5000	.47	
$\frac{5}{16}$ " HEX BUSH: #12-28 THD.  54 758 001	10A	500V	10,000	.39	
$\frac{3}{8}$ " HEX BUSH: # $\frac{5}{16}$ -24 THD.  54 763 001	25A	1500V	1000	.66	

DERATE WVdc AT +125°C BY 50%  
OTHER CAPACITANCE VALUES AVAILABLE FROM 10 pF —  
ASK FOR BULLETIN 64000

**SEND ORDER DIRECT  
TO OUR FAIRVIEW PLANT . . .**

OR CALL JOHN LANE  
814/474-5593  
FOR QUANTITY PRICES

**SPECTRUM CONTROL INC.**  
152 EAST MAIN ST. • FAIRVIEW, PENNSYLVANIA 16415



INFORMATION RETRIEVAL NUMBER 87

## INSTRUMENTATION

### Waveform generator produces 4 functions



Beckman Instruments, Inc., 2500 Harbor Blvd., Fullerton, Calif.  
Phone: (714) 817-4848.

Four basic functions of sinusoidal, square, triangular and sawtooth waveforms are produced by a new function generator over the variable frequency range of 0.0005 Hz to 1 MHz. Model 9030 unit provides outputs in both phases at levels up to 30 V with  $\pm 5$ -V offset capacity, has a burst mode to generate 1 to 99 positive and negative outputs and a three-step attenuator.

CIRCLE NO. 270

### Wideband scope probe goes out to 1 GHz

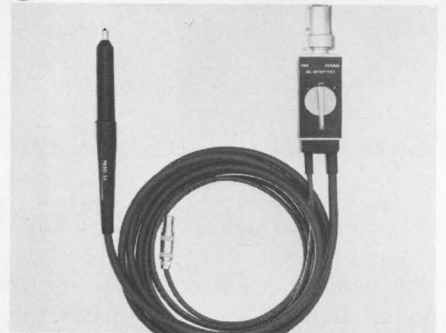

Tektronix, Inc., P.O. Box 500, Beaverton, Ore. Phone: (503) 644-0161. P&A: \$375; 1st quarter, 1970.

A new FET probe designed for use with real-time and sampling oscilloscopes features a bandwidth of dc to 1 GHz and a risetime of 0.35 ns. Type P6051 probe has a 1-M $\Omega$  input resistance (50  $\Omega$  at probe output), input capacitance of 2.8 pF, offset capability for ac-signal viewing with dc potentials up to 5 V, and is powered by the 7000-series main frames or an accessory power supply.

CIRCLE NO. 271



# New S. S. White system trims microelectronic hybrid resistors at 1,000 per hour...or more



If you're into hybrid circuitry in a big way, or hope to be, our Model AT-701AR may be just what you need. It offers high capacity, accurate trims, high yield — or, just what you need to keep your customers and your comptroller happy.

Model AT-701AR is similar to our highly successful Model AT-701A, but with the addition of a rotary feeding system which lets operator load and unload substrates during the machine's trimming cycle. Capacity is limited only by the man-

ual dexterity of your operator.

Accuracy of the AT-701AR is guaranteed — within 0.5%. 0.1% is attainable with care and some sacrifice of speed. Trimming is monitored by a precision system of electronics featuring a four-wire Kelvin bridge, and tolerances may be programmed from  $\pm 0.1\%$  through  $\pm 11\%$ . (No use making them better than the specs require!)

*But suppose the Model AT-701AR is too big or too small for you?*

Call us anyway. If you can get by with something like 600 accurate trims an hour, we can offer you our Model AT-701A, to which you can add the turntable feature later. If you're still experimenting, we have Model LAT-100 for breadboarding. It is accurate to 1% better, takes substrates up to 4 x 4 inches and sells for only \$5,950. If you're *really* big, there's the Model AT-704A, a rotary-feed

machine that trims four resistors simultaneously, monitors, and inspects them at the breathtaking rate of 4,000 per hour. And if *that's* not fast enough for you, buy two.

All the S. S. White resistor trimming systems are based on the proven Airbrasive® method of removing resistance material which produces neither heat nor shock, does not alter the substrate.

Call 212-661-3320 to arrange for a live demonstration. Speak to Hal Skurnick or Don Davis. These same gentlemen will be demonstrating the Model AT-701AR and the Model LAT-100 at major electronics trade shows around the country, and if that's not quick enough for you, we will arrange for you to visit our factory. We have also prepared an extensive technical bulletin on this equipment, called, rather cryptically, the "RT-14", a copy of which is yours for the asking.



**RT-14**

Write to S. S. White Division, Pennwalt Corporation, Dept. 28, 201 East 42nd Street, N.Y., N.Y. Tel.: 212-661-3320

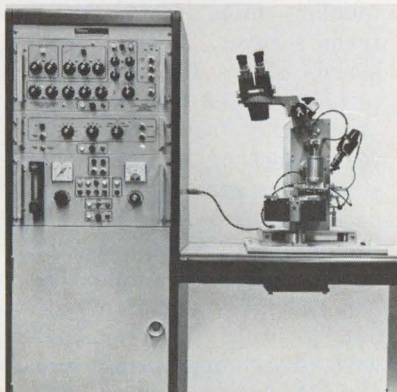

**Model AT-701AR**

**PENWALT**  
**S.S. WHITE**  
INDUSTRIAL PRODUCTS

INFORMATION RETRIEVAL NUMBER 88



MAXIMUM

**Strength**

MINIMUM

**Weight**

IMMEDIATE

**Availability****Skydyne  
Fiberglass  
Cases**

Specifically designed to provide maximum protection against shock and vibration for all types of delicate electronic and optical equipment and instrumentation. Shock absorbing interiors, equipment mounting facilities, cases to meet MIL-T-945 and MIL-T-21200, a complete custom fiberglass molding capability and over 35 standard, off-the-shelf case sizes are included in the comprehensive Skydyne Fiberglass line. Write for our complete catalog file. Chances are we have a standard Fiberglass Case to meet your requirements.

*Skydyne<sup>®</sup> Inc*

RIVER ROAD, PORT JERVIS, N. Y. 12771  
Telephone (914) 856-5241



## Solid-state sweeper system goes from 10 MHz to 18 GHz

*Micro-Power, Inc., 25-14 Broadway, Long Island City, N.Y. Phone: (212) 726-4060. P&A: \$1450 for mainframe, from \$1600 for plug-ins; 6 to 8 wks.*

Using all-solid-state electronics, a new microwave sweep oscillator covers the frequency range from 10 MHz to 18 GHz with a minimum power output of 20 mW up to 4 GHz and 5 to 10 mW up to 18 GHz. (The frequency range is inclusive except for the 4-to-8-GHz octave which is expected to be available by mid-1970.) All ranges have external leveling; internal leveling is available with all but the 12.4-to-18-GHz range.

In addition, model 230A offers stable multi-decade coverage down to 10 MHz with low spurious and harmonic content. Its full-rack-width dial scale permits precision frequency resolution, accuracy and linearity. For example, with the plug-in for 10 MHz to 2 GHz, accuracy and linearity are 0.25% of full scale and frequency settability on the dial is better than 1 MHz.

The use of load isolation in most of the rf plug-ins results in very low frequency pulling with changes in both VSWR and power level. At 4 GHz, a frequency shift of only 1 MHz occurs with a change in

load VSWR from a perfect match to a short circuit, and with a full change in output power level. Residual fm is typically better than 2 ppm.

Offering a leveled output to within  $\pm 0.3$  dB over each of two ranges, 10 MHz to 1 GHz and 1 to 2 GHz, is the 238A rf plug-in. It has a step attenuator with 10-dB increments and a continuous vernier control to provide absolute calibrated power levels from  $-70$  to  $+13$  dBm.

In order to minimize down-time, the 230 utilizes a new repair system called Quick-Fix, which allows a malfunction to be detected according to circuit function. Plug-in PC boards, which handle a given circuit function, are listed on a tabular guide inside the mainframe's cover. A set of spare PC boards allows the faulty function to be corrected within minutes.

Both the front panel and the rear panel of the 230A are designed for ease of use. The front panel features full knob and connector spacings, plus a high-resolution legible dial scale. The rear panel includes a marker video output, a sweep proportional output with two voltage slopes, and a remote frequency control.

CIRCLE NO. 272



# The Inside Story of Handling Current at High Speeds

Now, RCA introduces the multiple-emitter chip, a concept using RCA "overlay" techniques, in 2N5038 and 2N5039—multi-epitaxial silicon transistors for high-speed switching circuits. On the inside is the pellet with 12 discrete emitter sites, interconnected by a 12-pronged heat-conducting copper slug. The use of individual emitter sites provides the excellent 20-ampere current handling capabilities of these devices by increasing the emitter periphery. The copper slug assures good temperature and voltage distribution among the emitter sites across the pellet, and further contributes to the current handling, *while adding significantly to the forward second break-down capability of the device.* These concepts (discrete emitters and copper slug) eliminate the non-uniform current injection normally associated with high current interdigitated transistor structures.

For the design engineer, 2N5038 and 2N5039 represent the right combination of mechanical structure and performance characteristics. They have low saturation voltage (1.0 volt max. at 12 A for 2N5038 and at 10 A for 2N5039) and fast saturated switching times (turn-on less than  $0.5 \mu\text{s}$  and turn-off less than  $2 \mu\text{s}$ ).

Available in production quantities, 2N5038 and 2N5039 are useful in a wide variety of applications including: dc-to-dc converters (at 25 KHz, 250 watts and 85% eff. may be achieved) and high frequency switching regulators (up to 50 KHz, 700 watts output, with 95% eff.). Both units make good linear amplifiers at frequencies up to 5 MHz.

Call your RCA representative today for more information or see your RCA Distributor. For technical data, write: RCA Electronic Components, Commercial Engineering, Section No. IG-12-1, Harrison, N. J. 07029.

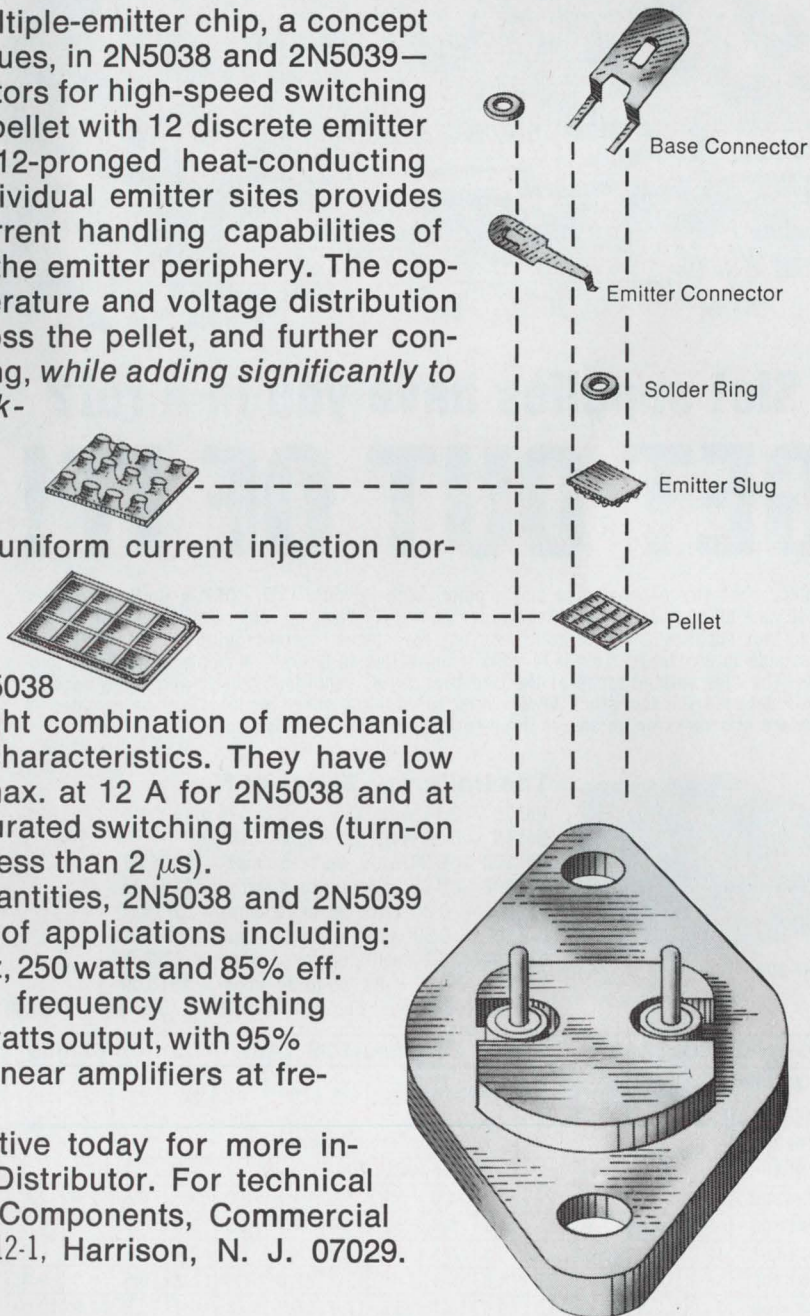

# RCA



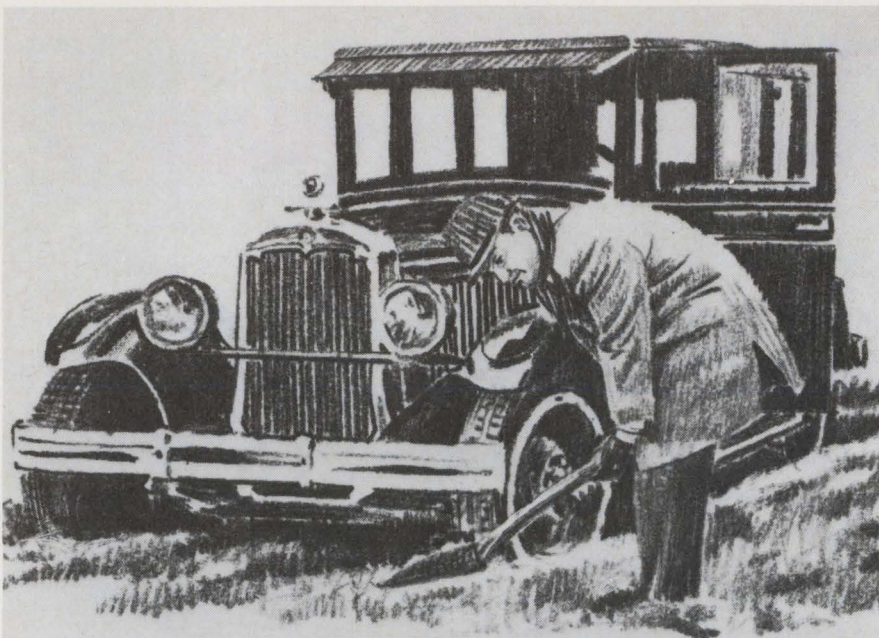

## Slot supplies have you in a rut? GET OUT OF IT!

Replace obsolete, narrow-range slot supplies with POWER/MATE CORP.'s UniPower Series. These nine all-purpose, wide voltage range power supplies can replace thousands of narrow-range slot supplies and give you these big advantages: current output up to 34 amps • adjustable to any range from 0-34 volts • regulation to 0.005% • ripple a low 250 microvolts. The wide voltage range of the UniPower Series simplifies your power supply requirements because you can stock fewer units. In addition, these modules can be mounted in standard size racks or on any of three surfaces and in any position!



UNI-30F

### The UniPower Series of Nine

- Uni-76 — 0-34 volts, 0.5 amps — \$76.00
- Uni-88 — 0-34 volts, 1.5 amps — \$99.00
- Uni-30C — 0-30 volts, up to 5 amps — \$134.00
- Uni-30D — 0-30 volts, up to 8 amps — \$151.00
- Uni-30E — 0-30 volts, up to 12 amps — \$174.00
- Uni-30F — 0-30 volts, up to 18 amps — \$205.00
- Uni-30G — 0-30 volts, up to 24 amps — \$265.00
- Uni-30H — 0-30 volts, up to 34 amps — \$315.00
- UniTwin-164 — dual output 0-25 volts, 0.75 amps — \$164.00

#### OUTPUT VOLTAGE vs. OUTPUT CURRENT FOR VARI-RATED UNI SERIES

MODEL	VOLTAGE													
	0-6V	8	10	12	14	15	16	18	20	22	24	26	28	30
UNI-76	0.05 amp throughout range													
UNI-88	1.5 amps throughout range													
UNI-30C	5.0	4.6	4.4	4.2	4.1	4.0	3.8	3.6	3.4	3.2	3.0	2.8	2.6	2.5
UNI-30D	8.0	7.6	7.3	6.9	6.6	6.4	6.2	6.0	5.7	5.3	5.0	4.7	4.4	4.0
UNI-30E	12.0	11.2	10.8	10.3	9.8	9.5	9.2	8.8	8.3	7.9	7.4	6.9	6.4	6.0
UNI-30F	18.0	16.9	16.2	15.5	14.8	14.4	14.0	13.3	12.6	11.9	11.2	10.5	9.8	9.0
UNI-30G	24.0	22.5	21.6	20.6	19.6	19.1	18.6	17.7	16.7	15.8	14.8	13.8	12.9	12.0
UNI-30H	34.0	31.9	30.5	29.2	27.8	27.1	26.4	25.0	23.7	22.4	21.0	19.7	18.3	17.0

**SPECIFICATIONS:** Regulation — up to  $\pm 0.005\%$  or 1 MV for line and load; Ripple — Less than 250 microvolts; Response Time — Less than 20 microseconds; Overload and Short Circuit Protection — Solid state. Instantaneous recovery, and automatic reset. Cannot be damaged by prolonged short circuit or overload. Internal or External Adjustable OVP Available.

FREE: Send for complete catalog. Write to:



**POWER/MATE CORPORATION**  
514 S. RIVER ST., HACKENSACK, NEW JERSEY 07601  
PHONE: (201) 343-6294 TWX: (710) 990-5023

INFORMATION RETRIEVAL NUMBER 91

## MICROWAVES & LASERS

### Npn power transistor delivers 50 W at 1 GHz

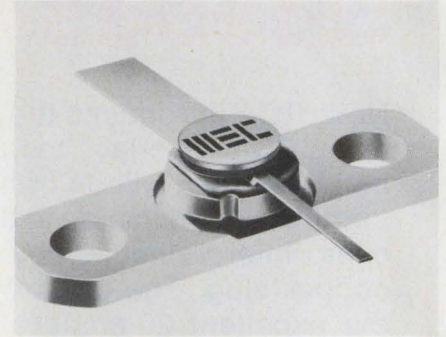

Microwave Semiconductor Corp., 100 School House Rd., Somerset, N.J. Phone: (201) 469-3311. Availability: 4 wks.

Designed for the L and S bands, a new transistor can deliver 10 W at 2 GHz with a 5-dB power gain at 35% efficiency, 20 W at 1 GHz with a 10-dB power gain at 60% efficiency and 50 W at 1 GHz in pulsed operation. The model MSC-2010 unit is an npn epitaxial device that is housed in a low input-Q case, making it ideal for use in broadband circuits.

CIRCLE NO. 273

### C-band TWT amplifier combines pulse and cw

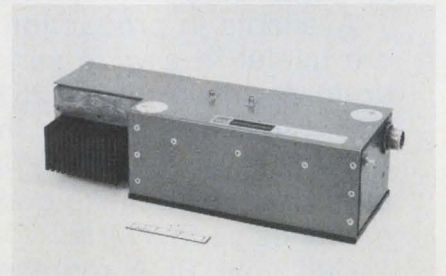

Watkins-Johnson Co., 3333 Hillview Ave., Stanford Industrial Park, Palo Alto, Calif. Phone: (415) 326-8830.

Combining pulse and cw capabilities in a medium power TWT amplifier, a new amplifier provides a choice of operating modes from 1  $\mu$ s pulses to cw over the C band. The model WJ-1129 device has output power of 20 W, 37-dB maximum noise figure, 38-dB minimum saturation gain, input primary power of 250 W maximum and a peak phase jitter of 10 degrees.

CIRCLE NO. 274



## Wideband generator sweeps 0.1 to 24 GHz

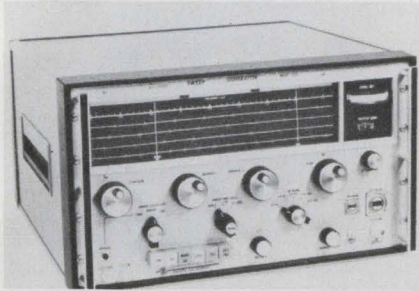

SpaceKom, Inc., P.O. Box 10, Goleta, Calif. Phone: (805) 967-7114. P&A: \$4380 to \$9800; 90 days.

Without the use of external plug-ins, a new sweep generator can generate swept signals from 0.1 to 24 GHz in five ranges with a front-panel range control. Model 101 offers a continuous sweep up to 4.1 GHz. Output power is calibrated and adjustable from  $-120$  to  $+3$  dBm,  $\pm 0.5$  dB up to 16.4 GHz and  $\pm 1.5$  dB over 16.4 GHz.

CIRCLE NO. 275

## High-gain transistor handles 5 W at 2 GHz

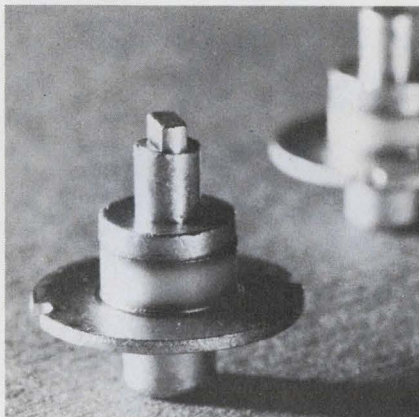

RCA Electronic Components, 415 S. 5th St., Harrison, N.J. Phone: (201) 485-3900. Price: \$180/100.

Furnishing what is claimed to be the highest combination of power, gain and efficiency in the industry, a new power transistor, the TA-7205, provides a minimum of 5-W output power with 7-dB gain at 2 GHz, and 10-W output power with over 10-dB gain at 1 GHz. Applications for this device include collision avoidance, electronic-counter-measure, telemetry and varactor-chain drives.

CIRCLE NO. 276

# Lectrohm knows Resistors...

## We should, they're our only business!

Fixed or Adjustable  
Standard or Custom

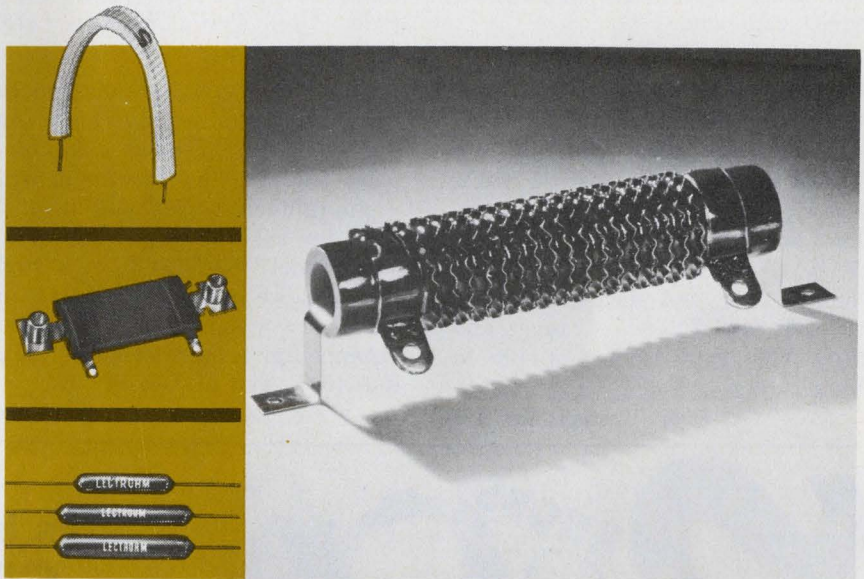

Specialization in the design and production of wire-wound resistors has established LECTROHM'S leadership in the resistor field.

For example, "Rib-on-Edge" resistors are made to order for high wattage service where low resistances from a fraction of an ohm to several ohms are required. They are also used for intermittent duty where relatively small size resistors must dissipate high wattages. Due to its greater heat dissipation and ability to operate at higher temperature, the "Rib-on-Edge" resistor is almost one-half the physical size of the equivalent standard round wire style resistor. It can be furnished in fixed, adjustable or tapped style to afford greater flexibility in equipment design.

Check your resistor needs today . . . send specifications, prints or requirements, no obligation . . . you can trust LECTROHM to match those needs quickly and economically.

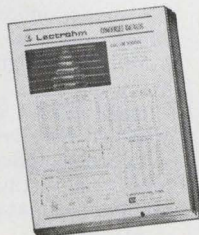

**FREE!**  
Full line  
LECTROHM  
catalog.  
Send for your  
copy today!



**Lectrohm, Inc.**

a subsidiary of



**COOK ELECTRIC**

5562 Northwest Highway, Chicago, Ill. 60630

INFORMATION RETRIEVAL NUMBER 92



### VSWR/wattmeter combo measures accurately

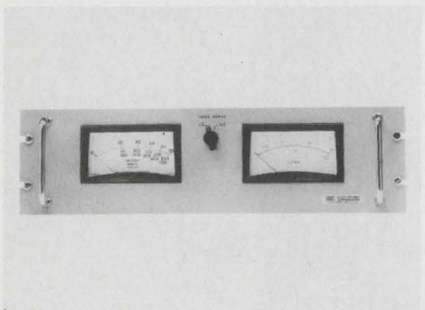

Bird Electronic Corp., 30303 Aurora Rd., Cleveland, Ohio. Phone: (216) 248-1200.

Designed to measure VSWR accurately and reliably, a new VSWR/wattmeter, with two expanded scales, measures full-scale VSWR on one scale of  $2.5/1 \pm 0.2$ , and  $1.3/1 \pm 0.06$  on the other scale. The model 3121 uses high-directivity coupling elements of better than 3000:1 and measures 25 to 1000 W in 6 full-scale ranges and three frequency ranges of 100 to 1000 MHz.

CIRCLE NO. 277

### S-band amplifier drives noise down

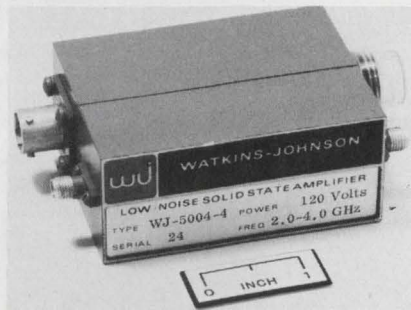

Watkins-Johnson Co., 3333 Hillview Ave., Stanford Industrial Park, Palo Alto, Calif. Phone: (415) 326-8830.

A new compact low-noise microwave transistor amplifier for operation in the S-band exhibits a noise figure of 8.5 maximum with a guaranteed power output of 7 dBm for a 1-dB compression gain. The model WJ-5004-4 is a high performance amplifier with an integral power supply that meets environmental requirements of MIL-E-16400F, and MIL-E-5400K.

CIRCLE NO. 278

### Ku-band oscillator offers 100 mW minimum

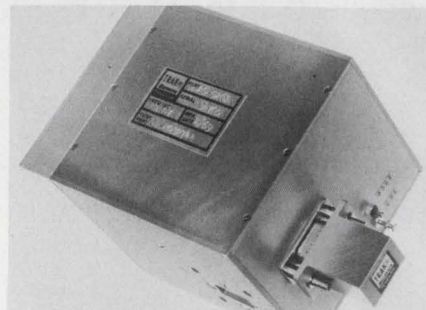

Trak Microwave Corp., 4726 Kennedy Rd., Tampa, Fla. Phone: (813) 884-1411.

Capable of being crystal-controlled with plug-in crystal oscillators or swept with an external supply, a new Ku-band source operates from 15.5 to 15.8 GHz with minimum and typical power outputs of 100 and 150 mW, respectively. The model 5025-9201 uses 38 V dc at 600 mA to operate within the range of  $-20$  to  $+71^\circ\text{C}$ . Applications include TWT amplifiers and frequency multipliers.

CIRCLE NO. 279

Outline your requirements for quotation and **FREE knob sample**



Write today for **FREE Full color Control Knob Catalog.**

**Radan** BROTHERS, INC.

8031 N. Monticello Ave. Skokie, Illinois 60076 312/675-1234

### This is our Model 8602 CRT DISPLAY

It is very compact

It is sensibly priced

It has much of the flexibility of a lab scope



This little scope has 1 MHz bandwidth in each axis in the X-Y mode; incorporates a multi-range (11 step) triggered sweep and TTL-compatible Z-axis control. Options include front panel signal attenuator, bandwidth to 2 MHz and many more.

8602 is only one of 66 standard models in our line, one of which may be just what you've been looking for.

Sub-assemblies in stock enable prompt delivery of prototype or quantity requirements. Catalog sheets or special-requirement data await your call.

**INFODEX** INCORPORATED

7 Cherry Ave., Waterbury, Conn. 06702 (203) 757-9291

INFORMATION RETRIEVAL NUMBER 94

ELECTRONIC DESIGN 25, December 6, 1969

INFORMATION RETRIEVAL NUMBER 93





## The \$1200 **Bad-Apple** Finder....

### ..... GR's New 1662 Resistance Limit Bridge!

You can't plug an apple into the new GR 1662 (it's only a one-terminal device), but if you have barrels of resistors to sort, the 1662 will find the out-of-tolerance components for you — quickly, easily, and inexpensively! It's the ideal instrument for selecting and qualifying resistors by percent deviation either manually or in an automatic system.

To handle all the resistance test requirements you're likely to face, the 1662 has percent-deviation ranges of  $\pm 0.3$ ,  $\pm 1.0$ ,  $\pm 3.0$ ,  $\pm 10$ , and  $\pm 30\%$ . Test results are indicated by meter reading, dc-voltage levels, and HIGH-GO-LOW lights. The high limit and low limit can be adjusted independently (by front-panel controls or external dc voltage) to any value within the full-scale meter range.

Use the 1662 for manual sorting and get precise meter readings in one second or use the HIGH-GO-LOW lights for faster sorting limited only by the speed of the operator. Use

automatic sorting equipment like the GR 1782 Analog Limit Comparator (from \$550) to get maximum test rates of four components per second. The 1782 allows simultaneous multiple-tolerance-limit sorting. (Apples can be tested only with a core-memory device.)

For straight resistance measurements, 1662 has a basic bridge accuracy of 0.02%, a comparison accuracy of 100 ppm, and a total range of 1 ohm to 111.1111 megohms. The resolution of the 1662 is 0.01 ohm on the 111-kilohm range to 10 ohms on the 111-megohm range.

Oh, yes. Even at \$1200, the 1662 Resistance Limit Bridge is available with a quantity discount for two or more. For more information, write General Radio Company, West Concord, Massachusetts 01781 or telephone (617) 369-4400. In Europe write Postfach 124, CH 8034 Zurich, Switzerland.

Prices apply in U.S.A.

**GENERAL RADIO**





**Plastic rectifiers carry 2 A for 15¢**



Sarkes Tarzian, Inc., Semiconductor Div., 415 N. College Ave., Bloomington, Ind. Phone: (812) 332-1435. Price: 15¢ to 47¢.

Series 2AF plastic silicon rectifiers, which have a dc current rating of 2 A, range in price from 15¢ each for 100-V units to 47¢ each for 1000-V units, in large OEM quantities. Six peak inverse voltage ratings are available, from 100 to 1000 V dc. Maximum rms input voltages can vary from 70 to 700 V, and surge currents can be as high as 60 A.

CIRCLE NO. 280

**Zero-voltage switch has on-chip supply**

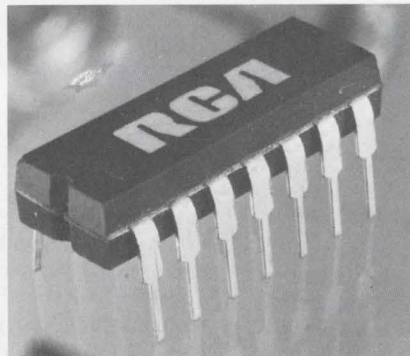

RCA/Electronic Components, 415 S. Fifth St., Harrison, N.J. Phone: (201) 485-3900. P&A: \$1.95; stock.

Designed for 50-to-400 Hz thyristor (triac) control applications, a monolithic zero-voltage switch features a self-contained dc power supply with access for supplying dc bias current to external components. Model CA3059 includes a threshold detector and trigger circuit that pulses the triac gate at the zero-voltage point to reduce radio-frequency interference.

CIRCLE NO. 281

**Triple shift register gates with MOSFETs**

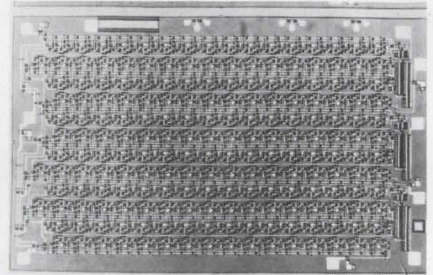

Motorola Semiconductor Products Inc., P.O. Box 20924, Phoenix, Ariz. Phone: (602) 273-6900. P&A: \$21; stock.

Containing 1191 p-channel enhancement-mode MOSFETs, a triple 66-bit dynamic monolithic shift register is designed to operate from 10 kHz to 1 MHz in the temperature range of 0 to 75°C. The new device, type MC1141, performs with a power dissipation of 1 mW per bit at 1 MHz. Each of the three registers has an independent input and output with common supply and clock lines.

CIRCLE NO. 282

**MOS logic arrays delay but 150 ns**

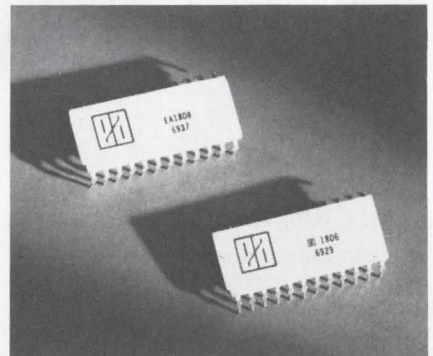

Electronic Arrays, Inc., 501 Ellis St., Mountain View, Calif. Phone: (415) 964-4321. P&A: \$14.10 or \$16.20; stock.

Two standard MOS logic arrays, the EA 1806 variable hex gate array, provide typical propagation delays of 250 and 150 ns, respectively. In addition, the EA 1806 offers eight different gate functions at the user's option. Both units are available in 24-pin metal-ceramic hermetically sealed dual-in-line packages.

CIRCLE NO. 283

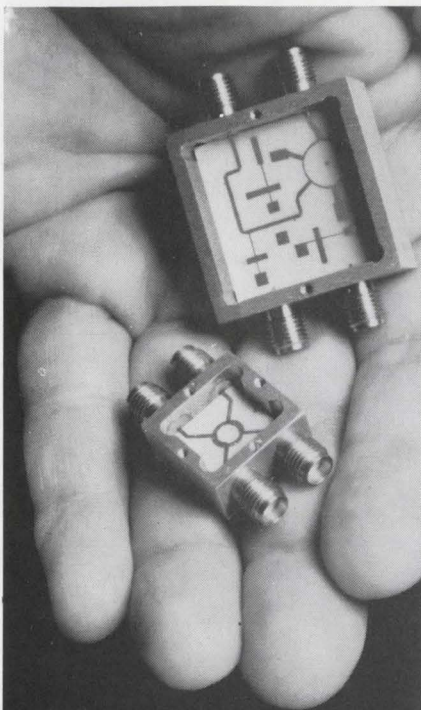

**MIC MICROSTRIP CIRCUIT FRAMES**

- frame sizes range from 1/2" x 1/2" to 2" x 2", and 1" x 3"
  - 36 different size frames are available from stock
  - frames mate with standard 1.7 mm or 3 mm connectors
  - 150 designs available for quick delivery
  - all launchers pretested and performance matched
  - 24 hour quote service on specials
- Tek-wave, inc., offers a comprehensive line of microstrip circuit frames. They consist of a frame that holds an etched substrate, covers, mounting fixtures, and a required number of coax-to-microstrip transitions. Completely sealable models are available for hermetic applications. For information write Tek-wave, inc., Raymond Rd., Princeton, New Jersey 08540, phone (609) 921-8910.



Leader in Advanced MIC Technology

INFORMATION RETRIEVAL NUMBER 96



## Three chopper FETs hold leakage to 250 pA

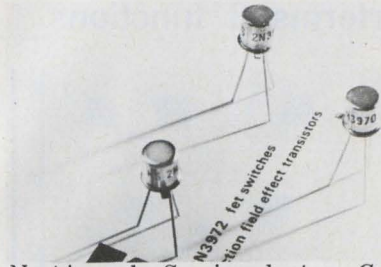

National Semiconductor Corp., 2975 San Ysidro Way, Santa Clara, Calif. Phone: (408) 245-4320. P&A: \$2.60 to \$3; stock.

Boasting fast switching times and low pinch-off voltages, a new series of FET choppers offers low leakage currents of only 250 pA. The new series includes types 2N3970, 2N3971 and 2N3972. These units may be used as switches in such digital applications as multiplexers, commutators or analog applications like TV equipment, oscilloscopes, and a-m and CB receivers.

CIRCLE NO. 284

## Nine chopper FETs offer power choice



General Instrument Corp., 600 W. John St., Hicksville, N.Y. Phone: (516) 733-3000. P&A: \$1.10 to \$11.50; stock.

Primarily designed for chopper applications, nine new n- and p-channel enhancement-mode insulated-gate field-effect transistors cover low-power (3N175, 3N176, 3N177), medium-power (3N181, 3N182, 3N183) and high-voltage (3N178, 3N179, 3N180) switching. Features include square-law characteristics and a high ratio of off-to-on resistance.

CIRCLE NO. 285

# How about acceleration better than 140,000 rad/sec<sup>2</sup> for a 200W motor?

## It's yours.

New Diehl moving coil motors are high response D.C. servo motors ideal for use in high speed printers, capstan motors and wherever high speed response is called for. In addition they offer these important advantages:

- High efficiency.
- Low armature inertia... much lower than normal DC motors.
- Less force cooling required, due to superior motor design.
- Very low inductance.
- Straight line speed-torque characteristics.
- High pulse acceleration torques.
- High overcurrent pulse capability... over 10x rated current with no harm to commutator or loss of field flux.
- Output torque, smooth and cogging free.

### Hi-Accel Motor Characteristics — Model HD5520-10-1



#### Typical Performance Data

<b>Motor Rating</b>	
Output .....	200 Watts
Speed .....	2500 RPM
Voltage .....	48 Volts
Current .....	6.2 Amps.
Torque (Continuous) .....	110 oz. in.
Torque (Stall) .....	840 oz. in.
Efficiency .....	69%
<b>Intrinsic Data</b>	
K <sub>T</sub> (Torque Const.) .....	22 oz. in./Amp.
K <sub>E</sub> (Back EMF Const.) .....	16 Volts/ KRPM
J <sub>M</sub> (Arm. Inertia) .....	.0062 oz. in. sec. <sup>2</sup>
R <sub>A</sub> (Arm. Resistance) .....	1.25 OHMS

#### Derived Constants

R <sub>M</sub> (Regulation) .....	3.6 RPM/oz. in.
a (Acceleration from stall) .....	140,000 Rad/Sec <sup>2</sup>
R <sub>P</sub> (Power Rate) .....	1258 KWatts/Sec.

#### Mechanical Data

Weight .....	14 lbs.
Housing Dia. ....	5.50 in.
Length .....	5.25 in.

# THE SINGER COMPANY Diehl Division

Finderne Avenue, Somerville, N.J. 08876/(201) 725-2200 • TWX 710-480-9325

INFORMATION RETRIEVAL NUMBER 97



### Dual-in-line op amp gives 150 mA at 10 V

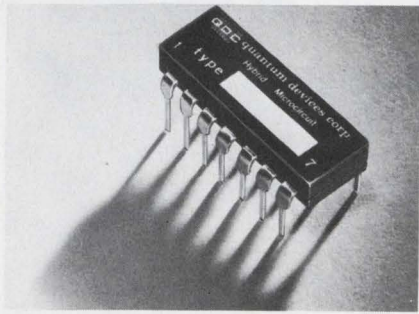

Quantum Devices, 15 W. Main St., Bergenfield, N.J.

Packaged in a dual-in-line case is a new operational amplifier that has an output of 150 mA at 10 V. The hermetically sealed model 0A201 has an open-loop gain greater than  $10^5$ , bias current of 200 nA, offset voltage of  $25 \mu\text{V}/^\circ\text{C}$ , is short-circuit proof and measures 0.78 by 0.28 by 0.15 in. maximum. It is ideal for use as a buffer, line driver, level shifter or booster amplifier.

CIRCLE NO. 286

### IC voltage comparator dissipates only 30 mW

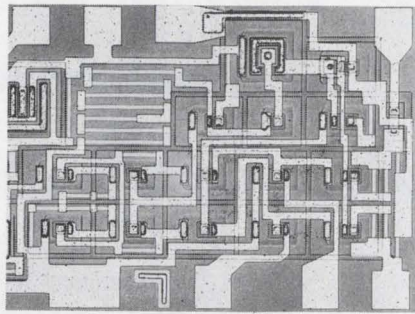

Intersil Inc., 10900 N. Tantau Ave., Cupertino, Calif. Phone: (408) 257-5450. P&A: \$15; stock.

A new low-power high-impedance voltage comparator, the ICB8001C, is a monolithic circuit with a power dissipation of less than 30 mW. Other features of this new IC are a wide common-mode range of  $\pm 10\text{ V}$  (90 dB), voltage gains of 60,000, and the capability to drive bipolar loads over its full temperature range. Offset current drift is less than  $35 \text{ pA}/^\circ\text{C}$ .

CIRCLE NO. 287

### Four-bit logic unit performs 8 functions

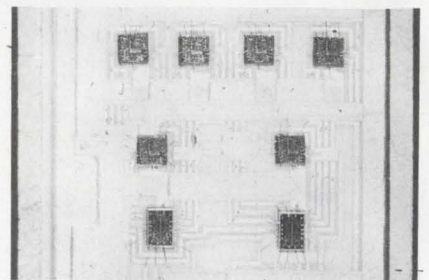

Fairchild Semiconductor Corp., 313 Fairchild Dr., Mountain View, Calif. Phone: (415) 962-3563. P&A: \$140; stock.

A four-bit arithmetic logic unit that performs all the basic functions of a computer consists of eight MSI circuits in a 30-pin flat package to allow the user to enter two four-bit words for addition, subtraction, or any of six other logic functions. The SH8081 hybrid IC operates at a speed as low as 16 ns and is compatible with TTL and DTL families.

CIRCLE NO. 288

## THE WORLD'S MOST ACCURATE FREQUENCY SWITCH

FASTER DATA TRANSMISSION

New, GO-NO-GO Audio Switches which fire whenever the input frequency goes above, below, or is within certain definite frequency limits are now available. Accuracies as close as 1 cycle per thousand can be maintained. Maximum response time is the length of two input cycles. All units are completely solid state.

The input frequency can be in the form of a sine or square wave. Or even in pulses in which case it measures the length of time between pulses. Frequencies from 1 Hz to 40,000 Hz can be handled easily and directly. Higher frequencies can be handled if dividers and/or mixers are incorporated.

Highpass, lowpass, and band-pass functions are all available.

# GOSH instruments inc

P.O. BOX 36 • WETHERSFIELD, CONNECTICUT 06109 • (203) 527-4794

NEW  
TELEMETERING  
FREQUENCY  
SWITCHES  
1 Hz to 40,000 Hz  
RESPONSE LIKE  
THIS

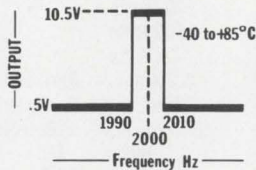

from  
**\$99.50**  
Single piece

## NO END OF PRECISION METAL TERMINALS

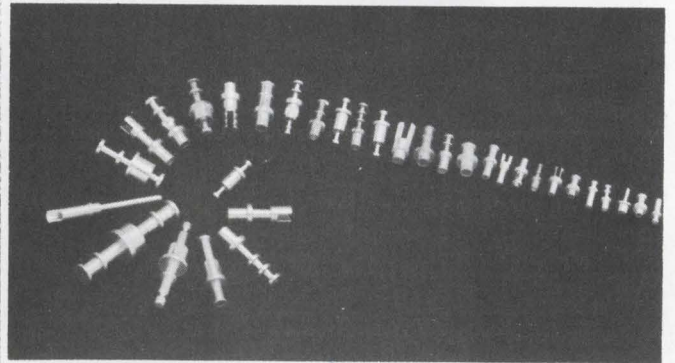

Stock or special, PMP can supply you with no end of low cost, precision machined terminals. Select from the most complete line in the industry (over 500 stock items). Specials are our specialty, often there's no tooling charge. We offer free engineering assistance in terminal selection or design.

Write for Free samples and New catalog.

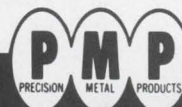

**PRECISION METAL PRODUCTS CO.**

41 ELM ST., STONEHAM, MASS. 02180  
Telephone: (Area Code 617) 438-3650





**El-Menco**

BETTER QUALITY AND RELIABILITY THROUGH CONTROL

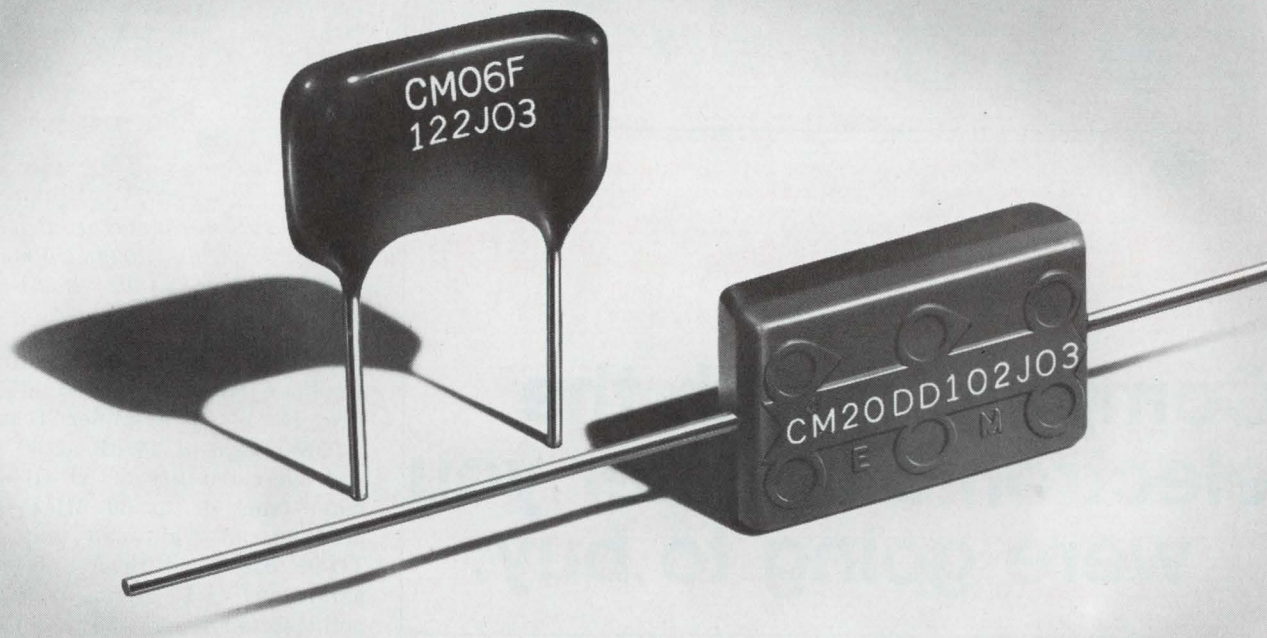

Shown 2½x Actual Size

## Capacitor Problems That Require A Lot Of Self-Control...Chemically Speaking

**Problem 1:** How to make sure the silver paste composition used for electrodes provides the best results for each electrical parameter in a given capacitor design?

**Problem 2:** How to improve the recognized moisture reliability of our dipped mica capacitors without adversely affecting life reliability?

**Problem 3:** How to upgrade the reliability of molded mica capacitors to equal that of dipped mica capacitors so designers can take advantage of body uniformity and axial lead design?

**Solution: Chemical self-control!** To do this we operate our own chemical manufacturing plant where we formulate silver pastes, phenolic dipping compounds, and epoxy molding compounds — all under strict controls.

**Result:** Dipped mica capacitors and molded mica capacitors of equally high reliability that operate up to 150°C. Send for technical literature and always insist on El-Menco brand capacitors . . . your assurance of better quality and reliability through control.

**THE ELECTRO MOTIVE MFG. CO., INC.**

WILLIMANTIC, CONNECTICUT 06226

Dipped Mica • Molded Mica • Silvered Mica Films • Mica Trimmers & Padders  
Mylar-Paper Dipped • Paper Dipped • Mylar Dipped • Tubular Paper

West Coast Manufacturers contact: **COLLINS & HYDE CO.**, 900 N. San Antonio Rd., Los Altos, California 94022  
5380 Whittier Blvd., Los Angeles, California 90022

ALSO SOLD NATIONALLY THROUGH ELECTRONIC PARTS DISTRIBUTORS  
INFORMATION RETRIEVAL NUMBER 101





## Simpson's new 2725.

Compare it with the electronic counter you were going to buy:

SPECIFICATIONS	SIMPSON 2725	YOUR COMPARISON
Wide frequency range?	<b>YES.</b> 5 Hz to 20 MHz.	
Measures frequency ratios?	<b>YES.</b> 1 to $1.99999 \times 10^5$ .	
Measures time periods?	<b>YES.</b> 300 $\mu$ seconds to 0.2 second.	
Measures time intervals?	<b>YES.</b> 300 $\mu$ seconds to $1.99999 \times 10^5$ seconds.	
Totalizes?	<b>YES.</b> 0 to $1.99999 \times 10^5$ counts.	
Crystal controlled time bases?	<b>YES.</b> 6 xtal-controlled bases, switch selected.	
Self-test circuitry?	<b>YES.</b> Front panel switch tests logic circuitry.	
Dependable solid state design?	<b>YES.</b> Integrated circuits.	
Number of full time digits	<b>5.</b> Plus automatic overrange indication.	
Accuracy	<b><math>\pm 0.01\%</math></b> $\pm 1$ digit	
Price	<b>\$525.</b> complete with probe and operator's manual.	\$

4-digit Model 2724 also available: \$450.

**Simpson** ELECTRIC COMPANY

GET "OFF-THE-SHELF" DELIVERY OF THE NEW SIMPSON DIGITAL ELECTRONIC COUNTERS AT DISTRIBUTORS STOCKING SIMPSON INSTRUMENTATION PRODUCTS

5200 W. Kinzie Street, Chicago, Illinois 60644 • Phone (312) 379-1121  
 Export Dept: 400 W. Madison Street, Chicago, Illinois 60606. Cable Simelco  
 IN CANADA: Bach-Simpson Ltd., London, Ontario • IN INDIA: Ruttonsha-Simpson Private Ltd., International House, Bombay-Agra Road, Vikhroli, Bombay



INFORMATION RETRIEVAL NUMBER 102

## ICs & SEMICONDUCTORS

### IC rf/i-f amplifier gains 45 dB at 60 MHz

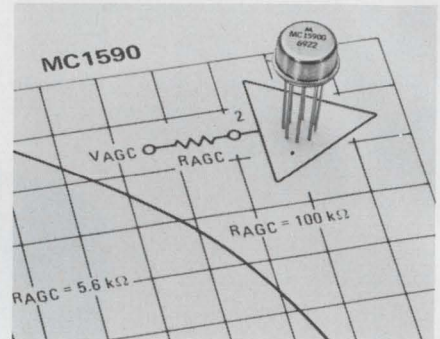

Motorola Semiconductor Products Inc., P.O. Box 20924, Phoenix, Ariz. Phone: (602) 273-6900. P&A: \$3.75; stock.

Operating as a general-purpose amplifier from dc to 150 MHz, a new IC rf/i-f amplifier features a power gain of 45 dB at 60 MHz and age capability of 60 dB minimum from dc to 60 MHz. Type MC1590, an eight-lead unit in a TO-99 case, has reverse transfer admittance of  $10 \mu\text{mhos}$  at 60 MHz and operates from  $-55$  to  $+125^\circ\text{C}$ .

CIRCLE NO. 289

### Tiny chip block diode can be reflow soldered

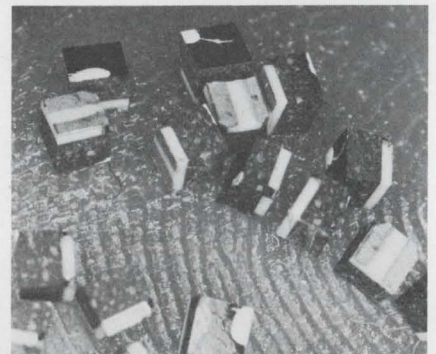

Acousticon Systems Corp., Microelectronics Div., Danbury, Conn. Phone: (203) 744-1900.

Packaged as a tiny leadless discrete component measuring only 50 by 50 by 35 mils, a chip block diode may be soldered into thick and thin-film hybrid circuits and printed circuit boards by reflow soldering methods. This eliminates the necessity for wire-bonding chips, or cutting, forming, and threading discrete devices into hybrid circuit assemblies.

CIRCLE NO. 290



MODULES & SUBASSEMBLIES

**Economy d/a converter is 8-bit \$75 hybrid**

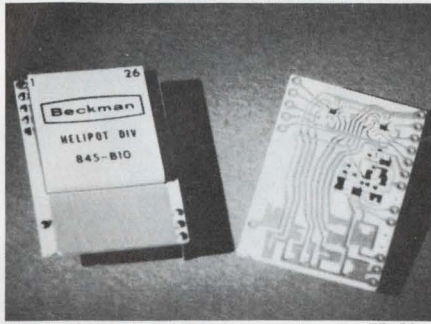

Beckman Instruments, Inc., Helipot Div., 2500 Harbor Blvd., Fullerton, Calif. Phone (714) 871-4848. Price: \$75.

Said to be the first complete d/a converter in hybrid IC form, a new eight-bit thick-film miniaturized d/a converter sells for only \$75. Model 845 offers a settling time of 17  $\mu$ s to within 1% of the final value, from 0 to 5 V. This new hybrid also has an enable gate that allows the output voltage to follow the digital inputs or remain at its zero input state.

CIRCLE NO. 291

**Low-cost dual supply covers many ac inputs**

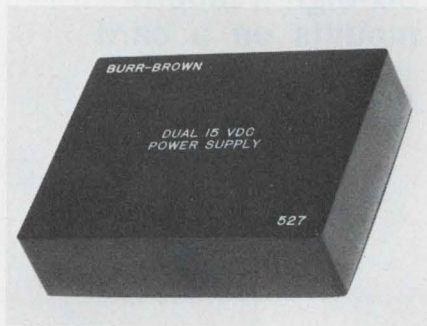

Burr-Brown Research Corp., International Airport Industrial Park, Tucson, Ariz. Phone: (602) 294-1431. P&A: \$39; stock to 4 wks.

For only \$39, model 527 encapsulated power supply provides two 15-V 50-mA outputs capable of common external connections with an accuracy of 1%. Rated input voltage is 115 or 230 V rms, but the unit will accept ac voltages in the range of 105 to 125 V from 210 to 250 V rms between 47 and 420 Hz. Line or load regulation is  $\pm 0.2\%$ .

CIRCLE NO. 292

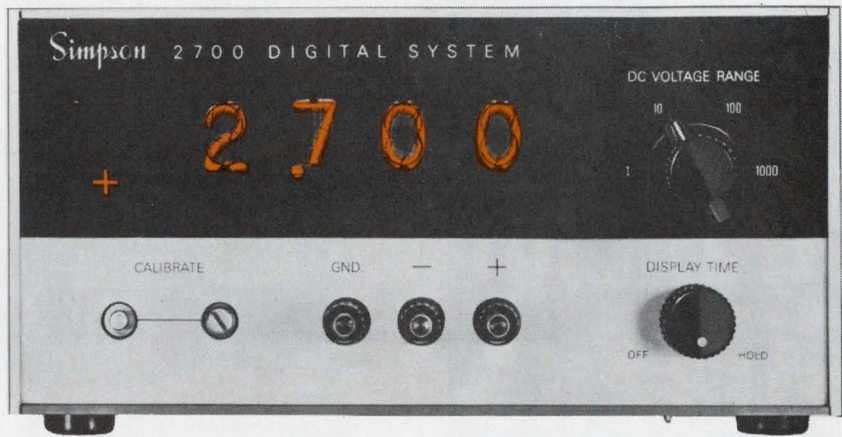

**Simpson's new 2700.**

**Versatile Digital System:**

- New, fast warm-up\*
- 4 1/2 digits
- 0.05% accuracy
- 5 plug-in function modules

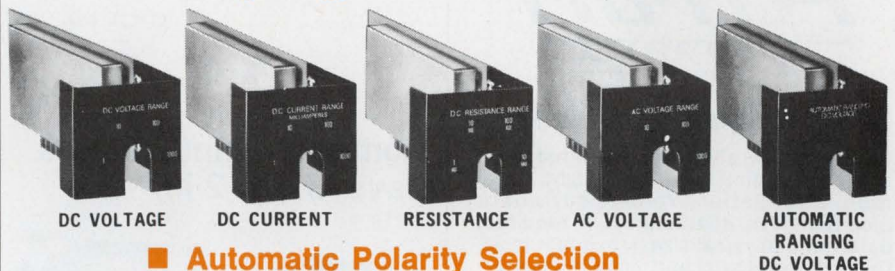

- Automatic Polarity Selection
- Built-in Self Calibration
- 100 Microvolt Resolution
- Optional BCD output
- IC Modular Design for reliability

\*Just 1 minute for 0.1% accuracy. 5 minutes for 0.05%.

**2700 DIGITAL SYSTEM \$615<sup>00</sup>**  
complete with DC voltage range module, test leads, and operator's manual

AVAILABLE "OFF-THE-SHELF" AT ELECTRONIC DISTRIBUTORS STOCKING SIMPSON INSTRUMENTATION PRODUCTS.

**Simpson ELECTRIC COMPANY**



5200 W. Kinzie Street, Chicago, Illinois 60644 • Phone (312) 379-1121  
Export Dept: 400 W. Madison Street, Chicago, Illinois 60606. Cable Simelco  
IN CANADA: Bach-Simpson Ltd., London, Ontario • IN INDIA: Ruttonsha-Simpson Private Ltd., International House, Bombay-Agra Road, Vikhroli, Bombay

INFORMATION RETRIEVAL NUMBER 103



TUBULAR,  
BULKHEAD  
MOUNTING TYPE

# RFI/EMI FILTERS



## Cylindrical Style Interference Filters

that reduce or eliminate unwanted noise or signals. Small size, light weight, maximum attenuation. Voltage current or insertion loss characteristics required, determine physical size. Maximum isolation of terminals and high frequency performance are assured by threaded neck design for bulkhead mounting. Feed-thru capacitor circuitry conservatively rated for both military and commercial applications.

**Rtron** corporation  
P.O.Box 743 Skokie, Illinois 60076

- Send catalog and prices.
- Have Representative call for appointment.
- Specifications enclosed on Multi-circuit or custom design filters. Send estimate.

Name \_\_\_\_\_

Firm \_\_\_\_\_

Address \_\_\_\_\_

City \_\_\_\_\_

State \_\_\_\_\_ Zip \_\_\_\_\_

INFORMATION RETRIEVAL NUMBER 104

## MODULES & SUBASSEMBLIES

### Constant-current units deliver 100 mA for \$10



Product Designs Inc., 111 Cardenas, N. E., Albuquerque, N.M. Phone: (505) 265-3551. Price: \$10.

Series CCM current modules provide constant-current outputs from 1  $\mu$ A to 100 mA, independent of input voltage and load resistance at a unit cost of \$10. Outputs are preset or remote resistance controlled and feature level stability of  $\pm 1\%$  at  $28 \pm 4$  V and load stability of  $\pm 1\%$  with a 100% load change, including 0  $\Omega$ . Preset units have a setting accuracy of  $\pm 0.5\%$ .

CIRCLE NO. 293

### Compact annunciators have 3 by 2-in. face

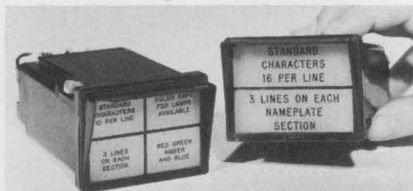

Scam Instrument Corp., 7401 N. Hamlin Ave., Skokie, Ill. Phone: (312) 675-2500.

A new line of light boxes for compact remote display of monitored points are complete annunciator units with a face plate measuring only 3 by 2-1/4 in. and a depth of only 4-1/4 in. The entire face can be devoted to a single monitored point, or it can be divided into two or four sections, each with a separate legend and backlighted with a separate incandescent lamp.

CIRCLE NO. 294

### Regulated supplies span 0.6 to 24 kV

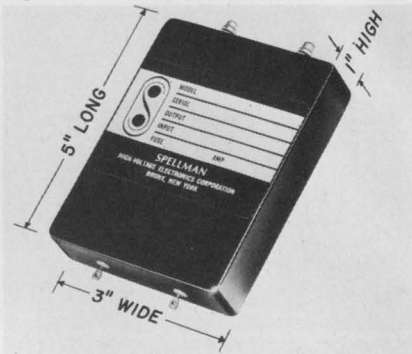

Spellman High Voltage Electronics Corp., 1930 Adee Ave., Bronx, N.Y. Phone: (212) 547-0306.

Designed for CRT and photo-multiplier tube applications, a new series of encapsulated regulated high voltage supplies delivers outputs from 600 to 24,000 V dc. Series MRM units require inputs of 24 to 32 V dc, line-regulate at  $\pm 0.01\%$  for 10% input variations and load-regulate at 0.3% for no load to full load variations, have 0.1% ripple and are resistance-programmable.

CIRCLE NO. 295

### Six-digit readout mounts on a card

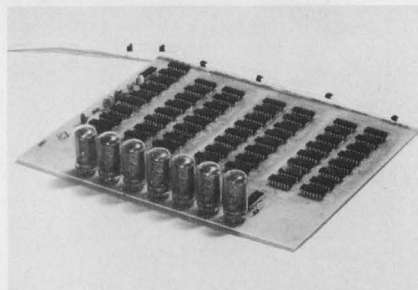

Digital Products Corp., 6950 N.W. 12 Ave., Fort Lauderdale, Fla. Phone: (305) 933-7151.

Featuring input, output, counting and display functions on a single printed circuit card assembly is the series DRC-100 bidirectional counter/display designed for machine tool applications. It has six digits with a plus or minus sign, selectable decimal point, pre-settable counter/display, buffered BCD outputs and is compatible with off-the-shelf optical coders.

CIRCLE NO. 296



# This "Bench Pac" Power Supply sets benchmarks for tight output control at low cost

**SAME DAY SHIPMENT** FROM POWER/MATE

Want features?  
Feature these!

- At front panel: adjustable current limiting, fine/coarse voltage control.
- Outputs from 0-34 V @ 0.5 A. ■ Tough metal case. ■ Large dual-range, switched meter for reading voltage and current outputs. ■ Regulation better than  $\pm 0.01\%$  or 1 MV for line and load. Ripple less than 250  $\mu$ V.



Only \$89.00

**Still more features:** Versatile, high performance, convenience, easy operation, long life. Easy to mount with POWER/MATE CORP.'s Rack Adapters. Complete information available from:

**PIMC POWER/MATE CORP.**  
514 S. RIVER ST., HACKENSACK, N. J. 07061  
(201) 343-6294 TWX (710) 990-5023

INFORMATION RETRIEVAL NUMBER 105

## MODUPRINT

**TIME  
DATE  
COUNT  
DATA**

IN ANY COMBINATION  
TAILORED TO YOUR  
SPECIFIC NEEDS

With optional data interfacing to accept BCD inputs. Count or time accumulated by simple signals to the least significant digit, or to any column. As many or as few positions as required up to frame capacity.

Price and design make printing possible where printing is now a necessity.

Send for Bulletins

**PRACTICAL  
AUTOMATION, INC.**

Shelton, Connecticut 06484  
Phone (203) 929-1495

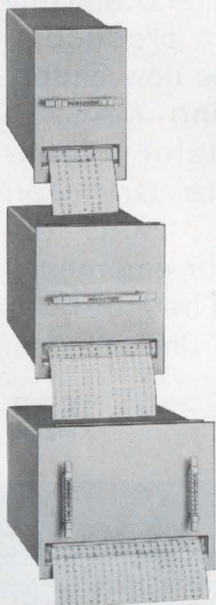

INFORMATION RETRIEVAL NUMBER 106

ELECTRONIC DESIGN 25, December 6, 1969

## New Oak Versatility

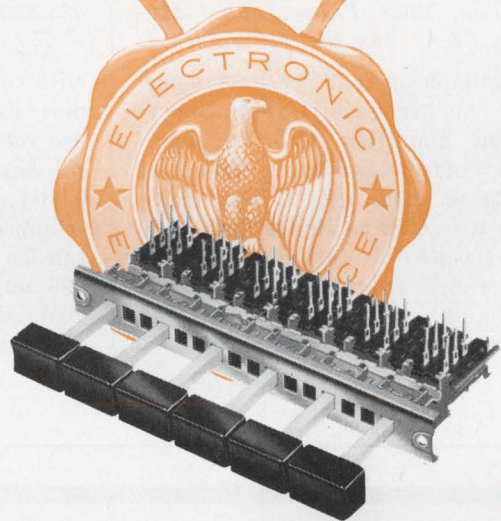

**OAK ECONO-LINE  
PUSHBUTTON<sup>T.M.</sup>**

**JUST 25¢ A BUTTON\***

\*For most applications

We've got the button... throws from 1 PST to 8 PDT per button; sizes: .388" sq., .388" x .585" or .388" x .782"; legends engraved to your specifications; black or white buttons are standard, other colors on special order.

Push Rod Stroke...  $\frac{3}{32}$ " plus  $\frac{3}{4}$ " overtravel; push rod lengths optional at  $\frac{1}{2}$ ",  $\frac{5}{8}$ " standard length,  $\frac{3}{4}$ ",  $\frac{7}{8}$ " and 1".

Easy to wire... clips are Oak-pioneered double-wiping. For printed circuit boards or wire-soldering, PCB terminals are  $\frac{3}{32}$ ",  $\frac{1}{8}$ ",  $\frac{3}{16}$ " standard length,  $\frac{3}{32}$ " and  $\frac{1}{4}$ " shoulder to tip. Choose terminals for wiring only or P.C. dual-purpose which have the wire hole in addition to the P.C. lug.

Compact Convenience... more buttons per area—24 on .394" centers, 16 on .591" centers, 12 on .788" centers. Any switching—momentary, push-push, interlock, or blockout or combinations. For full details, write today for Bulletin SP-346.

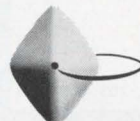

**OAK MANUFACTURING CO.**

A Division of OAK ELECTRO/NETICS CORP.  
Crystal Lake, Illinois 60014  
Phone: 815-459-5000 TWX: 910-634-3353

INFORMATION RETRIEVAL NUMBER 107

155



### Differential amplifier drifts only 250 nV/°C

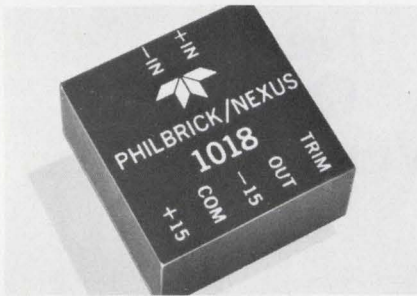

Philbrick/Nexus Research, a Tele-dyne Co., Allied Dr. at Route 128, Dedham, Mass. Phone: (617) 329-1600. P&A: \$68 to \$110; stock.

Available in four versions, model 1018 chopperless differential operational amplifier features maximum offset voltage drifts of  $\pm 0.25$  to  $\pm 1.5 \mu\text{V}/^\circ\text{C}$  and maximum bias current drifts from  $\pm 50$  to  $\pm 100 \text{ pA}/^\circ\text{C}$ . Initial offset voltages range from  $\pm 0.1$  to  $\pm 1 \text{ mV}$  maximum, gain is  $2 \times 10^6$ , and common-mode rejection is  $10^5$ .

CIRCLE NO. 297

### Regulator modules eliminate heat sinks

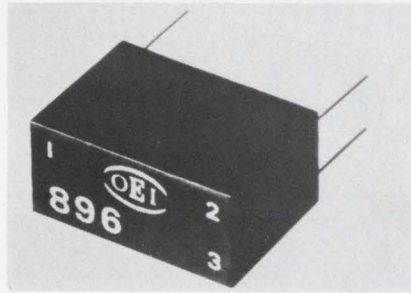

Optical Electronics Inc., P.O. Box 11140, Tucson, Ariz. Phone: (602) 624-3605. P&A: \$35; stock.

Able to operate at full current without external heat sinking, a new line of series-type point-of-use voltage regulators offer a typical line and load regulation of 0.03%. Output voltage, which is trimmed to within 1% of nominal, can be 5, 6, 12 or 15 V. Series 896 units can handle a maximum load current of 300 mA and can dissipate 1.2 W of power.

CIRCLE NO. 298

### Wideband crystal filter covers 35 kHz at 3 dB

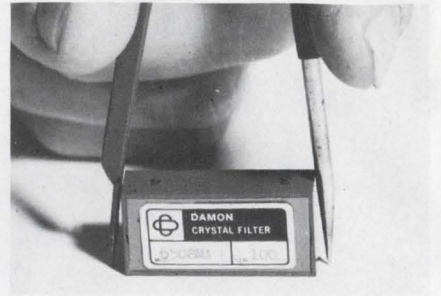

Electronics Div. of Damon Engineering Inc., 115 Fourth Ave., Needham Heights, Mass. Phone: (617) 449-0800.

A new monolithic crystal filter, the model 6508 MA provides a 3-dB bandwidth of 35 kHz minimum and a 60-dB bandwidth of 75 kHz maximum at a center frequency of 11.5 MHz  $\pm 2 \text{ kHz}$ . Other specifications are a 3-dB insertion loss, 1-dB ripple, 15-k $\Omega$  terminating impedance and an operating temperature range of 0 to 60°C.

CIRCLE NO. 299

## Here's A Switch

### Fast Response...No Bounce

The MERCUTRON SWITCH effectively combines the mechanical advantages of a snap-action switch with the electrical properties of a mercury switch. It is a miniature switch of unique and simple design relying on mercury movement in a flexible sealed tube for fast response with no bounce, perfect for direct switching of solid state circuits. Actuating a plunger simultaneously releases a pinch in the tube and "pumps" the divided mercury together to close the normally open circuit. A simple cricket spring in direct contact with the tube provides the snap-action.

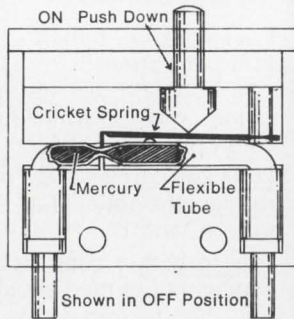

Switching Capacity .....	60 ma @ 24 VDC
Contact Rise Time .....	$< 1 \times 10^{-9}$ seconds
AC Contact Noise .....	10 Microvolts
Bounce Time .....	Zero
Maximum Cycling Rate .....	200 Hz
Life at Rated Load .....	250,000 cycles
Operating Temperature Limits .....	-30°C to 60°C
Shock Resistance .....	30 G's min.



For further information write or call  
**MECHANICAL ENTERPRISES**  
 3127 Colvin Street, Alexandria, Virginia 22314, (703) 549-3434



NOW... DRY CELLS THAT GIVE YOU  
**5 YEARS** SHELF LIFE PLUS **-40°F** PERFORMANCE



NO. 6 SIZE

C & D SIZES

Developed for The U.S. Army and currently in production for field use. The new battery chemistry, using MAGNE-SIUM, is a major breakthrough in the Dry Cell Battery Field... "MAG" dry cells are ideal for emergency equipments. They deliver more power at time of use.

**MAGNESIUM DRY CELLS**  
**BATTERY CORPORATION OF AMERICA**  
 SALES: 43 W. FRONT ST., RED BANK, N.J. 07701  
 201-741-0370



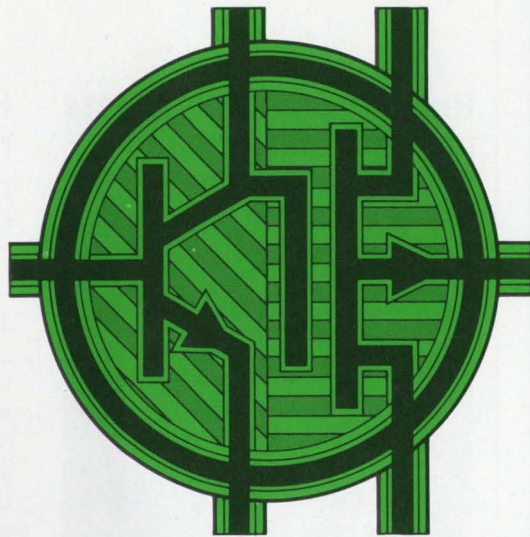

# MONOLITHIC BIPOLAR/MOS DRIVER-SWITCHES

Why Bipolar/MOS? By using bipolars in your analog switch driver circuits you get high breakdown voltages, fast switching speeds and low power dissipation.



The industry approach has been a chip for bipolars and a chip for the MOS FETs, or an all-MOS configuration at the expense of critical parameters.

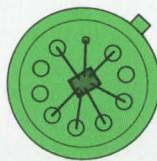

New Siliconix technology puts the bipolar and MOS transistors on one chip, reducing the number of bonds and die-attach steps and simplifying assembly. You get better mechanical and electrical integrity, increased reliability, lower cost.

- Switches are normally OFF P-channel MOS FETs
- Zener diodes protect all MOS gates
- Metal areas are glass passivated
- Each channel complete — no other components needed
- Input compatible with DTL, TTL and RTL logic
- Switches analog signals up to 20 volts

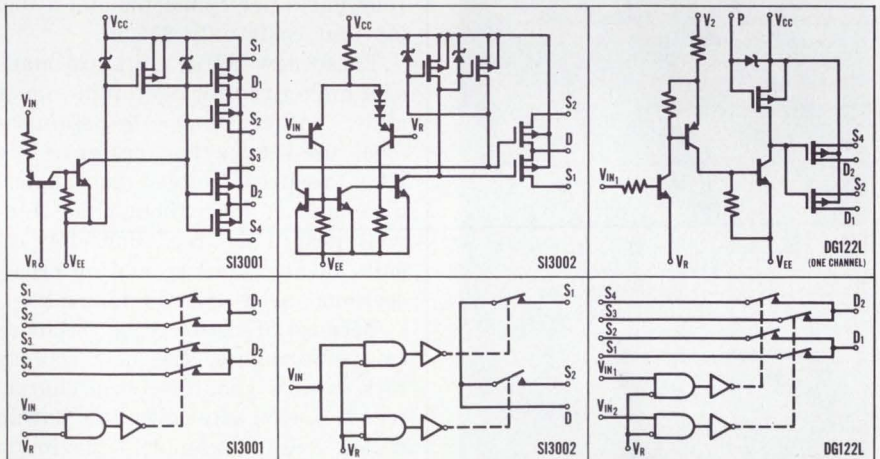

These are just three of more than 30 Siliconix multichannel driver-switch combinations with MOS or junction FET switches. A standard line of separately packaged drivers and switches is also available. Write or call for complete data on the industry's broadest line of driver-switches.

\* **Applications Power:** A wide variety of driver/FET switch combinations and an in-depth applications team waiting to serve you!



**Siliconix incorporated**

2201 Laurelwood Road • Santa Clara, Calif. 95054  
Phone (408) 246-8000 Ext. 201 • TWX 910-338-0227

in Europe... Siliconix Ltd., Siliconix House, Sketty Park, Saunders Way, Swansea, U.K.



# HANSEN'S NEW 900 SERIES

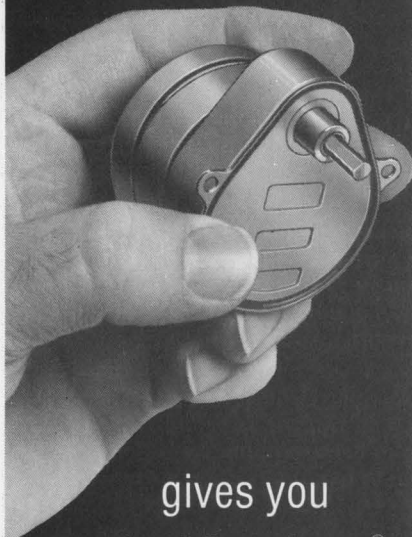

gives you  
standard Synchron®  
reliability with up  
to 98 oz.-in. torque

Now, without sacrificing compact size, you can get high torque even at higher speeds—from 1 to 900 RPM. Synchron® 900 Series has thick, wide gears, specially designed to give the added gear strength that makes full use of its power increase. Highest quality instrument gear train for all speeds below 900 RPM.

The new self-starting hysteresis motor has positive direction of rotation—right or left hand. Plus extra heavy phenolic first gear for low noise level. It can be stalled continuously without electrical or mechanical damage.

Added strength in both the rotor and gear train enables 900 Series to handle your toughest timing and control jobs. Because of its compact dimensions, it is often interchangeable with motors of lower torque. To find out what 900 SERIES can do for you, write or phone today to have a representative contact you.



**HANSEN MFG. CO., INC.**  
Princeton, Indiana 47570

**HANSEN REPRESENTATIVES:** CAREY & ASSOCIATES, Houston and Dallas, Texas; R. S. HOPKINS CO., Sherman Oaks, Calif.; MELCHIOR ASSOCIATES, INC., San Carlos, Calif.; THE FROMM CO., Elmwood Park, Ill.; JOHN ORR ASSOCIATES, Grand Rapids, Mich.; H. C. JOHNSON AGENCY, INC., Rochester, N.Y.; WINSLOW ELECTRIC CO., Essex, Conn.; Villanova, Pa., and New York, N.Y.

**EXPORT DEPARTMENT:** 2200 Shames Drive, Westbury, N.Y. 11590

INFORMATION RETRIEVAL NUMBER 111

## PACKAGING & MATERIALS

### Rugged SMA connectors increase performance



*Bunker-Ramo Corp., Amphenol RF Div., 33 E. Franklin St., Danbury, Conn. Phone: (203) 743-9272. P&A: \$1 to \$5; February, 1970.*

A complete new line of subminiature SMA (also called OMA) coaxial connectors improves electrical and mechanical performance and simplifies assembly over competitive designs. Simplified assembly is emphasized with a maximum of four parts per connector and a tool kit that costs only \$12.50.

These new SMA units are made of a high-strength beryllium-copper alloy, rather than the stainless steel used by other designs. The alloy assures rugged mechanical performance even though the thin-wall design of the connector results in an interface mating cross-sectional area of only 4.52 mils.

Because of their strong mechanical performance, the new connectors exhibit good electrical characteristics even after over 100 mating cycles. For example, maximum SWR for a mated pair of solder-type units for 0.141-in. semi-rigid cable is 1.09 to 12.4 GHz and 1.13 through 18 GHz.

Both solder and clamp-type plugs and jacks are available for 0.141-in. semi-rigid cable. Crimp and clamp-type plugs and jacks are offered for RG-58 and RG-223 cables.

CIRCLE NO. 334

### High-density paint resembles graphite

*Dylon Industries, 14430 Indian Creek, Cleveland, Ohio. Phone: (216) 243-2333.*

Known as type AE, a high-density paint gives coatings of almost pure graphite. It dries quickly into an extremely smooth, slippery, non-porous layer with a very low coefficient of friction and high electrical and thermal conductivities. The coating will not crack, melt or run at any temperature, is non-toxic, and when not needed is removable by cold water.

CIRCLE NO. 335

### Coated aluminum tapes ban cable moisture

*Dow Chemical Co., 2020 Abbott Rd. Center., Midland, Mich. Phone: (517) 636-5964.*

Consisting of metals that are coated with an adhesive polyethylene copolymer, two plastic-clad aluminum tapes for cable shielding prevent the penetration of moisture or corrosive agents into the cable core. Known as Zetabon A260 and A262, they use an aluminum substrate of 6-mil thickness which has a copolymer coating, on one side for the A260 and on both sides for the A262.

CIRCLE NO. 336

### Cable-shielding tape has high conductance

*Chase & Sons, Inc., 19 Highland St., Randolph, Mass. Phone: (617) 963-2600.*

Reducing concentrated electrical stresses at irregular points in high-voltage cable splices, a new semiconducting tape for shielding, splicing and terminating high-voltage cables provides high conductivity, is ozone resistant, highly conformable and void-free. Type C-7013 tape is available in minimum widths of 1/4 in. or the equivalent metric dimension.

CIRCLE NO. 337



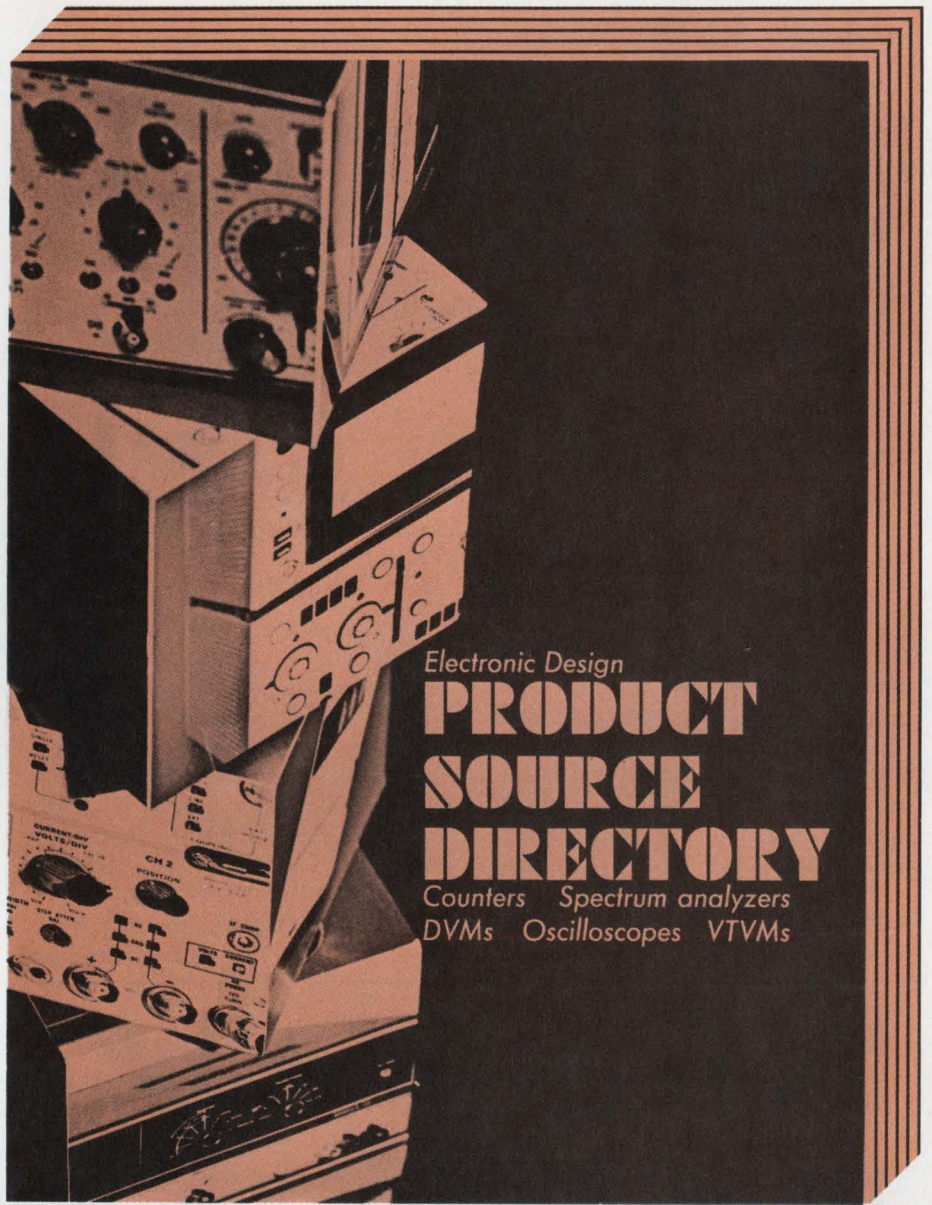

Electronic Design  
**PRODUCT  
SOURCE  
DIRECTORY**  
Counters Spectrum analyzers  
DVMs Oscilloscopes VTVMs

This special section of **Electronic Design's MEASURING INSTRUMENTS Product Source Directory** is available in a special 72 page reprint at \$2.00 per copy. Included are the complete tables—giving pertinent facts on over 1,000 instruments—as well as the advertising in the section. For your own handy copy, or for extra copies for use by your associates, fill-in and mail the blank below.

# ORDER EXTRA COPIES

Please send me \_\_\_\_\_ copies of MEASURING INSTRUMENTS Product Source Directory at \$2.00 per copy, including handling and postage. I enclose \$ \_\_\_\_\_

check

money order

Check or money order must accompany this order blank.

Name \_\_\_\_\_

Firm \_\_\_\_\_

Street \_\_\_\_\_

City \_\_\_\_\_

State & Zip \_\_\_\_\_



**Snap-on header/shell eliminates encapsulants**

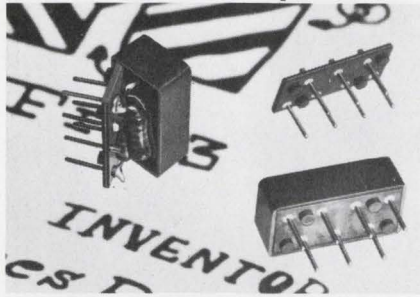

Capsonic Group, Inc., 1000 Bluff City Blvd., Elgin, Ill. Phone: (312) 695-6200. P&A: 6¢; 4 to 6 wks.

Custom circuits of all types, including high voltage, receive complete protection against moisture, dust and other environmental contamination when housed in a new fluid-tight snap-on header/shell. The head snaps instantly into the shell with a tight seal, eliminating encapsulation. The terminals are molded into the header with lead strength up to 30-lbs pull.

CIRCLE NO. 338

**Edgeboard connector matches impedance**

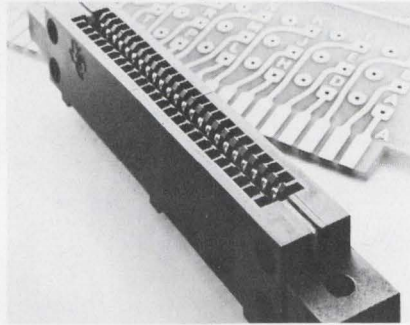

Texas Instruments Inc., Connector Products, 34 Forest St., Attleboro, Mass. Phone: (617) 222-2800.

Designed for rf and digital applications, a matched-impedance edgeboard connector, called MIEC, allows direct plug-in of rf and high-rise-time circuitry. The new unit also permits the use of various impedances or a dc input within the same connector. It can be used for signals of 30 MHz or higher and at switching speeds of 2 ns or faster.

CIRCLE NO. 339

**Silver-filled epoxy is usable to 400°C**

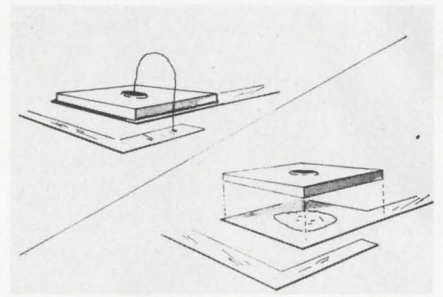

Epoxy Technology, Inc., 65 Grove St., Watertown, Mass. Phone: (617) 926-0136. Price: \$15/kit.

Designed for bonding semiconductor chips is Epo-Tek H-20, a two-component silver-filled epoxy compound, which can be used in the temperature range of 300 to 400°C intermittently or at 250°C continuously. Curing ranges from 1 hour at 80°C to 20 minutes at 120°C producing a lap shear strength of 1000 psi, while volume resistivity is 0.0001 to 0.0005 ohm-cm.

CIRCLE NO. 340

**You really turn me on!**



**HATHAWAY OPEN FRAME 2 AMP DRIREED RELAY**

And off! And vice-versa, back and forth. The reliability is part of the package. Inside of that open frame is a brace of Hathaway Drireed switches to make sure things always work. Rated at 2 amps, 25 Watts. For choosy specifiers the 2 amp relay is also available with a snap-on magnetic shielding case. Click! **Send for our full line mini-catalog.** Address: 5250 East Evans Avenue, Denver, Colorado 80222, (303) 756-8301 —TWX 910 931-0569.

**HATHAWAY**  
components

A DIVISION OF HATHAWAY INSTRUMENTS, INC.

INFORMATION RETRIEVAL NUMBER 113

WHEN THE  
FUSE GOES OUT,  
THE LIGHT  
GOES  
ON!

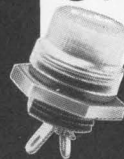

Littelfuse Indicating Micro-fuse Holders for military and commercial applications. Ranges 2-1/2 thru 250 Volts. Also available with RFI shielding.

**LITTELFUSE**

DES PLAINES, ILLINOIS

INFORMATION RETRIEVAL NUMBER 114



# Our Scotchpar<sup>®</sup> film is playing to capacitor audiences.

Capacitor makers bought more 3M Scotchpar<sup>®</sup> Brand polyester film this year than last year.

So did motor makers.

And transformer makers.

And wire and cable makers.

This isn't just us thumping our chest. It simply proves again, when you have a great show, you sell more tickets.

And we give you a great show. 3M Scotchpar now comes in a wider variety of thicknesses and types . . . for all these insulating uses. There's even a heat-sealable version (called Scotchpak.<sup>®</sup>)

We've made it tough, flexible, stubbornly resistant to moisture, solvents. We've given it excellent dielectric strength, and a tensile ruggedness as great as steel.

And we've given you a choice. There's more than one big-time show in the film business these days.

Have you seen the new one?

Write to 3M Company, Film & Allied Products Division, 3M Center, St. Paul, Minnesota 55101 . . . or the Dielectric Materials Desk at the 3M Office nearest you.

**Scotchpar<sup>®</sup>**  
BRAND POLYESTER FILM

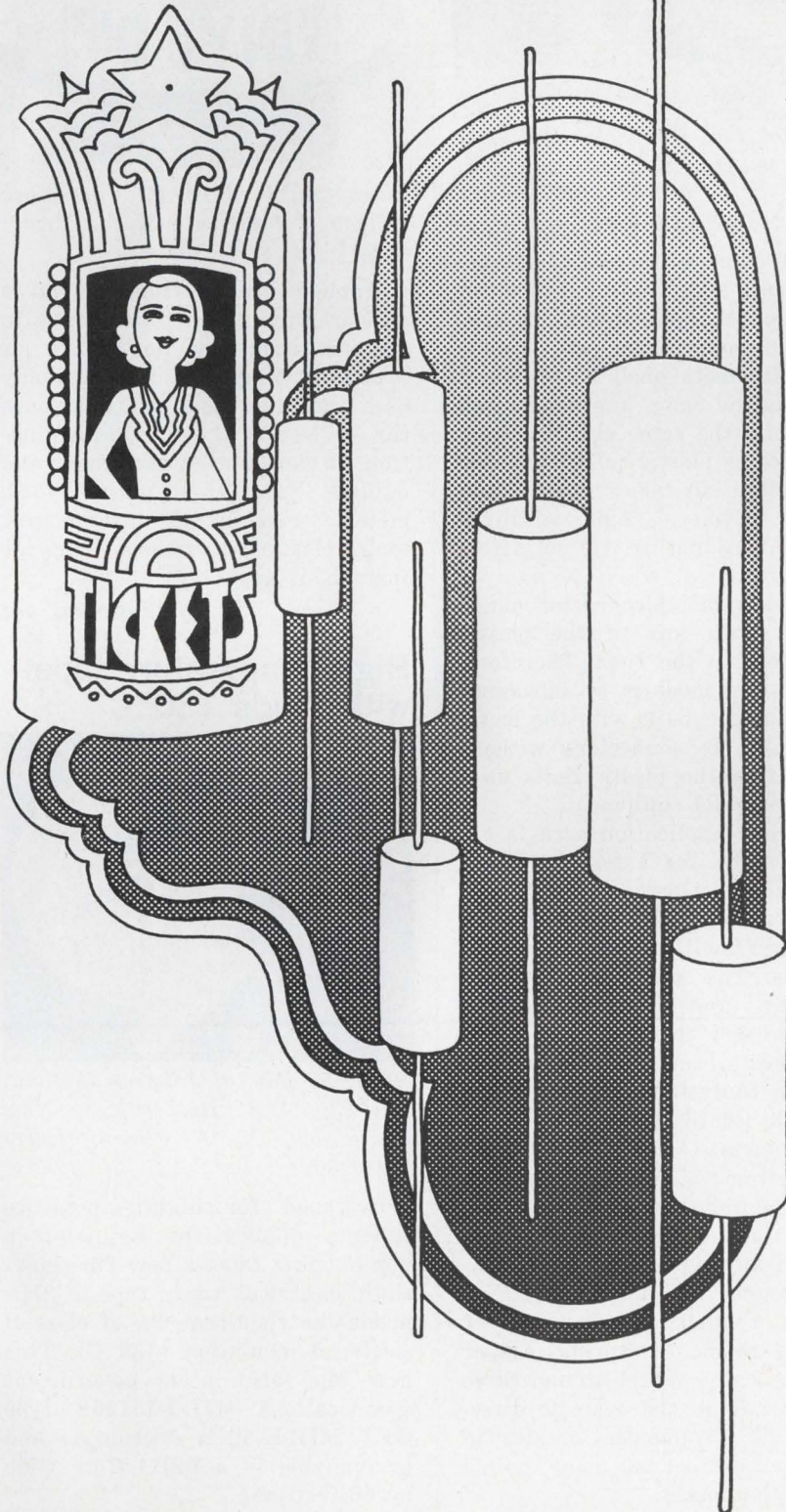



# Micro-Miniature Reed Relays

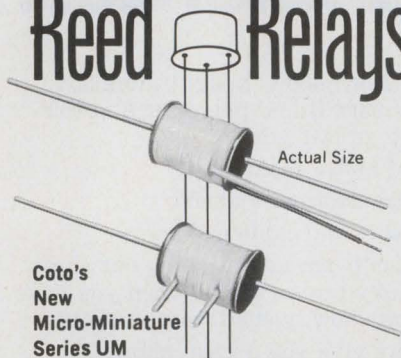

Coto's New Micro-Miniature Series UM

- Extremely small size: .400" x .300" OD
- Occupies less than 0.03 cu. in.
- Ultra-high speed 100 Microseconds operate time excluding bounce
- Stock voltages 3, 6, 12 and 24 volts
- Available with either leads or pins with 0.2" spacing

Special voltages, resistances, electrostatic and/or magnetic shields available. Write for new Data Sheet MR-9.1



COTO-COIL COMPANY, INC.  
Pavilion Avenue, Providence, R. I. 02905  
Tel: (401) 941-3355

INFORMATION RETRIEVAL NUMBER 100



## RF and POWER SWITCHES

A complete line of rotary, high voltage and high current ceramic-type switches for RF and low frequency applications.

Write for catalog, containing information on the mechanical and electrical properties of our standard line of switches.

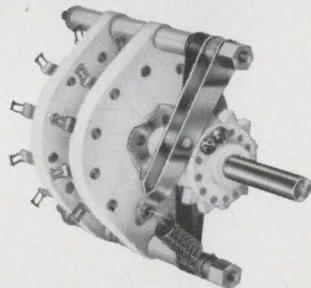

**RADIO SWITCH CORPORATION**

P.O. Box 79 Marlboro, N.J. 07746  
Tel. (201) 462-6100

INFORMATION RETRIEVAL NUMBER 116

## PACKAGING & MATERIALS

### Rack-and-panel set dons metal shells

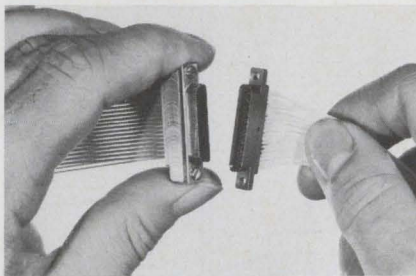

Microdot Inc., Connector Div., 220 Pasadena Ave., S. Pasadena, Calif. Phone: (213) 682-3351. P&A: \$12 per mated pair; 6 wks.

Made of metal instead of plastic, a new rack-and-panel connector can withstand the punishment of frequent disconnections and rematings. This metal-shell Micro-Con D unit has the same dimensions and essentially the same electrical performance as plastic connectors, but is substantially more rugged and durable. Even a slight misalignment during mating will not affect the contacts.

The new metal connector mates directly with any of the plastic connectors in the field. Therefore, new plug-in modules or subassemblies could be built with the metal Micro/Con D connectors without retrofitting the plastic units used in the original equipment.

A prime application area is expected to be for external connections where rough wear and handling problems in transportation create difficulties for the plastic versions. The new connectors are currently under evaluation for both military and commercial applications.

Seven contact arrangements are available (9, 15, 21, 25, 31, 37 and 51 contacts), while wire sizes range from AWG #28 through #24. The units are screw mounted, and can be supplied with any plating and any type of wire termination (round, flat or ribbon).

Each contact pin consists of seven strands of spring copper wire, helically wound around three strands laid in the opposite direction. This arrangement creates an electrical contact at many points within the socket.

CIRCLE NO. 341

### Clear vinyl coating multiplies its uses



Okun Co., Inc., 109-02 Van Wyck Expwy., Jamaica, N.Y. Price: \$4.95/pint, \$8.95/quart.

Applied directly from the can is a clear vinyl coating that dries in minutes requiring no mixing or brushing. Vinyl Dip has so many uses that the most practical ones can be left to the user's imagination. It can be used for indoor and outdoor jobs, for glass, wood, metals, machinery, instruments, tools, plastics, household items or just about anything.

CIRCLE NO. 342

### High-temperature tape withstands 130°C



Permacel Div. of Johnson & Johnson Co., U.S. Highway 1, New Brunswick, N. J. Phone: (201) 524-0400.

Designed for high-temperature splicing applications requiring a non-burning tape, a new fiberglass cloth electrical tape, type P-21D, meets the requirements of class B electrical insulation (130°C). This new tape also meets government specifications MIL-I-15126F type GFT, MIL-E-5272C section 4.8 and is available in a roll 1/2-in. wide by 66-feet long.

CIRCLE NO. 343



# HYBRID CIRCUIT CERAMIC CHIP CAPACITORS...

... THAT ARE REALLY THUMBTHING!

Put your finger on those so-and-so design problems with a selection of type K 1200's. Capacitance range is 10 pF to 2.5 Mfd. Dissipation factor is less than 2% @ 1 kHz. Working voltages available, 25 thru 200 WVDC and more. Tempco is  $\pm 15\%$  max.  $-55^{\circ}\text{C}$  to  $125^{\circ}\text{C}$ . Our full line meets the applicable portions of MIL-C-11015 and MIL-C-39014.

Want a complete description, characteristics curves, etc? . . . write us for our latest pattern K-1200.

Monolithic  
Dielectrics



Inc. P.O. Box 647  
Burbank, Calif. 91503  
Phone 213 848-4465

INFORMATION RETRIEVAL NUMBER 117

KEEP PACE WITH SPACE AGE! SEE MOON SHOTS—LANDINGS, SPACE FLIGHTS, CLOSE-UP!  
**AMAZING SCIENCE BUYS**  
for FUN, STUDY or PROFIT

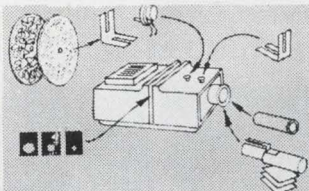

### Visual Effects Projector Set

Dazzling, avante-garde visual effects. Fantastic variety. Incredibly beautiful. Special package offer contains all necessary apparatus. Create floating, exploding, fiery bursts of color like "Symphony of Spheres", "Chromatic Starbursts", "Crystal Starburst". Features 35mm 500 W. fan cooled projector — produces big image at short distance. Accepts two 3" diam. wheels (Dry Kaleidoscope & Hexidoscope), 2 cylindrical accessories (6" Colored Cloud & 3" Hexidoscope w/six internal mirrored walls). Inst. Stock No. 71,212DA .....\$79.50 Ppd.



### Encapsulated Liquid Crystals

Amazing new development—appear like liquids but have orderly molecular structures similar to solids. Solutions contained in tiny (20-30 microns) capsules coated onto sides of six 6" x 12" Mylar sheets with 6 diff. temp. ranges. Surface changes color according to temp.  $-cover\ 66^{\circ}$  to  $120^{\circ}\text{F}$  ( $19^{\circ}$ - $49^{\circ}\text{C}$ ). Use for precise measurements, find hot spots, structural defects, study radiation, test conductivity, etc. Use indefinitely without mess, contamination. Easily handled. Instruct., color-temp. curves. Stock No. 71,143DA .....\$10.00 Ppd. EXPERIMENTERS KIT—4" x 6" Stock No. 60,756DA .....\$4.00 Ppd.



### 3" Astronomical Telescope

See moon shots, orbits, stars, phases of Venus, planets close up, 60 to 180 power. Aluminized, overcoated 3"-diam. f/10 primary mirror, ventilated cell. Equatorial mount with locks on both axes. 60x eyepiece and mounted Barlow lens. 3x finder telescope, hardwood tripod. FREE: "Star Chart," "Handbook of the Heavens." Stock No. 85,050DA .....\$29.95 Ppd. Stock No. 85,105DA .....\$94.50 FOB Stock No. 85,086DA .....\$239.50 FOB

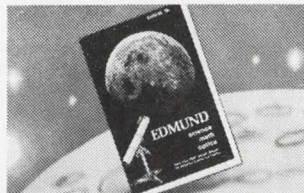

### Giant Free Catalog

Completely new 1970 edition, 148 pages—1000's of Bargains. New items, categories, illustrations. Dozens of electrical and electromagnetic parts, accessories. Enormous selection of Astronomical Telescopes, Microscopes, Binoculars, Magnifiers, Magnets, Lenses, Prisms. Many war surplus items for hobbyists, experimenters, workshop, factory. Write for catalog "DA."

# MINIATURE POWER RESISTORS

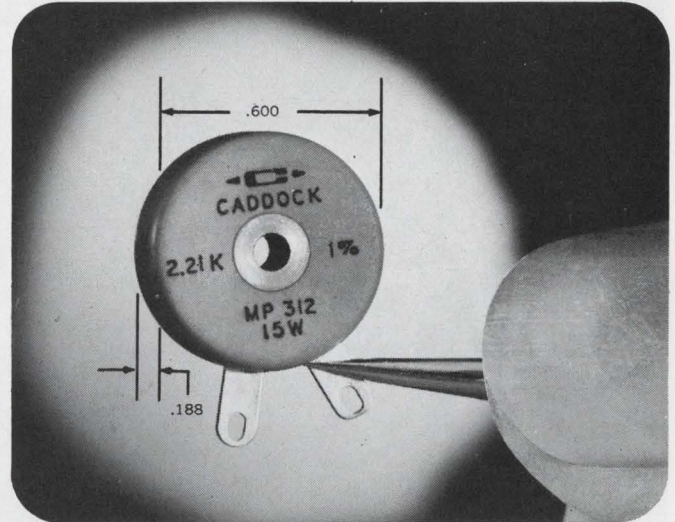

CHASSIS-MOUNT TYPE • NEW LAMINAR DESIGN • LOW PROFILE • 50% REDUCTION IN SIZE AND WEIGHT • COMPLETELY NON-INDUCTIVE • T.C.: 50 PPM/ $^{\circ}\text{C}$  • RESISTANCE TOLERANCE:  $\pm 1\%$

Model No.	Power Rating†	Max. Voltage	Diel. Str.	High Temp.TC‡	Resistance Range	Terminals
MP311	15 Watts	300	600	50	50 $\Omega$ -200K	12" Min Teflon Leads 26AWG 7x34
MP312	15 Watts	300	600	50	10 $\Omega$ -200K	Gold Plated Solder Lugs

†Power rating based on chassis mounting—MP311 and MP312 on 6"x4"x2"x.040 aluminum chassis

‡TC-50ppm/ $^{\circ}\text{C}$  Referenced to  $25^{\circ}\text{C}$ ,  $\Delta\text{R}$  taken at  $+150^{\circ}\text{C}$  and  $+275^{\circ}\text{C}$ . (Low temp. TC will be nominally  $-85\text{ppm}/^{\circ}\text{C}$  at  $-55^{\circ}\text{C}$ . See typical R-T curve.)

Resistance Tolerance:  $\pm 1\%$  standard (Other tolerances on special order.)

Insulation Resistance: 10,000 Megohms, dry. Method—Mil-R-18546D, para. 4.6.8.

Solderability: Per Mil-R-18546D, para. 3.7, para. 4.6.4.

Terminal Strength: Per Mil-Std-202, Method 211, Cond. A (Pull Test), 5 lbs., and Cond. B (Bend Test). Max.  $\Delta\text{R}$ , .2% or .2 $\Omega$ , whichever is greater.

Thermal Shock: Per Mil-R-18546D, para. 4.6.9, max.  $\Delta\text{R}$ , .5% or .2 $\Omega$ , whichever is greater.

Momentary Overload: 2 times rated power or 1.5 times max. allowable working voltage, whichever gives the lower power, for 5 seconds. Max.  $\Delta\text{R}$ , .5% or .2 $\Omega$ , whichever is greater.

Moisture Resistance: Mil-Std-202, Method 106B, less steps 7a and 7b, max.  $\Delta\text{R}$ , .5% or .2 $\Omega$ , whichever is greater.

Life: Per Mil-R-18546D, para. 4.6.12, 1,000 hrs. Max.  $\Delta\text{R}$ , .1% or .2 $\Omega$ , whichever is greater.

Shock, Medium Impact: 50G, per Mil-Std-202, Method 205, Cond. C.

Vibration, High Frequency: Per Mil-Std-202, Method 204, Cond. B, Max.  $\Delta\text{R}$ , .2% or .2 $\Omega$ , whichever is greater, through shock and vibration sequence.

### DERATING CURVE

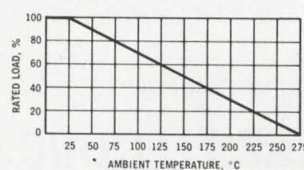

### TYPICAL R-T CURVE

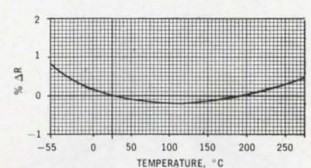

CADDOCK  ELECTRONICS

3127 Chicago Ave., Riverside, Calif. 92507 • Telephone: (714) 683-5361

ORDER BY STOCK NUMBER • OPEN ACCOUNT TO RATED FIRMS • MONEY-BACK GUARANTEE  
**EDMUND SCIENTIFIC CO.** 300 EDSCORP BUILDING  
BARRINGTON, NEW JERSEY 08007

INFORMATION RETRIEVAL NUMBER 118

ELECTRONIC DESIGN 25, December 6, 1969

INFORMATION RETRIEVAL NUMBER 119

163



It takes a lot of savvy  
to put this  
together... **RIGHT!**

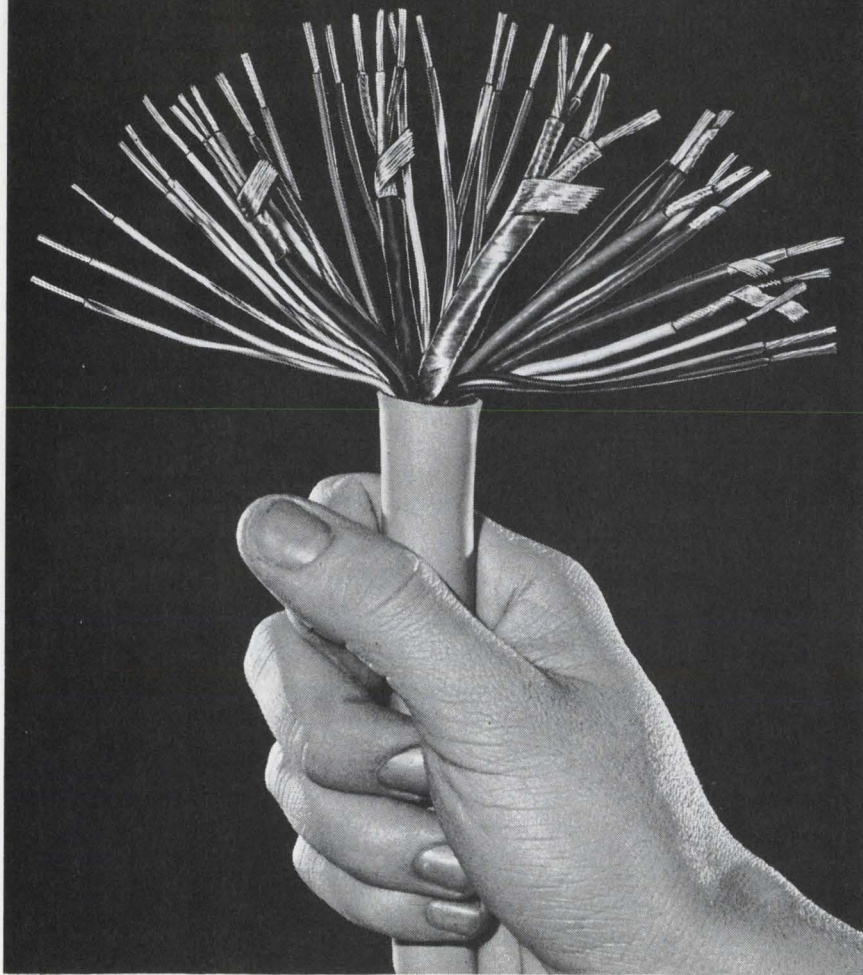

This exceptional multi-conductor cable was designed by Lenz technical staff to meet exacting requirements.

In the 60 years that Lenz has been making wires and cables, we have earned a reputation for high technical standards in the industry.

You are invited to take advantage of this experience by having your engineers contact Lenz with their cable problems.

Write for Catalog!



**LENZ ELECTRIC MFG. CO.**

1755 No. Western Ave., Chicago, Ill. 60647  
In Business Since 1904

In Northern California contact Winco Sales, Inc., P.O. Box 1238  
Mountain View, Calif. 94040. Phone: 415/961-8510

INFORMATION RETRIEVAL NUMBER 120

DATA PROCESSING

**Electronic calculator  
licks overflow snags**



*Singer Co., Friden Div., 2350  
Washington Ave., San Leandro,  
Calif. Phone: (415) 357-6800.  
P&A: \$895; 30 days.*

Winning the aggravating battle against overflow calculations, a new 14-digit electronic calculator trims solutions from the right, thus cutting out decimal digits instead of whole number digits. Other features of model 1114 include a floating decimal point, an automatic round-off switch and a decimal-point selector dial.

CIRCLE NO. 344

**Document copier  
ends warm-up wait**



*3M Co., 3M Center, St. Paul, Minn.  
Phone: (612) 733-0719. Price:  
\$5000 to \$6000.*

Based on a new copying process called Magne-Dynamic technology, a new console copier requires just 3.5 s to deliver the first copy. Subsequent copies are made at the rate of one every 3 s. The VHS copier utilizes a new type of reusable intermediate media and magnetic powder to produce images at high speeds. In the multiple-copy mode, it can make up to 99 prints.

CIRCLE NO. 345



## Fast calculators use LSI/MOS ICs



Toshiba America, Inc., Business Equipment Div., 477 Madison Ave., New York, N.Y. Phone: (212) 758-6161. Price: from \$1050.

Three new electronic calculators deliver performance and high operating speed through the use of LSI and MOS integrated circuits. Model BC-1611 has fixed and floating decimals, provision for automatic percentage calculations and a 16-digit memory. Model BC-1623 incorporates these features plus two 16-digit memories and automatic square root extraction. Model 1623G offers all of the BC-1623 features as well as a programming system.

CIRCLE NO. 346

## Computer for \$15k handles 32k words

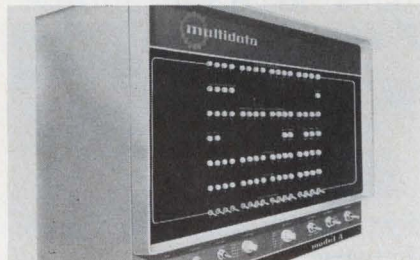

Multidata, 15142 Goldenwest Circle, Westminster, Calif. Phone: (213) 598-1377. Price: \$14,995.

In its basic \$14,995 configuration, the model A system-oriented computer includes: a core memory with 4096 words of 16 bits, 32,768 words of disc memory, a memory access controller, a central processor, an input/output buss, and a teletypewriter with paper-tape reader and punch. The core-disc memory combination enables the central processor to execute programs approaching 32,768 words in length.

CIRCLE NO. 347

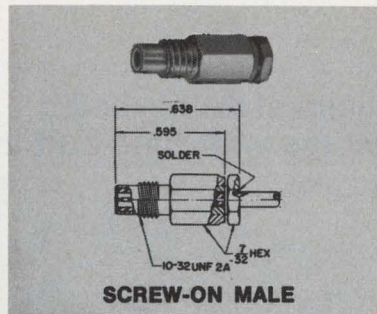

SCREW-ON MALE

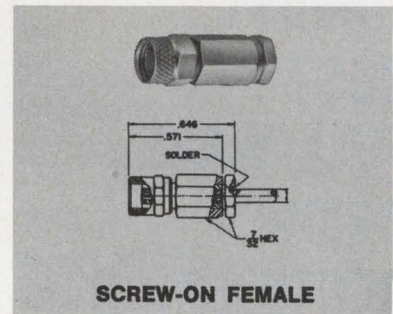

SCREW-ON FEMALE

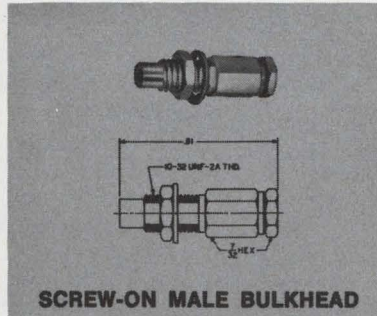

SCREW-ON MALE BULKHEAD

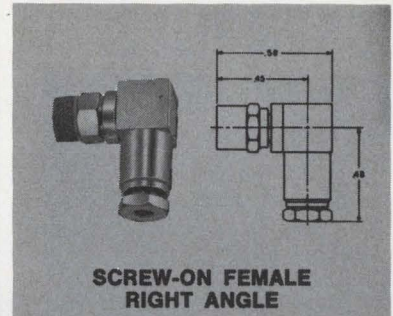

SCREW-ON FEMALE RIGHT ANGLE

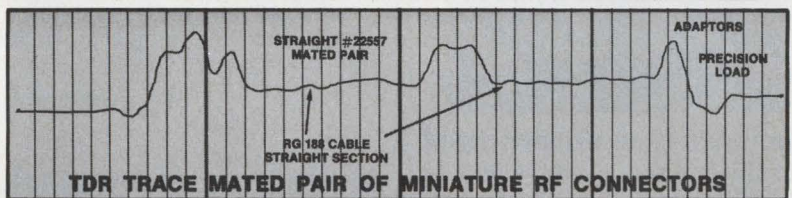
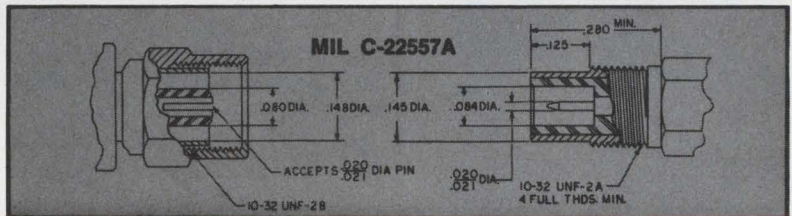

TDR TRACE MATED PAIR OF MINIATURE RF CONNECTORS

# MINIATURE RF CONNECTORS

Emlock® compression type RF connectors achieve a new high in reliability and are more than a match for crimp-type in assembly time, thanks to our new T15 bench tool. Incorporating metal-to-metal contact, coaxial cable simply cannot be pulled out of an Emlock® connector. Disengagement will be caused by braid failure, never pull-out of the compression.

We have a full range of Emlock®

sizes and interfaces available from stock for both semi-rigid and braided cable. If you remain unconvinced about the capability of Emlock® compression fit design to meet your needs, we also offer a full series of crimp-types.

Why not ask for all the details? Write for: Bulletin MMC Issue 1, Phelps Dodge Communications Company, 60 Dodge Avenue, North Haven, Connecticut 06473.

**PHELPS DODGE COMMUNICATIONS COMPANY**



# LOWEST COST . . . FULL WAVE BRIDGE RECTIFIERS & ASSEMBLIES

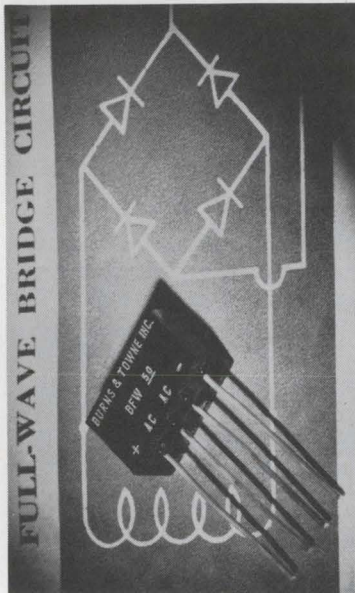

Burns & Towne pre-packaged rectifier circuits represent a significant cost savings over individual components used in multi-rectifier units. Yet, you are always assured of quality and reliability. The low cost BFW family of single phase full wave bridges . . . features high current capability of up to 2.0 amps.

Part No.	Max. PRV (volts)
BFW-50	50
BFW-100	100
BFW-200	200
BFW-300	300
BFW-400	400
BFW-500	500
BFW-600	600
BFW-800	800
BFW-1000	1000

Call or write for full specifications and price data.

Contact Fred Seigel



**BURNS & TOWNE INC.**  
18-36 Granite St.  
Haverhill, Mass. 01830. Tel (617) 373-1333

INFORMATION RETRIEVAL NUMBER 122

## DATA PROCESSING

### Solid-state keyboard works with tone buttons



Trepac Corp. of America, 30 W. Hamilton Ave., Englewood, N.J. Phone: (201) 567-3810.

Complete with encoders and power supply, a new miniaturized solid-state keyboard permits the use of any desired combination of tone-button encoders for single or multi-frequency operation. Datatone KTCT (Keyboard Tone Calling Terminal) is a transistorized unit designed for use with a data coupler or an acoustic coupler. It offers full alphanumeric capabilities.

CIRCLE NO. 348

### Military memory stack stores 16k 40-bit words

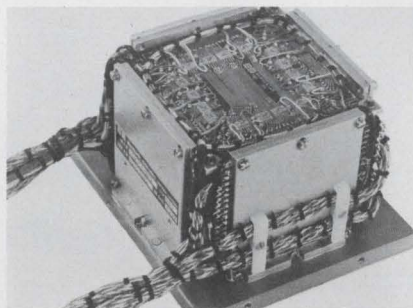

Electronic Memories, 12621 Chadron Ave., Hawthorne, Calif. Phone: (213) 772-5201.

Called Semstak-020, a new coincident-current military memory stack features a three-wire three-dimensional organization and word capacities from 4096 to 16,384 with lengths up to 40 bits. In addition, the memory offers full-cycle operating times as low as 1  $\mu$ s and access times as low as 0.5  $\mu$ s for up to 16k-by-32 memories. The unit qualifies for MIL-E-5400.

CIRCLE NO. 349

### Mass disc memory accesses in 8.7 ms



Applied Magnetics Corp., Computer Memories Div., 5 Robin Hill Rd., Goleta, Calif. Phone: (805) 964-4881. P&A: \$6440; 3 months.

Designed for today's small computers, the M 200C disc memory is a head-per-track-type unit with an average access time of 8.7 ms. It is available in four capacities, ranging from 426k to 3408k bits. The number of data tracks varies from 16 to 128 with 26,624 bits per track. Three timing tracks are included to provide a bit clock, a sector and an origin pulse.

CIRCLE NO. 350

### Dual-purpose typewriter codes in ASCII format



Electronic Engineering Co. of Calif. 1601 E. Chestnut Ave., Santa Ana, Calif. Phone: (714) 547-5501.

Compatible with all ASCII-coded systems, model 1651 dual-purpose input/output typewriter can operate on-line at 15.3 characters per second. During on-line operation, the unit is a keyboard-printer for transmitting and receiving data. The 1651 can also function as a basic I/O typewriter when interfaced directly to a computer I/O buss, or as a remote computer terminal when interfaced to a data set and telephone lines.

CIRCLE NO. 351



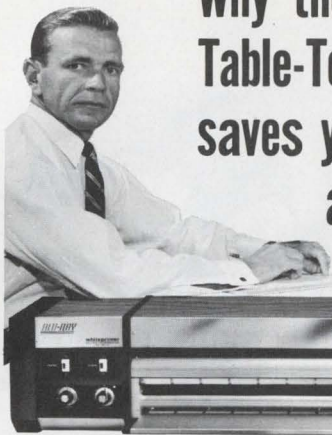

## Why the BLU-RAY 842 Table-Top Whiteprinter saves your time and money...

If a speed of twelve feet per minute will handle your needs (up to 200 "D" size prints per hour — 42" throat), the 842 can save you a lot of time and money.

Just plug in the 842 anywhere. It's handy and makes copies from translucent originals at 1½¢ per sq. ft. — all day long! This is a rugged performer, its dependability is backed by BLU-RAY's exclusive 1-year warranty.

And the 842 is always on GO... no waiting for warm-up, messing with liquids, or special wiring needed.

Fastest selling compact whiteprinter on the market, the 842 can be your time and money saver, too!

Send for brochure and free demonstration by one of our 600 dealers coast to coast.

# BLU-RAY

INCORPORATED

3822 Westbrook Road, Essex, Conn. 06426 • (203) 767-0141

INFORMATION RETRIEVAL NUMBER 123

## ATLAS

Turned and  
Precision Ground

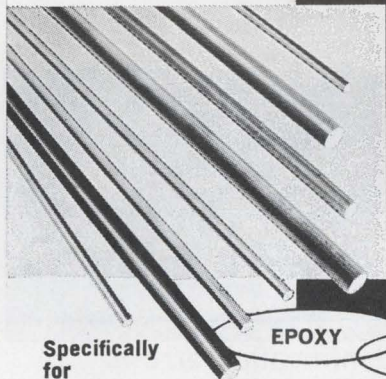

# PHENOLIC RODS

STOCK SIZES  
OR  
CUSTOM-MADE

EPOXY

BAKELITE

Glass Supported  
TEFLON

Specifically  
for

## RELAY and SWITCH applications

- Most sizes available for immediate delivery.
- Stock sizes in any diameter from 1/32" to 3/8"\*
- Increments of .001" at no extra charge
- Unsurpassed accuracy guaranteed to ±.001"\*

COMPLETE  
FACILITIES  
FOR  
FABRICATION

Atlas guarantees unequalled accuracy in the precision fabrication of parts from any of these materials. Send your blueprints and specifications for a prompt quote without any obligation.

\*Larger sizes and closer tolerances quoted on request.  
SEND FOR COMPLETE PRICE LIST

**ATLAS FIBRE COMPANY**  
6970 N. Central Park Avenue  
Chicago, Illinois 60645

INFORMATION RETRIEVAL NUMBER 124

ELECTRONIC DESIGN 25, December 6, 1969

# Transient Insurance

# \$2

## New Dale LVP-6 installs quickly, inexpensively to suppress DC overvoltages

For less than \$2 (in quantity), Dale's new LVP-6 prevents DC overvoltages from wiping out IC's and other costly board-mounted components. Its economy is enhanced by the fact that it saves on assembly time—replacing diodes and capacitors now individually installed to handle voltage suppression.

**SENSITIVE** The LVP-6 handles surges rising as fast as 10,000 volts/μsec. — clamps at preset levels from 6.2 to 13 volts.

**COMPACT:** Epoxy molded units (1/2" x 1/2" x 5/16") with leads for horizontal or vertical mounting across board's DC input.

Clamping Voltages: 6.2, 6.8, 7.5, 8.2, 9.1, 10, 11, 12, 13

Shunt Capacitance: 15 μfd ± 10%

Operating Temperature: -55° C to 85° C

Storage Temperature: -55° C to 125° C

For complete information  
call 605-665-9301 or write...



**DALE ELECTRONICS, INC.**  
**SIoux DIVISION** Dept. ED  
Yankton, South Dakota 57078  
A subsidiary of The Lionel Corporation

INFORMATION RETRIEVAL NUMBER 125

167



For a true record  
of temperature  
in service...

# Tempilabel<sup>®</sup>

Easy to use . . .



BEFORE

Easy to read



AFTER

Self-adhesive Tempilabels<sup>®</sup> assure dependable monitoring of attained temperatures. Heat-sensitive indicators, sealed under the little round windows, turn black and provide a permanent record of the temperature history. Tempilabel<sup>®</sup> can be removed easily to document a report.



#### AVAILABLE

Within the range 100° to 500°F Tempilabels<sup>®</sup> are available to indicate a single temperature rating each — and also in a wide choice of four-temperature combinations per Tempilabel<sup>®</sup>.

#### JUST A FEW OF THE TYPICAL APPLICATIONS

- Electrical Apparatus
- Electronic Assemblies
- Appliance Warranties
- Aircraft and Rockets
- Machinery and Equipment
- Storage and Transportation of Heat Sensitive Materials.

For descriptive literature and a sample Tempilabel<sup>®</sup> for evaluation . . . (please state temperature range of interest).



132 WEST 22nd St., NEW YORK, N.Y. 10011  
Phone: 212 • 675-6610 TWX: 212 • 640-5478

# Evaluation Samples

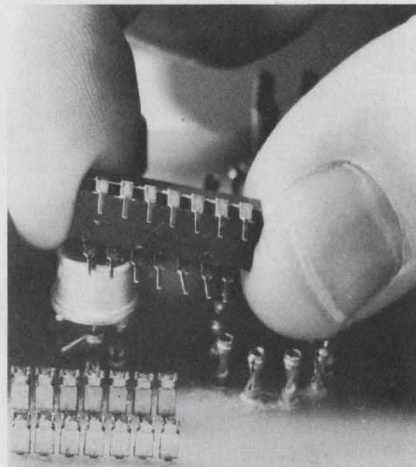

## DIP IC connectors

Providing all of the advantages of dual-in-line sockets, a new line of low-cost integrated circuit connectors features rapid installation and plug-in capability. Designated as series 1938-4 DIL, the new connectors offer good mechanical support for dual-in-line packages without an unnecessary and expensive insulator.

Conventional DIP sockets consist of an insulated and pre-insulated terminal that is fountain or wave-soldered to a PC board. Usually, the insulator is needed to give mechanical support, rather than electrical resistance or isolation.

Alternate methods entail wiring the leads of the integrated circuit directly into the PC board. This technique has obvious servicing and replacement disadvantages.

The new 1938-4 DIL connectors are actually spring-loaded tangs that provide both mechanical support and sound electrical contact. They are supplied in either loose form or chain form for use with automatic insertion machines.

Terminals are available in brass, tin-plated brass, phosphorous bronze, tin-plated phosphorous bronze, or selectively gold-plated bronze. Selective gold plating affects only the terminal contact points for additional cost savings.

Free evaluation samples of the new IC connectors are available from Molex Products Co., 5224 Katrine Ave., Downers Grove, Ill. Phone: (312) 969-4550.

CIRCLE NO. 352

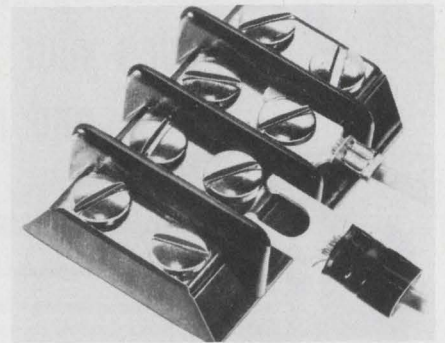

## Snap-and-stay terminals

Called Snap Spades, a new line of terminals combine the prime features of three popular types of terminals. The new series uses a spring-like action to lock onto a stud screw like a quick-disconnect type, and stays put like a ring type—all with the installation speed of a spade type. They are ideal for use with terminal blocks and in most panel board applications. Two styles can be supplied: an economical uninsulated butted seam barrel unit or a nylon insulated unit with a vibration-proof inner metal sleeve. Free evaluation samples are available. ETC Incorporated.

CIRCLE NO. 353

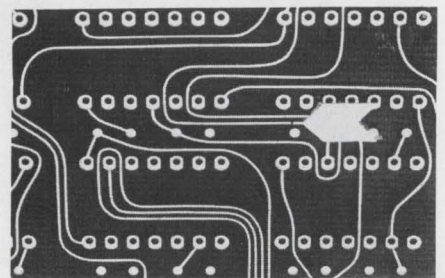

## Identification arrows

Small pressure-sensitive identification arrows, which can be affixed permanently or removed without adhesive transfer, are now available as free evaluation samples. These new markers can be used for flaggings, repair identifications, quality control inspections, flow diagrams, direction indicators, graphics, production assembly drawings and inventory control. They are available in paper and vinyl with a choice of colors. By-Buk Co.

CIRCLE NO. 354



# Design Aids

## Thermoplastics chart

Intended as an aid to designers and engineers, a wall-type properties chart conveniently lists and rates many thermoplastic materials. Physical, thermal, electrical and mechanical characteristics are shown for such thermoplastics as: Plexiglas, acetate, vinylite, styrene, Rexolite, nylon and Teflon. Comco Plastics, Inc.

CIRCLE NO. 355

## TTL IC cross reference

A handy letter-size chart is a cross-reference guide for a line (series 74N) of TTL integrated circuits and the equivalent replacements from 13 other manufacturers. Included in the cross reference are Fairchild, Motorola, Signetics, Sprague and Sylvania. National Semiconductor Corp.

CIRCLE NO. 356



## Visual-resins guide

Amplly illustrated with application photographs, a useful selector chart lists the characteristics of eleven Eccoclear casting resin systems. Because of their high optical clarity, these products are used for encapsulations and coatings wherever visual inspection of electrical/electronic assemblies or components is required. Listed properties and application data include viscosity, pot life, cure temperature, dielectric strength, and operating temperature. Emerson & Cuming, Inc.

CIRCLE NO. 357

# locally... off the shelf

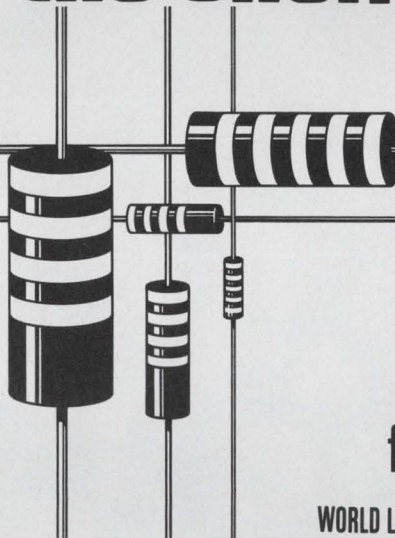

## Allen-Bradley hot-molded composition fixed resistors

WORLD LEADER IN FIXED RESISTORS

Unequalled for reliability—Allen-Bradley hot-molded resistors are *unique* in meeting the requirements of MIL-R-390008 *Established Reliability* Specifications at the highest level—the "S" level. This is true for all four ratings—RCR32 (1 watt), RCR20 ( $\frac{1}{2}$  watt), RCR07 ( $\frac{1}{4}$  watt), and RCR05 ( $\frac{1}{8}$  watt). And over the complete resistance range from 2.7 ohms (10 ohms for  $\frac{1}{8}$  watt) to 22 megohms.

The distributors listed below are the only authorized Allen-Bradley distributors, and each has added a new dimension of service—fully stocked to give you fast delivery on hot-molded fixed resistors, hot-molded and cermet variable resistors and trimmers, discoidal capacitors, and high-frequency low pass feed-thru filters.



## call now!

### PHILADELPHIA

#### ALMO ELECTRONICS CORP.

A Sterling Electronics Company  
Roosevelt Blvd. at Blue Grass Road  
Philadelphia, Pennsylvania 19114  
(215) OR 6-6000

### LOS ANGELES

#### KIERULFF ELECTRONICS INC.

A Subsidiary of Ducommun Inc.  
2585 Commerce Way  
Los Angeles, California 90022  
(213) 685-5511

### BOSTON

#### CRAMER ELECTRONICS INC.

320 Needham Street  
Newton, Massachusetts 02164  
(617) 969-7700

### CHICAGO

#### NEWARK ELECTRONICS CORPORATION

A Subsidiary of Premier Industrial Corporation  
500 North Pulaski Road  
Chicago, Illinois 60624  
(312) 638-4411

### SAN FRANCISCO

#### ELMAR ELECTRONICS INC.

A Subsidiary of Wyle Laboratories  
2288 Charleston Road  
Mountain View, California 94040  
(415) 961-3611

### NEW YORK

#### SCHWEBER ELECTRONICS

Jericho Turnpike  
Westbury, New York 11590  
(516) 334-7474

©Allen-Bradley Company 1969

EC69-88A

INFORMATION RETRIEVAL NUMBER 127



# Application Notes

## Lamp design data

Containing valuable design data, a 21-page catalog discusses the basic principles of lamp operation, primary evaluation criteria, and the environmental conditions that affect lamp life. This technical discussion of subminiature lamps goes on to point out how to select the right unit to do a specific job. Individual topics include voltage and current ratings, luminance, life and thermal effects. Chicago Miniature Lamp Works.

CIRCLE NO. 358

## Glass digital memories

A four-page application note on high-speed glass digital memories explains the interlacing techniques that enable these modules with operating rates between 2 and 20 megabits per second to function in systems with rates of less than 2 megabits per second. The folder shows how four-to-one interlacing with a 256- $\mu$ s delay line, operating at 8 megabits per second, provides storage of 2048 bits at 2 megabits per second. Corning Glass Works.

CIRCLE NO. 359

## Measuring op amp noise

"How to Characterize and Measure Noise in Operational Amplifiers" is an eight-page paper that gives the reader a unique outlook on the complex problems associated with noise measurements. It describes the various types of noise encountered and how to measure and minimize it. Also presented are noise problems in typical applications, suggested test circuits for measuring noise, and helpful brief notes that sum it all up in a nutshell. Philbrick/Nexus Research.

CIRCLE NO. 360

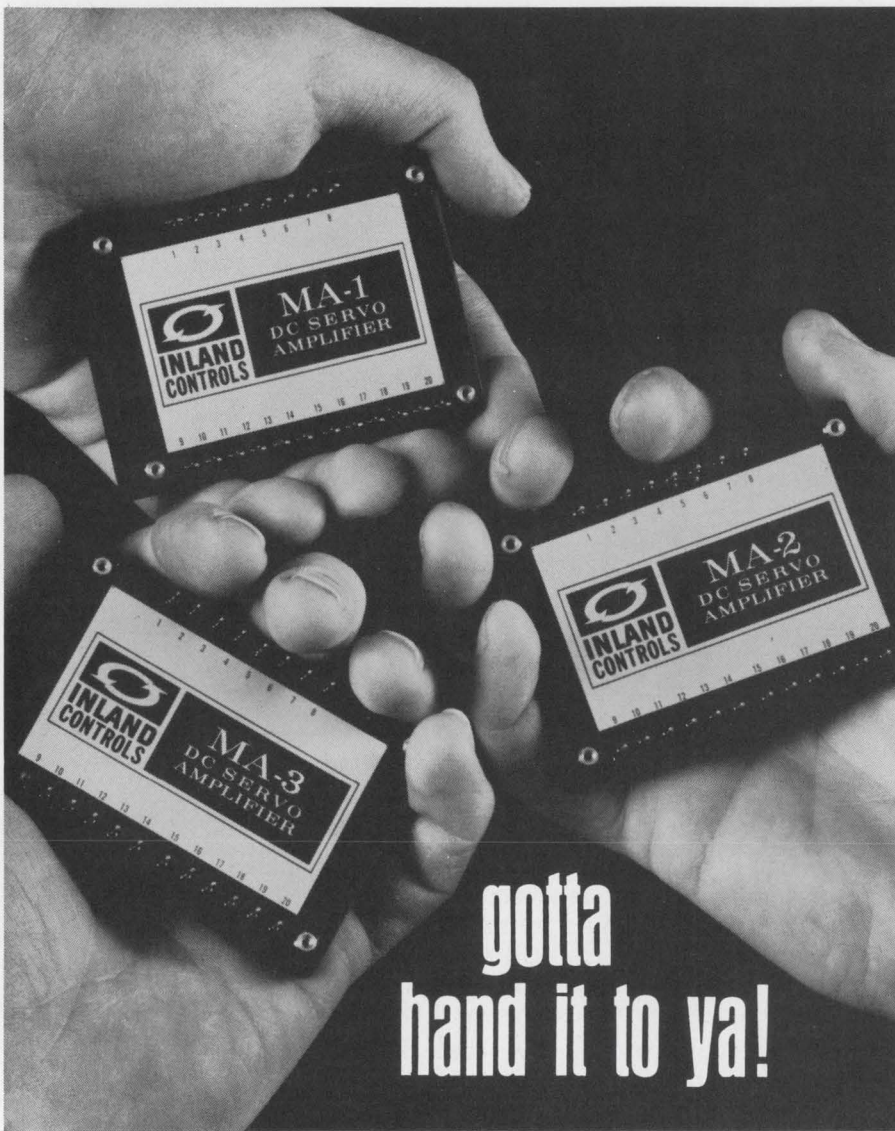

**gotta  
hand it to ya!**

But that's no compliment if you're still spending time and money to develop and build your own DC servo amplifiers. Don't duplicate Inland Controls' years of amplifier design and manufacturing experience which has produced this new MA series.

The MIL-SPEC MA amplifiers are designed to meet MIL-E-5400 including MIL-STD-704. They relieve you of design and development headaches and solve your component reliability problem, yet are priced to be below the cost of building your own. And we provide off-the-shelf delivery. The MA-1 is only 3" x 2" x 0.4" but can be configured to produce a massive 300 watts or more. The MA-1 offers unique packaging flexibility while the MA-2 and MA-3 give real packaging convenience. Flexibility or convenience — it's your decision.

The MA series amplifiers are ideally suited for driving DC torque motors. Designed with this in mind, they eliminate amplifier-motor interface

MODEL	MAX. POWER RATING	PRICE* (10 LOT)	DELIVERY
MA-1	25 Watts (See Note)	\$195..	In Stock
MA-2	200 Watts	\$275.	In Stock
MA-3	300 Watts	\$375.	In Stock

NOTE: The MA-1 output is configured to drive an external NPN bridge to an output of 300 watts or more.  
\*Quantity discounts available

problems frequently associated with "build your own" amplifiers.

If you want to draw upon our amplifier savvy, then turn the problem over to us. We'll be glad to help, with no obligation on your part.



250 ALPHA DR., PITTSBURGH, PA. 15238  
Telephone: 412 781-6011 TWX: 710-664-2082

INFORMATION RETRIEVAL NUMBER 128



No. 969VA

VIBRATION  
HANDBOOK  
for  
ROTATING  
MACHINERY

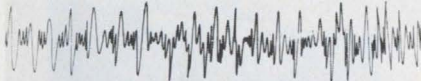

INDUSTRIAL PRODUCTS DIVISION

### Vibration handbook

Presenting material in an easy-to-understand manner, a 34-page vibration handbook for rotating machinery discusses the relationships between displacement, velocity and acceleration, as well as the correction of unbalances. Both force and couple unbalances are described. Vibration charts and tables are presented, along with many useful formulas applicable to vibration analysis. Dytronics Co., Inc.

CIRCLE NO. 361

### Light measurement

Offering a wealth of information on the measurement of optical radiation, "Techguide 70" is a 16-page folder that includes pertinent reference charts, nomographs, curves, and conversion factor tables. Also in the package are detailed articles on such topics as photometric calibration and radiometric color measurement. Each article and chart is printed on a separate sheet for easy reference and insertion in a notebook. International Light Inc.

CIRCLE NO. 362

# immediate delivery

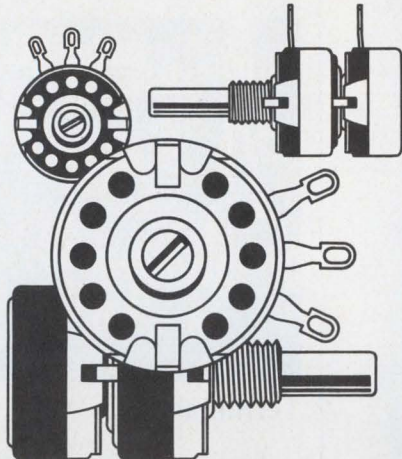

## Allen-Bradley hot-molded variable resistors

The famous Type J variable resistor has a solid hot-molded resistance element, which ensures smooth adjustment at all times—resolution is essentially infinite. Low inductance permits the Type J to be used in high-frequency circuits replacing wire-wound controls.

Type J controls are available in single and dual units. Rated 2.25 watts at 70°C in values from 50 ohms to 5.0 megohms, with a wide variety of tapers.

The distributors listed below are the only authorized Allen-Bradley distributors, and each has added a new dimension of service—fully stocked to give you fast delivery on hot-molded fixed resistors, hot-molded and cermet variable resistors and trimmers, discoidal capacitors, and high-frequency low pass feed-thru filters.



## call now!

### PHILADELPHIA

**ALMO ELECTRONICS CORP.**  
A Sterling Electronics Company  
Roosevelt Blvd. at Blue Grass Road  
Philadelphia, Pennsylvania 19114  
(215) OR 6-6000

### LOS ANGELES

**KIERULFF ELECTRONICS INC.**  
A Subsidiary of Ducommun Inc.  
2585 Commerce Way  
Los Angeles, California 90022  
(213) 685-5511

### BOSTON

**CRAMER ELECTRONICS INC.**  
320 Needham Street  
Newton, Massachusetts 02164  
(617) 969-7700

### CHICAGO

**NEWARK ELECTRONICS CORPORATION**  
A Subsidiary of Premier Industrial Corporation  
500 North Pulaski Road  
Chicago, Illinois 60624  
(312) 638-4411

### SAN FRANCISCO

**ELMAR ELECTRONICS INC.**  
A Subsidiary of Wyle Laboratories  
2288 Charleston Road  
Mountain View, California 94040  
(415) 961-3611

### NEW YORK

**SCHWEBER ELECTRONICS**  
Jericho Turnpike  
Westbury, New York 11590  
(516) 334-7474

©Allen-Bradley Company 1969

EC69-89A

INFORMATION RETRIEVAL NUMBER 129





IN LOGIC  
CIRCUIT TESTING ...

## ONLY ACRO-PROBE INSTANTLY DETECTS AN OPEN CIRCUIT

(And it sells for \$99.50)

Acro-Probe. It's the most useful logic circuit testing instrument there is. Hand-held, it has two lights right on top to give you instantaneous read-out on circuit status.

Perfect for assembly or field use, Acro-Probe has many practical features you can't get on any other probe. Like adjustable 0-state and 1-state threshold levels; open circuit detection capability; full performance with any logic circuit, even custom; response from dc to 5ns pulse; no operating controls; full protection from burn-out; and a lot more.

Acro-Probe: Better than any other computer logic circuit tester, yet it sells for \$99.50.

Write for details to **ACRON CORPORATION**, 1209 River Avenue, Lakewood, N.J. 08701. Or call (201) 364-7200.

# New Literature

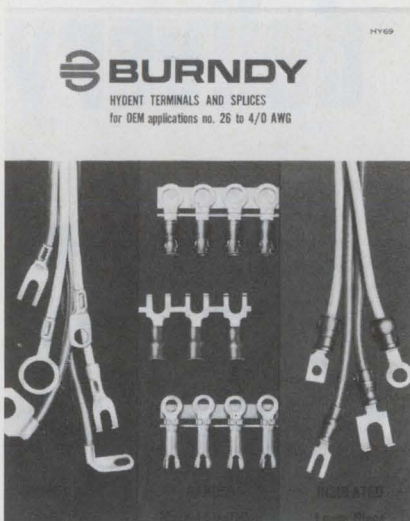

## Terminals

Meant for OEM applications, and featuring vinyl-insulated, nylon-insulated and uninsulated terminals and splices for either hand or automatic installation is a new 32-page terminal catalog. It includes wire ranges, dimensions, and recommended installation tooling with each connector series. Reference tables give military and Underwriters Laboratories performance requirements, pull-off values, temperature rise, voltage drop, and military specification equivalents. Burndy Corp.

CIRCLE NO. 363

## Magnetic shields

Anyone responsible for the protection, design, or manufacture of items requiring magnetic shielding will want this new short form catalog. It describes a full line of magnetic shielding products and materials including magnetic tape containers and carrying cases for safe handling and storage, magnetic tape storage cabinets, magnetic shielding foil in 1/2-in. tapes up to 15-in. rolls, large sheet stock, cathode-ray and photo multiplier tube shields and custom-engineered magnetic shielded enclosures for specific requirements. Rayseel Corp.

CIRCLE NO. 364



## Op amps

A complete line of operational amplifiers including FET-input models, chopper-stabilized amplifiers and electronic multipliers, are shown and described in a 16-page catalog. The catalog also describes amplifier accessories such as cabinets and power supplies. Zeltex, Inc.

CIRCLE NO. 365



## Electronic equipment

Thousands of listings of electronic equipment for electronics personnel, radio hams and high-fidelity enthusiasts are in a 416-page catalog. This complete catalog contains equipment for industrial and commercial use, radio and television stations, schools, laboratories as well as music lovers. Cameradio Co.

CIRCLE NO. 366



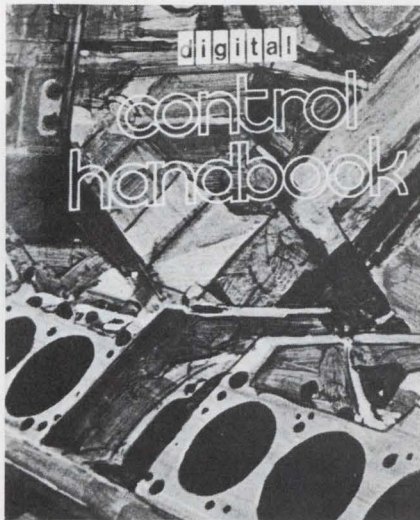

### Control logic

A new 288-page handbook contains hardware specifications, application notes and product information related to products designed for industrial and other control applications. The handbook is written for specifiers, designers, manufacturers or users of electronic or mechanical logic. It features an introduction to solid-state logic and includes chapters on industrial-control logic, a machine controller, an industrial data acquisition and control system and numerical control products. Digital Equipment Corp.

CIRCLE NO. 367

### Power semiconductors

A broad line of power transistors, both npn and pnp planar as well as npn diffused junction types and a line of triacs, in regular and economy lines are described in a two-color, 28-page short form catalog. Included in the new catalog are tables of operating characteristics, properties, ratings and performance curves along with a silicon interchangeability chart. Physical dimensions of 14 different packages are shown with engineering drawings. Pirgo Electronics Inc., a Sprague Electric Co.

CIRCLE NO. 368

# now... local stock

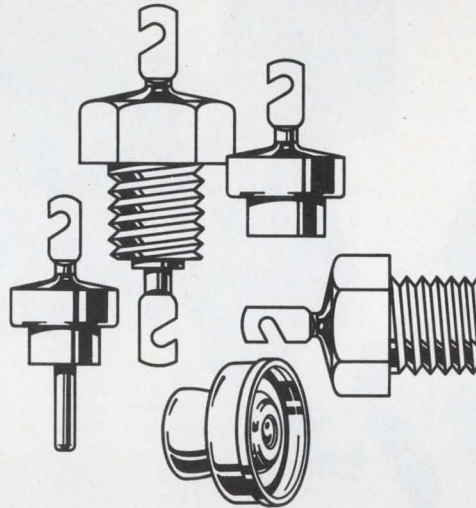

## Allen-Bradley discoidal capacitors

Discoidal design provides efficient filtering into the ultra-high frequency range—there are no parallel resonance effects up through 1000 megahertz. Insulation resistance is in excess of 100,000 megohms—assures superior direct current blocking.

Compact in size, yet rugged in construction. These capacitors resist the thermal shock of soldering and require no special handling during assembly. Available in a wide range of capacitance values.

The distributors listed below are the only authorized Allen-Bradley distributors, and each has added a new dimension of service—fully stocked to give you fast delivery on hot-molded resistors, hot-molded and cermet variable resistors and trimmers, discoidal capacitors, and high-frequency low pass feed-thru filters.



## call now!

### PHILADELPHIA

**ALMO ELECTRONICS CORP.**  
A Sterling Electronics Company  
Roosevelt Blvd. at Blue Grass Road  
Philadelphia, Pennsylvania 19114  
(215) 969-6000

### LOS ANGELES

**KIERULFF ELECTRONICS INC.**  
A Subsidiary of Ducommun Inc.  
2585 Commerce Way  
Los Angeles, California 90022  
(213) 685-5511

### BOSTON

**CRAMER ELECTRONICS INC.**  
320 Needham Street  
Newton, Massachusetts 02164  
(617) 969-7700

### CHICAGO

**NEWARK ELECTRONICS CORPORATION**  
A Subsidiary of Premier Industrial Corporation  
500 North Pulaski Road  
Chicago, Illinois 60624  
(312) 638-4411

### SAN FRANCISCO

**ELMAR ELECTRONICS INC.**  
A Subsidiary of Wyle Laboratories  
2288 Charleston Road  
Mountain View, California 94040  
(415) 961-3611

### NEW YORK

**SCHWEBER ELECTRONICS**  
Jericho Turnpike  
Westbury, New York 11590  
(516) 334-7474

©Allen-Bradley Company 1969

EC69-90A



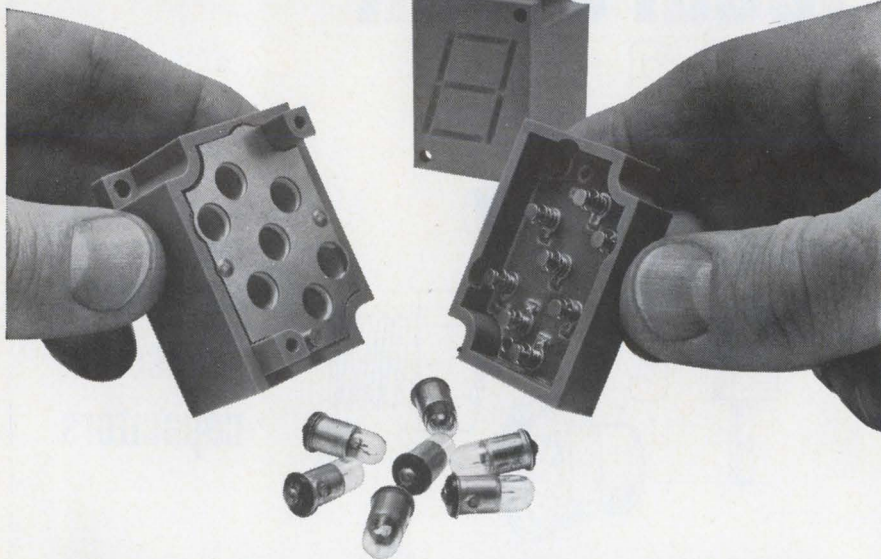

# What makes low-cost Dialight readouts so reliable and easy-to-read?

Reliable because of simple module construction and long life lamps. Designed for use with neon or incandescent lamps to meet circuit voltage requirements. Easy-to-read from any viewing angle. 1" high characters are formed by unique patented light-gathering cells, and may be read from distances of 30 feet. Sharp contrast makes for easy viewing under high ambient lighting conditions.

## Dialight Readout Features

1. Operate at low power.
2. 6V AC-DC, 10V AC-DC, 14-16V AC-DC, 24-28V AC-DC, 150-160V DC or 110-125V AC.
3. Non-glare viewing windows in a choice of colors.
4. Available with RFI-EMI suppression screen.
5. Available with universal BCD to 7 line translator driver.
6. Can be used with integrated circuit decoder devices now universally available.
7. Caption modules available; each can display 6 messages.

## Send for catalog

Catalog-folder contains complete specifying and ordering data on numeric and caption modules, translator drivers, mounting accessories. Dialight Corporation, 60 Stewart Avenue, Brooklyn, New York 11237. Phone: (212) 497-7600.



# DIALIGHT

INFORMATION RETRIEVAL NUMBER 132

DT-126

## NEW LITERATURE

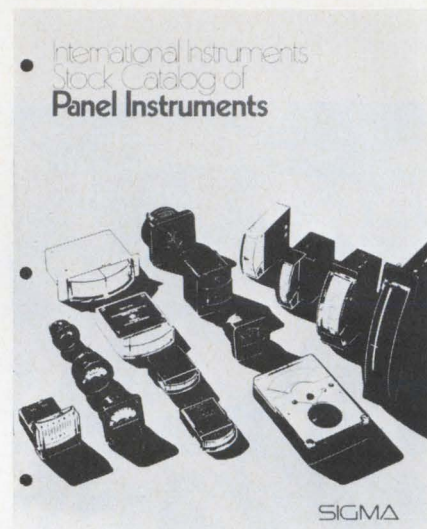

### Panel instruments

Photos, outline drawings, descriptions and prices on a wide range of round and edgewise panel instruments are contained in an eight-page brochure. Included are 40 different models for scientific, industrial, medical and commercial use. Sigma Instruments Inc.

CIRCLE NO. 369

### Instrumentation

A 16-page illustrated booklet shows recent additions to the fields of instrumentation, computation and analysis with a diversity of the latest electronic instruments, such as a 250-MHz real-time oscilloscope and a complex-measurement network analyzer. The booklet includes photographs, specifications and prices. Hewlett-Packard.

CIRCLE NO. 370

### Disposable lab wear

A complete line of specialized disposable products for industry is contained in a new illustrated catalog with descriptions and information. The new disposables include coveralls, lab coats, wrap-around smocks, caps, shoe covers and a selection of wipers, gloves and towels. All have been manufactured with attention to detail. Angelica Uniform Co.

CIRCLE NO. 371



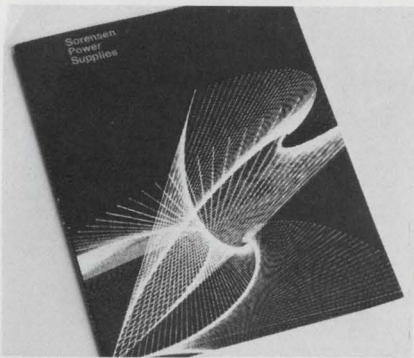

## Power supplies

Precision dc power supplies and ac voltage regulators are described in a new 124-page catalog. It gives specifications and features all standard and selected custom designs. Included are a selection guide which categorizes dc power supplies according to output (volts and amperes), regulation data, price information and a power supply handbook giving a glossary of terms, principles of operation, operating features and detailed specifications. Raytheon Co., Sorenson Operation.

CIRCLE NO. 372

## Data modems

Seven commercial and industrial data sets with speeds as high as 9600 bits/s over voice grade telephone circuits are described in a modem catalog. It includes a wide variety of speeds, modulation schemes, configurations and features for almost every application. Rixon Electronics, Inc.

CIRCLE NO. 373

## IC and discrete prices

A new 32-page OEM price list brochure details prices for hundreds of integrated circuits and discrete components. Included are DTL, TTL and MOS IC families, in plastic and ceramic dual-in-line, flatpack and special types plus a complete list of transistors. The brochure includes a table of IC device designations and a complete list of distributors. Texas Instruments.

CIRCLE NO. 374

# now... no delay

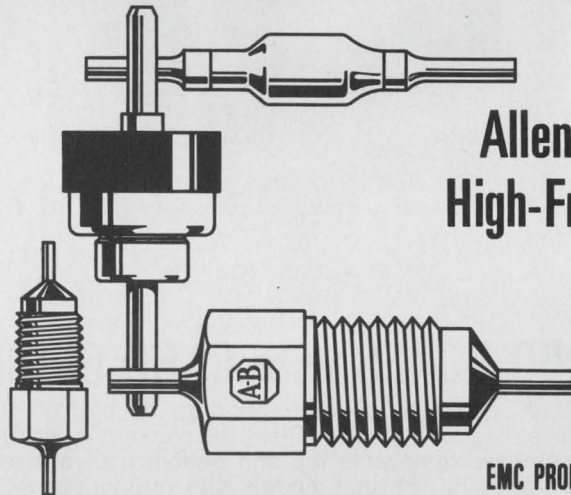

## Allen-Bradley High-Frequency Filters

EMC PRODUCT FROM A-B!

These miniature low-pass filters have been specifically designed for use in demanding EMC applications, where the necessary attenuation of undesired high frequencies cannot be obtained with conventional feed-thru capacitors. Attenuations of 75 db or more can be obtained in the frequency range of 50 MHz to 10,000 MHz.

DC working voltages of 200 and 500 volts with feed-thru currents of 10 and 25 amperes, respectively, are featured in this product line.

The distributors listed below are the only authorized Allen-Bradley distributors, and each has added a new dimension of service—fully stocked to give you fast delivery on hot-molded fixed resistors, hot-molded and cermet variable resistors and trimmers, discoidal capacitors, and high-frequency low pass feed-thru filters.



## call now!

### PHILADELPHIA

**ALMO ELECTRONICS CORP.**  
A Sterling Electronics Company  
Roosevelt Blvd. at Blue Grass Road  
Philadelphia, Pennsylvania 19114  
(215) OR 6-6000

### LOS ANGELES

**KIERULFF ELECTRONICS INC.**  
A Subsidiary of Ducommun Inc.  
2585 Commerce Way  
Los Angeles, California 90022  
(213) 685-5511

### BOSTON

**CRAMER ELECTRONICS INC.**  
320 Needham Street  
Newton, Massachusetts 02164  
(617) 969-7700

### CHICAGO

**NEWARK ELECTRONICS CORPORATION**  
A Subsidiary of Premier Industrial Corporation  
500 North Pulaski Road  
Chicago, Illinois 60624  
(312) 638-4411

### SAN FRANCISCO

**ELMAR ELECTRONICS INC.**  
A Subsidiary of Wyle Laboratories  
2288 Charleston Road  
Mountain View, California 94040  
(415) 961-3611

### NEW YORK

**SCHWEBER ELECTRONICS**  
Jericho Turnpike  
Westbury, New York 11590  
(516) 334-7474

©Allen-Bradley Company 1969

EC69-91A

INFORMATION RETRIEVAL NUMBER 133



**NEW**

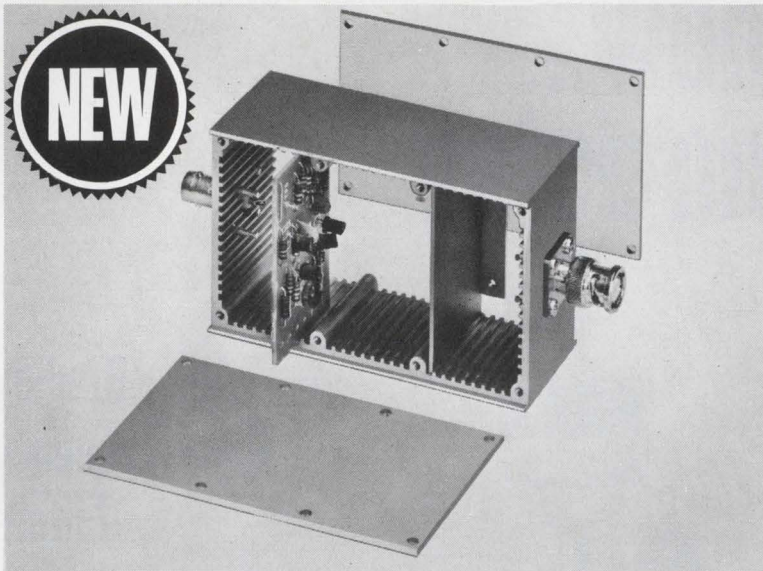

## SHIELDED BOXES with CARD GUIDES

Rugged die-cast aluminum boxes, slotted to accept  $\frac{1}{8}$ " circuit boards and shielding dividers. Excellent for packaging electronic circuitry. Boxes have removable top and bottom covers. Useable inside space: 4"x2"x1 $\frac{1}{2}$ ". Several models with various connectors.

Write for 1969 Catalog



**POMONA ELECTRONICS CO., INC.**  
1500 E. Ninth Street, Pomona, California 91766

INFORMATION RETRIEVAL NUMBER 134

NEW LITERATURE

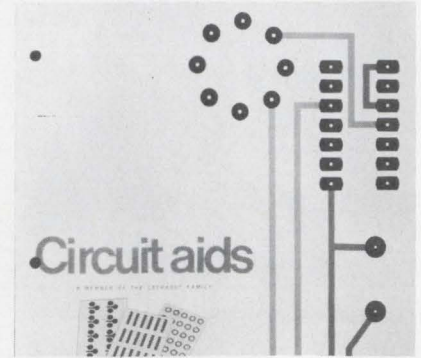

## Circuit symbols

A full line of pressure-sensitive, pre-cut electrical and electronic drafting aids for printed circuit draftsmen, engineers and artists is listed in a 28-page comprehensive catalog. These pressure-sensitive symbols are pre-printed on 1.5-mil matte acetate with a 4 by 8-in. card as the carrier. The catalog describes and specifies an entire circuit-aids line. Circuit Aids, Inc.

CIRCLE NO. 375

# DUAL-IN-LINE SOCKETS

for testing and packaging plug-in IC's

**LOW COST • HIGH PERFORMANCE • WIDE APPLICATION**

- Sockets for 14 and 16 lead packages having flat or round leads
- Large contoured entry holes for easy IC insertion
- Gentle wiping leaf contacts provide high reliability
- Available with or without mounting saddle for panel mount or printed circuit applications
- Molded diallyl phthalate body; beryllium copper, gold-plated contacts

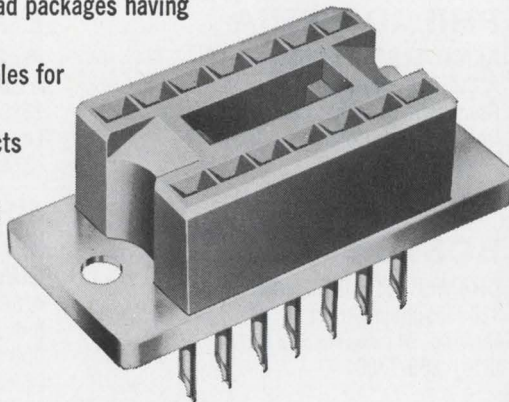

Request Complete I.C. Folder

**AUGAT**

INC. TEL: 617-222-2202  
31 PERRY AVE., ATTLEBORO, MASS. 02703

INFORMATION RETRIEVAL NUMBER 135

## Quartz crystals

A full line of coldweld and solder-seal crystal units is described in a 16-page brochure. It includes technical data for crystals providing frequencies from 850 Hz to 125 MHz. Reeves-Hoffman Division, Dynamics Corp. of America.

CIRCLE NO. 376

## Chip capacitors

An easy-to-use chip capacitor selection guide is contained in a six-page brochure. It includes a three-page foldout matrix listing the minimum and maximum capacitance values and dimensions of 36 different-size chip capacitors. They are selected by locating the maximum capacitance for the type and voltage rating, then a desirable size is selected corresponding to any of the possible maximum capacitance values. Actual-size drawings, temperature and frequency data and voltage-effect graphs are given. Varadyne, Inc.

CIRCLE NO. 377



## Magnetic tapes

Five new magnetic tapes designed to fulfill the most demanding requirements of today's technology are described in five four-page bulletins. Products include a wide-band instrumentation recording tape for wideband and predetection recording/reproducing, two oxide audio magnetic tapes for professional and extended-range professional quality recording and two oxide standard and extended-range standard telemetry tapes for standard telemetry recording. CEC/Data Instruments Div. of Bell & Howell Co.

CIRCLE NO. 387

## Microwave devices

The "Microwave Marketplace" is a new 40-page catalog that describes a complete product line of triode, tetrode, and klystron amplifiers, amplifier systems, modulators, broadband amplifiers, and signal sources from 0.3 to 18 GHz. Over 200 special designs, standard and custom, are listed. Also included is a helpful section on design considerations of interest to users of these components with thermal factors, tube parameters, modulation techniques and bypass construction. Microwave Cavity Laboratories, div. of KMS Industries, Inc.

CIRCLE NO. 388

## Connectors

A revised and expanded 36-page manual contains complete design information for back-panel connector arrays. It defines a metal plate interconnection concept and its associated terminating technique and automatic wire wrapping, and discusses in detail the voltage/ground plane and buss bar techniques of power distribution, connector grid pattern, plate size, layout dimensioning, material, and finish with a typical plate blueprint included. Elco Corp.

CIRCLE NO. 389

## Active filters

Providing the systems engineer with reference data needed for selection of proper filter characteristics is a new six page brochure on active filters. Presented are two to six poles for high-pass, low-pass, bandpass, band-reject, Butterworth, Bessel, Tchebyscheff and twin-T filters. Frequency Devices, Inc.

CIRCLE NO. 390

## Solenoids

A complete line of traditional and new tubular solenoids is described in a 44-page catalog. Included are complete specifications, pull/stroke graphs and schematic drawings of 24 basic models plus details of available variations. A special introductory section shows how to select a solenoid. Guardian Electric Manufacturing Co.

CIRCLE NO. 391

# Find a great job in the privacy of your own home.

If you're an engineer, scientist, computer professional or accountant our computer will get the jobs to you without your getting out to look for them. And our computerized file lets you choose from over 16,000 positions, developed by our 56 nationwide affiliated placement agencies. Just fill out this form at home and send it to us along with your latest resume. Naturally there's never any fee with NMR. And we only release your identity if we have your OK. Why no one even has to know you're looking.

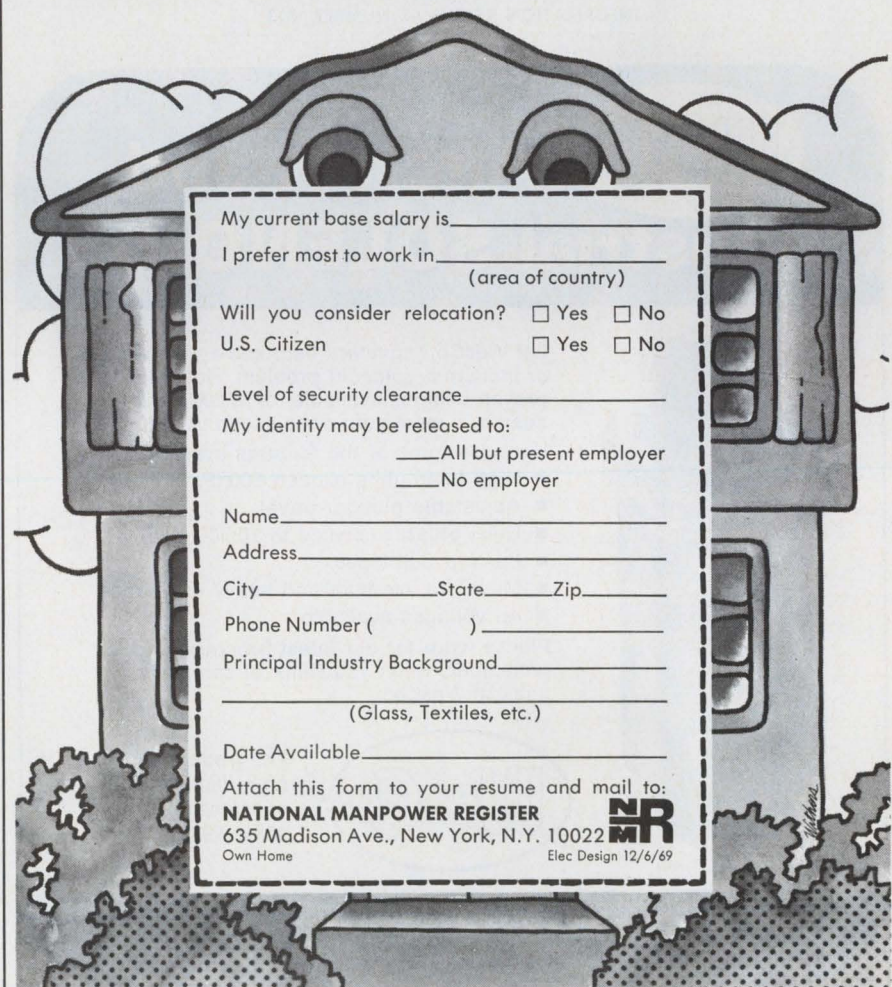

My current base salary is \_\_\_\_\_

I prefer most to work in \_\_\_\_\_  
(area of country)

Will you consider relocation?  Yes  No

U.S. Citizen  Yes  No

Level of security clearance \_\_\_\_\_

My identity may be released to:  
\_\_\_\_ All but present employer  
\_\_\_\_ No employer

Name \_\_\_\_\_

Address \_\_\_\_\_

City \_\_\_\_\_ State \_\_\_\_\_ Zip \_\_\_\_\_

Phone Number ( ) \_\_\_\_\_

Principal Industry Background \_\_\_\_\_  
(Glass, Textiles, etc.)

Date Available \_\_\_\_\_

Attach this form to your resume and mail to:  
**NATIONAL MANPOWER REGISTER**  
635 Madison Ave., New York, N.Y. 10022 **NMR**  
Own Home Elec Design 12/6/69

INFORMATION RETRIEVAL NUMBER 901



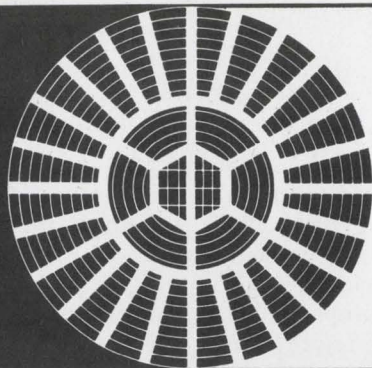

## ANTENNA ENGINEERS

Antenna design, development and test including large aperture unfurlable antennas. Background in electromagnetic theory, with experience in the design and development of sophisticated, broadband feed systems. Knowledge of computer programming and applications of computer techniques to antenna problems is desirable. For more information write to Mr. H. W. Bissell, Professional Placement Manager, P.O. Box 504, Sunnyvale, California 94088. Lockheed is an equal opportunity employer.

# LOCKHEED

MISSILES & SPACE COMPANY  
A GROUP DIVISION OF LOCKHEED AIRCRAFT CORPORATION

INFORMATION RETRIEVAL NUMBER 903

## WesCo Aircraft and Industrial SOLENOIDS

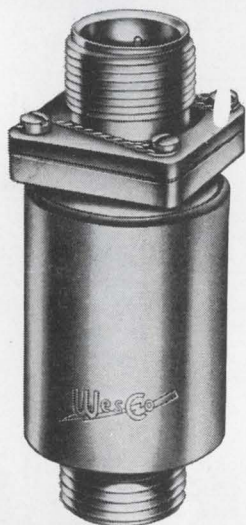

Let WesCo engineers help solve your aircraft or industrial solenoid problem. Hundreds of proven designs available, or WesCo will design to meet your specifications.

Here are some of the features available:

- High temp units exceed 500°F.
- Adjustable plunger travel
- Units pressure sealed to 10,000 p.s.i.
- Push or pull types
- Miniature, medium and heavy duty types
- All voltages available

Please write for our latest brochure and, remember, when you think of solenoids, think of WesCo!



The trademark  
on millions  
of solenoids  
since 1927

### WEST COAST ELECTRICAL MFG. CO.

233 WEST 116TH PLACE, LOS ANGELES, CALIFORNIA 90061 · PHONE (213) 755-1138

INFORMATION RETRIEVAL NUMBER 136

## NEW LITERATURE

### Solid-state relays

A complete line of solid-state variable time delay relays featuring external knob adjustments for delays of 0.1 to 10 s, 0.6 to 60 s or 1.8 to 180 s are described in a new eight-page three-hole punched catalog. Detailed relays consist of a solid-state timing network and an electromechanical relay energized by the timing network. Included in the catalog are photographs, line drawings, electrical characteristics, plug wiring diagrams and mechanical specifications. Ohmite Manufacturing Co., a North American Philips Co.

CIRCLE NO. 378

### Dc power supplies

Power supplies for systems, laboratory, test equipment and OEM applications make up a new 72-page general catalog. Included is a complete line of all-silicon dc power modules, instruments, systems and components which include military and industrial models, as well as new lines of ac line regulators and transformers. Performance specifications and complete price information on over 350 models of power supplies for rack or bench use are described. Lambda Electronics Corp.

CIRCLE NO. 379

### Business fundamentals

Written to answer such questions as "Where can business get broadly trained men who understand the fundamentals of all aspects of business?" and "Where can employees get training for executive responsibility?" is a new book called "Forging Ahead in Business." This updated and fully revised book is about how to achieve success in business, not by magical formulas, but by practical time-tested programs. Alexander Hamilton Institute Inc.

CIRCLE NO. 380



# Free Career Inquiry Service

## Absolutely Confidential

# 25

Respond to the career opportunities advertised in this issue. Fill out and send us this handy resume. **Electronic Design** will do the rest – neatly typed copies of this form will be mailed to the companies of your choice, indicated by the circled Career Inquiry Numbers at the bottom of this page.

<b>Name</b>		<b>Home Phone</b>	
<b>Home Address (Street)</b>		<b>City</b>	<b>State</b>
			<b>ZIP Code</b>
<b>Age</b>	<b>U.S. Citizen</b>	<b>Security Clearance</b>	
	<input type="checkbox"/> Yes <input type="checkbox"/> No		

Prime Experience	Secondary Experience

<b>Desired Salary</b>	<b>Availability Date</b>
-----------------------	--------------------------

**Employment History – present and previous employers**

Company	City, State	Dates	Title
		to	
		to	
		to	
		to	
		to	

**Education – indicate major if degree is not self-explanatory**

Degree	College	City, State	Dates
			to
			to
			to

**Additional Training – non-degree, industry, military, etc.**

---



---

**Professional Societies**

---

**Published Articles**

---

- Career Inquiry Numbers:**
- |     |     |     |     |     |     |     |     |     |     |     |
|-----|-----|-----|-----|-----|-----|-----|-----|-----|-----|-----|
| 900 | 901 | 902 | 903 | 904 | 905 | 906 | 907 | 908 | 909 |     |
| 910 | 911 | 912 | 913 | 914 | 915 | 916 | 917 | 918 | 919 | 925 |

**ELECTRONIC DESIGN**  
850 Third Avenue  
New York, New York 10022



# Electronic Design

ELECTRONIC DESIGN's function is:

- To aid progress in the electronics manufacturing industry by promoting good design.
- To give the electronic design engineer concepts and ideas that make his job easier and more productive.
- To provide a central source of timely electronics information.
- To promote two-way communication between manufacturer and engineer.

**Want a subscription?** ELECTRONIC DESIGN is sent free to qualified engineers and engineering managers doing design work, supervising design or setting standards in the United States and Western Europe. For a free subscription, use the postfree application form inside the back cover. If none is included, write to us direct for an application form.

If you do not qualify, you may take out a paid subscription for \$25 a year in the U.S.A., \$35 a year elsewhere. Single copies are \$1.50 each.

**If you change your address,** send us an old mailing label and your new address; there is generally a prepaid postcard for this inside the back cover. You will have to requalify to continue receiving ELECTRONIC DESIGN free.

**The accuracy policy** of ELECTRONIC DESIGN is:

- To make reasonable efforts to ensure the accuracy of editorial matter.
- To publish prompt corrections whenever inaccuracies are brought to our attention. Corrections appear at the end of the Letters column.
- To refuse any advertisement deemed to be misleading or fraudulent.

Microfilm copies are available of complete volumes of ELECTRONIC DESIGN at \$19.00 per volume, beginning with Volume 9, 1961. Work is now in process to complete the microfilm edition of Volumes 1-8. Reprints of individual articles may be obtained for \$2.00 each, prepaid (\$.50 for each additional copy of the same article) no matter how long the article. For further details and to place orders, contact the Customer Services Department, University Microfilms, 300 North Zeeb Road, Ann Arbor, Michigan 48106; telephone (313) 761-4700.

**Want to contact us?** If you have any comments or wish to submit a manuscript or article outline, address your correspondence to:

Howard Bierman, Editor,  
ELECTRONIC DESIGN,  
850 Third Avenue,  
New York, N.Y. 10022.

# Design Data from

## A SELECTION GUIDE TO MAGNETIC COMPONENTS

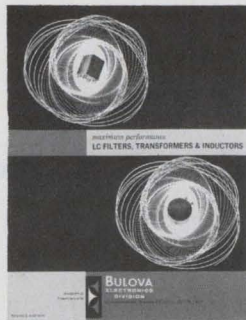

This 12 page catalog provides complete product and design data on the diversified line of Bulova Magnetic Components. Engineering information and construction layouts cover such products as Potcore Coils, Toroidal Coils, Toroidal Inductors and Transformers, Miniature Molded Inductors, and LC Filters for frequencies from DC to 50 MHz (high pass, low pass, band pass, lumped constant delay lines, IRIG filters). The graphic/tabular material is so correlated as to make rapid, unlimited design selection possible. The catalog is available FREE upon request.

**BULOVA Magnetic Components**  
Electronics Division of the Bulova Watch Company  
61-20 Woodside Avenue  
Woodside, N. Y. 11377

174

## Free: 2,500 Plastic Parts Catalog



New from Nylomatic, molders and fabricators of mechanical plastic components, a highly informative 48-page catalog of more than 2,500 standard parts. It can help you save time and money in design, test and production. Advantages of Nylomatic standard parts: no tooling charges, low unit costs, quick delivery, complete range of sizes. Nylomatic standard parts are made of Nylon, Delrin® and other thermoplastic materials. You'll find our new free catalog a real problem solver for designers, send for it today.

**Nylomatic Corporation**  
Dept. P  
Nolan Ave., Morrisville, Pa. 19067

175

## FUNDAMENTALS OF INTEGRATED CIRCUITS

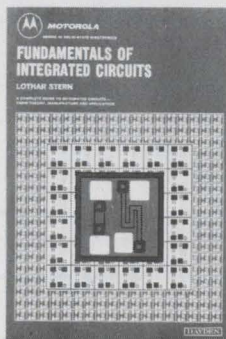

A practical guide to integrated circuits, their theory, manufacture, and applications. This new guide by Lothar Stern offers complete, highly readable coverage of the various techniques of circuit fabrication, and their effect on circuit design and performance. As to marketing considerations, it compares the characteristics of the numerous IC structures devised to date in terms of economics and logistics. A volume in the **Motorola Series in Solid-State Electronics**. 198 pages, 7 x 10, illustrated. \$8.95, clothbound. Send for 15-day examination copies.

**Hayden Book Company, Inc.**  
116 West 14th Street  
New York, N.Y. 10011

176



# Manufacturers

Advertisements of booklets, brochures, catalogs and data sheets. To order use Reader-ServiceCard.  
(Advertisement)

## Free Op-Amp Catalog/Handbook

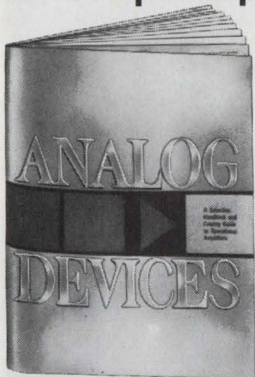

Analog Devices' 1969 edition of "A Selection Handbook and Catalog Guide to Operational Amplifiers" contains design reference data, comprehensive specifications and applications information for over 100 op-amps. Also included is detailed information on Analog function modules, instrumentation amplifiers and modular power supplies.

An "instant action" registration card is included which may be used to request up-dating material on newly developed products and application techniques.

This 36 page catalog/handbook is a must for all engineers who design with operational amplifiers.

### Analog Devices, Inc.

221 Fifth Street  
Cambridge, Mass. 02142  
(617) 492-6000

177

## NEW 16 PAGE LAMP CATALOG FROM HUDSON LAMPS



Hudson Lamp has announced the availability of a new catalog covering their line of Miniature, Subminiature and Micro-Miniature lamps. In addition to listing the most popular lamp types available, and giving pertinent technical data for each type, the catalog concerns itself with the selection of a particular lamp and terminology associated with physical and electrical characteristics. Another section of the catalog is devoted to the importance of quality control and some of the techniques that are part of the manufacturing procedures of the Hudson Lamp Co. The new Hudson Lamp Catalog is available at no charge on request by writing to

### The Hudson Lamp Company,

528 Elm Street  
Kearny, New Jersey 07032

178

## DRAFTING AIDS CATALOG

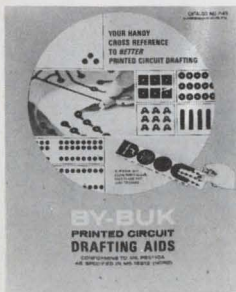

Send today for the By-Buk Printed Circuit Drafting Aids P-45 Catalog featuring the most comprehensive listings of basic pressure sensitive printed circuit drafting shapes, tapes and aids. Contains thousands of pads, tees, elbows, corners, donuts, connectors, fillets, colored tapes, multi-pads for dual in-lines, flat packs, TO cans and more. Here is your guide to better printed circuit drafting. Scores of ideas to speed master artwork preparation time and reduce drafting costs. Send for your free catalog and samples.

### By-Buk Company

4326 West Pico Blvd., Los Angeles, Calif. 90019  
Phone: (213) 937-3511

179

# Electronic Design

## Advertising Sales Staff

Keith Aldrich  
Sales Manager

### New York 10022

Robert W. Gascoigne  
Thomas P. Barth  
Samuel M. Deitch  
850 Third Avenue  
(212) Plaza 1-5530  
TWX: 867-7866

### Philadelphia 19066

William C. Repetto  
P. O. Box 206  
Merion Station, Pa.  
(215) MA-3-5888

### Boston 01945

Richard Parker  
P. O. Box 645  
Clifton Station  
Marblehead, Mass.  
(617) 742-0252

### Chicago 60611

Thomas P. Kavooras  
Berry Conner, Jr.  
200 East Ontario  
(312) 337-0588

### Cleveland

Thomas P. Kavooras  
(Chicago)  
(312) 337-0588  
(call collect)

### Los Angeles 90303

Stanley I. Ehrenclou  
W. James Bischof  
2930 Imperial Highway  
Inglewood, Calif.  
(213) 757-0183

### San Francisco 94022

Arthur R. Shields, Jr.  
175 San Antonio Rd., S 243  
Los Altos, Calif.  
(415) 941-3084

### London W. 1

For United Kingdom and Holland  
Brayton C. Nichols  
44 Conduit Street  
Tel: REGent 4714

### Verviers, Belgium

For Continental Europe  
Andre Jamar  
1, Rue Mallar, 1  
(087) 253.83 Telex 41563

### Tokyo

Haruki Hirayama  
Electronic Media Service  
Rm. 601, Daini Miyauchi Bldg.  
6-8-14, Roppongi,  
Minato-ku  
Phone: 402-4556  
Cable: Electronicmedia, Tokyo





**21.4 MHz quartz crystal monolithic filter. Miniature series.....**

**TO SAVE SPACE TOYOCOM HAS THE ANSWER**

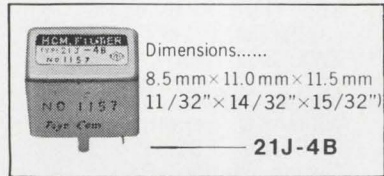

**■ 21J-4B**  
 Center Frequency.....21.4MHz  
 Bandwidth ..... 6dB:  $\pm 7.5$ KHz,  
 60dB:  $\pm 15$ KHz,  
 80dB:  $\pm 22$ KHz  
 Max. insertion loss.....4dB  
 Max. pass band variation.....2dB  
 Terminal Impedance .....1K $\Omega$ //1pF

**TOYOCOM**  
 TOYO COMMUNICATION  
 EQUIPMENT CO., LTD.  
 EXPORT DEPARTMENT:  
 TORANOMON BLDG.,  
 15, SHIBA-TORANOMON,  
 MINATO-KU, TOKYO, JAPAN.  
 CABLE: EXPORTOYOCOM TOKYO

INFORMATION RETRIEVAL NUMBER 139

## Looking for a great vacation? You don't have to look very far.

America with all its natural and man-made marvels is right in your own backyard.

You'll find everything from historical monuments, mile-high mountains, sand-duned deserts, bustling cities—and more. The natives, friendly.

America. It's a great place to visit, and aren't you glad you live here.



Space Contributed By  
 Hayden Publishing Company, Inc.

# Advertisers' Index

Advertiser	Page	Advertiser	Page
ACDC Electronics, Inc.	106	Microsonics, Inc.	126
Abbott Transistor Laboratories Incorporated	16	Midtex, Incorporated Aemco Division	123
Acron Corporation	172	Molex Products Company	131
Alfred Electronics	115	Monolithic Dielectrics, Inc.	163
Allen-Bradley Co.	23, 169, 171, 173, 175	Monsanto Company	33, Cover 111
American Lava Corporation	57	Motorola Semiconductor Products, Inc.	10, 11, 56
Analog Devices, Inc.	181	Narda Microwave Corporation, The	117
Arrow-Hart, Inc.	125	National Semiconductor Corporation	96, 97
Atlas Fibre Co.	167	Nortronics Company, Inc.	134
Augat, Inc.	176	Nylomatic Corporation	180
Battery Corporation of America	156	Oak Manufacturing Co.	155
Beckman Instruments, Inc., Electronic Instruments Division	50	Phelps Dodge Communications Company	165
Beckman Instruments, Inc., Helipot Division	98	Philco-Ford Corporation, Microelectronics Division	52, 53
Bell & Howell	119	Pomona Electronics Co., Inc.	176
Blu-Ray Incorporated	167	Power/Mate Corp.	144, 155
Bulova Electronics Division of Bulova Watch Company	180	Practical Automation, Inc.	155
Burns & Towne, Inc.	166	Precision Metal Products Co.	150
Burr-Brown Research Corporation	62	RCA Electronic Components and Devices	39, 79, 127, 143, Cover IV
Burroughs Corporation	8, 9	Radio Switch Corporation	162
By-Buk Company	181	Raytheon Company, Industrial Components Operation	78
Caddock Electronics	163	Redcor Corporation	130
Cinch Nu-Line, A Division of United-Carr	Cover II	Resistance Products Company	128
Clare & Co., C. P.	31	Rtron Corporation	154
Cohn Corp., Sigmund	46	Rogan Brothers, Inc.	146
Coors Porcelain Company	64	Schweber Electronics	17
Cornell-Dubilier Electronics	47	Servo-Tek Products Company	48
Corning Glass Works, Electronic Products Division	40, 41	Signalite, Incorporated	133
Coto Coil Company, Inc.	162	Signetics Corporation	4, 5
Dale Electronics, Inc.	167	Siliconix Incorporated	157
Damon Engineering, Inc.	27	Simpson Electric Company	152, 153
Datatron, Inc.	65	Singer Company, The, Diehl Division	149
Dialight Corporation	174	Skydyne, Inc.	142
Dow Corning Corporation	14, 15	Spectrol Electronics Corporation	135
Edmund Scientific Company	163	Spectrum Controls, Inc.	140
Electrical Industries	132	Sprague Electric Company	18, 20
Electro-Motive Mfg. Co., Inc., The	151	Stackpole Carbon Company	35
Electronic Design	58, 159, 183	Stauffer-Wacker Silicone Corporation	90, 91
Fairchild Du Mont Laboratories, Electronic Tube Division	42	Switchcraft, Inc.	54
General Automation, Inc.	139	Sylvania Electric Products, Inc.	100
General Electric Company	6, 7	Systron-Donner Corporation	2
General Radio Company	147	TRW Semiconductors, A Subsidiary of TRW, Inc.	49
Gosh Instruments, Inc.	150	Tek-Wave, Inc.	148
Gould, Inc., Brush Instruments Division	104	Tempil Division of Big Three Industrial Gas and Equipment Co.	168
Hansen Mfg. Co., Inc.	158	Toyo Communication Equipment Co., Ltd.	182
Hathaway Instruments, Inc.	160	Trans-Tech, Inc.	12, 13
Hayden Book Company, Inc.	180	Triplet Electrical Instrument Company	63
Hewlett-Packard	1, 59, 102, 129	Unitrode Corporation	29
Howard Industries, A Division of MSL Industries, Inc./Motor Group	45	Vactec Inc.	136
Hudson Lamp Company	181	Varo Inc.	122
Hughes Aircraft Company	61	Victoreen Instrument Division	83
Infodex, Incorporated	146	Waters Manufacturing, Inc.	124
Inland Controls, A Subsidiary of Kollmorgen	170	Wavetek	113
International Electronic Research Corporation	60	West Coast Electric Mfg. Co.	178
Kay Electric Company	109	White Industrial, S. S. A Division of Pennwalt Corporation	141
Lectrohm, Inc., A Subsidiary of Cook Electric	145	Winchester Electronics, Litton Industries	37
Lenz Electric Manufacturing Co.	164	Wyle Laboratories	138
Littelfuse	160	Xerox Data Systems	120
Lockheed Electronics Company	137	Career Advertising: Automatic Electric, Subsidiary of General Telephone & Electronics	183
3M Company, Film & Allied Products Division	161	Litton Guidance & Control Systems Division	183
Magnetics, Inc.	55	Lockheed Missiles & Space Company	178
Mechanical Enterprises	156	National Manpower Register	177
MicroSwitch, A Division of Honeywell	66		
Microdot, Inc.	111		



**BEGINNING  
WITH THIS ISSUE**

# **Electronic Design**

**WILL HAVE A**

## **PRODUCT SOURCE DIRECTORY**

**IN EVERY ISSUE.  
LOOK FOR THESE:**

---

DECEMBER 5, 1969  
**Sweep Generators**

---

DECEMBER 19, 1969  
**Field Strength Meters**

---

JANUARY 4, 1970  
**Pulse Generators**

---

JANUARY 18, 1970  
**Signal Generators**

---

FEBRUARY 1, 1970  
**Slotted Lines**

---

FEBRUARY 15, 1970  
**Power Supplies:  
High Current, Lab Type,  
High Voltage, Constant Current,  
Modular AC-DC, Power Supplies**

---

MARCH 1, 1970  
**Frequency Meters, Coat & WG**

---

MARCH 15, 1970  
**Noise Generators**

---

APRIL 1, 1970  
**Multitesters**

---

APRIL 12, 1970  
**AC Power Supplies, Special  
Purpose Power Supplies**

---

APRIL 26, 1970  
**Oscillators**

---

MAY 10, 1970  
**Squarewave & Function  
Generators**

---

MAY 24, 1970  
**Frequency Synthesizers**

---



## **CIRCUIT DESIGN ENGINEERS**

A leader in inertial navigation systems, such as the F14 and S3A programs, announces openings for circuit design specialists. BSEE's with 5-10 years experience in either platform electronic and control systems, power conversion or signal processing.

Please write J. D. Anderson  
5500 Canoga Avenue,  
Woodland Hills, California 91364



**GUIDANCE & CONTROL  
SYSTEMS DIVISION  
LITTON INDUSTRIES**

An equal opportunity employer M/F

INFORMATION RETRIEVAL NUMBER 906

## **MANUFACTURING ENGINEERING**

**Test Equipment Design  
Production Troubleshooting**

Automatic Electric, a leading innovator of computerized electronic switching systems and the largest producer of communications equipment for the independent telephone industry, has numerous entry level and experienced positions available for **MANUFACTURING ENGINEERS**.

We are seeking new and experienced degreed electronic or electrical engineers (or equivalent work experience) to initially learn new computerized electronic telephone switching systems, design test equipment and associated test procedures and trouble-shoot the mass-production of this equipment.

If you are interested in a progressive, growing company that offers well-equipped, modern facilities, a policy of promotion from within, and a pleasant Suburban location (17 miles West of downtown Chicago), send your resume in confidence to:

**Larry Wisniewski**

Professional Employment Representative

## **AUTOMATIC ELECTRIC**

Subsidiary of General Telephone & Electronics  
400 North Wolf Rd., Northlake, Illinois 60164  
An equal opportunity employer

INFORMATION RETRIEVAL NUMBER 907







# Small wonder:



**Our new "4th generation"  
12.5 MHz universal counter/timer**  
**Wonderful versatility.**  
**Wonderful small package.**  
**Wonderful small price.**

With the new Model 100A you can measure average frequency, frequency ratio, single period or time interval, or count total events. It has a crystal-controlled clock, Monsanto integrated circuit construction, and built-in compatibility with a rapidly growing assemblage of accessory modules.

With its \$575 price tag, FOB West Caldwell, New Jersey, you can have big-league counter/timer performance at costs never before possible. Small wonder we are selling and delivering Model 100A's just as fast as we can build them. Accessory modules are also comparably modestly priced.

For a demonstration of our "Small Wonder," the Model 100A universal counter/timer, or for full technical details call your local Monsanto Field Engineer, or contact us directly at: Monsanto Company, Electronic Instruments, West Caldwell, New Jersey 07006, (201) 228-3800.

## Monsanto



# COS/MOS makes other low-powered IC logic circuits look power-hungry

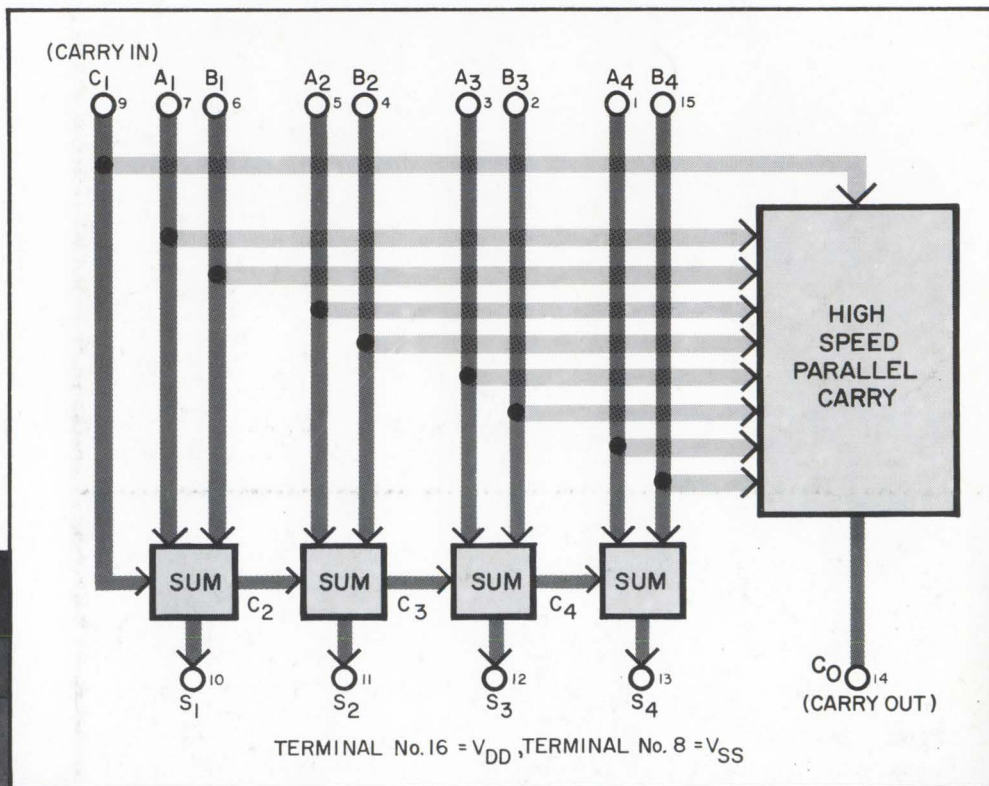

RCA's New CD4008D MSI 4-Bit Full Adder with Fast Parallel Carry Out, \$16.00 (1000+ units)

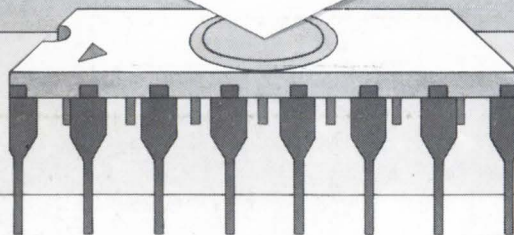

The CD4008D has a quiescent power dissipation rating of only 5  $\mu$ W (typ). It is a made-to-order 4-bit full adder for digital equipment where power dissipation, low package count or high noise immunity are primary design prerequisites.

You don't have to wait for summing before the carry signal is available with the CD4008D. The new adder includes a high speed parallel carry circuit that provides a fast carry output signal [ $t_{pd}(C_i-C_o)$ ]=50 ns (typ) at  $C_i=15$  pF] to permit high speed operation in arithmetic sections that may require several CD4008D's. Add to that: operation from a single power supply

(6 to 15 V); all "sum lines" propagation delay—400 ns (typ); noise immunity=4.5 V (typ) at  $V_{DD}=10$  V; fanout capability up to 50; protected inputs and outputs and operation over the full military temperature range. Here you have a 4-bit full adder that will fulfill many circuit applications.

For further details, see your local RCA Representative or your local RCA Distributor. Or write to RCA Electronic Components, Commercial Engineering, Section G12-1, CD20, Harrison, N. J. 07029. In Europe: RCA International Marketing S.A., 2-4 rue du Lièvre, 1227 Geneva, Switzerland.

THINK ABOUT IT.

**RCA** Integrated Circuits