

Electronic Design 13

FOR ENGINEERS AND ENGINEERING MANAGERS

VOL. 19 NO.

JUNE 24, 1971

REGISTERED
JUN 22 1971
CALMA CO.

Cut the costs of Doppler radars, intrusion alarms and other motion detecting and measuring systems by building a simple, solid-state microwave oscillator. This design

uses an Impatt diode mounted in a die-cast aluminum resonator. For the full details on both the microwave and the low-frequency circuitry, see the article on p. 48.



Circuit-Makers.

New DIP Tools from Dale.

DIP TRIMMERS

2600/8600 "Fastpacks". Wirewound model (2600) rated at 1 watt (40°C) over 10-50K ohm range $\pm 10\%$. T.C. 50 ppm/°C. Film model (8600) rated .75 watt (25°C) over 10 Ω -2 Meg. range $\pm 10\%$, $\pm 20\%$. T.C. 150 ppm/°C. Sealed cases, .75" long, machine or hand insertable.

85/87 "Fastpacks". Single or multi-turn models rated at .5 watt (25°C) over 10 Ω to 1 Meg. range $\pm 20\%$. T.C. 150 ppm/°C. Sealed cases, .265" wide x .28" long. Machine or hand insertable.

DIP RESISTOR NETWORKS

TKR. Molded or coated networks with 14 (T.O. 116) 16, 18 pins. 1/8 watt max. per resistor, 3/4 watt max. at 125°C per package. 10 Ω to 1 Meg., $\pm 2.5\%$, 200 ppm/°C. Available with DIP or P.C. pins on .3" x .1" or .6" x .1" grid (coated only).

WDP/FDP. Film (FDP) networks in 14 and 16 pin packages. Up to 15 elements, .05 watt max. with .5 watt max. per package; 10 Ω to 1 Meg. per resistor, $\pm 1\%$, 10-200 ppm/°C. Wirewound (WDP) networks have up to 7 elements per 14-pin package, .5 watt per element, 3.5 watts max. per package. 1 to 800 Ω per resistor, .1%-5%, ± 20 , ± 50 ppm/°C.

DIP PULSE TRANSFORMERS

PT-14/PT-16 with 3 (14-pin) or 4 (16-pin) pulse transformers per package. Inductance 1 μ h to 2.0 mh over -55 to +125°C. range. Temperature stability $\pm 10\%$, tolerance $\pm 20\%$. Sealed cases with pins on .3" x .1" grid. Machine or hand insertable.

In addition to these standard DIP packages, we're ready to quote on custom RC networks and hybrids with active and passive devices to your specification. Fast turnaround on prototypes. Write for new DIP Brochure or phone our Application Engineering Department, 402-564-3131 today!

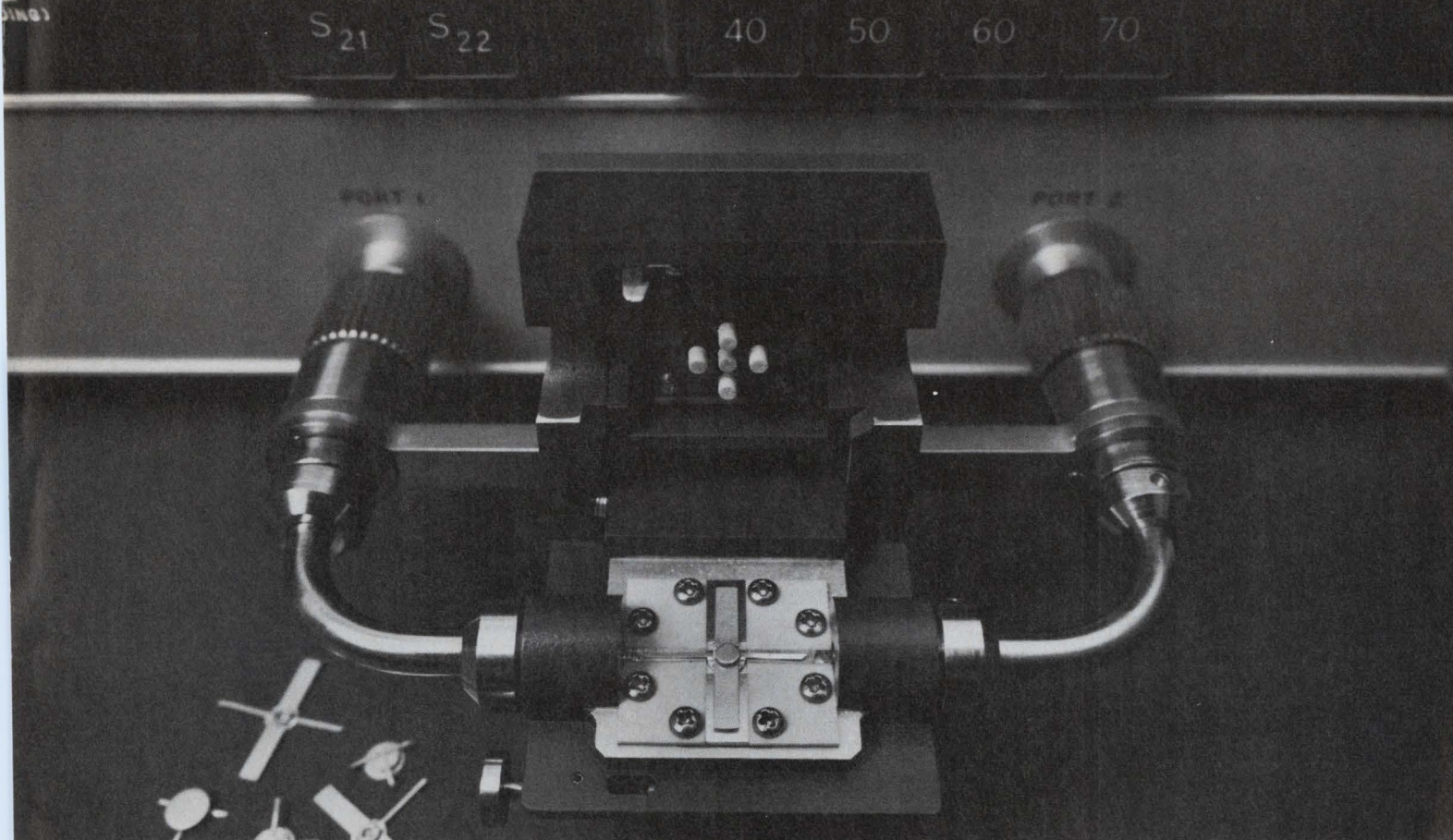

Who would have thought that measuring stripline devices could be this easy?

Now you can carry out repeatable tests on stripline microwave devices—even transistors! Just drop them in, close the lid, push the button and get accurate, swept-frequency characterization from 0.5 to 12.4 GHz.

This capability is achieved by the 8410S Network Analyzer system and its new S-Parameter Test Set and stripline test fixture. And, of course, the 8410S is a complete measurement system for all network parameters, including phase, gain, attenuation, impedance, return loss and reflection coefficient.

Sound like a simple solution for tough microwave measurements? Let us show you how easy it really is. Call for a demo. Or ask us for two Application Notes (AN 117 Series). These describe HP's 8410S Network Analyzers with comprehensive

information on how to use them for all your microwave measurement needs—including stripline. Hewlett-Packard, Palo Alto, California 94304; Europe: 1217 Meyrin-Geneva, Switzerland.



HEWLETT  PACKARD

NETWORK ANALYZERS

Siemens

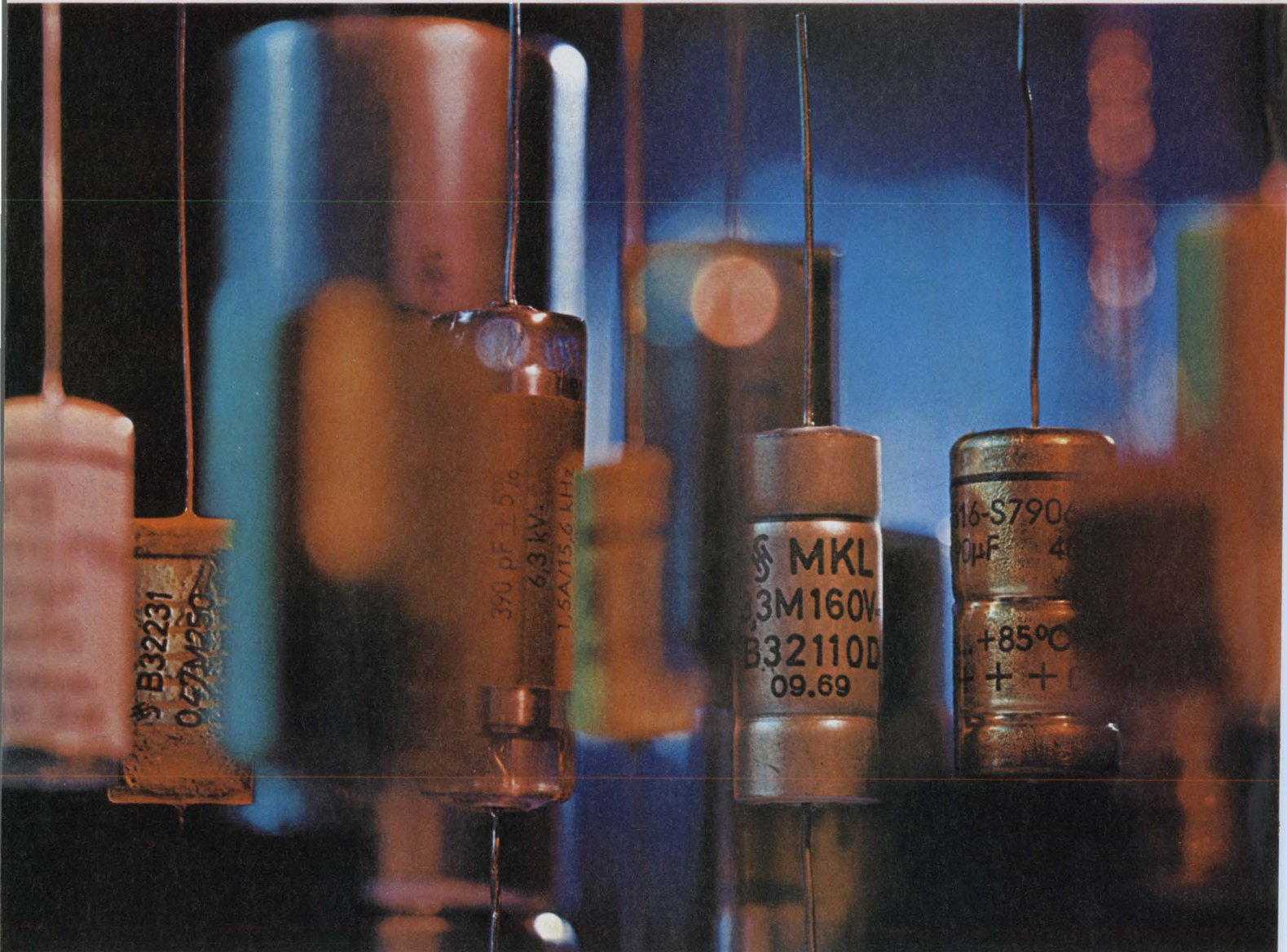

Our MKL metallized lacquer capacitors handle peak voltages four times their rated voltages.

And that means you can use a much smaller capacitor for any given application. This is just one of many Siemens innovations. Our double anodized foil aluminum electrolytics are 30% smaller than competitive units. And our unique MKM metallized polycarbonate construction makes possible a

dramatic reduction in the size of film capacitors.

Our capacitor line is one of the most extensive available. Film and metallized film dielectrics of paper, lacquer, polyester, polycarbonate, polypropylene and polystyrene. Tantalum and aluminum electrolytics. All for immediate delivery.

More and more engineers are designing in Siemens capacitors. You can benefit by doing the same.

Siemens Corporation, 186 Wood Avenue South, Iselin, N.J., 08830. (201) 494-1000. Siemens. A three billion dollar name in quality products.  **SIEMENS**

Reliability is staggered steps and a hunk of DAP.

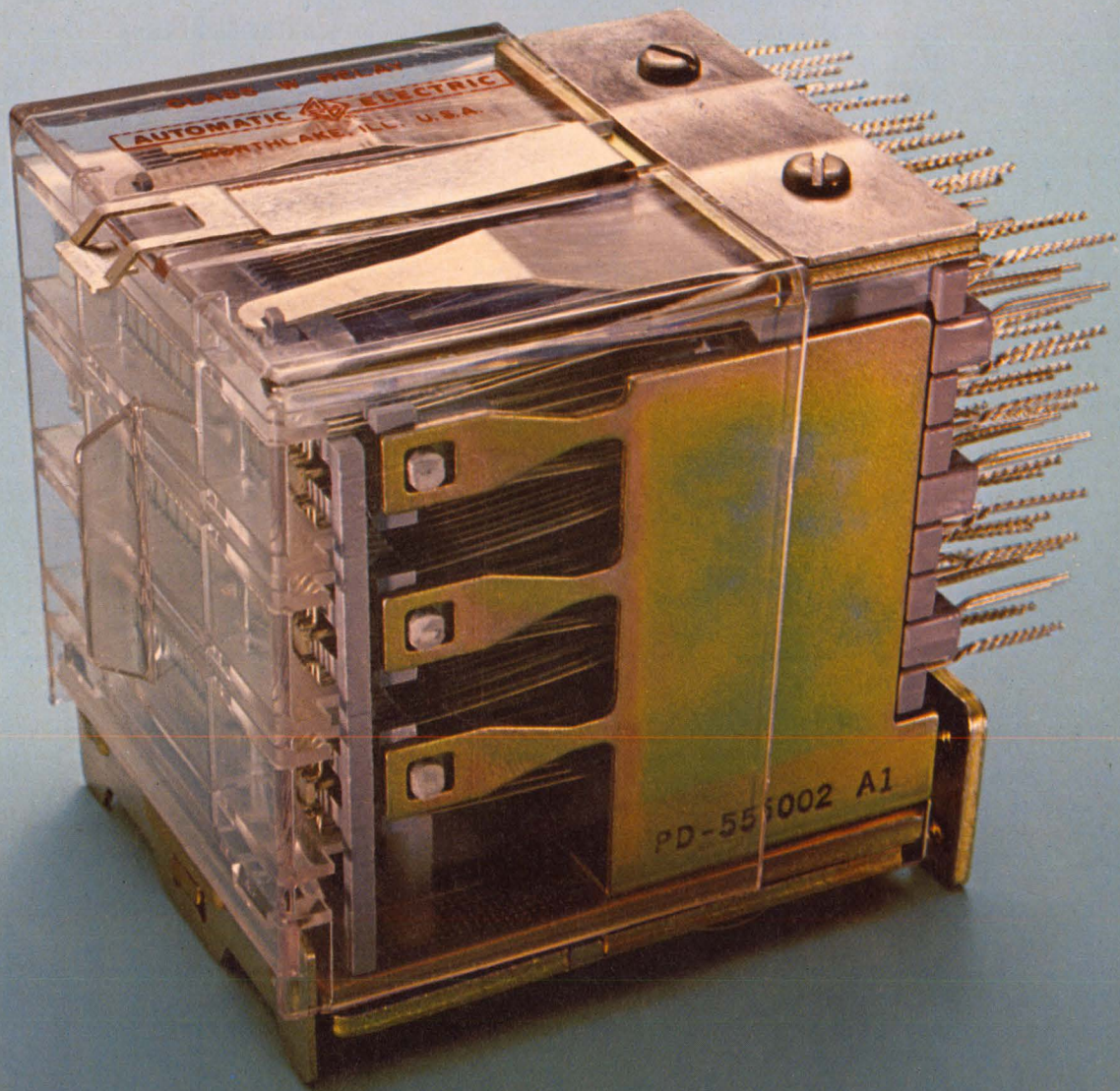

Expect over a billion operations.

Our Class W wire-spring relay is different. In fact, there's nothing like it in the entire industry. Where else can you find a relay with lots of contacts and a mechanical life of more than a billion operations! That's about two and a half times the life of the best conventional relay around.

Another nice thing about our Class W is that it takes up a lot less space and costs less than using a bunch of other relays. That's because we build our Class W relay with one, two or three levels of contact assemblies, with 17 form C combinations per level. By the way, they're available with gold contacts for low-level switching.

Making it tough on creepage.

All those staggered steps you see on the side were put in to raise the breakdown voltage between terminals. These molded steps add extra creepage distance between the terminals. This really counts for high voltage testing, or when using our Class W in unfavorable ambient conditions.

These steps, and all the molding compound used for insulating the contact springs, are made from

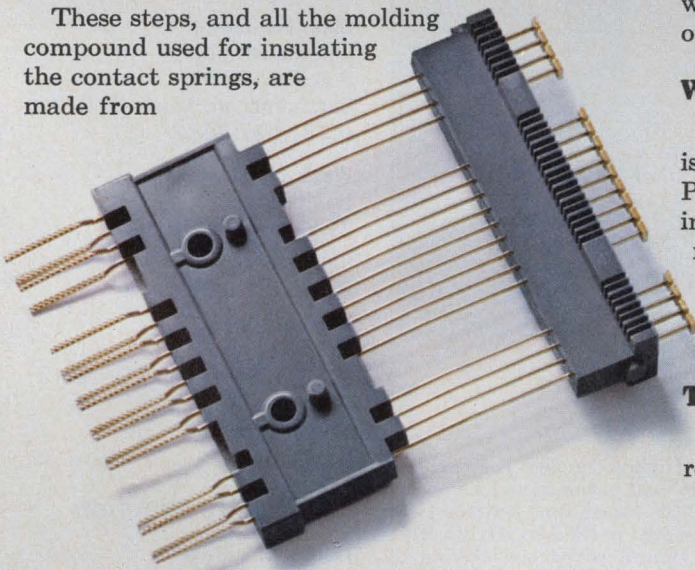

diallyl phthalate. (They call it DAP for short.) It has great insulating properties and it wears like iron. Even if the humidity is high, you have excellent protection.

Redundancy—two springs are better than one.

Each of our long wire-spring contacts has an independent twin with the same function. One tiny particle of dust could prevent contact on other relays. Not with our Class W. You can be sure one of the twins will function. That's back-up reliability.

The twin contacts are twisted together at the terminal end. Then we give them a spanking (you might call it swedging) to provide solderless wrap.

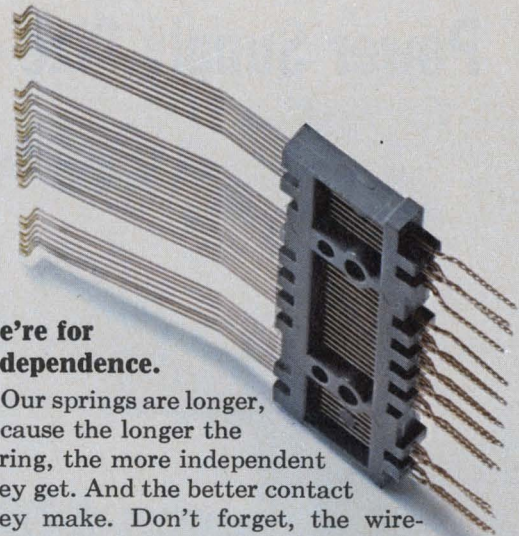

We're for independence.

Our springs are longer, because the longer the spring, the more independent they get. And the better contact they make. Don't forget, the wire-spring relay is the most reliable way to get a permissive make or break contact. You can rely on it.

The middle contact springs have to be stationary. To make sure they stay that way forever, we actually mold them between two thick pieces of DAP on both ends. Just try to move one.

When we say flat, it's flat.

Each frame, banged out by a gigantic machine is extra thick and extra flat. Then they're planished. Planishing is another step we go through in forming the frame to add strength and stability by relieving surface strain.

We've made our spring-loaded pile-up clamp extra thick, too. Once it's tightened down, the whole pile-up is nice and tight, and stays tight.

There's more.

We could tell you a lot more about our Class W relays. Like how the tough high-temp molded

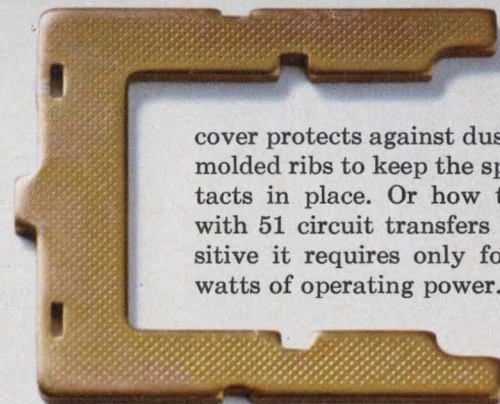

cover protects against dust and has molded ribs to keep the spring contacts in place. Or how this relay with 51 circuit transfers is so sensitive it requires only four to six watts of operating power.

But why don't you let us prove how much reliability we put into our Class W? We'll be waiting to hear from you. GTE Automatic Electric, Industrial Sales Division, Northlake, Ill. 60164.

GTE AUTOMATIC ELECTRIC

A Smart Way to Beat Your Power Supply Size Problem

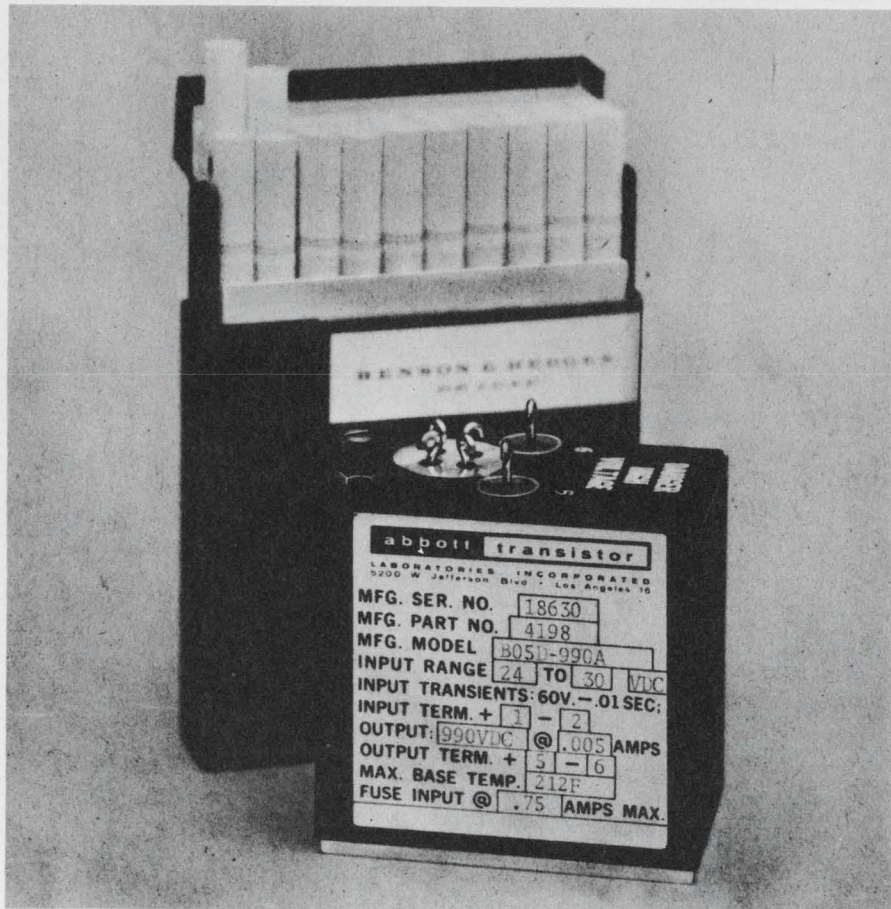

1½" thin, 2¾" narrow, 2¾" short

yet this converter produces 1000 volts DC, regulated, from a battery input of 28 VDC! It weighs less than 15 ounces. This is only one of our wide variety of many small light weight converters, inverters and power supplies — there are over 3000 models listed in our newest catalog, including size, weight and prices. If you have a size problem, why not send for an Abbott catalog?

MIL SPEC ENVIRONMENT — All of the power modules listed in our new catalog have been designed to meet the severe environmental conditions required by modern aerospace systems, including MIL-E-5272C and MIL-E-5400K. They are hermetically sealed and encapsulated in heavy steel containers. New all silicon units will operate at 100°C.

Please see pages 930 to 949 of your 1970-71 EEM (ELECTRONIC ENGINEERS MASTER Catalog) for complete information on Abbott modules.

Send for our new 68 page FREE catalog.

RELIABLE — Highest quality components are used in Abbott power modules to yield the high MTBF (mean time between failure) as calculated in the MIL-HDBK-217 handbook. Typical power modules have over 100,000 hours MTBF — proving that the quality was built in from the beginning.

WIDE RANGE OF OUTPUTS — Any voltage from 5 volts DC to 3,650 VDC is available by selecting the correct model you need from our catalog with any of a variety of inputs including:

- 60 Ω to DC, Regulated
- 400 Ω to DC, Regulated
- 28 VDC to DC, Regulated
- 28 VDC to 400 Ω , 1 ϕ or 3 ϕ
- 24 VDC to 60 Ω , 1 ϕ

abbott transistor

LABORATORIES, INCORPORATED

5200 W. Jefferson Blvd./Los Angeles 90016
(213) 936-8185

1224 Anderson Ave./Fort Lee, N.J. 07024
Cable ABTLABS (201) 224-6900

INFORMATION RETRIEVAL NUMBER 5

Publisher

Peter Coley

Editors

New York Office
850 Third Ave.
New York, N.Y. 10022
(212) 751-5530
TWX: 710-581-2874
Cable: Haydenpub

Editor: Frank Egan
Managing Editor: Ralph Dobriner
Managing Editor: Raymond D. Speer
Microelectronics, Steven A. Erenburg
Computers, Raymond D. Speer
Microwaves, Michael J. Riezenman
Circuits, Edward A. Torrero
Special Projects, George Rostky
Management, Richard L. Turmail
Military-Aerospace, John F. Mason
News, Michael P. London
New Products, Roger Allan

Field Offices

Massachusetts

Jim McDermott
P.O. Box 272
Easthampton, Mass. 01027
(413) 527-3632

West Coast

David Kaye
2930 Imperial Highway
Inglewood, Calif. 90303
(213) 757-0183

Washington

Don Byrne
1111 S. Army Navy Drive
Arlington, Va. 22202
(202) 296-8982

Editorial Production

Dollie S. Viebig

Art

Art Director, William Kelly
Rita Jendrzewski
Richard Luce

Production

Manager, Thomas V. Sedita
Helen De Polo
Kathleen McConkey

Circulation

Manager, Nancy L. Merritt

Information Retrieval

Peggy Long

letters

IBM clarifies its role in microscope system

While we appreciate your recognition of our experimental computer-electron microscope hookup ("Computer Aids Electron Microscope," ED 9, April 29, 1971), to say we "produced the system" could be misleading.

IBMers at the Poughkeepsie Materials Technology Laboratory have experimented with interface equipment to successfully link computer and microscope on a real-time basis. The system consists of an IBM System/360 Model 44, an AMR-900 Scanning Electron Microscope, equipped with dispersive and nondispersive X-ray analyzers, and interface equipment to link the two.

Dr. S. L. Levine

Analysis Manager
International Business Machines Corp.
Poughkeepsie, N. Y. 12602

A rave for mini series, with a bit of advice

I would like to commend ELECTRONIC DESIGN for the excellent series "The Minicomputer and the Engineer." Inadvertently, however, the series may have misled your readers on two counts:

1. Relative cost of hardware vs programming cost. On large-scale equipment the current rule of thumb is 50% hardware, 50% programming. With the substantial cost advantages of minicomputers, this ratio appears to be about 20% hardware, 80% programming.

2. Cost advantage of good software in installations running programs in both production and development modes. While you are correct in stating that the manufacturers provide minicomputer operating systems that run from

fair to "not currently available," a multi-task operating system with complete data management facilities can reduce program development costs by 40% and more. (Our operating system for Data General's Nova series has helped us cut costs by over 50%.)

One final point: If engineers ignore the diminutive prefix "mini" and look objectively at performance characteristics, they will discover that this class of equipment compares favorably with equipment as large as an IBM 360 Model 40, with the sole exception of core storage size (and sometimes even there).

Edwin H. Postel

Vice President, Marketing
Capidyne Systems Corp.
71 Rogers St.
Cambridge, Mass. 02142

A word from the doctor on electronic toxicity

Of the complimentary publications which I receive, yours is one of the few which I consistently read with interest and pleasure.

However, I hope that you will help me correct a recent error. In your issue of March 15, 1971 ("Medical Electronics Stirring, and IC Prognosis Is Excellent," ED 6), page 26, you quote me as saying that materials used in solid-state technology, such as copper, nickel and magnesium, could be cancer-producing. The proper term should have been toxic, rather than cancer-producing. Most agents associated with the production of cancer are more complex (though I suppose this is possible). And more importantly, toxicity is easier for the engineer to deal with than carcinogenicity.

Allen K. Ream, M.D.

National Heart and Lung Institute
Bethesda, Md. 20014

Electronic Design welcomes the opinions of its readers on the issues raised in the magazine's editorial columns. Address letters to Managing Editor, Electronic Design, 850 Third Ave., New York, N.Y. 10022. Try to keep letters under 200 words. Letters must be signed. Names will be withheld on request.

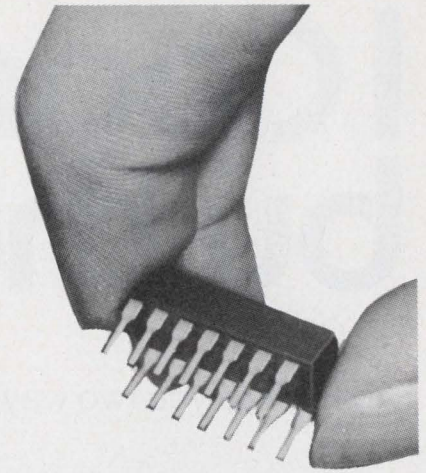

can one LATCHING RELAY offer all this?

- High Reliability
(100×10^6 operations)
- Inherent Contact Memory
- Bounce-Free Operation
- Self-Healing Contacts
- Operation in Any Mounting Position
- Miniature Size
- No Latching Current
- Virtually No Noise
- Shock and Vibration Resistance
- For Signals from DC to 120 MHz

Yes... if it's a LOGCELL® Mercury Film Relay

Both latching and nonlatching Logcell Relays are available. For more information about Logcell Relays, and Logcell Switches, too, write Fifth Dimension Inc., Box 483, Princeton, New Jersey 08540. Or call (609) 924-5990.

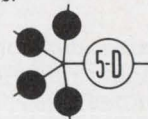

FIFTH DIMENSION INC.

IC panels: by the piece... or

AMP gives you two ways to go for building the IC panels you want, economically.

Make them yourself.

We'll supply all the mounting components you need.
Miniature spring sockets, IC receptacles,
DIP headers and strip receptacles.
And high-speed machines to apply them in your plant.

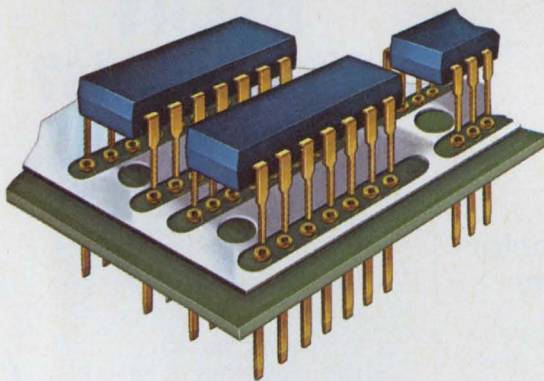

Miniature spring socket • inner spring exerts constant pressure on lead end for maximum retention and conductivity • wide bell-mouth for easy entry • low profile • flare lip for stop • accepts DIP leads and round leads .010" to .040" diameter • available with wrap-type or TERMI-POINT* clip-type posts, also solder version.

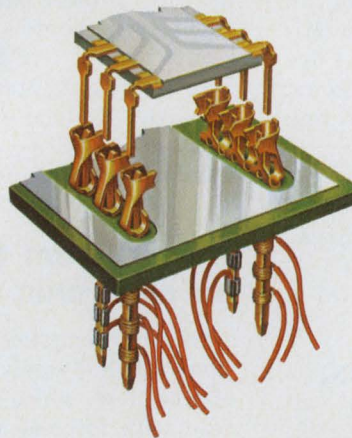

IC receptacles • accepts .022" round leads and .022" x .040" rectangular leads • has wide contact lead-in—unique anti-overstress feature assures good contact • available with wrap-type or TERMI-POINT clip-type posts • solder version available.

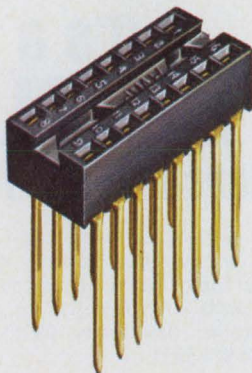

DIP headers • ideal for low-cost, high density packaging • built-in overstress design • bell-mouthed entry for easy insertion of IC's • 14 and 16 leads • available with wrap-type or TERMI-POINT clip-type posts • solder version available.

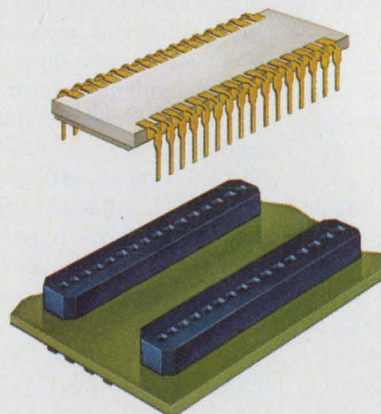

Low profile DIP header and DIP strip receptacles • only .150" high • housings are self-containing for solder operation • header accepts standard 14 and 16 pin DIP's • strip receptacle available in 4 position through 22 position DIP patterns.

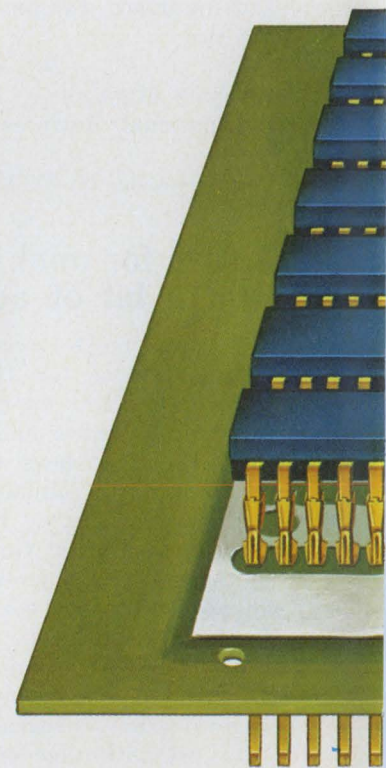

*Trademark of AMP Incorporated.

by the boardful.

Have us make them for you.

Finished IC panels made to your specifications and ready for you to insert IC packages.

Fact is, we can take your IC panels to the final step and supply them pre-wired with wrap-type point-to-point wiring, or our own TERMI-POINT clips.

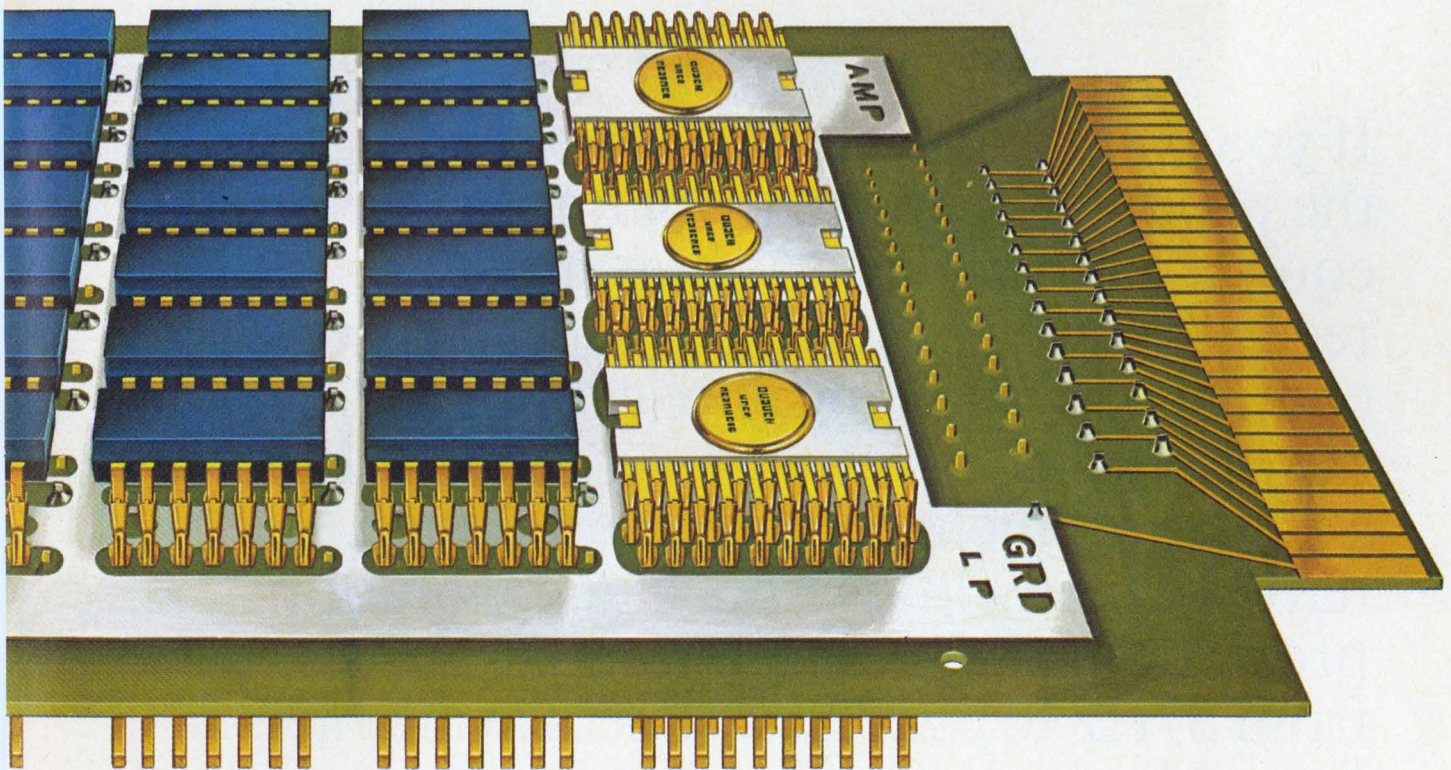

Either way you get all the reliability you need plus the benefits of AMPECONOMATION . . . high-speed AMP automated application machinery that gives you the greatest number of reliable connections at the lowest installed cost.

For details that can help you make a choice write:
AMP Incorporated, Harrisburg, Pa. 17105

AMP
INCORPORATED

Manufacturing and Direct Sales Facilities in: Australia, Canada, France, Great Britain, Holland, Italy, Japan, Mexico, Puerto Rico, Spain, Sweden, United States and West Germany.

INFORMATION RETRIEVAL NUMBER 7

A better source for reliable reeds.

If you want the best source for reeds, go to the people who make them for their own equipment. Us. The "Vibrasponder" reeds that we use for thousands of remote control and signaling applications are now for sale.

Features include contactless design, narrow bandwidths, shock and vibration protection, and over 120 standard tones from 67Hz to 3225.8Hz. Specs available from Motorola Component Products Dept., 4545 W. Augusta Blvd., Chicago, Ill. 60651.



MOTOROLA



Belden the Special "Specials" specialist

Here's what to do when cable catalog specs just won't do the job: Dial Area Code 317 ■
Then dial 966-6681 ■ You'll get action ■ From a man who devotes full time to solving
engineered cable problems ■ A Belden specialist that "lives"
with your design parameters from engineering through the
actual production run ■ Cables for underwater-under-
ground devices . . . extra-high voltage and pulse ap-
plications . . . medical instrumentation . . . low-level
signal interference problems . . . unusual environ-
mental conditions . . . he's tackled them all ■

Phone now.

8-5-0

DIAL (317) 966-6681

BELDEN 

... new ideas for moving electrical energy

Why invest in wire-wrapping facilities,



when you can use ours?

We can handle your complete back panel wire wrapping including all inventories right up to and including final inspection. Just bolt it in. And you can be sure of less than 0.1% error in your delivered panel.

All this at a price less than in-house fabrication. No inventory to warehouse, no capital tied up in costly equipment. Just send us your engineering drawings. You furnish the back panels or we can even supply our own.

Delivery? Just 2 to 8 weeks depending on the

job and material availability. And we have four locations to make things even easier. Los Gatos, California; Endicott, New York; Longmont, Colorado; Durham, North Carolina.

So why invest in costly equipment and inventories when you can economically give those problems to us. It's easy to find out all about us. For more details just call your nearest Amphenol sales office or write to us direct. Amphenol Cadre Division, The Bunker-Ramo Corporation, 20 Valley St., Endicott, New York 13760.

BUNKER RAMO AMPHENOL

designer's calendar

AUGUST 1971

S	M	T	W	T	F	S
1	2	3	4	5	6	7
8	9	10	11	12	13	14
15	16	17	18	19	20	21
22	23	24	25	26	27	28
29	30	31				

Aug. 17 - 19

Conference on High Frequency Generation and Amplification—Devices and Applications (Ithaca, N. Y.) Sponsors: Cornell Univ. et al. Joseph L. Rosson, Cornell Univ., Phillips Hall, Ithaca, N. Y. 14850.

CIRCLE NO. 418

Aug. 24 - 27

Western Electronic Show & Convention (San Francisco) Sponsors: IEEE, WEMA. WESCON Office, 3600 Wilshire Blvd., Los Angeles, Calif. 90005.

CIRCLE NO. 419

Aug. 25-27

International- Geoscience Electronics Symposium (Washington, D. C.) Sponsor: IEEE. M. T. Miyasaki, Johns Hopkins Univ., 8621 Georgia Ave., Silver Spring, Md. 20910.

CIRCLE NO. 420

SEPTEMBER 1971

S	M	T	W	T	F	S
			1	2	3	4
5	6	7	8	9	10	11
12	13	14	15	16	17	18
19	20	21	22	23	24	25
26	27	28	29	30		

Sept. 8-10

International Conference on Urban Transportation (Pittsburgh, Pa.) Sponsors: U. S. Dept. of Transportation et al. Arthur V. Harris, P.O. Box 2149, Pittsburgh, Pa. 15230.

CIRCLE NO. 421

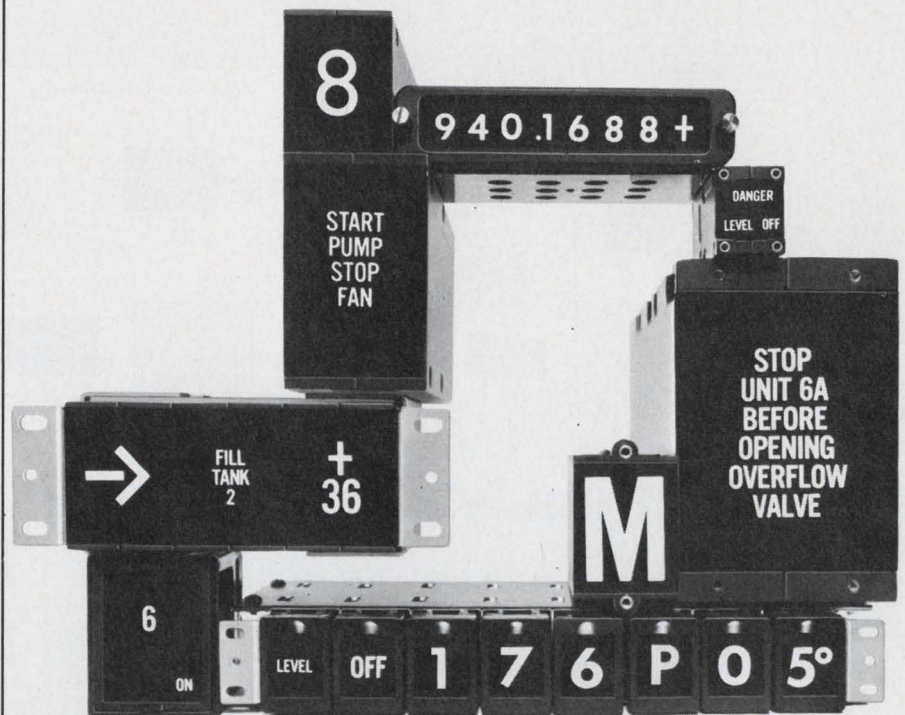

These versatile building blocks give you absolute display control

IEE rear projection readouts let you display everything from single alphanumeric to complex multiword, multiline messages in any type font or style, in your choice of colors, in any language from hieroglyphics to Sanskrit, using any set of symbols known to man, in all sorts of combinations, on a variable brilliance, single-plane viewing surface, all in a variety of sizes from 3/8-inch up to a huge 3 3/8-inch-high characters readable from 100 feet away, and you can get up to 64 different messages, numbers, letters, symbols, or combinations thereof in one single readout.

Be The Master Of Your Display

You can even change messages or characters right in the field to conform the display to programming changes in your system.

That's what we call absolute display control, an order of versatility unapproached by any other display system.

Where To Get Your Building Blocks

And you can get all the rear projection readout building blocks you need to configure a display system that will say just about anything you want it to from IEE.

For instance, we have big 3 3/8-inch by

2 3/4-inch viewing area readouts that let you display such things as 12 different 70- to 80-character messages or giant alphanumerics.

Also handy little fit-anywhere readouts about 1/2" by 3/4" that display 0.37 inch-high characters.

We have readouts that display 11, 12, 24, 48, or 64 different things, like a complete 64-step operator prompter program. And readouts that snap in from the front panel and readouts that display 2-inch characters on compact 2-inch centers.

New Can-Do Driver/Decoder

Now we have a nifty little low-cost hybrid driver/decoder that will drive any one of them, too. It's DTL and TTL-compatible, it puts out a big 300 ma at 30 volts from a .7" by 1.2" 24-pin DIP package, and you can get it separate or attached to the readout.

Ask for the Series 7610. Or information on our wide variety of other driver/decoders.

Our Short-Form Catalog Tells All

Get all the details on our rear projection readout building blocks. Send for our short-form catalog today.

IEE rear projection readouts. For machines with more to say.

Industrial Electronic Engineers, Inc.
7740 Lemona Ave., Van Nuys, California 91405
Telephone: (213) 787-0311 • TWX 910-495-1707



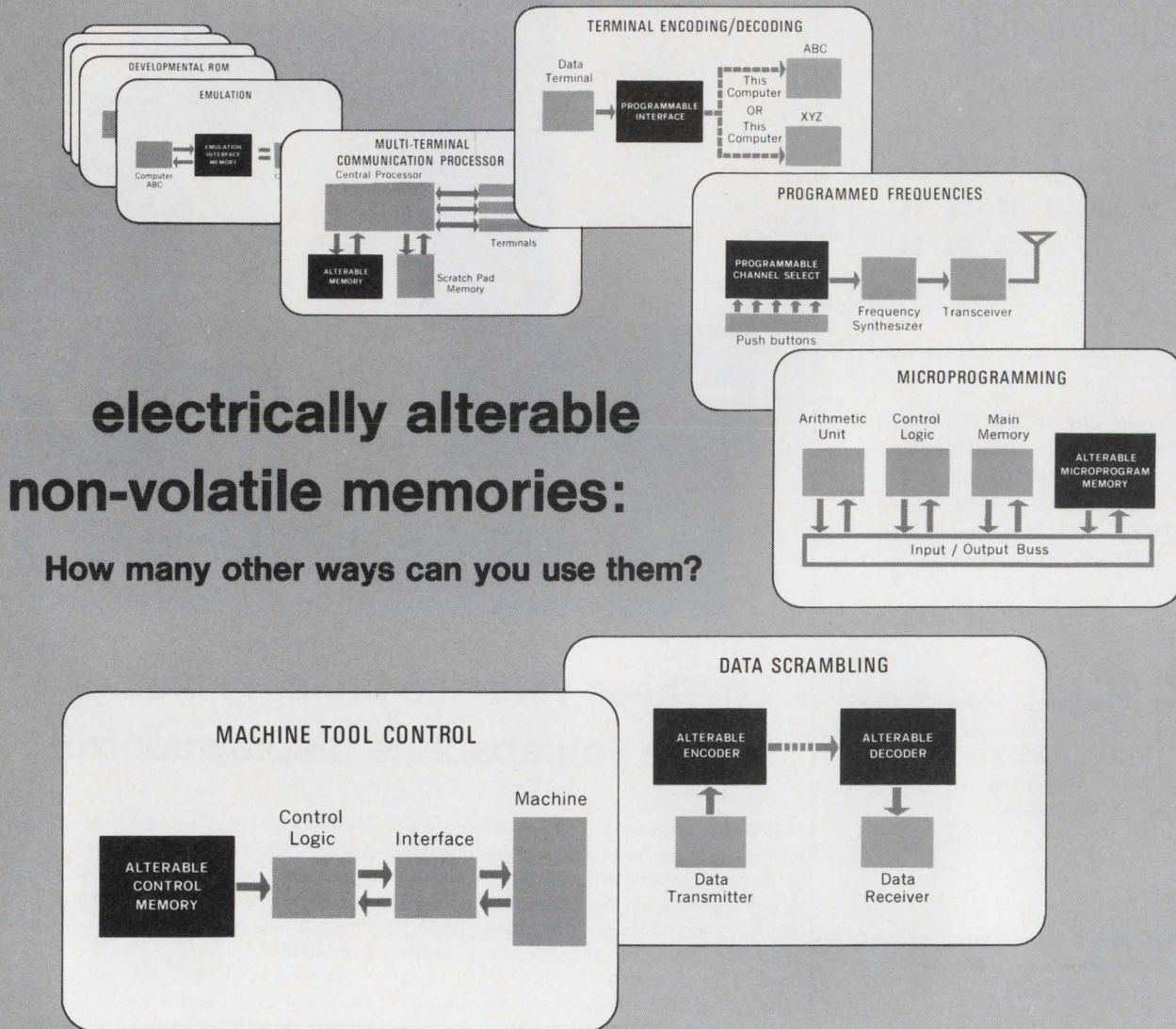

**electrically alterable
non-volatile memories:**
How many other ways can you use them?

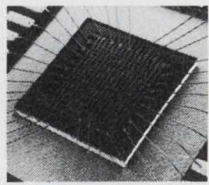

Up until now you've had to settle for non-volatility *or* electrical alterability in a semiconductor memory system. One or the other; not both together.

Today, we're glad to say, you can have your cake and eat it too. Because the

best of both have now been combined in a single device: our new 256-bit Read-Mostly Memories (RMM).

Key to their unique characteristics is the use of amorphous and silicon semiconductors integrated in a 16x16 matrix on a monolithic chip, with a diode-isolated Ovonic Memory Switch (OMS) at each cross-point. What makes them alterable and non-volatile, too, is the fact that the OMSs are, in essence, bistable resistors. They can be reversibly switched between their high resistance (300k Ω) and low resistance (500 Ω) states by the application of controlled current-time pulses. And they're also capable of remaining in either state indefinitely, even when power is removed.

Add to these exclusive features non-destructive readout plus read speeds of 150 nsec access and 200 nsec cycle time (including decoding delay) and you've got yourself a versatile memory element that's readily adaptable to a host of applications beyond those diagrammed above.

Availability? Off-the-shelf! At prices ranging from \$120 each in quantities of 1 to 9, \$75 each from 10 to 99, and \$60 each for 100 or more. Application engineering assistance is available upon request without obligation. Write or call for complete information today.

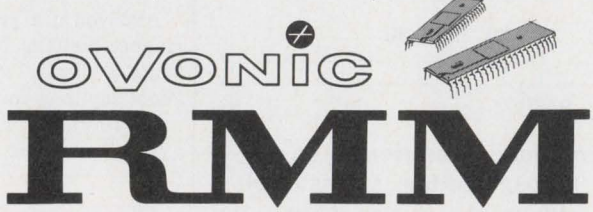

Energy Conversion Devices, Inc.
1675 WEST MAPLE ROAD • TROY, MICHIGAN 48064 • 313/549-7300

INFORMATION RETRIEVAL NUMBER 12



A new low in power supply design.

Acopian's new low profile power supply offers outstanding performance. Line and load regulation is .005% or 2 mv. Ripple is 250 microvolts. Prolonged short circuits or overloads won't damage it. And built-in over-voltage protection is available as an option.

Yet, it's the thinnest, flattest, most "placeable" 4.0 amp series regulated power supply ever offered . . . just 1.68" low. This low profile makes it perfect for mounting on a 1 $\frac{3}{4}$ " high panel, or vertically in a narrow space. Acopian's new flat package gives you design flexibility never before

possible. And a surprisingly low price gives you extra budget flexibility as well.

Standard models include both wide and narrow voltage ranges. Outputs from 0 to 48 volts. Current

ratings from 1 to 4 amp. Prices from \$80.00.

For the full low-down on the new low-down power supply, write or call Acopian Corp., Easton, Pa. 18042. Telephone: 215-258-5441. And remember, Acopian offers 82,000 other power supplies, each shipped with this tag . . .

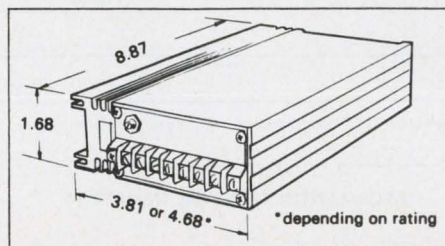

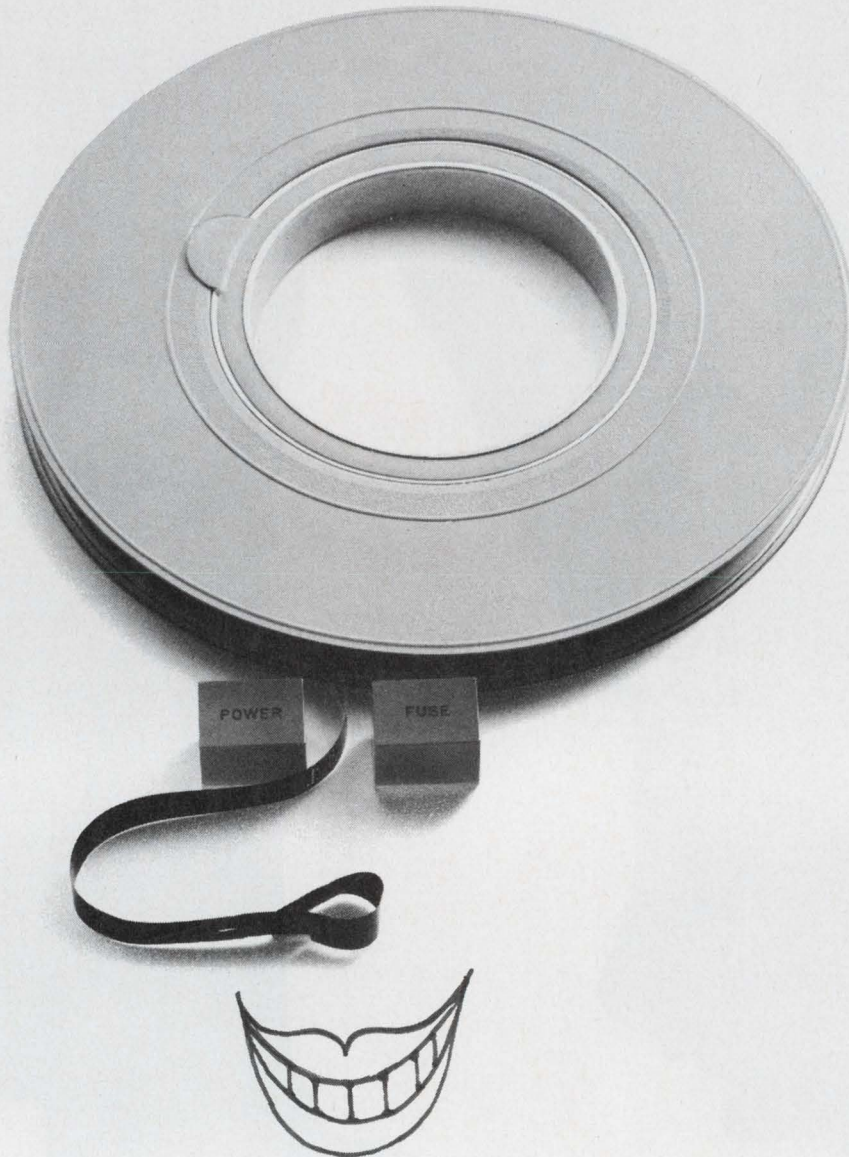

The Aussies make the only hardware trainer in the world

The best way to learn hardware is to train on it. So the Aussies built some computer hardware training equipment that enables students to build up their computer processes step by step. It's unique. So's their demonstrational microwave equipment. It gives you higher output at lower cost. What's more, they've got cartridge tape recorder systems for broadcasting and T.V. studios that outperform all the others—and do it for longer...a range of low-cost

high-performance oscilloscopes...a portable radio and T.V. interference locator that's unique in the world. Delivery? The Australians can get quality-checked quartz crystals to you between seven and ten days after your order's placed. They're just as live-wire in the capability field too. They'll make printed circuit boards, circuit assemblies, black boxes and systems to your exact specifications. Just mail the coupon.

AUSTRALIAN DEPARTMENT OF TRADE AND INDUSTRY
 Australian Government Trade Commissioner:
 New York—636 Fifth Avenue, Suite 426, New York 10020
 Los Angeles—3600 Wilshire Blvd., Suite 2208, California 90010
 San Francisco—1 Post Street, Suite 800, California 94104

Please send me further information on Australian Electronics.

Type of Product _____

Name _____ Title _____

Company _____ Phone _____

Address _____

City _____ State _____ Zip _____

Wholesaler Manufacturer Agent Importer User

ED 610

SEMICONDUCTOR NEWSBRIEFS

PUBLISHED BY MOTOROLA SEMICONDUCTOR PRODUCTS INC.

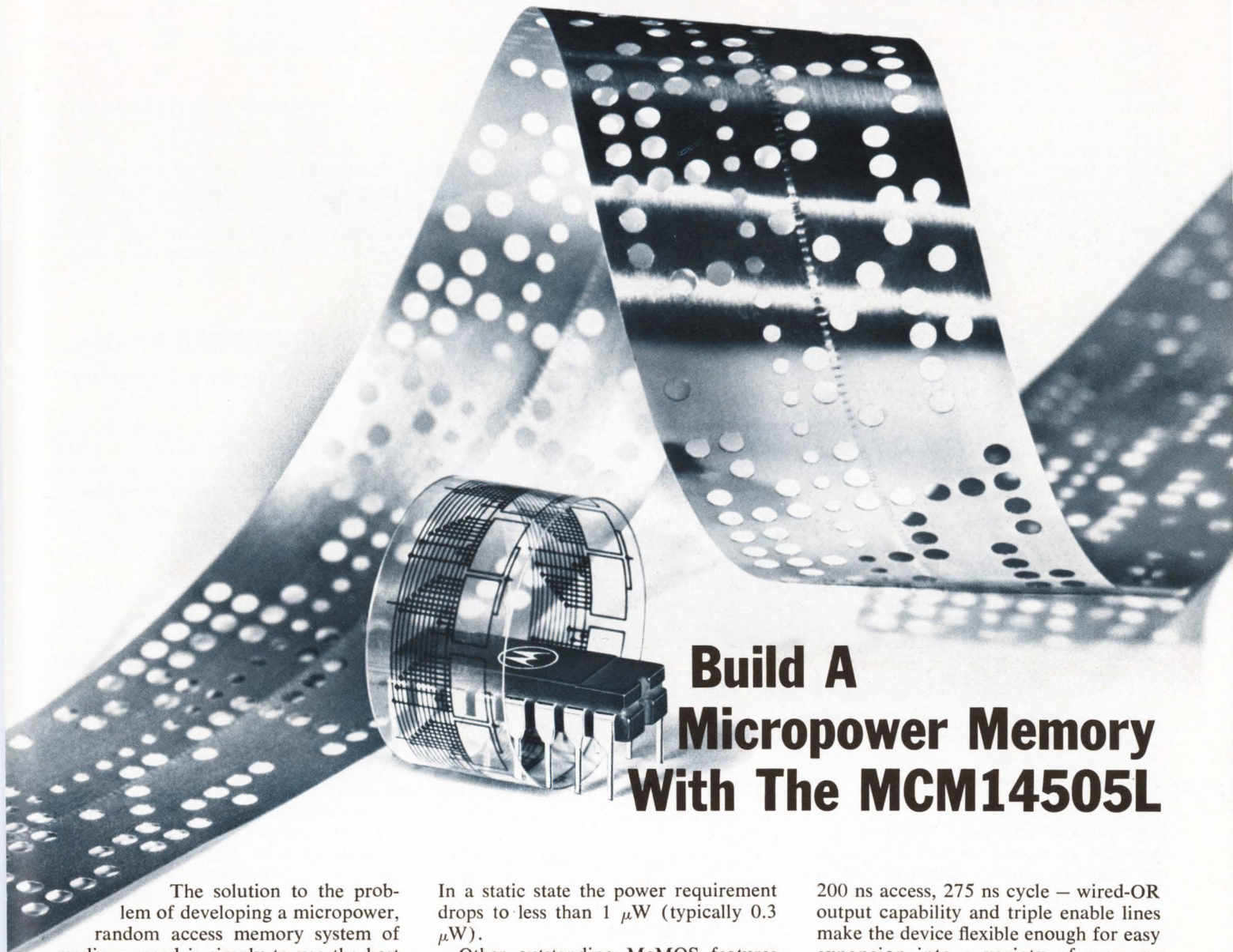

Build A Micropower Memory With The MCM14505L

The solution to the problem of developing a micropower, random access memory system of medium speed is simply to use the best complementary MOS building block. And the new 64-bit read-write MCM-14505L is simply — the best.

This fully decoded McMOS memory is unparalleled for use in battery powered systems. Operation at a 1 MHz cycle rate requires only 2 mW of power while at 1 KHz, dissipation is down to 25 μ W.

In a static state the power requirement drops to less than 1 μ W (typically 0.3 μ W).

Other outstanding McMOS features are also shared by the new memory: noise immunity is equal to 45% of V_{DD} (typ), and a 4.5 to 18 V supply voltage range that can be lowered to 3 V on special order. Single supply operation, either polarity, is standard for McMOS.

As a basic unit for medium-speed systems — typical MCM14505L times are

200 ns access, 275 ns cycle — wired-OR output capability and triple enable lines make the device flexible enough for easy expansion into a variety of memory configurations.

Separate input/output lines and a single read/write control line are provided. All inputs have diode protection and are fully buffered.

The MCM14505L is available now from Motorola distributors in 100-up quantities at only \$25.00 per memory.

For details, circle 211



MC4051 Features "One Chip" Driving For Digital Displays

The new MC4051 Counter-Latch-Decoder joins the previously announced MC4050 CLD to provide designers with a current sourcing device for use in active high systems as well as a current sinking, active low part.

The MC4051 includes on a single chip, a decade counter, a four bit latch, a seven-segment decoder and display drivers. In operation, the counter generates a count-sum in natural binary coded decimal format. The four bit latch holds the data during a sampling period while the decoder/driver generates outputs suitable for switching most solid-state monolithic seven-segment displays having separate anodes and a common cathode connection.

The MC4051 differs from the MC4050 in that it operates in the active high mode and sources current: up to

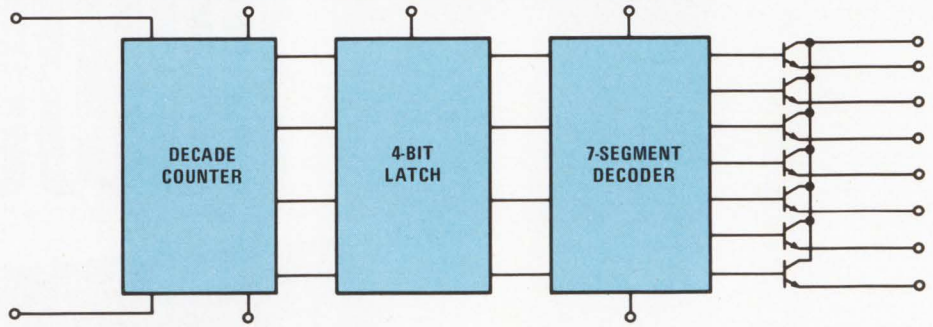

40 mA at a 10% duty cycle or 15 mA at a 100% duty cycle.

Like the MC4050, the MC4051 provides lamp blanking for intensity modulation, a lamp test input for segment verification, and automatic suppression of leading zeroes for easier display reading.

For details, circle 212

The MC4051 is available in the economical 16-pin plastic dual in-line package. Its 100-up price is \$9.80.

These devices can bring you immediate savings of 30% per display, reduced wiring costs and increased connection reliability. Switch over to "one chip," driving — you'll appreciate the savings.

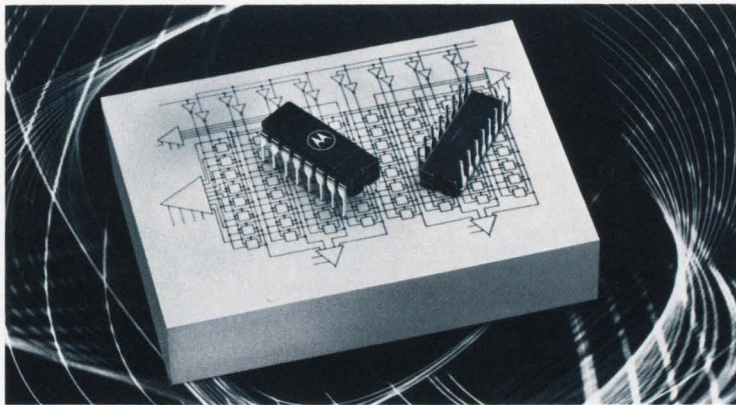

MCM4064L is an economical bipolar element for high-performance memory systems. Its full TTL compatibility and fanout > 9 lead to simple, efficient application.

MCM4064 64-Bit MTTL RAM Offers Speed, Price Advantages

Designers of high speed cache or buffer memories can now call upon a versatile bipolar element — Motorola's new MCM4064L 64-bit RAM. Organized as a 16-word by 4-bit array, the MCM4064L utilizes Schottky-diode-clamped transistors for fast switching speeds, and Schottky clamp diodes on all inputs to minimize line reflections. Minimum access time is 15 ns and maximum is specified at 60 ns.

Address decoding is performed on chip providing 1-of-16 decoding for the four address lines. Separate data in and data out lines, together with a Chip Enable input, facilitate easy expansion of memory capacity. A Write Enable is also provided that permits data presented at

the data in lines to be entered in the address storage cells. When writing, the Data Out level is the complement of Data In.

Large system designs can be readily accomplished through use of the Chip Enable feature and the memory's wired-OR output capability. A 512-word by 8-bit memory system is detailed on the MCM4064 data sheet illustrating the versatility of the device.

Available in the 16-pin dual in-line ceramic package (suffix L) the MCM4064L is priced at \$11.55 (100-up price), approximately 50% less than you're paying. Call your Motorola distributor for evaluation devices today.

For details, circle 213

1024-Bit MOS RAM Provides Low Cost, Memory Capability

Beat core and plated wire size and cost in your mini-computer, main-frame or bulk storage with Motorola's MCM-1173L 1024-bit MOS read/write memory. Its 1024-word by 1-bit organization provides maximum word capacity, and bit expansion is simply a matter of connecting additional MCM1173L's in parallel.

The memory is designed with an array of tiny three-transistor storage cells and associated support circuitry arranged as 32 rows by 32 columns of dynamic storage elements. Dynamic information storage is achieved through use of MOS gate capacitance.

Low address-line capacitance of 2.5 pF (typ) improves systems speeds and, with the output circuits' high ON/OFF current ratio, simplifies bipolar interfacing. Drive power requirements are low compared to other high-threshold MOS, and power dissipation is way down at 50 μ W/bit. Access time is specified at 40 ns and cycle time at 800 ns.

An important reliability factor is contributed by diode protection on all inputs. The chip select clock signal is not required to refresh stored information. The MCM1173L is available in both 24 and 22-pin dual in-line ceramic packages. Pricing is attractive... \$28.00 in 100-999 quantities, and even in medium quantities prices are below 1¢ per bit.

For details, circle 214



IC Hammer Driver Bangs Out 6 Amp Pulses

Take the hybrid integrated circuit route to single-unit operation of high-current loads from either TTL or DTL inputs. Motorola's new 120 V MCH2890 hybrid IC dual hammer driver handles high speed printers and paper-tape punches, and operates stepping motors, relays, and computer-controlled plotters.

This dual power driver is intended for six amps pulse operation and can take surges to 8 amps. I_C (peak) is 6 A (max) and I_C (continuous) is 1 A (max). As indicated, the breakdown voltage is 120 V, and $V_{CE(sat)}$ 2.5 V (max) @ $I_C = 6$ A.

The 10-pin TO-3 was chosen to house the MCH2890 because of its superior power handling capability, its rugged hermeticity, and its longtime popularity as a standard industrial power package.

Typical switching times for the dual hammer driver are $t_d - 40$ ns, $t_r - 20$ ns, $t_s - 600$ ns, and $t_f - 200$ ns. Thermal

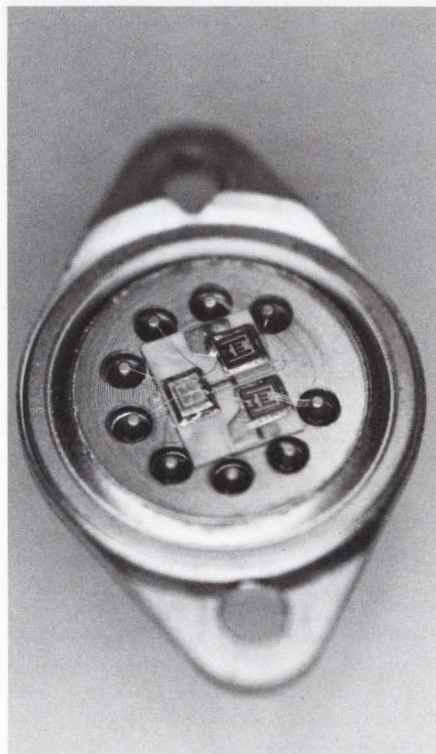

The MCH2890's two power transistors and an IC predriver pulse out a fast six amps for many driving jobs.

resistance is $7.5^\circ\text{C}/\text{W}$ for single channel operation and $5.0^\circ\text{C}/\text{W}$ for dual channel operation.

The MCH2890 is available now for \$7.95 each from your Motorola distributor in 100-up quantities.

For details, circle 215

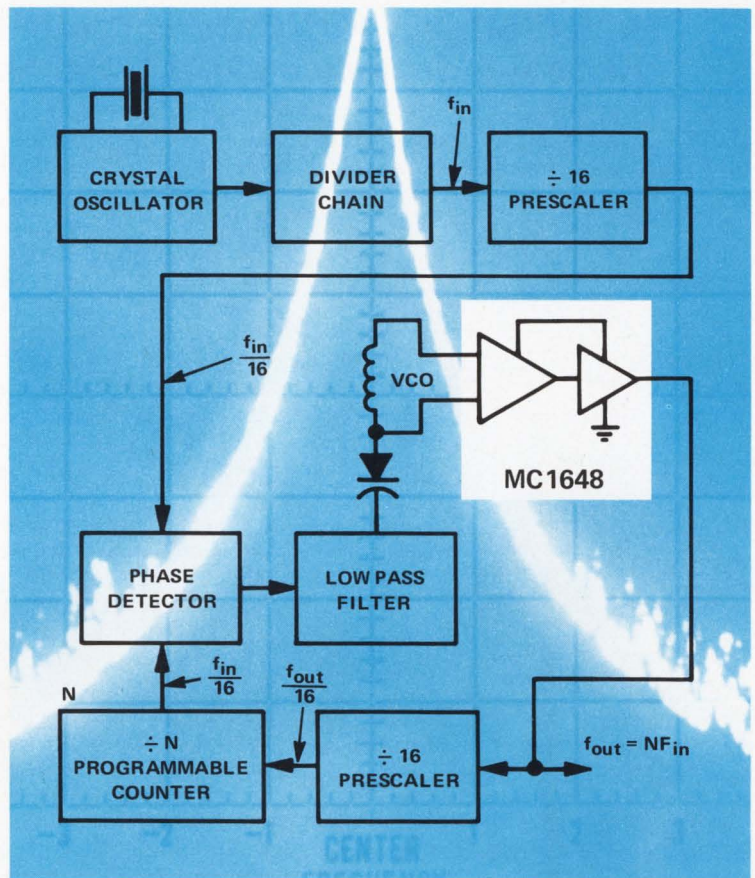

A principal application of the MC1648 Emitter-Coupled Oscillator will be as a voltage-controlled oscillator in communications-frequency systems employing phase-locked loops.

MC1648 Extends Frequency Synthesis To Communication Frequencies

Now you can generate frequencies well into the communications area by applying Motorola's new MC1648 Emitter-Coupled Oscillator to phase-locked loop designs. The MC1648 offers output levels compatible with MECL III and MECL 10,000 logic levels and operates up to a maximum frequency of 225 MHz typical. In addition to frequency synthesis, the MC1648 is recommended for applications requiring a fixed or variable frequency clock source of high spectral purity and for applications in the 60-225 MHz range needing a stable oscillator.

As illustrated, the MC1648 acts as a voltage-controlled oscillator in the frequency synthesizer approach commonly used in FM broadcast tuners, general aviation, maritime and land-mobile communications, amateur and CB receivers. The system operates from a single +5.0 Vdc supply.

The output frequency of the synthe-

size loop is determined by the reference frequency and the number set into the programmable counter; $f_{out} = Nf_{in}$. The channel spacing is equal to the reference frequency (f_{in}).

Frequency generation of this type offers the advantages of single crystal operation, simple channel selection, and elimination of special circuitry to prevent harmonic lockup. Additional features include dc digital switching (preferable over RF switching with a multiple crystal system) and a broad range of tuning (up to 180 MHz, the range being limited by the varactor diode).

Motorola now can supply IC devices for practically every phase-locked loop application. See your local Motorola representative for application assistance. And to evaluate the MC1648 call your nearest Motorola distributor. The MC1648 is available in the 14-pin DIP package and the price is \$2.50 (100-up).

For details, circle 216



High-Voltage, Hot-Carrier Diode Pair In Low-Inductance MINI-L Package

The 50-volt MBD502 and the 70-volt MBD702 hot-carrier detector and switching diodes offer designers the same outstanding qualifications as their high-

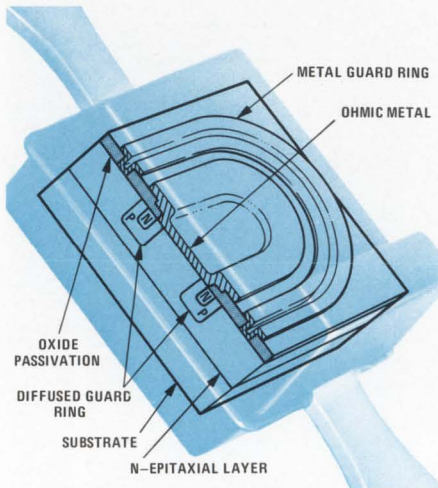

efficiency TO-92 encapsulated predecessors, MBD501/701, and *then some!*

Which is to say that they are now packaged in the MINI-L plastic case that features new lows in both inductance and capacitance. Typical series inductance is 3 nH and capacitance @ 1.0 MHz is 0.1 pF (typ).

The MINI-L features an L-shaped ridge running across one end of the package that clearly identifies the cathode lead. In addition, this ridge helps make automatic handling and mounting of the MINI-L so easy that commercially-available equipment can be readily adapted for this use. Its axial leads,

For details, circle 217

formed with a combination detent/stop near the case, provide the options of flush or standoff mounting.

One of the biggest benefits of the new package design is in its assembly and encapsulation on Motorola's proven, TO-92 type stripline, high-speed, high-volume production facilities to bring you industrial performance at consumer prices.

Although designed primarily for video detector and switching applications, the MBD502 and 702 are suited for many other fast-switching RF and digital applications.

The Schottky barrier void-free construction provides ultra-stable characteristics by eliminating the cat-whisker and S-bend contact. Both devices have an extremely low minority carrier lifetime (15 ps typical) which is responsible for the very high speed of these highly-efficient diodes. They also feature a high reverse voltage of 50 V for the MBD502 and 70 V for the MBD702, and low reverse leakage of 200 nAdc (max) for both devices.

The third, and recently-introduced member of this MINI-L hot-carrier diode family, the MBD102 (also available as the TO-92 cased MBD101) is designed for UHF mixer applications but is also suitable for use in detector and ultra-fast switching circuits.

MBD502, 702 and their sister part, MBD102, boast some of the most appealing 100-up prices in this field: MBD102 — 65¢; MBD502 — 71¢ and MBD702 — 77¢.

High-Gain RF Amplifiers Give "More Horses" To UHF Land-Mobile Designs

Now you can really move on out of the medium-powered land-mobile neighborhood with the new 2N5944-46 series . . . offering at least 2 dB more power gain for your 12.5 V land-mobile RF outputs, drivers and predrivers than existing UHF amplifiers!

Designed for large signal applications to 520 MHz in industrial/commercial FM equipment, the new units offer these P_{out}/G_{PE} performance advantages at 470 MHz: 2 W/9 dB for the 2N5944; 4 W/8 dB for the 2N5945 and 10 W/6 dB for the 2N5946 . . . each affording from 1 to 2 dB *greater* gain than any other comparably-priced device. This

gain in gain means fewer devices in the amplifier chain — saving you the cost of additional units and their installation.

Actually capable of much higher output levels, the series has been characterized at conservative levels for ruggedness and to ensure good performance after subjection to mismatch conditions.

These devices are loaded with other reliability features, too: nichrome protected overlay construction, strip-line-opposed-emitter technology and stud-mounted ceramic packaging.

Collector efficiency is a high, 60% (min) at 470 MHz and rated power

For details, circle 219

First Domestic Dual VVC Cuts Distortion, Saves Space

Where sharp tuning and minimum signal distortion are required, here's a dual, back-to-back, voltage-variable capacitance diode, type MV104.

This silicon EPICAP device is rated at 32 volts and provides between 37 and 42 pF diode capacitance at $V_R = 3.0$ Vdc. A manufacturing technique that produces diodes whose characteristics match within $\pm 1\%$ over the specified tuning range makes it possible to offer, on special order, sets of MV104 diodes matched to within $\pm 1.5\%$. Result? You can minimize distortion and detuning in your design.

But that's not all. Because it's supplied in the proven TO-92 package you can depend on the MV104 in rugged environments. And, the dual configuration of the MV104 saves board space.

Now that the MV104s are available,

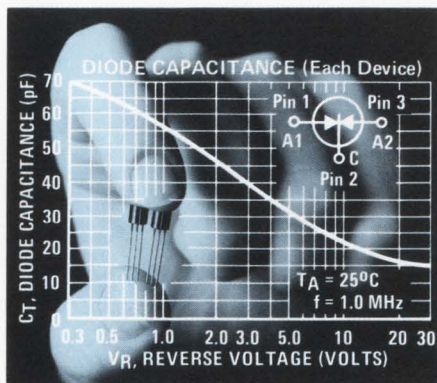

you don't have to look to Europe for the BB104. And at 59¢, 100-up, you can afford to give it a try.

For details, circle 218



PNP Uniwatt Darlington Transistors Perform Low-Power Amplifier/Driver Jobs

Motorola's new MPS-U95 PNP silicon Annular Uniwatt Darlington transistor, like its NPN complement, the MPS-U45, is characterized by one of the highest current gains in the industry, with typical ratings of 35,000 at 500 mA.

High gain means base drive requirements will be lessened in many of your low-power amplifier, driver and control applications. In addition, the MPS-U95's excellent linearity, like its complement, will provide your audio amplifiers — up to 5 watts — with the benefit of low distortion.

Emitter-base breakdown voltage is a high 10 Vdc (min), providing adequate protection against most transients. And

$V_{CE(sat)}$ at 1 Adc is typically 1.2 Vdc. C_{ch} at 10 volts is 2.5 pF (typ). Collector-emitter breakdown voltage is identical to MPS-U45 — 40 Vdc (min) at 100 μ A dc. Also identical are the total power dissipation figures for the devices: 1.0 W at $T_A = 25^\circ\text{C}$ and 10 W at $T_C = 25^\circ\text{C}$.

By eliminating predrivers, the MPS-U95 and its complement can reduce space requirements in your circuit layout.

The MPS-U95 is packaged in the exclusive Uniwatt plastic case. Its tab-lead is readily adaptable to custom forming for special mounting requirements, including heat sink needs.

Ample factory and distributor ware-

house stock of these versatile transistors are available at 100-up prices of \$0.84 for the MPS-U95 and \$0.76 for the MPS-U45. Send for data today.

BV _{EB} Volts Min	C _{CB} pF Typ/Max	h _{FE} Min/Typ/Max	@ I _c mA
(1)10	(1)2.5/12		
(2)12	(2)2.5/6.0		
		25K/65K/150K	200
		15K/35K/—	500
		4K/12K/—	1.0 A

(1)MPS-P95 (2)MPS-U45

For details, circle 220



Solid-state power gets a real "lift" with the advent of the 2N4361-78 SCRs. These 110 amp. devices are designed for those industrial applications requiring tough, reliable performers.

110 Amp SCR Boosts Control Reliability

There's no substitute for quality in a high-current SCR that really has to "take

it" in controls for high-power industrial/consumer welders, motors, space heaters,

For details, circle 221

electric trucks and other power/speed jobs . . . and there's no substitute for the new 110 A (RMS) 100 to 1,400 V 2N4361-4378 series in those designs.

For example, you'll find pressure-contact encapsulation ensures permanent electrical and thermal conduction to the mounting base despite the most rigorous thermal cycling. Additional freedom from thermal fatigue is afforded by matched-expansion mounting of the chip providing long-term stability and reliability. And, low, 0.28°C/W thermal resistance affords higher case operating temperatures and smaller heat sinks.

When you stress it with repetitive current/voltage conditions, center-fired gates give high repetitive di/dt and fast turn-on. Specified minimum 100 V/ μ s dv/dt means optimized protective, voltage-wave shaping networks. Low maximum V_F — 1.6 V — and high surge protection — 1,600 A — simplify heat sink and safety/fusing considerations.

You can torque this SCR to 130 inch-pounds without distortion because its high-stress copper allow resists stud damage and provides excellent heat transfer to boot.

Inside you'll find the highest quality piece parts in the industry: high-temperature alloy materials life-tested at 300°C. . . . hermetic ceramic seals . . . high-density refractory material . . . and all diffused junctions contoured for longest possible voltage creepage distance.

The 2N4361-78 series is available in both flexible lead and flag-tab packages — send for your data sheet today!



DUAL COMPARATORS

— Match Four-Bits — Economically

Here's two MTTL devices that can provide address comparison for use with multiple sequential memories or uniquely match separate input data against a common reference. Basically, the new MC4021 and MC4022 Dual 4-Bit Comparators compare four bits of input data to four bits of reference information. When both correspond bit-for-bit, the comparator output assumes the high state. Any other condition produces a low output level.

The MC4021, 22 are unusual in that the four reference inputs serve both comparators. There is no interrelation between the dual data input sections. A separate output is provided for each comparator. The MC4021 has open collector outputs for wired-OR applications while the MC4022 has totem-pole outputs.

The unique configuration of these dual devices could mean a savings in space, parts, or price in your design. Evaluate them now! They're available in the 16-pin DIP package for the 100-up price of \$2.45 — either comparator.

For details, circle 222



SILICON GATE MOS SHIFT REGISTERS

— Provide Low Power Drain and Bipolar Interface Capability

Motorola's MC2380G and MC2381G dual 100-bit dynamic shift registers provide low power consumption and direct bipolar interface capability for digital applications. Dual-512, quad-256, and 1024-bit registers also from silicon gate technology are scheduled for early second-half '71.

Both the MC2380G and MC2381G provide bipolar compatibility at inputs and outputs and both utilize low-voltage circuitry and a two-phase clock for minimum power dissipation. The MC2380G has open-drain outputs for high drive capability and the MC2381G achieves direct MOS compatibility with output pulldown resistors.

Performance features include 3 MHz operating frequency, 0.4 mW/bit power dissipation @ 1.0 MHz (typ), operating temperature range of -55°C to $+125^{\circ}\text{C}$, 40 pF clock input capacitance, and typical output impedance of 400 ohms.

In 100-999 quantities the price of either the MC2380G or the MC2381G is \$3.95. Each is supplied in the 8-pin metal case.

For details, circle 223

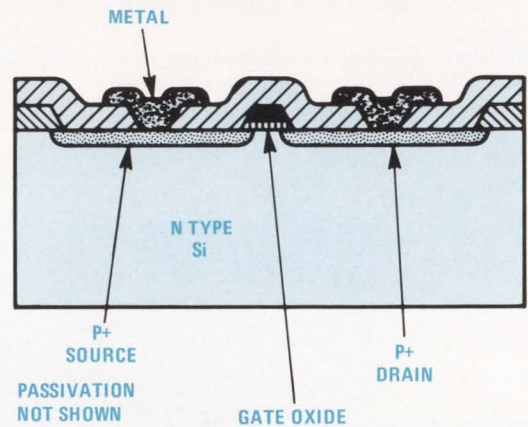

IMPROVED SILICON PLASTIC QUAD MEMORY-DRIVERS

— Offer High Power Rating and Increased Temperature Range

Originally introduced in the dual in-line TO-116 plastic package with a copper lead frame as 600 mW devices, the MPQ3725 and MPQ3303 quad memory driver transistors now offer the rating of 1.0 watt per single device or a collective 2.5 watts. And the operating and storage junction temperature range is now -55 to $+150^{\circ}\text{C}$.

MPQ3725 20 ns (t_{on} typ) @ $I_c = 500$ mA dc 50 ns (t_{off} typ) @ $I_c = 500$ mA dc
MPQ3303 15 ns (max) @ $I_c = 1.0$ A dc 20 ns (max) @ $I_c = 1.0$ A dc

Consider the new specs together with the MPQ3303's low collector-emitter saturation voltage and the MPQ3725's high collector-emitter breakdown voltage and you've got a system cents/space satisfying quad pair for your plated wire and core driving jobs. Either device is only \$3.75, 100-up.

For details, circle 224

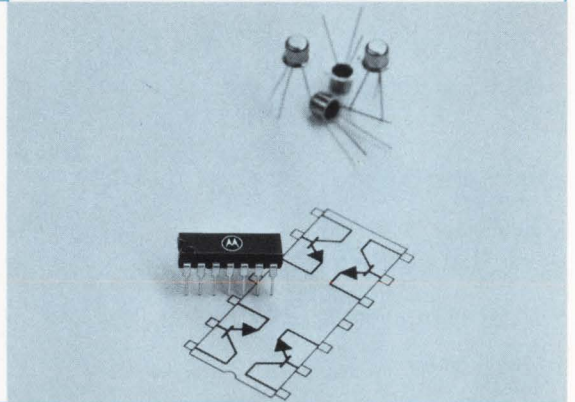

ISOTHERMAL LAND/MOBILE RF TRANSISTORS

— Reduce Heat Buildup 50%

The new 2N6080 family is designed for 12.5 V operation to 225 MHz and features minimum gains from 4.5 to 12 dB and 50% collector efficiency at rated power and 175 MHz.

Devices in this series are ideal for high band land/mobile, VHF marine and amateur radio (2 meter) applications where higher gain and increased ruggedness are needed in predrivers, drivers, and output stages.

4-40 WATT LAND/MOBILE RF TRANSISTORS

TYPE	P_{in}/P_{out} WATTS	Power Gain dB	Price 100-up
2N6080	0.25/4	12.0	\$6.00
2N6081	3.5/15	6.3	9.25
2N6082	6/25	6.2	18.50
2N6083	8/30	5.7	21.00
2N6084	14/40	4.5	36.00

For details, circle 225

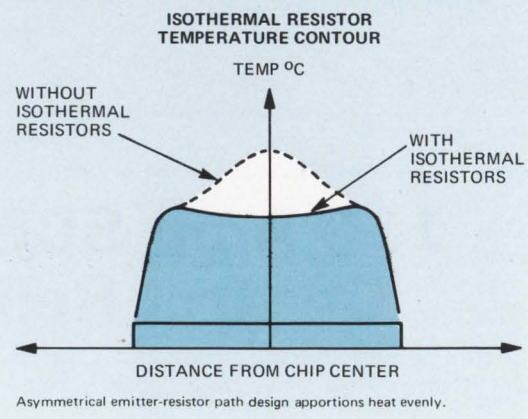

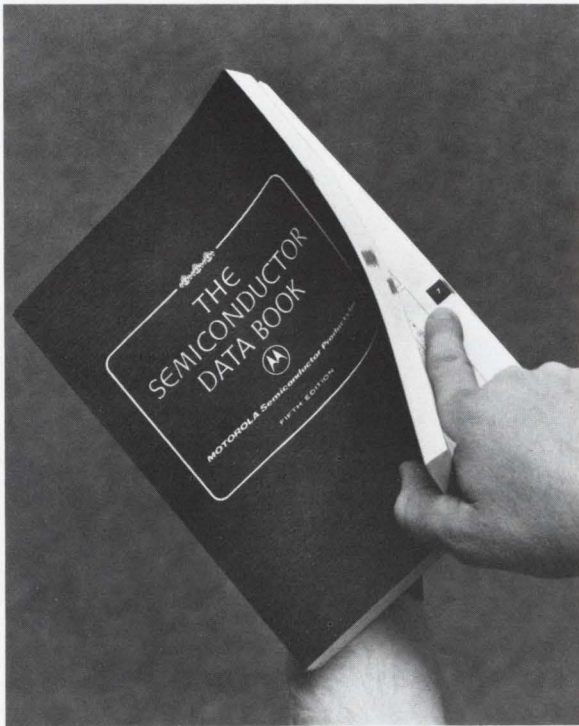

First Supplement To Semiconductor Data Book Available

It seems like the Fifth Edition of the Semiconductor Data Book is just barely off the presses and already it has its first supplement — 370 pages of supplement — a book in its own right. Actually, the Fifth Edition celebrated its half birthday this April and, at Motorola, six months now sees the introduction of nearly as many useful new products as were developed in its first six years.

Supplement 1 provides complete specifications for 150 new 1N, 2N, and 3N EIA registered devices plus 212 Motorola devices. As in the Fifth Edition, Supplement 1 is thoroughly indexed to provide easy entry to the characteristics of the device you want. Programmable unijunction transistors, field-effect transistors, thyristors and EIA registered types each have their own numerical index in which short-form specifications are given. There is also a device selection index listing the new semiconductors by product category. Another index handily presents all devices carried in both the Fifth Edition and Supplement 1 indicating those for which specifications are to be found in the supplement. Anyone who has ever wandered bewildered through an inadequately indexed catalog will appreciate Motorola's data books.

You can obtain Supplement 1 for \$1.00 a copy by using the coupon on the outside edge of this page. You may also use the coupon to: 1. purchase the Fifth Edition; 2. subscribe to the updating service which entitles you to Supplement 1 plus any others published during the life of the Fifth Edition to keep it current and up to date — a minimum of two.

Please PRINT clearly (To expedite your literature we may have to use this as return mailing address)

NAME _____

TITLE _____

COMPANY NAME _____

DIVISION _____

DEPARTMENT _____

COMPANY ADDRESS (Street or P. O. Box) _____

CITY _____

STATE _____ ZIP CODE _____

Please circle the Reader Service number of item(s) you are interested in receiving from NEWSBRIEFS No. 12-71.

ED				
211	212	213	214	215
216	217	218	219	220
221	222	223	224	225

List Application Notes you wish to receive below (by number):

Do you wish a Motorola Representative to contact you?

VISIT

PHONE

Phone No. _____ Area Code _____

NOTICE: Requests for literature on items described in this publication cannot be honored after Oct. 1, 1971.

Tear Along Perforated Line

DATA BOOKS ORDERING COUPON

SEMICONDUCTOR DATA BOOK	
Single copy @ \$5.95 ea.	\$
2-24 copies @ \$4.15 ea.	\$
25-up copies @ \$3.95 ea.	\$
Updating subscription @ \$2.00 ea.	\$
Supplement #1 @ \$1.00 ea.	\$
MTTL DATA BOOK	
Single copy @ \$2.50 ea.	\$
2-24 copies @ \$2.00 ea.	\$
25-up copies @ \$1.75 ea.	\$

Fill in your name and address on the other side of this coupon. Tear along perforated lines and enclose in envelope with proper remittance.



FOLD HERE

FIRST CLASS
Permit No. 2565
PHOENIX
ARIZONA

BUSINESS REPLY MAIL
NO POSTAGE NECESSARY IF MAILED IN UNITED STATES

POSTAGE WILL BE PAID BY

Semiconductor NEWSBRIEFS No. 12-71
Motorola Semiconductor Products Inc.
P. O. Box 20924
Phoenix, Arizona 85036

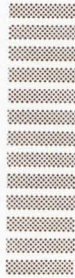

FOLD HERE

SEMICONDUCTOR NEWSBRIEFS

Motorola Semiconductor Products Inc., P. O. Box 20924, Phoenix, Arizona 85036

The circuitry shown external to Motorola products is for illustration purposes only, and Motorola does not assume any responsibility for its use or warrant its performance or that it is free from patent infringement.

The information and prices in this issue are believed to be accurate and correct at the time of publication. However, they are subject to change without notice at any time by Motorola.

Uniwatt, MINI-L, IsoThermal, EPICAP, McMOS, MTTL, MECL III, MECL 10,000 and MMOS are trademarks of Motorola Inc. Annular semiconductors are patented by Motorola Inc.

© Motorola Inc. 1971

SEAL HERE

(Please use tape — do not staple)

ORDER COUPON

Be sure to fill out both sides of this coupon, tear along perforated edge, and mail in envelope with check, money-order, or purchase-order (*) to:

Motorola Semiconductor Products Inc.
P. O. Box 20924
Phoenix, Arizona 85036

Note: (*)P.O.'s for less than \$20.00 cannot be accepted. Make checks or money-orders payable to: Motorola Inc.

NAME _____

TITLE _____

COMPANY _____

ADDRESS _____

CITY _____

STATE _____ ZIP CODE _____



LITERATURE BRIEFS



Umbilical To Microelectronics Book Cut — MTTL Data Book Born

The designer working on a system using principally one form of logic will swear the idea for Motorola's new IC data books was conceived just for him. And he'll very nearly be right!

The MTTL Data Book is the first in a series intended to divide the data for Motorola's ever-expanding IC population into manageable segments. We think you'll find this volume — and subsequent data book shelfmates — more convenient and easier to use if you work with one logic type or the entire family of integrated circuits.

The 552 pages of the MTTL Data Book are divided into general information, selector guides, application note abstracts and seven technical data sections. An interchangeability guide and packaging information are given in the general information section while the selector guides section provides a quick look at the major characteristics of all MTTL devices. The application notes section given abstracts of current notes explaining the use of MTTL.

Inside the front cover a tab index instantly points the way to the tabbed sheets of the technical data section of interest. These seven data sections constitute the main portion of the data book — 366 pages — and each provides an index to its devices plus all data sheets, in numerical order.

Use the coupon on the outside edge of this page to order your copies of Motorola's spanking new MTTL Data Book.

NOTE: If Motorola's Literature Request Coupon is missing, use magazine's standard Reader Service Card.

Tear Along Perforated Line and Drop in Mail (No Postage Required)

When the lights go out, the only really portable Digital Multimeter goes on



...and on.

Run the Fluke 8100A 0.02% digital multimeter anywhere, anytime up to 8 full hours off the rechargeable battery pack. Printer output now available.

There are twenty or thirty digital multimeters around that lay claim to portability. The only one you can move around easily and use without a nearby wall plug is ours. It's the only portable machine that works where you need a portable machine.

True portability is just part of the story. The Fluke 8100A, with an accuracy of 0.02% and a selling price of \$795, with rechargeable battery option, gives you nine times the accuracy of three digit instruments for half the price of comparable four digit multimeters. We've used a new A to D technique to give you an instrument with low power drain for eight-hour continuous battery operation without recharging. (line operation only \$695)

The Fluke 8100A measures ac and dc volts in four ranges to 1200 volts and ohms in five ranges to twelve megohms. Readout is four full digits plus "1" for 20% overranging. Features include an active 2-pole switchable filter and automatic polarity indicator. All functions are push-button selectable.

Also available are RF and high voltage probes, switched ac-dc current shunts, a ruggedized case, and data output (line operation only).

John Fluke Mfg. Co., Inc., P.O. Box 7428, Seattle, Washington 98133. Phone (206) 774-2211. TWX: 910-449-2850 / In Europe, address Fluke Nederland (N.V.), P.O. Box 5053, Tilburg, Holland. Phone: (04250) 70130. Telex: 884-50237 / In the U.K., address Fluke International Corp., Garnett Close, Watford, WD2 4TT. Phone: Watford, 27769. Telex: 934583.



741's don't work

... in critical situations. They're fine in ordinary applications. But, when specs get critical, save your design with one of our new "optimized 741's" — the successor to the good old 741.

When you need more gain or less drift, or more slew rate or less bias current error, or less power consumption (say, for battery operation), or more speed, why change or imperil your design?

The simplest, sure-fire solution is to select the "optimized 741" with the precise specifications your circuit demands — all with Philbrick's built-in reliability. Pin-for-pin compatibility makes the change-over easy. Models available in most popular package configurations.

What's more, if you want to produce something new or improve upon an existing design, without expensive circuit redesign — just plug in an "optimized 741." They're not ordinary or modified 741's.

They're different by design.

Philbrick takes over where others leave off. Right now we have seven models of microcircuit modules ready to ship — with premium versions also available.

Send for our data packet today. Or, contact your Philbrick sales representative. Teledyne Philbrick, Allied Drive at Route 128, Dedham, Massachusetts 02026. TEL. (617) 329-1600. TWX (710) 348-6726. TELEX: 92-4438. CABLE: TELEPHIL.

Round the clock service for Toll-Free Ready Data phone (800) 225-7883 In Mass. call (617) 329-1600

MODEL 1321 HIGH INPUT IMPEDANCE--
100 MHz GAIN BANDWIDTH, 300M Ω Diff
35 V/ μ sec SLEW RATE
IN 100's - \$12.50

MODEL 1420 FET 741-TYPE--
10¹¹ Ω || 3pF DIFFERENTIAL INPUT IMPEDANCE,
-15 pA TYPICAL I_B
IN 100's - \$15.75

MODEL 1322 HIGH SLEW, WIDEBAND--
20 MHz GAIN BANDWIDTH, 120 V/ μ sec
SLEW RATE
IN 100's - \$16.50

MODEL 1323 LOW POWER,
GENERAL PURPOSE--2,000,000 OPEN
LOOP GAIN, $\pm 80 \mu$ A QUIESCENT CURRENT,
 ± 5.5 V TO ± 20 V POWER SUPPLY RANGE
IN 100's - \$12.50

MODEL 1339 34V/ μ sec SLEW RATE,
GUARANTEED 60mA MAX OFFSET CURRENT,
GUARANTEED LATCH-UP PROOF PERFORMANCE
IN 100's - \$3.35

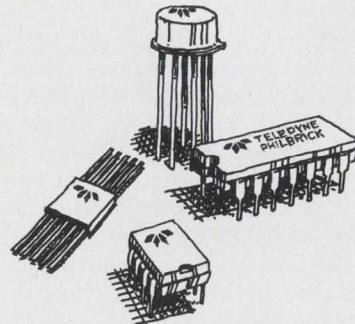

 **TELEDYNE PHILBRICK**
MICROCIRCUITS

Microwave transmission opened to competition

The way is now clear for a new microwave communications industry as a result of a Federal Communications Commission decision authorizing competition in specialized communications. Formerly A.T.&T. and Western Union had this microwave field to themselves.

The commission must still grant permits for the construction of microwave towers and assign transmission frequencies, but these are expected shortly.

The Electronic Industries Association estimates that as much as \$200-million will be spent for start-up electronic and microwave gear.

The decision permits Microwave Communications of America (Micom) to expand its Chicago-St. Louis hook-up and the Data Transmission Co. (Datran) to go ahead with a nationwide digital data system. Micom currently has Raytheon under contract for \$3.5-million to provide equipment for 11 microwave hops. These are to be used for such special services as private lines, voice, TV and facsimile transmission.

According to Gerald Taylor, assistant to the president of Micom, the company expects revenues in the first year of operations to be "around \$55-million."

Datran, which filed its application in 1969, intends to serve 35 "digitally mature cities"—those with a developing need for data communications—with a customer-to-customer, dial-up system. It will employ a combination of microwave radio and cable, and it may use existing transmission poles.

John Scorce, Datran's general counsel, says the company is "going for the occasional-use data customer, who will subscribe for a monthly charge—like the telephone system—and then according to his use on the line." Calls are to be placed in a maximum of three sec-

onds, with charges based on minimum use of six seconds.

Datran now employs 110 people but plans significant expansion, particularly in its engineering department.

In the Micom system, which is dedicated rather than dial-up, the user leases a channel and attaches whatever terminal equipment he chooses to that line. Micom eventually plans to link 165 cities with its private lines.

Although AT&T had opposed the FCC ruling, it now appears reconciled to sharing the microwave communications market.

In an announcement by the Western Union Corp., Russell McFall, chairman and president, said: "We welcome this competition on the basis that competition means freedom of pricing and freedom of deployment of resources."

MOS density offered in bipolar memory cell

Bipolar memories, known for their high speed, have traditionally been bypassed by designers for slower, but much smaller, MOS memories, so as much memory as possible could be crammed on a single chip. Now it's possible to have both speed and density in the same cell.

Raytheon Semiconductor of Mountain View, Calif., has announced a bipolar cell that measures 5 mils², which competes nicely with silicon-gate MOS memory cells (static) that are 18 mils² and dynamic cells measuring 6 mils².

Raytheon's new cell is the smallest bipolar memory cell yet announced. The former champion was Fairchild Semiconductor's Iso-planar cell, which measured 12.5 mils².

The key to cutting the cell's size,

according to Keith Taft, section head at Raytheon Semiconductor, is a new technique that reduces the metallization. Raytheon calls the process V-8, for vertical anisotropic etch. The metallurgy is of the type used to make beam-leaded circuits.

Employing Schottky-barrier instead of gold-doped technology, the cell includes two transistors hooked together in an emitter-coupled-logic configuration.

Taft says that by the end of 1971 Raytheon plans to be using this memory cell in a 1024-bit bipolar static RAM. The product will dissipate less than 0.5 W and will be contained on a 0.110-by-0.110-inch chip. The access time is expected to be about 30 ns, and the memory will be TTL compatible.

Digital multimeter cost cut 50% by new design

A new design technique in the input conversion circuitry of precision digital multimeters has brought the price of the meters down more than 50%.

Although the developer, Data Precision Co. of Wakefield, Mass., is not ready to reveal details, it is known that the cost has been cut by elimination of a number of expensive precision components normally required in the dual-slope conversion circuits. Present precision digital multimeters sell for \$500 to \$5000, depending on the capability and sophistication of the equipment.

Data Precision plans to introduce soon a series of 4-1/2 and 5-1/2-digit multimeters, with costs cut across the board.

For secret transmitting: A cable within a cable

Secret communications—voice, teletypewriter signals, computer data or TV video signals—can be sent in "plain language" over a new, tamper-proof cable communications network.

Developed for the military by the Anaconda Wire and Cable Co. of New York City, and RCA Services Co., Cherry Hill, N.J., the system links secure areas with up to three miles of special cable.

The cable, a key system element, is really two cables in one. The first is a signal-carrying core that contains a maximum of 75 twisted pairs of 600 ohms for low-frequency data, or up to seven balanced 124-ohm TV video pairs plus six 600-ohm pairs.

Laminated around the signal-carrying core is a protective triaxial cable made up of an outer weatherproof layer surrounding three copper sheaths, each separated by dielectric layers. The inner layer and the other sheaths of copper are ground potential, but from 10 to 15 kV, ac is impressed on the center copper layer. The cable requires little power because it is, in effect, a highly charged capacitor.

If the cable is penetrated through the outer copper layer, the dielectric is disturbed, and corona energy appears between the outer and center conductors. The corona produces a broadband noise that is transmitted, with little attenuation, down the triaxial cable.

Sensitive RCA electronic detectors, responding to noise signals in microvolts of rf, sound an alarm condition.

A market in billions seen for medical electronics

Medical electronics to fulfill national health-care goals will provide a \$2.5-billion market in the next 10 years, according to a study by a Connecticut company.

The report, "New Growth Markets in Biomedical Electronics," by Manley Management and Marketing Services Corp., Greenwich, discusses present and future advances in diagnostic equipment, patient-monitoring systems, multiphasic screening centers, automated clinical laboratory instrumentation and data processing.

Patient-monitoring equipment sales, which reached \$50-million in 1970, are projected at \$500-million by 1980. Medical markets for EDP hardware, peripheral and software products are envisioned as surpassing \$1-billion by the end of the decade.

The growth of clinical laboratory instrumentation will continue at a rapid pace, the survey says. As proof, it points to an increase

in the last 10 years in sales of wet-chemistry analyzers, from \$1-million to over \$90-million. More complex instruments are being developed, the report notes, including spectrophotometers and pattern-recognition systems for hematological and cytological investigations.

Computer cuts pollution in new steam buses

Three steam-power transit buses, with engines controlled by mini-computers to reduce polluting exhausts, will be operating in California before the end of this year, according to the U.S. Dept. of Transportation.

The department is footing two-thirds of the \$614,172 bill, and California the rest.

Each engine is slightly different, but all must be capable of adaptive control. Sensors are used to measure pressure and temperature of the steam, the speed and load of the engine, and the flow rate of fuel and water to the automatic steam generator.

Technical management of the program is being handled by the International Research and Technology Corp. of San Ramon, Calif. The business management is the responsibility of the Scientific Analysis Corp., San Francisco. The three companies building the steam engines are Steam Power Systems, Inc., San Diego; William Brobeck Associates, Berkeley, Calif., and Lear Motors Corp., Reno, Nev.

General aviation assails FAA transponder rule

A rule proposed by the Federal Aviation Administration that would scrap some 35,000 transponders in light planes is meeting opposition from general-aviation avionics manufacturers. One objection is that all transponders would be certified for operation above 15,000 feet—an altitude that thousands of light planes never reach.

William Rice, president of General Aviation Electronics, Indianapolis, calls the requirement a "blatant, deliberate action" that is "completely nonresponsive" to the

comments of the avionics industry.

"In essence," he told ELECTRONIC DESIGN, "the rules would require every transponder to meet the technical requirements for those used in airline jets."

The new rule would also redesignate present minimum-performance standards for general-aviation transponders—standards that are now voluntary—as a mandatory Technical Standard Order (TSO).

Robert W. Butche, president of In-Flight Devices Corp., Indianapolis, a manufacturer of low-cost transponders, said in comments to the FAA: "We believe that the proposal . . . is absolutely unnecessary to assure adequate system performance."

Butche also said that they question the need for TSO standards to be applied to general aviation equipment.

Gil Quinby, vice president of Narco Avionics, Ft. Washington, Pa., one of the largest manufacturers of general aviation equipment, agreed.

"Witness the fact that thousands and thousands of people fly around with avionics equipment that do not meet the TSOs. They don't degrade the system one bit."

Electrostatic engineers set up a new society

Engineers in the \$1-billion-a-year electrostatics field have formed a new society because, they say, the IEEE has failed to devote enough attention to their needs.

The first formal meeting of the group, the Electrostatics Society of America, was held at the recent Conference on Electrostatics in Albany, N.Y.

Engaged in the design of equipment that uses electrostatic principles for reproduction processes, coating of abrasives, spray painting and the separation of water from jet fuels and petroleum, the engineers at the conference heard informal papers by American and foreign experts.

The man credited with furnishing the impetus for the new society was also at the conference. He is A. D. Moore, professor emeritus of the University of Michigan, a well-known figure in the field.



SIZE & COST: NO BIG THING.

EASIER THAN EVER TO FIT
YOUR BOARD & BUDGET.

BROAD LINE GETS BROADER.
8 LOWER CAPACITANCE VALUES
(100 pF thru 390 pF @ 200 V).

Type 192P Pacer® Polyester Film Capacitors are mass-produced to beat the space/cost squeeze in commercial and industrial applications. Extended-foil PETP film sections with metal end caps provide best possible non-inductive construction. End caps also act as moisture barriers. Ideal for automatic insertion on printed wiring boards. Expanded line includes capacitance values from 100 pF to .47 μ F. Voltage range, 80 to 600vdc. Write for Bulletin 2066C.

Technical Literature Service
Sprague Electric Company
347 Marshall Street
North Adams, Mass. 01247

SPRAGUE®

THE MARK OF RELIABILITY

THE BROAD-LINE PRODUCER OF ELECTRONIC PARTS

45M-0143

INFORMATION RETRIEVAL NUMBER 17



Bodine drives packaging and labeling machines dependably

Compact. Rugged. There's an extra measure of stamina in Bodine fractional horsepower motors for packaging and labeling machines. Stamina that measures up to the reliability and performance you've designed into your product. Bodine fhp drive systems are more than the latest state of the art. There's Bodine craftsmanship and realistic ratings. These spell dependability for you—and your customers.

Whether your field is packaging or labeling—or both—you can do no better than to specify Bodine fhp drives and controls. Over 3500 standard specifications to choose from. Bodine also builds custom fhp drives and controls to meet design requirements. Our engineers will be happy to help you pinpoint the right one for your application.

Write for bulletin. Bodine Electric Company, 2500 W. Bradley Place, Chicago, Illinois 60618.

Bodine Motors Wear Out—It just Takes Longer

**BODINE MOTORS/GEARMOTORS
SPEED CONTROLS**



Plasma is getting better, and so is designer's choice of displays

When it comes to displays, designers have traditionally faced a feast-or-famine choice: mass-produced devices like CRTs and light-emitting diodes at one end, and custom displays like those designed for the Strategic Air Command at the other. In between, there has been relatively limited selection. But recent innovations in plasma displays are changing that.

Disclosures at the International Symposium of the Society for Information Display, held in Philadelphia, Pa., point to reduced cost, increased size, gray scale and color

for plasma displays. These developments were cited:

- Owens-Illinois, Inc., in Toledo, Ohio, has produced what is said to be the largest plasma panel ever assembled—an 8.5-inch square containing 3600 discharge sites per square inch and offering over 250,000 light-emitting junctions.

- Zenith Radio Corp., Chicago, and Bell Telephone Laboratories, Holmdel, N.J., have six and eight-level gray-scale techniques for providing plasmas with additional intensity discrimination.

- Owens-Illinois has also produced a three-color, 4-by-4-inch Digivue plasma display panel, and it has an 8.5-inch square version under development.

In addition the symposium noted improvements over the entire line of matrix displays—LEDs, plasmas, liquid crystals and ferroelectric ceramics.

The Owens-Illinois technique

In Owen's monochrome display, a mixture of inert neon and nitrogen is sandwiched between two glass plates, constituting a 1/2-inch thick composite (see diagram). The walls are formed by depositing a thin-film gold material on the glass substrate and photoetching an x-y grid of parallel electrodes—

Michael P. London
News Editor

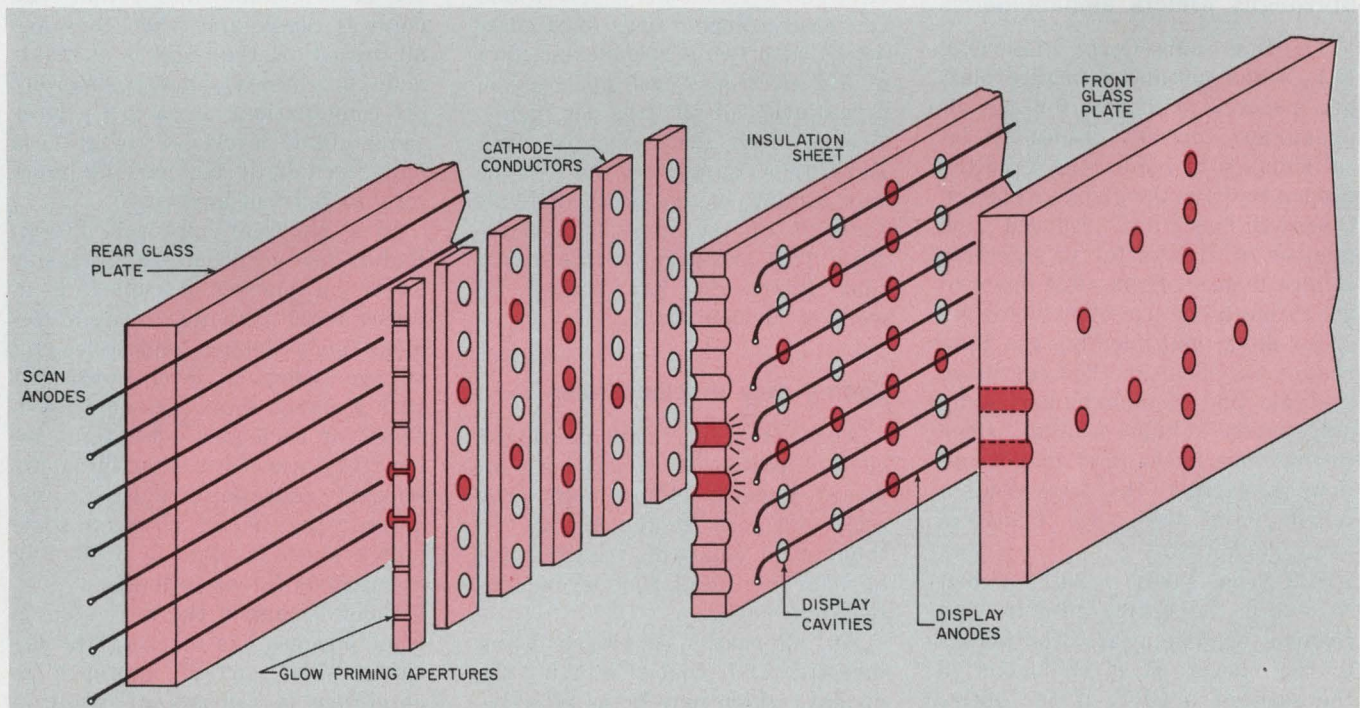

In the Burroughs Self-Scan plasma display, glow begins down the cathode, behind the first seven glow apertures, and diffuses through them to the viewing surface. The glow established on the cathode's rear is transferred along the panel to produce a scanning effect; when the

front anodes are properly addressed, each dot in the desired message is illuminated on the display side. The complete panel is scanned at 60 cps, and the viewing surface is illuminated and extinguished at a rate above the flicker perceptability of the human eye.

age properties is then applied over the electrode pattern.

As in all plasma displays, the electrodes distributed over the panel are used to pass a current through the gas, heating its local molecules to an excited state. When the gas relaxes—that is, electrons are permitted to drop to lower energy levels—photons of light are released and photo-luminescence is achieved.

A periodic-reversing sustaining voltage (± 100 V ac), applied to all x-y electrodes in the matrix array, is maintained at a threshold level that is insufficient to cause the gas to break down. To turn on a selected cell at an approximate x-y intersection, a writing pulse of proper amplitude and timing is superimposed on the sustaining waveform. As the sustaining voltage reverses direction, electrons trapped on the dielectric—in effect, constituting a wall charge—discharge across the gas gap and emit visible light.

The dielectric thus gives Digivue a unique local memory capability and eliminates the constant need for refreshing the display, since the dielectric stores charge when the gas is excited.

Burroughs prefers alphanumerics

The Burroughs Corp., Plainfield, N.J., which produces smaller plasma displays primarily for the alphanumeric market, trades off local memory to reduce the circuitry needed to drive the display. Though Owens-Illinois has reduced the number of drivers for its 8.5-inch-square display, from 1024 down to 96, through the use of external resistor diode multiplexing, the Burroughs Self-Scan method can drive a single line of alphanumerics, by only seven voltage sources. Once the extreme lefthand seven-dot column is excited, the first column relaxes, and the pulse transfers along each row.

Self-Scan takes 1/30th second to sweep the entire row in this fashion, and appears continuous to the viewer. It is analogous to the scan of a CRT, if the entire face were scanned in one sweep.

According to Dr. James Becker of Xerox Corp., Rochester, N.Y., who moderated a discussion on matrix displays at the symposium,

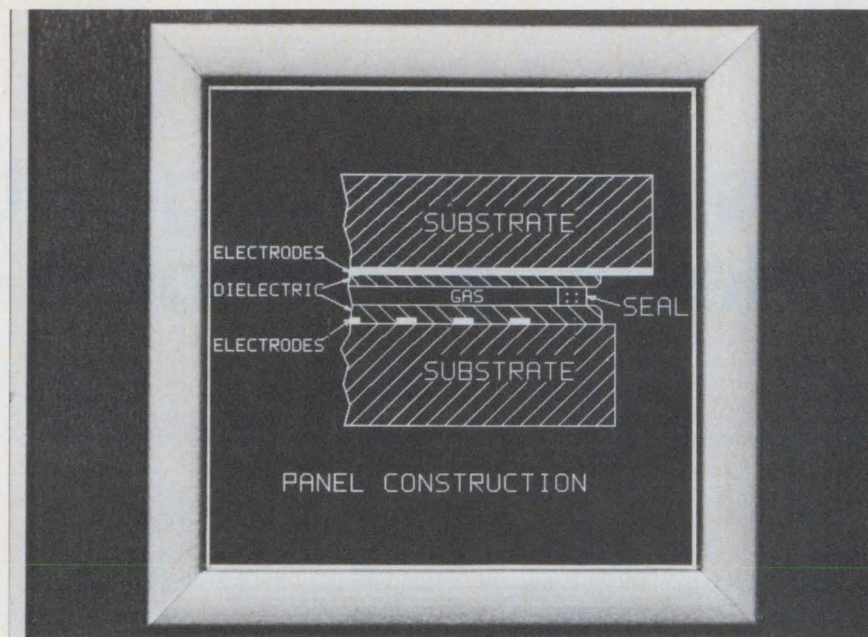

A cross-section view of Owens-Illinois' Digivue display is from its 8-1/2-inch square plasma panel—reported to be the largest ever produced.

the tradeoff in reducing drive circuitry appears in the loss of local memory, which must be compensated for by additional circuitry to provide external memory. While the Owens Digivue panel stays lit once each electrode intersection is addressed, the Burroughs panel must constantly be refreshed.

Referring to the size and sophistication of the Owens panel—which can easily display over 3000 characters with two perpendicular rows of 512 electrodes each and provide a resolution of 60 lines per inch—George Holz, staff scientist with Burroughs, suggested that Owens was aiming at the most difficult segment of the market to penetrate. It is probably for this reason that Burroughs has limited its work to smaller displays.

Coding may preclude color

Apart from increasing panel size, current plasma work has been directed toward adding both gray scale and color to the display, although no clear-cut requirements have been established beyond entertainment.

An alternative approach being investigated is that of blinking the display, which may be as effective as gray scale or color for getting attention. Although intensity discrimination by eye is better with color than with varying shades of gray, color coding of intensity is

another alternative being explored.

Should the designer desire gray scale, however, Bell Laboratories has developed a binary technique for generating an eight-level gray scale by sandwiching three transparent plasma panels with local memory and adding 50% more circuitry than the single panel has. When the three panels are turned off at a matrix intersection, the point is black, and when they are all turned on, the point is at maximum brightness. Superposing on/off combinations at each x-y location, eight levels of brightness have been built up, varying from zero to 5.9-foot-lamberts.

In a different approach, Zenith Radio has achieved six intensity levels by placing a capacitor in series with a switch at each element and storing and releasing voltage when a level consistent with a chosen intensity is achieved. Thus for each particular light intensity, a waveform containing the selected addressing pulse is required; the switch fires on some pulses and not others, producing the various intensity levels.

Color is simply the next step in what plasmas are offering the designer. The current approach to obtaining it consists of using a mixture of xenon, which emits in the ultraviolet, and surrounding electrode intersections with circular spots of phosphor materials which photoluminesce in color when

**Unbeatable
portability
and range
coverage!**



the
new

Simpson[®] 460 DIGITAL VOM



- Completely portable . . . no separate battery pack or power supply needed. Self-contained battery or line operation.
- Non-blinking 3½-digit display of 26 most used ranges . . . 5 each AC/DC voltages and AC/DC currents . . . 6 resistances . . . with "plus" and "minus" and overrange . . . analog meter readout . . . analog to digital converter uses the dual slope technique.
- A compact, lightweight, multi-use Digital VOM for lab, in-field or general testing only \$395.00 (less batteries)

NOW IN STOCK AT YOUR LOCAL ELECTRONICS DISTRIBUTOR • WRITE FOR BULLETIN T-811

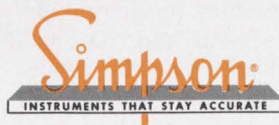

SIMPSON ELECTRIC COMPANY

GENERAL OFFICES AND EXPORT:

5200 West Kinzie Street, Chicago, Illinois 60644 • (312) 379-1121 • CABLE: SIMELCO

IN CANADA: Bach-Simpson, Ltd., London, Ontario

IN INDIA: Ruttonsha-Simpson Private, Ltd., International House, Bombay-Agra Road, Vikhroli, Bombay



DIVISION

INFORMATION RETRIEVAL NUMBER 19

The ambient-light test

One problem encountered with light-emitting devices like diodes and plasmas is that they wash out in bright ambient light. Both liquid crystals and ferro-electric ceramic displays, either reflect or scatter incident light; they get brighter while the contrast to ambient light remains fixed.

In liquid crystals, cigar-like organic molecules are aligned by an applied electro-magnetic field to obtain a variety of optical properties. In most applications, the display derives its characteristics by the dynamic scattering of light—the intense, wide-angle

scattering associated with field-induced turbulence.

Ferro-electric ceramic displays operate similarly—here it is the ceramic whose optical properties permit reflection and scattering when a field is imposed.

Both liquid crystals and ferro-electric ceramics appear dark in a dark room, where there is no light to be scattered. When ambient light is available, they light up and increase their brightness proportionate to the intensity of the ambient level; the contrast remains fixed, and the display never washes out.

struck by ultraviolet emission.

Expanding capabilities like these are what really offer the designer new choices among displays. The selection includes Nixie tubes, LEDs, plasmas, liquid crystals, ferro-electric ceramics and even CRTs. Dr. Becker suggests several advantages that the plasma panel has over the CRT: It is flat, mak-

ing undistorted electrical reproductions simpler, and it is smaller and potentially more portable.

Plasmas best for large displays

Most panelists at the symposium felt that in comparison with LEDs, plasmas should be superior for all but the smallest display require-

ments. Becker's view was that "plasma will have an edge for displays having a modest number of alphanumeric symbols, and an impact on the CRT with up to a few hundred characters."

Holz, who was chairman of the session on liquid-crystal technology, believes that plasma's peak brightness and luminous efficiency are at least an order of magnitude higher than those for LEDs, possesses no inherent size limitations due to materials or manufacturing processes and is more reliable, since it is without internal welds and requires a minimum of external connections. Both types are capable of long life and operate over wide temperature ranges.

According to Holz, if speed of operation is a design criterion LEDs have the edge, requiring nanoseconds compared to the microseconds for the plasma display. Both are able by far to exceed the observer's ability to absorb information, however. Though LEDs operate at low voltages compared with plasma—on the order of 5 V vs 150—their requirement for high currents tends to cancel this.

A larger challenge to plasmas may come from liquid-crystal displays, although this possibility is farther down the pike (see "Liquid Crystals: Material With a Hot Future," ED 19, Sept, 13, 1970, p. 76). Because of liquid crystal's unique properties (see box), low power requirements are not uncommon.

The challenge to plasmas from ferro-electric ceramics is as yet not so clearly defined. Though ceramics, too, often offer the unique light-scattering properties of liquid crystals, they are more expensive and require higher voltages. An additional shortcoming is that they cannot be fabricated into large area panels as readily as either plasmas or liquid crystals can. Becker feels that ceramics offer no real advantages over the other displays available.

Concentration of effort towards improving plasmas is greatest today in circuitry and memory, the largest cost factors in current designs. Large screens and color will add to the flexibility. The future for plasma displays, though not yet inevitable, is certainly getting brighter, speakers agreed. ■■

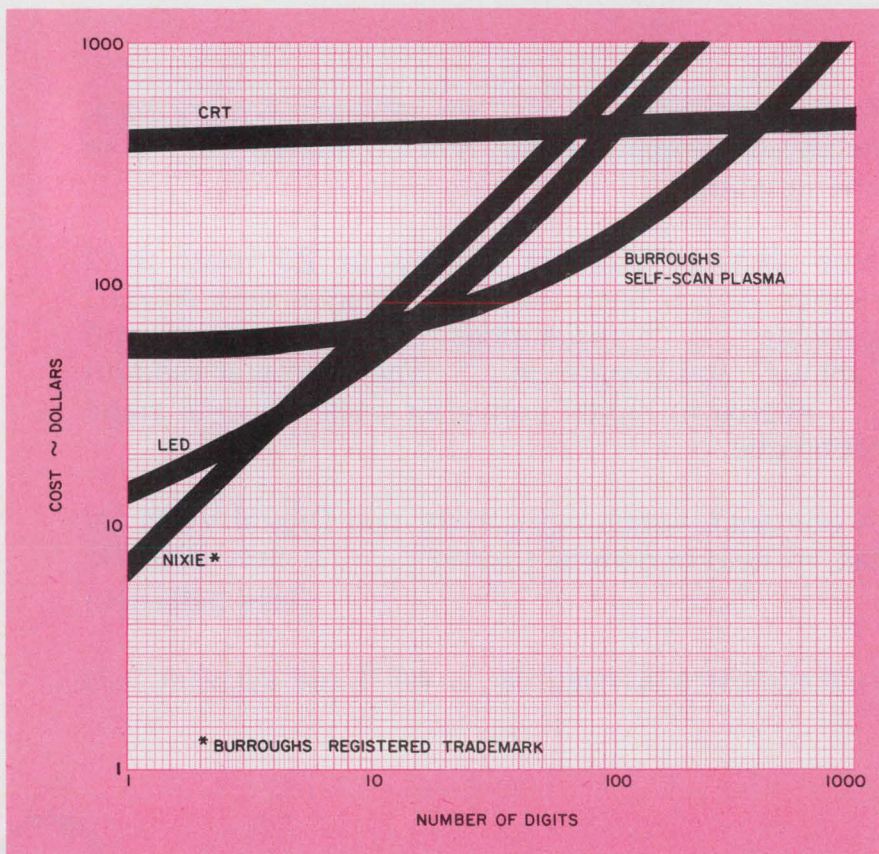

Disparity in cost between CRTs, LEDs and Nixies has kept the CRT out of the small display market. But plasmas offer increasing competition to the CRT at under 400 digits, and LEDs and Nixies at over a dozen digits.

C-LINE PROGRAMMABLE UNIUNCTION TRANSISTORS

guaranteed stability
from -55°C to $+125^{\circ}\text{C}$...

PUTs you a step ahead in design flexibility.

Unitrode offers the only 100V PUT type and the only type with guaranteed stability from -55°C to $+125^{\circ}\text{C}$. We also offered the first PUT in a hermetically sealed TO-18.

With Unitrode's Programmable Unijunction Transistors (PUTs), you're freed from the restricting fixed values of conventional UJTs. Simply by varying external resistor values, you can program E_{ta} , R_{BB} , I_p and I_v to meet your particular needs in timing, pulse, sweep and sensing circuits, oscillators and SCR triggers. The highest voltage, hermetic package and greatest temperature stability are three good reasons for specifying Unitrode PUTs. Three more are nano-amp leakage for long interval timing, low cost, and a strong applications engineering staff ready to help. PUT more design freedom at your fingertips; order any of six types directly off the shelf.

For fast action, call Sales Engineering collect at (617) 926-0404
Unitrode Corporation, 580 Pleasant St., Watertown, Mass. 02172.

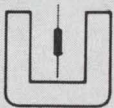

UNITRODE quality takes the worry out of paying less.

Unitrode Corporation, Inquiry Processing Dept. 6B
37 Newbury Street, Boston, Massachusetts 02116

Please send free samples of PUT checked below (including data sheet).

Check for Sample	Unitrode Type No.	Forward Voltage Rating Volts max.	Peak Point Current μa max.	Valley Point Current μa min.	Check for Sample	Unitrode Type No.	Forward Voltage Rating Volts max.	Peak Point Current μa max.	Valley Point Current μa min.
<input type="checkbox"/>	2N6119 ¹	40	2.0@10V ³	70@10V ⁴	<input type="checkbox"/>	2N6138	100	10@10V ⁵	40@10V ⁶
<input type="checkbox"/>	2N6120 ²	40	0.15@10V ³	25@10V ⁴	<input type="checkbox"/>	U13T3	100	2.0@10V ³	70@10V ⁴
<input type="checkbox"/>	2N6137	40	10@10V ⁵	40@10V ⁶	<input type="checkbox"/>	U13T4	100	0.15@10V ³	25@10V ⁴

1. Formerly U13T1 2. Formerly U13T2 3. $R_G=1\text{M}\Omega$ 4. $R_G=10\text{K}\Omega$ 5. $T=-55^{\circ}\text{C}$, $R_G=10\text{K}$ 6. $T=+125^{\circ}\text{C}$, $R_G=10\text{K}$

NAME _____ TITLE _____
COMPANY _____
ADDRESS _____
CITY _____ STATE _____ ZIP _____

Strong European technology preparing to challenge U.S.

Despite reports of drooping electronics markets in Europe, the level of technology there continues high. Product introductions in optoelectronics, ICs, consumer products, communications equipment and instrumentation demonstrate a state of the art that is very close to that of U. S. companies, and in some cases possibly more advanced.

European electronics companies believe that once they strengthen their economic muscle—through expansion of the European Economic Community and other arrangements—they will be in a good position to mount a strong challenge to American competition.

In optoelectronics, for example, Integrated Photomatrix Ltd. of Dorchester, Britain, offers a wide range of devices, including light-activated switches, light sensors, light-to-frequency converters, light-

sensing arrays and self-scanned photodiode arrays.

Among its products are a fixed-sensitivity light-emitting-diode optical analog coupler, including a ceramic substrate, thick-film resistor, 1-mm photodiode and MOS IC amplifier and linear, self-scanned photodiode arrays in lengths of 50 to 256 diodes and speeds to 5 MHz.

An impressive array of IC products are offered by Plessey, an 85,000-employee company headquartered in Essex, Britain, which has divisions in almost every area of electronics from microcircuits to airport lighting. Recently introduced are an MOS LSI chip that controls the printing function in an electronic printing calculator and contains five counters, a four-bit shift register, 13 output buffers and 50 additional gates and a new range of temperature-compensated ECL divider and interface circuits.

As much as 30% of the Western European electronics market is

taken up by the consumer sector, and this emphasis shows up in the sophistication of consumer products.

A big play for consumer products

Mullard Ltd. of London recently introduced a line of ICs for color and B/W TV receivers, as well as a number of new circuit developments for radios, record players and power amplifiers.

The company also offers a set of four ICs called Unitex, which are the heart of a complete do-it-yourself modular IC stereo system. Unitex includes an audio preamplifier, two 4-W audio amplifiers and a power supply.

Siemens, too, has recently added to its consumer IC lines. One of its products is a combined AM/FM i-f and audio preamplifier. In FM operation the i-f amp functions as a limiter; in AM operation the gain of the first stage is controlled by a regulating loop over a range of 60 dB. The audio section will drive a 10-W complementary first stage.

Mullard engineers have designed an all-solid-state TV receiver and are doing research on a 110° color TV set at their Central Application Laboratory in Mitcham, Britain. Four ICs in the set perform all signal processing from subcarrier detection to low-level red-green-blue signals.

European engineers are at work on TV cameras, too. English Electric at Chelmsford is developing a new TV camera tube called the Sidicon with a target of isolated silicon diodes. The tubes are intended to be interchangeable with one-inch vidicons, but they have much less lag than conventional vidicons and much higher sensitivity. Lag causes smearing of ob-

Raymond Daniel Speer
Managing Editor

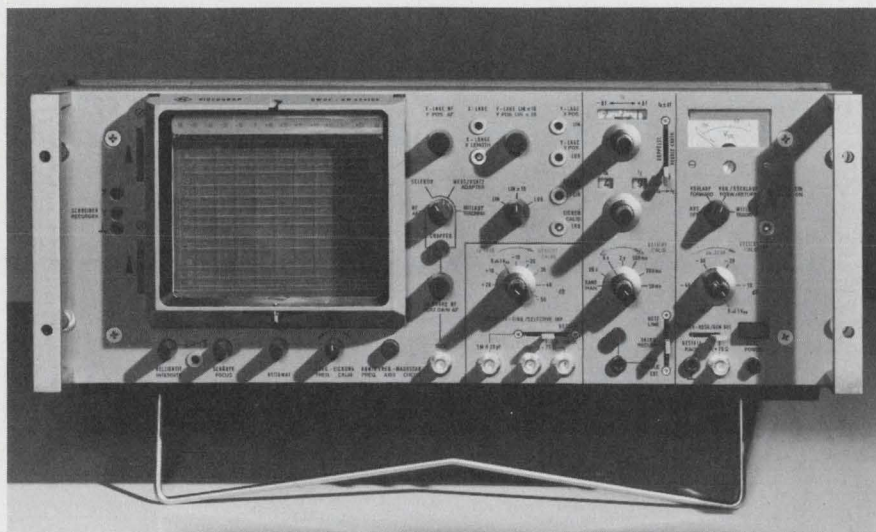

The new Videoskop III video sweep generator introduced by Rohde & Schwarz of Munich includes a sweep generator, selective receiver and display unit. It will measure amplitude-frequency response, gain, and phase and group delay of four-terminal networks in the range 10 kHz to 20 MHz.

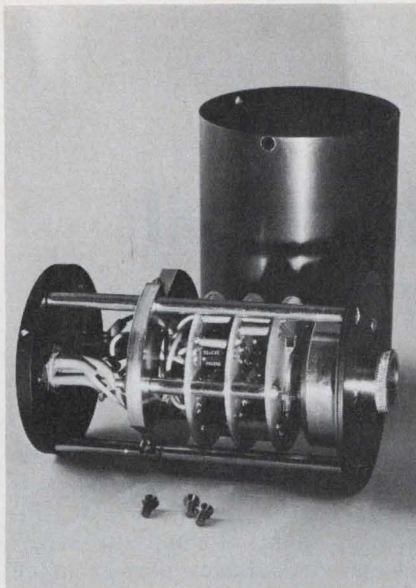

A single-line, solid-state camera head with a 20-diode self-scanned array and a focusing lens is offered by Integrated Photomatrix Ltd. of Dorset, U. K. Incorporating buffer stages for remote operation, the head is intended for optical character recognition and edge detection applications in process control.

jects photographed under low-light, low-signal current conditions.

Communications activity churns

In the telecommunications area, one of the hottest growth markets of the next few years, Western Europe countries are extremely active.

Thomson-CSF of Versailles, France, has broadened its magnetron line with the introduction of a family of coaxial devices. They offer high efficiency, because of the coaxial cavity structure and the absence of anode straps, a frequency stability improvement of 3:1 over conventional magnetrons, low thermal drift because of good cooling, and an rf spectrum close to theoretical for a rectangular pulse. Typical of the French manufacturer's new line is the MCV 1300, delivering over 200 kW peak over a tunable bandwidth of 8.5 to 9.6 GHz.

At GEC-Marconi, engineers are working with microstrip circuitry involving high permittivity and high dielectric constant materials. The staff of the company's research laboratories at Great Bad-

For further information

This article is based on visits to electronics plants in France, Germany, Denmark and England. An earlier report, on the immediate market outlook in Europe; "For European Electronics, Things Are Looking Down," appeared in ED 12, June 10, 1971.

For further information on the products discussed here, write to the following:

Peter J. W. Noble, Managing Director, Integrated Photomatrix Ltd., The Grove Trading Estate, Dorchester, Dorset, U.K.

Alan M. Patrick, Publicity & P.R. Director, Electronics Group, The Plessey Company Ltd., Surrey House, Temple Place, London WC2, England.

Brian M. Whale, Press Officer, Mullard Ltd., Mullard House, Torrington Place, London WC1, England.

Joachim Ullmann, Technischer Pressedienst, Zentralstelle für Information, Siemens Aktiengesellschaft, Werner-von-Siemens-Strass 50, 8520 Erlangen, West Germany.

Dan Boyle, Press Officer, GEC-Marconi Electronics Ltd., Marconi House, Chelmsford, Essex, England.

R. Brookshaw, Publicity Department, English Electric Valve Co., Water House Lane, Chelmsford, Essex, England.

Jacques Oudin, Direction des Relations Publiques, Thomson-CSF, Parc de Rocquencourt/B.P. 2000, 78-Versailles, France.

Bernd Machule, Pressereferent, Rohde & Schwarz, 8 Munchen 80, Muhlendorfstrasse 15, Germany.

Jean Trampe Broch, Bruel & Kjaer, Linde Alle, DK 2850, Copenhagen-Naerum, Denmark.

low, Britain, is interested in L-band radar and vhf frequency equipment, and it has been experimenting with BSZ substrate material—barium strontium zirconate—which has a dielectric constant of 30.

In electronic instrumentation, Marconi Instruments of St. Albans, Britain, has recently introduced several new additions to its lines. Among them are an AM/FM signal generator with 10-kHz-to-510-MHz capability, 5-ppm stability and a built-in frequency sweep and a uhf/FM signal generator for the 400-to-520-MHz range, suitable for measuring adjacent-channel rejection ratios of greater than 70 dB.

Rohde & Schwarz has announced a combination video sweep generator, selective receiver and display unit for TV testing, called the Videoskop III. With a range of 10 kHz to 20 MHz, the unit has a test range of -100 dB to +90 dB, generator output of 1 mV to 1.2 V into 75 ohms, receiver bandwidth of 2 kHz, selectivity of over 110 dB \pm 9kHz, sensitivity of 3 mVpp for full picture height and linear and log display of up to 50 dB.

Bruel & Kjaer has announced

a new line of shake tables with interchangeable heads, providing high side stiffness, high g levels, long strokes or a general-purpose compromise, as the job requires. New from the B & K Copenhagen plant is a noise dose-meter that reflects modern noise-pollution thinking, in that it registers integrated noise doses rather than average or rms levels.

Microminiature crystal oscillators in TO5 cans are being offered by Marconi Communications Systems Ltd. of Chelmsford, Britain. The oscillators operate at any frequency between 10 and 22 MHz, and have a short-term (about 1 second) stability of better than one part in 100 million over a temperature range of -55° to +90°C. Long-term stability is better than two parts in 10⁷.

Siemens has introduced a ferrite-core storage unit, Stapelblock design, with a capacity of 4000 16-bit words, suited for extreme environmental conditions, and two new ferrite materials, N32 and T37. The N32 material has a linear permeability characteristic over -40° to +70°C, and the T37 material has high pulse permeability. ■■

4 at microwave symposium tell how to get high power from low

Everyone seems to agree that the way to get a lot of solid-state microwave power is to combine the outputs of several low-power devices. What has not yet been determined is the best way to do this.

Four speakers at the 1971 International Microwave Symposium in Washington, D.C., discussed this topic. Basically they came up with three different ways to operate several devices together:

- Parallel operation.
- Anti-parallel operation.
- Distributed operation.

Parallel operation was described by two researchers in the context of power generation, while the two other approaches were described in connection with power amplification.

Parallel tuning can be tricky

In his paper "High-Power, Low-Noise Avalanche Diode Oscillators," Dr. Ferdo Ivanek of the Fairchild Microwave and Optoelectronics Div., Fairchild Camera and Instrument Corp., Palo Alto, Calif., described the design of a waveguide oscillator mount that could be cascaded with a second mount to double its output power. The design, developed by Ivanek and V. Gopala K. Reddi, is built in a piece of waveguide with a sliding short at one end and a slide-screw tuner at the other (Fig. 1).

Ideally, an unlimited number of these diode mounts can be cascaded together to obtain any desired power (as shown in the bottom of Fig. 1). This situation assumes that the diode mounts do not sig-

nificantly perturb the TE_{10} mode propagating in the waveguide.

In actuality, of course, the mounts do perturb the field patterns, making it difficult to cascade stages indefinitely. The problem is that tuning becomes very difficult, and also that the resulting periodic structure has a very narrow bandwidth. This second factor means that even when the multidiode structure can be made to oscillate, it will do so only over a very narrow frequency range.

In his experimental work, which was carried out with 1-W diodes at X-band, Ivantek typically obtained a tuning range of about 1.5 GHz for a single-diode unit, 200 to 300 MHz for a two-diode assembly and about 100 MHz when three diodes were used. The three-diode oscillator was much more sensitive to device spacing than the two-diode unit was, he reported.

When the diode spacing was optimized, the power-combining ef-

ficiency was essentially 100%. It sometimes slightly exceeded this figure in the two-diode case, indicating that the composite structure provided a more perfect match to the diodes than the individual mounts did.

Measurements of the two-mount composite oscillator showed that FM noise tended to exceed slightly that of a single mount (about 1 dB more), while AM noise was reduced by about 10 dB. These results are in good agreement with results obtained by others.¹

Another approach to multi-parallel operation was described by Y. Kaneko, K. Kimura and J. Nakagana of the Central Research Laboratory at Hitachi, Ltd., Kokubunji, Tokyo, Japan. In their paper "Multi-Parallel Operation of Gunn Diodes for High Rf Power," they described a resonator design for operating many diodes in a series-parallel combination.

The Hitachi researchers reported

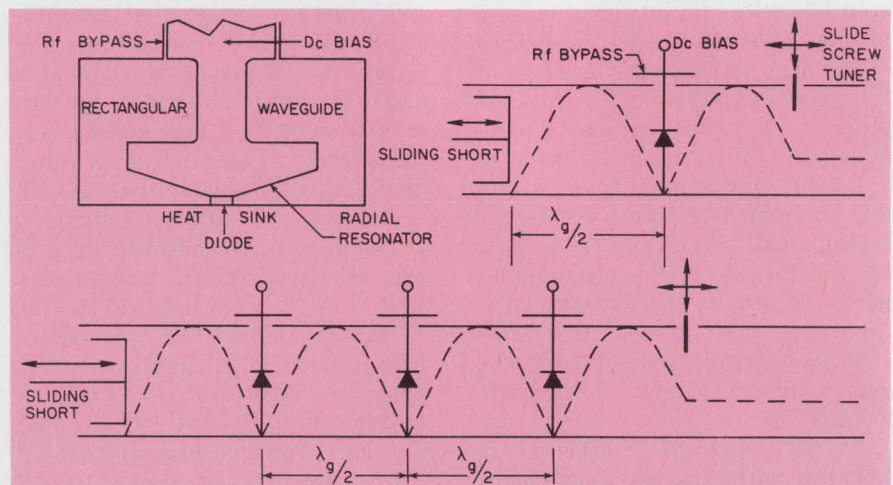

1. Either a Gunn or an Impatt diode can be used in this waveguide mount. The diode is placed about half a guide wavelength from the sliding short—at a null in the standing-wave pattern, as shown by the dashed lines. For increased power, several mounts can be cascaded (bottom).

successful operation of 12 diodes with a combining efficiency of 80% at 12.7 GHz. Their composite oscillator produced 920 mW of cw power. Like Ivanek, they reported considerable difficulty in tuning their oscillator as more diodes were added.

Also like Ivanek and Reddi, the Hitachi group developed a basic diode mount, several of which could be cascaded together. However, instead of holding only one diode, each mount held four, in a series-parallel circuit. One advantage of this configuration is that it can tolerate the failure of a single diode, or of two diodes, and still keep working. The power, of course, is reduced, but the frequency change was reported to be quite small as long as a parallel pair of diodes was alive.

By contrast, the failure of one diode in the multidiode oscillators described by Ivanek would cause the oscillator to fail.

Anti-parallel is like push-pull

A rather different method for combining avalanche diodes for increased output power was described by Dr. Hirohisa Kawamoto of RCA Laboratories, Princeton, N.J., in his paper "High-Power Microwave Amplifier Using Anti-Parallel Avalanche-Diode Pair." Basically his amplifier consists of a pair of diodes placed at the ends of a transmission line, whose length is approximately half a wavelength.

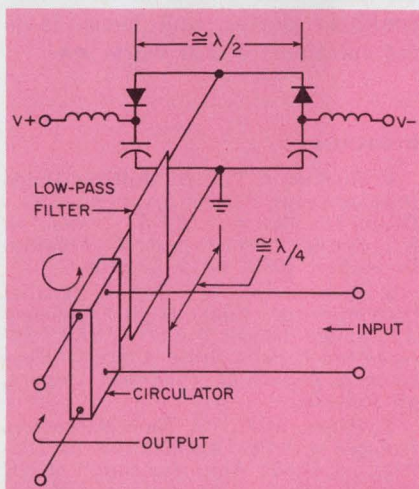

2. Like an ordinary push-pull amplifier, this anti-parallel pair of diodes produces an output with very little second-harmonic distortion.

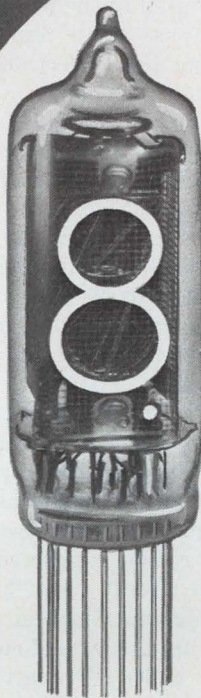

Tight Spots?

Tight Budgets?

HERE'S A NEW
**NATIONAL[®] READOUT
 TUBE FOR BOTH
 TIGHT SPOTS and
 TIGHT BUDGETS!**
THE NL-1222

SEND FOR DATA FROM:

NATIONAL ELECTRONICS, INC.
 a varian subsidiary

Geneva, Ill. 60134, phone 312-232-4300

LOW COST CONVERTERS

from ... **19**

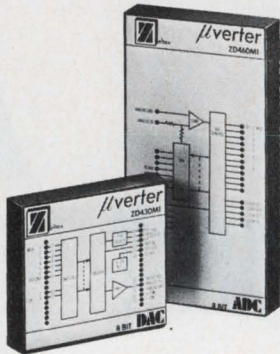

DAC's

8-Bit Binary . . .	\$19
2-Digit BCD . . .	\$19
10-Bit Binary . . .	\$29
3-Digit BCD . . .	\$39
12-Bit Binary . . .	\$49

ADC's

8-Bit Binary . . .	\$49
10-Bit Binary . . .	\$69

(Single Quantity Prices)

FEATURES:

- Ready to use (need only dc power)
- DAC settling time . . . from 2 μ s
- ADC conversion times . . . from 15 μ s
- ADC quantizing error . . . $\pm 1/2$ LSB
- Absolute accuracy . . . $> \pm 1/2$ LSB
- Linearity . . . from 0.01%
- Tempco . . . 20 ppm/ $^{\circ}$ C
- Operating temp . . . 0 $^{\circ}$ C to 70 $^{\circ}$ C
- Analog ranges . . .
 - ± 10 V, ± 5 V, 0V to 10V
- DTL/TTL compatible
- ADC - parallel & NRZ serial output
- All models pin-for-pin compatible

Write, call or TWX

TEL: (415) 686-6660
TWX: 910-481-9477

Zeltex INC.
A SUBSIDIARY OF REDCOR CORP.
1000 Chatham Road Concord, California 94520

INFORMATION RETRIEVAL NUMBER 22

The diodes, which are driven from the midpoint of the line, are connected with their polarities in opposition. (Fig 2). Both diodes are back-biased to the breakdown point. A low-pass filter and a circulator complete the reflection-type amplifier.

A key advantage of this circuit is that one of the two active devices amplifies one half cycle of the input signal, while the other device handles the other half. Thus, just like a push-pull amplifier, the anti-parallel circuit has only a small amount of second-harmonic distortion at the midpoint between the two diodes.

The circuit is quite versatile. It can act as either an amplifier or an oscillator, depending upon the number, sizes and positions of the tuning elements. And several pairs of diodes can be connected in a radial-shaped circuit (Fig. 3).²

In his experimental work, Kawamoto used high-efficiency (sometimes called Trapatt) avalanche diodes at an operating frequency of 1.01 GHz. He obtained 200 W of pulsed output power at saturation, with a gain of 10 dB. The 3-dB bandwidth was 17.5 MHz.

To obtain pulsed operation, Kawamoto used a cw input signal and pulsed the bias voltages on and off. He pointed out that the amplifier was best suited for use as a saturation amplifier, although it does have a small linear region.

A progress report on the Duma

A completely different approach to power combining is the Duma—Distributed Unidirectional Micro-

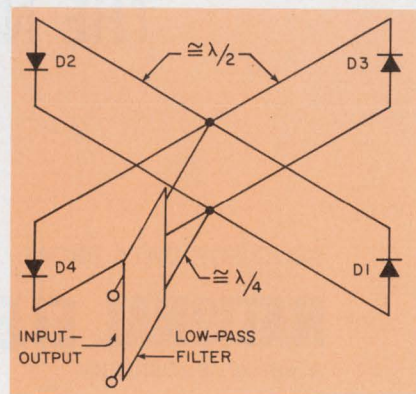

3. Many anti-parallel pairs can be connected in this fashion. The diodes in each pair are at the ends of a half-wavelength line.

wave Amplifier—first described at the 1970 International Microwave Symposium by Marion E. Hines of Microwave Associates, Inc., Burlington, Mass.³ The device uses a microstrip field-displacement ferrite isolator, in which the forward waves are concentrated along one edge of the microstrip line and the reverse waves along the other.⁴ Lossy material placed along the edge where the reverse wave travels allows a series of negative-resistance devices to operate as a stable amplifier when they are distributed along the opposite edge.

A basic advantage of this approach is that it allows the active devices to be mismatched deliberately to the forward wave. This means that each device only "sees" a small part of the total energy on the line. The gain per diode is very low in this case, but the power contributed by each diode accumulates in the line, so that very high power can be obtained with low-power devices.

According to Roger N. Wallace of Microwave Associates, who delivered a paper on "Distributed Unidirectional Microwave Amplification" at this year's symposium, the Duma appears to be a good way to obtain 10 to 20 times the power available from a single diode. He feels that 10 W of output power at a gain of 10 dB is a reasonable result to expect in the not-too-distant future.

So far he has obtained 9 W from a five-diode Duma with a net gain of 2 dB and 4.4 W from the same Duma with a gain of about 8.5 dB. Obviously the Duma is a grossly nonlinear device, and hence it is not suitable for AM work. ■■

References

1. Rucker, C.T., "A Multiple-Diode High-Average-Power Avalanche-Diode Oscillator," *IEEE Trans. on Microwave Theory and Techniques*, December, 1969, pp 1156-1158.
2. Kawamoto, H., "Anti-Parallel Operation of Four High-Efficiency Avalanche Diodes," *1971 IEEE International Solid-State Circuits Conference, Digest of Technical Papers*, pp 178-179.
3. Hines, M.E., "A New Microstrip Isolator and its Application to Distributed Diode Amplification," *IEEE G-MTT 1970 International Microwave Symposium, Digest of Papers*, pp 304-307.
4. Riezenman, M.J., "New Isolator Boosts Solid-State Power," *Electronic Design*, June 21, 1970, pp 25-26.

Under-drafting.

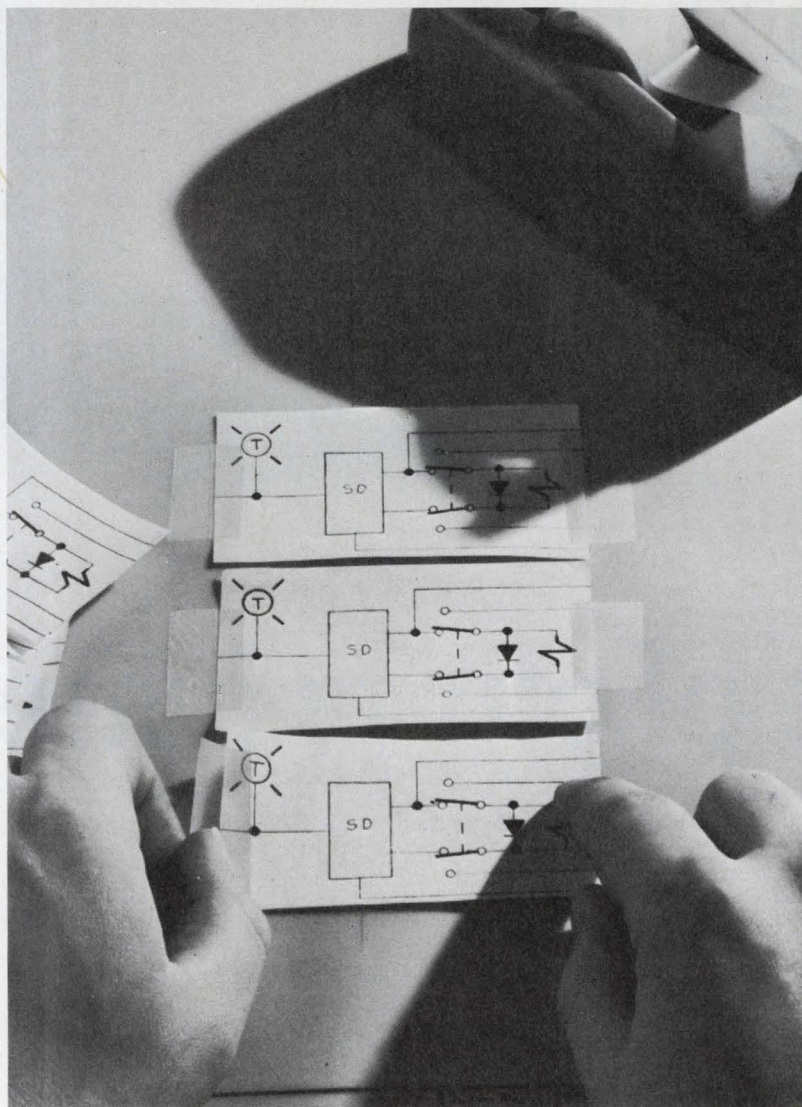

**Draw less.
Let photography
handle your repeat
drafting chores.**

If you're retracing design elements that are repeated again and again in a drawing, you're overdrafting. Same thing applies if you're retracing a design that's part of another drawing.

Save time. Underdraft with KODAGRAPH Films and Papers for a welcome change. Let them do the repetitive work — photographically.

Talk it over with your local Kodak Technical Service Representative. Or write Eastman Kodak Company, Business Systems Markets Division, Department DP795, Rochester, New York 14650.
**DRAWING REPRODUCTION
SYSTEMS BY KODAK**

Kodak

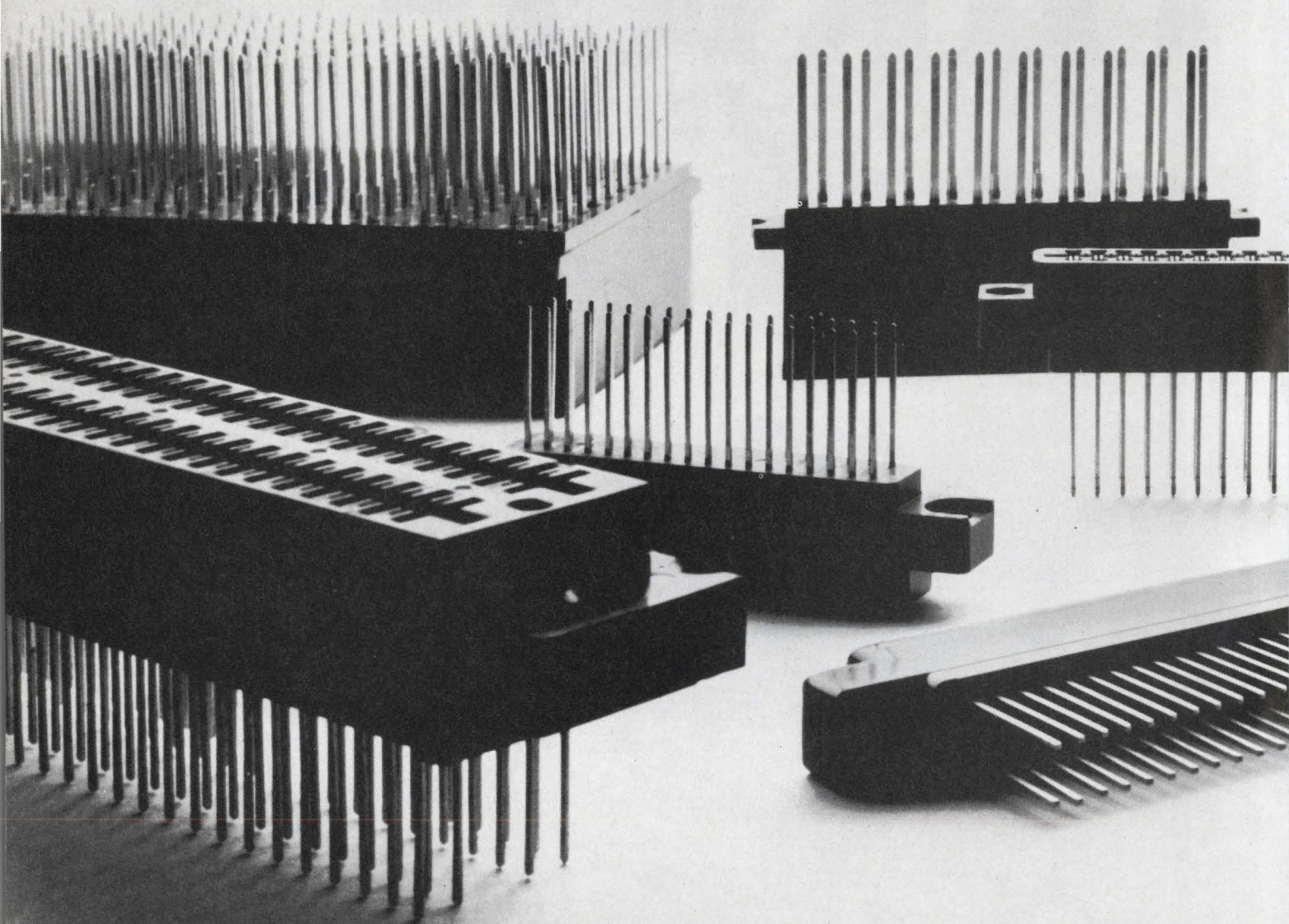

Some of our private

Most of our off-the-shelf connectors started out as custom designs for specific customers.

Now they're available to you.

You get a custom connector at off-the-shelf prices—and there's no tooling cost.

For example, our P101 and new P201 circuit-card connectors have custom features such as contact-tail tip locus within .020 inch diameter of true position; our exclusive gold-dot contact system (the dots don't fall off) and a life of at least 500 trouble-free insertions and withdrawals. The P101 is also available with gold-plated bellows contacts.

In addition to these, we've got other connectors coming off the drawing board.

For example, our soon-to-be-ready P108 is a rack-and-

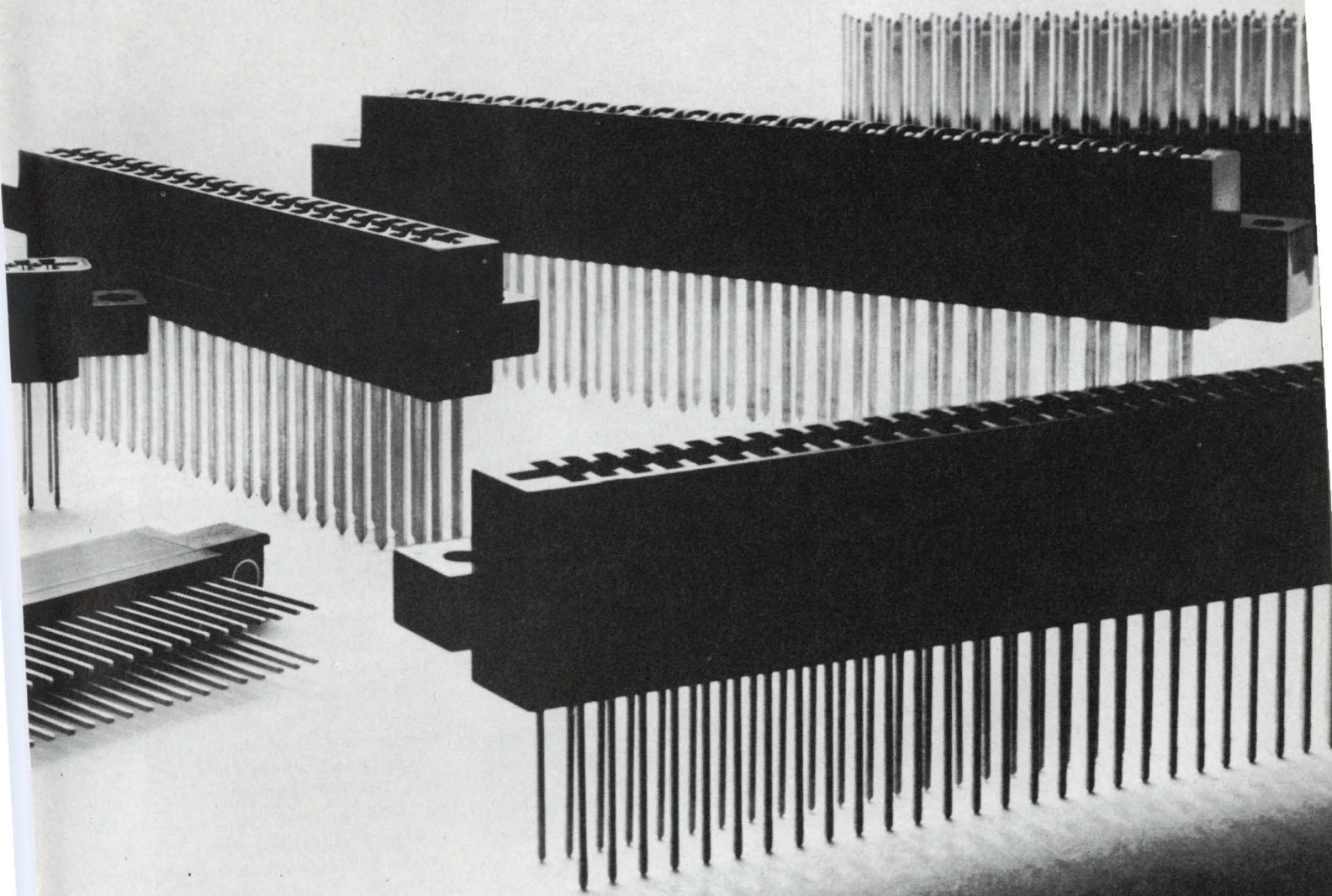

lines have gone public.

panel connector designed for the same tight contact-tail tolerances. It features a solid pin, solid housing construction and a low price.

The P101 is available with 12 to 100 contacts, and the P201 comes in 36, 72 and 100 contact sizes. The P108 has 50 and 104 contacts. Additional sizes can be made available.

They can become public property at low cost.

And, of course, we still have our complete custom facility available.

For those things you just wouldn't want to do in public.

GTE Sylvania, Precision Materials Group, Parts Division,
Warren, Pa. 16365.

GTE SYLVANIA

INFORMATION RETRIEVAL NUMBER 24

monolithics: the facts

Monolithic crystal filters are becoming a popular topic of discussion these days. Since we've been making them longer (since 1967) and making more of them (over a quarter-million last year), we'd like to clear up a few misconceptions about the state-of-the-art.

1. Monolithics are expensive—Wrong. They cost less than conventional crystal filters. And, their low cost/high performance has brought reality to many "someday" applications.

2. There are no standard models—Wrong again. PTI has over 20 standards at the 10.7 MHz frequency alone. Plus a big selection of standards at other popular frequencies.

3. There isn't enough variety of packaging—PTI offers several models in flatpack, upright mount and P.C. assembly. We've got more on the drawing board.

If you're now using standard crystal filters, or if you've been holding off because of cost, size or performance, we'd like to show you how monolithics can do the job better for less. Drop us a line and we'll send our new fact sheet.

For off-the-shelf or custom models, if you have questions about monolithics, we've got the answers.



Piezo Technology Inc.

2400 Diversified Way
Orlando, Florida 32804
305-425-1574

The standard in monolithic crystal filters

technology abroad

Extraordinarily fine positional control to an order of 0.01 μm is obtained with an optical grating system developed at Philips Research Laboratories, Eindhoven, The Netherlands. The new instrument can be used in machine-tool control, where digital measurements of one micron and smaller are becoming increasingly important. Even higher accuracies are required in the control of step-and-repeat cameras for manufacturing integrated-circuit masks. Movement in the system produces a shift in the plane of polarization of light shining on a moving table equipped with a reflecting phase-grating. The shift is detected by a system comprised of an electro-optic crystal modulator and a two-detector arrangement that converts the azimuth of the plane of polarization into a phase difference.

An MOS transistor that has useful gain up to 1 GHz has been produced at the Hirst Research Center, Wembley, Middlesex, England. The frequency response of the new transistor is double that of commercially available devices, which have an upper limit of approximately 400 MHz. Good cross-modulation performance and a wide dynamic range are available when the new device is used as the input transistor in communications equipment.

A novel and extremely sensitive infrared radiation detector has been developed by the French National Office for Aerospace Studies and Research. The detector consists of a gas-filled cavity, one wall of which is both a flexible membrane and the plate of a capacitor. When infrared radiation heats the gas, it expands, deforming the membrane. This

change in capacitance is sensed electronically and gives a direct measure of radiation. The detector is extremely sensitive and can detect as low as half a microwatt. It is sensitive over a wide infrared bandwidth, and, unlike equivalent devices, it requires no refrigeration. However, the minimum response time is fairly long—500 μs . Several versions of the detector have been produced, the latest of which is suitable for satellites. Here it can be used to stabilize the satellite on the earth's horizon, which it detects as an infrared horizon. It can also be used to detect atmospheric pollution and for earth resources studies.

To study the application of satellites to air navigation the European Space Research Organization, has awarded contracts worth \$600,000 each to three European consortia. The groups—Cosmos, Mesh and Star—will study the types of launchers required, their stabilization systems, types of antennas, eclipse conditions and antenna gain. The first phase of the study is expected to be completed by June of next year.

Power plants for electric cars, trucks and buses, as well as special service-station networks for the vehicles, will be developed by Rheinisch - Westfaelisch-Elektrizitaetswerke of Germany. The company now makes batteries that can be charged up to 2000 times—equivalent to a 62,000-mile lifetime. Company officials see electric vehicles consuming nine-billion kilowatt hours a year by 1980, or about 2.35% of West Germany's total consumption. Batteries would be charged during the low-power-load hours of night. Weak ones would be replaced by a service station.

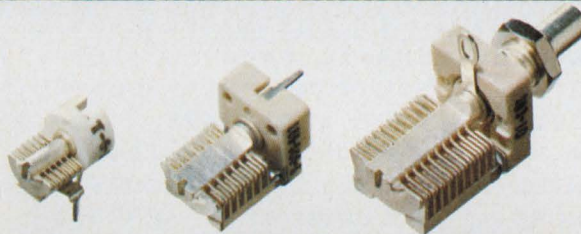
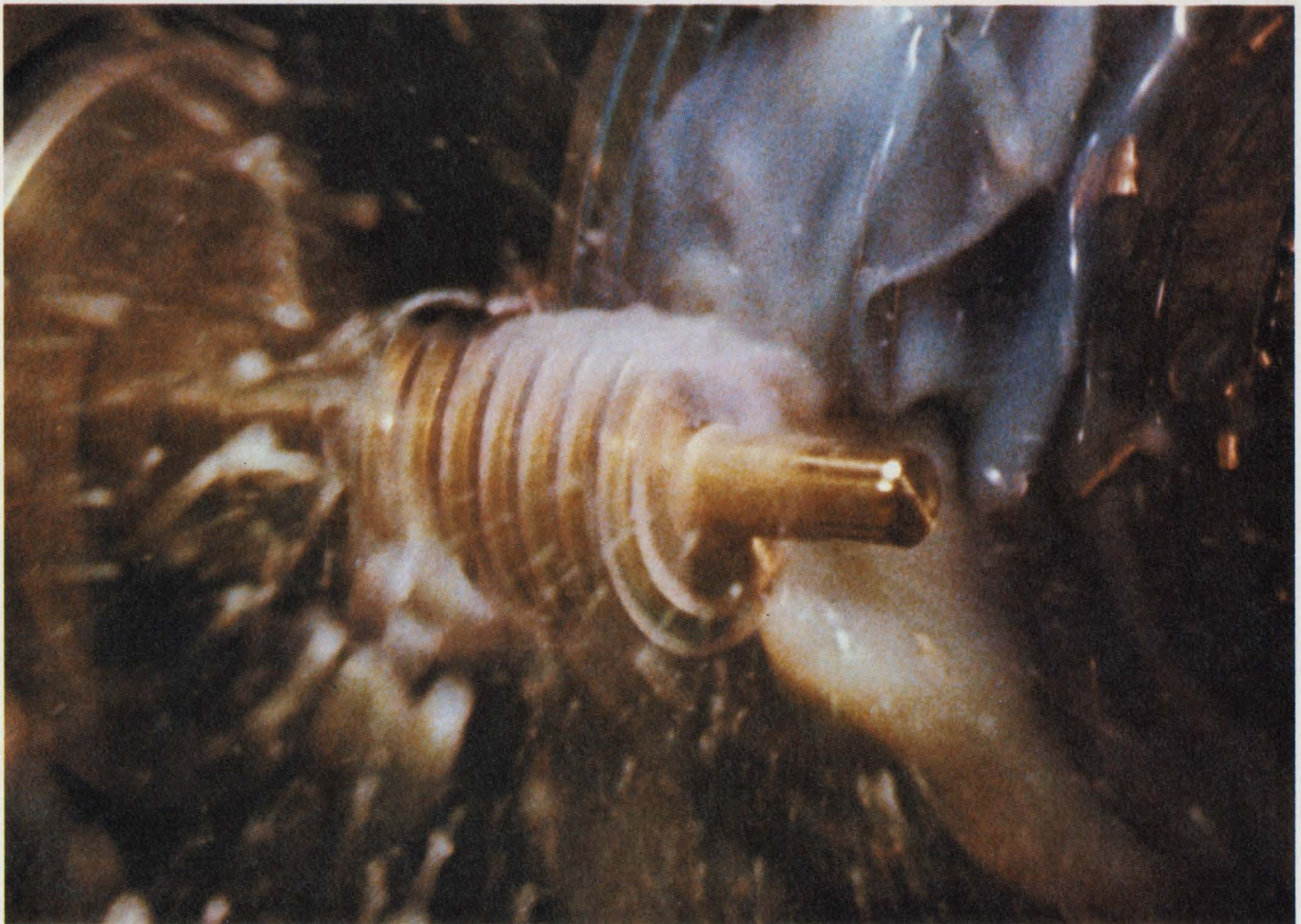

TYPE: T

Mtg. Area: 0.1 sq. in.
 Q: > 2000 @ 150 MHz
 pF: 1.3-5.4 to 1.9-15.7
 TC: plus 30 ± 15 ppm/°C

TYPE: U

Mtg. Area: 0.2 sq. in.
 Q: > 2000 @ 150 MHz
 pF: 1.2-4.2 to 2.4-24.5
 TC: plus 45 ± 15 ppm/°C

TYPE: V

Mtg. Area: 0.3 sq. in.
 Q: > 2000 @ 150 MHz
 pF: 1.4-13 to 2.2-34
 TC: plus 50 ± 20 ppm/°C

It takes brass to machine capacitors like these.

Johnson precision machines each rotor and stator for these compact capacitors from a single, solid brass extrusion. The benefits are outstanding mechanical stability and electrical uniformity. As a result, you get consistently high performance from every Johnson capacitor. You can rely on them for exceptionally high Q, low temperature coefficients and uniform minimum and maximum values. All at a cost probably lower than what you are now paying.

Return the coupon today for more complete information on the famous Johnson line of machined plate air variable capacitors. Or, perhaps you have a unique need. Our en-

gineers will be glad to work with you. Call (507) 835-2050.

 E. F. JOHNSON COMPANY / 3106 Tenth Ave. S.W. /
 Waseca, Minn. 56093

Please send new Capacitor Catalog (702-01)

Please send free product sample

Type T Type U Type V

Specifications: _____

NAME _____ TITLE _____

FIRM _____

ADDRESS _____

CITY _____ STATE _____ ZIP _____



E. F. JOHNSON COMPANY

Low cost computer microcircuitry is here. Dow Corning's silicone technology paved the way.

SILICONE PACKAGED MOS RAM DEVICES USED IN NEW, ADVANCED COMPUTERS.

A DOW CORNING SILICONE MOLDING COMPOUND IS CONTRIBUTING TO THE LOW COST AND HIGH PERFORMANCE RELIABILITY OF INTEL CORPORATION'S MOS AND BIPOLAR RAM PRODUCT LINE USED IN TODAY'S ADVANCED COMPUTER HARDWARE. THE TYPE 1101 16-PIN MOS RAM INCORPORATES A MOISTURE-PROOF SEAL OF SILICONE AROUND A SMALLER, HIGHER-YIELD CHIP. IT COSTS 50% LESS THAN THE EARLIER CERAMIC ENCAPSULATED DEVICE. TO DATE, SILICONE ENCAPSULATED DEVICES INCLUDING TYPE 1101 HAVE UNDERGONE A MILLION HOURS OF SYSTEM LIFE TESTS AT INTEL WITH ONLY ONE FAILURE--AN INPUT SHORT. INCLUDED WERE APPROXIMATELY 200 DEVICES OPERATED OVER 1100 HOURS EACH AT 125 C AMBIENT AND 175 C JUNCTION TEMPERATURE. THE RELIABILITY OF THE SILICONE ENCAPSULANT IS CLOSELY RELATED TO ITS PURITY AND RESISTANCE TO THERMAL DEGRADATION. DOW CORNING SILICONE MOLDING COMPOUNDS DO NOT CONTAMINATE DEVICE SURFACES AND ARE INHERENTLY SELF-EXTINGUISHING. THEY CONTRIBUTE TO THE LONG LIFE AND RELIABILITY OF SEMICONDUCTORS. CIRCLE INFORMATION RETRIEVAL NUMBER 851.



Evolving electronic technology is constantly mastering new industry problems. And silicones are helping to pave the way. Advanced silicone technology can expand your performance parameters. If it's miniaturization, thermal cycling or thermal shock—look to Dow Corning silicones. If it's nonburning safety, vibration damping or corrosion protection—there's a silicone protector to do the job better. Dow Corning silicones bond, seal, insulate, dissipate heat or encapsulate—in environments that no organic material could take.

Get acquainted with Dow Corning's silicone performance improvers. Write today for the complete story. Dow Corning Corporation, Dept. B-1222, Midland, Michigan 48640.

Electrical / electronic materials from

DOW CORNING

DOW CORNING

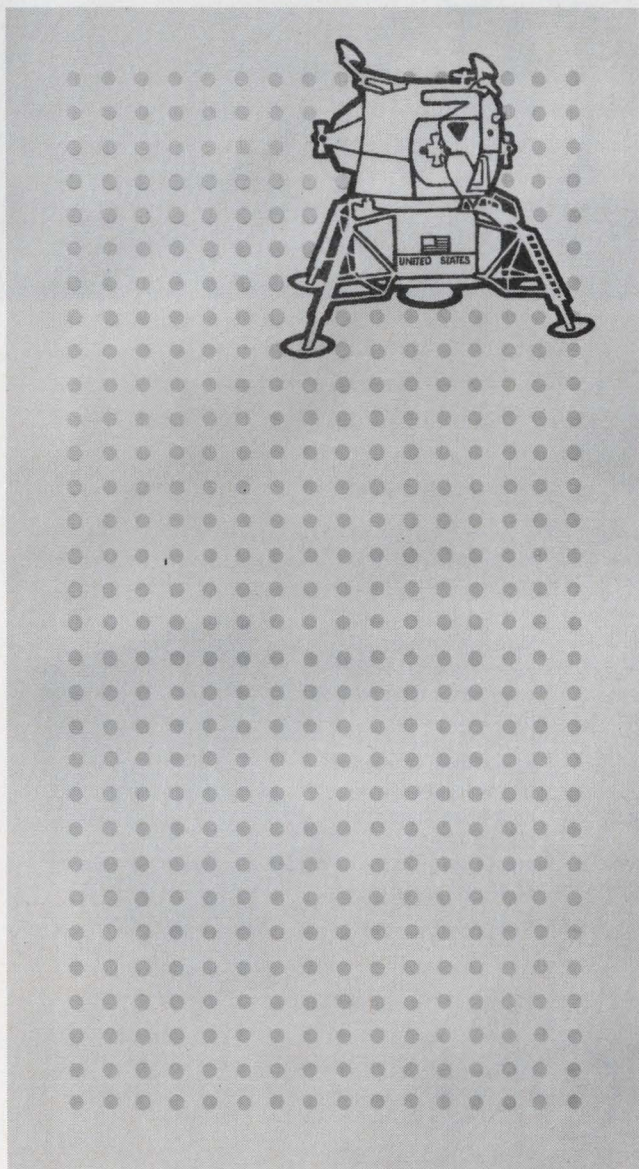

Silicone structural materials withstand even lunar environments. Instruments and wiring are protected from environmental damage inside the Apollo LM with nonflammable silicone laminated wall panels. Components such as coil bobbins, circuit boards and switch decks are also made from silicone laminates or structural molding compounds. These silicone materials provide excellent dielectric properties, strength and protection against tough environments. Write for a list of specialty fabricators that can help you evaluate these engineering materials.

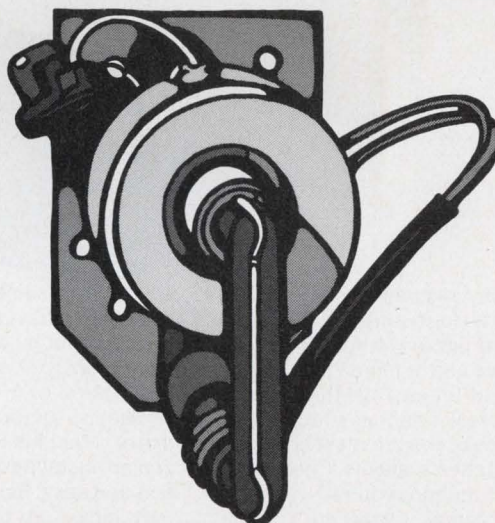

Silicones decrease fire hazard in color TV. Silicones are eliminating costly callbacks and helping to protect the reputations of color TV manufacturers. Flyback transformers impregnated and encapsulated with Sylgard® resin help eliminate fire hazards that result from abnormally high temperatures produced by set malfunctions. For the ultimate in TV safety, Dow Corning also recommends high-voltage wire insulated with silicone rubber and connections sealed with a silicone sealant. Circle Information Retrieval Number 852.

The toughest lighted switches.

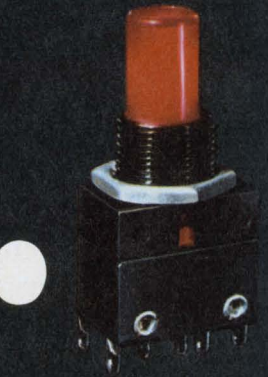
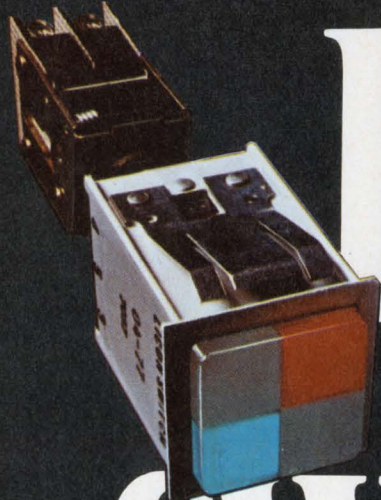

*Because every one is based on Licon's
incredibly reliable (up to 20 million
mechanical cycle) Butterfly switch.*

From the tiny inexpensive Type 01-700 to the four-lamp Type 04, every Licon® lighted switch incorporates one or more Licon Butterfly® switches. Thus the ultimate in double-break switches becomes the basis for one of the broadest lines of lighted switches available. Choose the indicating function required... one; two or four lamps... lens cap configuration... screen color and engraved legend. Name your switching

action... momentary, maintained, solenoid-held, indicator light only, or multi-circuit control. Select your mounting style... flange, barrier, bezel, bezel-barrier, horizontal or vertical, single-switch or multiple in matrix. Meet Mil Specs. In every choice, installation and servicing is fast and easy. Because ultra-reliable switching is our business. Test light the line yourself. Call your local Licon distributor or representative for a

lighted demo in your office. Or call or write for a Licon Switch Catalog. **Licon, Division Illinois Tool Works Inc., 6615 W. Irving Park Road, Chicago, Illinois 60634. Phone (312) 282-4040. TWX 910-221-0275.**



itw LICON

The Innovating Electronic Group of ITW... LICON ■ ELECTRO MATERIALS ■ PAKTRON

washington report

DON BYRNE, WASHINGTON BUREAU

FAA to request proposals for microwave landing system

The Federal Aviation Administration expects to put out a request for proposals in a week or so for system development work on a microwave aircraft instrument landing system. The FAA estimates that eventually the system will cost about \$100-million and that an additional \$90-million will be spent on R&D and development work. The program has been under review by the FAA, NASA and the Defense Dept. since last March. Defense Dept. agreement was necessary since the system will be used by military as well as civilian aircraft. The FAA expects the program to take five years for development and testing and another five years for procurement and installation. Plans call for 84 of the systems to be installed in major airports, and 370 smaller and less-complicated systems to go to less busy airports. The 84 larger systems are to cost a total of about \$42-million, and the 370 smaller units around \$55.5-million. The systems will interface with existing airborne instrumentation displays and will range all the way from having minimum landing requirements to all-weather capability.

TV networks eye alternate systems to Telpak

A spokesman for the three television networks has told the Federal Communications Commission that the networks may be forced to go to a microwave or satellite communications network if the rates for AT&T's Telpak bulk service are allowed to increase or if the offering itself is abolished. David M. Blank, vice president for economics and research for CBS, acting on behalf of the three major networks, told the FCC hearing on private line and program transmission rates that the networks are already looking at alternatives, particularly microwave and satellite communications. Government witnesses told the commission essentially the same thing in earlier hearings. Meanwhile, the Justice Dept. has told the FCC that it favors prompt approval of a domestic satellite system providing anti-trust protective measures are taken by the commission.

Space shuttle battle shaping in Congress

Sen. Walter F. Mondale (D-Minn.), a declared foe of the NASA space shuttle program, says that the program "could not be justified on economic grounds." In a Senate speech he cited a report prepared by the Rand Corp. for the Air Force that, he said, concluded that the space project would have to cost almost double its present \$3.2-billion estimate or "make no sense at all." NASA supporters immediately decried the report. Sen. Clinton Anderson (D-N.M.), chairman of the Senate Space Sciences Committee, said the report did not represent Air Force thinking or for that matter even the Rand Corp. thinking. He introduced correspondence from Air Force Secretary Robert Seamens which stated that

the Air Force backs the shuttle program. In the House, Rep. Louis G. Frey (R-Fla.), a member of the Science and Astronautics Committee, also criticized the report and added that Mondale may have been "mised" by his reading of it. In any event, there is \$100-million in the budget for the coming year for the space shuttle, and it promises to make appropriation debates in both House and Senate lively. The NASA budget is due on the House floor around the end of June.

Senators to query Industry Advisory Council

Sen. Lee Metcalf (D-Mont.) plans to call members of the Defense Dept.'s Industry Advisory Council before the Senate Intergovernmental Relations Subcommittee this week or next to examine the effect the group has on the Pentagon. The council is composed of 24 industry leaders drawn mainly from defense contractors and bankers. Deputy Defense Secretary David Packard is chairman of the group. The subcommittee will consider a Packard memo of May, 1970, calling for more cost-plus-incentive-fee contracts—in which the costs are covered and bonuses given for good work. This type of contract historically yields higher profits, and contractor profit percentages have come under fire lately from the General Accounting Office and some members of Congress.

Intelsat diluting its U. S. influence

U. S. influence over the International Telecommunications Satellite Consortium will be greatly reduced as Comsat is phased out as manager and an elected secretary general takes over the work. Comsat will continue to handle the technical functions of the organization for the next six years, after which a director general will assume that role. The 74 international delegations have been meeting on the problem of Intelsat control for a little over two years. They voted late last month to establish the offices of secretary general and director general.

Capital Capsules: Boeing has won the competition for the airborne segment of the undergraduate navigator training system. **The Defense Dept. award of \$81.7-million will cover 19 Boeing-737 aircraft.** Honeywell's Aerospace and Defense Group previously won a \$17.4-million contract for the ground simulator portion of the contract Sen. William Saxbe (R-Ohio) has inserted in the Congressional Record a **letter from former FAA Administrator E. R. Quesada on the "industrial military complex myth."** The letter points out that the combined value of the common stock of Lockheed, General Dynamics, McDonnell Douglas, United Aircraft, North American Rockwell, Litton Industries, Grumman, LTV, Boeing and Raytheon does not equal that of Avon Cosmetics A study made for the FCC recommends **the establishment of a microwave task force within the commission** to deal with the management of everything involving microwaves—from broadcasting to ovens **The Navy expects to award production contract for the Mark 48 torpedo this month to either Westinghouse or Gould Inc.'s Clevite Ordnance Div.** The program cost is now estimated at \$2.6-billion. **A development contract award for the Harpoon missile is expected at the same time.** That program will run between \$600-million and \$1-billion, the Navy says. McDonnell Douglas and General Dynamics are the bidders.



Cannon flexible circuitry and connectors do it all—for less.

ITT Cannon does the whole job—from circuitry design thru termination. We take any etched circuitry project from conception to graphic production, chemofacture and assembly. Then we put the right terminations on it—from the broadest line of connectors in the industry—standard rectangulars and circulars to special high density types. And we'll terminate it by welding, soldering or crimping—whichever method meets your specific application. What's in it for you? Savings. Costs reduced as much as 50%. Weight reduced as much as 60%. Over-

all volume by as much as 80%.

Add Cannon quality and reliability, complete design freedom and you see why our flexible circuitry systems meet the varied requirements of the communications, automotive, computer, appliance and aerospace industries.

For technical data, write for our FDG brochure. ITT Cannon Electric, a division of International Telephone and Telegraph Corporation, 666 E. Dyer Rd., Santa Ana, California 92702. (714) 557-4700.

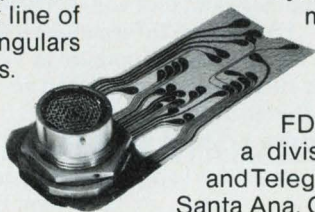

CANNON ITT

There is just one American peripheral manufacturer of computer rotating memory equipment with a European manufacturing capability.

Vermont Research.

Vermont Research Corporation has long been known as a leading supplier of a full line of fast, reliable drum memories and controllers.

You'll find VRC memory systems in use all over the world. In such diverse applications as process control; nuclear research; credit card checking systems; Air Defense systems; time sharing, graphic arts, telephone switching, theater lighting, medical electronics, education, numerical machine control, business machines and data terminals.

Now, we would like to announce a further development: our European manufacturing capability. For six months, VRC has been manufacturing and delivering memory systems in Europe. We're making them in England and installing and servicing them throughout the Continent.

This means that the products, skills and services you may have enjoyed from us in the United States are now available to any computer operation you have or plan in Europe . . . on a next-door basis. And as we have said, no other American peripheral manufacturer of computer rotating memory equipment can make such a statement.

For more information, write our home office in Vermont, or in England phone us at Leatherhead 6560.

VERMONT RESEARCH CORPORATION
Precision Park,
North Springfield, Vermont 05150

Es gibt nur eine amerikanische Herstellerfirma von Drehspeicheranlagen für Computer mit Fabrikationsmöglichkeiten in Europa.

Vermont Research.

Seit langem ist Vermont Research Corporation als ein führender Lieferant einer kompletten Serie schneller, zuverlässiger Trommelspeicher und Schaltapparate bekannt.

VRC Speicheranlagen werden auf der ganzen Welt verwandt – in so verschiedenartigen Bereichen wie Fertigungssteuerung; Atomforschung; Kreditkartenüberwachung; Luftverteidigung; Zeiteilung; Grafik, Telefonvermittlung; Theaterbeleuchtung; Elektromedizin; Erziehungswesen; Datensteuerung; Geschäftsmaschinen und Datenbestimmung.



Jetzt möchten wir Sie mit einer neuen Entwicklung bekanntmachen: unseren Fabrikationsmöglichkeiten in Europa. Seit sechs Monaten produziert und vertreibt VRC Speichersysteme in Europa. Wir stellen diese Systeme in England her und installieren und warten sie auf dem ganzen Kontinent.

Das heißt, dass Sie unsere Produkte, Erfahrung und Dienstleistungen – bisher nur in den Vereinigten Staaten erhältlich – nun auch für jeden Computerbetrieb, den Sie in Europa bereits haben oder erst planen, zur Verfügung stehen . . . und zwar in nächster Reichweite. Und wie gesagt, keine andere amerikanische Herstellerfirma von Speicheranlagen für Computer kann dies von sich behaupten.

Für weitere Informationen schreiben Sie an unser Hauptbüro in Vermont oder rufen Sie uns in England an – Leatherhead 6560.

VERMONT RESEARCH CORPORATION
Precision Park,
North Springfield, Vermont 05150

Il n'existe qu'un seul fabricant américain d'unités périphériques qui fabrique des mémoires tournantes de calculateur électronique et qui a des moyens de fabrication en Europe.

Vermont Research.

Vermont Research Corporation est connu depuis longtemps comme l'un des tout premiers fournisseurs de toute une gamme de contrôleurs et de mémoires rapides et sûres sur tambours.

Vous trouverez les mémoires VRC en utilisation dans le monde entier; pour des usages aussi divers que le "process control," la recherche nucléaire, les systèmes de vérification de carte de crédit, les systèmes de défense aérienne, dans les calculateurs fonctionnant en temps partagé, dans les arts graphiques, dans les standards téléphoniques, l'éclairage de théâtre, l'électronique médicale, l'éducation, le contrôle par machine numérique, les machines de gestion et les terminaux.

Nous aimerions annoncer maintenant un développement supplémentaire: nos moyens de fabrication en Europe. Depuis six mois, VRC fabrique et livre des mémoires en Europe. Nous les fabriquons en Angleterre et nous les installons et offrons un service après vente dans tout le Continent.

Cela signifie que les produits, la compétence et les services que nous vous avons offerts aux Etats-Unis sont maintenant à votre disposition . . . au coin de la rue pour n'importe quelle installation de calculateur électronique que vous avez ou envisagez en Europe. Comme nous le disions précédemment, il n'y a aucun autre fabricant américain d'unités périphériques de mémoires tournantes de calculateur électronique qui puisse affirmer cela.

Pour tout renseignement complémentaire, écrivez à notre centre administratif dans le Vermont ou en Angleterre téléphonez-nous à Leatherhead 6560.

VERMONT RESEARCH CORPORATION
Precision Park,
North Springfield, Vermont 05150



"Quite frankly, other linear I.C. devices need not feel threatened by us."

We're not competing as miniature low cost devices, we're competing as circuits—a new family of linear FET op amp circuits that are equal to any, better than most, and in many cases unique in the industry. Read these guaranteed min-max specifications.

AD-503 Bias current 10pA; offset voltage 20mV (trimmable to zero); gain 50K; slew rate 4V/μsec; offset voltage drift 25μV/°C.

AD-506 Internally laser-trimmed version of the 503 holds offset voltage to 1mV; eliminates requirement for external Vos trimming.

AD-513 Single capacitor external compensation; slew rate to 20V/μsec; settling time 3μsec to 0.1%; 5MHz gain bandwidth; (with feed-forward compensation: slew rate to 50V/μsec; gain bandwidth to 30MHz); bias current 20pA; offset voltage 20mV.

AD-516 Internally laser-trimmed version of the 513 holds offset voltage to 1mV; eliminates requirement for external Vos trimming.

AD-511 Bias current 5pA; offset voltage 1mV; gain 25K; economical replacement for C-118, 20-008, 20-108, 140801, and 501/P501 amplifiers.

That's the nucleus of the FET op amp family. Then there are the multipliers, converters, instrumentation amplifiers, and dual transistors. Like the op amps, these circuits are ready to use, typically with no need for outboard components. All are manufactured completely by us using the most advanced techniques and equipment.

Send for the family album—a 20 page in-depth description of the products and how they are made, including handy selection guides. Free. Analog Devices, Norwood, Mass. 02062. (617) 329-4700

 **ANALOG
DEVICES**

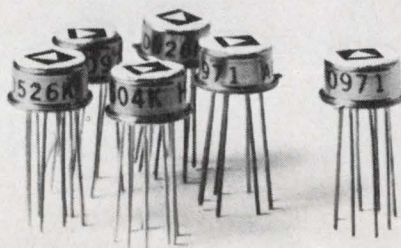



When space is at a premium turn to our stable $\frac{3}{8}$ " diameter cermet pots

Allen-Bradley Type SP. Tiny panel-mount pots for solving your severe space problems. These cermet pots give you exceptional stability in high-temperature or high-humidity environments. A lot of performance, in a small pot. Rugged, too. Handles 1 watt loads to 70°C.

Operational range -65° to $+150^{\circ}\text{C}$. Rotational life 25,000 cycles with less than a 10% resistance change. Resistance range 50 ohms to 1 meg. For panel or PC board mounting. Leads fit standard 0.1 inch spacing. Immersion-proof, can be encapsulated. Plain or locking

bushings, all watertight. Several shaft and bushing options. Allen-Bradley SP. Available from your A-B electronics distributor, or write: Allen-Bradley, Electronics Division, Milwaukee, Wisconsin 53204. Export: Bloomfield, N. J. 07003. In Canada: Galt, Ontario.



Actual Size

NEW DIMENSION ELECTRONICS
ALLEN-BRADLEY



editorial

Is there a lesson to be learned from Lockheed?

The furor that has been going on for months over the financial plight of Lockheed Aircraft Corp. has left many people upset and bewildered.

Here is a giant aerospace company, actually 33rd in Fortune's list of the 500 largest industrial corporations, contending it faces certain bankruptcy without a \$250-million Government loan guarantee. Opposed to such Government help is an influential array of Congressmen and other defense contractors, some arguing that Lockheed's management record isn't worthy of such aid, others saying similar assistance should be made available to other companies, and still others objecting that any Government help is a violation of free enterprise and fair competition.

Billions in investments and jobs are involved, with Lockheed reporting that for its L-1011 Tristar program alone, \$1.4-billion in U. S. investments and 30,000 U. S. jobs are at stake. Notwithstanding the chance that the impact on the economy won't be as bad as Lockheed would have us believe, the effect would still be significant, particularly now when some sectors of the economy are just beginning to see light at the end of the tunnel.

In view of this, the lesser of two evils would appear to be preventing Lockheed from falling into bankruptcy. But to do so in a no-strings-attached manner would be a promiscuous misuse of the taxpayers' money. Lockheed's management must be held accountable for the company's present decline, just as it would have received credit for its success. So any Government guarantee or other assistance should be predicated on suitable changes in that management.

The Government itself is not entirely blameless. The huge cost overruns on the C-5A jet transport and other projects, and the subsequent loss-agreement settlement with the Defense Dept. have contributed to Lockheed's plight. These cost overruns should never have been allowed to reach such staggering proportions—and here the Government must take itself to task.

All in all, the Lockheed story has progressed from bad to worse. It would be a shame if, after the final word is in, all the parties involved hadn't grown just a little wiser.

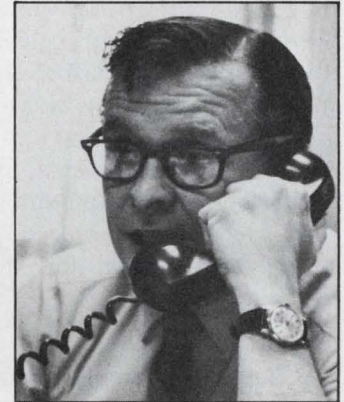

Frank Egan

FRANK EGAN

Cut the costs of Doppler radars and many other microwave detection and communications systems with this inexpensive Impatt-diode oscillator design.

The recent availability of cheap, solid-state sources of microwave energy has made possible the manufacture of such items as Doppler radars for the measurement of velocity, intrusion alarms and low-power microwave communications transmitters at prices that can be measured in tens, rather than thousands, of dollars. To see how such low-cost equipment can be made, let's consider the microwave oscillator requirements of a cw Doppler radar, and then design an oscillator to meet them.

The basics of Doppler radars

Doppler radars exploit the fact that the electromagnetic energy reflected by a moving object is shifted in frequency by an amount proportional to the object's velocity relative to the transmitter. For the frequency shift to take place, there must be a component of relative motion of the target along a line drawn between the target and the radar set.

If there is an angle θ between the target's direction of motion and the line connecting the transmitter with the target (Fig. 1), then the Doppler frequency shift, f_D , is given by

$$f_D = -2f_0(v/c) \cos \theta, \quad (1)$$

where f_0 is the frequency of the transmitter, v is the speed of the target and c is the speed of light.

The minus sign in Eq. 1, taken with the definitions of v and θ in Fig. 1, indicates that f_D will be negative for receding targets and positive for those that are approaching. Of course, $f_D=0$ for $\theta = \pm 90^\circ$, and it is maximum for $\theta = 0$ and 180° .

Applying Doppler shifts to measure velocity, or to detect the presence of a moving object, is very straightforward. A simple Doppler radar system (Fig. 2a) will typically send most of its

power out of its transmitter antenna, while feeding a small amount of it (typically 1%) to the receiver's mixer. Thus the transmitter serves as the receiver's local oscillator (LO). The transmitted signal, after reflection by an object, enters the receiving antenna and is fed to the mixer.

Since the frequency of the LO is f_0 , and that of the received microwave signal $f_0 \pm f_D$, the i-f signal emerges with a frequency of f_D —the Doppler shift of Eq. 1.

It is possible to eliminate one of the two antennas by using a circulator (Fig. 2b), but this limits the radar's maximum range to some extent because it reduces the isolation between the transmitter and the receiver.

Most commercial Doppler radars, such as police radars and intrusion alarms, operate at a microwave frequency of 10.525 ± 0.025 GHz. At this frequency, the Doppler shift caused by a target moving at a speed of 30 mph directly toward or away from the transmitter is about 935 Hz. A simple audio amplifier and frequency counting circuit at the i-f output of the radar set is used to measure f_D , and hence the target speed.

The only limitations on the accuracy of speed measurements made with this technique are the accuracies of f_0 and θ . The transmitter frequency can be measured easily to 0.01%, and θ can be measured to within a few degrees in most cases, so that for a directly approaching or receding target, the velocity measurement will be accurate to better than a few tenths of a percentage point.

Mere detection of motion, as in an intrusion alarm, requires even less sophisticated circuitry at the radar i-f output. Typical circuitry might consist of an audio amplifier followed by a diode peak detector and a Schmitt trigger. The presence of a signal in the amplifier passband would fire the Schmitt trigger, which, in turn, would energize an alarm or warning device.

What are the oscillator requirements?

From the description of a typical commercial cw Doppler radar, we can see that a suitable microwave oscillator will be characterized by the following description:

Written by **Michael Cowley**, Manager, Microwave Devices Section, and **Stephen Hamilton**, Applications Engineer, Hewlett-Packard Co., HP Associates Div., 620 Page Mill Road, Palo Alto, Calif. 94304.

Edited by **Michael J. Riezenman**, Microwaves Editor

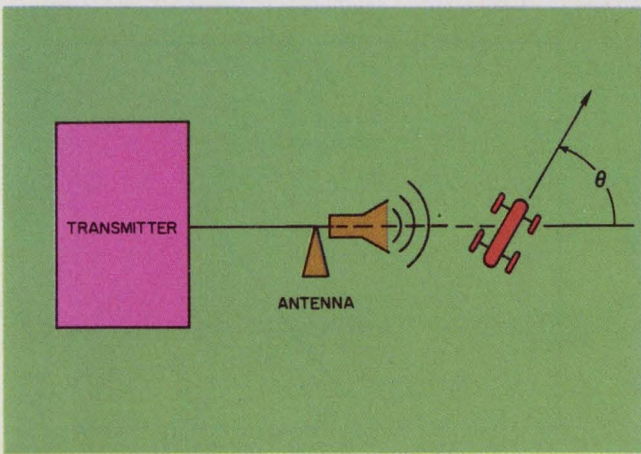

1. Doppler shifts are caused by relative motion along the line from the transmitter to the target. The magnitude of the shift is proportional to the target velocity, v , the radar frequency, f_0 , and $\cos \theta$.

3. This design cuts costs two ways: It uses an inexpensive diode, and it can be fabricated at low cost. Note that the distance from the cavity end wall to the centerline of the diode must be half a guide wavelength, λ_g , while the disc diameter is approximately half a free-space wavelength, λ_0 . The dimensions given in the diagram are for a 10.525-GHz oscillator built around a Hewlett-Packard 5082-0432 silicon Impatt diode.

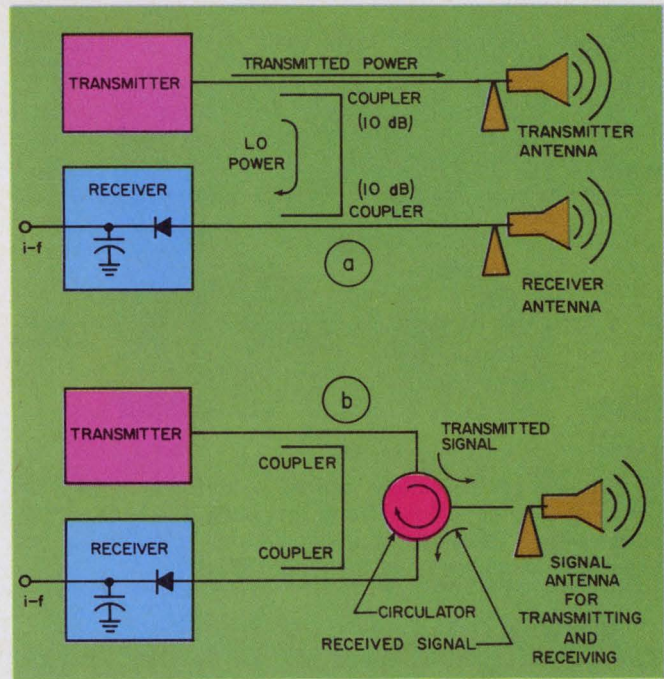

2. Doppler radars operate with a zero i-f because the transmitter is also the local oscillator. The two-antenna configuration (a) is more sensitive than the single-antenna version (b) because it has more isolation between the transmitter and the receiver.

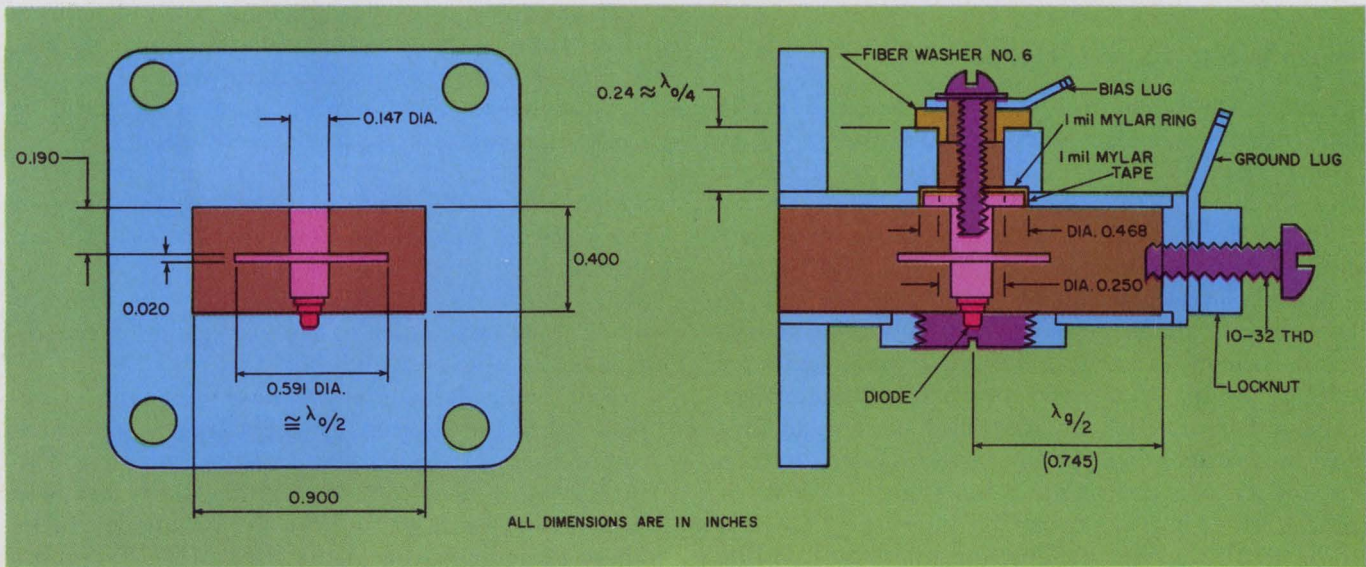

- Power output should be in the 25 to 100 mW range.

- AM noise close to the microwave carrier should be as low as possible, because the system is operating with a zero i-f and the AM noise of the transmitter, in most cases, is what limits the receiver sensitivity.

- The frequency of the oscillator must remain within ± 25 MHz of the 10.525-GHz nominal center frequency over temperature ranges expected in typical system operation. This is a Federal Communications Commission regulation.

- The over-all dc-to-rf conversion efficiency is not critical, and generally 3 to 5% is adequate.

- Power supply requirements for the oscillator should be compatible with available supply voltages. For equipment required to operate from 12 V, such as police radars, a dc-dc converter is necessary for silicon Impatt oscillators.

- Economy is extremely important in the design of commercial and industrial equipment. An over-all cost of about \$20 to \$30 for the complete oscillator is a typical design goal for these types of systems.

- Reliability and long operating life are important requirements in commercial and industrial designs—especially when the service personnel are unfamiliar with microwave equipment.

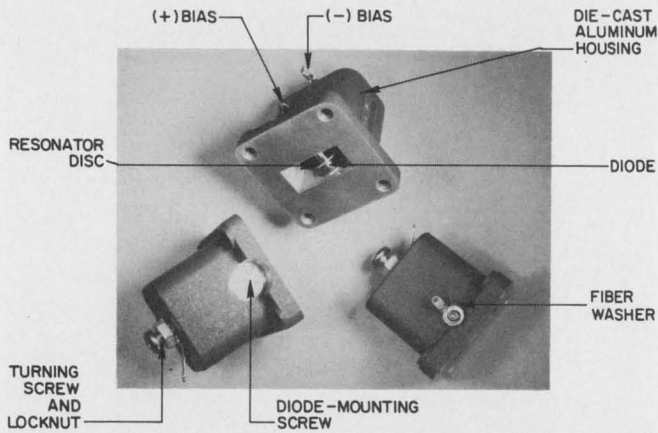

4. This die-cast oscillator can be built for only \$4 plus the cost of the diode. Note the hefty diode-mounting screw which provides a good thermal connection between the diode and the aluminum housing.

The reliability and operating-life factors provide some of the strongest reasons for favoring a solid-state approach to the rf design over the use of a reflex klystron.

■ The oscillator output should be waveguide, for compatibility with the waveguide horn antennas that are usually used in Doppler radars.

Impatt is 5 to 10 times cheaper

Given these requirements, the designer really has only two choices for a solid-state device to use in the oscillator—a Gunn diode or a silicon Impatt diode.

Gunn devices are fabricated from a relatively expensive material, gallium arsenide, and require much more critical fabrication processes than do the Impatt diodes, which can be manufactured from silicon—a well-understood semiconductor with a highly developed processing technology. Silicon Impatt diodes, therefore, have a decided cost advantage; at present, such diodes, with a capability of generating more than 100 mW of power at 10.525 GHz, can be purchased for less than \$10 each in production quantities, while comparable Gunn devices are currently priced at five to 10 times that for the same power capability.

An oft-cited advantage of Gunn devices is that they can operate at low voltages (6 to 10 V), and are therefore more compatible with such applications as police radar and automobile braking systems. However, a simple dc-dc converter is all that is required to enable a silicon Impatt oscillator to operate off 12 V, and if properly designed, this component adds as little as \$5 to \$10 to the over-all system cost.

An additional advantage of silicon Impatt diodes is their superior AM noise characteristics close to the carrier. This, coupled with their

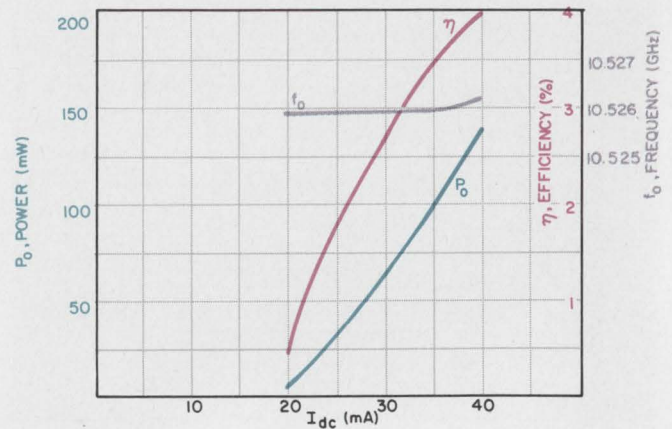

5. The diode bias current has little effect on the frequency of the oscillator. However, it profoundly affects the output power and the conversion efficiency, both of which go up as the current is increased.

greater power capability, means that the ultimate range achievable with an Impatt system is considerably greater than that of a system based on a Gunn diode.

Low-cost design uses die casting

A basic oscillator design, built around a piece of standard X-band waveguide, is shown in Fig. 3. The design is quite flexible, in that most of its dimensions need not be changed when it is desired to operate with different diodes.

The Impatt diode is soldered into a screw, which is securely mounted in the bottom wall of the X-band waveguide. This provides optimum heat-sinking for the diode, a very important design consideration. Matching of the Impatt diode's low impedance to the waveguide is accomplished by the post-and-disc assembly.

Bias is brought into the diode through a bypass capacitor formed by the upper disc, which compresses a 1-mil Mylar washer into a recess in the top wall of the waveguide. The screw in the end of the cavity allows the frequency to be finely adjusted, over about ± 80 MHz, from the nominal 10.525 GHz center frequency.

The most important design parameters in this oscillator are the location of the diode relative to the end of the cavity, and the post and disc dimensions that affect the Q and loading of the cavity. The distance between the cavity end wall and the diode center line must be half a guide wavelength at the desired operating frequency.

Optimization of the diode loading for a given diode type is done by adjustment of the post diameter, while holding the disc diameter constant at about half a free-space wavelength. The dimensions shown in Fig. 3 are optimum for the Hewlett-Packard 5082-0432 Impatt diode for 10.525-GHz operation.

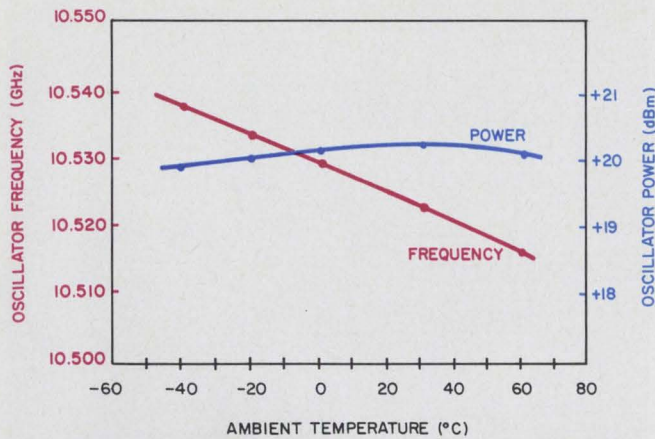

6. Frequency varies almost linearly with temperature, but the total variation is only 22 MHz from -40°C to $+60^{\circ}\text{C}$. The power level is within a few tenths of a decibel of 100 mW over the full temperature range.

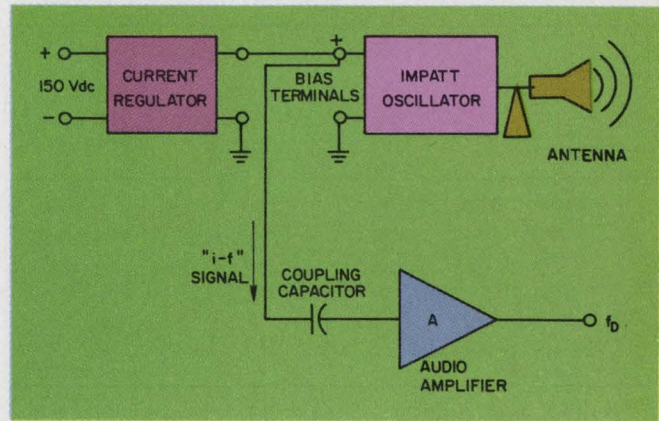

7. Great cost savings can be realized when the oscillator is used in the self-detecting mode. The output signal can be taken directly from the bias terminals because the current regulator has a very high impedance.

Table 1. Performance characteristics of low-cost Impatt oscillator

Power Output, nominal	100 mW
Frequency	10.525 ± 0.080 GHz.
Efficiency, typical	3.5%
Required Bias Current, typical	35 mA
Required Bias Voltage, typical	85 to 95 V
Oscillator Loaded Q	$\cong 1000$
Pulling Figure*	6 MHz
Pushing Figure	10 kHz/mA
Recommended Maximum Load VSWR	1.5:1
Incremental Diode resistance as seen at bias port	$\cong 150$ ohms
AM Noise-to-Carrier Ratio	-133 dB/100 Hz BW (SSB)
FM Noise, Δf_{rms} in 100 Hz bandwidth	7 Hz
Frequency stability over -40°C to $+60^{\circ}\text{C}$	± 10 MHz

* The pulling figure of a microwave oscillator is defined as the maximum deviation that can be produced by a load with a VSWR of 1.5:1 as it is moved through 360° of electrical phase angle.

When working with other diodes, you will have to change the post diameter to optimize the loading for the unit being used. As with most microwave design work, this is best done experimentally in the laboratory. With the disc diameter held constant at about half of a free space wavelength, decreasing the post diameter will increase the loading on the diode. Conversely, increasing the post diameter decreases the loading.

With the design described here, an oscillator has been constructed with its waveguide resonator portion fabricated from an aluminum die casting (Fig. 4). This method of fabrication, of course, is the least expensive way to make the microwave circuit. The manufacturing cost, excluding the price of the diode, has been estimated at about \$4 in production quantities (>1000) when this approach is used.

The alternative is to make the oscillator from brass parts, which can be brazed together. The X-band waveguide needed for this method of fabrication can be purchased commercially for

about \$1 a foot, and the total manufacturing cost, again excluding the price of the diode, has been estimated at about \$6.

If we recall the \$10 price mentioned earlier for 100-mW Impatt diodes, we see that, for either method of fabrication, the complete oscillator should cost less than \$20.

How well does it perform?

The die-cast aluminum oscillator of Fig. 4, using an HP 5082-0432 Impatt diode, has been thoroughly tested to determine all of its important performance characteristics. These are summarized in Table 1, while Figs. 5 and 6 give more detailed performance data as a function of bias current and temperature, respectively. The variation of frequency with temperature is well within FCC limits ($10.525 \text{ GHz} \pm 25 \text{ MHz}$).

This laboratory test data notwithstanding, the most meaningful way to evaluate an oscillator for a Doppler radar system is to use it in an

Table 2. System performance data

Application	Self-detecting mode	Conventional (external mixer) mode
Intrusion alarm band ($f_D = 5$ to 300 Hz):		
MDS (dBm)	-85	-107
Calculated range ¹ (ft.)	160	560
Measured range (ft.)	105	—
Police radar band ($f_D = 300$ to 3000 Hz):		
MDS (dBm)	-80	-107
Calculated range ² (ft.)	220	1000
Measured range (ft.)	200	—
Calculated range ³ (ft.)	—	2500

Notes: All of the calculations and measurements in this table are based on an output power of 100 mW and an antenna gain of 18 dB, except as noted.

1. $S/N = 10$ dB; effective target radar cross section, $\sigma = 1.0$ m²
2. $S/N = 3$ dB; $\sigma = 2.5$ m²
3. $S/N = 3$ dB; $\sigma = 2.5$ m²; antenna gain = 25 dB

actual system and to measure the system performance. The oscillator described has been evaluated in the laboratory and in the field in a conventional radar system like the one shown in Fig. 2a.

In addition the oscillator has been evaluated as a self-detecting unit in the configuration shown in Fig. 7. This mode of operation is extremely simple, because it eliminates the couplers and the mixer diode and only requires a single microwave component in addition to the oscillator—a horn antenna.¹

Self-detection is not a new phenomenon and can be used with almost any oscillator. It relies on the fact that the nonlinearity of the oscillator device itself performs the mixing function. In general, sensitivity in this mode is inferior to the conventional mixer-diode mode of operation. Part of the reason is that the full AM noise of the oscillator is available to be down-converted to the i-f in the self-detecting mode output, while in a conventional system, the noise is attenuated by the over-all coupling factor (typically 20 dB) of the couplers that bring oscillator power to the mixer diode. Nevertheless the performance in this mode is adequate for many short-range applications, such as intrusion alarms, traffic sensors, noncontacting velocity measurement systems, rate-of-descent indicators for light aircraft, and such automotive devices as braking radars and electronic speedometers.

Doppler radar receiver sensitivity is expressed as a minimum detectable signal (MDS), which is

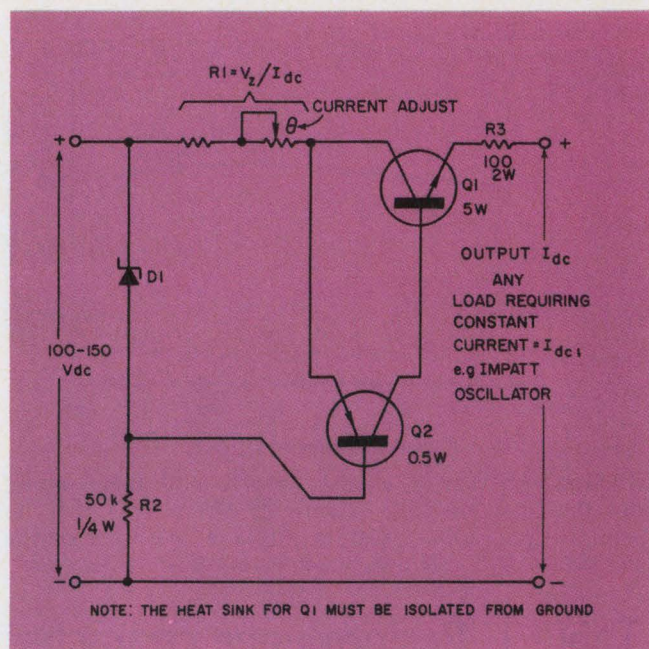

8. No expensive components are needed to build this constant-current source. Both transistors must be capable of handling 50 V; their choice is not critical as long as they meet the indicated power requirements. The zener diode voltage should be between 5 and 10 V.

the received microwave signal power required to produce an output at the i-f terminals equal to the receiver noise ($S/N = 1.0$). The MDS depends on the bandwidth and center frequency of the audio amplifier following the receiver; the required bandwidth and center frequency are, in turn, determined by the expected target speeds.

For automobile-related radars (police-radar, automatic-braking, antiskid and traffic-control systems) a passband of about 300 Hz to 3000 Hz—corresponding to speeds of 10 to 100 mph, respectively—is usually required. For intrusion alarms, the targets are humans, and the expected Doppler frequencies are correspondingly lower—in the range of 5 to 300 Hz.

The performance of the Impatt-diode oscillator in both a conventional system and in the self-detecting mode is summarized in Table 2. In the conventional system, a low-noise Schottky barrier diode was used as the mixer.

The expected ranges of the systems have been calculated with the radar-range equation² for audio passbands corresponding to the speed ranges of typical humans and automobiles. In addition the ranges for the self-detecting mode have been measured with typical humans and automobiles and they are listed for comparison.

The antenna gain used in the measurements was 18 dB. A calculated range for automobile velocity, using the conventional detection mode, is also shown for an antenna gain of 25 dB, such as might be used in a police-radar system.

The differences in range between systems using

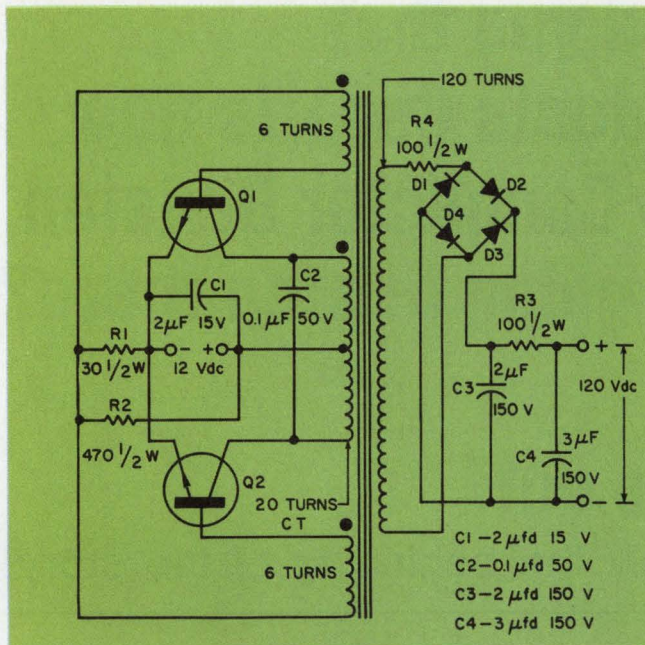

9. This dc-dc converter uses less than \$5 worth of parts. The transformer core is a Model H5C EP-20 AL 13500, made by TDK Electronics Corp., New York. The diode bridge is a General Instruments WO 4, or equivalent. And the transistors are type 2N3241A, or equivalent.

the self-detecting and conventional modes are apparent from Table 2. It is fairly clear that the self-detecting mode is quite restricted in range compared with the conventional mode. Its simplicity is its strong point.

Impatts need constant-current supplies

Impatt diodes must be biased with a constant current, not a constant voltage. The current regulator circuit of Fig. 8 is well suited for this job. It is simple, effective, cheap to build and consumes very little power. It will hold the oscillator bias current constant to within ± 1 mA over temperature variations from -40°C to $+60^\circ\text{C}$ and over supply-voltage variations from 100 to 150 V.

In addition it reduces power-supply ripple by a factor of about 1000, which considerably eases the power-supply filter design. For a fast laboratory evaluation setup, the regulator can be replaced by a large resistor in series with the voltage source and the Impatt diode.

If the radar system must operate from a 12-V source, such as an automobile battery, the dc-dc converter of Fig. 9 provides a cheap and simple way to boost the voltage to the 120 V needed by the constant-current source. The use of this converter caused no loss of sensitivity in comparison with a well-regulated laboratory supply. This result was ensured by paying careful attention to the converter filter design and by choosing a converter chopping frequency well above the

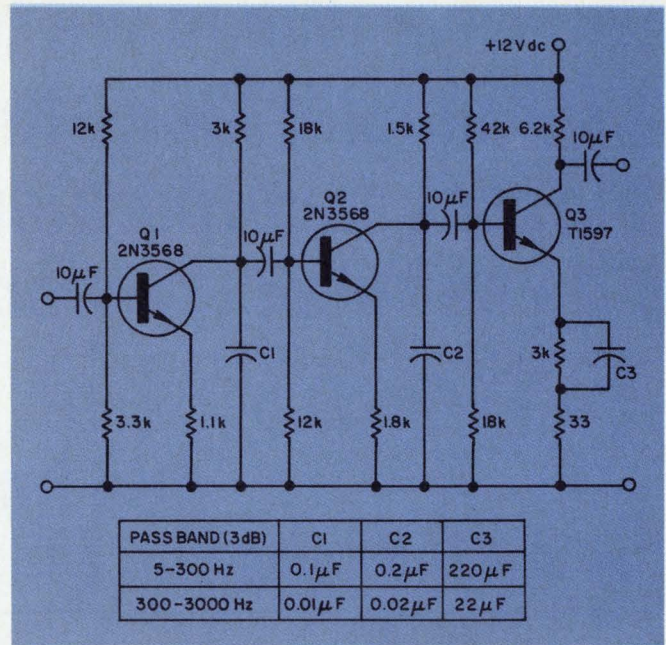

10. The audio amplifier determines the bandwidth of the radar. The bandwidth should be made only large enough to accept the expected Doppler signal frequencies. The capacitor combinations shown are for typical intrusion-alarm and police-radar applications.

desired Doppler frequency band. The converter chopping frequency in this case is 16 kHz.

A complete system

The only additional component that is needed to make a complete self-detecting mode radar system is the audio amplifier. A suitable unit, with 40 dB of gain, is shown in Fig. 10. Note that two sets of capacitor values are given—one for a 5-to-300-Hz passband, the other for 300 to 3000 Hz.

If all of the components are put together, as shown in the block diagram of Fig. 7, the result is a small, low-cost, reliable Doppler radar set that will draw only 0.5 to 0.7 A from a 12-volt automobile battery. And it will cost less than \$50, including the horn antenna. ■■

Acknowledgments

The design, optimization and evaluation of the oscillator described in this article were performed by G. Pfund. Contributions to some of the measurements were made by G. Hom and D. Gray.

References

- Southworth, G. E., *Principles and Applications of Waveguide Transmission*, D. Van Nostrand Co., Inc., 1955, p. 413.
- Terman, F. E., *Electronic and Radio Engineering*, fourth edition, McGraw-Hill Book Co., 1955, p. 1017.

Bibliography

"Microwave Power Generation and Amplification Using IMPATT Diodes," *Application Note No. 935*, Hewlett-Packard Co., 620 Page Mill Rd., Palo Alto, Calif. 94304.

When we told you that Automatic Metal Products Corp. is now Plessey Incorporated/Connector Division did you think we were going to stop there?

We hope not!

Our expanded product line is only the beginning of the story!

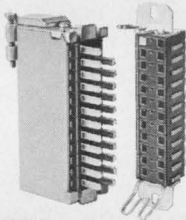

159 SERIES Rack and Panel Connectors.

11 sizes, 7 to 71 contacts. Optional mounting brackets and locking mechanism, or combination top and side opening hood.

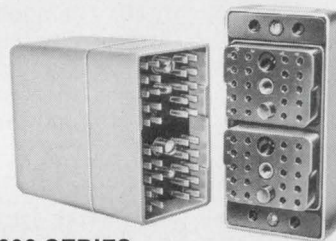

000 SERIES Rectangular Rack and Panel Connectors.

Available with 20, 30, 40, 60 or 80 contacts. Screwlock. Hoods with internal cable clamp. High reliability.

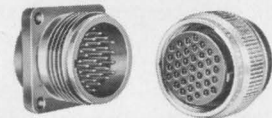

MARK 14 Microminiature Connectors.

Available in 5 sizes, with 3, 7, 14, 19 or 37 crimp type removable contacts. Light weight. High performance. Hoods and cable clamps available.



COAXIAL CONNECTORS

Connectors can be supplied in most of the standard connector styles, in all series from microminiature through large, and for virtually all popular cables from 1/16" through 9/16" diameter.



COAXIAL SWITCHES

Extensive line of coaxial switches and relays for microwave applications. Feature low VSWR, insertion loss and crosstalk.

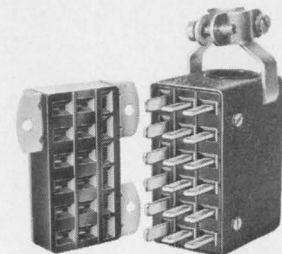

MULTICON Plugs and Receptacles.

Introducing many improved features not shown in conventional designs, yet retaining interchangeability. 2 to 33 contacts. Hoods and retainers are available.

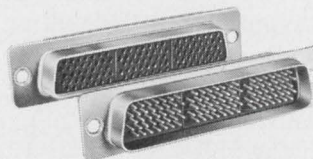

140 SERIES Double Density Rectangular Connectors.

111 crimp type removable contacts, 11 more than conventional double density connectors of the same size. Available with optional hood and cable clamp.

Further information in regard to any of the items shown, or details about our extensive line of cylindrical connectors, may be obtained by contacting us today.



PLESSEY INCORPORATED/CONNECTOR DIVISION

400 MORELAND ROAD/COMMACK, NEW YORK 11725

TELEPHONE: (516) 543-5000

INFORMATION RETRIEVAL NUMBER 33

INFORMATION RETRIEVAL NUMBER 34 ►

GOODBYE SOLID STATE.



PICOREED RELAY
PRME 1A 05
C.P. CLARE & CO. CHICAGO

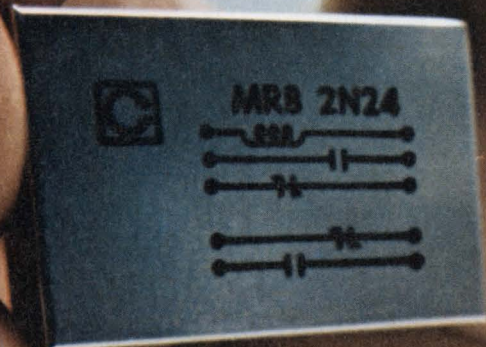

Hello better switching alternatives.

Have problems achieving isolation at reasonable cost?

Does your logic have to communicate to a noisy outside world?

Have an interface problem requiring complex interconnection and the capability of handling a wide range of signal levels in a bilateral mode?

No need to attempt a complicated solid-state design. Clare's complete line of reed relays solve these problems economically and reliably!

The classic interface between computer-controlled, automated test equipment and a module under test is accomplished easiest with a reed relay matrix. Reeds can switch signal and power levels simultaneously, with bandwidth from dc to MHz.

Open signal-path capacitance less than 0.1 pF, with 4-terminal control-to-signal-path isolation, have made reeds ideal for communication matrixing through RF. Multiplex common mode isolation is a normal characteristic of reed relays.

THREE TYPES

The Picoreed® is available in a standard TO-116 DIP package called the PRME, or a 0.7" x 0.1" grid-pattern relay called the PRB providing from one to six contacts. Both mount on 0.375" PCB centers.

Clare's MicroClareed® MRB 1.0" x 0.1" grid is an economical relay with U.L. recognition. It provides 10 watt switching capability, mounts on 0.5" PCB centers and is available with one to five contacts.

Clareed® CRU relays offer power handling to 15 watts, low millisecond switching speed, up to twelve contacts and U.L. recognition. Like *all* Clare reed relays, they're immune to false operation and insensitive to overload transients that affect solid state devices.

RELIABLE

Clare reed relays are rated for millions of operations, because we make every part ourselves . . .

including the hermetically sealed capsules! We manufacture our reed capsules on automated machines in a white-room environment, and we inspect every capsule for physical and electrical characteristics.

FAST DELIVERY

Clare standard reed relays are available from stock through our national distributor network. And, if you can't find what you need on the shelf, Clare can come up with a design for your requirements.

For more information on our reed relays than you could cover at one coffee break, write C. P. Clare and Company, 3101 Pratt Avenue, Chicago, Illinois 60645.



a GENERAL INSTRUMENT company

The minicomputer and the engineer—Part 6

A mini-based system takes careful planning

Just because the minicomputer costs less than \$25,000, compared with hundreds of thousands for a large computer, is no reason to rush into buying one without careful planning. In most cases where the use of a mini is considered, the solution to the problem is not just the mini's central processing unit (CPU), but a complete system. And for that you had better plan.

What makes a mini into a system? A low-cost, simple system for data processing and scientific computing might consist of a card reader and a low-speed printer tied to the mini. A slightly more sophisticated system might include, in addition to the reader and printer, adapters to allow the mini to talk to another (usually larger) computer via communications lines.

Many more possibilities present themselves when we consider the input or output of physical quantities— analog voltage or current signals, contact closures and other digital information.

As a system element, the minicomputer goes through three basic steps. It:

- Senses physical quantities.
- Performs logical or arithmetic operations.
- Drives physical quantities.

Obviously, for a mini to be economically justified, it must repeat these steps many times for many quantities. Or it must be used to solve complex problems.

Start with a definition

It seems obvious, too, that the implementation of any system should be preceded by a definition of that system. Yet many engineers who are usually very objective approach computers with a certain emotionalism. In some cases, a decision

is made to buy a minicomputer (at that price why not?) without knowledge of just how it will be used. If you plan carefully, you may buy a different mini, different services, or even no computer at all.

The definition phase is not meant to be a research project. Instead it should be a period of thinking about the system, talking about it and writing about it. Think about all possible hardware and software parts. Talk to the people who will be using it. Write down your ideas on what the system is intended to do.

Naturally the things to consider will vary with the scope of the system, so the definition could take as little as a day for a small system or a week to a month or more for larger system. Here are some of the more important steps to take in the definition phase:

▪ **Describe the system's function.** Briefly write down what it will do. This will serve as a jumping off point for the more detailed steps.

▪ **Identify the pieces.** List the items of equipment (computer and other) to be associated with the system. Draw a block diagram showing new and existing equipment. Also show any interfaces and, if they are not defined, at least identify the responsibility for defining them.

▪ **List the programs.** Review the functional requirements of the system and list the programs to be performed, including the frequency of each task. Try to write a brief paragraph on each function or program. This will help later in communicating with the computer vendor, with your programmers, or even in reminding yourself if this is a one-man job. Also, try to draw a block diagram showing the relationship between the various programs. Then try to make a rough estimate of the memory required for each program. If you are not a programmer, don't let that deter you. Make up program names and size estimates anyhow. Then have your programmer or computer vendor give you his estimates, and you

C. W. Eggers, Manager, General and Industrial Systems, Computer and Instrumentation Div., Westinghouse Electric Corp., 200 Beta Drive, O'Hara Township, Pittsburgh, Pa. 15238

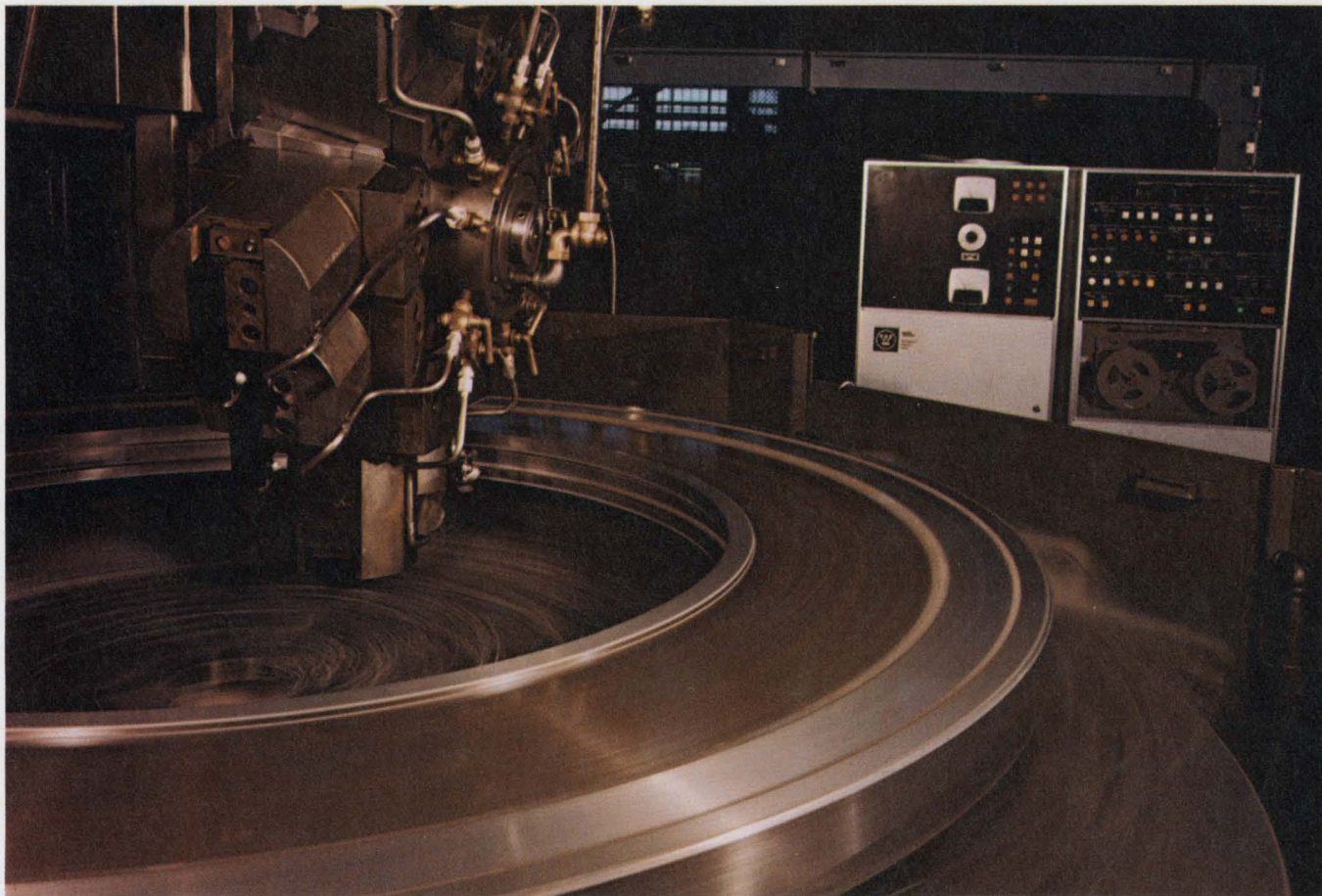

Minicomputers are the heart of many industrial control systems, such as this 86-inch vertical turret lathe, controlled by a Westinghouse Electric Corp. C20 system. It

uses a Westinghouse Prodac 2000 mini as its logic element, instead of relying on hard-wired logic. New control algorithms can be added with little downtime.

will have a better feel for the problem.

- **Describe the data base.** What sort of data will the computer need to maintain? You'll have to consider, for example, the instantaneous value of each input and output, the historical values of inputs (totals, averages, minimum, maximum, etc.), parameters for inputs (scaling, limits, etc.), parameters for control algorithms, and temporary variables used by the programs. Identify the data as logical (one-bit), integer (one-word) or floating-point (usually two words). Then determine the memory requirements by multiplying the number of variables of each type by the storage per variable. If the data storage requirements are large (say over 16 K words), you'll want to consider mass memory (drum, disc or magnetic tape). Then you need to examine another aspect of the data: How often is it accessed and at what speed do you need it?

- **Define expansion requirements.** Think ahead, beyond the immediate needs of the system. Will the system be "frozen" when it is installed and operating? Or do you expect it to expand, to include more equipment, more functions or more data? If so, examine the consequences of such expansion. It isn't necessary to buy all the equipment at one time for the ultimate in expansion.

This could run the cost out of proportion on the initial phase and possibly abort the whole project. However, be sure you take a close look at the minicomputers you are evaluating with an eye toward expansion. The most important aspect is memory expansion. If you plan to add significant programs and data, look for a mini that can go well beyond your initial estimates. This will also help cover for any underestimating. Another area to look at is the I/O expansion. If you add peripherals in the future, can you conveniently accommodate the necessary controllers?

- **Establish repeatability.** It may be presumptuous to speak of expansion and repeatability when you're barely off the ground in your project. But they can influence the approach to the engineering of the system and to make/buy decisions.

Repeatability affects the economics by a trade-off between one-time engineering costs and repeat hardware costs. For one-of-kind hardware, use the the computer vendor's standard products, if at all possible. For repeat hardware—where more than one of the same part is required—it may be cheaper and more efficient to buy in quantity a particular device exactly suited to your needs and to design the interface. Similarly in software: For a one-shot system, use generalized software

The definition phase: step by step

Suppose you want to use a minicomputer as part of a data-acquisition and control system. One of the first things to do is to define the system. This definition phase will lead to a functional specification, which you can update as the job progresses. Here's an example of the approach to follow in the definition phase:

Describe the Function

This system is in a remote, unattended site and is in communication with a master unit via telephone lines. It routinely collects and processes analog inputs and contact-closure input data. Upon command from the master, selected data is transmitted from the remote to the master. Data is also printed locally.

Identify the Pieces

Following are the major items of equipment (Fig. 1):

- (a) Minicomputer CPU (16 bit; memory to be specified later).
- (b) ASR-35 teleprinter for loading system and printing.
- (c) Analog Input Subsystem.
 - (1) 100 inputs.
 - (2) Approximately one-half are 0-5 V and the rest ± 50 mV, requiring a multiple range system or individual amplifiers for the low-level inputs.
 - (3) The environment is subject to significant common-mode and normal-mode 60-Hz noise. Some form of filtering is required.
 - (4) Speed requirements are not great; all inputs should be updated every five seconds. A rate of 30-40 pps is satisfactory. An integrating converter is suggested to achieve active filtering of the 60-Hz noise.
- (d) Digital Input Subsystem.
 - (1) 200 inputs.
 - (2) These are all from isolated contacts in a plant environment. A 125-V supply is suggested to "burn" dirty contacts, as is filtering against 60-Hz noise.
 - (3) All points should be read at least once per second.
- (e) Interrupt subsystem to have two interrupts from the plant.

(f) Communications Interface.

- (1) 1800 baud, asynchronous.
- (2) Interface to be RS 232-C compatible.
- (3) Code is not ASCII, but rather consists of a 32-bit message that includes address, data and BCH code security check.

(g) Real-time clock to be 60 Hz for time-keeping.

List the Programs

The programs (Fig. 2) are listed with only selected comments.

<u>Program</u>	<u>Word Estimate</u>
(a) Monitor, library, debug, etc.	3500
(b) Interrupt and clock routines	200
(c) Communications interface handler	500
(d) Analog input scan	700
(e) Digital input scan	500
(f) Local printout	900
TOTAL	6300 words

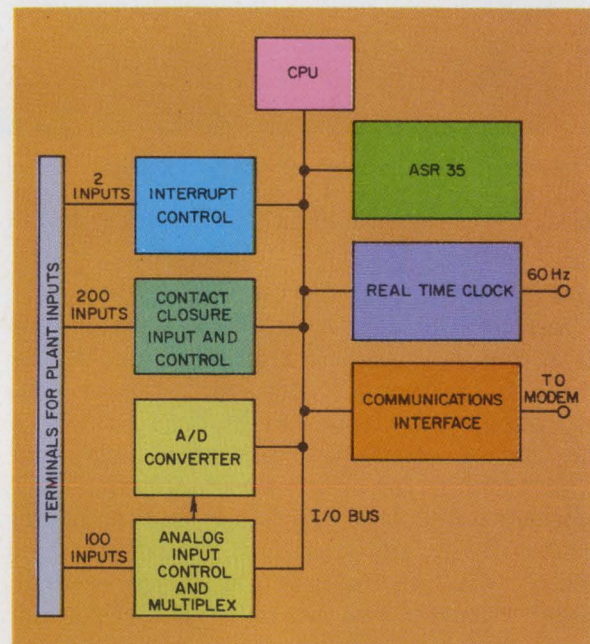

1. Identify the pieces of equipment required for your application. A block diagram, such as for this hypothetical data-acquisition system, may reveal items that may otherwise be overlooked.

at the expense of more core. In the repeat application, it may be better to optimize assembly language code to save memory cost.

■ **When do you need the system?** Examine alternate approaches. Should you buy the hardware and do the design and programming? Or should you buy a complete and programmed system? To evaluate alternates objectively, set down a time schedule for each approach. Decide whether the

system will go on line fully completed or will start with data collection and add control after experience is gained. Factor this into your schedule.

■ **Examine your resources.** Do you have people in your organization who can do programming? Maintenance? Are these people available, as needed, for work on your system? If you are going to make an economic comparison, establish a

Several hardware/software tradeoffs can be made for the communications handler interface.

(a) The 32-bit message can be input in 8-bit or 16-bit segments, as received, or the controller can buffer 32 bits or more and then input to the CPU.

(b) Control characters can be recognized by the interface or by the software.

(c) The security checking (BCH) can be done by hardware or software.

The local printout illustrates some of the flexibility of the mini compared with a hard-wired remote. The two interrupts tell the computer of a rather critical situation that requires selected data to be sent to the master for future analysis. If the communications line, the modem or other equipment is out-of-service, however, the data cannot be sent and could be lost. To avoid this, if the mini, upon receipt of either interrupt, finds the communications system out of service, it prints the required data locally. This is then collected during a weekly maintenance

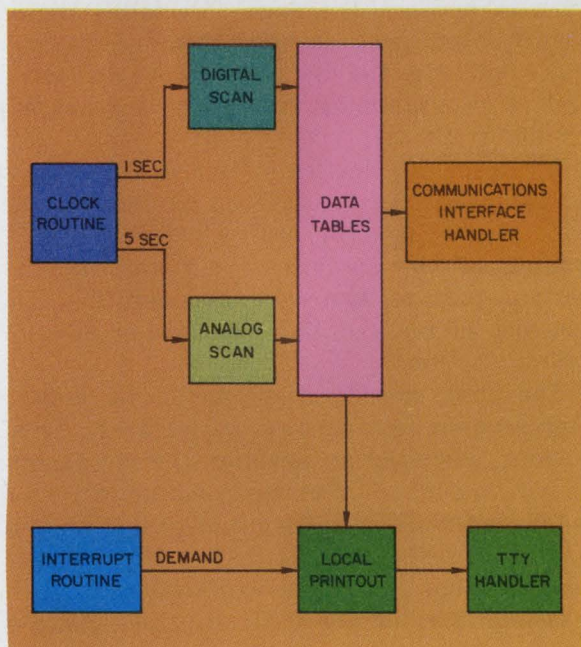

2. Prepare program word estimates more easily by using a block diagram to indicate the programs required and the relations between the programs. This program covers the example of Fig. 1.

trip to the site. Since this is an infrequent event, the system should have the ability to turn on the teleprinter only when it is in use.

Describe the Data Base

(a) Analog Inputs:	
Instantaneous value	1 word
Conversion constants	2 words
Engineering units	2 words
Limits	2 words
Multiplex address	1 word
Spare	2 words
<hr/>	
	$10 \times 100 =$
	1000 words

(b) Contact Inputs:	
Current value	1 bit
Past value	1 bit
Misc.	2 bits
Parameters	2 words
<hr/>	
	$2-1/4 \times 200 =$
	450 words

The total estimate is 1450 words for data, 6300 words for programs or a total of 7750. At least 8 K words of core memory are required.

Define Expansion Requirements

(a) Size. Analog inputs and contact inputs might increase in the future by as much as 10%.

(b) Scope. A possible future application is remote on/off control. To allow for this, the communications program might be designed to provide for control, thus increasing its size over the above estimate. The contact output controller might be included in the initial purchase, equipping a minimum of points with expansion space for future growth.

Establish Repeatability

Initially there will be two such remotes, with the possibility of up to 10 in the future. Hardware costs might be reduced through increased initial design and programming. In particular, you might try to hold the memory to 8-K words.

costing rate (salary plus overhead) for each type of skill.

▪ **Summarize your definition.** The net result of your efforts is a functional specification—not a nuts-and-bolts document but one that provides a basis for decisions as the project proceeds.

Having defined and specified the system, you are ready to buy it. But what do you make yourself? Remember that you have a problem you ex-

pect to solve by purchasing a minicomputer.

The demands on peripherals for mini applications are usually not great. For example, you won't usually be looking for 1000-card-per-minute readers. But there is a temptation to scour the catalogs for the best printer, the best card reader, etc., and, to interface them with your choice of CPU. Unless you have high repeatability and the economics of your problem supports this ap-

proach, don't use it.

Instead, look for a minicomputer seller who also has a complete line of peripherals for his mini. He will have selected a device that has general acceptance, though it may not be the exact one you selected. And, in knowing the I/O discipline of his CPU, he will have designed a set of interface controllers that are good neighbors to both the CPU and the peripherals and that get the best practical performance out of each.

Finally, if you must have a certain peripheral interfaced, consider letting a vendor do it.

Look at the process interface

Most systems have some sort of need for an interface between the minicomputer and the physical process being controlled or measured. Broadly, these include analog and digital inputs to the computer and analog and digital outputs from the computer. Again, most vendors have a complete and compatible line and you should buy it, if possible.

An important consideration in designing the system is signal conditioning. For example, in digital outputs it is convenient to purchase a mini with, say, a TTL interface. However, if you expect to drive lights, relays, motors, etc., you are better off looking for a system that includes drivers or output relays.

For input signals, an a/d converter designed for high-level inputs is well-suited for many applications. If you have noisy, low-level floating signals, you can build individual signal conditioners to isolate, filter and amplify. However, it is probably more economical to look for a subsystem that can accept these signals directly, thereby saving the cost of designing and building conditioners.

Is unbundling for you?

The term "unbundling" has been used to refer to separate hardware/software pricing. The unbundled software might include the monitor or operating system, compilers and other utility software. Fortunately this is representative of the large computer market and not of minicomputers. You have access to this software from the vendor—make use of it. Don't unbundle.

In an all-core minicomputer the monitor provides I/O handlers, coordinates the I/O devices with user programs and includes a degree of priority scheduling. Experience has shown that, except in the very smallest of applications, the use of a monitor simplifies the application programming and improves system performance. Furthermore, unless you have a small and highly repetitive application, don't consider writing your own monitor. Find a vendor who provides a moni-

tor with his mini and use it.

Similar logic could be applied to any utility software, but let's consider assemblers and compilers. Obviously if you intend to write programs for your mini, you need an assembler. In looking at one, consider the amount of processing time required on the peripherals you have selected. For small applications, a teleprinter is fine, but you could get gray hair programming, say, a 32-K system on it (the paper-tape output for one assembly of 30-K words at 10 characters per second requires 100 minutes; the printed output of the listing requires several times that for modest mnemonics and comments).

An alternate to buying card equipment and a high-speed printer for your mini is to obtain an assembler that can run on a large EDP machine and produce code for mini. Often unbundling is advantageous, because the extra cost may well be justified against the time saved.

What about a FORTRAN compiler? If you're doing a one-of-a-kind application, with possibilities of expansion and change, do as much programming as possible in FORTRAN (or some other higher-level language). Certainly the FORTRAN-coded program will require more core space, but with the low cost of core and the high cost of programming time, this becomes a reasonable trade off.

The term "application software" refers to what is custom-written for a given application, as opposed to the monitor, utility software, etc. The writing of the application software is an important part of system implementation, and it can cost as much as the hardware or more. Who will do the job?

The first consideration should be doing the programming in your own organization. This has obvious advantages: keeping the programming money "home," minimizing communications lines on the software definition and providing a basis for future software maintenance. But this approach requires that you have experienced people (at least for part of the total required manpower) and that they be available for your project. It makes little sense to invest heavily in training for a one-shot project. Still, if you are looking at repeatability in your mini application, you may be wise to invest in a training program.

If you don't have an experienced team and can't justify training one, there are two alternatives: the computer vendor and a third-party systems house. Either can bring considerable experience to bear on your system. ■■

This article completes the six-part series, "The Minicomputer and the Engineer." To obtain reprints, see page 123.

P&B Solid State Hybrid Relays.

We get them by mating semiconductors and relays. You get a whole new range of switching options.

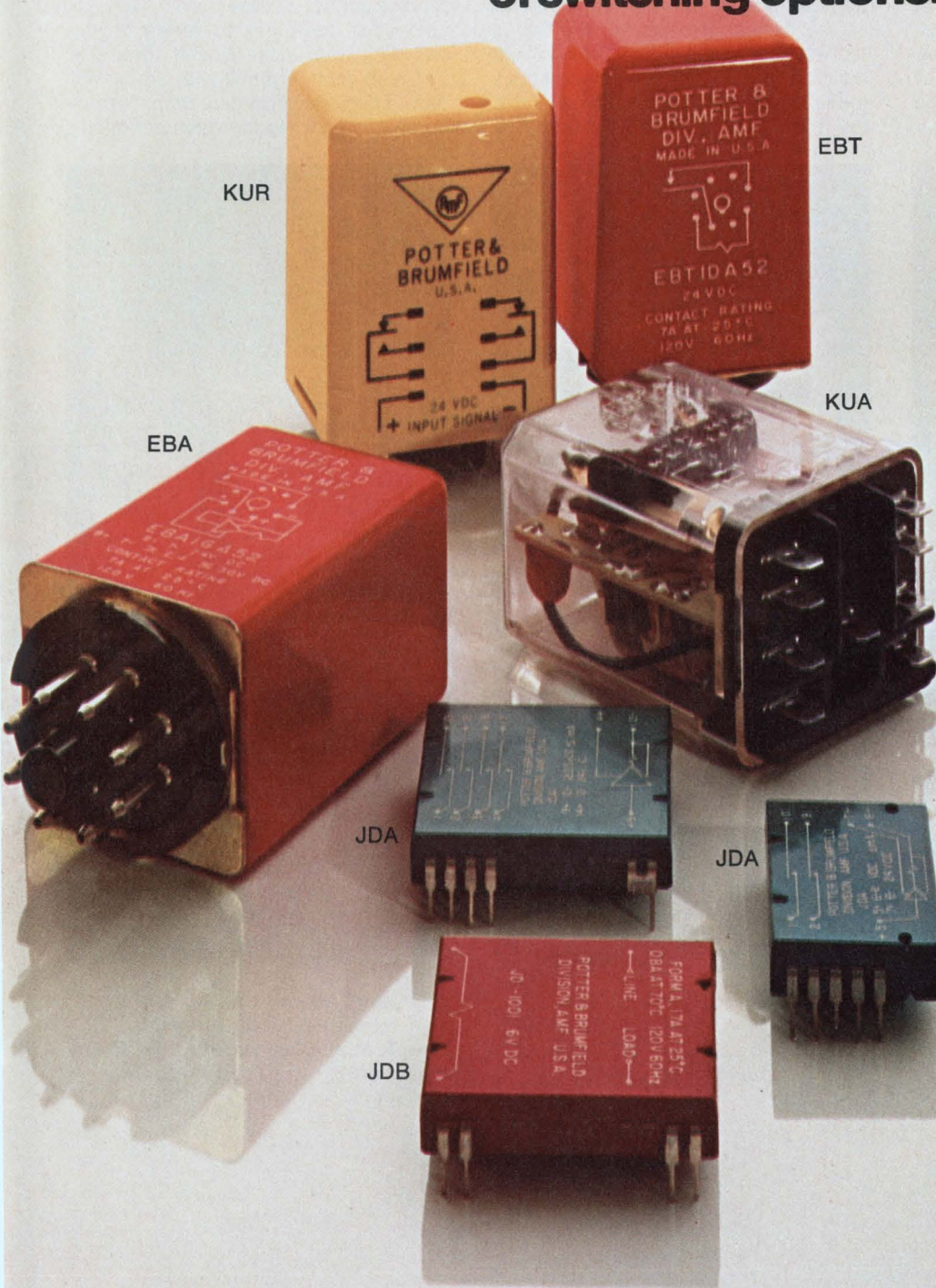

For example, you can interface semiconductor logic circuits with inductive loads like motors, solenoids, contactors. You can use inputs as low as 5 microwatts to switch 7 ampere loads. All with the isolation normal with relays. Wide choice of package sizes and terminations, too.

EBT Solid State Hybrid Relay. A solid state AC switch controlled by a reed relay. It switches 7 amperes rms, 60 Hz at 25°C ambient. Operate time: 2 milliseconds. Coil voltages range from 6 to 48V DC.

EBA Sensitive Solid State Hybrid Relay. Similar to the EBT but with sensitivity as high as 12 microwatts. Available for 12, 18 or 24V DC. Built-in polarity protection. Switching is bounce-free.

KUA Amplifier-Driven Relay. Standard sensitivity: 60 microwatts. DPDT contacts will switch 5 amperes at 28V DC or 120V 60 Hz, 80% PF. Features continuous duty operation, built-in polarity protection.

KUR Alternate, Direct-Action, Impulse Relay. Single coil, DPDT relay has permanent magnet in parallel with normal flux path plus solid state flip-flop circuit. Results? A relay with both permanent memory and alternate action features controlled from a single DC source. Contacts rated 5 or 10 amperes remain in last position without power.

JDA Amplifier-Driven Reed Relay. Low profile Dual Thin-Line reed relay has sensitivity as high as 5 microwatts (96 mw standard). Designed to operate in association with integrated circuits, in particular the output of DTL and TTL logics in current sourcing mode. High input/output isolation. Contact arrangements: 2 Form A and 4 Form A.

JDB Solid State/Reed AC Switch Ideal for interfacing solid state circuits intended to control 120V 60 Hz loads such as fractional HP motors, solenoids, contactors. Seated height: .275". 1 Form A contacts will switch 1.7 amperes at 25°C ambient.

P&B solid state hybrids are available from leading electronic parts distributors. For complete information, call your P&B representative or Potter & Brumfield Division of AMF Incorporated, Princeton, Indiana 47570. Telephone: (812) 385-5251.

AMF
POTTER & BRUMFIELD

P&B performance. Nothing else comes close.



What happened to the model 19?

You're looking at some of the Teletype® basics used in building a data communications system. Printer, keyboard, tape sending and receiving combinations in a variety of speed capabilities. Teletype's modular design concept gives you the opportunity to extract the best terminal combination for system

needs today, and refine, add to, subtract and adapt as system modifications are called for. Just as important as the basics, are some of the things not obvious in the photos below. The logic devices, options and accessories that add almost limitless possibilities for making things happen exactly as

your system requires. We have some solid state logic devices that provide precise control of data traffic. That enable your computer to automatically poll data from a number of terminals and feed each terminal with processed data. There are error detection, correction and signal regeneration options to

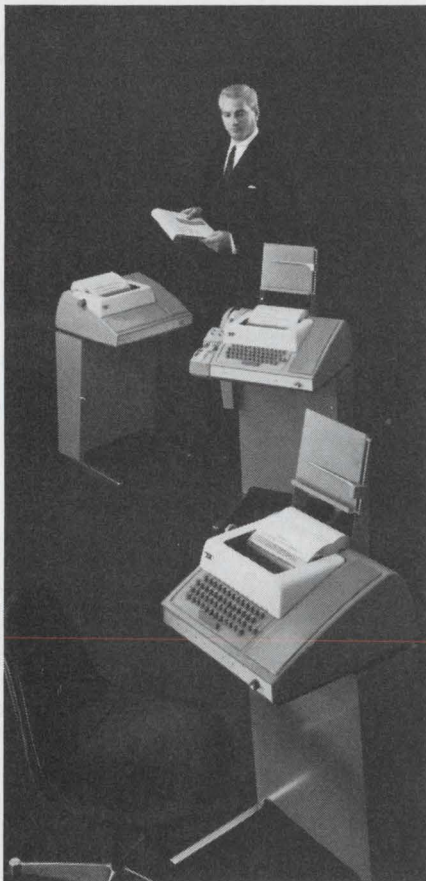

model 33 series: An extremely economical 100 wpm terminal line. Has 4-row keyboard, uses 8-level ASCII code. The most widely used terminal in time-sharing systems today.

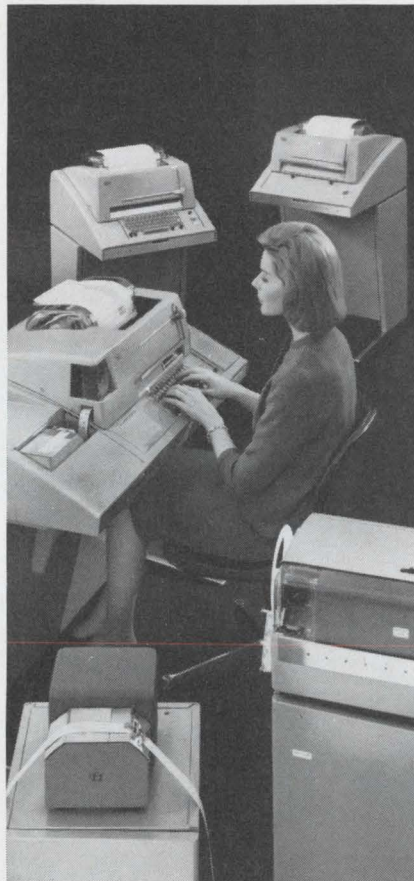

model 35 series: A rugged, heavy-duty line of 100 wpm terminals. Uses ASCII. Units in foreground are self-contained paper tape punch and paper tape reader.



Telespeed™ equipment: A line of high-speed tape-to-tape terminals capable of sending and receiving at speeds of 750, 1050 (shown above), or 1200 words per minute.

DATA COMMUNICATIONS

equipment for on-line, real-time processing

keep data flowing faultlessly. Options such as pin-feed platens and form feed controls that make it possible to fill multiple copy business forms on-line. And many, many more. What did happen to the model 19? Believe it or not, there are still some of these old, die-hard terminals around. And that's

another advantage your data communications dollar buys when you specify Teletype equipment. It lasts. Moves data reliably, economically, for a long time. On a price/performance basis, Teletype equipment is in a class by itself.

Teletype data communications equipment is available in send-receive capabilities of up to 2400 words per minute. If you would like specific information about any of the equipment described here, write: Teletype Corporation, Dept. 89-17, 5555 Touhy Ave., Skokie, Ill. 60076.

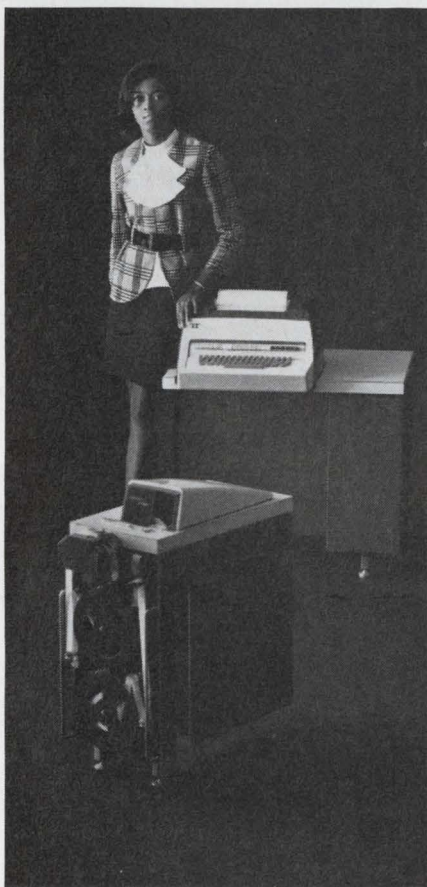

model 37 series: One of the most versatile heavy-duty terminal lines going. Generates all 128 characters of ASCII. Operates at 150 wpm. Prints in upper and lower case.

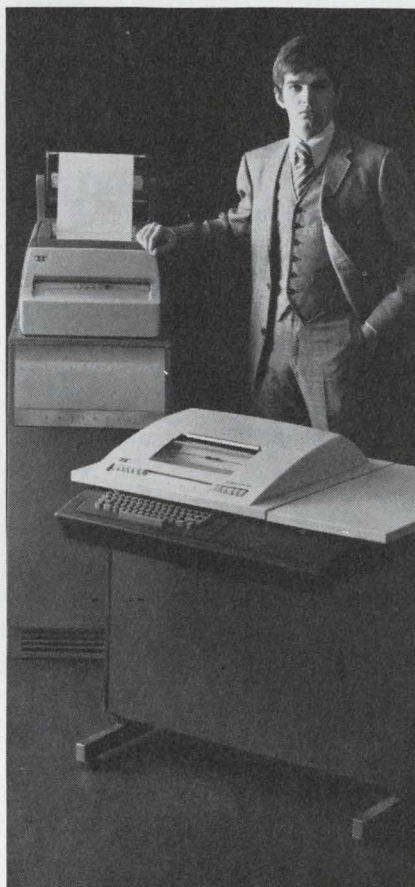

Inktronic® data terminals: A unique electronic, solid state terminal. Prints up to 1200 wpm. Forms characters through electrostatic deflection (no typebox). ASCII compatible.



magnetic tape data terminals: Use compact reusable tape cartridges. Operate on-line at up to 2400 wpm, and connect "locally" to lower speed Teletype terminals using ASCII code.

Teletype is a trademark registered in the U.S. Pat. Office

machines that make data move



'Rubber-band' memory acts as adjustable scratchpad. It moves data easily from A to B, even when the system clocks don't agree.

In digital systems, data must frequently be transferred between two subsystems that operate at different clock rates. When one or both clock rates are variable, and this is the case when a computer core memory is being loaded intermittently from a peripheral—problems of speed and hardware complexity arise. These problems can be overcome by use of a small "rubber-band" scratchpad memory for the data transfer. Such a scratchpad allows asynchronous operation at a near optimum rate.

As its name implies, the rubber-band scratchpad has a storage time that expands or contracts to compensate for differences in input/output rates. When the peripheral is supplying data faster than the computer can use it, the scratchpad fills to store the surplus inputs. Then, when the computer takes data faster than the peripheral can supply it, the scratchpad can empty and minimize the delay that would otherwise occur.

Scratchpad memories of this type can be built today with surprisingly few control and storage elements. Component counts are minimized by the use of high-speed, bus-connectable storage registers, whose input/output functions are readily controlled. The filling and emptying operations require selection of varying numbers of storage locations, which would ordinarily require multiplexers. They aren't needed now.

What are the requirements

Asynchronous data transfer calls for sufficient storage elements to compensate for differences in input/output clock rates, and for logic capable of keeping up with the fastest rate. The storage cells should be organized for sequential addressing and be capable of indefinitely long storage times between addressing. These requirements can be met by using high-speed, bus-connectable TTL flip-flops as the bit-storage elements.

The control logic for asynchronous data trans-

fer must sequentially address data into the storage locations to fill the memory, sequentially read out in the same order to empty it, and permit alternate write and read operations at times when the data source and data receiver rates may be crossing one another in terms of data demand. A conventional scratchpad memory, such as the digital delay line of Fig. 1a, can't do the job, because it can't be written into at one rate and read out at another. Data is only intermittently available, since the individual cells are not accessible, and there is a variable delay in data availability, depending on the amount of the line length loaded.

The arrangement shown in Fig. 1b comes much closer to the desired goal. It uses switches to steer data into and out of selected storage locations. The switching, however, becomes complex, and switching and settling times are rather long, limiting the rate differentials that can be accommodated with a reasonable number of storage cells.

The rubber-band memory system to be described has the form shown in Fig. 1c, which minimizes the logic, delays and number of cells required. It has input/output-enable controls on the storage chips, thus eliminating any need for demultiplexers and multiplexers. These functions are obtained directly by addressing the on-chip control elements.

A practical example of this type of memory is the eight-word rubber-band memory shown in Figs. 2 and 3. The design can maintain word-transfer rates up to 5 MHz and accommodate input/output rate differentials of 8:1—ample for most peripheral-to-computer transfer modes. The word length is 12 bits, but this can be expanded to any number without any change in control logic, simply by adding additional storage elements in parallel. The number of words governs the input/output differential, and it can be increased with minor additions to the control logic.

The cycle control logic's main functions are to advance sequentially the write or read address, to inhibit writing if no storage location is empty, to inhibit read-out if no data is available for transfer, and to effect the unprohibited transfer.

Don Femling, Engineer, National Semiconductor Corp.,
2900 Semiconductor Dr., Santa Clara, Calif. 95051

The storage cells are the heart of the rubber-band memory. In operation, each bit of a word is stored in one of four flip-flops in a tri-state, TTL quad-D flip-flop (Fig. 4). Three packages controlled in parallel then form each 12-bit storage cell (Figs. 2 and 3).

Tri-state storage cells make it possible

Tri-state refers to a recently developed type of active-pullup TTL output (or input) that is used in these flip-flops and other new devices designed for bus-organized systems. When an output is enabled in these devices, the output is in the normal TTL logical ONE or ZERO state. When disabled, however, the output is biased into a very high-impedance state, unable to define either logic level. Many outputs can then be directly connected to a bus line, if no more than one output on that line is enabled at any one time. The DM7551/DM8551 flip-flops used in this example have both tri-state inputs and outputs.

The required input-bus demultiplexing and output-bus multiplexing is obtained through the NOR gates (input and output disables) shown in Fig. 4. The input control (A through D) selects which cell is written into, and the output control selects which cell reads out onto the line, by enabling or disabling devices. Each NOR provides an enable when both its inputs are LOW (logical ZERO) and a disable when one or both

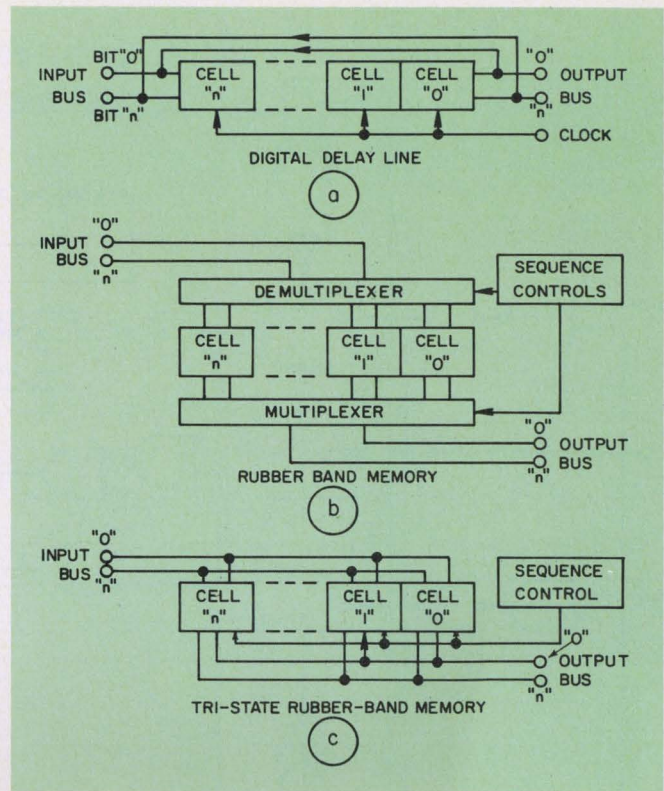

1. **Conventional scratchpad memories**, such as the digital delay line (a), can't be written into at one rate and out at another. Although this can be done by the memory arrangement of (b), switching problems make the technique impractical. Most efficient asynchronous data transfer is possible with the "rubber-band" scratchpad memory of (c), which uses tri-state logic elements.

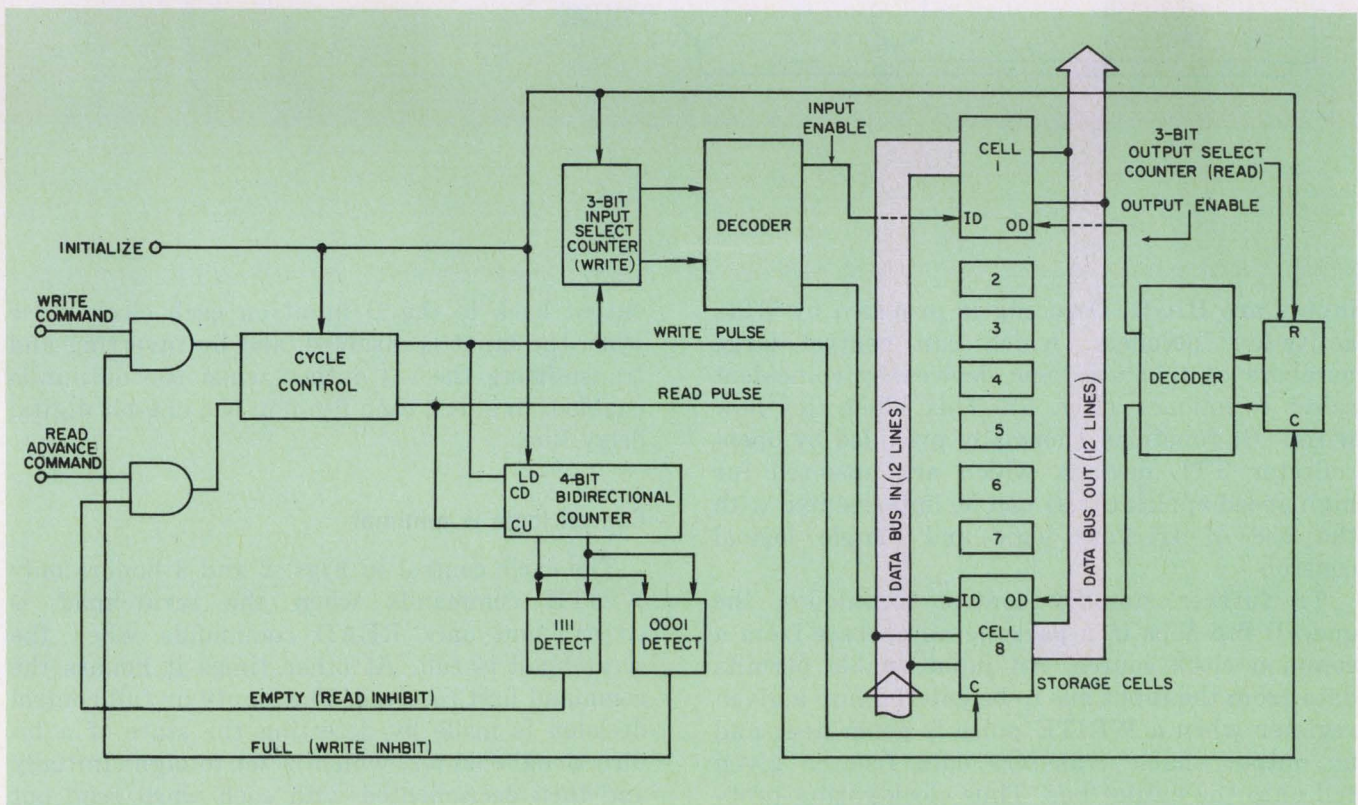

2. **Eight-word, rubber-band memory** provides asynchronous data transfer at word rates up to 5 MHz and at

input/output differentials up to 8:1. The word length is 12 bits, but this can easily be expanded.

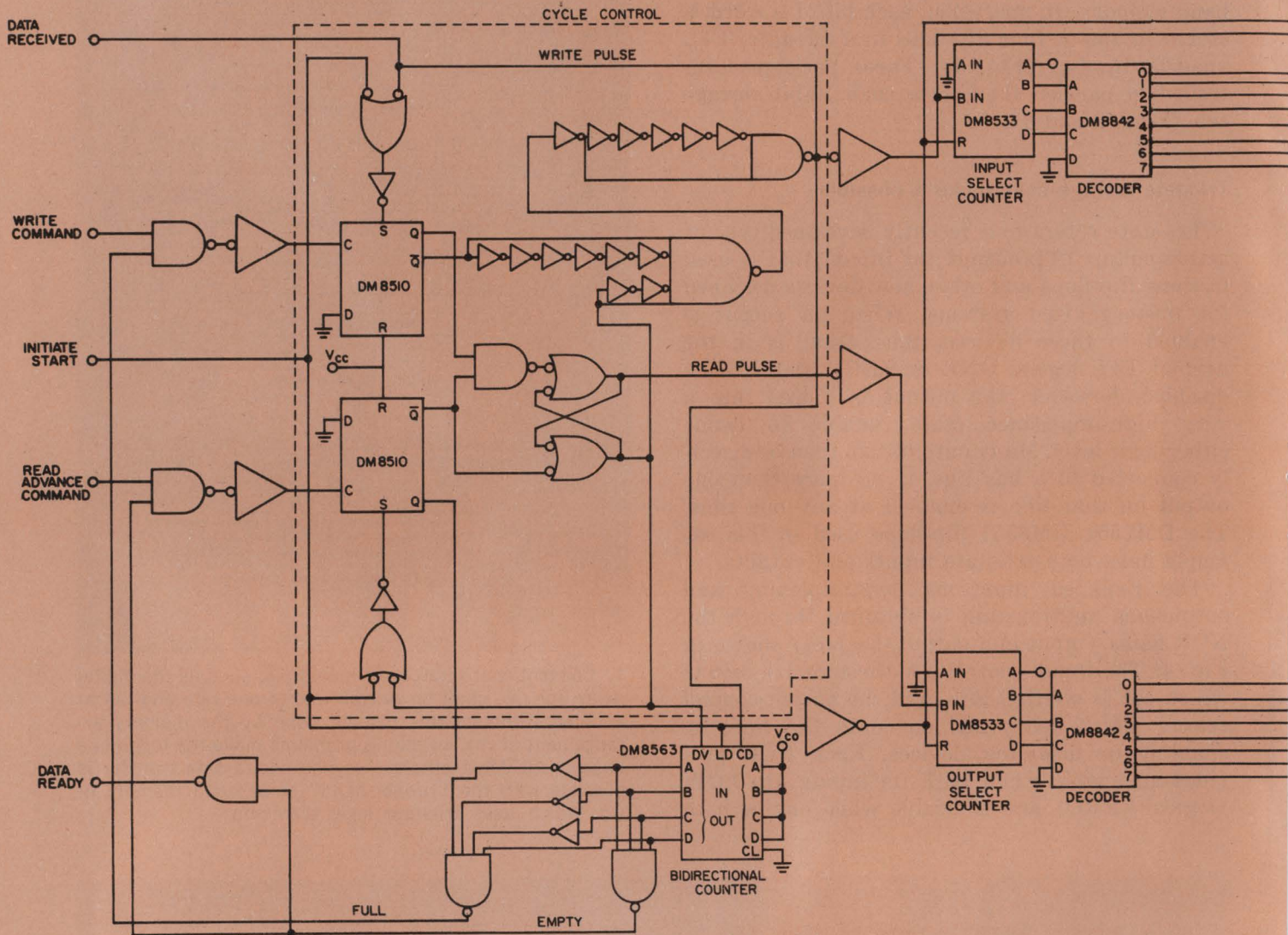

inputs are HIGH. Decoding is provided by TTL, active-low decoders, which can control large numbers of tri-state logic devices by coincident select techniques (Fig. 5). This illustrates how wired-OR functions (normally provided by open-collector TTL devices, which are unsuited for high-speed applications) can be implemented with the use of tri-state logic and simple logical controls.

To further simplify control techniques, the quad-D flip-flops in a package all operate from a common clock source. An input enable permits data from the input bus to be entered into a given register when a WRITE pulse is generated; and an output enable transfers data from a given cell onto the output bus. Thus clock-gating problems are eliminated. This mode is facilitated within the DM8551 (Fig. 4) by feeding the Q

output back to the D input on each clock pulse when the input is disabled, and by inverting and transmitting the \bar{Q} output when the output is enabled. In effect, each flip-flop is a one-bit digital delay line.

Control logic is minimal

The cycle control in Figs. 2 and 3 honors only WRITE commands when the scratchpad is empty, and only READ commands when the scratchpad is full. At other times it honors the command first received. The empty or full control decision is made by detecting the state of a bi-directional counter, which is set to eight initially and then decremented with each word read out and incremented with each read in. The counter magnitude indicates the difference between the

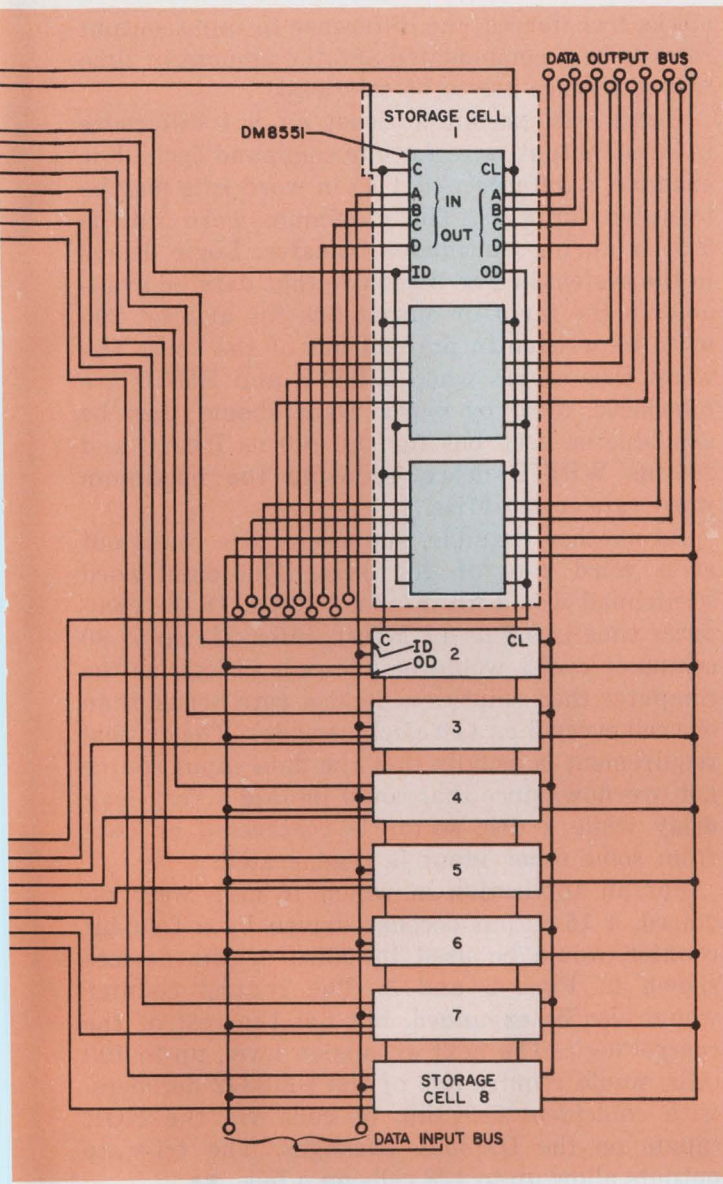

number of filled and empty cells. A difference of eight means full, and a lesser difference means cells are available for write-in. The WRITE and READ commands that are honored advance the write and read counters, causing the corresponding decoder to enable inputs or outputs of the cells in sequential order.

A typical example of the operation of the control logic for the case of a core memory being loaded from a disc memory is as follows: First, data must be written in when the disc sends a signal that it has data available. Then an update request from the core memory can generate a READ pulse after a write-in cycle ends. The control logic is initialized at startup by clearing all control logic and memory cells, thereby setting the control logic to "empty." The logic provides a "data received" output to the external

3. Actual example of rubber-band memory uses off-the-shelf IC packages for all control and storage functions. Component count is minimized by use of bus-connectable storage registers, whose input/output functions are easily controlled.

system after a write-in is accomplished, and a "data available" statement if the scratchpad may be read out. Data is continuously available, except when switching from one memory cell to the next.

Writing, reading and multiplexing

When a WRITE command is received, the cycle control (Figs. 2 and 3) checks first whether a storage cell is available. If not, the WRITE command is ignored (a FULL signal was generated). If a previous READ command is being processed, the WRITE command is stored temporarily in half of a conventional dual-D flip-flop. It is then processed at the end of the READ cycle.

The WRITE pulse then generated advances the input-select counter by one and decrements the bidirectional counter. The input-select counter moves the active-low decoder output from the cell previously selected and selects the next cell for write-in. The WRITE pulse also clocks the data on the input bus into the selected cell.

The process repeats with each WRITE command pulse until the cells are all full or the computer interrupts with a READ command. Therefore the input-select counter sequentially advances the bus input, stopping when it reaches the last empty cell, regardless of where that cell is in the scratchpad.

When the cycle control receives a READ command, it ignores it if all cells are empty, or stores it if a WRITE command is being processed. When a READ pulse is generated, the output-select counter advances from the cell last read out to the cell to be read out next. The READ pulse also advances the bidirectional control counter. The process repeats with subsequent READ commands, until all cells are empty or until a WRITE command interrupts.

The cell output selected last remains in the enabled, low-impedance state between READ commands—that is, the data last read out remains available on the bus line while all other cell outputs remain in the high-impedance, disabled state. This allows for continuous or intermittent multiplexing "on-the-bus" and completion of a data transfer cycle in a fully asynchronous manner.

Scratchpad capacity depends on application

The scratchpad's capacity—or the degree to which it can be stretched—depends on the data

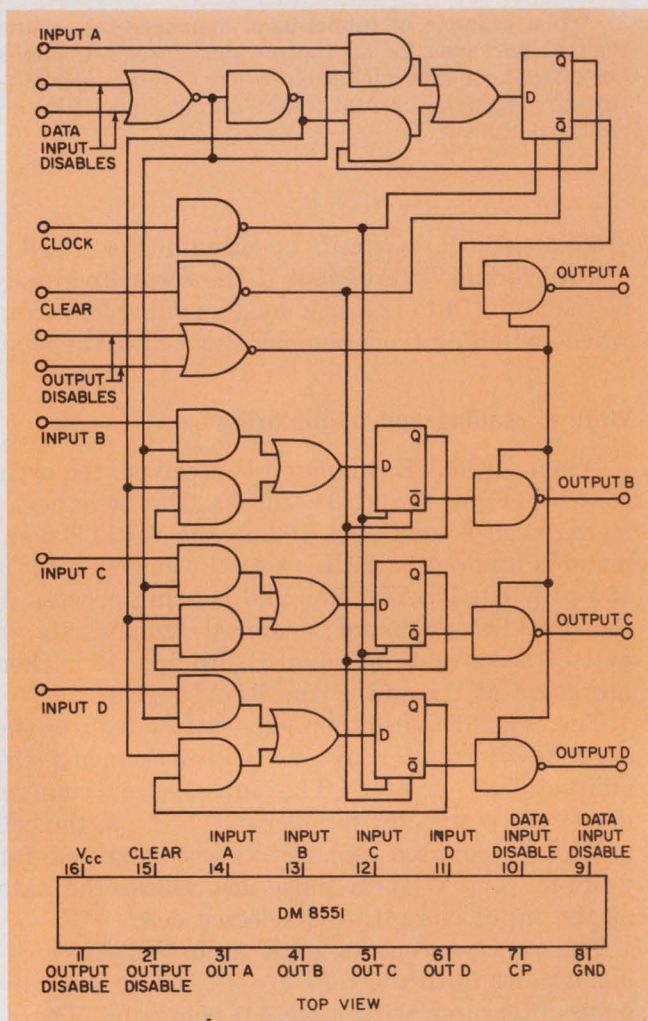

4. TTL quad-D flip-flops organized for bus-organized systems are used as the storage elements in the memory. These tri-state devices exhibit standard TTL logic states (ZERO or ONE) when the output is enabled. But if the output is disabled, a very high impedance state, which defines neither the ONE nor ZERO logic state, exists at the output.

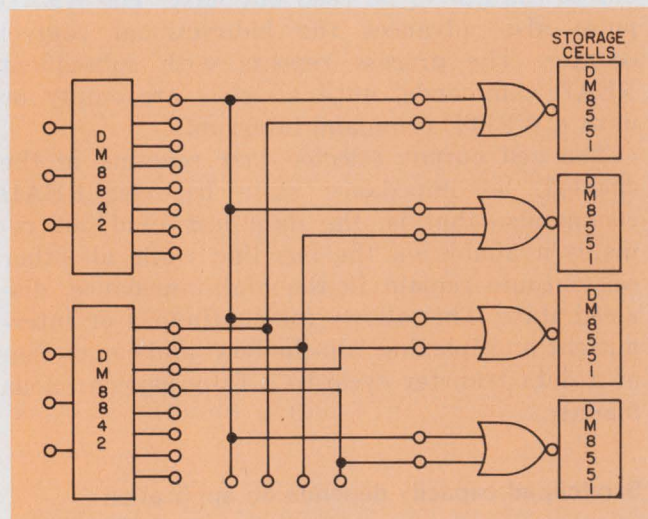

5. Decoding of tri-state devices is easily accomplished by decoders that use coincident selection.

blocks transferred, the difference in input/output rates to be accommodated and the amount of time that difference has to be tolerated.

Eight cells permit at least an 8:1 difference in input/output rates for one command cycle. For example, a difference of 1 μ s in word rate may be tolerated for 8 μ s. The maximum word rate is 5 MHz during continuous transfer. Logic delays in the system in Fig. 3 require that data be available on the input or output bus for at least 200 ns to be written in or read out of the cells. The worst case occurs when WRITE and READ are interlaced word by word. Data should then be available on each bus for the 200 ns READ and 200 ns WRITE delay, reducing the maximum word rate to 2.5 MHz.

As another example, suppose a disc reads out at a word rate of 200 kHz. The eight-word scratchpad would fill in about 40 μ s. If the computer time is 0.5 μ s (2 MHz), intervals up to 80 computer cycles would be allowed, as long as the computer then empties cells at a rate better than one cell every 5 μ s (10 clock periods). The critical requirement is usually that the data input source not overflow, since that could impose a very long delay while a disc sector is reaccessed or data from some other input is regenerated.

For an application in which 16 cells were required, a 16-output decoder driven by a four-bit counter would be used in place of the devices shown in Figs. 2 and 3. The control counter would also be expanded, but not the rest of the control logic. The next expansion level, up to 100 cells, would require two of the DM8842 decoders, with coincident selection of cells via the NOR inputs on the DM8551 packages. The tri-state outputs allow up to 128 cells on a bus. ■■

Test your retention

Here are questions based on the main points in this article. Their purpose is to help you make sure you have not overlooked any important ideas. You'll find the answers in the article.

1. *What is a rubber-band scratchpad memory?*
2. *What are the disadvantages of conventional scratchpad memories when used for asynchronous data transfer?*
3. *What are the advantages of using tri-state memory cells in the rubber-band memory?*
4. *The rubber-band memory's capacity is determined by what factors?*

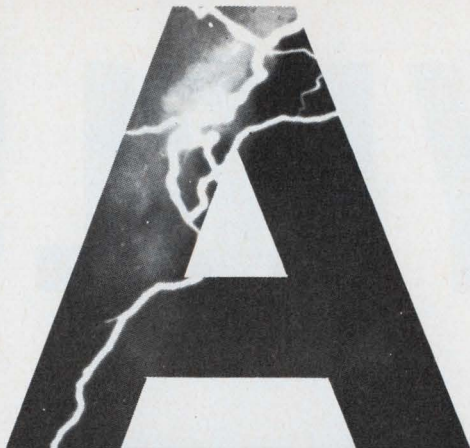
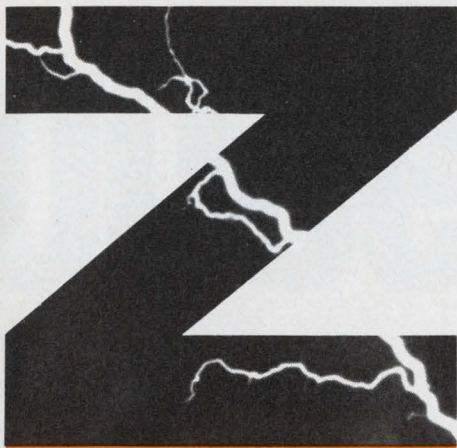

this



**protects
equipment
against
voltage
surges**

Electronic equipment is constantly running the risk of being "zapped" . . . by lightning, short circuits, switching of inductive components, etc. These ceramic gas filled arresters, from Signalite, offer maximum protection against voltage surges. They are low priced (under \$1.00) . . . reduce maintenance and down time . . . withstand shock and vibration. Some of the more vital statistics are listed, but for complete details, contact Signalite.

**Guaranteed 50
discharges . . .
200 typical**

**Fast response . . .
40 kv/ μ sec. wavefront**

**High temperature
capability with true
follow-on capability**

**Rugged ceramic
construction . . .
no glass**

Low cost...under \$1



**AVAILABLE UPON
REQUEST**

Detailed Data Sheet . . .
on Signalite Subminiature
Low Voltage Ceramic Gas
Filled Surge Arresters.



**The Broadest Line of Spark Gaps In
The World . . .** are described in the
Signalite "300" Spark Gap brochure . . .
including definition of terms,
characteristics of gap operation and
application information.

Signalite



**DIVISION OF
GENERAL INSTRUMENT**

1933 HECK AVE., NEPTUNE, N.J. 07753
(201) 775-2490

326

EASY ECL 9500

- 
- 1 Temperature dependence correction technique**
Temperature compensation.
Logic levels remain constant.
Noise immunity remains constant.
Same cooling requirements as standard TTL.
 - 2 Pull down resistors**
Internal pull down resistors; no external resistors needed for lines less than 8" long and fan out of less than 16 (this occurs in 95% of all connections).
Higher active component board density.
Low assembly and parts stocking cost.
Higher reliability (fewer connections).
 - 3 Output capacity**
Fan out of 16; or 10 loads on 50 ohm line; 40 mA DC current output.
Speed does not degrade with fan out.
DC noise immunity is higher because of higher output capacity, and requires no series terminating resistors.
 - 4 Cross talk & power pins**
Center power pins.
Easier board layout.
Reduces, if not eliminates completely, cross talk and on-chip noise.
Allows non-symmetrical loading of outputs.
 - 5 Thermal Management**
DC parameters specified in still air.
No air flow required to meet DC specs on temperature.
 - 6 Number of MSI functions now available**
Three (as of 5/1/71)
 - 7 Flexibility**
Offers low input impedance in standard speed (2.5nS) and high speed (1.5nS) gates; also offers high input impedance low power gates, (20mW).

Fairchild Easier ECL

Our 9500 series Easy ECL general purpose logic family is designed for high-speed application (1.5nS-2.5nS). It is *easier* to use because it is temperature compensated to maintain noise margins while simplifying cooling requirements. It's *easier* and *less costly* to use because the required optimum pull down resistors are built into each device, saving additional parts and assembly cost while preventing speed degradation as fan-out increases.

The Easy ECL family is already large. And getting even larger. It includes three MSI devices now in stock, and more on the way.

All of which means ever increasing freedom for the systems designer.

Make it easy on yourself

Send for our new ECL catalog, over 100 pages of detailed data sheets and applications notes. Then, when next you think about a new high speed system, make it easy on yourself. Think about Fairchild EASY ECL. It's the easiest.

Fairchild 9500 announcement schedule

Available now in quantity

9502 Dual 4-Input OR/NOR Gate
9503 Triple 2-Input OR/NOR Gate
9504 Quad 2-Input NOR Gate

9505 Quad OR-AND Gate
9528 "Dual D" Flip Flop
9538 3 line/8 line Decoder
9581 8-Input Multiplexer
9582 Multifunction Receiver/Schmitt Trigger
95H90 High Speed VHF Prescaler
9595 Level Converter

Available 3rd Quarter 1971

9507 Quad-AND-NAND Gate
95H02 High Speed 9502 (Dual 4-Input OR/NOR Gate)
95H03 High Speed 9503 (Triple 2-Input OR/NOR Gate)
95H04 High Speed 9504 (Quad 2-Input NOR Gate)
95L22 Low Power Dual Gate
95L23 Low Power Triple Gate
95L24 Low Power Quad Gate

VS. MECL 10,000

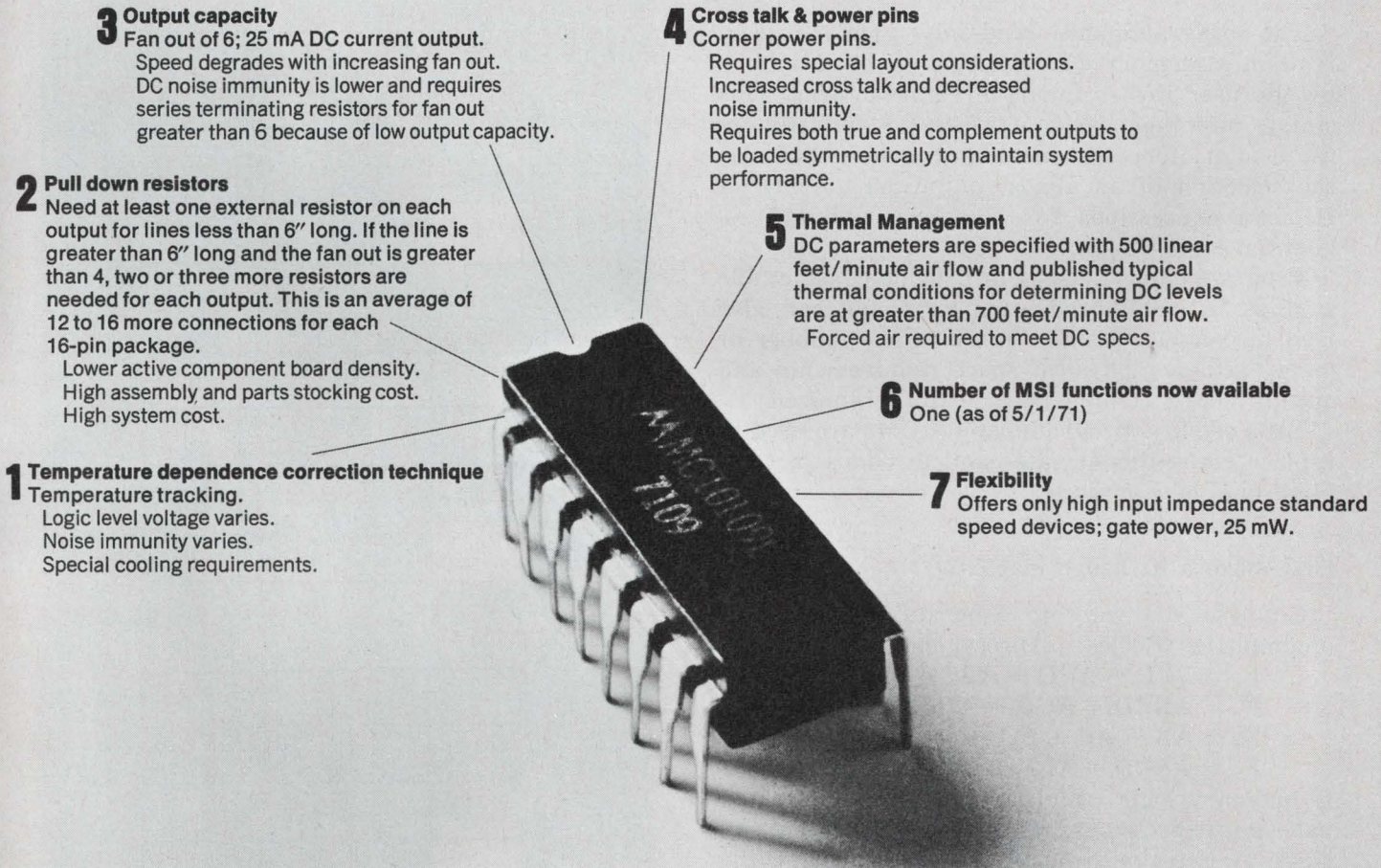

3 Output capacity

Fan out of 6; 25 mA DC current output. Speed degrades with increasing fan out. DC noise immunity is lower and requires series terminating resistors for fan out greater than 6 because of low output capacity.

2 Pull down resistors

Need at least one external resistor on each output for lines less than 6" long. If the line is greater than 6" long and the fan out is greater than 4, two or three more resistors are needed for each output. This is an average of 12 to 16 more connections for each 16-pin package.
Lower active component board density.
High assembly and parts stocking cost.
High system cost.

1 Temperature dependence correction technique

Temperature tracking.
Logic level voltage varies.
Noise immunity varies.
Special cooling requirements.

4 Cross talk & power pins

Corner power pins.
Requires special layout considerations.
Increased cross talk and decreased noise immunity.
Requires both true and complement outputs to be loaded symmetrically to maintain system performance.

5 Thermal Management

DC parameters are specified with 500 linear feet/minute air flow and published typical thermal conditions for determining DC levels are at greater than 700 feet/minute air flow. Forced air required to meet DC specs.

6 Number of MSI functions now available

One (as of 5/1/71)

7 Flexibility

Offers only high input impedance standard speed devices; gate power, 25 mW.

95H29 High Speed J-K Flip Flop
9534 Quad Latch
9578 Quad Exclusive-OR Gate/4-Bit Comparator
9579 Quad 2-Input Multiplexer
95H84 High Speed 2-Bit Adder/Subtractor

Available 4th Quarter 1971

95H00 High Speed 4-Bit Universal Register
95H10 High Speed Synchronous Decade Counter
95H16 High Speed Synchronous Binary Counter
95H28 High Speed Dual D Flip Flop
95H39 High Speed Multiport Register
95400 High Speed 64 Bit Scratch Pad
95H55 High Speed 5-Bit Comparator
9580 Triple 2-Input Multiplexer

FAIRCHILD
SEMICONDUCTOR

FAIRCHILD SEMICONDUCTOR, A Division of Fairchild Camera and Instrument Corporation,
Mountain View, California 94040. (415) 962-5011. TWX: 910-379-6435.

Simplify combination logic circuits

with programmable read-only memories. These new devices can minimize the size and package count of your design.

First of two articles

The programmable read-only memory is a read-only memory (ROM) that is programmed by the user rather than the manufacturer. This simple and inexpensive feature not only allows the design of normal memory functions but also the selection of an almost unlimited number of Boolean expressions for combinational and sequential logic design.

Programmable ROMs can provide considerable savings in small production runs and can also lead to complex designs in which the number of logic packages, physical space requirements and circuit board complexity are all minimized.

Let's see how programmable ROMs are used to replace conventional gates and flip-flops in combinational logic circuits.

First make a Karnaugh map

Suppose you want to generate the following unsimplified Boolean expressions:

$$F_1 = BCD + ACD + ABCD + \bar{A}\bar{B}CD$$

$$F_2 = \bar{A}BCD + \bar{A}CD + ABCD + ACD$$

$$F_3 = AB + AC + BC$$

$$F_4 = \bar{A}\bar{B}CD + \bar{A}BCD + \bar{A}\bar{C}\bar{D} + \bar{B}C.$$

If ordinary logic circuitry is used, these combinational expressions, when simplified, will require 17 gates with 50 inputs, or approximately ten 14-pin dual in-line packages. Obviously it will be advantageous to implement these expressions with a single programmable ROM.

The first step in programmable ROM implementation is to plot the combinational expressions in a series of Karnaugh maps (Fig. 1). Programming the ROM is the next step in the design. It requires the multi-function truth table, which is derived directly from the Karnaugh maps of Fig. 1 and is a specification of the contents of the memory.

The procedures for programming the programmable ROM are specified by the manufac-

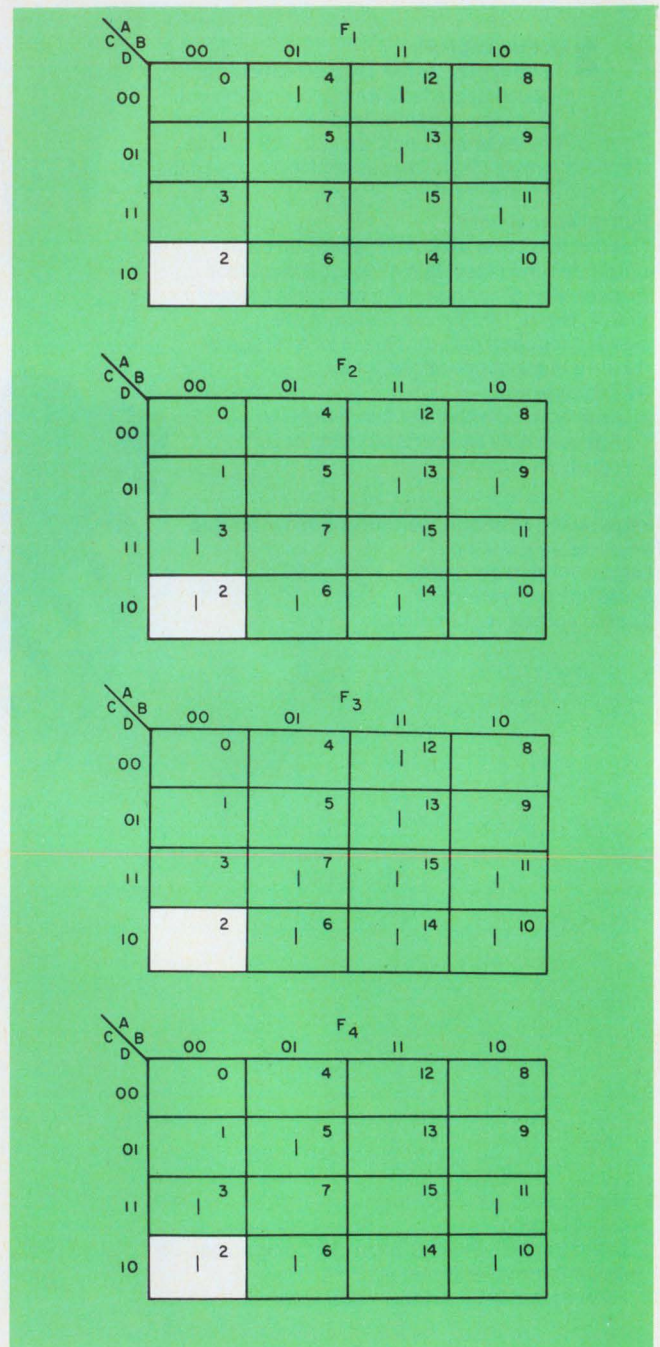

1. Making these Karnaugh maps is the first step in implementing a combinational logic circuit with a programmable read-only memory. Each of these maps specifies the state of one output line for every possible combination of input-signal levels.

ADDRESS	A, B, C, D				CONTENTS			
	F ₁	F ₂	F ₃	F ₄				
0	0	0	0	0	0	0	0	0
1	0	0	0	1	0	0	0	0
2	0	0	1	0	0	1	0	1
3	0	0	1	1	0	1	0	1
4	0	1	0	0	1	0	0	0
5	0	1	0	1	0	0	0	1
6	0	1	1	0	0	1	1	1
7	0	1	1	1	0	0	1	0
8	1	0	0	0	1	0	0	0
9	1	0	0	1	0	1	0	0
10	1	0	1	0	0	0	1	1
11	1	0	1	1	1	0	1	1
12	1	1	0	0	1	0	1	0
13	1	1	0	1	1	1	1	0
14	1	1	1	0	0	1	1	0
15	1	1	1	1	0	0	1	0

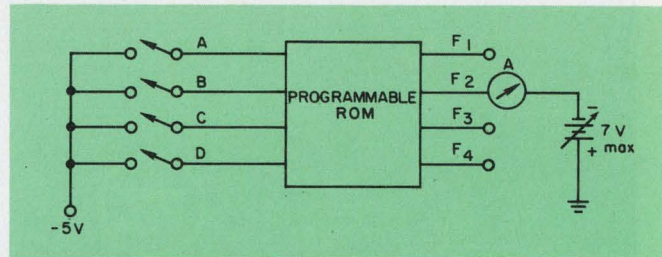

2. **Programming the programmable ROM is easy.** Just set the input switches to simulate each of the input addresses specified by the rows of the multi-function truth table and check the outputs to see if they are correct. If they aren't, change the incorrect ones by melting the appropriate fusible links in the programmable ROM.

Why should you use programmable ROMs?

In the manufacture of conventional ROMs, the programming is done photolithographically using a mask that is specially made for the user's requirements. In large production runs, the masking charges are an insignificant fraction of the total cost of the ROM. But in small-quantity production, these costs may be significant, and a programmable ROM can provide important savings.

Another area in which programmable ROMs can be used to advantage is in the design of con-

ventional ROMs. The programmable units not only save the masking charges, they also eliminate the six to eight-week turn-around time.

A third area in which it makes a lot of sense to use programmable ROMs is in the stocking of spare parts for a piece of equipment that uses many different ROMs. Rather than stocking many varieties of conventional ROMs, the user will often do better if he keeps a small stock of programmable devices which he can program in the field when it becomes necessary.

turer. For example, a method introduced by Harris Semiconductor, Inc., employs fusible links that can be selectively destroyed by electrical pulses. The method uses the setup of Fig. 2. When this type of programmable ROM is delivered, all of the outputs (F_s) are set to a logic ZERO value.

To program the memory, each row of the multi-function truth table must be treated separately. To see how it's done, let's look at Row 2. First we set the A, B and D switches to -5 V (because -5 V corresponds to a logic ZERO and an open circuit corresponds to a ONE).

Next we select F₂ and slowly increase the negative voltage applied to it while monitoring the current. When the current reaches approximately 50 mA, the fusible link will melt and the

current will drop to about 15 mA. A logic ONE has thus been set for the input conditions specified by the positions of the input switches.

Output F₄ is programmed in the same manner. Since F₁ and F₃ are already equal to ZERO, they need no modification.

By repeating this procedure for each row in the truth table, the ROM can be completely programmed. ■■

The second of these two articles will cover sequential circuits.

Bibliography

Marcus, M. P., *Switching Circuits for Engineers*, Prentice-Hall, Inc., Englewood Cliffs, N. J.
Wickes, W. E., *Logic Design with Integrated Circuits*, John Wiley and Sons, Inc., New York.

High energy silicon for the 70's.

Switching Regulator

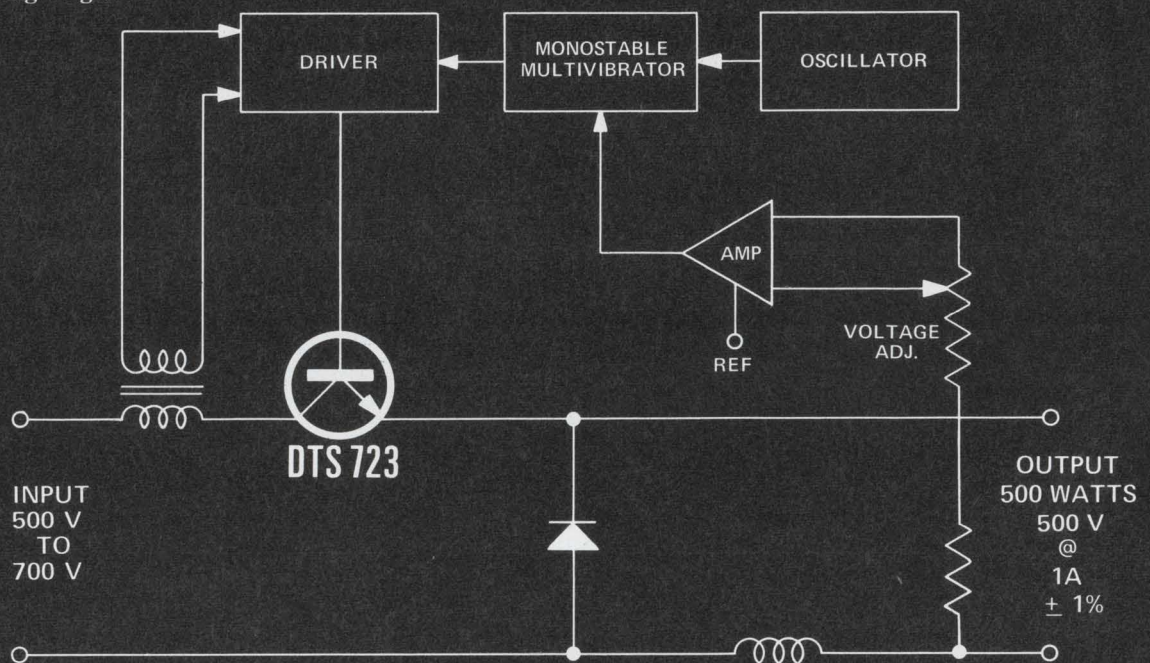

DC Regulator

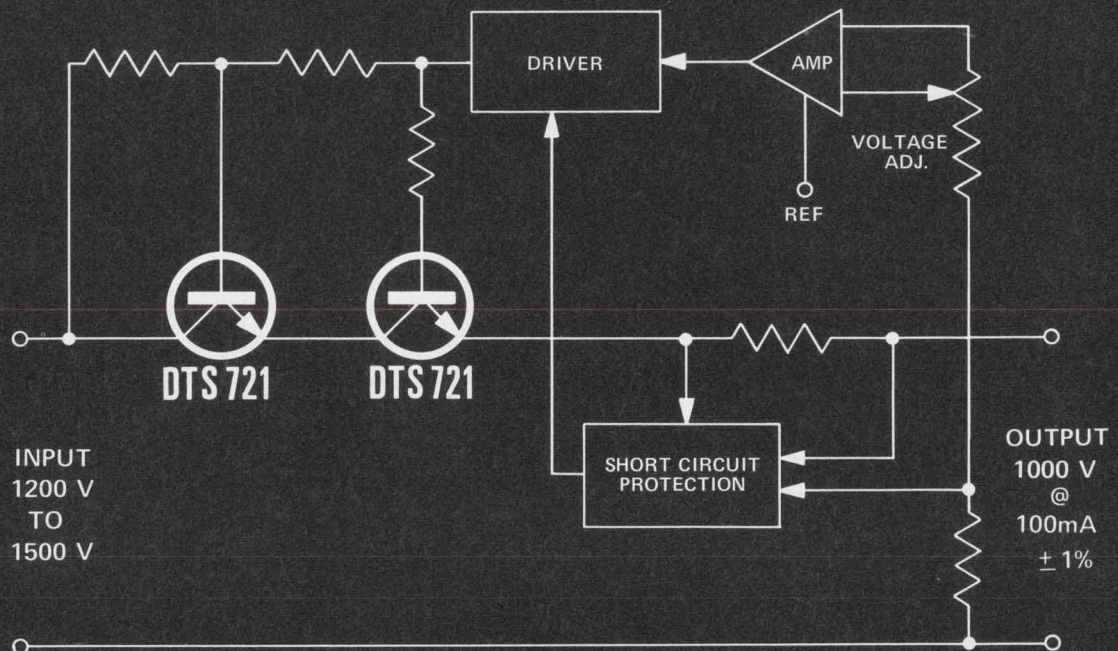

	V _{CEX}	V _{CEO}	V _{CEO} (sus)	I _C (cont)	h _{FE} @ I _C min/max V _{CE} = 5.0V	P _T
DTS-721	1000V	1000V	800	3A	20/60 @ 150 mA	50W
DTS-723	1200V	1000V	750	3A	2 min @ 2.5 A	50W

Delco announces two new 1000-volt transistors for high power regulators in small packages.

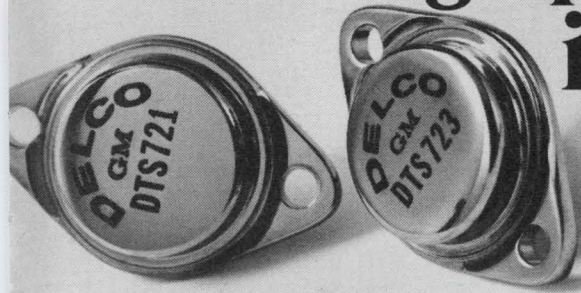

Our new DTS-721 and DTS-723 1000-volt silicon transistors permit you to design solid state circuits for industrial applications with capabilities previously reserved for tubes. Now you can think small.

These two new silicon devices were developed specially for instrumentation and power supply builders, as well as for computer and military applications. They can operate from DC inputs of 1200 volts to 1500 volts. With 1% regulation at full load.

In a switching regulator, they can operate directly from a 220-volt line or from rectified 440-volt single or polyphase sources.

Both devices are NPN triple diffused, packaged in Delco's solid copper TO-3 cases. They are mounted to withstand mechanical and thermal shock because of special bonding of the emitter and base contacts.

The DTS-721 and DTS-723 have been proven by

application tests from production lots by prospective users with stringent reliability requirements.

And their energy handling capability is verified by Delco Pulse Energy Testing.

These new high voltage silicon transistors make it possible for you to take advantage of reduced size, weight and component costs in designing circuits—and get far greater reliability.

The circuits shown are explained in detail in our application notes nos. 45 and 46.

Call the Kokomoans or your Delco Distributor for more information.



Delco Electronics

DIVISION OF GENERAL MOTORS CORPORATION, KOKOMO, INDIANA

Available from these Delco distributors:

ALA., BIRMINGHAM • Forbes Distributing Co., Inc. (205)-685-4104
ARIZ., PHOENIX • Cramer/Arizona (602)-263-1112 • Sterling Electronics (602)-258-4531
CAL., LOS ANGELES • Kierulff Electronics, Inc. (213)-685-5511 • Radio Products Sales, Inc. (213)-748-1271
CAL., PALO ALTO • Kierulff Electronics, Inc. (415)-968-6292
CAL., SAN DIEGO • Milo of California, Inc. (714)-232-8951
COLO., COLORADO SPRINGS • Walker Electronics (303)-636-1661
COLO., DENVER • Cramer/Denver (303)-758-2100 • Denver Walker Electronics (305)-935-2406
FLA., MIAMI • Mountain Electronics Subsidiary of Avnet, Inc. (305)-634-4556
FLA., WEST PALM BEACH • Mountain Electronics, Subsidiary of Avnet, Inc. (305)-833-5701
ILL., ROSEMONT (Chicago) • Kierulff/F-J-R (312)-678-8560
ILL., SKOKIE (Chicago) • Merquip Electronics (312)-282-5400
IND., INDIANAPOLIS • Graham Electronics Supply, Inc. (317)-634-8486
MD., BALTIMORE • Radio Electric Service Co. (301)-823-0070
MASS., NEWTON • The Greene-Shaw Co., Inc. (617)-969-8900
MICH., ROMULUS • Harvey/Detroit (313)-729-5500

MINN., MINNEAPOLIS • Stark Electronics Supply Co. (612)-332-1325
MO., KANSAS CITY • Walters Radio Supply, Inc. (816)-531-7015
MO., NO. KANSAS CITY • ECI Semiconductors, Inc. (816)-221-2400
MO., ST. LOUIS • Electronic Components for Industry Co. (314)-647-5505
N.J., CLIFTON • Eastern Radio Corporation (201)-471-6600
N.M., ALBUQUERQUE • Cramer/New Mexico (505)-265-5767 • Sterling Electronics (505)-247-2486
N.Y., BINGHAMTON • Harvey/Federal (607)-748-8211
N.Y., NEW YORK • Harvey/New York (212)-582-2590
N.Y., WOODBURY • Harvey/New York (516)-921-8700
OHIO, CINCINNATI • United Radio, Inc. (513)-761-4030
OHIO, CLEVELAND • Pattison Supply (216)-441-3000
OHIO, DAYTON • Kierulff/F-J-R (513)-278-9411
OKLA., OKLAHOMA CITY • Radio, Inc. (405)-235-1551
OKLA., TULSA • Radio, Inc. (918)-587-9123
PENN., PHILADELPHIA • Almo Electronics (215)-676-6000
PENN., PITTSBURGH • RPC Electronics (412)-782-3770
S.C., COLUMBIA • Dixie Radio Supply Co., Inc. (803)-253-5333

TEXAS, DALLAS • Adleta Electronics Company (214)-741-3151
TEXAS, FORT WORTH • Adleta Electronics Co. (817)-336-7446
TEXAS, HOUSTON • Harrison Equipment Co., Inc. (713)-224-9131
UTAH, SALT LAKE CITY • Cramer/Utah (801)-487-3681
VA., RICHMOND • Meridian Electronics, Inc., a Sterling Electronics Company (703)-353-6648
WASH., SEATTLE • Kierulff Electronics, Inc. (206)-763-1550
WASH., TACOMA • C & G Electronics Co. (206)-272-3181
CANADA, ONT., SCARBOROUGH • Lake Engineering Co., Ltd. (416)-751-5980
ALL OVERSEAS INQUIRIES:
General Motors Overseas Operations
Power and Industrial Products Dept.,
767 Fifth Avenue, New York, N.Y.
10022. Phone: (212)-486-3723.

Regional Headquarters, Union, New Jersey*
07083, Box 1018 Chestnut Station, (201)-687-3770 ■ El Segundo, Calif. 90245, 354 Coral Circle, (213)-772-5181
■ Chicago, Illinois* 60656,
5151 N. Harlem Avenue,
(312)-775-5411 ■ Kokomo,
Ind. 46901, 700 E. Firmin,
(317)-459-2175 Home Office
■ *Office includes field lab and resident engineer for application assistance.



Memo from an engineering secretary:

'Dear Boss: Please read this to find out how you can help me make your job easier.'

Richard L. Turmail, Management Editor

Remember the "what's black and white and read all over" type of quizzes? Here's an updated version: What writes ungrammatical business letters, bucks the company paperwork system and generally fails to recognize the potential of clerical help? According to three experienced electronics company secretaries; "an engineer," that's what.

ELECTRONIC DESIGN asked Gail Renz of ITT in Nutley, N. J.; Nancy Sorensen of Hewlett-Packard in Loveland, Colo., and Karen Starsiak of TRW, Inc., in Los Angeles, Calif., what problems they had encountered in assisting their engineering bosses. All three had many complimentary things to say about engineers. But they also indicated that the engineer could help his secretary help him to be more efficient.

All three women said their bosses, in general, had the following problems:

- They're poor letter writers.
- They have sloppy handwriting.
- They're uninformative.
- They're slow in handling reports, time cards, etc.
- They're poor in dictation.
- They're unable to work well with other disciplines.
- They're prone to fight the company paperwork system.
- They're guilty of not using the full office abilities of their secretaries.

The most troublesome trouble spots

Most engineering secretaries work for from 10 to 50 engineers. Only a few work for only one boss, who is usually an engineering manager, as in the case of Karen. "But during the age of lay-off," she says, "I've been helping about 20 additional engineers."

Asked what her most troublesome problem is in working for engineers, she said that failure to communicate is probably the most serious barrier to her helping the engineer more efficiently.

"They never volunteer to tell me what they're



Karen Starsiak: "If they could just organize their thoughts before dictation . . ."

working on," she says. "I like to know what the project is all about, so that I can feel that I'm a part of it. I feel I can do a better job if I know the whole story. They need encouragement to keep me informed; so I just keep asking questions."

On the other hand, Gail says: "Sloppy handwriting is my biggest problem." She's secretary to an engineering manager 20 per cent of the time, and works for 20 other engineers the rest of the time. "Very few of them know how to type," she says. "I frequently spend a lot of time translating their reports and business letters."

Nancy has worked for a "mixed bag of engineers," including the 19 or 20 electronics engineers she works for now.

"The biggest mistake an engineer makes with his secretary," she says, "is that he doesn't take full advantage of her office know-how. All an engineer seems to want is a clerk-typist. His schooling has not taught him to work well with other disciplines. He doesn't appreciate the fact that a good secretary can, among other things, lead him through the company paperwork system, advise him on the composition of his business letters and find out what the current company attitudes are, including what's going on in the other departments.

"If an engineer would ask his secretary for advice," Nancy says, "she'd be thrilled to death!"

The girls have been taking notes

Problems that these three secretaries have in common with their bosses are poor letter writing, poor dictation and poor scheduling of reports. "The engineer is not well known for his command of the English language," Nancy says. "After 'Dear Sir,' he's in trouble."

"Their letters are poor," Karen agrees. "They're filled with grammatical errors, misspelled words and mistakes in composition."

Gail says that she has to reword many of the letters she receives for typing. The girls think the problem would take care of itself if the engineer considered his correspondence as important as the rest of his work.

"He feels that the company paperwork system, consisting of correspondence, interoffice memos, documentation, report writing, etc., interferes with his engineering work," Nancy says.

Karen says that dictation is a problem, too, because engineers often speak disjointedly. "It would help," she says, "if they would stop to organize their thoughts before dictating to their secretary."



Gail Renz: "I've got them pretty much in line."

Plagued by the same problem, Nancy says: "I try to understand the concept of what the engineer is saying, rather than write down every word he says. When I type it out correctly and return it to him, he seldom notices that it's not the way he dictated it word for word."

The secretaries also agree that engineering terminology can be a difficult problem for a new secretary, especially when the engineers use com-



Nancy Sorensen: "After 'Dear Sir,' they're in trouble."

pany terms that aren't in the IEEE booklet of electronic abbreviations. The women feel that engineers should give a new secretary plenty of time to become accustomed to her work load, since engineers rarely follow established office procedures.

The problem with reports is that engineers fail to allow enough time for the secretary to type them by the deadline.

"The engineer should allow 24 hours for the typing of a 10-page report," Nancy says, "and then only if there are no reports ahead of his to be typed. Usually half of the 20 guys I work for want their reports typed at the same time. They should plan for the typing by taking the time requirements into consideration."

Helpmates for efficiency

Asked for comments in summary, the three secretaries said:

Karen: "I've found engineers to be generally cooperative; if they're not, I feel it's my responsibility to adjust."

Gail: "They're a pretty good bunch to work for; I've got them pretty much in line."

Nancy: "Engineers are argumentative usually only when their authority is questioned. Most of them take their work very seriously and get involved with it. To ease the tension, I flirt a lot—like 'Your eyes match your tie.' I think it helps."

Admittedly, the engineer is powerless to correct many of the problems that may be keeping his secretary from helping him best. Improving poor handwriting, for example, would take practice, and most engineers just don't have the time. But any engineer will find his secretary can make his job a lot easier if he'll remember to:

- Be more cognizant of the company system and time requirements for report typing.
 - Use the office knowledge of his secretary to advantage.
 - Keep his secretary informed.
- Any arguments? ■■

Air Controller.



Shown approx.
twice actual size.

Our new FW one piece electronic proximity switches guide the pilot by keeping him supplied with vital information about his aircraft.

They're solid state. Which eliminates moving parts. The result is precision monitoring of important systems or functions. As well as high reliability and long life. Even in severe atmospheres.

Ferromagnetic and all-metals sensing versions are available. Each conforms to MIL-STD-704 and is highly resistant to shock and vibration as well as protected from the effects of RFI.

Our FW proximity switches can also be used to monitor the status of aircraft entry, cargo, and landing gear doors. Or for baggage and cargo handling. They also may be just what is needed in most any tough ship, tank, missile or artillery application you have.

For more information, call your MICRO SWITCH Branch Office (in the Yellow Pages under "Switches, Electric"). Or write for Product Sheet FW.

MICRO SWITCH

FREEPORT, ILLINOIS 61032
A DIVISION OF HONEYWELL

HONEYWELL INTERNATIONAL—Sales and Service offices in all principal cities of the world. Manufacturing in Australia, Canada, Finland, France, Germany, Japan, Mexico, Netherlands, Spain, Taiwan, U.K. and U.S.A.

OUR ANGLE: Modular D/S and S/D Converters

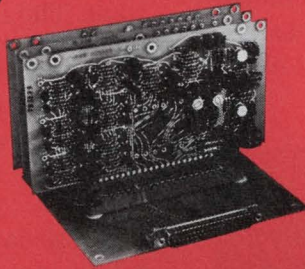

NT

A

Do Low Cost Repairable Circuit Cards Make Sense from Your Angle?

North Atlantic's new 701 D/S and 711 S/D Converters offer unmatched advantages for the digital/analog interface at low-low cost . . . typically \$1000. Open-card construction is easily and economically maintained. Adaptable to systems needs, interchangeable converter cards are compatible with your automatic test, simulation or digital control systems.

Compared to 19" panel designs, these units provide a choice of accuracy, frequency, resolution, and systems customization without the extra bulk and expense of unnecessary power supplies and other panel controls. They are ideal for multi-channel applications where a converter is assigned to a specific function.

These new converters are available to meet a wide range of systems needs. The 701 D/S has selectable accuracies of 9 or 12 bits with resolution of 8 through 14 bits, transformer output isolation and short circuit protection, operation at 60 Hz or 400 Hz with 1VA or 10VA output. The 711 S/D has 0.05° accuracy, 13 bit resolution with input transformer isolation, and continuously tracks 400 Hz synchro data to 1000°/second.

Don't these converters make sense from any angle? Talk it over with your North Atlantic sales engineering representative today.

NORTH ATLANTIC
industries, inc.

200 TERMINAL DRIVE, PLAINVIEW, NEW YORK 11803
cable: noatlantic / twx: 510-221-1879 / phone: (516) 681-8600

INFORMATION RETRIEVAL NUMBER 41

ideas for design

Set-reset flip-flop rejects input noise

With only five gates, it's possible to build a set-reset flip-flop whose output will not change when its inputs are the same. The circuit serves well as a differential line receiver, because of its

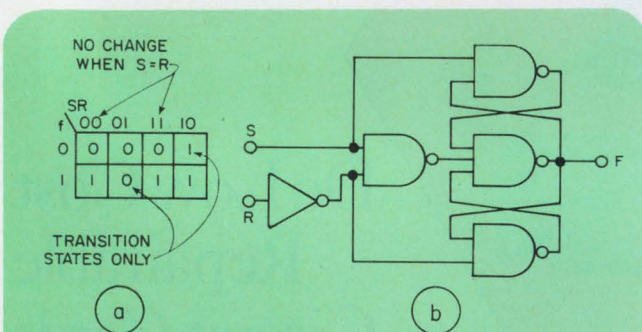

A set-reset flip-flop (b) that does not change state when its inputs are the same can be used as a line receiver because of its high noise rejection. A Karnaugh map (a) tabulates the various input and output functions of the flip-flop.

noise-rejection properties. Since common-mode input noise tends to make inputs equal and this flip-flop does not change states for equal inputs, it has a high degree of rejection.

Let's take a detailed look at the flip-flop we want. The inputs are set (S) and reset (R), and the output should be:

S	R	Output
0	0	No change
0	1	0
1	0	1
1	1	No change

A Karnaugh map (a) permits us to make a better representation of the necessary flip-flop. If we consider the next output (F) as a function of the present output (f), S and R, the output function is

$$\begin{aligned} F &= S\bar{R} + f(S + \bar{R}) \\ &= S\bar{R} + f(SR) \\ &= S\bar{R} + fS + f\bar{R}. \end{aligned}$$

This last equation allows us to realize the output function with only five gates, as indicated in (b).

William B. Crittenden, Senior Engineer, Westinghouse Aerospace and Electronic Systems Div., Baltimore, Md.

VOTE FOD 311

Single-supply trigger circuit works for three types of logic

A logic-compatible trigger circuit operates with supply voltages of 3 to 9 V, allowing it to be used with TTL, DTL or RTL. This also means that a common supply can be employed for both the trigger and the logic. The circuit accepts a sine-wave input of 50 mV to 1 V rms.

The differential amplifier performs like a comparator circuit, while the output transistor permits adjustment of the logic-level operating voltage. Output pulse width is controlled by the differentiating capacitor, C₁, connecting the two NAND gates that are used as inverters.

Operating frequencies can range from 1 kHz to 10 MHz with TTL. For lower frequencies, larger capacitors are needed for the input and the differentiator. The NAND gates in the diagram are 7400 TTL.

Ralph W. Burhans, Research Engineer, Ohio University, Dept. of Electrical Engineering, Clipping Building, Athens, Ohio.

VOTE FOR 312

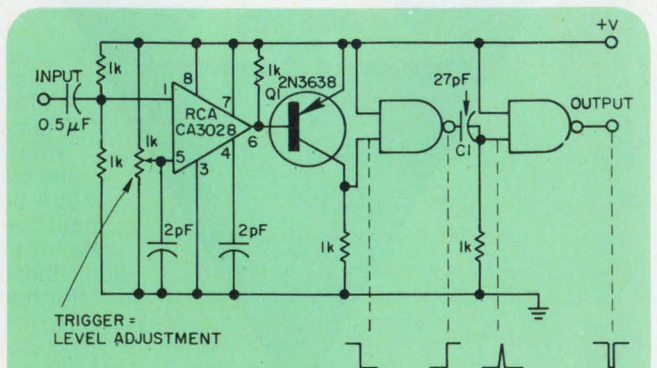

Use just one supply to power both your logic and trigger circuits. Compatible with either TTL, DTL or RTL, this trigger circuit requires only 3 to 9 V. It accepts sine waves of up to 1 V rms.

Model 844 is all you need for your low cost / high performance requirements in virtually unlimited applications. Think of it as a standard building block that's cost-effective, compatible, efficient, versatile — all in a hermetically sealed 12-pin TO-8 can.

These performance specifications are the best in the market for a dual regulator (to MIL-STD-883):
Regulation: $\pm 0.005\%$

Current: ± 300 mA, isolated
Output: preset ± 12 v or ± 15 v,
 $\pm 0.5\%$ initial tolerance

And the price? \$20 (1-9 quantity). Contact your local Helipot Sales Engineering Representative for additional information.

Beckman® INSTRUMENTS, INC.

HELIPOT DIVISION FULLERTON, CALIFORNIA 92634

Helipot's new dual voltage regulator has many facets!



Pulse-shaping circuitry has zero recovery time

The finite recovery time associated with conventional pulse-shaping circuits is usually an undesirable property when your application involves shaping pulses that are statistically distributed in time or pulses that have high repetition rates. If the input to such a circuit is two pulses whose mutual time distance is less than the recovery time of the shaper itself, the resulting output pulse may be distorted in both width and amplitude.

Figure 1 illustrates three possible ways of building a pulse shaper with zero recovery time. Gates G_1 and G_2 are controlled by the bistable circuit, BC. With input pulses applied, one of the gates is closed while the other is open. This is true for any instant except for the transient time required to trigger the bistable.

Pulses from the gates, G_1 and G_2 , enter the monostables, MC_1 and MC_2 , respectively. The outputs of the monostable circuits can be shaped for desired pulse width and amplitude.

The three networks of Fig. 1 differ only in the manner in which the bistable circuit is triggered. It can be triggered by separated inputs from the gates (Fig. 1a), or with input pulses (Fig. 1b), or with output pulses (Fig. 1c).

In all three versions, the bistable alternately opens and closes the gate, resulting in an interchange of action between the monostables. It is

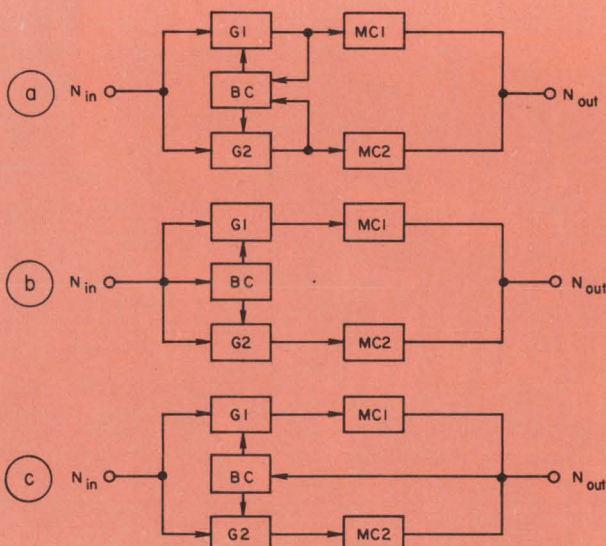

1. Here are three ways to build a pulse shaper with zero recovery time. The circuits differ only as to how the bistable is triggered—by the gates (a), with input pulses (b), or with output pulses (c).

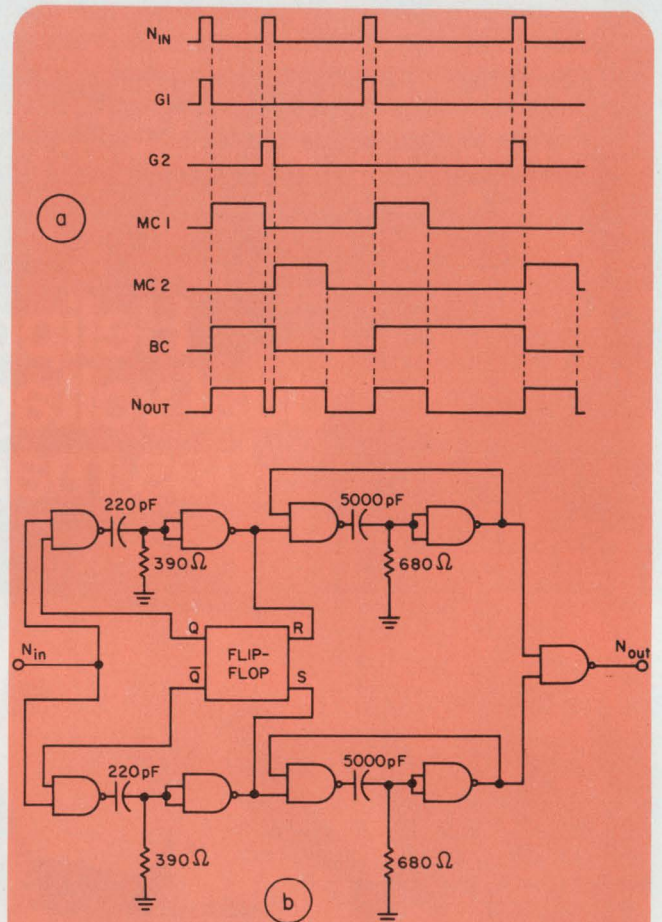

2. Timing diagram (a) indicates how recovery time is controlled by the monostables, MC_1 and MC_2 . One possible design (b) using the trigger mechanism of 1a employs standard off-the-shelf digital ICs.

important that the parameters of the two monostable circuits are the same to ensure proper circuit operation. A timing diagram (Fig. 2a) illustrates this.

The pulse-shaping circuitry has zero recovery time, since the minimal time distance between two successive output pulses can be decreased as much as required, provided that

$$T_r \leq T,$$

where T_r is the recovery time of the monostable circuits and T is the width of their output pulses.

One possible complete design of a pulse shaper with zero recovery time is shown in Fig. 2b. The circuit uses readily available digital ICs—a dual Type D, edge-triggered flip-flop (Texas Instruments SN7474N) and quad dual-input NAND gates (Texas Instruments SN7400N).

Jozef Sabol, Design Engineer, Technical University of Prague, Brehova 7, Prague 1 Czechoslovakia.

VOTE FOR 313

WE JUST MADE A LITTEL SWITCH A LOT BETTER.

We improved its looks and effectiveness.

New Switchcraft "BLACK SCREEN" display screens give you more distinctive lighting and legend arrangements in our popular Series 37000 and 38000 littel "MULTI-SWITCH"[®] switches . . . at the same low cost.

"BLACK SCREEN" is a new lighting technique. Colors don't show and legends are invisible when internal lamps aren't lit. All that can be seen is the uniform black surface of the plastic display screens. But when illuminated, legends and colors (or combinations of both) stand out . . . brilliantly and distinctly.

You'll find our new illumination technique ideal for use in computers, peripheral equipment, telephone and

industrial switching, broadcast, and all control panels where greater operator reaction is needed. "BLACK SCREEN" visual indications, whether illuminated by circuit functions or by the switch itself, will eliminate many man/machine interface problems.

"BLACK SCREEN" display screens are offered only on Series 37000, 38000 littel "MULTI-SWITCH"[®] switches . . . the compact, multiple station pushbutton switches you can squeeze in back of almost any panel. Switches are available in one to eighteen stations in a row, plus ganged and coupled matrices.

Each station provides up to 6PDT switching in just .6" of panel space. And you can have 8PDT in slightly more space.

Functions, like interlock with lock-out,

all-lock, non-lock and push-lock/push-release are housed in a precision stamped metal frame, only 2-5/16" deep.

You can choose single or twin lamp illumination; full or split screen display screens; contoured or beveled pushbutton faces; or "BLACK SCREEN" lighting. Each with front relamping.

It all adds up to quality and versatility . . . the kind that makes our littel switch a lot better.

For more information, call your Switchcraft representative or write for Catalogs S-323a and 232. Switchcraft, Inc. 5529 N. Elston Ave., Chicago, Illinois 60630

OUR



25th ANNIVERSARY

SWITCHCRAFT[®]
INC.

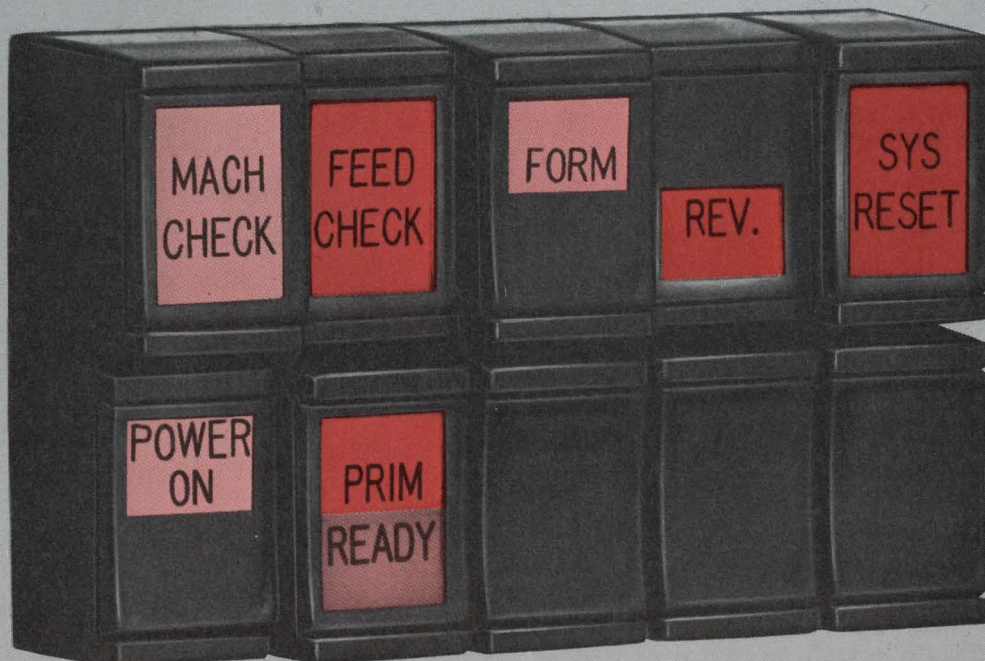

Use pulse coding to boost shift-register time resolution

Improve the time resolution of your shift register without increasing its length by using pulse coding. When shift registers are used as delay lines in pulse applications, they lose time resolution because pulse timing is quantized in units of the clock period. For instance, the timing of a pulse sent down a shift register being clocked at 1 MHz is only preserved to within 1 μ s. If greater time resolution is required, usually the shift register must be clocked at a higher frequency and more stages added.

Using pulse coding is simply a matter of timing. When a pulse is entered into the first stage of the register, note the time between the start of the pulse and the next clock pulse. A ONE is then propagated down the register followed by a code of ONES and ZEROS that indicate the time between the pulse and the clock. At the register's output, the first ONE and the following code are read. An additional incremental delay is then added to compensate for the delay between the arrival of the original pulse at the input and the next clock pulse.

Let's look at an example to make the principle clearer. An input pulse is first converted to one with a 0.5- μ s duration by a monostable circuit and then applied to the preset input of the shift register. The Q terminal of the first stage now goes to logic ONE. When the register is clocked, this ONE is shifted to the second stage.

If the input pulse is applied less than 0.5 μ s before clocking, it will still exist after the clock and Q will remain at ONE. The Q terminals of both the first and second register stages are now at logic ONE, and these two ONES will propagate together down the shift register.

The presence of the second ONE means that the input pulse was received less than 0.5 μ s before clocking. Conversely a ONE followed by a ZERO would indicate that the pulse was received between 0.5 and 1 μ s before clocking.

The output circuitry must detect the pulse pattern and add an appropriate further delay. If two ONES are propagated, the output of G₁ will go to ZERO and that of G₃ to ONE. The delay depends on the number of register stages and has an uncertainty of 0.5 μ s.

If the pulse pattern is a ONE followed by a ZERO, then the input pulse has already suffered a delay between 0.5 and 1 μ s. This permits us to take the output one stage earlier in the register using G₂, and to inhibit the output of G₂ another 0.5 μ s with the clock waveform. Gate G₃ again produces an output with a delay uncertainty of 0.5 μ s.

Extending this pulse-coding principle would mean even better time resolution, but at the expense of greater input and output circuit complexity. Another limiting factor is the spacing between successive input pulses.

M. Stevens, Cossor Electronics, The Pinnacles, Harlow, Essex, England.

VOTE FOR 314

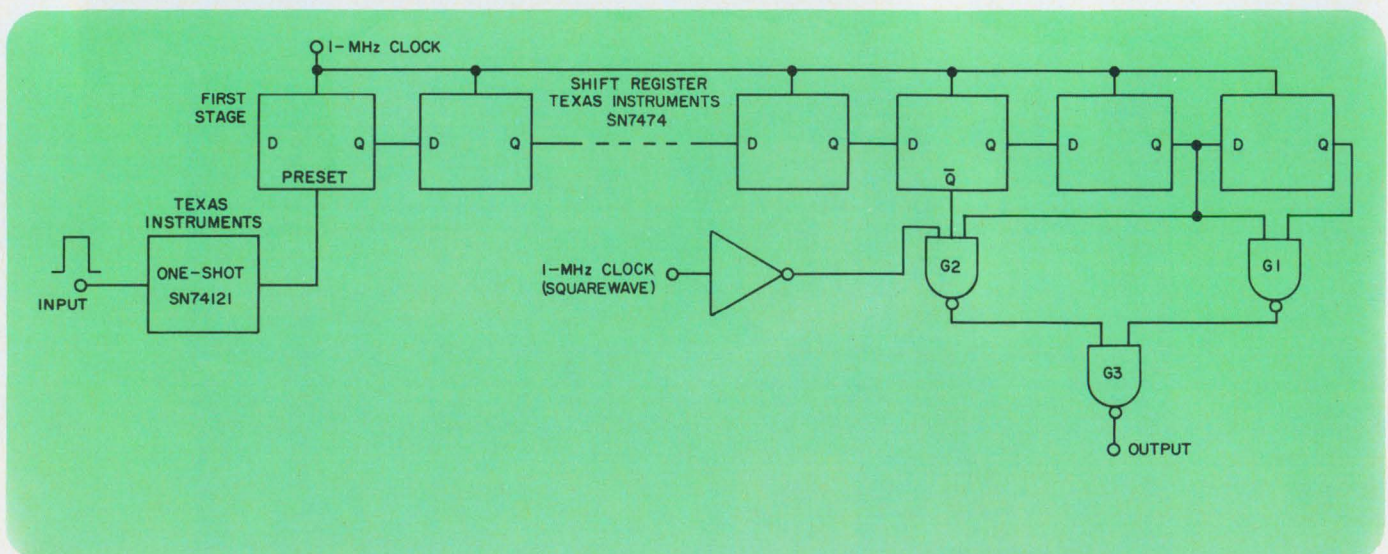

A pulse-coding technique increases the time resolution of a shift register without adding more stages

or raising the clock rate. Delay uncertainty is only 0.5 μ s with a 1-MHz clock.

75 MFD/30 VOLT DC CAPACITORS

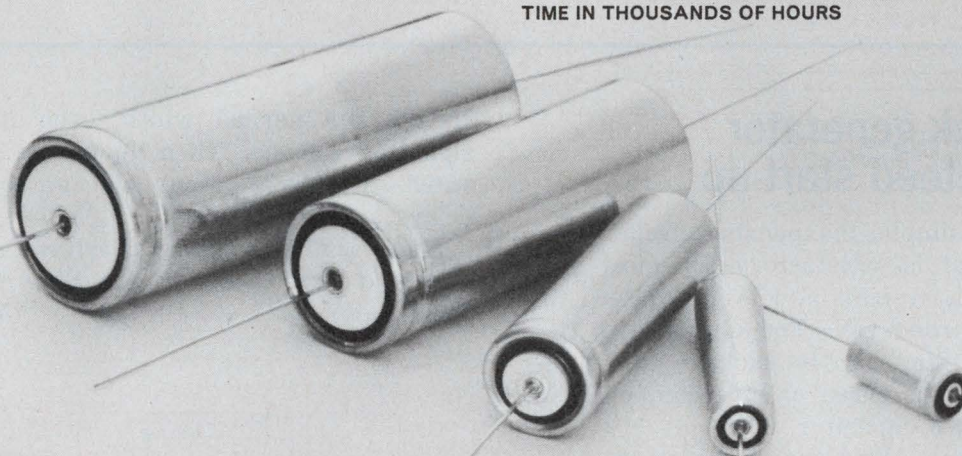
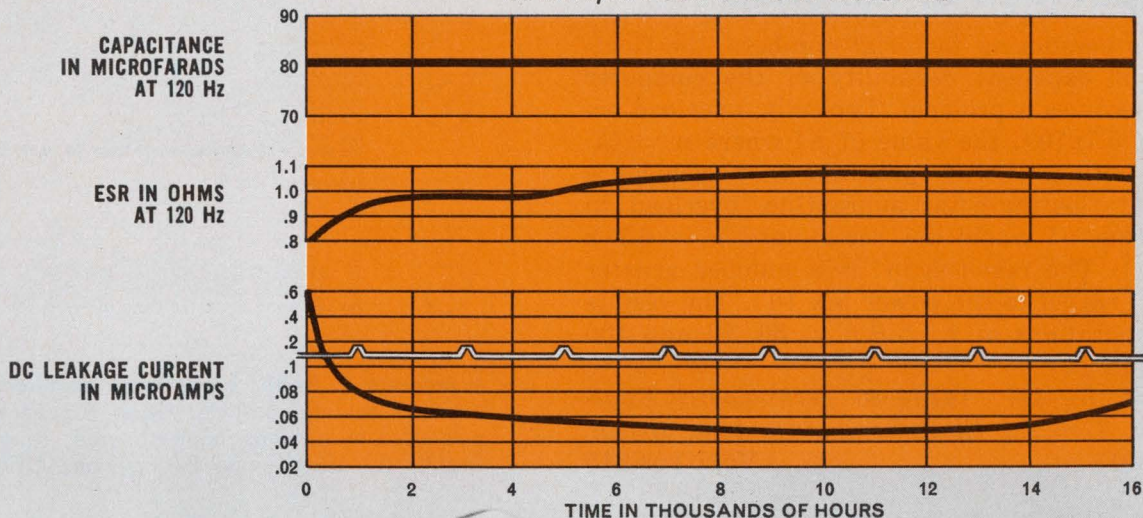

Our new TCG capacitor has curves you can't resist.

The curves tell at a glance the typical life story of one of our new TCG aluminum electrolytic capacitors. But there's more to a TCG than life curves. There are 45 case sizes, with safety vent protection where required; capacitances from 2 to 22,000 mfd; voltages from 3 to 450 VDC; and a -40 to $+85^{\circ}\text{C}$ temperature range.

Add to these a high C/V in a small package. Plus outstanding electrical and physical characteristics. And you've got our new TCG. Find out more by writing for Bulletin 4-307. Eighteen pages of data . . . and some curves that will open your eyes. Popular ratings available from authorized Mallory distributors.

MALLORY

MALLORY CAPACITOR COMPANY

a division of P. R. MALLORY & CO. INC.
Box 372, Indianapolis, Indiana 46206; Telephone: 317-636-5353

Electrical and electronic components • sequence timers • metallurgical products • batteries

Computer program extends computation of factorials

When computing factorial numbers, the floating-point exponent capability of the computer often becomes a problem. Typically, overload occurs at 5.7×10^{76} , the value of $n!$ where $n = 57$.

But with a BASIC program that includes a separate floating-point subroutine, overload in computing $n!$ would not occur until $n = 6.7 \times 10^{74}$ (a). The resulting $n!$ is a number greater than 10 raised to the power 5×10^{76} . The results of computations of $n!$ for $n = 30, 70$ and 100 are given (b).

W. M. Bunker, *Advanced Technologies Engineering, General Electric Co., Daytona Beach, Fla. 32015.*

VOTE FOR 315

```

80 READ N
90 DATA 30,70,100
95 LET E=0
100 LET F=1
110 FOR I=2 TO N
120 LET F=F*I
130 IF F<1E5 THEN 160
140 LET F=F*1E-5
150 LET E=E+5
160 NEXT I
170 PRINT N;"FACTORIAL =";F;"TIMES 10 TO THE";E;"POWER"
180 GO TO 80
200 END
    
```

RUN

N	FACTORIAL
30	FACTORIAL = 265.253 TIMES 10 TO THE 30 POWER
70	FACTORIAL = 1.19786 TIMES 10 TO THE 100 POWER
100	FACTORIAL = 939.262 TIMES 10 TO THE 155 POWER

A program in BASIC for factorial numbers avoids overload (a) and permits values exceeding those computed by conventional techniques (about 57!). Results (b) are given for 30! 70! and 100!.

Simple clock generator has guaranteed start-up

An extremely simple, inexpensive circuit provides a clock that is satisfactory for most uncomplicated T μ L systems and is guaranteed to oscillate when turned ON. The circuit (a) requires only a portion of an IC package (one-half Fairchild 9016), plus three passive components, two resistors and a capacitor.

These components yield the approximate frequencies given in the table and a 60% (high) to 40% (low) output waveform. Frequency variations with temperature are less than 10% for the smaller capacitor values from 0 to 70°C, but greater variations can be expected with the larger capacitor values. The output is capable of driving five additional T μ L loads.

An active low enable input can be provided by replacing the 9016 with a Fairchild 9002 quad two-input NAND gate (b). The cross-coupled gates ensure that a clock pulse will not be cut short by removal of the enable at the wrong time.

Once the clock output goes low, it stays low

for its full normal width, even if the enable signal is removed. When the enable input is activated, the clock output will go low two gate delays later (≈ 15 ns).

Mogens Ravn, *Digital Systems Applications, Fairchild Semiconductor, 464 Ellis St., Mountain View, Calif.*

VOTE FOR 316

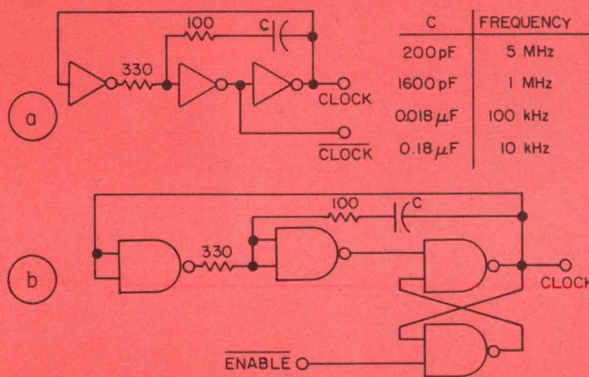

Sure-turn-on clock generator requires only four components (a). Change from inverters to NAND gates, and you can add an enable input (b). Operating frequencies range from 10 kHz to 5 MHz.

IFD Winner for March 4, 1971

Leon Fink, Jr., Engineering Technician, 1605 Grace Street, Arlington, Tex. 76010. His idea "Low-Cost Audio-Range Oscillator Uses An SCR And An RC Network" has been voted the Most Valuable of Issue award.

Vote for the Best Idea in this issue.

VOTE! Go through all Idea-for-Design entries, select the best, and circle the appropriate number on the Reader-Service-Card.

SEND US YOUR IDEAS FOR DESIGN. You may win a grand total of \$1050 (cash)! Here's how. Submit your IFD describing a new or important circuit or design technique, the clever use of a new component or test equipment, packaging tips, cost-saving ideas to our Ideas-for-Design editor. You will receive \$20 for each accepted idea, \$30 more if it is voted best-of-issue by our readers. The best-of-issue winners become eligible for the Idea Of the Year award of \$1000.

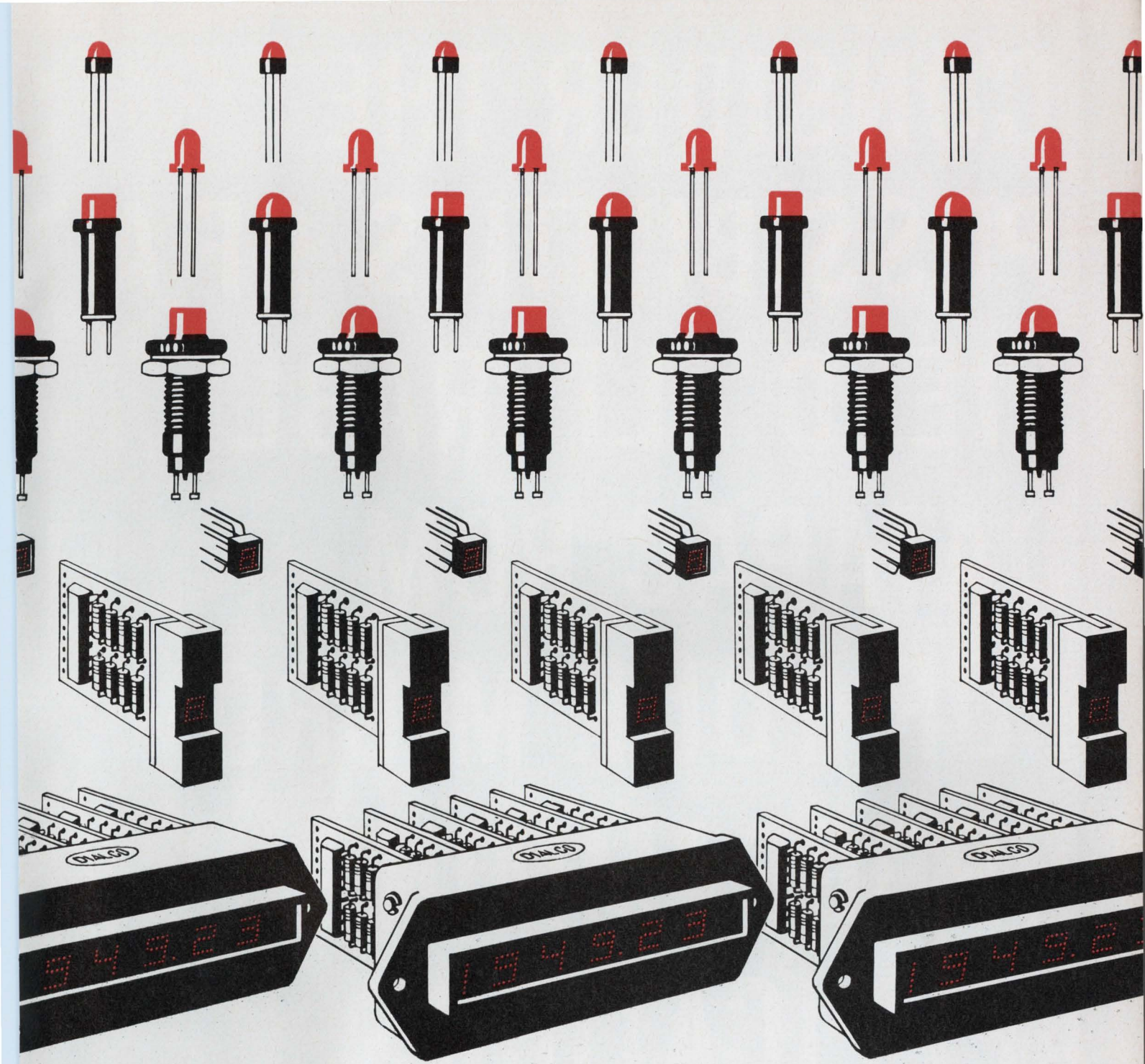

Dialight announces **DIODE-LITE™** the industry's broadest line of LED light sources, indicator lights and readouts.

Here is every component or package you might need to capitalize on the long life and reliability of LEDs: DIODE-LITE light sources . . . indicator lights utilizing DIODE-LITES in cartridges and complete assemblies . . . illuminated pushbutton switches . . . readout modules in .125", .205" and .600" character heights . . . these modules incorporated in readout packages complete with decoder/drivers . . . and finally, display assemblies of 2 to 10 read-

out packages mounted in a bezel frame with window. All are attractively priced. All are available off-the-shelf from Dialight or through selected distributors.

No one else offers you one-stop shopping in LED visual display. And no one has more experience in the visual display field. That's important too. Write today for our Data File on DIODE-LITES and compare it with anybody else's.

DIALIGHT

CONSIDER THE POSSIBILITIES OF A FIELD ALTERABLE DATAPAC ROM FOR YOUR MICRO- PROGRAMMING APPLICATIONS

Datapac Read-Only Memory Systems are unique in their design to let you easily change individual bits, words or an entire memory in the field. Datapac ROMs are available in a wide choice of models, sizes and configurations. Capacities from 1K to 1 Megabit. Word lengths to 80 bits. Speeds as fast as 200 Nsec Cycle and 75 Nsec Access. Off the shelf delivery — 50,000 hrs. MTBF. Mil Spec compatible. And 1.5¢ per bit. Write today for our FREE brochure containing the complete Datapac story.

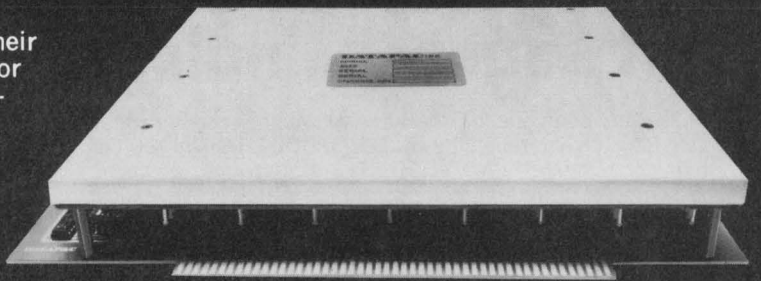

DATAPAC INCORPORATED

3839 S. Main St., Santa Ana, Calif. 92702, Tel. (714) 546-7781

"#1 in the field"

new products

Portable 25-MHz scope offers split-screen storage

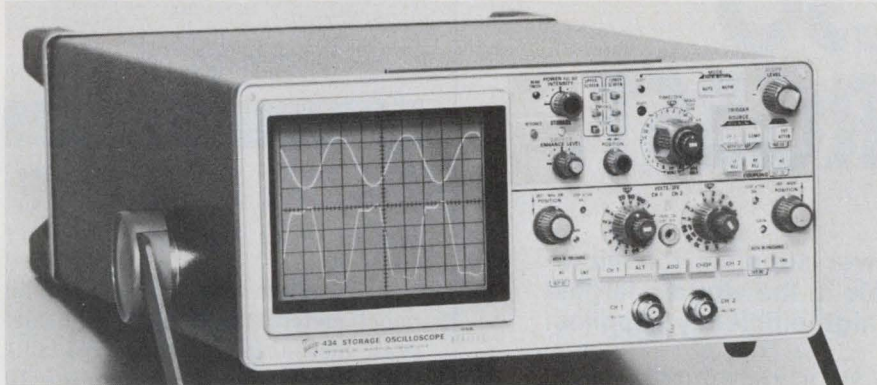

Tektronix, Inc., Box 500, Beaverton, Ore. Phone: (503) 644-0161. P&A: \$1585 (432), \$2150 (434); 30 days.

Tektronix introduces an important new feature in portable dual-trace oscilloscopes: storage up to a 25-MHz bandwidth on an 8-by-10-cm CRT.

The new 434 storage scope is virtually two instruments in one: it offers all of the advantages of bistable split-screen storage, plus those of a conventional portable scope.

Split-screen storage operates in any of three modes: upper, lower and full-screen. In the upper or lower screen modes the remaining half screen operates as a conventional scope.

Events stored on the upper (or lower) area are stable reference points for events displayed in a conventional mode on the lower (or upper) area. Thus, amplitude, duration, and other characteristics of the waveforms displayed in a conventional mode can be adjusted precisely to the stored reference trace.

The 434 frees the operator to concentrate on the test point rather than on the storage controls since operating it in a storage mode is as simple as pushing a front-panel control.

When an event occurs, it is stored and retained in a view mode without further operator attention for up to four hours.

To capture aperiodic events, the scope can be operated in a store-single-sweep mode. The user is then free to leave the scope unattended, confident that when the event occurs, it will be displayed in a stored mode for viewing at his convenience. Information may be retained on either half of the CRT, when the other half is erased.

Vertical deflection factors down to 1 mV/division are available. Scale factor readout is provided by lighted knob skirts which automatically indicate the correct reading, even when using the recommended 10X probe. This feature saves time and reduces errors in freeing the user from having to correct the scale factor each time a measurement is made with the 10X probe.

A wide-range, direct-reading magnifier expands the horizontal display up to a maximum of 50 times in six steps. The fastest magnified sweep rate is 20 ns/div.

A new mechanical format makes the 434 lightweight (only 20-3/4 lb) and easy to carry. Vertical height is only 5-3/4 in.—the oscilloscope can be carried with the user's arm in a natural, comfortable position.

The power supply permits operation over 100 to 240 V ac from 50 to 400 Hz, for the 434 and 432 (a non-storage version of the 434). Rack-mount versions 5-1/4-in.-wide are available.

CIRCLE NO. 250

Versatile electrometer has many functions



Dynasciences Corp., 9601 Chatsworth Ave., Chatsworth, Calif. Phone: (213) 341-0800. P&A: \$1150; 45 days.

The new model 736A electrometer is a multifunction instrument. It measures up to 10^{14} Ω full scale, provides current resolution to 10^{-15} A and charge resolution to 10^{-14} coulomb, and measures from 10 mV to 100 V with 10^{16} Ω input resistance. It has a MOSFET input and offers 200% overrange display capability.

CIRCLE NO. 251

Four-digit multimeter has 60 dB CMRR

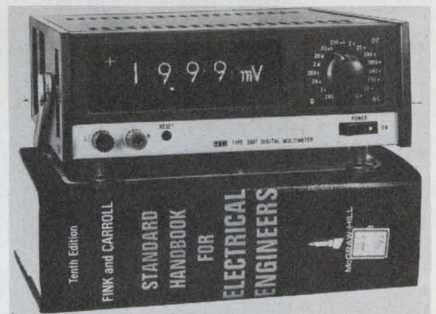

Yewtec Corp., 1995 Palmer Ave., Larchmont, N. Y. Phone: (212) 834-3550.

A new portable 4-digit multimeter, the model 2807, features common-mode noise rejection better than 60 dB at dc and 60 Hz. Voltage and resistance sensitivities of the instrument are 10 μ V/digit and 0.1 Ω /digit. Polarity and decimal point are automatically indicated. An over-range display is also provided. Dc and ac voltage accuracies are $\pm 0.1\%$ and $\pm 0.5\%$, respectively.

CIRCLE NO. 252

NOW THE SMALLEST IS ALSO THE LARGEST.

The world's smallest power supplies for micro-electronics are now available in the world's largest line of high power density, high efficiency supplies: **54 off-the-shelf models.**

From 100W to 500W; from 3VDC to 30VDC; single, dual, triple outputs; commercial, military, and export models.

Now in use by such leaders as Burroughs, Control Data, Honeywell, IBM, Litton, NCR, RCA, Univac, and many Government installations. We also custom develop/produce to specific needs.

Write for complete literature.

Trio Laboratories, Inc., 80 Dupont St., Plainview, L.I., N.Y. 11803. Tel.: (516) 681-0400. TWX: 510-221-1861.

triolab
POWER SUPPLIES

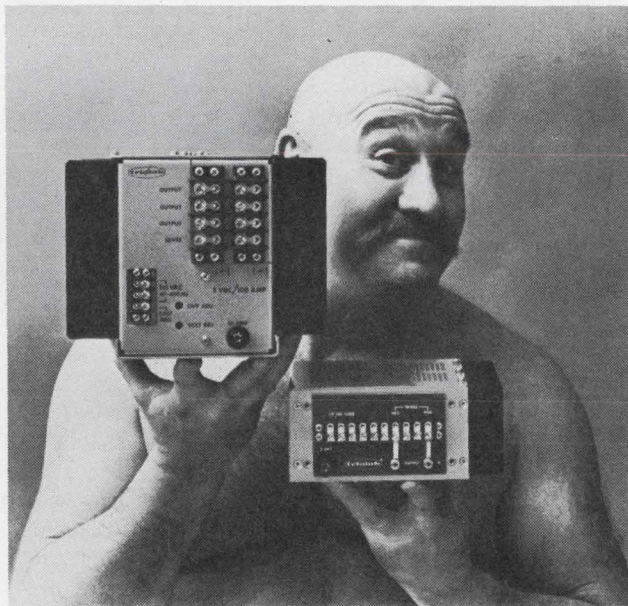

Model SP631
5VDC/100A
Typical efficiency 70%
8.50" x 6.81" x 8.75"
21.5 lbs.
\$695.

Model SP601
5VDC/20A
Typical efficiency 65%
3.25" x 6.50" x 7.50"
6 lbs.
\$400.

INSTRUMENTATION

10-M Ω panel meters include memory option

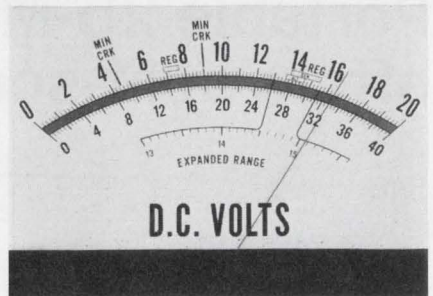

Ideal Precision Meter Co., Inc., 214 Franklin St., Brooklyn, N. Y. Phone: (212) 383-6904. P&A: see text; stock.

A complete line of commercial panel meters for voltage and current measurements are available with high input impedance—10 M Ω —and optional memory capability.

The high input impedance minimizes loading effects, a common problem with inexpensive VOMs, multimeters, and panel meters which exhibit typical impedances of 20 k Ω /V.

The memory option permits any of the meters to hold the last reading taken, within an accuracy of 1%, when the test leads are removed from the circuit being tested. The meter reading does not change or return to zero unless a new input is applied or the leads are shorted together.

Especially useful for making measurements in hard-to-reach circuit locations, the memory, achieved through capacitive storage, also allows the meter to function as a transient detector or as a frequency meter.

An enclosed 9-V battery provides the necessary memory circuit power. An external 9-V supply can also be used, with only microwatts or resultant power dissipation.

Two meter styles are available: edge-mount versions which are 4-in. wide and 4-in. deep; and panel-mount versions which are 4-in. deep and range in widths from 4.5 to 8 in.

Prices range from \$25 to \$30 per meter, depending on the meter size and type, in 100-unit quantities. The optional memory feature costs only \$1 and is included in this price range.

CIRCLE NO. 253



The only 160-MHz synthesizer with a full-range sweep!

If you're testing amplifiers, filters, or delay lines, GR's new 1065 Sweeping Frequency Synthesizer has the built-in full-range sweep capability, remote programmability, and low residual fm that you need. The 1065 gives you 24 calibrated sweep widths from 5 Hz to 160 MHz with sweep times from 20 ms to 50 s, plus a step-attenuated output from +13 to -67 dBm. The fixed-frequency characteristics include 1-Hz resolution and stability better than one part in 10^9 /day. Harmonic spurs are more than 30 dB below signal level and non-harmonics are more than 60 dB down. The 1065 does the whole job for just \$8950.*

and two just for fixed-frequency work

For those applications that require the stability and accuracy of a synthesizer, but don't need the sweep capability, there's the new 1168 Frequency Synthesizer. The 1168 gives you the same fixed-frequency characteristics as the 1065, with a continuously adjustable output from +13 to -7 dBm and a substantial cost savings — the 1168 with its precision internal oscillator is only \$6400. If you already have a stable 5- or 10-MHz source, you can save even more by ordering the \$5900 slave version of the 1168 to operate from your external source.

Should you need the synthesizer, but require only 100-Hz resolution, then the 1165 Frequency Synthesizer will fill the bill with still more savings because of its \$5900 price tag. The 1165 is also available in a slave version for \$5400.

If these three synthesizers don't provide just the performance you need, then let GR tailor a fixed-frequency or sweeping synthesizer to your specs. Complete information on the standard synthesizers or on special models is available from the nearest GR office or from 300 Baker Ave., Concord, Mass. 01742. In Europe write to Postfach 124, CH 8034, Zurich, Switzerland.
* Prices are net FOB, Concord, Mass.



General Radio

BOSTON 617 646-0550 / CHICAGO 312 992-0800 / LOS ANGELES 714 540-9830
NEW YORK (N.Y.) 212 964-2722 (N.J.) 201 943-3140 / WASHINGTON, D.C. 301 881-5333
TORONTO 416 252-3395 / ZURICH (051) 47 70 20

INFORMATION RETRIEVAL NUMBER 98

USING



Follow through with high density packaging... fast, computer-aided assembly and wiring techniques...and noise-free power distribution...

LOGICWARE

- starts with your...
- ...freehand logic diagram or
- ...pin and string lists or
- ...from-to pin list or
- ...(you name it)

LOGICWARE

- uses...
 - ...logic cards or
 - ...wired IC sockets or
 - ...planar PC boards or
 - ...combinations
- (whatever is best for your project)

LOGICWARE

includes modular concepts for economical changes or system additions.

Send for the latest LOGICWARE "literature kit"



E E C O

ELECTRONIC ENGINEERING COMPANY of Calif. 1441 East Chestnut Avenue, Santa Ana, California 92701 Phone: (714) 547-5651 • TWX 910-595-1550 • Telex 67-8420

INFORMATION RETRIEVAL NUMBER 48

ICs & SEMICONDUCTORS

MOS, 4-digit counter/display chip works from a +5-V line

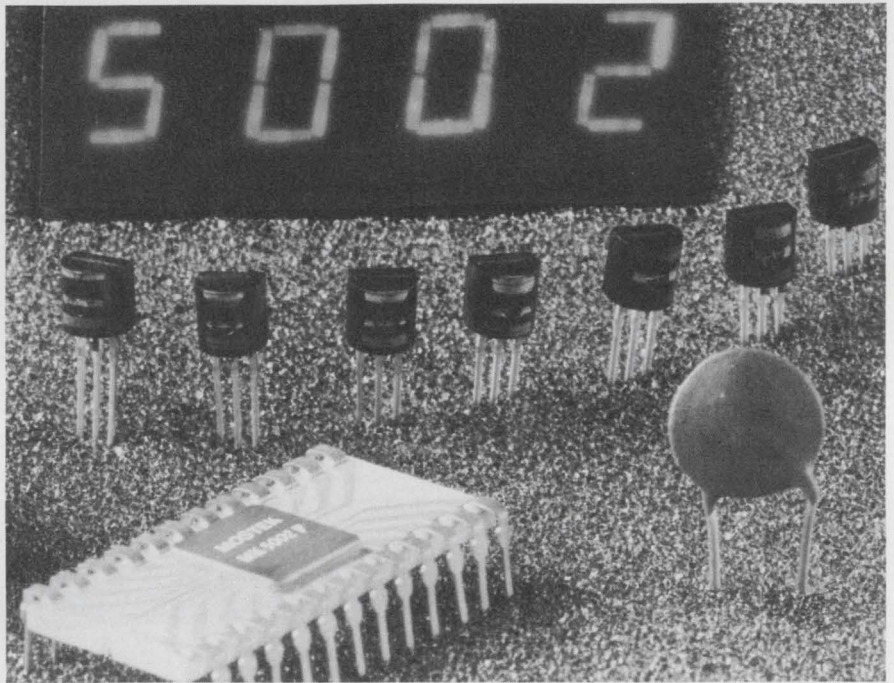

Mostek Corp., 1400 Upfield, Carrollton, Tex. Phone: (214) 242-1494. P&A: see text; 4 to 6 wks.

Mostek Corp. has developed the first p-channel MOS/LSI four-digit counter/display chip that operates from single +5-V lines.

The circuit, known as the MK-5002P, uses ion-implantation techniques. It includes enhancement and depletion-mode devices, allowing low threshold voltages for DTL/TTL compatibility. And it functions at a dissipation of less than 25 mW for the entire circuit, over 0 to +75°C.

Included in the MOS chip is a read-only memory that is programmed for a seven-segment and a BCD output (optional), and will count and display from 0 through 9999 input pulses.

After counting, it transfers the count into storage latches upon command, and multiplexes the four-digit data to the outputs.

Functionally, the MK5002P single LSI chip replaces eleven TTL/MSI packages: 4 decade

counters, 4 quad latches, 2 dual four-bit multiplexers, and a seven-segment decoder.

Besides replacing these functions, the chip includes synchronization for asynchronous transfer commands, logic for leading-zero blanking, a four-bit digit-select counter/decoder, logic for count, extend and overflow, and oscillators to self-drive of the counters.

Several options are available. In addition to the BCD output mentioned, they include blanking input, true-complement control, decimal point input and decimal point left or right control, overflow latch and count extend.

The MK5002P is available in a 28-pin DIP that includes all its standard and optional functions. A 24-pin DIP is available for those who do not need the options.

Prices for 1 to 24 quantities are \$30 and \$33 for the 24-pin and 28-pin devices, respectively. In quantities of 500 to 999, unit prices are \$14 and \$15, respectively.

CIRCLE NO. 254

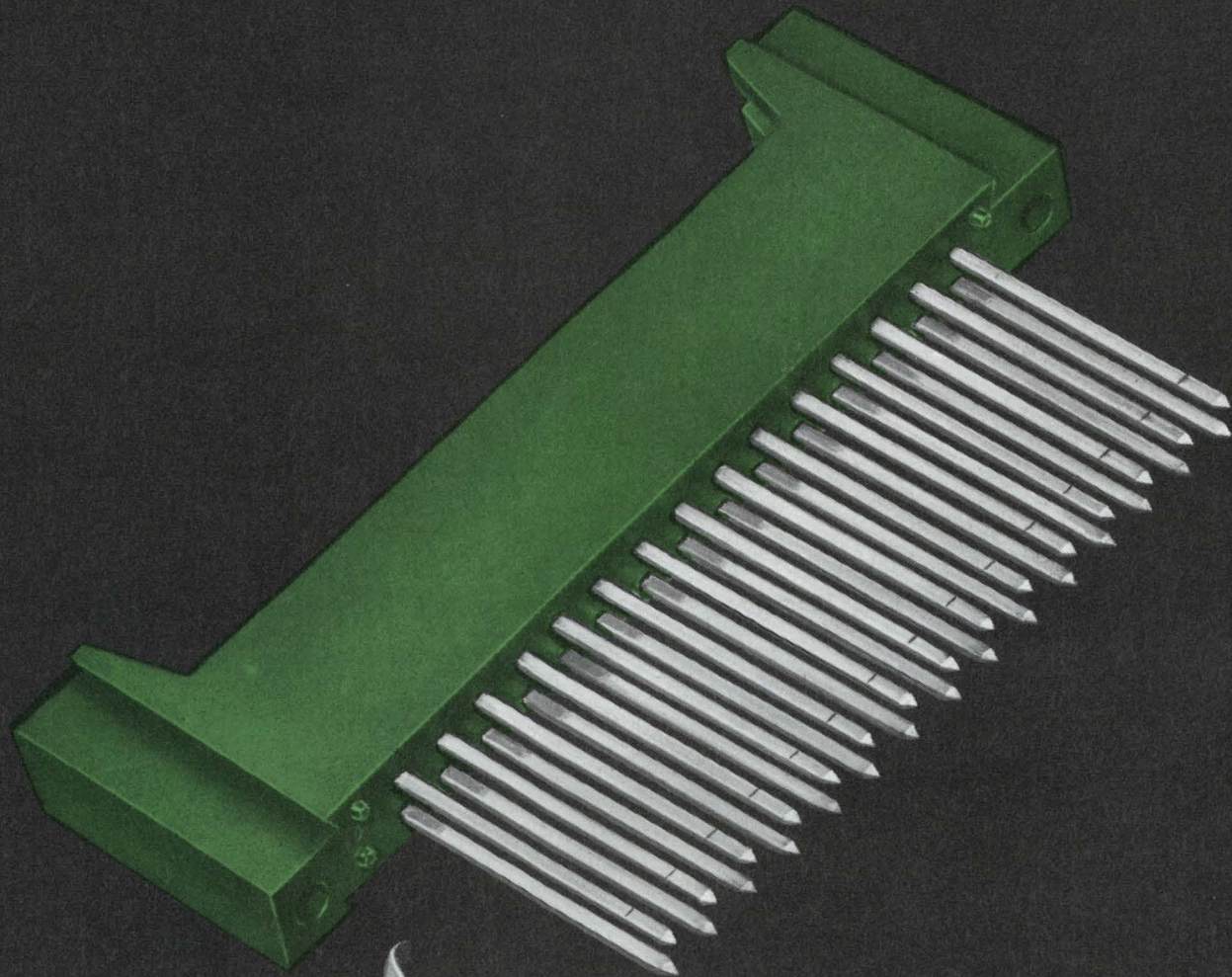

Good as gold.

Burndy has developed, for a substrate chip manufacturer, a printed circuit connector with contacts that are tin-plated over nickel. For a non-critical, low-voltage application such as a desk top calculator, tin is as good as gold, and costs considerably less.

Conversely, for a computer manufacturer, Burndy clad the springs with an unusually thick gold coating of .000500". Yet the price was held down by keeping the concentration only at point of contact.

A two-piece PC connector solved shock and vibration problems in another sophisticated airborne computer. One piece is fastened by

dip solder, the other by wire wrap effecting a firm, precise mating and a connection of highest reliability.

Whatever your needs—or your problems—Burndy can advise you. And with the greatest objectivity. Ours is the broadest line of printed circuit connectors made—with every type of termination: crimp, wire wrap and solder. And we can give you delivery as fast as you need it.

So come to Burndy right at the outset. We can make your designing job easier, and your product more reliable.

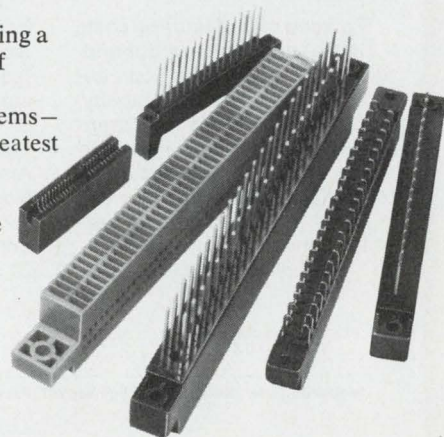

 **BURNDY**
Norwalk, Connecticut 06856

Linear IC amplifier slews at 130 V/ μ s

Intersil, 10900 N. Tantau Ave., Cupertino, Calif. Phone: (408) 257-5450. P&A: \$15; stock.

The 1CL8017 linear IC amplifier possesses a slewing rate of 130 V/ μ s, a 10-MHz full-power output, 50-nA input current, and short-circuit protection. Only one resistor controls and optimizes frequency response at different gains.

CIRCLE NO. 255

Silicon-gate transistors provide low thresholds

GEC Semiconductors, Ltd., Freebournes Rd., Witham, Essex, England.

A range of new silicon-gate transistors provide low capacitances and low threshold voltages. For 300 Ω devices, capacitance is 0.5 pF. Threshold voltage is -1 to -2 V. The transistors are compatible with 5-V bipolar logic.

CIRCLE NO. 256

IC crystal oscillators come in TO-5 cans

Statek Corp., 1200 Alvarez Ave., Orange, Calif. Phone: (714) 639-7810. P&A: \$95; stock to 6 wks.

New crystal oscillators and filters are available in TO-5 cans, operating from 10 to 100 kHz with stabilities of 1 to 10 ppm/ C° . The oscillators have sine or TTL square-wave outputs.

CIRCLE NO. 257

64-bit bipolar RAM accesses fully in 35 ns

Intel Corp., 365 Middlefield Rd., Mountain View, Calif. Phone: (415) 969-1670. P&A: \$9 (100 quantities).

A 64-bit bipolar RAM with an address-to-output access time of 35 ns max and a chip-select-to-output time of 17 ns max is the 3101A. It uses Schottky clamped bipolar transistors and is organized as 16 words of 4 bits each.

CIRCLE NO. 258

TO-18 thyristors get JAN approval

Unitrode Corp., 590 Pleasant St., Watertown, Mass. Phone: (617) 926-0404. P&A: from 80¢; stock.

Series 2N3027 through 3032 silicon planar passivated thyristors in TO-18 cans are now available with JAN approval. Non-JAN versions of these devices are also available in TO-18 or TO-46 cans.

CIRCLE NO. 259

Resettable frequency divider drives TTL

General Electric Co., Integrated Circuit Products Dept., Syracuse, N.Y. Phone: (315) 456-3510.

A new MOS resettable frequency divider features TTL drive capability. The GEM501 provides six stages of frequency division in a 16-lead plastic DIP. Whenever activated, a single reset pin resets all its six outputs to logic 0. Static charge protection is provided.

CIRCLE NO. 260

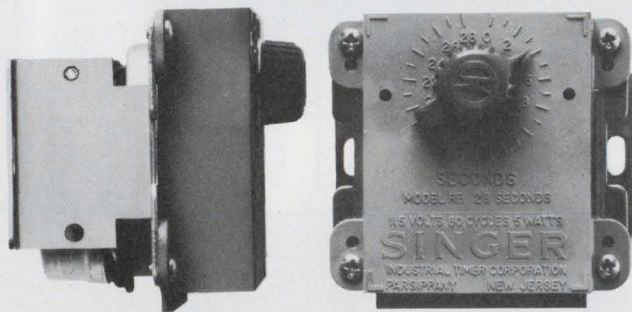

Viewed from every angle, our new R.B. Delay Timer is a great value at \$8.38*

To keep manufacturing costs in line and increase dependability, the R.B. is your answer. Has dial adjustability, automatic reset and guaranteed 100% electro-mechanical reliability and accuracy. Replaces cheaper delay devices of questionable performance.

Except for the motor, it is

completely enclosed in G.E. Noryl SE-1† plastic for total insulation and dimensional stability. Repeat accuracy is $\pm 1\%$ of total time cycle. Load switch capacity is 15 Amps. SPDT-120/240 VAC Non-Ind. snap action.

Choice of 7 time cycles between 5.5 sec. and 4 min.-24 sec. max. Ask for Bul.307.

*Maximum quantity discount.
†Trademark G.E. Co.

SINGER
INDUSTRIAL TIMER DIV.

Industrial Timer Division, U.S. Highway 287, Parsippany, N.J. 07054 201/887-2200

MINIATURE SPIROL PINS®



SMALL BUT MIGHTY!

In a nutshell these miniature Spirol Pins (1,140 in illustration above) offer the same spring pin advantages as the larger diameter Spirol Pins. Coiled spring construction allows wider hole tolerances—absorbs shock—gives greater static shear strength.

Ask for 12 page DESIGN/ APPLICATION MANUAL #169



CEM

COMPANY, INC.

55 SCHOOL ST., DANIELSON, CONN. 06239
IN CANADA: KOEHL INDUSTRIES, LTD. 1280 CRAWFORD AVE., WINDSOR, ONTARIO

*If your problem is measuring μV ,
 μA and milliohms
 in transistorized
 and integrated
 circuits . . .
 Solve it with
 Triplett's 801*

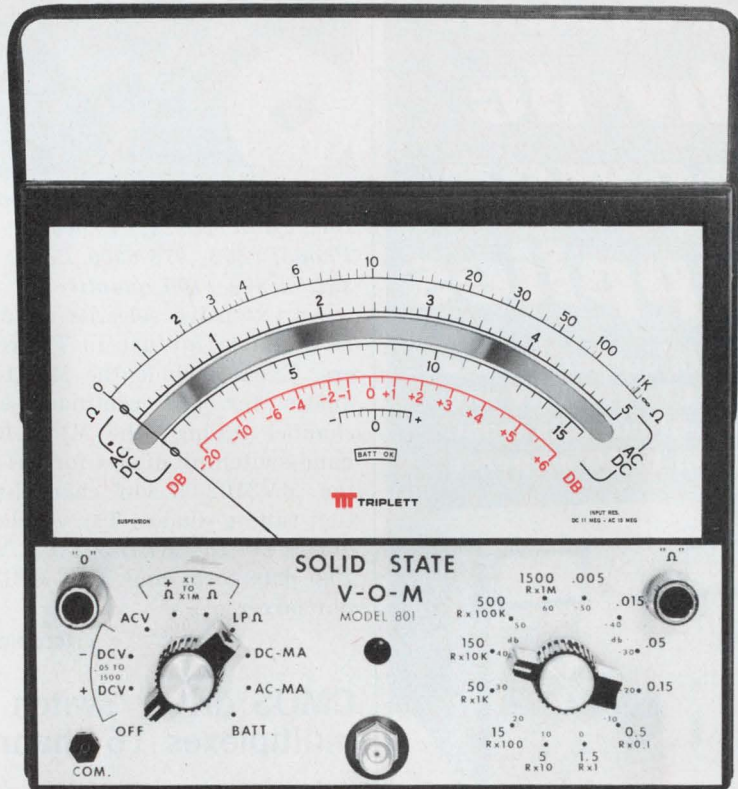

Model 801
 \$ 210

1. Lower power ohms — 8 ranges with 35 mV power source and 1 ohm center scale.
2. High sensitivity — 5 mV AC full scale at 10 megohm input impedance; 50 mV DC at 11 megohm input resistance.
3. Simplified scale — 8" meter with only 4 arcs for all 73 ranges.

It offers 73 measurement ranges including 8 low-power resistance ranges that apply only 35 mV to the device under test . . . does not activate or damage solid-state components. With full-scale readings as low as 50 mV DC and 5 mV AC, 5 μA DC and 100 Ohms (1 Ohm center-scale) — plus a 10 megohm input impedance on the AC scales and 11 megohm input resistance

on DC — Triplett's Model 801 V-O-M is ideally suited to in-circuit testing. When you add 2% DC and 3% AC accuracy on the voltage ranges (current: 3% DC and 4% AC) and a 25 μA suspension-type meter with a nearly 7½" scale length, there's no doubt that the Model 801 has no equal among analog V-O-M's in terms of sensitivity and versatility.

See the remarkable Model 801 V-O-M — priced at \$210 — at your Triplett distributor. For more information—or for a free demonstration—call him or your Triplett sales representative right away. Triplett Corporation, Bluffton, Ohio 45817.

TRIPLETT

The World's most complete line of V-O-M's...
 choose the one that's just right for you

INFORMATION RETRIEVAL NUMBER 52

at prices from \$40
**Hipotronics offers you
 immediate delivery
 on over 800 standard
 models of**
**regulated &
 unregulated**
**hv dc
 power
 supplies**

... with output voltages
 from 1 to 1000 KV and
 current outputs from
 0.1 ma to 50 amperes



7.5 KV, 130 ma,
 air-insulated unit,
 with HV section included in control box.

- Standard regulation ranges:**
 Unregulated 10-18%
 Regulated:
 Electromechanical
 (M Series) 0.5%
 Electronic (R Series) 0.01%

- HV components:** — transformers, capacitors, rectification assemblies, tanks, etc. — designed and manufactured under our roof.

- Custom design units:** for wide range of applications — electrostatics, accelerators, lasers, high power radars, high voltage testing, and more.

For more information call Keith Reed at (914) 279-8091, or send for our 24-page catalog, which lists complete specifications: "High Voltage DC Power Supplies and Components."

High Potential Technology [®]



HIPOTRONICS, INC.
 Brewster, N. Y. 10509 / (914) 279-8091

INFORMATION RETRIEVAL NUMBER 53

ICs & SEMICONDUCTORS

**Diodes for vhf/uhf
 enhance TV designs**

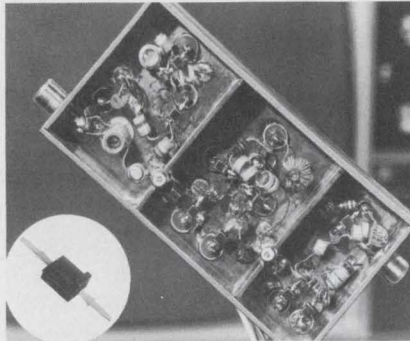

Motorola Semiconductor Products, Inc., Box 20924, Phoenix, Ariz. Phone: (602) 273-6900. P&A: from 35¢ to 80¢ (100 quantities).

An extensive selection of diodes is available for use in TV receivers. These include the MV3140-42 diodes for uhf continuous-sweep channel tuning; the MPN3401-02 band-switching diodes for vhf; and the MV3102-03 vhf channel-selection tuning diodes. Three Schottky diodes are the MBD-502 and MBD-702 detectors, and the MBD-102 uhf mixer.

CIRCLE NO. 261

**CMOS driver/switch
 multiplexes 16 channels**

Siliconix, Inc., 2201 Laurelwood Rd., Santa Clara, Calif. Phone: (408) 246-8000. P&A: \$59 (100 quantities); 3 wks.

A 16-channel multiplex driver/switch employing CMOS technology is available. The DG506A contains parallel n and p-channel FETs on a common silicon substrate, a 4-line binary decoder and drivers for each channel.

CIRCLE NO. 262

**Monolithic multiplexer
 separates drains/gates**

Solitron Devices, Inc., 8808 Balboa Ave., San Diego, Calif. Phone: (714) 278-8780.

The UC6410/7410 is a six-channel bi-directional MOSFET multiplexer built on a monolithic chip with separate drains and gates, and a common source. The multiplexer's substrate terminals allow biasing for analog switching. Features are low R_{on} of 250 Ω , and low leakage of 200 pA.

CIRCLE NO. 263

**MOS/LSI building blocks
 make digital filters**

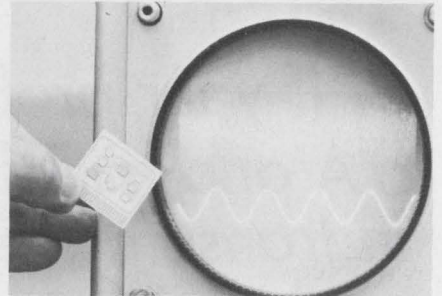

North American Microelectronics Co., 3430 Miraloma Ave., Anaheim, Calif. Phone: (714) 632-2321. P&A: see text; stock.

Digital filters that need no programming and operate on 300 mW can be produced from three new building-block MOS/LSI circuits — a serial/parallel multiplier, a shift-register/adder and an a/d converter. Prices of the circuits are: serial/parallel multiplier (65001NA) is \$50; shift register adder is \$60; converter (ADC/DAC) is \$80.

CIRCLE NO. 264

**Seven IC op amps
 are optimized 741s**

Teledyne Philbrick, Allied Dr. at Rte. 128, Dedham, Mass. Phone: (617) 329-1600. P&A: \$4 to \$20; stock.

Seven new optimized 741 op amps offer the circuit designer price/performance and applications features. These include low drift (model 1319), wideband and high impedance (1321), high slew rate (1322), micropower (1323), economy (1330), low bias (1413), and FET (1420).

CIRCLE NO. 265

**IC PC-card memories
 access in 300 ns**

Semiconductor Electronic Memories, Inc., 3883 N. 28th Ave., Phoenix, Ariz. Phone: (602) 263-0202. P&A: 4¢/bit (100 quantities); stock.

A new family of semiconductor memory systems, each on a single PC card, is available with 300-ns access. The RAM300 series includes 11 system configurations from 2048 to 9216 bits. Cycle time is 400 ns.

CIRCLE NO. 266

Electrodag[®] Coatings

Design Guide for
Painted Conductors

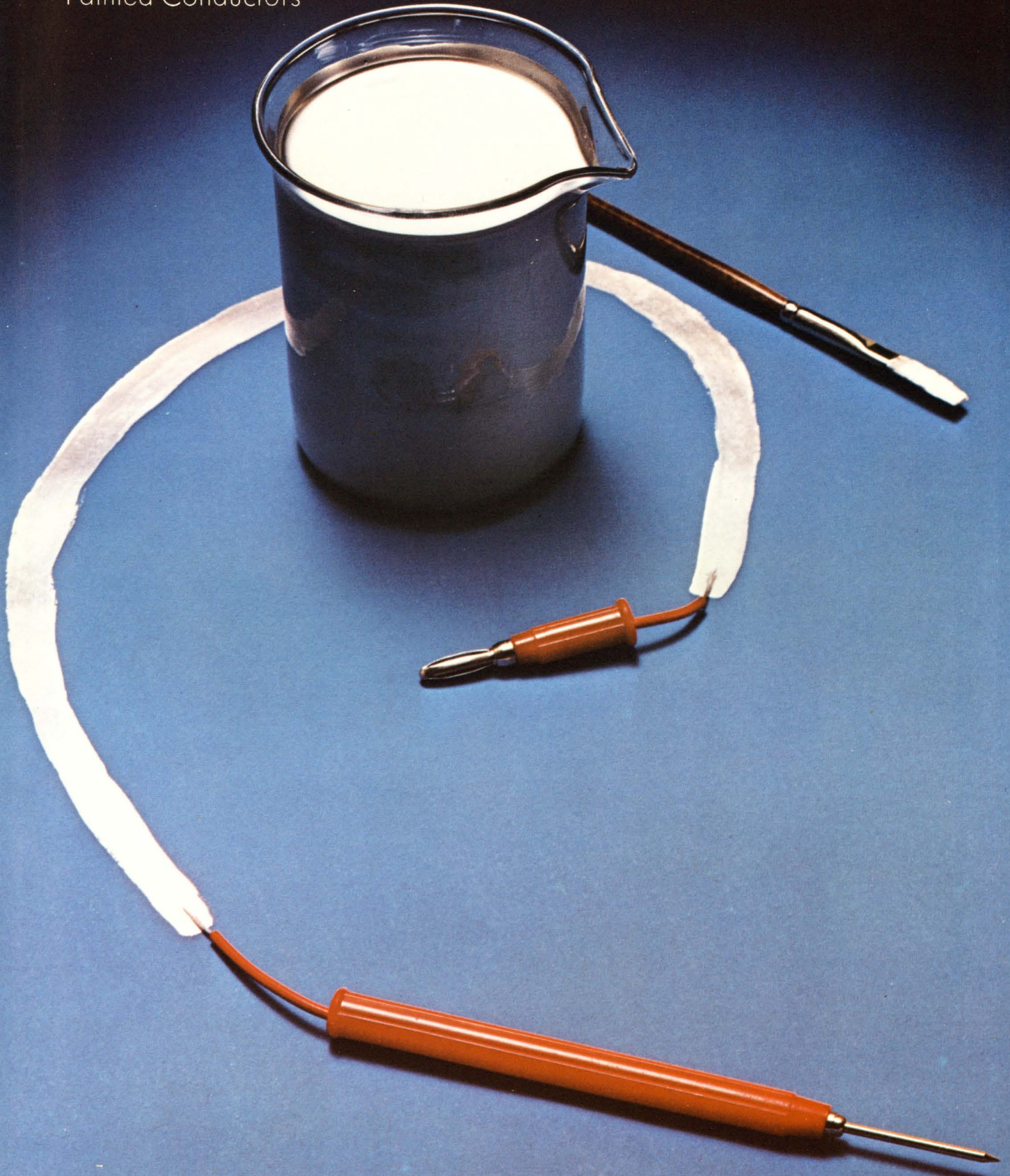

Summary for Design Engineers

All approaches to new electronic and electrical uses of materials should include consideration of *Electrodag*[®] coatings. These products demonstrate the extreme versatility of surface layers. They have advantages over conventional methods of moving electrons, including *formability, flexibility, lower material and application cost*, and such special properties as thermal absorption and gas adsorption.

The selection of an electrical coating is dependent upon sheet resistance level. If the level required is more than 10 ohms per square at a one mil thickness, the coating is classified as a *resistance coating*. A *conductive coating* will exhibit resistance of less than 10 ohms per square. Conductive *Electrodag* products are found in the table on this page. Resistance and CRT coatings are found on following pages.

The choice of any coating is also determined by operational environment including the following factors: *possible exposure to chemicals, maximum operating temperature and temperature resistance of the substrate*.

Versatility of Conductive Coatings

Sheet resistance can be varied by adjusting the coating thickness between 0.2 and 2.0 mils. This allows variation of product performance around one sheet resistance value.

Coatings with sheet resistance values less than 10 ohms per square at one mil thickness consist principally of the noble metals: gold, silver, palladium, platinum and rhodium. These provide both inertness to oxidation plus desired conductivity. The two water-based materials available, *Electrodag 420* and *Electrodag 422*, are superior pre-plating coatings. The presence of graphite in *Electrodag 422* improves conductivity and mold release. *Electrodag 416* is a low temperature curing, fast drying, alcohol-based material. Mixed with either *Electrodag 154* or *Electrodag 210*, it can meet a wide range of resistance values. The copper dispersion, *Electrodag 435*, is used extensively in printed circuit repair and the shielding of plastics but is susceptible to oxidation and must be used carefully.

When a substrate can withstand higher curing temperatures, products with appropriate characteristics should be applied. *Electrodag 415* is the most

versatile of these materials while *Electrodag 417* and *418* are useful when a very insoluble resin is required. For special sliding, low friction load contacts like resistors, *Electrodag 425* is ideal. *Electrodag 428* is designed for bulk application where coatings can be well baked out to remove all solvent. It also finds frequent use in special cable constructions. *Electrodag 413* and *430* are applied both as adhesives or bulk contact materials in typical solder type operation. The advantage of *Electrodag 430* is that it does not require excessive heat to cure.

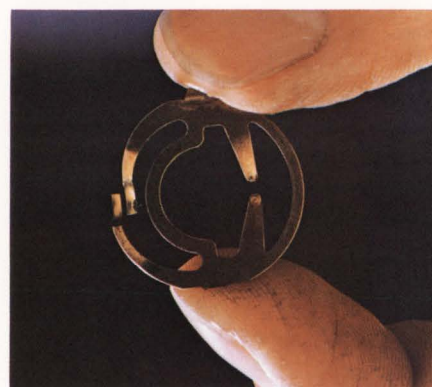

The fine copper springs used in contacting resistors can be coated with conductive/lubricating coatings. This provides for longer life before high electronic noise levels are reached.

CONDUCTIVE COATINGS (in order of sheet resistance)							
Product	Liquid Phase	Conditions for Cure (after air dry)	Typical Cured Sheet Resistance ohm/sq. @ 1 mil	Maximum Service Temperature	Color	Typical Uses	Reasons
Low Temperature Cure							
<i>Electrodag</i> [®] 420	Water	20 °C, 20 min.	0.01	300 °C	Silver	Preplate for unusual forms	Highly conductive in thin films
<i>Electrodag</i> 422	Water	20 °C, 20 min.	1.0	300 °C	Dark Gray	Dental inlays	Conductive with less adhesion
<i>Electrodag</i> 416	Ethanol	20 °C, 20 sec.	2	65 °C	Silver	Rapid RF Shielding	Very fast drying
<i>Electrodag</i> 435 (235)	Lacquer Thinner	20 °C, 20 min.	8	65 °C	Copper	Printed Circuit Repair RF Shielding	Low cost (easily oxidized)
High Temperature Cure							
<i>Electrodag</i> 415	MIB Ketone	125 °C, 10 min.	0.01	150 °C	Silver	Tantalum capacitors Hybrid circuits	Rapid dry at medium temperature
<i>Electrodag</i> 418	Ethanol	200 °C, 2 hrs.	0.1	200 °C	Silver	Circuits on ceramics	Good heat resistance
<i>Electrodag</i> 417	Toluol	175 °C, 10 min.	0.2	95 °C	Silver	Printed circuit contact strips	Good adhesion to smooth surfaces
<i>Electrodag</i> 425*	Aromatic Solvents	200 °C, 2 hrs.	0.5	200 °C	Silver	Sliding contacts and resistors	High conductivity plus high lubricity
<i>Electrodag</i> 428 (28X)	Glycol & Alcohol	200 °C, 2 hrs.	7	200 °C	Dark Gray	For conductive papers & fabrics	Low conductivity plus heat resistance
Solvent Free							
<i>Electrodag</i> 413	Epoxy	200 °C, 30 min.	0.05	200 °C	Silver	Terminations and conductive bonds	Conductive adhesive
<i>Electrodag</i> 430 (30X)*	Epoxy	100 °C, 1 hr.	1.5	200 °C	Silver	RF reflection and shielding	Low cure, conductive adhesive

NOTE: Trial sizes available at \$5.00 each for one ounce except *1/2 ounce.

Uses of Special CRT Coatings

The application of resistive coatings to Cathode Ray Tubes presents special problems. Coatings must be applied to several surfaces both inside and outside the tube. Products formulated for interior use are designed to withstand the high bakeout temperatures used to remove organic materials from inside the tube. The resultant coating prevents gas formation which could cause early tube failure. Funnel coatings must be hard and tenacious to withstand gun insertion and remain porous enough to adsorb gases from other parts of the tube. In addition, this coating must be able to withstand infrared radiation from the heaters of the electron guns. An Acheson product especially designed and employed for these purposes is *Electrodag 181*.

Coaters who prefer to make their own custom mix find *Electrodag 191* adaptable to a variety of formulas. Manufacturers who make special tubes not permitting full bakeout specify *Electrodag 121* to achieve an all inorganic coating. Where higher resistance levels are needed for electrostatic focusing and unusual

multigun configurations, *Electrodag 171* and *111* are frequently specified. For special surface effects in black surround and matrix tubes, *Aquadag® E* (which has become an industry standard) is manufactured to highest quality requirements and provides ease of processing with excellent particle adhesion and blackness. Other coatings like *Electrodag 154* are used in vacuum envelopes but their high organic content limits them to small usage and thorough bakeout. All of these coatings are also found to be useful in display tube applications.

For exterior use on every type of glass tube, including CRT's, *Electrodag 185* is widely accepted. It dries well with minimal heat, excellent cleanliness and resistivity. In those plant operations where there is insufficient cycle time to dry a water-based coating, *Electrodag 195* is an appropriate formulation.

Acheson *Electrodag* technical service is relied on by most of the world's leading CRT manufacturers. The same research which has earned this solid reputation can design coatings to solve your own electrical design problems.

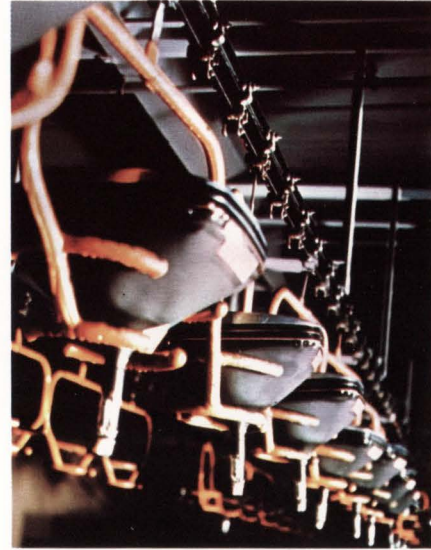

Photo courtesy of Zenith Radio Corp.

As these cathode ray tubes progress down the assembly line, they make use of at least two electrically conductive coatings.

CATHODE RAY TUBE COATINGS (in order of sheet resistance)

Product	Liquid Phase	Conditions for Cure (after air dry)	Typical Cured Sheet Resistance ohm/sq. @ 1 mil	Maximum Service Temperature	Color	Typical Uses	Reasons
Interior							
<i>Aquadag®E*</i>	Water	150°C, 5 min.	25	300°C	Black	Black surround	Best adhesion to glass
<i>Electrodag® 121 (226)</i>	Water	150°C, 1 hr. plus 350°C, 1 hr.	15	550°C	Black	For special purpose tubes	All inorganic
<i>Electrodag 191</i>	Water	20°C, 20 min.	25	300°C	Black	For custom formulation	Low organic content
<i>Electrodag 181</i>	Water	150°C, 1 hr. plus 450°C, 1 hr.	25	550°C	Black	Color tubes Display tubes	Very hard but porous coat—good degasser
<i>Electrodag 171* (7X)</i>	Water	150°C, 1 hr. plus 450°C, 1 hr.	325	550°C	Dark Gray	Spiral Coatings	Medium high resistance
<i>Electrodag 111* (11X)</i>	Water	150°C, 1 hr. plus 450°C, 1 hr.	7 K	550°C	Dark Gray	Internal bleed paths	Very high resistance
Exterior							
<i>Electrodag 185</i>	Water	100°C, 5 min.	250	65°C	Black	For mono & color tubes	Low resistance, easily removed
<i>Electrodag 195 (194)</i>	Aromatic Solvents	20°C, 24 hrs.	2.5 K	65°C	Black	Where heating is not possible	Solvent-based, air-dry
<i>Electrodag 135* (35X)</i>	Water	100°C, 5 min.	800 K	65°C	Black	For special purpose tubes	High resistance, easily removed

NOTE: Trial sizes available at \$5.00 each for one pound except *1/2 pound.

RESISTANCE COATINGS (in order of sheet resistance) (Cont'd.)

Product	Liquid Phase	Conditions for Cure (after air dry)	Typical Cured Sheet Resistance ohm/sq. @ 1 mil	Maximum Service Temperature	Color	Typical Uses	Reasons
Solvent-Based—Medium Temperature Cure							
Electrodag® 199	Aromatic Solvents	110°C, 15 min.	280	120°C	Black	Cable components Bleed coatings	Flexible coating with good conductivity
Electrodag 22	Aromatic Solvents	100°C, 5 min.	1.4 K	200°C	Black	Special components	Low adhesion
Electrodag 41	Lacquer Thinner	100°C, 5 min.	16 K	200°C	Black	Conductive fabrics	Fast drying, low adhesion
Electrodag 222	Aromatic Solvents	100°C, 5 min.	Infinite	200°C	Light Gray	Coil filling compositions Cable coatings	Insulating pigment for intermixing
Solvent-Based—High Temperature Cure							
Electrodag 440	Aromatic Solvents	300°C, 2 hrs.	200	250°C	Dark Gray	Heat generation & printed resistors	Very high temperature resistance
Electrodag 47	Aromatic Solvents	125°C, 45 min.	250	95°C	Black	For special components	High solids paste, low cure
Electrodag 213	Aromatic Solvents	175°C, 1 hr.	700	200°C	Black	Insulator bleed coatings	Excellent chemical resistance
Electrodag 158	Aromatic Solvents	150°C, 1 hr.	1000	200°C	Black	Printed resistors & bleed coatings	Good temperature & chemical resistance
Electrodag 35	Aromatic Solvents	125°C, 45 min.	3 K	95°C	Black	Printed resistors & bleed paths	Good adhesion and humidity resistance
Electrodag 250	Aromatic Solvents	150°C, 1 hr.	75 K	200°C	Black	Printed resistors	Good temperature & chemical resistance
Castordag®E	Castor Oil	260°C, 1 hr.	Very High	200°C	Black	Cable coatings	High bake but low residue

NOTE: Trial sizes available at \$5.00 each for 1/2 pound.

Component Uses

Electrodag coatings are important in the manufacture of many small components. For example:

- tantalum capacitors utilize both silver and graphite coatings for contact between the leads and condenser surface.
- carbon resistors make use of graphite coatings to improve contact between the leads and the active element.
- crystals use a graphite coating to move the electrons to the circuit.
- traveling wave guide tubes use Aquadag® E as an attenuation layer.

Acheson Colloids Company invites your inquiries and requests for application assistance. Secrecy is assured while we apply our chemical and electrical knowledge to your engineering problems. Our laboratories are staffed in-depth to provide state-of-the-art technical consultation. Call on us early in your test program. Frequently we can save months ... even years ... of development time for you.



These tantalum capacitors make use of both silver and graphite coatings. Their small size and high capacity make them of special use.

RESISTANCE COATINGS (in order of sheet resistance)

Product	Liquid Phase	Conditions for Cure (after air dry)	Typical Cured Sheet Resistance ohm/sq. @ 1 mil	Maximum Service Temperature	Color	Typical Uses	Reasons
Water-Based							
Aquadag®E*	Water	150°C, 5 min.	25	300°C	Black	Impregnation of fibers	Best adhesion to smooth surfaces
Electrodag® 444	Water	100°C, 5 min.	20	150°C	Black	Heat generation & bleed coatings	Fast drying & very hard coating
Electrodag 137	Water	150°C, 5 min.	50	200°C	Black	Fabric and paper coatings	Good adhesion with lower cost
Electrodag 183	Water	100°C, 5 min.	50	300°C	Black	Coating of crystals	Low residue of organic
Electrodag 187	Water	100°C, 5 min.	250	100°C	Black	Fabric and paper coatings	Good paintability Low cure
Electrodag 141	Water	150°C, 5 min.	2 K	300°C	Black	Coating of resistor pigtailed	Less precise resistance at lower cost
Electrodag 3	Water	150°C, 5 min.	4 K	300°C	Black	Bleed coatings	High resistance without inert ingredients
Solvent-Based—Low Temperature Cure							
Electrodag 155*	Trichloroethylene	75°C, 5 min.	140	65°C	Black	Bleed coatings for plastic	Non-flammable solvent, fast dry
Electrodag 154*	Isopropanol	75°C, 5 min.	1.2 K	65°C	Black	Impregnation of fibers, static bleed	Fast dry & good adhesion
Electrodag 99	Aromatic & Chlorinated Solvents	20°C, 20 min.	1.5 K	65°C	Black	Coil coatings, Conductive fabrics	Slower drying, hard coating
Electrodag 160	Aromatic Solvents	20°C, 24 hrs.	80 K	95°C	Black	Bleed coating for sensitive materials	Air dry thermoset, good adhesion
Electrodag 210*	Isopropanol	75°C, 5 min.	Infinite	65°C	Dark Gray	Addition to Electrodag 154	Insulating pigment for intermixing & lubricity

NOTE: Trial sizes available at \$5.00 each for one pound except *1/2 pound.

Resistance Coatings for Every Use

In many applications, high conductivity in an Electrodag coating is not required. As shown in the tables above, there are numerous water-based and resin-solvent systems which provide coatings having a higher electrical resistance, often at reduced cost.

In selecting one of these coatings, consideration should also be given to the possible cure, maximum service temperature, sheet resistance needed, and the solvent involved. Because the conductive path for these coatings is formed by non-metals, they do not give as much radiation attenuation as metallic coatings. However, in many cases, they serve to suppress static buildup by allowing electrons to bleed off. They can also provide circuit elements where the path not only substitutes for wire but for a resistor component. Their viscosity can be modified or designed to give silk-screening consistency. This allows the formation of printed circuits and thus, hybrid circuits to

use materials which do not require the extremely high cure of ceramic coatings.

Because graphite is a laminar solid, electrical coatings based upon it exhibit other special properties. Graphite promotes release in molding operations, imparts lubricity to electrical contact uses and



The resistive path in most approved ignition wire cables is made of a glass or linen fiber—impregnated with a coating of graphite.

adsorbs gases because of its high surface area and porosity. It has a natural tendency to form flat particles which helps to produce good electrical paths. This permits an extremely thin electrical coating of graphite to form anti-corona and bleed paths in high voltage coil applications. Even floors and fabrics can be made conductive by the appropriate application of a graphite electrical coating. This characteristic is particularly valuable in the presence of low flash point solvents or explosive chemicals.

Most resistance coatings contain specially formulated graphite blends. Other solids frequently used are carbon blacks, vermiculite, MoS₂, iron oxide and iron. The non-metals of high resistance levels are useful in mixing with other products to reach a specific high resistance. This is of special significance where voltage must be controlled to give a smooth gradient over a specific diameter of cable. Controlled leakage paths can be essential in the elimination of insulation breakdown by corona.



Acheson Colloids Company
Port Huron, Michigan
Tel: (313) 984-5581
Telex: 810-231-5265
Cable: Oildag

Worldwide Distribution

For additional information on Acheson products and services please contact us at any of the addresses listed below.

Our cable address in all cases (not district sales offices) is OILDAG plus the city. For the full addresses of U. S. sales offices, consult the Yellow Pages section of the local telephone directory.

This brochure is published by Acheson Colloids Company, Port Huron, Michigan, a member of the multi-national Acheson Industries Group.

Acheson Colloids Company designs and supplies precision electrical coating compounds, used as design components by the electrical/electronic industry.

Another of our specialties is the supply of lubricants, additives and equipment systems for industrial lubrication beyond the physical limitations of oil. We provide complete technical services for die and mold lubrication in the metalworking industries, and for the high temperature, extreme duty or dry film lubrication of moving parts.

The principal trademarks of Acheson Industries, Inc. include Dag, Oildag, Aquadag, Gredag, Prodag, Deltaforge, Kollag, Aerodag, Emralon and Electrodog. In addition to its U. S. operations, Acheson Industries, Inc. also has plants and sales offices in Canada, the United Kingdom, Netherlands, Italy, West Germany, France, Japan, and Australia.

Corporate Headquarters.

Acheson Industries Inc.
P.O. Box 8, Port Huron
Michigan 48060, U.S.A.
Tel: (313) 984-5581

Group Operations:

Acheson Industries Inc.
19675 West Ten Mile Road
Southfield, Michigan 48075
Tel: (313) 352-8070
Acheson Industries (Europe) Ltd.
1 Finsbury Square
London, E. C.2.
England
Tel: (01) 606-5811
Telex: 888188

U.S.A.:

Acheson Colloids Company
P.O. Box 288, Port Huron
Michigan 48060
Tel: (313) 984-5581
Telex: 810-231-5265

Sales Offices In:

Atlanta, Boston, Chicago,
Cincinnati, Dallas/Fort Worth,
Detroit, Los Angeles,
Milwaukee, New York,
Philadelphia, Pittsburgh,
Rochester, South Bend,
Cleveland

Canada.

Acheson Colloids (Canada) Ltd.
P.O. Box 665, Brantford
Ontario
Tel: (519) 752-5461

Europe:

Acheson Colloids Company
P.O. Box 12, Plymouth
Devon, England
Tel: (0752) 66351
Telex: 45549
Sales Offices In: London,
Birmingham, Manchester and
Glasgow

Acheson Colloiden N.V.
P.O. Box 1, Scheemda (Gr.)
Netherlands
Tel: Scheemda 303
Telex: 53281

Deutsche Acheson GmbH
7900 Ulm Donau, Postfach 792
W. Germany
Tel: (0731) 68657-9
Telex: 712441
Sales Offices In:
Berlin, Hamburg, Munich,
Düsseldorf, Frankfurt,
Stuttgart, Hannover,
Nürnberg

Acheson Italiana srl
20146 Milano, Via G. Frua 16
Tel: 434647
Telex: 33089

France: Societe d'Expansion
du Commerce International
Department Acheson
77 Rue de Richelieu
Paris 2e.

European Distributor Organizations:

Austria Norway
Belgium Portugal
Denmark Sweden
Finland Switzerland

Inquiries to:
Acheson Colloiden N.V.

Australia.

Acheson A.N.Z. Pty. Ltd.
P.O. Box 163
Broadway (Sydney)
N.S.W. 2007
Tel. 212-1644

Latin America:

Distributor Organizations:
Argentina Mexico
Brazil Venezuela
Inquiries to:
Acheson Colloids Company
P.O. Box 288, Port Huron
Michigan 48060, U.S.A.

Africa, Middle East:

Distributor Organizations:
India S. Africa
Israel
Inquiries to:
Acheson Colloids Company,
England

New Zealand, S.E. Asia

Inquiries to:
Acheson A.N.Z. Pty. Ltd.
Australia

Far East and Other Areas:

Distributor Organizations:
Japan Philippines
Hong Kong Taiwan

Inquiries to:
Acheson Colloids
International Services Inc.
P.O. Box 524, Port Huron
Michigan 48060, U.S.A.
or
(A.C.I.S.I. Branch Office)
Toa Road Building
15-2, 2 Chome
Shimoyamaterdori, Ikuta-ku
Kobe, Japan
Tel: (078) 398596

COMPONENTS

Tiny Hall-effect switch operates 10,000 times/s

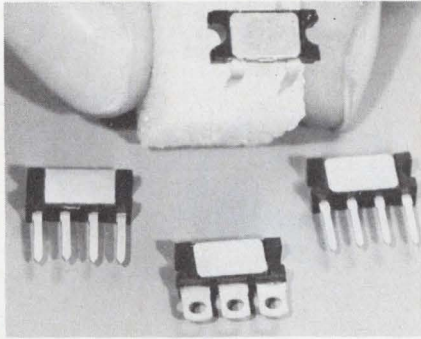

Micro Switch, Div. of Honeywell, Inc., 11 W. Spring St., Freeport, Ill. Phone: (815) 232-1122.

A magnetically operated general-purpose Hall-effect switch that can operate 10,000 times/s and is less than 1/2-in. long is available. The new 2SS series switch is 1/10-in. wide and 2/10-in. high, less terminals. Its max ratings include supply voltages of 8 V dc continuous and 10 V dc pulsed. Loads are 10 mA for each output, and 20 mA when outputs are paralleled.

CIRCLE NO. 267

Incandescent display plugs into DIP sockets

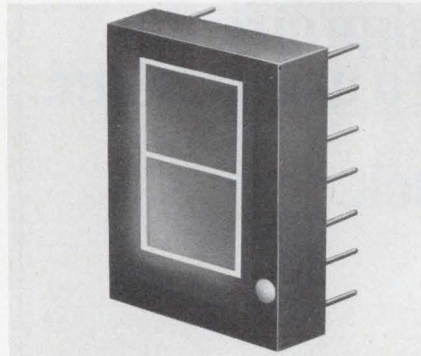

Pinlites, Inc., 1275 Bloomfield Ave., Fairfield, N. J. Phone: (201) 226-7724. P&A: \$5.45 (1000 quantities).

The DIP-LITE is a new low-cost digital and alphanumeric incandescent display which plugs into a standard DIP socket. It features variable brightness up to 9000 foot-lamberts and operates using 20 mA at 5 V or less. It is available in 5/16, 1/2, or 5/8-in. character heights. Each DIP-LITE is rated for 100,000 hours. Mating decoder/drivers are available.

CIRCLE NO. 268

From Nytronics:



mini-packaged
**super-high
capacitance**
for airborne power supplies



Up to
5600 μ f
in standard
CL55 sizes

This new line of metal-cased, wet sintered slug tantalum capacitors offers among the highest capacitances available in MIL-Style CL55 sizes. Nytronics NY55's—equivalent to CL55's—cover all standard ratings from 70 μ f at 150 volts to 2400 μ f at 15 volts. And nearly triple these values, in many ratings, are available in our NY56 series. At 15 volts, for example, NY56's give you up to 5600 microfarads capacitance! So whenever high capacitance, light weight and volumetric efficiency are essential, NY56 is the capacitor to specify.

All of these gelled electrolyte units are essentially dual rated, for operation at both 85°C and 125°C.

Particularly suited to airborne power supplies and other control, navigation and communications needs, NY55's and NY56's offer high performance and rugged dependability in coupling, filter, by-pass and energy storage applications. Write today for complete data.



Also write for details on tantalum, film, paper and ceramic capacitors and Nytronics inductors.

Nytronics, Inc.

ORANGE STREET, DARLINGTON, S. C. 29532 • (803) 393-5421 • TWX 810-665-2182

INFORMATION RETRIEVAL NUMBER 54

COMPONENTS

Stacked-foil capacitors span 0.0068 to 0.68 μ F

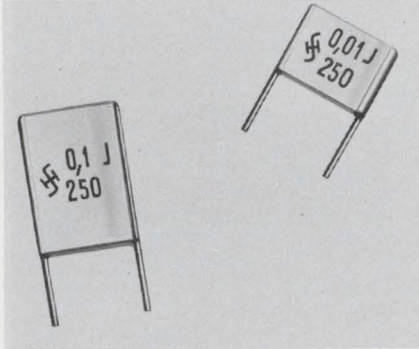

Siemens Corp., 186 Wood Ave., S., Iselin, N. J. Phone: (201) 494-1000.

An expanded line of metalized polycarbonate stacked-foil capacitors is available in values from 0.0068 to 0.68 μ F. The MKM line has capacitors with 0.4-in. lead spacing and standard tolerance of $\pm 5\%$. They consist of stacked metalized polycarbonate foils with a thin aluminum film evaporated onto one surface of each foil.

CIRCLE NO. 269

Solid-state relays switch, latch and time

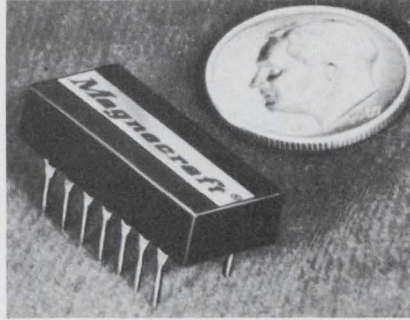

Magnecraft Electric Co., 5575 N. Lynch Ave., Chicago, Ill. Phone: (312) 282-5500. P&A: \$19.51 (100 quantities); stock.

New Class 505QIC DIP 14-pin solid-state relays are available with three different functions built in: switching, latching and timing. The latching function is achieved by shorting two pins on the PC tract. The user merely adds a simple resistor/capacitor network to the relay's existing circuitry, to accomplish the timing functions.

CIRCLE NO. 270

Tiny crystal oscillator has a 1/4-in. profile

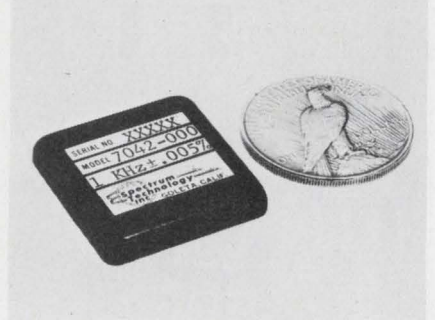

Spectrum Technology, Inc., Box 948, Goleta, Calif. Phone: (805) 964-7791.

A new thin crystal oscillator/IC logic clock features an ultra-low profile—only 1/4 in. A wide frequency range of 4 kHz to 20 MHz is another feature of the series 7042 device. Accuracy is ± 10 ppm, stability vs temperature is $\pm 0.005\%$ and operating temperature is from -55 to $+125^\circ\text{C}$. The 7042 mounts on 4 PC pins and is 1.5-in. long by 1.5-in. wide.

CIRCLE NO. 271

CRT Circuitry Breakthrough!

One Victoreen Corotron Acts As 100-Zener Equivalent Regulator

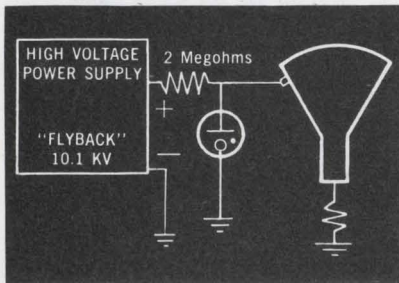

In this circuit example, a Corotron M42D-9.7 (9,700 volts) regulates a high voltage power supply for a computer data display system cathode ray tube. The Corotron provides reliable line and load regulation, and clarity of the CRT display.

Specifying one Victoreen Corotron is like gaining the equivalent regulating performance of hundreds of zener diodes. Ideal "failsafe" reference voltage in 400 to 25,000 volt range. Enables circuitry to hold constant high voltage. Operating range: -65°C to 200°C . Shock resistant to 2000G. Easy to design into circuits. Important size, weight, and cost savings. Send for Design Manual or call.



Free Design Manual
40-page manual contains specs and design data for circuit engineers. Request Corotron Manual.

VICTOREEN INSTRUMENT DIV. of VLN
10101 WOODLAND AVE. - CLEVELAND, OHIO 44104 - TEL. 216/795-8200



DMA 554

A few words to those who design circuits without a gaussmeter.

Good luck.

If you design or work with magnetic circuits, a gaussmeter can save you a lot of time. It converts flux density into voltage for measurement. So, you can check faults both magnetically and electrically to track down any trouble as quickly as possible. Our gaussmeter brochures are the place to start. Write. 4949 Freeway Drive East, Columbus, Ohio 43229

E.W. Bell Inc. A member company of Allegheny Ludlum Industries.

multiply your computer output controls

Get up to 240 low-cost control outputs from one I/O channel

Meet HP's new computer-stretcher, the Multiprogrammer . . . ready to help you solve the many problems encountered in designing automatic test and control systems — at minimal cost.

Minicomputers just don't have sufficient I/O channels and adding more is expensive. What's more important, many devices used in automatic test and control systems require control signals in forms other than the computer's binary output. This is why HP designed the Multiprogrammer System. It's a computer-controlled data distributor and converter that allows you to simultaneously or independently control up to 240 analog (or 2,880 digital) outputs . . . from a single computer I/O channel.

The Multiprogrammer houses a variety of plug-in cards that provide programmable resistance, voltage, contact closure, or TTL outputs. You "custom design" your own system by simply plugging in these cards, and you have the ability to change the system any time you want. There's an additional saving with reduced computer programming time. All outputs are automatically set to a safe state at power turn-on. Digital storage on each output card eliminates the need to refresh each output channel. Special circuits simplify event timing and sequencing. And, because you'll be operating the Multiprogrammer in rugged industrial environments, HP designed and built it to eliminate problems with noise transients, ground loops, and broken cables.

You need one master Multiprogrammer, Model 6936A (\$1,300), which has 15 channels. You can expand this capability at any time by adding on up to 15 Multiprogrammer Extenders with no changes in computer hardware or operating software. Each Multiprogrammer Extender, Model 6937A (\$800), has 15 channels. Programmable output cards now available are: Resistance Output (\$345), Low Speed D/A (\$385), High Speed D/A (\$420), Relay Register (\$370), and TTL Output (\$200).

A detailed brochure on the **HP MULTIPROGRAMMER SYSTEM** including system description, specifications, and applications is yours for the asking. Just contact one of the 220 HP Sales/Service offices.

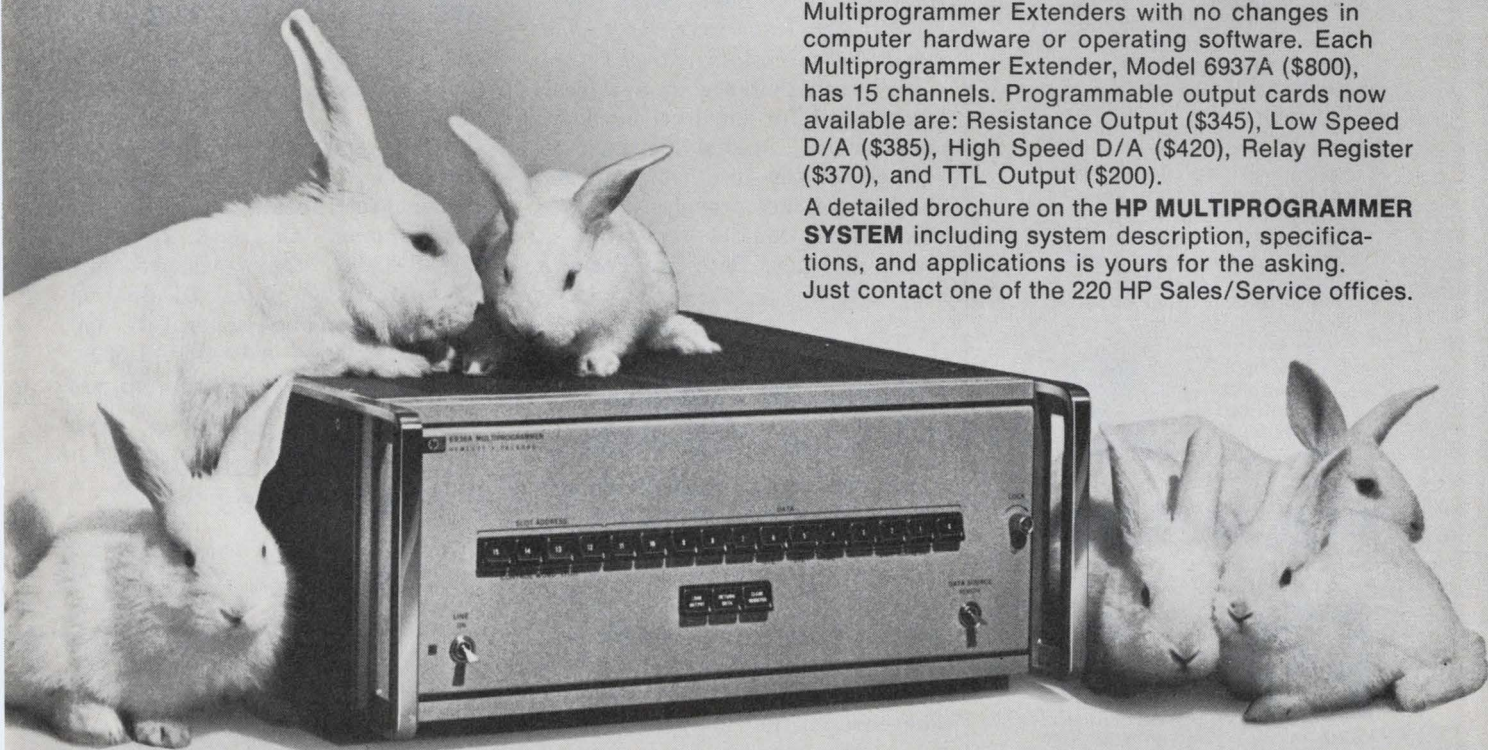

HEWLETT  PACKARD

100 Locust Avenue
Berkeley Heights, N. J. 07922 • (201) 464-1234

Synchron[®] motors help money make money



In the vending business, a would-be customer with dollar bills and no coins might just as well be flat broke. Unless there's a bill changer around. Like this one made by Rowe International.

Feed it a dollar bill and, presto! Instant alchemy. That useless paper is turned into spendable change.

The acceptance of the bill provides a signal which is transformed into multiple pulses in a Hansen-actuated electromechanical pulse chopper. Impulses are then sent to a memory unit and the payoff is actuated. The major reason why Hansen motors are specified:

"Dependability." Contact your Hansen man and find out how Hansen dependability can help you.

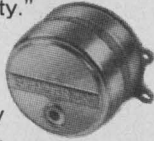

HANSEN
Manufacturing Company, Inc.
Princeton, Indiana 47570



HANSEN REPRESENTATIVES: CAREY & ASSOCIATES, Houston and Dallas, Texas; R. S. HOPKINS CO., Sherman Oaks, Calif.; MELCHIOR ASSOCIATES, INC., San Carlos, Calif.; THE FROMM CO., River Forest, Ill.; JOHN ORR ASSOCIATES, Grand Rapids, Mich.; H. C. JOHNSON AGENCY, INC., Rochester, N.Y.; WINSLOW ELECTRIC CO., Essex, Conn.; Villanova, Pa., and Teaneck, N.J.
EXPORT DEPARTMENT: 2200 Shames Drive, Westbury, N.Y. 11590

INFORMATION RETRIEVAL NUMBER 58

COMPONENTS

Dc-dc transfer unit time-delays inputs

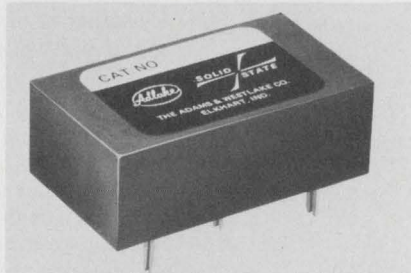

Adams & Westlake Co., 1025 N. Michigan St., Elkhart, Ind. Phone: (219) 264-1141.

A new versatile dc-dc transfer timer is ideal for relay-driving applications where time delay is required. Typical of its numerous applications are timed relay driving, process-control monitoring, delayed-start applications and cascade function control. The timer accepts a dc input and transfers it to the output circuit after a predetermined time that is fixed or adjustable.

CIRCLE NO. 272

Low-level reed switches complement keyboards

Hamlin, Inc., Lake Mills, Wis. Phone: (414) 648-2361. P&A: 35¢, 40¢ (1000-piece lots); 3 wks.

New reed switches are specifically designed for low-level keyboard applications. Special plating developed for the 10-mA Mark-3 and Mark-4 switches provides improved stability of contact resistance at low level loads. Both are Form A spst switches.

CIRCLE NO. 273

Leverwheel switches use 0.2-in.-high digits

Cherry Electrical Products Corp., 3600 Sunset Ave., Waukegan, Ill. Phone: (312) 689-7600. Price: see text.

A readout digit 0.2-in. high—big enough to be read several feet away—is now available on new subminiature leverwheel switches. They use an internal gear that revolves the readout wheel 360 degrees. Model L20-01A 10-position switch is priced at \$3.50 (500-digit quantities).

CIRCLE NO. 274

Single-turn trimmers are 1/2 in. in dia

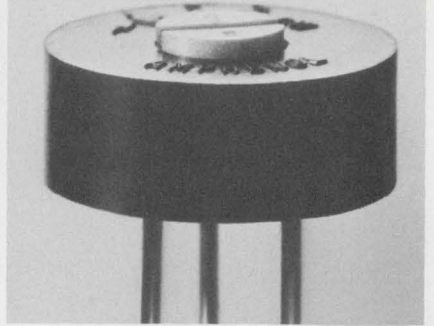

Amphenol Controls Div., Bunker-Ramo Corp., 120 S. Main St., Janesville, Wis. Phone: (608) 754-2211.

Two new round trimmers—cermet and wirewound—are each available in a tiny 1/2-in.-dia single-turn-adjustment package. The cermet version, designated 6905, features values from 20 Ω to 5 M Ω at $\pm 10\%$ tolerance. Power rating is 1/2 W. The 6900 wirewound unit offers values from 10 Ω to 50 k Ω at $\pm 10\%$ tolerance and power rating of 1 W.

CIRCLE NO. 275

Rectilinear trimmers are only 0.5-in. long

Dale Electronics, Inc., Box 609, Columbus, Neb. Phone: (402) 564-3131.

Series 800 Micro-Trims are a new line of space-saving film-element rectilinear trimmers only 1/2-in. long. Designed to meet MIL-R-22097, they measure only 0.5 by 0.1 by 0.15 in. Dissipation is 0.3 W at room temperature and resistance range is 10 Ω to 2 M Ω .

CIRCLE NO. 276

Wirewound resistors double as fuses

RCL Electronics, Inc., 700 S. 21 St., Irvington, N. J. Phone: (201) 374-3311.

New series F500 precision wirewound resistors serve as both resistors and fuses. They act as fusing elements, with precisely controlled predetermined characteristics. They protect semiconductor devices and operate within 0.2 to 200 Ω . Tolerance is 10%.

CIRCLE NO. 277

400 Watts

PACKED IN LESS THAN 1.5 CUBIC INCHES!

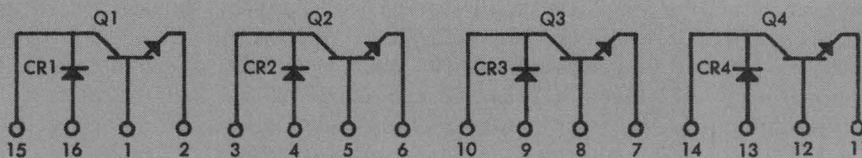
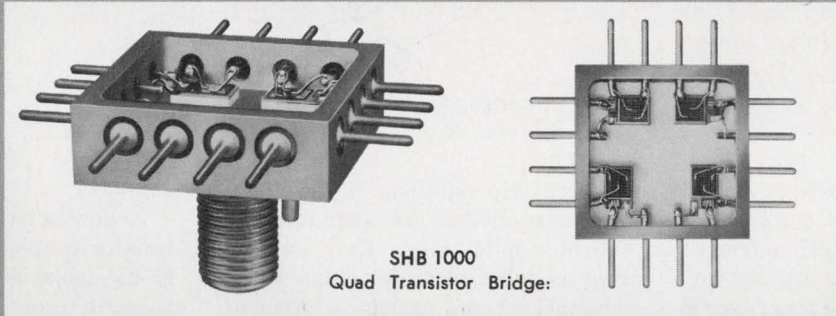

SOLITRON'S NEW 25 AMP BRIDGE MOTOR DRIVER FEATURES:

- High Reliability Construction
- Ultrasonic Aluminum Leads
- Ceramic Seals
- Complete Isolation with BeO
- All Gold-Silicon Eutectic Hand Mounting
- All Terminals 60 mills copper cored "52" alloy.

Now Solitron has developed a high reliability hybrid 25 Amp Bridge Motor Driver using 50 Amp NPN planar power transistors and planar rectifiers. This compact circuit is hermetically sealed in a unique 16-lead stud copper package. It delivers case dissipation exceeding 400 Watts, plus 80 Volts output, saturation voltage maximum 1.2 @ 25 Amps and Beta greater than 30 @ 30 Amps $V_{CE} = 1.0V$ for each transistor. The circuit utilizes fast recovery, planar diodes of less than 100ns t_{rr} with forward voltages less than 1.5 Volts @ 30 Amps. Reverse voltage is greater than 150 Volts.

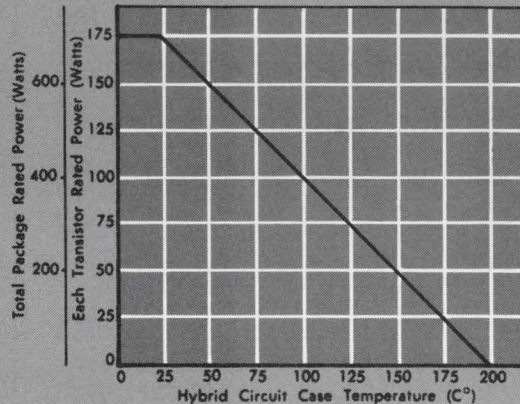

For complete information, prices and engineering application assistance, dial toll-free 1-800-327-3243. Or write:

Solitron DEVICES, INC.

1177 BLUE HERON BLVD. / RIVIERA BEACH, FLORIDA / (305) 848-4311
TWX: (510) 952-7610

SAN DIEGO, CAL.
8808 Balboa Avenue
FET & Dual FET
Transistors
MOS/FET Devices
MOS Memory Arrays
Shift Registers
Monolithic IC's
Small Signal
Transistors

RIVIERA BEACH, FLA.
1177 Blue Heron Blvd.
Hi-Rel Power Transistors
SI & Ge. Power
Transistors
Hi-Rel Power Hybrids
PNP-NPN Industrial
Transistors

PORT SALERNO, FLA.
Cove Road
Microwave Connectors
Plaxial (R) Cable
Precision RF Coaxial

JUPITER, FLA.
1440 W. Indiantown Rd.
Microwave Stripline
Components
Microwave Semiconductor
RF Semiconductor
Microwave Integrated
Circuits

TAPPAN, N. Y.
256 Oak Tree Road
Diodes & Rectifiers
Zeners
High Voltage
Assemblies
Power Rectifiers
Thick Film Hybrid
Circuits
Ferrite & Ferrite Devices

KENT, ENGLAND
Tubbs Hill House
London Road,
Sevenoaks
Solidev, Ltd.
Full line of
Solitron devices -

BEN BARAQ, ISRAEL
51 Hayarkon Street
AEL Israel, Ltd.
Full line of
Solitron devices

TOKYO 105, JAPAN
No. 5, 3-Chome
Shibahamamatsu-Cho
Minato-Ku
Matsushita Electric
Trading
Full line of
Solitron devices

INFORMATION RETRIEVAL NUMBER 59

Pulse-width modulator fits in a tiny case

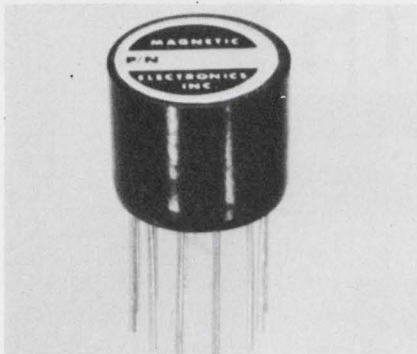

Magnetic Electronics, Inc., Box 25517, W. Los Angeles, Calif. P&A: \$60 to \$80; 4 to 6 wks.

A tiny new pulse-width modulator, the 1F, is ideally suited for driving switching transistors where pulse width on a transistor's base is controlled by microamperes of dc signals. Frequency response is up to 10 kHz, determined by external parameters. A typical input is 30 μ W and output is 1 W. Repetition rate is up to 100 kHz.

CIRCLE NO. 278

Reference diodes are for microstrips

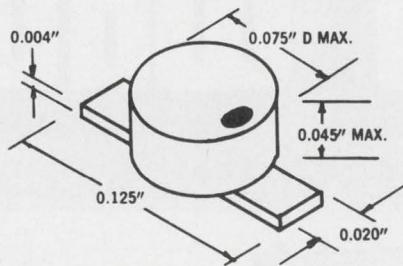

CODI Semiconductor, Pollitt Dr. S., Fairlawn, N. J. Phone: (201) 797-3900.

Microstrip ladybug TC voltage reference diodes are available for hybrid applications. They can be used as substitutes for chips or lid (channel) type packages. Attachment is with conductive epoxy, welding or soldering. MRD821 through MRD829 and MRD921 through MRD929 types are 6.2 V devices operating at 7.5 and 2 mA, respectively. Their outputs exhibit low noise of 1 mV.

CIRCLE NO. 279

Optic-coupled isolators handle 25 kV I/O



Optron, Inc., 1201 Tappan Circle, Carrollton, Tex. Phone: (214) 242-6571.

A new series of optically driven isolator-coupler assemblies exhibit 25-kV isolation breakdown ratings between inputs and outputs. Each glass-encased isolator consists of a GaAs input diode driving a silicon photodetector. The OP1063 uses a phototransistor detector with a transfer efficiency of 10%, the OP1023 of 2.5%, and the OP1033 of 20%.

CIRCLE NO. 280

YES! I WOULD LIKE TO ORDER A QUICK AD like the ads on pages 120, 121, 122 of this issue. Enclosed please find a glossy photo of my product, plus approximately 40 words which will set to no more than ten lines of 34 characters each. I understand Quick Ads cost only \$300 per insertion.

1x	7x	13x	19x	26x	39x	52x	104x
\$300	\$280	\$255	\$250	\$245	\$240	\$235	\$230

Company Name _____

Address _____

Authorized by _____ Title _____ Date _____

Mail to: ELECTRONIC DESIGN, 850 Third Ave., New York, NY 10022

At 4 cents a terminal, it's easy pin money.



Cut terminal connection costs with Lear Siegler Pin Bars.TM Unlike most common connection methods, no soldering is required, so installation time and production costs are significantly reduced. In fact, Pin Bars offer more current-carrying ability, equalized resistance, enhanced terminal contact, and minimum electrical noise — for as low as 3 or 4 cents per terminal.

If you'd like to simplify your bussing operation while increasing your electrical integrity, pin us down for details and a free sample.

LEAR SIEGLER, INC.



ELECTRONIC INSTRUMENTATION DIVISION
714 NORTH BROOKHURST STREET
ANAHAIM, CALIFORNIA 92803
PHONE (714) 774-1010

*Patented

TWX 910-591-1157

Nowhere can you find the selection of value designed Voltmeters and Multimeters as with DigiTec. You could spend much more and not receive the advantages of our outstanding specifications and features. Budget minded engineers have become increasingly aware of DigiTec's accuracy and performance uniquely designed for both bench and system applications.

If your requirements call for an inexpensive VOM which measures 10 ranges of DC volts and resistance, you need a **DIGITEC MODEL 261** for only **\$279**. Capable of measuring AC and DC volts and current and resistance, **THE MODEL 262A** is a "must" . . . value priced at **\$375**. Both of these instruments are in a rugged metal case and may be equipped with a battery pack for complete portability.

We have developed a new family of 4½ digit instruments which offer the very finest performance in their class. A few of the many features are: .02% accuracy, LED displays, guarded input and isolated BCD output. **THE BASIC DVM** is priced at a low **\$525** and is available from stock. An **AUTO-RANGING DVM** is offered at only **\$625**. **THE MODEL 269** is **A FULL MULTIMETER**, unmatched in value at **\$695** (including internal current shunts and isolated BCD . . . no add on prices). **A 6 RANGE MILLIVOLTMETER**, with 1μVolt resolution, is available at **\$795**.

Write or call for assistance in selecting the most suitable instrument for your application.



918 Woodley Road • Dayton, Ohio 45403 • (513) 254-6251
Representatives throughout the world
For complete specifications, request new catalog



INFORMATION RETRIEVAL NUMBER 87

The power supply you plan to build is built!

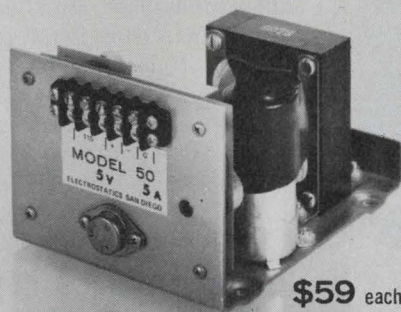

\$59 each

OTHER MODELS 3 to 50 V available

It's on the shelf, ready for immediate delivery from Electrostatics. With specs proven in service. Low cost. Brief specs on our Model 50:

- **5V 5A Power Supply**
- Input 105-125V, 47-420 Hz
- Regulation: Line 0.01%
Load 0.1%
- Ripple: 500 μV max.
- Temp: -20 to +70°C.
- Foldback current limiting
- Size: 5" W x 4.13" H x 7" L

(\$69 with overvoltage protection)

For full information call Robert McCartney, Manager of Application Engineering, (714) 279-1414. Or circle the number below for our latest data sheet.

Electrostatics, inc.

7718 Clairemont Mesa Blvd., San Diego, California 92111 DEPT. 102

INFORMATION RETRIEVAL NUMBER 88

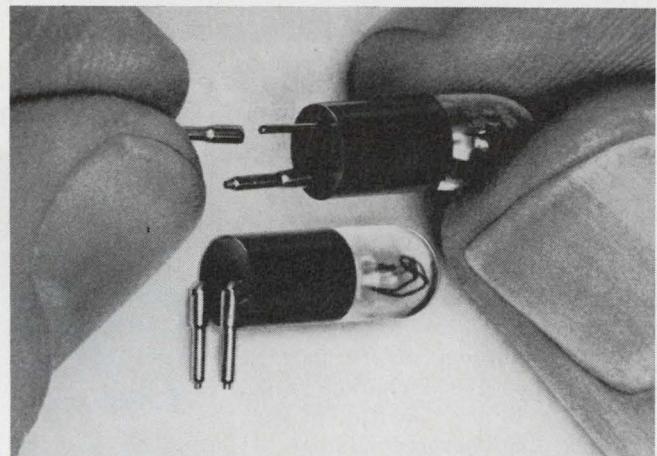

Lamps soldered to PC board unplug for replacement.

Incredible but true! Hudson T-1¼ Tu-Pin lamps are now available with PC board Pin Sockets already installed. Solder them to the board in the usual way. When the lamp must be replaced, merely unplug the lamp, leaving the pin sockets behind firmly soldered to the PC board and ready to receive a replacement.

Tu-Pin lamps equipped with Pin Sockets are available in a wide range of electrical specifications and cost only pennies more. For details, call your local Hudson Representative or write to Hudson Lamp Company, 528 Elm Street, Kearny, New Jersey 07032.

LAMP COMPANY
Hudson

INFORMATION RETRIEVAL NUMBER 89

New computer system fills processing needs

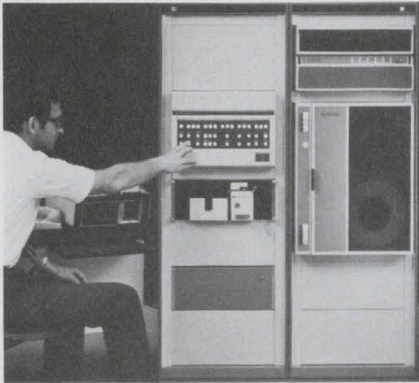

Hewlett-Packard, 1501 Page Mill Rd., Palo Alto, Calif. Phone: (415) 493-1501. P&A: see text; fall, 1971.

Three new data processing items from Hewlett-Packard are a low-cost minicomputer, a high-packing-density tape memory and a compact disc memory, all designed to provide the OEM and end user with a variety of low-cost solutions to their computational needs.

The 2100A minicomputer has a 16-bit word length, core memory capacity from 4096 to 32,768 words and a 12-in. mainframe for a basic price of \$6900.

With a memory cycle time of 980 ns, the 2100A is reported to be 40 to 100% faster than any of its predecessors.

The tape memory is available in two versions, phase-encoded (7970-E) and NRZI (7970B). The 7970E features speed ranges of 10 to 25 in./s, data transfer rates up to 72 kbits/s and a fast rewind rate of 160 in./s.

The E version offers packing density of 1600 characters/in., while the B has densities of 800, 556, and 220 characters/in.

Both tape memories are available in 7 or 9-track read-after-write, 7 and 9-track read/read, and NRZI/read configurations. Prices range from \$3900 for the basic B version to \$8650 for the more sophisticated E version.

The compact dual-disc memory, the model 7900A, reportedly has the fastest response of any rack-mountable memory device available—it can access an on-line data base of 5 million 8-bit bytes in 50 ms. Its average head-positioning time is 40 ms, and average rotational delay time is 12.5 ms.

CIRCLE NO. 281

Microprogram mini stores in IC memories



Microdata Corp., 644 E. Young St., Santa Ana, Calif. Phone: (714) 540-6730. P&A: \$5000 (basic system).

A new microprogrammable mini-computer stores logic in an IC control memory. Identified as Micro 1600, it provides microprogramming speed and capacity at a practical price. It has both single and dual CPU configurations and can employ large or small ROM arrays to cover a broad application environment. Three control configurations are available: bipolar, programmable and alterable ROM.

CIRCLE NO. 282

Portable CRT terminal fits in an attache case



Applied Digital Data Systems, Inc., 100 Marcus Blvd., Hauppauge, N.Y. Phone: (516) 231-5400.

A portable new alphanumeric and graphics CRT terminal, weighing 27 lb and built into a compact carrying case, may be taken anywhere and set up in less than a minute. The ENVOY comes in two models: the 640 which displays 16 lines of 64 characters, and the 680 which displays 24 lines of 80 characters. All alphanumerics and graphics are displayed as black characters on a white background.

CIRCLE NO. 283

Display monitor has X, Y and Z inputs



Dumont Oscilloscope Laboratories, Inc., 40 Fairfield Pl., W. Caldwell, N. J. Phone: (201) 228-3665. Price: \$800.

A new five-inch display monitor, model 1000, provides accurate displays at 2 MHz from X, Y and Z-signal inputs. A special CRT with an 8 by 10-cm scan area and identical X and Y sensitivities provides good linearity and small spot size. Its accelerating potential is 5 kV. Internal, external or no-graticule versions are available.

CIRCLE NO. 284

Modular core ROM cycles fully in 200 ns

Aztec Data Systems, Box CR, Irvine, Calif. Phone: (714) 557-6366. P&A: \$600 (10 kbits), \$2950 (100 kbits); 30 days.

The high-speed modular Romtec 480-9 planar core ROM features a full cycle time of 200 ns and max access time of 150 ns. It has densities up to 24,576 bits per module on a 15-1/2 by 12.9-in. board. Dissipation is only 600 μ W/bit.

CIRCLE NO. 285

Core memories replace IBM 360 mainframes

Ampex Corp., 9937 W. Jefferson Blvd., Culver City, Calif. Phone: (213) 836-5000. P&A: \$32,000 (16 kbytes), \$308,600 (262 kbytes); 60 days.

Two new core memories are designed to replace main-frame memories of four IBM 360 computers. Models ARM-30 and ARM-2365 replace core memories of IBM 360/30, /65, /67 and /75 computers without modification.

CIRCLE NO. 286

the one and only Heat Gun- made just for electronic assembly

Ungar's new, feather light, solid state Heat Gun #6955

Forget the old all-purpose hot-and-heavyweights. Ungar gives you the only flameless heat gun built to meet your special needs in electronics assembly and lab work. Now tackle shrink tubing, solder sleeves, shrink film packages, epoxy curing, parts drying/heating/cooling and numerous other jobs... all with this versatile new gun. And get greater accuracy, better handling, safer operation than ever before.

First, it's an ultra light 17 ounces (literally pounds lighter than other guns). That's because it's all solid state and encased in a rugged polyester glass case. Your girls get all the fatigue-free handling accuracy you've always needed. For even more operator comfort and safety, heat is isolated at the nozzle area... the handle stays cool!

Next it's versatile. Works cold or hot (a high 850°F approx.) and includes a standard set of baffles. Also, it stands by itself for hands-free operation. But that's not all, in addition to a neoprene plug and cord, it's trigger actuated, U.L. listed and carries Ungar's guarantee of excellence. You can get the new Princess at a pretty lightweight price, too.

It's at your nearest electronic distributor or dealer now. Order the Ungar Princess Heat Gun today — prove to yourself that in the age of solid state Ungar really outguns the heavyweights.



A Division of Eldon Industries, Inc.



Power transistor delivers 1/2 W at 4 GHz

Hewlett-Packard, 1501 Page Mill Rd., Palo Alto, Calif. Phone: (415) 493-1501. P&A: \$45; stock.

A new entry in the ranks of microwave power devices is the HP11 transistor commercially available to deliver 0.5 W cw at 4 GHz. It is in common-emitter and common-base configurations.

CIRCLE NO. 287

0.5-GHz balanced mixer prices down to \$12

Relcom, 2329 Charleston Rd., Mountain View, Calif. Phone: (415) 961-6265. P&A: see text; stock.

A new double-balanced 5 to 400-MHz mixer in a shielded hermetically sealed package, designated M6KC, costs \$12 (100 quantities). Its isolation is 35 dB, conversion loss 6 dB and temperature range -54 to +100°C.

CIRCLE NO. 288

Fast pulse amplifier has 1-ns rise for 8 V

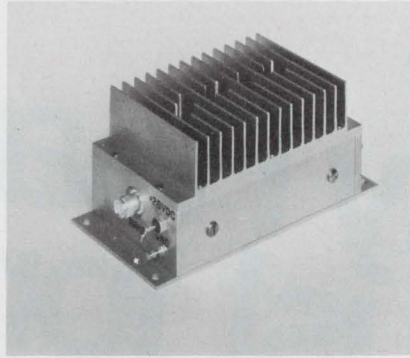

C-Cor Electronics, Inc. 60 Decibel Rd., State College, Pa. Phone: (814) 238-2461.

A fast-risetime high-output pulse amplifier is the 3310 with less than 1 ns risetime for a bipolar output greater than ±8 V into 50 Ω. Gain is 30 dB min with 35 μV rms equivalent input noise. Droop is 1%/μs and overshoot is ±3%. Power required is +28 V dc at 440 mA. Size is 3 by 5 by 3 in., including cooling fins.

CIRCLE NO. 289

Microstrip capacitor leads withstand 1500°F

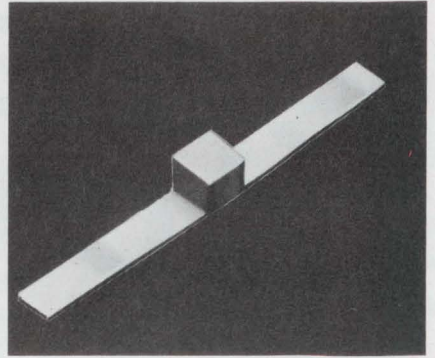

American Technical Ceramics, 1 Norden Lane, Huntington Station, N. Y. Phone: (516) 271-9600. P&A: \$2; 6 wks.

New microstrip capacitors have been developed with leads that withstand 1500°F. This is due to a new technique for attachment of silver leads to microwave porcelain capacitors. The leads permit brutal treatment by inexperienced labor using 200-W irons, or even furnace installation on MIC substrates.

CIRCLE NO. 290

New quartz tubing for diffusion... lasts 20-30% longer.

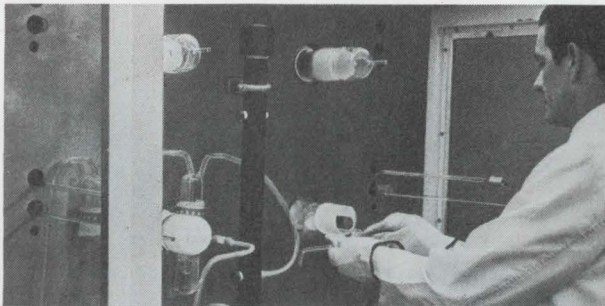

Courtesy Unitrode Corp.

More efficient furnace diffusion is now attainable with new Amersil T-07-OHF-ST tubing—a practically water free-stabilized-tubing—that lasts 20-30% longer than any other!

There's greater resistance to devitrification plus increased temperature resistance.

OHF-ST tubing provides outstanding cost-cutting opportunities, particularly at furnace temperatures exceeding 1250° centigrade.

For details on OHF-ST tubing and technology, write today to: Amersil, Inc., 685 Ramsey Ave., Hillside, N.J. 07205.



An Equal Opportunity Employer

208C

INFORMATION RETRIEVAL NUMBER 65

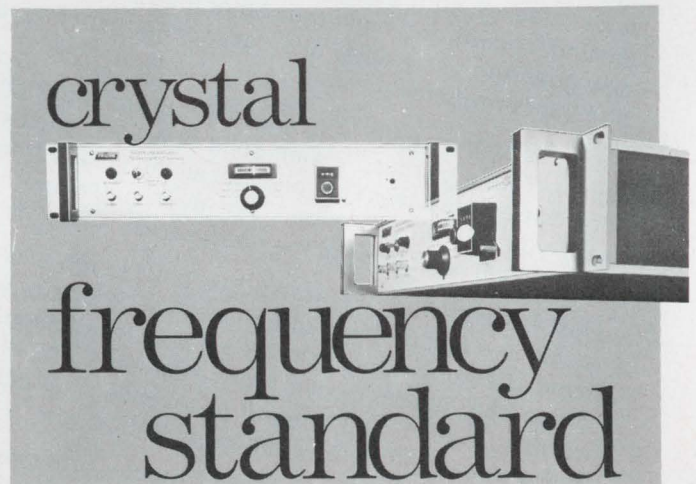

12 hours after turn-on...

... this Sulzer Labs 5D Crystal Standard outputs of 5MHz, Frequency Standard exhibits 1MHz, and 100 kHz are available on both the front and rear panels, complete with internal 10-hour standby battery. 1X10⁻¹⁰ per day or better, typically, after 30 days, less than 10-hour standby battery.

Manufacturers of: Rubidium and Crystal Frequency Standards and Clocks, VLF/LF Phase Tracking and Navigation Receivers, Frequency/Phase Comparators and Frequency Distribution Systems.

Industrial Instruments

6500 Tracor Lane, Austin, Texas 78721, AC 512/926-2800



IA-142

INFORMATION RETRIEVAL NUMBER 66

ELECTRONIC DESIGN 13, June 24, 1971

RADIO BUG

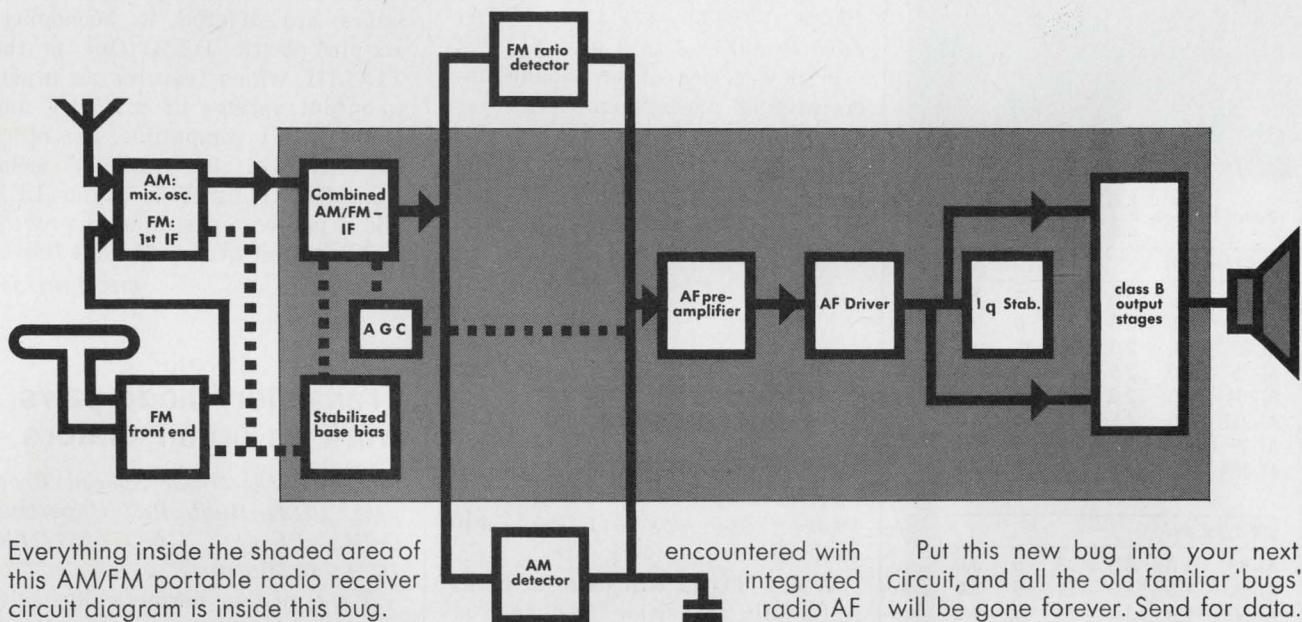
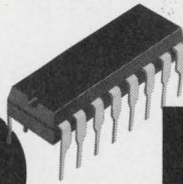

Everything inside the shaded area of this AM/FM portable radio receiver circuit diagram is inside this bug.

Philips' new TBA690 integrated circuit.

It has a voracious appetite for labour costs. Now instead of inspecting, installing and re-checking forty or fifty individual components, you insert just this one, with performance guaranteed.

The TBA690 contains everything in a 1/2 watt* AM/FM receiver that should be integrated, including output stage and quiescent current stabilisation. The unique design of its output stage and bias stabilisation overcomes all problems normally

* 1 watt version TBA700 soon available.

encountered with integrated radio AF amplifiers.

There is no loss of sensitivity, and no cross over distortion over the entire supply voltage range from 2.7V to 11.4V. The IC can be used for both FM and AM... even short wave.

Not included are the combined AM/FM input stage and the FM front end... so you have full freedom of circuit layout. Either conventional distributed or lumped IF filters can be used.

The cost of this plastic-encapsulated bug is no more than you would pay if you were using discrete components.

Put this new bug into your next circuit, and all the old familiar 'bugs' will be gone forever. Send for data.

N.V. Philips' Gloeilampenfabrieken
Electronic Components and
Materials Division
Eindhoven - The Netherlands

Distributed and sold in the U.S. by:
Amperex Electronic Corporation
Integrated Circuits Division
CRANSTON R.I. 02920

In Canada: Philips Electron Devices
a division of Philips Electronics
Industries Ltd. 116, Vanderhoof Avenue
TORONTO 17 - Ontario



electronic components
and materials

PHILIPS

INFORMATION RETRIEVAL NUMBER 67

Avantek VHF and UHF transistors

HIGHEST f_T
HIGHEST GAIN
LOWEST NOISE FIGURE

When you need premium performance for MIL-spec radar or communications, cable TV or other industrial usage, data communications, ECM receivers, or any high-performance application, specify Avantek transistors.

A sampling of our specifications tells you why.

Test Model	Frequency	N.F. Max. (dB)	G@ low NF (dB)	I _c (mA)	f _r (GHz)
VHF Types MHz					
AT-16	60	1.0	25	5	3.5
AT-17	60	1.5	25	5	3.5
AT-23	200	2.0	20	30	3.5
AT-25	500	2.5	11	3	3.5
AT25A	500	2.0	12	3	3.5
AT-25B	500	1.5	13	3	3.5
AT-35	500	1.5	14	5	4.0
AT-35A	500	1.2	14	5	4.0
UHF Types GHz					
AT-52	1.0	5.0	9	5	3.0
AT-51	1.0	4.0	11	5	3.0
AT-50	1.0	3.0	13	5	4.0
AT-50A	1.0	2.5	13	5	4.0
AT-53	1.0	3.0	12	10	3.5
AT-54	1.0	4.0	10	10	3.5
AT-55	1.0	5.0	8	10	3.5

Make the transition to Avantek's high f_T transistors. For performance and reliability, there's none better.

All Avantek transistors are manufactured, including epitaxial growth, chip diffusion, gold metallization and packaging processes, entirely within Avantek's complete in-house semiconductor facility.

Avantek

Avantek, Inc., 2981 Copper Road, Santa Clara, Calif. 95051. (408) 739-6170. Cable: AVANTEK

MICROWAVES & LASERS

IC power amplifiers cover 1.4 to 2.4 GHz

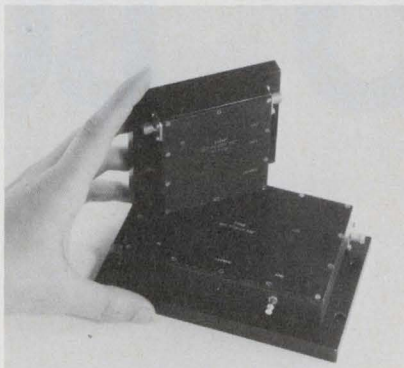

TRW Semiconductor Div., 14520 Aviation Blvd., Lawndale, Calif. Phone: (213) 679-4561. P&A: \$625 to \$975; 2 to 8 wks.

A new series of broadband microwave IC power amplifiers cover the frequency range of 1.4 to 2.4 GHz, with 1-dB bandwidths of 200 to 300 MHz. They deliver 0.5 to 5 W with power gains of 10 to 20 dB.

CIRCLE NO. 291

1.2-GHz transistor has micro-power drain

Texas Instruments, Inc., 13500 N. Central Expressway, Dallas, Tex. Phone: (214) 238-2011. P&A: \$40 (100 to 999); 3 wks.

A new TO-72 transistor achieves a 1.2-GHz transition frequency at emitter currents as low as 100 μ A. High-frequency operation for the MSX200 is possible with a collector voltage as low as 1 V. Power dissipation at 25°C is 10 mW at I_c of 1 mA.

CIRCLE NO. 292

Hybrid video xformers range out to 6 MHz

Deerfield Laboratory, Box 1300, Los Altos, Calif. Phone: (415) 948-4535. Price: \$60, \$90.

New 6-MHz video hybrid transformers allow flexibility in adding, subtracting and splitting video and digital signals. Model 200 3-port unit with 0.5 dB insertion loss adds and splits. Model 250 4-port unit with 1-dB insertion loss also can subtract.

CIRCLE NO. 293

Optic-coupled isolators use six-pin DIPs

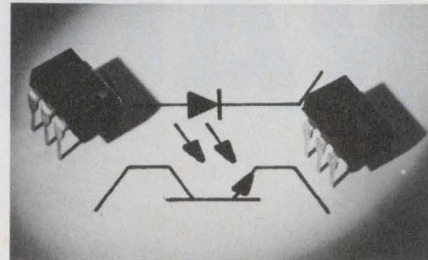

Texas Instruments, Inc., 13500 N. Central Expressway, Dallas, Tex. Phone: (214) 238-2011. P&A: \$3.35, \$1.70 (100 quantities); 2 wks.

Two new optically coupled isolators are offered in economical six-pin plastic DIPs. One is the TIXLIII, which features an input-to-output voltage of ± 1.5 kV and is DTL/TTL compatible. The other the TIXLII2, has ± 500 -V isolation. Offsetting TCs of an LED and a phototransistor used provide stable output over -55 to $+100^\circ\text{C}$.

CIRCLE NO. 294

Transistor/diode pairs work as opto-isolators

Monsanto Electronic Special Products, 10131 Bubb Rd., Cupertino, Calif. Phone: (408) 257-2140. P&A: \$6.50; stock.

Two new hermetically-sealed photocoupled pairs are the MCT4 phototransistor pair and the MCD4 photodiode pair. Voltage isolation of both opto-isolators exceeds 1 kV and isolation resistance is at least $10^{11} \Omega$.

CIRCLE NO. 295

Rf 28-V transistors deliver 10 W at 1 GHz

Solitron Devices, Inc., 1177 Blue Heron Blvd., Riviera Beach, Fla. Phone: (305) 848-4311.

A new series of rf power transistors deliver up to 10 W of output power at 1 GHz from a 28-V source. The SRF-8D141 (1 W), SRD-8D142 (2.5 W), SRF-4D143 (5 W) and SRD-4D144 (10 W)-devices were designed for the 600-MHz to 1.2-GHz region.

CIRCLE NO. 296

**new
I·DO·T
transformers
from
UTC**

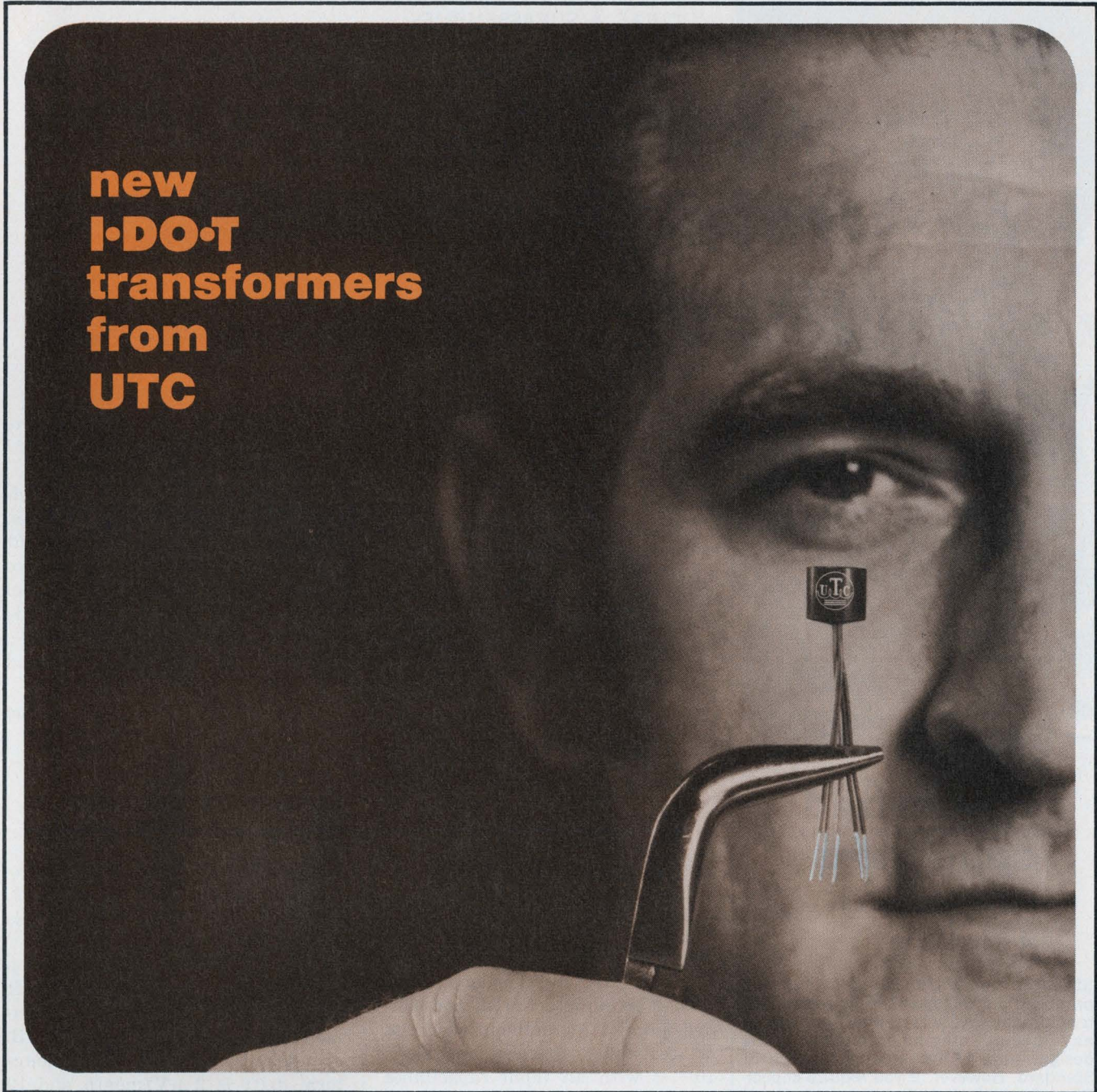

DO-T performance at industrial prices

Get the ruggedness of UTC DO-T units in the new industrial I-DO-T family of transformers and inductors. Stocked in 80 types, they're the most reliable available. Low price structure makes them ideal for isolation, matching, and push pull driving functions in modem and instrument applications. Eye-ball your circuits today and save!

Immediate delivery from UTC distributors.

Typical high efficiency power levels to ½ watt. Frequency response typically is ± 3 db 300 Hz to 100 kHz (400 kHz max.). Operating temperatures to 85° C. max.

Special impedance ratios and winding configurations are available. Request data on I-DO-T and

I-DI-T units from United Transformer Company Division of TRW Inc., 150 Varick St., New York, New York 10013. Tel: (212) 255-3500.

TRW

INFORMATION RETRIEVAL NUMBER 93



specialized capacitors

to your specifications
at stock prices

Standard Condenser has designed and produced thousands of specialized capacitors for industry. In fact, what you think of as "special" may be among the many designs already available from stock at Standard. However, if you require capacitors of unusual shape, size, value and material, our engineering department will help you design and produce them to your exact specifications at stock prices. For immediate action, send us a sketch and complete details.

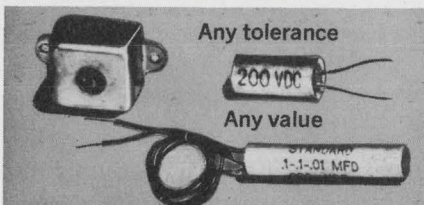

Send for Catalog and complete details.

Standard

CONDENSER CORPORATION
Dept. ED-6
1065 West Addison Street
Chicago, Illinois 60613 • (312) 327-5440

INFORMATION RETRIEVAL NUMBER 70

MODULES & SUBASSEMBLIES

Tiny modules deliver 12/15 V at 200 mA



Semiconductor Circuits, Inc., 163 Merrimac St., Woburn, Mass. Phone: (617) 935-5200. P&A: \$75; stock.

Two new tiny encapsulated power supply modules, P2.12.200 and P2.15.200, provide dual regulated outputs of ± 12 and ± 15 V at 200 mA, respectively. Their regulation is 0.01% for line and load. Ripple and noise are 1 mV rms and temperature coefficient is 0.015%/°C, typical. Over-all power supply size is 3.5 by 2.5 by 1.25 in.

CIRCLE NO. 297

High-gain op amp has 1.5×10^6 CMRR

Polytron Devices, Inc., 844 E. 25th St., Paterson, N. J. Phone: (201) 523-5000.

A new differential op amp, model P209-9, exhibits a CMRR and voltage gain of 1.5 million, each. Its dc resistance between inputs is $10^{12} \Omega$ with an input capacitance of 4 pF. Gain-bandwidth product is 2 MHz.

CIRCLE NO. 298

Module for CRTs corrects pincushions

Optical Electronics, Inc., Box 11140, Tucson, Ariz. Phone: (602) 624-8358. P&A: \$350; stock.

New model 5890 pincushion module, intended to correct deflection and focusing errors caused by flat-faced CRTs, offers a CRT corrected deflection position of typically $\pm 0.6\%$. All its parameters are externally programmable. The unit settles in 3 μ s.

CIRCLE NO. 299

Numeric 7-bar display uses 3-in. characters

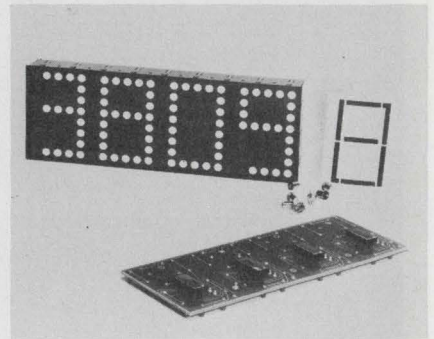

Info-Lite Corp., 2337 Lemoine Ave., Fort Lee, N. J. Phone: (201) 947-6646. Price: \$42/digit.

Series 68033 7-bar numeric read-outs contain 3-in. high characters. They are supplied with bezel, front panel and color filter, ready to mount into a rectangular panel cutout. Memory and/or decade counting logic are also available. Redundant lamping is optional and servicing is from the front.

CIRCLE NO. 300

Differential op amp drifts but $0.25 \mu\text{V}/^\circ\text{C}$

Burr-Brown Research Corp., International Airport Industrial Park, Tucson, Ariz. Phone: (602) 294-1431. P&A: \$65; stock.

The model 3440 differential op amp offers an input voltage drift on only $0.25 \mu\text{V}/^\circ\text{C}$ max. Its common-mode rejection is 100 dB, open-loop gain is 110 dB and long-term drift is 2 $\mu\text{V}/\text{month}$ and 10 $\mu\text{V}/\text{year}$.

CIRCLE NO. 301

Track/hold amplifier is accurate to 0.1%

Zeltex, Inc., 1000 Chalomar Rd., Concord, Calif. Phone: (415) 686-6660. P&A: \$95. stock.

The ZD450E1 is a hybrid track/hold amplifier that features $\pm 0.1\%$ accuracy, high input impedance, non-inverting operation and long hold decay time. Settling time is 15 μ s to $\pm 0.1\%$, aperture time is 100 ns and hold decay rate is 1 mV/s.

CIRCLE NO. 302

For us, the truth comes easy.

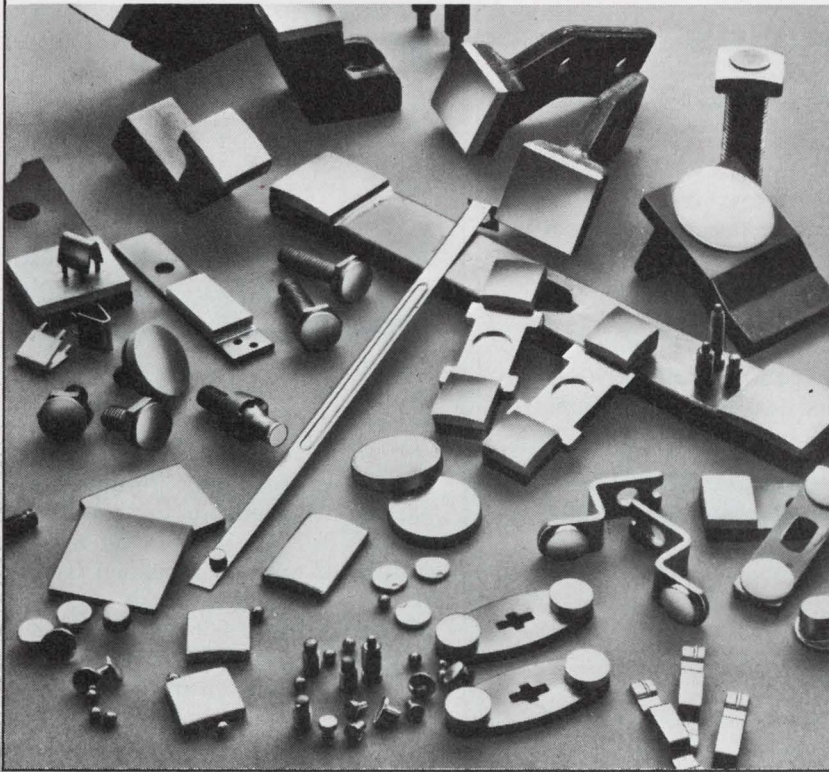

When we recommend a contact material for your switch, thermostat, relay, elevator control, or any other contact application, it's because it's the proper material for you to use.

... Not because it happens to be the one we manufacture.

When you produce the broadest line of contact materials you can afford to be objective. No one else can.

While this objectivity is good for our business, it's even better for yours because we'll only recommend a metal because it's best suited for your application ... not to make a sale.

Our engineering background, manufacturing facilities and broad experience in applications surpass those of any one in the field. So does our product line of contact metals. For information and/or technical assistance, call or write the H. A. Wilson Technical Service Department (201) 686-6600.

ENGELHARD

ENGELHARD INDUSTRIES DIVISION
ENGELHARD MINERALS & CHEMICALS CORPORATION
2655 U. S. ROUTE 22, UNION, NEW JERSEY 07083

An Equal Opportunity Employer

193

INFORMATION RETRIEVAL NUMBER 71

Say phooey to your fusible-link IC ROM programming problems!

Meet the **all new** Model 300 Manual Programmer. Just \$280 ... and a mere \$95 for each plug-in module to adapt to any manufacturer's ROM's.

Simple to operate, too. First ... insert the IC ROM.

Second ... press the AC power switch ...

Third ... select each word to be programmed on these easy-to-set thumbwheels ...

Last ... press the programmer switches corresponding to a previously prepared truth table ... current and time are carefully controlled to reliably program your ROM ... outputs for each word are indicated by these lights. Don't clown around! Call or write us today.



Spectrum Dynamics, Inc., 2307 East Oakland Park Boulevard, Fort Lauderdale, Florida 33306. Phone (305) 566-4467, 566-2547

INFORMATION RETRIEVAL NUMBER 72

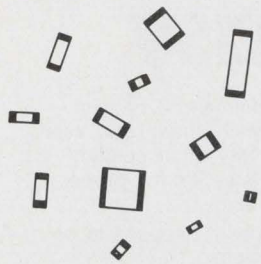

**NEW SIZES
NEW PRICES IN
CHIP CAPACITORS!**

Announcing the 1971 line of Ceramolitic® chip capacitors from USCC/CENTRALAB! Capacitance ranges — 1.0pF to .47Mfd in 50, 100 and 200 VDC ratings in sizes from .050" x .050" x .040". Lowest industry prices. New faster delivery — most catalog sizes now available off the shelf. Your choice of NPO or W dielectrics which meet or exceed the applicable portions of MIL-C-11015 and MIL-C-39014. The exclusive Ceramolitic® construction and 100% testing ensures highest reliability.

For free copies of new 1971 Catalog and Applications Manual, write USCC/CENTRALAB, 2151 N. Lincoln St., Burbank, Calif. 91504, (213) 843-4222 — or circle information retrieval number below.



U. S. CAPACITOR CORPORATION



CENTRALAB Electronics Division • GLOBE-UNION INC.

INFORMATION RETRIEVAL NUMBER 73



**WHAT OFFERS
YOU**

- GREATER RELIABILITY
- INCREASED OUTPUT
- REDUCED COSTS

IN ELECTRICAL/ELECTRONIC INSULATION?

To find out, plan to attend the 10th Electrical Insulation Conference, Chicago, Sept. 20-23. Write for details today!



ELECTRICAL INSULATION CONFERENCE
Box 2429C, Wilmington, DE 19899

INFORMATION RETRIEVAL NUMBER 74

**Standard MOS package
houses up to 64 leads**

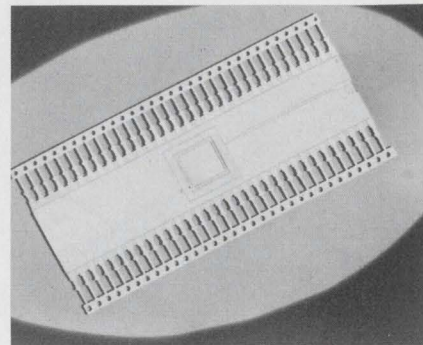

American Lava Corp., Manufacturers Rd., Chattanooga, Tenn. Phone: (615) 265-3411. Availability: 30 to 45 days.

A new standard 64-lead MOS package is available for the open market, for OEM and end users, instead of only on a custom basis. Its lead row spacing is 0.9 in. with leads on 0.1-in. centers. The chip mounting area is 0.325 in.² The package is entirely made of alumina.

CIRCLE NO. 303

**Miniature PC socket
holds round/flat leads**

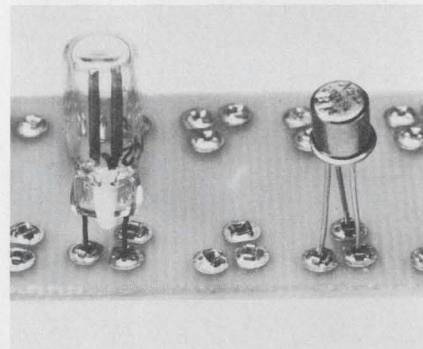

Berg Electronics, Inc., York Expressway, New Cumberland, Pa. Phone: (717) 938-6711.

A new miniature PC socket, called Minisert, gives positive retention to a wide range of round or flat leads and fits into holes sized from 0.043 to 0.058 in. in dia. A heat-treated spring within the socket's square cup gives positive contact to round leads from 0.014 to 0.022 in. in dia and flat leads 0.008 to 0.011-in. thick by 0.025-in. wide.

CIRCLE NO. 304

Edge-mount connector holds leadless ICs

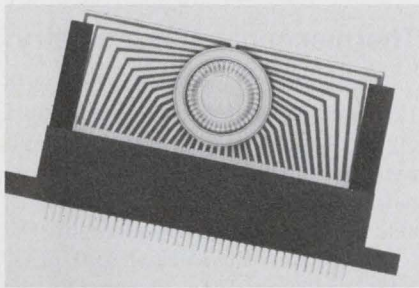

AMP Inc., Harrisburg, Pa. Phone: (717) 564-0101.

Designed to accept 0.04-in.-thick single-sided ceramic substrates, a new edge-mount connector is available in 40-position configurations with contacts on 0.05-in. centers. Its cantilever beam contacts are of beryllium copper with gold-over-nickel plating to withstand 100 insertions and extractions. A nylon housing measures 0.25 by 2.635 by 0.85 in.

CIRCLE NO. 305

Coating for displays eliminates hot spots

Panelgraphic Corp., 10 Henderson Dr., W. Caldwell, N. J. Phone: (615) 265-3411. Availability: 30 to 45 days.

A new optical coating is available for back-lit electronic display panels to eliminate hot spots without reducing light transmission. Known as Chromafuse, it diffuses the light source behind a display panel evenly across the legend and colored legend mask.

CIRCLE NO. 306

High-density boards house discretes/DIPs

Vector Electronic Co., 12460 Gladstone Ave., Sylmar, Calif. Phone: (213) 768-6250. Price: \$6 to \$8.

New high-density Plugboard series PC boards are available for DIPs and discretes. They are made from FR-4 or FL-PH glass epoxy, or FR2 phenolic, and are punched with grids of 0.042-in.-dia holes on 0.1-in. centers.

CIRCLE NO. 307

new

From Veeder-Root... mini package predetermining and control that coincidentally gives maxi information



Our little 7702 Counter is only about 4 x 4 x 7

inches small, but it does a big job. It contains a predetermining

counter which compares an input signal with a preset number. When coincidence is reached, the output circuit is activated to perform control functions. This solid state counter can replace — economically and efficiently — mechanical and electromechanical devices in machine tool, weaving, knitting, paper, chemical and pharmaceutical applications. For maxi information on our mini counter, write Veeder-Root, 70 Sargeant St., Hartford, Conn. 06102 (203-527-7201).

- Available with or without numerical display in 2, 3, or 4 decade models. (Without numerical display, a flashing light indicates every count.)

- Operates over DC to 10 kHz frequency range.

- State-of-the-art integrated circuits enable it to operate reliably over temperature range of 30 to 140°F.

VEEDER-ROOT

DIGITAL SYSTEMS DIVISION

A VEEDER INDUSTRIES COMPANY



INFORMATION RETRIEVAL NUMBER 75

evaluation samples

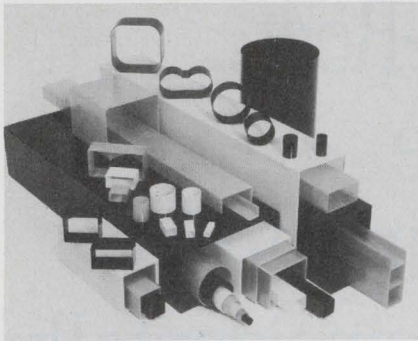

Coil tubing

Molded and laminated Nomex epoxy tubing is available in thousands of sizes for coil winding. These newly developed forms of DuPonts' Nomex paper are used to mold convolute wrapped tubes which are laminated with epoxy resin. They are available in standard 18-in. lengths and offer strength, toughness, clean inside surface, and high temperature resistance by convolute wrap molding of the Nomex. A multitude of tubing shapes can be accommodated. Samples, tooling list and details are available. Stevens Tubing Corp.

CIRCLE NO. 340



Temperature recorders

New 3/16-in.-dia Temp-Plate model 410 temperature recorders are calibrated to $\pm 1\%$ accuracy in ranges from 110 to 500°F. When exposed to rated critical temperature, each indicator window turns from pastel to black for a direct readout, which is permanent and irreversible. Rated temperatures are printed above central indicator windows. Installation is by self-adhesion of each indicator to any mounting surface. Thickness is only 0.01 in. max. Free evaluation samples and a catalog are available. William Wahl Corp.

CIRCLE NO. 341

design aids

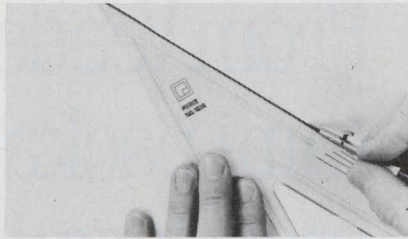

Drawing triangle

A new professional-grade triangle that floats above drawing surfaces on vertical lifts eliminates ink smears and pencil smudges in drafting. This is made possible because the triangle is injection-molded rather than die cut or stamped, thereby reducing the risk of ink smear due to capillary action. Vertical lifts on the triangle are ultra-smooth and cut down on surface drag. It is guaranteed to hold its angularity to ± 2 minutes at any point and is straight to within ± 0.003 in. along any rule edge. Pierce Corp.

CIRCLE NO. 342

CRT design slide-rule

For those who design CRT displays and deflection systems, a valuable shirt-pocket slide-rule is available. Its scales can be used for the variation of CRT focus current with anode voltage, response of dynamic focus coils, and other calculations involving first and second-power and square-root relationships. Constantine Engineering Laboratories, Inc.

CIRCLE NO. 343

Waveguide chart

A four-page microwave guide shows current and previous frequency designations for waveguides from 0.1 to 100 GHz. It also shows standard waveguide frequencies and wavelengths in inches as well as centimeters. Other charts are included: a voltage and power ratio-vs-decibels chart, a VSWR-vs-transmission-loss chart and a power-input-vs-frequency chart for common coaxial cables. Transco Products, Inc.

CIRCLE NO. 344

application notes

Thermocouple thermometry

Applications brochure 102 is a 12-page illustrated technical report on the theory and practice of temperature measurement with thermocouples. Numerous diagrams, charts and tables complement the text to cover theoretical and practical aspects of thermoelectric thermometry. Introductory material explains thermoelectric effects and thermoelectric laws, while following pages describe common thermocouple materials and circuits, and give useful tips on installing thermocouples to avoid temperature errors. A block diagram shows major elements of a thermocouple temperature measuring system. It also indicates optional features, such as electrical cold-junction compensation, zero suppression, and various types of readout devices. Gould, Inc., Brush Div.

CIRCLE NO. 345

Transformer design

A 16-page pocket-size illustrated folder contains excerpts from a seminar given during the 1970 IEEE Exhibition on design techniques for ferroresonant transformers. Authored by T. J. Workman, Jr., consultant for North Electric, Galion, Ohio, the folder lists important points to consider in the design and testing of constant-voltage transformers. This folder is the first in a new series of articles and reprints in pocket-size form on the subject of transformer design. Thomas & Skinner, Inc.

CIRCLE NO. 346

Ni-Cd battery handbook

A 200-page comprehensive engineering report on Ni-Cd batteries investigates their design configurations, applications and capabilities. Copies are available at a cost of \$2.50 from Battery Products Section, General Electric Co., P. O. Box 114, Gainesville, Fla., 32601.

CIRCLE NO. 347



Now we've got the biggest line of tiny Snap-Actors

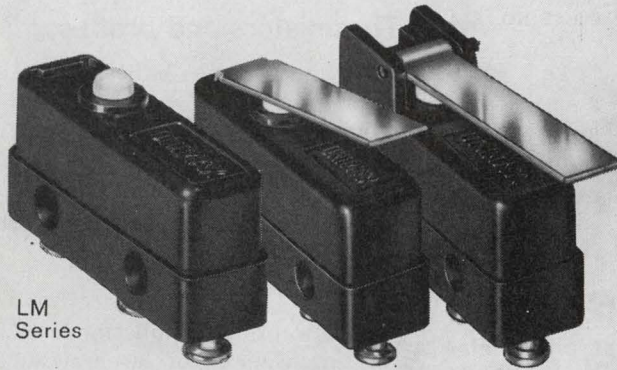

LM Series

With the introduction of the new LM subminiature series, Unimax now offers you the widest choice of snap-acting subminiature and miniature subminiature switches in the industry. Designed to meet applicable military specifications, the entire line offers extra long life and a complete range of forces and motions. Subminiatures are rated to 10 amps at 250 volts AC and are available in any of 10 standard terminal configurations. Miniature subminiatures are rated at 7 amps and can be supplied with differential motion as low as .0005" max. Integral actuators are available on all models and a wide variety of toggle and push button assemblies are standard.



Unimax Switch

A Riker-Maxson Subsidiary/Wallingford, Connecticut 06492

INFORMATION RETRIEVAL NUMBER 76

ELECTRONIC DESIGN 13, June 24, 1971

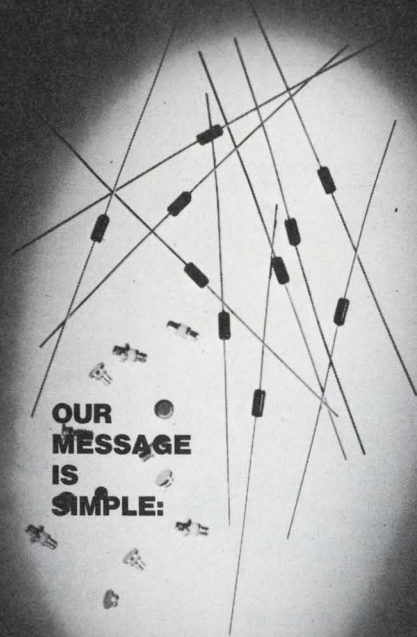

OUR MESSAGE IS SIMPLE:

"our high performance glass PIN diodes cost under \$5.*"

*unit cost per 100 quantity

APPLICATION	MINIMUM V _{BR} (Volts)	MAXIMUM C _{V_R} (pF)	MAXIMUM R _S (ohms)	TYPICAL T (ns)	TYPE NUMBER
UNIVERSAL SWITCH	150	0.3	1.2	200	A5S301
UNIVERSAL SWITCH	200	0.25	1.0	200	A5S302
LOW COST SWITCH	100	0.3	1.5	200	A5S339
FAST SWITCH	70	0.4	1.0	15	A5S342

NOTE: These devices are also available in ceramic case styles.

For further information on these devices or other semiconductors, contact your local Aertech representative, or write us directly.

Aertech

INDUSTRIES

825 STEWART DR. • SUNNYVALE • CALIF. 94086
(408) 732-0880 • TWX 910-339-9207

INFORMATION RETRIEVAL NUMBER 77

new literature

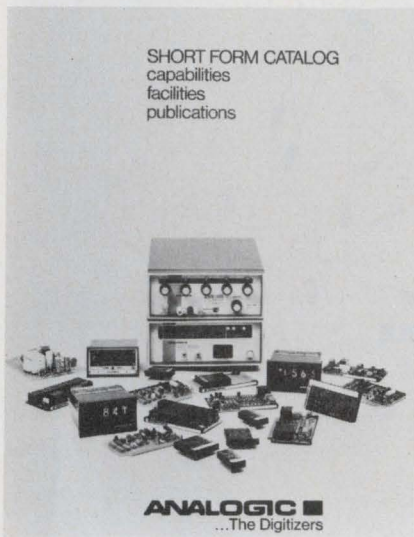

A/d/a converters

A complete line of a/d and d/a conversion, signal-conditioning and digital-display products are illustrated and described in a short-form catalog. These include card-mounted devices, complete systems, power supplies, DPMs and displays. Analogic.

CIRCLE NO. 348

Keyboards

A 12-page illustrated publication lists keypad and keyboard designs. Micro Switch, a division of Honeywell Inc.

CIRCLE NO. 349

Yagi antennas

A new brochure catalogs Yagi antennas. TACO-Technical Application Corp.

CIRCLE NO. 350

IC testers

A four-page short-form catalog describes six digital and linear IC testers. Microdyne Instruments.

CIRCLE NO. 351

Captive hardware

An eight-page illustrated catalog describes a line of stainless-steel captive hardware. Precision Metal Products Co.

CIRCLE NO. 352

1971 ISSCC digest available

The 226-page digest of technical papers from the 1971 IEEE International Solid-State Circuits Conference is available for \$15. Send checks to H. G. Sparks, Moore School of Electrical Engineering, University of Penn., Philadelphia. 19104

Relays and switches

A new 12-page brochure describes an expanded line of mercury-wetted relays and switches which operate in any mounting position. Fifth Dimension Inc.

CIRCLE NO. 353

TV camera

Designed for surveillance in adverse environments, a tamperproof self-contained television camera is described in a four-page data sheet. Cohu Electronics, Inc.

CIRCLE NO. 354

Magnetic pickups

A 16-page catalog describes the use and specification of magnetic pickups. Airpax Controls Div.

CIRCLE NO. 355

LED lights

A bulletin details an ultraminiature series of LED indicator lights. Dialight, Inc.

CIRCLE NO. 356

Resistors/potentiometers

A new catalog lists lines of resistors and potentiometers. TRW Inc.

CIRCLE NO. 357

Audio connectors

A family of 45 miniature audio/electronic cable-to-panel connectors are described in a four-page bulletin. The Bunker-Ramo Corp., Amphenol Industrial Div.

CIRCLE NO. 358

ICs and discretes

A new 16-page catalog describes a line of p-channel MOS and JFET multiple-channel switches, MOS-FETs, analog drivers and FET switches, drivers and gates. Also described are linear and digital ICs, FET chips and rf and microwave devices. Siliconix, Inc.

CIRCLE NO. 359

IC op amps

A four-page foldout data sheet describes three high-performance IC op amp families. Analog Devices, Inc.

CIRCLE NO. 360

Polycarbonate capacitors

A complete engineering bulletin for a series of miniature tubular polycarbonate-dielectric capacitors is available. Gudeman Co.

CIRCLE NO. 361

Thermistors and probes

An eight-page bulletin details sizes, types, and resistances of hundreds of negative-temperature thermistors plus thermistor probes. Keystone Carbon Co.

CIRCLE NO. 362

Lever switches

A new product bulletin describing seven series of lever switches which meet all requirements for Underwriters Laboratories listing is available. Switchcraft, Inc.

CIRCLE NO. 363

Microwave devices

Microwave devices and their performance capabilities are described in a 16-page brochure. General Electric.

CIRCLE NO. 364

Polyester capacitors

Two new series of miniature metalized polyester capacitors are described in a brochure. Industrial Condenser Corp.

CIRCLE NO. 365

Our R-250 three-speed data recorder you see below has more than enough going for it so it's a standout in any crowd.

As a solo performer, it's a rugged individualist.

But since made to IRIG standards, its character is congenial enough to work compatibly with other components in your system.

(One of the virtues born of its being a member of the large, world-renowned family of TEAC instrumentation products, where synergy is the watchword.)

When put to work by itself or

with other units, in the lab or the field, it provides precise FM recording and reproducing of analog signals from DC to 5kHz at 15 ips.

Its seven-inch reels carry half-inch tape that gives you seven independent record/reproduce data channels.

The eighth channel is an edge-track that takes voiced comments.

While one of the biggest (and best) in our family line, it still weighs in at an easy-to-get-along-with 67 pounds.

Front to back, the R-250 Series is a mere 12", 18" high, 20" wide—

a handsome addition to anyone's measuring instruments system.

Or as a starter of it.

It's not really particular how it's put to use. Or who it works with.

Only *how* it works.

To find out more about how it can work for you, just write or call Ken Williamson, Director of Marketing, Technical Products, TEAC Corporation of America, 2000 Colorado Ave., Santa Monica, CA 90404. Telephone: (213) 394-0240.

He'll give you all the particulars on why there's a good reason to go TEAC.

The particular data recorder that's not particular who it works with.



(Remote control unit is optional)

TEC LED LITE**LED READOUTS****READY TO MOUNT****\$23.00**
each*

When you buy a TEC-LITE IC compatible readout, you buy a unit that's ready to mount to your panel with two screws — nothing else! Or you can specify an attractive TEC aluminum bezel and mount up to 10 (or more) readouts** in your panel with just two nuts.

TEC has designed and built more completely packaged LED indicators, switch-indicators and readouts than anyone else — you expect more from the information display leader.

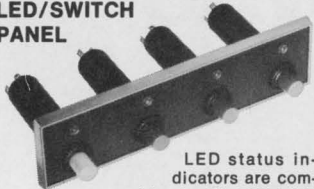
LED PACKAGES**LED/SWITCH PANEL**

LED status indicators are combined with TEC-LITE switches in this attractive, easy to mount panel assembly. Your choice of number and type of switches/indicators. Priced from \$2.25* complete, ready to mount.

PANEL MOUNT LED's

Slip bezel assembly in panel hole from the front, secure with Tinnerman clip from the rear. Replaceable LED snaps in place from the front. \$1.50* with clip.

PCB MOUNT LED's

Molded polycarbonate lamp holders are soldered to PCB. LED plugs into unit at right... permanently mounted in device at left. Priced from \$1.50*.

*100-499 quantity
**80¢ a position

See TEC-LITE for the complete line of readouts, indicators, switches, display panels, keyboards, CRT terminals.

TEC, Incorporated; 9800 North Oracle Road, Tucson, Arizona 85704; or phone (602) 297-2203.

INFORMATION RETRIEVAL NUMBER 79

NEW LITERATURE

Drive components

A new 516-page catalog features over 6500 off-the-shelf small commercial drive components. Stock Drive Products Div. of Designatronics, Inc.

CIRCLE NO. 366

Switches

A 24-page catalog features a line of miniature electronic switches and keyboard assemblies. Alco-switch, Div. of Alco Electronic Products, Inc.

CIRCLE NO. 367

Data terminal

Receive-only modules for high-speed electrostatic data communications terminals is described in a 12-page catalog. Teletype Corp.

CIRCLE NO. 368

Tri-state logic

A new 20-page brochure describes Tri-State logic circuits. National Semiconductor Corp.

CIRCLE NO. 369

Interconnections

Bulletin 111A describes a new interconnection system comprised of crimp-to-wire disconnects, wire-wrapping posts and multiple contact housings. Berg Electronics, Inc.

CIRCLE NO. 370

Tape recorder/reproducer

A portable instrumentation tape recorder/reproducer that offers precise automatic tape threading is described in a new brochure. Bell & Howell.

CIRCLE NO. 371

Motors

A new comprehensive 24-page booklet gives descriptions, applications, dimensions, prices and ordering information for over 500 fractional and integral-horsepower motors. Westinghouse Electric Corp.

CIRCLE NO. 372

TTL ICs

A 36-page catalog describes a complete line of low-power TTL ICs. National Semiconductor Corp.

CIRCLE NO. 373

Capacitors

A new 40-page catalog describes and illustrates a full range of film capacitors for industrial and commercial applications. Paktron, Div. of Illinois Tool Works, Inc.

CIRCLE NO. 374

Knobs and dials

A new four-color 24-page catalog describes a line of control knobs and custom dials. Rogan Brothers, Inc.

CIRCLE NO. 375

Micro mechanisms

An illustrated brochure describing a number of new miniature Swiss mechanical components is available. Micro Mechanisms Inc.

CIRCLE NO. 376

Computer graphics

A six-page brochure describes Conography—a unique new method of generating computer graphics. Conographic Corp.

CIRCLE NO. 377

Neon lamps

A complete line of neon glow lamps for indicator and circuit component applications are detailed in a catalog. Shigoto Industries, Ltd.

CIRCLE NO. 378

Dual FETs

A new dual field-effect transistor selection guide compares the specifications of 78 different devices. Teledyne Semiconductor.

CIRCLE NO. 379

Pot cores

A new bulletin describes and illustrates a line of pot cores. Siemens Corp.

CIRCLE NO. 380

bulletin board

of product news and development

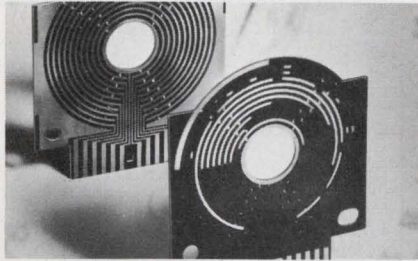

Die cost reductions and production savings are claimed for a new circuit fabricating method designed by Rogers Corp. The method involves direct circuitry generation on molded boards.

CIRCLE NO. 381

Polycrystalline GaP material is now being offered for sale by Metals Research of Monsey, N.Y.

CIRCLE NO. 382

Computer Investors Group, Inc., of Stamford, Conn., and Data Recall Corp., of El Segundo, Calif., have jointly announced the introduction of a new line of memory upgrade units. These provide mainframe memory capacity for IBM 360-30, -40 and -50 models, at levels said to substantially exceed those presently available from IBM.

CIRCLE NO. 383

Seventeen new products have been added to the Signetics line of 54/74 TTL ICs. They include multiplexers, parity generators/checkers, retriggerable multivibrators, decoders, hexadecimal inverters and logic gates.

CIRCLE NO. 384

Motorola Semiconductor has cut prices on some 48 high-frequency transistors by as much as 60%. These include low-noise small-signal, rf power amplifier and switching transistors.

CIRCLE NO. 385

Teledyne Semiconductor has announced the following FET op amp price cuts: the 2404BG has been reduced in price to \$38.80 from \$58.80; and the 2741CF was reduced in price from \$17.50 to \$10.80.

CIRCLE NO. 386

Radically New!

Photo-Isolated Solid-State Relays

...from Crydom

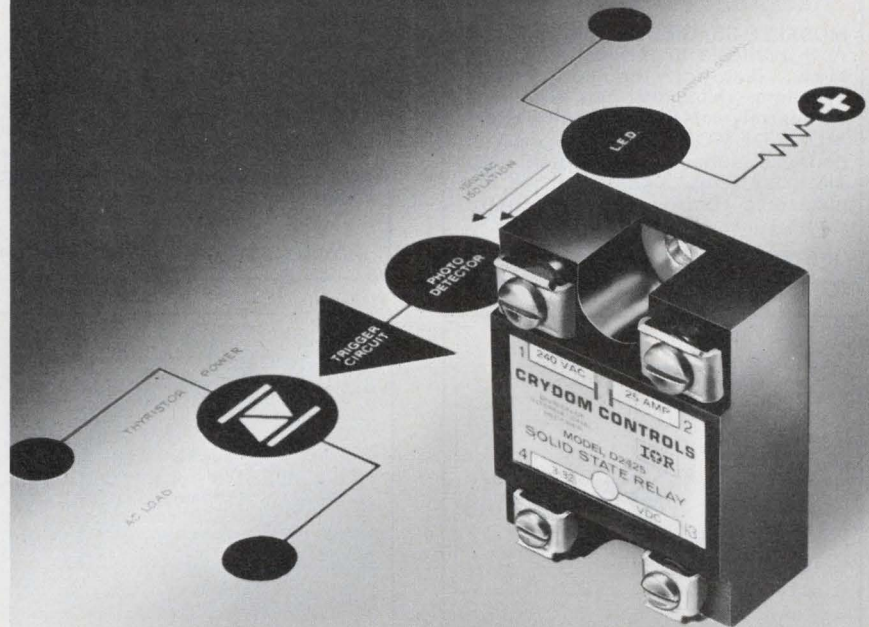

Transient-free Zero-Voltage Switching of 2-10-25 Amp AC Loads ...from DC or AC signals!

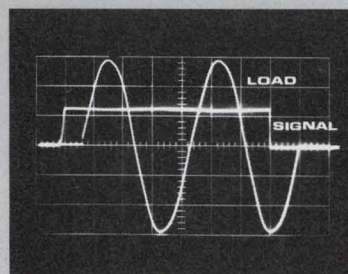

True Zero-Voltage "Turn-On"
Transient-free switching requires true zero voltage "turn-on" and "turn-off". Note Crydom's superior crossover action during switching.

Realize the full potential of solid-state switching! Photo-isolation eliminates transients, isolates all inputs from AC loads that can cause false triggering. Zero voltage switching (at no extra cost) makes transients and RFI caused by arcing contacts or current inrush impossible. Switch 120V and 240V circuits directly from low-level IC signals, or from standard 120V AC control voltages. No moving parts, transformers, coils or reed relays, means top reliability. The "4-way" industrial type terminals cut installation time and cost. They're your best buy for power, performance, price. Send for data!

CRYDOM CONTROLS 

DIVISION OF INTERNATIONAL RECTIFIER

1521 Grand Ave., El Segundo, California, 90245 (213) 322-4987

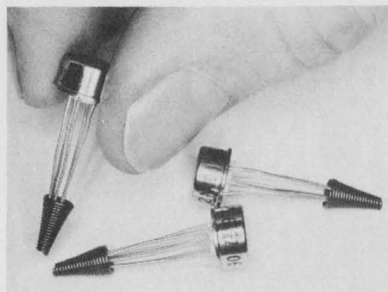

MOSFETS-85 G1FET™ device types now available in production quantities, featuring high-performance, excellent reliability and low cost; extensively used in multiplexers, MOD/DEMODO choppers, high-impedance sensitive instrumentation, alarm systems, signal switches and electronic controls. General Instrument, Hicksville, N.Y. 516-733-3237.

INFORMATION RETRIEVAL NUMBER 181

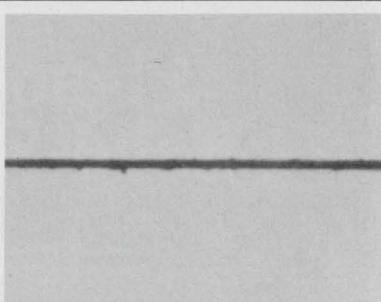

Typical microinch gap (200 x magnification) CMD 5005 high density ferrite. Density = 5.32 g/cm^3 - Resistivity 10^8 ohm cm - Initial perm at 6MHz. = 500. Ceramic Magnetics, Inc., 87 Fairfield Road, Fairfield, N. J. 07007. (201) 227-4222.

INFORMATION RETRIEVAL NUMBER 184



Fuzziness fighter 256-point real-time correlator for auto & cross-correlation, signal enhancement, probability. $2\frac{1}{2}X$ better resolution, $2\frac{1}{2}X$ wider time period, capture heretofore lost detail. Federal Scientific, 615 W. 131 St., NYC 10027. 212-286-4400.

INFORMATION RETRIEVAL NUMBER 187

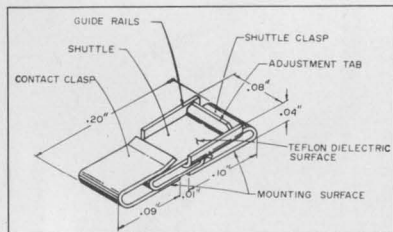

A new subminiature variable capacitor for microelectronic applications through 5 GHz, measures only .02" L x 0.08" W x 0.04" H. Tunes from 0.1 to 2.5 pf. Q factor is over 1000 at 250 MHz. Rated at 100 V. Completely stable during 40 G vibration tests. Accurately tunes micro-circuit substrates. Voltronics Corp., West St., Hanover, N. J. 07936.

INFORMATION RETRIEVAL NUMBER 182



Energy sentinel division — new product hi-voltage power supplies. Line regulation, less than 5%, 105-130v. Load regulation, 20%, no load to full load Ripple, less than 2%, 2KV to 15K priced from \$45.00 to \$92.00 ea. Chicago Condenser Corporation, 3255 W. Armitage Avenue, Chicago, Ill. 60647. Phone: (312) CA7-7070.

INFORMATION RETRIEVAL NUMBER 185



Four pole SR relay has all welded construction and seal. Meets MIL-R-5757/90. Coils for 6, 12, 24 VDC. Other QPL relays to MIL-R-5757/19. Send for free catalog. Branson Corp., P. O. Box "W", Denville, N. J. 07834. Phone: (201) 625-0600.

INFORMATION RETRIEVAL NUMBER 188



Pure fused quartz products. A free new 48 page catalog describes Vitreosil and Spectrosil quartz products and a 14 page catalog describing refractory products for electronic and laboratory applications. Complete price schedules included. Write Thermal American Fused Quartz Co., Montville, N. J. 07045

INFORMATION RETRIEVAL NUMBER 183

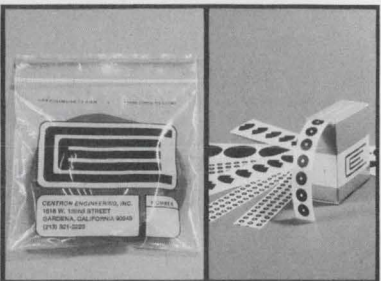

The latest catalog in pressure-sensitive precision component matched artwork symbols and drafting aids. Completely opaque pre-cut symbols are accurate to $\pm .001"$. Precision tape is packaged in air-tight zipper bags to preserve freshness even after use. Centron Engineering, Inc., 1518 W. 132nd St., Gardena, Calif. 90249.

INFORMATION RETRIEVAL NUMBER 186

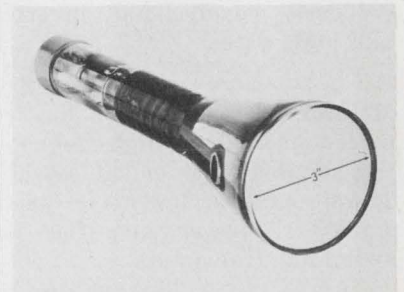

New 3" economical compact high resolution crt has a line resolution range from .002"-.004". Ideal for applications in confined areas, 3" crt quantity price range is under \$45. Contact Thomas Electronics, Inc., Wayne, N. J. (201) 696-5200 for design application assistance.

INFORMATION RETRIEVAL NUMBER 189

Advertisers wishing to reserve Quick Ad units should note the following mechanical requirements: Specs—Supply glossy photo of product and approximately 40 words which will set no more than 10 lines of 34 characters each. AFTER SUBMISSION NO COPY CHANGES CAN BE ACCEPTED. Quick Ads cost only \$300 per insertion, less for frequency advertisers. See order form page 102.

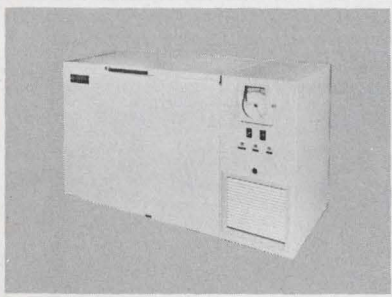

All-purpose chiller. Five sizes: 12, 15, 17, 21, 25 cubic feet. Temperatures: -40°F . or -100°F . For testing, storage, and other industrial applications. Prompt delivery Cincinnati Sub-Zero Products, Cincinnati, Oh. 45206. 513/751-8810.

INFORMATION RETRIEVAL NUMBER 190



Cramolin spray R improved contact cleaner contains Freon TF solvent and Cramolin Red Fluid not found in any other product. A cleaner, lubricant and anti-corrosive reduces contact resistance by dissolving oxide film formations. Effective all metals. Stays on. Safe to use. Tech. data available. Caig Labs, P. O. 788, Westbury, N. Y. 11590.

INFORMATION RETRIEVAL NUMBER 193



Free — General Instrument is offering, in a handy pocket size the industry's one and only complete cross-reference guide for silicon bridge rectifiers rated up to 25 Amperes. Send for your copy. General Instrument Corporation, Dept. P, 600 West John St., Hicksville, New York 11802. 516-733-3086-7.

INFORMATION RETRIEVAL NUMBER 196



EICO Model 443
Solid State Semiconductor Curve Tracer

Display diode & transistor curves on your general purpose scope with EICO 443 curve tracer. Diode measurements include relationship between forward V & I, PIV to 1400V, reverse leakage I. Power & signal tests for h_{FE} , h_{OE} , I_{CEO} , BV_{CEO} , etc. \$99.95 kit, \$149.95 wired. EICO, 283 Malta St., Bklyn., N. Y. 11207. (212) 949-1100.

INFORMATION RETRIEVAL NUMBER 191

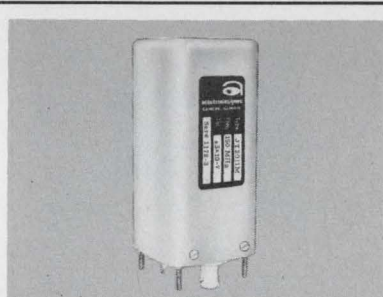

High stability oscillator from 1 MHz to 150 MHz provides high stabilities with spurious response at < 70 db down. Logic outputs for driving IC logic and sine wave at 0 dbm for multiplier chains are standard. Accutronics/G. M. R. C., Geneva, Illinois. 312-232-2600.

INFORMATION RETRIEVAL NUMBER 194

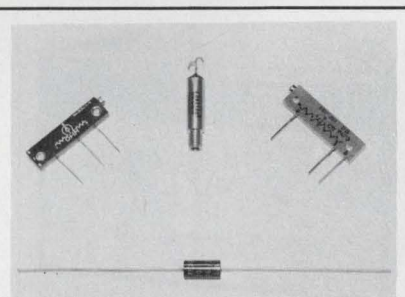

Wirewound trimmers and resistors for your special requirements. Quality products include CONELCO, ATOHM, QUIET-TRIM trimmers and RIEDON resistors. 3 to 10 days delivery on small resistor orders and 2 to 3 weeks on trimmers. TANGER ELECTRONICS, 12600 Daphne St., Hawthorne, Ca. (213) 757-9161.

INFORMATION RETRIEVAL NUMBER 197

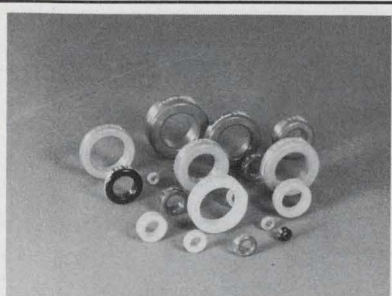

Genalex toroidal cores; pre-graded; marked mHy/1000 turns, color coded; permeabilities of 14 μ to 200 μ ; linear temperature characteristic; sizes .310 O.D. to 1.570 O.D.; stock; catalogs/design handbook available. Connolly & Company, Inc., Mountain View, California. (415) 967-6988.

INFORMATION RETRIEVAL NUMBER 192

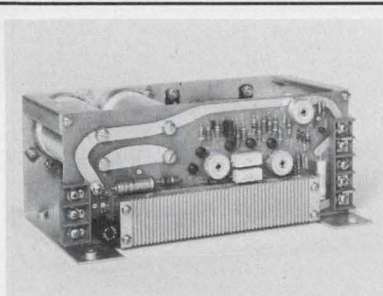

T. D. I. offers expanded range and multiple outputs in its low cost XL line of power supplies. All Models feature short circuit protection, remote sensing, adjustable outputs and 0.25% regulation. Outputs range from 1 to 30 Volts at current levels from 0.7A to 8A. Prices \$37.50 to \$115.00. Transistor Devices, Inc., Cedar Knolls, N. J.

INFORMATION RETRIEVAL NUMBER 195

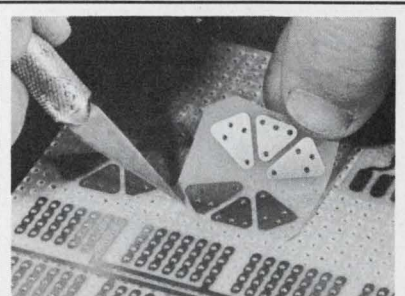

This aerospace proven concept in circuit packaging permits rapid assembly of all prototype systems directly from engineering sketches! Circuit sub-elements for mounting all electronic components are available. U. S. Pat. 3,538,389 and other patents pending. CIRCUIT-STIK INC.®, 1518 W. 132nd St., Gardena, Calif. 90249. Ph. (213) 532-1450.

INFORMATION RETRIEVAL NUMBER 198

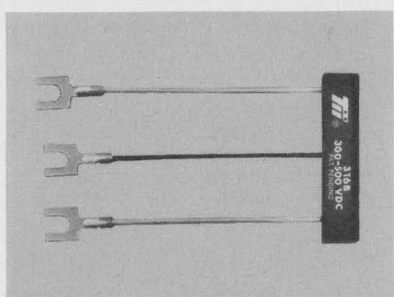

Model 316 3-electrode gas arrester offers maximum protection against longitudinal and metallic surges for sensitive equipment, data channels and solid state networks. Telecommunications Industries Inc., Copiague, N. Y. Phone 516-842-5000.

INFORMATION RETRIEVAL NUMBER 199



Datscan DPM's from 2½ to 4½ digits are priced from only \$99 (1-9). Special OEM designs include PH meters, temperature readouts, ratiometers, industrial packaging, and many more. Two specially low priced units-3 digit costs only \$124 and 4 digit only \$250. Send for information. Datscan Inc., 1111 Paulison Ave., Clifton, N. J. 07013.

INFORMATION RETRIEVAL NUMBER 202

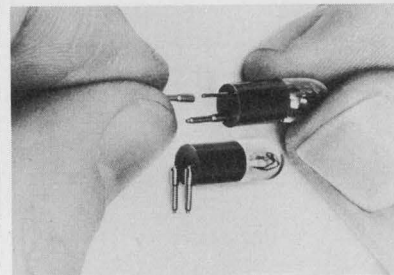

Tu-Pin Lamps soldered to PC Board Unplug for Replacement. When the lamp must be replaced, it is simply unplugged, leaving the gold plated pin sockets behind firmly soldered to the PC board and ready to receive a replacement. Hudson Lamp Co., Kearny, N. J. (201) 997-1850.

INFORMATION RETRIEVAL NUMBER 205



Low frequency spectrum analyzer: 1 to 5000 Hz; digital frequency readout; logarithmic and linear amplitude ranges: bandwidths 1, 10 and 100 Hz; electronic tuning: manual, internal automatic sweep, external; AFC, automatic tracking, search and track modes. Quan-Tech, Whippany, N. J. (201) 887-5508.

INFORMATION RETRIEVAL NUMBER 200

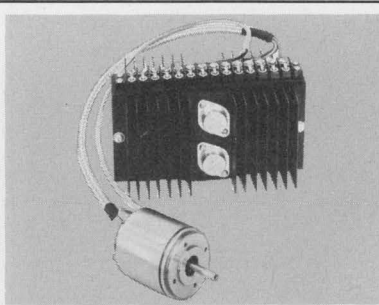

100,000 rpm brushless dc motor bi-directional variable speed control. High output capability with low motor loss. Custom built to specification. MacBar Mechanisms, Inc., Plainview, New York. Phone: 516-694-5360.

INFORMATION RETRIEVAL NUMBER 203

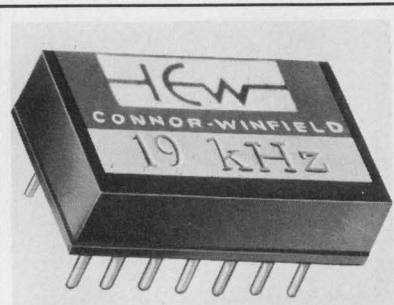

IC compatible oscillator less than 0.9" x 0.5" x 0.25" has dual-in-line termination, drawing only 1 ma nominal from 5Vdc±5% drives 2 IC's with 2Vp nominal pulses at any fixed frequency from 100 Hz to 50 kHz, ±0.25% from 0°C to +50°C. Connor-Winfield Corp., Winfield, Illinois 60190. (312) 231-5270.

INFORMATION RETRIEVAL NUMBER 206

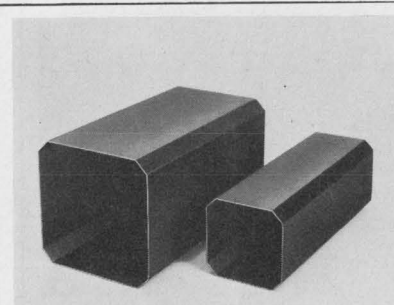

Arinc cans—AMALCO manufactures aluminum aircraft instrument enclosures in standard and special design sizes to Arinc specifications. Available secondary operations include: spot welding, piercing, anodizing, painting, etc. American Aluminum Company, Mountainside, N. J. (201) 233-3500.

INFORMATION RETRIEVAL NUMBER 201

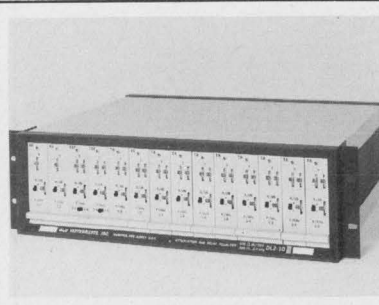

Voice channel equalizer DLZ-10 features defined and repeatable settings. Units interchangeable in case of failure or channel equalized by computer. Plug-in versatility. Tailor to C2 or C5 condition, or install fixed wired equalizer with resistors determined by adjustable settings or computer program. W. & G. Instruments, Inc. (201) 887-8700.

INFORMATION RETRIEVAL NUMBER 204

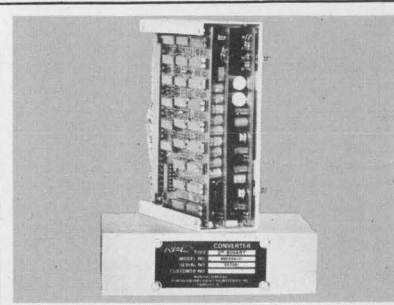

Northern Precision Laboratories introduces a new solid state Synchro to Digital Converter. This unit produces a 13 bit output word and has an accuracy of plus or minus one bit. Standard temperature range is zero to 70°C. The conversion time for 13 bits is 500 microseconds. Northern Precision Laboratories, Inc., Fairfield, N. J. 201-227-4800.

INFORMATION RETRIEVAL NUMBER 207

Get your extra copies now!

The Minicomputer and the Engineer...

An in-depth, up-to-date and complete analysis of what the mini can do, how to specify it, the problems of programming, peripherals, interfacing and system applications, ELECTRONIC DESIGN's special technical series on the mini in the world of the engineer is *must* reading for every designer. In the minicomputer world of the 70's no engineer should be without it. Order extra copies now, for yourself and your associates, by filling in the order blank below.



...a special reprint of the complete 6-part series for only \$3.75

William H. Smith, Electronic Design Magazine,
50 Essex Street, Rochelle Park, N. J. 07662

Please send me _____ copies of
THE MINICOMPUTER AND THE ENGINEER.

I enclose \$3.75 for each copy, including
handling and postage.

check

money order

Checks or money orders only, please.

Name _____

Firm _____

Street _____

City _____

State/Zip _____

ELECTRONIC DESIGN'S function is:

- To aid progress in the electronics manufacturing industry by promoting good design.
- To give the electronic design engineer concepts and ideas that make his job easier and more productive.
- To provide a central source of timely electronics information.
- To promote two-way communication between manufacturer and engineer.

Want a subscription? ELECTRONIC DESIGN is sent free to qualified engineers and engineering managers doing design work, supervising design or setting standards in the United States and Western Europe. For a free subscription, use the postfree application form inside the back cover. If none is included, write to us direct for an application form.

If you do not qualify, you may take out a paid subscription for \$25 a year in the U.S.A., \$35 a year elsewhere. Single copies are \$1.50 each.

If you change your address, send us an old mailing label and your new address; there is generally a prepaid postcard for this inside the back cover. You will have to requalify to continue receiving ELECTRONIC DESIGN free.

The accuracy policy of ELECTRONIC DESIGN is:

- To make reasonable efforts to ensure the accuracy of editorial matter.
- To publish prompt corrections whenever inaccuracies are brought to our attention. Corrections appear at the end of the Letters column.
- To refuse any advertisement deemed to be misleading or fraudulent.

Microfilm copies are available of complete volumes of ELECTRONIC DESIGN at \$19.00 per volume, beginning with Volume 9, 1961. Work is now in process to complete the microfilm edition of Volumes 1-8. Reprints of individual articles may be obtained for \$2.00 each, prepaid (\$.50 for each additional copy of the same article) no matter how long the article. For further details and to place orders, contact the Customer Services Department, University Microfilms, 300 North Zeeb Road, Ann Arbor, Michigan 48106; telephone (313) 761-4700.

Want to contact us? If you have any comments or wish to submit a manuscript or article outline, address your correspondence to:

Editor
ELECTRONIC DESIGN,
850 Third Avenue,
New York, N.Y. 10022.

Design Data from

Bishop's Deluxe 10X Optical Comparator — \$18.75



Catalog SG-1000 fully describes this precision instrument for the close inspection, alignment and comparison of diameters, widths, thicknesses . . . all linear values. An accurate reticle with both millimeter and inch scales is photo-printed on the base glass. Precision optics include a two-group, achromatic, 35 mm lens system consisting of four coated elements with full-focusing 10X magnification. Price includes leather carrying case, lens cap, and lint-free lens cleaning cloth. Order (Cat. No. 3500) directly from Bishop, or send today for free Catalog.

Bishop Graphics, Inc.
7300 Radford Avenue
North Hollywood, California 91605
(213) 982-2000 Telex 674672

CIRCLE NO. 174

High Voltage Power Supplies



Spellman High Voltage Electronics Corp. has a new 6 page brochure describing their line of high voltage power supplies.

The fold-out catalog contains information on regulated solid state, unregulated RF, and series regulated high power supplies—as well as miniature encapsulated modules. Over 300 models including rack mounted, portable and modular types are priced and described.

SEND FOR YOUR FREE CATALOG.

Spellman High Voltage Electronics Corp.
1930 Adee Ave., Bronx, New York 10469
Telephone (212) 671-0300

CIRCLE NO. 175

150°C Metallized Polysulfone Capacitors

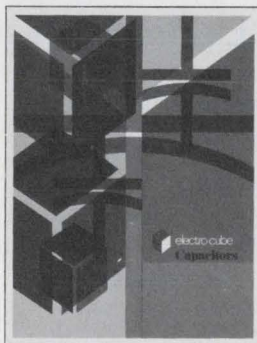

Six pages of data on these new, high temperature capacitors present electrical ratings, performance curves and package dimensions.

More than 800 units in four voltage ratings and six case styles are listed, with complete part number ordering information.

Capacitance values range from .0010 to 20Mfd. Voltages available are 100, 200, 400, and 600 VDC. Case styles are round or oval wrap and fill, rectangular epoxy with axial or radial leads, plus round and rectangular hermetically sealed metal cases. The units are stable within 1% over the temperature range.

Electrocube, Inc.
1710 South Del Mar Avenue
San Gabriel, California 91776

CIRCLE NO. 176

Manufacturers

Advertisements of booklets, brochures, catalogs and data sheets. To order use Reader-ServiceCard (Advertisement)

Mini-Computer + Real-Time Analyzer for Automatic Testing



Complete Spectrum Processing System SP-6-1 automatically scales, equalizes, processes underwater acoustic data and noise/vibration signatures for production testing. Monitors on-line signals (nuclear reactor noise, heart sounds, machine tool vibration), recognizes aberrations, gives alarm. Setup conditions are entered via teletype unit as requested by computer. System prints out all spectral data or only frequency amplitude above preset levels. Data also pre-recordable on tape, played back often faster than real time. Analysis over frequency bands as wide as 40 kHz are possible. Many options.

Federal Scientific Corporation
a subsidiary of Elgin National Industries, Inc.
615 West 131st Street, New York, N. Y. 10027.

CIRCLE NO. 177

PC Drafting Aids Catalog

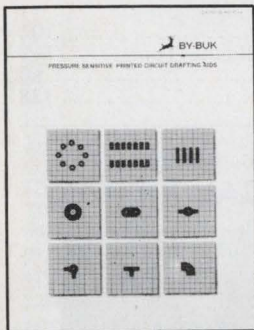

Thousands of time saving, cost saving artwork ideas are found in the By-Buk P-50 catalog of pressure sensitive printed circuit drafting aids. With the most practical artwork patterns for: TO cans, multi-pads, dual-inlines and flat packs featured. Donuts, connector strips, teardrops, ovals, tapes, tees, elbows, etc., by the hundreds are included in the most comprehensive list of sizes. Opaque black, transparent red and transparent blue materials for one and two-sided board designs. For a free copy and samples, write today.

By-Buk Company
Subsidiary of Webtek Corp.
4326 W. Pico Blvd.
Los Angeles, California 90019
(213) 937-3511

CIRCLE NO. 178

New! Sceptre, the Most Powerful Program Available

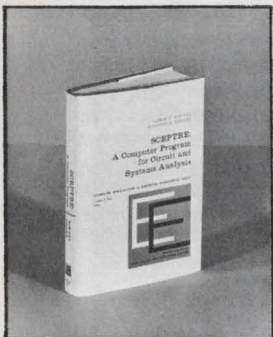

Here is your practical manual to the mastery of SCEPTRE, a new program solving the widest array of design and analysis problems possible — for virtually every type of system, accommodating any device model configuration. Methods can be used for any given circuit and it solves state equations describing all systems. The manual gives you scores of procedures in such areas as solid state circuits, automatic control systems, heat transfer and many others. This entirely flexible and versatile program eliminates phase-plane techniques, describing functions and other time-consuming manual methods — without requiring any real programming. Pub. Mar. '71, 455pp. 337 illus. 9½ x 6¾", \$16.50. Circle the reader service number for a 15-day examination copy. If payment accompanies your order, we pay postage and handling. Same return privilege, refund guaranteed.

Prentice-Hall, Inc.
Englewood Cliffs, N.J. 07632
d-elde-ur

CIRCLE NO. 179

ELECTRONIC DESIGN 13, June 24, 1971

Electronic Design

Advertising Sales Staff

Keith Aldrich
Sales Manager

New York 10022

Robert W. Gascoigne
Samuel M. Deitch
Daniel J. Rowland
850 Third Avenue
(212) Plaza 1-5530
TWX: 710-581-2874

Philadelphia 19025

Mort Sullivan
P.O. Box 126
Dresher, Pa.
(215) 884-6880

Boston 02154

Joseph F. Palmer
1268 Main Street
Waltham, Mass.
(617) 894-2700

Chicago 60611

Thomas P. Kavooras
Berry Conner, Jr.
200 East Ontario
(312) 337-0588

Cleveland

Thomas P. Kavooras
(Chicago)
(312) 337-0588
(call collect)

Los Angeles 90303

Stanley I. Ehrenclou
Burt Underwood
2930 Imperial Highway
Inglewood, Calif.
(213) 757-0183

San Francisco 94022

Jerry D. Latta
95 Main Street
Los Altos, Calif.
(415) 941-3084

London W. 1

For United Kingdom and Holland
Brayton C. Nichols

For Eastern Europe

Peter Kehr

The American Magazine Group

27 Maddox Street
London, W. 1, England
Phone: 499-0180

Cable: Ammagnic, London

Verviers, Belgium

For Continental Europe

Andre Jamar
1, Ru Mallar, 1
087) 253.83 Telex 41563

Tokyo

Haruki Hirayama
Electronic Media Service
5th Floor, Lila Bldg.,
4-9-8 Roppongi
Minato-ku
Phone: 402-4556
Cable: Electronicmedia, Tokyo



AMERICAN BUSINESS PRESS, INC.

Newer, Higher Quality

NDK

Products

ULTRASONIC FETAL PULSE DETECTOR

PULTONE

Ideally suited to fetal heart sound detection, operates on a doppler effect.



DELAY LINE

For Color TV

63.943uS
4.43MHZ
TYPE DP-1C
NDK

CRYSTAL OSCILLATOR

High Stability 1 MHz
HS-Series



**World's Leading
Manufacturer of:**

- Synthetic Quartz Crystals
- Water Soluble Crystals (LH, ADP, KDP)
- Quartz Crystal Units
- Crystal Oscillators
- Delay Lines
- Ultrasonic Instruments



**NIHON DEMPA
KOGYO CO., LTD.**

Since 1948

1-21 Nishihara, Shibuya-ku, Tokyo, Japan
Tel: 460-2111

Cable: CRYSTALUNITS TOKYO TLX: TK4893

advertiser's index

Advertiser	Page
AMP, Incorporated	8, 9
Abbott Transistor Laboratories Incorporated	6
Accutronics/G.M.R.C.	121
Acheson Industries	96A-F
Acopian Corp.	15
Aertech Industries	115
Allen-Bradley Co.	46
American Aluminum Company	122
Amersil, Inc.	106
Amphenol Components Group	12
Analog Devices, Inc.	45
Australian Department of Trade and Industry	16
Automatic Electric Company	4, 5
Avantek, Inc.	108
Beckman Instruments, Inc., Helipot Division	81
Belden Corporation	11
Bell, Inc., F. W.	98
Bishop Graphics, Inc.	124
Bodine Electric Company	22
Branson Corp.	120
Burndy Corporation	93
By-Buk Subsidiary Webtek Corp.	125
CEM Company, Inc.	94
Caig Labs	121
Centron Engineering, Inc.	120
Ceramic Magnetics, Inc.	120
Chicago Condenser Corporation	120
Cincinnati Sub-Zero Products	121
Circuit Stik, Inc.	121
Clare & Co., C. P.	55
Connolly & Company	121
Connor-Winfield Corporation	122
Crydom Control, Division of International Rectifier	119
Dale Electronics, Inc.	Cover II
Datapac Incorporated	88
Datascan, Inc.	122
Delco Electronics, Division of General Motors	74, 75
Dialight Corporation	87
Dow Corning Corporation	38, 39
EICO	121
Eastman Kodak Company	33
Electrical Insulation Conference	112
Electro Cube, Inc.	124
Electronic Design	102, 123, 127
Electronic Engineering Company of California	92
Electrostatics, Inc.	103
Energy Conversion Devices, Inc.	14
Engelhard Industries Division, Engelhard Minerals & Chemicals Corporation	111
Fairchild Semiconductor, A Division Fairchild Camera and Instrument Corporation	70, 71
Federal Scientific Corporation	120, 125
Fifth Dimension, Inc.	7
Fluke Mfg. Co., Inc., John	17
GTE Sylvania, Precision Materials Group	34, 35

Advertiser	Page
General Instrument Corporation	120, 121
General Radio Company	91
Hansen Mfg. Co., Inc.	100
Hayden Book Company, Inc.	64B
Hewlett-Packard	1
Hewlett-Packard, New Jersey	99
Hipotronics, Inc.	96
Hudson Lamp Company	103, 122
ITT Cannon Electric, A division of International Telephone and Telegraph Corp.	43
Industrial Electronic Engineers, Inc.	13
Industrial Timer Corporation	94
Johnson Company, E. F.	37
Lear Siegler Inc.	102
Licon, Division Illinois Tool Works, Inc.	40
Logitek, Inc.	128

Low Frequency MECHANICAL FILTERS



SL-Ns 907 Hz

(actual size)

- Applications:
- Paging systems
 - Remote control systems
 - Remote supervisory systems

Mechanical filters distributed by Seiko Instruments Inc. are derivatives of world renowned SEIKO precision, the outcome of exacting processes and production technology. With almost a decade of experience in the manufacture of mechanical filters, DAINI SEIKOSHA is able to offer miniature types exhibiting truly high performance. Reliability? Not questionable if you're talking about one of our products.

Many types are available. On special order, we can satisfy a wide range of specifications.

SI Sole distributor in the United States:
SEIKO INSTRUMENTS INC.
14333, South Figueroa Street, Gardena, Calif.
90247 Phone: 213-770-0152
Telex No. 673688

Advertiser	Page	Advertiser	Page	Advertiser	Page
MacBar Mechanisms Inc.	122	Quan Tech	122	Thermal American Fused Quartz Co.	120
Mallory Capacitor Company	85	RCA Electronic Components and Devices	Cover IV	Thomas Electronics	120
MicroSwitch, A Division of Honeywell	78	Seiko Instruments Inc.	126	Tracor, Inc.	106
Molex, Incorporated	Cover III	Siemens Corporation	2	Transistor Devices, Inc.	121
Motorola Component Products Dept.	10	Signalite Division of General Instruments	69	Trio Laboratories, Inc.	90
Motorola Semiconductor Products, Inc.	16A—H	Siliconix Incorporated	32A1—16	Triplett Corporation	95
National Electronics, Inc.	27	Simpson Electric Company	25	Unger, A Division of Eldon Industries, Inc.	105
Nihon Dempa Kogyo Co., Ltd.	126	Solitron Devices, Inc.	101	Unimax Switch, Division Maxon Electronics Corporation	115
North Atlantic Industries, Inc.	79	Sprague Electric Company	21	United Systems Corporation	103
Northern Precision Laboratories, Inc.	122	Spectrum Dynamics, Inc.	111	United Transformer Co., Division of TRW	109
Nytronics, Inc.	97	Standard Condenser Corporation	110	U. S. Capacitor Corporation	112
Philips Electronic Components and Materials Division	2, 64A, 107	Switchcraft, Inc.	83	Unitrode Corporation	27
Piezo Technology, Inc.	36	TEAC Incorporated	117	Veeder-Root	113
Plessey, Incorporated	54	TEC, Incorporated	118	Vermont Research Corporation	44
Potter & Brumfield Division of AMF Incorporated	61	Tanger Electronics	121	Victoreen Instrument Division	98
Prentice-Hall, Inc.	125	Teledyne Philbrick	18	Voltronics Corp.	120
		Telecommunications Industries, Inc.	122	W. & G. Instruments, Inc.	122
		Teletype Corporation	62, 63	Zeltex, Inc.	32

a new space unit from Electronic Design

**A NEW 1/9 PAGE SIZE FOR ONLY \$300
INCLUDING PRODUCTION CHARGES!**

Quick Ads will be placed in their own special section, attractively laid out to insure maximum attention. Each will have its own Information Retrieval Number, assuring many inquiries, many sales leads. You simply provide an 8 x 10" glossy photograph, plus approximately 40 words of copy. We do the rest at no cost to you.

For full information, including even lower frequency rates, mail the form at right to Peter D. Coley, Publisher, Electronic Design, 850 Third Avenue, New York, N.Y. 10022

Quick Ads

PLEASE RUSH ME FULL DETAILS ON QUICK ADS IN ELECTRONIC DESIGN

NAME _____

FIRM _____

STREET _____

CITY _____

STATE _____

TITLE _____

ZIP _____

INDUSTRIAL POWER MONITOR AUTOMATICALLY SENSES CHANGES IN VOLTAGE, FREQUENCY AND PHASE



Logitek's Power Monitor is an inexpensive, solid state device that prevents system damage when voltage, frequency or phase go out of spec. The power monitor allows normal

operation when power line characteristics are within pre-set limits. Should voltage or frequency go out of spec, or phase be other than in its proper sequence, the power monitor's relay de-energizes to sound an alarm, begin corrective action, or shut down the system.

A pickup and dropout time delay of from 250 ms to 10 seconds is built in to allow short duration voltage or frequency changes.

The Logitek unit is available in both 3-phase and single phase models and can be made to sense only voltage, only frequency, only phase, or any combination. Prices range from \$100 to \$300.

PARTIAL SPECIFICATIONS

Input Operating

Voltage (nominal)	120/208 VRMS $\pm 20\%$
Frequency	50/60 Hz $\pm 20\%$
Phase	Single or 3-phase

Input Sensing

Voltage Band	} as required
Frequency Band	
Phase Sequence	ABC
Accuracy	$\pm 1\%$

Output Contacts

Form	3 form C (3PDT)
Rating	10A res.

Operating Temperature -10°C to $+70^{\circ}\text{C}$

Delivery Off-the-shelf



LOGITEK

42 Central Drive,
Farmingdale, New York 11735
(516) 694-3080

product index

Information Retrieval Service. New Products, Evaluation Samples (ES), Design Aids (DA), Application Notes (AN), and New Literature (NL) in this issue are listed here with page and Information Retrieval numbers. Reader requests will be promptly processed by computer and mailed to the manufacturer within three days.

Category	Page	IRN	Category	Page	IRN
Components			Packaging & Materials		
capacitors, polycarbonate	98	269	coating, optical	113	306
diodes, microstrip	102	279	connector, edge-mount	113	305
displays, DIP	97	268	package, 64-lead	112	303
isolators, optical	102	280	PC boards	113	307
modulator, pulse-width	102	278	socket, PC	112	304
oscillator, crystal	98	271			
potentiometers	100	275	new literature		
relays, solid-state	98	270	antennas, Yagi	116	350
resistors, fuse	100	277	camera, TV	116	354
switch, Hall-effect	97	267	capacitors	116	361
switches, leverwheel	100	274	capacitors	116	365
switches, reed	100	273	capacitors	118	374
timer, dc-to-dc transfer	100	272	connectors, audio	116	358
trimmers, film	100	276	converters, a/d/a	116	348
			cores, pot	118	380
Data Processing			FETs, dual	118	379
computer system	104	281	graphics, computer	118	377
display monitor	104	284	hardware, captive	116	352
memories, core	104	286	ICs	116	359
minicomputer	104	282	ICs, Tri-state	118	369
ROM, high-speed core	104	285	ICs, TTL	118	373
terminal, CRT	104	283	keyboards	116	349
			knobs and dials	118	375
ICs & Semiconductors			lamps, neon	118	378
amplifier, linear IC	94	255	LEDs, indicator	116	356
counter/display IC	92	254	microwave devices	116	364
diodes, vhf/uhf TV	96	261	motors	118	372
divider, frequency	94	260	op amps, IC	116	360
filters, IC digital	96	264	relays	116	353
memory systems, IC	96	266	resistors	116	357
multiplexer, 6-channel	96	263	switches	118	367
multiplexer, 16-channel	96	262	switches, lever	116	363
op amps, IC	96	265	tape recorder	118	371
oscillators, crystal	94	257	terminal, data	118	368
RAM, 64-bit bipolar	94	258	testers, IC	116	351
thyristors, JAN	94	259	thermistors	116	363
transistors, silicon-gate	94	256			
			application notes		
Instrumentation			battery handbook, Ni-Cd	114	347
electrometer	89	251	thermocouple ther-		
meters, panel	90	253	metry	114	345
multimeter, digital	89	252	transformer design	114	346
scopes, storage	89	250			
			design aids		
Microwaves & Lasers			slide-rule, CRT design	114	343
amplifier, pulse	106	289	triangle, drawing	114	342
amplifiers, microwave	108	291	waveguide chart	114	344
capacitors, microstrip	106	290			
isolators, optical	108	294	evaluation samples		
mixer, double-balanced	106	288	temperature monitors	114	341
photocoupled pairs	108	295	tubing coil	114	340
transformers, video	108	293			
transistor, 4-GHz power	106	287			
transistors, micro-power	108	292			
transistors, 1.2-GHz	108	296			
			Modules & Subassemblies		
amplifier, track/hold	110	302	amplifier, track/hold	110	302
display, 7-bar	110	300	display, 7-bar	110	300
op amp	110	301	op amp	110	301
op amp, differential	110	298	op amp, differential	110	298
pincushion module	110	299	pincushion module	110	299
power supplies, modular	110	297	power supplies, modular	110	297

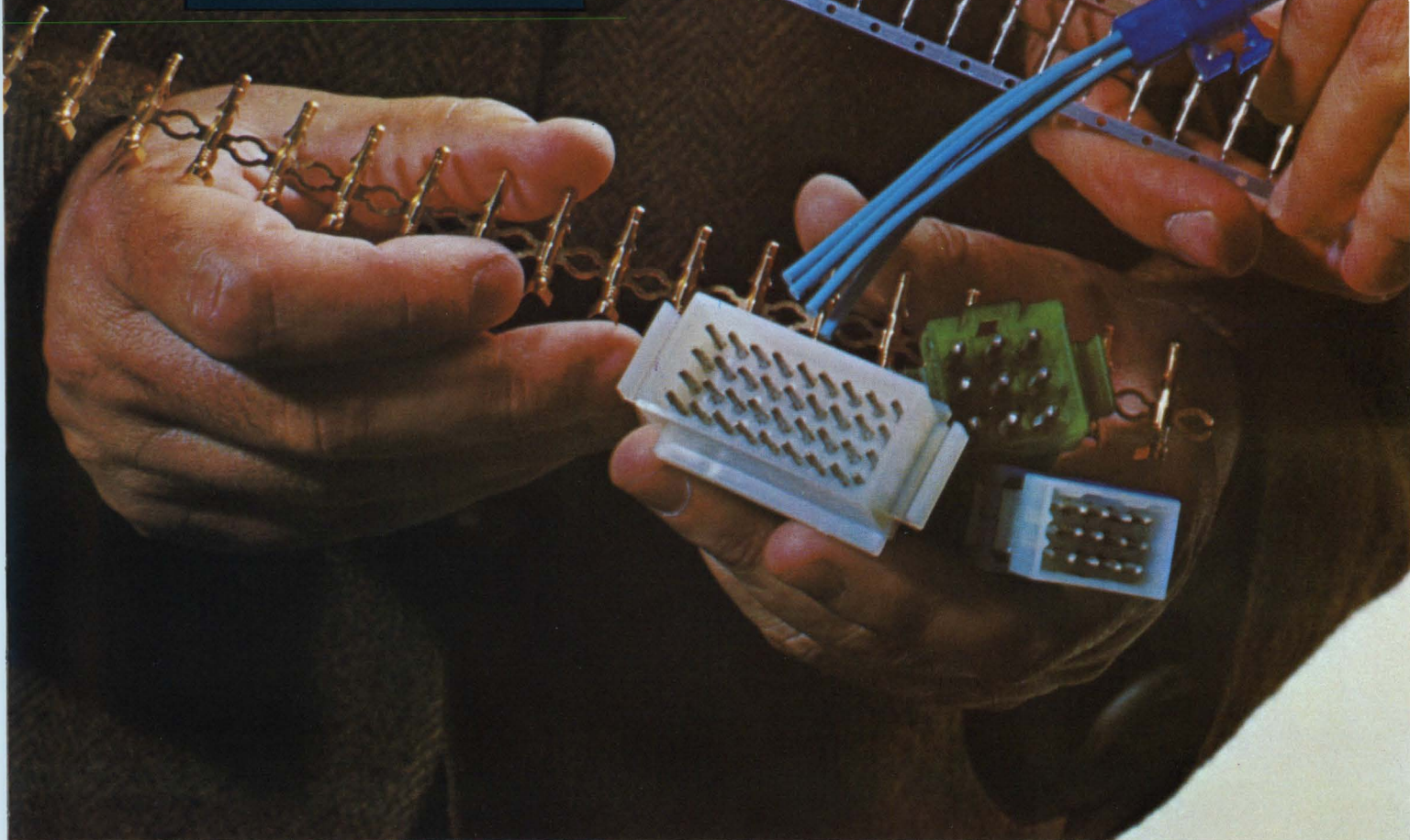

MAKE YOUR CONNECTIONS: FAST. With Molex standard and miniature connectors. They're easier to work with. Simplify wiring. Speed production. Save assembly steps. Make installation and servicing extra easy, too. This is why circuitry idea men everywhere are making connections with Molex. From one circuit to 104 or more. Production keyed and available in a variety of colors to meet design requirements. Molex has the

connector. Plus the design and engineering capability to solve the most complex wiring problems . . . fast. For a colorful free sample of the Molex connector write: Molex Incorporated, Downers Grove, Illinois 60515. Or you can make connections by calling (312) 969-4550.

*...creating components that
simplify circuitry*



Use these RCA 450-V transistors as standards for off-line 25 kHz power conversion

TRANSISTOR TYPE	POWER SUPPLY OUTPUT (W)	PACKAGE	I_c (A)	PROTOTYPE
40850	125	TO-66	2	2N3585
40851	250	TO-66	4	2N6079
40852	250	TO-3	4	2N5840
40853	500	TO-3	8	2N5805
40854	1000	TO-3	16	TA7007

REDUCE SIZE BY FACTOR OF 4

REDUCE WEIGHT BY FACTOR OF 5

COOLER OPERATION

INCREASE RELIABILITY

LOWER COSTS

Also available now: 40 A fast recovery rectifiers (TA7987 series) in DO-5 packages. For the full story, call your local RCA Representative or your RCA Distributor. For application note, AN4509, write: RCA, Commercial Engineering, Section 57F-24 /UTS17, Harrison, N. J. 07029.

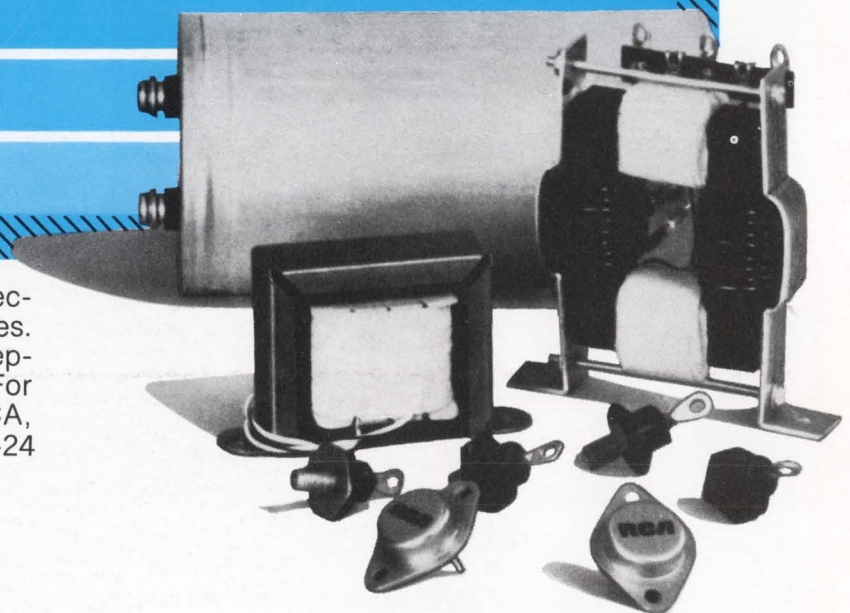

5 V, 50 A, 250 W power supply

RCA Solid State