

Electronic Design

FOR ENGINEERS AND ENGINEERING MANAGERS

VOL. 21 NO

5

MARCH 1, 1973

Looking for a PC connector? There are thousands of them in all shapes and sizes. You could get lost trying to find what you really need. Should you use a

one-piece or a two-piece type? What about contact style? The housing? Contact material? You can easily get trapped. Learn the ins and outs, starting p.50.



Think big



50,000 Volts

For long-term continuous loading, Dale Type F film resistors provide working voltages to 14 KV, pulse voltages to 50 KV with less than 1% change after 2,000 hours. Lead and/or threaded cap terminations. Write for Bulletin M7C.



1,000,000,000 Ohms

Fill ultra-high resistance requirements with Dale Type M and MH film resistors. Miniature sleeved or glass enclosed models with values from 60 Meg. to 1,000KM. Excellent stability (0.5%/yr.). Tolerances as low as 1%. Write for Bulletin HV8C.



1,000,000 pieces
RL20...3¢

RL07 and RL20 needs can be swiftly met with a choice of two materials—metal film (Type CM) and metal oxide (Type F). Fast delivery in quantity. Call for details.

Think Dale



Save selection time...send for and use Dale's helpful and complete **Guide to Film Resistors**. Circle Reply Number for your free copy.

DALE ELECTRONICS, INC., 1300 28th Ave., Columbus, NE 68601
A subsidiary of The Lionel Corporation • In Canada Dale Electronics Canada, Ltd.

INFORMATION RETRIEVAL NUMBER 212

Microdata unwraps a bold, new communications package.

We've combined microprogramming with communications and created a system which outperforms them all at a price no one else can match. It's the new Microdata 1600/60. And it features our Twin Mini, a processor with two microprogrammed CPU's each having separate high speed control memories and I/O facilities. The Microdata 1600/60 handles up to 256 asynchronous lines, up to 32 synchronous lines or any combination of the two at the rate of 40,000 characters per second. Find out why our entry into the communications market is the finest package available today. Write for details. Microdata Corporation. 17481 Red Hill Avenue. Irvine, California 92705. (714) 540-6730.



from the bold guys at

Microdata™

THE SMALLEST

5 AMP

GENERAL PURPOSE

RELAY

Available now, Teledyne's new Mini-T.

This industrial, heavy-duty 120 volt 5 amp relay features a life expectancy of over 10 million dependable operations. The space-saving 2PDT Mini-T with transparent dust cover has a full line of complementary sockets and hold down clips for P.C. board or chassis mounting. This Teledyne relay employs an unusual shaded pole design that permits direct AC operation without the need for rectifying diodes. Available with either AC or DC coils and demonstrating cost effectiveness that's hard to beat, the United States-manufactured Mini-T is truly worth its one-half ounce weight. The Mini-T . . . another finely-crafted relay from Teledyne. Call our nearest distributor today.

3155 West El Segundo Boulevard
Hawthorne, California 90250
Telephone (213) 679-2205



**TELEDYNE
RELAYS**



NEWS

- 23 **News Scope**
- 26 **Consumerism and the makers of medical electronics collide:** A report on a new watchdog group and its effect on the industry.
- 32 **Amorphous metallic films** promise easy-to-make bubble memories with higher densities.
- 34 **Top medical care for rural areas** planned via electronics network.
- 36 **Technology Abroad**
- 41 **Washington Report**

TECHNOLOGY

- 50 **Focus on Connectors for PCs and substrates:** A special report on how to maximize your system reliability by specifying the right connector for the job.
- 66 **CMOS logic elements interface easily** with other logic families and discrete devices. Because the inverter characteristics are simple, there are a few problems.
- 72 **Don't get burned!** Watch the heat when testing IC voltage regulators, or your results may not match the manufacturer's specifications.
- 76 **The easy way to match impedances:** The Mac Chart provides approximate element values for commonly used designs without tedious calculations.
- 80 **Ideas for Design:** Single diode extends duty-cycle range of astable circuit built with timer IC . . . D/a converter design modification permits operation over a specified output range . . . Series SCR lamp flasher operates with a wide range of loads.

PRODUCTS

- 87 **Instrumentation:** 4-1/2-digit DMM resolves 1 μ V on signals to 20 mV.
- 88 **Instrumentation:** 14-bit conversion with sign in 1 μ s given by a/d unit.
- 90 **Instrumentation:** Single-slope conversion makes cool, tough DPM.
- 94 **ICs & Semiconductors:** Four-bit microprocessor cycles instructions in 5 μ s.
- 97 **Microwaves & Lasers**
- 99 **Data Processing**
- 102 **Modules & Subassemblies**
- 104 **Components**

Departments

- 47 **Editorial:** How exact is engineering?
- 7 **Across the Desk**
- 106 **Evaluation Samples**
- 107 **Application Notes**
- 108 **New Literature**
- 112 **Advertisers' Index**
- 114 **Product Index**
- 114 **Information Retrieval Card**

Cover: Photo by Art Director, Bill Kelly—Connectors courtesy of AMP, Inc.; Amphenol Industrial Div. of Bunker Ramo Corp.; Augat, Inc.; Burndy Corp.; Cinch Mfg. Co., Div. of TRW, Inc.; Continental Connector Corp.; Elco Corp.; ITT Cannon Electric, Div. of ITT Corp.; Molex, Inc.; 3M Co.; Teradyne Components; Texas Instruments Inc.; Winchester Electronics Group.

**The world didn't
need another
darned-good-and-expensive
rack and panel connector.**

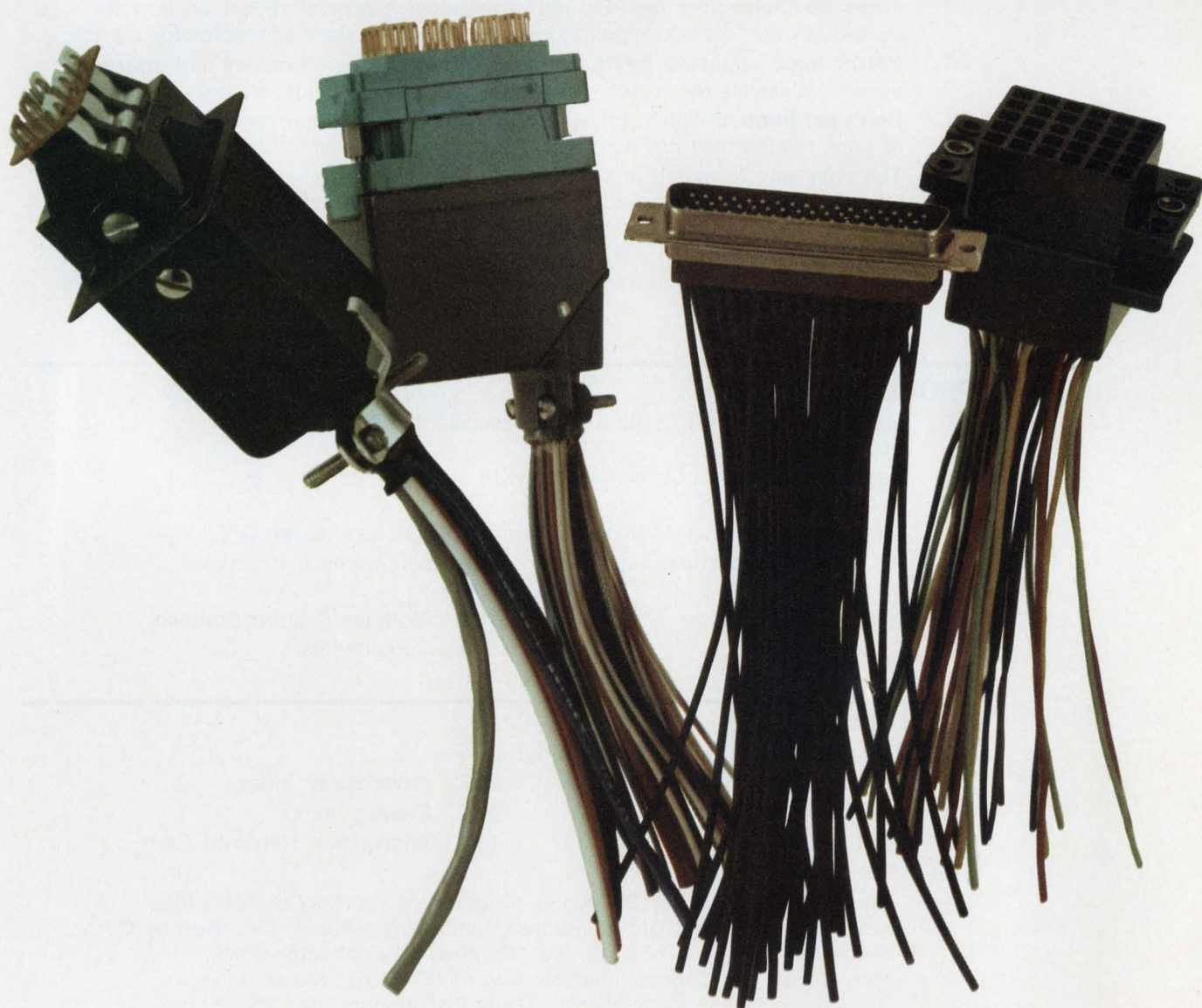

So we came up with a darned good one that costs you about 25% less.

If you still live in a "let's-go-first-class-and-hang-the-expense" kind of world, you may not need us. But if you live in today's world, read on, rejoice and return the coupon below. For several good reasons:

WE'VE GOT A DARNED GOOD NEW CONNECTOR

It's UL recognized. The glass-filled nylon insulator block is moisture resistant. Contacts are recessed, both in the male and female contact housings. It provides positive cable strain relief.

Our Tuning-Fork type contact has two important things going for it: low electrical resistance and little change in contact pressure over the specified contact life.



WE'VE GOT PROOF

Excellent contact alignment was maintained through 500 insertion-withdrawal cycles and no "scooping" action took place. The forces show a gradual increase over 500 cycles caused by plating abrasion.

Take a look at these results computed from more than 100 hours on our Instron testing machine:

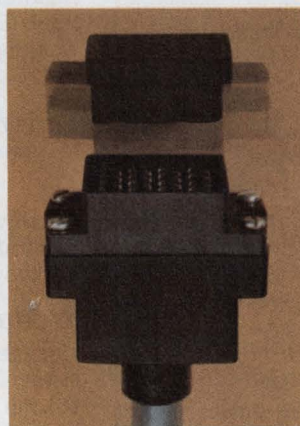

CONTACT INSERTION AND WITHDRAWAL
(Cadmium Plating)
First Cycle 100 Cycles 500 Cycles

Contact No.	Insertion (oz.)	Withdrawal (oz.)	Insertion (oz.)	Withdrawal (oz.)	Insertion (oz.)	Withdrawal (oz.)
1	6.9	5.3	8.1	6.4	9.2	6.5
2	7.2	4.5	7.8	6.0	8.9	6.6
3	7.1	5.1	8.0	5.4	9.2	6.0
4	6.5	4.7	7.8	5.4	8.6	5.3
5	7.4	5.4	7.9	5.9	8.9	6.5
Averages	7.0	5.0	7.9	5.8	9.0	6.2

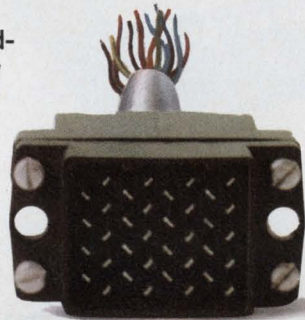

WE'VE GOT WHAT IT TAKES

Technical experience. True, we're new in multi-pin connectors. But we're old hat at making other types. We make JCM miniature coaxial connectors, for example — which are a lot more demanding and sophisticated from both an engineering and production point of view.

WE'RE AS GOOD BUT LESS EXPENSIVE

Of course, we want you to check it all out for yourself. So ask us about a free sample along with all its specifications.

Specs such as:

- Voltage Rating (adjacent contacts)250 VRMS
- Flashover Voltage1000 VDC
- Current Rating (con't max/ckt)3 amp
- Contact Resistance (typical)0.003 ohms
- Insulation Resistance5000 megohms
- Insertion Force*6 oz. min./12 oz. max.
- Withdrawal Force*5 oz. min./10 oz. max.
- Cycle Life500 min.

*Per contact



E. F. JOHNSON COMPANY
WASECA, MINNESOTA 56093

- Please send literature, price and test data.
 Yes, I'm interested in evaluating a test sample.
 Call me at: _____

Name _____ Phone _____

Title _____

Firm _____

Address _____

City _____ State _____ Zip _____

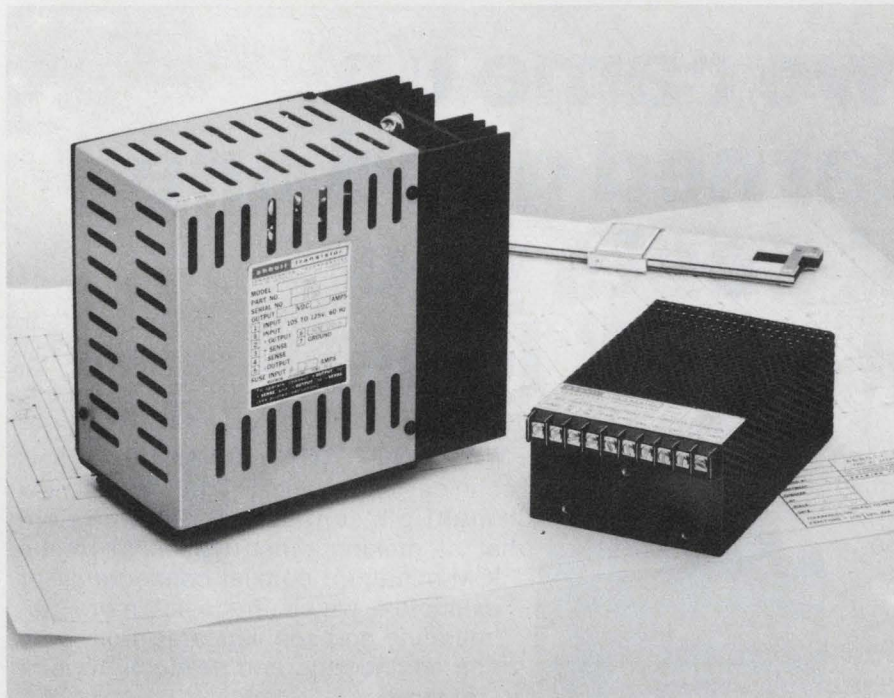

Reduce Your Power Supply Size and Weight By 70% for \$49

A new way has been found to substantially reduce power supply size and weight. Consider the large power supply shown at left in the above photo — it uses an input transformer, into a bridge rectifier, to convert 60 Hz to 5 volts DC at 5 amperes. This unit measures 6½"x4"x7½" and weighs 13 pounds. It sells for \$170 in small quantities. For just \$49.00 more, Abbott's new model Z5T10, shown at right, provides the same performance with 70% less weight and volume. It measures only 2¼"x4"x6" and weighs just 3 pounds.

This size reduction in the Model Z5T10 is primarily accomplished by eliminating the large input transformer and instead using high voltage, high efficiency, DC to DC conversion circuits. Abbott engineers have been able to control the output ripple to less than 0.02% RMS or 50 millivolts peak-to-peak

maximum. This design approach also allows the unit to operate from 100 to 132 Volts RMS and 47 to 440 Hertz. Close regulation of 0.15% and a typical temperature coefficient of 0.01% per degree Centigrade are some of its many outstanding features. This new Model "Z" series is available in output voltages of 2.7 to 31 VDC in 9 days from receipt of order.

Abbott also manufactures 3,000 other models of power supplies with output voltages from 5 to 740 VDC and with output currents from 2 milliamps to 20 amps. They are all listed with prices in the new Abbott catalog with various inputs:

- 60 AC to DC, Regulated
- 400 AC to DC, Regulated
- 28 VDC to DC, Regulated
- 28 VDC to 400 AC , 1 ϕ
- 24 VDC to 60 AC , 1 ϕ

Please see pages 618 to 632 of your 1971-72 EEM (ELECTRONIC ENGINEERS MASTER Catalog) for complete information on Abbott modules.

Send for our new 56 page FREE catalog.

abbott transistor

LABORATORIES, INCORPORATED
general offices eastern office

5200 W. Jefferson Blvd./Los Angeles 90016
(213) 936-8185 Telex: 69-1398

1224 Anderson Ave./Fort Lee, N.J. 07024
(201) 224-6900 Telex: 13-5332

INFORMATION RETRIEVAL NUMBER 5

Vice President, Publisher

Peter Coley

Editors

Editorial Offices
50 Essex St.
Rochelle Park, N.J. 07662
(201) 843-0550
TWX: 710-990 5071
Cable: Haydenpubs Rochellepark

Editor-in-Chief: George Rostky

Managing Editors:

Ralph Dobriner
Michael Elphick

Associate Editors:

Jules H. Gilder
Richard Lee Goldberg
Morris Grossman
Seymour T. Levine
John F. Mason
Stanley Runyon
Edward A. Torrero
Richard L. Turmail

Contributing Editor:

Peter N. Budzilovich

Editorial Field Offices

East

Jim McDermott, Eastern Editor
P.O. Box 272
Easthampton, Mass. 01027
(413) 527-3632

West

David N. Kaye, Senior Western Editor
2930 West Imperial Highway
Inglewood, Calif. 90303
(213) 757-0183

Washington

Heather M. David, Bureau Chief
2506 Eye St., N.W.
Washington, D.C. 20037
(202) 338-3470

Editorial Production

Marjorie A. Duffy

Art

Art Director, William Kelly
Richard Luce
Anthony J. Fischetto

Production

Manager, Dollie S. Viebig
Helen De Polo
Maxine Correal
Anne Molfetas

Circulation

Manager, Nancy L. Merritt
Ron Deramo

Information Retrieval

Peggy Long

Promotion

Manager, Jeffrey A. Weiner
Karen Kerrigan

Market Research

Director, Seymour Brines

across the desk

Job security and pay draw fire and ire

I have just finished reading your article "Engineering Jobs: What, Why and Where" (ED 1, Jan. 4, 1973, p. 68). I am quite perturbed. Why is it that everybody always talks about an engineering shortage and uses all types of statistics to support this shortage, when in reality there are plenty of engineers available, especially those over 40 or 45? You keep harping on engineering graduates and how good the future market will be for the engineering graduate. What you mean is how the engineering market will be for the engineering graduate for the first five to 10 years after graduation. What about after that?

We have some very basic problems in engineering that no one seems to be solving—namely, maintaining capability in a fast-moving, dynamic profession and maintaining long-term employment. Come to think of it, I even question the term "profession." As someone once remarked, "A professional is an individual who has a large say in determining his destiny." Such is not the case for "employed" engineers. Doctors are professionals, lawyers are professionals, but engineers—I have to laugh. We are like cattle bought and sold on the open market.

Name withheld on request

I must take issue with your article on engineering jobs. The figures you cite may lead you to infer that everything is coming up roses; however, I find the implications horrible. The past two years have shown us that engineer-

ing is a poor employment-security profession, yet the compensations offered to people in the field are low indeed.

Take, for example, these figures from your article: an MSEE, \$13.5-k; a project engineer, \$12-k; a lab manager, \$16-k. At this rate a construction worker makes up to twice what a graduate engineer earns (after the latter gives up a minimum of four years of earnings and pays out as much as \$10-k toward tuition and books). Then look at engineers with advanced degrees. Your article lists only one company out of 21 offering over \$20-k to any engineer, while a physician or a lawyer at the same educational level can expect to earn in excess of \$30-k, with a ceiling in some pathological cases of \$500-k.

In view of this, I do not find the future all that rosy. As long as engineers can look forward to relatively low salaries, high risks and pension plans that disappear along with their jobs, I think their future looks downright bleak.

Dr. R. S. Perloff

Senior Project Engineer

Hickok Electrical Instrument Co.
10514 Dupont Ave.
Cleveland, Ohio 44108

Just switch the resistors

The author and some readers have pointed out an error in the Idea for Design "Self-Stabilized Zener Insures Constant Current in Op-amp Voltage Reference" (ED 26, Dec. 21, 1972, p. 66). The author, Leonard Accardi, accidentally transposed the values for R_t and R_i .

Electronic Design welcomes the opinions of its readers on the issues raised in the magazine's editorial columns. Address letters to Managing Editor, Electronic Design, 50 Essex St. Rochelle Park, N. J. 07662. Try to keep letters under 200 words. Letters must be signed. Names will be withheld on request.

THIN-TRIM[®] CAPACITORS FOR HYBRID-CIRCUIT DESIGNERS



ACTUAL SIZE



THIN-TRIM capacitors are a new development in miniaturized variable capacitors for application in circuits where size and performance is critical. The Thin-Trim concept provides a variable device to hybrid circuit designers which replaces fixed tuning techniques and cut and try methods of adjustment.

FEATURES

- Low profile for HYBRID CIRCUIT applications.
- High capacity values for BROADBAND applications.
- High Q - low capacity values for MICROWAVE applications.

U.S. Patent 3,701,932

Johanson

MANUFACTURING CORPORATION

ROCKAWAY VALLEY ROAD
BOONTON, N.J. 07005
PHONE (201) 334-2676
TWX 710-987-8367

Centralab perspectives

FOR USERS OF ELECTRONIC COMPONENTS

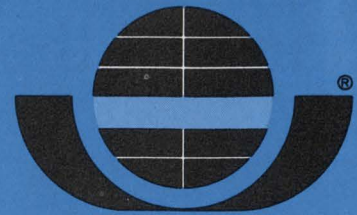

CENTRALAB

Electronics Division
GLOBE-UNION INC.

5757 NORTH GREEN BAY AVENUE
MILWAUKEE, WISCONSIN 53201

This new generation of push button switches saves more than money.

Designers are discovering the new configurations of Centralab push button switches deliver all the functions of most conventional types, but in half the space and at 1/10th the cost per pole or less.

Can a domestic producer of push button switches compete with imports? Centralab customers will answer with a resounding yes!

Centralab spokesmen readily admit their automated process of manufacture makes Centralab push button switches prudent choices on a competitive basis vs. both imported

and other U.S. types. They hasten to add, however, that prompt availability, a reliable sampling service, and unique design are equally important advantages over imports.

Sophisticated users are looking into Centralab's new generation of push button switches because they require so little space — highly im-

portant considerations in aircraft instrumentation, computers and oscilloscopes, for example. The fact that the terminal pins interface with printed circuit boards (optionally available with selective pin cutting or solder lug terminations) simplifies installation.

As for functions, Centralab push button switches feature momentary, push-push, and push-pull actions. Standard interlock with 4 optional lockouts are offered for ganged assemblies. The switches can also be horizontally or vertically ganged, rear coupled, or coupled back to back allowing 16 poles to be operated by a single button. And as an example of versatility, Centralab push button switches can be coupled to a potentiometer.

Centralab can lay claim to several other unique product properties, such as gold contacts and terminals, especially important in dry circuitry. Similarly, Centralab provides diallyl phthalate for the highest possible insulation resistance, as well as phenolic or glass alkyd.

Other salient features of the line include epoxy sealed terminals to preclude flux penetration. Up to 29 individual modules can be ganged on a common bracket with optional module spacing of 10, 12.5, 15, 17.5, and 20mm. You can choose from a wide range of button colors, sizes, shapes and legends. Both lighted and non-lighted types are available. The line switch can be gang mounted with or without interlock and is interchangeable with other modules in any position.

Why not consider Centralab push button switches in your upcoming applications by requesting samples. Write Centralab for complete information.

*Isostat licensed.

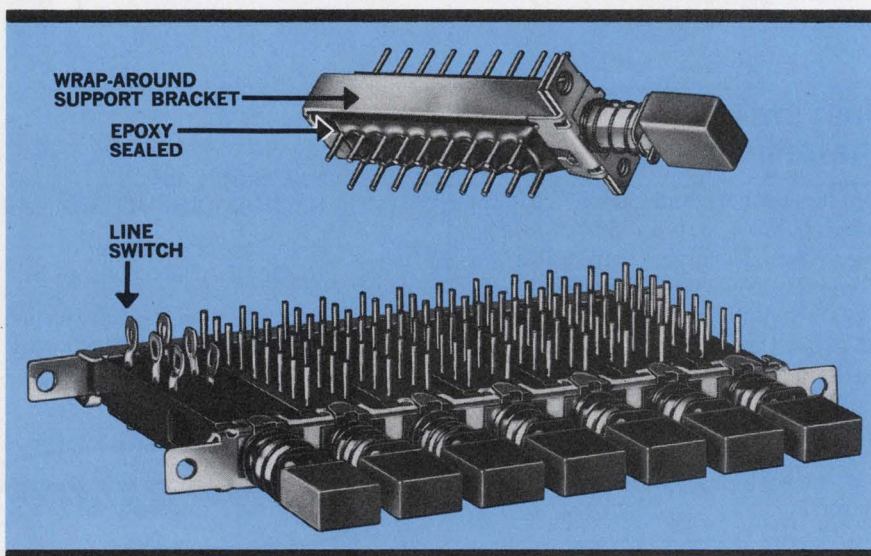

Centralab push button switches* are available as single modules (wrap-around support bracket optional) or as ganged assemblies. They are rated .45 Amp at 115 VAC or 1 Amp at 28 VAC. Other options include epoxy seal and modular size line switches.

Centralab perspective:

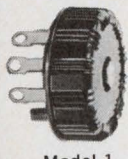

Model 1

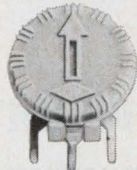

Model 9

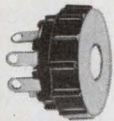

Model 6



Model 8

Actual size

Miniature pots at a mini-price.

Centralab gives you more to choose from in miniature potentiometers. Take the $\frac{1}{8}$ watt, $45/64$ " dia. **Model 9** for example. Typical pricing, in production quantities of 1000, is 34¢. That's economy because you also get:

- Rotational life in excess of 25,000 cycles.
- Choice of mountings — perpendicular or parallel plug-in.
- Resistance Range — 100 ohms to 10 megohms.
- Adjustability — Knob edge or screwdriver slot.
- Tolerance — $\pm 20\%$

For quantities under 250 contact your local Centralab Distributor.

Three other miniature potentiometers in the Centralab line of standard controls are:

- **Model 1** — $\frac{5}{8}$ " dia. $\frac{1}{8}$ watt (Available with switch)
- **Model 6** — $\frac{1}{2}$ " dia. $1/10$ watt (Available with switch)
- **Model 8** — $9/32$ " dia. $1/10$ watt

Get complete specifications on all four. Write Centralab for Bulletin No. EP2184.



Centralab perspective:

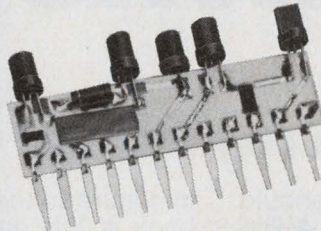

Two thick film hybrid systems. PEC and MEC.

Centralab offers the flexibility to design and fabricate thick film modules to fit virtually any application and cost parameter.

Low-cost silver/carbon or **PEC**® systems for consumer applications:

- Resistor Range. 10 ohms to 10 megohms
- Resistor Tolerance. $\pm 10\%$, preferred minimum
- Ratio Matching. $\pm 5\%$, minimum
- Capacitor Types. Ceramic and tantalum
- Active Devices. Diodes, transistors & IC's
- Operating Temp. Range. -55°C to $+85^{\circ}\text{C}$

Noble metal/cermet or **MEC** systems for commercial and industrial uses:

- Resistor Range. 3 ohms to 3 megohms
- Resistor Tolerance. $\pm 5\%$, minimum
- Ratio Matching. $\pm 1\%$, minimum
- Capacitor Types. Ceramic and tantalum
- Active Devices. Diodes, transistors & IC's
- Operating Temp. Range. -55°C to $+150^{\circ}\text{C}$

For more information write A. R. Wartchow, Marketing Manager, Electroceramic Products. Or ask for Centralab Bulletin No. 1429H.



Centralab perspective:

9 AMP-115 VAC-RMS power switches. Heavy-duty flexibility.

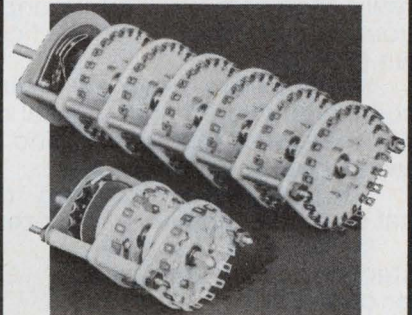

These heavy-duty rotary power switches offer high standards of accuracy, long life, flexibility of switching configurations — all at low cost. They meet all engineering requirements for use in transmitters, industrial controls, laboratory test equipment and many other special applications. Features include:

- **Positions and throw** —
15° throw up to 24 positions
30° throw up to 12 positions (Fixed stop)
20° throw up to 18 positions
40° throw up to 9 positions (Adjustable stop option)
- **Current and voltage rating** — make and break resistive load:
9 amp. @ 115 VAC-RMS; 30 amp. @ 5 VDC.
- **Contact resistance** — Average initial 7 milliohms.
- **Insulation** — ceramic, grade L-422 per MIL-1-10A.
- **Rotational life** — 25,000 cycles minimum.

See your Centralab Distributor or write Centralab for Bulletin No. 1562S.



Cannon really packs 'em in.

High Density Microminiature Connectors.

When you're talking high density you should be talking to ITT Cannon. MDM Coax, Nano, MDM Rectangular, Micro-K,* 50-MIL Strips, Center Jack Screw—they give you performance's worth as well as your money's worth in contact centers from .100" down to .025"

MDM Coax. Rugged environmental series. Layouts with two 50 ohm coaxial contacts and five D.C. contacts, or four coaxial and 20 D.C. contacts. Several new layouts in design.

MDM Series. Rugged, moisture-sealed metal shell rectangulars—in 7 sizes.

MICRO-K. 7 and 55 contact microminiature circular connectors.

50-MIL STRIPS. Low profile, lightweight strips up to 6 inches long with 120 contacts on .050" centers.

NANO. Mini-micro-

miniature connectors with contacts on .025" centers. Look at this one when .050" spacing is not good enough. Available in strip form now and in circulars and rectangulars soon.

CENTER JACK SCREW. 4 layouts available in multiple row strip configurations. Ask us about your special requirement.

We produce more types, shapes and sizes of microminiatures than anyone. That's why we really stand out in the design and production of special microminiature configurations. So whatever you're looking for, standards or special designs, contact Cannon. We're the heavyweights in lightweight microminiatures.

ITT Cannon Electric,
International Telephone
and Telegraph Corporation,
666 East Dyer Road,
Santa Ana, Calif. 92702.
(714) 557-4700.

CANNON ITT

INFORMATION RETRIEVAL NUMBER 8

*Licensed by New Twist





**Uniform
resistors
reduce
costs.**

**If you're really
serious about cost,
be serious about quality.**

That could be money in your pocket. Allen-Bradley's exclusive hot molding process offers physical consistency that can reduce your installation costs. Bodies are a uniform size with clean squared ends, free from coatings which adversely affect automatic handling equipment. Lead

lengths and diameters are precise. Resistors with uniform physical characteristics, accurately placed on tape reels, eliminate insertion machine jam-ups. And trouble free assembly means less production down-time; lower cost. That's A-B quality. Consistent shipment after shipment. If

you think all resistors are the same, send for our free booklet, "7 ways to tell the difference in fixed resistors." Allen-Bradley Electronics Div., 1201 S. 2nd St., Milwaukee, WI 53204. Export: Bloomfield, NJ 07003. Canada: Allen-Bradley Canada Ltd., Galt, Ont. U. K.: Jarrow, Co. Durham NE32 3EN.



Allen-Bradley
Milwaukee, Wisconsin 53204

Get an original for the price of a copy.

A lot of imitations have come along since MICRO SWITCH introduced its low-cost line of DM pushbuttons.

Our price is still tough to beat. And so is our package of features.

There's ease of installation.

Snap-in mounting eliminates the use of tools. Quick-connect terminals simplify wiring.

There's versatility.

A wide choice of circuitry. Buttons in several styles and colors. Lighted or unlighted displays. Colored faceplates. Momentary, push-pull maintained, pull-to-cheat and a two-level alternate action (visually tells what mode you're in).

There's reliability.

Rugged construction plus a corrosion-resistant plunger and case. Our time-proven snap-action switch. A high electrical capacity (UL and CSA listed at 10 amps., 1/3 hp; 125 or 250 vac).

For more information, contact your MICRO SWITCH Branch Office or Authorized Distributor (Yellow Pages, "Switches, Electric"). The help they can provide is another feature our imitators have never been able to beat.

MICRO SWITCH makes your ideas work.

MICRO SWITCH

FREEPORT, ILLINOIS 61032
A DIVISION OF HONEYWELL



MICRO SWITCH products are available worldwide through Honeywell International.



MULTI-CHANNEL GRAPHIC DISPLAY SYSTEMS

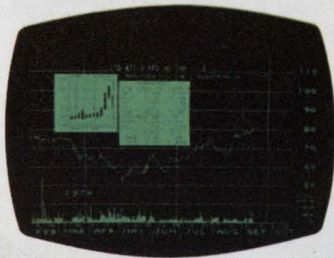

MULTI-TERMINAL SYSTEMS

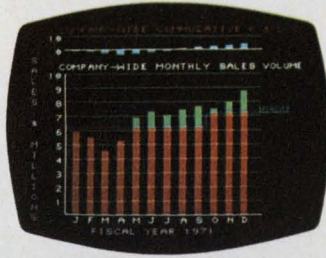
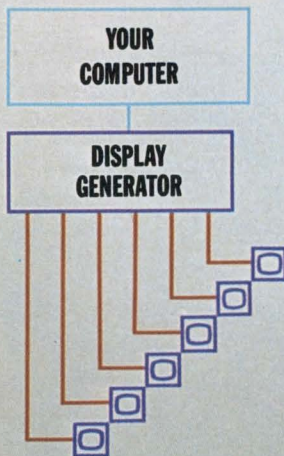

COLOR OR GRAY SCALE DISPLAY

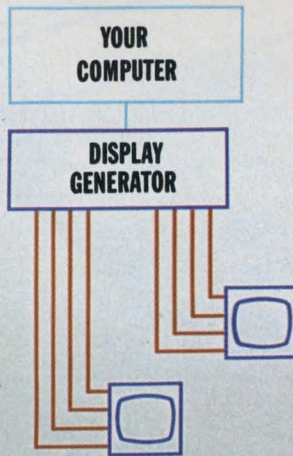

FORM OVERLAY DISPLAY

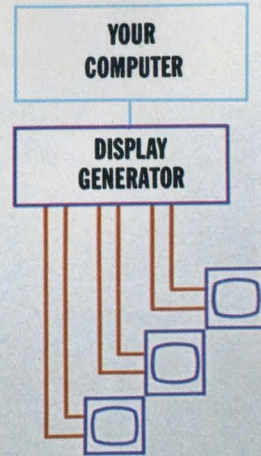

Choose one from column A, two from column B

Or choose all from column C, or . . .

Because this is a multichannel graphic display system, you can choose most any combination you wish. And like a Chinese dinner, any way you order it, you get an excellent buy.

This system uses a common display generator and a disc memory refresh to drive up to 16 independent, high resolution channels.

For **multiterminal applications**, use each channel to drive a low cost, daylight viewable TV monitor. Cost for a 16 terminal monochrome system, complete with 14" monitors, keyboards, and typical computer interface, works out to just under \$4000/terminal.

If you want **color or gray scale displays**, just combine channels. Two channels give you three colors and black; four channels give you 16 colors plus

black. And for a full color display (4095 levels) use twelve channels. Color can make even the most complex graphics understandable.

You can also use **multiple channels for convenience in editing or data entry**. Put a standard grid or form on one channel, your graph or data on another. Then superimpose the channels on a single display monitor. Because you don't have to regenerate the grid when you change the data, you can have more efficient software.

These systems have all the capability you need for most applications—there are over ¼ million individually addressable points in the graphic display. You can selectively erase any rectangular area of the screen; write up to 51 lines of 85 alphanumeric characters. And because the displays are disc re-

freshed, the CPU need generate each display only once.

So think of the multichannel display system when you need computer graphics. Call your Data Disc representative for more information, or contact us at 686 West Maude Avenue, Sunnyvale, California 94086; 408 / 732-7330.

And for dessert, have a fortune cookie.



One part in 10 million from 0° to 55°C. Without an oven.

Unlike an oven oscillator, it's smaller, more reliable, uses less power, needs no warm-up time, and it's not as expensive. The K1098A TCXO has TTL compatible output, $\pm 1 \times 10^{-9}$ /sec. rms short term stability, operates from 5 and 12VDC. Prototype quantities available at 10MHz for immediate delivery. Full details from Motorola Component Products Dept., 4545 W. Augusta Blvd., Chicago, Ill. 60651.  **MOTOROLA**

INFORMATION RETRIEVAL NUMBER 12



“Scotchflex” Flat Cable Connector System makes 50 connections at a time.

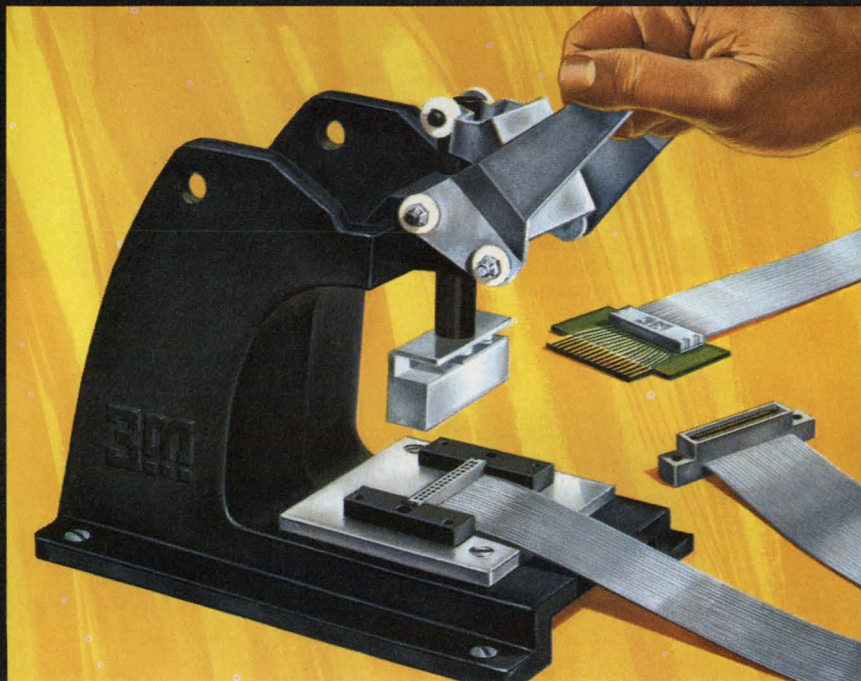

“SCOTCHFLEX” IS A REGISTERED TRADEMARK OF 3M CO.

Build assembly cost savings into your electronics package with “Scotchflex” flat cable and connectors. These fast, simple systems make simultaneous multiple connections in seconds without stripping or soldering. Equipment investment is minimal; there’s no need for special training. The inexpensive assembly press, shown above, crimps connections tightly, operates easily and assures error free wiring.

Reliability is built in, too, with “Scotchflex” interconnects. Inside of connector bodies, unique U-contacts strip through flat cable insulation, grip each conductor for dependable gas-tight connections.

“Scotchflex” offers you design freedom, with a wide choice of cable and connectors. From off-the-shelf stock you can choose: 14 to 50-conductor cables. Connectors to interface with standard DIP sockets, wrap posts on standard grid patterns, printed circuit boards. Headers for de-pluggable connection between cable jumpers and PCB. Custom assemblies are also available on request.

For more information, write Dept. EAH-1, 3M Center, St. Paul, Minn. 55101.

3M COMPANY
“Scotchflex”.
**Your systems approach
to circuitry.**

INFORMATION RETRIEVAL NUMBER 13

displays are
on our side.



cmos...

FROM SOLID STATE SCIENTIFIC

IC's you can count on — the power and drive behind the new numbers that are lighting up today's living! That's SOLID STATE SCIENTIFIC — a leader when it comes to supplying CMOS for display applications.

We're there — ready when you want to show your stuff — in the watches of the seventies, either liquid crystal or LED. For calculating, counting, decoding and interfacing — our 4000 series. And the latest addition, CMOS logic combined with bipolar outputs on a single chip — to deliver that extra drive necessary for a direct interface with LED.

Numbers — on display — in calculators, counters, volt meters, clocks, watches and all the new and varied designs you're coming up with — SOLID STATE SCIENTIFIC. When it all adds up — displays are on our side!

SOLID STATE SCIENTIFIC, INC.

Montgomeryville, Pa. 18936 • (215) 855-8400 • TWX-510-661-7269



INFORMATION RETRIEVAL NUMBER 14

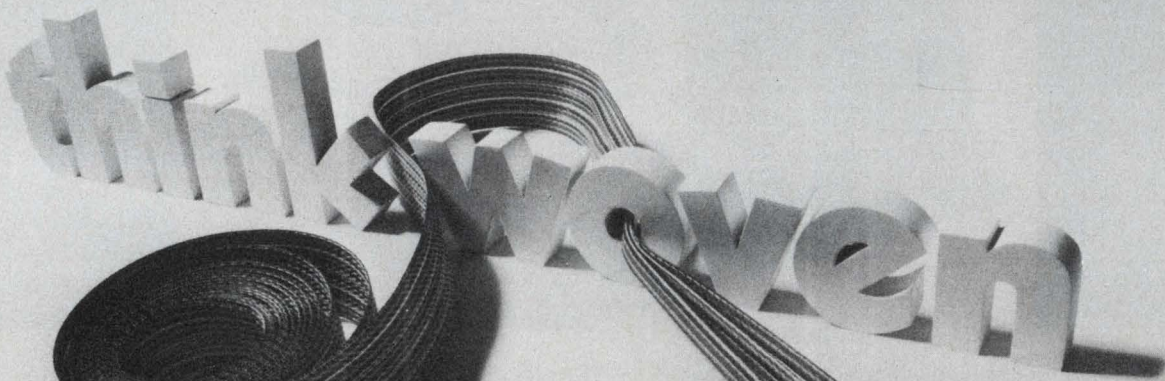

Seen our folder?

What's low and flat, then neat and narrowly stacked? You got it. Flat woven cable with woven-in fold lines. One of the handiest cable-bilities introduced since interconnects went slim.

WOVEN ELECTRONICS

P.O. Box 189, Mauldin, South Carolina 29662

INFORMATION RETRIEVAL NUMBER 15



**How to
repackage
your system
with greater ease,
lower cost and
complete pluggability.**

Change over to the new interconnection system that makes it easy — and economical — to redesign or modify any pc package configuration by simply repositioning existing mother/daughter boards. AMP has the system.

AMP Commercial Interconnection System.

The lower-cost interconnection system with high reliability.

Just three basic styles of connector housings, each preloaded with specially designed receptacles and ready to solder to mother or daughter boards. And two types of easy-to-insert posts that ensure positive electrical contact any way your interconnection system requirements dictate...from top, bottom or side. Board-to-board configurations are practically unlimited. And, when you need to change pc package design... just change your choice of connector/post combinations. This advanced concept in printed circuit interconnection offers the ultimate in versatility and reliability for the cost-conscious systems designer.

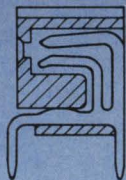

Cross section of side entry connector.

Pre-assembled housings for 2 to 16 circuits.

Design flexibility—and economy—begins with the wide range of connector sizes available for top, side or bottom entry. From 2 to 16 circuits can be interconnected with completely pre-assembled female housings made of flame retardant SE-O Melamid, UL approved. No costly tooling time is required to mount contacts in the housings. Housing design provides for wide tolerance of contact misalignment to assure correct post/receptacle mating and remating.

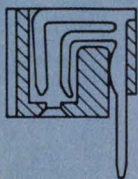

Cross section of bottom entry connector.

High-pressure, self-cleaning contacts on .100 and .150-inch centers.

Contacts are reliable fork-type, for positive retention of posts with controlled pressure to maintain strong metal-to-metal contact under the most adverse service conditions. The long travel area of the post provides self-cleaning wiping action for assured electrical continuity where applications call for frequent

circuit removal and reconnection. Contacts are brass with bright tin-

for excellent

and gold plated contacts are also available.

Spacing may be on .100-inch centers in the receptacle housing for 2 to 16 circuits, or .150-inch centers for sizes up to 11 circuits. Connector housings and crimp-type receptacles can also be supplied for wire-to-board

connections.

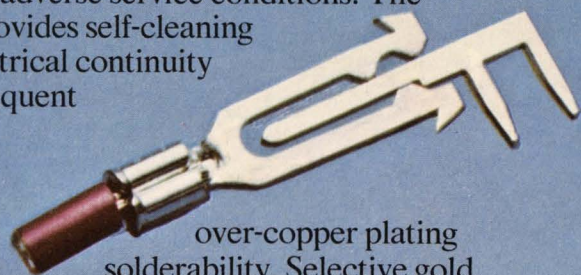

over-copper plating solderability. Selective gold

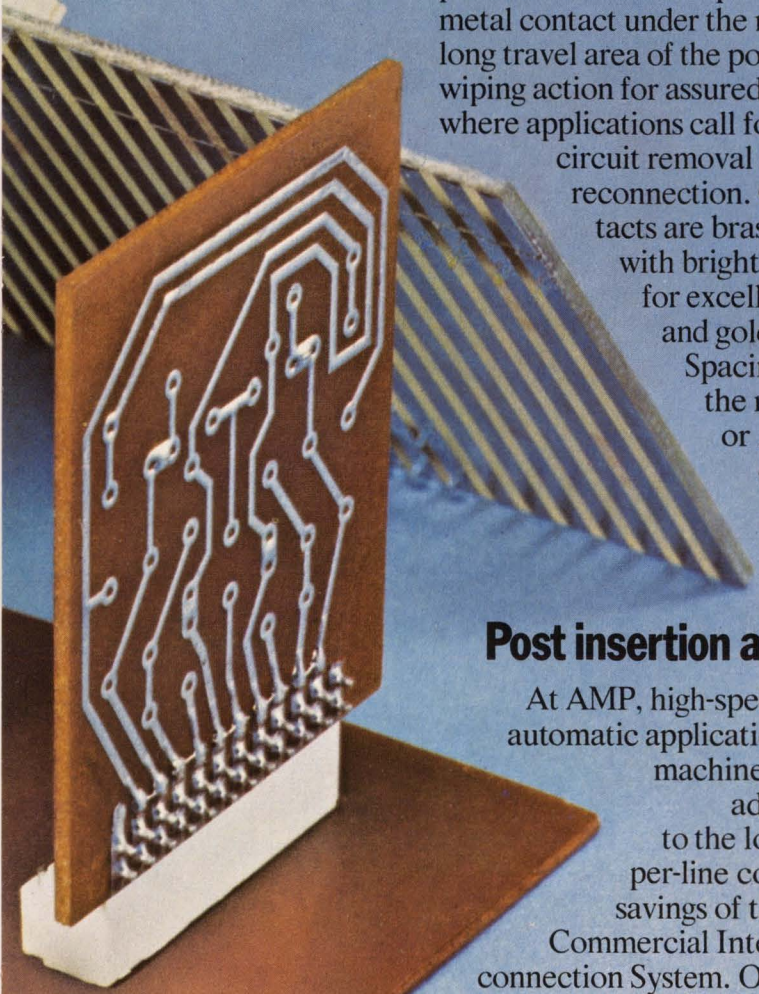

Post insertion at speeds up to 4,000 per hour.

At AMP, high-speed automatic application machinery adds to the low

per-line cost savings of the

Commercial Interconnection System. Our

bench mounted Post Insertion Machine can insert posts into predrilled pc boards .062 to .125-inch thick, in virtually any pattern...and at speeds up to 4000 insertions an

hour. For automatic machine application, posts are

supplied in continuous strip form on reels. Posts

can also be furnished on polyethylene extruded

strip for gang insertion into boards, without an applicator.

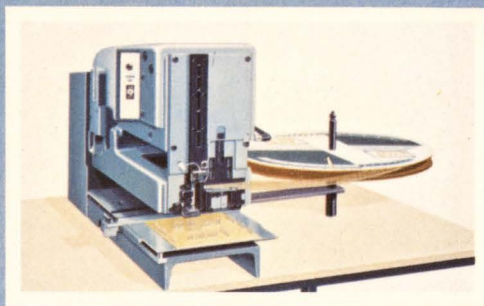

Cross section of top entry connector.

Tested and proven for low-voltage modular systems.

As a result of extensive testing, AMP specialists have shown that no insulating film thickness greater than one atom can develop between the receptacle and mating posts in the Commercial Interconnection System. There is, therefore, no minimum voltage at which the interconnections cannot operate. If your design takes you into the "dry-circuit" range, we welcome the opportunity to discuss our test results with you.

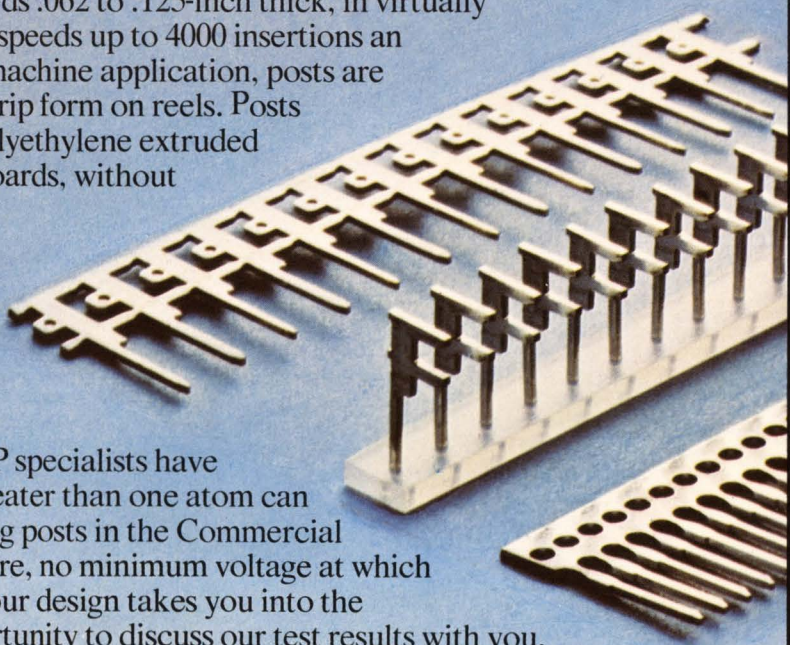

Special kits for designers.

See for yourself the unusual design versatility of our Commercial Interconnection System. Special kits assembled by AMP contain all the system components required for prototype design. Each kit contains 10-circuit connector housings for top, bottom and side entry—a total of ninety housing assemblies—*together with easy-to-insert F-posts and straight posts. In addition, crimp-type housings and crimp receptacles are provided for wire-to-board interconnection. The complete kit is available with contacts on either .100- or .150-inch centers, as desired. For complete information, specifications and prices on the kit, write to AMP, "CIS Kit."*



An AMP Sales Engineer will also arrange for you to see a demonstration of the Commercial Interconnection System, and other AMP products, at one of our strategically located AMP Economation rooms...or have our special AMP Economation van visit your plant.

Complete system distribution and engineering backup... worldwide.

Commercial Interconnection System products are designed and made to international standards. System components produced in our network of plants in the United States, are duplicated by those made at AMP plant locations and distribution facilities throughout the world. You'll find AMP in Barcelona, Brussels, Buenos Aires, Frankfurt, London, Mexico City, Paris, Puerto Rico, Sao Paulo, s'Hertogenbosch (Holland), Sydney, Stockholm, Tokyo, Toronto, Turin and Vienna.

And where you find AMP, you'll also find AMP customer service specialists. More than 700 highly qualified application and sales engineers ready to assist you with design or production problems...anywhere in the world.

For more information on AMP Commercial Interconnection System products, circle bingo number 301. Or write to AMP Industrial Division, Harrisburg, Pa. 17105.

AMP
INCORPORATED

AMP is a trademark of AMP Incorporated.

DATEL Systems has done it again!

Datel Systems' minicomputer-compatible, data acquisition/distribution system solves the problem of on-line/off-line interfacing of analog signals to and from digital computers . . . once and for all.

A reliable and speedy system, it provides you the versatility to mix Analog Multiplexers, A/D's, Sample and Hold amplifiers and D/A's in virtually any configuration. Plug-in cards anticipate your expansion.

The System 256, which utilizes C/MOS (Complimentary Metal Oxide Silicon) logic throughout, uses less power than any unit currently available, yet provides four times the channel capacity . . . up to 256 single ended or 128 differential analog channels, 32 simultaneous sample and hold channels plus up to 32 D/A channels . . . and cost about half as much. Other features include — A/D-D/A Resolution to 14 bits; throughput speeds up to 100kHz.



SYSTEM 256

A Computer Compatible Data Acquisition/Distribution System

FREE 20-page catalog giving specifications and applications on this latest Datel Systems achievement.

name _____
 company _____
 street _____
 city _____ state _____ zip _____
 telephone _____

What more is there to say.
 See us at Booth 2609-2611
 IEEE INTERCOM SHOW.

 **DATEL**
 SYSTEMS, INC.

1020 Turnpike Street, Canton, Ma. 02021
 Phone (617) 828-6395

TWX: 710-348-0135

INFORMATION RETRIEVAL NUMBER 221



Introducing the new, faster Rolm 1602 Ruggednova..the world's toughest computer.

Tough enough to meet Mil Specs E-5400 airborne environment and E-16400 shipboard environment with a more powerful interrupt structure, expanded instruction set, extensive I/O interfaces, proven software and upward compatibility with Data General's Nova Series.



Here is the most complete mil spec computer system you can buy. The heart of the 1602 is a 16-bit, rugged and powerful microprogrammed processor with a 1 microsecond core memory cycle time . . . but the total package is a lot more.

MORE SOFTWARE THAN ANY MIL SPEC COMPUTER

Our licensing agreement with Data General Corporation allows us to provide you with a wide selection of proven and documented software. Any program written on the Nova will operate on the 1602 Ruggednova. Our software set includes assemblers, compilers, debugging aids, utility routines, math libraries and powerful operating systems. And to get your software started immediately, we have a 1602 assembler that runs on the Nova series of machines.



This snow cat carries a Ruggednova interfaced with two radar systems to help map the Canadian glacial fields.

OVER 30 GENERAL-PURPOSE INTERFACES

Most military computers are required to interface with more kinds of devices than any other class of computer. That's why Rolm makes available a wide selection of general purpose I/O interfaces for the 1602. These range from serial and parallel digital interfaces to communication interfaces to D/A and A/D converters . . . all the way to NTDS interfaces. They can give you an edge when you go after those contracts. No design costs. No technical risks.

AN EXPANDED INSTRUCTION SET SAVES YOU TIME

Military applications place more rigorous demands on computer execution time

and memory requirements than do commercial applications. That's why we expanded the 1602 instruction set beyond the basic Data General set. This gives you increased computational and memory reference capabilities plus reduced program storage and execution time. New instruction types include: stack-oriented instructions, exclusive and inclusive "or," n-bit shift capability, signed and unsigned multiply-divide, double precision arithmetic, a powerful new file search instruction and a special interrupt branching and nesting feature.

A UNIQUE APPROACH TO YOUR SPECIAL INTERFACES

The 1602 is designed so that you can place your special interface inside the chassis. We can provide you with I/O cards with room for 42 integrated circuits and 55 pins to connect your interface to the outside world or other cards in the chassis. You don't have to design a rugged chassis or power supply, plus your interface is qualified to Mil E-5400 and Mil E-16400 by similarity. One of our customers followed this approach in totally packaging an Omega Navigation Set within a Ruggednova chassis.

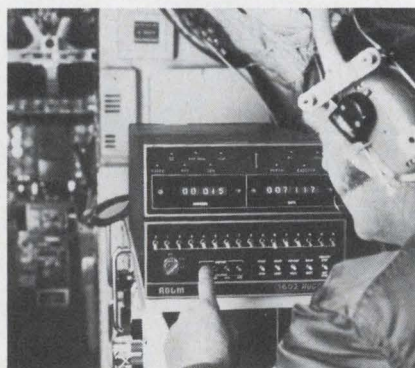

Ruggednova, shown above, is aboard a Sabreliner jet performing data acquisition and navigation functions for atmospheric research.

MEETS MIL SPECS E-5400 AND E-16400

The 1602 has been designed to meet Mil-E-5400 airborne environments, Class II; Mil-E-16400 shipboard environments, Class I; Mil-Std-461A electromagnetic interference and Mil-S-901 for high impact shock. It has an operating temperature range of -55° to $+95^{\circ}\text{C}$ case temperature, at altitudes from sea level to 80,000 feet. It meets shock specifications of 15

g's with 11 ms duration and vibration tests of 10 g's, 5 to 2000 Hz. Then there are the requirements for humidity, sand and dust, salt spray, salt fog and fungus. The 1602 meets or exceeds them all . . . to become the world's toughest computer.

A FULL LINE OF PERIPHERALS

We can provide you with peripheral devices in every major category . . . fully integrated and documented. These include tape and disc storage units, communication interfaces, line printers, and paper tape equipment . . . plus software that enables you to easily use these devices.

PROVEN IN OVER 300 APPLICATIONS

Ruggednovas have been used in over 300 applications in the past 3 years. The software has been used in over 4,000 systems. These range from helicopter transportable communication systems to shipboard fire control to scientific exploration on a snow cat. If it moves, it should be a Ruggednova.

ATTENTION PROGRAM MANAGERS

The Ruggednova is a complete package of hardware and software. Now, let's talk about the support package you get at no cost. These are items which can reduce your budget and design risk at the same time. We can give you detailed reliability reports, provide two weeks of training, supply a complete documentation package and top it off with a 90-day warranty. We also give you a "how to" software manual, individual software write-ups, and full diagnostic software. And you don't have to worry about qualification tests . . . we are doing them for you. All of this adds up to savings and success for your program.

ROLM

CORPORATION

18922 Forge Drive, Cupertino, CA 95014
(408) 257-6440 • TWX 910-338-0247

REGIONAL SALES OFFICES: Los Angeles 213-784-8500; Palo Alto 415-965-2224; Washington, D. C. 301-652-0900; Boston 617-237-5752; New York 914-297-9533.

DOMESTIC REPRESENTATIVES: Kansas 913-362-0919; Minnesota 612-491-5400; Missouri 314-895-4100; Texas 214-233-6809; Washington 206-762-2310.

QIKMATE™ Burndy's new self-mounting rectangular connector block is a real penny pincher. It saves money from the start because it costs less to buy. And its unique, one-piece design saves on installation costs, too.

Install the receptacle with a snap. It quick-locks into a standard punched hole, without screws or nuts. Quick release design lets you remove it with simply a squeeze. The plug and receptacle mate easily and are held together by quick-disconnect latches.

There are no loose pieces to assemble or lose. The quick dis-

connect clasps, pin protection skirt and polarization are all molded into the blocks. And contact hole numbers are molded into both wiring side and mating side for faster, more accurate wiring.

QIKMATE comes in a 6, 12 and 24 circuit model. Consult your Burndy representative for additional configurations. It accommodates the Burndy Trim Trio line. That means it takes coax, machined or strip-formed contacts. Which means it can also cut your costs on stocking and inventory.

Cutting costs is a snap!

 **BURNDY**
Norwalk, Connecticut 06856



BURNDY CONNECTS

International Sales Headquarters & Manufacturing Facilities: Canada/England/Belgium/Mexico/Brazil/Australia/Japan/Sales Offices in Major Cities

INFORMATION RETRIEVAL NUMBER 223

“When Foxboro changed from P.C. boards to Augat panels for FOX 2 process computer systems, we had some doubts about how much development time we would actually save.

“6,000 man-hours convinced us.”

Ben Franklin, Manager, Equipment Product Engineering,
Systems Operations Division, The Foxboro Company

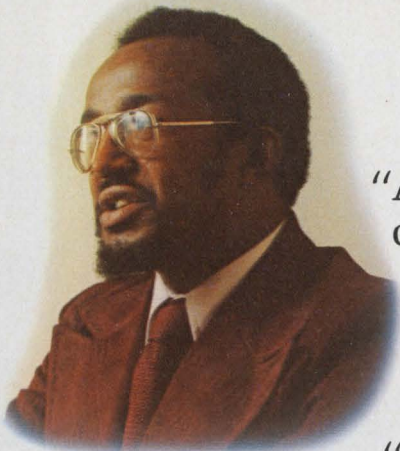

Ben Franklin

"Augat panels provided significant savings in our overall development time, and helped us bring our new FOX 2 process computer systems to the market-place faster. And Augat's precision-machined socket contacts helped us maintain our high standards of reliability.

"Why the change from P.C. boards? P.C. boards inherently have a long development cycle, high development cost and lower initial hardware cost. In the development of the FOX 2 System, the timing was critical to get the system designed and released to the market. By selecting the Augat packaging approach, we shortened the development cycle significantly and minimized the cost of rework with no overall effect on hardware cost.

"But no one likes to gamble with new methods, so our initial evaluation of the Augat system was unusually thorough. We liked what we saw — a good, quality product and a company with lots of experience and a positive attitude towards customer service. Since our past experience with other, less-precision sockets had been comparatively unsatisfactory, we decided to try their wire-wrapped plug-in panels. The results far exceeded our expectations.

"With Augat, we achieved superior modularity, minimum downtime, easier field service, and a system that allows our logic to evolve with the technology. And all this while saving 6,000 man-hours of engineering time. That's not bad."

As you can see, Augat offers you plug-in flexibility allowing component and wiring changes to be made in minutes (saving precious and expensive man-hours), plus tapered-entry sockets and machined contacts that offer unsurpassed reliability.

All of which just might tell you why Augat has become the world's leading producer of wire-wrapped panels and other IC interconnection products. But Augat has more to offer than just hardware. Augat's technical experience is ready to help solve your interconnection requirements.

Call or write to us today. We'll send you our free brochure and complete product information. Augat, Inc., 33 Perry Avenue, Attleboro, Massachusetts 02703. Represented and distributed internationally.



The FOX 2

Plug into Augat. Foxboro did.

You don't need external components with this new IC multiplier!

Here's a small, new IC multiplier which will significantly reduce engineering time, production time and component costs. Burr-Brown's new 4203 multiplier/divider is self-contained, it requires no time-consuming trimming, no additional components. Prior to final packaging, the 4203 is actively laser trimmed and guaranteed to its rated accuracy with no external amplifiers, resistors or pots.

In addition to four-quadrant multiplication, the 4203 also performs division and square-rooting of analog signals. Its fast slew rate and 1 MHz bandwidth are key factors in applications where delay and phase shift need to be minimized. A zener-regulated reference is incorporated to reduce sensitivity to supply voltage variations. The unit is also available with MIL-Std-883 screening.

Burr-Brown also has a variety of other IC and discrete multipliers which offer specific advantages for various applications situations.

MODEL NO. Type	4203K IC	4201J IC	4202B Discrete	4200 Discrete
Total Error (Max) With Trim	—	2%	—	0.1%
Without Trim	1%	—	1%	0.2%
Slew Rate	25V/ μ sec	25V/ μ sec	25V/ μ sec	0.3V/ μ sec
Bandwidth	1 MHz	1 MHz	1 MHz	7 KHz
Package	TO-100	TO-100	module	module
Price, 1-24	\$39.00	\$22.50	\$45.00	\$129.00

FOR COMPLETE INFORMATION, use this publication's reader service card or call Burr-Brown.

BURR-BROWN
RESEARCH CORPORATION
International Airport Industrial Park • Tucson, Arizona 85706
TEL: 602-294-1431 • TWX: 910-952-1111 • CABLE: BBRCORP



CHICAGO OFFICE (312) 832-6520
UNITED KINGDOM OFFICE: Watford WD1 8BY PHONE 33080/30336

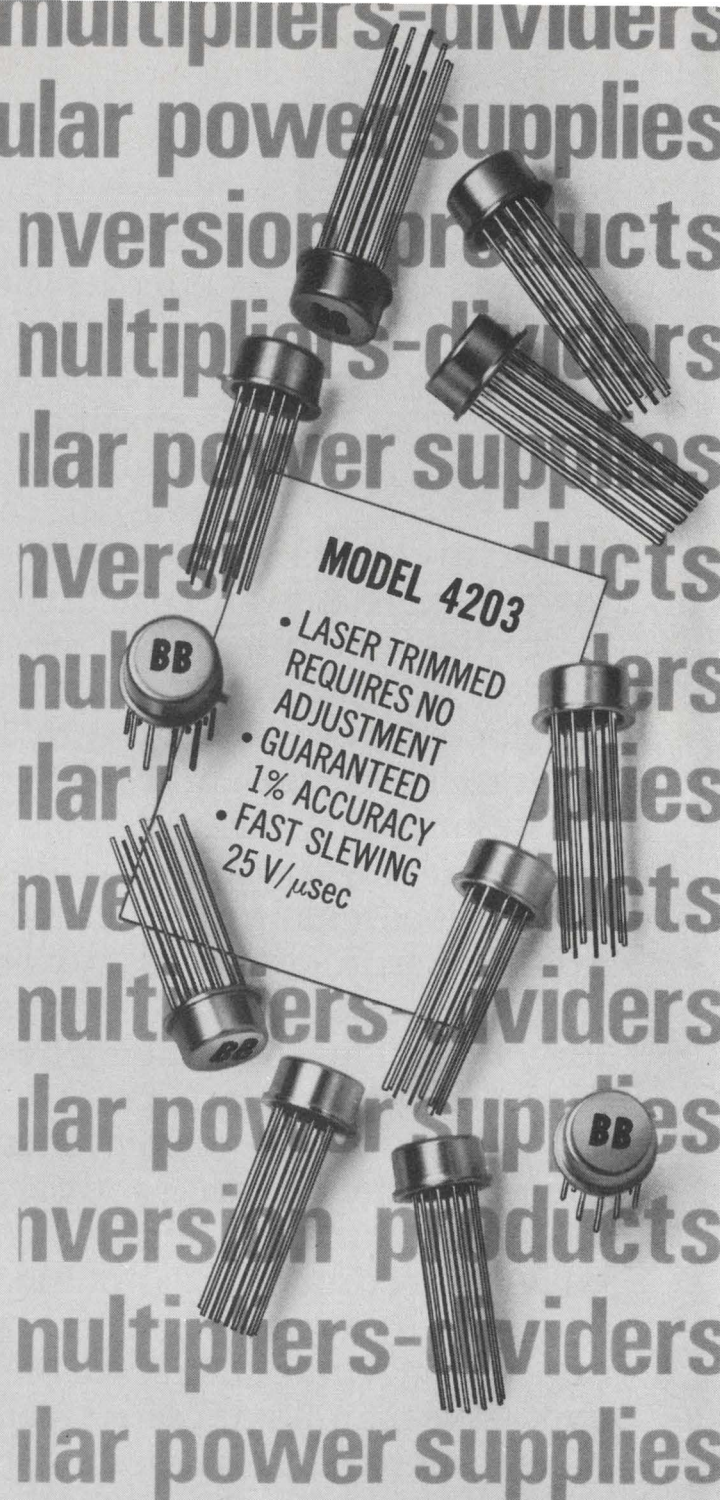

Burr-Brown multipliers deliver what they promise!

If you need
top-quality
panel
instruments
 with a clean,
 modern look...

Buy
Triplett's
Series GL
or GL/B

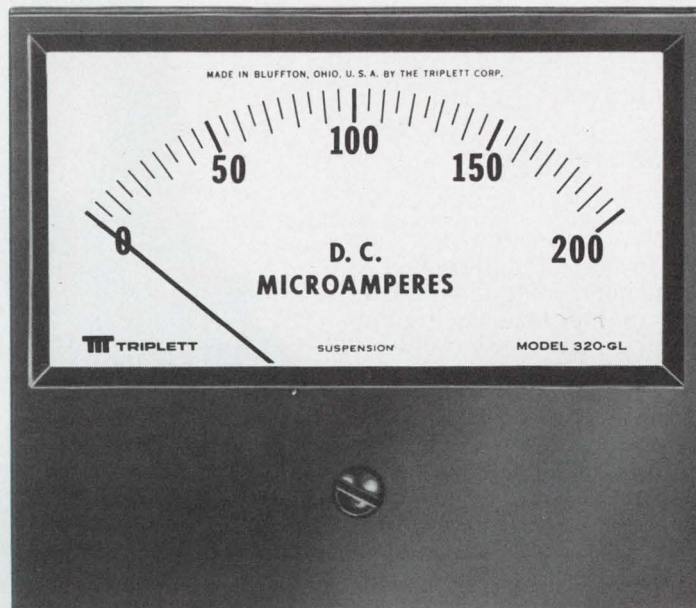

GL

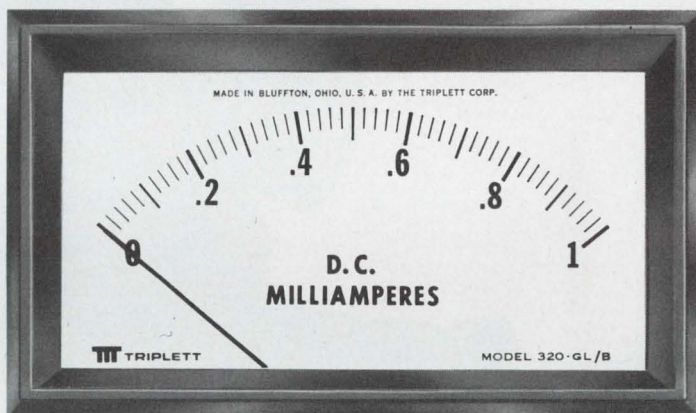

GL/B (mounted appearance)

Triplett's newest panel instruments, the Series GL and GL/B, feature glass windows, matte-finish phenolic cases and a dial design that can readily accommodate multiple scales. They are available in 3½", 4½" and 5½" sizes.

The GL Series features a standard 2-stud mount with 3- and 4-stud mounts available.

The feature of the GL/B Series is behind-the-panel mounting with a bezel which is an integral part of the case.

There's a choice of more than 275 stock sizes and ranges — in DC microammeters, milliammeters, ammeters, millivoltmeters and voltmeters; AC milliammeters, ammeters, and voltmeters; RF thermoammeters; dB meters and VU meters. For those who need special instruments . . . custom dials, pointers, scales, accuracy, tracking, resistance, response time or practically any combination of unusual specs can be put into these new cases. For quick, dependable delivery

of small quantities of these adaptable new instruments, contact your Triplett Sales/Service/Modification Center or distributor. For prototypes or production quantities, contact your Triplett representative. Triplett Corporation, Bluffton, Ohio 45817.

TRIPLETT
 BLUFFTON, OHIO 45817
 Manufacturers of the World's
 most complete line of V-O-M's

Janice.

A nice, quiet, English Girl.

Meet her any day after office hours and you'll find her reading Jane Austen, writing to her mother, listening to good music or setting off on a long country walk. With an enormous dog for bodyguard.

But up to 5 p.m. (West Coast Time) she's yours to command.

Janice runs the Jermyn sales office in San Francisco, and her working day is one long scamper to answer the phone, send off catalogs, or pack up parcels of urgent components, all despatched the day she receives the order.

She can tempt you with DIP sockets, IC mounting pads, heat sinks, and all the other semiconductor hardware made by Jermyn.

And she's making a huge success of the job, for two reasons.

The famous Jermyn same-day despatch means that when you want something in a hurry, you get it.

And the equally famous Jermyn quality means that when you get it, you won't want to change back to any other brand.

Here are a few examples, with prices and an order form, for you to try for yourself.

We'll send a complete catalog of course.

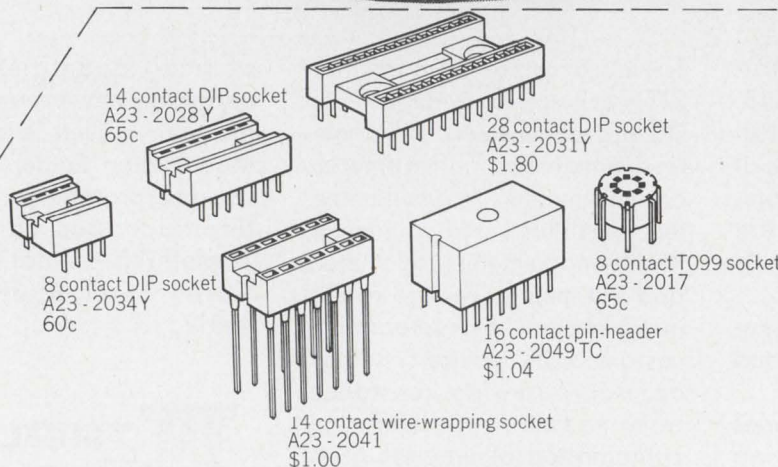

Please send me the following Jermyn components.

Type number

Quantity

I enclose check/money order \$

(Please add California sales tax where appropriate)

Name

Address

Jermyn

712 Montgomery Street San Francisco California 94111 Telephone (415) 362-7431
East Coast Sales Office Telephone (914) 634 6151

INFORMATION RETRIEVAL NUMBER 227



“Putting a minicomputer inside your new product? You’ve got problems.”

1. You’ve got to get your product on the market as fast and economically as possible.
2. You want lots of money left over for profit.
3. Your product (and all components) must be reliable.
4. You have to deliver on time.
5. You have to start out and stay price competitive.
6. You don’t want any surprise problems when Version II is ready.
7. You want the right internal hardware, software, and all the rest.
8. You have to have good technical service back-up when you need it.
9. You’re getting into bed with your major suppliers and want to play it as safe as possible.
10. You need all the help you can get from your vendor.
11. You don’t want suppliers who end up competing with you.

Big problems. And we have some unique solutions proven by some of the biggest minicomputer buyers in the country. Our customers ran us through some of the toughest competitive bidding you ever saw. Against every name competitor you can mention.

We solved their problems. Partly, because we’re not newcomers. Five years and thousands of minicomputers later, we’re still solving problems. Successfully. And economically. How about yours?

Call or write me personally. I’ll answer by phone or by airplane.

Dave Methvin
President



COMPUTER AUTOMATION, INC.
the naked mini™ company

18651 Von Karman, Irvine, California 92664. (714) 833-8830, TWX 910-595-1767

INFORMATION RETRIEVAL NUMBER 16

6 Reasons to look to PRD for RF instruments



1 The 7815 Tunable Power Amplifier

It's tunable in 6 band-switched ranges from 10 to 500 MHz. Offers high power output (8 watts) and low distortion. Unit is solid state except for final amplifier tube, and provides output metering and overload protection. Has 2.0 to 5.0 MHz bandwidth.

INFORMATION RETRIEVAL NUMBER 121



3 The 7828 Programmable Frequency Synthesizer

It's offered with 1 kHz phase-locked steps. An optional vernier provides 1 Hz resolution. It's fully programmable with contact closures, RTL, DTL, TTL logic. One part in 10^6 /mo. stability; up to 1.0 volt output into 50 ohms.

INFORMATION RETRIEVAL NUMBER 123



5 The NEW 7825 Wideband Power Amplifier

Designed for applications in the 10 Hz to 10 MHz range, this unit requires no tuning or adjustments and delivers 10 watts into a 50 ohm load with harmonics and intermodulation distortion down more than 40 dB. It provides over 15 watts with higher drive levels, and operates with 40 or 60 dB gain, overdrive protection and its 3 ohm output impedance will drive any load.

INFORMATION RETRIEVAL NUMBER 125

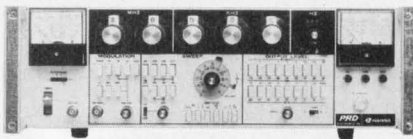

2 The 7808 Synthesized Signal Generator

This is three instruments in one. It has synthesizer accuracy and stability, yet retains the manual tuning and sweep capabilities of conventional signal generators. Frequency range: 0.05 to 80 MHz in 1 kHz phase-locked steps, and an optional vernier provides 1 Hz resolution. Stability: 1 part in 10^6 /mo. Frequency, modulation and attenuation are fully programmable.

INFORMATION RETRIEVAL NUMBER 122



4 The 7805 Low Distortion Power Amplifier

A solid state broadband amplifier with -30 dB harmonic and intermodulation distortion. Gain is 47 dB minimum, constant within 1 dB for full output with less than 0.1 volt at 50 ohm input. Has highly effective input and output protection so that overdriving or operation into a short or open circuit is possible without damage.

INFORMATION RETRIEVAL NUMBER 124

6 The PRD Quality and Reliability

Built into every PRD product, from our first microwave instrument to these five new RF instruments. They all feature the excellent design, workmanship and service that have been synonymous with PRD for three decades.

INFORMATION RETRIEVAL NUMBER 126



PRD Electronics, Inc. • A Division of Harris-Intertype Corporation

1200 Prospect Avenue • Westbury, New York 11590 • Tel. (516) 334-7810 • TWX 510-222-4494

Rising \$26.9-billion market seen for electronics in '73

Despite heavy inroads by consumer electronic imports, U.S. electronics manufacturers managed to roll up record sales year last year, and further gains are forecast for 1973.

According to the annual "Industrial Outlook" compiled by the U. S. Dept. of Commerce, American electronics shipments should reach \$26.9-billion this year. Shipments for 1972 totaled \$25.6-billion—7% over the 1971 figure, according to the department.

Rising demand for consumer electronics last year helped reverse a downturn in the components market. L. H. Niemann, Commerce Dept. analyst, says that shipments by component producers are expected to total \$6-billion this year—up 4.5% from the 1972 level.

Integrated circuits now dominate the semiconductor industry, the survey shows, representing 55% of the total value of semiconductor shipments in 1972.

Component imports, now at about \$470-million, have increased at nearly twice the rate of exports, the department says, with more than half of the imported items consisting of semiconductor devices and the rest almost entirely of tubes, capacitors and resistors.

The department forecasts a 2.5% annual growth rate in components despite the imports, with ICs, charged-coupled devices, magnetic-bubble memories and electronic solid-state telephone switching systems among the new products likely to stimulate this growth. Ivan J. Morrison, Commerce Dept. analyst, sees the components market reaching \$8.7-billion by 1980.

Shipments in the consumer electronics industry are expected to remain at about the 1972 level—\$4.3 billion. Almost a third of the market will be supplied by imported products, the department esti-

mates, with imports increasing from \$1.7-billion in 1972 to about \$2.1-billion this year. But U.S. manufacturers, through overseas subsidiaries, are cutting the Japanese share of the U.S. market substantially, the department stresses.

Eight-track cartridge tape players and recorders and home video tape systems will be important products in the mid-70s the report predicts. By 1980, it says, home electronic communication systems with 24-hour capability will be a reality.

"The Japanese can already provide much of this equipment at moderate prices," the survey notes.

Shipments of commercial, industrial and government electronic systems and equipment will reach \$9.5-billion in 1973, the department predicts—up 4% from the \$9.2-billion of 1972.

The survey looks for all phases of the civilian aerospace industry to improve this year, while programs dependent on Government funding decline. However, Randolph Myers Jr., a department analyst, warns that it is questionable whether U.S. manufacturers can maintain first place in the world aerospace competition in the 1970s as new ventures financed by foreign governments enter the marketplace.

Electronic flying passes initial Air Force test

The Air Force has successfully flown an F-4 Phantom fighter equipped with a fly-by-wire system in place of conventional mechanical controls. If the tests go well, fly-by-wire will probably be adopted for future aircraft, both military and civilian.

The fly-by-wire system which will be used on the F-4 through

June at Edwards Air Force Base, Calif., uses electronic sensors to measure the pilot's stick and pedal commands and the aircraft's responses to these commands in pitch, roll and yaw.

Four special purpose analog computers process the sensor inputs and provide electrical impulses that move primary control surfaces to produce the desired change in the aircraft's flight path. The computer signals are carried to the controls over four redundant electrical channels. The computers, each housed in a separate box, were built by the Sperry Flight Systems Div. in Phoenix, Ariz.

Fly-by-wire has a number of advantages over mechanical controls, according to James W. Morris, program manager at the Aeronautical Systems Div., Wright-Patterson Air Force Base, near Dayton, Ohio. He says: "Control of the plane is more accurate, the flight is smoother—a big consideration for commercial passenger planes. There are no mechanical connections between the pilot's stick and the control actuators. There is more reliability, due to the quadruple redundancy, and the system weighs less than a mechanical system does."

Fly-by-wire is already designed into the Air Force's YF-16 lightweight fighter, now being built by General Dynamics. The Army is said to be studying such a system for a proposed heavy-lift helicopter.

Meanwhile another significant development in aircraft design is under way at Wright-Patterson. A variety of sensors and two analog minicomputers on a B-52 bomber are permitting tests that could lead to a complex system of ailerons on the nose of the plane. According to the program manager, Robert Johannes, such a system could result in greater speed before wing flutter or stress become a problem, greater resistance to turbulence, gusts and pilot maneuvers, lighter weight and less fuel consumption and pollution.

"If the B-52 had been designed with this system," Johannes says, "it would have weighed 8000 pounds less."

Tests with the B-52 are well under way, with the first phase

completed. Tests with a fighter plane have just begun.

New material simplifies making of ceramic parts

A new silicone-ceramic compound simplifies the production of intricate ceramic electronic parts for high-temperature applications—and at a reported saving in manufacturing costs.

The material, developed by Dow Corning of Midland, Mich., eliminates the need for difficult, costly machining of the close-tolerance parts. Instead, thermoset plastic pressers can be used.

The experimental material, according to G. T. Kookootsedes, technical service and development specialist at Dow, consists of an electrical-grade silicone resin binder with 70% alumina ceramic and a catalyst. When mixed, the material forms a compound with the consistency of stiff putty.

The silicone-ceramic compounds can be molded in a thermal-setting press at about 350 F. In the molded state the parts look like conventional plastic components. They are then fired in a kiln at between 2000 to 2700 F for from 16 to 64 hours, Kookootsedes notes. During the firing the silicone partly decomposes and forms an inorganic matrix for the fired shape.

After firing the material is a shiny white ceramic that is impervious to water. In the "green state" the mixture has a flexural strength of 7000 PSI, and in the fired state this approaches 15,000 PSI.

The strength of epoxy plastics approaches 20,000 PSI, while that of pure alumina ceramics runs to about 50,000 or 60,000 PSI.

Liquid crystals used in holographic memory

A three-inch circle of 1024 liquid-crystal cells is the optical modulator in an RCA holographic memory that uses a thermoplastic storage medium. "It could be the forerunner of a new generation of mass memories equal in capacity to, but 100 times faster than, the largest disc system," according to Thomas O. Stanley, the company's

staff vice president of research programs.

Demonstrated by RCA Laboratories, Princeton, N.J., the system was developed with support from the Marshall Space Flight Center in Huntsville, Ala. The experimental memory has 1024 pages, each with 10 to 24 bits—a capacity of more than a million bits.

The system has an argon laser beam that passes through two acousto-optical crystal reflectors that move the beam up or down or left or right. The beam can be aimed at any one of 1024 different optical areas in a flat array called a holo-lens.

This lens divides the beam into two parts, one of which falls on the three-inch circle of liquid-crystal cells. For experimental purposes, selected areas of the liquid-crystal device have been made opaque or transparent by control voltages. The opaque areas block the laser beam, while the transparent allow it to pass, thus chopping the beam into ONEs or ZEROS.

The chopped beam is recombined with a reference beam at discrete locations on the storage medium, where they produce a holographic bit pattern.

The storage medium is a thermoplastic photoconductor sandwich that is charged to a few hundred volts. Laser light flowing on the various data sites alters the potential at those sites in accordance with the light intensity. This produces a differential in electrostatic forces that causes the thermoplastic to deform when heated.

Readout is achieved by sending the argon laser beam through the data-bit holograms. The light and

dark images of the holograms are projected onto an array of light-sensitive elements that produce an electrical output for each data bit.

One-day courses due at the IEEE show

A series of one-day courses to update engineers on new developments in design will be offered in conjunction with the annual IEEE show in New York from March 26 through 30.

The subjects include several "hot" topics, such as minicomputers, digital filters, semiconductors, semiconductor memories and computer-aided design. Classes will be held at either the United Engineering Center or the Engineers Club, the IEEE says.

The minicomputer course, to be held March 26, will focus on how to choose and use minis. It will cover such topics as minicomputer systems, concepts and applications, and it will point out some of the important tradeoffs between hardware and software and system cost. Microprogramming will also be explored, along with its relation to standard minicomputer applications.

The digital filters course, slated for March 29, will explore the feasibility of processing analog signals digitally. Subjects to be covered include the sampling and digitizing of signals, peripheral hardware and integrated-circuit package requirements.

Further information on the courses can be obtained from the IEEE Educational Registrar, 345 East 47 St., New York City.

News Briefs

A laser communication system designed to transmit a billion bits of information per second is being developed by GTE Sylvania of Mountain View, Calif. Intended for use in satellite systems, the neodymium YAG laser transmitter will produce a 1/4-W power beam. The system, being developed for the Air Force, uses an unusual conductive cooling technique in which the heat produced by the laser is dispersed to the body of the satellite and then radiated into space.

A special feature of this year's IEEE show is a working printed-circuit-board production line. Arranged by the Manufacturing Technology Group of the IEEE, it will let the designer be the "manufacturer" and explore advances in IC technology, test methods at both the component and finished product levels and assembly techniques for economical manufacturing. An engineer who operates the entire line will end up with a working pulse generator that is his to keep.

expand your power

**NEW UES 500 SERIES GIVES YOU
HIGHER CURRENT HANDLING CAPABILITIES—
UP TO 50A.**

with ESP rectifiers

It's another good reason to believe in ESP.

We're continually expanding and improving the line to help you design with more Efficiency, Speed and Power.

Packaging is now industry-standard with the 50A series in the DO-5 and the 20A series in the DO-4. The advantage is that Unitrode provides up to twice the current output of other devices in the same packages.

Recovery time is the fastest available in a power rectifier—typically 15 to 25nsec in any circuit. Voltages to 150V in all four series. And leakage is low even at high temperatures.

They're designed to operate over the full military range of -65°C to $+175^{\circ}\text{C}$ and they are

radiation tolerant. ESP rectifiers are also available in high efficiency assemblies as center tap rectifiers, bridges and higher current modules.

Check the table/coupon below for details on standard ESP rectifiers. They're on the shelves at your local Unitrode distributor.

And you don't need ESP to locate him. You can find out by simply dialing (800) 645-9200 toll free, or in New York State (516) 294-0990 collect. For immediate action on any specific problem, call Sales Engineering collect at (617) 926-0404, Unitrode Corporation, Department 3X, 580 Pleasant Street, Watertown, Massachusetts 02172.

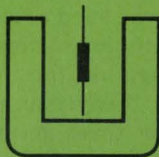

UNITRODE

Unitrode Corporation, Dept. 3X, 580 Pleasant Street, Watertown, Mass. 02172

Please send complete technical information and prices on the following ESP Rectifiers:

Type	PIV	Maximum Average D.C. Output Current	Non-Replicative Sinusoidal Surge (8.3ms)	Maximum Forward Voltage Drop	Leakage Current @ PIV 25°C	Maximum Reverse Recovery Time	Type	PIV	Maximum Average D.C. Output Current	Non-Replicative Sinusoidal Surge (8.3ms)	Maximum Forward Voltage Drop	Leakage Current @ PIV 25°C	Maximum Reverse Recovery Time
Check Here							Check Here						
<input type="checkbox"/> 1N5802	50V	2.5A	35A	0.875V@1A	1μA	25ns	<input type="checkbox"/> 1N5812	50V	20A	250A	0.900V@10A	10μA	35ns
<input type="checkbox"/> 1N5803	75						<input type="checkbox"/> 1N5813	75					
<input type="checkbox"/> 1N5804	100						<input type="checkbox"/> 1N5814	100					
<input type="checkbox"/> 1N5805	125						<input type="checkbox"/> 1N5815	125					
<input type="checkbox"/> 1N5806	150						<input type="checkbox"/> 1N5816	150					
<input type="checkbox"/> 1N5807	50V	6A	125A	0.875V@4A	5μA	30ns	<input type="checkbox"/> UES501	50V	50A	500A	1.950V@50A	25μA	50ns
<input type="checkbox"/> 1N5808	75						<input type="checkbox"/> UES502	75					
<input type="checkbox"/> 1N5809	100						<input type="checkbox"/> UES503	100					
<input type="checkbox"/> 1N5810	125						<input type="checkbox"/> UES504	125					
<input type="checkbox"/> 1N5811	150						<input type="checkbox"/> UES505	150					

NAME _____ TITLE _____

COMPANY _____

ADDRESS _____

CITY _____ STATE _____ ZIP _____

TELEPHONE _____

Consumerism and the makers of medical electronics collide

Like the sensitive equipment used on manned space missions, electronic devices in modern American hospitals can kill if they fail to perform reliably. But unlike spaceships, virtually no hospitals have automatic backup redundancy. What is the best way to ensure the reliability of medical electronic equipment?

As reports of defective electronic equipment continue to cause wide concern in hospitals and clinics, suggestions that the Government regulate the design and testing of the equipment traditionally meet with general skepticism among manufacturers and others.

Jules H. Gilder
Associate Editor

Into the breach has stepped a relatively small, private technical group in Philadelphia—the Emergency Care Research Institute. It has taken on the formidable task of policing the medical electronics industry and is creating inevitable waves of dissent as a result.

Calling itself a sort of “Consumers Union” of medical electronics, the institute—with eight engineers, a physicist, a physiologist and other help—is busily engaged in testing medical electronic equipment and issuing monthly reports to clients. About 1200 hospitals subscribe to its services at \$265 a year—including 65% of all hospitals with more than 200 beds, or about 50% of the medical electronics market.

Supporters say the institute is

performing a valuable watchdog role in warning users of defects in equipment and steering them to products it rates as superior. Detractors range from manufacturers who question the technical competence of the institute to a physician user who sees the group as “a bunch of moneymakers who mask as a tax-free institution and are really an engineering service making money hand over fist.”

In fact, the institute does offer, for extra fees, several side services besides the testing of equipment.

The physician-critic, who requests anonymity because he once was sued after giving an outspoken opinion, sums up the antagonism against the institute this way:

“Anytime a single group of two or three people set themselves up as a consensus organization and make their own rules for testing, lambast people and [inject] their own personal opinion, it gets to be absurd, particularly when they charge like hell for it.”

To barbs like this, Dr. Joel J. Nobel, the institute’s director, replies calmly that the criticisms are “clearly not true.”

A switch in goals

Established in 1955 as a designer and developer of medical electronic systems, the Emergency Care Research Institute switched its technical goal to evaluation in 1971. The changeover came at a time when there were mounting complaints among medical-electronics users that a disturbingly high percentage of the equipment was unreliable (see “Defects in Medical Electronics Draw Heavy Fire From Hospitals,” ED 22, Oct. 28, 1971, p. 22).

Dr. Nobel breaks down the in-

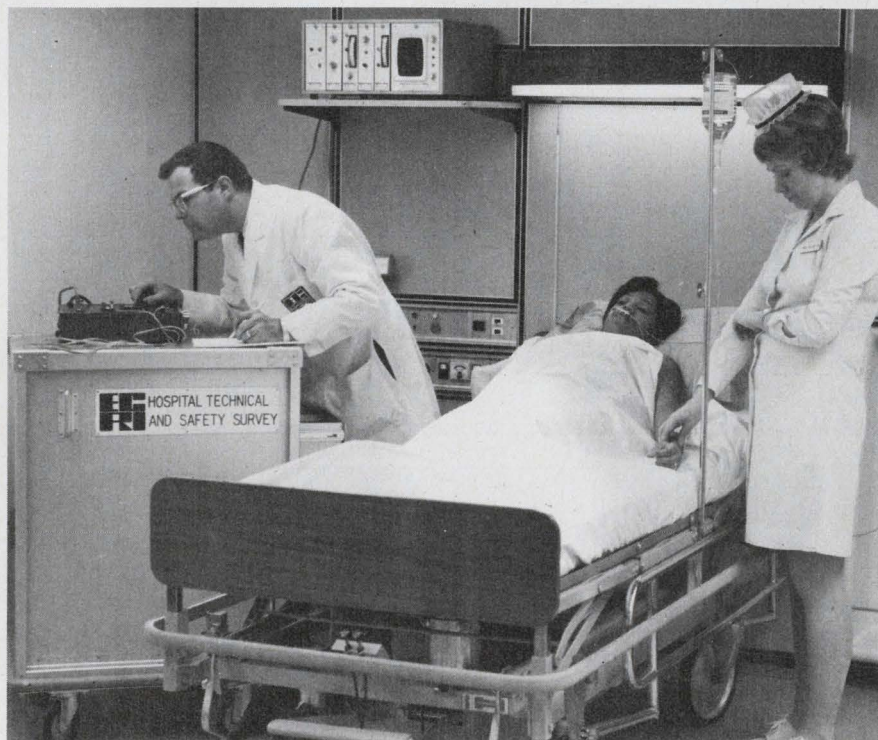

Hospital surveys are performed by the Emergency Care Research Institute to evaluate the efficiency of equipment. A nurse watches over the patient while equipment is disconnected for testing.



New Licon® LPB switch has a secret!

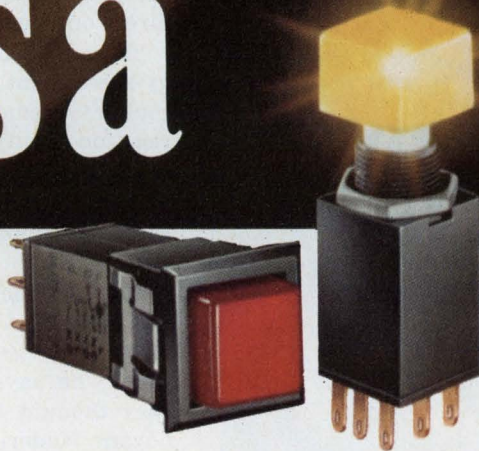

Licon's new C-III LPB Switch... it's either alternate or momentary action. Just slide the concealed selector to the mode you want. Either action in same compact size.*

Quick-change artist: that's the new low-cost Licon® C-III Lighted Push-Button Switch. You or your distributor can change it from alternate to momentary action and back again. Just by sliding the concealed selector. Only $2\frac{1}{8}$ " x $\frac{5}{8}$ " square, this crisp-operating snap-action lighted switch comes in a selection of lens cap styles, colors, shapes and sizes. Lists as low as \$2.25 each. Features simplicity throughout. For example,

to replace lamp, just pull out cap assembly, insert new lamp, snap back together. Licon's C-III LPB Switch is immediately available in SPDT and DPDT circuitry, and various mounting configurations—including rear or front panel mounting, time-saving snap-in mounting with bezel or bezel barrier configurations. Look into Licon's secret. Call your local Licon rep or distributor for a demo

of the new C-III LPB in your office. Or call or write for a Licon Switch Catalog. **Licon, Division Illinois Tool Works Inc., 6615 W. Irving Park Road, Chicago, Illinois 60634. Phone (312) 282-4040. TWX 910-221-0275.**



*Patent Applied for

itw LICON

The Electronic Group of ITW...LICON ■ ELECTRO MATERIALS ■ PAKTRON ■ CHRONOMATIC

INFORMATION RETRIEVAL NUMBER 19

© ILLINOIS TOOL WORKS INC. 1972



Minicomputer helps evaluate heart defibrillators. The output of the defibrillator is sampled by the computer, which then calculates the energy that the instrument delivers.



Electrocardiograph tester developed by the institute is being checked out. A semiautomatic device, it speeds evaluation of equipment.

stitute's work into four major categories:

1. The testing of medical equipment and publication of the results, with hazard warnings where warranted.

2. Surveys for hospitals and other health facilities to measure the efficiency, safety and economy with which they use medical electronic equipment.

3. Planning and design advice for hospital health facilities, including interior architectural design and equipment specification.

4. Special services for any interested client, including research, the conducting of seminars and technical support for projects.

Evaluations of medical equipment are performed at the institute on a comparative basis, with equip-

ment to be tested supplied free by the manufacturer. The latter practice—different from that of most consumer-testing groups, which buy the products in the open market—leaves open the possibility that the medical equipment tested by the institute is not always indicative of the average device in use. When questioned by *ELECTRONIC DESIGN* about this, Gregory Hieb, the institute's director of engineering, admits that companies can submit better than average equipment for testing. But he notes that, in some cases, if these are the best units, he'd hate to see the average ones.

When the institute has finished evaluating equipment, it publishes the results in *Health Devices*, its monthly journal. Detailed comparisons with competitive equipment and brand-name ratings are included. If hazards are found, a warning is circulated, indicating the problems and any solutions that might be available.

"We are attempting," notes Nobel, "to educate the marketplace, which in turn will put pressure on industry to innovate, produce and provide technical support in the directions needed."

"When we first became technology-assessment oriented in 1971, we couldn't predict what the industry reaction would be. We knew that we'd antagonize some manufacturers—after all, we were affecting their livelihood, not to mention their egos."

Initial reaction, Nobel recalls, was mixed. A fair portion of the medical device industry was outraged, he says, "probably because they thought that we'd be a flamboyant Naderist type of consumer organization." But, he continues, "as soon as our journal appeared, this attitude changed."

A spot check by *ELECTRONIC DESIGN* among medical-electronics manufacturers, however, shows less than unanimous enthusiasm for the institute. Some manufacturers question the institute's technical evaluations, noting that they often contain what they regard as personal preferences. Others say that certain manufacturers are often recommended to the exclusion of others.

But for better or for worse, the Emergency Care Research Insti-

New Era in film capacitors!

POLYESTER MICROMATIC® CAPACITORS*
provide a self-encased film capacitor . . . wound on its own leads in smaller sizes than comparable wrap and fill polyester capacitors.

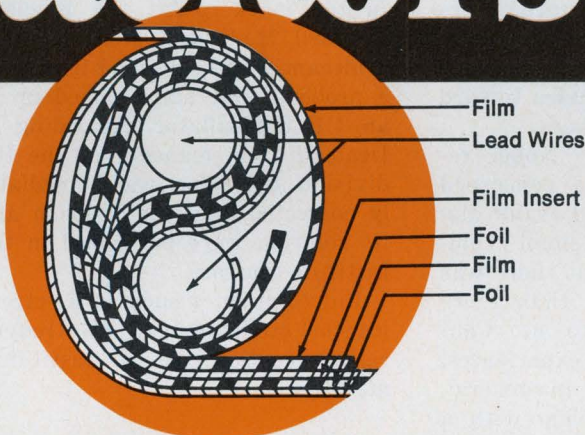

ITW Paktron does it again. Following closely the introduction of the unique design breakthrough of its Micromatic Polypropylene Capacitor; Paktron now offers another new era in film capacitors—the Polyester Micromatic. Once again, here is a completely self-encased capacitor. Outside wrapping is eliminated. Nor are there any separate lead attachments because the new Polyester Micromatic is wound on

its own leads. Best of all, this all new film capacitor is smaller in size than comparable wrap and fill polyester capacitors. And they're competitive with shrink tube and/or conformal coated axial lead products presently marketed. Capacitance tolerances are a low $\pm 5\%$. Capacitance value range .001 to 0.15mfd. Up to 600 volts. You'll find the Polyester Micromatic ideal for automatic PC board insertion due to its lead

concentricity. In addition to polyester, Micromatic Capacitors are also available in Polypropylene dielectrics. See and test the new era of film capacitors for yourself, write to the innovator in capacitors: **Paktron, Division Illinois Tool Works Inc., 1321 Leslie Avenue, Alexandria, Va. 22301. Phone (703) 548-4400. TWX 710-832-9811.**



itw PAKTRON

* Patent No. 3638086
 Other Patents Pending

The Electronic Group of ITW...PAKTRON ■ LICON ■ ELECTRO MATERIALS ■ CHRONOMATIC



Shake test is among the stresses that the institute employs to check the ruggedness and reliability of medical electronic equipment.

tute appears to be a powerful organization capable of serious effect on the future of medical-electronics companies. One fact alone—that its journal goes to some 50% of all potential customers—has prompted most manufacturers to cooperate with the institute. In return, the institute has changed some of its early attitudes toward medical-electronics makers.

“In the beginning,” Nobel reports, “we were quite concerned because we encountered frank dishonesty with some small companies. We thought that there was a lot more dishonesty than there actually turned out to be. Contrary to our earlier experiences, we now believe that, in general, where there is a problem with a product, it is not so much a matter of purposeful dishonesty as it is a failure to perceive the situation.”

As an example, the institute director points to one company that makes hypothermia machines—devices that keep the body temperature abnormally low. The company had a policy of refusing to sell parts or provide schematics or maintenance manuals to customers; instead it insisted on doing the maintenance itself at its factory. After a moderate battle, Nobel says, that practice changed.

“I don’t believe that the manufacturer was manipulating technical support to increase profits,” the institute chief explains.

In apparent recognition of both the institute’s role and its clout in the marketplace, the Hewlett-Packard Medical Systems Div. in Waltham, Mass., notified it once of a problem that had cropped up in an HP defibrillator. According to Dean Morton, manager of the HP division, the defect was immediately corrected, and the problem and its solution were publicized in the institute journal.

But companies such as Electronics for Medicine and Electrodyne take exception to the institute’s methods.

Institute decisions disputed

Martin Kutik, engineering manager for Electronics for Medicine in White Plains, N.Y., says that an institute hazard warning on his company’s cardioversion defibrillator was unwarranted. The defect, a faulty cable, was minor and did not represent a hazard, Kutik contends.

In another hazard warning put out by the institute, a defibrillator made by Electrodyne of Sharon, Mass., was classified as dangerous. Long before the printed warning,

Electrodyne says, it had determined on its own that a serious defect existed and had taken energetic steps to recall all such units already sold. It informed the institute of this, it says, and reported that it had managed to locate all but four of the defective defibrillators. The institute went ahead and put out its warning anyway.

When questioned about this case, Hieb says that as far as the institute knew, the faulty devices were still in the field at the time the warning was issued.

Several industry representatives object to the institute’s practice of outlining what it considers to be an “ideal” piece of equipment. The ideal units, says Kutik of Electronics for Medicine, are simply personal opinions. “What,” he asks, “makes their opinion correct?”

When asked about the effectiveness of the institute, Kutik says that, in general, it is hurting manufacturers but probably is of benefit to hospitals. Other manufacturers feel that the institute is detrimental to hospitals because where no standards exist, it determines on its own what is best—in effect, writes its own standards.

Nobel recognizes that the institute may sometimes ruffle feathers in industry. But he argues that since medical electronics is a changing technology, a group such as his is much more desirable than Government control.

HP’s Morton backs this position. Henry Littleboy, former biomedical engineering head at Massachusetts General Hospital in Boston and now president of his own consulting firm, demurs. He says that while there is a great need for an independent testing organization, the institute is not effective in solving problems and, in the long run, is of no real value.

Still others in industry—probably a small minority—indicate that they would welcome some form of Government control, now that they have experienced consumerism in action. An agency similar to the Atomic Energy Commission, which requires that both manufacturers and users be licensed, might be effective, says an Electrodyne representative. At least, he adds, it would eliminate a lot of the abuse and misuse of medical electronic equipment. ■

To celebrate our 50th Anniversary—1923-1973

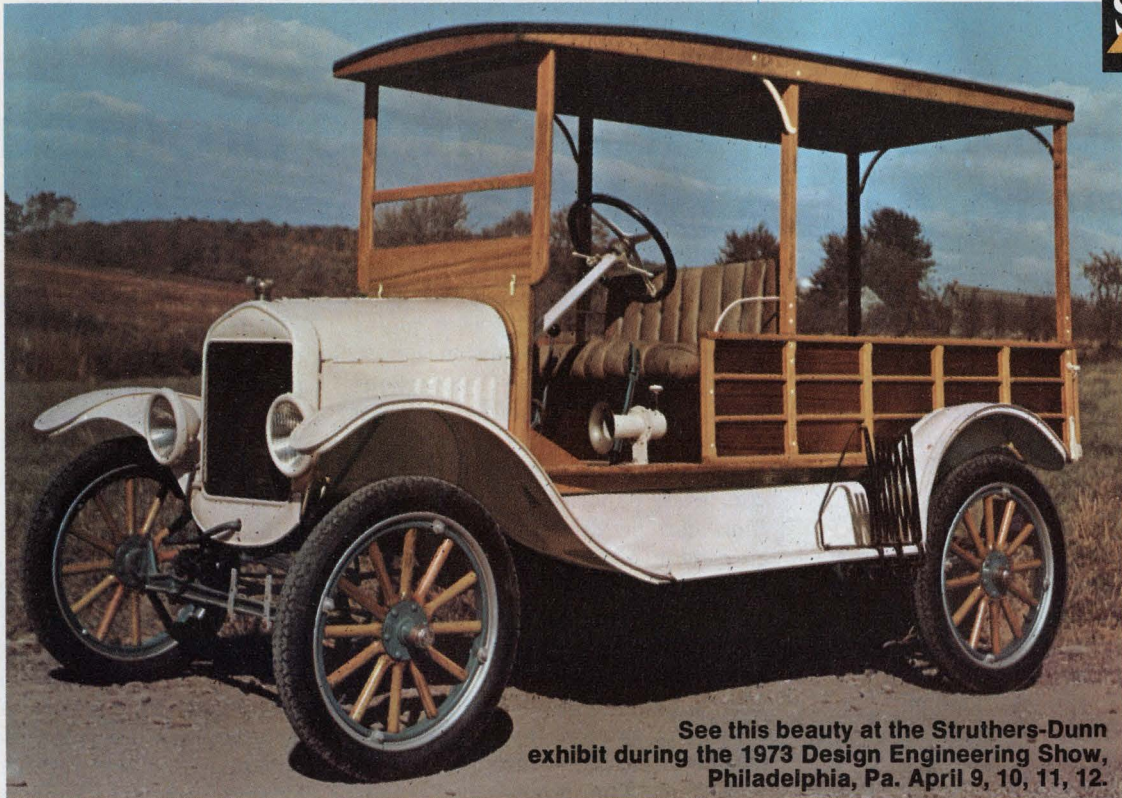

See this beauty at the Struthers-Dunn exhibit during the 1973 Design Engineering Show, Philadelphia, Pa. April 9, 10, 11, 12.

This 1923 Model T FORD as GRAND PRIZE for your most unusual relay application!

Second 50th Anniversary prize: TEN \$50.00 U.S. Savings Bonds.
Third Prize: FIVE \$50.00 U.S. Savings Bonds.

ALL entrants will receive a 9" x 12" four-color print of this photograph by contest end. Perfect for framing.

Yes! A beautifully restored Model T Ford Station Wagon from the same year the first Struthers-Dunn relays came out! It could be yours for telling us about your most unusual or interesting relay application, as detailed in the rules below. You and the car will be the talk of your town from the day it is delivered. Start writing or thinking about your application today! Note those second and third prizes, too! *Be sure to follow the rules below.*

CONTEST RULES

- (1) Entrants must give a clear and complete description of an unusual, but practical and operating, relay application or solution of a relay problem, using electromechanical or reed relays of any make or price. *Entries must contain nonconfidential matter only.* No purchase necessary.
- (2) Winning entries will be judged on basis of the most unusual applications and/or imaginative thinking of widest interest to relay specifiers.
- (3) The three judges, familiar with design and use of relays, will be from the editorial departments of technical trade publications, and their decision will be final.
- (4) Brevity, clarity and completeness will count. Be formal or informal. Schematics welcome.
- (5) No limit on entries, but keep each entry to one application.
- (6) Entries must be postmarked no later than midnight May 15, 1973. Address: 50th Anniversary Contest, Suite 1500, 1201

Chestnut Street, Philadelphia, Pa. 19107. Do not send entries to Struthers-Dunn or its distributors.

- (7) For anonymity in judging, entries will be coded and identification removed insofar as possible.
- (8) Winning entrants will be notified by July 1, 1973 and publicly announced and identified shortly thereafter.
- (9) Grand prize will be delivered to winner's home.
- (10) All entries become property of Struthers-Dunn, Inc. and none will be returned. Struthers-Dunn reserves the right to use all entries in its advertising and promotion on an anonymous basis, but entrants will be paid \$50.00 for each entry used.
- (11) Contest void where prohibited, regulated or limited by law. Winners will be responsible for taxes, if any, on prizes.
- (12) Employees of Struthers-Dunn, Inc., its sales affiliates, distributors, advertising agencies, contest judges and members of their families are not eligible.



STRUTHERS-DUNN, INC.

PITMAN, NEW JERSEY 08071

Canada: Struthers-Dunn Relay Div., Renfrew Electric Co., Ltd.

Amorphous metallic films promise easy-to-make bubble memories

From laboratory curiosity to manufacturing reality—that's what the discovery of amorphous magnetically ordered films promises to do for bubble memories. If the experimental work is successful, cheap, high-speed, high-density memories could become available to designers.

The storage density indicated by this new bubble material may exceed 10^9 bits/in.²—16 times the practical limit of crystalline garnet films now used.

Prior to the development work at the IBM Watson Research Center, Yorktown Heights, N.Y., only crystalline films with requisite magnetic anisotropy were used. Such films had to be deposited on defect-free single crystals. Otherwise the defects interfered with the mobility of the bubbles and curtailed or annihilated their ability to transfer data. The cost of growing and polishing

defect-free crystals and of then forming epitaxial film is a major barrier to mass production.

By contrast, the amorphous films used at IBM need no crystal substrate; they can be deposited on almost any material—glass, silicon, even paper. For example, the films can be deposited on a semiconductor circuit chip to create a hybrid technology.

"It could mean a whole new way of looking at magnetic bubble technology," says Dr. Praveen Chaudhari, coordinator of the IBM research group that discovered magnetic bubbles in the amorphous materials. The other members of the group are R. J. Gambino and Jerome J. Cuomo.

Bubbles as small as 0.1μ have been observed in the amorphous materials. By contrast, the limit is about 0.4μ for garnet crystals. Since the bit density is inversely proportional to bubble diameter squared, a 16:1 improvement of storage density is indicated.

Improvements in data-transfer

speed over crystalline films can result from the smaller bubble diameter. The maximum data rate is proportional to a bubble's mobility divided by its diameter—hence a throughput increase of 4:1.

In the new amorphous films, as in the garnet films now used, cylindrically shaped islands of reverse magnetization called "bubbles" can be created and made to follow predetermined paths. These circuit paths are defined by permeable magnetic metal strips deposited on the surface of the film. The bubbles progress along these paths under the influence of an external rotating magnetic field that is applied perpendicularly to the plane of the film. Actually the magnetic poles induced by the field on the strips alternate, thereby attracting the bubbles from strip to strip. Bits are defined by the absence or presence of a bubble in the stream.

Current research at IBM is being directed at a thorough understanding of this amorphous magnetic anisotropy rather than product development. The principle elements being investigated are sputtered films of gadolinium-cobalt (Gd-Co) and gadolinium-iron (Gd-Fe) alloys. The materials have also shown superior qualities for laser magneto-optic storage applications.

A demonstration 100-bit shift register built with Gd-Co operates at 100 kHz. The bubbles in this register are about 2μ in diameter. With $0.2\text{-}\mu$ bubbles, the practical speed may easily be increased to 1 MHz, which compares favorably with large-scale disc storage. According to Cuomo, the presence of a bubble (which represents a logical ONE) can be sensed by measurement of the change of resistance in a magnetoresistive metallic strip or by use of a Hall Effect sensor. The magnetoresistive technique is preferred because it produces a larger output signal. ■■

Seymour T. Levine
Associate Editor

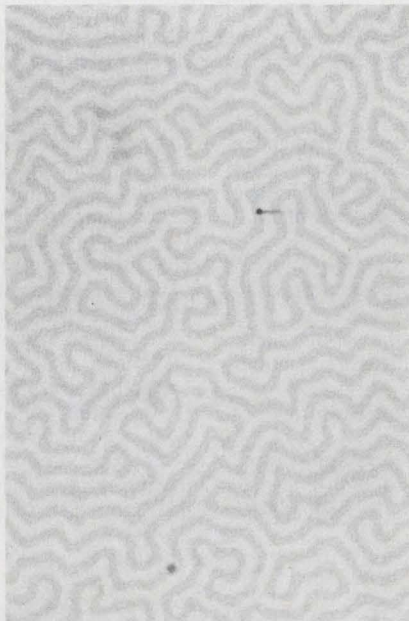
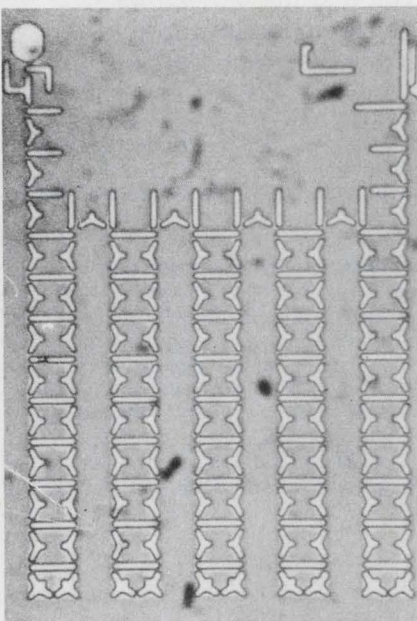

Experimental shift-register configuration (left) uses amorphous film sputtered onto a glass substrate. Magnetic stripe domains (right) are clearly visible when viewed with polarized light.

We're everything you need in trimmers.

We're TRW/IRC Potentiometers.

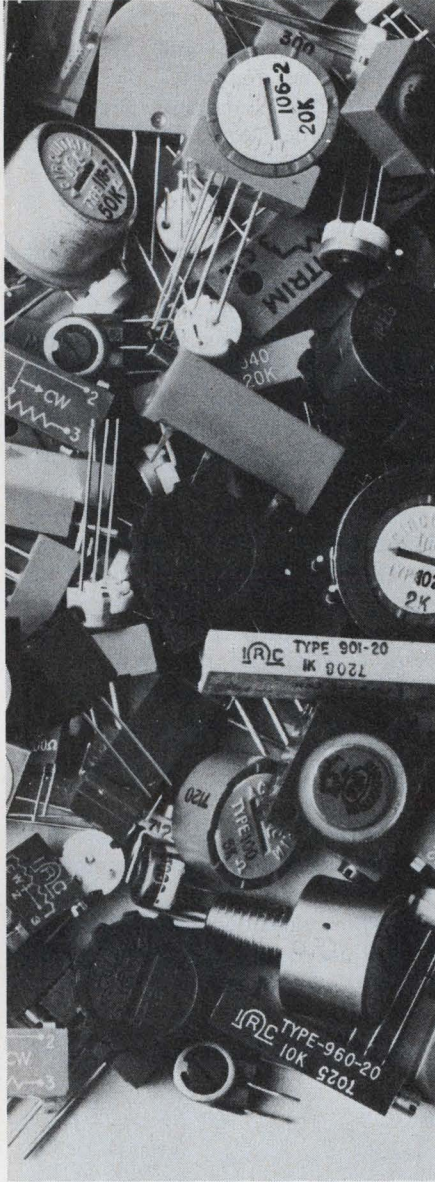

To fit any space, to satisfy any mounting requirement, to meet any environmental specification, with wire wound or cermet elements, TRW/IRC Potentiometers has the trimmer you need.

From 1/4" round, 3/8" square, or 3/4" rectangular, millions of high quality TRW/IRC trimmers are currently being used in the most critical equipment applications. Most types are available both as military

approved devices, and as low cost industrial units.

For fast delivery, from stock, contact any TRW/IRC Potentiometer distributor.

Call us, or your distributor, for information on our complete line.

TRW/IRC Potentiometers, an Electronic Components Division of TRW Inc., 2801-72nd Street, North, St. Petersburg, Florida 33733. Phone (813) 347-2181.

CPI-7304

TRW[®] IRC POTENTIOMETERS

INFORMATION RETRIEVAL NUMBER 21

Top medical care for rural areas planned via electronics network

A telemetry and computer-based system is being developed to bring health care now found only at big-city medical centers to the rural areas of the world. The same concept may one day be used to care for astronauts on space missions.

The system will enable doctors at major medical centers to use television, transmitted information about vital signs of life, computer-based diagnostic aids and other electronic techniques to diagnose illnesses and prescribe treatment for patients a great distance away.

Called Integrated Medical and Behavioral Laboratory Measurement System by the funding agency, the National Aeronautics and Space Administration, the network is to be ready for field-testing by 1975. According to a spokesman at NASA's Manned Space Center in Houston, Tex., it will have a control center in or adjacent to a major urban hospital. This center will serve several rural health centers, and the latter, in turn, will be able to serve mobile vans. The entire system is to be tied together by a variety of radio and microwave telemetry and commu-

nications systems.

Both real-time and processed data will be generated, according to the prime contractor, the Lockheed Missiles and Space Co. of Sunnyvale, Calif. James M. Smith, manager of biotechnology at Lockheed, notes:

"The only real-time data that are telemetered around the system are electrocardiogram and voice. Other processed or semi-real-time data that are transmitted from the field to the control center include color and black-and-white television and medical histories via facsimile or computer terminal."

Smith says that information transmitted by television from rural centers to the control center would primarily include remotely controlled zoom patient viewing, X-rays, infrared and microscopy viewing, and fiber-optic internal visualizations. Television would also be used to send educational material from the control center to the field.

George M. Loh, research specialist in electronic data systems at Lockheed, says that three modes of communication will be used:

- Voice/data—for voice, data (up to 7.2 Kb/s) and facsimile.
- Dispatcher voice—for use between dispatchers and mobile units.

■ Television—to transmit visual information.

Loh feels that the major unknown in the present communications system design is the required bandwidth for adequate resolution on X-ray transmissions.

Data management in the control center will be accomplished by a minicomputer.

The doctor's console includes a storage scope and strip-chart recorder for electrocardiogram viewing; two additional scopes for multi-channel data reception and redundancy; a television monitor and control panel for image selection, remote control of the TV cameras and data call-up, and a video tape recorder and stop-motion video disc recorder.

Using his console, the doctor at the control center will be able to communicate with field units by voice, view the patient or his X-rays or slide cultures by television, call for the patient's medical history or make diagnostic inquiries of the computer, or view the patient's vital signs.

Paramedics could be used

The rural health centers and mobile vans could be manned by paramedics and nurses. Radio transceivers for audio communications and a microwave relay and transmission station for television are to be available to the rural centers.

The vans are to have equipment for diagnosis, treatment and communication packaged in portable bags. Included will be such equipment as defibrillator, a pacemaker, an electrocardiogram monitor, an aspirator, a ventilator; eye, ear, nose and throat diagnostics, an acoustic phone coupler and an rf transmitter.

Lockheed's contract with NASA calls for about \$4.8-million over four years. ■■

David N. Kaye
Senior Western Editor

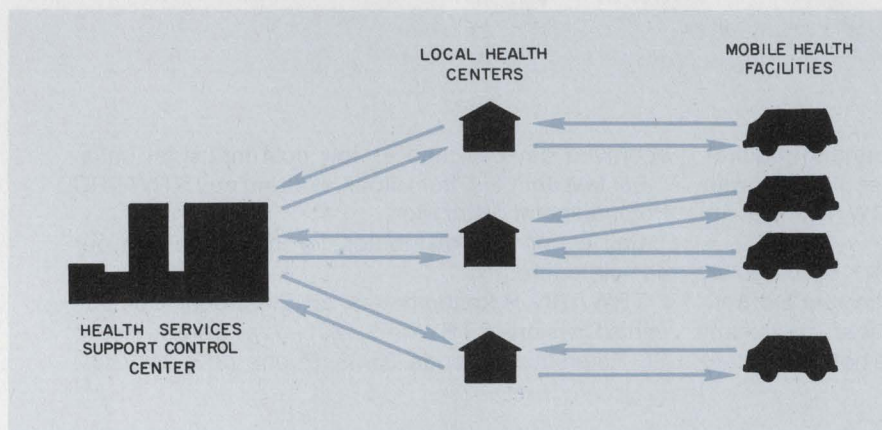

Telemetry-computer system linking urban medical centers to outlying health-care units promises to improve rural medicine.

For all that goes into a Heinemann Type J circuit breaker, it's amazing that it sells for so little.

SHOCK- AND VIBRATION-RESISTANT CONSTRUCTION. A counterbalance affixed to the actuating armature serves to prevent mechanical tripping under conditions of shock (100 G's) and vibration (10 to 500 Hz, 10 G's).

HIGH-SPEED ARC QUENCHING. Fragmentation plates and a magnetic blowout are used to attenuate the arc and quench it away from the breaker contacts. This appreciably extends service life and reliability.

FUNGUS AND MOISTURE RESISTANCE. All ferrous parts are treated to resist moisture attack, and special inherently fungus-resistant phenolics are used for all molded parts—cases, cover, and handle.

SELF-CLEANING CONTACTS. The contact arm moves on a sliding pivot point, causing a wiping action every time the contacts are opened or closed. Contacts are made of silver alloy.

PRECISION CURRENT SENSING. The Heinemann hydraulic-magnetic sensing element provides closely controlled tripping characteristics with very accurate calibration. Nominal continuous-duty current rating is decimal-point precise, can be supplied in any integral or fractional value from 0.020 to 30 amp.

ADAPTABILITY TO SPECIAL FUNCTIONS. The auxiliary switch shown here is one of seven standard internal circuit modifications optionally available. The miniature snap-action SPDT or DPDT switch is rated at up to 10 amp contact capacity, can be used to operate remote indicating or alarm devices.

ATTRACTIVE, FUNCTIONAL PACKAGING. Type J circuit breakers are available with a variety of actuating devices—pushbuttons, rocker handles, and two types of toggle handles. For extra speed and convenience in mounting, there is a snap-in model that can be installed without hardware or tools. Our Bulletin J-3333 gives full details on the entire Type J line. It's yours for the asking. Heinemann Electric Co., 2616 Brunswick Pike, Trenton, N.J. 08602.

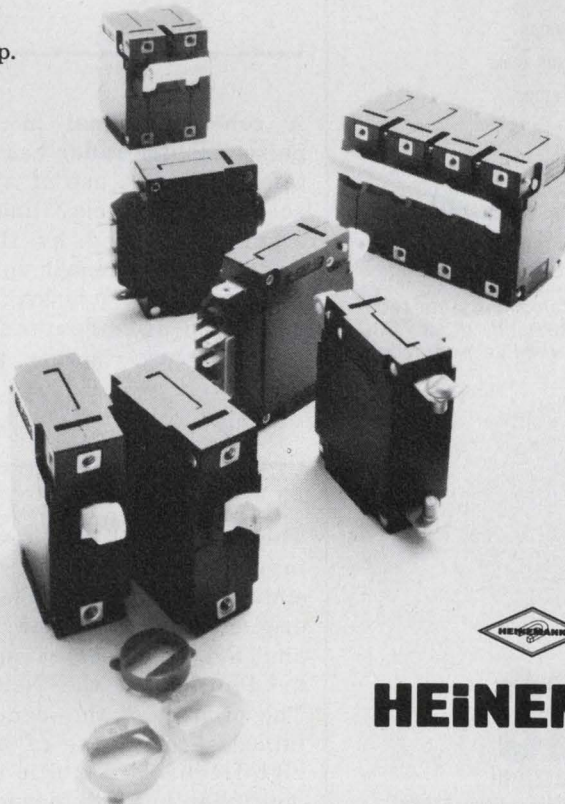

HEINEMANN

5533

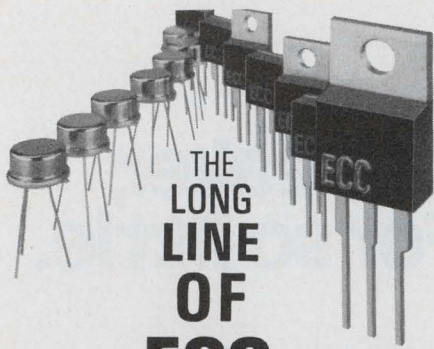

THE
LONG
LINE
OF
ECC

SENSITIVE and STANDARD GATE

TRIACS

World's leading triac producer offers fast delivery, electrical isolation and competitive pricing.

SENSITIVE GATE TRIACS

TO-5 Metal and Plastic; THERMOPAK® and THERMOTAB® Packages

$I_{T(RMS)}$	0.8 - 3 amps
I_{gt}	3 & 10 ma (all 4 quadrants)
I_{TSM}	20 amps
V_{DROM}	200 - 400 volts

STANDARD GATE TRIACS

THERMOTAB and THERMOPAK Packages (13 other packages available up to 40 amps)

$I_{T(RMS)}$	0.8 - 40 amps
I_{gt}	25 & 50 ma max.
I_{TSM}	20 - 300 amps
V_{DROM}	200 - 800 volts

All ECC triacs feature heavily glass passivated junctions for high reliability. They are available from your nearest ECC Sales Representative or Authorized Distributor.

New Condensed Catalog contains technical data on these and other ECC semiconductors. To receive your copy, circle No. 246.

*trademark of ECC

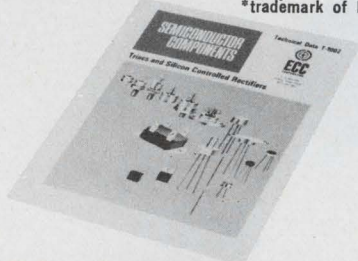

ECC

CORPORATION

P.O. Box 669 • Euless, Texas 76039
817/267-2601

technology abroad

A new, alterable and nonvolatile MOS memory transistor has been demonstrated by researchers at the University of Manchester's Institute of Science and Technology in cooperation with Ferranti of England. The new device is based on the fact that a floating gate embedded in a silicon dielectric in a MOS-type

structure can be reversibly charged and discharged by use of electron currents alone. In the device demonstrated, the dielectric was a double layer of silicon dioxide and silicon nitride. Avalanche electrons are collected by the floating gate, and these charges can be removed by conduction through the nitride layer.

CIRCLE NO. 441

An Austrian system to check telephone lines and station equipment—the ROMputer—uses a mini-computer to control the test sequence of telephone-test calls and to analyze the results statistically. Developed by GPM Gmbh of Vienna, Austria, it eliminates test-program interruptions caused by

spurious voltage pulses or power outages. A read-only memory contains all the test-program information, and the software is controlled to meet the varying test conditions. This ROMputer is also being used for control of nuclear experiments as well as industrial processes.

CIRCLE NO. 442

A coherent signal in a small-pulse Doppler radar has been obtained through use of a surface-acoustic-wave delay line. In the system, produced by the Royal Radar Establishment in Britain, a portion of the transmitted wave is delayed after conversion to an i-f frequency, thereby providing

a reference signal. This signal is subsequently added to incoming target signals to aid in Doppler-frequency extraction. Preliminary experiments give a 10-to-12-dB gain in Doppler signal when compared with a clutter reference system in a low-clutter environment.

CIRCLE NO. 443

The product of two oscilloscope input signals can be displayed simultaneously with one of the original signals on new PM 3252 and PM 3253 scopes announced by Phillips of the Netherlands. The product of the signals is obtained through use of a built-in high-frequency multiplier. The multiplier has a bandwidth of 25 MHz, which is provided by cus-

tom-designed, high-frequency integrated circuits. The PM 3252 is a standard 50-MHz portable instrument, while the PM 3253 employs a storage tube, making it useful in applications where products of single short events are studied. This includes destructive tests on devices or materials or gas-discharge studies.

CIRCLE NO. 444

FREE

NEW '73 HEATHKIT® CATALOG

Over 350 electronic kits...
world's largest selection

- Easy, fun to build
- Savings of up to 50%
- Designed for first time kit builders
- Kits for every interest — amateur radio, color TV, test & automotive instruments, marine electronics, radio control, home appliances, short-wave, stereo hi-fi, electronic organs, education, photographic . . and more!

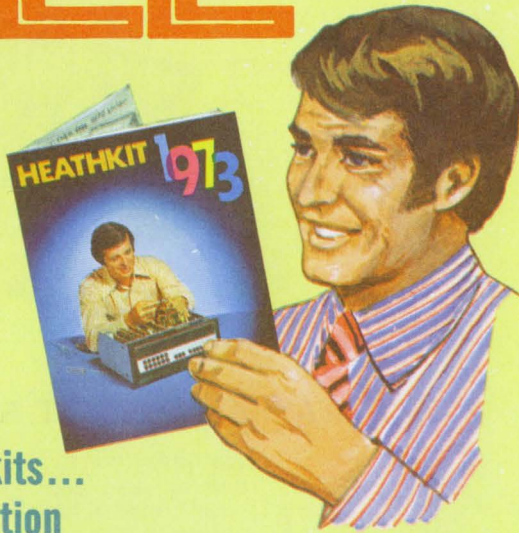

Please send my FREE Heathkit® Catalog

Name

(Please print)

Address

City

State

Zip



**SEND FOR YOUR
FREE COPY TODAY!**

...World's largest electronic kit catalog. A kit for every interest... every budget. Easy credit terms.



Radio equipment kits for every interest — Shortwave, Amateur Radio, AM & FM Broadcast, including new VHF 8-Channel Scanning Monitor for automatic listening of police, fire, weather, and marine calls.

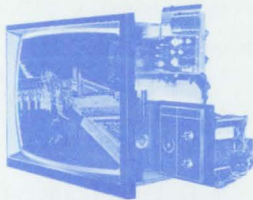

Color and B & W TV Kits — consoles, table models, portables, in a selection of screen sizes and cabinets, including the incomparable GR-900 offering 25 inches (diagonal) of glorious color, UHF and VHF power detent tuning, full remote control.



Test instruments for hobbyists and professionals — including new 2½ digit VOM, generators, frequency counters, oscilloscopes, meters of all kinds.



Automotive instrument kits — like the new Portable Engine Analyzer, new Capacitive Discharge Ignition System, tachometer, battery charger, and ignition analyzer timing lights.



Kits for music lovers — such as the new AR-1214 50-Watt Stereo Receiver, a new Dolby® cassette deck, 2 and 4-channel equipment, speakers and turntables, new Spinet electronic organ, guitar amplifiers.



Exciting kit ideas for the home — like the timely new Solid-State 6-Digit Electronic Clock-Alarm, 8-Digit Calculator, garage door openers, intercoms, microwave oven and more.

Please send my FREE Heathkit® Catalog

Name

(Please print)

Address

City

State

Zip



**SEND FOR YOUR
FREE COPY TODAY!**

...World's largest electronic kit catalog. A kit for every interest... every budget. Easy credit terms.

HEATH COMPANY
Benton Harbor, Michigan 49022



FREE

NEW 1973 EDITION
HEATHKIT CATALOG

HEATH COMPANY
DEPARTMENT 60-3
BENTON HARBOR, MICHIGAN 49022

PLACE
STAMP
HERE

YOUR FREE

**Heathkit Catalog
is ready and waiting**

Join the millions who have experienced the creative satisfaction and savings of a Heathkit hobby — Mail your card for one today. If the postcards at left have been removed, use the handy coupon below.



EVERY HEATHKIT PROJECT GIVES YOU —



Creative Enjoyment. A totally different, totally rewarding experience. And each easy-to-follow assembly manual has an appendix that's loaded with information, so you can learn how your kit works, even how to service it yourself. No special skills or experience needed — we show you how to do it — and there are rafts of experts at the factory and each Heathkit store ready with free consultation to assure your success.

Quality Performance. Every kit in our catalog is the result of 25 years of kit design experience to give you guaranteed performance specifications. Quality design, quality components, quality performance. Ask an electronics expert. He'll tell you about Heathkit quality.

Unmatched Value. Every Heathkit product is designed to give you unusual performance and features for its price. And many will save you up to 50% of the cost of comparable ready-made products.

EVERY HEATHKIT PRODUCT INCLUDES —



Complete Kitbuilder's Guide. A comprehensive beginner's booklet that shows you how to unpack your kit, how to identify parts and install them — even how to solder correctly.

Famous Heathkit Assembly Manual. In simple, non-technical language, it shows you step-by-step how to build your kit. We always assume you know nothing about electronics. That way everyone in the family can take part in your Heathkit project.

All The Parts — both electronic and mechanical, plus chassis, circuit boards (many even include the cabinet) and every kit includes all the solder you need. No self-fabricating for you to do, no searching for parts sources — everything included, ready to assemble.

GET STARTED TODAY — SEND FOR YOUR FREE HEATHKIT CATALOG

HEATH COMPANY, Dept. 60-3
Benton Harbor, Michigan 49022

Please send FREE Heathkit Catalog.

Name _____

Address _____

City _____ State _____ Zip _____

CL-451



FREE

NEW 1973 EDITION
HEATHKIT CATALOG

HEATH COMPANY
DEPARTMENT 60-3
BENTON HARBOR, MICHIGAN 49022

PLACE
STAMP
HERE

The 5-volt, N-channel MOS static RAM.

(Much more useful. Much easier to use.)



100% TTL compatibility—without clocks, without refresh. Interfacing's so simple you'll think you're working with bipolar parts. All the performance you've been itching to get your hands on. Backed by the smoothest specs ever put into MOS static RAMs. 1024 bits. 500ns access time. Single +5V supply.

N-channel technology developed by Signetics makes the difference. We designed out the kinks in competing devices, and came up with a new trouble-free line of ion-implanted N-channel MOS static RAMs.

And what a difference N-channel makes on your boards. Three times the circuit speed of P-channel RAMs. 50% lower power dissipation. Absolutely no fudging on bipolar compatibility—no clocks, no refreshing needed. So the parts are much easier to understand and put to use.

First super-RAM off the line: Signetics' new ion-implanted 2602 static RAM. N-channel delivers

2602

1024x1 organization: four times the density of similar products. With extremely fast access time for a static RAM: 500ns. And we threw out the -12V power requirement that made terminal applications so sticky. 2602 operates from only +5 and ground.

In production now in a 16-pin package. For full details, write Signetics, or call your Signetics rep, salesman or distributor.

And ask about our breakthrough N-channel dynamic RAM, the 2601: non-overlapping clocks, 1024x1 in 18-pin packs, with 85ns access time, requiring under 300mW power.

High speed, high density, lower power, optimized convenience. Signetics make it in MOS. Of course.

Signetics-MOS
811 East Arques Avenue
Sunnyvale, California 94086
(408) 739-7700

Please send complete specs and technical data on your new N-channel line of RAMs; including the 2602 5V static RAM and the 2601 dynamic RAM.

Name

Title

Company

Address

City

State

Zip

Telephone

Signetics Corporation—A subsidiary of Corning Glass Works.

signetics

INFORMATION RETRIEVAL NUMBER 23

Are you getting static?

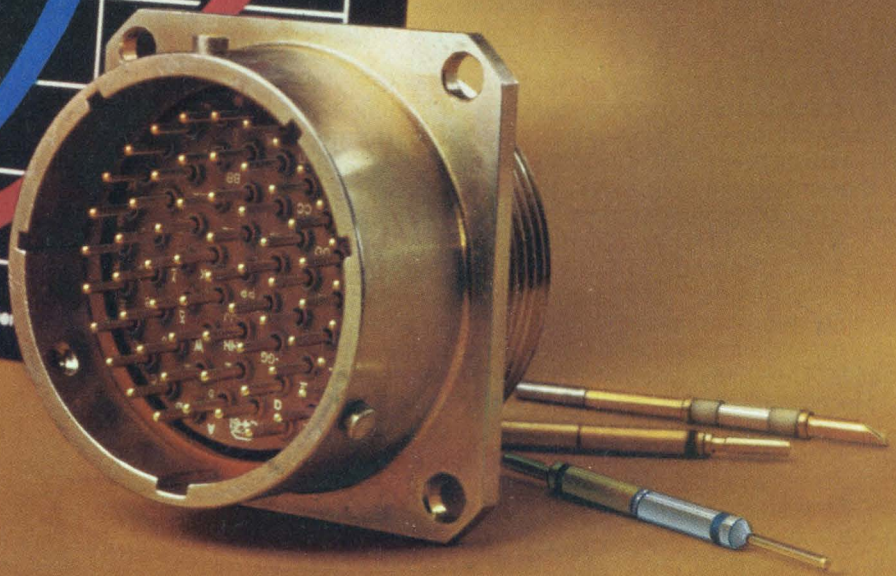
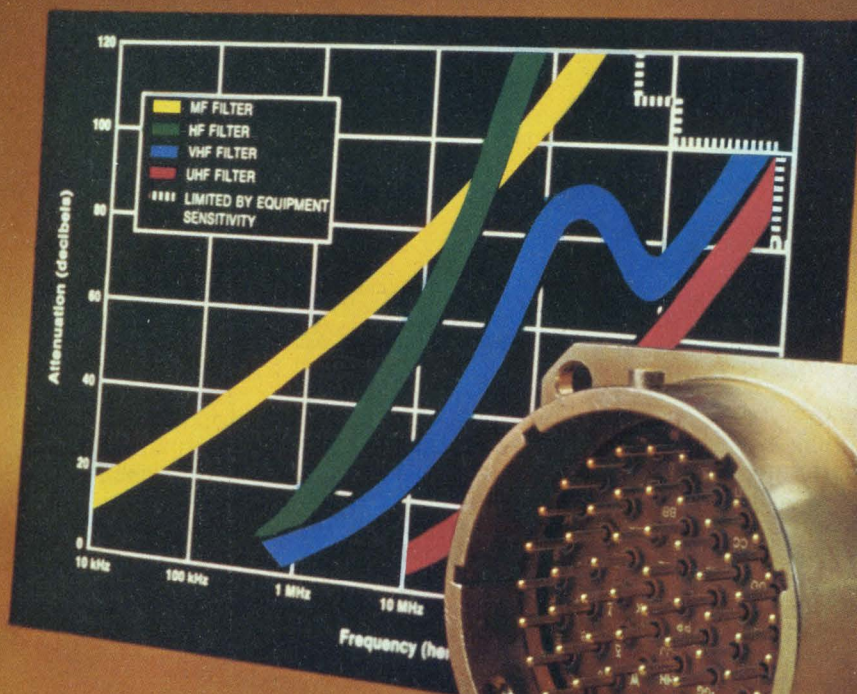

Our filter connectors are designed to eliminate interference from your circuits. See those attenuation curves? They are just a part of our selection. We can mix and match filters to solve your low pass filtering requirements. Small wonder Bendix filter connectors are first choice in the fight against electronic noise pollution.

Bendix filters come packaged in connectors intermateable with MIL-C-26482, MIL-C-83723, MIL-C-38999 and

MIL-C-5015 connectors. In addition, filter contacts can be packaged to mate with other popular connector types including rectangular in military, industrial and commercial applications. There's sure to be one to meet your attenuation and frequency requirements.

You'll like the price, too.

Delivery? We won't give you any static there, either. Write for our brochure. The Bendix Corporation, Electrical Components Division, Sidney, New York 13838.

Bendix

washington report



Heather M. David
Washington Bureau

Defense Dept. steps up EMP studies

The Defense Dept. is intensifying its research on electromagnetic pulse (EMP) effects on electronic systems. Several million dollars will be spent in constructing a new test facility to simulate the EMP phenomenon, which is caused by interaction of the atmosphere with gamma and X-rays during a nuclear explosion. The result can be devastating for electronic equipment, burning it out in some cases. The simulator will be used to test EMP effects on strategic communications equipment.

The Air Force Special Weapons Center at Kirkland Air Force Base, Albuquerque, N. M., is asking industry for help in a number of areas, including electron emission studies, field generation, cable coupling and direct cable response, black-box susceptibility, computer analysis for systems-generated EMP effects, and analysis of hardening techniques. A separate contract will be awarded to study survivability of ground base communications systems.

The Navy is looking for a contractor to develop an EMP-hardened enclosure that would shield sensitive radio equipment in three Federal Communications Centers near Denver, Seattle and Dallas.

Industry asks relaxation in laser standard

The Electronic Industries Association is asking the Bureau of Radiological Health to modify the proposed laser safety standard that the bureau plans to submit to its advisory committee on Mar. 26. The standard would separate continuously emitting lasers in the visible region into four categories: Class I up to $1\mu\text{W}$; Class II up to 1 mW; Class III up to 10 mW; and Class IV, over 10 mW. The bureau would require that all lasers manufactured after a certain date be labeled according to class, with only Classes I and II suitable for use by the general public. The requirement would not affect existing lasers, although many lasers now used in classrooms and in construction may be operating at Class III levels. The EIA's position is that there has been no demonstrable safety hazards as a result of laser use and that the proposed standard is too stringent.

Supersonic electronic-warfare plane sought

The Air Force has been looking for years for a tactical aircraft with electronic jamming capability to accompany its fighter aircraft into battle. It has considered and discarded the idea of modifying its aging EB-66 and the Navy's EA-6B, both of which are subsonic planes. Now

it is asking for authority—and \$15-million in R&D funds—to modify its F-111 fighter jet. It would call the redesigned craft the EF-111. The initial funding would cover design of a flight prototype system, which would combine the Navy-developed AN/ALQ-99 electronic countermeasures system with the long-range, supersonic F-111 aircraft.

The time may be right, since Congressional interest in the F-111 has been sparked by reports of the plane's success in knocking out enemy radars in the final days of the B-52 bombings in North Vietnam.

LAMPS electronics work begins

Bidding on new electronic systems for the Navy's next generation LAMPS (light airborne multipurpose system) helicopter starts today as requests for proposals go out to potential contractors. The subsystems include data transmission equipment, displays, an electromagnetic receiver, processing equipment for magnetic anomaly detection and an active acoustic generator. The Navy is working on a later request for proposals to be issued in about 90 days for a radar warning receiver.

The new LAMPS, to be carried on the DD 963 destroyer and other ships, will have separate electronic packages for electronic countermeasures, cruise missile defense and antisubmarine warfare roles. It will also act as an over-the-horizon data relay to the ship.

Capital Capsules: The House of Representatives is considering several bills that call for a **study of radio frequency allocation**. At least two would abolish the Federal Communications Commission.....The General Accounting Office has recommended that the Defense Dept. and General Service Administration **speed efforts to multiplex their communications systems at all feasible levels**. The director of the White House Office of Telecommunications Policy and the Defense Dept. have been told to take charge of the program.....A sign of the times: **NASA has cancelled a request for proposals on a nuclear high-power communications satellite study**.....The Dept. of Health, Education and Welfare plans to build an **earth terminal for the ATS-F satellite**. The terminal would consist of a 10-foot-diameter parabolic antenna, a microwave translator and a separate indoor demodulator unit capable of receiving two frequencies.....A compromise trade bill taking shape in Congress would include **protection for U. S. industry in the form of import quotas** but would abandon clauses in the Burke-Hartke bill restricting income on U. S. ventures abroad. Senator Vance Hartke (D-Ind.) has indicated he is willing to modify his bill, which has been opposed by segments of the electronics industry.....The Army is looking for a contractor to take over the job of giving **technical assistance to the South Vietnamese Navy and Marine Corps in communications and electronic equipment**.....The Air Force will issue a **request for proposals soon for a new Loran navigation system chain**, including shelters, antenna towers, tactical 30-kw transmitters and ground monitors, and cesium oscillators.....**The Air Force's choice of Fairchild Industries in Farmingdale, N.Y., to build the A-10 close-support aircraft is under attack** from many sides. The Defense Dept. is conducting a review of the award, Senator Abraham Ribicoff (D-Conn.) has asked the General Accounting Office to investigate why Northrup's plane, with AFCO-Lycoming engines manufactured in Connecticut, did not win the contract, and Senator John Tower (R-Tex.) and others are leading a quiet effort to persuade the Air Force to buy the Texas-built LTV-A7 aircraft. Meanwhile the Army insists that it, and not the Air Force, should have the plane.

350 MHz

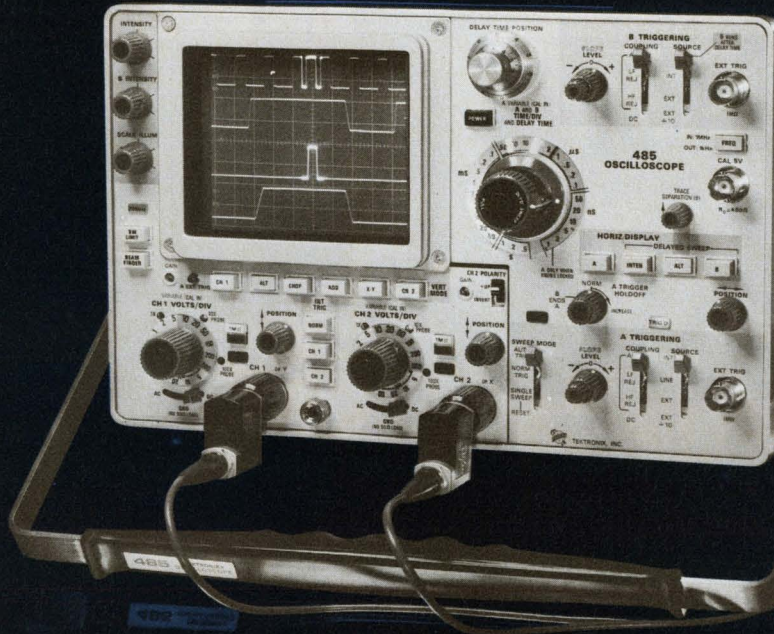

in a portable laboratory oscilloscope that weighs only 23 pounds.

The dual-trace, 350-MHz TEKTRONIX 485 Oscilloscope is the newest addition to the world's most widely used portable family. Many features of earlier TEKTRONIX portables are retained, many others are expanded and a lot of new ones are added. The result is a new product which significantly expands the performance spectrum of portable scopes. Following are some of the features of the 485, an oscilloscope which measures with laboratory precision and carries with small-package ease.

350-MHz Bandwidth at 5 mV/Div—More dual-trace high frequency measurement capability at 5 mV/Div than any other laboratory-quality scope—portable or cabinet.

1-M Ω and 50- Ω Selectable Inputs—Scope circuitry automatically disconnects the 50- Ω inputs when signals exceed 5 V RMS or 0.5 watts to protect your equipment.

Time Resolution to 1 ns/Div—More time resolution than any other portable. And it's direct reading.

A-External Trigger—Just press this button to display the external trigger signal and quickly verify your trigger source or check timing reference.

Alternate Sweep Switching—View intensified waveforms and delayed waveforms at the same time. When you move the intensified zone you always know precisely where you are, and still see the delayed waveform. It saves time and adds operation convenience.

Weight without accessories, just 20½ lb (23 lb with accessories). As much as 30% lighter than other portables which have only 150-MHz bandwidth.

For complete information or to arrange a demonstration, contact any TEKTRONIX Field Office. Our offices are located in or near major cities and industrial centers—worldwide. If you prefer, write Tektronix, Inc., P.O. Box 500, Beaverton, Oregon 97005. In Europe, write Tektronix Ltd., P.O. Box 36, St. Peter Port, Guernsey, C.I., U.K.

485 Oscilloscope \$4200
U.S. Sales Price FOB Beaverton, Oregon



TEKTRONIX®

committed to
technical excellence

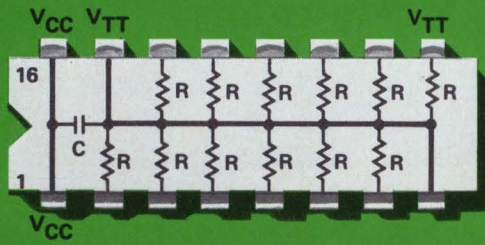

SERIES 898-41 -2.0 VOLT TERMINATORS contain eleven resistors for ECL line termination to a -2.0 volt bus. Each unit includes a 0.01 μ F decoupling capacitor to bypass the -2.0 volt bus. Standard R values of 50, 75, and 100 ohms are available and are designated 898-41-R50, 898-41-R75, and 898-41-R100. Price (1,000-4,999) \$1.25

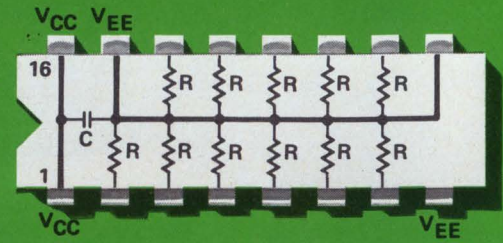

SERIES 898-42 -5.2 VOLT TERMINATORS contain twelve resistors for pull-down to the -5.2 volt bus. Each unit contains a 0.01 μ F decoupling capacitor to bypass the -5.2 volt bus. Price (1,000-4,999) \$1.25

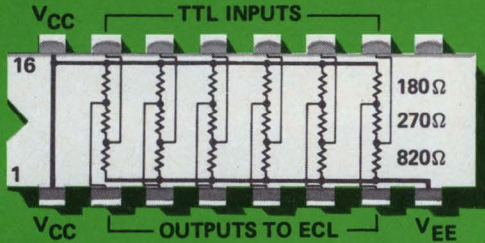

SERIES 898-45 TTL TO ECL TRANSLATOR contains six identical three-resistor sections for direct translation from TTL to ECL, both operating between a +5 volt supply and ground. Price (1,000-4,999) \$1.25



Butterfly
Diurnal insect of the order *Lepidoptera*, characterized by clubbed antenna, a slender body, and large, broad, often conspicuously marked wings. Often found fluttering about the design engineer's stomach.

Our Bugs will get rid of your Butterflies

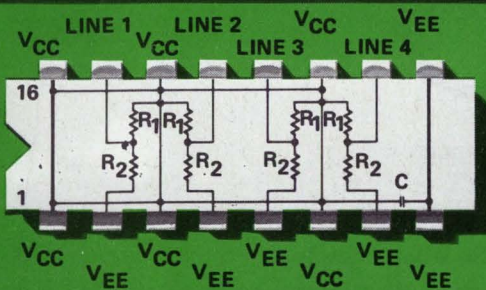

SERIES 898-43 THEVENIN EQUIVALENT TERMINATORS contain four Thevenin equivalent terminator sections. Each terminator section consists of two resistors connected as a divider from the ground bus to the -5.2 volt bus providing a Thevenin equivalent voltage of -2.0 volts. Each unit contains a $0.01 \mu\text{F}$ decoupling capacitor to bypass the -5.2 volt bus. Series 898-43 units are available with Thevenin equivalent impedances of 50, 75, and 100 ohms.

Series 898-43 R_1 and R_2 Values

Model	R_1	R_2
898-43-Z50	81 Ω	130 Ω
898-43-Z75	121 Ω	195 Ω
898-43-Z100	162 Ω	260 Ω

Price (1,000-4,999) \$1.25

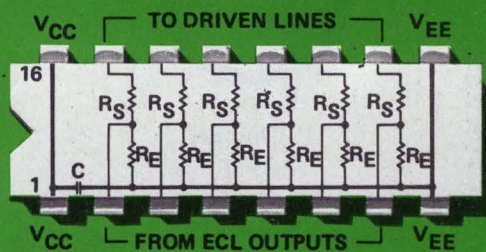

SERIES 898-44 SERIES LINE TERMINATORS contain six series terminator sections. Each section is designed for terminating a line at the driven end with a series resistor value equal to the line impedance minus the 7 ohm output impedance for 10,000 series ECL. The second resistor in each section is a pull-down resistor to the -5.2 volt bus. Each unit contains a $0.01 \mu\text{F}$ decoupling capacitor to bypass the -5.2 volt bus.

Series 898-44 R_S and R_E Values

Model	R_S	R_E
898-44-S43	43 Ω	457 Ω
898-44-S68	68 Ω	682 Ω
898-44-S93	93 Ω	907 Ω

Price (1,000-4,999) \$1.25

ECL Terminator Collection

Dependable Beckman ECL terminator networks are specifically designed for, and compatible with, the following Emitter Coupled Logic families:

- Motorola MECL 10,000 Series
- Signetics 10,000 Series ECL
- Fairchild 95K and F10K Series ECL
- Texas Instruments Series SN10000 ECL
- National Semiconductor 10,000 Series ECL

Each Beckman ECL terminator network utilizes thick film resistor materials

with layouts specifically designed for low inductance and the high speed requirements of ECL systems. Where possible, the terminator networks include $0.01 \mu\text{F}$ decoupling capacitors.

Each network is capable of operating in a $+85^\circ\text{C}$ still air environment at standard ECL voltage levels and tolerances without heat sinking.

For complete technical data, contact your local Beckman/Helipot representative or write to Beckman Instruments, Inc., Helipot Division, 2500 Harbor Blvd., Fullerton, Calif. 92634.

Beckman

HELIPOT DIVISION
INFORMATION RETRIEVAL NUMBER 26



P-Channel
JFET



N-Channel
JFET

Since 1962, Siliconix has evolved FET technology and applied it to a complete line of singles, duals, arrays, and ICs. So what's new?

Economy Epoxy FETs

Siliconix, the world's leading supplier of FETs, now brings you a full line of plastic encapsulated field-effect transistors—at economy prices as low as 32c each in 1000-unit quantities. Why be concerned over alternate sources? Call on the FET leader for quality devices at rock-bottom cost.

The Siliconix line of epoxy products includes

- FETs for general purpose amplifiers
- FETs for VHF/UHF amplifiers and mixers
- FETs for switches, choppers, and commutators
- FET pairs for differential amplifiers
- FET diodes for current limiters and regulators

Use these new epoxy FETs with the same confidence you have placed in Siliconix products in the past—they are typed, manufactured, and tested specifically for the industrial and commercial markets.

A copy of our new epoxy FET cross-reference guide and full line catalog is yours for the asking. Just circle the bingo card number or call your nearest Siliconix distributor.

Write for Data



Siliconix incorporated

2201 Laurelwood Road, Santa Clara, California 95054

INFORMATION RETRIEVAL NUMBER 27

How exact is engineering?

We kid ourselves a lot. We say that engineering differs from other disciplines in that engineers deal with exact data—not intuition. Baloney! Sure, when we do our paper work, we can generate numbers that look impressive. But when we switch from paper designs to real equipment, we're in a different world. We know almost nothing about the key components we're going to use.

Let's say we buy an IC with a typical dissipation of 200 mW. What does "typical" mean? It means whatever the vendor wants it to mean. And he normally doesn't tell us. So a man lives dangerously if he tries to design with "typical" specs. Yet some manufacturers persist in omitting the minimum and maximum specs we can use.

I know it's impossible for a manufacturer to test every IC for every spec. But he should know enough about his process to provide key min/max specs with a fair degree of confidence. Unfortunately engineers tend to read numbers rather than words. A typical 200-mW dissipation looks twice as good as a maximum 400-mW dissipation—if you don't check the qualifiers. But in the real world the typical 200-mW device might consume 500 mW.

Annoyingly, specs seem to have their own version of Gresham's Law, which states that bad money drives good money out of circulation (try to find a silver quarter today). When a vendor writes a clever spec that makes his product look better than others, his competitors follow suit. And the engineer must work with increasingly meaningless numbers—not just for ICs, but for any product.

Can we repeal Gresham's Law? Maybe. Several vendors have already begun to buck the tide. They don't release a product until they can include min/max specs.

What about other vendors? That depends on us. If we raise enough hell with those who don't give us the specs we need; if we insist on minimum specs for parameters like bandwidth, slew rate and noise rejection, and maximum specs for parameters like drift and access time; if we push vendors for worst-case specs over temperature and power-supply extremes—we should be able to get numbers we can use. Then, and only then, can we call engineering an exact discipline.

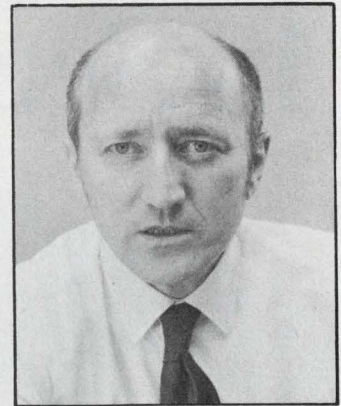

George Rostky

GEORGE ROSTKY
Editor-in-Chief

How Would You Like To Get Answers Like These In Seconds?

It took only 27 seconds for HP's 3042A Automated Network Analyzer System to perform this complete low-pass elliptic filter analysis. Note the detailed plot of amplitude response as well as the tabulated printout of all the important filter characteristics. HP's 50 Hz to 13 MHz network analyzer systems are truly state-of-the-art. They can free you from countless hours of point-by-point measuring and plotting—and they're equally valuable on the production line and in the lab.

The Most-Powerful 3042A System not only can perform your entire testing process, but it lets you make measurements that you never could do before. It's a fully-automatic two-channel analyzer that will completely characterize any two-port linear device. Because it's automated, you get outstanding

ELLIPTIC FILTER
TEST

FILTER NO. = 25003

INSERTION LOSS
PASS
0.15 DB

PASSBAND RIPPLE
PASS
≤ 0.3 DB

STOPBAND REJ.
PASS
> 50DB

1600 HZ REJ.
-65.87 DB

2400 HZ REJ.
-91.97 DB

3DB FREQUENCY
1066.9 HZ

PASSBAND DELAY
PASS
≤ 0.4 MSEC

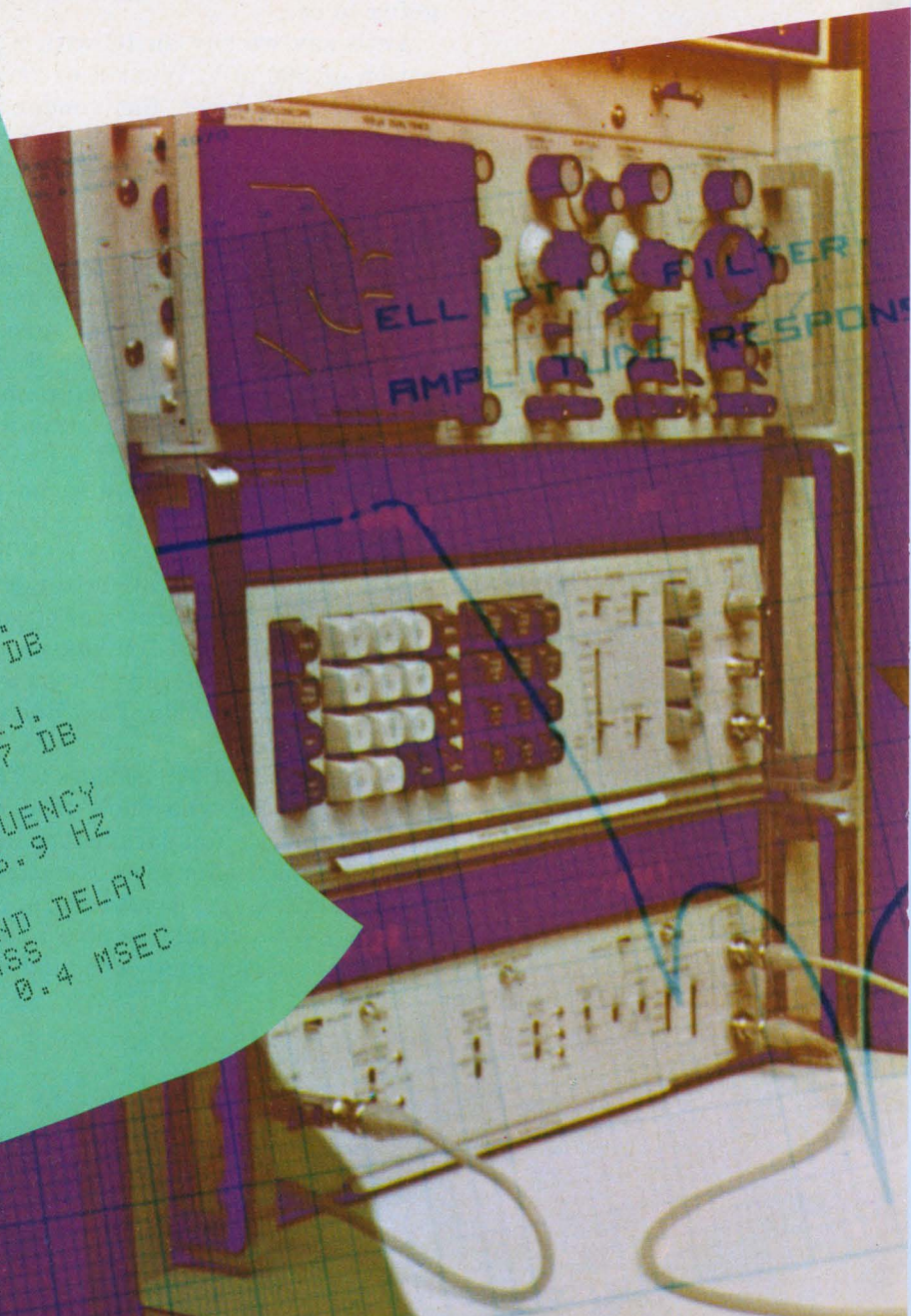

data repeatability along with the dramatic speedup in testing rate. Use it to fully test such time-takers as active filters, crystals or op amps. You can do them in seconds or minutes instead of the usual hours or days.

The system is comprised of three standard HP products—a synthesizer source, a tracking detector, and a calculator. This powerful combination applies equally to one-of-a-kind lab tests, or to repetitive production line testing. And, in addition to being able to make such tests as group delay, limit testing and offset measurements automatically, you also gain the capabilities of data reduction and decision making. You can have this fast, capable 3042A System for \$22,300—ready to operate.

Semi-Automatic 3041A System brings you the advantages of partial automation for significantly less money than full automation would cost. It incorporates the same synthesizer source and tracking detector used in the fully-automated system, but is controlled by a more economical marked card programmer (instead of the calculator). You can even make group delay, limit test and offset measurements with the 3041A. At \$14,000, it's modestly priced but does the work of systems costing much more.

Basic 3040A System teams the tracking detector with one of four automatic synthesizer sources. It's a budget-priced combination that provides you with many of the capabilities of a dedicated automated system, but at much lower cost. When you select the top-of-the-line automatic synthesizer you get a lab-in-a-box with a "brain." It combines the performance of a synthesizer, a sweeper, a marker generator, a counter, a programmable attenuator, a precision level generator, and a controller in one instrument. Depending on

the synthesizer you choose, these high-capability systems cost from \$6,900 to \$11,000.

All three of the Network Analyzer systems help you do more work in less time and with less labor. With them you can telescope what formerly took hours, or even days, into only minutes or seconds. Optional accessories let you select and pay for only the exact capability you need. For full details on these network analyzer systems call your local HP field engineer. Or, write Hewlett-Packard, Palo Alto, California 94304. In Europe: HPSA, P.O. Box 85, CH-1217 Meyrin 2, Geneva, Switzerland. In Japan: Yokogawa-Hewlett-Packard, 1-59-1, Yoyogi, Shibuya-Ku, Tokyo, 151.

093/40

HEWLETT  **PACKARD**

NETWORK ANALYZERS



Focus on Connectors for PCs and substrates

What could be simpler? You stick some pieces of metal in a hunk of plastic, and you've got a connector. Its sole job: to join and separate lengths of wire without being noticed. Can such an uncomplicated device cause more havoc in a system than complex ICs? It can. And often does.

We demand rather little of a connector. In general, we want contact resistance that remains low despite a series of insertion/withdrawal cycles and despite possible harmful environments. We may want to carry high currents as well as low currents. We may want to withstand high voltages. But these "simple" requirements can be awesomely difficult to nail down. Specs are too often ambiguous and too seldom helpful. And if we choose the wrong connector, not only may it hurt our system; it may be more expensive than one that would better fill our needs. Connector cost—if custom tooling is called for—may be very high and unnecessarily so.

Most requirements can be met with catalog items. But catalogs can mislead. Specs are almost always inadequate. Let's look at the factors that can make connector selection so tough.

Two-piece vs one-piece connectors

Because the Army's MIL-STD-275 and the Air Force's MIL-E-5400 forbid the use of one-piece (or card-edge) connectors in airborne and life-support systems, many engineers leap to the conclusion that one-piece connectors—those that use etched pads on the PC board for the male contacts—are banned in military equipment. It's not so. The military does accept one-piece connectors in ground equipment, and the ban on one-piece units in airborne and life-support systems should not

suggest that two-piece connectors—those with half the connector pair mounted on the board—are better for all needs.

The military and most connector authorities do consider the two-piece connector more reliable. But for many applications the reliability of the one-piece is adequate.

The two-piece can't be avoided in high-density applications that require three or more rows of contacts (the one-piece can accommodate no more

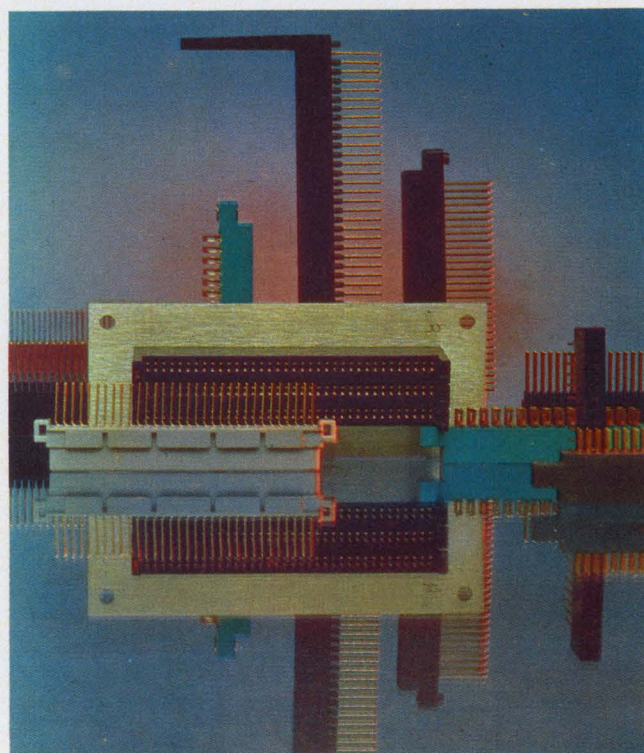

One- and two-piece connectors from ITT Cannon Electric show three types of termination tails—dip solder, solder eyelet and wrapped wire.

Richard Lee Goldberg
Associate Editor

than two rows). And there are other applications where a one-piece is theoretically, but not practically, suitable. For example, you're asking for trouble if you try to use a one-piece with 100 contacts on 50-mil centers. It would be more practical to partition the board to accommodate several smaller, one-piece connectors or a multi-row two-piece unit.

If you need more than, say, a hundred insertion/withdrawal cycles, you're far safer with two-piece connectors, many of which (but not all) are good for 500 cycles. The failure of the one-piece connector for many insertions is more likely to be in the PC pads than in the connector itself.

Many people feel that two-piece connectors offer much higher tolerance to shock and vibration, especially since the connector halves can be bolted together. However, if a one-piece is used with a card guide and the guide is clamped to the board, the connector can offer similar vibration and shock tolerance.

The two-piece is superior for moisture and fungus environments, if you conformally coat the board. Conformal coating is far more difficult, though not impossible, with one-piece boards. Finally, the two-piece is inherently more immune to the effects of board warpage, which can break contact in one-piece construction.

Despite its merits, the two-piece has some severe limitations. First, it occupies more volume than the one-piece. Second—and most important in many applications—it generally costs at least three times as much (though Molex has a two-piece connector, the Konektcon, that costs less than many one-piece units). Third, board preparation for the two-piece costs quite a bit more, since it's usually necessary to drill holes for the

contact tails. Finally, for many two-piece connectors, there is less normal force (at and perpendicular to the contact-mating surfaces) and less contact area, resulting in higher contact resistance. However, most two-piece types have less contact wear for many insertion/withdrawal cycles, so contact resistance remains more stable.

Which contact style?

The choice of one-piece or two-piece affects the choice of contact style. Though there are variations, each has three basic styles (Fig. 1).

One-piece connectors can use bellows, cantilever or tuning-fork contacts. The bellows contact—a type of a folded ribbon patented in 1954 by Leon Gilbert, president of Continental Connector—increases effective contact-spring length (providing more springiness or compliance) without increasing contact length inside the connector body.

The bellows is a formed contact, developed by bending round wire that has been flattened. But its tails aren't formed for solderless wrapping; they're intended for soldering. Nevertheless the bellows still dominates in one-piece connectors because of its superiority with boards of uneven thickness. But this formed contact is the most expensive of all six types, not only because of the forming process, which is slow, but because each contact must be inserted in the connector body individually.

There are other folded-ribbon contacts aside from the bellows. The leaf or ribbon contact, which has a single fold, is usually formed from flat wire. When made from round wire, it may be called the wire, folded-wire or formed-wire contact. These contacts offer similar characteristics

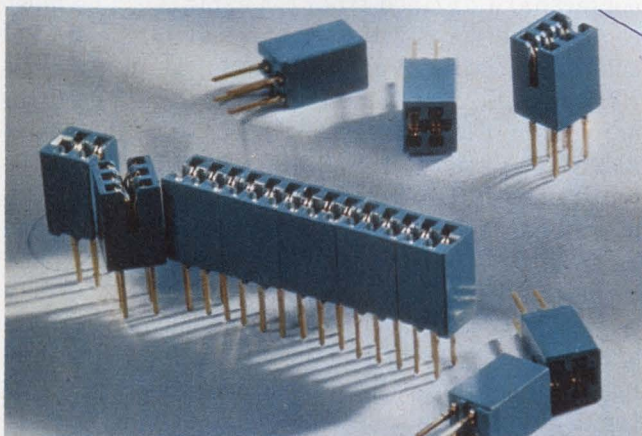

The modularity of Elco's Series 6308/6318 allows a user to join individual sections together to form almost any size of card-edge connector.

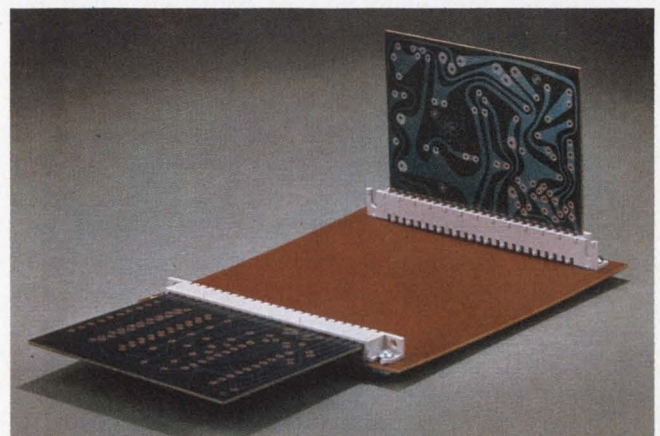

With solder tails, either straight or right-angled, these units from AMP allow daughter boards to be mounted parallel to or perpendicular to a mother board.

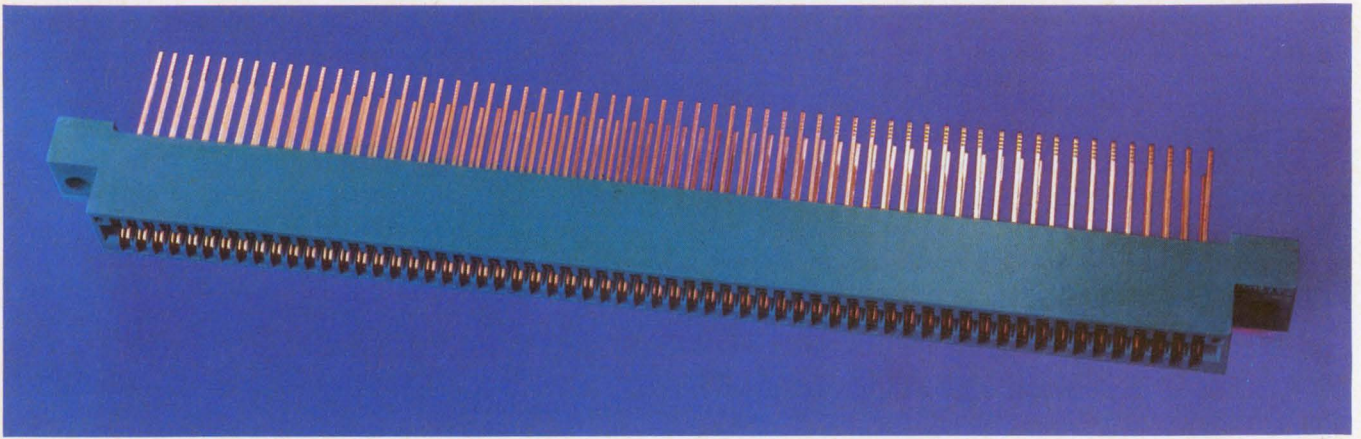

Bifurcated contacts are housed in a diallyl phthalate molded body in this Augat unit.

to those of the more popular bellows. But they have less compliance and shorter cycling lifetimes.

Cantilever and tuning-fork contacts can be stamped rapidly from flat wire. And a connectorful can be prestressed and mounted in a connector body at one time. Unlike the bellows, these can accept selective gold plating over just the contacting surfaces. They can also be stamped with tails for wrapping or soldering.

The cantilever, which may be single or double, lacks the compliance of the bellows contact; so it shouldn't be used with warped boards or boards with widely varying thickness. Further, the cantilever is more susceptible to permanent set than the bellows. Normal force thus decreases after insertion cycling at a much faster rate for the cantilever than the bellows.

The tuning fork is cheaper to manufacture than the other types. The tuning fork, first used in a plate connector by Malco in 1959, comes with only a single readout termination, and is less compliant than either the cantilever or bellows.

Bifurcation: Good or bad?

All three card-edge contact styles are available in bifurcated versions (the contact is slit lengthwise to produce two contact segments). Bifurcation is important because it is one of the industry's most touted and least useful gimmicks. If the two contact segments have different resonant frequencies, one segment will always maintain contact, even during vibration. But to have different resonant frequencies, the segments should be of unequal width—which is almost never the case. Even so, a properly anchored board is a much better way to cope with vibration than bifurcated contacts.

The other advantage cited for bifurcation is that it provides redundancy; there are two contact pairs instead of one. So if a speck of dirt blocks one mating pair, the other pair—in theory,

but not necessarily in practice—will continue to make contact.

But bifurcation reduces contact area and lowers normal force. The material removed for the slit is not available for making contact. And this material reduction cuts spring force.

Most vendors interviewed by ELECTRONIC DESIGN concede that bifurcation is actually bad. But they offer it because: (1) other vendors do, and (2) engineers ask for it.

Three contact styles for two-piece

Two-piece connectors can use pin-and-socket, blade-and-tuning-fork or hermaphroditic contacts. Pin-and-socket contacts are machined, so dimensional tolerances can be tighter than those for the two other contact types. The tighter tolerances make for more intimate mating, greater contact area and more insertion/withdrawal cycles. These contacts can also tolerate more misalignment. But pin-and-socket contacts, being screw-machine parts, are substantially more expensive than the others, which are stampings.

The least expensive of the three is the hermaphroditic, because identical "male" and "female" contacts are stamped from the same die. The most common hermaphroditic contact available in PC connectors is the Varicon, developed in 1950 by Benjamin Fox, president of Elco. It is available only from Elco and its licensees, and it has a maximum density of 100-mil centers. Resembling the tuning fork in shape, Varicon requires close alignment and, because of its high normal force, is sensitive to permanent set and wear after repeated insertion cycling.

The blade-and-tuning-fork also has both male and female contacts stamped from flat wire, but not from the same die. It was patented by Malco for a Polaris missile control in 1959 and is presently used by the Navy in its Standard Hardware Program. Misalignment in the plane parallel to the width of the blade can be accommodated

if the blade is sufficiently wide. Performance after cycling is similar to that of the herma-phroditic type.

Measuring contact performance

Contact performance is determined by many factors, including style, spring constant, contact thickness; material properties and mating area. But how does one measure contact performance? With difficulty.

Two specs—contact resistance and insertion and withdrawal forces—are extremely popular and extremely deceptive.

Contact resistance (the dominant part of which is the constriction resistance at the mating surface) is meaningless when given alone. For a given board in a given connector, the contact resistance depends on current. The resistivity of the contact material and its surface oxides are functions of temperature, which rises with current. If a vendor measures a certain contact resistance with a 1-A test current, you're not likely to get the same resistance if you use an ohmmeter that delivers 10 mA. So it's essential to know the test current at which the vendor specifies contact resistance.

To be most conservative—to learn the highest contact resistance likely—use a test current that approximates the lowest current the contacts are likely to pass in operation. And, of course, see that the contacts can safely carry the high currents that might be required. The test environment, including factors like temperature and humidity, should match operating conditions.

Check to see that the vendor's quoted contact resistance isn't lower than the theoretical value calculated from the resistivity of the bulk contact material itself. If it is lower—which you find occasionally—it has some value: It pinpoints vendors to avoid.

Further, a connector itself, of course, has no

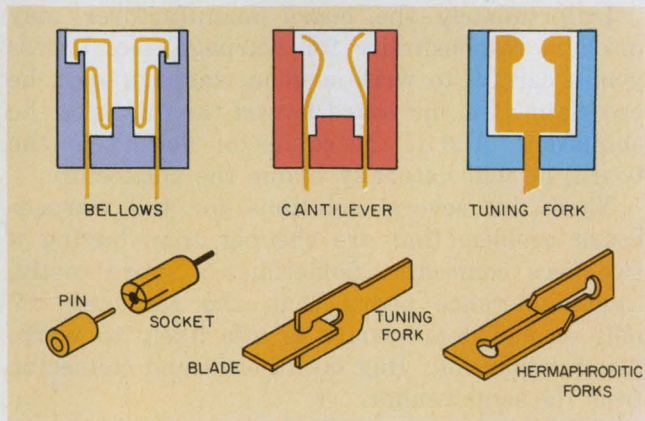

1. There are six basic contact styles. For the one-piece connector, there are the bellows, cantilever and tuning fork. For the two-piece connector, there are the pin-and-socket, blade-and-tuning-fork and hermaphroditic.

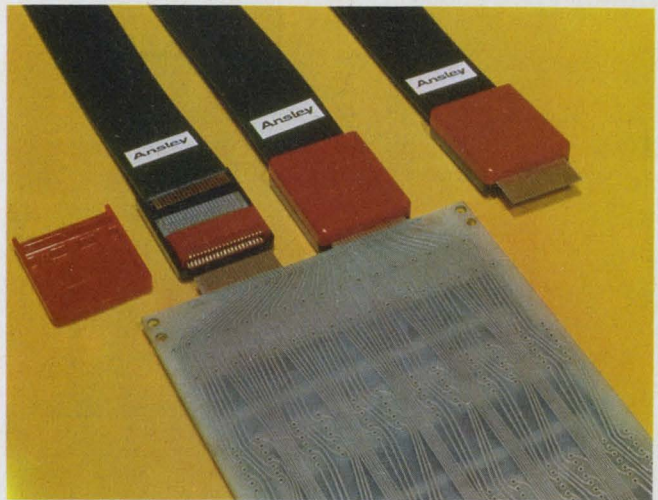

This flat cable, zero-insertion-force connector from Ansley clamps spring-loaded contacts to the PC board.

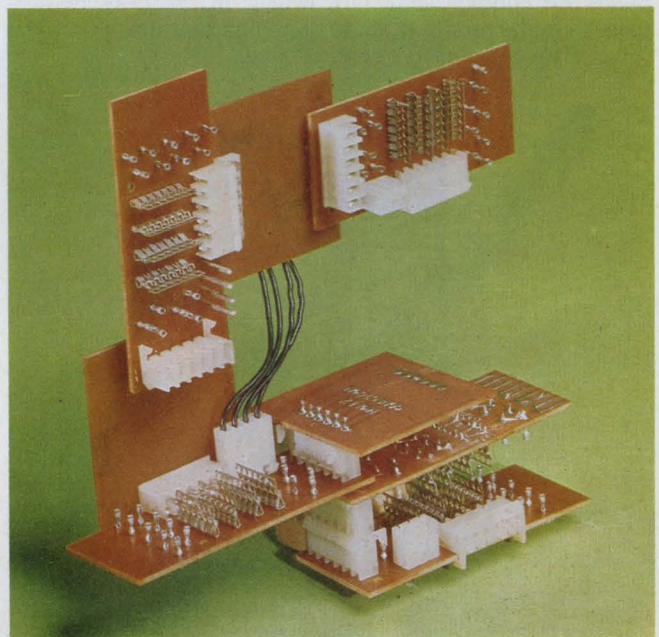

Two-piece Konektcon connectors from Molex are sturdy enough to support a stack of small daughter boards.

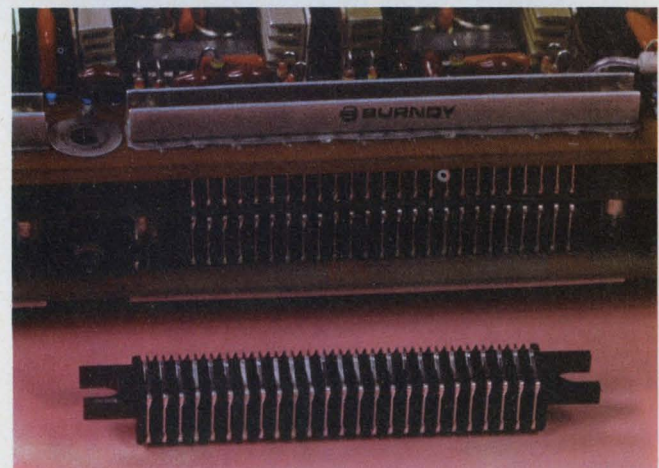

High pressure contacts in Burndy's brand new board-to-board connector allow stacking of boards without solder or jumper cables.

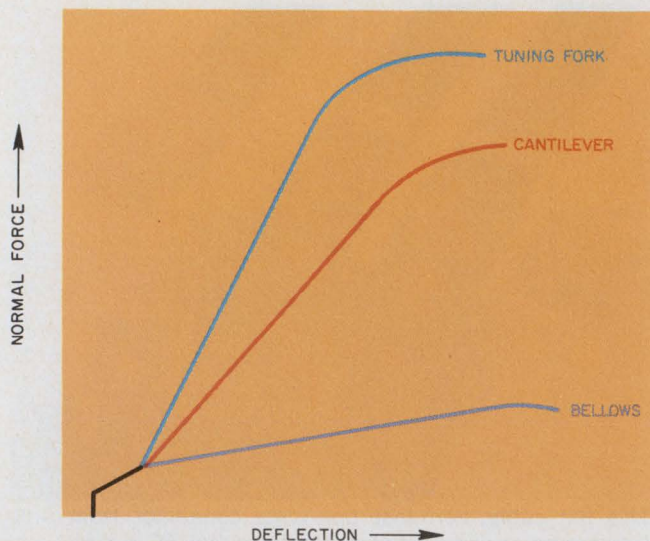

2. The normal force at the contact-mating surfaces depends on contact deflection which, in the case of one-piece connectors, depends on board thickness. The force also depends on contact style.

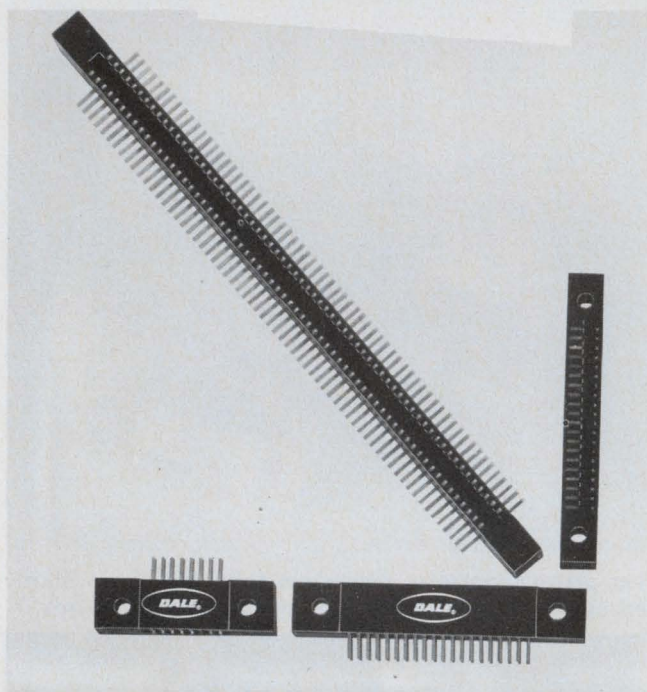

These Dale card-edge connectors feature 50-mil contact spacing, which is the highest density available for this type of connector.

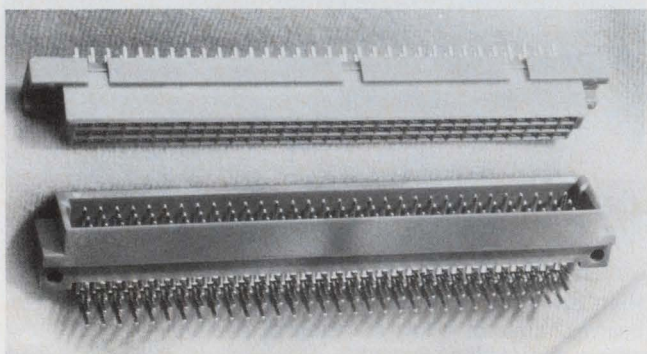

Square pins and sockets appear in three rows in Amphenol's Series 128.

contact resistance without an inserted board. A one-piece connector is designed for a board with a certain nominal thickness. But boards have a thickness tolerance. A board with minimum thickness may contribute to a higher contact resistance than a thicker board, which increases the normal force at the contacting surfaces (Fig. 2).

How much force?

Insertion and withdrawal forces also depend on board thickness and normal force. So the board tolerance must be given if force specs are to have any meaning.

When insertion/withdrawal forces are given for an individual contact, do not extrapolate the results for the entire board. The total board insertion force (which is what you want) is not the sum of the individual contact forces, because some contact fingers may be out of alignment. In addition, if the board is warped, the total insertion force cannot be guessed from the individual contact forces. If the board is thinner than the maximum board thickness for which the connector was designed, the insertion force will be lower.

While insertion/withdrawal forces depend on many factors, the key influence on contact resistance is normal force—that applied at and perpendicular to the mating surfaces. To minimize contact resistance, normal force should be higher than about 100 grams. But not much higher. The more the force exceeds 100 grams (as it will with a thicker board) the faster the contact will wear during cycling.

Vendors rarely give normal-force specifications for two principal reasons. First, it's very difficult to measure normal force. Second, it's a function of board thickness (with one-piece connectors). And the connector vendor can't accept responsibility for the tolerances or warpage of your board.

Unfortunately the board manufacturer may disclaim responsibility for warpage, too. Unless you're careful to write a good warpage spec, he can claim that the board bowed the day after he shipped it. And if the connector doesn't fit the board, he will naturally blame the connector.

There are several solutions for the warped-board problem that are cheaper than buying a two-piece connector. Sometimes a more costly, tighter-tolerance board than the standard ± 7 mils on a 62.5-mil board is less likely to warp. Another solution: Buy both board and connector from the same vendor.

Insertion/withdrawal cycling

An important measure of contact life is, of course, the number of insertion and withdrawal

cycles the contacts can withstand. But what does "withstand" mean? It's not uncommon to find specs that indicate that a connector will withstand 500 insertion/withdrawal cycles. But what about contact condition at the end of the cycling test? The specs are silent here. It's essential then that cycling specs describe environmental conditions during cycling and the contact resistance before and after the test. It's also valuable to check contact condition a few days after the cycling test. A 500-cycle test can completely scrape away the contact finish, but it may take a day or two of exposure to the atmosphere before you can clearly see the effect in a contact-resistance test.

Unfortunately insertion/withdrawal cycling has become a horsepower race. Engineers pay good money for 500 cycles when they're not likely to remove a board more than half a dozen times.

Further, like contact resistance and insertion force, cycling life depends on board thickness. You cannot expect long cycling life if you force a contact to operate beyond its yield point, where it permanently deforms because of a thick board. The yield point depends on the contact material (Fig. 3).

Which contact material?

Many contacts are still made of brass, though phosphor bronze and beryllium copper are more common. At about 85¢ a pound, brass is the cheapest contact material. But it reaches its yield point at the lowest deflection force. Some brass contacts will yield with a maximum-thick board. But up to its yield point, brass has the same normal force/deflection properties as the other contact materials. If you can keep thickness under the upper tolerance limit, +7 mils, brass can be a good choice.

Phosphor bronze, at around \$1.15 a pound, offers a slightly higher yield point than brass. It thus provides more compliance and better fatigue characteristics, resulting in better ability to handle thick boards.

Beryllium copper, priced around \$6 a pound, is commonly found in bellows contacts because it has the highest yield point of all the materials. It is therefore the most flexible. But it is only for maximum-thick boards that its flexibility has any effect on contact performance.

Which plating?

Contacts are plated over a nickel, silver or copper undercoat to improve their electrical conductivity at the plating surface. So why is the entire contact plated? Because it is easier than plating just the mating surface.

Three techniques are available for applying

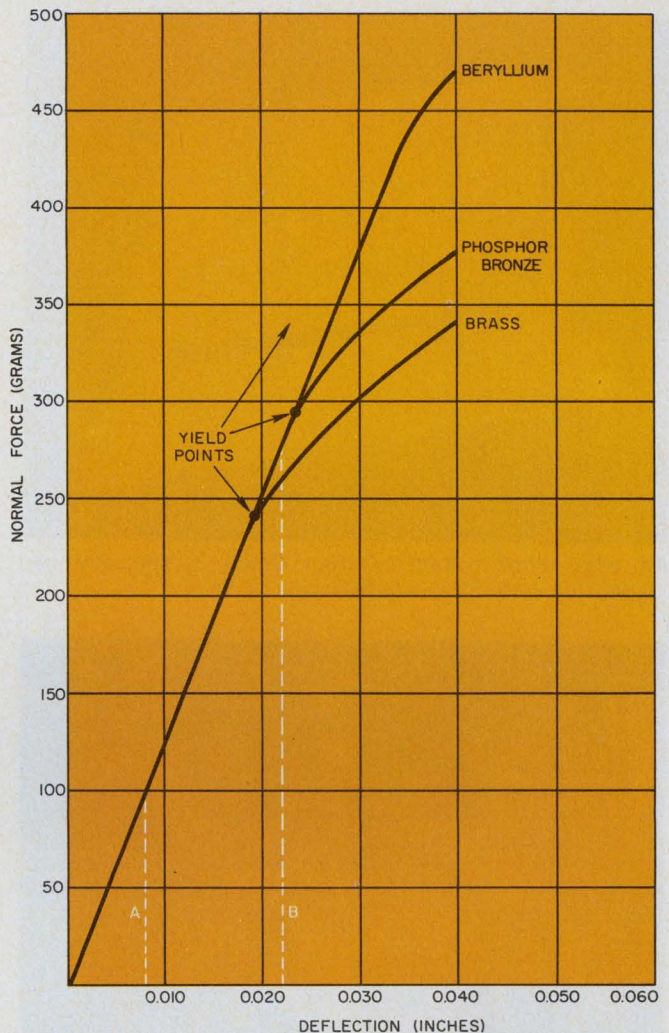

3. Theoretical curves show the normal force developed for cantilever-beam contacts as a function of contact deflection. Beyond its yield point, each material deforms permanently. Curves are based on advertised yield points of the materials. For a 62-mil nominal board, line A represents the deflection for a minimum-thick board (54 mils) with maximum contact gap (38 mils) and line B represents deflection for a maximum-thick board (70 mils) with minimum gap (26 mils). Curves are for contacts designed for a minimum of 100-grams normal force and a spring rate of 12.5 g/mil. (Courtesy of Marvin Yeager and Leon Ritchie of AMP Inc.)

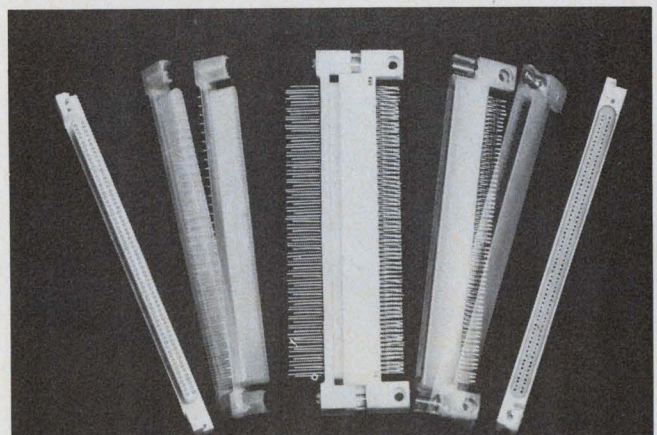

Keyed slots at the ends of the housing prevent incorrect mating of the two halves of this Malco pin-and-socket connector.

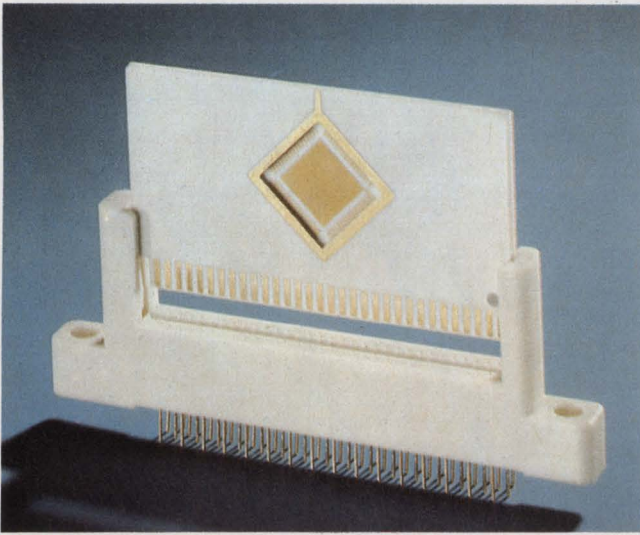

An edgemount connector from Cinch is specially designed for ceramic LSI substrates.

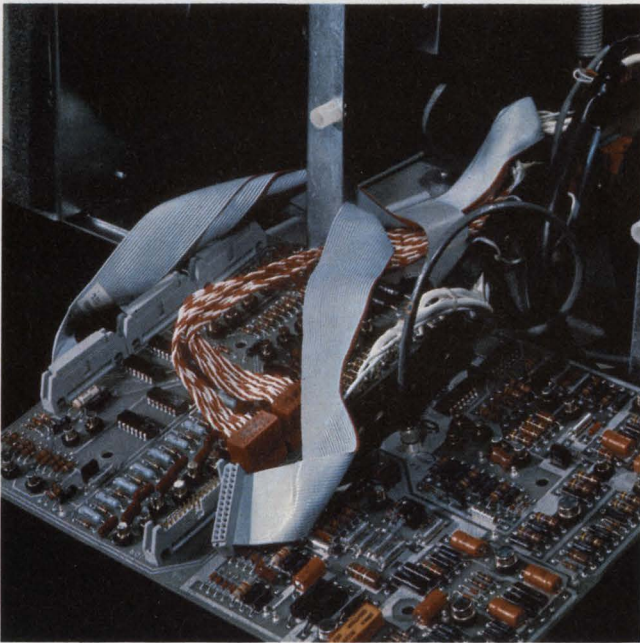

Flat-cable connectors from 3M, with wrapped-wire or dip-solder tails, can be mounted on the surface of a board, either vertically or horizontally.

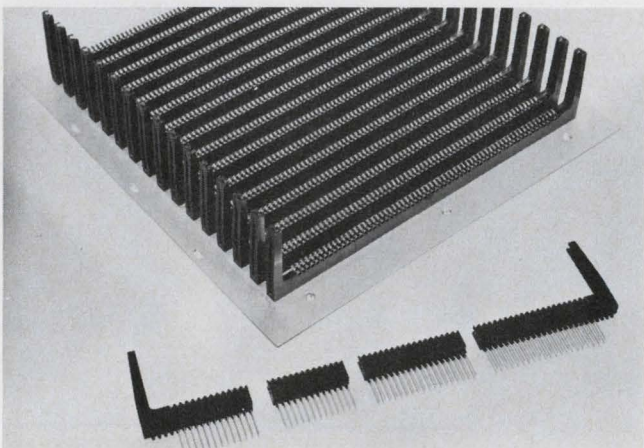

Built-in card guides and modularity are features of these metal-backplane, card-edge connectors from Fabri-Tek.

noble metal solely to the contacting surface. All three conserve gold, whose price has more than doubled in the last two years. The welded gold dot, available from GTE Sylvania and others, forms a metallurgical junction with the bulk contact material. Though the process uses less gold than it would if the entire contact were plated, the dots have been known to separate from the contact during board insertion.

In addition, since the dot protrudes from the contact surface, the entering board can cause increased wear and shorter cycling lifetime than can be expected from a fully-plated contact. The cost advantage of the gold-dot approach must be weighed against rapid wear of the contact pads on the board. For only a few insertion cycles, gold-dot contacts present few problems.

Beware, however, of gold-dot contacts in an edgemount substrate connector, even for a small number of cycles. Since the ceramic substrate is not chamfered, its square edge causes rapid wear to a protruding gold dot, and it can knock off the gold.

The ceramic edgemount connector—available from TI, ITT Cannon Electric, Amphenol, Winchester, Burndy and others—shares many problems with conventional card-edge connectors and adds a few of its own. Because the “card” is of ceramic and is relatively small (2 inches wide), it’s not likely to warp. But it has an extremely hard edge that’s not chamfered, so it can really beat up a low-compliance contact.

The second process for gilding just the mating surface is to selectively electroplate only the surface that makes contact. Selective gold plating is offered by many vendors, but it is usually restricted to cantilever contacts. Though the gold does not protrude from the contact as much as the gold dot, it can wear more rapidly than it would if the entire contact were plated.

Another alternative to electroplating the entire contact is the gold-clad process of Texas Instruments. In this technique a layer of gold is laid into just the contacting surface. The metallurgical bond is said to be stronger than the metals themselves. The process uses a layer of gold (at least 100 $\mu\text{in.}$), which is thicker than that formed by electroplating (typically 40 $\mu\text{in.}$).

Why use gold? Though rhodium is sometimes used for high temperatures (over 300 C), and silver has occasionally been used because of its high electrical conductivity, the inertness of gold favors its use. But to combat gold’s rising price, several vendors offer contacts without noble metal plating.

Either a bright tin-lead alloy or nickel-silver (which, like German silver, does not contain silver) is used over the bulk contact material. The metallurgy of these techniques is not new. But it took the stimulus of higher gold prices for non-

Here it is! Allochiral. The most rugged, reliable solderless interconnect system available. Lowest profile ever... .025" Low price, too!

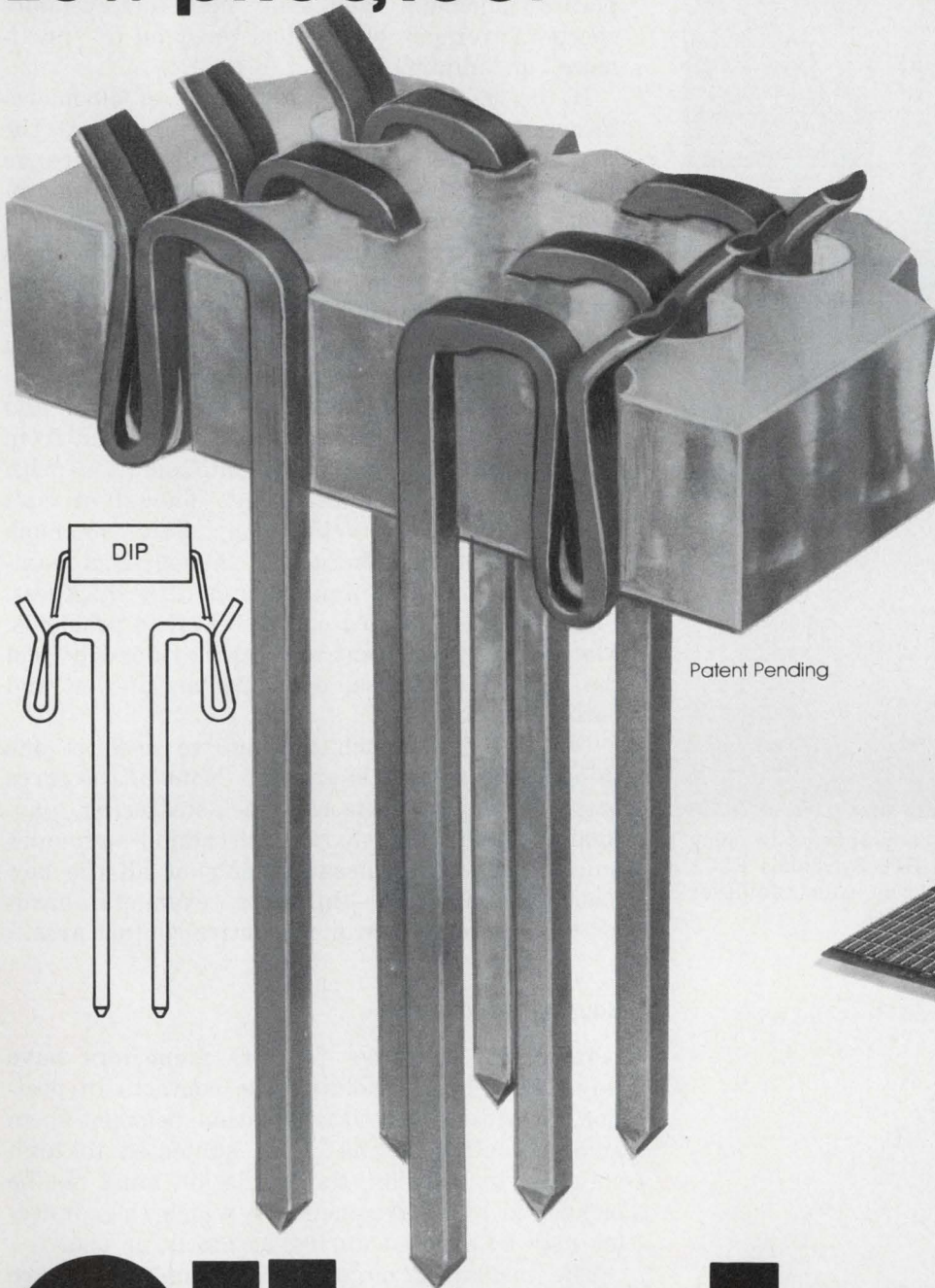

You gain...

Super-Low Profile for greater packaging density!

One-piece construction for greater reliability, production savings on each contact, board and finished assembly!

Short IC lead lengths - as short as .035 below device for full contact - as much as 60% of lead perimeters!

And, more. A complete array of associated equipment. Boards. Connectors. IC carriers. Packaging Hardware. Insertion tools (manual, semi- and full automatic)!

It's new. From Robinson-Nugent, the socket people. Push an Allochiral contact/terminal through a pre-drilled board and it becomes a properly and permanently aligned, self-supporting connector socket for ICs. Or, with its available associated equipment and hardware, a complete back panel solderless interconnect system.

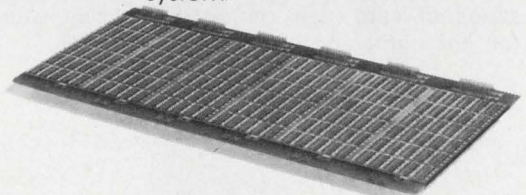

Try the new Allochiral system. From...



800 East Eighth Street
New Albany, Indiana 47150
(812) 945-0211
TWX 810-540-4082

(al-o-kir'-el)

Allochiral

INFORMATION RETRIEVAL NUMBER 31



Connectors can be fun. The young lady appears to enjoy the somewhat oversized models of GTE Sylvania's P101 series of card-edge connectors, shown with cantilever (on her right) and bellows contact styles.

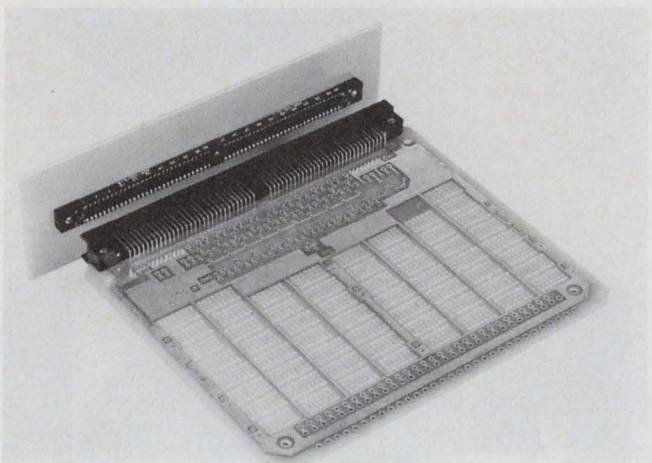

A two-piece connector from Robinson-Nugent is shown here used with a circuit board for DIP ICs.

noble platings to appear. Don't expect a large number of insertion cycles, however, and make sure the price is lower than that for a contact with gold, for low price is the only advantage of non-noble contacts.

Specifying contact plating

When specifying plating, include plating thickness and area, porosity, evenness, hardness and type of gold. But when you ask for a certain plating thickness, you may find that vendors specify "average" or "typical" instead of "maximum" or "minimum."

If the thickness is an "average" of 50 microinches, there may be only 2 microinches at the contact interface and perhaps 98 elsewhere on the contact. Most users ask for 30 to 40 microinches for commercial applications, and at least 50 for military use. Be careful if the thickness is unspecified. It may be only 10 microinches, which is too porous.

Surprisingly, too much gold can cause problems also. Solder can amalgamate with the gold, forming an intermetallic bond where the gold and solder meet. This causes the gold to unbond from the contact. The gold goes into solution with the solder and contaminates it. Though it isn't likely a vendor will deliberately plate too much gold, accidents have happened. So specify a maximum as well as a minimum for plating thickness.

The speed of plating can also lead to problems. Plating at high current for a short time can yield the desired thickness, but with an uneven and porous surface.

Deciding how much plating we need is one thing: measuring it is another. None of the three basic techniques—beta-ray back-scattering, photomicrography and X-ray diffraction—provides quick, inexpensive measurements of all the key plating parameters—thickness, evenness, hardness and porosity—over the entire contact area.

Housing the contacts

Insulating housings for PC connectors have three basic tasks: holding the contacts in position, providing electrical isolation between them and preventing arcing when subjected to high voltages. In addition, the insulation must not be influenced by environments to which the connector may be exposed during assembly or use.

The insulating materials commonly used are either thermoplastics or thermosetting plastics. The thermoplastics—polyesters (nylon) and polycarbonates (Lexan, Noryl, etc.)—offer resiliency and low cost. But the polyesters absorb moisture, are flammable if not made self-extinguishing by the addition of glass, work only to around 100 C and have poor resistance to arcing. The polycar-

SURPRISE!



The LED with a built-in resistor.

Now, two direct 5-volt lamp replacements offering no increase in size over our standard LED lamps. Because we've built in the resistor, they're both directly TTL compatible. That adds up to space savings and reduced assembly costs and a lamp ideal for high density arrays. Two sizes are available: a T-1 package (5082-4468) and a T-1 $\frac{3}{4}$ package (5082-4860). Get the full story on our new Resistor LED lamps from your nearby HP distributor.

Or write us, you'll find our 1K price of 60¢ hard to resist.

HEWLETT  PACKARD

Sales, service and support in 172 centers in 65 countries.
Palo Alto, California 94304. Offices in principal cities throughout the U. S.

01322

INFORMATION RETRIEVAL NUMBER 32

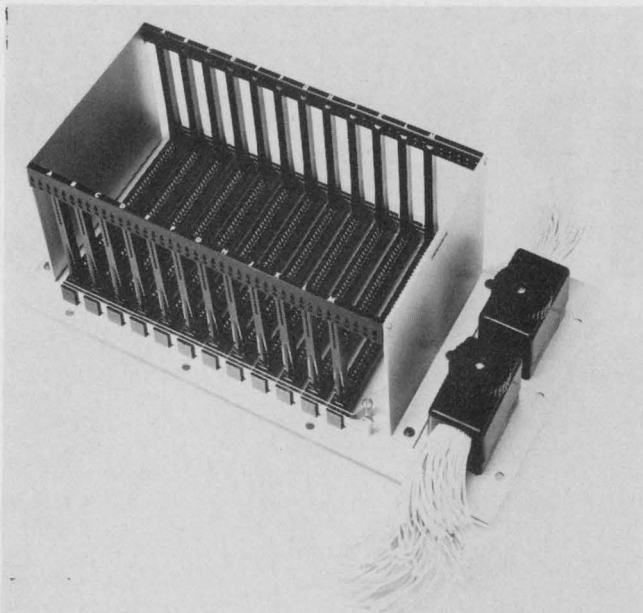

Card-edge connectors from Teradyne Components can be pressure fitted into a metal backplane. The units come with bifurcated contacts and detachable card guides.

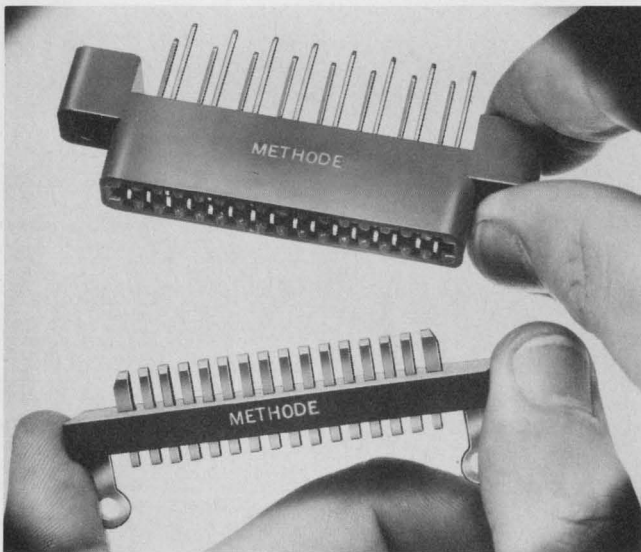

Blade-and-tuning-fork two-piece connector from Methode comes with single-readout, wrapped-wire tails in two staggered rows for easy tool access.

bonates, in addition to having these disadvantages, do not resist board-cleaning solvents.

The thermosetting plastics—phenolic (bakelite) and diallyl phthalate—have increased temperature and moisture resistance, but at a higher price. Phenolics have higher crush strength and dielectric strength than the thermoplastics and work to 150 C. Diallyl phthalate, dubbed the “military material” because of its predominance in MIL specs, works to over 200 C. It also resists fungus, moisture and solvents. But it is the most expensive of all the materials, and it is brittle enough to break if the walls around the contacts are too thin.

If glass is added to polyester, the low cost and resiliency of thermoplastic can be combined with the flame and solvent resistance of diallyl phthalate. The resulting material, a popular example of which is 30% glass-filled nylon 612, is preferred by many users.

After specifying connector type, contact material, style and density, and insulator material, make sure the connector has been properly tested.

Were the specs tested?

When reading test data, watch for coverups. Some of the “data” may represent design goals rather than test results.

To know if his product meets a particular spec, a vendor has to test it. But not all vendors test for all specs. Beware the connector “designed to meet” a spec, for it may not actually meet it, despite the vendor’s good intentions. If the connector meets the “applicable” portion of a MIL spec, it may not be “applicable” to your requirement. If the connector was “delivered for use in a military program,” it may not have been actually used. The program may have been bought five evaluation samples which were all discarded.

Don’t infer that a vendor has tested a connector unless he describes the test conditions. Then ask him *when* the test data were taken, and if the connector has been changed since then.

The part number is not enough

In the interests of reducing prices or improving quality, vendors may change a part but keep the same part number. They might have the best intentions. One of their engineers may have found a better way to make the same connector, perhaps to cut costs. Or more glass may have been added to a nylon insulator, increasing its temperature range. The connector may have the same cavity size and appearance. But the shrink rate may be different. Watch out for “improved” materials. Obviously the vendor can’t go to every customer to get approval for a change.

Part numbers, unfortunately, can cover a multitude of sins. The same part number can cover connectors available with a choice of contact tails—but the tail locations may differ for connectors with different types of tails. And the drawing may not show that tail locations may differ for dip-solder, crimp, eyelet and wrapped-wire tails.

Further, there can be a problem even in wrapped-wire tails alone. A vendor may offer a connector with tails suitable for wrapped wire, but his idea of suitable Wire-Wrap post dimensions may differ from Gardner-Denver’s. Still further, tip-position tolerances on post spacing depend on whether you intend hand-wrap, semi-automatic

SURPRISE!

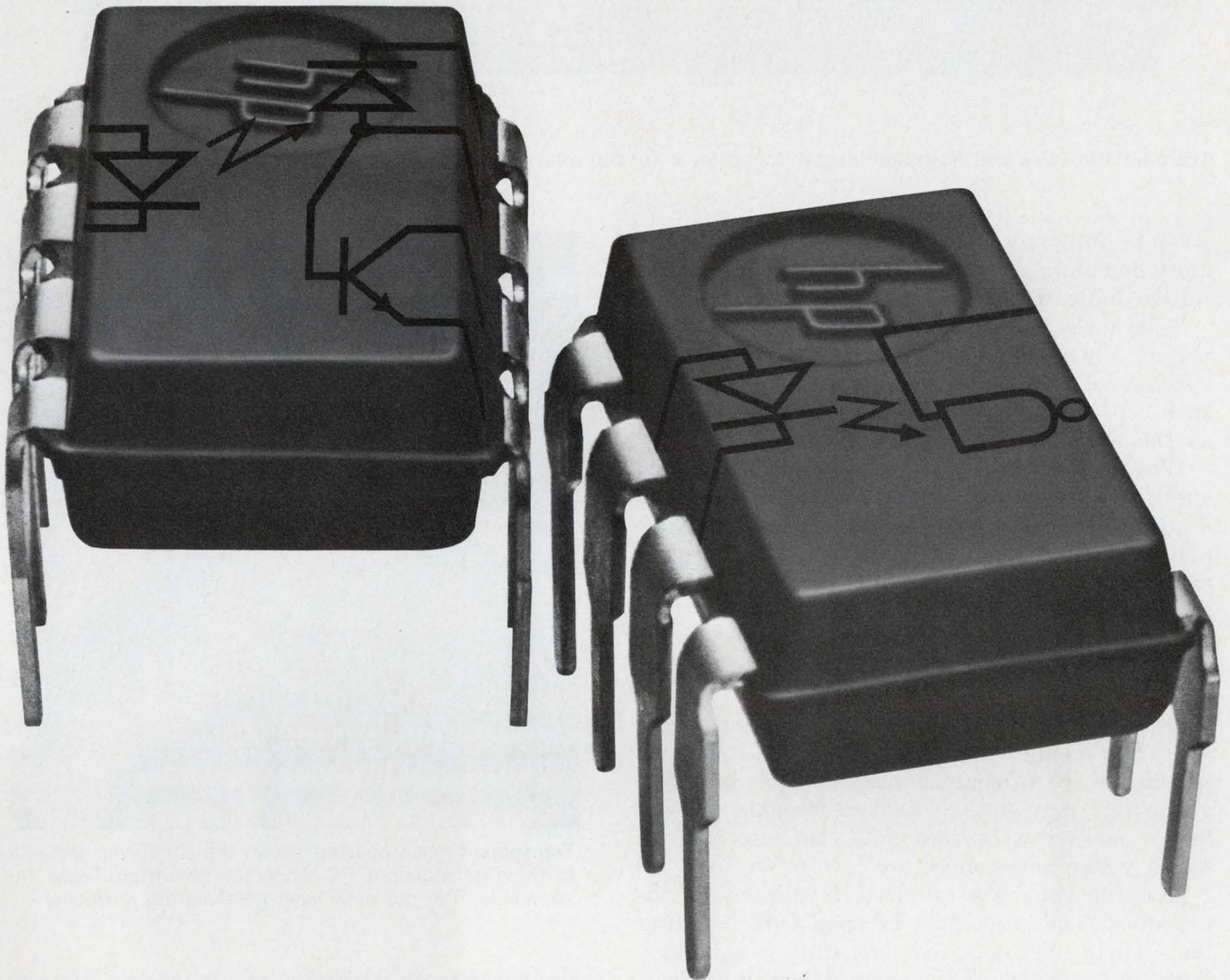

A high-speed isolator breakthrough.

Two new optically-coupled isolators take advantage of our advanced photo IC capability giving speeds four times faster than other opto couplers. The 5082-4360 Series optically-isolated gates operate up to 20M bits. This device has a photo detector IC circuit consisting of a photo diode and high-frequency linear amplifier. It is completely TTL compatible at the input and output and it's capable of feeding eight TTL gate loads. The 5082-4350 Series isolators operate up to 4MHz bandwidth. This device consists of a monolithic photo detector with a photo diode and high frequency transistor on the same substrate, making it ideal for linear and digital applications. The 5082-4350 Series prices start at \$2.00 in 1K quantity; the 5082-4360 Series is priced at \$4.50 in 1K quantities. Detailed specs are as close as your nearby HP distributor.

01323

HEWLETT  PACKARD

Sales, service and support in 172 centers in 65 countries.
Palo Alto, California 94304. Offices in principal cities throughout the U.S.

INFORMATION RETRIEVAL NUMBER 33

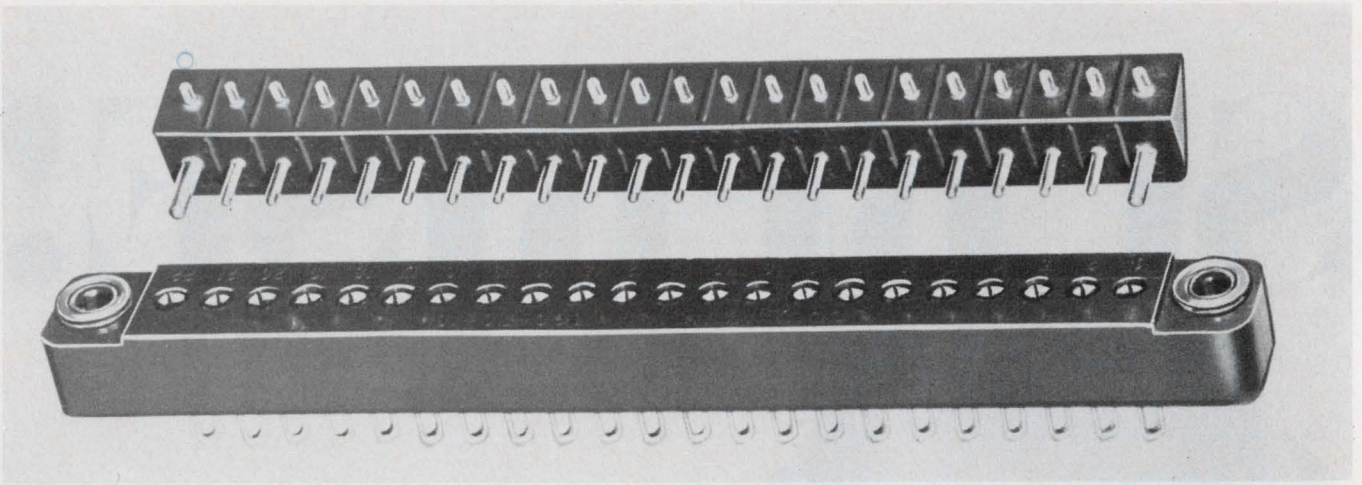

The pin half of this unit from Continental Connector is for dip soldering, while the socket half has solder eyelets.

wrap or fully automatic wrap, with the last being most demanding. But the connector vendor may fail to indicate the spacing tolerances.

Tolerances are most important when the number of contacts exceeds a dozen. Though center-spacing tolerances may or may not be cumulative, each contact pair becomes more difficult to align as the number of contacts increases.

When ordering keying—or polarizing—slots, specify tolerances as well as lengths. Check your design to see if power contacts disconnect first and ground pins break contact last, to prevent arcing. This is especially important for inductive loads or high voltages.

Mounting the connector

Beware of special problems you can encounter when you mount a connector to a panel. If mounting hardware is sourced only by the connector vendor, it may not be field-replaceable. If you lose a jackscrew or jam nut, you may have to buy a whole new connector.

Riveting can be a problem if your rivets are too short. The rivet must be spun with a flaring tool. The spinning speed and rate of approach must be controlled or the connector may break.

Threaded inserts may require repositioned holes in the connector housing. A threaded insert normally requires a larger hole than a clearance hole, so the vendor may move the hole if it is too close to the end of the connector. But vendors don't usually provide drawings for each mounting possibility. This problem can be rather unpleasant if you've already drilled your panel and you decide to switch from a threaded-insert mount to a nut-and-bolt mount.

How to find a reliable vendor

Are you on the "qualified customer list" of a reputable vendor? How do you find a reputable

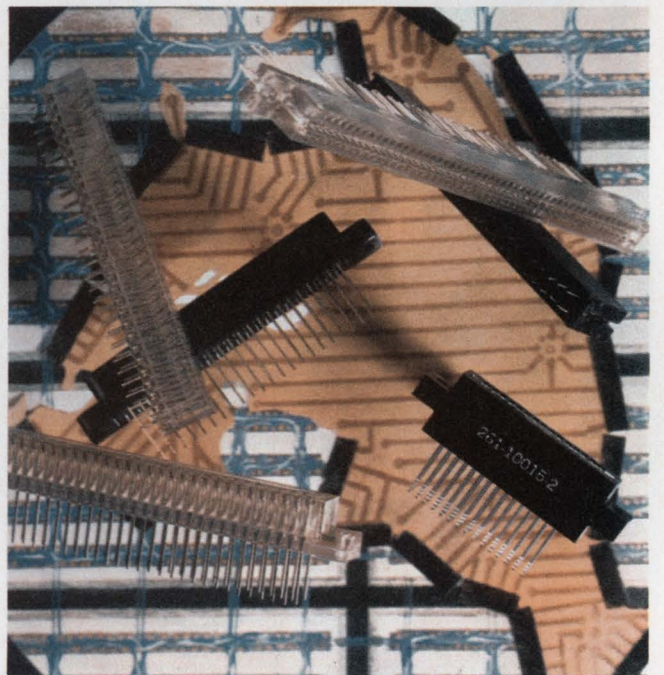

Transparent nylon housing shows the cantilever contacts in the first standard PC-connector line from Texas Instruments. The contacts have gold mating surfaces.

vendor to begin with? Volume is the key. If your needs are big enough—say, over 100,000 pieces—send a list of your requirements to several vendors. Each will try to prove his competitive advantages. But if your order is fairly small—say, under 1000 pieces—many vendors won't bother with you. What to do? Emphasize quality rather than cost. In small volume, the difference in your system's cost is usually negligible.

Most catalog connector lines are available from multiple sources. Since vendors are often reluctant to give prices—even for catalog items—and test data are often incomplete, shopping for a connector can be discouraging. So you're often forced to consider vendors in terms of particular strengths they may have or in terms of their

SURPRISE!



HP's 17¢ LEDs.

That's your price when you order 100K. And make no mistake about it, thanks to some highly advanced production facilities, HP can deliver that kind of volume to meet your schedule. Quality? The best around. Advanced design and high volume production make these low prices possible. Two sizes of lamps are available. A T-1 (5082-4484) and a T-1 ¼ (5082-4850) for any application where you need a brilliant, long-life LED: automobiles, appliances, homewares, instrumentation. Contact your nearby HP distributor for detailed specs and a free sample. Or write us. This is one bright idea you can't afford not to design into your next product.

HEWLETT  PACKARD

Sales, service and support in 172 centers in 65 countries.
Palo Alto, California 94304. Offices in principal cities throughout the U.S.

01324

INFORMATION RETRIEVAL NUMBER 34

specialties. Most vendors see themselves in a particular role.

If you want to buy both board and connector from the same vendor, your choices can include AMP, Cinch, ITT Cannon Electric and Methode. Augat offers 1/8-inch boards and connectors. Companies like Ansley, Kings and 3M specialize in PC connectors with flat-cable terminations. Amphenol, Burndy, Cinch, Continental Connector and Elco now offer tin-lead platings on contacts, and other vendors are expected to offer non-noble platings in the near future.

Ansley, Bendix, Burndy, Fabri-Tek and ITT Cannon Electric have zero-insertion-force, one-piece connectors. They are bolted to boards, and spring mechanisms force the contacts onto board eyelets or plated-through holes. Airborn, Berg, Fabri-Tek, Teradyne Components and Winchester claim special expertise in connectors with wrapped-wire tails.

Teledyne Kinetics feels that its main strength lies in aerospace connectors, and Dale's forte is in cantilever contacts. Hypertronics uses a special

pin-and-socket connector, the Hypertac, that uses a wire spiral for the socket.

While almost any connector house offers custom capabilities as well as catalog items, some companies—like Malco—consider themselves basically custom houses. ■■

Our Special Thanks

ELECTRONIC DESIGN is grateful to scores of individuals who provided information for this report. For outstanding contributions, we wish to extend our special gratitude to James T. Pletcher of AMP, Harrisburg, Pa.; Keith Woodman of Burndy, Norwalk, Conn.; Frank Apple of Cinch, Elk Grove Village, Ill.; Erving F. Coulson of Electronic Component Consultants, Devon, Pa.; Gerald Ginzburg of Philco-Ford, Willow Grove, Pa.; Leonard Pahutski and William H. Taylor 3d of Excel Products, New Brunswick, N.J.; William Rees of Burroughs, Paoli, Pa. and Bernard Schwartz of RCA, Moorestown, N.J.

Need more information?

The companies and products cited in this report have, of necessity, received only cursory coverage. The products mentioned don't represent the vendors' full lines. Readers may wish to consult the manufacturers listed here for further details:

Airborn, Inc., 2618 Manana Dr., Dallas, Tex. 75220. (214) 357-0274. (Robert J. Baxter). **Circle 401**
 American Lava Corp., Sub. 3M Co., Cherokee Blvd. & Mfrs. Rd., Chattanooga, Tenn. 37405. (615) 265-3411. **Circle 402**
 AMP, Inc., Harrisburg, Pa. 17105. (717) 564-0101. (James T. Pletcher). **Circle 403**
 Amphenol Ind'l. Div., Bunker-Ramo Corp., 1830 S. 54th Ave., Chicago, Ill. 60650. (312) 242-1000. (Dennis Clark). **Circle 404**
 Ansley Electronics Corp., Old Easton Rd., Doylestown, Pa. 18901. (215) 345-1800. (John Rocks). **Circle 405**
 Augat, Inc., 33 Perry Ave., Attleboro, Mass. 02703. (617) 222-2202. (Dick Grubb). **Circle 406**
 Bendix Corp., Elec. Comp. Div., Sidney, N.Y. 13838. (607) 563-9511. (M. C. Sposili). **Circle 407**
 Berg Electronics, Inc., York Expressway, New Cumberland, Pa. 17070. (717) 938-6711. (Frank L. Morris). **Circle 408**
 Burndy Corp., Richards Ave., Norwalk, Conn. 06856. (203) 838-4444. (J. F. Bradley). **Circle 409**
 Cambridge Thermionic, 445 Concord Ave., Cambridge, Mass. 02138. (617) 491-5400. **Circle 410**
 Cinch Mfg. Co., A Div. of TRW Inc., 1501 Morse Ave., Elk Grove Village, Ill. 60007. (312) 439-8800. (Frank Apple). **Circle 411**
 Continental Connector Corp., 34-63 56th St., Woodside, N.Y. 11377. (212) 899-4422. (David A. Harkavy). **Circle 412**
 Control Data Corp. Connector Operation, 31829 W. Tienda Dr., Westlake Village, Calif. 91361. (213) 889-3535. (David Davidson). **Circle 413**
 Daburn Electronics & Cable Corp., 2360 Hoffman St., Bronx, N.Y. 10458. (212) 295-0050. (Howard Danziger). **Circle 414**
 Dale Electronics, Inc., Sioux Div., E. Hwy. 50, Yankton, S.D. 57078. (605) 665-9301. (Fred Coe). **Circle 415**
 Deutsch Co., Electronic Comps. Div., Municipal Airport, Banning, Calif. 92220. (714) 849-6701. **Circle 416**
 Douglas Electronics, Inc., 718 Marina Blvd., San Leandro, Calif. 94577. (415) 483-8770. **Circle 417**

Elco, Maryland Rd. & Computer Ave., Willow Grove, Pa. 19090. (215) 659-7000. (Lou Roberts). **Circle 418**
 Fabri-Tek, Inc., National Connector Div., 5901 S. County Rd. 18, Minneapolis, Minn. 55436. (612) 935-8811. (L. E. Harrod). **Circle 419**
 GTE Sylvania, Inc., 730 Third Ave., N.Y., N.Y., 10017. (212) 551-1405. (Lawrence P. Riddle). **Circle 420**
 Hughes Connecting Devices, 500 Superior Ave., Newport Beach, Calif. 92663. (714) 548-0671. (David Cianciulli). **Circle 421**
 Hypertronics Corp., 50 Hunt St., Watertown, Mass. 02172. (617) 924-1822. (Dick Downey). **Circle 422**
 Industrial Electronic Hardware, 109 Prince St., N.Y., N.Y. 10012. (212) 677-1881. **Circle 423**
 ITT Cannon Electric, Div. of ITT Corp., P.O. Box 929, 666 E. Dyer Rd., Santa Ana, Calif. 92702. (714) 557-4700. (R. L. Harmon). **Circle 424**
 Johnson, E. F., Co., 1923 Tenth Ave. S. W., Waseca, Minn. 56093. (507) 835-2050. **Circle 425**
 Kings Electronics, 40 Marbledale Rd., Tuckahoe, N.Y. 10701. (914) 793-5000. (Fred Della Iacono). **Circle 426**
 Loranger Mfg. Corp., Box 948, Warren, Pa. 16365. (814) 723-8600. **Circle 427**
 Malco Mfg. Co., A Microdot Co., 5150 W. Roosevelt Rd., Chicago, Ill. 60650. (312) 287-6700. (R. E. Gerhardt). **Circle 428**
 Methode Electronics, Inc., 7447 W. Wilson Ave., Chicago, Ill. 60656. (312) 867-9600. (William B. Schwartz). **Circle 429**
 Molex, Inc., 2222 Wellington Ct., Lisle, Ill. 60532. (312) 969-4550. (Fred Krehbiel). **Circle 430**
 3M Co., Electro-Products Div., 3M Center, St. Paul, Minn. 55101. (612) 773-1110. (Carl R. Goodwin). **Circle 431**
 Positronic Ind., Gorn Connector Div., 1906 S. Stewart, Springfield, Mo. 65804. (417) 883-3434. **Circle 432**
 Robinson-Nugent Inc., 800 E. 8th St., New Albany, Ind., 47150. (812) 945-0211. (Sam M. Shine). **Circle 433**
 Stanford Applied Engineering Inc., Advanced Packaging Products, 2165 S. Grand Ave., Santa Ana, Calif. 92705. (714) 540-9256. **Circle 434**
 Teledyne Kinetics, 410 S. Cedros Ave., Solana Beach, Calif. 93075. (714) 755-1181. **Circle 435**
 Teradyne Components, Lawrence St., Lowell, Mass. 01852. (617) 454-9195. (Len Johnson). **Circle 436**
 Texas Instruments, 34 Forest St., Attleboro, Mass. 02704. (617) 222-2800. (Loren M. Smith). **Circle 437**
 Vector Electronics Co., Inc., 12460 Gladstone Ave., Sylmar, Calif. 91342. (213) 365-9661. (Floyd Hill). **Circle 438**
 Viking Industries, Inc., 21001 Nordhoff St., Chatsworth, Calif. 91311. (213) 341-4330. **Circle 439**
 Winchester Electronics Group, Main & Hillside Ave., Oakville, Conn. 06779. (203) 274-8891. (Jef Frost). **Circle 440**

SURPRISE!

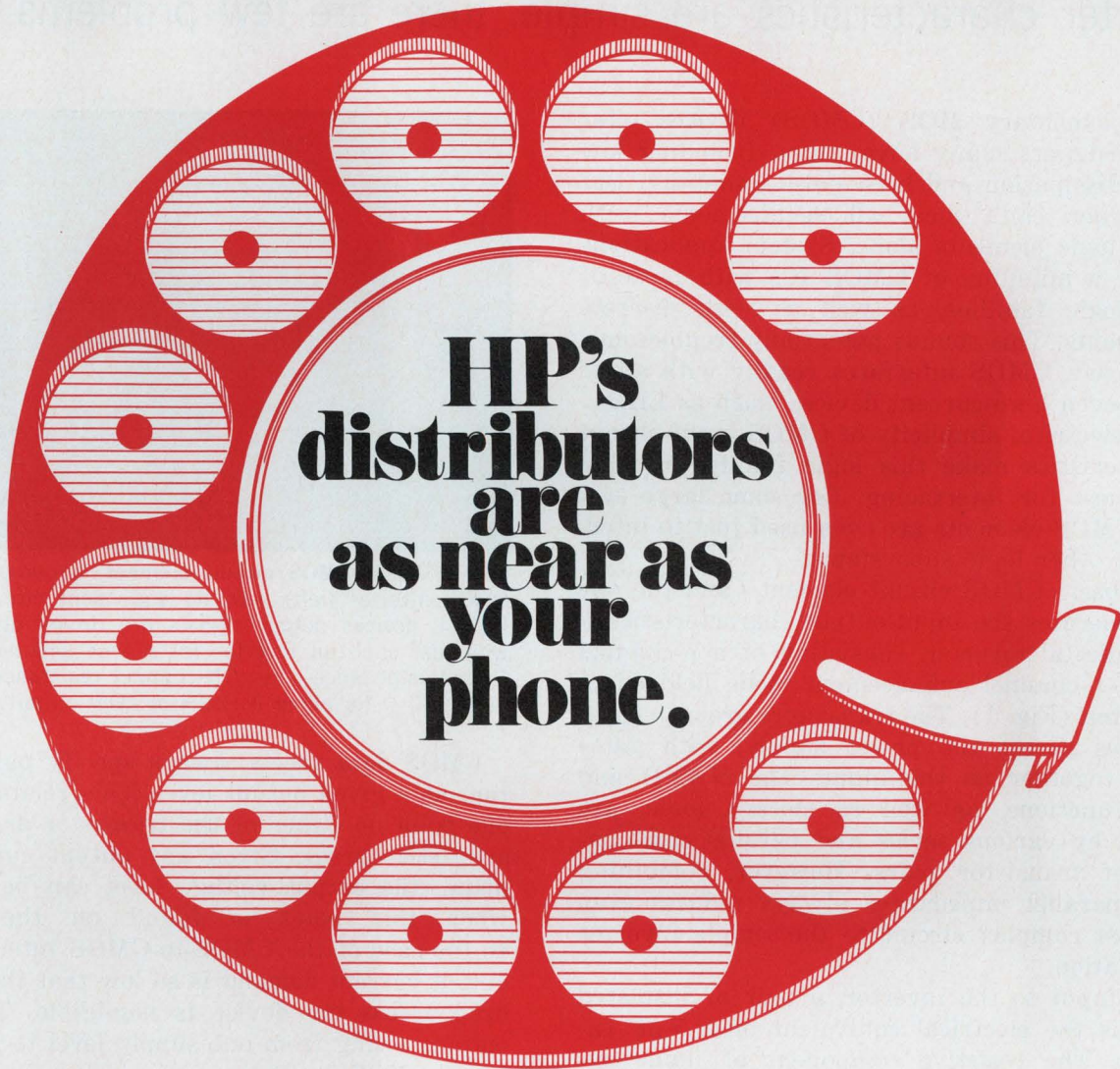

Distributor Stocking Locations:

SCHWEBER ELECTRONICS

Hollywood, Florida
(305) 927-0511
Elk Grove Village, Illinois
(312) 593-2740
Rockville, Maryland
(301) 881-2970
Waltham, Massachusetts
(617) 890-8484
Rochester, New York
(716) 328-4180
Westbury, New York
(516) 334-7474
Beachwood, Ohio
(216) 464-2970

WYLE DISTRIBUTION GROUP

Liberty Electronics/Arizona
Phoenix, Arizona (602) 264-4438
Liberty Electronics
El Segundo, California (213) 322-8100
Elmar Electronics
Mt. View, California (415) 961-3611
Western Radio
San Diego, California (714) 235-6571
Elmar Electronics
Commerce City, Colorado (303) 287-9611
Liberty Electronics/Northwest
Seattle, Washington (206) 763-8200

HALL-MARK ELECTRONICS

Huntsville, Alabama
(205) 539-0691
Lenexa, Kansas
(913) 888-4747
St. Louis, Missouri
(314) 521-3800
Raleigh, North Carolina
(919) 832-4465
Oklahoma City, Oklahoma
Enterprise 224
Tulsa, Oklahoma
(918) 835-8458
Austin, Texas
(512) 454-4839
Dallas, Texas
(214) 231-6111
Houston, Texas
(713) 781-6100

EUROPE

Celdis Ltd.
37-39 Loverock Road, READING, Berks, England
Tel.: READING 58 22 11
I.S.C. France
20, rue Gambetta, 92-Boulogne, France
Tel.: 604.52.75
Ingenieurbüro Dreyer
238 Schleswig, Flensburger Strasse 3, Germany
Tel.: (04621) 2 31 21
EBV Elektronik
8 Munich 2, Augustenstrasse 79, Germany
Tel.: (0811) 52 43 40/48
6 Frankfurt 1, Myliusstrasse 54, Germany
Tel.: (0611) 72 04 16/8

All of our distributors have our complete line of optoelectronic products ready for immediate delivery to you. LED displays, LED lamps, Isolators and photodetectors. All of these devices are solid state and directly DTL-TTL compatible. And they are designed for ease of application. When you need HP optoelectronic products call your nearest distributor (listed above). With HP's low prices and high volume capability you can't afford not to. 01325

HEWLETT  PACKARD

Sales, service and support in 172 centers in 65 countries.
Palo Alto, California 94304. Offices in principal cities throughout the U.S.

INFORMATION RETRIEVAL NUMBER 35

CMOS logic elements interface easily

with other logic families and discrete devices. Because the inverter characteristics are simple, there are few problems.

Complementary MOS (CMOS) devices offer logic designers many advantages, including low power dissipation and high noise immunity. But a designer can't meet all requirements with CMOS logic elements alone. System applications call for a mingling of CMOS ICs with those of other logic families, as well as with discrete components. This sounds potentially troublesome, but it isn't. CMOS interfaces readily with all of these—even high-current devices, such as LEDs.

The electrical simplicity of CMOS input-output characteristics make this logic family probably the easiest for interfacing. For some large systems, CMOS elements are even used just to interconnect other logic subsystems.

The basic CMOS circuit element—and the one that generates the input-output characteristics—is the digital inverter, consisting of a p-channel and an n-channel enhancement mode field effect transistor (Fig. 1). The transistors are connected in series across the power supply, with gates linked together as the input. The NAND and NOR functions, as well as clocked logic, are formed by various series and parallel combinations of transistor pairs. However, combining series/parallel impedances always reduces even the most complex circuit to the simple inverter combination.

The input to the inverter, a pair of insulated gates, is the electrical equivalent of a 5-pF capacitor. The resistive component of input impedance is created by reverse-biased junction leakage in the input protection network. It's typically greater than $10^9 \Omega$. Output, or driving, impedance can be approximated by an ideal switch in series with several hundred ohms of resistance in the conducting transistor channel.

This analogy is adequate when CMOS-to-CMOS interfacing is considered, but it can be an oversimplification when the interface with other logic or load elements is at stake. The source resistor is actually a conducting MOSFET channel with nonlinear I_D vs V_{DS} characteristics (Fig. 2).

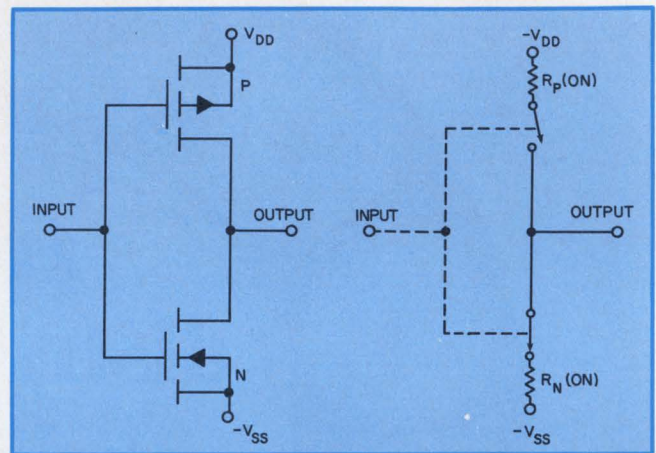

1. The basic CMOS circuit element is composed of a CMOS inverter (left) with its equivalent circuit (right). In SCL devices output signals are driven off the chip with just such an inverter for higher sinking currents. Output impedance—the ON-channel resistance—is typically 500Ω for either a HIGH or LOW output.

CMOS data sheets always specify output current at a given output level. This relates to just one point on either of the transistor drain characteristic curves. Given any output current demand, the output voltage level can be deduced when this point is found on the curves. In the case of the CMOS-to-CMOS interface, the output current demand is so low that the voltage drop across the device is negligible. Therefore outputs swing from one supply level to the other in all CMOS systems.

On the other hand, CMOS elements can drive high current devices if several volts are allowed across the driving transistor. Also, CMOS devices are advertised to be short-circuit proof because of the current-limiting nature of the V_{DS} vs I_D characteristic. But the product of $V_{DS} \times I_D$ should not exceed the 200-to-300 mW-per-package maximum usually given in the manufacturer's specification. In addition output drive capability, as a function of temperature, deteriorates at a factor of $0.3\%/^{\circ}\text{C}$ rise.

Interfacing CMOS to CMOS

The simplicity of the CMOS-to-CMOS interface follows from the fact that with all elements work-

Walter F. Kalin, Solid State Scientific, Inc., Montgomeryville Industrial Center, Montgomeryville, Pa. 18936.

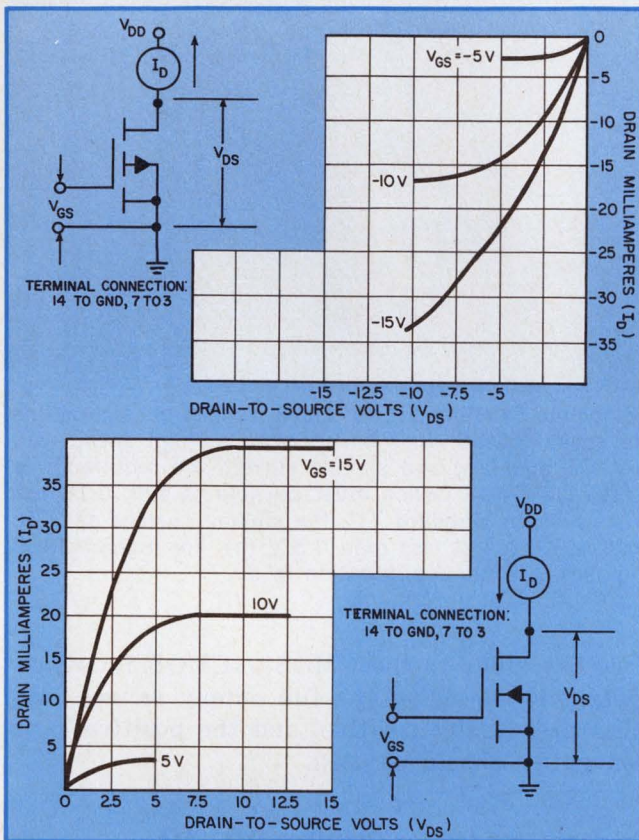

2. Typical drain characteristics for a p-channel (above) and n-channel (below) device—the transistors in the basic CMOS inverter. The current-limiting nature of the nonlinear, I_D vs V_{DS} curves results in a degree of short-circuit protection.

ing from the same power supply, outputs swing from positive-supply to negative-supply levels. The supply voltage can be anywhere from 3 to 15 V (4000A series). Noise margin, typically 45% of supply voltage, is specified to be no worse than 30% of supply level. The dc fanout is virtually infinite, since a source of less than 1 k Ω drives a load with a million times greater resistance. Fan-out, however, is limited to a finite number by the number of parallel capacitive loads that can be charged and discharged while system speed requirements are maintained.

Dynamic operating characteristics are specified on the data sheet at 15-pF loading. In system operation stray capacitances from, say, backplane

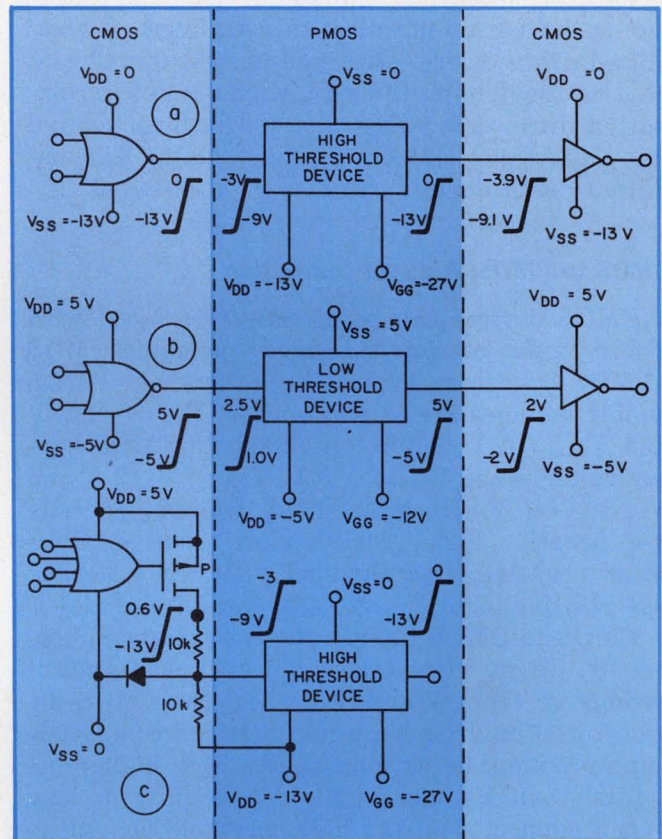

3. The CMOS-PMOS interface can be accomplished by a direct connection, since typical output swings go from V_{SS} to V_{DD} (a and b). When interfacing positive-logic, positive-supply CMOS with negative-logic, negative-supply PMOS, the configuration in c can be used.

wiring can cause loading to be far greater than 15 pF, and that adversely affects system speed. Some manufacturers offer CMOS logic elements with lower output impedances, so that they can work well with capacitive loads that are substantially higher than 15 pF.

It's possible that CMOS devices may be interfaced in systems where power-supply levels are not the same. This situation requires special attention, and two cases can occur, both of which reduce system speed. In the first, the driving circuit level is greater than the load-circuit level.

This case violates the general rule that signal inputs not exceed the supply level. Such an operating mode forces the input protection diodes

into forward conduction. Input currents of greater than 10 mA can cause failure of the devices, while any current of less than 10 mA will probably not cause failure but significant power drain.

The best way to interface in such a situation is to include a resistance of 100 k Ω to several megohms in series with the inputs of the driven circuit. And, of course, the 4009A and 4010A buffer, logic-level converters can be used.

In the second case, the driving-circuit level is less than the load-circuit level. Here the minimum "high" is 70% of supply and a maximum "low" is 30% of supply. If the supply levels of interfacing devices do not meet these criteria, uncommitted drain devices with pull-up resistors should be used for driving the load. Examples of uncommitted drain devices are the 4007A inverter and the 4402A and 4412A expandable gates. Uncommitted drain devices can also be wire-ORed.

CMOS to PMOS: A direct connection

CMOS devices can be directly interfaced with either high or low-threshold p-channel MOS (PMOS) devices. Typical high-threshold PMOS supply voltages are $V_{DD} = -13$ V, $V_{GG} = -27$ V and $V_{SS} = 0$ V, while low-threshold PMOS supply voltages are $V_{DD} = -5$ V, $V_{GG} = -12$ V and $V_{SS} = +5$ V. High-threshold devices generally use negative logic—ZERO most positive, ONE most negative. Low-threshold devices generally use positive logic.

CMOS-to-PMOS interfacing can be accomplished by direct connection, since typical output swings go from V_{SS} to V_{DD} (Fig. 3). CMOS devices need only be connected between compatible supply potentials as long as V_{DD} is a higher potential than V_{SS} and $V_{DD} - V_{SS}$ is 15 V or less. When connected in the high-threshold configuration, negative logic convention is imposed on the CMOS devices. This means that NAND functions become NORs and vice versa. This inverted sense of operation in clocked logic and MSI functions should be considered accordingly.

It's also possible that positive-logic, positive-supply CMOS may be interfaced with negative-logic, negative-supply PMOS. This interface, going from CMOS to PMOS, can be constructed with open-drain p-channel transistors, which are available in 4007A, 4402A or 4412A devices (Fig. 3c).

Noise margins—quite good in the CMOS-PMOS interface—can be deduced from the logic levels shown in Fig. 3. Levels indicated are typical no-load outputs and worst-case HIGH/LOW input levels. In the case of CMOS-to-high-threshold-PMOS, noise margins are in the range of 3 to 4 V. With low-threshold PMOS, noise margins are at least 2.5 V.

The CMOS-to-n-channel-MOS (NMOS) inter-

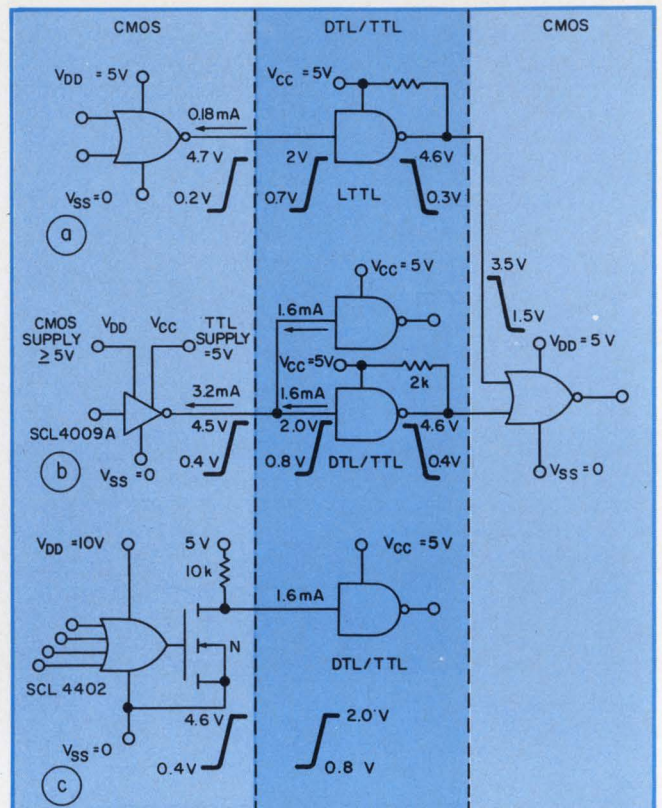

4. For the CMOS-to-TTL interface, special considerations for speed (CMOS can't be operated at high speed with 5-V TTL supplies) and sinking current are required. For LTTL, the CMOS device must be able to sink 0.18 mA (a), while for standard TTL the sinking current per TTL load is 1.6 mA at less than 0.5 V (b). For higher CMOS supplies, use the configuration in c.

face is similar to the CMOS-to-CMOS interface. Output levels swing the full supply range. Supplies are usually positive, and the positive logic convention should be used.

Tradeoffs needed for CMOS to DTL/TTL

The interface of CMOS to DTL/TTL requires some tradeoffs. To begin with, both CMOS and bipolar logic work on a single positive supply. But TTL/DTL logic requires a 5-V supply, which is compatible with CMOS but does not allow CMOS to operate at very high speed. At 5 V, aluminum gate CMOS—today's major technology—is fundamentally a 2-MHz logic family. Future developments in silicon-gate CMOS and other technology refinements should improve this speed.

The next consideration is the current-sinking requirement for popular bipolar logic, such as TTL. In standard TTL the typical current-sinking requirement reaches 1.6 mA at a voltage level of less than 0.5 V. For low-power TTL (LTTL) inputs, the current-sinking requirement decreases to about 0.18 mA. Not all CMOS devices can furnish this amount of sinking current with a 5-V supply.

Specific CMOS devices, however, can interface

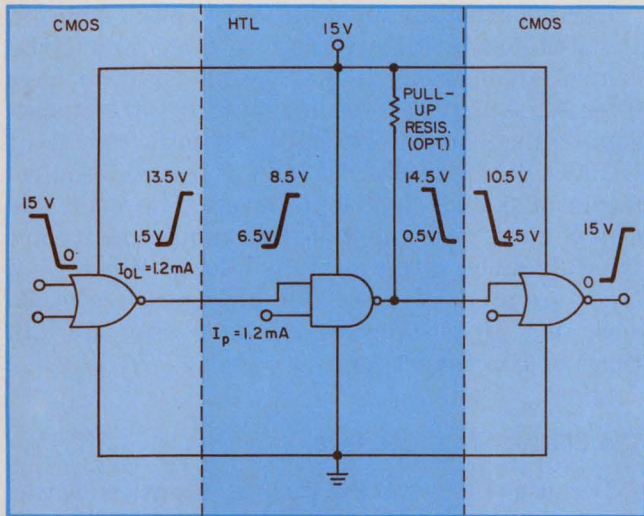

5. CMOS-to-high-threshold-logic interfaces require only a direct connection, since sufficient drive currents are obtained with supplies of 12 V or more. Noise margins are 4 to 5 V.

with higher-current bipolar logic—for example, Solid State Scientific's SCL 4009A and 4010A hex buffers, which are inverting and noninverting, respectively. These devices feature two-power supply terminals and can operate from any CMOS level of 5 to 15 V with the V_{DD} terminal connected to the CMOS supply. The V_{CC} terminal is connected to the bipolar supply, which enables the device output to swing from 0 to 5 V with adequate current to interface with two TTL loads (requiring 3.2 mA). With V_{DD} connected to a higher CMOS supply voltage, much higher system speed is possible.

One rule of operation for SCL 4009A devices: The V_{CC} supply level can never exceed the V_{DD} supply, because a parasitic diode can then become forward-biased with sufficient current to destroy the IC. To get around this problem, insert a resistor of several thousand ohms in series with the V_{DD} supply terminal if you suspect that V_{CC} will exceed V_{DD} . Of course, both V_{CC} and V_{DD} terminals can still be tied together at 5 V to provide CMOS-to-TTL interfacing.

Additional CMOS devices are available for interfacing with higher current bipolar logic. The following devices furnish sufficient drive to interface directly with TTL logic with a 5-V CMOS supply: the SCL 4041A, a quad true/complement buffer, with 2-mA (at 0.4 V) sinking current from TRUE outputs, and the SCL 4441A, a quad buffer/driver, with 5-mA (at 0.4 V) sinking current from each output.

It's also possible to parallel CMOS devices to obtain greater output currents. Current hogging is no problem, as it is with bipolar devices, so any number of devices can be paralleled.

Some manufacturers suggest wiring the inputs of the 4001, 4002 or 4025 NOR gates to obtain

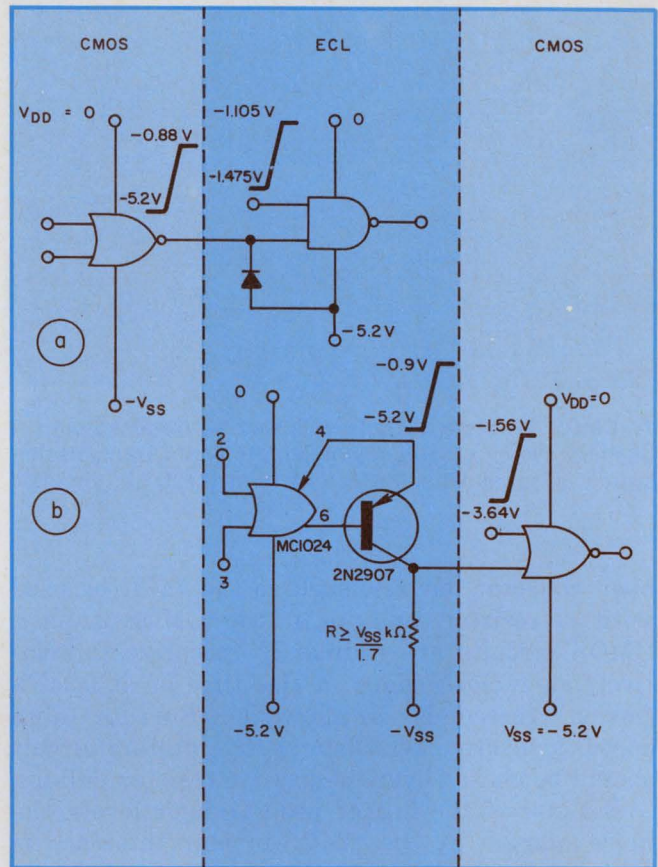

6. For higher-speed operation in a CMOS-to-ECL interface, connect the CMOS V_{SS} terminal to any supply from -5 to -15 V and diode-clamp the ECL gate input (a). Going from ECL to CMOS requires level shifting (b).

greater output sinking current. The connection parallels n-channel transistors for more current. However, with devices from other manufacturers, this connection doesn't work when the output is driven from a single inverting buffer. In that case output current is constant regardless of the number of active inputs, and it equals the maximum current obtainable from devices of other standard CMOS lines. Of course, any vendor's gates can be paralleled for greater output drive.

Several variations of the CMOS-to-TTL interface (Fig. 4) show CMOS to LTTL (a) and CMOS to standard TTL (b). The configuration of Fig. 4c allows a 3-to-15-V CMOS logic input swing, with the output driven by an uncommitted-drain, n-channel device and a pull-up resistor. If the gate of the n-channel device is driven with 10 V, the sinking current available reaches typically about 3 mA at 0.5 V. Both logic and interfacing can be performed with a single IC.

Going from DTL/TTL to CMOS requires the addition of a pull-up resistor for either standard or low-power devices. Either open-collector or standard logic output devices can be used when both CMOS and bipolar logic are powered by the same 5-V supply. If the CMOS is powered by a higher supply voltage, it's recommended that

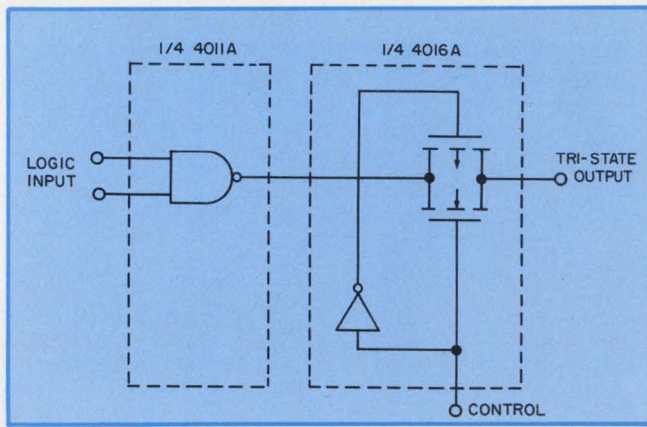

7. CMOS Tri-State outputs can also be obtained with a bilateral switch circuit. A simple gate and a transmission switch in series with the output form the basic circuit.

open collector devices, such as the 7407, be used with a resistor pull-up to the CMOS supply. CMOS circuits are ordinarily receptive to relatively slow clock edges; a rise time of at least a few microseconds is allowable. But for high speed, a discrete transistor active pull-up circuit should be chosen over the passive resistor pull-up.

Because of the higher positive logic levels, the noise margin at the CMOS-bipolar interface is higher than at a bipolar-bipolar. From Fig. 4b, the high-level noise margin, $V_{OH} - V_{IH}$, at the interface between the CMOS driver and the bipolar gate is 2.5 V, while the low-level noise margin, $V_{OL} - V_{IL}$, is 0.4 V. At the DTL/TTL-to-CMOS interface, both high and low-level noise margins are around 1.1 V. Similar noise margins exist with the interface conditions of Fig. 4a and 4c.

CMOS compatible with HTL

CMOS devices are directly compatible with high-voltage, high-threshold logic. High-threshold logic (HTL) is commonly used in industrial control systems, where high noise immunity and high output drive capability are required. The broad choice of CMOS functions available can be used to supplement the limited selection of devices in HTL or HNIL (high-noise-immunity logic).

Going from CMOS to HTL requires just a direct connection (Fig. 5), since at supply levels of 12 to 15 V the CMOS devices can furnish sufficient drive currents. At the HTL-to-CMOS interface, a pull-up resistor is desirable, as in the TTL-to-CMOS. With a 15-V supply, worst-case output levels for the CMOS IC are $V_{OH} = 13.5$ V and $V_{OL} = 1.5$ V. With HTL input levels of $V_{IH} = 8.5$ V and $V_{IL} = 6.5$ V, at least 5 V of noise margin exists at the CMOS-to-HTL interface. Likewise a 4-V noise margin exists at the HTL-to-CMOS interface.

Careful attention must be paid to clock edges in the HTL-to-CMOS interface. In many industrial control applications it may be all right to have clock edges that have been slowed by large noise-suppressing capacitors. Most manufacturers of CMOS specify clock rise and fall-time requirements at 5 and 10-V logic levels. However, the CMOS clock rise and fall-time requirements are typically much faster with 15-V logic. When 15-V levels are used, it's generally good practice to assure that all clocking levels have rise and fall times of less than 1 μ s.

The CMOS-to-ECL interface

Because ECL works with a negative power supply, there is a similarity between the CMOS-PMOS and CMOS-ECL interface (Fig. 6). If V_{SS} of the CMOS devices is connected to the -5.2 V ECL supply, the speed of the CMOS device will be limited to about 1 MHz. But with the connection of Fig. 6a, higher speeds are obtained when V_{SS} is connected to any negative supply between -5 and -15 V. A clamping diode must also be used to keep the ECL input within a diode drop of 5.2 V.

At the CMOS-to-ECL interface, the high-level noise margin is only about 0.25 V, but the low-level margin is about 4.3 V.

Because the typical ECL output swing is only about 0.7 V, there is not enough differential voltage to interface directly with CMOS. Level translation is therefore required to drive CMOS devices with ECL. Fig. 6b shows how this interface can be implemented. The use of a two-input, expandable ECL gate provides a differential output voltage large enough to drive a transistor. In combination with a pull-down resistor, the transistor provides an adequate logic swing to drive the CMOS device. The noise margin at the ECL-to-CMOS interface is typically 0.66 V in the high state and 1.56 V in the low.

CMOS logic versatility includes Tri-State output for any available function. The CMOS bilateral switch circuit—the basic circuit that permits such operation—consists of a simple gate function with a transmission switch in series with the output (Fig. 7). As an interface element, the circuit has several desirable characteristics. Its dynamic capability will support digital logic transitions at a 10-MHz rate, and it can be controlled at up to the same rate.

In a 10-V logic system the ON resistance of a 4016A device is 200 Ω or less. This additional series resistance should be considered when voltage drops at the interface are determined with current-sinking logic. OFF resistance of the order of 10^{10} Ω makes the bilateral switch useful for MOS logic interfacing. ■■



SMALLEST IN THE INDUSTRY

THEIR PRICE IS, TOO!

Solitron/Microwave's new 8100 Series of "push-on" coaxial connectors mounted on RG-178/U Cable solve application problems where micro-minia-

ture size and limited space are of prime concern. These low cost quick disconnect cable assemblies are available off the shelf.

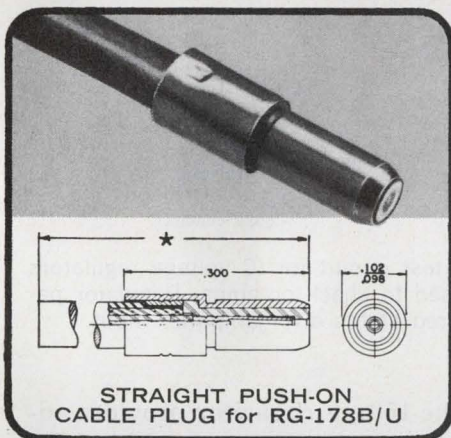

SERIES NO.	*	DESCRIPTION	CABLE TYPE & LENGTH
8101-0001	-1	Plug Assembly	12" length, RG-178
8101-0001	-2	Plug Assembly	6" length, RG-178
8101-0001	-3	Plug Assembly	3" length, RG-178
8121-0001	-5	Jack Assembly	12" length, RG-178
8121-0001	-6	Jack Assembly	6" length, RG-178
8121-0001	-7	Jack Assembly	3" length, RG-178

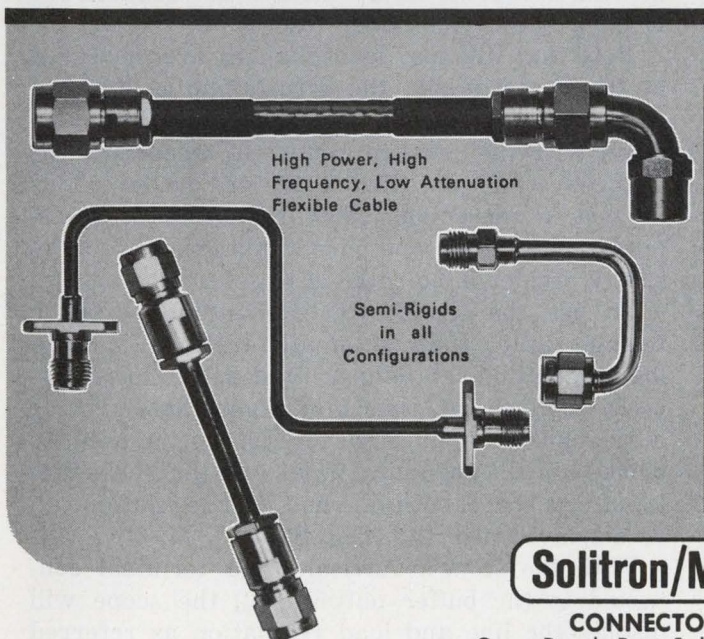
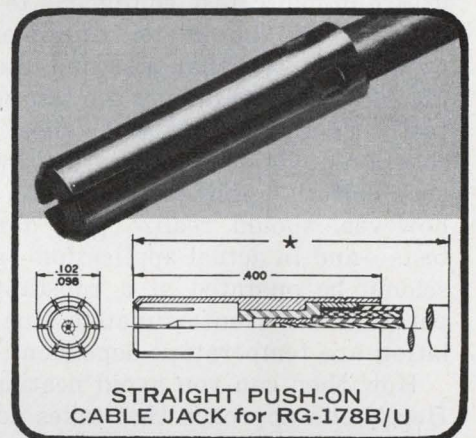

Solitron/Microwave

has everything you
want in Cable Assemblies!

No matter what your cable assembly requirements... from flexible micro-coaxial to 1/8" semi-rigid... we have the largest selection available. Including Plaxial Coaxial Cable harnesses, featuring the only precision 100% shielded cable in the industry with flexibility. Our cable assemblies can be supplied in any configuration, with the connectors you desire—at competitive prices.

Whatever your requirement, contact Solitron/Microwave, the "Cable Assembly Specialists" Write today for our latest cable assembly brochure.

Solitron/Microwave

CONNECTOR DIVISION
Cove Road, Port Salerno, Florida 33492
(305) 287-5000 TWX (510) 953-7500

OTHER SOLITRON PLANTS:

Riviera Beach, Florida ● Jupiter, Florida ● Tappan, New York ● San Diego, California

Don't get burned!

Watch the heat when testing IC voltage regulators, or your results may not match the manufacturer's specifications.

You've got an IC voltage regulator whose parameters need checking, and it sounds like an easy enough job. All you need to do is plug in the regulator, vary the input voltage and the load current, then measure the output voltage. A few quick calculations, and you've found the regulation. Right?

Right until you discover that your test results don't match the manufacturer's specs for line and load regulation. What went wrong?

Chances are your procedure was okay. What you've probably forgotten is that a manufacturer uses automatic test equipment to keep his costs down. Since automatic equipment can test a regulator in less than a second, there's little heating of the device during the test sequence. Manufacturers therefore specify most parameters at constant-junction temperature, while temperature drift is specified separately. A device user, however, should realize that during his bench tests—and in actual application—a regulator will seldom be operated at a constant-junction temperature. And, unfortunately, line and load regulation are temperature-dependent parameters.

How then can you avoid heating during tests? Here's one approach that takes advantage of the similarity between IC regulators and op amps.

Modified op amp test circuit is used

A test circuit similar to one used to check op amps automatically can also be used for automated or bench testing of IC regulators (Fig. 1). (Note that this circuit will not work for fixed-output regulators.) If required, the switches shown in Fig. 1 can be transistors whose on/off states are controlled by the test program.

The regulator's output voltage is established by a feedback loop that contains a buffer amplifier. The voltage is set to the desired value by application of an opposite-polarity reference voltage to the V_{set} terminal of the buffer. In the schematic, R_s is the feedback-divider impedance seen by the

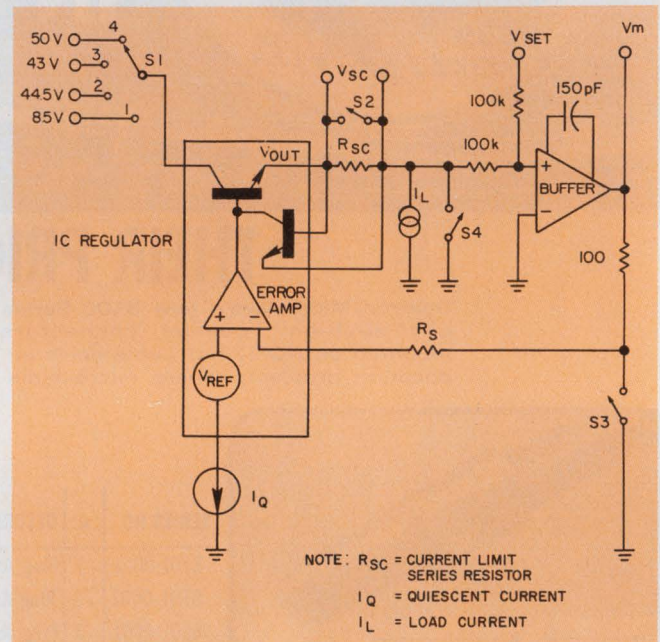

1. General-purpose test circuit for IC voltage regulators is similar to that used to check op-amps. Regulator parameters are measured at the error amplifier input.

error amplifier; the 150-pF capacitor provides additional frequency compensation to stabilize the loop for the device under test.

Note that line and load changes are measured at the V_m terminal—the error-amplifier input—with the output held at a fixed value. This contrasts with the usual procedure of measuring the changes right at the regulator output. This method is convenient when regulation is measured at more than one output voltage, since a resistive divider is not needed to set up the output.

To use the circuit for semiautomatic bench testing rather than automatic testing, line and load regulation can be measured with a low-duty-cycle input signal, thus minimizing heat rise. If a triangular input signal (Fig. 2) is used to drive both the regulator input and the horizontal input of a scope, both line and load regulation can be displayed directly (Fig. 3).

With the scope's vertical input terminal connected to the buffer output, V_m , the scope will display the line and load regulation as referred to the error-amplifier input. Since the value of V_m is much larger than changes in V_m , a com-

Eugene Hnatek, Linear Applications Engineer, Signetics Corp., 811 E. Arques Ave., Sunnyvale, Calif. 94086, and Larry Goldstein, Linear Test Manager, National Semiconductor Corp., 2900 Semiconductor Dr., Santa Clara, Calif. 95051.

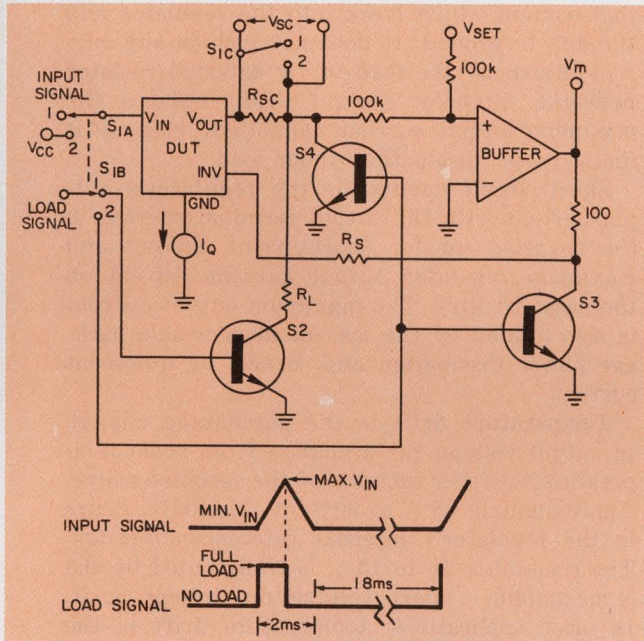

2. To avoid heating the IC chip, line and load regulation are measured semiautomatically with a low-duty-cycle input voltage. Load is varied from zero to full.

parator scope should be used to observe any change. Alternatively, a reference supply and subtractor (Fig. 4a) can provide high resolution. A similar technique yields high-resolution line and load regulation measurements for a fixed-voltage regulator (Fig. 4b).

Modify the basic test circuit for other tests

If you have only a few ICs to check, you can manually measure each of the regulator parameters by closing or opening the correct switches. But the tests should be done as fast as possible to avoid excessive heating.

Thus to determine load regulation, place switch S_1 in position 1. This closes switch S_2 and opens switches S_3 and S_4 . Then apply a constant -4.5 V to V_{set} and 8.5 V to V_{in} . Set the load current, I_L , to its minimum value and measure voltage V_{m1} at the V_m terminal. Next set the load current to its maximum value and measure V_{m2} at V_m . For low-input voltages, load regulation is then

$$\text{percent load regulation} = \frac{V_{m2} - V_{m1}}{V_{m1}} \times 100. (1)$$

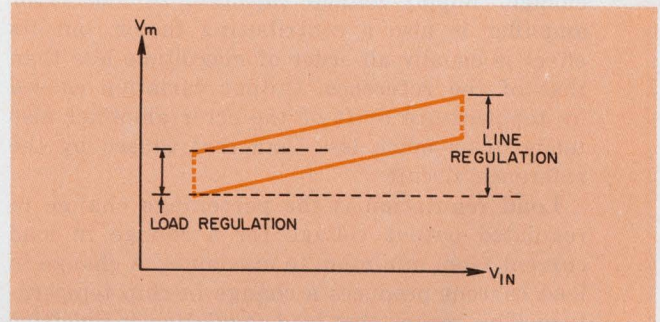

3. Graph depicts scope display when V_{in} drives horizontal input and V_m drives vertical input. Line and load regulation are read directly from display.

What is an IC regulator?

An IC voltage regulator (simplified block diagram below) consists of an error amplifier (op amp), a voltage reference and a series pass transistor—all on one chip. The reference circuit is generally a temperature-compensated zener diode. An emitter follower is sometimes added to isolate the reference from the error amplifier and other loads. The error amplifier has a high dc gain to enhance load regulation, a wide bandwidth to lower regulator output impedance, and low temperature drift to ensure output voltage stability. The pass circuit usually includes a short-circuit, current-limiting transistor. In effect, therefore, tests of the various regulator characteristics represent tests of the individual circuit elements.

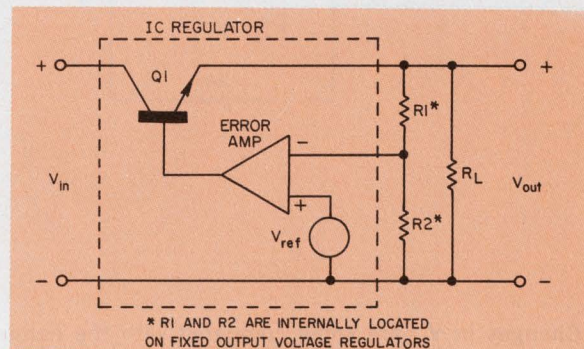

IC regulator parameters—what the major ones mean

Not all manufacturers specify voltage-regulator parameters in the same way. Here are some widely used definitions:

Line regulation is the percentage change in regulated output voltage for a specified change in input voltage. Variation of the reference voltage with input voltage change is usually the major contributing factor to output voltage change. Supply-voltage rejection of the error amplifier is also a contributing factor, but its effect is usually an order of magnitude less than that of the reference. Output variation caused by temperature drift of the error amplifier also tends to be much less than that caused by the reference circuit.

Load regulation is the percentage change in regulated output voltage for a change in load current from minimum to maximum. A change in load current produces a change in chip temperature. This means that load regulation is sensitive to the temperature coefficient of the output voltage. Load regulation is governed by the amplifier gain, as is the regulator output impedance. The pass transistor also affects both the load regulation and the output impedance of the regulator. As the load current increases, the drop across the current-limiting sense resistor increases, and the current-limiting transistor begins to conduct. This causes the regulator output voltage to change before current limiting occurs, thereby affecting load regulation and regulator output impedance. For this reason, some regulators are specified

with the current-sensing resistor shorted.

Ripple rejection is the line regulation for ac input signals at or above a given frequency, with a specified value of bypass capacitor on the reference terminal. Like line regulation, ripple rejection is sensitive to input-output differential voltage.

Standby current drain (quiescent current) is that current which flows into the regulator and through to ground. It does not include any current drawn by the load or by external resistor networks. Standby current drain reduces the maximum output current capability, because it limits power dissipation under load.

Short-circuit current is the regulator's output current with the output terminal shorted to the negative supply. Short-circuit current and maximum regulator output current depend on the pass circuitry. The maximum output current is also limited by the maximum allowable package power dissipation and, hence, by quiescent current.

Temperature drift is the percentage change in output voltage for a change from room temperature to either extreme of the specified range. Approximately 85% to 90% of this drift occurs in the regulator's internal reference circuitry. The remaining 10 to 15% is contributed by the error-amplifier offset voltage or current drift. In most applications, temperature drift is the major cause of output voltage change in an IC regulator.

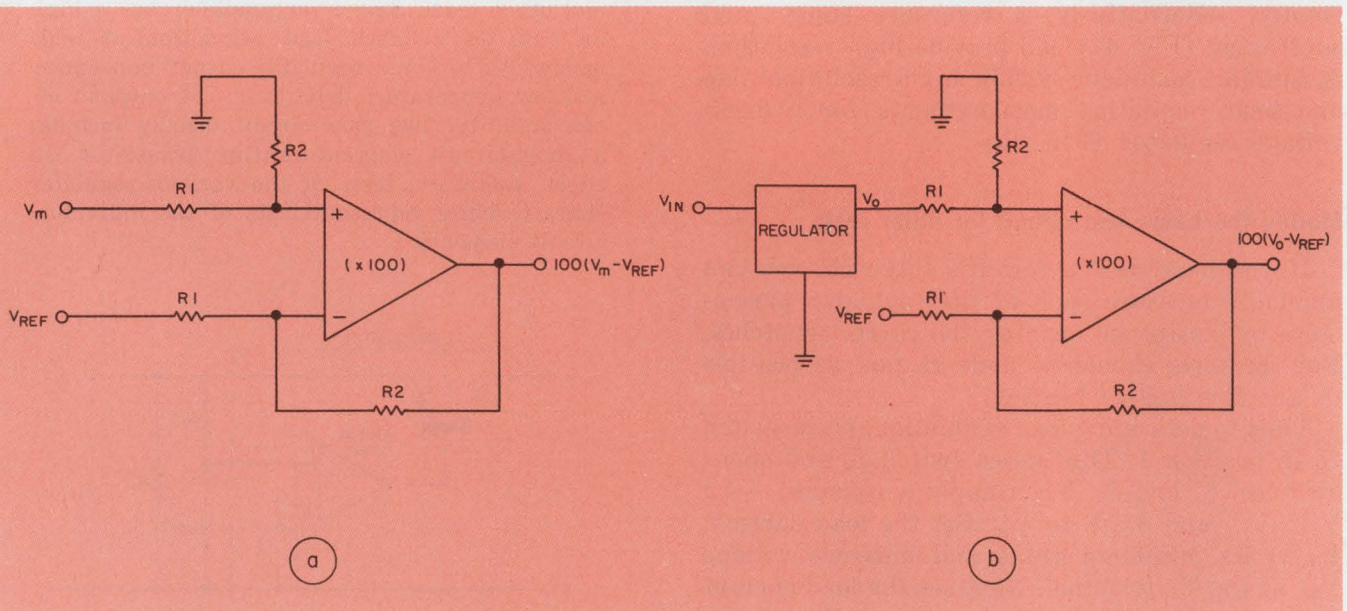

4. Changes in V_m are small compared with the nominal value of V_m , making it difficult to determine regulation accurately. Resolution is considerably improved (above) with a difference amplifier. A similar circuit

(above) is used to get better resolution when testing a fixed voltage regulator. In this case, the reference voltage (V_{REF}) must be obtained from an independent source. Both circuits multiply variations by 100.

Regulation depends on junction temperature

Because of temperature drift, load regulation under actual use will be worse than the regulator spec limits. Here's an example.

Conditions	Regulator Spec Limits
$V_{IN} = 12\text{ V}$	Load regulation = 0.1%
$V_{OUT} = 5\text{ V}$	Temp. Drift = 0.01%/°C
$I_L = 1\text{ to }50\text{ mA}$	$\Theta_{JA} = 160^\circ\text{C/W}$

The output voltage change caused by temperature drift is then calculated in the following way:

1. Change in power dissipation = $(12\text{ V} - 5\text{ V}) \times (50\text{ mA} - 1\text{ mA}) = 7\text{ V} \times 49\text{ mA} = 343\text{ mW}$.

2. For a Θ_{JA} of 160°C/W , the temperature rise will be $(160^\circ\text{C/W}) \times (0.343\text{ W}) = 55\text{ C}$.

3. With a temperature drift of 0.01%/°C, the output voltage change is $(5\text{ V}) (0.01\%) (55\text{ C}) = 27.5\text{ mV}$.

4. However, the output voltage change caused by the load change is $(0.1\%) (5\text{ V}) = 5\text{ mV}$.

5. Thus the output voltage change caused by temperature drift swamps out that caused by load variation.

A similar analysis applies to line regulation. However, it should be noted that the line variations commonly-encountered seldom raise the chip temperature more than a few degrees.

Similarly, to determine line regulation, apply -4.5 V to V_{set} and 44.5 V to V_{in} , with S_1 still in position 1. Then set the load current, I_L , to its maximum value and measure voltage V_{m3} at V_m . The line regulation is then calculated from

$$\text{percent line regulation} = \frac{V_{m3} - V_{m1}}{V_{m1}} \times 100, \quad (2)$$

where V_{m1} was previously measured to determine load regulation.

Load regulation for high input voltages is determined in the same way as for small voltages, except that -40 V is applied to V_{set} and 43 V is applied to V_{in} .

To measure quiescent current, -4.5 V is applied to V_{set} and -50 V is applied to V_{in} . Switch S_1 is still in position 1. The load current is adjusted to its minimum value and the quiescent current, I_Q , is measured directly in milliamps, as indicated in Fig. 2.

Finally, to determine short-circuit current, I_{sc} , apply -4.5 V to V_{set} , 8.5 V to V_{in} and place S_1 in position 2. Measure V_{sc} in millivolts and calculate I_{sc} from

$$I_{sc} = \frac{V_{sc}}{R_{sc}} \text{ mA}. \quad (3)$$

Thus, with the basic circuit of Fig. 2, you can determine most major regulator parameters without excessively heating the generator. ■■

When you're hot, you're hot!

So you need a rugged cement that really stands up to hostile heat?

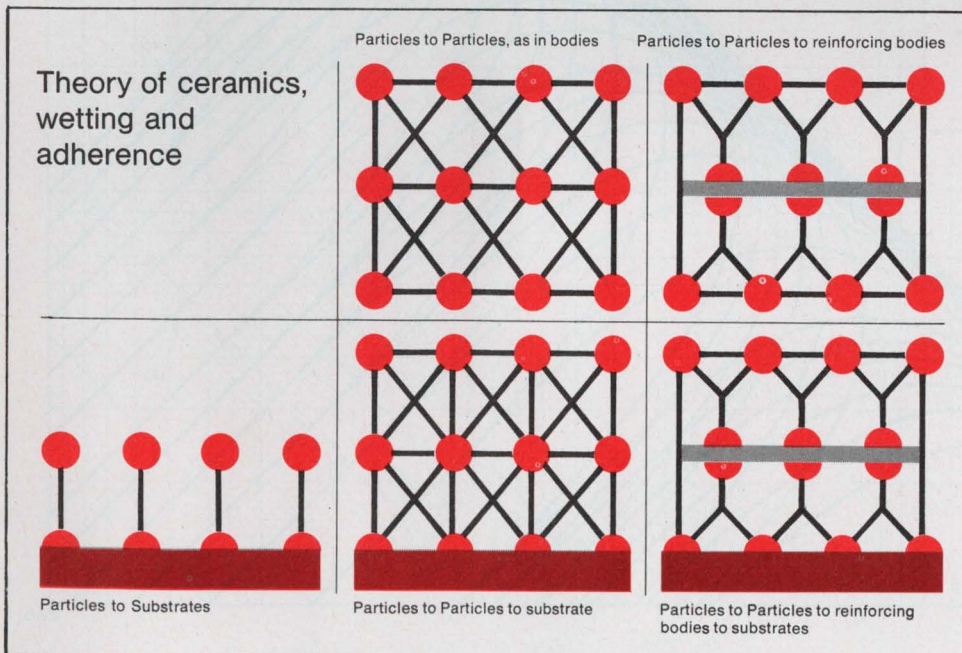

SermeTel bonding product systems have the answer to difficult applications. Can be custom mixed to offer electrical properties ranging from non-conductors to high conductors and bonding for temperatures from -375°F to 6000°F .

APPLICATIONS:

- High temperature instrumentation
- Strain Gauges
- Thermocouples
- Transducers
- Steam turbines
- Heat exchangers
- Nuclear reactors
- Missile systems
- Turbine engines
- Abradable seals
- Potting and joining compounds
- Electronic Assemblies

For a basic introduction to a fascinating new family of proven SermeTel products offering advantages that generate big money savings, write on your company letterhead for a copy of the newest in a series of definitive documents entitled "The Sciences of SermeTel Bonding Products."

P.O. Box 187
North Wales, Pa.
19454



SERMETEL®

A DIVISION OF Teleflex® INCORPORATED

INFORMATION RETRIEVAL NUMBER 37

The easy way to match impedances:

The Mac Chart provides approximate element values for commonly used designs without tedious calculations.

The design of impedance matching networks usually requires successive series-parallel transformations to reduce the original network to a simpler ac equivalent. Values are then calculated for the simplified network and a set of reverse transformations are used to compute the final actual network values. The Mac (McAlister) Chart provides an aid to the design of matching networks and avoids most of the tedious calculations needed to solve the equations (Fig. 1).

James E. McAlister, Production Engineer, Arkansas Power and Light Co., Box 551, Little Rock, Ark. 72203.

With the chart, no calculations are necessary for an approximate solution. Only the choice of conversions need concern the designer.

A series combination of resistance and reactance can always be found that exhibits the same equivalent impedance as any given parallel combination of resistance, R_p , and reactance, X_p . The resulting equations (see box) are plotted to yield the family of curves in Fig. 1. These curves display the relationships between R_p , R_s , X_p , X_s and Q . The location of any two variables on the chart yields values for the three others. For example, the series combination of 8.6 Ω resistance and 15 Ω reactance has the same impedance as the

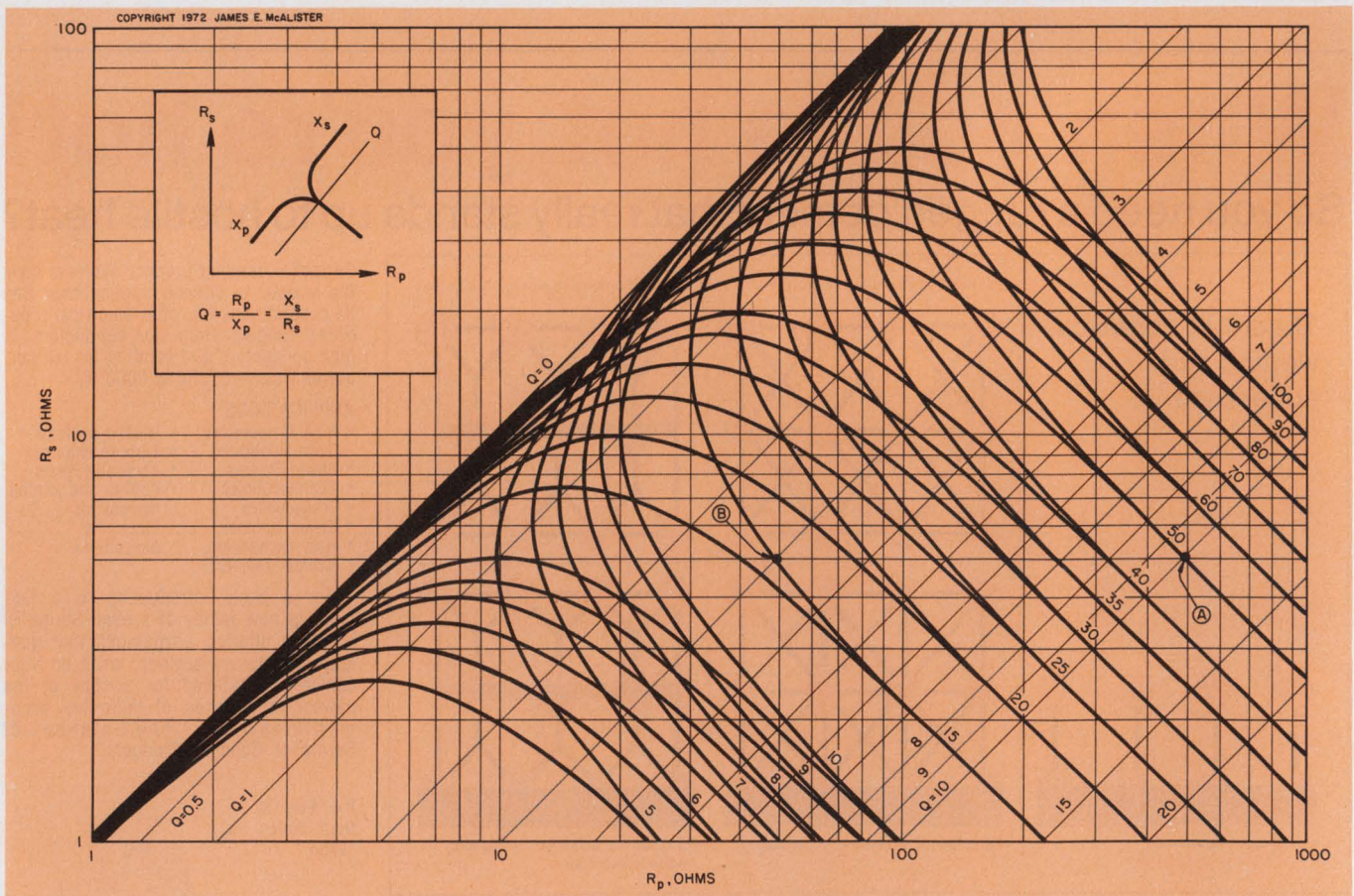

1. Two-element series or parallel networks are represented along with their over-all circuit Q . The family of curves represents a general series-parallel transfor-

mation for equal driving-point impedance. The chart can be entered with any two of five circuit quantities; it determines the three others.

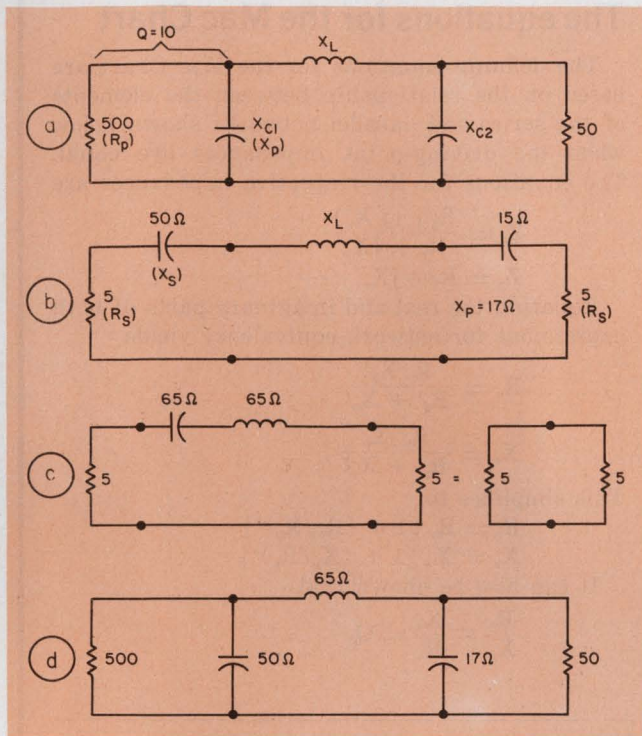

2. A π -network problem is solved with two parallel-to-series transformations (b, c). The value of inductive reactance is chosen to cancel the capacitive reactance. Just two resistance values and the circuit Q constitute the initial design data (a).

parallel combination of 35Ω resistance and 20Ω reactance. Both combinations have the same Q .

Design example: A π -network

Consider the π -network (Fig. 2a) to match 500Ω to 50Ω with an over-all Q of at least 10. Values for X_{c1} , X_L and X_{c2} must be specified.

Begin by considering the parallel combination of X_{c1} and R_p and assuming a Q of 10. These values define point A on the Mac Chart. The values of R_s , X_s and X_{c2} are then found to be 5Ω , 50Ω and 50Ω , respectively, and the left half of the network can be changed to its series equivalent $5 - j50 \Omega$.

A parallel-to-series transformation should next be performed on the right half of the network to provide an R_s of 5Ω from an R_p of 50Ω . This transformation (point B) provides an X_s of 15Ω and, incidentally, an X_p of 17Ω .

The resulting network (Fig. 2b) shows that an X_L of 65Ω (Fig. 2c) will cancel the capacitive reactance, and this is the value assigned to the inductance.

We then complete the design by placing the

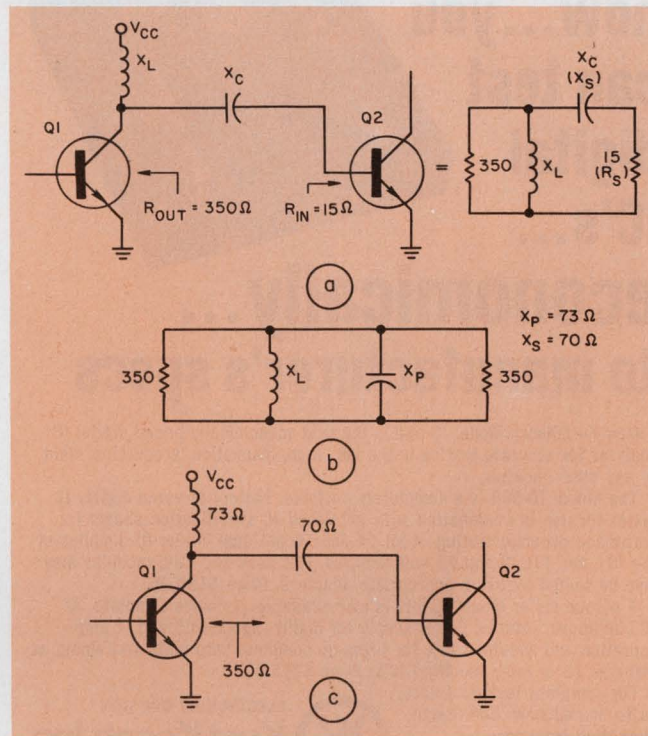

3. A series-to-parallel conversion solves the interstage coupling problem (a) for X_L and X_c . The inductive reactance is made equal to the equivalent parallel capacitor reactance of X_c . No additional transformations are required to determine the value for X_L .

circuit back into its original configuration (Fig. 2d) and adding the values of X_{c1} and X_{c2} . Cascaded sections can be designed in a similar fashion through a sequence of transformations.

Interstage-coupling values determined

How about an interstage coupling design? In Fig. 3a, transistor Q_2 has an input resistance of 15Ω while Q_1 has an output resistance of 350Ω . Proper choices for X_L and X_c will yield an impedance match.

The coupling capacitor and base-load resistance are converted to a parallel combination (Fig. 3b) with an R_p of 350Ω to match that of the driving transistor. This is done by entering the Mac Chart with an R_s of 15Ω and an R_p of 350Ω .

From the chart, the values for X_p and X_s are, respectively, 73Ω and 70Ω . And the inductive reactance is therefore made 73Ω to cancel the capacitive reactance (Fig. 3b). The final circuit values are shown in 3c.

A wide variety of impedance-matching problems can be tackled by means of series-parallel conversions. No calculations are necessary for an

now...you
can test
digital
IC's...
economically...
to manufacturer's specs



New Kurz-Kasch Model IC-590 is the first economically priced digital IC analyzer for accurate testing in the lab, shop, inspection, production, field or any other location.

The Model IC-590 is a completely portable, battery powered digital IC tester for use in conjunction with published IC specification sheets for static and dynamic testing of all 14 and 16 pin dual in-line IC modules of the DTL and TTL, 5 and 15 volt families. Flat pack and TO-5 modules may also be tested by using appropriate adapters. Price \$169.95.

A unique sister Model IC-591 is also available. It comes complete, as IC-590 above, internal power supply for highly regulated 5 volt, 1 amp operation and adapter cable for firing-up complete card units containing as many as 15 or more mounted IC's. Price \$295.00.

For complete technical data, write or call now: Tom Barth, Marketing Manager



ELECTRONICS DIVISION
Kurz-Kasch, Inc.

1421 S. Broadway,
Dayton, Ohio 45401

(513) 223-8161

INFORMATION RETRIEVAL NUMBER 29



TWO New SCRs
from **NATIONAL ELECTRONICS**
featuring

- Patented Regenerative Gate
- High di/dt with low power gate drive

F-390 850 A RMS, 500-1300 V. DC motor control and power supplies.

F-395 700 A RMS, 100-600V. Fast switching, high frequency for inverter use.



NATIONAL ELECTRONICS
a varian division
geneva, illinois 60134 (312) 232-4300

INFORMATION RETRIEVAL NUMBER 38

The equations for the Mac Chart

The defining equations for the Mac Chart are based on the relationship between the elements of the series and parallel networks shown below when the driving-point impedances are equal. The equations for the respective impedances are

$$Z_p = \frac{R_p \cdot (j X_p)}{R_p + j X_p}$$

$$Z_s = R_s + j X_s$$

Equating the real and imaginary parts of both expressions for network equivalency yields

$$R_s = \frac{R_p X_p^2}{R_p^2 + X_p^2}$$

$$X_s = \frac{R_p^2 X_p}{R_p^2 + X_p^2}$$

This simplifies to

$$R_p = R_s [1 + (R_p/X_p)^2]$$

$$X_p = X_s [1 + (X_p/R_p)^2]$$

It can also be shown that

$$\frac{R_p}{X_p} = \frac{X_s}{R_s} = Q$$

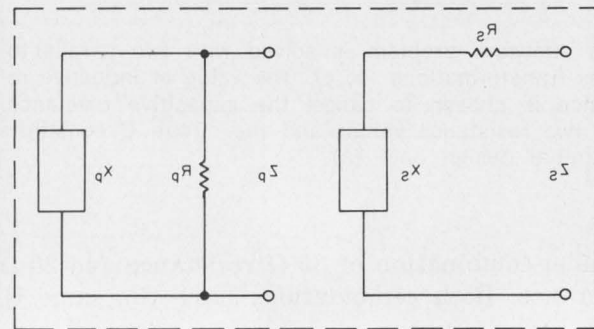

approximate solution with the Mac Chart. If greater accuracy is required, use the defining equations to perform the required transformations.

The range of the chart can also be extended by multiplying all element values by 10. The values of Q will not be changed. Similar alteration of the Q values can be made by proper manipulation of X_s , X_p , R_s and R_p . ■■

The author wishes to acknowledge the prior publication of similar charts for impedance matching. For instance see "Radio Transmitters" by L. F. Gray and R. Graham, McGraw-Hill Book Co., New York, 1961, p. 448. However, the Mac Chart was developed without knowledge of such previous work since the other charts were out of print for a number of years. The name "Mac Chart" was added for ease of identification, and does not imply that the author invented the chart.

innovation today

The broadest line of Digital Input Rotary Switches in the world. A switch for any digital input requirement.

DIGISWITCH®

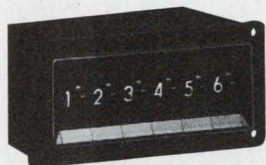

Developed in 1959, this is the original Thumbwheel switch.

Features:

- 8, 10, 12, 16 dial positions
- Front or back panel mounting
- Sealed version QPL approved
- Dozens of codes available
- Modular construction
- Dial lighting available

MINISWITCH®

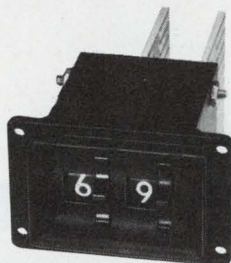

The original miniature Thumbwheel switch.

Features:

- 8, 10, 16 dial positions
- Sealed versions QPL approved
- Dozens of codes available
- Modular construction
- Miniature in size
- Dial lighting available

MINILEVER

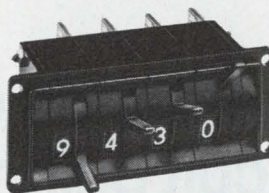

Fast action, lever actuated, switch for rapid setting.

Features:

- 10, 12 dial positions
- Rapid setting and resetting
- Modular construction
- Numerous codes available
- Miniature

ECONOMY THUMBWHEEL

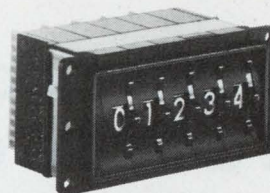

New, low cost, miniature Thumbwheel switch.

Features:

- 10 dial positions
- Sealed construction
- Modular construction
- Miniature
- Numerous codes available

Ask about our new low prices.

'SNAP-IN' THUMBWHEEL



New Thumbwheel that snaps into panel.

Features:

- Snaps in single or multiple panel cut-outs
- Eliminates end flanges and hardware
- May be grouped in one panel cut-out
- Front panel mounting
- Easily removeable

TOGGLE SWITCH

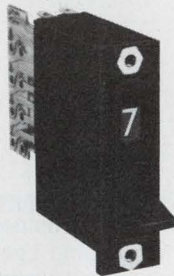

New bi-directional toggle switch.

Features:

- 10 dial positions
- Fast action
- Bi-directional
- Front face sealed
- May be grouped in single or multiple panel cut-outs

DIGIVIDER DIGIDECADE & PURE BINARY

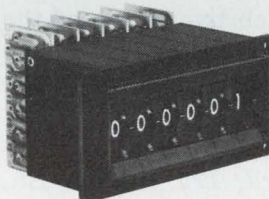

Voltage dividers, Resistance decades and Pure Binary Thumbwheel switches produced to standard or special customer specifications. As with all Digitran switches, additional electronics can be provided as an integral part of the switch.

Write for our new catalog on all of these and other Digitran products.

DIGIDIP

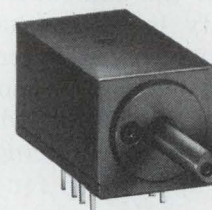

New P/C board mounted switch for I.C. socket or flow solder applications.

Features:

- 10 detent positions
- Plugs into standard 14 or 16 pin I.C. socket
- Dip or flow solder P/C boards
- Miniature
- Low cost

See us in
EEM 1972-73
Vol. 2 Pages
2116-2117

THE DIGITRAN® COMPANY

A Division of Becton, Dickinson and Company **B-D**

855 So. Arroyo Parkway / Pasadena, Ca. 91105 / Tel. (213) 449-3110 / TWX 910-588-3794

Single diode extends duty-cycle range of astable circuit built with timer IC

By adding a single diode, you can get almost double the duty-cycle range of an astable circuit built around the NE 555 timer IC.

Use of the diode in the circuit shown makes the charging time constant of C_1 independent of the discharge time constant. The capacitor charges through R_1 , R_2 and CR_1 , but discharges only through R_3 . Since the ON time of the circuit depends on the charging rate of C_1 , a suitable time constant can be chosen without affecting the OFF time. The latter period is controlled by the discharge rate of C_1 . Resistor R_2 allows the use of an external control signal, V_c , to vary the charging rate of C_1 .

With the component values shown, duty-cycle stability is better than $\pm 5\%$ over a 40-C temperature range. Different combinations of R_1 , R_2 , R_3 and V_c can be chosen so long as the voltage across C_1 is permitted to reach two-thirds of the supply voltage during the charging cycle. One useful application for the circuit occurs in pulsed power-supply regulators.

T. W. James, Project Engineer, Medical Electronics Div., Hewlett-Packard, 175 Wyman St., Waltham, Mass. 02154.

CIRCLE NO. 311

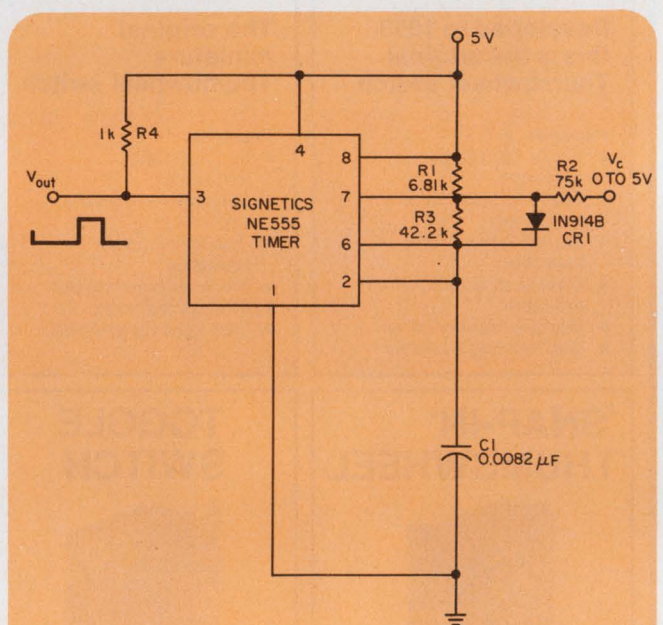

Duty cycle range of astable circuit is increased by the use of diode CR_1 , because the charge and discharge time constants of C_1 become independent. Charging current depends on R_1 , R_2 , V_c and the 5-V supply, but the discharge rate depends only on R_3 .

D/a converter design modification permits operation over a specified output range

A simple d/a converter can be easily modified to operate between fixed output limits. And the circuit requirements are less stringent than they would be if you used a standard converter but restricted the operation to the same limits.

The modification is accomplished by adding a two-resistor voltage divider to the standard binary weighting network. A few calculations suffice to solve for the values of the resistors. Output voltage limits can be specified from just

KEEP PACE

practical guides for
designers, managers
from  HAYDEN

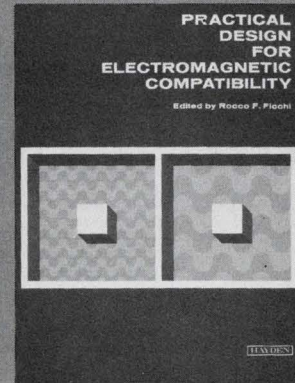
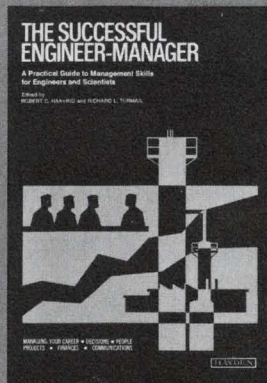

Practical Design for Electromagnetic Compatibility

Edited by ROCCO F. FICCHI

In one convenient source, all the basic information you need to analyze, predict, control, and reduce unwanted signals. It details measurement techniques and equipment, recent advances in filtering and shielding, and fully covers the special problems encountered in computers, semi-conductors, and solid-state devices. 272 pp., 7 1/8 x 9 3/4, illus., #5685-0, cloth, \$13.95

Durability and Reliability in Engineering Design

GILBERT KIVENSON

This thought-provoking work places at your disposal highly relevant findings from a variety of technical areas. It examines materials properties, breakdown mechanisms and phenomena, and failure modes along with steps to counter them; provides a capsule course in reliability theory; relates design considerations to the user's needs. 200 pp., 6 x 9, illus., #5851-9, cloth, \$9.95

The Successful Engineer-Manager

A Practical Guide to Management Skills for Engineers and Scientists

Edited by ROBERT C. HAAVIND and RICHARD L. TURMAIL

A well-organized, realistic guide to the critical areas of technical management — career, decisions, people, projects, finances, and communications. Articles carefully chosen from *Electronic Design* offer you valuable pointers on financial analysis, person-to-person dealings, project scheduling, promoting new ideas, and much more. 176 pp., 7 1/8 x 9 3/4, illus., #5879-9, cloth, \$8.95

Practical Instrumentation Transducers

FRANK J. OLIVER

You'll find virtually every known device for industrial or aerospace application covered in this complete, well-planned volume. Heavily illustrated, it reviews the state-of-the-art, clears up areas of confusion, presents pertinent data for specific applications. 352 pp., 7 1/8 x 9 3/4, illus., #5833-0, cloth, \$20.00

400 Ideas for Design, Volume Two

Edited by FRANK EGAN

Ranging from the ingenious to the amazingly simple, these top recent contributions to *Electronic Design's* "Ideas for Design" column are yours to use or adapt. They are gathered together by subject category for your convenience: amplifiers, design and laboratory aids, pulse, digital and control circuits, etc. 288 pp., 7 1/8 x 9 3/4, illus., #5067-4, cloth, \$11.95

Practical Relay Circuits

also by FRANK J. OLIVER

Grouping relays by function, this time-saver will give you a rapid overview of the circuits that can solve the problem at hand. You can then check operating principles, standards, and other specifications in manufacturers' data or sources such as Hayden's *Engineers' Relay Handbook*. 384 pp., 6 x 9, illus., #5802-0, cloth, \$14.95

Materials Science and Technology for Design Engineers

Edited by ALEX E. JAVITZ

The fundamentals of materials integrated with the hard facts of day-to-day engineering practice. The coverage offered you ranges from basic structure and behavior through new materials and applications, to environmental effects, reliability concepts, and cost effectiveness. 560 pp., 6 x 9, illus., #5640-0, cloth, \$23.95

Advanced Electronic Instruments and Their Use

SOL D. PRENSKY

Here, fully described and illustrated, are the highly sophisticated new instruments used for sensing, measurement, and control monitoring. You'll find detailed coverage of femtometers, solid-state multimeters, digital display devices, and much more. 208 pp., 6 x 9, illus., #0796-5, paper, \$6.95; #0797-3, cloth, \$9.50

15-DAY FREE EXAMINATION

Please send the book(s) circled on 15-day free examination. At the end of that time, I will remit payment, plus postage, or return the book(s) with no further obligation.

5685-0 5851-9 5879-9 5833-0 5067-4
5802-0 5640-0 0796-5 0797-3

Save Money!

Payment Enclosed. Publisher will pay all shipping and handling charges — same 15-day guarantee.

Name _____

Firm _____

Address _____

City/State _____ Zip _____

\$10.00 minimum for free exam orders. Because of higher billing and collection costs, we must ask for payment in full with any order for less than \$10.00. Same 15-day guarantee.



HAYDEN BOOK COMPANY, INC., 116 W. 14th Street. New York, N.Y. 10011

ISBN Prefix 0-8104

72-58

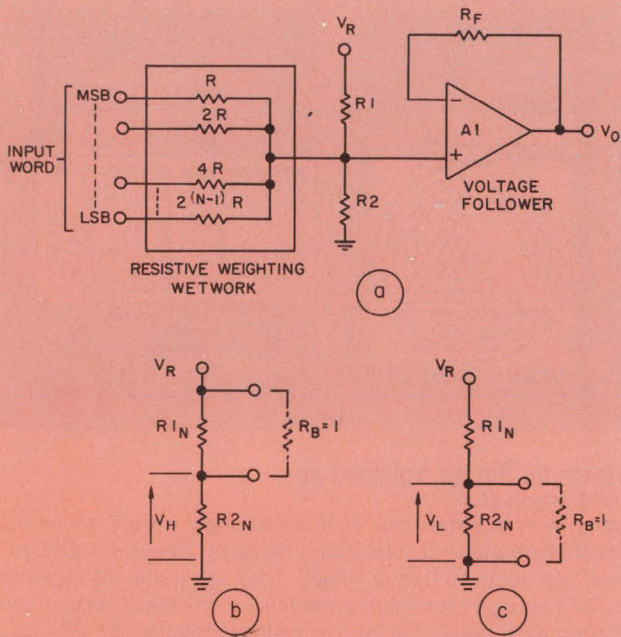

1. Resistive divider, interposed between binary weighting network, allows d/a conversion with outputs that lie between two specified limits (a). The circuit model for calculation of R_1 and R_2 places the binary network across R_1 at maximum output (b) and across R_2 at minimum output (c).

above zero to slightly under a given reference voltage.

The circuit model (Fig. 1a) assumes a conventional binary-weighted resistive network plus resistors R_1 and R_2 . Voltage V_R is the designated reference value. A voltage follower buffers the output, which is taken at the junction of R_1 and R_2 .

Solutions are obtained first for the normalized values of R_1 and R_2 . These values, designated R_{1N} and R_{2N} , are later multiplied by an appropriate scale factor to meet circuit requirements. The normalized equivalent resistance of the weighting network is taken to be unity.

At the upper output limit (Fig. 1b) voltage V_H appears at the junction of R_{1N} and R_{2N} . The input network is shunted across R_{1N} . And the relationship between V_H and V_R is

$$\frac{V_H}{V_R} = \frac{R_{2N}}{R_{2N} + R_{1N}/(R_{1N} + 1)} \quad (1)$$

A similar equation is obtained for the model (Fig. 1c) governing the lower output voltage V_L . Note that the input network is parallel with R_{2N} rather than with R_{1N} :

$$\frac{V_L}{V_R} = \frac{R_{2N}/(1 + R_{2N})}{R_{1N} + R_{2N}/(1 + R_{2N})} \quad (2)$$

To solve for R_{1N} , divide Eq. 1 by Eq. 2.

All terms containing R_{2N} cancel out, leaving

$$R_{1N} = (V_H - V_L)/(V_L) \quad (3)$$

Substituting in either Eqs. 1 or 2 the value for R_{1N} found in Eq. 3, we get

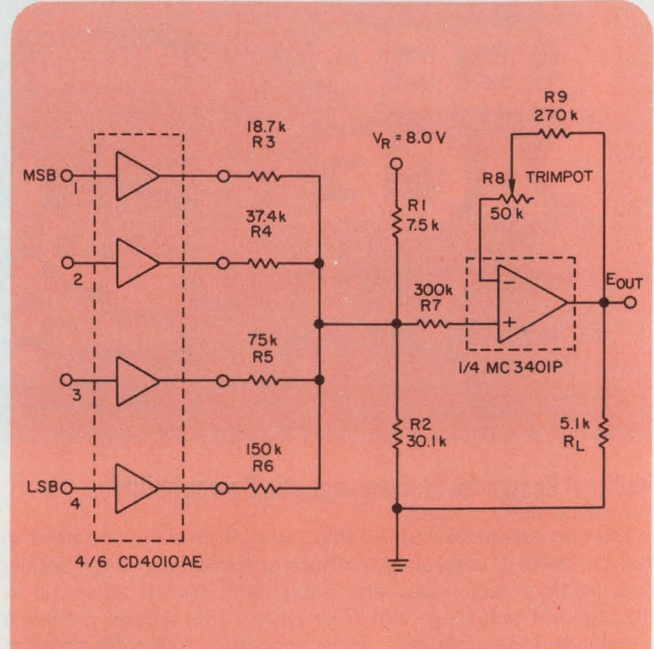

2. Practical four-bit converter is designed on the basis of Eqs. 3 to 5. Normalized values have been scaled by 10^4 . Potentiometer R_4 is used to compensate for offset and to obtain maximum accuracy. The calibration point is 0111, with an output of 5.4 V.

$$R_{2N} = (V_H - V_L)/(V_R - V_H) \quad (4)$$

To compute the normalized values for the binary-weighted input network, use the fact that resistance of the parallel combination is equal to one. Therefore:

$$1/[R^{-1} + (2R)^{-1} + \dots + (2^{N-1}R)^{-1}] = 1 \quad (5)$$

As a concrete design illustration, consider the four-bit converter (Fig. 2). The power supply or reference voltage is 8 V, and the specified output limits are 4 and 7 V, respectively. The input values to Eqs. 3 and 4 are:

$$\begin{aligned} V_L &= 4 \\ V_H &= 7 \\ V_R &= 8, \end{aligned}$$

giving

$$\begin{aligned} R_{1N} &= 0.75 \\ R_{2N} &= 3.0. \end{aligned}$$

The normalized values for the four binary weighting resistors are found from Eq. 5 to be 1.875, 3.75, 7.5 and 15.0 Ω , respectively, from MSB to LSB. All of these normalized values are multiplied by a scaling factor of 10,000, and the closest $\pm 1\%$ resistors are selected.

To compensate for offset and to obtain maximum accuracy, adjust R_4 for the calculated output with the digital word 0111 (5.4 V). With the circuit shown, the maximum error is less than 0.5%.

Leo Mahler, Biomedical Engineer, Statham Instruments, Inc., 2230 Statham Blvd., Oxnard, Calif. 93030. CIRCLE NO. 312

CTS puts the squeeze on space wasters

CTS Cermet "Saver Pac" Resistor Networks Increase Circuit Density ... At Economical Prices

Space comes *high*! So you'll like how much a CTS 750 Series "SAVER PAC" network can save you, and your circuit. Less space ... fewer components ... greater system reliability ... quicker, easier installation ... reduced handling costs ... and faster inspection. Consolidate up to 13 discrete resistors into one compact in-line resistor module. CTS can do it easily

with twenty standard packages ... available in .100", .125", or .150" lead centers. High power capabilities to 4.3 watts @ 70°C per module.

CTS 750 series cermet thick-film resistors assure proven performance—ultra high stability and reliability—backed by over 700,000,000 hours of test data. Hand install or use automatic assembly equipment...they're designed for either. Pick a SAVER PAC today. Large or small orders welcome. CTS of Berne, Inc., 406 Parr Road, Berne, Indiana 46711. Phone: (219) 589-3111.

INFORMATION RETRIEVAL NUMBER 41



CTS CORPORATION

A world leader in cermet resistor technology.

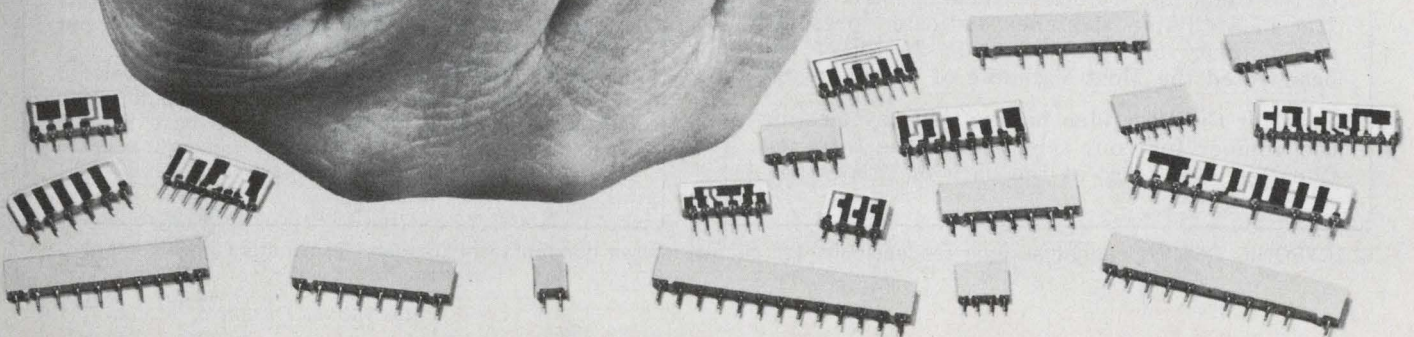

Series SCR lamp flasher operates with a wide range of loads

Although it is inexpensive, the simple series thermal flasher is both short-lived and its flashing rate is very sensitive to average load current. The simple circuit shown overcomes these flaws. It is solid-state and flashes anything from a miniature Christmas tree light-string to several hundred watts of bulbs, with no observable change in the flash rate.

Flashing occurs during positive cycles of the line voltage. Capacitor C_1 charges through R_2 from the rectified potential at D_2 . When the voltage at the divider, consisting of R_3 and R_4 , reaches the gate-firing level, SCR_1 conducts. The bulb current doubles, an action that more than doubles the light output. At this time the capacitor discharges more rapidly through R_1 and D_3 than it charged through R_2 and D_2 . The cycle is complete when the current through R_1 falls below the SCR holding current (during a negative half-cycle of the power line). This occurs somewhere between one and three discharge time constants.

Diode D_1 conducts during the reverse voltage cycle at the SCR. The resulting preheating of the lamp filaments enhances flashing visibility and limits current surges through the SCR. Also, the discharge rate of capacitor C_1 is made more rapid than the charge rate, since a shorter full-power flash is more pleasing to the eye and the continuous glow helps extend the lamp life.

When used with a small heat sink, the flasher accommodates loads to several hundred watts. And no contact spark noise is generated. The low, continuous lamp glow between flashes en-

hances the legibility of flashing signs or gives the appearance of more lights on a display.

To minimize the flow of dc line currents, reverse the power line connections of individual flasher circuits. This allows alternate conductive cycles of the SCRs to occur on alternate halves of the powerline cycles.

Peter Lefferts, National Semiconductor Corp., 2900 Semiconductor Dr., Santa Clara, Calif. 95051.

CIRCLE NO. 313

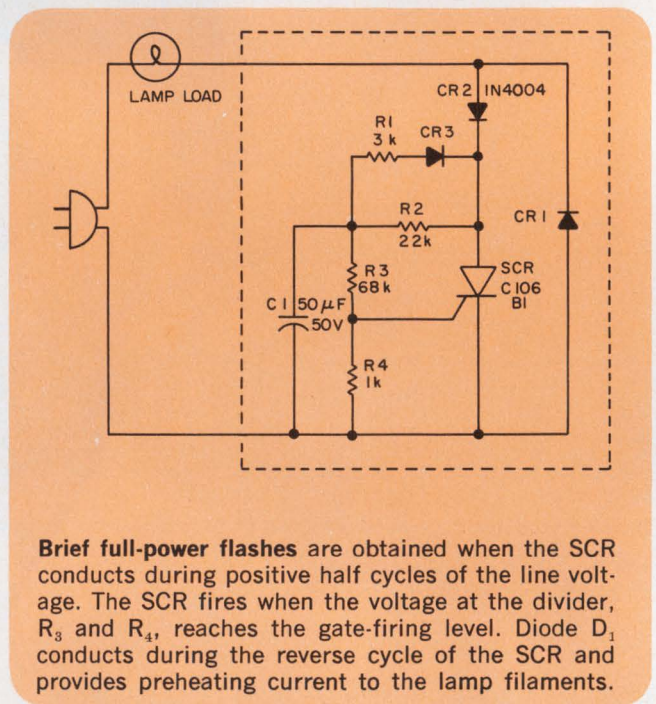

Brief full-power flashes are obtained when the SCR conducts during positive half cycles of the line voltage. The SCR fires when the voltage at the divider, R_3 and R_4 , reaches the gate-firing level. Diode D_1 conducts during the reverse cycle of the SCR and provides preheating current to the lamp filaments.

IFD Winner of October 26, 1972

Jeff Duer, Hewlett-Packard Co., 1900 Garden of the Gods Rd., Colorado Springs, Colo. 80907. His idea "Pulse stretcher indicates presence and polarity of TTL pulses to 20 MHz" has been voted the Most Valuable of Issue Award.

Vote for the Best Idea in this issue by circling the number for your selection on the Information Retrieval Card at the back of this issue.

SEND US YOUR IDEAS FOR DESIGN. You may win a grand total of \$1050 (cash)! Here's how. Submit your IFD describing a new or important circuit or design technique, the clever use of new component or test equipment, packaging tips, cost-saving ideas to our Ideas for Design editor. Ideas can only be considered for publication if they are submitted exclusively to ELECTRONIC DESIGN. You will receive \$20 for each published idea, \$30 more if it is voted best of issue by our readers. The best-of-issue winners become eligible for the Idea of the Year award of \$1000.

ELECTRONIC DESIGN cannot assume responsibility for circuits shown nor represent freedom from patent infringement.

Model 501

5MHz Function Generator with trigger/gate.

\$395



If you find that hard to believe, you know a lot about function generators.

But do you know about our modular solid state Model 501? And what it can do? It can make sine waves, square waves or triangles with variable offset or with DC. With symmetry control it can make pulses or ramps — and at rates to 5 MHz with our 1000:1 voltage generator control.

You can start and stop Model 501 as you choose with trigger / gate for one-pulse, tone bursts or synchronous timing. And you can add in your own signals to our built-in, input-summing, high-output wide-band amplifier.

What more could you ask for \$395?

If you're skeptical, that's fine. Because we'd like you to take Model 501 home with you and test it till your heart's content. Write or call today. Find out what Model 501 can do for you. And if you'd like the complete story on function generators, write for our "Free-folding, function generator guide."

We're making this offer because we have a theory—the more you know about function generators, the better for us.

WANT TO TEST MODEL 501? WRITE OR CALL AILTECH TODAY.

THE GOLD LINE SERIES FROM

AILTECH 
A CUTLER-HAMMER COMPANY CONTROL

EAST COAST OPERATION • 815 BROADHOLLOW ROAD • FARMINGDALE, NEW YORK 11735 • TELEPHONE: (516) 595-6471
WEST COAST OPERATION • 19535 EAST WALNUT DRIVE • CITY OF INDUSTRY, CA. 91748 • TELEPHONE: (213) 965-4911

INFORMATION RETRIEVAL NUMBER 42

OTHER SOLID GOLD PRODUCTS FROM AILTECH INCLUDE SPECTRUM ANALYZERS, NOISE MEASUREMENT EQUIPMENT, RF POWER SOURCES, OSCILLATORS AND TRANSDUCERS.

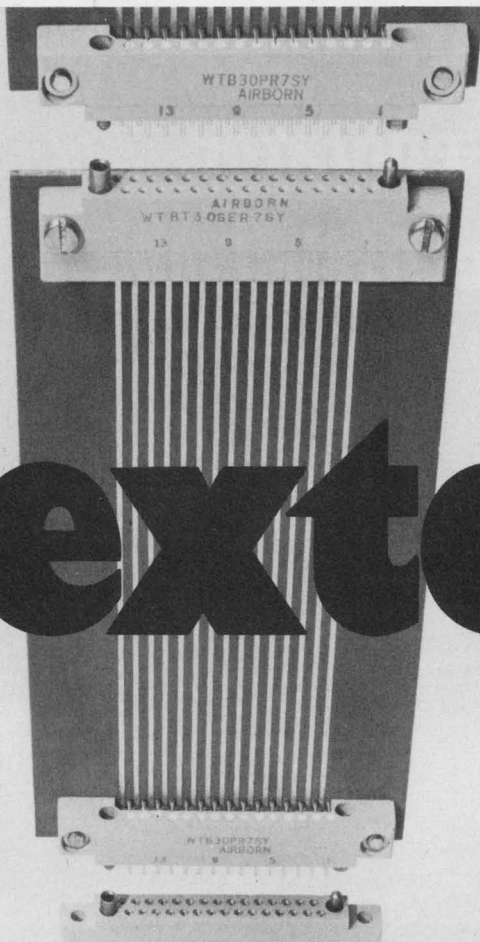

Now, **right angle receptacles** combine with right angle plugs for extender board applications. Available in combinations from 10 to 70 contacts. Choice of .109" or .140" termination lengths. Also provides a test vehicle using conventional plugs with guiding or jackscrew locking devices.

extender

For details about AirBorn's new WTBT series, call 214-357-0274 or write 2618 Manana Drive, Dallas Texas 75220

AirBorn, Inc.

Specializing in Right Angle Pin-to-Socket PWB Connectors.

INFORMATION RETRIEVAL NUMBER 43

Our mercury switch package deal: a new twist on old faithful.

Frankly, sometimes it's just not enough to design and build mercury switches for specific functions. So we offer customized packaging services, too.

After we sit down with you to work out the details of your application and performance needs, we can fabricate your entire sub-assembly . . . however complex the configuration.

For us, it's no problem. For you, it can be the easiest, surest, most economical way to ensure the long

life and reliability that made you specify Gordos mercury switches in the first place. But that's just one way we can put you ahead.

For more details on our complete selection of mercury, mercury-wetted, and reed switches and complete relay assemblies, write: Gordos Corporation, 250 Glenwood Ave., Bloomfield, N.J. 07003, or call (201) 743-6800.

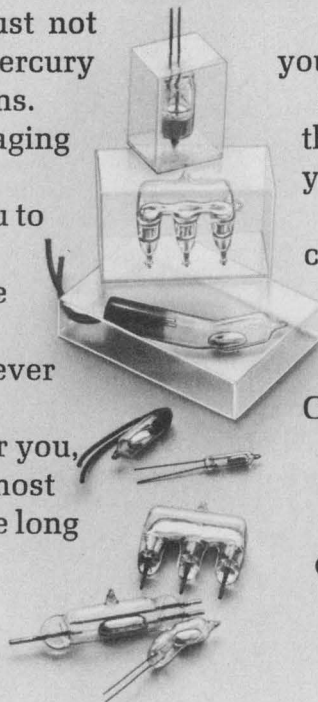

GORDOS
CORPORATION

INFORMATION RETRIEVAL NUMBER 44

new products

4-1/2-digit DMM resolves 1 μ V on signals to 20 mV



The Hickok Electrical Instrument Co., 10514 Dupont Ave., Cleveland, Ohio 44108. (216) 541-8060. \$695; 30 days.

Engineers who make low-level voltage measurements should be interested in Hickok's new DMM, the Model 3410. The 4-1/2-digit instrument offers 1- μ V resolution on signals to 20 mV dc.

Up to now, an engineer monitoring, say, transducer output voltages, had to use voltmeters especially intended for that particular job. These are not only expensive, but they also are usually limited to measurement of just dc voltages or low-level voltages.

Hickok's 3410 overcomes these limitations by also providing ac and dc voltage and current functions, as well as resistance—and all at an attractive price of \$695. The price includes two additional features that may be useful to engineers who make measurements with strain gauges:

- A high-level analog output proportional to the input signal, which may be used to drive a strip-chart recorder.

- A guarded box-within-a-box construction that provides a high common-mode rejection of 100 dB on the dc-volts function (at 60 Hz with 1-k Ω source unbalance).

One example of a competing unit is Keithley's new multimeter, the Model 171. This 4-1/2-digit DMM also provides 1- μ V dc resolution, plus ac/dc current and voltage and ohms. However, the 171 costs \$895—and it resolves a microvolt on signals to 10 mV—half of Hickok's lowest full-scale range.

The 3410 has 23 ranges; dc voltage can be read to ± 1500 V (many DMMs don't provide 100% over-ranging on the highest voltage ranges); ac voltage can be read from 10 μ V to 1000 V; dc and ac current can be measured from 100 nA to 1.9999 A and resistance from 1 milliohm to 19.999 M Ω .

One-month accuracies are $\pm 0.01\%$ of reading ± 1 count (digit) for dc volts—except for the 19.999-mV range, where accuracy drops to $\pm 0.1\%$ of reading ± 5 counts; $\pm 0.1\%$ of reading ± 10 counts for ac volts; $\pm 0.1\%$ of reading ± 1 count for dc current; $\pm 0.3\%$ of reading ± 10 counts for ac current; and, finally, $\pm 0.05\%$ of reading ± 2 counts for resistance measurements. Twelve-month accuracies are, of course, worse.

Input resistance of the Hickok 3410 is 10 M Ω for dc volts and 1000 M Ω /75 pF for ac volts. Bandwidth on ac volts is 30 Hz to 50 kHz. Response to a full-scale step

input varies from 500 ms on dc volts to 3 s on the current scales.

Other features include a fluorescent segmented display with buffer storage, automatic decimal point, automatic polarity, blinking overrange indication and a display rate variable from 10 readings per second to one every 5 seconds.

A battery option is available for an additional \$200, as is a 300% overrange option for \$100.

For Hickok
For Keithley

CIRCLE NO. 253
CIRCLE NO. 254

Memory tester uses CRT-keyboard link

Adar Associates, Inc., 85 Bolton St., Cambridge, Mass. 02140. (617) 492-7110. \$25,000 range.

Doctor 12 is a computer-controlled, microprogrammable system that can test either memory cards or systems up to 16-million locations by 72 bits. An optional test head converts Doctor 12 into a chip tester. Test programs are activated via a CRT-keyboard link. Both the test program and test results are displayed on the CRT. In addition to go/no-go testing, Doctor 12 is capable of complete memory system debugging and engineering evaluation. A microprogrammed address generator allows changing any address fields for each cycle. Enabling and disabling of carry linkage between fields under microprogram control can be accomplished, as well as incrementing and decrementing of any field by any amount and complementing of any field. The System's computer core memory is programmed from magnetic tape and can store up to 20 test programs which may be executed individually or in a sequence selected by the operator. The programs are edited on-line through the display console.

CIRCLE NO. 255

14-bit conversion with sign in 1 μ s given by a/d unit

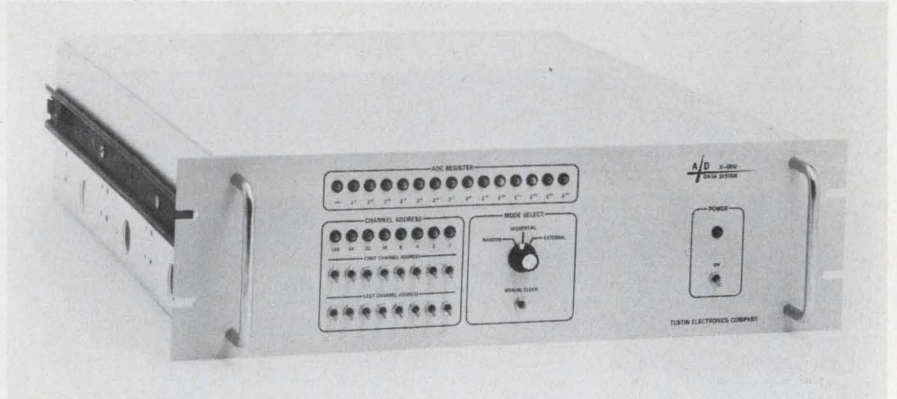

Tustin Electronics Co., 1656 S. Minnie St., Santa Ana, Calif. 92707. (714) 835-0677. \$6000; 60-90 days.

Using a parallel conversion technique, an a/d converter in a new series of Tustin Electronics completes a 14-bit conversion with sign in 1 μ s. And it does this for \$1840 less than competitive 14-bit units with 1.5- μ s conversions. A proprietary amplifier gives Tustin's converter the edge over competing high-resolution units.

A major competitor, Preston Scientific advertises its GMAD-1 (14 bits with sign at 1.5 μ s) for \$7840.

Tustin's Series 2000 converters also come in 13 and 12-bit models. The 13-bit model, which converts at 0.9 μ s, sells for \$5600, against \$7840 for Preston's GMAD-14B, which converts at 1.4 μ s. At 12 bits the 2000 series and the GMAD series run neck and neck on speed (both 0.5 μ s), while for 11 and 10 bits, the GMAD series is faster (0.4 μ s and 0.3 μ s vs 0.5 and 0.4 μ s). In all cases, however, the Tustin units cost at least \$1800 less.

At 10 bits and below, the picture changes rather sharply. For example, Computer Laboratories' soon-to-be-announced 7000 series will feature 100 ns comparison speeds, whereas Preston and Tustin are now offering 300 and 400 ns, respectively. But the prices vary sharply too. At 10 bits, they are \$10,000 for the Computer Labora-

tories unit, \$6930 for the Preston and \$4000 for the Tustin. All units are rack-mounted with their own power supplies.

Major electrical specifications for the 2000 series include a full scale input of ± 10 V with 20 M Ω impedance. The 14-bit unit provides accuracy of 0.005%, based on full scale, plus 1/2 LSB and a temperature coefficient of 5 ppm/ $^{\circ}$ C.

A conversion in the Tustin 14-bit model is performed each time the digitize command goes true, and the parallel outputs (two's complement) are available until the end of the next conversion period. A 100-ns pulse at the end of the conversion period signals that the conversion has been completed. All digital outputs are of the TTL totem-pole type.

The unit is 5-1/4-in. high by 19 in. wide by 22 in. deep and comes equipped with a front-panel readout of the a/d converter in binary form.

A mode-select switch permits controlled sampling of up to 128 channels (standard) with optional multiplexer equipment in the same housing. Channel selection may be sequential, between preset low and high channel numbers; or selected at random, as directed by a computer.

For Tustin Electronics

CIRCLE NO. 250

For Preston Scientific

For Computer Labs

CIRCLE NO. 251
CIRCLE NO. 252

AMPERITE DELAY RELAYS

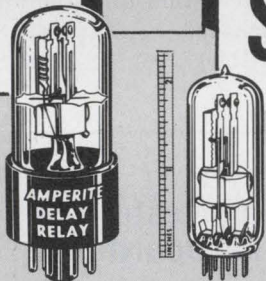

THERMOSTATIC
DELAYS: 2 to 180 Sec.*

Actuated by a heater, they operate on A.C., D.C., or Pulsating Current... Being hermetically sealed, they are not affected by altitude, moisture, or climate changes... SPST only — normally open or normally closed... Compensated for ambient temperature changes from -55° to $+80^{\circ}$ C... Heaters consume approximately 2 W, and may be operated continuously. The units are rugged, explosion-proof, long-lived, and inexpensive!

TYPES: Standard Radio Octal and 9-Pin Miniature.
List Price, \$4.00

*Miniatures Delays: 2 to 120 seconds.

All Amperite Delay Relays are recognized under component program of Underwriters' Laboratories, Inc. for all voltages up to and including 115V.

PROBLEM? Send for Bulletin No. TR-81.

AMPERITE BALLAST REGULATORS

Hermetically sealed, they are not affected by changes in altitude, ambient temperature (-50° to $+70^{\circ}$ C), or humidity... Rugged, light, compact, most inexpensive.

List Price, \$3.00

Write for 4-p. Bulletin No. AB-51.

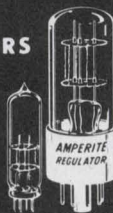

AMPERITE

600 PALISADE AVE., UNION CITY, N.J. 07087

Telephone: 201-UNion 4-9503

In Canada: Atlas Radio Corp., Ltd.,
50 Wingold Ave., Toronto 10



The upsetting problems, the roaring frustrations of defining, specifying and procuring the right printed circuit board connectors are over.

Over, because Winchester Electronics offers one of the world's largest, most varied lines of printed circuit connectors. To this purring thought, we'll add another. That Winchester Electronics has the unmatched capability to custom-design and produce special printed circuit connectors, as well. For you and you alone. Even if your order is relatively small and requires special tooling.

Our standard lines include connectors for single and double sided boards. With contact spacing of .100, .125, .150, .156 and .200. With as few as 6 contacts or as many as 100. And with an array of termination types that include wrap-post, solder-eyelet, dip-solder and crimp.

Add to these our ceramic substrate connectors. And our newest standard connector lines, the HSD and HMD*. With .156 contact spacing center-to-center plus .140 contact spacing between rows for double sided 1/16" cards. And add our DW



series edgeboard connectors. Featuring .025 square wrappable cantilever contacts on a .125 x .125 grid, 18 to 50 contacts per row.

Yes, add it all up. You'll see why Winchester Electronics has manufactured and delivered more than 15 million printed circuit connectors in the last 10 years. And why Winchester Electronics' record of successful innovations goes back for more than 3 solid decades.

So take the snarls out of your life, tiger. With the all-inclusive line of printed circuit connectors from Winchester Electronics. You'll get what you need. When you need it. And at very competitive prices. Call the Authorized Distributor near you for details, now. Or, for applications, contact Winchester Electronics Division, Main St. & Hillside Ave., Oakville, Connecticut 06779. Phone(203)274-8891.



WINCHESTER ELECTRONICS

INFORMATION RETRIEVAL NUMBER 46

*The HMD meets performance requirements of MIL-C-21097.

COMPUTERIZED WIRE WRAPPING

D
DATATEX

WE'VE GOT CONNECTIONS!

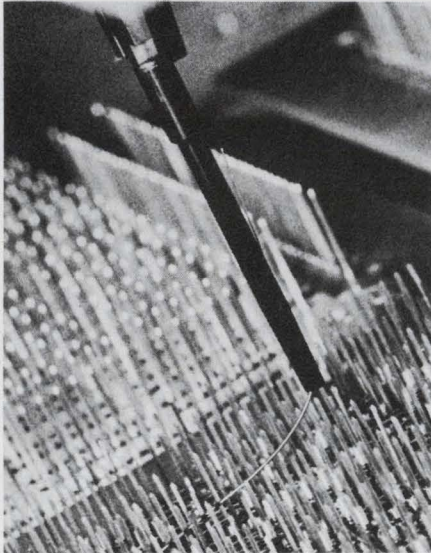

Specialists in connection and interconnection techniques for the electronic industry.

- **Computerized wire-wrapping services**
- **Comprehensive computer-aided design services**
- **Complete electrical assembly**
- **Wire cutting and stripping**
- **Complete mechanical assembly**
- **Complete electronic design services**

Contact DATATEX with your electronic connection and design problems. Investigate the services that Datatex Corporation is providing to the electronics industry.

COMPUTERIZED WIRE WRAPPING

D
DATATEX CORPORATION

6119 Jessamine Houston, Texas
77036 (713) 774-9741

INSTRUMENTATION

Single-slope conversion makes cool, tough DPM

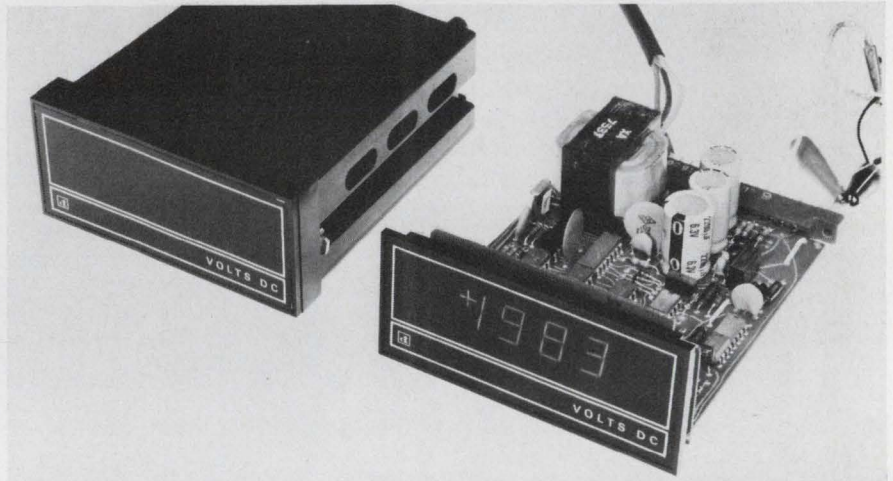

Data Technology Corp., 2700 S. Fairview Ave., Santa Ana, Calif. 92704. (714) 546-7160. \$89 (100s); 2 wks.

Instead of the widely used dual-slope conversion, a new digital panel meter uses a proprietary single-slope conversion technique, Unislope, that cuts parts count without LSI, reduces heat dissipation and boosts ruggedness.

Except for the 3-1/2-digit display and the decoder/driver circuitry, everything in Data Technology's 3312 fits comfortably on a single 3-5/8 × 4-1/2-inch board. There are no flying components dangling by their leads and no stand-up resistors or large capacitors. All fit snug on the board. So there's almost no chance that leads will shake loose if the meter is subjected to shock and vibration.

Use of the single, compact board allows the meter to slip easily into a case that extends 4 inches behind a panel (4.3 inches including the PC connector fingers) through a 3.9-inch wide by 1.7-inch panel cutout. A 4 by 1.8-inch flip-up bezel takes up a half inch in front of the panel.

The meter uses a three-wire power input. A third-wire guard shield completely surrounds the high and low sides of the ac line and power transformer, isolating

the power supply from the logic circuitry, thus contributing to a common-mode rejection of 80 dB—with no filtering—at 50-60 Hz with 1 kΩ in series.

In most respects the 3312 is electrically like other bipolar 3-1/2-digit DPMs. Operation is from 0 to 50°C. Accuracy is ±0.1% of reading ±1 digit. Tempco is 80 ppm/°C around 25°C. Input resistance is 1000 MΩ for 200-mV and 2-V ranges, 10 MΩ for 20-V and 200-V ranges. The meter differs from others, however, in that it can withstand 200 V pk-pk continuously on any range. The 3312 dissipates a maximum of 2-1/2 W with a nominal line of 117 V, 60 Hz, and little more at worst-case line of 127 V, 50 Hz. Most other meters dissipate at least 3 W at nominal line and three to five times that power at high line and low frequency.

The lower dissipation is due, in part, to the use of Sperry's planar gas-discharge display (with half-inch-high digits), and, in part, to the Unislope circuitry.

The flip-up bezel makes it easy to mount this DPM without a screwdriver. There are no internal mounting or retaining screws. The unit has a programmable decimal point and includes a BCD output that can drive five TTL loads.

CIRCLE NO. 256

This is not the end of the line

FOR GRAYHILL
TERMINATION HARDWARE.

We currently make over one hundred different items of termination hardware. And we're constantly adding to the line so there's no end to it.

But that's not the termination of our hardware story either. What we really make are quality features our customers couldn't find in existing hardware products. Like firm positive contacts the first time and every time a connection is made with a push post. Or rapid test clip connections without having to open and close jaws manually. Plus caps that resist melting at soldering temperatures, exceptional dielectric strength and better insulation.

Want to learn more about our hardware and miniature switch lines? Write today for our newest Engineering Catalog. Grayhill, Inc., 565 Hillgrove Avenue, La Grange, Illinois 60525. (312) 354-1040.



INFORMATION RETRIEVAL NUMBER 48

CHOOSE FROM OVER 4,000 UNUSUAL BARGAINS!

OPTICS • SCIENCE
ELECTRONICS

FREE CATALOG!

1,000's OF HARD-TO-FIND
BUYS FOR INDUSTRY

Brand new 164-page easy-to-read edition packed with new products, charts, diagrams, illustrations. On-the-job helps; quality control aids, unique, exclusive items to speed your work, improve quality, cut development and production costs! Loaded with optical, scientific and electronic equipment available from stock for industry, research labs, design engineers, experimenters, hobbyists.

ONE SOURCE FOR ALL YOUR NEEDS

Tremendous variety. Terrific savings. Countless hard-to-get surplus bargains. Many "one-of-a-kinds" nowhere else. Ingenious scientific tools. Thousands of components: lenses, prisms, wedges, mirrors, mounts, all types of accessories. Hundreds of instruments: pollution testing equipment, lasers, comparators, magnifiers, microscopes, projectors, telescopes, binoculars, photo attachments, ecological items, black light equipment and America's largest collection of unique lighting products.

BUY DIRECT WITH MONEY-BACK GUARANTEE

Edmund ships over 5,000 orders monthly to America's largest industrials — every item guaranteed! You must be satisfied, or return your purchase in 30 days for your money back. Shop the catalog of America's largest Science-Optics-Electronics Mart with confidence! Get your FREE copy without obligation. No salesman will call. Write now for free catalog "DA"

EDMUND SCIENTIFIC CO.
300 EDSCORP BUILDING
BARRINGTON, NEW JERSEY 08007
TELEPHONE: 609-547-3488

INFORMATION RETRIEVAL NUMBER 49

ELECTRONIC DESIGN 5, March 1, 1973

The smallest*

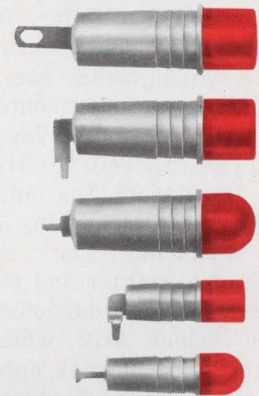

re-lampable indicators are



Marco-Oak QT Series incandescent, neon, and LED indicators



- Long-life reliability
- Simplified press-in panel mounting
- All popular lens colors and styles
- Distributor on-shelf availability now

*Actual size shown

MARCO-OAK

Subsidiary of OAK Industries Inc.

P.O. Box 4011
207 S. Helena Street, Anaheim, Calif. 92803
Tel. (714) 535-6037 • TWX — 910-591-1185

INFORMATION RETRIEVAL NUMBER 50

Frequency counter reads 0.001 Hz in 1 s

Systron Donner, 1 Systron Dr., Concord, Calif. 94520. (415) 682-6161. \$350; 30 days.

The Model 6220 2-MHz frequency/multiplier counter features a unique phase lock/multiplier technique which makes possible high-resolution measurements without an increase in measuring time. The 6220 can resolve 0.001 Hz in 1 second. Heretofore, the only accurate methods for measuring audio and low frequency were the period mode of a counter and the reciprocal counter. Additional new features include AGC, which sets all input adjustments automatically for total hands-off operation, zero suppression to blank out all leading zeros for easier reading of measurements and a highly legible, parallax-free digital readout with an autoranging decimal point and units annunciator.

CIRCLE NO. 257

New line of DPMs uses liquid-crystal display



Tekelec, Inc., 31829 W. La Tienda Dr., Westlake Village, Calif. 91361. (213) 889-2834. 2-1/2 digits: \$47 (100s).

An all new line of low-cost DPMs that combine custom MOS-LSI and field-effect liquid-crystal displays has just been announced by Tekelec, Inc. The TA 300 Series includes 2-1/2, 3-1/2 and 4-1/2-digit displays. Prices start at just \$47 each in quantities of 100 for the 2-1/2-digit meter. The company's proprietary Poly-Tek a/d conversion system features resolution as high as 0.005%, 10 readings/second, 10-ms response time, and normal mode rejection of 40 dB without an input filter.

CIRCLE NO. 258

Programmable timing unit gives 1-ns resolution

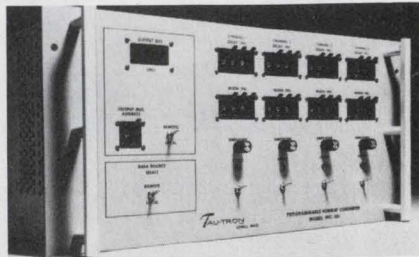

Tau-Tron, Inc., 683 Lawrence St., Lowell, Mass. 01852. (617) 458-6871. \$7995 (four channels); 8 wks.

The PFC-101 programmable timing unit and pulse driver allows precision control of width and delay out to 999 ns. It has four independent channels. Resolution of both width and delay settings on each channel is a constant 1 ns, irrespective of the programmed value of width and delay. The unit operates to 35 MHz, accepts asynchronous channel-to-channel inputs; width plus delay duty cycle approaches 200%. The PFC-101 can be programmed by front panel, by remote TTL signals, or both.

CIRCLE NO. 259

POWER SUPPLY HANDBOOK

YOUR'S

FREE

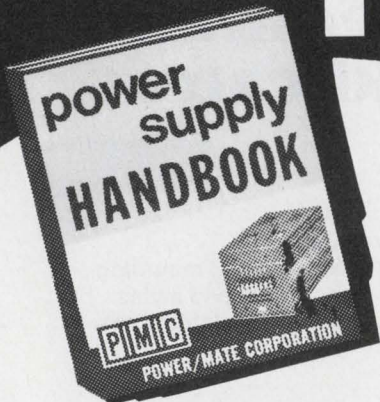

A complete reference of definitions, principles of operation, load connections and performance measurements. A working tool for the Engineer. Yours for the asking . . . and its FREE from Power/Mate.

SEND FOR YOUR FREE COPY



POWER/MATE CORP.

514 S. RIVER STREET HACKENSACK, N. J. 07601
Phone (201) 343-6294 TWX (710) 990-5023

MINIATURE BITE INDICATOR OPERATES DIRECTLY FROM LOGIC LEVEL...

BUILT-IN TEST EQUIPMENT



M151LP

The Minelco® M151LP BITE Indicator features a desirable combination of features for the design engineer including:

- Miniature size.
- Negligible power drain.
- Operation directly from logic level.
- Manual reset with spring return.
- Environmental sealings without "O" rings.
- Long life capability - virtually burn-out proof.

For further information ask for Bulletin M-12.



MINELCO®

DIVISION
GENERAL TIME CORP.
A Talley Industries Company

135 SOUTH MAIN STREET • THOMASTON, CONN. 06787
PHONE: 203/283-8261 • TWX: 710/475-1091

Reflectometer resolves coefficients to 0.1%

Rohde & Schwarz, 111 Lexington Ave., Passaic, N.J. 07055. (201) 773-8010. \$5250.

A new reflectometer can measure reflection coefficients below 3% with a resolution of less than 0.1%. The Type ZRZ covers wide ranges of frequency (10 to 1000 MHz), attenuation (70 dB), and reflection (0.5 to 100%). It also permits swept-frequency display of reflection coefficients and transmission factors over its entire frequency range. Four ranges of sensitivity can be manually selected or programmed for full-scale deflections of 100, 30, 10 or 3%.

CIRCLE NO. 260

Function generator sells for \$295

Krohn-Hite, 580 Massachusetts Ave., Cambridge, Mass. 02139. (617) 491-3211. \$295; 6 wks.

Model 5700 function generator provides sine, square and triangle waveforms from 0.002 Hz to 2 MHz. Frequency accuracy is $\pm 5\%$ of reading for the entire 1000:1 tuning range of the dial. Output is controlled by a two-position step attenuator and amplitude vernier, providing both a 50- Ω single-ended and a 600- Ω balanced output. The outputs provide 15-V pk-pk and 30-V pk-pk, respectively. A 1-V auxiliary output is also supplied.

CIRCLE NO. 261

Differential amplifier boasts 120-dB CMRR

Dynamics, 12117 E. Slauson Ave., Sante Fe Springs, Calif. 90670. (213) 945-2493. From \$470. Stock to 30 days.

The Model 7521 uses ICs to provide these standard features: ± 10 V at 100-mA output, dc to 75-kHz bandwidth, 120-dB CMRR, 0.1% gain accuracy and 0.01% linearity. Several gain options are available to cover the range of 1 to 3300. Also available are dual outputs with filters, current limiting and offset controls. Integrated circuit sockets are used throughout.

CIRCLE NO. 262

NEW

TRUE RMS VOLTMETER OPTIONAL dB DISPLAY

PROGRAMMABLE ■ SENSITIVE ■ WIDE BANDWIDTH

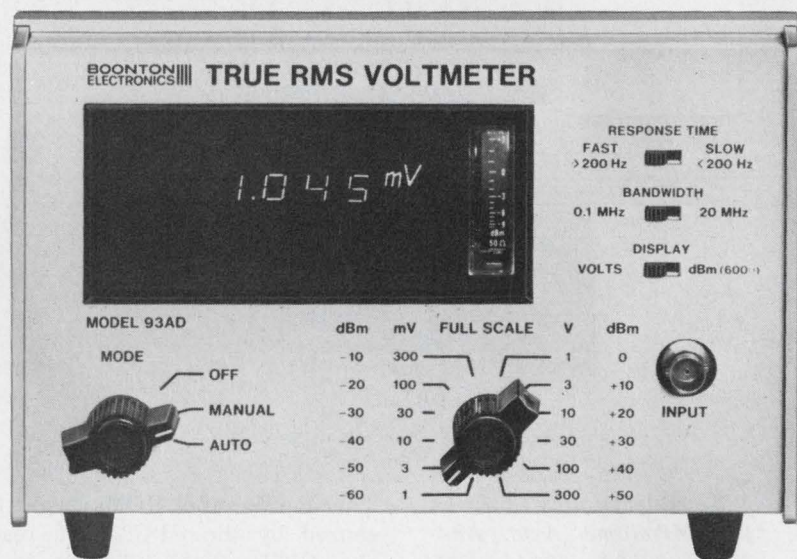

These important features, usually extra-cost or unavailable, are standard with the 3½ digit 93AD at its \$1200 base price:

- 300 μ V sensitivity usable over the full 20 MHz bandwidth.
- Full remote control.
- Digital and analog outputs.
- Auxiliary analog meter.
- Selectable bandwidth and response time.

Several options and accessories are available for special requirements:

- Digital dB display and outputs.
- Automatic ranging.
- High impedance probe.

See the 93AD at IEEE Intercon, Booth 2727

BOONTON ■■■
ELECTRONICS

ROUTE 287 AT SMITH RD.
PARSIPPANY, N.J. 07054
TEL.: 201-887-5110
TWX: 710-986-8241

Four-bit microprocessor cycles instructions in 5 μ s

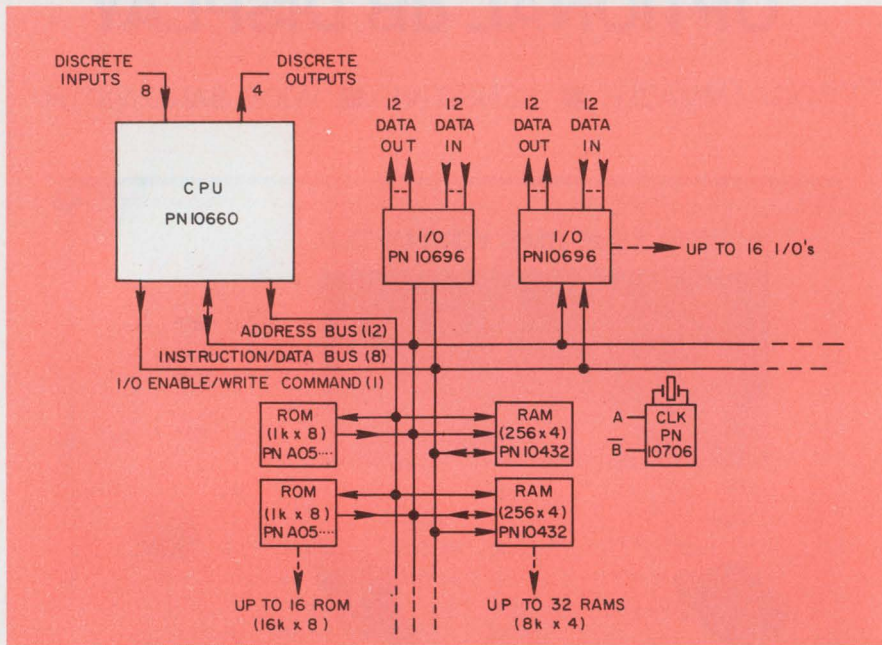

Rockwell Microelectronics Co., Box 3669, 3430 Miraloma Ave., Anaheim, Calif. 92803. (714) 632-2859. See text; 30 days.

What the calculator chip has done for the small hand-held electronic calculator the single-chip, central-processing unit (CPU) is about to do for the more sophisticated calculator, point-of-sale terminal, computer terminal, automated test and measurement systems and industrial control systems. And as new manufacturers enter the marketplace, CPU chips and their supporting circuits are becoming progressively cheaper and more powerful.

The newest, fastest and most sophisticated of the 4-bit CPU chips is the Model 10660 from Rockwell Microelectronics. It has a 5- μ s instruction cycle time and a 2.5- μ s register-to-register add time. In 1000 quantities, it sells for \$22. It normally is sold as part of a set with at least one RAM, one ROM, one interface chip (I/O) and one multiphase clock generator. Together the chips form a bus-organized microprogrammed parallel-processing system.

The RAMs and ROMs are time-shared by the CPU. As a result, the CPU can handle up to 16 ROMs, each organized as 1024 \times 8 bits, and up to 32 RAMs, each organized as 256 \times 4 bits. The 1000-quantity prices for the ROM and RAM chips are \$22 and \$17, respectively.

Each I/O chip can interface up to 12 I/O data lines with the microprocessor. Up to 16 I/O chips can be used with each CPU, thus yielding a total of 192 possible inputs and 192 possible outputs. The 1000-quantity price of the I/O chip is \$12.

A 200-kHz clock is necessary to make the microprocessor work. This is available for \$7 in 1000 quantities, and it comes in a 10-lead TO-100 can. All other chips are in 42-lead, plastic dual-inline packages.

Another IC in the new series is useful for smaller applications. This is a ROM/RAM chip containing a 5632-bit ROM and a 304-bit RAM. The price is \$22 in 1000 quantities.

All of the circuits are fabricated with standard p-channel, metal-

gate technology, and they work from 0 to 70 C.

Only one power supply (-17 V) is needed. The CPU responds to a basic set of 50 instructions.

Subroutine nesting uses RAM storage instead of a push-down stack register. As a result a large number of nesting levels are possible, limited only by the available RAM storage. Microprocessors using a push-down stack usually allow only 3 or 4 levels of nesting.

Two 8-digit numbers can be added in 240 μ s. Two 8-digit numbers can be multiplied in 15 ms.

To help engineers develop suitable microprograms and, hence, to specify the ROM coding, the manufacturer offers several aids. An evaluation board, at \$500, contains a CPU, two RAMs, two I/Os and a clock. By using one of the RAMs in place of a ROM, the system designer can set up a basic microprocessor. Assembly and simulation software will be available in Fortran on the Tymeshare network to output paper tape with ROM encoding. This paper tape will load a ROM emulator that can be built by the customer or supplied by Rockwell.

CIRCLE NO. 263

Zero-voltage switch IC minimizes EMI

Texas Instruments Inc., P.O. Box 5012, M/S 308, Dallas, Tex. 75222. (214) 238-3741. SN72440N: \$2.24 (100 up); stock.

A combined threshold detector and zero-crossing trigger IC, designated the SN72440, allows a triac or SCR to be fired when the ac input signal crosses through zero volts. Thus, undesirable electromagnetic interference can be minimized as the load uses full cycles of line voltage.

CIRCLE NO. 264

New PM motors/gearmotors

The people at Bodine have a new permanent magnet field D-C motor line: The 42A. But, there's a lot more to it than meets the eye.

High quality barium ferrite magnet material, magnetized and stabilized by Bodine gives you consistent output capabilities. Day to day. Over the long haul.

From motor to motor, lot to lot. The 42A delivers more power from a smaller, lighter package. It runs cool. Quiet. Has surprising control capabilities. Other design benefits include: High-starting torque, low-speed operation and self-braking. Brush life is outstanding: A unique thermoplastic end-shield assembly

has precision metal brush boxes and constant force roll-type springs that continuously maintain even brush pressure.

Bodine application engineers are ready to help you apply the 42A. Bodine Electric Company, 2500 W. Bradley Place, Chicago, Ill. 60618.

BODINE
ELECTRIC
COMPANY

BODINE MOTORS
GEARMOTORS
SPEED CONTROLS



42A Motor Line: Diameter is 4.3 inches. Standard continuous duty ratings are 1/8, 1/4 and 1/2 hp at 2500 rpm, 115V D-C. Available with or without NEMA Type C face mounting shield.

42A-E Gearmotor Line: Output torques to 350 lb-in. Output shaft rotates in large needle bearings providing high overhung load capabilities.



Rectifier diodes rated at 1 A

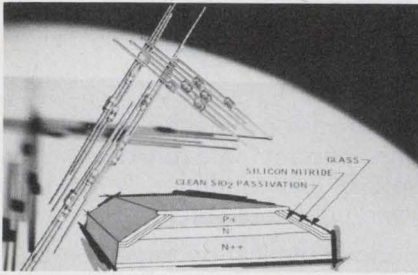

Texas Instruments, P.O. Box 5012, M/S 308, Dallas, Tex. 75222. 26¢ to 65¢ (100 up); stock.

The 1N4001/6 series of 1-A rectifier diodes, with an operating ambient temperature range from -65 to +175 C, has a peak reverse voltage range from 50 V for the 1N4001 to 800 V for the 1N4006. Average rectified forward current is 1 A, with peak-surge current up to 30 A.

CIRCLE NO. 360

COS/MOS line adds 6 ICs

RCA Solid State, Route 202, Somerville, N.J. 08876. (201) 722-3200. \$15 (1-24).

Three data multiplexers with low-level, logic-control inputs and three liquid-crystal display drivers that provide level-shifting functions are added to the company's COS/MOS line. The CD-4051A, an eight-channel multiplexer, is functionally equivalent to a SP8T switch; the CD4025A, a differential four-channel multiplexer, to a DP4T switch; and the CD-4053A, a triple two-channel multiplexer, to three SPDT switches. The CD4054A, a four-segment display driver, provides level shifting, four independently strobed latches and ac modulation of the four-output-signal lines. The CD4055A, a single-digit, seven-segment decoder/driver, provides the drive for liquid-crystal displays as well as the BCD-to-seven-segment decoder and seven ac-segment drivers. The CD4056A, a single-digit seven-segment decoder/driver, features a stored latch function at the BCD inputs.

CIRCLE NO. 269

**i'm
tuff
and
lite**

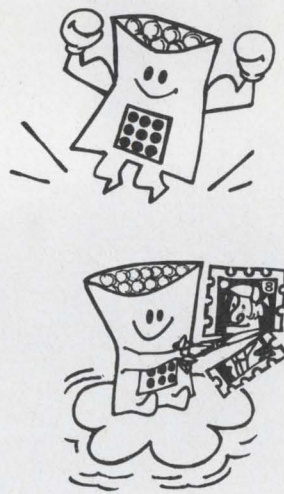

I'M A MAIL-LITE® SHIPPER

THE TOUGHEST AND LIGHTEST CUSHIONED SHIPPING BAG YOU CAN BUY . . .

TOUGH because I'm made of a strong tear-resistant laminate of plastic air bubbles and heavy duty golden kraft.

I'm light, seven ounces lighter than a No. 7 macerated padded bag. On a thousand bags I can save you \$560 in first class and \$280 in third class postage.

Like all Sealed Air® products, my bubbles are barrier coated for better protection.

Write for **FREE MAIL-LITE SAMPLE** . . . and receive the Mail-Lite Guaranteed Postal Savings Chart.



Sealed Air Corporation

19-01 STATE HIGHWAY 208/FAIR LAWN, NEW JERSEY 07410

One-shot pulser delivers 8 A at 60 V

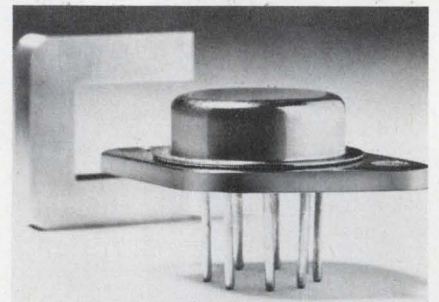

Unitrode Corp., 580 Pleasant St., Watertown, Mass. 02172. (617) 926-0404. \$44 (100-999).

The PIC 410 power pulser boasts a high-power output pulse of up to 8 A and 60 V for an internally preset interval ranging from 500 μs to 50 ms. The output pulse, which is current regulated to within 1% of an externally preset value, has a width temperature-coefficient of -0.04%/°C from 0 to 125 C. Packaging is in an eight-lead TO-3 case.

CIRCLE NO. 270

2-to-4 GHz VCOs offer 100 mW output

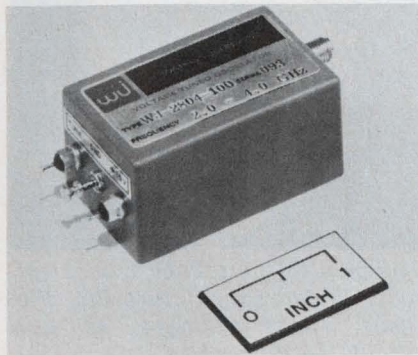

Watkins-Johnson Co., 3333 Hillview Ave., Stanford Industrial Park, Palo Alto, Calif. 94304. (415) 493-4141.

The fundamental power of the WJ-2804-100 voltage-controlled oscillators has been boosted to 100 mW. The VCOs cover the 2-to-4 GHz range and meet the environmental specifications of MIL-E-5400, Class 2. Tuning voltage requirements are 60 V dc maximum.

CIRCLE NO. 271

P-i-n driver is TTL/DTL compatible



LRC, Inc., 11 Hazelwood Rd., Hudson, N.H. 03051. (603) 883-8001. \$75 (1-9); stock to 20 days.

A single-pole, double-throw switch driver that provides switching input to p-i-n diode spdt switches offers full compatibility with TTL/DTL circuits. Called the Model SD-2101, it has a total switching time of less than 1000 ns (from 50% TTL input gate to 90% current output) and insures consistent diode switching by providing current spikes to inject and remove carriers from the switching diode junction.

CIRCLE NO. 272

Another Sprague Breakthrough!

PRODUCTION-ORIENTED SOLID TANTALUM CAPACITORS

Solid flame-retardant epoxy with precise dimensions for automatic insertion. Completely shock and vibration resistant.

Flat surface permits clear easy-to-read marking.

No rundown to interfere with seating of capacitors on printed wiring board.

Rugged 0.025" dia. tinned leads maintain alignment. 0.100" lead spacing for standard PWB grids.

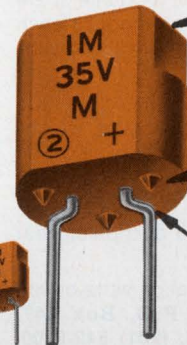
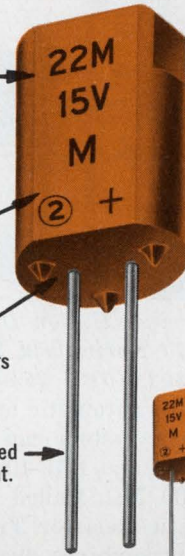

ACTUAL SIZE

Top flat for easy identification of positive lead either visually or by touch.

Standoff feet on base to eliminate moisture entrapment and facilitate cleaning of wiring boards.

Formed leads with either 0.200" or 0.250" spacing to permit interchangeability with dipped capacitors.

Type 198D Low-cost Econoline* Tantalum Capacitors Lead in Performance!

When it comes to low-cost solid tantalum capacitors, the new Sprague Type 198D Econoline Capacitors outperform all other designs. Here are some additional advantages:

- Low d-c leakage
- Low dissipation factor
- Wide voltage range, 4 to 50 VDC
- Capacitance range from 0.1 to 100 μ F
- Withstand severe temperature cycling and temperature shock over -55 C to +85 C
- Speedier handling for insertion
- Easier-to-read markings

The new Sprague Type 198D epoxy-encased Econoline Capacitor is tooled for mass production and priced competitively with imported dipped units. Investigate this new Sprague breakthrough without delay.

Call your nearest Sprague district office or sales representative, or write for Engineering Bulletin 3546 to: Technical Literature Service, Sprague Electric Co., 347 Marshall Street, North Adams, Mass. 01247.

*Trademark

THE BROAD-LINE PRODUCER OF ELECTRONIC PARTS



49M-2110

Noise Immunity—All solid state MOS circuitry provides higher noise immunity than other electronic counters. **Output Options**—Pulse or latching relay output, selectable by rear terminal connections. Automatic recycling feature works without loss of counts even up to 5,000 cps. **Two 10 amp Outputs**—The counter is preset to the desired number. Upon reaching zero an output signal is provided. In addition, a factory set warning or presignal is available at any number between 9998 and 1. Both output contacts are rated for 10 amps. **LED Display**—Seven segment LEDs provide easy readability and long life. A unique built-in display test circuit is standard. **12 Models**—Counters are available in 2, 3 or 4 digit models, each with or without display and with or without presignal.

Typical applications for the AO 611 are in high speed numerical control, weighing, blending, batching, packaging and cut-to-length operations.

The Hecon Electronic Counter is available from the factory or a distributor near you.

For additional information write or call **Hecon Corporation, P.O. Box 247, Eatontown, N.J. 07724, (201) 542-9200.** In Canada: Hecon of Canada, Ltd., 80 Galaxy Boulevard, Rexdale, Ontario, (416) 678-2441.

electronic predetermining counter has a lot to offer



INFORMATION RETRIEVAL NUMBER 56

MICROWAVES & LASERS

Resistor trimmer has trim range to 1000 M Ω .



Arvin NU/Con Div. Systems, Inc., 1771 Springfield St., Dayton, Ohio 45403. (513) 254-6177. \$45,000 up.

An automatic laser resistor-trimming system can be used to trim thick and thin-film resistors up to 1000 M Ω . Called the ART (Automatic Resistor Trimmer), the system combines dual-probe operation with an X-Y table for production versatility. The manufacturer claims the system can be changed over in a few minutes—from circuit to circuit—and is completely self-programmable.

CIRCLE NO. 273

Thermistor mount offers broadband efficiency

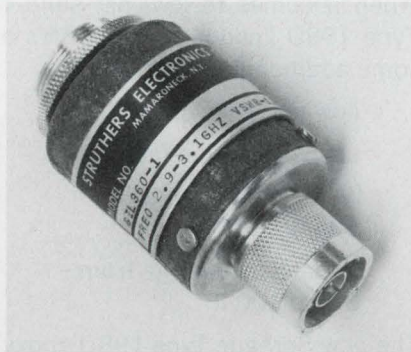

Struthers Electronics Corp., Railroad Pl., Mamaroneck, N.Y. 10543. (914) 698-3000.

The Model 360 thermistor mount provides greater than 90% efficiency over the frequency range of 10 MHz to 10 GHz and over the -40 to +65 C temperature range. A temperature-compensated mount, the 360 can mate with HP, PRD and similar power meters to measure microwave power from 1 μ W to 10 mW.

CIRCLE NO. 274

Gunn oscillator lists 1.5-ppm stability

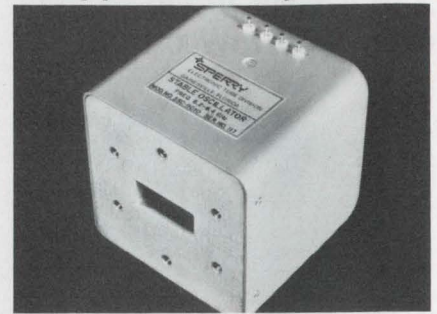

Sperry Electronic Tube Div., Dept. 9002, Waldo Rd., Gainesville, Fla. 32601. (904) 372-0411. 45 days (small qty.).

A Gunn oscillator features a frequency stability of only ± 1.5 ppm/ $^{\circ}$ C without temperature controller. Designated the SSC-11010, the oscillator operates at a fixed center frequency of 6.5 GHz and is mechanically tunable ± 120 MHz. The SSC-11010 has a minimum output power of 10 mW.

CIRCLE NO. 275

Noncryogenic paramp has 55-K noise factor

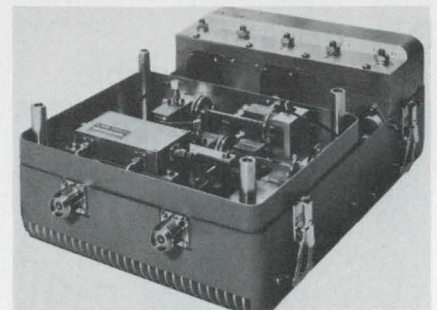

LNR Communications Inc., 35 Central Ave., Farmingdale, N.Y. 11735. (516) 293-1010.

A noncryogenic parametric amplifier, Model NC4-50, has a 55-K noise temperature from 3.7 to 4.2 GHz. This is the lowest noise factor of noncryogenic paramps presently available, according to the company. Moreover, the manufacturer says the NC4 Series provides faster turn-on times, greater reliability, and reduced size, weight and power consumption over the equivalent cryogenic units. Other features include a bandwidth of 500 MHz (-1 dB gain points), net gain of 40 dB typical, dynamic range of -50 dBm (input for 40 dB gain) and gain stability of ± 0.5 dB/week.

CIRCLE NO. 276

Low-cost core-memory units cycle in 650 ns

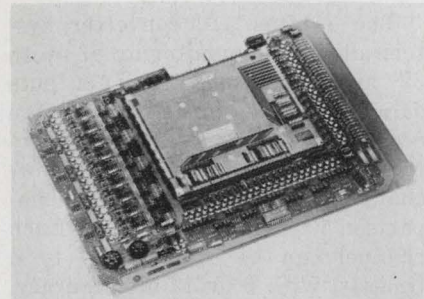

Standard Memories, Inc., 2801 E. Oakland Park Blvd., Fort Lauderdale, Fla. 33306. (305) 566-7611. 30 days.

The series-SA core memory is constructed as a single 11.5 x 13.75 x 1.25 in. PC board assembly. It is organized as a 3D coincident-current system with a capacity of 4 k or 8 k words having 18, 16, 14, 12, 9 or 8-bits per word. The full cycle time is 650 ns, and the access time is 275 ns. The I/O is compatible with DTL or TTL. The output of each unit is of the open-collector type. This configuration allows up to 16 modules to be joined in a party-line fashion. The series is slated to sell for less than 1¢ per bit in OEM quantities.

CIRCLE NO. 277

Digitizer features large grid size

Computer Equipment Corp., 14616 Southlawn Lane, Rockville, Md. 20850. \$15,000; 3-4 wks.

Model DG-10C is provided with a 42 by 60 in. digitizing work surface and uses a free cursor. It can digitize any graphic pattern with an accuracy of 0.005 in. and can resolve points 0.001-in. apart. A separate electronics console and readout unit contains a 5-digit X-Y display plus electronics for formatting and interfacing to external output devices. The unit is designed for off-line use, but is supplied with a software support package than can be run on most computers, if the computer is equipped with a Fortran IV compiler.

CIRCLE NO. 278

ARE THESE PRODUCTION PESTS JAMMING UP YOUR SCHEDULE?

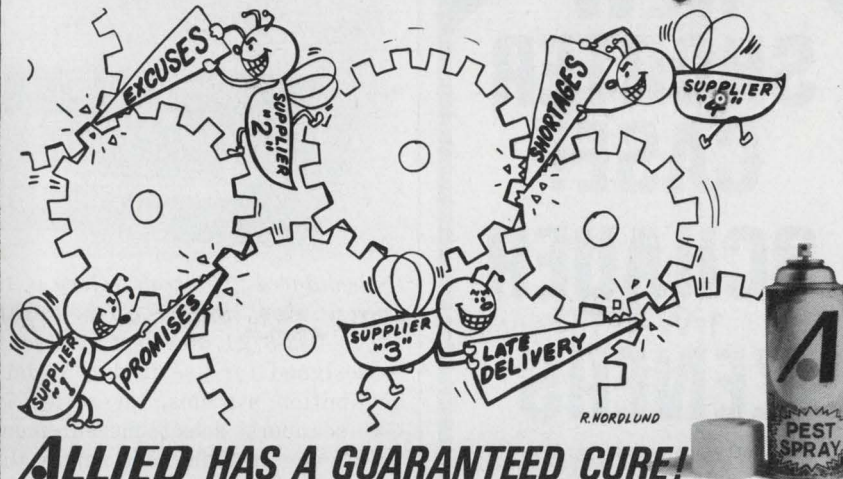

ALLIED HAS A GUARANTEED CURE!

... Immediate Shipment of Thousands of Items—Partial List Below

The sure-cure for production line ills—our Guaranteed Shipment Program covering thousands of popular and often hard-to-get items. Check your open order files, then check the list below—it's just a sample of our IN-DEPTH inventory—parts from Arco/Elmenco, Brady, Clauson, Duncan, Essex-Stancor, Fahnestock, General Cement, Grayhill, Harry Davies, Hunter, Johnson, Jonard, Microflame, Moody,

National Tel-Tronics, Smith, Struthers-Dunn, Tape-switch, Thermalloy, Triplett, and Unimat. All ready to be shipped to you today! And, you get what you order from our published list or we give you a Credit Voucher for 10% of your total order (good for 90 days) to be applied to your next order. See the next issue of this publication for more Guaranteed Shipment items. Call us now for total service!

ARCO/ELMENCO	ARCO/ELMENCO	HARRY DAVIES	GRAYHILL	E.F. JOHNSON	H. H. SMITH	H. H. SMITH	H. H. SMITH
CCD-050	DM19FD272.03	140U	2-0	111-0104-001	270 Red	1596-36-102 Red	8349
CCD-100	ME2-D-010	1450	2-1	111-0107-001	270 Blk	1596-36-103 Blk	8351
CCD-200	ME4-D-100	1475	2-4	111-0110-001	275	1596-60-102 Red	8352
CCD-300	ME1-E-005	1500 Blk	2-20		302 Red	1596-60-103 Blk	8353
CCD-330	ME2-E-010	1550	2-21		302 Blk	1597-12-102 Red	8880
CCD-390	ME4-E-100	1800	2-41	JONARD	304 Red	1597-12-103 Blk	
CCD-680	ME1-G-001	2150	1001015	D-300	304 Blk	1597-36-102 Red	
CCD-620	ME2-G-005		2181004-2	K-55	317 Red	1597-36-103 Blk	
CCD-101	ME2-G-010		2181006-2	K-234	317 Blk	1756	
CCD-201	ME4-G-025		22-164	P-6	319 Red	1759	
CCD-221	ME4-G-050	61	29-114	PB-7	319 Blk	1863-12-102 Red	
CCD-271	ME4-G-100	71	29-110	P-4	325 Red	1863-12-103 Blk	
CCD-331	ME1-J-001	81	29-1 Blk	P-6	338 Blk	1863-36-102 Red	
CCD-391	ME3-J-010	2015A-10K	29-3 Red		337 Red	1863-36-103 Blk	
CCD-681	ME4-J-015	3253-1K	29-3 Blk	MICROFLAME	436 Red	1863-60-102 Red	
CCD-392	ME4-J-020	3253-2K	29-3 Red	1000	436 Blk	1866-36-102 Red	
CCD-393	ME7-J-050	3253-5K	29-100R	1001	436 Whi	1866-36-103 Blk	
DMS-050K	RME-F-D-100	3253-10K	29-101B	1902	436 Blue	1866-60-102 Red	
DMS-070K	RME-B-E-010	3253-20K	29-104B	4000	459 Red	1866-60-103 Blk	
DMS-090K	RME-E-050	3253-50K	29-104R	MOODY	491 Red	2094	
DMS-100J	RME-E-F-100	3253-100K	29-104R	BK-5	491 Blk	2100	
DMS-150J	Fused Plug (FP-502)			BK-5		2101	
DMS-180J				HPS-2		2102	
DMS-200J	BRADY	ESSEX-STANCOR		JS-6		2103	
DMS-220J	B-600 (1-33)	P-6134		JS-6		2104	
DMS-240J	B-600 (1)	P-6375		MMK-6		2120	
DMS-270J	B-600 (2)	P-6377		MS-2		2121	
DMS-300J	B-600 (4)	P-6378		OE-5		2122	
DMS-330J	B-700MM (0-49)	P-6379		OE-5		2123	
DMS-360J	B-700MM (50-99)	P-6465		PS-3		2123	
DMS-470J	B-700MM (100-132)	P-6469		SC-5		2127	
DMS-500J	CSR031	P-6130		59		2128	
DMS-560J	CSR032	P-8357		59		2129	
DMS-680J	CSR040	P-8358		HUNTER		2130	
DMS-820J	CSR060	P-8384		A44MS		2131	
DMS-810J	CSR125	P-8394		MP101		2134	
DMS-101J	CSR250	P-8395		905		2143	
DMS-111J	PW05-PK-1	P-8397				2144	
DMS-121J	TC129-001	RS-8415		E.F. JOHNSON		2145	
DMS-131J	TC178-001	RT-201		105-0901-001		2146	
DMS-151J	TC187-062	RT-202		105-0302-001	H. H. SMITH	2147	
DMS-161J	TC260-062	RT-204		105-0303-001	103	2147	
DMS-181J	TC127-062	RT-206		105-0304-001	109	2148	
DM10E0101.03	TC127-062			105-0602-001	120	2149	
DM15E0200.03	TC500-062			105-0602-001	151	2150	
DM15E0300.03	TF-4			105-0603-001	152	2151	
DM15E0360.03	V05 (O)	FAHNESTOCK		105-0607-001	257 Red	2643	
DM15E0510.03		10		105-0803-001	257 Blk	2644	
DM15E0560.03		GENERAL CEMENT		105-0203-001	260 Blk	2645	
DM15E0600.03	15S	10 702		105-0301-001	206 Red	2646	
DM15E0680.03	35S	10 916		105-0302-001	206 Blk	2647	
DM15E0750.03	75S	10 916		105-0303-001	211 Whi	2648	
DM15E0820.03	55	28-2		105-0307-001	211 Grn	3004	
DM15E0900.03	55	30-3		105-0310-001	212 Yel	3005	
DM15E0910.03	92S	31-2A		105-0901-001	213 Red	3009	
DM15F0121.03	92S	43-2		105-0902-001	213 Blk	3010	
DM15F0151.03	92S	50-2		105-0903-001	218 Blk	3012	
DM15F0201.03	92S	90-2		105-0904-001	220 Blk	3016RB	
DM15F0221.03	92S	113-16		105-0905-001	221 Red	3050	
DM15F0271.03	92S	81-1		108-0907-001	221 Blk	6252	
DM15F0301.03	92S	8665		108-0910-001	222 Blk	6253	
DM15F0331.03	92S	8666		108-0911-001	226 Blk	6266	
DM15F0361.03	92S	8667		108-0912-001	226 Blk	6327	
DM15F0391.03	92S	8670		111-0101-001	236 Blk	8329	
DM19F0102.03	92S	8663		111-0102-001	257 Red	8343	
DM19F0202.03	92S	8662-16		111-0103-001	257 Blk	1596-12-102 Red	
					269 RB	1596-12-103 Blk	8347

CALL YOUR NEAREST ALLIED FACILITY TODAY!

Garden Grove, Calif. (213) 598-6805	Washington, D.C. (301) 345-4600	Chicago, Ill. (312) 421-2400	Boston, Mass. (617) 848-4150
Detroit, Mich. (313) 846-7720	Fort Lauderdale, Fla. (305) 772-6464	Fort Worth, Texas (817) 336-5401	

NEW CATALOG
1973 Edition. Write or phone for your copy today.

ALLIED ELECTRONICS DIVISION OF TANDY CORP.
2400 WEST WASHINGTON BLVD., CHICAGO, ILL. 60612

NEW SHORTER CASE! SCHAUER 1-WATT ZENERS



**SAME LOW PRICES FOR
1% TOLERANCE ZENERS
ANY VOLTAGE
FROM 2.0 TO 18.0**

Quantity	Price Each
1-99	\$1.07
100-499	.97
500-999	.91
1000-4999	.86
5000 up	.82

IMMEDIATE SHIPMENT
Send for rating data and
20%, 10%, 5% and 2%
tolerance prices.

Semiconductor Division

SCHAUER

MANUFACTURING CORP.

4511 Alpine Ave., Cincinnati, Ohio 45242
Telephone 513/791-3030

DATA PROCESSING

Data acquisition units scan up to 1000 points

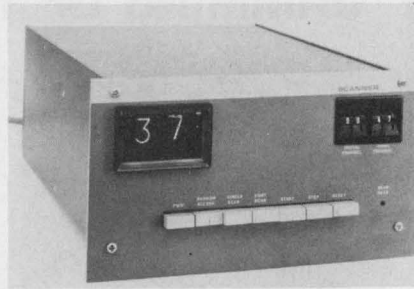

Consolidated Controls Corp., 15
Durant Ave., Bethel, Conn. 06801.
(203) 743-6721. See text; 2 weeks.

Designed for use in digital data acquisition systems, the series 70 GP scanners select measurement points one at a time and supply the output along with the channel's BCD address to auxiliary recording or processing equipment. The scan rate can be set from a 5 s dwell at each point to a maximum rate of 200 points per second. Four pushbutton selectable operating modes are provided—single scan, continuous scan, random access and step. Thumbwheel switches enable the unit to scan only a portion of the available data points. Model 70GP3 accommodates 10 to 100 inputs; Model 70GP10 accommodates up to 1000 inputs. The price for Model 70GP3 is \$580 plus \$150 for each block of 10 inputs.

CIRCLE NO. 279

Error detector tests T-1 and V.35 carriers

Data-Control Systems, Inc., Com-
merce Dr., Danbury, Conn. 06810.
(203) 743-9241. \$1970; 45 days.

Model 4661 bit-error-rate detector is designed to test high-speed digital communication networks using T-1, V.35 or 75 Ω interfaces. The unit provides a 1,048,575-bit pseudorandom pattern to the system under test and the bit-error count is presented on a four-digit front panel display. With external clock inputs, the unit operates from 600 bit/s to 8 Mbit/s. The self-contained clocks provide operation at 1.544 and 6.2763 Mbit/s. Additional features include a printer interface and self-test circuits.

CIRCLE NO. 280

Data acquisition system ignores redundant data

Sun Systems, Inc., P.O. Box 182,
Sun Valley, Idaho 83353. (208)
726-4763. \$3360; stock.

The Adacus a/d converter system allows the monitoring of up to 32 analog channels and outputs data only when a preselected change occurs in the input signal. Selection can occur on signal rate-of-change, signal increment or comparison with threshold value. Each channel can be sampled up to 3 times/s, with 8 or 12-bit accuracy. Data are provided in the form of two 8- or 12-bit words, one for data and the other for clock time. Full scale input ranges of 0.01, 0.1, 1, or 10 V may be specified. Optional features include programmable control of selection criteria and input-amplifier gain.

CIRCLE NO. 281

CRT data terminal displays 18 lines



Video Systems Corp., 7300 N.
Crescent Blvd., Pennsauken, N.J.
08110. (609) 665-6688. \$1995;
stock.

A low-cost alphanumeric CRT terminal, designated the Model VST-1440, generates all 128 ASCII characters and displays 64. The 12-inch CRT, in conjunction with a MOS memory, can display up to 18 lines each containing 80 characters. All data lines move up on the screen as a new line is entered. The unit is self-contained with a TTY style keyboard plus a 10-key numeric pad. All controls are located on the front panel including a selector switch for baud rates of 110, 150, 330, 600 and 1200. Communication is via standard EIA RS-232 interface. Quantity discounts are available.

CIRCLE NO. 300

Pulse format converter tailors TTL waveforms

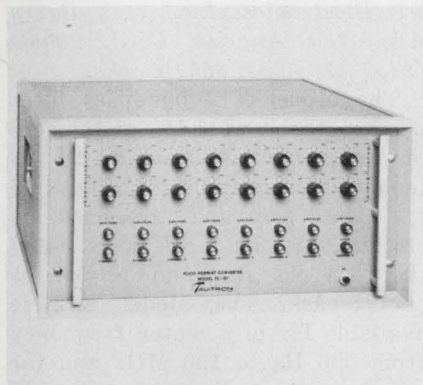

Tau-Tron, 685 Lawrence St., Lowell, Mass. 01852. (617) 458-6871. \$6500; 6 wks.

Each FC-101 unit has eight channels and each channel is independent from every other channel in terms of control of the four waveshape parameters. Waveshape control means the variation, by front panel switches, of width, delay, amplitude, and offset. This unit may be driven by any TTL signal at rates from single shot to 35 MHz.

CIRCLE NO. 302

Modem sends 19,200 bit/s over twisted pair



Prentice Electronics Corp., 795 San Antonio Rd., Palo Alto, Calif. 94303. (415) 327-0490. \$800; stock.

Model P-LRA is a synchronous modem designed for the serial transmission of binary data over two twisted pairs of wire for distances up to 10 miles. Data rates are selectable from 600 to 19,200 bit/s in either the full or half-duplex modes. The preferred method of connection between the modems is two shielded pairs. The manufacturer also offers the units on a 30-day cancellable rental basis.

CIRCLE NO. 303

Repackaged mini comes with extra features

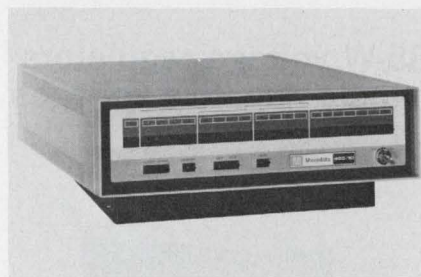

Microdata Corp., 17481 Red Hill Ave., Irvine, Calif. 92705 (714) 540-6730. \$2,250 (200).

Microdata's 400/10 has several standard features which are normally available only as extra-cost options. These are: power fail/auto restart, real time clock, DMA channel, hardware priority interrupt and hardware index register. The 4-k memory core is composed of 8-bit rather than 16-bit words. An optional I/O system can be specified which includes four buffer interfaces each having three control and two interrupt lines. Core memory is expandable to 65,536 bytes.

CIRCLE NO. 304

"IT'S GOOD BUSINESS
TO HIRE THE HANDICAPPED."

ISN'T THAT A GREAT IDEA, SNOOPY?



THE PRESIDENT'S COMMITTEE ON EMPLOYMENT
OF THE HANDICAPPED, WASHINGTON, D. C.



Need fast,
low cost switching?

Our correeds may be the answer. Much faster switching and lower power consumption than conventional relays. And less temperamental than solid state devices. Want to know more? Just write us for application handbook. GTE Automatic Electric, Industrial Sales Division, Northlake, Illinois 60164.

THE SOURCE

GTE AUTOMATIC ELECTRIC

INFORMATION RETRIEVAL NUMBER 60

85-W voltage regulators handle negative voltages

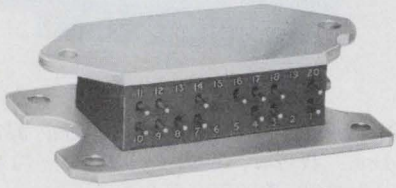

Lambda Electronics Corp., 515 Broad Hollow Rd., Melville, N.Y. 11746. (516) 694-4200. \$20 (100 up).

The LAS Series are negative hybrid voltage regulators. The 85-W devices come in four varieties and 22 models: a narrow-range input voltage with fixed output voltage (four-pin package); a narrow-range input voltage with adjustable output voltage (14-pin package); a wide-range input voltage with fixed output (four-pin package); and a wide-range input voltage with adjustable output (14-pin package). Variety 1 is available in seven models with fixed negative-output voltages from -5.2 to -28 V. Variety 2 is available in seven models with adjustable negative output voltages from -5 to -28 V. Variety 3 is available in four models with fixed negative output voltages from -5.2 to -15 V. And Variety 4 is available in four models with adjustable negative output voltages from -5 to -15 V.

CIRCLE NO. 305

12-bit d/a converter offered for \$39

Analogic, Audubon Rd., Wakefield, Mass. 01880. (617) 246-0300. \$39 (100 up); 2 wks.

The MP1412 features typical settling times (1/2 LSB) of 5 μ s, 0.012% linearity and relative accuracy and a typical tempo of 15 ppm/ $^{\circ}$ C. The MP1412 makes extensive use of MSI components to keep the parts count down to 27 components, resulting in an MTBF of 500,000 hours. Full-scale analog outputs of -10 to +10 V, 0 to +10 V, -5 to +5 V and 0 to +5 V are pin selectable. The unit accepts standard TTL logic level inputs. Power requirements are 22 mA plus external load current at +15 V \pm 3%, 8 mA plus external load current at -15 V \pm 3% and 45 mA at +5 V \pm 5%. Size is 2 \times 2 \times 0.4 in.

CIRCLE NO. 306

Volts sensor gives 20- μ V sensitivity

California Electronic Manufacturing Co., Inc., P.O. Box 555, Alamo, Calif. 94507. (415) 932-3911. \$74; stock.

The 582 dual set point millivolt-sensor provides an accurate window for analog signals within the \pm 100 mV range. Each set-point is individually adjustable through the entire scale, and has its own output. The unit has a set-point sensitivity of better than 20 μ V. Outputs are 80% of power supply voltage at 50 mA. An optional output yields a TTL-compatible 5-V dc.

CIRCLE NO. 307

Bandpass filters offer narrow bw

TT Electronics, Inc., 2214 Barry Ave., Los Angeles, Calif. 90064. (213) 478-8224. \$65; 2 wks.

The Model K12 bandpass filter has a 3-dB bw of \pm 1% of the center frequency (f_c) and 30-dB attenuation min at 0.94 f_c and 1.06 f_c . The passband response is smooth between 3-dB points, and there is no stopband return or bounce-back. The Model K12 is available for any center frequency from 500 Hz to 100 MHz and for any impedance from 50 Ω to 500 k Ω , depending upon the center frequency specified. Max dimensions for high-frequency units are 1.88 \times 1.44 \times 0.50 in.

CIRCLE NO. 308

12-bit a/d module converts in 4 μ s

Phoenix Data, Inc., 3384 W. Osborn Rd., Phoenix, Ariz. 85017. (602) 278-8528. 8 bits: \$295; 10 bits: \$380; 14 bits: \$695; stock to 4 wks.

The 800 Series are a/d converters featuring binary resolution from eight through 14 bits, with total conversion time as short as 2 μ s. All units in the series are complete plug-in modules. No external reference-voltage source, amplifiers, or trimming potentiometers are required. Conversion times are: 10 μ s for 14 bits, 4 μ s for 12 bits, 3 μ s for 10 bits and 2 μ s for 8 bits. Accuracy—including all error sources—is within \pm 0.01% of full range for the 814.

CIRCLE NO. 309

YOU COMPOSE AN AD ON ANY ONE OF THE PRODUCTS YOU LIKE. THE WINNING CARTOON WILL BE PUBLISHED RIGHT HERE IN THIS MAGAZINE AND WIN A VALUABLE PRIZE.

SEND ME AN ANA & LOG CARTOON KIT, POSTER, DATA SHEET PACK AND OF COURSE, THE LIST OF PRIZES.

NAME _____

COMPANY _____

ADDRESS _____

intech INCORPORATED
 (408) 244-0500
 1220 COLEMAN, SANTA CLARA, CALIF. 95050

Power supplies intended for computer peripherals

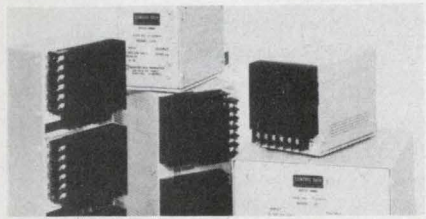

Control Data Corp., Magnetic Components Div., 7801 Computer Ave. S., Minneapolis, Minn. 55435. (612) 920-8600. \$65 to \$275; stock.

Called "STAK-PAK," these power supplies are for builders of computer peripheral equipment. Thirteen models, in six packages, are available. All models have adjustable outputs with a range of +15%, -10%, adjustable current-limit foldback protection and adjustable crowbar overvoltage protection. Output regulation bw is $\pm 0.5\%$ with pk-pk ripple at $\pm 0.5\%$ max. Input voltages are 115 V ac $\pm 10\%$, reconnectable for 230 V. The supplies will accept an input frequency of 47 to 480 Hz. Outputs range from 5 to 24 V and from 1.5 to 35 A.

CIRCLE NO. 320

A/d converter system handles 32 channels

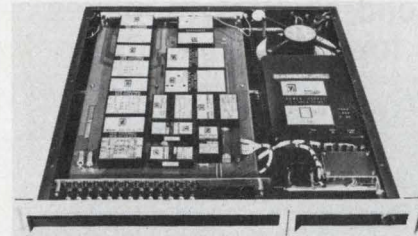

Zeltex, Inc., 1000 Chalomar Rd., Concord, Calif. 94520. (415) 686-6660. 7200: \$1250; 7210: \$1550. (12 bits, 8 channels, single-ended); stock.

Multichannel a/d converters, Models 7200 and 7210, accept up to 32 single-ended or 16 differential input channels of analog data to provide a time-shared multiplexed digital output. The high-speed Model 7210 features throughput rates of 100 kHz, 120 kHz or 140 kHz and resolutions of 8, 10, or 12 bits. The Model 7200 offers resolutions of eight to 13 bits at throughput rates ranging from 16 kHz to 40 kHz. Both models can sample analog data either sequentially or at random.

CIRCLE NO. 321

Instrumentation amp drifts only 0.5 $\mu\text{V}/^\circ\text{C}$

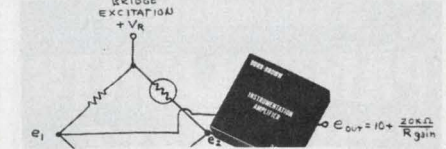

Burr-Brown Research Corp., International Airport Industrial Park, Tucson, Ariz. 85706. (602) 294-1431. 3625A: \$29; 3625B: \$45; 3625C: \$59; stock.

Models 3625A, 3625B and 3625C are instrumentation amplifiers that feature input voltage drifts of 3.0 $\mu\text{V}/^\circ\text{C}$, 1.0 $\mu\text{V}/^\circ\text{C}$ and 0.5 $\mu\text{V}/^\circ\text{C}$, respectively, at a gain of 1000. Bias current is only 100 nA and dc gain linearity is $\pm 0.02\%$. Small differential signals can be amplified, with gains of 10 to 1000 selected by the use of a single external resistor, in the presence of ± 10 V common mode. Input impedance is a high 1000 Ω and CMR at G-1000 is 100 dB. Output is ± 10 V at ± 5 mA. Input noise level at G = 100 is 5 μV rms from 10 Hz to 10 kHz. Size is 1.5 \times 1.5 \times 0.4 in. and weight is 1.5 oz.

CIRCLE NO. 322

Attention Advertisers:

Could you use copies of your ad exactly as it appeared in ELECTRONIC DESIGN? Then order your reprints directly from us; the minimum unit order is 500 copies.

Please specify if you would like the reprint line omitted on your copies and mail your/written order to:

Production Dept.
ELECTRONIC DESIGN
50 Essex St.
Rochelle Park, N.J. 07662

	500	1,000	Add'l M
<u>8x10 or smaller</u>			
1 color, 1 side	\$74.70	82.95	18.15
2 color, 1 side	95.47	108.00	25.28
4 color, 1 side	311.03	342.00	44.33
<u>Spreads</u>			
1 color	113.66	126.65	25.98
2 color	191.19	205.98	29.58
4 color	354.17	380.76	53.19

Prices FOB Waseca, Minn.



Looking for one relay to do the work of four?

Our class W relay can transfer as many as 51 circuits at one time. And do it with communications system reliability. That's why it's used for telephone switching and computer peripheral equipment applications. Write us for details on other ways to use it. GTE Automatic Electric, Industrial Sales Division, Northlake, Ill. 60164.

THE SOURCE

GTE AUTOMATIC ELECTRIC

INFORMATION RETRIEVAL NUMBER 63

Subminiature PANEL LIGHTS THAT LAST (up to 50 years)

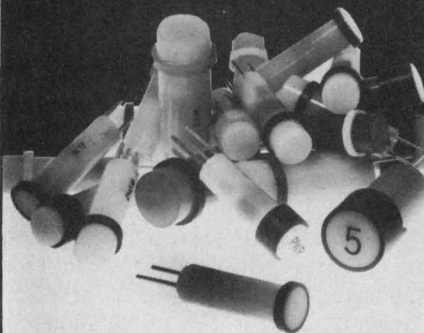

**low cost
IMMEDIATE
AVAILABILITY**

- LED's** (3/16" & 1/4" mtg. dia.)
- Self-Driven Incandescents**
(built-in drivers & keep alive bias)
- Standard Neons & Incandescents**
- Customs too!**

Ruggedly built with shock proof and fully insulated bodies. ■ Attractively designed and available in several lens and collar colors. ■ Low profile and standard mounting models.
Call or write for more information today!

the little light people

DATA DISPLAY PRODUCTS

8036 Westlawn Ave., Los Angeles, Ca. 90045
(213) 641-1232

INFORMATION RETRIEVAL NUMBER 64

COMPONENTS

Solid electrolyte makes a low-leak coulometer

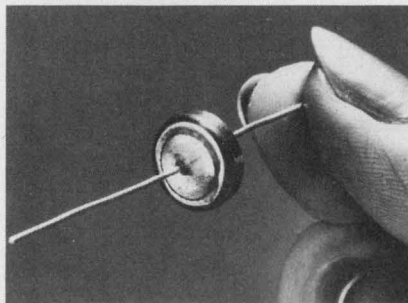

Unican Security Systems Ltd., 5795 De Gaspe Ave., Montreal 326, Canada. (514) 273-9451.

Coulocom, a dry solid-electrolyte coulometer, is suitable for use in timing and integrating circuits. It can replace conventional liquid-electrolyte coulometers. The unit is a low-leakage, two-lead device and has very-high charge retention. Elapsed-time measurement circuits built with coulocom units can range from a few secs to 8000 hrs and they can compete with mechanical timers in many applications.

CIRCLE NO. 323

Carbon film is cheaper, stabler than composition

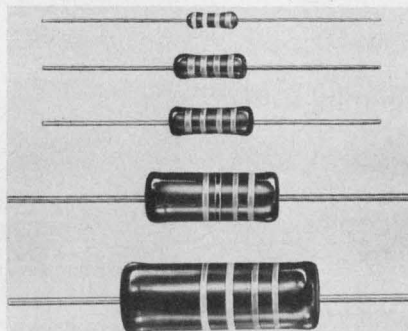

Piher International Corp., 1239 Rand Rd., Des Plaines, Ill. 60016. (312) 297-1560.

Piher's carbon-film resistors are claimed to provide 80% better temperature stability and four times the shelf life of carbon composition resistors. The film resistors generate less than 0.5 $\mu\text{V}/\text{V}$ of noise, and they are available at half the cost of composition resistors. Power ratings cover 1/4 to 2 W in five sizes and come in all standard resistance values.

CIRCLE NO. 324

Capacitors provide RFI noise suppression

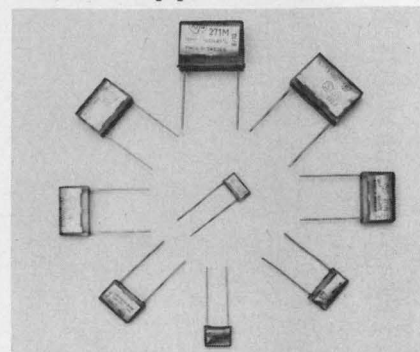

Presin Co., Inc., Trap Falls Rd., Shelton, Conn. 06484. (203) 929-1495. Stock to 3 wks.

The PME 271 metallized-paper suppressor capacitors are designed specifically to quiet small appliances and instruments that generate excessive RFI noise. Available capacitors range from 1000 pF to 0.6 μF with a maximum one-minute test voltage to 2000 V at 60 Hz. Free samples will be supplied upon request.

CIRCLE NO. 325

Interface unit converts mV to pneumatic output

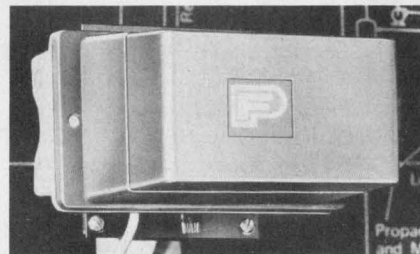

Fischer & Porter Co., 48 Warminster Rd., Warminster, Pa. 18974. (215) 675-6000.

Fisher & Porter's new converter-transmitter enables the use of thermocouples and resistance bulbs with pneumatic indicating and recording instruments. Other devices with millivolt outputs, such as pollution control devices, can also be coupled to pneumatic instruments. The transmitter weighs only 8 lb. Case dimensions are 5-1/4 \times 7-1/4 \times 8-1/4-in. Electrical power requirements are 110 to 125 V ac, at 50/60 Hz and the required pneumatic source is 20 \pm 2 lb/in². The output ranges from 3 to 15 lb/in² with an over-all accuracy of \pm 0.5% of full scale. Inputs range from 50 to 200 mV.

CIRCLE NO. 326

Stepping motor provides bidirectional operation



Addmaster Corp., 416 Junipero Serra Dr., San Gabriel, Calif. 91776. (213) 285-1121.

Addmaster offers a new Size 14, Stepmaster stepping motor. It is a variable-reluctance, bidirectional, dual-phase motor. The step angle is 15 degrees with a no-load response of 380 steps per second. Running torque is 4 oz-in. at 10 steps per second. Stall torque is 6.5 oz-in. Dimensions are 1-3/8-in. D, 1-13/16-in. L; and the weight is 6 oz. The standard voltage is 24 V, but other voltages are available.

CIRCLE NO. 327

Circuit breaker trips at adjustable ratings



Westinghouse Electric Corp., P.O. Box 2278, Pittsburgh, Pa. 15320. (412) 255-3321.

Westinghouse claims that its Sel-tronic Breaker is the world's first molded-case circuit breaker with a solid-state tripping mechanism. The most important feature, unique to the new breaker, is the easy way you can change the rating. Simply remove and change a rating plug that fits into the face of the breaker. Also each rating plug can be continuously adjusted over the range of 70 to 100%.

CIRCLE NO. 328

Split-flap display unit has large characters

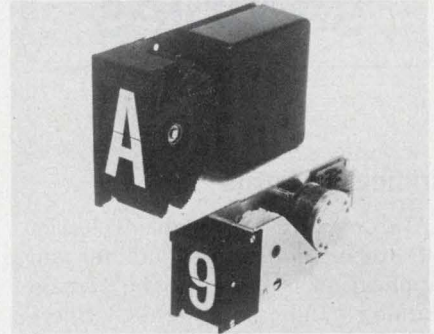

Conrac Corp., Cramer Div., Mill Rock Rd., Old Saybrook, Conn. 06475. (203) 388-3574.

Conrac's modular split-flap displays feature a range of character widths, from 1-3/4 in. for a single-width flap with 1-3/4-in. character height to a 60-in. wide flap with 6-in. character height. Standard module capacity is 32 or 64 flaps. The average character positioning time for a 64 character unit is 2.5 s and the stop/start time is 150 ms. Two code types are available—ASCII and a select code, 3 of 6 and 4 of 8.

CIRCLE NO. 329

BUCKEYE

19" CIRCUIT BOARD RACK

and guides with .347 or .500 spacing

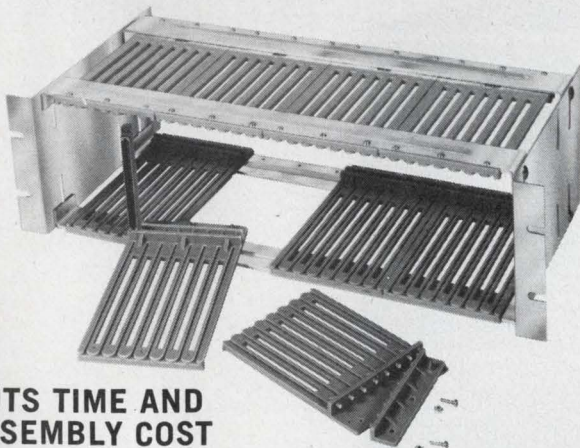

CUTS TIME AND ASSEMBLY COST

Flexibility of the unique design of these new Bord-Pak components brings maximum simplicity to the 19" Circuit Board Rack. Fewer parts, less assembly time and lower cost. Racks completely assembled in lots of 1 to 24. Partially assembled in larger quantities. 1/4, 1/2 and 3/4 racks also available. Write for details.



INFORMATION RETRIEVAL NUMBER 65

ELECTRONIC DESIGN 5, March 1, 1973



Need a small relay that will take punishment?

Our class H relay may be just the answer. Its unique actuating card assures contact reliability—over 100 million operations are standard. Available from stock too. Write for information. GTE Automatic Electric, Industrial Sales Division, Northlake, Illinois 60164.

THE SOURCE

GTE AUTOMATIC ELECTRIC

INFORMATION RETRIEVAL NUMBER 66

evaluation samples

Indicator lights

Information to enable selection of proper indicator lights for any application is given in the 12-page catalog "Indicator Lights." Specifications, features and ordering instructions are provided. Leecraft Manufacturing Co., Inc.

CIRCLE NO. 330

Dual-inline sockets

Fourteen and 16-pin sockets have a high insulation suitable for MOS devices and other circuits with high input impedance. Both sockets have 0.3-inch spacing, and the socket bodies are made from glass-filled polyethylene oxide. The sockets come with a choice of contact material. Jermyn.

CIRCLE NO. 331

Head-drive rivet

An all-aluminum liner head-drive rivet for use in blind-hole metal and wood applications has a flat-headed design which lessens the likelihood of overdriving in assembly. The lug design of the drive pin ensures positive retention, and its larger diameter gives outstanding shear strength. The smooth pin end remains inside the rivet legs after installation. Cherry Commercial Products Div., Townsend Co.

CIRCLE NO. 332

Temperature sensors

Form A and C switches consist of specially developed reed switches, two toroidal magnets and a ferrite whose magnetic reluctance varies with temperature within a narrow range around its Curie point. The four components are potted in an epoxy matrix to hold the magnets in the proper location and to provide protection for the glass seals. Hamlin, Inc., Lake and Grove Sts., Lake Mills, Wis. 53551.

Base for tiny lamps

A two-lead bipin base used in the assembly of tiny lamps and other lighting products is made of nylon and comes with two nickel leads in place. The bases are 0.198-in. ID, 0.228-in. OD, 0.320-in. high and lead wire diameter is 0.020-in. This configuration can be used for encapsulation of light-emitting diodes, photo cells and other solid-state devices. General Electric Co., Lamp Parts and Equipment Sales Operation.

CIRCLE NO. 333

Thermofilm insulators

Thermofilm insulators for semiconductor packages are made of a newly developed material which, the company claims, will not chip, crack, peel or break and will withstand temperatures from -269°C to $+400^{\circ}\text{C}$. They can be used as a replacement for mica insulators with a dielectric strength of 7000 V/mil and a thermal resistance of 0.6 C/watt. Thermalloy.

CIRCLE NO. 334

Pertec introduces the new T8000 Transport.



SALES OFFICE: Los Angeles (213) 882-0030 • Orange County (714) 830-9323 • San Francisco (415) 964-9966 • Chicago (312) 696-2460 • Philadelphia (215) 849-4545

application notes

Mobile-ion measurement

An illustrated 10-page application note describes a simple method of measurement for the study of mobile-ionic charge in silicon-dioxide dielectric material. The note includes a general discussion of mobile-ion effects, device characteristics, and a detailed description of measurement techniques for determining carrier density, mobile oxide charge and the capacitance derivative. Also included is a brief discussion of measurement considerations, block diagrams of the measurement setup and a pair of multitrace plots made with the method described. Princeton Applied Research Corp., Princeton, N.J.

CIRCLE NO. 335

PIN diodes

"Applications of PIN Diodes," a 14-page booklet, contains information on subjects such as design of switches and attenuators, design of PIN-diode phase shifters and a section discussing power handling capability of PIN diodes. Hewlett-Packard Co., Palo Alto, Calif.

CIRCLE NO. 336

Exar insulation

A paper entitled "Exar: A Flame Resistant, High Temperature, Cross-Linked Wire Insulation System" includes information on the properties and applications of this insulation. Havg Industries, Inc., Winooski, Vt.

CIRCLE NO. 337

Rubber molds

How to make a rubber mold with DPR compounds is described in an instruction sheet. The quick, one-step method can be used to obtain a mold of any thickness with the minimum of labor. Hardman Inc., Belleville, N.J.

CIRCLE NO. 338

Electronic access control

A 16-page workbook clarifies problems in the field of electronic access control and provides important help in planning for the security of a wide range of commercial, industrial and institutional facilities. The workbook gives an up-to-the-minute comparison of contemporary access control systems, their advantages and disadvantages and optional features. Survey forms and worksheets permit both planning and estimating of customized systems for any desired level of access security. Rusco Electronic Systems, Pasadena, Calif.

CIRCLE NO. 339

Permanent magnet motors

Motorgram (Vol. 52, No. 6) features an article which examines the permanent-magnet motor's primary advantages and answers recurring questions on performance and design flexibility. An application case history on a portable welding wire control/feeder is also included. Bordine Electric Co., Chicago, Ill.

CIRCLE NO. 340

Packed with customer inspired features. At the same low price.

Now you can have the easiest tape loading and the most rugged transport for your data entry, remote terminal, or minicomputer system. And it won't cost you any more.

Pertec introduces new 10½-inch reel tape transports with increased data reliability and convenient new features that you have been looking for. Like an all new quick-lock hub which automatically seats the tape reel. Retractable tension arms and contoured head cover for easier tape loading. A new tape cleaner. A fast 200 ips rewind speed. Rotatable card cage for ease of maintenance. And a rugged, attractive new design to enhance your own system.

And these IBM compatible transports also have all the standard Pertec reliable features such as single-adjustment electronic write deskewing, remote edit capability, dynamic braking, photo-sensing arm positioner, low power consumption and temperature stable head guide assembly.

Pertec T8000-Series transports are available in 7 or 9 track, NRZI or 1600 cpi phase encoded or the new NRZI/PE electronically switchable tape formats. They're completely compatible with the popular Pertec 6000-Series transports and our own exclusive data formatter. Tape speed is up to 45 ips and you can choose from a variety of models including read only.

Pertec's new T8000 transports are backed by a complete factory-trained customer service and support organization in 30 U.S. cities and 20 foreign countries. We also offer complete application assistance to help you in your special requirements.

For more information on the new Pertec T8000 transport and the company behind it, write or call today. Pertec Corporation, Peripheral Equipment division, 9600 Irondale Avenue, Chatsworth, California 91311. (213) 882-0030.

PERTEC

Boston (617) 890-6230 • Washington, D.C. (703) 573-7887 • New York (203) 966-3453 • Detroit (313) 769-4376 • London Reading 582115

INFORMATION RETRIEVAL NUMBER 67

new literature

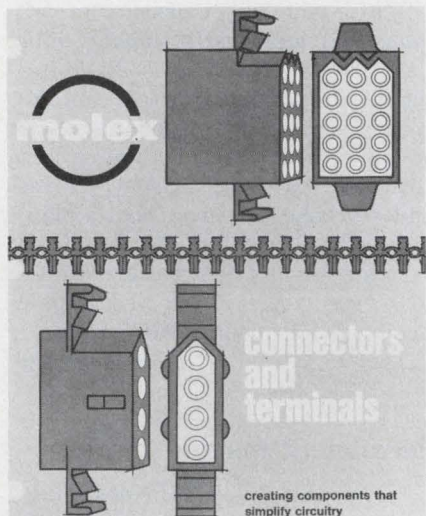

Terminals and connectors

Five hundred terminals and connectors with complete electrical, mechanical and application information are described in a 16-page catalog. Separately classified for ease of ordering in the two-color catalog are 0.093-in. and 0.062-in. diameter pin-and-socket, crimp-type or solder-tail terminals. Standard and miniature nylon or phenolic connector housings are shown with all dimensions and with various mounting applications. The catalog lists tooling required for each terminal assembly, along with part numbers. Molex Inc., Lisle, Ill.

CIRCLE NO. 341

Silicon card/tape sensors

A series of high-speed silicon card/tape sensors is described in a four-page data sheet. Included are eight graphs, a dimensioned outline drawing, electrical characteristics and a photograph of the device. International Rectifier Corp., Semiconductor Div., El Segundo, Calif.

CIRCLE NO. 342

Power supplies

A 16-page catalog describes a line of low and medium-voltage precision dc power supplies. Trygon Electronics Subsidiary of Systron-Donner Corp., Westbury, N.Y.

CIRCLE NO. 343

Temperature measurement

The Temperature Measurement Handbook and Catalog contains temperature-emf tables for thermocouples. The reference tables list thermocouple alloy combinations in both °C and °F. The catalog lists temperature-measurement devices, instruments and accessories, ranging from ultra-miniature probes to large rugged industrial-type thermocouples and control instrumentation. Omega Engineering Inc., Stamford, Conn.

CIRCLE NO. 344

Riveting systems and tools

A set of two catalogs describes the company's line of riveting systems and riveting tools. The 30-page catalog on riveting systems details the complete line of rivets. Specifications and application drawings are shown. The tool catalog illustrates and describes the various tools and accessories required to install the company's blind rivets. Cherry Commercial Products—div. of Townsend, Santa Ana, Calif.

CIRCLE NO. 345

Voice-response system

A four-page brochure describes how a computer interfaced with the Mini-Speechmaker audio response system can provide a direct, real time communications between data processing systems and their operators by using standard telephone equipment and computer generated voice response. Cognitronics Corp., Stamford, Conn.

CIRCLE NO. 346

Noise generators

Noise Generator Note 1 describes the current plug-in PC card library and outlines some of the new cards under development. Each card has its own theory-of-operation description, schematic, parts list, etc. Testronic Development Laboratory, Las Cruces, N.M.

CIRCLE NO. 347

MOS calculator chip

A four-page data sheet describes Model CT5002, a four-function MOS chip containing all of the logic necessary for a 12-digit calculator with display readout. Cal-Tex, Inc., Santa Clara, Calif.

CIRCLE NO. 348

Coaxial components

Coaxial equipment is described in a 36-page catalog. Specifications, drawings and characteristics are included. General Radio, Concord, Mass.

CIRCLE NO. 349

Potentiometers

Total Capability Short Form Catalog shows the complete line of the company's potentiometers, trimmers, resistor modules, hybrid circuits, rotary selector switches and frequency control devices. Complete sales office listings are included. CTS Corp., Elkhart, Ind.

CIRCLE NO. 350

Capacitors

Three kinds of capacitors, dipped silver-mica, aluminum electrolytic and Mylar film, are described in an eight-page all-line catalog. General Instrument Corp., Capacitor Div., Chicopee, Mass.

CIRCLE NO. 351

Digital multiplexer

A second-level digital multiplexer is described in a two-page catalog sheet. Vicom, Mountain View, Calif.

CIRCLE NO. 352

Magnetic shielding

Practical calculations for electrical attenuations are featured in an eight-page catalog. A chart gives the dc permeability of the company's alloys commonly used for magnetic shielding. Drawings show the configurations and dimensions of shields for 12 common types of cathode-ray and direct-view-storage tubes. Cost and design considerations are included. Eagle Magnetic Co., Inc., Indianapolis, Ind.

CIRCLE NO. 353

Rf power signal sources

Rf power signal sources are described in a 12-page brochure. The brochure features the company's 445, 125 and 126 laboratory power sources covering 10 kHz to 8 GHz with up to 90 W output at some frequencies. Rf power amplifiers, an FM signal generator and a command-control transmitter are included. Ailtech, A Cutler-Hammer Co., Farmingdale, N.Y.

CIRCLE NO. 354

HV power supplies

A 28-page catalog includes data on module-type and rack-mounted high-voltage power supplies for CRTs, photomultipliers, capacitor charging and general high-voltage uses. Advanced High Voltage Co., Inc., Van Nuys, Calif.

CIRCLE NO. 355

LED displays

Solid-Lite LED numeric displays are described in data sheets. Specifications on the company's 0.33-in. and 0.77-in. characters using gallium phosphide red-light-emitting diodes are included. Opcoa, Inc., Edison, N.J.

CIRCLE NO. 356

Metric fasteners

An eight-page Metric Catalog 883-M, supplementing the company's full-line catalog, provides specifications for metric-sized lock nuts and screws. MacLean-Fogg Lock Nut Co., Mundelein, Ill.

CIRCLE NO. 357

Isolated microchopper

Data related to the Model NS-8000A microchopper or analog switch include applications and schematics for the following circuits: half and full-wave synchronous modulators and demodulators, quadrature rejection, positive servos, phase detector, difference frequency generator, chopper operational amplifier, summing amplifier, differentiators, integrators, pulse sampling and pulse gating. Solid State Electronics Corp., Sepulveda, Calif.

CIRCLE NO. 358

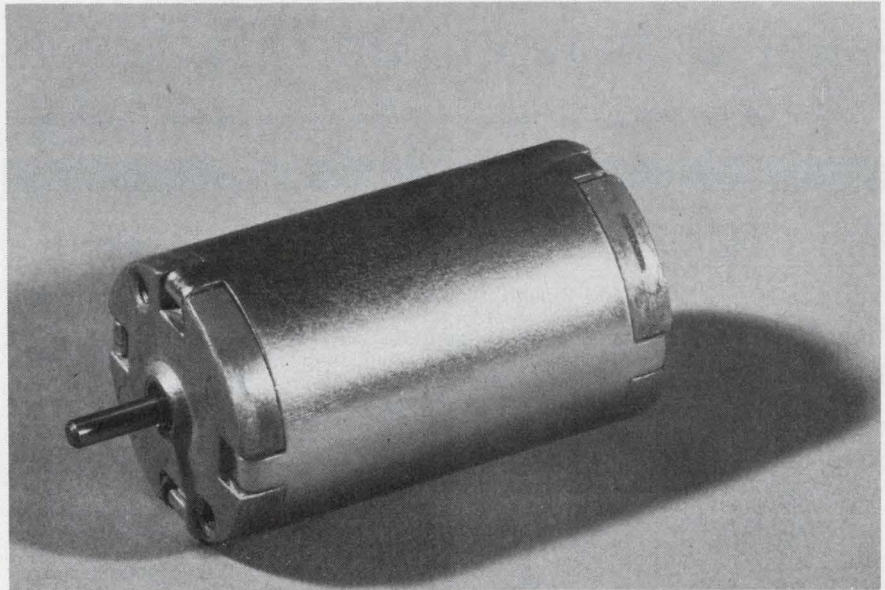

new d-c motor

speed regulated with variable-speed control

Introducing the Type FYQM, a new 1.3-inch dia, subfractional hp, commercial d-c motor. Speed control circuit board and built-in tachometer generator permit speed adjustment while motor is running, with close regulation at selected speed. Available with or without speed control. Gear-heads also available. For details, ask for Bulletin F-14652.



BARBER-COLMAN COMPANY

Electro-Mechanical Products Division
Dept. O, 12117 Rock Street, Rockford, Illinois 61101

BC-m-4

INFORMATION RETRIEVAL NUMBER 68

USING ACTIVE FILTERS OR PASSIVE FILTERS ?

**Are size, shape or weight considerations important?
Special mechanical configurations offered—Hermetically sealed or encapsulations for pcb installations**

Low, high, band pass and reject designs—Butterworth, Chebishev, Bessel or elliptic response characteristics—wide range of source and load impedances

Low frequency actives, stable toroidal LC's, RC twin-T's

No EXTERNAL components required

Unbiased recommendations on active or passive filter selections for maximum economy



instruments, incorporated

PHONE AREA 512/892-0752 • P.O. Box 698 AUSTIN TEXAS 78767

INFORMATION RETRIEVAL NUMBER 69

Design Data from Manufacturers

Advertisements of booklets, brochures, catalogs and data sheets. To order use Reader-Service Card.
(Advertisement)

INSTANT DIAGNOSIS OF GEAR-MESHING PROBLEMS

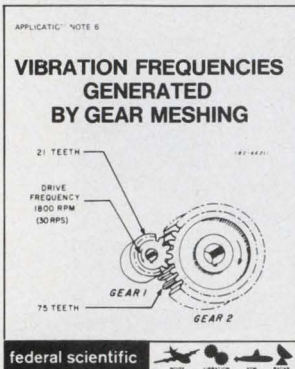

New 2-page "Application Note 6" shows how hidden defects in gears can be pinpointed on-line with Federal Scientific's Ubiquitous® Real-Time Frequency Analyzer. Mechanical aberrations in a gear create identifiable frequency signatures. The technical paper shows how real-time frequency analysis can isolate the tell-tale frequencies of such specific defects as: eccentricities in gear shafts, and run-outs in pitch diameter of a gear. It includes tables showing typical frequencies and sidebands to watch for, and a suggested diagnostic set-up. The Ubiquitous Analyzer contains no critical adjustments and is easily operated, even by non-technical personnel. For a free copy of "Application Note 6", write directly to Federal Scientific, originators of the Ubiquitous® brand of analyzers, correlators, and allied spectrum analysis instruments.

CIRCLE NO. 171

Federal Scientific Corp.

615 West 131st Street, New York, N.Y. 10027
(212) 286-4400

SIGNAL TRACKING WITHOUT A REFERENCE



Two new analyzers which provide wave and spectrum analysis with selectable bandwidths described in new Quan-Tech brochure. Model 304 covers range from 0-5 kHz with selectable passbands of 1, 3, 10, 30 and 100 kHz. Model 306 covers 0 to 50 kHz with 10, 30, 100, 300 and 1000 Hz bandwidths. Six operating modes, including automatic tracking of a signal without a reference or pilot frequency. Selectable averaging times for optimum results in random signal analysis. Panel contains 5 digit LED display. Amplitudes available in linear and log meter displays and analog outputs.

CIRCLE NO. 172

Quan-Tech

Div. of KMS Industries, Inc.
43 South Jefferson Road
Whippany, N.J., 07981

Practical Instrumentation Transducers

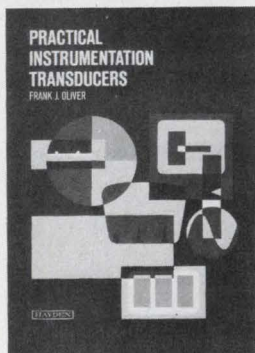

A thorough, authoritative information source on transducer selection and use. This well-planned guide by Frank J. Oliver covers virtually every known device for industrial or aerospace application. Stressing topics neglected elsewhere, it clarifies such areas as interference problems in hard-wire telemetry systems, and transducers as feedback devices in servo systems. Hundreds of diagrams, charts, and tables included. 352 pp., 7-1/8 x 9-3/4, illus., cloth, \$20.00. Circle the reader-service number for 15-day examination copies.

CIRCLE NO. 173

Hayden Book Company, Inc.

50 Essex Street
Rochelle Park, N.J. 07662

Electronic Design

ELECTRONIC DESIGN's function is:

- To aid progress in the electronics manufacturing industry by promoting good design.
- To give the electronic design engineer concepts and ideas that make his job easier and more productive.
- To provide a central source of timely electronics information.
- To promote communication among members of the electronics engineering community.

Want a subscription? ELECTRONIC DESIGN is sent free to qualified engineers and engineering managers doing design work, supervising design or setting standards in the United States and Western Europe. For a free subscription, use the application form bound in the magazine. If none is included, write to us direct for an application form.

If you do not qualify, you may take out a paid subscription for \$30 a year in the U.S.A., \$40 a year elsewhere. Single copies are \$1.50 each.

If you change your address, send us an old mailing label and your new address; there is generally a postcard for this bound in the magazine. You will have to requalify to continue receiving ELECTRONIC DESIGN free.

The accuracy policy of ELECTRONIC DESIGN is:

- To make diligent efforts to ensure the accuracy of editorial matter.
- To publish prompt corrections whenever inaccuracies are brought to our attention. Corrections appear in "Across the Desk."
- To encourage our readers as responsible members of our business community to report to us misleading or fraudulent advertising.
- To refuse any advertisement deemed to be misleading or fraudulent.

Microfilm copies are available of complete volumes of ELECTRONIC DESIGN at \$19.00 per volume, beginning with Volume 9, 1961. Work is now in process to complete the microfilm edition of Volumes 1-8. Reprints of individual articles may be obtained for \$2.00 each, prepaid (\$.50 for each additional copy of the same article) no matter how long the article. For further details and to place orders, contact the Customer Services Department, University Microfilms, 300 North Zeeb Road, Ann Arbor, Michigan 48106 telephone (313) 761-4700.

Want to contact us? If you have any comments or wish to submit a manuscript or article outline, address your correspondence to:

Editor
ELECTRONIC DESIGN
50 Essex Street
Rochelle Park, N.J. 07662

Electronic Design

Advertising Sales Staff

Bryce Gray
Sales Manager

Rochelle Park, N.J. 07662

Robert W. Gascoigne
Daniel J. Rowland
50 Essex Street
(201) 843-0550
TWX: 710-990-5071

Philadelphia

Thomas P. Barth
50 Essex Street
Rochelle Park, N. J. 07662
(201) 843-0550

Boston 02116

Richard L. Green
20 Columbus Avenue
Boston, Mass.
(617) 482-7989

Chicago 60611

Thomas P. Kavooras
Berry Conner, Jr.
200 East Ontario
(312) 337-0588

Cleveland

Thomas P. Kavooras
(Chicago)
(312) 337-0588
(call collect)

Los Angeles 90303

Stanley I. Ehrenclou
Burt Underwood
2930 Imperial Highway
Inglewood, Calif
(213) 757-0183

San Francisco 94022

Jerry D. Latta
P.O. Box 1248
Los Altos, Calif.
(415) 965-2636

London W. 1

For United Kingdom and Holland
Brayton C. Nichols

For Eastern Europe
Peter Kehr

The American Magazine Group
9 Warwick Street
London, W. 1, England
Phone: 437 5462

Cable: Ammagnic, London

4800 Verviers, Belgium

For Continental Europe
Andre Jamar
Rue Mallar, 1
(087) 253.85 Telex 41563

Tokyo

Haruki Hirayama
Electronic Media Service
5th Floor, Lila Bldg.,
4-9-8 Roppongi
Minato-ku
Phone: 402-4556
Cable: Electronicmedia, Tokyo



AMERICAN BUSINESS PRESS, INC.



This probe detects EMI problems...

At least 80% of today's magnetic shield designs were developed at the Magnetic Shield Division of Perfection Mica Co. Our Netic and Co-Netic shielding materials are recognized industry standards around the world. They are cited in many military procedural documents.

Our shielding experience has resulted in the world's most comprehensive line of standardized and specialized designs like: Netic and Co-Netic foil and sheet stock - Photo-multiplier

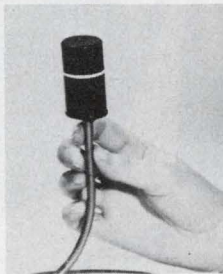

and CRT shields - Zero gauss chambers - Transformer, relay, motor and other component shields - Shielded rooms - Field evaluator probes - Tape data preservers - Shielded conduit & cable.

We'll tackle prototype through production runs.

Check the reader service number for current literature or contact: MAGNETIC SHIELD DIVISION, Perfection Mica Company, 740 Thomas Drive, Bensenville, Illinois 60106, (312) 766-7800.

...and our complete line of shielding materials solves them.

INFORMATION RETRIEVAL NUMBER 70

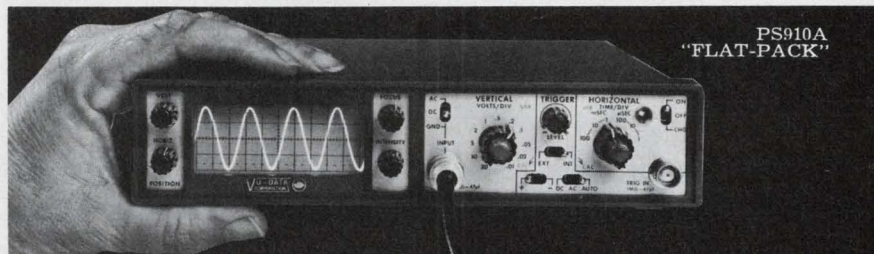

20MHz ... and small enough to fit in your brief case!

- Mini-portable Oscilloscope • Battery or AC powered
- DC-20 MHz bandwidth • 10 mV/div sensitivity
- Recharging circuitry • Rack mountable • Laboratory Quality

The PS900's are the first mini-portable scopes to bring lab-quality to "on-site" DC to 20 MHz test and measurement applications. These are "true" portables, since they are of rugged construction, small size (will fit into your tool kit or brief case) and light weight (only 7 pounds with batteries), and since they will operate from internal batteries for up to 5 hours. Recharging circuitry is included, and standard "C" size cells can be used... nickel-cadmium, alkaline or in a pinch, even common flashlight batteries!

- Interested? Call Bill Kraus at (714) 279-6572, or write us at 7170 Convooy Court, San Diego, California 92111.



PS920A
"STACK-PACK"

Two configurations are available...
"FLAT-PACK"—
1 3/4" H x 8 1/2" W x 12" D
"STACK-PACK"—
3 1/2" H x 4 1/4" W x 12" D

\$595

AVAILABLE NOW FROM

From the leader in Multi-Channel Monitor Oscilloscopes

VU-DATA CORPORATION

INFORMATION RETRIEVAL NUMBER 71



**Yes,
I'd suggest
you come in
and talk it over
with us.**

Are you turned off by the telephone business? Don't be. For the computer-wise, the tele-communications industry is a vast new field that requires imaginative, innovative, responsible people with your kind of training. Whether your career is in its early stages, or at a mature level in a specific discipline we can use you to help us grow in telephones. Some of the key job areas we have available include: *Common Control Design, System Hardware Design, Diagnostic Development, Software Development, Support Programmers.*

If there's interest here for you, send your resumé in complete confidence. If you'd like further information on job requirements/benefits/our growth and plans, just jot your name and address on a slip of paper; we'll send you a complete listing of the fine computer-wise opportunities we have, details on our company and other pertinent information.

**Send to: Mr. Dennis Kave
Professional Employment**

GTE AUTOMATIC ELECTRIC

400 North Wolf Road, Northlake, Illinois 60164

An Equal Opportunity Employer/MF

INFORMATION RETRIEVAL NUMBER 900

advertiser's index

Advertiser	Page
AMP, Incorporated	17, 18, 19, 20
Abbott Transistor Laboratories Incorporated	6
Ailtech, A Cutler-Hammer Company	85
AirBorn, Inc.	86
Alden Electronic & Impulse Recording Equipment Co., Inc.....	113
Allen-Bradley Co.	11
Allied Electronics, Division of Tandy Corp.	99
Amperite	88
Augat, Inc.	20D, 20E
Barber-Colman Company	109
Beckman Instruments, Inc., Helipot Division	44, 45
Bendix Corporation, The, Electrical Components Division....	40
Bodine Electric Company	95
Boonton Electronics Corporation.....	93
Buckeye Stamping Company, The....	105
Burdy Corporation	20C
Burr-Brown Research Corporation.....	20F
Burroughs Corporation	Cover IV
CTS Corporation	83
Centralab, the Electronics Division of Globe-Union, Inc.	8, 9
Computer Automation, Inc.	21
Dale Electronics, Inc.	Cover II
Data Disc, Inc.	13
Data Display Products	104
Datatex Corporation	90
Datel Systems, Inc.	20A
Digitran Company, The	79
Dormeyer Industries, Inc.	101
ECC Corporation	36
Edmund Scientific Company	91
Federal Scientific Corporation	110
GTE Automatic Electric	101, 103, 105, 112
Gordos Corporation	86
Grayhill, Inc.	91
Hayden Book Company, Inc.	44, 45, 81, 110
Heath Company	37, 38
Hecon Corporation	98
Heinemann Electric Company.....	35
Hewlett-Packard	48, 49, 59, 61, 63, 65
IEE Intercon/73	70 A-B-C-D
ITT Cannon Electric, A division of International Telephone and Telegraph Corp.	10
Intech, Incorporated	102
Jermyn Industries	20H
Johanson Manufacturing Corp.....	7, 114
Johnson Company, E. F.....	4, 5

PICTURE, PATTERN, OR PLOT

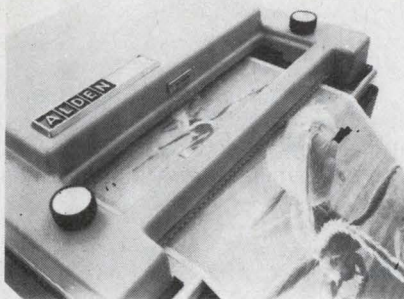

Now you can afford to add instant graphic hard copy output to your data terminals, storage tubes, computer outputs, SSTV, scanning sensors.

- Get low cost hard copy by instant graphic recording on ALFAX Type A electrosensitive paper where electricity is the ink.
- Interface ALDEN "Flying Spot" Component Recorders by simple synchronizing with your sweep circuit or scanning sensors and record directly from your target or cathode signal current.

Send for free brochure:
"ALDEN Components to Picture,
Pattern or Plot"

ALDEN
ELECTRONIC & IMPULSE RECORDING EQUIPMENT CO., INC.

Westboro, Mass. 01581 Tel: (617) 366-8851 TELEX: 94-8404

"See us in Booth 2519."

INFORMATION RETRIEVAL NUMBER 74

THE BASICS



Audio Frequency Meter

MODEL 1200A **\$245**

Designed for modem, touch-tone, filter, electronic organ industries, and related service fields.

- * 10 Hz - 2 MHz Range
- * 0.1 Hz Resolution
- * Large LED Display
- * .005% Crystal Time Base
- * LSI Circuitry

Available for immediate shipment

Linear Digital Systems
Box 954, Glenwood Spgs, CO. 81601
(303) 945-6122 TWX 910-929-6681

INFORMATION RETRIEVAL NUMBER 75

Advertiser	Page
Kurz-Kasch, Inc.	78
Lambda Electronics Corp.	Cover III
Licon, Division Illinois Tool Works, Inc.	27
Linear Digital Systems	113
3M Company	15
Magnetic Shield Division	
Perfection Mica Company.....	111
Marco-Oak, Subsidiary of Oak Industries, Inc.	91
Microdata Corporation	2
MicroSwitch, A Division of Honeywell	12
Minelco Division, of General Time Corp.	92
Motorola Component Products Dept.	14
Mouser Corp.	114
National Electronics, Inc.	78
National Micronetics Inc.	114

PRD Electronics, Inc.	22
Paktron Division, Illinois Tool Works, Inc.	29
Perfection Mica Company	111
Pertec Corporation	106, 107
Power/Mate Corp.	92

Quan-Tech Div. of KMS Industries, Inc.	110
---	-----

Robinson, Nugent, Inc.	57
Rolm	20B

Schauer Manufacturing Corp.	100
Sealed Air Corporation	96
SermeTel, A Division of Teleflex Incorporated	75
Signetics Corporation	39
Siliconix Incorporated	46
Solid State Scientific, Inc.	16
Solitron/Microwave, Connector Division	71
Sprague Electric Company	97
Struthers-Dunn, Inc.	31

TRW/IRC Potentiometers, an Electric Components Division of TRW Inc.	33
Tektronix, Inc.	43
Teledyne Relays, A Teledyne Company	2
Triplett Corporation	20G

Unitrode Corporation	25
----------------------------	----

Vernitron Electrical Components.....	113
Vu-Data Corp.	111

White Instruments, Incorporated	109
Winchester Electronics Group.....	89
Woven Electronics	16

SO... "JONES" PLUGS ARE ALL ALIKE

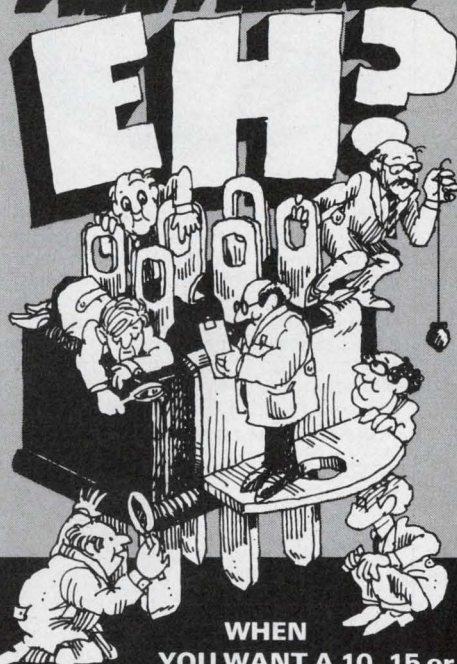

WHEN
YOU WANT A 10, 15 or
25 AMP CONNECTION WITH 2-33
CONTACTS, TAKE A CLOSE LOOK
AT BEAU PLUGS and SOCKETS...

1. INSTANT MOUNTING! Panel-mount in 1/4 the time with our exclusive C-Clips. No drilling holes or mounting screws.
2. AUTOMATIC SOLDERING! Our new S₆ contacts are designed for wave soldering—and direct mounting to PCs and flex tape.
3. ACTIVE POLARIZING PINS! These special designs get more contacts in less space.
4. SUPERIOR PLATING! You can see the difference in contact plating quality. Connections are better—and last longer too.
5. CHOICE OF BACKSHELLS. Metal? Yes. But only Beau has polypropylene backshells for greater dielectric strength, safety, non-rusting, acid resistance, etc.
6. STANDARDS & SPECIALS! Beau is set up to give you the best of both. Just ask!

Send for 20-page catalog
on Beauplug Connectors
and Terminal Strips

**BEAUPUG[®]
CONNECTORS**

Beau Products
Division

Vernitron Electrical Components

117 Union Avenue, Laconia, N.H. 03246
Tel: (603) 524-5101 TWX: 710-364-1843

In CANADA: Brimark Electronics Ltd. / Toronto 8, Ontario



Thin-Trim® variable capacitors are designed to replace fixed tuning techniques. Applications include crystal oscillators, CATV amplifiers, communication and test equipment. Series 9410 has high Q's with five capacitance ranges from 1.0 - 4.5 pf to 10.0 - 50.0 pf. Johanson Manufacturing Corporation, Boonton, N. J. (201) 334-2676

INFORMATION RETRIEVAL NUMBER 181

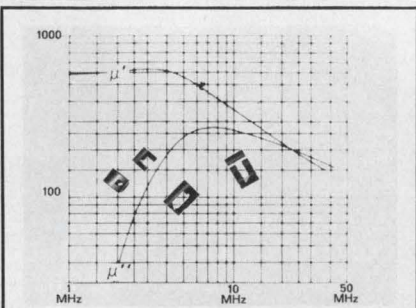

20 MHz ferrite components are possible with new "hot-pressed" ferrite manufacturing technique. Extremely low losses and exceptional high frequency performance are combined in these new materials for digital and analog recording heads and inductors. National Micronetics, Inc., Route 28, West Hurley, N.Y. 12491. 914-338-0333.

INFORMATION RETRIEVAL NUMBER 182

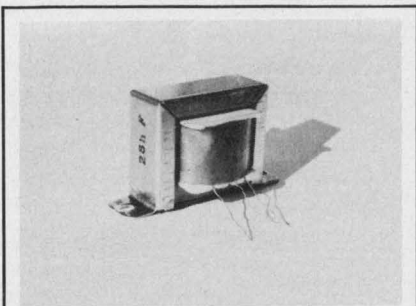

Over 50 types of Mouser transformers—printed circuit & lead types—available on 1 to 2 day delivery from stock. Including power & small signal, subminiature transistor, driver, input & output types, as well as 455KC IF transformers & filament types. All are low cost, rugged reliable. Mouser Corp., 11511 Woodside Av., Lakeside, Ca. 92040.

INFORMATION RETRIEVAL NUMBER 183

Information Retrieval Service. New Products, Evaluation Samples (ES), Design Aids (DA), Application Notes (AN), and New Literature (NL) in this issue are listed here with page and Information Retrieval numbers. Reader requests will be promptly processed by computer and mailed to the manufacturer within three days.

Category	Page	IRN
Components		
capacitors (NL)	108	351
capacitors, RFI	104	325
circuit breaker	105	328
converter, MV to air	104	326
coulometer	104	323
displays, LED (NL)	109	356
displays, split-flap	105	329
motors (AN)	107	340
motors, stepping	105	327
potentiometers (NL)	108	350
resistor, carbon film	104	324
sensors, card/tape (NL)	108	342
temperature measurement (NL)	108	344

Data Processing		
converter system, a/d	100	281
digitizer, grid	99	278
error detector	100	280
formatter, waveshape	101	302
memory, core	99	277
minicomputer	101	304
modem, wired	101	303
multiplexer (NL)	108	352
scanner, data	100	279
terminal, CRT	100	300
voice response system (NL)	108	346

ICs & Semiconductors		
diodes, p-i-n (AN)	107	336
flip-flop	96	267
interface circuits	96	265
MOS chip (NL)	108	348
microprocessor	94	263
multiplexers/display drivers	96	269
pulsar	96	270
RAM	96	266
rectifiers	96	268
switch, IC	94	264

Instrumentation		
a/d converter	88	250
a/d converter	88	251
a/d converter	88	252
amplifier	93	262
DMMs	87	253
DMMs	87	254
DPMs	90	256
DPMs	92	258
frequency counter	92	257
function generator	93	261
memory tester	87	255
noise generator (NL)	108	347
reflectometer	93	260
signal generator, rf (NL)	109	354
timing unit	92	259

Microwaves & Lasers		
Gunn oscillator	98	275
paramp	98	276
p-i-n driver	97	272

Category	Page	IRN
resistor trimmer	98	273
thermistor mount	98	274
VCOs	97	271
Modules & Subassemblies		
a/d converters	102	309
a/d converters	103	321
d/a converters	102	306
filter	102	308
instrument amplifier	103	322
microchopper (NL)	109	358
power supplies	103	320
power supplies (NL)	108	343
power supplies (NL)	109	355
voltage regulator	102	305
voltage sensor	102	307

new literature

capacitors	108	351
components, coaxial	108	349
displays, LED	109	356
fasteners	109	357
magnetic shielding	108	353
microchopper	109	358
MOS chip	108	348
multiplexer	108	352
noise generator	108	347
potentiometers	108	350
power supplies	108	343
power supplies	109	355
riveting	108	345
sensors, card/tape	108	342
signal generator, rf	109	354
temperature measurement	108	344
terminals	108	341
voice response system	108	346

application notes

access control	107	339
diodes, p-i-n	107	336
insulation	107	337
mobile-ion measurement	107	335
motors	107	340
rubber molds	107	338

evaluation samples

head-driver rivet	106	332
insulators	106	334
lamp base	106	333
lights, indicator	106	330
sockets, DIP	106	331

Do you face a make or buy decision on power supplies?

BUY LAMBDA LX SERIES

Now LX series available in 54 models in 9 package sizes
... single, dual and triple outputs

Regulation: 0.1% Ripple: 1.5 mV RMS

Temperature Coef.: 0.03% /°C

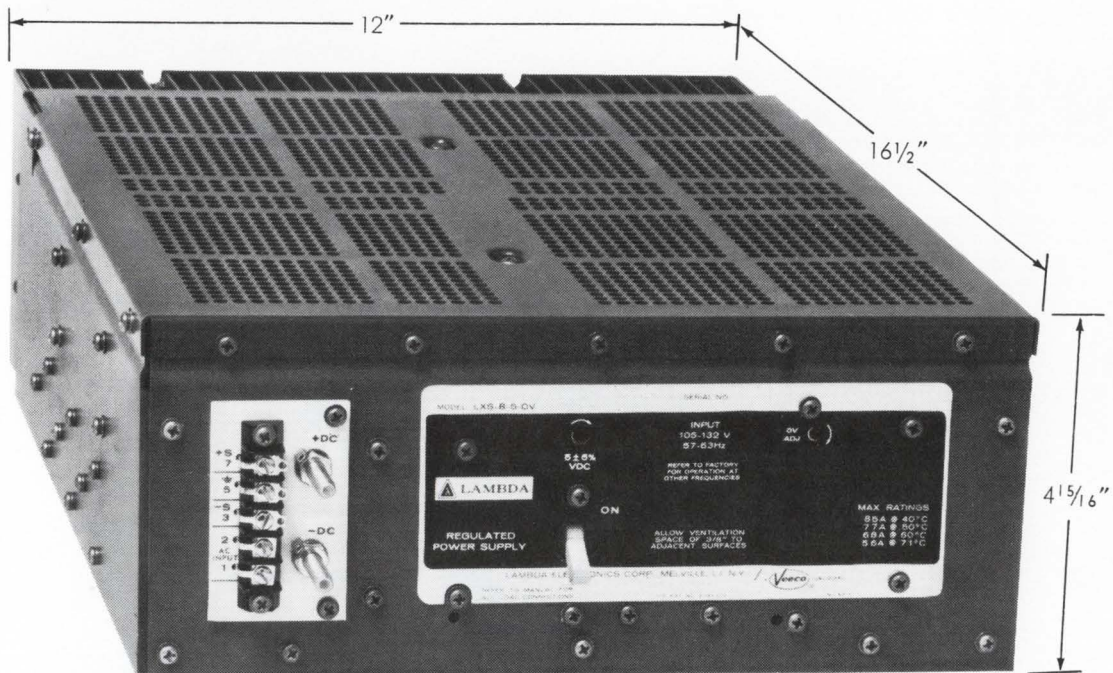

NEW $\frac{2}{3}$ RACK, SINGLE OUTPUT "8" PACKAGE
LXS-8-5-OV 5 VOLTS 85 AMPS (WITH OV)

\$560

listed in Underwriters' Recognized
Components Index *

designed to meet MIL environmental specifications

in stock for 1-day delivery

guaranteed 5 years

AC input: 105-132 VAC; 47-440 Hz.

LX-8 available in 7 models up to 28 volts

Send for 1973 Power Supply Catalog and Application Handbook

* LX-8 and LX-EE models presently undergoing qualifying tests.

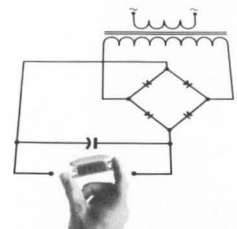

**WHETHER
YOU MAKE
OR BUY...**
LAMBDA
ELECTRONICS CORP.
A Veeco Company

MELVILLE, NEW YORK 11746 515 Broad Hollow Road Tel. 516-694-4200 ARLINGTON HEIGHTS, ILL. 60005 2420 East Oakton St., Unit Q Tel. 312-593-2550
NORTH HOLLYWOOD, CALIF. 91605 7316 Varna Ave. Tel. 213-875-2744 MONTREAL, QUEBEC 100C Hymus Blvd., Pointe-Claire, Quebec-730 Tel. 514-697-6520
PORTSMOUTH, HANTS, ENG. Marshlands Road, Farlington Tel. Cosham 73221 VERSAILLES, FRANCE 64a 70 rue des Chantiers 78004 Tel. 950-2224

INFORMATION RETRIEVAL NUMBER 213

whatever your computer says...

SELF-SCAN® SAYS IT BEST

PANEL DISPLAYS

ABCDEFGHIJ

16/18 Character Position Panel, 5 x 7 Dot Matrix, Characters 0.4" High. Available as numeric only or alphanumeric panel with 64-character format.

PQRSTUVWXYZ12345

32/37, 80 Character Position Panel, 5 x 7 Dot Matrix, Characters 0.2" High. Alphanumeric panel with 64-character format.

SELF-SC

NOW IN 256
FOR COMM
WITH ALL
ABCDEFGHI
123456789
@~()()

SELF-SCAN Panel Display Subsystem, 256 Character Capacity, 5 x 7 Dot Matrix, Characters 0.25" High. 64-character format, available with all drive electronics including memory, character generator, and timing.

Whether it's a police officer in a patrol car requesting information on a suspect, an architect specifying coordinates for plumbing fixtures in a new building, or a type setter verifying type for a mail-order catalog, SELF-SCAN panel displays guarantee the most accurate transfer of data between the operator and the computer. If you need a computer display and demand error-free communications, follow the lead of Kustom Electronics (1) in Chanute, Kansas; Science Accessories Corporation (2) in Southport, Connecticut; Automix Keyboards (3) in Bellevue, Washington, and the many other SELF-SCAN panel display users. Have a Burroughs salesman demonstrate his "terminal in a briefcase." You'll see why the SELF-SCAN panel display is the most effective man/machine interface device available today.

Burroughs Corporation, Electronic Components Division, Plainfield, New Jersey 07061. (201) 757-3400.



Burroughs

